



Product Catalog

Issue 16

Table of Contents

SMARTER SOLUTIONS FOR A SMARTER WORLD	1	MEDIA CONVERTERS	41
COMING SOON	2	Standalone.....	42
SWITCHES	3	Desktop Powered.....	44
Allied Telesis Management Framework.....	4	PoE.....	45
SwitchBlade x8100 Series	6	Industrial	45
SwitchBlade x908.....	8	Mounting Hardware.....	46
SwitchBlade x3100 Series	10	Converteon	47
Aggregation and Distribution	12	Chassis-Based.....	48
Intelligent Edge.....	13	TRANSCEIVER MODULES	49
CentreCOM Gigabit Edge	16	Pluggable Transceivers.....	50
CentreCOM Fast Ethernet Edge.....	18	Network Service Provider Transceivers.....	52
WebSmart.....	20	NETWORK ADAPTERS	53
Unmanaged	22	Laptop Adapters.....	54
Industrial Switches	24	Desktop/Workstation Adapters.....	55
SECURITY APPLIANCES	25	Server Adapters	58
Firewalls.....	26	NETWORK MANAGEMENT	59
Secure VPN Routers.....	28	Vista Manager.....	60
WIRELESS	29	AlliedView NMS Service Provider	61
TQ Series Access Points	30	INDEX	63
Wireless Controllers	31	ENVIRONMENTAL POLICY	68
Wireless Accessories	32		
Antennas	34		
MULTISERVICE ACCESS	35		
iMAP.....	36		
iMG.....	38		

Smarter Solutions for a Smarter World

Our world is increasing in complexity. Organizations are changing at an ever-increasing rate. Businesses face an uphill battle to adapt to change, and to stay ahead of the competition. At the same time, our cities are increasingly becoming more populated; and with this growth, issues such as demand on resources and public safety become a key focus for government and civic leaders.

Not only do people expect instant access to an always-on network, but there is a rapidly increasing number of “things” that are being connected—devices that deliver information to enable smarter decisions to be made, improving the efficiency of organizations and cities, alike. Like people, these devices require instant access to an always-on network. Unlike people, these devices are a critical component of various services and infrastructure that must always be available.

Delivering reliable connectivity for everything from enterprise organizations to complex, critical infrastructure projects is not a trivial task. Ensuring new services can be deployed quickly, that changes can be made simply, and that the network “just works” requires intelligent technology from the edge to the core. Technology that delivers value and reduces operational expenditure, allowing more to be done with less. That superior technology has made Allied Telesis the default standard for many organizations around the world today.

Allied Telesis has engineered advanced networking products and technologies for more than a quarter of a century. Our solutions-based philosophy of producing products that deliver value to our customers, together with extensive service and support, has resulted in Allied Telesis solutions being deployed globally—in organizations of all types and sizes. With a portfolio of products and technologies providing end-to-end networking solutions for enterprise, government, service provider, and critical infrastructure customers, Allied Telesis is the smarter choice.

As a major networking industry manufacturer, Allied Telesis is committed to providing our customers with solutions designed and built to the highest standards and quality. Our manufacturing conforms to ISO 9001 standards and all of our facilities adhere to the strict ISO 14001 standard to ensure a healthier planet.

As a leading provider of networking solutions, Allied Telesis enables reliable and efficient delivery of a broad variety of services over a single, unified network, meeting the demands of today’s organizations, both now and into the future. We are committed to innovating the way in which services and applications are delivered and managed, resulting in smarter solutions, delivering increased value and lower operating costs.

Coming Soon...

NEW

SwitchBlade® x908 Generation 2

CORE CHASSIS SWITCHES

Following on from the incredible success of the SwitchBlade x908, the upcoming Generation 2 builds on the popular modular design, with performance to satisfy the most demanding network applications and traffic requirements.

New expansion modules (XEMs) will support today's fastest Ethernet standards, with 100G, 40G and 10G/IG options. The ability to use any combination of XEMs, as well as stack up to four units, will make the SwitchBlade x908 Gen2 the most flexible and powerful 3RU switching solution available.

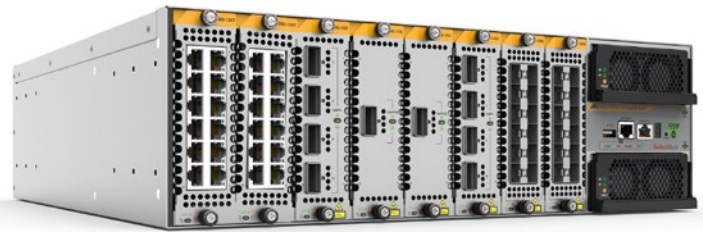

Available end-2017, highlights include:

- ▶ High-speed – hot-swap XEM modules for 100G, 40G and 10G/IG
- ▶ High bandwidth – each slot delivers 160G bandwidth (1.28Tbps total)
- ▶ Resilient – stack up to four units using any bandwidth, including fiber for long distance
- ▶ Reliable – dual hot-swap PSUs and fan modules
- ▶ Large network support – hardware tables support 288K MAC addresses and 128K routes

x550 Series

10 GIGABIT INTELLIGENT SWITCHES

The x550 Series of compact 10 Gigabit switches provide an ideal solution for 10G aggregation with 40G uplinks in larger networks, or a resilient 10G network core for smaller networks with stacked units providing high availability.

The x550 Series have models with copper or fiber ports, while the combined model is ideal for wireless AP connectivity, with Power over Ethernet to simplify deployment and operation, and 2.5G to maximize performance.



Available mid-2017, other highlights include:

- ▶ Compact design
- ▶ Resilient – stackable to four units over long distance
- ▶ Advanced – Layer 3 features (with Premium license)
- ▶ Reliable – 0°C to 50°C operation, and front to back cooling
- ▶ Flexible – 1G/10G fiber, 1G/10G copper and 40G ports
- ▶ PoE+ – full 30 watts per port

Switches



Allied Telesis engineers high-performance, high-quality, future-proof products to meet requirements for enterprise, campus, branch, and private cloud networks of various sizes.

Allied Telesis SwitchBlade and xSeries switches, with the AlliedWare Plus™ operating system, provide scalable and versatile switching solutions for today's enterprise and service provider networks from edge to core. These switches, featuring Allied Telesis Management Framework™ (AMF), decrease network operating expenses by automating and simplifying many day-to-day tasks. Allied Telesis also produces top-of-rack switches for the enterprise data center market, extended temperature products for industry, and unmanaged and WebSmart switches for small and medium business.

ALLIED TELESIS MANAGEMENT FRAMEWORK

Intelligent and Automated Network Management

AMF is an intelligent and scalable network management platform. It supports Allied Telesis switching, firewall, and wireless products, as well as a wide range of third-party devices—including video surveillance cameras and IP phones—for truly inclusive network automation. Reducing network running costs by automating and simplifying many day-to-day tasks, AMF allows skilled staff to be better utilized.

Save time and reduce costs by up to 60% with AMF

CENTRALIZED MANAGEMENT Manage the entire network as a single virtual device.

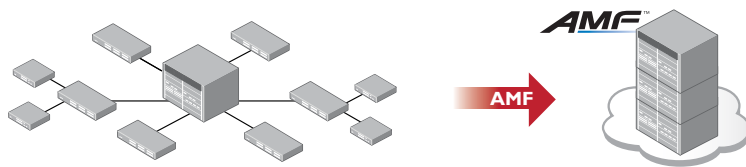

AUTO-BACKUP Automatically backup the entire network daily for peace-of-mind networking.

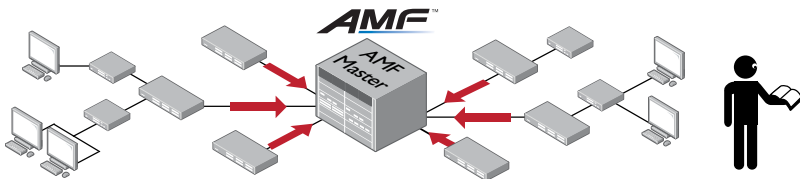

AUTO-UPGRADE Upgrade the network with a single command.

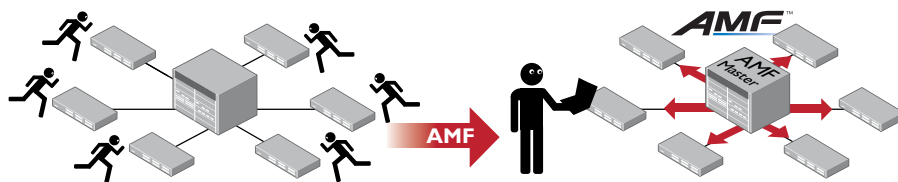

AUTO-PROVISIONING AND AUTO-RECOVERY Plug-and-Play additions or replacements.

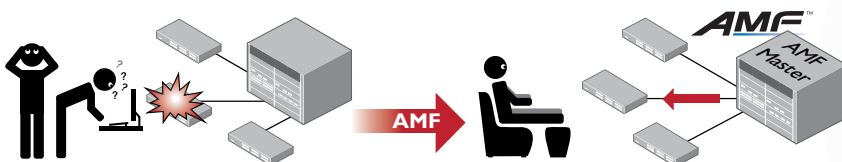

Business Value Through Automation

AMF delivers immediate value to businesses of all sizes, with centralized network management able to treat a network of any size as a single, converged entity. This reduces cost and complexity by delivering:

- ▶ **Centralized management** of many or all devices right across the network—locally or world-wide.
- ▶ **Network automation**, with zero-touch or one-touch backup, provisioning, upgrade, and recovery.
- ▶ **Network intelligence** reacts to changes in the network and automatically changes the topology.
- ▶ **Smart commands** allow network problems to be quickly identified and issues resolved.

AMF saves time and money!

Simplify Your Network

Software Defined Networking (SDN) is moving networking towards the ideal combination of optimal network utilization and centralized management. An integral part of the Allied Telesis SDN solution, AMF delivers powerful management capabilities that are easy to use, and reduce the time and skill required to maintain the network. Configuration and firmware files are regularly backed up, network expansion is automated, and device recovery is fully zero-touch.

Graphical Management and Monitoring

Allied Telesis **VISTA** MANAGER
Vista Manager

provides visual management of an AMF network, automatically creating a complete topology map of switches, firewalls and wireless access points. Vista Manager facilitates simple management of many, or all, network devices at once. It also monitors up-to-date network status, and provides alerts and actionable reporting for the timely resolution of any network problems.

Flexible Deployment

AMF can be deployed with network management integrated right into the Allied Telesis switching or firewall hardware, with licensing options for any size network. Alternately, AMF Cloud offers all of the functionality of integrated hardware-based management, with the advantages of private or public cloud access and flexibility. Powerful benefits include lower cost of entry, scalability, and cloud-based backup for peace of mind networking

Fully Scalable

AMF can manage networks that span different locations in different time zones, supporting multi-site businesses. Whether your network spans the campus, or the continent, AMF is simple to use. Support business growth locally, and in remote locations, with plug-and-play simplicity. With an AMF Controller, extend the benefits of AMF network intelligence to thousands of network switches, firewalls, and third-party devices.

Products Featuring AMF

AMF Master or Member

- ▶ **SwitchBlade x8100 Series**
Core chassis switches
- ▶ **SwitchBlade x908**
8-slot core chassis switch
- ▶ **DC2552XS/L3**
High-performance aggregation switch
- ▶ **x930 Series**
Advanced core switches
- ▶ **x510 Series**
Intelligent stackable edge switches
- ▶ **AR4050S**
High-performance UTM firewall

(AMF Master license required)

AMF Member

- ▶ **IX5-28GPX**
High availability video surveillance switch
- ▶ **x310 Series**
Fast Ethernet intelligent stackable access switches
- ▶ **x230 Series**
Gigabit intelligent PoE access switches
- ▶ **IE510 Series** NEW
Industrial Ethernet, stackable Layer 3 switches
- ▶ **IE300 Series** NEW
Industrial Ethernet, Layer 3 switches
- ▶ **IE200 Series**
Industrial Ethernet, Layer 2 switches
- ▶ **XS900MX Series** NEW
Basic Layer 3 switches
- ▶ **GS900MX Series**
Basic Layer 3 stackable Gigabit switches
- ▶ **GS970M Series** NEW
Basic Layer 3 Gigabit managed switches
- ▶ **FS980M Series** NEW
Basic Layer 3 Fast Ethernet managed switches
- ▶ **AR3050S**
UTM firewall
- ▶ **AR2050V** NEW
VPN firewall
- ▶ **AR2010V** NEW
Compact VPN firewall

AMF™ CLOUD

AMF Cloud allows the AMF Master and/or Controller to be virtual appliances, rather than integrated into an Allied Telesis switch or firewall. AMF Cloud offers all of the functionality of integrated hardware-based AMF network management, with the advantages of cloud-based access and flexibility.

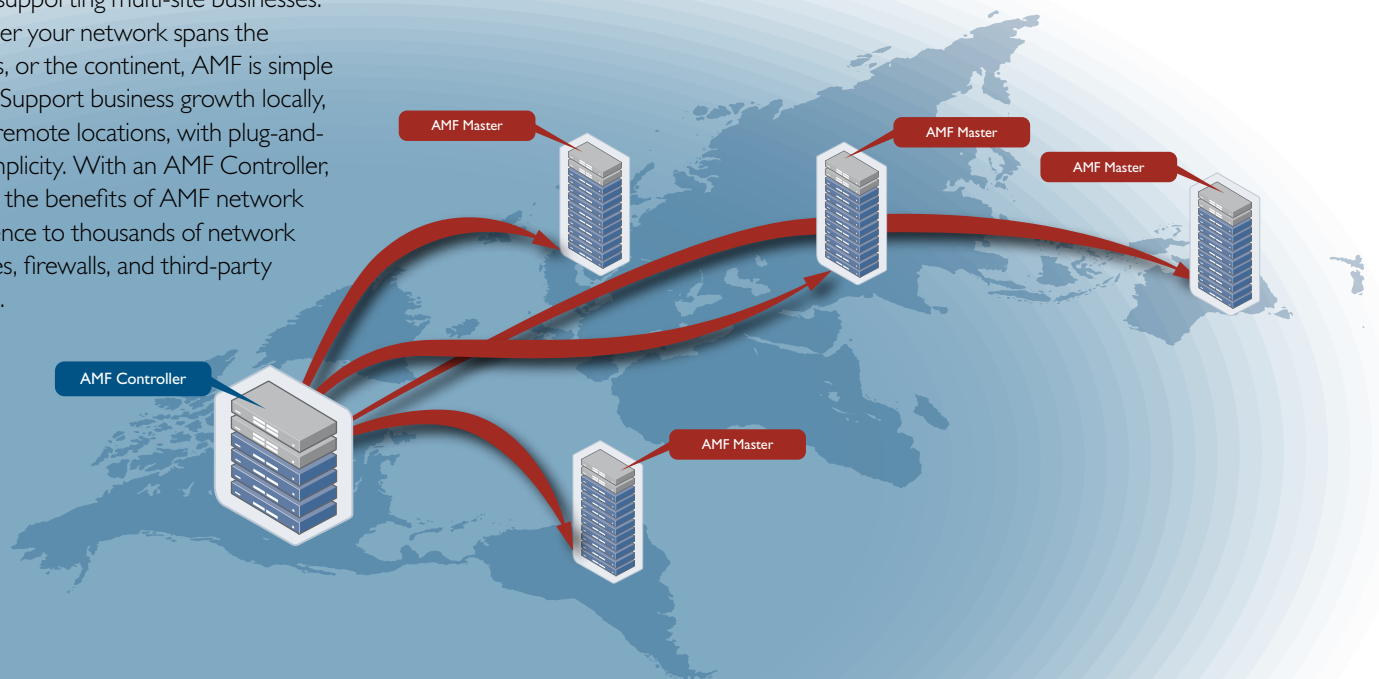

SwitchBlade® x8100 Series

CORE CHASSIS SWITCHES



SwitchBlade x8100 Series core chassis switches are primarily engineered for medium to large enterprise networks — but are equally at home in the enterprise data center. They are designed to deliver high availability, maximum performance, future scalability, and high port count in compact, eco-friendly packages.

Advanced Operating System

The SwitchBlade x8100 Series features the AlliedWare Plus operating system, providing users with advanced Layer 3 functionality and an industry-standard Command Line Interface (CLI).

AlliedWare Plus™
OPERATING SYSTEM

High Availability Architecture

The SwitchBlade x8100 Series is designed to deliver high availability for mission-critical applications found in data centers, hospitality, government, and financial institutions. Dual redundant control/fabric modules inter-connecting through redundant paths to all the line cards ensure continuous operation even in the event of a fabric failure or a firmware upgrade. Dual redundant power supplies ensure maximum system up-time, while two PoE power supplies ensure continuous power to the end-points.

Small Physical Size

The SwitchBlade x8112 packs up to 400 Gigabit, 120 x 10G or 24 x 40G Ethernet ports into a single, compact 7RU-high chassis.

The 6-slot SwitchBlade x8106 chassis is the ultimate choice in compact flexibility. It is designed to provide high-density Gigabit, 10 Gigabit or 40 Gigabit connectivity in 4RU and has the same high availability architecture as the SwitchBlade x8112.

Scalable Architecture

The SwitchBlade x8100 Series guarantees performance for medium and large network core solutions.

With CFC960 control cards, two chassis can be stacked together into a single virtual unit using VCStack Plus.™ This creates a powerful and completely resilient network core, which can even be distributed over long distance.

In-Service Software Upgrade (ISSU)

In-Service Software Upgrade (ISSU) increases network uptime by enabling a customer to upgrade the software running on their chassis without disrupting network traffic. This means that upgrades and maintenance tasks can be completed without having to schedule an outage. ISSU can be used on any SwitchBlade x8100 system with two CFC960 controller cards installed, and is compatible with VCStack Plus so that software upgrades can be performed hitlessly across two chassis to further reduce downtime.

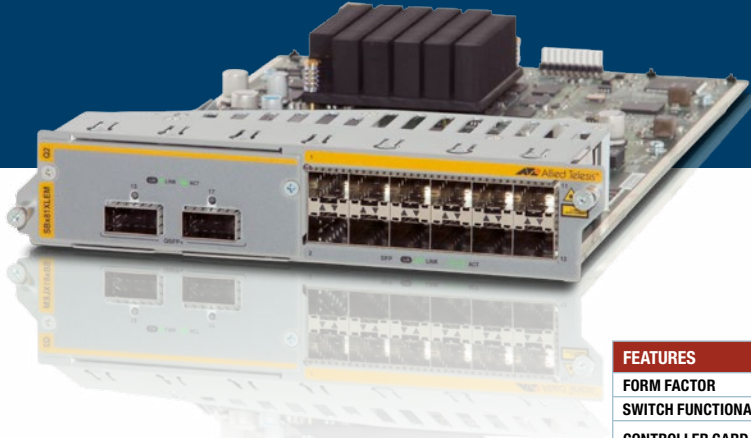

SwitchBlade x8100 Series Components

- ▶ **SBx8106**
Rackmount 6-slot chassis including fan tray
- ▶ **SBx8112**
Rackmount 12-slot chassis including fan tray
- ▶ **SBx81CFC400**
Control/fabric module with 400Gbps of switching performance
- ▶ **SBx81CFC960**
Control/fabric module with 960Gbps of switching performance and 4-port 10GbE SFP+
- ▶ **SBx81XS6**
6-port 10GbE SFP+ Ethernet line card
- ▶ **SBx81XS16**
16-port 10GbE SFP+ Ethernet line card
- ▶ **SBx81GT24**
24-port 10/100/1000T Ethernet line card
- ▶ **SBx81GT40**
40-port 10/100/1000T RJ point five Ethernet line card
- ▶ **SBx81GP24** PoE+
24-port 10/100/1000T PoE+ Ethernet line card
- ▶ **SBx81GS24a**
24-port SFP Ethernet line card
- ▶ **SBx81XLEM** NEW
Modular 40G line card with 12 x 100/1000X SFP
- ▶ **SBx81XLEM/XS8** NEW
8 x 10G SFP+ module for the SBx81XLEM line card
- ▶ **SBx81XLEM/Q2** NEW
2 x 40G QSFP+ module for the SBx81XLEM line card
- ▶ **SBx81XLEM/XT4** NEW
4 x 1/10G RJ-45 module for the SBx81XLEM line card
- ▶ **SBx81XLEM/GT8** NEW
8 x 10/100/1000T RJ-45 module for the SBx81XLEM line card
- ▶ **SBxPWRSYS2**
1200W AC system power supply
- ▶ **SBxPWRSYS1-80**
1200W DC system power supply
- ▶ **SBxPWRPOE1** PoE+
1200W AC PoE+ power supply
- ▶ **FL-CFC400-01**
Premium feature license for CFC400
- ▶ **FL-CFC960-01**
Premium feature license for CFC960
- ▶ **FL-CF9-VCSPL**
VCStack Plus license for CFC960

FEATURES	SBx8112	SBx8106	
FORM FACTOR	Rackmount		
SWITCH FUNCTIONALITY	Advanced Layer 3		
CONTROLLER CARD	CFC400 CFC960		
CHASSIS MODULE SLOTS	12	6	
LINE CARD SLOTS	10	4 (5 with one CFC)	
CARDS/MODULES	10/100/1000T ports	24 x RJ-45 (SBx81GT24) 24 x PoE+ (SBx81GP24) 40 x RJ point five (SBx81GT40)	
	100/1000X SFP ports	24 x SFP (SBx81GS24a)	
	10G ports	6 x 10G SFP+ (SBx81XS6) 16 x 10G SFP+ (SBx81XS16)	
	40G ports	2 x 40G QSFP+ (SBx81XLEM + Q2)	
POWER SUPPLY	PSU type	Dual system hot-swappable internal Dual PoE+ hot-swappable internal	
	-48VDC PSU option	■	
	Additional PSU	SBxPWRSYS2 / SBxPWRPOE1	
POWER OVER ETHERNET	IEEE 802.3at (PoE+)	■	
	PoE+ enabled ports	240	120
	Max PoE+ power	2400W	
	Max full power ports (boost power)	80	
ENVIRONMENTAL	Cooling	Hot-swappable fan tray	
	Temperature range	0°C to 40°C	
MANAGEMENT	Web GUI	■	
	CLI / Telnet / SNMP	■	
	IPv6 management	■	
	DHCPv4 / v6 server	■	
	AMF Master	■	
	AMF Controller	■ (CFC960 only)	
NETWORK RESILIENCE	Spanning Tree	■	
	Link aggregation (LACP)	■	
	EPSRing	■	
	VCStack Plus	■ (CFC960 only)	
	ISSU	■ (CFC960 only)	
	VRRPv3	■	
QoS	IEEE 802.1p priority queues	8	
	IEEE 802.1Q VLANs	4K	
SECURITY	RADIUS / TACACS+	■	
	SSH / SSL	■	
	IEEE 802.1x	■	
	DoS protection	■	
	DHCP snooping	■	
	Static routes v4 / v6	■	
ROUTING	RIP / RIPv6	■	
	OSPFv2 / v3	■	
	VRF Lite	■ (CFC960 only)	
	BGP4 / BGP4+	■	
MULTICASTING	IGMPv1 / v2 / v3	■	
	MLDv1 / v2	■	
	PIMv4 / PIMv6	■	
	PIM-SSM	■	

SwitchBlade x8100 AMF Licenses

Licenses available for the SwitchBlade x8100 controller cards.

CONTROLLER CARD	AMF MASTER		AMF CONTROLLER
SBx81CFC400	FL-CF4-AM40-1YR FL-CF4-AM80-1YR	FL-CF4-AM40-5YR FL-CF4-AM80-5YR	n/a
SBx81CFC960	FL-CF9-AM40-1YR FL-CF9-AM80-1YR FL-CF9-AM120-1YR	FL-CF9-AM40-5YR FL-CF9-AM80-5YR FL-CF9-AM120-5YR	FL-CF9-AC10 FL-CF9-AC30 FL-CF9-AC60

SwitchBlade® x908

ADVANCED LAYER 3 MODULAR COMPACT SWITCH



Advanced Operating System

The SwitchBlade x908 features the AlliedWare Plus operating system, which combines superior networking functionality and strong management



capabilities with the exceptional performance that today's networks demand. As a standards-based implementation, it also assures full interoperability with other major network equipment, and features enhanced usability for a superior customer experience.

Virtual Chassis Stacking (VCStack™)

VCStack provides excellent resiliency by creating a single "virtual chassis" from two SwitchBlade x908 physical devices, using dedicated high-speed stacking links. VCStack provides a highly available system where network resources are spread out across stacked units, reducing the impact should one of the stacked units fail. Switch ports may be aggregated on different units, for high availability. VCStack delivers a resilient solution at a fraction of the cost of a full chassis-based system, and the stack may be managed as a single network node, greatly simplifying management tasks.



Active-Active Architecture

The Active-Active architecture allows two SwitchBlade x908 chassis to be inter-connected via a passive 160Gbps rear panel connector, allowing the two switches to communicate. This architecture ensures that edge devices, which are connected to both switches, can continue to operate even in the event of a single SwitchBlade x908 failure. This architecture, unlike some competitive Active-Redundant architectures, ensures users achieve the full 100% utilization of their purchased network components for the maximum time, thus decreasing Total Cost of Ownership (TCO).

Ethernet Protection Switched Rings (EPSRing™)

The use of the SwitchBlade x908, in conjunction with other EPSRing-enabled devices, provides a 10Gbps high-bandwidth resilient ring backbone capable of providing sub 50ms failover. This architecture is perfect for the backbone core of any enterprise or service provider network, as it allows nearly hit-free networking to be accomplished, and is suitable for the delivery of voice, video, and data.



The SwitchBlade x908 8-slot industry-leading modular compact switch is the ideal solution for the small to medium modern enterprise network core where reliability, resiliency, and high performance are the key requirements.

Allied Telesis Management Framework (AMF)

AMF is a sophisticated suite of management tools that simplifies network management. The SwitchBlade x908 can act as an AMF Master (license required), to control a network of AMF nodes and provide a central point for network management and configuration backups.



High Availability

The SwitchBlade x908 was designed with reliability in mind. With dual power supplies, fan modules, and a comprehensive range of expansion modules (XEMs) — all hot-swappable — the network can be maintained and reconfigured when necessary without affecting uptime.

Scalable

The SwitchBlade x908 supports up to eight XEM expansion modules, allowing the user to change the configuration of his network as needed. Each SwitchBlade x908 can support up to 192 Gigabit ports or up to 16 x 10GbE ports, while stacking two chassis, to build a resilient core that doubles the number of ports.



SwitchBlade x908 Components

- ▶ **SBx908**
Rackmount 8-slot chassis including fan module
 - ▶ **XEM-2XS**
2-port 10GbE SFP+ expansion module
 - ▶ **XEM-2XP**
2-port 10GbE XFP expansion module
 - ▶ **XEM-12Sv2**
12-port SFP expansion module
 - ▶ **XEM-12Tv2**
12-port 10/100/1000T expansion module
 - ▶ **XEM-24T**
24-port 10/100/1000T RJ point five expansion module
 - ▶ **PWR05**
AC load sharing system power supply
 - ▶ **PWR05-80**
DC load sharing system power supply
 - ▶ **HS-STK-CBL**
650 mm high-speed stacking cable
 - ▶ **FAN03**
Spare fan module
 - ▶ **FL-RADIUS-FULL**
Local RADIUS server (license up to 5000 users and 1000 NAS) †
 - ▶ **FL-SBx9-01**
Advanced Layer 3 feature license
 - ▶ **FL-SBx9-02**
IPv6 feature license
 - ▶ **FL-SBx9-AM40***
AMF master license for up to 40 nodes
 - ▶ **UTP/RJ.5-100-A-008**
RJ point five to RJ-45 1 m Ethernet cables (pack of eight)
 - ▶ **UTP/RJ.5-300-A-008**
RJ point five to RJ-45 3 m Ethernet cables (pack of eight)
- * 1 year/5 year license
† One basic license includes 100 users and 24 NAS



Allied Telesis delivers increased port density with the addition of the latest Ethernet connectivity technology, RJ point five. These half-size copper Gigabit port connectors allow twice the port density of the current RJ-45 standard connectors, ideal for the aggregation of large numbers of Gigabit links.

Enterprise Applications

The SwitchBlade x908 is the ideal enterprise switch for small- to medium-sized network installations, but is also at home in larger distributed campus-type networks, when individual switches are connected using EPSRing technology.

MEF Certified

The SwitchBlade x908 has been certified by the Metro Ethernet Forum (MEF) certification program, which tests products for conformance to the strict requirements of carrier Ethernet. Compliance with this certification makes the deployment of this chassis a much easier option for Network Service Providers (NSPs).



Small Physical Size

The SwitchBlade x908 packs a remarkable amount of networking performance into a small, 3RU-high box. Taking up no more rack space than three simple “pizza box” switches, the SwitchBlade x908 provides users with unrivaled reliability and flexibility.

FEATURES		SBx908
FORM FACTOR		Rackmount / stack
SWITCH FUNCTIONALITY		Advanced Layer 3
CHASSIS MODULE SLOTS		8
CARDS/MODULES	10/100/1000T ports	12 × RJ-45 (XEM-12Tv2) 24 × RJ point five (XEM-24T)
	100/1000X SFP ports	12 × 1000X SFP (XEM-12Sv2)
	10G ports	2 × 10G XFP (XEM-2XP) 2 × 10G SFP+ (XEM-2XS) 2 × 10G RJ-45 (XEM-2XT)
POWER SUPPLY	PSU type	Dual hot-swappable internal
	-48VDC PSU option	■
Additional PSU		PWR05
SCALABILITY	MAC address table size	16K / 64K
	Stacking (VCStack)	■ (2)
	Stacking bandwidth	160G
ENVIRONMENTAL	Cooling	Hot-swappable fan modules
	Temperature range	0°C to 40°C
MANAGEMENT	Web GUI	■
	CLI / Telnet / SNMP	■
	IPv6 management	■
	DHCPv4 / v6 server	■
	Allied Telesis Management Framework (AMF)	■
NETWORK RESILIENCE	Spanning Tree	■
	Link aggregation (LACP)	■
	EPSRing	■
QoS	VRRPv3	■
	IEEE 802.1p priority queues	8
SECURITY	IEEE 802.1Q VLANs	4K
	RADIUS / TACACS+	■
	SSH / SSL	■
	IEEE 802.1x	■
	DoS protection	■
	DHCP snooping	■
ROUTING	Static routes v4 / v6	■
	RIP / RIPng	■
	OSPFv2 / v3	■
	BGP4 / BGP4+	■
	Policy-based routing	■
	VRF Lite	■
MULTICASTING	IGMPv1 / v2 / v3	■
	MLDv1 / v2	■
	PIMv4 / PIMv6	■
PIM-SSM		■

SwitchBlade® x3100 Series

ACCESS EDGE CHASSIS SWITCHES

The SwitchBlade x3100 Series access edge chassis switch is available in either a 12- or 6-slot version and primarily targeted for service provider fiber access networks. Equally at home in the enterprise network edge or in the data center, the switch is designed to deliver high availability and maximum performance with a wirespeed non-blocking backplane and high port count.

FTTx Service Provider Applications





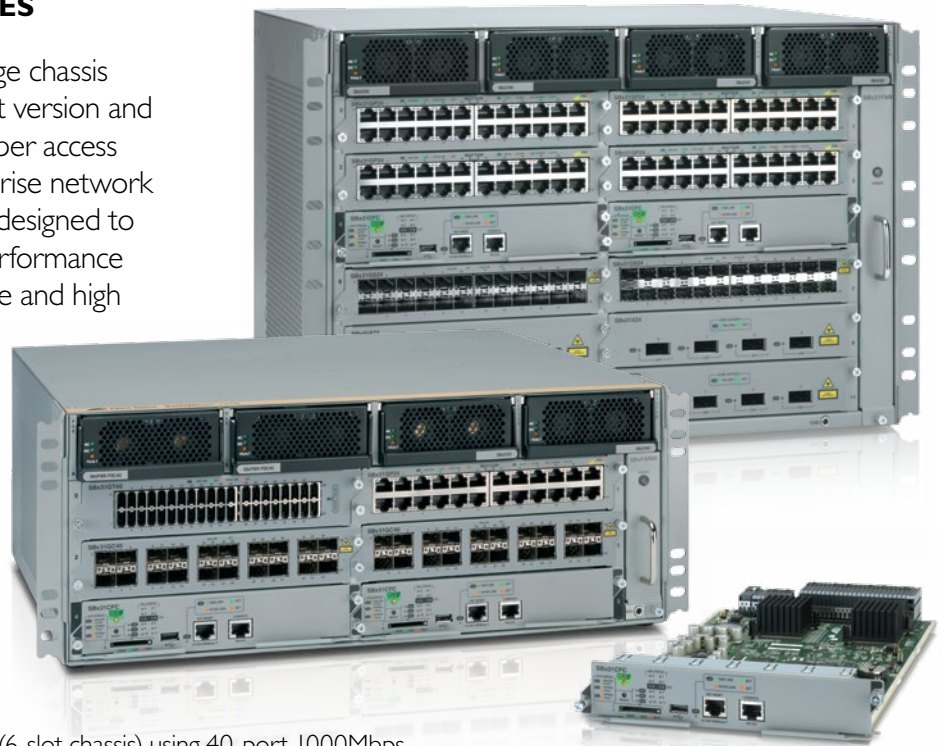

The SwitchBlade x3100 is a versatile, carrier-class FTTx platform for delivering Gigabit services to residential, Multi-Dwelling Unit (MDU) and business customers in the last mile. It features redundant power supplies, controllers, and WAN ports to ensure reliability standards in carrier networks are met, along with powerful sub-50 millisecond failover protection using EPSRing for link level protection. The Series is available with AC or DC power options.

As a FTTx platform, the SwitchBlade x3100 can support a maximum of 440 ports (12-slot chassis) or 200 ports



(6-slot chassis) using 40-port 1000Mbps CSFP-based line cards (SBx31GC40). It can also support redundant 10G uplinks using 4 ports on the CFC960 or 6-port SFP+-based line cards (SBx31XS6). Both the CFC and the line card support LAG and EPSR on uplinks when used as transport. The SwitchBlade x3100 can act as an aggregation hub for last-mile

FTTx applications using 10G line cards. It features 80 Gigabit non-blocking throughput to each slot, thus providing a maximum level of performance for FTTx services, both 1G and 10G. Coupled with ultra-fast 960G central fabric controllers (CFC960), FTTx services can operate at wirespeed connectivity.

FEATURES	PoE+  SBx3112 SBx3106	PoE+  SBx3112-96POE+	PoE+  SBx3112-8XR	PoE+  SBx3112-12XS-80	PoE+  SBx3112-6XS-80	PoE+  SBx3112-B01-80	
PRODUCT	Chassis with fan tray	Chassis bundle	Chassis bundle	Chassis bundle	Chassis bundle	Chassis bundle	
SWITCH FUNCTIONALITY	Layer 2+	Layer 2+	Layer 2+	Layer 2+	Layer 2+	Layer 2+	
ACCESSORIES	Controller Fabric Card (CFC)	1 × SBx31CFC400	2 × SBx31CFC400	2 × SBx31CFC400	1 × SBx31CFC400	2 × SBx31CFC960	
	24 × 10/100/1000T PoE+	4 × XFP (10GbE)	2 × SBx31XZ4				
	6 × SFP+ (10GbE)			2 × SBx31XS6	1 × SBx31XS6		
	System power supply		1 × SBxPWRSYS2	2 × SBxPWRSYS2	2 × SBxPWRSYS1-80 (DC)	1 × SBxPWRSYS1-80 (DC)	2 × SBxPWRSYS1-80
	PoE power supply		1 × SBxPWRPOE1				
	Fan tray		Included in chassis	Included in chassis	Included in chassis	Included in chassis	
POWER SUPPLY	PSU type	Dual internal hot-swap	Dual internal hot-swap	Dual internal hot-swap	Dual internal hot-swap	Dual internal hot-swap	
	-48VDC PSU option	■	■	■	■	■	
POWER OVER ETHERNET	IEEE 802.3at Class 4 and 802.3af Class 3	■	■	■	■	■	
	Max PoE-enabled ports (per chassis)		96				
	Max IEEE 802.3at ports (per chassis)		80				
	Max IEEE 802.3af ports (per chassis)		200				
	Mode	A					
ENVIRONMENTAL	Cooling	Hot-swappable fan tray	Hot-swappable fan tray	Hot-swappable fan tray	Hot-swappable fan tray	Hot-swappable fan tray	
	Temperature range	0°C to 40°C	0°C to 40°C	0°C to 40°C	0°C to 40°C	0°C to 40°C	
MANAGEMENT	CLI / Telnet / SNMP / NMS	■	■	■	■	■	
NETWORK RESILIENCE	Spanning Tree	■	■	■	■	■	
	Link aggregation (LACP)	■	■	■	■	■	
	EPSRing	■	■	■	■	■	
QoS	IEEE 802.1p priority queues	8	8	8	8	8	
SECURITY	IEEE 802.1Q VLANs	4K	4K	4K	4K	4K	
	VLAN double tagging (Q-in-Q)	■	■	■	■	■	
	RADIUS / TACACS+ / SSH	■	■	■	■	■	



SwitchBlade x3112 Line Cards						
FEATURES	SBx31GP24	SBx31GT24	SBx31GT40	SBx31GS24	SBx31GC40	SBx31XS6
COPPER	10/100/1000T or 10/100/1000T plus PoE+ 10/100/1000T	24	24	40		
FIBER	100MB / 1 Gigabit SFP 1 Gigabit CSFP / SFP 10G SFP+				24	40 (20 CSFP slots)
						6

FEATURES		SBx3106	SBx3112
POWER SUPPLY	AC		SBxPWRSYS2-xx
	DC		SBxPWRSYS1-80
	PoE		SBxPWRPOE1-xx
CENTRAL FABRIC CONTROL	Primary		SBx31CFC960
	Secondary		SBx31CFC960
UPLINK AND TRANSPORT	Slots	4	8
	Number of ports	32	68
	Port speed	10Gbps	
LINE CARDS	Slots	4	8
	FTTx	160 (200 one controller only)	400 (440 one controller only)
	Ethernet	160 (200 one controller only)	400 (440 one controller only)
TEMPERATURE RANGE	0°C to 40°C		

An evolution of the Allied Telesis tried and tested iMAP carrier-grade platform, the SwitchBlade x3100 delivers true IP Triple Play services such as IPTV, VoIP, Tiered High Speed Internet Access (HSIA), and other cloud-based services such as Over-the-Top video, remote storage and backup, and cloud computing.

Raw performance combined with high availability also allows it to be deployed as both end-of-row and aggregation in data center applications, and in campus applications as the ultimate in network edge connectivity.

High-Availability Architecture

The SwitchBlade x3100 is designed to deliver 99.999% reliability, while offering high availability with sub-millisecond hitless failover for mission-critical applications where uptime is essential such as data centers, hospitality, government, financial institutions, and medical institutions.

Dual redundant management/fabric modules inter-connecting through

redundant paths to the line cards over a passive backplane, and dual redundant power options, ensure maximum system up-time. Power is delivered via up to two system power supplies and two Power over Ethernet supplies to ensure continual operation.

Power over Ethernet Plus (PoE+)

The SwitchBlade x3100 supports IEEE 802.3at PoE+ (30W) to enable customers to future-proof their networks. PoE+ provides greater power for applications such as IP surveillance cameras supporting pan, tilt, and zoom, IP video phones, RFID readers, Point-of-Sale, or wireless access points.



Secure Management

Only authorized administrators can access the management interface of the SwitchBlade x3100. Protocols such as SSH provide an encrypted interface for both local and remote connections, with out-of-band management achieved through a dedicated Gigabit port if required.

Securing the Network Edge

To ensure the protection of the data, it is important to control access to the network. Protocols such as IEEE 802.1x authentication guarantee that only known users are connected to the network. Unknown users who physically connect can be isolated to a predetermined part of the network, offering guests such benefits as Internet access while ensuring the integrity of private network data.

Secure Differentiation

QoS schemes for SwitchBlade x3100 access solutions are designed to ensure that application performance and availability are not impacted with network growth. Features such as IEEE 802.1p/Q enable tiered data services for residential, business, and enterprise users to prioritize real-time applications such as IP phones and IP cameras.

Environmentally Friendly

In keeping with the Allied Telesis commitment to environmentally friendly processes and products, the SwitchBlade x3100 is designed to reduce power consumption and minimize hazardous waste. Features include the use of high-efficiency power supplies and low-power chip sets. The switches also include an eco-friendly button on the front panel, allowing conservation of additional power by turning off all diagnostic LED indicators when they are not required.



Aggregation and Distribution

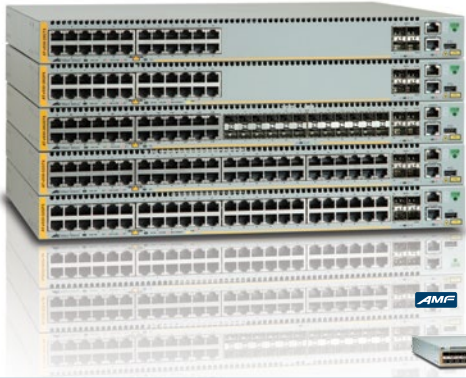

x930 Series

Allied Telesis x930 Series switches are a high-performing and feature-rich choice for today's networks. With a range of 24- and 48-port models with 10 Gigabit uplink ports, the option of PoE+, and the power of Allied Telesis Virtual Chassis Stacking (VCStack), the x930 Series has the flexibility and performance for demanding aggregation and distribution applications.

EXTENDED TEMP
PoE+ AMF eco3



EXTENDED TEMP
AMF eco3



EXTENDED TEMP
PoE+ AMF eco3



FEATURES		DC2552XS/L3	x930-28GTX x930-28GPX	x930-28GSTX	x930-52GTX x930-52GPX
FORM FACTOR		Desktop / rackmount / stack	Desktop / rackmount / stack	Desktop / rackmount / stack	Desktop / rackmount / stack
SWITCH FUNCTIONALITY		Advanced Layer 3	Advanced Layer 3	Advanced Layer 3	Advanced Layer 3
PORTS AND MEDIA SUPPORT	10/100/1000T ports		24	24 combo	48
	100/1000X SFP ports			24 combo	
	1G/10G SFP+ ports	48 (64 with breakout cable)	4	4	4
	40G QSFP+ ports	4	2 (StackQS)	2 (StackQS)	2 (StackQS)
	Expansion module bays		1	1	1
POWER SUPPLY	PSU type	Dual internal hotswap	Dual internal hotswap	Dual internal hotswap	Dual internal hotswap
	-48VDC PSU option		■ (PWR250-80)	■ (PWR250-80)	■ (PWR250-80)
	Redundant power supply	N/A	N/A	N/A	N/A
	Additional PSU	PWR06	PWR150 PWR250 PWR800 PWR1200	PWR150 PWR250 PWR800 PWR1200	PWR150 PWR250 PWR800 PWR1200
POWER OVER ETHERNET	IEEE 802.3af (PoE)		■ (GPX model only)		■ (GPX model only)
	IEEE 802.3at (PoE+)		■ (GPX model only)		■ (GPX model only)
	PoE-enabled ports		24 (GPX model only)		48 (GPX model only)
	Max PoE+ power		720W (GPX model only)		1440W (GPX model only)
	Max full power PoE+ ports		24 (GPX model only)		48 (GPX model only)
SCALABILITY	MAC address table size	128K	64K	64K	64K
	Stacking (VCStack)	■ 2	■ 8	■ 8	■ 8
	Long-distance VCStack	■ 2	■ 8	■ 8	■ 8
	Stacking bandwidth	160G (QSFP+)	40G (SFP+) 160G (StackQS)	40G (SFP+) 160G (StackQS)	40G (SFP+) 160G (StackQS)
	ENVIRONMENTAL				
	Cooling	Fan	Fan	Fan	Fan
	Temperature range	0°C to 40°C	0°C to 45°C (GPX); to 50°C (GTX)	0°C to 50°C	0°C to 45°C (GPX); to 50°C (GTX)
MANAGEMENT	Web GUI		■	■	■
	CLI / Telnet / SNMP	■	■	■	■
	IPv6 management	■	■	■	■
	DHCPv4 / v6 server	■	■	■	■
	AMF Master	■	■	■	■
	AMF Member	■	■	■	■
NETWORK RESILIENCE	Spanning Tree	■	■	■	■
	Link aggregation (LACP)	■	■	■	■
	EPSRing	■	■	■	■
QoS	VRRPv3	■	■	■	■
	IEEE 802.1p priority queues	8	8	8	8
SECURITY	IEEE 802.1Q VLANs	4K	4K	4K	4K
	RADIUS / TACACS+	■	■	■	■
	SSH / SSL	■	■	■	■
	IEEE 802.1x	■	■	■	■
	DoS protection	■	■	■	■
	DHCP snooping	■	■	■	■
	Static routes v4 / v6	■	■	■	■
ROUTING	RIP / RIPng	■	■	■	■
	OSPFv2 / v3	■	■	■	■
	Policy-based routing	■	■	■	■
	VRF Lite	■	■	■	■
	IGMPv1 / v2 / v3	■	■	■	■
MULTICASTING	MLDv1 / v2	■	■	■	■
	PIMv4 / PIMv6	■	■	■	■
	PIM-SSM / PIM-SSMv6	■	■	■	■
SDN	OpenFlow	■	■	■	■

Intelligent Edge



x230 Series

Allied Telesis x230 Series switches provide optimal solutions for edge connectivity and distributing PoE power to wireless access points, IP video surveillance cameras, and IP phones. The GP models provide 8, 16 and 24 PoE Gigabit ports, and SFP uplinks, for secure powered connectivity at the network edge.



FEATURES	x230-10GP	x230-18GP	x230-28GP	x230-10GT	x230-18GT	x230-28GT
FORM FACTOR	Desktop / rackmount	Desktop / rackmount	Desktop / rackmount	Desktop / rackmount	Desktop / rackmount	Desktop / rackmount
SWITCH FUNCTIONALITY	Basic Layer 3	Basic Layer 3	Basic Layer 3	Basic Layer 3	Basic Layer 3	Basic Layer 3
PORTS AND MEDIA SUPPORT	10/100/1000T 100/1000X SFP ports	8 2	16 2	24 4	8 2	16 2
POWER SUPPLY	PSU type	Single fixed internal	Single fixed internal	Single fixed internal	Single fixed internal	Single fixed internal
POWER OVER ETHERNET	IEEE 802.3af (PoE)	■	■	■		
	IEEE 802.3at (PoE+)	■	■	■		
	PoE+ enabled ports	8	16	24		
	Max PoE+ power	124W	247W	370W		
	Max full power ports (30W)	4	8	12		
SCALABILITY	MAC address table size	16K	16K	16K	16K	16K
	Stacking (VStack) Stacking bandwidth					
ENVIRONMENTAL	Cooling	Fan	Fan	Fan	Fanless	Fan
	Temperature range	0°C to 50°C	0°C to 50°C	0°C to 50°C	0°C to 50°C	0°C to 50°C
MANAGEMENT	Web GUI	■	■	■	■	■
	CLI / Telnet / SNMP	■	■	■	■	■
	IPv6 management	■	■	■	■	■
	DHCPv4 / v6 server					
	AMF Member	■	■	■	■	■
NETWORK RESILIENCE	Spanning Tree	■	■	■	■	■
	Link aggregation (LACP)	■	■	■	■	■
	EPSRing	■	■	■	■	■
QoS	IEEE 802.1p priority queues	8	8	8	8	8
SECURITY	IEEE 802.1Q VLANs	4K	4K	4K	4K	4K
	RADIUS / TACACS+	■	■	■	■	■
	SSH / SSL	■	■	■	■	■
	IEEE 802.1x	■	■	■	■	■
	DoS protection	■	■	■	■	■
	DHCP snooping	■	■	■	■	■
ROUTING	Static routes v4 / v6	■ (v4 only)	■ (v4 only)	■ (v4 only)	■ (v4 only)	■ (v4 only)
	RIP / RiPng	■ (RIP only)	■ (RIP only)	■ (RIP only)	■ (RIP only)	■ (RIP only)
	OSPFv2 / v3					
MULTICASTING	IGMPv1 / v2 / v3	■ (snooping)	■ (snooping)	■ (snooping)	■ (snooping)	■ (snooping)
	MLDv1 / v2	■ (snooping)	■ (snooping)	■ (snooping)	■ (snooping)	■ (snooping)
	PIMv4 / PIMv6					
	PIM-SSM / PIM-SSMv6					
SDN	OpenFlow	■	■	■	■	■

CentreCOM Gigabit Edge

CentreCOM™ is the Allied Telesis global brand of cost-effective switches for customers who need to manage their network communications with a minimal investment. CentreCOM Gigabit Ethernet switches provide advanced management and security features to the edge while cost-effectively enhancing delivery of converged data.

SFP/SFP+ Optics 
 Learn more about Allied Telesis pluggable optics on page 50.



		GIGABIT ETHERNET			
FEATURES		GS924MX	GS924MPX	GS948MX	GS948MPX
SWITCH FUNCTIONALITY		Basic Layer 3	Basic Layer 3	Basic Layer 3	Basic Layer 3
PORTS AND MEDIA SUPPORT					
	10/100/1000T	24 + 2 combo	24 + 2 combo	48 + 2 combo	48 + 2 combo
	SFP	2 combo (100/1000X)	2 combo (100/1000X)	2 combo (100/1000X)	2 combo (100/1000X)
	SFP+	2 (if not stacked)	2 (if not stacked)	2 (if not stacked)	2 (if not stacked)
POWER SUPPLY					
POWER OVER ETHERNET					
	Power over Ethernet (PoE)		■		■
	PoE ports		24		48
	IEEE 802.3af Class 3 (15.4W)		24		24
	IEEE 802.3at Class 4 (30W)		12		12
	PoE budget		370W		370W
SCALABILITY					
	MAC address table size	16K	16K	16K	16K
	Stacking	■ (4)	■ (4)	■ (4)	■ (4)
ENVIRONMENTAL					
	Cooling	Fan	Fan	Fan	Fan
	Eco-friendly	■	■	■	■
	Temperature range	0°C to 50°C	0°C to 50°C	0°C to 50°C	0°C to 50°C
MANAGEMENT					
	Web	■	■	■	■
	CLI / Telnet / SNMP	■	■	■	■
	IPv6	■	■	■	■
	AMF	Edge node	Edge node	Edge node	Edge node
NETWORK RESILIENCE					
	Spanning Tree	■	■	■	■
	Link aggregation (LACP)	■	■	■	■
	EPSRing	■	■	■	■
QoS					
	IEEE 802.1p priority queues	8	8	8	8
SECURITY					
	IEEE 802.1Q VLANs	4K	4K	4K	4K
	IEEE 802.1x	■	■	■	■
	MAC-based authentication	■	■	■	■
	Web-based authentication	■	■	■	■
	RADIUS / IEEE 802.1x	■	■	■	■
	TACACS	■	■	■	■
	SSH / SSL	■	■	■	■
	DHCP snooping				
ROUTING					
	Static routes v4 / v6	■ (v4 only)	■ (v4 only)	■ (v4 only)	■ (v4 only)
	RIP / RIPng	■ (RIP only)	■ (RIP only)	■ (RIP only)	■ (RIP only)
MULTICASTING					
	IGMPv1 / v2 / v3	■ (snooping)	■ (snooping)	■ (snooping)	■ (snooping)
	MLDv1 / v2	■ (snooping)	■ (snooping)	■ (snooping)	■ (snooping)



GS970M Series

Allied Telesis CentreCOM GS970M Series switches provide an excellent access solution for today's networks, supporting Gigabit to the desktop for maximum performance. The Power over Ethernet Plus (PoE+) models are ideal solution for connecting and remotely powering wireless access points, IP video surveillance cameras, and IP phones.

EXTENDED TEMP
AMF PoE+ eco2
NEW

EXTENDED TEMP
AMF PoE+ eco2
NEW

EXTENDED TEMP
AMF PoE+ eco2
NEW

EXTENDED TEMP
AMF eco2
NEW

EXTENDED TEMP
AMF eco2
NEW

EXTENDED TEMP
AMF eco2
NEW

GIGABIT ETHERNET

	GS970M/10PS	GS970M/18PS	GSP70M/28PS	GS970M/10	GS970M/18	GS970M/28
	Basic Layer 3	Basic Layer 3	Basic Layer 3	Basic Layer 3	Basic Layer 3	Basic Layer 3
	8	16	24	8	16	24
	2	2	4	2	2	4
	Single fixed internal	Single fixed internal	Single fixed internal	Single fixed internal	Single fixed internal	Single fixed internal
	■	■	■			
	8	16	24			
	8	16	24			
	4	8	12			
	124W	247W	370W			
	16K	16K	16K	16K	16K	16K
	Fan	Fan	Fan	Fanless	Fan	Fan
	■	■	■	■	■	■
	0°C to 50°C	0°C to 50°C	0°C to 50°C	0°C to 50°C	0°C to 50°C	0°C to 50°C
	■	■	■	■	■	■
	■	■	■	■	■	■
	■	■	■	■	■	■
	Edge node	Edge node	Edge node	Edge node	Edge node	Edge node
	■	■	■	■	■	■
	■	■	■	■	■	■
	■	■	■	■	■	■
	8	8	8	8	8	8
	4K	4K	4K	4K	4K	4K
	■	■	■	■	■	■
	■	■	■	■	■	■
	■	■	■	■	■	■
	■	■	■	■	■	■
	■	■	■	■	■	■
	■ (v4 only)	■ (v4 only)	■ (v4 only)	■ (v4 only)	■ (v4 only)	■ (v4 only)
	■ (RIP only)	■ (RIP only)	■ (RIP only)	■ (RIP only)	■ (RIP only)	■ (RIP only)
	■ (snooping)	■ (snooping)	■ (snooping)	■ (snooping)	■ (snooping)	■ (snooping)
	■ (snooping)	■ (snooping)	■ (snooping)	■ (snooping)	■ (snooping)	■ (snooping)

CentreCOM Fast Ethernet Edge

Allied Telesis CentreCOM Fast Ethernet edge switches provide security, performance and flexibility at an affordable price. These switches are ideal for the enterprise edge market, traditionally used in defense, government, campus, and security applications. With Power over Ethernet models providing connectivity for IP cameras, IP phones, and wireless access points.

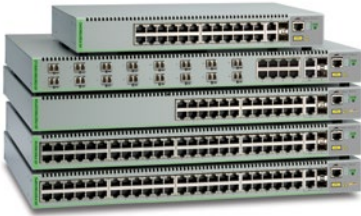

CentreCOM FS970M Series

The Allied Telesis FS970M Series of high performance Fast Ethernet switches provides advanced enterprise features at an affordable investment level to improve the delivery of converged data. The FS970M Series is ideal for branch offices or the wiring closet of larger offices. The state-of-the-art QoS capability of this product ensures reliable delivery of advanced network services, such as voice, while effectively controlling the continually increasing traffic needs of today's networks.

SFP/SFP+ Optics
Learn more about Allied Telesis pluggable optics on page 50.



FEATURES		FAST ETHERNET FIBER		
		FS970M/16F8-LC	FS970M/16F8-SC	FS970M/24F
SWITCH FUNCTIONALITY		Basic Layer 3	Basic Layer 3	Basic Layer 3
PORTS AND MEDIA SUPPORT	10/100TX	8	8	
	10/100/1000T	2 (combo)	2 (combo)	2 (combo)
	SFP	2 combo (100/1000X)	2 combo (100/1000X)	2 combo (100/1000X)
POWER OVER ETHERNET	16 (LC) MMF	16 (LC) MMF	24 (LC) MMF	
	IEEE 802.3af (PoE)			
	IEEE 802.3at (PoE+)			
	PoE enabled ports			
POWER SUPPLY	Max PoE power			
	Max PoE+ enabled ports			
SCALABILITY	PSU type	2 fixed internal	2 fixed internal	2 fixed internal
	MAC address table size	16K	16K	16K
	Stacking (VcStack)			
ENVIRONMENTAL	Stacking bandwidth			
	Cooling	Fan	Fan	Fan
	Variable-speed fan	■	■	■
	Eco-friendly	■	■	■
MANAGEMENT	Temperature range	0°C to 40°C	0°C to 40°C	0°C to 40°C
	Web GUI			
	CLI / Telnet / SNMP	■	■	■
NETWORK RESILIENCE	IPv6 management			
	AMF			
	Spanning Tree	■	■	■
QoS	Link aggregation (LACP)	■	■	■
	EPSRing			
SECURITY	IEEE 802.1p priority queues	8	8	8
	IEEE 802.1Q VLANs	4K	4K	4K
	RADIUS / TACACS	■	■	■
	SSH/SSL	■	■	■
	IEEE 802.1x	■	■	■
ROUTING	DHCP snooping			
	Static routes v4			
MULTICASTING	RIP			
	IGMPv1 / v2 / v3			
	MLDv1 / v2			



Security of Data

Allied Telesis guarantees protection and secure management of networks by providing administrators strong security standards and authentication mechanisms for access at the edge of a network. Allied Telesis edge switches allow network controllers to restrict external devices from gaining unauthenticated access to the network.

Effective Traffic Monitoring

In order to fully understand the performance of the network and ensure the ongoing smooth delivery of critical data, users must be able to measure and analyze the traffic in real time. Allied Telesis edge switches facilitate effective traffic monitoring with sFlow and RMON, which together provide better visibility of the performance and use of the network, helping management to make appropriate decisions crucial for an organization to function efficiently.

Securing the Network Edge

Protocols such as IEEE 802.1x port-based authentication guarantee that only known users are connected to the network, ensuring data

protection. Unknown users who physically connect can be isolated to a predetermined part of the network, offering guest benefits such as Internet access, while ensuring the integrity of private network data. Security protocols such as SSL, SSH, and SNMPv3 facilitate this protection of the network for both local or remote connections.

Access Control Lists (ACLs)

Access Control Lists enable inspection of incoming frames and classify them based on various criteria. Specific actions can then be applied to these frames to more effectively manage the network traffic. Typically, ACLs are used as a security mechanism, either permitting or denying entry for frames in a group; but they can also be applied to QoS.

Ideal and Reliable Connectivity

Powerful line rate performance makes these switches ideal for branch offices or the wiring closet of larger offices. The state-of-the-art QoS capability of these products ensures reliable delivery of advanced network services, such as voice and video, while effectively controlling the continually increasing traffic needs of today's networks.



FAST ETHERNET COPPER

	FS980M/9	FS980M/18	FS980M/28	FS980M/52	FS980M/9PS	FS980M/18PS	FS980M/28PS	FS980M/52PS
Basic Layer 3	Basic Layer 3	Basic Layer 3	Basic Layer 3	Basic Layer 3	Basic Layer 3	Basic Layer 3	Basic Layer 3	Basic Layer 3
8	16	24	48	8	16	24	48	
1 combo	2 combo			1 combo	2 combo	4		
1 combo	2 combo	4	4	1 combo	2 combo		4	
				■	■	■	■	
				■	■	■	■	
				8	16	24	48	
				150W	250W	375W	375W	
				4	8	12	12	
8K	8K	8K	8K	8K	8K	8K	8K	
		■ (4) *	■ (4) *			■ (4) *	■ (4) *	
		2G (2 x SFP)	2G (2 x SFP)			2G (2 x SFP)	2G (2 x SFP)	
Fanless	Fanless	Fanless	Fan	Fan	Fan	Fan	Fan	
0°C to 50°C	0°C to 50°C	0°C to 50°C	0°C to 50°C	0°C to 50°C	0°C to 50°C	0°C to 50°C	0°C to 50°C	
■	■	■	■	■	■	■	■	
■	■	■	■	■	■	■	■	
■	■	■	■	■	■	■	■	
Edge node	Edge node	Edge node	Edge node	Edge node	Edge node	Edge node	Edge node	
■	■	■	■	■	■	■	■	
■	■	■	■	■	■	■	■	
■	■	■	■	■	■	■	■	
8	8	8	8	8	8	8	8	
4K	4K	4K	4K	4K	4K	4K	4K	
■	■	■	■	■	■	■	■	
■	■	■	■	■	■	■	■	
■	■	■	■	■	■	■	■	
■	■	■	■	■	■	■	■	
■	■	■	■	■	■	■	■	
■ (snooping)	■ (snooping)	■ (snooping)	■ (snooping)	■ (snooping)	■ (snooping)	■ (snooping)	■ (snooping)	
■ (snooping)	■ (snooping)	■ (snooping)	■ (snooping)	■ (snooping)	■ (snooping)	■ (snooping)	■ (snooping)	

* 4 units stacking is supported in 5.4.7 or later

WebSmart



Allied Telesis WebSmart switches perform a dual role in providing connectivity for a variety of computer networks. For small office networks, they provide security and data priority, allowing the deployment of Voice over IP and similar applications. In larger networks, WebSmart switches provide security, authentication, and data priority — but at a lower cost point than a fully-managed device.

Simple Configuration

Allied Telesis WebSmart switches may be used directly from the box, with no additional configuration. Additional features can be enabled using a simple Graphical User Interface (GUI) management system, allowing less technical users to configure the devices.

Affordable Solutions

Allied Telesis WebSmart switches offer a solution with key “managed switch” features — without the price tag associated with managed switches.

These switches are perfect for budget-sensitive companies looking for advanced features such as Quality of Service (QoS), port mirroring, Virtual LAN (VLAN), and Power over Ethernet (PoE). In addition, WebSmart switches may be used on the edge of a large managed network while still providing high levels of security.



		FAST ETHERNET			
FEATURES		FS750/20	FS750/28	FS750/28PS	FS750/52
PORTS AND MEDIA SUPPORT	10/100TX	16	16	24	24
	10/100/1000T	2+2 (combo)	2+2 (combo)	2+2 (combo)	2+2 (combo)
	SFP	2 combo	2 combo	2 combo	2 combo
	100FX SFP support	■	■	■	■
POWER SUPPLY		Internal	Internal	Internal	Internal
POWER OVER ETHERNET	Power over Ethernet (PoE)			■	
	PoE enabled ports			24	
	IEEE 802.3af (PoE)			■	
	IEEE 802.3at (PoE+)			■	
	Max PoE power			193W	
Max PoE+ enabled ports			4 (port 1-4)		
SCALABILITY	MAC address table size	8K	8K	8K	16K
ENVIRONMENTAL	Cooling	Fanless	Fanless	Fan	Fanless
	Eco-friendly	■	■	■	■
	Temperature range	0°C to 40°C	0°C to 40°C	0°C to 40°C	0°C to 40°C
MANAGEMENT	Web	■	■	■	■
	SNMPv1 / v2	■	■	■	■
NETWORK RESILIENCE	Spanning Tree	■	■	■	■
	Rapid Spanning Tree	■	■	■	■
	Link aggregation (LACP)	■	■	■	■
	IGMP snooping (v1 / v2)	■	■	■	■
	Port setting (speed, availability, flow control)	■	■	■	■
QoS	IEEE 802.1p priority queues	4	4	4	4
SECURITY	IEEE 802.1Q VLANs	256	256	256	256
	IEEE 802.1x	■	■	■	■
	RADIUS / DHCP client	■	■	■	■
OTHER	Jumbo frames (9K)	■	■	■	■
	Port mirroring	■	■	■	■
	MAC filtering / ingress / egress rate limiting / broadcast storm control	■	■	■	■
IDEAL ENVIRONMENT	Home office / SMB / security at the edge	Home office / SMB / security at the edge	POS and retail / home office / SMB / security cameras / security at the edge	Home office / SMB / security at the edge	
CUSTOMER'S NEEDS	Management at the edge / basic, entry-level security / Web-based management / copper Ethernet at the edge of the fiber network	Management at the edge / basic, entry-level security / Web-based management / copper Ethernet at the edge of the fiber network	Security and video surveillance / management at the edge / basic, entry-level security / Web-based management / copper Ethernet at the edge of the fiber network	Management at the edge / basic, entry-level security / Web-based management / copper Ethernet at the edge of the fiber network	



GS950 Series

Allied Telesis redesigned the popular GS950 Series of Gigabit WebSmart switches with PoE, delivering up to 30 watts per port to support video surveillance and security cameras, wireless access points, IP phones, and other PoE-powered devices. The GS950 Series also features IPv6 management and TACACS+ to add an extra layer of security.



GIGABIT ETHERNET

	GS950/8	GS950/10PS	GS950/16	GS950/16PS	GS950/24	GS950/28PS	GS950/48PS	GS950/48
Ports	6+2 (combo) 2 combo	8+2 (combo) 2 combo	14+2 (combo) 2 combo	14+2 (combo) 2 combo	20+4 (combo) 4 combo	24 4	44+4 (combo) 4 combo	44+4 (combo) 4 combo
Internal PoE	Internal	Internal	Internal	Internal	Internal	Internal	Internal	Internal
Power		8 75W		16 185W		24 185W	24 370W	
Ports per shelf	2	2		6		4	12	
Ports per rack	8K	8K	8K	8K	8K	8K	8K	8K
Fans	Fanless	Fanless	Fanless	Fan	Fanless	Fan	Fan	Fan
Temperature	0°C to 40°C	0°C to 40°C	0°C to 40°C	0°C to 40°C	0°C to 40°C	0°C to 40°C	0°C to 40°C	0°C to 40°C
Management	v3	v3	v3	v3	v3	v3	v3	v3
Ports per shelf	4	4	4	4	4	4	4	4
Ports per rack	256	256	256	256	256	256	256	256
Applications	Home office / SMB / security at the edge	POS and retail / home office / SMB / security cameras / security at the edge	Home office / SMB / security at the edge	POS and retail / home office / SMB / security cameras / security at the edge	Home office / SMB / security at the edge	POS and retail / home office / SMB / security cameras / security at the edge	POS and retail / home office / SMB / security cameras / security at the edge	Home office / SMB / security at the edge
Features	Management at the edge / basic, entry-level security / Web-based management / copper Ethernet at the edge of the fiber network	Security and video surveillance / management at the edge / basic, entry-level security / Web-based management / copper Ethernet at the edge of the fiber network	Management at the edge / basic, entry-level security / Web-based management / copper Ethernet at the edge of the fiber network	Security and video surveillance / management at the edge / basic, entry-level security / Web-based management / copper Ethernet at the edge of the fiber network	Management at the edge / basic, entry-level security / Web-based management / copper Ethernet at the edge of the fiber network	Security and video surveillance / management at the edge / basic, entry-level security / Web-based management / copper Ethernet at the edge of the fiber network	Security and video surveillance / management at the edge / basic, entry-level security / Web-based management / copper Ethernet at the edge of the fiber network	Management at the edge / basic, entry-level security / Web-based management / copper Ethernet at the edge of the fiber network

Unmanaged

Unmanaged switches are simple to deploy, requiring no user setup — making them the ideal solution for Small Office / Home Office (SOHO) applications. Their silent, eco-friendly, low-power operation ensures both minimal running costs and no intrusive noise.

Auto-Negotiation and Auto MDI/MDI-X

Allied Telesis unmanaged copper switch ports support auto-negotiation and auto MDI/MDI-X, enabling them to interface with legacy Ethernet and Fast Ethernet products without the need for special cables or user configuration.

Fanless Design

All Allied Telesis unmanaged switches feature a fanless design. This quiet operation makes them perfectly suited for use in home and small-office installations.

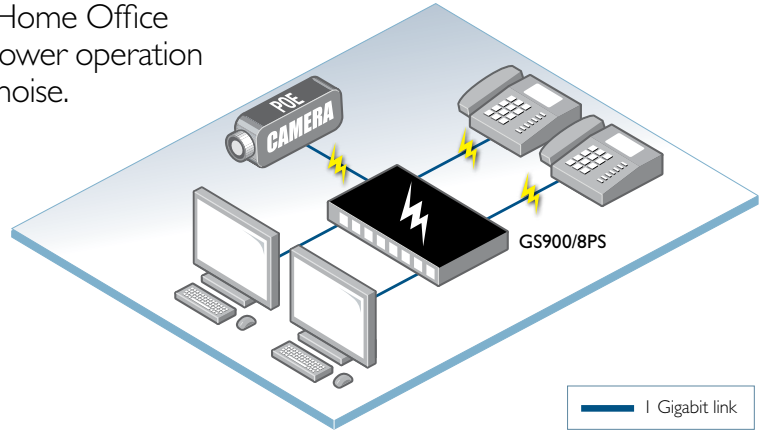

		GIGABIT ETHERNET		
FEATURES		GS900/8PS	GS910/5	GS910/5E
PORTS AND MEDIA SUPPORT	10/100/1000T	8	5	5
	SFP	1		
POWER SUPPLY		Internal	Internal	External (high efficiency)
POWER OVER ETHERNET	Power over Ethernet (PoE)	■		
	PoE ports	4		
	IEEE 802.3af Class 3 (15.4W)	4		
	IEEE 802.3at Class 4 PoE+ (30W)	2		
	PoE budget	75W		
SCALABILITY	MAC address table size	8K		
ENVIRONMENTAL	Cooling	Fanless	Fanless	Fanless
	Eco-friendly	■	■	■
IDEAL ENVIRONMENT		SOHO / network edge	Home office / SMB / security at the edge	POS and retail / home office / SMB / security cameras / security at the edge
CUSTOMER'S NEEDS		High performance / Plug and Play / low maintenance / cost-effective / simple to install / centralized power	Management at the edge / basic, entry-level security / Web-based management / copper Ethernet at the edge of the fiber network	Security and video surveillance / management at the edge / basic, entry-level security / Web-based management / copper Ethernet at the edge of the fiber network



		FAST ETHERNET		
FEATURES		FS705LE	FS705EFC/SC	FS708LE
PORTS AND MEDIA SUPPORT	10/100TX	5	4	8
	100FX		1 × SC, MMF	
	SFP (1000X)			
POWER SUPPLY		External (high efficiency)	External (high efficiency)	External (high efficiency)
POWER OVER ETHERNET	Power over Ethernet (PoE)			
	PoE ports			
	IEEE 802.3af Class 3 (15.4W)			
	PoE budget			
SCALABILITY	MAC address table size	2K	4K	4K
ENVIRONMENTAL	Cooling	Fanless	Fanless	Fanless
	Eco-friendly	■	■	■
IDEAL ENVIRONMENT		SOHO / network edge	Edge switch on fiber-based network	SOHO / network edge
CUSTOMER'S NEEDS		Plug and Play / cost-effective / simple to install	Interface to fiber / backbone network / longer than 100 m cable runs / cost-effective / simple to install	Plug and Play / cost-effective / simple to install



GS910 Series

The Allied Telesis GS910 Series offers unmanaged Gigabit switching solutions for the desktop, and small networks. The series has internal and external power supply versions, and also features network loop guard technology, which automatically detects any unexpected network loops, and prevents network devices from broadcast packet storms. With minimal to no set-up, GS910 Series switches provide simple and seamless connectivity to existing network infrastructure. Each unmanaged switch is backed with a lifetime limited warranty.

EXTENDED TEMP



NEW



EXTENDED TEMP



NEW



EXTENDED TEMP



NEW



EXTENDED TEMP



NEW



GIGABIT ETHERNET

GS910/8	GS910/8E	GS910/16	GS910/24
8	8	16	24
Internal	External (high efficiency)	Internal	Internal
Fanless	Fanless	Fanless	Fanless
Home office / SMB / security at the edge	POS and retail / home office / SMB / security cameras / security at the edge	Home office / SMB / security at the edge	POS and retail / home office / SMB / security cameras / security at the edge
Management at the edge / basic, entry-level security / Web-based management / copper Ethernet at the edge of the fiber network	Security and video surveillance / management at the edge / basic, entry-level security / Web-based management / copper Ethernet at the edge of the fiber network	Management at the edge / basic, entry-level security / Web-based management / copper Ethernet at the edge of the fiber network	Security and video surveillance / management at the edge / basic, entry-level security / Web-based management / copper Ethernet at the edge of the fiber network

PoE eco



PoE eco



eco



eco



FAST ETHERNET

FS708/POE	FS708LE/POE	FS716L	FS724L
8	8	16	24
1			
Internal	External	Internal	Internal
8	4		
4	2		
65W	31W		
8K	1K	8K	8K
Fanless	Fanless	Fanless	Fanless
Small office network with wireless, IP cameras	Small office network with wireless, IP cameras	Small office network	Small office network
Ability to power wireless access points, cameras, etc. / interface to fiber backbone network / longer than 100 m cable runs / cost-effective / simple to install	Ability to power wireless access points, cameras, etc. / cost-effective / simple to install	Plug and Play / cost-effective / simple to install	Plug and Play / cost-effective / simple to install

Industrial Switches

Our ruggedized Industrial Ethernet switches are built for enduring performance in harsh environments, such as those found in manufacturing, transportation and physical security. Offering high throughput, rich functionality and advanced security features, IE switches deliver the performance and reliability demanded by industrial deployments in the Internet of Things (IoT) age.



		LAYER 2 INDUSTRIAL ETHERNET				
FEATURES		IFS802SP IFS802SP/POE(W)	IE200-6FP IE200-6FT	IE200-6GP IE200-6GT	IE300-12GP IE300-12GT	IE510-28GSX
FORM FACTOR		DIN rail / wallmount	DIN rail / wallmount	DIN rail / wallmount	DIN rail / wallmount	Desktop / rackmount / stack
SWITCH FUNCTIONALITY		Layer 2	Basic Layer 2, upgradable	Basic Layer 2, upgradable	Basic Layer 3, upgradable	Basic Layer 3, upgradable
PORTS AND MEDIA SUPPORT	10/100TX	8	4			
	10/100/1000T	2 combo		4	8	
	100/1000X SFP	2 combo	2	2	4	24
	1G/10G SFP+					4 (2 if stacked)
POWER SUPPLY	PSU type	DC powered device	DC powered device	DC powered device	DC powered device	DC powered device
	Redundant power supply	■	■	■	■	■
POWER OVER ETHERNET	IEEE 802.3af (PoE)	■ (POE(W))	■ (6FP)	■ (6GP)	■ (12GP)	
	IEEE 802.3at (PoE+)		■ (6FP)	■ (6GP)	■ (12GP)	
	PoE enabled ports	8 (POE(W))	4 (6FP)	4 (6GP)	8 (12GP)	
	Max PoE power	123.2W (POE(W))	120W (6FP)	120W (6GP)	240W (12GP)	
	Max PoE+ enabled ports		4 (6FP)	4 (6GP)	8 (12GP)	
	High-PoE (60W) enabled ports				4 (12GP)	
SCALABILITY	MAC address table size	8K	2K	2K	16K	16K
	Stacking (VCStack)					■ (4)
	Long-distance VCStack					■ (4)
	Stacking bandwidth					40G (2 x SFP+)
ENVIRONMENTAL	Cooling	Fanless	Fanless	Fanless	Fanless	Fan
	Temperature range	-40°C to 65°C -40°C to 75°C (POE(W))	-40°C to 75°C	-40°C to 75°C	-40°C to 75°C	-40°C to 75°C
MANAGEMENT	Web GUI	■	■	■		■
	CLI / Telnet / SNMP	■	■	■	■	■
	IPv6 management		■	■	■	■
	DHCPv4/v6 server	■ (v4 only)			■	■
	AMF Member		■	■	■	■
NETWORK RESILIENCE	Spanning Tree	■	■	■	■	■
	Link aggregation (LACP)	■	■	■	■	■
	EPSRing		■	■	■	■
	ITU-T G.8032 with Ethernet CFM		■	■	■	■
	VRRPv3			■	■	■
QoS	IEEE 802.1p priority queues	4	8	8	8	8
SECURITY	IEEE 802.1Q VLANs	256	4K	4K	4K	4K
	RADIUS / TACACS+	■ (RADIUS only)	■	■	■	■
	SSH / SSL		■	■	■	■
	IEEE 802.1x	■	■	■	■	■
	DoS protection		■	■	■	■
	DHCP snooping		■	■	■	■
ROUTING	Static routes v4 / v6				■	■
	RIP / RIPv6				■	■
	OSPFv2 / v3				■	■
	Policy-based routing					■
MULTICASTING	IGMPv1 / v2 / v3	■ (snooping)	■ (snooping)	■ (snooping)	■	■
	MLDv1 / v2		■ (snooping)	■ (snooping)	■	■
	PIMv4 / PIMv6				■	■
	PIM-SSM / PIM-SSMv6				■	■

Security Appliances



The comprehensive, high-performance Allied Telesis AR Series features UTM Firewalls and conventional secure VPN routers. Both product types offer functions such as advanced routing, QoS, IPv6, and advanced security, which includes firewall and VPN services. AR Series products are able to deliver the breadth of functionality that small- and medium-sized businesses require at a price point they can afford, and with a proven reliability that makes Allied Telesis a trusted networking partner.

Firewalls

Allied Telesis UTM (Unified Threat Management) and VPN firewalls are an ideal integrated security platform for today's networks. Application-aware firewall, threat protection and secure remote access is combined with routing and switching, to provide an innovative high-performance solution.

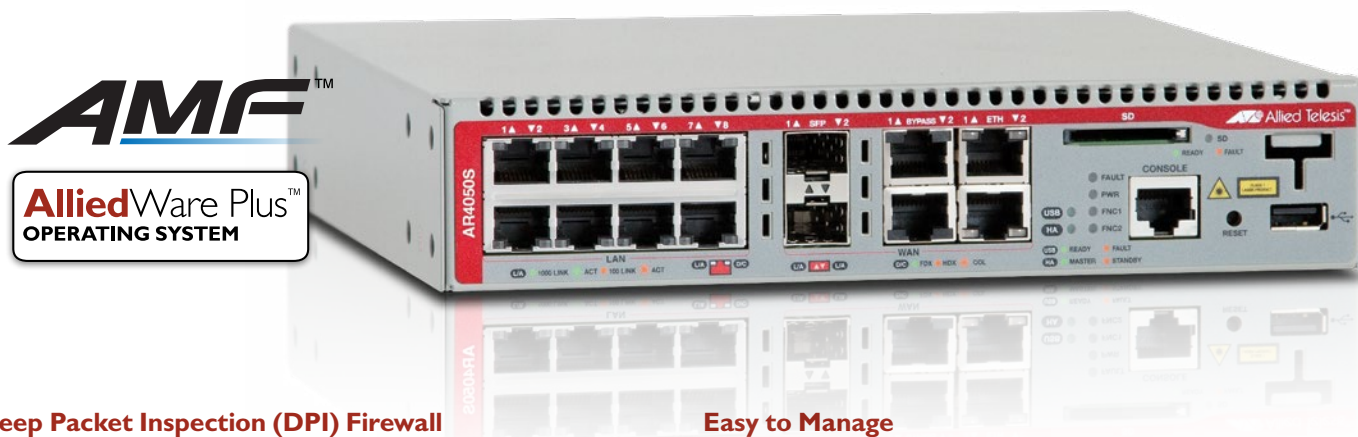

Deep Packet Inspection (DPI) Firewall

The Allied Telesis firewall is a next-generation, Deep Packet Inspection (DPI) engine that provides real-time, Layer 7 classification of network traffic. Rather than being limited to filtering packets based on protocols and ports, the firewall can determine the application associated with the packet. This allows enterprises to differentiate business-critical from non-critical applications, and enforce security and acceptable use policies in ways that make sense for the business.

Best-of-Breed Security

Allied Telesis integrated security platforms utilize best-of-breed security providers for the ultimate in up-to-the-minute protection from all known threats. Flexible licensing options make it easy to choose the right combination of security features to best meet business needs.

PERFORMANCE	UTM FIREWALLS		VPN FIREWALLS	
	AR4050S	AR3050S	AR2050V	AR2010V
FIREWALL THROUGHPUT (RAW)	1.9Gbps	750Mbps	750Mbps	750Mbps
FIREWALL THROUGHPUT (APP CONTROL)	1.8Gbps	700Mbps		
CONCURRENT SESSIONS	300,000	100,000	100,000	100,000
NEW SESSIONS PER SECOND	12,000	3,600	3,600	3,600
IPS THROUGHPUT	750Mbps	220Mbps	200Mbps	200Mbps
IP REPUTATION THROUGHPUT	1Gbps	350Mbps		
MALWARE PROTECTION THROUGHPUT	1.3Gbps	300Mbps		
VPN THROUGHPUT	1Gbps	400Mbps	400Mbps	400Mbps

Easy to Manage

Allied Telesis firewalls run the advanced AlliedWare Plus fully featured operating system. The comprehensive Graphical User Interface (GUI) provides a single-pane-of-glass interface, with the dashboard providing at-a-glance status of threat detection and protection. The GUI centralizes management of the integrated components, to control and protect online business resources and applications.

Full support for Allied Telesis Management Framework (AMF) allows Allied Telesis firewalls to integrate with Allied Telesis switching products to form a network able to be managed as a single virtual device. A full suite of automated tools ensures that the firewall configuration is backed up, and able to be recovered with no user intervention, maximizing availability of online services.

High Performance

High performance is guaranteed by harnessing the power of multi-core processors and application acceleration engines. This dramatically increases throughput and enables simultaneous packet inspection.

Sophisticated Application Control

The Internet has evolved exponentially. Whereas once it simply provided pages to be browsed, it now offers applications that enable people to interact, with services such as collaborative document creation, social networking, video conferencing, cloud-based storage, banking, and much more.

Organizations must be able to control the applications that their people use, and how they use them. Allied Telesis UTM and VPN firewalls provide the visibility and control that are necessary to safely navigate the increase in online applications used for effective business today.

Intrusion Detection and Prevention Systems (IDS/IPS)

IDS/IPS is an intrusion detection and prevention system that can protect networks from malicious traffic. IDS/IPS monitors inbound and outbound traffic, and identifies threats which may not be detected by the firewall alone.

IP Reputation

IP reputation is becoming increasingly popular as a method of improving the success of intrusion prevention by reducing false positives. IP reputation provides an extra variable to the prevention decision, which allows drop rules to be actioned only if the reputation of the website exceeds a chosen threshold.



		UTM FIREWALLS		VPN FIREWALLS	
FEATURES		AR4050S	AR3050S	AR2050V	AR2010V
FORM FACTOR		Desktop / rackmount	Desktop / rackmount	Desktop / rackmount	Desktop / DIN rail
WAN PORTS	10/100/1000T	2 combo	2 combo	1	1
	100/1000X (SFP)	2 combo	2 combo		
	WAN bypass	2	2	1	1
LAN PORTS	10/100/1000T	8	8	4	1
MEDIA SUPPORT	USB port	1	1	1	1
	SDHC slot	1	1		
POWER SUPPLY		Fixed internal	Fixed internal	Fixed internal	AC adapter or DC inlet
ENVIRONMENTAL	Temperature range	0°C to 50°C	0°C to 50°C	0°C to 45°C	0°C to 50°C
	Cooling	Speed-controlled fan	Speed-controlled fan	Fanless	Fanless
PERFORMANCE	CPU	Quad-core 1.5GHz	Dual-core 800MHz	Dual-core 800MHz	Dual-core 800MHz
	RAM	2 GB	1 GB	512 MB	512 MB
	Throughput	See table on page 26	See table on page 26	See table on page 26	See table on page 26
MANAGEMENT	Console port	RJ-45	RJ-45	RJ-45	RJ-45
	Web-based GUI	■	■	■	■
	CLI	■	■	■	■
	SNMP	■	■	■	■
	Telnet / SSH	■	■	■	■
	AMF	■ (Master support)	■	■	■
NETWORK RESILIENCE	VRRP and VRRPV3	■	■	■	■
	Spanning Tree	■	■	■	■
THREAT PROTECTION	Anti-virus	■			
	Anti-malware	■	■		
	IDS / IPS	■	■	■	■
	IP reputation	■	■		
	Automatic threat updates	■	■		
SECURITY	IEEE 802.1Q VLANs	■	■	■	■
	RADIUS / TACACS+	■	■	■	■
QoS		■	■	■	■
FIREWALL	DPI Firewall	■	■	■	■
	Application control	■	■		
	URL filter (URL black list)	■	■	■	■
	Web content control and IP reputation	■	■		
	Traffic shaping	■	■	■	■
	DMZ	■	■	■	■
	Port forwarding	■	■	■	■
TUNNELLING	Dynamic NAT	■	■	■	■
	IPsec VPN tunnels	■	■	■	■
	SSL / TLS VPN tunnels	■	■	■	■
	L2TPv3	■	■	■	■
	GRE	■	■	■	■
ROUTING	Static routing	■	■	■	■
	RIP / RIPng	■	■	■	■
	OSPFv2 / OSPFv3	■	■	■	■
	BGP4 / BGP4+	■	■	■	■
	IGMP	■	■	■	■
	PIMv4 / PIMv6	■	■	■	■
	Bridging (LAN / WAN)	■	■	■	■
	PPPoE	■	■	■	■
DHCPv4/v6 client, server, relay	■	■	■	■	

Secure VPN Routers

Allied Telesis WAN and Internet multiservice access VPN routers include solutions for T1/E1, ISDN, xDSL, and leased-line connections.



		SECURE MODULAR VPN ROUTERS		SECURE xDSL ROUTER
FEATURES		AR415S	AR750S	AR440S
FORM FACTOR		Desktop / rackmount	Desktop / rackmount	Desktop / wallmount / rackmount
PORTS AND MEDIA SUPPORT		10/100TX xDSL (WAN) Async port PIC bays (unpopulated)	1 (WAN) + 4 (LAN) 1 2	2 (WAN) + 5 (LAN) 1 1
OPTIONAL PIC CARDS		5 (LAN) ADSL2/2+ (Annex A)	AR020 AR021S AR023 AR024 AR027	AR020 AR021S AR023 AR024 AR027
POWER SUPPLY		Fixed internal	Fixed internal	Fixed internal
ENVIRONMENTAL		Indoor / outdoor usage Temperature range	Indoor 0°C to 40°C	Indoor 0°C to 50°C
MANAGEMENT		Web CLI access SNMP	■ Async, Telnet v2 and v3	■ Async, Telnet v2 and v3
NETWORK RESILIENCE		RRP	■	■
QoS		IEEE 802.1p priority queues Queueing mechanisms Priority mechanisms	■ ■ ■	■ ■ ■
SECURITY		IEEE 802.1Q VLANs RADIUS SSL IEEE 802.1x DoS protection Firewall	64 ■ ■ ■ ■ 4000 sessions (FL18B) 8000 sessions (FL18C)	64 ■ ■ ■ ■ ■
OTHER		DMZ MAC filter IP / TCP / UDP filter URL filter Peer-to-peer protocols detection Encryption (DES, 3DES, AES) UPnP VPN concurrent tunnels	■ ■ ■ ■ ■ ■ ■ 1 - standard 5 - FL19B, 10 - FL19C 25 - FL19D, 50 - FL19E	■ ■ ■ ■ ■ ■ ■ 250 100
ROUTING		RIPv1 and v2 IPv4 IPv6 OSPF NAT / NATP NAT VPN pass-through (sessions) PPPoE / PPTP / L2TP DHCP client / server / relay WAN load balancing Server load balancing BGP-4	■ ■ AR400-ADVL3UPGRD ■ ■ ■ ■ ■ FL15 (option) AR400-ADVL3UPGRD AR400-ADVL3UPGRD	■ ■ AR400-ADVL3UPGRD ■ ■ ■ ■ ■ Included AR700-ADVL3UPGRD AR700-ADVL3UPGRD
IDEAL ENVIRONMENT		Medium business	Medium business	Branch office
CUSTOMER'S NEEDS		Remote access	Remote access	Head office connectivity

Wireless

The broad portfolio of Allied Telesis wireless products provides customers with high performance and low operating costs. Optimized for deployment across most environments, Allied Telesis wireless solutions are ideal for every application — from offices to classrooms, from distributed retail stores to large hospitals and campuses, and from warehouses to convention centers and sports arenas/stadiums. Advanced software features and a broad range of accessories meet the demands of SOHO to enterprise-class networks.



TQ Series

WIRELESS ACCESS POINTS

Allied Telesis TQ Series wireless access points support the latest IEEE 802.11ac standards, doubling the raw wireless capacity available with an IEEE 802.11n access point. With flexible deployment modes: standalone, AP-cluster, or controlled by the UWC WLAN controller, TQ Series access points are suitable for a wide variety of environments — from small offices to large campuses.



ACCESS POINTS AND ROUTERS

FEATURES		TQ4400E	TQ4600
FORM FACTOR		Pole / wallmount	Desktop / wallmount / ceiling mount
PORTS AND MEDIA SUPPORT	Ethernet	1 x 10/100/1000T	1 x 10/100/1000T
	Wireless radio	1 x IEEE 802.11a/n/ac (2x2 MIMO 867Mbps) 1 x IEEE 802.11b/g/n (2x2 MIMO : 300Mbps)	1 x IEEE 802.11a/n/ac (3x3 MIMO 1300Mbps) 1 x IEEE 802.11b/g/n (3x3 MIMO : 450Mbps)
POWER SUPPLY		IEEE 802.3at PoE (PD)	External or IEEE 802.3af/at PoE (PD)
ENVIRONMENTAL	Indoor / outdoor usage	Outdoor	Indoor
	Temperature range	-40°C to 65°C	0°C to 40°C
SCALABILITY	Clustering	Up to 16 members (recommend: 10)	Up to 16 members (recommend: 10)
	Operations management	Standalone / controlled mode	Standalone / controlled mode
MANAGEMENT	Web-based GUI	HTTP, HTTPS	HTTP, HTTPS
	SNMP	v1, v2c, v3*	v1, v2c, v3*
SECURITY	RADIUS / IEEE 802.1x / SSL	■	■
	Encryption AES	AES	AES
	MAC filtering	■	■
BRIDGING	VLAN	■	■
	IEEE 802.11e (WMM)	■	■
	IEEE 802.11i (enhanced security)	■	■
	Mode: infrastructure	Access point	Access point
	Wireless Distribution System (WDS)	■	■
	Captive portal	Controlled mode only	Controlled mode only
WIRELESS	Dynamic channel planning	■	■
	Multiple SSID	32	32
	VLAN to SSID mapping	■	■
	Regulatory domain compliance	■	■
	Rogue AP detection	■	■
	Antenna	2 x 2.4GHz (5dBi) / 2 x 5GHz (7dBi), external antennas	3 x 2.4GHz (3.17dBi) / 3 x 5GHz (4.15dBi), omni embedded
	Antenna diversity mode	■	■
	Wi-Fi certified	■	■
AMF			■ Guest node
SDN / OPENFLOW			■ License: FL-TQ4600-0F13
IDEAL ENVIRONMENT		Enterprise / campus	Enterprise / campus
CUSTOMER'S NEEDS		Outdoor wireless bridge / hotspot	User access (BYOD) / indoor wireless bridge / hotspot

* support on version 3.3.0 or later

Wireless Controllers

CONTROLLER FOR ACCESS POINTS

The Allied Telesis Unified Wireless Controller is the single point of management for the operation, administration, and maintenance of all access points in an enterprise. The UWC controller is available as either a hardware appliance or hosted software for cloud-based applications.

Key features of the UWC include:

- ▶ Simplified Plug-and-Play access ports
- ▶ RF management and control
- ▶ Wireless Intrusion Prevention System
- ▶ Security safeguards
- ▶ Resilience
- ▶ Seamless mobility
- ▶ Client location tracking
- ▶ Graphic visualization

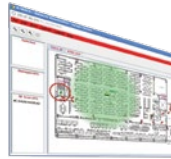

FEATURES		SOFTWARE APPLIANCE	HARDWARE APPLIANCE	
		UWC-Install + UWC-BaseST	UWC-60-APL	
FORM FACTOR		Virtual machine software	Desktop, 1RU	
DEPLOYMENT MODE	Data forwarding		Distributed, centralized	
	Grouping / clustering		RF group, mobility group	
	Wireless network topology		Access point, WDS	
SCALABILITY	Clients per AP		200	
	Clients per controller		8000	
	APs per controller	10, upgradable up to 200		10, upgradable up to 60
	Groups		255	
	Controllers per group		64	
	APs per group		2000	
	WLANs		64	
	VLANS		4096	
	AP profiles		16	
	Network profile		64	
PORTS AND MEDIA SUPPORT	Ethernet	1 × vNIC	6 × 1000T	
	Serial		1	
	USB		2	
POWER SUPPLY			AC/DC adapter	
ENVIRONMENTAL	Temperature range		5°C to 40°C	
	Cooling		Fan	
MANAGEMENT	RF coverage hole arrangement		■	
	Self-recovery of AP fault		■	
	RF interference mitigation		■	
	Dynamic Tx power adjustment		■	
	Dynamic channel selection		■	
	Client load balancing		■	
	Plug and Play / discovery mechanism		Layer 2 and Layer 3	
	Client location service		■	
HIGH AVAILABILITY	Adaptive AP operations mode		■	
	Controller redundancy		N:N	
ROUTING	Bridging		■	
	Routing		■	
	Mobility		Layer 2 and Layer 3, Fast BSS transition	
NETWORKING	Client load balancing		■	
	Wireless Multimedia Media (WMM)		■	
	Optimized video streaming		■	
	Rate limiting		■	
	MAC layer QoS		■	
SECURITY	Access Control List (ACL)		■	
	Guest access		Captive portal, Web authentication	
	Intrusion detection / prevention system		Wireless IDS (wIDS), rogue AP detection, rogue client	
IDEAL ENVIRONMENT		Small to mid-sized enterprise		
CUSTOMER'S NEEDS		Cloud-based application	Dedicated server model	
		User access (BYOD) / Hotspot / centralized WLAN management		

Wireless Accessories

Allied Telesis offers a variety of wireless network accessories, including antennas, power supplies, service modules, splitters, mounting hardware, and cabling.

PoE



FEATURES		PSE PoE		PD PoE
		6101G	6101GP	6102G
FORM FACTOR		Desktop	Desktop	Desktop / wallmount
PORTS AND MEDIA SUPPORT	10/100/1000T	1	1	1
POWER SUPPLY	PSU type	Fixed internal	Fixed internal	PoE
POWER OVER ETHERNET	IEEE 802.3af	■	■	■
	IEEE 802.3at		■	
	PoE-enabled ports	1	1	1
	Max number of full power ports	1	1	1
	Mode	B	B	A or B
	PoE power	15.4W	30W	10W
	DC out (vDC)			5 / 7.5 / 9 / 12
ENVIRONMENTAL	Cooling	Fanless	Fanless	Fanless
MANAGEMENT		Unmanaged	Unmanaged	Unmanaged
CUSTOMER'S NEEDS		Feeding protected PoE to any Fast and Gigabit Ethernet equipment without having to replace non-PoE switches	Feeding protected PoE to any Fast and Gigabit Ethernet equipment without having to replace non-PoE switches	Makes any non-PoE equipment capable of PoE up to Gigabit Ethernet speed / extract power from a PoE line and supply 5 / 7.5 / 9 or 12vDC to any equipment

PoE MODE

- A: Feeding and receiving power on data pairs
- B: Feeding and receiving power on spare pairs

PSE

Power Sourcing Equipment feeding power to a Powered Device.

PD

Powered Device receives power from Power Sourcing Equipment.

WMM

Wireless Multimedia is a Wi-Fi Alliance interoperability certification that provides basic Quality of Service (QoS) to applications running over Wi-Fi.

WISP

Wireless Internet Service Provider.



Accessories



CLIENT (STA) MODE

The equipment's wireless interface can be configured to operate as a wireless client connecting to any other access points.

IEEE 802.11f (IAPP)

Inter Access Point Protocol simplifies and speeds roaming between two access points.

WLL

Wireless Local Loop defines the wireless access of customer's premises to the Telco operator network.

FULL HOTSPOT

The equipment is able to implement a full-featured hotspot system including wireless access, Web page management, multiple virtual hotspots on a single radio interface, RADIUS server, and customer's profile management application.

		COAX CABLES		
FEATURES		AN0001	AN0002	AN0003
ENVIRONMENTAL	Indoor / outdoor usage	■	■	■
ANTENNA GAIN (dBi)		2.4GHz, 5GHz	2.4GHz, 5GHz	2.4GHz, 5GHz
INSERTION LOSS (dB)	@ 2.4GHz	-1.6	-1.9	-2.4
	@ 5GHz	-3.6	-3.5	-3.9
CONNECTOR		2 × type N male	2 × type N male	2 × type N male
COMPATIBLE EQUIPMENT	TQ4400e	■	■	■

Antennas



FEATURES	AN2458-10DP	AN5158-16DP	AN5158-19DP
ENVIRONMENTAL	Indoor / outdoor usage		
TYPE	Panel, MIMO	Sector, MIMO	Panel, MIMO
FREQUENCY RANGE	2400~2500 MHz 4900~5850 MHz	5150~5850 MHz	4900~5850 MHz
POLARIZATION	Vertical / horizontal		
GAIN	8 dBi @ 2.4GHz 10 dBi @ 5GHz	16 dBi	19 dBi
BEAMWIDTH	Vertical	11°	23°
	Horizontal	90° @ 2.4GHz 70° @ 5GHz	120°
CONNECTOR	2 × type N female		
COMPATIBLE EQUIPMENT	TQ4400e		

Antenna Types

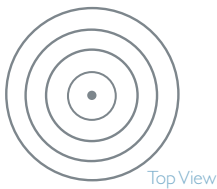

Omni
Omnidirectional antennas radiate power uniformly in every direction on the horizontal plane. Most access points and client devices have omnidirectional antennas.



Panel
A flat antenna with a radiation lobe similar to a cone. It is directional and is normally used for point-to-point links or at the end-points of a point-to-multipoint network.



Sector
A flat antenna with a radiation lobe similar to a cone with an elliptical footprint. It is directional and is normally used in the central site of a point-to-multipoint network.

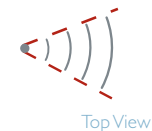

Parabolic
A dish-shaped, directional antenna with a radiation lobe similar to that of a panel antenna. It is usually larger than a panel and has a higher gain. Parabolic antennas are suitable for long-distance, point-to-point links.

Gain
Gain expresses how much an antenna enhances its transmitted and received signals relative to a simple dipole. Gain is expressed in dB and is logarithmic.

Polarization
Polarization defines the position in space of electrical and magnetic fields. The best signal transfer happens when both transmitting and receiving antennas have the same polarization. A 90° difference between transmitting and receiving antennas may produce up to -30dB of signal attenuation.

Loss
Loss is the attenuation or reduction in power of a system, expressed in dB. All cables and connector devices have a loss variable and must be considered when designing a wireless system, especially when directional antennas are used.

LOW GAIN

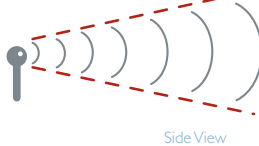

An omnidirectional antenna concentrates the signal in a 360° belt around it. The higher the gain, the thinner the belt, resulting in a better signal far from the antenna — but a narrower communication area.

produce a focused beam, and are typically deployed in medium- to long-distance point-to-point links.

HIGH GAIN

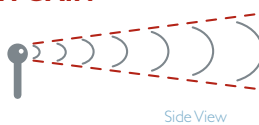

Panel and parabolic antennas have a nearly circular footprint. Low gain panels can be used for both short distance point-to-point and point-to-multipoint links, such as wireless coverage for user access. High-gain panel and parabolic antennas

A sector antenna footprint is a horizontal ellipse with a width of 30°, 60°, 90°, or 120°. High gain sector antennas have a vertically thinner footprint while keeping the same horizontal width, suited for the central site of a point-to-multipoint link or coverage of a certain “sector” in mobile networks.

Multiservice Access

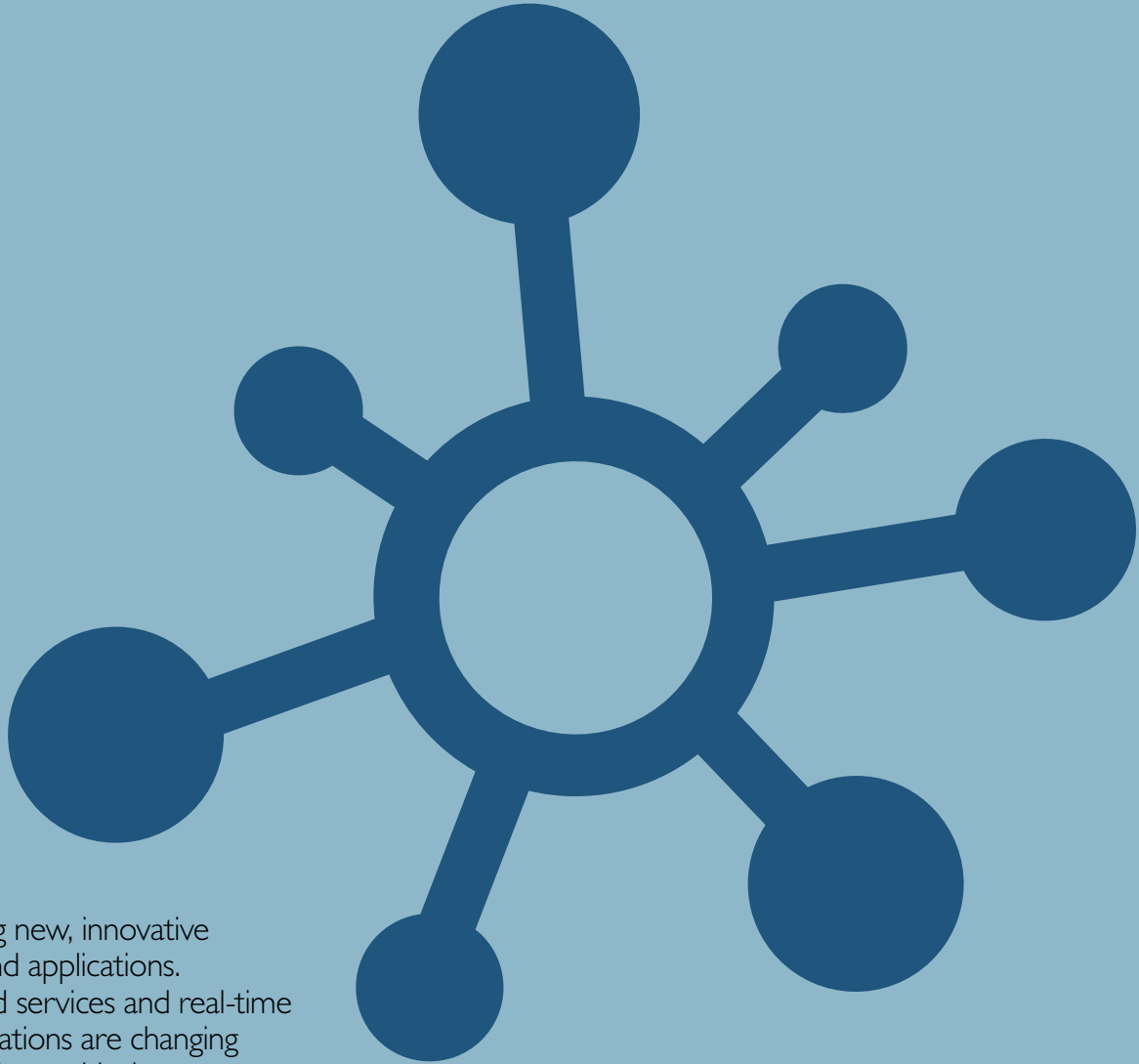

IP is driving new, innovative services and applications. Converged services and real-time communications are changing lifestyles, along with the type of network required to deliver them. Service providers face the challenge of re-architecting the access network to meet today's IP-driven broadband service, such as IP Triple Play, and at the same time try to anticipate the requirements for the "next new service." Selecting the best platform and technology becomes critical to protecting investments and responding competitively to new service needs.

The rapid changes from broadcast to on-demand video and from surfing the Web to content sharing have not only increased demands for bandwidth, but created greater needs to manage converged IP services. If a service

provider is to capitalize on the revenue opportunities derived from multimedia services and satisfied consumer needs, an intelligent home gateway approach becomes essential.

Multiservice Access Platform iMAP

The Allied Telesis integrated Multiservice Access Platform (iMAP™) is the benchmark of true next-generation IP access solutions, fulfilling all of today's critical broadband service needs — and designed to evolve with new service demands.

As the world's communications systems move to an all IP and Ethernet access network with IP/MPLS core, the Allied Telesis iMAP represents the first and only true IP access platform designed for this purpose. Its unique carrier-grade IP/Ethernet capabilities are suitable for any provider building an IP access network. Industry-leading capabilities position the iMAP as the access network for alternative and emerging carriers, Independent Operating Companies (IOCs), PTTs, ILECs, ISPs, public utilities, and private organizations such as hospitals, hotels, and Multi-Tenant Units/Multi-Dwelling Units (MTU/MDU).

Chassis



FEATURES	MicroMAP 9001	MiniMAP 9100	iMAP 9700		iMAP 9810	
PART NUMBER	TN-254-80	TN-9101 / 2 / 3	TN-250G-B		TN-253G	
PHYSICAL HEIGHT		1RU	9RU		3RU	
POWER SUPPLY	Single AC		Requires additional TN-R113		Requires additional TN-R113	
	Dual AC (option)	Future	Requires additional TN-R113 and TN-R114		Requires additional TN-R113 and TN-R114	
	Dual DC	Standard	Standard		Standard	
CONTROLLER CARDS	Primary fabric controller	Not required	CFC12	CFC56	CFC100	CFC100
	Optional redundant controller	Not required		CFC56	CFC100	CFC100
NETWORK TRANSPORT	Slots	None integrated into chassis	None – transport on CFC12 fabric	2	2	2
	Model	None	CFC12 fabric	XE1S	XE6	XE1S
	Uplink ports	4 × SFP 1/2.5G	4 × SFP + 2 × 10/100/1000T	1 × SFP+	6 × SFP+	1 × SFP+
	Uplink speed		Gigabit	10GbE	10GbE	10GbE
CHANNEL UNIT SLOTS	1	3	17	15 (when dual XE6 installed, 14 with dual-fabric cards)	8	6 (when dual XE6 installed)
MAX PORTS	xDSL		72	408	360	192
	POTS		72	408	360	192
	T1/E1		24	136	120	64
	Dual fiber (100Mbps)		30	170	150	80
	BiDi fiber (100Mbps)		60	340	300	192
	BiDi fiber (1000Mbps)		72	408	360	192
	10/100TX (copper)		30	170	150	80
	Gigabit SFP		24	136	120	64
	GEAPON		192	1088	960	512
UDSL24	24	N/A	N/A	192		
TEMPERATURE RANGE	-40°C to 65°C	-40°C to 65°C (TN-9102/3 AC version: 0°C to 55°C)	-40°C to 65°C		-40°C to 65°C	

One Access Platform, Any Service

The iMAP product family is designed to support IP Triple Play services using Ethernet technology. With redundant Gigabit Ethernet connections, or 10 Gigabits on the iMAP 9810 to each line card from the control modules, there is ample bandwidth and throughput for all current and future services and access technologies. The central fabric control cards enable multiple 10 Gigabit uplink and transport capability, ensuring future capacity and performance needs are addressed without requiring a major hardware upgrade.

Multiple Services, Diversified and Increased Revenues

In addition to traditional and enhanced ADSL/ADSL2+ and VDSL2, the iMAP provides the capability to offer revenue-generating residential and business services such as FTTH, T1/E1, G.SHDSL, and POTS — all from the same platform. With features like Ethernet Protection Switched Rings, iMAPs can be networked together with full redundancy and sub-50ms switchover times, ensuring carrier-grade 99.999% availability and maximum uptime.

Controller Cards



FEATURES		CFC12	CFC56	CFC100
PART NUMBER		TN-408	TN-407	TN-409
CHASSIS COMPATIBLE	MiniMAP 9100	■		
	iMAP 9700		■	
	iMAP 9810			■
PERFORMANCE	Switching fabric	12Gbps	56Gbps	100Gbps
	EPSR	■	■	■
	VLANs per port	4K	4K	4K
	Per VLAN rate limiting	■	■	■
UPLINKS	SFP (1000Mbps)	4		
	10/100/1000T	2		
SECURITY	Upstream forwarding only	■	■	■
	ACL support	■	■	■
QoS	Priority queues	8	8	8
	Priority scheduling	■	■	■

Channel Units



FEATURES		POTS24C	UDSL24
PART NUMBER		TN-143	TN-146-A
COPPER	POTS	24	
	ADSL (Annex A)		24
	VDSL2 (Annex A)		24
PHYSICAL	Single / double width channel unit	Single	Single
SALES REGION		All	All



FEATURES		GE24BX	GE8	GEAPON
PART NUMBER		TN-144	TN-117	TN-118
	100/1000Mbps BiDi, SMF	24 (20 km)		
	SFP (1000Mbps)		8	
	GEAPON			2
PHYSICAL	Single / double width channel unit	Single	Single	Single
SALES REGION		All	All	All

intelligent Multiservice Gateways iMG

Moving from a “dumb pipe” to a service-oriented connection requires having both management and functionality at both the access side and the terminal side. Whether a single-family home or MDU, with the home gateway located outdoors or within the residence, service providers need management, control, and provisioning capabilities. Allied Telesis iMG products for DSL and fiber applications are designed as extensions of the Allied Telesis access platform, with unified management functionality and features.

Fiber-based iMGs offer Gigabit or 100 Megabit-to-the-home service and include such features as GR909 testing, TDR wire analysis, and HPNA endpoint analysis. In addition, the iMGs support Layer 3 capabilities, whole home service, and Microsoft Mediaroom.

Allied Telesis iMG ONT products provide a smarter, feature-rich, flexible approach to delivering subscriber services, and are critical to a service provider wanting to deliver reliable, high-quality, high-revenue services.

AlliedView™ NMS

Allied Telesis Network Management Software tools can help visualize and plan for network growth while maintaining the health and performance of the network. See page 61.



FEATURES		iMG634 Series	iMG634W Series	iMG1405	iMG1405W	iMG1425	iMG1425W	iMG1425RF
ENVIRONMENTAL	Indoor usage	■	■	■	■	■	■	■
	Outdoor usage							
UPLINK	ADSL2+ Annex A	iMG634A-R2	iMG634WA-R2					
	ADSL2+ Annex B	iMG634B-R2	iMG634WB-R2					
	Ethernet 100Mbps copper	■	■					
	Ethernet 100Mbps fiber (SMF)							
	Ethernet 100Mbps fiber (BIDI)							
	Ethernet 100Mbps fiber SFP module							
	Ethernet 1000Mbps fiber (BIDI)			■ SFP	■ SFP	■ SFP	■ SFP	■ SFP
LAN INTERFACE	10/100TX	4	4	3	3	3	3	3
	10/100/1000T			2	2	2	2	2
	T1/E1							
	Wireless IEEE 802.11b/g		■					
	Wireless IEEE 802.11b/g/n				■		■	
HPNAv3.1								
WAN PORT	Copper / fiber	Copper	Copper	Fiber	Fiber	Fiber	Fiber	Fiber
CATV RF OVERLAY	High output power							■
PHONE INTERFACES	FXS	2	2			2	2	2
	PSTN lifeline	■	■			■	■	■
VoIP PROTOCOLS	SIP / MGCP	■	■			■	■	■
CONSOLE INTERFACE	RS232 R-J-45 connector	■	■					
	USB			■	■	■	■	■
QoS	IEEE 802.1p priority queues	■	■	■	■	■	■	■
	IEEE 802.1Q VLANs mgmt	■	■	■	■	■	■	■
MANAGEMENT	AlliedView NMS	■	■	■	■	■	■	■
	TR-069	■	■	■	■	■	■	■
	SNMPv1, v2 and v3	■	■	■	■	■	■	■
	Telnet, Web, GUI, CLI	■	■	■	■	■	■	■
	Remote software upgrade	■	■	■	■	■	■	■
ACCESSORY AVAILABLE	Fiber outlet kit iMG001							
	Battery backup iMG008	■	■	■	■	■	■	■
	Outdoor case EN-SFR-ONT							

The iMG family of full-featured indoor and outdoor gateways support xDSL and fiber (FTTH) options, all designed with the features, management, and IP functionality needed to deliver the “connected home.” As the name implies, intelligent Multiservice Gateway products are fully featured for delivering multimedia services such as broadcast and streaming IP video, Internet data, analog voice, and VoIP from a single subscriber line to multiple devices in the home.

Features and functionality between the iMAP access family, or the SwitchBlade x3112 and iMG home gateway family, are intelligently integrated with Allied Telesis AlliedView NMS for end-to-end management and diagnostics. This ensures every service is manageable all the way to the subscriber, eliminating the “holes” often caused by using “dumb” devices that merely terminate subscriber lines. Consequently, less time is spent on provisioning, and unnecessary truck rolls are reduced — leading to lower OPEX and greater customer satisfaction.



	iMG1525	iMG1525RF	iMG2426F	iMG2504	iMG2522	iMG2524	iMG2524F	iMG2524H	iMG746MOD
■	■	■	■	■	■	■	■	■	■
			■	■	■	■	■	■	■
							■	■	■
	■	■	■ SFP						■
	■ (20 km)	■ (20 km)	■ SFP	■ (20 km)	■ (20 km)	■ (20 km)	■ (20 km)	■ (20 km)	■
									6
	5	5	6	4	4	4	4	4	1
									■
								■	
	Fiber	Fiber	Fiber	Fiber	Fiber	Fiber	Fiber	Fiber	Fiber
		■					■		
	2	2	2		2	2	2	2	4
	■	■	■		■	■	■	■	■
	■	■	■		■	■	■	■	■
	■	■	■	■	■	■	■	■	■
	■	■	■	■	■	■	■	■	■
	■	■	■	■	■	■	■	■	■
	■	■	■	■	■	■	■	■	■
	■	■	■	■	■	■	■	■	■
	■	■	■	■	■	■	■	■	■
	■	■	■	■	■	■	■	■	■
	■	■	■	■	■	■	■	■	■
	■	■	■	■	■	■	■	■	■

iMG Feature Matrix

MODEL	DEPLOYMENT		WAN							POTS	LAN ETHERNET			LAN — OTHER				
	Outdoor	Indoor	xDSL	100X	100/1000X	GE	FTTX	EPON	GPON	FXO	10/100	10/100/1000	T1/E1	VDSL	G.Fast	RF	HPNA	Wireless
iMG746MOD	■	■		■		■		■		4	6	1	2				■	
iMG1405		■				■ (SFP)					2	3						
iMG1405W		■				■ (SFP)					2	3						IEEE 802.11
iMG1425		■				■ (SFP)				2	2	3						
iMG1425W		■				■ (SFP)				2	2	3						IEEE 802.11
iMG1425RF		■				■ (SFP)				2	2	3				■		
iMG1525		■			■					2		5						
iMG1525RF		■			■					2		5				■		
iMG2426F	■	■		■		■		■		2		6						
iMG2504	■	■			■							4						
iMG2522	■	■				■				2		2						
iMG2524	■	■				■				2		4						
iMG2524F	■	■			■							4						
iMG2524H	■	■			■					2		4						■



Media Converters



Allied Telesis media converters extend network distances by adding fiber and VDSL (via coax and telephone-grade twisted pair) only where it is needed. This enables customers to keep pace with changing technology and to integrate high-bandwidth devices into the network without changing the entire network infrastructure. From standalone units to chassis-based blades, Allied Telesis media converters are highly configurable to meet every need.

Standalone



ETHERNET AND FAST ETHERNET STANDALONE MEDIA CONVERTERS

FEATURES		MC13	MC101XL	MC102XL	MC103XL	MC103LH	MC104XL	MC115XL	MC116XL
PORTS	Port 1	10T	100TX	100TX	100TX	100TX	100FX MMF (SC)	10T or 100TX	10T or 100TX
	Port 2	10FL (ST)	100FX (ST)	100FX (SC)	100FX (SC)	100FX (SC)	100FX (SC)	10FL (ST) or 100SX (ST)	10FL (SC) or 100SX (SC)
	Type	MMF	MMF	MMF	SMF	SMF	SMF	MMF	MMF
IEEE STANDARD		10FL	100FX	100FX	100FX	100FX	100FX	100SX	100SX
Tx WAVELENGTH		850 nm	1310 nm	1310 nm	1310 nm	1310 nm	1310 nm	850 nm	850 nm
Rx WAVELENGTH		850 nm	1310 nm	1310 nm	1310 nm	1310 nm	1310 nm	850 nm	850 nm
MAX DISTANCE		2 km	2 km	2 km	15 km	40 km	15 km	2 km	2 km
FUNCTIONALITY	Rate and speed								
	MissingLink support		■	■	■	■	■	■	■
	Smart MissingLink support								
	Max frame size	9KB	9KB	9KB	9KB	9KB	9KB	9KB	9KB
	Diagnostic LEDs	6	7	7	7	7	7	8	8
POWER SUPPLY	PSU type	External	External	External	External	External	External	External	External
	Multi-region	■				■	■	■	■
	Compatible with MCR12 12-slot chassis	■	■	■	■	■	■	■	■
	Compatible with MCR1 1-slot chassis	■	■	■	■	■	■	■	■

Allied Telesis media converters enable the connection of disparate cabling types in networks where many cabling types exist. Network segments may also operate at different speeds, and media converters can be used to convert between speeds. Typically, media converters are used to connect copper and fiber-optic cabling that coexist in a network. Converters exist in a variety of standalone, multi-port, and modular forms. These different physical forms address the need for different applications and conversion densities.

MMC

The Allied Telesis MMC Series of Fast Ethernet mini media converters leverages its smaller size to not only help the environment with a small carbon footprint, but also to save space in its working environment. Despite its compact size, the MMC Series delivers all the power and functionality of standard size media converters.

PoE

Allied Telesis PC PoE Series switches are the ideal solution for powering remote devices such as IP phones, video cameras, wireless access points, etc., which are more than 100 m from a Power over Ethernet switch.

Desktop Powered

The Allied Telesis DMCI000 Series of Gigabit mini media converters are among the smallest media converters in the market today. At just 1.25 in wide x 3.6 in deep x 0.85 in high, these media converters can easily fit into the palm of your hand. In addition to being compact — with a small carbon footprint — the DMCI000 Series can also be powered with the included micro USB to USB cable, and plugged directly into a laptop or PC. This saves installation time and cabling as there are no further power requirements necessary.



ETHERNET AND FAST ETHERNET STANDALONE MEDIA CONVERTERS

	FS201	FS202	FS232	FS232/1	F232/2	FS238A/1	FS238B/1
10/100TX	10/100TX	10/100TX	10/100TX	10/100TX	10/100TX	10/100TX	10/100TX
100FX (ST)	100FX (SC)	100FX (SC)	100FX (SC)	100FX (SC)	100FX (SC)	100FX (SC)	100FX (SC)
MMF	MMF	MMF	SMF	SMF	BiDi - SMF	BiDi - SMF	
100FX	100FX	100FX	100FX	100FX	100FX	100FX	100FX
1310 nm	1310 nm	1310 nm	1310 nm	1310 nm	1310 nm	1310 nm	1550 nm
1310 nm	1310 nm	1310 nm	1310 nm	1310 nm	1310 nm	1550 nm	1310 nm
2 km	2 km	2 km	15 km	40 km	15 km	15 km	
■	■	■	■	■	■	■	■
■	■	■	■	■	■	■	■
1532 bytes	1532 bytes	1532 bytes	1532 bytes	1532 bytes	1532 bytes	1532 bytes	1532 bytes
7	7	9	9	9	9	9	9
External	External	External	External	External	External	External	External
■	■	■	■	■	■	■	■
MCR12	MCR12	MCR12	MCR12	MCR12	MCR12	MCR12	MCR12
■	■	■	■	■	■	■	■



FAST ETHERNET AND GIGABIT ETHERNET STANDALONE MINI MEDIA CONVERTERS

FEATURES		MMC200/LC	MMC200/SC	MMC200/ST	MMC2000/LC	MMC2000/SC	MMC2000/SP	MMC2000/ST
PORTS	Port 1	10/100TX	10/100TX	10/100TX	10/100/1000T	10/100/1000T	10/100/1000T	10/100/1000T
	Port 2	100FX (LC)	100FX (SC)	100FX (ST)	1000SX (LC)	1000SX (SC)	100/1000 SFP	1000SX (ST)
	Type	SMF	SMF	SMF	SMF	SMF	SMF / MMF	MMF
IEEE STANDARD		100FX	100FX	100FX	1000SX	1000SX	100FX / 1000X	1000SX
Tx WAVELENGTH		1310 nm	1310 nm	1310 nm	850 nm	850 nm	Depends on SFP	850 nm
Rx WAVELENGTH		1310 nm	1310 nm	1310 nm	850 nm	850 nm	Depends on SFP	850 nm
MAX DISTANCE		2 km	2 km	2 km	550 m	550 m	Depends on SFP	550 m
FUNCTIONALITY	Rate and speed	■	■	■	■	■	■	■
	Smart MissingLink support	■	■	■	■	■	■	■
	Max frame size	10KB	10KB	10KB	10KB	10KB	10KB	10KB
	Diagnostic LEDs	4	4	4	4	4	4	4
	Smart Link restoration	■	■	■	■	■	■	■
POWER SUPPLY	PSU type	External	External	External	External	External	External	External
	Multi-region	■	■	■	■	■	■	■
	Compatible with a rackmount chassis	MMCR18	MMCR18	MMCR18	MMCR18	MMCR18	MMCR18	MMCR18



GIGABIT ETHERNET STANDALONE MEDIA CONVERTERS

FEATURES		GS2002/SP	MMC6005	MMC6006	MC1004	MC1008/SP
PORTS	Port 1	10/100/1000T	10/100/1000T	10/100/1000T	1000T	1000T
	Port 2	SFP 100/1000X	RJ-11 VDSL/2	BNC VDSL/2	1000SX (SC)	SFP
	Fiber type	LC*			MMF	LC*
IEEE STANDARD		1000SX and LX			1000SX	1000SX and LX
Tx WAVELENGTH		Depends on SFP			850 nm	Depends on SFP
Rx WAVELENGTH		Depends on SFP			850 nm	Depends on SFP
MAX LINK DISTANCE		Depends on SFP	3 km	2 km	550 m	Depends on SFP
FUNCTIONALITY	Rate and speed	■	■	■	■	■
	MissingLink support	■	■	■	■	■
	Smart MissingLink support	■	■	■	■	■
	Max frame size	1536 bytes			9KB	9KB
	Diagnostic LEDs	11	4	4	8	8
POWER SUPPLY	Smart Link restoration	■	■	■	■	■
	PSU type	External	External	External	External	External
	Multi-region	■	■	■	■	■
	Compatible with a rackmount chassis	■	■	■	■	■
Compatible with MCR1 1-slot chassis		■			■	■

* Dependant on SFP

Desktop Powered



FAST ETHERNET AND GIGABIT DESKTOP USB POWERED

FEATURES		DMC100/LC	DMC100/SC	DMC100/ST	DMC1000/LC	DMC1000/SC	DMC1000/ST
PORTS	Port 1	100TX	100TX	100TX	1000T	1000T	1000T
	Port 2	100FX (LC)	100FX (SC)	100FX (ST)	1000SX (LC)	1000SX (SC)	1000SX (ST)
	Type	MMF	MMF	MMF	MMF	MMF	MMF
IEEE STANDARD		100FX	100FX	100FX	1000SX	1000SX	1000SX
Tx WAVELENGTH		1310 nm	1310 nm	1310 nm	850 nm	850 nm	850 nm
Rx WAVELENGTH		1310 nm	1310 nm	1310 nm	850 nm	850 nm	850 nm
MAX DISTANCE		2 km	2 km	2 km	550 m	550 m	550 m
FUNCTIONALITY	Smart MissingLink support	■	■	■	■	■	■
	Max frame size	16KB	16KB	16KB	16KB	16KB	16KB
	Diagnostic LEDs	4	4	4	4	4	4
	Smart Link restoration	■	■	■	■	■	■
	Wake-on-LAN	■	■	■	■	■	■
POWER SUPPLY		External	External	External	External	External	External



MissingLink

The Allied Telesis MissingLink™ feature enables media converters to pass the link status of their connections and thereby trigger corrective action when a problem on a link is detected.

For example, if the twisted-pair cable to the 10/100TX port on an Allied Telesis media converter were to fail, the unit would respond by dropping the link on the 100FX fiber-optic port.

Most managed devices, such as switches and routers, can be configured to take a specific recovery action in the event of the loss of connection on a port. In some cases, the unit can be configured to seek a redundant path to a disconnected end-node or send out a trap to a network management station, and so alert the network administrator of the problem.

Smart MissingLink

The Allied Telesis Smart MissingLink™ feature has identical operation to MissingLink, with an added link failure alert system. If any of the media converter ports fail, the link LED will begin to flash. This aids with diagnostics, allowing network administrators to more quickly locate and rectify the fault.

Smart Link Restoration

Smart Link restoration allows the devices, in the cases of power failure, link loss or other interrupted service, to automatically restore the link without the need to restart/reset them.

Redundancy

In many cases, Allied Telesis media converters are critical components in a network, carrying data between sites over long distances. It is imperative that all efforts are taken to ensure reliability of the network, and thus a network design with redundancy is mandatory. The components most likely to fail are the power supplies. The majority of Allied Telesis media converters can be deployed with hot-swappable, hot-removable power supplies to ensure maximum uptime.



Universal Power Supply

For customers already using Allied Telesis media converters, replacement power adapters are available.

- ▶ **MCPWR**
Universal, high-efficiency external power adapter



SUPERSPEED USB 3.1/USB-C TO FIBER MEDIA CONVERTERS

FEATURES		UMC200/SC	UMC200/ST	UMC2000/LC	UMC2000/SC
PORTS	Port 1	USB 3.1/USB-C	USB 3.1/USB-C	USB 3.1/USB-C	USB 3.1/USB-C
	Port 2	100FX (SC)	100FX (ST)	1000SX (LC)	1000SX (SC)
	Type	MMF	MMF	MMF	MMF
IEEE STANDARD		100FX	100FX	1000SX	1000SX
Tx WAVELENGTH		1310 nm	1310 nm	850 nm	850 nm
Rx WAVELENGTH		1310 nm	1310 nm	850 nm	850 nm
MAX DISTANCE		2 km	2 km	550 m	550 m
FUNCTIONALITY	Smart MissingLink support	■	■	■	■
	Max frame size	16KB	16KB	16KB	16KB
	Diagnostic LEDs	4	4	4	4
	Smart Link restoration	■	■	■	■
	Wake-on-LAN	■	■	■	■
POWER SUPPLY		USB 3.0/C	USB 3.0/C	USB 3.0/C	USB 3.0/C

PoE & Industrial

PoE

Allied Telesis PC PoE Series switches are the ideal solution for powering remote devices such as IP phones, video cameras, wireless access points, etc., which are more than 100 m from a Power over Ethernet switch.



		GIGABIT ETHERNET STANDALONE MEDIA CONVERTERS				FAST ETHERNET STANDALONE	
FEATURES		PC2000/LC	PC2000/SC	PC2000/SP	PC2002POE	PC232/POE	PC200/SC
PORTS	Port 1	10/100/1000T	10/100/1000T	10/100/1000T	10/100/1000T	10/100TX	10/100TX
	Port 2	1000SX (LC)	1000SX (SC)	SFP 100/1000X	SFP 100/1000X	100FX	100FX
	Fiber type	LC	SC	LC*	LC*	SC	SC
IEEE STANDARD		1000SX	1000SX	100FX and 1000X	100FX and 1000X	100FX	100FX
Tx WAVELENGTH		850 nm	850 nm	Depends on SFP	Depends on SFP	1310 nm	1310 nm
Rx WAVELENGTH		850 nm	850 nm	Depends on SFP	Depends on SFP	1310 nm	1310 nm
MAX FIBER DISTANCE		550 m	550 m	Depends on SFP	Depends on SFP	2 km	2 km
FUNCTIONALITY	Rate and speed	■	■	■	■	■	■
	MissingLink support	■	■	■	■	■	■
	Smart MissingLink support	■	■	■	■	■	■
	Max frame size	10 KB	10 KB	10 KB	1536 bytes	1916 bytes	10KB
	Diagnostic LEDs	6	6	6	15	13	6
	Smarm Link restoration	■	■	■	■	■	■
POWER OVER ETHERNET	PoE-enabled ports	1	1	1	1	1	1
	Max no. of full power ports	1	1	1	1	1	1
	Mode	Mode A	Mode A	Mode A	Mode A	A	A
PoE power		IEEE 802.3at (30W)	IEEE 802.3at (30W)	IEEE 802.3at (30W)	IEEE 802.3af (15W)	IEEE 802.3af (15W)	IEEE 802.3af (15W)
POWER SUPPLY	PSU type	Internal	Internal	Internal	Internal	Internal	Internal
	Multi-region	■	■	■	■	■	■

* Dependant on SFP

Industrial

Allied Telesis industrial Ethernet media converters offer an operating range from -40° to 75°C. The temperature-hardened IMC Series features Plug-and-Play and auto-negotiation.



		INDUSTRIAL MEDIA CONVERTERS			
FEATURES		IMC1000TP/SFP	IMC1000T/SFP	IMC100T/SCMM	IMC100T/SCSM
PORTS	Port 1	10/100/1000T	10/100/1000T	10/100TX	10/100TX
	Port 2	1000X SFP	100/1000X SFP	100FX (SC)	100FX (SC)
	Fiber type	Depends on SFP	Depends on SFP	MMF	SMF
IEEE STANDARD		100FX and 1000X	1000X	100FX	100FX
Tx WAVELENGTH		Depends on SFP	Depends on SFP	1310 nm	1310 nm
Rx WAVELENGTH		Depends on SFP	Depends on SFP	1310 nm	1310 nm
MAX FIBER DISTANCE		Depends on SFP	Depends on SFP	2 km	30 km
FUNCTIONALITY	Rate and speed	■	■	■	■
	Max frame size	9K	9K	9K	9K
	Diagnostic LEDs	4	6	7	7
POWER OVER ETHERNET	IEEE 802.3at Class 4	■	■	■	■
	PoE+ enabled ports	1	1	1	1
	Max no. of full power ports	1	1	1	1
	Mode	Mode A	Mode A	Mode A	Mode A
PoE power		30W	30W	30W	30W
POWER SUPPLY	PSU type	External	External	External	External

Mounting Hardware

The majority of unmanaged Allied Telesis MC, GS, and FS Series media converters can be mounted in a number of ways.

Desktop

All Allied Telesis media converters have the option to be fitted with rubber feet. These allow the product to be positioned on the desktop.

Wall

A standalone media converter or switch can be easily mounted on a wall or under a table using this wallmount fixture.

▶ WLMT

Wallmount fixture (supplied in packages of 10)



DIN Rail

This universal bracket allows a wide range of Allied Telesis media converters and media/rate converters to be mounted onto an industry-standard 35 mm DIN rail.

▶ DINRAIL1-010

Mounting kit (supplied in packages of 10)



Rack

Larger multi-channel and modular media converters ship with 19" rackmount kits. Smaller media converters may also be rackmounted in a number of ways:



▶ MCR1 chassis

This small chassis can be rackmounted, and allows a single standalone media converter or 2-port switch to be powered by an internal power supply. It is available with either AC or -48VDC power supply.



▶ MCR12 chassis

This chassis allows mounting of up to 12 standalone media converters or switches. The chassis supports optional redundant power supplies and can be AC or DC powered.

▶ TRAY1 and TRAY4

These simple trays allow one to four standalone media converters to be mounted into a rack.



MMC Rack

▶ MMCR18 NEW

This chassis allows mounting of up to 18 standalone MMC Series media converters. The chassis supports optional redundant power supplies and can be AC or DC powered. Standard, 19-inch, rack.





The Converteon™ family provides the next generation of managed media conversion. Expandable from a single unit to a modular 18-slot chassis, Converteon primarily provides Fast Ethernet and Gigabit-rate media conversion. Support for IEEE 802.3ah Ethernet in the First Mile (EFM) makes Converteon ideal for both service providers and the enterprise.



- ▶ **CV1000**
1-slot chassis
- » External power adapter
- » Silent, fanless design
- » Standalone or wallmount



- ▶ **CV1203**
2-slot chassis
- » External power adapters (one as standard)
- » Resilient power adapters (CV1200PSU)
- » Supports dying gasp
- » Standalone or wallmount



- ▶ **CV5001**
18-slot rackmount chassis
- » Optional redundant power supply
- » Optional Telnet and SNMP management (CV5M02)
- » Optional redundant management with the addition of a second management module (CV5M02)
- » Hot-swappable blades
- » Field-serviceable power supplies and fans
- » Hot-swappable power supply modules (CV5001AC-60 and CV5001DC-80)
- » Resilient power supply modules (maximum of two)

SFP and SFP+ Optics

Learn more about Allied Telesis pluggable optics on page 50.



FEATURES		CONVERTEON MODULES			
		CM301	CM302	CM3K0S	CV1KSS
PORTS	Port 1	10/100TX	10/100TX	10/100/1000T	SFP
	Port 2	100FX (ST)	100FX (SC)	100/1000X SFP	SFP
	Fiber type	MMF	MMF	Depends on SFP	Depends on SFP
IEEE STANDARD		100FX	100FX	1000X	1000X
Tx WAVELENGTH		1310 nm	1310 nm		1310 nm
Rx WAVELENGTH		1310 nm	1310 nm		1310 nm
MAX FIBER DISTANCE		2 km	2 km	Depends on SFP	Depends on SFP
FUNCTIONALITY	Media type	■	■	■	■
	Rate and speed	■	■	■	■
	MissingLink support	■	■	■	■
	Smart MissingLink support	■	■	■	■
	Max frame size	10KB	10KB	10KB	9KB
	Dagnostic LEDs	9	9	9	5
OAM	Rate limiting	■	■	■	■
	Dying gasp support	■	■	■	
Management		■	■	■	
ECO-FRIENDLY		■	■	■	

Chassis-Based

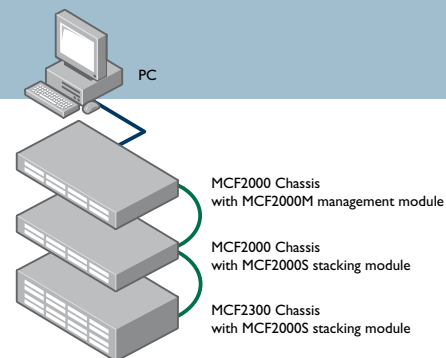

► MCF2000

Multi-channel manageable media converter

The MCF2000 provides ultra high-density, modular, multi-channel media conversion, with high availability and is ideal for fiber deployments. The units can be used unmanaged, or SNMP managed with the installation of the optional management module.

- » Small, 1RU chassis
- » High-density conversion, with up to 24 Fast Ethernet channels
- » Hot-swappable media blades (maximum of two)
- » Hot-swappable management module (MCF2000M)
- » Stack multiple chassis using stacking modules (MCF2000S)
- » Hot-swappable power supply modules (MCF2000AC)
- » Resilient power supply modules
- » Hot-swappable fan module for use when only one power module is installed (MCF2K2FAN)
- » Operates in unmanaged and managed modes

► MCF2300

4-slot chassis

The MCF2300 is an end-to-end managed media conversion system. Holding one to four multi-channel blades, the 3RU chassis provides a maximum of 48 independent channels. An optional management module provides control of the chassis, while dual hot-swappable power modules ensure maximum system uptime.

- » 3RU chassis
- » High-density conversion, with up to 48 Fast Ethernet channels
- » Hot-swappable media blades (maximum of four)
- » Hot-swappable management module (MCF2000M)
- » Stack multiple chassis using stacking modules (MCF2000S)
- » Hot-swappable power supply modules (MCF2300AC)
- » Resilient power supply modules
- » Hot-swappable fan module (MCF2300FAN)
- » Operates in unmanaged and managed modes

Stacking MCF2x00 Chassis

The MCF2000 and MCF2300 can be stacked together to provide a single management entity for the complete stack of up to eight chassis or a maximum of 16 media blades. One chassis has a SNMP management module installed, and this interconnects with the other chassis that are fitted with a stacking module.



MODULES FOR MCF2x00 CHASSIS

FEATURES		MCF2012LC	MCF2012LC/1	MCF2032SP
PORTS	Port 1	12 × 10/100TX	12 × 10/100TX	12 × 10/100/1000T
	Port 2	12 × 100FX (LC)	12 × 100FX (LC)	12 × SFP
	Fiber type	MMF	SMF	Depends on SFP
IEEE STANDARD		100FX	100FX	100/1000X
Tx WAVELENGTH		1310 nm	1310 nm	Depends on SFP
Rx WAVELENGTH		1310 nm	1310 nm	Depends on SFP
MAX FIBER DISTANCE		2 km	15 km	Depends on SFP
FUNCTIONALITY	Media type	■	■	■
	Rate and speed	■	■	■
	MissingLink support	■	■	■
	Smart MissingLink support	■	■	■
	Max frame size	1632 bytes	1632 bytes	10KB
	Diagnostic LEDs	■	■	■

Transceiver Modules

Allied Telesis optics provide fiber and copper connectivity for the full range of Allied Telesis product lines. Pluggable transceivers allow one product the flexibility to expand by media type (copper or fiber), speed (Fast Ethernet and 1, 10, or 40 Gigabit), and/or distance (220 m to 80 km).

Allied Telesis offers SFP, CSFP, XFP, SFP+, and QSFP+ pluggable transceivers, which comply with industry networking regulations. This compliance allows Allied Telesis pluggable optics to be used on any industry-standard networking equipment.



Pluggable Transceivers

SFP Series (SP)

The SP Series delivers flexible, full-duplex Ethernet connectivity. These hot-swappable fiber interfaces simply plug into an SFP slot on Allied Telesis products that are SFP compatible. Configurations can be optimized to meet a variety of distance and service requirements.

CSFP Series

The CSFP Series offers two channel Bi-Directional SFP designed expressly for high-speed communication applications. This hot-pluggable transceiver simply plugs into a CSFP slot on an Allied Telesis product for convenient transmission capacity upgrade.

QSFP Series (QSFP+)

The QSFP Series offers the latest industry-standard 40 Gigabit Ethernet connectivity in a flexible, small form factor. It is ideal for Datacom/Telecom switch and router connections, as well as data aggregation, backplane, proprietary protocol, and high-density applications. This hot-swappable transceiver simply plugs into a QSFP slot on any compatible Allied Telesis product.



GIGABIT FIBER TRANSCEIVERS					
FEATURES	SPSX	SPSX/I	SPEX	SPLX10	SPLX10/I
FORM FACTOR	SFP	SFP	SFP	SFP	SFP
FIBER TYPE	MMF	MMF	MMF	SMF	SMF
NUMBER OF FIBERS	2 (Rx, Tx)	2 (Rx, Tx)	2 (Rx, Tx)	2 (Rx, Tx)	2 (Rx, Tx)
SPEED	1000Mbps	1000Mbps	1000Mbps	1000Mbps	1000Mbps
DIGITAL DIAGNOSTICS MONITORING (DDM)		■			■
Rx WAVELENGTH	850 nm	850 nm	1310 nm	1310 nm	1310 nm
Tx WAVELENGTH	850 nm	850 nm	1310 nm	1310 nm	1310 nm
MAX DISTANCE	220 / 550 m	220 / 550 m	2 km	10 km	10 km
CONNECTOR TYPE	LC	LC	LC	LC	LC
TEMPERATURE	0°C to 70°C	-40°C to 85°C	0°C to 70°C	0°C to 70°C	-40°C to 85°C



FAST ETHERNET FIBER TRANSCEIVERS				
FEATURES	SPFX/2	SPFXBD-LC-13	SPFXBD-LC-15	SPFX/15
FORM FACTOR	SFP	SFP	SFP	SFP
FIBER TYPE	MMF	SMF	SMF	SMF
NUMBER OF FIBERS	2 (Rx, Tx)	1 (BiDi)	1 (BiDi)	2 (Rx, Tx)
SPEED	100Mbps	100Mbps	100Mbps	100Mbps
Rx WAVELENGTH	1310 nm	1550 nm	1310 nm	1310 nm
Tx WAVELENGTH	1310 nm	1310 nm	1550 nm	1310 nm
MAX DISTANCE	2 km	15 km	15 km	15 km
CONNECTOR TYPE	LC	LC - BiDi	LC - BiDi	LC
TEMPERATURE	0°C to 70°C	0°C to 70°C	0°C to 70°C	0°C to 70°C

QSFP+ Cables

- ▶ **QSFP1CU**
QSFP+ 1 m cable
- ▶ **QSFP3CU**
QSFP+ 3 m cable



Breakout Cables

- ▶ **QSFP-4SFP10G-3CU**
QSFP+ port to 4 × 10G ports, 3 m
- ▶ **QSFP-4SFP10G-5CU**
QSFP+ port to 4 × 10G ports, 5 m



Optical Cables

- ▶ **MTP12-1**
MTP cable for QSFP+ Series, 1 m
- ▶ **MTP12-5**
MTP cable for QSFP+ Series, 5 m



40 GIGABIT FIBER (QSFP+)		
FEATURES	QSFP SR4	QSFP LR4
FORM FACTOR	QSFP+	QSFP+
FIBER TYPE	MMF	SMF
COPPER TYPE		
NUMBER OF FIBERS	2 (Rx, Tx)	2 (Rx, Tx)
SPEED	40G	40G
DIGITAL DIAGNOSTICS MONITORING (DDM)	■	■
Rx WAVELENGTH	850 nm	4 CWDM lanes*
Tx WAVELENGTH	850 nm	4 CWDM lanes*
MAX DISTANCE	Up to 150 m	Up to 10 km
CONNECTOR TYPE	MPO	LC
TEMPERATURE	0°C to 70°C	0°C to 70°C

* Central wavelengths of the 4 CWDM channels - 1271, 1291, 1311 and 1331 nm



SPI0 Series (SFP+)

The SPI0 Series offers customers a wide variety of 10 Gigabit Ethernet connectivity options for data center, enterprise, and service provider transport applications. These hot-swappable devices plug into an Ethernet SFP+ port and have the smallest 10G form factor in the industry. Configurations can be optimized to meet a variety of distance and service requirements.

IEEE 802.3 Ethernet specification for networks over multi-mode fiber

Standard	Speed	Max Distance (MMF)
100X	100Mbps	2 km
1000X	1000Mbps	220 m



GIGABIT FIBER TRANSCEIVERS				COMPACT GIGABIT FIBER (CSFP)	
SPBD10-13	SPBD10-14	SPLX40	SPZX80	SPBD20DUAL-14	SPBD40DUAL-14
SFP	SFP	SFP	SFP	CSFP	CSFP
SMF	SMF	SMF	SMF	SMF	SMF
1 (BiDi)	1 (BiDi)	2 (Rx, Tx)	2 (Rx, Tx)	2 (BiDi)	2 (BiDi)
1000Mbps	1000Mbps	1000Mbps	1000Mbps	1000Mbps	1000Mbps
		■	■	■	■
1490 nm	1310 nm	1310 nm	1550 nm	1310 nm	1310 nm
1310 nm	1490 nm	1310 nm	1550 nm	1490 nm	1490 nm
10 km	10 km	40 km	80 km	20 km	40 km
LC - BiDi	LC - BiDi	LC	LC	2 × LC	2 × LC
0°C to 70°C	0°C to 70°C	0°C to 70°C	0°C to 70°C	-40°C to 85°C	-40°C to 85°C



NEW

COPPER RJ-45 TRANSCEIVERS

FEATURES	SPTX	SP10T
FORM FACTOR	SFP	SFP+
SPEED	10/100/1000T	100M / 1G / 10G BaseT
MAX DISTANCE	100 m	30 m
CONNECTOR TYPE	RJ-45	RJ-45
TEMPERATURE	0°C to 70°C	-5°C to 85°C

EXTENDED TEMPERATURE

Allied Telesis supports a wide range of industrial temperature optical accessories for use in all its extended and industrial temperature products. All optical accessories support operating temperatures of -40°C to 85°C.

- ▶ **SPSX/I**
1000SX SFP for multi-mode fiber
- ▶ **SPLX10/I**
1000LX SFP for single-mode fiber (10 km)
- ▶ **SP10SR/I**
10G SFP+ for multi-mode fiber (300 m)
- ▶ **SP10LR/I**
10G SFP+ for single-mode fiber (10 km)
- ▶ **SP10ER40/I**
10G SFP+ for single-mode fiber (40 km)
- ▶ **SP10ZR80/I**
10G SFP+ for single-mode fiber (80 km)
- ▶ **SPBD20-13/I**
1 Gigabit SFP, for single-mode fiber (20 km)
- ▶ **SPBD20-14/I**
1 Gigabit SFP, for single-mode fiber (20 km)
- ▶ **SPBD40-13/I**
1 Gigabit SFP, for single-mode fiber (40 km)
- ▶ **SPBD40-14/I**
1 Gigabit SFP, for single-mode fiber (40 km)



10 GIGABIT FIBER TRANSCEIVERS (SFP+)

SP10SR	SP10SR/I	SP10LR	SP10LR/I	SP10LRM	SP10ER40/I	SP10ZR80/I	SP10TW1	SP10TW3	SP10TW7
SFP+	SFP+	SFP+	SFP+	SFP+	SFP+	SFP+	SFP+	SFP+	SFP+
MMF	MMF	SMF	SMF	MMF	SMF	SMF	Twinax	Twinax	Twinax
2 (Rx, Tx)	2 (Rx, Tx)	2 (Rx, Tx)	2 (Rx, Tx)	2 (Rx, Tx)	2 (Rx, Tx)	2 (Rx, Tx)	10G	10G	10G
10G	10G	10G	10G	10G	10G	10G			
■	■	■	■	■	■	■			
850 nm	850 nm	1310 nm	1310 nm	1310 nm	1550 nm	1550 nm			
850 nm	850 nm	1310 nm	1310 nm	1310 nm	1550 nm	1550 nm			
300 m	300 m	10 km	10 km	Up to 220 m	40 km	80 km	1 m	3 m	7 m
LC	LC	LC	LC	LC	LC	LC			
0°C to 70°C	-40°C to 85°C	0°C to 70°C	-40°C to 85°C	0°C to 70°C	-40°C to 85°C	-40°C to 85°C	0°C to 70°C	0°C to 70°C	0°C to 70°C

Network Service Provider Transceivers



GIGABIT OPTICS (NSP)				
FEATURES	SPBD20-13/I	SPBD20-14/I	SPBD40-13/I	SPBD40-14/I
FORM FACTOR	SFP	SFP	SFP	SFP
FIBER TYPE	SMF	SMF	SMF	SMF
NUMBER OF FIBERS	1 (BiDi)	1 (BiDi)	1 (BiDi)	1 (BiDi)
SPEED	1000Mbps	1000Mbps	1000Mbps	1000Mbps
DDM	■	■	■	■
Rx WAVELENGTH	1550 nm	1310 nm	1490 nm	1310 nm
Tx WAVELENGTH	1310 nm	1490 nm	1310 nm	1490 nm
MAX DISTANCE	20 km	20 km	40 km	40 km
CONNECTOR TYPE	SC	SC	LC	LC
TEMPERATURE	-40°C to 95°C	-40°C to 95°C	-40°C to 85°C	-40°C to 85°C

iMG Transceivers

- ▶ **TN-P015-A**
SC, Gigabit/100M, 20 km SFP, Tx 1310, Rx 1480 - 1560, use with iMG1400 Series
- ▶ **SPBD20EPON-13/I**
20 km, bi-directional, 1 Gigabit GE PON SFP for iMG2426F



TAA Compliant Transceiver Modules

Allied Telesis provides many options for Trade Act Compliant (TAA) optics. These products are manufactured in TAA compliant countries and continue our commitment to providing a wide range of offerings for any network requirement.

Transceivers that can be ordered in TAA compliant versions are noted with **TAA**.

Network Adapters

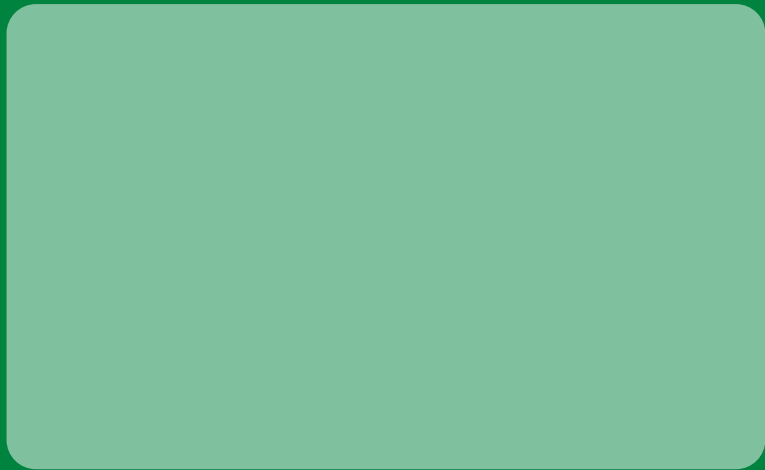

From 100Mbps to 10 Gigabit, Allied Telesis seamlessly connects desktops, laptops, servers, and thin clients with a continually expanding portfolio of high-quality, reliable, and cost-effective network adapters.

With the addition of the 2911 Series multi-port Gigabit and 10 Gigabit server network adapters, Allied Telesis has optimized adapters for virtualization. Using multi-port cards in virtualized environments is critical to applications in order to provide redundancy and data connectivity for these workloads. The priority queuing offered by Allied Telesis server network adapters can help set up networks based on specific needs. The comprehensive diagnostics and configuration software suite (Broadcom Advanced Control Suite) provides system administrators and engineers with a powerful tool to analyze interface cards and review specific data.

As the worldwide leader in fiber adapter cards Allied Telesis continues to offer the highest-quality cards at competitive prices. All Allied Telesis server adapters are Citrix, VMware, and Microsoft Hyper-V qualified.

Laptop Adapters



FEATURES		FAST ETHERNET FIBER	GIGABIT FIBER
		2814FX	2874SX
BUS TYPE		ExpressCard/34 (54 compatible)	ExpressCard/34 (54 compatible)
PORTS AND MEDIA SUPPORT	100FX	SC	
	1000X		SC
QoS		IEEE 802.1p priority queues	■
PERFORMANCE		TCP/IP checksum CPU offload	■
MANAGEMENT		Managed boot agent (PXE remote boot ROM)	2.1
		VLAN support	■
		Advanced power management (ACPI)	■
DRIVER SUPPORT	Windows 10 (32/64-bit)	■	■
	Windows 7	■	■
	Windows 7 (64-bit)	■	■
	Windows Vista	■	■
	Windows Vista (64-bit)	■	■
	Windows XP	■	■
	Windows 8	■	■
	Windows 8 (64-bit)	■	■
IPV6 SUPPORT		■	■
DIAGNOSTICS		LEDs	■
IDEAL ENVIRONMENT		Laptop computers with fiber connectivity	Laptop computers with fiber connectivity
CUSTOMER'S NEEDS		100Mbps fiber connectivity / laptop connectivity	1000Mbps fiber connectivity / laptop connectivity

Preboot Execution Environment (PXE) Support

PXE allows network administrators to perform preboot procedures on a system, such as installing an operating system, running a virus checker, or downloading a predefined system configuration. PXE support included in Allied Telesis adapter cards allows a workstation or computer to boot from a remote server connected to the network prior to booting from the local hard drive.

Desktop/Workstation



FEATURES		GIGABIT COPPER			COPPER AND FIBER			
		2912T	2911T/2	2701FTXa	2716POE/FX	2911GP/SX	2911GP/LX	2911GP/SFP
BUS TYPE		PCIe (x1)	PCIe (x1)	PCI (32-bit)	PCIe (x1)	PCIe (x1)	PCIe (x1)	PCIe (x1)
PORTS AND MEDIA SUPPORT	100TX			■				
	10/100/1000T PoE				IEEE 802.3af (15W)	IEEE 802.3at (30W)	IEEE 802.3at (30W)	IEEE 802.3at (30W)
	10/100/1000T	■	■ (2 ports)					
	100FX			SC, ST	SC, ST			
	1000X					SC, LC	SC, LC	1000Mbps SFP
FIBER TYPE				MMF	MMF	MMF	SMF	Depends on SFP
MAX FIBER DISTANCE				2 km	2 km	220 m / 500 m	10 km	Depends on SFP
QoS		IEEE 802.1p priority queues	■	■	■	■	■	■
PERFORMANCE	TCP/IP checksum CPU offload	■	■		■	■	■	■
	Jumbo frames		■		■	■	■	■
	Link aggregation support		■		■	■	■	■
	Link aggregation failover		■		■	■	■	■
MANAGEMENT	Wake-on-LAN	■	Copper port	■	■	Copper port	Copper port	Copper port
	Managed boot agent (PXE remote boot ROM)	2.1	2.1	2.1	2.1	2.1	2.1	2.1
	DASH (TruManage)	■						
	VLAN support	■	■	■	■	■	■	■
	Advanced power management (ACPI)	■	■	■	■	■	■	■
SECURITY	SNMP	■	■		■	■	■	■
	IPSec offload	■						
DRIVER SUPPORT	Windows 10 (32 and 64-bit)		■		■	■	■	■
	Windows 7 (32 and 64-bit)	■	■	■	■	■	■	■
	Windows 2008	■	■		■	■	■	■
	Windows Vista (32 and 64-bit)	■	■	■	■	■	■	■
	Windows XP (64-bit)		■	■	■	■	■	■
	Windows 8	■	■	■	■	■	■	■
	Windows 8 (64-bit)	■	■	■	■	■	■	■
	Windows Server 2008 R2	■	■		■	■	■	■
	Windows Server 2012	■	■		■	■	■	■
	Windows Server 2016	■	■		■	■	■	■
NDIS2	■	■	■	■	■	■	■	
Linux 2.6	■	■	■	■	■	■	■	
IPv6 SUPPORT		■	■	■	■	■	■	■
DIAGNOSTICS	LEDs	■	■	■	■	■	■	■
	Virtual cable tester	■	■					
PHYSICAL	Low profile bracket and full height provided	■	■	■	■	■	■	■
IDEAL ENVIRONMENT		Desktop computers in ultra secure areas	Desktop computers in secure areas, virtualization servers	Desktop computers in secure areas	Desktop computers with fiber interfaces that want to power a PoE phone (or other device) from the secondary port	Desktop computers with fiber interfaces that want to power a PoE phone (or other device) from the secondary port	Desktop computers with fiber interfaces that want to power a PoE phone (or other device) from the secondary port	Desktop computers with fiber interfaces that want to power a PoE phone (or other device) from the secondary port
CUSTOMER'S NEEDS		Data encryption	High performance / load balancing / virtualization	100Mbps fiber connectivity / choice of fiber or copper interfaces	PoE / VoIP connectivity	PoE+	PoE+	PoE+ / choice of SFP

Desktop/Workstation

Jumbo Frames Support

Normal Ethernet packets are limited to a maximum size of 1548 bytes. Received packets larger than this are normally rejected by the interface card as errors. Jumbo frames support is beneficial for sending large packets, especially when the data contained in these packets either has a time-critical element, or is so large that the time taken to send multiple smaller packets is too great. Jumbo frame packets are normally up to 9000 bytes long.

Long-Distance Fiber

With the introduction of single-mode fiber adapters, Allied Telesis has extended the size of a fiber network from up to two kilometers over multi-mode fiber; to up to 20 km for Fast Ethernet, and 10 km for Gigabit Ethernet.

Advanced Power Management (ACPI)

ACPI is part of the environmental control initiative for computers. Allied Telesis adapter cards support ACPI, which places the system in a low power state when it is not receiving or transmitting data.



FEATURES		GIGABIT COPPER AND FIBER				GIGABIT FIBER		
		2911STX	2911LTX	2916SX	2916LX10	2914SX/LC	2914SX/SC	2914SX/SP
BUS TYPE		PCIe (x1)	PCIe (x1)	PCI (32-bit)	PCI (32-bit)	PCIe (x1)	PCIe (x1)	PCIe (x1)
PORTS AND MEDIA SUPPORT	10/100/1000T	■	■					
	100FX							SFP
	1000X	SC, LC	SC, LC	SC, LC	LC	LC	SC	SFP
FIBER TYPE		MMF	SMF	MMF	SMF	MMF	MMF	10/100 SFP
MAX FIBER DISTANCE		220 m / 500 m	10 km	220 m / 500 m	10 km	220 m / 500 m	220 m / 500 m	Depends on SFP
QoS		IEEE 802.1p priority queues	■	■	■	■	■	■
		TCP/IP checksum CPU offload	■	■	■	■	■	■
		Jumbo frames	■	■	■	■	■	■
PERFORMANCE	Link aggregation support	■	■	■	■	■	■	■
	Link aggregation failover	■	■	■	■	■	■	■
	Teaming	■	■	■	■	■	■	■
	Wake-on-LAN	Copper port	Copper port			■	■	■
MANAGEMENT	Managed boot agent (PXE remote boot ROM)	2.1	2.1	2.1	2.1	2.1	2.1	2.1
	DASH (TruManage)							
	VLAN support	■	■	■	■	■	■	■
	Advanced power management (ACPI)	■	■	■	■	■	■	■
	SNMP	■	■	■	■	■	■	■
	IPSec offload							
DRIVER SUPPORT	Windows 10 (32 and 64-bit)	■	■	■	■	■	■	■
	Windows 7 (32 and 64-bit)	■	■	■	■	■	■	■
	Windows 2008 (32 and 64-bit)	■	■	■	■	■	■	■
	Windows Vista (32 and 64-bit)	■	■	■	■	■	■	■
	Windows XP (32 and 64-bit)	■	■	■	■	■	■	■
	Windows 8	■	■	■	■	■	■	■
	Windows 8 (64-bit)	■	■	■	■	■	■	■
	Windows Server 2008 R2	■	■	■	■	■	■	■
	Windows Server 2012	■	■	■	■	■	■	■
	Windows Server 2016	■	■	■	■	■	■	■
	NDIS2	■	■	■	■	■	■	■
Linux 2.6	■	■	■	■	■	■	■	
IPv6 SUPPORT		■	■	■	■	■	■	■
DIAGNOSTICS		LEDs	■	■	■	■	■	■
PHYSICAL		Low profile bracket and full height provided	■	■	■	■	■	■
IDEAL ENVIRONMENT		Desktop computers in secure areas	Desktop computers in secure areas	Desktop computers in secure areas	Desktop computers in secure areas	Service requiring Gigabit connectivity	Service requiring Gigabit connectivity	Service requiring Gigabit connectivity
CUSTOMER'S NEEDS		1000Mbps fiber connectivity / choice of fiber or copper interfaces	1000Mbps fiber connectivity / choice of fiber or copper interfaces	Performance	Performance / long-distance networking	High performance / load balancing / virtualization	High performance / load balancing / virtualization	High performance / load balancing / long-distance networking / virtualization

Server Adapters

Network Virtualization

Allied Telesis server adapter cards are specifically designed for use in a virtualized environment. The cards interact directly with the virtualization hypervisor software, offloading many of the interface tasks from the main CPU, thus increasing the overall performance of the virtual machine.

The ANCIOS Series 10 Gigabit adapter card improves performance with next-generation technology — VMware, Data Center Bridging, Direct Path, NetQueue — that includes features such as loopback (inter-VM communication), priority-weighted bandwidth management, and doubling the number of data queues per port from four to eight. Also supported are multicast and broadcast data on a virtualized server.



FEATURES		SFP+ 10 GIGABIT
		ANCIOS/2
BUS TYPE		PCIe (x8)
PORTS AND MEDIA SUPPORT	SFP+	■ (2 ports)
	Fiber type	MMF, SMF
	Max fiber distance	Depends on SFP+
QoS	IEEE 802.1p priority queues	■
	TCP/IP checksum CPU offload	■
	Jumbo frames	■
	Link aggregation support	■
	Link aggregation failover	■
	TOE	■
	iSCSI	■
MANAGEMENT	Managed boot agent (PXE remote boot ROM)	2.1
	VLAN support	■
	Advanced power management (ACPI)	■
	SNMP	■
DRIVER SUPPORT	Windows 2008 (32 and 64-bit)	■
	Windows Server 2008 R2	■
	Windows Server 2012	■
	Windows Server 2016	■
	Linux 2.6	■
IPv6 SUPPORT		■
DIAGNOSTICS	LEDs	■
PHYSICAL	Low profile bracket and full height provided	■
IDEAL ENVIRONMENT		Virtualization servers
CUSTOMER'S NEEDS		High performance with low CPU utilization

Superior Functionality

The ANCIOS Series includes dedicated hardware and processors to process frames at the highest levels for both transmit and receive paths in the operating system — advantageous for virtualization applications.

The ANCIOS Series enables convergence of all networked communications possible in a server, such as data (LAN), storage networks (iSCSI), and clustering.

SFP/SFP+ Optics
Learn more about Allied Telesis pluggable optics on page 50.

Network Management



It's a complex job to administer a network. Rapid trouble resolution and the ability to monitor network performance is critical for every business. One size does not fit all when it comes to network management — everything depends on the network and user needs.

Allied Telesis software tools can help visualize and plan for network growth while maintaining the health and performance of the network.

VISTA Manager

NETWORK MONITORING AND MANAGEMENT

VISTA MANAGER

Vista Manager is a graphical network monitoring and management tool for Allied Telesis Management Framework (AMF) networks. Vista Manager automatically creates a complete topology map of switches, firewalls and wireless access points, and enables easy management of many, or all, network devices at once.

Vista Manager provides a broad view of the complete network including third party devices such as security cameras.

Intuitive usability and simple navigation means comprehensive network information is just a click away, easing the burden of network management, while the dashboard allows monitoring of up-to-date network status, and provides actionable reporting for the timely resolution of any network problems.

Supported AMF Devices

PRODUCT	AMF NODE	AMF MASTER	AMF CONTROLLER
AMF Cloud		■	■
Switches			
SwitchBlade x8100 (CFC960)	■	■	■
SwitchBlade x8100 (CFC400)	■	■	
SwitchBlade x908	■	■	
DC2552XS/L3	■	■	
x930 Series	■	■	
x900 Series	■		
x610 Series	■	■	
x510 Series	■	■	
IX5-28GPX	■		
x310 Series	■		
x230 Series	■		
x210 Series	■		
IE510-28GSX	■		
IE300 Series	■		
IE200 Series	■		
CentreCOM XS900MX Series	■		
CentreCOM GS900MX Series	■		
CentreCOM GS970M Series	■		
CentreCOM FS980M Series	■		
Firewalls			
AR4050S UTM firewall	■	■	
AR3050S UTM firewall	■		
AR2050V VPN firewall	■		
AR2010V VPN firewall	■		



Features

- ▶ Intuitive graphical interface
- ▶ Autonomous topology maps
- ▶ Automatic network backup/restore
- ▶ Network software management
- ▶ Alarms with email notifications
- ▶ Cut through SNMP
- ▶ Secure SSH management
- ▶ Windows OS server support
- ▶ Manages Allied Telesis and third party AMF compliant elements

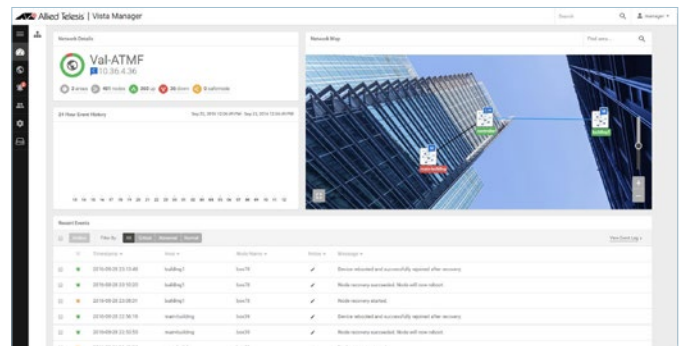

The overview dashboard provides at-a-glance status of network health with actionable reporting.

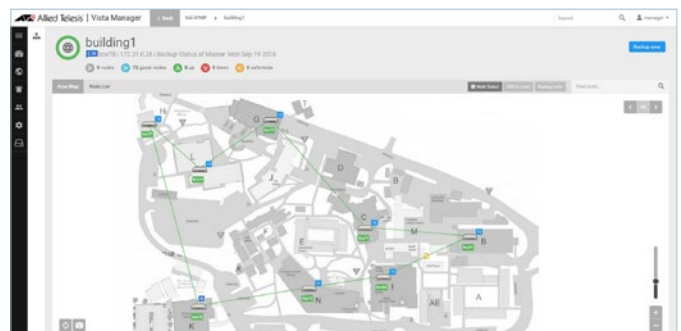

Add an image to the map view to provide context for your network layout.

AlliedView NMS

SERVICE PROVIDER EDITION

AlliedView NMS provides a unified management platform for network, element, and service management for every type of service provider and enterprise network. AlliedView NMS supports more than 200 different Allied Telesis products, including switches, routers, multiservice access, and fiber- or copper-based gateways.

AlliedView NMS incorporates user interfaces that are efficient as well as operator friendly to take the complexity out of performing routine tasks. The Command Line Interface (CLI) used for provisioning and element management is based on a format widely used and recognized in the industry. It is combined with an intuitive GUI for diagnostics, network mapping, and alarm reporting, among other features, which offer the operator an easy-to-understand means of displaying and reviewing information.

The scalability of AlliedView NMS offers a wide range of use from medium-sized networks all the way to large service provider networks with thousands of devices and multiple services. This includes support and administrative security for centralized or distributed client-side operations based on its software architecture. The enhanced tools incorporated into AlliedView NMS address the critical need to reduce time and labor to manage the network, and at the same time offer higher levels of customer service through rapid responsiveness.

Scalable Architecture

AlliedView NMS is a Java-based application suite that supports both Java and HTML clients. The core services include a relational database and may be deployed on a dedicated Windows server, or in a virtual server environment. The server supports core functions such as discovery of managed

Features

- ▶ Intuitive graphical interface
- ▶ Drill-down functionality
- ▶ MIB browser
- ▶ MIB compiler
- ▶ GUI snapshot utility
- ▶ RMON 4 group support
- ▶ Supports NMS alarms
- ▶ Supports SNMP v1, v2c and v3
- ▶ VLAN management
- ▶ QoS management
- ▶ Multi-platform
- ▶ HP OpenView, Tivoli NetView, Ispswitch
- ▶ WhatsUp and SNMPc interoperability
- ▶ Supports Allied Telesis managed devices

objects, receiving and processing alarm information and notifications, data collection, report generation, status polling, and northbound interfaces.

All updates relative to the database are processed through the server.

The server software also supports distributed user clients, and provides scalability in terms of the number of clients that can be concurrently supported. The distributed clients act as the user interfaces between the

end-users or administrators and the AlliedView NMS server. Client support is comprised of the following functions:

- ▶ Interfaces with the clients and channels all of their transactions to the server applications
- ▶ Generates the user view of the network through database operations
- ▶ Generates alarms and autonomous messaging from the server database to the clients



Auto-Discovery Features

AlliedView NMS performs active auto-discovery of every network element whenever a new element or device is added to the network. Auto-discovery features go beyond merely capturing hardware inventory populated in the network, to providing detailed network topology and configuration information.

If a new network element, iMG, or port is added to the network, auto-discovery provides the operator automated information and updates for inventory and configuration management. This allows the network to be maintained at a “current state,” while eliminating any need to manually enter information when changes occur.

Network Mapping

AlliedView NMS provides the ability to create and maintain a logical network map, including sites and locations where each piece of equipment resides, and to actually create an overlay of the network on a geographic network map.

Network Topology

Auto-discovery allows the operator to create and view the actual topology of the network, including Layer 2 and 3 networks, VLANs, EPSRings (domains), physical nodes, physical cards (network interfaces and ports), terminal devices (iMGs), and physical links.

Zero Touch Service Provisioning

Allied Telesis has streamlined the provisioning process through its “one-touch provisioning” feature in AlliedView NMS. Each type of service, as well as port or link, can be assigned its own profile using configuration data that matches the requirement. Once done, the profile can be applied to each subscriber line, port, or link in a single keystroke rather than having to re-enter the same data over and over again. In a large service network with large numbers of subscribers, the time savings are tremendous, as is the reduction in configuration errors that sometimes occurs.

An additional key benefit in a service network, where revenue generation is critical, is in rapid service deployment and turn up. New subscribers can be added and activated quickly, thereby increasing revenues as well as providing a higher level of customer service.

In addition to auto- or bulk-provisioning the service VLANs using a defined service profile, the same procedure could be applied to the uplink or port for applying configuration and QoS parameters. Auto-configuring enables new nodes to be added and turned up quickly, and likewise new line cards or modules added to existing nodes. At the same time, it ensures conformity

in the provisioning of the network configuration — eliminating the problems that sometimes occur when a new piece of equipment is added to the network and configured incorrectly.

Network Upgrades

AlliedView NMS allows software and firmware upgrades to be made network-wide on either a scheduled or unscheduled basis, as the network operator requires. Since AlliedView NMS maintains an up-to-date inventory of all the equipment in the network, as well as release level of the software and firmware, it becomes the tool to manage periodic upgrades.

Northbound Interface

AlliedView NMS can be integrated with existing Operation Support Systems (OSS) and Business Support Systems (BSS) through a Web services-based northbound interface. This enables the automation of service activations, changes, and deactivations to be done on the higher level OSS/BSS systems and flow through to the Allied Telesis network elements.

Index

2701FTXa.....	55	6102G.....	32	CV5M02.....	47
2701FXa.....	57	Allied Telesis Management Framework (AMF).....	4	CV1000.....	47
2711FX.....	57	AlliedView NMS Service Provider Edition.....	61	CV1200PSU.....	47
2711LX.....	57	AMF Cloud.....	5	CV1203.....	47
2712FX.....	57	AN0001.....	33	CV1KSS.....	47
2716POE/FX.....	55	AN0002.....	33	CV5001.....	47
2814FX.....	54	AN0003.....	33	CV5001AC-60.....	47
2874SX.....	54	AN2458-10DP.....	34	CV5001DC-80.....	47
2911GP/LX.....	55	AN5158-16DP.....	34	DC2552XS/L3.....	12
2911GP/SFP.....	55	AN5158-19DP.....	34	DINRAIL1-010.....	46
2911GP/SX.....	55	ANC10S/2.....	58	DMC100/LC.....	44
2911LTX.....	56	AR020.....	28	DMC100/SC.....	44
2911LX.....	57	AR021S.....	28	DMC100/ST.....	44
2911LX/2LC.....	57	AR023.....	28	DMC1000/LC.....	44
2911SFP.....	57	AR024.....	28	DMC1000/SC.....	44
2911SFP/2.....	57	AR027.....	28	DMC1000/ST.....	44
2911STX.....	57	AR2010V.....	26, 27	FAN03.....	9
2911SX.....	57	AR2050V.....	26, 27	FL15.....	28
2911SX/2LC.....	57	AR3050S.....	26, 27	FL18B.....	28
2911T/2.....	55	AR400-ADVL3UPGRD.....	28	FL18C.....	28
2912T.....	55	AR4050S.....	26, 27	FL19B.....	28
2914SX/LC.....	56	AR415S.....	28	FL19C.....	28
2914SX/SC.....	56	AR440S.....	28	FL19D.....	28
2914SX/SP.....	56	AR700-ADVL3UPGRD.....	28	FL19E.....	28
2916LX10.....	56	AR750S.....	28	FL-CF4-AM40.....	7
2916SX.....	56	CM301.....	47	FL-CF4-AM80.....	7
6101G.....	32	CM302.....	47	FL-CF9-AC10.....	7
6101GP.....	32	CM3K0S.....	47	FL-CF9-AC30.....	7

FL-CF9-AC60	7	FS970M/24F	18	GS970M/10.....	17
FL-CF9-AM40	7	FS980M/18.....	19	GS970M/10PS	17
FL-CF9-AM80	7	FS980M/18PS.....	19	GS970M/18.....	17
FL-CF9-AM120.....	7	FS980M/28.....	19	GS970M/18PS	17
FL-CF9-VCSPLE.....	7	FS980M/28PS	19	GS970M/28	17
FL-CFC400-01	7	FS980M/52.....	19	GS970M/28PS	17
FL-CFC960-01	7	FS980M/52PS	19	GS2002/SP	43
FL-RADIUS-FULL	9	FS980M/9.....	19	HS-STK-CBL.....	9
FL-SBx9-01	9	FS980M/9PS	19	IE200-6FP.....	24
FL-SBx9-02.....	9	GS900/5E	22	IE200-6FT.....	24
FL-SBx9-AM40.....	9	GS900/8E	22	IE200-6GP	24
FL-TQ4600-OF13	30	GS900/8PS.....	22	IE200-6GT	24
FS201	43	GS910/16.....	23	IE300/12GP.....	24
FS202	43	GS910/24.....	23	IE300/12GT	24
FS232	43	GS910/5.....	22	IE510-28GSX.....	24
FS232/1.....	43	GS910/5E.....	22	IFS802SP	24
FS232/2.....	43	GS910/8.....	23	IFS802SP/POE (W).....	24
FS238A/1	43	GS910/8E.....	23	iMAP 9700	36
FS238B/1.....	43	GS916M	16	iMAP 9810	36
FS705EFC/SC	22	GS924M.....	16	iMAP CFC100.....	36, 37
FS705LE	22	GS924MPX.....	16	iMAP CFC12.....	36, 37
FS708LE	22	GS924MX.....	16	iMAP CFC56.....	36, 37
FS708LE/POE	23	GS948MPX	16	iMAP GE24BX.....	37
FS708/POE	23	GS948MX.....	16	iMAP GE8.....	37
FS716L.....	23	GS950/10PS	21	iMAP GEPON.....	37
FS724L.....	23	GS950/16	21	iMAP POTS24C	37
FS750/20.....	20	GS950/16PS	21	iMAP UDSL24.....	37
FS750/28.....	20	GS950/24	21	IMC100T/SCMM.....	45
FS750/28PS.....	20	GS950/28PS.....	21	IMC100T/SCSM.....	45
FS750/52.....	20	GS950/48	21	IMC1000TP/SFP	45
FS970M/16F8-LC	18	GS950/48PS	21	IMC1000T/SFP	45
FS970M16F8-SC.....	18	GS950/8	21	IMG634A-R2	38

IMG634B-R2.....	38	MCF2000S.....	48	PWR05-80.....	9
IMG634WA-R2.....	38	MCF2012LC.....	48	PWR150.....	12
IMG634WB-R2.....	38	MCF2012LC/1.....	48	PWR250.....	12
IMG746MOD.....	39, 40	MCF2032SP.....	48	PWR250-80.....	12
IMG1405.....	38, 40	MCF2300.....	48	PWR800.....	12, 13
IMG1405W.....	38, 40	MCF2300AC.....	48	PWR1200.....	12
IMG1425.....	38, 40	MCF2300FAN.....	48	QSFP1CU.....	50
IMG1425RF.....	38, 40	MCPWR.....	44	QSFP3CU.....	50
IMG1425W.....	38, 40	MCR1.....	46	QSFP4.....	50
IMG1525.....	39, 40	MCR12.....	43, 46	QSFP4SR4.....	50
IMG1525RF.....	39, 40	MicroMAP 9001.....	36	QSFP-4SFP10G-3CU.....	50
IMG2426F.....	39, 40, 52	MiniMAP 9100.....	36	QSFP-4SFP10G-5CU.....	50
IMG2504.....	39, 40	MMC200/LC.....	43	SBx3106.....	10, 11
IMG2522.....	39, 40	MMC200/SC.....	43	SBx3112.....	10, 11
IMG2524.....	39, 40	MMC200/ST.....	43	SBx3112-6XS-80.....	10
IMG2524F.....	39, 40	MMC2000/LC.....	43	SBx3112-8XR.....	10
IMG2524H.....	39, 40	MMC2000/SC.....	43	SBx3112-12XS-80.....	10
IX5-28GPX.....	13	MMC2000/SP.....	43	SBx3112-96POE+.....	10
MC1004.....	43	MMC2000/ST.....	43	SBx3112-B01-80.....	10
MC1008/SP.....	43	MMC6005.....	43	SBx31CFC960.....	10, 11
MC101XL.....	42	MMC6006.....	43	SBx31GC40.....	10, 11
MC102XL.....	42	MMCR18.....	46	SBx31GP24.....	10, 11
MC103LH.....	42	MTP12-1.....	50	SBx31GS24.....	11
MC103XL.....	42	MTP12-5.....	50	SBx31GT24.....	11
MC104XL.....	42	PC200/SC.....	45	SBx31GT40.....	11
MC115XL.....	42	PC2000/LC.....	45	SBx31XS6.....	10, 11
MC116XL.....	42	PC2000/SC.....	45	SBx31XZ4.....	10
MC13.....	42	PC2000/SP.....	45	SBx81CFC400.....	7, 10
MCF2KFAN.....	48	PC2002POE.....	45	SBx81CFC960.....	7, 10
MCF2000.....	48	PC232/POE.....	45	SBx81GP24.....	7, 10
MCF2000AC.....	48	PWR05.....	9	SBx81GS24a.....	7
MCF2000M.....	48	PWR06.....	12	SBx81GT24.....	7

SBx81GT40	7	SPBD40-14/I	51, 52	TN-9103	36
SBx81XS16	7	SPBD40DUAL-14	51	TN-P015-A	52
SBx81XS6	7, 10	SPEX	50	TN-R113	36
SBx8106	7	SPFX/2	50	TN-R114	36
SBx8112	7	SPFX/15	50	TQ4400E	30
SBx81XLEM	7	SPFXBD-LC-13	50	TQ4600	30
SBx81XLEM/GT8	7	SPFXBD-LC-15	50	TRAY1	46
SBx81XLEM/Q2	7	SPLX10	50	TRAY4	46
SBx81XLEM/XS8	7	SPLX10/I	50, 51	UMC200/SC	44
SBx81XLEM/XT4	7	SPLX40	51	UMC200/ST	44
SBx908	9, 10	SPSX	50	UMC2000/LC	44
SBxPWRPOE1	7, 10, 11	SPSX/I	50, 51	UMC2000/SC	44
SBxPWRSYS1-80	7, 10, 11	SPTX	51	UTP/RJ.5-100-A-008	9
SBxPWRSYS2	7, 10, 11	SPZX80	51	UTP/RJ.5-300-A-008	9
SP10ER40/I	51	StackQS	12	UWC-60-APL	31
SP10LR	51	SwitchBlade x3100 Series	10	UWC-Install + UWC-BaseST	31
SP10LR/I	51	SwitchBlade x8100 Series	6	Vista Manager	60
SP10LRM	51	SwitchBlade x908	8	WLMT	46
SP10SR	51	SwitchBlade x908 Generation 2	2	x230-10GP	14
SP10SR/I	51	TN-117	37	x230-10GT	14
SP10T	51	TN-118	37	x230-18GP	14
SP10TW1	51	TN-143	37	x230-18GT	14
SP10TW3	51	TN-144	37	x230-28GP	14
SP10TW7	51	TN-146-A	37	x230-28GT	14
SP10ZR80/I	51	TN-250G-B	36	x310-26FP	15
SPBD10-13	51	TN-253G	36	x310-26FT	15
SPBD10-14	51	TN-254-80	36	x310-50FP	15
SPBD20-13/I	51, 52	TN-407	37	x310-50FT	15
SPBD20-14/I	51, 52	TN-408	37	x510-28GPX	13
SPBD20DUAL-14	51	TN-409	37	x510-28GSX	13
SPBD20EPON-13/I	52	TN-9101	36	x510-28GTX	13
SPBD40-13/I	51, 52	TN-9102	36	x510-52GPX	13

x510-52GTX.....	13
x510DP-28GTX.....	13
x510DP-52GTX	13
x510L-28GP.....	13
x510L-28GT	13
x510L-52GP.....	13
x510L-52GT.....	13
x550 Series	2
x930-28GPX.....	12
x930-28GSTX	12
x930-28GTX.....	12
x930-52GPX	12
x930-52GTX	12
XEM-12Sv2	9
XEM-12Tv2.....	9
XEM-2XP.....	9
XEM-2XS.....	9
XEM-24T	9
XS916MXS.....	15
XS916MXT	15

Allied Telesis continuously enhances its products. As a result, this catalog may not correctly represent all products currently available. Products may also vary by geographic region. Product specifications can change without notice, and while Allied Telesis makes every effort to ensure the accuracy of information presented in this catalog, the Company does not accept liability for errors or changes in the stated specifications.

For current product availability by region, full and complete product specifications and warranty information, please contact your regional sales manager or visit alliedtelesis.com.

Environmental Policy

As a major industry developer and manufacturer of networking equipment, Allied Telesis is committed to providing our customers with products designed and built to the highest quality, while minimizing the impact to the environment during both manufacturing and product operation.

Our Philosophy

Allied Telesis recognizes the importance of protecting the global environment and promoting conservation of biodiversity. We creatively utilize technology for sustainable social progress and for protecting the environment. Allied Telesis is committed to passing down a healthy global environment to the next generation.

Our Policy

Allied Telesis takes a proactive approach to:

- ▶ continual improvement of the local and global environment,
- ▶ prevention of pollution, and
- ▶ environmental management to fulfill corporate social responsibilities.

To achieve these objectives:

- ▶ Allied Telesis executive management has established and provides the resources for an Environmental Management System (EMS).
- ▶ We offer products designed to conserve energy; manufactured to save resources.
- ▶ We seek to reduce the risks to human health and the health of the environment from the use of hazardous chemical substances.
- ▶ We strive to reduce our impact on the environment through reduction, reuse, and recycling of waste materials (we practice 3R).
- ▶ We comply with all applicable environmental regulatory requirements, industry-specific self-regulation and stakeholder's requirements.

Reduced Operational Power Consumption

Using the latest technology and a range of power saving techniques, Allied Telesis has reduced power consumption by up to 50% over a wide range of its network devices. Reducing power consumption has a direct benefit for the environment. Additionally, further energy savings can also be made where products are installed in controlled temperature environments such as server rooms. Such environments allow the equipment to run cooler, requiring less effort and power from the device, resulting in a decrease in power utility costs and an increase in equipment reliability.

Eco-friendly is the brand name used by Allied Telesis to signify our low power range of networking products. Eco-friendly products will eventually encompass our entire product portfolio, as we continue to introduce new, lower power technology to meet customer demand.

Reducing Power on Network Ports: The latest switching silicon can detect the length of cables connected to a port. Using "measure and minimize" technology, Allied Telesis can ensure that maximum power is only injected into cables with the longest lengths, reducing the power injected into short

cable lengths. Advanced products can ensure that selected ports are disabled overnight or on weekends, further reducing power.

Reducing Indicator Activity: All networking devices feature a varying array of power-consuming indicator devices (typically LEDs) to aid in installation and diagnostics. On the latest Allied Telesis products, these LEDs can be disabled when not required, saving up to a further 2% of operating power.

Power Supply Efficiency: The overall power consumption of a network device is ultimately dictated by the efficiency of the power supply. A power supply delivering only 50% efficiency draws twice the actual required power; with half the power wasted in the form of heat. Allied Telesis uses ultra-efficient power supplies, delivering conversion efficiencies of more than 80%, which produce less heat and reduce power consumption by up to 30%. Allied Telesis is now rating power supplies, informing the user of their efficiency.

Manufacturing

Allied Telesis prides itself on using state-of-the-art manufacturing equipment. While quality and efficiency are key parameters, Allied Telesis is also focused on reducing the potential damage to the environment caused during the manufacturing process.

ISO 9001 Standard: All Allied Telesis manufacturing facilities conform to ISO 9001 standards. Efficient production techniques, coupled with stringent design parameters ensure that Allied Telesis maintains its position as one of the highest quality networking producers in the industry.

ISO 14001 Standard: Allied Telesis has long been a responsible manufacturer, ensuring the minimum damage to the world's environment. All of our facilities adhere to the strict ISO 14001 standard for environment management of our production processes.

Allied Telesis manufacturing facilities also ensure minimal impact on the environment by use of the latest technology and processes. All water used in our manufacturing process is recycled.

Logistics

The majority of Allied Telesis network products are manufactured in Asia. Transporting these products across the world to the consumer markets can therefore have significant impact on the environment. Whenever possible, Allied Telesis attempts to use bulk sea transportation, as this has significantly less environmental impact when compared to air freight.

Restrictions on Hazardous Substances (RoHS) Compliance

Allied Telesis declares that the homogeneous content of the materials and components used in products bearing the CE Mark conform to the requirements established by the European Union RoHS (Restriction of the use of certain Hazardous Substances in electrical and electronic equipment) Directive, 2011/65/EU. Maximum Concentration Values of lead (Pb), mercury (Hg), hexavalent chromium (Cr+6), polybrominated biphenyls (PBB), and polybrominated diphenyl ethers (PBDE) shall be no more than 1000 ppm and cadmium (Cd) shall be no more than 100 ppm. Allied Telesis ensures RoHS conformance by requiring Declarations of Conformity and Full Materials Disclosure from all suppliers; by monitoring incoming materials and by maintaining strict manufacturing process controls.

REACH Policy

As a manufacturer of Articles that do not release chemical substances into the environment, Allied Telesis is committed to ensuring that there are no SVHCs (Substances of Very High Concern) above allowable threshold (1000 ppm) used in our products. We have procedures and processes in place to ensure continued conformity with REACH regulations.

WEEE Policy

Allied Telesis distributors and channel partners share a common commitment to recycle waste electronic equipment and safely dispose of what cannot be recycled, in accordance with the WEEE directive.

Conflict Minerals Policy

Allied Telesis is committed to social and environmental responsibility and we expect the same commitment from our supply chain. This includes compliance with Section 1502 of the Dodd-Frank Wall Street Reform and Consumer Protection Act, which requires U.S. publicly traded companies to trace the origins of tin, tantalum, tungsten, and gold (3TG) used in their products. The intended purpose of which is to prevent the use of (3TG) mined in the Democratic Republic of Congo (DRC) and adjoining countries in order to eliminate these "conflict minerals" as a source of funding for the ongoing conflict. We have a dedicated team of people working with our suppliers to reasonably assure that the 3TG in our products are "conflict free."



Company Details