

GRAPHIC OPERATION TERMINAL

GOT2000 Series

Connection Manual (Non Mitsubishi Product 2)

For GT Works3 Version1



- HITACHI IES PLC
- HITACHI PLC
- FUJI PLC
- FUJI TEMPERATURE CONTROLLER
- YASKAWA PLC
- YOKOGAWA PLC
- YOKOGAWA TEMPERATURE CONTROLLER
- RKC TEMPERATURE CONTROLLER
- ALLEN-BRADLEY PLC
- GE PLC
- LS INDUSTRIAL SYSTEMS PLC
- SICK SAFETY CONTROLLER
- SIEMENS PLC

● SAFETY PRECAUTIONS ●

(Always read these precautions before using this equipment.)

Before using this product, please read this manual and the relevant manuals introduced in this manual carefully and pay full attention to safety to handle the product correctly.

The precautions given in this manual are concerned with this product.

In this manual, the safety precautions are ranked as "WARNING" and "CAUTION".



WARNING

Indicates that incorrect handling may cause hazardous conditions, resulting in death or severe injury.



CAUTION

Indicates that incorrect handling may cause hazardous conditions, resulting in medium or slight personal injury or physical damage.

Note that the  caution level may lead to a serious accident according to the circumstances. Always follow the instructions of both levels because they are important to personal safety.

Please save this manual to make it accessible when required and always forward it to the end user.

[DESIGN PRECAUTIONS]



WARNING

- Some failures of the GOT, communication unit or cable may keep the outputs on or off.
Some failures of a touch panel may cause malfunction of the input objects such as a touch switch.
An external monitoring circuit should be provided to check for output signals which may lead to a serious accident. Not doing so can cause an accident due to false output or malfunction.
- Do not use the GOT as the warning device that may cause a serious accident.
An independent and redundant hardware or mechanical interlock is required to configure the device that displays and outputs serious warning.
Failure to observe this instruction may result in an accident due to incorrect output or malfunction.
- The GOT backlight failure disables the operation on the touch switch(s).
When the GOT backlight has a failure, the POWER LED blinks (orange/blue) and the display section dims. In such a case, the input by the touch switch(s) is disabled.
- The display section of the GOT is an analog-resistive type touch panel.
[GT27]
The GOT is multi-touch compliant; however, do not touch three points or more simultaneously on the display section. Doing so may cause an accident due to incorrect output or malfunction.
[GT23]
If you touch the display section simultaneously in two points or more, the switch that is located around the center of the touched point, if any, may operate. Do not touch the display section in two points or more simultaneously. Doing so may cause an accident due to incorrect output or malfunction.
- When programs or parameters of the controller (such as a PLC) that is monitored by the GOT are changed, be sure to reset the GOT, or turn on the unit again after shutting off the power as soon as possible. Not doing so can cause an accident due to false output or malfunction.

[DESIGN PRECAUTIONS]

WARNING

- If a communication fault (including cable disconnection) occurs during monitoring on the GOT, communication between the GOT and PLC CPU is suspended and the GOT becomes inoperative. For bus connection (GT27 Only) : The CPU becomes faulty and the GOT becomes inoperative. For other than bus connection : The GOT becomes inoperative. A system where the GOT is used should be configured to perform any significant operation to the system by using the switches of a device other than the GOT on the assumption that a GOT communication fault will occur. Not doing so can cause an accident due to false output or malfunction.

CAUTION

- Do not bundle the control and communication cables with main-circuit, power or other wiring. Run the above cables separately from such wiring and keep them a minimum of 100mm apart. Not doing so noise can cause a malfunction.
- Do not press the GOT display section with a pointed material as a pen or driver. Doing so can result in a damage or failure of the display section.
- When the GOT is connected to the Ethernet network, the available IP address is restricted according to the system configuration.
 - When multiple GOTs are connected to the Ethernet network :
Do not set the IP address (192.168.3.18) for the GOTs and the controllers in the network.
 - When a single GOT is connected to the Ethernet network :
Do not set the IP address (192.168.3.18) for the controllers except the GOT in the network.Doing so can cause the IP address duplication. The duplication can negatively affect the communication of the device with the IP address (192.168.3.18). The operation at the IP address duplication depends on the devices and the system.
- Turn on the controllers and the network devices to be ready for communication before they communicate with the GOT. Failure to do so can cause a communication error on the GOT.
- When the GOT is subject to shock or vibration, or some colors appear on the screen of the GOT, the screen of the GOT might flicker.

[MOUNTING PRECAUTIONS]

WARNING

- Be sure to shut off all phases of the external power supply used by the system before mounting or removing the GOT main unit to/from the panel. Not doing so can cause the unit to fail or malfunction.
- Be sure to shut off all phases of the external power supply used by the system before mounting or removing the option unit onto/from the GOT.(GT27 Only)

[MOUNTING PRECAUTIONS]

CAUTION

- Use the GOT in the environment that satisfies the general specifications described in this manual. Not doing so can cause an electric shock, fire, malfunction or product damage or deterioration.
- When mounting the GOT to the control panel, tighten the mounting screws in the specified torque range (0.36 N·m to 0.48 N·m) with a Phillips-head screwdriver No.2.
Undertightening can cause the GOT to drop, short circuit or malfunction.
Overtightening can cause a drop, short circuit or malfunction due to the damage of the screws or the GOT.
- When loading the communication unit or option unit other than wireless LAN unit to the GOT, fit it to the connection interface of the GOT and tighten the mounting screws in the specified torque range (0.36 N·m to 0.48 N·m) with a Phillips-head screwdriver No.2.
When loading the wireless LAN unit to the GOT, fit it to the side interface of GOT and tighten the mounting screws in the specified torque range (0.10 N·m to 0.14 N·m) with a Phillips-head screwdriver No.2.
Under tightening can cause the GOT to drop, short circuit or malfunction.
Overtightening can cause a drop, failure or malfunction due to the damage of the screws or unit.(GT27 Only)
- When closing the USB environmental protection cover, fix the cover to the GOT by pushing the [PUSH] mark on the latch firmly to comply with the protective structure.(GT27 Only)
- Remove the protective film of the GOT.
When the user continues using the GOT with the protective film, the film may not be removed.In addition, for the models equipped with the human sensor function, using the GOT with the protective film may cause the human sensor not to function properly
- Operate and store the GOT in environments without direct sunlight, high temperature, dust, humidity, and vibrations.
- When using the GOT in the environment of oil or chemicals, use the protective cover for oil.Failure to do so may cause failure or malfunction due to the oil or chemical entering into the GOT.

[WIRING PRECAUTIONS]

WARNING

- Be sure to shut off all phases of the external power supply used by the system before wiring. Failure to do so may result in an electric shock, product damage or malfunctions.

CAUTION

- Make sure to ground the FG terminal and LG terminal of the GOT power supply section to the protective ground conductors dedicated to the GOT with a ground resistance of 100 Ω or less.
- When tightening the terminal screws, use a Phillips-head screwdriver No.2.
- Terminal screws which are not to be used must be tightened always at torque 0.5 N·m to 0.8 N·m. Otherwise there will be a danger of short circuit against the solderless terminals.

[WIRING PRECAUTIONS]

CAUTION

- Use applicable solderless terminals and tighten them with the specified torque.
If any solderless spade terminal is used, it may be disconnected when the terminal screw comes loose, resulting in failure.
- Correctly wire the GOT power supply section after confirming the rated voltage and terminal arrangement of the product.
Not doing so can cause a fire or failure.
- Tighten the terminal screws of the GOT power supply section in the specified torque range (0.5 N·m to 0.8 N·m).
Undertightening can cause a short circuit or malfunction.
Overtightening can cause a short circuit or malfunction due to the damage of the screws or the GOT.
- Exercise care to avoid foreign matter such as chips and wire offcuts entering the GOT.
Not doing so can cause a fire, failure or malfunction.
- The module has an ingress prevention label on its top to prevent foreign matter, such as wire offcuts, from entering the module during wiring.
Do not peel this label during wiring. Before starting system operation, be sure to peel this label because of heat dissipation. (GT27 Only)
- Plug the communication cable into the GOT interface or the connector of the connected unit, and tighten the mounting screws and the terminal screws in the specified torque range.
Undertightening can cause a short circuit or malfunction.
Overtightening can cause a short circuit or malfunction due to the damage of the screws or unit.
- Plug the QnA/ACPU/Motion controller(A series) bus connection cable by inserting it into the connector of the connected unit until it "clicks".
After plugging, check that it has been inserted snugly.
Not doing so can cause a malfunction due to a contact fault.(GT27 Only)

[TEST OPERATION PRECAUTIONS]

WARNING

- Before performing the test operations of the user creation monitor screen (such as turning ON or OFF bit device, changing the word device current value, changing the settings or current values of the timer or counter, and changing the buffer memory current value), read through the manual carefully and make yourself familiar with the operation method.
During test operation, never change the data of the devices which are used to perform significant operation for the system.
False output or malfunction can cause an accident.

[STARTUP/MAINTENANCE PRECAUTIONS]

WARNING

- When power is on, do not touch the terminals.
Doing so can cause an electric shock or malfunction.
- Correctly connect the battery connector.
Do not charge, disassemble, heat, short-circuit, solder, or throw the battery into the fire.
Doing so will cause the battery to produce heat, explode, or ignite, resulting in injury and fire.
- Before starting cleaning or terminal screw retightening, always switch off the power externally in all phases.
Not switching the power off in all phases can cause a unit failure or malfunction.
Undertightening can cause a short circuit or malfunction.
Overtightening can cause a short circuit or malfunction due to the damage of the screws or unit.

CAUTION

- Do not disassemble or modify the unit.
Doing so can cause a failure, malfunction, injury or fire.
- Do not touch the conductive and electronic parts of the unit directly.
Doing so can cause a unit malfunction or failure.
- The cables connected to the unit must be run in ducts or clamped.
Not doing so can cause the unit or cable to be damaged due to the dangling, motion or accidental pulling of the cables or can cause a malfunction due to a cable connection fault.
- When unplugging the cable connected to the unit, do not hold and pull from the cable portion.
Doing so can cause the unit or cable to be damaged or can cause a malfunction due to a cable connection fault.
- Do not drop the module or subject it to strong shock. A module damage may result.
- Do not drop or give an impact to the battery mounted to the unit.
Doing so may damage the battery, causing the battery fluid to leak inside the battery. If the battery is dropped or given an impact, dispose of it without using.
- Before touching the unit, always touch grounded metals, etc. to discharge static electricity from human body, etc.
Not doing so can cause the unit to fail or malfunction.
- Use the battery manufactured by Mitsubishi Electric Corporation.
Use of other batteries may cause a risk of fire or explosion.
- Dispose of used battery promptly.
Keep away from children. Do not disassemble and do not dispose of in fire.
- Be sure to shut off all phases of the external power supply before replacing the battery or using the dip switch of the terminating resistor.
Not doing so can cause the unit to fail or malfunction by static electricity.

[TOUCH PANEL PRECAUTIONS]

CAUTION

- For the analog-resistive film type touch panels, normally the adjustment is not required. However, the difference between a touched position and the object position may occur as the period of use elapses.
When any difference between a touched position and the object position occurs, execute the touch panel calibration.
- When any difference between a touched position and the object position occurs, other object may be activated.
This may cause an unexpected operation due to incorrect output or malfunction.

[PRECAUTIONS WHEN THE DATA STORAGE IS IN USE]

WARNING

- If the SD card mounted on drive A of the GOT is removed while the GOT is accessed, processing for the GOT might be interrupted about for 20 seconds.
The GOT cannot be operated during this period.
The functions that run in the background including a screen updating, alarm, logging, scripts, and others are also interrupted.
Since this interruption makes an impact to the system operation, it might cause failure. After checking the light off of SD card access LED, remove the SD card.

CAUTION

- If the data storage mounted on the GOT is removed while the GOT is accessed, the data storage and files are damaged.
To remove the data storage from the GOT, check that the access to the data storage in SD card access LED, the system signal, and others is not performed.
- When inserting a SD card into the GOT, make sure to close the SD card cover.
Failure to do so causes the data not to be read or written.
- When removing the SD card from the GOT, make sure to support the SD card by hand as it may pop out.
Failure to do so may cause the SD card to drop from the GOT, resulting in a failure or break.
- When inserting a USB device into a USB interface of the GOT, make sure to insert the device into the interface firmly.
Failure to do so may cause the USB device to drop from the GOT, resulting in a failure or break.
- Before removing the USB device from the GOT, follow the procedure for removal on the utility screen of the GOT.
After the successful completion dialog is displayed, remove the USB device by hand carefully.
Failure to do so may cause the USB device to drop from the GOT, resulting in a failure or break.

[DISPOSAL PRECAUTIONS]

CAUTION

- When disposing of this product, treat it as industrial waste.
When disposing of batteries, separate them from other wastes according to the local regulations.
(Refer to the GOT2000 Series User's Manual (Hardware) for details of the battery directive in the EU member states.)

[TRANSPORTATION PRECAUTIONS]

CAUTION

- When transporting lithium batteries, make sure to treat them based on the transport regulations.
(Refer to the GOT2000 Series User's Manual (Hardware) for details of the regulated models.)
- Make sure to transport the GOT main unit and/or relevant unit(s) in the manner they will not be exposed to the impact exceeding the impact resistance described in the general specifications of this manual, as they are precision devices.
Failure to do so may cause the unit to fail.
Check if the unit operates correctly after transportation.
- When fumigants that contain halogen materials such as fluorine, chlorine, bromine, and iodine are used for disinfecting and protecting wooden packaging from insects, they cause malfunction when entering our products.
Please take necessary precautions to ensure that remaining materials from fumigant do not enter our products, or treat packaging with methods other than fumigation (heat method).
Additionally, disinfect and protect wood from insects before packing products.

INTRODUCTION

Thank you for choosing Mitsubishi Graphic Operation Terminal (Mitsubishi GOT).
Read this manual and make sure you understand the functions and performance of the GOT thoroughly in advance to ensure correct use.

CONTENTS

SAFETY PRECAUTIONS	A - 1
INTRODUCTION	A - 8
CONTENTS	A - 8
List of Manuals for GT Works3	A - 15
Abbreviations and Generic Terms	A - 16

1. PREPARATORY PROCEDURES FOR MONITORING

1.1 Setting the Communication Interface.....	1 - 3
1.1.1 Setting connected equipment (Channel setting).....	1 - 3
1.1.2 I/F communication setting.....	1 - 9
1.1.3 Precautions.....	1 - 11
1.2 Writing the Project Data and OS onto the GOT	1 - 12
1.2.1 Writing the project data and OS onto the GOT	1 - 12
1.2.2 Checking the project data and OS writing on GOT.....	1 - 13
1.3 Option Devices for the Respective Connection	1 - 14
1.3.1 Communication module	1 - 14
1.3.2 Option unit	1 - 15
1.3.3 Conversion cable	1 - 15
1.3.4 Serial multi-drop connection unit	1 - 15
1.3.5 Installing a unit on another unit (Checking the unit installation position)	1 - 16
1.4 Connection Cables for the Respective Connection	1 - 19
1.4.1 GOT connector specifications.....	1 - 19
1.4.2 Coaxial cableconnector connection method	1 - 20
1.4.3 Terminating resistors of GOT	1 - 21
1.5 Verifying GOT Recognizes Connected Equipment.....	1 - 22
1.6 Checking for Normal Monitoring	1 - 24
1.6.1 Check on the GOT	1 - 24
1.6.2 Confirming the communication state on the GOT side (For Ethernet connection)	1 - 26
1.6.3 Confirming the communication state to each station (Station monitoring function)	1 - 28

CONNECTIONS TO NON-MITSUBISHI PRODUCTS

2. CONNECTION TO HITACHI IES PLC

2.1 Connectable Model List	2 - 2
2.2 System Configuration	2 - 3
2.2.1 Connection to large-sized H series.....	2 - 3
2.2.2 Connecting to H-200 to 252 series, H series board type or EH-150 series	2 - 5
2.3 Connection Diagram	2 - 7
2.3.1 RS-232 cable	2 - 7

2.3.2	RS-422 cable	2 - 7
2.4	GOT Side Settings	2 - 9
2.4.1	Setting communication interface (Communication settings)	2 - 9
2.4.2	Communication detail settings	2 - 9
2.5	PLC Side Setting	2 - 11
2.6	Device Range that Can Be Set	2 - 12
2.6.1	HITACHI HIDIC H Series	2 - 14

3. CONNECTION TO HITACHI PLC

3.1	Connectable Model List	3 - 2
3.2	System Configuration	3 - 3
3.2.1	Connecting to S10V	3 - 3
3.2.2	Connecting to S10mini	3 - 4
3.3	Connection Diagram	3 - 5
3.3.1	RS-232 cable	3 - 5
3.3.2	RS-422 cable	3 - 5
3.4	GOT Side Settings	3 - 6
3.4.1	Setting communication interface (Communication settings)	3 - 6
3.4.2	Communication detail settings	3 - 6
3.5	PLC Side Setting	3 - 7
3.5.1	Connecting to communication module	3 - 7
3.6	Device Range that Can Be Set	3 - 8
3.6.1	HITACHI S10mini/S10V	3 - 8

4. CONNECTION TO FUJI PLC

4.1	Connectable Model List	4 - 2
4.2	System Configuration	4 - 3
4.2.1	Connecting to MICREX-F55	4 - 3
4.2.2	Connecting to MICREX-F70	4 - 5
4.2.3	Connecting to MICREX-F120S/140S/15[S]	4 - 8
4.3	Connection Diagram	4 - 11
4.3.1	RS-232 cable	4 - 11
4.3.2	RS-485 cable	4 - 12
4.4	GOT Side Settings	4 - 13
4.4.1	Setting communication interface (Communication settings)	4 - 13
4.4.2	Communication detail settings	4 - 13
4.5	PLC Side Setting	4 - 14
4.5.1	Connecting to NV1L-RS2, NC1L-RS2	4 - 14
4.5.2	Connecting to NC1L-RS4	4 - 15
4.5.3	Connecting to FFU120B	4 - 16
4.5.4	Connecting to FFK120A-C10	4 - 17
4.5.5	Station number setting	4 - 18
4.6	Device Range that Can Be Set	4 - 19
4.6.1	FUJI MICREX-F Series	4 - 19
4.7	Precautions	4 - 21

5. CONNECTION TO FUJI TEMPERATURE CONTROLLER

5.1	Connectable Model List	5 - 2
5.2	System Configuration	5 - 3
5.2.1	Connecting to PXR3, PXR4, PXR5 or PXR9	5 - 3
5.2.2	Connecting to PXG4, PXG5, PXG9 or PXH9	5 - 4
5.3	Connection Diagram	5 - 7
5.3.1	RS-232 cable	5 - 7
5.3.2	RS-485 cable	5 - 8
5.4	GOT Side Settings	5 - 12
5.4.1	Setting communication interface (Communication settings)	5 - 12
5.4.2	Communication detail settings	5 - 12
5.5	Temperature Controller Side Setting	5 - 14
5.5.1	Connecting to PXR3/4/5/9	5 - 14
5.5.2	Connecting to PXG4, PXG5 or PXG9	5 - 14
5.5.3	Connecting to PXH9	5 - 15
5.5.4	Connecting to interface converter (RC-77)	5 - 15
5.5.5	Connecting to interface converter (SI-30A)	5 - 16
5.5.6	Connecting to interface converter (KS-485)	5 - 17
5.5.7	Connecting to interface converter (K3SC-10)	5 - 17
5.5.8	Station number setting	5 - 18
5.6	Device Range that Can Be Set	5 - 19
5.6.1	FUJI PXR/PXG/PXH	5 - 20
5.7	Precautions	5 - 20

6. CONNECTION TO YASKAWA PLC

6.1	Connectable Model List	6 - 2
6.2	Serial Connection	6 - 3
6.2.1	System configuration for connecting to GL120 or GL130	6 - 3
6.2.2	System configuration for connecting to GL60S, GL60H or GL70H	6 - 4
6.2.3	System configuration for connecting to MP-920/930, CP-9300MS/9200(H) or PROGIC-8 ..	6 - 5
6.2.4	System configuration for connecting to MP-940	6 - 7
6.2.5	System configuration for connecting to CP-9200SH, CP-317	6 - 8
6.2.6	System configuration for connecting to MP2200, MP2300 or MP2300S	6 - 9
6.2.7	Connection Diagram	6 - 10
6.2.8	GOT Side Settings	6 - 13
6.2.9	PLC Side Settings	6 - 14
6.3	Ethernet Connection	6 - 17
6.3.1	System configuration for connecting to MP-920 or MP2200 or MP2300 or MP2300S or CP-9200SH or CP-312 or CP-317	6 - 17
6.3.2	GOT Side Settings	6 - 18
6.3.3	GOT Ethernet setting	6 - 19
6.3.4	PLC side setting (MP2000 series, MP920 series)	6 - 20
6.3.5	PLC side setting (CP-9200SH series, CP-312, CP-317 series)	6 - 24
6.3.6	Precautions	6 - 27
6.4	Device Range that Can Be Set	6 - 28
6.4.1	YASKAWA GL/PROGIC8	6 - 28
6.4.2	YASKAWA CP9200SH/MP900	6 - 29
6.4.3	YASKAWA CP9200 (H)	6 - 29

6.4.4	YASKAWA CP9300MS (MC compatible).....	6 - 29
6.4.5	YASKAWA MP2000/MP900/CP9200SH Series.....	6 - 30

7. CONNECTION TO YOKOGAWA PLC

7.1	Connectable Model List.....	7 - 2
7.2	Serial Connection.....	7 - 3
7.2.1	System configuration for connecting to FA-M3/M3V.....	7 - 3
7.2.2	System configuration for connecting to FA500.....	7 - 5
7.2.3	System configuration for connecting to STARDOM.....	7 - 5
7.2.4	Connection diagram.....	7 - 6
7.2.5	GOT side settings.....	7 - 8
7.2.6	PLC side setting.....	7 - 9
7.2.7	Connecting to CPU port/D-sub 9-pin conversion cable, SIO port adapter cable.....	7 - 10
7.2.8	Connecting PC link module (F3LC01-1N, F3LC11-1N, F3LC11-2N).....	7 - 10
7.2.9	Connecting PC link module (F3LC11-1F, F3LC12-1F).....	7 - 11
7.2.10	Connecting PC link module (LC01-0N, LC02-0N).....	7 - 12
7.2.11	Connecting to STARDOM.....	7 - 13
7.2.12	Precautions.....	7 - 15
7.3	Ethernet Connection.....	7 - 16
7.3.1	System configuration for connecting to FA-M3/M3V.....	7 - 16
7.3.2	GOT Side Settings.....	7 - 17
7.3.3	PLC side setting.....	7 - 19
7.3.4	Connecting to Ethernet Interface Module (F3LE01-5T, F3LE11-0T).....	7 - 19
7.3.5	Connecting to Ethernet Interface Module (F3LE12-0T).....	7 - 20
7.3.6	Connecting to F3SP66, F3SP67, F3SP71-4N (built-in Ethernet interface).....	7 - 21
7.3.7	Precautions.....	7 - 21
7.4	Device Range that Can Be Set.....	7 - 22
7.4.1	YOKOGAWA FA500/FA-M3 Series.....	7 - 23
7.4.2	YOKOGAWA STARDOM/FA-M3 Series.....	7 - 23

8. CONNECTION TO YOKOGAWA TEMPERATURE CONTROLLER

8.1	Connectable Model List.....	8 - 2
8.2	System Configuration.....	8 - 3
8.2.1	Connecting to GREEN Series.....	8 - 3
8.2.2	Connecting to UT100 Series.....	8 - 5
8.2.3	Connecting to UT2000 Series.....	8 - 6
8.2.4	Connecting to UTAdvanced Series.....	8 - 8
8.3	Connection Diagram.....	8 - 12
8.3.1	RS-232 cable.....	8 - 12
8.3.2	RS-485 cable.....	8 - 13
8.4	GOT Side Settings.....	8 - 27
8.4.1	Setting communication interface (Communication settings).....	8 - 27
8.4.2	Communication detail settings.....	8 - 27
8.5	Temperature Controller Side Setting.....	8 - 29
8.5.1	Connecting to GREEN Series.....	8 - 29
8.5.2	Connecting to UT100 Series.....	8 - 30
8.5.3	Connecting to UT2000 Series.....	8 - 30
8.5.4	Connecting to UTAdvanced Series.....	8 - 30
8.5.5	Connecting to RS232C/RS485 converter (ML2-[]).....	8 - 31

8.5.6	Station number setting.....	8 - 32
8.6	Device Range that Can Be Set.....	8 - 33
8.6.1	YOKOGAWA GREEN/UT100/UT2000/UTAdvanced	8 - 33
8.7	Precautions	8 - 34

9. CONNECTION TO RKC TEMPERATURE CONTROLLER

9.1	Connectable Model List	9 - 2
9.2	System Configuration	9 - 4
9.2.1	Connecting to H-PCP-J	9 - 4
9.2.2	Connecting to H-PCP-A or H-PCP-B.....	9 - 7
9.2.3	Connecting to SRZ	9 - 9
9.2.4	Connecting to CB Series (CB100, CB400, CB500, CB700, CB900).....	9 - 12
9.2.5	Connecting to FB series (FB100, FB400 or FB900).....	9 - 14
9.2.6	Connecting to RB Series (RB100, RB400, RB500, RB700, RB900).....	9 - 18
9.2.7	Connection to PF900/901, HA400/401, HA900/901, RMC500, MA900/901, AG500, SA100/200	9 - 20
9.2.8	Connection to THV-A1.....	9 - 23
9.2.9	Connection to SRX	9 - 26
9.2.10	Connecting to SB1.....	9 - 27
9.2.11	Connecting to B400	9 - 29
9.3	Connection Diagram	9 - 30
9.3.1	RS-232 cable	9 - 30
9.3.2	RS-422 cable	9 - 31
9.3.3	RS-485 cable	9 - 33
9.4	GOT Side Settings.....	9 - 39
9.4.1	Setting communication interface (Communication settings).....	9 - 39
9.4.2	Communication detail settings.....	9 - 39
9.5	Temperature Controller Side Setting	9 - 41
9.5.1	Connecting to H-PCP-J	9 - 41
9.5.2	Connecting to H-PCP-A, H-PCP-B	9 - 42
9.5.3	Connecting to Z-TIO, Z-DIO, Z-CT	9 - 43
9.5.4	Connecting to Z-COM.....	9 - 44
9.5.5	Connecting to CB Series	9 - 45
9.5.6	Connecting to FB Series.....	9 - 45
9.5.7	Connecting to RB Series	9 - 46
9.5.8	Connecting to PF900/900.....	9 - 46
9.5.9	Connecting to HA400/401, HA900/901.....	9 - 46
9.5.10	Connecting to AG500	9 - 47
9.5.11	Connecting to RMC500	9 - 47
9.5.12	Connecting to MA900, MA901	9 - 47
9.5.13	Connecting to THV-A1.....	9 - 47
9.5.14	Connecting to SA100/SA200	9 - 48
9.5.15	Connecting to X-TIO Module	9 - 48
9.5.16	Connecting to SB1.....	9 - 49
9.5.17	Connecting to B400	9 - 49
9.5.18	Station number setting.....	9 - 50
9.6	Device Range that Can Be Set.....	9 - 52
9.6.1	RKC SR Mini HG	9 - 53
9.7	Precautions	9 - 53

10. CONNECTION TO ALLEN-BRADLEY PLC

10.1	Connectable Model List	10 - 2
10.2	Serial Connection	10 - 4
10.2.1	System Configuration for connecting to SLC500 Series	10 - 4
10.2.2	System configuration for connecting to MicroLogix1000/1200/1500 Series	10 - 5
10.2.3	System Configuration for connecting to Control/Compact/FlexLogix Series	10 - 6
10.2.4	Connection Diagram	10 - 7
10.2.5	GOT Side Settings	10 - 8
10.2.6	PLC Side Setting	10 - 10
10.3	Ethernet Connection	10 - 11
10.3.1	System configuration for connecting to ControlLogix or CompactLogix	10 - 11
10.3.2	GOT Side Settings	10 - 12
10.3.3	PLC side setting	10 - 14
10.3.4	Precautions	10 - 14
10.4	Device Range that Can Be Set	10 - 15
10.4.1	AB SLC500	10 - 16
10.4.2	AB MicroLogix1000/1200/1500 Series	10 - 17
10.4.3	AB MicroLogix1000/1200/1500 Series (Device extended)	10 - 17
10.4.4	AB Control/CompactLogix	10 - 17

11. CONNECTION TO GE PLC

11.1	Connectable Model List	11 - 2
11.2	System Configuration	11 - 3
11.2.1	Connecting to Series90-30	11 - 3
11.2.2	Connecting to Series90-70	11 - 6
11.2.3	Connecting to VersaMax Micro	11 - 7
11.3	Connection Diagram	11 - 9
11.3.1	RS-232 cable	11 - 9
11.3.2	RS-422 cable	11 - 10
11.4	GOT Side Settings	11 - 12
11.4.1	Setting communication interface (Communication settings)	11 - 12
11.4.2	Communication detail settings	11 - 12
11.5	PLC Side Setting	11 - 13
11.5.1	Connecting to Series 90-30	11 - 13
11.5.2	Connecting to VersaMaxMicro	11 - 13
11.5.3	Connecting to IC693CMM311	11 - 14
11.5.4	Connecting to IC697CMM711	11 - 14
11.5.5	Station number setting	11 - 14
11.6	Device Range that Can Be Set	11 - 15
11.6.1	GE Series 90	11 - 15
11.7	Precautions	11 - 15

12. CONNECTION TO LS INDUSTRIAL SYSTEMS PLC

12.1	Connectable Model List	12 - 2
12.2	System Configuration	12 - 3
12.2.1	Connecting to K80S or K120S	12 - 3
12.2.2	Connecting to K200S	12 - 5
12.2.3	Connecting to K300S	12 - 6

12.3	Connection Diagram	12 - 7
12.3.1	RS-232 cable	12 - 7
12.3.2	RS-422 cable	12 - 7
12.4	GOT Side Settings	12 - 9
12.4.1	Setting communication interface (Communication settings).....	12 - 9
12.4.2	Communication detail settings.....	12 - 9
12.5	PLC Side Setting	12 - 10
12.5.1	Connecting to PLC CPU.....	12 - 10
12.5.2	Connecting to Cnet I/F module	12 - 10
12.6	Device Range that Can Be Set.....	12 - 11
12.6.1	LS Industrial Systems MASTER-K	12 - 11

13. CONNECTION TO SICK SAFETY CONTROLLER

13.1	Connectable Model List	13 - 2
13.2	System Configuration	13 - 2
13.2.1	Connecting to Flexi Soft.....	13 - 2
13.3	GOT Side Settings	13 - 3
13.3.1	Setting communication interface (Communication settings).....	13 - 3
13.3.2	Communication detail settings.....	13 - 3
13.4	PLC Side Setting	13 - 4
13.4.1	Connecting to Flexi Soft.....	13 - 4
13.5	Device Range That Can Be Set.....	13 - 5
13.5.1	SICK Safety Controller (SICK Flexi Soft).....	13 - 6

14. CONNECTION TO SIEMENS PLC

14.1	Connectable Model List	14 - 2
14.2	Serial Connection	14 - 3
14.2.1	System configuration for connecting to SIMATIC S7-300/400 series.....	14 - 3
14.2.2	System configuration for connecting to SIMATIC S7-200	14 - 4
14.2.3	Connection Diagram	14 - 5
14.2.4	GOT Side Settings.....	14 - 6
14.2.5	PLC Side Setting	14 - 7
14.2.6	Connecting to HMI Adapter	14 - 7
14.2.7	Connecting to SIMATIC S7-200	14 - 8
14.2.8	Precautions.....	14 - 8
14.3	Ethernet Connection	14 - 9
14.3.1	System configuration for connecting to SIMATIC S7-300/400 series (Ethernet connection type: FETCH/WRITE).....	14 - 9
14.3.2	System configuration for connecting to SIMATIC S7-200/300/400/1200 series (Ethernet connection type: OP communication)	14 - 10
14.3.3	GOT Side Settings.....	14 - 11
14.3.4	PLC side setting.....	14 - 13
14.3.5	Precautions.....	14 - 14
14.4	Device Range that Can Be Set.....	14 - 15
14.4.1	SIEMENS S7-300/400 Series.....	14 - 17
14.4.2	SIEMENS S7-200 Series.....	14 - 17
14.4.3	SIEMENS S7 (Ethernet)	14 - 17
14.4.4	SIEMENS OP (Ethernet)	14 - 17

REVISIONS

WARRANTY

List of Manuals for GT Works3

For the manuals related to this product, install the manuals with the drawing software.
If you need a printed manual, consult your local Mitsubishi representative or branch office.

■ 1. List of Manuals for GT Designer3(GOT2000)

(1) Screen drawing software manuals

Manual name	Manual number (Model code)
GT Works3 Version1 Installation Procedure Manual	-
GT Designer3 (GOT2000) Help	-
GT Converter2 Version3 Operating Manual for GT Works3	SH-080862ENG (1D7MB2)
GOT2000 Series MES Interface Function Manual for GT Works3 Version1	SH-081228ENG

(2) Connection manuals

Manual name	Manual number (Model code)
GOT2000 Series Connection Manual (Mitsubishi Products) for GT Works3 Version1	SH-081197ENG (1D7MJ8)
GOT2000 Series Connection Manual (Non-Mitsubishi Products 1) for GT Works3 Version1	SH-081198ENG
GOT2000 Series Connection Manual (Non-Mitsubishi Products 2) for GT Works3 Version1	SH-081199ENG
GOT2000 Series Connection Manual (Microcomputer, MODBUS Products, Peripherals) for GT Works3 Version1	SH-081200ENG

(3) GT SoftGOT2000 manuals

Manual name	Manual number (Model code)
GT SoftGOT2000 Version1 Operating Manual	SH-081201ENG

(4) GOT2000 manuals

Manual name	Manual number (Model code)
GOT2000 Series User's Manual (Hardware)	SH-081194ENG (1D7MJ5)
GOT2000 Series User's Manual (Utility)	SH-081195ENG (1D7MJ6)
GOT2000 Series User's Manual (Monitor)	SH-081196ENG (1D7MJ7)

■ 2. List of Manuals for GT Designer3(GOT1000)

Refer to the Help and manuals for GT Designer3(GOT1000)

Abbreviations and Generic Terms

The following shows the abbreviations and generic terms used in Help.

1. GOT

Abbreviations and generic terms		Description	
GOT2000 Series	GT27	GT2712-S	GT2712-STBA, GT2712-STWA, GT2712-STBD, GT2712-STWD
		GT2710-S	GT2710-STBA, GT2710-STBD
		GT2710-V	GT2710-VTBA, GT2710-VTWA, GT2710-VTBD, GT2710-VTWD
		GT2708-S	GT2708-STBA, GT2708-STBD
		GT2708-V	GT2708-VTBA, GT2708-VTBD
	GT23	GT2310-V	GT2310-VTBA, GT2310-VTBD
		GT2308-V	GT2308-VTBA, GT2308-VTBD
GT SoftGOT2000		GT SoftGOT2000 Version1	
GOT1000 Series		GOT1000 Series	
GOT900 Series		GOT-A900 Series, GOT-F900 Series	
GOT800 Series		GOT-800 Series	

2. Communication unit

Abbreviations and generic terms		Description	
Bus connection unit		GT15-QBUS, GT15-QBUS2, GT15-ABUS, GT15-ABUS2, GT15-75QBUSL, GT15-75QBUS2L, GT15-75ABUSL, GT15-75ABUS2L	
Serial communication unit		GT15-RS2-9P, GT15-RS4-9S, GT15-RS4-TE	
MELSECNET/H communication unit		GT15-J71LP23-25, GT15-J71BR13	
CC-Link IE Controller Network communication unit		GT15-J71GP23-SX	
CC-Link IE Field Network communication unit		GT15-J71GF13-T2	
CC-Link communication unit		GT15-J61BT13	
Wireless LAN communication unit		GT25-WLAN	
Serial multi-drop connection unit		GT01-RS4-M	
Connection conversion adapter		GT10-9PT5S	

3. Option unit

Abbreviations and generic terms		Description	
Printer unit		GT15-PRN	
Video/RGB unit	Video input unit	GT27-V4-Z (A set of GT16M-V4 and GT27-IF1000)	
	RGB input unit	GT27-R2-Z (A set of GT16M-R2 and GT27-IF1000)	
	Video/RGB input unit	GT27-V4R1-Z (A set of GT16M-V4R1 and GT27-IF1000)	
	RGB output unit	GT27-ROUT-Z (A set of GT16M-ROUT and GT27-IF1000)	
Multimedia unit		GT27-MMR-Z (A set of GT16M-MMR and GT27-IF1000)	
Video signal conversion unit		GT27-IF1000	
External I/O unit		GT15-DIO, GT15-DIOR	
Sound output unit		GT15-SOUT	

■ 4. Option

Abbreviations and generic terms		Description
SD card		L1MEM-2GBSD, L1MEM-4GBSD
Battery		GT11-50BAT, GT11-BAT
Protective sheet	For GT27	GT25-12PSGC, GT25-10PSGC, GT25-08PSGC, GT25-12PSCC, GT25-10PSCC, GT25-08PSCC, GT25-12PSCC-UC, GT25-10PSCC-UC, GT25-08PSCC-UC
	For GT23	GT25-10PSCC-UC, GT25-08PSCC-UC
Protective cover for oil		GT20-10PCO, GT20-08PCO
USB environmental protection cover		GT25-UCOV
Stand		GT15-90STAND, GT15-80STAND, GT15-70STAND, GT15-60STAND
Attachment		GT15-70ATT-98, GT15-70ATT-87, GT15-60ATT-97, GT15-60ATT-96, GT15-60ATT-87, GT15-60ATT-77

■ 5. Software

(1) Software related to GOT

Abbreviations and generic terms		Description
GT Works3		SW1DNC-GTW3-J, SW1DND-GTW3-J, SW1DNC-GTW3-E, SW1DND-GTW3-E, SW1DND-GTW3-C
GT Designer3 Version1		Screen drawing software GT Designer3 for GOT2000/GOT1000 series
GT Designer3		Screen drawing software for GOT2000 series included in GT Works3
GT Designer3 (GOT2000)		
GT Designer3 (GOT1000)		
GT Simulator3		Screen simulator GT Simulator3 for GOT2000/GOT1000/GOT900 series
GT SoftGOT2000		Monitoring software GT SoftGOT2000 series
GT Converter2		Data conversion software GT Converter2 for GOT1000/GOT900 series
GT Designer2 Classic		Screen drawing software GT Designer2 Classic for GOT900 series
GT Designer2		Screen drawing software GT Designer2 for GOT1000/GOT900 series
DU/WIN		Screen drawing software FX-PCS-DU/WIN for GOT-F900 series

(2) Software related to iQ Works

Abbreviations and generic terms		Description
iQ Works		Abbreviation of iQ Platform compatible engineering environment MELSOFT iQ Works
MELSOFT Navigator		Generic term for integrated development environment software included in the SW DNC-IQWK (iQ Platform compatible engineering environment MELSOFT iQ Works) (□ indicates a version.)

(3) Other software

Abbreviations and generic terms	Description
GX Works2	SW□DNC-GXW2-J (-JA, -JAZ) type programmable controller engineering software (□ indicates a version.)
GX Simulator2	GX Works2 with the simulation function
GX Simulator	SW□D5C-LLT-J (-JV) type ladder logic test tool function software package (SW5D5C-LLT (-V) or later versions) (□ indicates a version.)
GX Developer	SW□D5C-GPPW-J (-JV)/SW□D5F-GPPW (-V) type software package (□ indicates a version.)
GX LogViewer	SW□DNN-VIEWER-J type software package (□ indicates a version.)
PX Developer	SW□D5C-FBDQ-J type FBD software package for process control (□ indicates a version.)
MT Works2	Motion controller engineering environment MELSOFT MT Works2(SW□DNC-MTW2-J) (□ indicates a version.)
MT Developer	SW□RNC-GSV type integrated start-up support software for motion controller Q series (□ indicates a version.)
MR Configurator2	SW□DNC-MRC2-J type servo configuration software (□ indicates a version.)
MR Configurator	MRZJW□-SETUP type servo configuration software (□ indicates a version.)
FR Configurator	Inverter setup software (FR-SW□-SETUP-WJ) (□ indicates a version.)
NC Configurator	CNC parameter setting support tool NC Configurator
FX Configurator-FP	Parameter setting, monitoring, and testing software packages for FX3U-20SSC-H (SW□D5CFXSSCJ) (□ indicates a version.)
FX3U-ENET-L Configuration tool	FX3U-ENET-L type Ethernet module setting software (SW1D5-FXENETL-J)
RT ToolBox2	Robot program creation software (3D-11C-WINJ)
MX Component	MX Component Version□(SW□D5C-ACT-J, SW□D5C-ACT-JA) (□ indicates a version.)
MX Sheet	MX Sheet Version□(SW□D5C-SHEET-J, SW□D5C-SHEET-JA) (□ indicates a version.)
QnUDVCPULCPU Logging Configuration Tool	QnUDVCPULCPU logging configuration tool (SW1DNN-LLUTL-J)

■ 6. License key (for GT SoftGOT2000)

Abbreviations and generic terms	Description
License key	GT27-SGTKEY-U

■ 7. Others

Abbreviations and generic terms	Description
IAI	IAI Corporation
AZBIL	Azbil Corporation
OMRON	OMRON Corporation
KEYENCE	KEYENCE CORPORATION
KOYO EI	KOYO ELECTRONICS INDUSTRIES CO., LTD.
JTEKT	JTEKT Corporation
SHARP	Sharp Manufacturing Systems Corporation
SHINKO	Shinko Technos Co., Ltd.
CHINO	CHINO CORPORATION
TOSHIBA	TOSHIBA CORPORATION
TOSHIBA MACHINE	TOSHIBA MACHINE CO., LTD.
PANASONIC	Panasonic Corporation
PANASONIC IDS	Panasonic Industrial Devices SUNX Co., Ltd.
HITACHI IES	Hitachi Industrial Equipment Systems Co., Ltd.
HITACHI	Hitachi, Ltd.
FUJI ELECTRIC	FUJI ELECTRIC CO., LTD.
YASKAWA	YASKAWA Electric Corporation
YOKOGAWA	Yokogawa Electric Corporation
RKC	RKC INSTRUMENT INC.
ALLEN-BRADLEY	Allen-Bradley products manufactured by Rockwell Automation, Inc.
GE IP	GE Intelligent Platforms KK
LS IS	LS Industrial Systems Co., Ltd.
SCHNEIDER	Schneider Electric SA
SICK	SICK AG
SIEMENS	Siemens AG
PLC	Programmable controller manufactured by each corporation
Control equipment	Control equipment manufactured by each corporation
Temperature controller	Temperature controller manufactured by each corporation
Indicating controller	Indicating controller manufactured by each corporation
Controller	Controller manufactured by each corporation

1

PREPARATORY PROCEDURES FOR MONITORING

1.1	Setting the Communication Interface	1 - 3
1.2	Writing the Project Data and OS onto the GOT	1 - 12
1.3	Option Devices for the Respective Connection	1 - 14
1.4	Connection Cables for the Respective Connection	1 - 19
1.5	Verifying GOT Recognizes Connected Equipment	1 - 22
1.6	Checking for Normal Monitoring.	1 - 24

1. PREPARATORY PROCEDURES FOR MONITORING

The following shows the procedures to be taken before monitoring and corresponding reference sections.

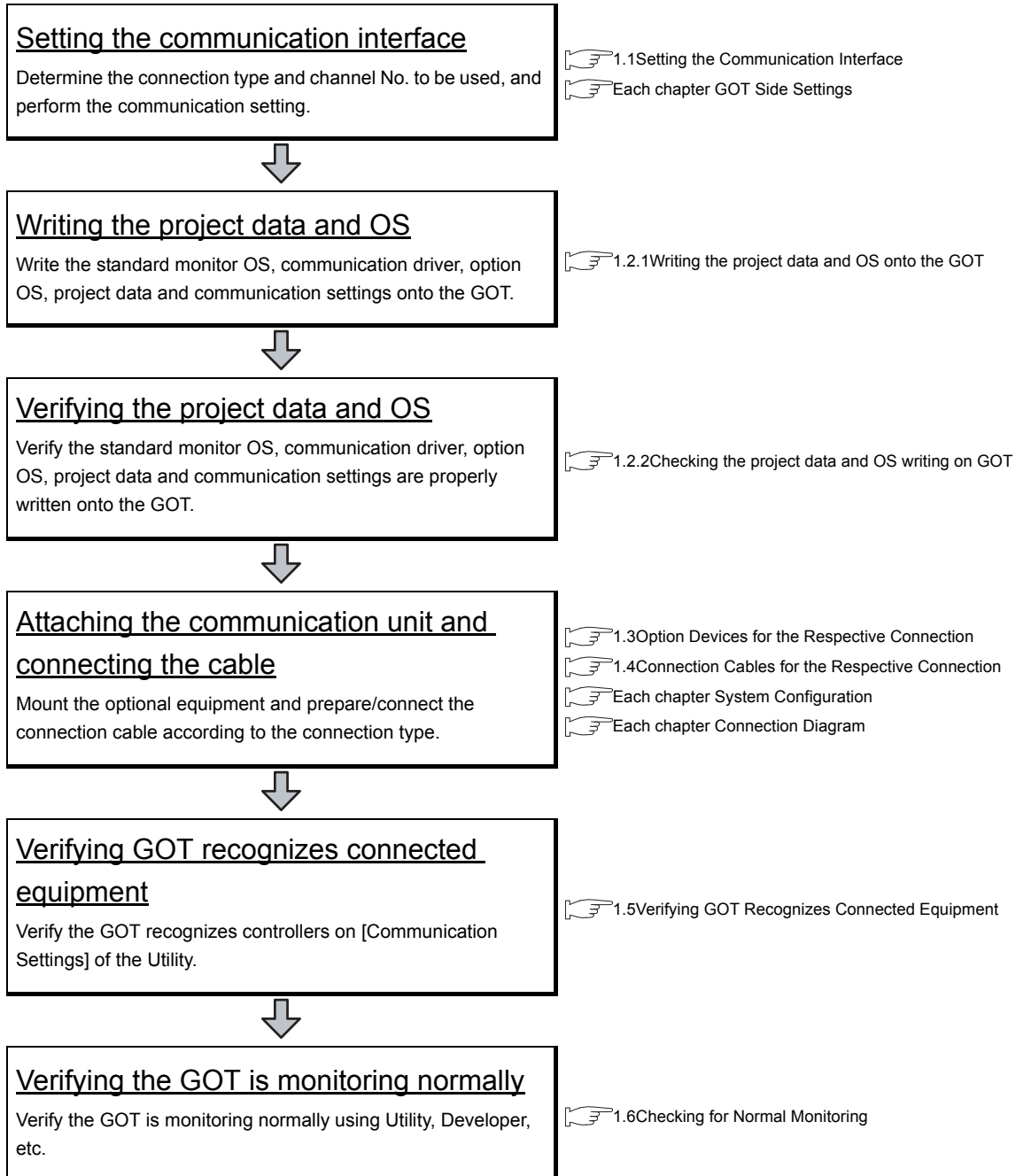

1.1 Setting the Communication Interface

Set the communication interface of GOT and the connected equipment.

When using the GOT at the first time, make sure to set the channel of communication interface and the communication driver before writing to GOT.

Set the communication interface of the GOT at [Controller Setting] and [I/F Communication Setting] in GT Designer3.

1.1.1 Setting connected equipment (Channel setting)

Set the channel of the equipment connected to the GOT.

■ Setting

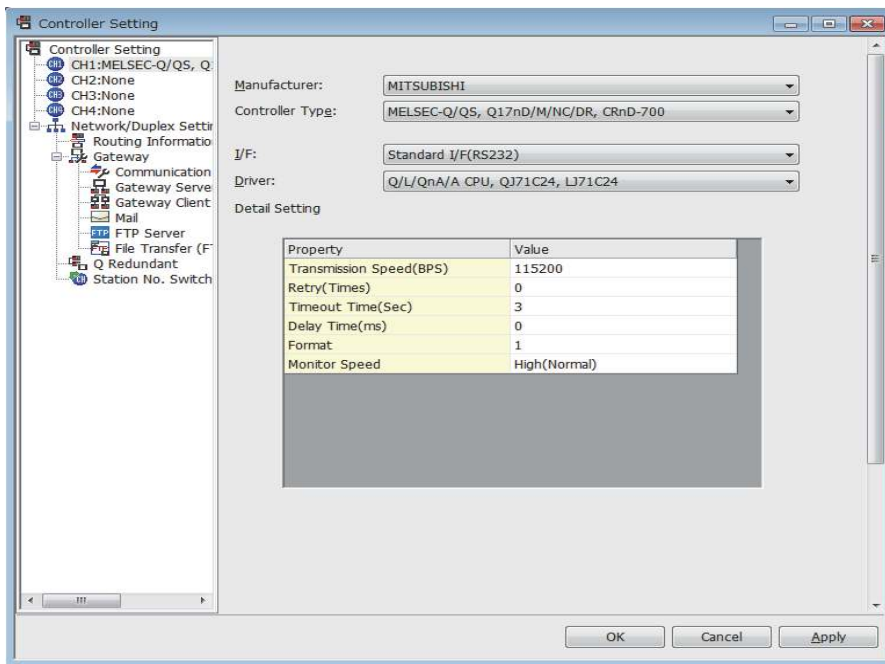

1. Select [Common] → [Controller Setting] from the menu.
2. The Controller Setting dialog box appears. Select the channel No. to be used from the list menu.
3. Refer to the following explanations for the setting.

POINT

Channel No.2 to No.4

Use the channel No.2 to No.4 when using the Multi-channel function.

For details of the Multi-channel function, refer to the following.

Mitsubishi Products 20. MULTI-CHANNEL FUNCTION

Setting item

This section describes the setting items of the Manufacturer, Controller Type, Driver and I/F. When using the channel No.2 to No.4, put a check mark at [Use CH*].

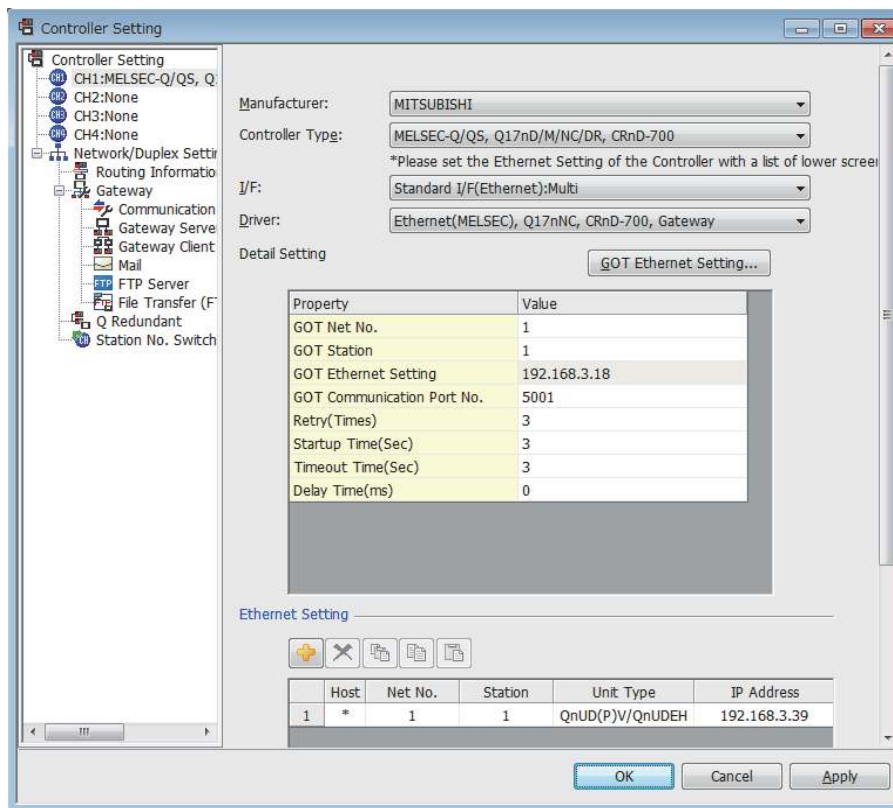

Item	Description
Use CH*	Select this item when setting the channel No.2 to No.4.
Manufacturer	Select the manufacturer of the equipment to be connected to the GOT.
Type	Select the type of the equipment to be connected to the GOT. For the settings, refer to the following. (2)Setting [Controller Type]
I/F	Select the interface of the GOT to which the equipment is connected. For the settings, refer to the following. (3)Setting [I/F]
Driver	Select the communication driver to be written to the GOT. For the settings, refer to the following. (1)Setting [Driver]
Detail Setting	Make settings for the transmission speed and data length of the communication driver. Refer to each chapter of the equipment to be connected to the GOT.

(1) Setting [Driver]

The displayed items for a driver differ according to the settings [Manufacturer], [Controller Type] and [I/F]. When the driver to be set is not displayed, confirm if [Manufacturer], [Controller Type] and [I/F] are correct. For the settings, refer to the following.

[Setting the communication interface] section in each chapter

(2) Setting [Controller Type]

The types for the selection differ depending on the PLC to be used.
For the settings, refer to the following.

Type	Model name
HITACHI HIDIC H Series	H-302
	H-702
	H-1002
	H-2002
	H-4010
	H-300
	H-700
	H-2000
	H-200
	H-250
	H-252
	H-252B
	H-252C
	H-20DR
	H-28DR
	H-40DR
	H-64DR
	H-20DT
	H-28DT
	H-40DT
	H-64DT
	HL-40DR
	HL-64DR
	EH-CPU104
EH-CPU208	
EH-CPU308	
EH-CPU316	
HITACHI S10mini/S10V	LQP510
	LQP520
	LQP800
	LQP000
	LQP010
	LQP011
	LQP120
FUJI MICREX-F Series	F55
	F70
	F120S
	F140S
	F15□S
FUJI PXR/PXG/PXH	PXR3
	PXR4
	PXR5
	PXR9

Type	Model name
FUJI PXR/PXG/PXH	PXG4
	PXG5
	PXG9
	PXH9
YASKAWA GL/PROGIC8	PROGIC-8
	GL120
	GL130
	GL60S
	GL60H
	GL70H
YASKAWA CP-9200SH/MP-900 Series	MP920
	MP930
	MP940
	CP-9200SH
YASKAWA CP-9200 (H)	CP-9200(H)
YASKAWA CP-9300MS (MC compatible)	CP-9300MS
YASKAWA MP2000/MP900/CP9200SH Series	MP2200
	MP2300
	MP920
	MP930
	MP940
	CP-9200SH
	CP-312
	CP-317
YOKOGAWA FA500/FA-M3 Series	FA500
	F3SP05
	F3SP08
	F3SP10
	F3SP20
	F3SP30
	F3FP36
	F3SP21
	F3SP25
	F3SP35
	F3SP28
	F3SP38
	F3SP53
F3SP58	
F3SP59	
F3SP66	
F3SP67	
F3SP76-7S	

Type	Model name
YOKOGAWA STARDOM/FA-M3 Series	NFCP100
	NFJT100
	F3SP05
	F3SP08
	F3SP10
	F3SP20
	F3SP30
	F3FP36
	F3SP21
	F3SP25
	F3SP35
	F3SP28
	F3SP38
	F3SP53
	F3SP58
	F3SP59
	F3SP66
	F3SP67
	F3SP76-7S
	YOKOGAWA GREEN/UT100/UT2000 / UTAdvanced Series
UT321	
UT350	
UT351	
UT420	
UT450	
UT520	
UT550	
UT551	
UT750	
UP350	
UP351	
UP550	
UP750	
UM330	
UM331	
UM350	
UM351	
US1000	
UT130	
UT150	
UT152	
UT155	
UP150	
UT2400	
UT2800	
UT32A	

Type	Model name
YOKOGAWA GREEN/UT100/UT2000 / UTAdvanced Series	UT35A
	UT52A
	UT55A
	UP35A
	UP55A
	UM33A
RKC SR Mini HG	H-PCP-J
	H-PCP-A
	H-PCP-B
	Z-TIO
	Z-DIO
	Z-CT
	CB100
	CB400
	CB500
	CB700
	CB900
	FB100
	FB400
	FB900
	RB100
	RB400
	RB500
	RB700
	RB900
	PF900
PF901	
HA400/401	
HA900/901	
RMC500	
MA900	
MA901	
AG500	
THV-A1	
SA100	
SA200	
X-TIO	
AB SLC500	SLC500-20
	SLC500-30
	SLC500-40
	SLC5/01
	SLC5/02
	SLC5/03
SLC5/04	
SLC5/05	

Type	Model name	
AB MicroLogix1000/1200/1500 Series	1761-L10BWA	
	1761-L10BWB	
	1761-L16AWA	
	1761-L16BWA	
	1761-L16BWB	
	1761-L16BBB	
	1761-L32AWA	
	1761-L32BWA	
	1761-L32BWB	
	1761-L32BBB	
	1761-L32AAA	
	1761-L20AWA-5A	
	1761-L20BWA-5A	
	1761-L20BWB-5A	
	1762-L24BWA	
	1764-LSP	
	AB Control/CompactLogix	1756-L
1756-L1M1		
1756-L1M2		
1756-L1M3		
1756-L61		
1756-L62		
1756-L63		
1756-L55M12		
1756-L55M13		
1756-L55M14		
1756-L55M16		
1756-L55M22		
1756-L55M23		
1756-L55M24		
1769-L31		
1769-L32E		
1769-L32C		
1769-L35E		
1769-L35CR		
1794-L33		
1794-L34		
GE Series 90		IC693CPU311
		IC693CPU313
	IC693CPU323	
	IC693CPU350	
	IC693CPU360	
	IC693CPU363	
	IC693CPU366	
	IC693CPU367	
	IC693CPU374	

Type	Model name
GE Series 90	IC697CPU731
	IC697CPX772
	IC697CPX782
	IC697CPX928
	IC697CPX935
	IC697CPU780
	IC697CGR772
	IC697CGR935
	IC697CPU788
	IC697CPU789
	IC697CPM790
	IC200UAA003
	IC200UAL004
	IC200UAL005
	IC200UAL006
	IC200UAA007
	IC200UAR028
	IC200UDD110
	IC200UDD120
	IC200UDD212
IC200UDR005	
LS Industrial Systems MASTER-K	IC200UDR006
	IC200UDR010
	IC200UDD064
	IC200UDD164
	IC200UDR164
	IC200UDR064
	IC200UAR014
	IC200UDD104
	IC200UDD112
	IC200UDR001
IC200UDR002	
SICK Flexi Soft	IC200UDR003
	K7M-D□□□S(/DC)
	K7M-D□□□U
SIEMENS S7-300/400 Series	K3P-07□S
	K4P-15S
SIEMENS S7-200	FX3-CPU000000
	FX3-CPU130002
SIEMENS S7-200	SIMATIC S7-300
	SIMATIC S7-400
SIEMENS S7-200	SIMATIC S7-200

(3) Setting [I/F]

The interface differs depending on the GOT to be used.

Set the I/F according to the connection and the position of communication unit to be mounted onto the GOT.

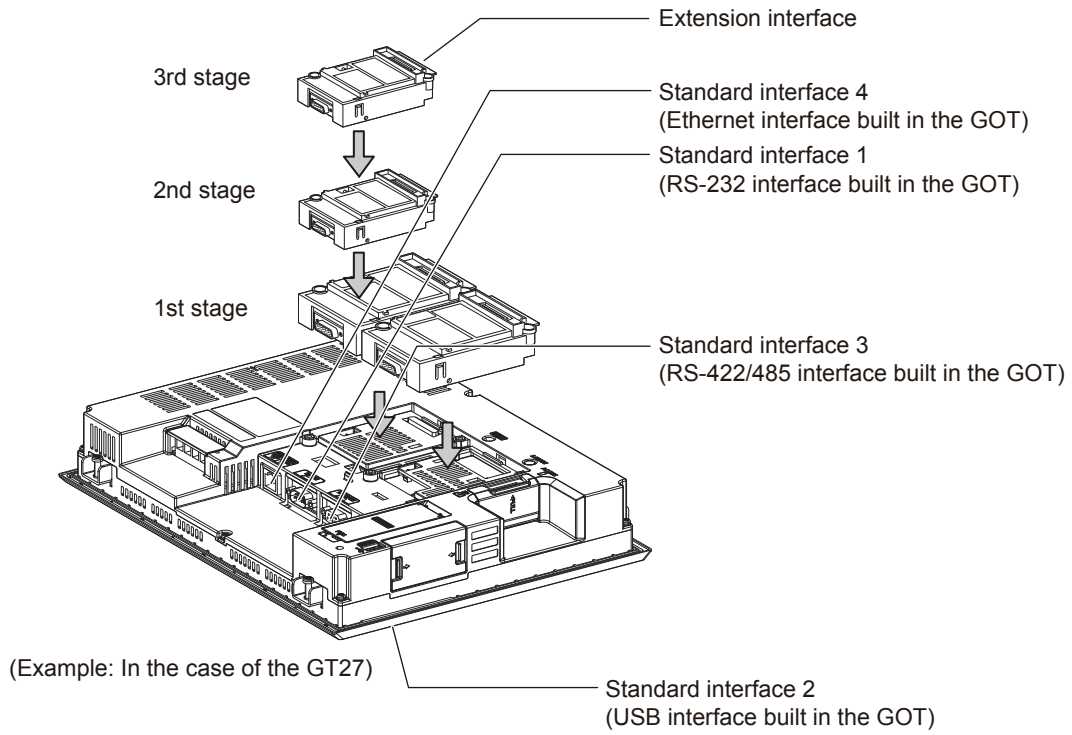

1.1.2 I/F communication setting

This function displays the list of the GOT communication interfaces.
Set the channel and the communication driver to the interface to be used.

■ Setting

Standard I/F Setting		
	CH No.	Driver
I/F-1: RS422/485	1	Q/L/QnA/A CPU, QJ71C24, LJ71C24
I/F-2: RS232	0	None
I/F-3: USB	9	Host (PC)
I/F-4: Ethernet	0	None

RS232 Setting

Enable the 5V power supply

Extend I/F Setting		
	CH No.	Driver
1st	0	None
2nd	0	None
3rd	0	None
Wireless LAN	0	None

1. Select [Common] → [I/F Communication Setting] from the menu.
2. The I/F Communication Setting dialog box appears. Make the settings with reference to the following explanation.

■ Setting item

The following describes the setting items for the standard I/F setting and extension I/F setting.

Item	Description
Standard I/F Setting	Set channel No. and drivers to the GOT standard interfaces.
CH No.	Set the CH No. according to the intended purpose. 0: Not used 1 to 4: Used for connecting a controller of channel No. 1 to 4 set in Setting connected equipment (Channel setting) 5 to 8: Used for barcode function, RFID function, remote personal computer operation function (serial) 9: Used for connecting Host (PC), Ethernet download A: Used for the report function (with a serial printer), hard copy function (with a serial printer), remote personal computer operation function (Ethernet), VNC server function, gateway function, and MES interface function. Multi: Used for multi-channel Ethernet connection
I/F	The communication type of the GOT standard interface is displayed.
Driver	Set the driver for the device to be connected. · None · Host (Personal computer) · Each communication driver for connected devices
Detail Setting	Make settings for the transmission speed and data length of the communication driver. Refer to each chapter of the equipment to be connected to the GOT.
RS232 Setting	To validate the 5V power supply function in RS232, mark the [Enable the 5V power supply] checkbox. The RS232 setting is invalid when the CH No. of [I/F-1: RS232] is [9].
Extend I/F Setting	Set the communication unit attached to the extension interface of the GOT.
CH No.	Set the CH No. according to the intended purpose. The number of channels differs depending on the GOT to be used. 0: Not used 1 to 4: Used for connecting a controller of channel No. 1 to 4 set in Setting connected equipment (Channel setting) 5 to 8: Used for barcode function, RFID function, remote personal computer operation (serial) A: Used for the video/RGB display function, multimedia function, external I/O function, operation panel function, RGB output function, report function, hard copy function (with a printer), sound output function, gateway function, MES interface function, and wireless LAN connection.

POINT

Channel No., drivers, [RS232 Setting]

(1) Channel No.2 to No.4

Use the channel No.2 to No.4 when using the Multi-channel function.
For details of the Multi-channel function, refer to the following.

 Mitsubishi Products 20. MULTI-CHANNEL FUNCTION

(2) Drivers

The displayed items for a driver differ according to the settings [Manufacturer], [Controller Type] and [I/F].
When the driver to be set is not displayed, confirm if [Manufacturer], [Controller Type] and [I/F] are correct.

 [Setting the communication interface] section in each chapter

1.1.3 Precautions

■ Precautions for changing model

(1) When devices that cannot be converted are included.

When setting of [Manufacturer] or [Controller Type] is changed, GT Designer3 displays the device that cannot be converted (no corresponding device type, or excessive setting ranges) as [??]. In this case, set the device again.

(2) When the changed Manufacturer or Controller Type does not correspond to the network.

The network will be set to the host station.

(3) When the Manufacturer or Controller Type is changed to [None]

The GT Designer3 displays the device of the changed channel No. as [??]. In this case, set the device again.
Since the channel No. is retained, the objects can be reused in other channel No. in a batch by using the [Device Batch Edit], [CH No. Batch Edit] or [Device List].

1.2 Writing the Project Data and OS onto the GOT

Write the standard monitor OS, communication driver, option OS, project data and communication settings onto the GOT. For details on writing to GOT, refer to the following manual.

 GT Designer3 (GOT2000) Help

1.2.1 Writing the project data and OS onto the GOT

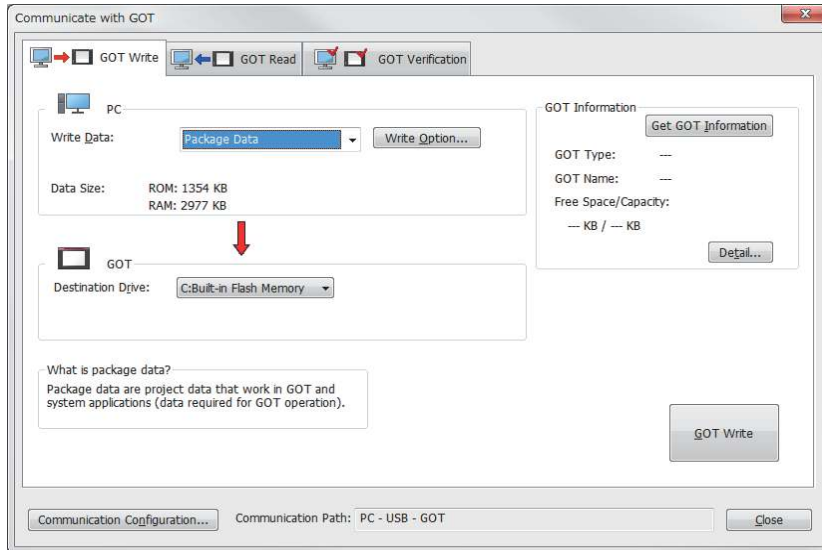

1. Select [Communication] → [Write to GOT...] from the menu.
2. The [Communication configuration] dialog box appears. Set the communication setting between the GOT and the personal computer. Click the [OK] button when settings are completed.
3. The [GOT Write] tab appears on the [Communicate with GOT] dialog box. Select the [Project data, OS] radio button of the Write Data.
4. Check-mark a desired standard monitor OS, communication driver, option OS, extended function OS, and Communication Settings and click the [GOT Write] button.

1.2.2 Checking the project data and OS writing on GOT

Confirm if the standard monitor OS, communication driver, option OS, project data and communication settings are properly written onto the GOT by reading from GOT using GT Designer3.

For reading from the GOT, refer to the following manual.

 GT Designer3 (GOT2000) Help

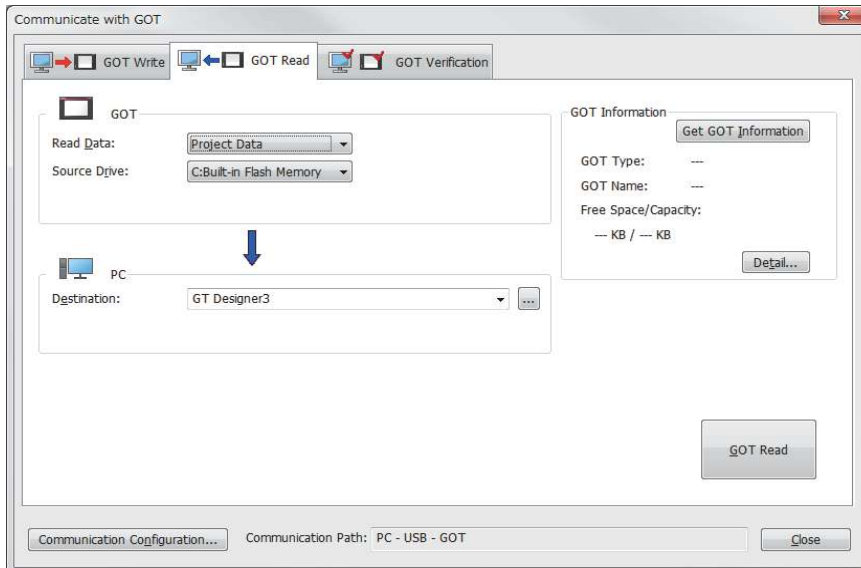

1. Select [Communication] → [Read from GOT...] from the menu.
2. The [Communication configuration] dialog box appears.
Set the communication setting between the GOT and the personal computer.
Click the [OK] button when settings are completed.
3. The [GOT Read] tab appears on the [Communicate with GOT] dialog box.
Select the [Drive information] radio button of the Read Data.
4. Click the [Info Reception] button.
5. Confirm that the project data and OS are written correctly onto the GOT.

1.3 Option Devices for the Respective Connection

The following shows the option devices to connect in the respective connection type.

For the specifications, usage and connecting procedure on option devices, refer to the respective device manual.

1.3.1 Communication module

Product name	Model	Specifications
Bus connection unit	GT15-QBUS	For QCPU (Q mode), motion controller CPU (Q series) Bus connection (1ch) unit standard model
	GT15-QBUS2	For QCPU (Q mode), motion controller CPU (Q series) Bus connection (2ch) unit standard model
	GT15-ABUS	For A/QnACPU, motion controller CPU (A series) Bus connection (1ch) unit standard model
	GT15-ABUS2	For A/QnACPU, motion controller CPU (A series) Bus connection (2ch) unit standard model
	GT15-75QBUSL	For QCPU (Q mode), motion controller CPU (Q series) Bus connection (1ch) unit slim model
	GT15-75QBUS2L	For QCPU (Q mode), motion controller CPU (Q series) Bus connection (2ch) unit slim model
	GT15-75ABUSL	For A/QnACPU, motion controller CPU (A series) Bus connection (1ch) unit slim model
	GT15-75ABUS2L	For A/QnACPU, motion controller CPU (A series) Bus connection (1ch) unit slim model
Serial communication unit	GT15-RS2-9P	RS-232 serial communication unit (D-sub 9-pin (male))
	GT15-RS4-9S	RS-422/485 serial communication unit (D-sub 9-pin (female))
	GT15-RS4-TE	RS-422/485 serial communication unit (terminal block)
MELSECNET/H communication unit	GT15-J71LP23-25	Optical loop unit
	GT15-J71BR13	Coaxial bus unit
MELSECNET/10 communication unit	GT15-J71LP23-25	Optical loop unit (MELSECNET/H communication unit used in the MNET/10 mode)
	GT15-J71BR13	Coaxial bus unit (MELSECNET/H communication unit used in the MNET/10 mode)
CC-Link IE Controller Network communication unit	GT15-J71GP23-SX	Optical loop unit
CC-Link IE Field Network communication unit	GT15-J71GF13-T2	CC-Link IE Field Network (1000BASE-T) unit
CC-Link communication unit	GT15-J61BT13	Intelligent device station unit CC-LINK Ver. 2 compatible
Ethernet communication unit	Built into GOT	Ethernet (100Base-TX)
Wireless LAN communication unit	GT25-WLAN	For the connection to personal computer, IEEE802.11b/g/n compatible, built-in antenna, station (wireless LAN adapter), for Japanese domestic use

1.3.2 Option unit

Product name	Model	Specifications
Multimedia unit	GT27-MMR-Z	For video input signal (NTSC/PAL) 1 ch, playing movie
Video input unit	GT27-V4-Z	For video input signal (NTSC/PAL) 4 ch
RGB input unit	GT27-R2-Z	For analog RGB input signal 2 ch
Video/RGB input unit	GT27-V4R1-Z	For video input signal (NTSC/PAL) 4 ch, for analog RGB mixed input signal 1 ch
RGB output unit	GT27-ROUT-Z	For analog RGB output signal 1 ch
Sound output unit	GT15-SOUT	For sound output
External I/O unit	GT15-DIOR	For the connection to external I/O device or operation panel (Negative Common Input/Source Type Output)
	GT15-DIO	For the connection to external I/O device or operation panel (Positive Common Input/Sink Type Output)

1.3.3 Conversion cable

Product name	Model	Specifications
RS-485 terminal block conversion modules	FA-LTBGT2R4CBL05	RS-422/485 (Connector) ↔ RS-485 (Terminal block) Supplied connection cable dedicated for the conversion unit
	FA-LTBGT2R4CBL10	
	FA-LTBGT2R4CBL20	

1.3.4 Serial multi-drop connection unit

Product name	Model	Specifications
Serial multi-drop connection unit	GT01-RS4-M	GOT multi-drop connection module  Mitsubishi Products 18. GOT MULTI-DROP CONNECTION

1.3.5 Installing a unit on another unit (Checking the unit installation position)

This section describes the precautions for installing units on another unit.

For the installation method of each unit, refer to the User's Manual for the communication unit and option unit you are using.

For the method for installing a unit on another unit, refer to the following.

 User's Manual of GOT used

■ When using a bus connection unit

The installation position varies depending on the bus connection unit to be used.

- (1) Wide bus units (GT15-75QBUS(2)L, GT15-75ABUS(2)L, GT15-QBUS2, GT15-ABUS2)

Install a bus connection unit in the 1st stage of the extension interface.

If a bus connection unit is installed in the 2nd stage or above, the unit cannot be used.

Example: Installing a bus connection unit and serial communication units

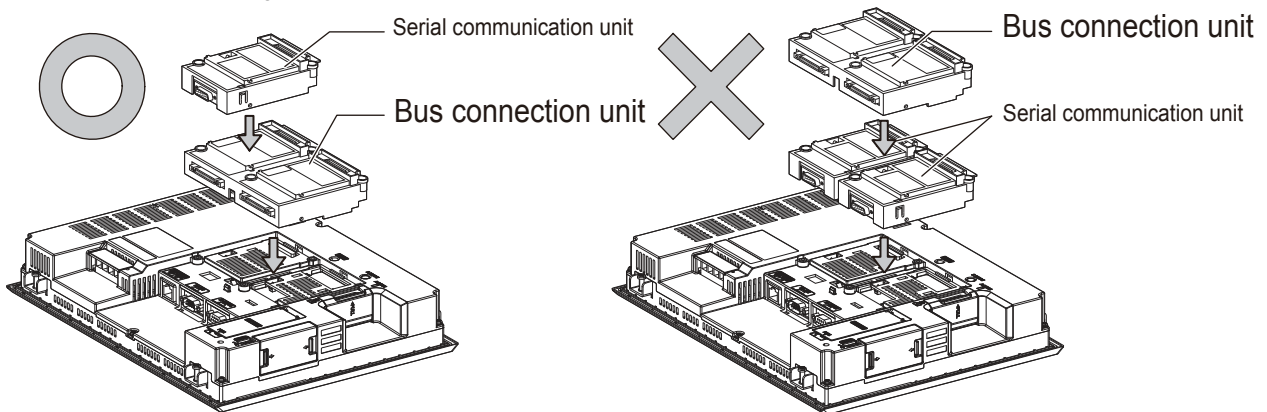

- (2) Standard size bus connection unit (GT15-QBUS and GT15-ABUS)

A bus connection unit can be installed in any position (1st to 3rd stage) of the extension interface.

Example: Installing a bus connection unit and serial communication units

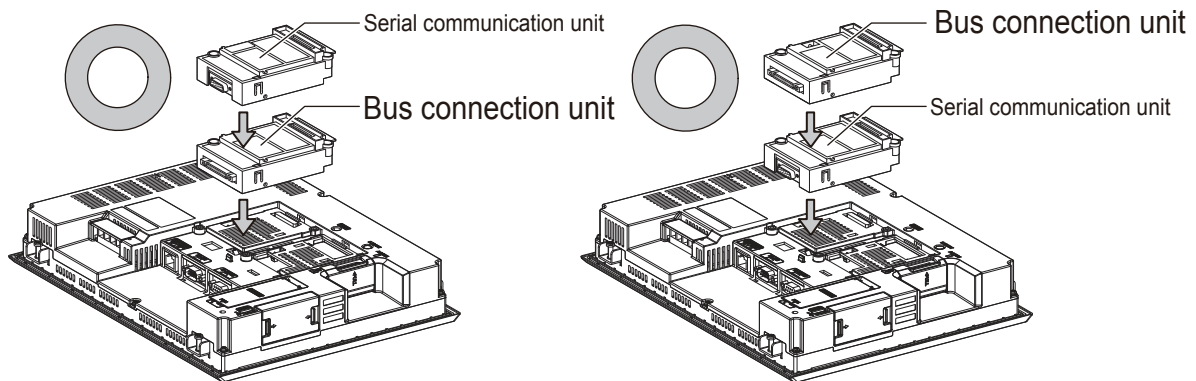

■ When using a MELSECNET/H communication unit, CC-Link IE controller network communication unit, or CC-Link communication unit (GT15-J61BT13)

Install a MELSECNET/H communication unit, CC-Link IE controller network communication unit, or CC-Link communication unit in the 1st stage of an extension interface.

These communication units cannot be used if installed in the 2nd or higher stage.

Example: When installing a MELSECNET/H communication unit and a serial communication unit

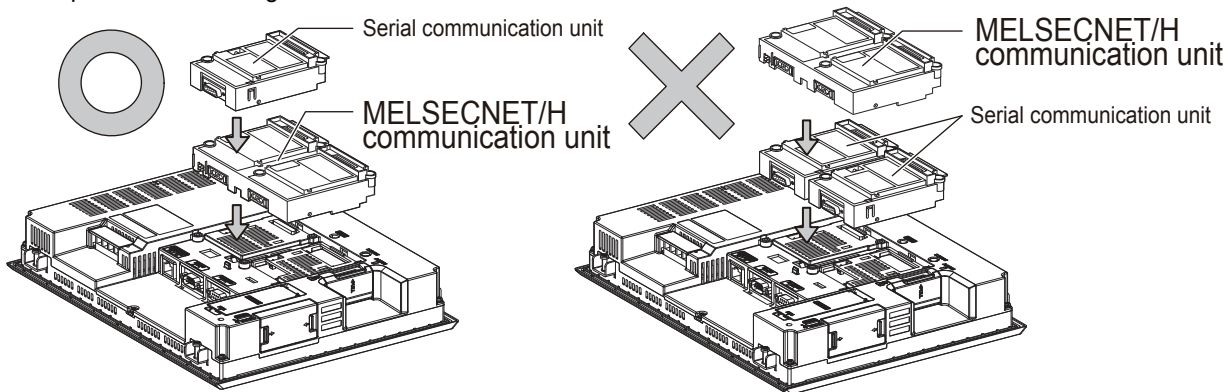

■ When using a serial communication unit

A serial communication unit can be installed in any position (1st to 3rd stage) of the extension interface.

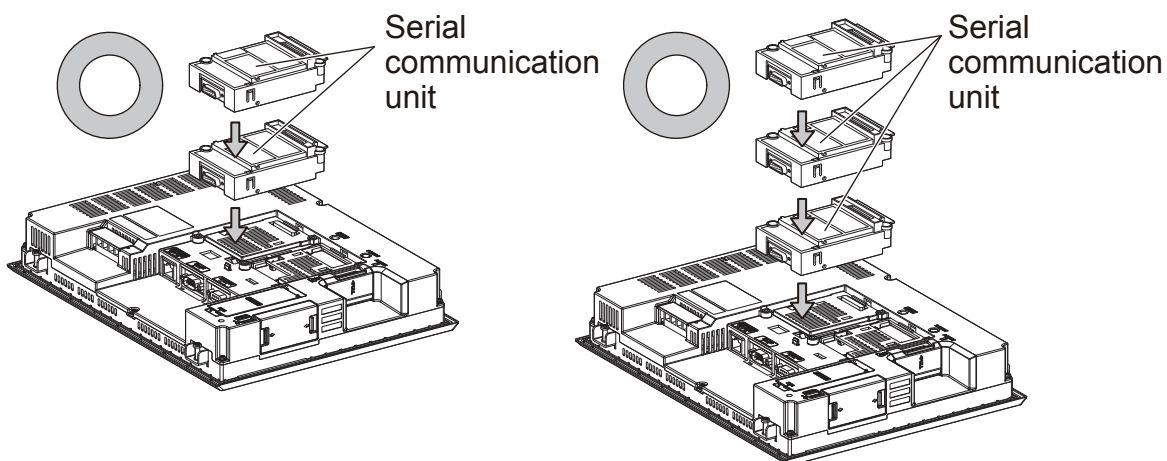

■ When using the sound output unit or external I/O unit

The sound output unit or external I/O unit can be installed in any position (1st to 3rd stage) of the extension interface.

Example: When installing a sound output unit

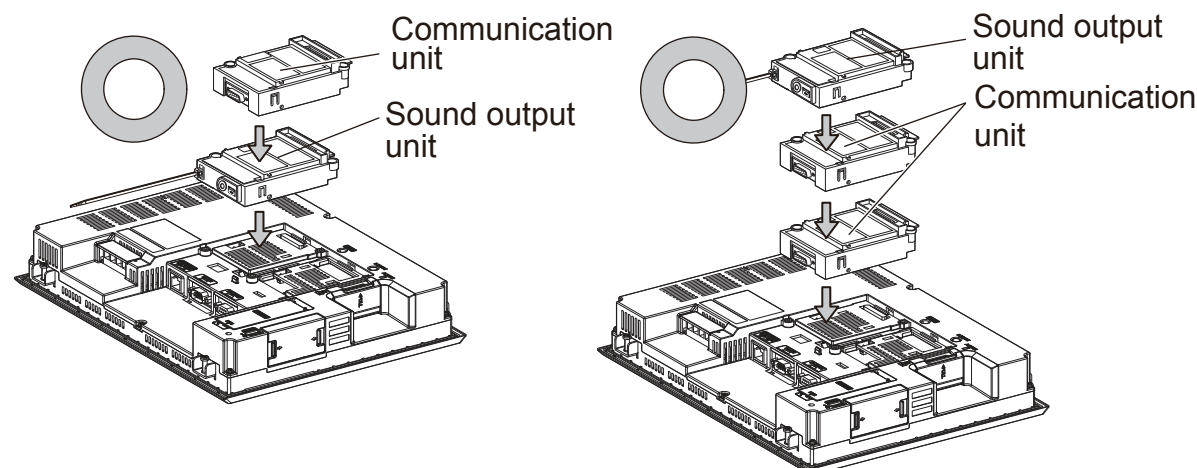

■ When using the video input unit, RGB input unit, video/RGB input unit, RGB output unit, or multimedia unit

Install the video input unit, RGB input unit, video/RGB input unit, RGB output unit, or multimedia unit at the 1st stage of the extension interface. These communication units cannot be used if installed in the 2nd or higher stage. When any of these units is used, the communication units indicated below must be installed in the 2nd stage of the extension interface.

Model	Communication unit	
Bus connection unit	GT15-QBUS2,	GT15-ABUS2
MELSECNET/H communication unit	GT15-J71LP23-25,	GT15-J71BR13
CC-Link IE controller network communication unit	GT15-J71GP23-SX	
CC-Link communication unit	GT15-J61BT13	

Example: When installing a video input unit and a MELSECNET/H communication unit

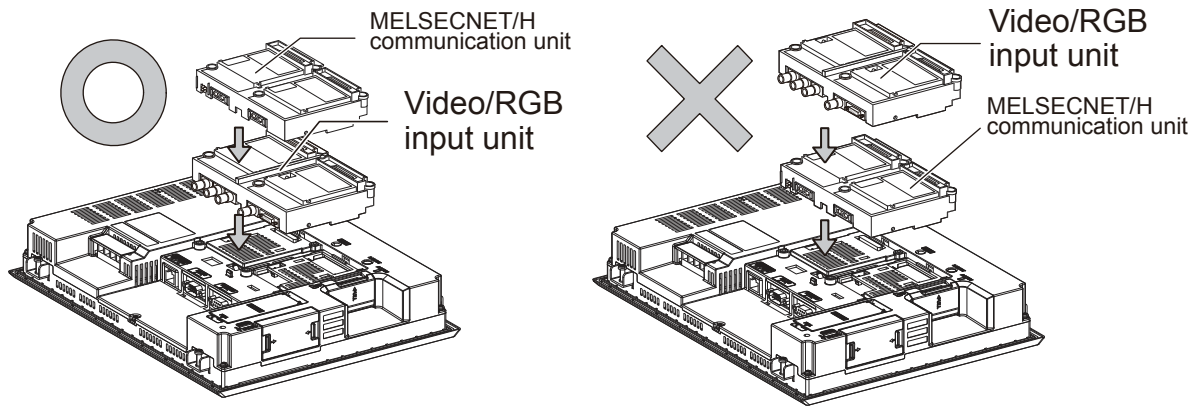

1.4 Connection Cables for the Respective Connection

To connect the GOT to a device in the respective connection type, connection cables between the GOT and a device are necessary.

For cables needed for each connection, refer to each chapter for connection.

1.4.1 GOT connector specifications

The following shows the connector specifications on the GOT side.

Refer to the following table when preparing connection cables by the user.

■ RS-232 interface

Use the following as the RS-232 interface and the RS-232 communication unit connector on the GOT. For the GOT side of the connection cable, use a connector and connector cover applicable to the GOT connector.

(1) Connector specifications

GOT	Hardware version*1	Connector type	Connector model	Manufacturer
GT27 GT23	—	9-pin D-sub (male) inch screw fixed type	17LE-23090-27(D4C□)	DDK Ltd.
GT15-RS2-9P GT01-RS4-M	— —	9-pin D-sub (male) inch screw fixed type	17LE-23090-27(D3CC)	DDK Ltd.

(2) Connector pin arrangement

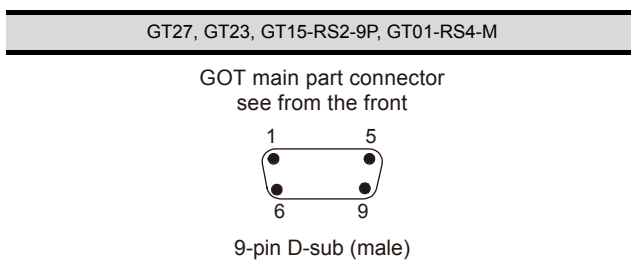

■ RS-422/485 interface

Use the following as the RS-422/485 interface and the RS-422/485 communication unit connector on the GOT.

For the GOT side of the connection cable, use a connector and connector cover applicable to the GOT connector.

(1) Connector model

GOT	Connector type	Connector model	Manufacturer
GT27 GT23	9-pin D-sub (female) M2.6 millimeter screw fixed type	17LE-13090-27(D2AC)	DDK Ltd.
GT15-RS4-9S GT01-RS4-M	9-pin D-sub (female) M2.6 millimeter screw fixed type	17LE-13090-27(D3AC)	DDK Ltd.
GT15-RS4-TE	—	—	SL-SMT3.5/10/90F BOX

(2) Connector pin arrangement

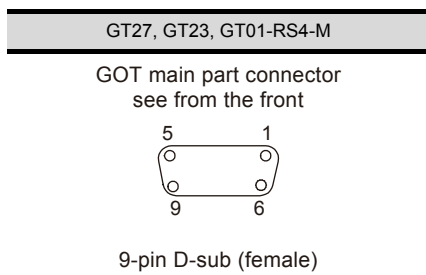

1.4.2 Coaxial cableconnector connection method

The following describes the method for connecting the BNC connector (connector plug for coaxial cable) and the cable.

⚠ CAUTION

- Solder the coaxial cable connectors properly. Insufficient soldering may result in malfunctions.

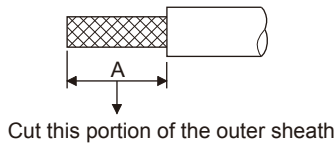
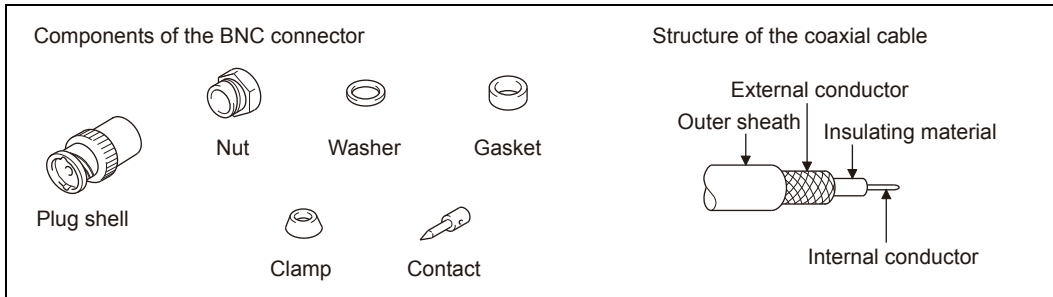

1. Remove the external sheath of the coaxial cable with dimensions as shown below.

Cable in use	A
3C-2V	15 mm
5C-2V, 5C-2V-CCY	10 mm

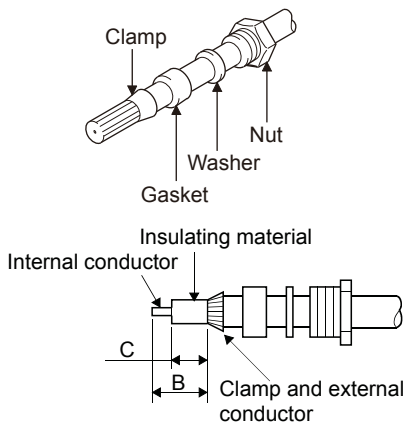

2. Pass the nut, washer, gasket, and clamp through the coaxial cable as shown on the left and loosen the external conductor.

3. Cut the external conductor, insulating material, and internal conductor with the dimensions as shown below. Note that the external conductor should be cut to the same dimension as the tapered section of the clamp and smoothed down to the clamp.

Cable in use	B	C
3C-2V	6 mm	3 mm
5C-2V, 5C-2V-CCY	7 mm	5 mm

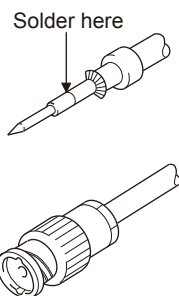

4. Solder the contact to the internal conductor.
5. Insert the connector assembly shown in 4. into the plug shell and screw the nut into the plug shell.

Precautions for soldering

Note the following precautions when soldering the internal conductor and contact.

- Make sure that the solder does not bead up at the soldered section.
- Make sure there are no gaps between the connector and cable insulator or they do not cut into each other.
- Perform soldering quickly so the insulation material does not become deformed.

1.4.3 Terminating resistors of GOT

The following shows the terminating resistor specifications on the GOT side.
When setting the terminating resistor in each connection type, refer to the following.

■ RS-422/485 communication unit

Set the terminating resistor using the terminating resistor setting switch.

Terminating resistor*1	Switch No.	
	1	2
100 OHM	ON	ON
Disable	OFF	OFF

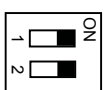

SW1

*1 The default setting is "Disable".

- For RS422/485 communication unit

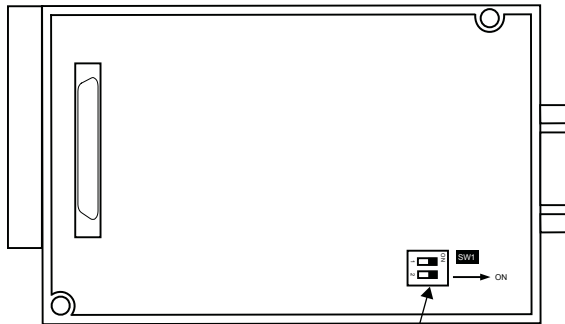

Terminating resistor setting switch
Rear view of RS-422/485 communication unit.

■ GT27

Set the terminating resistor using the terminating resistor setting switch.

Terminating resistor*1	Switch No.	
	1	2
100 OHM	ON	ON
Disable	OFF	OFF

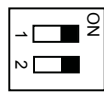

SW1

*1 The default setting is "Disable".

- For GT2710-V

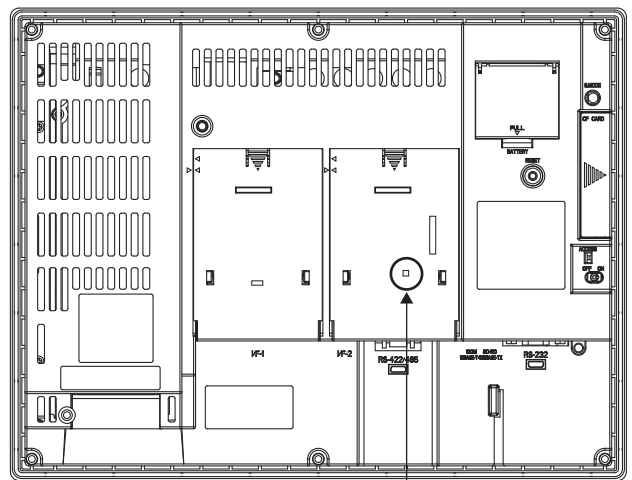

Terminating resistor setting switch
(inside the cover)

- For GT2310-V

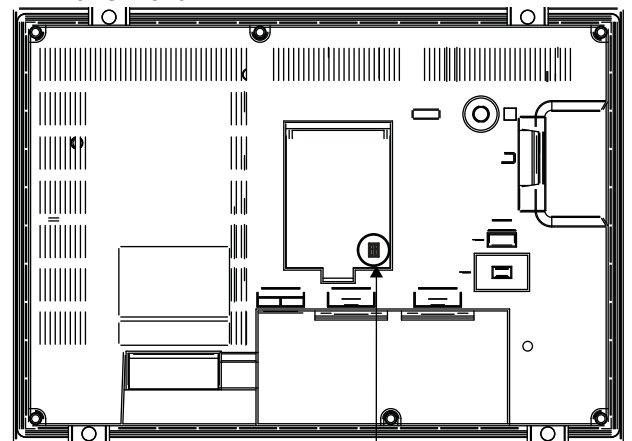

Terminating resistor setting switch
(inside the cover)

1.5 Verifying GOT Recognizes Connected Equipment

Verify the GOT recognizes controllers on [Communication Settings] of the Utility.

- Channel number of communication interface, communication drivers allocation status
- Communication unit installation status

For details on the Utility, refer to the following manual.

GOT2000 Series User's Manual (Utility)

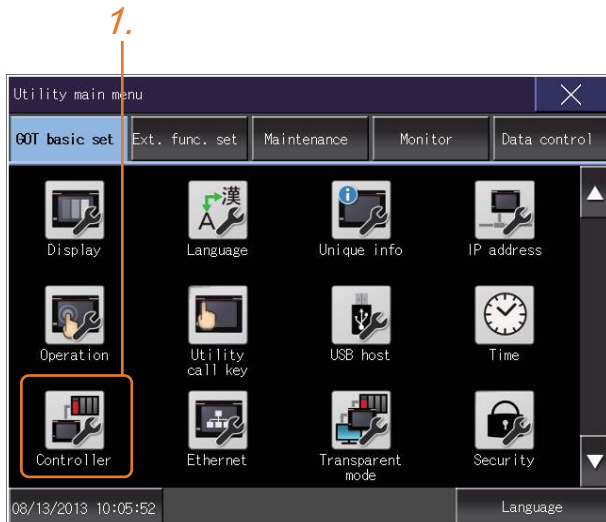

1. After powering up the GOT, touch [GOT basic set] → [Controller] from the Utility.

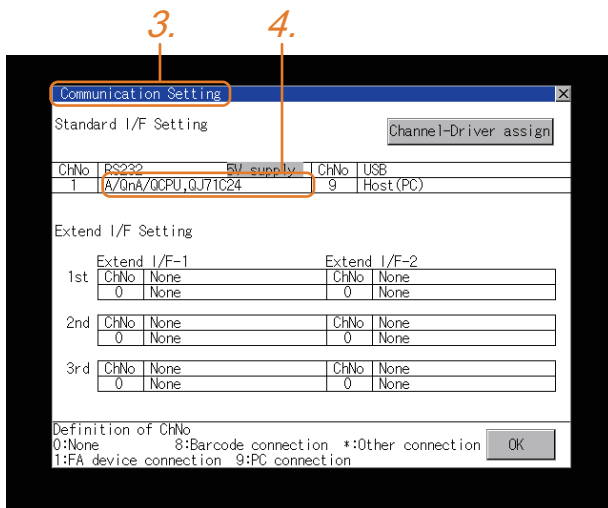

2. The [Communication Settings] appears.
3. Verify that the communication driver name to be used is displayed in the communication interface box to be used.
4. When the communication driver name is not displayed normally, carry out the following procedure again.
 - 1.1 Setting the Communication Interface

POINT

Utility

(1) How to display Utility (at default)

Utility call key
1-point press on GOT screen upper-left corner

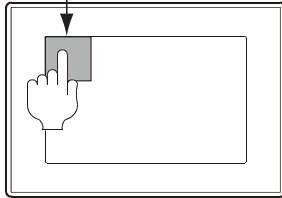

Utility display



(2) Utility call

When setting [Pressing time] to other than 0 second on the setting screen of the utility call key, press and hold the utility call key until the buzzer sounds. For the setting of the utility call key, refer to the following.

 GOT2000 Series User's Manual (Utility)

(3) Communication interface setting by the Utility

The communication interface setting can be changed on the Utility's [Communication setting] after writing [Communication Settings] of project data.

For details on the Utility, refer to the following manual.

 GOT2000 Series User's Manual (Utility)

(4) Precedence in communication settings

When settings are made by GT Designer3 or the Utility, the latest setting is effective.

1.6 Checking for Normal Monitoring

1.6.1 Check on the GOT

■ Check for errors occurring on the GOT

Presetting the system alarm to project data allows you to identify errors occurred on the GOT, PLC CPU, servo amplifier and communications.

For details on the operation method of the GOT Utility screen, refer to the following manual.

 GOT2000 Series User's Manual (Utility)

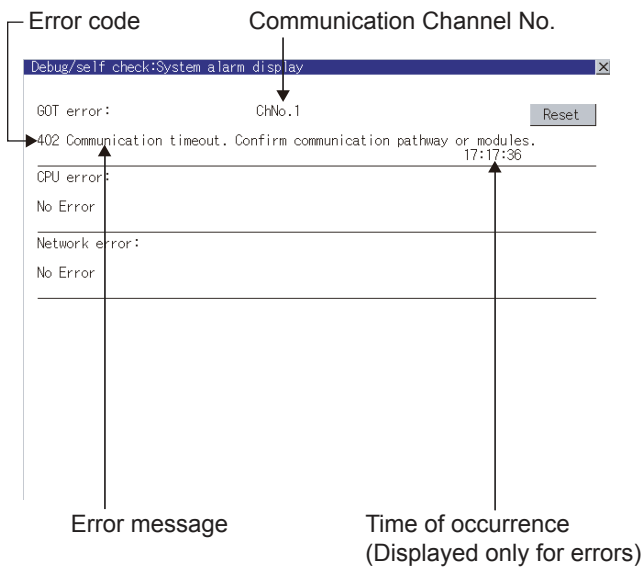

Advanced alarm popup display

With the advanced alarm popup display function, alarms are displayed as a popup display regardless of whether an alarm display object is placed on the screen or not (regardless of the display screen).

Since comments can be flow from right to left, even a long comment can be displayed all.

For details of the advanced popup display, refer to the following manual.

 GT Designer3 (GOT2000) Help

■ Perform an I/O check

Whether the PLC can communicate with the GOT or not can be checked by the I/O check function. If this check ends successfully, it means correct communication interface settings and proper cable connection. Display the I/O check screen by Main Menu.

- For GT16
Display the I/O check screen by [Main menu] → [Self check] → [I/O check].
- For GT15, GT14, GT11
Display the I/O check screen by [Main menu] → [Debug & self check] → [Self check] → [I/O check].

For details on the I/O check, refer to the following manual.

 GOT2000 Series User's Manual (Utility)

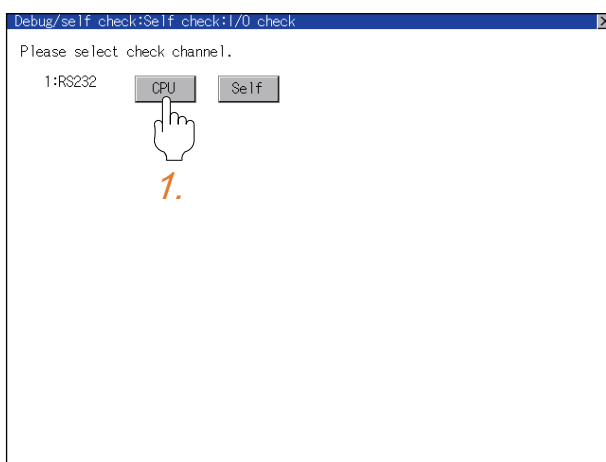

1. Touch [CPU] on the I/O check screen. Touching [CPU] executes the communication check with the connected PLC.

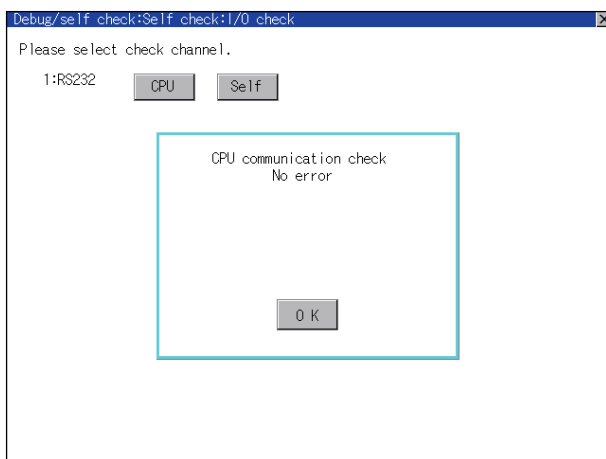

2. When the communication screen ends successfully, the screen on the left is displayed.

1.6.2 Confirming the communication state on the GOT side (For Ethernet connection)

■ Confirming the communication state on Windows[®], GT Designer3

(1) When using the Command Prompt of Windows[®]

Execute a Ping command at the Command Prompt of Windows[®].

(a) When normal communication

```
C:\>Ping 192.168.3.18
```

```
Reply from 192.168.3.18: bytes=32 time<1ms TTL=64
```

(b) When abnormal communication

```
C:\>Ping 192.168.3.18
```

```
Request timed out.
```

(2) When using the [PING Test] of GT Designer3

Select [Communication] → [Communication configuration] → [Ethernet] and → [Connection Test] to display [PING Test].

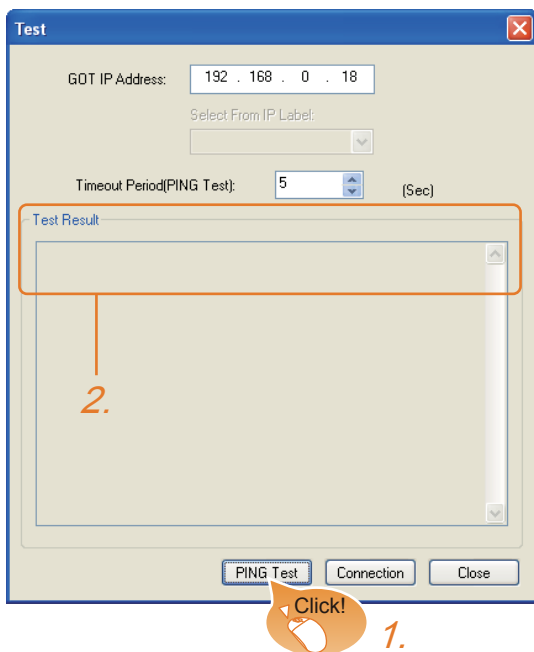

1. Specify the [GOT IP Address] of the [PING Test] and click the [PING Test] button.

2. The [Test Result] is displayed after the [PING Test] is finished.

(3) When abnormal communication

At abnormal communication, check the followings and execute the Ping command again.

- Mounting condition of Ethernet communication unit
- Cable connecting condition
- Confirmation of [Communication Settings]
- IP address of GOT specified by Ping command

■ **Confirming the communication state on the GOT**

[PING Test] can be confirmed by the Utility screen of the GOT.

For details on the operation method of the GOT Utility screen, refer to the following manual.

 GOT2000 Series User's Manual (Utility)

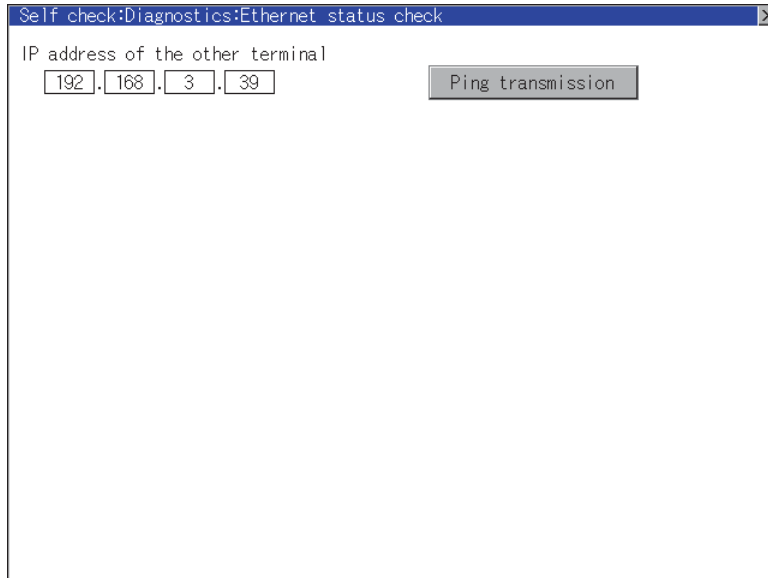

1.6.3 Confirming the communication state to each station (Station monitoring function)

The station monitoring function detects the faults (communication timeout) of the stations monitored by the GOT. When an abnormal state is detected, the function assigns the information of the faulty station to the GOT special register (GS).

(1) No. of faulty stations

(a) For the Ethernet connection (except for the Ethernet multiple connection)

Total No. of the faulty CPU are stored.

Device	b15 to b8	b7 to b0
GS230	(00H fixed)	No. of faulty stations

(b) For Ethernet multiple connection

The total No. of the faulty devices is stored.

Channel	Device	b15 to b8	b7 to b0
Ch1	GS280	(00H fixed)	No. of faulty stations
Ch2	GS300	(00H fixed)	No. of faulty stations
Ch3	GS320	(00H fixed)	No. of faulty stations
Ch4	GS340	(00H fixed)	No. of faulty stations

POINT

When monitoring GS230 on Numerical Display

When monitoring GS230 on Numerical Display, check [mask processing] with data operation tab as the following. For the data operation, refer to the following manual.

GT Designer3 (GOT2000) Help

● Numerical Display (Data Operation tab)

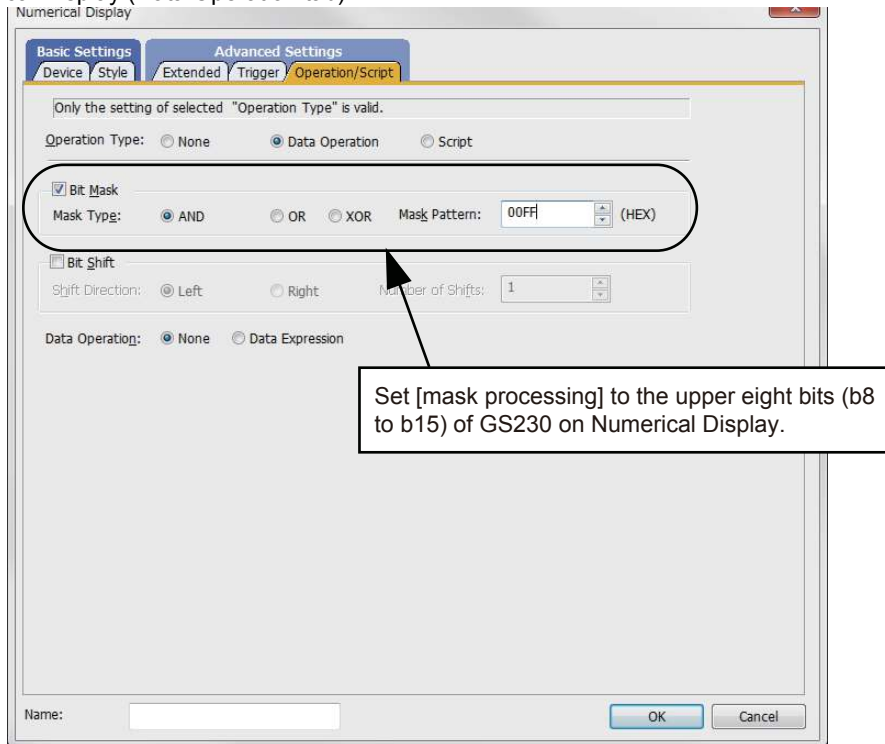

(2) Faulty station information

The bit corresponding to the faulty station is set. (0: Normal, 1: Abnormal)
 The bit is reset after the fault is recovered.

(a) For the Ethernet connection (except for the Ethernet multiple connection)

Ethernet Setting							
	Host	Net No.	Station	Unit Type	IP Address	Port No.	Communication
GS231 bit 0	1	*	1	2	QJ71E71/LJ71E71	192.168.3.39	5001 UDP
GS231 bit 1	2		1	3	QJ71E71/LJ71E71	192.168.3.40	5001 UDP
GS231 bit 2	3		1	4	AJ71QE71	192.168.3.41	5001 UDP
GS231 bit 3	4		1	5	AJ71E71	192.168.3.42	5006 UDP

Device	Ethernet setting No.															
	b15	b14	b13	b12	b11	b10	b9	b8	b7	b6	b5	b4	b3	b2	b1	b0
GS231	16	15	14	13	12	11	10	9	8	7	6	5	4	3	2	1
GS232	32	31	30	29	28	27	26	25	24	23	22	21	20	19	18	17
GS233	48	47	46	45	44	43	42	41	40	39	38	37	36	35	34	33
GS234	64	63	62	61	60	59	58	57	56	55	54	53	52	51	50	49
GS235	80	79	78	77	76	75	74	73	72	71	70	69	68	67	66	65
GS236	96	95	94	93	92	91	90	89	88	87	86	85	84	83	82	81
GS237	112	111	110	109	108	107	106	105	104	103	102	101	100	99	98	97
GS238	128	127	126	125	124	123	122	121	120	119	118	117	116	115	114	113

(b) For the Ethernet multiple connection or the temperature controller connection

The station number to which each device corresponds changes according to the connection/non connection with Ethernet.

With Ethernet connection: 1 to 128

With other than Ethernet connection: 0 to 127

Example) With Ethernet connection, when PC No. 100 CPU connecting to Ch3 is faulty, GS327.b3 is set. The following table shows the case with Ethernet connection.

Device				Station No.															
Ch1	Ch2	Ch3	Ch4	b15	b14	b13	b12	b11	b10	b9	b8	b7	b6	b5	b4	b3	b2	b1	b0
GS281	GS301	GS321	GS341	16	15	14	13	12	11	10	9	8	7	6	5	4	3	2	1
GS282	GS302	GS322	GS342	32	31	30	29	28	27	26	25	24	23	22	21	20	19	18	17
GS283	GS303	GS323	GS343	48	47	46	45	44	43	42	41	40	39	38	37	36	35	34	33
GS284	GS304	GS324	GS344	64	63	62	61	60	59	58	57	56	55	54	53	52	51	50	49
GS285	GS305	GS325	GS345	80	79	78	77	76	75	74	73	72	71	70	69	68	67	66	65
GS286	GS306	GS326	GS346	96	95	94	93	92	91	90	89	88	87	86	85	84	83	82	81
GS287	GS307	GS327	GS347	112	111	110	109	108	107	106	105	104	103	102	101	100	99	98	97
GS288	GS308	GS328	GS348	128	127	126	125	124	123	122	121	120	119	118	117	116	115	114	113

For details on the GS Device, refer to the following manual.

 GT Designer3 Screen Design Manual (Fundamentals) Appendix.2.3 GOT special register (GS)

(3) Network No., station No. notification

The network No. and station No. of the GOT in Ethernet connection are stored at GOT startup.

If connected by other than Ethernet, 0 is stored.

Device				Description
CH1	CH2	CH3	CH4	
GS376	GS378	GS380	GS382	Network No. (1 to 239)
GS377	GS379	GS381	GS383	Station No. (1 to 64)

CONNECTIONS TO NON-MITSUBISHI PRODUCTS

2.	CONNECTION TO HITACHI IES PLC	2 - 1
3.	CONNECTION TO HITACHI PLC	3 - 1
4.	CONNECTION TO FUJI PLC.	4 - 1
5.	CONNECTION TO FUJI TEMPERATURE CONTROLLER	5 - 1
6.	CONNECTION TO YASKAWA PLC	6 - 1
7.	CONNECTION TO YOKOGAWA PLC	7 - 1
8.	CONNECTION TO YOKOGAWA TEMPERATURE CONTROLLER.	8 - 1
9.	CONNECTION TO RKC TEMPERATURE CONTROLLER.	9 - 1
10.	CONNECTION TO ALLEN-BRADLEY PLC.	10 - 1
11.	CONNECTION TO GE PLC.	11 - 1
12.	CONNECTION TO LS INDUSTRIAL SYSTEMS PLC	12 - 1
13.	CONNECTION TO SICK SAFETY CONTROLLER.	13 - 1
14.	CONNECTION TO SIEMENS PLC	14 - 1

2









CONNECTION TO HITACHI IES PLC

2.1	Connectable Model List	2 - 2
2.2	System Configuration	2 - 3
2.3	Connection Diagram	2 - 7
2.4	GOT Side Settings	2 - 9
2.5	PLC Side Setting	2 - 11
2.6	Device Range that Can Be Set	2 - 12

2. CONNECTION TO HITACHI IES PLC

2.1 Connectable Model List

The following table shows the connectable models.

Series	Model name	Clock	Communication Type	Connectable model	Refer to
Large-sized H Series	H-302	○	RS-232 RS-422		 2.2.1
	H-702				
	H-1002				
	H-2002				
	H-4010				
	H-300	×			
	H-700				
H-2000					
H-200 to 252 Series	H-200	○	RS-232		 2.2.2
	H-250				
	H-252				
	H-252B				
	H-252C				
H Series board type	H-20DR	○	RS-232		 2.2.2
	H-28DR				
	H-40DR				
	H-64DR				
	H-20DT				
	H-28DT				
	H-40DT				
	H-64DT				
	HL-40DR				
	HL-64DR				
EH-150 series	EH-CPU104	×	RS-232		 2.2.2
	EH-CPU208	○			
	EH-CPU308				
	EH-CPU316				
	EH-CPU516				
	EH-CPU548				





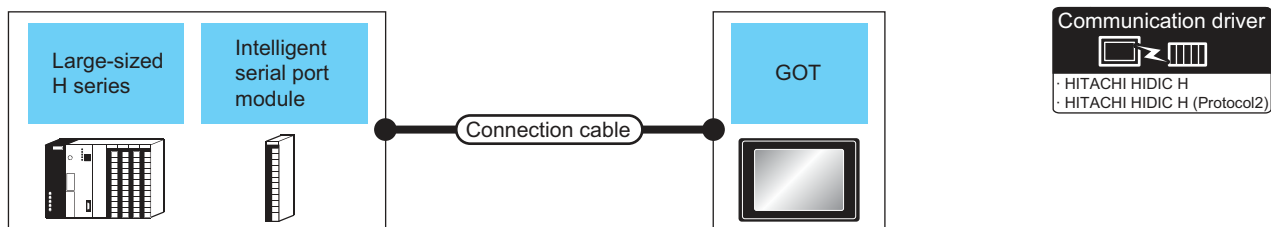









2.2 System Configuration

2.2.1 Connection to large-sized H series



To use "transmission control procedure 2" as a protocol, select "HITACHI HIDIC H (Protocol2)" as a communication driver.

PLC			Connection cable		GOT		Number of connectable equipment
Model name	Intelligent serial port module ^{*1}	Communication Type	Cable model Connection diagram number	Max. distance	Option device	Model	
H-302 ^{*2} H-702 ^{*2} H-1002 ^{*2} H-2002 ^{*2} H-300 H-700 H-2000	-	RS-232	GT09-C30R20401-15P(3m) or RS-232 connection diagram 1)	15m	- (Built into GOT) GT15-RS2-9P	 	1 GOT for 1 PLC
H-4010	-	RS-232	<ul style="list-style-type: none"> Specified transmission speed: 4800bps GT09-C30R20401-15P(3m) or RS-232 connection diagram 1) Specified transmission speed: 19200bps GT09-C30R20402-15P(3m) or RS-232 connection diagram 2) Specified transmission speed: 38400bps^{*3} GT09-C30R20402-15P(3m) or RS-232 connection diagram 2) Transmission speed other than the above GT09-C30R20401-15P(3m) or RS-232 connection diagram 1) GT09-C30R20402-15P(3m) or RS-232 connection diagram 2) 	15m	- (Built into GOT) GT15-RS2-9P	 	

PLC			Connection cable		GOT		Number of connectable equipment
Model name	Intelligent serial port module ^{*1}	Communication Type	Cable model Connection diagram number	Max. distance	Option device	Model	
H-302 H-702 H-1002 H-2002 H-4010 H-300 H-700 H-2000	COMM-H COMM-2H	RS-232	GT09-C30R20401-15P(3m) or  RS-232 connection diagram 1)	15m	- (Built into GOT)	  	1 GOT for 1 intelligent serial port module
					GT15-RS2-9P	  	
		RS-422	GT09-C30R40401-7T(3m) GT09-C100R40401-7T(10m) GT09-C200R40401-7T(20m) GT09-C300R40401-7T(30m) or  RS-422 connection diagram 1)	200m	- (Built into GOT)	  	
					GT15-RS4-9S	  	

*1 Product manufactured by HITACHI Industrial Equipment Systems Co., Ltd. For details of this product, contact HITACHI Industrial Equipment Systems Co., Ltd.

*2 Connect to the peripheral port of the CPU module.

*3 Can be specified with the CPU software of revision "J" or later.

2.2.2 Connecting to H-200 to 252 series, H series board type or EH-150 series

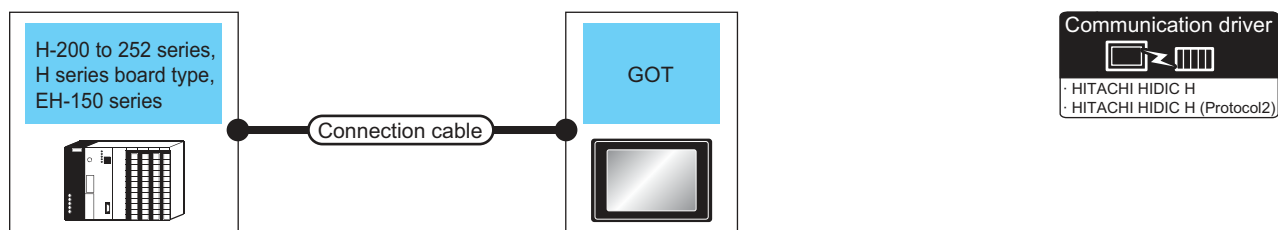

To use "transmission control procedure 2" as a protocol, select "HITACHI HIDIC H (Protocol2)" as a communication driver.

PLC		Connection cable		GOT		Number of connectable equipment
Model name	Communication Type	Cable model Connection diagram number	Max. distance	Option device	Model	
H-200*1, H-250*1 H-252*1, H-252B*1 H-20DR, H-28DR H-40DR, H-64DR H-20DT, H-28DT H-40DT, H-64DT HL-40DR, HL-64DR	RS-232	GT09-C30R20401-15P(3m) or RS-232 connection diagram 1)	15m	- (Built into GOT)	 	1 GOT for 1 PLC
				GT15-RS2-9P	 	
H-252C*1*2	RS-232	<ul style="list-style-type: none"> Specified transmission speed: 4800bps GT09-C30R20401-15P(3m) or RS-232 connection diagram 1) Specified transmission speed: 19200bps GT09-C30R20402-15P(3m) or RS-232 connection diagram 2) Transmission speed other than the above GT09-C30R20401-15P(3m) or RS-232 connection diagram 1) GT09-C30R20402-15P(3m) or RS-232 connection diagram 2) 	15m	- (Built into GOT)	 	
				GT15-RS2-9P	 	
EH-CPU104*3 EH-CPU208*3 EH-CPU308*3 EH-CPU316*3 EH-CPU516*3 EH-CPU548*3	RS-232	<ul style="list-style-type: none"> Specified transmission speed: 4800bps GT09-C30R20401-15P(3m) or RS-232 connection diagram 1) Specified transmission speed: 19200bps GT09-C30R20402-15P(3m) or RS-232 connection diagram 2) Specified transmission speed: 38400bps GT09-C30R20402-15P(3m) or RS-232 connection diagram 2) Transmission speed other than the above GT09-C30R20401-15P(3m) or RS-232 connection diagram 1) GT09-C30R20402-15P(3m) or RS-232 connection diagram 2) 	15m	- (Built into GOT)	 	
				GT15-RS2-9P	 	

*1 To connect to H-200 to 252 series, connect to the peripheral port of the CPU module.

*2 To connect to serial port 2 of H-252C (CPU22-02HC, CPE22-02HC), the round connector (8 pins)/D-sub connector (15 pins) conversion cable (CNCOM-05 made by HITACHI Industrial Equipment Systems Co., Ltd.) is necessary.

- *3 To connect to the EH-150 series, connect to the serial port of the CPU module.
The module jack (8 pins)/D-sub connector (15 pins) conversion cable (EHR505 made by HITACHI Industrial Equipment Systems Co., Ltd.) is necessary.

2.3 Connection Diagram

The following diagram shows the connection between the GOT and the PLC.

2.3.1 RS-232 cable

■ Connection diagram

(1) RS-232 connection diagram 1)

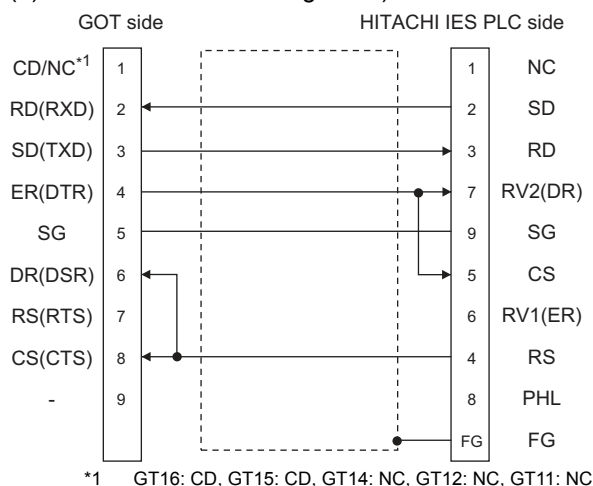

(2) RS-232 connection diagram 2)

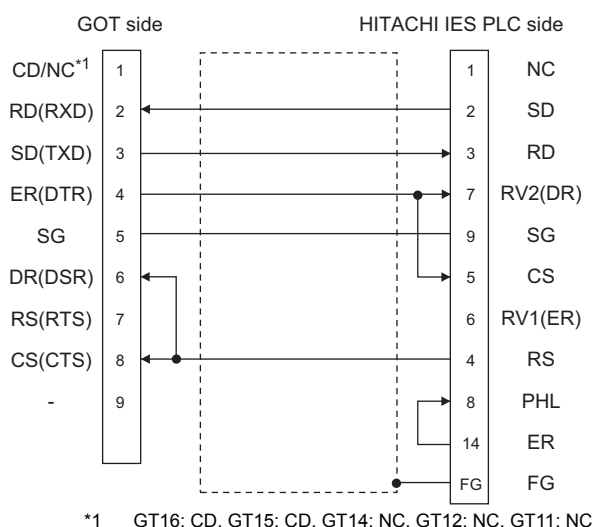

■ Precautions when preparing a cable

(3) Cable length

The length of the RS-232 cable must be 15m or less.

(4) GOT side connector

For the GOT side connector, refer to the following.

☞ 1.4.1 GOT connector specifications

(5) HITACHI IES PLC side connector

Use the connector compatible with the HITACHI IES PLC side module.

For details, refer to the HITACHI IES PLC user's manual.

2.3.2 RS-422 cable

■ Connection diagram

(1) RS-422 connection diagram 1)

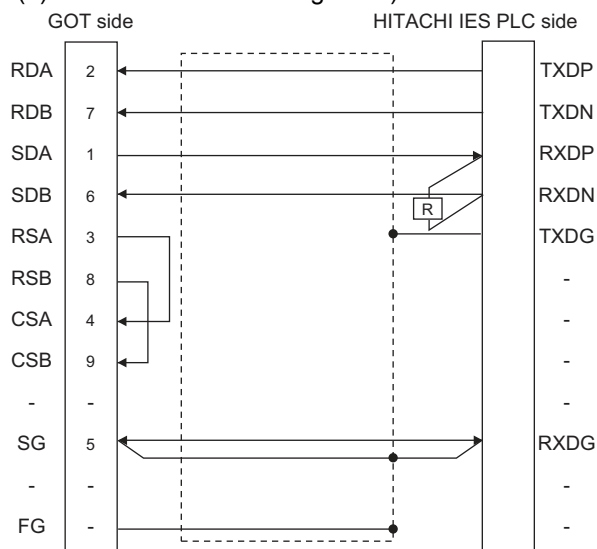

■ Precautions when preparing a cable

(2) Cable length

The length of the RS-422 cable must be 200m or less.

(3) GOT side connector

For the GOT side connector, refer to the following.

 1.4.1 GOT connector specifications

(4) HITACHI IES PLC side connector

Use the connector compatible with the HITACHI IES PLC side module.

For details, refer to the HITACHI IES PLC user's manual.

■ Connecting terminating resistors

(1) GOT side

Set the terminating resistor setting switch of the GOT main unit to "Disable".

For the procedure to set the terminating resistor, refer to the following.

 1.4.3 Terminating resistors of GOT

(2) HITACHI IES PLC side

When connecting an intelligent serial port module to a GOT, a terminating resistor has to be connected to the intelligent serial port module.

 HITACHI IES PLC user's Manual

2.4 GOT Side Settings

2.4.1 Setting communication interface (Communication settings)

Set the channel of the connected equipment.

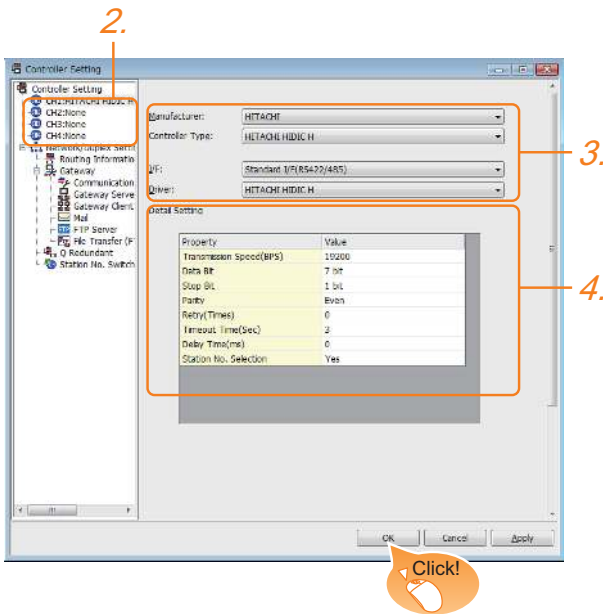

1. Select [Common] → [Controller Setting] from the menu.
2. The Controller Setting window is displayed. Select the channel to be used from the list menu.
3. Set the following items.
 - Manufacturer: HITACHI
 - Controller Type: HITACHI HIDIC H
 - I/F: Interface to be used
 - Driver: Set either of the following.
 - HITACHI HIDIC H
 - HITACHI HIDIC H (Protocol2)
4. The detailed setting is displayed after Manufacturer, Controller Type, I/F, and Driver are set. Make the settings according to the usage environment.

2.4.2 Communication detail settings

Click the [OK] button when settings are completed.

POINT

The settings of connecting equipment can be confirmed in [I/F Communication Setting]. For details, refer to the following.

1.1.2 I/F communication setting

2.4.2 Communication detail settings

Make the settings according to the usage environment.

(1) HITACHI HIDIC H

Property	Value
Transmission Speed(BPS)	19200
Data Bit	7 bit
Stop Bit	1 bit
Parity	Even
Retry(Times)	0
Timeout Time(Sec)	3
Delay Time(ms)	0
Station No. Selection	Yes

Item	Description	Range
Transmission Speed	Set this item when change the transmission speed used for communication with the connected equipment. (Default: 19200bps)	4800bps, 9600bps, 19200bps, 38400bps
Data Bit	Set this item when change the data length used for communication with the connected equipment. (Default: 7bit)	7bit (fixed)
Stop Bit	Specify the stop bit length for communications. (Default: 1bit)	1bit (fixed)
Parity	Specify whether or not to perform a parity check, and how it is performed during communication. (Default: Even)	Even (fixed)
Retry	Set the number of retries to be performed when a communication error occurs. (Default: 0time)	0 to 5times
Timeout Time	Set the time period for a communication to time out. (Default: 3sec)	1 to 30sec
Delay Time	Set this item to adjust the transmission timing of the communication request from the GOT. (Default: 0ms)	0 to 300 (ms)
Station No. Selection	Specify whether to use the station No. during communication. If [Yes] is selected, the station No. is fixed to "0." (Default: Yes)	Yes or No

(2) HITACHI HIDIC H (Protocol2)

Property	Value
Transmission Speed(BPS)	19200
Data Bit	7 bit
Stop Bit	1 bit
Parity	Even
Retry(Times)	0
Timeout Time(Sec)	3
Delay Time(ms)	0
Station No. Selection	Yes

Item	Description	Range
Transmission Speed	Set this item when change the transmission speed used for communication with the connected equipment. (Default: 19200bps)	4800bps, 9600bps, 19200bps, 38400bps
Data Bit	Set this item when change the data length used for communication with the connected equipment. (Default: 7bit)	7bit (fixed)
Stop Bit	Specify the stop bit length for communications. (Default: 1bit)	1bit (fixed)
Parity	Specify whether or not to perform a parity check, and how it is performed during communication. (Default: Even)	Even (fixed)
Retry	Set the number of retries to be performed when a communication error occurs. (Default: 0time)	0 to 5times
Timeout Time	Set the time period for a communication to time out. (Default: 3sec)	1 to 30sec
Delay Time	Set this item to adjust the transmission timing of the communication request from the GOT. (Default: 0ms)	0 to 300 (ms)
Station No. Selection	Specify whether to use the station No. during communication. If [Yes] is selected, the station No. is fixed to "0." (Default: Yes)	Yes or No

POINT

- (1) Communication interface setting by the Utility
The communication interface setting can be changed on the Utility's [Communication Settings] after writing [Communication Settings] of project data.

For details on the Utility, refer to the following manual.

 GOT2000 Series User's Manual (Utility)

- (2) Precedence in communication settings
When settings are made by GT Designer3 or the Utility, the latest setting is effective.

2.5 PLC Side Setting

POINT

HITACHI IES PLC

For details of the HITACHI IES PLC, refer to the following manual.

 HITACHI IES PLC user's Manual

■ Directly connecting to the CPU

Item	Set value
Transmission speed ^{*1*2*3}	4800bps, 9600bps, 19200bps, 38400bps
Station No.	0
Data bit	7bit
Stop bit	1bit
Parity bit	Even
Control Method	DTR control
Communication format	RS-232
Sum check	Done
Protocol	transmission control procedure 1

- *1 Indicates only the transmission speeds that can be set on the GOT side.
- *2 The transmission speed setting must be consistent with that of the GOT side.
For the transmission speed setting on the GOT side, refer to the following.
 2.4.2 Communication detail settings
- *3 The setting range varies with the connected PLC.

■ Connecting to the intelligent serial port module

(1) For transmission control procedure 1

Item	Set value
Transmission speed	19200bps
Station No.	0
Data bit	7bit
Stop bit	1bit
Parity bit	Even
Control Method	None
Communication format	For RS-232 communication: RS-232 MODE switch 2 For RS-422 communication: RS-422 MODE switch 2
Sum check	Done

(2) For transmission control procedure 2

Item	Set value
Transmission speed	19200bps
Station No.	0
Data bit	7bit
Stop bit	1bit
Parity bit	Even
Control Method	None
Communication format	For RS-232 communication: RS-232 MODE switch 9 For RS-422 communication: RS-422 MODE switch 9
Sum check	Done

2.6 Device Range that Can Be Set

The device ranges of controller that can be used for GOT are as follows.

Note that the device ranges in the following tables are the maximum values that can be set in GT Designer3.

The device specifications of controllers may differ depending on the models, even though belonging to the same series. Please make the setting according to the specifications of the controller actually used.

When a non-existent device or a device number outside the range is set, other objects with correct device settings may not be monitored.

■ Setting item

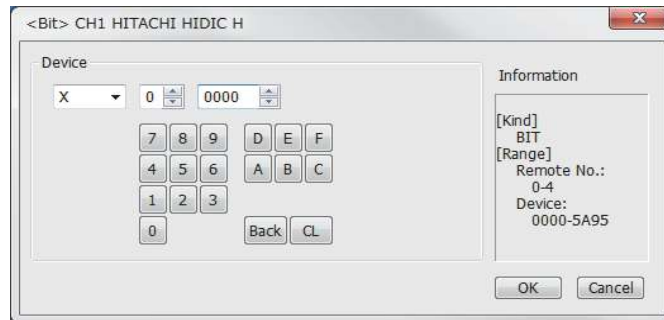

Item	Description
Device	Set the device name, device number, and bit number. The bit number can be set only when specifying the bit of word device.
Information	Displays the device type and setting range which are selected in [Device].

POINT

Device settings of HITACHI IES PLC

(1) When specifying an external I/O device

(a) When setting a bit device

Set the device using the format of module No. + slot No. + module bit No.

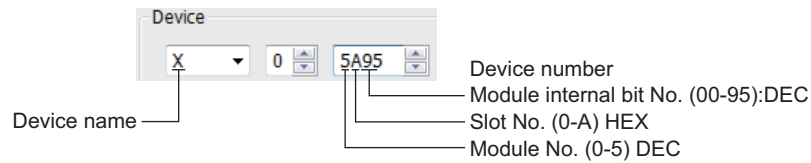

(b) When setting a word device

Set the device using the format of module No. + slot No. + module bit No.

For the device name setting, enter "w" before the bit device name.

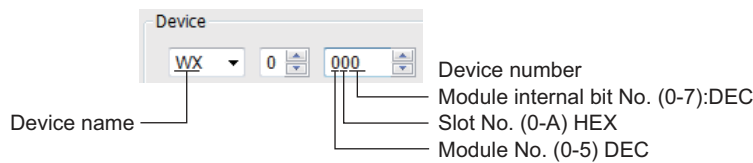

(2) When specifying a remote external I/O device

(a) When setting a bit device

Set the device using the format of remote master station + remote slave station + slot No. + module bit No.

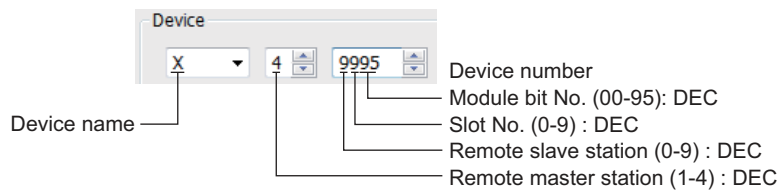

(b) When setting a word device

Set the device using the format of remote master station + remote slave station + slot No. + module bit No.

For the device name setting, enter "w" before the bit device name.

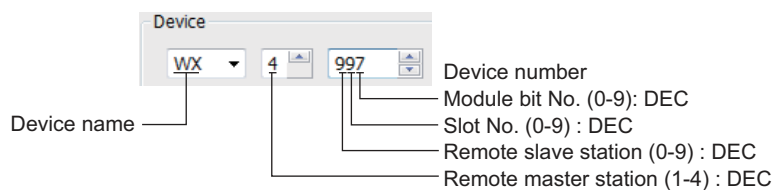

2.6.1 HITACHI HIDIC H Series

	Device name	Setting range	Device No. representation
Bit device	External input (X)	X00000 to X05A95	Hexadecimal + Decimal
	External output (Y)	Y00000 to Y05A95	
	Remote external input (X)	X10000 to X49995	Decimal
	Remote external output (Y)	Y10000 to Y49995	
	1st CPU link (L)	L0000 to L3FFF	Hexadecimal
	2nd CPU link (L1)	L10000 to L13FFF	
	Data area (M)	M0000 to M3FFF	
	On-delay timer (TD) ^{*1}	TD0 to TD255	Decimal
	Single-shot timer (SS) ^{*1}	SS0 to SS255	
	Watchdog timer (WDT) ^{*1}	WDT0 to WDT255	
	Monostable timer (MS) ^{*1}	MS0 to MS255	
	Retentive timer (TMR) ^{*1}	TMR0 to TMR255	
	Up counter (CU) ^{*1}	CU0 to CU511	
	Ring counter (RCU) ^{*1}	RCU0 to RCU511	
	Up/Down counter (CT) ^{*1}	CT0 to CT511	Hexadecimal
	Bit internal output (R)	R0 to R7BF	
	Rising edge detection (DIF) ^{*1}	DIF0 to DIF511	
	Falling edge detection (DFN) ^{*1}	DFN0 to DFN511	Decimal
	Word device bit	Specified bit of the following word devices timer/counter, word internal output	—
Word device	External input (WX)	WX0000 to WX05A7	Hexadecimal + Decimal
	External output (WY)	WY0000 to WY05A7	
	Remote external input (WX)	WX1000 to WX4997	Decimal
	Remote external output (WY)	WY1000 to WY4997	
	First CPU link (WL)	WL000 to WL3FF	Hexadecimal
	2nd CPU link (WL1)	WL1000 to WL13FF	
	Data area (WM)	WM000 to WM3FF	
	Timer/Counter (Elapsed value) (TC) ^{*1}	TC0 to TC511	Decimal
	Word internal output (WR)	WR000 to WR3FF	Hexadecimal

*1 Overlapped numbers cannot be used.

*2 Do not set device outside the range.

If the set device is outside the range, the object set by the device within the range may not be displayed.

3









CONNECTION TO HITACHI PLC

3.1	Connectable Model List	3 - 2
3.2	System Configuration	3 - 3
3.3	Connection Diagram	3 - 5
3.4	GOT Side Settings	3 - 6
3.5	PLC Side Setting	3 - 7
3.6	Device Range that Can Be Set	3 - 8

3. CONNECTION TO HITACHI PLC

3.1 Connectable Model List









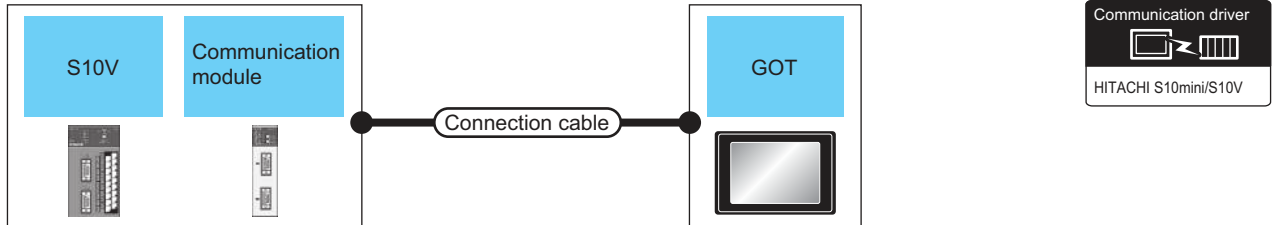











The following table shows the connectable models.

Series	Model name	Clock	Communication Type	Connectable model	Refer to
S10V	LQP510	○	RS-232 RS-422	  	 3.2.1
	LQP520				
S10mini	LQP800	○	RS-232 RS-422	  	 3.2.2
	LQP000				
	LQP010				
	LQP011				
	LQP120				

3.2 System Configuration

3.2.1 Connecting to S10V



PLC			Connection cable		GOT		Number of connectable equipment	
Model name	Communication module ^{*1}	Communication Type	Cable model Connection diagram number	Max. distance	Option device	Model		
LQP510 LQP520	LQE560	RS-232	GT09-C30R21301-9S (3m) or  RS-232 connection diagram 1)	15m	- (Built into GOT)	  	1 GOT for 1 communication module	
					GT15-RS2-9P	  		
LQE565	RS-422	GT09-C30R41301-9S (3m) GT09-C100R41301-9S(10m) GT09-C200R41301-9S(20m) GT09-C300R41301-9S(30m) or  RS-422 connection diagram 2)	500m	- (Built into GOT)	  			
				GT15-RS4-9S	  			
LQP510		RS-422	GT09-C30R41301-9S (3m) GT09-C100R41301-9S(10m) GT09-C200R41301-9S(20m) GT09-C300R41301-9S(30m) or  RS-422 connection diagram 2)	500m	- (Built into GOT)	  		1 GOT for 1 PLC
					GT15-RS4-9S	  		

*1 Product manufactured by Hitachi, Ltd. For details of the product, contact Hitachi, Ltd.

3.2.2 Connecting to S10mini

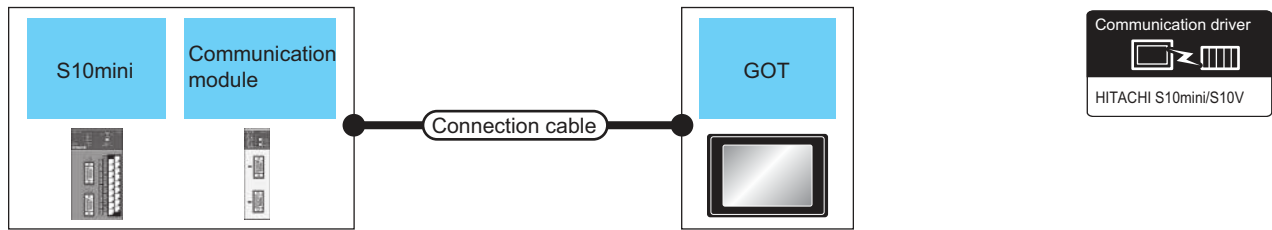

PLC			Connection cable		GOT		Number of connectable equipment
Series	Communication module*1	Communication Type	Cable model Connection diagram number	Max. distance	Option device	Model	
S10mini	LQE560 LQE060 LQE160	RS-232	GT09-C30R21301-9S (3m) or RS-232 connection diagram 1)	15m	- (Built into GOT)	 	1 GOT for 1 communication module
					GT15-RS2-9P	 	
	LQE565 LQE165	RS-422	GT09-C30R41301-9S (3m) GT09-C100R41301-9S(10m) GT09-C200R41301-9S(20m) GT09-C300R41301-9S(30m) or RS-422 connection diagram 2)	500m	- (Built into GOT)	 	
					GT15-RS4-9S	 	

*1 Product manufactured by Hitachi, Ltd. For details of the product, contact Hitachi, Ltd.

3.3 Connection Diagram

The following diagram shows the connection between the GOT and the PLC.

3.3.1 RS-232 cable

■ Connection diagram

(1) RS-232 connection diagram 1)

For the GT16, GT15

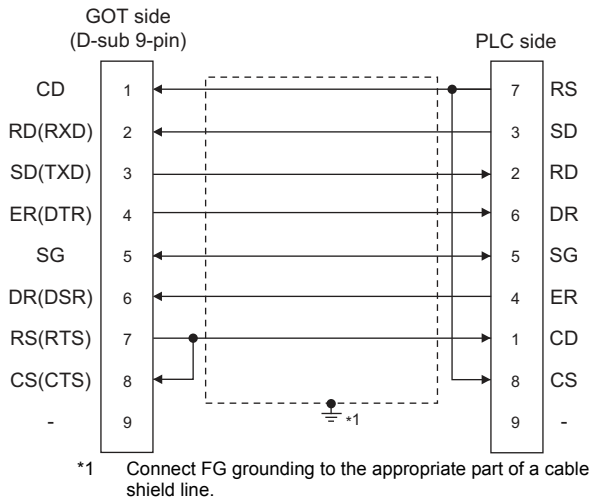

■ Precautions when preparing a cable

(2) Cable length

The length of the RS-232 cable must be 15m or less.

(3) GOT side connector

For the GOT side connector, refer to the following.

☞ 1.4.1 GOT connector specifications

(4) HITACHI PLC side connector

Use the connector supporting the HITACHI PLC side module.

For details, refer to the HITACHI PLC user's manual.

3.3.2 RS-422 cable

■ Connection diagram

(1) RS-422 connection diagram 2)

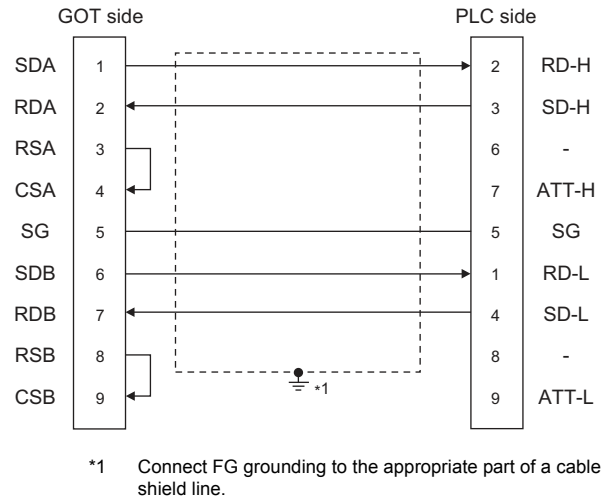

■ Precautions when preparing a cable

(2) Cable length

The length of the RS-422 cable must be 500m or less.

(3) GOT side connector

For the GOT side connector, refer to the following.

☞ 1.4.1 GOT connector specifications

(4) HITACHI PLC side connector

Use the connector compatible with the HITACHI PLC side module.

For details, refer to the HITACHI PLC user's manual.

■ Connecting terminating resistors

(1) GOT side

When connecting a PLC to the GOT, a terminating resistor must be connected to the GOT.

For the procedure to set the terminating resistor, refer to the following.

☞ 1.4.3 Terminating resistors of GOT

3.4 GOT Side Settings

3.4.1 Setting communication interface (Communication settings)

Set the channel of the connected equipment.

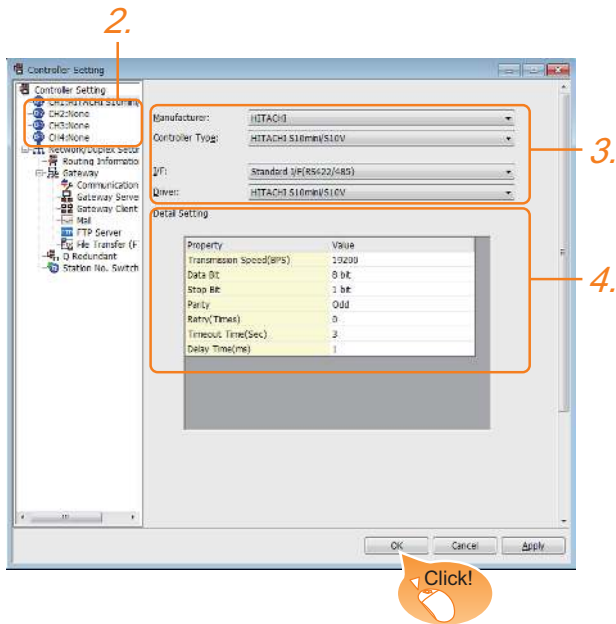

1. Select [Common] → [Controller Setting] from the menu.
2. The Controller Setting window is displayed. Select the channel to be used from the list menu.
3. Set the following items.
 - Manufacturer: HITACHI
 - Controller Type: HITACHI S10mini/S10V
 - I/F: Interface to be used
 - Driver: HITACHI S10mini/S10V
4. The detailed setting is displayed after Manufacturer, Controller Type, I/F, and Driver are set. Make the settings according to the usage environment.

☞ 3.4.2 Communication detail settings

Click the [OK] button when settings are completed.

POINT

The settings of connecting equipment can be confirmed in [I/F Communication Setting]. For details, refer to the following.

☞ 1.1.2 I/F communication setting

3.4.2 Communication detail settings

Make the settings according to the usage environment.

Property	Value
Transmission Speed(BPS)	19200
Data Bit	8 bit
Stop Bit	1 bit
Parity	Odd
Retry(Times)	0
Timeout Time(Sec)	3
Delay Time(ms)	1

Item	Description	Range
Transmission Speed	Set this item when change the transmission speed used for communication with the connected equipment. (Default: 19200bps)	9600bps, 19200bps, 38400bps, 57600bps, 115200bps
Data Bit	Set this item when change the data length used for communication with the connected equipment. (Default: 8bits)	7bits/8bits
Stop Bit	Specify the stop bit length for communications. (Default: 8bits)	1bit/2bits
Parity	Specify whether or not to perform a parity check, and how it is performed during communication. (Default: Odd)	None Even Odd
Retry	Set the number of retries to be performed when a communication error occurs. (Default: 0time)	0 to 5times
Timeout Time	Set the time period for a communication to time out. (Default: 3sec)	1 to 30sec
Delay Time	Set this item to adjust the transmission timing of the communication request from the GOT. (Default: 0)	0 to 300m

POINT

- (1) Communication interface setting by the Utility
The communication interface setting can be changed on the Utility's [Communication Settings] after writing [Communication Settings] of project data.
For details on the Utility, refer to the following manual.

☞ GOT2000 Series User's Manual (Utility)

- (2) Precedence in communication settings
When settings are made by GT Designer3 or the Utility, the latest setting is effective.

3.5 PLC Side Setting

POINT

HITACHI PLC

For details of HITACHI PLCs, refer to the following manuals.

HITACHI PLC user's Manual

Model name	Refer to	
Communication module	LQE560	3.5.1
	LQE060	
	LQE160	
	LQE565	
	LQE165	

3.5.1 Connecting to communication module

■ Communication settings

Make the communication settings of the Communication module.

Item	Set value
Channel No. setting ^{*1*2}	#0 to #3
Protocol setting	H-7338 protocol
Transmission speed	19200bps (fixed)
Data bit	8bits (fixed)
Parity bit	Odd (fixed)
Start bit	1 bit (fixed)
Stop bit	1 bit (fixed)

- *1 The ranges of available channel No. differ depending on the model of communication module.
- *2 Avoid duplication of the channel No.

■ Settings by switch

Make the communication settings using each setting switch.

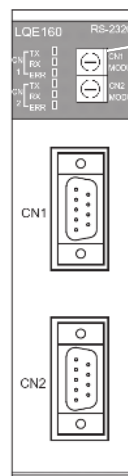

Setting switches for the channel No. and the protocol
CN1 MODU, CN2 MODU

(1) Settings of the channel No. and the protocol

Switch position	Protocol	Channel No.
8	H-7338	#0
9		#1
A		#2
B		#3

CN1 MODU

CN2 MODU

3.6 Device Range that Can Be Set

The device ranges of controller that can be used for GOT are as follows.

Note that the device ranges in the following tables are the maximum values that can be set in GT Designer3.

The device specifications of controllers may differ depending on the models, even though belonging to the same series.

Please make the setting according to the specifications of the controller actually used.

When a non-existent device or a device number outside the range is set, other objects with correct device settings may not be monitored.

Setting item



Item	Information
Device*1	Set the device name, device number, and bit number. The bit number can be set only when specifying the bit of word device.
Information	Displays the device type and setting range which are selected in [Device].

*1 The uppermost bit is b0 and the lowermost bit is b15.

POINT

Device settings of HITACHI PLC

- When setting a bit device
Set the device using the format of address (word unit) + bit number (0 to F).

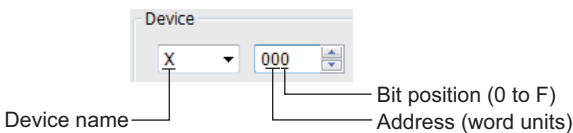

- When setting a word device
For external input (XW), external output (YW), internal register (RW), extended internal register (MW, AW), keep relay (KW), on-delay timer (TW), one-shot timer (UW), up-down counter (CW), global link register (GW), event register (EW), system register (SW), transfer register (JW), and receive register (QW), set as follows.

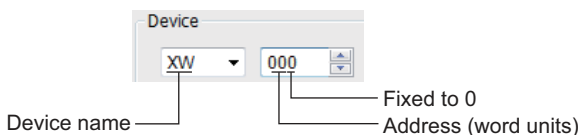

3.6.1 HITACHI S10mini/S10V

Device name	Setting range	Device No. representation	
External input (X)	X000 to XFFF	Hexadecimal	
External output (Y)	Y000 to YFFF		
Internal register (R)	R000 to RFFF		
Keep relay (K)	K000 to KFFF		
Extended internal register (M)	M000 to MFFF		
Extended internal register (A)	A000 to AFFF		
On-delay timer (T)	T000 to T1FF		
One-shot timer (U)	U000 to U0FF		
Up-down counter (C)	C00 to CFF		
Global link register (GL)*6	GL000 to GLFFF		
Event register (E)	E000 to EFFF		
System register (S)*1	S000 to SBFF		
Transfer register (J)	J000 to JFFF		
Receive register (Q)	Q000 to QFFF	—	
Word device bit	Specified bit of the following word devices One-shot timer, up-down counter, function data register, function work register, extended function work register, backup work register, backup long-word work register		
External input (XW)	XW000 to XWFF0		Hexadecimal
External output (YW)	YW000 to YWFF0		
Internal register (RW)	RW000 to RWFF0		
Extended internal register (MW)	MW000 to MWFF0		
Extended internal register (AW)	AW000 to AWFF0		
Keep relay (KW)	KW000 to KWFF0		
On-delay timer (TW)	TW000 to TW1F0		

Device name	Setting range	Device No. representation
One-shot timer (UW)	UW000 to UW0F0	Hexadecimal
Up-down counter (CW)	CW00 to CWF0	
Global link register (GW)	GW000 to GWFF0	
Event register (EW)	EW000 to EWFF0	
System register (SW) ^{*1}	SW000 to SWBF0	
Transfer register (JW)	JW000 to JWFF0	
Receive register (QW)	QW000 to QWFF0	
On-delay timer (current value) (TC) ^{*2}	TC000 to TC1FF	
On-delay timer (set value) (TS) ^{*2}	TS000 to TS1FF	
One-shot timer (current value) (UC) ^{*2}	UC000 to UC0FF	
One-shot timer (set value) (US) ^{*2}	US000 to US0FF	
Up-down counter (current value) (CC) ^{*2}	CC00 to CCFF	
Up-down counter (set value) (CS) ^{*2}	CS00 to CSFF	
Function data register (DW) ^{*4*5}	DW000 to DWFFF	
Function work register (FW) ^{*4*5}	FW000 to FWBFF	
Extended function work register (LWW) ^{*4*5}	LWW0000 to LWWFFFF	
Backup work register (LXW) ^{*5}	LXW0000 to LXW3FFF	
Long-word work register (LLL) ^{*3}	LLL0000 to LLL1FFF	
Backup Long-word work register (LML) ^{*3*4}	LML0000 to LML1FFF	
Floating-point work register (LF) ^{*3}	LF0000 to LF1FFF	
Backup single-precision floating-point work register (LG) ^{*3}	LG0000 to LG1FFF	

*1 Only reading is possible.

*2 Only 16-bit (1-word) designation is allowed.

*3 Only 32-bit (2-word) designation is allowed.

*4 When it is used with bit specification (bit specification of word device), the offset function cannot be used.

*5 When bit specification (bit specification of word device) is performed, the uppermost bit is b0 and the lowermost bit is b15.

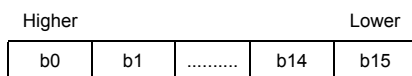

*6 Device "GL" corresponds to device "G" of the PLC.

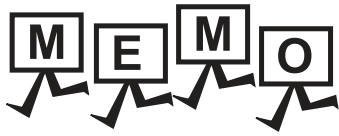

4













CONNECTION TO FUJI PLC

4.1	Connectable Model List	4 - 2
4.2	System Configuration	4 - 3
4.3	Connection Diagram	4 - 11
4.4	GOT Side Settings	4 - 13
4.5	PLC Side Setting	4 - 14
4.6	Device Range that Can Be Set	4 - 19
4.7	Precautions	4 - 21

4. CONNECTION TO FUJI PLC

4.1 Connectable Model List

The following table shows the connectable models.

Series	Model name	Clock	Communication Type	Connectable model	Refer to
MICREX-F	F55	×	RS-232 RS-485	  	 4.2.1
	F70	×	RS-232 RS-485	  	 4.2.2
	F120S	×	RS-232 RS-485	  	 4.2.3
	F140S				
	F15□S				

4.2 System Configuration





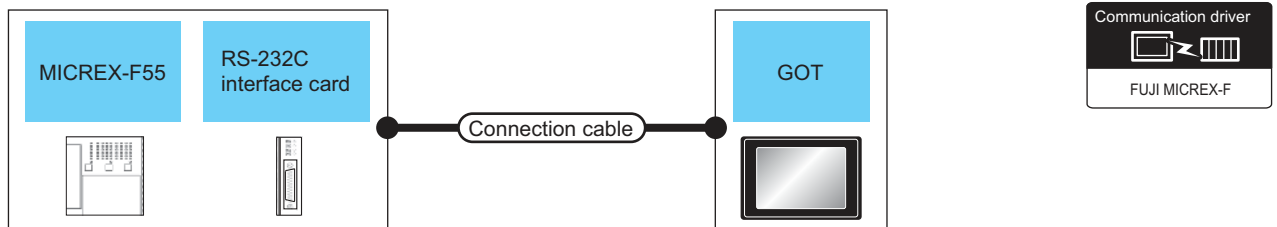

4.2.1 Connecting to MICREX-F55

For details on the system configuration on the PLC side, refer to the following section.

 4.7 Precautions

■ When using the RS-232 interface card







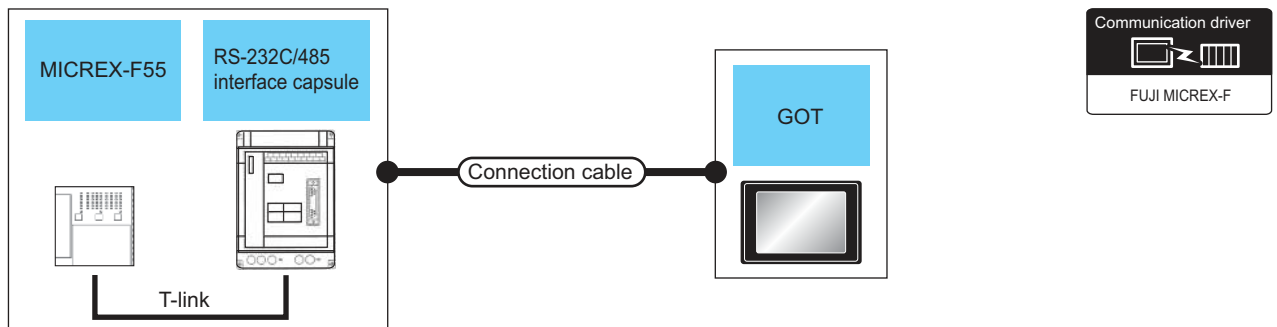

PLC			Connection cable		GOT		Number of connectable equipment
Model name	RS-232C interface card*1	Communication Type	Cable model Connection diagram number	Max. distance	Option device	Model	
F55	NV1L-RS2	RS-232	GT09-C30R21003-25P(3m) or  RS-232 connection diagram 1)	15m	- (Built into GOT)	  	1 GOT for 1 RS-232C interface card
					GT15-RS2-9P	  	

*1 Product manufactured by Fuji Electric Co., Ltd. For details of the product, contact Fuji Electric Co., Ltd.

■ When using the RS-232C/485 interface capsule



PLC			Connection cable		GOT		Number of connectable equipment
Model name	RS-232C/485 interface capsule*1	Communication Type	Cable model Connection diagram number	Max. distance	Option device	Model	
F55	FFK120A-C10	RS-232	GT09-C30R21003-25P(3m) or  RS-232 connection diagram 1)	15m	- (Built into GOT)	  	1 GOT for 1 RS-232C/485 interface capsule
					GT15-RS2-9P	  	

*1 Product manufactured by Fuji Electric Co., Ltd. For details of the product, contact Fuji Electric Co., Ltd.

■ When connecting to multiple PLCs

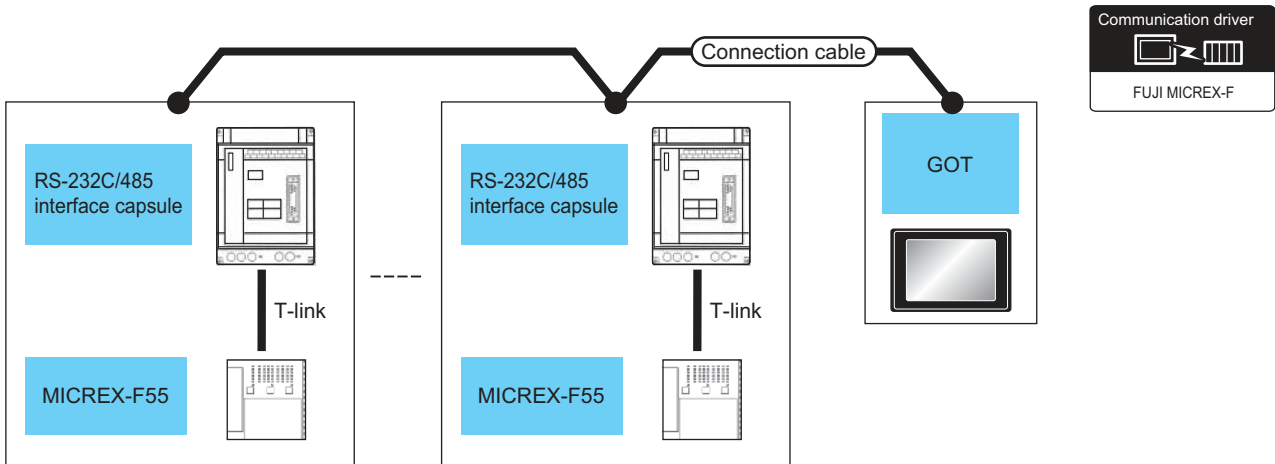

PLC			Connection cable		GOT		Number of connectable equipment
Model name	RS-232C/485 interface capsule*1	Communication Type	Cable model Connection diagram number	Max. distance	Option device	Model	
F55	FFK120A-C10	RS-485	GT09-C30R41001-6T(3m) GT09-C100R41001-6T(10m) GT09-C200R41001-6T(20m) GT09-C300R41001-6T(30m)	500m*2	- (Built into GOT)	<div style="display: flex; flex-direction: column; align-items: center;"> <div style="border: 1px solid black; padding: 2px; margin-bottom: 2px;">GT 27</div> <div style="border: 1px solid black; padding: 2px; margin-bottom: 2px;">GT 23</div> <div style="border: 1px solid black; padding: 2px;">GS</div> </div>	1 GOT for up to 6 PLCs (RS-232C/485 interface capsules)
			or RS-485 connection diagram 1)	500m	GT15-RS4-9S	<div style="display: flex; flex-direction: column; align-items: center;"> <div style="border: 1px solid black; padding: 2px; margin-bottom: 2px;">GT 27</div> <div style="border: 1px solid black; padding: 2px; margin-bottom: 2px;">GT 23</div> <div style="border: 1px solid black; padding: 2px;">GS</div> </div>	

*1 Product manufactured by Fuji Electric Co., Ltd. For details of the product, contact Fuji Electric Co., Ltd.

*2 Including the cable length of the option devices.





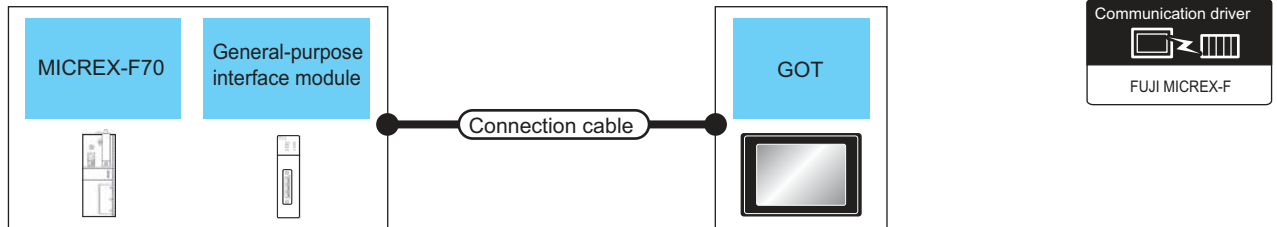

4.2.2 Connecting to MICREX-F70

For details on the system configuration on the PLC side, refer to the following.

 4.7 Precautions

■ When using general-purpose interface modules







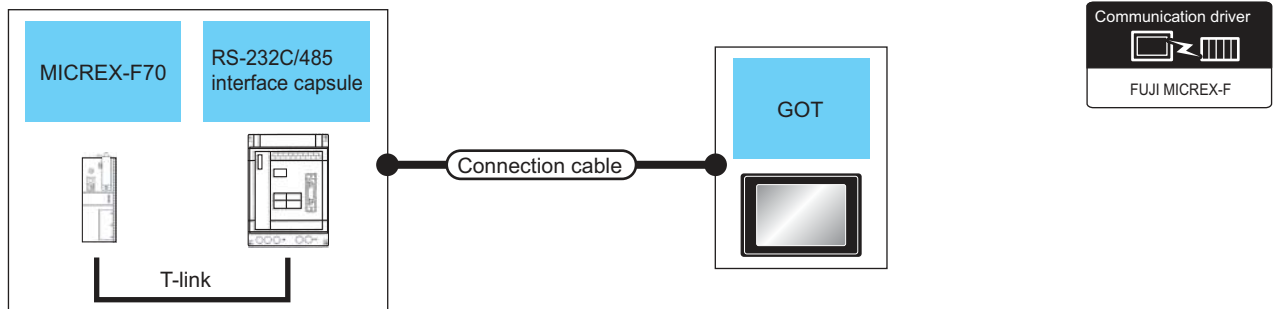

PLC			Connection cable		GOT		Number of connectable equipment
Model name	General-purpose interface module*1	Communication Type	Cable model Connection diagram number	Max. distance	Option device	Model	
F70	NC1L-RS2	RS-232	GT09-C30R21003-25P(3m) or  RS-232 connection diagram 1)	15m	- (Built into GOT)	  	1 GOT for 1 general-purpose interface module
					GT15-RS2-9P	  	

*1 Product manufactured by Fuji Electric Co., Ltd. For details of the product, contact Fuji Electric Co., Ltd.

■ When using the RS-232C/485 interface capsule



PLC			Connection cable		GOT		Number of connectable equipment
Model name	RS-232C/485 interface capsule*1	Communication Type	Cable model Connection diagram number	Max. distance	Option device	Model	
F70	FFK120A-C10	RS-232	GT09-C30R21003-25P(3m) or  RS-232 connection diagram 1)	15m	- (Built into GOT)	  	1 GOT for 1 RS-232C/485 interface capsule
					GT15-RS2-9P	  	

*1 Product manufactured by Fuji Electric Co., Ltd. For details of the product, contact Fuji Electric Co., Ltd.

■ When connecting to multiple PLCs (using RS-232C/485 interface capsules)

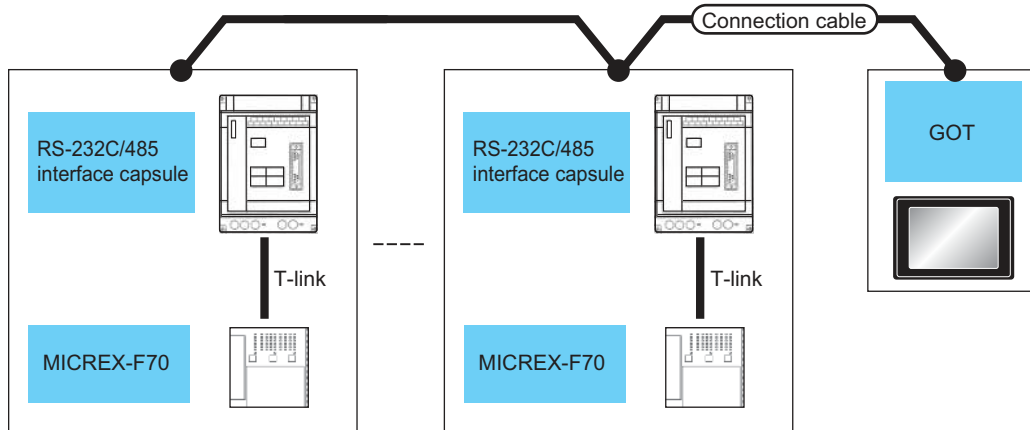







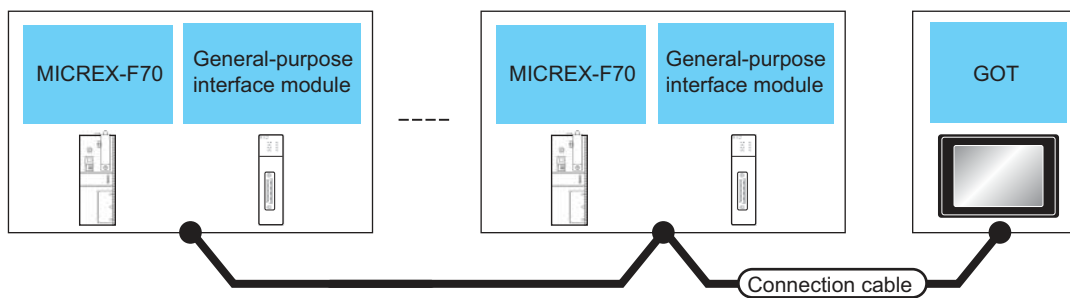

PLC			Connection cable		GOT		Number of connectable equipment
Model name	RS-232C/485 interface capsule*1	Communication Type	Cable model Connection diagram number	Max. distance	Option device	Model	
F70	FFK120A-C10	RS-485	GT09-C30R41001-6T(3m) GT09-C100R41001-6T(10m) GT09-C200R41001-6T(20m) GT09-C300R41001-6T(30m)	500m*2	- (Built into GOT)	 	1 GOT for up to 6 PLCs (RS-232C/485 interface capsules)
			RS-485 connection diagram 1)	500m	GT15-RS4-9S	 	

*1 Product manufactured by Fuji Electric Co., Ltd. For details of the product, contact Fuji Electric Co., Ltd.

*2 Including the cable length of the option devices.

■ When connecting to multiple PLCs (using general-purpose interface modules)



PLC			Connection cable		GOT		Number of connectable equipment
Model name	General-purpose interface module*1	Communication Type	Cable model Connection diagram number	Max. distance	Option device	Model	
F70	NC1L-RS4	RS-485	GT09-C30R41001-6T(3m) GT09-C100R41001-6T(10m) GT09-C200R41001-6T(20m) GT09-C300R41001-6T(30m)	500m*2	- (Built into GOT)	  	1 GOT for up to 31 PLCs (general-purpose interface modules)
			or  RS-485 connection diagram 1)	500m	GT15-RS4-9S	  	1 GOT for up to 10 PLCs (general-purpose interface modules)

*1 Product manufactured by Fuji Electric Co., Ltd. For details of the product, contact Fuji Electric Co., Ltd.

*2 Including the cable length of the option devices.

4.2.3 Connecting to MICREX-F120S/140S/15[S

For details on the system configuration on the PLC side, refer to the following.

 4.7 Precautions

■ When using general-purpose interface modules

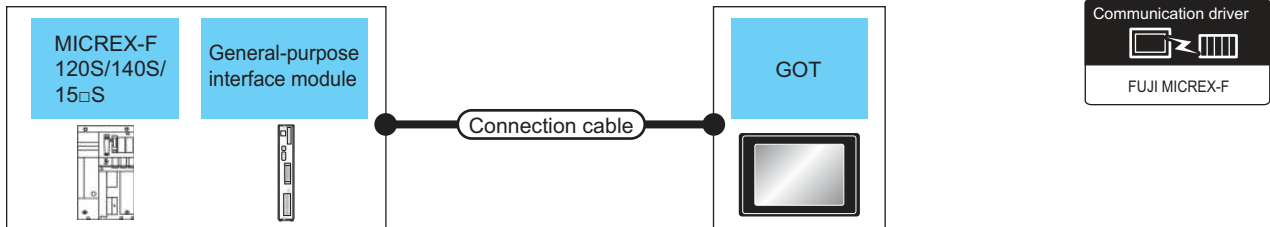

PLC			Connection cable		GOT		Number of connectable equipment
Model name	General-purpose interface module*1	Communication Type	Cable model Connection diagram number	Max. distance	Option device	Model	
F120S F140S F15[S	FFU120B	RS-232	GT09-C30R21003-25P(3m) or  RS-232 connection diagram 1)	15m	- (Built into GOT)	GT 27 GT 23 GS	1 GOT for 1 general-purpose interface module
					GT15-RS2-9P	GT 27 GT 23 GS	

*1 Product manufactured by Fuji Electric Co., Ltd. For details of the product, contact Fuji Electric Co., Ltd.

■ When using the RS-232C/485 interface capsule

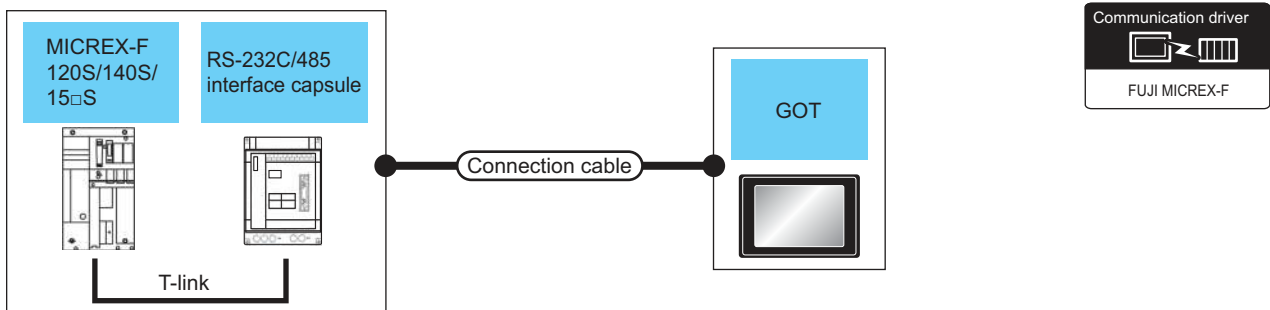

PLC			Connection cable		GOT		Number of connectable equipment
Model name	RS-232C/485 interface capsule*1	Communication Type	Cable model Connection diagram number	Max. distance	Option device	Model	
F120S F140S F15[S	FFK120A-C10	RS-232	GT09-C30R21003-25P(3m) or  RS-232 connection diagram 1)	15m	- (Built into GOT)	GT 27 GT 23 GS	1 GOT for 1 RS-232C/485 interface capsule
					GT15-RS2-9P	GT 27 GT 23 GS	

*1 Product manufactured by Fuji Electric Co., Ltd. For details of the product, contact Fuji Electric Co., Ltd.

■ When connecting to multiple PLCs (using RS-232C/485 interface capsules)

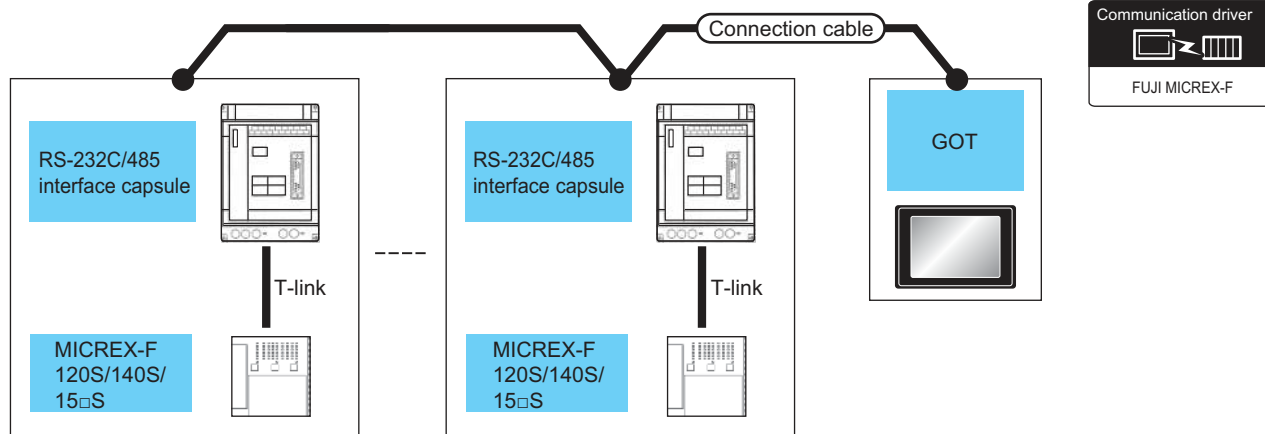

PLC			Connection cable		GOT		Number of connectable equipment
Model name	RS-232C/485 interface capsule*1	Communication Type	Cable model Connection diagram number	Max. distance	Option device	Model	
F120S F140S F15□S	FFK120A-C10	RS-485	GT09-C30R41001-6T(3m) GT09-C100R41001-6T(10m) GT09-C200R41001-6T(20m) GT09-C300R41001-6T(30m)	500m*2	- (Built into GOT)	GT 27 GT 23 GS	1 GOT for up to 6 PLCs (RS-232C/485 interface capsules)
			or RS-485 connection diagram 1)	500m		GT15-RS4-9S	

*1 Product manufactured by Fuji Electric Co., Ltd. For details of the product, contact Fuji Electric Co., Ltd.

*2 Including the cable length of the option devices.

■ When connecting to multiple PLCs (using general-purpose interface modules)

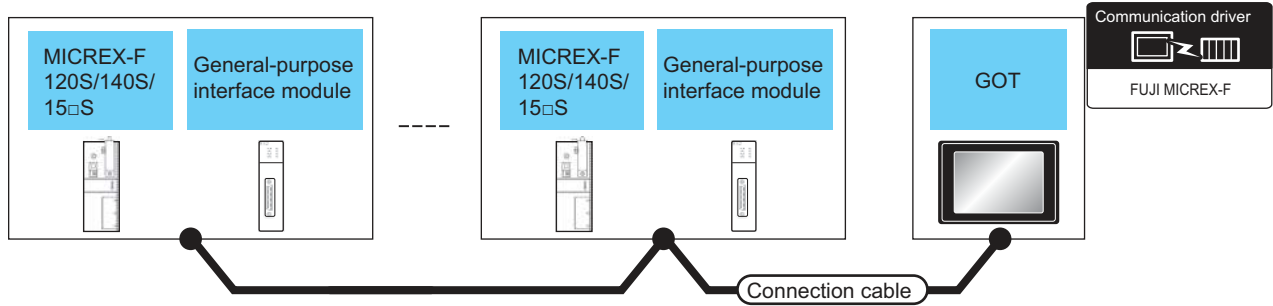

PLC			Connection cable		GOT		Number of connectable equipment
Model name	General-purpose interface module*1	Communication Type	Cable model Connection diagram number	Max. distance	Option device	Model	
F120S F140S F15□S	FFU120B	RS-485	GT09-C30R41001-6T(3m) GT09-C100R41001-6T(10m) GT09-C200R41001-6T(20m) GT09-C300R41001-6T(30m) or RS-485 connection diagram 1)	500m*2	- (Built into GOT)	 	1 GOT for up to 31 PLCs (general-purpose interface modules)
				500m	GT15-RS4-9S	 	

*1 Product manufactured by Fuji Electric Co., Ltd. For details of the product, contact Fuji Electric Co., Ltd.

*2 Including the cable length of the option devices.

4.3 Connection Diagram

The following diagram shows the connection between the GOT and the PLC.

4.3.1 RS-232 cable

■ Connection diagram

(1) RS-232 connection diagram 1)

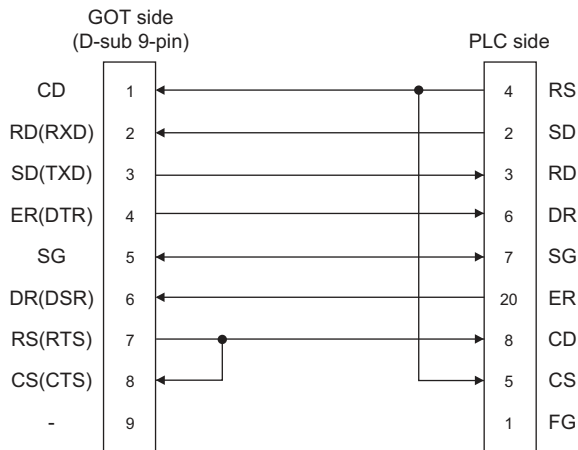

■ Precautions when preparing a cable

(1) Cable length

The length of the RS-232 cable must be 15m or less.

(2) GOT side connector

For the GOT side connector, refer to the following.

 1.4.1 GOT connector specifications

(3) FUJI PLC side connector

Use the connector compatible with the FUJI PLC side module.

For details, refer to the user's FUJI PLC manual.

4.3.2 RS-485 cable

(1) RS-485 connection diagram 1

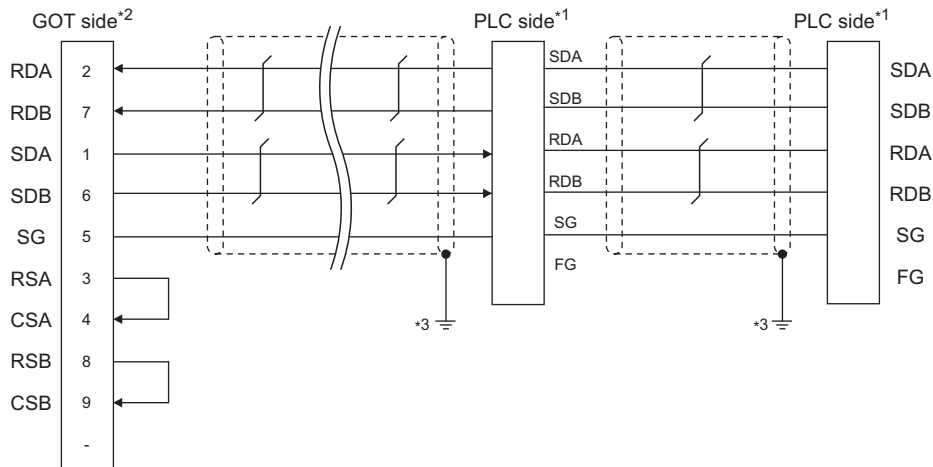

*1 Turn ON the terminating switch of a interface converter which will be a terminal.

*2 Set the terminating resistor of GOT side which will be a terminal.

 ■ Connecting terminating resistors

*3 Connect FG grounding to the appropriate part of a cable shield line.

■ Precautions when preparing a cable

(2) Cable length

The length of the RS-485 cable must be 500m or less.

(3) GOT side connector

For the GOT side connector, refer to the following.

 1.4.1 GOT connector specifications

(4) FUJI PLC side connector

Use the connector compatible with the FUJI PLC side module.

For details, refer to the user's FUJI PLC manual.

■ Connecting terminating resistors

(1) GOT side

Set the terminating resistor setting switch of the GOT main unit to "100 OHM".

For the procedure to set the terminating resistor, refer to the following.

 1.4.3 Terminating resistors of GOT

(2) FUJI PLC side

When connecting a FUJI PLC to the GOT, a terminating resistor must be connected.

 4.5 PLC Side Setting

4.4 GOT Side Settings

4.4.1 Setting communication interface (Communication settings)

Set the channel of the connected equipment.

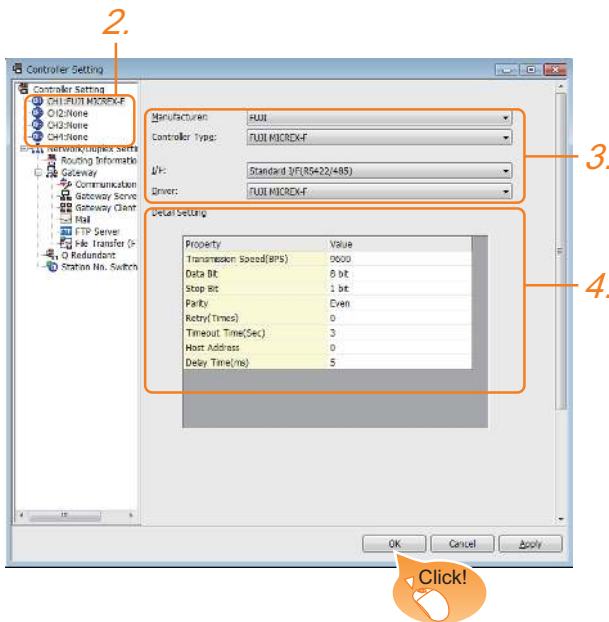

1. Select [Common] → [Controller Setting] from the menu.
2. The Controller Setting window is displayed. Select the channel to be used from the list menu.
3. Set the following items.
 - Manufacturer: FUJI
 - Controller Type: FUJI MICREX-F
 - I/F: Interface to be used
 - Driver: FUJI MICREX-F
4. The detailed setting is displayed after Manufacturer, Controller Type, I/F, and Driver are set. Make the settings according to the usage environment.

☞ 4.4.2 Communication detail settings

Click the [OK] button when settings are completed.

POINT

The settings of connecting equipment can be confirmed in [I/F Communication Setting]. For details, refer to the following.

☞ 1.1.2 I/F communication setting

4.4.2 Communication detail settings

Make the settings according to the usage environment.

Property	Value
Transmission Speed(BPS)	9600
Data Bit	8 bit
Stop Bit	1 bit
Parity	Even
Retry(Times)	0
Timeout Time(Sec)	3
Host Address	0
Delay Time(ms)	5

Item	Description	Range
Transmission Speed	Set this item when change the transmission speed used for communication with the connected equipment. (Default: 9600bps)	9600bps, 19200bps, 38400bps, 57600bps, 115200bps
Data Bit	Set this item when change the data length used for communication with the connected equipment. (Default: 8bits)	7bits/8bits
Stop Bit	Specify the stop bit length for communications. (Default: 1bit)	1bit/2bits
Parity	Specify whether or not to perform a parity check, and how it is performed during communication. (Default: Even)	None Even Odd
Retry	Set the number of retries to be performed when a communication error occurs. (Default: 0time)	0 to 5times
Timeout Time	Set the time period for a communication to time out. (Default: 3sec)	1 to 30sec
Host Address	Specify the host address (station No. of the GOT to which the PLC is connected) in the connected network. (Default: 0)	0 to 99
Delay Time	Set this item to adjust the transmission timing of the communication request from the GOT. (Default: 5ms)	0 to 300ms

POINT

- (1) Host address
When connecting to PLC by RS-232 communication, set the Host Address to "0".
- (2) Communication interface setting by the Utility
The communication interface setting can be changed on the Utility's [Communication Settings] after writing [Communication Settings] of project data. For details on the Utility, refer to the following manual.
☞ GOT2000 Series User's Manual (Utility)
- (3) Precedence in communication settings
When settings are made by GT Designer3 or the Utility, the latest setting is effective.

4.5 PLC Side Setting

POINT

FUJI PLC

For details of FUJI PLCs, refer to the following manuals.

 FUJI PLC user's Manual

Model name		Refer to
RS-232C interface card	NV1L-RS2	4.5.1
	NC1L-RS2	
General-purpose interface module	NC1L-RS4	4.5.2
	FFU120B	4.5.3
	FFK120A-C10	4.5.4

4.5.1 Connecting to NV1L-RS2, NC1L-RS2

■ Communication settings

Make the communication settings using setting switches.

Item	Set value
MODE	Command-setting-type start-stop synchronization, nonsequence format
Transmission speed*1	9600bps, 19200bps
Data bit*1	8bits or 7bits
Parity bit*1	Even or Odd Done, None
Stop bit*1	1bit, 2bits
Initializing method	By switch

*1 Adjust the settings with GOT settings.

■ Settings by switch

Make the communication settings using each setting switch.

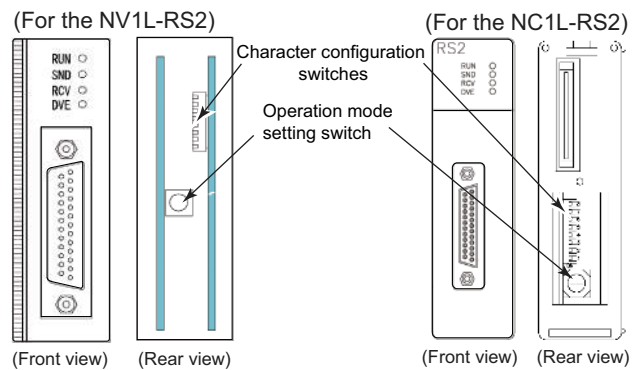

(1) Setting of the MODE

Make the MODE settings using the MODE switch.

MODE	Switch position	
	NV1L-RS2	NC1L-RS2
Command-setting-type start-stop synchronization, nonsequence format	1	1

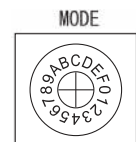

(2) Setting of Transmission speed, Stop bit, Data bit, Parity bit, Initializing method

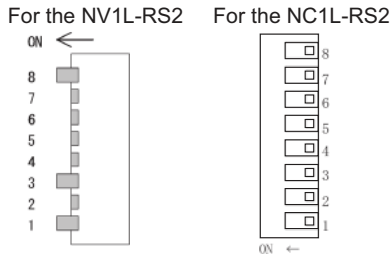

Setting item	Set value	Switch No.								
		1	2	3	4	5	6	7	8	
Transmission speed	9600bps	ON	OFF	ON						
	19200bps	OFF	ON	ON						
Stop bit	1bit				ON					
	2bits				OFF					
Data bit	7bits					ON				
	8bits					OFF				
Parity bit	Even							ON		
	Odd							OFF		
	Done								ON	
	None									OFF
Initializing method	By switch									ON

4.5.2 Connecting to NC1L-RS4

Communication settings

Make the communication settings using setting switches.

Item	Set value
MODE	Command-setting-type start-stop synchronization, nonsequence format
Transmission speed*1	9600bps, 19200bps
Data bit*1	8bits or 7bits
Parity bit*1	Even or Odd
	Done, None
Stop bit*1	1bit, 2bits
Initializing method	By switch
Station No.*1*2	0 to 99
Terminating resistor*3	ON or OFF

- *1 Adjust the settings with GOT settings.
- *2 Avoid duplication of the station No. with any of the other units.
- *3 Turn ON the terminating switch of a general-purpose interface module which will be a terminal.

Settings by switch

Make the communication settings using each setting switch.

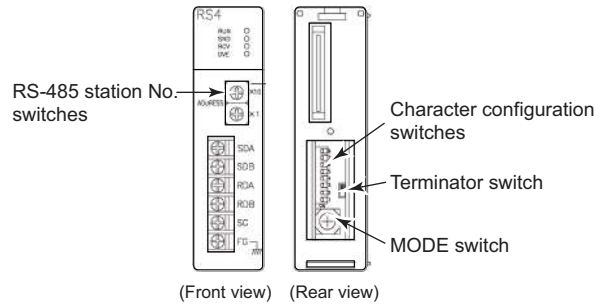

(1) Setting of the MODE

Make the MODE settings using the MODE switch.

MODE	Switch position
Command-setting-type start-stop synchronization, nonsequence format	3

(2) Setting of the station No.

Make the station No. using RS-485 station No. switches.

Station No.
0 to 99

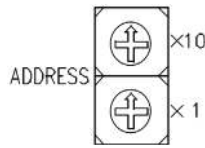

(3) Connecting terminating resistors

Turn ON/OFF the terminating resistor using RS-485 terminating resistor ON/OFF switch.



(4) Setting of Transmission speed, Stop bit, Data bit, Parity bit, Initializing method

Make the settings using the character configuration switches.



Setting item	Set value	Switch No.							
		1	2	3	4	5	6	7	8
Transmission speed	9600bps	ON	OFF	ON					
	19200bps	OFF	ON	ON					
Stop bit	1bit				ON				
	2bits				OFF				
Data bit	7bits					ON			
	8bits					OFF			
Parity bit	Even						ON		
	Odd						OFF		
	Done							ON	
	None								OFF
Initializing method	By switch								ON

4.5.3 Connecting to FFU120B

Communication settings

Make the communication settings using setting switches.

Item	Set value
MODE	Command-setting-type start-stop synchronization, nonsequence format
Transmission speed ^{*1}	9600bps, 19200bps
Data bit ^{*1}	8bits or 7bits
Parity bit ^{*1}	Even or Odd
	Done, None
Stop bit ^{*1}	1bit, 2bits
Initializing method	By switch
Station No. ^{*1*2}	0 to 99
Terminating resistor ^{*3}	ON or OFF

*1 Adjust the settings with GOT settings.

*2 Avoid duplication of the station No. with any of the other units.

*3 Turn ON the terminating switch of a general-purpose interface module which will be a terminal.

Settings by switch

Make the communication settings using each setting switch.

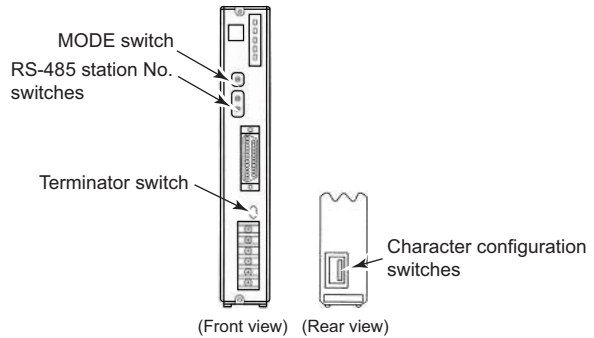

(1) Setting of the MODE

Make the MODE settings using the MODE switch.

MODE	Switch position
Command-setting-type start-stop synchronization, nonsequence format RS-232C 1:1	1
Command-setting-type start-stop synchronization, nonsequence format RS-232C 1:1, and RS-485 1:N	2
Command-setting-type start-stop synchronization, nonsequence format RS-485 1:N	3

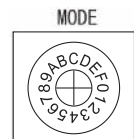

(2) Setting of the station No.

Make the station No. using RS-485 station No. switches.

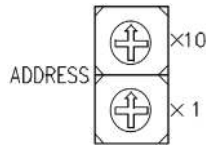
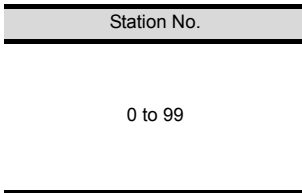

(3) Connecting terminating resistors

Turn ON/OFF the terminating resistor using RS-485 terminating resistor ON/OFF switch.



(4) Setting of Transmission speed, Stop bit, Data bit, Parity bit, Initializing method

Make the settings using the character configuration switches.

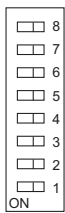

Setting item	Set value	Switch No.							
		1	2	3	4	5	6	7	8
Transmission speed	9600bps	ON	OFF	ON					
	19200bps	OFF	ON	ON					
Stop bit	1bit				ON				
	2bits				OFF				
Data bit	7bits					ON			
	8bits					OFF			
Parity bit	Even						ON		
	Odd						OFF		
	Done							ON	
	None								OFF
Initializing method	By switch								ON

4.5.4 Connecting to FFK120A-C10

Communication settings

Make the communication settings using setting switches.

Item	Set value
MODE*4	Command-setting-type start-stop synchronization, nonsequence format RS-232C 1:1
	Command-setting-type start-stop synchronization, nonsequence format RS-232C 1:1, and RS-485 1:N
	Command-setting-type start-stop synchronization, nonsequence format RS-485 1:N
Transmission speed*1	9600bps, 19200bps
Data bit*1	8bits or 7bits
Parity bit*1	Even or Odd
	Done, None
Stop bit*1	1bit, 2bits
Initializing method	By switch
Station No.*1*2	0 to 99
Terminating resistor*3	ON or OFF
T-link channel switch	
T-link terminating resistor	FUJI PLC user's Manual

- *1 Adjust the settings with GOT settings.
- *2 Avoid duplication of the station No. with any of the other units.
- *3 Turn ON the terminating switch of a general-purpose interface module which will be a terminal.
- *4 Set as necessary.

Settings by switch

Make the communication settings using each setting switch.

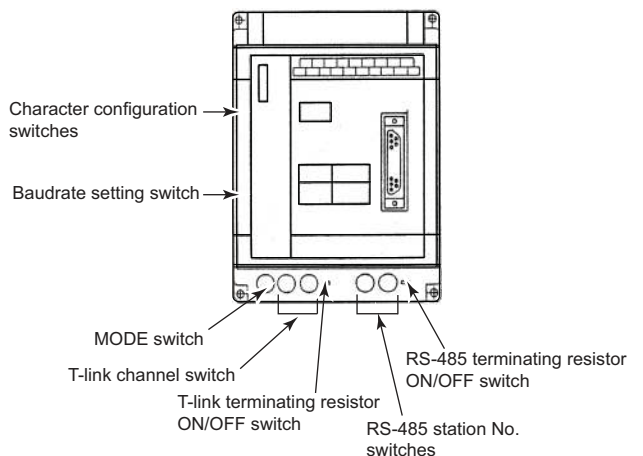

(1) Setting of the MODE

Make the MODE settings using the MODE switch.

MODE	Switch position
Command-setting-type start-stop synchronization, nonsequence format RS-232C 1:1	1
Command-setting-type start-stop synchronization, nonsequence format RS-232C 1:1, and RS-485 1:N	2
Command-setting-type start-stop synchronization, nonsequence format RS-485 1:N	3



(5) Transmission speed settings

Make the settings using the baudrate setting switches.

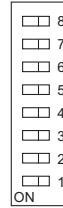

Setting item	Set value	Switch No.							
		1	2	3	4	5	6	7	8
Transmission speed	9600bps	OFF	OFF	OFF	OFF	OFF	ON	OFF	OFF
	19200bps	OFF	OFF	OFF	OFF	OFF	OFF	ON	OFF

(2) Setting of the station No.

Make the station No. using RS-485 station No. switches.

Station No.
0 to 99

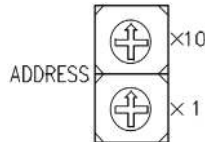

4.5.5 Station number setting

Set each station number so that no station number overlaps.

The station number can be set without regard to the cable connection order. There is no problem even if station numbers are not consecutive.

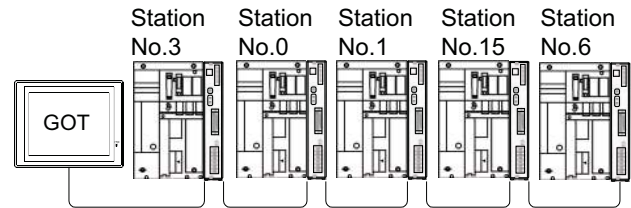

Examples of station number setting

(3) Connecting terminating resistors

Turn ON/OFF the terminating resistor using RS-485 terminating resistor ON/OFF switch.

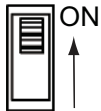

(4) Setting of Stop bit, Data bit, Parity bit, Initializing method

Make the settings using the character configuration switches.

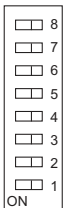

Setting item	Set value	Switch No.							
		1	2	3	4	5	6	7	8
disable		OFF	OFF	OFF					
Stop bit	1bit				ON				
	2bits				OFF				
Data bit	7bits					ON			
	8bits					OFF			
Parity bit	Even						ON		
	Odd						OFF		
	Done							ON	
	None							OFF	
Initializing method	By switch								ON

(1) Direct specification

Specify the station No. of the PLC to be changed when setting device.

Specification range
0 to 99

4.6 Device Range that Can Be Set

The device ranges of controller that can be used for GOT are as follows.

Note that the device ranges in the following tables are the maximum values that can be set in GT Designer3.

The device specifications of controllers may differ depending on the models, even though belonging to the same series.

Please make the setting according to the specifications of the controller actually used.

When a non-existent device or a device number outside the range is set, other objects with correct device settings may not be monitored.

Setting item

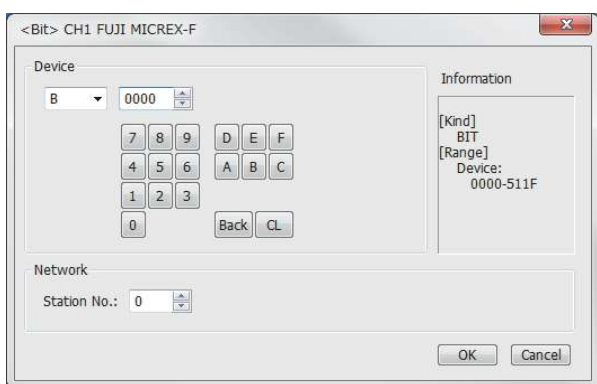

Item	Information
Device	Set the device name, device number, and bit number. The bit number can be set only when specifying the bit of word device. The uppermost bit is b0 and the lowermost bit is b15.
Information	Displays the device type and setting range which are selected in [Device].
Network	Set the monitor target of the set device.
	Station No. Select this item when monitoring the PLC of the specified station No.

POINT

Device settings of FUJI FA PLC

- When setting a bit device
Set the device using the format of word number (DEC) + bit No. (0 to F (HEX)).

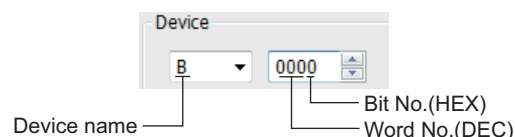

- When setting a word device
For direct access (W24) and user file (W30 to W109, W9), set as follows.

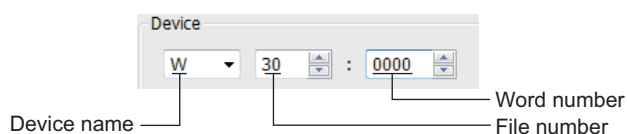

4.6.1 FUJI MICREX-F Series

	Device name	Setting range	Device No. representation	
Bit device	I/O relay (B)	B0000 to B511F	Decimal + Hexadecimal	
	Auxiliary relay (M)	M0000 to M511F		
	Keep relay (K)	K0000 to K063F		
	Special relay (F) ^{*1}	F0000 to F125F		
	Annunciator relay (A)	A0000 to A045F		
	Differential relay (D)	D0000 to D063F		
	Link memory (L)	L0000 to L511F		
	Timer output (0.01s) (T)	T000 to T511		Decimal
	Timer output (0.1s) (T)	T512 to T999		
	Counter output (C)	C000 to C511		
	Word device bit ^{*5}	Specified bit of the following word devices Direct access, user file	—	
Word device	I/O relay (WB)	WB000 to WB511	Decimal	
	Auxiliary relay (WM)	WM000 to WM511		
	Keep relay (WK)	WK000 to WK063		
	Special relay (WF) ^{*1}	WF000 to WF125		
	Annunciator relay (WA)	WA000 to WA045		

Device name	Setting range	Device No. representation
Differential relay (WD)	WD000 to WD063	Decimal
Link memory (WL)	WL000 to WL511	
Direct access (W24) ^{*6*7}	W24:0000 to W24:0255	
User file (W30) ^{*4*6*7} User file (W31) ^{*4*6*7} : User file (W108) ^{*4*6*7} User file (W109) ^{*4*6*7}	W30:0000 to W30:4095 W31:0000 to W31:4095 : W108:0000 to W108:4095 W109:0000 to W109:4095	Decimal
Data memory (BD) ^{*2}	BD0 to BD4095	
Timer set value (0.01s) (TS) ^{*2*3}	TS0 to TS511	
Timer current value (0.01s) (TR) ^{*2*3}	TR0 to TR511	
Timer current value (0.1s) (W9) ^{*2*3}	W9:0000 to W9:0487	
Counter set value (CS) ^{*2*3}	CS0 to CS511	
Counter current value (CR) ^{*2*3}	CR0 to CR511	

Word device

- *1 Only reading is possible.
- *2 Only 32-bit (2-word) designation is allowed.
- *3 Decimal points are not displayed.
- *4 To read/write data from/to a user file, set SI data for the data format of the PLC CPU and 16 bits for data length on GT Designer3.
With any setting other than the above, the PLC does not operate normally.

Data format of the PLC CPU	GT Designer3 setting
SI (Binary 16-bit length)	Device data bit: 16 bits
DI (Binary 32-bit length)	Cannot be used
BD (8-digit BCD)	Cannot be used

- *5 As bit specification of a word device is performed after the GOT reads the value, do not change the value in the sequence program during this period.
- *6 When it is used with bit specification (bit specification of word device), the offset function cannot be used.
- *7 When bit specification (bit specification of word device) is performed, the uppermost bit is b0 and the lowermost bit is b15.

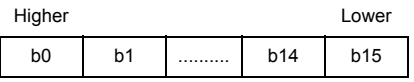

4.7 Precautions

■ Station No. settings of the PLC side

In the system configuration, the PLC with the station number set with the host address must be included. For details of host address setting, refer to the following.

 4.4.2 Communication detail settings

■ System configuration of the PLC side

GOT can communicate in a system configuration where NC1L-PS4, FFU120B and FFK120A-C10 are mixed. When using FFK120A-C10, the number of PLCs that can communicate is at most 6 units.

■ GOT clock control

The GOT clock function is available only for the PLC with the station number set with the host address. For details of host address setting, refer to the following.

 4.4.2 Communication detail settings



5









CONNECTION TO FUJI TEMPERATURE CONTROLLER

5.1	Connectable Model List	5 - 2
5.2	System Configuration	5 - 3
5.3	Connection Diagram	5 - 7
5.4	GOT Side Settings	5 - 12
5.5	Temperature Controller Side Setting	5 - 14
5.6	Device Range that Can Be Set	5 - 19
5.7	Precautions	5 - 20

5. CONNECTION TO FUJI TEMPERATURE CONTROLLER

5.1 Connectable Model List

The following table shows the connectable models.

Series	Model name	Clock	Communication Type	Connectable model	Refer to
Micro Controller X	PXR3	×	RS-232	  	 5.2.1
	PXR4				
	PXR5				
	PXR9				
	PXG4	×	RS-485	  	 5.2.2
	PXG5				
	PXG9				
	PXH9				

5.2 System Configuration

5.2.1 Connecting to PXR3, PXR4, PXR5 or PXR9

■ When connecting via the RS-232 communication

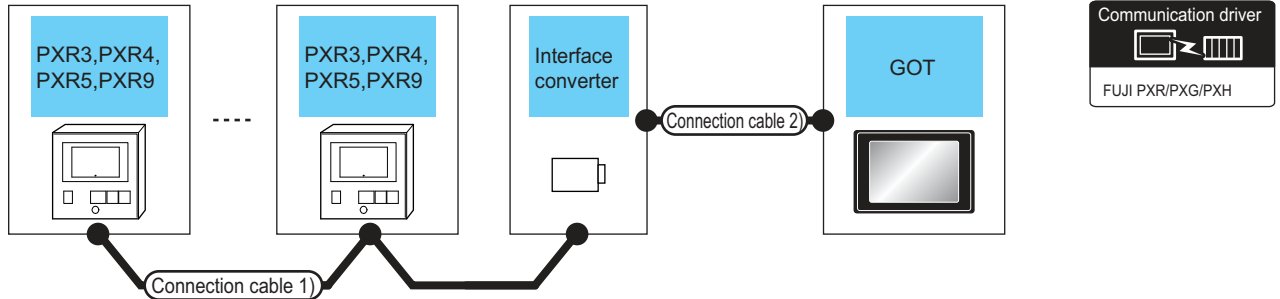

Temperature controller	Connection cable 1)		Interface converter		Connection cable 2)		GOT		Number of connectable equipment
	Model name	Cable model Connection diagram number	Max. distance	Model name	Communication Type	Cable model Connection diagram number	Max. distance	Option device	
PXR3 PXR4 PXR5 PXR9	User RS-485 connection diagram 1)	500m	RC-77*1	RS-232	User RS-232 connection diagram 1)	15m	- (Built into GOT)	GT 27 GT 23 GS	Up to 31 temperature controllers for 1 GOT
							GT15-RS2-9P	GT 27 GT 23 GS	
	User RS-485 connection diagram 2)	500m	SI-30A*2	RS-232	User RS-232 connection diagram 2)	15m	- (Built into GOT)	GT 27 GT 23 GS	
							GT15-RS2-9P	GT 27 GT 23 GS	
	User RS-485 connection diagram 3)	500m	KS-485*3	RS-232	User RS-232 connection diagram 2)	15m	- (Built into GOT)	GT 27 GT 23 GS	
							GT15-RS2-9P	GT 27 GT 23 GS	

*1 Product manufactured by SYSMEXRA CO., LTD. For details of the product, contact SYSMEXRA CO., LTD.

*2 Product manufactured by LINEEYE CO., LTD. For details of the product, contact LINEEYE CO., LTD.

*3 Product manufactured by System Sacom corp. For details of the product, contact System Sacom corp.

■ When connecting via RS-485 communication

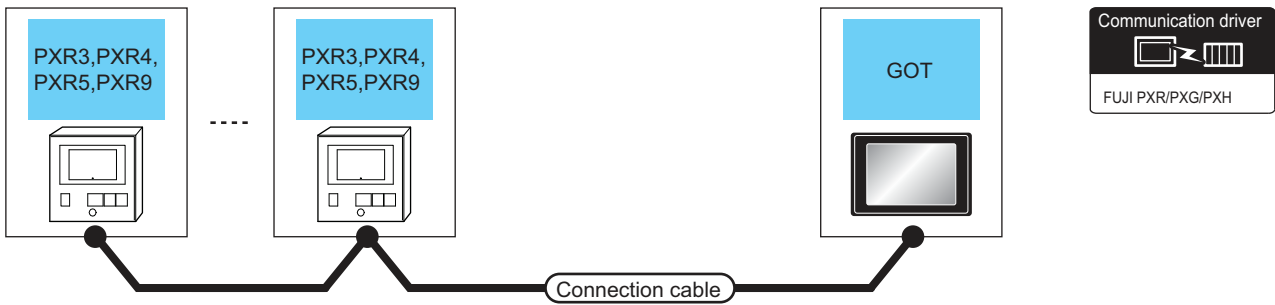

Temperature controller		Connection cable		GOT		Number of connectable equipment
Model name	Communication Type	Cable model Connection diagram number	Max. distance	Option device	Model	
PXR3 PXR4 PXR5 PXR9	RS-485	RS-485 connection diagram 4)	500m ^{*1}	FA-LTBGT2R4CBL05(0.5m) ^{*2} FA-LTBGT2R4CBL10(1m) ^{*2} FA-LTBGT2R4CBL20(2m) ^{*2}	GT 27 GT 23 GS	Up to 31 temperature controllers for 1 GOT
		RS-485 connection diagram 5)	500m	GT15-RS4-TE	GT 27 GT 23 GS	
		RS-485 connection diagram 7)	500m	- (Built into GOT)	GT 27 GT 23 GS	

*1 Including the cable length of the option devices.

*2 Product manufactured by MITSUBISHI ELECTRIC ENGINEERING COMPANY LIMITED. For details of the product, contact MITSUBISHI ELECTRIC ENGINEERING COMPANY LIMITED.

5.2.2 Connecting to PXG4, PXG5, PXG9 or PXH9

■ When connecting to one temperature controller

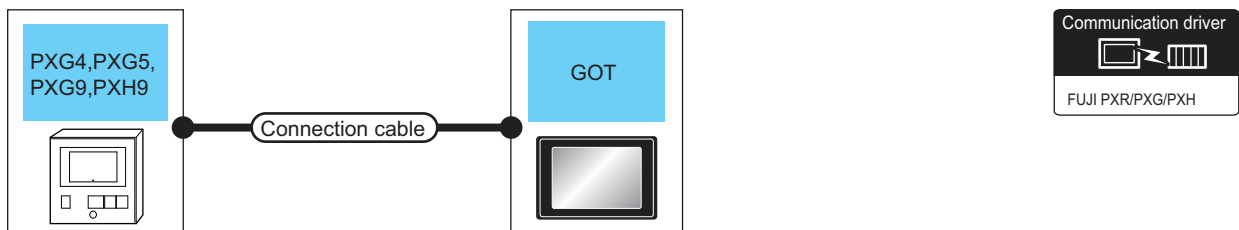

Temperature controller		Connection cable		GOT		Number of connectable equipment
Model name	Communication Type	Cable model Connection diagram number	Max. distance	Option device	Model	
PXG4 PXG5 PXG9 PXH9	RS-232	ZZPPXH1*TK4H4563 ^{*1}	3m	- (Built into GOT)	GT 27 GT 23 GS	1 temperature controller for 1 GOT
				GT15-RS2-9P	GT 27 GT 23 GS	

*1 Product manufactured by FUJI CO., LTD. For details of the product, contact FUJI CO., LTD.

■ When connecting to multiple temperature controllers (RS-232 communication)

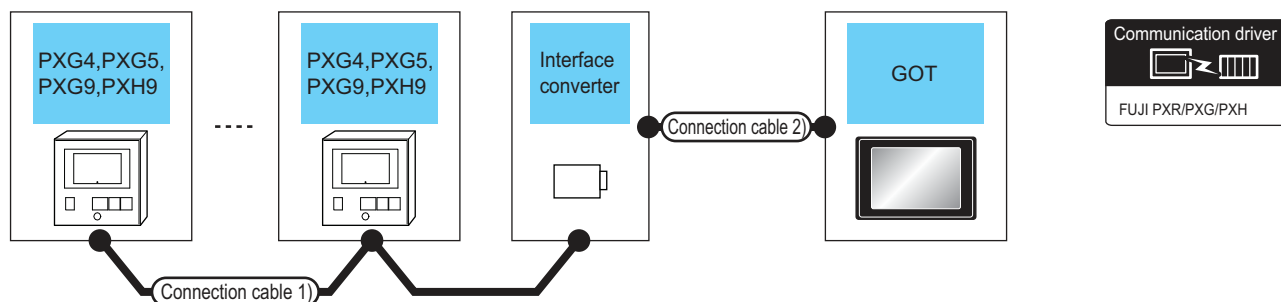

Temperature controller	Connection cable 1)		Interface converter		Connection cable 2)		GOT		Number of connectable equipment
Model name	Cable model Connection diagram number	Max. distance	Model name	Model name	Cable model Connection diagram number	Max. distance	Option device	Model	
PXG4 PXG5 PXG9 PXH9	(User preparing) RS-485 connection diagram 1)	500m	RC-77*1	RS-232	(User preparing) RS-232 connection diagram 1)	15m	- (Built into GOT)	GT 27 GT 23 GS	Up to 31 temperature controllers for 1 GOT
							GT15-RS2-9P	GT 27 GT 23 GS	
	(User preparing) RS-485 connection diagram 6)	500m	K3SC-10*2	RS-232	(User preparing) RS-232 connection diagram 3)	15m	- (Built into GOT)	GT 27 GT 23 GS	
							GT15-RS2-9P	GT 27 GT 23 GS	

*1 Product manufactured by SYSMEXRA CO., LTD. For details of the product, contact SYSMEXRA CO., LTD.

*2 Product manufactured by OMRON Corporation. For details of the product, contact OMRON Corporation.

■ When connecting to multiple temperature controllers (RS-485 communication)

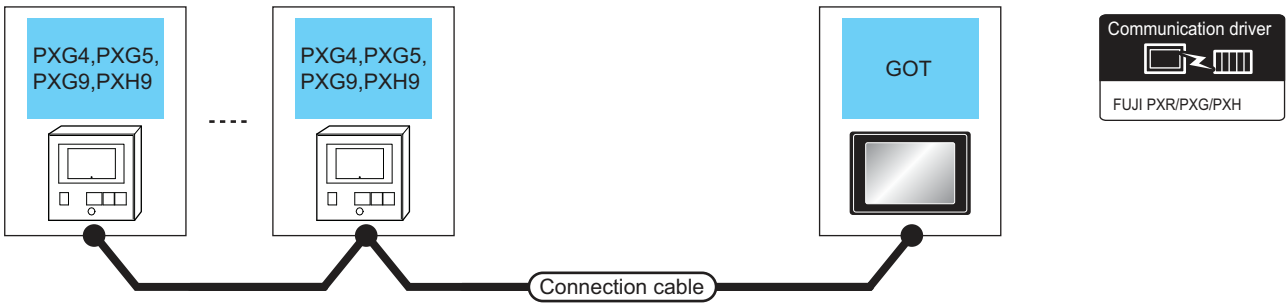

Temperature controller		Connection cable		GOT		Number of connectable equipment
Model name	Communication Type	Cable model Connection diagram number	Max. distance	Option device	Model	
PVG4 PVG5 PVG9 PVH9	RS-485	RS-485 connection diagram 4)	500m ^{*1}	FA-LTBGT2R4CBL05(0.5m) ^{*2} FA-LTBGT2R4CBL10(1m) ^{*2} FA-LTBGT2R4CBL20(2m) ^{*2}	GT 27 GT 23 GS	Up to 31 temperature controllers for 1 GOT
		RS-485 connection diagram 5)	500m	GT15-RS4-TE	GT 27 GT 23 GS	
		RS-485 connection diagram 7)	500m	- (Built into GOT)	GT 27 GT 23 GS	

*1 Including the cable length of the option devices.

*2 Product manufactured by MITSUBISHI ELECTRIC ENGINEERING COMPANY LIMITED. For details of the product, contact MITSUBISHI ELECTRIC ENGINEERING COMPANY LIMITED.

5.3 Connection Diagram

The following diagram shows the connection between the GOT and the temperature controller.

5.3.1 RS-232 cable

■ Connection diagram

(1) RS-232 connection diagram 1)

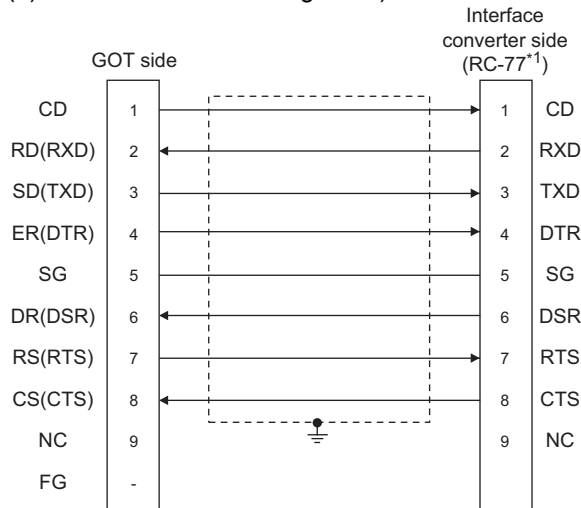

*1 Use the interface converter in the DCE mode.

(2) RS-232 connection diagram 2)

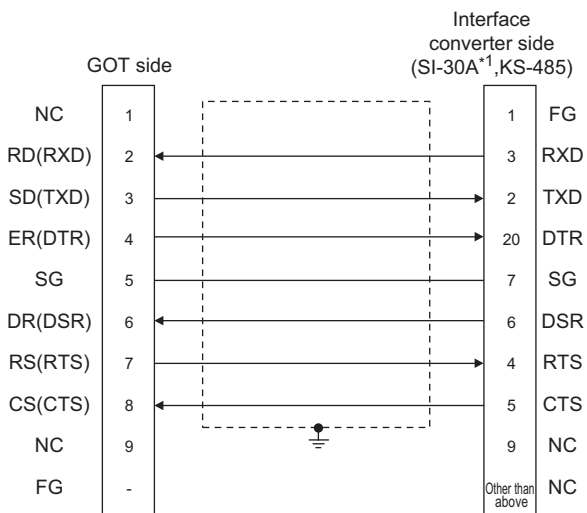

*1 Use the interface converter in the DCE mode.

(3) RS-232 connection diagram 3)

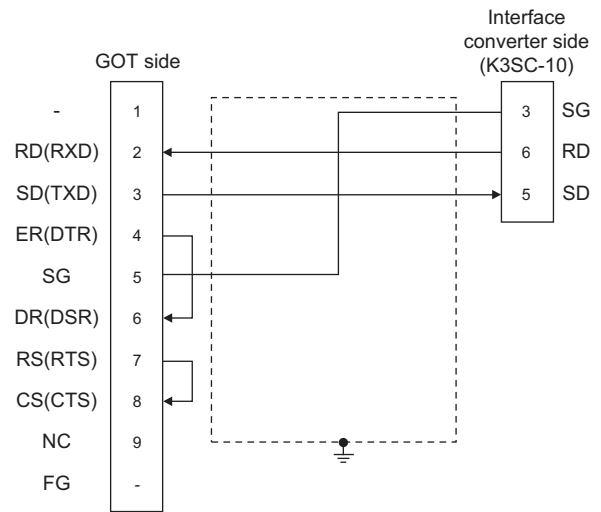

■ Precautions when preparing a cable

(4) Cable length

The length of the RS-232 cable must be 15m or less.

(5) GOT side connector

For the GOT side connector, refer to the following.

☞ 1.4.1 GOT connector specifications

(6) FUJI temperature controller side connector

Use the connector compatible with the FUJI temperature controller side.

For details, refer to the user's manual of the FUJI temperature controller.

5.3.2 RS-485 cable

■ Connection diagram

(1) RS-485 connection diagram 1)

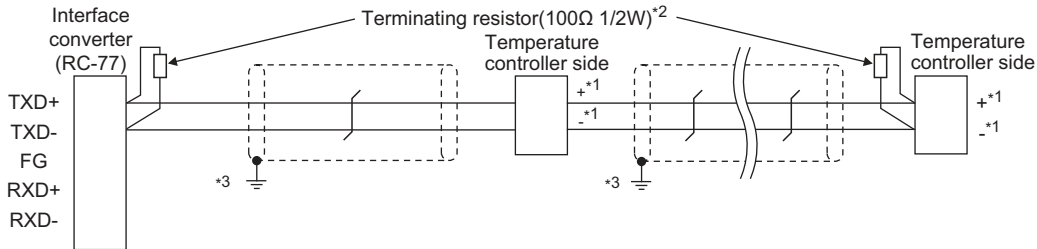

*1 Pin No. of temperature controller differs depending on the model. Refer to the following table.

Signal name	Model of temperature controller					
	PXR3	PXR4	PXR5/9	PXG4	PXG5/9	PXH9
	Pin No.	Pin No.	Pin No.	Pin No.	Pin No.	Pin No.
+	15	7	1	7	1	14
-	14	8	2	8	2	16

*2 Terminating resistor should be provided for a temperature controller which will be a terminal.

Terminating resistor should be provided outside for an interface converter which will be a terminal, with the terminating switch turned OFF.

*3 Connect FG grounding to the appropriate part of a cable shield line.

(2) RS-485 connection diagram 2)

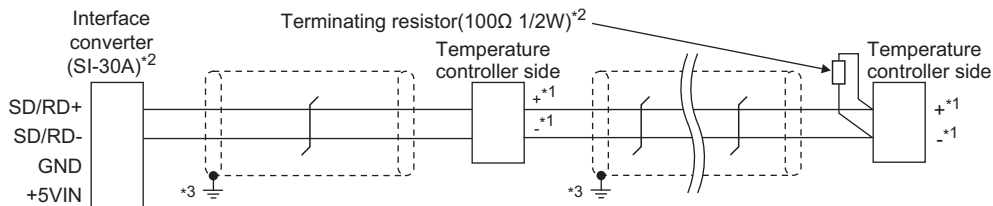

*1 Pin No. of temperature controller differs depending on the model. Refer to the following table.

Signal name	Model of temperature controller					
	PXR3	PXR4	PXR5/9	PXG4	PXG5/9	PXH9
	Pin No.	Pin No.	Pin No.	Pin No.	Pin No.	Pin No.
+	15	7	1	7	1	14
-	14	8	2	8	2	16

*2 Terminating resistor should be provided for a temperature controller which will be a terminal.

Turn ON the terminating switch of an interface converter which will be a terminal.

*3 Connect FG grounding to the appropriate part of a cable shield line.

(3) RS-485 connection diagram 3)

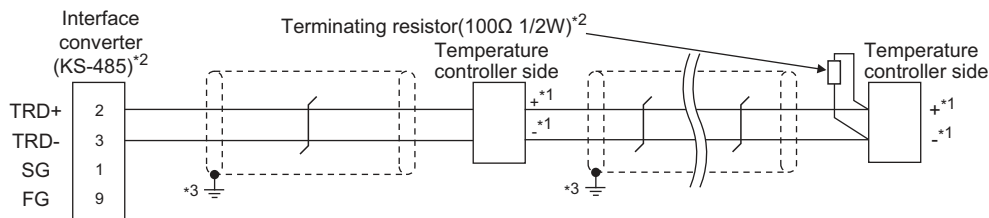

*1 Pin No. of temperature controller differs depending on the model. Refer to the following table.

Signal name	Model of temperature controller					
	PXR3	PXR4	PXR5/9	PXG4	PXG5/9	PXH9
	Pin No.	Pin No.	Pin No.	Pin No.	Pin No.	Pin No.
+	15	7	1	7	1	14
-	14	8	2	8	2	16

*2 Terminating resistor should be provided for a temperature controller which will be a terminal.

Turn ON the terminating switch of an interface converter which will be a terminal.

*3 Connect FG grounding to the appropriate part of a cable shield line.

(4) RS-485 connection diagram 4)

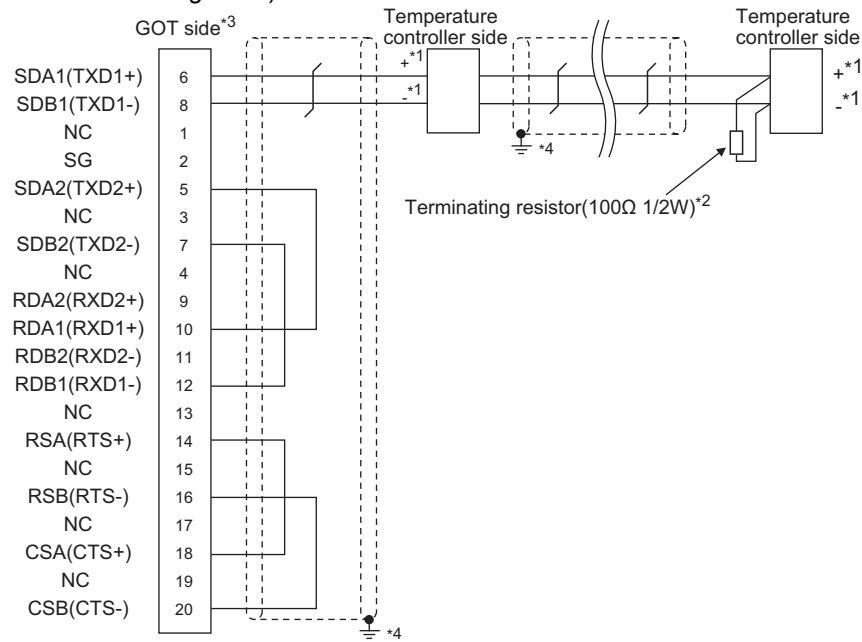

*1 Pin No. of temperature controller differs depending on the model. Refer to the following table.

Signal name	Model of temperature controller					
	PXR3	PXR4	PXR5/9	PXG4	PXG5/9	PXH9
	Pin No.	Pin No.	Pin No.	Pin No.	Pin No.	Pin No.
+	15	7	1	7	1	14
-	14	8	2	8	2	16

*2 Terminating resistor should be provided for a temperature controller which will be a terminal.

*3 Set the terminating resistor of GOT side which will be a terminal.

 ■ Connecting terminating resistors

*4 Connect FG grounding to the appropriate part of a cable shield line.

(5) RS-485 connection diagram 5)

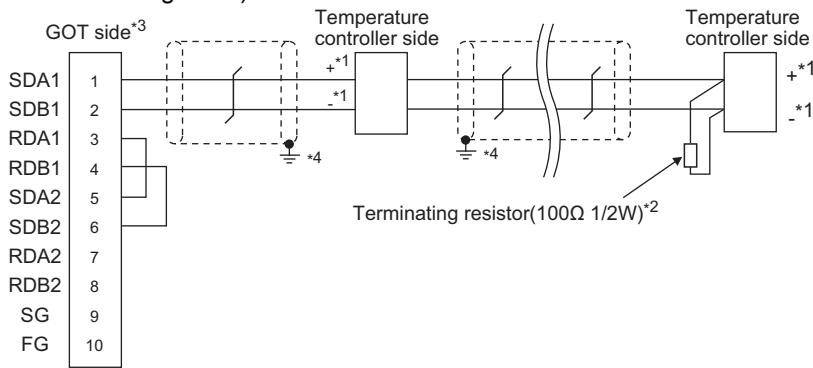

*1 Pin No. of temperature controller differs depending on the model. Refer to the following table.

Signal name	Model of temperature controller					
	PXR3 Pin No.	PXR4 Pin No.	PXR5/9 Pin No.	PXG4 Pin No.	PXG5/9 Pin No.	PXH9 Pin No.
+	15	7	1	7	1	14
-	14	8	2	8	2	16

*2 Terminating resistor should be provided for a temperature controller which will be a terminal.

*3 Set the terminating resistor of GOT side which will be a terminal.

■ Connecting terminating resistors

*4 Connect FG grounding to the appropriate part of a cable shield line.

(6) RS-485 connection diagram 6)

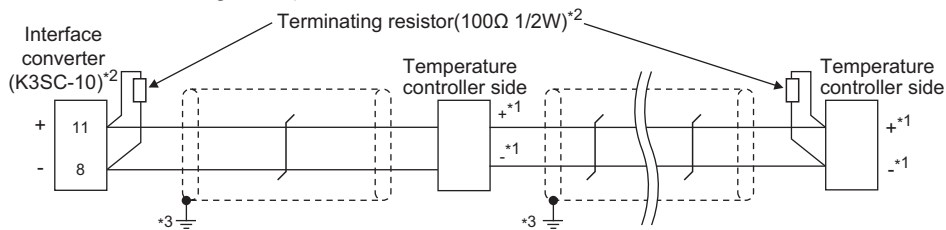

*1 Pin No. of temperature controller differs depending on the model. Refer to the following table.

Signal name	Model of temperature controller					
	PXR3 Pin No.	PXR4 Pin No.	PXR5/9 Pin No.	PXG4 Pin No.	PXG5/9 Pin No.	PXH9 Pin No.
+	15	7	1	7	1	14
-	14	8	2	8	2	16

*2 Terminating resistor should be provided for a temperature controller and an interface converter which will be terminals.

*3 Connect FG grounding to the appropriate part of a cable shield line.

(7) RS-485 connection diagram 7)

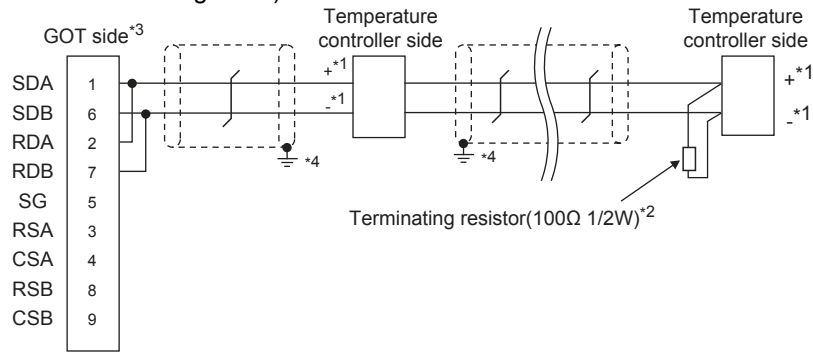

*1 Pin No. of temperature controller differs depending on the model. Refer to the following table.

Signal name	Model of temperature controller					
	PXR3	PXR4	PXR5/9	PXG4	PXG5/9	PXH9
	Pin No.	Pin No.	Pin No.	Pin No.	Pin No.	Pin No.
+	15	7	1	7	1	14
-	14	8	2	8	2	16

*2 Terminating resistor should be provided for a temperature controller which will be a terminal.

*3 Set the terminating resistor of GOT side which will be a terminal.

■ Connecting terminating resistors

*4 Connect FG grounding to the appropriate part of a cable shield line.

■ Precautions when preparing a cable

(1) Cable length

The length of the RS-485 cable must be 500m or less.

(2) GOT side connector

For the GOT side connector, refer to the following.

1.4.1 GOT connector specifications

(3) FUJI temperature controller side connector

Use the connector compatible with the FUJI temperature controller side.

For details, refer to the user's manual of the FUJI temperature controller.

■ Connecting terminating resistors

(1) GOT side

Set the terminating resistor setting switch of the GOT main unit to "100 OHM".

For the procedure to set the terminating resistor, refer to the following.

1.4.3 Terminating resistors of GOT

(2) FUJI temperature controller side

When connecting a FUJI temperature controller to the GOT, a terminating resistor must be connected.

5.5 Temperature Controller Side Setting

5.4 GOT Side Settings

5.4.1 Setting communication interface (Communication settings)

Set the channel of the connected equipment.

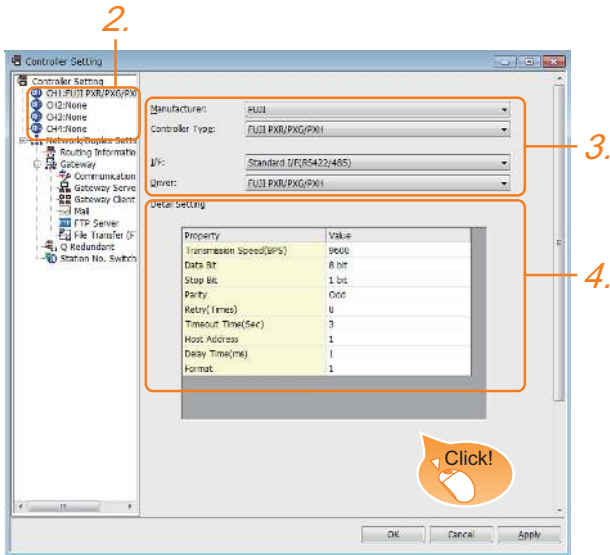

1. Select [Common] → [Controller Setting] from the menu.
2. The Controller Setting window is displayed. Select the channel to be used from the list menu.
3. Set the following items.
 - Manufacturer: FUJI
 - Controller Type: FUJI PXR/PXG/PXH
 - I/F: Interface to be used
 - Driver: FUJI PXR/PXG/PXH
4. The detailed setting is displayed after Manufacturer, Controller Type, I/F, and Driver are set. Make the settings according to the usage environment.

☞ 5.4.2 Communication detail settings

Click the [OK] button when settings are completed.

POINT

The settings of connecting equipment can be confirmed in [I/F Communication Setting]. For details, refer to the following.

☞ 1.1.2 I/F communication setting

5.4.2 Communication detail settings

Make the settings according to the usage environment.

Property	Value
Transmission Speed(BPS)	9600
Data Bit	8 bit
Stop Bit	1 bit
Parity	Odd
Retry(Times)	0
Timeout Time(Sec)	3
Host Address	1
Delay Time(ms)	1
Format	1

Item	Description	Range
Transmission Speed	Set this item when change the transmission speed used for communication with the connected equipment. (Default: 9600bps)	9600bps, 19200bps, 38400bps, 57600bps, 115200bps
Data Bit	Set this item when change the data length used for communication with the connected equipment. (Default: 8bits)	7bits/8bits
Stop Bit	Specify the stop bit length for communications. (Default: 1bit)	1bit/2bits
Parity	Specify whether or not to perform a parity check, and how it is performed during communication. (Default: Odd)	なし Even Odd
Retry	Set the number of retries to be performed when a communication error occurs. (Default: 0time)	0 to 5times
Timeout Time	Set the time period for a communication to time out. (Default: 3sec)	1 to 30sec
Host Address	Specify the host address (station No. of the GOT to which the temperature controller is connected) in the connected network. (Default: 1)	1 to 255
Delay Time	Set this item to adjust the transmission timing of the communication request from the GOT. (Default: 5ms)	0 to 300ms
Format	Select the communication format. (Default: 1) Format 1: Accessible to PXR/PXG/PXH Format 2: Accessible to PXR/PXG, Not accessible to PXH	1/2

POINT

- (1) Host address
Do not specify a number between 200 and 215.
- (2) Format
 - When connecting to PXH, specify the format 1.
 - When connecting to only PXR/PXG, specifying the format 2 is recommended.
- (3) Delay Time
Set the delay time to 5ms or more.
- (4) Communication interface setting by the Utility
The communication interface setting can be changed on the Utility's [Communication Settings] after writing [Communication Settings] of project data.
For details on the Utility, refer to the following manual.
 GOT2000 Series User's Manual (Utility)
- (5) Precedence in communication settings
When settings are made by GT Designer3 or the Utility, the latest setting is effective.

5.5 Temperature Controller Side Setting

POINT

- (1) FUJI temperature controller
For details of FUJI temperature controller, refer to the following manual.

 User's Manual of the FUJI temperature controller

- (2) Interface converter
For details on communication settings of the interface converter, refer to the following manual.

 User's Manual of interface converter

Model name	Refer to	
Temperature controller	PXR3, PXR4, PXR5, PXR9	5.5.1
	PXG4, PXG5, PXG9	5.5.2
	PXH9	5.5.3
Interface converter	RC-77	5.5.4
	SI-30A	5.5.5
	KS-485	5.5.6
	K3SC-10	5.5.7

5.5.1 Connecting to PXR3/4/5/9

■ Communication settings

Make the communication settings by operating the key of the temperature controller.

Item	Set value
Transmission speed	9600bps (fixed)
Data bit	8bits (fixed)
Parity bit ^{*1}	Even, Odd, None
Stop bit	1bit (fixed)
Station No. ^{*2}	1 to 255
Communication protocol	MODBUS

^{*1} Adjust the settings with GOT settings.

^{*2} Avoid duplication of the station No. with any of the other units.

5.5.2 Connecting to PXG4, PXG5 or PXG9

■ Communication settings

Make the communication settings by operating the key of the temperature controller.

(1) RS-485 communication settings

Item	Set value
Transmission speed ^{*1}	9600bps, 19200bps
Data bit	8bits (fixed)
Parity bit ^{*1}	Even, Odd, None
Stop bit ^{*1}	1bit (fixed)
Station No. ^{*2}	1 to 255
Communication permissions ^{*3}	Read only permission or read and overwrite permission

^{*1} Adjust the settings with GOT settings.

^{*2} Avoid duplication of the station No. with any of the other units.

^{*3} Set as necessary.

(2) RS-232 communication settings (PC loader communication)

Item	Set value
Transmission speed	9600bps (fixed)
Data bit	8bits (fixed)
Parity bit	None (fixed)
Stop bit	1bit (fixed)

5.5.3 Connecting to PXH9

■ Communication settings

Make the communication settings by operating the key of the temperature controller.

(1) RS-485 communication settings

Item	Set value
Transmission speed*1	9600bps, 19200bps, 38400bps
Data bit	8bits (fixed)
Parity bit*1	Even, Odd, None
Stop bit	1bit (fixed)
Station No.*2	1 to 255

*1 Adjust the settings with GOT settings.

*2 Avoid duplication of the station No. with any of the other units.

(2) RS-232 communication settings (PC loader communication)

Item	Set value
Transmission speed*1	9600bps, 19200bps, 38400bps
Data bit	8bits (fixed)
Parity bit*1	Even, Odd, None
Stop bit	1bit (fixed)
Station No.	1 (fixed)

*1 Adjust the settings with GOT settings.

5.5.4 Connecting to interface converter (RC-77)

■ Communication settings

Make the communication settings using setting switches.

Item	Set value
Transmission speed*1	9600bps, 19200bps, 38400bps
MANUAL-AUTO	AUTO
DCE/DTE switching	DCE
RS-422/485 switching	RS-485
Terminating resistor selection	OFF

*1 Adjust with GOT and temperature controller settings.

■ Settings by switch

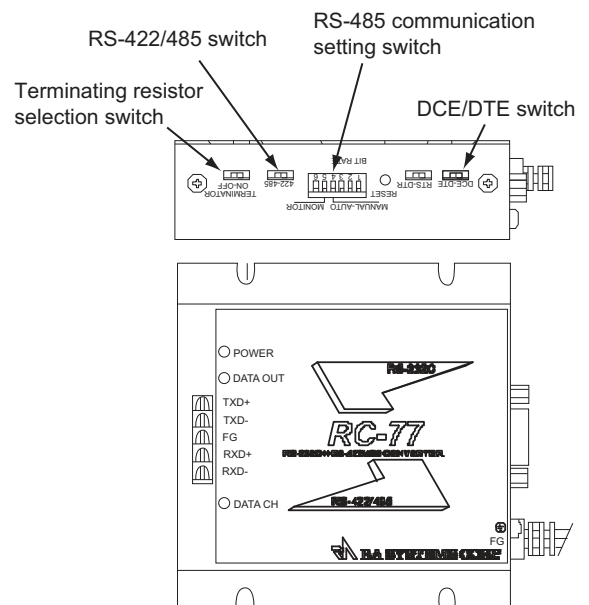

(1) Settings of transmission speed and MANUAL-AUTO

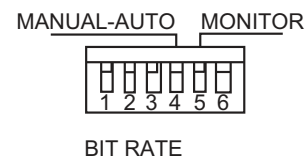

Setting item	Set value	Switch No.			
		1	2	3	4
Transmission speed	9600bps	ON	ON	OFF	
	19200bps	OFF	OFF	ON	
	38400bps	ON	OFF	ON	
MANUAL-AUTO	AUTO				ON

(2) Settings of DCE/DTE, RS-422/485 and terminating resistor selection

Setting item	Set value
DCE/DTE	DCE
RS-422/485	RS-485
Terminating resistor selection	OFF



5.5.5 Connecting to interface converter (SI-30A)

Communication settings

Make the communication settings using setting switches.

Item	Set value
Transmission speed	9600bps
MANUAL-AUTO	AUTO
DCE/DTE switching	DCE
Terminating resistor selection*1	ON/OFF

*1 Set as necessary.

Settings by switch

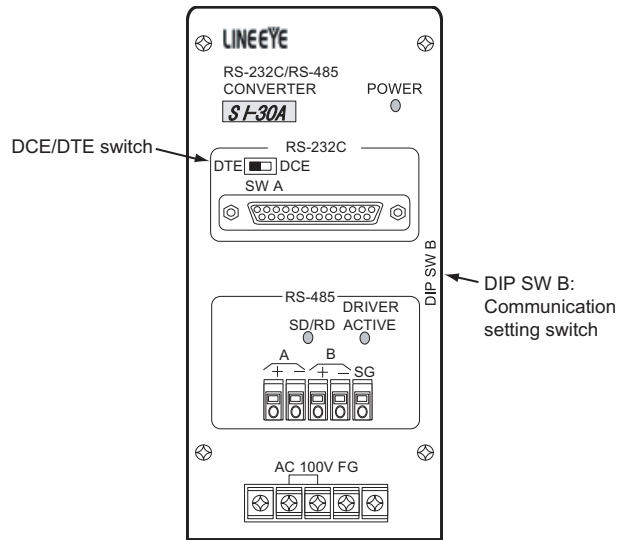

(1) Settings of transmission speed, MANUAL-AUTO and terminating resistor selection

Setting item	Set value	Switch No. of DIP SWB				
		1	2	3	4	5
Transmission speed	9600bps	ON	ON	OFF		
MANUAL-AUTO	AUTO				ON	
Terminating resistor selection*1	Enable					ON
	Disable					OFF

*1 Set as necessary.

(2) Setting of DCE/DTE switching

Setting item	Set value
DCE/DTE	DCE

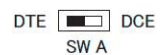

5.5.6 Connecting to interface converter (KS-485)

■ Communication settings

Make the communication settings using setting switches.

Item	Set value
Transmission speed	9600bps
Terminating resistor selection*1	ON/OFF

*1 Set as necessary.

■ Settings by switch

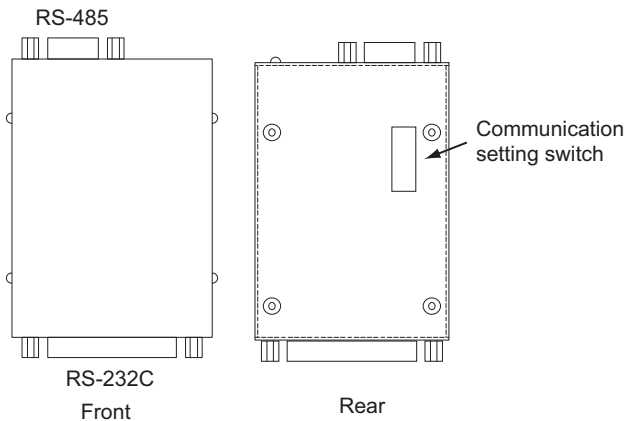

(1) Settings of transmission speed and terminating resistor selection

Setting item	Set value	Switch No.							
		1	2	3	4*2	5	6*2	7	8
Transmission speed	9600bps	ON	OFF	ON	—	ON	—		
Terminating resistor selection*1	Enable							ON	ON
	Disable							OFF	OFF

*1 Set as necessary.

*2 Disabled.

5.5.7 Connecting to interface converter (K3SC-10)

■ Communication settings

Make the communication settings by operating the DIP switch of the temperature controller.

Item	Set value
Transmission speed*1	9600bps, 19200bps, 38400bps
Data bit	8bits
Parity bit*1	Odd, even, none
Stop bit	1bit
Communication Type	RS-232C ↔ RS-485
Echo back	Without

*1 Make the same setting as that of GOT side.

■ Settings by DIP switch

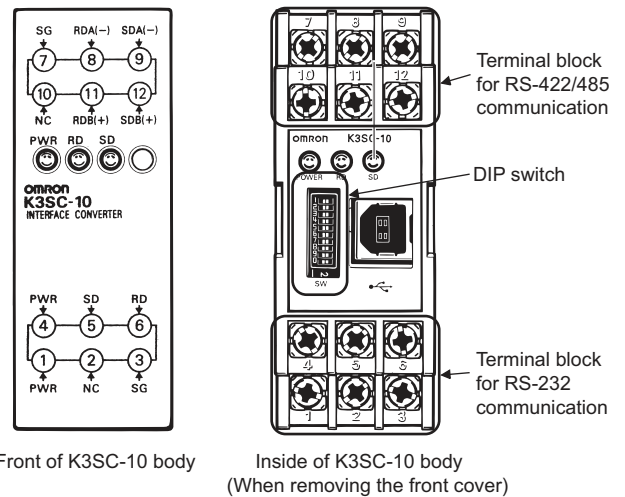

(1) Transmission speed settings

Transmission speed (bps)	Switch No.		
	1	2	3
9600	OFF	OFF	OFF
19200	ON	OFF	ON
38400	OFF	ON	ON

Set these switches.



(2) Settings of data length, parity bit, stop bit, master/slave device and echoback

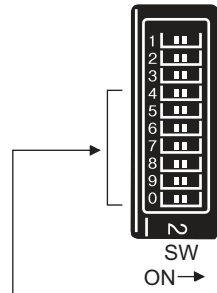

Set these switches.

Setting item	Set value	Switch No.							
		4	5	6	7	8	9	0	
Stop bit	1bit		ON						
Parity bit	Even			OFF	OFF				
	Odd			ON	OFF				
	None			OFF	ON				
Communication Type	RS-232C ↔ RS-485					OFF	OFF		
Echo back	Without								OFF

5.5.8 Station number setting

Set each station number so that no station number overlaps. The station number can be set without regard to the cable connection order. There is no problem even if station numbers are not consecutive.

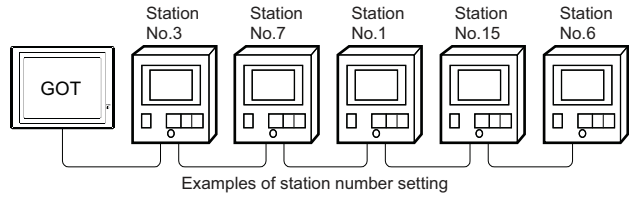

(1) Direct specification

When setting the device, specify the station number of the temperature controller of which data is to be changed.

Specification range
1 to 199
216 to 255

POINT

Specifying a station No. between 200 and 215 (Example of specifying the station No. 215)

1. Set the station No. to "200".
2. Input "215" to the internal device GD10.
3. The station No. 215 is specified. For details, refer to (2) Indirect specification shown below.

(2) Indirect specification

When setting the device, indirectly specify the station number of the inverter of which data is to be changed using the 16-bit GOT internal data register (GD10 to GD25). When specifying the station No. from 200 to 215 on GT Designer3, the value of GD10 to GD25 compatible to the station No. specification will be the station No. of the temperature controller.

Specification station NO.	Compatible device	Setting range
200	GD10	1 to 255 For the setting other than the above, error (dedicated device is out of range) will occur.
201	GD11	
202	GD12	
203	GD13	
204	GD14	
205	GD15	
206	GD16	
207	GD17	
208	GD18	
209	GD19	
210	GD20	
211	GD21	
212	GD22	
213	GD23	
214	GD24	
215	GD25	

5.6 Device Range that Can Be Set

The device ranges of controller that can be used for GOT are as follows.

Note that the device ranges in the following tables are the maximum values that can be set in GT Designer3.

The device specifications of controllers may differ depending on the models, even though belonging to the same series. Please make the setting according to the specifications of the controller actually used.

When a non-existent device or a device number outside the range is set, other objects with correct device settings may not be monitored.

■ Setting item

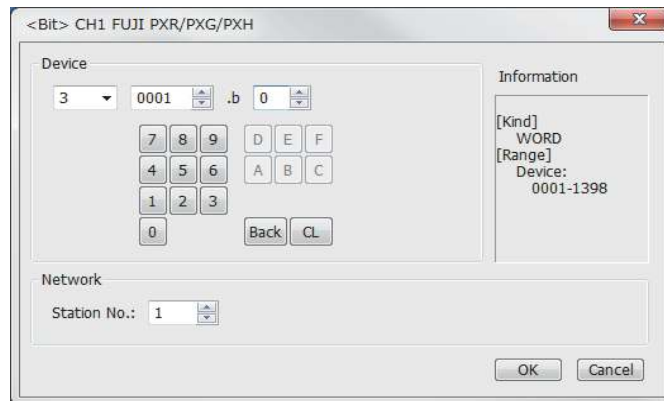

Item	Description
Device*1	Set the device name, device number, and bit number. The bit number can be set only when specifying the bit of word device.
Information	Displays the device type which is selected in [Device].(Bit/Word)
Network	Set the monitor target of the set device.
	Station No. To monitor the temperature controller of the specified station No. 1 to 119, 216 to 255 : To monitor the temperature controller of the specified station No. 200 to 215: To specify the station No. of the temperature controller to be monitored by the value of GOT data register (GD).*1

*1 The following shows the relation between station numbers of the temperature controller and the GOT data register.

Station No.	GOT data register (GD)	Setting range
200	GD10	1 to 255 (If setting a value outside the range above, a device range error occurs.)
201	GD11	
:	:	
214	GD24	
215	GD25	

POINT

The device setting of FUJI temperature controller

Devices are set with the coil and register numbers of the temperature controller.

For parameters (such as an address map of coil/register number and a parameter) corresponding to each number, refer to the manual of the temperature controller to be used.

5.6.1 FUJI PXR/PXG/PXH

Device name		Setting range	Device No. representation
Bit device	Bit data (0)	00001 to 00001	Decimal
	Bit data (1)* ¹	10001 to 10016	
	Word device bit	Specified bit of the following word devices	—
Word device	Word data (3)* ¹	30001 to 31398	Decimal
	Word data (4)	40001 to 43776	

*1 Only reading is possible.

5.7 Precautions

■ Station number settings of temperature controller

In the system configuration, the temperature controller with the station number set with the host address must be included. For details of host address setting, refer to the following.

 5.4.2 Communication detail settings

■ FIX processing of temperature controller

The temperature controller power must not be turned off during the FIX processing. Otherwise, data within the non-volatile memory will corrupt and the temperature controller will be unavailable.

■ GOT clock control

Since the temperature controller does not have a clock function, the settings of "time adjusting" or "time broad cast" by GOT clock control will be disabled.

■ Disconnecting some of multiple connected equipment

The GOT can disconnect some of multiple connected equipment by setting GOT internal device. For example, the faulty station where a communication timeout error occurs can be disconnected from connected equipment. For details of GOT internal device setting, refer to the following manual.

 GT Designer3 (GOT2000) Help

6





























CONNECTION TO YASKAWA PLC

6.1	Connectable Model List	6 - 2
6.2	Serial Connection	6 - 3
6.3	Ethernet Connection	6 - 17
6.4	Device Range that Can Be Set	6 - 28

6. CONNECTION TO YASKAWA PLC

6.1 Connectable Model List

The following table shows the connectable models.

Model name	Clock	Communication	Connectable model	Refer to
GL120	○	RS-232 RS-422	  	 6.2.1
GL130				
GL60S	×	RS-232 RS-422	  	 6.2.2
GL60H				
GL70H				
MP920	×	RS-232 RS-422	  	 6.2.3
MP930				
CP-9300MS				
CP-9200(H)				
PROGIC-8				
MP940	×	RS-232 RS-422	  	 6.2.4
CP-9200SH	×	RS-232	  	 6.2.5
CP-317				
MP2200	×	RS-232 RS-422	  	 6.2.6
MP2300				
MP2300S				
MP920	×	Ethernet	  	 6.3.1
MP2200				
MP2300				
MP2300S				
CP-9200SH				
CP-312				
CP-317				

6.2 Serial Connection

6.2.1 System configuration for connecting to GL120 or GL130

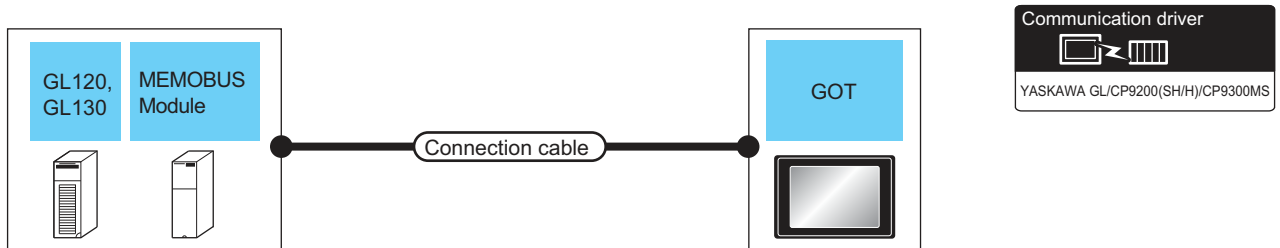

PLC			Connection cable		GOT		Number of connectable equipment
Model name	MEMOBUS module*1	Communication Type	Cable model Connection diagram number	Max. distance	Option device	Model	
GL120 GL130	-	RS-232	GT09-C30R20201-9P (3m) or RS-232 connection diagram 1)	Differs according to PLC side specifications.	- (Built into GOT)	 	1 GOT for 1 PLC
					GT15-RS2-9P	 	
GL120 GL130	JAMSC-120NOM27100	RS-422	GT09-C30R40201-9P (3m) GT09-C100R40201-9P (10m) GT09-C200R40201-9P (20m) GT09-C300R40201-9P (30m) or RS-422 connection diagram 1)	same as above	- (Built into GOT)	 	1 GOT for 1 MEMOBUS module
					GT15-RS4-9S	 	

*1 Product manufactured by YASKAWA Electric Corporation. For details of the product, contact YASKAWA Electric Corporation.

6.2.2 System configuration for connecting to GL60S, GL60H or GL70H

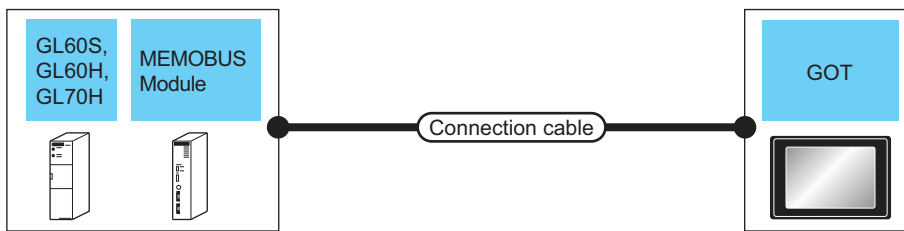







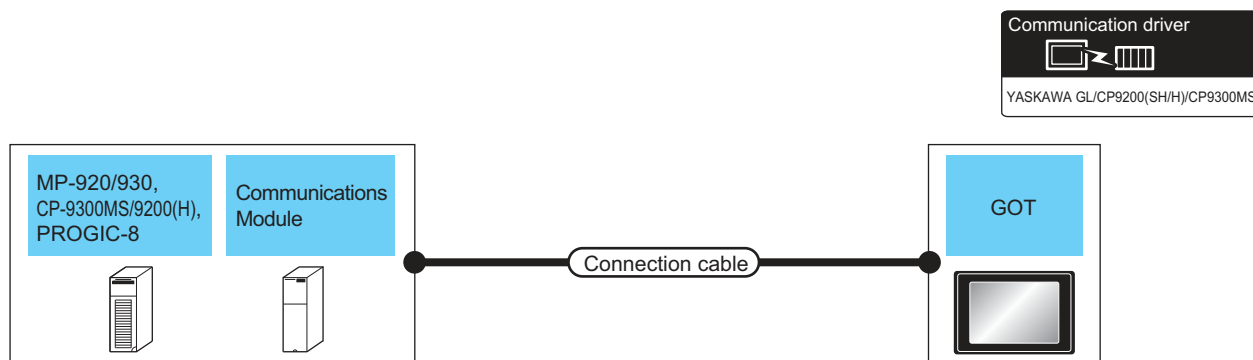







PLC			Connection cable		GOT		Number of connectable equipment
Model name	MEMOBUS module*1	Communication Type	Cable model Connection diagram number	Max. distance	Option device	Model	
GL60S GL60H GL70H	JAMSC-IF60 JAMSC-IF61	RS-232	GT09-C30R20201-9P (3m) or RS-232 connection diagram 1)	Differs according to PLC side specifications.	- (Built into GOT)	 	1 GOT for 1 MEMOBUS module
					GT15-RS2-9P	 	
	JAMSC-IF612	RS-422	GT09-C30R40201-9P (3m) GT09-C100R40201-9P (10m) GT09-C200R40201-9P (20m) GT09-C300R40201-9P (30m) or RS-422 connection diagram 1)	same as above	- (Built into GOT)	 	
					GT15-RS4-9S	 	

*1 Product manufactured by YASKAWA Electric Corporation. For details of the product, contact YASKAWA Electric Corporation.

6.2.3 System configuration for connecting to MP-920/930, CP-9300MS/9200(H) or PROGIC-8











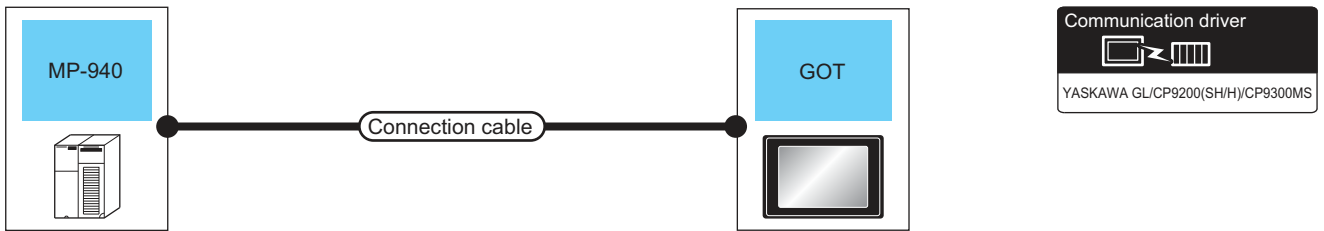





PLC			Connection cable		GOT		Number of connectable equipment
Model name	Communication module	Communication Type	Cable model Connection diagram number	Max. distance	Option device	Model	
MP-920 MP-930	-	RS-232	GT09-C30R20201-9P (3m) or RS-232 connection diagram 1)	Differs according to PLC side specifications.	- (Built into GOT)	 	1 GOT for 1 PLC
					GT15-RS2-9P	 	
CP-9200(H) PROGIC-8 (connecting to port1)	-	RS-232	GT09-C30R20201-9P (3m) or RS-232 connection diagram 1)	same as above	- (Built into GOT)	 	
					GT15-RS2-9P	 	
PROGIC-8 (connecting to port2)	-	RS-232	GT09-C30R20202-15P (3m) or RS-232 connection diagram 2)	same as above	- (Built into GOT)	 	
					GT15-RS2-9P	 	
CP-9300MS (CP-9300MC compatible/non-compatible)	-	RS-232	GT09-C30R20203-9P (3m) or RS-232 connection diagram 3)	same as above	- (Built into GOT)	 	
					GT15-RS2-9P	 	

PLC		Connection cable			GOT		Number of connectable equipment
Model name	Communication module	Communication Type	Cable model Connection diagram number	Max. distance	Option device	Model	
MP-920 (connecting to 217IF)	217IF	RS-232	GT09-C30R20201-9P (3m) or  RS-232 connection diagram 1)	same as above	-(Built into GOT)	  	1 GOT for 1 communication module
					GT15-RS2-9P	  	
		RS-422	 RS-422 connection diagram 2)	same as above	-(Built into GOT)	  	
					GT15-RS4-9S	  	

*1 Product manufactured by YASKAWA Electric Corporation. For details of the product, contact YASKAWA Electric Corporation.

6.2.4 System configuration for connecting to MP-940



PLC		Connection cable		GOT		Number of connectable equipment
Model name	Communication Type	Cable model Connection diagram number	Max. distance	Option device	Model	
MP-940	RS-232	GT09-C30R20204-14P (3m) or  RS-232 connection diagram 4)	Differs according to PLC side specifications.	- (Built into GOT)	  	1 GOT for 1 PLC
				GT15-RS2-9P	  	
	RS-422	GT09-C30R40202-14P (3m) GT09-C100R40202-14P (10m) GT09-C200R40202-14P (20m) GT09-C300R40202-14P (30m) or  RS-422 connection diagram 3)	300m	- (Built into GOT)	  	
				GT15-RS4-9S	  	

6.2.5 System configuration for connecting to CP-9200SH, CP-317

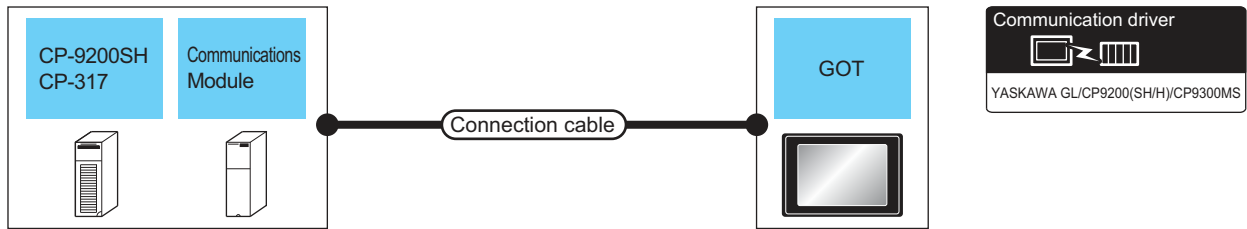

PLC			Connection cable		GOT		Number of connectable equipment
Model name	Communication module*1	Communication Type	Cable model Connection diagram number	Max. distance	Option device	Model	
CP-9200SH CP-317	CP-217IF (CN1 connection)	RS-232	GT09-C30R20203-9P(3m) or RS-232 connection diagram 6)	Differs according to PLC side specifications.	- (Built into GOT)	 	1 GOT for 1 communication module
					GT15-RS2-9P	 	
	CP-217IF (CN2 connection)	RS-232	GT09-C30R20205-25P (3m) or RS-232 connection diagram 5)	same as above	- (Built into GOT)	 	
					GT15-RS2-9P	 	

*1 Product manufactured by YASKAWA Electric Corporation. For details of the product, contact YASKAWA Electric Corporation.

6.2.6 System configuration for connecting to MP2200, MP2300 or MP2300S

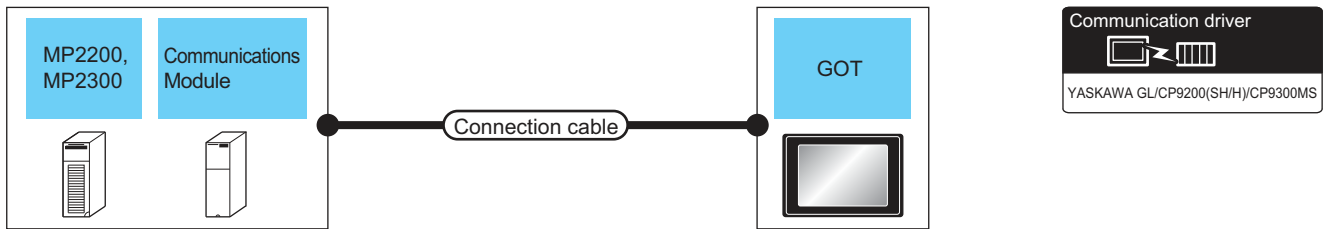

PLC			Connection cable		GOT		Number of connectable equipment
Model name	Communication module* ¹	Communication Type	Cable model Connection diagram number	Max. distance	Option device	Model	
MP2200 MP2300 MP2300S	2171F-01 2181F-01 2181F-02* ³	RS-232	GT09-C30R20201-9P(3m) or RS-232 connection diagram 1)	Differs according to PLC side specifications.	- (Built into GOT)	 	1 GOT for 1 communication module
					GT15-RS2-9P	 	
	2171F-01	RS-422	RS-422 connection diagram 4)	same as above	- (Built into GOT)	 	
					GT15-RS4-9S	 	

*1 Product manufactured by YASKAWA Electric Corporation. For details of the product, contact YASKAWA Electric Corporation.

6.2.7 Connection Diagram

The following diagram shows the connection between the GOT and the PLC.

■ RS-232 cable

(1) Connection diagram

(a) RS-232 connection diagram 1)

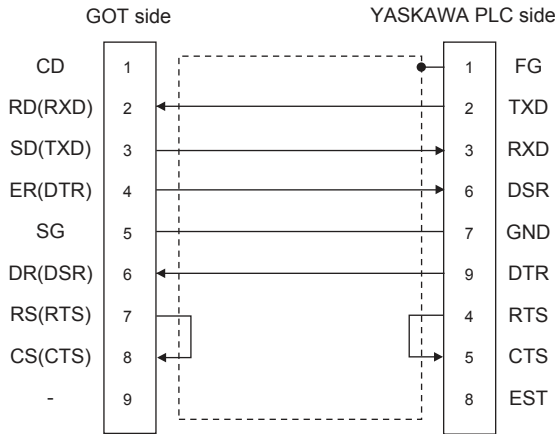

(b) RS-232 connection diagram 2)

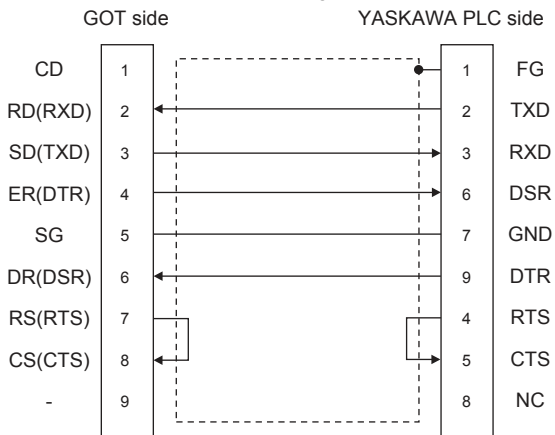

(c) RS-232 connection diagram 3)

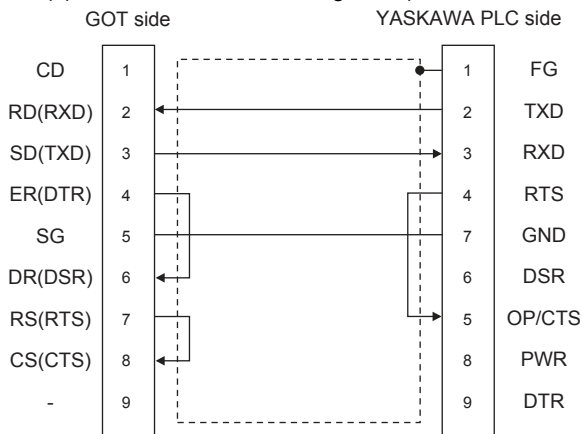

(d) RS-232 connection diagram 4)

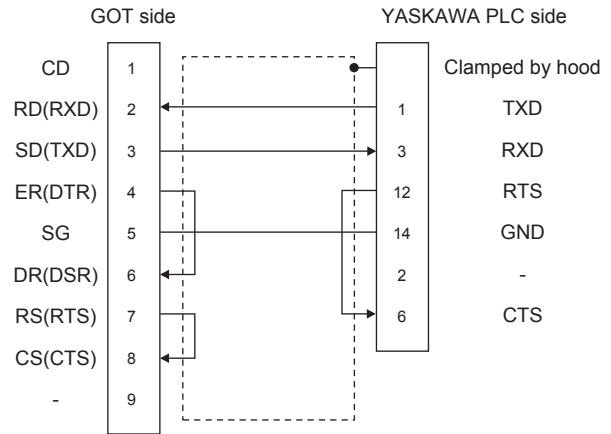

(e) RS-232 connection diagram 5)

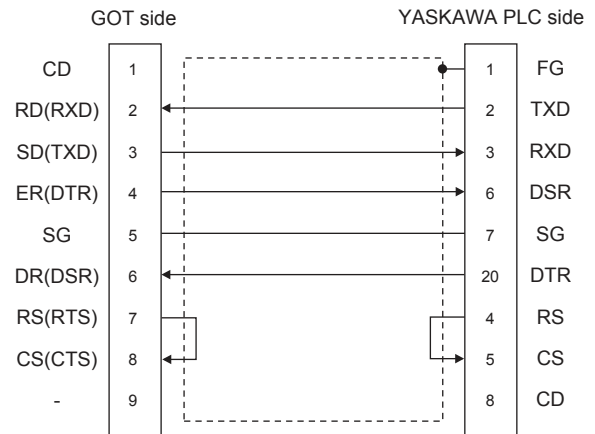

(f) RS-232 connection diagram 6)

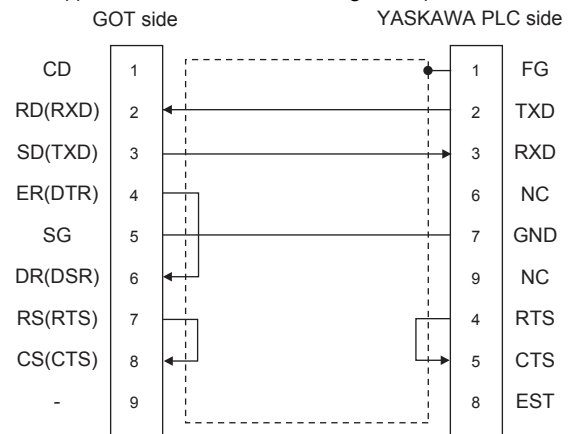

(2) Precautions when preparing a cable

(a) Cable length

The maximum length of the RS-232 cable differs according to the specifications of the YASKAWA PLC side.

For details, refer to the YASKAWA PLC user's manual.

(b) GOT side connector

For the GOT side connector, refer to the following.

1.4.1 GOT connector specifications

(c) YASKAWA PLC side connector

Use the connector compatible with the YASKAWA PLC side module.

For details, refer to the YASKAWA PLC user's manual.

■ RS-422 cable

(1) Connection diagram

(a) RS-422 connection diagram 1)

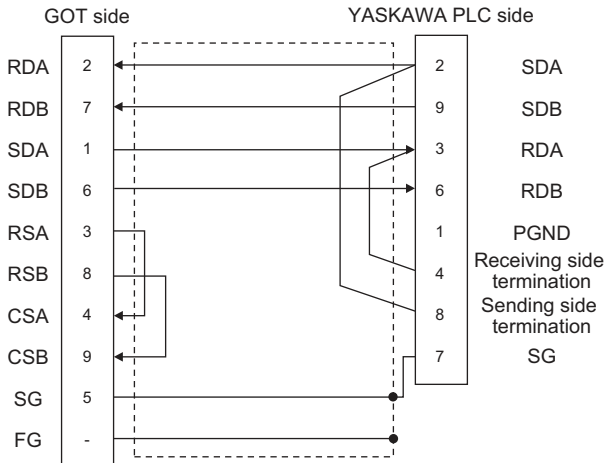

(b) RS-422 connection diagram 2)

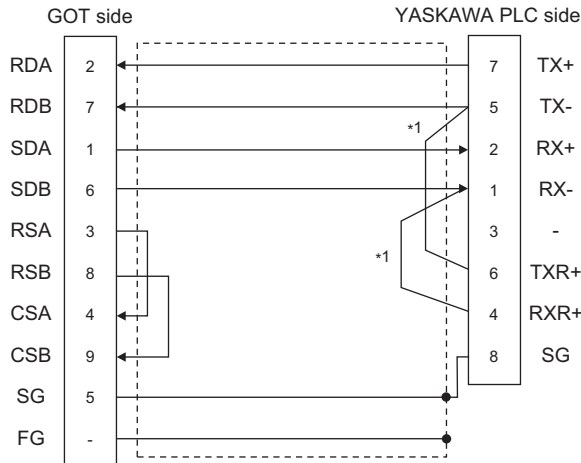

*1 The terminating resistor (120Ω) is valid by connecting pin 1 with pin 4 and pin 5 with pin 6 of the YASKAWA PLC side.

(c) RS-422 connection diagram 3)

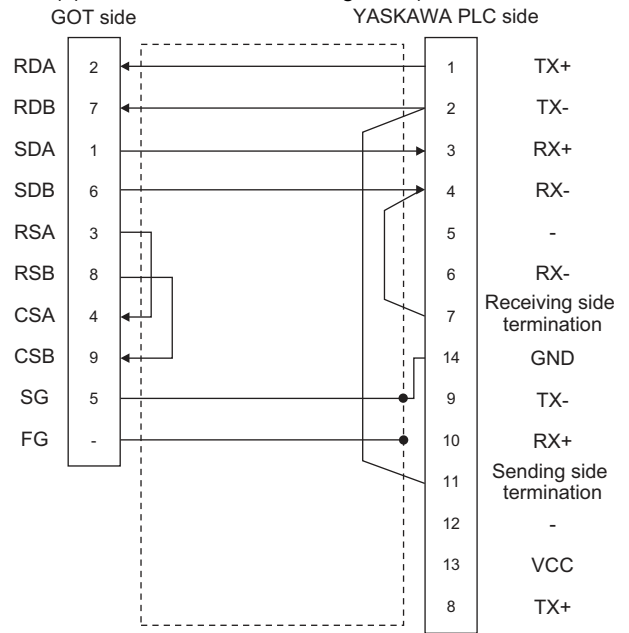

(d) RS-422 connection diagram 4)

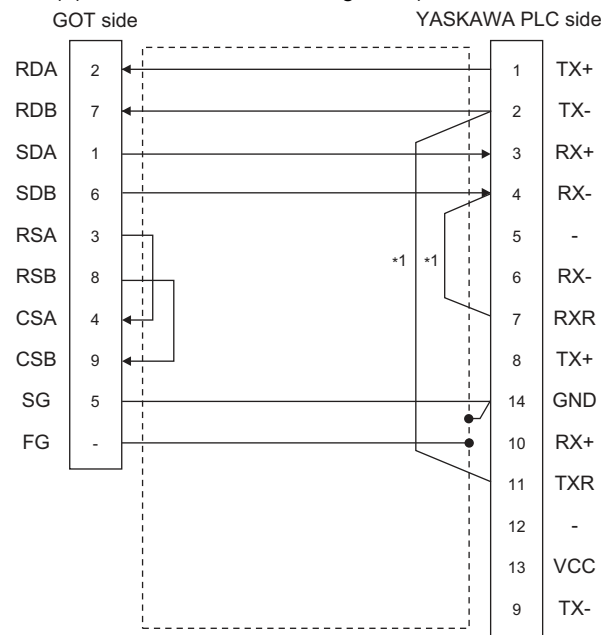

*1 Connect RXR with RX(-) and TXR with TX(-) of 217IF01, and insert the terminating resistor.

(2) Precautions when preparing a cable

(a) Cable length

The length of RS-422 cable 2) must be 300m or less.

The maximum length of RS-422 cable 1) differs according to the specifications of the YASKAWA PLC side.

For details, refer to the YASKAWA PLC user's manual.

(b) GOT side connector

For the GOT side connector, refer to the following.

 1.4.1 GOT connector specifications

(c) YASKAWA PLC side connector

Use the connector compatible with the YASKAWA PLC side module.

For details, refer to the YASKAWA PLC user's manual.

(3) Connecting terminating resistors

(a) GOT side

Set the terminating resistor setting switch of the GOT main unit to "Disable".

For the procedure to set the terminating resistor, refer to the following.

 1.4.3 Terminating resistors of GOT

(b) YASKAWA PLC side

When connecting a YASKAWA PLC to a GOT, connect a terminating resistor to the YASKAWA PLC if required.

 YASKAWA PLC user's Manual

6.2.8 GOT Side Settings

■ Setting communication interface (Communication settings)

Set the channel of the connected equipment.

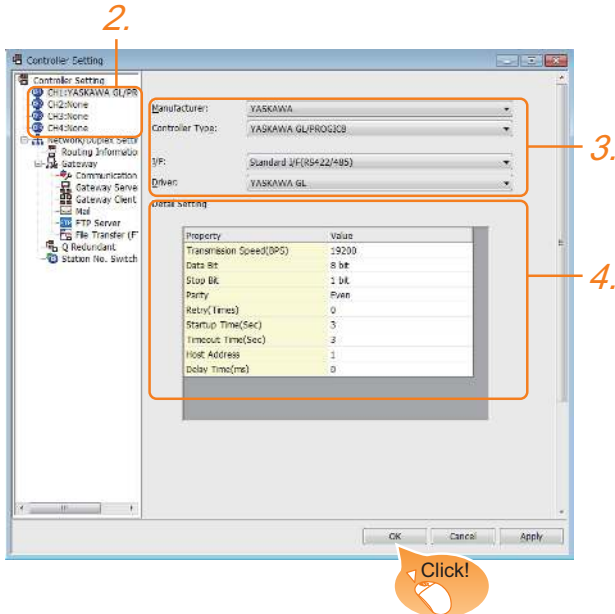

1. Select [Common] → [Controller Setting] from the menu.
2. The Controller Setting window is displayed. Select the channel to be used from the list menu.
3. Set the following items.
 - Manufacturer: YASKAWA
 - Controller Type: Set either of the following
 - YASKAWA GL/PROGIC8
 - YASKAWA CP9200(H)
 - YASKAWA CP9300MS (MC compatible)
 - YASKAWA MP2000/MP900/CP9200SH series
 - I/F: Interface to be used
 - Driver: Set either of the following.
 - YASKAWA GL/PROGIC8
 - YASKAWA CP9200(H)
 - YASKAWA CP9300MS (MC compatible)
 - YASKAWA MP2000/MP900/CP9200SH
4. The detailed setting is displayed after Manufacturer, Controller Type, I/F, and Driver are set. Make the settings according to the usage environment.

☞ 6.2.8 ■ Communication detail settings

Click the [OK] button when settings are completed.

POINT

The settings of connecting equipment can be confirmed in [I/F Communication Setting]. For details, refer to the following.

☞ 1.1.2 I/F communication setting

■ Communication detail settings

Make the settings according to the usage environment.

Property	Value
Transmission Speed(BPS)	19200
Data Bit	8 bit
Stop Bit	1 bit
Parity	Even
Retry(Times)	0
Startup Time(Sec)	3
Timeout Time(Sec)	3
Host Address	1
Delay Time(ms)	0

Item	Description	Range
Transmission Speed	Set this item when change the transmission speed used for communication with the connected equipment. (Default: 19200bps)	4800bps, 9600bps, 19200bps, 38400bps, 57600bps
Data Bit	Set this item when change the data length used for communication with the connected equipment. (Default: 8bit)	8bit (fixed)
Stop Bit	Specify the stop bit length for communications. (Default: 1bit)	1bit (fixed)
Parity	Specify whether or not to perform a parity check, and how it is performed during communication. (Default: Even)	Even (fixed)
Retry	Set the number of retries to be performed when a communication error occurs. (Default: 0time)	0 to 5times
Startup Time	Specify the time period from the GOT startup until GOT starts the communication with the PLC CPU. (Default: 3sec)	3 to 30sec
Timeout Time	Set the time period for a communication to time out. (Default: 3sec)	1 to 30sec
Host Address	Specify the host address (station No. of the PLC to which the GOT is connected) in the network of the GOT. (Default: 1)	1 to 31
Delay Time	Set this item to adjust the transmission timing of the communication request from the GOT. (Default: 0ms)	0 to 30 (× 10ms)

POINT

- (1) Delay Time
When connecting to PLC CP-9200(H) and CP-9300MS, set the following.

Model name		Delay Time
CP-9200(H)		30ms or more
CP-9300MS	port:0	10ms or more
	port:1	30ms or more

- (2) Communication interface setting by the Utility
The communication interface setting can be changed on the Utility's [Communication setting] after writing [Communication Settings] of project data.

For details on the Utility, refer to the following manual.

 GOT2000 Series User's Manual (Utility)

- (3) Precedence in communication settings
When settings are made by GT Designer3 or the Utility, the latest setting is effective.

6.2.9 PLC Side Settings

POINT

YASKAWA PLC

For details of YASKAWA PLCs, refer to the following manuals.

 YASKAWA PLC user's Manual

■ Communication and port settings

Make the communication and port settings with a peripheral tool.

Device name	Set value
Address*1	1 to 31
Protocol	MEMOBUS
Mode	RTU
Transmission speed*2*3	4800bps, 9600bps, 19200bps, 38400bps, 57600bps
Data bit	8bits
Stop bit	1bit
Parity bit	Even
Error check	CRC16

*1 Set the address according to the Host Address setting on the GOT side.
For the Host Address setting on the GOT side, refer to the following.

 6.2.8 ■ Communication detail settings

*2 Only transmission speeds available on the GOT side are shown.
Also, the setting range differs depending on the YASKAWA PLC model.

*3 The transmission speed setting must be consistent with that of the GOT side.
For the transmission speed setting on the GOT side, refer to the following.

 6.2.8 ■ Communication detail settings

■ Sequence program

To communicate the YASKAWA PLCs with the GOT1000 series, the ladder program to receive messages is required. The following shows an example ladder program for MP2000 series.

ladder program to receive messages

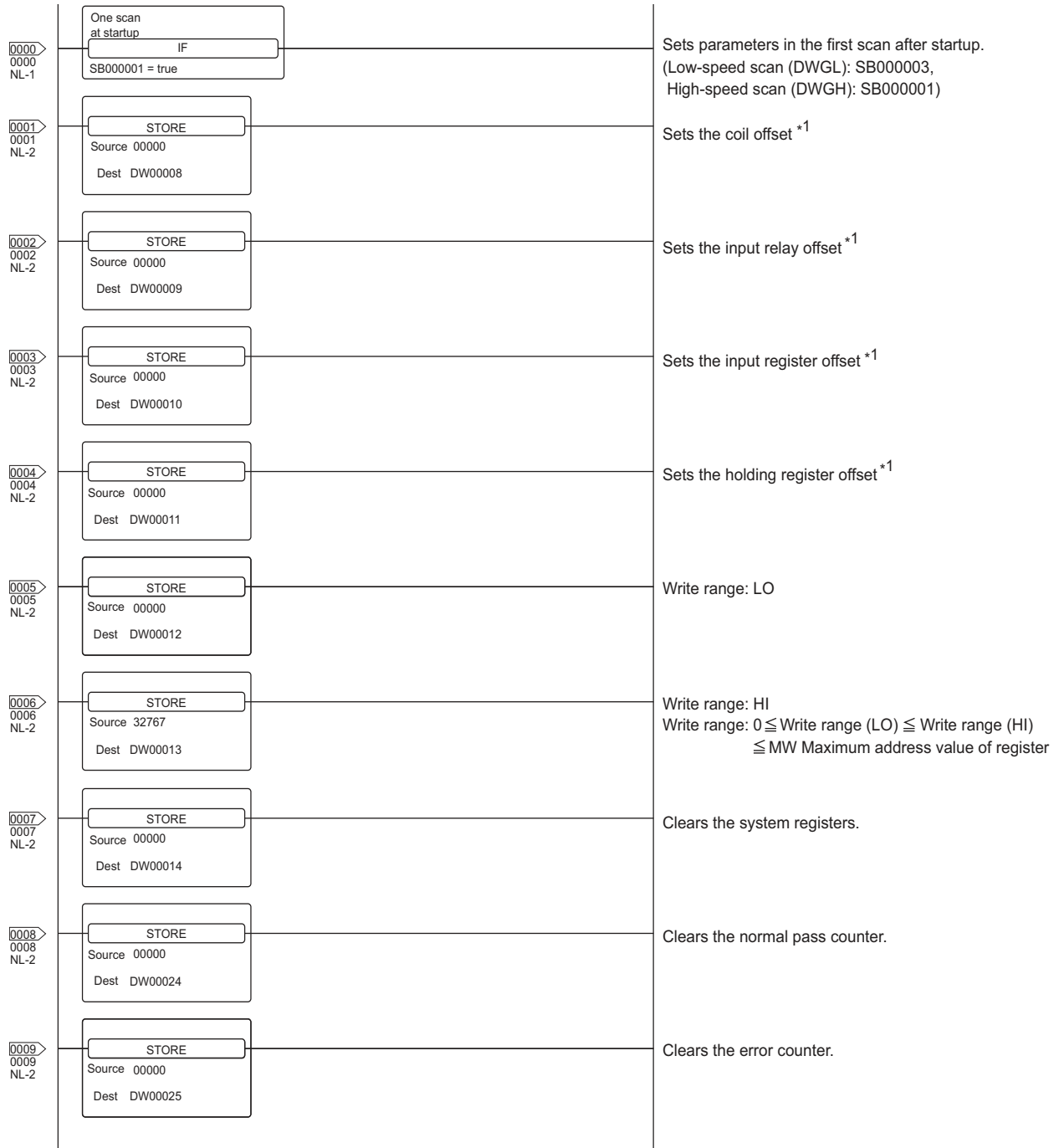

(Continued to next page)

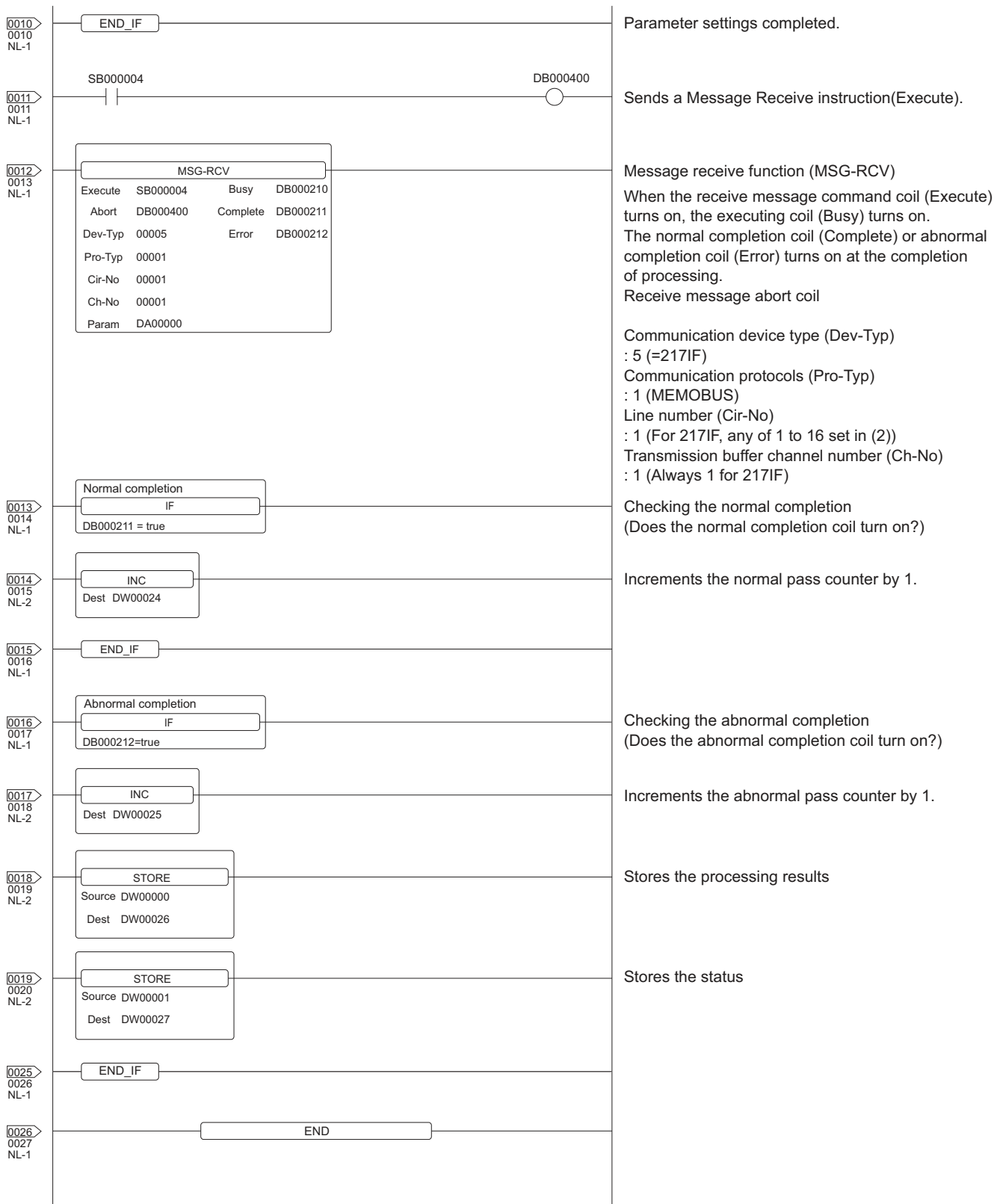

*1: Set 0 to the PARAM08 to 11 of the MSG_RCV (input relay, input register, coil, holding register offset). (Do not make the offset settings.) When the offset is needed, set [Option] → [Offset] to each object or make a setting added the offset value to the device.

6.3 Ethernet Connection

6.3.1 System configuration for connecting to MP-920 or MP2200 or MP2300 or MP2300S or CP-9200SH or CP-312 or CP-317

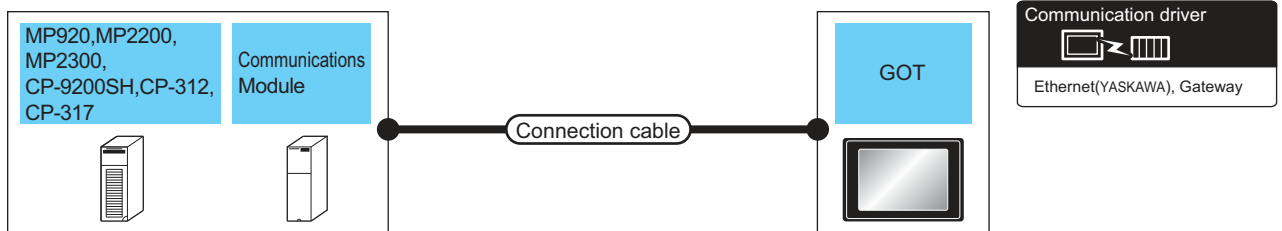

PLC		Connection cable		GOT		Number of connectable equipment
Model name	Communication module* ³	Cable model* ¹	Maximum segment length* ²	Option device	Model	
MP-920	218IF	<ul style="list-style-type: none"> • 100BASE-TX Shielded twisted pair cable (STP) or unshielded twisted pair cable (UTP) of category 5 or higher • 10BASE-T Shielded twisted pair cable (STP) or unshielded twisted pair cable (UTP) of category 3 or higher 	100m	- (Built into GOT)		When PLC (module):GOT is N:1 The following shows the number of PLCs for 1 GOT TCP: 128 or less UDP: 128 or less When PLC (module):GOT is 1:N The following shows the number of GOTs for 1 PLC (module) TCP/UDP: 10 or less
MP2200 MP2300 MP2300S	218IF-01 218IF-02					
CP-9200SH CP-312	CP-218IF					
CP-317	218TXB					

*1 The destination connected with the twisted pair cable varies with the configuration of the applicable Ethernet network system. Connect to the Ethernet module, hub, transceiver or other system equipment corresponding to the applicable Ethernet network system.

Use cables, connectors, and hubs that meet the IEEE802.3 10BASE-T/100BASE-TX standards.

*2 A length between a hub and a node.

The maximum distance differs depending on the Ethernet device to be used.

The following shows the number of the connectable nodes when a repeater hub is used.

- 10BASE-T: Max. 4 nodes for a cascade connection (500m)
- 100BASE-TX: Max. 2 nodes for a cascade connection (205m)

When switching hubs are used, the cascade connection between the switching hubs has no logical limit for the number of cascades.

For the limit, contact the switching hub manufacturer.

*3 Product manufactured by YASKAWA Electric Corporation. For details of the product, contact YASKAWA Electric Corporation.

6.3.2 GOT Side Settings

■ Setting communication interface (Communication settings)

Set the channel of the connected equipment.

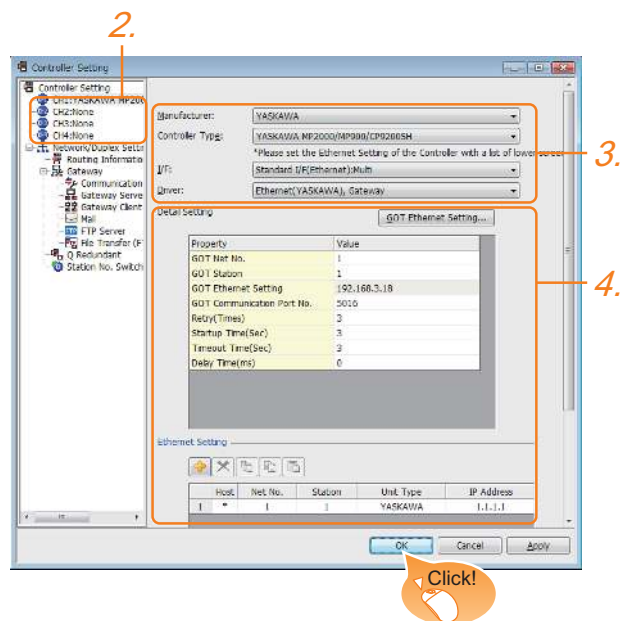

1. Select [Common] → [Controller Setting] from the menu.
2. The Controller Setting window is displayed. Select the channel to be used from the list menu.
3. Set the following items.
 - Manufacturer: YASKAWA
 - Controller Type: YASKAWA MP2000/MP900/CP9200SH
 - I/F: Interface to be used
 - Driver: Ethernet (YASKAWA), Gateway
4. The detailed setting is displayed after Manufacturer, Controller Type, I/F, and Driver are set. Make the settings according to the usage environment.

☞ 6.3.2 ■ Communication detail settings

Click the [OK] button when settings are completed.

POINT

The settings of connecting equipment can be confirmed in [I/F Communication Setting]. For details, refer to the following.

☞ 1.1.2 I/F communication setting

■ Communication detail settings

Make the settings according to the usage environment.

Property	Value
GOT Net No.	1
GOT Station	1
GOT Ethernet Setting	192.168.3.18
GOT Communication Port No.	5016
Retry(Times)	3
Startup Time(Sec)	3
Timeout Time(Sec)	3
Delay Time(ms)	0

Item	Description	Range
GOT Net No.	Set the network No. of the GOT. (Default: 1)	1 to 239
GOT 局番	Set the station No. of the GOT. (Default: 1)	1 to 64
GOT Ethernet 設定	Set the GOT IP address, subnet mask, default gateway, peripheral S/W communication port No., transparent port No.	
GOT Communication Port No.	Set the GOT port No. for the connection with the Ethernet module. (Default: 5016)	1024 to 5010, 5014 to 65534 (Except for 5011, 5012, 5013 and 49153)
Retry	Set the number of retries to be performed when a communication timeout occurs. When receiving no response after retries, the communication times out. (Default: 3times)	0 to 5times
Startup Time	Specify the time period from the GOT startup until GOT starts the communication with the PLC CPU. (Default: 3sec)	3 to 255sec
Timeout Time	Set the time period for a communication to time out. (Default: 3sec)	1 to 90sec
Delay Time	Set the delay time for reducing the load of the network/destination PLC. (Default: 0ms)	0 to 10000(10ms)

POINT

- (1) Communication interface setting by the Utility
The communication interface setting can be changed on the Utility's [Communication setting] after writing [Communication Settings] of project data.

For details on the Utility, refer to the following manual.

☞ GOT2000 Series User's Manual (Utility)

- (2) Precedence in communication settings
When settings are made by GT Designer3 or the Utility, the latest setting is effective.

6.3.3 GOT Ethernet setting

GOT Ethernet Setting

Reflect GOT Ethernet setting in the GOT.
This setting is shared by other Ethernet driver settings.

GOT IP Address: 192 . 168 . 3 . 18

Select from GOT Setting List:
List...

Subnet Mask: 255 . 255 . 255 . 0

Default Gateway: 0 . 0 . 0 . 0

Peripheral S/W Communication Port No.: 5015

Transparent Port No.: 5014

OK Cancel

Item	Description	Range
GOT IP Address	Set the IP address of the GOT. (Default: 192.168.0.18)	0.0.0.0 to 255.255.255.255
Subnet Mask	Set the subnet mask for the sub network.(Only for connection via router) If the sub network is not used, the default value is set. (Default: 255.255.255.0)	0.0.0.0 to 255.255.255.255
Default Gateway	Set the router address of the default gateway where the GOT is connected.(Only for connection via router) (Default: 0.0.0.0)	0.0.0.0 to 255.255.255.255
Peripheral S/W Communication Port No.	Set the GOT port No. for the S/W communication. (Default: 5015)	1024 to 5010 5014 to 65534 (Except for 5011, 5012, 5013 and 49153)
Transparent Port No.	Set the GOT port No. for the transparent function. (Default: 5014)	1024 to 5010 5014 to 65534 (Except for 5011, 5012, 5013 and 49153)

Ethernet setting

Controller Setting

Manufacturer: YASKAWA
Controller Type: YASKAWA MP2000/MP900/CP9200SH
I/F: Standard I/F(Ethernet)/Multi
Driver: Ethernet(YASKAWA), Gateway

Detail Setting

Property	Value
GOT Net No.	1
GOT Station	1
GOT Ethernet Setting	192.168.3.18
GOT Communication Port No.	5015
ReTry(Times)	3
Startup Time(Sec)	3
Timeout Time(Sec)	3
Delay Time(ms)	0

Ethernet Setting

Host	Net No.	Station	Unit Type	IP Address
1	1	1	YASKAWA	1.1.1.1

OK Cancel Apply

Item	Description	Set value
Host	The host is displayed. (The host is indicated with an asterisk (*).)	—
Net No.	Set the network No. of the connected Ethernet module. (Default: blank)	1 to 239
Station	Set the station No. of the connected Ethernet module. (Default: blank)	1 to 64
Type	YASKAWA (fixed)	YASKAWA (fixed)
IP address*1	Set the IP address of the connected Ethernet module. (Default: blank)	PLC side IP address
Port No.	Set the port No. of the connected Ethernet module. (Default: 10500)	256 to 65534
Communication format	Select a communication protocol. (Default: UDP)	UDP, TCP

*1 Connection with the PLC is unavailable if the IP address is the default value. Set the value to the IP address of the PLC to be connected.

6.3.4 PLC side setting (MP2000 series, MP920 series)

POINT

YASKAWA PLC

For details of YASKAWA PLCs, refer to the following manuals.

 YASKAWA PLC user's Manual

Parameter settings

Make the parameter settings with a peripheral tool.

(1) Settings for 218IF-01

	Item	Set value	Range
Parameter setting	Local IP Address	[].[].[.]	PLC side IP address
	Response Time	0	Not required for communication with GOT
	Count of Retry (Number of Retries)	0	Not required for communication with GOT
	CNO *1 (Connection Number)	1	1 to 20
	Local Port (Local Station's Port Number)	10500	256 to 65534
	Node IP Address (Remote Station's IP Address)*2	[].[].[.]	IP address of GOT
	Node Port (Remote Station's Port Number)*2	[]	Port No. of GOT
	Connection Type	UDP (recommended)	UDP/TCP
	Protocol Type	Extended MEMOBUS	Extended MEMOBUS, MEMOBUS, MELSEC, None, MODBUS/TCP
	Code	BIN	RTU, BIN, ACII
	Node Name (Remote Station's Name)	GOT1000	Name of GOT
Local Port: TCP/IP Setting	Subnet Mask	[].[].[.]	PLC side setting
	Gateway IP Address	[].[].[.]	
	System Port No. (Diagnostic/ Engineering Port No.)	10000	
	TCP (Transmission Control Protocol) Zero Window Timer Value	3 sec	
	TCP Retry Time	500ms	
	TCP Close Time	60 sec	
	IP Assemble Time	30 sec	
	MAX. Packet Length	1500 bytes	

*1 When MITSUBISHI PLC and YASKAWA PLC are used together in the same network, do not set the same value for the Station of MITSUBISHI PLC and the CNO (Connection number) of YASKAWA PLC.

*2 Set the same the Node IP Address (Remote Station's IP Address) and the Node Port (Remote Station's Port Number) as the Local IP Address and the Local Port (Local Station's Port Number) on the GOT side. For the Local IP Address and the Local Port (Local Station's Port Number) on the GOT side, refer to the following.

 6.3.2 ■ Ethernet setting

(2) Setting for the built-in MP2300S Ethernet and 218IF-02

	Item	Set value	Range
Transmission parameter setting	IP Address	[].[].[.]	PLC side IP address
	Subnet Mask	[].[].[.]	PLC side setting
	Gateway IP Address	[].[].[.]	
	Device name	Arbitrary	Up to 16 one-byte characters
Transmission parameter detailed setting	Engineering Port	256 to 65535	For a connection with software MPE720
	Response Time	0	Not required for communication with GOT
	Count of Retry (Number of Retries)	0	
Message communication of connection parameter setting	Connection Number	1	<ul style="list-style-type: none"> • Range of built-in MP2300S Ethernet: 1 to 4 • Range of 218IF-02: 1 to 20
	Local Port	10500	256 to 65534
	Node IP Address*1	[].[].[.]	IP address of GOT
	Node Port *1	[]	Port No. of GOT
	Connection Type	UDP (recommended)	TCP/UDP
	Protocol Type	Extended MEMOBUS	Extended MEMOBUS, MEMOBUS, MELSEC, None, MODBUS/TCP
	Code	BIN	RTU, BIN, ACII
	Node Name	Arbitrary	Up to 32 one-byte characters (16 two-byte characters)

*1 Set the same the Node IP Address (Remote Station's IP Address) and the Node Port (Remote Station's Port Number) as the Local IP Address and the Local Port (Local Station's Port Number) on the GOT side. For the Local IP Address and the Local Port (Local Station's Port Number) on the GOT side, refer to the following.

 6.3.2 ■ Ethernet setting

Sequence program

To communicate the MP2000 series or MP920 series with the GOT1000 series, the ladder program to receive messages is required. When connecting the MP2000 series or MP920 series with multiple GOTs, ladder programs to receive messages for each GOT are required.

ladder program to receive messages

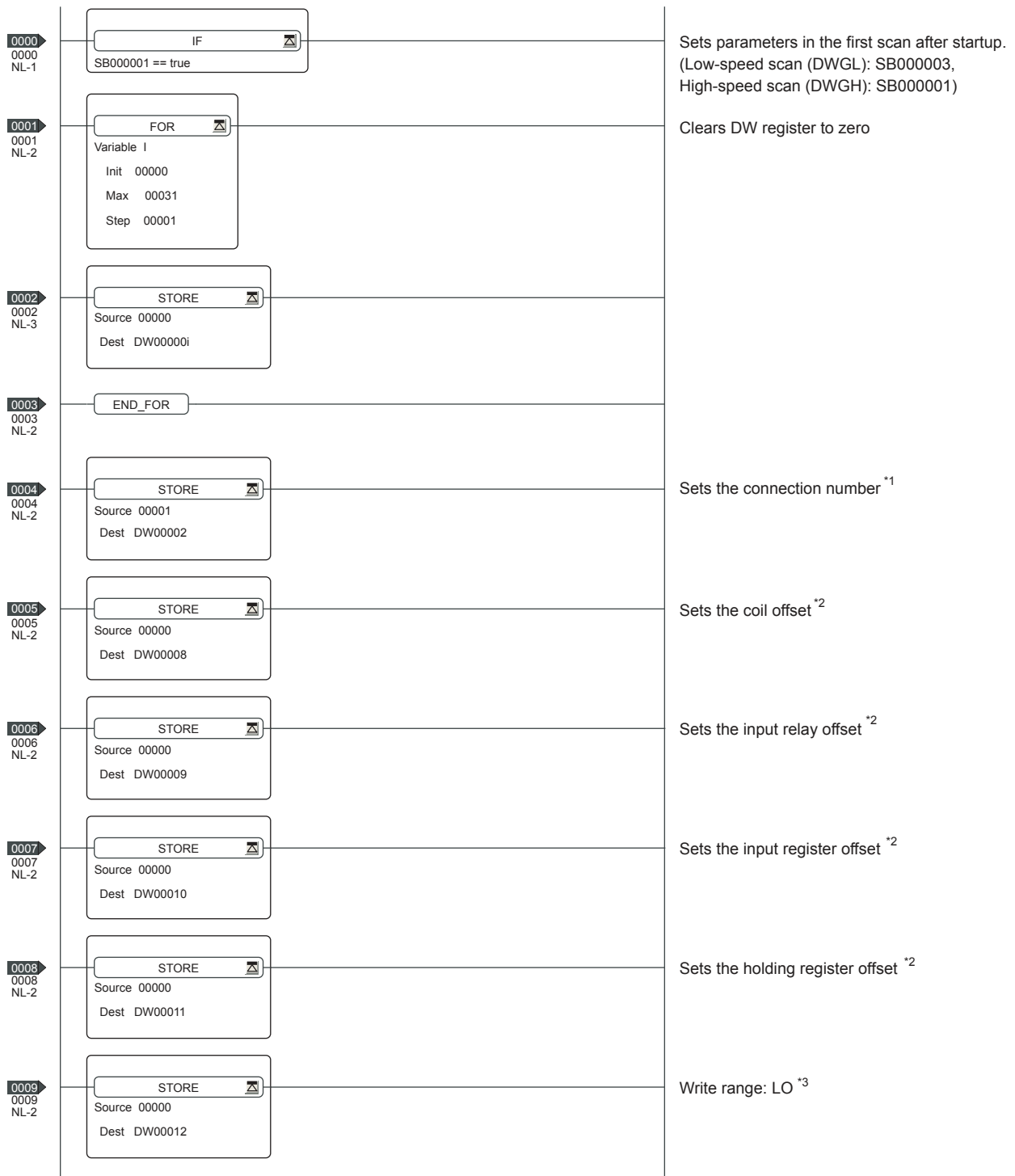

(Continued to next page)

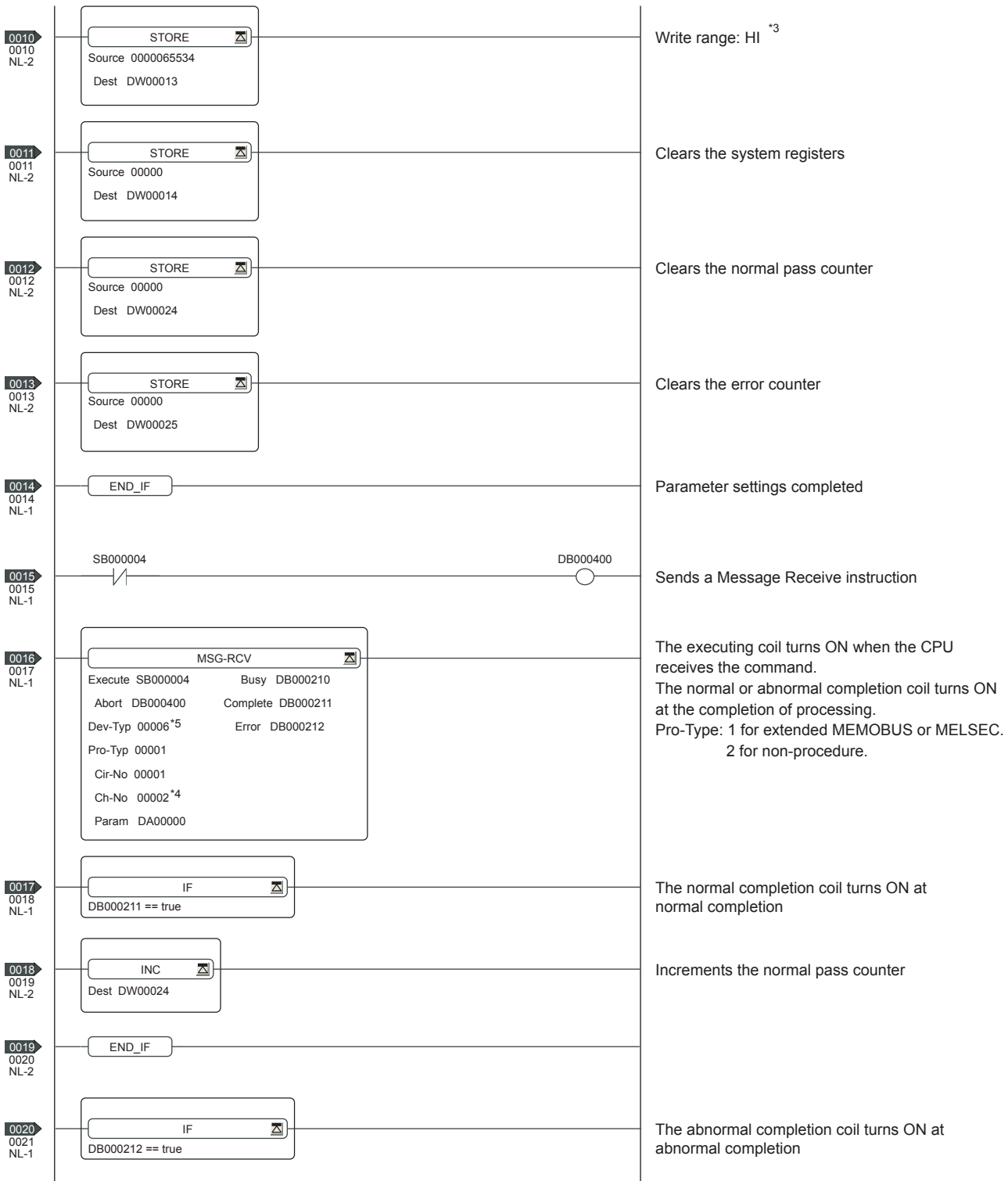

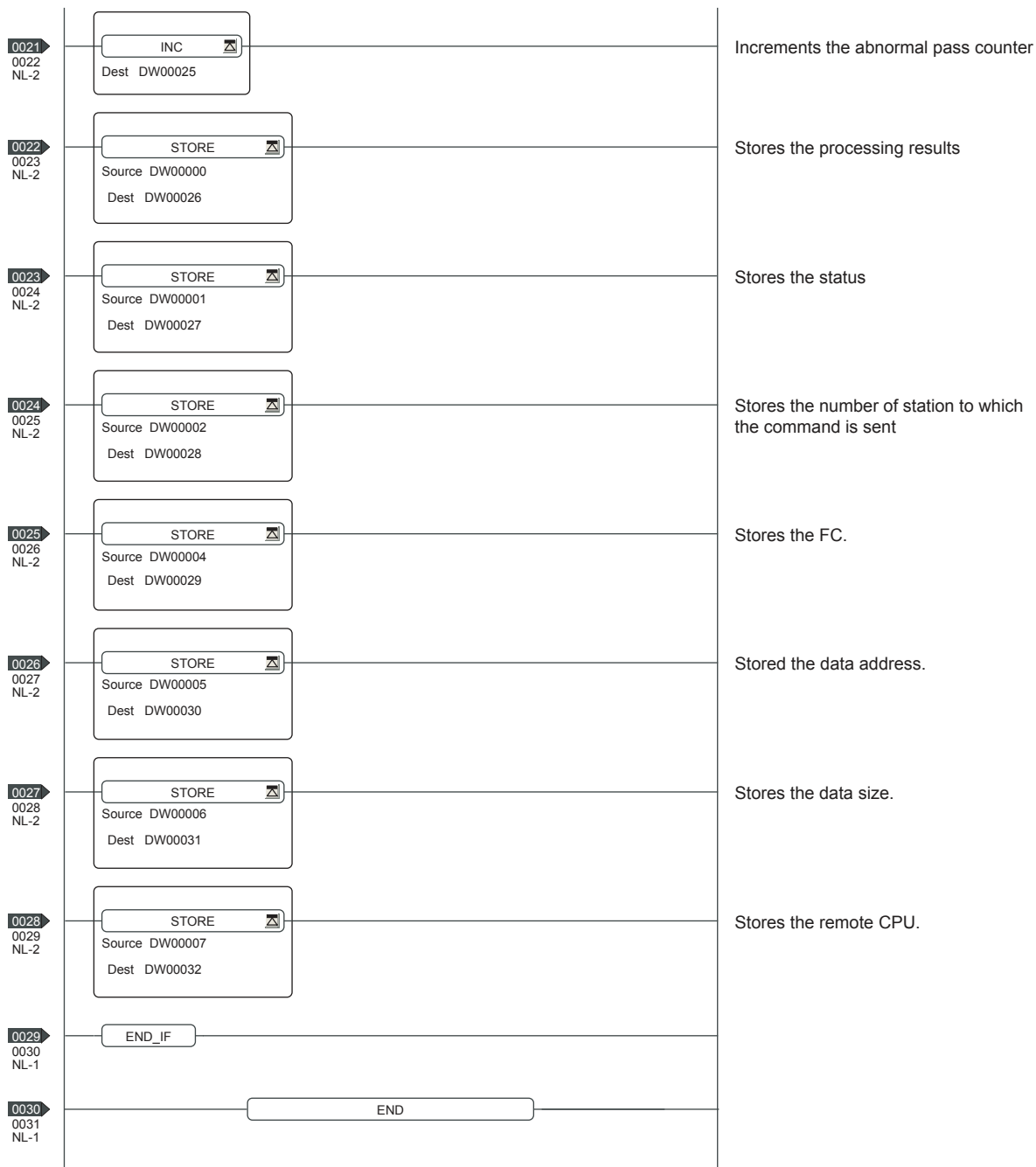

*1: When connecting to multiple GOTs, set connection numbers individually for each GOT.

*2: Set the offset for each device.

*3: Set the available write range for the holding registers.

*4: When connecting to multiple GOTs, set channel numbers individually for each GOT.

*5: Set the Dev-Typ of the message receive function <MSG-RCV> to [00016] for the built-in MP2300S Ethernet connection or the Ethernet port connection of 218IF-02.

6.3.5 PLC side setting (CP-9200SH series, CP-312, CP-317 series)

POINT

YASKAWA PLC

For details of YASKAWA PLCs, refer to the following manuals.

 YASKAWA PLC user's Manual

Parameter settings

Make the parameter settings with a peripheral tool.

(1) Settings for CP-218IF

Item	Set value
Module Type	CP-218
CPU Number	01
Circuit Number	01
Hot Swapping	○

Item	CNO 03	CNO 04	CNO 05
Local Port	10500	10501	10030
Node IP Address*1	192.168.001.018	192.168.001.020	192.168.001.073
Node Port*1	05016	05017	21001
Connection Type	TCP	TCP	UDP
Protocol Type	Extended MEMOBUS	Extended MEMOBUS	Extended MEMOBUS
Code	BIN	BIN	BIN

*1 Be sure to set the values above for the address so that the GOT communicates with the programmable controller correctly.
For the Host Address setting on the GOT side, refer to the following.

 6.3.2 ■ Ethernet setting

(2) Settings for CP-218IF

Item	Set value	
Transmission parameter setting	IP Address	IP address for 218TXB
	Response Time	Not required
	Count of Retry (Number of Retries)	Not required
Connection parameter setting	Connection Number	1
	Local Port	10500
	Node IP Address	Local IP address of GOT
	Node Port	Local port No. of GOT
	Connection Type	UDP
	Protocol Type	Extended MEMOBUS
	Code	BIN
Node Name	Any string	

Settings by DIP switch

(1) Settings for 218TXB

Set the DIP switch (SW2) as follows.

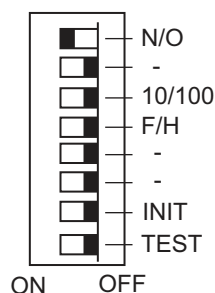

Setting Item	Set value	Setting range
N/O	Mode Selection	ON ON: Extended mode (13 channels, up to 1024 words) OFF: Basic mode (10 channels, up to 512 words)
-*1	Not used	OFF
10/100	Transmission Speed	OFF ON :10Mbps OFF :100Mbps
F/H	Transmission Mode	OFF ON: Full duplex mode OFF: Half duplex mode
INIT	Initial Startup	OFF ON: Start up by the default IP address and the engineering port No. OFF: Start up by the IP address and the engineering port No. set for CP-717
TEST*2	Test	OFF ON: The module starts the self-diagnosis when the PLC is started. OFF: The module does not start the self-diagnosis when the PLC is started.

*1 Turn off all the unused switches.
When even one of those switches is on, the PLC may not normally operate.

*2 When the PLC is started with the TEST switch on, the module starts the self-diagnosis and may not perform the communication.
Turn off the switch before the communication is started.

■ Sequence program

To communicate the CP-9200SH series, CP-312 series, or CP-317 series with GOT1000 series, the ladder program to receive messages is required. When multiple GOTs are connected to the CP-9200SH series, CP-312 series, or CP-317 series, ladder programs to receive messages for each GOT are required.

ladder program to receive messages

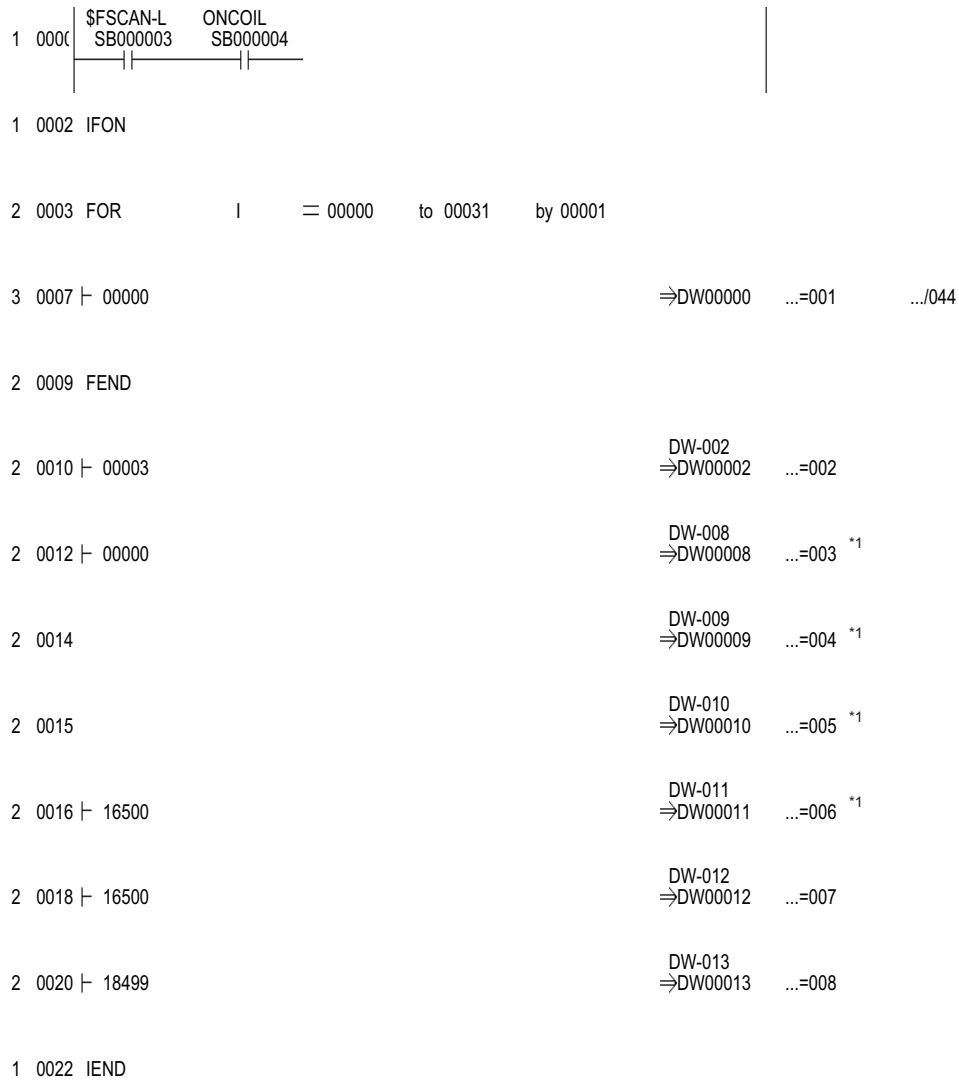

(Continued to next page)

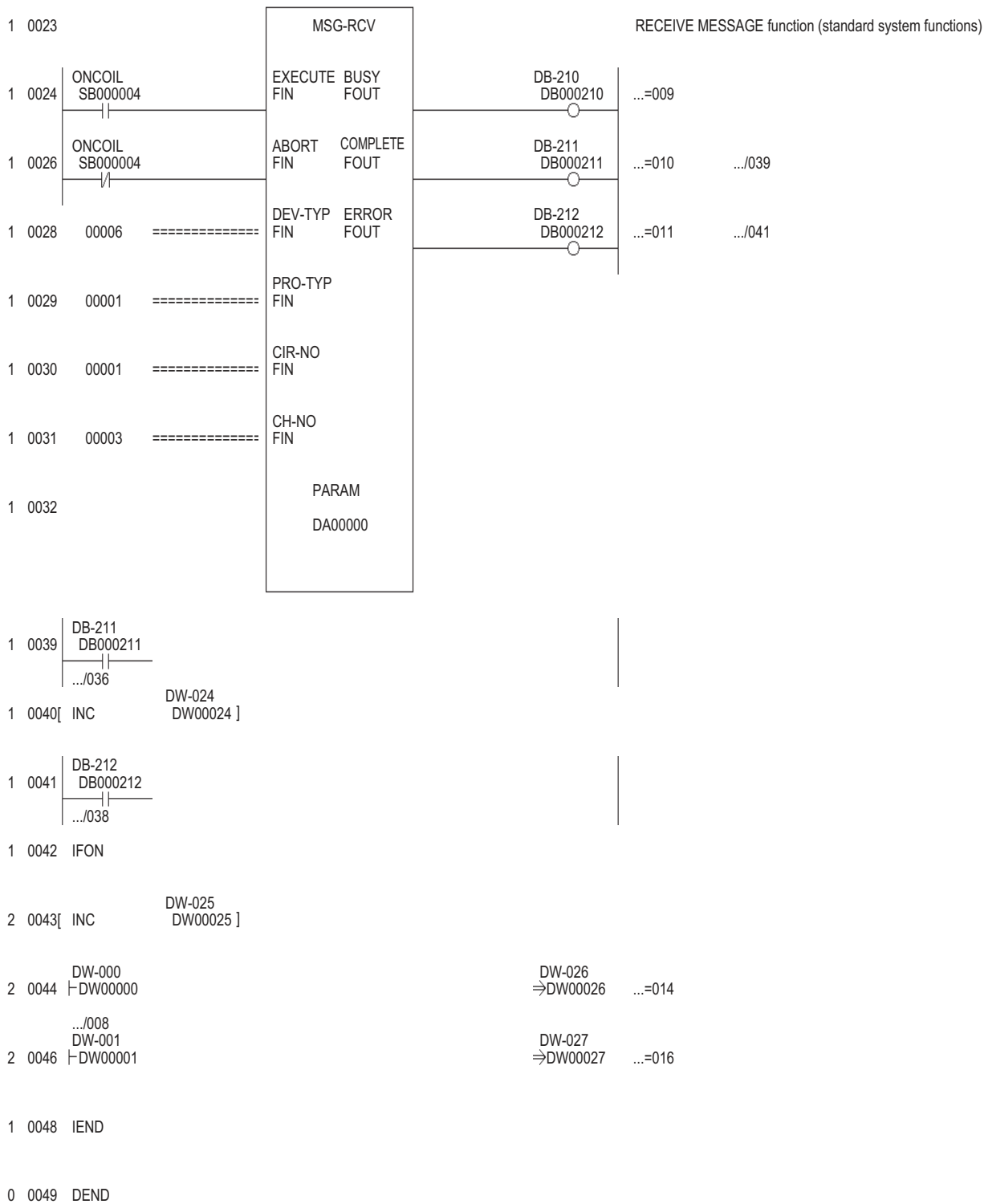

*1: Set 0 to PARAM08 to 11 of MSG_RCV (input relay, input register, coil, holding register offset). (Do not make the offset settings.)
When the offset is needed, set [Option] → [Offset] to each object or make a setting added the offset value to the device.

6.3.6 Precautions

■ When connecting to multiple GOTs

(1) Setting Station

When connecting two or more GOTs in the Ethernet network, set each [Station] to the GOT.

 6.3.2 ■ Ethernet setting

(2) Setting IP address

Do not use the IP address "192.168.3.18" when using multiple GOTs.

A communication error may occur on the GOT with the IP address.

■ When setting IP address

Do not use "0" and "255" at the end of an IP address. (Numbers of *.**.0 and *.**.255 are used by the system.)

The GOT may not monitor the controller correctly with the above numbers.

Consult with the administrator of the network before setting an IP address to the GOT and controller.

■ When connecting to the multiple network equipment (including GOT) in a segment

By increasing the network load, the transmission speed between the GOT and PLC may be reduced.

The following actions may improve the communication performance.

- Using a switching hub
- More high speed by 100BASE-TX (100Mbps)
- Reduction of the monitoring points on GOT

6.4 Device Range that Can Be Set

The device ranges of controller that can be used for GOT are as follows.

Note that the device ranges in the following tables are the maximum values that can be set in GT Designer3.

The device specifications of controllers may differ depending on the models, even though belonging to the same series.

Please make the setting according to the specifications of the controller actually used.

When a non-existent device or a device number outside the range is set, other objects with correct device settings may not be monitored.

Setting item

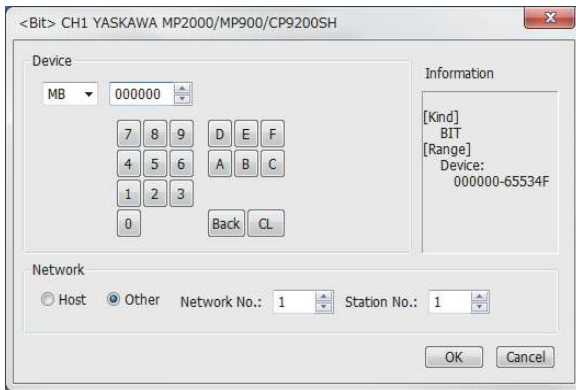

Item	Description			
Device	Set the device name, device number, and bit number. The bit number can be set only when specifying the bit of word device.			
Information	Displays the device type and setting range which are selected in [Device].			
Network	Set the station number of the controller to be monitored.			
	<table border="0"> <tr> <td>Host</td> <td>Select this item for monitoring the host controller.</td> </tr> <tr> <td>Other</td> <td>Select this for monitoring other controllers. After selecting, set the station number of the controller to be monitored. NW No.: Set the network No. Station No.: Set the station No.</td> </tr> </table>	Host	Select this item for monitoring the host controller.	Other
Host	Select this item for monitoring the host controller.			
Other	Select this for monitoring other controllers. After selecting, set the station number of the controller to be monitored. NW No.: Set the network No. Station No.: Set the station No.			

- (2) When setting as a word device
Set the device using the format of word address (DEC).

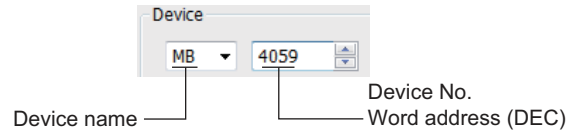

6.4.1 YASKAWA GL/PROGIC8

Device name	Setting range	Device No. representation	
Bit device	Coil (O) ^{*5}	O1 to O63424	Decimal
	Input relay (I) ^{*6*7}	I1 to I63424	
	Link coil (D)	D1 to D2048	
		D10001 to D12048 D20001 to D22048	
Word device bit	Specified bit of the following word devices	—	
Word device	Input register (Z) ^{*1*7}	Z1 to Z31840	Decimal
	Holding register (W) ^{*2*4}	W1 to W28291	
		SW1 to SW28291	
	Link register (R, SR) ^{*4}	R1 to R2048	
		R10001 to R12048 R20001 to R22048	
		SR1 to SR2048	
	Constant register (K) ^{*3}	SR10001 to SR12048 SR20001 to SR22048	
K1 to K4096			
Bit device word	Converting the following bit devices to words Link coil	—	

*1 Change the input register "30001 to 30512" to "Z1 to Z512" for setting. (When set in default)
 *2 Change the holding register "40001 to 49999" to "W1 to W9999" for setting. (When set in default)
 *3 Change the constant register "31001 to 35096" to "K1 to K4096" for setting. (When set in default)

(Continued to next page)

POINT

Device settings of YASKAWA PLC (when using CP-9200SH, CP-9300MS, MP-920, MP-930)

Set the coil device (MB) as follows:

- (1) When setting as a bit device
Set the device using the format of word address (DEC) + bit number (HEX).

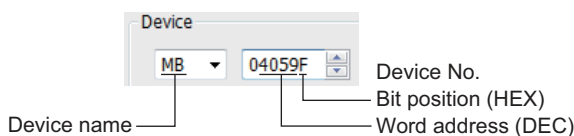

- *4 SR and SW indicate registers (virtual register) compatible to the data format where internal data of PLC is displayed using R or W.

The following shows the difference between the display values of SR, SW and those of R, W corresponding to the values of PLC internal data.

PLC internal data (16 bit)	SR, SW	R, W
9999	9999	9999
1001	1001	1001
1000	1000	1000
999	999	999
0	0	0
-1	-1	32769
-999	-999	33767
-1000	-1000	33768
-1001	-1001	33769
-9999	-9999	42767

- *5 The internal coil N1 to N1536 can be set as O513 to O2048. However, setting must not exceed O1 to O512 and O513 to O2048.
- *6 Change the input relay "10001 to 14096" to "I1 to I4096" for setting. (When set in default)
- *7 Only reading is possible.

6.4.2 YASKAWA CP9200SH/MP900

Device name	Setting range	Device No. representation
Bit device	Coil (MB) ^{*1}	MB000000 to MB32767F Decimal + Hexadecimal
	Input relay (IB)	MB000000 to MB32767F Hexadecimal
	Word device bit	Specified bit of the following word devices input register, holding register —
Word device	Input register (IW)	IW0000 to IW7FFF Hexadecimal
	Holding register (MW)	MW0 to MW32767 Decimal
	Coil (MB)	MB0 to MB32767 Decimal
	Input relay (IB)	IB000 to IBFFF Hexadecimal

- *1 MB40960 to MB32767F is available for MP-940 only.

6.4.3 YASKAWA CP9200 (H)

Device name	Setting range	Device No. representation
Bit device	Coil (OB) ^{*3}	OB000 to OB7FFF Hexadecimal
	Coil (OB) ^{*3}	IB000 to IB7FFF Hexadecimal
	Word device bit	Specified bit of the following word devices —
Word device	Input register (IW)	IW00 to IW7F Hexadecimal
	Output register (OW)	OW00 to OW7F Hexadecimal
	Data register (DW, ZD) ^{*1}	DW0 to DW2047 Decimal
		ZD0 to ZD2047 Decimal
	Common register (MW) ^{*2}	MW0 to MW7694 Decimal
Bit device word	Converting bit devices into word —	

- *1 Setting is available only when CP-9200H is used.
- *2 To use data registers of CPU #1 during operation of CP-9200, copy them to MW0 to 7694.
- *3 During operation of CP-9200H, specify the reference No. and quantities so that they do not cover both OB*** and IB***.

6.4.4 YASKAWA CP9300MS (MC compatible)

Device name	Setting range	Device No. representation
Bit device	Coil (OB)	OB0 to OB1023 Decimal
	Input relay (IB)	IB0 to IB1023 Decimal
	Word device bit	Specified bit of the following word devices —
Word device	Input register (I)	I0 to I63 Decimal
	Data register (M)	M0 to M2047 Decimal
	Output register (O)	o0 to o63 Decimal
	Bit device word	Converting bit devices into word —

6.4.5 YASKAWA MP2000/MP900/ CP9200SH Series

	Device name	Setting range	Device No. representation
Bit device	Coil (MB)	MB000000 to MB65534F	Decimal + Hexadecimal
	Input relay (IB) *1	IB000000 to IB7FFFFF	Hexadecimal
	Word device bit*2	Specified bit of the following word devices	—
Word device	Input register (IW)*1	IW0000 to IW7FFF	Hexadecimal
	Holding register (MW)	MW0 to MW65534	Decimal
	Bit device word	Converting bit devices into word	—

*1 Only reading is possible.

*2 For CP-317, the bit access of word device (MW) is enabled for reading only.

7









CONNECTION TO YOKOGAWA PLC

7.1	Connectable Model List	7 - 2
7.2	Serial Connection	7 - 3
7.3	Ethernet Connection	7 - 16
7.4	Device Range that Can Be Set	7 - 22

7. CONNECTION TO YOKOGAWA PLC

7.1 Connectable Model List

The following table shows the connectable models.

Series	Model name	Clock	Communication Type	Connectable model	Refer to
FA-M3	F3SP05	○	RS-232 RS-422		 7.2.1
	F3SP08				
	F3SP10				
	F3SP20				
	F3SP30				
	F3FP36				
	F3SP21				
	F3SP22-0S				
	F3SP25				
	F3SP35				
	F3SP28				
	F3SP38				
	F3SP53				
	F3SP58				
	F3SP59				
F3SP66					
F3SP67					
FA-M3V	F3SP76-7S				
FA500	FA500	○	RS-232 RS-422		 7.2.2
STARDOM	NFCP100	×	RS-232		 7.2.3
	NFJT100				
FA-M3	F3SP05	○	Ethernet		 7.3.1
	F3SP08				
	F3FP36				
	F3SP21				
	F3SP25				
	F3SP35				
	F3SP28				
	F3SP38				
	F3SP53				
	F3SP58				
	F3SP59				
	F3SP66				
F3SP67					
FA-M3V	F3SP71-4N				
	F3SP76-7S				

7.2 Serial Connection

7.2.1 System configuration for connecting to FA-M3/M3V

■ When using the conversion cable

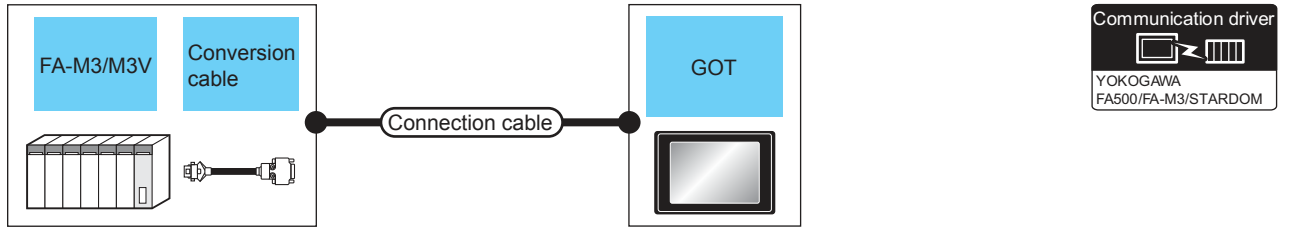

PLC			Connection cable		GOT		Number of connectable equipment
Model name	Conversion cable* ¹	Communication Type	Cable model Connection diagram number	Max. distance	Option device	Model	
F3SP05 F3SP08 F3SP21 F3SP22-0S F3SP25 F3SP28 F3SP35 F3SP38 F3SP53 F3SP58 F3SP59	KM10-0C* ²	RS-232	GT09-C30R20301-9P(3m) or RS-232 connection diagram 1)	15m* ⁴	- (Built into GOT)	 	1 GOT for 1 PLC
			RS-232 connection diagram 1)		GT15-RS2-9P	 	
F3SP66 F3SP67	KM10-0S* ³	RS-232	GT09-C30R20301-9P(3m) or RS-232 connection diagram 1)	15m* ⁴	- (Built into GOT)	 	
			RS-232 connection diagram 1)		GT15-RS2-9P	 	

*1 Product manufactured by YOKOGAWA Electric Corporation. For details of the product, contact Yokogawa Electric Corporation.

*2 CPU port/D-Sub 9-pin conversion cable

*3 SIO port adapter cable

*4 Including the length of the CPU port/D-Sub 9-pin conversion cable or the SIO port adapter cable.

■ When using the PC link module

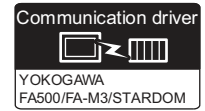
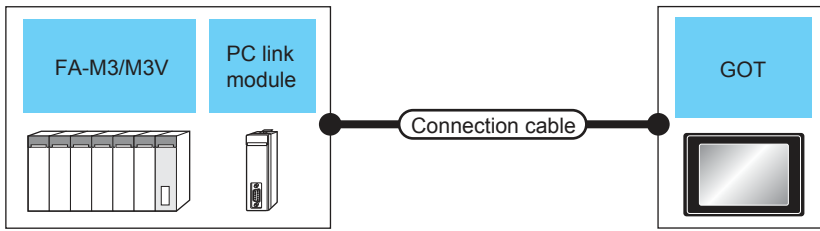

PLC			Connection cable		GOT		Number of connectable equipment
Model name	PC link module*1	Communication Type	Cable model Connection diagram number	Max. distance	Option device	Model	
F3SP05 F3SP08 F3SP10 F3SP20 F3SP30 F3FP36 F3SP21 F3SP25 F3SP35 F3SP28 F3SP38 F3SP53 F3SP58 F3SP59 F3SP66 F3SP67	F3LC01-1N F3LC11-1N F3LC11-1F F3LC12-1F	RS-232	GT09-C30R20302-9P(3m) or RS-232 connection diagram 2)	15m	- (Built into GOT)	GT 27 GT 23 GS	1 GOT for 1 PC link module
F3SP76-7S	F3LC12-1F				GT15-RS2-9P	GT 27 GT 23 GS	
F3SP05 F3SP08 F3SP20 F3SP30 F3FP36 F3SP21 F3SP25 F3SP35 F3SP28 F3SP38 F3SP53 F3SP58 F3SP59 F3SP66 F3SP67	F3LC11-2N	RS-422	GT09-C30R40301-6T(3m) GT09-C100R40301-6T(10m) GT09-C200R40301-6T(20m) GT09-C300R40301-6T(30m) or RS-422 connection diagram 1)	1200m	- (Built into GOT)	GT 27 GT 23 GS	1 GOT for 1 PC link module
					GT15-RS4-9S	GT 27 GT 23 GS	

*1 Product manufactured by YOKOGAWA Electric Corporation. For details of the product, contact Yokogawa Electric Corporation.

7.2.2 System configuration for connecting to FA500

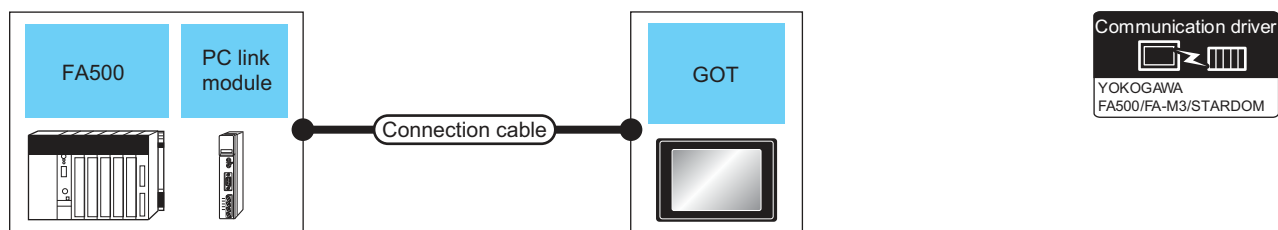

PLC			Connection cable		GOT		Number of connectable equipment
Series	PC link module*1	Communication Type	Cable model Connection diagram number	Max. distance	Option device	Model	
FA500	LC01-0N LC02-0N	RS-232	GT09-C30R20205-25P(3m) or RS-232 connection diagram 3)	15m	-(Built into GOT)	 	1 GOT for 1 PC link module
					GT15-RS2-9P	 	
	LC02-0N	RS-422	GT09-C30R40302-6T(3m) GT09-C100R40302-6T(10m) GT09-C200R40302-6T(20m) GT09-C300R40302-6T(30m) or RS-422 connection diagram 2)	1200m	-(Built into GOT)	 	
					GT15-RS4-9S	 	

*1 Product manufactured by YOKOGAWA Electric Corporation. For details of the product, contact Yokogawa Electric Corporation.

7.2.3 System configuration for connecting to STARDOM

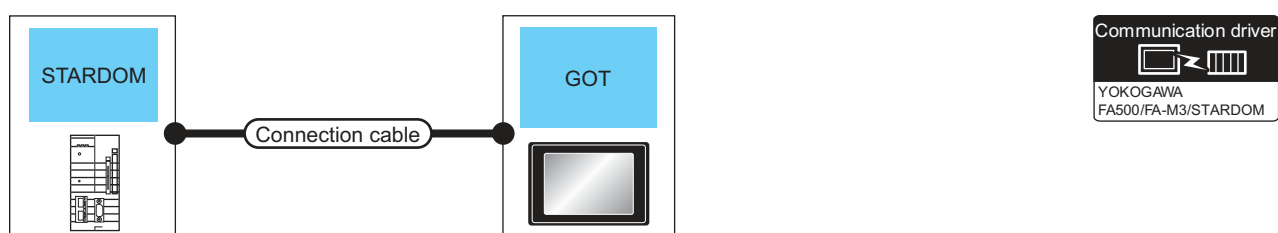

PLC		Connection cable*1		GOT		Number of connectable equipment
Series	Communication Type	Cable model Connection diagram number	Max. distance	Option device	Model	
STARDOM	RS-232	GT09-C30R20305-9S(3m) or RS-232 connection diagram 2)	15m	-(Built into GOT)	 	1 GOT for 1 PLC
				GT15-RS2-9P	 	

*1 Connect the connection cable to the COM port of the PLC.

7.2.4 Connection diagram

The following diagram shows the connection between the GOT and the PLC.

■ RS-232 cable

(1) Connection diagram

(a) RS-232 connection diagram 1)

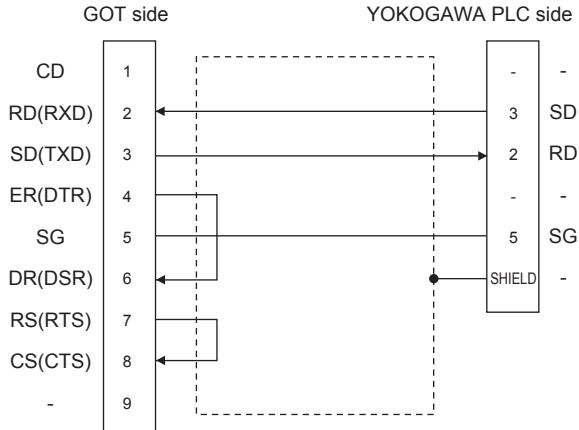

(b) RS-232 connection diagram 2)

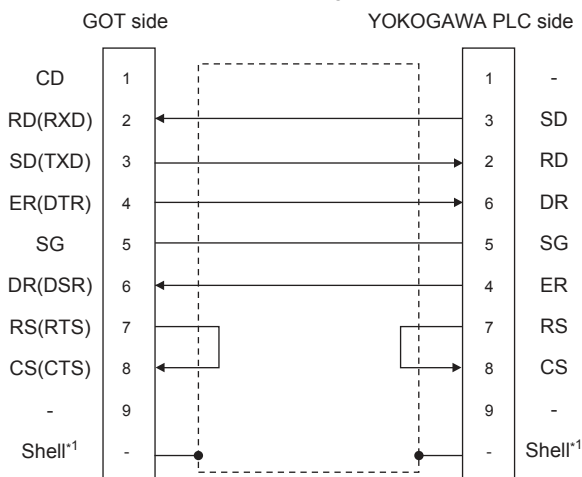

*1 Connect the shield to the housing of the connectors on both the GOT and YOKOGAWA product sides.

(c) RS-232 connection diagram 3)

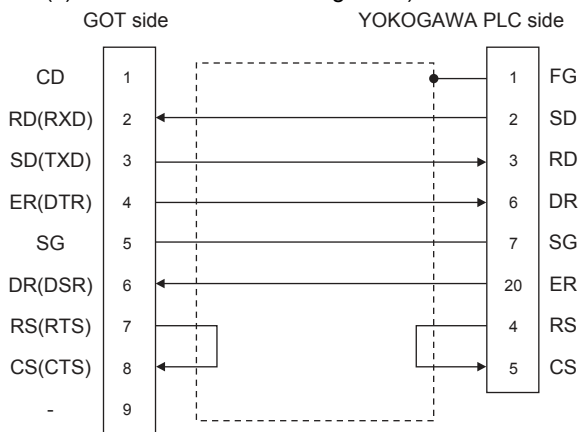

(2) Precautions when preparing a cable

- (a) Cable length
The length of the RS-232 cable must be 15m or less.
- (b) GOT side connector
For the GOT side connector, refer to the following.

1.4.1 GOT connector specifications

- (c) YOKOGAWA PLC side connector
Use the connector compatible with the YOKOGAWA PLC side module.
For details, refer to the YOKOGAWA PLC user's manual.

■ RS-422 cable

(1) Connection diagram

(a) RS-422 connection diagram 1)

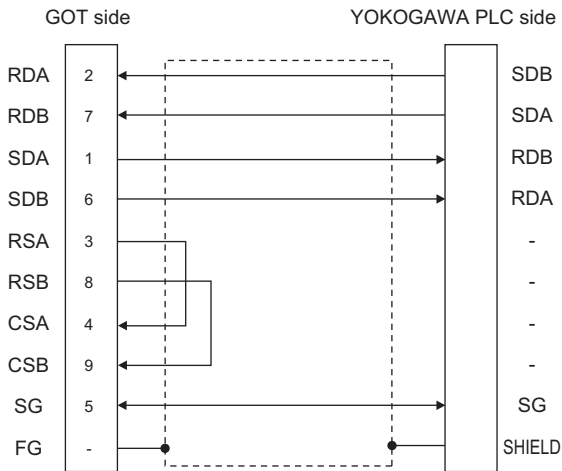

(b) RS-422 connection diagram 2)

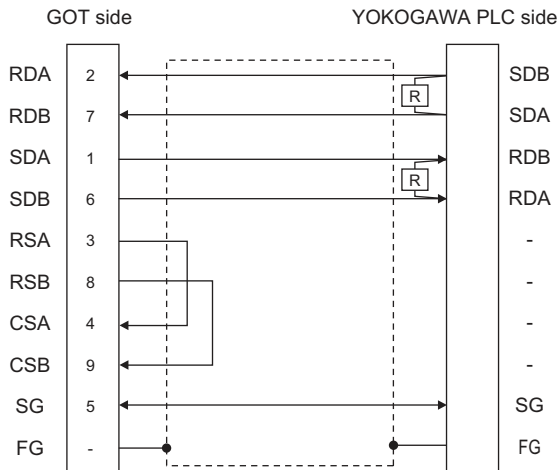

(2) Precautions when preparing a cable

- (a) Cable length
The length of the RS-422 cable must be 1200m or less.
- (b) GOT side connector
For the GOT side connector, refer to the following.

☞ 1.4.1 GOT connector specifications

- (c) YOKOGAWA PLC side connector
Use the connector compatible with the YOKOGAWA PLC side module.
For details, refer to the YOKOGAWA PLC user's manual.

(3) Connecting terminating resistors

- (a) GOT side
Set the terminating resistor setting switch of the GOT main unit to "Disable".
For the procedure to set the terminating resistor, refer to the following.

☞ 1.4.3 Terminating resistors of GOT

- (b) YOKOGAWA PLC side
When connecting a PLC link module to a GOT, a terminating resistor must be connected to the PC link module.
The following describes how to connect it on the PC link module.
 - F3LC11-2N
Set the terminator switch (TERMINATOR) on the front panel of F3LC11-2N to the "4-WIRE" side to enable the terminator.
 - LC02-0N
Connect the terminating resistor provided with the LC02-0N across SDA and SDB, and across RDA and RDB on the terminal block.

7.2.5 GOT side settings

■ Setting communication interface (Communication settings)

Set the channel of the connected equipment.

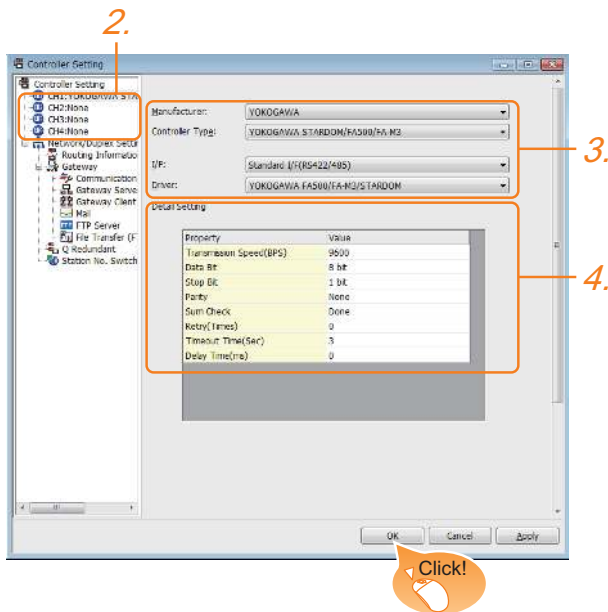

1. Select [Common] → [Controller Setting] from the menu.
2. The Controller Setting window is displayed. Select the channel to be used from the list menu.
3. Set the following items.
 - Manufacturer: YOKOGAWA
 - Controller Type: YOKOGAWA STARDOM/FA500/FA-M3
 - I/F: Interface to be used
 - Driver: YOKOGAWA FA500/FA-M3/STARDOM
4. The detailed setting is displayed after Manufacturer, Controller Type, I/F, and Driver are set. Make the settings according to the usage environment.

☞ 7.2.5 ■ Communication detail settings

Click the [OK] button when settings are completed.

POINT

The settings of connecting equipment can be confirmed in [I/F Communication Setting]. For details, refer to the following.

☞ 1.1.2 I/F communication setting

■ Communication detail settings

Make the settings according to the usage environment.

Property	Value
Transmission Speed(BPS)	9600
Data Bit	8 bit
Stop Bit	1 bit
Parity	None
Sum Check	Done
Retry(Times)	0
Timeout Time(Sec)	3
Delay Time(ms)	0

Item	Description	Range
Transmission Speed	Set this item when change the transmission speed used for communication with the connected equipment. (Default: 9600bps)	4800bps, 9600bps, 19200bps, 38400bps, 57600bps, 115200bps
Data Bit	Set this item when change the data length used for communication with the connected equipment. (Default: 8bits)	7bits/8bits
Stop Bit	Specify the stop bit length for communications. (Default: 1bit)	1bit/2bits
Parity	Specify whether or not to perform a parity check, and how it is performed during communication. (Default: No)	None Even Odd
Sum Check	Set whether or not to perform a sum check during communication. (Default: Yes)	Yes or No
Retry	Set the number of retries to be performed when a communication timeout occurs. When receiving no response after retries, the communication times out. (Default: 0time)	0 to 5times
Timeout Time	Set the time period for a communication to time out. (Default: 3sec)	1 to 30sec
Delay Time	Set this item to adjust the transmission timing of the communication request from the GOT. (Default: 0ms)	0 to 300(ms)

POINT

- (1) Communication interface setting by the Utility
The communication interface setting can be changed on the Utility's [Communication setting] after writing [Communication Settings] of project data.
For details on the Utility, refer to the following manual.

☞ GOT2000 Series User's Manual (Utility)

- (2) Precedence in communication settings
When settings are made by GT Designer3 or the Utility, the latest setting is effective.

7.2.6 PLC side setting

POINT

YOKOGAWA PLC

For details of YOKOGAWA PLCs, refer to the following manuals.

 YOKOGAWA PLC user's Manual

Model name		Refer to
CPU port/D-Sub 9-pin conversion cable	KM10-0C	7.2.7
SIO port adapter cable	KM10-0S	
PC link module	F3LC01-1N	7.2.8
	F3LC11-1N	
	F3LC11-2N	
	F3LC11-1F	7.2.9
	F3LC12-1F	
	LC01-0N	7.2.10
LC02-0N		
STARDOM		7.2.11

7.2.7 Connecting to CPU port/D-sub 9-pin conversion cable, SIO port adapter cable

Setting of PLC CPU

Make the PLC CPU settings, displaying [Configuration] → [Communication Settings] with the program development tool or the ladder-programming tool.

Item	Set value				
Communication mode*1	Set the communication mode of the CPU (transmission speed and data format). Set the transmission speed and data format according to settings of the transmission speed, data length, parity and stop bit on the GOT side. For details on these GOT side settings, refer to the following. ☞ 7.2.5 Setting communication interface (Communication settings)				
	Item	Transmission speed and data format			
		Transmission speed	Data bit	Parity	Stop bit
	Communication mode 0	9600 bps	8bits	Even	1bit
	Communication mode 1	9600 bps	8bits	None	1bit
	Communication mode 2	19200 bps	8bits	Even	1bit
	Communication mode 3	19200 bps	8bits	None	1bit
	Communication mode 4	38400 bps	8bits	Even	1bit
	Communication mode 5	38400 bps	8bits	None	1bit
	Communication mode 6	57600 bps	8bits	Even	1bit
	Communication mode 7	57600 bps	8bits	None	1bit
	Communication mode 8	115200 bps	8bits	Even	1bit
	Communication mode 9	115200 bps	8bits	None	1bit

CPU PC link function settings	Set the following when using the CPU programming port as the PC link function. Make the checksum setting according to the sum check setting on the GOT side. For the sum check setting on the GOT side, refer to the following. ☞ 7.2.5 ■ Setting communication interface (Communication settings)	
	Item	Set value
	Use of PC link function	Mark. (Use enabled)
	Checksum	Mark. (ON) Do not mark. (OFF)
	End character	Do not mark. (OFF)
Protect function	Do not mark. (OFF)	

*1 The communication mode that can be selected differs according to the CPU.

7.2.8 Connecting PC link module (F3LC01-1N, F3LC11-1N, F3LC11-2N)

Switch setting on the PC link module

Set the switches accordingly.

POINT

Switch setting

Set the switches before mounting the Ethernet Interface Module on the base unit.

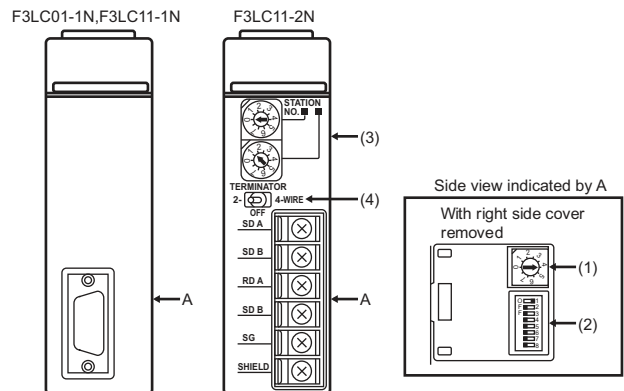

- (1) Transmission speed setting switch
Set the same transmission speed of the GOT.
For the transmission speed setting on the GOT side, refer to the following.

☞ 7.2.5 ■ Communication detail settings

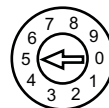

Setting*1	Transmission speed
4	4800bps
5	9600bps
6	19200bps

*1 Only transmission speeds available on the GOT side are shown.

- (2) Data format setting switch
Set the data length, parity, stop bit and checksum consistent with the corresponding settings on the GOT side.
For the settings on the GOT side, refer to the following.

☞ 7.2.5 ■ Communication detail settings



Switch No.	Description	Settings
1	Data bit	ON (8bits), OFF (7bits)
2	Parity	ON (done), OFF (none)
3		ON (even), OFF (odd)
4	Stop bit	ON (2bits), OFF (1bit)
5	Checksum	ON (done), OFF (none)
6	End character specification	OFF (none)
7	Protect function	OFF (disabled)
8	—	OFF

(3) Station No. switch (F3LC11-2N only)

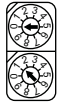

Rotary switch	Description	Settings
1)	Station No. (10's digit)	0
2)	Station No. (1's digit)	1

(4) Terminator switch (F3LC11-2N only)

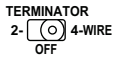

Settings	Description
4-WIRE	Resistor connected (4-wire type)

7.2.9 Connecting PC link module (F3LC11-1F, F3LC12-1F)

- Switch setting on the PC link module
Set the switches accordingly.

POINT

Switch setting

Set the switches before mounting the Ethernet Interface Module on the base unit.

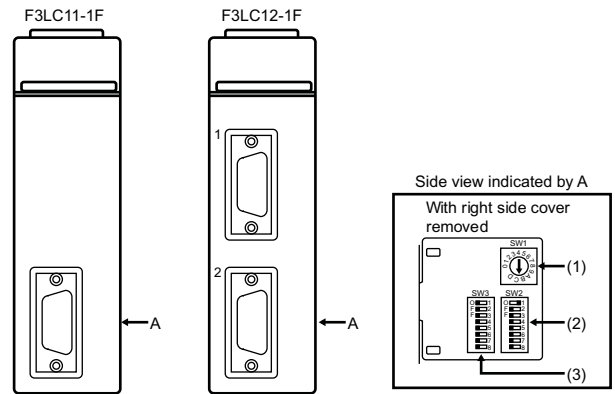

(1) Transmission speed switch (SW1)

Set the same transmission speed of the GOT.
For the transmission speed setting on the GOT side, refer to the following.

7.2.5 ■ Communication detail settings

Setting ^{*1}	Transmission speed
4	4800bps
5	9600bps
7	19200bps
9	38400bps
A	57600bps
C	115200bps

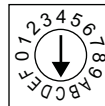

*1 Only transmission speeds available on the GOT side are shown.

(2) Data format switch (SW2)

Set the character length, parity, stop bit and checksum consistent with the corresponding settings on the GOT side.

For the settings on the GOT side, refer to the following.

7.2.5 ■ Communication detail settings

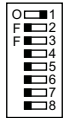

Switch No.	Description	Settings
1	Character length	ON (8bits), OFF (7bits)
2	Parity	ON (done), OFF (none)
3		ON (even), OFF (odd)
4	Stop bit	ON (2bits), OFF (1bit)
5	Checksum	ON (done), OFF (none)
6	End character specification	OFF (none)
7	Protect function	OFF (disabled)
8	Security function	OFF (disabled)

(3) Module function switch (SW3)

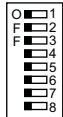

Switch No.	Description	Settings
1 to 6	User setting inhibited	OFF
7	Modem compatibility	OFF (not compatible)
8	External modem	OFF (none)

7.2.10 Connecting PC link module (LC01-0N, LC02-0N)

Switch setting on the PC link module

Set the switches accordingly.

POINT

Switch setting

Set the switches before mounting the Ethernet Interface Module on the base unit.

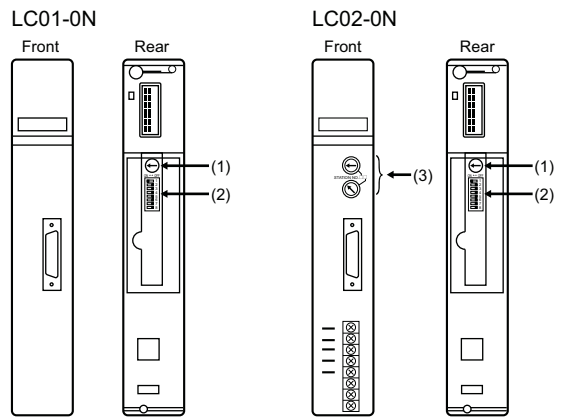

(1) Transmission speed setting switch

Set the same transmission speed of the GOT. For the transmission speed setting on the GOT side, refer to the following.

7.2.5 ■ Communication detail settings

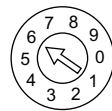

Setting ^{*1}	Transmission speed
4	4800bps
5	9600bps
6	19200bps

*1 Only transmission speeds available on the GOT side are shown.

(2) Data format setting switch

Set the data length, parity, stop bit and checksum consistent with the corresponding settings on the GOT side.

For the settings on the GOT side, refer to the following.

7.2.5 ■ Communication detail settings



Switch No.	Description	Settings
1	Data bit	ON (8bits), OFF (7bits)
2	Parity	ON (done), OFF (none)
3		ON (even), OFF (odd)
4	Stop bit	ON (2bits), OFF (1bit)
5	Checksum	ON (done), OFF (none)
6	End character specification	OFF (none)
7	Protect function	OFF (disabled)
8	—	OFF

(3) Station No. switch (LC02-0N only)

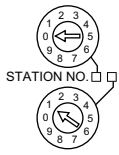

Rotary switch	Description	Settings	
		For RS-232 communication	For RS-422 communication
1)	Station No. (10's digit)	0	0
2)	Station No. (1's digit)	1	2

7.2.11 Connecting to STARDOM

Make the communication settings as shown below. For details of the communication settings, refer to the following manual.

Peripheral Software Manual for YOKOGAWA PLC

POINT

Connection between STARDOM and the PC for communication settings

For the communication settings of STARDOM, STARDOM and the PC for communication settings must be connected to Ethernet using the Resource Configurator (peripheral software).

COM port setting

Make the settings on the FCX Maintenance Page for STARDOM.

1. Select [Reboot (Maintenance Mode)] on the Reboot screen of the FCX Maintenance Page to set the maintenance mode.
2. Set the COM1 port driver to be used. Execute [JEROS Basic Setting File] from the [Edit System Setting File] screen on the FCX Maintenance Page. Confirm that the line of [Com1SioDriver] is as follows. Com1SioDriver=DUONUS_SIO
3. Set the COM1 port to be used. Execute [COM1 Port Setting File] from the [Edit System Setting Files] screen on the FCX Maintenance Page. Make the settings as follows according to the communication specifications on the setting screen. Leave the settings as default if not listed on the communication setting items. (Communication setting items) () in the table shows the names on the FCX Maintenance Page.

Item	Set value
Transmission speed (Baudrate)*1	4800bps, 9600bps, 19200bps, 38400bps, 57600bps, 115200bps
Data length (DataBitLength)*1	8bits, 7bits
Stop bit (StopBitLength)*1	1bit, 2bits
Parity bit (Parity)*1	none/odd/even

Baudrate = *1
 DataBitLength = *1
 StopBitLength = *1
 Parity = *1
 FifoMode = YES
 InitialDTRState = ON
 SendFlowControlMode = CTS
 ReceiveFlowControlMode = DTR

*1 Adjust the settings with GOT communication settings.

7.2.5 ■ Communication detail settings

4. Select "Reboot (Online Mode)" on the "Reboot" screen of the FCX Maintenance Page to set the online mode.

■ Defining Logic POU

Define Logic POU using Logic Designer (peripheral software), and download the project to STARDOM.

1. Start Logic Designer and create a new project using a template.
Use [STARDOM Serial Communication] template.
2. Insert FA-M3 Emulator Firmware Library to the new project.
 - (1) Right-click [Library] under the project tree in Logic Designer.
 - (2) Right-click [Insert] and select [Firmware Library].
 - (3) Double-click the [SD_FCXP_LCR_LIB] folder and double-click [SD_FCXP_LCR_LIB.fwl] to select it.
 - (4) The library path inserted in the procedures above is as follows.
{Install Folder}\LogicDesigner\Mwt\Plc\Fw_lib\SD_FCXP_LCR_LIB\SD_FCXP_LCR_LIB.fwl
3. Insert FA-M3 Emulator User Library to the new project.
 - (1) Right-click [Library] under the project tree in Logic Designer.
 - (2) Right-click [Insert] and select [User Library].
 - (3) Double-click [SD_CFAM3R_PF.mwt] to select it.
 - (4) The library path inserted in the procedures above is as follows.
{Install Folder}\LogicDesigner\Libraries\SD_CFAM3R_PF.mwt

4. Copy a sample project POU to the new project.

- (1) Open C{Install Folder}\LogicDesigner\Projects\EXAMPLE_J.mwt.
- (2) Right-click [FAM3_Emulator] in the Logic POU under the project tree in the Example_J project, and select [Copy].
- (3) Right-click the [Logic POU] under the project tree in the created new project, and select [Paste].
- (4) Double-click the [FAM3_Emulator*] file in the [FAM3_Emulator*] folder.
- (5) For the following terminals, set as shown below.
REQ terminal : TRUE
TERMCHAR terminal : FALSE
PORT terminal : COM1
STATION terminal : STATION1

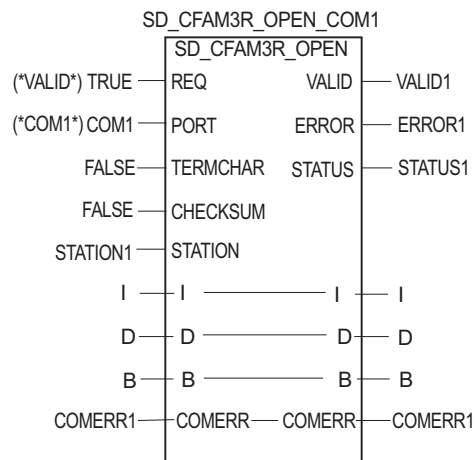

(Definition example of Logic POU)

5. Defining the instance
Instantiate Logic POU. Define an already defined instance to Task0.
 - (1) Right-click the [Physical hardware] [Configuration:IPC_33/FCX01:FCX/Tasks/Task0:CYCLIC] and select [Insert] - [Program instance].
 - (2) Define the program instance name and select FAM3_Emulator for the program type.

6. Defining Target Setting
Define the IP address or host name of STARDOM for which the communication settings are made.
Double-click [Physical hardware]
[Configuration:IPC_33/FCX01:FCX/Target Setting]
and input the IP address or the host name.
7. Downloading the project
 - (1) Execute [Build] - [Make].
(Same as when pressing the function key F9).
 - (2) Download after confirming that the compile error does not occur. Select [Download] in the project control dialog displayed when [Online] - [Project control] is selected.
 - (3) When the download is completed, select [Cold] and start STARDOM.

7.2.12 Precautions

■ Device range

When performing monitoring with the GOT connected to a YOKOGAWA PLC and setting devices for objects, use devices within the device range of the YOKOGAWA PLC.

When a device outside the range is set on an object, an indefinite value is displayed on the object.

(No error is displayed in the system alarm.)

For details on the device range of YOKOGAWA PLCs, refer to the following manual:

 7.4 Device Range that Can Be Set

■ Connecting to STARDOM

(1) Redundant system

When STARDOM is configured with a redundant system, the connection is not supported.

(2) System alarm

The PLC error does not appear in the system alarm.

(3) GOT clock control

Since the STARDOM does not have a clock function, the settings of [time adjusting] or [time broad cast] by GOT clock control will be disabled.

7.3 Ethernet Connection

7.3.1 System configuration for connecting to FA-M3/M3V

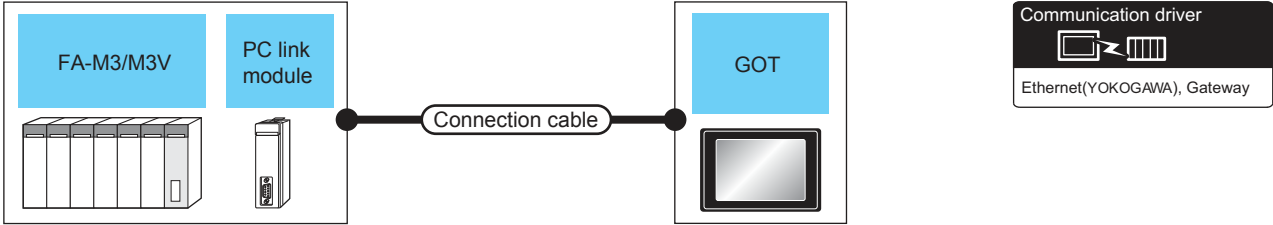

PLC		Connection cable		GOT		Number of connectable equipment
Model name	Ethernet interface module*1	Cable model*2 Connection diagram number	Maximum segment length*3	Option device	Model	
F3SP05 F3SP08 F3FP36 F3SP21 F3SP25 F3SP35 F3SP28 F3SP38 F3SP53 F3SP58 F3SP59 F3SP76-7S	F3LE01-5T F3LE11-0T F3LE12-0T	<ul style="list-style-type: none"> 10BASE-T Shielded twisted pair cable (STP) or unshielded twisted pair cable (UTP) : Category 3, 4, and 5 100BASE-TX Shielded twisted pair cable (STP) : Category 5 and 5e 	100m	- (Built into GOT)	<div style="border: 1px solid black; padding: 2px; display: inline-block;">GT 27</div> <div style="border: 1px solid black; padding: 2px; display: inline-block;">GT 23</div> <div style="border: 1px solid black; padding: 2px; display: inline-block;">GS</div>	<p>When PLC:GOT is N:1 The following shows the number of PLCs for 1 GOT TCP: 128 or less UDP: 128 or less</p> <p>When PLC:GOT is 1:N The following shows the number of GOTs for 1 PLC TCP: 8 or less UDP: 128 or less (recommended to 16 or less)</p>
F3SP66 F3SP67 F3SP71-4N F3SP76-7S	-					

*1 Product manufactured by YOKOGAWA Electric Corporation. For details of the product, contact Yokogawa Electric Corporation.

*2 The destination connected with the twisted pair cable varies with the configuration of the applicable Ethernet network system. Connect to the Ethernet module, hub, transceiver or other system equipment corresponding to the applicable Ethernet network system. Use cables, connectors, and hubs that meet the IEEE802.3 10BASE-T/100BASE-TX standards.

*3 A length between a hub and a node.
The maximum distance differs depending on the Ethernet device to be used.
The following shows the number of the connectable nodes when a repeater hub is used.

- 10BASE-T: Max. 4 nodes for a cascade connection (500m)
- 100BASE-TX: Max. 2 nodes for a cascade connection (205m)

When switching hubs are used, the cascade connection between the switching hubs has no logical limit for the number of cascades.
For the limit, contact the switching hub manufacturer.

7.3.2 GOT Side Settings

■ Setting communication interface (Communication settings)

Set the channel of the connected equipment.

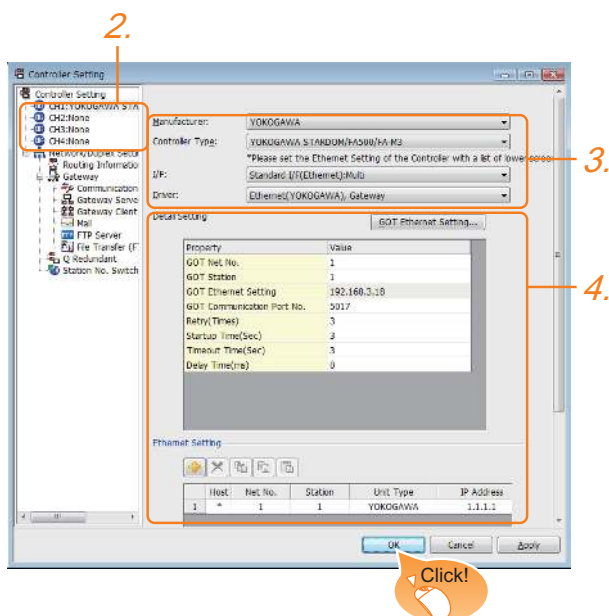

1. Select [Common] → [Controller Setting] from the menu.
2. The Controller Setting window is displayed. Select the channel to be used from the list menu.
3. Set the following items.
 - Manufacturer: YOKOGAWA
 - Controller Type: STARDOM/FA500/FA-M3
 - I/F: Interface to be used
 - Driver: Ethernet (YOKOGAWA), Gateway
4. The detailed setting is displayed after Manufacturer, Controller Type, I/F, and Driver are set. Make the settings according to the usage environment.

☞ 7.3.2 ■ Communication detail settings

Click the [OK] button when settings are completed.

POINT

The settings of connecting equipment can be confirmed in [I/F Communication Setting]. For details, refer to the following.

☞ 1.1.2 I/F communication setting

■ Communication detail settings

Make the settings according to the usage environment.

Property	Value
GOT Net No.	1
GOT Station	1
GOT Ethernet Setting	192.168.3.18
GOT Communication Port No.	5017
Retry(Times)	3
Startup Time(Sec)	3
Timeout Time(Sec)	3
Delay Time(ms)	0

Item	Description	Range
GOT Net No.	Set the network No. of the GOT. (Default: 1)	1 to 239
GOT 局番	Set the station No. of the GOT. (Default: 1)	1 to 64
GOT Ethernet 設定	Set the GOT IP address, subnet mask, default gateway, peripheral S/W communication port No., transparent port No.	☞ GOT Ethernet setting
GOT Communication Port No.	Set the GOT port No. for the connection with the Ethernet module. (Default: 5017)	1024 to 5010, 5014 to 65534 (Except for 5011, 5012, 5013 and 49153)
Retry	Set the number of retries to be performed when a communication timeout occurs. When receiving no response after retries, the communication times out. (Default: 3times)	0 to 5times
Startup Time	Specify the time period from the GOT startup until GOT starts the communication with the PLC CPU. (Default: 3sec)	3 to 255sec
Timeout Time	Set the time period for a communication to time out. (Default: 3sec)	1 to 90sec
Delay Time	Set the delay time for reducing the load of the network/destination PLC. (Default: 0ms)	0 to 10000 (× 10 ms)

POINT

- (1) Communication interface setting by the Utility
The communication interface setting can be changed on the Utility's [Communication setting] after writing [Communication Settings] of project data.
For details on the Utility, refer to the following manual.

☞ GOT2000 Series User's Manual (Utility)

- (2) Precedence in communication settings
When settings are made by GT Designer3 or the Utility, the latest setting is effective.

■ GOT Ethernet setting

Item	Description	Range
GOT IP Address	Set the IP address of the GOT. (Default: 192.168.0.18)	0.0.0.0 to 255.255.255.255
Subnet Mask	Set the subnet mask for the sub network.(Only for connection via router) If the sub network is not used, the default value is set. (Default: 255.255.255.0)	0.0.0.0 to 255.255.255.255
Default Gateway	Set the router address of the default gateway where the GOT is connected.(Only for connection via router) (Default: 0.0.0.0)	0.0.0.0 to 255.255.255.255
Peripheral S/W Communication Port No.	Set the GOT port No. for the S/W communication. (Default: 5015)	1024 to 5010, 5014 to 65534 (Except for 5011, 5012, 5013 and 49153)
Transparent Port No.	Set the GOT port No. for the transparent function. (Default: 5014)	1024 to 5010, 5014 to 65534 (Except for 5011, 5012, 5013 and 49153)

■ Ethernet setting

Item	Description	Set value
Host	The host is displayed.(The host is indicated with an asterisk (*).)	—
Net No.	Set the network No. of the connected Ethernet module. (Default: blank)	1 to 239
Station	Set the station No. of the connected Ethernet module. (Default: blank)	1 to 64
Type	YOKOGAWA (fixed)	YOKOGAWA (fixed)
IP address ^{*1}	Set the IP address of the connected Ethernet module. (Default: blank)	PLC side IP address
Port No. ^{*2}	Set the port No. of the connected Ethernet module. (Default: 12289)	12289, 12291
Communication format ^{*1}	Select a communication protocol. (Default: UDP)	UDP, TCP

^{*1} Set the same IP address and communication format as those of the PLC side.

^{*2} Set the port No. of the host link service used on the PLC side.

7.3.3 PLC side setting

POINT

YOKOGAWA PLC

For details of YOKOGAWA PLCs, refer to the following manuals.

👉 YOKOGAWA PLC user's Manual

Model name	Refer to	
Ethernet interface module	F3LE01-5T	7.3.4
	F3LE11-0T	
	F3LE12-0T	
Built-in Ethernet interface	F3SP66	7.3.6
	F3SP67	
	F3SP71-4N	

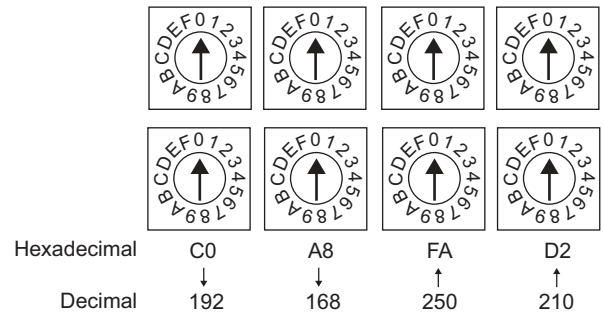

7.3.4 Connecting to Ethernet Interface Module (F3LE01-5T, F3LE11-0T)

- Switch settings of Ethernet Interface Module
Set the switches accordingly.

POINT

Switch setting

Set the switches before mounting the Ethernet Interface Module on the base unit.

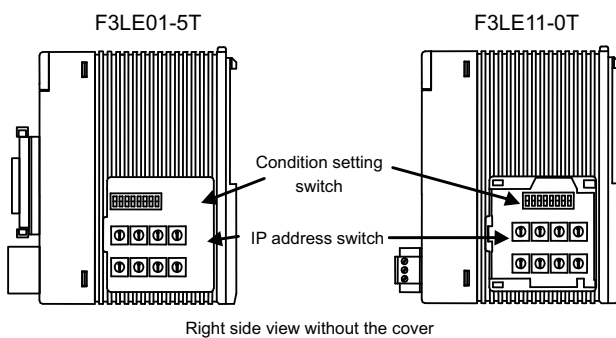

- (1) IP address switch
Set the IP address with eight Hex rotary switches on the side of the base unit.

(2) Condition setting switch

Set the data format, write protection, line processing at TCP timeout error or operation mode with the DIP switch on the side of the base unit.

Switch No.	Description	Set value
1	Data code	OFF (ASCII)
2	Write protect	OFF (not protect)
3	Reserved	ON (not available), OFF (always)
4		
5		
6		
7	Line processing on TCP timeout*1	OFF (close the line)
8	Operation mode	OFF (normal operation)

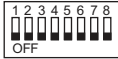

*1 Applicable to only F3LE01-5T.

7.3.5 Connecting to Ethernet Interface Module (F3LE12-0T)

Switch settings of Ethernet Interface Module
Set the switches accordingly.

POINT

Switch setting

Set the switches before mounting the Ethernet Interface Module on the base unit.

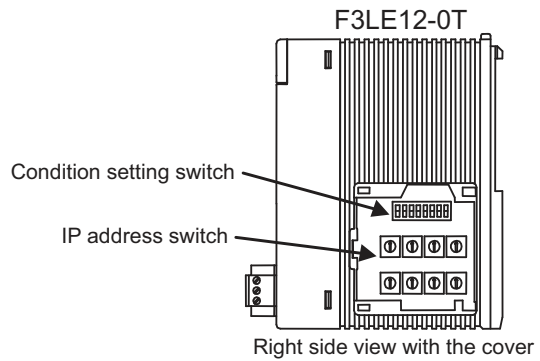

(1) IP address switch

Set the IP address with eight Hex rotary switches on the side of the base unit.

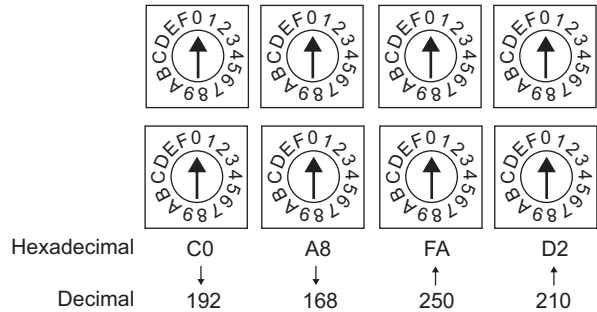

(2) Condition setting switch

Set the data format, write protection, or operation mode with the DIP switch on the side of the base unit.

Switch No.	Description	Set value
1	Data code	OFF (ASCII)
2	Write protect	OFF (not protect)
3	Reserved	ON (not available), OFF (always)
4		
5		
6		
7		
8	Operation mode	OFF (normal operation)



7.3.6 Connecting to F3SP66, F3SP67, F3SP71-4N (built-in Ethernet interface)

■ Project setting/configuration setting

Set the setting with software for programming apparatus.

Item	Set value	Description
IP address*1	0.0.0.0 to 255.255.255.255	Set the IP address of the connected Ethernet module.
Host link service A protocol*2 Port No.: 12289	0=TCP/IP*1 1=UDP/IP*1	Select the protocol to be used in the port A of the host link service via Ethernet.
Host link service A protocol command data type*2 Port No.: 12289	0=ASCII format	Select the command data type to be used in the port A of the host link service via Ethernet.
Host link service B protocol*2 Port No.: 12291	0=TCP/IP*1 1=UDP/IP*1	Select the protocol to be used in the port B of the host link service via Ethernet.
Host link service B protocol command data type*2 Port No.: 12291	0=ASCII format	Select the command data type to be used in the port B of the host link service via Ethernet.
Write protection*3	0 = Not protected 1 = Protected	Disables the write command to this module with the host link service via Ethernet.

*1 Adjust the settings with GOT settings.

 7.3.2 ■ Ethernet setting

*2 For the port No. of the GOT, set the port No. of the host link service to be used.

 7.3.2 ■ Ethernet setting

*3 Set this as necessary.

7.3.7 Precautions

■ Device range

When performing monitoring with the GOT connected to a YOKOGAWA PLC and setting devices for objects, use devices within the device range of the YOKOGAWA PLC.

When a device outside the range is set on an object, an indefinite value is displayed on the object. (No error is displayed in the system alarm.)

For details on the device range of YOKOGAWA PLCs, refer to the following manual:

 7.4 Device Range that Can Be Set

■ When setting IP address

Do not use "0" and "255" at the end of an IP address. (Numbers of *.**.0 and *.**.255 are used by the system.)

The GOT may not monitor the controller correctly with the above numbers.

Consult with the administrator of the network before setting an IP address to the GOT and controller.

■ When connecting to multiple GOTs

(1) Setting Station

When connecting two or more GOTs in the Ethernet network, set each [Station] to the GOT.

 7.3.2 ■ Ethernet setting

(2) Setting IP address

Do not use the IP address "192.168.0.18" when using multiple GOTs.

A communication error may occur on the GOT with the IP address.

■ When connecting to the multiple network equipment (including GOT) in a segment

By increasing the network load, the transmission speed between the GOT and PLC may be reduced.

The following actions may improve the communication performance.

- Using a switching hub
- More high speed by 100BASE-TX (100Mbps)
- Reduction of the monitoring points on GOT

7.4 Device Range that Can Be Set

The device ranges of controller that can be used for GOT are as follows.

Note that the device ranges in the following tables are the maximum values that can be set in GT Designer3.

The device specifications of controllers may differ depending on the models, even though belonging to the same series.

Please make the setting according to the specifications of the controller actually used.

When a non-existent device or a device number outside the range is set, other objects with correct device settings may not be monitored.

POINT

- (1) When using YOKOGAWA PLC FA-M3
When YOKOGAWA PLC FA-M3 is used, the device range that can be used differs depending on the PLC model selected by the GT Designer3. Since [YOKOGAWA STARDOM/FA-M3] has larger device points that can be set than [YOKOGAWA FA500/FA-M3], select [YOKOGAWA STARDOM/FA-M3] if a large device points should be set.
- (2) Devices to be set for an object
When a device outside the range is set for an object, an indefinite value is displayed on the object. (No error is displayed in the system alarm.) A device to be set for an object must be in the device range of YOKOGAWA PLC. For details on the device range of YOKOGAWA PLCs, refer to the following manual:

 YOKOGAWA PLC user's Manual

Setting item

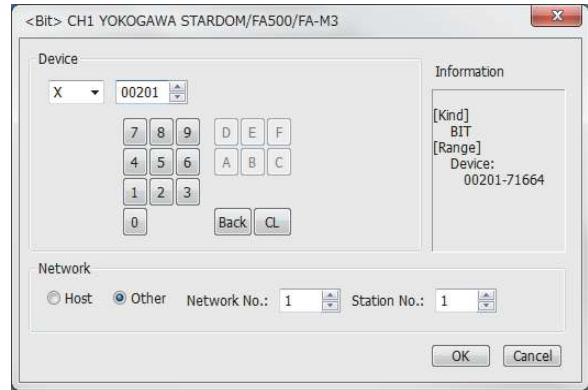

Item	Description	
Device	Set the device name, device number, and bit number. The bit number can be set only when specifying the bit of word device.	
	File No.	Set the file No.
Information	Displays the device type and setting range which are selected in [Device].	
Network	Set the station number of the controller to be monitored.	
	Host	Select this item for monitoring the host controller.
	Other	Select this for monitoring other controllers. After selecting, set the station number of the controller to be monitored. NW No.: Set the network No. Station No.: Set the station No.

7.4.1 YOKOGAWA FA500/FA-M3 Series

Device name	Setting range	Device No. representation	
Bit device	Input relay (X) ^{*1}	X00201 to X71664	Decimal
	Output relay (Y)	Y00201 to Y71664	
	Internal relay (I)	I1 to I65536	
	Link relay (L)	L1 to L71024	
	Common relay (E)	E1 to E4096	
	Special relay (M) ^{*3}	M1 to M9984	
	Timer (TU) ^{*2}	TU1 to TU3072	
	Counter (CU) ^{*2}	CU1 to CU3072	
Word device bit	Specified bit of the following word devices (Except Timer (TP, TS), Counter (CP, CS))		
Word device	Timer (TP)	TP1 to TP3072	Decimal
	Timer (TS) ^{*1}	TS1 to TS3072	
	Counter (CP)	CP1 to CP3072	
	Counter (CS) ^{*1}	CS1 to CS3072	
	File register (B)	B1 to B262144	
	Data register (D)	D1 to D8192	
	Common register (R)	R1 to R4096	
	Index register (V)	V1 to V256	
	Link register (W)	W1 to W71024	
	Special register (Z) ^{*3}	Z1 to Z512	
Bit device word	Converting bit devices into word (Except Timer (TU), Counter (CU))		

*1 Writing is not possible.

*2 Writing to continuous devices is not possible.

*3 The GOT cannot read or write data from/to consecutive devices.

7.4.2 YOKOGAWA STARDOM/FA-M3 Series

Device name	Setting range	Device No. representation	
Bit device	Input relay (X) ^{*1}	X00201 to X71664	Decimal
	Output relay (Y)	Y00201 to Y71664	
	Internal relay (I) ^{*4}	I1 to I65535	
	Link relay (L)	L00001 to L08192 L10001 to L18192 L20001 to L28192 L30001 to L38192 L40001 to L48192 L50001 to L58192 L60001 to L68192 L70001 to L78192	
	Common relay (E)	E1 to E4096	
	Special relay (M) ^{*3}	M1 to M9984	
	Timer (TU) ^{*2}	TU1 to TU3072	
	Counter (CU) ^{*2}	CU1 to CU3072	
	Word device bit	Specified bit of the following word devices (Excluding TP, TS, CP and CS)	
	Word device	Timer (TP)	
Timer (TS) ^{*1}		TS1 to TS3072	
Counter (CP)		CP1 to CP3072	
Counter (CS) ^{*1}		CS1 to CS3072	
File register (B) ^{*5}		B1 to B262144	
Data register (D)		D1 to D65535	
Common register (R)		R1 to R4096	
Index register		V1 to V256	
Link register (W)		W00001 to W08192 W10001 to W18192 W20001 to W28192 W30001 to W38192 W40001 to W48192 W50001 to W58192 W60001 to W68192 W70001 to W78192	
Special register (Z) ^{*3}		Z1 to Z1024	
Bit device word	Converting bit devices into word (Except TU and CU)		

*1 Writing is not possible.

*2 Writing to continuous devices is not possible.

*3 The GOT cannot read or write data from/to consecutive devices.

*4 With STARDOM, FA-M3 (F3SP59 only), if communications that include the maximum device number (32767 or 65535) occurs, system alarm "322 Dedicated device is out of range. Confirm device range." may be detected. If such system alarm is detected, do not use the last 15 bits.

*5 With STARDOM, do not use B32768 or later. Otherwise, normal monitoring is not performed.

8









CONNECTION TO YOKOGAWA TEMPERATURE CONTROLLER

8.1	Connectable Model List	8 - 2
8.2	System Configuration	8 - 3
8.3	Connection Diagram	8 - 12
8.4	GOT Side Settings	8 - 27
8.5	Temperature Controller Side Setting	8 - 29
8.6	Device Range that Can Be Set	8 - 33
8.7	Precautions	8 - 34

8. CONNECTION TO YOKOGAWA TEMPERATURE CONTROLLER

8.1 Connectable Model List

The following table shows the connectable models.

Series	Model name	Clock	Communication Type	Connectable model	Refer to
GREEN	UT320	×	RS-232 RS-485		 8.2.1
	UT321				
	UT350				
	UT351				
	UT420				
	UT450				
	UT520				
	UT550				
	UT551				
	UT750				
	UP350				
	UP351				
	UP550				
	UP750				
	UM330				
	UM331				
UM350					
UM351					
US1000					
UT100	UT130	×	RS-232 RS-485		 8.2.2
	UT150				
	UT152				
	UT155				
	UP150				
UT2000	UT2400	×	RS-232 RS-485		 8.2.3
	UT2800				
UTAdvanced	UT32A	×	RS-232 RS-485		 8.2.4
	UT35A				
	UT52A				
	UT55A				
	UP35A				
	UP55A				
UM33A					

8.2 System Configuration

8.2.1 Connecting to GREEN Series

■ When using the RS232C/RS485 converter

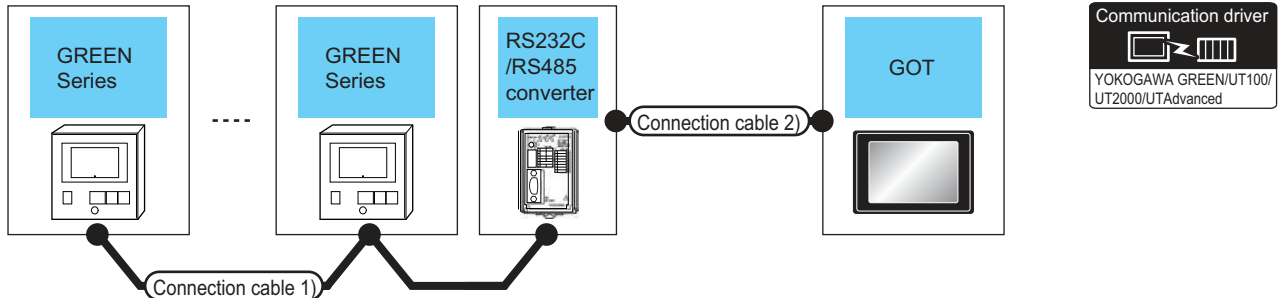

Temperature controller	Connection cable 1)		RS232C/RS485 converter*1		Connection cable 2)		GOT		Number of connectable equipment
	Model name	Cable model Connection diagram number	Max. distance	Model name	Communication Type	Cable model Connection diagram number	Max. distance	Option device	
UT320 UT321 UT350 UT351 UT420 UT450 UT520 UT550 UT551 UT750 ^{*2} UP350 UP351 UP550 UP750 ^{*2} UM330 UM331 UM350 UM351 US1000	RS-485 connection diagram 1) (4-wire type)	1200m	ML2-□	RS-232	GT09-C30R20304-9S (3m) or RS-232 connection diagram 1)	15m	- (Built into GOT)	 	Up to 31 temperature controllers for 1 GOT
GT15-RS2-9P							 		
UP750 ^{*3} UT750 ^{*3}	RS-485 connection diagram 9) (2-wire type)	1200m	ML2-□	RS-232	GT09-C30R20304-9S (3m) or RS-232 connection diagram 1)	15m	- (Built into GOT)	 	
							GT15-RS2-9P	 	

*1 Product manufactured by YOKOGAWA Electric Corporation. For details of the product, contact Yokogawa Electric Corporation.

*2 Connect the connection cable 1) to the standard RS-485 communication interface.

*3 Connect the connection cable 1) to the high performance RS-485 communication interface.

■ When connecting directly

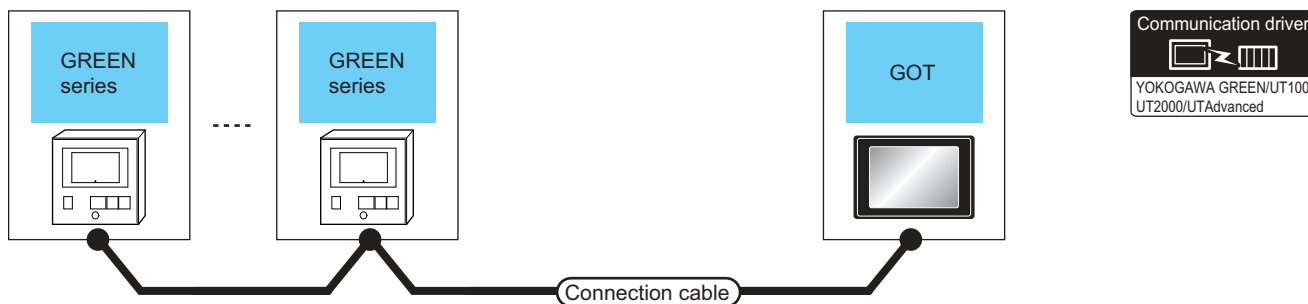

Temperature controller		Connection cable		GOT		Number of connectable equipment
Model name	Communication Type	Cable model Connection diagram number	Max. distance	Option device	Model	
UT320 UT321 UT350 UT351 UT420 UT450 UT520 UT550 UT551 UT750 ^{*1} UP350 UP351 UP550 UP750 ^{*1} UM330 UM331 UM350 UM351 US100	RS-485	GT09-C30R40303-6T (3m) GT09-C100R40303-6T (10m) GT09-C200R40303-6T (20m) GT09-C300R40303-6T (30m) or RS-485 connection diagram 3) (4-wire type)	1200m	- (Built into GOT)	 	Up to the following number of temperature controllers for 1 GOT GT16, GT15: 31 GT11: 10
		RS-485 connection diagram 2) (4-wire type)	1200m	FA-LTBGT2R4CBL05 (0.5m) ^{*3} FA-LTBGT2R4CBL10 (1m) ^{*3} FA-LTBGT2R4CBL20 (2m) ^{*3}	 	
		RS-485 connection diagram 6) (2-wire type)				
		RS-485 connection diagram 4) (4-wire type)	1200m	GT15-RS4-TE	 	
	RS-485 connection diagram 8) (2-wire type)					
UP750 ^{*2} UT750 ^{*2}	RS-485	RS-485 connection diagram 7) (2-wire type)	1200m	FA-LTBGT2R4CBL05 (0.5m) ^{*3} FA-LTBGT2R4CBL10 (1m) ^{*3} FA-LTBGT2R4CBL20 (2m) ^{*3}	 	
		RS-485 connection diagram 10) (2-wire type)	1200m	GT15-RS4-TE	 	

*1 Connect the connection cable to the standard RS-485 communication interface.

*2 Connect the connection cable to the high performance RS-485 communication interface.

*3 Product manufactured by MITSUBISHI ELECTRIC ENGINEERING COMPANY LIMITED. For details of the product, contact MITSUBISHI ELECTRIC ENGINEERING COMPANY LIMITED.

8.2.2 Connecting to UT100 Series

■ When using the RS232C/RS485 converter

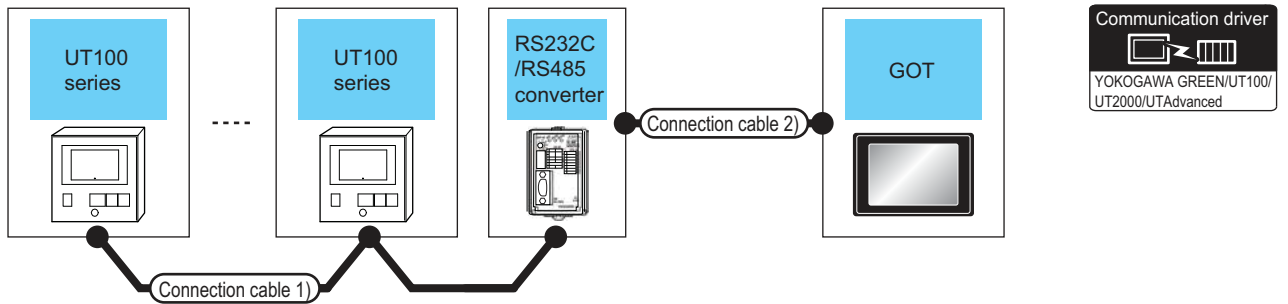

Temperature controller	Connection cable 1)		RS232C/RS485 converter ^{*1}		Connection cable 2)		GOT		Number of connectable equipment	
	Series	Cable model Connection diagram number	Max. distance	Model name	Communication Type	Cable model Connection diagram number	Max. distance	Option device		Model
UT100		RS-485 connection diagram 9)	1200m	ML2-□	RS-232	RS-232 connection diagram 1)	15m	- (Built into GOT)	 	31 temperature controllers for 1 GOT
								GT15-RS2-9P	 	

^{*1} Product manufactured by YOKOGAWA Electric Corporation. For details of the product, contact Yokogawa Electric Corporation.

■ When connecting directly

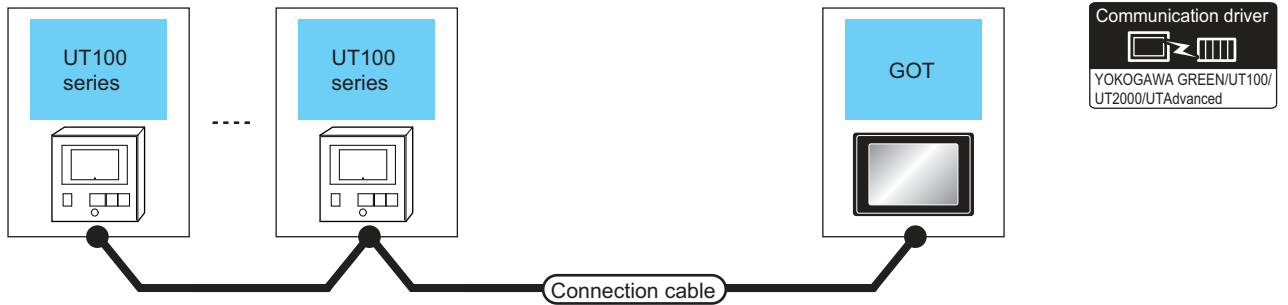

Temperature controller	Connection cable			GOT		Number of connectable equipment	
	Series	Communication Type	Cable model Connection diagram number	Max. distance	Option device		Model
UT100	RS-485		RS-485 connection diagram 7) (2-wire type)	1200m	FA-LTBGT2R4CBL05(0.5m) ^{*1} FA-LTBGT2R4CBL10(1m) ^{*1} FA-LTBGT2R4CBL20(2m) ^{*1}	 	Up to 31 temperature controllers for 1 GOT
			RS-485 connection diagram 10) (2-wire type)	1200m	GT15-RS4-TE	 	

^{*1} Product manufactured by MITSUBISHI ELECTRIC ENGINEERING COMPANY LIMITED. For details of the product, contact MITSUBISHI ELECTRIC ENGINEERING COMPANY LIMITED.

8.2.3 Connecting to UT2000 Series

■ When using the RS232C/RS485 converter

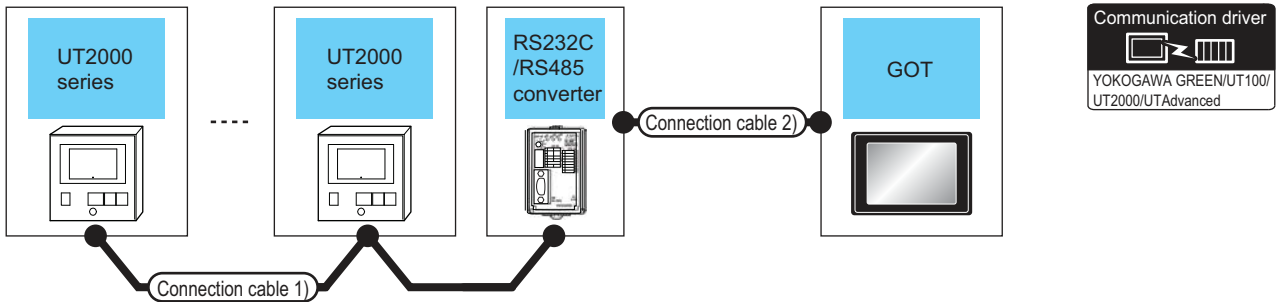

Temperature controller	Connection cable 1)		RS232C/RS485 converter*1		Connection cable 2)		GOT		Number of connectable equipment
	Cable model Connection diagram number	Max. distance	Model name	Communication Type	Cable model Connection diagram number	Max. distance	Option device	Model	
UT2000	RS-485 connection diagram 12)	1200m	ML2-□	RS-232	GT09-C30R20304-9S (3m) or RS-232 connection diagram 1)	15m	- (Built into GOT) GT15-RS2-9P	 	Up to 16 temperature controllers for 1 GOT

*1 Product manufactured by YOKOGAWA Electric Corporation. For details of the product, contact Yokogawa Electric Corporation.

■ When connecting directly

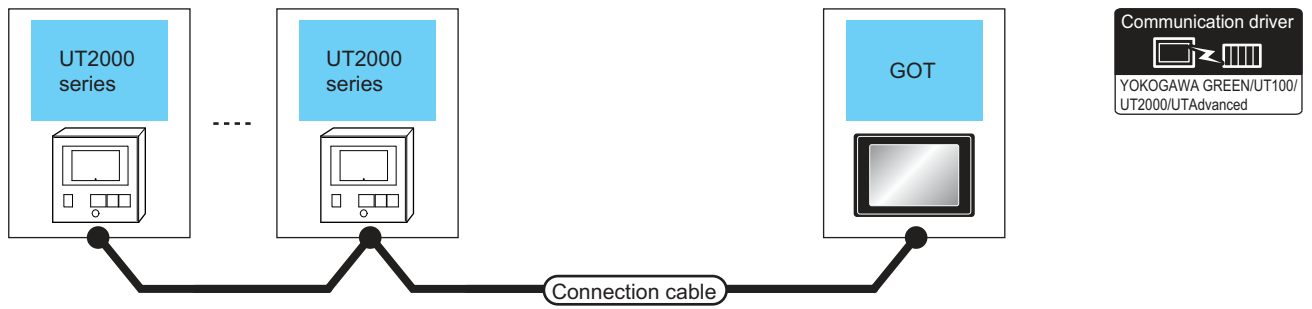

Temperature controller		Connection cable		GOT		Number of connectable equipment
Series	Communication Type	Cable model Connection diagram number	Max. distance	Option device	Model	
UT2000	RS-485	GT09-C30R40304-6T (3m) GT09-C100R40304-6T (10m) GT09-C200R40304-6T (20m) GT09-C300R40304-6T (30m) or RS-485 connection diagram 13) (4-wire type)	1200m	- (Built into GOT)	 	Up to 16 temperature controllers for 1 GOT
		RS-485 connection diagram 11) (4-wire type)	1200m	GT15-RS4-9S	 	Up to 16 temperature controllers for 1 GOT
		RS-485 connection diagram 14) (4-wire type)	1200m	FA-LTBGT2R4CBL05(0.5m) ^{*1} FA-LTBGT2R4CBL10(1m) ^{*1} FA-LTBGT2R4CBL20(2m) ^{*1}	 	Up to 16 temperature controllers for 1 GOT
				GT15-RS4-TE	 	

*1 Product manufactured by MITSUBISHI ELECTRIC ENGINEERING COMPANY LIMITED. For details of the product, contact MITSUBISHI ELECTRIC ENGINEERING COMPANY LIMITED.

8.2.4 Connecting to UTAdvanced Series

■ When using the RS232C/RS485 converter

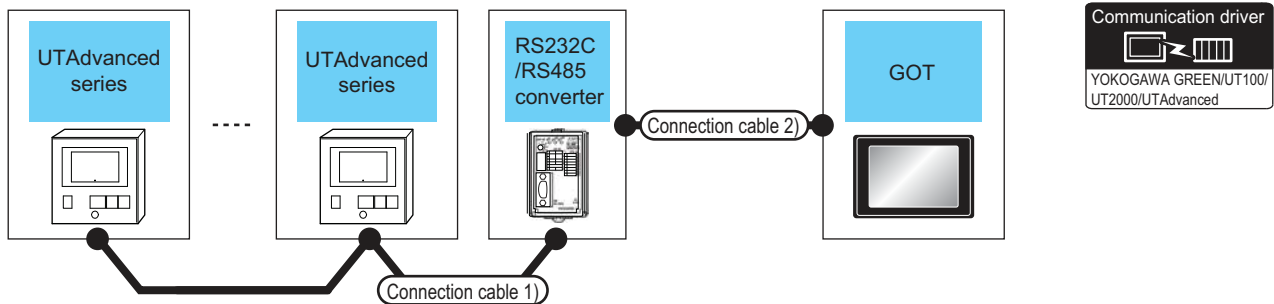

Temperature controller	Connection cable 1)		RS232C/RS485 converter*1		Connection cable 2)		GOT		Number of connectable equipment	
	Series	Cable model Connection diagram number	Max. distance	Model name	Communication Type	Cable model Connection diagram number	Max. distance	Option device		Model
UT32A UT35A UT55A*2 UP35A UP55A*3 UM33A*4		RS-485 connection diagram 15) (4-wire type)	1200m	ML2-□	RS-232	GT09-C30R20304-9S (3m) or RS-232 connection diagram 1)	15m	- (Built into GOT)	 	Up to 31 temperature controllers for 1 GOT
								GT15-RS2-9P	 	
UT52A UT55A*5 UP55A*6 UM33A*7		RS-485 connection diagram 9) (2-wire type)	1200m	ML2-□	RS-232	GT09-C30R20304-9S (3m) or RS-232 connection diagram 1)	15m	- (Built into GOT)	 	Up to 31 temperature controllers for 1 GOT
								GT15-RS2-9P	 	







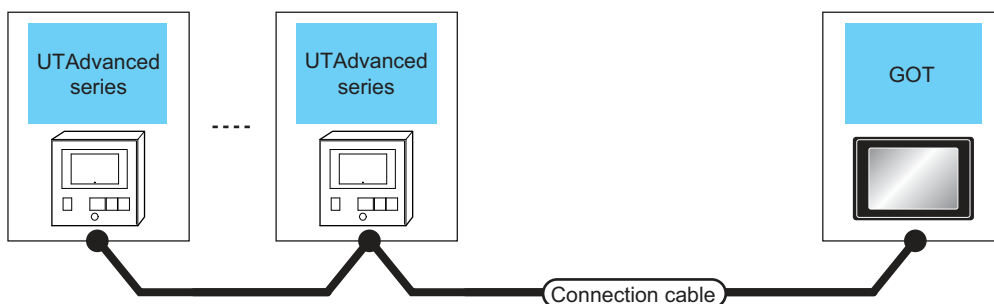





*1 Product manufactured by YOKOGAWA Electric Corporation. For details of the product, contact Yokogawa Electric Corporation.
For *2 to *7, only the products that meet the following conditions can be connected

Annotation	Suffix code		Optional suffix code	Remark
	Function	Open network		
*2	1 or 2	-	Without "/LP"	Product with two RS-485 communication ports (4-wire type/2-wire type) and without the power supply for 24VDC sensor
	-	1	-	Product with the open network port of RS-485 communication (4-wire type/2-wire type)
*3	2	-	-	Product with two RS-485 communication ports (4-wire type/2-wire type) (Standard code model)
	Other than 3	-	-	Product without the additional contact output points (DO) and with the open network port of RS-485 communication (4-wire type/2-wire type) (Standard code model)
	-	-	With "/CH3"	Product with RS-485 communication port (4-wire type/2-wire type) specified in the E3 terminal area option (Detailed code model)
	-	-	With "/C4"	Product with the RS-485 communication port (4-wire type/2-wire type) specified in the E4 terminal area option (Detailed code model)
*4	1	-	Without "/LP"	Product with two RS-485 communication ports (4-wire type) and without the power supply of 24VDC sensor
*5	1 or 2	-	With "/LP"	Product with two RS-485 communication ports (4-wire type/2-wire type) and with the power supply for 24VDC sensor
*6	2	-	-	Product with two RS-485 communication ports (4-wire type/2-wire type) (Standard code model)
	-	-	With "/C4"	Product with the RS-485 communication port (4-wire type/2-wire type) specified in the E4 terminal area option (Detailed code model)
*7	1	-	With "/LP"	Product with two RS-485 communication ports (4-wire type/2-wire type) and with the power supply for 24VDC sensor

■ When connecting directly



Temperature controller		Connection cable		GOT		Number of connectable equipment
Series	Communication Type	Cable model Connection diagram number	Max. distance	Option device	Model	
UT32A UT35A UT55A ^{*1} UP35A UP55A ^{*2}	RS-485	GT09-C30R40303-6T(3m) GT09-C100R40303-6T(10m) GT09-C200R40303-6T(20m) GT09-C300R40303-6T(30m) or RS-485 connection diagram 3) (4-wire type)	1200m	- (Built into GOT)	 	Up to 31 temperature controllers for 1 GOT
		RS-485 connection diagram 3) (4-wire type)	1200m	GT15-RS4-9S	 	
		RS-485 connection diagram 17) (4-wire type)	1200m	FA-LTBGT2R4CBL05 (0.5m) ^{*7} FA-LTBGT2R4CBL10 (1m) ^{*7} FA-LTBGT2R4CBL20 (2m) ^{*7}	 	
		RS-485 connection diagram 4) (4-wire type)	1200m	GT15-RS4-TE	 	
		RS-485 connection diagram 18) (2-wire type)	1200m	FA-LTBGT2R4CBL05 (0.5m) ^{*7} FA-LTBGT2R4CBL10 (1m) ^{*7} FA-LTBGT2R4CBL20 (2m) ^{*7}	 	
		RS-485 connection diagram 8) (2-wire type)	1200m	GT15-RS4-TE	 	
UM33A ^{*7}	RS-485	GT09-C30R40303-6T(3m) GT09-C100R40303-6T(10m) GT09-C200R40303-6T(20m) GT09-C300R40303-6T(30m) or RS-485 connection diagram 3) (4-wire type)	1200m	- (Built into GOT)	 	Up to 31 temperature controllers for 1 GOT
		RS-485 connection diagram 3) (4-wire type)	1200m	GT15-RS4-9S	 	
		RS-485 connection diagram 4) (4-wire type)	1200m	GT15-RS4-TE	 	

Temperature controller		Connection cable		GOT		Number of connectable equipment
Series	Communication Type	Cable model Connection diagram number	Max. distance	Option device	Model	
UM33A ^{*8}	RS-485	 RS-485 connection diagram 17) (4-wire type)	1200m	FA-LTBGT2R4CBL05 (0.5m) ^{*7} FA-LTBGT2R4CBL10 (1m) ^{*7} FA-LTBGT2R4CBL20 (2m) ^{*7}	  	Up to 31 temperature controllers for 1 GOT
UT52A UT55A ^{*3} UP55A ^{*4} UM33A ^{*5}	RS-485	 RS-485 connection diagram 19) (2-wire type)	1200m	FA-LTBGT2R4CBL05 (0.5m) ^{*7} FA-LTBGT2R4CBL10 (1m) ^{*7} FA-LTBGT2R4CBL20 (2m) ^{*7}	  	
		 RS-485 connection diagram 10) (2-wire type)	1200m	GT15-RS4-TE	  	

For *1 to *6, only the products that meet the following conditions can be connected.

Annotation	Suffix code		Optional suffix code	Remark
	Function	Open network		
*1	1 or 2	-	Without "/LP"	Product with two RS-485 communication ports (4-wire type/2-wire type) and without the power supply for 24VDC sensor
	-	1	-	Product with the open network port of RS-485 communication (4-wire type/2-wire type)
*2	2	-	-	Product with two RS-485 communication ports (4-wire type/2-wire type) (Standard code model)
	Other than 3	1	-	Product without the additional contact output points (DO) and with the open network port of RS-485 communication (4-wire type/2-wire type) (Standard code model)
	-	-	With "/CH3"	Product with RS-485 communication port (4-wire type/2-wire type) specified in the E3 terminal area option (Detailed code model)
	-	-	With "/C4"	Product with the RS-485 communication port (4-wire type/2-wire type) specified in the E4 terminal area option (Detailed code model)
*3	1 or 2	-	With "/LP"	Product with two RS-485 communication ports (4-wire type/2-wire type) and with the power supply for 24VDC sensor
*4	2	-	-	Product with two RS-485 communication ports (4-wire type/2-wire type) (Standard code model)
	-	-	With "/C4"	Product with the RS-485 communication port (4-wire type/2-wire type) specified in the E4 terminal area option (Detailed code model)
*5	1	-	With "/LP"	Product with two RS-485 communication ports and without the power supply for 24VDC sensor
*6	1	-	Without "/LP"	Product with two RS-485 communication ports (4-wire type) and without the power supply of 24VDC sensor

*7 Product manufactured by MITSUBISHI ELECTRIC ENGINEERING COMPANY LIMITED. For details of the product, contact MITSUBISHI ELECTRIC ENGINEERING COMPANY LIMITED.

8.3 Connection Diagram

The following diagram shows the connection between the GOT and the temperature controller.

8.3.1 RS-232 cable

■ Connection diagram

(1) RS-232 connection diagram 1)

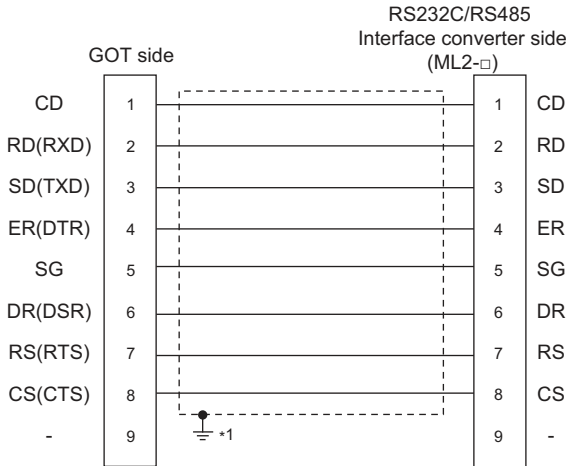

*1 Connect FG grounding to the appropriate part of a cable shield line.

■ Precautions when preparing a cable

(2) Cable length

The length of the RS-232 cable must be 15m or less.

(3) GOT side connector

For the GOT side connector, refer to the following.

 1.4.1 GOT connector specifications

(4) YOKOGAWA temperature controller side connector

Use the connector compatible with the YOKOGAWA temperature controller side.

For details, refer to the user's manual of the YOKOGAWA temperature controller.

8.3.2 RS-485 cable

■ Connection diagram

(1) RS-485 connection diagram 1)

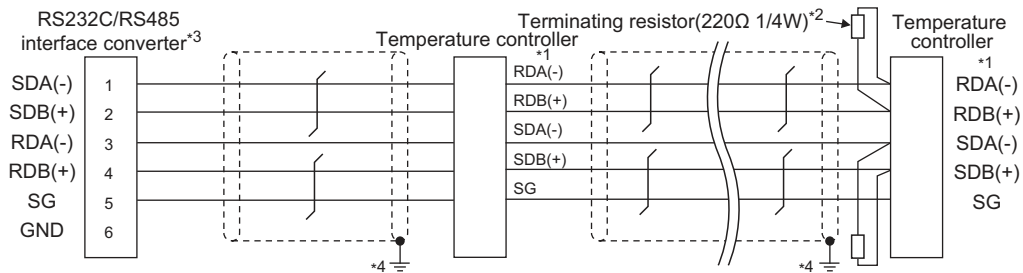

*1 Pin No. of temperature controller differs depending on the model. Refer to the following table.

Signal name	Model of temperature controller	
	GREEN Series UT/UP/UM	GREEN Series US
	Pin No.	Pin No.
RDA (-)	26	24
RDB (+)	25	23
SDB (+)	23	21
SDA (-)	24	22
SG	27	25

*2 Terminating resistor should be provided for a temperature controller which will be a terminal.

*3 Turn on the terminating switch on the RS232C/RS485 converter at the end.

*4 Connect FG grounding to the appropriate part of a cable shield line.

(2) RS-485 connection diagram 2)

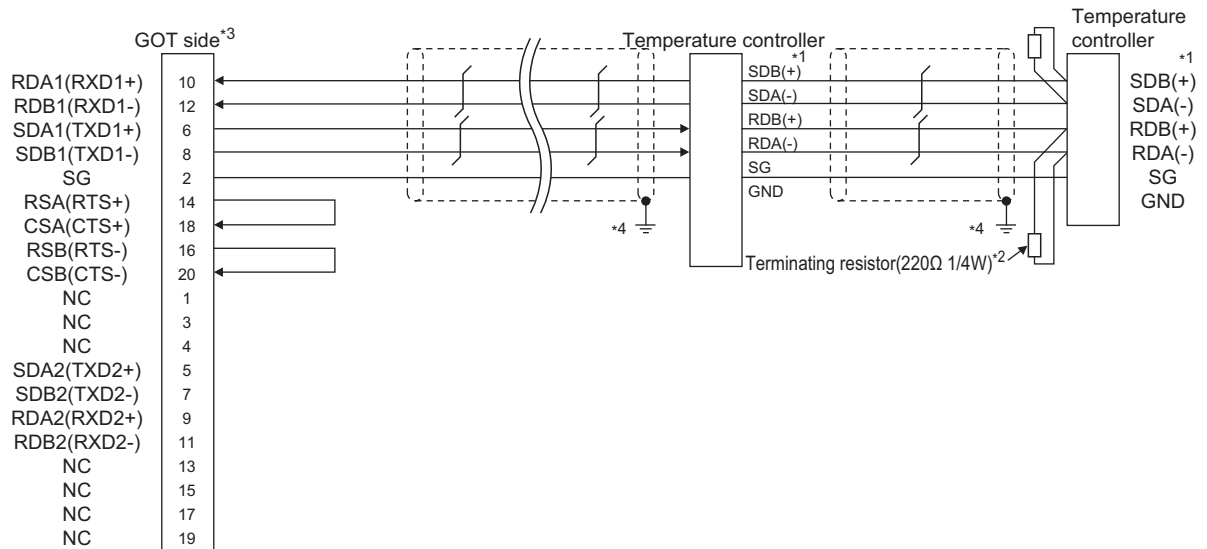

*1 Pin No. of temperature controller differs depending on the model. Refer to the following table.

Signal name	Model of temperature controller	
	GREEN Series UT/UP/UM	GREEN Series US
	Pin No.	Pin No.
SDB (+)	23	21
SDA (-)	24	22
RDB (+)	25	23
RDA (-)	26	24
SG	27	25

*2 Terminating resistor should be provided for a temperature controller which will be a terminal.

*3 Set the terminating resistor of GOT side which will be a terminal.

☞ ■ Connecting terminating resistors

*4 Connect FG grounding to the appropriate part of a cable shield line.

(3) RS-485 connection diagram 3)

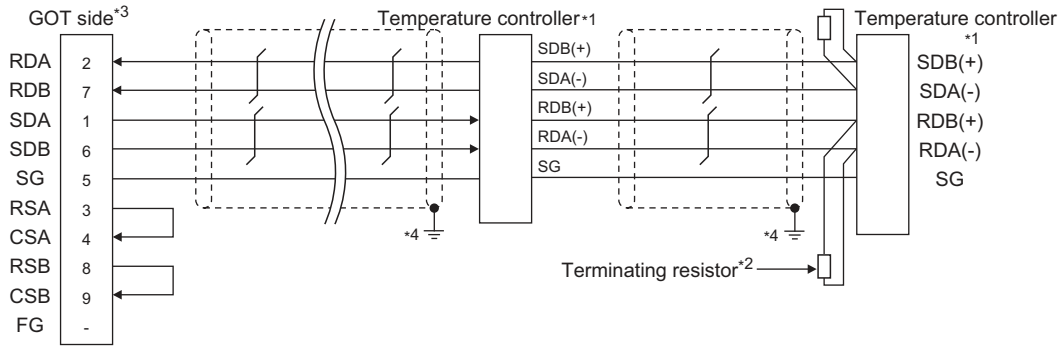

*1 Pin No. of temperature controller differs depending on the model. Refer to the following table.

Signal name	Model of temperature controller				
	GREEN Series UT/UP/UM	GREEN Series US	UTAdvanced Series		
			UT32A/UP35A/UM33A	UT35A/ UT55A (product condition A)/ UP55A (product condition A)	UT55A (product condition B)/ UP55A (product condition B)
Pin No.	Pin No.	Pin No.	Pin No.	Pin No.	
SDB (+)	23	21	301	407	501
SDA (-)	24	22	302	408	502
RDB (+)	25	23	304	410	504
RDA (-)	26	24	305	411	505
SG	27	25	303	409	503

• For the product condition of UTAdvanced series, refer to the following table.

Model	Product condition	Suffix code		Optional suffix code	Remark
		Function	Open network		
UT55A	A	-	1	-	Product with the open network port of RS-485 communication (4-wire type/2-wire type)
	B	1 or 2	-	Without "/LP"	Product with two RS-485 communication ports (4-wire type/2-wire type) and without the power supply for 24VDC sensor
UP55A	A	Other than 3	1	-	Product without the additional contact output points (DO) and with the open network port of RS-485 communication (4-wire type/2-wire type) (Standard code model)
		-	-	With "/CH3"	Product with the RS-485 communication port (4-wire type/2-wire type) specified in the E3 terminal area option (Detailed code model)
	B	2	-	-	Product with two RS-485 communication ports (4-wire type/2-wire type) (Standard code model)
		-	-	With "/C4"	Product with the RS-485 communication port (4-wire type/2-wire type) specified in the E4 terminal area option (Detailed code model)

*2 Terminating resistor having 100 Ω 1/2W should be provided for a temperature controller which will be a terminal.

*3 Set the terminating resistor of GOT side which will be a terminal.

■ Connecting terminating resistors

*4 Connect FG grounding to the appropriate part of a cable shield line.

(4) RS-485 connection diagram 4)

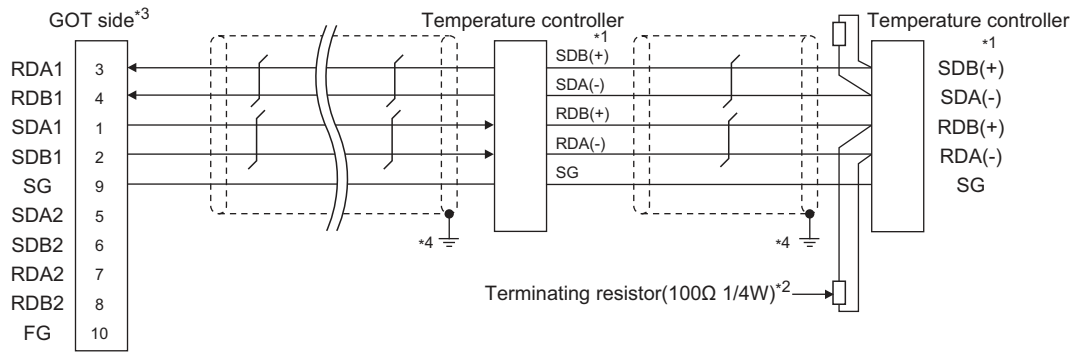

*1 Pin No. of temperature controller differs depending on the model. Refer to the following table.

Signal name	Model of temperature controller				
	GREEN Series UT/UP/UM	GREEN Series US	UTAdvanced Series		
			UT32A/UP35A/UM33A	UT35A/ UT55A (product condition A)/ UP55A (product condition A)	UT55A (product condition B)/ UP55A (product condition B)
Pin No.	Pin No.	Pin No.	Pin No.	Pin No.	
SDB (+)	23	21	301	407	501
SDA (-)	24	22	302	408	502
RDB (+)	25	23	304	410	504
RDA (-)	26	24	305	411	505
SG	27	25	303	409	503

• For the product condition of UTAdvanced series, refer to the following table.

Model	Product condition	Suffix code		Optional suffix code	Remark
		Function	Open network		
UT55A	A	-	1	-	Product with the open network port of RS-485 communication (4-wire type/2-wire type)
	B	1 or 2	-	Without "/LP"	Product with two RS-485 communication ports (4-wire type/2-wire type) and without the power supply for 24VDC sensor
UP55A	A	Other than 3	1	-	Product without the additional contact output points (DO) and with the open network port of RS-485 communication (4-wire type/2-wire type) (Standard code model)
		-	-	With "/CH3"	Product with the RS-485 communication port (4-wire type/2-wire type) specified in the E3 terminal area option (Detailed code model)
	B	2	-	-	Product with two RS-485 communication ports (4-wire type/2-wire type) (Standard code model)
		-	-	With "/C4"	Product with the RS-485 communication port (4-wire type/2-wire type) specified in the E4 terminal area option (Detailed code model)

*2 Terminating resistor should be provided for a temperature controller which will be a terminal.

*3 Set the terminating resistor of GOT side which will be a terminal.

■ Connecting terminating resistors

*4 Connect FG grounding to the appropriate part of a cable shield line.

(5) RS-485 connection diagram 5)

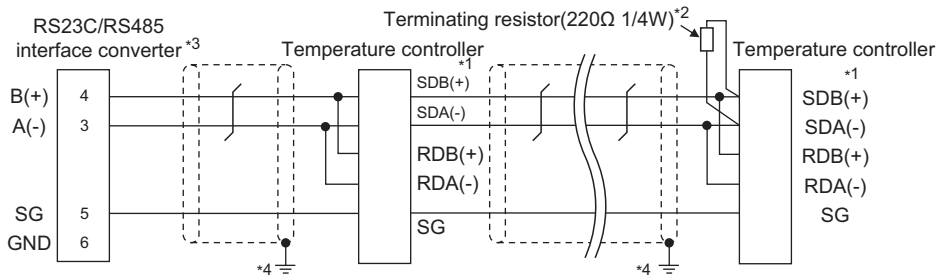

*1 Pin No. of temperature controller differs depending on the model.Refer to the following table.

Signal name	Model of temperature controller	
	GREEN Series UT/UP/UM	GREEN Series US
	Pin No.	Pin No.
SDB (+)	23	21
SDA (-)	24	22
RDB (+)	25	23
RDA (-)	26	24
SG	27	25

*2 Terminating resistor should be provided for a temperature controller which will be a terminal.

*3 Turn on the terminating switch on the RS232C/RS485 converter at the end.

*4 Connect FG grounding to the appropriate part of a cable shield line.

(6) RS-485 connection diagram 6)

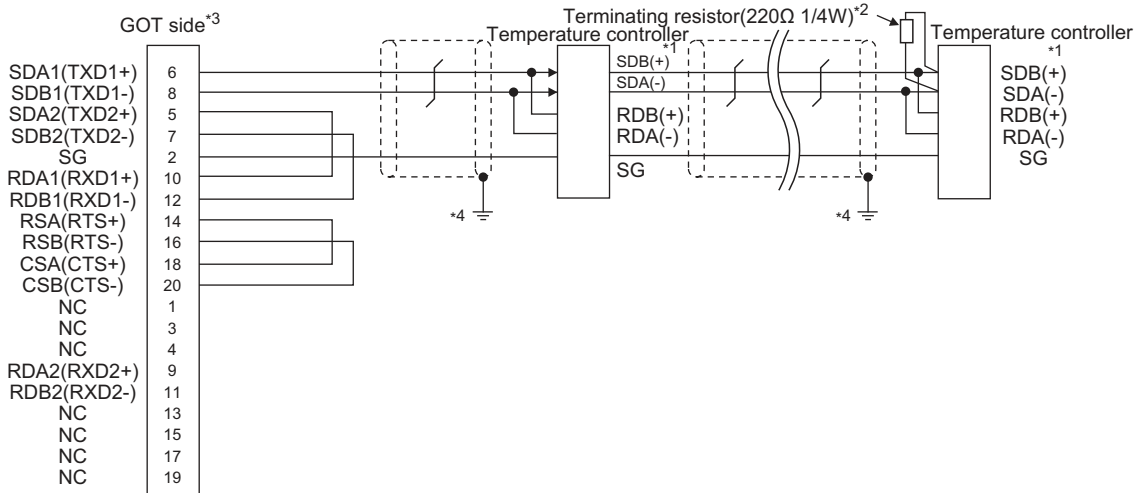

*1 Pin No. of temperature controller differs depending on the model.Refer to the following table.

Signal name	Model of temperature controller	
	GREEN Series UT/UP/UM	GREEN Series US
	Pin No.	Pin No.
SDB (+)	23	21
SDA (-)	24	22
RDB (+)	25	23
RDA (-)	26	24
SG	27	25

*2 Terminating resistor should be provided for a temperature controller which will be a terminal.

*3 Set the terminating resistor of GOT side which will be a terminal.

■ Connecting terminating resistors

*4 Connect FG grounding to the appropriate part of a cable shield line.

(7) RS-485 connection diagram 7)

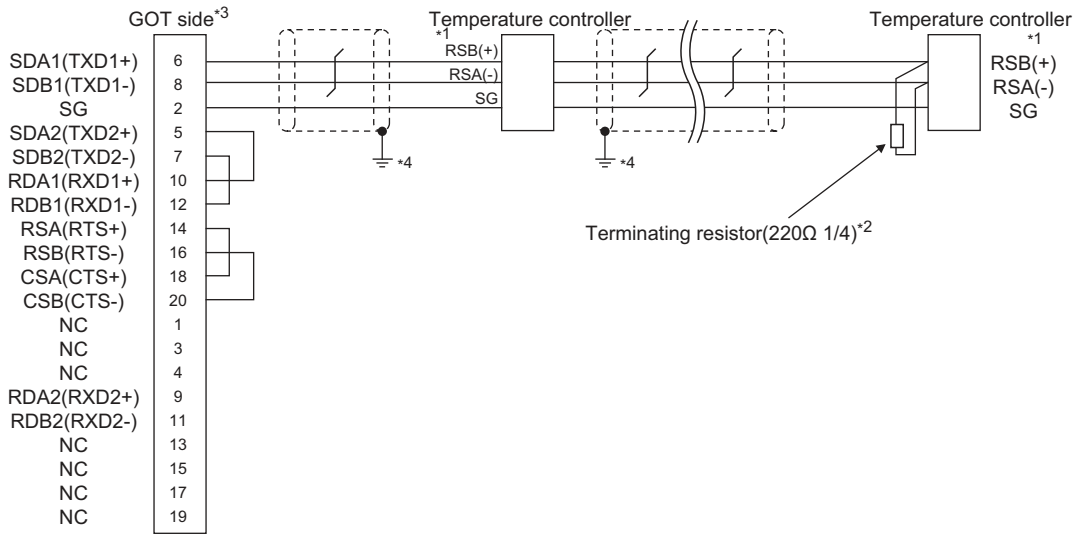

*1 Pin No. of temperature controller differs depending on the model.Refer to the following table.

Signal name	Model of temperature controller		
	GREEN Series UT750/UP750	UT100 Series UT130/UT150/UP150	UT100 Series UT152/UT155
	Pin No.	Pin No.	Pin No.
RSB (+)	28	3	26
RSA (-)	29	4	27
SG	30	5	28

*2 Terminating resistor should be provided for a temperature controller which will be a terminal.

*3 Set the terminating resistor of GOT side which will be a terminal.

■ Connecting terminating resistors

*4 Connect FG grounding to the appropriate part of a cable shield line.

(8) RS-485 connection diagram 8)

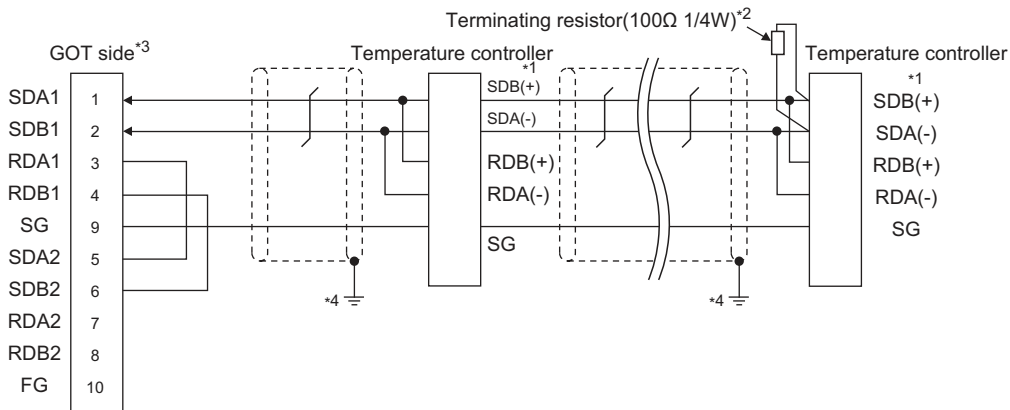

*1 Pin No. of temperature controller differs depending on the model.Refer to the following table.

Signal name	Model of temperature controller				
	GREEN Series UT/UP/UM	GREEN Series US	UTAdvanced Series		
			UT32A/UP35A	UT35A/ UT55A (product condition A)/ UP55A (product condition A)	UT55A (product condition B)/ UP55A (product condition B)
Pin No.	Pin No.	Pin No.	Pin No.	Pin No.	
SDB (+)	23	21	301	407	501
SDA (-)	24	22	302	408	502
RDB (+)	25	23	304	410	504
RDA (-)	26	24	305	411	505
SG	27	25	303	409	503

- For the product condition of UTAdvanced series, refer to the following table.

Model	Product condition	Suffix code		Optional suffix code	Remark
		Function	Open network		
UT55A	A	-	1	-	Product with the open network port of RS485 communication (4-wire type/2-wire type)
	B	1 or 2	-	Without "/LP"	Product with two RS485 communication ports (4-wire type/2-wire type) and without the power supply for 24VDC sensor
UP55A	A	Other than 3	1	-	Product without the additional contact output points (DO) and with the open network port of RS485 communication (4-wire type/2-wire type) (Standard code model)
		-	-	With "/CH3"	Product with the RS485 communication port (4-wire type/2-wire type) specified in the E3 terminal area option (Detailed code model)
	B	2	-	-	Product with two RS485 communication ports (4-wire type/2-wire type) (Standard code model)
		-	-	With "/C4"	Product with the RS485 communication port (4-wire type/2-wire type) specified in the E4 terminal area option (Detailed code model)

*2 Terminating resistor should be provided for a temperature controller which will be a terminal.

*3 Set the terminating resistor of GOT side which will be a terminal.

 ■ Connecting terminating resistors

*4 Connect FG grounding to the appropriate part of a cable shield line.

(9) RS-485 connection diagram 9)

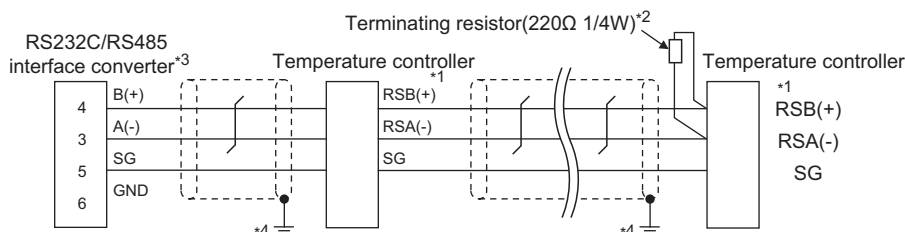

*1 Pin No. of temperature controller differs depending on the model. Refer to the following table.

Signal name	Model of temperature controller				
	GREEN Series UT750/UP750	UT100 Series UT130/UT150/UP150	UT100 Series UT152/UT155	UTAdvanced Series UT52A/UM33A	UTAdvanced Series UT55A/UP55A
	Pin No.	Pin No.	Pin No.	Pin No.	Pin No.
RSB (+)	28	3	26	301	501
RSA (-)	29	4	27	302	502
SG	30	5	28	303	503

*2 Terminating resistor should be provided for a temperature controller which will be a terminal.

*3 Turn on the terminating switch on the RS232C/RS485 converter at the end.

*4 Connect FG grounding to the appropriate part of a cable shield line.

(10) RS-485 connection diagram 10

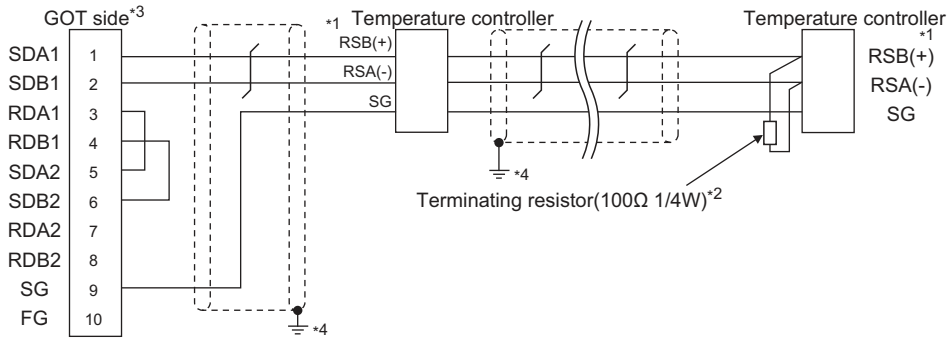

*1 Pin No. of temperature controller differs depending on the model. Refer to the following table.

Signal name	Model of temperature controller				
	GREEN Series UT750/UP750	UT100 Series UT130/UT150/UP150	UT100 Series UT152/UT155	UTAdvanced Series UT52A/UM33A	UTAdvanced Series UT55A/UP55A
	Pin No.	Pin No.	Pin No.	Pin No.	Pin No.
RSB (+)	28	3	26	301	501
RSA (-)	29	4	27	302	502
SG	30	5	28	303	503

*2 Terminating resistor should be provided for a temperature controller which will be a terminal.

*3 Set the terminating resistor of GOT side which will be a terminal.

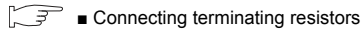

*4 Connect FG grounding to the appropriate part of a cable shield line.

(11) RS-485 connection diagram 11

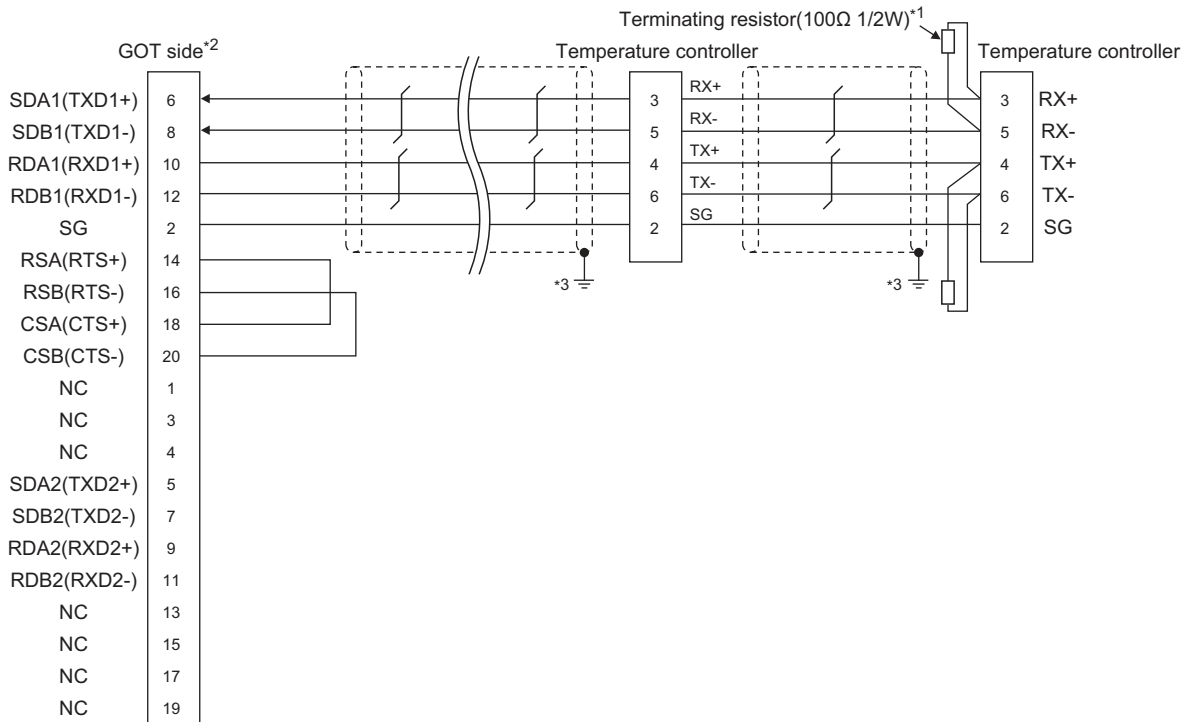

*1 Terminating resistor should be provided for a temperature controller which will be a terminal.

*2 Set the terminating resistor of GOT side which will be a terminal.

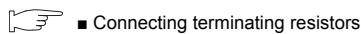

*3 Connect FG grounding to the appropriate part of a cable shield line.

(12) RS-485 connection diagram 12)

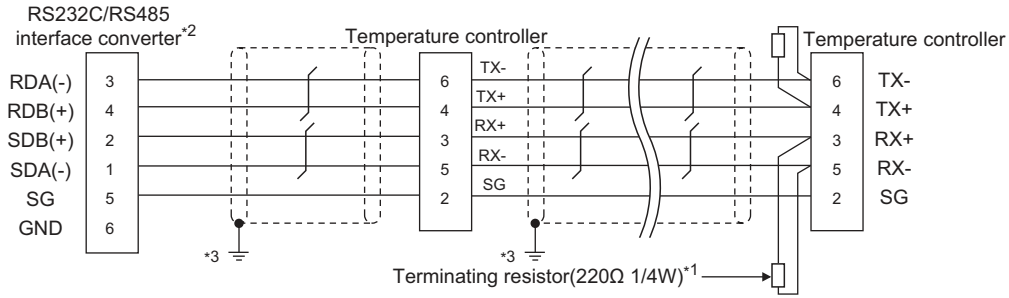

- *1 Terminating resistor should be provided for a temperature controller which will be a terminal.
- *2 Turn on the terminating switch on the RS232C/RS485 converter at the end.
- *3 Connect FG grounding to the appropriate part of a cable shield line.

(13) RS-485 connection diagram 13)

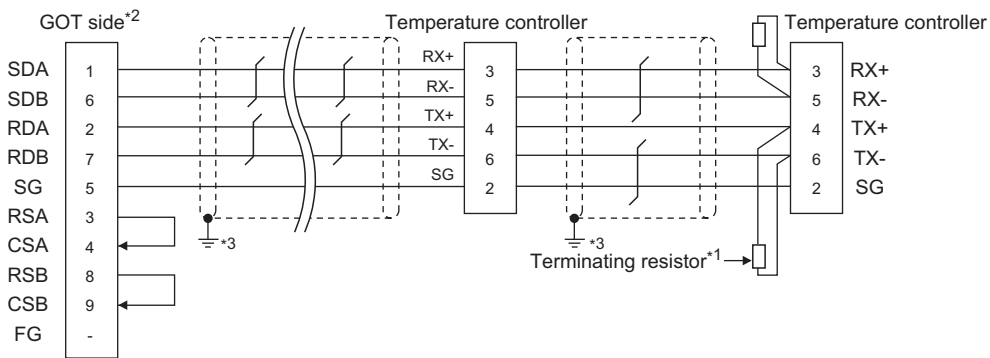

- *1 Terminating resistor having 100 Ω 1/2W should be provided for a temperature controller which will be a terminal.
- *2 Set the terminating resistor of GOT side which will be a terminal.
- ☞ ■ Connecting terminating resistors
- *3 Connect FG grounding to the appropriate part of a cable shield line.

(14) RS-485 connection diagram 14

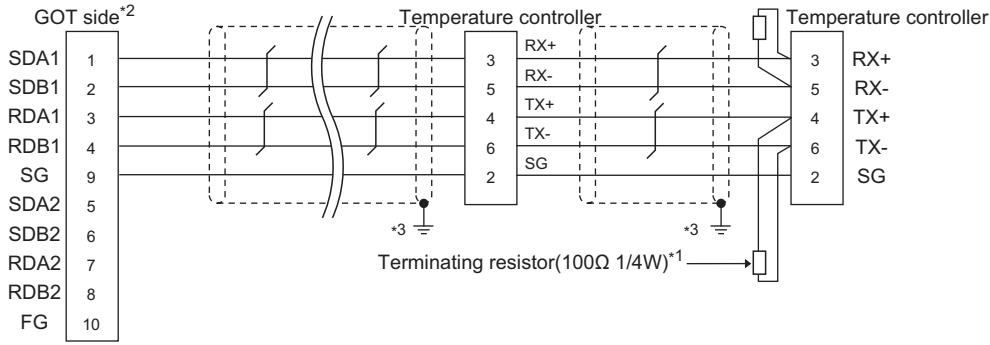

- *1 Terminating resistor should be provided for a temperature controller which will be a terminal.
- *2 Set the terminating resistor of GOT side which will be a terminal.
- Connecting terminating resistors
- *3 Connect FG grounding to the appropriate part of a cable shield line.

(15) RS-485 connection diagram 15

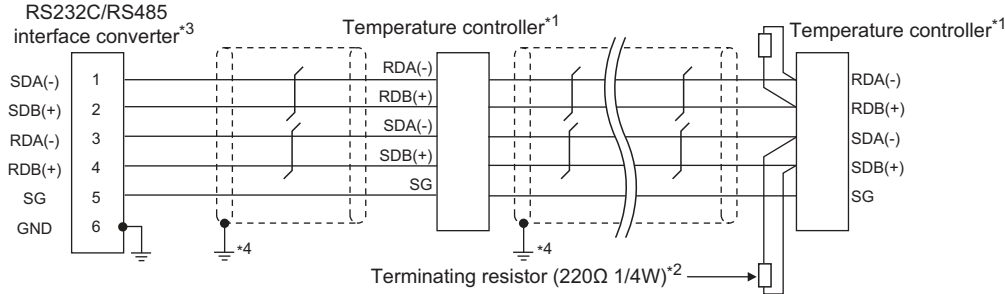

- *1 Pin No. of temperature controller differs depending on the model. Refer to the following table.

Signal name	Model of temperature controller		
	UTAdvanced Series		
	UT32A/UP35A/UM33A	UT35A/ UT55A (product condition A)/ UP55A (product condition A)	UT55A (product condition B)/ UP55A (product condition B)
	Pin No.	Pin No.	Pin No.
SDB (+)	301	407	501
SDA (-)	302	408	502
RDB (+)	304	410	504
RDA (-)	305	411	505
SG	303	409	503

- For the product condition of UTAdvanced series, refer to the following table.

Model	Product condition	Suffix code		Optional suffix code	Remark
		Function	Open network		
UT55A	A	-	1	-	Product with the open network port of RS-485 communication (4-wire type/2-wire type)
	B	1 or 2	-	Without "/LP"	Product with two RS-485 communication ports (4-wire type/2-wire type) and without the power supply for 24VDC sensor
UP55A	A	Other than 3	1	-	Product without the additional contact output points (DO) and with the open network port of RS-485 communication (4-wire type/2-wire type) (Standard code model)
		-	-	With "/CH3"	Product with the RS-485 communication port (4-wire type/2-wire type) specified in the E3 terminal area option (Detailed code model)
	B	2	-	-	Product with two RS-485 communication ports (4-wire type/2-wire type) (Standard code model)
		-	-	-	With "/C4"

- *2 Terminating resistor should be provided for a temperature controller which will be a terminal.
- *3 Turn on the terminating switch on the RS232C/RS485 converter at the end.
- *4 Connect FG grounding to the appropriate part of a cable shield line.

(16) RS-485 connection diagram 16)

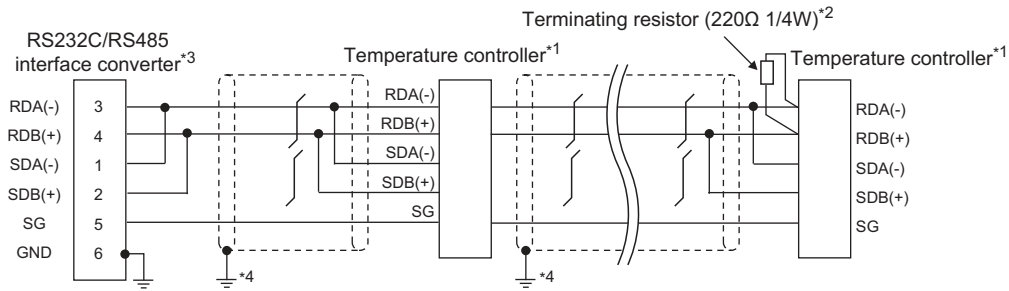

*1 Pin No. of temperature controller differs depending on the model. Refer to the following table.

Signal name	Model of temperature controller		
	UTAdvanced Series		
	UT32A/UP35A/UM33A	UT35A/ UT55A (product condition A)/ UP55A (product condition A)	UT55A (product condition B)/ UP55A (product condition B)
	Pin No.	Pin No.	Pin No.
SDB (+)	301	407	501
SDA (-)	302	408	502
RDB (+)	304	410	504
RDA (-)	305	411	505
SG	303	409	503

• For the product condition of UTAdvanced series, refer to the following table.

Model	Product condition	Suffix code		Optional suffix code	Remark
		Function	Open network		
UT55A	A	-	1	-	Product with the open network port of RS-485 communication (4-wire type/2-wire type)
	B	1 or 2	-	Without "/LP"	Product with two RS-485 communication ports (4-wire type/2-wire type) and without the power supply for 24VDC sensor
UP55A	A	Other than 3	1	-	Product without the additional contact output points (DO) and with the open network port of RS-485 communication (4-wire type/2-wire type) (Standard code model)
		-	-	With "/CH3"	Product with the RS-485 communication port (4-wire type/2-wire type) specified in the E3 terminal area option (Detailed code model)
	B	2	-	-	Product with two RS-485 communication ports (4-wire type/2-wire type) (Standard code model)
		-	-	With "/C4"	Product with the RS-485 communication port (4-wire type/2-wire type) specified in the E4 terminal area option (Detailed code model)

*2 Terminating resistor should be provided for a temperature controller which will be a terminal.

*3 Turn on the terminating switch on the RS232C/RS485 converter at the end.

*4 Connect FG grounding to the appropriate part of a cable shield line.

(17) RS-485 connection diagram 17)

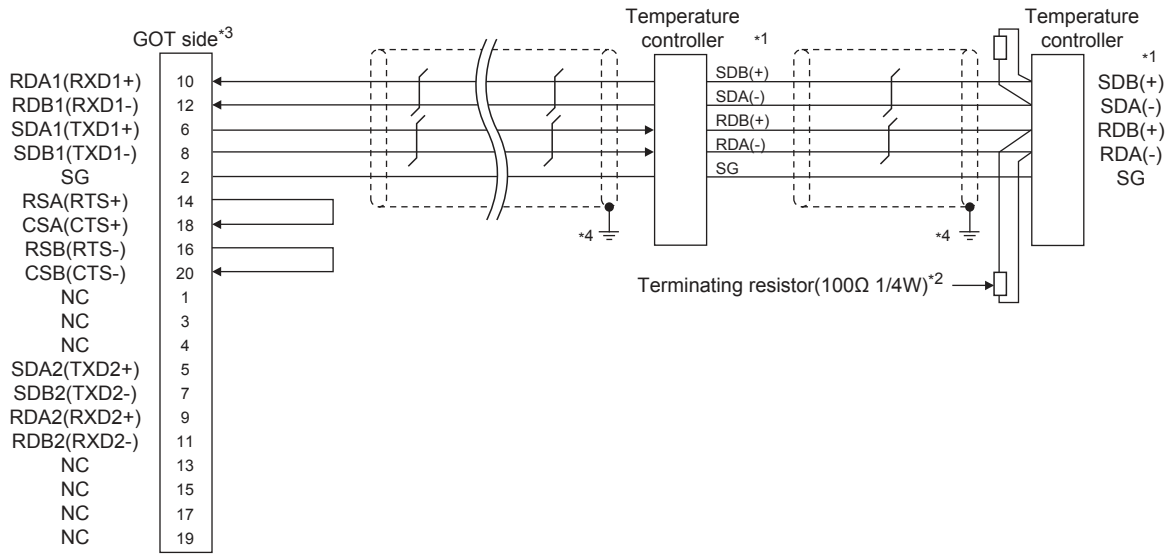

*1 Pin No. of temperature controller differs depending on the model. Refer to the following table.

Signal name	Model of temperature controller				
	GREEN Series UT/UP/ UM	GREEN Series US	UTAdvanced Series		
			UT32A/UP35A/UM33A	UT35A/ UT55A (product condition A)/ UP55A (product condition A)	UT55A (product condition B)/ UP55A (product condition B)
Pin No.	Pin No.	Pin No.	Pin No.	Pin No.	
SDB (+)	23	21	301	407	501
SDA (-)	24	22	302	408	502
RDB (+)	25	23	304	410	504
RDA (-)	26	24	305	411	505
SG	27	25	303	409	503

• For the product condition of UTAdvanced series, refer to the following table.

Model	Product condition	Suffix code		Optional suffix code	Remark
		Function	Open network		
UT55A	A	-	1	-	Product with the open network port of RS-485 communication (4-wire type/2-wire type)
	B	1 or 2	-	Without "/LP"	Product with two RS-485 communication ports (4-wire type/2-wire type) and without the power supply for 24VDC sensor
UP55A	A	Other than 3	1	-	Product without the additional contact output points (DO) and with the open network port of RS-485 communication (4-wire type/2-wire type) (Standard code model)
		-	-	With "/CH3"	Product with the RS-485 communication port (4-wire type/2-wire type) specified in the E3 terminal area option (Detailed code model)
	B	2	-	-	Product with two RS-485 communication ports (4-wire type/2-wire type) (Standard code model)
		-	-	With "/C4"	Product with the RS-485 communication port (4-wire type/2-wire type) specified in the E4 terminal area option (Detailed code model)

*2 Terminating resistor should be provided for a GOT and a temperature controller which will be a terminal.

*3 Set the terminating resistor of GOT side which will be a terminal.

■ Connecting terminating resistors

*4 Connect FG grounding to the appropriate part of a cable shield line.

(18) RS-485 connection diagram 18)

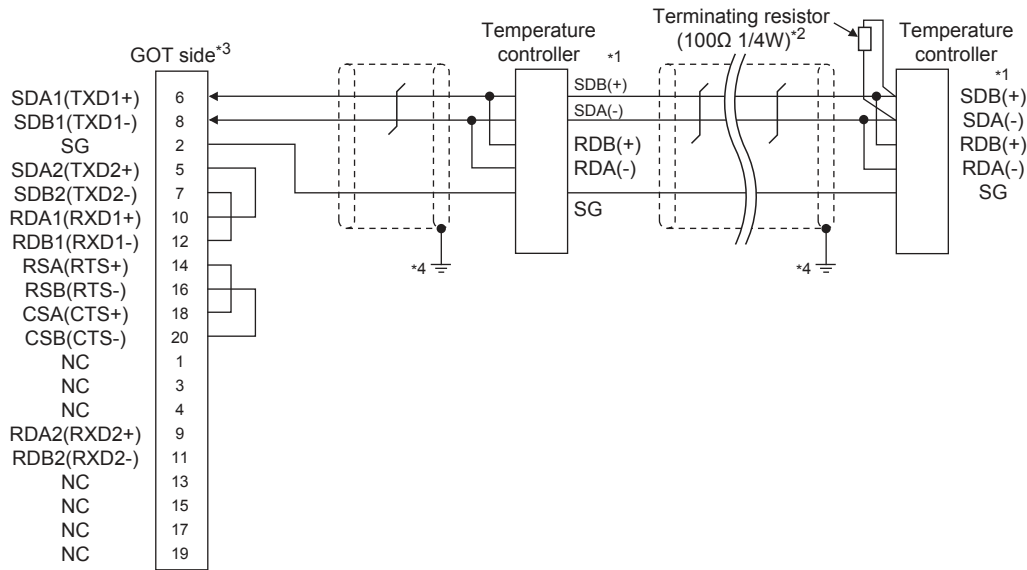

*1 Pin No. of temperature controller differs depending on the model. Refer to the following table.

Signal name	Model of temperature controller				
	GREEN Series UT/UP/ UM	GREEN Series US	UTAdvanced Series		
			UT32A/UP35A	UT35A/ UT55A (product condition A)/ UP55A (product condition A)	UT55A (product condition B)/ UP55A (product condition B)
Pin No.	Pin No.	Pin No.	Pin No.	Pin No.	
SDB (+)	23	21	301	407	501
SDA (-)	24	22	302	408	502
RDB (+)	25	23	304	410	504
RDA (-)	26	24	305	411	505
SG	27	25	303	409	503

• For the product condition of UTAdvanced series, refer to the following table.

Model	Product condition	Suffix code		Optional suffix code	Remark
		Function	Open network		
UT55A	A	-	1	-	Product with the open network port of RS-485 communication (4-wire type/2-wire type)
	B	1 or 2	-	Without "/LP"	Product with two RS-485 communication ports (4-wire type/2-wire type) and without the power supply for 24VDC sensor
UP55A	A	Other than 3	1	-	Product without the additional contact output points (DO) and with the open network port of RS-485 communication (4-wire type/2-wire type) (Standard code model)
		-	-	With "/CH3"	Product with the RS-485 communication port (4-wire type/2-wire type) specified in the E3 terminal area option (Detailed code model)
	B	2	-	-	Product with two RS-485 communication ports (4-wire type/2-wire type) (Standard code model)
		-	-	With "/C4"	Product with the RS-485 communication port (4-wire type/2-wire type) specified in the E4 terminal area option (Detailed code model)

*2 Terminating resistor should be provided for a GOT and a temperature controller which will be a terminal.

*3 Set the terminating resistor of GOT side which will be a terminal.

■ Connecting terminating resistors

*4 Connect FG grounding to the appropriate part of a cable shield line.

(19) RS-485 connection diagram 19)

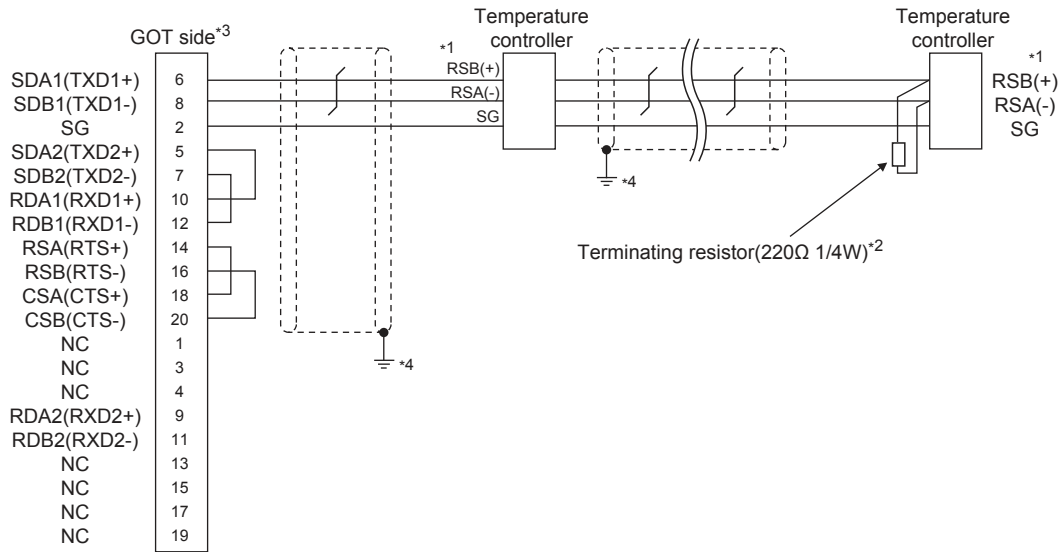

*1 Pin No. of temperature controller differs depending on the model. Refer to the following table.

Signal name	Model of temperature controller				
	GREEN Series UT750/UP750	UT100 Series UT130/UT150/UP150	UT100 Series UT152/UT155	UTAdvanced Series UT52A/UM33A	UTAdvanced Series UT55A/UP55A
	Pin No.	Pin No.	Pin No.	Pin No.	Pin No.
RSB (+)	28	3	26	301	501
RSA (-)	29	4	27	302	502
SG	30	5	28	303	503

*2 Terminating resistor should be provided for a GOT and a temperature controller which will be a terminal.

*3 Set the terminating resistor of GOT side which will be a terminal.

 ■ Connecting terminating resistors

*4 Connect FG grounding to the appropriate part of a cable shield line.

■ Precautions when preparing a cable

(1) Cable length

The length of the RS-485 cable must be within the maximum distance.

(2) GOT side connector

For the GOT side connector, refer to the following.

 1.4.1 GOT connector specifications

(3) YOKOGAWA temperature controller side connector

Use the connector compatible with the YOKOGAWA temperature controller side.

For details, refer to the user's manual of the YOKOGAWA temperature controller.

■ Connecting terminating resistors

(1) GOT side

Set the terminating resistor setting switch of the GOT main unit to "100 OHM".

For the procedure to set the terminating resistor, refer to the following.

 1.4.3 Terminating resistors of GOT

(2) YOKOGAWA temperature controller side

When connecting a YOKOGAWA temperature controller to the GOT, a terminating resistor must be connected.

 8.5 Temperature Controller Side Setting

8.4 GOT Side Settings

8.4.1 Setting communication interface (Communication settings)

Set the channel of the connected equipment.

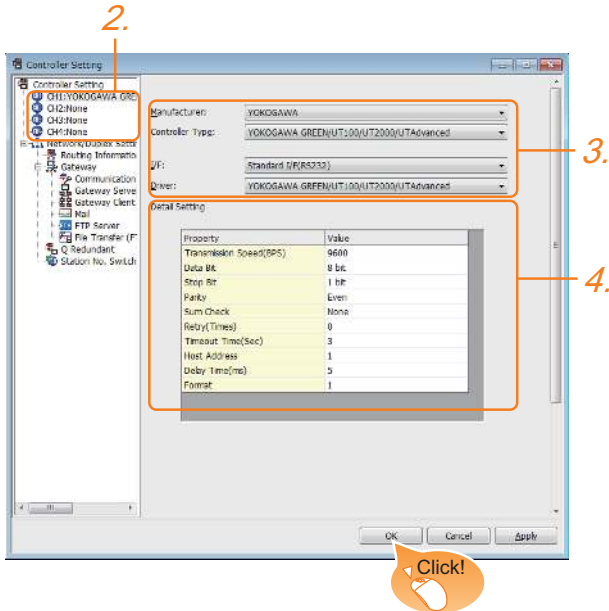

1. Select [Common] → [Controller Setting] from the menu.
2. The Controller Setting window is displayed. Select the channel to be used from the list menu.
3. Set the following items.
 - Manufacturer: YOKOGAWA
 - Controller type: YOKOGAWA GREEN/UT100/UT2000/UTAdvanced
 - I/F: Interface to be used
 - Driver: YOKOGAWA GREEN/UT100/UT2000/UTAdvanced
4. The detailed setting is displayed after Manufacturer, Controller Type, I/F, and Driver are set. Make the settings according to the usage environment.

☞ 8.4.2 Communication detail settings

Click the [OK] button when settings are completed.

POINT

The settings of connecting equipment can be confirmed in [I/F Communication Setting]. For details, refer to the following.

☞ 1.1.2 I/F communication setting

8.4.2 Communication detail settings

Property	Value
Transmission Speed(BPS)	9600
Data Bit	8 bit
Stop Bit	1 bit
Parity	Even
Sum Check	None
Retry(Times)	0
Timeout Time(Sec)	3
Host Address	1
Delay Time(ms)	5
Format	1

Item	Description	Range
Transmission Speed	Set this item when change the transmission speed used for communication with the connected equipment. (Default: 9600bps)	4800bps, 9600bps, 19200bps, 38400bps, 57600bps, 115200bps
Data Bit	Set this item when change the data length used for communication with the connected equipment. (Default: 8bits)	7bits/8bits
Stop Bit	Specify the stop bit length for communications. (Default: 1bit)	1bit/2bits
Parity	Specify whether or not to perform a parity check, and how it is performed during communication. (Default: Even)	None Even Odd
Sum Check	Set whether or not to perform a sum check during communication. (Default: No)	Done, None
Retry	Set the number of retries to be performed when a communication error occurs. (Default: 0time)	0 to 5times
Timeout Time	Set the time period for a communication to time out. (Default: 3sec)	1 to 30sec
Host Address	Specify the host address (station No. of the GOT to which the temperature controller is connected) in the connected network. (Default: 1)	1 to 99
Delay Time	Set this item to adjust the transmission timing of the communication request from the GOT. (Default: 5ms)	0 to 300ms
Format	Select the communication format. (Default: 1) Format 1: Accessible to GREEN/UT100/UT2000/UTAdvanced Series Format 2: Accessible to GREEN/UT2000/UTAdvanced Series, Not accessible to UT100 Series.	1/2

POINT

- (1) Format
 - When connecting to UT100 Series, specify the format 1.
 - When connecting to only GREEN/UT2000/UTAdvanced Series, specifying the format 2 is recommended.
 - (2) Communication interface setting by the Utility

The communication interface setting can be changed on the Utility's [Communication setting] after writing [Communication Settings] of project data.

For details on the Utility, refer to the following manual.

 GOT2000 Series User's Manual (Utility)
 - (3) Precedence in communication settings

When settings are made by GT Designer3 or the Utility, the latest setting is effective.
-

8.5 Temperature Controller Side Setting

POINT

- (1) YOKOGAWA temperature controller
For details of YOKOGAWA temperature controller, refer to the following manual.

 User's Manual of the YOKOGAWA temperature controller

- (2) RS232C/RS485 converter
For details on communication settings of the RS232C/RS485 converter, refer to the following manual.

 User's Manual of RS232C/RS485 converter

	Model name	Refer to
Temperature controller	GREEN	8.5.1
	UT100	8.5.2
	UT2000	8.5.3
	UTAdvanced	8.5.4
RS232C/RS485 converter	ML2-□	8.5.5

8.5.1 Connecting to GREEN Series

■ Communication settings

Make the communication settings by operating the key of the temperature controller.

- (1) For the UT□/UP□/UM□/US1000 (except UT750, UP750)

Item	Set value
Transmission speed	9600bps (fixed)
Data bit ^{*1}	7bits, 8bits
Parity bit ^{*1}	Even, odd, none
Stop bit ^{*1}	1bit, 2bits
Address ^{*1*2}	1 to 99
Protocol selection ^{*1}	0: PC link communication (without sum check) 1: PC link communication (with sum check)

^{*1} Adjust the settings with GOT settings.

^{*2} Avoid duplication of the address with any of the other units.

- (2) For the UT750, UP750

Item	Set value	
Transmission speed ^{*1}	RS-485 communication	9600bps (fixed)
	High performance RS-485 communication	9600bps, 19200bps, 38400bps
Data bit ^{*1}	7bits, 8bits	
Parity bit ^{*1}	Even, odd, none	
Stop bit ^{*1}	1bit, 2bits	
Address ^{*1*2}	1 to 99	
Protocol selection ^{*1}	RS-485 communication	0: PC link communication (without sum check) 1: PC link communication (with sum check)
	High performance RS-485 communication	0: PC link communication (without sum check) 1: PC link communication (with sum check)

^{*1} Adjust the settings with GOT settings.

^{*2} Avoid duplication of the address with any of the other units.

8.5.2 Connecting to UT100 Series

■ Communication settings

Make the communication settings by operating the key of the temperature controller.

Item	Set value
Transmission speed	9600bps
Data bit ^{*1}	7bits, 8bits
Parity bit ^{*1}	Even, odd, none
Stop bit ^{*1}	1bit, 2bits
Address ^{*1*2}	1 to 99
Protocol selection ^{*1}	0: PC link communication (without sum check) 1: PC link communication (with sum check)

^{*1} Adjust the settings with GOT settings.

^{*2} Avoid duplication of the address with any of the other units.

8.5.3 Connecting to UT2000 Series

■ Communication settings

Make the communication settings using setting switches.

Item	Set value
Transmission speed	9600bps
Data bit ^{*1}	8bits (fixed)
Parity bit ^{*1}	Even, odd, none
Stop bit ^{*1}	1bit (fixed)
Station No. ^{*1*2}	1 to 16
Communication mode	PC link communication mode

^{*1} Adjust the settings with GOT settings.

^{*2} Avoid duplication of the station No. with any of the other units.

■ Settings by switch

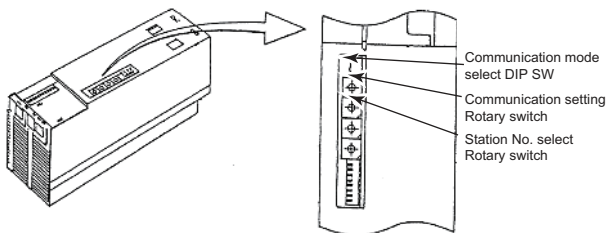

(1) Settings of the transmission speed and the parity
Make those settings by operating the communication setting Rotary switch.

Switch position	Transmission speed	Parity bit
0	9600bps	None
1		Odd
2		Even



(2) Communication mode settings

Make this setting by operating the communication mode select DIP SW.

Switch position	Communication mode
ON	PC link communication mode

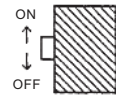

(3) A setting of the station No.

Make this setting by operating the station No. select Rotary switch.

Switch position	Station No.
0	1
1	2
2	3
3	4
4	5
5	6
6	7
7	8
8	9
9	10
A	11
B	12
C	13
D	14
E	15
F	16



8.5.4 Connecting to UTAdvanced Series

■ Communication settings

Make the communication settings by operating the key of the temperature controller.

Item	Set value
Transmission speed ^{*1}	9600bps, 19200bps, 38400bps
Data bit ^{*1}	7bits, 8bits
Parity bit ^{*1}	Even, odd, none
Stop bit ^{*1}	1bit, 2bits
Address ^{*1*2}	1 to 99
Minimum response time ^{*1}	0 to 10 (x 10ms)
Protocol selection ^{*1}	0: PC link communication (without sum check) 1: PC link communication (with sum check)

^{*1} Adjust the settings with GOT settings.

^{*2} Avoid duplication of the address with any of the other units.

8.5.5 Connecting to RS232C/RS485 converter (ML2-[])

■ Communication settings

Make the communication settings using setting switches.

Item	Set value
Transmission speed*1	9600bps, 19200bps, 38400bps
Setting (2-wire/4-wire)*2	2-wire type or 4-wire type
Terminating resistor*2	With, Without
Echo back	OFF
RS-485 driver-active control	AUTO

*1 Adjust the settings with GOT settings.

*2 Refer to the following connection diagram for setting.

 8.3.2 RS-485 cable

■ Settings by switch

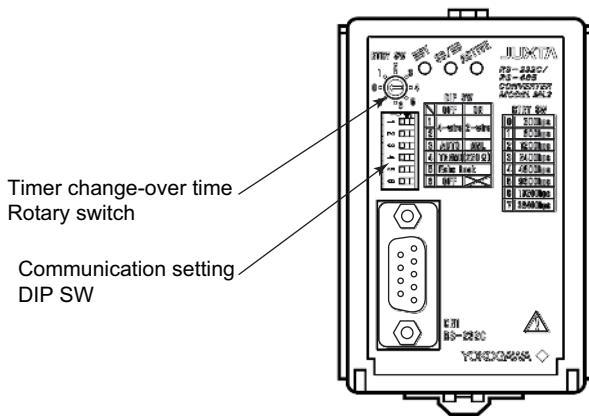

(1) Settings of the setting (2-wire/4-wire), the RS-485 driver-active control, the terminating resistor, the echo back

Make those settings by operating the communication setting DIP SW.

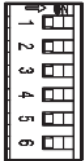

Setting item	Set value	Switch position					
		1	2	3	4	5	6
Setting(2-wire/4-wire)	4-wire type	OFF	OFF				
	2-wire type	ON	ON				
RS-485 driver-active control	AUTO			OFF			
Terminating resistor	with				ON		
	without				OFF		
Echo back	OFF					OFF	

(2) A setting of the transmission speed

Make this setting by operating the timer change-over time Rotary switch.

Switch position	Transmission speed
5	9600bps
6	19200bps
7	38400bps



8.5.6 Station number setting

Set each station number so that no station number overlaps.

The station number can be set without regard to the cable connection order. There is no problem even if station numbers are not consecutive.

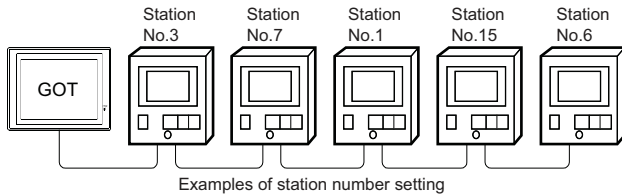

(1) Direct specification

When setting the device, specify the station number of the temperature controller of which data is to be changed.

Specification range
1 to 99

(2) Indirect specification

When setting the device, indirectly specify the station number of the inverter of which data is to be changed using the 16-bit GOT internal data register (GD10 to GD25).

When specifying the station No. from 100 to 115 on GT Designer3, the value of GD10 to GD25 compatible to the station No. specification will be the station No. of the temperature controller.

Specification station NO.	Compatible device	Setting range
100	GD10	1 to 99 For the setting other than the above, error (dedicated device is out of range) will occur.
101	GD11	
102	GD12	
103	GD13	
104	GD14	
105	GD15	
106	GD16	
107	GD17	
108	GD18	
109	GD19	
110	GD20	
111	GD21	
112	GD22	
113	GD23	
114	GD24	
115	GD25	

(3) All station specification

Target station differs depending on write-in operation or read-out operation.

- For write-in operation, all station will be a target. In the WORD BIT write-in operation, only the temperature controller whose station No. is the same as host address is applicable.

☞ 8.4.2 Communication detail settings

- In the read-out operation, only the temperature controller whose station No. is the same as host address is applicable.

For details of host address setting, refer to the following.

☞ 8.4.2 Communication detail settings

POINT

The all station specification can be set for the following temperature controllers only.

UT420, UT450, UT520, UT550, T551, UT750,
UP550, UP750,
US1000

8.6 Device Range that Can Be Set

The device ranges of controller that can be used for GOT are as follows.

Note that the device ranges in the following tables are the maximum values that can be set in GT Designer3.

The device specifications of controllers may differ depending on the models, even though belonging to the same series.

Please make the setting according to the specifications of the controller actually used.

When a non-existent device or a device number outside the range is set, other objects with correct device settings may not be monitored.

■ Setting item



Item	Description
Device	Set the device name, device number, and bit number. The bit number can be set only when specifying the bit of word device.
	CPU No.*2 Set the CPU No. (1, 2) of the device to be monitored. When device B is selected, the CPU No. is fixed to 1.
Information	Displays the device setting range which are selected in [Device].
Network	All Set the monitor target of the set device. Select this item when writing data to all the temperature controllers connected. When bit specification of word device is performed, data are written to the temperature controller of the station No. set for [Host Address] of the communication detail settings. Monitoring and writing with bit specification of word device are performed only for the station No. set for [Host Address]. (When writing the data in numerical input, the data is written to the connected temperature controller other than the ones specified by the word device during input, and the temperature controller set for [Host Address] is monitored during other than input (displaying).)
	Station No. Select this item when monitoring the temperature controller of the specified station No. After selecting, set the station No. in the following range. 1 to 99 : To monitor the temperature controller of the specified station No. 100 to 115 : To specify the station No. of the temperature controller to be monitored by the value of GOT data register (GD).*1

*1 The following shows the relation between station numbers of the temperature controller and the GOT data register.

Station No.	GOT data register (GD)	Setting range
100	GD10	1 to 99 (If setting a value outside the range above, a device range error occurs.)
101	GD11	
:	:	
114	GD24	
115	GD25	

*2 When there is no setting for the CPU No. in the communication settings on the temperature controller side, set the CPU No. on the GOT side to (1) (default).

8.6.1 YOKOGAWA GREEN/UT100/UT2000/UTAdvanced

	Device name	Setting range	Device No. representation
Bit device	Internal relay (I)	I0001 to I7072	Decimal
	Word device bit*1	Specified bit of the following word devices	—
Word device	Data register (D)*1	D0001 to D9000	Decimal
	File register (B)*1*2	B0001 to B1600	
	Bit device word	Converting bit devices into word	—

*1 Only 16-bit (1-word) designation is allowed.

*2 This is available only for UP750 and UP550.

8.7 Precautions

■ Station number settings of temperature controller

In the system configuration, the temperature controller with the station number set with the host address must be included. For details of host address setting, refer to the following.

 8.4.2 Communication detail settings

■ GOT clock control

Since the temperature controller does not have a clock function, the settings of "time adjusting" or "time broadcast" by GOT clock control will be disabled.

■ Disconnecting some of multiple connected equipment

The GOT can disconnect some of multiple connected equipment by setting GOT internal device. For example, the faulty station where a communication timeout error occurs can be disconnected from connected equipment.

For details of GOT internal device setting, refer to the following manual.

 GT Designer3 (GOT2000) Help

9

CONNECTION TO RKC TEMPERATURE CONTROLLER

9.1	Connectable Model List	9 - 2
9.2	System Configuration	9 - 4
9.3	Connection Diagram	9 - 30
9.4	GOT Side Settings	9 - 39
9.5	Temperature Controller Side Setting	9 - 41
9.6	Device Range that Can Be Set	9 - 52
9.7	Precautions	9 - 53













9. CONNECTION TO RKC TEMPERATURE CONTROLLER

9.1 Connectable Model List

The following table shows the connectable models.

Series	Model name*1	Clock	Communication Type	Connectable model	Refer to
SR Mini HG	H-PCP-J	×	RS-232 RS-422 RS-485	GT 27 GT 23 GS	 9.2.1
	H-PCP-A	×	RS-232 RS-422	GT 27 GT 23 GS	 9.2.2
	H-PCP-B				
SRZ	Z-TIO	×	RS-232 RS-422 RS-485	GT 27 GT 23 GS	 9.2.3
	Z-DIO				
	Z-CT				
CB	CB100	×	RS-232 RS-485	GT 27 GT 23 GS	 9.2.4
	CB400				
	CB500				
	CB700				
	CB900				
FB	FB100	×	RS-485	GT 27 GT 23 GS	 9.2.5
	FB400	×	RS-232 RS-422 RS-485		
	FB900				
RB	RB100	×	RS-485	GT 27 GT 23 GS	 9.2.6
	RB400				
	RB500				
	RB700				
	RB900				
PF	PF900 PF901	×	RS-232 RS-422 RS-485	GT 27 GT 23 GS	 9.2.7
HA	HA400/401 HA900/901	×	RS-232 RS-422 RS-485		
RMC	RMC500	×	RS-485		
MA	MA900 MA901	×	RS-232 RS-422 RS-485		
AG	AG500	×	RS-422 RS-485		
THV	THV-A1	×	RS-422 RS-485	GT 27 GT 23 GS	 9.2.8
SA	SA100 SA200	×	RS-232 RS-485	GT 27 GT 23 GS	 9.2.7

(Continued to next page)

Series	Model name*1	Clock	Communication Type	Connectable model	Refer to
SRX	X-TIO	×	RS-232 RS-485	  	 9.2.9
SB1	SB1	×	RS-232 RS-485	  	 9.2.10
B400	B400	×	RS-232 RS-485	  	 9.2.11

*1 From the models of temperature controller, select the detailed model name which supports each communication type and communication protocol (MODBUS). For details of RKC temperature controller detailed model names, refer to the following catalog.









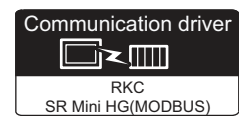
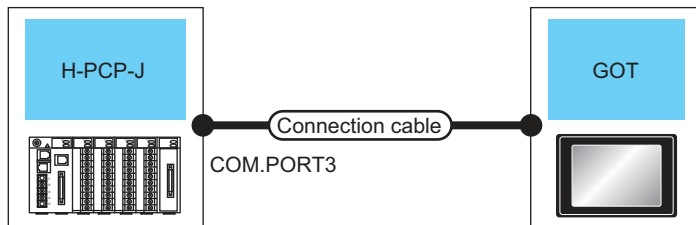

























 [Catalog of RKC temperature controllers](#)

9.2 System Configuration

9.2.1 Connecting to H-PCP-J

- When connecting to one temperature controller



Temperature controller		Connection cable		Conversion connector ^{*1}	GOT		Number of connectable equipment
Model name	Communication Type	Cable model Connection diagram number	Max. distance	Model name	Option device	Model	
H-PCP-J	RS-232	W-BF-28-0500(0.5m) ^{*1} W-BF-28-1000(1m) ^{*1} W-BF-28-3000(3m) ^{*1} or  RS-232 connection diagram 1)	15m	-	- (Built into GOT)	  	Up to 1 temperature controller for 1 GOT
					GT15-RS2-9P	  	
		W-BF-02-0500(0.5m) ^{*1} W-BF-02-1000(1m) ^{*1} W-BF-02-3000(3m) ^{*3}	15m	FAX067 ^{*1}	- (Built into GOT)	  	
					GT15-RS2-9P	  	
	RS-422	 RS-422 connection diagram 1)	1200m	-	- (Built into GOT)	  	
					GT15-RS4-9S	  	
	RS-485	 RS-485 connection diagram 1)	1200m	-	- (Built into GOT)	  	
					GT15-RS4-9S	  	
		 RS-485 connection diagram 3)	1200m	-	FA-LTBGT2R4CBL05(0.5m) ^{*3} FA-LTBGT2R4CBL10(1m) ^{*3} FA-LTBGT2R4CBL20(2m) ^{*3}	  	
					GT15-RS4-TE	  	
	W-BF-01-0500(0.5m) ^{**2} W-BF-01-1000(1m) ^{**2} W-BF-01-3000(3m) ^{**2} or  RS-485 connection diagram 2)	1200m	-				

*1 Product manufactured by RKC. For details of the product, contact RKC.

*2 To use the dedicated cable, conversion of the cable may be necessary.

*3 Product manufactured by MITSUBISHI ELECTRIC ENGINEERING COMPANY LIMITED. For details of the product, contact MITSUBISHI ELECTRIC ENGINEERING COMPANY LIMITED.

■ When connecting to multiple temperature controllers

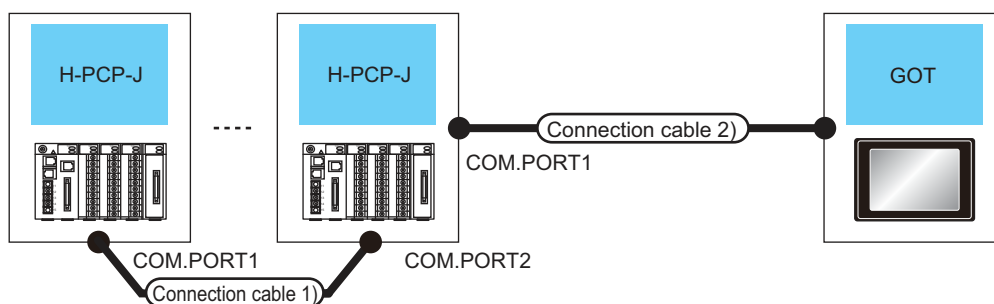

Temperature controller		Connection cable 1)	Connection cable 2)	Max. distance	GOT		Number of connectable equipment
Model name	Communication Type	Cable model Connection diagram number	Cable model Connection diagram number		Option device	Model	
H-PCP-J	RS-422	W-BF-02-0500(0.5m) ^{*3} W-BF-02-1000(1m) ^{*3} W-BF-02-3000(3m) ^{*3}	RS-422 connection diagram 1)	1200m ^{*1}	- (Built into GOT)	 	Up to 16 temperature controllers for 1 GOT
					GT15-RS4-9S	 	
	RS-485	W-BF-02-0500(0.5m) ^{*3} W-BF-02-1000(1m) ^{*3} W-BF-02-3000(3m) ^{*3}	RS-485 connection diagram 1)	1200m	- (Built into GOT)	 	
					GT15-RS4-9S	 	
			RS-485 connection diagram 3)	1200m ^{*2}	FA-LTBGT2R4CBL05(0.5m) ^{*5} FA-LTBGT2R4CBL10(1m) ^{*5} FA-LTBGT2R4CBL20(2m) ^{*5}	 	
			W-BF-01-0500(0.5m) ^{*3*4} W-BF-01-1000(1m) ^{*3*4} W-BF-01-3000(3m) ^{*3*4} or RS-485 connection diagram 2)	1200m ^{*1}	GT15-RS4-TE	 	

*1 The total length of the connection cable 1) + connection cable 2)

*2 The total length of the connection cable 1) + connection cable 2) + option device cable

*3 Product manufactured by RKC. For details of the product, contact RKC.

*4 To use the dedicated cable, conversion of the cable may be necessary.

*5 Product manufactured by MITSUBISHI ELECTRIC ENGINEERING COMPANY LIMITED. For details of the product, contact MITSUBISHI ELECTRIC ENGINEERING COMPANY LIMITED.

9.2.2 Connecting to H-PCP-A or H-PCP-B

- When connecting to one temperature controller

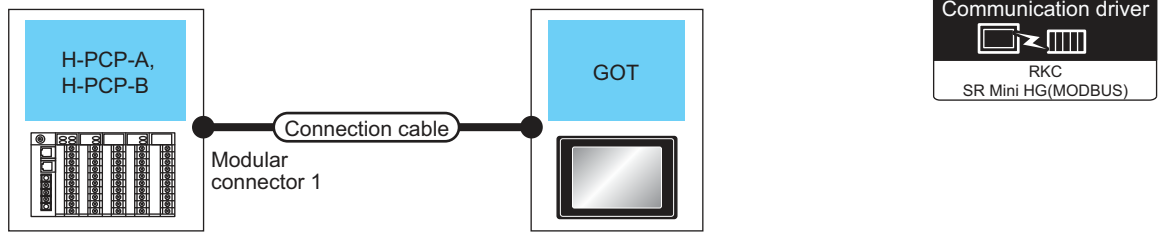

Temperature controller		Connection cable		Conversion connector*1	GOT		Number of connectable equipment	
Model name	Communication Type	Cable model Connection diagram number	Max. distance		Option device	Model		
H-PCP-A H-PCP-B	RS-232	W-BF-28-0500(0.5m) ^{*1} W-BF-28-1000(1m) ^{*1} W-BF-28-3000(3m) ^{*1} or RS-232 connection diagram 1)	15m	-	- (Built into GOT)	GT 27 GT 23 GS	Up to 1 temperature controller for 1 GOT	
				-	GT15-RS2-9P	GT 27 GT 23 GS		
		W-BF-02-0500(0.5m) ^{*1} W-BF-02-1000(1m) ^{*1} W-BF-02-3000(3m) ^{*1}	15m	FAX067	-	- (Built into GOT)		GT 27 GT 23 GS
						GT15-RS2-9P		GT 27 GT 23 GS
	RS-422	RS-422 connection diagram 1)	1200m	-	-	- (Built into GOT)		GT 27 GT 23 GS
						GT15-RS4-9S		GT 27 GT 23 GS

*1 Product manufactured by RKC. For details of the product, contact RKC.

■ When connecting to multiple temperature controllers

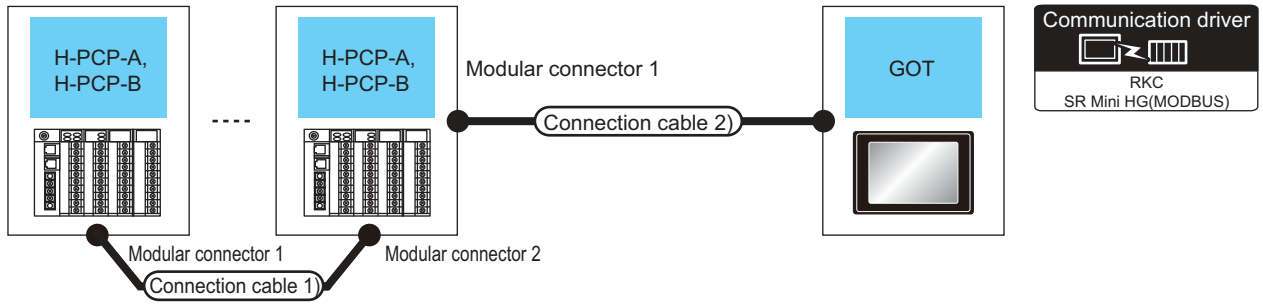

Temperature controller		Connection cable 1)	Connection cable 2)	Max. distance	GOT		Number of connectable equipment
Model name	Communication Type	Cable model Connection diagram number	Cable model Connection diagram number		Option device	Model	
H-PCP-A H-PCP-B	RS-422	W-BF-02-0500(0.5m) ^{*1} W-BF-02-1000(1m) ^{*1} W-BF-02-3000(3m) ^{*1}	User preparing RS-422 connection diagram 1)	1200m	- (Built into GOT)	GT 27 GT 23 GS	Up to 16 temperature controllers for 1 GOT
					GT15-RS4-9S	GT 27 GT 23 GS	

*1 Product manufactured by RKC. For details of the product, contact RKC.

9.2.3 Connecting to SRZ

■ When connecting to temperature control module (Z-TIO, Z-CT) with a converter

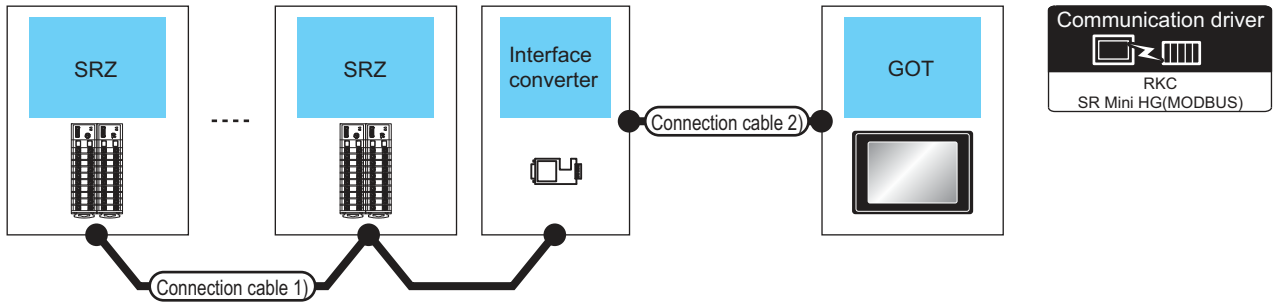

Temperature controller	Connection cable 1)		Converter		Connection cable 2)		GOT		Number of connectable equipment	
	Series	Cable model Connection diagram number	Max. distance	Model name	Communication Type	Cable model Connection diagram number	Max. distance	Option device		Model
SRZ		(User preparing) RS-485 connection diagram 8)	1200m	CD485/V ^{*1}	RS-232	(User preparing) RS-232 connection diagram 3)	15m	- (Built into GOT)	GT 27 GT 23 GS	Z-TIO: Up to 16 Z-CT: Up to 16 Z-DIO: Up to 16 Total of Z-TIO, Z-CT and Z-DIO: Up to 31 for 1 GOT
								GT15-RS2-9P	GT 27 GT 23 GS	

*1 Product manufactured by DATA LINK Co.,Ltd. For details of the product, contact DATA LINK Co.,Ltd.

■ When connecting directly to temperature control module (Z-TIO, Z-CT)

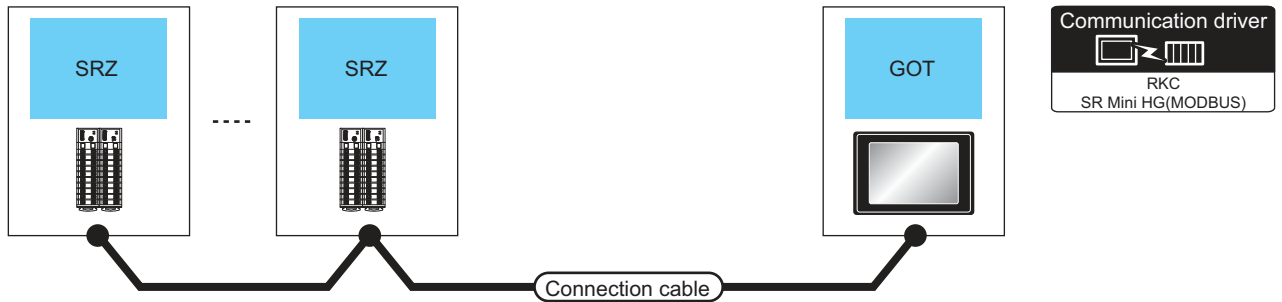

Temperature controller	Connection cable			GOT		Number of connectable equipment
	Series	Communication Type	Cable model Connection diagram number	Max. distance	Option device	
SRZ	RS-485	(User preparing) RS-485 connection diagram 5)	1200m	- (Built into GOT)	GT 27 GT 23 GS	Z-TIO: Up to 16 Z-CT: Up to 16 Z-DIO: Up to 16 Total of Z-TIO, Z-CT and Z-DIO: Up to 31 for 1 GOT
		(User preparing) RS-485 connection diagram 6)	1200m ^{*1}	FA-LTBGT2R4CBL05(0.5m) ^{*2} FA-LTBGT2R4CBL10(1m) ^{*2} FA-LTBGT2R4CBL20(2m) ^{*2}		
		(User preparing) RS-485 connection diagram 7)	1200m	GT15-RS4-TE	GT 27 GT 23 GS	

*1 Including the cable length of the option devices.

*2 Product manufactured by MITSUBISHI ELECTRIC ENGINEERING COMPANY LIMITED. For details of the product, contact MITSUBISHI ELECTRIC ENGINEERING COMPANY LIMITED.

■ When connecting to communication extension module (Z-COM) with a converter

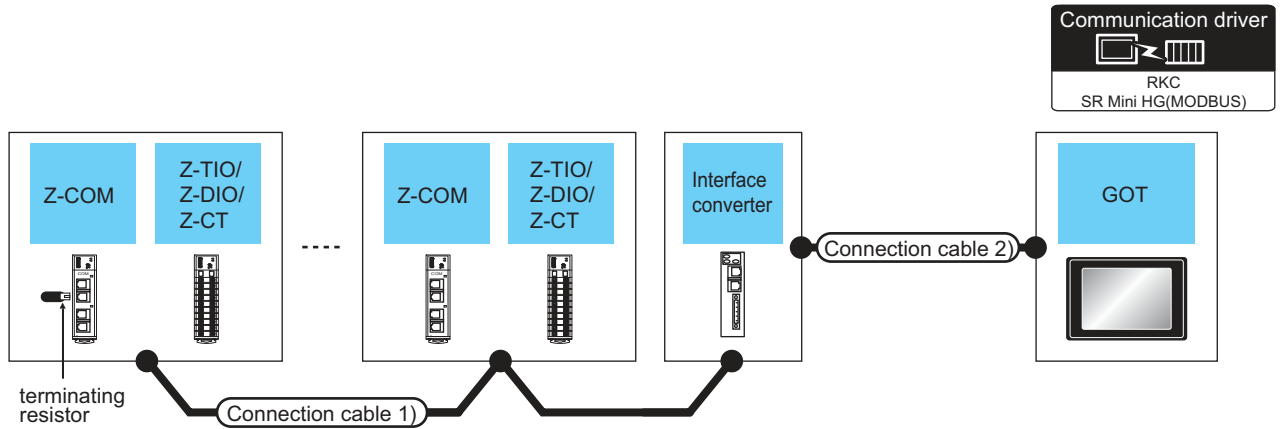

Z-COM		Connection cable 1)		Converter ^{*1}		Connection cable 2)		GOT		Number of connectable equipment
Model name	Terminating resistor ^{*1}	Cable model Connection diagram number	Max. distance	Model name	Communication Type	Cable model Connection diagram number	Max. distance	Option device	Model	
Z-COM	W-BW-02	W-BF-02-0500(0.5m) ^{*1} W-BF-02-1000(1m) ^{*1} W-BF-02-3000(3m) ^{*1} or RS-422 connection diagram 2)	1200m	COM-A	RS-232	W-BF-28-0500(0.5m) ^{*1} W-BF-28-1000(1m) ^{*1} W-BF-28-3000(3m) ^{*1} or RS-232 connection diagram 2)	15m	- (Built into GOT) GT15-RS2-9P	 	Up to 16 Z-COMs for 1 GOT Z-TIO: Up to 16 Z-CT: Up to 16 Z-DIO: Up to 16 Total of Z-TIO, Z-CT and Z-DIO: Up to 31 for Z-COM

^{*1} Product manufactured by RKC. For details of the product, contact RKC.

■ When connecting directly to communication extension module (Z-COM)

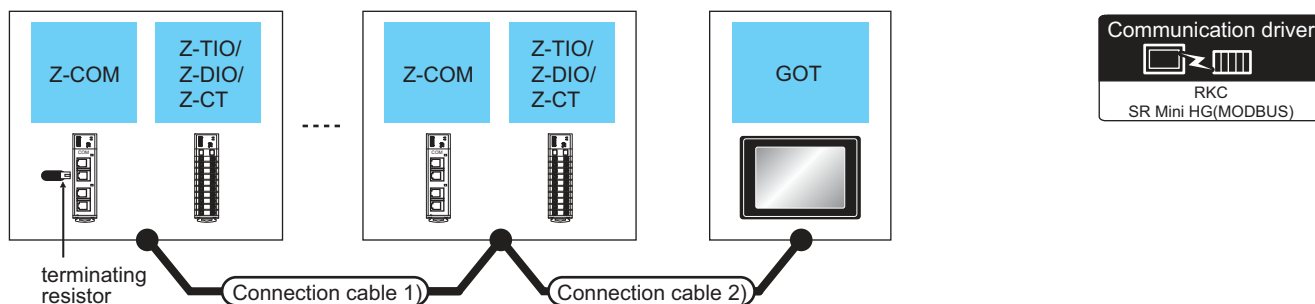

Z-COM			Connection cable 1)	Connection cable 2)	Max. distance	GOT		Number of connectable equipment
Model name	Communication Type	Terminating resistor ^{*1}	Cable model Connection diagram number	Cable model Connection diagram number		Option device	Model	
Z-COM	RS-422	W-BW-02	W-BF-02-0500(0.5m) ^{*1}	RS-422 connection diagram 1)	1200m ^{*2}	- (Built into GOT)	 	Up to 16 Z-COMs for 1 GOT Z-TIO: Up to 16 Z-CT: Up to 16 Z-DIO: Up to 16 Total of Z-TIO, Z-CT and Z-DIO: Up to 31 for Z-COM
			W-BF-02-1000(1m) ^{*1} W-BF-02-3000(3m) ^{*1} or RS-422 connection diagram 2)			GT15-RS4-9S	 	
	RS-485	W-BW-01	W-BF-02-0500(0.5m) ^{*1}	RS-485 connection diagram 1)	1200m ^{*2}	- (Built into GOT)	 	
			W-BF-02-1000(1m) ^{*1} W-BF-02-3000(3m) ^{*1} or RS-485 connection diagram 9)	RS-485 connection diagram 3)		1200m ^{*2}	FA-LTBGT2R4CBL05(0.5m) ^{*4} FA-LTBGT2R4CBL10(1m) ^{*4} FA-LTBGT2R4CBL20(2m) ^{*4}	
				RS-485 connection diagram 4)	1200m ^{*2}	GT15-RS4-TE	 	

*1 Product manufactured by RKC. For details of the product, contact RKC.

*2 The total length of the connection cable 1) + connection cable 2)

*3 The total length of the connection cable 1) + connection cable 2) + option device cable

*4 Product manufactured by MITSUBISHI ELECTRIC ENGINEERING COMPANY LIMITED. For details of the product, contact MITSUBISHI ELECTRIC ENGINEERING COMPANY LIMITED.

9.2.4 Connecting to CB Series (CB100, CB400, CB500, CB700, CB900)

■ When using the converter

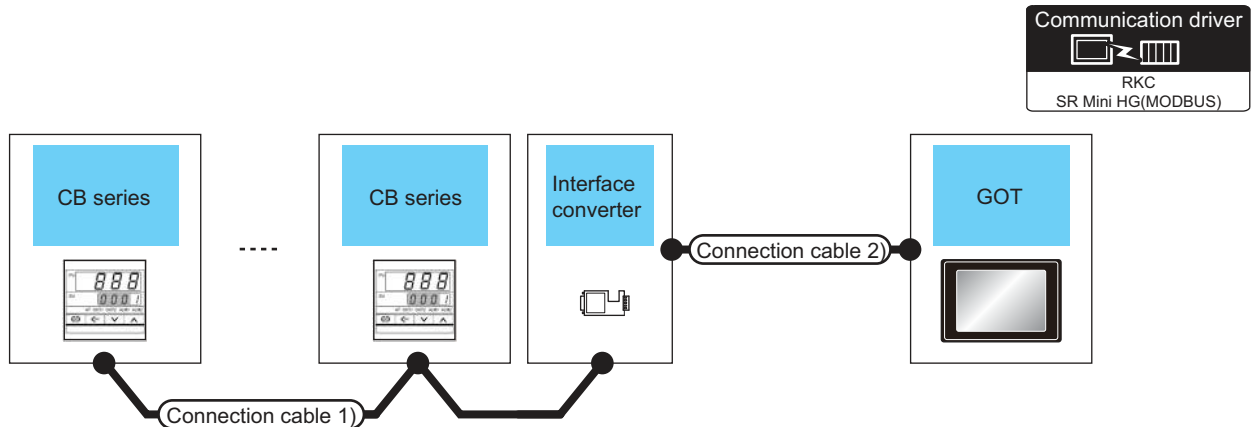

Temperature controller	Connection cable 1)		Converter		Connection cable 2)		GOT		Number of connectable equipment
	Series	Cable model Connection diagram number	Max. distance	Model name Communication Type	Cable model Connection diagram number	Max. distance	Option device	Model	
CB		RS-485 connection diagram 8)	1200m	CD485/V*1 RS-232	RS-232 connection diagram 3)	15m	- (Built into GOT)	 	Up to 31 temperature controllers for 1 GOT
							GT15-RS2-9P	 	

*1 Product manufactured by DATA LINK Co.,Ltd. For details of the product, contact DATA LINK Co.,Ltd.

■ When connecting directly

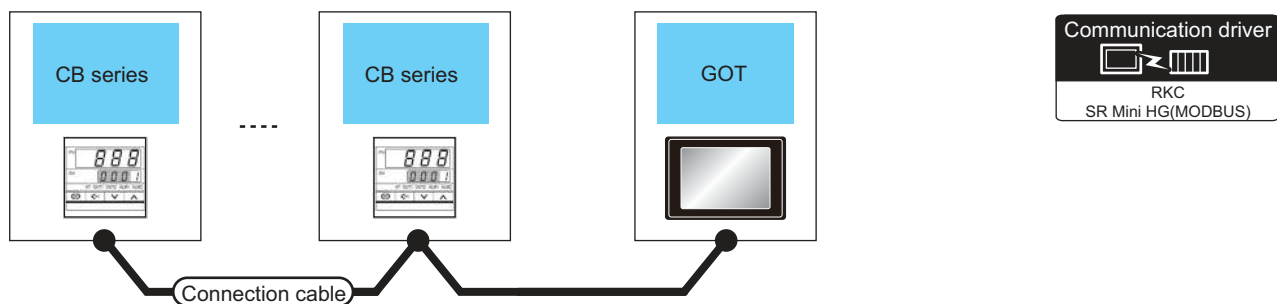

Temperature controller		Connection cable		GOT		Number of connectable equipment
Series	Communication Type	Cable model Connection diagram number	Max. distance	Option device	Model	
CB	RS-485	RS-485 connection diagram 5)	1200m	- (Built into GOT)	 	Up to 31 temperature controllers for 1 GOT
		RS-485 connection diagram 6)	1200m	FA-LTBGT2R4CBL05(0.5m) ^{*1} FA-LTBGT2R4CBL10(1m) ^{*1} FA-LTBGT2R4CBL20(2m) ^{*1}	 	
		RS-485 connection diagram 7)	1200m	GT15-RS4-TE	 	

*1 Product manufactured by MITSUBISHI ELECTRIC ENGINEERING COMPANY LIMITED. For details of the product, contact MITSUBISHI ELECTRIC ENGINEERING COMPANY LIMITED.

*2 Connect it to the RS-232 interface (built into GOT).

9.2.5 Connecting to FB series (FB100, FB400 or FB900)

■ When connecting to one temperature controller

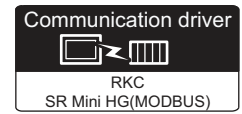
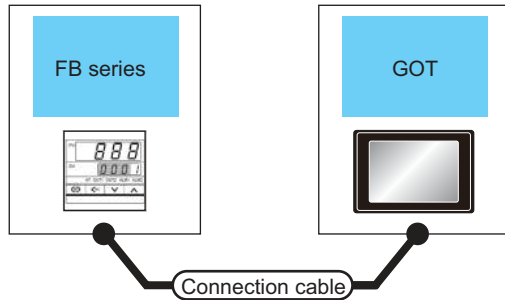

Temperature controller		Connection cable		GOT		Number of connectable equipment
Model name	Communication Type	Cable model Connection diagram number	Max. distance	Option device	Model	
FB400 FB900	RS-232*1	 RS-232 connection diagram 4)	15m	- (Built into GOT)	GT 27 GT 23 GS	Up to 1 temperature controller for 1 GOT
				GT15-RS2-9P	GT 27 GT 23 GS	

*1 Use communication 1 for the communication format.

■ When connecting to multiple temperature controllers with interface converter (COM-A)

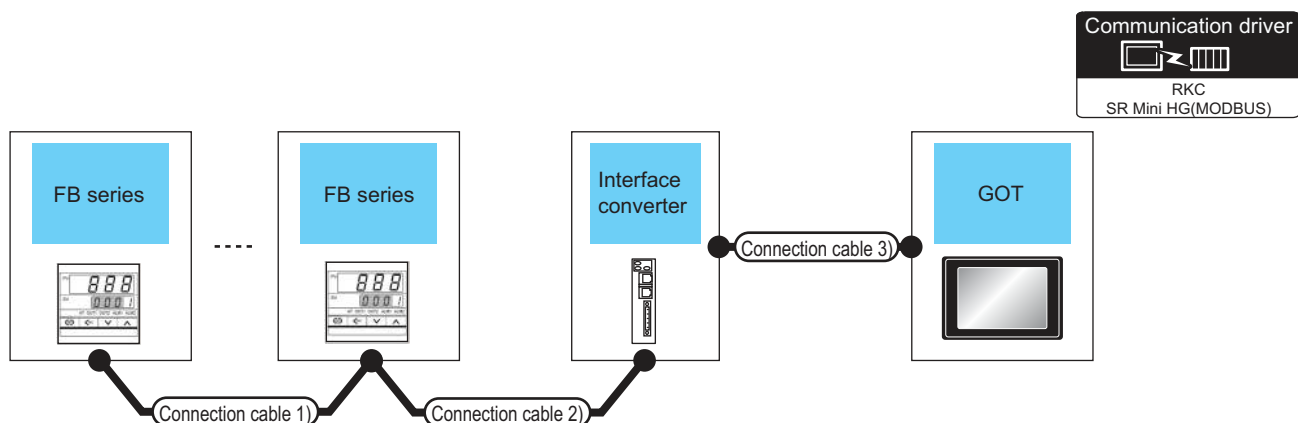

Temperature controller	Connection cable 1)		Max. distance	Converter*2		Connection cable 3)		GOT		Number of connectable equipment
	Model name	Cable model Connection diagram number		Cable model Connection diagram number	Model name	Communication Type	Cable model Connection diagram number	Max. distance	Option device	
FB400 FB900	(User creating) RS-422 connection diagram 3)*1	W-BF-01-0500 (0.5m)*2 W-BF-01-1000 (1m)*2 W-BF-01-300 (3m)*2	1000m*3	COM-A	RS-232	W-BF-28-0500 (0.5m)*2 W-BF-28-1000 (1m)*2 W-BF-28-3000 (3m)*2 or (User creating) RS-232 connection diagram 2)	15m	- (Built into GOT) GT15-RS2-9P	GT 27 GT 23 GS GT 27 GT 23 GS	Up to 31 temperature controllers for 1 GOT

*1 Use communication 1 for the communication format.

*2 Product manufactured by RKC. For details of the product, contact RKC.

*3 The total length of the connection cable 1) + connection cable 2)

■ When connecting to multiple temperature controllers with interface converter (CD485/V)

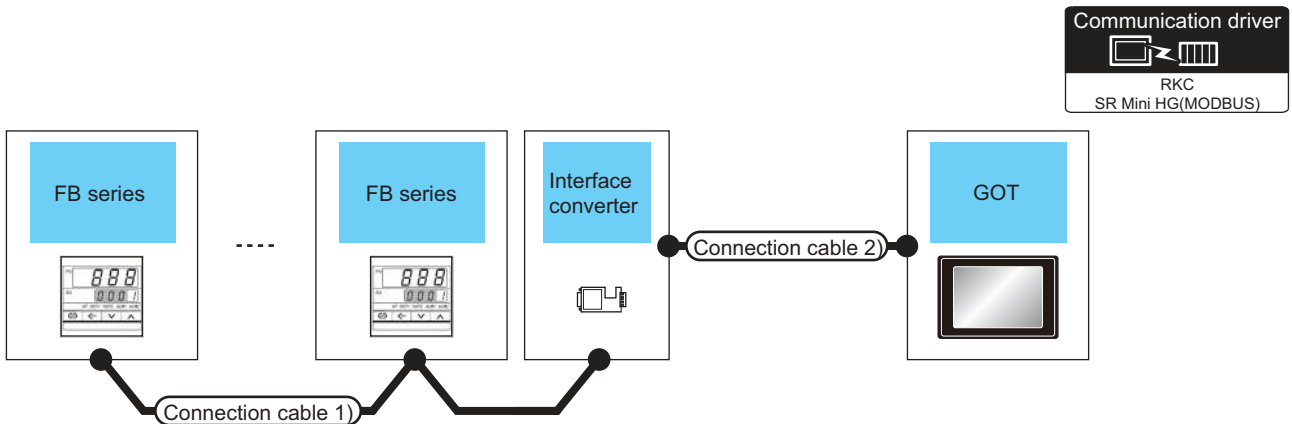

Temperature controller	Connection cable 1)		Converter*1		Connection cable 2)		GOT		Number of connectable equipment
	Model name	Cable model Connection diagram number	Max. distance	Model name	Communication Type	Cable model Connection diagram number	Max. distance	Option device	
FB100 FB400 FB900	(User preparing) RS-485 connection diagram 8)	1200m	CD485/V	RS-232	(User preparing) RS-232 connection diagram 3)	15m	(Built into GOT)	GT 27 GT 23 GS	Up to 31 temperature controllers for 1 GOT
							GT15-RS2-9P	GT 27 GT 23 GS	

*1 Product manufactured by DATA LINK Co.,Ltd. For details of the product, contact DATA LINK Co.,Ltd.

■ When connecting directly to a temperature controller by RS-422

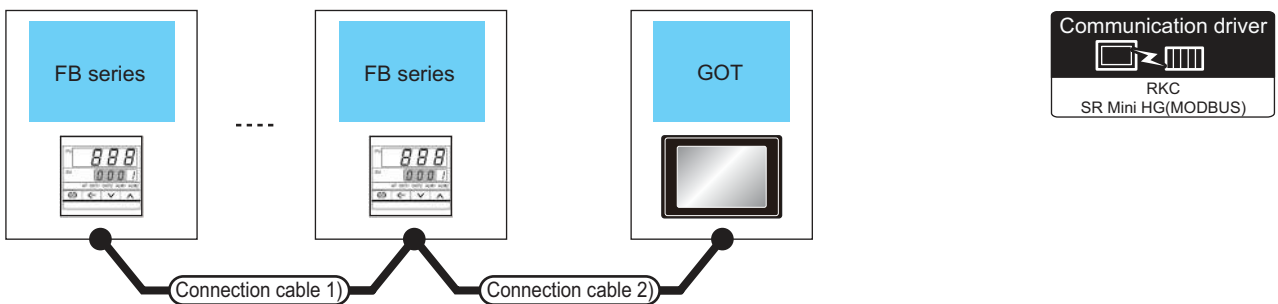

Temperature controller		Connection cable 1)	Connection cable 2)	Max. distance	GOT		Number of connectable equipment
Model name	Communication Type	Cable model Connection diagram number	Cable model Connection diagram number		Option device	Model	
FB400 FB900	RS-422*1	(User preparing) RS-422 connection diagram 3)	(User preparing) RS-422 connection diagram 4)	1000m*2	(Built into GOT)	GT 27 GT 23 GS	Up to 31 temperature controllers for 1 GOT
					GT15-RS4-9S	GT 27 GT 23 GS	

*1 Use communication 1 for the communication format.

*2 The total length of the connection cable 1) + connection cable 2)

■ When connecting directly to a temperature controller by RS-485

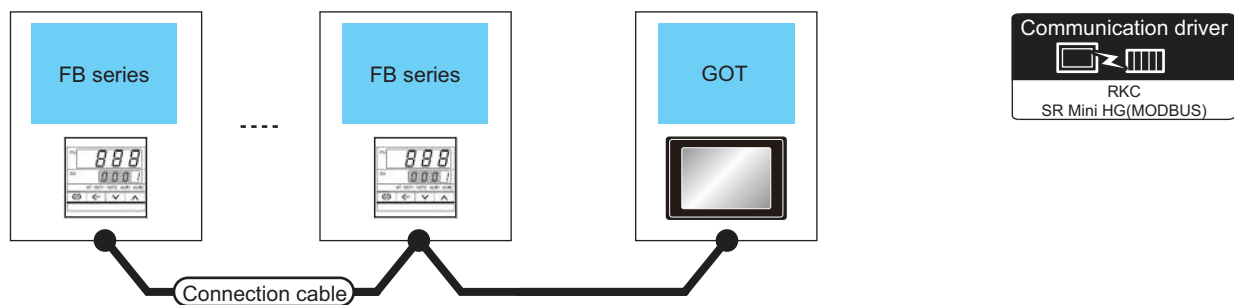

Temperature controller		Connection cable		GOT		Number of connectable equipment
Model name	Communication Type	Cable model Connection diagram number	Max. distance	Option device	Model	
FB100 FB400 FB900	RS-485	RS-485 connection diagram 5)	1200m	- (Built into GOT)	GT 27 GT 23 GS	Up to 31 temperature controllers for 1 GOT
		RS-485 connection diagram 6)	1200m	FA-LTBGT2R4CBL05(0.5m) ^{*1} FA-LTBGT2R4CBL10(1m) ^{*1} FA-LTBGT2R4CBL20(2m) ^{*1}	GT 27 GT 23 GS	
		RS-485 connection diagram 7)	1200m	GT15-RS4-TE	GT 27 GT 23 GS	

*1 Product manufactured by MITSUBISHI ELECTRIC ENGINEERING COMPANY LIMITED. For details of the product, contact MITSUBISHI ELECTRIC ENGINEERING COMPANY LIMITED.

9.2.6 Connecting to RB Series (RB100, RB400, RB500, RB700, RB900)

■ When using the converter

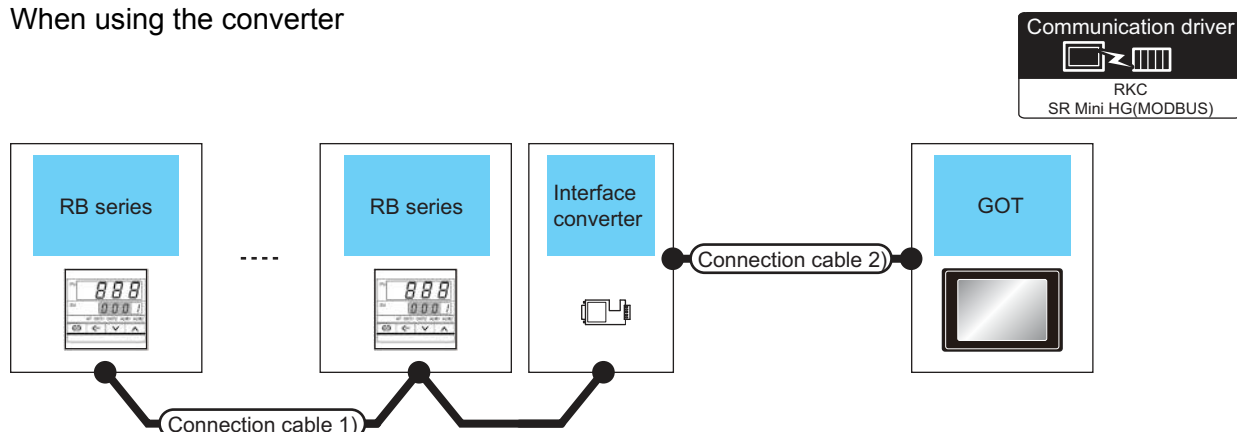

Temperature controller	Connection cable 1)		Converter*1		Connection cable 2)		GOT		Number of connectable equipment
	Model name	Cable model Connection diagram number	Max. distance	Model name	Communication Type	Cable model Connection diagram number	Max. distance	Option device	
RB100 RB400 RB500 RB700 RB900	(User preparing) RS-485 connection diagram 8)	1200m	CD485/V	RS-232	(User preparing) RS-232 connection diagram 3)	15m	(Built into GOT)	GT 27 GT 23 GS	Up to 31 temperature controllers for 1 GOT
							GT15-RS2-9P	GT 27 GT 23 GS	

*1 Product manufactured by DATA LINK Co.,Ltd. For details of the product, contact DATA LINK Co.,Ltd.

■ When connecting directly

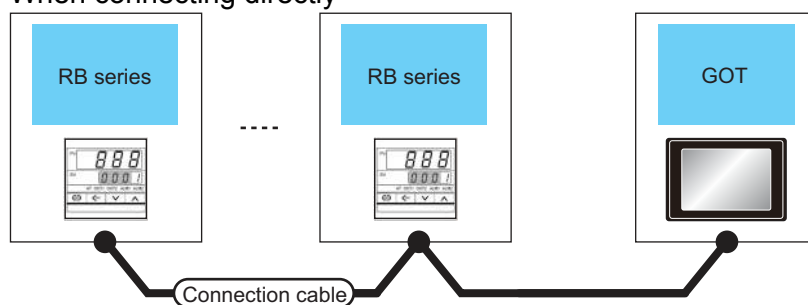

Temperature controller		Connection cable		GOT		Number of connectable equipment
Model name	Communication Type	Cable model Connection diagram number	Max. distance	Option device	Model	
RB100 RB400 RB500 RB700 RB900	RS-485	RS-485 connection diagram 5)	1200m	- (Built into GOT)	 	Up to 31 temperature controllers for 1 GOT
		RS-485 connection diagram 6)	1200m	FA-LTBGT2R4CBL05(0.5m) ^{*1} FA-LTBGT2R4CBL10(1m) ^{*1} FA-LTBGT2R4CBL20(2m) ^{*1}	 	
		RS-485 connection diagram 7)	1200m	GT15-RS4-TE	 	

*1 Product manufactured by MITSUBISHI ELECTRIC ENGINEERING COMPANY LIMITED. For details of the product, contact MITSUBISHI ELECTRIC ENGINEERING COMPANY LIMITED.

9.2.7 Connection to PF900/901, HA400/401, HA900/901, RMC500, MA900/901, AG500, SA100/200

■ When connecting to multiple temperature controllers

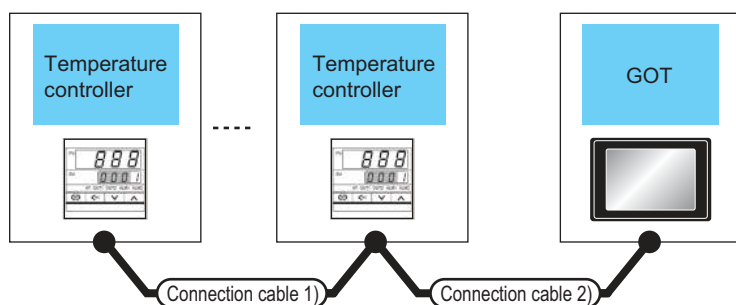

Temperature controller		Connection cable 1)	Connection cable 2)	Max. distance	GOT		Number of connectable equipment
Model name	Communication Type	Cable model Connection diagram number	Cable model Connection diagram number		Option device	Model	
PF900 PF901 HA400 HA401 HA900 HA901 MA900 MA901	RS-232	-	RS-232 connection diagram 4)	15m	- (Built into GOT)	GT 27 GT 23 GS	Up to 1 temperature controller for 1 GOT
					GT15-RS2-9P	GT 27 GT 23 GS	
PF900 PF901 HA400 HA401 HA900 HA901 MA900 MA901 AG500	RS-422	RS-422 connection diagram 3)	RS-422 connection diagram 4)	1000m	- (Built into GOT)	GT 27 GT 23 GS	Up to 31 temperature controllers for 1 GOT* ³
					GT15-RS4-9S	GT 27 GT 23 GS	
PF900 PF901 HA400 HA401 HA900 HA901 MA900 MA901 AG500 RMC500 SA100 SA200	RS-485	RS-485 connection diagram 5)		1200m	- (Built into GOT)	GT 27 GT 23 GS	Up to 31 temperature controllers for 1 GOT
		RS-485 connection diagram 6)		1200m	FA-LTBGT2R4CBL05 (0.5m)* ¹ FA-LTBGT2R4CBL10 (1m)* ¹ FA-LTBGT2R4CBL20 (2m)* ¹	GT 27 GT 23 GS	
		RS-485 connection diagram 7)		1200m	GT15-RS4-TE	GT 27 GT 23 GS	

*1 Product manufactured by MITSUBISHI ELECTRIC ENGINEERING COMPANY LIMITED. For details of the product, contact MITSUBISHI ELECTRIC ENGINEERING COMPANY LIMITED.

■ When connecting to multiple temperature controllers with interface converter (COM-A)

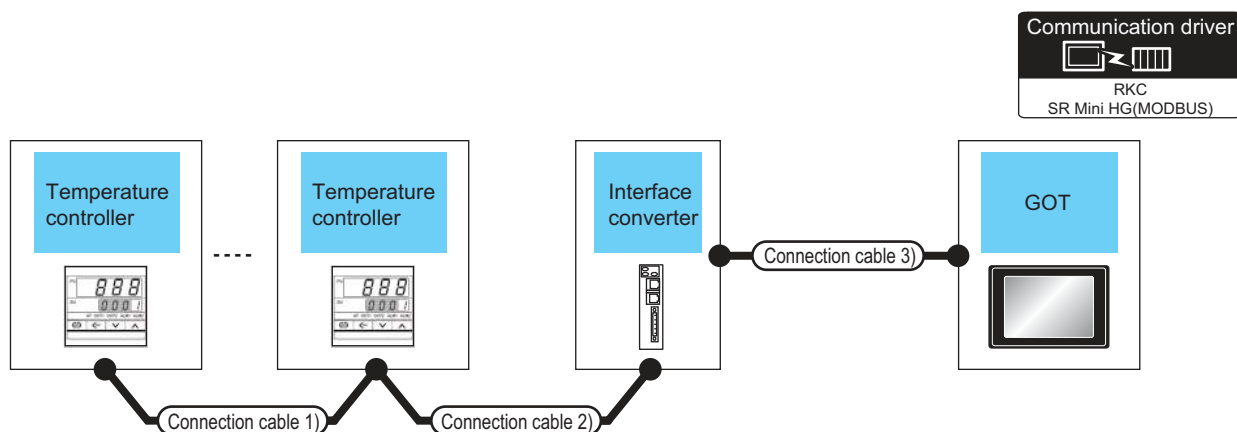

Temperature controller	Connection cable 1)		Max. distance	Interface converter*1		Connection cable 3)		GOT		Number of connectable equipment
	Model name	Cable model Connection diagram number		Cable model*1 Connection diagram number	Model name	Communication Type	Cable model Connection diagram number	Max. distance	Option device	
PF900 PF901	(User preparing) RS-422 connection diagram 3)	W-BF-01-0500 (0.5m) W-BF-01-1000 (1m) W-BF-01-3000 (3m)	1000m	COM-A	RS-232	W-BF-28-0500 (0.5m)*1 W-BF-28-1000 (1m)*1 W-BF-28-3000 (3m)*1 or (User preparing) RS-232 connection diagram 2)	15m	- (Built into GOT)	GT 27 GT 23 GS	Up to 31 temperature controllers for 1 GOT
								GT15-RS2-9P	GT 27 GT 23 GS	

*1 Product manufactured by RKC. For details of the product, contact RKC.

■ When connecting to multiple temperature controllers with interface converter (CD485/V)

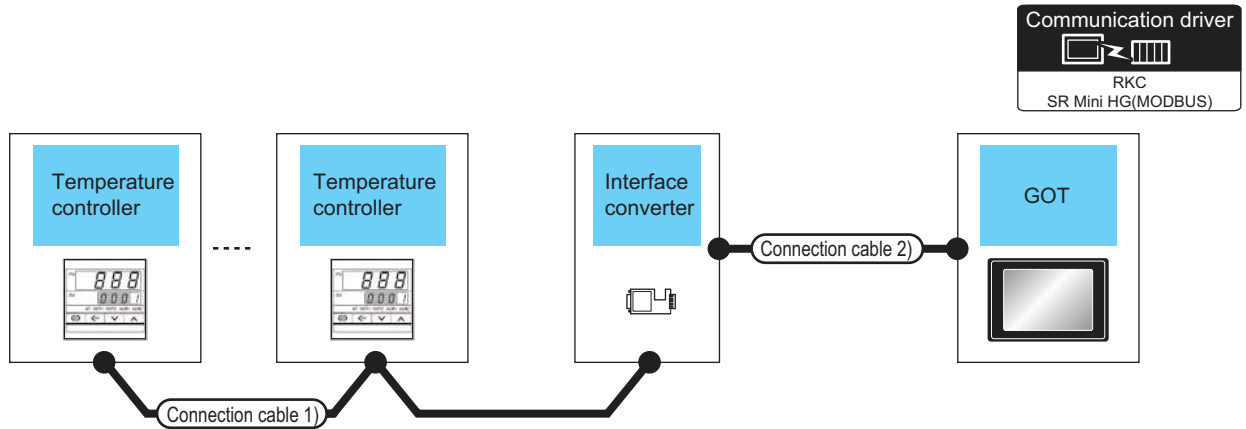

Temperature controller	Connection cable 1)		Interface converter*1		Connection cable 2)		GOT		Number of connectable equipment	
	Model name	Cable model*1 Connection diagram number	Max. distance	Model name	Communication Type	Cable model Connection diagram number	Max. distance	Option device		Model
PF900 PF901 HA400 HA401 HA900 HA901 RMC500 SA100 SA200		(User preparing) RS-485 connection diagram 8)	1200m	CD485/V	RS-232	(User preparing) RS-232 connection diagram 3)	15m	- (Built into GOT)	GT 27 GT 23 GS	Up to 31 temperature controllers for 1 GOT
								GT15-RS2-9P	GT 27 GT 23 GS	

*1 Product manufactured by RKC. For details of the product, contact RKC.

9.2.8 Connection to THV-A1

■ When connecting to multiple temperature controllers

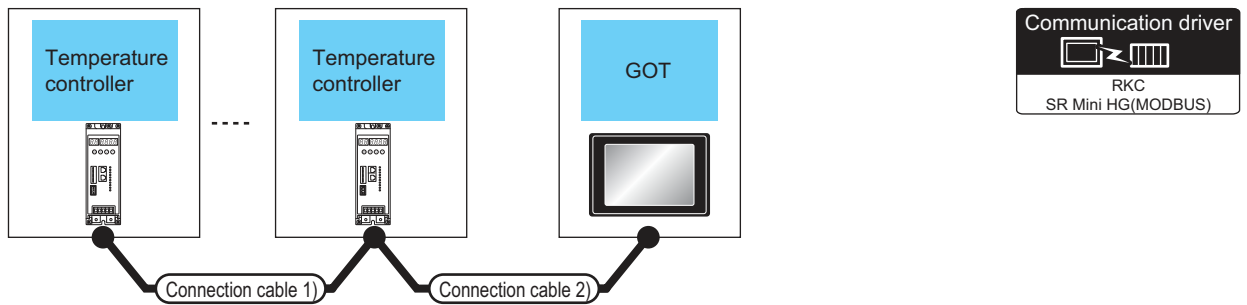

Temperature controller		Connection cable 1)	Connection cable 2)	Max. distance	GOT		Number of connectable equipment	
Model name	Communication Type	Cable model* ¹ Connection diagram number	Cable model Connection diagram number		Option device	Model		
THV-A1	RS-422	W-BF-02-0500 (0.5m) W-BF-02-1000 (1m) W-BF-02-3000 (3m)	RS-422 connection diagram 1)	1000m	- (Built into GOT)	GT 27 GT 23 GS	Up to 31 temperature controllers for 1 GOT	
					GT15-RS4-9S	GT 27 GT 23 GS		
	RS-485	W-BF-02-0500 (0.5m) W-BF-02-1000 (1m) W-BF-02-3000 (3m)	RS-485 connection diagram 1)	RS-485 connection diagram 3)	1200m	- (Built into GOT)	GT 27 GT 23 GS	Up to 31 temperature controllers for 1 GOT
						FA-LTBGT2R4CBL05 (0.5m) ^{*2} FA-LTBGT2R4CBL10 (1m) ^{*2} FA-LTBGT2R4CBL20 (2m) ^{*2}	GT 27 GT 23 GS	
			RS-485 connection diagram 4)	W-BF-01-0500 (0.5m) ^{*1} W-BF-01-1000 (1m) ^{*1} W-BF-01-3000 (3m) ^{*1} or RS-485 connection diagram 4)		GT15-RS4-TE	GT 27 GT 23 GS	

*1 Product manufactured by RKC. For details of the product, contact RKC.

*2 Product manufactured by MITSUBISHI ELECTRIC ENGINEERING COMPANY LIMITED. For details of the product, contact MITSUBISHI ELECTRIC ENGINEERING COMPANY LIMITED.

■ When connecting to multiple temperature controllers with interface converter (COM-A)

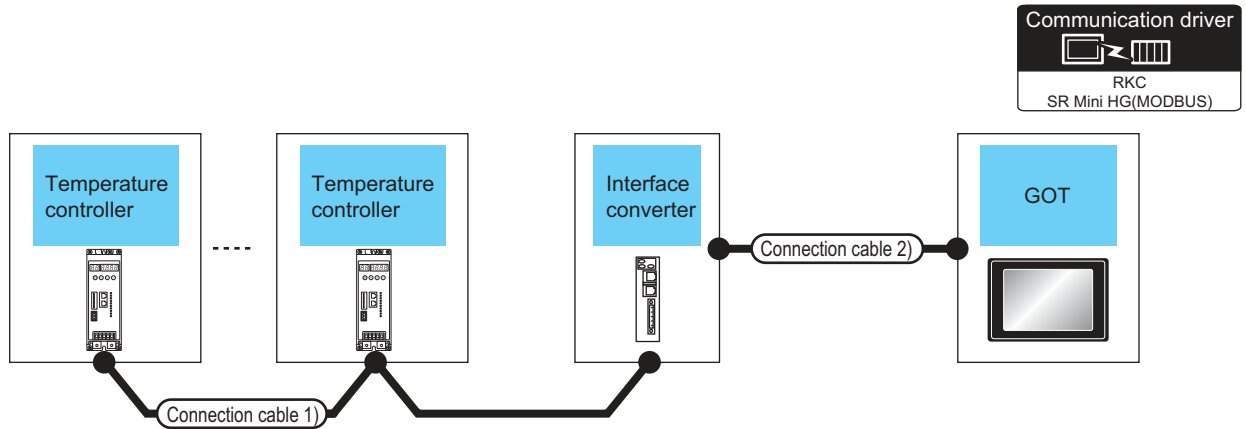

Temperature controller	Connection cable 1) Cable model ^{*1} Connection diagram number	Max. distance	Interface converter ^{*1}		Connection cable 2)		GOT		Number of connectable equipment
			Model name	Communication Type	Cable model Connection diagram number	Max. distance	Option device	Model	
THV-A1	W-BF-02-0500 (0.5m) W-BF-02-1000 (1m) W-BF-02-3000 (3m)	1000m	COM-A	RS-232	W-BF-28-0500 (0.5m) ^{*1} W-BF-28-1000 (1m) ^{*1} W-BF-28-3000 (3m) ^{*1} or RS-232 connection diagram 2)	15m	- (Built into GOT) GT15-RS2-9P	 	Up to 31 temperature controllers for 1 GOT

*1 Product manufactured by RKC. For details of the product, contact RKC.

■ When connecting to multiple temperature controllers with interface converter (CD485V)

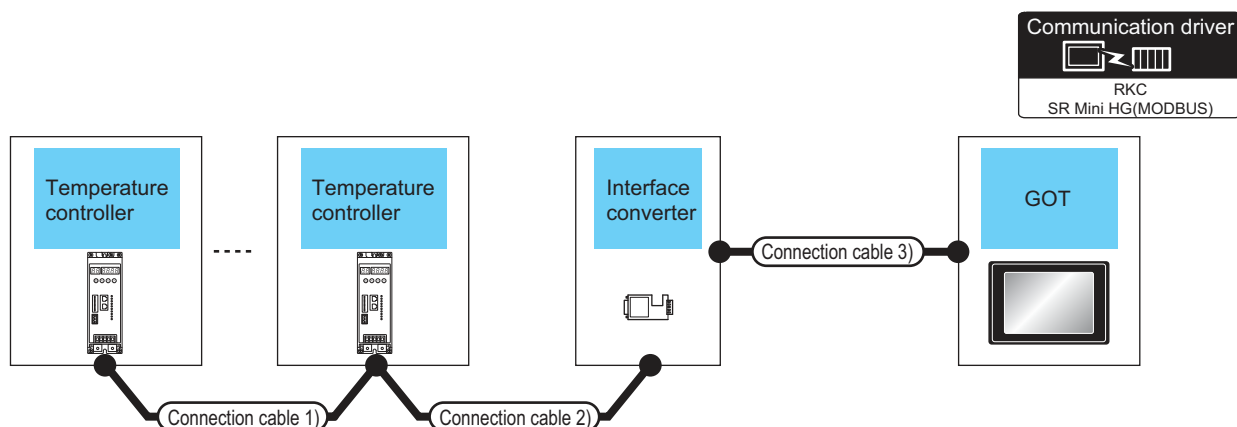

Temperature controller	Connection cable 1)	Connection cable 2)	Max. distance	Interface converter*1		Connection cable 3)		GOT		Number of connectable equipment
				Model name	Communication Type	Cable model Connection diagram number	Max. distance	Option device	Model	
THV-A1	W-BF-02-0500 (0.5m) ^{*1} W-BF-02-1000 (1m) ^{*1} W-BF-02-3000 (3m) ^{*1}	RS-485 connection diagram 8)	1200m	CD485V	RS-232	RS-232 connection diagram 3)	15m	- (Built into GOT)	 	Up to 31 temperature controllers for 1 GOT
								GT15-RS2-9P	 	
	RS-485 connection diagram 8)	1200m	CD485V	RS-232	RS-232 connection diagram 3)	15m	- (Built into GOT)	 		
							GT15-RS2-9P	 		

*1 Product manufactured by RKC. For details of the product, contact RKC.

9.2.9 Connection to SRX

■ When connecting to temperature control module (X-TIO) with a converter

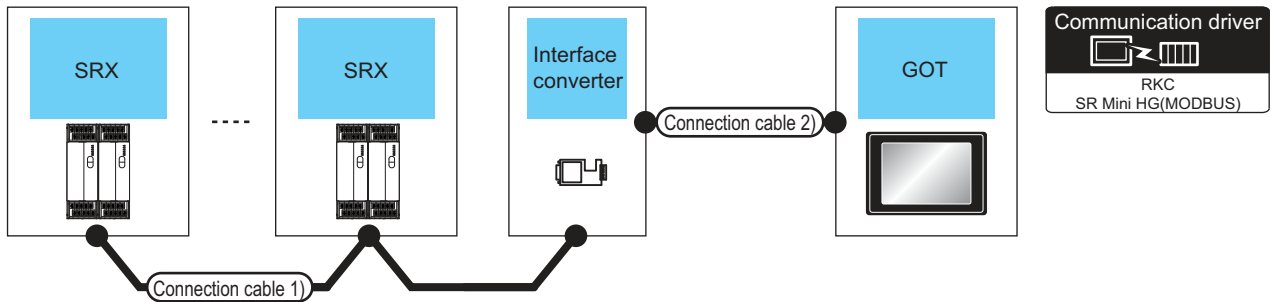

Temperature controller	Connection cable 1)		Interface Converter		Connection cable 2)		GOT		Number of connectable equipment	
	Series	Cable model Connection diagram number	Max. distance	Model name	Communication Type	Cable model Connection diagram number	Max. distance	Option device		Model
SRX		RS-485 connection diagram 8)	1200m	CD485/V*1	RS-232	RS-232 connection diagram 3)	15m	-(Built into GOT)	GT 27 GT 23 GS	X-TIO: Up to 31 Total of X-TIO, X-DI and X-DO: Up to 31 for 1 GOT
								GT15-RS2-9P	GT 27 GT 23 GS	

*1 Product manufactured by DATA LINK Co.,Ltd. For details of the product, contact DATA LINK Co.,Ltd.

■ When connecting directly to temperature control module (X-TIO)

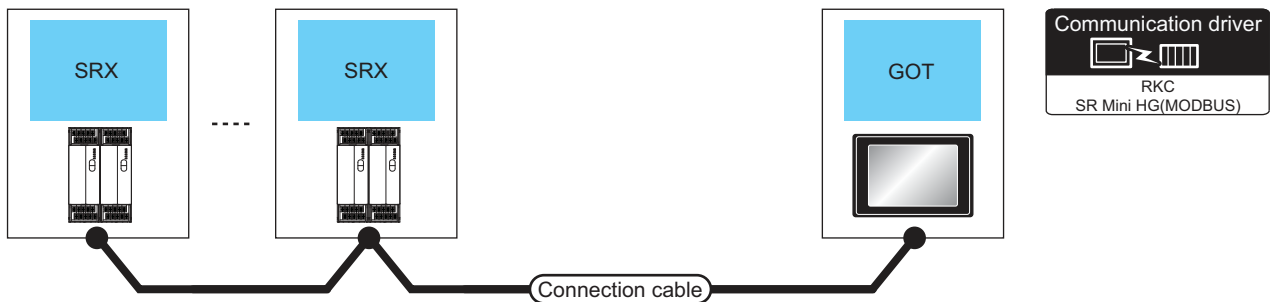

Temperature controller		Connection cable		GOT		Number of connectable equipment
Series	Communication Type	Cable model Connection diagram number	Max. distance	Option device	Model	
SRX	RS-485	RS-485 connection diagram 5)	1200m	-(Built into GOT)	GT 27 GT 23 GS	X-TIO: Up to 31 Total of X-TIO, X-DI and X-DO: Up to 31 for 1 GOT
		RS-485 connection diagram 6)	1200m*1	FA-LTBGT2R4CBL05 (0.5m)*2 FA-LTBGT2R4CBL10 (1m)*2 FA-LTBGT2R4CBL20 (2m)*2	GS	
		RS-485 connection diagram 7)	1200m	GT15-RS4-TE	GT 27 GT 23 GS	

*1 Including the cable length of the option devices.

*2 Product manufactured by MITSUBISHI ELECTRIC ENGINEERING COMPANY LIMITED. For details of the product, contact MITSUBISHI ELECTRIC ENGINEERING COMPANY LIMITED.

9.2.10 Connecting to SB1

■ When connecting to multiple temperature controllers

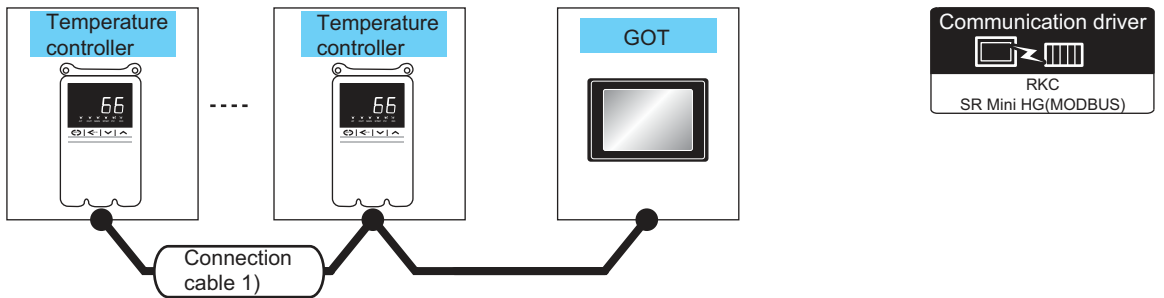

Temperature controller		Connection cable 1)		GOT		Number of connectable equipment
Model name	Communication Type	Cable model Connection diagram number	Max. distance	Option device	Model	
SB1	RS-485	RS-485 connection diagram 5)	1200m	- (Built into GOT)	 	Up to 31 temperature controllers for 1 GOT
		RS-485 connection diagram 6)	1200m	FA-LTBGT2R4CBL05 (0.5m) ^{*1} FA-LTBGT2R4CBL10 (1m) ^{*1} FA-LTBGT2R4CBL20 (2m) ^{*1}	 	
		RS-485 connection diagram 7)	1200m	GT15-RS4-TE	 	

*1 Product manufactured by MITSUBISHI ELECTRIC ENGINEERING COMPANY LIMITED. For details of the product, contact MITSUBISHI ELECTRIC ENGINEERING COMPANY LIMITED.

■ When connecting to multiple temperature controllers with interface converter (CD485V)

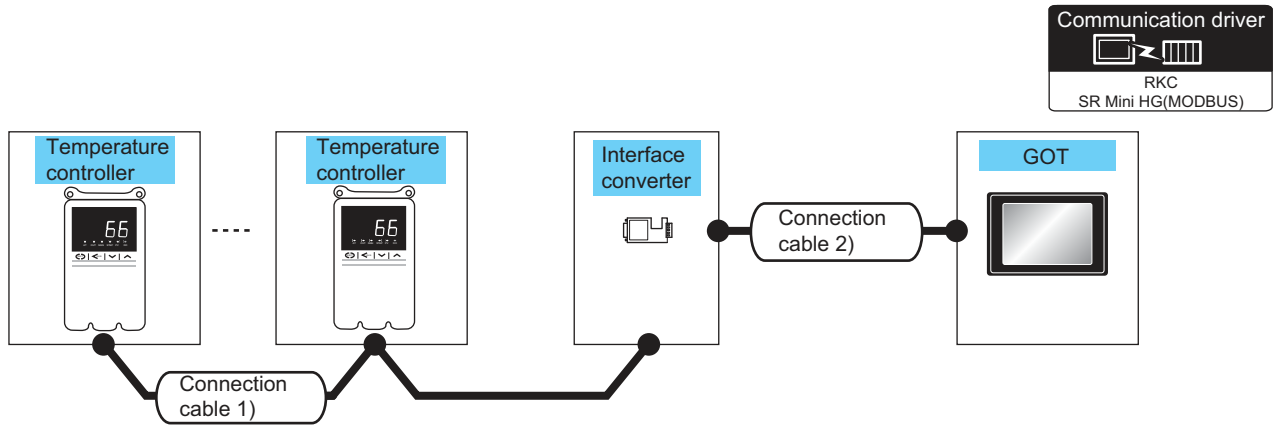

Temperature controller	Connection cable 1)		Converter*1		Connection cable 2)		GOT		Number of connectable equipment
	Model name	Cable model Connection diagram number*1	Max. distance	Model name	Communication Type	Cable model Connection diagram number	Max. distance	Option device	
SB1	RS-485 connection diagram 8)	1200m	CD485/V ²	RS-232	RS-232 connection diagram 3)	15m	(Built into GOT)	 	Up to 31 temperature controllers for 1 GOT
							GT15-RS2-9P	 	

*1 Product manufactured by RKC. For details of the product, contact RKC.

*2 Product manufactured by DATA LINK Co.,Ltd. For details of the product, contact DATA LINK Co.,Ltd.

9.2.11 Connecting to B400

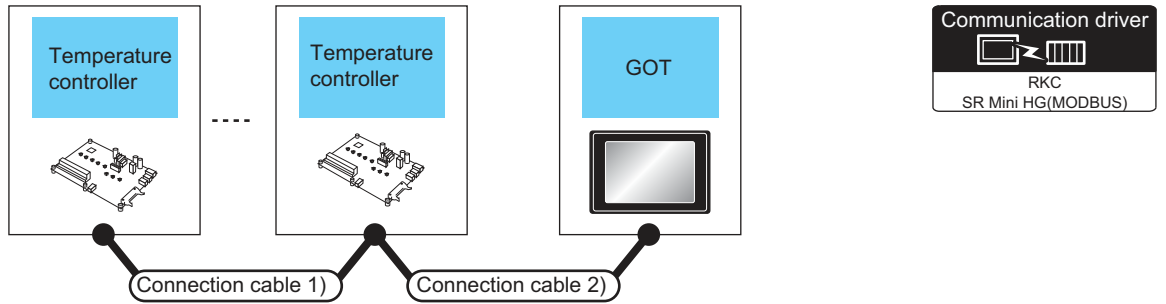

Temperature controller		Connection cable 1)	Connection cable 2)	Max. distance	GOT		Number of connectable equipment
Model name	Communication Type	Cable model Connection diagram number	Cable model Connection diagram number		Option device	Model	
B400 (RS-422 specifications)	RS-422	RS-422 connection diagram 3)	RS-422 connection diagram 4)	1200m	- (Built into GOT)	 	Up to 31 temperature controllers for 1 GOT
					GT15-RS4-9S	 	
B400 (RS-485 specifications)	RS-485	RS-485 connection diagram 5)		1200m	- (Built into GOT)	 	Up to 31 temperature controllers for 1 GOT
		RS-485 connection diagram 6)		1200m	FA-LTBGT2R4CBL05 (0.5m) ^{*1} FA-LTBGT2R4CBL10 (1m) ^{*1} FA-LTBGT2R4CBL20 (2m) ^{*1}	 	
		RS-485 connection diagram 7)		1200m	GT15-RS4-TE	 	

*1 Product manufactured by MITSUBISHI ELECTRIC ENGINEERING COMPANY LIMITED. For details of the product, contact MITSUBISHI ELECTRIC ENGINEERING COMPANY LIMITED.

9.3 Connection Diagram

The following diagram shows the connection between the GOT and the temperature controller.

9.3.1 RS-232 cable

■ Connection diagram

(1) RS-232 connection diagram 1)

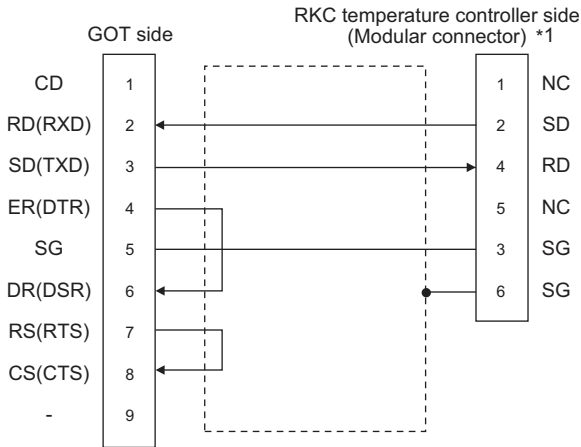

*1 For details of the pin assignment, refer to the following manual.
 User's Manual of the RKC temperature controller

(2) RS-232 connection diagram 2)

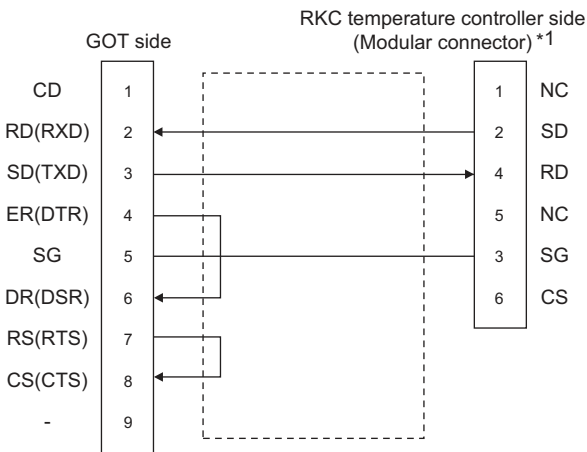

*1 For details of the pin assignment, refer to the following manual.
 User's Manual of the RKC temperature controller

(3) RS-232 connection diagram 3)

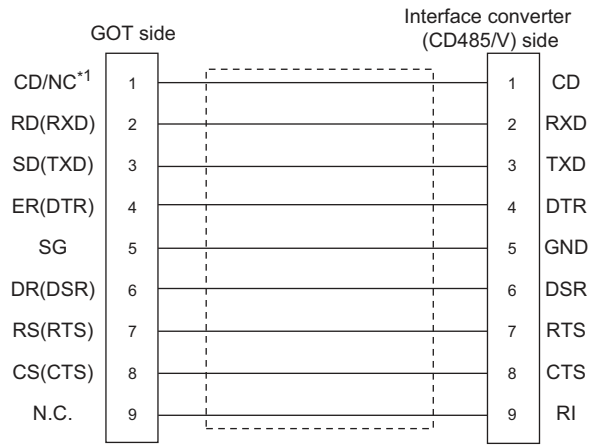

*1 GT16: CD, GT15: CD, GT14: NC, GT12: NC, GT11: NC

(4) RS-232 connection diagram 4)

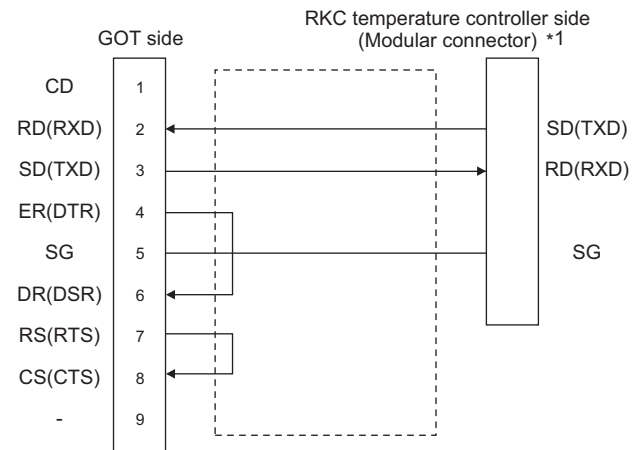

*1 For the terminal number of the temperature controller, refer to the following table.

Signal name	Terminal No.				
	FB400 FB900	PF900 PF901	HA400/401 HA900/901		MA900 MA901
			Communication 1	Communication 2	
SG	25	25	13	25	44
SD(TXD)	26	26	14	26	45
RD(RXD)	27	27	15	27	46

■ Precautions when preparing a cable

(5) Cable length

The length of the RS-232 cable must be 15m or less.

(6) GOT side connector

For the GOT side connector, refer to the following.

1.4.1 GOT connector specifications

(7) RKC temperature controller side connector

Use the connector compatible with the RKC temperature controller side module.

For details, refer to user's manual of the RKC temperature controller side.

9.3.2 RS-422 cable

POINT

Differences in polarity between GOT and RKC temperature controllers

The polarity of poles A and B in signal names is reversed between GOT and RKC temperature controllers.

Connect a cable according to the following connection diagrams.

■ Connection diagram

(1) RS-422 connection diagram 1)

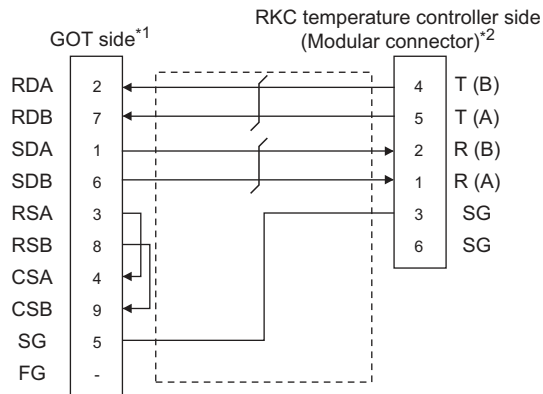

*1 Set the terminating resistor setting switch of the GOT main unit to "Disable".

■ Connecting terminating resistors

*2 For details of the pin assignment, refer to the following manual.

User's Manual of the RKC temperature controller

(2) RS-422 connection diagram 2)

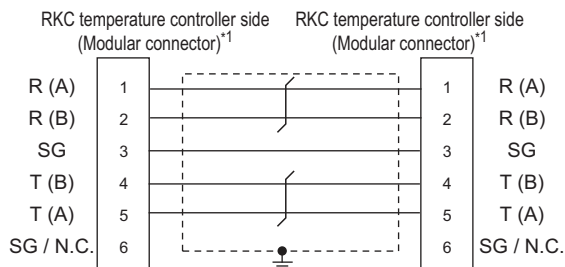

*1 For details of the pin assignment, refer to the following manual.

User's Manual of the RKC temperature controller

(3) RS-422 connection diagram 3)

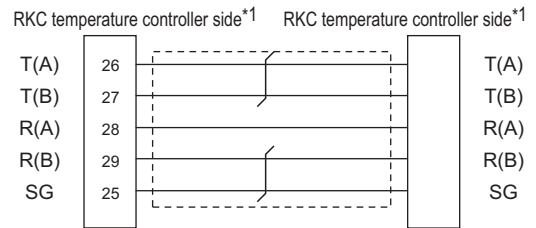

*1 For the terminal number of the temperature controller, refer to the following table

Signal name	Terminal No.			
	FB400 FB900	PF900/901 AG500 HA400/401 HA900/901	MA900 MA901	B400 (RS-422 specifications)
SG	25	25	44	3/6
T(A)	26	26	45	5
T(B)	27	27	46	4
R(A)	28	28	47	1
R(B)	29	29	48	2

(4) RS-422 connection diagram 4)

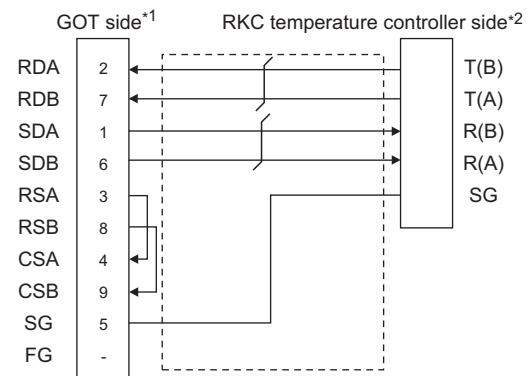

*1 Set the terminating resistor setting switch of the GOT main unit to "100 OHM".

■ Connecting terminating resistors

*2 For the terminal number of the temperature controller, refer to the following table

Signal name	Terminal No.				B400 (RS-422 specifications)
	FB400 FB900	PF900/901 AG500 HA400/401 HA900/901	MA900 MA901	THV-A1*3	
SG	25	25	44	3	3/6
T(A)	26	26	45	5	5
T(B)	27	27	46	4	4
R(A)	28	28	47	1	1
R(B)	29	29	48	2	2

*3 The following shows the pin assignment of the modular connector.

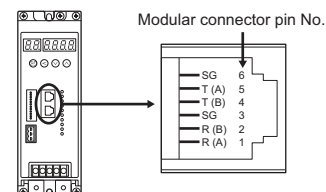

■ Precautions when preparing a cable

(5) Cable length

The length of the RS-422 cable must be within the maximum distance.

(6) GOT side connector

For the GOT side connector, refer to the following.

 1.4.1 GOT connector specifications

(7) RKC temperature controller side connector

Use the connector compatible with the RKC temperature controller side module.

For details, refer to user's manual of the RKC temperature controller.

■ Connecting terminating resistors

(1) GOT side

Set the terminating resistor by operating the terminating resistor setting switch.

For the procedure to set the terminating resistor, refer to the following.

 1.4.3 Terminating resistors of GOT

9.3.3 RS-485 cable

■ Connection diagram

(1) RS-485 connection diagram 1)

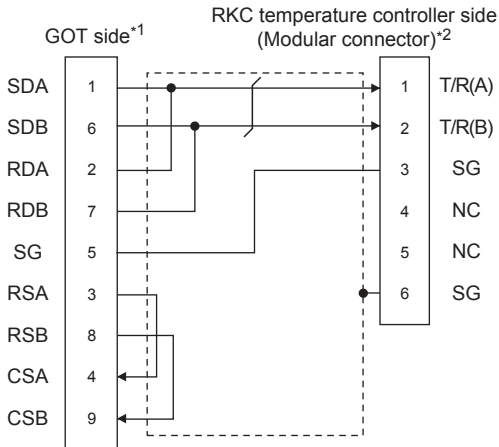

*1 Set the terminating resistor setting switch of the GOT main unit to "100 OHM".

■ Connecting terminating resistors

*2 For details of the pin assignment, refer to the following manual.

☞ User's Manual of the RKC temperature controller

(2) RS-485 connection diagram 2)

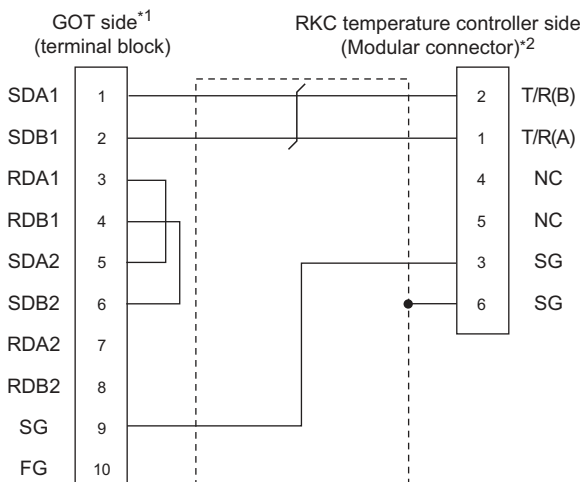

*1 Set the terminating resistor setting switch of the GOT main unit to "100 OHM".

■ Connecting terminating resistors

*2 For details of the pin assignment, refer to the following manual.

☞ User's Manual of the RKC temperature controller

(3) RS-485 connection diagram 3)

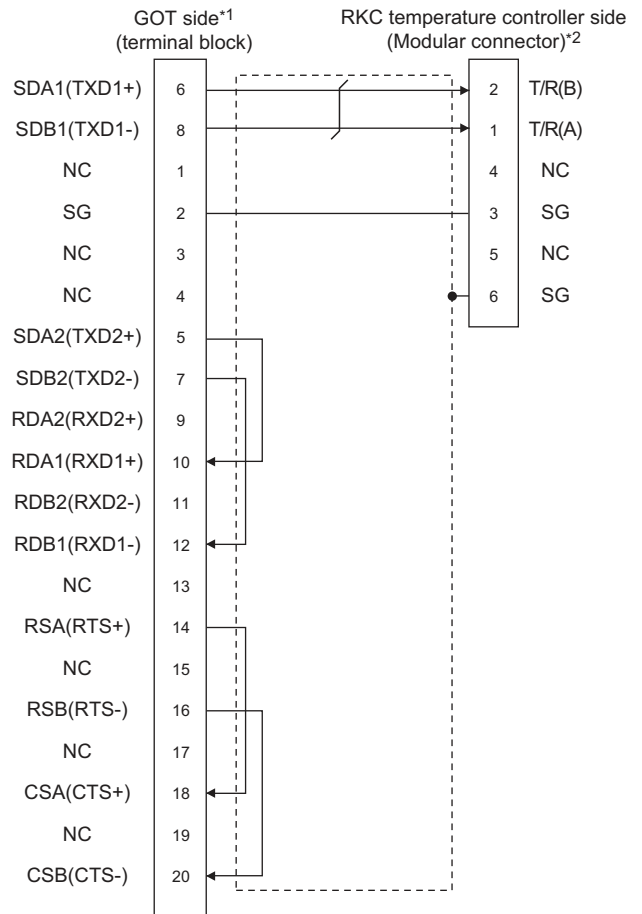

*1 Set the terminating resistor setting switch of the GOT main unit to "100 OHM".

■ Connecting terminating resistors

*2 For details of the pin assignment, refer to the following manual.

☞ User's Manual of the RKC temperature controller

(4) RS-485 connection diagram 4)

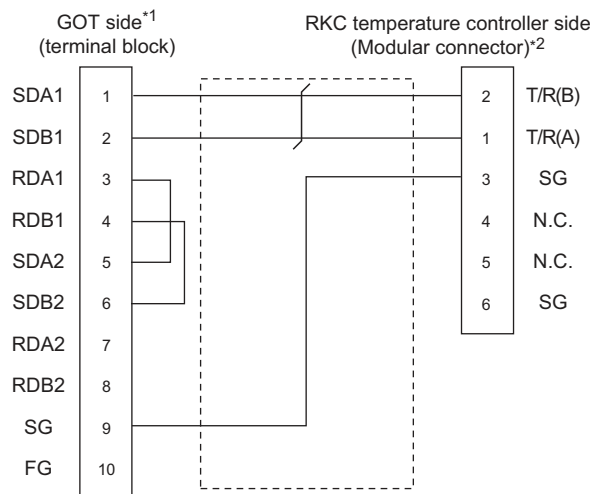

*1 Set the terminating resistor setting switch of the GOT main unit to "100 OHM".

■ Connecting terminating resistors

*2 For details of the pin assignment, refer to the following manual.

☞ User's Manual of the RKC temperature controller

(5) RS-485 connection diagram 5)

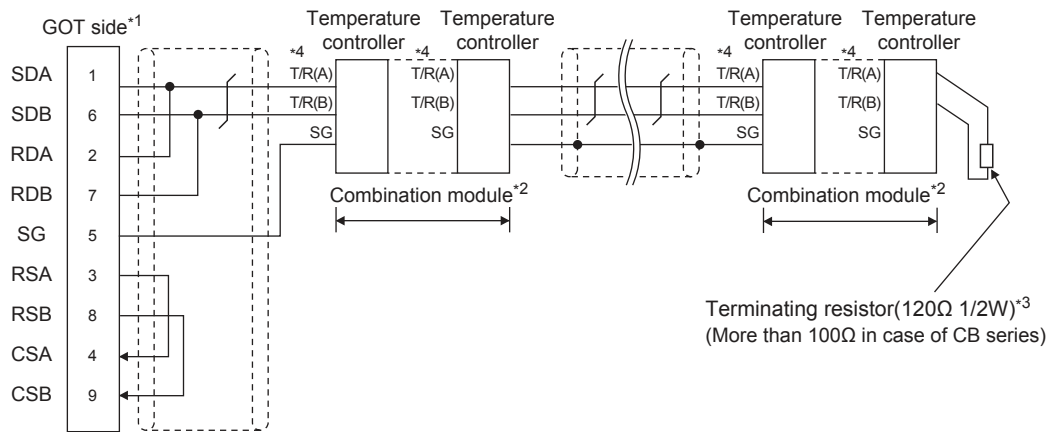

- *1 Set the terminating resistor setting switch of the GOT main unit to "100 OHM". ■ Connecting terminating resistors
- *2 When combining the module, because the communication line is connected between the modules with each other, wire only the communication terminal on the both end of the combination module.
- *3 Terminating resistor should be provided for a temperature controller which will be a terminal. When using X-TIO, turn ON the terminating resistor selector in the terminal base. When combining the module, provide the terminating resistor to the end of the combination module (the one that is far from the converter).
- *4 For the terminal number of the temperature controller, refer to the following table.

Signal name	Terminal No.								
	Z-TIO/ Z-CT	CB100/CB400 /CB500/CB900	CB700	FB100		FB400/FB90		RB100/RB400 /RB500/RB900	RB700
				Communication 1	Communication 2	Communication 1	Communication 2		
SG	5	13	7	13	16	25	25	13	25
T/R(A)	3	14	8	14	17	26	28	14	26
T/R(B)	4	15	9	15	18	27	29	15	27

Signal name	Terminal No.									
	PF900 PF901 AG500	HA400/401 HA900/901		MA900/MA901	RMC500	X-TIO	SA100	SA200	SB1	B400 (RS-485 specifications)
		Communication 1	Communication 2							
SG	25	13	25	44	13	17	1	10	1	3/6
T/R(A)	26	14	26	45	14	16	2	11	2	1/5
T/R(B)	27	15	27	46	15	15	3	12	3	2/4

(6) RS-485 connection diagram 6)

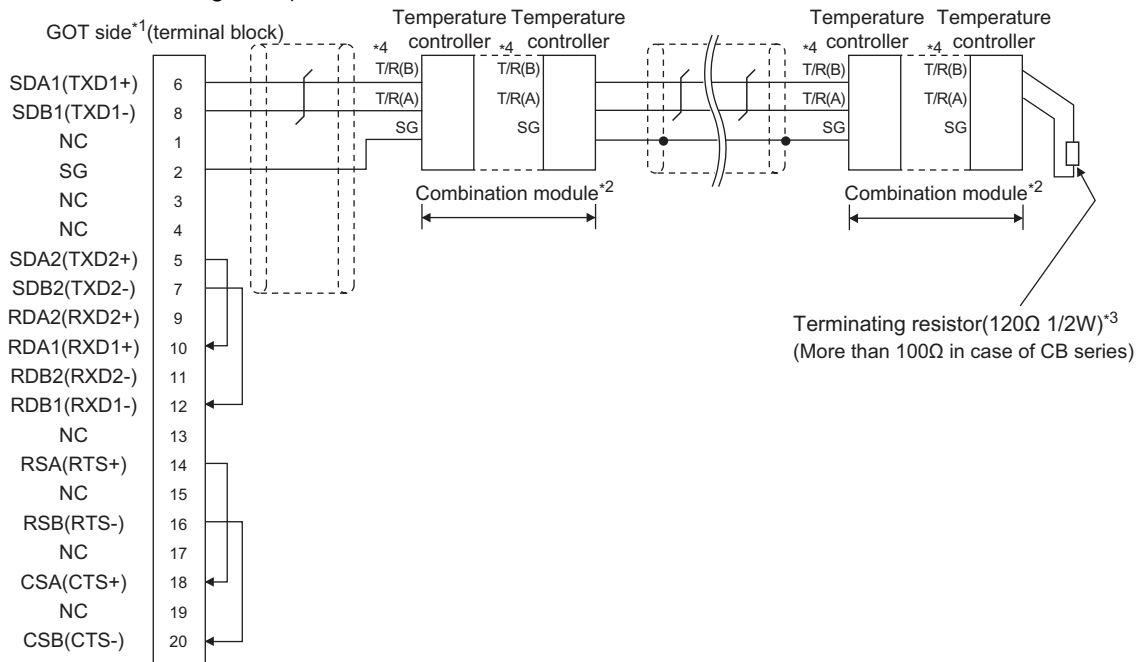

- *1 Set the terminating resistor setting switch of the GOT main unit to "100 OHM". ■ Connecting terminating resistors
- *2 When combining the module, because the communication line is connected between the modules with each other, wire only the communication terminal on the both end of the combination module.
- *3 Terminating resistor should be provided for a temperature controller which will be a terminal. When using X-TIO, turn ON the terminating resistor selector in the terminal base. When combining the module, provide the terminating resistor to the end of the combination module (the one that is far from the converter).
- *4 For the terminal number of the temperature controller, refer to the following table.

Signal name	Terminal No.								
	Z-TIO/ Z-CT	CB100/CB400 /CB500/CB900	CB700	FB100		FB400/FB90		RB100/RB400 /RB500/RB900	RB700
				Communication 1	Communication 2	Communication 1	Communication 2		
SG	5	13	7	13	16	25	25	13	25
T/R(A)	3	14	8	14	17	26	28	14	26
T/R(B)	4	15	9	15	18	27	29	15	27

Signal name	Terminal No.									
	PF900 PF901 AG500	HA400/401 HA900/901		MA900/ MA901	RMC500	X-TIO	SA100	SA200	SB1	B400 (RS-485 specifications)
		Communication 1	Communication 2							
SG	25	13	25	44	13	17	1	10	1	3/6
T/R(A)	26	14	26	45	14	16	2	11	2	1/5
T/R(B)	27	15	27	46	15	15	3	12	3	2/4

(7) RS-485 connection diagram 7)

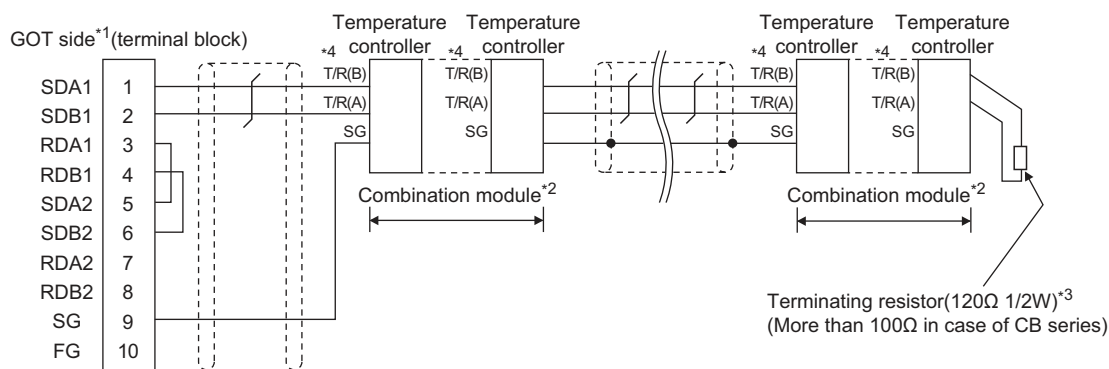

*1 Set the terminating resistor setting switch of the GOT main unit to "100 OHM".

■ Connecting terminating resistors

- *2 When combining the module, because the communication line is connected between the modules with each other, wire only the communication terminal on the both end of the combination module.
- *3 Terminating resistor should be provided for a temperature controller which will be a terminal. When using X-TIO, turn ON the terminating resistor selector in the terminal base. When combining the module, provide the terminating resistor to the end of the combination module (the one that is far from the converter).
- *4 For the terminal number for connecting to FB series or RB series, refer to the table below.

Signal name	Terminal No.								
	Z-TIO/ Z-CT	CB100/CB400 /CB500/CB900	CB700	FB100		FB400/FB90		RB100/RB400 /RB500/RB900	RB700
				Communication 1	Communication 2	Communication 1	Communication 2		
SG	5	13	7	13	16	25	25	13	25
T/R(A)	3	14	8	14	17	26	28	14	26
T/R(B)	4	15	9	15	18	27	29	15	27

Signal name	Terminal No.									
	PF900 PF901 AG500	HA400/401 HA900/901		MA900/ MA901	RMC500	X-TIO	SA100	SA200	SB1	B400 (RS-485 specifications)
		Communication 1	Communication 2							
SG	25	13	25	44	13	17	1	10	1	3/6
T/R(A)	26	14	26	45	14	16	2	11	2	1/5
T/R(B)	27	15	27	46	15	15	3	12	3	2/4

(8) RS-485 connection diagram 8)

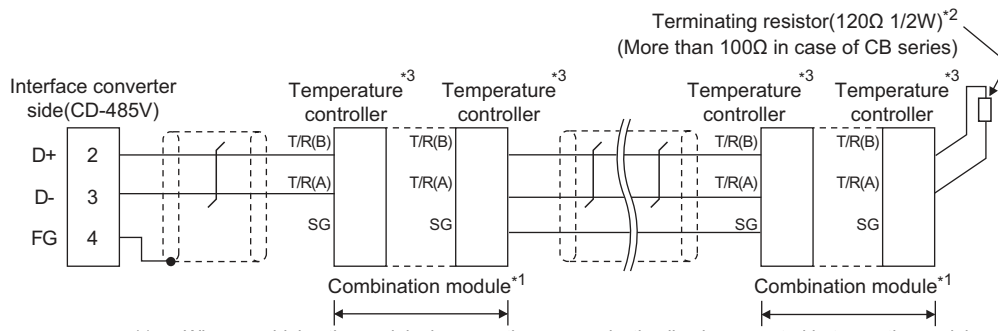

- *1 When combining the module, because the communication line is connected between the modules with each other, wire only the communication terminal on the both end of the combination module.
- *2 Terminating resistor should be provided for a temperature controller which will be a terminal. When using X-TIO, turn ON the terminating resistor selector in the terminal base. When combining the module, provide the terminating resistor to the end of the combination module (the one that is far from the converter).
- *3 For the terminal number of the temperature controller, refer to the following table.

Signal name	Terminal No.								
	Z-TIO/ Z-CT	CB100/CB400 /CB500/CB900	CB700	FB100		FB400/FB90		RB100/RB400 /RB500/RB900	RB700
				Communication 1	Communication 2	Communication 1	Communication 2		
SG	5	13	7	13	16	25	25	13	25
T/R(A)	3	14	8	14	17	26	28	14	26
T/R(B)	4	15	9	15	18	27	29	15	27

Signal name	Terminal No.								
	PF900 PF901 AG500	HA400/401 HA900/901		MA900/MA901	RMC500	THV-A1 ⁴	X-TIO	SA100	SA200
		Communication 1	Communication 2						
SG	25	13	25	44	13	3	17	1	10
T/R(A)	26	14	26	45	14	1	16	2	11
T/R(B)	27	15	27	46	15	2	15	3	12

- *4 The following shows the pin assignment of the modular connector.

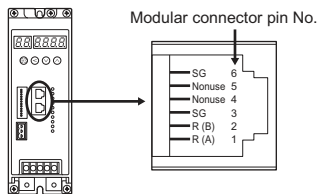

(9) RS-485 connection diagram 9)

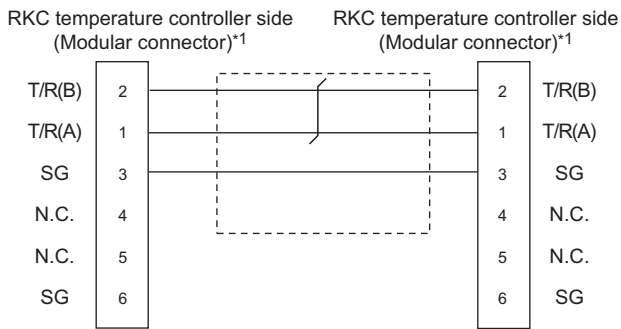

*1 For details of the pin assignment, refer to the following manual.

User's Manual of the RKC temperature controller

■ Precautions when preparing a cable

(10) Cable length

The length of the RS-485 cable must be 1200m or less.

(11) GOT side connector

For the GOT side connector, refer to the following.

1.4.1 GOT connector specifications

(12) RKC temperature controller side connector

Use the connector compatible with the RKC temperature controller side module.

For details, refer to user's manual of the RKC temperature controller.

■ Connecting terminating resistors

(1) GOT side

Set the terminating resistor by operating the terminating resistor setting switch.

For the procedure to set the terminating resistor, refer to the following.

1.4.3 Terminating resistors of GOT

9.4 GOT Side Settings

9.4.1 Setting communication interface (Communication settings)

Set the channel of the connected equipment.

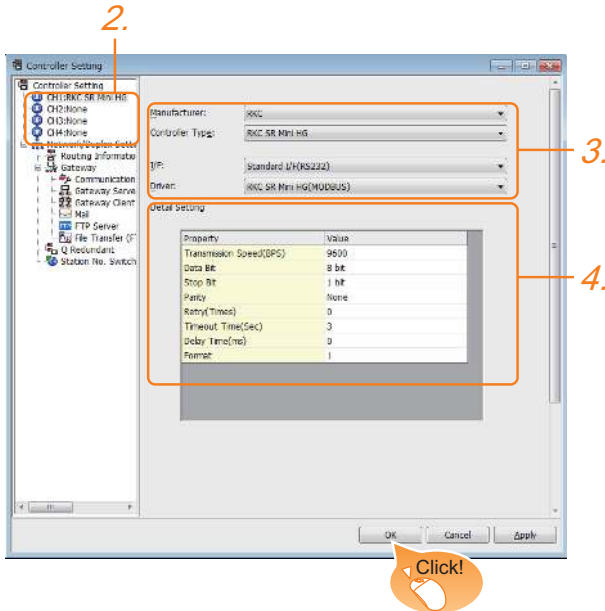

1. Select [Common] → [Controller Setting] from the menu.
2. The Controller Setting window is displayed. Select the channel to be used from the list menu.
3. Set the following items.
 - Manufacturer: RKC
 - Controller Type: RKC SR Mini HG
 - I/F: Interface to be used
 - Driver: RKC SR Mini HG(MODBUS)
4. The detailed setting is displayed after Manufacturer, Controller Type, I/F, and Driver are set. Make the settings according to the usage environment.

☞ 9.4.2 Communication detail settings

Click the [OK] button when settings are completed.

POINT

The settings of connecting equipment can be confirmed in [I/F Communication Setting]. For details, refer to the following.

☞ 1.1.2 I/F communication setting

9.4.2 Communication detail settings

Property	Value
Transmission Speed(BPS)	9600
Data Bit	8 bit
Stop Bit	1 bit
Parity	None
Retry(Times)	0
Timeout Time(Sec)	3
Delay Time(ms)	0
Format	1

Item	Description	Range
Transmission Speed	Set this item when change the transmission speed used for communication with the connected equipment. (Default: 9600bps)	9600bps, 19200bps, 38400bps, 57600bps, 115200bps
Data Bit	Set this item when change the data length used for communication with the connected equipment. (Default: 8bits)	7bits/8bits
Stop Bit	Set this item when change the data length used for communication with the connected equipment. (Default: 1bit)	1bit/2bits
Parity	Specify whether or not to perform a parity check, and how it is performed during communication. (Default: No)	None Even Odd
Retry	Set the number of retries to be performed when a communication error occurs. (Default: 0time)	0 to 5times
Timeout Time	Set the time period for a communication to time out. (Default: 3sec)	3 to 30sec
Delay Time	Set this item to adjust the transmission timing of the communication request from the GOT. (Default: 0ms)	0 to 300ms
Format	Select the communication format. (Default: 1) Format 1: Accessible to H-PCP-J, H-PCP-A, H-PCP-B, SRZ, FB, PF, HA, MA, RMC, SRX, B400 series Format 2: Accessible to CB series, RB, AG, THV, SA, SB1 series	1/2

POINT

- (1) Communication interface setting by the Utility
The communication interface setting can be changed on the Utility's [Communication setting] after writing [Communication Settings] of project data.
For details on the Utility, refer to the following manual.

 GOT2000 Series User's Manual (Utility)

- (2) Precedence in communication settings
When settings are made by GT Designer3 or the Utility, the latest setting is effective.
-

9.5 Temperature Controller Side Setting

POINT

YOKOGAWA temperature controller
For details of RKC temperature controller, refer to the following manual.

 User's Manual of the RKC temperature controller

Model name	Refer to
H-PCP-J	9.5.1
H-PCP-A, H-PCP-B	9.5.2
Z-TIO module, Z-DIO module, Z-CT module	9.5.3
Z-COM module	9.5.4
CB Series	9.5.5
FB Series	9.5.6
RB Series	9.5.7
PF900/901	9.5.8
HA400/401, HA900/901	9.5.9
AG500	9.5.10
RMC500	9.5.11
MA900, MA901	9.5.12
THV-A1	9.5.13
SA100 SA200	9.5.14
X-TIO module	9.5.15

Temperature controller

9.5.1 Connecting to H-PCP-J

Communication settings

Make the communication settings of the temperature controller.

Item	Setting range
Transmission speed ^{*1}	9600bps, 19200bps, 38400bps
Communication mode	MODBUS
Data bit	8bits
Parity bit	None
Stop bit ^{*1}	1bit
Unit address ^{*2}	0 to F

*1 Adjust the settings with GOT settings.

*2 Select the unit address without overlapping with that of other units.

Setting DIP switches

Make the settings of transmission speed, communication mode, data length, parity bit and stop bit.

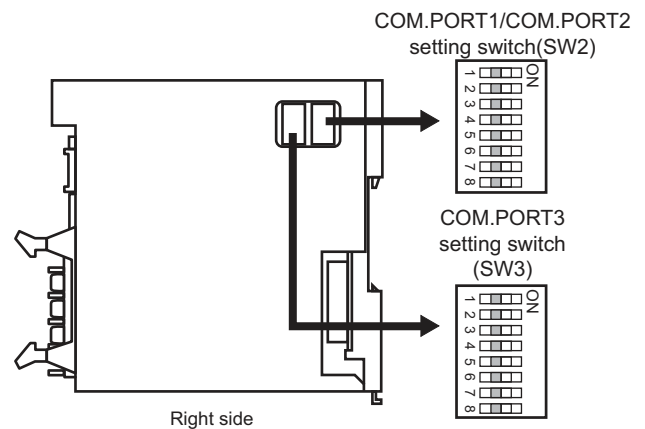
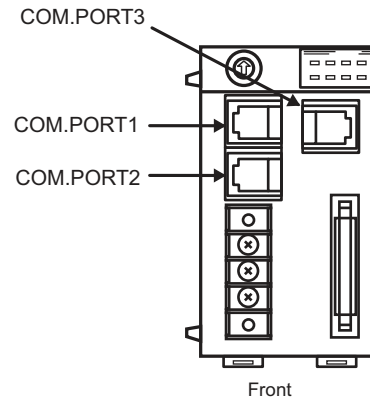

(1) Transmission speed settings

(a) COM.PORT1/COM.PORT2

SW2		Communication speed
3	4	
OFF	OFF	9600bps
ON	OFF	19200bps
OFF	ON	38400bps

(b) COM.PORT3

SW3		Communication speed
3	4	
OFF	OFF	9600bps
ON	OFF	19200bps
OFF	ON	38400bps

(2) Communication mode settings

(a) COM.PORT1/COM.PORT2

SW2				Communication protocol
5	6	7	8	
ON	OFF	OFF	OFF	MODBUS protocol

(b) COM.PORT3

SW3		Communication protocol
5		
ON		MODBUS protocol

(3) Settings of data length, parity bit, and stop bit

(a) COM.PORT1/COM.PORT2

SW2		Data bit configuration
1	2	
OFF	OFF	Data 8-bit, Non parity, Stop 1bit

(b) COM.PORT3

SW3		Data bit configuration
1	2	
OFF	OFF	Data 8-bit, Non parity, Stop 1bit

■ Unit address settings

Set the unit address using the unit address setting switch.

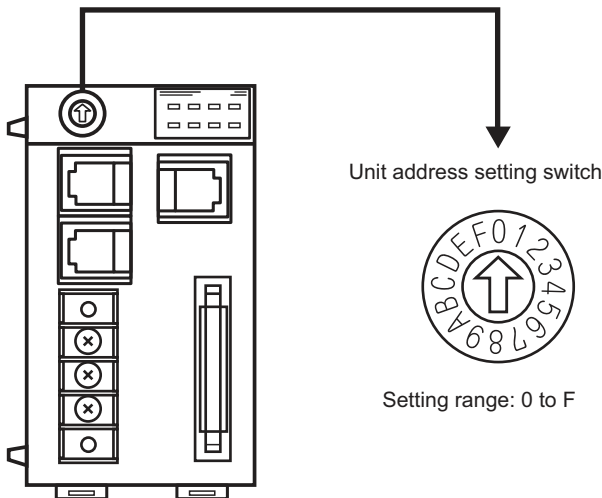

9.5.2 Connecting to H-PCP-A, H-PCP-B

■ Communication settings

Make the communication settings of the temperature controller.

Item	Setting range
Transmission speed*1	9600bps, 19200bps
Data bit	8bits
Parity bit	None
Unit address*2	0 to F

*1 Adjust the settings with GOT settings.

*2 Select the unit address without overlapping with that of other units.

■ Setting DIP switches

Make the settings of transmission speed, data length, parity bit, and stop bit.

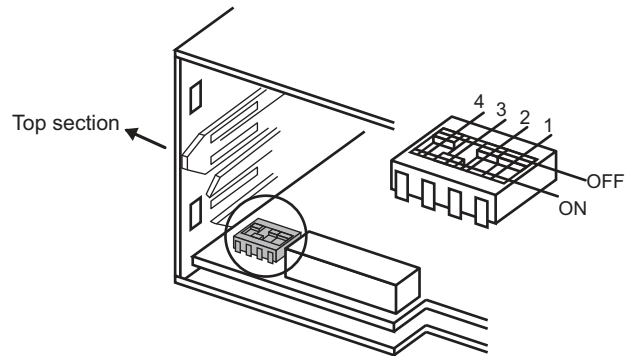

Rear view of module mainframe with mother block removed

(1) Transmission speed settings

3	4	Communication speed
OFF	ON	9600bps
ON	ON	19200bps

(2) Settings of data length and parity bit

1	2	Data bit configuration
OFF	OFF	Data 8-bit, Non parity

■ Unit address settings

Set the unit address using the unit address setting switch.

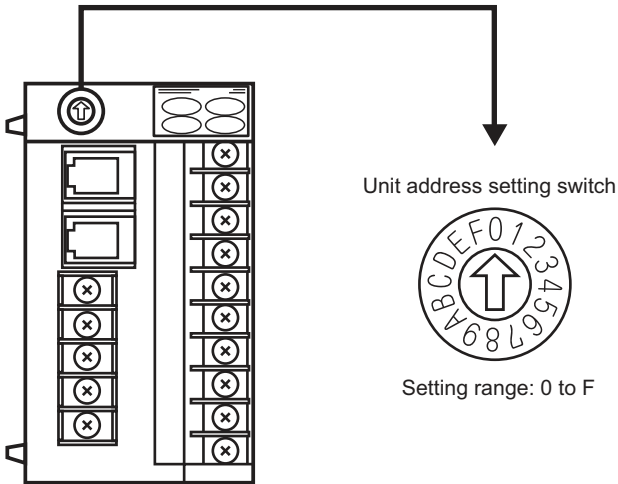

9.5.3 Connecting to Z-TIO, Z-DIO, Z-CT

(1) Communication settings

Make the communication settings of the temperature controller.

Item	Setting range
Communication speed*1	9600bps, 19200bps, 38400bps
Communication protocol	MODBUS
Data bit configuration	Data bit : 8bits, Parity : None
	Data bit : 8bits, Parity : Even
	Data bit : 8bits, Parity : Odd
	Stop bit : 1bit (fixed)
Unit address*2	0 to F
Interval time	0 to 250ms

*1 Adjust the settings with GOT settings.
 *2 Select the module address without overlapping with that of other units.

(2) Setting DIP switches

Make the settings of transmission speed, data bit configuration, communication protocol

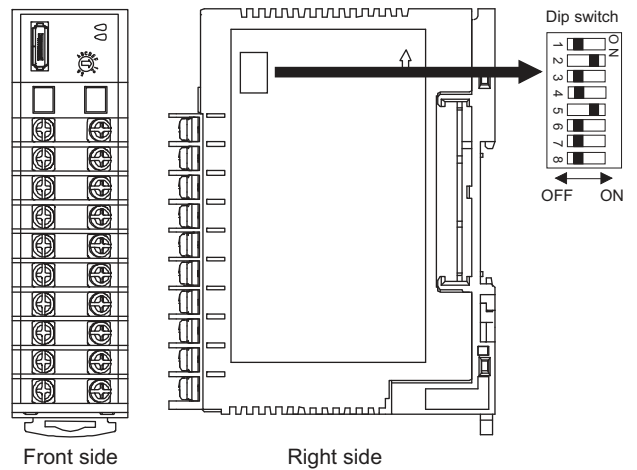

Setting item	Set value	Switch position					
		1	2	3	4	5	6
Communication speed	9600bps	ON	OFF				
	19200bps	OFF	ON				
	38400bps	ON	ON				
Data bit configuration	Data bit: 8bits, Parity: None			OFF	OFF	ON	
	Data bit: 8bits, Parity: Even			OFF	ON	ON	
	Data bit: 8bits, Parity: Odd			ON	ON	ON	
Communication protocol	MODBUS						ON

(3) Unit address settings

Set the unit address using the unit address setting switch.

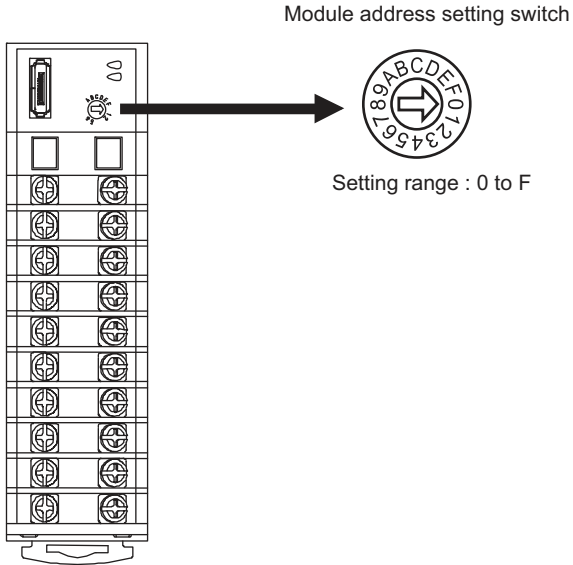

(4) Interval time settings

Configure the interval time setting using the RKC communication setting tool (WinPCI).
After the communication is started, set as follows.

Setting item	Set value
Instrument	0
CFG file	ZTIO_rkc.cfg
Interval time	0 to 250ms

For the using method of RKC communication setting tool, refer to the following.

RKC communication setting tool user's manual

9.5.4 Connecting to Z-COM

(1) Communication settings

Item	Setting range
Communication speed*1	9600bps, 19200bps, 38400bps
Communication protocol	Host (MODBUS)
Data bit	8bits (fixed)
Parity	None (fixed)
Stop bit	1bit (fixed)
Unit address*2	0 to F
Interval time	0 to 250ms
Dip switch settings valid / invalid	valid

*1 Adjust the settings with GOT settings.

*2 Select the unit address without overlapping with that of other units.

(2) Setting DIP switches

Make the settings of transmission speed, data bit configuration, communication protocol.

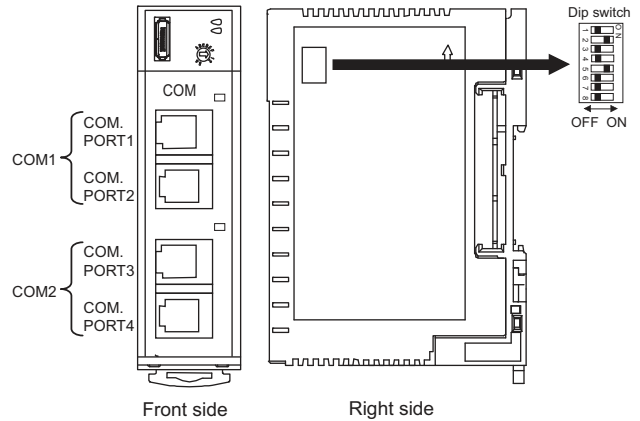

Setting item	Set value	Switch position							
		1	2	3	4	5	6	7	8
Communication speed (COM1)	9600bps	ON	OFF						
	19200bps	OFF	ON						
	38400bps	ON	ON						
Communication protocol (COM1)	Host (MODBUS)			ON					
Communication speed (COM2)	9600bps				OFF				
	19200bps				ON				
Communication protocol (COM2)	Host (MODBUS)					ON	OFF	OFF	
Dip switch settings valid / invalid	valid								OFF

9.5.6 Connecting to FB Series

(3) Unit address settings

Set the unit address using the unit address setting switch.

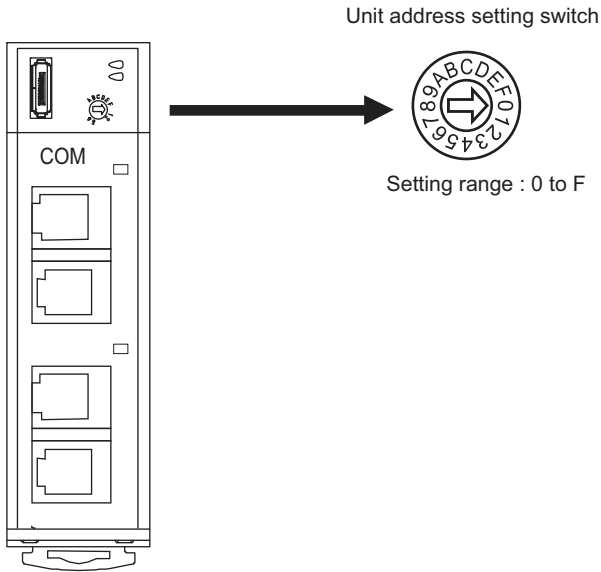

(4) Interval time settings

Configure the interval time setting using the RKC communication setting tool (WinPCI). After the communication is started, set as follows.

Setting item	Set value
Instrument	0
CFG file	ZCOM_rkc.cfg
Communication 1 interval time	0 to 250ms
Communication 2 interval time	

For the using method of RKC communication setting tool, refer to the following.

RKC communication setting tool user's manual

(1) Communication settings

Item ^{*1}	Setting range ^{*1}
Communication protocol	1: MODBUS
Device address (Slave address) ^{*2}	1 to 99
Communication speed ^{*3}	96: 9600bps 19.2: 19200bps 38.4: 38400bps
Data bit configuration	(2) Refer to the data bit configuration.
Interval time	0 to 250

- *1 Items and setting range are common to communication 1 and communication 2.
- *2 When the setting value is set to 0, a communication is not made.
- *3 Adjust the settings with GOT settings.

(2) Data bit configuration

Set value	Data bit	Parity bit	Stop bit
8n1	8	None	1
8n2	8	None	2
8E1	8	Even	1
8E2	8	Even	2
8o1	8	Odd	1
8o2	8	Odd	2

(3) Communication setting mode

Set the communication setting mode using the operation panel of the FB series main unit.

For details of the communication setting mode, refer to the following.

FB series "Communication Instruction Manual"

9.5.5 Connecting to CB Series

(1) Communication settings

Item	Setting range
Device address ^{*1}	1 to 99
Communication speed ^{*2}	2: 9600bps 3: 19200bps
Data bit configuration	0: 8/1/None 6: 8/1/Even 7: 8/1/Odd
Interval time	0 to 150

- *1 When the setting value is set to 0, a communication is not made.
- *2 Adjust the settings with GOT settings.

(2) Communication setting mode

Set the communication setting mode using the operation panel of the CB series main unit.

For details of the communication setting mode, refer to the following.

CB series "Communication Instruction Manual"

9.5.7 Connecting to RB Series

(1) Communication settings

Item	Setting range
Communication protocol	1: MODBUS
Device address (Slave address) ^{*1}	1 to 99
Communication speed ^{*2}	2: 9600bps 3: 19200bps
Data bit configuration	(2) Refer to the data bit configuration.
Interval time	0 to 250

*1 When the setting value is set to 0, a communication is not made.

*2 Adjust the settings with GOT settings.

(2) Data bit configuration

Set value	Data bit	Parity bit	Stop bit
0	8	None	1
1	8	None	2
2	8	Even	1
3	8	Even	2
4	8	Odd	1
5	8	Odd	2

(3) Communication setting mode

Set the communication setting mode using the operation panel of the RB series main unit.

For details of the communication setting mode, refer to the following.

 RB series "Communication Instruction Manual"

9.5.8 Connecting to PF900/900

■ Communication settings

Make the communication settings by operating the key of the temperature controller.

Item	Setting range
Communication speed 1 ^{*1}	9600bps, 19200bps, 38400bps, 57600bps
Communication protocol 1	MODBUS
Data bit configuration 1 ^{*1} (Data bit, Parity bit, Stop bit)	[8N1]: 8bit, None, 1bit [8N2]: 8bit, None, 2bit [8E1]: 8bit, Even, 1bit [8E2]: 8bit, Even, 2bit [8O1]: 8bit, Odd, 1bit [8O2]: 8bit, Odd, 2bit
Device address 1 ^{*2} (Slave address 1)	1 to 99 ^{*4}
Interval time ^{*3}	0 to 250 (ms)

*1 Adjust the settings with GOT settings.

*2 Select the device address1 without overlapping with that of other units.

*3 Set the maximum time from the sending of the last character stop bit from the GOT side until the switching of the GOT side to the receiving status (until the temperature controller becomes ready to send). Set as necessary.

*4 When the setting value is set to 0, a communication is not made.

9.5.9 Connecting to HA400/401, HA900/901

■ Communication settings

Make the communication settings by operating the key of the temperature controller.

(Communication 1)

Item	Setting range
Communication speed 1 ^{*1}	9600bps, 19200bps, 38400bps
Data bit configuration 1 ^{*1} (Data bit, Parity bit, Stop bit)	[8N1]: 8bit, None, 1bit [8N2]: 8bit, None, 2bit [8E1]: 8bit, Even, 1bit [8E2]: 8bit, Even, 2bit [8O1]: 8bit, Odd, 1bit [8O2]: 8bit, Odd, 2bit
Device address 1 ^{*2} (Slave address 1)	1 to 99 ^{*4}
Interval time ^{*3}	0 to 250 (ms)

(Communication 2)

Item	Setting range
Communication speed 2 ^{*1}	9600bps, 19200bps, 38400bps
Data bit configuration 2 ^{*1} (Data bit, Parity bit, Stop bit)	[8N1]: 8bit, None, 1bit [8N2]: 8bit, None, 2bit [8E1]: 8bit, Even, 1bit [8E2]: 8bit, Even, 2bit [8O1]: 8bit, Odd, 1bit [8O2]: 8bit, Odd, 2bit
Device address 2 ^{*2} (Slave address 2)	1 to 99 ^{*4}
Interval time ^{*3}	0 to 250 (ms)

*1 Adjust the settings with GOT settings.

*2 Select the device address1/2 without overlapping with that of other units.

*3 Set the maximum time from the sending of the last character stop bit from the GOT side until the switching of the GOT side to the receiving status (until the temperature controller becomes ready to send). Set as necessary.

*4 When the setting value is set to 0, a communication is not made.

9.5.10 Connecting to AG500

■ Communication settings

Make the communication settings by operating the key of the temperature controller.

Item	Setting range
Communication speed ^{*1}	9600bps, 19200bps, 38400bps
Communication protocol	MODBUS
Data bit configuration ^{*1} (Data bit, Parity bit, Stop bit)	[8N1]: 8bit, None, 1bit [8N2]: 8bit, None, 2bit [8E1]: 8bit, Even, 1bit [8E2]: 8bit, Even, 2bit [8O1]: 8bit, Odd, 1bit [8O2]: 8bit, Odd, 2bit
Device address ^{*2} (Slave address)	1 to 99 ^{*4}
Interval time ^{*3}	0 to 250 (ms)

- *1 Adjust the settings with GOT settings.
- *2 Select the device address1 without overlapping with that of other units.
- *3 Set the maximum time from the sending of the last character stop bit from the GOT side until the switching of the GOT side to the receiving status (until the temperature controller becomes ready to send). Set as necessary.
- *4 When the setting value is set to 0, a communication is not made.

9.5.11 Connecting to RMC500

■ Communication settings

Make the communication settings by operating the key of the temperature controller.

Item	Setting range
Communication speed ^{*1}	9600bps, 19200bps, 38400bps
Communication protocol	MODBUS
MODBUS data ^{*2} Extension time	0 to 255 (ms)
Data bit configuration ^{*1} (Data bit, Parity bit, Stop bit)	[8N1]: 8bit, None, 1bit [8N2]: 8bit, None, 2bit [8E1]: 8bit, Even, 1bit [8E2]: 8bit, Even, 2bit [8O1]: 8bit, Odd, 1bit [8O2]: 8bit, Odd, 2bit
Device address ^{*3} (Slave address)	1 to 99 ^{*4}
Interval time ^{*5}	0 to 250 (ms)

- *1 Adjust the settings with GOT settings.
- *2 Set the extension time for the data interval time in the MODBUS communication (which is lower than 24 bit time). Set when the data time interval exceeds 24 bit time.
- *3 Select the device address without overlapping with that of other units.
- *4 When the setting value is set to 0, a communication is not made.
- *5 Set the maximum time from the sending of the last character stop bit from the GOT side until the switching of the GOT side to the receiving status (until the temperature controller becomes ready to send). Set as necessary.

9.5.12 Connecting to MA900, MA901

■ Communication settings

Make the communication settings by operating the key of the temperature controller.

Item	Setting range
Communication speed ^{*1}	9600bps, 19200bps
Data bit configuration ^{*1} (Data bit, Parity bit, Stop bit)	[8N1]: 8bit, None, 1bit [8N2]: 8bit, None, 2bit [8E1]: 8bit, Even, 1bit [8E2]: 8bit, Even, 2bit [8O1]: 8bit, Odd, 1bit [8O2]: 8bit, Odd, 2bit
Device address ^{*2} (Slave address)	1 to 99 ^{*4}
Interval time ^{*3}	0 to 250 (ms)

- *1 Adjust the settings with GOT settings.
- *2 Select the device address1 without overlapping with that of other units.
- *3 Set the maximum time from the sending of the last character stop bit from the GOT side until the switching of the GOT side to the receiving status (until the temperature controller becomes ready to send). Set as necessary.
- *4 When the setting value is set to 0, a communication is not made.

9.5.13 Connecting to THV-A1

■ Communication settings

Make the communication settings by operating the key of the temperature controller.

Item	Setting range
Communication speed ^{*1}	9600bps (fixed)
Data bit configuration ^{*1}	Data bit: 8bit (fixed) Parity bit: None (fixed) Stop bit: 1bit (fixed)
Device address ^{*2} (Slave address)	1 to 99 ^{*4}
Interval time ^{*3}	0 to 250 (ms)

- *1 Adjust the settings of the GOT side with the temperature controller settings.
- *2 Select the device address1 without overlapping with that of other units.
- *3 Set the maximum time from the sending of the last character stop bit from the GOT side until the switching of the GOT side to the receiving status (until the temperature controller becomes ready to send). Set as necessary.
- *4 When the setting value is set to 0, a communication is not made.

9.5.14 Connecting to SA100/SA200

■ Communication settings

Make the communication settings by operating the key of the temperature controller.

Item	Setting range
Communication speed ^{*1}	9600bps, 19200bps
Data bit configuration ^{*1} (Data bit, Parity bit, Stop bit)	[8N1]: 8bit, None, 1bit [8N2]: 8bit, None, 2bit [8E1]: 8bit, Even, 1bit [8E2]: 8bit, Even, 2bit [8O1]: 8bit, Odd, 1bit [8O2]: 8bit, Odd, 2bit
Device address ^{*2} (Slave address)	1 to 99 ^{*4}
Interval time ^{*3}	0 to 250 (ms)

*1 Adjust the settings with GOT settings.

*2 Select the device address1 without overlapping with that of other units.

*3 Set the maximum time from the sending of the last character stop bit from the GOT side until the switching of the GOT side to the receiving status (until the temperature controller becomes ready to send). Set as necessary.

*4 When the setting value is set to 0, a communication is not made.

9.5.15 Connecting to X-TIO Module

(1) Communication settings

Make the communication settings of the temperature controller.

Item	Setting range
Communication speed ^{*1}	9600bps, 19200bps, 38400bps
Communication protocol	MODBUS
Data bit configuration	Data bit: 8bit, Parity: None Data bit: 8bit, Parity: Even Data bit: 8bit, Parity: Odd Stop bit: 1bit (fixed)
Module address ^{*2}	1 to 99
Internal data bus terminating resistor	When combining the module, turn ON the internal data bus terminating resistor at both ends of the module.
Data interval extension time	0 to 99ms

*1 Adjust the settings with GOT settings.

*2 When the setting value is set to 0, a communication is not made.

(2) Setting DIP switches

Make the settings of transmission speed, data bit configuration, communication protocol.

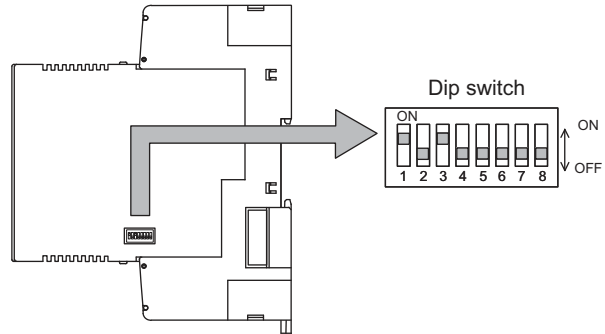

Setting item	Set value	Switch position								
		1	2	3	4	5	6	7	8	
Communication speed	9600bps	ON	OFF							
	19200bps	OFF	ON							
	38400bps	ON	ON							
Data bit configuration	Data bit: 8bit, Parity: None			ON	OFF	OFF				
	Data bit: 8bit, Parity: Even			ON	OFF	ON				
	Data bit: 8bit, Parity: Odd			ON	ON	ON				
Communication protocol	MODBUS							ON		
Internal data bus terminating resistor setting	OFF									OFF
	ON									ON
Data interval extension time	0 to 99ms				ON	OFF	ON			

(3) Module address settings

Set the unit address using the rotary switch (address setting switch).

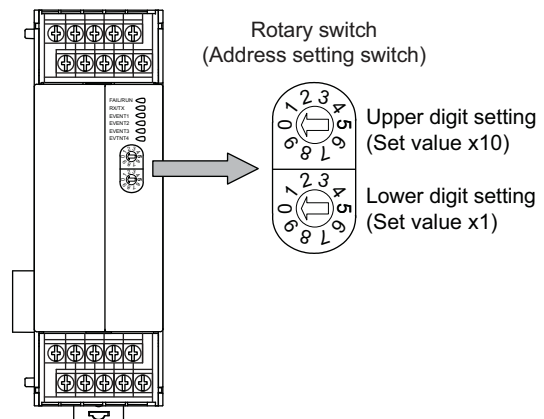

HINT

The rotary switch (address setting switch) is also used for the data interval extension time setting. The setting method is the same as that of the module address. For the data interval extension time, refer to the following.

 (4) Data interval extension time settings

(4) Data interval extension time settings
Set the data interval extension time as the following procedure.

1. Turn the power of the module OFF.
2. Set the DIP switch 4 and 6 to ON and 5 to OFF.
3. Set the data interval extension time using the rotary switch (address setting switch).
For the setting method, refer to the following.
 (3) Module address settings
4. Turn the power of the module ON.
The FAIL/RUN lamp lights in green and the set time becomes valid.
5. Turn the power of the module OFF again and set the DIP switches and rotary switch to the original position.

9.5.16 Connecting to SB1

■ Communication settings

Make the communication settings of SB1 using the switch key on the front surface. For the operation procedure, refer to the SB1 manual.

Item	Setting range
Communication protocol*2	0: RKC communication 1: MODBUS
Device address**1*3 (Slave address)	0 to 99
Communication speed*1*4	0: 2400bps 1: 4800bps 2: 9600bps 3: 19200bps
Data bit configuration**1*5	0 to 5
Interval time*6	0 to 250ms

- *1 Adjust the settings with GOT settings.
- *2 Select 1: MODBUS.
- *3 When the setting value is 0, communication is not performed.
- *4 The communication speed cannot be set to 2400bps or 4800bps on the GOT side. Select 2 or 3.
- *5 For details on the data bit configuration, refer to the following.

Set value	Data bit	Parity bit	Stop bit
0	8	None	1
1	8	None	2
2	8	Even	1

Set value	Data bit	Parity bit	Stop bit
3	8	Even	2
4	8	Odd	1
5	8	Odd	2

*6 Set the maximum time from when the last character stop bit is sent from the GOT side until the transmission cable becomes ready to receive.

9.5.17 Connecting to B400

■ Communication settings

Make the communication settings of B400 using the rotary switch key and the DIP switch. For the operation procedure, refer to the B400 manual.

Item	Setting range	Settings
Unit address setting (CH1 to CH8)	0 to 99*1	(1) Rotary switch setting (SW1, SW2)
Communication speed	4800bps, 9600bps, 19200bps, 38400bps	(2) DIP switch setting (SW3)
Data bit configuration	0 to 5	(3) DIP switch settings (SW4)
Communication specification setting	RS-422A, RS-485	
Termination resistor setting	Enable, Disable	

*1 When the setting value is 98 or 99, the communication address is the same as for 97.

(1) Rotary switch setting (SW1, SW2)
Set the unit address using the rotary switch.

Rotary switch
(Address setting switch)



SW1: Lower digit setting
(Set value x1)



SW2: Upper digit setting
(Set value x10)

Item	Setting range
Unit address setting (CH1 to CH4)	The communication address is the rotary switch setting value + 1.
Unit address setting (CH5 to CH8)	The communication address is the rotary switch setting value + 2.

(2) DIP switch setting (SW3)

Set the communication speed and the data bit configuration using the DIP switch (SW3).

Dip switch(SW3)

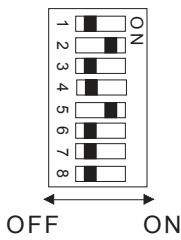

Setting item	Set value	Switch position							
		1	2	3	4	5	6	7	8
Communication speed	4800bps	OFF	OFF						
	9600bps	ON	OFF						
	19200bps	OFF	ON						
	38400bps	ON	ON						
Data bit configuration	Data bit: 8 bits, Parity: None, Stop: 2 bits	-	OFF	OFF					
	Data bit: 8 bits, Parity: None, Stop: 1 bit	-	ON	OFF					
	Data bit: 8 bits, Parity: Even, Stop: 1 bit	-	OFF	ON					
	Data bit: 8 bits, Parity: Odd, Stop: 1 bit	-	ON	ON					

(3) DIP switch settings (SW4)

Set the communication specifications and the termination resistor using the DIP switch (SW4).

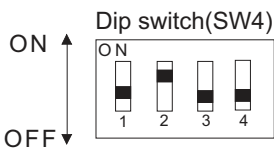

Setting item	Set value	Switch position			
		1	2	3	4
Communication specification setting	RS-422A	OFF	OFF		
	RS485	ON	ON		
Termination resistor setting	Enable				ON
	Disable				OFF

9.5.18 Station number setting

Set each station number so that no station number overlaps.

The station number can be set without regard to the cable connection order. There is no problem even if station numbers are not consecutive.

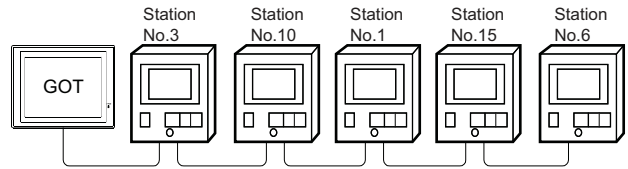

Examples of station number setting

(1) Direct specification

The station number setting range of the temperature controller side differs from that of the GOT side.

Specify the station No. of the temperature controller to be changed when setting devices referring the following table.

Temperature controller	Module address setting of temperature controller side	GOT side station number setting	Remark
H-PCP-J H-PCP-A H-PCP-B Z-TIO Z-COM	0 to F (Hexadecimal)	1 to 16 (Decimal)	The GOT side station number setting is the module address setting value +1.
Z-DIO	0 to F (Hexadecimal)	17 to 32 (Decimal)	The GOT side station number setting is the module address setting value +17.
Z-CT	0 to F (Hexadecimal)	33 to 48 (Decimal)	The GOT side station number setting is the module address setting value +33.
X-TIO	1 to 99 (Decimal)	2 to 100 (Decimal)	The GOT side station number setting is the module address setting value +1.
CB, FB, RB, PF, AG, HA, MA, RMC, THV, SA, SB1	1 to 99 (Decimal)	1 to 99 (Decimal)	The GOT side station number setting is the same as the module address setting value.
B400	1 to 99 (Decimal)	1 to 99 (Decimal)	The GOT side station number is the module address setting value +1 or +2.

(2) Indirect specification

When setting the device, indirectly specify the station number of the temperature controller of which data is to be changed using the 16-bit GOT internal data register (GD10 to GD25).

When specifying the station No. from 100 to 115 on GT Designer3, the value of GD10 to GD25 compatible to the station No. specification will be the station No. of the temperature controller.

Specification station NO.	Compatible device	Setting range
100	GD10	1 to 99 For the setting other than the above, error (dedicated device is out of range) will occur.
101	GD11	
102	GD12	
103	GD13	
104	GD14	
105	GD15	
106	GD16	
107	GD17	
108	GD18	
109	GD19	
110	GD20	
111	GD21	
112	GD22	
113	GD23	
114	GD24	
115	GD25	

9.6 Device Range that Can Be Set

The device ranges of controller that can be used for GOT are as follows.

Note that the device ranges in the following tables are the maximum values that can be set in GT Designer3.

The device specifications of controllers may differ depending on the models, even though belonging to the same series. Please make the setting according to the specifications of the controller actually used.

When a non-existent device or a device number outside the range is set, other objects with correct device settings may not be monitored.

■ Setting item

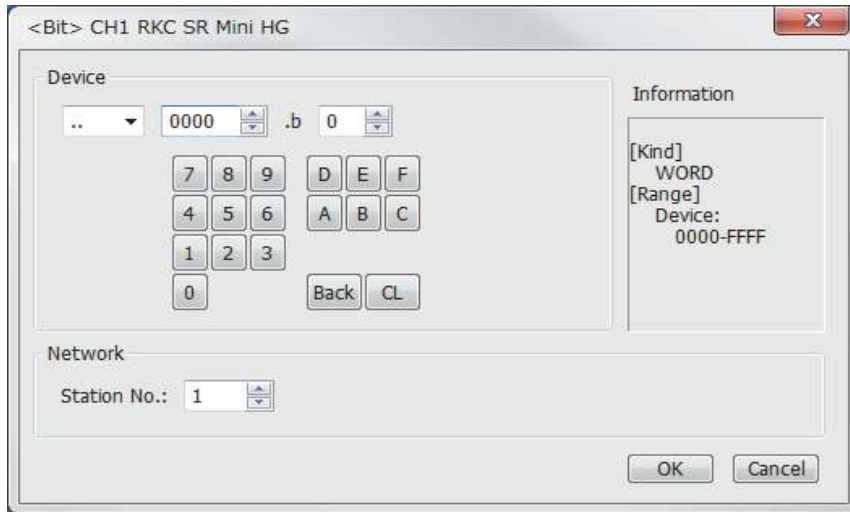

Item	Description
Device	Set the device name, device number, and bit number. The bit number can be set only when specifying the bit of word device.
Information	Displays the device type and setting range which are selected in [Device].
Network	Set the monitor target of the set device.
	Station No. 1 to 99 :To monitor the temperature controller of the specified station No. 100 to 115 To specify the station No. of the temperature controller to be monitored by the value of GOT data register (GD). ^{*1}

*1 The following shows the relation between station numbers of the temperature controller and the GOT data register.

Station No.	GOT data register (GD)	Setting range
100	GD10	1 to 99 (If setting a value outside the range above, a device range error occurs.)
101	GD11	
:	:	
114	GD24	
115	GD25	

POINT

Device settings of RKC temperature controller

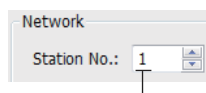

- Set by a value of "unit address + 1".
- For unit address 0: Set "1".
 - For unit address F: Set "16".

9.6.1 RKC SR Mini HG

	Device name	Setting range	Device No. representation
Bit device	Word device bit	Specified bit of the following word devices	—
Word device	Data (..)	..0000 to ..FFFF	Hexadecimal

9.7 Precautions

■ Station number setting of the temperature controller system

Make sure to establish temperature controller system with No.01 station.

■ GOT clock control

Since the temperature controller does not have a clock function, the settings of "time adjusting" or "time broad cast" by GOT clock control will be disabled.

■ Disconnecting some of multiple connected equipment

By setting GOT internal device, GOT can cut the portion of multiple connection of the controller. For example, faulty station that has communication timeout can be cut from the system.

For details of GOT internal device setting, refer to the following manual.

 GT Designer3 (GOT2000) Help

10























CONNECTION TO ALLEN-BRADLEY PLC















10.1 Connectable Model List	10 - 2
10.2 Serial Connection	10 - 4
10.3 Ethernet Connection	10 - 11
10.4 Device Range that Can Be Set	10 - 15

10. CONNECTION TO ALLEN-BRADLEY PLC

10.1 Connectable Model List

The following table shows the connectable models.

Series	Model name	Clock	Communication Type	Connectable model	Refer to
SLC500	SLC500-20	x	RS-232	  	 10.2.1
	SLC500-30				
	SLC500-40				
	SLC5/01				
	SLC5/02	O	RS-232	  	
	SLC5/03				
	SLC5/04				
SLC5/05	x	RS-232	  	 10.2.2	
1761-L10BWA					
1761-L10BWB					
1761-L16AWA					
1761-L16BWA					
1761-L16BWB					
1761-L16BBB					
1761-L32AWA					
1761-L32BWA					
1761-L32BWB					
1761-L32BBB					
1761-L32AAA	x	RS-232	  		
1761-L20AWA-5A					
1761-L20BWA-5A					
1761-L20BWB-5A	x	RS-232	  		
MicroLogix1200	1762-L24BWA	x	RS-232	  	
MicroLogix1500	1764-LSP	x	RS-232	  	

Series	Model name	Clock	Communication Type	Connectable model	Refer to
ControlLogix	1756-L	x	RS-232 Ethernet	  	 10.2.3  10.3.1
	1756-L1M1				
	1756-L1M2				
	1756-L1M3				
	1756-L61				
	1756-L62				
	1756-L63				
	1756-L55M12				
	1756-L55M13				
	1756-L55M14				
	1756-L55M16				
	1756-L55M22				
	1756-L55M23				
	1756-L55M24				
CompactLogix	1769-L31	x	RS-232 Ethernet	  	 10.2.3  10.3.1
	1769-L32E				
	1769-L32C				
	1769-L35E				
	1769-L35CR				
FlexLogix	1794-L33	x	RS-232	  	 10.2.3
	1794-L34				

10.2 Serial Connection

10.2.1 System Configuration for connecting to SLC500 Series

■ When connecting to one PLC

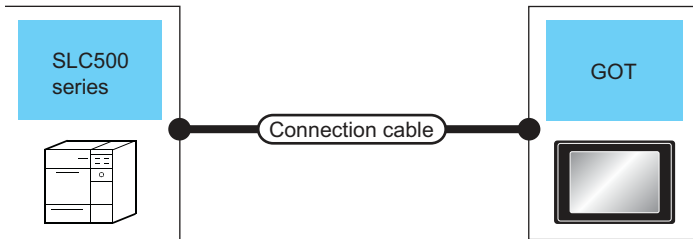

Communication driver

 AB SLC500, AB 1:N
 (For GT16, GT15, GT14, GT12, GT11)

PLC		Connection cable		GOT		Number of connectable equipment
Series	Communication Type	Cable model Connection diagram number	Max. distance	Option device	Model	
SLC500	RS-232	GT09-C30R20701-9S(3m) or RS232 connection diagram 1)	15m	-(Built into GOT)	 	1 GOT for 1 PLC
				GT15-RS2-9P	 	

■ When connecting to multiple PLCs

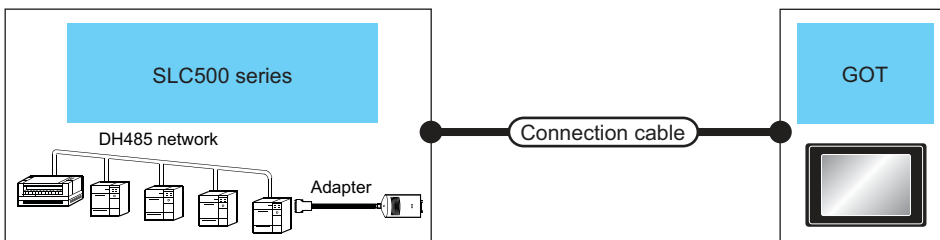

Communication driver

 AB SLC500, AB 1:N
 (For GT16, GT15, GT14, GT12, GT11)

PLC			Connection cable		GOT		Number of connectable equipment
Series	Adapter ^{*1}	Communication Type	Cable model Connection diagram number	Max. distance	Option device	Model	
SLC500	1770-KF3	RS-232	RS232 connection diagram 2)	15m	-(Built into GOT)	 	1 GOT for 1 adapter
					GT15-RS2-9P	 	

*1 Allen-Bradley product manufactured by Rockwell Automation, Inc. For details of the product, contact Rockwell Automation, Inc.

10.2.2 System configuration for connecting to MicroLogix1000/1200/1500 Series

■ When connecting to one PLC

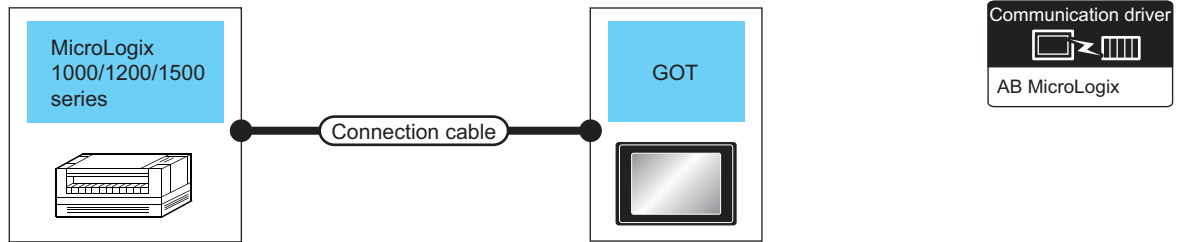

PLC		Connection cable		GOT		Number of connectable equipment
Series ^{*2}	Communication Type	Cable model Connection diagram number	Max. distance	Option device	Model	
MicroLogix1000/ 1200/1500	RS-232	1761-CBL-PM02 ^{*1} (Series C or later) or RS232 connection diagram 3)	15m	- (Built into GOT)	 	1 GOT for 1 PLC
MicroLogix1000/ 1200/1500	RS-232			GT15-RS2-9P	 	

*1 Allen-Bradley product manufactured by Rockwell Automation, Inc. For details of the product, contact Rockwell Automation, Inc.

*2 For MicroLogix1000 (Digital CPU), it is supported in the series D and later.

■ When connecting to multiple PLCs

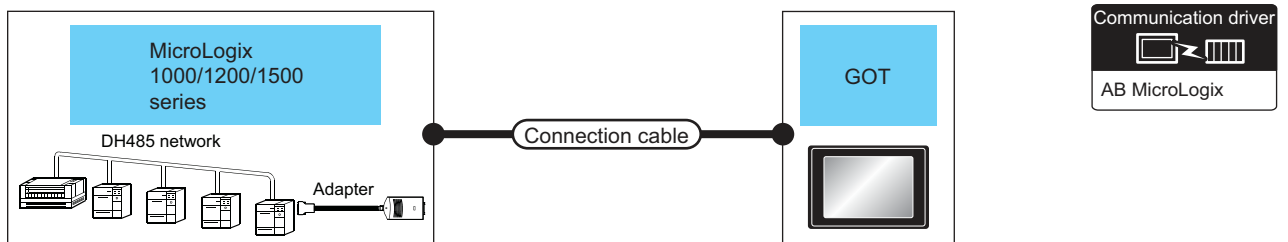







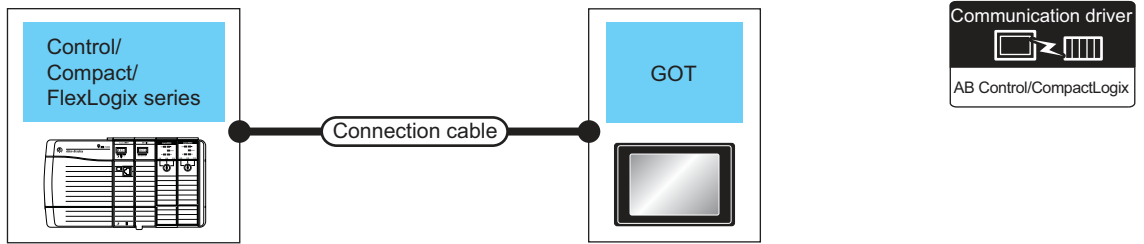

PLC			Connection cable		GOT		Number of connectable equipment
Series ^{*2}	Adapter ^{*1}	Communication Type	Cable model Connection diagram number	Max. distance	Option device	Model	
MicroLogix1000/ 1200/1500	1770-KF3	RS-232	RS232 connection diagram 2)	15m	- (Built into GOT)	 	1 GOT for 1 adapter
					GT15-RS2-9P	 	

*1 Allen-Bradley product manufactured by Rockwell Automation, Inc. For details of the product, contact Rockwell Automation, Inc.

*2 For MicroLogix1000 (Digital CPU), it is supported in the series C and later.

10.2.3 System Configuration for connecting to Control/Compact/FlexLogix Series



PLC		Connection cable		GOT		Number of connectable equipment
Series	Communication Type	Cable model Connection diagram number	Max. distance	Option device	Model	
Control/Compact/ FlexLogix	RS-232	1747-CP3* ¹ 1756-CP3* ¹ or  RS232 connection diagram 4)	15m	- (Built into GOT)	  	1 GOT for 1 PLC
				GT15-RS2-9P	  	

*1 Allen-Bradley product manufactured by Rockwell Automation, Inc. For details of the product, contact Rockwell Automation, Inc.

10.2.4 Connection Diagram

The following diagram shows the connection between the GOT and the PLC.

■ RS-232 cable

(1) Connection diagram

RS232 connection diagram 1)

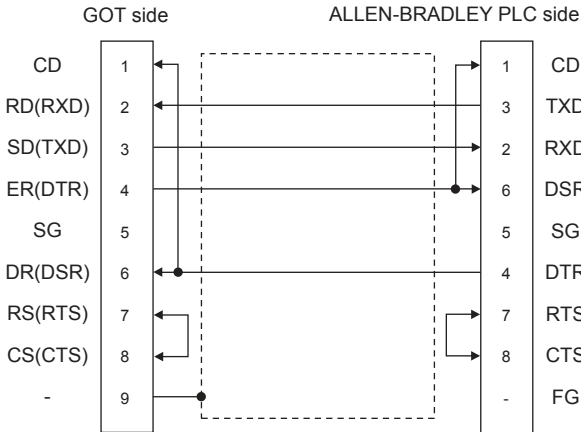

RS232 connection diagram 2)

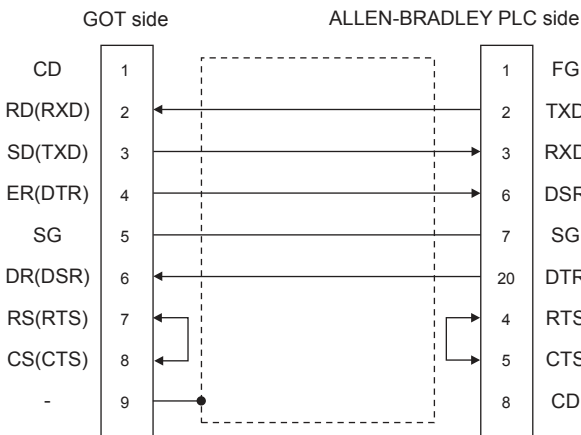

RS232 connection diagram 3)

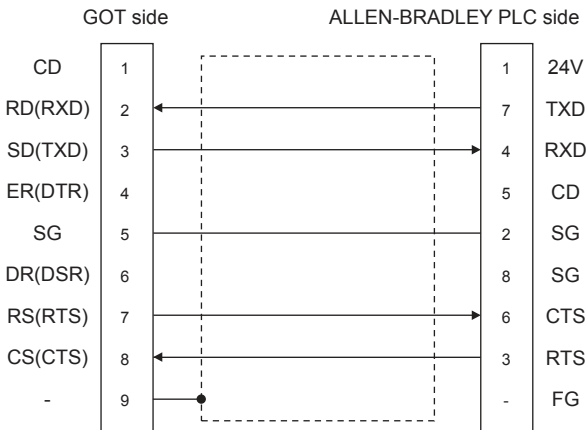

RS232 connection diagram 4)

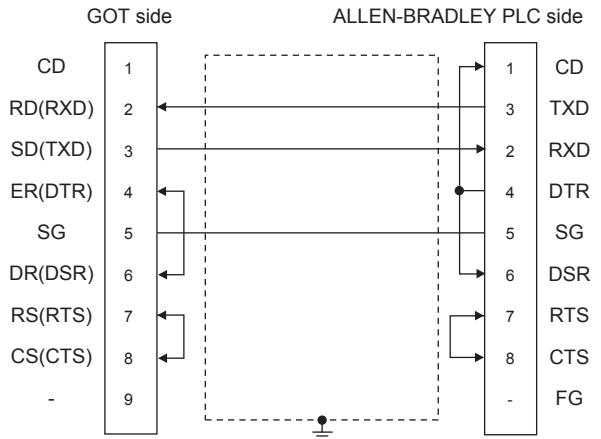

(2) Precautions when preparing a cable

(a) Cable length

The length of the RS-232 cable must be 15m or less.

(b) GOT side connector

For the GOT side connector, refer to the following.

1.4.1 GOT connector specifications

(c) ALLEN-BRADLEY PLC side connector

Use the connector compatible with the ALLEN-BRADLEY PLC side module.

For details, refer to the ALLEN-BRADLEY PLC user's manual.

10.2.5 GOT Side Settings

■ Setting communication interface (Communication settings)

Set the channel of the connected equipment.

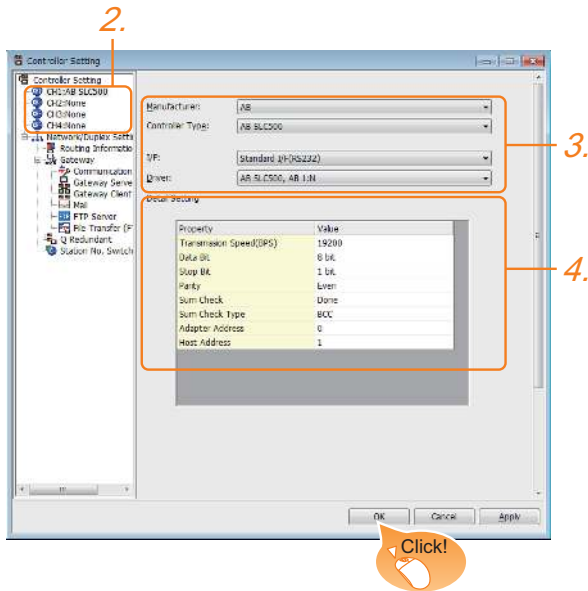

1. Select [Common] → [Controller Setting] from the menu.
2. The Controller Setting window is displayed. Select the channel to be used from the list menu.
3. Set the following items.
 - Manufacturer: AB
 - Controller Type: Set either of the followings.
 - AB SLC500
 - AB MicroLogix1000/1200/1500
 - AB Control/CompactLogix
 - I/F: Interface to be used
 - Driver: Set either of the followings.
 - AB SLC500, AB 1:N 接続
 - AB MicroLogix
 - AB Control/CompactLogix
4. The detailed setting is displayed after Manufacturer, Controller Type, I/F, and Driver are set. Make the settings according to the usage environment.

☞ 10.2.5 ■ Communication detail settings

Click the [OK] button when settings are completed.

POINT

The settings of connecting equipment can be confirmed in [I/F Communication Setting]. For details, refer to the following.

☞ 1.1.2 I/F communication setting

■ Communication detail settings

(1) AB SLC500, AB 1: Ns

Property	Value
Transmission Speed(BPS)	19200
Data Bit	8 bit
Stop Bit	1 bit
Parity	Even
Sum Check	Done
Sum Check Type	BCC
Adapter Address	0
Host Address	1

Item	Description	Range
Transmission Speed	Set this item when change the transmission speed used for communication with the connected equipment. (Default: 19200bps)	4800bps, 9600bps, 19200bps
Adapter Address *1	Specify the adapter address (station No. of the PLC that the GOT will monitor) in the connected network. (Default: 0)	0 to 31
Host Address *1	Specify the host address (station No. of the adapter to which the GOT is connected) in the connected network. (Default: 1)	1 to 31

*1 Do not specify the same value for the adapter address and host address.

(2) AB MicroLogix

Property	Value
Transmission Speed(BPS)	19200
Data Bit	8 bit
Stop Bit	1 bit
Parity	None
Sum Check	Done
Sum Check Type	BCC
Adapter Address	0
Host Address	1

Item	Description	Range
Transmission Speed	Set this item when change the transmission speed used for communication with the connected equipment. (Default: 19200bps)	4800bps, 9600bps, 19200bps, 38400bps
Sum Check Type	Specify the format in which the sum check is performed during communication when performing sum check. (Default: BCC)	BCC, CRC16
Adapter Address *1	Specify the adapter address (station No. of the PLC that the GOT will monitor) in the connected network. (Default: 0)	0 to 63
Host Address *1	Specify the host address (station No. of the adapter to which the GOT is connected) in the connected network. (Default: 1)	0 to 63

*1 Do not specify the same value for the adapter address and host address.

(3) AB Control/CompactLogix

Property	Value
Transmission Speed(BPS)	19200
Data Bit	8 bit
Stop Bit	1 bit
Parity	None
Sum Check Type	BCC
Retry(Times)	3
Timeout Time(Sec)	3
Adapter Address	0
Host Address	0
Delay Time(ms)	0

Item	Description	Range
Transmission Speed	Set this item when change the transmission speed used for communication with the connected equipment. (Default: 19200bps)	9600bps, 19200bps, 38400bps, 57600bps 115200bps
Data Bit	Set this item when change the data length used for communication with the connected equipment. (Default: 8bits)	7bits/8bits
Stop Bit	Specify the stop bit length for communications. (Default: 1bit)	1bit/2bits
Parity	Specify whether or not to perform a parity check, and how it is performed during communication. (Default: None)	None Even Odd
Sum Check Type	Specify the format in which the sum check is performed during communication when performing sum check. (Default: BCC)	BCC, CRC16
Retry	Set the number of retries to be performed when a communication error occurs. (Default: 3times)	0 to 5times
Timeout Time	Set the time period for a communication to time out. (Default: 3sec)	3 to 30sec
Adapter Address	Specify the adapter address (station No. of the PLC that the GOT will monitor) in the connected network. (Default: 0)	0 to 254
Host Address	Specify the host address (station No. of the adapter to which the GOT is connected) in the connected network. (Default: 0)	0 to 254
Delay Time	Set this item to adjust the transmission timing of the communication request from the GOT. (Default: 0ms)	0 to 300ms

POINT

- (1) Communication interface setting by the Utility
The communication interface setting can be changed on the Utility's [Communication setting] after writing [Communication Settings] of project data.
For details on the Utility, refer to the following manual.
 GOT2000 Series User's Manual (Utility)
- (2) Precedence in communication settings
When settings are made by GT Designer3 or the Utility, the latest setting is effective.

10.2.6 PLC Side Setting

POINT

ALLEN-BRADLEY PLC

For details of ALLEN-BRADLEY PLCs, refer to the following manuals.

 ALLEN-BRADLEY PLC user's Manual

■ Directly connecting to the CPU

Item	Setting details		
	SLC500 Series	MicroLogix 1000/1200/1500 Series	Control/Compact/FlexLogix Series
Baud Rate ^{*1}	4800bps, 9600bps, 19200bps	4800bps, 9600bps, 19200bps, 38400bps	4800bps, 9600bps, 19200bps, 38400bps
Parity	EVEN	NONE	NONE
Control Line	NO HANDSHAKING		
Communication Driver	DF1 HALF-DUPLEX SLAVE		
Duplicate Packet Detection	DISABLE		
Station Address	0		
Error Detection	BCC	BCC, CRC ^{*2}	BCC, CRC ^{*2}

^{*1} Set the Baud Rate according to the transmission speed setting on the GOT side.
For the transmission speed setting on the GOT side, refer to the following.

 10.2.5 ■ Communication detail settings

^{*2} Set the Error Detection according to the sum check format setting on the GOT side.
For the sum check format setting on the GOT side, refer to the following.

 10.2.5 ■ Communication detail settings

■ Connecting to DH485 network via adapter (1770-KF3) (Setting of Adapter)

Item	Setting details
Baud Rate ^{*1}	4800bps, 9600bps, 19200bps
Parity	Even
Flow Control	Disable (No Handshaking)
DF1 Device Category	DF1 half-duplex slave, local mode
Error Detection ^{*2}	BCC
DH-485 Baud Rate	19200bps
Maximum Node Address	1 to 31 ^{*3}
DH-485 Node Address	0 to 31 ^{*4}

^{*1} Set the Baud Rate according to the transmission speed setting on the GOT side.
For the transmission speed setting on the GOT side, refer to the following.

 10.2.5 ■ Communication detail settings

^{*2} Set the Error Detection according to the sum check format setting on the GOT side.
For the sum check format setting on the GOT side, refer to the following.

 10.2.5 ■ Communication detail settings

^{*3} For the Maximum Node Address, set the same address as the Maximum Node Address on the DH-485 network.

^{*4} Set the DH-485 Node Address according to the Host Address on the GOT side.
Set a unique DH-485 Node Address so that it does not conflict with the Node Address of the PLC CPU on the DH-485 network.

For the Host Address setting on the GOT side, refer to the following.

 10.2.5 ■ Communication detail settings

10.3 Ethernet Connection

10.3.1 System configuration for connecting to ControlLogix or CompactLogix

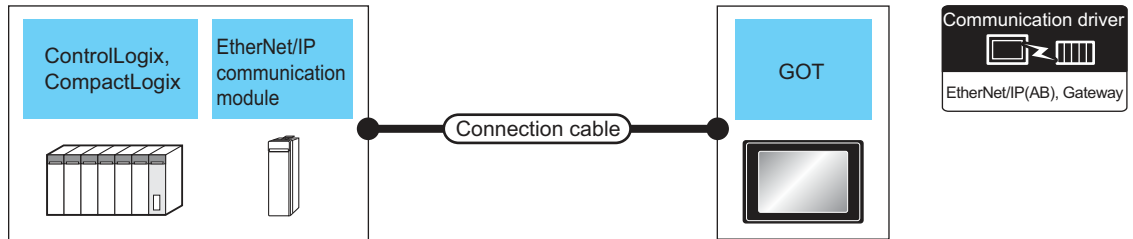

PLC			Connection cable		GOT		Number of connectable equipment
Series	EtherNet/IP communication module ^{*1}	Communication Type	Cable model ^{*2}	Maximum segment length ^{*3}	Option device	Model ^{*4}	
ControlLogix	1756-ENET(10Mbps) ^{*4} 1756-ENBT(10/100Mbps) ^{*4} 1756-EN2TR(10/100Mbps) ^{*4}	Ethernet	<ul style="list-style-type: none"> 10BASE-T Shielded twisted pair cable (STP) or unshielded twisted pair cable (UTP) of category 5 or higher 100BASE-TX Shielded twisted pair cable (STP) or unshielded twisted pair cable (UTP) of category 3 or higher 	100m	- (Built into GOT)	 	*7
CompactLogix	-	Ethernet	<ul style="list-style-type: none"> 10BASE-T Shielded twisted pair cable (STP) or unshielded twisted pair cable (UTP) of category 5 or higher 100BASE-TX Shielded twisted pair cable (STP) or unshielded twisted pair cable (UTP) of category 3 or higher 	100m	- (Built into GOT)	 	When PLC:GOT is N:1 TCP: 128 PLCs or less for 1 GOT When PLC:GOT is 1:N TCP: 32 GOTs or less (recommended to 16 or less) for 1 PLC

- *1 Allen-Bradley product manufactured by Rockwell Automation, Inc. For details of the product, contact Rockwell Automation, Inc.
- *2 The destination connected with the twisted pair cable varies with the configuration of the applicable Ethernet network system. Connect to the Ethernet module, hub, transceiver or other system equipment corresponding to the applicable Ethernet network system.
Use cables, connectors, and hubs that meet the IEEE802.3 10BASE-T/100BASE-TX standards.
- *3 A length between a hub and a node.
The maximum distance differs depending on the Ethernet device to be used.
The following shows the number of the connectable nodes when a repeater hub is used.
- 10BASE-T: Max. 4 nodes for a cascade connection (500m)
 - 100BASE-TX: Max. 2 nodes for a cascade connection (205m)
- When switching hubs are used, the cascade connection between the switching hubs has no logical limit for the number of cascades. For the limit, contact the switching hub manufacturer.
- *4 The connectable EtherNet/IP communication module differs depending on the PLC series.
(ControlLogix5550/5555/5560)
1756-ENET(10Mbps), 1756-ENBT(10/100Mbps)
(ControlLogix5570)
1756-EN2TR(10/100Mbps)
- *5 The number of the connectable GOTs for 1 PLC differs depending on the PLC series.
(ControlLogix5550/5555/5560)
- When PLC:GOT is N:1, the following number of the PLCs can be connected to 1 GOT.
TCP: 128 or less
 - When PLC:GOT is 1:N, the following number of the GOTs can be connected to 1 PLC.
TCP: 64 or less (recommended to 16 or less)
(ControlLogix5570)
 - When PLC:GOT is N:1, the following number of the PLCs can be connected to 1 GOT.
TCP: 128 or less
 - When PLC:GOT is 1:N, the following number of the GOTs can be connected to 1 PLC.
TCP: 128 or less (recommended to 16 or less)

10.3.2 GOT Side Settings

■ Setting communication interface (Communication settings)

Set the channel of the connected equipment.

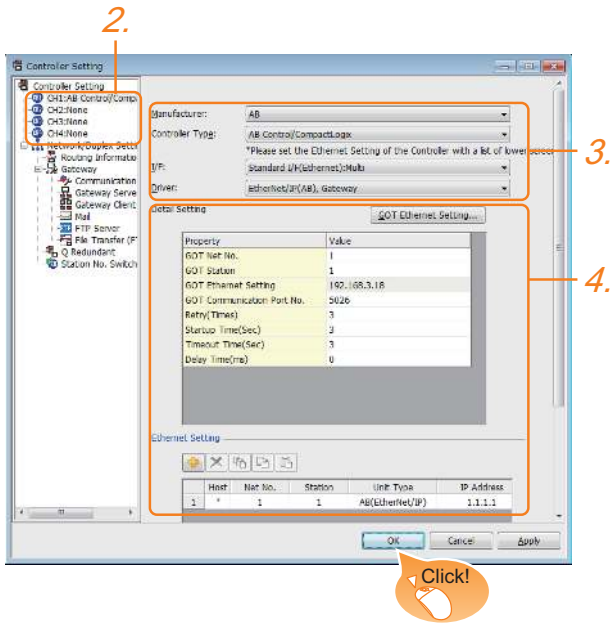

1. Select [Common] → [Controller Setting] from the menu.
2. The Controller Setting window is displayed. Select the channel to be used from the list menu.
3. Set the following items.
 - Manufacturer: AB
 - Controller Type: Control/CompactLogix
 - I/F: Interface to be used
 - Driver: EtherNet/IP(AB), Gateway
4. The detailed setting is displayed after Manufacturer, Controller Type, I/F, and Driver are set. Make the settings according to the usage environment.

☞ 11.3.2 ■ Communication detail settings

Click the [OK] button when settings are completed.

POINT

The settings of connecting equipment can be confirmed in [I/F Communication Setting]. For details, refer to the following.

☞ 1.1.2 I/F communication setting

■ Communication detail settings

Make the settings according to the usage environment.

Property	Value
GOT Net No.	1
GOT Station	1
GOT Ethernet Setting	192.168.3.18
GOT Communication Port No.	5026
Retry(Times)	3
Startup Time(Sec)	3
Timeout Time(Sec)	3
Delay Time(ms)	0

Item	Description	Range
GOT Net No.	Set the network No. of the GOT. (Default: 1)	1 to 239
GOT 局番	Set the station No. of the GOT. (Default: 1)	1 to 64
GOT Ethernet 設定	Set the GOT IP address, subnet mask, default gateway, peripheral S/W communication port No., transparent port No.	☞ GOT Ethernet setting
GOT Communication Port No.	Set the GOT port No. for the connection with the Ethernet module. (Default: 5015)	1024 to 5010, 5014 to 65534 (Except for 5011, 5012, 5013, 44818 and 49153)
Retry	Set the number of retries to be performed when a communication timeout occurs. When receiving no response after retries, the communication times out. (Default: 3times)	0 to 5times
Startup Time	Specify the time period from the GOT startup until GOT starts the communication with the PLC CPU. (Default: 3sec)	1 to 255sec
Timeout Time	Set the time period for a communication to time out. (Default: 3sec)	3 to 90sec
Delay Time	Set the delay time for reducing the load of the network/destination PLC. (Default: 0ms)	0 to 10000 (ms)

■ GOT Ethernet setting

Item	Description	Range
GOT IP Address	Set the IP address of the GOT. (Default: 192.168.0.18)	0.0.0.0 to 255.255.255.255
Subnet Mask	Set the subnet mask for the sub network.(Only for connection via router) If the sub network is not used, the default value is set. (Default: 255.255.255.0)	0.0.0.0 to 255.255.255.255
Default Gateway	Set the router address of the default gateway where the GOT is connected.(Only for connection via router) (Default: 0.0.0.0)	0.0.0.0 to 255.255.255.255
周辺 S/W 通信ポート No.	Set the GOT port No. for the S/W communication. (Default: 5015)	1024 to 5010, 5014 to 65534 (Except for 5011, 5012, 5013 and 49153)
トランスペアレント用ポート No.	Set the GOT port No. for the transparent function. (Default: 5014)	1024 to 5010, 5014 to 65534 (Except for 5011, 5012, 5013 and 49153)

■ Ethernet setting

Item	Description	Set value
Host	The host is displayed.(The host is indicated with an asterisk (*).)	—
Net No.	Set the network No. of the connected Ethernet module. (Default: blank)	1 to 239
Station	Set the station No. of the connected Ethernet module. (Default: blank)	1 to 64
Type	AB(EtherNet/IP) (fixed)	AB(EtherNet/IP) (fixed)
IP address	Set the IP address of the connected Ethernet module. (Default: blank)	PLC side IP address
Port No.	44818 (fixed)	44818 (fixed)
Communication format	TCP (fixed)	TCP (fixed)
Slot No.	Set the slot No. of the PLC to which the Ethernet module is connected. (Default: blank)	0 to 16

POINT

- Communication interface setting by the Utility
The communication interface setting can be changed on the Utility's [Communication setting] after writing [Communication Settings] of project data.
For details on the Utility, refer to the following manual.
 - GOT2000 Series User's Manual (Utility)
- Precedence in communication settings
When settings are made by GT Designer3 or the Utility, the latest setting is effective.
- Setting IP address and port No
The same IP address cannot be set for the same port No. The same IP address can be set for the different port No.

10.3.3 PLC side setting

POINT

ALLEN-BRADLEY PLC

For details of ALLEN-BRADLEY PLCs, refer to the following manuals.

 ALLEN-BRADLEY PLC user's Manual

■ Parameter setting

Set the following parameters with the software package manufactured by the Allen-Bradley.

Item	Setting details
Name	Sets the name.
IP Address	IP address of the connected module*1
Slot	Slots No. for installing the EtherNet/IP communication module

*1 For the IP address, make the same setting as that of each Ethernet module set on GT Designer3.
Do not set the same IP Address as those of GOT and controller on the Ethernet network.
For the address setting on GT Designer3, refer to the following.

 11.3.2 ■ Communication detail settings

10.3.4 Precautions

■ When setting IP address

Do not use "0" and "255" at the end of an IP address. (Numbers of *.**.0 and *.**.255 are used by the system.)

The GOT may not monitor the controller correctly with the above numbers.

Consult with the administrator of the network before setting an IP address to the GOT and controller.

■ When connecting to multiple GOTs

(1) Setting Station

When connecting two or more GOTs in the Ethernet network, set each [Station] to the GOT.

 10.3.2 ■ Ethernet setting

(2) Setting IP address

Do not use the IP address "192.168.3.18" when using multiple GOTs.

A communication error may occur on the GOT with the IP address.

■ When connecting to the multiple network equipment (including GOT) in a segment

By increasing the network load, the transmission speed between the GOT and PLC may be reduced.

The following actions may improve the communication performance.

- Using a switching hub
- More high speed by 100BASE-TX (100Mbps)Reduction of the monitoring points on GOT

10.4 Device Range that Can Be Set

The device ranges of controller that can be used for GOT are as follows.

Note that the device ranges in the following tables are the maximum values that can be set in GT Designer3.

The device specifications of controllers may differ depending on the models, even though belonging to the same series.

Please make the setting according to the specifications of the controller actually used.

When a non-existent device or a device number outside the range is set, other objects with correct device settings may not be monitored.

Setting item

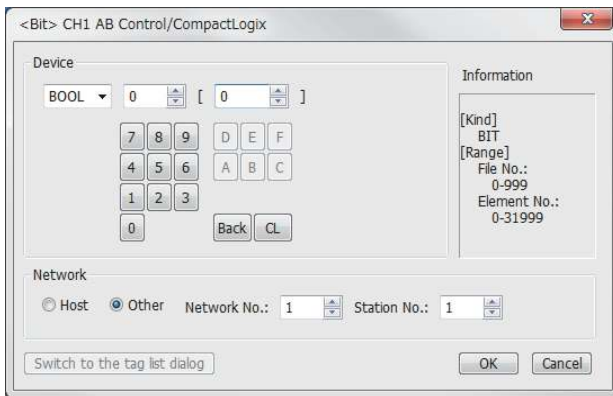

Item	Description	
Device	Set the device name, file number, element number, and bit number. The bit number can be set only when specifying the bit of word device.	
Information	Displays the device type and setting range which are selected in [Device].	
Network	Host	Select this item when monitoring the host PLC.
	Other	Select this when monitoring the other PLCs. After selecting, set the station number of the PLC to be monitored. NWNNo.: Set the network No. Station No.: Set the station No.
[タグ一覧画面に切り換え]	Select this button to importing the tag file created by RSLogix5000 and set devices while checking the tag names. For how to import tag files, refer to the following. GT Designer3 (GOT2000) Help	

POINT

Device settings of ALLEN-BRADLEY PLC

The ALLEN-BRADLEY PLC device addressing consists of a file and element.

Make setting as follows using GT Designer3.

(1) AB SLC500, AB Micro Logix

(a) When setting a bit address as a bit device

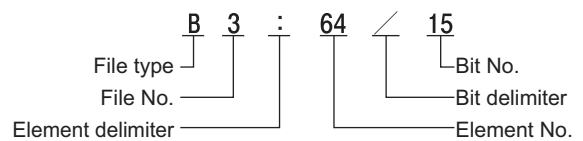

· Setting by GT Designer3

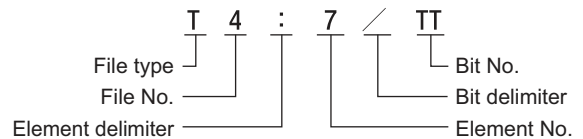
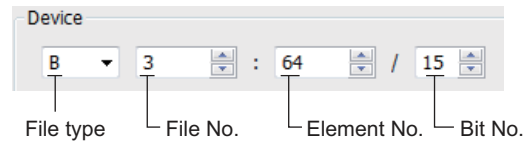

· Setting by GT Designer3

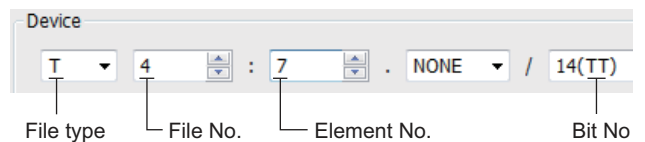

10.4.1 AB SLC500

(b) When setting an element address as a word device

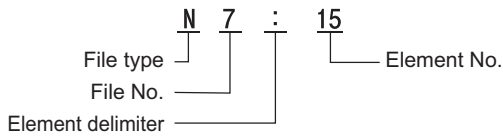

· Setting by GT Designer3

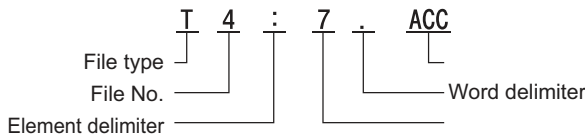
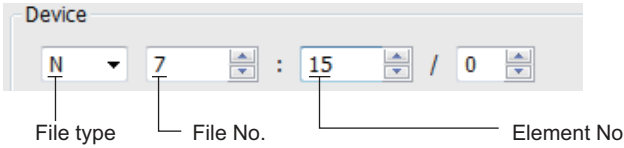

· Setting by GT Designer3

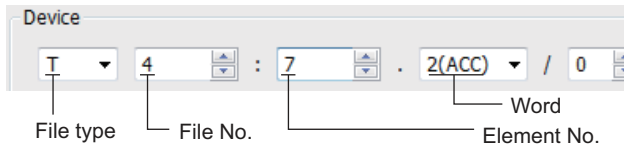

(2) AB Control/CompactLogix

(a) When setting a bit address as a bit device

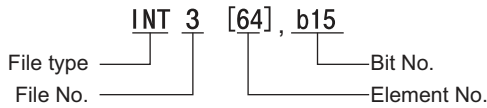

· Setting by GT Designer3

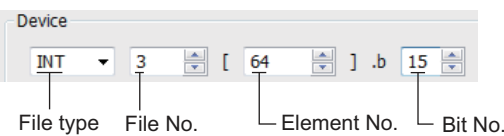

(b) When setting an element address as a word device

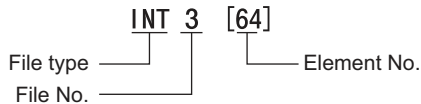

· Setting by GT Designer3

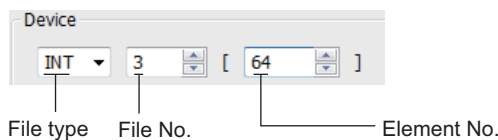

Device name	Setting range	Device No. representation
Bit (B)	B3:0/0 to B3:255/15 B10:0/0 to B255:255/15	Decimal
Timer (Timing bit) (T) ^{*2}	T4:0/14(TT) to T4:255/14(TT) T10:0/14(TT) to T255:255/14(TT)	
Timer (Timing bit) (T) ^{*2}	T4:0/13(DN) to T4:255/13(DN) T10:0/13(DN) to T255:255/13(DN)	
Counter (Up counter) (C) ^{*2}	C5:0/15(CU) to C5:255/15(CU) C10:0/15(CU) to C255:255/15(CU)	
Counter (Down counter) (C) ^{*2}	C5:0/14(CD) to C5:255/14(CD) C10:0/14(CD) to C255:255/14(CD)	
Counter (Completion bit) (C)	C5:0/13(DN) to C5:255/13(DN) C10:0/13(DN) to C255:255/13(DN)	
Integer (N)	N7:0 to N7:255 N10:0 to N255:255	
Bit (B) ^{*3}	B3:0 to B3:255 B10:0 to B255:255	Decimal
Timer (Set value) (T) ^{*1*2}	T4:0.1(PRE) to T4:255.1(PRE) T10:0.1(PRE) to T255:255.1(PRE)	
Timer (Current value) (T) ^{*1*2}	T4:0.2(ACC) to T4:255.2(ACC) T10:0.2(ACC) to T255:255.2(ACC)	
Counter (Set value) (C) ^{*1*2}	C5:0.1(PRE) to C5:255.1(PRE) C10:0.1(PRE) to C255:255.1(PRE)	
Counter (Current value) (C) ^{*1*2}	C5:0.2(ACC) to C5:255.2(ACC) C10:0.2(ACC) to C255:255.2(ACC)	
Integer (N) ^{*1}	N7:0 to N7:255 N10:0 to N255:255	

*1 Writing to device is not allowed for 32 bit data.

*2 Monitoring or writing is not possible in the continuous device designation mode.

10.4.2 AB MicroLogix1000/1200/1500 Series

Device name	Setting range	Device No. representation
Bit (B)	B3:0/0 to B255:255/15	Decimal
Timer (Timing bit) (T) ^{*3}	T3:0/14(TT) to T255:255/14(TT)	
Timer (Completion bit) (T) ^{*3}	T3:0/13(DN) to T255:255/13(DN)	
Counter (Up counter) (C) ^{*3}	C3:0/15(CU) to C255:255/15(CU)	
Counter (Down counter) (C) ^{*3}	C3:0/14(CD) to C255:255/14(CD)	
Counter (Completion bit) (C) ^{*3}	C3:0/13(DN) to C255:255/13(DN)	
Integer (N)	N3:0/0 to N255:255/15	
Bit (B)	B3:0 to B255:255	Decimal
Timer (Set value) (T) ^{*1*3}	T3:0.1(PRE) to T255:255.1(PRE)	
Timer (Current value) (T) ^{*1*3}	T3:0.2(ACC) to T255:255.2(ACC)	
Counter (Set value) (C) ^{*1*3}	C3:0.1(PRE) to C255:255.1(PRE)	
Counter (Current value) (C) ^{*1*3}	C3:0.2(ACC) to C255:255.2(ACC)	
Integer (N) ^{*1}	N3:0 to N255:255	
32bit integer (L) ^{*2}	L3:0 to L3:255 L255:0 to L255:255	

- *1 Writing to device is not allowed for 32 bit data.
 *2 Writing to device is not allowed for 16 bit data.
 *3 Monitoring or writing is not possible in the continuous device designation mode.

10.4.3 AB MicroLogix1000/1200/1500 Series (Device extended)

For details of this communication driver, please contact our company.

10.4.4 AB Control/CompactLogix

Device name	Setting range	Device No. representation	
Bit device	BOOL	BOOL0[0] to BOOL999[31999]	Decimal
Word device	INT	INT0[0] to INT999[999]	Decimal
	DINT ^{*1}	DINT0[0] to DINT999[999]	
	REAL ^{*1}	REAL0[0] to REAL999[999]	

*1 Only 32-bit (2-word) designation is allowed.



11







CONNECTION TO GE PLC

11.1 Connectable Model List	11 - 2
11.2 System Configuration	11 - 3
11.3 Connection Diagram	11 - 9
11.4 GOT Side Settings	11 - 12
11.5 PLC Side Setting	11 - 13
11.6 Device Range that Can Be Set	11 - 15
11.7 Precautions	11 - 15

11. CONNECTION TO GE PLC

11.1 Connectable Model List

The following table shows the connectable models.

Series	Model name	Clock	Communication Type	Connectable model	Refer to
Series90-30	IC693CPU311	x	RS-232 RS-422		 11.2.1
	IC693CPU313				
	IC693CPU323				
	IC693CPU350				
	IC693CPU360				
	IC693CPU363				
	IC693CPU366				
	IC693CPU367				
IC693CPU374					
Series90-70	IC697CPU731	x	RS-232 RS-422		 11.2.2
	IC697CPX772				
	IC697CPX782				
	IC697CPX928				
	IC697CPX935				
	IC697CPU780				
	IC697CGR772				
	IC697CGR935				
	IC697CPU788				
	IC697CPU789				
IC697CPM790					
VersaMax Micro	IC200UAA003	x	RS-232 RS-422		 11.2.3
	IC200UAL004				
	IC200UAL005				
	IC200UAL006				
	IC200UAA007				
	IC200UAR028				
	IC200UDD110				
	IC200UDD120				
	IC200UDD212				
	IC200UDR005				
	IC200UDR006				
	IC200UDR010				
	IC200UDD064				
	IC200UDD164				
	IC200UDR164				
	IC200UDR064				
	IC200UAR014				
	IC200UDD104				
	IC200UDD112				
IC200UDR001					
IC200UDR002					
IC200UDR003					

11.2 System Configuration

11.2.1 Connecting to Series90-30

POINT

Connectable model
 Only the models that are compatible with SNP-X protocol can be connected.

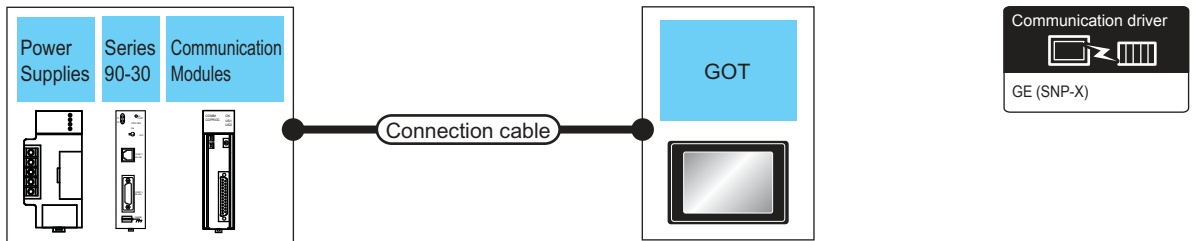





















■ For the RS-232 connection

PLC				Connection cable		GOT		Number of connectable equipment
Power Supplies ^{*1}	Model name	Communication Modules ^{*1}	Communication Type	Cable model Connection diagram number	Max. distance	Option device	Model	
IC693PWR321 IC693PWR330 IC693PWR331 IC693PWR332 IC693PWR328	IC693CPU311 IC693CPU313 IC693CPU323	IC693CMM311	RS-232	RS-232 connection diagram 1)	15m	- (Built into GOT)	GT 27 GT 23 GS	1 PLC for 1 GOT
						GT15-RS2-9P	GT 27 GT 23 GS	
IC693PWR321 IC693PWR330 IC693PWR331 IC693PWR332 IC693PWR328	IC693CPU350 IC693CPU360 IC693CPU366 IC693CPU367 IC693CPU374	IC693CMM311	RS-232	RS-232 connection diagram 1)	15m	- (Built into GOT)	GT 27 GT 23 GS	
						GT15-RS2-9P	GT 27 GT 23 GS	
IC693PWR321 IC693PWR330 IC693PWR331 IC693PWR332 IC693PWR328	IC693CPU363	IC693CMM311	RS-232	RS-232 connection diagram 1)	15m	- (Built into GOT)	GT 27 GT 23 GS	
						GT15-RS2-9P	GT 27 GT 23 GS	

^{*1} Product manufactured by GE Corporation.
 For details of the product, contact GE Corporation.















■ For the RS-422 connection (connecting to the Communication Modules)

PLC				Connection cable		GOT		Number of connectable equipment
Power Supplies* ¹	Model name	Communication Modules* ¹	Communication Type	Cable model Connection diagram number	Max. distance	Option device	Model	
IC693PWR321 IC693PWR330 IC693PWR331 IC693PWR332 IC693PWR328	IC693CPU311 IC693CPU313 IC693CPU323	IC693CMM311	RS-422	 RS-422 connection diagram 1)	1200m	- (Built into GOT)	  	
						GT15-RS4-9S	  	
IC693PWR321 IC693PWR330 IC693PWR331 IC693PWR332 IC693PWR328	IC693CPU350 IC693CPU360 IC693CPU366 IC693CPU367 IC693CPU374	IC693CMM311	RS-422	 RS-422 connection diagram 1)	1200m	- (Built into GOT)	  	
						GT15-RS4-9S	  	
IC693PWR321 IC693PWR330 IC693PWR331 IC693PWR332 IC693PWR328	IC693CPU363	IC693CMM311	RS-422	 RS-422 connection diagram 1)	1200m	- (Built into GOT)	  	
						GT15-RS4-9S	  	

8 PLCs for 1 GOT







*1 Product manufactured by GE Corporation.
For details of the product, contact GE Corporation.

■ For the RS-422 connection (connecting to the Power Supplies)

PLC			Connection cable		GOT		Number of connectable equipment
Power Supplies ^{*1}	Model name	Communication Type	Cable model Connection diagram number	Max. distance	Option device	Model	
IC693PWR321 IC693PWR330 IC693PWR331 IC693PWR332 IC693PWR328	IC693CPU350 IC693CPU360 IC693CPU366 IC693CPU367 IC693CPU374	RS-422	 RS-422 connection diagram 2)	1200m	- (Built into GOT)	  	8 PLCs for 1 GOT
					GT15-RS4-9S	  	
IC693PWR321 IC693PWR330 IC693PWR331 IC693PWR332 IC693PWR328	IC693CPU363	RS-422	 RS-422 connection diagram 2)	1200m	- (Built into GOT)	  	
					GT15-RS4-9S	  	

*1 Product manufactured by GE Corporation.
For details of the product, contact GE Corporation.

■ For the RS-422 connection (connecting to the PLC)

PLC			Connection cable		GOT		Number of connectable equipment
Power Supplies ^{*1}	Model name	Communication Type	Cable model Connection diagram number	Max. distance	Option device	Model	
IC693PWR321 IC693PWR330 IC693PWR331 IC693PWR332 IC693PWR328	IC693CPU363 (CPU port 2)	RS-422	 RS-422 connection diagram 2)	1200m	- (Built into GOT)	  	8 PLC for 1 GOT
					GT15-RS4-9S	  	

*1 Product manufactured by GE Corporation.
For details of the product, contact GE Corporation.

11.2.2 Connecting to Series90-70

POINT

Only the models that are compatible with SNP-X protocol can be connected.

■ For the RS-232 connection

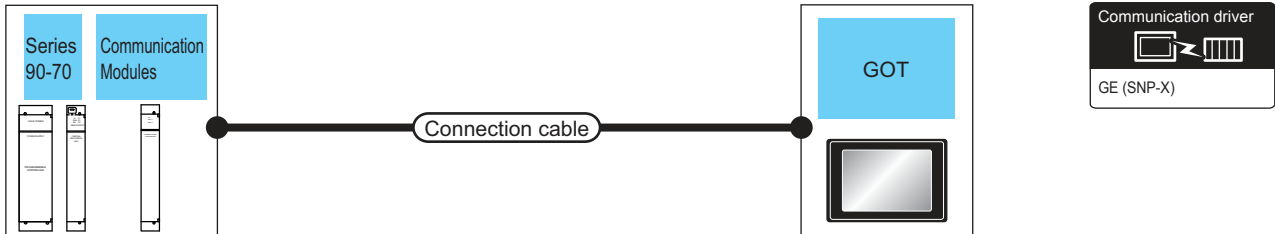

Model name	PLC		Connection cable		GOT		Number of connectable equipment
	Communication Modules ^{*1}	Communication Type	Cable model Connection diagram number	Max. distance	Option device	Model	
IC697CPX772 IC697CPX782 IC697CPX928 IC697CPX935 IC697CPU780 IC697CPU788 IC697CPU789 IC697CPU731 IC697CGR772 IC697CGR935 IC697CPM790	IC697CMM711	RS-232	RS-232 connection diagram 1)	15m	- (Built into GOT) GT15-RS2-9P	 	1 PLC for 1 GOT

*1 Product manufactured by GE Corporation.
For details of the product, contact GE Corporation.

■ For the RS-422 connection

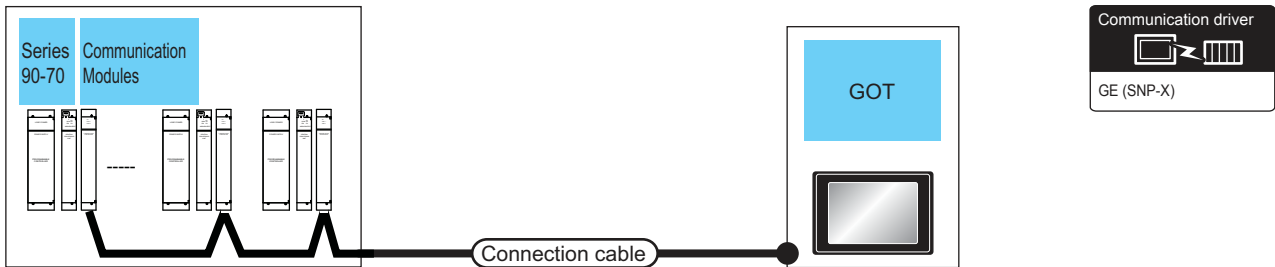

PLC	PLC		Connection cable		GOT		Number of connectable equipment
	Communication Modules ^{*1}	Communication Type	Cable model Connection diagram number	Max. distance	Option device	Model	
IC697CPX772 IC697CPX782 IC697CPX928 IC697CPX935 IC697CPU780 IC697CPU788 IC697CPU789 IC697CPU731 IC697CGR772 IC697CGR935 IC697CPM790	IC697CMM711	RS-422	RS-422 connection diagram 1)	1200m	- (Built into GOT) GT15-RS4-9S	 	Up to 8 PLCs for 1 GOT

*1 Product manufactured by GE Corporation.
For details of the product, contact GE Corporation.
*2 Including the cable length of the option devices.
*3 Connect it to the RS-232 interface (built into GOT). It cannot be mounted on GT1655 and GT155□.









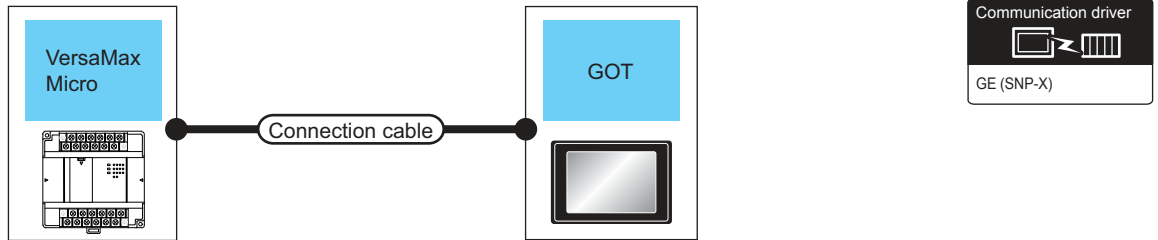





11.2.3 Connecting to VersaMax Micro

POINT

Only the models that are compatible with SNP-X protocol can be connected.







■ For the RS-232 connection

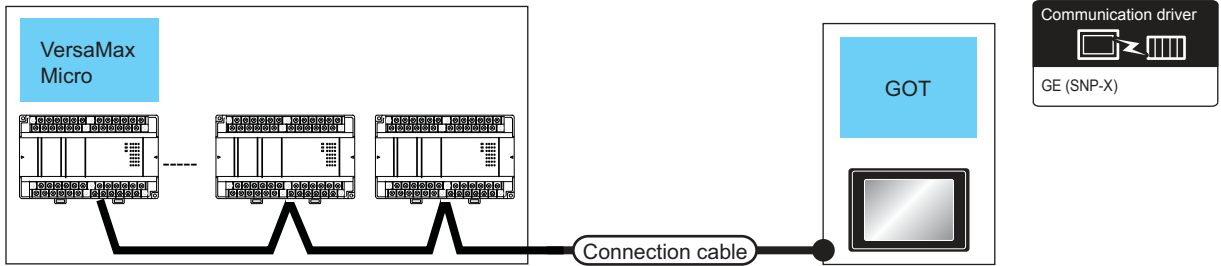

PLC		Connection cable		GOT		Number of connectable equipment
Model name	Communication Type	Cable model Connection diagram number	Max. distance	Option device	Model	
IC200UAA003 IC200UAR014 IC200UDD104 IC200UDD112 IC200UDR001 IC200UDR002 IC200UDR003	RS-232	 RS-232 connection diagram 2)	15m	- (Built into GOT)	  	1 PLC for 1 GOT
				GT15-RS2-9P	  	
IC200UAL004 IC200UAL005 IC200UAL006 IC200UAA007 IC200UAR028 IC200UDD110 IC200UDD120 IC200UDD212 IC200UDR005 IC200UDR006 IC200UDR010 IC200UDD064 IC200UDD164 IC200UDR164 IC200UDR064	RS-232	 RS-232 connection diagram 2)	15m	- (Built into GOT)	  	
				GT15-RS2-9P	  	

■ For the RS-422 connection



PLC		Connection cable		GOT		Number of connectable equipment
PLC	Communication Type	Cable model Connection diagram number	Max. distance	Option device	Model	
IC200UAL004 IC200UAL005 IC200UAL006 IC200UAA007 IC200UAR028 IC200UDD110 IC200UDD120 IC200UDD212 IC200UDR005 IC200UDR006 IC200UDR010 IC200UDD064 IC200UDD164 IC200UDR164 IC200UDR064	RS-422	 RS-422 connection diagram 3)	1200m	- (Built into GOT)	  	Up to 8 PLCs for 1 GOT
GT15-RS4-9S				  		

11.3 Connection Diagram

The following diagram shows the connection between the GOT and the PLC.

11.3.1 RS-232 cable

■ Connection diagram

(1) RS-232 connection diagram 1)

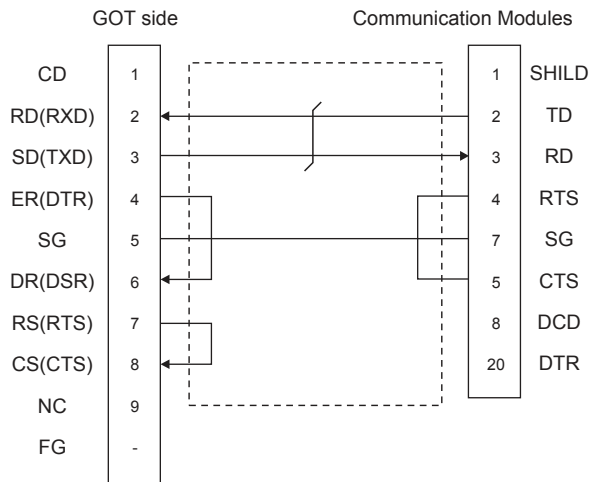

(2) RS-232 connection diagram 2)

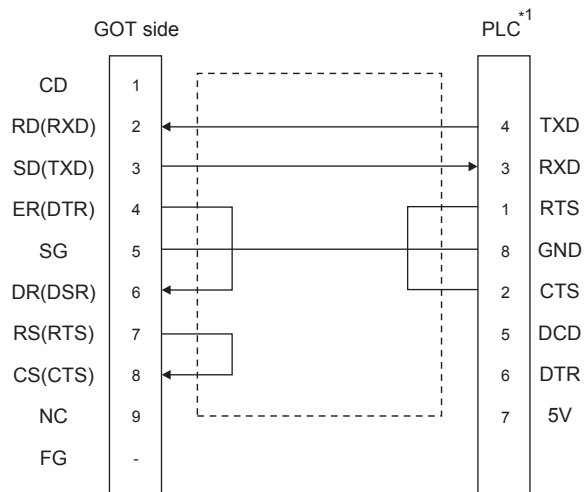

*1 For details of the pin assignment, refer to the following manual.

GE PLC user's Manual

■ Precautions when preparing a cable

(3) Cable length

The length of the RS-232 cable must be 15m or less.

(4) GOT side connector

For the GOT side connector, refer to the following.

1.4.1 GOT connector specifications

(5) GE PLC side connector

Use the connector compatible with the GE PLC side module.

For details, refer to the GE PLC user's manual.

11.3.2 RS-422 cable

■ Connection diagram

(1) RS-422 connection diagram 1)

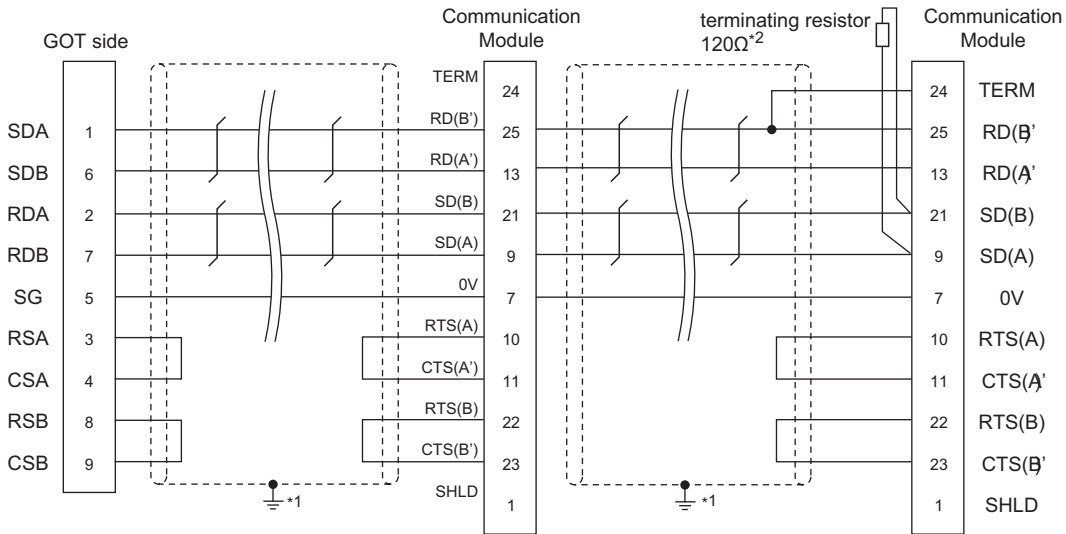

*1 Connect FG grounding to the appropriate part of a cable shield line.

*2 A terminating resistor should be connected to communication module at a terminal station.

(2) RS-422 connection diagram 2)

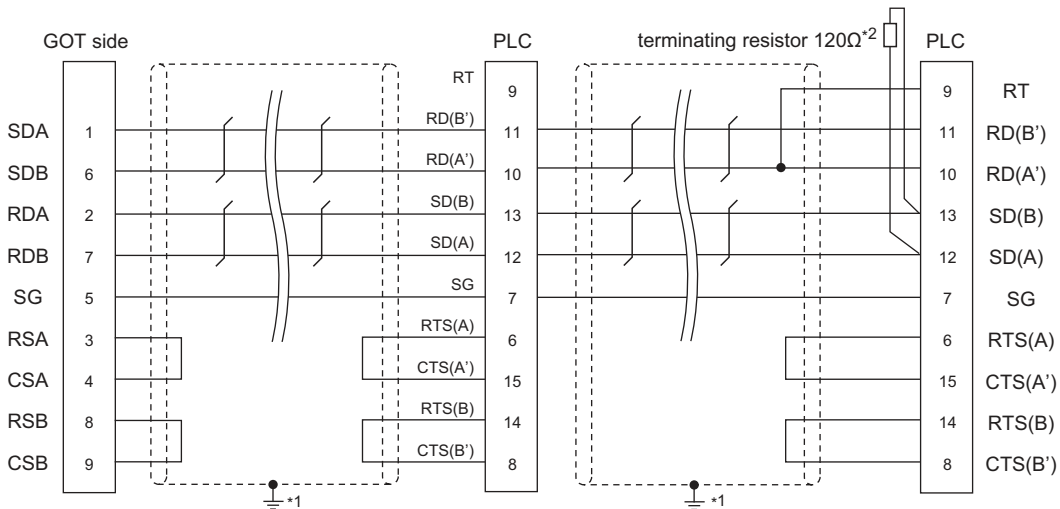

*1 Connect FG grounding to the appropriate part of a cable shield line.

*2 Terminating resistor should be provided for a PLC which will be a terminal.

(3) RS-422 connection diagram 3)

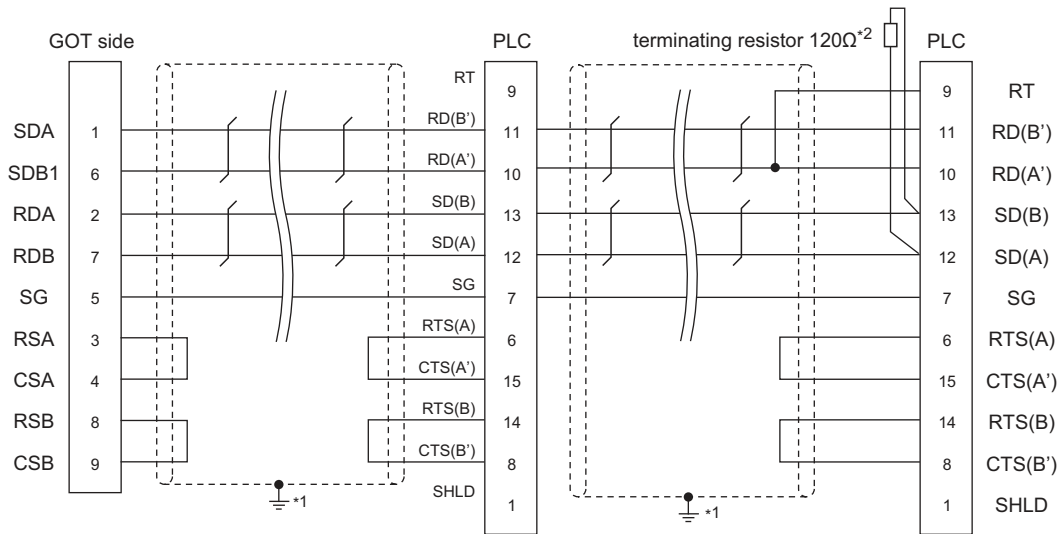

- *1 Connect FG grounding to the appropriate part of a cable shield line.
- *2 Terminating resistor should be provided for a PLC which will be a terminal.

■ Precautions when preparing a cable

- (1) Cable length
The length of the RS-422 cable must be 1200m or less.
- (2) GOT side connector
For the GOT side connector, refer to the following.
☞ 1.4.1 GOT connector specifications
- (3) GE PLC side connector
Use the connector compatible with the GE PLC side module.
For details, refer to the GE PLC user's manual.

■ Connecting terminating resistors

- (1) GOT side
Set the terminating resistor setting switch of the GOT main unit to "Disable".
For the procedure to set the terminating resistor, refer to the following.
☞ 1.4.3 Terminating resistors of GOT
- (2) GE PLC side
When connecting a GE PLC to the GOT, a terminating resistor must be connected.
☞ GE PLC user's Manual

11.4 GOT Side Settings

11.4.1 Setting communication interface (Communication settings)

Set the channel of the connected equipment.

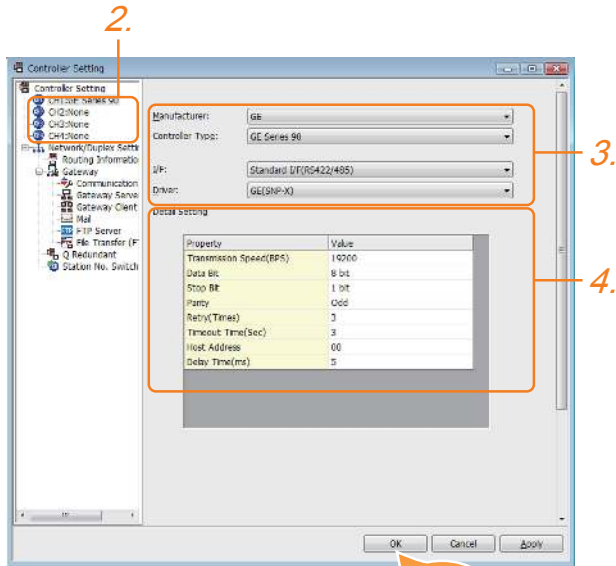

1. Select [Common] → [Controller Setting] from the menu.
2. The Controller Setting window is displayed. Select the channel to be used from the list menu.
3. Set the following items.
 - Manufacturer: GE
 - Controller Type: GE Series 90
 - I/F: Interface to be used
 - Driver: GE (SNP-X)
4. The detailed setting is displayed after Manufacturer, Controller Type, I/F, and Driver are set. Make the settings according to the usage environment.

☞ 11.4.2 Communication detail settings

Click the [OK] button when settings are completed.

POINT

The settings of connecting equipment can be confirmed in [I/F Communication Setting]. For details, refer to the following.

☞ 1.1.2 I/F communication setting

11.4.2 Communication detail settings

Make the settings according to the usage environment.

(1) GE (SNP-X)

Property	Value
Transmission Speed(BPS)	19200
Data Bit	8 bit
Stop Bit	1 bit
Parity	Odd
Retry(Times)	3
Timeout Time(Sec)	3
Host Address	00
Delay Time(ms)	5

Item	Description	Range
Transmission Speed	Set this item when change the transmission speed used for communication with the connected equipment. (Default: 19200bps)	9600bps, 19200bps, 38400bps, 57600bps, 115200bps
Data Bit	Set this item when change the data length used for communication with the connected equipment. (Default: 8bits)	7bits/8bits
Stop Bit	Specify the stop bit length for communications. (Default: 1bit)	1bit/2bits
Parity	Specify whether or not to perform a parity check, and how it is performed during communication. (Default: Odd)	None Even Odd
Retry	Set the number of retries to be performed when a communication error occurs. (Default: 3times)	0 to 5times
Timeout Time	Set the time period for a communication to time out. (Default: 3sec)	1 to 30sec
Host Address	Specify the host address (station No. of the GOT to which the PLC is connected) in the connected network. (Default: 00)	00 to 31
Delay Time	Set this item to adjust the transmission timing of the communication request from the GOT. (Default: 5ms)	0 to 300ms

POINT

- (1) Communication interface setting by the Utility
The communication interface setting can be changed on the Utility's [Communication setting] after writing [Communication Settings] of project data. For details on the Utility, refer to the following manual.

☞ GOT2000 Series User's Manual (Utility)

- (2) Precedence in communication settings
When settings are made by GT Designer3 or the Utility, the latest setting is effective.

11.5 PLC Side Setting

POINT

GE PLC

For details of GE PLCs, refer to the following manuals.

 GE PLC user's Manual

Model name		Refer to
PLC CPU	Series 90-30	11.5.1
	VersaMaxMicro	11.5.2
Communication Modules	IC693CMM311	11.5.3
	IC697CMM711	11.5.4

11.5.1 Connecting to Series 90-30

■ Communication settings

Make the communication settings using the engineering tool.

When making the settings, set [Configuration Mode] on the [Setting] tab of the engineering tool to "SNP only".

Setting item	PLC side setting
Port Mode ^{*1}	SNP
Port Type ^{*2}	Slave
Data Rate	9600bps, 19200bps
Flow Control	NONE
Parity	EVEN, ODD, NONE
Stop Bits	1bit, 2bits
Timeout ^{*3}	Long
Turn Around Delay ^{*4}	0
SNP ID ^{*5}	00 to 31
Converter Power Consumption ^{*6}	0

- *1 Set to SNP.
- *2 Set to Slave.
- *3 Set to Long.
- *4 Set to 0.
- *5 Set within the range of 00 to 31.
When specifying the station No. from 0 to 9, add "0" before the number and set it as 00 to 09.
- *6 Set to 0.(only when connecting to Port2)

11.5.2 Connecting to VersaMaxMicro

■ Communication settings

Make the communication settings using the engineering tool.

Setting item	PLC side setting
Data Rate	9600bps, 19200bps, 38400bps
Bits / Character	7bits, 8bits
Parity	EVEN, ODD, NONE
Stop Bits	1bit, 2bits
Port Mode ^{*1}	SNP
Port Type ^{*2}	Slave
Flow Control	NONE
Timeout ^{*3}	Long
Turn Around Delay ^{*4}	0
SNP ID ^{*5}	00 to 31

- *1 Set to the SNP protocol.
- *2 Set to Slave.
- *3 Set to Long.
- *4 Set to 0.
- *5 Set within the range of 00 to 31.
When specifying the station No. from 0 to 9, add "0" before the number and set it as 00 to 09.

11.5.3 Connecting to IC693CMM311

■ Communication settings

Make the communication settings using the engineering tool.

When making the settings, set [Configuration Mode] on the [Setting] tab of the engineering tool to "SNP only".

Setting item	PLC side setting
SNP Enable ^{*1}	YES
SNP Mode ^{*2}	Slave
Interface ^{*3}	RS232, RS485
Data Rate	9600bps, 19200bps
Parity	ODD, NONE, EVEN
Stop Bits	1bit, 2bits
Flow Control ^{*4}	NONE
Turn Around Delay ^{*5}	NONE
Timeout ^{*6}	Long

- *1 Set to YES.
- *2 Set to SLAVE.
- *3 Set the communication format to be used.
(only when connecting to Port2)
- *4 Set to NONE.
- *5 Set to NONE.
- *6 Set to LONG.

11.5.4 Connecting to IC697CMM711

■ Communication settings

Make the communication settings using the engineering tool.

When making the settings, set [Configuration Mode] on the [Setting] tab of the engineering tool to "SNP only".

Setting item	PLC side setting
SNP Enable ^{*1}	YES
SNP Mode ^{*2}	Slave
Interface ^{*3}	RS232, RS485
Data Rate	9600bps, 19200bps
Parity	ODD, NONE, EVEN
Stop Bits	1bit, 2bits
Flow Control ^{*4}	NONE
Turn Around Delay ^{*5}	NONE
Timeout ^{*6}	Long

- *1 Set to YES.
- *2 Set to SLAVE.
- *3 Set the communication format to be used.
(only when connecting to Port2)
- *4 Set to NONE.
- *5 Set to NONE.
- *6 Set to LONG.

11.5.5 Station number setting

Set each station number so that no station number overlaps.

The station number can be set without regard to the cable connection order. There is no problem even if station numbers are not consecutive.

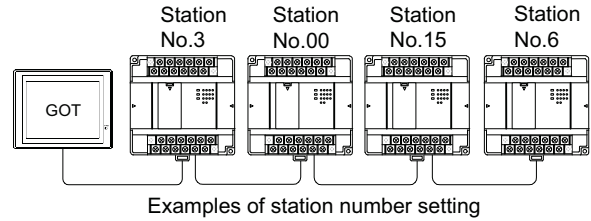

(1) Direct specification

Specify the station No. of the PLC to be changed when setting device.

Specification range
00 to 31

POINT

PLC Station No. settings

Make sure to set a 2-digit number for the station No. of the PLC to be monitored by the GOT.

11.6 Device Range that Can Be Set

The device ranges of controller that can be used for GOT are as follows.

Note that the device ranges in the following tables are the maximum values that can be set in GT Designer3.

The device specifications of controllers may differ depending on the models, even though belonging to the same series.

Please make the setting according to the specifications of the controller actually used.

When a non-existent device or a device number outside the range is set, other objects with correct device settings may not be monitored.

Setting item

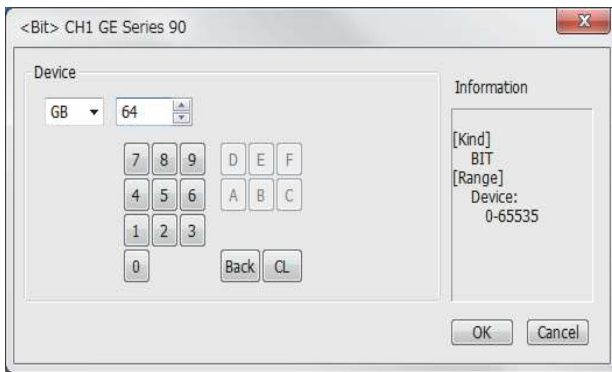

Item	Description
Device	Set the device name, device number, and bit number. The bit number can be set only when specifying the bit of word device.
Information	Displays the device type and setting range which are selected in [Device].
Network	Set the monitor target of the set device.
	Station No. Select this item when monitoring the PLC of the specified station No.

11.7 Precautions

GOT clock control

The PLC clock data cannot be written to or read from the GOT.

The settings of "time adjusting" or "time broadcast" made on the GOT will be disabled on the PLC.

11.6.1 GE Series 90

	Device name	Setting range	Device No. representation
Bit device	input (I)	I00001 to I12288	Decimal
	output (Q)	Q00001 to Q12288	
	internal (M)	M00001 to M12288	
	temporary (T)	T001 to T256	
	system status (S)	S001 to S128	
	system status (SA)	SA001 to SA128	
	system status (SB)	SB001 to SB128	
	system status (SC)	SC001 to SC128	
	global data (G)	G0001 to G7680	
Word device	system register (R)	R00001 to R32640	Decimal
	analog input register (AI)	AI0001 to AI32640	
	analog output register (AQ)	AQ0001 to AQ32640	

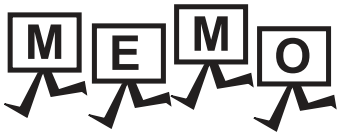

12













CONNECTION TO LS INDUSTRIAL SYSTEMS PLC

12.1 Connectable Model List	12 - 2
12.2 System Configuration	12 - 3
12.3 Connection Diagram	12 - 7
12.4 GOT Side Settings	12 - 9
12.5 PLC Side Setting	12 - 10
12.6 Device Range that Can Be Set	12 - 11

12. CONNECTION TO LS INDUSTRIAL SYSTEMS PLC

12.1 Connectable Model List

The following table shows the connectable models.

Series	Model name	Clock	Communication Type	Connectable model	Refer to
K80S	K7M-D□□□S(/DC)	○	RS-232 RS-422	  	 12.2.1
K120S	K7M-D□□□U				
K200S	K3P-07□S	○	RS-232 RS-422	  	 12.2.2
K300S	K4P-15S	○	RS-232 RS-422	  	 12.2.3

12.2 System Configuration

12.2.1 Connecting to K80S or K120S

■ When connecting to one PLC

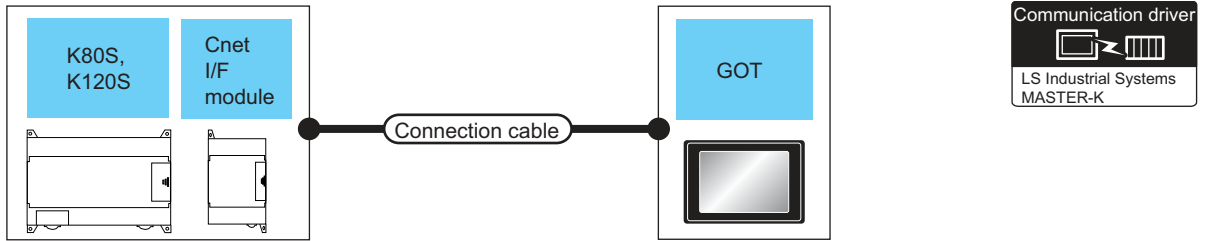

PLC			Connection cable		GOT		Number of connectable equipment
Series	Cnet I/F module*1	Communication Type	Cable model Connection diagram number	Max. distance	Option device	Model	
K80S K120S	-	RS-232	RS-232 connection diagram 1)	15m	-(Built into GOT)	 	1 PLC for 1 GOT
					GT15-RS2-9P	 	
	G7L-CUEB	RS-232	RS-232 connection diagram 2)	15m	-(Built into GOT)	 	
					GT15-RS2-9P	 	

*1 Product manufactured by LS Industrial Systems Co., Ltd. For details of the product, contact LS Industrial Systems Co.,Ltd.

■ When connecting to multiple PLCs

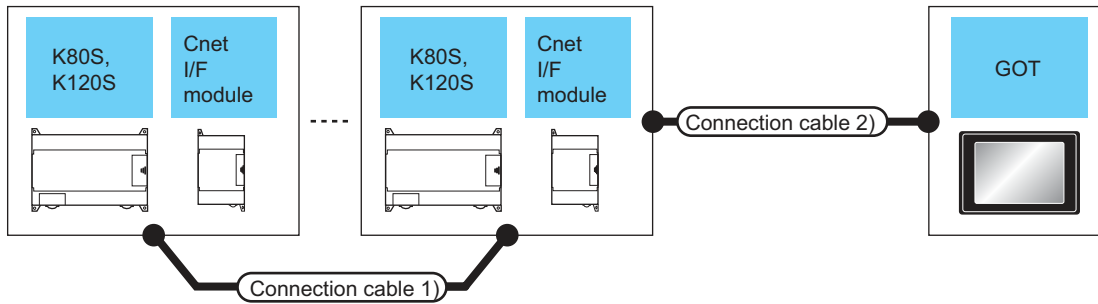

PLC Series	Connection cable 1) Cable model Connection diagram number	Cnet I/F module*1		Connection cable 2) Cable model Connection diagram number	Max. distance	GOT		Number of connectable equipment
		Model name	Communication Type			Option device	Model	
K80S K120S	User RS422 connection diagram 3)	G7L-CUEC	RS-422	User RS-422 connection diagram 1)	500m*3	- (Built into GOT)	GT 27 GT 23 GS	31 PLCs for 1 GOT
						GT15-RS4-9S	GT 27 GT 23 GS	

*1 Product manufactured by LS Industrial Systems Co., Ltd. For details of the product, contact LS Industrial Systems Co., Ltd.

*2 The total length of the connection cable 1) + connection cable 2)

12.2.2 Connecting to K200S

■ When connecting to one PLC

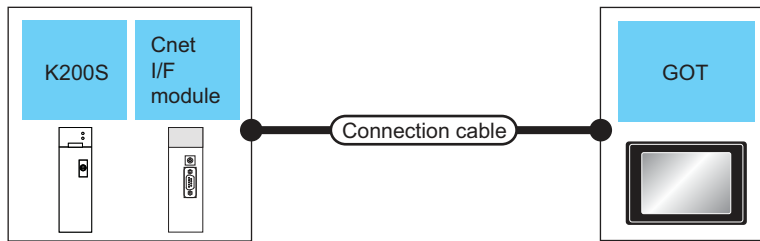

PLC		Connection cable		GOT		Number of connectable equipment	
Series	Cnet I/F module ^{*1}	Communication Type	Cable model Connection diagram number	Max. distance	Option device		Model
K200S	G6L-CUEB	RS-232	RS-232 connection diagram 2)	15m	-(Built into GOT)	GT 27 GT 23 GS	1 PLC for 1 GOT
					GT15-RS2-9P	GT 27 GT 23 GS	

^{*1} Product manufactured by LS Industrial Systems Co., Ltd. For details of the product, contact LS Industrial Systems Co., Ltd.

■ When connecting to multiple PLCs

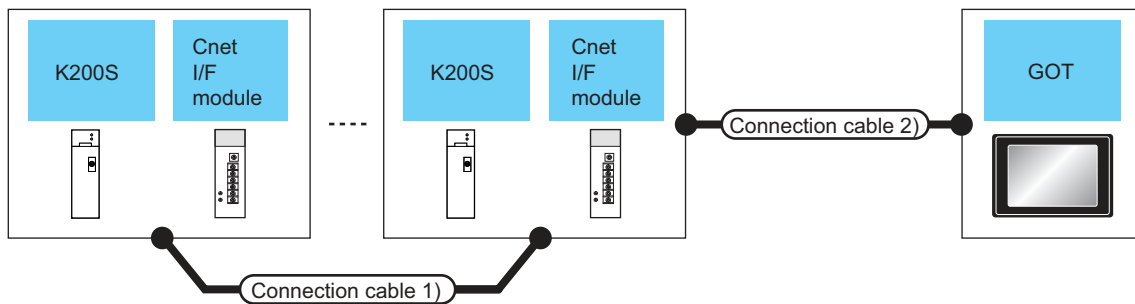

PLC Series	Connection cable 1) Cable model Connection diagram number	Cnet I/F module ^{*1}		Connection cable 2) Cable model Connection diagram number	Max. distance	GOT		Number of connectable equipment
		Model name	Communication Type			Option device	Model	
K200S	RS422 connection diagram 3)	G6L-CUEC	RS-422	RS-422 connection diagram 1)	500m ^{*3}	-(Built into GOT)	GT 27 GT 23 GS	31 PLCs for 1 GOT
						GT15-RS4-9S	GT 27 GT 23 GS	

^{*1} Product manufactured by LS Industrial Systems Co., Ltd. For details of the product, contact LS Industrial Systems Co., Ltd.

^{*2} The total length of the connection cable 1) + connection cable 2)

^{*3} The total length of the connection cable 1) + connection cable 2) + option device cable

^{*4} Connect it to the RS-232 interface (built into GOT). It cannot be mounted on GT1655 and GT155□.

12.2.3 Connecting to K300S

■ When connecting to one PLC

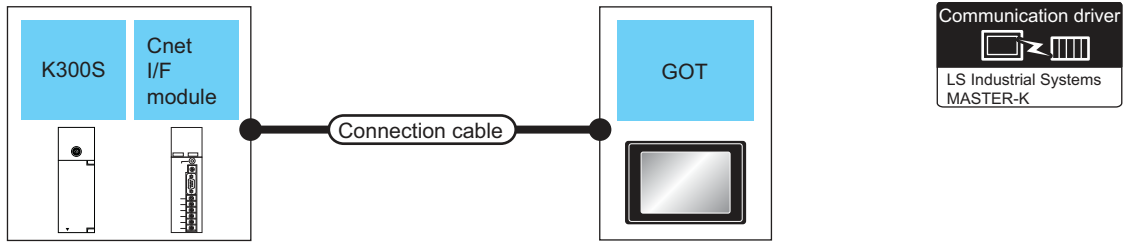

PLC			Connection cable		GOT		Number of connectable equipment
Series	Cnet I/F module ^{*1}	Communication Type	Cable model Connection diagram number	Max. distance	Option device	Model	
K300S	G4L-CUEA	RS-232	RS-232 connection diagram 2)	15m	- (Built into GOT)	 	1 PLC for 1 GOT
					GT15-RS2-9P	 	

*1 Product manufactured by LS Industrial Systems Co., Ltd. For details of the product, contact LS Industrial Systems Co.,Ltd.

■ When connecting to multiple PLCs

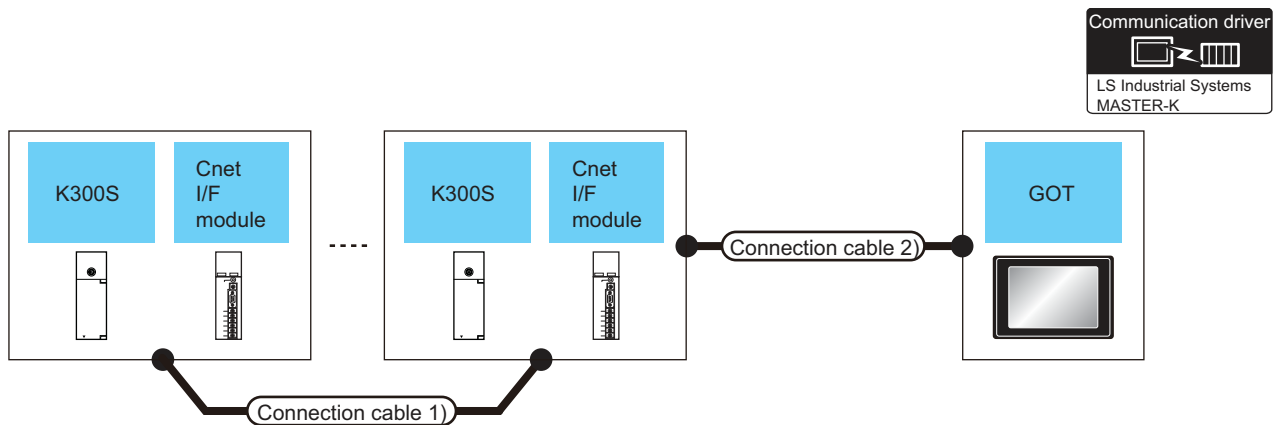

PLC Series	Connection cable 1) Cable model Connection diagram number	Cnet I/F module ^{*1}		Connection cable 2) Cable model Connection diagram number	Max. distance	GOT		Number of connectable equipment
		Cnet I/F module ^{*1}	Communication Type			Option device	Model	
K300S	RS422 connection diagram 3)	G4L-CUEA	RS-422	RS-422 connection diagram 1)	500m ^{*3}	- (Built into GOT)	 	31 PLCs for 1 GOT
						GT15-RS4-9S	 	

*1 Product manufactured by LS Industrial Systems Co., Ltd. For details of the product, contact LS Industrial Systems Co.,Ltd.

*2 The total length of the connection cable 1) + connection cable 2)

12.3 Connection Diagram

The following diagram shows the connection between the GOT and the PLC.

12.3.1 RS-232 cable

■ Connection diagram

(1) RS-232 connection diagram 1)

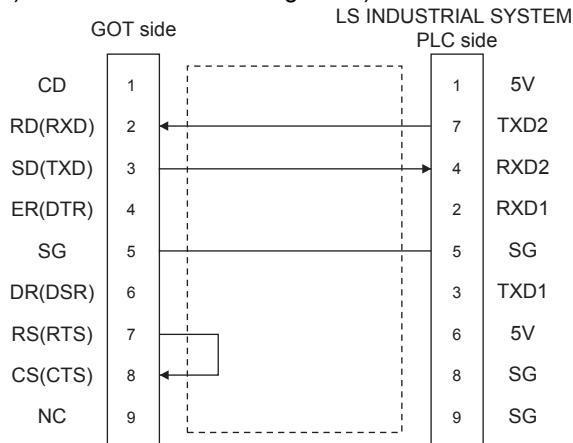

(2) RS-232 connection diagram 2)

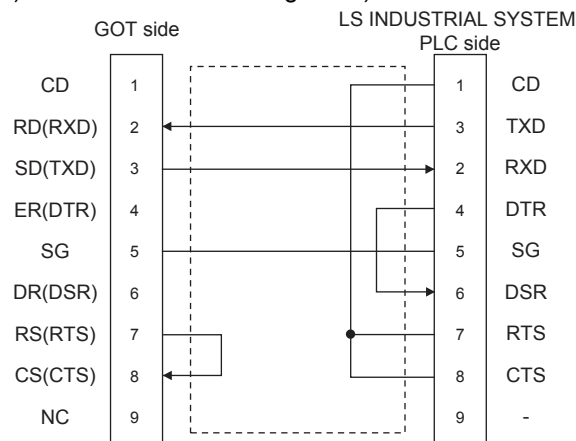

■ Precautions when preparing a cable

(1) Cable length

The length of the RS-232 cable must be 15m or less.

(2) GOT side connector

For the GOT side connector, refer to the following.

1.4.1 GOT connector specifications

(3) LS INDUSTRIAL SYSTEMS PLC side connector

Use the connector compatible with the LS INDUSTRIAL SYSTEMS PLC side module. For details, refer to the user's manual of the LS INDUSTRIAL SYSTEMS PLC.

12.3.2 RS-422 cable

■ Connection diagram

(1) RS-422 connection diagram 1)

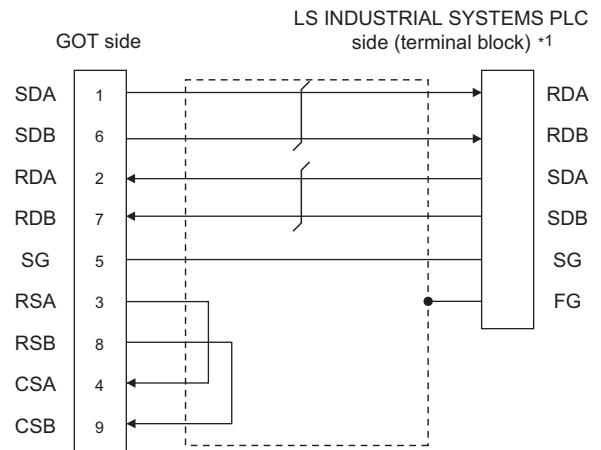

*1 For the system terminal, connect a 120Ω (1/2W) terminating resistor across RDA and RDB, and across SDA and SDB respectively.

(2) RS422 connection diagram 3)

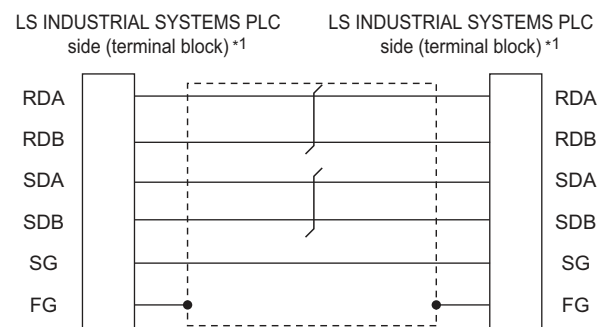

*1 For the system terminal, connect a 120Ω (1/2W) terminating resistor across RDA and RDB, and across SDA and SDB respectively.

■ Precautions when preparing a cable

(3) Cable length

The length of the RS-422 cable must be 500m or less.

(4) GOT side connector

For the GOT side connector, refer to the following.

1.4.1 GOT connector specifications

(5) LS INDUSTRIAL SYSTEMS PLC side connector

Use the connector compatible with the LS INDUSTRIAL SYSTEMS PLC side module. For details, refer to the user's manual of the LS INDUSTRIAL SYSTEMS PLC.

■ Connecting terminating resistors

(1) GOT side

Set the terminating resistor setting switch of the GOT main unit to "Disable".

For the procedure to set the terminating resistor, refer to the following.

 1.4.3 Terminating resistors of GOT

(2) LS INDUSTRIAL SYSTEMS PLC side

When connecting an LS INDUSTRIAL SYSTEMS PLC to the GOT, a terminating resistor must be connected.

 12.3.2 RS-422 cable ■ Connection diagram

12.4 GOT Side Settings

12.4.1 Setting communication interface (Communication settings)

Set the channel of the connected equipment.

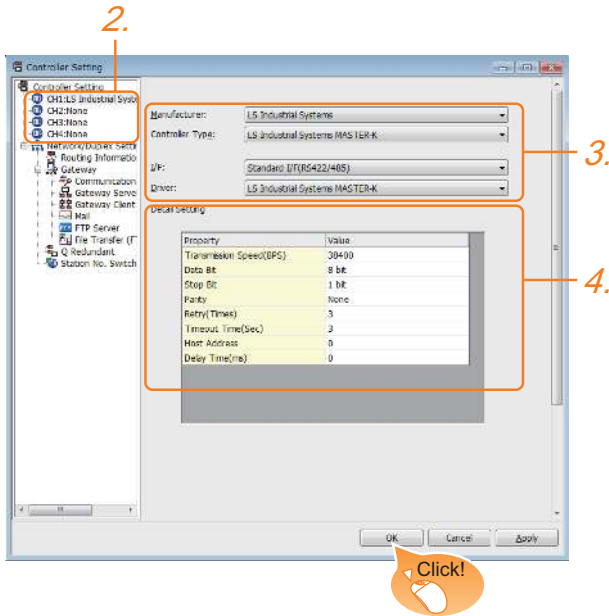

1. Select [Common] → [Controller Setting] from the menu.
2. The Controller Setting window is displayed. Select the channel to be used from the list menu.
3. Set the following items.
 - Manufacturer: LS Industrial Systems
 - Controller Type: LS Industrial Systems MASTER-K
 - I/F: Interface to be used
 - Driver: LS Industrial Systems MASTER-K
4. The detailed setting is displayed after Manufacturer, Controller Type, I/F, and Driver are set. Make the settings according to the usage environment.

☞ 12.4.2 Communication detail settings

Click the [OK] button when settings are completed.

POINT

The settings of connecting equipment can be confirmed in [I/F Communication Setting]. For details, refer to the following.

☞ 1.1.2 I/F communication setting

12.4.2 Communication detail settings

Make the settings according to the usage environment.

Property	Value
Transmission Speed(BPS)	38400
Data Bit	8 bit
Stop Bit	1 bit
Parity	None
Retry(Times)	3
Timeout Time(Sec)	3
Host Address	0
Delay Time(ms)	0

Item	Description	Range
Transmission Speed	Set this item when change the transmission speed used for communication with the connected equipment. (Default: 38400bps)	9600bps, 19200bps, 38400bps, 57600bps, 115200bps
Data Bit	Set this item when change the data length used for communication with the connected equipment. (Default: 8bits)	7bits/8bits
Stop Bit	Specify the stop bit length for communications. (Default: 1bit)	1bit/2bits
Parity	Specify whether or not to perform a parity check, and how it is performed during communication. (Default: None)	None Even Odd
Retry	Set the number of retries to be performed when a communication error occurs. (Default: 3times)	0 to 5times
Timeout Time	Set the time period for a communication to time out. (Default: 3sec)	3 to 30sec
Host Address	Specify the host address (station No. of the PLC to which the GOT is connected) in the network of the GOT. (Default: 0)	0 to 31
Delay Time	Set this item to adjust the transmission timing of the communication request from the GOT. (Default: 0ms)	0 to 300 (ms)

POINT

- (1) Communication interface setting by the Utility
The communication interface setting can be changed on the Utility's [Communication setting] after writing [Communication Settings] of project data. For details on the Utility, refer to the following manual.

☞ GOT2000 Series User's Manual (Utility)

- (2) Precedence in communication settings
When settings are made by GT Designer3 or the Utility, the latest setting is effective.

12.5 PLC Side Setting

POINT

LS INDUSTRIAL SYSTEMS PLC

For details of LS INDUSTRIAL SYSTEMS PLCs, refer to the following manual.

 User's Manual of the LS INDUSTRIAL SYSTEMS PLC

Model name		Refer to
PLC CPU	K80S	12.5.1
	K120S	
	K200S	
	K300S	
Cnet I/F module	G7L-CUEB	12.5.2
	G7L-CUEC	
	G6L-CUEB	
	G6L-CUEC	
	G4L-CUEA	

12.5.1 Connecting to PLC CPU

■ Settings of the communication specifications

There is no item to be set using the hardware.

Set the items using the engineering software for MASTER-K.

Item	Setting details
Station No.	0 to 31
Communication speed	1200, 2400, 4800, 9600, 19200, 38400, 57600bps
Data bit	7 or 8
Parity bit	None, Even, Odd
Stop bit	1 or 2

*1 For the setting method of the engineering software, refer to the following.

 User's Manual of the LS INDUSTRIAL SYSTEMS PLC

12.5.2 Connecting to Cnet I/F module

■ Settings of the communication specifications

There is no item to be set using the hardware.

Set the items using the engineering software for MASTER-K.

Item		Setting details
Communication protocol		Dedicated protocol
Communication format	Data bit	7 or 8
	Stop bit	1 or 2
	Start bit	1
	Parity bit	Even/Odd/None
Channel selection		Stand-alone mode/Interlocking mode
Synchronization		Asynchronous
Transmission speed (bps)	RS-232C	300/600/1200/2400/4800/9600/19200/38400
	RS-422/485	300/600/1200/2400/4800/9600/19200/38400/76800

*1 For the setting method of the engineering software, refer to the following.

 User's Manual of the LS INDUSTRIAL SYSTEMS PLC

12.6 Device Range that Can Be Set

The device ranges of controller that can be used for GOT are as follows.

Note that the device ranges in the following tables are the maximum values that can be set in GT Designer3.

The device specifications of controllers may differ depending on the models, even though belonging to the same series.

Please make the setting according to the specifications of the controller actually used.

When a non-existent device or a device number outside the range is set, other objects with correct device settings may not be monitored.

■ Setting item

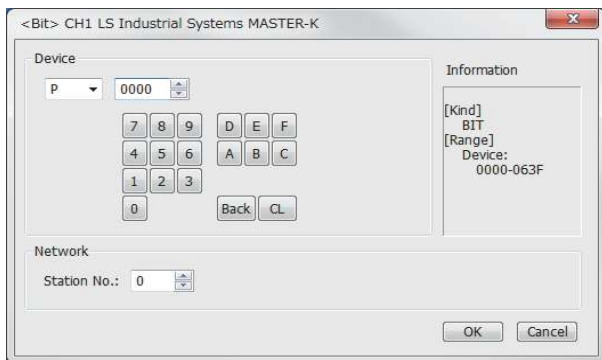

Item	Description					
Device	Set the device name, device number, and bit number. The bit number can be set only when specifying the bit of word device.					
Information	Displays the device type and setting range which are selected in [Device].					
Network	Set the monitor target of the set device.					
	<table border="0"> <tr> <td>Station No.</td> <td>0 to 31</td> <td>: To monitor the PLC of the specified station No.</td> </tr> <tr> <td></td> <td>100 to 115</td> <td>: To specify the station No. of the PLC to be monitored by the value of GOT data register (GD).^{*1}</td> </tr> </table>	Station No.	0 to 31	: To monitor the PLC of the specified station No.		100 to 115
Station No.	0 to 31	: To monitor the PLC of the specified station No.				
	100 to 115	: To specify the station No. of the PLC to be monitored by the value of GOT data register (GD). ^{*1}				

*1 The following shows the relation between station numbers of the PLC and the GOT data register.

Station No.	GOT data register (GD)	Setting range
100	GD10	0 to 31 (If setting a value outside the range above, a device range error occurs.)
101	GD11	
:	:	
114	GD24	
115	GD25	

POINT

Device settings of LS IS PLC

(1) When setting bit device (except timer and counter)

Set the bit device using the decimal number (three digits) and the hexadecimal number.

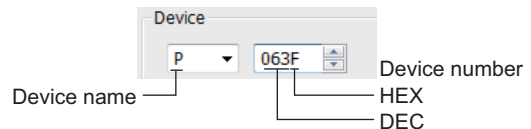

12.6.1 LS Industrial Systems MASTER-K

	Device name	Setting range	Device No. representation
Bit device	I/O relay (P)	P0000 to P063F	Decimal + Hexadecimal
	Auxiliary relay (M)	M0000 to M191F	
	Keep relay (K)	K0000 to K031F	
	Link relay (L)	L0000 to L063F	
	Special relay (F) ^{*1}	F0000 to F063F	
	Timer contact (T)	T0 to T255	Decimal
Counter contact (C)	C0 to C255		
Word device	I/O relay (P)	P000 to P063	Decimal
	Auxiliary relay (M)	M000 to M191	
	Keep relay (K)	K000 to K031	
	Link relay (L)	L000 to L063	
	Special relay (F) ^{*1}	F000 to F063	
	Timer current value (T)	T0 to T255	
	Counter current value (C)	C0 to C255	
	Step controller (S)	S0 to S99	
Data register (D)	D0 to D9999		

*1 Only reading is possible.

13



CONNECTION TO SICK SAFETY CONTROLLER

13.1 Connectable Model List	13 - 2
13.2 System Configuration	13 - 2
13.3 GOT Side Settings	13 - 3
13.4 PLC Side Setting	13 - 4
13.5 Device Range That Can Be Set	13 - 5

13. CONNECTION TO SICK SAFETY CONTROLLER

13.1 Connectable Model List



The following table shows the connectable models.

Series	Model name	Clock	Communication Type	Connectable model	Refer to
Flexi Soft	FX3-CPU000000	x	RS-232		 13.2.1
	FX3-CPU130002				

13.2 System Configuration

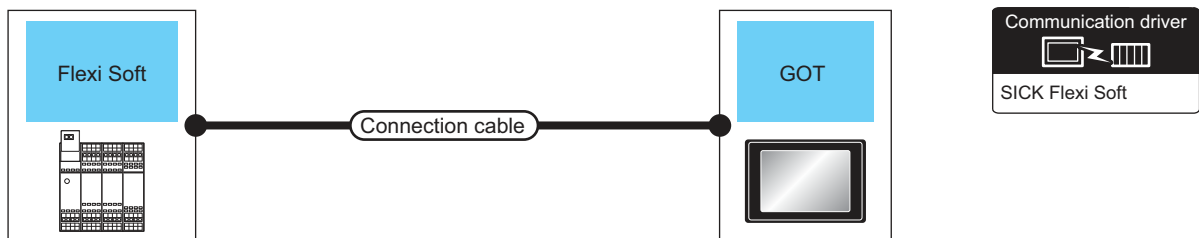
13.2.1 Connecting to Flexi Soft



PLC		Connection cable		GOT		Number of connectable equipment
Series	Communication Type	Cable model Connection diagram number	Max. distance	Option device	Model	
Flexi Soft	RS-232	Part Number:6021195(2m) ^{*1} Part Number:6036342(3m) ^{*1}	3m	- (Built into GOT)		1 PLC for 1 GOT
				GT15-RS2-9P		

*1 Product manufactured by SICK Inc. For details of the product, contact SICK Inc.

13.3 GOT Side Settings

13.3.1 Setting communication interface (Communication settings)

Set the channel of the connected equipment.

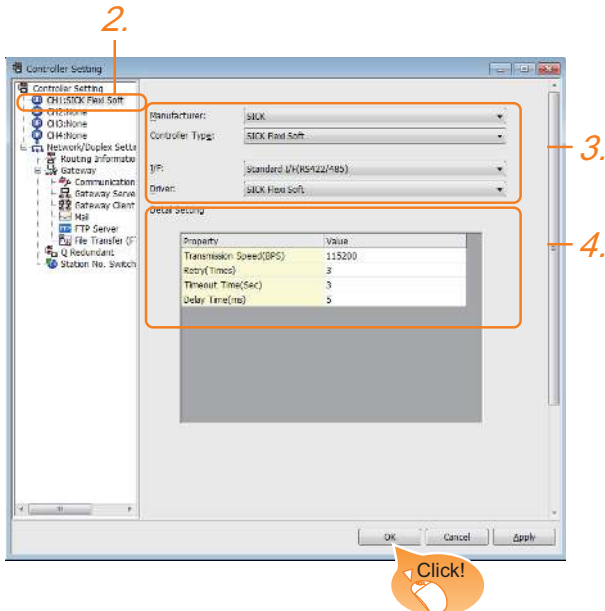

1. Select [Common] → [Controller Setting] from the menu.
2. The Controller Setting window is displayed. Select the channel to be used from the list menu.
3. Set the following items.
 - Manufacturer: SICK
 - Controller Type: SICK Flexi Soft
 - I/F: Interface to be used
 - Driver: SICK Flexi Soft
4. The detailed setting is displayed after Manufacturer, Controller Type, I/F, and Driver are set. Make the settings according to the usage environment.

☞ 13.3.2 Communication detail settings

Click the [OK] button when settings are completed.

POINT

The settings of connecting equipment can be confirmed in [I/F Communication Setting]. For details, refer to the following.

☞ 1.1.2 I/F communication setting

13.3.2 Communication detail settings

Make the settings according to the usage environment.

(1) SICK Flexi Soft

Property	Value
Transmission Speed(BPS)	115200
Retry(Times)	3
Timeout Time(Sec)	3
Delay Time(ms)	5

Item	Description	Range
Transmission Speed	Set this item when change the transmission speed used for communication with the connected equipment. (Default: 115200bps)	9600bps, 19200bps, 38400bps, 57600bps, 115200bps
Retry	Set the number of retries to be performed when a communication error occurs. (Default: 3times)	0 to 5times
Timeout Time	Set the time period for a communication to time out. (Default: 3sec)	1 to 30sec
Delay Time	Set this item to adjust the transmission timing of the communication request from the GOT. (Default: 5ms)	0 to 300 (ms)

POINT

- (1) Communication interface setting by the Utility
The communication interface setting can be changed on the Utility's [Communication setting] after writing [Communication Settings] of project data. For details on the Utility, refer to the following manual.
☞ GOT2000 Series User's Manual (Utility)
- (2) Precedence in communication settings
When settings are made by GT Designer3 or the Utility, the latest setting is effective.

13.4 PLC Side Setting

POINT

SICK PLC

For details of SICK PLCs, refer to the following manual.

 User's Manual of the SICK PLC

13.4.1 Connecting to Flexi Soft

■ Communication settings

Communication settings are not required, since the following contents are fixed.

Setting item	Controller Side Settings
Communication speed	115200bps (Fixed)
Data bit	8bits (Fixed)
Parity bit	Without (Fixed)
Stop bit	1bit (Fixed)

13.5 Device Range That Can Be Set

The device ranges of controller that can be used for GOT are as follows.

Note that the device ranges in the following tables are the maximum values that can be set in GT Designer3.

The device specifications of controllers may differ depending on the models, even though belonging to the same series.

Please make the setting according to the specifications of the controller actually used.

When a non-existent device or a device number outside the range is set, other objects with correct device settings may not be monitored.

Setting item

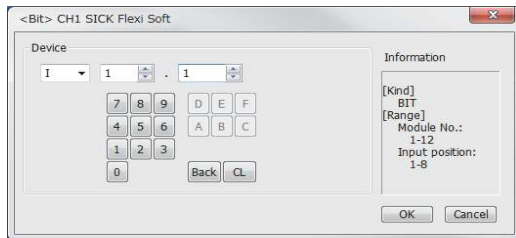

Item	Description
Device	Set the device name, device number, and bit number. The bit number can be set only by specifying the bit of word device.
Information	Displays the device type and its setting range selected in [Device].

POINT

- (1) Device settings of SICK Safety controller
 (a) Input (I), Output (Q)

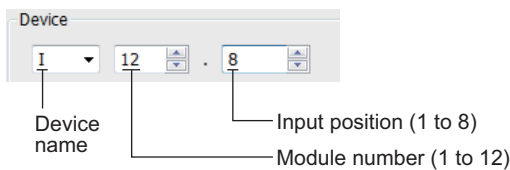

- (b) Logic result (LQ), Logic input (LI)

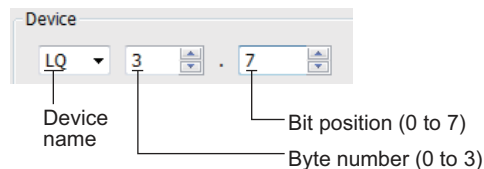

- (c) EFI input (EI)

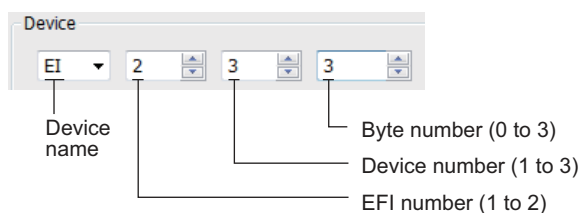

(d) EFI output (EQ)

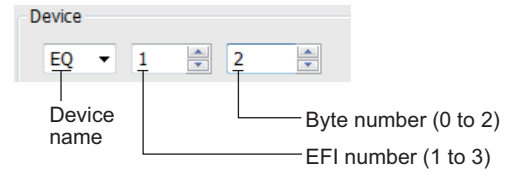

- (2) Engineering software for SICK and device representation of GT Designer3
 The engineering software for SICK and the device representation of GT Designer3 are different. Set the device by referring to the following table.

Device	GT Designer3	Engineering software for SICK
I ^{*1}	I□□.△ □□(1-12(Dec)): Module number △(1-8): Input position	▲▲▲▲[□□].I△ ▲▲▲▲: I/O model name (such as XTIO) □□(1-12(Dec)): Module number △(1-8): Input position
Q ^{*1}	Q□□.△ □□(1-12(Dec)): Module number △(1-8): Output position	▲▲▲▲[□□].Q△ ▲▲▲▲: I/O model name (such as XTIO) □□(1-12(Dec)): Module number △(1-8): Output position
LQ ^{*1}	LQ□.△ □(0-3): Byte number △(0-7): Bit position	▲▲□.△ ▲▲: "Result" □(0-3): Byte number △(0-7): Bit position
LI ^{*1}	LI□.△ □(0-3): Byte number △(0-7): Bit position	▲▲▲▲[0].□.△ ▲▲▲▲: CPU type(CPU0, CPU1) □(0-3): Byte number △(0-7): Bit position
EI ^{*1}	EI□□△ □(1-2): EFI number □(1-3): Device number △(0-3): Byte number	▲▲▲▲[0].EFI□:□,Byte△ ▲▲▲▲: CPU type(CPU0, CPU1) □(1-2): EFI number □(1-3): Device number △(0-3): Byte number
EQ ^{*1}	EQ□△ □(1-2): EFI number △(0-2): Byte number	▲▲▲▲[0].EFI□:1,Byte△ ▲▲▲▲: CPU type(CPU0, CPU1) □(1-2): EFI number △(0-2): Byte number
D	D△ △(0-99(Dec)): Byte number	RS232 data (Safety controller to RS232)
W	W△ △(0-49(Dec)): Word number Word virtualization of D device W0= (D1(Upper bits), D0(Lower bits))	GOT independent device (Not available)
LD	LD△ △(0-3): Byte number	RS232 data (RS232 to safety controller)
LW	LW△ △(0-1): Word number Word virtualization of LD device LW0= (LD1(Upper bits), LD0(Lower bits))	GOT independent device (Not available)

*1 When the mapping position is changed by the engineering software for SICK, a mismatch occurs between virtual devices on GOT and SICK safety controller mapping devices. When mapping is changed, use D devices or LD devices.

- (3) When using offset specification
When setting devices using the offset function, the device values are as follows.

(a) Input (I)

Offset	+0	+1	+2	+3	+4	+5	+6	+7	+8 to +15	
+0	I1.1	I1.2	I1.3	I1.4	I1.5	I1.6	I1.7	I1.8	Fixed to 0 (OFF)	
+16	I2.1	I2.2	I2.3	I2.4	I2.5	I2.6	I2.7	I2.8		
+32	I3.1	I3.2	I3.3	I3.4	I3.5	I3.6	I3.7	I3.8		
+48	I4.1	I4.2	I4.3	I4.4	I4.5	I4.6	I4.7	I4.8		
+64	I5.1	I5.2	I5.3	I5.4	I5.5	I5.6	I5.7	I5.8		
+80	I6.1	I6.2	I6.3	I6.4	I6.5	I6.6	I6.7	I6.8		
+96	I7.1	I7.2	I7.3	I7.4	I7.5	I7.6	I7.7	I7.8		
+112	I8.1	I8.2	I8.3	I8.4	I8.5	I8.6	I8.7	I8.8		
+128	I9.1	I9.2	I9.3	I9.4	I9.5	I9.6	I9.7	I9.8		
+144	I10.1	I10.2	I10.3	I10.4	I10.5	I10.6	I10.7	I10.8		
+160	I11.1	I11.2	I11.3	I11.4	I11.5	I11.6	I11.7	I11.8		
+176	I12.1	I12.2	I12.3	I12.4	I12.5	I12.6	I12.7	I12.8		
+192	Device range error									

(b) Output (Q)

Offset	+0	+1	+2	+3	+4	+5	+6	+7	+8 to +15	
+0	Q1.1	Q1.2	Q1.3	Q1.4	Q1.5	Q1.6	Q1.7	Q1.8	Fixed to 0 (OFF)	
+16	Q2.1	Q2.2	Q2.3	Q2.4	Q2.5	Q2.6	Q2.7	Q2.8		
+32	Q3.1	Q3.2	Q3.3	Q3.4	Q3.5	Q3.6	Q3.7	Q3.8		
+48	Q4.1	Q4.2	Q4.3	Q4.4	Q4.5	Q4.6	Q4.7	Q4.8		
+64	Q5.1	Q5.2	Q5.3	Q5.4	Q5.5	Q5.6	Q5.7	Q5.8		
+80	Q6.1	Q6.2	Q6.3	Q6.4	Q6.5	Q6.6	Q6.7	Q6.8		
+96	Q7.1	Q7.2	Q7.3	Q7.4	Q7.5	Q7.6	Q7.7	Q7.8		
+112	Q8.1	Q8.2	Q8.3	Q8.4	Q8.5	Q8.6	Q8.7	Q8.8		
+128	Q9.1	Q9.2	Q9.3	Q9.4	Q9.5	Q9.6	Q9.7	Q9.8		
+144	Q10.1	Q10.2	Q10.3	Q10.4	Q10.5	Q10.6	Q10.7	Q10.8		
+160	Q11.1	Q11.2	Q11.3	Q11.4	Q11.5	Q11.6	Q11.7	Q11.8		
+176	Q12.1	Q12.2	Q12.3	Q12.4	Q12.5	Q12.6	Q12.7	Q12.8		
+192	Device range error									

(c) Logic result (LQ)

Offset	+0	+1	+2	+3	+4	+5	+6	+7	
+0	LQ0.0	LQ0.1	LQ0.2	LQ0.3	LQ0.4	LQ0.5	LQ0.6	LQ0.7	
+8	LQ1.0	LQ1.1	LQ1.2	LQ1.3	LQ1.4	LQ1.5	LQ1.6	LQ1.7	
+16	LQ2.0	LQ2.1	LQ2.2	LQ2.3	LQ2.4	LQ2.5	LQ2.6	LQ2.7	
+24	LQ3.0	LQ3.1	LQ3.2	LQ3.3	LQ3.4	LQ3.5	LQ3.6	LQ3.7	
+32	Device range error								

(d) Logic input (LI)

Offset	+0	+1	+2	+3	+4	+5	+6	+7	
+0	LI0.0	LI0.1	LI0.2	LI0.3	LI0.4	LI0.5	LI0.6	LI0.7	
+8	LI1.0	LI1.1	LI1.2	LI1.3	LI1.4	LI1.5	LI1.6	LI1.7	
+16	LI2.0	LI2.1	LI2.2	LI2.3	LI2.4	LI2.5	LI2.6	LI2.7	
+24	LI3.0	LI3.1	LI3.2	LI3.3	LI3.4	LI3.5	LI3.6	LI3.7	
+32	Device range error								

(e) EFI input (EI)

Offset	+0	+1	+2	+3	+8 to +15	
+0	EI110	EI111	EI112	EI113	Fixed to 0	
+16	EI120	EI121	EI122	EI123		
+32	EI130	EI131	EI132	EI133		
+48	Fixed to 0					
+240	Fixed to 0					
+256	EI210	EI211	EI212	EI213		
+272	EI220	EI221	EI222	EI223		
+288	EI230	EI231	EI232	EI233		Device range error
+302	Device range error					

(f) EFI output (EQ)

Offset	+0	+1	+2	+3 to +15
+0	EQ10	EQ11	EQ12	Fixed to 0
+16	Fixed to 0			
+240	Fixed to 0			
+256	EQ20	EQ21	EQ22	Device range error
+272	Device range error			

13.5.1 SICK Safety Controller (SICK Flexi Soft)

Device	Setting range	Device No. representation	
Bit device	Input (I)	I1.1 to I12.8	Decimal +Decimal
	Output (Q)	Q1.1 to Q12.8	
	Logic result (LQ)	LQ0.0 to LQ3.7	
	Logic input (LI)	LI0.0 to LI3.7	
Word device bit	Specified bit of the following word devices		-
Word device	Data (byte)(D)	D0 to D99	Decimal
	Data (word)(W)	W0 to W49	
	EFI input (byte)(EI)	EI110 to EI233	Decimal +Decimal +Decimal
	EFI output (byte)(EQ)	EQ10 to EQ22	
	Logic input (byte)(LD)	LD0 to LD3	Decimal
	Logic input (word)(LW)	LW0 to LW1	Decimal

POINT

Device of SICK Flexi Soft
Only reading is possible for all devices.

14









CONNECTION TO SIEMENS PLC

14.1 Connectable Model List	14 - 2
14.2 Serial Connection.....	14 - 3
14.3 Ethernet Connection	14 - 9
14.4 Device Range that Can Be Set	14 - 15

14. CONNECTION TO SIEMENS PLC

14.1 Connectable Model List

The following table shows the connectable models.

Series	Clock	Communication Type	Ethernet Connection Type	Connectable model	Refer to
SIMATIC S7-200	x	RS-232	-	GT 27 GT 23 GS	 14.2.2
		Ethernet	OP communication	GT 27 GT 23 GS	 14.3.2
SIMATIC S7-300	O*1	RS-232	-	GT 27 GT 23 GS	 14.2.1
		Ethernet	FETCH/ WRITE	GT 27 GT 23 GS	 14.3.1
			OP communication	GT 27 GT 23 GS	 14.3.2
SIMATIC S7-400	O*1	RS-232	-	GT 27 GT 23 GS	 14.2.1
		Ethernet	FETCH/ WRITE	GT 27 GT 23 GS	 14.3.1
			OP communication	GT 27 GT 23 GS	 14.3.2
SIMATIC S7-1200	x	Ethernet	OP communication	GT 27 GT 23 GS	 14.3.2

*1 Not available with the Ethernet connection.

14.2 Serial Connection

14.2.1 System configuration for connecting to SIMATIC S7-300/400 series

■ When connecting to one PLC

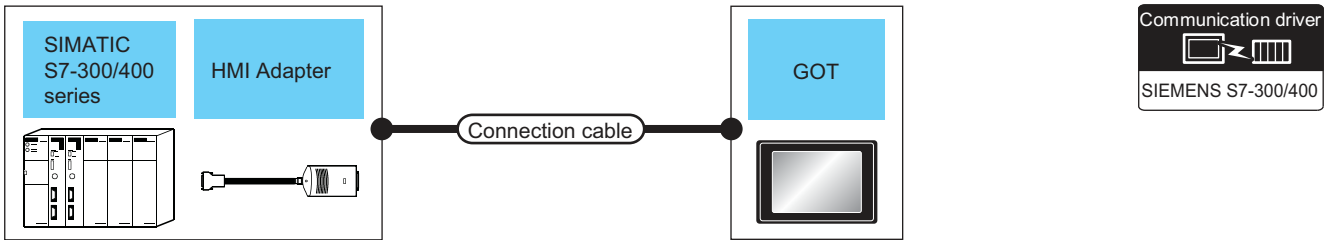

PLC		Connection cable		GOT		Number of connectable equipment	
Series	HMI Adapter ^{*1}	Communication Type	Cable model Connection diagram number	Max. distance	Option device		Model
SIMATIC S7-300/400	MLFB: 6ES7 972-0CA11-0XA0	RS-232	GT09-C30R20801-9S (3m) or RS232 connection diagram 1)	15m	- (Built into GOT)	GT 27 GT 23 GS	1 GOT for 1 HMI Adapter
					GT15-RS2-9P	GT 27 GT 23 GS	

*1 Product manufactured by Siemens AG. For details of this product, contact Siemens AG.

■ When connecting to multiple PLCs

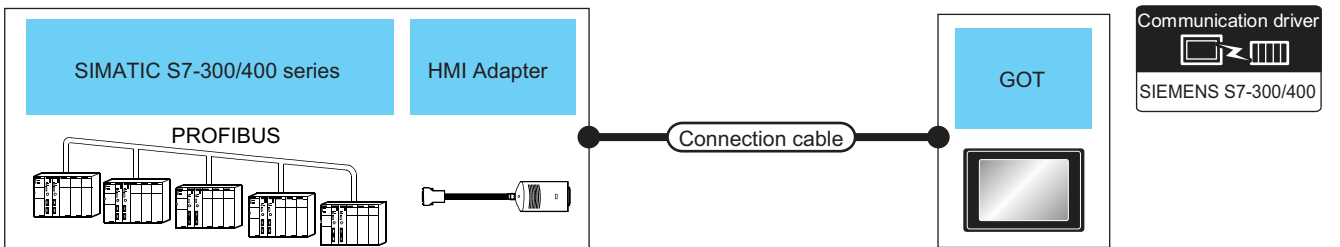

PLC		Connection cable		GOT		Number of connectable equipment	
Series	HMI Adapter ^{*1}	Communication Type	Cable model Connection diagram number	Max. distance	Option device		Model
SIMATIC S7-300/400	MLFB: 6ES7 972-0CA11-0XA0	RS-232	GT09-C30R20801-9S (3m) or RS232 connection diagram 1)	15m	- (Built into GOT)	GT 27 GT 23 GS	1 GOT for 1 HMI Adapter
					GT15-RS2-9P	GT 27 GT 23 GS	

*1 Product manufactured by Siemens AG. For details of this product, contact Siemens AG.

14.2.2 System configuration for connecting to SIMATIC S7-200

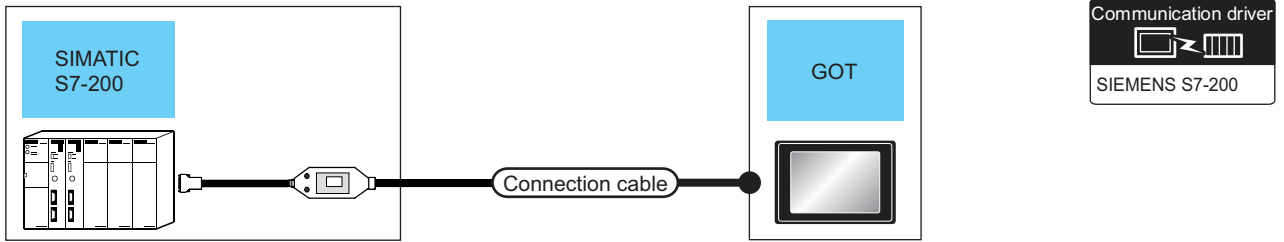

PLC		Connection cable		GOT		Number of connectable equipment
Series	Communication Type	Cable model Connection diagram number	Max. distance	Option device	Model	
SIMATIC S7-200	RS-232	6ES7 901-3BF20-0XA0* ¹ 6ES7 901-3CB30-0XA0* ¹	15m	- (Built into GOT)	<div style="display: flex; flex-direction: column; align-items: center;"> <div style="background-color: black; color: white; padding: 2px;">GT</div> <div style="background-color: black; color: white; padding: 2px;">27</div> <div style="background-color: black; color: white; padding: 2px;">GT</div> <div style="background-color: black; color: white; padding: 2px;">23</div> <div style="background-color: black; color: white; padding: 2px;">GS</div> </div>	1 GOT for 1 PLC
				GT15-RS2-9P	<div style="display: flex; flex-direction: column; align-items: center;"> <div style="background-color: black; color: white; padding: 2px;">GT</div> <div style="background-color: black; color: white; padding: 2px;">27</div> <div style="background-color: black; color: white; padding: 2px;">GT</div> <div style="background-color: black; color: white; padding: 2px;">23</div> <div style="background-color: black; color: white; padding: 2px;">GS</div> </div>	

*1 Product manufactured by Siemens AG. For details of this product, contact Siemens AG.

14.2.3 Connection Diagram

The following diagram shows the connection between the GOT and the PLC.

■ RS-232 cable

(1) Connection diagram

(a) RS232 connection diagram 1)

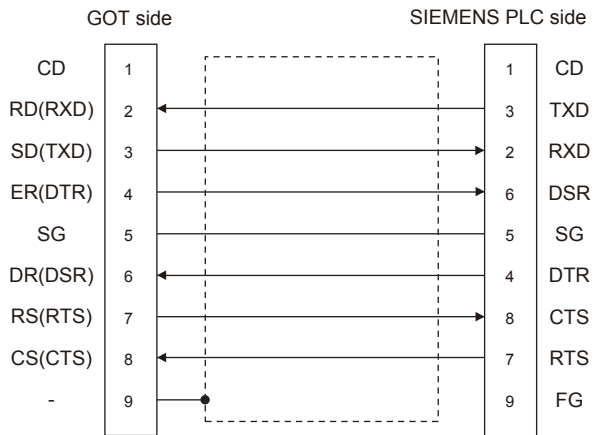

(2) Precautions when preparing a cable

(a) Cable length

The length of the RS-232 cable must be 15m or less.

(b) GOT side connector

For the GOT side connector, refer to the following.

 1.4.1 GOT connector specifications

(c) SIEMENS PLC side connector

Use the connector compatible with the SIEMENS PLC side.

For details, refer to the SIEMENS PLC user's manual.

14.2.4 GOT Side Settings

■ Setting communication interface (Communication settings)

Set the channel of the connected equipment.

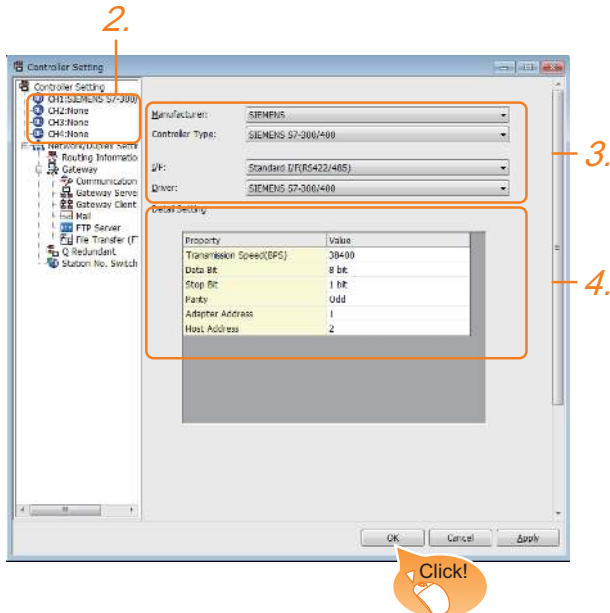

1. Select [Common] → [Controller Setting] from the menu.
2. The Controller Setting window is displayed. Select the channel to be used from the list menu.
3. Set the following items.
 - Manufacturer: SIEMENS
 - Controller Type: Set either of the following.
S7-300/400
S7-200
 - I/F: Interface to be used
 - Driver: Set either of the following.
 - When connecting to SIEMENS S7-300/400:
SIEMENS S7-300/400
 - When connecting to SIEMENS S7-200:
SIEMENS S7-200
4. The detailed setting is displayed after Manufacturer, Controller Type, I/F, and Driver are set. Make the settings according to the usage environment.

☞ 14.2.4 ■ Communication detail settings

Click the [OK] button when settings are completed.

POINT

The settings of connecting equipment can be confirmed in [I/F Communication Setting]. For details, refer to the following.

☞ 1.1.2 I/F communication setting

■ Communication detail settings

Make the settings according to the usage environment.

(1) SIEMENS S7-300/400

Property	Value
Transmission Speed(BPS)	38400
Data Bit	8 bit
Stop Bit	1 bit
Parity	Odd
Adapter Address	1
Host Address	2

Item	Description	Range
Transmission Speed ^{*2}	Set this item when change the transmission speed used for communication with the connected equipment. (Default: 38400bps)	9600bps, 19200bps, 38400bps
Data Bit	Set this item when change the data length used for communication with the connected equipment. (Default: 8bit)	8bit (fixed)
Stop Bit	Specify the stop bit length for communications. (Default: 1bit)	1bit (fixed)
Parity	Specify whether or not to perform a parity check, and how it is performed during communication. (Default: Odd)	Odd (fixed)
Adapter Address ^{*1*2}	Specify the adapter address (station No. of the adapter to which the GOT is connected) in the connected network. (Default: 1)	1 to 31
Host Address ^{*1*2}	Specify the host address (station No. of the PLC that the GOT will monitor) in the connected network. (Default: 2)	1 to 31

*1 Set the address without overlapping the address of other units.

*2 The GOT automatically sets the values of Transmission Speed, Adapter Address, and Host Address to the HMI Adapter.

(2) SIEMENS S7-200

Property	Value
Transmission Speed(BPS)	19200
Data Bit	8 bit
Stop Bit	1 bit
Parity	Even
Adapter Address	0
Host Address	2

Item	Description	Range
Transmission Speed	Set this item when change the transmission speed used for communication with the connected equipment. (Default: 19200bps)	9600bps, 19200bps, 38400bps, 57600bps, 115200bps
Data Bit	Set this item when change the data length used for communication with the connected equipment. (Default: 8bits)	7bits/8bits
Stop Bit	Specify the stop bit length for communications. (Default: 1bit)	1bit/2bits
Parity	Specify whether or not to perform a parity check, and how it is performed during communication. (Default: Even)	None Even Odd
Adapter Address	Specify the adapter address (station No. of the adapter to which the GOT is connected) in the connected network. (Default: 0)	0 to 31
Host Address	Specify the host address (station No. of the PLC that the GOT will monitor) in the connected network. (Default: 2)	1 to 31

POINT

- (1) Communication interface setting by the Utility
The communication interface setting can be changed on the Utility's [Communication setting] after writing [Communication Settings] of project data.
For details on the Utility, refer to the following manual.
 GOT2000 Series User's Manual (Utility)
- (2) Precedence in communication settings
When settings are made by GT Designer3 or the Utility, the latest setting is effective.

14.2.5 PLC Side Setting

POINT

SIEMENS PLC

For details of SIEMENS PLCs, refer to the following manuals.

 SIEMENS PLC user's Manual

	Model name	Refer to
PLC CPU	S7-200	14.2.7
HMI Adapter	6ES7 972-0CA11-0XA0	14.2.6
PC/PPI cable	6ES7 901-3BF20-0XA0 6ES7 901-3CB30-0XA0	14.2.7

14.2.6 Connecting to HMI Adapter

■ Communication settings

The following communication settings are made at the communication detail settings of the GOT side.
For details, refer to the following.

 14.2.4 ■ Communication detail settings

Setting item	PLC side setting
Transmission speed	9600bps, 19200bps, 38400bps
Data bit	8bits (fixed)
Parity bit	Odd (fixed)
Stop bit	1bit (fixed)
Adapter address	1 to 31
Host address	1 to 31

14.2.7 Connecting to SIMATIC S7-200

■ Communication settings

Set the communication settings of PLC and PC/PPI cable.

(1) PLC settings

Set the communication settings of PLC by operating the SIEMENS programming tool(STEP7-WIN32).

Setting item	PLC Side Setting
Transmission speed*1	9600bps, 19200bps
Data bit	8bits (fixed)
Parity bit	Even (fixed)
Stop bit	1bit (fixed)
Host address*2	1 to 31

*1 Adjust the settings with GOT settings.

*2 Set the address without overlapping the address of other units.

(2) PC/PPI cable settings

Set the transmission speed by operating the DIP switch on the PC/PPI cable.

DIP switch

(down side:0, upper side:1)

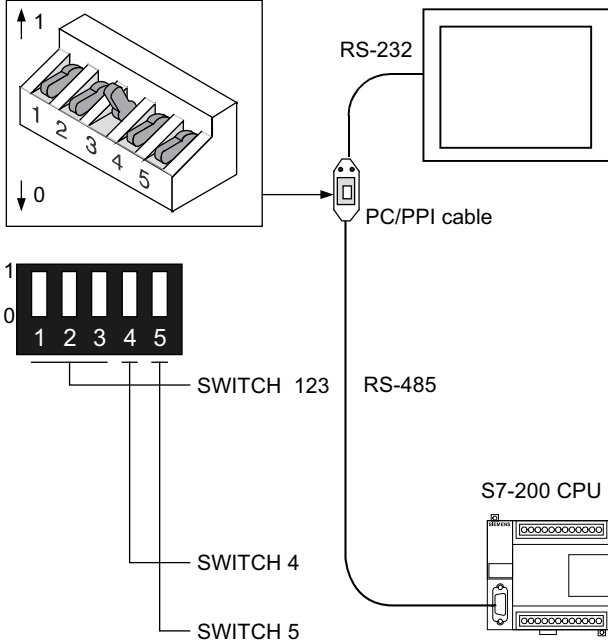

SWITCH 1	SWITCH 2	SWITCH 3	SWITCH 4	SWITCH 5	Transmission speed
0	0	1	0	0	19200bps*1
0	1	0	0	0	9600bps*1

*1 Adjust with GOT settings.

14.2.8 Precautions

■ GOT alarm list (system alarm) function

Error information cannot be monitored when the GOT is connected to a SIEMENS PLC.

(The error information on the PLC CPU side can be monitored.)

For details on the alarm list (system alarm), refer to the following manual:

GT Designer3 (GOT2000) Help

(1) When powering ON the system

Turn ON all PLC CPUs before turning ON the GOT.

If the GOT is turned ON before power-up of the PLC CPUs, restart the GOT.

(2) When powering OFF a PLC CPU at another station

When a PLC CPU at another station (the PLC CPU to which the HMI Adapter is not connected) is turned OFF, monitoring by the GOT is stopped.

To resume the monitoring, restart the GOT.

(Monitoring will not be resumed on GOT even if the PLC CPU is turned ON again.)

14.3 Ethernet Connection

14.3.1 System configuration for connecting to SIMATIC S7-300/400 series (Ethernet connection type: FETCH/WRITE)

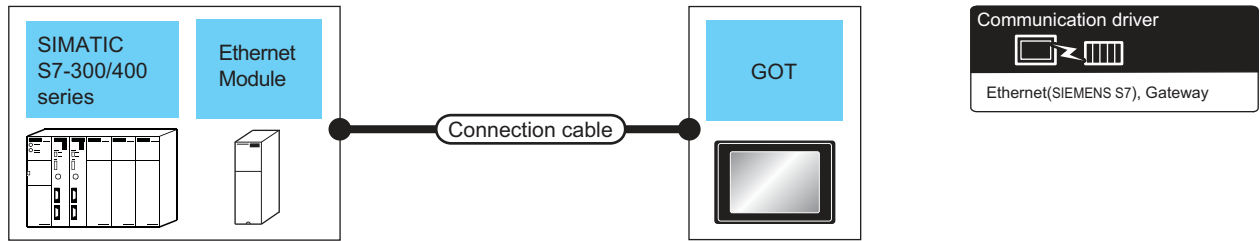



PLC		Connection cable		GOT		Number of connectable equipment
Series	Ethernet Module ^{*3}	Cable model ^{*1}	Maximum segment length ^{*2}	Option device	Model	
SIMATIC S7-300	CP343-1 IT CP343-1 CP343-1 Lean CP343-1 Advanced	<ul style="list-style-type: none"> 100BASE-TX Shielded twisted pair cable (STP) or unshielded twisted pair cable (UTP) of category 5 or higher 10BASE-T Shielded twisted pair cable (STP) or unshielded twisted pair cable (UTP) of category 3 or higher 	100m	- (Built into GOT)		When PLC:GOT is N:1 16 PLCs or less for 1 GOT When PLC:GOT is 1:N The following shows the number of GOTs for 1 PLC 32 or less ^{*4} (recommended to 16 or less)
SIMATIC S7-400	CP443-1 IT CP443-1	<ul style="list-style-type: none"> 100BASE-TX Shielded twisted pair cable (STP) or unshielded twisted pair cable (UTP) of category 5 or higher 10BASE-T Shielded twisted pair cable (STP) or unshielded twisted pair cable (UTP) of category 3 or higher 	100m	- (Built into GOT)		When PLC:GOT is N:1 16 PLCs or less for 1 GOT When PLC:GOT is 1:N The following shows the number of GOTs for 1 PLC 32 or less ^{*4} (recommended to 16 or less)

- ^{*1} The destination connected with the twisted pair cable varies with the configuration of the applicable Ethernet network system. Connect to the Ethernet module, hub, transceiver or other system equipment corresponding to the applicable Ethernet network system.
Use cables, connectors, and hubs that meet the IEEE802.3 10BASE-T/100BASE-TX standards.
- ^{*2} A length between a hub and a node.
The maximum distance differs depending on the Ethernet device to be used.
The following shows the number of the connectable nodes when a repeater hub is used.
- 10BASE-T: Max. 4 nodes for a cascade connection (500m)
 - 100BASE-TX: Max. 2 nodes for a cascade connection (205m)
- When switching hubs are used, the cascade connection between the switching hubs has no logical limit for the number of cascades.
For the limit, contact the switching hub manufacturer.
- ^{*3} Product manufactured by Siemens AG. For details of the product, contact Siemens AG.
- ^{*4} If the number of GOTs increases, the communication becomes highloaded, and it may affect the communication performance.

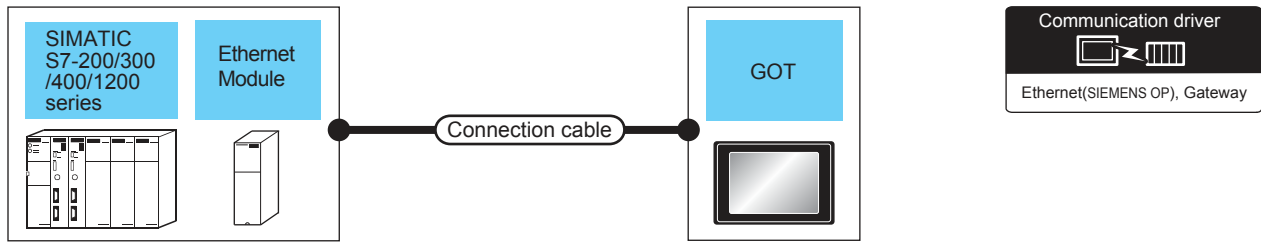
14.3.2 System configuration for connecting to SIMATIC S7-200/300/400/1200 series (Ethernet connection type: OP communication)



PLC		Connection cable		GOT		Number of connectable equipment
Series	Ethernet Module* ³	Cable model* ¹	Maximum segment length* ²	Option device	Model	
SIMATIC S7-200	CP 243-1 CP 243-1 IT	<ul style="list-style-type: none"> • 100BASE-TX Shielded twisted pair cable (STP) or unshielded twisted pair cable (UTP) of category 5 or higher • 10BASE-T Shielded twisted pair cable (STP) or unshielded twisted pair cable (UTP) of category 3 or higher 	100m	- (Built into GOT)	  	When PLC:GOT is N:1 128 PLCs or less for 1 GOT
SIMATIC S7-300	CP 343-1 CP 343-1 Lean CP 343-1 Advanced-IT - (Built into GOT)					
SIMATIC S7-400	CP 443-1 CP 443-1 Advanced-IT - (Built into GOT)					
SIMATIC S7-1200	- (Built into GOT)					

*1 The destination connected with the twisted pair cable varies with the configuration of the applicable Ethernet network system. Connect to the Ethernet module, hub, transceiver or other system equipment corresponding to the applicable Ethernet network system.

Use cables, connectors, and hubs that meet the IEEE802.3 10BASE-T/100BASE-TX standards.

*2 A length between a hub and a node.

The maximum distance differs depending on the Ethernet device to be used.

The following shows the number of the connectable nodes when a repeater hub is used.

- 10BASE-T: Max. 4 nodes for a cascade connection (500m)
- 100BASE-TX: Max. 2 nodes for a cascade connection (205m)

When switching hubs are used, the cascade connection between the switching hubs has no logical limit for the number of cascades.

For the limit, contact the switching hub manufacturer.

*3 Product manufactured by Siemens AG. For details of the product, contact Siemens AG.

*4 If the number of GOTs increases, the communication becomes highloaded, and it may affect the communication performance.

14.3.3 GOT Side Settings

■ Setting communication interface (Communication settings)

Set the channel of the connected equipment.

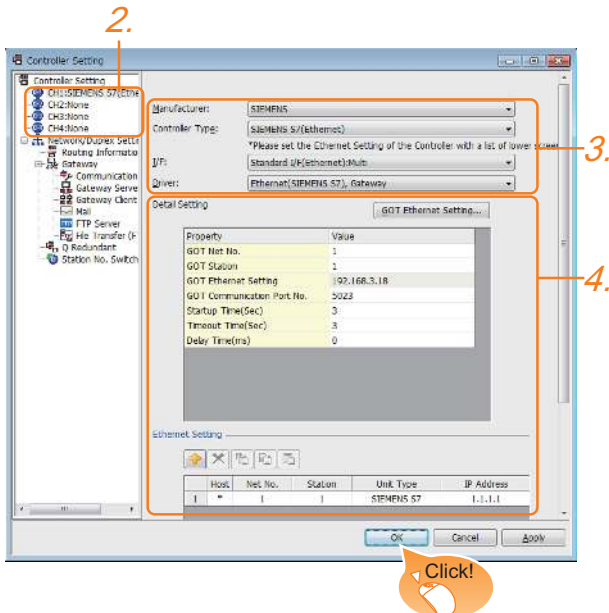

1. Select [Common] → [Controller Setting] from the menu.
2. The Controller Setting window is displayed. Select the channel to be used from the list menu.
3. Set the following items.
 - Manufacturer: SIEMENS
 - Controller Type: Depends on Ethernet connection type.
FETCH/WRITE: SIEMENS S7 (Ethernet)
OP communication: SIEMENS OP (Ethernet)
 - I/F: Interface to be used
 - Driver: Depends on Ethernet connection type.
FETCH/WRITE: Ethernet (SIEMENS S7), Gateway
OP communication: Ethernet (SIEMENS OP), Gateway
4. The detailed setting is displayed after Manufacturer, Controller Type, I/F, and Driver are set. Make the settings according to the usage environment.

☞ 14.3.3 ■ Communication detail settings

Click the [OK] button when settings are completed.

POINT

The settings of connecting equipment can be confirmed in [I/F Communication Setting]. For details, refer to the following.

☞ 1.1.2 I/F communication setting

■ Communication detail settings

Make the settings according to the usage environment.

Property	Value
GOT Net No.	1
GOT Station	1
GOT Ethernet Setting	192.168.3.18
GOT Communication Port No.	5023
Startup Time (Sec)	3
Timeout Time (Sec)	3
Delay Time (ms)	0

Item	Description	Range
GOT Net No.	Set the network No. of the GOT. (Default: 1)	1 to 239
GOT 局番	Set the station No. of the GOT. (Default: 1)	1 to 254
GOT Ethernet 設定	Set the GOT IP address, subnet mask, default gateway, peripheral S/W communication port No., transparent port No.	☞ GOT Ethernet setting
GOT Communication Port No.	Set the GOT port No. for the connection with the Ethernet module. (Default:) Ethernet (SIEMENS S7), Gateway: 5023 Ethernet (SIEMENS OP), Gateway: 5024	1024 to 5010, 5023 to 65534 (Except for 5011, 5012, 5013, and 49153)
Startup Time	Specify the time period from the GOT startup until GOT starts the communication with the PLC CPU. (Default: 3sec)	3 to 255 sec
Timeout Time	Set the time period for a communication to time out. (Default: 3sec)	3 to 90 sec
Delay Time	Set the delay time for reducing the load of the network/destination PLC. (Default: 0ms)	0 to 10000 (× 10ms)

POINT

- (1) Communication interface setting by the Utility
The communication interface setting can be changed on the Utility's [Communication setting] after writing [Communication Settings] of project data.
For details on the Utility, refer to the following manual.
☞ GOT2000 Series User's Manual (Utility)
- (2) Precedence in communication settings
When settings are made by GT Designer3 or the Utility, the latest setting is effective.

■ GOT Ethernet setting

Item	Description	Range
GOT IP Address	Set the IP address of the GOT. (Default: 192.168.0.18)	0.0.0.0 to 255.255.255.255
Subnet Mask	Set the subnet mask for the sub network. (Only for connection via router) If the sub network is not used, the default value is set. (Default: 255.255.255.0)	0.0.0.0 to 255.255.255.255
Default Gateway	Set the router address of the default gateway where the GOT is connected. (Only for connection via router) (Default: 0.0.0.0)	0.0.0.0 to 255.255.255.255
周辺 S/W 通信 用ポート No.	Set the GOT port No. for the S/W communication. (Default: 5015)	1024 to 5010, 5014 to 65534 (Except for 5011, 5012, 5013, and 49153)
トランスパレ ント用ポート No.	Set the GOT port No. for the transparent function. (Default: 5014)	1024 to 5010, 5014 to 65534 (Except for 5011, 5012, 5013, and 49153)

■ Ethernet setting

- (1) Ethernet connection type: FETCH/WRITE
This section describes the Ethernet setting for the communication driver SIEMENS S7 (Ethernet).

Item	Description	Set value
Host	The host is displayed. (The host is indicated with an asterisk (*).)	—
Net No.	Set the network No. of the connected Ethernet module. (Default: blank)	1 to 239
Station	Set the station No. of the connected Ethernet module. (Default: blank)	1 to 64
Type	SIEMENS S7 (fixed)	SIEMENS S7 (fixed)
IP Address	Set the IP address of the connected Ethernet module. (Default: blank)	PLC side IP address
FETCH Port No.	Set the FETCH port No. of the connected Ethernet module. (Default: 2000)	1024 to 65534
WRITE Port No.	For the WRITE port No. of the connected Ethernet module, the value that the FETCH port No. is incremented by one is set automatically. (Default: 2001)	1025 to 65535
Communication	TCP (fixed)	TCP (fixed)

- (2) Ethernet connection type: OP communication
 This section describes the Ethernet setting for the communication driver SIEMENS OP (Ethernet).

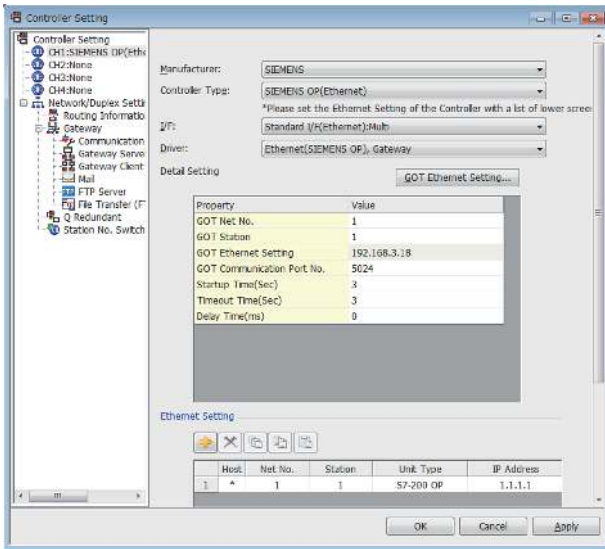

Item	Description	Set value
Host	The host is displayed. (The host is indicated with an asterisk (*).)	—
Net No.	Set the network No. of the connected Ethernet module. (Default: blank)	1 to 239
Station	Set the station No. of the connected Ethernet module. (Default: blank)	1 to 254
Type	Set the PLC type to be connected.	S7-200 OP S7-300/400 OP S7-1200 OP
IP Address	Set the IP address of the connected Ethernet module. (Default: blank)	PLC side IP address
Port No.	102 (fixed)	102 (fixed)
Connection No./Rack No.*1	Set the Connection No./Rack No. set on the PLC side. (Default: 0)	0 to 7
Module Position/Slot No.*1	Set the Module Position/Slot No. set on the PLC side. (Default) S7-200 OP: 0 S7-300/400 OP: 2	S7-200 OP: 0 to 6 S7-300/400 OP: 0 to 31
Communication	TCP (fixed)	TCP (fixed)

*1 Connection No./Rack No. and Module Position/Slot No. are unnecessary for S7-1200 OP.

14.3.4 PLC side setting

POINT

SIEMENS PLC

For details of SIEMENS PLCs, refer to the following manuals.

SIEMENS PLC user's Manual

Parameter settings

Set the following parameters with the SIEMENS software package.

- (1) Ethernet connection type: FETCH/WRITE

- (a) Settings of IP address and subnet mask

Item	Setting details	
Parameters	IP Address	PLC side IP address
	Subnet mask	PLC side subnet mask

- (b) Fetch port setting

Item	Setting details		
Options	Mode	Select [Fetch passive].	
Addresses	IP(dec)	Local	PLC side IP address
		Remote	GOT side IP address
	PORT (dec)	Local	PLC side port No.
		Remote	GOT side port No.

- (c) Write port setting

Item	Setting details		
Options	Mode	Select [Write passive].	
Addresses	IP(dec)	Local	PLC side IP address
		Remote	GOT side IP address
	PORT (dec)	Local	PLC side port No.
		Remote	GOT side port No.

- (d) Precautions for setting

The Keep Alive function of the Siemens CP Module is not supported. Specify 0 for [Keep Alive].

(2) Ethernet connection type: OP communication

(a) S7-200

Set the following parameters.

Item	Setting details	
Module Position	Value in [Position] of the Ethernet module	
Module Address	IP Address	PLC side IP address
	Subnet mask	PLC side subnet mask
Number of connections to configure for this module	Set "1" as the number of connected GOT.	
This is a Server connection: Servers respond to connection request from remote clients.	Mark the check box.	
Local Properties (Server)	Select [Accept all connection requests]	
Remote Properties (Client)	Set "10.00" in [TSAP].	
Enable the Keep Alive function for this connection.	Unmark the check box.	

(b) S7-300/400

Set the following parameters.

- When using the Ethernet module

Item	Setting details	
Properties	IP Address	PLC side IP address
	Subnet mask	PLC side subnet mask

- When using the built-in Ethernet port

Item	Setting details	
Device name	Set [PN-IO]	
Properties	IP Address	PLC side IP address
	Subnet mask	PLC side subnet mask

(c) S7-1200

Set the following parameters.

Item	Setting details	
Ethernet addresses	IP Address	PLC side IP address
	Subnet mask	PLC side subnet mask

14.3.5 Precautions

■ When connecting to multiple GOTs

(1) Setting Station

When connecting two or more GOTs in the Ethernet network, set each [Station] to the GOT.

 14.3.3 ■ Ethernet setting

(2) Setting IP address

Do not use the IP address "192.168.0.18" when using multiple GOTs.

A communication error may occur on the GOT with the IP address.

■ When setting IP address

Do not use "0" and "255" at the end of an IP address. (Numbers of *.**.0 and *.**.255 are used by the system.)

The GOT may not monitor the controller correctly with the above numbers.

Consult with the administrator of the network before setting an IP address to the GOT and controller.

■ When connecting to the multiple network equipment (including GOT) in a segment

By increasing the network load, the transmission speed between the GOT and PLC may be reduced.

The following actions may improve the communication performance.

- Using a switching hub
- More high speed by 100BASE-TX (100Mbps)
- Reduction of the monitoring points on GOT

■ When monitoring a nonexistent or turned-off

station

If a time-out occurs with the initial communication by monitoring a nonexistent or turned-off station, the time-out can delay the communication with the normally operating station.

■ Timing to start GOT communication

After the PLC starts up, start the GOT communication. When the GOT starts communication before the PLC starts up, a communication timeout occurs.

■ Operations during communication

During normal communication, any operation which makes the GOT restart (including writing a project and changing utility data) may display the system alarm, "402 Communication timeout. Confirm communication pathway or modules.", when the GOT restarts.

14.4 Device Range that Can Be Set

The device ranges of controller that can be used for GOT are as follows.

Note that the device ranges in the following tables are the maximum values that can be set in GT Designer3.

The device specifications of controllers may differ depending on the models, even though belonging to the same series.

Please make the setting according to the specifications of the controller actually used.

When a non-existent device or a device number outside the range is set, other objects with correct device settings may not be monitored.

Setting item

(a) S7-300/400 series and S7(Ethernet)

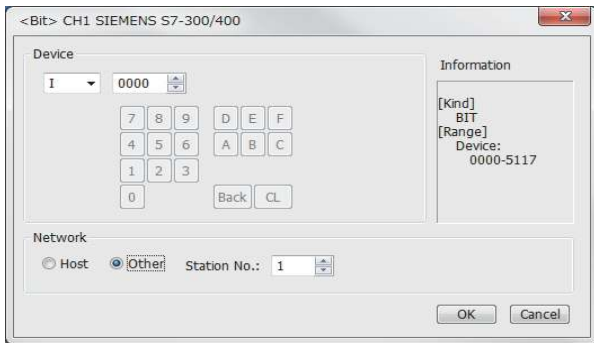

Item	Description			
Device	Set the device name, device number, and bit number. The bit number can be set only when specifying the bit of word device.			
Information	Displays the device type and setting range which are selected in [Device].			
Network	Set the monitor target of the set device.			
	<table border="0"> <tr> <td>Host</td> <td>Select this item to monitor the controller specified as the host station in the GOT utility (setup).</td> </tr> <tr> <td>Other</td> <td>Select this item to monitor a controller other than the one specified as the host station. <ul style="list-style-type: none"> SIEMENS S7-300/400 <ul style="list-style-type: none"> Set the MPI address of the controller monitored. SIEMENS S7(Ethernet) <ul style="list-style-type: none"> Set the network number and the station number of the controller monitored. </td> </tr> </table>	Host	Select this item to monitor the controller specified as the host station in the GOT utility (setup).	Other
Host	Select this item to monitor the controller specified as the host station in the GOT utility (setup).			
Other	Select this item to monitor a controller other than the one specified as the host station. <ul style="list-style-type: none"> SIEMENS S7-300/400 <ul style="list-style-type: none"> Set the MPI address of the controller monitored. SIEMENS S7(Ethernet) <ul style="list-style-type: none"> Set the network number and the station number of the controller monitored. 			

POINT

Device settings of SIEMENS PLC (S7-300/400 series, S7(Ethernet))

- When setting a bit device as a bit device
Set the device using the format of byte address (DEC) + bit address (0 to 7).

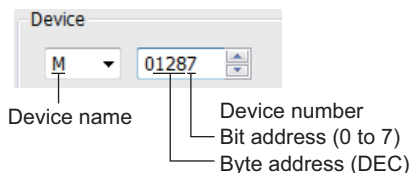

- When setting a bit device as a word device
Set the device number.
For the device name setting, enter "W" after the bit memory device name.

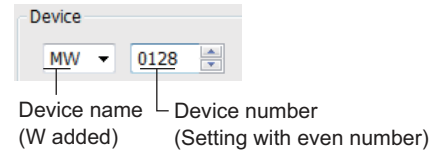

- When setting a data register
Set the device using the format of data block (DB) + data word (DW).

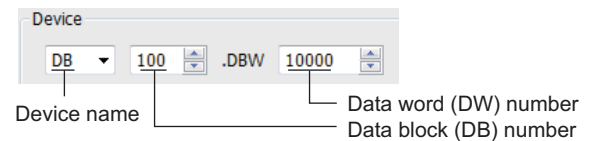

- Precautions when setting devices
 - Notation method of the bit device
The difference in bit memory notation between GOT and PLC is as follows.

Notation of GOT	Notation of PLC
Q0007	Q0.7

- Preparing to set a data register
It is necessary to define the data block using a peripheral software and sequence program, before using a data register.
Setting more than one data block cannot be done for the data register.
- Object that cannot be set Timer (current value) (T)
Only one device can be set for the write target of this device.
Therefore, multiple devices, such as, using the recipe function, etc., cannot be used.
- Notation method of the data registers with the bit specification
The notation of the data registers with the bit specification differs between the GOT and the PLC.

The following shows the correspondence table.

Notation in GOT	Notation in PLC
DB1.DBW0.b0	DB1.DBX1.0
DB1.DBW0.b1	DB1.DBX1.1
:	:
DB1.DBW0.b7	DB1.DBX1.7
DB1.DBW0.b8	DB1.DBX0.0
:	:
DB1.DBW0.b15	DB1.DBX0.7
DB1.DBW2.b0	DB1.DBX3.0
:	:
DB1.DBW2.b7	DB1.DBX3.7
DB1.DBW2.b8	DB1.DBX2.0
:	:
DB1.DBW2.b15	DB1.DBX2.7
:	:

(b) S7-200 Series

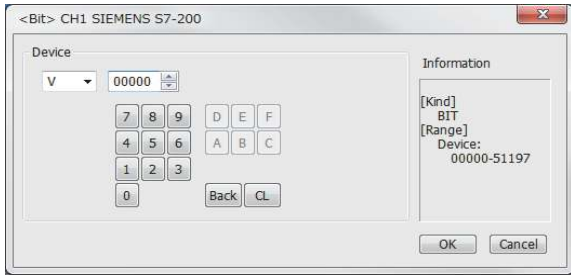

Item	Description
Device	Set the device name, device number, and bit number. The bit number can be set only when specifying the bit of word device.
Description	Displays the device type and setting range which are selected in [Device].

POINT

Device settings of SIEMENS PLC (S7-200 series)

- (1) When setting bit devices (except Timer and Counter)
Set the device using the byte address (DEC) and the bit address (0 to 7).

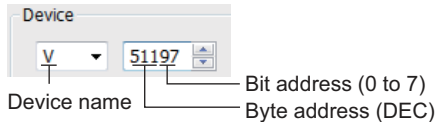

(c) SIEMENS OP (Ethernet)

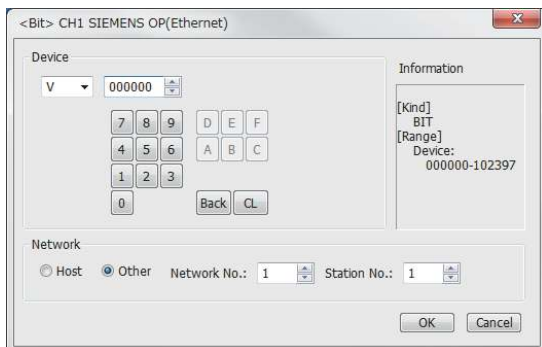

Item	Description			
Device	Set the device name, device number, and bit number. The bit number can be set only when specifying the bit of word device.			
Information	Displays the device type and setting range which are selected in [Device].			
Network	Set the monitor target of the set device.			
	<table border="0"> <tr> <td>Host</td> <td>Select this item to monitor the controller specified as the host station in the GOT utility (setup).</td> </tr> <tr> <td>Other</td> <td>Select this item to monitor a controller other than the one specified as the host station.</td> </tr> </table>	Host	Select this item to monitor the controller specified as the host station in the GOT utility (setup).	Other
Host	Select this item to monitor the controller specified as the host station in the GOT utility (setup).			
Other	Select this item to monitor a controller other than the one specified as the host station.			

POINT

Device settings of SIEMENS PLC (S7-200/300/400/1200 series, SIEMENS OP (Ethernet))

- (1) When setting a bit device as a bit device
Set the device using the format of byte address (DEC) + bit address (0 to 7).

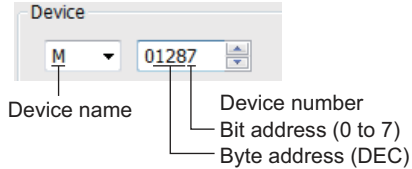

- (2) When setting a data register
Set the device using the format of data block (DB) + data word (DW).

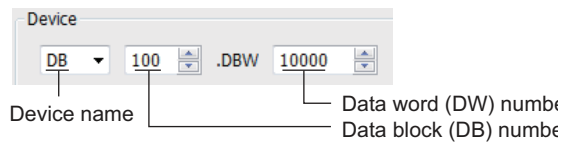

- (3) Precautions when setting devices
 - (a) Preparing to set a data register
It is necessary to define the data block using a peripheral software and sequence program, before using a data register. Setting more than one data block cannot be done for the data register.
 - (b) Object that cannot be set Timer (current value) (T)
Only one device can be set for the write target of this device. Therefore, multiple devices, such as, using the recipe function, etc., cannot be used.
 - (c) Notation method of the data registers with the bit specification
The notation of the data registers with the bit specification differs between the GOT and the PLC. The following shows the correspondence table.

Notation in GOT	Notation in PLC
DB1.DBW0.b0	DB1.DBX1.0
DB1.DBW0.b1	DB1.DBX1.1
:	:
DB1.DBW0.b7	DB1.DBX1.7
DB1.DBW0.b8	DB1.DBX0.0
:	:
DB1.DBW0.b15	DB1.DBX0.7
DB1.DBW2.b0	DB1.DBX3.0
:	:
DB1.DBW2.b7	DB1.DBX3.7
DB1.DBW2.b8	DB1.DBX2.0
:	:
DB1.DBW2.b15	DB1.DBX2.7
:	:

14.4.1 SIEMENS S7-300/400 Series

	Device name	Setting range	Device No. representation	
Bit device	Input relay (I)	I0000 to I5117	Decimal	
	Output relay (Q)	Q0000 to Q5117		
	Bit memory (M)	M00000 to M20477		
	Word device bit	Specified bit of the following word devices	—	
Word device	Input relay (IW)	IW0 to IW510	Decimal	
	Output relay (QW)	QW0 to QW510		
	Bit memory (MW)	MW0 to MW2046		
	Timer (Current value) (T) ^{*1}	T0 to T511		
	Counter (Current value) (C)	C0 to C511		
	Data register (DB)	DB1.DBW0 to DB1.DBW65534		.
		DB2.DBW0 to DB2.DBW65534		
		DB4094.DBW0 to DB4094.DBW65534		
		DB4095.DBW0 to DB4095.DBW65534		

*1 Monitoring or writing is not possible in the continuous device designation mode.

14.4.2 SIEMENS S7-200 Series

	Device name	Setting range	Device No. representation
Bit device	variable memory (V)	V0 to V51197	Decimal
	Input relay (I)	I0 to I77	
	Output relay (Q) ^{*3}	Q0 to Q77	
	Bit memory (M)	M0 to M317	
	special memory (SM)	SM0 to SM1947	
	Timer (T) ^{*1}	T0 to T255	
	Counter (C) ^{*1}	C0 to C255	
	sequence control relay (S)	S0 to S317	
Word device	variable memory (VW)	VW0 to VW5118	Decimal
	Input relay (IW)	IW0 to IW6	
	Output relay (QW) ^{*3}	QW0 to QW6	
	analog input (AIW) ^{*1}	AIW0 to AIW30	
	analog output (AQW) ^{*3}	AQW0 to AQW30	
	Bit memory (MW)	MW0 to MW30	
	special memory (SMW)	SMW0 to SMW192	
	Timer (T) ^{*4}	T0 to T255	
	Counter (C) ^{*4}	C0 to C255	
	High-speed counter (HC) ^{*2}	HC0 to HC2	
	sequence control relay (SW)	SW0 to SW30	

*1 Only reading is possible.
 *2 Only reading 32-bit (two-word data) designation is allowed.
 *3 Writing is possible only while the PLC is running.
 *4 Only 16-bit (1-word) designation is allowed.

14.4.3 SIEMENS S7 (Ethernet)

	Device name	Setting range	Device No. representation	
Bit device	Input relay (I)	I0000 to I1277	Decimal	
	Output relay (Q)	Q0000 to Q1277		
	Bit memory (M)	M0000 to M2557		
	Word device bit	Specified bit of the following word devices Data register	—	
Word device	Input relay (IW)	IW0 to IW126	Decimal	
	Output relay (QW)	QW0 to QW126		
	Bit memory (MW)	MW0 to MW254		
	Timer (Current value) (T) ^{*1}	T0 to T255		
	Counter (Current value) (C)	C0 to C255		
	Data register (DB)	DB1.DBW0 to DB1.DBW2046		.
		DB2.DBW0 to DB2.DBW2046		
		DB254.DBW0 to DB254.DBW2046		
		DB255.DBW0 to DB255.DBW2046		

*1 Monitoring or writing is not possible in the continuous device designation mode.

14.4.4 SIEMENS OP (Ethernet)

	Device name	Setting range	Device No. representation	
Bit device	variable memory (V)	V0 to V102397	Decimal	
	Input relay (I)	I0 to I655357		
	Output relay (Q) ^{*3}	Q0 to Q655357		
	Bit memory (M)	M0 to M655357		
Word device bit	Specified bit of the following word devices (Except variable memory, Input relay, Output relay, Bit memory, Timer, Counter)			
Word device	variable memory (VW)	VW0 to VW10238	Decimal	
	Input relay (IW)	IW0 to IW65534		
	Output relay (QW) ^{*3}	QW0 to QW65534		
	Bit memory (MW)	MW0 to MW65534		
	Timer (T) ^{*1*2*4}	T0 to T65535		
	Counter (C) ^{*1*2*4}	C0 to C65535		
	Data register (DB)	DB1.DBW0 to DB1.DBW65534		.
		DB2.DBW0 to DB2.DBW65534		
		DB4094.DBW0 to DB4094.DBW65534		
		DB4095.DBW0 to DB4095.DBW65534		

*1 Data format to input into Timer (T), Counter (C) varies according to a type of the PLC.
 • S7-300/400: BCD code
 • S7-200: BIN code
 *2 S-1200 does not support Timer (T), Counter (C).
 *3 Writing is possible only while the PLC is running.
 *4 Only 16-bit (1-word) designation is allowed.

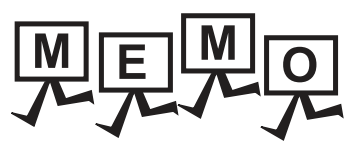

REVISIONS

* The manual number is given on the bottom left of the back cover.

Print Date	* Manual Number	Revision
Sep., 2013	SH(NA)-081199ENG-A	Compatible with GT Works3 Version1.100E
Nov., 2013	SH(NA)-081199ENG-B	Compatible with GT Works3 Version1.104J <ul style="list-style-type: none"> • Changing the icons of the supported models
Jan., 2014	SH(NA)-081199ENG-C	Compatible with GT Works3 Version1.108N <ul style="list-style-type: none"> • Writing errors have been corrected.

This manual confers no industrial property rights or any rights of any other kind, nor does it confer any patent licenses. Mitsubishi Electric Corporation cannot be held responsible for any problems involving industrial property rights which may occur as a result of using the contents noted in this manual.

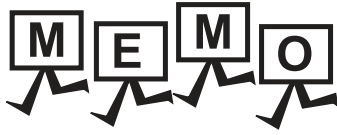

WARRANTY

Please confirm the following product warranty details before using this product.

1. Gratis Warranty Term and Gratis Warranty Range

If any faults or defects (hereinafter "Failure") found to be the responsibility of Mitsubishi occurs during use of the product within the gratis warranty term, the product shall be repaired at no cost via the sales representative or Mitsubishi Service Company. However, if repairs are required onsite at domestic or overseas location, expenses to send an engineer will be solely at the customer's discretion. Mitsubishi shall not be held responsible for any re-commissioning, maintenance, or testing on-site that involves replacement of the failed module.

[Gratis Warranty Term]

The gratis warranty term of the product shall be for thirty-six (36) months after the date of purchase or delivery to a designated place.

Note that after manufacture and shipment from Mitsubishi, the maximum distribution period shall be six (6) months, and the longest gratis warranty term after manufacturing shall be forty-two (42) months. The gratis warranty term of repair parts shall not exceed the gratis warranty term before repairs.

[Gratis Warranty Range]

- (1) The customer shall be responsible for the primary failure diagnosis unless otherwise specified.
If requested by the customer, Mitsubishi Electric Corporation or its representative firm may carry out the primary failure diagnosis at the customer's expense.
The primary failure diagnosis will, however, be free of charge should the cause of failure be attributable to Mitsubishi Electric Corporation.
- (2) The range shall be limited to normal use within the usage state, usage methods and usage environment, etc., which follow the conditions and precautions, etc., given in the instruction manual, user's manual and caution labels on the product.
- (3) Even within the gratis warranty term, repairs shall be charged for in the following cases.
 1. Failure occurring from inappropriate storage or handling, carelessness or negligence by the user. Failure caused by the user's hardware or software design.
 2. Failure caused by unapproved modifications, etc., to the product by the user.
 3. When the Mitsubishi product is assembled into a user's device, Failure that could have been avoided if functions or structures, judged as necessary in the legal safety measures the user's device is subject to or as necessary by industry standards, had been provided.
 4. Failure that could have been avoided if consumable parts designated in the instruction manual had been correctly serviced or replaced.
 5. Replacing consumable parts such as the battery, backlight and fuses.
 6. Failure caused by external irresistible forces such as fires or abnormal voltages, and Failure caused by force majeure such as earthquakes, lightning, wind and water damage.
 7. Failure caused by reasons unpredictable by scientific technology standards at time of shipment from Mitsubishi.
 8. Any other failure found not to be the responsibility of Mitsubishi or that admitted not to be so by the user.

2. Onerous repair term after discontinuation of production

- (1) Mitsubishi shall accept onerous product repairs for seven (7) years after production of the product is discontinued.
Discontinuation of production shall be notified with Mitsubishi Technical Bulletins, etc.
- (2) Product supply (including repair parts) is not available after production is discontinued.

3. Overseas service

Overseas, repairs shall be accepted by Mitsubishi's local overseas FA Center. Note that the repair conditions at each FA Center may differ.

4. Exclusion of loss in opportunity and secondary loss from warranty liability

Regardless of the gratis warranty term, Mitsubishi shall not be liable for compensation to damages caused by any cause found not to be the responsibility of Mitsubishi, loss in opportunity, lost profits incurred to the user by Failures of Mitsubishi products, special damages and secondary damages whether foreseeable or not, compensation for accidents, and compensation for damages to products other than Mitsubishi products, replacement by the user, maintenance of on-site equipment, start-up test run and other tasks.

5. Changes in product specifications

The specifications given in the catalogs, manuals or technical documents are subject to change without prior notice.

6. Product application

- (1) In using the Mitsubishi graphic operation terminal, the usage conditions shall be that the application will not lead to a major accident even if any problem or fault should occur in the graphic operation terminal device, and that backup and fail-safe functions are systematically provided outside of the device for any problem or fault.
- (2) The Mitsubishi graphic operation terminal has been designed and manufactured for applications in general industries, etc. Thus, applications in which the public could be affected such as in nuclear power plants and other power plants operated by respective power companies, and applications in which a special quality assurance system is required, such as for Railway companies or Public service purposes shall be excluded from the graphic operation terminal applications.
In addition, applications in which human life or property that could be greatly affected, such as in aircraft, medical applications, incineration and fuel devices, manned transportation equipment for recreation and amusement, and safety devices, shall also be excluded from the graphic operation terminal range of applications.
However, in certain cases, some applications may be possible, providing the user consults the local Mitsubishi representative outlining the special requirements of the project, and providing that all parties concerned agree to the special circumstances, solely at our discretion.
In some of three cases, however, Mitsubishi Electric Corporation may consider the possibility of an application, provided that the customer notifies Mitsubishi Electric Corporation of the intention, the application is clearly defined and any special quality is not required.

GOT is a registered trademark of Mitsubishi Electric Corporation.

Microsoft, Windows, Windows NT, Windows Server, Windows Vista, and Windows 7 are registered trademarks or trademarks of Microsoft Corporation in the United States and other countries.

Adobe and Adobe Reader are registered trademarks of Adobe Systems Incorporated.

Pentium and Celeron are a registered trademarks of Intel Corporation in the United States and other countries.

Ethernet is a trademark of Xerox Corporation in the United States.

MODBUS is a trademark of Schneider Electric SA.

VNC is a registered trademark of RealVNC Ltd. in the United States and other countries.

Other company and product names herein are either trademarks or registered trademarks of their respective owners.

GOT2000 Series Connection Manual (Non Mitsubishi Product 2)

For GT Works3 Version1

MODEL	GOT2000-CON3-SW1-E
MODEL CODE	_____
SH(NA)-081199ENG-C(1401)MEE	

When exported from Japan, this manual does not require application to the Ministry of Economy, Trade and Industry for service transaction permission.

mitsubishi ELECTRIC CORPORATION

HEAD OFFICE : TOKYO BUILDING, 2-7-3 MARUNOUCHI, CHIYODA-KU, TOKYO 100-8310, JAPAN
NAGOYA WORKS : 1-14, YADA-MINAMI 5-CHOME, HIGASHI-KU, NAGOYA, JAPAN

Specifications subject to change without notice. Printed in Japan, January 2014.