



Residential Price Book 7

Effective February, 2020



Schlage Sense™ Smart Deadbolt
with Century trim in Satin Nickel



SCHLAGE



Personal style, **perfected.**

For more than 95 years, Schlage has offered durable door hardware in a range of unique style combinations to express any personality. So welcome home. Welcome thousands of possibilities. Welcome style.



Quickly install Schlage products with just a Phillips screwdriver



Choose from a range of lever, knob and trim styles to instantly elevate any room



Built with premium metal construction that adds strength, security and long life



Products feature advanced technology to keep the state-of-the-art moving forward

Electronic Locks

Connected deadbolts and levers. 7
 Available functions 7
 Product identification 7
 Finish codes & descriptions 7
 Latches & strikes 7
 Standard features / configurations. 8
 Packaging & carton specs. 8
 BE489WB Series Schlage Encode™ 9
 Schlage Encode Standard features / configurations 10
 BE479AA Series Schlage Sense™ 11
 BR400 Series Schlage Sense Wi-Fi Adapter. 11
 BE469ZP Series Schlage Connect™ 12
 BE468ZP Series 12
 FE468GBAK Series Connect™ Touchscreen Deadbolt 13
 FE599NX Series Connected Keypad Lever 13
 Keypad Locks. 15
 Code entry locks 15
 Available functions 15
 Product identification 15
 Finish codes & descriptions 15
 Standard features / configurations. 16
 Latches & strikes 16
 Standard features / configurations. 17
 Packaging & carton specs. 17
 Schlage Touch™ Deadbolts. 18
 Schlage Touch™ Keyless Touchscreen levers 19
 Keypad deadbolts 20
 Keypad lever lock 21
 Keypad lever auto locks 22

Handlesets

F Series. 23
 Available functions 23
 Product identification 23
 Latches & strikes 23
 Standard features / configurations. 24
 Finish codes & descriptions 24
 Packaging & carton specs. 24
 Available styles. 25
 Pricing. 26
 Decorative collection 30
 J Series 31
 Available functions 31
 Product identification 31
 Standard features / configurations. 32
 Finish codes & descriptions 32
 Packaging & carton specs. 32
 Pricing. 33

Levers

F Series. 35
 Available functions 35
 Product information. 35
 Latches & strikes 35
 Standard features / configurations. 36
 Finish codes & descriptions 36
 Packaging & carton specs. 36
 Available styles. 37
 Pricing. 38
 Decorative collection 45
 J Series 46
 Available functions 46
 Product identification 46
 Latches & strikes 46
 Standard features / configurations. 47
 Finish codes & descriptions 47
 Packaging & carton specs. 47
 Pricing. 48

Table of contents

Knobs

F Series	52
Available functions	52
Product identification	52
Latches & strikes	52
Standard features / configurations.	53
Finish codes & descriptions	53
Available styles.	54
Pricing.	55
Decorative collection	59
J Series	60
Available functions	60
Product identification	60
Latches & strikes	60
Standard features / configurations.	61
Finish codes & descriptions	61
Packaging & carton specs.	61
Pricing.	62

Deadbolts

B Series.	64
Available functions	64
Product identification	64
Latches & strikes	64
Standard features / configurations.	65
Finish codes & descriptions	65
Packaging & carton specs.	65
Pricing.	66
Decorative Collection	68
J Series	70
Available functions	70
Product identification	70
Latches & strikes	70
Standard features / configurations.	71
Finish codes & descriptions	71
Packaging & carton specs.	71
Pricing.	72
Security sets	73
Available functions	73
Product identification	73
Finish codes & descriptions	73
Pricing.	74

Hardware & Accessories

Builder’s hardware 76

 Barndoor hardware 77

 J Strap. 77

 Top mount 77

 Track adapter 77

 Handrail brackets, & door stops 78

 Chain door guards. 79

 Coat, hat & wardrobe hooks. 80

 Pocket door locks, hinges. 82

 Classic house numbers 84

 Door knockers, push & pull & plates 86

 Kickplates 87

 Window hardware, flush pulls. 88

Parts 89

 Latch & strike quick reference guide 89

 Latches 90

 Strikes 93

 Rekeying. 95

 Assembly screw kits. 96

 Thick door installation kits,
 miscellaneous parts 97

 Key & cylinder stamping,
 residential master &
 construction keying 98

 Construction core program 101

 J-Series Latches, Strikes 102

Cables, Chains & Padlocks

Padlocks 108

Cables & chains 109

Security hasps 111

Warranties

Product warranties. 112

General terms & conditions 119

Standard product terms and conditions 124

How to Order

How to order 126

Visual pack carton specifications 127

Table of contents

Notes

Connected Deadbolts & Levers 7
 Code Entry Locks 15

Connected Deadbolts & Levers

AVAILABLE FUNCTIONS

Deadbolts



BE479AA

BE469



BE468ZP or BE469GAK

BE479 - Schlage Sense™ Smart Deadbolt

- Share and control access with Schlage Home app for iOS and Android
- Remote access available with Schlage Sense Wi-Fi Adapter
- Works with Apple HomeKit™ technology
- App includes access codes schedules and audit trail capability
- ANSI/BHMA A156.36-2010 Commercial Grade 1
- ANSI/BHMA 156.40-2015 Residential Grade AAA

BE469 - Schlage Connect™ with Alarm

- Uses Z-Wave® Plus to connect to an existing smart home or security system
- Includes a built-in alarm that detects activity at the door
- ANSI/BHMA A156.36-2010 Commercial Grade 1
- ANSI/BHMA 156.40-2015 Residential Grade AAA
- Auto Lock capability when programmed

BE468 - Schlage Connect™

- Uses Z-Wave® Plus or Zigbee to connect to an existing smart home or security system
- ANSI/BHMA A156.36-2010 Commercial Grade 2
- ANSI/BHMA 156.40-2015 Residential Grade BAA

Levers



FE599NX

FE599 - Connected Keypad Lever

- Uses Z-Wave® to connect to an existing smart home or security system
- ANSI/BHMA A156.36-2003 Commercial Grade 2

PRODUCT IDENTIFICATION

BE	469ZP	V	CAM	619	12-342	10-116
Lock Series	Product	Vis Pack	Style	Finish Code	Latch	Strike

FINISH CODES & DESCRIPTIONS

505	530	605	608	609	613	618	619	620	621	622	625	626	716
Lifetime Bright Brass	Black Stainless	Bright Brass (US3)	Satin Brass	Antique Brass (US5)	Oil-Rubbed Bronze (US10B)	Polished Nickel	Satin Nickel (US15)	Antique Pewter (US15A)	Distressed Nickel	Matte Black (US19)	Bright Chrome (US26)	Satin Chrome (US26D)	Aged Bronze

Non-standard finishes are not available.
 Full-color swatch examples available on inside Electronics tab.

LATCHES & STRIKES

Latches

Motorized Deadbolt Latches

12-342 - Tapered Deadbolt Dual Option (Round, Drive-in) - **STANDARD**

12-344 - Tapered Deadbolt Triple Option (Round, Square, Drive-in)

Motorized Deadbolt Entry Set Latches

16-264 - Combo Taper Deadbolt & Spring Latch Dual Option (Round, Drive-in) - **STANDARD**

Non-Motorized Deadbolt Latches

12-321 - Dual Option (Round, Drive-in) - **STANDARD**

12-287 - Triple Option (Round, Square, Drive-in)

Keyed Latches - Dead Latches

16-086 - Dual Option (Round, Drive-in) - **STANDARD**

16-211 - Triple Option (Round, Square, Drive-in)

Strikes

Deadbolt Strikes

10-116 - Round Corner Strike with Reinforcer - **STANDARD**

Deadbolt Entry Set Strikes

10-115 - Round Corner Full Lip Strike Set - **STANDARD**

Lever Strike

10-027 - Round Corner Full Lip Strike - **STANDARD**

STANDARD FEATURES / CONFIGURATIONS

	Schlage Sense™ BE479AA	Schlage Connect™ BE469ZP	Schlage Connect™ BE468ZP or BE468GBAK	Connected Keypad Lever FE599NX
Certification:	ANSI/BHMA A156.36-2010 Commercial Grade 1 ANSI/BHMA 156.40-2015 Residential Grade AAA	ANSI/BHMA A156.36-2010 Commercial Grade 1 ANSI/BHMA 156.40-2015 Residential Grade AAA	ANSI/BHMA A156.36-2010 Commercial Grade 2 ANSI/BHMA 156.40-2015 Residential Grade BAA	ANSI/BHMA A156.39 Residential Grade BAA
Product Dimensions: (wxhxd)	ext: 3"x 5"x 1" int: 3"x 8"x 2"	ext: 3"x 5"x 1" int: 3"x 8"x 2"	ext: 3"x 5"x 1" int: 3"x 8"x 2"	ext: 6 ⁷ / ₈ " x 3"x 2 ³ / ₄ " int: 3 ¹ / ₄ " x 8 ¹ / ₄ " x 2 ³ / ₄ "
Weight:	3.5 lbs	3.5 lbs	3.5 lbs	5.2 lbs
Warranty:	3 year electronics, limited lifetime mechanical & finish	3 year electronics, limited lifetime mechanical & finish	3 year electronics, limited lifetime mechanical & finish	3 year electronics, limited lifetime mechanical & finish
Battery:	4 AA	4 AA	4 AA	4 AA
Latch Throw:	1"	1"	1"	1/2"
Key & Cylinder:	1 key, 5-pin, C keyway	1 key, 5-pin, C keyway	1 key, 5-pin, C keyway	1 key, 5-pin, C keyway
Door Thickness:	1 ³ / ₈ " to 1 ³ / ₄ "; Thick door kit extends 1 ¹ / ₈ " to 2 ¹ / ₂ "	1 ³ / ₈ " to 1 ³ / ₄ "; Thick door kit extends 1 ¹ / ₈ " to 2 ¹ / ₂ "	1 ³ / ₈ " to 1 ³ / ₄ "; Thick door kit extends 1 ¹ / ₈ " to 2 ¹ / ₂ "	1 ³ / ₈ " to 1 ³ / ₄ "
Cross Bore Distance:	4" center-to-center minimum	4" center-to-center minimum	4" center-to-center minimum	5 ¹ / ₂ " center-to-center minimum
Cross Bore Diameter:	1 ¹ / ₂ " or 2 ¹ / ₈ "	1 ¹ / ₂ " or 2 ¹ / ₈ "	1 ¹ / ₂ " or 2 ¹ / ₈ "	2 ¹ / ₈ "
Edge Bore Diameter:	1"	1"	1"	1"
Backset:	2 ³ / ₈ " or 2 ³ / ₄ "	2 ³ / ₈ " or 2 ³ / ₄ "	2 ³ / ₈ " or 2 ³ / ₄ "	2 ³ / ₈ " or 2 ³ / ₄ "
Faceplate Size:	1" x 2 ¹ / ₄ "	1" x 2 ¹ / ₄ "	1" x 2 ¹ / ₄ "	1" x 2 ¹ / ₄ "
Faceplate Options:	Round corner, square corner, and drive-in (dual option standard)	Round corner, square corner, and drive-in (dual option standard)	Round corner, square corner, and drive-in (dual option standard)	Round corner, square corner, and drive-in
Strike:	1 ¹ / ₈ " x 2 ³ / ₄ " round corners, strike reinforcer	1 ¹ / ₈ " x 2 ³ / ₄ " round corners, strike reinforcer	1 ¹ / ₈ " x 2 ³ / ₄ " round corners, strike reinforcer	1 ¹ / ₈ " x 2 ³ / ₄ " radius corner, full lip, latch strike
Codes:	Pre-set, unique 6 digit programming code, 2 pre- set unique 4-digit access codes, 30 access code capacity (4-8 digits)	Pre-set, unique 6-digit programming code, two pre-set unique 4-digit access codes, 30 code capacity	Pre-set, unique 6-digit programming code, two pre-set unique 4-digit access codes, 30 code capacity	Pre-set, unique 6-digit programming code, two pre-set unique 4-digit access codes, 19 code capacity
Communications:	Bluetooth® Smart***	900 MHz (Z-Wave® RF)**	900 MHz (Z-Wave® RF)**	900 MHz (Z-Wave® RF)**
Operating Temps:	Ext: -35C to 66C Int: -10C to 49C	Ext: -30C to 66C Int: -10C to 49C	Ext: -30C to 66C Int: -10C to 49C	Ext: -30C to 66C Int: -10C to 49C

*** The Bluetooth® word mark and logos are registered trademarks owned by Bluetooth SIG, Inc. and any use of such marks by Schlage Lock Company, LLC is under license. ^HomeKit™ is a trademark of Apple Inc.

PACKAGING & CARTON SPECS

	INDIVIDUAL CARTON				SHIPPER					
	CARTON WEIGHT	HEIGHT	WIDTH	DEPTH	QTY. SHIPPER	CARTON WEIGHT	CU. FT.	HEIGHT	WIDTH	DEPTH
BE479	5.2 lbs	9.8 in.	6.5 in.	5.7 in.	1	5.2	0.21	9.8 in.	6.5 in.	5.7 in.
BE469	3.8 lb	9.25 in.	5.125 in.	4.5 in.	4	16.0	0.58	10.0 in.	9.625 in.	10.5 in.
BE468	3.8 lb	9.25 in.	5.125 in.	4.5 in.	4	16.0	0.58	10.0 in.	9.625 in.	10.5 in.
FE599	5.15 lb	8.86 in.	7.42 in.	5.87 in.	2	10.8	0.42	9.55 in.	7.8 in.	12.08 in.

For Vis Pack carton specs, see page 127



exterior

interior

BE489WB
Camelot
(CAM)



BE489WB
Century
(CEN)

**BE489WB Series
Schlage Encode™ Smart Deadbolt**

FINISHES

Function	Packaging	605	505	530	608	609	618	619	620	621	622	625	626	716	613
BE489WB Camelot	Box/Vis	•	•	\$540	•	•	•	\$540	•	•	540	\$540	•	\$540	•
BE489WB Century	Box/Vis	•	•	540	•	•	•	540	•	•	540	540	•	540	•

List Price Adders:

Visual Package Options (highlighted) - add \$5 to list price

STANDARD FEATURES / CONFIGURATIONS

Schlage Encode™ BE489WB

Certification:	ANSI/BHMA A156.36 Commercial Grade 1 ANSI/BHMA 156.40-2015 Residential Grade AAA UL Listed for 20 minute fire door. No hose
Product Dimensions: (wxhxd)	ext: 3" x 5" x 0.9" int: 3" x 5.5" x 2.2"
Weight:	3.4 lbs
Warranty:	3 year electronics, limited lifetime mechanical & finish
Battery:	4 AA
Latch Throw:	1"
Key & Cylinder:	1 key, 5-pin, C keyway
Door Thickness:	1 ³ / ₈ " to 1 ³ / ₄ "; Thick door kit extends 1 ⁷ / ₈ " to 2 ¹ / ₂ "
Cross Bore Distance:	4" center-to-center minimum
Cross Bore Diameter:	1 ¹ / ₂ " or 2 ¹ / ₈ "
Edge Bore Diameter:	1"
Backset:	2 ³ / ₈ " or 2 ³ / ₄ "
Faceplate Size:	1" x 2 ¹ / ₄ "
Faceplate Options:	Round corner, square corner, and drive-in (triple option standard)
Strike:	1 ¹ / ₈ " x 2 ³ / ₄ " round corners, strike reinforcer
Codes:	Pre-set, unique 6 digit programming code, 2 pre-set unique 4-digit access codes, 100 access code capacity
Communications:	WiFi
Operating Temps:	Ext: -35C to 66C Int: -10C to 49C



exterior

interior

BE479AA
Camelot
(CAM)

BE479AA
Century
(CEN)

**BE479AA Series
Schlage Sense™ Smart Deadbolt**

FINISHES

Function	Packaging	605	505	530	608	609	618	619	620	621	622	625	626	716	613
BE479AA Camelot	Box/Vis	•	•	\$490	•	•	•	\$490	•	•	490	\$490	•	\$490	•
BE479AA Century	Box/Vis	•	•	490	•	•	•	490	•	•	490	490	•	490	•

List Price Adders:

- Visual Package Options (highlighted) - add \$5 to list price
- Triple Option Latch - add \$2 to list price
- Split Finish - add \$6.50 to highest list price

**BR400 Series
Schlage Sense Wi-Fi Adapter**

With the optional Schlage Sense™ Wi-Fi Adapter users can lock and unlock their Schlage Sense™ Smart Deadbolt from anywhere using iOS and Android™ smartphones.*

Features:

- Lock/unlock your Schlage Sense Smart Deadbolt from anywhere*
- Easy setup and pairing with smartphone through Schlage Home app
- Get lock/unlock push notifications
- One Adapter can support up to two Schlage Sense™ Smart Deadbolts
- Pairs only with Schlage Sense Smart Deadbolt (Sold Separately)
- 1-year warranty



front



back

* For remote capability, Schlage Sense Wi-Fi Adapter should be plugged into power, connected to Wi-Fi and in Bluetooth range of the Schlage Sense Smart Deadbolt (about 40 feet).

UPC	Part No /Description	List Price
061045148522	BR400V Schlage Sense Wi-Fi Adapter	\$ 126

PACKAGING & CARTON SPECS

	INDIVIDUAL CARTON				QTY. SHIPPER	SHIPPER				
	CARTON WEIGHT	HEIGHT	WIDTH	DEPTH		CARTON WEIGHT	CU. FT.	HEIGHT	WIDTH	DEPTH
BR400	0.4 lbs	4 in.	2.6 in.	4 in.	4	2.2 lbs.	0.15	8.7 in.	9 in.	3.3 in.



BE469ZP
Camelot
(CAM)

BE469ZP
Century
(CEN)

**BE469ZP Series
Schlage Connect™**

FINISHES

Function	Packaging	605	505	530	608	609	618	619	620	621	622	625	626	716	613	
BE469ZP	Camelot	Box/Vis	\$440	•	\$445	•	•	•	\$445	•	•	\$445	\$445	•	\$445	•
BE469ZP	Century	Box/Vis	•	•	445	•	•	•	445	•	•	445	445	445	445	•

List Price Adders:

- Visual Package Options (highlighted) - add \$5 to list price
- Triple Option Latch - add \$2 to list price
- Split Finish - add \$6.50 to highest list price



BE468ZP features:

- ANSI/BHMA Commercial Grade 2 Security Rating
- ANSI/BHMA Residential Grade BAA in Security, Durability, Finish
- White backlighting
- No alarm function

BE468ZP
Camelot
(CAM)

BE468ZP
Century
(CEN)

BE468ZP Series

FINISHES

Function	Packaging	605	505	530	608	609	618	619	620	621	622	625	626	716	613	
BE468ZP	Camelot	Box/Vis	\$390	•	\$395	•	•	•	\$395	•	•	\$395	\$395	•	\$395	•
BE468ZP	Century	Box/Vis	•	•	395	•	•	•	395	•	•	395	395	395	395	•

List Price Adders:

- Split Finish - add \$6.50 to highest list price
- Triple Option Latch- add \$2 to list price"

BE468GBAK features:

- ANSI/BHMA Commercial Grade 2 Security Rating
- ANSI/BHMA Residential Grade BAA in Security, Durability, Finish
- White backlighting
- No alarm function



BE468GBAK
Camelot
(CAM)



BE468GBAK
Century
(CEN)

BE468GBAK (Zigbee)
Schlage Connect™ Touchscreen Deadbolt

FINISHES

Function	Packaging	605	505	530	608	609	618	619	620	621	622	625	626	716	613
BE468GBAK	Camelot Box/Vis	\$440	•	\$445	•	•	•	\$445	•	•	\$445	\$445	•	\$445	•
BE468GBAK	Century Box/Vis	•	•	445	•	•	•	445	•	•	445	445	•	445	•

List Price Adders:

- Triple Option Latch - add \$2 to list price
- Split Finish - add \$6.50 to highest list price



FE599NX
Camelot x Accent
(CAM x ACC)

FE599NX Series
Connected Keypad Lever

FINISHES

Function	Packaging	605	505	608	609	618	619	620	621	622	625	626	716	613
FE599NX	Camelot	•	\$420	•	•	•	\$420	•	•	•	•	•	\$420	•

List Price Adders:

- Triple Option Latch - add \$2 to list price

Notes

Code Entry Locks

AVAILABLE FUNCTIONS



BE375



FE695

Schlage Touch™ Locks
ANSI/BHMA Commercial Grade 2

BE375 – Touchscreen Deadbolt

- Deadbolt retracted by entering valid user code then rotating outside thumbturn, or by inside thumb turn
- Deadbolt thrown by using outside thumbturn after pressing Schlage button, or by inside thumbturn

FE695 – Touchscreen Lever

- Unlocked by valid access code from outside
- Inside knob or lever always unlocked
- Interior switch sets lock to unlocked or automatic re-locking modes



BE365



FE595

Keypad Locks
ANSI/BHMA Commercial Grade 2

BE365 - Keypad Deadbolt

- Deadbolt thrown from outside by keyway turn after pressing Schlage button or by inside thumbturn
- Deadbolt retracted from outside by entering valid access code then rotating keyway turn or by inside thumbturn
- Key can be used to unlock as backup

FE595 - Keypad Entry with Flex-Lock

- Flex-locking, switch between unlocked or automatic re-locking
- Unlocked by valid access code from outside
- Inside knob or lever always unlocked
- Key can be used to unlock as back-up



FE575

FE575 - Keypad Entry with Auto-Lock

- Auto-locking, automatically re-locks after 5 seconds
- Unlocked by valid access code from outside
- Inside knob or lever always unlocked
- Key can be used to unlock as back-up

NOTE:
FE285 is now located in the
Handleset section of the pricebook

PRODUCT IDENTIFICATION

FE	595		PLY	505	FLA		12-322	10-115	KD
Lock Series	Product	Suffix Package	Style	Finish Code	Design	Hand	Latch	Strike	Keying

FINISH CODES & DESCRIPTIONS

505	530	605	608	609	613	618	619	620	621	622	625	626	716
Lifetime Bright Brass	Black Stainless	Bright Brass (US3)	Satin Brass	Antique Brass (US5)	Oil-Rubbed Bronze (US10B)	Polished Nickel	Satin Nickel (US15)	Antique Pewter (US15A)	Distressed Nickel	Matte Black (US19)	Bright Chrome (US26)	Satin Chrome (US26D)	Aged Bronze

Non-standard finishes are not available.
Full-color swatch examples available on inside Handleset tab.

CODE ENTRY LOCKS

STANDARD FEATURES / CONFIGURATIONS

Certification	Schlage Touch™ Electronic Deadbolt BE375	Schlage Touch™ Electronic Lever FE695
	ANSI/BHMA Commercial Grade 2 ANSI/BHMA Residential Grade AAA	ANSI/BHMA Commercial Grade 2 ANSI/BHMA Residential Grade BAA
Product Dimensions (inches) (w x h x d)	3 x 5.4 x 5.2	3 x 5.4 x 7.9
Weight	3.4 lbs	4.5 lbs
Warranty	3 year electronics, limited lifetime mechanical and finish	3 year electronics, limited lifetime mechanical and finish
Battery	9V battery (1)	9V battery (1)
Latch Throw	1"	1/2" throw, 7/8" housing diameter
Cylinder	None	None
Door Thickness	extends 1 3/8" to 1 3/4" 1 7/8" to 2 1/2"; thick door kit	1 3/8" to 1 3/4"
Cross Bore	2 1/8"	2 1/8"
Latch Faceplate Size	1"	1" x 2 1/4" radius corner
Latch/Backset	2 3/8" to 2 3/4" adjustable	2 3/8" OR 2 3/4" adjustable
Latch Faceplate Size	1" x 2 1/4"	1" x 2 1/4"
Latch Faceplate Options	Round corner, square corner and drive-in (Dual Option standard)	Deadlatch radius corner and circular drive-in faceplates
Strike	1 1/8" x 2 3/4" round corners, strike reinforcer	1 5/8" x 2 1/4", radius corner, full lip latch strikes
Keys	None	None
Codes	2 pre-set unique 4-digit access codes, storage of up to 19 access codes	2 pre-set unique 4-digit access codes, storage of up to 19 access codes
Operating Temperatures	Outside lock body (exterior mounted): -35C to 66C Inside lock body (interior mounted): -10C to 50C	Outside lock body (exterior mounted): -35C to 66C Inside lock body (interior mounted): -10C to 50C

LATCHES & STRIKES

FE Keypad Levers

Keyed Latches - Dead Latches

16-086 - Dual Option (Round, Drive-in) - **STANDARD**

16-207 - Square Corner

16-211 - Triple Option (Round, Square, Drive-in)

Strikes

10-027 - Round Corner Full Lip - **STANDARD**

10-001 - Square Corner T Strike

10-026 - Square Corner Full Lip

10-058 - Circular - Adjustable

10-063 - Dual Strikes (Round & Square Full Lip)

10-025 - ANSI Square Corner

BE Keypad Deadbolts

Latches

12-321 - Dual Option (Round, Drive-in) - **STANDARD**

12-288 - Square Corner

12-287 - Triple Option (Round, Square, Drive-in)

12-294 - UL Listed Square Corner with Firecup

12-397 - UL Listed Round Corner with Firecup

Strikes

10-116 - Round Corner Strike with Reinforcer - **STANDARD**

10-092 - Round Corner Full Lip Strike

10-094 - Square Corner Strike with Reinforcer

CODE ENTRY LOCKS

STANDARD FEATURES / CONFIGURATIONS

Certification	Electronic Keypad Lock BE365	Electronic Keypad Lock FE595	Electronic Keypad Lock FE575
	ANSI/BHMA Commercial Grade 2 ANSI/BHMA Residential Grade AAA	ANSI/BHMA Commercial Grade 2	ANSI/BHMA Commercial Grade 2
Product Dimensions (inches) (w x h x d)	6.77 x 4.22 x 8.39	3.01 x 6.84 x 6.85	3.01 x 6.84 x 6.85
Weight	5.5 lbs	5.05 lbs	4.25 lbs
Warranty	3 year electronics, limited lifetime mechanical and finish	3 year electronics, limited lifetime mechanical and finish	3 year electronics, limited lifetime mechanical and finish
Battery	9V battery (1)	9V battery (1)	9V battery (1)
Latch Throw	1"	1/2" throw, 7/8" housing diameter	1"
Cylinder	5 pin, C keyway	5 pin, C keyway	5 pin, C keyway
Door Thickness	1 3/8" to 1 3/4"	1 3/8" to 1 3/4"	1 3/8" to 1 3/4"
Cross Bore	2 1/8"	2 1/8"	2 1/8"
Latch Faceplate Size	1" x 2 1/4"	1" x 2 1/4"	1" x 2 1/4"
Latch/Backset	2 3/8" to 2 3/4" adjustable	2 3/8" to 2 3/4" adjustable	2 3/8" to 2 3/4" adjustable
Latch Faceplate Size	1" x 2 1/4"	1" x 2 1/4"	1" x 2 1/4"
Latch Faceplate Options	Round corner, square corner, and drive-in (dual option standard)	Deadlatch radius corner and circular drive-in faceplates (dual option standard)	Dead-latch, radius corner and circular drive-in faceplates (dual option standard)
Strike	1 1/8" x 2 3/4" round corners, strike reinforcer	1 5/8" x 2 1/4", radius corner, full lip latch strikes,	1 1/8" x 2 3/4" round corners, strike reinforcer
Keys	1 Key	1 Key	1 Key
Codes	2 pre-set unique 4-digit access codes, storage of up to 19 access codes	2 pre-set unique 4-digit access codes, storage of up to 19 access codes	2 pre-set unique 4-digit access codes, storage of up to 19 access codes
Operating Temperatures	Outside lock body (exterior mounted): -35C to 66C Inside lock body (interior mounted): -10C to 50C	Outside lock body (exterior mounted): -35C to 66C Inside lock body (interior mounted): -10C to 50C	Outside lock body (exterior mounted): -35C to 66C Inside lock body (interior mounted): -10C to 50C

PACKAGING & CARTON SPECS

	INDIVIDUAL CARTON				SHIPPER					
	CARTON WEIGHT	HEIGHT	WIDTH	DEPTH	QTY. SHIPPER	CARTON WEIGHT	CU. FT.	HEIGHT	WIDTH	DEPTH
Levers										
FE375	3.31	4.63 in.	9.25 in.	5.00 in.	6	20.80	0.83	9.75 in.	9.50 in.	15.50 in.
FE695	4.04	6.00 in.	6.50 in.	9.13 in.	6	27.00	1.44	9.75 in.	12.75 in.	20.00 in.
BE365	5.50	4.22 in.	6.77 in.	8.39 in.	6	33.00	1.00	9.30 in.	13.50 in.	14.10 in.
FE595	5.05	4.75 in.	8.00 in.	9.50 in.	6	30.30	1.50	10.60 in.	14.00 in.	17.00 in.
FE575	4.25	4.75 in.	8.00 in.	9.50 in.	6	25.50	1.50	10.60 in.	14.00 in.	17.00 in.
FE285	5.00	3.88 in.	8.00 in.	16.25 in.	4	21.00	1.36	8.50 in.	16.00 in.	17.30 in.

For Vis Pack carton specs, see page 127

Electronic Locks Keypad Locks

Schlage Touch™ Deadbolts



exterior



interior

BE375
Camelot
(CAM)



exterior

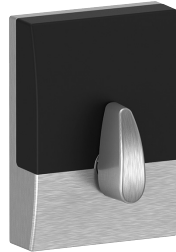

interior

BE375
Century
(CEN)

BE375 Series Schlage Touch™ Deadbolts

FINISHES

Function	Style/Design	Packaging	605	505	608	609	618	619	620	621	622	625	626	716	613
BE375	Camelot	Box/Vis	\$250	·	·	\$255	·	\$255	·	·	\$255	\$255	\$255	\$255	·
BE375	Century	Box/Vis	·	·	·	·	·	255	·	·	255	255	255	255	·

List Price Adders:

Visual Package Options (highlighted) - add \$5 to list price

Triple Option Latch - add \$2 to list price

Schlage Touch™ Keyless Touchscreen levers



FE695
Camelot x Accent
(CAM) (ACC)

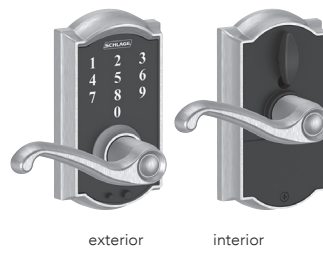

FE695
Camelot x Flair
(CAM) (FLA)

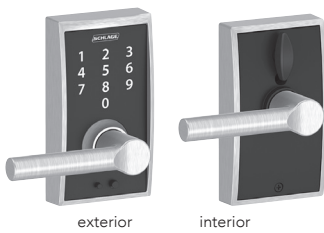

FE695
Century x Broadway
(CEN) (BRW)



FE695
Century x Latitude
(CEN) (LAT)



FE695
Century x Merano
(CEN) (MER)

FE695 Series
Schlage Touch Keyless Touchscreen Levers

FINISHES

Function	Style/Design	Packaging	605	505	608	609	618	619	620	621	622	625	626	716	613
(CAM) Camelot															
FE695	Accent	Box/Vis	\$270	•	•	\$275	•	\$275	•	•	\$275	\$275	\$275	\$275	•
FE695	Flair	Box	270	•	•	275	•	275	•	•	•	•	275	275	•
(CEN) Century															
FE695	Broadway	Box	•	•	•	•	•	275	•	•	275	275	275	275	•
FE695	Elan	Box	•	•	•	•	•	•	•	•	•	•	275	•	•
FE695	Latitude	Box/Vis	•	•	•	•	•	275	•	•	275	275	275	275	•
FE695	Merano	Box	•	•	•	•	•	275	•	•	275	275	275	275	•

List Price Adders:

Visual Package Options (highlighted) - add \$5 to list price
Triple Option Latch - add \$2 to list price

Electronic Locks Keypad Locks

Keypad Deadbolts



exterior



interior

BE365
Camelot
(CAM)



exterior



interior

BE365
Plymouth
(PLY)

BE Series Keypad Locks

FINISHES

Function	Packaging	605	505	530	608	609	618	619	620	621	622	625	626	716	613
BE365 Camelot	Box/Vis	•	\$225	\$225	•	\$225	•	\$225	\$225	•	\$225	•	\$225	\$225	•
BE365 Plymouth	Box/Vis	•	225	•	•	225	•	225	225	•	225	•	225	225	•
BE365F20 Camelot	Box	•	240	•	•	240	•	240	240	•	•	•	240	240	•
BE365F20 Plymouth	Box	•	240	•	•	240	•	240	240	•	•	•	240	240	•
BE365F Camelot UL	Box	•	280	•	•	280	•	280	280	•	•	•	280	280	•
BE365F Plymouth UL	Box	•	280	•	•	280	•	280	280	•	•	•	280	280	•

List Price Adders:

Visual Package Options (highlighted) - add \$5 to list price
Triple Option Latch - add \$2 to list price

Keypad Lever Lock

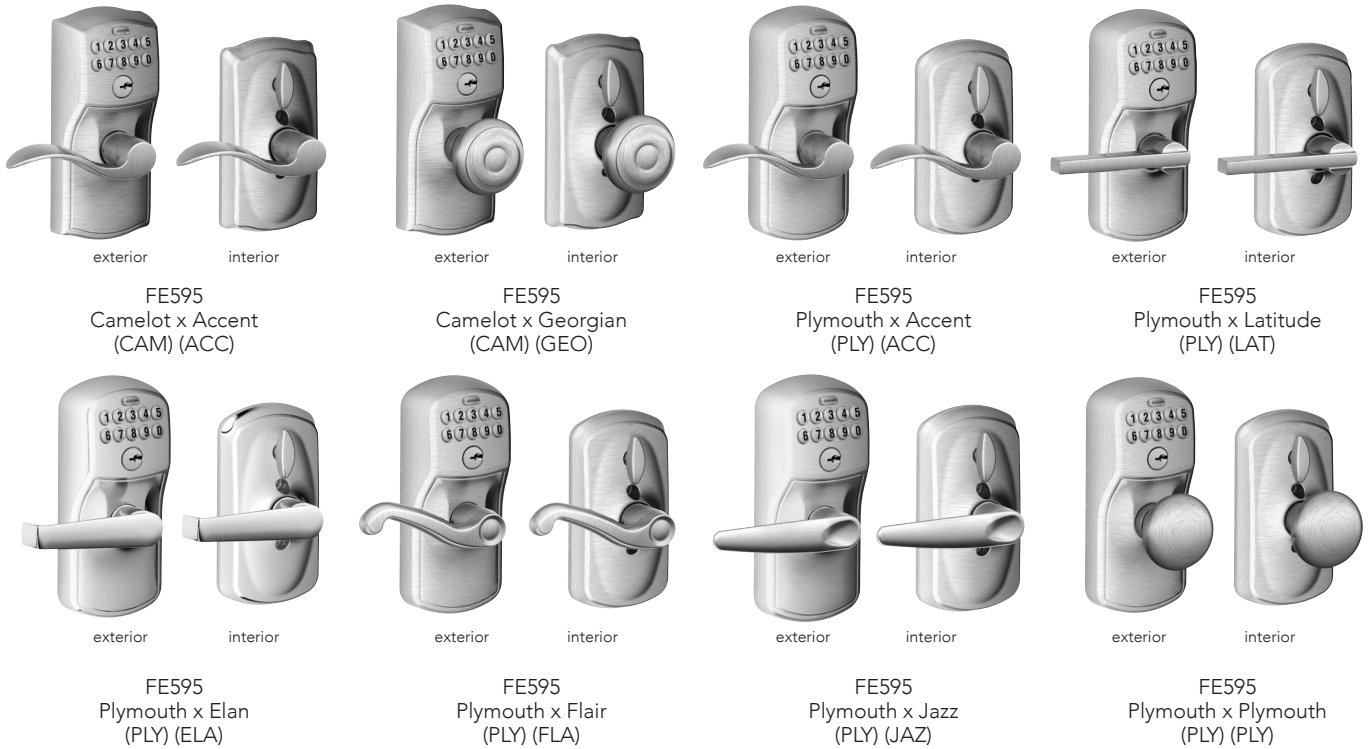

FE595 Series Keypad Locks

FINISHES

Function	Style/Design	Packaging	605	505	608	609	618	619	620	621	622	625	626	716	613
(CAM) Camelot															
FE595	Accent Lever	Box/Vis	•	\$245	•	\$245	•	\$245	\$245	•	\$245	•	\$245	\$245	•
FE595	Georgian Knob	Box	•	230	•	230	•	230	•	•	•	•	•	230	•
(PLY) Plymouth															
FE595	Accent Lever	Box	•	245	•	•	•	245	245	•	•	•	•	245	•
FE595	Latitude Lever	Box/Vis	•	•	•	•	•	245	•	•	\$245	•	245	•	•
FE595	Elan Lever	Box/Vis	•	•	•	•	•	•	•	•	•	•	\$245	•	•
FE595	Flair Lever	Box/	•	245	•	245	•	245	245	•	•	•	245	245	•
FE595	Jazz Lever	Box	•	•	•	•	•	•	•	•	•	•	245	•	•
FE595	Plymouth Knob	Box	•	230	•	•	•	230	•	•	•	•	•	•	•

List Price Adders:

Visual Package Options (highlighted) - add \$5 to list price
 Triple Option Latch - add \$2 to list price

Electronic Locks Keypad Locks

Keypad Lever Auto Locks



FE575
Camelot x Accent
(CAM) (ACC)

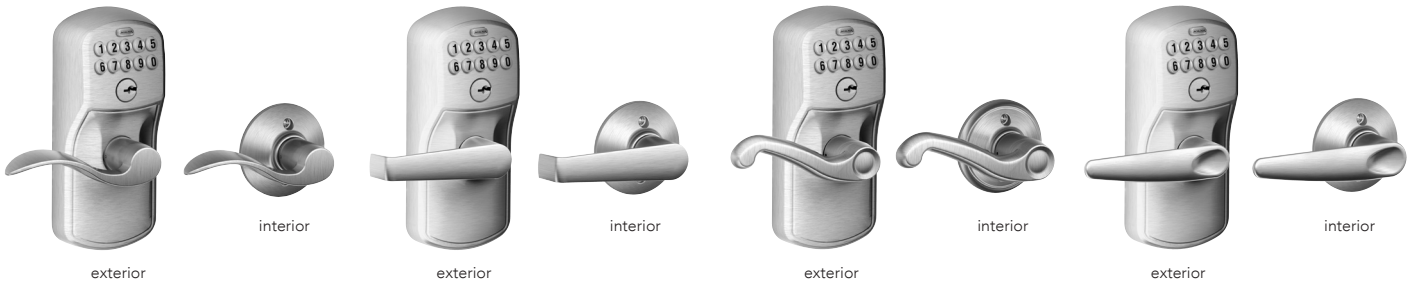

FE575
Plymouth x Accent
(PLY) (ACC)

FE575
Plymouth x Elan
(PLY) (ELA)

FE575
Plymouth x Flair
(PLY) (FLA)

FE575
Plymouth x Jazz
(PLY) (JAZ)

FE575 Series Keypad Entry Auto-Locks (cont.)

FINISHES

Function	Style/Design	Packaging	605	505	608	609	618	619	620	621	622	625	626	716	613
(CAM) Camelot															
FE575	Accent Lever	Box	•	\$235	•	\$235	•	\$235	\$235	•	•	•	\$235	\$235	•
(PLY) Plymouth															
FE575	Accent Lever	Box	•	•	•	•	•	235	235	•	•	•	•	235	•
FE575	Elan Lever	Box	•	•	•	•	•	•	•	•	•	•	235	•	•
FE575	Flair Lever	Box	•	235	•	235	•	235	235	•	•	•	235	235	•
FE575	Jazz Lever	Box	•	•	•	•	•	•	•	•	•	•	235	•	•
FE575	Plymouth Knob	Box	•	235	•	•	•	•	•	•	•	•	•	•	•

F Series Handlesets

AVAILABLE FUNCTIONS

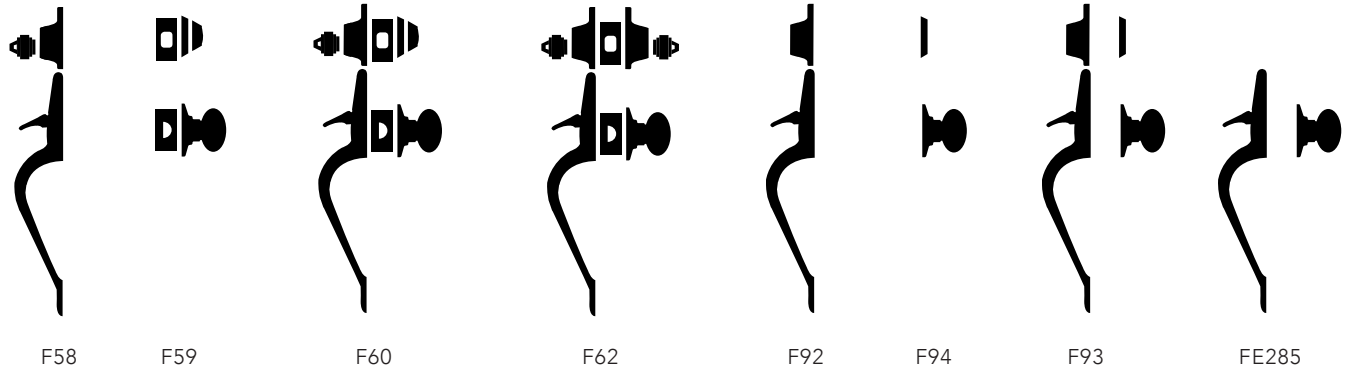

**ANSI/BHMA A156.36 Commercial Grade 1
ANSI/BHMA A156.40 Residential Grade AAA
Entrance Handlesets**

F58 – Handleset/Entrance Lock Exterior

- Outside grip and deadbolt trim of F60
- Pair with an F59 for a complete handleset

F59 – Handleset/Entrance Lock Interior

- Inside trim, deadbolt thumbturn, latches, strikes & screws for F60
- Pair with an F58 for a complete handleset

F60 – Single Cylinder Deadbolt/Entrance Lock

- Deadbolt thrown or retracted by key from outside or by inside thumbturn
- Latch retracted by thumbpiece from outside or by inside knob/lever

F62 – Double Cylinder Handleset/Entrance Lock*

- Deadbolt thrown or retracted by key from either side
- Latch retracted by thumbpiece from outside or by inside knob/lever

F92 – Inactive Handleset Exterior

- Outside inactive grip & dummy deadbolt
- Pair with an F94 for a complete inactive handleset

F94 – Inactive Handleset Interior

- Inside inactive knob/lever, blank deadbolt trim & screws
- Pair with an F92 for a complete inactive handleset

F93 – Inactive Handleset

- For use as door pull or as decorative trim on inactive leaf of pair of doors
- Fixed thumbpiece and inside knob/lever
- Decorative deadbolt with inside trim

FE285 - Lower Half - Front Entry Set

- Combine with Electronic Deadbolt for complete Front Entry Set
- Latch retracted by thumbpiece from outside or by inside knob/lever

***CAUTION:** Double cylinder locks on residences and any door in any structure which is used for egress are a life safety hazard in times of emergency and their use is not recommended. Installation should be in accordance with existing codes only.

PRODUCT IDENTIFICATION

F	60	F	CEN	619	MER	CEN	RH	12-322	10-115	KD
Lock Series	Product	UL Fire Rated (V - VisPack) (GC - Graphic Cover)	Style	Finish Code	Design	Decorative Trim	Hand	Latch	Strike	Keying

LATCHES & STRIKES

Latches

- 12-322** - Dual Option - Round Corner + Drive-in (16-080 + 12-321) **STANDARD**
- 12-326** - Triple Option - Round Corner + Square Corner + Drive-in (16-210 + 12-287)
- 12-353** - F60/62 UL Listed, 1" Square Corner
- 12-354** - F60/62 UL Listed, 1" Round Corner

Strikes

- 10-115** - Round Corner Full Lip Strike Set (10-027 + 10-116) **STANDARD**
- 10-269** - Round Corner Strike Set (10-026 + 10-027 + 10-116)
- 10-257** - Round Corner Full Lip (10-027 + 10-092)

STANDARD FEATURES / CONFIGURATIONS

F-Series Entrance Handlesets*

Certification:	ANSI/BHMA A156.36-2016 Commercial Grade 1 ANSI/BHMA A156.40-2015 Residential Grade AAA Available UL Listed for 3-hour fire door
Latch:	1" x 2 1/4", 1/4" radius corner faceplate, 7/8" housing diameter, 1/2" throw springlatch
Deadbolt:	1" x 2 1/4", 1/4" radius corner faceplate, 1" housing diameter, 1" throw, latchset number 12-321
Strike:	Part 10-269, includes: 1 1/4" radius corner deadbolt strike (10-116), radius round corner full lip strike (10-027)
Reinforcement:	Door frame reinforcer with 3" screws
Backset:	Universal backset latch and deadbolt, fits either 2 3/8" or 2 3/4" backsets
Cylinder:	5-Pin, keyed 5-Pin, C keyway, keyed different (KD)
Door Range**:	1 5/8" - 1 7/8"
Keys:	Two cut keys per lock, 5-pin, C section
Adjustable Throughbolt:	Adjustable throughbolt can move up and down 1 1/2" to fit a variety of pre-existing holes

*Locks are furnished with standard features unless otherwise specified
To order locks with non-standard features specify non-standard feature desired

**Thick door kit available for door thicknesses up to 2 1/4"
See Parts sections for item number and pricing

FINISH CODES & DESCRIPTIONS

505	605	608	609	613	618	619	620	621	622	625	626	716
Lifetime Bright Brass	Bright Brass (US3)	Satin Brass	Antique Brass (US5)	Oil-Rubbed Bronze (US10B)	Polished Nickel	Satin Nickel (US15)	Antique Pewter (US15A)	Distressed Nickel	Matte Black (US19)	Bright Chrome (US26)	Satin Chrome (US26D)	Aged Bronze

Non-standard finishes are not available.
Full-color swatch examples available on inside Handleset tab.

PACKAGING & CARTON SPECS

	INDIVIDUAL CARTON				SHIPPER						
	CARTON WEIGHT	HEIGHT	WIDTH	DEPTH	QTY. SHIPPER	CARTON WEIGHT	CU. FT.	HEIGHT	WIDTH	DEPTH	
Levers											
F58	4.30	3.90 in.	7.97 in.	16.25 in.	4.00	22.00	1.36	8.50 in.	16.00 in.	17.25 in.	
F59	1.75	3.62 in.	4.31 in.	8.06 in.	8.00	20.00	0.94	6.00 in.	15.00 in.	18.00 in.	
F60	6.16	3.90 in.	7.97 in.	16.25 in.	4.00	23.00	1.36	8.50 in.	16.00 in.	17.25 in.	
F62	6.36	3.90 in.	7.97 in.	16.25 in.	4.00	24.00	1.36	8.50 in.	16.00 in.	17.25 in.	
F92	4.30	3.90 in.	7.97 in.	16.25 in.	4.00	22.00	1.36	8.50 in.	16.00 in.	17.25 in.	
F94	1.75	3.62 in.	4.31 in.	8.06 in.	20.00	33.60	1.73	9.13 in.	18.12 in.	18.12 in.	
F93	5.75	3.90 in.	7.97 in.	16.25 in.	4.00	22.00	1.36	8.50 in.	16.00 in.	17.25 in.	

For Vis Pack carton specs, see page 127

AVAILABLE STYLES

**F58
Available
Exterior
Styles**

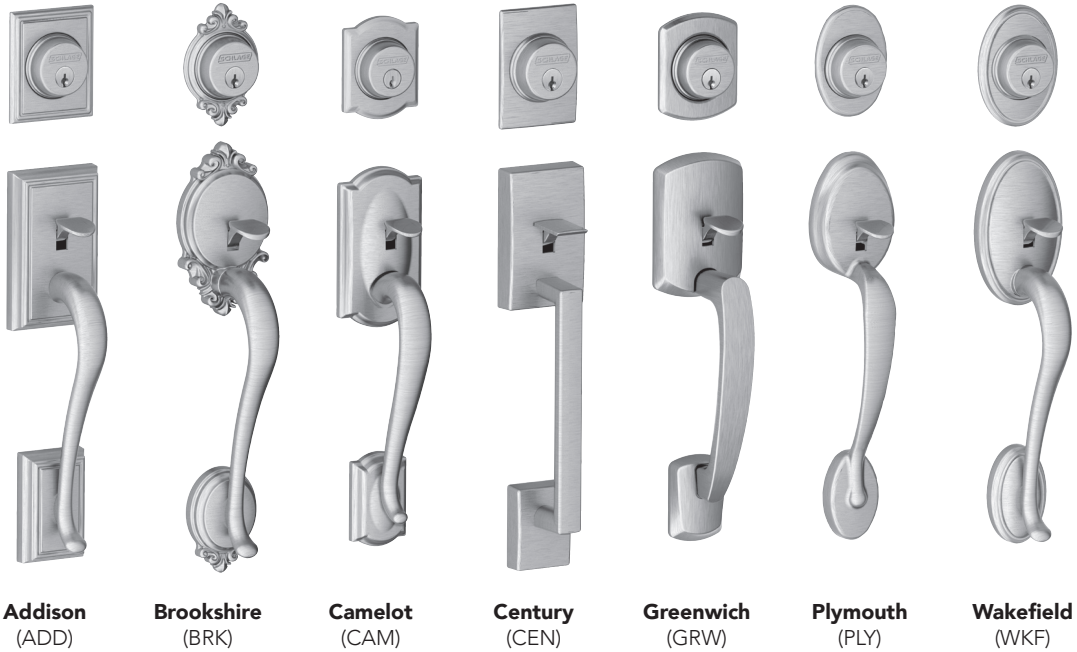

F59 Available Interior Styles

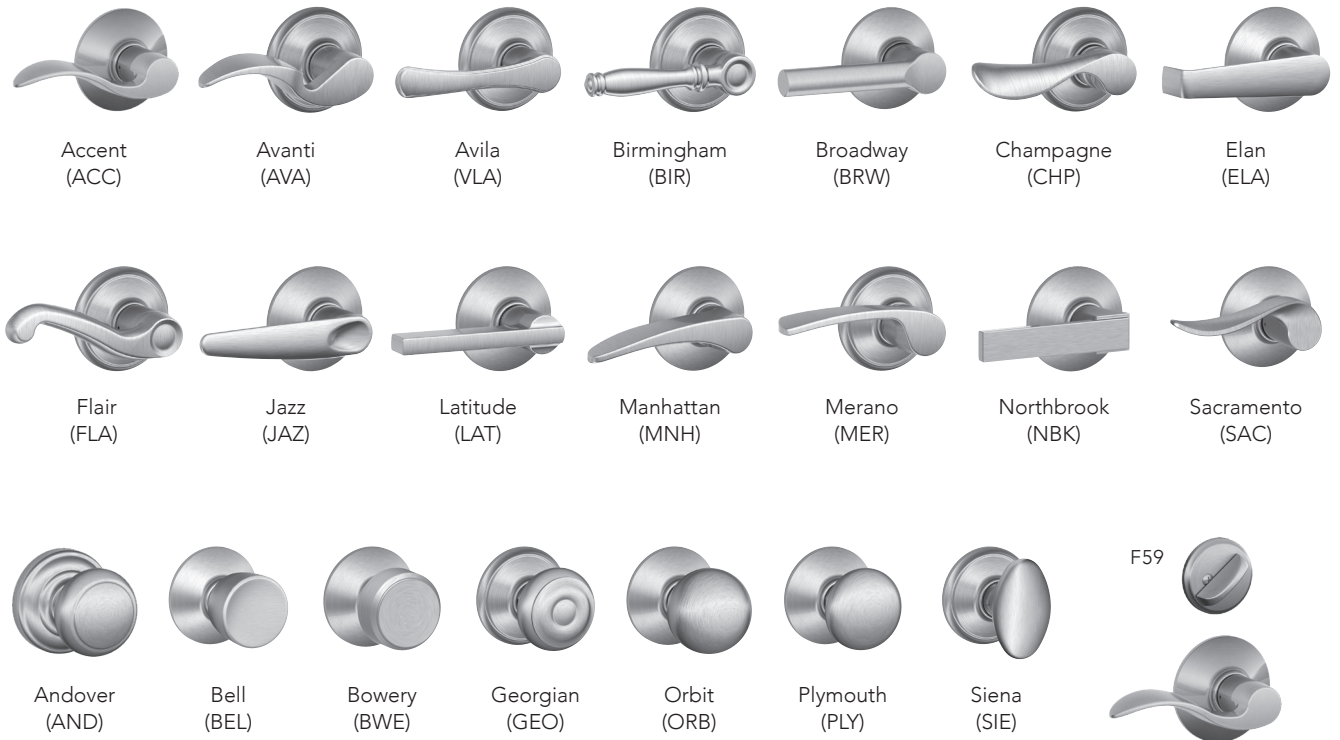

F58 Series

Handleset Exterior

FINISHES

Style/Design	Packaging	605	505	608	609	618	619	620	621	622	625	626	716	613
(PLY) Plymouth	Box	\$140	\$175	•	\$175	•	\$175	\$175	•	\$175	\$175	\$175	\$175	\$205
(CAM) Camelot	Box	148	183	183	183	•	183	183	•	183	183	•	183	•
(CEN) Century	Box	•	•	•	•	183	183	•	•	183	183	183	183	•
(ADD) Addison	Box	•	•	•	188	•	188	188	188	188	188	•	188	•
(BRK) Brookshire	Box	153	188	•	188	•	188	•	•	188	•	•	188	•
(GRW) Greenwich	Box	•	•	•	•	188	188	•	•	188	188	188	188	•
(WKF) Wakefield	Box	•	•	•	•	188	188	188	•	188	188	•	188	•

F59 Series

Handleset/Entrance Lock Interior

FINISHES

Style/Design	Packaging	605	505	608	609	618	619	620	621	622	625	626	716	613
Interior Thumbturn & Interior Lever														
(VLA) Avila Lever	Box	\$100	•	•	\$105	•	\$105	•	•	•	\$105	\$105	\$105	•
(SAC) Sacramento Lever*	Box	•	•	•	•	105	105	•	•	•	105	105	105	•
(ACC) Accent Lever*	Box	103	•	108	108	108	108	108	108	108	108	108	108	111
(AVA) Avanti Lever*	Box	•	•	•	108	•	108	•	•	•	108	•	108	•
(BIR) Birmingham Lever	Box	•	•	•	•	•	108	•	•	•	108	•	108	•
(BRW) Broadway Lever	Box	•	•	•	•	•	108	•	•	108	108	108	108	•
(ELA) Elan Lever	Box	103	•	•	108	•	108	•	•	108	108	108	108	•
(FLA) Flair Lever*	Box	103	•	108	108	•	108	108	•	•	108	108	108	•
(JAZ) Jazz Lever	Box	•	•	•	•	•	108	•	•	108	108	108	108	•
(LAT) Latitude Lever	Box	•	•	•	•	108	108	•	•	108	108	108	108	•
(MER) Merano Lever*	Box	•	•	•	•	•	108	•	•	108	108	108	108	•
(MNH) Manhattan Lever*	Box	•	•	•	•	•	108	•	•	•	108	108	•	•
(NBK) Northbrook Lever	Box	•	•	•	•	•	108	•	•	•	•	•	•	•
(CHP) Champagne Lever*	Box	•	•	•	•	•	118	•	•	•	•	•	118	•
Interior Thumbturn & Interior Knob														
(BEL) Bell Knob	Box	\$83	•	•	\$86	•	•	•	•	•	•	\$86	•	•
(GEO) Georgian Knob	Box	83	•	86	86	•	86	86	86	86	86	•	86	•
(PLY) Plymouth Knob	Box	83	•	•	86	•	86	86	•	86	86	86	86	•
(AND) Andover Knob	Box	90	•	•	93	•	93	93	•	•	93	93	93	\$107
(BWE) Bowery Knob	Box	•	•	•	•	93	93	•	•	93	93	93	93	•
(ORB) Orbit Knob	Box	90	•	•	•	•	93	•	•	•	93	93	•	•
(SIE) Siena Knob	Box	97	•	•	100	•	100	100	•	100	100	100	100	•

*Specify handing

Note:

For F60 Pricing, combine pricing from F58 Series and F59 Series above.

List Price Adders:

Visual Package Options

Decorative Trim Option - See chart on page 30

Triple Option Latch - add \$2 to list price; Box Pack Only

UL Latch - add \$12 to list price (F59 and F60 Functions - Box Pack Only)

**F92 Series
Inactive Handleset Exterior**

Style/Design	Packaging	FINISHES												
		605	505	608	609	618	619	620	621	622	625	626	716	613
(PLY) Plymouth	Box	\$130	\$165	•	\$165	•	\$165	\$165	•	\$165	\$165	\$165	\$165	\$195
(CAM) Camelot	Box	138	173	173	173	•	173	173	•	173	173	•	173	•
(CEN) Century	Box	•	•	•	•	173	173	•	•	173	173	173	173	•
(ADD) Addison	Box	•	•	•	178	•	178	178	178	178	178	•	178	•
(BRK) Brookshire	Box	143	178	•	178	•	178	•	•	178	•	•	178	•
(GRW) Greenwich	Box	•	•	•	•	178	178	•	•	178	178	178	178	•
(WKF) Wakefield	Box	•	•	•	•	178	178	178	•	178	178	•	178	•

**F94 Series
Inactive Handleset Interior**

Style/Design	Packaging	FINISHES												
		605	505	608	609	618	619	620	621	622	625	626	716	613
Interior Lever														
(VLA) Avila Lever	Box	\$60	•	•	\$65	•	\$65	•	•	•	\$65	\$65	\$65	•
(SAC) Sacramento Lever*	Box	•	•	•	•	65	65	•	•	•	65	65	65	•
(ACC) Accent Lever*	Box	\$63	•	68	\$68	\$68	\$68	\$68	\$68	\$68	\$68	\$68	\$68	\$71
(AVA) Avanti Lever*	Box	•	•	•	68	•	68	•	•	•	68	•	68	•
(BIR) Birmingham Lever	Box	•	•	•	•	•	68	•	•	•	68	•	68	•
(BRW) Broadway Lever	Box	•	•	•	•	•	68	•	•	68	68	68	68	•
(ELA) Elan Lever	Box	63	•	•	68	•	68	•	•	68	68	68	68	•
(FLA) Flair Lever*	Box	63	•	68	68	•	68	68	•	•	68	68	68	•
(JAZ) Jazz Lever	Box	•	•	•	•	•	68	•	•	68	68	68	68	•
(LAT) Latitude Lever	Box	•	•	•	•	68	68	•	•	68	68	68	68	•
(MER) Merano Lever*	Box	•	•	•	•	•	68	•	•	68	68	68	68	•
(MNH) Manhattan Lever*	Box	•	•	•	•	•	68	•	•	•	68	68	•	•
(NBK) Northbrook Lever	Box	•	•	•	•	•	68	•	•	•	•	•	•	•
(CHP) Champagne Lever*	Box	•	•	•	•	•	78	•	•	•	•	•	78	•
Interior Knob														
(BEL) Bell Knob	Box	\$43	•	•	\$46	•	•	•	•	•	•	\$46	•	•
(GEO) Georgian Knob	Box	43	•	46	46	•	46	46	46	46	46	•	46	•
(PLY) Plymouth Knob	Box	43	•	•	46	•	46	46	•	46	46	46	46	•
(AND) Andover Knob	Box	50	•	•	53	•	53	53	•	•	53	53	53	67
(BWE) Bowery Knob	Box	•	•	•	•	53	53	•	•	53	53	53	53	•
(ORB) Orbit Knob	Box	50	•	•	•	•	53	•	•	•	53	53	•	•
(SIE) Siena Knob	Box	57	•	•	60	•	60	60	•	60	60	60	60	•

*Specify handing

Note:

For F93 Pricing, combine pricing from F92 Series and F94 Series above.

List Price Adders:

Decorative Trim Option - See chart on page 30

Handlesets F Series

F62 Series

Handleset/Entrance Lock Interior & Exterior

FINISHES

Style/Design	Packaging	605	505	608	609	618	619	620	621	622	625	626	716	613
Plymouth Handleset														
(ACC) Accent Lever*	Box	\$268	\$200	*	\$308	*	\$308	\$308		\$308	\$308	\$308	\$308	\$341
(BIR) Birmingham Lever	Box	*	*	*	*	*	308	*	*	*	308	*	308	*
(GEO) Georgian Knob	Box	248	200	*	286	*	286	286	*	286	286	*	286	*
(PLY) Plymouth Knob	Box	248	200	*	286	*	286	286	*	286	286	286	286	*
Camelot Handleset														
(ACC) Accent Lever*	Box	\$276	\$208	*	\$316	*	\$316	\$316	*	\$316	\$316	*	\$316	*
(BIR) Birmingham Lever	Box	*	*	*	*	*	316	*	*	*	316	*	316	*
(GEO) Georgian Knob	Box	256	208	*	294	*	294	294	*	294	294	*	294	*
(PLY) Plymouth Knob	Box	256	208	*	294	*	294	294	*	294	294	*	294	*
Century Handleset														
(LAT) Latitude Lever	Box	*	*	*	*	*	\$316	*	*	*	\$316	\$316	\$316	*
(MER) Merano Lever*	Box	*	*	*	*	*	316	*	*	*	316	316	316	*
(ORB) Orbit Knob	Box	*	*	*	*	*	301	*	*	*	301	301	*	*
Addison Handleset														
(ACC) Accent Lever*	Box	*	*	*	\$321	*	\$321	\$321	\$321	\$321	\$321	*	\$321	*
(BIR) Birmingham Lever	Box	*	*	*	*	*	321	*	*	*	321	*	321	*
(GEO) Georgian Knob	Box	*	*	*	299	*	299	299	299	299	299	*	299	*
(PLY) Plymouth Knob	Box	*	*	*	299	*	299	299	*	299	299	*	299	*
Brookshire Handleset														
(FLA) Flair Lever*	Box	\$281	\$213	*	\$321	*	\$321	*	*	*	*	*	\$321	*
(GEO) Georgian Knob	Box	261	213	*	299	*	299	*	*	299	*	*	299	*
Wakefield Handleset														
(ACC) Accent Lever*	Box	*	*	*	*	*	\$321	\$321	*	\$321	\$321	*	\$321	*
(AND) Andover Knob	Box	*	*	*	*	*	306	306	*	*	306	*	306	*
(BIR) Birmingham Lever	Box	*	*	*	*	*	321	*	*	*	321	*	321	*
(GEO) Georgian Knob	Box	*	*	*	*	*	299	299	*	299	299	*	299	*

F60 Series

Handleset Exterior/Interior

FINISHES

Style/ Design	Packaging	605	505	608	609	618	619	620	621	622	625	626	716	613
Addison Handleset														
(ACC) Accent	Vis	*	*	*	*	*	\$316	*	*	\$316	*	*	\$316	*
(PLY) Plymouth	Vis	*	*	*	*	*	*	*	*	\$294	*	*	*	*
Camelot Handleset														
(ACC) Accent	Vis	*	*	\$306	\$311	\$311	*	\$311	*	*	*	*	\$311	*
(AVA) Avanti	Vis	*	*	*	*	*	*	\$311	*	*	*	*	*	*
(GEO) Georgian	Vis	*	*	*	*	*	\$289	\$289	*	*	*	*	\$289	*
Century Handleset														
(BRW) Broadway	Vis	*	*	*	*	*	*	*	*	\$311	*	*	*	*
(LAT) Latitude	Vis	*	*	*	*	*	\$311	*	*	*	*	*	*	*
(MNH) Manhattan	Vis	*	*	*	*	*	*	*	*	*	*	\$311	*	*
(MER) Merano	Vis	*	*	*	*	*	\$311	*	*	*	*	*	*	*
(BWE) Bowery	Vis	*	*	*	*	*	\$296	*	*	\$304	*	*	*	*
Greenwich Handleset														
(VLA) Avila	Vis	*	*	*	*	*	\$313	*	*	*	*	*	\$313	*
(BRW) Broadway	Vis	*	*	*	*	*	\$316	*	*	*	*	*	*	*
(LAT) Latitude	Vis	*	*	*	*	*	*	*	*	\$316	*	*	*	*
Plymouth Handleset														
(ACC) Accent	Vis	*	*	\$298	*	*	\$303	\$303	*	*	*	*	*	*
(FLA) Flair	Vis	*	*	*	\$303	*	*	*	*	*	*	*	*	*
(GEO) Georgian	Vis	*	*	*	*	*	*	\$281	*	*	*	*	*	*
(ORB) Orbit	Vis	*	*	\$285	*	*	*	*	*	*	*	*	*	*
(PLY) Plymouth	Vis	*	*	\$278	*	*	\$281	*	*	*	*	\$281	\$281	*
Wakefield														
(SAC) Sacramento	Vis	*	*	*	*	*	\$313	*	*	*	*	*	*	*

*Specify handing

**FE285 Series
Handleset Exterior Options**

FINISHES

Style/Design	Packaging	605	505	608	609	618	619	620	621	622	625	626	716	613
(PLY) Plymouth	Box	\$110	\$145	•	\$145	•	\$145	\$145	•	\$145	\$145	\$145	\$145	\$175
(CAM) Camelot	Box	118	153	153	153	•	153	153	•	153	153	•	153	•
(CEN) Century	Box	•	•	•	•	153	153	•	•	153	153	153	153	•
(ADD) Addison	Box	•	•	•	158	•	158	158	158	158	158	•	158	•
(BRK) Brookshire	Box	123	158	•	158	•	158	•	•	158	•	•	158	•
(GRW) Greenwich	Box	•	•	•	•	158	158	•	•	158	158	158	158	•
(WKF) Wakefield	Box	•	•	•	•	158	158	158	•	158	158	•	158	•

**FE285 Series
Handleset Interior Options**

FINISHES

Style/Design	Packaging	605	505	608	609	618	619	620	621	622	625	626	716	613
Interior Thumbturn & Interior Lever														
(VLA) Avila Lever	Box	\$70	•	•	\$75	•	\$75	•	•	•	\$75	\$75	\$75	•
(SAC) Sacramento Lever*	Box	•	•	•	•	75	75	•	•	•	75	75	75	•
(ACC) Accent Lever*	Box	73	•	78	78	78	78	78	78	78	78	78	78	81
(AVA) Avanti Lever*	Box	•	•	•	78	•	78	•	•	•	78	•	78	•
(BIR) Birmingham Lever	Box	•	•	•	•	•	78	•	•	•	78	•	78	•
(BRW) Broadway Lever	Box	•	•	•	•	•	78	•	•	78	78	78	78	•
(ELA) Elan Lever	Box	73	•	•	78	•	78	•	•	78	78	78	78	•
(FLA) Flair Lever*	Box	73	•	78	78	•	78	78	•	•	78	78	78	•
(JAZ) Jazz Lever	Box	•	•	•	•	•	78	•	•	78	78	78	78	•
(LAT) Latitude Lever	Box	•	•	•	•	78	78	•	•	78	78	78	78	•
(MER) Merano Lever*	Box	•	•	•	•	•	78	•	•	78	78	78	78	•
(MNH) Manhattan Lever*	Box	•	•	•	•	•	78	•	•	•	78	78	•	•
(NBK) Northbrook lever	Box	•	•	•	•	•	78	•	•	•	•	•	•	•
(CHP) Champagne Lever*	Box	•	•	•	•	•	88	•	•	•	•	•	88	•
Interior Thumbturn & Interior Knob														
(BEL) Bell Knob	Box	\$53	•	•	\$56	•	•	•	•	•	•	\$56	•	•
(GEO) Georgian Knob	Box	53	•	56	56	•	56	56	56	56	56	•	56	•
(PLY) Plymouth Knob	Box	53	•	•	56	•	56	56	•	56	56	56	56	•
(AND) Andover Knob	Box	60	•	•	63	•	63	63	•	•	63	63	63	77
(BWE) Bowery Knob	Box	•	•	•	•	63	63	•	•	63	63	63	63	•
(ORB) Orbit Knob	Box	60	•	•	•	•	63	•	•	•	63	63	•	•
(SIE) Siena Orbit Knob	Box	67	•	•	70	•	70	70	•	70	70	70	70	•

*Specify handing

Note:

For FE285 Pricing, combine pricing from Exterior Options and Interior Options above.

List Price Adders:

- Decorative Trim Option - See chart on page 30
- Triple Option Latch - add \$2 to list price; Box Pack Only
- UL Latch - add \$6 to list price (Box Pack Only)

Stand out **effortlessly.**

Schlage's Decorative Collections make it easy to match our strength to your style. With more than 1,000 customized design and finish options in all, your decor will be limited by only your imagination.



Pair a knob or lever with our inspired decorative trim options to bring your vision to life.*

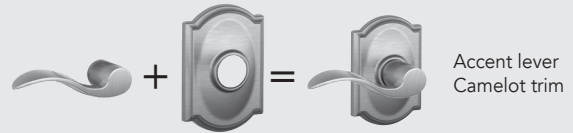

* LOCKS SHIP COMPLETE WITH TRIM ATTACHED



Follow these steps for pricing decorative combinations:

1. Locate the list price of the handleset in the Handlesets section.
2. Use the chart below to find the list price adder for the matching Decorative Collection upgrade.
3. Add the list prices together for the total list price of the new combination.

For F60 / F59 / F93 / F94 / FE285

Finishes available

Decorative trim finish	605	505	608	609	618	619	620	621	622	625	626	716	613
Addison (ADD)*	•	•	•	\$16	•	\$16	•	\$16	\$16	\$16	\$16	\$16	•
Andover (AND)	16	16	•	16	•	16	16	•	16	16	16	16	16
Brookshire (BRK)	•	•	•	16	•	16	•	•	•	•	•	16	•
Camelot (CAM)	16	16	16	16	•	16	16	•	16	16	•	16	•
Century (CEN)	•	•	•	•	16***	16	•	•	16	16	16	16	•
Collins (COL)	•	•	•	•	•	16	•	•	•	•	•	•	•
Greenwich (GRW)	•	•	•	•	16***	16	•	•	16	16	16	16	•
Greyson (GSN)*	•	•	•	•	16***	16	•	•	16	16	•	16	•
Upland (ULD)**	•	•	•	•	•	16	•	•	•	•	•	•	•
Wakefield (WKF)*	•	•	•	•	16***	16	•	•	•	16	16	16	•



EXAMPLE 1: To Price a F59 ACC 619 CAM

Take the list price of a F59 ACC 619 12-321 10-116 at \$108.00 and add the Camelot Decorative Trim Adder of \$16.00 for a total list price of \$124.00

\$108 (F59 ACC 619)
+ \$16 (Camelot Decorative Trim 619)

\$124 Total cost
(F59 ACC 619 CAM)

When ordering a Handleset decorative collection product, specify the trim after the finish code
Example: F59 ACC 619 **CAM** or F59 ACC 619 **ADD**

* Andover, Greyson & Wakefield trim available on interior knob or lever and not on deadbolt

** ULD trim available on interior knob or lever with COL trim on deadbolt.

*** Trim and finish combination not available for F92, F93, and F94 products.

To order latches and strikes see page 102-103

**J Series Handlesets
AVAILABLE FUNCTIONS**



JH58



JH59

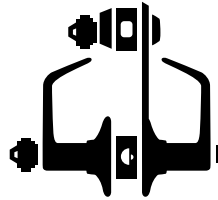

JI58/59

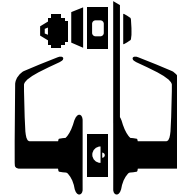

JI18/19

**ANSI/BHMA A156.36-2010 Commercial Grade 3
J Series Entrance Handlesets**

JH58 - Outside Handleset

- Outside grip and deadbolt trim

JH59 - Inside Handleset

- Inside trim, deadbolt thumbturn, latches, strikes & screws

JI58/59 - Keyed Entrance Lock (Interconnect)

- Deadbolt operated by key from outside or by turn unit from inside. Bolt automatically deadlocks when fully thrown
- Outside lever unlocked by key from outside when locked by turn-button in inside lever
- Turning inside lever retracts deadbolt and latch simultaneously for immediate exit
- Latch automatically deadlocks when door is closed
- UL Listed

JI18/19 - Passage Lock with Keyed Deadbolt (Interconnect)

- Deadbolt operated by key from outside or by turn unit from inside
- Bolt automatically deadlocks when fully thrown
- Latch retracted by lever from either side
- Turning inside lever retracts deadbolt and latch simultaneously for immediate exit
- UL Listed

PRODUCT IDENTIFICATION

JH	59		SEV	619	RH	16-068	10-103
Lock Series	Product	Suffix/Package	Style	Finish Code	Hand	Latch	Strike

LATCHES & STRIKES

Latches

16-258* - JH59/JH60 Triple Option Spring Latch - Round Corner + Square Corner + Drive-in + Dual Option Deadbolt Latch - Round Corner + Drive-in (16-068 + 16-070) - **STANDARD**

16-057** - JI19/JH59 UL Listed (16-059 + 16-062)

16-065*** - JI59 UL Listed (16-061 + 16-063)

* Sold separately as 16-068 and 16-070

** Sold separately as 16-059 and 16-063

*** Sold separately as 16-061 and 16-063

NOTE:

- 1) standard spring latch is Triple Option
- 2) standard deadbolt latch is Dual Option 1/4" round faceplate and drive-in latch

Strikes

10-268* - Radius Full Lip + Radius Deadbolt (10-101 + 10-102 + 10-103) - **STANDARD**

10-105 ** - Radius Full Lip + Square Corner Reinforced Deadbolt (10-101 + 10-099)

10-106 *** - JI19/JI59 Radius Full Lip + Radius Full Lip Dead bolt (10-101 + 10-102)

* Sold separately as 10-101 and 10-102 and 10-103

** Sold separately as 10-101 and 10-099

*** Sold separately as 10-101 and 10-102

STANDARD FEATURES / CONFIGURATIONS

J Series Entrance Handlesets

Certification:	ANSI/BHMA A156.36-2010 Commercial Grade 3
Deadbolt	Dual Option: 1" x 2 1/4", 1/4" round corner and drive-in
Latch:	round faceplates, drive-in latch, 1" housing diameter, 1" throw
Spring Latch:	Triple Option: 1" x 2 1/4", 1/4" round faceplate, drive-in latch
Deadbolt Strike:	1" x 2 1/4", round corner and radius corner, full lip
Latch Strike:	1 5/8" x 2 1/4", radius corner, full lip
Backset:	Adjustable for 2 3/8" or 2 3/4"
Cylinder:	5-pin, C keyway, keyed different (KD)
Door Range:	1 3/8" - 1 3/4"
Keys:	Two brass cut keys per lock, 5-pin, C section

FINISH CODES & DESCRIPTIONS

605	609	619	620	622	625	626	630	716
Bright Brass (US3)	Antique Brass (US5)	Satin Nickel (US15)	Antique Pewter (US15A)	Matte Black (US19)	Bright Chrome (US26)	Satin Chrome (US26D)	Satin Stainless Steel (US32D)	Aged Bronze

*Non-standard finishes are not available
Full-color swatch examples available on inside Handleset tab

PACKAGING & CARTON SPECS

	INDIVIDUAL CARTON				SHIPPER						
	CARTON WEIGHT	HEIGHT	WIDTH	DEPTH	QTY. SHIPPER	CARTON WEIGHT	CU. FT.	HEIGHT	WIDTH	DEPTH	
Knobs											
JH58	3.47	3.46 in.	5.51 in.	12.20 in.	4	13.86	0.754	13.6 in.	8.0 in.	12.0 in.	
JH59	1.19	3.11 in.	2.56 in.	7.48 in.	24	28.62	1.142	8.7 in.	13.6 in.	16.8 in.	
JI58	0.64	2.76 in.	3.15 in.	13.39 in.	20	12.8	1.64	14.17 in.	13.39 in.	14.96 in.	
JI59	2.83	3.15 in.	3.94 in.	9.05 in.	12	33.96	1.1	10.35 in.	13.19 in.	13.89 in.	
JI18	1.19	2.79 in.	5.04 in.	6.22 in.	24	28.62	1.8	7.8 in.	18.31 in.	21.77 in.	
JI19	2.83	3.15 in.	3.94 in.	9.05 in.	12	33.96	1.1	10.35 in.	13.19 in.	13.89 in.	

For Vis Pack carton specs, see page 127

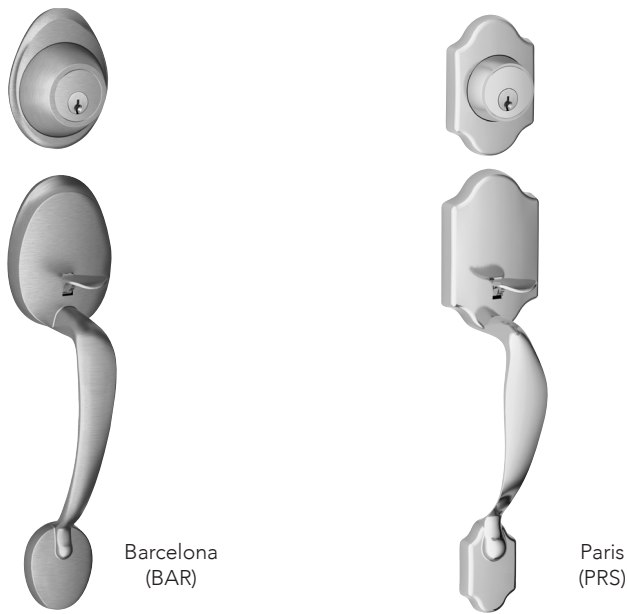

**JH58 Series
Handleset Exteriors**

FINISHES

Style/Design	Packaging	605	609	619	620	622	625	626	630	716
Handlesets Outside Trim, JH58 (JH58 + JH59 = complete handleset)										
JH58 (BAR) Barcelona	Box	\$92	\$92	\$92	\$92	.	\$92	.	\$92	\$92
JH58 (PRS) Paris	Box	92	92	92	.	.	92	.	92	92
Handlesets Inside Trim, JH59 (JH58 + JH59 = complete handleset)										
JH59 (BYR) Byron Knob	Box	\$64	\$64	.
JH59 (CNA) Corona Knob	Box	64	64	64	64	.	64	.	64	64
JH59 (DUB) Dublin Knob	Box	.	.	64	64
JH59 (STR) Stratus Knob	Box	64	.	64	.	.	64	.	64	64
JH59 (DOV) Dover Lever	Box	.	.	75	75	75
JH59* (LAS) LaSalle Lever	Box	75	75	75	75
JH59 (MAR) Marin Lever	Box	.	.	75	75	.
JH59* (SEV) Seville Lever	Box	.	.	75	.	.	75	.	.	75
JH59 (SOL) Solstice Lever	Box	.	.	79	.	.	79	79	.	79
JH59 (TOR) Torino Lever	Box	.	.	75	75	.	75	.	75	75
JH59 (SOL) Solstice/COL Lever	Box	.	.	84	.	84	84	.	.	84
JH59 (BRW) Broadway/COL Lever	Box	.	.	84	.	84	84	.	.	84

*Specify handing

Handlesets J Series



J118
Marin (MAR)



J119
Marin (MAR)



J158
Torino (TOR)



J159
Torino (TOR)

J1 Series Interconnect Locksets-UL

FINISHES

Style/Design	Packaging	605	609	619	620	622	625	626	630	716
J158 Interconnect, Exterior Torino (TOR)	Box	•	•	•	•	•	•	•	\$72	•
J159 Interconnect, Interior Torino (TOR)	Box	•	•	•	•	•	•	•	92	•
J118 Interconnect, Exterior Marin (MAR)	Box	•	•	•	•	•	•	•	64	•
J119 Interconnect, Interior Marin (MAR)	Box	•	•	•	•	•	•	•	82	•

JH60-Series Entrance Handlesets

FINISHES

Style/Design	Packaging	605	609	619	620	622	625	626	630	716
Barcelona Handleset										
(CNA) Corona	Vis	\$166	•	•	•	•	•	•	\$166	•
(SOL) Solstice	Vis		\$181	•	•	•	•	•	•	•
Paris Handleset										
(SEV) Seville Lever	Vis			177	•	•	•	•	•	\$177
Sutton Handleset										
(SOL) Solstice	Vis			181	•	•	•	•	•	•
(SOL/COL) Solstice / Collins	Vis			186	•	\$186	•	•	•	•

F Series Levers

AVAILABLE FUNCTIONS

Non-keyed Locks



Schlage F10 F40 F170
ANSI F75 F76

Keyed Locks

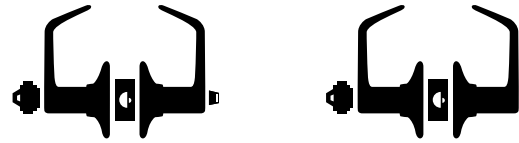

F51A F80
F81 F86

ANSI/BHMA A156.2-2017 Commercial Grade 2
ANSI/BHMA A156.39-2015 Residential Grade AAA

Non-keyed Locks



F10/F75 – Hall & Closet

- Both knobs/levers always unlocked



F40/F76 – Bed & Bath

- Push-button locking
- Can be opened from outside with small circular tool
- Turning inside knob/lever releases button



F170 – Non-turning

- Non-turning trim for one side of door
- Used for door pull or as matching inactive trim

Keyed Locks



F51A/F81 – Keyed Entry

- Keyed entry function unlocks when door is opened from the inside, allowing you to leave quickly, conveniently and re-enter easily
- Locked by inserting key and rotating cylinder from outside, or manually rotating interior turn-button after exit



F80/F86 – Storeroom Lock

- Outside knob/lever fixed. Entrance by key only.
- Inside knob/lever always unlocked

PRODUCT IDENTIFICATION

F	51A	F	ACC	619	CAM	RH	16-086	10-027	KA4
Lock Series	Product	UL Fire Rated (V - VisPack) (GC - Graphic Cover)	Style	Finish Code	Decorative Trim	Hand	Latch	Strike	Keying

LATCHES & STRIKES

Keyed Latches - Dead Latches

16-086 - Dual Option (Round, Drive-in)
STANDARD

16-207 - Square Corner

16-211 - Triple Option (Round, Square, Drive-in)

16-203 - UL Listed Square Corner with Firecup

16-204 - UL Listed Round Corner with Firecup

16-126 - 5" Backset, Square Corner

Non Keyed - Spring Latches

16-080 - Dual Option (Round, Drive-in)
STANDARD

16-200 - Square Corner

16-210 - Triple Option (Round, Square, Drive-in)

16-203 - UL Listed Square Corner with Firecup

16-204 - UL Listed Round Corner with Firecup

16-126 - 5" Backset, Square Corner

Strikes

10-027 - Round Corner Full Lip
STANDARD

10-001 - Square Corner T Strike

10-026 - Square Corner Full Lip

10-058 - Circular - Adjustable

10-063 - Dual Strikes (Round & Square Full Lip)

10-025 - ANSI Square Corner

STANDARD FEATURES / CONFIGURATIONS

F-Series Levers/Decorative Trim*

Description

- Certification:** ANSI/BHMA A156.2-2017 Commercial Grade 2
ANSI/BHMA A156.39-2015 Residential Grade AAA
Available UL Listed for 3-hour fire door, 20 minute cUL with hose stream
- Latch:** 1" x 2 1/4", 1/4" radius corner faceplate, 7/8" housing diameter, 1/2" throw, circular drive-in included, universal latch
- Strike:** 1 5/8" x 2 1/4" radius corner, full lip, no box
- Backset:** Dual backset latches, fits either 2 3/8" or 2 3/4" backsets
- Cylinder:** 5-Pin, C keyway, keyed alike (KA4)
- Door Range:** 1 3/8" - 1 3/4"
- Keys:** Two per lock, 5-pin, C section

* Locks are furnished with standard features unless otherwise specified. To order locks with non-standard features specify non-standard feature desired.

FINISH CODES & DESCRIPTIONS

505	605	608	609	613	618	619	620	621	622	625	626	716
Lifetime Bright Brass	Bright Brass (US3)	Satin Brass	Antique Brass (US5)	Oil-Rubbed Bronze (US10B)	Polished Nickel	Satin Nickel (US15)	Antique Pewter (US15A)	Distressed Nickel	Matte Black (US19)	Bright Chrome (US26)	Satin Chrome (US26D)	Aged Bronze

Non-standard finishes are not available.
Full-color swatch examples available on inside Levers tab.

PACKAGING & CARTON SPECS

	INDIVIDUAL CARTON				SHIPPER						
	CARTON WEIGHT	HEIGHT	WIDTH	DEPTH	QTY. SHIPPER	CARTON WEIGHT	CU. FT.	HEIGHT	WIDTH	DEPTH	
Levers											
F10	1.55	3.25 in.	6.00 in.	7.00 in.	8	12.50	0.760	7.8 in.	12.6 in.	13.5 in.	
F40	1.55	3.25 in.	6.00 in.	7.00 in.	8	12.50	0.760	7.8 in.	12.6 in.	13.5 in.	
F51A	1.55	3.25 in.	6.00 in.	7.00 in.	8	12.50	0.760	7.8 in.	12.6 in.	13.5 in.	
F80	1.55	3.25 in.	6.00 in.	7.00 in.	8	12.50	0.760	7.8 in.	12.6 in.	13.5 in.	
F170	0.80	2.86 in.	4.38 in.	5.66 in.	20	16.00	1.000	6.5 in.	15.3 in.	18.3 in.	
Decorative Collections Levers											
All Levers	1.55	3.25 in.	6.00 in.	7.00 in.	8	19.00	1.090	8.13 in.	12.63 in.	18.4 in.	
F170	1.20	2.86 in.	4.38 in.	5.66 in.	20	25.00	1.000	6.5 in.	15.3 in.	18.3 in.	

For Vis Pack carton specs, see page 127

AVAILABLE STYLES



Accent
(ACC)



Avanti
(AVA)



Avila
(VLA)

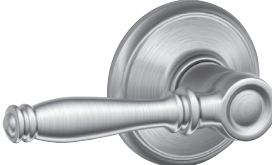

Birmingham
(BIR)



Broadway
(BRW)



Champagne
(CHP)



Elan
(ELA)



Flair
(FLA)



Jazz
(JAZ)



Latitude
(LAT)



Manhattan
(MNH)



Merano
(MER)

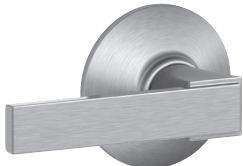

Northbrook
(NBK)

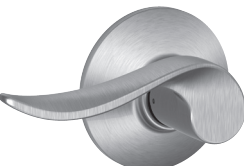

Sacramento
(SAC)



Accent
(ACC)



(ACC) Accent

FINISHES

Function	Packaging	605	505	608	609	618	619	620	621	622	625	626	716	613
F10 Hall & Closet	Box/Vis	\$50	\$57	\$57	\$57	\$57	\$57	\$57	\$57	\$57	\$57	\$57	\$57	\$65
F40 Bed & Bath	Box/Vis	53	•	60	60	60	60	60	60	60	60	60	60	68
F51A Keyed Entry	Box/Vis	100	107	107	107	107	107	107	107	107	107	107	107	115
F80* Storeroom	Box	110	117	117	117	117	117	117	117	117	117	117	117	125
F170* Non-turning	Box/Vis	25	•	29	29	29	29	29	29	29	29	29	29	33



Avanti
(AVA)



(AVA) Avanti

FINISHES

Function	Packaging	605	505	608	609	618	619	620	621	622	625	626	716	613
F10 Hall & Closet	Box/Vis	•	•	•	\$71	•	\$71	\$71	•	•	\$71	•	\$71	•
F40 Bed & Bath	Box/Vis	•	•	•	74	•	74	74	•	•	74	•	74	•
F51A Keyed Entry	Box/Vis	•	•	•	121	•	121	121	•	•	121	•	121	•
F80* Storeroom	Box	•	•	•	131	•	131	131	•	•	131	•	131	•
F170* Non-turning	Box/Vis	•	•	•	36	•	36	36	•	•	36	•	36	•

List Price Adders:

- Visual Package Options (highlighted) - add \$5 to list price
 - Decorative Trim Option - See chart on page Levers-45
 - Triple Option Latch - add \$2 to list price; Box Pack Only
 - UL Latch - add \$6 to list price (F10, F51A, F80 Functions Box Pack Only)
 - Split Finish/Design - add \$6.50 to highest list price; Box Pack Only
- * Specify Handing

Stand out **effortlessly.**
Schlage's Decorative Collections offer thousands of additional design and finish combinations.
See page 45 for details.

Levers F Series

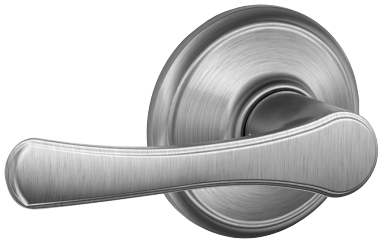

Avila (VLA)

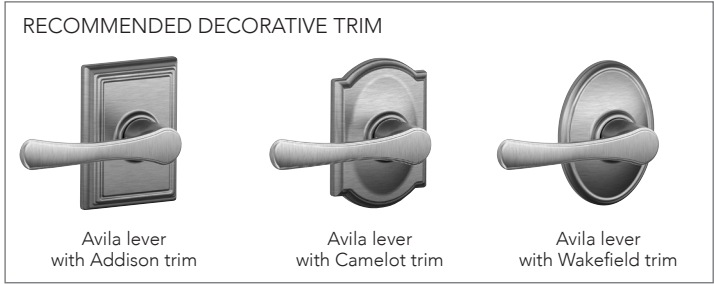

(VLA) Avila

FINISHES

Function	Packaging	605	505	608	609	618	619	620	621	622	625	626	716	613
F10 Hall & Closet	Box/Vis	\$40	\$44	•	\$44	•	\$44	•	•	•	\$44	\$44	\$44	•
F40 Bed & Bath	Box/Vis	43	•	•	47	•	47	•	•	•	47	47	47	•
F51A Keyed Entry	Box/Vis	70	74	•	74	•	74	•	•	•	74	74	74	•
F80 Storeroom	Box	80	84	•	84	•	84	•	•	•	84	84	84	•
F170 Non-turning	Box/Vis	20	•	•	22	•	22	•	•	•	22	22	22	•

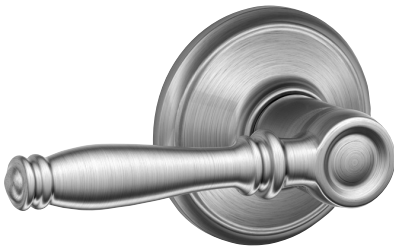

Birmingham (BIR)



(BIR) Birmingham

FINISHES

Function	Packaging	605	505	608	609	618	619	620	621	622	625	626	716	613
F10 Hall & Closet	Box	•	•	•	•	•	\$57	•	•	•	\$57	•	\$57	•
F40 Bed & Bath	Box	•	•	•	•	•	60	•	•	•	60	•	60	•
F51A Keyed Entry	Box	•	•	•	•	•	107	•	•	•	107	•	107	•
F80 Storeroom	Box	•	•	•	•	•	117	•	•	•	117	•	117	•
F170 Non-turning	Box	•	•	•	•	•	29	•	•	•	29	•	29	•

List Price Adders:

- Visual Package Options (highlighted) - add \$5 to list price
- Decorative Trim Option - See chart on page Levers-15
- Triple Option Latch - add \$2 to list price; Box Pack Only
- UL Latch - add \$6 to list price (F10, F51A, F80 Functions Box Pack Only)
- Split Finish/Design - add \$6.50 to highest list price; Box Pack Only

* Specify Handing



Broadway (BRW)



Broadway lever with Greenwich trim

Broadway lever with Greyson trim

Broadway lever with Collins trim

(BRW) Broadway

FINISHES

Function	Packaging	605	505	608	609	618	619	620	621	622	625	626	716	613
F10	Hall & Closet	Box/Vis	*	*	*	*	\$57	*	*	\$57	\$57	\$57	\$57	*
F40	Bed & Bath	Box/Vis	*	*	*	*	60	*	*	60	60	60	60	*
F51A	Keyed Entry	Box/Vis	*	*	*	*	107	*	*	107	107	107	107	*
F80	Storeroom	Box	*	*	*	*	117	*	*	117	117	117	117	*
F170	Non-turning	Box/Vis	*	*	*	*	29	*	*	29	29	29	29	*



Champagne (CHP)



Champagne lever with Andover trim

Champagne lever with Wakefield trim

(CHP) Champagne

FINISHES

Function	Packaging	605	505	608	609	618	619	620	621	622	625	626	716	613
F10	Hall & Closet	Box	*	*	*	*	\$71	*	*	*	*	*	\$71	*
F40	Bed & Bath	Box	*	*	*	*	74	*	*	*	*	*	74	*
F51A	Keyed Entry	Box	*	*	*	*	121	*	*	*	*	*	121	*
F80*	Storeroom	Box	*	*	*	*	131	*	*	*	*	*	131	*
F170*	Non-turning	Box	*	*	*	*	36	*	*	*	*	*	36	*

List Price Adders:

- Visual Package Options (highlighted) - add \$5 to list price
- Decorative Trim Option - See chart on page Levers-45
- Triple Option Latch - add \$2 to list price; Box Pack Only
- UL Latch - add \$6 to list price (F10, F51A, F80 Functions Box Pack Only)
- Split Finish/Design - add \$6.50 to highest list price; Box Pack Only

* Specify Handing

Stand out **effortlessly.**
Schlage's Decorative Collections offer thousands of additional design and finish combinations.
See page 45 for details.

Levers F Series

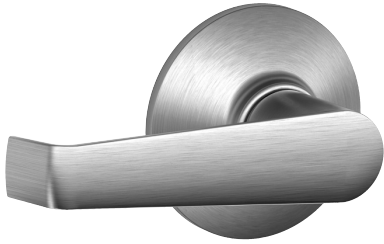

Elan
(ELA)



Elan lever
with Century trim

(ELA) Elan

FINISHES

Function	Packaging	605	505	608	609	618	619	620	621	622	625	626	716	613
F10 Hall & Closet	Box	\$50	•	•	\$57	•	\$57	•	•	\$57	\$57	\$57*	\$57	•
F40 Bed & Bath	Box	53	•	•	60	•	60	•	•	60	60	60*	60	•
F51A Keyed Entry	Box	100	107	•	107	•	107	•	•	107	107	107*	107	•
F80 Storeroom	Box	110	117	•	117	•	117	•	•	•	117	117	117	•
F170 Non-turning	Box	25	•	•	29	•	29	•	•	29	29	29	29	•

***NOTE:**

- 1) Elan F10, F40, F51A and F80 in 626 Finish are available as CSV - add \$11 to list price
- 2) CSV - Contractor Series VisPack (Includes Light Commercial packaging and comes standard with UL fire rated latches.)



Flair
(FLA)

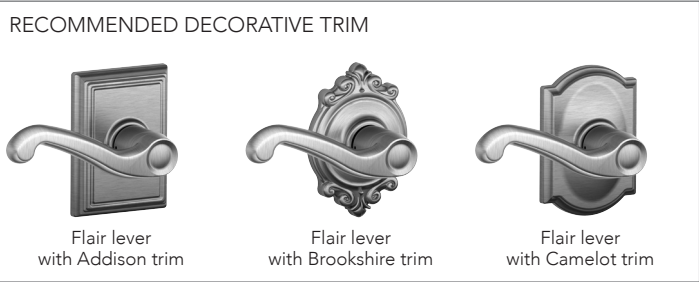

Flair lever
with Addison trim

Flair lever
with Brookshire trim

Flair lever
with Camelot trim

(FLA) Flair

FINISHES

Function	Packaging	605	505	608	609	618	619	620	621	622	625	626	716	613
F10 Hall & Closet	Box	\$50	\$57	\$57	\$57	•	\$57	\$57	•	•	\$57	\$57	\$57	•
F40 Bed & Bath	Box	53	•	60	60	•	60	60	•	•	60	60	60	•
F51A Keyed Entry	Box	100	107	107	107	•	107	107	•	•	107	107	107	•
F80* Storeroom	Box	110	117	117	117	•	117	117	•	•	117	117	117	•
F170* Non-turning	Box	25	•	29	29	•	29	29	•	•	29	29	29	•

List Price Adders:

- Visual Package Options (highlighted) - add \$5 to list price
- Decorative Trim Option - See chart on page Levers-45
- Triple Option Latch - add \$2 to list price; Box Pack Only
- UL Latch - add \$6 to list price (F10, F51A, F80 Functions Box Pack Only)
- Split Finish/Design - add \$6.50 to highest list price; Box Pack Only

* Specify Handing

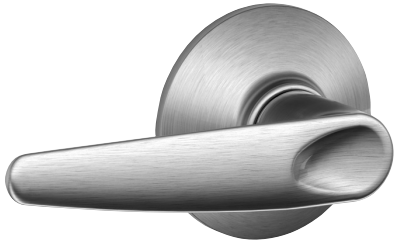

Jazz
(JAZ)

(JAZ) Jazz

FINISHES

Function	Packaging	605	505	608	609	618	619	620	621	622	625	626	716	613
F10 Hall & Closet	Box	•	•	•	•	•	\$57	•	•	\$57	\$57	\$57	\$57	•
F40 Bed & Bath	Box	•	•	•	•	•	60	•	•	60	60	60	60	•
F51A Keyed Entry	Box	•	•	•	•	•	•	•	•	•	•	•	•	•
F80 Storeroom	Box	•	•	•	•	•	•	•	•	•	•	•	•	•
F170 Non-turning	Box	•	•	•	•	•	29	•	•	29	29	29	29	•

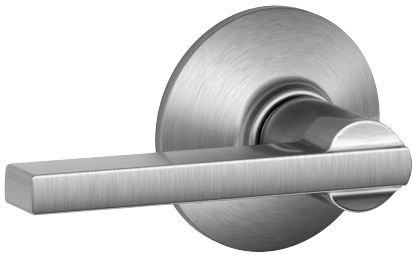

Latitude
(LAT)

RECOMMENDED DECORATIVE TRIM



Latitude lever with Century trim

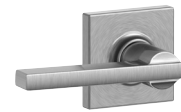

Latitude lever with Collins trim

(LAT) Latitude

FINISHES

Function	Packaging	605	505	608	609	618	619	620	621	622	625	626	716	613
F10 Hall & Closet	Box /Vis	•	•	•	•	\$57	\$57	•	•	\$57	\$57	\$57	\$57	•
F40 Bed & Bath	Box /Vis	•	•	•	•	60	60	•	•	60	60	60	60	•
F51A Keyed Entry	Box /Vis	•	•	\$107	•	107	107	•	•	107	107	107	107	•
F80 Storeroom	Box	•	•	•	•	117	117	•	•	117	117	117	117	•
F170 Non-turning	Box/Vis	•	•	•	•	29	29	•	•	29	29	29	29	•

List Price Adders:

- Visual Package Options (highlighted) - add \$5 to list price
- Decorative Trim Option - See chart on page Levers-45
- Triple Option Latch - add \$2 to list price; Box Pack Only
- UL Latch - add \$6 to list price (F10, F51A, F80 Functions Box Pack Only)
- Split Finish/Design - add \$6.50 to highest list price; Box Pack Only

* Specify Handing

Stand out **effortlessly.**

Schlage's Decorative Collections offer thousands of additional design and finish combinations. **See page 45 for details.**

Levers F Series

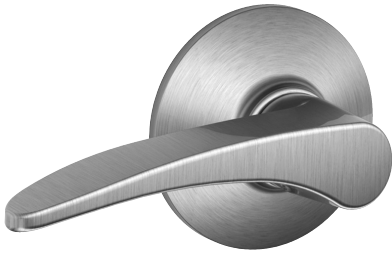

Manhattan
(MNH)



(MNH) Manhattan

FINISHES

Function			Packaging	605	505	608	609	618	619	620	621	622	625	626	716	613
F10	Hall & Closet	Box/Vis		•	•	•	•	•	\$57	•	•	•	\$57	\$57	•	•
F40	Bed & Bath	Box/Vis		•	•	•	•	•	60	•	•	•	60	60	•	•
F51A	Keyed Entry	Box/Vis		•	•	•	•	•	107	•	•	•	107	107	•	•
F80*	Storeroom	Box		•	•	•	•	•	117	•	•	•	117	117	•	•
F170*	Non-turning	Box		•	•	•	•	•	29	•	•	•	29	29	•	•

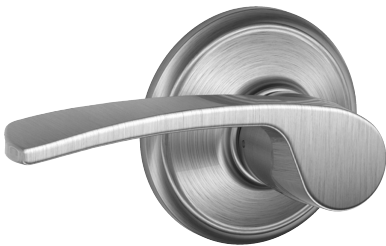

Merano
(MER)



(MER) Merano

FINISHES

Function			Packaging	605	505	608	609	618	619	620	621	622	625	626	716	613
F10	Hall & Closet	Box/Vis		•	•	•	•	•	\$57	•	•	\$57	\$57	\$57	\$57	•
F40	Bed & Bath	Box/Vis		•	•	•	•	•	60	•	•	60	60	60	60	•
F51A	Keyed Entry	Box/Vis		•	•	•	•	•	107	•	•	107	107	107	107	•
F80*	Storeroom	Box		•	•	•	•	•	117	•	•	117	117	117	117	•
F170*	Non-turning	Box/Vis		•	•	•	•	•	29	•	•	29	29	29	29	•

List Price Adders:

- Visual Package Options (highlighted) - add \$5 to list price
- Decorative Trim Option - See chart on page Levers-45
- Triple Option Latch - add \$2 to list price; Box Pack Only
- UL Latch - add \$6 to list price (F10, F51A, F80 Functions Box Pack Only)
- Split Finish/Design - add \$6.50 to highest list price; Box Pack Only

* Specify Handing

Stand out **effortlessly.**

Schlage's Decorative Collections offer thousands of additional design and finish combinations.
See page 45 for details.

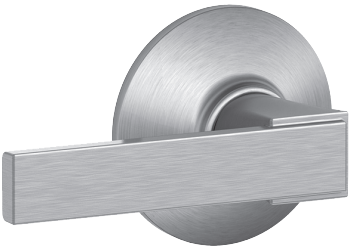

Northbrook
(NBK)



(NBK) Northbrook

FINISHES

Function	Packaging	605	505	608	609	618	619	620	621	622	625	626	716	613
F10 Hall & Closet	Box	•	•	•	•	•	\$57	•	•	•	•	•	•	•
F40 Bed & Bath	Box	•	•	•	•	•	60	•	•	•	•	•	•	•
F51A Keyed Entry	Box	•	•	•	•	•	107	•	•	\$107	\$107	•	\$107	•
F80 Storeroom	Box	•	•	•	•	•	117	•	•	•	•	•	•	•
F170 Non-turning	Box	•	•	•	•	•	29	•	•	•	•	•	•	•

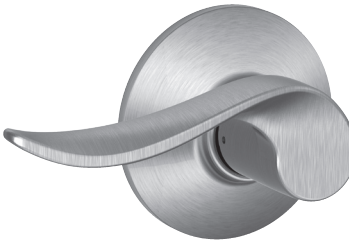

Sacramento
(SAC)



(SAC) Sacramento

FINISHES

Function	Packaging	605	505	608	609	618	619	620	621	622	625	626	716	613
F10 Hall & Closet	Box/Vis	•	•	•	•	\$44	\$44	•	•	•	\$44	\$44	\$44	•
F40 Bed & Bath	Box/Vis	•	•	•	•	47	47	•	•	•	47	47	47	•
F51A Keyed Entry	Box/Vis	•	•	•	•	74	74	•	•	•	74	74	74	•
F80* Storeroom	Box	•	•	•	•	84	84	•	•	•	84	84	84	•
F170* Non-turning	Box	•	•	•	•	22	22	•	•	•	22	22	22	•

List Price Adders:

- Visual Package Options (highlighted) - add \$5 to list price
- Decorative Trim Option - See chart on page Levers-45
- Triple Option Latch - add \$2 to list price; Box Pack Only
- UL Latch - add \$6 to list price (F10, F51A, F80 Functions Box Pack Only)
- Split Finish/Design - add \$6.50 to highest list price; Box Pack Only

* Specify Handing

Stand out **effortlessly.**

Schlage's Decorative Collections make it easy to match our strength to your style. With more than 1,000 customized design and finish options in all, your decor will be limited by only your imagination.



Pair a knob or lever with our inspired decorative trim options to bring your vision to life.*

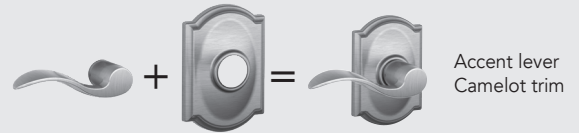

* LOCKS SHIP COMPLETE WITH TRIM ATTACHED



Follow these steps for pricing decorative combinations:

1. Locate the price of the standard knob or lever from the Knobs/Levers section.
2. Use the chart below to find the list price adder for the matching Decorative Collection upgrade.
3. Add the prices together for the total cost of the new combinations.

*Decorative trim are staked on the lock chassis for strength and durability and can only be ordered as a complete lock product.

Finishes available

Decorative trim finish	605	505	608	609	618	619	620	621	622	625	626	716	613
Addison (ADD)	•	•	•	\$16	•	\$16	\$16	\$16	\$16	\$16	\$16	\$16	•
Andover (AND)*	16	16	•	16	•	16	16	•	16	16	16	16	16
Brookshire (BRK)	16	16	•	16	•	16	•	•	16	•	•	16	•
Camelot (CAM)	16	16	16	16	•	16	16	•	16	16	•	16	•
Century (CEN)	•	•	•	•	16	16	•	•	16	16	16	16	•
Collins (COL)***	•	•	16	•	•	16	•	•	16	16	16	16	•
Greenwich (GRW)	•	•	•	•	16	16	•	•	16	16	16	16	•
Greyson (GSN)*	•	•	•	•	16	16	•	•	16	16	16	16	•
Upland (ULD)**	•	•	•	•	•	16	•	•	•	•	•	•	•
Wakefield (WKF)	•	•	•	•	16	16	16	•	16	16	16	16	•



EXAMPLE 1: To price a Accent passage lever with an Addison trim in Antique Pewter Take the price listed in the price book for the F10 ACC 620 and add the additional charge from the chart above

\$57 (F10 ACC 620)
 + \$16 (Addison Decorative Trim 620)

\$73 Total cost
 (F10 ACC 620 ADD)

When ordering a decorative collection product, specify the trim at the end of the product code
 Example: F40 ACC 716 **CAM** or F170 LAT 625 **CEN**

NOTE: The deco trim cost for an F170 is 50% of the cost listed on this chart
 AND and GSN deco trim are not available for PLY or GEO styles

*Greyson and Andover are not available in B60 or F59 functions
 *Greyson and Andover feature concealed screws
 ** ULD unavailable in B60 function. ULD F59 features COL deadbolt.
 *** Collins 608, 622, 625,626 and 716 finishes are only available on F51A keyed product and Schlage Custom Interiors
 Collins deco trim not available on F80 function

**To order
latches and strikes
see page 102-103**

J Series Levers

AVAILABLE FUNCTIONS

Non-keyed Locks

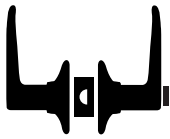

J10
F75

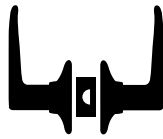

J40
F77



J170

Keyed Locks



J54
F82

ANSI

**ANSI/BHMA A156.2-2011 Commercial Grade 3
J Series Levers**

Non-keyed Locks

J10/F75 - Hall & Closet

- Both levers always unlocked

J40/F77 - Bed & Bath

- Turn-button locking. Can be opened from outside by turning outside turn mechanism
- From interior, turning inside turn-button releases inside lever

J40P - Bed & Bath (Pushbutton)

- Push-button locking. Can be opened from outside with small circular tool.
- Turning inside knob/lever releases button
- ADA Compliant

J170 - Non-turning

- Non-turning trim for one side of door
- Used for door pull or as matching inactive trim

Keyed Locks

J54/F82 - Keyed Entry

- Unlocked by key from outside when outer knob is locked by turn-button in inside knob
- Inside knob is locked and unlocked by turn-button

PRODUCT IDENTIFICATION

J	54	F	SEV	619	SQR	16-255	10-101	KA4
Lock Series	Product	UL Fire Rated	Design	Finish Code	Collins Trim	Latch	Strike	Keying

LATCHES & STRIKES

Keyed Latches - Dead Latches

16-255 - Triple Option (Round, Square, Drive-in) - **STANDARD**

16-061 - UL Listed, Square Corner

Non Keyed - Spring Latches

16-254 - Dual Option (Round, Drive-in) - **STANDARD**

16-070 - Triple Option Spring Latch for handlesets

Strikes

10-101 - Round Corner Full Lip - **STANDARD**

STANDARD FEATURES / CONFIGURATIONS

J Series Levers

	Description
Certification:	ANSI/BHMA A156.2-2011 Commercial Grade 3
Latch:	Dual Option: 1" x 2 1/4", 1/4" round faceplate and drive-in Triple Option: 1" x 2 1/4", square corner and round corner faceplate, drive-in latch (J54)
Strike:	1 5/8" x 2 1/4", radius corner, full lip, no box
Backset:	Adjustable for 2 3/8" or 2 3/4"
Cylinder:	5-pin, C keyway, keyed alike (KA4)
Door Range:	1 3/8" - 1 3/4"
Keys:	Two brass cut keys per lock, 5-pin, C section

FINISH CODES & DESCRIPTIONS

605	609	619	620	622	625	626	630	716
Bright Brass (US3)	Antique Brass (US5)	Satin Nickel (US15)	Antique Pewter (US15A)	Matte Black (US19)	Bright Chrome (US26)	Satin Chrome (US26D)	Satin Stainless Steel (US32D)	Aged Bronze

*Non-standard finishes are not available
Full-color swatch examples available on inside Levers tab

PACKAGING & CARTON SPECS

	INDIVIDUAL CARTON				SHIPPER						
	CARTON WEIGHT	HEIGHT	WIDTH	DEPTH	QTY. SHIPPER	CARTON WEIGHT	CU. FT.	HEIGHT	WIDTH	DEPTH	
Levers											
J10	1.58	3.07 in.	5.71 in.	6.69 in.	24	37.84	2.143	14.8 in.	13.7 in.	18.3 in.	
J40	1.58	3.07 in.	5.71 in.	6.69 in.	24	37.84	2.143	14.8 in.	13.7 in.	18.3 in.	
J54	1.58	3.07 in.	5.71 in.	6.69 in.	24	37.84	2.143	14.8 in.	13.7 in.	18.3 in.	
J170	0.56	2.44 in.	2.64 in.	5.43 in.	50	28.16	1.420	12.2 in.	13.7 in.	14.7 in.	
J10F	1.58	3.07 in.	5.71 in.	6.69 in.	24	37.84	2.143	14.8 in.	13.7 in.	18.3 in.	
J54F	1.58	3.07 in.	5.71 in.	6.69 in.	24	37.84	2.143	14.8 in.	13.7 in.	18.3 in.	

For Vis Pack carton specs, see page 127

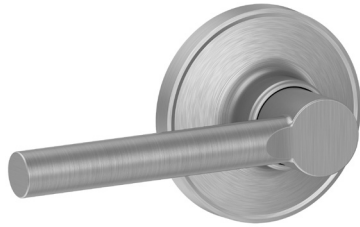

J10
Broadway (BRW)

(BRW) Broadway

FINISHES

Function	Packaging	605	609	619	620	622	625	626	630	716
J10 Hall & Closet	Box	•	•	\$42	•	\$42	\$42	\$42	•	\$42
J38 Bed & Bath	Box	•	•	45	•	45	45	45	•	45
J54 Keyed Entry	Box	•	•	57	•	57	57	57	•	57
J170 Non-turning	Box	•	•	22	•	22	22	22	•	22



J10
Dover (DOV)

(DOV) Dover

FINISHES

Function	Packaging	605	609	619	620	622	625	626	630	716
J10 Hall & Closet	Box/Vis	•	•	\$38	•	\$38	\$38	\$38	\$38	\$38
J38 Bed & Bath	Box/Vis	•	•	41	•	41	41	41	41	41
J54 Keyed Entry	Box/Vis	•	•	56	•	56	56	56	56	56
J170 Non-turning	Box	•	•	20	•	20	20	20	20	20



J10
Marin (MAR)

(MAR) Marin

FINISHES

Function	Packaging	605	609	619	620	622	625	626	630	716
J10 Hall & Closet	Box	•	•	\$38	•	\$38	\$38	\$38	\$38	\$38
J38 Bed & Bath	Box	•	•	41	•	41	41	41	41	41
J54 Keyed Entry	Box	•	•	56	•	56	56	56	56	56
J170 Non-turning	Box	•	•	20	•	20	20	20	20	20

List Price Adders:

Visual Package Options (highlighted) - add \$3 to list price

UL Latch - add \$6 to list price (J10F, J54F)

*Specify handing

NOTE:

- 1) J10 and J40 standard latch is Dual Option (Round, Drive-in)
- 2) J54 standard latch is Triple Option (Round, Square, Drive-in)

Levers J Series



J10
Solstice (SOL)

(SOL) Solstice

FINISHES

Function	Packaging	605	609	619	620	622	625	625	630	716
J10 Hall & Closet	Box/Vis	•	•	\$42	•	\$42	\$42	\$42	•	\$42
J40 Bed & Bath	Box/Vis	•	•	45	•	45	45	45	•	45
J54 Keyed Entry	Box/Vis	•	•	57	•	57	57	57	•	57
J170 Non-turning	Box	•	•	22	•	22	22	22	•	22



J10
LaSalle (LAS)

(LAS) LaSalle

FINISHES

Function	Packaging	605	609	619	620	622	625	625	630	716
J10 Hall & Closet	Box	\$38	\$38	\$38	•	•	•	•	•	\$38
J40 Bed & Bath	Box	41	41	41	•	•	•	•	•	41
J54 Keyed Entry	Box	56	56	56	•	•	•	•	•	56
J170* Non-turning	Box	20	20	20	•	•	•	•	•	20



J10
Seville (SEV)

(SEV) Seville

FINISHES

Function	Packaging	605	609	619	620	625	625	630	716
J10 Hall & Closet	Box/Vis	•	•	\$38	•	•	\$38	•	\$38
J40 Bed & Bath	Box/Vis	•	•	41	•	•	41	•	41
J54 Keyed Entry	Box/Vis	•	•	56	•	•	56	•	56
J170* Non-turning	Box	•	•	20	•	•	20	•	20

List Price Adders:

Visual Package Options (highlighted) - add \$3 to list

UL Latch - add \$6 to list price (J10F, J54F)

*Specify handing

NOTE:

- 1) J10 and J40 standard latch is Dual Option (Round, Drive-in)
- 2) J54 standard latch is Triple Option (Round, Square, Drive-in)



J10
Torino (TOR)

(TOR) Torino

FINISHES

Function		Packaging	605	609	619	620	622	625	625	630	716
J10	Hall & Closet	Box/Vis	·	·	\$38	\$38	·	\$38	·	\$38	\$38
J40	Bed & Bath	Box/Vis	·	·	41	41	·	41	·	41	41
J54	Keyed Entry	Box/Vis	·	·	56	56	·	56	·	56	56
J170	Non-turning	Box	·	·	20	20	·	20	·	20	20

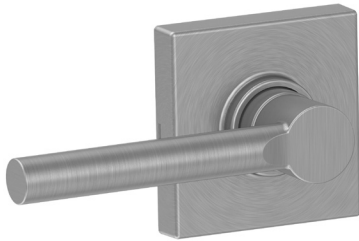

J10
Broadway with
Collins Trim (BRW/COL)

(BRW/COL) Broadway with Collins Rose

FINISHES

Function		Packaging	605	609	619	620	622	625	625	630	716
J10	Hall & Closet	Box	·	·	\$47	·	\$47	\$47	\$47	·	\$47
J40	Bed & Bath	Box	·	·	50	·	50	50	50	·	50
J54	Keyed Entry	Box	·	·	62	·	62	62	62	·	62
J170	Non-turning	Box	·	·	25	·	25	25	25	·	25

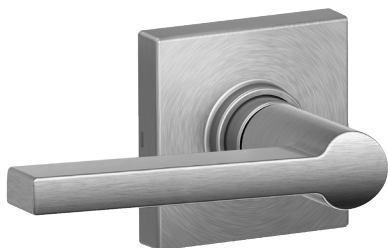

J10
Solstice with
Collins Trim (SOL/COL)

(SOL/COL) Solstice with Collins Rose

FINISHES

Function		Packaging	605	609	619	620	622	625	625	630	716
J10	Hall & Closet	Box/Vis	·	·	\$47	·	\$47	\$47	\$47	·	\$47
J40	Bed & Bath	Box/Vis	·	·	50	·	50	50	50	·	50
J54	Keyed Entry	Box/Vis	·	·	62	·	62	62	62	·	62
J170	Non-turning	Box	·	·	25	·	25	25	25	·	25

List Price Adders:

Visual Package Options (highlighted) - add \$3 to list price

UL Latch - add \$6 to list price (J10F, J54F)

*Specify handing

NOTE:

- 1) J10 and J40 standard latch is Dual Option (Round, Drive-in)
- 2) J54 standard latch is Triple Option (Round, Square, Drive-in)

Notes

F Series Knobs

AVAILABLE FUNCTIONS

Non-keyed Locks



Schlage F10 F40 F170
ANSI F75 F76

Keyed Locks



F51A F80
F81 F86

ANSI/BHMA A156.2-2017 Commercial Grade 2
ANSI/BHMA A156.39-2015 Residential Grade AAA

Non-keyed Locks



F10/F75 – Hall & Closet
• Both knobs/levers always unlocked



F40/F76 – Bed & Bath
• Push-button locking
• Can be opened from outside with small circular tool
• Turning inside knob/lever releases button



F170 – Non-turning
• Non-turning trim for one side of door
• Used for door pull or as matching inactive trim

Keyed Locks



F51A/F81 – Keyed Entry
• Keyed entry function unlocks when door is opened from the inside, allowing you to leave quickly, conveniently and re-enter easily
• Locked by inserting key and rotating cylinder from outside, or manually rotating interior turn-button after exit



F80/F86 – Storeroom Lock
• Outside knob/lever fixed. Entrance by key only.
• Inside knob/lever always unlocked

PRODUCT IDENTIFICATION

F	51A	F	PLY	619	CAM	RH	16-086	10-027	KA4
Lock Series	Product	UL Fire Rated (V - VisPack) (GC - Graphic Cover)	Style	Finish Code	Decorative Trim	Hand	Latch	Strike	Keying

LATCHES & STRIKES

Keyed Latches - Dead Latches

16-086 - Dual Option (Round, Drive-in)
STANDARD

- 16-207** - Square Corner
- 16-211** - Triple Option (Round, Square, Drive-in)
- 16-203** - UL Listed Square Corner with Firecup
- 16-204** - UL Listed Round Corner with Firecup
- 16-126** - 5" Backset, Square Corner

Non Keyed - Spring Latches

16-080 - Dual Option (Round, Drive-in)
STANDARD

- 16-200** - Square Corner
- 16-210** - Triple Option (Round, Square, Drive-in)
- 16-203** - UL Listed Square Corner with Firecup
- 16-204** - UL Listed Round Corner with Firecup
- 16-126** - 5" Backset, Square Corner

Strikes

10-027 - Round Corner Full Lip
STANDARD

- 10-001** - Square Corner T Strike
- 10-026** - Square Corner Full Lip
- 10-058** - Circular - Adjustable
- 10-063** - Dual Strikes (Round & Square Full Lip)
- 10-025** - ANSI Square Corner

STANDARD FEATURES / CONFIGURATIONS

F-Series Knobs/Decorative Trim*

Description

- Certification:** ANSI/BHMA A156.2-2017 Commercial Grade 2
ANSI/BHMA A156.39-2015 Residential Grade AAA
Available UL Listed for 3-hour fire door, 20 minute cUL with hose stream
- Latch:** 1" x 2 1/4", 1/4" radius corner faceplate, 7/8" housing diameter, 1/2" throw, circular drive-in included, universal latch
- Strike:** 1 5/8" x 2 1/4" radius corner, full lip, no box
- Backset:** Dual backset latches, fits either 2 3/8" or 2 3/4" backsets
- Cylinder:** 5-Pin, C keyway, keyed alike (KA4)
- Door Range:** 1 3/8" - 1 3/4"
- Keys:** Two per lock, 5-pin, C section

* Locks are furnished with standard features unless otherwise specified. To order locks with non-standard features specify non-standard feature desired.

FINISH CODES & DESCRIPTIONS

505	605	608	609	613	618	619	620	621	622	625	626	716
Lifetime Bright Brass	Bright Brass (US3)	Satin Brass	Antique Brass (US5)	Oil-Rubbed Bronze (US10B)	Polished Nickel	Satin Nickel (US15)	Antique Pewter (US15A)	Distressed Nickel	Matte Black (US19)	Bright Chrome (US26)	Satin Chrome (US26D)	Aged Bronze

Non-standard finishes are not available.
Full-color swatch examples available on inside Knobs tab.

PACKAGING & CARTON SPECS

	INDIVIDUAL CARTON				SHIPPER						
	CARTON WEIGHT	HEIGHT	WIDTH	DEPTH	QTY. SHIPPER	CARTON WEIGHT	CU. FT.	HEIGHT	WIDTH	DEPTH	
Knobs											
F10	1.55	3.06 in.	4.37 in.	8.14 in.	20	31.00	1.520	9.0 in.	15.6 in.	18.8 in.	
F40	1.55	3.06 in.	4.37 in.	8.14 in.	20	31.00	1.520	9.0 in.	15.6 in.	18.8 in.	
F51A	1.55	3.06 in.	4.37 in.	8.14 in.	20	31.00	1.520	9.0 in.	15.6 in.	18.8 in.	
F80	1.55	3.06 in.	4.37 in.	8.14 in.	20	31.00	1.520	9.0 in.	15.6 in.	18.8 in.	
F170	0.45	2.77 in.	3.60 in.	3.88 in.	20	9.00	0.575	4.8 in.	14.5 in.	15.0 in.	
Decorative Collections Knobs											
All Knobs	1.55	3.25 in.	6.00 in.	7.00 in.	8	15.00	1.090	8.13 in.	12.63 in.	18.4 in.	
F170	1.20	2.86 in.	4.38 in.	5.66 in.	20	25.00	1.000	6.5 in.	15.3 in.	18.3 in.	

For Vis Pack carton specs, see page 127

AVAILABLE STYLES



Andover
(AND)



Bell
(BEL)



Bowery
(BWE)



Georgian
(GEO)



Orbit
(ORB)



Plymouth
(PLY)



Siena
(SIE)

Knobs F Series



Andover
(AND)



(AND) Andover

FINISHES

Function	Packaging	605	505	608	609	618	619	620	621	622	625	626	716	613
F10 Hall & Closet	Box	\$40	\$42	*	\$42	*	\$42	\$42	*	*	\$42	\$42	\$42	\$55
F40 Bed & Bath	Box	43	*	*	45	*	45	45	*	*	45	45	45	58
F51A Keyed Entry	Box	62	66	*	66	*	66	66	*	*	66	66	66	75
F80 Storeroom	Box	72	76	*	76	*	76	76	*	*	76	76	76	85
F170 Non-turning	Box	20	*	*	21	*	21	21	*	*	21	21	21	28



Bell
(BEL)

(BEL) Bell

FINISHES

Function	Packaging	605	505	608	609	618	619	620	621	622	625	626	716	613
F10 Hall & Closet	Box	\$30	\$32	*	\$32	*	*	*	*	*	*	\$32	*	*
F40 Bed & Bath	Box	33	*	*	35	*	*	*	*	*	*	35	*	*
F51A Keyed Entry	Box	52	56	*	56	*	*	*	*	*	*	56	*	*
F80 Storeroom	Box	62	66	*	66	*	*	*	*	*	*	66	*	*
F170 Non-turning	Box	15	*	*	16	*	*	*	*	*	*	16	*	*

List Price Adders:

- Visual Package Options (highlighted) - add \$5 to list price
- Decorative Trim Option - See chart on page Knobs-59
- Triple Option Latch - add \$2 to list price; Box Pack Only
- UL Latch - add \$6 to list price (F10, F51A, F80 Functions Box Pack Only)
- Split Finish - add \$6.50 to list price; Box Pack Only



Bowery (BWE)



(BWE) Bowery

FINISHES

Function	Packaging	605	505	608	609	618	619	620	621	622	625	626	716	613
F10 Hall & Closet	Box/Vis	•	•	•	•	\$42	\$42	•	•	\$42	\$42	\$42	\$42	•
F40 Bed & Bath	Box/Vis	•	•	•	•	45	45	•	•	45	45	45	45	•
F51A Keyed Entry	Box/Vis	•	•	•	•	66	66	•	•	66	66	66	66	•
F80 Storeroom	Box	•	•	•	•	76	76	•	•	76	76	76	76	•
F170 Non-turning	Box/Vis	•	•	•	•	21	21	•	•	21	21	21	21	•



Georgian (GEO)

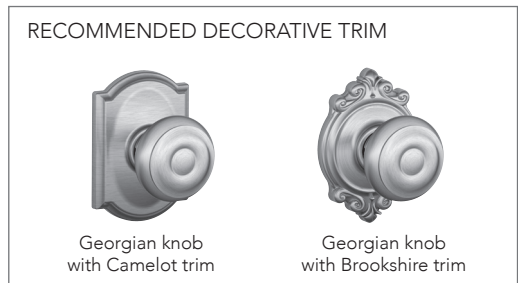

(GEO) Georgian

FINISHES

Function	Packaging	605	505	608	609	618	619	620	621	622	625	626	716	613
F10 Hall & Closet	Box/Vis	\$30	\$32	\$32	\$32	•	\$32	\$32	\$32	\$32	\$32	•	\$32	•
F40 Bed & Bath	Box/Vis	33	•	35	35	•	35	35	35	35	35	•	35	•
F51A Keyed Entry	Box/Vis	52	56	56	56	•	56	56	56	56	56	•	56	•
F80 Storeroom	Box	62	66	66	66	•	66	66	66	66	66	•	66	•
F170 Non-turning	Box/Vis	15	•	16	16	•	16	16	16	16	16	•	16	•

List Price Adders:

- Visual Package Options (highlighted) - add \$5 to list price
- Decorative Trim Option - See chart on page Knobs-59
- Triple Option Latch - add \$2 to list price; Box Pack Only
- UL Latch - add \$6 to list price (F10, F51A, F80 Functions Box Pack Only)
- Split Finish/Design - add \$6.50 to highest list price; Box Pack Only

Stand out **effortlessly.**

Schlage's Decorative Collections offer thousands of additional design and finish combinations. **See page 59 for details.**

Knobs F Series



Orbit (ORB)



(ORB) Orbit

FINISHES

Function	Packaging	605	505	608	609	618	619	620	621	622	625	626	716	613
F10 Hall & Closet	Box/Vis	\$40	\$42	•	•	•	\$42	•	•	•	\$42	\$42*	•	•
F40 Bed & Bath	Box/Vis	43	•	•	•	•	45	•	•	•	45	45*	•	•
F51A Keyed Entry	Box/Vis	62	66	•	•	•	66	•	•	•	66	66*	•	•
F80 Storeroom	Box	72	76	•	•	•	76	•	•	•	76	76	•	•
F170 Non-turning	Box/Vis	20	•	•	•	•	21	•	•	•	21	21*	•	•

Note: 1) Orbit F10, F40, F51A and F80 in 626 Finish are available as CSV - add \$11 to list price
 2) CSV - Contractor Series VisPack (Includes Light Commercial packaging and comes standard with UL fire rated latches.)



Plymouth (PLY)

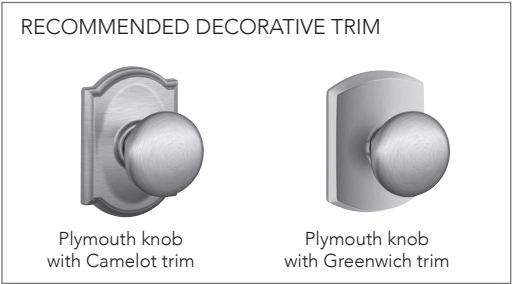

(PLY) Plymouth

FINISHES

Function	Packaging	605	505	608	609	618	619	620	621	622	625	626	716	613
F10 Hall & Closet	Box/Vis	\$30	\$32	•	\$32	•	\$32	\$32	•	\$32	\$32	\$32	\$32	•
F40 Bed & Bath	Box/Vis	33	•	•	35	•	35	35	•	35	35	35	35	•
F51A Keyed Entry	Box/Vis	52	56	•	56	•	56	56	•	56	56	56	56	•
F80 Storeroom	Box	62	66	•	66	•	66	66	•	66	66	66	66	•
F170 Non-turning	Box/Vis	15	•	•	16	•	16	16	•	16	16	16	16	•

List Price Adders:

- Visual Package Options (highlighted) - add \$5 to list price
- Decorative Trim Option - See chart on page Knobs-59
- Triple Option Latch - add \$2 to list price; Box Pack Only
- UL Latch - add \$6 to list price (F10, F51A, F80 Functions Box Pack Only)
- Split Finish/Design - add \$6.50 to highest list price; Box Pack Only



Siena
(SIE)

RECOMMENDED DECORATIVE TRIM



Siena knob
with Wakefield trim



Siena knob
with Collins trim

(SIE) Siena

FINISHES

Function	Packaging	605	505	608	609	618	619	620	621	622	625	626	716	613
F10 Hall & Closet	Box	\$41	\$49	•	\$49	•	\$49	\$49	•	\$49	\$49	\$49	\$49	•
F40 Bed & Bath	Box	44	•	•	52	•	52	52	•	52	52	52	52	•
F51A Keyed Entry	Box	72	69	•	69	•	69	69	•	69	69	69	69	•
F80 Storeroom	Box	82	79	•	79	•	79	79	•	79	79	79	79	•
F170 Non-turning	Box	21	•	•	25	•	25	25	•	25	25	25	25	•

Note: Siena 626, 605, and 505 knobs available while supplies last

List Price Adders:

- Visual Package Options (highlighted) - add \$5 to list price
- Decorative Trim Option - See chart on page Knobs-59
- Triple Option Latch - add \$2 to list price; Box Pack Only
- UL Latch - add \$6 to list price (F10, F51A, F80 Functions Box Pack Only)
- Split Finish/Design - add \$6.50 to highest list price; Box Pack Only

Stand out **effortlessly.**

Schlage's Decorative Collections offer thousands of additional design and finish combinations.

See page 59 for details.

Stand out **effortlessly.**

Schlage's Decorative Collections make it easy to match our strength to your style. With more than 1,000 customized design and finish options in all, your decor will be limited by only your imagination.



Pair a knob or lever with our inspired decorative trim options to bring your vision to life.*

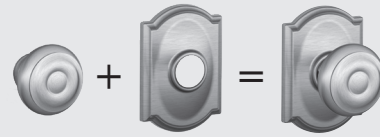

Georgian knob
Camelot trim

* LOCKS SHIP COMPLETE WITH TRIM ATTACHED



Follow these steps for pricing decorative combinations:

1. Locate the price of the standard knob or lever from the Knobs/Levers section.
2. Use the chart below to find the list price adder for the matching Decorative Collection upgrade.
3. Add the prices together for the total cost of the new combinations.

*Decorative trim are staked on the lock chassis for strength and durability and can only be ordered as a complete lock product.

Finishes available

Decorative trim finish	605	505	608	609	618	619	620	621	622	625	626	716	613
Addison (ADD)	•	•	•	\$16	•	\$16	\$16	\$16	\$16	\$16	\$16	\$16	•
Andover (AND)*	16	16	•	16	•	16	16	•	16	16	16	16	16
Brookshire (BRK)	16	16	•	16	•	16	•	•	16	•	•	16	•
Camelot (CAM)	16	16	16	16	•	16	16	•	16	16	•	16	•
Century (CEN)	•	•	•	•	16	16	•	•	16	16	16	16	•
Collins (COL)***	•	•	16	•	•	16	•	•	16	16	16	16	•
Greenwich (GRW)	•	•	•	•	16	16	•	•	16	16	16	16	•
Greyson (GSN)*	•	•	•	•	16	16	•	•	16	16	16	16	•
Upland (ULD)**	•	•	•	•	•	16	•	•	•	•	•	•	•
Wakefield (WKF)	•	•	•	•	16	16	16	•	16	16	16	16	•



EXAMPLE 1: To price a Siena passage knob with an Addison trim in Antique Pewter Take the price listed in the price book for the F10 SIE 620 and add the additional charge from the chart above

\$49 (F10 SIE 620)
 + \$16 (Addison Decorative Trim 620)

\$65 Total cost
 (F10 SIE 620 ADD)

When ordering a decorative collection product, specify the trim at the end of the product code
 Example: F40 ACC 716 **CAM** or F170 LAT 625 **CEN**

NOTE: The deco trim cost for an F170 is 50% of the cost listed on this chart
 AND and GSN deco trim are not available for PLY or GEO styles

*Greyson and Andover are not available in B60 or F59 functions
 *Greyson and Andover feature concealed screws and are not available with the BEL knob and ORB knob.
 ** ULD unavailable in B60 function. ULD F59 features COL deadbolt.
 *** Collins 608, 622, 625, 626 and 716 finishes are only available on F51A keyed product and Schlage Custom Interiors
 Collins deco trim not available on F80 function

To order latches and strikes see page 102-103

J Series Knobs

AVAILABLE FUNCTIONS

Non-keyed Locks



ANSI J10
F75



J40
F77



J170

Keyed Locks



J54
F82

ANSI/BHMA A156.2-2011 Commercial Grade 3

Non-keyed Locks

J10/F75 - Hall & Closet

- Both knobs always unlocked

J40/F77 - Bed & Bath

- Turn-button locking. Can be opened from outside by turning outside turn mechanism
- From interior, turning inside turn-button releases inside knob

J170 - Non-turning

- Inactive trim for one side of door
- Used for door pull or as matching inactive trim

Keyed Locks

J54/F82 - Keyed Entry

- Unlocked by key from outside when outer knob is locked by turn-button in inside knob
- Inside knob is locked and unlocked by turn-button

PRODUCT IDENTIFICATION

J	54	F	BYR	619	16-255	10-101	KA4
Lock Series	Product	UL Fire Rated	Design	Finish Code	Latch	Strike	Keying

LATCHES & STRIKES

Keyed Latches - Dead Latches

16-255 - Triple Option (Round, Square, Drive-in) - **STANDARD**

16-061 - UL Listed, Square Corner

Strikes

10-101 - Round Corner Full Lip - **STANDARD**

Non Keyed - Spring Latches

16-254 - Dual Option (Round, Drive-in) - **STANDARD**

16-070 - Triple Option Spring Latch for handlesets

STANDARD FEATURES / CONFIGURATIONS

J Series Knobs

	Description
Certification:	ANSI/BHMA A156.2-2011 Commercial Grade 3
Latch:	Dual Option: 1" x 2 1/4", 1/4" round faceplate and drive-in Triple Option: 1" x 2 1/4", square corner and round corner faceplate, drive-in latch (J54)
Strike:	1 5/8" x 2 1/4", radius corner, full lip, no box
Backset:	Adjustable for 2 3/8" or 2 3/4"
Cylinder:	5-pin, C keyway, keyed alike (KA4)
Door Range:	1 3/8" - 1 3/4"
Keys:	Two brass cut keys per lock, 5-pin, C section

FINISH CODES & DESCRIPTIONS

605	609	619	620	622	625	626	630	716
Bright Brass (US3)	Antique Brass (US5)	Satin Nickel (US15)	Antique Pewter (US15A)	Matte Black (US19)	Bright Chrome (US26)	Satin Chrome (US26D)	Satin Stainless Steel (US32D)	Aged Bronze

*Non-standard finishes are not available
Full-color swatch examples available on inside Levers tab

PACKAGING & CARTON SPECS

	INDIVIDUAL CARTON				SHIPPER						
	CARTON WEIGHT	HEIGHT	WIDTH	DEPTH	QTY. SHIPPER	CARTON WEIGHT	CU. FT.	HEIGHT	WIDTH	DEPTH	
Knobs											
J10	1.04	2.76 in.	3.23 in.	6.77 in.	24	24.86	1.175	15.0 in.	10.9 in.	12.4 in.	
J40	1.04	2.76 in.	3.23 in.	6.77 in.	24	24.86	1.175	15.0 in.	10.9 in.	12.4 in.	
J54	1.04	2.76 in.	3.23 in.	6.77 in.	24	24.86	1.175	15.0 in.	10.9 in.	12.4 in.	
J170	0.34	3.03 in.	2.60 in.	2.68 in.	50	16.94	0.923	7.6 in.	14.4 in.	14.6 in.	
J10F	1.04	2.76 in.	3.23 in.	6.77 in.	24	24.86	1.175	15.0 in.	10.9 in.	12.4 in.	
J54F	1.04	2.76 in.	3.23 in.	6.77 in.	24	24.86	1.175	15.0 in.	10.9 in.	12.4 in.	

For Vis Pack carton specs, see page 127



J10
Byron (BYR)

(BYR) Byron

FINISHES

Function	Packaging	605	609	619	620	622	624	626	630	716
J10 Hall & Closet	Box	\$24	•	•	•	•	•	•	\$24	•
J40 Bed & Bath	Box	27	•	•	•	•	•	•	27	•
J54 Keyed Entry	Box	36	•	•	•	•	•	•	36	•
J170 Non-turning	Box	13	•	•	•	•	•	•	13	•



J10
Corona (CNA)

(CNA) Corona

FINISHES

Function	Packaging	605	609	619	620	622	624	626	630	716
J10 Hall & Closet	Box/Vis	\$24	\$24	\$24	\$24	•	\$24	•	\$24	\$24
J40 Bed & Bath	Box/Vis	27	27	27	27	•	27	•	27	27
J54 Keyed Entry	Box/Vis	36	36	36	36	•	36	•	36	36
J170 Non-turning	Box	13	13	13	13	•	13	•	13	13



J10
Dublin (DUB)

(DUB) Dublin

FINISHES

Function	Packaging	605	609	619	620	622	624	626	630	716
J10 Hall & Closet	Box	•	•	\$24	•	•	•	•	•	\$24
J40 Bed & Bath	Box	•	•	27	•	•	•	•	•	27
J54 Keyed Entry	Box	•	•	36	•	•	•	•	•	36
J170 Non-turning	Box	•	•	13	•	•	•	•	•	13

List Price Adders:

Visual Package Options (highlighted) - add \$3 to list price

UL Latch - add \$6 to list price (J10F, J54F)

NOTE:

- 1) J10 and J40 standard latch is Dual Option (Round, Drive-in)
- 2) J54 standard latch is Triple Option (Round, Square, Drive-in)



J10
Stratus (STR)

(STR) Stratus

FINISHES

Function		Packaging	605	609	619	620	622	624	626	630	716
J10	Hall & Closet	Box/Vis	\$24	•	\$24	•	•	\$24	•	\$24	\$24
J40	Bed & Bath	Box/Vis	27	•	27	•	•	27	•	27	27
J54	Keyed Entry	Box/Vis	36	•	36	•	•	36	•	36	36
J170	Non-turning	Box	13	•	13	•	•	13	•	13	13

List Price Adders:

Visual Package Options (highlighted) - add \$3 to list price
 UL Latch - add \$6 to list price (J10F, J54F)

NOTE:

- 1) J10 and J40 standard latch is Dual Option (Round, Drive-in)
- 2) J54 standard latch is Triple Option (Round, Square, Drive-in)

B Series64
 B Series Decorative Collection68
 J Series69

B Series Deadbolts
AVAILABLE FUNCTIONS



Schlage
ANSI

B60
E2152

B62
E2142

B80
E2192

B81

ANSI/BHMA A156.36-2016 Commercial Grade 1
ANSI/BHMA A156.40-2015 Residential Grade AAA
 B80 and B81 are not graded

B60 / E2152 - Single Cylinder Deadbolt Lock

- Deadbolt thrown or retracted by key from outside or by inside turn unit
- Bolt automatically deadlocks when fully thrown

B62 / E2142 - Double Cylinder Deadbolt Lock*

- Deadbolt thrown or retracted by key from either side
- Bolt automatically deadlocks when fully thrown

B80 / E2192 - One-Sided Deadbolt

- Deadbolt thrown or retracted from interior side only
- No exterior plate or exposed trim
- Non-graded

B81 - One-sided Deadbolt with Exterior Plate

- Deadbolt thrown or retracted from interior side only
- Exterior plate covers exposed prep on outside
- Non-graded

***Caution.** Double cylinder locks on residences and any door in any structure which is used for egress are a life safety hazard in times of emergency and their use is not recommended. Installation should be in accordance with existing codes only.

Note: Double cylinder locks are not available as UL Listed

PRODUCT IDENTIFICATION

B	60	F	CAM	619	12-321	10-116	KA4
Lock Series	Product	UL Fire Rated (V - VisPack) (GC - Graphic Cover)	Decorative Trim	Finish Code	Latch	Strike	Keying

LATCHES & STRIKES

Latches

- 12-321** - Dual Option (Round, Drive-in) - **STANDARD**
- 12-288** - Square Corner
- 12-287** - Triple Option (Round, Square, Drive-in)
- 12-294** - UL Listed Square Corner with Firecup
- 12-397** - UL Listed Round Corner with Firecup
- 12-355** - Tapered Deadbolt Triple Option (Round, Square, Drive-in)

Strikes

- 10-116** - Round Corner Strike with Reinforcer - **STANDARD**
- 10-092** - Round Corner Full Lip Strike
- 10-094** - Square Corner Strike with Reinforcer

STANDARD FEATURES / CONFIGURATIONS

B-Series Deadbolts/Decorative Trim*

Grade 1 / AAA deadbolt standard features / configurations

B80 and B81 are not graded

Models:	B60, B62, B80, B81
Certification:	ANSI/BHMA A156.36-2016 Commercial Grade 1 ANSI/BHMA A156.40-2015 Residential Grade AAA Available UL Listed for 3-hour fire door (B60 only), 20 minute cUL with hosestream.
Deadbolt:	1" x 2 1/4", radius corner, 1" housing diameter, 1" throw, latch number 12-321
Strike:	1 1/8" x 2 3/4", 1/4" radius corner, strike number 10-116
Backset:	Adjustable for 2 3/8" or 2 3/4"
Cylinder:	5-pin, keyed 5-pin, C keyway, keyed alike (KA4)
Door Range:	Standard 1 3/8" - 1 3/4", Optional door thickness available up to 2.1/4" for B60 and B62.
Keys:	Two keys per lock, 5-pin, keyed 5-pin, C section
Reinforcement:	Door frame strike reinforcer with 3" screws

Locks are furnished with standard features unless otherwise specified. To order locks with non-standard features, specify non-standard feature desired.

FINISH CODES & DESCRIPTIONS

505	605	608	609	613	618	619	620	621	622	625	626	716
Lifetime Bright Brass	Bright Brass (US3)	Satin Brass	Antique Brass (US5)	Oil-Rubbed Bronze (US10B)	Polished Nickel	Satin Nickel (US15)	Antique Pewter (US15A)	Distressed Nickel	Matte Black (US19)	Bright Chrome (US26)	Satin Chrome (US26D)	Aged Bronze

Non-standard finishes are not available.
Full-color swatch examples available on inside Deadbolts tab.

PACKAGING & CARTON SPECS

	INDIVIDUAL CARTON				SHIPPER						
	CARTON WEIGHT	HEIGHT	WIDTH	DEPTH	QTY. SHIPPER	CARTON WEIGHT	CU. FT.	HEIGHT	WIDTH	DEPTH	
Deadbolts											
B60	1.60	2.86 in.	4.38 in.	5.66 in.	20	33.50	1.047	6.5 in.	15.3 in.	18.3 in.	
B62	1.60	2.86 in.	4.38 in.	5.66 in.	20	33.50	1.047	6.5 in.	15.3 in.	18.3 in.	
B80	1.08	2.86 in.	4.38 in.	5.66 in.	12	17.00	0.630	6.5 in.	15.3 in.	18.3 in.	
B81	1.08	2.86 in.	4.38 in.	5.66 in.	12	17.00	0.630	6.5 in.	15.3 in.	18.3 in.	
Decorative Collections Deadbolts											
	2.10	3.06 in.	4.37 in.	8.14 in.	20	42.10	1.520	9.0 in.	15.6 in.	18.8 in.	

For Vis Pack carton specs, see page 127



B60



B62

B Series Deadbolts

FINISHES

Function	Packaging	605	505	530	608	609	618	619	620	621	622	625	626	716	613
B60 Single Cylinder	Box/Vis	\$56	\$62	\$62	\$62	\$62	\$62	\$62	\$62	\$62	\$62	\$62	\$62	\$62	\$71
B62 Double Cylinder	Box	81	87	·	87	87	87	87	87	87	87	87	87	87	96
B80 One-sided	Box	38	·	·	44	44	44	44	44	44	44	44	44	44	53
B81 One-sided w/ trim	Box	40	47	·	47	47	47	47	47	47	47	47	47	47	55
B60R6 Single Cylinder Interchgl. Core-6 Pin	Box	·	161	·	·	·	·	159	·	·	·	·	159	161	·

List Price Adders:

- Visual Package Options (highlighted) - add \$5 to list price
- Decorative Trim Option - See chart on page 68 (available only with B60)
- Triple Option Latch - add \$2 to list price; Box Pack Only
- UL Latch - add \$6 to list price (B60, B80, B81 Functions Box Pack Only)
- B62 NOT AVAILABLE WITH UL LATCH**
- Split Finish - add \$6.50 to highest list price; Box Pack Only

Stand out **effortlessly.**
 Schlage's Decorative Collections offer thousands of additional design and finish combinations.
See page 68 for details.

Deadbolts B Series



FB50



FB52

B Series Deadbolt Combo Packs

FINISHES

Function	Packaging	605	505	608	609	618	619	620	621	622	625	626	716	613
Single Cylinder Deadbolt & Lever														
FB50V (ACC) Accent	Vis	179
FB50V (LAT) Latitude	Vis	179
Single Cylinder Deadbolt & Knob														
FB50V (GEO) Georgian	Vis	128	128	.
FB50V (PLY) Plymouth	Vis	.	128	.	.	.	128	128	.	.
FB50V (ORB) Orbit	Vis	.	138	138	.	.

Stand out **effortlessly.**

Schlage's Decorative Collections make it easy to match our strength to your style. With more than 1,000 customized design and finish options in all, your decor will be limited by only your imagination.



Pair a deadbolt with our inspired decorative trim options to bring your vision to life.*

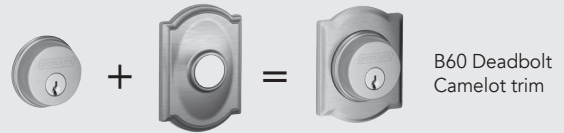

* LOCKS SHIP COMPLETE WITH TRIM ATTACHED



Addison (ADD)



Brookshire (BRK)



Camelot (CAM)



Century (CEN)



Collins (COL)



Greenwich (GRW)



Wakefield (WKF)

Follow these steps for pricing decorative combinations:

1. Locate the list price of the deadbolt in the Deadbolt section.
2. Use the chart below to find the list price adder for the matching Decorative Collection upgrade.
3. Add the list prices together for the total list price of the new combination.
4. Photos shown are representative of the design only.

Finishes available

Decorative trim finish	605	505	608	609	618	619	620	621	622	625	626	716	613
Addison (ADD)	•	•	•	\$16	•	\$16	•	\$16	\$16	\$16	•	\$16	•
Brookshire (BRK)	•	•	•	16	•	16	•	•	•	•	•	16	•
Camelot (CAM)	16	16	16	16	•	16	16	•	16	16	•	16	•
Century (CEN)	•	•	•	•	16	16	•	•	16	16	16	16	•
Collins (COL)	•	•	•	•	16	16	•	•	16	16	16	16	•
Greenwich (GRW)	•	•	•	•	16	16	•	•	16	16	16	16	•
Wakefield (WKF)	•	•	•	•	16	16	•	•	•	16	•	16	•



EXAMPLE 1: To Price a B60 CAM 619 12-321 10-116

Take the list price of a B60 619 12-321 10-116 at \$62.00 and add the Camelot Decorative Trim Adder of \$16.00 for a total list price of \$78.00

\$62 (B60 619 12-321 10-116)
 + \$16 (Camelot Decorative Trim 619)

\$78 Total cost
 (B60 CAM 619 12-321 10-116)

When ordering a decorative collection product, specify the trim after the function code

Example: B60 **CAM** 619 or B60 **ADD** 716

Only available in B60 function

Split finish - add \$6.50 to highest list price; Box pack only

Notes

To order
latches and strikes
see page 102-103

J Series Deadbolts

AVAILABLE FUNCTIONS



JD60



JD80



JD81

ANSI/BHMA A156.36-2010 Commercial Grade 3

JD60 - Single Cylinder Deadbolt Lock

- Deadbolt thrown or retracted by key from outside or by inside turn unit
- Bolt automatically deadlocks when fully thrown

JD80 - One Sided Deadbolt

- Deadbolt thrown or retracted from interior side only

JD81 - One-sided Deadbolt Lock with Exterior Plate

- Deadbolt thrown or retracted from interior side only

* **Caution:** Double cylinder locks on residences and any door in any structure which is used for egress are a life safety hazard in times of emergency and their use is not recommended. Installation should be in accordance with existing codes only.

PRODUCT IDENTIFICATION

JD	60	F	605	16-068	10-103	KA4
Lock Series	Product	Suffix/Package	Finish Code	Latch	Strike	Keying

LATCHES & STRIKES

Latches

16-068 - Dual Option (Round, Drive-in) - **STANDARD**

Strikes

10-267 - One Radius Deadbolt Full Lip Strike (10-102) & One Radius Deadbolt Strike (10-103) - **STANDARD**

10-099 - Square Strike Plate & Strike Frame Reinforcer

STANDARD FEATURES / CONFIGURATIONS

J Series Deadbolts

	Description
Certification:	ANSI/BHMA A156.36-2010 Commercial Grade 3
Deadbolt Latch:	Dual Option: 1" x 2 1/4", 1/4" round faceplate, drive-in latch, 1" housing diameter, 1" throw
Strike:	1" x 2 1/4" round corner and radius corner, full lip
Backset:	Adjustable for 2 3/8" or 2 3/4"
Cylinder:	5-pin, C keyway, keyed alike (KA4)
Door Range:	1 3/8" - 1 3/4"
Keys:	Two brass cut keys per lock, 5-pin, C section

FINISH CODES & DESCRIPTIONS

605	609	619	620	622	625	626	630	716
Bright Brass (US3)	Antique Brass (US5)	Satin Nickel (US15)	Antique Pewter (US15A)	Matte Black (US19)	Bright Chrome (US26)	Satin Chrome (US26D)	Satin Stainless Steel (US32D)	Aged Bronze

*Non-standard finishes are not available
Full-color swatch examples available on inside Deadbolts tab

PACKAGING & CARTON SPECS

	INDIVIDUAL CARTON				SHIPPER					
	CARTON WEIGHT	HEIGHT	WIDTH	DEPTH	QTY. SHIPPER	CARTON WEIGHT	CU. FT.	HEIGHT	WIDTH	DEPTH
Levers										
JD60	1.49	3.15 in.	3.74 in.	3.74 in.	24	35.86	0.886	8.9 in.	12.4 in.	13.8 in.
JD80	1.05	2.80 in.	3.11 in.	3.31 in.	24	25.30	0.595	8.0 in.	10.4 in.	12.3 in.
JD81	1.05	2.80 in.	3.11 in.	3.31 in.	24	25.30	0.595	8.0 in.	10.4 in.	12.3 in.
JD60F	1.49	3.15 in.	3.74 in.	3.74 in.	24	35.86	0.886	8.9 in.	12.4 in.	13.8 in.

For Vis Pack carton specs, see page 127



JD60

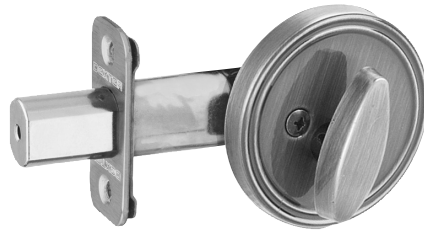

JD80

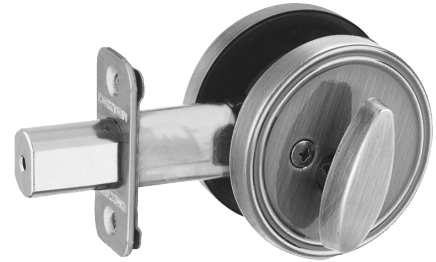

JD81

**J Series
Deadbolts**

FINISHES

Function	Packaging	605	609	619	620	622	625	626	630	716
JD60 Single Cylinder Deadbolt	Box	\$32	\$32	\$32	\$32	\$32	\$32	\$32	\$32	\$32
JD80 One-Sided Cylinder Deadbolt	Box	28	28	28	•	•	•	•	28	28
JD81 One-Sided Deadbolt with trim	Box	28	28	28	•	•	•	•	28	•
JD60F Single Cylinder UL Version	Box	38	38	38	38	38	38	38	38	38
JW60V Single Cylinder Deadbolt	Vis	35	•	35	•	•	•	•	35	35
JW60V Double Cylinder Deadbolt, Collins Trim	Vis	•	•	40	•	40	•	•	•	•

NOTE:

- 1) standard latch is Dual Option (Round, Drive-in)
- 2) JD60 requires 2 1/8" door prep
- 3) JW60V fits both 1 1/2" and 2 1/8" door prep

Security Sets

J Series Security Sets
AVAILABLE FUNCTIONS

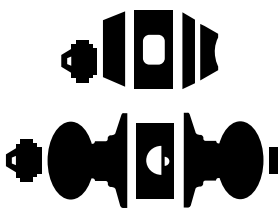

JC60V

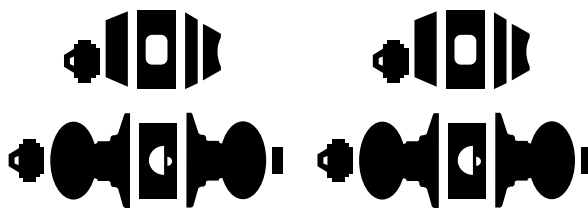

JCT60V

ANSI/BHMA A156.36-2010 Commercial Grade 3

**ANSI/BHMA A156.2, 2011, Grade 3
J Series Entrance Locks**

JC60V - Single Cylinder Deadbolt Lock

- Deadbolt thrown or retracted by key from outside or by inside turn unit
- Bolt automatically deadlocks when fully thrown

JCT60V - Twin Pack

- 2 single cylinder deadbolts and 2 keyed entry knobs all keyed alike

* **Caution:** Double cylinder locks on residences and any door in any structure which is used for egress are a life safety hazard in times of emergency and their use is not recommended. Installation should be in accordance with existing codes only.

PRODUCT IDENTIFICATION

JC	60	V	605			KA4
Lock Series	Product	Vis Package	Finish Code	Latch	Strike	Keying

FINISH CODES & DESCRIPTIONS

605	609	619	630	716
Bright Brass (US3)	Antique Brass (US5)	Satin Nickel (US15)	Satin Stainless Steel (US32D)	Aged Bronze

*Non-standard finishes are not available
 Full-color swatch examples available on inside Deadbolts tab

SECURITY SETS

Function	Pkg.	Style/Design	Packaging	605	609	619	620	622	625	626	630	716
Single Cylinder Deadbolt and Keyed Lever												
JWC60V	Vis Only	(SEV) Seville	Vis	•	•	\$94	•	•	•	•	•	•
JWC60V	Vis Only	(SOL) Solstice	Vis	•	•	\$95.	•	•	•	•	•	•
Single Cylinder Deadbolt and Keyed Knob												
JWC60V	Vis Only	(CNA) Corona	Vis	\$69	•	•	•	•	•	•	\$74	•
JWC60V	Vis Only	(STR) Stratus	Vis	•	•	\$74	•	•	•	•	•	\$74

Notes

Builder's Hardware76
 Barn Door Hardware77
 Handrail Brackets,
 Door Stops & Chain Door Guards78
 Coat, Hat & Wardrobe Hooks,
 Mail Slots, Viewers81
 Pocket Door Locks, Hinges82
 Classic House Numbers84
 Door Knockers, Push,
 Pull & Kick Plates86
 Window Hardware, Flush Pulls88
 Parts89
 Latch & Strike Quick Reference Guide89
 Latches90
 Strikes93
 Rekeying95
 Thick Door Installation Kits97
 Miscellaneous Parts,
 Key & Cylinder Stamping
 Residential Master & Construction Keying . .98
 Construction Core Program101
 J-series latches, strikes102

FINISH CODES & DESCRIPTIONS

28	32D	605/3	609/5	619	620	716
Satin Aluminum	Satin Stainless Steel	Bright Brass (US3)	Antique Brass (US5)	Satin Nickel (US15)	Antique Pewter (US15A)	Aged Bronze

Full-color swatch examples available on inside Hardware & Accessories tab.

Barndoor Hardware

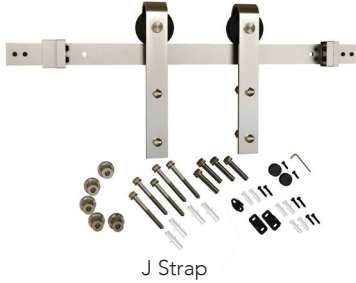

J Strap

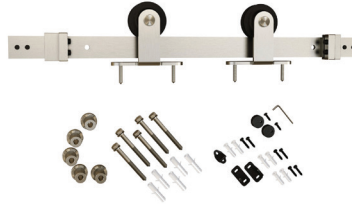

Top Mount

J STRAP

Description	Finish	Track Length	SKU	Price
SD10-6.6 619 JSTP N N SL, SATIN NICKEL J STRAP	619	6FT 6IN	043156002634	\$275.00
SD10-6.6 622 JSTP N N SL, BLACK J STRAP	622	6FT 6IN	043156002641	\$174.00
SD10-6.6 630 JSTP N N SL, STAINLESS STEEL J STRAP	630	6FT 6IN	043156002658	\$347.00
SD10-6.6 716 JSTP N N SL, AGED BRONZE J STRAP	716	6FT 6IN	043156002672	\$268.00
SD10-8.0 619 JSTP N N SL, SATIN NICKEL J STRAP	619	8FT	043156002832	\$283.00
SD10-8.0 622 JSTP N N SL, BLACK J STRAP	622	8FT	043156002849	\$179.00
SD10-8.0 630 JSTP N N SL, STAINLESS STEEL J STRAP	630	8FT	043156002856	\$354.00
SD10-8.0 716 JSTP N N SL, AGED BRONZE J STRAP	716	8FT	043156002870	\$265.00

TOP MOUNT

Description	Finish	Track Length	SKU	Price
SD10-6.6 619 TMNT N N SL, SATIN NICKEL TOP MOUNT	619	6FT 6IN	043156002788	\$275.00
SD10-6.6 622 TMNT N N SL, BLACK TOP MOUNT	622	6FT 6IN	043156002795	\$174.00
SD10-6.6 630 TMNT N N SL, STAINLESS STEEL TOP MOUNT	630	6FT 6IN	043156002801	\$347.00
SD10-6.6 716 TMNT N N SL, AGED BRONZE TOP MOUNT	716	6FT 6IN	043156002825	\$268.00
SD10-8.0 619 TMNT N N SL, SATIN NICKEL TOP MOUNT	619	8FT	043156002986	\$283.00
SD10-8.0 622 TMNT N N SL, BLACK TOP MOUNT	622	8FT	043156002993	\$179.00
SD10-8.0 630 TMNT N N SL, STAINLESS STEEL TOP MOUNT	630	8FT	043156003006	\$354.00
SD10-8.0 716 TMNT N N SL, AGED BRONZE TOP MOUNT	716	8FT	043156003020	\$265.00

TRACK ADAPTER

DESCRIPTION	FINISH	SKU	PRICE
SD10 619 ADPTR N N SL, SATIN NICKEL TRACK ADAPTER	619	043156003051	\$14.40
SD10 622 ADPTR N N SL, BLACK TRACK ADAPTER	622	043156003068	12.30
SD10 630 ADPTR N N SL, STAINLESS STEEL TRACK ADAPTER	630	043156003075	15.00
SD10 716 ADPTR N N SL, AGED BRONZE TRACK ADAPTER	716	043156003099	14.40

NOT PACKAGED FOR RETAIL

Handrail Brackets,
Door Stops & Chain Door Guards



Handrail Bracket

HANDRAIL BRACKETS

UPC	Part No./Description	Model	Substrate	Case Qty.	Pkg. Type	Price
044074681567	SPS059B 605 N N (HANDRAIL BRACKETS, BRIGHT BRASS)	059	BRASS	10	SLIM PACK	\$18.70
044074681598	SPS059B 619 N N (HANDRAIL BRACKETS, SATIN NICKEL)	059	BRASS	10	SLIM PACK	21.50
044074681604	SPS059B 620 N N (HANDRAIL BRACKETS, ANTIQUE PEWTER)	059	BRASS	10	SLIM PACK	21.50
044074681581	SPS059B 716 N N (HANDRAIL BRACKETS, AGED BRONZE)	059	BRASS	10	SLIM PACK	21.50
044074680904	SC059B 716 N N (HANDRAIL BRACKET, AGED BRONZE)	059	BRASS	5	CARDED	21.50



Solid Door Stop

SOLID DOOR STOPS

UPC	Part No./Description	Model	Substrate	Case Qty.	Pkg. Type	Price
044074683172	SC61Z* 605 N N (SOLID DOOR STOP, BRIGHT BRASS)	61	ZINC	5	CARDED	\$3.40
044074681369	SPS61MB 605 N N (SOLID DOOR STOP, BRIGHT BRASS)	61	BRASS	20	SLIM PACK	11.40
044074681376	SPS61MB 609 N N (SOLID DOOR STOP, ANTIQUE BRASS)	61	BRASS	20	SLIM PACK	11.40
044074681390	SPS61MB 619 N N (SOLID DOOR STOP, SATIN NICKEL)	61	BRASS	20	SLIM PACK	15.40
044074681406	SPS61MB 620 N N (SOLID DOOR STOP, ANTIQUE PEWTER)	61	BRASS	20	SLIM PACK	15.40
044074681383	SPS61MB 716 N N (SOLID DOOR STOP, AGED BRONZE)	61	BRASS	20	SLIM PACK	15.40
044074680782	SC61MB 605 N N (SOLID DOOR STOP, BRIGHT BRASS)	61	BRASS	20	CARDED	11.40
044074680799	SC61MB 609 N N (SOLID DOOR STOP, ANTIQUE BRASS)	61	BRASS	20	CARDED	11.40
044074680812	SC61MB 619 N N (SOLID DOOR STOP, SATIN NICKEL)	61	BRASS	20	CARDED	15.40
044074680805	SC61MB 716 N N (SOLID DOOR STOP, AGED BRONZE)	61	BRASS	20	CARDED	15.40

*While supplies last

English packaging only



Hinge Pin Door Stop



Wall Stop Convex



Floor Door Stop

SOLID DOOR STOPS (cont)

UPC	Part No./Description	Model	Substrate	Case Qty.	Pkg. Type	Price
044074680584	SC70Z* 716 N N (HINGE PIN DOOR STOP, AGED BRONZE)	70	ZINC	5	CARDED	\$3.50
044074683189	SC70Z* 605 N N (HINGE PIN DOOR STOP, BRIGHT BRASS)	70	ZINC	5	CARDED	3.10
044074681413	SPS70B 605 N N (HINGE PIN DOOR STOP, BRIGHT BRASS)	70	BRASS	15	SLIM PACK	10.90
044074681444	SPS70B 619 N N (HINGE PIN DOOR STOP, SATIN NICKEL)	70	BRASS	15	SLIM PACK	13.50
044074681451	SPS70B 620 N N (HINGE PIN DOOR STOP, ANTIQUE PEWTER)	70	BRASS	15	SLIM PACK	13.50
044074681437	SPS70B 716 N N (HINGE PIN DOOR STOP, AGED BRONZE)	70	BRASS	15	SLIM PACK	13.50
044074680836	SC70B 605 N N (HINGE PIN DOOR STOP, BRIGHT BRASS)	70	BRASS	5	CARDED	10.90
044074680850	SC70B 716 N N (HINGE PIN DOOR STOP, AGED BRONZE)	70	BRASS	5	CARDED	13.50
044074680867	SC70B 619 N N (HINGE PIN DOOR STOP, SATIN NICKEL)	70	BRASS	5	CARDED	13.50
44074680874	SC70B 620 N N (HINGE PIN DOOR STOP, ANTIQUE PEWTER)	70	BRASS	5	CARDED	13.50
044074681468	SPS407B* 605 N N (WALL DOOR STOP- CONVEX, BRIGHT BRASS)	407	BRASS	15	SLIM PACK	3.90
044074681482	SPS407B* 716 N N (WALL DOOR STOP- CONVEX. AGED BRONZE)	407	BRASS	15	SLIM PACK	4.30
044074681505	SPS407B* 620 N N (WALL DOOR STOP- CONVEX, ANTIQUE PEWTER)	407	BRASS	15	SLIM PACK	4.30
044074681970	SPS436B 605 N N (FLOOR DOOR STOP, BRIGHT BRASS)	436	BRASS	15	SLIM PACK	6.20
044074682007	SPS436B 619 N N (FLOOR DOOR STOP, SATIN NICKEL)	436	BRASS	15	SLIM PACK	6.60
044074681994	SPS436B 716 N N (FLOOR DOOR STOP, AGED BRONZE)	436	BRASS	15	SLIM PACK	6.60

*While supplies last



Chain Door Guard

CHAIN DOOR GUARDS

UPC	Part No./Description	Model	Substrate	Case Qty.	Pkg. Type	Price
044074679076	SC481F 3 N N (CHAIN DOOR GUARD, BRIGHT BRASS)	481	STEEL	5	CARDED	\$6.60
044074682113	SC481F 619 N N (CHAIN DOOR GUARD, SATIN NICKEL)	481	STEEL	5	CARDED	6.60
044074683158	SC481F 716 N N (CHAIN DOOR GUARD, AGED BRONZE)	481	STEEL	5	CARDED	6.60

English packaging only

Coat, Hat & Wardrobe Hooks,
Mail Slots, Viewers



Coat & Hat Hook



Wardrobe Hook - Single



Wardrobe Hook - Double

COAT, HAT & WARDROBE HOOKS

UPC	Part No./Description	Model	Substrate	Case Qty.	Pkg. Type	Price
044074681048	SC571MB 619 N N (COAT & HAT HOOK, SATIN NICKEL)	571	BRASS	5	CARDED	\$9.80
044074681611	SPS571MB 605 N N (COAT & HAT CEILING HOOKS, BRIGHT BRASS)	571	BRASS	25	SLIM PACK	8.00
044074681628	SPS571MB 609 N N (COAT & HAT CEILING HOOKS, ANTIQUE BRASS)	571	BRASS	25	SLIM PACK	10.10
044074681642	SPS571MB 619 N N (COAT & HAT CEILING HOOKS, SATIN NICKEL)	571	BRASS	25	SLIM PACK	10.10
044074681659	SPS571MB 620 N N (COAT & HAT CEILING HOOKS, ANTIQUE PEWTER)	571	BRASS	25	SLIM PACK	10.10
044074681635	SPS571MB 716 N N (COAT & HAT CEILING HOOKS, AGED BRONZE)	571	BRASS	25	SLIM PACK	10.10
044074681666	SPS581MB 605 N N (WARDROBE HOOK, BRIGHT BRASS)	581	BRASS	25	SLIM PACK	5.50
044074681673	SPS581MB 609 N N (WARDROBE HOOK, ANTIQUE BRASS)	581	BRASS	25	SLIM PACK	6.80
044074681703	SPS581MB 619 N N (WARDROBE HOOK, SATIN NICKEL)	581	BRASS	25	SLIM PACK	6.80
044074681710	SPS581MB 620 N N (WARDROBE HOOK, ANTIQUE PEWTER)	581	BRASS	25	SLIM PACK	6.80
044074681680	SPS581MB 716 N N (WARDROBE HOOK, AGED BRONZE)	581	BRASS	25	SLIM PACK	6.80
044074681093	SC581MB 619 N N (SINGLE WARDROBE HOOK, SATIN NICKEL)	581	BRASS	5	CARDED	6.80
044074681123	SC582MB 609 N N (DOUBLE WARDROBE HOOK, ANTIQUE BRASS)	582	BRASS	5	CARDED	8.70
044074681147	SC582MB 619 N N (DOUBLE WARDROBE HOOK, SATIN NICKEL)	582	BRASS	5	CARDED	8.70
044074681130	SC582MB 716 N N (DOUBLE WARDROBE HOOK, AGED BRONZE)	582	BRASS	5	CARDED	8.70
044074681727	SPS582MB 605 N N (WARDROBE HOOK, BRIGHT BRASS)	582	BRASS	25	SLIM PACK	7.00
044074681734	SPS582MB 609 N N (WARDROBE HOOK, ANTIQUE BRASS)	582	BRASS	25	SLIM PACK	8.70
044074681741	SPS582MB 619 N N (WARDROBE HOOK, SATIN NICKEL)	582	BRASS	25	SLIM PACK	8.70
044074681758	SPS582MB 620 N N (WARDROBE HOOK, ANTIQUE PEWTER)	582	BRASS	25	SLIM PACK	8.70
044074681963	SPS582MB 716 N N (WARDROBE HOOK, AGED BRONZE)	582	BRASS	25	SLIM PACK	8.70

English packaging only



Mail Slot

MAIL SLOTS

UPC	Part No./Description	Model	Substrate	Case Qty.	Pkg. Type	Price
044074008333	C620PA 28 2 X 11 N N (MAIL SLOT, SATIN ALUMINUM)	620	ALUMINUM	2	CARDED	\$43.70
044074678642	SC620B 3 2 x 11 N N (MAIL SLOT, BRIGHT BRASS)	620	BRASS	2	CARDED	72.10
044074678659	SC620B 619 2 x 11N N (MAIL SLOT, SATIN NICKEL)	620	BRASS	2	CARDED	88.60
044074681239	SC620B 716 2 x 11N N (MAIL SLOT, AGED BRONZE)	620	BRASS	2	CARDED	88.60

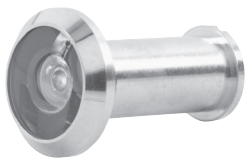

190° Viewer



120° Viewer

Viewers

UPC	Part No./Description	Model	Substrate	Case Qty.	Pkg. Type	Price
044074678536	SC698P* B 619 N N (190 DEGREE VIEWER, SATIN NICKEL)(1 3/8 - 2 1/8")	698	BRASS	5	CARDED	\$19.80
044074678550	SC700P* B 605 N N (120 DEGREE VIEWER, BRIGHT BRASS)(1 3/8 - 2 1/16")	700	BRASS	5	CARDED	7.50

*While supplies last

English packaging only

Pocket Door Locks, Hinges



Pocket Door Lock
Passage



Pocket Door Lock
Privacy

POCKET DOOR LOCKS

UPC	Part No./Description	Model	Substrate	Case Qty.	Pkg. Type	Price
044074681260	SC990B 605 N N (SLIDING DOOR PULL, BRIGHT BRASS)	990	BRASS	5	CARDED	\$9.20
044074681277	SC990B 609 N N (SLIDING DOOR PULL, ANTIQUE BRASS)	990	BRASS	5	CARDED	11.00
044074681284	SC990B 716 N N (SLIDING DOOR PULL, AGED BRONZE)	990	BRASS	5	CARDED	11.00
044074681291	SC990B 619 N N (SLIDING DOOR PULL, SATIN NICKEL)	990	BRASS	5	CARDED	11.00
044074681307	SC990B 620 N N (SLIDING DOOR PULL, ANTIQUE PEWTER)	990	BRASS	5	CARDED	11.00
044074681314	SC991B 605 N N (SLIDING DOOR LOCK, BRIGHT BRASS)	991	BRASS	5	CARDED	15.20
044074681321	SC991B 609 N N (SLIDING DOOR LOCK, ANTIQUE BRASS)	991	BRASS	5	CARDED	16.80
044074681338	SC991B 716 N N (SLIDING DOOR LOCK, AGED BRONZE)	991	BRASS	5	CARDED	16.80
044074681345	SC991B 619 N N (SLIDING DOOR LOCK, SATIN NICKEL)	991	BRASS	5	CARDED	16.80
044074681352	SC991B 620 N N (SLIDING DOOR LOCK, ANTIQUE PEWTER)	991	BRASS	5	CARDED	16.80



3.5"
Square Hinge



3.5" Radial Hinge
5/8" Radius

HINGES

UPC	Part No./Description	Model	Substrate	Case Qty.	Pkg. Type	Price
043156557646	SC3P1010F 622 N N SL (3.5" SQ HINGE 3PK, MATTE BLACK)	1010	STEEL	3	CARDED	\$22.80
044074677577	SC3P1010F 605 N N (3.5" SQ HINGE 3PK, BRIGHT BRASS)	1010	STEEL	3	CARDED	19.00
044074677584	SC3P1010F 619 N N (3.5" SQ HINGE 3PK, SATIN NICKEL)	1010	STEEL	3	CARDED	22.80
044074677591	SC3P1010F 716 N N (3.5" SQ HINGE 3PK, AGED BRONZE)	1010	STEEL	3	CARDED	19.70
044074680935	SC3P1010F 609 N N (3.5" SQ HINGE 3PK, ANTIQUE BRASS)	1010	STEEL	3	CARDED	22.80
043156548736	SC3P1010F-608E (SATIN BRASS)	1010	STEEL	3	CARDED	22.80
043156557653	SC3P1011F 622 N N SL (3.5" RD HINGE 3PK 5/8 RAD, MATTE BLACK)	1011	STEEL	3	CARDED	22.80
044074677607	SC3P1011F 605 N N (3.5" RD HINGE 3PK, 5/8 RAD, BRIGHT BRASS)	1011	STEEL	3	CARDED	19.00
044074677614	SC3P1011F 619 N N (3.5" RD HINGE 3PK, 5/8 RAD, SATIN NICKEL)	1011	STEEL	3	CARDED	22.80
044074677621	SC3P1011F 716 N N (3.5" RD HINGE 3PK, 5/8 RAD, AGED BRONZE)	1011	STEEL	3	CARDED	22.80
044074680959	SC3P1011F 609 N N (3.5" RD HINGE 3PK, 5/8 RAD, ANTIQUE BRASS)	1011	STEEL	3	CARDED	22.80
044074680966	SC3P1011F 620 N N (3.5" RD HINGE 3PK, 5/8 RAD, ANTIQUE PEWTER)	1011	STEEL	3	CARDED	22.80
043156548743	SC3P1011F-608E (SATIN BRASS)	1011	STEEL	3	CARDED	22.80

English packaging only



3.5" Radial Hinge
1/4" Radius



4" Square Hinge



4" Radial Hinge
5/8" Radius

HINGES (cont)

UPC	Part No./Description	Model	Substrate	Case Qty.	Pkg. Type	Price
043156557660	SC3P1012F 622 N N SL (3.5" RD HINGE 3PK 1/4 RAD, MATTE BLACK)	1012	STEEL	3	CARDED	\$22.80
043156548750	SC3P1012F-608E (SATIN BRASS)	1012	STEEL	3	CARDED	22.80
044074683103	SC3P1012F 605 N N (3.5" RD HINGE 3PK, 1/4 RAD, BRIGHT BRASS)	1012	STEEL	3	CARDED	19.00
044074683127	SC3P1012F 619 N N (3.5" RD HINGE 3PK, 1/4 RAD, SATIN NICKEL)	1012	STEEL	3	CARDED	22.80
044074683110	SC3P1012F 716 N N (3.5" RD HINGE 3PK, 1/4 RAD, AGED BRONZE)	1012	STEEL	3	CARDED	22.80
044074683912	SC3P1012F 609 N N (3.5" RD HINGE 3PK, 1/4 RAD, ANTIQUE BRASS)	1012	STEEL	3	CARDED	22.80
044074677638	SC3P1020F 605 N N (4" SQ HINGE 3PK, BRIGHT BRASS)	1020	STEEL	3	CARDED	22.80
044074677645	SC3P1020F 619 N N (4" SQ HINGE 3PK, SATIN NICKEL)	1020	STEEL	3	CARDED	24.50
044074677652	SC3P1020F 716 N N (4" SQ HINGE 3PK, AGED BRONZE)	1020	STEEL	3	CARDED	24.50
044074680973	SC3P1020F 609 N N (4" SQ HINGE 3PK, ANTIQUE BRASS)	1020	STEEL	3	CARDED	24.50
044074677676	SC3P1021F 619 N N (4" RD HINGE 3PK, 5/8 RAD, SATIN NICKEL)	1021	STEEL	3	CARDED	24.50
044074677683	SC3P1021F 716 N N (4" RD HINGE 3PK, 5/8 RAD, AGED BRONZE)	1021	STEEL	3	CARDED	24.50
044074681000	SC3P1021F 620 N N (4" RD HINGE 3PK, 5/8 RAD, ANTIQUE PEWTER)	1021	STEEL	3	CARDED	24.50

English packaging only

Classic House Numbers



4" Classic House Numbers

4" CLASSIC HOUSE NUMBERS

UPC	Part No./Description	Model	Substrate	Case Qty.	Pkg. Type	Price
044074678666	SC2 3006 605 N N (4" CLASSIC HOUSE NUMBER 0, BRIGHT BRASS)	3006	BRASS	5	CARDED	\$7.70
044074678772	SC2 3006 619 N N (4" CLASSIC HOUSE NUMBER 0, SATIN NICKEL)	3006	BRASS	5	CARDED	10.00
044074680485	SC2-3006 716 N N (4" CLASSIC HOUSE NUMBER 0, AGED BRONZE)	3006	BRASS	5	CARDED	10.00
044074678673	SC2 3016 605 N N (4" CLASSIC HOUSE NUMBER 1, BRIGHT BRASS)	3016	BRASS	5	CARDED	7.70
044074678789	SC2 3016 619 N N (4" CLASSIC HOUSE NUMBER 1, SATIN NICKEL)	3016	BRASS	5	CARDED	10.00
044074680492	SC2 3016 716 N N (4" CLASSIC HOUSE NUMBER 1, AGED BRONZE)	3016	BRASS	5	CARDED	10.00
044074678697	SC2 3026 605 N N (4" CLASSIC HOUSE NUMBER 2, BRIGHT BRASS)	3026	BRASS	5	CARDED	7.70
044074678796	SC2 3026 619 N N (4" CLASSIC HOUSE NUMBER 2, SATIN NICKEL)	3026	BRASS	5	CARDED	10.00
044074680508	SC2 3026 716 N N (4" CLASSIC HOUSE NUMBER 2, AGED BRONZE)	3026	BRASS	5	CARDED	10.00
044074678703	SC2 3036 605 N N (4" CLASSIC HOUSE NUMBER 3, BRIGHT BRASS)	3036	BRASS	5	CARDED	7.70
044074678802	SC2 3036 619 N N (4" CLASSIC HOUSE NUMBER 3, SATIN NICKEL)	3036	BRASS	5	CARDED	10.00
044074680515	SC2 3036 716 N N (4" CLASSIC HOUSE NUMBER 3, AGED BRONZE)	3036	BRASS	5	CARDED	10.00
044074678710	SC2 3046 605 N N (4" CLASSIC HOUSE NUMBER 4, BRIGHT BRASS)	3046	BRASS	5	CARDED	7.70
044074678819	SC2 3046 619 N N (4" CLASSIC HOUSE NUMBER 4, SATIN NICKEL)	3046	BRASS	5	CARDED	10.00
044074680522	SC2 3046 716 N N (4" CLASSIC HOUSE NUMBER 4, AGED BRONZE)	3046	BRASS	5	CARDED	10.00

English packaging only



4" Classic House Numbers

4" CLASSIC HOUSE NUMBERS

UPC	Part No./Description	Model	Substrate	Case Qty.	Pkg. Type	Price
044074678727	SC2 3056 605 N N (4" CLASSIC HOUSE NUMBER 5, BRIGHT BRASS)	3056	BRASS	5	CARDED	\$7.70
044074678826	SC2 3056 619 N N (4" CLASSIC HOUSE NUMBER 5, SATIN NICKEL)	3056	BRASS	5	CARDED	10.00
044074680539	SC2 3056 716 N N (4" CLASSIC HOUSE NUMBER 5, AGED BRONZE)	3056	BRASS	5	CARDED	10.00
044074678734	SC2 3066 605 N N (4" CLASSIC HOUSE NUMBER 6, BRIGHT BRASS)	3066	BRASS	5	CARDED	7.70
044074678833	SC2 3066 619 N N (4" CLASSIC HOUSE NUMBER 6, SATIN NICKEL)	3066	BRASS	5	CARDED	10.00
044074680546	SC2 3066 716 N N (4" CLASSIC HOUSE NUMBER 6, AGED BRONZE)	3066	BRASS	5	CARDED	10.00
044074678741	SC2 3076 605 N N (4" CLASSIC HOUSE NUMBER 7, BRIGHT BRASS)	3076	BRASS	5	CARDED	7.70
044074678840	SC2 3076 619 N N (4" CLASSIC HOUSE NUMBER 7, SATIN NICKEL)	3076	BRASS	5	CARDED	10.00
044074680553	SC2 3076 716 N N (4" CLASSIC HOUSE NUMBER 7, AGED BRONZE)	3076	BRASS	5	CARDED	10.00
044074678758	SC2 3086 605 N N (4" CLASSIC HOUSE NUMBER 8, BRIGHT BRASS)	3086	BRASS	5	CARDED	7.70
044074678857	SC2 3086 619 N N (4" CLASSIC HOUSE NUMBER 8, SATIN NICKEL)	3086	BRASS	5	CARDED	10.00
044074680560	SC2 3086 716 N N (4" CLASSIC HOUSE NUMBER 8, AGED BRONZE)	3086	BRASS	5	CARDED	10.00
044074678765	SC2 3096 605 N N (4" CLASSIC HOUSE NUMBER 9, BRIGHT BRASS)	3096	BRASS	5	CARDED	7.70
044074678864	SC2 3096 619 N N (4" CLASSIC HOUSE NUMBER 9, SATIN NICKEL)	3096	BRASS	5	CARDED	10.00
044074680577	SC2 3096 716 N N (4" CLASSIC HOUSE NUMBER 9, AGED BRONZE)	3096	BRASS	5	CARDED	10.00

English packaging only

Door Knockers,
Push, Pull & Kick Plates



3107 Door Knocker



3125 Door Knocker

DOOR KNOCKERS

UPC	Part No./Description	Model	Substrate	Case Qty.	Pkg. Type	Price
044074678475	SC2 3107 605 N N (DOOR KNOCKER, BRIGHT BRASS)	3107	BRASS	2	CARDED	\$45.80
044074680461	SC2 3107 619 N N (DOOR KNOCKER, SATIN NICKEL)	3107	BRASS	2	CARDED	56.60
044074678499	SC2 3125 605 N N (DOOR KNOCKER, BRIGHT BRASS)	3125	BRASS	5	CARDED	25.40
044074678505	SC2 3125 619 N N (DOOR KNOCKER, SATIN NICKEL)	3125	BRASS	5	CARDED	30.50
044074680478	SC2 3125 716 N N (DOOR KNOCKER, AGED BRONZE)	3125	BRASS	5	CARDED	30.50
044074680768	SC2 3125 609 N N (DOOR KNOCKER, ANTIQUE BRASS)	3125	BRASS	5	CARDED	30.50



Pull



Push Plate



Pull Plate

PUSH AND PULL PLATES

UPC	Part No./Description	Model	Substrate	Case Qty.	Pkg. Type	Price
044074008371	C8112 5PA 28 N N (DOOR PULL, SATIN ALUMINUM)	8112	ALUMINUM	2	CARDED	\$23.40
044074008395	C8200PA 28 3X12 N N (PUSH PLATE, SATIN ALUMINUM)	8200	ALUMINUM	5	CARDED	8.90
044074008418	C8200PA 28 3.5X15 N N (PUSH PLATE, SATIN ALUMINUM)	8200	ALUMINUM	5	CARDED	9.20
044074679014	SC8200B 3 3.5X15 N N (PUSH PLATE, BRIGHT BRASS)	8200	BRASS	5	CARDED	21.20
044074008425	CGC8200S32D 3.5X15 N N (PUSH PLATE, STAINLESS STEEL)	8200	STAINLESS	5	CARDED	15.20
044074008432	C8302 6PA 28 3.5X15G N N (PULL PLATE, SATIN ALUMINUM)	8302	ALUMINUM	2	CARDED	34.00
044074008456	C8311 5PA 28 3.5X15G N N (PULL PLATE, SATIN ALUMINUM)	8311	ALUMINUM	5	CARDED	36.90
044074589498	CGC8311-5B26D 3.5X15 (PULL PLATE, SATIN CHROME)	8311	BRASS	5	CARDED	71.20
043156253258	SC8311-5 PA3 3.5X15 N N (PULL PLATE, BRIGHT BRASS)	8311	ALUMINUM	5	CARDED	39.60
044074681253	SC8311 5B 3 3.5X15G N N (PULL PLATE, BRIGHT BRASS)	8311	BRASS	5	CARDED	64.50

English packaging only



Kick Plate

KICKPLATES

UPC	Part No./Description	Model	Substrate	Case Qty.	Pkg. Type	Price
044074006940	C8400B 3 6X30 N N (KICKPLATE, BRIGHT BRASS)	8400	BRASS	5	CARDED	\$50.40
044074008623	C8400PA 28 6X30 N N (KICKPLATE, SATIN ALUMINUM)	8400	ALUMINUM	5	CARDED	22.30
044074051087	C8400B 3 6X34 N N (KICKPLATE, BRIGHT BRASS)	8400	BRASS	5	CARDED	53.40
044074051063	C8400PA 28 6X34 N N (KICKPLATE, SATIN ALUMINUM)	8400	ALUMINUM	5	CARDED	23.80
044074589337	CGC8400S 32D 8X34 N N (KICKPLATE, STAINLESS STEEL)	8400	STAINLESS	5	CARDED	33.40
044074678581	SC8400B 3 8X34 N N (KICKPLATE, BRIGHT BRASS)	8400	BRASS	5	CARDED	59.30
044074678611	SC8400PA 28 8X34 N N (KICKPLATE, SATIN ALUMINUM)	8400	ALUMINUM	5	CARDED	29.70
044074678628	SC8400PA 3 8X34 N N (KICKPLATE, BRIGHT BRASS))	8400	BRASS	5	CARDED	41.50
044074681185	SC8400B 619 6X30 N N (KICKPLATE, SATIN NICKEL)	8400	BRASS	5	CARDED	53.40
044074681178	SC8400B 716 6X30 N N (KICKPLATE, AGED BRONZE)	8400	BRASS	5	CARDED	53.40
044074682038	SC8400PA 716 8X34 N N (KICKPLATE, AGED BRONZE)	8400	ALUMINUM	5	CARDED	40.80
044074678574	SC8400PA 3 6X34 N N (KICKPLATE, BRIGHT BRASS)	8400	ALUMINUM	5	CARDED	34.10
044074678567	SC8400PA 3 6X30 N N (KICKPLATE, BRIGHT BRASS)	8400	ALUMINUM	5	CARDED	32.60
044074678598	SC8400PA 619 8X34 N N (KICKPLATE, SATIN NICKEL)	8400	ALUMINUM	5	CARDED	41.70

English packaging only

Window Hardware,
Flush Pulls



Window Lock



Bar Window Lift

WINDOW HARDWARE

UPC	Part No./Description	Model	Substrate	Case Qty.	Pkg. Type	Price
044074681765	SPS07MB 605 N N (WINDOW LOCKS, BRIGHT BRASS)	07	BRASS	20	SLIM PACK	\$18.80
044074681772	SPS07MB 609 N N (WINDOW LOCKS, ANTIQUE BRASS)	07	BRASS	20	SLIM PACK	18.80
044074681796	SPS07MB 619 N N (WINDOW LOCKS, SATIN NICKEL)	07	BRASS	20	SLIM PACK	18.80
044074681802	SPS07MB 620 N N (WINDOW LOCKS, ANTIQUE PEWTER)	07	BRASS	20	SLIM PACK	18.80
044074681789	SPS07MB 716 N N (WINDOW LOCKS, AGED BRONZE)	07	BRASS	20	SLIM PACK	18.80
044074681819	SPS026MB 605 N N (WINDOW LIFTS, BRIGHT BRASS)	026	BRASS	20	SLIM PACK	8.00
044074681826	SPS026MB 609 N N (WINDOW LIFTS, ANTIQUE BRASS)	026	BRASS	20	SLIM PACK	9.50
044074681840	SPS026MB 619 N N (WINDOW LIFTS, SATIN NICKEL)	026	BRASS	20	SLIM PACK	9.50
044074681857	SPS026MB 620 N N (WINDOW LIFTS, ANTIQUE PEWTER)	026	BRASS	20	SLIM PACK	9.50
044074681833	SPS026MB 716 N N (WINDOW LIFTS, AGED BRONZE)	026	BRASS	20	SLIM PACK	9.50



Flush Pull

FLUSH PULLS

UPC	Part No./Description	Model	Substrate	Case Qty.	Pkg. Type	Price
044074681512	SPS221B* 605 N N (DOOR PULL, BRIGHT BRASS)	221	BRASS	25	SLIM PACK	\$3.30
044074681529	SPS221B* 609 N N (DOOR PULL, ANTIQUE BRASS)	221	BRASS	25	SLIM PACK	4.30

*While supplies last

English packaging only

Latch & Strike Quick Reference Guide
Deadbolt & Latches

F Series Parts

LATCH & STRIKE QUICK REFERENCE GUIDE

LATCH REFERENCE GUIDE

Latches / Configuration	Deadbolt Latches				Spring Latches
	B60/B62/B80/ B81	BE365 BE375	F51/F80	FE575/FE595/ FE599NX/ FE695	FE285
Dual Option (Round, Drive-in) STANDARD	12-321	12-321	16-086	16-086	16-080
Square	12-288	12-288	16-207	16-207	16-200
Triple Option	12-287	12-287	16-211	16-211	16-210
UL Square	12-294	n/a	16-203	n/a	n/a
UL Round	12-397	n/a	16-204	n/a	n/a
5"	12-349*	n/a	16-126	16-126	n/a

*Must be ordered separately

STRIKE REFERENCE GUIDE

Latches / Configuration	Handlesets	Deadbolt	Dead Latches	Spring Latches	Tapered Deadbolt
	F59/F60/F62	BE375/BE365/ B60/B62/B80/ B81	FE595/FE575/ FE695/ FE599NX F51/F80	FE285/F10	BE468 BE469 BE479
Round Corner Full Lip	10-115	10-092	10-027	10-027	10-115
Round Corner		10-116*			10-116*
Square Corner Full Lip	n/a	10-094	10-026	10-026	10-094
Square Corner - T	n/a	n/a	10-001	10-001	n/a
Circular - Adjustable	n/a	n/a	10-058	10-058	n/a
Dual - Square & Round	10-269	n/a	10-063	10-063	n/a
ANSI Square	n/a	n/a	10-025	10-025	n/a
Dustbox (Black Plastic)	B520-283	B520-283	n/a	n/a	B520-283
Reinforcement Strike Plate	B502-914	B502-914	n/a	n/a	B502-914
3" Reinforcement Screws (2ea)	B502-873	B502-873	n/a	n/a	B502-873

*Includes Reinforcement Strike Plate & Screws

LATCHES (does not include Multi-Family product)

Category	Part Product	Specify Number	Finish	Description	Price Sold Separately	Add To Lock Price
Electronics/ Connected & Light Commercial	BE468/BE469/BE479	12-342	x	Tapered Deadbolt Dual Option (Round, Drive-in) (Standard Configuration)	\$37.30	NC
		12-344	x	Tapered Deadbolt Triple Option (Round, Square, Drive-in)	37.30	2.00
	BE375/BE365/	12-321	x	1" x 2 1/4" Dual Option - Round Corner + Drive-in (Standard Configuration)	32.20	NC
		12-287	x	1" x 2 1/4" Triple Option - Round Corner + Square Corner + Drive-in	41.70	2.00
		12-288	x	1" x 2 1/4" Square Corner Faceplate	36.00	NC
	FE595/FE575/ FE695/ FE599NX	16-086	x	1" x 2 1/4" Dual Option - Round Corner + Drive-in (Standard Configuration)	16.50	NC
		16-207	x	1" x 2 1/4" Square Corner Faceplate	14.90	NC
		16-211	x	1" x 2 1/4" Triple Option - Round Corner + Square Corner + Drive-in	18.50	2.00
		16-126	X	1" x 2 1/4" Square Corner Faceplate - 5" backset	14.90	5.40
	FE285	16-080	x	1" x 2 1/4" Dual Option - Round Corner + Drive-in (Standard Configuration)	14.60	NC
		16-200	x	1" x 2 1/4" Square Corner Faceplate	13.50	NC
		16-210	x	1" x 2 1/4" Triple Option -Round Corner + Square Corner + Drive-in	16.60	2.00

*Sold with complete UL lockset; not available for individual purchase

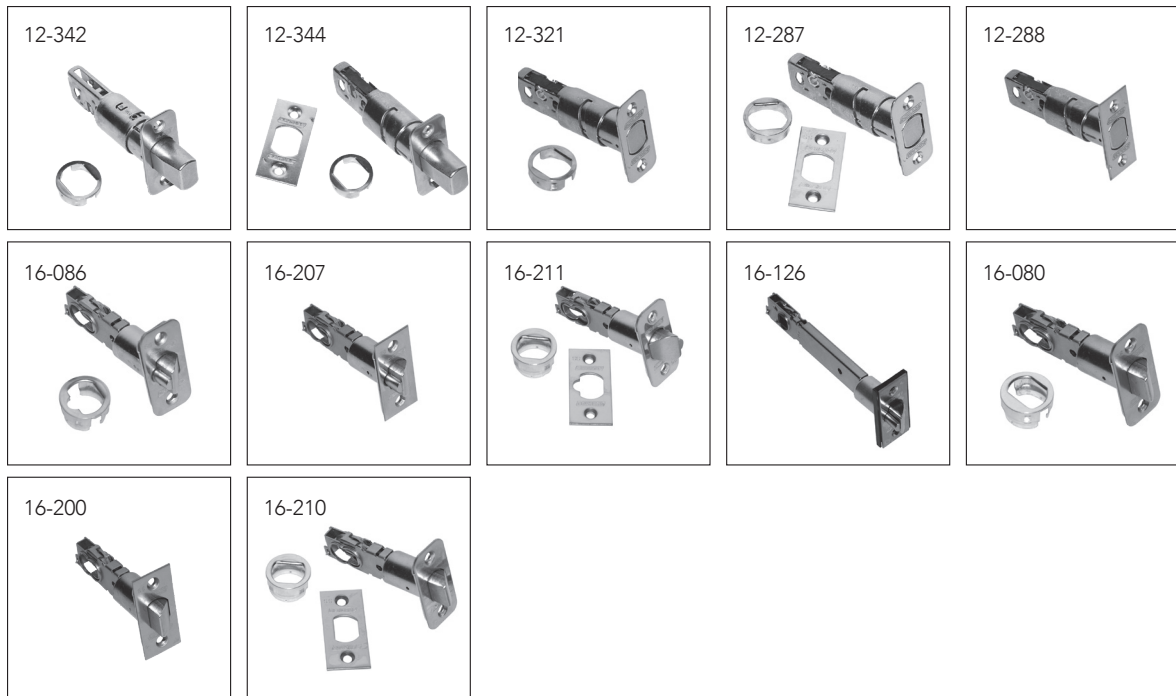

F Series Parts

LATCHES CONT. (does not include Multi-Family product)

Category	Part Product	Specify Number	Finish	Description	Price Sold Separately	Add To Lock Price
F Series Handlesets	F59/F60/F62	12-322	x	1" x 2 1/4" Dual Option - Round Corner (16-080) + Drive-in (12-321) (Standard Configuration)	47.10	NC
		12-353	x	1" x 2 1/4" Square Corner – UL (12-294 + 16-203) (Standard Configuration-UL Listed)	*	12.00
		12-326	x	1" x 2 1/4" Triple Option - Round Corner + Square Corner (16-210) + Drive-in (12-287)	54.70	2.00
		12-354	x	1" x 2 1/4" Round Corner UL (12-397 + 16-204)	*	12.00
F Series Knobs/Levers /Light Commercial	F10/F40 Levers/ Knobs	16-080	x	1" x 2 1/4" Dual Option - Round Corner + Drive-in (Standard Configuration)	14.60	NC
		16-203	x	1" x 2 1/4" Square Corner Faceplate + Firecup + 1 1/8" Adaptor – UL (Standard Configuration-UL LISTED)	*	6.00
		16-204	x	1" x 2 1/4" Radius Corner Faceplate + Firecup + 1 1/8" Adaptor – UL	*	6.00
		16-207	x	1" x 2 1/4" Square Corner Faceplate	14.90	NC
		16-200	x	1" x 2 1/4" Square Corner Faceplate	13.50	NC
		16-210	x	1" x 2 1/4" Triple Option - Round Corner + Square Corner + Drive-in	16.60	2.00
		92852	x	1" x 2 1/4" Triple Option - Round Corner + Square Corner + Drive-in VisPack ONLY (order in qtls of 4)	16.60	N/A

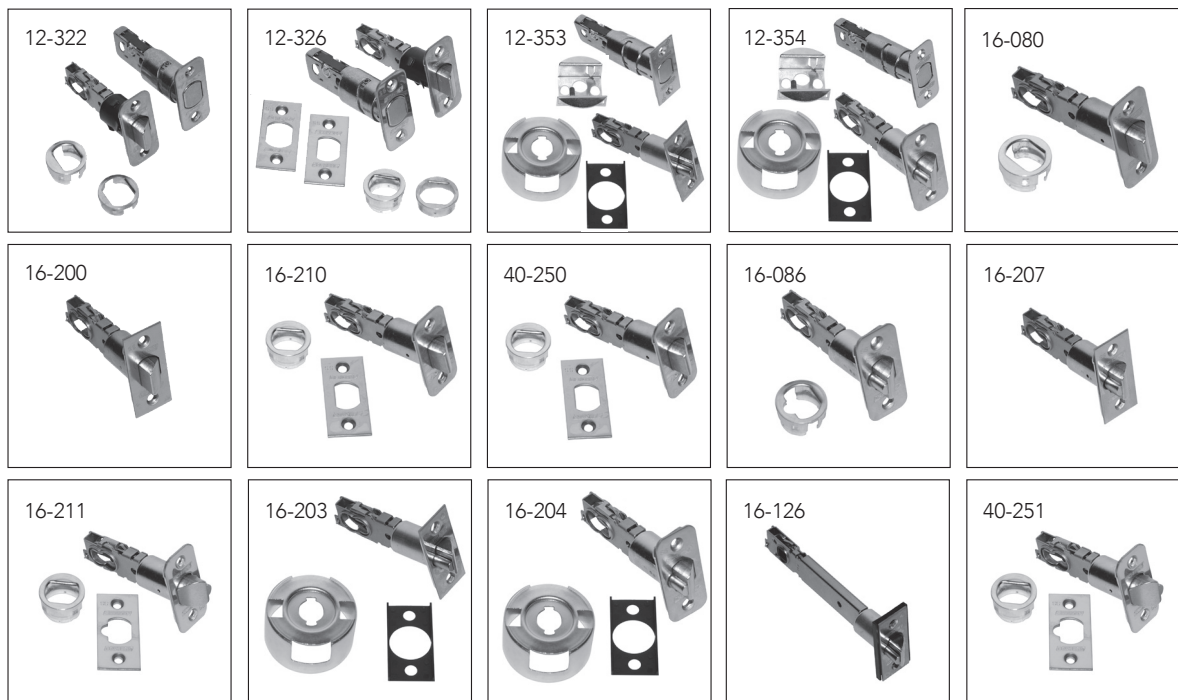

*Sold with complete UL lockset; not available for individual purchase

LATCHES CONT. (does not include Multi-Family product)

Category	Part Product	Specify Number	Finish	Description	Price Sold Separately	Add To Lock Price
F Series Knobs/Levers / Light Commercial (cont.)	F51A/F80 Levers/Knobs	16-086	x	1" x 2 1/4" Dual Option - Round Corner + Drive-in (Standard Configuration)	\$16.50	NC
		16-203	x	1" x 2 1/4" Square Corner Faceplate + Firecup + 1 1/8" Adaptor – UL (Standard Configuration-UL LISTED)	*	6.00
		16-207	x	1" x 2 1/4" Square Corner Faceplate	14.90	NC
		16-211	x	1" x 2 1/4" Triple Option - Round Corner + Square Corner + Drive-in	18.50	2.00
		16-204	x	1" x 2 1/4" Radius Corner Faceplate + Firecup + 1 1/8" Adaptor – UL	*	6.00
		16-126	x	1" x 2 1/4" Square Corner Faceplate - 5" Backset	14.90	5.40
		92853	x	1" x 2 1/4" Triple Option - Round Corner + Square Corner + Drive-in VisPack ONLY (order in qty's of 4)	18.50	N/A
B-Series	B60/B62/B80/B81	12-294	x	1" x 2 1/4" Square Corner Faceplate + Firecup n/a with B62 (Standard Configuration-UL LISTED)	*	6.00
		12-288	x	1" x 2 1/4" Square Corner Faceplate	36.00	NC
		12-287	x	1" x 2 1/4" Triple Option - Round Corner + Square Corner + Drive-in	41.70	2.00
		12-321	x	1" x 2 1/4" Dual Option-Round Option + Drive-In (Standard Configuration)	32.20	NC
		12-349	x	1" x 2 1/4" Square Corner Faceplate - 5" backset	65.40	N/A
		12-355	x	Tapered Deadbolt Triple Option	37.30	2.00
		12-397	x	1" x 2 1/4" Round Corner Faceplate + Firecup UL Listed n/a with B62	*	6.00

*Sold with complete UL lockset; not available for individual purchase

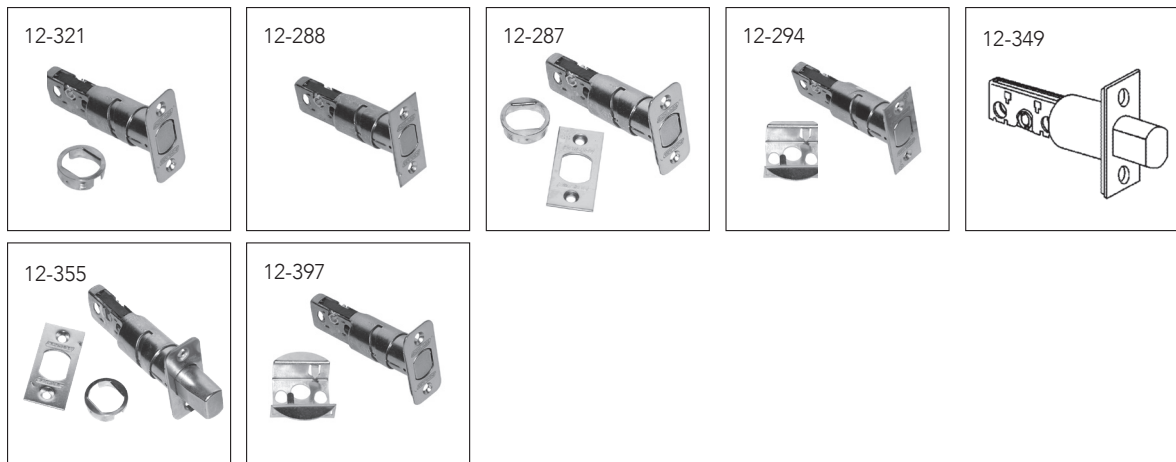

Strikes

F Series Parts

STRIKES (does not include Multi-Family product)

Category	Part Product	Specify Number	Finish	Description	Price Sold Separately	Add To Lock Price	
Electronics/ Connected & Light Commercial	BE479/BE469/BE468/ BE375/BE365	10-116	x	Round Corner Strike 1 1/8" x 2 3/4" (Standard Configuration)	\$13.70	NC	
		10-115	x	Round Corner Full Lip Strike Set (10-027 + 10-116) (Round, Square, Drive-in) (Standard Configuration-Entry Sets)	17.70	NC	
		B502-914		Reinforcement Strike Plate	2.00	NC	
		B502-873		3" Reinforcement Screws (2 ea.)	0.54	NC	
	All strikes available for B60/B62/B80/B81						
		FE695/FE595/FE575/ FE285/ FE599NX	10-027	x	10-027 Round Corner Full Lip Strike 1 5/8" x 2 1/4" (Standard Configuration)	7.60	NC
All strikes available for F10/F40/F51/F80 Levers/Knobs							
F Series Handlesets	F59/F60/F62	10-115	x	Round Corner Full Lip Strike Set (10-027 + 10-116) (Standard Configuration)	17.70	NC	
		10-257	x	Round Corner Full Lip (10-027 + 10-092)	15.50	NC	
		10-269	x	Round & Square Corner Strike Set (10-026 + 10-027 + 10-094 + 10-116)	24.40	2.00	
		B502-914		Reinforcement Strike Plate	2.00	NC	
		B502-873		3" Reinforcement Screws (2 ea.)	0.54	NC	

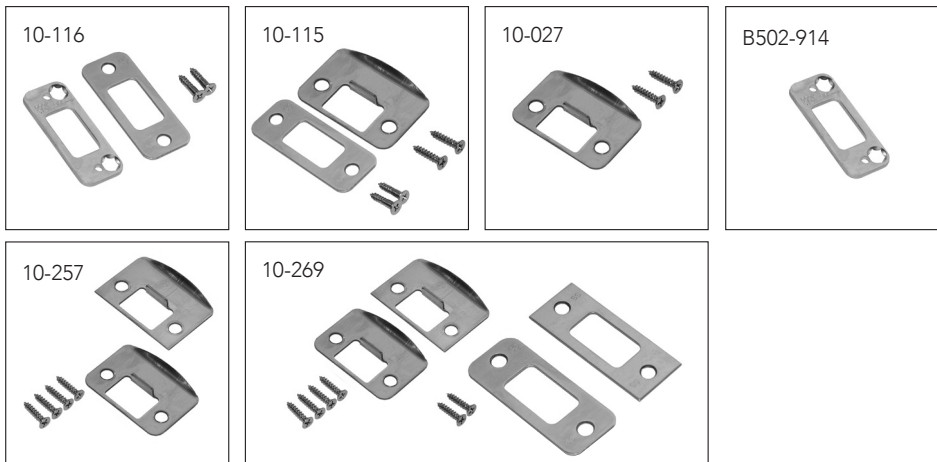

STRIKES CONT. (does not include Multi-Family product)

Category	Part Product	Specify Number	Finish	Description	Price Sold Separately	Add To Lock Price
F Series Knobs/ Levers/Light Commercial	F10/F40/F51A/F80 Levers/Knobs	10-027	x	10-027 Round Corner Full Lip Strike 1 5/8" x 2 1/4" (Standard Configuration)	\$7.60	NC
		10-026	x	Square Corner Full Lip Strike 1 5/8" x 2 1/4"	7.60	NC
		10-001	x	10-001* Square Corner T Strike 1 1/8" x 2 3/4" + Box	8.00	NC
		10-058	X	Circular - Adjustable 1 3/4" Diameter (605 and 626 finish only)	10.90	NC
		10-063	x	Dual Strikes (10-026 + 10-027) 1 5/8" x 2 1/4"	10.00	2.00
		10-025	x	ANSI Square Corner T Strike 1 1/4" x 4 7/8"	15.20	5.40
B-Series Deadbolts/ Light Commercial	B60/ B62/B80/B81	10-116	x	Round Corner Strike 1 1/8" x 2 3/4" (Standard Configuration)	13.70	NC
		10-094	x	Square Corner Strike 1 1/8" x 2 3/4"	12.20	NC
		B502-914		Reinforcement Strike Plate	2.00	NC
		B502-873		3" Reinforcement Screws (2 ea.)	0.54	NC
		B520-283		Black Plastic Dustbox for Standard Strike 1 1/8" x 2 3/4"; 3" Reinforcement Screws (2 ea.)	2.00	NC
		10-112		Metal Dust Box	12.10	N/A
		10-092		Full lip strike radius	7.90	NC



Cylinders

F Series Parts

CYLINDER PINS

Part Number	Description	Price
34-101*	Top Pin - #1	\$0.08
34-102*	Top Pin - #2	0.08
34-103*	Top Pin - #3	0.08
34-202*	Master Pin - #2	0.08
34-203*	Master Pin - #3	0.08
34-204*	Master Pin - #4	0.08
34-205*	Master Pin - #5	0.08
34-206*	Master Pin - #6	0.08
34-207*	Master Pin - #7	0.08
34-208*	Master Pin - #8	0.08
34-209*	Master Pin - #9	0.08
34-300*	Bottom Pin - #0	0.08
34-301*	Bottom Pin - #1	0.08
34-302*	Bottom Pin - #2	0.08
34-303*	Bottom Pin - #3	0.08
34-304*	Bottom Pin - #4	0.08
34-305*	Bottom Pin - #5	0.08
34-306*	Bottom Pin - #6	0.08
34-307*	Bottom Pin - #7	0.08
34-308*	Bottom Pin - #8	0.08
34-309*	Bottom Pin - #9	0.08

REKEY PARTS

Part Number	Description	Price
F506-451*	Top T Pin - Compressible F Series	\$0.12
F506-452*	Removable Top Cap - Compressible F Series	0.19
F506-453*	Top T Pin Spring- Compressible F Series	0.19
34-401	Construction Balls (Pack of 1000)	32.00
40-104	Key Gage	14.80
M540-051	Follower Bar	3.30
M540-056	Cylinder Cap Removal Tool	57.50
40-132	Retail Metal ReKey Kit	236.00
40-133	Home Secure RCK ReKey Kit	407.00
40-229	Rekeying Training Kit	93.40

*Order in multiples of 100

ASSEMBLY SCREW KITS (does not include Multi-Family product)

Category	Part Product	Specify Number	Finish	Description	Price
Connected	BE469/BE468/BE479	24283962	x	Screw Kit, Mtg Screws & Wood Screws	\$5.00
	BE375/BE365	B220-279	x	(2) B520-621 Finish Screws (2) B600-100 Internal Screws	10.10 10.10
Electronic/ Light Commercial	FE595/FE575	F206-450	x	Mtg Screw Kit	5.50
	FE285	F206-450	x	Mtg Screw Kit	5.50
		F506-828		(1) Thru Bolt	1.30
		F605-339		(1) Washer	0.56
B-Series Deadbolts/F Series Knobs & Levers/ F Series Handlesets	B60	33815664	605	Screw Kit, Mtg. Screws, Strike Reinforcement	10.10
		33815671	625	Screw Kit, Mtg. Screws, Strike Reinforcement	10.10
		33815688	716	Screw Kit, Mtg. Screws, Strike Reinforcement	10.10
	B62	33815725	605	Screw Kit, Mtg. Screws, Strike Reinforcement	10.10
		33815732	625	Screw Kit, Mtg. Screws, Strike Reinforcement	10.10
		33815749	716	Screw Kit, Mtg. Screws, Strike Reinforcement	10.10
	B80	33815756	605	Screw Kit, Mtg. Screws, Strike Reinforcement	10.10
		33815763	625	Screw Kit, Mtg. Screws, Strike Reinforcement	10.10
		33815770	716	Screw Kit, Mtg. Screws, Strike Reinforcement	10.10
	F60	33815787	605	Screw Kit, Mtg. Screws, Strike Reinforcement	10.10
		33815794	625	Screw Kit, Mtg. Screws, Strike Reinforcement	10.10
		33815800	716	Screw Kit, Mtg. Screws, Strike Reinforcement	10.10
	F62	33815817	605	Screw Kit, Mtg. Screws, Strike Reinforcement	10.10
		33815824	625	Screw Kit, Mtg. Screws, Strike Reinforcement	10.10
		33815831	716	Screw Kit, Mtg. Screws, Strike Reinforcement	10.10
	F10/F40/F51A	33815848	605	Screw Pack	10.10
		33815855	625	Screw Pack	10.10
		33815862	716	Screw Pack	10.10
	F170	33815879	605	Screw Pack	10.10
		33815886	625	Screw Pack	10.10
		33815893	716	Screw Pack	10.10

Thick Door Installation Kits
Miscellaneous Parts

THICK DOOR INSTALLATION KITS (does not include Multi-Family product)

Category	Part Product	Specify Number	Finish	Description	Price
Connected	BE468/469/479	23997877	x	1 7/8" – 2 1/2" Thick	\$24.90
	BE489	B489-106	x	1 7/8" – 2 1/2" Thick	24.90
Electronic/ Light Commercial	BE365	02-007	x	1 7/8" – 2 1/2" Thick	24.90
	FE285	61-075	x	1 7/8" – 2 1/4" Thick	15.00
Touch	BE375	24666356	x	1 7/8" - 2 1/2" Thick	24.90
F Series Handlesets	F58 (old)	61-075	x	2" - 2 1/4" - Includes mounting screws, thick door grip chassis, and thick door driver bar (Used for Old Style F58 shipped before 3/1/19)	15.00
	F58(new)/F60	61-076	x	2" - 2 1/4" - Includes mounting screws and thick door driver bar (Used for New Style F58 shipped after 3/1/19)	12.00
B-Series Deadbolts/ Light Commercial	B60	61-072	x	2" - 2 1/4" - Includes longer mounting screws only for deadbolt	5.00
		61-073	x	2 1/4" - 4" - Includes longer mounting screws and longer driver bar	10.00

MISCELLANEOUS PARTS

Category	Specify Finish	Description	Price
B202-578	x	Latch/Bolt/Strike Screw Kit(4) C604-246 Latch/Bolt/Strike Wood Screw	\$4.80
M504-271		(Emergency Key) F40 Function	1.60
02-035	x	Throughbolt Cap	1.60
06-133	X	Handleset Slider Assembly	2.00
B300-208	x	F62 & B62 Drive Pins (deadbolt screw covers)	1.30
B302-043	x	Trim and Turn Unit, F60 (inside trim)	30.00
F506-828		(1) Thru Bolt	1.30
F605-339		(1) Washer	0.56

LESS LOCK COMPONENTS

Description	Specify	Price
Less Springlatch	LLL for Springlatch	\$4.10 (subtract from list price of lock)
Less Deadlatch	LLL for Deadlatch	4.50 (subtract from list price of lock)
Less Handleset Deadbolt	LLL for Handleset Deadbolt	8.10 (subtract from list price of lock)
Less Handleset Deadbolt Strike	LLL for Handleset Deadbolt Strike	3.20 (subtract from list price of lock)
Less Handleset Latch Strike	LLL for Handleset Latch Strike	2.10 (subtract from list price of lock)
Less Deadbolt	LLL for Deadbolt	8.30 (subtract from list price of lock)
Less Deadbolt Strike	LLL for Deadbolt Strike	3.30 (subtract from list price of lock)
Less Knob Strike	LLL for Knob Strike	2.10 (subtract from list price of lock)
Less Lever Strike	LLL for Lever Strike	2.10 (subtract from list price of lock)

F Series Parts

Key & Cylinder Stamping

Residential Master & Construction Keying

35 - BLANK KEYS

Part No.	Description	Price
35-100*	5 Pin - Standard Bow - Embossed Both Sides	\$1.50
35-101*	6 Pin - Standard Bow - Embossed Both Sides	2.00
35-130*	5 Pin - Standard Bow - Unembossed Both Sides - No Stamping	1.50
35-131*	6 Pin - Standard Bow - Unembossed Both Sides - No Stamping	2.00
35-140	5 Pin - Large Bow - Embossed Both Sides	5.90
35-141	6 Pin - Large Bow - Embossed Both Sides	5.90
35-143	5 Pin - Access Bow - Embossed Both Sides	5.90
35-144	6 Pin - Access Bow - Embossed Both Sides	5.90

*Order in multiples of 50

48 - CUT KEYS

Part No.	Description	Price
48-130	Cut Key - 5 Pin - Standard Bow - Unembossed Both Sides - No Stamping	\$6.20
48-140	Cut Key - 5 Pin - Large Bow - Embossed Both Sides	8.90
48-143	Cut Key - 5 Pin - Access Bow - Embossed Both Sides	8.90
48-180*	Cut Key - 5 Pin - Standard Bow - Embossed Both Sides / Construction Key	6.20
48-181	Cut Key - 6 Pin - Standard Bow - Embossed Both Sides	6.20

*48-180 is used for standard cut keys and residential construction keys

49 - MASTER KEYS

Part No.	Description	Price
49-130	Master Key - 5 Pin - Standard Bow - Embossed Both Sides	\$10.80
49-140	Master Key - 5 Pin - Large Bow - Embossed Both Sides	14.60
49-143	Master Key - 5 Pin - Access Bow - Embossed Both Sides	14.60
49-180	Schlage Cut Master Key - 5-Pin - Standard with Key Symbol & Registry Number	12.50
49-181	Master Key - 6 Pin - Standard Bow - Unembossed Both Sides - Standard with Key Symbol & Registry Number	10.40

50 - KEY CHARGES

Part No.	Description	Add To Price
50-001	Conventional Cylinder Keyed to Specific Combination	\$10.00
50-215	Extra Cut Standard Bow Keys Ordered on Lock or Cylinder	4.30
50-227	Extra Cut Large or Access Bow Keys Ordered on Lock or Cylinder	6.70
50-228	Cut Large Bow or Access Bow Keys Substituted for Standard Bow Keys	3.10

*Key Charges are added to the list price of the lock

60 - KEY PACKAGING

Part No.	Description	Price
60-000	Pack Change Keys Independently - PKI - for Split Key Construction Keying	NC
60-001	Pack Change Keys Independently (PKI)	0.60

Key & Cylinder Stamping
Residential Master & Construction Keying

F Series Parts

KEY STAMPING AREA

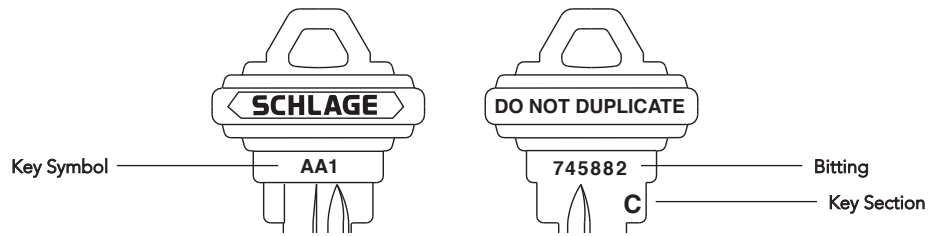

KEY STAMPING

Description	Notes	Key Type	Specify	Part Number	Price Ea. Key
Visual Key Control (VKC)	1	Classic Conventional	Stamp Key Symbol on Key	50-217	\$2.80
Non-Standard Code	1, 5, 8	All Conventional	Non-Standard Code	50-003	7.40/side
DO NOT DUPLICATE		Classic Conventional	Stamp Key "Do Not Duplicate"	XQ06-878	N/C
Delete Key Section From Bow		Classic Conventional	Delete Key Section	50-220	5.00
Bitting Not Stamped		Classic Conventional	Delete Key Combination	50-221	2.80
Stamp Bitting		Classic Conventional	(Furnished as Standard)	N/A	N/A

Notes:

- 1. Maximum of 6 characters for VKC, Non-Standard Code or serial number stamping
- 5. Only available on unembossed keys
- 8. Sequential stamping will be charged as Non-Standard Code (example: AA1-1, AA1-2)

CYLINDER STAMPING AREA

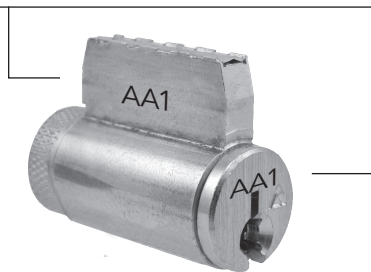

KEY STAMPING

Description	Notes	Key Type	Specify	Part Number	Price Ea. Key
Visual Key Control (VKC) with standard key symbols or Non-standard codes	1	Classic Conventional	Stamp key symbol or non-conventional code on face (VKC) or Cylinder core.	50-002	\$6.80
Concealed Key Control (CKC) with standard key symbols or Non-standard codes	1	Classic Conventional	Stamp key symbol or non-conventional code on side (CKC) of core.	50-216	6.80

Notes:

- 1. Maximum of 6 characters for VKC, Non-Standard Code or serial number stamping

Residential Master Keying (RMK) and/or Residential Construction Keying (RCK)

Qualifications:

- Residential projects
- RMK and/or RCK must be specified on the order
- **Systems are available in 5-Pin C keyway only**
- Systems cannot be combined with Contract Master Key Systems
- **Two levels of keying (Change Key and Master Key levels only)**
- **Three levels of keying allowed if complete expansion requirements are submitted (Grandmaster, Master Key, and Change Key levels)**
- Maison keying allowed
- Door detailing and labeling allowable as listed below
- Master keys must be ordered separately and are not added by default

RESIDENTIAL MASTER KEYING (RMK)

Part No.	Description	Price
50-223*	Cylinder Residential Master Keyed (RMK)	2.60
50-009	Cylinder Residential Master keyed with Door ID Labeling (RMKID)	N/C
49-180	Residential Master Key – Not offered for commercial products	12.50

RESIDENTIAL CONSTRUCTION KEYING (RCK) – LOST BALL CONSTRUCTION KEYING

Part No.	Description	Price
50-224*	Cylinder Residential Construction Keyed (RMK)	2.60
50-010	Cylinder Residential Construction keyed with Door ID Labeling (RCK)	N/C
48-180	Residential Construction Key – Not offered for commercial products	6.20

Notes: Lost ball construction device is triggered by the highest level permanent key unless otherwise specified.
 Change keys packed in envelopes and packed in lock box. PKI packing available for additional charge of \$0.60.
 If you desire a masterkey with your RCK (50-224), you must add the RMK (50-223) charge listed above.

* If Door Labeling is required, the 50-009 RMK with labeling and/or 50-010 RCK with labeling charges will apply

Master Keys and Construction Keys ship UPS 2nd Day Air and will require a signature upon delivery. Standard freight terms apply.

BITTING LISTS (TRANSCRIPTS)

Part No.	Description	Price
50-123	Bitting list for factory master keyed products (requires a written authorization from end-user).	\$233.00**
50-120	Establish new master key system for field master keying (one-time charge). Each bitting is assessed a 50-121 or 50-122 charge below.	34.80
50-121	New master key bitting for cylinders keyed in the field. 50-120 charge assessed if this bitting establishes a new system.	4.50
50-122	New change key bitting for cylinders keyed in the field.	3.50

Notes **Can be used for SiteMaster download (keying and bitting details) if ordered as such. Please specify SiteMaster download file if applicable in the details column. Information required: Structure or original order number, end user name, city and state (used to verify the structure number). Also required is an email address for the end user, include their full name to address the email and a "Letter Of Authorization".

Construction Core Program

F Series Parts

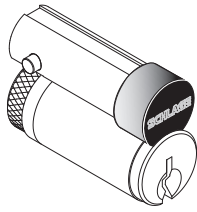

23-030-ICX

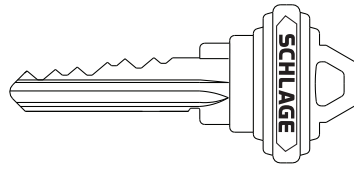

48-101-ICX

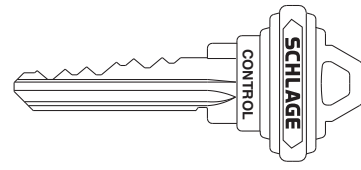

48-056-ICX

FULL-SIZE CONSTRUCTION CORE PROGRAM

Temporary construction cores may be ordered with full size interchangeable core locks, mortise cylinders and rim cylinders. These cores may also be ordered separately. All construction cores are assessed a non-refundable handling charge (50-231). See Terms & Conditions for more information.

Features:

- 6 Pin C keyway
- Construction cores have a two-tone face: the faceplate is a flat black finish (622) and the plug is unfinished brass
- Back of each core is marked with the letter that identifies the keyed alike group: A, B or C
- Construction cores are furnished with no keys (NCK). Cut keys must be ordered separately
- A control key is required to install and remove construction cores. Control keys must be ordered separately. If a control key is not ordered, one will be supplied at a charge of \$13
- Construction cores may be returned for credit. Contact your Schlage representative for return authorization. Credit is issued upon receipt of cores at our factory

Part No.	Description	Specify	Price (ea.)
23-030-ICX	Construction core	New jobs: Specify "ICX"	\$73.00
48-101-ICX	Cut key for construction phase (order separately)	Existing jobs: Specify "ICA"	16.30
48-056-ICX	Cut control key (order separately)	"ICB" or "ICC"	16.30
50-231*	Non-refundable handling charge (per core)		10.40

*Net price - no further discounts apply

Notes:

- 1) To order mortise and rim cylinders with full-size construction cores for a new job, suffix ICX to non-Primus cylinder number. Example: 30-008 ICX. For existing construction core combinations, specify ICA, ICB, or ICC
- 2) Construction cores for a given project are keyed alike to one of a limited number of combinations nationwide. Other Schlage projects in the same area using the same or different contractors may use the same key

Example: For construction core charges and credits: distributor XYZ ordered 150 construction cores with 20 keys and one control key

The following charges apply to this order:

1. 23-030-ICX construction cores (150 units)
2. 48-101-ICX cut keys (20 units)
3. 48-056-ICX cut control key (1 unit)
4. 50-231 non-refundable handling charge (150 units-one per core ordered)

Upon return of the cores to the factory the distributor will be credited for the following:

1. 23-030-ICX construction cores (150 units)

There is no credit for the keys or handling fee

B60 Cylinder Options

FINISHES

		605	608	609	618	619	625	626	505	716	613	620	621	622
B60J	B60 less IC core	•	\$89	•	\$89	\$89	•	\$89	\$91	\$91	•	•	•	•
B60T	B60 with Full Size Construction core	•	132.00	•	132.00	132.00	•	132.00	134.00	134.00	•	•	•	•

J Series Parts
Latches



16-254



16-255

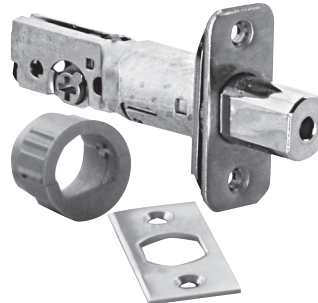

16-068

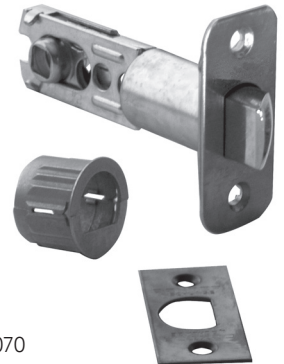

16-070

J Series Parts
Latches

LATCHES

FINISHES

Function	Pkg.	Style/Design	FINISHES							
			605	609	619	625	626	630	620	716
16-254	Poly Bag	Dual Option Adjustable Spring Latch	\$6.50	\$6.50	•	•	•	\$6.50	•	\$6.50
16-255	Poly Bag	Triple Option Adjustable Dead Latch	8.90	8.90	•	•	•	8.90	•	8.90
16-068	Poly Bag	Triple Option Adjustable Deadbolt Latch	9.20	9.20	•	•	•	9.20	•	9.20
16-070	Poly Bag	Triple Option Adjustable Spring Latch	8.90	8.90	•	•	•	8.90	•	8.90
16-059*	Poly Bag	UL-Springlatch, 2 3/8" or 2 3/4"	6.00	6.00	•	•	•	6.00	•	6.00
16-061*	Poly Bag	UL-Deadlatch, 2 3/8" or 2 3/4"	6.00	6.00	•	•	•	6.00	•	6.00
16-063*	Poly Bag	UL-Deadbolt, 2 3/8" or 2 3/4"	6.00	6.00	•	•	•	6.00	•	6.00
16-057*	Poly Bag	UL-Springlatch 16-059 and UL-Deadbolt 16-063	11.50	11.50	•	•	•	11.50	•	11.50

* Sold with complete UL lockset; not available for individual purchase

Note: 1) 630 latches are used for all 619,620, 625, 626 finishes.
2)UL latches available with square corner faceplate only.

Strikes

J Series Parts

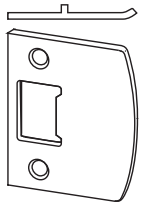

10-100

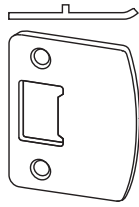

10-101

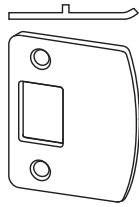

10-102



10-103

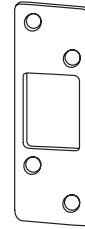

10-104

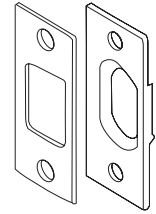

10-099

STRIKES

FINISHES

Part No. w/Lock	Part. No. Sold Separately	Style/Design	FINISHES							
			605	609	619	625	626	630	620	716
10-100	J250-008	Poly Bag , Square Full Lip Strike Knobs and Levers Including 2 Screws	\$2.00	\$2.00	•	•	•	\$2.00	•	\$2.00
10-101	J250-009	Poly Bag , Radius Full Lip Strike Knobs and Levers Including 2 Screws	2.00	2.00	•	•	•	2.00	•	2.00
10-102	J250-010	Poly Bag , Radius Full Lip Strike Deadbolts Including 2 Screws	2.00	2.00	•	•	•	2.00	•	2.00
10-103	J250-026	Poly Bag , Radius Deadbolt Strike 1" x 2 1/4" Round Corner	2.00	2.00	•	•	•	2.00	•	2.00
10-104	J250-027	Poly Bag , Radius Deadbolt Strike 1 1/4" x 3 5/8" Round Corner	2.40	2.40	•	•	•	2.40	•	2.40
10-099	J250-003	Poly Bag , Sq. Strike Plate & Strike Frame Reinforcer 1 1/8" x 2 3/4" Square Corner Deadbolts Including 2 Screws + 2 x 3" Screws	2.40	2.40	•	•	•	2.40	•	2.40

Note: 1) 630 strikes are used for all 619, 620, 625, 626 finishes.

J Series Parts
REKEYING PINNING PARTS & ACCESSORIES

Function	Style Design	Price
J750-002	#1 Top Pin, 200 pcs/per poly bag	\$0.06
J750-003	#2 Top Pin, 200 pcs/per poly bag	0.06
J750-004	#3 Top Pin, 200 pcs/per poly bag	0.06
J750-005	#0 Bottom Pin, 200 pcs/per poly bag	0.06
J750-006	#1 Bottom Pin, 200 pcs/per poly bag	0.06
J750-007	#2 Bottom Pin, 200 pcs/per poly bag	0.06
J750-008	#3 Bottom Pin, 200 pcs/per poly bag	0.06
J750-009	#4 Bottom Pin, 200 pcs/per poly bag	0.06
J750-010	#5 Bottom Pin, 200 pcs/per poly bag	0.06
J750-011	#6 Bottom Pin, 200 pcs/per poly bag	0.06
J750-012	#7 Bottom Pin, 200 pcs/per poly bag	0.06
J750-013	#8 Bottom Pin, 200 pcs/per poly bag	0.06
J750-014	#9 Bottom Pin, 200 pcs/per poly bag	0.06
J750-015	#2 Master Pin, 200 pcs/per poly bag	0.06
J750-016	#3 Master Pin, 200 pcs/per poly bag	0.06
J750-017	#4 Master Pin, 200 pcs/per poly bag	0.06
J750-018	#5 Master Pin, 200 pcs/per poly bag	0.06
J750-019	#6 Master Pin, 200 pcs/per poly bag	0.06
J750-020	#7 Master Pin, 200 pcs/per poly bag	0.06
J750-021	#8 Master Pin, 200 pcs/per poly bag	0.06
J750-022	#9 Master Pin, 200 pcs/per poly bag	0.06
J750-023	Pin Tumbler Key Gauge	3.80
J750-024	Plug Clip, 50 pcs/per poly bag	0.06
J750-025	Pin Spring, 100 pcs/per poly bag	0.12
J750-026	Cylinder Cap, 50 pcs/per poly bag	0.12
J750-027	Deadbolt Spring, 100 pcs/per poly bag	0.12
J750-028	Deadbolt Cap Pin, 100 pcs/per poly bag	0.06
J750-029	Follower Tool	4.20
J750-030	Cylinder Removing Tool	3.40
J750-001	RCK Lost Balls, 200 pcs/per poly bag	0.04
J250-029	Spanner Wrench for removing cylinder face	1.10
Key Kits		
J250-006	Master Rekeying Kit	\$167.00
J250-007	Retail Key Kit	135.00

HANDLESET THROUGHOLT KITS

FINISHES

Function	Style/Design	605	609	619	625	626	630	620	716
								for use with 619/625/626/630 finishes	
J250-036	Handleset Throughbolt Kit - throughbolt screw, washer, and cap	\$2.30	\$2.30	.	.	.	\$2.30	\$2.30	\$2.30

- Ordering part includes interior and exterior tailpiece
Notes: 1) 630 throughbolt cap also used for 619/625/626

J Series Parts

- Master keys must be ordered separately and are not added by default

REKEYING PINNING PARTS & ACCESSORIES

Function	Style Design	Price
Keys Ordered with Locks or Cylinders		
50-001	Lock Keyed to a Specific Combination	\$9.70
50-215	Extra Cut Keys Ordered on Lock with Cylinder	4.20
Residential Master Keying (RMK)		
50-223	Cylinder Residential Master Keyed	2.60
49-155	Residential Master Key	10.50
Residential Construction Keying (RCK)		
50-224	Cylinder Residential Construction Keyed	2.60
48-155	Residential Construction Key	6.20
Key Blanks		
J750-061	5-Pin Standard Bow, Embossed Both Sides, No Stamping, C-Section Only, (order in quantities of 50)	0.80

Notes

Cables, Chains & Padlocks

Padlocks

Padlocks	108
Cables & Chains	109
Security Hasps	111



KS43F
Brass Padlock



KS72F
Steel Padlock

Commercial Security - Rekeyable Padlocks

UPC	Description	Shackle Height (in.)	Shackle Cable Link Dia. (in.)	Size (in.)	Size (mm)	Price
720018997412	Brass Padlock 23 Series, K-N-K Cyl 1 1/2" Shackle, KD	1 1/2	5/16	1 25/32	45mm	\$62.60
720018997405	Brass Padlock 23 Series Brass K-N-K Cyl 2" Shackle, KD	2	5/16	1 25/32	45mm	62.80
720018997290	Brass Padlock 43 Series Brass K-N-K Cyl 1 1/2" Shackle, KD	1 1/2	3/8	1 15/16	50mm	66.60
720018997283	Brass Padlock 43 Series Brass K-N-K Cyl 2" Shackle, KD	2	3/8	1 15/16	50mm	67.00
720018997764	Steel Padlock - 72 Round body, K-N-K Cyl 2", KD	2	7/16	2 5/8	67.5mm	72.10



850410
Laminated Padlock



855156
Steel Padlock



851226
Steel Padlock

FlexSecurity - Non Rekeyable Padlocks

UPC	Description	Shackle Height (in.)	Shackle Cable Link Dia. (in.)	Size (in.)	Size (mm)	Price
720018850410	Covered Laminated Steel Padlock, 2 Pack - KA	1 1/8	1/4	1 1/2	38mm	\$26.20
720018999232	Extra Large "U" Steel Padlock 4" x 11", - KD	11	1/2	7 1/8	181mm	38.00
720018855156	Shackle-less Steel, Round body Padlock - KD	•	3/8	2 7/8	73mm	47.60
720018851226	Steel Padlock, Round body 2" Shackle - KA	2	7/16	2 1/2	63.5mm	37.80
720018994831	Steel Padlock, Round body 2" Shackle - KA, 2-Pack	2	7/16	2 1/2	63.5mm	72.10

Cables & Chains



999218
Locking Cable



994862
Double Looped
Cable & Padlock



999225
Locking Resettable
Combination Cable



001140
Locking Chain

FlexSecurity - Cables & Chains

UPC	Description	Shackle Cable Link Dia. (in.)	Loop Height (in.)	Loop Width (in.)	Chain/Cable Length (ft.)	Price
720018001140	Locking Chain - 5' x 5/16" (7mm)	5/16	•	•	5	\$42.80
720018001157	Locking Chain - 4' x 3/16" (5mm)	7/32	•	•	4	26.10
720018994800	Double Looped Cable & Padlock - 4' x 3/8" with Covered Weather-proof Padlock	3/8	2 1/4	•	4	27.20
720018994862	Double Looped Cable & Padlock - 15' x 3/8" with Covered Weather-proof Padlock	3/8	2 1/4	•	15	42.70
720018999201	Rekeyable Locking Cable - 6' x 5/8"	5/8	•	•	6	70.00
720018999218	Locking Cable - 5' x 1/2"	1/2	•	•	5	29.00
720018999225	Locking Resettable Combination Cable - 5' x 3/8"	3/8	•	•	5	30.10

Cables, Chains & Padlocks



999263
Double Loop Cable



999461
Cinch Chain

FlexSecurity - Double Looped Cables

UPC	Description	Shackle Cable Link Dia. (in.)	Loop Height (in.)	Loop Width (in.)	Chain/Cable Length (ft.)	Price
720018820406	Double Looped Cable - 7' x 5/8"	5/8	•	3 3/8	7	\$43.00
720018999249	Double Looped Cable - 4' x 3/8"	3/8	•	1 1/8	4	15.80
720018999256	Double Looped Cable - 7' x 3/8"	3/8	•	1 1/8	7	20.20
720018999263	Double Looped Cable - 15' x 3/8"	3/8	•	1 1/8	15	34.20
720018999270	Double Looped Cable - 30' x 3/8"	3/8	•	1 1/8	30	55.00

FlexSecurity - Cinch Chains

UPC	Description	Shackle Cable Link Dia. (in.)	Loop Height (in.)	Loop Width (in.)	Chain/Cable Length (ft.)	Price
720018999461	Cinch Ring Security Chain - 3' 3" - (No lock)	1/2	•	•	3.25	\$49.70
720018999478	Cinch Ring Security Chain - 5' - (No Lock)	1/2	•	•	5	94.00

Security Hasps



855101

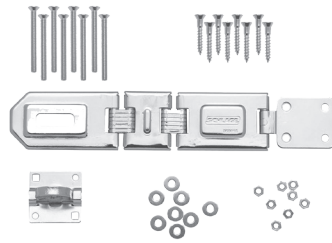

855118



855125



994848

FlexSecurity - Hasps

UPC	Description	Body Size (in.)	Body Size (mm)	Locking Eye Dia. (in.)	Price
720018855101	Vehicle Security Hasp	8 1/2 x 4 1/2	21.6cm x 11.4cm	5/8	\$39.20
720018855118	Flexible Double-Hinged Security Hasp	7 3/4 x 1 3/4	19.7cm x 4.4cm	1/2	12.50
720018855125	Center Hole Security Hasp	5 x 2	12.7cm x 5.1cm	1/2	11.90
720018994848	Steel Bar Security Hasp	4 1/2 x 1 5/8	11.4cm x 4.1cm	1/2	6.40

Product Warranties	112
General Terms & Conditions	119
Standard Product Terms & Conditions	124

PRODUCT WARRANTIES

COMMERCIAL APPLICATIONS

Limited Warranty

Schlage Lock Company, LLC (the "Company") extends a three year limited warranty to the original user of the products manufactured by the Company (the "Products") against defects in material and workmanship from the date of purchase. Certain Products contain restrictions to this limited warranty, additional warranties, or different warranty periods. Please see below for specific Product warranty information.

What The Company Will Do: Upon return of the defective Product to the Company or its authorized distributor for inspection, free and clear of all liens and encumbrances and accompanied by the statement of defects of proof of purchase, the Company will replace the Product.

Original User: These warranties only apply to the Original User of Products. These warranties are not transferable.

What Is Not Covered: The following costs, expenses and damages are not covered by the provisions of this limited warranty: (i) labor costs including, but not limited to, such costs as the removal and reinstallation of Product; (ii) shipping and freight expenses required to return Product to Schlage; (iii) failures, defects, or damage (including, but not limited to, any security failure or loss of data) caused by any third party product, service, or system connected or used in conjunction with the Product; and (iv) any other incidental, consequential, indirect, special and/or punitive damages, whether based on contract, warranty, tort (including, but not limited to, strict liability or negligence), patent infringement, or otherwise, even if advised of the possibility of such damages.

The provisions of these limited warranties do not apply to Products: (i) used for purposes for which they are not designed or intended; (ii) which have been subjected to alteration, misuse, abuse, negligence, or accident; (iii) which have been improperly stored, installed, maintained, repaired or operated; (iv) which have been used in violation of written instructions provided by Schlage; (v) which have been subjected to improper temperature, humidity, or other environmental

conditions (i.e., corrosion); or (vi) which, based on the Company's examination, do not disclose to the Company's satisfaction non-conformance to the warranties. Additionally, the Company will not warrant ANSI A156.2 Grade 2 lever Product installed in educational facilities and student housing.

Additional Terms: The Company does not authorize any person to create for it any obligation or liability in connection with the Products. The Company's maximum liability under these warranties is limited to the purchase price of the Product. No action arising out of any claimed breach of these warranties by the Company may be brought by the Original User more than one (1) year after the cause of action has arisen.

How Local Law Applies: These warranties give you specific legal rights, and you may also have other rights permitted by law.

SPECIFIC PRODUCT WARRANTY RESTRICTIONS/ ADDITIONAL WARRANTIES:

ND-Series Levers 7-Year Mechanical Warranty

The limited warranty is for a period of seven (7) years from the date of purchase and is subject to the restrictions of these limited warranties.

Small Format Interchangeable Core (SFIC) Warranty

The limited warranty also applies to Schlage locks and housings when used with another manufacturer's cores, or to Schlage cores (i.e, SFIC) when used in another manufacturer's locks and housings. The use of unauthorized cylinder cams or other components with the Products shall void these warranties.

Everest® Primus® and Everest Primus XP Limited Lifetime Key Breakage Warranty

A limited lifetime warranty is provided to the original user against breakage and is subject to the restrictions of these limited warranties.

Portable Security Limited Lifetime Warranty

A limited lifetime warranty is provided to the original user and is subject to the restrictions of these limited warranties.

RESIDENTIAL APPLICATIONS

Lifetime Limited Mechanical & Finish Warranty and 3-Year Limited Electronics Warranty

Subject to the terms and conditions of this warranty, Schlage extends a lifetime limited mechanical and finish warranty and a three-year limited electronics warranty to the original consumer user ("Original User") of our Schlage brand product ("Product") against defects in material and workmanship, as long as the Original User occupies the residential premises upon which the Product was originally installed.

What Schlage will do: Upon return of the defective Product to Schlage, Schlage's sole obligation, at its option, is to either repair or replace the Product, or refund the original purchase price in exchange for the Product. Original User: This warranty only applies to the Original User of Products. This warranty is not transferable.

What Is Not Covered: The following costs, expenses and damages are not covered by the provisions of this limited warranty: (i) labor costs including, but not limited to, such costs as the removal and reinstallation of Product; (ii) shipping and freight expenses required to return Product to Schlage; (iii) failures, defects, or damage (including, but not limited to, any security failure or loss of data) caused by any third party product, service, or system connected or used in conjunction with the Product; and (iv) any other incidental, consequential, indirect, special and/or punitive damages, whether based on contract, warranty, tort (including, but not limited to, strict liability or negligence), patent infringement, or otherwise, even if advised of the possibility of such damages.

The provisions of this warranty do not apply to Products: (i) used in commercial applications; (ii) used in common area applications; (iii) used for purposes for which they are not designed or intended; (iv) which have been subjected to alteration, abuse, misuse, negligence or accident; (v) which have been improperly stored, installed, maintained or operated; (vi) which have been used in violation of written instructions provided by Schlage; (vii) which have been subjected to improper temperature, humidity or other environmental conditions; or (viii) which, based on Schlage's examination, do not disclose to Schlage's satisfaction non-conformance to the warranty. Additionally, this warranty DOES NOT COVER scratches, abrasions, or deterioration due to the use of paints, solvents or other chemicals.

Exclusions: Oil Rubbed Bronze finish (613) is designed to improve over time and change in appearance, creating a living finish through daily use and thus, finish discoloration is not applicable to the above warranty. Additional terms: Schlage does not authorize any person to create for it any obligation or liability in connection with the Product. Schlage's maximum

liability here under is limited to the original purchase price of the Product. No action arising out of any claimed breach of this warranty by Schlage may be brought by the Original User more than one (1) year after the cause of action has arisen.

How local law applies: This warranty gives you specific legal rights, and you may also have other rights as otherwise permitted by law. If this Product is considered a consumer product, please be advised that some local laws do not allow limitations on incidental or consequential damages or how long an implied warranty lasts, so that the above limitations may not fully apply. Refer to your local laws for your specific rights under this warranty.

Guaranteed Fit Program: Schlage products are designed to fit standard residential door preparations and retrofit existing tubular locks. Note: Mortise locks and preparations are not considered standard and are not guaranteed under this program. During the initial installation, if there is a problem with the Product's performance, the Original User may simply contact Schlage Customer Service at 888-805-9837 in the U.S. and Canada or 800-506-7866 in Mexico for assistance.

Program and warranty claims: If you encounter a residential door preparation or fit issue under the Guaranteed Fit Program or have a claim under this warranty, please contact Schlage Customer Service for repair, replacement or refund of the original purchase price in exchange for the return of the Product to Schlage.

J-Series Lifetime Mechanical Warranty and 5-year Finish Warranty

Subject to the terms and conditions of this warranty, Schlage Lock Company, LLC ("Schlage") extends a lifetime limited mechanical and 5-year finish warranty to the original consumer user ("Original User") of Dexter by Schlage products ("Product") against defects in material and workmanship, as long as the Original User occupies the residential premises upon which the Product was originally installed.

What Schlage will do: Upon return of the defective Product to Schlage, Schlage's sole obligation, at its option, is to either repair or replace the Product, or refund the original purchase price in exchange for the Product. Original User: This warranty only applies to the Original User of Products. This warranty is not transferable.

What is not covered: The following costs, expenses and damages are not covered by the provisions of this limited Warranty: (i) labor costs including, but not limited to, such costs as the removal and reinstallation of Product; (ii) shipping and freight expenses required to return Product to Schlage; and (iii) any other incidental, consequential, indirect, special and/or punitive damages, whether based on contract, warranty, tort (including, but not limited to, strict liability or negligence), patent infringement, or otherwise, even if advised of the possibility of such damages. Some local laws do not allow the exclusion or limitation of incidental or consequential damages, so the above exclusion or limitation may not apply to you.

The provisions of this warranty do not apply to Products: (i) used in commercial applications; (ii) used in common area applications; (iii) used for purposes for which they are not designed or intended; (iv) which have been subjected to alteration, abuse, misuse, negligence or accident; (v) which have been improperly stored, installed, maintained or operated; (vi) which have been used in violation of written instructions provided by Schlage; (vii) which have been subjected to improper temperature, humidity or other environmental conditions; or (viii) which, based on Schlage's examination, do not disclose to Schlage's satisfaction non-conformance to the warranty. Additionally, this warranty DOES NOT COVER scratches, abrasions, or deterioration due to the use of paints, solvents or other chemicals.

PRODUCT WARRANTIES, ADDITIONAL TERMS & CONDITIONS:

Commercial and Residential Applications

Additional Terms: The Company does not authorize any person to create for it any obligation or liability in connection with the Products. The Company's maximum liability under these warranties is limited to the purchase price of the Product. No action arising out of any claimed breach of these warranties by the Company may be brought by the Original User more than one (1) year after the cause of action has arisen.

How Local Law Applies: This warranty gives you specific legal rights, and you may also have other rights as otherwise permitted by law.

Note: Should the Product be considered a consumer product as may be covered by the Magnusson Moss Federal Warranty Act, please be advised that: (1) Some states do not allow limitations or incidental consequential damages or how long an implied warranty lasts so that the above limitations may not fully apply; and (2) This warranty gives specific legal rights and a user may have other rights which may vary from state to state.

For warranty service and shipping instructions contact:

Schlage Customer Commitment Center
2119 East Kansas City Road
Olathe, KS 66061
(800) 847-1864, Option 1
(888) 805-9837 Consumer
Fax (800) 366-5625

The Schlage Lock Company, LLC reserves the right to make changes in designs and specifications or to make additions or improvements on its products without notice and without incurring any obligation to incorporate them on products previously manufactured. The Schlage Lock Company, LLC is not responsible for any modification, addition or alteration to our products by others.

DISTRIBUTION FUNCTION AND LOCATION POLICY

The Schlage customer relationship includes the non-exclusive area of primary sales responsibility and the channel of distribution assigned by Schlage. It is vital to our success and for the effective management of the distribution of our products that the Schlage customer relationship, once it is satisfactorily established between us, should not be changed without our approval. Therefore, after selection by Schlage as a distributor of one or more of Schlage products, a customer should continue to perform that distribution function from the location of its business at the place or places utilized at the time of selection. A customer should not change its Schlage distribution function or establish a different or additional location without the prior written consent of Schlage.

Schlage reserves the right to discontinue, after appropriate notice, sale of its products to any customer which refuses to adhere to this policy. Schlage also reserves the right to change, in its sole discretion, the number and locations of the distributors authorized to distribute its products in any area. This determination will be based upon, among other considerations, the success or failure in developing the market for Schlage products.

HARDWARE FINISHES

Schlage Lock finishes are durable, top quality finishes obtained by the careful processing of solid brass, bronze, stainless steel or other materials. Where required, a protective clear coating is applied and cured under high temperature. It is important that climatic conditions and usage be taken under consideration when selecting finishes. This is especially true in areas subjected to strong corrosive vapors, humid

climate or sea air which, in a short time, may have a damaging effect on metal finishes. The longevity and preservation of the finish appearance is determined by base metal and finishing process. Clear protective coating or other organic finishing applications may require different methods of cleaning and care. As an example, non-clear coated finishes should not be cleaned with soaps or any solvents; organically coated surfaces should periodically be cleaned with a mild, nonabrasive soap and buffed lightly with a clean cloth. The type of base metal and finishing techniques must be considered when applying any cleaning or preservative method. Contact the Schlage Technical Services Department for further information on the care of finished hardware.

In some instances, for customer convenience, the most appropriate BHMA finish symbols are used to indicate similarity of appearance, regardless of base metal of finishing process. A, AL, D, ND, F, FA, H, S, S200-Series and Dexter by Schlage levers are zinc-based material and are plated to match finishes indicated. Finishes of latches, strikes, cylinders/cores, and visible mounting screws, though similar in appearance, may differ from the finish of the trim. Finish numbers in the 600-Series are the BHMA (Builders Hardware Manufacturers Association) industry standard.

Finish Codes and Descriptions:

The nearest old U.S. equivalent code designations are shown in parenthesis ().

Code	Description
505	Bright Brass
605 (3)	BRIGHT BRASS, Clear Coated
608	Satin Brass
609 (5)	ANTIQUÉ BRASS, Satin Brass, Blackened, Satin Relieved, Clear Coated
613* (10B)	OIL RUBBED BRONZE, Oxidized Satin Bronze, Oil Rubbed, No Coating
618	Polished Nickel
619 (15)	SATIN NICKEL, Satin Nickel Plated, Clear Coated
620 (15A)	ANTIQUÉ PEWTER, Satin Nickel Plated, Blackened, Satin Relieved, Clear Coated
621	Distressed Nickel, Clear Coated
622	MATTE BLACK, Coated
625 (26)	BRIGHT CHROMIUM PLATED, No Coating
626 (26D)	SATIN CHROMIUM PLATED, No Coating
630 (32D)	SATIN STAINLESS STEEL, No Coating
716	AGED BRONZE, Clear Coated

* Oil rubbed bronze (613) is considered a category "B" finish by ANSI/BHMA and will vary in color when applied to different alloys and forms of base material. 613 will also vary from production lot and additionally from one manufacturer to another. Oil rubbed bronze will wear off over time due to the "rubbed" finishing method that has no protective coating or plating.

Dexter J Series Grade 3 finishes have durable, top quality finishes obtained by the careful processing of solid brass, stainless steel or other materials. Where required, a protective clear coating is applied and cured under high temperature. It is important that climatic conditions and usage be taken under consideration when selecting finishes. This is especially true in areas subjected to strong corrosive vapors, humid climate or sea air which, in a short time, may have a damaging effect on metal finishes. The longevity and preservation of the finish appearance is determined by base metal and finishing process. Clear protective coating or other organic finishing applications may require different methods of cleaning and care. As an example, non-clear coated finishes should not be cleaned with soaps or any solvents; organically coated surfaces should periodically be cleaned with a mild, non-abrasive soap and buffed lightly with a clean cloth. The type of base metal and finishing techniques must be considered when applying any cleaning or preservative method. Contact the Schlage Technical Service Department for further information on the care of finished hardware.

In some instances, for customer convenience, the most appropriate Builders Hardware Manufacturers Association (BHMA) finish symbols are used to indicate similarity of appearance, regardless of base metal of finishing process. J-Series levers are zinc-based material and are plated to match finishes indicated. Finish numbers in the 600-Series are the BHMA industry standard. The nearest old U.S. equivalent code designations are shown in parentheses. Refer to each lock series section for standard finish availability.

Finish Codes and Descriptions:

Code	Description
605 (US3)	BRIGHT BRASS, Clear Coated
609 (US5)	ANTIQUÉ BRASS, Satin Brass, Blackened, Satin Relieved, Clear Coated
619 (US15)	SATIN NICKEL, Clear Coated
620 (US15A)	ANTIQUÉ PEWTER, Clear Coated
625 (US26)	BRIGHT CHROME, Clear Coated
626 (US26D)	SATIN CHROME, No Coating
630 (US32D)	SATIN STAINLESS STEEL, No Coating
716	Aged Bronze, Clear Coated

Lifetime Mechanical Warranty

Schlage Lock Company, LLC ("Schlage") extends a lifetime Mechanical Warranty to the original user ("User") of Dexter by Schlage products ("Product") against mechanical defects in material and workmanship as long as the User occupies the residential premises in which the Product was originally installed.

This warranty DOES NOT COVER (i) product finish, (ii) abused or misused Products, or (iii) Products used in commercial applications. Upon return of a defective Product to Schlage, Schlage shall either replace the Product or refund the purchase price in exchange for the Product.

SCHLAGE MAKES NO OTHER WARRANTY, CONDITION OR REPRESENTATION OF ANY KIND WHATSOEVER, EXPRESSED OR IMPLIED, STATUTORY OR OTHERWISE, EXCEPT THAT OF TITLE, AND ALL IMPLIED WARRANTIES AND CONDITIONS RELATING TO MERCHANTABILITY AND FITNESS FOR A PARTICULAR PURPOSE, ARE HEREBY DISCLAIMED. IN NO EVENT SHALL SCHLAGE BE LIABLE FOR ANY INCIDENTAL, SPECIAL, INDIRECT, PUNITIVE OR CONSEQUENTIAL DAMAGES ARISING FROM THE SALE, USE OR MISUSE OF THIS PRODUCT.

Note: Some states do not allow limitations on incidental, special, or consequential damages, so the above limitations may not fully apply.

This warranty gives specific legal rights, and you may also have other rights which vary from state to state.

5-Year Finish Warranty

Schlage Lock Company, LLC ("Schlage") extends a 5-Year Finish Warranty to the original user ("User") of Dexter by Schlage products ("Product") against tarnishing, and damage from corrosives like salt, sun, humidity and cleaning products for a period of 5 years provided that the User continues to occupy the residential premises in which the Product was originally installed.

This warranty DOES NOT COVER (i) scratches or abrasion, (ii) abused or misused Products, or (iii) Products used in commercial applications. Upon return of a defective Product to Schlage, Schlage shall either replace the Product or refund the purchase price in exchange for the Product.

SCHLAGE MAKES NO OTHER WARRANTY, CONDITION OR REPRESENTATION OF ANY KIND WHATSOEVER, EXPRESSED OR IMPLIED, STATUTORY OR OTHERWISE, EXCEPT THAT OF TITLE, AND ALL IMPLIED WARRANTIES AND CONDITIONS RELATING TO MERCHANTABILITY AND FITNESS FOR A PARTICULAR PURPOSE, ARE HEREBY DISCLAIMED. IN NO EVENT SHALL SCHLAGE BE LIABLE FOR ANY INCIDENTAL, SPECIAL, INDIRECT, PUNITIVE OR CONSEQUENTIAL DAMAGES ARISING FROM THE SALE, USE OR MISUSE OF THIS PRODUCT.

Note: Some states do not allow limitations on incidental, special, or consequential damages, so the

above limitations may not fully apply. This warranty gives specific legal rights, and you may also have other rights which vary from state to state.

Product Warranties, Additional Terms and Conditions

THE COMPANY MAKES NO OTHER WARRANTY, AND ALL IMPLIED WARRANTIES INCLUDING ANY WARRANTY OF MERCHANTABILITY OR FITNESS FOR A PARTICULAR PURPOSE ARE HEREBY DISCLAIMED. THE COMPANY'S MAXIMUM LIABILITY HEREUNDER IS LIMITED TO THE PURCHASE PRICE OF THE PRODUCT. IN NO EVENT SHALL THE COMPANY BE LIABLE FOR ANY CONSEQUENTIAL, INDIRECT, INCIDENTAL OR SPECIAL DAMAGES OF ANY NATURE ARISING FROM THE SALE OR USE OF THIS PRODUCT, WHETHER IN CONTRACT, TORT, STRICT LIABILITY OR OTHERWISE.

Should the Product be considered a consumer product as may be covered by the Magnusson Moss Federal Warranty Act, please be advised that:

(1) Some states do not allow limitations on incidental consequential damages or how long an implied warranty lasts so that the above limitations may not fully apply; (2) This warranty gives specific legal rights and a buyer may also have other rights which may vary from state to state.

For warranty service and shipping instructions, contact the:

Schlage Customer Commitment Center
2119 East Kansas City Road
Olathe, KS 66061
(800) 847-1864, option 1
(888) 805-9837, consumer
fax (800) 366-5625

Schlage reserves the right to make changes in designs and specifications or to make additions or improvements on its products without notice and without incurring any obligation to incorporate them on products previously manufactured. Schlage is not responsible for any modification, addition or alteration to our products by others.

Distribution Function and Location Policy

The Schlage customer relationship includes the non-exclusive area of primary sales responsibility and the channel of distribution assigned by Schlage. Each member of the Schlage channel of distribution is free to sell in any area and at any price. It is vital to our success and for the effective management of the distribution of our products that the Schlage customer relationship, once it is satisfactorily established between us, should not be changed without our approval. Therefore, after selection by Schlage as a distributor of one or more of Schlage products, a customer should continue to perform that distribution function from the location

of its business at the place or places utilized at the time of selection. A customer should not change its Schlage distribution function or establish a different or additional location without the prior written consent of Schlage.

Schlage reserves the right to discontinue, after appropriate notice, sale of its products to any customer which refuses to adhere to this policy. Schlage also reserves the right to change, in its sole discretion, the number and locations of the distributors authorized to distribute its products in any area. This determination will be based upon, among other considerations, the success or failure in developing the market for Schlage products.

CONNECTED HOME PRODUCTS WARRANTY

PATENT NOTICE: Schlage® products and those of its subsidiary companies and licensees may be covered by both issued and pending U.S. and foreign patents, copyrights and trademarks.

Manufactured items are covered by one or more of the following patents:

5070715	5152558	5308131	5395144	5593193
5598726	5640863	5683127	5715717	5765412
5769472	5809816	5816086	5820290	5881590
5918916	6286347	6297725	6523375	6533336
6540274	6581426	6802546	6905773	6926319
7143477	7159424	D372417	D372854	D406056
D406528	D426452	D428324	D450558	D457048
D457049	D458829	D467155	D472788	D487388
D520331	D520332	D537702	D541620	D543435

LOCK PRODUCT: Lifetime Limited Mechanical and Finish Warranty and 3-Year Limited Electronics Warranty Subject to the terms and conditions of this warranty, Schlage extends a lifetime limited mechanical and finish warranty and a three- year limited electronics warranty to the original consumer user (“Original User”) of our Schlage brand lock product (“Lock Product”) against defects in material and workmanship, as long as the Original User occupies the residential premises upon which the Lock Product was originally installed.

Guaranteed Fit Program: Schlage Lock Products are designed to fit standard residential door preparations and retrofit existing tubular locks. Note: Mortise locks and preparations are not considered standard and are not guaranteed under this program. During the initial installation, if there is a problem with the Lock Product’s performance, the Original User may simply contact Schlage Customer Service at 877-288- 7707 in the U.S. and Canada.

NON-LOCK PRODUCT: 1-Year Limited Mechanical and Electronics Warranty Subject to the terms and conditions of this warranty, Schlage extends a 1-year limited mechanical and electronics warranty to the original consumer user (“Original User”) of our Schlage brand non-lock

product used in conjunction with our Lock Product (“Non- Lock Product”) against defects in material and workmanship, as long as the Original User occupies the residential premises upon which the Lock Product was originally installed. “Lock Product” and “Non-Lock Product” are collectively referred to herein as “Product”.

What Schlage will do: Upon return of the defective Product to Schlage, Schlage’s sole obligation, at its option, is to either repair or replace the Product, or refund the original purchase price in exchange for the Product.

Original User: This warranty only applies to the Original User of Products. This warranty is not transferable.

What is not covered: The following costs, expenses and damages are not covered by the provisions of this limited warranty: (i) labor costs including, but not limited to, such costs as the removal and reinstallation of Product; (ii) shipping and freight expenses required to return Product to Schlage; (iii) failures, defects, or damage (including, but not limited to, any security failure or loss of data) caused by any third party product, service, or system connected or used in conjunction with the Product; and (iv) any other incidental, consequential, indirect, special and/ or punitive damages, whether based on contract, warranty, tort (including, but not limited to, strict liability or negligence), patent infringement, or otherwise, even if advised of the possibility of such damages. The provisions of this warranty do not apply to Product: (i) used in commercial applications; (ii) used in common area applications; (iii) used for purposes for which they are not designed or intended; (iv) which have been subjected to alteration, abuse, misuse, negligence or accident; (v) which have been improperly stored, installed, maintained or operated; (vi) which have been used in violation of written instructions provided by Schlage; (vii) which have been subjected to improper temperature, humidity or other environmental conditions; or (viii) which, based on Schlage’s examination, do not disclose to Schlage’s satisfaction non-conformance to the warranty. Additionally, this warranty DOES NOT COVER scratches, abrasions, or deterioration due to the use of paints, solvents or other chemicals.

Exclusions: Oil Rubbed Bronze finish (613) is designed to improve over time and change in appearance, creating a living finish through daily use and thus, finish discoloration is not applicable to the above warranty. Additional terms: Schlage does not authorize any person to create for it any obligation or liability in connection with the Product. Schlage’s maximum liability hereunder is limited to the original purchase price of the Product. No action arising out of any claimed breach of this warranty by Schlage may be brought by the Original User more than one (1) year after the cause of action has arisen.

Warranties

How local law applies: This warranty gives you specific legal rights, and you may also have other rights as otherwise permitted by law. If this Product is considered a consumer product, please be advised that some local laws do not allow limitations on incidental or consequential damages or how long an implied warranty lasts, so that the above limitations may not fully apply. Refer to your local laws for your specific rights under this warranty.

Program and warranty claims: If you encounter a residential door preparation or fit issue under the Guaranteed Fit Program or have a claim under this warranty, please contact Schlage Customer Service for repair, replacement or refund of the original purchase price in exchange for the return of the Product to Schlage.

For details on terms and conditions please visit:

www.allegion.ca/policies

For details on terms and conditions please visit:

www.allegion.ca/policies

For details on terms and conditions please visit:

www.allegion.ca/policies

For details on terms and conditions please visit:

www.allegion.ca/policies

For details on terms and conditions please visit:

www.allegion.ca/policies

STANDARD PRODUCT TERMS AND CONDITIONS

Residential

The following specific product terms and conditions supersede the general terms and conditions of sale and service only to the extent provided herein. All other terms and conditions contained in the General Terms and Conditions of Sale and Service provided in this Price Book will govern the sale of products identified in this Price Book.

Residential Patent Numbers:

5070715	5765412	6523375	D372417	D458829
5152558	5769472	6533336	D372854	D467155
5308131	5809816	6540274	D406056	D472788
5395144	5816086	6581426	D406528	D487388
5593193	5820290	6802546	D426452	D520331
5598726	5881590	6905773	D428324	D520332
5640863	5918916	6926319	D450558	D537702
5683127	6286347	7143477	D457048	D541620
5715717	6297725	7159424	D457049	D543435

The price list in this price book supersedes and cancels all previous price lists contained in any other price books or versions thereafter. Prices shown are subject to change without notice. All prices are subject to discount. Products considered "Specials" ("X" designated part numbers) fall outside of standard discount terms. Contact customer service for clarification.

Service Charges: Service charges on past due invoices (except validly disputed items) will be assessed as follows: 1 1/2% per month or the maximum allowable by law on past due amounts open as of the last day of each calendar month until the past due amounts are paid.

Changes or Cancellations: Changes or cancellations to an order must be in writing and may result in additional charges for labor and/or materials. Changes may result in a delay in the scheduled ship date. Additions to orders will be entered as separate stand-alone orders and must qualify for all terms of sale, including discounts, on an individual basis. Changes or deletions resulting in an order size of less than our minimum will not be accepted. Orders for non-cataloged, special or nonstandard items may not be canceled. Factory orders may not be changed within 7 days.

Claims and Returns: Claims for shortages and/or incorrectly filled orders must be filed with Customer Service within 10 days of receipt of material. Price adjustments must also be made in writing to Customer Service within 30 days from receipt of invoice. No returned goods will be accepted without written approval from Schlage. Credit will be based upon the written authorization of the IR Schlage represen-

tative and final acceptance by Schlage. Such returns must be prominently marked with the return goods authorization number and shipped prepaid. Returns, if approved, will be subject to a minimum restocking charge of 35% for unopened cases received in the same condition as when sold by Schlage. Non-stock materials are not returnable. Charge-backs will not be allowed.

Shipping: a. Freight Charges. Company will ship all Deliverables in accordance with Company's freight shipment guidelines, which are set forth on the My Allegion Portal ("Freight Shipping Guidelines"), **WHICH TERMS ARE EXPRESSLY INCORPORATED HEREIN.** b. Rush Charges. Expedited order options are available as set forth in Company's Freight Shipping Guidelines. c. Packing and Marking. Company will pack, mark, and ship Deliverables according to its standard procedures for shipment, unless the parties agree, in writing, that Company will comply with any special instructions provided by Customer. Special instructions may result in an increased price. d. International Shipments. For all international orders, a Shipper's letter of instruction must be submitted in writing with the order. Failure to do so will result in the order being rejected. Complete adherence to this order requirement will be strictly enforced. Company will not be held liable for any charges resulting from delays due to lack of complete required information being supplied. e. Once received by the Company, a purchase order cannot be combined with any other order to increase average order size as it relates to Company's Freight Shipping Guidelines. However, for orders placed under Company's FastTrack 24 Hour/5 Day Program (available for Schlage, Von Duprin, LCN and Glynn-Johnson products); ii) FastTrack 24 Hour/3 Day Program (available for Ives products); or ProExpress (available for specific product lines stated in the ProExpress price book for Falcon, Ives, Glynn Johnson, LCN, Schlage and Von Duprin products), the applicable brands or product categories may, subject to certain order requirements identified by Company, be combined on a single order to increase average order size used in Company's Freight Shipping Guidelines.

Taxes: Prices do not include any present or future Federal, State or local property, license, privilege, sales, use, excise, gross receipts or other like taxes or assessments which may result from transactions or any services performed in connection therewith.

Delivery: Orders will be assigned ship dates and acknowledged accordingly, based on estimates of availability of products. Specific scheduled ship dates are not guaranteed by Schlage because of the nature of

STANDARD PRODUCT TERMS AND CONDITIONS

product, labor, availability of material or manufacturing conditions that might be beyond our control. Schlage will not be liable for back charges incurred based on availability of product in accordance with acknowledged ship dates.

Certifications: Schlage products, as noted in our catalog, are produced and tested by independent laboratories for compliance with UL and ANSI standards. Any field modification or alteration of product will void certification.

Thank you for your order.

Thank you for your order and continuing business. Please submit purchase orders to Canada.orders.service@allegion.com In order to expedite order processing, please include the following information on purchase orders:

- Schlage account number
- Product UPC numbers (if available)
- Quote number (if applicable)
- Specific keying requirements

Note: Line quantities of keyed products must be divisible by KA quantities.

Example: 20 locks ordered KA4 results in 5 groups of 4 locks keyed alike, however, 20 locks ordered KA3 is not divisible and results in order processing delays as Schlage seeks clarification

- Door handing

How to identify door handing:

Handing of all doors is determined from the exterior of the room's entrance.

- If the hinge is on the left side of the door, the door is "left hand" (LH)
- If the hinge is on the right side of the door, the door is "right hand" (RH)
- To order a handed product, please specify LH or RH
- To order a handleset, handing is still determined from the exterior of the door
- We will use that information to determine the handing for the inside of the door



VISUAL PACK CARTON SPECIFICATIONS

PRODUCT	MASTER CARTON							INDIVIDUAL CARTON					
	PKG. TYPE	CASE QTY	HEIGHT (IN.)	WIDTH (IN.)	DEPTH (IN.)	CUBIC FEET	WEIGHT (LBS.)	PKG. TYPE	HEIGHT (IN.)	WIDTH (IN.)	DEPTH (IN.)	CUBIC FEET	WEIGHT (LBS.)
ELECTRONICS CONNECTED DEADBOLTS & LEVERS													
BE365	Box	2	10.05	5.90	12.60	0.43	9.87	Carton	9.30	5.25	6.19	0.17	4.75
BE375	Box	2	9.70	5.60	9.90	0.31	8.09	Carton	4.50	5.00	9.30	0.12	3.87
BE468	Box	2	9.75	5.60	10.10	0.32	9.05	Carton	9.25	4.50	5.00	0.12	4.35
BE469	Box	2	9.75	5.60	10.10	0.32	9.05	Carton	9.25	4.50	5.00	0.12	4.35
BE479AA	Box	1	6.75	6.05	10.00	0.24	5.49	Carton	9.50	5.38	5.38	0.16	5.14
FBE365	Box	3	23.63	11.60	10.63	1.69	21.40	Carton	7.88	10.70	9.75	0.48	6.45
FBE375	Box	3	10.63	11.25	23.63	1.64	19.40	Carton	9.75	10.70	7.88	0.48	5.92
FE595	Box	2	10.00	7.00	16.88	0.68	10.29	Carton	9.25	8.25	6.63	0.29	4.86
FE695	Box	2	10.10	7.05	12.60	0.52	9.96	Carton	9.40	6.65	6.20	0.22	4.72
F SERIES HANDLESETS													
F60 V	Box	1	21.38	8.30	7.00	0.72	8.00	Carton	20.5	8.0	6.5	0.617	8.0
F62 V	Box	1	22.88	8.30	7.00	0.77	8.00	Carton	22.0	8.0	6.5	0.662	8.0
B SERIES DEADBOLTS													
B60 V	Shroud	4	8.6	5.88	16.00	0.56	9.00	Carton	7.7	5.1	3.6	0.105	2.0
B62 V	Shroud	4	8.6	5.88	16.00	0.56	9.80	Carton	7.7	5.1	3.6	0.105	2.2
FB50 V	Shroud	4	10.125	8.875	15.625	0.81	17.20	Carton	9.5	7.875	3.625	0.16	3.60
FB52 V	Shroud	4	10.125	8.875	15.625	0.81	18.00	Carton	9.5	7.875	3.625	0.16	3.80
F SERIES KNOBS/LEVERS													
Knobs													
F10 V	Shroud	4	10.125	5.875	13.125	0.45	9.40	Carton	9.5	4.875	3.125	0.08	2.10
F40 V	Shroud	4	10.125	5.875	13.125	0.45	9.40	Carton	9.5	4.875	3.125	0.08	2.10
F51A V	Shroud	4	10.125	5.875	13.125	0.45	9.40	Carton	9.5	4.875	3.125	0.08	2.10
F170 V	Shroud	4	9.38	5.75	13.25	0.41	3.00	Carton	8.8	4.8	3.3	0.078	0.4
Levers													
F10 V	Shroud	4	10.125	7.25	13.125	0.67	11.40	Carton	9.5	6.50	3.125	0.13	2.60
F40 V	Shroud	4	10.125	7.25	13.125	0.67	11.40	Carton	9.5	6.50	3.125	0.13	2.60
F51A V	Shroud	4	10.125	7.25	13.125	0.67	11.40	Carton	9.5	6.50	3.125	0.13	2.60
F170 V	Shroud	4	9.38	5.75	13.25	0.41	3.00	Carton	8.8	4.8	3.3	0.078	0.4
F SERIES DECORATIVE COLLECTIONS													
Knobs													
F10 V	Shroud	4	11.00	5.875	14.25	0.53	9.40	Carton	5.25	5.125	6.50	0.10	2.10
F40 V	Shroud	4	11.00	5.875	14.25	0.53	9.40	Carton	5.25	5.125	6.50	0.10	2.10
F51A V	Shroud	4	11.00	5.875	14.25	0.53	9.40	Carton	5.25	5.125	6.50	0.10	2.10
Levers													
F10 V	Shroud	4	11.00	7.375	14.25	0.67	11.40	Carton	5.25	6.50	6.50	0.13	2.60
F40 V	Shroud	4	11.00	7.375	14.25	0.67	11.40	Carton	5.25	6.50	6.50	0.13	2.60
F51A V	Shroud	4	11.00	7.375	14.25	0.67	11.40	Carton	5.25	6.50	6.50	0.13	2.60
DEXTER J SERIES GRADE 3 LOCKS													
JW60V	Shroud	4	7.87	5.99	7.87	0.37	5.25	Carton	7	4.33	2.9	0.05	1.17
JH60V	Shroud	1	18.43	6.02	7.85	0.5	5.26	Carton	17.13	5.12	7.48	0.38	4.91
J54V Knob	Shroud	4	10.63	6.22	14.69	0.56	5.4	Carton	9.76	4.92	2.93	0.08	1.19
J40V Knob	Shroud	4	10.63	6.22	14.69	0.56	4.64	Carton	9.76	4.92	2.93	0.08	1.02
J10V Knob	Shroud	4	10.63	6.22	14.69	0.56	4.37	Carton	9.76	4.92	2.93	0.08	0.93
J54V Lever	Shroud	4	10.63	8.35	14.69	0.75	8.31	Carton	9.76	7.28	2.96	0.12	1.85
J40V Lever	Shroud	4	10.63	8.35	14.69	0.75	6.97	Carton	9.76	7.28	2.96	0.12	1.58
J10V Lever	Shroud	4	10.63	8.35	14.69	0.75	6.77	Carton	9.76	7.28	2.96	0.12	1.53

NOTE: Vispack products must be ordered in full case quantities.

How to order

PORTABLE SECURITY

Product	Master Carton							Inner Pack					Individual Selling Unit (ea.)					
	Pkg. Type	Case Qty.	Ht. (in.)	Wid. (in.)	Dpt. (in.)	Cubic Ft.	Wt. (lbs.)	Inner Pkg. Type	Case Qty.	Ht. (in.)	Wid. (in.)	Dpt. (in.)	Pkg. Type	Ht. (in.)	Wid. (in.)	Dpt. (lbs.)	Cubic Ft.	Wt. (lbs.)
Padlock 23 Series Brass K-N-K Cyl 1 1/2" Shackle, KD	Box	24	7.17	10.39	8.70	0.37	26.49	Box	6	2.76	7.76	4.53	Box	4.13	2.31	1.00	0.006	1.10
Padlock 23 Series Brass K-N-K Cyl 2" Shackle, KD	Box	24	7.17	11.34	8.70	0.41	26.49	Box	6	2.76	7.76	5.00	Box	4.63	2.31	1.00	0.006	1.10
Padlock 43 Series Brass K-N-K Cyl 1 1/2" Shackle, KD	Box	24	7.17	10.39	8.70	0.37	28.7	Box	6	2.76	7.76	4.53	Box	4.13	2.31	1.00	0.006	1.21
Padlock 43 Series Brass K-N-K Cyl 2" Shackle, KD	Box	24	7.17	11.34	8.70	0.41	28.7	Box	6	2.76	7.76	5.00	Box	4.63	2.31	1.00	0.006	1.21
Padlock 72 Round Steel K-N-K Cyl 2", KD	Box	18	4.27	17.27	9.79	0.42	54.95	Box	6	3.27	9.29	5.59	Box	4.94	2.81	1.19	0.010	0.85
Covered Laminated Steel Padlock - 2 Pack - KA	Box	18	14.50	9.00	19.25	1.45	24	Display	3	7.10	8.27	5.31	Blister	6.50	7.75	2.00	0.058	1.12
Extra Large "U" Padlock 4" x 11", KD	Box	Display	4	14.00	7.30	8.70	Bulk/ Belly-Band	12.50	7.00	1.75	0.089	2.30
Shackle-less Padlock, KD	Box	36	19.25	12.25	20.75	2.83	88	Display	6	8.75	6.50	11.25	Blister	7.75	5.00	2.00	0.045	2.25
Padlock Round Steel, 2" Shackle, KA	Box	18	19.50	7.50	19.75	1.67	36	Box	3	9.00	6.70	6.30	Box	7.50	4.75	1.50	0.031	1.60
Padlock Round Steel, 2" Shackle, KA - 2-Pack	Box	18	19.00	10.00	18.75	2.06	64	Box	3	9.00	8.70	6.30	Box	7.50	7.50	1.50	0.049	3.20
Rekeyable Locking Cable 6' x 5/8" Replaced item 997719)	Box	Display	5	12.75	7.75	17.25	Bulk/ Insert Card	12.00	10.00	1.50	0.104	3.00
Double Looped Cable 4' x 3/8" with Covered Weather-proof Padlock	Box	Display	4	9.45	11.40	8.66	Bulk/ Insert Card	10.00	8.50	1.50	0.074	1.30
Double Looped Cable 15' x 3/8" with Covered Weather-proof Padlock	Box	Display	4	10.60	12.20	9.40	Bulk/ Insert Card	11.00	9.50	1.50	0.091	2.70
Locking Cable 5' x 1/2"	Box	Display	4	12.00	5.10	7.28	Bulk/ Insert Card	10.00	3.75	1.25	0.027	1.00
Locking Resettable Combination Cable 5' x 3/8"	Box	Display	4	10.25	5.75	7.25	Bulk/ Insert Card	10.00	5.25	1.25	0.038	1.16

PORTABLE SECURITY (cont)

Product	Master Carton							Inner Pack					Individual Selling Unit (ea.)					
	Pkg. Type	Case Qty.	Ht. (in.)	Wid. (in.)	Dpt. (in.)	Cubic Ft.	Wt. (lbs.)	Inner Pkg. Type	Case Qty.	Ht. (in.)	Wid. (in.)	Dpt. (in.)	Pkg. Type	Ht. (in.)	Wid. (in.)	Dpt. (lbs.)	Cubic Ft.	Wt. (lbs.)
Locking Chain 5' x 5/16" (7mm)	Box	3	11.75	9.25	14.00	.	16.70	Display	3	11.25	9.25	14.00	Blister	13.50	8.25	1.75	.	4.95
Locking Chain 4' x 7/32" (3.5mm)	Box	3	9.75	8.25	10.00	.	7.55	Display	3	9.25	7.75	9.25	Blister	10.50	7.00	1.35	.	2.20
Double Looped Cable 7' x 5/8"	Box	Display	5	11.25	12.00	10.75	Bulk/ Insert Card	10.50	11.50	2.00	0.140	2.70
Double Looped Cable 30' x 3/8"	Box	Display	4	10.50	11.75	10.75	Bulk/ Insert Card	10.50	10.00	3.00	0.182	4.40
Double Looped Cable 15' x 3/8"	Box	Display	4	12.38	9.79	7.88	Bulk/ Insert Card	9.00	9.00	2.00	0.094	2.26
Double Looped Cable 7' x 3/8"	Box	Display	4	13.91	6.20	5.75	Bulk/ Insert Card	12.00	7.00	1.00	0.049	1.21
Double Looped Cable 4' x 3/8"	Box	Display	4	11.75	6.20	5.25	Bulk/ Insert Card	10.50	5.50	1.00	0.033	0.60
Cinch Ring Security Chain 3' 3" - (No lock)	Box	2	7.50	4.25	7.25	0.13	14	Box	1	3.60	3.85	3.50	Bulk/ Hang Tag	22.50	3.50	2.00	0.091	6.85
Cinch Ring Security Chain 5' - (No Lock)	Box	2	7.75	4.25	7.25	0.14	20	Box	1	3.60	3.85	3.50	Bulk/ Hang Tag	33.00	3.50	2.00	0.134	10.60
Vehicle Hasp	Box	18	11.50	17.25	26.00	2.98	59	Display	3	10.50	8.25	8.25	Blister	9.75	5.25	2.25	0.067	2.95
Flexible Dbl-Hinged Hasp 7 3/4" x 1 3/4"	Box	36	22.50	14.50	17.50	3.30	49	Display	6	10.50	5.25	14.00	Blister	9.50	3.75	1.75	0.036	1.05
Center Hole Hasp 5" x 2"	Box	36	21.00	17.50	19.00	4.04	65	Display	6	10.00	5.50	18.00	Blister	9.50	3.75	2.50	0.052	1.33
90 Degree Hasp 4 1/4" x 1 5/8"	Box	36	20.75	15.50	19.50	3.63	64	Display	6	9.50	6.00	15.00	Blister	8.50	4.25	2.50	0.052	1.29
Heavy Duty Steel Bar Hasp 7 1/4" x 1 5/8"	Box	36	22.50	14.50	17.50	3.30	63	Display	6	10.50	5.25	13.75	Blister	9.50	4.00	2.75	0.060	1.40
Steel Bar Hasp 4 1/2" X 1 5/8"	Box	24	11.00	10.25	20.00	1.30	13	Display	6	10.25	5.00	9.50	Blister	7.75	3.75	1.25	0.021	0.35
Repl Accessory Service Repair Kit, SFIC, KNK, Specialty	Box	6	14.75	18.25	11.25	1.75	63.7	Box	1	2.38	18.25	11.25	Box



About Allegion

Allegion (NYSE: ALLE) is a global pioneer in safety and security, with well-known brands like CISA®, Interflex®, LCN®, Schlage® and Von Duprin®. Focusing on security around the door and adjacent areas, Allegion produces a range of solutions for homes, businesses, schools and other institutions. Allegion is a \$2 billion company, with products in more than 120 countries around the world.

For more, visit www.allegion.ca