

TELEDYNE SEALED BATTERIES



The Gill LT Sealed line provides reliable sealed valve regulated lead acid (VRLA) batteries with higher starting power, higher residual power and faster re-charging. These batteries are ideal for the high demands of Jet, Rotor and Turbo aircraft and for anyone who needs more power. They are backed by a 2 year mfg. warranty and do not require a capacity check for a full 18 months.



LT SEALED BATTERY SPECIFICATIONS

Model	Volts	Amp Hours	30 Minute Emergency Capacity	Max Weight lbs.	Power Performance (A)						Part No.	Price
					73F (23C)		0F (-18C)		-22F (-30C)			
					IPP	IPR	IPP	IPR	IPP	IPR		
7025-20	12	20	32	22.6	1125	850	725	550	500	400	11-13274	\$274.00
7025-24	12	24	33	23.4	1100	825	725	550	500	400	11-16889	\$346.00
7035-28	12	28	45	30.0	1,599	1,088	1,100	840	850	600	11-11312	\$324.00
7035-34	12	34	55	31.4	1557	1040	1028	710	800	575	11-16890	\$346.00
7242-14	24	14	22	28.9	1,200	270	720	230	512	220	11-15282	\$698.00
7242-16	24	16	25	29.7	1,100	480	640	300	495	250	11-17223	\$798.00
7243-14	24	14	22	29.0	1,200	270	720	230	512	220	11-13534	\$715.00
7243-16	24	16	25	29.8	1,100	480	640	300	495	250	11-11210	\$682.00
7246-20	24	20	28	43.9	1,250	850	810	550	610	410	11-15485	\$825.00
7407-28	24	28	45	66.5	1,599	1,088	1,100	840	850	600	11-14426	\$4,385.00
7638-36	24	36	63	84.9	1,660	1,260	1,300	985	980	775	11-10756	\$2,529.00
7638-44	24	44	70	88.6	1,857	1,247	1,677	1,051	1,411	948	11-12594	\$2,516.00
7638-44ST	24	44	70	91.0	1,857	1,247	1,677	1,051	1,411	948	11-16277	\$3,577.00
7638-44T	24	44	70	88.6	1,857	1,247	1,677	1,051	1,411	948	11-14439	\$2,998.00
7638-48P	24	48	75	97.3	2,200	1,600	1,660	1,240	1,350	1,005	11-14093	\$2,752.00
7638-53	24	53	80	95.8	1,959	1,323	1,526	1,021	1,225	828	11-10759	\$3,358.00
7639-25	24	25	45	61.8	1,503	1,002	1,104	734	793	596	11-10758	\$2,370.00
7639-27	24	27	45	61.8	1,503	1,002	1,104	734	793	596	11-07462	\$2,810.00
7639-30LT	24	30	50	66.3	1,627	1,173	1,180	870	849	642	11-13535	\$2,367.00
7639-34	24	34	55	66.4	1,636	1,168	962	774	761	604	11-10757	\$2,429.00
7641-20	24	20	35	44.3	1,430	920	850	560	630	410	11-06245	\$2,529.00

**FREE UPS GROUND* SHIPPING IN 48 STATES NO UPS HAZARDOUS CHARGE.
*SOME RESTRICTIONS MAY APPLY.**

SEE OUR WEBSITE FOR A COMPLETE SELECTION OF BATTERIES AND APPLICATION CHARTS AT WWW.AIRCRAFTSPRUCE.COM.

GILL DRY CHARGE BATTERIES

The Gill LT Sealed line provides reliable sealed valve regulated lead acid (VRLA) batteries with higher starting power, higher residual power and faster re-charging. These batteries are ideal for the high demands of Jet, Rotor and Turbo aircraft and for anyone who needs more power. They are backed by a 2 year mfg. warranty and do not require a capacity check for a full 18 months.



DRY CHARGED (FLOODED NOT SEALED) BATTERY SPECIFICATIONS

Model	Volts	Amp Hours (C1)	30 Minute Emergency Rate. (A)	Electrolyte (Qts.)	60 Second Discharge at -18°C (0°F, A)	Weight lbs	Part No.	Price
G-25	12	18	30	2	225	21.3	11-01833	\$240.95
G-35	12	23	40	3	250	27	11-01832	\$296.95
G-242	24	10	17	3	150	27	11-01657	\$562.00
G-243	24	10	17	3	150	28	11-01658	\$549.00
G-244	24	18	30	4	225	38.5	11-01555	\$698.00
G-245	24	18	30	4	225	39.5	11-01660	\$695.00
G-246	24	19	32	4	250	41.5	11-01661	\$615.00
G-247	24	19	32	4	250	42.5	11-01772	\$710.00
G-6381E	24	43	70	9	445	80	11-01557	\$2,562.00
G-639E	24	24	40	5	345	55	11-04158	\$2,137.00
G-640C	24	14	25	3	180	34	11-04159	\$1,076.00
GE-50C	24	31	55	8	325	80	11-03808	\$1,130.00
GE-50E	24	31	55	8	325	80	11-03809	\$1,149.00
GE-51E	24	22	35	4	235	56	11-04192	\$1,082.00
GE-54C	24	10	16	3	106	34	11-01558	\$931.00
G-88	12	65	108	8	500	78	11-04011	\$1,910.00
G-641	24	18	30	4	275	41.5	11-02448	\$1,531.00

EL



GILL BATTERY ELECTROLYTE (ACID)

Battery electrolyte (battery grade sulfuric acid) in sealed polyethylene pouch with self-contained dispenser tube, packaged in sturdy cardboard container. Specific gravity 1.285. Detailed filling & disposal instructions on container.

2 Quarts P/N 11-00300 \$7.65
 3 Quarts P/N 11-00305 \$10.75

Free UPS Ground* Shipping in 48 States No UPS Hazardous Charge.
 *Some restrictions may apply.

SEE OUR WEBSITE FOR A COMPLETE SELECTION OF BATTERIES AND APPLICATION CHARTS AT WWW.AIRCRAFTSPRUCE.COM.

CONCORDE BATTERIES

Concorde Battery Corporation has hand crafted safe and reliable batteries in West Covina, California for over 40 years. A dedicated Research & Development Department continuously improves and refines the Recombinant Gas (RG®) product line resulting in industry leading performance and reliability in sealed Valve Regulated Lead Acid (VRLA) batteries. Concorde batteries are the choice of OEM, DOM, owners and pilots due to unmatched performance, quality, safety and customer support.

Concorde Batteries are certified for installation, and as Original Equipment, on more aircraft than any other lead acid battery.

NOTE - The STCs for some aircraft may be required at an additional cost please call 877-4-SPRUCE (777823) if applicable to your aircraft.

Concorde batteries are designed with large positive and negative plates, aircraft quality terminals (brass terminal bolts with conical silicon bronze lock washers), and robust over the partition intercell connections. These unique features contribute to an increase in capacity, greater sustained starting power in extreme heat and at sub-zero temperatures and increased longevity. RG® Series batteries feature fully aerobatic sealed construction; no spillable electrolyte or flammable gas emissions.

CONCORDE GENERAL AVIATION SEALED LEAD ACID BATTERIES



RG-25 RG-25XC RG-35A RG-35AXC RG-24-11 RG-24-11M RG-380E/44

“XC” in the model number indicates extra cranking power. “M” in the model number indicates manifold venting.

Model No.	Battery Type	Connect Type	Amp Hour	Volt	Part No.	Price
RG-25	Sealed Lead Acid	A	22	12	11-03879	\$299.00
RG-25XC	Sealed Extra Crank	A	24	12	11-03880	\$346.00
RG-35A	Sealed Lead Acid	A	29	12	11-03881	\$375.00
RG-35AXC	Sealed Extra Crank	A	33	12	11-03882	\$409.00
RG-2411	Sealed Lead Acid	A	11	24	11-03876	\$679.00
RG-2411 M	Sealed Lead Acid	A	11	24	11-03877	\$715.00
RG24-9	Sealed Lead Acid	M	9	24	11-11608	\$618.00
RG24-10	Sealed Lead Acid	M	9	24	11-11609	\$615.00

Model No.	Battery Type	Connect Type	Amp Hour	Volt	Part No.	Price
RG-12LSA	Sealed Lead Acid	A	11.00	12	11-09455	\$327.00
RG24-15	Sealed Lead Acid	A	13.60	24	11-03878	\$775.00
RG24-15M	Sealed Lead Acid	A	13.60	24	11-04951	\$775.00
RG24-16	Sealed Lead Acid	A	13.60	24	11-05112	\$775.00
RG24-20	Sealed Lead Acid	A	19	24	11-00174	\$925.00
RG-380E/44*	Sealed Lead Acid	E	42	24	11-03883	\$3,228.00
RG24-12	Sealed Lead Acid	M	11	24	11-11612	\$674.00

CONCORDE CORPORATE BATTERIES

Model	Capacity	Connector Type	Weight	Part No.	Price
RG-28-7	9	GG	32	11-11613	\$3,117.00
RG-42	17	E	44	11-11614	\$3,497.00
RG-45	12	U	35	11-11616	\$2,574.00
RG-46	12	E	35	11-11617	\$2,544.00
RG-47	17	U	44	11-11618	\$2,975.00
RG-49	17	E	44	11-11619	\$2,814.00
RG-76	44	E	102	11-11621	\$5,080.95
RG-91	22	E	57	11-11643	\$4,060.00
RG-120	0.7	W	5	11-11645	\$1,493.00
RG-121-1	2	L	8	11-11647	\$1,646.00
RG-121-2	2	L	8	11-11650	\$1,858.00
RG-121-3	3.3	L	12	11-11654	\$1,894.00
RG-121-4	3.3	L	12	11-11655	\$3,040.00
RG-122-1	2	L	8	11-11656	\$1,774.00
RG-122-2	2	L	8	11-11657	\$2,853.00
RG-122-3	3.3	L	12	11-11658	\$2,014.00
RG-122-4	3.3	L	12	11-11659	\$3,096.00
RG-123	11	F	28	11-11660	\$2,709.00
RG-123-1	11	F	28	11-11661	\$2,207.00
RG-124	17	N	43	11-11662	\$6,497.00
RG-124-1	17	N	43	11-11664	\$5,293.00
RG-125	3.5	J	14	11-11666	\$1,897.00
RG-126	3.5	K	14	11-11668	\$1,989.00
RG-128-1	3.8	P	16	11-11673	\$2,912.00
RG-128-2	3.8	P	16	11-11676	\$3,033.00
RG-128-3	3.8	P	16	11-11678	\$3,038.00
RG-129	3.8	B	16	11-11681	\$4,851.00
RG-130-1	11	F	28	11-11682	\$3,079.00
RG-130-2	11	F	28	11-11687	\$3,925.00
RG-132	6	Y	16	11-10853	\$3,047.00
RG-135	2	V	8	11-11689	\$3,142.00
RG-140	7	E	16	11-11694	\$2,793.00
RG-145-1	17	E	44	11-11695	\$3,794.00
RG-145-2	17	E,L	44	11-11696	\$4,785.00
RG-206	17	E	43	11-11388	\$2,895.00
RG-209	22	E	52	11-11701	\$5,671.00

Model	Capacity	Connector Type	Weight	Part No.	Price
RG-222	17	E	43	11-11385	\$3,234.00
RG-223	17	E	44	11-11702	\$3,527.00
RG-224	24	E	52	11-11383	\$3,389.00
RG-292-102	17	E	43.5	11-17172	\$3,740.00
RG-292-103A	24	E	53	11-17173	\$4,350.00
RG-235	44	E	88	11-13428	\$4,301.00
RG-300	11	X	11	11-11703	\$2,102.00
RG-325	17	M	53	11-11704	\$2,562.00
RG-330	17	M	63	11-11706	\$3,284.00
RG-332-1	38	BB,II	90	11-13429	\$6,683.00
RG-332-2	38	BB,II	90	11-13430	\$8,127.00
RG-343	38	E	29	11-11707	\$3,677.00
RG-350	38	U	42	11-11386	\$2,857.00
RG-355	38	U	42	11-11387	\$2,823.00
RG-380E/40B	38	E	85	11-11708	\$3,222.00
RG-380E/40D	38	E	86	11-13431	\$5,644.00
RG-380E/40K	38	E	86	11-11709	\$3,500.00
RG-380E/40KH	38	E	84	11-11711	\$6,123.00
RG-380E/40KS	38	E	88	11-11712	\$3,785.00
RG-380E/40KSH	38	E	88	11-11713	\$6,839.00
RG-380E/40L	38	E	86	11-11456	\$3,985.00
RG-380E/40LH	38	E	86	11-11714	\$6,125.00
RG-380E/40LS	38	E	88	11-11716	\$3,989.00
RG-380E/40LSH	38	E	88	11-11718	\$6,411.00
RG-380E/44	42	E	90	11-03883	\$3,228.00
RG-380E/44K	42	E	92	11-11623	\$3,968.00
RG-380E/44KH	42	E	92	11-11624	\$6,362.00
RG-380E/44KS	42	E	93	11-11625	\$4,168.00
RG-380E/44KSH	42	E	93	11-11626	\$6,353.00
RG-380E/44L	42	E	92	11-02949	\$3,969.00
RG-380E/44LH	42	E	92	11-11627	\$6,056.00
RG-380E/44LS	42	E	93	11-11628	\$4,245.00
RG-380E/44LSH	42	E	93	11-11629	\$6,278.00
RG-380E/46	46	E	90	11-11630	\$3,556.00
RG-380E/46K	46	E	92	11-11631	\$3,487.00
RG-380E/53GH	53	-	97.4	11-19209	\$6,672.00

EL

CONCORDE BATTERIES

CONCORDE CORPORATE BATTERIES

Model	Capacity	Connector Type	Weight	Part No.	Price
RG-380E/46KH	46	E	92	11-11632	\$5,930.00
RG-380E/46KS	46	E	93	11-11634	\$3,749.00
RG-380E/46KSH	46	E	93	11-11635	\$7,309.00
RG-380E/46L	46	E	92	11-11636	\$3,806.00
RG-380E/46LH	46	E	92	11-11637	\$6,092.00
RG-380E/46LS	46	E	93	11-11638	\$4,220.00
RG-380E/46LSH	46	E	93	11-11639	\$6,850.00
RG-380E/53K	53	E	94	11-11640	\$4,188.00
RG-380E/53KH	53	E	94	11-11641	\$6,672.00
RG-380E/53KSH	53	E	95	11-11646	\$7,419.00
RG-380E/53L	53	E	94	11-11649	\$4,635.00
RG-380E/53L	STC Kit Only				\$1,007.00
RG-380E/53L	Sovereign STC Kit with Batteries, Temp Sensors, STC			11-16841	\$10,154.00
ST04366AT	Sovereign STC Only - Buy 2 RG-380E/53L Separately			11-16834	\$884.00
RG-380E/53LH	53	E	94	11-11651	\$6,672.00
RG-380E/53LS	53	E	95	11-11652	\$5,576.00
RG-380E/53LSH	53	E	95	11-11653	\$6,999.00
RG-380E/60B	48	E	100	11-11663	\$5,839.00
RG-380E/60F	48	E	100	11-11665	\$7,478.00
RG-380E/60K	48	E	100	11-11667	\$4,056.00
RG-380E/60KH	48	E	100	11-11672	\$6,144.00
RG-380E/60KS	48	E	102	11-11674	\$3,799.00
RG-380E/60KSH	48	E	102	11-11677	\$6,851.00
RG-380E/60L	48	E	100	11-10837	\$4,127.00
RG-380E/60L	STC Kit Only			11-17551	\$1,007.00
RG-380E/60L	Sovereign STC Kit with 2 Batteries, Temp Sensors, STC			11-16839	\$9,138.00
ST04366AT	Sovereign STC Only - Buy 2 RG-380E/60L Separately			11-16834	\$884.00
RG-380E/60L	With STC Kit for Cessna Sovereign			11-16839	\$9,138.00
RG-380E/60LH	48	E	100	11-11679	\$6,144.00

Model	Capacity	Connector Type	Weight	Part No.	Price
RG-380E/60LS	48	E	102	11-11684	\$4,337.00
RG-380E/60LSH	48	E	102	11-11686	\$6,419.00
RG-385	13	E	36	11-11688	\$3,523.00
RG-390E	28	E	64	11-11384	\$3,125.00
RG-390E/KH	28	E	64	11-11717	\$5,706.00
RG-390E/KSH	28	E	66	11-11719	\$5,836.00
RG-390E/L	28	E	64	11-11721	\$3,955.00
RG-390E/LH	28	E	64	11-11723	\$5,706.00
RG-390E/LS	28	E	66	11-11725	\$4,310.00
RG-390E/LSH	28	E	66	11-11728	\$5,836.00
RG-390ES	28	E	64	11-11730	\$3,195.00
RG-390E/25	25	E	55	11-11732	\$2,936.00
RG-390E/25L	25	E	57	11-11733	\$3,191.00
RG-390E/25LS	25	E	59	11-11736	\$3,966.00
RG-390E/25S	25	E	55	11-11738	\$2,998.00
RG-390E/30	30	E	63	11-15456	\$3,258.00
RG-400E/13	13	E	38	11-11741	\$2,344.00
RG-407	27	E	64	11-10836	\$4,558.00
RG-41/53	53	E	96	11-18415	\$4,728.00
RG-41/53 with STC	53	E	96	11-18427	\$4,995.00
RG-412-1	15	E	50	11-11740	\$3,805.00
RG-412-2	15	G & E	50	11-11739	\$5,753.00
RG-418-1	24	E	66	11-13432	\$6,005.00
RG-418-2	24	G & E	666	11-13433	\$7,290.00
RG-427	34	E	81	11-12015	\$5,327.00
RG-441	44	E	90	11-11737	\$6,276.00
RG-442	44	E	90	11-11735	\$6,496.00
RG-443	11	E	29	11-02948	\$3,165.00
RG-445E	18	E	45	11-11729	\$3,994.00
RG-500	17	E	45	11-04738	\$3,475.00
RG-600-1	17	E	45	11-11726	\$3,458.00
RG-600-2	17	E	45	11-11724	\$3,490.00
RG-616	6	HH	18	11-13434	\$3,033.00
RG-641	17	E	43	11-12016	\$2,686.00

EL

CONCORDE ARINC SERIES EMERGENCY BATTERIES

Model	Capacity	Connector Type	Weight	Part No.	Price
RG-131	12	H	36	11-13436	\$4,629.00
RG-150-1	3.5	Z	18	11-13437	\$6,618.00
MB-150-1	3.5	N/A	16	11-13439	\$2,850.00
RG-150-2	3.5	Z	18	11-13440	\$9,607.00
MB-150-2	3.5	N/A	16	11-13441	\$5,841.00
BS-150-A	3.5	Z	14	11-13442	\$3,008.00

Model	Capacity	Connector Type	Weight	Part No.	Price
RG-150-1-[y]	3.5	Z	18	11-13443	\$5,738.00
MB24-3.5-1	3.5	N/A	14	11-13444	\$2,459.00
RG-150-2-[y]	3.5	Z	18	11-13445	\$8,299.00
MB24-3.5-2	3.5	N/A	14	11-13446	\$5,043.00
BS-150-C	N/A	Z	14	11-13447	\$2,593.00



CONCORDE 4002 BATTERY QUICK DISCONNECT

ELCON type connector
 In accordance with MS 3349-2. This versatile 2 wire connector is capable of mounting with wires coming in from the bottom or wires coming in from the top..... P/N 11-16302 \$212.95

BATTERIES - CHARGERS

POWERSONIC BATTERIES



Power Sonic sealed maintenance-free batteries allow safe, trouble-free operation in any position. You never need to add electrolyte; gases generated during over charge are recombined in a unique "oxygen cycle". Under normal operating conditions, 4 or 5 years of dependable service can be expected in standby applications, or between 200 and 1000 charge/discharge cycles, depending on depth of discharge. Temp. range: -76° to +140°F.

P/N 11-03153

3-AMP Battery - Model: Powersonic PS-1230, PPS SKU: 35L116S1
Shipping Weight: 3 lbs, Dimensions: 5.23"L x 2.64"W x 2.36"H, Voltage: 12 Volts, Capacity: 3 Amp Hour(s), Chemistry: Lead.

P/N 11-03153 **\$34.60**

18-AMP Battery - Model: Powersonic PS-12180NB, PPS SKU: 35L105S3, Shipping Weight: 14 lbs, Dimensions: 7.13"L x 2.99"W x 6.57"H, Voltage: 12 Volts, Capacity: 18 Amp Hour(s), Chemistry: Lead.

P/N 11-03154 **\$135.75**

26-AMP Battery - Model: Powersonic PS-12260NB, PPS SKU: 35L107S1, Shipping Weight: 18 lbs, Dimensions: 6.56"L x 6.97"W x 4.92"H, Voltage: 12 Volts, Capacity: 26 Amp Hour(s), Chemistry: Lead

P/N 11-03155 **\$125.75**

AEROVOLTZ BALANCE CHARGER KIT



The only charger on the market designed specifically to work with the Aerovoltz battery. The primary advantage is the balance charging function. The Balance mode balances the voltage of each cell or cell pack while charging. By balance charging your you insure that the battery is operating at its maximum power. Periodic balance charging can also double the expected life of your battery. This charger is not required to operate your Battery, but it is highly recommended.

120V P/N 11-13081 **\$114.85**

240V P/N 11-13082 **\$116.75**

ANTIGRAVITY 16 CELL SMALL CASE BATTERY

480 Cranking Amps. It is the smallest 16-Cell lithium battery made at only 4.5" Length x 3.25" Depth and 5.25" height (to the top of the terminals).

P/N 11-12104 **\$263.95**



ANTIGRAVITY 20 CELL OEM YTX12-20 BATTERY

600 Cranking Amp and extremely compact size 5.8" Length x 3.4" Depth and 5.12" height (to the top of battery) P/N 11-12105 **\$450.00**



MID-CONTINENT TRUE BLUE CHARGER MX TT28-2

Charge and maintain lithium-ion and lead-acid aircraft batteries with the intelligent and compact TT28-2 True Blue Charger Mx.

Charge and maintain lithium-ion and lead-acid aircraft batteries with the intelligent and compact TT28-2 True Blue Charger Mx. The intelligent True Blue Charger Mx extends battery life and provides simple, safe and automatic charging for lithium-ion and sealed lead-acid aircraft batteries.

The intelligent True Blue Charger Mx extends battery life and provides simple, safe and automatic charging for lithium-ion and sealed lead-acid aircraft batteries. The direct-connect, 2.5-amp charger maintains batteries of any capacity, from zero to full state-of-charge (SOC), while continuously displaying battery voltage. The highly-efficient True Blue Charger Mx can be used for standby maintenance without trickle charging. P/N 10-07287 **\$1,095.00**



BATTERY CORROSION GUARD

Battery Corrosion Guard forms a thin protective coating that will neutralize battery acid on all treated areas. It is an excellent way to clean the battery, hold down straps, and all metal parts you want to protect including cables, clamps, box, and posts. Excellent for aluminum battery boxes. Widely used in the aircraft, truck, and boat industries.

3 oz. can P/N 11-00310 **\$16.65**

8 oz. can P/N 11-00320 **\$24.75**

11 oz. can P/N 11-09615 **\$31.50**



PULSETECH POWERPULSE

PowerPulse is not a charger. It's a performance device designed to help batteries charge faster and provide maximum performance and power. Used extensively by the consumers and the U.S. Military worldwide for almost ten years. The PowerPulse system can also be used together with an existing charging system. In fact, it will work even faster and stronger. This means batteries can be both charged and desulfated at the same time.

12V P/N 11-07464 **\$62.75**



ODYSSEY DRYCELL BATTERIES



11-01651



11-02233



11-01945

Odyssey batteries, with an eight year design life saves you time and money because you do not have to replace your battery as often. It is also the only battery that is capable of delivering a large number of deep cycles up to 400 when fully discharged or up to 500 when discharged to 80%. Plus, the battery is specially designed for high vibration applications.

Unlike conventional batteries that need to be recharged every six to twelve weeks, the Odyssey battery will maintain up to 50% state of charge after 2 yrs if stored at room temperature (77°F). At temperatures lower than 77°F, storage times will be even longer. The cranking power of Odyssey batteries is double to triple that of equally sized conventional batteries, even when the temperature is as low as -40°F. Odyssey batteries may be shipped worry free by UPS/Federal Express or air. 2 Year Warranty

Note: MJ=Metal Jacket. See website for additional Specs.

Part No.	Model	Dimensions	Weight	Price
11-08080	PC-625	6.7" x, 3.90" x 6.89"	13.2	\$177.75
11-08081	PC-545	7/8" x 3-3/16" x 5-1/8"	11.7	\$129.99
11-08082	PC-545MJ	7.0" x 3-3/8" x 5-1/8"	12.6	\$151.99
11-02233	PC-680	7.15" x 3.00" x 6.65"	15.4 Lbs.	\$158.95
11-05173	PC-925	6-15/32" X 6-7/8" X 4-7/8"	24 lbs	\$220.99
11-17113	PC-925L	6.64" x 7.05" x 5.04"	28 lbs	\$220.99
11-01651	PC-925MJ	6-9/16" x 6-7/8" x 5-11/16"	24 Lbs.	\$230.99
11-01945	SBSJ16	7-3/16" x 3-1/16" x 6-9/16"	15 Lbs.	\$217.95

METAL JACKET (TRAY)

For Odyssey 680Amp battery

P/N 11-02234 **\$22.50**



HOLD DOWN BRACKET FOR ODYSSEY 680AMP BATTERY

This hold down bracket for the Odyssey PC 680 battery can be easily mounted in any orientation. **Note:** this is not made of steel, and production methods may leave variance in alignment.

Color: Black P/N 11-01853 **\$38.75**



BATTERY TERMINAL TOOL

This unique tool is designed to provide positive tightening of battery terminals on all popular brands of lead/acid aircraft batteries without over-torquing and without the danger of an electrical short. The tool is made from steel for rugged service and is fully insulated with a rubber hand grip for protection against electrical shorts.

P/N 12-16200 **\$21.95**



MID-CONTINENT TRUE BLUE CHARGER PRO TT28-12

Charge, discharge and evaluate True Blue Power lithium-ion aircraft batteries with the intelligent and easy-to-use TT28-12 True Blue Charger PRO.

The ONLY battery charger to automatically discharge lithium-ion aircraft batteries to 30% state-of-charge, as required for air shipment.

The True Blue Charger PRO is pre-loaded with all charge and discharge parameters for True Blue Power lithium-ion batteries, allowing maintenance personnel to safely and efficiently top charge batteries and perform scheduled capacity checks.

Features: Specifically engineered to charge, discharge and test True Blue Power lithium-ion aircraft batteries:

- TB17 (17 amp-hour) - TB40 (40 amp-hour)
- TB20 (20 amp-hour) - TB44 (46 amp-hour)
- TB30 (30 amp-hour) - TB60 (60 amp-hour) . P/N 10-07286 **\$3,275.00**



EL

BATTERY BOXES - BATTERIES

ALUMINUM BATTERY RACKS & BOXES



RACK



BOX

These top quality battery racks and battery boxes are constructed from 5052 aluminum and are heli-arc welded. A corrosion resistant epoxy powder coating is applied using an electrostatic process and oven baked for a long lasting finish. Complete hold down hardware kits are provided with all racks and boxes, and mount flange are pre-drilled for mounting ease using 3/16" diameter bolts. Use battery racks when mounting in a ventilated area. Use battery boxes when mounting battery in a confined area, where enclosed battery protection is required. Battery boxes include a 1/4" tube for venting and drainage. Specify make and model of battery and horizontal or vertical mount when ordering.

Battery Racks

Part No.	Model	Dimensions	Price
11-00105 Horizontal	HR-25	8"H x 5-3/16"W x 7-7/8"L	\$137.75
11-00110 Vertical	VR-25	8"H x 5-3/16"W x 7 7/8"L	\$137.75
11-00115 Horizontal	HR-35	8"H x 5-3/16"W x 9-7/8"L	\$145.75
11-00120 Vertical	VR-35	8"H x 5-3/16"W x 9-7/8"L	\$143.75

Battery Boxes

Part No.	Model	Dimensions	Price
11-00125 Side load	HB-25	8"H x 5-3/16"W x 7-7/8"L	\$209.00
11-00130 Top Load	VB-25	8"H x 5-3/16"W x 7-7/8"L	\$209.00
11-00135 Top Load	HB-35	8"H x 5-3/16"W x 9-7/8"L	\$209.00
11-00140 Top Load	VB-35	8"H x 5-3/16"W x 9-7/8"L	\$209.00

CESSNA FIREWALL MOUNTED BATTERY BOX



Firewall battery box that allows the SBS-J16 battery to be used for Cessna Models 170, 170A, 170B, 180 thru 180K, 185 thru 185E, A185E, A185F STC Approved: SA02333AK-D.

Note: Does not include battery.
P/N 05-04766**\$597.00**

GEL CELL BATTERIES



- Maintenance-free operation • Excellent shelf life
- Long cycle life • Can be mounted on its side • Delivered fully charged and ready for use • No corrosive gas generation • 300 Starting AMPS • Warranty 1 year or 100 hours. • Quality construction provides superior resistance to shock and vibration • DOT AND IATA approved for shipment by air as dry cells

Note: FOR EXPERIMENTAL AIRCRAFT ONLY
P/N 11-03156**\$162.75**

AEROTAR CESSNA BATTERY BOX



Cessna Battery Box (C614002-0101).
P/N 08-15785**\$899.99**

FIBERGLASS BATTERY BOX



Available as standard fiberglass battery box or as gel coated version. Gel coated battery box is same dimensions but with gray gel coating. Sturdy, lightweight, corrosion-resistant. Accommodates both 25 amp and 35 amp batteries. With hold-down tabs and drain outlet.

Note: For experimental aircraft only.
CoatedP/N 05-15354**\$135.75**
Uncoated.....P/N 05-15353**\$120.75**



BOGERT BATTERY BOXES

Many battery boxes in Piper and Cessna aircraft are 30, 40 or 50 years old and battery acid, vibration as well as time have taken their toll. Acid leaking into the belly of your airplane can severely damage the structure where you can't see it, between the laps of aluminum and the rivets. STC/PMA FAA approved for most Piper Aircraft.

Protects your investment. Replaceable vent fittings. Eliminates acid leaks in the aircraft. Improves starting performance. Eliminates extra connection on outside of the battery box. Positive battery box venting. Includes lid.

SEE OUR WEBSITE FOR APPLICATION LIST.

Part No.	Description	Price
11-06954	Piper 18/24/30/39	\$1,085.00
11-13480	Piper 20/22	\$924.00
11-13481	PA-23	\$1,616.00
11-13482	Piper 24-260	\$1,286.00
11-13484	Piper 28/32	\$924.00
11-13485	Piper 28-161	\$1,634.00
11-13486	Piper 31	\$1,830.00
11-13487	Piper 32	\$925.00
11-13488	Cessna 150	\$1,175.00
11-13489	Cessna 172	\$1,175.00
11-13490	Cessna 180/182/185/188	\$969.00
11-13491	Bogert Positive And Negative Cables	\$50.00

BOGERT BATTERY BOX MODIFICATION



The Battery Box Mod greatly improves battery performance. It modifies Piper Metal Battery Boxes to eliminate the braided straps and ground connections known for heat generating, high resistance connection.

Hard starting and other electrical problems can often be tracked back to poor battery and group connections. Use this inexpensive mod with a new positive and negative cable if your battery box is still mechanically sound.....P/N 12-16400**\$137.00**

BOGERT BATTERY BOX NYLON FLANGES



Improve Starting Performance. Easier Removal & Installation of Battery. May prolong life of battery and starter. Less expensive to modify existing box than to replace. Compatible with our famous "Low Loss" Cable Kits! Eliminate extra connection

on outside of the battery box. Do away with the troublesome braided negative strap.
Nylon Flanges replacement or experimental..... P/N 11-02892.....**\$41.55**
Nylon Flanges STC'd / PMA'd..... P/N 11-02893.....**\$87.00**

BOGERT CONCORDE BATTERY POST ADAPTERS



The Concorde copper battery adapter raises the battery terminal height to match the standard G-35 battery terminal. Moves the cable to battery connection inward away from the battery box to increase clearance and promote safety. Aligns the battery connection with the battery box cable cut outs and sealing grommets to reduce stress on the cable and adapter plates which reduces maintenance. Can be moved from battery to battery. - PMA'd P/N 11-02891**\$70.00**

PANASONIC LC-R127R2P BACKUP RECHARGEABLE BATTERY



Panasonic's tough-sealed lead-acid (SLA) rechargeable batteries are designed to provide outstanding performance in withstanding overcharge, over-discharge and resisting vibration and shock. Compact, these batteries save installation space while providing full and reliable power. The use of special sealing epoxies, tongue-and-groove case construction, long-sealing paths

for posts and connectors assures that the battery will offer exceptional leak resistance and allows them to be used in any position.

Applications: • UPS (Uninterruptible Power Supplies) • Emergency Lighting • Wheelchairs • Telecom Back-Up Power Supplies • Portable VCRs • Lawn and Garden Tools • Engine Starters

P/N 11-17583**\$256.95**

EL

BATTERY CHARGERS AND TESTERS



TDMC+ BATTERY CHARGER

For 12V and 24V aircraft batteries
 • New! LCD Screen shows • Real time voltage and current • Reverse polarity and short circuit protection • Battery voltage before and during charge • Constant current and constant voltage charge • 1A to 6A selectable charging current (upgrade from 4A) • Input: 110/220 VAC 50/60 Hz Operation • Output: 14.4 or 28.8 VDC 0-6 Amps • Dimensions: 5.71"W x 9.12"H x 3.15"D • Weight, lb.: 6.0
 • 2-year warrantyP/N 11-18842\$1,237.00



GC-024 24VDC BATTERY BUDDY CHARGER

Light weight / High strength aluminum case. Fully automatic: 3 stage charger can be left on the battery for long periods. Charge Status LED's: Power on, charging and full charging. Circuit protection: reverse polarity and short circuit protected (fused). UL and CE approved. Power cord length 6 feet and 4 foot Charger cord with alligator clips included. Charge control: Modified constant current charge to a constant finishing voltage, then to a float standby. Supported with a 2 year warranty.....P/N 11-10570\$239.95

GC-024E 24VDC BATTERY BUDDY CHARGER ASSEMBLY



This light weight GC-024E charger is designed for larger batteries with the Elcon connector. Elcon Assembly for Quick Set-Up . Light Weight / High Strength Aluminum Case. Full Automatic: 3 Stage Charger can be left on the Battery for long periods. Charge Status LED's: Power On, Charging and Fully Charged. Circuit Protection: Reverse

Polarity and Short Circuit Protected (Fused).UL and CE Approved. Power Cord Length: 6 Feet. Charge Cord Connected to Elcon Assembly. Charge Control: Constant potential then reverts to a float standby. Supported with a 2 Year Warranty. Input: 110-240 VAC 50/60 Hz +/-10% Auto Switch. Output Equalizer Voltage: 28.8 VDC +/-0.2V. Output Float Voltage: 26.8 VDC +/-0.2V. Dimensions: 7.2"W X 3.1"H X 7.8"D. Weight: 2.6 poundsP/N 11-13011\$1,075.00



GILL TCT-1000 12V/24V CAPACITY TESTER

The TCT -1000 Battery Capacity Analyzer has been designed to perform automatic capacity testing of 12 and 24 Volt lead-acid batteries. This unit is capable of accurately measuring the capacity of a fully charged battery with a rating between 10 and 59 amphotours.

It is self-contained and easy to operate. The load tester will display, in percentage, the conformance to the battery's one hour rating.

P/N 11-03302\$2,849.00

CONCORDE AIRCRAFT BATTERY PARASITIC LOAD TESTER



This Parasitic Load Tester Adaptor (PLTA) measures the parasitic load / drain on aircraft batteries when the master switch is off and the aircraft is inactive. The adaptor is designed to mate with a MS3509 style quick disconnect receptacle. Measuring parasitic load is easy to do by connecting the PLTA between the battery receptacle and the aircraft mating plug. The PLTA is a molded polypropylene body equipped with separate test leads for connection to a digital multimeter (DMM). It is rated for loads up to 10 amperes and is equipped with a 10 amp fuse.

P/N 11-09841\$61.95

TELEDYNE GROUND POWER BATTERIES

Model	Voltage	Wt. Dry	Acid	Part No.	Price
T1100	4	70	None	11-10767	\$740.00
T1100L	4	70	None	11-10768	\$877.00
T2200	8	118	None	11-10765	\$968.00
T2200L	8	118	None	11-10769	\$1,101.00
T6200	12	147	None	11-10766	\$1,073.00
T6200L	12	147	None	11-10770	\$1,208.00

L= Lektro Start Cart

BC-5000 BATTERY CAPACITY TESTER



From Concorde, a portable, light weight unit designed to provide the operator with an economical, easy, and accurate means for capacity testing aircraft batteries. Fully automatic testing for 12 Volt AND 24 Volt lead acid aircraft batteries. Powered by the battery being tested - No AC power required. Constant current load adjustable in 1.0 Amp increments 10 to 55 Adc. 50 mv voltage resolution. 10 LBS / 4.5 KG Length 12" (30 cm). Width 9" (23 cm). Height 10" (25 cm). LCD display. Overtemperature protection. Audio alert when capacity test is complete.
 P/N 11-07388\$1,565.00

BC-6000 BATTERY CAPACITY TESTER



From Concorde, the BC-6000 is a portable, light weight unit similar to the BC-5000 with an added feature for printing test reports. Plugged into a USB port, the B-6000 will create test reports directly from your computer. Tests both 12V and 24V lead acid batteries with capacity ratings from 10 AH to 55 Adc. Powered by the battery being tested - No AC power required. Constant current load adjustable in 1.0 Amp increments 10 to 55 Adc. 50 mv voltage resolution. 10 LBS / 4.5 KG Kg. Length 12" (30 cm). Width 9" (23 cm). Height 10" (25 cm). LCD display. Overtemperature protection. Audio alert when capacity test is complete or malfunction of unit. USB 2.0 port for test report print out..... P/N 11-10482\$1,785.00

BC-7000 BATTERY CAPACITY TESTER



From Concorde, the BC-7000 is similar to the BC-6000 with the benefit of adjustable current loads in smaller increments and the ability to use on Lead Acid or Ni-Cd batteries. The unit is AC powered. Fully automatic testing for 12V AND 24V aircraft batteries. Universal AC power input 85 -265Vac (47 to 63Hz). Constant current load adjustable in 0.1 Amp increments from 0.5 to 15Adc. Constant current load adjustable in 1.0 Amp increments from 15 to 50 Adc. 10mv voltage resolution. Displayed battery capacity (CI) %. 10 LBS / 4.5 KG. Length 12" (30 cm). Width 9" (23 cm). Height 7.5" (19 cm). LCD Display. USB 2.0 port for test report print out. Overtemperature protection. Audio alert when capacity test is complete or malfunction of unit... P/N 11-10483\$2,653.00

BC-8000 BATTERY CHARGER & CAPACITY TESTER



The BC-8000 has been designed to provide the operator with a cost effective battery charger and capacity tester in one unit. The step by step digital display is easy to program in order to set it and forget it. For use on Nickel Cadmium or Lead Acid Batteries.

Capacity Tester Features:

- Adjustable constant current load in 0.1 Ampere increments from 0.5 Ampere to 15 Ampere (+/- 1.5%)
- Adjustable constant current load in 1.0 Ampere increments from 15 Ampere to 55 Ampere (+/- 1.0%)
- USB 2.0 port for PC connection
- BC Report Utility software for hard copy printout of test results

Charger Features:

- Adjustable output from 3.0 to 36.0 Vdc
- Adjustable output amperes from 0.05 to 25 Adc
- Constant voltage (CV) or constant current (CC) charge
- Adjustable charge time from 1-999 min
- Single or two step charge routine

Common Features:

- Universal AC power input 90~264vac (47 to 64Hz)
- 10mv voltage resolution 4 line LCD display
- Over temperature protection
- Audio warning when capacity test is complete or if the unit malfunctions
- Real time internal clock with battery backup

P/N 11-10484\$4,765.00

EL

SCHAUER BATTERY CHARGERS

BATTERY CHARGERS BY SCHAUER

Over 70 years of manufacturing experience assures, the user of the finest line of battery chargers—solid state circuitry, non-aging silicon rectifiers at low prices. All chargers furnished with complete operating instructions. One year warranty.



11-00885

JAC1212, JAC0524, & JAC0724 - Fully Automatic - World-Wide Universal Input, Electronic Charger. Intelligent chargers follow battery impedance to end of charge cycle for all battery types. Fully automatic. Red LED indicates AC power on, yellow LED indicates battery is charging, green LED indicates float mode. Aluminum case.

Amps	Volts	Size	Weight	Part No.	Price
12	12	6.5"W x 3.5"H x 1.8"D	1.8 lbs.	11-00890 (2)	\$99.75
5	24	6.5"W x 3.5"H x 1.8"D	1.8 lbs.	11-00885 (1)	\$94.75
7	24	6.5"W x 3.5"H x 1.8"D	1.8 lbs.	11-00889 (1)	\$107.95

(1) DC cordsets 3' long: with ring terminals or XLR connector.
 (2) With stripped leads



MODEL JAC2024H - Intelligent chargers follow battery impedance to end of charge cycle for all battery types. Fully automatic. Green LED indicates AC power on, yellow LED indicates battery is charging, yellow LED off indicates float mode. Charge control: constant current charge to a constant voltage, then to a float standby. Current limiting. Fully automatic 3 stage charger can be left on the battery in maintaining/float mode. Can be set for any type lead acid battery, including conventional, maintenance free, deep cycle, gelled-type, valve regulated batteries. Cyclic voltage: FLOODED 2.5 volts/cell; GEL & AGM 2.4 volts/cell. 2.6 volts/cell for 36 & 48 volt batteries. May be preset to customer's specification for battery type. Not intended for use as a DC power supply. Continuous - 100% duty cycle. Low voltage start: will start charging a deeply discharged battery with terminal voltage less than 4 volts. Reverse polarity and short circuit proof. Aluminum case. AC Input 115/230 volts, 50 or 60Hz Input voltage autosensed. 20 AMPS / 24 Volts. 10"W x 7.5"H x 3"D. 6.5 lbs.....P/N 11-00891\$279.95

MANUAL CHARGERS

Manual chargers must be disconnected when battery is charged to prevent overcharging and damage to the battery. Normal indication that battery is charged is when ammeter stabilizes for one hour.



BATTERY CHARGER 24V/5AMP

Fully Automatic. World-Wide Universal Input Electronic Charger. Intelligent chargers follow battery impedance to end of charge cycle for all battery types. Fully automatic. Red LED indicates AC power on, yellow LED indicates battery is charging, green LED indicates float mode. Aluminum case.

With Battery Clips.....P/N 11-00885\$94.75
 With Ring Terminals.....P/N 11-14678\$94.75



BATTERY CHARGER 24V/7AMP WITH BATTERY CLIPS

Intelligent chargers follow battery impedance to end of charge cycle for all battery types. Fully automatic. Red LED indicates AC power on, yellow LED indicates battery is charging, green LED indicates float mode. Aluminum case.....P/N 11-14737\$125.95



BATTERY CHARGER 24V/30AMP WITH BATTERY CLIPS

Intelligent chargers follow battery impedance to end of charge cycle for all battery types. Fully automatic. Red LED indicates AC power on, yellow LED indicates battery is charging, green LED indicates float mode.....P/N 11-14738\$382.00



BATTERY CHARGER 24V/3AMP WITH BATTERY CLIPS

Intelligent chargers follow battery impedance to end of charge cycle for all battery types. Fully automatic. Red LED indicates AC power on, yellow LED indicates battery is charging, green LED indicates float mode. Aluminum case. P/N 11-14736\$104.75



BATTERY CHARGER 24V/2AMP WITH BATTERY CLIPS

Intelligent chargers follow battery impedance to end of charge cycle for all battery types. Fully automatic. Red LED indicates AC power on, yellow LED indicates battery is charging, green LED indicates float mode. Aluminum case. P/N 11-14735\$45.50



BATTERY CHARGER 12V/5AMP WITH RING TERMINALS

Intelligent chargers follow battery impedance to end of charge cycle for all battery types. Fully automatic. Red LED indicates AC power on, yellow LED indicates battery is charging, green LED indicates float mode. Aluminum case. P/N 11-14733\$117.75



BATTERY CHARGER 12V/2AMP WITH BATTERY CLIPS

Intelligent chargers follow battery impedance to end of charge cycle for all battery types. Fully automatic. Red LED indicates AC power on, yellow LED indicates battery is charging, green LED indicates float mode. Aluminum case. P/N 11-14732\$49.50



BATTERY CHARGER 12V/25AMP WITH BATTERY CLIPS

Intelligent chargers follow battery impedance to end of charge cycle for all battery types. Fully automatic. Red LED indicates AC power on, yellow LED indicates battery is charging, green LED indicates float mode.....P/N 11-14734\$238.95



SCHAUER CESSNA PLUG ADAPTER

Schauer Cessna Plug Adapter With SB50 Gray Connector.....P/N 11-14741\$99.75



SCHAUER PIPER PLUG ADAPTER

Schauer Piper Plug Adapter With SB50 Gray Connector.....P/N 11-14742\$59.75



SCHAUER DC BATTERY CLIP ADAPTER

Schauer DC Battery Clip Adapter With SB50 Gray Connector.....P/N 11-14739\$15.65

EL

BATTERY CHARGERS



AVIATION BATTERY CHARGER

Industrial quality charger. Is user programmable to charge all lead acid batteries, wet cell, AGM, or gel type. A digital volt meter and amp meter gives the operator REAL information, along with a tri-color LED to track charge progress. For safety, polarity protected, and current limited. Can be left connected and charging while engine is started. Prevents sulfation of battery if left connected, no need for an extra product. Will turn on and recover batteries with as little as 2 volts. 3 year warranty. Made in U.S.A.
P/N 11-14846\$417.00

POWERALL JUMPSTARTER WITH BLUETOOTH SPEAKER



Easy to use Emergency Jump starter & portable Power bank with the added bonus of a 5W audiophile speaker.

The PowerAll Journey is the world's first and only all-in-one portable 600A emergency 12V vehicle jump starter with built-in 5W Bluetooth™ speaker. The jump start feature is powerful enough to start up a V8 engine, making it a must have emergency accessory for all your vehicles. Equipped with

an ultra-bright 110 lumen LED flashlight with SOS and strobe features to assist you in the dark and emergency situations. It's also equipped with two 5V / 2.1A USB ports to charge your mobile devices on the go. Designed with a portable IPX5 shock proof exterior, the Journey is protected from water, dust, sand and snow. Enjoy your favorite music playlist with your friends and family all day long with its built-in 16,000mAh lithium battery. It plays louder and longer than any 5W speaker on the market with its combination of advanced technologies and audiophile sound tuning that reproduce the fullness, clarity and depth of your music the way the artist intended. The PowerAll Journey is truly the only multi-purpose portable jump starter and power bank out on the market.
P/N 11-14679\$149.95

BATTERY AND ALTERNATOR CONDITION TESTER



Instant and accurate battery condition status: indicates if battery is "healthy" or in need of charging. Instant status of your alternator/charging system: determines whether battery or alternator is at fault. Non-Aviation / Not for Aircraft.
P/N 11-04302\$17.50

QUICKI DUAL 12-24VDC ULTRA FAST CHARGER



The Quicki Dual Voltage / Dual USB charger is a compact and powerful device for ULTRA FAST charging your portable electronics. Built for rugged use in any 12 or 24 Volt vehicle, it provides 2.4 Amps of charging power to both USB ports (4.8A Max, 60W). A combination of internal over-voltage, over-current and internal UL-approved fuse provide superior protection of your devices while charging. FCC approval ensures the device won't create RF interference with nearby electronics and radios. Designed for use in Aviation, Commercial Vehicles, Marine, Utility applications and Automotive use. Compact design (3" x 1.1") with LED status indicator. Tested to ensure compatibility with Apple, Android, Tablet and other USB-compatible devices, the Quicki charger provides super fast recharging.....P/N 11-14110\$18.50

RC ALLEN ESP BATTERY BACKUP



The ESP - Emergency Standby Power, is a battery-based emergency power unit designed to give you at least an hour of auxiliary power when you need it the most.

The ESP comes complete with a wire harness and panel-mounted status light.

Part No.	Description	For Use With	Price
10-04171	RC Allen ESP 14V 702-0014-01	1. RCA26AK-1,-3,-4,-6,-7,-8 2. RCA26EK-10 3. RCA2600-2,-3	\$895.00
10-04645	RC Allen ESP 14V 702-0014-02	1. RCA26AK-2,-5 2. RCA26EK-1,-2,-3,-4,-5,-6,-7,-8,-9,-11,-12,-13,-14	\$725.00
10-04525	RC Allen ESP 28V 702-0028-01	1. RCA26BK-2,-3,-6,-7,-8,-9,-10,-11,-12,-14,-15,-16,-20,-22,-26,-28,-29,-30,-32,-34,-35,-36,-37 2. RCA26EK-1,-2,-3,-4,-5,-6,-7,-8,-9,-11,-12,-13,-14	\$899.00
10-04646	RC Allen ESP 28V 702-0028-02	1. RCA26EK-10 2. RCA2600-2,-3	\$899.00



WHITE LIGHTNING M1435-EXP 14V MINI GPU

Clean, stable, airframe power specifically for the needs of the E/A-B aircraft. Output fixed at 14.25VDC, up to 35A maximum continuous power. Ideal for cockpit database and EFIS updates, flight planning, powered preflight, procedures training, and general maintenance. Includes an Airframe Interface Kit to permanently wire a quick-connect polarized receptacle to the aircraft's main electrical bus. Detachable, replaceable 6' output cable included. Fully protected operation with automatic recovery. For Experimental AircraftP/N 11-18939\$445.00



WHITE LIGHTNING M1435 14V MINI GPU

Clean, stable, airframe power for 12/14-volt aircraft. Output fixed at 14.25VDC, up to 35A maximum continuous power. Ideal for cockpit database and EFIS updates, flight planning, powered preflight, procedures training, and general maintenance. Detachable, replaceable 6' output cable. Fully protected operation with automatic recovery. For Certified Aircraft. 3-Pin Oval Plug.....P/N 11-18943\$495.00
Piper Plug.....P/N 11-18941\$495.00



WHITE LIGHTNING M2827 28V MINI GPU

Clean, stable, airframe power for 24/28-volt aircraft. Output fixed at 28.5VDC, up to 27A maximum continuous power. Ideal for cockpit database and EFIS updates, flight planning, powered preflight, procedures training, and general maintenance. Detachable, replaceable 6' output cable with AN2551 3-pin oval plug. Fully protected operation with automatic recovery. Suitable for most piston powered aircraft. For Certified Aircraft.
P/N 11-18942\$595.00



MICRO-START PERSONAL POWER SUPPLY XP-1

World's smallest Jump Starter and Personal Power Supply. Just charge it once and take your power where ever you go. So small it fits in your pocket, yet so powerful it can jump-start Motorcycles, Cars and Trucks! Amazingly, it will also power and charge your electronics. Built in flashlight with an S.O.S. pattern. Whatever you do, don't get stuck without back-up power again!
P/N 11-12103\$143.95

KELLY BC3000 BATTERY ANALYZER



"Your Battery M.D." Portable and cordless the BC-3000 is a lightweight fully automated battery analyzer assessing the health of all lead-acid aircraft batteries with an ampere hour range of 1-59. Connect the battery using the included quick battery connection adapters, the unit automatically senses and selects 12 or 24 volts.
P/N 08-07161\$1,525.00

POWERALL ELEMENT 12V 400A JUMP STARTER



Designed for the outdoor enthusiast. Water (IP65), snow, shock, dust proof. Great for your 12volt supported lightsport single engine aircraft on a full charge! It's so easy and convenient to use that every driver should keep one at all times.
P/N 11-13734\$159.95

POWERALL SUPREME PORTABLE 12V 600A JUMP STARTER



Use the PowerAll with the jumper cables to start your battery in a matter of seconds. It can jump start you vehicle 20x on a full charge! It's so easy and convenient to use. A great travel companion that you can take with you on the go to charge all of your portable devices, such as smart phones, tablets, cameras, camcorders, GPS unit, MP3 players, wireless headphones, and portable gaming systems. It's equipped with two 5V / 2.1A USB ports to charge your mobile devices on the go!P/N 11-13732\$159.95

EL

BATTERYMINDER® BATTERY CHARGERS

AVIATION-SPECIFIC MAINTENANCE CHARGER-DESULFATOR

These ensure 100% charge to sealed and wet-cell lead-acid aviation batteries made by Concorde, Gill, Hawker, Odyssey, etc. Temperature compensation prevents overcharging. Designed to be left connected whenever plane is hangered. Supplied with battery clips for temporary or bench connection to battery. Patented high frequency pulse desulfation is designed to reverse and eliminate harmful battery sulfation, the #1 cause of early battery failure.

Note: Aviation batteries require different charging voltages than automotive, marine or other battery types. General purpose chargers can over time severely shorten battery life and performance. Aviation specific chargers are multi-stage, microprocessor controlled and sense ambient temperature sensing to prevent under or overcharging. They are very "smart", yet operate automatically. These are the only type recommended/approved by major battery manufacturers.

AVIATION SPECIFIC MODELS

Model Suffix	Battery Types
-S2	Standard Aviation, Gill (sealed + wet-cell, flooded)
-S3	Hawker-Odyssey, Gill LT 7000
-S5	Concorde (sealed AGM + wet-cell, flooded)

BATTERYMINDER S3 12V AVIATION SOLAR CHARGER / MAINTAINER / DESULFATOR FOR AGM



Actively monitor you battery's voltage any time the sun is up. The internal program adjusts its output several times a second based on this reading to quickly and correctly charge your battery. When used as a maintainer, it is guaranteed to maximize your battery's life and storage capacity.

The long-term float (maintenance) stage can add years of service. For AGM "Pure Lead" Aviation Batteries, such as Gill 7000 Series, Odyssey, Hawker, etc. One year 100% money back guarantee. Five year "no hassle" warranty.

15 WattP/N 11-09901\$215.99



BATTERYMINDER AIRFRAME INTERFACE KIT

This kit provides standard aircraft parts acceptable under 14 CFR §21.9 for a FAA certificated mechanic to fabricate and install a fused, 2-wire harness for connecting an aviation-specific BatteryMINDER® brand

of low-current, continuous-duty, maintenance-type battery charger. The finished harness typically has ring terminals attached to the battery relay connecting to a Anderson SB50 polarized plug at the opposite end by up to 6 feet of MIL-spec unshielded 16-gauge aircraft wire, with a 10-amp in-line fuse. The SB50 plus is encased in a 670-420 SB50 Handle Kit which provides a rugged hand grip. An insulating dust cover protects the plug when not connected to the charger. Anti-chafe sleeving is included. This kit is eligible for installation by a licensed mechanic as a minor alteration under 14 CFR §1.1 and §21.93(a) as it has "no appreciable effect on the weight, balance, structural strength, reliability, operational characteristics, or other characteristics affecting the airworthiness" of the aircraft. No STC, Form 337 submittal or FSDO field approval is required per FAA Order 8900.1 Figure 4-67. A \$43.9 airframe logbook entry is sufficient to document this alteration and return the aircraft to service. Also includes a short harness to adapt the charger's SAE output connector to a mating Anderson SB50 plug. This harness is connected to and remains with the charger. It is not installed on the aircraft.

Model BM-AIK2 Airframe Interface Kit.....P/N 11-10835\$81.75
Model RTA-2415EXPP/N 11-14576\$29.95



BATTERYMINDER RT2ELCON CONNECTOR

The BatteryMINDER RT2ELCON Elcon Connector/Adapter to Ring Terminal Assembly is designed to be used only with BatteryMINDER models 244CEC1-AA-S2, -S3 and -S5.

The Elcon Adapter combined with the Ring Terminal Assembly allows an easy, foolproof connection from an aviation battery's terminals to the BatteryMINDER Aviation-Calibrated charger-maintainer-desulfators (not for use with the BatteryMINDER 28252-AA Power Supply), eliminating the need to connect with battery clips which may become accidentally detached while in use.

Note: RT2ELCON Type Connector designed for use with 24V Aviation models only.P/N 11-18167\$79.95

BATTERYMINDER® CEC1-AA 12V AND 24V MAINTENANCE CHARGER-DESULFATOR



Over the last decade, BatteryMINDers have earned a reputation among pilots, maintenance shops, and aviation press as the very best battery charging and full-time maintenance solution. The new CEC1-AA series builds on that technology to improve battery condition analysis, diagnostics, and weak battery recovery. The

BatteryMINDER features 12 LED indicators to tell you everything you need to know about your battery's condition, and the operation of the charger. There are no controls as such because its operation is completely automatic. Multistage charging begins with battery condition analysis and reporting, then a Soft-Start stage to recover deeply discharged batteries if necessary. Bulk charging stage applies constant current up to 85% of charge, then Absorption stage applies constant voltage to 100%. Automatic testing every 12 hours make sure battery will hold its charge. Continuous pulse desulfation restore and preserves airworthy battery capacity. Maintenance or Float stage with ambient temperature compensation ensure battery is never under or overcharged by regulating voltage with temperature extremes. The payoff for this effort is maximum battery capacity for strong cool engine starts and emergency reserves, while dramatically extending the airworthy service life of your battery, which reduces operating costs. Select appropriate model by battery voltage and type (see battery chart).

Note: BatteryMINDER does not recommend connecting charger to aircraft battery terminals while it is installed in the aircraft. Charger comes with alligator clip harness, suitable for bench or temporary connections. For permanent quick-connect options, see harness options below for FAA-certified and Experiment aircraft.

BATTERYMINDER AVIATION-CALIBRATED CEC1 MODELS

	-S2	-S3	-S4
12 Volt 128CEC1-AA	Gill (Sealed + Flooded [Wet Cell/ Filler Cap]) ¹	Hawker-Odyssey ²	Concorde (Sealed Valve-Regulated AGM + Flooded [Wet Cell/Filler Cap]) ⁴
24 Volt 244CEC1-AA	Gill (Sealed + Flooded [Wet Cell/ Filler Cap]) ¹	Hawker-Odyssey ² Gill LT 7000 Series ³	Concorde (Sealed Valve-Regulated AGM + Flooded [Wet Cell/Filler Cap]) ⁴

¹ Exclusively for Gill EXCEPT the Gill LT 7000 Series

² Exclusively for that brand

³ Exclusively for that brand

⁴ Exclusively for Concorde

Description	Part No.	Price
12V Model 128CEC1-AA-S2 (Gill)	11-14347	\$265.14
12V Model 128CEC1-AA-S3 (Odyssey)	11-14348	\$265.14
12V Model 128CEC1-AA-S5 (Concorde)	11-14349	\$265.14
24V Model 244CEC1-AA-S2 (Gill)	11-14350	\$265.14

BATTERYMINDER® AVIATION ACCESSORIES



Accessories for use with 28252-AA ONLY			
1	11-09561	ELCTC ELCON Type Connector	optional \$77.85
3	11-09559	A2ELCON Anderson Gray to ELCON-type	optional \$102.75
4	11-09560	A2RT 11/32" Ring Terminals	optional \$44.50
5	11-09562	A2GPU-1 Anderson to "Cessna"-type GPU Plug Assembly	optional \$117.85

BATTERYMINDER® CIGARETTE LIGHTER ADAPTER

12-V / 24-V w/15A Pwr Plug. Works with ALL BatteryMINDER products.
P/N 11-07209\$12.75

BATTERYMINDER® RTA-2415 - 2 FOOT RING TERMINAL ASSEMBLY
The 6-foot long BatteryMINDER® RTA-2415 Quick Connect/Disconnect Ring Terminal Assembly allows easy connect/disconnect of BatteryMINDER® chargers to battery terminals.....P/N 11-12440\$12.70



AVTEK PRODUCTS — BATTERY CHARGERS

PULSETECH QUADLINK MULTI STATION CHARGER KITS



The 4-Station QuadLink 12V Battery Maintenance Charger Kit includes an Xtreme Charge Battery Charger & Desulfator and a QuadLink 4-Channel Battery Multiplier enabling you to easily charge, maintain and desulfate up to FOUR 12V batteries at a time without the expense of buying three additional chargers or the hassle of monitoring and swapping batteries on a lone charger.

The 8-Station QuadLink 12V Battery Maintenance Charger Kit includes both an X2 Xtreme 2-Station Pulse Maintenance 12V Battery Charger and two QuadLink 4-Channel Battery

Multipliers allowing you to charge, maintain and desulfate up to EIGHT individual 12V (VRLA, AGM and flooded cell) batteries, up to FOUR 24V commercial systems composed of two 12V batteries connected in series such as those in generators, buses, heavy trucks and fork lifts or 12V batteries in 36 and 48V series connected configurations.

4 Station P/N 11-11379 **\$189.75**
8 Station P/N 11-11380 **\$362.00**



LOW BATTERY ALARM

These are a micro processor-controlled low battery alarm. The purpose of this product is to alert you of low battery voltage. This will allow you to prevent damage to the battery.

Featuring a wide range of settings, the Low Battery Alarm can be preset to meet voltage specifications. The device comes with an LED indicator for visual reading along with a buzzer to warn of low voltage. Multi-color LED configurations indicates the battery status.

Applications: Battery Backup Systems, RV house batteries, Trolling motor battery, Marine batteries, Auxiliary Power Units (APU), Travel trailers, Power gate backup battery, Generator battery, Battery backup safety equipment, Bass Boat Central Approved Manufacturer, Bass Boat Supplies and Accessories.

Low Battery Alarm XL (5V to 24V)..... P/N 11-10010 **\$47.50**

AVIATION SOLAR CHARGER / MAINTAINER / DESULFATOR PANEL SERIES - 12 VOLT, 15 WATT



Actively monitor your battery's voltage any time the sun is up. Quickly and correctly charge your battery. The long-term float (maintenance) stage can add years of service. One-year 100% money back guarantee, five-year "no hassle" warranty. **Qualifies for FREE DMM**
15 Watt P/N 11-09901 **\$215.99**

EL



FREE DIGITAL MULTI-METER (DMM) DT-830B when you purchase a select BatteryMINDER unit and register your warranty at www.BatteryMINDers.Com. Get seven functions and nineteen ranges to cover AC and DC voltage, resistance, DC amps, battery and diode testing. Includes 23" leads and low battery indicator. Requires one 9-V battery (not included).

PORTABLE POWER AND JUMP STARTER



Heavy Duty 12/24 Volt - 720 CCA Portable Power & Jump Starter.

Designed for the Professional Market.

- Two 12 Volt 22Ah Heavy-Duty Sealed AGM Battery provides "Best in Class" Performance
- Jump starts with 720 CCA of power
- Three position "12V/OFF/24V" Switch with Easy-to-Read LED Battery Status Indicator
- Two 12 Volt DC Accessory Outlet to Power and/or Recharge DC Electronics
- LED Work Light
- Ideal for jump-starting cars, trucks, boats, RV's and tractors
- Up to 100 hours of portable 12 Volt DC for power tools, work lights and more
- Heavy Duty 500A Insulated Clamps
- Designed for rough use
- UL listed external wall charger
- Patented.

P/N 11-14030 **\$567.00**

BATTERY TENDER CHARGER



BATTERY TENDER PLUS 12V - 12V @ 1.25A. The Battery Tender Plus is a 1.25 amp battery charger designed to fully charge a battery and maintain it at proper storage voltage without the damaging effects caused by trickle chargers. Included is a quick connect harness for hard to reach areas. 12 Volt, 1.25Amps. **DO NOT USE WITH GILL OR CONCORDE AVIATION BATTERIES**..... P/N 11-03157 **\$54.95**

BATTERY TENDER® 12V - 10/6/2 AMP BATTERY CHARGER



The Battery Tender® 2 Amp/6 Amp/10 Amp Battery Charger features a charger mounting hook and high intensity LED lights, the Battery Tender® 10 Amp is full on features and compact on size. Equipped with integrated alligator clips, the charger has WiFi capabilities with the new Deltran Connected App, this charger is smart, lightweight and fully automatic. Has a 3-year warranty..... P/N 11-18354 **\$196.75**

BATTERY TENDER JUNIOR



120 VAC /60 Hz input. Includes Ring Terminals and Alligator Clips with BLACK (6, 8, & 12V) QDC. **DO NOT USE WITH GILL OR CONCORDE AVIATION BATTERIES.**

12V 0.75A..... P/N 11-05164 **\$34.95**
8V 1.25A..... P/N 10-06024 **\$43.50**
6V 1.25A..... P/N 10-06023 **\$34.95**

CHARGERS - APU'S

OPTIMATE DIAGNOSTIC DESULFATING CHARGERS AND TESTERS



OPTIMATE 6 can SAVE a neglected / sulfated* leadacid battery unable to accept charge from the engine charging system (even after jump starting). The micro processor controlled multi step charging system with cell equalizing is suitable for deep cycle and starter (SLI) batteries and the ampmatic auto current control takes the guesswork out of charge current selection. During the continuous maintenance and testing cycle the battery is tested daily and recharged as necessary. Hook it up, walk away, OptiMate6 does the rest, automatically, safely. Recommended for all lead-acid batteries from 15Ah – 240Ah.
P/N 11-07221**\$125.95**



OPTIMATE PRO-S has a charging system able to save a neglected *sulfated battery that cannot accept charge from a standard charger or the engine charging system. Battery power is optimized during bulk, absorption & cell balancing charge modes, and then tested to verify charge retention. Battery life is extended if left connected to OptiMate PRO-S when vehicle/craft/ equipment is not in use. Initializes, desulfates & charges 1 x 12V battery at a time – from small to large.
P/N 11-07222**\$199.90**



OPTIMATE 5 VOLTMATIC - Advanced 6V & 12V battery care for power sport / auto / marine size batteries. OptiMate 5 VoltMatic can SAVE & CHARGE all 6V & 12V lead-acid batteries. Simply connect the charger to the battery, the VoltMatic micro-processor automatically makes the correct charge voltage selection for a 6V battery in any condition or healthy* 12V battery and then proceeds to charging. Charging Amps: 4A (6V) / 2.8A (12V) (Ampmatic). Use: Indoor / Outdoor (lowest temperature: -4°F / -20°C). Save: Low Volt Start of 1V + 2-step desulphation recovery. Ideal for: STD, AGM

& GEL 6 & 12V batteries from 8 – 120Ah (up to 192Ah for 6V). Input: Global (100-240V 50-60Hz), high efficiency (CEC listed), fully sealed. Style: Weatherproof case with wall mounts, with 6ft / 180cm AC supply lead and 6ft / 180cm charge lead ending in SAE connector. Weatherproof battery lead & standard battery clip set included.
P/N 11-14751**\$94.89**



OPTIMATE 7 SELECT TM-251 - 9-step 14.4V/14.7V 10A Battery Saving charger-tester-maintainer with 13.6V 8A powersupply (BC - California & Oregon approved) The world's most advanced 10 Amp battery charger for starter & deep cycle batteries! OptiMate 7 Select is perfect for starter and deep cycle 12V batteries that demand accurate temperature controlled charging and unsupervised safe long term maintenance. Voltage selection (14.4V / 14.7V) ensure the battery receives charge at the correct voltage
P/N 07-18075**\$179.95**



OPTIMATE 7 SELECT TM-261 - 8-step 12V 10A/24V 5A Battery Saving charger-tester-maintainer (BC - California & Oregon approved) The world's most advanced 12V & 24V battery charger! OptiMate 7 12V-24V is perfect for high performance 12V and 24V starter and deep cycle batteries that demand accurate temperature controlled charging and unsupervised safe long term maintenance. Designed for sensitive electronics: The SAVE program has been designed for SAFE fully automatic low volt start (from 0.5 Volts) and PULSE recovery of deep discharged batteries connected to very sensitive electronics e.g. light aircraft, industrial equipment.....P/N 07-18076**\$179.95**

AUXILIARY POWER UNIT (APU) & BATTERY CHARGER



Designed to supply filtered DC bus power through standard APU receptacle in private and commercial aircraft. Up to 25 or 50 amp is available for operating avionics and flight control systems when the master switch is activated. It can also charge the battery through the plug at a 10 amp rate. Output is current limited, and will withstand starting loads. Voltage is limited to prevent battery overcharging. DC Current and voltage are displayed on panel meters, voltage accurate to 00.00

NOTE: Available with piper plug too.

Model	Part No.	DC Amps	DC Volts	AC Power	Dimensions H.W.D.	Wt.	Price
Single Pin Plug 14v 25amp	11-07068	25	14	117 volts 60hz. 3 amps	8.5x10x12	22	\$794.00
3 Pin Plug 14v 25amp	11-05662	25	14	117 Volts 60hz. 3amps	8.5x10x12	22	\$780.00
Single Pin Plug 28v 25amp	11-07067	25	28	117 volts 60hz. 6 amps	8.5x10x12	33	\$725.00
3 Pin Plug 28v 25amp	11-08146	25	28	117 volts 60hz. 6 amps	8.5x10x12	33	\$895.00

REDIPULSE PRO-12 CHARGE / MAINTENANCE SYSTEM



The PulseTech Pro-12 Charge/Maintenance System. It is designed to keep new batteries "factory-fresh" while they rest on the shelf waiting to be installed or sold. Batteries that sit idle suffer from damaging sulfation buildup (lead sulfate deposits on the battery plates). This buildup is the main cause of battery problems and failure. The Pro-12 uses our scientifically-proven ReNew-IT Pulse Technology to keep these deposits off the plates. By removing these energy-dampening deposits, your batteries are stronger than ever. This means your "shelf-life" warranty issues and other battery-related expenses are reduced dramatically.
P/N 11-07122**\$242.95**

OPTIMATE 7 SELECT TM-271



OptiMATE Lithium 4s 9.5A / 5s 7.5A TM-271, 10-step 12.8/16V 9.5A Battery saving charger-tester-maintainer (BC - California & Oregon approved) The ultimate professional battery charger for 12.8V/16V Lithium batteries. OptiMate Lithium LFP Select is perfect for high performance 12.8V (4s) and 16V (5s) LiFePO4 / LFP batteries that demand fully automatic, fast and accurate temperature controlled charging. Perfect for 12.8V / 16V LiFePO4 / LFP batteries sized from 2.5 to 200 Ah. Power saving standby mode. Full electronic protection against errors.
P/N 07-18077**\$185.75**

OPTIMATE LITHIUM 4S 5A



Ultimate LiFePO4 professional level battery charger. High efficiency diagnostic charger and tester for LiFePO4 / LFP batteries. Perfect for charging and seasonal maintenance of a 12.8V-13.2V LiFePO4 / LFP battery sized from 2 to 100 Amp-hour. SAFE: No risk of overcharging. Totally safe for vehicle electronics. Sparks suppressed. Safe for long-term battery maintenance. Automatic shut-down if short-circuited or battery disconnected. 3-year limited replacement warrantyP/N 11-14676**\$132.95**

***A battery discharged over time that has built up chemical resistance to charging, but otherwise undamaged and measuring at least 2V.**

POWER BARS – GPU'S

POWER PRODUCTS ACTIVATOR 282/282V 24V AIRCRAFT BATTERY CHARGER



The Activator 282/282V is a direct connect, fully automatic 2 Amp charger capable of charging a 24 volt military or aviation battery of any rating from zero to full capacity. It is also a standby maintenance unit without the use of "trickle" charging, thus extending the life and durability of the battery. There is no gassing, heat or other detrimental results of trickle or float charge. The digital voltmeter continuously displays battery voltage during charge and standby.

282.....P/N 11-13888**\$843.00**
282VP/N 11-16338**\$949.00**

POWER PRODUCTS 25 AMP BATTERY CHARGER ALPHA 25



Isolated charge - one or two batteries. Charges all 12 and 24 volt Lead Acid batteries and 1-22 cell NiCads. Current adjustable from 0 to 25 amps. True constant current (CI) for NiCad batteries or constant potential (CP) for Lead Acid batteries. Digital ammeter and voltmeter read charge current and voltage for either battery. Selectable charge time from 1 to 999 minutes with digital elapsed time. Operates on either 115 or 230 VAC.

P/N 11-13887**\$3,617.00**

POWER PRODUCTS BETA D-50 BATTERY ANALYZER 50 AMP



Discharge capacity tester for all types of Nickel Cadmium, sealed or vented Lead Acid aircraft batteries. Services any voltage or type of battery. Constant current discharge adjustable from 0.1 to 50 amperes. Selectable low voltage cutoff. Selectable discharge time from 1 to 999 minutes with digital elapsed time readout. Audible alarm at end of test. Meters & timer lock-in their reading for amp-hr capacity. Accept and Fail lights for simplified GO/NO-GO test. Operates on either 115 or 230 VAC

P/N 11-13889**\$2,799.00**

POWER PRODUCTS BATTERY CHARGER ANALYZER CM-1550 CML



The CA-1550 CML Charger/Analyzer is a portable or benchmounted self-contained unit for charging and discharging capacity testing aircraft or ground support batteries. It is simple to use and does not require programming or use of a computer. Digital read-outs of volts, amperes and time are clearly displayed. The CA-1550 CML has been designed to accurately charge, test and guarantee the emergency capacity of sealed or vented lead-acid or nickel-cadmium batteries. Guaranteed emergency capacity is especially important for aircraft batteries.

P/N 11-13886**\$5,674.00**

POWER PRODUCTS CHARGER ANALYZER CA-1550-MIL



The CA-1550 MIL Charger/Analyzer is a portable or benchmounted self-contained unit for charging and discharging capacity testing aircraft or ground support batteries. It is simple to use and does not require programming or use of a computer. Digital read-outs of volts, amperes and time are clearly displayed. The CA-1550 MIL has been designed to accurately charge, test and guarantee the emergency capacity of sealed or vented lead-acid or nickel-cadmium batteries. Guaranteed emergency capacity is especially important for aircraft batteries.

P/N 11-17174**\$6,639.00**

POWER PRODUCTS AC25C 12 VOLT BATTERY CONDITIONER AND CHARGER



Dual output charger for all types and ratings of Nickel Cadmium, sealed or vented Lead Acid aircraft batteries.

- Isolated charge - one or two batteries. Charges all 12 and 24 volt Lead Acid batteries and 1-22 cell NiCads.
- Current adjustable from 0 to 25 amps.
- True constant current (CI) for NiCad batteries or constant potential (CP) for Lead Acid batteries
- Digital ammeter and voltmeter read charge current and voltage for either battery.
- Selectable charge time from 1 to 999 minutes with digital elapsed time.
- Operates on either 115 or 230 VAC

P/N 11-15069**\$3,983.00**

POWERVAMP PS300 28V AIRCRAFT POWER SUPPLY



Produced in partnership with Powervamp, the PS300 is a solid state hand-portable power supply delivering a maximum of 300A at a pre-set voltage of 28V DC for avionics use.

The unit can be connected directly to the aircraft's external ground power receptacle and is primarily for regional airline operators of turbine and turboprop DC aircraft or MROs requiring continuous power for maintenance. It has also been used to

power large DC aircraft at various air shows.

The PS300 is compact and lightweight and able to power air conditioning on most business jets. It can be placed under the fuselage or wing of small aircraft or helicopters, freeing up hangar floor space.

The PS300 is fitted with three 100A power supplies connected in parallel. Power supply healthy LEDs are fitted to the front panel for diagnostics. When pressed, the emergency stop button immediately disconnects power to the aircraft.

The front-mounted quick-disconnect output connector allows leads of different configurations to be instantly connected to the unit. Key-switch input voltage selection allows operation at either 180-264V AC three phase or 311-457V AC/47-63Hz three phase for international use. A solid state voltmeter and ammeter displays the output voltage and current, enabling operators to monitor the current draw of avionics and other pre-flight loads. Supplied with NATO lead set, input lead and heavy-duty canvas protective jacket.

1 Phase EC3P/N 11-18675**\$5,931.00**
3 Phase EC1P/N 11-18673**\$6,055.00**
3 Phase EC2P/N 11-18674**\$6,094.00**

POWERVAMP GA PACK KITS



A tough, budget-priced, dual voltage GPU designed for the private operator and general aviation, it uses the same top-quality, high discharge batteries as in other Powervamp packs.

Ideal for smaller turbine helicopter operators, all piston aircraft or where the starting of 24 volt trucks and plant and 12 volt automobiles is a useful feature.

The deep drawn polyethylene case allows the pack to sit in flooded sites up to 200mm (8in) deep without water ingress. The 12 volt outlet provides a CCA of 470 amps and a peak amp figure of 925. The 25.4 volt DC outlet will deliver up to 850 amps with power control by removable key and 1000 amp switch.

This pack is supplied with 2m (6ft) output lead with rubber Nato plug and 2m (6ft) output lead with 1000 amp cast brass, braided and fully insulated, 'Vulture beak' colour-coded alligator clips. It is cleared for air transportation with key removed.

Connector	Length	Model	Part No.	Price
Aircraft Connector	6.5'	USA	11-18487	\$1,426.00
Croc Clip Output	6.5'	USA	11-18489	\$1,249.00
Piper Connector	6.5'	USA	11-18491	\$1,286.00
Aircraft Connector	13'	USA	11-18488	\$1,463.00
Croc Clip Output	13'	USA	11-18490	\$1,290.00
Piper Connector	13'	USA	11-18492	\$1,286.00
Aircraft Connector	6.5'	International	11-18493	\$1,446.00
Croc Clip Output	6.5'	International	11-18495	\$1,267.00
Piper Connector	6.5'	International	11-18497	\$1,267.00
Aircraft Connector	13'	International	11-18494	\$1,481.00
Croc Clip Output	13'	International	11-18496	\$1,306.00
Piper Connector	13'	International	11-18498	\$1,302.00

SEE OUR WEBSITE FOR COMPLETE SELECTION OF POWERVAMP PRODUCTS

RED BOX POWER UNITS

Red Box Model	Description	Part Number	Price
START UNITS, LEAD ACID			
RB25A-12	RED BOX - 12V HAND PORTABLE START UNIT	11-09806	\$1,683.00
RB25A-24	RED BOX - 24V HAND PORTABLE START UNIT	11-09807	\$1,599.00
RB50A-12	RED BOX - 12V HAND PORTABLE START UNIT	11-09814	\$1,899.00
RB50A-24	RED BOX - 24V HAND PORTABLE START UNIT	11-09815	\$2,090.00
RB75A-24	RED BOX - 24V HAND PORTABLE START UNIT	11-09820	\$2,179.00
RB60A-28	RED BOX - 28V HAND PORTABLE START UNIT	11-15545	\$2,273.00
RB85A-28	RED BOX - 28V HAND PORTABLE START UNIT	11-15546	\$2,358.00
RB50AT-24	RED BOX - 24V TWIN RB50A PORTABLE START UNIT	11-15547	\$4,900.00
RB60AT-28	RED BOX - 28V TWIN RB60A PORTABLE START UNIT	11-15548	\$5,258.00
RB85AT-28	RED BOX - 28V TWIN RB85A PORTABLE START UNIT	11-15549	\$5,441.00
RB75AT-24	RED BOX - 24V TWIN RB75A PORTABLE START UNIT	11-15550	\$5,056.00
TC400A/28C	95A for 1 hr; 55A for 2hr; 39A for 3hr. Max Current 5200A/3500A nominal	11-15561	\$6,095.00
START UNITS, LITHIUM			
RBL2500-28	RED BOX - HAND PORTABLE LITHIUM START UNIT	11-15551	\$2,826.00
RBL4000-28	RED BOX - HAND PORTABLE LITHIUM START UNIT	11-15552	\$3,618.00
RBL4000-28TWIN	Thermal bag for Twin RBL4000 (Included w/ new RBL4000 Twin system)	11-15553	\$7,352.00
SWITCHABLE START UNITS (12V AND 24V)			
RB25A 12/24	RED BOX- SWITCHABLE 12V AND 24V- LEAD ACID	11-15554	\$2,495.00
RB50A 12/24	RED BOX- SWITCHABLE 12V AND 24V- LEAD ACID	11-15556	\$2,599.00
CONTINUOUS DC POWER SUPPLY			
RBPS25	RED BOX - 14/28V 25AMP POWER SUPPLY	11-09824	\$1,454.00
RBPS50	RED BOX - 14/28V 50AMP POWER SUPPLY	11-09825	\$1,766.00
RBSC100	RED BOX - 14/28V 100AMP POWER SUPPLY	11-09827	\$3,608.00
TC3000 RANGE, COMBO START AND CONTINUOUS POWER			
TC3000/50-4	RED BOX - COMBINATION START AND CONTINUOUS POWER UNIT	11-15563	\$6,580.00
HYBRED, COMBO START & CONTINUOUS (* START POWER IS FROM BATTERIES, CONTINUOUS POWER FROM ENGINE)			
HYBRED/170-4	RED BOX - COMBINATION START AND CONTINUOUS POWER UNIT	11-15562	\$11,195.00
CONTINUOUS POWER FROM BATTERIES, START POWER TOO			
TC400A/28C	95A for 1 hr; 55A for 2hr; 39A for 3hr. Max Current 5200A/3500A nominal	11-15561	\$6,095.00
ACCESSORIES, EXTRAS & OPTIONS			
CART/TROLLEY FOR TWIN AN SINGLE START UNITS			
ETOL50FPS	Single Trolley for RB50A and RB75A and RB60A and RBL4000	11-09817	\$914.00
OPTIONS FOR TC3000, HYBRED, AND RBSC150(150 AMPS CONT. UNITS AND UP)			
TCASTKIT	Handle Bar and Extra Castors Option	11-09829	\$399.00
TCASTB	TOW BAR FOR TC 3000/400	11-09828	\$184.95
RE-CELL KITS FOR "RESALE" CAPACITY MATCHED BATTERIES			
TCEL30GSET	RE-CELL FOR RB50A	11-09818	\$734.00
TCEL40GSET	RE-CELL FOR RB75A	11-09823	\$799.00



POWER UNITS – BATTERIES



RED BOX START POWER RB25A POWER UNITS

These power packs are designed for starting of piston, turboprop or turbine aircraft and helicopters in the field or in remote locations and Red Box units may be carried safely on board all aircraft. The power packs are "all weather" units and being modular, can be used in single or dual format. They can be used or stored in any orientation, even inverted. Cells used are cleared as non-hazardous cargo for carriage in the aircraft. They are able to operate in extremes of temperature and have excellent standby characteristics. They are maintenance free and do not require cycling. They can be re-celled "on condition" at any Red Box service center in the world and are designed to give years of repeated service. In addition to aviation, these highly portable units can be used with Armored Fighting vehicles and Military equipment. They can be recharged from the automatic charging system, which is supplied in the package, or from any vehicle using a suitable interface.

Model	Description	Part No.	Price
RB25A	12V Power Unit	11-09806	\$1,683.00
RB25A	24V Power Unit	11-09807	\$1,599.00
RB50A	12V Power Unit	11-09814	\$1,899.00
RB50A	24V Power Unit	11-09815	\$2,090.00
RB75A	24V Power Unit	11-09820	\$2,179.00



RED BOX CONTINUOUS POWER UNITS

Compact, lightweight and highly portable power units. Red Box systems may be carried safely on board all aircraft.

They are designed to give continuous high quality DC power for crew training, aircraft servicing in the workshop, on the ramp or in the field. This continuous power supply is ideal for diagnostic

work, pre-flight checks or for continuous powering of equipment during operations, without draining the onboard aircraft batteries. There is a range of built in safety features and the units are simple to use. This switchable unit will produce a steady 14.4 or 28.8 Volts up to the fully rated output current with power factor correction. The power supplies are multi-fan cooled with built-in thermal management for operation up to 50°C ambient environments. The safety features include over current and short circuit protection. The power modules conform to EMC standards for noise emissions and immunity.

Model	Description	Part No.	Price
RBP525	25 Amp Power Unit	11-09824	\$1,454.00
RBP550	50 Amp Power Unit	11-09825	\$1,766.00
RBPS100	100 Amp Power Unit	11-09827	\$3,608.00
TOWBAR	Towbar	11-09828	\$184.95
HANDLE	Towbar Handle and Caster Kit	11-09829	\$399.00

IFDR USB POWER SUPPLIES FOR INSTRUMENT PANEL



IFDR Power 150 Single USB
Square Faceplate Option
Clean, Custom Appearance
Model 150-1015



IFDR Power 150 Single USB
Round Faceplate Option
Fits Standard Cigarette Lighter Cutout
Model 150-1018



Approved for FAA Certified Part 23 Aircraft and Part 27 and 29 Rotorcraft. Smartphones / iPhones / Cell and Mobile Phones. Tablets and iPads. GPS Units. Cameras / GoPros. GPS Receivers / Augmenters. 2.1 amps (Output Current). Input Voltage: 9 - 48 VDC. Output Voltage: 5 VDC +/- 0.25 (10 watt). Green LED Internal Backlight. Weight: 2.6 ounces. Dimensions: 1.5" W x 1.5" H x 2.1" D (panel cut 0.785" x 0.785"). One year limited warranty.

Description	Part No.	Price
Single USB Power for Panel Mount	13-19298	\$239.95
Single USB Power for Round Panel Mount	13-19774	\$276.95
Single USB Power for Remote Mount	13-19299	\$269.95
Single USB Power for IFDR Panel Mount iPads	13-19301	\$269.95
Dual USB Power for Panel Mount	13-19303	\$300.95
Dual USB Power for Round Panel Mount	13-19775	\$293.95
Dual USB Power for Remote Mount	13-19304	\$296.95
Dual USB Power for IFDR Panel Mount iPads	13-19306	\$296.95



BATTERY CAPACITY TESTER BC-9000

The BC 9000 has been designed to provide the operator with accurate battery charging with ease of operation. Charger Features include: • Universal AC power input 90~264vac (47 to 63hz) • Adjustable DC output from 3.0 to 36.0 Vdc (0.1 steps) • Adjustable DC Current

Output from 0.05 to 25Adc • Constant Voltage or Constant Current Charge • Adjustable charge time from 1-999 min • Single or two step charge routine. • 4 line LCD display • Removable DC Charge Cord • Fan Cooled • 14.00" L (335.6mm) 9.250" W (234.6mm) • 9.50" H (241.3mm) 14lbs (6.350kg).....P/N 11-15071**\$1,996.00**

MCI TRUE BLUE TB17 LITHIUM-ION BATTERY



The TB17 Advanced Lithium-ion Battery uses the most sophisticated lithium-ion chemistry available, providing aviators with an unmatched advantage of power, safety, life and energy. Ideal for the piston, turbine, and emergency power market, the TB17 starts the aircraft's engine quickly and features superior energy density — Nanophosphate® lithium-ion cells offer 3x the energy per kilogram, resulting in a battery that is 45% lighter than lead-acid or nickel-cadmium alternatives.

This advanced battery system is engineered to deliver an overall lower cost of ownership with a 2-year maintenance schedule, efficient engine starts, extended useful life and intelligent battery status communication to the cockpit.

P/N 11-15375**\$6,295.00**

CHARGEMASTER 1 AMP SELECTABLE 6 OR 12 VOLT BATTERY CHARGER



Schauer 1A, 6V/12V Automatic Battery Charger / Maintainer – Model CM1A

• Fully Automatic Battery Charger / Maintainer / Conditioner • 1 Amp, 6 or 12 volt • LED charging indicator lights • 10 ft. charging cable • Battery Clips and Ring Terminal connections included – quick disconnect • Reverse Polarity, Short Circuit, Output Overload & Internal Overheat protection 3.9" x 2.6" x 1.5", 1.5 lbs • For any type Lead Acid battery – wet, VRLA, Gel, AGM • UI, cUI, BC approved.

P/N 11-14320**\$35.80**

CHARGE MASTER SMART CHARGE PLUS MAINTENANCE



Schauer ChargeMaster 6A max., 12V Multi-Current Automatic Charger / Maintainer – Model CM6A • Fully Automatic Battery Charger / Maintainer / Rejuvenator • Selectable Charge Rate: 1 / 4 / 6 amp • Selectable Charger Voltage: 14.1 / 14.4 / 14.7 VDC (match to battery manufacturer specifications) LED Charging indicator lights • 7 Charging Modes: Soft Start, Bulk Charging, Absorption, Equalization, Analysis, Float, Maintenance • Battery Clips and Ring Terminal connectors – quick disconnect Reverse Polarity, Short Circuit, Internal Overheat and Timer protection • Eco energy saving mode • Battery Rejuvenation for batteries in poor condition / Sulphated (US Patented) • 7.5" x 3.8" x 2", 2.4 lbs.

• For any type Lead Acid battery – wet, VRLA, Gel, AGM • UL, cUL, BC approved.

12V 1/4/6 Amp.....P/N 11-14332**\$68.75**
12V 1/8/12 Amp.....P/N 11-14333**\$98.85**

EL

BATTERIES – BATTERY CHARGERS



EARTH X LITHIUM BATTERIES

Note: Not FAA Approved. Intended for use in experimental aircraft only. EarthX Lithium batteries are designed to be a replacement of a standard 12 volt lead-acid battery. The batteries will work with any vehicle charging system and "modern" lead-acid battery chargers, thanks to the built-in battery management system. And the batteries are an exceptional value given the fact they last years longer than a lead-acid battery.

Model	Volts	1 Hr 1C Rate	Crank Amps (PCA/CCA)	Wt.	Case Size L x W x H (In.)	Part No.	Price
ETX680C	13.2	12.4	680/320	3.9 lb	5.9 x 4.5 x 3.9	11-14292	\$379.00
ETX680	13.2	12.4	680/320	4.1 lb	6.5 x 3.1 x 6.6	11-13907	\$379.00
ETX900	13.2	16	900/420	5.0 lb	6.5 x 3.1 x 6.6	11-13926	\$449.00
ETX900-24	26.4	15.6	840/400	8.9 lb	6.5 x 5.1 x 6.6	11-16601	\$899.00
EXT1200	13.2	24.8	1200/600	7.7 lb	6.6 x 3.4 x 6.9	11-13930	\$799.00
ETX900-VNT	13.2	16	840/400	5.4lb	6.5 x 3.1 x 6.6	11-16211	\$607.00



EARTH X ETX680 26.4 VOLT LITHIUM AIRCRAFT BATTERY

Note: Not FAA Approved. Intended for use in experimental aircraft only WITH turbine engines up to 900hp or piston engines up to 550ci. ETX680-24-VNT is a replacement battery for a 24-28V battery with 850 cranking amps and only weighs 7.2 pounds. This battery is intended for 400ci engine size or less; 60 amp alternator/generator or lessP/N 11-18681\$799.00



EARTH X ETX680 24V LITHIUM AIRCRAFT BATTERY - FOR CERTIFIED AIRCRAFT

Note: STC not currently available, must attain your own field approval to install it.

The FAA approved 24V ETX680-24-TSO designed for certified aircraft! This battery is only 7.2 pounds and can be used in an aircraft that has an alternator/generator with 70 amps output or less. This battery has electronic protections (BMS) and built in thermal runaway containment and venting ability built in. The ETX680-24-TSO meets all of the DO-311a and DO-160 requirements for a lithium battery in aircraft.P/N 11-18796\$999.00

EARTH X ALUMINUM BATTERY BOXES



EARTH X FOR ETX680 / ETX900 / ETX1200

Aluminum battery box designed specifically for the ETX680, ETX900 series of EarthX batteries. This battery box was engineered to be strong enough to withstand 30 G of force yet only weighs 7 ounces or 198 grams and will fit the ETX680 and ETX900 like a glove. This unique design allows for simple, easy installation with the dimensions: 6.5" L x 3.1" W x 6.6" HP/N 11-14074\$49.00



MULTI-USE ALUMINUM BATTERY BOX

For the ETX680, the ETX900 or the PC680. Dimensions: 7.1" L x 3.1" W x 6.5-6.6 (adjustable)"H or (180mm x 80mm 166-168mm)P/N 11-14136\$59.00



EARTH X COMPACT BATTERY BOX

This is a custom made aluminum battery box designed specifically for the EarthX lithium battery ETX680C. This battery box was engineered to be strong enough to withstand 30 G of force yet only weighs 4.9 ounces or 140 grams and will fit your ETX680C like a glove. This unique design allows for simple, easy installation with the dimensions: 5.9" L x 3.4" W x 4.5"H. This case fits all "C" battery modelsP/N 11-17403\$49.00



EARTH X THERMAL BATTERY BOX

The EarthX thermal battery box is designed to protect the battery in engine compartment installations from periods of high temperature (up to 1 hour), such as after shutdown, and from radiant heat from hot surfaces like exhaust systems during and after flight. This stainless-steel box has a mirror finish to minimize the effect of radiant heat, and it has a high-performance insulating foam layer between the box and battery to reduce effect of convection heat. The hold-down tab comes with a mounting fixture that can hold a cooling air duct up to 1" in diameter. This battery box was engineered to be strong enough to withstand 30 G of force yet only weighs 1 pound. It has the same mounting holes as the custom battery box or the multi-use battery box. This battery box is designed to be compatible with our existing "E" case battery models; ETX680/900/1200.....P/N 09-05653\$115.00



EARTH X ETX-900 TSO 14V AIRCRAFT LITHIUM BATTERY

Item qualifies for free ground shipping via UPS (Lower 48 USA Only - Additional Items May Void Promotion) **Note:** STC is not provided by EarthX Batteries. The ETX900-TSO Certified Aircraft battery is only 5.4 pounds and can be used in an aircraft that has an alternator/generator with 80 amps output or less. This battery has electronic protections (BMS) and built in thermal runaway containment and venting with 2 venting tubes that are 3 feet in length each. The ETX900-TSO meets all of the DO-311a and DO-160 requirements for a lithium battery in aircraft.

The battery also has an LED battery fault light indicator on the battery itself plus it can be programed into your EFIS or wired to an LED on your panel. The fault indicator alerts you to the state of charge and state of health of the battery.....P/N 11-18242\$699.00



QUIET POWER CHARGERS

The QUIET POWER® QP™-100 Series Dual USB Charging Port is designed specifically for aircraft cockpit and cabin installation and is compatible with both standard and high-power USB. Simultaneously charges two USB powered devices, including cell phones, tablets, radios, ADS-B receivers and GPS devices. An Auxiliary Charging Port is available in the QP101-QP104 series products, producing 5, 9, 11 or 12 Volts DC. USB port is dual 5 VDC. Input Voltage Range 10–36 VDC on QP-100, 101 & 102. It is 13.2-36 VDC on Q 103 & 104.

Part No.	Description	Price
11-13834	Non Lit No Aux Qp-100	\$245.00
11-13835	Lit No Aux Qp-100I	\$249.95
11-13836	Non Lit 5 Volts Qp-101	\$289.95
11-13837	Lit 5 Volts Qp-101I	\$299.95
11-13838	Non Lit 9 Volts Qp-102	\$289.95
11-13839	Lit 9 Volts Qp-102I	\$299.95
11-13840	Non Lit 11 Volts Qp-103	\$289.95
11-13841	Lit 11 Volts Qp-103I	\$299.95
11-13842	Non Lit 12 Volts Qp-104	\$289.95
11-13843	Lit 12 Volts Qp-104I	\$299.95

QUIET POWER CHARGING CABLE KITS



Auxiliary Charging Port for the Quiet Power Chargers. Auxiliary Charging Port Kit comes complete with a device specific charging cord and a barrel power jack (2.5mm ID x 5.5mm OD). The barrel power jack is designed to be panel mounted, allowing for quick disconnect of the charging cord.

Model	Plug	Plug Size	Cable	Part No.	Price
QPC-001	Barrel	2.5mm ID x 5.5mm OD	4	11-13844	\$33.95
QPC-002	Barrel	2.1mm ID x 5.5mm OD	4	11-14451	\$33.95
QPC-003	Barrel	1.3mm ID x 3.5mm OD	4	11-14452	\$33.95
QPC-004	Barrel	1.7mm ID x 4.0mm OD	4	11-14453	\$33.95
QPC-005	Barrel	1.7mm ID x 4.75mm OD	4	11-14454	\$33.95
QPC-006	Barrel	0.9mm ID x 3.2mm OD	4	11-14455	\$33.95
QPC-007	Barrel	3.3mm ID x 5.5mm OD	4	11-14456	\$33.95

EARTH X LED FAULT LIGHT INDICATORS



Easily see if you have a battery fault with this 5mm Red LED light for your EarthX experimental aircraft. The LED has a built in resistor for easy installation and compatibility with a 10-15V electrical system. Details installation directions are located in the

EarthX manual but it is very simple. To install, connect red wire to a positive bus connection, connect the black wire to fault monitoring wire (also black) that is located on the EarthX battery.

10-15VP/N 11-17281\$29.99
26.2-29.2VP/N 11-17286\$29.99

EARTH X EMERGENCY JUMP PACK CHARGER



Premium quick connect permanent battery lead for power sport batteries that can either charge your battery or be used to jump start your battery quickly and easily! Designed to carry 400 amps so it can be used as both your charging pig tail or for a jump start.....P/N 11-15073\$49.95



START PAC® STARTERS - POWER SUPPLIES

START PAC® PORTABLE STARTING UNITS

The new patent pending Start Pac QC models have separate removable batteries that can be changed in 15 seconds. This feature allows the user to change the batteries in the field without needing to send the Start Pac back to the shop or manufacturer. Batteries have no memory effect and can be recharged at anytime. Made in the USA. Certain aircraft will allow the ship's generator to back charge a GPU. In this manner, Start Pacs can be recharged in the field without an AC source indefinitely.

NOTE: When storing the Start Pac for more than 30 days, remove the battery pack from the charging unit and store separately.



MODEL 1324-1 QC

• 13 AMP hours @ 10 Amp Hour Rate • 1300 AMPS Peak Current complete with built in charger, power plug and cables • 15.5"x4"x11.75" • 35 LBS. Complete • Units are 24 VDC output with a universal charger that will accept 90-240 VAC 50/60 hertz. Will start turbine or piston engines up to 500 horse power. Has a 4.5 amp charger and will provide a charge time of approx. 4 hours. Will give two to three starts between charges. This portable unit is mainly designed for emergency starting in remote locations. This unit is not designed for repeated daily starts or maintenance functions.

1324-1 QC P/N 11-04538 **\$1,276.00**
1324-1 QC-RBS (Battery Set) P/N 11-07231 **\$357.00**



MODEL 2300 QC

Built in chargers, power plug and cables. 24/26 VDC output, with universal chargers that will accept 90-240 VAC 50/60 hertz. • 26 AMP hours @ 10 Hour Rate • 2300 AMPS Peak Current • Trolley available • 19.2"x7.5"x11.5" • 69 LBS. Complete. For starting engines up to

1500 horse power and give four to six starts between charges. This unit has a dual redundant 4 amp chargers. When plugged into an AC source, 8 amps at 28VDC, is available for maintenance functions without depleting the batteries. Recharge time is approx. 3-1/2 hours.

2300 QC P/N 11-06780 **\$2,866.00**
2300QC-B (Batteries) P/N 11-06781 **\$935.00**



MODEL 6028 QC

All In One air portable/carry-on START PAC® with built in chargers, power plug and cables. Units are 28.5 VDC output, with universal chargers that will accept 90-240VAC 50/60 hertz. 26 AMP hours @ 10 Hour Rate. 2300 AMPS Peak Current. Available with separate trolley. 19.2"x7.5"x11.5". 77 LBS. Complete.

6028 QC P/N 11-06783 **\$3,265.00**
6028 QC-B (Batteries) P/N 11-07189 **\$1,145.00**



MODEL Li2800 QC

A full 28VDC battery pack and will provide superior starts on all electrically-started turbine engines. It has dual, redundant chargers with a total of 7 amps output and a recharge time of approximately 4 hours. • 28 AMP hours @ 10 Hour Rate • 2400 AMPS Peak Current • L 19.2" x W 7.5" x H 9.75" • 46 LBS. Complete. Utilizes the latest technology in Lithium batteries. (can be left in a completely discharged state without causing damage)

Li2800 QC P/N 11-06782 **\$4,180.00**
Replacement Battery P/N 11-17613 **\$1,829.00**



START PAC® ONE™

START PAC® ONE™ The smallest and lightest 26V micro starting unit for aircraft on the market, this light duty air portable/carry-on START PAC® Lithium-ion weighs only 12lbs/5.4kg. Providing emergency starts for turbine or piston engines, this unit is designed for engine starting only. Designed to be used with voltage sensitive aircraft that cannot accept 28V external starters, this START PAC ONE jump-starting system is small but mighty. This START PAC® will provide a faster and cooler engine start than most ship's aircraft batteries (the turbine is spooled to more revolutions per second before fuel is injected). Thus, turbine life will be extended because there is less stress on the starter and other engine components. This will preserve the aircraft's costly batteries and help lower operating costs. Your on-board battery can then be saved for emergency use only.

P/N 11-14192 **\$2,737.00**

QUICK CHANGE TROLLEY

The Start Pac® QC trolley is a light weight accessory for either the Start Pac® Models 1324-2QC, 1628QC, 2300QC or the 6028QC

P/N 11-06775 **\$389.00**



START PAC® POWER SUPPLIES

The entire aircraft electrical system can be powered up for GPS programming and electrical maintenance. Thus the on board aircraft battery can be saved for starting. Do not use for starting as starter motors require far more amperage than is available from the StartPac® Portable Power Supply. Not for battery charging. Made in the USA.

MODEL 53025

This START PAC®'s maximum amperage output is 50 amps which is more than adequate for powering up various systems such as GPS and avionics programming. It is also an excellent choice for powering the aircraft's maintenance equipment bypassing the aircraft battery and thus preserving it from unnecessary wear. This means that the on board aircraft battery is conserved for starting only. The environmentally responsible, low VOC powder coating protects the unit from wear, tear and poor weather conditions. **Features:** • Smallest and lightest portable aircraft power supply in the world • No duty cycle, clean continuous power • Resistant aluminum case with environment friendly, low VOC durable powder coat finish, easy to handle, built for heavy duty usage

Standard Plug 53025 - 12V P/N 11-04536 **\$695.00**
Standard Plug 53025 - 24V P/N 11-06833 **\$1,195.00**
Piper Plug 53025 - 12V P/N 11-10088 **\$677.00**



MODEL 53050

Specifications: • No duty cycle, output voltage 28.5 VDC • AC input is universal 90-240 Volts.

• Over current protection • Over voltage protection • Over temperature protection • Forced air-cooling • **Dimensions:** Wt. 10 lbs./4.54 kilos 14" X 5.25" X 5.50". A 28.5 Volt continuous DC power supply when plugged into 110/220 Volt single phase AC power. Will deliver full 50 amp DC output continuously, but will not provide enough current for aircraft engine starting or mining equipment starting.

53050 P/N 11-06833 **\$1,195.00**



MODEL 53105

Specifications: • Maximum continuous 105 amps +5%. No duty cycle • AC input 190-240 Volts • Over current protection • Over voltage protection • Over temperature protection • Forced air cooling • 8 foot power cable • Weights 26 lbs./11.80 kilos complete with power cable

• 14.5"x7"x13.75". A 28.5 Volt continuous DC power supply when plugged into 220Volt single-phase AC power. Will deliver full 105 amp DC output, but will not provide enough current for engine starting.

53105 P/N 11-06834 **\$2,254.00**

START PAC® GROUND POWER UNITS

The following dimensions apply to each of the 3300s: 38"x21"x20" Handle Height 48". Avoid discharging the batteries completely as damage can result.

MODEL 3324

Combination power supply and battery pack. **Batteries:** • 78 Amp Hours at 10 hour rate • 24 Volt DC - 25.5

Volts at rest Sealed cells non-hazardous Valve regulated high amperage output lead acid * 3200 Peak Amps Power supply / charger: • Multi-unit 58 Amp DC continuous output • 28 - 28.5 Volt output from 0 - 58 amp load • Battery recharge time from fully discharged - 2 hours • AC Input - 110 Volt or 220 Volts (only 1) Limitations: 200 amps maximum DC load.

3324 P/N 11-07225 **\$5,879.00**
3324-RBS (Battery Set) P/N 11-07234 **\$1,329.00**

FOR ADDITIONAL GROUND POWER UNITS PLEASE CALL OR VISIT OUR WEBSITE AT WWW.AIRCRAFTSPRUCE.COM

START PAC QUICK CHARGE GROUND POWER UNIT



These ground power units are designed to perform starting, powering up aircraft systems and maintenance functions. When connected to AC power, the depleted batteries can be charged in a matter of hours with the built in power supply/battery charger.

Volts	Amps	Part No.	Price
24	105	11-14338	\$6,215.00
24	200	11-14339	\$7,026.00
24	300	11-14340	\$7,658.00
28	400	11-14341	\$5,990.00
28	105	11-14342	\$6,531.00
28	200	11-14343	\$7,298.00
28	300	11-14344	\$7,809.00
28	400	11-14345	\$8,340.00

EL

START PAC® STARTERS - POWER SUPPLIES

START PAC LI2600QC STARTER 26VDC



The all new Patent Pending Start Pac model Li2600QC utilizes the latest technology in Lithium batteries. These batteries provide the same power as the lead-acid type but are 42% lighter and 32% smaller. In addition, lithium batteries have two other major advantages:

twice the battery life of lead-acid batteries and no sulphation problems (can be left in a discharged state without causing damage to the battery plates). This compact portable Lithium Ion starting unit is a full 26VDC battery pack and will provide superior starts on small to medium size turbine engines. It has a built in charger with a total of 4.0 amps output and a recharge time of approximately 6 hours. This unit is especially designed for aircraft that will not accept a full 28 volt battery pack (actually reads 30-31 volts). Aircraft such as the Phenom 100 and Eclipse 500 will accept this 26 volt unit (actually reads 28.5 volts).....P/N 11-09515**\$2,936.00**

START PAC LI2000QC STARTER 28.5VDC



The all new Patent Pending Start Pac model Li2000QC utilizes the latest technology in Lithium batteries. These batteries provide the same power as the lead-acid type but are 42% lighter and 32% smaller. In addition, lithium batteries have two other major advantages:

twice the battery life of lead-acid batteries, no sulphation problems (can be left in a discharged state without causing damage to the battery plates). This compact portable Lithium Ion starting unit is a full 28VDC battery pack and will provide superior starts on small to medium size turbine engines. It has a built in charger with a total of 3.5 amps output and a recharge time of approximately 6 hoursP/N 11-09516**\$3,143.00**

START PAC LI2800QC TWIN PAC STARTER, 28.5VDC



The all new Start Pac Model Li2800 QC Twin Pac utilizes the latest technology in Lithium Batteries. These batteries provide the same power as the lead-acid type but are 42% lighter and 32% smaller. The multi-purpose Li2800QC

Twin Pac can be easily broken down into 2 separate units for easy transport and shipping. In addition, lithium batteries have two other major advantages: twice the battery life of lead-acid batteries, no sulfation problems (can be left in a discharged state without causing damage). This powerfully versatile Lithium Ion Twin Pac starting unit is a full 28VDC battery pack and will provide superior starts on all electrically-started turbine engines. It has dual, redundant chargers with a total of 7 amps output and a recharge time of approximately 4 hours.

P/N 11-09517**\$8,468.00**

START PAC LI2700QC STARTING UNIT



This compact portable Lithium Ion starting unit is a full 26VDC battery pack and will provide superior starts on all electrically-started turbine engines. It has dual, redundant chargers with a total of 9 amps output and a recharge time of approximately 4 hours. The engineers at

Start Pac specifically designed the Li2700QC Lithium aircraft starter for aircraft with over voltage protection relays that are set lower than most aircraft so that they can not accept more than 29.5 volts from an external starting source. Some of these aircraft include the Agusta Westland AW139, Sikorsky S-76, Eclipse 500, Phenom 100 and Phenom 300. This unit is designed for engine starting only.

Specifications: • 31 AMP hours @ 10 Hour Rate • 2400 AMPS Peak Current • L 19." x W 7.5" x H 9.75"/ L 49cm x W19cm x H29cm • 46 lbs./20.8 kg Complete weight with built in charger and aircraft cable • Not to be used as an aircraft battery charger.....P/N 11-14709**\$4,190.00**

START PAC MODEL 6028QC TWIN PAC - 28V

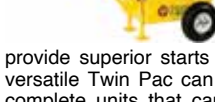

This powerful portable 28 volt aircraft starter unit is a full 28VDC battery Twin Pac and will provide superior starts on all electrically-started turbine engines. This versatile Twin Pac can be used as a single unit or separated for two complete units that can be easily carried on board different aircraft. The 6028QC twin pack has redundant chargers with a total of 14 amps output and a recharge time of approximately four hours. **Note:** This unit is designed for engine starting only.....P/N 11-17717**\$6,113.00**

START PAC MOBILE SUPPLY MODEL 53400 - 28.5V

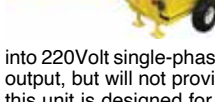

Start Pac® Model 53400 is a 28.5 Volt continuous DC power supply when plugged into 220Volt single-phase AC power. This unit will deliver full 400 amp DC output, but will not provide enough current for engine starting. Therefore this unit is designed for maintenance and to power up various functions such as inverters, avionics, GPS, and air conditioning.

Note: This unit is NOT designed for engine starting or battery charging. P/N 11-17746**\$6,995.00**

START PAC LI2700QC STARTING UNIT TWIN PAC

This powerful Lithium Ion starting unit is a full 26VDC portable battery pack and will provide superior starts on all electrically-started turbine engines. This versatile Twin Pac can be used as a single unit or separated for two complete Lithium units that can be easily carried on board. It has redundant chargers with a total of 18 amps output and a recharge time of approximately four hours. The engineers at Start Pac specifically designed the Li2700QC as an airplane starting unit with voltage protection relays that are set lower than most aircraft so that they cannot accept more than 29.5 volts from an external starting source. Some of these aircraft include the Agusta Westland AW139, Sikorsky S-76, Eclipse 500, Phenom 100 and Phenom 300. This unit is designed for engine starting only. **Specifications:** • 31 AMP hours @ 10 Hour Rate • 62 AMPS Peak Current • 2400 AMPS Peak Current • L 38.4" x W 7.5" x H 9.75"/ L 98cm x W19cm x H29cm • 120 lbs./ 55 kilos Complete with Twin Pac trolley • Not to be used as an aircraft battery chargerP/N 11-14749**\$8,465.00**

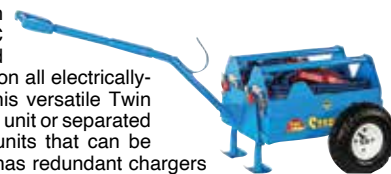

STARTPAC MINI PORTABLE POWER SUPPLY MODEL 53050 - 12V



This Start Pac® Portable Power Supply is a 12 Volt output unit. This unit is ideal for powering up aircraft cockpits. When utilizing this mini power supply, the aircraft electrical system can be powered up for GPS programming and light duty maintenance, bypassing the aircraft battery and preserving it for starting. The Start Pac® Portable Power Supply model 53050/12 is designed to power up 12 Volt aircraft systems. The voltage output is set to 14.2 Volts to simulate the same voltage as when the aircraft is running under power. Maximum amperage output is 50 amps which is adequate for most light aircraft. If overloaded, the 53050/12 will trip off and reset itself after a short period of time. This unit is ideal for powering up new and old aircraft with glass cockpits. **Note:** This unit is NOT designed for engine starting or battery charging.....P/N 11-10088**\$677.00**

STARTPAC MINI PORTABLE POWER SUPPLY MODEL 53025 - 24V



This Start Pac® Portable Power Supply is a 24 Volt output unit and is ideal for powering up aircraft cockpits. GPS programming and other aircraft systems can be easily powered up by bypassing the aircraft battery to save it for engine starting. The Start Pac® Portable Power Supply model 53025/24 is designed to power up 24 Volt aircraft systems. The voltage output is set to 28.5 Volts to simulate the same voltage as when the aircraft is running under power. Maximum amperage output is 25 amps which is adequate for most light aircraft. If overloaded, the 53025/24 will trip off and reset itself after a short period of time. This unit is ideal for powering up new and old aircraft with glass cockpits. **Note:** This unit is NOT designed for engine starting or battery charging.

P/N 11-04537**\$695.00**

START PAC MODEL LI3328QC SET



Start Pac® Model Li3328QC Set includes the model Li2800QC Twin Pac Starting and the model 53050 Power Supply.

Model Li2800QC Twin Pac Starting

This powerful Lithium aircraft starter unit is a full 28VDC battery Twin Pac and will provide superior starts on all electrically-started turbine engines. Versatile and highly portable, this Twin Pac can be used as a single unit or separated into two complete Lithium units that can easily be carried on board two different aircraft. The Lithium twin pack has redundant chargers with a total of 14 amps output and a recharge time of approximately four hours.

Model 53050 Power Supply

When plugged into 110/220 Volt single phase AC power, PAC® Model 53050 is a 28.5 Volt continuous DC portable power supply. Continually delivering full 50 / 105 / 200 / 300 / 400 amp DC output, this unit does not, however, provide enough current for starting an aircraft engine or mining equipment. Instead, it has been designed to power up various systems, such as programming GPS and avionics. The PAC® Model 53050 is also an excellent choice for powering aircraft maintenance equipment.

50 amp.....P/N 11-18184**\$6,793.00**
105 amp.....P/N 11-18185**\$7,260.00**
200 amp.....P/N 11-18186**\$8,074.00**
300 amp.....P/N 11-18187**\$8,883.00**
400 amp.....P/N 11-18188**\$9,702.00**

EL

START PAC® STARTERS - POWER SUPPLIES

STARTPAC PRO UNIT FOR 28V AIRCRAFT



The Start Pac PRO is a very portable unit that is designed to be used as a safe and reliable jump-starting solution when aircraft batteries fail or are too weak to provide a satisfactory engine start.

This lightweight solution is unique in that it addresses the requirements across both civil, commercial and military markets. The Start Pac PRO Jump Starting System can be used for helicopters and fixed wing aircraft as well as military UAVs. The Start Pac PRO comes standard as a complete set with a patent pending aircraft cable adaptor kit, proprietary charger and carrying case P/N 11-17718 **\$2,644.00**

START PAC® PORTABLE STARTING UNIT - 26V 2326QC



All In One air portable/carry-on START PAC® with built in chargers, power plug and cables. This 26 Volt unit is designed for voltage sensitive aircraft that cannot accept a true 28V external starter. This Start Pac will provide a faster and cooler engine start than most ship's aircraft batteries, thus extending turbine life which helps to lower operating costs. The 2326QC has dual redundant chargers with a total of 7 amps output with a recharge time of approximately 2-4 hours after having been depleted from multiple engine starts. Certain aircraft will allow the ship's generator to back charge a GPU. In this manner, Start Pac® can be recharged in the field without an AC source indefinitely. **Note:** When storing the Start Pac® for more than 30 days, remove the battery box from the charging unit and store separately.

P/N 11-17715 **\$2,955.00**

START PAC® GROUND POWER SUPPLY & STARTING UNIT - 26V 3326 SPECIAL

These StartPac GPUs are designed for ground use to perform repeated engine starting functions. When connected to AC power, the depleted batteries can be charged in four hours with the built-in battery chargers. This turbine starting unit is designed to provide repeated superior starting power for voltage sensitive turbine engines. The Model 3326 Special GPU is designed for repeated engine starting requirements on voltage sensitive aircraft..... P/N 13-22425 **\$5,745.00**



START PAC® TWIN PAC 2326QC - 26V

This powerful portable 26 volt aircraft starter unit is a full 26VDC battery Twin Pac and will provide superior starts on all electrically-started turbine engines. This versatile Twin Pac can be used as a single unit or separated for two complete units that can be easily carried on board different aircraft. The 2326QC Twin Pac has redundant chargers with a total of 14 amps output and a recharge time of approximately four hours from being depleted. **Note:** This unit is designed for engine starting only. **Note:** When storing the Start Pac® for more than 30 days, remove the battery box from the charging unit and store separately..... P/N 11-17716 **\$5,773.00**



START PAC® TWIN PAC PORTABLE STARTING UNIT - 24V 2300QC

This 24V All-In-One air portable/carry-on START PAC® with built-in chargers, power plug and cables is ideal for starting aircraft, tank, and military truck engines. It is designed for engine starting only. This portable starting unit is one of our most popular starters for use at home base and in the field. It will start turbine, or piston engines up to 1500 horsepower. This versatile 24 volt Twin Pac can be used as a single unit or separated for two complete units that can be easily carried on board different aircraft. It is equipped with universal chargers that will accept 90-240 VAC at 50/60 hertz with a recharge time of less than 3.5 hours P/N 11-17714 **\$5,088.00**



START PAC® MICRO® HANDHELD 12V AIRCRAFT ENGINE STARTER



Handheld 12v DC Aircraft Engine Starter. Not only can the START PAC MICRO® be used for all 12V aviation applications (helicopters and fixed wings), but it will also jump start any type of engine running on 12V. This unit is specifically designed for engine starting only. This unit is the sturdiest 12V lead acid jump starter on the market, capable of starting either piston aircraft or experimental aircraft. Small, powerful and light weight, it will allow you to start your engines swiftly, preventing any downtime. The environmentally responsible, low VOC powder coating protects the case from wear and poor weather conditions. P/N 11-17855 **\$1,095.00**

START PAC® RANGER - 26V



START PAC is offering the "Ranger™" as a more economical alternative to the Patent Pending Self-Propelled "Hi-Brd 3", which provides 300Amps of continuous power for powering aircraft systems along with 3200 peak amps for starting. The Ranger™ is the only diesel powered GPU on the market to utilize Start Pac's signature, state of the art safe batteries for aircraft engine starting. It comes in at a lower weight and price than that of the "Hi- Brd 3" making it one of the smallest, quietest, most advanced, and most affordable GPU's on the market. The "Ranger™" is equipped with a diesel engine (2 Cylinder, 14hp) that will allow the GPU to provide 150Amps of continuous power for running aircraft systems, along with 2400 peak amps for engine starting provided by the on board batteries. These batteries are sealed, contain no liquid, and will outlast standard lead acid batteries by a factor of two to three. They also do not suffer from any sulfation issues that will cause the batteries to fail prematurely from being left sitting in a discharged state. P/N 11-17738 **\$26,976.00**

START PAC® SELF-PROPELLED DIESEL-ELECTRIC HI-BRD™ 4



The Self-Propelled Hi-Brd 4 GPU is ideal for operations that do not always have access to a tug but need to have the ability to easily walk the unit to the aircraft out on the ramp. The unique self-propelled feature makes this eco-friendly 28 volt ground power unit simple and easy to maneuver on the ramp for shorter distances and yet can be towable for longer distances. The 28 volt Start Pac Hi-Brd 4 GPU is one of a select few GPU units that meets current Tier IV EPA emissions standards. This compact economical 28 volt hybrid ground power unit consumes up to 75% less fuel than traditional equipment and runs much more quietly and efficiently. The simple easy to use key ignition allows for fast on the job training and operation. The unit comes standard with our patent pending 26 volt battery technology that read 28 volts when fully charged with a lead acid option if preferred P/N 11-17739 **\$39,136.00**

START PAC QUICK CHARGE GROUND POWER UNIT 26 VOLTS - 3326QC



The 3326QC -50 / -105 / -200 / -300 / -400 are a full 26 Volt starting unit that will give faster, cooler starts on voltage sensitive turbine engines. When plugged into 110 VAC or 220 VAC, the -50 / -105 / -200 / -300 / -400 Amp power supply is large enough to power various systems such as inverters, avionics and GPS. Always recharge immediately after use to achieve maximum battery life. Once charged, leave the unit plugged in. Avoid fully discharging the batteries as damage to the cells may result. To recharge the unit, simply plug it into an AC wall power outlet and leave it plugged in when not in use. The high tech proprietary chargers will maintain 100% battery charge without over charging the batteries.

Volts	Amps	Part Number	Price
26 Volt DC- 27.6 Volts	50	11-17722	\$5,925.00
26 Volt DC- 27.6 Volts	105	11-17723	\$6,659.00
26 Volt DC- 27.6 Volts	200	11-17724	\$7,554.00
26 Volt DC- 27.6 Volts	300	11-17725	\$8,101.00
26 Volt DC- 27.6 Volts	400	11-17726	\$8,754.00

START PAC® GPU 3324XL SPECIAL - 72V



This Start Pac GPU is designed for ground use to perform repeated engine starting functions on the ramp. The 3324XL Special unit is designed for electrically started standard and voltage sensitive turbine engines. Due to the size of the battery bank in this Start Pac engine starting unit, when the unit is depleted, recharge time may be as long as 7-9 hours. **Note:** Unit comes with two front wheels for added safety on non-truck mount version.

P/N 11-17737 **\$8,268.00**

START PAC GPU 3326XL SPECIAL - 26V



This Start Pac GPU is designed for ground use to perform repeated engine starting functions on the ramp. The 3326XL Special unit is designed for electrically started standard and voltage sensitive turbine engines. Due to the size of the battery bank in this Start Pac engine starting unit, when the unit is depleted, recharge time may be as long as 7-9 hours. **Note:** Unit comes with two front wheels for added safety on non-truck mount version.

P/N 11-17857 **\$8,766.00**

EL

START PAC – POWERALL – EXP BUS

START PAC QUICK CHARGE GROUND POWER UNIT



- The GPU is rated at 3200 peak starting amps and a continuous -50 / -105 / -200 / -300 / -400 Amp DC output when connected to a 110 Volt or 220 Volt AC source (voltage must be specified when order is placed)
- The Li3328QC weighs approximately

120 lbs. and is pulled by hand or tug. Locking the handle in an upright position sets the GPU brake • The environmentally friendly durable low VOC powder coating helps to make this unit weather resistant and the recyclable non-toxic lithium batteries can be easily and safely returned to the Earth without any detrimental environmental repercussions.

Volts	Amps	Part No.	Price	Volts	Amps	Part No.	Price
28	50	11-17732	\$5,961.11	28	300	11-17735	\$7,988.89
28	105	11-17733	\$6,455.56	28	400	11-17736	\$8,800.00
28	200	11-17734	\$7,277.78				

START PAC QUICK CHARGE GROUND POWER UNIT



- The GPU is rated at 3200 peak starting amps and a continuous -50 / -105 / -200 / -300 / -400 Amp DC output when connected to a 220 Volt AC source • The Li3326QC weighs approximately 120 lbs. and is pulled by hand or tug • Locking the handle in an upright position

sets the GPU brake • The environmentally friendly durable low VOC powder coating helps to make this unit weather resistant and the recyclable non-toxic lithium batteries can be easily and safely returned to the Earth without any detrimental environmental repercussions.

Volts	Amps	Part No.	Price	Volts	Amps	Part No.	Price
26	50	11-17727	\$6,077.78	26	300	11-17730	\$7,983.33
26	105	11-17728	\$6,455.56	26	400	11-17731	\$8,800.00
26	200	11-17729	\$7,277.78				

START PAC MODEL LI3326QC SET



The engineers at START PAC specifically designed the Li2700QC as an airplane starting unit for aircraft with voltage protection relays that are set lower than most aircraft, meaning that they cannot accept more than 29.5 volts from an external starting source. These aircraft include but are not limited to the Agusta Westland AW139, Sikorsky S-76, Eclipse 500 and both the Phenom 100 and Phenom 300.

This unit is designed for engine starting only. Not to be used as an aircraft battery charger. Do not charge in flight. 50 amp.....P/N 11-18179\$6,793.00
105 amp.....P/N 11-18180\$7,260.00
200 amp.....P/N 11-18181\$8,074.00
300 amp.....P/N 11-18182\$8,888.00
400 amp.....P/N 11-18183\$9,702.00

POWERALL PORTABLE GROUND POWER UNIT



Portable power for hangar and ramp operations ranging from 25 to 50 Amp Continuous Power with up to 2400 Peak Amps for Starting.

Multi-Purpose and Powerful, the PA-4500 and PA-4500-100 are designed for optimum versatility providing constant, reliable power and up to 4500 Peak Amps for starting and maintaining a large variety of Turbine Powered Aircraft and Helicopters.

This powerful dual unit is the appropriate choice for large turboprops, mid-size turboprop-powered aircraft, and large helicopters. The PA-4500 is actually 2 PA-2400 units coupled together in parallel delivering up to 4500 Peak Amps for starting aircraft and helicopters with a higher amperage draw such as the Raytheon HS-125-800XP, Westwind, Brasilia 120, Lear 40 series, Jetstream 30 Series aircraft, and Agusta Westwind AW139 and Sikorski S76 Series Helicopters.

50 AmpsP/N 11-17898\$9,720.00
100 AmpsP/N 11-17899\$11,658.00

B&C HIGH/LOW VOLTAGE WARNING INDICATOR



The BC207 is a solid-state high/low voltage sensor which mounts behind the instrument panel, and provides a visual indication of abnormal bus voltage via an included panel-mounted warning light. When flashing, this light indicates bus voltage greater than 15.5 volts D.C. (or 31.0 volts D.C.); when steady, it indicates bus voltage below 12.5 volts D.C. (or 25.0 volts D.C.). **Weight:** 4.5 oz. Select the appropriate sensor below according to battery voltage.

BC207-1 OV/LV Sensor (14 volt).....P/N 07-06830\$109.75
BC207-2 OV/LV Sensor (28 volt).....P/N 07-03435\$93.75

POWERALL PORTABLE GROUND POWER UNIT



The PA-2400 has been used in the field to start the following fixed-wing aircraft and helicopters:

All Beechcraft King Air Models, Beechcraft 1900 Series, Cessna Caravan 208, Citation 500 and 550 Series, Embraer Bandeirante 110, Piper Cheyenne Series, and Lear 20 Series. All Boeing/McDonnell Douglas Series helicopters, Agusta Series, Bell 205, 206, 407, 222, 230, 430 Series, Airbus Helicopters AS 350, EC120, BO105 and BK117 Series. The PA-2400-

50 portable GPU has all the capabilities as the PA-2400, delivering up to 2400 Peak Amps for starting a wide variety of aircraft while providing up to 50 Continuous Amps for maintenance and pre-flight operations. This unit offers the same light-weight compact versatility as the PA-2400 and can be easily stowed in the aircraft luggage compartment when necessary. The PA-2400-50 is the optimum choice for Turbo Prop Aircraft and Turbine Helicopters with EFIS such as the Pilatus PC12, King Air Series, Eclipse 500, Bell 407, Airbus Helicopters EC135 and 145 helicopters and most light turbine helicopters, turboprops, and VLJ's with EFIS

25 AmpsP/N 11-17897\$5,485.00
50 AmpsP/N 11-16658\$6,690.00

POWERALL TW60 ENGINE WASH SYSTEM



PowerAll Systems manufactures two options of the TEWS products, the TW60 and the TW60AT. Both units are with hard-line plumbing and bulkhead fittings for durability and come with two, five-gallon fluid tanks and 25 ft. of hose. Fluid can be diverted from either tank, Solution or Water, with a valve on the faceplate of the unit. A pressure regulator and gauge allow for pressures ranging from 0-60 PSI which allows for use with a variety of aircraft engine manufacturers whose maintenance specifications for compressor and turbine wheel washes fall within these parameters. The TW60 utilizes shop air as its source. It is widely considered within the aircraft maintenance industry that regular engine washes greatly improve engine efficiency, reduce fuel consumption and extend engine life. The TW60 and TW60AT Turbine Engine Wash Systems (TEWS) are designed for use in the hangar or on the ramp.

TW-60 - Uses Shop Air as its Source..... P/N 11-17900\$4,182.00
TW-60AT - Uses On-Board 5 Gal Compressed Air Tank / Shop Air
P/N 11-16659\$4,934.00

AEROVOLTZ CO-PILOT BATTERY JUMP PACK



The Co-Pilot is a 1000 Amp Jump Starter & Portable Power Bank with rapid 10 watts wireless cell phone charging and is compact and powerful. It's a sleek, portable, and lightweight lithium battery jump starter for all 12-volt batteries. Will easily jump start your aircraft or vehicle on a single charge and store in your flight bag for convenience. The Co-Pilot is safe for anyone to use, featuring spark-proof technology, as well as reverse polarity protection. It's rated at 1000 Amp and suitable for engines up to V8 engines such as a car, boat, SUV, truck as well as your six-cylinder Aircraft engine. It comes with smart alligator clips that provide warnings for faults and error protectionP/N 11-17468\$121.75

EXP BUS PRODUCTS



IND 2 - Annunciators for each solid state breaker on the EXP BUS • Over and undervoltage warning lights • Ammeter display • Instrument light dimmer circuit • Single ribbon cable installation to EXP Bus. The Indicator module is an accessory for the EXP BUS DC LOAD CENTER. This optional accessory provides several enhancements to the basic load center, all mounted in a small panel mount module, 4.6 inches long, and 2 inches wide. The module extends 2 inches in depth, behind the panel. The module provides an annunciator output for each fused output on the LOAD CENTER, which illuminates if the circuit is tripped. It also provides OVER and UNDER VOLTAGE annunciators, an AMP-METER indicator, and a light dimmer circuit for the instrument lightsP/N 11-00432\$134.95



BRKT 2 - Mounting brackets to simplify mounting the PC board in the aircraft. Put things where you want them to be. Free Shipping on this item.
P/N 11-00433\$21.95



USB PANEL POWER ADAPTER

CRAZEDpilot USB Panel Mount provides a simple and convenient mounting option for dual USB power adapter with easy access and integrated dust seal. Can be driven with 6-30v input power source, so works great in either 12v or 24v aircraft!.....P/N 11-14866\$19.85

D B ASSEMBLY BATTERY CHARGERS

D B ASSEMBLY APU BATTERY CHARGER AND POWER SERIES B-14/28-50



The P-1450 series plugs directly into the aircraft APU connector and is tied to the electrical system when the master switch is activated.

This ramp or hangar accessory is an absolute must for avionics service, gear and flap actuator exercising and other electrical system service.

The battery charging mode is selectable by a front panel switch. The charging process is fully automatic. When the charge is in progress a red LED is illuminated. This is replaced by a green LED when the aircraft battery is fully charged. The on/off switch on the unit also resets the unit.

Specifications: • 50 amperes filtered 14 & 28 volt supply • Dual charging capability from 14 to 28 volts • Aircraft APU connectors furnished • Operates from 115 VAC, 60 Hz • Weighs only 50 pounds. "Portable"

Description	Part Number	Price
APU Charger Only	11-18258	\$1,490.00
APU Charger Only w/ Piper Plug	11-18259	\$1,495.00
APU Charger Only (European)	11-18260	\$1,742.00
APU Charger (European) w/ Piper Plug	11-18261	\$1,741.00

D B ASSEMBLY APU POWER SUPPLY SERIES P28100/1



The D B Assembly, Inc. P-28100 series is the latest to join the family of power supplies for commercial aircraft servicing.

This equipment will provide the amps needed for gear retraction tests as well as the filtered power for all types of avionics service.

The P-28100 series will furnish up to 100 amps at 28 VDC. It plugs into the APU connector on the engine cowling and automatically disconnects the battery so that it will not be drained by the servicing processes. A valuable ramp accessory.

Specifications: • 100 amperes filtered 28 volt supply • Aircraft APU connectors furnished • Portable, weighs only 64 lb.

Description	Part Number	Price
Power Supply Only	11-18285	\$1,056.00
Power Supply w/ Piper Plug	11-18286	\$1,122.00
Power Supply Only (Pilatus P12)	11-18287	\$1,092.00
Power Supply Only (Eclipse e500)	11-18288	\$1,142.00
Power Supply (Extra Meter)	11-18289	\$1,095.00

D B ASSEMBLY APU POWER SUPPLY SERIES P-14100



The D B Assembly, Inc. P-14100 is designed to operate avionics equipment for commercial aircraft servicing.

This equipment will provide the amps needed for gear retraction tests as well as the filtered power for all types of avionics service. The P-14100 will furnish up to 100 amps at 14 VDC. It plugs into the APU connector on the engine cowling and automatically disconnects the battery so that it will not be drained by the servicing processes.

Specifications: • 100 amperes filtered 14 volt supply • Aircraft APU connectors furnished • Portable, weighs only 61 lb.

Description	Part Number	Price
APU Power Supply Only	11-18269	\$960.00
APU Power Supply w/ Piper Plug	11-18270	\$1,000.00
APU Power Supply Only (European)	11-18271	\$1,028.00
APU Power Supply w/ Piper Plug (European)	11-18272	\$1,069.00

D B ASSEMBLY APU POWER SUPPLY SERIES P-28100



The D B Assembly, Inc. P-28100 is designed to operate avionics equipment for commercial aircraft servicing.

This equipment will provide the amps needed for gear retraction tests as well as the filtered power for all types of avionics service.

The P-28100 will furnish up to 100 amps at 28 VDC. It plugs into the APU connector on the engine cowling and automatically disconnects the battery so that it will not be drained by the servicing processes.

Specifications: • 100 amperes filtered 28 volt supply • Aircraft APU connectors furnished • Portable, weighs only 64 lb.

Description	Part Number	Price
APU Power Supply Only	11-18282	\$1,088.00
APU Power Supply Only (European)	11-18283	\$1,135.00
APU Power Supply w/ Piper Plug (European)	11-18284	\$1,138.00

D B ASSEMBLY APU POWER SUPPLY SERIES R-14/28-25



The R-14/28-25 will output 14 or 28 volts DC at up to 25 amperes. The voltage is filtered to eliminate hum and is regulated against input AC line voltage changes.

The RB-14/28-25 plugs directly into the APU receptacle on the aircraft. It comes equipped with either the standard three-prong connector or the Piper coaxial connector. Both connectors can be supplied, optionally at a slight extra cost. DC cable length is 8'.

The AC line cord is normally 8' in length, but special lengths up to 50' are available.

The housing is steel, powder coated in red, for optimum flight line safety. Rubber feet and handle are included.

Specifications: • AC Line Voltage: 115v, 60 Hz. • AC Current Drain: 7 amperes maximum • DC Output: 14 or 28 volts, up to 25 amperes • Portable, weight only 35 lb. (16 Kg)

Description	Part Number	Price
APU Charger Only	11-18290	\$773.00
APU Charger Only w/ Piper Plug	11-18292	\$840.00
APU Charger Only (European)	11-18291	\$871.00
APU Charger (European) w/ Piper Plug	11-18293	\$942.00

D B ASSEMBLY APU BATTERY CHARGERS / POWER SUPPLY SERIES P-2850



This ramp or hangar accessory is an absolute must for avionics service, gear and flap actuator exercising and other electrical system service.

The P-2850 plugs directly into the aircraft APU connector and is tied to the electrical system when the master switch is activated.

The battery charging mode is selected by a front panel switch. The charging process is fully automatic. When the charge is in progress a red LED is illuminated. This is replaced by a green

LED when the aircraft battery is fully charged. The ON/OFF switch on the unit also resets the unit.

The 14-volt version, P-1450 provides 50 amperes of filtered DC at 14 volts.

Specifications: • 50 amperes filtered 28-volt supply • Aircraft APU connectors furnished

Description	Part No.	Price
Power Supply Power Supply Only	11-18274	\$859.00
Power Supply Power Supply w/ Piper Plug	11-18277	\$983.00
Power Supply Power Supply Only (European)	11-18275	\$1,004.00
Power Supply Power Supply w/ Piper Plug (European)	11-18276	\$1,078.00
Battery Charger Power Supply Only	11-18273	\$884.00
Battery Charger Power Supply w/ Piper Plug	11-18281	\$952.00
Battery Charger Power Supply Only (European)	11-18279	\$979.00
Battery Charger Power Supply w/ Piper Plug (European)	11-18278	\$1,053.00
Battery Charger Battery Charger Only (Japan)	11-18280	\$979.00

D B ASSEMBLY APU BATTERY CHARGERS / POWER SUPPLY SERIES P-1450



The P-1450 series plugs directly into the aircraft APU connector and is tied to the electrical system when the master switch is activated.

This ramp or hangar accessory is an absolute must for avionics service, gear and flap actuator exercising and other electrical system service.

The battery charging mode is selectable by a front panel switch. The charging process is fully automatic. When the charge is in progress a red LED is illuminated. This is replaced by a green

LED when the aircraft battery is fully charged. The on/off switch on the unit also resets the unit.

Specifications: • 50 amperes filtered 14 volt supply • Aircraft APU connectors furnished • 7 foot DC cable furnished

Description	Part No.	Price
Power Supply Power Supply Only	11-18263	\$784.00
Power Supply Power Supply Only (European)	11-18264	\$823.00
Power Supply Power Supply w/ Piper Plug (European)	11-18265	\$858.00
Battery Charger Battery Charger Only	11-18262	\$799.00
Battery Charger Battery Charger Only (European)	11-18266	\$883.00
Battery Charger Battery Charger w/ Piper Plug	11-18268	\$910.00
Battery Charger Battery Charger w/ Piper Plug (European)	11-18267	\$947.00

EL

GROUND STARTING COMPONENTS/GPU'S

AIRCRAFT JUMPER CABLES

Cable is heavy duty, 4 ga. copper, 20 ft. long, twin extruded to help prevent tangling, and room temperature flexible at 40 degrees below zero. Fully insulated clamps wont arc or spark and are rated 00-amp/600 peak, have a solid copper jaw, and have a flexispring strain relief to prevent cable breakage. Polarity light warns if clamps are connected incorrectly, preventing electrical system damage and personal injury. Available in two styles (above).



6141 - Jumper Cable with standard 3-pin Lexan female plug (equivalent to AN2551) on one end and alligator clamps on other end.
P/N 11-02952**\$160.00**



6142 - Jumper Cable with special Piper single-pin plug on one end and alligator clamps on other end.....P/N 11-02953**\$150.00**



REPLACEMENT PAIR OF 500 AMP CLAMPS

Used on #6141 and #6142 jumper cables. (above)
P/N 11-06202**\$49.50**

3 PIN JUMPER PLUG AN2551

Standard 3-pin female plug equivalent to AN2551 plug. Red Lexan construction screws together in minutes. Sleeves are solid copper, silver plated. With solenoid pin. Corrosion proof. Mates with AN2552-3A external power receptacle.

P/N 11-03158**\$42.50**



SOS AUXILIARY JUMP CABLE

SOS Aviation Battery Booster replacement for auxiliary jump cable with a Piper plug and auxiliary red connector.....P/N 11-16623**\$396.00**



SB50 HANDLE KIT

The SB50 Handle Kit encases the common SB50 power plug to provide a rugged hand grip for temporary DC power applications such as battery charging. Its ABS plastic case features internal wiring guides for strain relief. These are sized for 16-gauge insulated wire, but can be easily enlarged to accommodate wire pairs up to 10 AWG for higher current applications. Smaller gauge wire pairs can be tied or otherwise bound to prevent passage through the strain relief channels.....P/N 11-16517**\$10.00**



PIPER TYPE PLUG

Mates with 11041 socket. Electrical conductors and connections are designed for maximum efficiency and long life. With ground return terminal. Single pole. Brass female contact with spring-grip tension provides solid engagement with the socket. Cable clamp holds wires firmly in place. Diecast housing. Accepts up to 0AWG cableP/N 11-03159**\$32.60**



PIPER TYPE SOCKET

Self-grounding socket. Single pole. Diecast housing, spring-loaded door. Solid brass contact, 3/8" (9.5mm) diameter, with insulated tip to prevent short circuits. Rubber boot protects terminals and connections. Accepts up to 0AWG cable. Fits 2" (50.8mm) diameter hole. Flange holes 21/64" (8.6mm) diameter, 2 15/16" (74.6mm) on centers. Mates with 11042 plug.

P/N 11-00500**\$30.85**



PORTABLE POWER SUPPLY

These portable power supplies are an excellent way to power your avionics on the ground while you train or practice in the cockpit. Especially helpful in learning how to operate glass cockpit avionics and panel mount GPS units. To use the



Portable Power Supply plug the cord into an AC wall outlet, and then connect the plug into the external power receptacle on your aircraft. Furnished with power supply plug. Manufactured in U.S.A.

This unit can also be used as a battery charger, by using the battery clip adapter which is provided with the unit.

12V Port Power Supply 3 Pin Plug.....P/N 11-05084**\$299.95**
12V Port Power Supply Single Pin.....P/N 11-05085**\$259.95**
24V Port Power Supply 3 Pin Plug.....P/N 11-05086**\$377.00**
24V Port Power Supply Single Pin.....P/N 11-05087**\$325.00**

AVIATION GROUND POWER UNITS (GPU)

Safe, Affordable, Airframe Power for Piston and Light Turbine Aircraft, the Enhanced Flight 2800 Series GPU achieves a remarkable 89% electrical efficiency to provide up to 2,000W of power. Its cool running, switching-mode power modules provide massive amounts of stable,



noise-free 28V DC power from a 90-230 volts AC input. It will safely power the most delicate airframe systems with laboratory-grade DC without risk of costly damage to sophisticated avionics, instruments, or electronic equipment. This new generation GPU is designed as a practical alternative to large, expensive start carts, battery chargers, and other devices designed for spinning starter motors. Unique, ergonomic design features dual, removable cord/tool caddies. Choose 35A or 70A output. Comes with 2-meter output cable with 3-pin AN2551 NATO power plug, compatible with standard AN2552-3A or MS3506-1 aircraft external power receptacle. Not for turbine engine motoring or start assist. Option of integral BatteryMINDER 244CEC1-AA multi-stage maintenance charger-desulfator for lead-acid aviation batteries. Ambient temperature compensation ensures precise charging under all conditions. Airframe charging harness kit included.

24V 35A GPU.....P/N 11-10831**\$895.00**
24V 35A GPU built-in BatteryMINDER.....P/N 11-14771**\$1,195.00**
24V 70A GPU.....P/N 11-10833**\$1,245.00**
24V 70A GPU built-in BatteryMINDERP/N 11-14772**\$1,545.00**

PLUG & JUMP

The Plug & Jump is a very portable unit which can be carried in the aircraft at all times because it is so lightweight. It can be used to start the aircraft from an ordinary car using standard jumper cables. It comes in two models; The Universal Model is used for Cessna, Beechcraft, etc. (3 pin plug) and the Piper Model is a single pin. The Plug and Jump is a simple conduit of power from any external power source to the aircraft. It is not a battery in and of itself. The Plug n Jump can be used for either 28V or 14V systems.

Universal Model.....P/N 11-00971**\$99.95**
Piper Model.....P/N 11-00972**\$89.95**



MASTER RELAY

(Battery Solenoid) - Applicable to all homebuilts. Continuous duty. 12V and 24V.

Not for certified aircraft.

Features: • High current capacity control • Isolated or grounded coils • Enclosed in dust-resistant case • Longer steel encasement permits lower heat rise and more sensitive operation on Type 71



Specifications: • Dielectric Strength: 500 Volts • Temperature Range: -40°F/-40°C to 122°F/50°C • Mechanical Life (no load): 250,000 operations • Electrical Life (rated load): 100,000 operations • Vibration: 5 g's vertical and horizontal planes • Duty Cycle: Continuous
111-226 (12V).....P/N 11-03161**\$33.85**
111-226 (24V).....P/N 11-05799**\$41.65**

EXTERNAL POWER RECEPTACLE

This external power receptacle is designed to mount in a hole in the skin of aircraft. Hole is then covered with hinged access door (not included). Mates with AN2551 type plugs. Model 4621B.

P/N AN2552-3A.....**\$99.85**



EL

POWER PANELS

POWER PANELS FOR HOMEBUILTS



Mini Power Panel



Homebuilder's Power Panel

Based on a heavy duty printed circuit board that eliminates the bus bars and provides a user serviceable and logical arrangement of all power system components. Only DC rated switches and quality resettable thermal circuit breakers are utilized. Connections to the panels are via screw type terminal blocks. The avionics 'sub' bus is filtered. All metal parts are stamped aluminum. Lexan overlay on the faceplate. Complete documentation and suggested wiring diagrams are included.

Standard Power Panel: 8 Switches: Fuel Pump, Landing Light, Strobe Lights, Navigation Lights, Panel Power, Pitot Heat, Radio Master, and a Cessna type split master switch for master solenoid and alternator field control. **18 Circuit Breakers:** Fuel Pump, Landing Light, Strobes, Nav Lights, Panel Power, Pitot, Alternator Field, Gyros, Gauges, Trim, and Spare, (on Radio Bus) Radio 1, Radio 2, GPS, Transponder, Audio, Avionics. **Dims & Wt:** 2.25"H x 13.00"W x 7.50"D, approximately 3.0 lbs. **Mini Power Panel: 6 Switches:** (main panel) Fuel Pump, Landing Light, Strobe Lights, Navigation Lights, Panel Power, (side panel) has a Cessna type split master switch for master solenoid and alternator field control. **13 Circuit Breakers:** Fuel Pump, Landing Light, Strobes, Nav Lights, Panel Power, Engine Instruments, & Spare, (on Radio Bus) Radio 1, Radio 2, GPS, Transponder, Avionics, (side panel) 30 amp alternator output breaker. **Dims & Wt:** (main panel) 2.375"H x 8.375"W x 6.50"D, (side panel) 2.375"H x 2.5"W x 2.0"D, approximately 2.5 lbs. Homebuilders Panel P/N 11-11675 **\$820.00 ea** Mini Power Panel P/N 11-11680 **\$645.00 ea**

LIGHT SPORT POWER PANEL



The Light Sport Power Panel was designed for LSA and light aircraft applications. It offers a new degree of flexibility in modern "Glass Panel" equipped aircraft. The electrical power bus is split into three segments including the Main Bus, Radio Bus and the Essential bus. The Radio Bus is switched and filtered. The Essential Bus can wire direct to the Main Bus or easily connected to

a back up system such as the Composite Design Power Guard to allow dependable, constant power to critical flight and engine instruments. As with all Composite Design power systems, this panel is rugged, serviceable and dependable.

Specifications: • 6 Switches: Fuel Pump, Landing Lite, Nav Lite, Strobes, Radio Bus Master, and Cessna type split master for Master Solenoid and Alternator Field. • 14 Circuit Breakers: Main Bus - Fuel Pump, Landing Lite, Nav Lite, Strobes, Panel Power, Accessories • Radio Bus (Filtered) Radio 1, Radio 2, Transponder, GPS, Audio Panel • Essential Bus EFIS#1, EFIS#2, Flight Instruments, Engine Data • Dimensions & Weight: 2.375"H x 10.5"W x 6.5"D, approx 2.25 pounds. 28V P/N 11-09207 **\$660.00** 14V P/N 11-09206 **\$725.00**

POWER GUARD MODULE



The Power Guard Module manages up to 10 Amps of secondary power for aircraft accessories that require back-up power. Typical accessories include electronic ignition, electronic engine/flight instrumentation and EFIS systems. The module works with

a small 7-10 A secondary battery. The on board circuitry includes a secondary battery master relay, primary power controls, filter and charging circuit. Dims: 4.75"L x 2.75"W x 1.2"H P/N 11-02044 **\$203.95**

VERTICAL POWER VP-X



The VP-X integrates with many popular EFIS products enabling you to monitor and control your entire electrical system on the EFIS display. In addition using the EFIS for attitude, navigation, and engine information, you now can use the EFIS display to monitor the health of your electrical system, view and control the status of individual circuits, and respond to circuit faults.

Vertical Power offers these capabilities through the use of a patented electronic circuit breaker (ECB) technology that is at the core of all of our products. Of course, ECBs provide circuit protection like old-fashion thermal circuit breakers, but ECBs do a lot more than just detect circuit faults. ECBs are intelligent, configurable, and offer capabilities not otherwise available with old-style breakers. For example, ECBs can detect a burned-out landing light or disable the starter circuit while the engine is running.

The VP-X supports a single bus electrical architecture with a single or dual alternator configuration. It additionally supports the ability to measure the voltage on an aux battery. There are enough circuits to wire a typical RV (including the RV-10), Glastar, Lancair Legacy, Velocity, Cozy, or other 2 to 4 place aircraft.

Specifications:

- Power: 4-32 volts DC, 60A max continuous
- Weight: 1.9 lbs

Note: Either a wiring harness kit or connector-only kit is required with the VP-X system.

Vertical Power VP-X-PRO	P/N 11-09293	\$2,395.00
Vertical Power VP-X Sport	P/N 11-09294	\$1,695.00
VP-X Pro Wiring Harness	P/N 11-09295	\$695.00
VP-X Sport Wiring Harness	P/N 11-09296	\$625.00
VP-X Sport Connector-Only Kit	P/N 11-09834	\$265.00
VP-X Pro Connector-Only Kit	P/N 11-09835	\$265.00
Crimp Tool (Req. w/ Connector-Only kit)	P/N 11-09836	\$75.75

VERTICAL POWER PPS PRIMARY POWER SYSTEM



Finally, a simple and reliable primary power solution. The Vertical Power Primary Power System (PPS) is an entirely new approach to the master, starter, and charging circuit on your experimental aircraft or LSA. It combines the functions of multiple high-current, electro-mechanical components into a single, solid-state device that installs

in minutes with plug-and-play simplicity. Plus, the high-reliability of the PPS means you won't find yourself stranded on a deserted landing strip without the power to start your plane. The PPS is a new power distribution component that handles your aircraft's high-current power. It controls the flow of power from the battery to the starter and supplies power to the Vertical Power VP-X (or a traditional bus) for your electrical system loads. The PPS also supports the charging circuit by completing the B-lead connection to the alternator.

PPS P/N 11-15519 **\$1,695.00**

RADIO STACK POWER PANEL



The Radio Stack Power Panel is designed to fit neatly in the 6.25" radio stack format. It is well suited for LSA and light aircraft applications, offering a new degree of flexibility in modern "Glass Panel" equipped aircraft. The power bus is split into three segments including the Main Bus, Radio Bus and the Essential Bus. The Radio Bus is switched and filtered. The Essential Bus can be

wired directly to the Main Bus or easily connected to a back up system such as the Composite Design Power Guard. This allows dependable, constant power to critical flight and engine instruments. As with all Composite Design power systems, this panel is rugged, serviceable, and dependable..... P/N 11-10081 **\$783.00**

EL

POWER SUPPLIES – VOLTAGE CONVERTERS

TRUE BLUE POWER® MD835 EMERGENCY POWER SUPPLY



Automatically supplies 24.5 VDC power for critical or standby equipment. 4.5 Amp-hour battery with Nanophosphate® lithium-ion cell chemistry. Lightweight 4.7 lbs. – 8 lbs. Input Voltage: 24–32 VDC. 5V module connector available. Direct replacement for PS-835/PS-855 or forward-fit installations. 2-year capacity check, 10-year replacement life. (approx.)

3.1"H x 12.6"L x 2.3"W Mounts in standard ¼ ATR Rack. Maintains full charge by recharging during normal flight operations. Remote mounted self-test switch required. FAA TSO C179a certified. Part 23 AML STC Certified. Qualified to RTCA/DO-160F and RTCA/DO-311. Designed and built in the USA. Two year limited warranty.

MD835P/N 11-08713\$4,618.00
MD835 28V/5VP/N 11-15297\$5,730.00

TRUE BLUE POWER® TI500 STATIC INVERTER

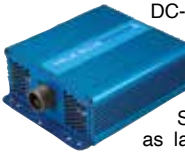

DC-to-AC static inverter produces 115 volts at 60 Hz for 500 watts of "wall outlet" power from an aircraft's 28 VDC input. Has the same connector and footprint of legacy designs, plus overload and short-circuit protection up to 150 percent of the rated load.

Supplies power for various cabin accessories, such as laptops, cell phones and iPods, Compact design. Remote On/Off feature, 500VA rated output power, 85-90%

efficiency, Input voltage: 20-36 VDC, Input current: 20A at 28 VDC input, Output voltage: 115 VAC, Frequency: 60 Hz ± 1%, Single phase, true sine wave output, Overload and short-circuit protection up to 150% of rated load, Rated from -65 F° to +160°F (-55°C to +71°C), FAA TSO-C73 certified and RTCA DO-160F qualified, Designed and built in the USA., USA, Two year limited warrantyP/N 11-09613\$3,895.00

TRUE BLUE POWER TI1200 STATIC INVERTER

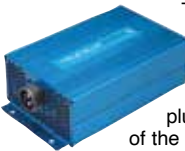

The TI1200 DC-to-AC static inverter produces 115 volts at 60 Hz for 1200 watts of "wall outlet" power from an aircraft's 28 VDC input. Lighter and smaller than competing inverters, the TI1200 has the same connector and footprint of legacy designs, plus overload and short-circuit protection up to 150% of the rated loadP/N 11-10743\$5,626.00

TRUE BLUE POWER® DC/AC INVERTER



This classic DC to AC solid-state "peanut" inverter provides a reliable source of 26 volt, 400 Hz, AC power. Versatile, compact and lightweight, it is ideal for use with Stormscope bootstrap and multifunction display installations. Input: 11-40VDC @ 0.75 amp. Output: 26 VAC, 400 Hz, Single Phase, 10 volt-amperesP/N 11-07062\$533.00

MID-CONTINENT TRUE BLUE TI250 STATIC INVERTER

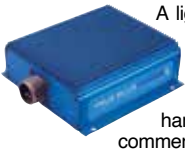

A lightweight power converter that translates a 20 to 36 VDC input to a 115 VAC output at 60 Hertz and provides 250 watts (VA) of power. The alternating current output is defined as a pure sine wave with less than 2% of total harmonic distortion for clean, noise-free, harmonic-free power to supply nearly any common commercial or consumer load rated for a nominal input of 115VAC. FAA certified to TSO C73 and tested to rigorous environmental standards and levels of RTCA DO-160.....P/N 11-12858\$3,001.00

MID-CONTINENT TRUE BLUE POWER CONVERTER 24-36 VDC TC120



The highly efficient TC120 DC-to-DC Converter produces 120 watts of power from an aircraft's 28 VDC input. Engineered to run cooler and featuring a fanless design, the TC120 saves energy and reduces weight. It produces enough energy to power electronic equipment throughout the aircraft, including in-seat, cabin and cockpit power applications. P/N 11-14449\$479.95

MID-CONTINENT TW15 WIRELESS CHARGER COIL



Manufactured by Mid-Continent Instruments and Avionics for True Blue Power. • Standby, Charging, Charge Complete and Fault status indication • Short circuit, power surges, overload, over temperature, reverse polarity and foreign object detection protection • Ideal for in-seat, cabin and cockpit applications • Designed and built in Wichita, Kansas, USA • 2-year limited warranty

Number of Coils	Weight	Dimensions	Part No.	Price
Single, Slim	3.4 oz.	4.50" x 2.28" x 0.21"	11-19191	\$698.00
Single, Compact	3.0 oz.	2.45" x 2.28" x 0.35"	11-19192	\$698.00

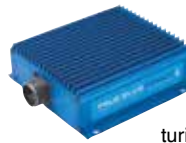

TRUE BLUE AC-DC CONVERTER 280 WATTS

The highly efficient TC280 AC-to-DC Converter produces 280 watts of power from an aircraft's 115 VAC input. Engineered to run cooler and featuring a fanless design, the TC280 saves energy and reduces weight. It produces enough energy to power electronic equipment throughout the aircraft, including in-seat, cabin and cockpit power applications. It has a compact and lightweight design that can be conveniently mounted in the floor or cabin wall. Supplies 280 watts of 28 volt power. Greater than 88% energy efficiency. Compact and lighter design weighing only 2.0 lb. Input transit, overload, and short circuit-protection. Designed and built in Wichita, KA, USA.P/N 11-14193\$2,756.00



TRUE BLUE POWER CONVERTER 24-36 VDC TC120

The TC120 is a multi-purpose DC-to-DC Converter with a variable input and output. This converter is an ideal power source for low-voltage DC accessories and equipment. Supplies 120 watts of 24–36 volt power. Greater than 88% energy efficiency. Compact and lighter design weighing only 2.0 lb. Input transit, overload, and short circuit-protection. Designed and built in Wichita, KA, USA. P/N 11-14270\$485.00

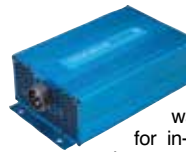

TRUE BLUE DC TO AC STATIC INVERTER 1200 WATTS

28 VDC to 230 VAC 1200VA, 50 Hz, Sine wave. The TI1200 Series DC-to-AC Inverter produces 1200 watts of power from the aircraft's 28 VDC input. It is ideal for in-flight entertainment and galley equipment, such as microwaves and coffee makersP/N 11-14268\$5,117.00

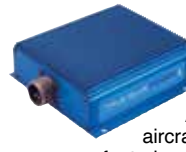

TRUE BLUE DC TO AC STATIC INVERTER 250 WATTS

28 VDC, 115/26 VAC 250VA, 400 Hz, Sine wave. The highly-efficient TI250 Series DC-to-AC Inverter produces 250 watts of power from the aircraft's 28 VDC input. Engineered to run cooler and featuring a fanless design, the TI250 Series saves energy and reduces weight. At only 2.2 pounds, these inverters are lighter and smaller than competing units and include overload, short-circuit and ground fault interrupter protectionP/N 11-14267\$3,185.00

MID-CONTINENT TRUE BLUE MOUNTING ADAPTER



Mounting adapter for TI500 Mid-Continent True Blue DC To AC Static Inverter 500 Watts. P/N 11-14269\$72.75

MID-CONTINENT TRUE BLUE POWER TC230 DC TO DC CONVERTERS



A lightweight power converter that translates a direct current (DC) input of 14 volts to an output of 28 volts direct current (DC) output. Converting an input operation voltage range of 10-18 V DC to 28VDC makes the TC230 suitable for power to a wide variety of general, business, or commercial aviation applications. The unit is rated for a nominal output of 230 watts to power avionics, instrumentation, lighting, and many other applications. FAA certified to TSO-C71 and tested to rigorous environmental standards and levels of RTCA DO-160G. Ideal choice for aircraft power needs while reducing the challenges associated with other similar products.

Description	Part No.	Price
10-18 VDC in, 28 VDC out, 230 watts	10-06250	\$864.00
10-18 VDC in, 28 VDC out, 230 watts with remote on/off feature	10-06251	\$864.00

MID-CONTINENT TRUE BLUE POWER TC240 VDC TO VDC CONVERTER



The model TC240 VDC/VDC Power Converter that supplies 240 watts of 5 to 18-volt power to electronic equipment, including lighting and cabin accessories.

Features: • Lightweight — 0.7 lbs • 240 watts output power • Input Voltage: 24 – 32 VDC • Output Voltage: 5 – 18 VDC adjustable • Mating Connector: MCI P/N 9018654 (included). P/N 11-17843\$863.00

VOLTAGE CONVERTERS - INVERTERS



TRUE BLUE TA202 USB CHARGING PORT

The high-powered TA202 Series USB Charging Port simultaneously provides 3 amps per port. Offering an extensive list of USB Type-C and Type-A configurations, the TA202 powers the next generation of electronic devices.

Model No.	Description	Part No.	Price
6430202-1	10-32 VDC, Dual Type-A / Type-C Rear connector	11-14397	\$325.00
6430202-11	10-32 VDC, Dual Type-A / Type-C Rear connector Lighted	11-14677	\$325.00
6430202-2	10-32 VDC, Dual Type-A / Type-C Bottom connector	11-14430	\$325.00
6430202-12	10-32 VDC, Dual Type-A / Type-C Bottom connector Lighted	11-16389	\$325.00
6430202-3	10-32 VDC, Dual Type-C / Type-C Rear connector	11-14431	\$325.00
6430202-13	10-32 VDC, Dual Type-C / Type-C Rear connector Lighted	11-14940	\$325.00
6430202-4	10-32 VDC, Dual Type-C / Type-C Bottom connector	11-14432	\$325.00
6430202-14	10-32 VDC, Dual Type-C / Type-C Bottom connector Lighted	11-16390	\$325.00
6430202-5	10-32 VDC, Dual Type-A / Type-A Rear connector	11-14433	\$326.00
6430202-5	10-32 VDC, Dual Type-A / Type-A Rear connector Lighted	11-16394	\$325.00
6430202-6	10-32 VDC, Dual Type-A / Type-A Bottom connector	11-14434	\$325.00
6430202-16	10-32 VDC, Dual Type-A / Type-A Bottom connector Lighted	11-16391	\$325.00
6430202-7	10-32 VDC, Single Type-C Rear connector	11-14435	\$163.95
6430202-8	10-32 VDC, Single Type-C Bottom connector	11-14436	\$152.75
6430202-9	10-32 VDC, Single Type-A Rear connector	11-14437	\$163.95
6430202-10	10-32 VDC, Single Type-A Bottom connector	11-14438	\$163.95
6430202-19	10-32 VDC, Single Type-A Rear connector, Lighted	11-14938	\$163.95
6430202-17	10-32 VDC, Single Type-C Rear connector, Lighted	11-14939	\$163.95
6430202-13	10-32 VDC, Dual Type-C / Type-C Rear connector, Lighted	11-14940	\$325.00
6430202-20	10-32 VDC, Single Type-A Bottom connector, Lighted	11-16393	\$163.95
6430202-18	10-32 VDC, Single Type-C Bottom connector, Lighted	11-16392	\$163.95



TRUE BLUE DC TO AC 250W STATIC INVERTER

The model TI250 series Static Electrical Power Inverter is a lightweight power converter that translates a 20 to 36 VDC input to a 115 VAC output at 400 Hertz and provides 250 watts (VA) of power. Supplies 250 watts of power to multiple cabin accessories, such as laptops,

tablets and cell phones.

Application: • Single engine turbo/piston prop, most small jets. (storm scope & boot type)

Highlighted features include short circuit protection, overload capability, low voltage shut-down, temperature monitoring, a self-resettable over-temperature disable, a remote on/off function, and a fault indication output. P/N 11-16365 **\$2,575.00**

MCI CONVERTERS

AmeriKing #	MCI #	Description	Part No.	Price
AK-551-9	6430120-1	Functional Equivalent Different Connector	11-14270	\$485.00
AK-551-9M	6430120-1	Functional, Equivalent., Same connector	11-14270	\$485.00
AK-551-9M1	6430120-2	Functional, Equivalent, Same connector, remote feature	11-14449	\$479.95
AK-551-9M2	6430120-1	Functional, Equivalent, Same connector	11-14270	\$485.00

TRUE BLUE DC TO AC 2000W STATIC INVERTER

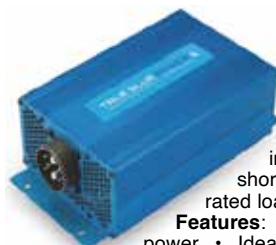

The TI2000 Series Inverter provides 2,000 watts of wall outlet power to cabin and galley accessories, including entertainment systems, personal electronic devices, microwave ovens, and coffee makers. Smaller, lighter and more efficient than competing units and includes input transient, overload and short-circuit protection up to 150% of the rated load.

Features: • Supplies 2,000 watts of wall outlet power • Ideal for emergency medical equipment, special mission and VIP cabin configurations • Lightweight — 7.7 lbs • 93% efficient • Input transient, overload and short-circuit protection — up to 150% of rated load without damage • Remote On/Off optional • FAA TSO-C73 certified • EASA ETSO-C73 certified • RTCA DO-160G qualified P/N 11-16367 **\$11,195.00**

MYGOFLIGHT INFINITYPOWER™ TSO CERTIFIED USB-A / USB-C PANEL CHARGER



This two-part panel mounted charging system provides you with infinite upgrade potential. The Power Base Module once installed becomes a power receptacle capable of receiving any future USB Module. It can be installed in any direction, is quite thin, and power can come in from the side or rear making it simple for installation. It can be installed in the avionics panel, galley, in-seat or anywhere USB power is desired.

The second component, the USB Module, easily connects to the power base module without having to remove the power base from the panel. There is a digital display that shows power input and amps used by each device. This display is dimmable or can be turned off.

TSO Certification is Expected Q4 2021

Complete Unit..... P/N 11-18868 **\$300.00**
Power Base Module Only..... P/N 11-18867 **\$150.00**
USB Module Only..... P/N 11-18866 **\$150.00**

APPAREO STRATUS POWER PRO USB CHARGING PORT



Features: • Dual 3.0 amp charging ports, USB-A and USB-C • Blue LED lighted front • FAA certified to TSO-C71 • Designed and built in the USA • Cylindrical shape for easy, drill-in panel installation • Shielded to prevent any added RF noise in comm radios • 5-year warranty backed by Appareo

Specifications: • 1.848" w x 1.848" h x 1.263" d - (Depth includes the mating connector).
P/N 11-18449 **\$399.00**



DELUXE COCKPIT VOLTAGE CONVERTER

DC-DC Converter, Device to reduce voltage from 28V to 12V. Allowing the user to operate 12V items in a 28/24V airplane. The device is fully electronic, no passive elements generating heat. It is fully protected and fused. A green

LED indicates normal and abnormal conditions (overload). The unit is enclosed in a small precision machined aluminum box with integrated heatsink. Input is via a fused lighter plug and output is via a female light receptacle. Size: 1.3" x 1.3" x 2.3"; Weight: approx. 5.0 oz.

3 AMP, 28-12V DC-DC Converter P/N 11-04330 **\$65.99**

10 AMP, 28-12V DC-DC Converter P/N 11-04331 **\$139.75**

INVERTER — Simple solution for a 28 Volt airplane. Plug it in to the 28 Volt lighter socket and out comes 117 Volts. 2 AC sockets. Max Wattage is 800W. Over and undervoltage warnings. On-Off switch. All metal enclosure. Dimensions: 7" x 5" x 2". Weight: 2 lbs 4 oz.
400W 28-110V Inverter P/N 11-00402 **\$112.75**

MID-CONTINENT TRUE BLUE POWER AC OUTLET



The True Blue Power AC outlets offer pilots, passengers and crew convenient access to accessory power. The North American, three-prong outlet, and the Universal outlet are rated up to 15 amps of power each, and can be easily mounted in the cabin, cockpit and galley..... P/N 10-06624 **\$372.00**



MCI TRUE BLUE REAR MOUNT COVER PLATE

MCI True Blue Rear Mount, small square cover plate for Single Configuration USB TA202 / TA360 Charging Ports.

In The Box: • 1 - Small square face plate • 1 - Mounting plate • 2 - Silicone washers • 2 - Adhesives (0.5")
P/N 11-17907 **\$97.95**

EL

LONESTAR PRODUCTS

LONE STAR DC-AC INVERTER KITS



Lone Star Aviation is proud to announce it's new PORTABLE INVERTER Kit to provide airborne or military vehicles with an (ac outlet) to operate low power devices on 115 or 220 AC voltages. The inverter kit includes an FAA -TSO Approved Power Adapter for 24vdc and a MIL C-5015 connector for 12 vdc systems, a 36 inch harness and pelican case for transporting to and from your base of operation. The Inverter Kit meets FAA TSO, MIL STD C-5015 qualified for panel power and UL safety requirements for the inverter's GFCI AC receptacle for operator safety.

Model No.	Input	Output	Part No.	Price
LS03-06302	12Vdc	115VAC 60Hz Pure Sine Wave	11-12998	\$726.00
LS03-06304	24Vdc	115VAC 60Hz Pure Sine Wave	11-13001	\$749.95

LONESTAR POWER ADAPTER TSO WITH USB



Power Adapter USB Socket. Just Plug in your USB socket into your Cigarette Lighter Power Adapter and get 5 volt USB power out. Perfect for charging cell phones, iPads, iPods, GPS, PDA, Laptop and many consumer electronic devices. This is a kit that comes with a FAA-TSO Approved Cigarette lighter power adapter and plug-in USB 5V converter. 12VP/N 11-13345\$189.75

LONE STAR USB CHARGER MULTI-PORT



Lone Star's USB Multi-Port can be ordered with 1, 2, or 3 USB ports. The USB circuit is designed to work with apple products, as well as android, and most other USB devices. The USB Multi-Port Charger is compatible with both 12V and 24V aircraft and rotorcraft.

Description	Part No.	Price
Lonestar USB Charger With 1 Port	11-12988	\$249.95
Lonestar USB Charger With 2 Ports	11-12989	\$299.95
Lonestar USB Charger With 3 Ports	11-12991	\$349.95

LONE STAR DC BULK-HEAD FILTER



DC Bulk-Head Filter. DO-160D Testing Pending. Full feed thru design....P/N 11-08617\$159.95

LONESTAR CONNECTOR KIT DC STEP DOWN CONVERTER



Connector Kit DC Step Down Converter with Cigarette Lighter Receptacle allows you to connect directly to one of the Down Converters (LS03-05003). Cable length is 36 inches. Lone Star Aviation's FAA-TSO approved • Charging Cell-SAT Phones • Portable radios • GPS, Back-up • And More!.....P/N 11-08637\$128.75

LONE STAR 90 DEGREE ADAPTER



Lone Star Aviation's new 90 degree adapter is made precisely from a tough and durable plastic and is designed to help in Avionics Cooling Fan installations in confined areas under the panel. This item is made to fit our new 5/8" tubing. P/N 11-08623\$20.85

LONE STAR STEP DOWN 24V TO 12V CONVERTER



With this TSO-C71 DC to DC Converter you can operate 12 Volt Radios, GPS's, and Electronic Devices in a 24 Volt Aircraft. Size: 6.0"W x 5.0"D x 1.75"H. Weight: 1.5 lbs. Color: Gold Anodized. Material: Aluminum Extrusion. P/N 11-03309\$449.95

LONE STAR ALTITUDE SWITCHES



Altitude Switch is designed to turn on a circuit for various fixed wing and rotorcraft applications. P/N 11-12996: • 12,000ft Set Point • actuates: 12,000 +/-500ft • deactuates: 10,000ft P/N 11-12997: • 9,500ft Set Point • actuates: 9,500 +/-500ft • deactuates: 7,500ft.

12,000 Ft. Set PointP/N 11-12996\$499.95
9,500 Ft. Set PointP/N 11-12997\$499.95

LONE STAR DC CONVERTER



DC Converter, Dual Output. Dual Output Converter 12V, 3.3V Camera Systems and other low current dual voltage requirements. 12-24V Aircraft/Rotorcraft. Output 1: 12V, 1A. Output 2: 3.3V, 0.5A. 9 Pin D-Sub, 2" x 1.5" .935". P/N 11-12994\$599.95

LONESTAR NYLON Y ADAPTER



Nylon 5/8" Y adapter for splitting airflow from one avionics cooling fan to two units. P/N 11-08622\$16.95

LONESTAR FILTER 70 AMP



70 amp filter attenuates EMI-RFI noise generated from alternator, generator systems, gear motors, blowers for a/c systems and other higher current noise sources. Can be used to filter the aircraft's avionics buss to filter RF, NAV, GPS, as well as other navigational equipment. The filter is FAA- PMA for certificated aircraft as well as for experimental aircraft.....P/N 11-04849\$299.95

LONESTAR FILTER 100 AMP



100 amp filter (FEED THRU) (Fail Safe Design) attenuates both low and high frequency, (10hz to 30 mhz) of EMI-RFI noise generated from the aircraft's alternator systems to the aircraft's dc buss. This filter, (100 amp Fail Safe design) is used by OEM aircraft manufacturers to attenuate 100% of the on board noise before it penetrates the aircraft's dc buss. The filter is FAA- PMA pending for certificated aircraft but can be used on experimental aircraft.....P/N 11-04850\$350.00

LONESTAR THE ELIMINATOR



The Eliminator is a low pass double (LC) PI type filter designed to suppress both low and high frequency line noise. The filter may be connected at the source of the noise or on the input of the effected component.....P/N 11-08055\$150.00

LONESTAR USB POWER CONVERTOR PLUG



USB 2 Amp Power Converter Plug (LS03-05021) is the updated model of the LS03-05020. It's the same small size but with even more power for onboard charging of iPads, iPhone, iPods, cell phones and most things that use USB power to charge. P/N 11-10454\$99.99

LONE STAR FAN FAILURE WARNING SYSTEM



The Fan Failure Warning system (FFW) was designed for Lone Star Aviation's Cyclone-21 (3) Port fan with a (3 wire) TTL 5v output. The FFW system will switch the dual color LED from green to red when a fan's RPM is reduced to less than 50% of the fans normal speed. The FFW, Fan Failure Warning system has an (optional circuit) designed to monitor the temperature of a remote electronics bay or entertainment equipment and will turn on a remote fan when the predetermined temperature has been reached.

12V Warning System.....P/N 11-13894\$450.00
24V Warning System.....P/N 11-13895\$450.00
Remote Temperature Switch.....P/N 11-13793\$129.95
Remote Temperature Sensor.....P/N 11-13794\$129.95



LONE STAR PRODUCTS

LONE STAR DC CIGARETTE LIGHTER RECEPTACLE



Perfect for portable GPS systems, cell phone chargers, laptop power supplies, or anything else you would plug into your car during a road trip. 12V Aircraft: If your aircraft runs on 12V you will not need any extra equipment to operate 12V equipment, and it comes with a rubber cap marked with DC12V. 24V Aircraft: Please note, you will need a 28V to 12V converter to power most 12 volt consumer electronic devices.

Non TSO'd P/N 11-04862 **\$79.95**
 TSO'd P/N 11-09432 **\$99.90**
 DC Converter 28-14VDC TSO P/N 11-03309 **\$449.95**
 SD Converter 24-13.8VDC TSO P/N 11-04894 **\$598.00**

LONE STAR APPLE IPAD LIGHTNING CABLES



Available in 2 meter Straight Cord or 1 meter Coiled Cord. Ruggedized, reinforced rubber jacket. For iPhone 5 and newer. For iPad 4 and newer.

2m Straight P/N 11-12992 **\$50.50**
 1m Coiled P/M 11-12993 **\$49.95**

LONE STAR RUGGEDIZED IPAD-USB CORDS



The Ruggedized apple to USB Coil Cord stretches from 20" to 29", with an apple specific connector on one end, with USB on the other. This cable is a perfect match with both Lone Star Aviation's USB

plugs for Power Adapters and MS-USB panel mount USB receptacle. USB to iPad Cors (1M)q P/N 11-10697 **\$49.95**

LONE STAR IPAD / IPHONE USB CHARGER KIT



This Kit includes a 28V to 5V Down Converter and a panel mount USB plug with Lone Star's proprietary circuit for use with apple products.

This Kit also includes our converter connector kit and locking connectors for easy installation behind aircraft panels. Charging an iPad in flight has never been simpler or more reliable. P/N 11-10588 **\$749.95**

LONE STAR LED PANEL INDICATOR (DUAL COLOR)



The Dual color LED illuminates green for normal and red for a problem. Use for any (stand alone annunciation).

- LED Panel Indicator: .625, .468 or alternate mounting
- Dual Color - (3) wire Red LED 660nm, Green LED 525nm = .20ma
- Wide angle 180 degrees. **Note:** Price listed below is for the LED Panel Indicator ONLY. You will need to purchase the Cyclone 21 Blower and the Fan Failure Warning Unit separately to complete the system.

P/N 11-10592 **\$99.99**

LONE STAR NOISE FILTER EVALUATION KIT (LOW CURRENT)



Not sure what filter you need? Order a Filter Evaluation Kit. Kit includes Lone Star's most popular and widely used Filters; the Magneto Filter, Alternator Filter, and the Eliminator Filter P/N 11-08620 **\$349.95**

LONE STAR NOISE FILTER EVALUATION KIT (HIGH CURRENT)



Not sure what filter will best solve your noise problem? Check out Lone Star's new High current filter Evaluation kit. This kit comes with 1 100 Amp filter, 1 70 amp filter, and 1 10 amp eliminator filter in a beautiful pelican micro case P/N 11-08621 **\$445.00**

LONESTAR LED PRESS TO TEST INDICATORS



Lone Star Aviation's line of LED panel indicators are available in a RED, Green, or Amber lenses. The indicators are TESTED by a PRESS to TEST function. The panel indicators are available in 14V and 28V, and non-dimmable and dimmable versions. Are installed into a (.468 mounting hole) in the aircraft's instrument panel.

The indicator is a MS 25041 aluminum body and standard T1-3/4 led. Indicators are also available in 28vdc with standard led bulb as well as an FAA T1-3/4 bulb at 28vdc

Description	Color	Volt	Part No.	Price	Volt	Part No.	Price
Non-Dim	Red	14V	11-08768	\$79.95	28V	11-08676	\$79.95
Non-Dim	Green	14V	11-08769	\$79.95	28V	11-08677	\$79.95
Non-Dim	Amber	14V	11-08770	\$79.95	28V	11-08678	\$79.95
Dim	Red	14V	11-08764	\$79.95	28V	11-08673	\$79.95
Dim	Green	14V	11-08766	\$79.95	28V	11-08674	\$79.95
Dim	Amber	14V	11-08767	\$79.95	28V	11-08675	\$79.95

LONE STAR DC-AC INVERTER



Lone Star Aviation's new inverter line boasts cutting edge DC/AC 60Hz technology in addition to innovative circuitry to operate most DC-AC applications within the following markets, i.e. commercial, industrial, solar, aviation and military. The DC/AC inverter is a high reliability model that is mission ready and TSO approved for airborne applications.

500 Watt Inverter P/N 11-08632 **\$3,500.00**
 1000 Watt Inverte P/N 11-08634 **\$5,500.00**

Accessories

Plug MS3106E18-9P 9 (For 500W Inverter) ..P/N 11-08633 **\$175.00**
 Plug MS3106E24-12S(For 1000W Inverter) ..P/N 11-08635 **\$249.95**

LONESTAR GROUND LOOP FILTER



Designed to ELIMINATE onboard ground loop noise problems in an easy to use module. Plugs in between your portable device and your aircrafts audio system. Was designed with a low frequency isolation audio transformers that isolates normal audio from unbalanced AC noise interference. Incorporates RCA,

2.5mm and 3.5mm connectors that ensures compatibility with numerous consumer devices currently used in modern aircraft. Easy Plug and Play Installation, Approval Types: Form 337, Portable Device 1 year Limited Warranty Ultra small footprint Custom configurations Portable device.

P/N 11-09493 **\$99.95**

LONESTAR VOLTAGE CONVERTERS



Lone Star Aviation's new 12V STEP-UP Converter is the smallest (3" x 5" x 2"), most efficient (93-95%) and the most versatile STEP-UP aircraft converter in our industry today. RTCA/DO 160D tested to operate 28V NAC/COM radio equipment such as KX 155, KX 165, KY 196A, KY 196B, and Motorola VHF transceivers on

12V aircraft. Additional 28V electronic devices are HSI, cameras, audio panels, battery backup systems, etc. FAA Approved Under TSO-C71 Now Approved LS03-05002B-MS * FAA TSO-C71 Approved (Pending)
 Step-up 14V DC to 28V DC Converter P/N 11-02888 **\$599.95**
 Step-down 24VDC to 12VDC Converter P/N 11-03309 **\$449.95**
 Connector Kit 5 Pin DB Style P/N 11-06001 **\$89.95**

LONE STAR DC TO DC CONVERTER



Ultra Small (2.5 x 3.5 inch) dc converter, the installer now has multiple mounting points. Its narrow body shape, mounting brackets, multiple voltages, and FAA-TSO make it the ideal candidate for aircraft and rotorcraft installs. With more demanding and sophisticated aircraft applications like EFB's systems, cell phone charging, computers, LCD, entertainment sub-systems this dc power supply is a real winner.

Output Voltage	Output Current	Model No.	Part No.	Price
5.0 VDC	7.0C/7.5PA	LS03-05003-005	11-10700	\$563.00
9.0 VDC	7.0C/7.5PA	LS03-05003-009	11-10589	\$599.00
13.8 VDC	7.0C/7.5PA	LS03-05003-138	11-04894	\$598.00
16.0 VDC	4.0C/4.5PA	LS03-05003-160	11-04895	\$600.00
19.0 VDC	4.0C/4.5PA	LS03-05003-190	11-04898	\$600.00

EL

USB CHARGERS



GARMIN GSB™ 15 USB CHARGER

The GSB 15, a small, lightweight USB charger designed specifically for aircraft installations. GSB 15 includes two powerful USB Type-A charging ports capable of charging at up to 3A or 18W per port simultaneously. A single GSB 15 is capable of charging two full-size tablets while pilots or passengers use them at full backlight.

Dual USB Type-A - Rear.....	P/N 11-17434	\$259.95
Dual USB Type-A - Side.....	P/N 11-17435	\$259.95
Dual USB Type-C - Rear.....	P/N 11-18774	\$389.95
Dual USB Type-C - Side.....	P/N 11-18775	\$389.95
USB Type-A & Type C - Rear.....	P/N 11-18772	\$389.95
USB Type-A & Type C - Side.....	P/N 11-18773	\$389.95



BENDIX KING AEROPOWER USB CHARGING PORT

AeroPower is a panel-mount or cabin-mount USB power product for charging any handheld electronic device such as a phone, tablet and ADS-B portable, while the aircraft is in operation. This useful accessory has two USB type A input ports that provide 2.5 amps of dedicated power per port to charge any USB electronic portable. Tables, phones, ADS-B portables, and more.

P/N 11-17589 **\$364.00**



USB DUAL HIGH POWER SMART CHARGER BY SPT

The Superior Panel Technology Dual USB Smart Charging Port (SPTUSBSC) is a DCP (Dedicated Charging Port) to industry standard protocol per the USB Battery Charging 1.2 Compliance Plan. Early generation or smaller consumer electronics typically accept one (1) amp of power during charging.

Black Anodized.....	P/N 11-17461	\$195.00
Clear Anodized.....	P/N 11-17462	\$189.00



GARMIN GSB™

15 USB CHARGER MOUNTING KIT

Simplify your GSB 15 installation by using one of these optional mounting kits to easily mount your GSB 15 into an existing 2.25" or 3.125" instrument cutout.

2-1/4 Inch.....	P/N 11-17437	\$64.95
3-1/8 Inch.....	P/N 11-17438	\$64.95
Connector Kit.....	P/N 11-17491	\$23.95



GARMIN GSB™

15 DECORATIVE COVER

Clean up your GSB™ 15 installation with this decorative cover. Available in black, or as an unfinished version that you can custom paint to match your aircraft interior.

Note: Product image shows black powder coat version.

GSB 15 shown for reference, separate purchase is required.		
Unfinished.....	P/N 11-18620	\$39.95
Black Powder Coat.....	P/N 11-18622	\$49.95



BELITE RADIANT USB-C/A DUAL CHARGING PORT

Belite Radiant USB-C/A features dual ports and charge rates up to 3.0 amps, the attractive product is easy to install and perfect for use in any experimental or ultralight aircraft. **Features:** • USB-C and USB-A ports • 3.0 amps and 2.4 amps charging capability • 9 to 16 volt operation, up to 3.8 amp draw..... P/N 10-07142 **\$113.95**

FAST CHARGE DUAL USB CHARGER

Having a dedicated USB outlet is easier than using an adapter or the device's charger with an AC outlet. Install the charger in the nav-station or within a Contura switch panel. Microprocessors recognize the needs of your device and charges it as necessary. An integrated cover protects the outlets from dust and moisture while not in use. Make better use of the space at your helm by installing a practical USB charger. P/N 11-16258 **\$56.75**



ICARUS CHARGE ON THE FLY LEMO POWERED USB CHARGER

The PD port supplies up to 30 watts and will charge a completely dead iPad Pro 11" in 1:45. This charger plugs into the aircraft's ANR headset LEMO jack using a short captive cable. The headset is then plugged into the LEMO jack on the opposite end. All audio signals pass through the charger to the aircraft's audio system. Power for the internal charger is provided by the ship's power (12-30 volts). The USB-A and USB-C ports may be used at the same time.

If your aircraft lacks a cigarette lighter power source, or it is already being utilized, the Charge On Fly will integrate seamlessly and provide you clean power straight to your portable device. P/N 11-18869 **\$159.95**

RAM GDS® TYPE-C 18W MINI WALL CHARGER

The GDS® USB Type-C mini wall charger offers 18W of power delivery to compatible devices. It features a low-profile design while providing short circuit, overvoltage, overcurrent, and temperature protection.

P/N 11-17474 **\$22.49**



RAM GDS® 63W USB TYPE-C AND TYPE-A2-PORT CIGARETTE CHARGER

This two-port GDS® USB Type-C and USB Type-A cigarette charger allows for charging two devices simultaneously. In addition, the USB Type-A port takes advantage of Qualcomm® Quick Charge™ 3.0 for compatible devices – allowing you to get the most out of your devices while on the go. With the USB Type-C port, utilize full 45W power delivery. To prevent overcharging and overheating, multiple built-in safeguards protect against over-current. The low-profile design fits easily in your dash without getting in the way, and the indicator light lets you know that the charger is plugged in and your devices are charging.

P/N 11-17472 **\$36.95**

RAM GDS® TYPE-C AND TYPE-A 48W PREMIUM 2-PORT WALL CHARGER

The GDS® USB Type-C and USB Type-A premium wall charger allows for two devices to be charged simultaneously. Utilize full 30W USB Type-C power delivery, and take advantage of the 18W USB Type-A Qualcomm® Quick Charge™ 3.0 port. This rugged two-port wall charger also provides short circuit, overvoltage, overcurrent, and temperature protection P/N 11-17473 **\$48.50**



RAM GDS® 2-PORT USB CIGARETTE CHARGER

The GDS® 2-Port USB Car Charger can charge two devices at once, while also taking advantage of Qualcomm® Quick Charge™ 2.0 and 3.0 for compatible devices – quickly charging your devices on the go. To prevent overcharging and overheating, multiple built-in safeguards protect against over-current. The low-profile design fits easily in your dash without getting in the way, and the indicator light lets you know that the charger is plugged in and your devices are charging P/N 11-17592 **\$29.65**

CRAZED PILOT DUAL USB CIGARETTE LIGHTER ADAPTER



Dual USB Cigarette Lighter Adapter. Excellent solution to your USB charging needs! Power that iPad and Cellphone with your CRAZEDpilot Dual-USB Cigarette Lighter adapter!..... P/N 11-16636 **\$9.95**

SCOSCHE REVOLT 12W / 2.4 AMP CIGARETTE USB CHARGER



reVOLT is the world's smallest yet most powerful car charger for USB powered devices. Each of the 2 USB ports packs 12 Watts (2.4A) of power to charge two iPads at once. reVOLT is low-profile and lightweight - perfect for any vehicle's power socket. This car charger packs colossal power into a modest frame, naming it the best USB car charger on the market today. This car charger allows you to charge 2 devices at once - even 2 iPads simultaneously. Plug in any combination of iPads, iPhones or iPods with your existing charge/sync cables P/N 11-13313 **\$19.50**

EA SMART DUAL USB PANEL MOUNT CHARGING JACK



SMART version dual USB 4.2 Amp charging jack autodetects Apple and other brands of phones and tablets for a charge at the maximum rate! Compatible with 12 or 24 Volt DC input, and mounts in a 1-1/8" hole. Suitable for Experimental aircraft, cars, boats, motorcycle, RV, anywhere you need a charging jack P/N 11-17221 **\$25.95**
Inverter Cable Kit..... P/N 11-13503 **\$4.85**

SINGLE RECEPTACLE CIGARETTE LIGHTER



12V Receptacle has a weatherproof cap to protect the contacts from corrosion. The plug features a built-in LED power status indicator and 10A fuse.

Specifications:

- Cutout Size: 1 1/8" dia. x 2 1/2" D
- Dimensions: 1 5/8"H x 2 5/16W x 2 1/2"D

P/N 11-17580 **\$8.80**



DYNON USB PORT PANEL MOUNT

12 Inch.....	P/N 10-06852	\$49.00
24 Inch.....	P/N 10-06853	\$49.00
36 Inch.....	P/N 10-06854	\$49.00

BATTERY ACCESSORIES – FLAP CONTROLLERS

BATTERY BOX BUMPER SEAL

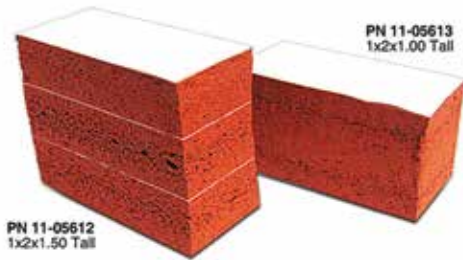

Battery Box Bumper Seal. 1103M foam with sticky back. Mil Spec: AMS3195E
Bumper Seal 1"P/N 11-05613 **\$39.50**

AIRCRAFT BATTERY HYDROMETER



Special Tester designed for testing aircraft batteries. Requires only small amount of fluid & ideal for close quarters. Float calibrated from 1.100-1.300 Sp. Gr. in 5° intervals.....P/N 11-01674 **\$64.75**

AIRCRAFT BATTERY LOCK



Designed to disable the battery from the electrical system which cuts off all power to the aircraft unattended many pilots. However, many panel locks are easy to pick and pry open. The battery lock is constructed using a tough space age plastic polymer and a seven pin round ball bearing lock that is impossible to pick which in turn prevents aircraft theft and increases security. P/N 11-02753 **\$358.00**

BATTERY MAT



The Battery Mat is the world's only acid neutralizing and absorbing mat designed for use beneath any lead-acid battery. Each mat is simple, efficient, and cost-effective. It's ideal for use with all aircraft, as well as standard and heavy duty equipment. The acid-neutralizing and absorbing fabric is patented and manufactured with recycle material in the U.S. Battery Mat absorbs and neutralizes battery acid that may leak or result from a "boil over", prevents corrosion, cushions vibration shock, is simple to use and install, and is safe to handle. Width: 12". Sold by linear ft. P/N 11-00170 **\$11.50 Ft**

GROUNDING BLOCK / TERMINAL BLOCK / BUSS BAR



Complete with a nickel-plated copper buss bar and stainless steel nuts with nylon lock washers, stainless steel flat and locking washes and 6 stainless steel screws (5 are 6/32 screws and one is 8/32 for the incoming ground/power). Each screw can accept up to four ring terminals by placing them back to back (see picture). Overall dimension is 4.25" long by .75 wide. P/N 11-13347 **\$37.65**

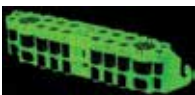

STORACELL BATTERY CADDYS

- Originally designed for pilots, but also great for camping, boating, travel or at home.
- Dispenses batteries with one hand for safety and convenience.

- Terminal protection at both ends regardless of how the battery is inserted.
- Built-in hook for hanging at home or work.
- Store your batteries in a compact, easy to find caddy
- Batteries not included

Description	Part No.	Price
Holds 4 9V batteries	13-21644	\$6.65
Holds 4 C batteries	13-21648	\$6.65

FPS PLUS - FLAP POSITIONING SYSTEM



The FPS-Plus is a full service, automatic, flap positioning system. This system operates similar to the "Cessna type flap systems" that many pilots were trained in. The pilot can easily go from one flap position to another with one quick press of the flap button. All flap stop positions (from 0 to 10, your choice) are easily, user programmable. This system is also fairly simple to retrofit it to your "already flying" aircraft.

The Plus feature of this system, allows you to program an elevator trim position for each flap position. Your elevator trim will be automatically adjusted, for every different flap setting that you choose. NO more manual tweaking of the elevator trim is needed for every different flight configuration.

The pilot can now pay more attention to the actual "flying the aircraft", rather than tweaking the correct amount of elevator trim for every different flight configuration. Flying is made much more enjoyable. If you desire to retract the flaps fully, all you have to do, is press the "flap up" button for more than 1 second. The flaps will be automatically retracted to their full up position. The elevator trim is also automatically adjusted to your cruise trim position.

FPS-PLUS with Elev. TrimP/N 11-02980 **\$209.00**
FPS-PLUS without Elev. TrimP/N 11-02981 **\$169.00**
FPS - PLUS REFLEX.....P/N 11-06440 **\$229.00**

SEAL-ALL MINI FUSE / MICRO RELAY PANELS



Seal-All Mini Fuse Panel: • Holds 20 Mini Fuses (30A max output per contact) • Sealed cap cover and seals for wires to make it a weather tight unit • Compact size (4.44"H x 3.33"W) • Each row of 10 fuses is separately bused with #10-32 input

studs (you can separate avionics and lighting circuits on separate busses and control power to them by relays) • Accepts wire size 22-12 gauge • Easy wiring (crimp terminal and push into hole on the backside) • Uses crimp terminals (sold separately based on wire size and accepts 22-12 ga wire) • Wire seals are included with the crimp terminals to make a weather tight seal • Available mounting bracket for easy mounting and wiring (sold separately) • Cavity plugs are available to seal any unused openings.

Seal-All Combination Mini Fuse and Micro Relay Panel: • Holds 10 Mini Fuses (30A max output per contact) and 5 Micro Relays (at 12V rated at 35A for SPST) • Sealed cap cover and seals for wires to make it a weather tight unit • Compact size (only 4.44"L x 3.33"W) • Row of fuses and relays are bused separately with #10-32 nickel plated brass input studs (you can separate essential and non-essential circuits and control power to them by relays) • Easy wiring (crimp terminal and push into hole on the backside) • Accepts wire size 22-12 gauge • Uses tangles terminals (sold separately based on wire size and includes seals) • Available mounting bracket for easy mounting and wiring (sold separately) • Wire seals available for every wire size (and cavity plugs for any unused openings).

Description	Part No.	Price
Rear Terminal Mini Fuse Panel	11-13348	\$58.75
Rear Terminal Combo Mini Fuse & Micro Relay Panel	11-13351	\$59.95
Bracket Sold as Pair	11-13352	\$19.85
Terminals 22-20ga with seals Red (10 terminals & 10 Seals)	11-13353	\$9.75
Terminals 18-16ga with seals Purple (10 terminals & 10 Seals)	11-13354	\$9.75
Terminals 16-14ga with seals Green (10 terminals & 10 Seals)	11-13355	\$9.75
Terminals 14-12ga with seals Gray (10 terminals & 10 Seals)	11-13356	\$9.75
Cavity Plug - 5 plugs	11-13357	\$2.75
Terminal Removal Tool	11-13358	\$16.85
Mini Fuse Gray 2 Amp Pack of 5 fuses	11-13359	\$4.75
Mini Fuse Tan 5 Amp Pack of 5 fuses	11-13360	\$4.75
Mini Fuse Brown 7.5 Amp Pack of 5 fuses	11-13361	\$4.75
Mini Fuse Red 10 Amp Pack of 5 fuses	11-13362	\$4.75
Mini Fuse Blue 15 Amp Pack of 5 fuses	11-13363	\$4.75
Mini Fuse Green 30 Amp Pack of 5 fuses	11-18507	\$4.75
Micro Relay 12 Volt AMP RATING NO-35/ NC-- / SPST contact	11-13364	\$7.85
AMP RATING NO-35/NC-25 / SPDT contact Micro Relay 12 Volt	11-13365	\$7.50
Micro Relay 24 Volt AMP RATING NO-20/ NC-15 / SPDT contact	11-13366	\$7.50

EL

POWER PANELS – FLAP CONTROLLERS – GRIPS

POWER BUSS 2075



The Power Buss 2075 is an electronic device designed to control and monitor the electrical circuits in an aircraft. The device employs solid state PTC current limiting fuse devices that automatically remove power from a circuit if it becomes overloaded. Just like conventional circuit breakers, a tripped circuit can be reset by turning off the device for a few seconds, then turning it back on. If a circuit trips due to overload, the pilot will instantly hear a distinctive voice message in his headset, and through the built in speaker. The voice warning will continue until the pilot pushes the panel mounted switch, with built in light, stopping the voice and turning on the built in red light. This provides a visual indication of the tripped circuit. The red light remains illuminated as long as the fault exists. The power buss can be mounted anywhere behind the panel. The combination switch/light should be mounted in the panel, within the pilots normal scan. A separate buss is provided for the avionics. The Power Buss is designed for 12volt systems only. Maximum current on the board is 30 amps. Maximum current on any one circuit is 11 amps. The audio output is designed to connect to an unswitched input in an audio panel or a radio. **Note: This system is not FAA approved. It is intended for installation in Experimental category aircraft only.**

The Power Buss is available in two versions:

2075-A: Designed specifically for use in both fixed and retractable gear land aircrafts that are powered by Rotax engines. It incorporates PTC fuses and voice messages for the most common circuits used in these aircrafts.....P/N 10-06264**\$395.00**

ELECTRONIC FLAP ACTUATOR / INDICATOR



The Electronic Flap Actuator (2071/2072) is an electronic module designed to automatically control an electrical flap actuator and provide visual readout of 3 or 4 flap positions. The device can be used with any electrical actuator providing the operating current is less than 8 amps at 12 volts. A 5K or 10K resistive sensor is required to provide a voltage readout of the actuator position. The control unit incorporates pushbutton switches with built in LED lights. The system can be easily calibrated to your flap system. Once calibrated, pushing any of the switches will activate the actuator and drive the flaps to the correct pre-defined position. When the flaps are at the correct position, the actuator will stop, and the LED in the correct switch will illuminate indicating that the flaps are in the correct position. **Note: This system is not FAA approved. It is intended for installation in Experimental category aircraft only.** The Electronic Flap Actuator is available with 3 flap position switches (full up, takeoff position, and full down) or 4 flap position switches (full up, 20 degrees, 40 degrees, and full down).

3 switch.....P/N 11-10502**\$198.75**
4 switch.....P/N 11-07728**\$185.00**

FLAP HANDLE



This flap handle is a well built, durable, and cost effective alternative to the plain round standard flap toggle switch that exists in most experimental aircraft. This unit is easily installed over the existing toggle switch with the included set screws. This unit is powder coated for a long lasting, durable finish.

Note: This is the Flap Handle Only

Flap HandleP/N 11-11337**\$44.95**
Flap Handle and anti rotation plate that limits knob rotation and also provides a nice labeling of the flap handle.P/N 11-11338**\$89.95**

MGL ECB LIGHT AND SWITCH KIT



This flexible module provides up to 8 individual circuit breakers that can be configured for trip currents up to 10A. Breaker doubling and tripling options allow for trip currents of up to 30A.

Up to 8 of these modules may be used in a single, connected system giving up to 64 usable breakers.

This module can operate completely stand alone and does not require any form of external device such as an EFIS system or laptop computer for configuration - however, using an MGL EFIS does extend the configuration to detail level.P/N 11-16724**\$125.00**

VINTAGE AN 8002 REPLICA RUBBER STICK GRIPS



Get a grip on authenticity! The "AN 8002" grip is back in 1" and 1-1/8" sizes. Used in Piper, Aeronca, Taylorcraft and many others from prewar to 1947 Correct grip for L- birds, looks great on homebuilts!

1 Inch.....P/N 11-12769**\$61.75**
1-1/8 Inch.....P/N 11-12767**\$61.75**

TOSTEN STICK GRIPS

Wired with 22 gauge wiring. 7/16 stainless steel shaft with custom machine bushings to fit any diameter shaft. Comfortable grip. Made with lightweight glass-filled Wellman nylon. Rotates easily to any position. Made in the USA. For use in Experimental Aircraft Only.

Model	Functions	Part No..	Price
 CS-2	Two function control stick Index trigger button Additional button underneath trigger Ambidextrous design	11-10508	\$119.75
 CS-4	Four function control stick Two trigger buttons Two face buttons Ambidextrous design	11-10509	\$139.75
 CS-6	Eight function control stick Four-way hat switch Trigger button and index button Ambidextrous design	11-10510	\$149.00
 CS-8	Eight function control stick Four-way hat switch Two face buttons Trigger button and index button Ambidextrous design	11-10511	\$159.00

INFINITY AEROSPACE LIGHTED RETRACT HANDLE WITH GEAR SWITCH



Canard and Non-Canard RED / GREEN lighted Retractable Handle with DPDT Lever Lock Gear Switch (12 VDC / 7.5 amp, or 24 VDC / 4 amp) Gear DN the handle LED light is GREEN; Gear in Transit or is Unsafe, or the Canard Retractable Handle and Switch is in the Center OFF position, the LED light in the handle is RED; Gear UP the handle LED light is OFF, or BLUE (your choice).

The GREEN / RED LED light in the handle can be changed to different colors (such as GREEN / BLUE for amphibians), or GREEN / RED / BLUE, but GREEN / RED gear lights for retractable landing gear are standard colors in retractable planes. Pre-wired with 2 feet each of 22 gauge GREEN, RED, BLUE and BLACK wires.

Description	Part No.	Price
12 Volt Canard	11-12220	\$150.00
12 Volt Non-Canard	11-12361	\$150.00
24 Volt Canard	11-12221	\$150.00
24 Volt Non-Canard Purple	11-12362	\$150.00
Infinity Lighted Gear Switch With Solid State Black Box	11-12925	\$219.95

PISTOL GRIP COVER



These Grip Covers are made of soft, durable red neoprene and feature a high quality zipper to wrap snugly around most stick grips. These covers help prevent UV damage to your stick grip. In addition to protecting against dirt and other foreign object damage, these covers also prevent switch damage when entering cockpits or when working under instrument panels.P/N 11-13088**\$17.75**



RELAY DECK

Two axis relay deck to be used for both elevator and aileron servos...P/N 11-10512**\$79.95**

STICK GRIPS

INFINITY MILITARY STICK GRIPS



P/N 11-00031

Infinity Aerospace designed these grips with safety, comfort, functionality, durability and aesthetics in mind. The ergonomic design is contoured to the shape of your fingers and includes a fatigue reducing hand rest at the base. The non-glare matte black finish is abrasion and impact resistant for long life, yet easily removable, maintainable and repairable. Matching customized Right and Left hand models available. All the major cockpit functions can be at your finger tips. Reduces pilot workload and fatigue. Thousands have already been installed in over 50 models of

aircraft (even a 314 foot custom Yacht and a submarine!) FAA certified in the new Micco and Eagle FAA certified aircraft, field approved in Bell 206, Hughes 500 and Hiller helicopters, Aero Commander 500 A's, Mooney's, Cessna's, Swift's and in blimps. Standard issue in several of today's finer Sport Aircraft Kits.

Possible Switch Functions :

Two-Axis Trim Switch: Pitch & Aileron (typical) or Pitch & Rudder (standard in Lancair IV's);

OR Step frequencies and/or flip-flop frequencies and/or transponder ident.; OR sweep spotlights, cameras, computer cursors, etc.

Red Trigger Switch: Push-To-Talk (PTT); OR 35mm camera, video camera, audio recorder, paint ball or propane machine gun, etc.;

ON/OFF Tactical Push-Buttons: Main fuel pump, aux fuel pump, landing light(s), taxi light(s), nav lights, strobe lights, pitot heat, ident., etc.

Features:

- 6" long with 6 switches
- Fits stick OD's from 5/8" to 1-1/4"
- Delivered with color coded pre-wiring and installation schematic
- Completed grip only weighs approx. 12oz
- Has matte black cooley hat and grip with red trigger
- 4 molded in brass inserts hold the halves together

Description	Part No.	Price
Military Stick Grip A/C with Flap/Brake (Right)	11-00031	\$199.95
Military Stick Grip A/C with Flap/Brake (Left)	11-00032	\$199.95
Military Stick Grip A/C without Flap/Brake (R)	11-00033	\$199.95
Military Stick Grip A/C without Flap/Brake (L)	11-00034	\$199.95
Military Stick Grip with Spoilers (Right)	11-00036	\$199.50
Military Stick Grip with Spoilers (Left)	11-00667	\$199.75
Replacement Switches for extra customizing:		
Momentary push-button switch	11-00218	\$14.85
ON/OFF (8636) SPDT push-button	11-00219	\$14.50
Toggle [spring loaded-to-center - ON/OFF/ON]	11-00220	\$14.85
Toggle [ON/Center OFF/Momentary ON-OFF/ON]	11-00221	\$14.80
Spacers/Adapters:		
1" OD x 3/4" ID (i.e.-for Lancairs & canard tubes)	11-00222	\$28.85
1" OD x 7/8" ID (i.e.-for Glasairs & RV co-pilot tubes)	11-00223	\$24.95
Infinity Switch with China Hat (Right)	11-04757	\$24.95

TEAKWOOD STANDARD PISTOL GRIPS



Teak wood is beautiful, absorbs sweat, preventing any sticky slime build-up. Grips come in standard, master and ultra styles in left and right hand. The standard grip comes with a push button on its top with a special dust proof cover. Normally is used for a push-to-talk button, is normally open switch and is good for 250,000 cycles minimum. The master grip has larger head to accommodate a 4-way trim switch & push-to-talk button.

The trim switch is the same one used with M.A.C. systems. The ultra grip has a larger surface to accommodate the 4-way trim and a auto-pilot and/or air brake with the push-to-talk located near the tip of the index finger. The ultra can handle a total of four switches, when using the air brake, in its head. Configurations can also be custom designed. All grips come with buttons and a 3/4" or 1" standard bore. Larger bores available.

- Right Hand 3/4 inch.....P/N 11-02910\$142.75
- Right Hand 1 inch.....P/N 11-02910-1\$142.75
- Left Hand 3/4 inch.....P/N 11-02915\$142.75
- Left Hand 1 inch.....P/N 11-02915-1\$142.75

RAC STICK GRIPS



G101

G205

G301

G401

Ray Allen Company G1 and G2 series stick grips use modern, flush fitting push-button switches to control one or two axis electric trim. When one grip is used, these switches can be wired directly to RAC trim servos. This eliminates the need to wire relays in your trim system. However, if two grips are used, you will need either relays or a switch to transfer the control of trims from one grip to the other. The grip itself is made of semi-soft UV and oil resistant foam. The upper switch housing is made of nylon with a lightly textured finish.

G101

The **G101** grip (4.75" height) features a momentary contact switch on top that can be used as a PTT button. (Old MAC Model G1)
P/N 11-09930\$68.75

G205

The **G205** grip (5.25" height) has 5 functions which include a PTT and a 4 SPDT, momentary contact switches. These switches are rated at 5 amps and can be used for other purposes. (Old MAC Model G5)
P/N 11-09920\$178.75

G301

The **G301** stick grip feature four individual SPDT momentary contact switches to control one or two axis electric trim. The switches are triggered via a traditional 4-way "hat" type activator. 6.5" (165 mm) tall.
P/N 11-08644\$78.75

G303

The **G303** stick grip has two trim switches, a faceplate slotted vertically for 1-axis trim and a PTT switchP/N 11-02538\$168.75

G305

The **G305** stick grip has 4 trim switches, a faceplate slotted vertically and horizontal for 2-axis trim and PTT switch....P/N 11-02539\$208.75

G307

The **G307** stick grip has 4 trim switches, a faceplate slotted vertically and horizontal for 2-axis trim and PTT switch...P/N 11-02540\$248.75

G401

The basic **G401** stick grip includes a momentary contact, 50 mA, SPST Push-To-Talk (PTT) switch located on the front side of the grip. Featuring the same comfortable foam grip as the G2 Series.
P/N 11-16321\$78.75

G403

The **G403** stick grip features a momentary contact, 50 mA, SPST Push-To-Talk (PTT) switch located on the front side of the grip, and two Auxiliary pushbutton SPDT switches. The pushbutton switches can be replaced with four different style toggle switches.
P/N 11-16322\$148.75

G405

The **G405** stick grip features a momentary contact, 50 mA, SPST Push-To-Talk (PTT) switch located on the front side of the grip, and four SPST switches.....P/N 11-16323\$188.75

G407

The **G407** stick grip features a PTT switch, four SPST switches and two Auxiliary pushbutton SPDT switches.....P/N 11-14708\$238.75

Ray Allen stick grips are designed to fit any stick size up to 1" in diameter with the use of spacers. Two nylon spacer are included with each grip enabling easy installation on 3/4", 7/8" and 1" sticks. All Ray Allen grips come as a complete kit and include pre-cut and stripped, Teflon insulated wire. A die-cut label sheet is also supplied in the G205, G207, G403, G405, G407 and G407F grips.



RUBBER STICK GRIPS

- Rubberized urethane with granular like non-slip surface.
- 7/8" I.D. Stick GripP/N 11-00100\$18.65 ea.
- 1" I.D. Stick GripP/N 11-00101\$17.85 ea.
- 1-1/8" I.D. Stick GripP/N 11-00102\$17.85 ea.

EL

RAC TRIM SYSTEMS

RAC ELECTRIC TRIM SERVOS

Ray Allen trim systems were designed specifically for experimental aircraft. Ray Allen servos are small enough to fit in individual control surfaces or can be used with lightweight springs acting directly on the control system.

Ray Allen trim systems also come with RS2 rocker switches and RP4 LED indicators. All Ray Allen indicators operate off of feedback sensors located inside the servo. These feedback sensors are purposefully isolated from the power supply to the servo motor to guard against possible electronic failure. Ray Allen trim systems also come with a RC8-7 clevis/pushrod kit.

T2-10A



T2/T3 SERVO SPECIFICATIONS

Operating Voltage.....12-14 VDC
No Load Current.....150 ma
Weight.....4oz. (113 g)
Max Thrust.....40 lbs. (18 kg)
Max Operating Thrust.....20 lbs. (0.9 kg)

B6-7C



T4-5 SERVO SPECIFICATIONS

Operating Voltage.....12-14 VDC
No Load Current.....75 ma
Weight.....2.5 oz. (71 g)
Max Thrust.....30 lbs. (13.5 kg)
Length.....2.25" (57mm)
Width.....2.25" (57mm)
Height.....0.77" (20mm)

*T2-7A = exact replacement for MAC 4A servo. *T2-10A = exact replacement for MAC 6A servo. *T3-12A = exact replacement for MAC 8A servo. *T4-5 is exact replacement for the Mac S9 servo.

RAC SERVO SYSTEMS

RAC Servo System	Part Number	Output Shaft		Price ea.
		Movement	Travel Time	
T2-7A	11-11505	0.7 in.	10 sec.	\$518.75
T2-10A	11-11605	1.0 in.	16 sec.	\$518.75
T3-12A	11-11615	1.2 in.	19 sec.	\$542.00

SERVOS ONLY

RAC Servo System	Part Number	Output Shaft		Price ea.
		Movement	Travel Time	
T2-7A	11-02048	0.7 in.	10 sec.	\$258.75
T2-10A	11-02058	1.0 in.	16 sec.	\$258.75
T3-12A	11-02065	1.2 in.	19 sec.	\$288.75

MINIATURE LINEAR ACTUATORS

RAC Servo System	Part Number	Output Shaft		Price ea.
		Movement	Travel Time	
B6-7C	11-16311	0.7 in.	12 sec.	\$328.75
B6-7T	11-16312	0.7 in.	12 sec.	\$328.75
B6-11C	11-16313	1.1 in.	19 sec.	\$328.75
B6-11T	11-16314	1.1 in.	19 sec.	\$328.75

*T2-7A = exact replacement for MAC 4A servo. *T2-10A = exact replacement for MAC 6A servo. *T3-12A = exact replacement for MAC 8A servo. *T4-5 is exact replacement for the Mac S9 servo.

RAC SWITCHES



RS2 ROCKER SWITCH - Very positive snap action in 2 directions and returns to a center off position. It was designed specifically for Ray Allen trim systems. It is wired to connect both power leads to ground when the rocker is released. This eliminates motor coasting & allows very precise trimming. The RS2 switch is rated at 1 amp. The faceplate measures 1.75" (44mm) x 1.0" (25mm) x 1.47" (37mm) deep. Included with trim systems or can be purchased separately. Self adhesive labels are not included. Sold separately. P/N 11-02035.....\$78.75



RANS ELEVATOR TRIM SYSTEM

Rans Elevator Trim System features a trim tab actuated by a push-pull wire. By turning the trim wheel, the wire moves the trim tab. The system has the look and feel of a standard aircraft trim wheel. The trim tab is constructed of sheet aluminum and can be adapted to the trailing edge of many homebuilts and ultralights. The trim tab is sized for both low & high speed aircraft and since it is mechanical, requires no battery or power source other than the pilot's hands.

Trim System less Tab (no panel or flap lever mount). P/N 11-09955...\$585.00
Trim System with Lower Panel.....P/N 11-09960...\$720.00
Trim System Flap Mount.....P/N 11-09965...\$336.00
Trim System without Wheel.....P/N 11-09970...\$256.95

RAC INDICATORS/SENSORS/ACCESSORIES



RP4 LED POSITION INDICATOR -

The RP4 LED position indicator is designed to be installed in the cockpit and give an indication of the servo output shaft position. The 10 LEDs are the brightest available for superior visibility in sunlight, but can be dimmed for night flight. It can be installed horizontally or vertically.

P/N 11-16285.....\$178.75



POSITION INDICATOR/ROCKER SWITCH LABELS

Finish off your panel with these high quality labels. Rocker switches and needle indicators require a LARGE label, LED indicators use a SMALL label. Elev 1 shows trim down at top of label.

Rudder - Large.....	P/N 11-01819.....	\$0.95
Rudder - Small.....	P/N 11-01820.....	\$0.95
Aileron - Large.....	P/N 11-01816.....	\$0.95
Elev 1 - Large.....	P/N 11-01822.....	\$0.95
Elev 1 - Small.....	P/N 11-01821.....	\$0.95
Wing Flap - Large.....	P/N 11-01818.....	\$0.95
Wing Flap - Small.....	P/N 11-01817.....	\$0.95
Cowl Flap - Large.....	P/N 11-01576.....	\$0.95
Cowl Flap - Small.....	P/N 11-01814.....	\$0.95



POS-12 POSITION SENSOR - When combined with a Ray Allen indicator, this sensor can be used to measure the position of wing flaps, cowl flaps, or many other mechanisms. Small enough to be installed anywhere, size: 2.7"l x 0.8"w x 0.5"h. (note: T2 & T3 servos have their own built-in sensors) 1.2" travel.

P/N 11-01321.....\$78.75



REL-2 SERVO RELAY DECK - This device converts the momentary contact action of the ROS-4 4-way switch, or any SPST pushbutton switch, into a DPDT action that is necessary to operate Ray Allen servos. You will need one of these relay decks for each servo in your installation. Measures 1.6" (40 mm) x 1.8" (49 mm) x 1.1" (28 mm).

P/N 11-05312.....\$98.75



SPD-1 SERVO SPEED CONTROL - Enables you to slow the speed of your trim servo to suit your individual installation. Size: 2"x 0.5"x 0.8"P/N 11-02078.....\$98.75



REG-1 12V REGULATOR - Enable you to operate servos and indicators in aircraft having 28V electrical systems. Converts all input voltages up to 35V to 12V. Capable of supplying 1 amp of current allowing you to operate 2 trim systems simultaneously. Size: 2"x 0.5"x 0.8".

P/N 11-02036.....\$98.75



RAY ALLEN BEZEL ONLY WITH HARDWARE - They make an excellent addition to any instrument panel. The bezel was designed to integrate a professional appearing label near the switch. The bezel measures 1.25" (32 mm) x 1.35" (34 mm).....P/N 11-08642.....\$15.75



RAC CLEVIS / PUSHROD KITS - Contains two threaded clevis forks, one 7" stainless steel pushrod and clevis pin hardware. The Ray Allen clevis/pushrod kit is included with Ray Allen trim systems, or can be purchased separately.

RAC PN	Part No.	Compatible Unit	Thread	Price
RC8-7	11-02040	T2/T3 Servos	8/32"	\$58.75
RC8	11-02041	T2/T3 Servos	8/32"	\$28.75
RC10	11-08643	T2/T3 Servos	10/32"	\$31.75
C2-8	11-16318	B6 Actuator	8/32"	\$34.75
C2-10	11-16319	B6 Actuator	10/32"	\$34.75



WC2 5-WIRE TEFLON® INSTALLATION CABLE - This durable, flexible wire cable is highly recommended for Ray Allen installations. 5 separate color coded, 26-gauge, 19-strand, silver-plated, FEP Teflon® insulated wires inside a tough, all Teflon® sheathing.

20 ft. roll.....P/N 11-01577.....\$37.00
25 ft. roll.....P/N 11-01578.....\$46.25
50 ft. roll.....P/N 11-01579.....\$92.50

RAC BEZEL SWITCHES – STICK GRIPS

RAC - RBS SERIES BEZEL SWITCHES

An excellent addition to any instrument panel. The bezel measures 1.25" w x 1.35" h. A die-cut label sheet is purchased separately. The switches are SPST. They have screw terminals and are rated at 15 amps. Specify Toggle (RBS-T11) or Pushbutton (RBS-P11) when ordering. The Ray Allen Gear Bezel Switch (RBS-GS) is the same custom bezel as above combined with SPDT retract gear toggle switch. The switch is rated at 15 amps and has a pull to unlock feature preventing accidental engagement. The Gear Bezel Switch comes with the labels pre-installed.

RAC Part No.	Description	Part No.	Price
RBS-T11	Bezel Switch - Toggle	11-01364	\$27.75
RBS-P11	Bezel Switch - Push Button	11-01365	\$27.75
RBS-GS	Bezel Gear Switch	11-01366	\$108.75
RBS-L1	Bezel Switch label sheet	11-01367	\$6.75



PIONEER CLASSIC WALNUT CONTROL GRIP

Guy's classic design! Crafted from walnut with a durable polyurethane finish. On the fully serviceable switchplate, you'll find three push button switches and a four way hat switch. On the forward face is a sleek, domed push to talk button positioned right where you want it. Comfort, convenience and style in the palm of your hand.

Each grip is delivered prewired with a 2' pig tail and a termination guide.

Price is per grip.

Wood is a diverse medium and the end finish may vary in grain structure.

Description	Part No.	\$589.00
5/8" Diameter Right Hand Grip	11-18982	\$589.00
5/8" Diameter Left Hand Grip	11-18983	\$589.00
3/4" Diameter Right Hand Grip	11-18984	\$589.00
3/4" Diameter Left Hand Grip	11-18985	\$589.00
7/8" Diameter Right Hand Grip	11-18986	\$589.00
7/8" Diameter Left Hand Grip	11-18987	\$589.00
1" Diameter Right Hand Grip	11-18988	\$589.00
1" Diameter Left Hand Grip	11-18989	\$589.00
1-1/8" Diameter Right Hand Grip	11-18990	\$589.00
1-1/8" Diameter Left Hand Grip	11-18991	\$589.00

FEELFLIGHT FLIGHT GRIP

The FeelFlight Grip is a newly developed and patented product inspired by the FAA FlySafe mission to reduce fatal loss of control accidents. The basic component is the unique haptic feedback control grip. This grip signals the pilot "angle of attack" and "inclination" by pulsing the fingers. This is accomplished by electronic solenoids inside the grip. Best rate of climb - Vy, is signaled at the ring finger. Best angle of climb - Vx, is signaled at the middle finger, and STALL is signaled at the index finger. Inadvertent stalls often become fatal because the pilot does not have his turn coordinated. This can result in a spin. There are signaling pins on the left side of the grip and right side of the grip that signal "inclination." The signal pulses the thumb on the left or the lower index finger on the right. Inclination is the same signal broadcast by the conventional "ball" instrument. Proper pilot maintenance of angle of attack and inclination is crucial for safe flight.

P/N 11-19003\$2,395.00

FLIGHT GRIPS



The control stick grips from Flight Grip are modular in design to allow maximum flexibility when specifying switches to control the various electrical items on your aircraft and for ease of installation and assembly. Two "off-the-shelf" configurations are listed below. The Model #2 grip provides for control of two functions using the rocker trigger switch. The trigger switch features momentary contact either side of center, with spring return to center OFF action. The Model #4 grip is the same as the Model #2, but adds two push-button switches for thumb activation in the top cap of the grip. The switch mounted closest to the thumb rest is a latching type (push on - push off), and the remaining switch is a momentary type. Left hand grips are available with all the same switch options. Grips are designed to fit 1-1/8" OD control sticks and adapter bushings are available to adapt to 1", 7/8" and 3/4" OD control sticks.

#2 (Right Hand-2 Functions).....	P/N 11-02000	\$128.75
#4 (Right Hand-4 Functions).....	P/N 11-02050	\$199.85
#2L (Left Hand-2 Functions).....	P/N 11-06753	\$129.75
#4L (Left Hand-4 Functions).....	P/N 11-06754	\$199.85
Adapter Bushing 1".....	P/N 11-06755	\$45.95
Adapter Bushing 7/8".....	P/N 11-06756	\$45.95
Adapter Bushing 3/4".....	P/N 11-06757	\$45.91



LANDING LIGHT	CABIN LIGHTS	BATTERY MASTER	ALTERNATE AIR	OFF
NAV LIGHTS	PANEL LIGHTS	AVIONICS MASTER	INVERTER	OFF
ROTATING BEACON	PULSE LIGHT	ALTERNATOR	CARGO HEAT	OFF
STROBE LIGHTS	TAXI LIGHT	AUTOPILOT	ON	OFF
STARTER	DIMMER	PILOT HEAT	ON	OFF
ENGAGE	IGNITION No. 1	HYDRAULIC PUMP	OFF	OFF
FLAPS UP	IGNITION No. 2	LOW BOOST	ON	OFF
FLAPS DN	FUEL PUMP	HIGH BOOST	ON	OFF
CABIN FAN	AVIONICS MASTER A	BOOST PUMP	ON	OFF
CABIN AIR COLD	AVIONICS MASTER B	STANDBY ALTERNATOR	ON	OFF
CABIN AIR HOT	LEFT MAGNETO	TRIM MASTER	OFF	OFF
OXYGEN	RIGHT MAGNETO	PARKING BRAKE	OFF	OFF

TRIM SPEED CONTROLS



A trim motor that moves too fast can be distracting and dangerous in a high performance aircraft. The Trim Speed Control module lets you adjust the speed of a motor in trim sensitive applications. It has also been used in many 24 volt aircraft that are equipped with 12 volt trim motors. The module installs in-line in an existing trim system with only four connections and requires no external power supply.

Trim speed is easily set on the module as required. This unit does not generate any noise during operation and draws zero current when not in use.

Example part selection - 24 volt aircraft with a small 12 volt trim motor would need a TSC24-LC.

There are four (continuous) options available:

TSC12-LC 12/14 volt operation 3A - 7A surge.... P/N 11-11561 \$69.95

TSC24-LC 24/28 volt operation 3A - 7A surge.... P/N 11-11562 \$75.95

TSC12-HC 12/14 volt operation 5A - 7A surge... P/N 11-11563 \$102.95

TSC24-HC 24/28 volt operation 5A - 7A surge... P/N 11-11564 \$107.95

CUSTOM TEAK WOOD AIRCRAFT GRIPS



Teak wood is beautiful, absorbs sweat, preventing any sticky slime build-up. Grips come in standard, master and ultra styles in left and right hand. The standard grip comes with a push button on its top with a special dust proof cover. Normally is used for a push-to-talk button, is normally open switch and is good for 250,000 cycles minimum. The master grip has larger head to accommodate a 4-way trim switch & push-to-talk button.

The trim switch is the same one used with M.A.C. systems. The ultra grip has a larger surface to accommodate the 4-way trim and an auto-pilot and/or air brake with the push-to-talk located near the tip of the index finger. The ultra can handle a total of four switches, when using the air brake, in its head. Configurations can also be custom designed. All grips come with buttons and a 3/4", 7/8", 1" or 1-1/8" standard bore. Larger bores available.

Comes with Push-to-Talk, Cooley Hat, Flap, Autopilot and Radio Flip Flop.

VISIT WWW.AIRCRAFTSPRUCE.COM FOR COMPLETE LISTING OF GRIPS AND PRICING.

HOMEBUILT CONTROL STICKS

These homebuilt control sticks are made of high-strength urethane plastic, finish painted in matte black and come complete with all necessary hardware (AN screw, nut, washers). Available unbored or bored to accept 7/8", 1", or 1-1/8" diameter tubing.



All of these grips (except unbored) are available w/PTT Switch at \$129.75 Add -1 to end of part number for PTT.

Grip	Bore	Part No.	Price
Right	Unbored	11-01010	\$89.95
Right	7/8" Bore	11-01015	\$99.85
Right	1" Bore	11-01020	\$99.75
Right	1-1/8" Bore	11-01025	\$95.75
Left	Unbored	11-01010-L	\$95.75
Left	7/8" Bore	11-01015-L	\$97.85
Left	1" Bore	11-01020-L	\$97.75
Left	1-1/8" Bore	11-01025-L	\$95.75
Neutral	Unbored	11-02010	\$95.75
Neutral	7/8" Bore	11-02015	\$94.90
Neutral	1" Bore	11-02016	\$99.75
Neutral	1-1/8" Bore	11-02017	\$99.85

TCW TECHNOLOGIES



SMARTSTART MODULE

An electronic control module that controls the operation of the engine starter system. Improves the safety and security of push-button or key-switch starting systems by providing an interlocked and time limited operation of the engine starter. SmartStart controls standard aviation starter contactors and provides simple integration of control stick switch or panel mounted start switches. SmartStart includes inputs for interlock and arming switches and provides a 1 minute timer for activating the starter contactor and includes an armed LED that indicates when the engine may be started. Helps avoid unintentional activation of the engine starting system. Available with an optional airspeed switch that ensures in flight restarting of the engine may be accomplished at anytime without the need to press the arming button. Hidden arming switch provides improved anti-theft protection. Door/canopy interlock provides improved safety. Compatible with standard keyed mag/starter switch.

Description	Part No.	Price
Smartstart Module	11-08499	\$100.00
SmartStart Module Kit - Includes: module, wiring harness, and airspeed switch	11-08502	\$148.50
Accessories		
Description	Part No.	Price
Smartstart Wiring Harness	11-08501	\$61.75
Airspeed Switch 40 Knot for 2 speed function	11-08665	\$47.95

INTELLIGENT POWER STABILIZER

Provides aircraft bus voltage surge and sag protection for the connected electrical equipment. The IPS system allows electronic equipment such as engine monitors, EFIS and GPS's to be operational before and during engine starting. Used with aircraft engine monitors it ensures the pilot can monitor critical engine operating parameters such as oil pressure during the engine starting process. Ensures the connected electronic equipment is provided with a stabilized source of power even when the aircraft battery voltage drops significantly. Additionally provides surge protection by actively clamping the regulated output voltage. Features a panel mounted low voltage warning light which may be used to provide a pilot warning when the aircraft bus voltage falls below 12 volts. 4 amp.....P/N 11-08495\$265.50
8 amp.....P/N 11-08496\$328.50



INTELLIGENT POWER STABILIZER 24 VOLTS, 5 AMP

The Intelligent Power Stabilizer, IPS, is an electronic power converter for critical electrical equipment found in general aviation aircraft. The IPS system provides aircraft bus voltage surge and sag protection for the connected electrical equipment. The IPS system will operate over an input voltage range from 10 volts to 30 volts and provides a regulated output voltage of 24 volts. The IPS system allows electronic equipment such as engine monitors, EFIS and GPS's and radios to be operational before and during engine starting. This important feature allows the pilot to load flight plan data into the aircraft GPS prior to starting the engine, thereby saving fuel and operating expense. When used with aircraft engine monitors it ensures the pilot can monitor critical engine operating parameters such as oil pressure during the engine starting process..... P/N 11-09712\$325.00

INTELLIGENT LIGHTING CONTROLLER

Designed specifically to operate the lighting circuits used in homebuilt aircraft. Provides control of up to 4 lighting circuits plus dimmable control of up to 3 channels of instrument and cabin lights. The 4 lighting circuits may be used to control landing lights, taxi lights, strobe lights and navigation lights. Each channel is independently powered and controlled. Provides a wig-wag function between two of the lighting circuits. Each dimmable channel may include incandescent or LED lighting up to 1 amp.

Specifications: • Input Voltage: 10-30 volts DC • Output Voltage: 4-Switched circuit rated at 10 amps each, 3 - Dimmed circuits rated 1 amp each • Dimmers: True DC:DC converter with full power filtering and regulated 2-12 volt outputs • Inputs: All switch inputs are low current closures to +voltage • Wig-Wag: 150 cycles/minute between channel 1&2; 1 minute warm-up time • Wiring: Standard 15-pin D-sub connector (male on controller) for connection to switching panel. • Enclosure: Overall dimensions 4.7" x 3.7" x 1.2"; Cast aluminum • Weight: 1.0 lb P/N 11-08497\$346.50

UNIVERSAL SWITCH-SPDT AIRSPEED KIT

Universal switch airspeed kit (USW-1) includes an ASW-1 airspeed switch and a Universal Switch-SPDT controller. This combination of components allows for the switching of electrical loads up to 10 amps and up to 30 volts based on aircraft speed. The airspeed set point is factory calibrated to 100 knots, however, it may be field adjusted to switch at any speed between 55 and 140 knots. Provides both a normally open and a normally closed contact for controlling any electrical load up to 10 amps. The system works with aircraft power systems from 10-30 volts.....P/N 11-08498\$85.50



TCW SAFETY-TRIM SERVO CONTROLLER



An electronic speed control system for standard electric trim servos found on many homebuilt aircraft. It replaces other speed controllers and relay modules with an electronic solution that resolves issues such as run-away trim and failure to operate conditions.

Features: Very simple wiring, no extra parts needed for pilot and co-pilot trim switches • Designed for standard electric trim servos, such as the Ray Allen T2 & T3 series • Short circuit proof, reverse polarity protected • 1 axis, 2 axis models available • For Experimental aircraft only NOT TSO'd • Made in USA -- patented.

Specifications: • Input voltage: 10-30 volts DC • Output voltage: User adjustable 6-12 volts DC 1 amp maximum • Enclosure: Overall dimensions 5.7" x 2.5" x 1.5" • Weight: 6oz.

Description	Part No.	Price
Safety-Trim Single Axis Servo Controller	11-08506	\$166.50
Safety-Trim Single Axis, 2 Speed Servo Controller	11-08529	\$220.50
Safety-Trim Dual Axis Servo Controller	11-08530	\$256.50
Safety-Trim Dual Axis, 2 Speed Servo Controller	11-08531	\$310.50
Accessories		
Description	Part No.	Price
Safety-trim 8 ft wiring harness for single axis controller	11-08532	\$58.50
Safety-trim 8 ft wiring harness for dual axis controller	11-08533	\$76.75
Airspeed Switch 100 Knot for triggering 2 speed function	11-08534	\$47.95

TCW CONTROL VALVE SERVO KIT



Fully proportional linear actuator servo for valves and dampers: Ideal for: Heater flapper doors, Oil cooler control, Alternate air door, Ventilation dampers. P/N 11-11298\$185.00

TCW CONTROL VALVE SERVO BUTTERFLY VALVE



Butterfly Valve for oil coolers works with the TCW Control Valve Servo Kit P/N 11-11299\$72.50

TCW INTEGRATED BACK UP BATTERY SYSTEM



The Integrated Back-up Battery System provides back-up power to critical electronics such as EFIS, GPS, Navigators, Radios, Autopilots and Engine monitors. The IBBS is a fully automatic system that combines a Li-Fe-PO4 battery pack, a smart charger and switching logic in one convenient package. The IBBS provides an engineered solution to enable an endurance bus for critical electrical loads found in today's aircraft. It simplifies wiring and installation of a source of back-up power by integrating all the key elements into a single enclosure. The IBBS system is an FAA approved article produced exclusively by TCW Technologies, LLC under TSO-C179(a). Compliant with DO-311 & DO-160.

3AH.....P/N 11-15479\$575.00
6AH.....P/N 11-15480\$875.00

TCW INTELLIGENT FLAP CONTROL



Intelligent Flap Controller (IFC) is an electronic controller designed specifically to operate DC motor actuators, particularly the Van's Aircraft series of Flap Actuators used in RV type homebuilt aircraft. IFC connects to the standard up-off-(down) switches commonly used to control flap operation and directly drives a Van's flap actuator. IFC provides Vfe protection by sensing airspeed and preventing flap deployment above a set airspeed. IFC allows for Pilot and Co-pilot flap switches and resolves the possible conflicts if the switches are operated in opposite directions. IFC requires NO flap position sensor and is fully compatible with Safety-Trim servo controllers.

Features: • Protects against flap deployment above Vfe • Dual Inputs: Allows for Pilot and Co-Pilot side flap switches • Uses the standard Up-off-Down flap switch or the Infinity stick grip • Controls the standard Van's flap actuator • Eliminates the need for a flap positioning sensor • Eliminates flap motor run-on associated with traditional relay system • Very easy to use, UP switch drives flaps UP, Down switch drives flaps Down. Great for tandem aircraft!

P/N 11-13462\$239.00

SEE WWW.AIRCRAFTSPRUCE.COM FOR SPECIFICATIONS ON TCW PRODUCTS.

WWW.AIRCRAFTSPRUCE.COM

EL

IGNITION SWITCHES – LABEL PRINTER

ACS KEYED IGNITION SWITCHES



MFG BY ACS PRODUCTS CO.

These fine quality switches are being used in many aircraft. The switch housing is now machined from billet aluminum which makes this switch 25% lighter. They provide "ON" and "OFF" electrical control of both magnetos on single engine aircraft. The key-operated switches mount from the rear of the panel in a 7/8" dia. hole. Available with or without starter position.

Experimental aircraft only or 337 Form required for Production aircraft. Made in the U.S.A.

A-510-5 Experimental, without Starter Position, Supplied with switch plate and two keys. (diode not required).....P/N 11-03169 **\$173.85**

A-510-2 FAA/PMA with Starter Position, Supplied with switch plate two keys. (diode included)P/N 11-03170 **\$187.75**

ACS DOOR AND BAGGAGE LOCK SETS



P/N 11-01600

The door and baggage locks furnished with the ignition switches above are also available separately. Set of two locks (one door and one baggage lock) furnished with one key mated to both locks. The baggage lock may be used as second door lock if preferred.....P/N 11-01600 **\$49.85**
ACS Cut Key with boot (specify key #)P/N 05-04103 **\$12.65**

ACS LEVER TYPE IGNITION SWITCH

A-510-1 Lever Type - Twist-Knob Without Starter Position. (diode not required)

P/N 11-03176 **\$189.75**

ACS IGNITION SWITCH AND LOCK SETS



MODEL NO. A-510-5K

Includes ignition switch without starter position, two aircraft locks (one door and one baggage lock)* and two keys mated to ignition switch and locks. (Diode not required)P/N 11-03171 **\$187.75**

MODEL NO. A-510-2K

Includes ignition switch with starter position, two aircraft locks (one door and one baggage lock)* two keys mated to ignition switch and locks. (diode included)P/N 11-03172 **\$219.95**

* Baggage lock may be modified to second door lock if preferred.



11-03667

11-03668

ACS IGNITION SWITCH PLATES

Plate without start - A-2255-A1P/N 11-03668 **\$1.75**

Plate with start - A-2255-AP/N 11-03667 **\$1.75**

ACS STARTER SOLENOID DIODE ASSEMBLY

This is required for all new A-510-2 and A-510-2K ignition switches for compliance with ACS Service Bulletin SB92-01.

Diode Assembly for Starter Solenoid with one or Two Coil Contacts
P/N 16050-2 **\$8.50**

EL

BENDIX IGNITION SWITCHES



MODEL NO. 10-357200-1

With Starter Position. Includes two keys. Furnished with Switch Plate **\$568.00**

MODEL NO. 10-357210-1

With push to start feature. Includes two keys. Furnished with Switch Plate **\$657.00**



10-51127

10-126676

BENDIX SWITCH PLATES

Without Starter Position

Switch PlateP/N 10-51127 **\$6.95**

With Starter Position

Switch PlateP/N 10-126676 **\$8.50**

BENDIX STARTING VIBRATORS



Part Number	Description	Used with Ignition System	Price
10-176487-121	12V DC	S-200, S-600, S-700	\$689.00
10-357487-241	24V DC	S-200, S-600, S-700	\$754.00
10-357487-242	24V DC	S-1200	\$780.00
10-176485-121	12V DC W/Relay	S-200, S-600, S-700	\$2,408.00
10-176485-241	24V DC W/Relay	S-200, S-600, S-700	\$2,271.00
10-176485-242	24V DC W/Relay	S-1200	\$2,270.00

LABELWORKS LABEL PRINTER



The LW-PX350 is a low-cost, portable wire marking, barcode and general identification label printer up to 3/4" (18 mm) wide. Identify wires and equipment, organize tool cribs, identify storage bins, make safety labels, tag assets and more. With special-function hot keys and automatic cutter, this easy-to-use label maker offers extraordinary flexibility and power at an affordable price.

With the LW-PX350, you can print on variety of materials such as; magnetic tape, heat shrink tube, and super strong adhesive tapes. Best of all, the LW-PX350 is backed by the LABELWORKS PX lifetime warranty.....P/N 11-15517 **\$128.75**

E.I. COMMANDER – SWITCHES

SINGLE AXIS TRIM RELAY BOARD



These Trim Relay Boards allow control of an aircraft's trim motors from the typical switches found in most stick grips. As the switches in the grips are too small to handle the motor loads and usually do not have the required number of poles, the 'TRB' offers a simple, elegant solution that is easy to wire and understand. The boards have a per axis rating of 10A at 12 volts. 4.00"L x 2.50"W x 1.00"H.

12VP/N 11-09849**\$61.85**
24VP/N 11-13714**\$76.85**

3 AXIS TRIM RELAY BOARD



3 Axis trim relay and buffer board has been designed to allow easy control of trim motors from small grip mounted or remote switches. Three Axis control is possible with each of the circuits being configured in a double throw format. "Off" circuit conditions apply ground to both motor wires providing an effective braking actions. Board will work with single or winding DC motors. Other remote controls are possible such as auto pilot disconnect or recognition lights and more. Relays are continuous DC rated at 10 Amps. 5.6"L x 4"W x 1.0"H.

P/N 11-02043**\$148.75**

EI COMMANDER EIC 32



The EI Commander EIC 32 Ignition Monitor on a 2-1/4" LCD Display. • New and improved case that fits a standard 2 1/4" instrument hole • Advanced 2.4" LCD screen • View-able from any angle • 800 nits - 8 times easier to read in Sunlight • Weighs less than 3.5 ounces • Restart timing synchronization verification and Continuous verification of timing mark synchronization • Monitoring of ignition harness and spark-plug health • Detects fouled plugs and/or broken plug wires • Simpler / easier to use • Data logging – 2.5 hours continuous loop • Download to a USB memory stick via a front mounted micro USB port • Three user definable timing configurations in addition to the default A & B curves. • Easy to dim screen for night operations • Audio alarm / LED warning functions • User selectable alarms and volumesP/N 11-13749**\$899.95**

TRIM SWITCHES



TRIM SWITCH CA100-1 - The CA100-1 switch is used on a certified aircraft. It uses MIL-SPEC switches (SPST) and precision machined from aircraft aluminum and will not crack or break like cheap plastic switches. It has a nice tactile click actionP/N 11-07355**\$479.00**

CARLING SWITCHES AND COVERS



Carling' sealed V-Series Contura switches are well known for their cutting edge design, high quality, maximum performance and unmatched reliability. These switches are a staple in the marine and transportation industries and have passed a range of environmental, corrosion, temperature, vibration, shock and sealing tests including MIL Std 202F,

MIL Std 510.1, UL 1500, ISO 8846, IEC 60529 and BS 5490 among others, making them one of the most rugged and reliable switches ever manufactured. **Features:** • Certified to IP66/68 with dual seals around lamps and rocker stem. • Silver plated butt contact mechanism provides reliability up to and beyond 100K electrical cycles • Greaseless construction withstands temperature extremes down to -40° C • The switch accommodates up to 10 terminals and endless illumination and circuit options. • The switch connector allows the user to pre-load FQC terminals for ease of assembly. • Numerous choices of removable rockers allow for style change without having to retest or re-qualify the switch base.

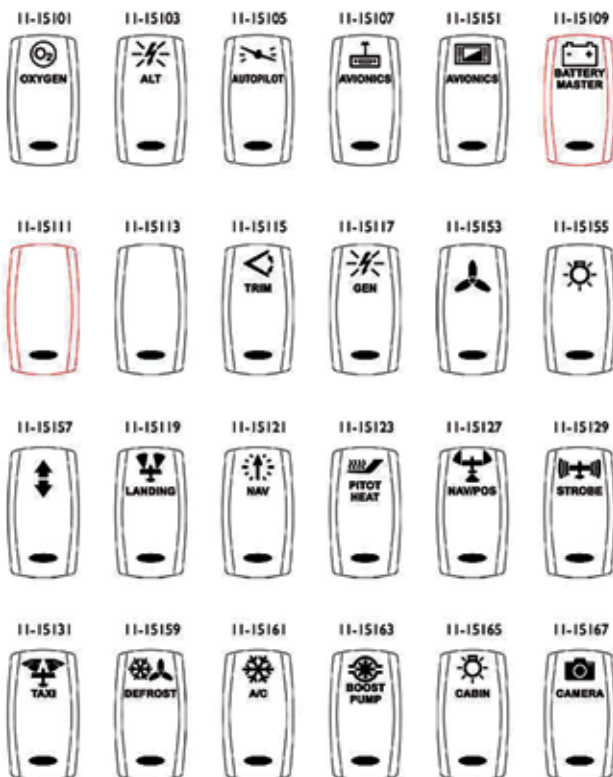

Steps	Model No.	Description	Contact	Part No.	Price
1. Pick Your Switches	V1D1-S00B	On-Off No Light	SPST	11-15079	\$10.95
	VLD1-S00B	(On)-Off-(On) No Light	DPDT	11-15080	\$17.65
	V8D1S00B	(On)-Off-(On) No Light	SPDT	11-15081	\$13.00
	VJD1-S00B	On-Off-On No Light	DPDT	11-15082	\$16.50
	V6D1-D66B	On-Off-On No Light	SPDT	11-15083	\$22.00
	V1D1-B60B	On-Off White Light	SPST	11-15084	\$12.55
	V2D1-S00B	(On)-Off White Light	SPST	11-15085	\$11.99
	VJD1-D66B	On-Off-On White Light	DPDT	11-15086	\$24.70
	VLD1-A60B	(On)-Off-(On) White Light	DPDT	11-15087	\$23.50
	V1D1-G66B	On-Off White Light	SPST	11-15088	\$17.50
	V2D1-A60B	(On)-Off White Light	SPST	11-15089	\$16.50
	V4D1-A60B	On-On White Light	SPDT	11-15090	\$27.50
	V7D1-A60B	On-Off-(On) White Light	SPDT	11-15091	\$23.70
	VJD2-U66B	On-Off-On White Light	DPDT	11-15092	\$30.95
	V1D1-GCCB	On-Off Red Light	SPST	11-15093	\$28.75
	V2D1-ACOB	(On)-Off Red Light	SPST	11-15094	\$27.60
	VJD2-ACOB	On-Off-On Red Light	--	11-15095	\$39.50
	VLD1-ACOB	(On)-Off-(On) Red Light	DPDT	11-15096	\$34.50
	V1D1-GXXB	On-Off Blue Light	SPST	11-15097	\$32.55
	V2D1-AXOB	(On)-Off Blue Light	SPST	11-15098	\$33.65
	VJD2-UXXB	On-Off-On Blue Light	DPDT	11-15099	\$43.65
	VLD1-AXOB	(On)-Off-(On) Blue Light	DPDT	11-15100	\$35.50
	VAD1-G66B	On-Off Ind White	DPST	11-18719	\$23.21
	V2D1-S00B-LIT	(On)-Off White	SPST	11-18720	\$11.61
	V1D1-GWWB	On-Off White	SPST	11-18721	\$36.21
V2D1-AW0B	(On)-Off Ind White	SPST	11-18722	\$31.03	
VJD2-UWWB	On-Off-On Ind White	DPDT	11-18723	\$49.14	
VLD1-AW0B	(On)-Off-(On) Ind White	DPDT	11-18724	\$40.52	
2. Pick Your Covers	--	Oxygen	--	11-15101	\$15.00
	--	Alternator	--	11-15103	\$18.50
	--	Autopilot	--	11-15105	\$17.50
	--	Avionics	--	11-15107	\$17.50
	--	Battery Master Avionics	--	11-15109	\$17.50
	--	Red Blank	--	11-15111	\$14.50
	--	Black Blank	--	11-15113	\$17.50
	--	Trim	--	11-15115	\$18.50
	--	Generator	--	11-15117	\$17.50
	--	Landing	--	11-15119	\$17.50
	--	Nav	--	11-15121	\$17.50
	--	Pitot Heat	--	11-15123	\$18.50
	--	Nav/Pos	--	11-15127	\$17.50
	--	Strobe	--	11-15129	\$18.50
	--	Taxi Custom Switch	--	11-15131	\$18.50
	--	Glass Panel Avionics	--	11-15151	\$18.50
	--	Fan	--	11-15153	\$17.50
	--	Light	--	11-15155	\$17.50
	--	Up/Down	--	11-15157	\$17.50
	3. Pick Your Brackets	--	Defrost	--	11-15159
--		Air Conditioning	--	11-15161	\$17.50
--		Boost Pump	--	11-15163	\$17.50
--		Cabin Light	--	11-15165	\$17.50
--		Camera	--	11-15167	\$17.50
--		End	--	11-15139	\$3.95
--		Middle	--	11-15141	\$4.75
4. Pick Your Mounts	--	Single	--	11-15143	\$3.95
	44385	VHP Mounting Panel Plug	--	11-15449	\$1.95



CIRCUIT BREAKERS

KLIXON 7270-5 CIRCUIT BREAKERS



Klixon 7270 series circuit breakers were designed to utilize less space behind the panel while protecting wire and cable in aircraft and ground support equipment on 120 VAC, 400 Hz or 30 VDC systems. Inherently resistant to shock and vibration, the Klixon disc element is capable of calibration within close tolerances throughout the service life of the breaker. **Features:** Trip-free operation, Snap-acting thermal element, Small size, Light weight, MIL-C-5809 qualified,

High interrupting capacity, Typical use: Aircraft and ground support equipment. **Specifications:** Vibration: 10G minimum, 50–500 Hz (other vibration levels available). Mechanical Shock: 30G. Acceleration: 10G. Weight: 39 grams maximum (7270-1 and 7271-8). Interrupt Current: 4,000 amps at 30 VDC; 3,500 amps at 120 VAC, 400 Hz. Endurance: 5,000 cycles: 120 VAC, 400 Hz, inductive; 5,000 cycles: 120 VAC 400 Hz, resistive; 5,000 cycles: 30 VDC, inductive; 2,500 cycles: 30 VDC, resistive; 5,000 cycles: Mechanical, no load.

Description	Current Rating	Part No.	Price
7270-5-3	3 amps	11-08344	\$224.95
7270-5-5	5 amps	11-08345	\$224.95
7270-5-7.5	7.5 amps	11-08346	\$224.95
7270-5-10	10 amps	11-08347	\$223.95
7270-5-15	15 amps	11-08348	\$225.95
7270-5-20	20 amps	11-08349	\$224.95
7270-5-25	25 amps	11-08350	\$222.95
7270-5-30	30 amps	11-08351	\$224.95
7270-5-35	35 amps	11-08352	\$225.95

KLIXON 7274-2 CIRCUIT BREAKERS



Klixon 7274 series are small, lightweight, low amperage devices that are specifically designed to protect aircraft/aerospace cable and components in airborne vehicles and equipment. The commercial grade version is the Klixon 7277 series. The 7274 features a trip-free, indicating reset button and is available in standard ratings from ½ to 20 amps. A “wiping action” contact design assures low voltage drop, faster trip time and high reliability in low voltage applications. They are available in standard ratings from ½ to 20 amps. A water resistant panel seal designed to fit over the push button actuator is available for applications that require this type of protection. **Features:** Uses minimum space, Light weight, Trip-free, MIL-C-5809 qualified, Low amp, High vibration resistance, Typical use: Military airborne vehicle and equipment protection. **Specifications:** MS#: MS26574-1.5. Vibration: 10G minimum, 50–500 Hz (other vibration levels available). Mechanical Shock: 35G. Acceleration: 10G. Weight: 7274-2 (MS 26574): 28 grams maximum; 7274-4 (MS 26574 A): 28 grams maximum; 7274-11 (MS 22073): 33 grams maximum; 7274-69 (MS 22073V): 33 grams; 7274-70 (MS 26474L): 33 grams. Interrupt Current: 0.50–5 amps: unlimited at 28 VDC; 7.50–15 amps: 2,000 amps at 28 VDC; 0.50–1.50 amps: unlimited at 120 VAC, 400 Hz; 2–5 amps: 800 amps at 120 VAC, 400 Hz; 7.50–20 amps: 500 amps at 120 VAC, 400 Hz. Endurance: 2,500 cycles: 120 VAC, 400 Hz inductive; 5,000 cycles: 120 VAC, 400 Hz resistive; 2,500 cycles: 30 VDC inductive; 5,000 cycles: 30 VDC resistive; 10,000 cycles: Mechanical, no load

Features: Uses minimum space, Light weight, Trip-free, MIL-C-5809 qualified, Low amp, High vibration resistance, Typical use: Military airborne vehicle and equipment protection. **Specifications:** MS#: MS26574-1.5. Vibration: 10G minimum, 50–500 Hz (other vibration levels available). Mechanical Shock: 35G. Acceleration: 10G. Weight: 7274-2 (MS 26574): 28 grams maximum; 7274-4 (MS 26574 A): 28 grams maximum; 7274-11 (MS 22073): 33 grams maximum; 7274-69 (MS 22073V): 33 grams; 7274-70 (MS 26474L): 33 grams. Interrupt Current: 0.50–5 amps: unlimited at 28 VDC; 7.50–15 amps: 2,000 amps at 28 VDC; 0.50–1.50 amps: unlimited at 120 VAC, 400 Hz; 2–5 amps: 800 amps at 120 VAC, 400 Hz; 7.50–20 amps: 500 amps at 120 VAC, 400 Hz. Endurance: 2,500 cycles: 120 VAC, 400 Hz inductive; 5,000 cycles: 120 VAC, 400 Hz resistive; 2,500 cycles: 30 VDC inductive; 5,000 cycles: 30 VDC resistive; 10,000 cycles: Mechanical, no load

Description	Current Rating	Part No.	Price
7274-2-5	0.5 amps	11-16406	\$111.75
7274-1	1.0 amps	7274-2-1	\$22.50
7274-2-1.5	1.5 amps	11-08353	\$22.50
7274-2-2	2 amps	11-08354	\$22.50
7274-2-2.5	2.5 amps	11-08355	\$22.50
7274-2-3	3 amps	11-08356	\$22.85
7274-2-4	4 amps	11-08357	\$22.50
7274-2-5	5 amps	11-08358	\$22.50
7274-2-7.5	7.5 amps	11-08359	\$22.50
7274-2-10	10 amps	11-08360	\$22.50
7274-2-15	15 amps	11-08361	\$22.50
7274-2-20	20 amps	11-08362	\$22.50

KLIXON 3TC7 CIRCUIT BREAKER



A lightweight, high performance, non-ambient temperature compensated circuit breaker. The series features a trip-free design that prevents the circuit breaker from being closed manually on overload. **Features:** Miniature size, Light weight, Trip-free design, Current rating: 5 amps, AS58091 qualified (MS25244), High vibration resistance, Typical use: Aircraft, avionics and electrical systems. **Specifications:** MS25244-5. Voltage Drop: 0.25. Vibration: 10G. Mechanical Shock: 30G at peak. Acceleration: 10G. Weight: 38.9g. Operating Altitude: 65,000 ft

Description	Current Rating	Part No.	Price
3TC7-5	5 amps	11-08374	\$63.90
3TC7-7.5	7.5 amps	11-08375	\$63.90
3TC7-10	10 amps	11-08376	\$67.75
3TC7-15	15 amps	11-08377	\$67.75
3TC7-20	20 amps	11-08378	\$67.75
3TC7-25	25 amps	11-08379	\$63.90
3TC7-30	30 amps	11-08380	\$63.90
3TC7-35	35 amps	11-08381	\$63.90

KLIXON 2TC2 CIRCUIT BREAKER



Their light weight and small size make them especially well suited for aircraft, avionics and electronic systems. The Klixon trademark has set the standard for aerospace circuit breakers and the TC series offers the endurance and reliability required by exacting military specifications. The 2TC series breaker ratings are coordinated so any rating will trip before another rating twice its capacity in the event of a fault. of up to 6,000 amps let-thru current. This results in improved overall equipment performance since only the smallest faulted circuit is interrupted, while larger circuits remain operational. Ambient compensated

circuit breakers let designers specify smaller gauge wire where the circuit breaker and wiring are exposed to different ambient temperatures. They are especially suited for application where ambient temperature exceeds the 160°F (71°C) maximum of non-ambient compensated thermal circuit breakers. The TC series may be applied where operating temperatures are as high as 250°F (121°C) with no derating of the circuit breaker. This eliminates the need for cooling air and allows substantial weight, space, and cost savings. The complete line of TC series circuit breakers is trip-free. The circuit breaker cannot be maintained closed during an overload even with the actuator button held closed. For its miniature size, the 2TC series offers unusually high current interrupting capacity. Overloads can be safely interrupted without affecting calibration or operating performance in the standard 2TC series for: • Overloads up to 6,000 amps at 28 VDC • Overloads of 2,000–3,500 amps at 120 VAC, 400 Hz. **Features:** Miniature size, Light weight, Trip-free design, High vibration resistance, High interrupting capacity, Coordinated ratings, AS58091 qualified (Also: Military Approvals, FAA PMA), Typical end use: Aircraft power distribution systems **Specifications:** Vibration 10G minimum, 50–500 Hz (other vibration levels available) Mechanical Shock 50G. Acceleration 10G

Description	Current Rating	Part No.	Price
2TC2-1	1 amps	11-08382	\$21.75
2TC2-2	2 amps	11-08383	\$29.50
2TC2-2-1/2	2.5 amps	11-08384	\$21.75
2TC2-3	3 amps	11-08385	\$22.85
2TC2-4	4 amps	11-08386	\$21.75
2TC2-5	5 amps	11-08387	\$22.85
2TC2-7.5	7.5 amps	11-08388	\$21.75
2TC2-10	10 amps	11-08390	\$22.85
2TC2-15	15 amps	11-08394	\$22.85
2TC2-20	20 amps	11-08395	\$29.50
2TC2-25	25 amps	11-08396	\$22.85

KLIXON 6752100-100 CIRCUIT BREAKERS



Klixon 6752-100 series thermal-magnetic circuit breakers are designed and manufactured to meet stringent military standards with the reliability of the 6752 design. The 6752-100 is similar to the 6752-12 in size, and includes current ratings ranging from 50 to 100 amps.

The higher interrupting capacity, vibration resistance and longer cycling life of the 6752-100 series exceed previous military standards. In addition, the 6752-100 series provide ambient compensation, fault coordination of all ratings an option for auxiliary circuits.

The 6752-100 series circuit breakers maintain their performance capabilities by means of a thermal compensator in the temperature range of -40°C to 70°C.

A deionizing grid and magnetic assist enable the 6752-100 series to successfully interrupt four fault currents of 6,000 amperes — two at sea level and two at 60,000 feet — on either a 120 VAC, 400 Hz system or a 30 VDC system. **Features:** Proven reliability and performance of the 6752 series circuit breaker, Trip-free design, Circuit protection unaffected by temperature fluctuations MIL-C-5809 qualified, Ambient compensated, High vibration resistance, High interrupting capacity: 6,000 amps, Typical use: Military, **Specifications:** Vibration: 10G, 50–2,000 Hz (other vibration levels available). Mechanical Shock: 30G. Acceleration: 10G. Weight: 113.6 gram (0.25 pound) maximum. Interrupt Current: 120VAC, 400 Hz: 3,500 amps; 28 VDC: 6,000 amps. Endurance: 5,000 cycles: 120 VAC, 400 Hz inductive; 5,000 cycles: 120 VAC, 400 Hz resistive; 2,500 cycles: 28 VDC, 400 Hz inductive; 5,000 cycles: 28 VDC, 400 Hz resistive; 5,000 cycles: Mechanical, no load

Description	Current Rating	Part No.	Price
6752100-50	50 amps	11-08397	\$232.95
6752100-60	60 amps	11-08398	\$232.95
2752100-70	70 amps	11-08399	\$232.95
6752100-75	75 amps	11-08400	\$232.95
6752100-80	80 amps	11-08401	\$232.95
6752100-90	90 amps	11-08402	\$232.95
6752100-100	100 amps	11-08403	\$232.95

EL

CIRCUIT BREAKERS

KLIXON 7270 & 7271 CIRCUIT BREAKERS



The Klixon 7270/7271 series circuit breakers were designed to utilize less behind panel space while protecting wire and cable in aircraft and ground support equipment on either 120 VAC, 400 Hz or 30 VDC systems. The units are available with neck mounting (7270-1 and 7271-8) or standard cover plate (7270-7 and 7271-3). In each of these Klixon circuit breakers, the bi-metallic element assures uniform current distribution

throughout its responsive area. This design reduces current density at the critical areas, resulting in an element having a much higher interrupting capability than conventional design. Inherently resistant to shock and vibration, the Klixon disc element is capable of precise calibration settings and will retain the initial calibration within close tolerances throughout the service life of the breaker. Both circuit breakers have conventional actuator action; i.e., the toggle actuator on the 7270 moves to the OFF position for trip indication and the button the 7271 pops out. A standard black button with a white collar is used.

Features: • Trip-free • Snap-acting Thermal Element • Simplicity of Design • Lightweight • High Rupture Capacity - 3500 Amps, 120 VAC, 400 Hz 4000 Amps, 30 VDC • Small Size

Part No.	Price	Part No.	Price	Part No.	Price
7270-1-3	\$179.75	7270-7-10	\$277.95	7271-3-35	\$207.95
7270-1-5	\$179.75	7270-7-15	\$277.95	7271-8-3	\$174.75
7270-1-7.5	\$179.75	7270-7-20	\$277.95	7271-8-5	\$167.75
7270-1-10	\$179.75	7270-7-30	\$277.95	7271-8-7 1/2	\$174.75
7270-1-15	\$179.75	7270-7-35	\$277.95	7271-8-10	\$167.75
7270-1-20	\$179.75	7271-3-3	\$203.95	7271-8-15	\$167.75
7270-1-25	\$179.75	7271-3-5	\$202.95	7271-8-20	\$167.75
7270-1-30	\$179.75	7271-3-7.5	\$204.95	7271-8-25	\$167.75
7270-1-35	\$179.75	7271-3-10	\$198.75	7271-8-30	\$167.75
7270-7-3	\$278.95	7271-3-15	\$207.95	7271-8-35	\$167.75
7270-7-5	\$278.95	7271-3-20	\$208.95		
7270-7-7.5	\$273.95	7271-3-25	\$206.95		

The last dash no. in the Part Number is the Amperage rating

KLIXON 7277 CIRCUIT BREAKERS



7277-1 Aux. Switch Contact
7277-2

The 7277 series circuit breakers is physically and electrically identical to the 7274-2 style circuit breaker, with the exception that the 7277 series has wider calibration limits. Originally developed as an alternative to slow blow fuses, the trip free 7277 is used extensively as primary electrical circuit protection on general aviation aircraft. The wider calibration limits of the 7277 has also resulted in applications including protection for data processing and telecommunications equipment, computers, flight simulators, construction, material handling and other industrial electronic equipment.

Features: The 7277 series is designed for applications that do not require the tighter performance characteristics and approvals of our military circuit breakers. • Small size • Light Weight • Inexpensive Auxiliary switch 7277-1 Only Longer Push Buttons 7277-5 Only

Temp.	Min Ult	Max Ult	Trip Time - Seconds		
°C	Traip	Trip	200%	500%	1000%
+25	110%	150%	2-35	.15-1.75	.028-.8

* Performance characteristics and dimensions are equivalent to 7274 Calibration: 1/2 - 20 amps*

Part No.	Price	Part No.	Price	Part No.	Price
7277-5-1	\$36.80	7277-1-3	\$38.50	7277-2-2	\$22.75
7277-5-2	\$36.80	7277-1-4	\$36.75	7277-2-5	\$22.75
7277-5-3	\$36.80	7277-1-7.5	\$37.95	7277-2-3	\$22.50
7277-5-5	\$36.80	7277-1-10	\$37.95	7277-2-4	\$22.85
7277-5-7.5	\$36.80	7277-1-15	\$37.95	7277-2-5	\$22.85
7277-5-10	\$36.80	7277-2-1/2	\$118.95	7277-2-7.5	\$22.50
7277-5-15	\$36.80	7277-2-3/4	\$21.75	7277-2-10	\$22.85
7277-1-1	\$37.50	7277-2-1	\$22.75	7277-2-15	\$22.85
7277-1-2	\$37.95	7277-2-1.5	\$21.75	7277-2-20	\$22.85

ELECTRICAL PLUG CONNECTORS



Make your panel a "plug and play" panel with these heavy-duty electrical connectors. The connectors are designed for either panel mount or free hanging. Connectors are available in 4, 6, 9, 12, 18, 24, and 36 pin configurations. Choose the pins and sockets based on wire size. The pins and sockets are top quality and are gold/nickel plated. The plugs are sold in pairs and include both the plug and the connector.

Connectors	Part No.	Configuration	Price
SPT015/16	11-02147	4 pin	\$8.90
SPT152/153	11-02148	6 pin	\$10.85
SPT039/40	11-07356	9 pin	\$19.55
SPT017/18	11-02149	12 pin	\$11.85
SPT442/43	11-02150	18 pin	\$14.50
SPT019/20	11-07357	36 pin	\$15.95
Pins	Part No.	Wire Gauge Size	Price
SPT103-1	11-02153	24/20	\$1.15
SPT099-1	11-02154	18/16	\$1.30
Sockets	Part No.	Wire Gauge Size	Price
SPT105-1	11-02155	24/20	\$1.55
SPT101-4	11-02156	18/16	\$1.60

SEAL-ALL CRIMP TOOL - Crimp tool works with all Seal-All Terminals and seals. Its compact, low-cost parallel jaw design eliminates terminal rocking. P/N 11-06592 \$43.85

STATIC DISCHARGERS

ESD-1 STATIC WICK - Length: (including mounting base) 7.65 inches. (discharger element) 4.75 inches. Weight: Less than 4.5 grams. Airspeed: To 150 knots. Altitude: To 20,000 feet msl. Temperature: +85°C to -55°C, MIL-STD0202C, Method 102A, Condition D. Solvents: No physical changes after one hour immersion in aviation gasoline, jet fuel or hydraulic fluids. Equivalent to Cessna P/N C592001-0201. Note: This is Non-Certified Version. Fully Qualified to MIL-D-9129D P/N 11-10574 \$27.50

EDS-3 STATIC WICK - Non-Certified. 7.65 inches. Weight: Less than 5.5 grams. Airspeed 300 knots +85°C to -55°C, MIL-STD-202C, Method 102A, Condition D. Tension: 50 pound pull longitudinal from plastic end to metal shank. No physical changes after one hour immersion in aviation gasoline, jet fuel or hydraulic fluids. P/N 11-10681 \$27.80

STATIC WICK
Comes with 2 holes to rivet to trainline edge and plain wire extension. Eligible For Installation: Beech Baron 58, Cessna 402, Eurocopter: BK117, BK117 C-2 P/N 11-04154 \$80.75

NULL FIELD TRAILING DISCHARGER
For general aviation & business class aircraft. FAA/PMA, MIL-9129D. Mounting: (2) #8-32 flat head screws. Length: 10-9/32". Wt: .78 oz. P/N 11-16320 \$133.95

MICROPOINT TRAILING DISCHARGER
For general aviation aircraft (speeds below 300 mph). Mounting: (2) #4-40 screws, 100% countersunk. Length: 8.75" Weight: 0.17 oz. P/N 11-16630 \$70.99

MICROPOINT TRAILING DISCHARGER (FLEXIBLE)
For general aviation & business class aircraft. FAA/PMA, MIL-9129D. Mounting: 15401, 15488, 15660-1, or 16195 screw retainer. Length: 7-5/8" Wt: 0.53 oz. P/N 11-16606 \$78.95

NULL FIELD TIP DISCHARGER
For general aviation & business class aircraft. FAA/PMA, MIL-9129D. Mounting: (2) #8-32 flat head screws. Length: 7-15/32". Wt: 0.53 oz. P/N 11-16325 \$102.75

STATIC WICK WITH CARBON POINT
17770 Trailing Discharger: Mounting: Fits Chelton Retainer or DG p/n 540095. For Commercial & Business Class Aircraft. FAA PMA, MIL-9129D. Noise Quieting: 40+ db. Length: 7-7/8" Weight: 0.15 oz. P/N 11-11504 \$93.75



CIRCUIT BREAKERS

TYCO CIRCUIT BREAKERS

These bi-metallic single pole breakers weigh less than 2oz. and especially suitable for homebuilt aircraft. Used as original equipment in Beech, Cessna and Piper aircraft. Max. operating voltages: 32 VDC & 250 VAC (to 400 Hz).

W23 SERIES



White band around body of reset button becomes visible if breaker trips. Has heater wire for fast tripping. 8-32 screw terminals.

W31 SERIES



These are combination single pole switches and circuit breakers. Has a plain steel toggle w/ rating inscribed on tip. 8-32 screw terminals.

W58 SERIES



Recessed reset button has red band around it for visible trip indication. 6-32 screw terminals.

P&B P/N	AMP Rating	Aircraft Application			Prices Ea.
		Beech	Cessna	Piper	
W23X1A1G1	1			111-201-105	\$41.50
W23X1A1G2	2			111-202-105	\$53.65
W23X1A1G3	3			111-203-105	\$46.85
W23X1A1G4	4			111-204-105	\$50.85
W23X1A1G5	5	CB-2305A	S-1232-5	454656	\$27.50
W23X1A1G7.5	7.5	CB-2307A			\$27.50
W23X1A1G10	10	CB-2310A		454657	\$25.50
W23X1A1G15	15	CB-2315A		454658	\$25.50
W23X1A1G20	20	CB-2320A		454659	\$27.50
W23X1A1G25	25	CB-2325A		454660	\$27.50
W23X1A1G30	30	CB-2330A		454661	\$44.85
W23X1A1G35	35	CB-2335A		454663	\$27.50
W23X1A1G40	40	CB-2340A		454665	\$27.50
W23X1A1G50	50	CB-2350A		454662	\$29.95
W31X2M1G5	5				\$41.50
W31X2M1G10	10				\$34.50
W31X2M1G15	15				\$34.50
W31X2M1G20	20				\$41.75
W31X2M1G25	25				\$41.90
W31X2M1G30	30				\$34.50
W31X2M1G35	35				\$41.90
W31X2M1G40	40				\$41.90
W31X2M1G50	50				\$41.90
W58XC4C12A1	1	431-201-101	S-1360-1A,-1L		\$9.95
W58XC4C12A2	2	431-202-101	S-1360-2A,-2L		\$10.50
W58XC4C12A3	3	431-203-101	S-1360-3A,-3L		\$9.65
W58XC4C12A4	4	431-204-101	S-1360-4A,-4L		\$13.85
W58XC4C12A5	5	435-205-101	S-1360-5,-5L	454668	\$7.85
W58XC4C12A7	7	435-207-101	S-1360-7,-7L		\$7.85
W58XC4C12A10	10	435-210-101	S-1360-10,-10L	454669	\$8.85
W58XC4C12A15	15	435-215-101	S-1360-15,-15L	454670	\$7.85
W58XC4C12A20	20	435-220-101	S-1360-20,-20L		\$7.90
W58XC4C12A30	30	435-230-101	S-1360-30,-30L		\$8.50

TYCO ROCKER TYPE CIRCUIT BREAKER



W33S2N1Q series breakers are 2 pole rocker actuated. Pole 1 is switch only, pole 2 is series trip overload sensing. These breakers are non-lighted with white rocker.

W33S4B1Q series breakers are also 2-pole rocker actuated. Pole 1 is switch only, pole 2 is series trip overload sensing. These breakers feature 20 amp max. switch & amber plastic rockers.

Item / Description	Amps	Part No.	Price
W33S4B1Q-5 - Amber 24VDC	5	11-01887	\$29.99
W33S4B1Q-10 - Amber 120VAC	10	11-01888	\$41.90
W33S4B1Q-15 - Amber 120VAC	15	11-01889	\$31.95
W33S4B1Q-20 - Amber 120VAC	20	11-01976	\$36.50
W33S1N1Q-5 - Black	5	11-01977	\$31.99
W33S1N1Q-10 - Black	10	11-01978	\$39.95
W33S1N1Q-15 - Black	15	11-01979	\$24.95
W33S1N1Q-20 - Black	20	11-01980	\$69.75
W33S2N1Q-5 - White	5	11-01981	\$49.50
W33S2N1Q-10 - White	10	11-01890	\$74.95
W33S2N1Q-20 - White	20	11-01983	\$42.75

FUSE HOLDERS



These fuseholders are non-indicating, plate mounted. The body is molded black phenolic. Knob grips fuse and pulls it from holder when knob is removed. Spring provides contact pressure on ends of fuse. For use with fuse size 1/4" x 1-1/4". Type HKP.

P/N 11-13400 \$2.35

Nylon Twist-Lock in-line fuseholder. Supplied with 8" loop of 14-gauge wire and 1 spring to accommodate AGC fuses. Simple "twist-lock" allows easy fuse removal & replacement P/N 11-04010 \$3.40

Bayonet knob in-line fuseholder. Supplied with 8" loop of 14-gauge wire and 1 spring to accommodate AGC fuses. Simple "twist-lock" allows easy fuse removal and replacement P/N 11-01359 \$5.90

KLIXON 7274-11.75 CIRCUIT BREAKER



Klixon 7274 series are small, lightweight, low amperage devices that are specifically designed to protect aircraft/aerospace cable and components in airborne vehicles and equipment. The commercial grade version of this circuit breaker is the Klixon 7277 series. The 7274 features a trip-free, indicating reset button and is available in standard ratings from 1/2 to 20 amps. They are available in standard ratings from 1/2 to 20 amps.

Description	Amps	Part No.	Price	Description	Amps	Part No.	Price
7274-11-1	1	11-08364	\$22.90	7274-11-5	5	11-08369	\$22.90
7274-11-2	2	11-08365	\$22.90	7274-11-7.5	7.5	11-08370	\$22.95
7274-11-2.5	2.5	11-08366	\$22.90	7274-11-10	10	11-08371	\$22.90
7274-11-3	3	11-08367	\$22.90	7274-11-15	15	11-08372	\$22.90
7274-11-4	4	11-08368	\$22.90	7274-11-20	20	11-08373	\$22.90

KLIXON CIRCUIT BREAKERS



Feature a bi-metallic snap-acting disc as the sensing element. Widely used in production and military aircraft. The most popular models are illustrated. Models PSM and PSM-N are available in the following ampere ratings: 2, 3, 5, 10, 15, 20, 25, 35. When ordering specify if neck-mounting style is wanted by placing "N" after ampere rating. Example: PSM-10N (P/N 11-04244) \$206.95 ea. For weatherproof circuit breakers in ratings from 50 to 150 amperes, order Model PDLM. Example: PDLM-50 (P/N 11-04241) \$180.85 ea.

60 AMP CIRCUIT BREAKERS FOR ALTERNATORS



These heavy duty circuit breakers are ideal for use with aircraft alternators and other applications using high amperage. 10-32 screw terminals. Size: 1-3/8" d x 1-3/8" h x 1/2" w. 60 Amp ..P/N 11-02191 \$13.50

70 AMP CIRCUIT BREAKERS FOR ALTERNATORS



These heavy duty 70 AMP circuit breakers are ideal for use with aircraft alternators and other applications using high amperage. 10-32 screw terminals. 1 3/8" D x 1 3/8" H x 1/2" W P/N 11-05652 \$34.50

ELECTRONIC CIRCUIT BREAKERS



These circuit breakers have no mechanical parts, except for the reset switch. The power switching and control components are completely solid state. They have added benefit of overvoltage and undervoltage protection. Will turn off if the input voltage goes too high, protecting valuable avionics or other equipment. The circuit breakers operate differently than conventional ones in the following ways: If the circuit breaker 'trips', the switch will remain in the up or on position, but a red LED will illuminate indicating the condition. To reset the circuit breaker, the switch is set to off, then back to on. Removing power from the circuit breaker via a master switch and then restoring power will perform the same function. If a short or overcurrent condition exists at the output, the circuit breaker will continue to trip after a reset. The electronic circuit breaker is a 3-terminal device. In addition to the usual 2 terminals, a ground reference is required for the electronics to operate and as a reference for the overvoltage & undervoltage protection. The 14V circuit breakers will shutdown with an overvoltage of 16V & undervoltage of 10V. The 28V will shutdown with an overvoltage of 33V & undervoltage of 20V. Available in 14V & 28V versions, with the following current levels: 1A, 2A, 5A, 10A. Not FAA Approved. For experimental aircraft only.

Model No.	Amps	Volts	Part No.	Price
ECB-28-01	1	28	11-01156	\$76.50
ECB-28-02	2	28	11-01157	\$76.50
ECB-28-10	10	28	11-01159	\$76.50

FUSES



AGC-type fuses are glass-enclosed with a single fuse element. Fast acting to protect sensitive instruments and radios.

Fuse dimensions 1/4" dia. x 1-1/4" long.

Part No.	Ampere Rating	Price Ea.	Part No.	Ampere Rating	Price Ea.
11-03743	1	\$0.30	11-03745	15	\$0.27
11-03746	2	\$0.25	11-03747	20	\$0.48
11-03749	3	\$0.30	11-03748	25	\$0.28
11-03753	5	\$0.30	11-03750	30	\$0.48
11-03754	7	\$0.23	11-03751	35	\$0.48
11-03744	10	\$0.38			

SWITCHES

ULTRA-MINIATURE TOGGLE SWITCHES



Ultra-miniature switches are rated at 6 amps at 125V AC and 4 amps at 28V DC. Solid silver contacts. Terminals are gold flashed to inhibit oxidation and to provide easier soldering. Case material is green diallyl phthalate resin. Bushing thread size: 1/4-40, usable in panel thickness up to 1/4". Micro Switch Co. have discontinued the manufacture of the 8A and 8H type switches, so switches by alternate manufacturers will be furnished. In most instances, Alco switches will be supplied. Switches furnished complete with locking ring and attaching hardware.

Alco Sw. Part No.	Micro Sw. Part No.	Contact	Toggle Circuit*	Price Each
MTA-106D	8A1011	SPST	01	\$13.50
MTA-106E	8A1021	SPDT	02	\$15.50
MTA-106G	8A1041	SPDT	04	\$19.65
MTA-206N	8A2011	DPST	01	\$31.50
MTA-206P	8A2021	DPDT	02	\$19.85
MTA-206S	8A2041	DPDT	04	\$22.65
JMT-226	8A2061	DPST	06	\$24.50
MTA-306D	8A3011	3PDT	01	\$29.95
MTA-406N	8A4011	4PDT	01	\$33.50

* See Toggle Circuit Table

LEVER/CIRCUIT RELATIONSHIP

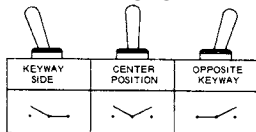

*Use the "01" circuitry for On-Off switch. In hook-up, use center terminal & one side terminal. Leave other side terminal blank.

The operating sequence above is repeated in multipole devices. Each pole has double-throw circuitry and consists of three terminals which exit at the bottom of the switch case. The keyway is a helpful reference when you are applying a switch with the momentary (ON) circuit at one of the extreme lever positions.

TOGGLE CIRCUIT TABLE

Toggle Circuit	Circuitry*		
	One Side	Center	Other Side
01	On	None	On
02	On	Off	On
04	(On)	Off	(On)
05	On	Off	(On)
06	On	None	(On)

TWIN CESSNA SWITCH COVERS



Are your switch covers faded by the sun or just looking grimy? These replacement switch covers fit on nearly every typical switch in Cessna Twins. Switch cover sets are available for 300 series twins (4 red, 3 black, and 18 white switches) and 400 series twins (4 red, 3 black, & 23 white switches). Also available are sets of 30 mini-switch covers for audio panels, prop sync, fuel transfer pumps, DME, etc. 300 Series.....P/N 11-22210\$29.95
400 Series.....P/N 11-22220\$29.95
Mini Switch Package.....P/N 11-22230\$23.95

TOGGLE SWITCH COVERS



Dress up the appearance of your panel and color code your toggle switches with high quality vinyl covers that do not have a nipple at the end of the cover. Available in various colors.

Standard Size

Red.....P/N 11-00815.....\$1.35 Green.....P/N 11-00817.....\$1.35
White.....P/N 11-00816.....\$1.35 Blue.....P/N 11-00819.....\$1.35
Yellow.....P/N 11-01698.....\$1.35 Black.....P/N 11-02823.....\$1.35

Mini Size

Red.....11-00820.....\$1.35 White.....11-00821.....\$1.35

SUB-MINIATURE PUSH BUTTON SWITCH



This sub-miniature push button switch, with one-piece bushing and case construction, and hex nut. It has a relatively high current carrying capacity (3 amps at 125VAC) and a life expectancy of 25,000 operations at rated current. Momentary type SPDT switch, ideal for use as a mic switch on control wheel.

ON (ON) SPDT Plunger - 3A 250VAC Momentary Contact - .256 inch mounting hole.....P/N 11-18894\$25.50

LED ILLUMINATED TOGGLE SWITCHES WITH LEVER



20 AMP Silver Contacts
Single pole switches with Plastic Lever.
Note: Illuminated switches work as ON-OFF switches.

Red.....P/N 11-17748\$6.55
Amber.....P/N 11-17750\$6.55
Blue.....P/N 11-17751\$6.55

MINIATURE MOMENTARY PUSHBUTTON SWITCH



Normally open. Found in many Piper aircraft. Color: Black.
#8631ZBD2.....P/N 11-01899\$11.65

MS25224 SWITCHGUARDS



Prevents inadvertent operation of the switch. Switch can be operated only when the spring-loaded guard is lifted up. Returning guard to the down position forces the switch lever to the off position. Single-hole type for neck-mount switches such as AN3021 and AN3027. 3-hole type for panel-mounted switches such as AN3023. Color: Red.

MS25224-1 (one hole).....\$14.50 Ea.

MS25224-2 (3 holes).....\$23.50 Ea.

KLIXON SWITCH GUARDS



Spring Loaded Switch Guards. Klixon switch guards can be used with 2 or 3 position switches. Covers are molded out of Thermoset molding materials. Guard covers are spring loaded to close.

Description	Pos.	Color	Code	Part No.	Price
Phenolic	2	Red	2	11-04228	\$23.50
Metal	2	Green	4	11-06222	\$36.50
Phenolic	3	Red	9	11-06223	\$21.65
Phenolic	2	Red	10	11-03917	\$14.50
Phenolic	2	Red	11	11-06225	\$15.50

CESSNA SPLIT MASTER SWITCH



This versatile split red master switch has been used in virtually all single engine Cessna models since 1970 and can be used in most light aircraft with single alternator systems. Left rocker normally used for alternator and right half for battery. Order mount separately.

Red Switch.....P/N 11-15900\$46.85

Beige Switch.....P/N 11-05733\$67.85

Mount.....P/N 11-15910\$3.35

TOGGLE SWITCHES



Toggle switches are available with 2 or 3 operating positions, one or three hole mounting and a variety of circuitry and electrical ratings. Contacts are made of solid silver. Wide usage is found in aircraft, mobile, marine, electronic and industrial applications. Available in full "AN" standard size and Ultra Miniature 1/2" size. The leading manufacturers of toggle switches are

Micro Switch, Alcoswitch, Cutler Hammer, and JBT (now Cutler Hammer). Orders will be filled with switches of manufacturer whose product is available in local stock.

AN No.	MS No.	Mfgs. P/N	Size	Contact	Toggle Circuit *	Price
AN3021-1	MS35058-21	JBT - MS No.	1/2 Miniature	SPDT	1*	\$16.85
AN3021-2	MS35058-22	JBT - MS No.	1/2 Miniature	SPDT	2*	\$13.50
AN3021-3	MS35058-23	JBT - MS No.	1/2 Miniature	SPDT	3*	\$16.85
AN3027-1	MS35059-21	JBT - MS No.	Full Standard	DPDT	1*	\$37.75
AN3027-2	MS35059-22	JBT - MS No.	Full Standard	DPST	2*	\$18.50
AN3027-3	MS35059-23	JBT - MS No.	Full Standard	DPDT	3*	\$38.75
AN3027-7	MS35059-27	JSBT-MS No.	Full Standard	DPDT	5*	\$27.50
AN3027-4	MS35059-24	JBT - MS No.	Full Standard	DPST	7	\$29.85

* See Toggle Circuit Table * Available toggle lever positions & circuits

TOGGLE CIRCUIT CODE (*)	Circuitry with Toggle at:		
	UP	CENTER	DOWN
1	On	Off	On
2	On	None	Off
3	On	None	On
4	On	Off	On**
5	On*	Off	On**
6	Off	None	On*
7	On	Off	None

PUSH BUTTON SWITCH



Honeywell MS24524-23 Switch Toggle (On/On).
P/N 05-22876\$43.60

PUSH BUTTON SWITCH



A quality momentary SPST switch, perfect as a starter button, Comes with a special boot that keeps out dust and weather.
P/N SPB01\$8.50

CIRCUIT BREAKER SAFETY LOCKS



Skylox™ is a unique product that will provide safety to your aircraft ground service crews. The circuit breaker safety lock is easy to use and is an innovative safety solution, all at a very low price. Simple to use. Just squeeze and place over an open circuit breaker to prevent accidental closing of breaker circuits being serviced. Regular round Skylox™ for standard size breakers and Skylox™ L for larger sizes. Hexagonal shape easily differentiates between the two sizes. Add Skytags™ for added safety. NOTICE! Skylox™ are designed for use by ground maintenance crews during ground maintenance procedures only! Skylox™ are NOT to be used during flight operations.

Danger.....P/N 11-07737\$3.40 Warning...P/N 11-07738.....\$3.90

Large.....P/N 11-07734\$5.35 Standard..P/N 11-07736.....\$5.65

OTTO SWITCHES & PISTOL GRIPS



T7 COMMERCIAL TOGGLE SWITCHES

T7 commercial toggle switch, waterproof bushing seal switches up to 16 amps 15/32-32 thread mount. Includes mounting hardware.

SPECIFICATIONS

Electrical: (at 28VDC or 115VAC, 60/400 Hz.)		
Load	Amperes	Life (Nominal)
Resistive	16	25,000
Inductive	10	25,000
Motor	1/2 HP	25,000

No. of Poles	OTTO No.	Circuit	Our P/N	Price ea.
1	T7-131A1	on-off	11-00755	\$21.50
1	T7-131B1	on-on	11-00756	\$21.50
1	T7-131C1	mom-off	11-00757	\$21.50
1	T7-131D1	mom-on	11-00758	\$21.50
1	T7-131E1	mom-off-mom	11-00759	\$21.50
1	T7-131F1	on-off-on	11-00760	\$21.50
1	T7-131G1	mom-off-on	11-00761	\$21.50
2	T7-231A1	on-off	11-00762	\$24.50
2	T7-231B1	on-on	11-00763	\$22.50
2	T7-231C1	mom-off	11-00764	\$20.50
2	T7-231D1	mom-on	11-00765	\$15.85
2	T7-231E1	mom-off-mom	11-00766	\$23.75
2	T7-231F1	on-off-on	11-00767	\$22.85
2	T7-231G1	mom-off-on	11-00768	\$23.75

Note: MOM designates Momentary On.



T3 MINIATURE TOGGLE SWITCHES

Military MS27718 qualified. High reliability, rugged. Solder turret for wire attachment. 303 stainless toggle, 15/32" bushing version has a waterproof seal. Specifications Electrical: (at 28VDC or 115VAC, 60/400 Hz.)

Load	Amps	Life (full load)	Load	Amps	Life (full load)
Resistive	5	30,000	Lamp	1	30,000
Inductive/Motor	2	30,000	Mechanical Life	n/a	100,000

No. of Poles	MIL No.	OTTO No.	Circuit	Our P/N	Price ea.
1	MS27718-21-1	T3-11111	on-off-on	11-00772	\$33.50
1	MS27718-22-1	T3-11121	off-on	11-00773	\$33.50
1	MS27718-23-1	T3-11131	on-on	11-00774	\$33.95
1	MS27718-26-1	T3-11141	mom-on	11-00775	\$35.70
1	MS27718-27-1	T3-11151	mom-off-mom	11-00776	\$36.60
1	MS27718-31-1	T3-11161	mom-off-on	11-00777	\$35.70
2	MS27719-22-1	T3-11221	off-on	11-00779	\$33.75
2	MS27719-23-1	T3-11231	on-on	11-00780	\$36.60
2	MS27719-27-1	T3-11251	mom-off-mom	11-00782	\$37.85
2	MS27719-31-1	T3-11261	mom-off-on	11-00783	\$35.50

Note: MOM designates Momentary On.

P5 ON-OFF ALTERNATE ACTION SWITCH



Push and the P5 series switch holds "on" push again and the P5 switch turns "off". Positive tactile feedback is featured so the operator is clearly aware the switch mode has been executed. The button returns to the original position after each actuation.

To guard against front panel splash and dirt, the P5 series is sealed at the button with OTTO's patented rolling sleeve principle. The terminals are sealed with epoxy, providing a seal against flux during wiring and behind panel dirt and moisture. The combination of sealing provides smooth operation over a wide temperature range. Watertight sealing to 1meter (IP68) pressure is also available.

Load	Amps	Life (full load)	Load	Amps	Life (full load)
Resistive	10	25,000	Motor	3	25,000
Inductive	5	25,000	Lamp	1	25,000

Switch	Part No.	Price	Switch	Part No.	Price
Press Fit-red	11-00796	\$28.75	Thread Mount Red	11-00769	\$28.85
Press Fit-black	11-00797	\$28.75	Thread Mount Black	11-00770	\$27.50
Press Fit-white	11-00798	\$28.95	Thread Mount White	11-00771	\$28.75

OTTO PISTOL GRIPS



Otto Controls has been making the switches used in a majority of military and commercial flight grips manufactured for the last 40 years. Otto has evolved from a switch supplier into a major gri supplier with flight grips in numerous military and commercial aircraft. These rugged grips are the same as our military qualified grips but without the expensive threaded connector. Grips have a 1.15" ID which can be adapted to a 3/4" or 7/8" joystick with separate sleeves sold below.

Grip Kit	Otto Part No.	2-position Trigger	4-Way Trim Switch	Push-Button Switch	Our Part No.	Price Each
B8	G2-0048	1	1	3	11-00751	\$789.00
Cobra	G2-0049	1	1	4	11-00752	\$885.00
T4-0204 4-WAY SWITCH FOR B8 - Four way trim with a large hat style button. Fits into the trim position of the G2-0048 and G2-0049 flight grip kits. Can handle up to a 1 amp inductive load at 28VDC.					11-07956	\$259.85

Grip/Joystick Sleeve			
Joystick O.D.	Part No.	Our Part No.	Price
3/4" shaft	302379	11-00753	\$69.75
7/8" shaft	302380	11-00754	\$88.75

P1 MOMENTARY SWITCHES

MIL qualified. Dustproof, snap action, solder terminals, rugged reliable construction.

SPECIFICATIONS

Electrical: (at 28VDC or 115VAC, 60/400 Hz.)		
Load	Amperes	Life (Nominal)
Resistive	10	25,000 cycles
Inductive/Motor	5	25,000 cycles
Lamp	3	25,000 cycles

PRESS FIT				
MIL No.	Otto No.	Button Color	Our Part No.	Price
MS25089-1AL	P1-12121	Red	11-00745	\$21.55
MS25089-1A	P1-12122	Black	11-00746	\$22.85
MS25089-1AW	P1-12129	White	11-00747	\$21.80

THREADED BEZEL				
MIL No.	Otto No.	Button Color	Our Part No.	Price
MS25089-1CR	P1-32121	Red	11-00748	\$21.80
MS25089-1C	P1-32122	Black	11-00749	\$22.95
MS25089-1CW	P1-32129	White	11-00750	\$22.70



T3 1/4-40 UNSEALED BUSHING TOGGLE SWITCHES



These miniature toggles are rugged, highly reliable switches offering positive detent action for safe switching operation. Featuring the unique OTTO snap-action switch mechanism in conjunction with a unique toggle actuator design, the T3 series offers snap-action contact actuation.

No. of Poles	MIL No.	OTTO No.	Circuit	Our Part Number	Price each
1	MS27716-21-1	T3-21111	On-Off-On	11-00784	\$24.85
1	MS27716-22-1	T3-21121	Off-None-On	11-00785	\$23.80
1	MS27716-23-1	T3-21131	On-None-On	11-00786	\$24.85
1	MS27716-26-1	T3-21141	On-None-(On)	11-00787	\$18.65
1	MS27716-27-1	T3-21151	(On)-Off-(On)	11-00788	\$24.95
1	MS27716-31-1	T3-21161	On-Off-(On)	11-00789	\$21.50
2	MS27717-21-1	T3-21211	On-Off-On	11-00790	\$25.50
2	MS27717-22-1	T3-21221	Off-None-On	11-00791	\$23.75
2	MS27717-23-1	T3-21231	On-None-On	11-00792	\$25.50
2	MS27717-26-1	T3-21241	(On)-None-On	11-00793	\$26.50
2	MS27717-27-1	T3-21251	(On)-Off-(On)	11-00794	\$28.95
2	MS27717-31-1	T3-21261	On-Off-(On)	11-00795	\$24.99

Note: () denotes Momentary action.

EL

SWITCHES – LIGHTS

• SILVER SWITCH CONTACTS (MOST)

SWITCHES & INDICATOR LIGHTS

• .25" TAB TERMINAL (UNLESS SHOWN)

Commercial 12 VDC Illuminated & Non-Illuminated Toggle, Rocker, Push-Button, Pull Switches...
Incandescent & L.E.D. Indicator Lights...Switch Guards...Lever Covers



LEVER SWITCHES 20 AMP SILVER CONTACTS

Non-Illuminated	Single Pole	Price
On-Off	11-103	\$6.65
On-On	11-107	\$7.90
On-Off-On	11-123	\$7.50



DASH LIGHTS

Replaceable Lamp					
Red	Green	Amber	Blue	MTG. HOLE	Price
17-410	17-411	17-412	17-413	1/2"	\$5.95
Jumbo					
17-420	17-421	17-432	17-423	3/4"nut	\$8.90
17-440	17-441	17-442	17-443	1"nut	\$27.60



LEGEND LIGHTS

Illuminated words.
Dimensions: 7/8" x 11/16" x 1-3/8"
Mounting Hole: .629" Diameter (16 mm)

Color	Part No.	Price	Color	Part No.	Price
Red	11-06000	\$37.60	Orange	11-06050	\$34.70
Green	11-06060	\$38.50	Clear	11-06070	\$24.50
Blue	11-06065	\$44.50			

REPLACEMENT BULBS

12 VoltP/N 31-963.1\$3.85
24 VoltP/N 31-963.2\$5.95

NOTE: Order labeling (words) separately from list below.

LEGEND LIGHT LABELS

Description	Part No.	Price	Description	Part No.	Price
Alarm	17-538	\$0.55	Hi Oil Pressure	17-625	\$0.55
Auto-Pilot	17-710	\$0.55	Hi Oil Temp	17-518	\$0.45
AUX Lights	17-501	\$0.55	Interior Lights	17-679	\$0.55
AUX Rank	17-606	\$0.55	Lock	17-711	\$0.40
Battery	17-536	\$0.55	Loran	17-716	\$0.35
Carb Heat	17-712	\$0.45	Low Fuel	17-512	\$0.55
Caution	17-714	\$0.55	Mags	17-715	\$0.35
Danger	17-540	\$0.55	Aux Brake Light	17-507	\$0.40
De-ice	17-713	\$0.35	Oil Filter	17-609	\$0.55
Flaps Up	17-730	\$0.55	Pitot Heat	17-709	\$0.55
Flashing Lights	17-560	\$0.50	Radio	17-717	\$0.55
Fuel Pumps	17-587	\$0.55	Strobe Lights	17-631	\$0.55
Gear Down	17-718	\$0.50	Wing Lights	17-614	\$0.50

MS25041 PRESS-TO-TEST INDICATOR



Miniature press-to-test indicator with built-in bulb testing device. Adjustable dimmer. Uses #330 (12V) or #327 (24V) bulb. Bulbs NOT included, order separately.

Clear	11-04226	\$45.50
Red	11-03910	\$45.50
Green	11-03911	\$45.50
Amber	11-03912	\$45.50
Blue	11-04227	\$45.50

ROCKER SWITCHES SILVER CONTACTS

Non-Illuminated	Single Pole	Price	Double Pole	Price
On-Off	14-100	\$1.75	14-200	\$5.75
Off-(On)	14-101	\$5.75	---	---
On-On	14-102	\$6.50	14-210	\$9.60
On-Off-On	---	---	14-220	\$9.90
(On)-Off-(On)	14-104	\$5.85	14-225	\$9.95

Illuminated Single Pole (20 AMP, OnOff-OFF)				
Red	Green	Amber	Blue	Price
14-305	14-306	14-307	14-308	\$6.95

PUSH BUTTON

Off-(On), 5 AMP
Mounting Hole: 1/2"
Aluminum Guard.....P/N 15-112\$9.95

Push On-Push Off, 16 AMP
Mounting Hole: 1"
Red Button.....P/N 15-132\$8.35

Off-(On), 40 AMP, Sealed
Mounting Hole: 5/8"
Screw Terminal.....P/N 15-100\$11.50

PULL SWITCHES

Pull On/Push Off, 75 AMP
Chromed.....P/N 16-140\$11.50 ea.

METAL LEVER TOGGLE SWITCHES
25" TAB TERMINAL. 21 AMP at 12VDC 9 AMP at 24VDC
15 AMP at 125VAC 1/2" panel hole size.

Operation	Single Pole	Price	Double Pole	Price
Off-On	*12-100	\$5.35	12-200	\$7.50
Off-(On)	*12-101	\$6.85	12-201	\$7.90
On-On	*12-102	\$7.55	12-202	\$6.75
On-Off-On	12-103	\$6.65	12-203	---
(On)-Off-(On)	12-104	\$8.80	12-204	\$7.70

()=Momentary

SWITCH LEVER COVERS

Fits most metal switches with 15/32" bushing
Black Neoprene - Hex Nut
P/N 19-516\$2.45

BUSS BARS

These MS25226 series buss bars are used as replacement bars for MS27212 board assemblies.



Part No.	Hole Size	# of Holes	Length	Our Part No.	Price
MS25226-10-4	3/16	4	2 5/8"	11-04676	\$18.99

PLAIN WIRE SPOOLS

Chipboard tube & top wire spools, complete with metal spool plugs that have pre-stamped drive holes and locking anchors for a long lasting use.

These wire spools can be easily assembled in a moments time; insert the spool plug through the ID of a flange and pressed into a spiral wound paper tube. The end caps have locking anchors that hold the spools simply & securely unassembled.

Description	Part No.	Price
7X2X3X3/4 5 Pack	11-11507-5	\$25.00
7X2X3X3/4 10 Pack	11-11507-10	\$50.00
7X6X3X3/4 5 Pack	11-11508-5	\$26.75
7X6X3X3/4 10 Pack	11-11508-10	\$54.25

SKYLOX® — SLEEVING — HEAT SHRINK

SKYLOX® CIRCUIT BREAKER LOCKS



Skylox® is a unique product that will provide safety to your aircraft ground service crews. The circuit breaker safety lock is easy to use and is an innovative safety solution, all at a very low price. Simple to use. Just squeeze and place over an open circuit breaker to prevent accidental closing of breaker circuits being serviced. Regular round Skylox® for standard size breakers and Skylox® L for larger sizes. Hexagonal shape easily differentiates

between the two sizes. Add Skytags® for added safety. Red with white letters and all white backs for adding notes or special instructions. Use whiteboard markers for reusability, or permanent markers for repeating conditions. **NOTICE!** Skylox® are designed for use by ground maintenance crews during ground maintenance procedures only! Skylox® are NOT to be used during flight operations.

Size	Color	Part No.	Price	Color	Part No.	Price
Large	Orange	11-14282	\$4.95	Yellow	11-07734	\$5.35
Standard	Orange	11-07736	\$5.65	Yellow	11-10572	\$4.95

ISOLOX® FOR CIRCUIT BREAKERS



The patented isolox® is a larger version of the popular Skylox® product that has been specifically designed to accommodate large breakers and those with color coding collars attached. isolox® will complete your toolbox of Circuit Breaker Lockout tools fitting the widest variety of breakers currently in use. isolox® are also compatible with Skyclip® and Skytags® and can be packaged in configurations of the Skykit® tool

accountability kit.
Orange.....P/N 11-13569.....\$5.35

SKYTAGS®



Skytags® are durable plastic tags for use with Skylox® and isolox™ do designate Danger, Warning or simply Maintenance. The yellow Maintenance tag is double sided while the Danger and Warning tags feature a glossy white back suited for grease pencil, dry erase markers or permanent markers for instructions, technician's name or other desired information. Size: 3-1/2" length x 1" width

Warning.....P/N 11-07738.....\$3.90
Danger.....P/N 11-07737.....\$3.40
Maintenance.....P/N 11-13571.....\$3.90

SKYLOX® SKYCLIP®



Skyclip® is a stainless steel spring clip for attaching Skytags® to isolox™ and Skylox®.

P/N 11-13572.....\$2.95

SKYLOX® SKYKIT® 1



Kit Includes • 10 Standard Skylox • 2 Large Skylox • 2 Skyvault Sleeves • 12 Warning Or Danger Tags And Clips In A Sturdy Poly Case. NOT to be used in flight.

P/N 11-13573.....\$208.95

SKYLOX® SKYKIT® 2



Kit Includes • 18 Standard Skylox • 18 Warning Or Danger Tags • 18 Skyclips In A Sturdy Poly Case. NOT to be used in flight.

P/N 11-13574.....\$208.95

SKYLOX® SKYKIT® CASES WITH FOAM ONLY



Have Skylox® but don't have a case to store them in, then try this Skykit® Poly Case - a sturdy poly case with foam. Available for 12pc kit or 18 pc kit. Secure your loose Skylox today. Skylox are not included.

12 pc. Case.....P/N 11-13575.....\$74.95
18 pc. Case.....P/N 11-13576.....\$74.95

CIRCUIT BREAKER LOCKOUT RING



With Tag. Prevents the inadvertent closing of circuit breakers connected to equipment that is under repair or removed from the aircraft. Easily installed and removed from Klixon and similar type circuit breakers. All locks are red, tags are red with white lettering.

Tags measure 2"x3/4"......P/N 11-04464.....\$6.60

THIN WALL HEAT-SHRINKABLE TUBING



This is a general purpose heat shrinkable tubing with a wide scope of applications including harnessing, wire bundling, strain reliefs or any application where components or cables must be insulated or packaged. Material is an irradiated, thermally stabilized, modified polyolefin which is vastly superior to thermoplastic type materials. Flexible & flame retardant. Shrinkable by any hot air source such as an electric hair dryer or any heating device delivering at least 250°F. One person can complete installation in seconds. No need for special skills. Meets spec. MIL-I-23053B. Standard length - 4 ft. Min. purchase 4 ft. per size. Sold only in full 4 ft. lengths. *P/N 11-00900 is sold per foot.

Black

Expanded Size	Expanded I.D.	Recovered I.D.	Nominal Wall	Part No.	Price / 4 ft. Piece
1/16"	.063	.031	.017	11-00700	\$1.30
3/32"	.093	.046	.020	11-00800	\$1.20
1/8"	.125	.062	.020	11-00900*	\$1.25
3/16"	.187	.093	.020	11-01000	\$1.65
3/16"	.188	.094	.019	11-16893	\$0.50
1/4"	.250	.125	.025	11-01100	\$1.75
3/8"	.375	.187	.025	11-01200	\$1.95
1/2"	.500	.250	.025	11-01300	\$2.20
3/4"	.750	.375	.030	11-01400	\$4.35
1"	1.000	.500	.035	11-01500	\$5.35

White

1/16"	.063	.031	.017	11-09443	\$1.25
1/8"	.125	.062	.020	11-04029	\$1.35
1/4"	.250	.125	.025	11-04028	\$2.15
3/8"	.375	.187	.028	11-04030	\$2.15
1/2"	.500	.250	.025	11-04027	\$2.45

Discount: 25% Discount on 12 or more 4' Lengths (Per Size)

Always order the largest size which will fit snugly over the component being covered. Wall thickness will be less if recovery is restricted during shrinking.

ADHESIVE LINED HEAT-SHRINKABLE TUBING



Adhesive Lined Shrink Tubing is made of flame retardant, cross-linked, black, polyolefin with an inner coating of hot-melt adhesive and an outer layer. It has excellent physical, chemical, and electrical properties and provides electrical and mechanical protection.

Features: • Shrink Ratio: 3:1 • Operating Temperature: -55° C to +110° C • Shrink temperature: 120° C • Inner layer glue melting temperature: 70° C -90° C • Waterproof • Meets: Mil-23053/4 Class 3, UL224 • UL Recognized • RoHS Compliant:3:1 ADHESIVE LINED.

Tube Size (In.)	Expanded I.D.	Recovered I.D.	Part No.	Price Per 4ft. Piece
1/8"	.118"	.039"	11-11536	\$3.85
3/16"	.0187"	.059"	11-11537	\$2.90
1/4"	.236"	.078"	11-11538	\$3.15
3/8"	.254"	.118"	11-11539	\$3.95
1/2"	.472"	.157"	11-11540	\$6.50
3/4"	.708"	.236"	11-11541	\$7.50
1"	.945"	.315"	11-11542	\$11.55

IGNITION SHIELDING BRAID



Tinned copper tubular braid. Very flexible multi-strand braid. Excellent way to shield spark plug wires to reduce radio frequency interference (RFI). Fits over standard spark plug wire. Use 1/2" heat shrink to secure the ends.

Shielding Braid per foot.....P/N 11-02463.....\$0.97
Heat Shrink Tubing, 1/2", 4 ft. length.....P/N 11-01300.....\$2.20

TINNED COPPER BRAID

Used for static shielding on short lengths of wire or cable and for flexible bonding connections and ground straps. Made of extra flexible tinned copper wire. Rolled flat for spooling.

P/N	Nominal Flat Width	Current *Capacity Amps.	Wt./100 Ft.		Price	
			Lbs.	Per Ft.	100 Ft.	
858	1/8"	16	0.7	\$0.22	\$18.70	
863	1/4"	32	1.5	\$0.55	\$46.75	
864	3/8"	46	2.5	\$0.87	\$73.95	
868	1/2"	53	3.3	\$1.35	\$114.75	

EXPANDABLE ICO-FLEX™ XPF SLEEVING



ICO-FLEX™ XPF is flame retardant & light weight, self-fitting, monofilament sleeveings designed to encapsulate and protect cable bundles and wire assemblies. These expandable sleeveings adjust to irregular surfaces and contours, providing abrasion resistance and protection with a minimum of bulk and weight. Black.

Nominal ID In/mm	Bundle Size Range		Part No.	Price/ Ft.
	Minimum	Maximum In/mm		
.125 / 3.18	.094	0.125 / 2.38 - 3.18	11-12352	\$0.20
.250 / 6.35	.125	.0375 / 3.18-9.53	11-04275	\$0.40
.375 / 9.53	.250	0.625 / 6.35 - 15.88	11-03899	\$0.45
.500 / 12.70	.250	0.750 / 6.35-19.05	11-04274	\$0.75
.750 / 19.05	.500	1.250 / 12.70-31.75	11-12353	\$0.95
1.250 / 31.75	.750	1.500 / 19.05-38.10	11-12354	\$1.35
1.750 / 44.45	1.25	2.500 / 31.75-63.50	11-12356	\$1.94
2.000 / 50.80	1.500	3.000 / 38.10-76.20	11-12357	\$2.70

AIRCRAFT WIRE

UNSHIELDED WIRE MIL-W-22759

Standard tin-plated copper conductor and is insulated with extruded Tefzel (ethylene/tetrafluorobethylene) which has a maximum temperature rating of 150°C. This wire is rated for 600 volts.



Part No.	Mil-Spec	Wire Gauge	Color	Price per ft.	Price (100ft)	Price (1,000ft)
11-14524	M22759/16-24-9	24	White	\$0.27	\$22.95	\$162.00
11-06254	M22759/16-24-0	24	Black	\$0.32	\$27.20	\$192.00
11-07790	M22759/16-24-6	24	Blue	\$0.26	\$22.10	\$156.00
11-07795	M22759/16-24-5	24	Green	\$0.26	\$22.10	\$156.00
11-06253	M22759/16-24-2	24	Red	\$0.27	\$22.95	\$162.00
11-06252	M22759/16-24-4	24	Yellow	\$0.36	\$30.60	\$216.00
11-14522	M22759/16-22-9	22	White	\$0.33	\$28.05	\$198.00
11-06257	M22759/16-22-0	22	Black	\$0.40	\$34.00	\$240.00
11-07791	M22759/16-22-6	22	Blue	\$0.34	\$28.90	\$204.00
11-07796	M22759/16-22-5	22	Green	\$0.31	\$26.35	\$186.00
11-06256	M22759/16-22-2	22	Red	\$0.41	\$34.85	\$246.00
11-06255	M22759/16-22-4	22	Yellow	\$0.34	\$28.90	\$204.00
11-11982	M22759/16-22-90	22	White w/ Black Stripe	\$0.50	\$42.50	\$300.00
11-11985	M22759/16-22-96	22	White w/ Blue Stripe	\$0.41	\$34.85	\$246.00
11-11981	M22759/16-22-95	22	White w/ Green Stripe	\$0.50	\$42.50	\$300.00
11-11983	M22759/16-22-92	22	White w/ Red Stripe	\$0.38	\$32.30	\$228.00
11-11984	M22759/16-22-94	22	White w/ Yellow Stripe	\$0.67	\$56.95	\$402.00
11-14520	M22759/16-20-9	20	White	\$0.42	\$35.70	\$252.00
11-06260	M22759/16-20-0	20	Black	\$0.52	\$44.20	\$312.00
11-07792	M22759/16-20-6	20	Blue	\$0.49	\$41.65	\$294.00
11-07797	M22759/16-20-5	20	Green	\$0.43	\$36.55	\$258.00
11-06259	M22759/16-20-2	20	Red	\$0.44	\$37.40	\$264.00
11-06258	M22759/16-20-4	20	Yellow	\$0.56	\$47.60	\$336.00
11-14518	M22759/16-18-9	18	White	\$0.52	\$44.20	\$312.00
11-01596	M22759/16-18-0	18	Black	\$0.63	\$53.55	\$378.00
11-01599	M22759/16-18-6	18	Blue	\$0.67	\$56.95	\$402.00
11-07798	M22759/16-18-5	18	Green	\$0.87	\$73.95	\$522.00
11-01597	M22759/16-18-2	18	Red	\$0.79	\$67.15	\$474.00
11-06261	M22759/16-18-4	18	Yellow	\$0.51	\$43.35	\$306.00
11-15601	M22759/16-18-90	18	White w/ Black Stripe	\$0.78	\$66.30	\$468.00
11-15607	M22759/16-18-92	18	White w/ Red Stripe	\$0.65	\$55.25	\$390.00
11-14516	M22759/16-16-9	16	White	\$0.83	\$70.55	\$498.00
11-01601	M22759/16-16-0	16	Black	\$0.73	\$62.05	\$438.00
11-01604	M22759/16-16-6	16	Blue	\$0.68	\$57.80	\$408.00
11-07799	M22759/16-16-5	16	Green	\$0.77	\$65.45	\$462.00
11-01602	M22759/16-16-2	16	Red	\$0.66	\$56.10	\$396.00
11-01603	M22759/16-16-4	16	Yellow	\$0.78	\$66.30	\$468.00
11-15501	M22759/16-16-90	16	White w/ Black Stripe	\$0.76	\$64.60	\$456.00
11-19522	M22759/16-16-95	16	White w/ Green Stripe	\$0.81	\$68.85	\$486.00
11-15507	M22759/16-16-92	16	White w/ Red Stripe	\$0.77	\$65.45	\$462.00
11-14514	M22759/16-14-9	14	White	\$0.95	\$80.75	\$570.00
11-07788	M22759/16-14-0	14	Black	\$0.87	\$73.95	\$522.00
11-07793	M22759/16-14-6	14	Blue	\$1.17	\$99.45	\$702.00
11-07801	M22759/16-14-5	14	Green	\$2.78	\$236.30	\$1,668.00
11-07806	M22759/16-14-2	14	Red	\$1.25	\$106.25	\$750.00
11-07804	M22759/16-14-4	14	Yellow	\$1.50	\$127.50	\$900.00
11-14512	M22759/16-12-9	12	White	\$0.90	\$76.50	\$540.00
11-07789	M22759/16-12-0	12	Black	\$1.73	\$147.05	\$1,038.00
11-07802	M22759/16-12-5	12	Green	\$1.95	\$165.75	\$1,170.00
11-07807	M22759/16-12-2	12	Red	\$2.26	\$192.10	\$1,356.00
11-07805	M22759/16-12-4	12	Yellow	\$1.13	\$96.05	\$678.00
11-14510	M22759/16-10-9	10	White	\$1.66	\$141.10	\$996.00
11-14508	M22759/16-8-9	8	White	\$3.85	\$327.25	\$2,310.00
11-14506	M22759/16-6-9	6	White	\$6.50	\$552.50	\$3,900.00
11-14504	M22759/16-4-9	4	White	\$8.50	\$722.50	\$5,100.00
11-14502	M22759/16-2-9	2	White	\$12.50	\$1,062.50	\$7,500.00
11-14501	M22759/16-01-9	0	White	\$14.65	\$1,245.25	\$8,790.00
11-14500	M22759/16-02-9	00	White	\$18.55	\$1,576.75	\$11,130.00

SHIELDED WIRE MIL-C-27500

This shielded and jacketed aircraft wire conforms to MIL-C-27500 and replaces MIL-C-7078/3. It incorporates MIL-W-22759/18 basic wire and features a Tefzel insulation, a shield of tin-plated copper braid and a jacket of Tefzel. It is temperature rated to 150°C & voltage rated at 600V. Top quality wire to military specifications.



Part No.	Mil-Spec	Wire Gauge	Number of Conductors	Price per ft.	Price (100ft)	Price (1,000ft)
11-04476	M27500-24TG1T14	24	1	\$0.78	\$66.30	\$468.00
11-04477	M27500-24TG2T14	24	2	\$1.47	\$124.95	\$882.00
11-04478	M27500-24TG3T14	24	3	\$1.80	\$153.00	\$1,080.00
11-14422	M27500-22TG1T14	22	1	\$1.10	\$93.50	\$660.00
11-05650	M27500-22TG2T14	22	2	\$1.84	\$156.40	\$1,104.00
11-05651	M27500-22TG3T14	22	3	\$1.97	\$167.45	\$1,182.00
11-07773	M27500-22TG4T14	22	4	\$2.24	\$190.40	\$1,344.00
11-06580	M27500-22TG5T14	22	5	\$2.94	\$249.90	\$1,764.00
11-07774	M27500-22TG6T14	22	6	\$2.80	\$238.00	\$1,680.00
11-09782	M27500-22TG8T14	22	8	\$3.35	\$284.75	\$2,010.00
11-12535	M27500-22TG9T14	22	9	\$3.85	\$327.25	\$2,310.00
11-14420	M27500-20TG1T14	20	1	\$1.26	\$107.10	\$756.00
11-14585	M27500-20TG3T14	20	3	\$1.71	\$145.35	\$1,026.00
11-18168	M27500-20TG2T14	20	2	\$1.65	-	-
11-04474	M27500-18TG2T14	18	2	\$2.30	\$195.50	\$1,380.00
11-04475	M27500-18TG3T14	18	3	\$2.95	\$250.75	\$1,770.00
11-14418	M27500-18TG1T14	18	1	\$1.67	\$141.95	\$1,002.00
11-04473	M27500-16TG2T14	16	2	\$3.35	\$284.75	\$2,010.00
11-14416	M27500-16TG1T14	16	1	\$1.79	\$152.15	\$1,074.00
11-14414	M27500-14TG1T14	14	1	\$1.90	\$161.50	\$1,140.00
11-14412	M27500-12TG1T14	12	1	\$2.50	\$212.50	\$1,500.00
11-14410	M27500-10TG1T14	10	1	\$7.50	\$637.50	\$4,500.00
11-14408	M27500-8TE1T14	8	1	\$5.95	\$505.75	\$4,462.50



SWITCHES – SPLICES



ARINC 646 CAT 5 DATA BUS CABLE

Applications: ARINC 646, Cat 5, LAN, 10 Base T
P/N 11-18304\$4.50

MALE SUB-D CRIMP PIN



20/24G Crimp Pin. Pins/Sockets.
P/N 11-00139\$0.55

FEMALE SUB-D CRIMP SOCKET



Subminiature D Pins/Sockets for MIL-C-24308 and MIL-C-39029.
P/N 11-11877\$0.59

SINGLE CONDUCTOR INCH SOLDER SLEEVES WITH PIGTAIL



Perfect for single conductor shielded cable and great for terminating "P Leads".
1/8".....P/N 11-12363\$1.75
1/4".....P/N 11-14743\$1.49

TE SOLDER SLEEVE WITH LEAD



Shield Sleeve shield grounding terminators provide an environmentally sealed, insulated, and encapsulated solder connection for a variety of applications. Specifications: • Jacket Outside Diameter: 4.3 mm [.169 in] • Expanded Inside Diameter (Min): 4.3 mm [.17in] • Recovered Inside Diameter (Max): 2 mm [.079in] • Shield Outside Diameter (Min): 2 mm [.079 in] • Overall Length: 29.3 mm [1.15 in] • Pre-Installed Lead Wire Size (mm²): .38P/N 11-16370\$1.30

BATTERY CABLE



6-gauge multi-strand copper core cable. Meets SAE Spec J1127-SGT. Price is per foot.
BlackP/N 11-03942\$1.75
Red.....P/N 11-03943\$1.95
Lug (6 Gauge).....P/N 11-05110\$1.20

GPL RED BATTERY CABLE



Description	Part No.	Price
4 Ga / 26 in	15-08035	\$17.90

4 CONDUCTOR UNSHIELDED WIRE 18 AWG



The cable can be cut to length, jacket removed and conductors stripped to custom specifications. Awg Size: 18 Thickness: .016" Nominal O.D: .032" Suitable for EIA RS-232 applications. P/N 11-08280 \$1.90 /ft.

SOLDERING SLEEVES



One-step, heat-shrinkable wire and cable interconnection device. Create strong, soldered connections. Consist of a heat-shrinkable sleeve and a premeasured, fluxed solder band. When heated, the tubing shrinks and the solder melts, making reliable, insulated terminations.
.125"SM.....P/N 11-04480\$1.00
.200"MD.....P/N 11-04481\$0.75
.300"LG.....P/N 11-04482\$1.15

SOLDERING SLEEVES



Termination sleeves consist of a heat-shrinkable, transparent, polyvinylidene fluoride sleeve with an inner, pre-fluxed, solder preform and two thermoplastic sealing inserts. When heat is applied, the solder melts and flows to provide a superior connection between the ground lead and the shield. At the same time, the two thermoplastic sealing inserts melt and the outer sleeve shrinks to provide an environmentally protected termination.
.125P/N 11-07902\$0.65
1/4".....P/N 11-07903\$0.49
.300P/N 11-07905\$1.16

MU-METAL MAGNETIC SHIELDING



Provides shielding when placed around electronic equipment prior to installation. 4"x4 mil. Sold by the inch.....P/N 11-04483\$5.25/inch

MOMENTARY PUSH-BUTTON SWITCHES

Switch, Micromini, Pushbutton, SPST, Off-Moment, PC Terminal



SPDT, Momentary, Black
P/N 11-04468\$16.65
SPDT, Momentary, Black
P/N 11-04471\$9.95



HEAT-SHRINK BUTT SPLICES

Heat-Shrinkable crimp butt splices completely insulate and protect electrical connections from water, condensation, salt and corrosion. Provides strain relief and protects against wire pull-out and vibration in the most rugged environments. Qualified to MIL-S-81824/1.

Description	AWG	Part No.	Price
Raychem Butt Splice Blue Tin-Plated (Pk of 10)	20-16	11-04427-10	\$16.50
Raychem Butt Splice Blue Nickel-Plated (Pk of 10)	20-16	11-04428-10	\$24.60
Raychem Butt Splice Blue Tin-Plated (Pk of 25)	20-16	11-04427-25	\$36.70
Raychem Butt Splice Blue Nickel-Plated (Pk of 25)	20-16	11-04428-25	\$61.80
Raychem Butt Splice Red Tin-Plated (Pk of 10)	26-20	11-04425-10	\$24.90
Raychem Butt Splice Red Nickel-Plated (Pk of 10)	26-20	11-04426-10	\$31.50
Raychem Butt Splice Red Tin-Plated (Pk of 25)	26-20	11-04425-25	\$62.75
Raychem Butt Splice Red Nickel-Plated (Pk of 25)	26-20	11-04426-25	\$76.75
Raychem Butt Splice Yellow Tin-Plated (Pk of 10)	16-12	11-04429-10	\$13.75
Raychem Butt Splice Yellow Nickel-Plated (Pk of 10)	16-12	11-04430-10	\$34.75
Raychem Butt Splice Yellow Tin-Plated (Pk of 25)	16-12	11-04429-25	\$35.25
Raychem Butt Splice Yellow Nickel-Plated (Pk of 25)	16-12	11-04430-25	\$86.95

COLOR CODED CIRCUIT BREAKER CAPS



These color coded caps can easily be installed and removed from Klixon and similar type circuit breakers. Colored caps are used to "flag" designated circuit breakers for flight check and other purposes. In addition, they greatly improve grip. Won't shake loose and rattle like others can.

WhiteP/N 11-04455\$2.65
RedP/N 11-04457\$2.65
YellowP/N 11-04459\$2.65
Gray.....P/N 11-04461\$2.65
Orange.....P/N 11-04456\$2.65
BlueP/N 11-04458\$2.65
BlackP/N 11-04460\$2.65
GreenP/N 11-04462\$2.65

Discount: 10% Discount on 6 or more of the same Part number.



CIRCUIT BREAKER LOCKS

Circuit Breaker Safety Locks - With & Without Tags. Prevents the inadvertent closing of circuit breakers connected to equipment that is under repair or removed from the aircraft. Easily installed and removed from Klixon and similar type circuit breakers. Safety locks come both with and without tags. All locks are red, tags are red with white lettering. Tags measure 2"x3/4".

Description	Tag	Ring Color / Tag Color	Part No.	Price
Circuit Breaker Lockout Ring S4933959-501	--	Red / --	11-04463	\$2.65
Circuit Breaker Lockout Ring S4933959-503	--	Yellow / --	11-14695	\$2.65
Circuit Breaker Lockout Ring S4933959-505	--	Blue / --	11-14696	\$2.65
Circuit Breaker Lockout Ring S4933959-507	--	Black / --	11-14697	\$6.50
Circuit Breaker Lockout S4933959-521	Remove Before Flight	Red / Red	11-04464	\$6.60
Circuit Breaker Lockout S4933959-523	Remove Before Flight	Yellow / Red	11-14698	\$6.70
Circuit Breaker Lockout S4933959-525	Remove Before Flight	Blue / Red	11-14699	\$5.65
Circuit Breaker Lockout S4933959-527	Remove Before Flight	Black / Red	11-14700	\$5.65
Circuit Breaker Lockout S4933959-531	Inoperative Do Not Operate	Red / Red	11-04465	\$6.60
Circuit Breaker Lockout S4933959-533	Inoperative Do Not Operate	Yellow / Red	11-14701	\$5.75
Circuit Breaker Lockout S4933959-535	Inoperative Do Not Operate	Blue / Red	11-14702	\$5.90
Circuit Breaker Lockout S4933959-537	Inoperative Do Not Operate	Black / Red	11-14703	\$5.85

EL

BNC/TNC CONNECTORS — AVIONICS CONNECTORS

COAXIAL CABLE

- RG 400** - Standard cable for radio installations. Double shielded stranded conductor, MIL-DTL-17 spec. Approved for certified aircraft. P/N 11-09202 **\$3.95**
- RG 142** - Double shielded solid conductor, MIL-C-17 spec. Approved for certified aircraft..... P/N 11-00043 **\$6.50**
- RG 58A/U** - Standard cable for experimental avionics installations. Single shielded stranded conductor, jacket type - PVC. For experimental aircraft only..... P/N 11-03920 **\$0.55**
- RG 58C/U** - Standard cable for experimental avionics installations. Single shielded stranded conductor, jacket type - Non-PVC. For experimental aircraft only..... P/N 11-04258 **\$0.57**

BNC COAXIAL ANTENNA CONNECTORS

- Male P/N 11-03992 **\$2.02**
- Female P/N 11-03993 **\$4.35**

SMA COAX CONNECTOR

- SMA straight PCB Jack, through hole, 50 Ohm, reverse polarized. For use with Coax Cable RG400... P/N 11-14064 **\$3.35**

TNC FEMALE CRIMP RG142

- TNC Female Crimp RG142 P/N 11-08641 **\$13.50**

BNC CONNECTOR RIGHT ANGLE BNC MALE TO FEMALE

- Male to Female P/N 11-04454 **\$6.95**

BNC FEMALE TO C MALE ADAPTER - PE9087

- BNC to type C adapter has a female to male gender configuration. PE9087 BNC female to type C male adapter operates to 4 GHz. The RF adapter provides good VSWR of 1.3:1 maximum P/N 11-18318 **\$76.65**

MALE BNC TO SMA FEMALE ADAPTER

- Male BNC/SMA Female adapter. Configuration: Straight Connector 1: BNC Male. Connector 2: SMA Female. P/N 11-10463 **\$15.50**

BNC FEMALE BULKHEAD DUAL CRIMP RG58

- P/N 11-04445 **\$15.85**

BNC RF MALE CONNECTOR - RIGHT ANGLE

- Connector - RF • Plug • Housing Gender = Plug
- Terminate To Coaxial Cable • Coaxial Cable Termination Type = Crimp P/N 11-08415 **\$96.75**

BNC STRAIGHT ADAPTERS - PLUG/PLUG 50 OHMS

- RF/Coaxial Adapter. Dimensions: a 1.25"; b .562". Connector Type: Intra-Series Coaxial. Convert From: BNC Plug. Convert To: BNC Plug P/N 11-08416 **\$8.50**

BNC STRAIGHT ADAPTERS - JACK/JACK 50 OHM

- RF/Coaxial Adapter. Connector Type: Intra-Series Coaxial. Convert From: BNC Jack. Convert To: BNC Jack P/N 11-08417 **\$4.75**

TNC CONNECTOR AMP MALE, DUAL CRIMPS

- Dual Crimp RG58 P/N 11-04446 **\$51.75**
- Dual Crimp RG142-400 P/N 11-04447 **\$21.50**

TNC CONNECTOR AMP RIGHT ANGLE, MALE, DUAL CRIMP RG58

- P/N 11-04449 **\$65.95**

TNC CONNECTOR AMP RIGHT ANGLE, MALE, DUAL CRIMP RG142-400

- P/N 11-04450 **\$42.75**

TNC CONNECTOR RIGHT ANGLE SOLDER/ SCREW RG58

- P/N 11-04452 **\$169.96**

TNC CONNECTOR FEMALE, DUAL CRIMP RG58

- P/N 11-04453 **\$65.75**

TE MATE-N-LOK MALE PIN

- PIN/Male, 250V, MATE-N-LOK series. Brass material. For use with 24-18 gauge wire. ROHS compliant. P/N 11-16605 **\$0.13**

TE MATE-N-LOK 3 PIN CONNECTOR

- PIN/Male, 3 pin, MATE-N-LOK series. P/N 11-16607 **\$0.60**

RF BNC MALE RIGHT ANGLE CRIMP PLUG

- RF Connectors / Coaxial Connectors - BNC Right Angle Crimp Plug RG 400 - 142 for RG-55, RG-142, and RG-223 has a 50 Ohms P/N 11-17167 **\$7.85**

RF FEMALE TNC STRAIGHT CRIMP JACK

- Amphenol RF Female TNC - 122373 - Straight Crimp Jack for RG-55, RG-223, 50 Ohm P/N 11-17224 **\$6.75**

RF TNC STRAIGHT CRIMP JACK

- Amphenol RF TNC Straight Crimp Jack - 122122 for RG-58 LMR-195 - 50 Ohms P/N 11-17225 **\$2.70**

TNC FEMALE TO QMA MALE ADAPTER

- P/N 11-17386 **\$48.00**

D-SUB HIGH DENSITY 15 PIN 3 ROW CONNECTOR

- P/N 11-16005 **\$5.90**

BNC RIGHT ANGLE CRIMP PLUG FOR RG 58

- RF Connector - BNC Right Angle Crimp Plug for RG-58 LMR-195 50 Ohms P/N 11-17888 **\$10.95**

TE MATE-N-LOK 3 CIRCUIT POSITION POWER CONNECTOR

- 3 Circuit Mate-N-Lok Plug P/N 11-18450 **\$0.45**

CPC CONNECTOR KITS



P/N 11-14011

The Sealed CPC using UL F1-rated resin is ideal for UV resistance in outdoor applications. The UL F1 rating meets industry standards for long-term UV exposure, making

the housings suitable for outside applications where parts are subject to frequent or extended periods of exposure to sun light. The CPC is sealed from water exposure, making it easier to install and lowering the cost of installation. The circular configuration requires less space than a rectangular-style connector with an equal number of contacts for an efficient use of space on your equipment.

Receptacle and plug housings accept Type III+ signal contacts and/or AMP POWERBAND (size 8) contacts. The housings come in three sizes designed to handle standard signal, power with current up to 50A per contact and combinations of signal and power in the same housing. All housing variations include sealing to IP67. Mounting options include panel mount and free-hanging.

Description	Part No.	Price
8 Pin CPC Free Hang Male Base	11-14010	\$39.75
8 Pin CPC Free Hang Female Base	11-14011	\$42.50
8 Pin CPC Bulk Head Male Base	11-13999	\$40.00
8 Pin CPC Bulk Head Female Base	11-14001	\$41.50
9 Pin CPC Free Hang Male Base	11-14005	\$45.00
9 Pin CPC Bulk Head Male Base	11-14003	\$45.00
28 Pin CPC Free Hang Male Base	11-14006	\$61.75
28 Pin CPC Free Hang Female Base	11-14007	\$62.75
28 Pin CPC Bulk Head Male Base	11-14008	\$59.85
28 Pin CPC Bulk Head Female Base	11-14009	\$60.75

SPT FIREWALL CABLE GROMMET MOUNTS



Superior Panel Technology's Firewall Penetration Kit (Cable Grommet Mount) allows you to make a rectangular opening large enough to pass a plug measuring 1.25" x 2.9" (which will accept the largest sized plug used for installing the Garmin G3X - GEA24 engine sensors LRU plugs). The opening is then sealed with the 1/8" thick, center-stepped, stainless-steel cover plates.

Description	ID	OD	Panel Hole	Part No.	Price
Firewall Cable Grommet Mount	--	--	--	11-13458	\$51.85
Grommet Id Size 3/16"	3/16"	7/16"	5/16"	11-13459	\$2.95
Grommet Id Size 5/16"	5/16"	13/16"	9/16"	11-13460	\$3.50
Grommet Id Size 3/8"	3/8"	7/8"	5/8"	11-13461	\$3.95

PROTECT-FAST BRAIDED EXPANDABLE WRAP



Protect-Fast™ AERO Braided PFA-PFW Sleeving is an efficient 'slip-over' solution allowing for easy installation of wires or bundles of cables' entire run. Flame spread is a vital safety consideration

in applications such as home built aircraft wiring and or retrofitting new avionics. Self-extinguishing Protect-Fast PFA-PFW material is FAR25 approved, fully complies with UL standard VW-1. The addition of an organic flame inhibitor to our triaxially braided PFW split sleeving provides the perfect solution to a wide range of cable management needs. Protect-Fast is a tough, lightweight method used to contain and protect cable assemblies, hoses and wire harnesses from abrasion and cutting. Solvent resistant with a temperature rating from -75°C to 125°C (-103°F to 257°F). Provides 150% Expansion Sleeve with 25% Overlap Wrap.

Nominal (Inch)	Feet (per Roll)	Part No	Price	Feet (per Roll)	Part No	Price
1/8	100	05-12884	\$71.85	400	05-12892	\$0.95
1/4	100	05-12885	\$96.75	200	05-12893	\$1.35
1/2	75	05-12886	\$102.95	150	05-12894	\$1.85
3/4	50	05-12887	\$84.00	100	05-12895	\$2.15
1	50	05-12888	\$116.95	100	05-12896	\$2.95
1-1/4	75	05-12889	\$275.95	75	05-15257	\$4.60
1-1/2	25	05-12890	\$110.95	75	05-12898	\$5.75
2	25	05-12891	\$152.95	50	05-12899	\$8.50

PROTECT-FAST INSTALLATION TOOLS

Sieve	Part No.	Price
1/4"	05-12900	\$11.50
1/2"	05-12901	\$13.95
3/4"	05-12902	\$16.50

Sieve	Part No.	Price
1"	05-12903	\$15.50
1-1/2"	05-12904	\$22.70

VISHAY DALE RESISTOR - METAL FILM



Vishay Dale Resistor 15 OHMS Metal Film. Note: For Garmin G5 Certified Aircraft.
 15 OHMS P/N 11-17265 **\$0.68**
 120 OHMS P/N 11-17470 **\$0.34**

ELECTRICAL TERMINALS

KOROSEAL LACING



Excellent lacing material. Permanently flexible. Resists oxidation, impervious to petroleum products. Holds tension on knots indefinitely. Perfect for holding wire bundles, tubing, etc. Rectangular cross-section 3/32" x 5/32" P/N 11-12200 **\$0.74/Ft.**

KSL-1 KOROSEAL LACING



Koroseal Lacing used as a tie-off for hose & aeroduct tubing. Perfect for a nose strut seal kit and many other applications, FAA/PMA, 3/32" x 5/32" x 100' roll. P/N 04-03465 **\$46.50**

BREYDEN POLYESTER LACING TAPES



Flat braided tape manufactured from 100% high tenacity, continuous filament polyester fiber. This product conforms to the requirements of A-A-52081-C-3 MIL-T-43435B; Type II, Size 3, Finish C. The tape is uniformly impregnated with a synthetic elastomer coating to improve knot holding and tying characteristics. Ideal for spot tying. 500 yd. rolls. Width: .085" (±10%); Thickness: .014" (±.003"); Tensile Strength: 50 Lb. (min.); Elongation: 40% (max.)

Natural P/N 11-02012 **\$29.65**
Black P/N 11-02013 **\$33.50**

BREYDEN NYLON LACING TAPES

Flat braided tape manufactured from 100% high tenacity, continuous filament nylon yarn. This tape is impregnated with a specially formulated microcrystalline, fungicidal wax. Conforms to the requirements of A-A-52080-B-3. Recommended for continuous lacing. 500 yd. rolls. Width: .077" (min.) / .094" (max.); Thickness: .011" (min.) / .017" (max.); Tensile Strength: 50 Lb. (min.); Wax Content: 15-32%; Elongation: 40% (max.)

Natural P/N 11-12170 **\$35.65**
Black P/N 11-12160 **\$37.50**

MS25181 NYLON SPLICES

Butt-type, self insulated.



Part No.	Wire Range	Price
320559	22-18	\$0.80
320562	16-14	\$0.77
320570	12-10	\$1.23

AMP® BATTERY TERMINALS

Terminals may be crimped or soldered.



Part No.	AWG Size	Amps	Stud Size	Price
33461	8	35	1/4"	\$0.30
33466	6	50	5/16"	\$0.46
33470	4	70	5/16"	\$0.70
321600	2	90	3/8"	\$2.25
321868	1/0	125	3/8"	\$2.45

COPPER EYELET BATTERY LUG

6 GA Copper Eyelets 1/4" Stud.



P/N 11-05110 **\$1.20**

RING AND SPADE TONGUE TERMINAL

Specifications: Wire Range (mm [AWG]): 0.30-1.40² [22-16], Wire/Cable Size (CMA): 509 - 3,260 Tongue Material Thickness (mm [in]): 0.84 [0.033], Voltage (VAC): 300

Ring Tongue Term 320572 5/16" P/N 11-09313 **\$0.80**
Ring Tongue Term 320573 3/8" P/N 11-09314 **\$0.70**
Ring Tongue Term 328975 1/2" P/N 11-09315 **\$0.95**

MS25171 ELECTRICAL TERMINAL NIPPLES



Right angle nipples made of silicone rubber (MIL-R-5847, Class II, Grade 50).

Part No.	Dimension								Dash No.	Price Each
	A	B	C	D	E	F	G	H		
11-03913	1.38	.56	.06	.40	.63	.16	.41	.76	-1S Red	\$1.20
11-04837	1.38	.56	.06	.40	.63	.16	.41	.76	-1S Black	\$1.22
11-14260	1.38	.56	.06	.40	.63	.16	.41	.76	-1S White	\$1.15
11-14261	2.50	1.00	.06	.56	.82	.31	.56	.95	-2S Red	\$1.65
11-03914	2.50	1.00	.06	.56	.82	.31	.56	.95	-2S White	\$1.41
11-08287	2.50	1.00	.06	.56	.82	.31	.56	.95	-2S Black	\$1.70
11-14262	2.50	1.00	.06	.56	.82	.43	.68	.95	-3S Red	\$1.65
11-14263	2.50	1.00	.06	.56	.82	.43	.68	.95	-3S Black	\$1.70
11-03915	2.50	1.00	.06	.56	.82	.43	.68	.95	-3S White	\$1.40
11-14265	2.50	1.00	.06	.56	.82	.56	.82	.95	-4S Red	\$1.79
11-14266	2.50	1.00	.06	.56	.82	.56	.82	.95	-4S Black	\$1.78
11-03916	2.50	1.00	.06	.56	.82	.56	.82	.95	-4S White	\$1.42

AMP® SOLDERLESS TERMINALS & SPLICES



AMP's solderless electrical terminals and splices meet and exceed today's requirements for reliable terminals in applications ranging from control circuits to heavy duty power wiring. A limited number of sizes and types of terminals and tools are featured in this catalog. Information and pricing on unlisted items furnished on request.

RING TONGUE, NON-INSULATED TERMINALS

The barrel and tongue of these terminals are fabricated of the finest electrolytic copper and electro-tinned for optimum performance. The seam is brazed for uniform metal strength around the entire barrel area.

Part No.	AWG Size	Stud Size	Price	Part No.	AWG Size	Stud Size	Price
34104	22-16	4	\$0.24	34123	16-14	10	\$0.16
34105	22-16	6	\$0.60	34124	16-14	1/4	\$0.22
34108	22-16	8	\$0.22	32994	12-10	8	\$0.31
34109	22-16	10	\$0.22	33457	12-10	10	\$0.13
34113	22-16	1/4	\$0.28	33469	4	1/4	\$0.65
321684	16-14	6	\$0.57	35772	12-10	1/4	\$0.22
34122	16-14	8	\$0.20	35135	12-10	1/2	\$0.65

RING TONGUE, NYLON INSULATED TERMINALS

Each insulated PIDG terminal consists of a tin plated copper body, a tin plated copper wire support sleeve and a color-coded insulation sleeve.



Part No.	AWG Size	Stud Size	Price	Part No.	AWG Size	Stud Size	Price
31880	22-16 Red	4	\$0.44	31903	16-14	10	\$0.28
31885	22-16	6	\$0.26	31906	16-14	1/4	\$0.84
31890	22-16	8	\$0.30	35149	12-10 Yellow	6	\$0.48
36154	22-16	10	\$0.18	35108	12-10	8	\$0.35
31894	22-16	1/4	\$0.40	35109	12-10	10	\$0.30
32442	16-14 Blue	6	\$0.29	35110	12-10	1/4	\$0.45
31902	16-14	8	\$0.20	35112	12-10	3/8	\$0.63

KNIFE DISCONNECTS



Nylon Insulated Two Required Per Assembly.

32446 22-16 Red **\$0.45 ea.**
32448 16-14 Blue **\$1.37 ea.**
35762 12-10 Yellow **\$1.35 ea.**

BUTT TYPE SPLICES PLASTI-GRIP

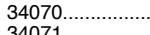

34070 22-16 Red **\$0.16 ea.**
34071 16-14 Blue **\$0.20 ea.**
34072 12-10 Yellow **\$0.39 ea.**
2RB14 16-14 Blue **\$0.75 ea.**

AMP TERMINAL KITS

Terminal & Splice Kit P/N 11-50000 **\$94.00**
Above w/15 Drawer Cabinet P/N 11-50005 **\$168.00**
Above w/Cabinet and 604252-1 tool P/N 11-50010 **\$189.00**

**FOR KIT COMPONENTS VISIT
WWW.AIRCRAFTSPRUCE.COM
OR CALL OUR SALES TEAM AT: 1-877-4-SPRUCE**

PIDG FASTON RECEPTACLES BY AMP



Part #	Style	Tab Width	AWG	Tab Thk.	Price
640903-1	B	0.250"	22-18	.032	\$0.29
640905-1	B		16-14	.032	\$0.27
42844-1	B		14-12	.032	\$0.55
640909-1	B	0.205"	22-18	.020	\$0.30
640911-1	B		22-18	.032	\$0.55
640913-1	B		16-14	.020	\$0.30
640915-1	B	0.187"	16-14	.032	\$0.35
640917-1	B		22-18	.020	\$0.25
640919-1	B		16-14	.020	\$0.30
61048-1	B	.110"	22-18	.016	\$0.58
61060-1	B		22-18	.020	\$0.30
60894-1	B		22-18	.032	\$0.37
640923-1	A	.110"	22-18	.020	\$0.30
640925-1	A		22-18	.032	\$0.30
640929-1	A		16-14	.020	\$0.30

*Style A:
No dimple w/wire stop.
**Style B: Dimple w/wire stop. Less 20% on 100 pcs. (per P/N)

WIRE PIDG CAPS



16-14G closed barrel end splice.

Color	Part No.	Price
Blue	11-11842	\$0.65
Yellow	11-11843	\$0.62
Red	11-11841	\$0.39

LIQUID ELECTRICAL TAPE



Protects connections with applicator brush protects electrical connections and terminals against corrosion. 4oz. Bottle
P/N 09-42565 **\$14.50**

EL

SEAL-ALL CONNECTORS

Seal-All Connectors are an environmentally sealed connection system developed to withstand exposure to extreme temperatures, moisture and harsh engine compartment fluids and chemicals with unfaltering performance. It consists of mating heat stabilized polyamide housings, male and female "pin and socket" terminals and self-lubricating silicone connector and cable seals. Seal-All connector configurations are available for one to six wires. -40 C to 125 C temperature range. Now you can have the same superior Plug/Connector that is used in vehicle OEM manufacturing.

Below are sold as the shell only. Terminal connector kits are not included. Order separately.

SEAL-ALL CONNECTORS (MALE AND FEMALE SHELLS ONLY)

	SINGLE CONDUCTOR KIT MANF P/N - WHT1C P/N 11-06581 \$3.50
	DOUBLE CONDUCTOR KIT MANF P/N - WHT2C P/N 11-06582 \$4.65
	TRIPLE CONDUCTOR KIT MANF P/N - WHT3C P/N 11-06583 \$4.95
	4 CONDUCTOR KIT MANF P/N - WHT4C P/N 11-06584 \$5.90
	4 CONDUCTOR KIT MANF P/N WHT4CSQ P/N 11-06585 \$8.70
	5 CONDUCTOR KIT MANF P/N - WHT5C P/N 11-06586 \$11.95
	6 CONDUCTOR KIT MANF P/N - WHT6C P/N 11-06587 \$7.85

VINYL TUBING

Clear PVC tubing for cable protection. Commonly called "spaghetti". Meets Spec. MIL-I-631D.

AWG Size	I.D.	Wire Wall	Size	Part No.	Price/Ft.	100 Ft.
9	.118	.020	20-22	11-02200	\$0.25	\$20.00
7	.148	.020	16-18	11-02300	\$0.35	\$28.00
5	.186	.020	12-14	11-02400	\$0.19	\$15.20
2	.263	.020	8-10	11-02500	\$0.24	\$19.20
5/16	.312	.025	6	11-02600	\$0.39	\$31.20
3/8	.375	.025	4	11-02700	\$0.45	\$36.00

PREMIUM VINYL TUBING

This premium vinyl tubing is recommended for use in extremely cold temperatures where tubing can be prone to becoming stiff and brittle. Manufactured to Spec. MIL-I-7444B, this tubing can be coiled and bent easily and will retain some flexibility even in extreme temperatures. Sold in 50 ft. and 100 ft. coils in the sizes listed below.

AWG Size	Wire Size	I.D. (In.)	Wall (In.)	50 Ft. Coil		100 Ft. Coil	
				Part No.	Price	Part No.	Price
9	20-22	.118	.020	11-16195	\$15.75	11-16190	\$31.50
7	16-18	.148	.020	11-16175	\$15.75	11-16170	\$31.50
5	12-14	.186	.020	11-16155	\$22.50	11-16150	\$44.75
2	8-10	.263	.020	11-16125	\$27.50	11-16120	\$54.90
5/16	6	.312	.025	11-16165	\$32.00	11-16160	\$64.00

METALIZED PLASTIC D-SUB HOUSINGS

Straight / Top entry. 4-40 Thumbscrews supplied with backshell. Perimeter sealing lips for secure sealing. Available in metalized plastic and plastic. Metalized plastic provides up to 60 dB shielding.

Description	Part No.	Price
9 Pin	11-13014	\$6.95
15 Pin	11-13015	\$10.85

Description	Part No.	Price
25 Pin	11-13016	\$13.50
37 Pin	11-13017	\$10.85

TERMINAL CONNECTOR KITS FOR SEAL-ALL CONNECTORS



Terminal Kits (includes 6 each-male, female terminals and 12 seals). Will work with all Seal-All Shells. Note-the male terminal pin goes into the female shell.

24-22 Ga Wire MANF P/N - WHT2422.....	P/N 11-06588	\$11.95
20-18 Ga Wire MANF P/N - WHT2018.....	P/N 11-06589	\$9.35
16-14 Ga Wire MANF P/N - WHT1614.....	P/N 11-06590	\$9.75

SEAL-ALL HEAVY DUTY CONNECTOR



Heavy Duty Connector-42 amps continuous maximum current rating. For 12-10 gauge wire. Complete 2 conductor kit

P/N 11-06591 \$17.65

SEAL-ALL HEAVY-DUTY CRIMP TOOL



Non-ratchet tool designed to crimp the terminals and seal for the Seal-All Heavy-duty connector (P/N: 11-06591).

P/N 11-17552 \$153.85

SEAL-ALL CRIMP TOOL



Crimp tool works with all Seal-All terminals and seals. Its compact, low-cost parallel jaw design eliminates terminal rocking. Seal-All Crimp Tool

P/N 11-06592 \$43.85

PROFESSIONAL SEAL-ALL CRIMPER



Crimps Seal-All terminals and seals in one cycle. Features two double Cavities, an orientation block and a ratchet mechanism to ensure that each crimp cycle is completed. Factory calibrated to be used only with Seal-All terminals and seals. Wire range 20-14.

Pro Seal-All Crimper
P/N 11-06593 \$164.75

SEAL-ALL TERMINAL RELEASE TOOL



A must have tool for working with Seal-All shells and terminals. Designed to depress Seal-All retention bars to allow terminal removal from shells. Seal-All Tool

P/N 11-06594 \$8.60

AVIONICS CONNECTORS

Descriptions	Part No.	Price
9 Pin Female D Connector / Crimp	11-12149	\$1.65
9 Pin Silver Female Sub-D Crimp Connector	10-05731	\$1.14
15 Pin Silver Female Sub-D Connector Crimp Style	11-13296	\$1.20
25 Pin Silver Female Sub-D Connector Crimp Style	11-13297	\$1.35
37 Pin Silver Female Sub-D Connector Crimp Style	11-13298	\$2.65
9 Pin Male D Connector / Crimp	11-12150	\$1.20
37 Pin Female D Connector / Crimp	11-12151	\$2.75
37 Pin Male D Connector / Crimp	11-12152	\$3.50
25 Pin Female D Connector / Crimp	11-12153	\$2.15
9 Pin D Connector Cable Clamp	11-12154	\$1.95
37 Pin D Connector Clamp Cable	11-12155	\$2.85
15 Pin Male Crimp Sub-d Connector	11-11892	\$1.85
25 Pin Male Crimp Sub-d Connector	11-11893	\$1.55
25 Pin D Connector Cable Clamp	11-11894	\$2.48
SMA Male Crimp RG58	11-12173	\$32.50
Dual SMA Male Crimp RG142-400	11-12172	\$68.85
15 Pin Female Crimp Style-d Connect	11-11878	\$1.75
15 Pin Sub-d Cable Clamp Housing	11-11879	\$2.65
34 Pin Grounding Block	11-01297	\$129.95
Female Sub-d Pin 20-24 Gauge Crimp Socket	11-11877	\$0.59
Female Screw Lock For Sub-d Connector	11-11896	\$1.45
Molex 19417 Connector AWG Crip Contact Female	10-05932	\$0.14
Molex 19417 Connector AWG Crip Contact Male	10-06266	\$0.21
Male High Density Sub-D Pin 24 to 22 Gauge Crimp Pin - Garmin	11-12111	\$0.55
34 Pin Receptacle	10-05895	\$15.50

CRIMP SOCKETS FOR GROUNDING BLOCKS



Crimp Sockets. For use with grounding blocks and CPC Series 1 Connectors.

Model	Description	Part No.	Price
66105-1	24-20 AWG, Gold/Nickel finish	10-05891	\$1.95
66105-4	24-20 AWG, Selenium/Gold/Nickel finish	10-05892	\$1.10
66101-1	18-16 AWG, Gold/Nickel finish	10-05893	\$2.15
66101-4	18-16 AWG, Selenium/Gold/Nickel finish	10-05894	\$1.10

CRIMPING TOOLS



LITTLE BLUE CRIMPER

The Daniels AFM8 is designed for most of the miniature and sub-miniature connector types that are so widely used in all types of electronic systems. Originally developed for the Air Force, the AFM8 meets the need for a miniature tool accommodating wire sizes 20 thru 32 AWG. The cycle controlled precision ratchet assures consistently accurate crimps every time. The tool has a built-in eight step selector knob for ease in dialing the correct crimp depth setting for the wire being used.....P/N 11-04443 **\$466.00**
 K13-1 Low Density Pin Positioner for Little Blue Crimper.. P/N 11-12211 ...**\$83.75**
 K42 High Density Pin Positioner for Little Blue Crimper.. P/N 11-12212 ...**\$83.75**
 DMC Crimp Tool Turret Head Assembly P/N 11-12197 **\$159.95**
 DMC Crimp Tool Universal Head Assembly..... P/N 11-12198 **\$123.75**

BIG BLUE CRIMPER

The Daniels AF8 has virtually limitless application within the specified wire range of 12 thru 26 AWG. Over 1,000 turret heads or positioners are available to adapt the tool frame to your specific military or proprietary contact/wire combination. The eight impression crimp, which is standard in the AF8, assures absolute maximum tensile strength with almost every closed barrel contact. The precision ratchet controls cycling on the tool in both directions of handle movement. This assures the same, accurate crimp every time. It's like having a quality control inspector at every work station.....P/N 11-04442 **\$466.00**

HAND INSERTION TOOL

This inexpensive, manual tool is lightweight and easy to use in the placement and/or removal of a terminal in a housing.....P/N 11-04439 **\$68.75**

MATE-N-LOK INSERTION PIN & SOCKET TOOL

Insertion tool for grounding blocks and locking connectors. The AMP insertion tool for MATE-N-LOK pins. Contact sizes 20-24 AWG P/N 11-04437 **\$65.75**

MATE-N-LOK EXTRACTION PIN & SOCKET TOOL

Insertion tool for grounding blocks and locking connectors. The AMP insertion tool for MATE-N-LOK pins. Contact sizes 20-24 AWG P/N 11-04438 **\$19.75**

PIN & SOCKET TOOL W/INTERCHANGEABLE TIPS

This insertion & extraction tool consists of a handle, a cap, six insertion/extraction tips, a plug, and a .050-in. hex wrench. The handle of the tool provides storage for the tips, plug and hex wrench. Each tip is color coded according to specific type and wire size. P/N 11-04436 **\$33.75**

AMPHENOL RF TNC CONNECTORS

Amphenol RF TNC Threaded Connector Series are miniature, threaded weatherproof units with a constant 50Ω impedance that operate from 0-11GHz. There are two types of TNC connectors: Standard and Reverse Polarity. Reverse polarity is a keying system accomplished with a reverse interface, and ensures that reverse polarity interface connectors do not mate with standard interface connectors. Many TNC connectors are recognized under the component program of Underwriter's Laboratories and have undergone stringent testing from an independent laboratory.

- TNC 400 Right Angle Male P/N 11-15368 **\$6.60**
- TNC 400 Straight Plug P/N 11-15369 **\$2.70**
- TNC 12108 Straight Plug P/N 11-15370 **\$2.48**
- TNC 122430 Right Angle Male P/N 11-15371 **\$6.85**

QUICK DISCONNECT FEMALE PANEL MOUNT COUPLING

1 / 4 Hose Barb Valved Panel Mount Coupling Body. P/N 11-04068 **\$24.50**

QUICK DISCONNECT FEMALE - IN LINE

1 / 4 Hose Barb Non - Valved In - Line Coupling Body P/N 11-04066 **\$7.95**

QUICK DISCONNECT INSERT

For 1/4" ID tubing. Used with 11-04066 Quick Disconnect In-line or 05-01984 Quick Disconnect Panel Mount. P/N 11-04067 **\$3.35**

QUICK DISCONNECT MALE IN LINE W SHUT OFF

P/N 11-04069 **\$9.90**

MS27488-22-2 SEALING PLUG

MS27488-22-2 - Connector Accessory, Sealing Plug, Circular Connectors. The MS27488-22-2 is a black grommet End Sealing Plug made of fluorinated ethylene propylene (FEP). The connector grommet end sealing plug from Aiconics can be used with the connectors and the terminal junction systems having wire sealing grommets conforming to MIL-DTL-26500, MIL-DTL-28804, MIL-C-29600, MIL-DTL-38999, MIL-C-81511 series 3 & 4, SAE-AS81659. The high quality connector sealing plug can be installed in connector grommet cavity sizes 23-22 P/N 11-16603 **\$0.13**

TE MALE JACKSCREW KIT 203618-1

Male Jackscrew Kit, Unassembled, Short for Ground Connector, M Series P/N 10-07121 **\$16.50**



HAND CRIMP TOOL CENTER CRIMP TERMINAL 18-30 AWG

Hand Crimp Tool for 3.96mm Centers Crimp Terminals, intended for use when tooling. P/N 10-05929 **\$359.00**



HAND CRIMP TOOL - LOOSE PIECE TERMINALS 14-22 AWG

Hand Crimp Tool for 2mm Loose Crimp Terminals, intended for use when tooling.....P/N 10-05928 **\$399.00**



CRIMPER FOR BATTERY LUGS 8-1 GA

Tool For Crimpable Battery Lugs. Light duty crimping tool. Crimps battery lugs from 8-1 ga. P/N 12-03718 **\$248.95**



CRIMPER HAMMER TOOL FOR 8GA 4/0 BATTERY LUGS

Economically priced. Used with a hammer for a quick crimp in maintenance and repair situations. Handles terminals from 8-4/0 ga.P/N 12-03719 **\$32.50**



BENCH MOUNT TOOL HEX CRIMP BATTERY LUGS 8 GA TO 250 MCM

Bench mountable version of stock #460. Crimps 8-4/0 ga lugs.....P/N 12-03721 **\$420.00**

CRIMPER FOR COPPER BATTERY EYELET LUGS 8-4/0 GA



Crimps eyelet style copper lug terminals 8-4/0 ga. Includes 3 separate dies.....P/N 12-03722 **\$199.85**

QUICK DISCONNECT FEMALE BULK

For 1/4" ID tubing. Used with 05-01984 Quick Disconnect Panel Mount or 11-04066 Quick Disconnect In-line P/N 05-01984 **\$18.85**

PIN INSERTION & EXTRACTION TOOL

The insertion of contacts during assembly or replacement during repair is quick and easy with the appropriate tools. The tools have to fit the contacts and the connectors if assembly and repair are to be carried out correctly. This tool is also absolutely necessary to use for extracting a broken pin for replacement or moving a misplaced pin for relocation. Insert and extract all your connector pins & sockets with this premium tool. It will work with both standard and high-density pins. **For Garmin high density pins, please use part 22-28 AWG, part # 11-04435.**

- 16 AWG Blue/White P/N 11-04431 **\$11.95**
- 20 AWG Red/White P/N 11-04432 **\$23.50**
- 24-20AWG Red/White..... P/N 11-04433 **\$4.95**
- 20 AWG Green/White..... P/N 10-06933 **\$0.95**
- 22 AWG Green/White..... P/N 11-04434 **\$9.95**
- 22-28AWG Green/White P/N 11-04435 **\$3.50**

EXTRACTION HAND TOOL

Use With Part(s): Loose Piece Terminals. P/N 11-14948 **\$29.95**

M81969/14-11 INSERTION AND EXTRACTION TOOL

The M81969/14-11 insertion/extraction tool can be used to insert and extract contacts for the following connector series: • MIL-DTL-26482 Series II • AS81703 Series III • MIL-DTL-83733 • MIL-DTL-83723 Series II & III • AS50151 • AS81714 P/N 11-16736 **\$0.40**

REMOVAL TWEEZERS #20

Removal tweezer designed for size 20 contacts installed in ITT-Cannon "D*C and D*U" Series, rear release D-subminiature connectors. Contact numbers: 030-1952-000, 030-1953-000, 030-1954-000, 030-1955-000.

- Removal Tweezer #20 P/N 11-14936 **\$109.75**
- Removal Tweezer #20 Long Probe P/N 11-14937 **\$98.75**

EL

CABLE TIES – SPIRAL WRAP



AMP® FLEXI-BLOCK MODULAR TERMINAL BLOCK SYSTEM

Assemble terminal blocks to custom requirements in seconds:

1. Pull out the number of block assemblies required from dispenser box. 2. Cut the track with hacksaw or cutting tool two spaces longer than unit. Slip the block assembly into the track 3. Insert end stops and assembly is complete.

PROFESSIONAL KIT - No. 6 kit consists of 100 ea. P/N 604101-1 block assemblies, 25 ea. of P/N 604111-1 end stops & 2 ea. P/N 601805-1 track 3 ft. long. Complete kit.P/N 601804-8**\$699.00**

COPPER BUS BAR - 0.125" x .5" WideP/N 03-40890 **\$3.80/ft**

AMP® SPIRAP SPIRAL PLASTIC TUBING

Spirap plastic tubing is a fast and economical way to bundle wires and harnesses. It is designed to protect wire insulation for the life of the circuit even under severe vibration. Spirap tubing obtains its gripping ability from the memory of the plastic. When 1/4" diameter Spirap is wrapped around a 3/4" diameter wire bundle, the Spirap tubing tries to return to its original 1/4" diameter size, effectively gripping the wire bundle. Flame retardant polyethylene. Bundle diameter range: 3/16" to 2". Discount: 20% less on orders of 100 feet.

WhiteP/N 500004-1 **\$2.50/ft.**
BlackP/N 11-08320 **\$0.84/ft.**

SPIRAL WRAP WIRE PROTECTORS

Permits flexible routing of cable harness while forming a neat, protective bundle. It twists on easily and quickly and allows lead-outs at any point. When installed, it may be gapped for greater economy and flexibility or it may be butted tightly for maximum abrasion resistance, insulation protection and greater rigidity. Nylon type-for use in wider temperature ranges with high resistance to abrasion and good solvent resistance.

PE=Polyethylene
NY=Nylon

Part No.	Size	Material	Color	Temp Rate	Price/ft
11-12316	3/16"	PE-FR	Natural	-4°F to +176°F	\$0.75
11-12314	1/4"	PE-FR	Natural	-4°F to +176°F	\$0.65
11-12338	3/8"	PE-FR	Natural	-4°F to +176°F	\$1.35
11-17147	1/2"	PE-FR	Natural	-4°F to +176°F	\$1.55
11-12334	3/4"	PE-FR	Natural	-4°F to +176°F	\$2.75
11-17146	1"	PE-FR	Natural	-4°F to +176°F	\$5.35
11-16881	1/8"	PTFE	Natural	-449°F to +500°F	\$2.10
11-16880	1/4"	PTFE	Natural	-449°F to +500°F	\$5.80
11-16883	3/8"	PTFE	Natural	-449°F to +500°F	\$9.70
11-16882	1/2"	PTFE	Natural	-449°F to +500°F	\$11.55
11-17144	3/4"	PTFE	Natural	-449°F to +500°F	\$19.50
11-17145	1"	PTFE	Natural	-449°F to +500°F	\$23.50
11-17150	1/8"	PA6	Natural	-40°F to +250°F	\$0.65
11-17149	1/4"	PA6	Natural	-40°F to +250°F	\$0.90
11-17151	3/8"	PA6	Natural	-40°F to +250°F	\$1.55
11-12312	1/2"	PA6	Natural	-40°F to +250°F	\$1.75
11-17148	3/4"	PA6	Natural	-40°F to +250°F	\$4.35
11-12311	1"	PA6	Natural	-40°F to +250°F	\$4.35
11-17153	1/8"	PA6	Black	-40°F to +250°F	\$0.65
11-17155	1/4"	PA6	Black	-40°F to +250°F	\$0.95
11-17156	3/8"	PA6	Black	-40°F to +250°F	\$1.80
11-17154	1/2"	PA6	Black	-40°F to +250°F	\$2.15
11-17158	3/4"	PA6	Black	-40°F to +250°F	\$5.80
11-17157	1"	PA6	Black	-40°F to +250°F	\$3.60
11-17159	1/8"	PE-FR	Black	-4°F to +176°F	\$0.95
11-17160	3/8"	PE-FR	Black	-4°F to +176°F	\$1.55
11-17161	1/2"	PE-FR	Black	-4°F to +176°F	\$2.11
11-17162	3/4"	PE-FR	Black	-4°F to +176°F	\$2.60
11-17163	1"	PE-FR	Black	-4°F to +176°F	\$7.50



NYLON BULKHEAD SEALS

Nylon Bulkhead seals are used when electrical harnesses or tubing is passed through bulkheads in pressurized and non-pressurized aircraft.

Bulkhead Seal, Square, 1-1/8" Hole.....P/N 11-04059**\$51.75**
Bulkhead Seal, Elliptical, 3/4" HoleP/N 11-04061**\$7.50**
Bulkhead Seal, Elliptical, 1/2" HoleP/N 11-04060**\$6.25**
Bulkhead Seal, Square, 1-3/8" Hole.....P/N 11-04062**\$52.75**

CABLE TIES

This all nylon cable tie is designed to hold cables securely. Bundling strength military requirements. Installs in just seconds.

Cat. #	L"	Tensile Strength	Max Dia.	Part No.	Price
MS3367-4-9	4"	18 lbs	0.63"	11-04230	\$0.04
MS3367-5-9	5"	30 lbs	1.13"	11-04039	\$0.13
MS3367-1-9	7"	50 lbs	1.75"	11-04229	\$0.11
--	8"	18 lbs	2"	11-12866	\$0.08
MS3367-7-9	11"	50 lbs	3"	11-12865	\$0.20
MS3367-2-9	14"	50 lbs	4"	11-04058	\$0.13
MS3367-3-9	14"	120 lbs	4"	11-13475	\$1.05

35% discount on 500 per part no. 40% Discount on 1000 per part no.

CABLE TIE ASSORTMENT PACK

Includes: MS3367-5-9 Cable Ties 5"(15), Cable Ties MS3367-4-9(15), Cable Ties MS3367-1-9(20), Cable TiesMS3367-29(5).... P/N 11-03768**\$7.25**

TYTON HORIZONTAL IDENTIFICATION CABLE TIES

Length: 8"; Strength: 50 lbs.... P/N 11-12360**\$0.22**

TYTON VERTICAL IDENTIFICATION CABLE TIES

Length: 4"; Strength: 18 lbs .. P/N 11-12365**\$0.16**

TYTON MOUNTING CABLE TIES

Length: 4"; Strength: 18 lbs .. P/N 11-12350**\$0.10**
Length: 8"; Strength: 50 lbs .. P/N 11-12355**\$0.09**

TY-RAP™ CABLE TIES WITH SS LOCK

Stainless steel locking device in the head secures tie with longer-lasting, corrosion-resistant "grip of steel". Oval, low profile head prevents snagging while pulling through bulkheads. No sharp edges to be the source of installation injuries or to damage the wire insulation. 1000 per pack.

Mfg. No.	Length	Max Dia.	Tensile Strength	Part No.	Price 100 Pack	Price 1000 Pack
TY23M	4"	0.63"	18 lb	04-02628	\$10.95	\$99.75
TY24M	5.5"	1.13"	40 lb	04-02630	\$17.50	\$154.75
TY25M	7"	0.63"	18 lb	04-02631	\$23.50	\$209.95
TY26M	11"	1.13"	40 lb	04-02633	\$42.50	\$386.00
TY28M	14"	3"	30 lb	04-02632	\$63.80	\$580.00

READY-ZIP-PACK™ CABLE TIE ORGANIZER WITH BELT

Ready-Zip-Pack is a portable solution for carrying zip ties in a handy ready to use fashion. Whether climbing a ladder, walking a line or in a tight space. No more fumbling in your apron pockets or worse holding them in your mouth, our assorted length zip ties will be conveniently ready right on your hip. Along with the customized holster for the Ty-D-Up flush cutter and the all-weather 50-inch long canvas belt makes all your jobs go faster, cleaner and easier. Grommetted corner holes will also allow the user to secure or carry the RZP as an over the shoulder carrier or can be positively affixed to a surface of your choosing.

In The Box: • 1 - Wearable zip tie organizer pack with belt • 1 - 50 Black each of 4", 6", 8", 11", 14" ties • 1 - Flush cutterP/N 11-17396**\$36.67**

READY-ZIP-GO™ CABLE TIE ORGANIZER WITH MAGNETIC BASE

Ready-Zip- Go Zip Tie Holder for all your projects and hobbies No more fumbling or sorting through bags, drawers or tubes for the right zip tie. The convenient system makes your workplace orderly and uncluttered. The magnetic tie holder is equipped with 250 or 500 black zip ties and a flush cutter.

In The Box: Depending on quantity size:
• For 500 Pack - 100 Black Zip Ties each of 4", 6", 8", 11" 14" (P/N 11-17394) • For 250 Pack - 50- Black Zip Ties each of 4", 6", 8", 11" 14" (P/N 11-17395) • 1-Flush Cutter
250 Pack.....P/N 11-17395**\$42.75**
500 Pack.....P/N 11-17394**\$62.75**

STA-KON ELECTRICAL TERMINALS

Color-coded MS25036 nylon ring w/self-insulated grip. 20% Discount on 100

Wire Range: 22-16				Wire Range: 18-14 Cont.			
Mfg. No.	P/N	Bolt Hole	Price	Mfg. No.	P/N	Bolt Hole	Price
RA18-4	11-03864	4	\$0.80	RB14-10	11-03867	10	\$0.71
RA18-6	11-03865	6	\$1.28	RB14-14	11-03868	1/4	\$0.98
RA18-8	11-03866	8	\$0.75	Wire Range: 12-10			
RA18-10	11-03862	10	\$0.90	RC10-6	11-03874	6	\$0.92
RA18-14	11-03863	1/4	\$1.60	RC10-8	11-03875	8	\$0.88
Wire Range: 18-14				RC10-10	11-03871	10	\$0.98
RB14-4	11-04093	4	\$0.55	RC10-14	11-03872	1/4	\$1.50
RB14-6	11-03869	6	\$1.45	RC10-38	11-03873	3/8	\$1.20
RB14-8	11-03870	8	\$0.85				

CABLE TIES – HEAT SHRINK TUBING



COBRA® CABLE TIES

With a contoured locking head, the Cobra configuration is safer, more flexible and stronger than existing cable ties. Safer because the (often barbed) stub is now deflected into a pocket at the rear of the head. More flexible because the flat lock section curves to the bundle contour and stronger because the Cobra uses an inline geometry, eliminating the stress points of traditional cable ties. Bundles down to 3/8" diameter and meets new AS 3361 specs. Features pick-proof underside lock & all rounded edges.

Color	Qty.	Tensil	Length/Width	Part No.	Price
UV Black	100	50 Lbs.	7.5" x .178"	11-01883	\$7.90
UV Black	1000	50 Lbs.	7.5" x .178"	11-01884	\$56.75
Natural	100	50 Lbs.	7.5" x .178"	11-01885	\$7.50
Natural	1000	50 Lbs.	7.5" x .178"	11-01886	\$57.75
UV Black	100	50 Lbs.	11"	11-08033	\$11.50
UV Black	100	50 Lbs.	14"	11-08034	\$16.50
Black	-	120 Lbs.	14" x .178"	11-02416	\$21.90
Natural	-	120 Lbs.	14" x .178"	11-02417	\$21.95
Black	-	18 Lbs.	4" x .178"	11-02464	\$4.70
Natural	-	18 Lbs.	4" x .178"	11-02466	\$4.60
Natural	-	18 Lbs.	4" x .178"	11-02467	\$39.95

COBRA® CABLE TIE KITS

STANDARD - Kit includes: 100 low profile blk Cobra® ties , the rugged Cinch&Trim application gun and an instruction manual. Gun applies traditional as well as low profile ties. 7.5" Ties
 Black.....P/N 11-06319\$39.00 Natural P/N 11-06320...\$39.00

COBRA® FLEXROUTE TIES



A universal, durable, and simple cable management solution that secures and protects both the frame and cable. Utilizes the lowest profile nylon cable tie on the market.
 Standard.....P/N 11-16303\$9.50
 X-Large.....P/N 11-16304\$6.70

COBRA® RUBBER MOUNTS

Part No.	Size	Color	Qty.	Price
11-02470	3/4"	Black	100	\$18.50
11-02472	3/4"	Natural	100	\$16.50
11-02474	1"	Black	100	\$24.50
11-02476	1"	Natural	100	\$23.50

COBRA® ACRYLIC MOUNTS

Part No.	Size	Color	Qty.	Price
11-02478	3/4"	Black	100ct	\$18.50
11-02479	3/4"	Natural	100ct	\$16.50
11-02482	1"	Black	100ct	\$26.85
11-02484	1"	Natural	100ct	\$25.65

STANDARD CINCH AND TRIM GUN



C-200 Wraps ties from 18 to 50 lbs with auto tension setting & a rugged die cast aluminum body. Applies traditional ties as well as low profile ties.
 P/N 11-02468\$31.50

TYTON ADHESIVE CABLE TIE MOUNTS



Hellermann Tyton Adhesive Cable Tie Mounting Bases are used with T18 through T150 Series cable ties to provide stability when securing bundles. The mounts are installed using the adhesive backing and/or by securing two or four screws. The 4-way opening allows the cable ties to be inserted parallel or perpendicular to the wire bundles. Rubber-based adhesive allows for a permanent bond to most surfaces.

Features:

- Durable adhesive achieves high pull-off force and is unaffected by vibration.
- The 4-way opening allows cable ties to be installed parallel or perpendicular to bundles.
- Predrilled holes extend mounting options and security.
- Extended adhesive liner is easy to remove quickly.

Description	Dimensions	Max Tie Width	Hole Dia.	Part Number	Price
Adhesive Cable Tie Mount	.75" x .75"	.14"	.12"	11-16678	\$20.95
Adhesive Cable Tie Mount	.75" x .75"	.14"	.12"	11-16680	\$8.50
Adhesive Cable Tie Mount	1.12" x 1.12"	.18"	.18"	11-16681	\$12.55
Adhesive Cable Tie Mount	1.49" x 1.49"	.35"	.19"	11-16683	\$29.50

TYTON CABLE TIE ANCHOR MOUNTS



Hellermann Tyton cable tie mounts are designed for use with 18 through 120 pound cable ties to provide stability when securing bundles. The mounts are installed quick and easy by securing a single screw.

Features:

- Designed for use with 18 through 50 pound cable ties to provide stability when securing bundles.
- Secures with a single screw providing quick installation.

Description	Dimensions	Hole Dia.	Max Tie Width	Part Number	Price
Cable Tie Anchor Mount	.58" x .37"	.15"	.2"	11-16684	\$6.50
Cable Tie Anchor Mount	.58" x .37"	.19"	.2"	11-16685	\$6.50
Cable Tie Anchor Mount	.86" x .61"	.18"	.31"	11-16686	\$12.55
Cable Tie Anchor Mount	.86" x .61"	.2"	.31"	11-16687	\$13.70
Cable Tie Anchor Mount	.86" x .62"	.25"	.31"	11-16688	\$14.50

TYTON HEAT SHRINK TUBING



TFN21 is a highly flexible thin wall heat shrink tubing with a 2 to 1 shrink ratio and excellent flame retardant properties. In addition to providing insulation and abrasion protection for wires and cables, the polyolefin material also offers resistance to oils, solvents and chemicals.

Features:

- Thin, 2 to 1 shrink ratio tubing provides insulation and abrasion protection for wires and cables.
- Flammability rating of UL224 VW-1 for use in applications requiring the highest degree of flame protection (excludes clear tubing).
- Flexible-yet-durable material resists most common oils, chemicals and fluids.
- Available in a variety of diameters and colors for identifying and marking wires and cables.

Description	Diameter	Color	Part Number	Price Per Foot
Heat Shrink Tubing, Mini Reel, 2:1 Shrink Ratio	1/16"	Black	11-16689	\$0.43
Heat Shrink Tubing, Mini Reel, 2:1 Shrink Ratio	1/2"	White	11-16690	\$0.42
Heat Shrink Tubing, Mini Reel, 2:1 Shrink Ratio	1/4"	White	11-16691	\$0.50
Heat Shrink Tubing, Mini Reel, 2:1 Shrink Ratio	1/8"	White	11-16692	\$0.25
Heat Shrink Tubing, Mini Reel, 2:1 Shrink Ratio	3/8"	White	11-16693	\$0.55
Heat Shrink Tubing, Mini Reel, 2:1 Shrink Ratio	1/16"	White	11-16694	\$0.15
Heat Shrink Tubing, Mini Reel, 2:1 Shrink Ratio	3/32"	Black	11-16695	\$0.44
Heat Shrink Tubing, Mini Reel, 2:1 Shrink Ratio	1/8"	Black	11-16696	\$0.28
Heat Shrink Tubing, Mini Reel, 2:1 Shrink Ratio	1/4"	Black	11-16697	\$0.20
Heat Shrink Tubing, Mini Reel, 2:1 Shrink Ratio	3/8"	Black	11-16698	\$0.65
Heat Shrink Tubing, Mini Reel, 2:1 Shrink Ratio	1/2"	Black	11-16699	\$0.65
Heat Shrink Tubing, Mini Reel, 2:1 Shrink Ratio	3/4"	Black	11-16700	\$0.95
Heat Shrink Tubing, Mini Reel, 2:1 Shrink Ratio	1"	Black	11-16701	\$1.35

EL

BOGERT CABLES



BOGERT'S LOW LOSS COPPER CABLE KITS

Benefits:

- Starting performance improved, both hot & cold
- Eliminates nearly all voltage drop between battery & starter
 - Starter current draw reduced
- Faster cranking, crank longer on the same battery
 - Prolonged battery and starter life
 - Less stress on battery & starter system
 - Helps assure confidence in passengers
- Reduces the personal frustration and irritation factor
- Exceeds Piper Service Bulletins SB836 and SB836a

Contents:

- STC & AML Copy
- Sample log book entry
- Sample 337 sample entries
- Formula for figuring weight & balance, & C.G. Change
- Easy to follow instructions
- Schematic listing part numbers for all cables in the kit
- Flexible 1 gauge M22759, cut to length & assembled
 - Cut to the correct length
- Assembled with 'slim-head' style terminals
- Insulated with shrink tubing

Aircraft Application	Part No.	Our Price	Aircraft Application	Part No.	Our Price	
PA-12	11-00247	\$395.00	PA-28-235	Cherokee	11-15150	\$468.00
PA-16	11-00248	\$293.00	PA-28-236	Dakota	11-15152	\$532.00
PA-18	11-15102	\$346.00	PA-30	Twin Comanche	11-15154	\$724.00
PA-20	11-15104	\$247.95	PA-31-300	Navajo	11-15156	\$736.00
PA-22	11-15106	\$282.00	PA-31-310	Navajo	11-15158	\$736.00
PA-23-150/160	11-15108	\$769.00	PA31-325	Navajo	11-15160	\$736.00
PA-23-250	11-15110	\$843.00	PA-31-350	Navajo	11-15162	\$772.00
PA-24-180/250	11-15112	\$433.00	PA-31P	Navajo	11-15164	\$772.00
PA-24-260	11-15114	\$360.00	PA-31T1	Cheyenne I	11-15168	\$1,513.00
PA-31T	11-15166	\$1,510.00	PA-32R-301T	-----	11-15184	\$343.00
PA-24-260	11-15116	\$428.95	PA-32-260/300	Cherokee Six	11-15170	\$412.00
PA-24-400	11-15118	\$305.95	PA-32R-300	Lance	11-15172	\$367.00
PA-25-235/260	11-15120	\$430.00	PA-32RT-300	Lance	11-15174	\$357.00
PA-25-235/260	11-15122	\$430.00	PA-32RT-300T	Lance	11-15176	\$357.00
PA-28-140	11-15124	\$464.00	PA-32-301	-----	11-15178	\$387.00
PA-28-150/160	11-15126	\$466.00	PA-32R-301	-----	11-15180	\$296.95
PA-28-151	11-15128	\$419.00	PA-32-301T	Turbo Saratoga	11-15182	\$585.00
PA-28-161	11-15130	\$474.00	PA-34-200	Seneca I	11-15186	\$881.00
PA-28-180	11-15132	\$532.00	PA-34-200T	Seneca II	11-15188	\$814.00
PA-28R-180	11-15134	\$466.00	PA-34-220T	Seneca III	11-15190	\$814.00
PA-28-181	11-15136	\$467.00	PA-36-285		11-00250	\$379.00
PA-28R-200	11-15138	\$465.00	PA-36-300		11-00251	\$379.00
PA-28R-201	11-15140	\$468.00	PA-36-375		11-00252	\$508.00
PA-28R-201T	11-15142	\$457.00	PA-38-112	Tomahawk	11-15192	\$266.95
PA-28RT-201	11-15144	\$378.00	PA-39 C/R		11-00253	\$700.00
PA-28RT-201T	11-15146	\$457.00	PA-44-180	Seminole	11-15194	\$998.00
PA-28-201T	11-15148	\$457.00	PA-44-180T	Turbo Seminole	11-15196	\$998.00

CESSNA - BEECHCRAFT - BELLANCA - GRUMMAN - LUSCOMBE - MOONEY - STINSON - COMMANDER - SWIFT

Aircraft Application	Part No.	Our Price
Cessna 150 A, B, C	11-00273	\$288.95
Cessna 150 D, E, F, G, H	11-00274	\$198.75
Cessna 150 J, K, L, M	11-00275	\$228.95
Cessna 152 no APU	11-00276	\$308.00
Cessna 152 with APU	11-00277	\$370.00
Cessna 170 A	11-00278	\$266.95
Cessna 172 A	11-00280	\$306.00
Cessna 172 B, C	11-00281	\$346.00
Cessna 172 D, E (rear), F	11-00282	\$258.95
Cessna 172 G, H	11-00283	\$256.95
Cessna 172 I, K, L, M	11-00284	\$337.00
Cessna 172N	11-00285	\$346.00
Cessna 172P	11-00286	\$337.00
Cessna 175 A, B, C	11-00287	\$356.00
Cessna 177 B	11-00288	\$479.00
Cessna 177 RG	11-00289	\$483.00
Cessna 180	11-00290	\$369.00
Cessna 180 A, B, C, D, E	11-00291	\$408.00
Cessna 180 J	11-00292	\$408.00
Cessna 180 K	11-00293	\$369.00
Cessna 182 1956 model	11-00294	\$426.00
Cessna 182 A	11-00295	\$456.00
Cessna 182 J	11-00296	\$418.00
Cessna 182 E, F, G, H, J, K, L, M, N, P, Q	11-00297	\$517.00
Cessna 185 E & A185E	11-00298	\$458.00
Cessna A185F 12 VOLT	11-00299	\$456.00
Cessna A185F 24 VOLT	11-02211	\$543.00
Cessna U206 C-G	11-00301	\$316.00

Aircraft Application	Part No.	Our Price
Cessna U206 C-G	11-00301	\$316.00
Cessna 210 E	11-00303	\$279.95
Cessna T210 F	11-00304	\$297.95
Cessna 210 K, T210K	11-00307	\$356.00
Cessna 210 N, T210N	11-00306	\$327.00
Beechcraft BE-35-C33	11-00254	\$328.00
Beechcraft BE-V35	11-00255	\$365.00
Beechcraft BE-C35	11-00256	\$316.00
Beechcraft BE-S35	11-00257	\$316.00
Bellanca BL-14-19-2	11-00258	\$427.00
Bellanca BL-14-19-3	11-00259	\$418.00
Bellanca BL-17-30	11-00260	\$418.00
Bellanca BL-17-30A	11-00261	\$417.00
Bellanca/Champion 7GCBA, 7ECA	11-00262	\$408.00
Bellanca/Champion 7GCAA, 7KCAB	11-00263	\$407.00
Bellanca/Champion 8KCAB	11-00264	\$407.00
Bellanca/Champion 7GCBC	11-00265	\$299.95
Bellanca/Champion 7GCBC	11-00266	\$408.00
Grumman GRUM-AA5, 5A, 5B	11-00267	\$228.95
Grumman GRUM-AA-1A, 1B, 1C	11-00268	\$228.95
Luscombe LU-8E	11-00269	\$310.00
Mooney MO-M20C	11-00270	\$295.95
Mooney MO-M20F	11-00271	\$359.00
Stinson STI-108 1, 2, 3	11-00272	\$256.95
Rockwell Commander RW-112	11-00308	\$624.00
Rockwell Commander RW-114	11-00309	\$670.00
Swift GC-1A, 1B	11-00311	\$277.95



PLEASE VISIT OUR WEBSITE FOR MORE DETAILED INFORMATION ON BOGERT AVIATION CABLES.

AIRPORT LIGHTING

LANDING STRIP LIGHT KITS



P/N 11-07953 P/N 11-07954 P/N 11-07952 P/N 11-07955

An "airfield in a suitcase" solution. A fast-deployed, 40 light kit of our Landing Strip Light. Used for expeditionary, improvised or temporary airfields. Suitable for a 4,000' runway, if placed at typical 200' intervals (max.). Order multiple kits for longer runways. Operators Liability-The system has been designed to be operated under normal visual meteorological conditions for night flying by a pilot with normal vision. The system is utilized at the operator's discretion and risk. The suppliers accept no liability whatsoever whether implied or explicit for any incidents/accidents that may incur. The operator must ensure that trained personnel operate the system and are made fully aware of aviation safety and that the runway remains clear of animals, pedestrians and obstructions at all times during landings and takeoffs. Only competent and currently night rated pilots may use this system. Use by student pilots training for night rating is prohibited.

Landing Strip Light Kit - 40 light basic kit, packed in a Pelican 1660 wheeled equipment case for ease of storage, handling, and set up. 180 lb. (82 kg) per kit.

Description	Part No.	Price
Landing Strip Light Kit with 40 Lights	11-07953	\$4,429.00
Landing Strip Light Kit Jr. with 10 Lights	11-07954	\$992.00
Landing Strip/Runway Light - Not available for sale to European Union at this time, not RoHS compliant.	11-07952	\$94.75
Multifunction Strobe - Flashing or Steady! Use steady mode as a backup light or area light. Turn on the light. If it is not in the mode you want, quickly turn it off/on to change modes.	11-07955	\$785.00

RUNWAY LIGHTS / TAXI LIGHTS



- 10 Watts
- Operates on standard 115V
- Equipped with long-life outdoor bulb
- Uses No. 8 or No. 10 standard underground cable. Check w/State & local building codes
- Uses standard 1" wood or steel stake
- Marker cone has high luster baked-on finish
- High illuminated optical lens
- Equipped with 6" attached pigtail
- Constructed of lifetime aluminum components
- Preamsembled - Strip kits ready for hookup.

• **Excellent Quality** • **Economical Pricing** • **High Optical Output** • **Immediate Delivery** • **Lowest Operating Cost** • **Minimum Installation & Maintenance Cost**



RUNWAY LIGHT KITS

These realistically priced lights are inexpensive to install, require little maintenance, and are economical to operate. The shield has a baked on finish equipped with high illuminating lens. Also includes 6" attach pigtail. Operates on standard 115V. Code 7

THRESHOLD DUAL RED/GREEN ASSEMBLY

Designed for threshold installations requiring this type of configuration. Includes 6 red/green lamps.
Set of 6P/N 05-05201\$349.00

SOLAR POWERED AVIATION LIGHTS



The solar powered AV-70 aviation light offers enormous benefits over traditional battery and hard-wired aviation lights including low maintenance and no underground wiring. Mounts are not included. Integrated solar/battery system. Dual internal high-performance solar modules angled to maximize solar collection. Fast & easy to deploy - no programming IP68 waterproof rating User-replaceable battery Ultra-high intensity LEDs (no changing globes ever).

Description	Part No.	Price
Solar Runway Edge Light (White)	11-13399	\$418.00
Solar Taxiway Edge Light (Blue)	11-13402	\$534.00
Solar Runway Threshold Light (Red/Green)	11-13403	\$519.00
Solar Warning/Barricade Light (Red)	11-13404	\$518.00
Solar Tactical Light (Infrared)	11-13405	\$389.00

MOUNTS

Mounts are made out of 7-stage powder-coated heavy duty aluminum and are available in yellow.

Description	Part No.	Price
Frangible stakemount set complete for AV-70. • Including light mounting plate, frangible coupling, ground stake, fasteners (excluding light fixture bolt set) • In ground insertion: 28cm / 11 inches	11-13408	\$95.00
Frangible concrete mount solution complete for AV-70. • Includes: light mounting plate, base plate, coupling, anchor bolts (4), fasteners (excluding light fixture bolt set)	11-13409	\$95.00

AIRPORT CONE MARKERS



Markers are available in two sizes - Large Cone AV-LC - Ø750mm and Mini Cone AV-MC - Ø400mm. Rotationally-moulded polyethylene with a 20 year life expectancy - unmatched by any other product on the market. Less servicing than fiberglass models. Can be easily secured UV-stabilised. Molded in color - no need for painting. 100% recyclable.

Size	Part No.	Price
Large	11-13406	\$70.75

EMS HELIPAD LIGHTING KIT



Avlite's EMS Helipad Kit is ideal for medevac and other emergency situations where a temporary lit landing area is needed and can be easily configured and deployed to suit local requirements during natural disasters, humanitarian operations, emergency rescue missions or any other emergency situation.

Minimum range of 2 miles (4km). Autonomy >750 hours Easy to configure & deploy. Long-life, user-replaceable battery Ultra-high intensity LEDs Magnetic bases hold the lights securely in place. Easy-to-handle case. Robust, high impact & lightweight construction. IP67 waterproof rating ON/OFF switch for easy activation. Flashing white light with integrated IR (infrared) provides NVG signatureP/N 11-13411\$2,750.00

SOLAR WINDSOCK LIGHTING KIT



Avlite's Solar Windsock Light Kit provides users with a complete, reliable and low maintenance solution to windsock illumination. The AV09-4WL suits existing windsock assemblies and can be installed immediately requiring no costly underground wiring. Windsocks are not included. Complete stand-alone unit ready for immediate installation. Incorporates four (4) AV-09 lights mounted onto 12mm powder-coated square tubing arms, a 140watt multicrystalline solar module and mounting bracket. Each AV-09 light incorporates a 3watt ultra-high intensity LED as a light source offering up to 100,000 hours of service - no need to change any globes. Integrated solar/battery system. 140watt solar module (standard). 2 x 55Ah SLA batteries (standard)P/N 11-13410\$5,395.00

WHELEN AVIATION LIGHTING

POSITION LIGHTS AND ANTI-COLLISION LIGHT DISTRIBUTION PATTERNS REQUIREMENTS

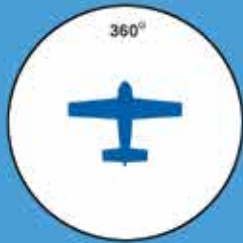

An approved anti-collision strobe light system must project light 360° around the aircraft's vertical axis. One or more strobe lights can be used.

An approved anti-collision strobe light system must project light + or - 30° above and below the horizontal plane of the aircraft. One or more strobe lights can be used. The + or - 75° projected light is required since July 18, 1977.

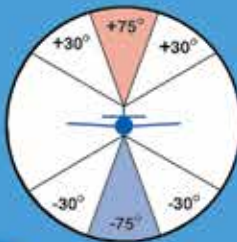

LOCATIONS ON THE AIRCRAFT FOR ANTI-COLLISION STROBE LIGHTS, TO COMPLY TO THE LIGHT PATTERN REQUIREMENTS



VERTICAL FIN

One anti-collision strobe light mounted on the vertical fin will meet the minimum requirements on most aircraft. A half red and half white lens is recommended.

WING TIP

Two wing tip strobe lights that protrude beyond the wing tip.

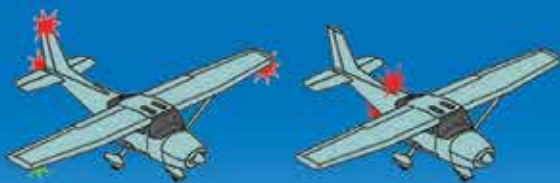

ENCLOSED WING TIP

Enclosed wing tip anti-collision strobe lights, require a third strobe light on the tail or vertical fin, to fill in the required light envelope. This is an approved anti-collision system.

FUSELAGE

In a fuselage mounted anti-collision strobe light system, a minimum of two strobe lights are necessary to get the required vertical coverage. This is an approved anti-collision system.

ANTI-COLLISION AND POSITION LIGHT REQUIREMENTS, LOCATIONS, & DISTRIBUTION PATTERNS

All aircraft must have an approved anti-collision light and position light system for nighttime operations. The position lights consist of an Aviation Red on the left side, an Aviation Green on the right and an Aviation White taillight (REF. FAR 23.1389).

The anti-collision lighting system is required under FAR PART 91.205(c). There are different requirements affecting different aircraft. These aircraft are categorized by the date of application for type certificate. Home built aircraft are determined by the date of issuance of the Experimental Operating Limitations. The different categories are as follows:

Aircraft for which type certificate was applied for after April 1, 1957 to August 10, 1971:

These anti-collision systems must produce a minimum of 100 effective candela in Aviation Red or White (REF. FAR 23.1397), 360° around the aircraft's vertical axis, 30° above and below the horizontal plane (REF. FAR 23.1401).

Aircraft for which type certificate was applied for after August 11, 1971 to July 18, 1977:

These anti-collision systems must produce a minimum of 400 effective candela in Aviation Red or White (REF. FAR 23.1397), 360° around the aircraft's vertical axis, 30° above and below the horizontal plane (REF. FAR 23.1401).

Aircraft for which type certificate was applied for after July 18, 1977:

These anti-collision systems must produce a minimum of 400 effective candela in Aviation Red or White (REF. FAR 23.1397), 360° around the aircraft's vertical axis, 75° above and below the horizontal plane (REF. FAR 23.1401).

Note: The position lights must be wired independently of anti-collision lights.

INSTALLATION LOCATIONS

WING TIP:

The major difference in systems is the location of the strobe power supplies which can be mounted locally, one in each wing tip, or a single power supply can be mounted in the fuselage. Installation time can be greatly reduced if done in conjunction with an annual or one hundred-hour inspection. Properly installed power supplies and cabling are necessary for the safe operation of Whelen or any light systems.

FUSELAGE:

Fuselage mounted units can be either self-contained with the power supply and lighthouse as one unit, or remote lighthouses run off a separate power supply. To meet the field of coverage, one must be on the top of the fuselage and one on the bottom.

VERTICAL FIN:

Finally, if applicable, a single anti-collision light can be mounted on the vertical stabilizer. It can be either a self-contained or remote lighthouse depending on the aircraft.

HOME BUILT & KIT AIRCRAFT

For Aircraft with Standard Wing Tips – The most widely used system on the market, this provides all of the components for anti-collision and position lights without the need for a taillight. The power supply is mounted in the fuselage and shielded cable is run to the strobe lights. The following is recommended:

Quantity	Model #	Part #	Description
1 each	HDACF	01-0770028-05	Power supply
1 each	A600PG14	01-0790006-00	Wing tip strobe/position/taillight, 14 VDC
1 each	A600PR14	01-0790006-02	Wing tip strobe/position/taillight, 14 VDC
Note: Model 9034001 and 9034002 can replace Model A600 for a LED solution			
1 each	HD60	01-0750206-00	Installation package

For Aircraft with Enclosed Wing Tip Fairings – If the position and strobe lights are mounted under a clear fairing, a third tail strobe is required. The following is recommended:

Quantity	Model #	Part #	Description
1 each	HDACF	01-0770028-05	Power supply
1 each	A650PG14	01-0770054-00	Wing tip strobe/position light, 14 VDC
1 each	A650PR14	01-0770054-02	Wing tip strobe/position light, 14 VDC
Note: Model 7111001 and 7111002 can replace Model A650 for a LED solution			
1 each	A500AV14	01-0770024-00	Tail position/strobe light assembly
1 each	HDT390	01-0750205-00	Installation package

For Aircraft with Enclosed Wing Tip Fairings & Wing Tip Mounted Power Supplies – If position and strobe lights are mounted under a clear fairing, the need for a third tail strobe is required. The following is recommended:

Quantity	Model #	Part #	Description
2 each	A490ATSC	01-0770062-03	Power supply
1 each	A650PG14	01-0770054-00	Wing tip strobe/position/taillight, 14 VDC
1 each	A650PR14	01-0770054-02	Wing tip strobe/position/taillight, 14 VDC
Note: Model 7111001 and 7111002 can replace Model A650 for a LED solution			
1 each	A500AV14	01-0770024-00	Tail position/strobe light assembly, 14 VDC
3 each	HS5	01-0750215-00	Installation package

For strobe system recommendations for certified aircraft and for Whelen/Aeroflash/Grimes/Cessna cross reference lists please visit our website WWW.AIRCRAFTSPRUCE.COM

EL

WHELEN AVIATION LIGHTING

WHELEN ORION 600 SERIES WINGTIP POSITION / ANTI-COLLISION LED LIGHTS



ORION600 Series of FAA/TSO approved LED aviation lighting. Incorporating the latest state of the art LED Technology available in an all-inclusive package, the ORION600 series eliminates the need for external flasher boxes. Flush mountable for a wide variety of applications with minimal integration and

easily retrofitable to the Whelen legacy strobe products. The ORION600 series is quite simply the brightest form of LED Anti-collision and Position lighting available.

Model ORION600 Position/Anti-Collision Lighthouse All LED self-contained wingtip mounted Position/Anti-Collision system. Eliminates the need for external power supplies and reduces current draw and provides thousands of hours of operation. FAA TSO-C96c Class II / TSO-C30c Type II & III.

Whelen No.	Model No.	Color	Voltage	Part No.	Price
01-0771733-01	OR6001G	Green	12V	11-11365	\$625.00
01-0771733-02	OR6001R	Red	12V	11-11366	\$625.00
01-0771733-11	OR6002G	Green	24V	11-11367	\$625.00
01-0771733-12	OR6002R	Red	24V	11-11368	\$625.00

WHELEN ORION™ 650 SERIES LIGHTING



Whelen Engineering is proud to introduce the ORION650 Series of FAA/TSO approved LED aviation lighting. Incorporating the latest state-of-the-art LED Technology available in an all-inclusive package, the ORION650 series eliminates the need for external flasher boxes. Flush mountable for a wide

variety of applications with minimal integration and easily retrofitable to the Whelen legacy strobe products. The ORION650 series is quite simply the brightest form of LED Anti-collision and Position lighting available. **Features:** • All LED self-contained wingtip mounted Position/Anti-Collision system. • Fully FAA/TSO-C96a & TSO-C30c Approved • FAR SPEC Certified • Replaceable hard coated polycarbonate lens to maintain maximum light output • Aerodynamic design without sacrificing light output • Exceeds FAA minimum intensity requirements for maximum visibility and increased safety of flight • Environmentally tested and certified to RTCA/D0-160G standards. FAA TSO-C96a Class III/TSO-C30c Type II. STC SA800EA.

Model No.	Description	Part No.	Price
OR6501G	Wingtip PTA Green, 12V	11-18768	\$509.00
OR6501R	Wingtip PTA Red, 12V	11-18766	\$509.00
OR6502G	Wingtip PTA Green, 28V	11-18767	\$509.00
OR6502R	Wingtip PTA Red, 28V	11-18765	\$509.00

WHELEN ORION™ 650E SERIES LIGHTING



All LED self-contained wingtip mounted Position/Anti-Collision system. Eliminates the need for external power supplies and reduces current draw and provides thousands of hours of operation.

• Fully FAA/TSO-C96a & TSO-C30c Approved FAR SPEC Certified • Exceeds FAA minimum intensity requirements for maximum visibility and increased safety of flight • Environmentally tested and certified to RTCA/D0-160G standards. STC SA800EA.

Model No.	Description	Part No.	Price
OR6501GE	Embedded PTA Green, 12V	11-11971	\$535.00
OR6501RE	Embedded PTA Red, 12V	11-11972	\$535.00
OR6502GE	Embedded PTA Green, 28V	11-11973	\$535.00
OR6502RE	Embedded PTA Red, 28V	11-11974	\$535.00

WHELEN ORION™ 500 SERIES LIGHTING



All LED self-contained wingtip mounted Position/Anti-Collision system. Eliminates the need for external power supplies and reduces current draw and provides thousands of hours of operation.

• Fully FAA/TSO-C96a & TSO-C30c Approved • FAR SPEC Certified • Replaceable hard coated polycarbonate lens to maintain maximum light output • Aerodynamic design without sacrificing light

output • Exceeds FAA minimum intensity requirements for maximum visibility and increased safety of flight • Environmentally tested and certified to RTCA/D0-160G standards. STC SA800EA.

Model No.	Description	Part No.	Price
OR5001V	Tail PTA Light White, 12V	11-11975	\$455.00
OR5002V	Tail PTA Light White 28 V	11-11977	\$455.00

WHELEN PARMETHEUS PLUS REPLACEMENT LANDING LIGHTS



Parmetheus Plus PAR36/46 LED lights are a drop-in replacement for outdated Halogen PMA pending. Lightweight, low-current and moisture resistant, they provide stable light output for thousands of operating hours.

These PAR 36 LED lights are 40% brighter output than the original Parmetheus Series assemblies, and the PAR 46 are 80% brighter. LED lighting is the ideal technology for aviation applications. Whelen LED lights are time and field-tested for reliability and long-life performance under the tough conditions required by Fire, Emergency, DOT and Law Enforcement professionals around the world. STC-PMA Pending.

Description	Part No.	Price
PAR 36 14V Landing	11-12976	\$245.00
PAR 36 14V Taxi	11-12977	\$245.95
PAR 36 28V Landing	11-12978	\$245.00
PAR 36 28V Taxi	11-12979	\$245.00
PAR 46 14V Landing	11-12980	\$295.00
PAR 46 28V Landing	11-12981	\$295.00

WHELEN 9035201 PAR46 LANDING LIGHTS



Model 9035201 is a self-contained LED Landing Light Assembly. The design is intended to provide a solution to the needs for a Taxi & Landing Light on a wide variety of aircraft. All current source and electronic circuitry is contained within the housing. Unit is available in several mounting configurations to retrofit existing typical PAR-46 lighting. Unit is designed to be mounted internally behind existing lens. LED Landing/Taxing Light Internal Mount (Black Finish)....P/N 11-06180\$1,422.00

MICROBURST PLUS SERIES LIGHTING FROM WHELEN



LED Wingtip and Tail Lighting for Experimental and Light Sport Aircraft. **MB3(Red or Green)** .21 lbs., .45 amp (avg). Forward facing Wingtip Nav, with CometFlash 180° LED-Strobe and rear facing white Nav. **MB2(Red or Green)** .20 lbs., .40 amp (avg). Forward facing Wingtip Nav with MB2G Green CometFlash 180° LED-Strobe. **MB1WT** White, .15 lbs., .35 amp (avg). Nav taillight with CometFlash 180° LED-Strobe. Utilizes same mounting as all (A500/A555 Style).

Description	Part No.	Price
MicroBurst I MB1WT Single Taillight	11-08472	\$269.95
MicroBurst III Kit MB3K 1 MB3R (R) and 1 MB3G (G)	11-08473	\$469.00
MicroBurst II Kit MB2K 1 MB2R (R) and 1 MB2G (G)	11-08474	\$369.00
MicroBurst II with Taillight Kit MB2KWT 1 MB2R (R) and 1 MB2G (G) plus 1 MB1WT Taillight	11-08475	\$549.00

WAT PAR 36/46 LED LANDING/TAXI LIGHTS



Lazr PAR 36 LED with STC for GA Aircraft.

Illumination is proud to present the Lazr LED. The Lazr is the brightest LED light available. By combining powerful diodes, innovative optics, and patented cooling technology, Illumination created an LED that is

60% brighter than any certified LED. **Benefits:** • 5-year warranty • Simple drop-in installation • 60-day product buyback guarantee • 60% brighter than any certified LED • Top notch customer service with 24/7 AOG line • Low amp draw • Low heat output • Increased reliability • STC included. PAR 36P/N 11-16619\$499.00 PAR 46P/N 11-16621\$599.00

WHELEN PARMETHEUS G3 PAR 36 LANDING & TAXI LIGHT



The Parmetheus™ G3 is the latest addition to the Parmetheus product family. Keeping the tradition of industry leading performance and value, the new G3 Series is 2.5 times brighter than the Parmetheus™ Plus

all while maintaining the same form, fit and functionality of a drop-in LED replacement for legacy landing lights. No need to specify voltage as the G3 operates from 14-28 volts. **Features:** Direct replacement for outdated PAR36 Halogen and HID lamps. FAA-PMA

Landing Light.....P/N 11-18873\$299.00 Taxi Light.....P/N 11-18874\$299.00

WHELEN PARMETHEUS™ G3 PAR 46 LANDING LIGHT



The Parmetheus™ G3 Par 46. Keeping the tradition of industry leading performance and value, the new Par 46 G3 Series is 2.5 times brighter than the Parmetheus™ Plus all while maintaining the same form, fit and functionality of a drop-in LED replacement for legacy landing lights. Variable voltage 14-28 VDC. FAA-PMAP/N 11-19156\$399.00

EL

WHELEN AVIATION LIGHTING



7108051

MODEL 71080 SERIES LED BEACON FOR ROTORCRAFT, (150 EFF. CD) (14 VDC & 28 VDC)

71080 series LED beacons are FAA TSO compliant self-contained LED anti-collision lights (Ref. Class I - 150 effective candlepower). They are designed to replace a range of products. Refer to models and descriptions below. **Electrical:** Models ending: 8001, 8004, 8005, 8014, 8015, 8020, 8051, 8055: 12" Flying Leads. Models ending: 8007, 8017, 8008, 8018: MS3102R10SL-3P Connector

Mechanical: Models: 8004, 8014, 8008, 8018 are designed to replace existing beacons utilizing a 5-Hole mounting pattern on a 4.656 diameter bolt circle (Whelen 70285 series/7090501 series or 70900 with A440 adapter). Models: 8005, 8015, 8007, 8017 are 3 3/4" opening designed to fit inside an A440 mounting adapter, mounting holes to fit in place of rotating beacons, Whelen Model HRCFA, or 7090004, -05 series LED beacons
Specifications: • Current: 0.87 amps average, 3.0 amps peak • Weight: 0.65 lbs. (295gm) (8001 & 8051) • Lens: Clear polycarbonate • Dimensions: 2.6" (66mm) diameter, exposed height, 3.74" (95mm) (8001 & 8051)

ALL Part Numbers are FAA TSO-C96a Class I (150 ecp) approved.

Model No.	Description	Part No.	Price
7108001	LED red, 28 VDC Rotocraft (no adapter)	11-06173	\$640.00
7108001	LED red, 28 VDC & Mt.	11-06174	\$650.00
7108051	LED red, 14 VDC & 8 hole mount	11-07686	\$650.00
7108004	LED red, 28 VDC & 5-Hole mount	11-07687	\$725.00
7108014	Same as 8004, lower Mt	11-07688	\$725.00
7108055	LED Red, 14 VDC, 3.75" adapter	11-09909	\$725.00
7108005	LED red, 28 VDC, 3.75" adapter	11-07689	\$725.00
7108015	Same as 8005, lower Mt	11-07690	\$725.00
7108007	LED red, 28 VDC, 3.75" adapter	11-07691	\$725.00
7108017	Same as 8007, lower Mt.	11-07692	\$725.00
7108008	LED red, 28 VDC & 5 hole mount	11-07693	\$725.00
7108018	Same as 8008, lower Mt.	11-07694	\$725.00

MODEL 90520 SERIES LED FLASHING BEACON (RED & WHITE LEDS)



9052051

90520 series LED beacons are FAA TSO compliant self-contained LED anti-collision lights (Ref. Class I - 100 effective candlepower). They are designed to replace strobe lighthoods as small as the A470A with available models to replace HR self-contained beacons (HRCFA) or our legacy 70900 LED beacon. Mounting plate included with assembly. Refer to models and descriptions below.

Electrical: Models ending: 2001, 2004, 2005, 2014, 2015, 2051, 2055: 12" Flying Leads. Models ending: 2007, 2017, 2008, 2018: MS3102R10SL-3P Connector

Mechanical: Models: 2004, 2014, 2008, 2018 are designed to replace existing beacons utilizing a 5 Hole mounting pattern on 4.656 diameter bolt circle (Whelen 70285 series / 7090501 series or 70900 with A440 adapter). Models: 2005, 2015, 2007, 2017 are 3 3/4" opening designed to fit inside an A440 mounting adapter, mounting holes to fit in place of rotating beacons, Whelen model HRCFA, or 7090004, -05 series LED beacons

Specifications: • Current: 0.67 amps Average, 3.0 amps Peak Weight: 0.65 lbs. (295gm) (-01 & -51) • Lens: Clear polycarbonate • Dimensions: 2.6" (66mm) Diameter, Exposed Height, 3.74" (95mm) (-01 & 51)

ALL Part Numbers are FAA TSO-C96a Class III Approved.

Model No.	Description	Part No.	Price
9052001	LED red/white, 28 VDC & mount	11-07615	\$650.00
9052051	LED red/white, 14 VDC & mount	11-07616	\$650.00
9052004	LED red/white, 28 VDC & 5 hole mount	11-07617	\$725.00
9052014	LED red/white, 28 VDC & 5 lower mount	11-07618	\$725.00
9052005	LED red/white, 28 VDC, 3.75" adapter	11-07619	\$725.00
9052055	LED Red/White, 14 VDC 3.75" adapter	11-09908	\$725.00
9052015	Same as 9052005, lower mount	11-07620	\$725.00
9052007	LED red/white, 28 VDC, 3.75" adapter	11-07621	\$725.00
9052017	Same as 9052007, lower mount	11-07622	\$725.00
9052008	LED red/white, 28 VDC & 5 hole mount	11-07623	\$725.00
9052018	LED red/white, 28 VDC & 5 lower mount	11-07624	\$636.00

WHELEN 90028 SERIES LIGHTHEADS



90028 series wing tip strobe light used on Beech aircraft with commonality wing tip 1974 & later. It is a direct replacement for 30-0467-(), 30-1331-() and the 30-1467-() series.

Note: Do not use with Cannon plug. Light assembly, 45° mounting bracket. Weight: 0.4 lbs. (181gm) • Exposed Height: 1.87" (48mm) • Length: 4.37" (111mm) • Depth: 2.25" (57mm)

P/N 11-00712 \$249.95

MODEL 70509 SERIES



70509 series self-contained halogen flashing anti-collision light with the same mounting pattern as the factory installed beacon on single engine Cessna's 1967 & later. Available in three different lens colors, Aviation red, aviation white and split aviation red/white. When used in conjunction with the model 50519 mounting adapter, it can replace rotating beacons with the 3-3/4" (95mm) dia. mounting hole. **Note:** Not recommended for installation on helicopters or twin engine aircraft.

Specifications: • Weight: 0.27 lbs. (122gm) • Height: 3.75" (95mm) • Diameter: 2.65" (67mm) • Power Consumption: 2.7 amps @ 14 VDC, 1.3 amps @ 28 VDC **ALL Part Numbers are FAA TSO-C96a approved, unless otherwise noted.**

Model No.	Description	Part No.	Price
7050900	14V, red lens	11-03235	\$409.00
7050901	14V, white lens	11-03268	\$399.00
7050902	14V, red/white lens	11-03231	\$409.00
7050903	28V, red lens	11-03276	\$399.00
7050905	28V, red/white lens	11-03292	\$399.00
7050907	28V, red lens w/ mask, Cessna single engine	11-07628	\$409.00
50519001	Option Mounting Adapter (Not Approved)	11-03238	\$95.85

ORION 360 BEACON LED LIGHTING



ORION 360 s are the 4th Generation LED s for fixed wing aircraft. These are designed to replace legacy 2.6" and 3.67" round s. ORION 360 s are lower profile than legacy product by 60%.

ALL Part Numbers are FAA TSO-C96a Class III approved.

Model No.	Description	Part No.	Price
01-0772010-50	LED Red, 14 VDC, 2.6" Base	11-16637	\$620.00
01-0772010-52	LED Red, 14 VDC, 3.75" Base	11-16638	\$680.00
01-0772010-10	LED Red, 28 VDC, 2.6" Base	11-16639	\$620.00
01-0772010-12	LED Red, 28 VDC, 3.75" Base	11-16641	\$680.00
01-0772010-13	LED Red, 28 VDC, 3.75" Base Lower Mount	11-16642	\$680.00
01-0772010-70	LED Red/White Split, 14 VDC, 2.6" Base	11-16643	\$652.00
01-0772010-72	LED Red/White Split, 14 VDC, 3.75" Base	11-16644	\$680.00
01-0772010-30	LED Red/White Split, 28 VDC, 2.6" Base	11-16645	\$620.00
01-0772010-32	LED Red/White Split, 28 VDC, 3.75" Base	11-16646	\$680.00
01-0772010-33	LED Red/White Split 28 VDC, 3.75" Base Lower Mount	11-16648	\$680.00
01-0772010-20	LED White, 28 VDC, 2.6" Base	11-16649	\$620.00
01-0772010-22	LED White, 28 VDC, 3.75" Base	11-16651	\$680.00
01-0772010-23	LED White, 28 VDC, 3.75" Base Lower Mount	11-16652	\$680.00

WHELEN ORION™ 660 SERIES LED WINGTIP POSITION / ANTI-COLLISION LIGHT



The Orion 660 series products incorporate RED or GREEN Forward Position Lights as well as the WHITE flashing Anti-Collision Light function. State of the art LED circuitry is built in to eliminate the need for separate flasher boxes for operation. The footprint, and mounting, are identical to legacy Whelen products for ease of installation and retrofit. Fully FAA/TSO approved. TSO-C96a Class III

Model No.	Approvals	Description	Part No.	Price
OR6601G	TSO-C30c Type II & III	Green, 14 VDC	11-18777	\$555.00
OR6601R	TSO-C30c Type I & III	Red, 14 VDC	11-18778	\$555.00
OR6602G	TSO-C30c Type II & III	Green, 28 VDC	11-18779	\$555.00
OR6602R	TSO-C30c Type I & III	Red, 28 VDC	11-18780	\$555.00

WHELEN AVIATION LIGHTING

WHELEN MODEL 90044 SERIES



5-Hole

90044 series self-contained, 150 watt, quartz halogen flashing anti-collision light. Factory installed on Lear 31, Falcon 900 and Cessna Citation X. It is also a direct replacement for oscillating beacons on most corporate aircraft.

Specifications: • Weight: 1.6 lbs. (726gm) to 2.5 lbs. (1134gm) • Height: 5.5" (140mm)

• Power Consumption: 3.25 amps @ 28 VDC • Replaces: G9950(-), 40-0100(-), 30-2140(-), 40-0117(-), 40-0127(-), 30-2647(-)

To determine model required for replacement, the following information is needed: Lens color (red or white), upper or lower mounting location, number of mounting holes (5, 8, or 9), weight and position installed. Beacons installed on the rudder. Top replacement on GII and GIII require 9004401 or 9004402 in conjunction with the 16 hole mounting plate, P/N 06-170618-00. FAA TSO-C96a

Model No.	Remarks	Lens	Mount	Base	Part No.	Price
9004402	Standard Assembly	white	upper	5 hole	90044-02	\$1,178.00
9004403	Standard Assembly	red	lower	5 hole	90044-03	\$1,154.00
9004404	Standard Assembly	white	lower	5 hole	90044-04	\$910.00
9004417	Standard Assembly	red	upper	8 hole	90064-17	\$1,154.00
9004418	Standard Assembly	white	upper	8 hole	90044-18	\$910.00
9004419	Standard Assembly	red	lower	8 hole	90044-19	\$1,643.00
9004420	Standard Assembly	white	lower	8 hole	90044-20	\$910.00
9004453	Masked Lens	white	lower	8 hole	11-07647	\$1,625.00
9004433	Rudder Mount	red	upper	5 hole	11-07641	\$1,625.00
9004457	2.25 lbs., Cable Pigtail (Beech Barons)	red	upper	5 hole	11-01968	\$1,616.00

MODEL 90033 SERIES SELF-CONTAINED LIGHT ASSEMBLIES



2-Hole

90033 series self-contained, 150 watt, quartz halogen flashing anti-collision light which is factory installed on Beechcraft. It is also a direct replacement for oscillating beacons on most corporate aircraft.

Specifications: • Weight: 0.6 lbs.(272gm) to 0.9 lbs. (408gm) • Height: 4.4" (112mm) • Power

Consumption: 5.5 amps @ 28 VDC

ALL Part Numbers are FAA TSO-C96a approved.

Model No.	Remarks	Lens	Mount	Base	Part No.	Price
900331	18" cable, no connector	red	lower	2 hole	90033-1	\$1,253.00
900332	18" cable, no connector	white	lower	2 hole	90033-2	\$1,036.00

FOR ADDITIONAL 90044 AND 90033 SERIES LIGHTS PLEASE CALL OR VISIT OUR WEBSITE AT WWW.AIRCRAFTSPRUCE.COM



WHELEN TAIL POSITION LIGHT - MODEL 70805 SERIES

FAA/TSO-C30c Type III approved. The model 70805 series LED Tail Position Light is a high quality, long lasting, modern alternative to incandescent and halogen tail position lights. It offers significant technological upgrades over previous products.

Model No.	Description	Part No.	Price
7096600	28 VDC - no connectors Note: Replaces 01-0770805-00 (FAA TSO-C30c Type III)	11-01228	\$472.00
7096601	28 VDC - connectors, case ground used on Beechjet Note: Replaces 01-0770805-01 (FAA TSO-C30c Type III)	11-07699	\$471.00
70804A30	Lens, Clear, Hard Coated	11-18499	\$26.50



WHELEN LED 7198700 ANTI-COLLISION LIGHT

The Model 7198700 & 7198517 is designed to replace the legacy strobe light (01-0770818-00) and power supply (01-0770006-12 & -17) system on Cessna single engine restart aircraft 1996 & newer. FAA/PMA Approved.

****Note:** If replacing either 7081800 strobe assembly or 7000617 power supply both 7198517 & 7198700 are needed to convert to LED.

LED Color - Aviation White
LED Anti-Collision Light, White.....P/N 11-18321\$399.00
Flasher Assembly.....P/N 11-18320\$337.00



MODEL A470A SERIES

A470A series remote strobe light assembly is compatible with all Whelen power supplies. It can be installed on the fuselage or the vertical fin. The unique polycarbonate optic lens and reflector design, re-directs stray light rays into the horizontal plane to provide the maximum 360° of uniform light coverage possible. Available in three different lens colors, aviation red, aviation white and split aviation red/white. Available in radio-shielded configurations. All assemblies require either the model H102 or H103 mounting adapter.

Specifications: • Weight: 0.3 lbs. (136gm) • Exposed Height: 3.75" (95mm) • Diameter: 2.5" (64mm)

ALL Part Numbers are FAA/PMA approved.

Model #	Description	Part No.	Price
A470AR	Standard assembly, red lens	11-03273	\$255.95
A470AW	Standard assembly, white lens	11-03277	\$239.00
A470AS	Standard assembly, split red/white lens	11-03259	\$256.95
A470ADR	Radio-shielded assembly, red lens	11-03714	\$306.00
A470ADW	Radio-shielded assembly, white lens	11-03291	\$280.95
A470ADS	Radio-shielded assembly, split red/white lens	11-04976	\$257.95

H102



H103



MODELS H102 & H103

Designed for the model A470A or model A450 series remote strobe lighthead assemblies. The model H102 allows flush mounting of the lighthead to the skin of the fuselage or the vertical stabilizer on later model Cessna Single engines. The H103 is designed for strobe assemblies to be installed in the standard 3-3/4" (95mm) dia. rotating beacon mounting hole.

Model #	Approvals	Description	Part No.	Price
H102	FAA/PMA	Flush mount adapter	11-03243	\$28.55
H103	—	Rotating beacon mount adapter	11-03284	\$116.75



MODEL A450 SERIES

A450 series remote strobe light assembly is compatible with all Whelen power supplies. It can be installed on the fuselage or the vertical fin. The Pyrex® Glass lens (clear only) makes the assembly suitable for use in severe vibration, chemical and moisture conditions (i.e. agricultural aircraft).

Requires either the model H102 or model H103 mounting adapter.
Specifications: • Weight: 0.3 lbs. (136gm) • Exposed Height: 2.25" (57mm) • Diameter: 2.5" (64mm)

Model #	Approvals	Description	Part No.	Prices
A450	FAA/PMA	Standard assembly, clear lens	11-03280	\$418.00
SA418-1	—	Gasket for A450	11-03690	\$17.70



MODEL A650 SERIES

Converts W1285 position lights into a position/anti-collision system by removing the existing retainer & replacing it with the A650 assembly. Radio-shielded version available. **Specifications:** • Weight: 0.2 lbs. (91gm) • Exposed Height: 2.4" (61mm)

Model No.	Approvals	Description	Part No.	Price
A650	FAA/PMA	Standard unit	11-03215	\$265.95
A650D	FAA/PMA	Radio-shielded	11-07604	\$370.00



MODEL A625 SERIES

Many different applications. It can be used for aircraft with tip-tanks with enclosed position lights (under a fairing), or as an add-on strobe on the wing or the tail. Available in a radio-shielded version.

Specifications:

• Weight: 0.2 lbs. (91gm)
• Exposed Height: 1.7" (43mm)

Model No.	Approvals	Description	Part No.	Price
A625	FAA/PMA	Standard unit, clear lens	11-03228	\$272.95
A625D	FAA/PMA	Radio-shielded, clear lens	11-03659	\$442.00
A625DR	—	Radio-shielded, red lens	11-07607	\$667.00

MODEL A440 MOUNTING ADAPTER

A440 mounting adapter is 3.75" for fuselage installations for the HRCFA series and the SACF series Self-Contained, Anti-Collision Lights.

Specifications: Measurement: 3.75" FAA/PMA.....P/N 11-03699\$61.75



WHELEN AVIATION LIGHTING



MODEL 90340 SERIES STROBE ANTI-COLLISION/LED POSITION LIGHT ASSEMBLY (FOR COMPOSITE WINGTIP STRUCTURE) -

Same as 90340 series with addition of 3 feet of braided bonded protection.

Specifications: • LED Navigation Light Power Consumption: 0.5 amps @ 14 VDC, 0.25 amps @ 28 VDC • Weight: 0.60 lbs. (272gm) 14 VDC, 0.65 lbs. (295gm) 28 VDC • Exposed Height: 2.70" (69mm) • LED Colors: Aviation Red, Aviation Green & Aviation White 1.1 lbs. (499gm) • Lenses: Clear RFI coated glass: strobe, Clear Polycarbonate: Navigation Lights

Model No.	Approvals	Description	Part No.	Price
9034001	FAA TSO-C96a, TSO-C30c Types I	Pos Grn, 14V	11-05625	\$825.00
9034002	FAA TSO-C96a, TSO-C30c Types I	Pos Red, 14V	11-05626	\$825.00
9034003	FAA TSO-C96a, TSO-C30c Types I	Pos Grn, 28V	11-05627	\$825.00
9034004	FAA TSO-C96a, TSO-C30c Types I	Pos Red, 28V	11-05628	\$825.00
9037501	FAA TSO-C96a, TSO-C30c Types I	Pos Grn, 28V	11-06598	\$780.00
9037502	FAA TSO-C96a, TSO-C30c Types I	Pos Red, 28V	11-06599	\$780.00
19-170049-010	Retainer, A600 Lens Complete		11-13903	\$119.75



MODEL 71110 SERIES STROBE ANTI-COLLISION/LED POSITION LIGHT ASSEMBLY -

71110 series is a wing tip mounted strobe anti-collision/position light assembly utilizing LED's for the forward position lights. The LED's provide a significant reduction in current draw over conventional position light bulbs. The strobe

light lens assembly is radio shielded for maximum EMI/RFI protection. Direct replacement (exact footprint) for the Whelen Model A650PG/PR series without replacing the current strobe power supply. Navigation light portion is wired with flying leads.

Specifications: • LED Colors: Aviation Red, Aviation Green • LED Navigation Light Power Consumption: 0.25 amps @ 14 VDC or 28 VDC • Weight: 0.45 lbs. (204gm) 14 VDC, 0.50 lbs. (227gm) 28 VDC • Exposed Height: 2.70" (69mm) • Lens: Clear RFI coated glass: strobe, Clear Polycarbonate: Navigation Lights

Model #	Approvals	Description	Part #	Price
7111001	FAA TSO-C96a / TSO-C30c Type II	Pos Green, 14 V	11-05630	\$689.00
7111002	FAA TSO-C96a / TSO-C30c Type I	Pos Red, 14 V	11-05633	\$675.00
7111003	FAA TSO-C96a / TSO-C30c Type II	Pos Green, 28 V	11-05635	\$675.00
7111004	FAA TSO-C96a / TSO-C30c Type I	Pos Red, 28 V	11-05636	\$665.00



MODEL A500A SERIES - A500A series combination strobe/tail navigation light used when the wing tip anti-collision lights are mounted in an enclosure and can't provide 360° of strobe coverage. It is a direct replacement for the standard tail position light. Available in a radio-shielded version. Voltage (14 or 28) and mounting (horizontal or vertical) must be specified when ordering.

Specifications: • Weight: 0.3 lbs. (136gm) • Exposed Height: 1.7" (43mm) • Diameter: 1.5" (38mm) FAA/PMA, FAA TSO-C30b

Model No.	Description	Part No.	Price
A500AV14	Vertical Mount, 14V	11-03223	\$559.00
A500AV28	Vertical Mount, 28V	11-03255	\$583.00
A500AH14	Horizontal Mount, 14V	11-03249	\$577.00
A500AH28	Horizontal Mount	11-03264	\$366.00
A500AVD2	Vertical Mount, 28V, radio-shielded	11-06407	\$563.00
A500ABV1	Beech Special 14V, MS connector	11-03715	\$812.00
A500ABV2	Beech Special 24V, MS connector	11-03716	\$815.00



MODEL 71105 SERIES LED POSITION LIGHT ASSEMBLY -

71105 series are fully FAA TSO compliant forward position lights. LED's provide a significant reduction in electrical current draw over conventional light bulbs. The 71105 is our latest design and lowest priced forward position light. Direct replacement for Whelen Model W1285 series (Version STC'd on Learjet Aircraft). **Specifications:** • LED Navigation Light Power Consumption: 0.25 amps @ 14 VDC or 28 VDC • LED Colors: Aviation Red, Aviation Green • Weight: 0.20 lbs. (91gm) 14 VDC, 0.25 lbs. (113gm) 28 VDC • Exposed Height: 2.70" (69mm) • Lens: Clear Polycarbonate

Model #	Description	Volt	Color	Leads	Part No.	Price
7110501	LED Forward Position Light FAA/TSO-C30c Type II	14	Green	Std - Red/Black	11-05629	\$330.00
7110502	LED Forward Position Light FAA/TSO-C30c Type I	14	Red		11-05631	\$330.00
7110503	LED Forward Position Light FAA/TSO-C30c Type II	28	Green		11-05632	\$330.00
7110504	LED Forward Position Light FAA/TSO-C30c Type I	28	Red		11-05634	\$330.00
7110511	LED Forward Position Light FAA/TSO-C30c Type I	28	Green	Shielded: White -	11-13982	\$889.00
7110512	LED Forward Position Light FAA/TSO-C30c Type I	28	Red	White/Blue - Shield	11-13983	\$893.00



WHELEN LED TAIL POSITION LIGHTS 71554 SERIES

Whelen 71554 Series LED Tail Position Lights are an exact footprint for Whelen Models A555A and 71011 Tail Lights.

ALL Part Numbers are FAA TSO-C30c Type III, E-TSO approved.

Model No.	Description	Part No.	Price
7155401	Horizontal Mount, 28 VDC	11-10682	\$269.95
7155402	Vertical Mount, 28 VDC	11-10683	\$269.95
7155403	Vertical Mount (Cessna), 28 VDC	11-10684	\$235.00
7155411	Horizontal Mount, 14 VDC	11-10568	\$269.95
7155412	Vertical Mount, 14 VDC	11-10686	\$280.00



MODEL A555A SERIES - A555A series tail mounted position light which uses a 25 watt halogen lamp. The suffix "V" or "H" in the part number designates the aircraft mounting screw locations in respect to the light shield. "V" designates vertical mounting and "H" indicates horizontal mounting on the aircraft. Supplied with a 2 position "AMP" connector. Specify 14 VDC or 28 VDC. Replaces the brand "G" A2064 series.

Specifications: • Exposed Height: 1.4" (36mm) • Mounting Diameter: 1.06" (27mm) • Power Consumption: 2 amps @ 14 VDC, 1 amp @ 28 VDC • Weight: 0.1 lbs. (45gm)

ALL Part Numbers are FAA TSO-C30b Type III approved.

Model No.	Description	Part No.	Price
A555AV14	Vertical, 14 VDC	11-03256	\$271.95
A555AV28	Vertical, 28 VDC	11-03267	\$272.95
A555AH14	Horizontal, 14 VDC	11-03270	\$283.95
A555AH28	Horizontal, 28 VDC	11-03275	\$269.95



MODEL 50626 SERIES STROBE TUBE ASSEMBLY - 50626 series strobe tube assemblies are used with the following model numbers listed in chart below:

Model #	Description	Used on	Part No.	Price
5062600	6"	Model 9011102	11-07681	\$218.95
5062601	6" w/Grom	Model 9034000 - 07, 20, 21 Model 7111001 - 04	11-07682	\$213.95
5062602	12.5" w/Grom	Model 9034008, 09	11-07683	\$129.75
5062603	2" w/Grom	Model 9037501, 02	11-07685	\$99.75



MODELS A610 & A612 - A610 flash tube and A612 glass lens are used for installing wing tip strobes in single engine Cessna's 1972 and later. The existing position light retainer is modified to accommodate the lens, and the flash tube is mounted directly behind. The unique magnifying design of the A612 lens increases the light intensity by two to three times in the horizontal plane. These items may be used for custom installations or as spare parts for existing light assemblies. The A612 lens is available in Aviation Red and an RFI coated version. Lenses meet material requirements of MIL-C-7989B Class B.

Specifications: • Drawing Number A612: 90005 • A610 Flash Tube Weight: 0.09 lbs. (41gm) • A612 Lens Weight: 0.08 lbs. (36gm)

Model No.	Approvals	Description	Part No.	Price
A610	FAA/PMA	Standard unit, 6" leads	11-03213	\$194.75
A610M	FAA/PMA	Molex connector, 6" leads	11-03734	\$126.75
5027601	FAA/PMA	14" leads	11-07611	\$385.00
5027602	FAA/PMA	12.5" leads	11-07612	\$131.75
A612	FAA/PMA	Standard clear lens	11-03222	\$72.90
A612D	—	Radio-shielded, clear lens	11-03735	\$189.95
A612DR	—	Radio-shielded, red lens	11-07614	\$533.00

WHELEN AVIATION LIGHTING

HOW TO CHOOSE A POWER SUPPLY AND ABOUT COMETFLASH®

The power supply needed depends on the application, and the mounting location. Model HDACF Series is a fuselage mounted power supply that will power two or three lights. Model A490ATSC Series is designed for installation adjacent to the strobe lighthouse and will power one light assy. Model A490TCF Series is the most economical power supply when adding only one light. It mounts adjacent to the strobe lighthouse assembly (not legal for light output with red strobe light). Most other Whelen power supplies are CometFlash®. A major advancement in the field of safety lighting. By pulsing the flash tube four times in rapid succession, the effective "on-time" of the strobe is increased from 2/1000 of a second to 4/10 of a second. This increases your airplane's visibility.



MODEL HDACF SERIES - HDACF series provides simultaneous flashing, alternate flashing or both. It will operate one, two or three strobe lighthouses. Operating the wing tip strobes in the alternating mode will provide an accumulated 42 joules of power to each light.

When in the simultaneous mode, the accumulated power to each light is 21 joules. In the three light mode, the wing flash simultaneous at an accumulated 21 joules each, they alternate with a third light operating at an accumulated 42 joules. On the trigger selector outlet, a switch mounted in place of the jumper will allow wing tip outlets 2 & 3 to be turned off, while the tail outlet 1 will remain on. This power supply will operate from 10 to 30 VDC.FAA/PMA

Specifications: • Power Consumption: 7.0 amps @ 14 VDC; 3.5 amps @ 28 VDC • Weight: 2.1 lbs. (953gm) • Length: 5.50" (140mm) • Width: 5.0" (127mm) • Height: 2.37" (60mm).....P/N 11-16218**\$877.00**



MODEL A490ATSC SERIES - Operates one strobe lighthouse. It produces an accumulated 34 joules of power and can be equipped to flash simultaneously with up to 5 other like units by connecting an 18 gauge wire between outlet 3 on the input power connector. This power supply will operate from 10 to 30 VDC. FAA/PMA

Specifications: • Power Consumption: 4.0 amps @ 14 VDC; 2.0 amps @ 28 VDC • Weight: 1.7 lbs. (771gm) • Length: 5.0" (127mm) • Width: 3.12" (79mm) • Height: 3.06" (78mm). P/N 11-02666**\$845.00**



MODEL A490TCF Operates one strobe lighthouse. It produces an accumulated 19 joules of power. It will only meet 400 CP when used with the A470A-W. This unit cannot be synchronized. Operates from 10 to 30 VDC (not approved for use with red strobe light).

Specifications: • Power Consumption: 1.7 amps @ 14 VDC; 0.85 amps @ 28 VDC • Weight: 1.2 lbs. (544gm) • Length: 5.0" (127mm) • Width: 3.12" (79mm) • Height: 2.38" (60mm) FAA/PMA • 20" leads, amp connectors P/N 11-14714**\$830.00**



MODEL A490TCF Same as the A490TCF but has a mounting plate with additional holes that directly replaces factory installed systems on single engine Cessna's, Aero Commanders, and Grumman Americans. FAA/PMA • 20" leads, amp connectors P/N 11-02661**\$845.00**



MODEL HDS SERIES - Produces 20 joules of energy, SingleFlash, alternating between two light assemblies. The SingleFlash allows for a low current draw. This power supply will operate from 10 to 30 VDC.

Specifications: • Power Consumption: 4.0 amps @ 14 VDC; 2 amps @ 28 VDC • Weight: 2.0 lbs. (907gm) • Length: 5.50" (140mm) • Width: 5.0" (127mm) • Height: 2.37" (60mm).....P/N 11-03279**\$1,109.00**



MODEL 01-0770062-05 (CIRRUS) - Operates one (1) strobe light head at 36 joules in CometFlash. It is equipped to flash simultaneously with up to 5 other like units by connecting an 18 gauge wire between outlet 3 on the input connector.

Specifications: • Power Consumption: 1.6 amps avg. Input Voltage: 28 VDC Nominal • Weight 1.3lbs Length: 5.00" • Width: 3.12" • Height: 3.00" P/N 11-08306**\$856.00**



READING LIGHT - The Model A325 ML reading light will replace original equipment on 14 volt Piper aircraft. It is designed for passenger convenience and is equipped with an on/off slide switch. Specify voltage (14V or 28V).

14V.....P/N 11-03294**\$533.00**
28V.....P/N 11-03682**\$517.00**



OVERHEAD CABIN LIGHT - The Model A360 is designed for recessed overhead lighting. Aluminum housing & Pyrex lens. Weight: 0.25 Lb.

14V.....P/N 11-03685**\$237.95**
Dome light assy. with switch 14V P/N 11-03629**\$256.95**
Dome light assy. with switch 28V P/N 11-12924**\$243.95**



MODEL 7114416 'GOOSENECK' LED LIGHT ASSEMBLY Whelen LED Gooseneck Light Assembly. Features a positive off position & rheostat controlled light intensity. Available in 28VDC only.

• Power Consumption: 0.06 amps @ 28 VDC. • LED Colors: Aviation White • Weight: 0.46 lbs. (209gm). • Black Nylon Hood: fixed in position. P/N 11-07701**\$304.00**



A350 WHELEN POST LIGHTS

A350 and A350CN series instrument post light assemblies are designed to illuminate the instrument panel and function as instrument mounting bolts. The A350 is identical to the A350CN, but without the connector nut.

Specifications: • Drawing Number A350: 70116 • Drawing Number A350CN: 70119 • Exposed Height: .875" (22mm) without spacer, 1.00" (25mm) with spacer • Power Consumption: 0.2 amps @6 VDC, 0.08 amps @14 VDC, & 0.04 amps • @ 28 VDC • Weight: 0.037 lbs. (17gm) Post Light Assembly w/ nut black post P/N 11-08133**\$69.95**

Model Number	Description	Part No.	Price
A350CN09	White, 14 VDC	11-03205	\$82.80
A350CN10	Red, 14 VDC	11-03214	\$69.95
A350CN15	White, 28 VDC	11-03210	\$78.75
A350CN16	Red, 28 VDC	11-03653	\$82.80



INSTALLATION CABLE KITS - Cable kits include all required connectors for hooking up the strobe light to the power supply only. Warning placards included. All cable is 16 gauge 3/C shielded. The cable diameter is .275" (7mm). Weight is .050 lbs. per linear foot. (Kits do not include switches or breakers)

Model No.	Description	Part No.	Price
HS5	5' Cable kit	11-04204	\$57.75
HT10	10' Cable kit	11-08173	\$68.75
HS30	30' Cable kit	11-03285	\$112.75
HD60	60' Cable kit	11-02667	\$185.75
HDT390	90' Cable kit	11-02668	\$259.95
HT	Install Placard Kit: Includes (1) A421 & (1) A421-1 Pilots Warning Placards, (1) A445 Switch Label. No connectors included.	11-02669	\$26.55

REPLACEMENT CONNECTORS - Replacement connector kits and assemblies for cables.

Model No.	Description	Part No.	Price
A441	3 Position male with pins kit	11-03211	\$16.85
A442	3 Position male with sockets kit	11-03212	\$16.85
A444	2 Position male with pins assembly	11-03700	\$16.95
A446	2 Position female with sockets assembly	11-03702	\$16.95
A447	4 Position male with pins	11-07706	\$18.95
A448	4 Position female with sockets	11-07707	\$17.50



CRIMP TOOL - Pin and socket crimping tool.

P/N 11-07708**\$257.95**

NOTE: All non-FAA approved Whelens parts are signified by a (—) in the approval column. Parts without FAA approval may still be purchased, however, installation of these parts on U. S. Type Certificated products may require additional FAA approvals.

WHELEN AVIATION LIGHTING



MODEL 71125 SERIES LED RECOGNITION LIGHT - 71125 series LED recognition light is designed to provide supplemental lighting for a wide variety of aircraft applications. Provides all of the advantages of LED's as a light source, no EMI/RFI, low current draw, low heat, long life. Perfect for vibration prone areas. Item ships with flying leads. Several different beam spreads available. Designed to replace the

Whelen A775 series. Version containing integrated MS connector also available. Can be used in conjunction with 71115 Flasher control assembly. Contact your OEM for installation eligibility on your aircraft.

Specifications: • Power Consumption: 0.9 amps @ 14 Volts, 0.45 amps @ 28 Volts • Lens: Clear polycarbonate • LED Color: Aviation White • Weight: 0.3 lbs. (136gm) • Overall Width: 3.25" (83mm) • Overall Depth: 1.25" (32mm) • Overall Height: 1.95" (50mm)

Model No.	Description	Part No.	Price
7112510	10 degree beam pattern, 14V	11-06164	\$295.95
7112511	20 degree beam pattern, 14V	11-06165	\$295.95
7112512	90 degree beam pattern, 14V	11-06166	\$295.95
7112520	10 degree beam pattern, 28V	11-06167	\$295.95
7112521	20 degree beam pattern, 28V	11-06168	\$296.00
7112522	90 degree beam pattern, 28V	11-06169	\$295.00
7112523	30 degree beam pattern, 28V	11-07703	\$295.95



MODEL A775 SERIES - A775 series recognition light assembly which produces up to 22,000 beam candlepower using only a 35 watt lamp.

Specifications: • Drawing Number: 70110 • Weight: 0.14 lbs. (64gm) • Width: 3.25" (83mm) • Height: 1.75" (44mm) • Depth: 2.25" (57mm) • Power Consumption: 2.5

amps @ 14 VDC, 1.25 amps @ 28 VDC

Model #	Approvals	Description	Part No.	Price
7011001	FAA/PMA	Molex connector (Piper), 14V	11-07704	\$131.75
7011002	FAA/PMA	Molex connector (Piper), 28V	11-07705	\$84.75
A77528	—	12" leads, 28 VDC	11-03742	\$92.80



A715-1 LANDING LIGHT

The Model A715-1 landing light is standard equipment on new Beechcraft, and will retrofit into older aircraft, as well. Accommodates PAR 36 sealed beam lamp. Order lamp separately (#4509 - 100W, 12V; #4594 or #4613 100W, 24V; Wt. 1/2 lb. Size: 4-3/4" dia. x 6-1/2" long x 2-1/8" deep.

P/N 11-03281\$319.00



71685 RECOGNITION/ LANDING LIGHT

71685 Series LED Recognition/Landing light assembly. Dimensions H x W x D: 2.07" (53mm) x 3.64" (93mm) x Depth: 0.979" (25mm)

14V.....P/N 11-11189\$130.00
28V.....P/N 11-11190\$130.00

WHELEN VERTEX™ SUPER-LED® LIGHT



Only 7/8 in height, this small hemispheric LED lighthouse is perfect for most applications where size and intensity are critically important. Self-contained unit using an in-line combination lamp driver/flasher. This self-contained LED Hideaway requires

only a one inch hole in any composite style head light, cornering light or tail light assembly to deliver true wide angle warning to the front, side and rear of your vehicle... without interference to your vehicle computer and warning equipment! Less than 1 tall, it may also be surface mounted to outside surfaces anywhere on the vehicle!

Model No.	Description	Dimensions	Part No.	Price
VTX609R	Red Anti-Collision	1"H x 1.625" Dia.	11-12527	\$112.75
VTX609C	Clear Anti-Collision	1"H x 1.625" Dia.	11-12475	\$134.99
VTX3609R	360° Side Emitter Lighthouse	1.49" Dia.	11-15417	\$130.00
VTXFC11	Chrome Flange Kit	2.25"L x 1.7"W x 0.4"W	11-15423	\$17.85
VTXFB11	Black Flange Kit	2.25"L x 1.7"W x 0.4"W	11-15424	\$10.95



WHELEN LED RECOGNITION LIGHT ASSEMBLY

LED Form / Fit / Function replacement to A775 & A775EXP series. LED Form / Fit / Function replacement to A775 & A775EXP series. Used only for Experimental Aircraft.

14VP/N 11-14105\$310.00
28VP/N 11-14106\$310.00



WHELEN 71434 LED POST LIGHT

Product (Aviation) - The 71434 Series LED (Light Emitting Diode) instrument post light assemblies are designed to illuminate the instrument panel and function as instrument mounting bolts. They are a high quality, long lasting modern alternatives to standard incandescent post lights.

Model 71434 is identical to the 71450 without the connector nut. Both are available in Black and Grey. 14V version available with White LED, 28V version with White or Red. Made to replace existing A350 and A350CN assemblies.

Description	Part No	Price
White Long Black 14V	11-13607	\$75.75
White Long Black 28V	11-13610	\$75.75
White Short Black 14V	11-13608	\$74.95
White Short Black 28V	11-13612	\$74.95



WHELEN 71440 LED POST LIGHT

Product (Aviation) - The 71440 Series LED (Light Emitting Diode) instrument post light assemblies are designed to illuminate the instrument panel and function as instrument mounting bolts. They are a high quality, long lasting modern alternatives to standard incandescent post lights. Model 71440 has a #10-32 mounting thread.

Description	Part No.	Price
28V W/spacer 01-0771440-00	11-13619	\$89.75
28v White 01-0771440-01	11-13620	\$66.75
28v Red 01-0771440-02	11-13621	\$89.75



WHELEN 71450 LED POST LIGHT

Product (Aviation) - The 71450 Series LED (Light Emitting Diode) instrument post light assemblies are designed to illuminate the instrument panel and function as instrument mounting bolts. They are a high quality, long lasting modern alternatives to standard incandescent post lights. Model 71434 is identical to the 71450 without the connector nut. Both are available in Black and Grey. 14V version available with White LED, 28V version with White or Red. Made to replace existing A350 and A350CN assemblies.

Description	Part No	Price
White Long Black 14V	11-13622	\$89.95
White Long Black 28V	11-13625	\$89.95
White Short Black 14V	11-13623	\$89.95
White Short Black 28V	11-13627	\$88.85
White Long Grey 28V	11-13631	\$76.85



WHELEN POST LIGHT ASSEMBLY A350

Instrument post light assemblies designed to illuminate the instrument panel and function as instrument mounting bolts. The A350 is identical to the A350CN, but without the connector nutP/N 11-18794\$71.75



WHELEN 71898 SERIES LED RECOGNITION LIGHT

Whelen 71898 Series 28V Led Recognition Light is designed to be direct replacement for A775EXP and 7042900 assemblies.

Model 71898P0 is painted White and is the spare part for the legacy 7045301 recognition light used in the 90029 assembly. 7189801 is the replacement for 7042900 (King Air B300's) PMA approvals pending.

Model No.	Description	Part No.	Price
7189801	LED Recognition Light	11-17270	\$310.00
71898P0	LED Recognition Light - Painted	11-17271	\$360.00



WHELEN AVIATION LIGHTING

WHELEN CHROMA™ POSITION LED LAMPS



Direct replacements for W129028 / 129028 / A7512-24 / W628 / 628 incandescent bulbs. Unique reflector design allows for full FAR coverage compliance. Robust machined base provides vibration resistance tested in accordance with RTCA/DO160 CAT U2, Curves F, F1 for rotorcraft. All electronic logic conformal coated for weather resistance. Nickel Plated hard contact eliminates premature wear. Keeps original lens configuration to maintain FAA approvals of light assembly. LED bulbs have a 10,000 hour operating life, while incandescent bulbs have a fragile filament and a 300 hour average life. 85% reduced current draw. Five year warranty.

Color	Volts	Part No.	Price
Red	14	11-15017	\$130.00
Red	28	11-15012	\$130.00
Green	14	11-15019	\$130.00
Green	28	11-15013	\$130.00

WHELEN SELF-CONTAINED ANTI-COLLISION STROBE 70285 SERIES



Model 90101 series is similar to the HTCF but has military connectors. It is available in SingleFlash or CometFlash. Several different configurations are available for application specific installations.

Specifications:

- Power Consumption: 4 Amps @ 14 VDC; 2 Amps @ 28 VDC • Weight: 1.7 lbs (771gm) • Length: 5.0 (127mm) • Width: 3.12 (79mm) • Height: 3.50 (89mm) • Approvals: FAA/TSO-C96a

Model No.	OEM Part No.	Description	Part Number	Price
9010104	01-0790101-04	24 joule, SingleFlash, w/add on mounting plate	11-01972	\$974.00
9010102	01-0790101-02	34 joule, CometFlash, replaces Grimes 60-2799 when used with mounting brackets	11-16943	\$1,003.00
9010105	01-0790101-05	34 joule, CometFlash	11-16944	\$1,003.00

WHELEN 71994 SERIES LED ANTI-COLLISION LIGHT ASSEMBLY



The 71994 is a self-contained LED Anti-Collision light assembly designed to replace the original 71818 strobe light on Cessna Restarts. These assemblies are the same fit, form, function as the original light assembly and come with the comet flash pattern. The 71994 light is TSO-C96a Class II approved and comes with a 5-year warranty.

- Specifications:** • TSO-C96a Class III Approved • Weight: 0.46 lbs • Voltage: 28 VDC • Current Draw: 1.8 Amps Pulse (0.32 Amps Average) P/N 11-17559**\$665.00**

WHELEN ORION™ 550 WHITE TAIL POSITION / ANTI-COLLISION LED LIGHT



Whelen Aerospace Technologies (WAT) provides the highest performance lighting system for the Orion 550 Series products incorporating both the WHITE flashing Anti-Collision light, and the Tail

Position light functions. State of the art LED circuitry is built in to eliminate the need for separate flasher boxes for operation. The footprint, and mounting, are identical to legacy Whelen products for ease of installation and retrofit. FAA/TSOP/N 11-18745**\$487.00**

WHELEN 02-0371773-30 LENS ASSEMBLY WITH HARDCOAT



ORION600 Series of FAA/TSO approved LED aviation lighting. Part 02-0371773-30 is a Whelen replacement lens assembly with hardcoat. FAA TSO-C96c Class II / TSO-C30c Type II & III P/N 11-18176**\$17.85**

WHELEN 90613 SERIES LED RH GREEN WINGTIP ANTI-COLLISION LIGHTS



90613 is a self-contained LED wingtip light head assembly utilized for Cessna Caravans. The unit complies with TSO-C96a Class II (400 ECP) anti-collision light requirements and TSO-C30c forward / rear position light requirements. Model 9061391/ 92 is a direct mechanical replacement, same fit / form / function for the legacy Caravan wingtip lights. Currently, these assemblies are TSO approved with STC PENDING.

Model No.	OEM Part No.	Description	Part No.	Price
9061391	01-0790613-91	RH Green Wingtip Position Anti-Collision LED	11-17549	\$1,215.00
9061392	01-0790613-92	LH Red Wingtip Position Anti-Collision LED	11-17550	\$1,198.00

MODEL A650 PG/PR SERIES



Wing tip with anti-collision & forward position lights can be used to convert non-Whelen position lights into a position/anti-collision light system. The small size allows for mounting into a wing tip enclosure. Available in 14 or 28V and in a radio-shielded version. The forward position lamp is 26 watts.

- Specifications:** • Weight: 0.6 lbs. (272gm) • Position Lamp Power Consumption: 2 amps @ 14V; 1 Amp @ 28V • Exposed Height: 2.4" (61mm) • Length:

4.0" (102mm) • Width: 1.7" (43mm)

ALL Part Numbers are FAA/PMA approved.

	Description	Part No.	Price
A650PG14	Position Green, 14V	11-03217	\$780.00
A650PG28	Position Green, 28V	11-03239	\$768.00
A650PR14	Position Red, 14V	11-03218	\$780.00
A650PR28	Position Red, 28V	11-03247	\$765.00
A650PGD1	Position Green, 14V, Radio-Shielded	11-03639	\$735.00
A650PGD2	Position Green, 28V, Radio-Shielded	11-06336	\$735.00
A650PRD1	Position Red, 14V, Radio-Shielded	11-03642	\$735.00
A650PRD2	Position Red, 28V, Radio-Shielded	11-06337	\$735.00

WHELEN BLAZE™ LED WINGTIP POSITION / ANTI-COLLISION LIGHT FOR EXPERIMENTAL / LSA



Whelen Blaze™ an all LED wingtip position, anti-collision and tail light assembly for the LSA and experimental market. Low drag and light weight without compromising safety and visibility.

Note: For Experimental Use Only. Not TSO Approved.

- Specifications:** • Weight: 0.19 lbs • Position LED Colors: Aviation Red / Aviation Green

- Anti-Collision LED Color: Aviation White
 - Measurements: 4.5" L x 1.3" W x 1.2" H
- Red + Green Bundle.....P/N 11-18403**\$469.95**

BONANZA COWL MOUNTED BOOMBEAM 28V - 85 WATT



28V 85W Cowl mounted BoomBeam. Comes with LoPresti 28V 85W ballast, new Par46 housing assembly and composite ring for fit.

- Benefits:** • Produces 3-15 times more light, engineered specifically for each model aircraft. • Increases safety, see and be seen • Reduces electrical load and heat output • Decreases AOG time for lighting issues, no filament to break. • 5 Year / 5,000 HR Warranty, a proven system based on time-tested experience

- More closely approximates the color temperature of natural daylight
- FAA / STC / PMA Approved.....P/N 11-17562**\$2,798.92**

WHELEN REPLACEMENT BULB 34-0070372-01

- Replacement bulb.....P/N 11-18795**\$93.50**

EL

WHELEN STROBES

STROBE SYSTEM PARTS

Model No.	Description	Part No.	Price
A402R	Red Optic Lens	11-03254	\$79.75
A402W	White Optic Lens	11-03271	\$72.75
A402R/W	Split Red/White Optic Lens	11-03248	\$74.95
A406	Flash Tube Assembly	11-03687	\$213.95
A409	Clamp Ring Assembly	11-03688	\$23.50
A414A, HDH, CF	HDH,CF Power Supply	11-03632	\$1,278.00
A417-1	Interconnecting Cable	11-03658	\$2.20
A421-1	Warning Decal	11-03691	\$19.70
A425	Tail Strobe Lens Retainer	11-03692	\$27.50
A426	Wingtip Strobe Lens Retainer	11-03233	\$134.75
A427	Flash Tube Assembly	11-03219	\$244.95
A427-M	Flash Tube Assembly with Molex Connector	11-03272	\$212.95
A427-4	Rubber Pad Spacer	11-03693	\$18.50
A428	Wingtip Strobe Lens	11-03236	\$142.75
A428-C	Wingtip Strobe Radio Shielded Lens	11-03694	\$128.75
A428-D	Wingtip Strobe Radio Shielded Lens plus A426 Retainer Assembly	11-03290	\$261.95
A469A	Strobe Tube Assembly	11-03242	\$199.95
A430	Tail Strobe Head Assembly	11-03696	\$235.95
A435	Flash Tube Assembly	11-03697	\$233.95
A440	WRM-65 Mounting Adapter, for HR,DF & SA,DF	11-03699	\$61.75
A441	AMP Connector and 3 Pins	11-03211	\$16.85
A442	AMP Connector and 3 Sockets	11-03212	\$16.85
M441	Molex Connector and 3 Pins for Piper Installation	11-04215	\$16.95
M442	Molex Connector and 3 Sockets for Piper Installation	11-04216	\$16.50
A444	AMP Connector and 2 Pins	11-03700	\$16.95
M444	Molex Connector and 2 Pins for Piper Installation	11-04217	\$16.50
A445	Switch Label	11-03701	\$9.00
A446	AMP Connector and 2 Sockets	11-03702	\$16.95
A450	Strobe Head Assembly	11-03280	\$418.00
A455	Gasket	11-03703	\$18.50
A457A	Tail Light Lens for A500 and A555	11-03227	\$72.90
A457A-D	Radio Shielded Tail Light Lens Assembly for A500	11-03704	\$155.75
A466A-1	Radio Shielded Lens	11-03708	\$238.95
A467	Gasket for A470	11-03709	\$17.70
A469B	Flash Tube Assembly	11-03225	\$199.95
A469D-K	Radio Shielded Kit for A469A	11-03711	\$227.95

Model No.	Description	Part No.	Price
A470-D	Radio Shielded Remote Strobe Head Assembly, Specify Color	11-03291	\$280.95
A470-A-D-S	Strobe Head Assembly, Shielded Red/White	11-04976	\$257.95
A470-D-R-SU	Radio Shielded Remote Strobe	11-03714	\$306.00
A490 TC CF	14V Power Supply	11-02661	\$845.00
A500-V-D-28	28V Radio Shielded Tail Position Strobe Light Head Assembly Vertical Mount	11-06407	\$563.00
A500-V-D-M-14	Radio Shielded Tail Position & Strobe Light Head Assembly Vertical Mount with Molex Connector	11-03722	\$566.00
A500B-V-14	Tail Position & Strobe Light Head Assembly (Beech)	11-03715	\$812.00
A500B-V-28	Tail Position & Strobe Light Head Assembly (Beech)	11-03716	\$815.00
A502	Flash Tube & Socket Assembly	11-03723	\$330.00
A506	Flash Tube & Socket Assembly	11-03274	\$374.00
A506-B	Flash Tube & Socket Assembly		\$478.00
A506-M	Flash Tube & Socket Assembly	11-03725	\$372.00
A506-SP	Flash Tube & Socket Assembly	11-03726	\$348.00
A507	Lamp Socket Assembly for A555	11-03240	\$61.75
A508-14	Halogen Lamp for A500, A555, A600	11-03216	\$55.80
A508-28	Halogen Lamp for A500, A555, A600	11-03208	\$56.90
A509	Lamp Shield for A500 and A555	11-03727	\$18.60
A510-28	Lamp Assembly for A500 & A555	11-03266	\$68.75
A50828	Lamp for A500, A555, & A600	11-03208	\$56.90
A512-V-28	Tail Position & Strobe Light Head Assembly (Gulfstream Commander)	11-03729	\$342.00
A540	Long Mounting Adapter	11-03730	\$106.75
A605	Base Plate Assembly	11-03733	\$172.85
A606	Retainer	11-03260	\$87.75
A610	Flash Tube Assembly	11-03213	\$194.75
A610-M	Flash Tube Assembly	11-03734	\$126.75
A612	Magnifying Lens	11-03222	\$72.90
A612-D	Radio Shielded Lens Retainer Assembly	11-03735	\$189.95
A615	Lens for A600 Tail Light	11-03230	\$128.75
A616	Gasket for A600 Tail Light	11-03261	\$18.70
A625	Tail Strobe Head	11-03228	\$272.95
A625-D	Radio Shielded Tail Strobe Head Assembly	11-03659	\$442.00
A626	Retainer Lens	11-03229	\$71.85
A626-D	Radio Shielded Lens Retainer Assembly	11-03736	\$210.95
A627	Flash Tube Assembly	11-03263	\$213.95
A628	Retainer Lens	11-03737	\$53.75
A629	Gasket	11-03660	\$18.70
A650	Wingtip Strobe Head Assembly	11-03215	\$265.95



WHELEN STROBES

STROBE SYSTEM PARTS #3

Model #	Description	Part No.	Price
A650-PG-D-14	Wingtip Position & Strobe (Radio Shielded) Head Assy.	11-03639	\$735.00
A650-PG-D-28	Wingtip Position & Strobe (Radio Shielded) Head Assy.	11-06336	\$735.00
A650-PR-D-14	Wingtip Position & Strobe (Radio Shielded) Head Assy.	11-03642	\$735.00
A650-PR-D-28	Wingtip Position & Strobe (Radio Shielded) Head Assy.	11-06337	\$735.00
A650-PG-D-M-28	Radio Shielded Wingtip Strobe & Position Light Head Assemble w/Molex Connector	11-06338	\$421.00
A730	Tail Flood Light Assembly	11-03740	\$571.00
A1610-14	Power Supply	11-03666	\$1,338.00
C-70178-1	Power Supply (Single Flash)	11-04132	\$1,084.00
C-70188-1	Power Supply	11-04133	\$990.00
70294-1	Power Supply	70294-1	\$739.00
H102	"B" Mounting Adapter	11-03243	\$28.55
H103	"A" Mounting Adapter 3-3/4"	11-03284	\$116.75
HR-CF200-14	14V Power supply for HR or SA	11-03838	\$456.00
SA402	Lens Assembly for SA & A450	11-04259	\$269.95
SA406	Flash Tube Assembly for SA & A450	11-03250	\$229.95
W1282	Forward Position Light Lens Retainer	11-03232	\$89.90
W1283	Forward Position Light Gasket	11-03209	\$23.65
W1284-G	Forward Position Light Lens (Green)	11-03206	\$95.75
W1284-R	Forward Position Light Lens (Red)	11-03207	\$89.95
W1285-2	Forward Position Light Base	11-03244	\$165.75
W1284C	Lens, Clear	11-04117	\$245.95
W1290-14	14 Volt Position Light Bulb	11-02602	\$113.75
W1290-28	28 Volt Position Light Bulb	11-02604	\$106.90
90029-1	Combination Wing-tip Light Assy.	90029-1	\$2,713.00
90029-2	Combination Wing-tip Light Assy.	90029-2	\$2,713.00
90029-3	Combination Wing-tip Light Assy.	90029-3	\$2,695.00
90029-4	Combination Wing-tip Light Assy.	90029-4	\$2,695.00
90033-1	Anti Collision Beacon Assy. Red	90033-1	\$1,253.00
90033-2	Anti Collision Beacon Assy. White	90033-2	\$1,036.00
34-0226010-91	Lamp Quartz 150 Watt	11-05091	\$89.95

INTERIOR LIGHTING

Model #	Description	Part No.	Price
A300-14	14V Map Light Assembly	11-03673	\$319.00
A300-28	28V Map Light Assembly	11-03674	\$310.00
A315HIR2	28V Cockpit Utility Light - Red	11-03678	\$134.75
A315-LO-B-14	14V Cockpit Utility Light	11-03679	\$51.75
A325-ML-14	14V Reading Light Assembly	11-03294	\$533.00
A325-ML-28	28V Reading Light Assembly	11-03682	\$517.00
*A350-14	14V Post Light Assembly	11-03205	\$82.80
*A350-28	28V Post Light Assembly	11-03210	\$78.75
A360-14	14V Dome Light Assembly Overhead	11-03685	\$237.95
A360SW	Dome Light Assembly w/Switch	11-03629	\$256.95
70339-1	Floodlight Assembly (14V)	70339-1	\$230.95
70339-02	Floodlight Assembly (28V)	70339-02	\$228.95
70339-03	Floodlight Assembly (14V Switch)	70339-03	\$254.95
70339-04	Floodlight Assembly (28V Switch)	70339-04	\$266.95
70348-00	Post Light (28V 10-32Thread) (IW)	70348-00	\$112.75
70348-01	Post Light (28V 10-32Thread) (RD)	70339-01	\$115.75

PARTS FOR POST LIGHTS

Model #	Description	Part No.	Price
*A354	Head Assembly	CALL	\$46.95
*A358	Base Assembly	CALL	\$38.50

* Requires dash numbers for lens color and finish. Please contact factory.

‡ For complete information contact factory.

RECOGNITION LIGHT & LANDING LIGHT

Model#	Description	Part No.	Price
A775-28	28V Recognition Light 35 Watt	11-03742	\$92.80
A777	Lens for A775-EXP	11-03649	\$26.60
70346-00	Recognition Light (14V No Lens)	70346-00	\$62.75
70346-01	Recognition Light (28V No Lens)	70346-01	\$83.75
70346-03	Recognition Light (28V Clear Lens)	70346-03	\$79.95
70346-04	Recognition Light (14V Optic Lens)	70346-04	\$81.90
70346-05	Recognition Light (28V Optic Lens)	70346-05	\$79.95
01-0790095-02	Fixed Landing Light (PAR 46)	01-070095-02	\$386.00
38-0240063-00	Sealed Beam Gasket (PAR 46)	11-05103	\$23.50
38-0240197-01	Sealed Beam Gasket (PAR 36)	38-0240197-01	\$23.50
19-270407-000	Clamp Ring (PAR 46)	19-270407-000	\$80.95
19-250147-000	Clamp Ring (PAR 36)	19-250147-00	\$77.75

SURFACE ILLUMINATING LIGHTS

Model #	Description	Part No.	Price
A708-28	28V Halogen Lamp (50 Watt)	11-00023	\$53.75
A750	Flasher Assembly	11-00024	\$178.80

PARTS FOR ROTATING BEACON

Rotating Beacon Replacement- The round mechanical rotating beacon was used on the vertical fin of all Barons from 1961 thru 1969. Models using this light are 95-55 (1961), A55 (1968-1969). Note: The B55 Baron continued to use this beacon until production stopped in 1982.

Model#	Description	Part No.	Price
WRM-10	Lexan Dome	11-03257	\$56.75
WRM-30	Gasket	11-04273	\$25.60

MISCELLANEOUS HARDWARE

Model#	Description	Part No.	Price
GLJ-106	Lamp Retainer	11-03811	\$39.50
GLJ-111	Lamp Assembly	11-03812	\$269.95

EL

WHELEN STROBE LIGHTS

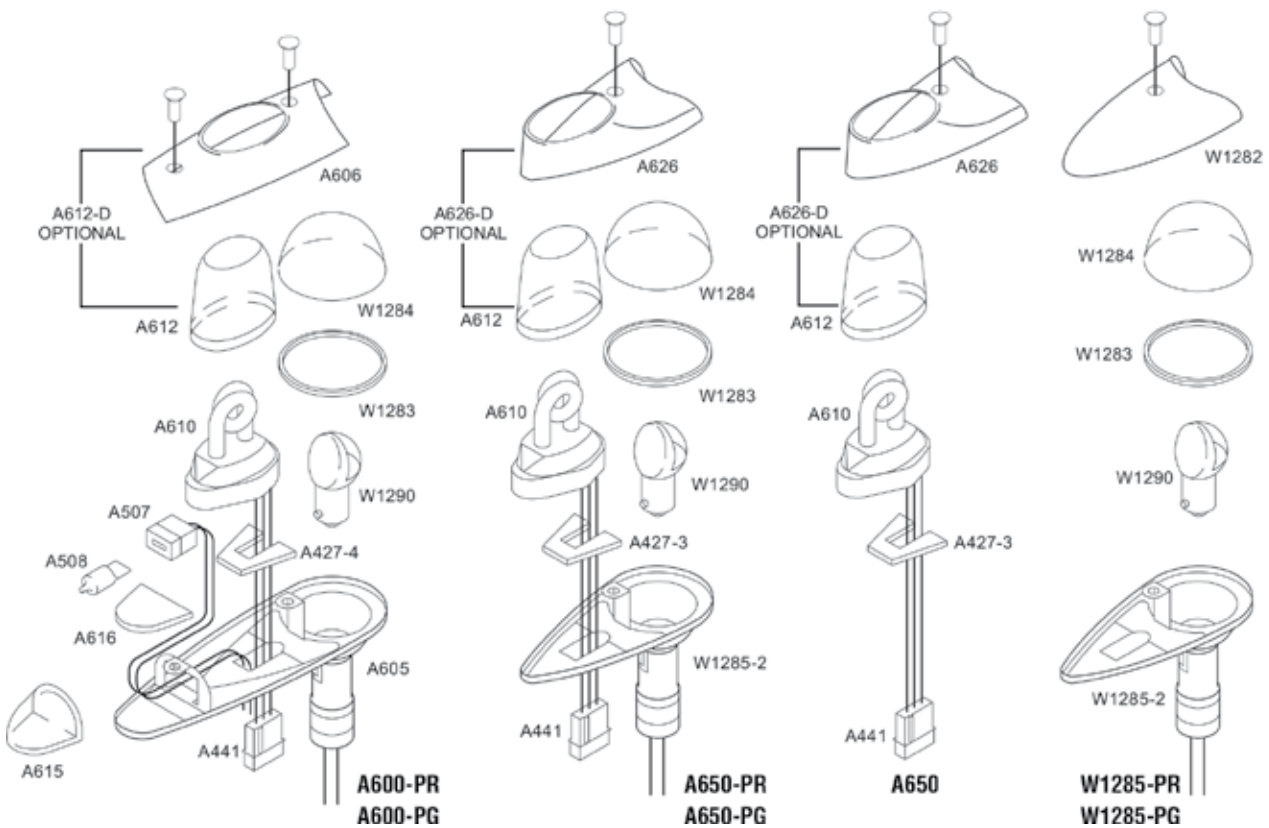
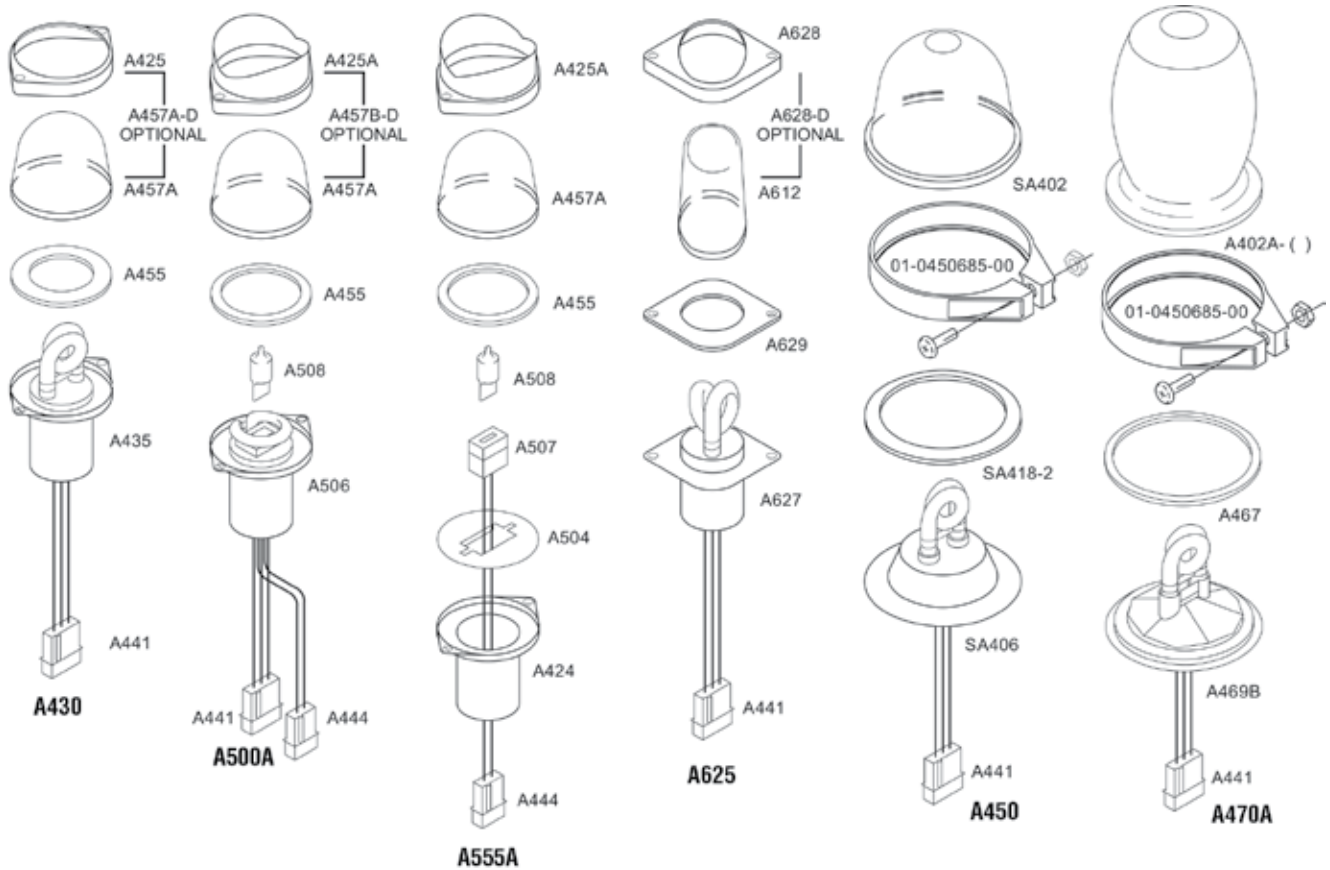

EL

WARNING SYSTEMS

VOLT AND VAC ALERT



• Provides an instantly recognizable voice warning directly in your headset if low vacuum (or pressure) or low voltage develops • Includes a red warning light mounted close to the gyro instruments. Many aircraft are equipped with backup vacuum systems, however you must first know that your instrument power system has failed before any of these backup systems are engaged. You must “know you have a problem before you have a problem”.

Volt & Vac Alert consists of a small electronic unit that can be mounted anywhere in the aircraft. It connects to aircraft voltage, instrument power (vacuum or pressure), and the aircraft audio system. If the voltage falls below 12v or 24v the voice message “CHECK VOLTAGE CHECK VOLTAGE” will be heard. Should the gyro power fail, the pilot will hear the voice message “CHECK GYROS, CHECK GYROS” directly in his headset. The voice message will sound once, and then the red warning light will illuminate until the problem is fixed. The unit can be used in 12v or 24v aircraft with either vacuum or pressure gyro power systems. It can be installed in pressurized or un-pressurized aircraft. Sold as a complete assembly with everything necessary for the installation except a 1 amp fuse or circuit breaker. STC'd for most general aviation aircraft P/N 10-00393**\$495.00**

VOICE ALERT



Whenever the existing stall horn sounds, the pilot will hear the instantly recognizable voice message “STALL, STALL” from the built in speaker, and directly in his headset. If the gear warning horn sounds, the pilot will hear the voice message “CHECK LANDING GEAR, CHECK LANDING GEAR” alerting of the problem. No more confusion over which horn is sounding. These voice messages are in addition to the original horn sounds. The Voice Alert consists of a small electronic unit about 2-1/2" by 3-1/2" in size that can be mounted almost anywhere in the cockpit. Installed weight is less than 1 lb. Supplied as a complete kit consisting of the electronic unit, a pre-wired cable assembly, and all the connectors and mounting hardware. Requires is a 1 amp fuse or circuit breaker. Installation can be performed by an A&P mechanic or an avionics shop. The system is approved for both fixed and retractable gear aircraft.

Description	Part No.	Price
VOICE ALERT 2040-1-1 produces voice messages for gear and stall warnings, and can be programmed with up to 8 additional warning voices such as altitude, vacuum, fuel, pressures, etc. Supplemental system only.	10-03713	\$675.00
VOICE ALERT 2040-1-2 produces stall and gear voice messages in the pilot's headset. Supplemental system only.	10-00394	\$675.00
VOICE ALERT 2040-1-1P similar to the 2040-1-1 except approved for installation as primary replacement for existing warning units like Cessna Electronic Dual Warning units	10-03714	\$875.00
VOICE ALERT 2040-1-2P similar to the 2040-1-2 except approved for installation as primary replacement for existing warning units like Cessna Electronic Dual Warning units	10-03715	\$795.00
VOICE ALERT 2040-1-1 Custom Voice settings produces voice messages for gear and stall warnings, and can be programmed with up to 8 additional warning voices such as altitude, vacuum, fuel pressures, etc. Supplemental system only.	10-04964	\$882.00

GEAR WARNING SYSTEM (2048)

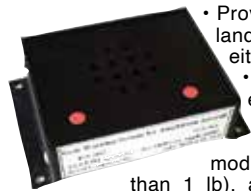

• Provides both voice and visual warning if the landing gear is not in the correct position for either a runway landing or a water landing • Airspeed activated, activation speed is easily set from 45 to 90 mph • Works with aircraft having 2, 4, or 8 gear indicating lights. Consists of a small electronic module (2.5 inch by 3.25 inch weighing less than 1 lb), and a panel mounted switch with light. Activation speed can be easily set using a screwdriver. Time delay is built in to prevent false triggering due to speed fluctuations. Pilot can perform a self test of the system. Can place in a disengage mode which temporarily disengages the system for slow flight. If the aircraft has flaps, a flap switch can be added to cause the landing sequence to be initiated whenever the flaps are fully extended. The unit also includes an airspeed activated switch which closes whenever the airspeed is above 45 mph. This can be used to activate a transponder, Hobbs meter etc. Experimental aircraft. P/N 11-02258**\$584.00**

AMPHIBIAN GEAR WARNING SYSTEM



Designed to provide an additional margin of safety for amphibian pilots by providing a backup electronic means of verifying landing gear position for both water and runway landings. Consists of a small electronic box (about 2.5 inch by 3.25 inch weighing less than 1 lb) that can be mounted anywhere in the aircraft, and 2 panel mounted switches with lights. The system is activated by airspeed. The activation speed can be set by a simple screwdriver adjustment. On takeoff, as the airspeed exceeds the activation speed, the system becomes active. There is a time delay built in to prevent false triggering. When the system becomes active, the lights in the panel switches will illuminate for 6 sec, to alert the pilot that the system is active. The pilot can perform a self test. Can be temporarily disengaged for slow flight. As the aircraft slows below the activation speed for a landing, the landing sequence is initiated. Panel switches are marked "L" for land, and "W" for water. If the gear is in the correct position, the voice message "GEAR O.K." will be heard. If the gear is not in the proper position, the voice message "CHECK LANDING GEAR, CHECK LANDING GEAR" will be heard. This message will continue until the speed is increased above the activation speed, or the gear is placed in the proper position. When installed in aircraft having multiple gear indicating lights, the system will respond with the "CHECK LANDING GEAR" voice warning if it determines that any of the wheels are in the wrong position. Also responds with the warning if the gear indicating lights loose power. Also incorporates an airspeed activated electronic switch which closes whenever the airspeed is above 45 mph. This can be used to activate a transponder, Hobbs meter etc. Supplied as a complete kit consisting of the electronic module, a pre-wired, color coded cable, switches, connectors, mounting hardware etc. The only other item required is a 1 amp fuse or breaker. STC'd for many amphibian aircraft and aircraft on amphibian floatsP/N 11-07537**\$899.00**

GEAR ALERT SYSTEM 2050

NOTE: This system is not FAA approved. It is intended for installation in Experimental category aircraft only.

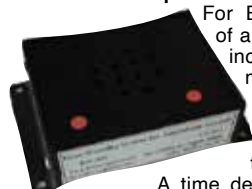

For Experimental amphibian aircraft consists of a small electronic module (2.5 inch by 3.25 inch weighing less than 1 lb), and a panel mounted switch with light. The system is airspeed activated. The activation speed can be easily set using a screwdriver. On takeoff, once the speed has exceeded the activation speed, the system activates. A time delay is built in to prevent false triggering due to speed fluctuations. The light in the switch illuminates when the system is activated. The pilot can perform a self test of the system. Disengage mode which temporarily disengages the system for slow flight. During this period, the light in the switch flashes indicating the system is disengaged. Pushing the switch again re-engages the system. As the aircraft slows for landing, the system enters the landing mode. The light turns off, and the electronics then checks the gear position lights to determine the gear position. If the aircraft has flaps, a flap switch can be added to cause the landing sequence to be initiated whenever the flaps are fully extended. A switch can be added to the throttle so that closing the throttle with the gear up will cause the warning voice message to be heard. The unit also includes an airspeed activated switch which closes whenever the airspeed is above 45 mph. This can be used to activate a transponder, Hobbs meter etc. The unit is sold as a complete system including the electronic unit, a pre-made cable assembly, a pre-wired switch, connectors, mounting hardware etc.P/N 11-07538.....**\$585.00**

POWER GUARD BUS MANAGEMENT SYSTEM



An essential bus management circuit designed to protect power sensitive and critical electronics. Starting currents are usually high enough to cause battery voltage to drop below tolerable limits for many electronics systems. The result could leave you without engine instrumentation until EFIS “reboots” (up to 30 seconds). Protection includes low voltage drop out and essential backup in the event of primary power loss. Filtration on the secondary supply and secondary battery charging are also an integral parts of the circuit. A secondary battery is required for the Power Guage we recommend a 5-12 Amp battery for emergency supply. Several control modes are possible with the system allowing for installation and operational flexibility. Load Ratings: 7A continuous, 10A 10% duty. Dims: 4.75"l x 2.75"w x 1.2"hP/N 11-02044**\$203.95**

EL

ELECTRONIC ACCESSORIES - STROBES

INTERCOM GEAR WARNING DEVICE



A small electronic device that can be connected to either the landing gear throttle warning switch or the Flap UP Light or Switch and the Landing Gear Down Light or Switch. The pilots headphones are connected to the audio circuit in the IGWD II and should an unsafe condition occur, a loud pulsing tone is heard in the

pilots headphones. In the single input mode, Throttle gear safety switch, if the throttle is reduced and the gear is Up, the IGWD II will sound. The two input mode with the flap UP light and the landing gear down light connected to the sensing inputs, provide added safety by ensuring that the landing gear is down before the flaps are lowered. Should the flap UP light go out before the landing gear Down light is on, the warning tone will be enabled. In addition to the warning tone, a warning light output is available for a panel mounted light as well as a Test Switch input.

Features: • Small size: 3.2"L x 2.3"W x 1.0"H • Adjustable Tone Level • Input triggering for Throttle switch or Landing Gear and Flap Lights or Switches • Remote Test Switch Option • Remote Warning Light • DC voltage range 12 to 28 VDC • Weight, 10 oz • Two Year Warranty • Not Approved for Certified Aircraft.....P/N 11-01943**\$269.00**

LOW VOLTAGE WARNING SYSTEMS



An amber light will come on at the moment of low voltage condition which will inform the pilot of attention needed to the alternator, generator, or voltage regulator. Any of these conditions allowed to continue will result in a weak or completely discharged battery condition and loss of radio and electrical equipment. Indicator light features a built in dimmer and press to test with amber lens. Lights will trigger at 13 volts for 14V systems and 25 volts for 28V system. Accuracy, plus or minus 0.2 volts. Size: 1/2" Dia. 3" Depth required behind panel. Weight: .2 lbs., Power: less than 1/10 amp. Fuse supplied with kit. Made in the USA

Model No.	Description	Part No.	Price
33-2013A	14 Volt, Red Lens Low Voltage Warning System	10-02572	\$185.95
33-2013	14 Volt, Amber Lens with Dimmer Low Voltage Warning System	33-2013	\$185.95
33-2025A	28 Volt, Red Lens Low Voltage Warning System	10-02573	\$185.95
33-2025	28 Volt, Amber Lens with Dimmer Low Voltage Warning System	33-2025	\$185.95

FLIGHT STROBE FS 4400



This precision compact unit mounts easily on top or below fuselage, and directly replaces rotating beacons. It features a high-intensity Xenon arc lamp, a high-efficiency push pull inverter circuit for stable flash voltage and a flame-resistant military circuit board assembly. The lamp is readily replaceable without removing the unit from the aircraft, and the unit weighs only 1 lb. 4 oz. The Flight Strobe FS-4400 is visible for over 50 miles at night, in haze, smog or bright sunlight and is manufactured using the highest quality

components for maximum reliability and service life. Amp draw 3 Amp. (14V) & 1.5 Amp (28V). STC'D for Cessna 180. FAA form 337 for field approval is required for installation of other certified aircraft. Order adapter separately.

14V (FS-4400-14V)	P/N 11-01018	\$258.95
28V (FS-4400-28V)	P/N 11-01019	\$285.95
FS-4400 Adapter	P/N 11-06500	\$23.50
FS-227 Repl. Bulb 14V/28V	P/N 11-06510	\$48.50
FS-210C Clear Lens.....	P/N 11-01024	\$28.50
FS-210C/R2 (1/2 Clear-1/2 Red)	P/N 11-01026	\$52.75
FS-210R Red Lens.....	P/N 11-01021	\$32.50
Fuse for FS-4400	P/N 11-02027	\$5.35

DIGITAL VOLTAGE MONITOR



Helps pilots monitor critical electrical system. STC approved. Features a Multi Color LED display, which is easily viewable from a wide angle. In the event of an alternator/generator failure, the LED display indicates the reserve battery capacity. The display automatically adjusts to the ambient light for IFR or night operation and also serves as a reminder to turn off the electrical system after flight. Comes in either 12V or 24V models and includes all necessary hardware and FAA Documents. The display must be set to Dot

mode for FAA approved installations.

12 Volt Digital Voltmeter.....	P/N 10-00752	\$80.00
24 Volt Digital Voltmeter.....	P/N 10-00753	\$80.00

ILLUSION AIRCRAFT STROBE



Powered by the lighting coil of Rotax and other two-cycle engines, this is the most efficient strobe light on the market because it uses only the power normally wasted by the voltage regulator in a battery charging system. It has no effect on the charging system, so you can still connect other equipment to the lighting coil. The two strobe lights flash alternately an average of 55 times per second. Lesser strobe systems fire their lights simultaneously, resulting in a much longer firing cycle because the lighting coil can only develop so much power in a given time. The illusion Strobe use a specialized prismatic Fresnel lens. This lens increase the strobe's effective light intensity up to 8 times. The illusion Strobe works with the new Rotax 170W dual-ignition lighting coils and the standard 125W single-ignition type. It meets Part 103 requirements to add to an extra hour of legal flying time each day. The illusion Strobe comes with 2 lights rated at 25 joules; driver, wire, hardware, instructions, and a two-year manufacturer's warranty.

Dual Wingtip Strobe Sys.P/N 10-00819**\$245.00**

ELECTRONIC POSITION LIGHTS LED FOR WINGTIPS



The EPL is made of a high-optic, scratch resistant plastic module. The entire control element is integrated into the ACL module where the ACL's dimensions determine the required space.

The EPL has a brilliant green and red light with modulated beacon impulse for better perception. It has a defined angle of light of 110° in compliance with the regulations of general aviation.

The wingtip lights are prewired to allow easy connection to a 2-lead cable of minimum 0.4 mm² cross section. Flanges allow simple fixture. In addition, it can be affixed to the fuselage or rudders by means of a silicone adhesive. An instructions manual and the shrink tubing required for the assembly are included in the EPL package. Note: The set contains 2 EPLs for an airplane (NON-TSO'd). One each for the right and left wing to be mounted at the wing tips. The illumination angle is equivalent to the required angle of 110 deg. as prescribed for general aviation.

Specifications: • Color: Red and green • Operating voltage: 10 -17 volts D. C., typically: 12.8 - 13.4 volts (on board power supply) • Wattage: Each EPL approx. 4,5 watts • Dimensions: 93 x 40 x 28 mm (L x B x H) • Weight: Aprox. 78 g incl. connecting cables • Warranty: 5,000 operating hours or max.

3 years.....P/N 11-18248**\$289.00**

STROBES – POSITION LIGHTS - LED LIGHTS

LED BASED LIGHTS



8000 SERIES (LED) ANTI-COLLISION BEACON
LED based self-contained, High Impact Polycarbonate Optical Lens. Lighter, Brighter, Cooler Longer Life (up-to 50,000 hrs.) and draws less than 1 amp. (.13 amps) @ 12vdc. Weighing in at 3.5oz. it stands 3" high and 2.5" in diameter.
Red 12v P/N 11-07241 **\$128.75**
Red 24v P/N 11-18421 **\$128.75**
Clear 12v P/N 11-07246 **\$127.80**
Clear 24v P/N 11-18426 **\$79.85**



MODEL 918TL (LED) TAIL LIGHT TL918 TAIL LIGHT
LED based Tail Light that weighs only 1.5oz. High Impact Polycarbonate Optical Lens. Up-to (50,000 hrs.) life. Draws .13 amps @12vdc. It measures approximately 1.6" high and 1.4" diameter.
P/N 11-07242 **\$129.95**



MODEL 927ACB (LED) ANTI-COLLISION BEACON
Completely Self-Contained LED Based Anti-Collision Beacon 927ACB - RED High impact polycarbonate optical lens. Up-to (50,000 hr.) life. Draws .14 amps@12vdc. It measures approximately 1.6" high and 1.4" diameter. That's right, it is in the same package as the Tail Light! Lighter, Brighter and Cooler, and weighs only 1.6 oz. Flasher included.
Red 12V P/N 11-07243 **\$137.75**
Clear 12V P/N 11-07244 **\$137.75**
Red 24V P/N 11-14889 **\$137.75**
Clear 24V P/N 11-14890 **\$137.75**

REPLACEMENT LAMPS FOR NAVIGATION LIGHTS



Upgrade your Indicating, Position, or Recognition lights to LED's. These lamps fit standard S.C. Bayonet Indexed Base Sockets (Bay15S). Converts common Incandescent Lamps to LED Lighting without modifications. (Use a new clear plastic lens for maximum brightness) and you are ready to go. They last longer, run cooler, and draw less than .15amps. Non-PMA.

Description	Part No.	Price
LED75 12V Red Lamp	11-07744	\$43.50
LED75 12V Green Lamp	11-07745	\$43.50
LED75 24V Red Lamp	11-07746	\$43.50
LED75 24V Green Lamp	11-07747	\$43.50
LED75 TPL-12 Tail Position Lamp	11-07748	\$43.50
LED75 TPL-24V Tail Position Lamp	11-07749	\$43.50
Combination Tail and Beacon Lamp 12V	11-12042	\$145.75
Combination Tail and Beacon Lamp 24V	11-12043	\$142.75
Replacement Lamp Only 12V	11-12040	\$81.75
Replacement Lamp Only 24V	11-12041	\$81.75

LED REPLACEMENT NAV LIGHT BULBS



LED retro-fit for older Grimes navigation lights. Glass-covered, protected dome. Models: 1156, 1157 and 1076.

Model No.	Volts Amps/Watts	Description	Part No.	Price
1156 (BA15S)	10 to 30VDC	3 Watt - Super Bright	13-15810	\$26.50
1157 (BAY15D)	12-14VDC	3 Watt - Super Bright One Lighting. Mode for Indicator Light. Dual Lighting Mode for Brake Light	13-17741	\$25.95
1076 (BA15D)	10 to 30VDC	3 Watt - Super Bright	13-17742	\$26.50

2 COLOR PANEL POST LIGHT



Panel Post Light. Compact design. White and Red leds powered separately. 12V or 24V versions. Ideal for instrument and panel lighting.
12V P/N 11-18503 **\$18.95**
24V P/N 11-18502 **\$18.95**

WHELEN WING LIGHTS



W1285 series are the same design as Grimes Model E. Available with red or green lens and 12V or 24V bulb. W1250 PG/PR are FAA approved position lights and are designed to fit underneath the wing tip fairings.



W1250		
14V Red W1250 Assembly	11-12473	\$285.00
Replacement Bulbs		
14V W1290 Bulbs	11-02602	\$113.75
28V W1290 Bulbs	11-02604	\$106.90



GRIMES MODEL B -

Early type wing light with flat mounting pad. Mounts on tip of wing. Wt. 7oz Order by part number.

SINGLE CONTACT -

w/#93 Bulb New Surplus **\$223.95**
Green, 14V P/N A-2430-1-G
Red, 14V P/N A-2430-1-R

STEEL FORMED NAVIGATION LIGHT PLATES



Wing tip light plate is welded or screwed to wing tip bows to attach teardrop type position lights. Tail light plate is welded to rudder to attach Model S tail light. Units are steel without any coatings as they need to be welded. Surface rust may be present as a result



Model E Wing Light Plate
P/N 11-06900 **\$38.50**
Model S Tail Light Plate
P/N 11-07000 **\$37.50**

"C-LITE" WING TIP NAV LIGHT INDICATORS



These indicators identify your wingtips when taxiing at night, and assure your nav lights are working. Installs in minutes with just a screwdriver, and you don't disconnect the lights to do it. Works with high-or-low-wing aircraft, thick wing too. Designed for use with Grimes #A-1285 & #B-6345 nac lights, which means practically all aircraft..... P/N 5122 **\$19.50**

GRIMES TAIL LIGHTS

GRIMES MODEL S

For tailcone or rudder installation. Wt. 3 oz. Single contact. 15 Candlepower. For 12V use, order #93 bulb (PN 11-04199)
P/N 11-03652 **\$237.95**

GRIMES EARLY MODEL C

Mounts on trailing edge of rudder. Wt. 5 oz. Double contact. 15 Candlepower. For 12V use, order #94 bulb (PN 11-04200)
Model B-1943-4 (New Surplus)..... **\$352.00**

REPLACEMENT PARTS FOR POSITION LIGHTS

Lenses for Grimes A, B, C Wing or Tail Lights

Clear..... P/N 11-03662..... **\$66.75** Red..... P/N 11-03655..... **\$75.75**
Green..... P/N 11-03663..... **\$78.75**

Lenses for Grimes Model E or Whelen Wing Tip Lights

Red..... P/N 11-02754..... **\$35.50** Green..... P/N 11-02755..... **\$34.90**
Lens for Model S Tail Light (Clear) P/N 11-07400 **\$59.95**
Bale Wire - Grimes..... P/N 11-03664 **\$35.50**



T1284PC CLEAR LENS

T1284PC-Clear, polycarbonate lens high impact polycarbonate optical lens, for use with new LED lights. Direct replacement for your standard red, green and clear glass navigation lens. Use with standard 1283 nav lens gasket.

P/N 11-09299 **\$15.65**

EL

AVEOFLASH LIGHTING

AVEO ULTRA EMBEDDED GALACTICA



Popular choice for certified and general aviation aircraft of any size, due to their compact design and easy installation. With full optical testing for brightness and chromacity, the Ultra also completed the rigorous DO-160F testing regime exceeding all requirements. The leading winglight solution for numerous military and law enforcement/surveillance UAVs around the world and is very popular with aircraft manufacturers. Ultra wing lights are virtually unbreakable. Aircraft lifetime warranty.

Packed with 27 ultra high brightness LEDs that are the industry state-of-the-art in performance and output lumens, the Ultras still feature the same tiny footprint the popular Aveo e-series wing lights have become so well-known for in the aviation world.

These aircraft lights meet both TSO C30c and C96a design specifications and EXCEED the requirements of TSO C30c, C96a, SAE AS 8037 and AS8017A, plus DO-160.

Features: • Position / Strobe LED light • Extremely Lightweight at 83 grams • 9-32 volt DC input range • No External Power Supply or Strobe Unit • Light Synchronization Feature • Unbreakable Diamidium™ encapsulation • Unmatched Circuit Technology • Advanced Computer and Goniophotometer Engineered Optics • Limited Warranty - Product must be registered within 30 days of purchase Here

P/N 05-08364\$1,173.00



AVEO NITELITE

Compatible with the Aveo StarFob™ remote control system, this light provides dual functions, a blue light for illumination of the ground around your aircraft nose and a white light for the wing leading edge illumination,

which also double as an ice light.

The conditions and tests required for TSO approval of this article are minimum performance standards. Those installing this article either on or within a specific type or class of aircraft must determine that the aircraft installation conditions are within TSO Standards which include any accepted integrated non-TSO function standards. TSO articles and any accepted integrated non-TSO function(s) must have separate approval for installation on an aircraft. The article may be installed only according to 14 CFR Part 43 or the applicable airworthiness requirements.

14 Volt LeftP/N 11-14674\$369.00
 28 Volt LeftP/N 11-12855\$369.00
 14 Volt RightP/N 11-14675\$369.00
 28 Volt RightP/N 11-12856\$369.00

AVEO ULTRA EMBEDDED DAYLITE™ WINGTIP 2-IN-1 LED LIGHTS NAVIGATION / STROBE



The Ultra Embedded Daylite™ is only 34 millimeters in height (1.34 inches), but does not sacrifice performance or standards. With exclusive advanced optics and chrome reflector system, unmatched power and led management circuitry, and the lowest-drag profile in the industry. The Ultra Embedded Daylite™ gives unmatched power and features, while being lower, narrower, shorter, and lighter than the competition. For Experimental Use Only.

Features: • Navigation/Strobe LED Light
 • Lower, narrow, and shorter than other industry lights • Lightweight at 127 grams • 9-36 volt DC input range • Unmatched circuit technology • Limited Warranty - Product must be registered within 30 days of purchaseP/N 11-15068\$835.00

AVEO EXCELERON DAYLITE LANDING / TAXI LED LIGHT



The new Excleron DayLite™ is a value light that does not sacrifice anything in performance or standards as other economy-priced lights offered by the competition. Our exclusive and highly advanced optics, our unmatched power and led management circuitry are all combined into a product that gives you unmatched POWER and FEATURES. Lower,

narrower and shorter PLUS much lighter than industry lights in this category!
 9°P/N 05-27099\$298.00
 12°P/N 05-27100\$298.00
 9x10.5°P/N 05-27101\$298.00
 9x10°P/N 05-27102\$298.00

AVEO POWERBURST DAYLIGHT SET



At only 26 millimeters in height (1.024 inch) the PowerBurst™ DayLite is a value wingtip 3-in-1 LED light – Navigation / Position / Strobe that does not sacrifice anything in performance or standards as other economy-priced lights.

The exclusive and highly advanced optics and chrome reflector system, unmatched power and LED management circuitry, and Aveo's famous lowest-drag profile in the industry are all combined into a product that gives you unmatched POWER and

Features: Lower, narrower and shorter PLUS much lighter than industry lights in this category! For Experimental Use Only. Not approved for installation on certified aircraft. This is not a TSO certified light. **Features:** • 3-in-1 Nav/Position/Strobe • Extremely lightweight • Unmatched circuit technology • Waterproof • Vibration-proof • Shock-proof • Dust-proof • Limited 3yr Warranty - Product must be registered within 30 days of purchase.

Black BaseP/N 05-04877\$468.00
 White BaseP/N 05-26588\$459.00
 Red/Green BaseP/N 05-26589\$459.00

AVEO ULTRA DAYLITE™ 3-IN-1 NAVIGATION / POSITION / STROBE LED LIGHTS



The Ultra Daylite™ is only 34 millimeters in height (1.34 inches), but does not sacrifice performance or standards. With exclusive advanced optics and chrome reflector system, unmatched power and led management circuitry, and the lowest-drag profile in the industry. The Ultra Daylite™ gives unmatched power and features, while being lower, narrower, shorter, and lighter than the competition. For Experimental Use Only.

Features: • 3-in-1 Navigation/Position/Strobe • Lower, narrow, and shorter than other industry lights • Lightweight at 127 grams • 9-36 volt DC input range • Unmatched circuit technology • Limited Warranty - Product must be registered within 30 days of purchase Here

P/N 11-15067\$835.00

AVEO MINIMAX ARIEL™ LED ANTI-COLLISION / STROBES



Developed originally at the request of the world's leading UAV manufacturers, all of which now utilize Aveo lighting, the MiniMax Ariel is a compact powerhouse of hemispheric light. It is also a great anticollision light to use on the upper and lower fuselage in combination with AveoFlash wing lights due to its incredibly small footprint.

WhiteP/N 11-17558\$446.00
 RedP/N 11-17569\$429.00

AVEO PICOMAX DRONE BEACON STROBES



This is Aveo's ultimate small drone strobe light, PicoMax, a cousin of its highly successful MicroMax™ defense industry strobe for UAVs. Battery operated with DC adapter recharging, the PicoMax will strobe for longer than your drone flies on its charge. Exceeding the 2 nautical mile standard, the PicoMax actually surpasses 3 nm, and due to its

proprietary Aveo firmware and circuitry it offers the brightest and fully airworthy tested features for the serious drone operator. PicoMax comes in either red or white strobe color.

Features: • Microcontroller drive • Pushbutton ON/OFF • Auto OFF when full discharge • Signal LED for battery charge status • Charge status (one blink 100%-40%, two blink 40%-20%, four blink 20%-0%) • Signal LED for charging status (ON when charging, OFF when full charge) • Micro USB Charging • Synchronization input • RF control input - for ON/OFF • External battery via US

WhiteP/N 11-15171\$138.95
 RedP/N 11-15169\$139.00



AVEOFLASH LIGHTING

AVEO RED BARON MINI LED LIGHT



The RedBaron Mini™ is a cousin to the RedBaronXP™, the world's smallest and brightest total coverage LED anticollision light. The new RedBaron Mini™ resulted from requests by high-performance racing aircraft, super lightweight UAVs in the defense industry, and aircraft/helicopter manufacturers who wanted an upper and lower anti-collision light due to mounting area constraints. The answer came in this incredible new light, only 27 mm high and only 110 grams in weight. Exceeding all TSO intensity requirements and all DO-160F environmental requirements, the RedBaron Mini™ is now the world's smallest anti-collision light.

WhiteP/N 11-10534**\$535.00**
RedP/N 11-15481**\$535.00**



REDBARONXP™

Incorporates 36 of the brightest LEDs available in the world today.

WhiteP/N 11-08423**\$489.00**

AVEO REDBARON ADAPTER

If you are replacing a Whelen anticollision light, this adapter by Aveo is designed to match up perfectly with your existing mounting site.

Adapter works for following Whelen models:

• A450 • A470A • 7108001 • 7108006 • 7108051

• 7105500 • 7105501 • 9052001 • 9052051

Specifications: Universal holes (4x1.75" x 4x1.625", 4x1.25").

Color: SilverP/N 11-10631**\$74.00**



AVEO REDBARON MAXIMINI RECOGNITION LED LIGHT

Introducing the Aveo MaxiMini™ - the ultimate recognition light. Spawned from the incredible technology of the incredible and unmatched RedBaron™ AntiCollision series, the new MaxiMini™ is the world's brightest and smallest

recognition light, at only 27 mm high and weighing only 85 grams. The MaxiMini™ only comes in aviation white led color, since it is 43% brighter than red leds, which means you will BE SEEN, NOT SORRY for sure! And of course, the EXCLUSIVE AVEO LIFETIME WARRANTY means your investment is protected. The MaxiMini™, when only the best and the brightest will do. Features include: Exclusive Lifetime Warranty, Unbreakable Diamidium™ encapsulation, 9-32 Volt Input Range, Vibration Proof, Waterproof, Lowest Drag Profile recognition light, Anodized aluminum finish, Extremely light weight.P/N 05-04934**\$599.00**



AVEO MAXX HERCULES LED LANDING / TAXI / WIGWAG LIGHT

Designed for those of you that want your plane to look like a jumbo jet in the pattern, we went to our skunk works and using our AveoMaxiChip™ technology, we built you the ultimate landing light. The Hercules™ is nonpareil in the industry as verified by test pilots at major aircraft

manufacturers in night runway tests against all our competitors' lights. Again, featuring the landing, taxi, and wigwag functions, the Hercules™ is also available with TCAS activation for recognition mode.

Voltage input 9 to 32 VDC, please remove legacy strobe boxes first!
30(Brightest) With Bracket.....P/N 05-06492**\$965.00**
30(Brightest) Without Bracket.....P/N 11-10639**\$965.00**
20 With Bracket.....P/N 05-06493**\$825.00**
20 Without Bracket.....P/N 11-10643**\$825.00**



AVEO MAXX ATLAS LED LANDING / TAXI / WIGWAG LIGHT

Aveo's most compact 3-mode light featuring landing, taxi, and wigwag recognition functions, the Atlas™ is 2x to 5x brighter than the rest of its industry competitors. With a variety of mounting options that are part of the rear heat sink variations themselves, the Atlas™ also has optional built-in TCAS signal activation to act as an automatic recognition light.

Voltage input 9 to 32 VDC, please remove legacy strobe boxes first!
15(brightest) With Bracket.....P/N 05-06495**\$755.00**
15(brightest) Without Bracket.....P/N 11-10647**\$755.00**



AVEO EYEBEAM MINI



Aveo's incredible capacitive-sensing technology from its highly popular EyeBeam Touch™ products has now been engineered into an even smaller footprint, providing a one-color LED cabin/cockpit/area lighting product for those with limited installation space or only simple lighting needs. With one light finger touch you can control the power and the brightness scale and the light easily swivels to put the beam where you want it. No mechanical switches to fail, no bulbs to burn out. The EyeBeam Mini™ comes with a variety of

easily-applied color faceplates, with standard colors of silver and black. The EyeBeam Mini™ is made from anodized aircraft grade aluminum. Cockpit and cabin lighting, especially on aircraft, helicopters, boats, recreational vehicles and trucks are plagued by problems from vibration... the EyeBeam™ product line from AveoEngineering overcomes this with a vibration-proof product that has the exclusive Aveo lifetime warranty.

Featuring: • 9-32 volt input range • No external power supply • Swiveling light permits light beam control • Capacitive sensing touch controls • No mechanical switches to fail • Exclusive Lifetime Warranty • Unmatched circuit technology.

Silver.....P/N 11-09678**\$257.95**
Black.....P/N 11-09679**\$254.95**

AVEO EYEBEAM DOME



EyeBeam Dome™ - Remote Touch Control Interior LED Light The EyeBeam Dome was developed to meet the requests of an interior dome light for all aircraft, that would complement the amazing Aveo EyeBeam products, and their unique touch-controls. Long gone are the days of mechanical switches which can corrode and spark, etc. Available with a remote control finger-slide panel for intensity and operation.

BlackP/N 11-10627**\$218.95**
SilverP/N 11-10629**\$214.95**

AVEO MICROMAXLITE ANTI-COLLISION LED LIGHT WHITE



Fully DO-160 tested and weighing less than 30 grams, MicroMax™ will help you comply with all the tightening and future regulations around operating small UAVs/MiniDrones and ensure SAFETY is included in your flight operations.

Available in Red or White, the patented MicroMax™ provides a 360 degree arc of coverage. An amazing product from Aveo's famous engineering prowess, which has made it the world market leader in UAV lighting by a wide margin. Note: Not Approved for installation on Certified Aircraft. This is not a TSO Certified Light.

WhiteP/N 05-26402**\$245.00**
RedP/N 05-26403**\$245.00**

AVEO POSISTROBE TITANIA WHITE LED POSITION / STROBE LIGHT



The PosiStrobe CP™ is a generation rudder white position and strobe light. It fits almost all the standard rudder mounts of aircraft and also features an optional aluminum adapter mount plate pictured in the installation page.

An extremely lightweight, aerodynamic and low-profile design make this the light of choice for any certified aircraft requiring a rear coverage light due to wingtip light coverage zone limits.

P/N 11-17599**\$538.00**

AVEO EXCELERON DAYLITE™ LANDING TAXI LED LIGHTS

For Experimental Use Only.

Taxi LightP/N 11-15173**\$289.00**



AVEO BORG MINI™ CARGO STEP LIGHT

Aveo Borg Mini™ Cargo Step Light. Cargo / Wheel Well / Step LED light **For Experimental Use Only**P/N 11-15179**\$315.00**



EL

AVEOFLASH LIGHTING

AVEO EYE BEAM TOUCH NVG



The popular Aveo EyeBeam Touch™ capacitive sensing controlled cockpit and cabin lights are now available in NVG configuration, that is they include green LED lighting compatible with night vision equipment. Also included with the NVG model EyeBeam is the standard selection faceplate locations of white, red and blue LEDs too, so whatever your operational conditions there is a lighting option to match it available

from this amazing product. With one light finger touch you can control power, white LED, red LED, green LED, blue LED or the brightness slider scale easily with no mechanical switches to fail and no bulbs to burn out. The EyeBeam NVG™ also features as standard in its firmware automatic light dimming to OFF and automatic ON for the light when coupled to a door microswitch sensor. With a standard 2 minute delay programmed in. The EyeBeam overcomes this with a vibration-proof product that has the exclusive Aveo lifetime warranty. Features: 9-32 volt input range, No external power supply, Swiveling light permits light beam control, Capacitive sensing touch controls, No mechanical switches to fail, Limited 3 year warranty, Unmatched circuit technology. Specifications: Power supply: 9-32 Volts, Current consumption: 110 mA @ 12 Volts, Capacitive Sensing Interface with LED backlighting, 9 Incremental steps capacitive sensing slide bar for brightness adjust, Swiveling Beam, 2024 Anodized Aluminum Construction

Description	Part No.	Price
Silver Eye Beam Touch NVG	11-08444	\$274.95
Black Eye Beam Touch NVG	11-08445	\$274.95
Accessories		
Description	Part No.	Price
Silver Faceplate	11-08429	\$8.20
Black Faceplate	11-08428	\$8.20

POSISTROBE JP DAYLITE WHITE REAR POSITION LIGHT



Rear Position / Strobe LED light
At only 30 millimeters in height (1.180 inch) the PosiStrobe DayLite™ is a value light that does not sacrifice anything in performance or standards as other economy - priced lights offered by the competition. The exclusive and highly advanced optics and chrome reflector system, The unmatched power and led management circuitry and the famous lowest - drag profile in the industry are all combined into a product that gives you unmatched Power and Features. Lower, narrower and shorter PLUS much lighter than industry lights in this category. Experimental.

P/N 05-26730\$279.95



AVEOFLASH WING FAIRING E SERIES

The wing fairings come in a molded fiberglass pair that fits the LSA and Ultra lights footprint. Cessna 150-180 fairings for wing nav lights - pair of right and left.

P/N 11-08136\$98.95

AVEO 2-IN-1 EMI / OVERVOLTAGE SPIKE-D MODULE



Spike-D can be use with lights: Ultra Galactica, Ultra Embedded Galactica, Ultra Aurora, Ultra Embedded Aurora, LSA, Andro-meda, PowerBurst, Power-Burst Plues, Gliderburst, PosiStrobe CP Aurora, PosiStrobe CP Galactica, PosiStrobe XP, MiniMax, RedBaron XP Aurora, RedBaron XP Galactica, RedBaron Maxi, RedBaron Mini, RedBaron MaxiMini (NOT HISL!!). R2D2. AveoMaxx. Vega TL, Vega TLR, Vega Helo. All EyeBeam series. For Experimental Aircraft..... P/N 11-14460\$199.00

AVEO 2-IN-1 EMI / OVERVOLTAGE SUPER SPIKE-SD MODULE



Hercules Drop-In, 9-18VDC has one input and can not be use with Spike-SD, current consumption is 12.6A at 9VDC, what more than 8A per channel. Samson Drop-In has one input and can not be use with Spike -SD, current consumption is 11.1A at 18VDC, what more than 8A per channel. For Experimental Aircraft.....P/N 11-14461\$239.00



AVEO SAMSON JP TAXI / LANDING LIGHT

Aveo Samson JP landing and taxi lights combine high intensity and affordability. Choose from 6 anodized finishes to enhance your paint scheme. Available with either landing or taxi lenses, optimized for superior illumination. Simple installation -- "Drop In" upgrade for legacy lights. High performance. PAR 46

Description	Part Number	Price
Aveo Samson JP Taxi Silver	11-18213	\$629.00
Aveo Samson JP Taxi Red	11-18219	\$629.00
Aveo Samson JP Taxi Purple	11-18223	\$629.00
Aveo Samson JP Taxi Blue	11-18221	\$629.00
Aveo Samson JP Taxi Black	11-18215	\$629.00
Aveo Samson JP Taxi Green	11-18217	\$629.00
Aveo Samson JP Landing Silver	11-18214	\$629.00
Aveo Samson JP Landing Red	11-18220	\$629.00
Aveo Samson JP Landing Purple	11-18224	\$629.00
Aveo Samson JP Landing Blue	11-18222	\$629.00
Aveo Samson JP Landing Black	11-18216	\$629.00
Aveo Samson JP Landing Green	11-18218	\$629.00



AVEO HERCULES JP TAXI / LANDING LIGHT

Aveo Hercules JP landing and taxi lights combine high intensity and affordability. Choose from 6 anodized finishes to enhance your paint scheme. Available with either landing or taxi lenses, optimized for superior illumination. Simple installation -- "Drop In" upgrade for legacy lights. High performance. PAR 36

Description	Part Number	Price
Aveo Hercules JP Taxi Silver	11-18201	\$349.00
Aveo Hercules JP Taxi Red	11-18207	\$349.00
Aveo Hercules JP Taxi Purple	11-18211	\$349.00
Aveo Hercules JP Taxi Blue	11-18209	\$349.00
Aveo Hercules JP Taxi Black	11-18203	\$349.00
Aveo Hercules JP Taxi Green	11-18205	\$349.00
Aveo Hercules JP Landing Silver	11-18202	\$349.00
Aveo Hercules JP Landing Red	11-18208	\$349.00
Aveo Hercules JP Landing Purple	11-18212	\$349.00
Aveo Hercules JP Landing Blue	11-18210	\$349.00
Aveo Hercules JP Landing Black	11-18204	\$349.00
Aveo Hercules JP Landing Green	11-18206	\$349.00

AVEO DAYLITE™ PACIFICA I MINI TAXI / LANDING LIGHT



Aveo Daylite™ Aerodynamic under-wing/under fuselage Pacifica Series of taxi or landing lights. Incorporating Aveo's proprietary CuPillar™, AfterBurners™ and NTC technologies, coupled with our KrystalKelvin™ optical grade lenses for exact wavelength transmissions. Aveo makes retrofit upgrades easily possible for incredible intensity lights in low drag, simple to mount shapes. Note: Not Approved for

Installation on Certified Aircraft. This is Not a TSO Certified Light
Specifications: • Dimensions (inches): 6" x 2.14" x 2.23" • Weight (oz): 5.43 oz • Operating Voltage Range: 9 – 36 VDC • Output Power: 4 W

Description	Part Number	Price
3 Degrees White	11-18453	\$219.95
3 Degrees Black	11-18454	\$295.00
10 Degrees White	11-18455	\$328.00
10 Degrees Black	11-18456	\$219.95
28 Degrees White	11-18457	\$242.95
28 Degrees Black	11-18458	\$295.00
90 Degrees White	11-18459	\$219.95
90 Degrees Black	11-18460	\$219.95

EL

NAVSTROBE LIGHTING

NAVSTROBE SEXTANT AIRCRAFT NAVIGATION SYSTEM WITH CONSTANT & FAST STROBES 45W



These are standard parts and certified to be FAA/TCCA TSO-C30c Approved. Combination navigation and strobe lights for your aircraft.

Emitter Types: Cree LED's
Operation: Turn on first; Constant lighting / Turn on second time; <3s: Fast Strobe. Switch between modes in fog/cloud etc. The reset mode sets them back to constant on by removing the power for ~> 30 seconds. Handy after fuel up to start again in steady on mode.....P/N 11-18888**\$399.00**



NAVSTROBE WINGTIP RED 45 WATT

These bulbs are standard parts and are certified to be FAA TSO-C30c Approved.

Emitter Type: Green Cree LED's
Turn on first: Constant lighting / Turn on second time <3s: Fast Strobe. Switch between modes in fog/cloud etc.
Note: This product must be used in conjunction with Aircraft Wingtip Navigation Light Clear Lens Cover (Sextant A-1233A-1) to be compliant.

RedP/N 11-18889**\$142.95**
GreenP/N 11-18890**\$142.95**



NAVSTROBE AIRCRAFT NAVIGATION SYSTEM

2 Modes: Constant & Fast Strobe.
Kit Includes: • 2ea. Wingtip combination navigation and strobe light (BAY15scs-10w-A-1512) • 1ea. White tailfin combination navigation and strobe light (BA15sWcs-10w-1156) • 2ea. Lens cover gaskets (Sextant A450) • 1ea. Dielectric grease pouch (Sextant 31880)

Operation: Turn on first; Constant lighting / Turn on second time; <3s: Fast Strobe. Switch between modes in fog/cloud etc. The reset mode sets them back to constant on by removing the power for > 30 seconds. Handy after fuel up to start again in steady on mode.
P/N 11-16470**\$219.95**

AIRCRAFT ANTI-COLLISION STROBE LIGHT



Aircraft Anti-Collision Strobe Light, 45w, 1350 LM CREE LEDs. Total Emitters: 9 x 5w. Power: 45W. Rated Voltage: 10-15VDC. Draws <280ma @ 14.2VDC. Luminous Flux: 1350 LM/108cdl. 1 mode: fast strobe

(100ms). Base Type: 12"/30cm twin leads. Application: Aircraft Anti-Collision Strobe Light. Non-PMA'd. Contains 1 light bulb per pack. Dimensions: 2.7 in x 1.2 in (60 mm x 30 mm). Weight: 0.28 oz (8 g)
Installation: 1- Clean surfaces with alcohol. 2- Apply adhesive tape 3- Let stand for 24 hours.

WhiteP/N 11-12424**\$99.95**
RedP/N 11-12986**\$69.80**
Green.....P/N 11-12985**\$72.85**

NAVSTROBE TAILFIN LIGHT



These bulbs are standard parts and have been designed to meet the requirements of TSO-C30c.
• Total Emitters: 6 • Power: 30W Equivalent
• Color BIN: White • Rated Voltage: 10-28VDC • Draws <340ma @ 14.2VDC
• Luminous Flux: 676LM (0 degrees),

666LM (90 degrees) • Color Temperature: 6000~6500K • 2 modes: constant & fast strobe • Base Type: BA15s = Single contact with inline pins. (GE1691 & 1156) • Application: Tailfin Navigation Light replacement. • Contains 1 light bulb per pack • Dimensions: 1.9 in x 0.7 in (50.5 mm x 1.6 cm) • Weight: 0.32 oz (9 g).
P/N 11-13587**\$98.75**



NAVSTROBE PAR 36 LED LANDING LIGHT

Aircraft PAR36 Landing Light, 220w, 109, 400 LM LEDs.

These are non-TSO'd ..P/N 11-14745**\$215.95**



NAVSTROBE PAR 36 LED TAXI LIGHT

Aircraft PAR36 Taxi Light, 220w, 109, 400 LM LEDs.
These are non-TSO'd ..P/N 11-14744**\$215.95**

BEACON LIGHT CONSTANT & FAST WHITE STROBES



Note: For Experimental aircraft use only. Not FAA/PMA Approved. NavStrobe Aircraft Beacon Light with Constant & Fast White Strobe 503 LM LED's.

Dimensions: 1.9 in x 0.7 in (49.0 mm x 1.8 cm) **Weight:** 0.32 oz (9 g). 10-28VDC.

Turn on first: Constant lighting / Turn on second time <3s: Fast Strobe. Switch between modes in fog/cloud etc.
5 WATTP/N 11-12193**\$48.55**
30 WATTP/N 11-13522**\$88.75**



AIRCRAFT WINGTIP NAVLIGHT CLEAR LENS COVER

Color: Clear Optical Borosilicate glass. Application: Wingtip Navigation Light lens cover replacement. Contains 1 per pack. Dimensions: 1.57 in x 1.04 in (40 mm x 26.5 mm) **Weight:** 0.55 oz (14 g)

P/N 11-11990**\$41.90**



NAVSTROBE AIRCRAFT PANEL LED LIGHT

Note: For Experimental aircraft use only. Not FAA/PMA Approved. Replacement for GE1815 bulb. Rated Voltage: 8-16VDC. 1 mode: constant on. Draws <110ma @ 14.4VDC. Color Temperature: Aviation White 4300k. 1 light per pack.

12VP/N 11-14929**\$7.50**
24VP/N 11-15995**\$7.50**

NAVSTROBE AIRCRAFT WINGTIP LIGHT STATUS INDICATOR



Material: Acrylic. Color BIN: Clear with frost coating to reflect light. Application: Wingtip Navigation Light status indicator. Use on Left wingtip in down position or Right wingtip in up position.

Right.....P/N 11-14927**\$13.50**
LeftP/N 11-14928**\$13.50**

AIRCRAFT WINGTIP NAVLIGHT LENS COVER GASKET



Color: Gray. Application: Wingtip Navigation Light lens gasket replacement. Contains 1 per pack. Dimensions: 2.57 in x 1.14 in (40 mm x 28.5 mm x 1.5 mm) **Weight:** 0.15 oz (2.5 g)

P/N 11-11991**\$11.90**



AIRCRAFT WINGTIP NAVLIGHT GREASE

Color: Clear
Application: Wingtip Navigation Light lubricant. Contains 1 per pack. Dimensions: 4.25 in x .11 in (108 mm x 2.8 mm) **Weight:** 0.176 oz (5 g)P/N 11-11992**\$7.60**

EL

KUNTZLEMAN STROBE SYSTEMS

KUNTZLEMAN MAGNUM STROBES

SINGLE MAGNUM SMART STROBE

This driver is a state of the art single strobe light system. There is not another system on the market like this one. It will operate on 10 to 80 volts of AC or DC input power. It can be powered directly from the engine lighting coil (AC) or from a battery (DC) without any change in brightness or its double wink flash pattern at a 74 per min. rate There are NO options to change and NO special equipment needed. This model is a favorite for king post installations and with the PPC flyers. It is also available with either the standard STREAMLINE HEAD or the COMBO STREAMLINE WHITE HEAD. Both are popular for tail mounting. Average current draw is less than 2 Amps. The driver measures 4 1/2" X 3 1/2" X 1 1/2" and weighs 10 ounces.



Smart Strobe Driver Box only - Single Magnum Smart Strobe driver only, without a strobe head. SS-DO
P/N 11-05116**\$109.99**



Single Magnum Smart Strobe with round clear Fresnel Head - The globe style is a Fresnel lens. The head comes with 6' of wire and plug attached. SS-TM
P/N 10-01609**\$149.00**



Streamline Model with Driver and Streamline Head - Includes 25' of 3 conductor wire, plug, pins and mounting hardware (includes adaptor plate for curved surface mounting if needed). SS-SLM
P/N 10-01611**\$149.00**



Single Magnum Smart Strobe Driver with a Round Taillight Strobe - Includes 25' of wire and mounting hardware. SS-TL-STR.....P/N 11-07345**\$198.95**



Streamline Combo Head, White Led & Strobe Combination - Includes 25' of 5 conductor shielded wire, plug, pins and mounting hardware (includes adaptor plate for curved surface mounting if needed). SS-SLCW.....P/N 11-05114**\$239.95**



Round Taillight Combo Head - White Led & Strobe Combination Includes 25' of wire and mounting hardware. SS-TL-L/SP/N 11-07346**\$231.95**

DOUBLE DUAL MAGNUM STROBE

Driver is available in two models, the DDM 12 volt DC model and the SDDM smart model. The SMART Model simply means it can be powered by 10 to 80 volts of AC or DC. The 12 volt model is powered by the 12 volt electrical system of your aircraft. The strobe bulb fires a rapid double flash on one head and then the other in an alternating pattern. The first flash catches the eye and the second identifies your position. Total flash rate is 74 per min. Average current draw is less than 2 Amps. The driver measures 4 1/2" X 3 1/2" X 1 1/2" and weighs 10 ounces.



Double Dual Magnum Driver Box Only
12VDC Driver Box Only 12 volt Model DDM-DO
P/N 11-05118**\$139.95**



Double Dual Magnum Driver Box with round clear Fresnel Heads - Two Round Fresnel Heads, driver, 6' of 3 conductor wire, plugs, pins, and installation hardware (Tang Mount used on PPC, TRIKES, or where bolting heads to frame is desired).
STANDARD
12 VDC Model with /ROUND FRESNEL heads DDM-RH
P/N 10-01610**\$228.00**



Double Dual Magnum Driver Box with standard streamline Heads - Two Streamline Heads, driver, 50' of 3 conductor wire, plugs, pins, and installation hardware (includes adaptor plates for curved surface mounting if needed).
STANDARD
12 volt Model with Driver and Two STANDARD STREAMLINE Heads.....P/N 10-00824**\$228.00**



Two **STREAMLINE COMBO** heads, driver, 50' of 5 conductor shielded wire, plugs, pins, adaptor plates (for curved or flat surface mounting) and installation hardware. SONEX Aircraft adapter plates available at no additional charge when mentioned at time of purchase.
COMBO - 12 VDC Model with Streamline Combo Heads DDM-SLC
P/N 11-04835**\$379.00**

KUNTZLEMAN DOUBLE DUAL MAGNUM STROBES KIT #1 IS A SET OF SPECIAL HEADS



For builders of RV 7, 9, & 10 aircraft or any other kit that has like mounted wing lights. Due to the wing light configuration on these aircraft, the white rear facing LED on the regular Combo head is of no use, because it can't be seen from the rear. A white position or tail light is then needed. These are strobe and red / green position light equipped heads No white LEDs, a 2 strobe driver box, that fires both wing strobes in an alternating double wink pattern, a white round LED equipped tail light to be mounted at the rear of the aircraft. 50 feet of 5 conductor shielded wire for the wings, plugs, pins and mounting hardware. Total power draw for this system is about 2 1/2 Amps at 14 volts.....P/N 11-05833**\$465.00**



TRI 3 Driver with 3 STANDARD HEADS, Streamline or Round with 3 standard SL or ROUND FRESNEL heads, please specify. Complete with 75' of wire, plugs, pins, adaptor plates (for flat or curved surface mounting) and all the installation hardware.
TRI3-SLP/N 11-01829**\$375.00**

TRI 3 Driver with 2 Combo Heads & 1 Streamline, Round Fresnel or Taillight Head



The TRIPLE MAGNUM 3 light system with 2 COMBO & a choice of either 1 Standard Streamline Head, 1 Round Fresnel head or 1 Round Tail Light without LEDs (Additional cost for the Round Tail Light) for the third head, please specify. Complete with 75' of shielded wire, plugs, pins, adaptor plates (for flat or curved surface mounting) and all the installation hardware. (Please specify choice at time of order) TRI3-SLC
P/N 11-05125**\$532.00**

TRI 3 Driver with 3 Combo Heads



The TRIPLE MAGNUM 3 light system with 3 COMBO heads, please specify Streamline Combo or Round Tail light Combo for third head. Complete with 75' of shielded wire, plugs, pins, adaptor plates (for flat or curved surface mounting) and all the installation hardware. The tail COMBO heads both have a strobe and white LEDs to be used as a STROBE and WHITE tail light. TRI3-SLC...P/N 11-05119**\$600.00**

EL

KUNTZLEMAN STROBE SYSTEMS

KUNTZLEMAN LED CONTROLLER ONLY



LED Controller only. The controller is capable of powering up to 4 of our special strobe heads. So, if you would like to add more visibility we have 3 additional heads to choose from that will work in conjunction with the two wing tip heads. LED-HACW is a streamline

strobe & White AFT Position light, LED-SO is a streamline strobe only and LED-TLS is a Round taillight style strobe only. Each additional head requires a Y-PC patch cord.....P/N 11-12343\$146.75

KUNTZLEMAN LED REPLACEMENT POSITION AND STROBE HEADS



LED replacement position and strobe heads. This item comes with an LED replacement part with Red/White position or a Green/White position and strobe head. This part is for the Anti Collision and Navigation Position Light System. (Part Numbers 11-10687 or 11-12342) This head requires a Y-PC patch cord.

Red/White.....P/N 11-12344\$146.75
Green White.....P/N 11-12345\$146.75

KUNTZLEMAN DOUBLE DUAL MAGNUM STROBES KIT #2 VANS RV LIGHT KIT



For builders of RV 7, 9, & 10 aircraft or any other kit that has like mounted wing lights. Due to the wing light configuration on these aircraft, the white rear facing LED on the regular Combo head is of no use. A white position or tail light is then needed. They are STROBE and RED / GREEN Position light equipped heads WITHOUT the white LEDs, a 3 strobe driver box, that fires both wing strobes in an alternating double wink pattern and a third STROBE and LED equipped round tail light for mounting at the rear of the aircraft. The tail strobe fires in sync with each wing. Also, included is 75 feet of 5 conductor shielded wire, plugs, pins and mounting hardware. Total power draw for this system is about 4 Amps at 14 volts. TRI3-RV.....P/N 11-05834\$584.00

KUNTZLEMAN Y-PATCH CORD ADAPTER



Y-PC patch cord for the Anti Collision and Navigation Position Light System. (Part Numbers 11-10687 or 11-12342) This head requires a Y-PC patch cord... P/N 11-12347\$22.50

KUNTZLEMAN REPLACEMENT PARTS AND ACCESSORIES

Standard Streamline Head Assembly - Silicon and lexan head measures 3-1/4" x 1" and weighs 1.8 ounces each. (bulb unit, clear lens, adapter plate, 25 feet wire, plug, pins, hardware and heat shrink) SL-HA P/N 11-05127\$64.95

Standard Streamline Bulb Unit - Less lens SL-BU P/N 11-05128\$48.75

Standard Streamline Lens Only - SL-L. P/N 11-05130\$23.50

Round head Assembly - Round clear Fresnel lens. Measures 2-1/2" dia. at the base and 3-1/2" tall. Weighs 6 ounces, and standard 6 ft. wire and plug installed. RND-HA-CLEAR.....P/N 11-05135\$62.75

Round Clear Fresnel Lens - RND-L.....P/N 11-05139\$23.50

Round Wire Bulb Unit - Works on all Magnum drivers. RND-3WBW - 3 Wire.....P/N 11-05137\$46.90

Combo Streamline Head Assembly - Fitted with LED position lights. Measures 3-1/4" x 1" and weighs 2.8 ounces. 12 volt LEDs draw only (complete 2 head & wire) SL-HAC-S.....P/N 11-07465\$259.95

SL-HAC-G - Green & White aft LEDs(1 head & wire) SL-HAC-G.....P/N 11-07466\$92.75

SL-HAC-WG.....P/N 11-07348\$92.75

SL-HAC-R - Red/Wht aft LED SL-HAC-R.....P/N 11-07467\$134.95

W/O Strobe Bulb SL-HAC-WR.....P/N 11-07349\$92.75

SL-HAC-W - White aft LEDs SL-HAC-W.....P/N 11-07469\$134.95

W/O Strobe Bulb SL-HAC-W.....P/N 11-05132\$91.75

Combo Streamline - REPLACEMENT Strobe Bulb Unit Only, fits SL and ROUND Combo tail light heads.....P/N 11-05133\$53.75

Combo Streamline - LENS Only SL-LC.....P/N 11-05134\$23.50

Round Taillight with Strobe Only.....P/N 11-05805\$97.80

Round COMBO Taillight.....P/N 11-05804\$139.95

Round Taillight with LEDs TL-LED.....P/N 11-05806\$103.85

Strobe Head Plug Set - SH-PS.....P/N 11-05140\$3.35

Inline Plug Set - IL-PS.....P/N 11-05141\$7.80

Trike Mount Adaptor Kit - TRK-MT.....P/N 11-05143\$35.60

3 Wire Cable Extension - EXT-3W.....P/N 11-05142\$29.70

Mounting Kit - RND-MK.....P/N 11-07347\$39.70

KUNTZLEMAN LED WING TIP STROBE AND NAVIGATION SYSTEM



This new wing tip, 100% LED, strobe and navigation light system features a cluster of very bright LEDs and using a common controller that furnishes the heads with a junction point for synchronizing and selecting one of the 7 flash patterns of the LED STROBES. It also allows for a separate power source to the navigation red, green and white LEDs.

The system includes 2 heads (one left & one right), mounting adapter plates for mounting on a radius, 50 feet of 3 conductor wire, plugs, pins, 1 controller, misc. wire connectors and mounting hardware.

Specifications: • Made in USA • Navigation Colors: Aviation Red / Green forward and White aft • Strobe: Synchronized with seven (7) selectable flash patterns • Weight: 2 heads and controller / 12 ounces • Power draw: Strobe and Position lights are LESS than 2 Amps at 12 to 14 volts • Footprint Dimensions (Heads): 3.2" long x 1.1" wide • Footprint Dimensions (Controller): 2.2" x 5"

Kuntzleman Led Wing Tip Strobe And Navigation System Standard.....P/N 11-10687\$410.00
LED wing tip strobe with Sonex Adapters...P/N 11-10688\$410.00

Accessories

Kuntzleman Bushcaddy Adapter.....P/N 11-10689\$11.50
Kuntzleman Trike Adapter.....P/N 11-10690\$27.95

KUNTZLEMAN SELF CONTAINED 12 VDC STROBE



The SC103 STROBE is a self contained 12 volt DC operated light designed specifically for Ultralight use where an external 12 vdc power source (battery) is available. Its physical size is the smallest of any self contained strobe light in its class. Measuring 2 1/2" dia. At the base and 4" tall. Using the same xenon flash tube and Fresnel lens that is currently being used on its big brother the Single Magnum Smart Strobe. The brightness has been actual flight tested

before sunset and is visible at 3 statute miles (FAR 103 requirement). The flash is in a single wink pattern at about 42 per minute, power consumption is 500 ma (1/2 Amp) and it weighs only 7 1/2 ounces. The SC103 is mounted with a 1/4 X 20 stud located in the center on the bottom of the unit. Also, a stainless steel tang is supplied. Its rugged construction makes it a great economical stand alone unit P/N 11-04098\$118.50
SHOCK MOUNT - Designed to be used when mounting the SC103 strobe in an area of high vibration.....P/N 11-06251\$17.50

KUNTZLEMAN SC-LED LED STROBE



The SC-LED STROBE is a self-contained WHITE LED 12/14 VDC operated strobe light. Designed specifically for use where an external 12 VDC power source (battery) is available. Its size is the smallest of any self-contained LED strobe light in its class, measuring 2 1/2" diameter at the base by 4.75" tall, and weighing only 7.8 ounces. It is fitted with a Fresnel lens. The flash is in a 5 MULTIPLE BURST PATTERN of 72 cycles per minute. Power consumption is 500 ma (1/2 Amp) with an average draw of 0.3 Amps. The SC-LED strobe is mounted with a 1/4" x 20" stud located in the center on the bottom of the unit. A stainless steel tang is supplied for mounting. Its rugged construction makes it a great economical stand-alone unit.

P/N 11-13527\$169.95

KUNTZLEMAN LED STREAMLINE STROBE ONLY HEAD



LED-SO is a streamline strobe only. This part is for the Anti Collision and Navigation Position Light System. (Part Numbers 11-10687 or 11-12342). This head requires a Y-PC patch cord.P/N 11-12348\$102.75

KUNTZLEMAN LED STREAMLINE WHITE AFT POSITION AND STROBE HEAD



LED-HACW is a streamline strobe & White AFT Position light. This part is for the Anti Collision and Navigation Position Light System. (Part Numbers 11-10687 or 11-12342). This head requires a Y-PC patch cord.P/N 11-12346\$146.75

KUNTZLEMAN LED ROUND TAILLIGHT STYLE STROBE



LED-TLS is a Round taillight style strobe only. This part is for the Anti Collision and Navigation Position Light System. (Part Numbers 11-10687 or 11-12342) This head requires a Y-PC patch cord. .P/N 11-12349\$104.85

EL

AEROLEDS LED AVIATION LIGHTING



SUNSPOT™ 36 LX LANDING LIGHT

SunSpot™ 36 LX Landing Light is designed as an LED drop-in replacement for existing legacy lights. The SunSpot™ 36 LX Landing Lights will fit all PAR36 configurations. Wide input voltage range (9-40VDC) - Lumens 4950 - Candela 65,000 - Power consumption: 45 watts max - Simple drop-in replacement - Approvals: FAA-PMA/STC - 5-year warranty.

P/N 11-09351\$349.00



SUNSPOT™ 36 LX TAXI LIGHT

SunSpot™ 36 LX Taxi Light is designed as an LED drop-in replacement for existing legacy lights.

The SunSpot™ 36 LX Taxi Lights will fit all PAR36 configurations. Wide input voltage range (9-40VDC) - Lumens 4950 - Candela 15,000 - Power consumption: 45 watts max - Simple drop-in replacement - Approvals: FAA-PMA/STC - 5-year warranty.

P/N 11-09352\$349.00



SUNSPOT™ 36-4000 SERIES LANDING LIGHT

Highest performance in the industry. SunSpot™ 36-4000 Series Landing Lights are designed as an LED drop-in replacement for existing legacy lights. -H version includes an integrated Pulse or "WigWag" feature that

helps significantly increase recognition in broad daylight as well as night operations to help avoid midair collisions and bird strikes while drawing half the current. The SunSpot™ 36-4000 Series Landing Lights will fit all PAR36 configurations. Available for 12V and 24V systems - Lumens 11,000 - Candela 150,000 - Power consumption: 100 watts max - Simple drop-in replacement - Approvals: FAA-PMA/STC - 5-year warranty

Description	Part No.	Price
SunSpot 36-4596 Landing Light (24v)	11-14572	\$349.00
SunSpot 36-4313 Landing Light (12v)	11-17127	\$449.00
SunSpot 36-4596-H Landing Light w/Pulse (24v)	11-17132	\$17.00
SunSpot 36-4313-H Landing Light w/Pulse (12v)	11-17129	\$696.00
SunSpot Synchronizer Circuit (-H Models Only)	11-14028	\$17.00



SUNSPOT™ 36-4000 SERIES TAXI LIGHT

Highest performance in the industry. SunSpot™ 36-4000 Series Taxi Lights are designed as an LED drop-in replacement for existing legacy lights. -H version includes an integrated Pulse or "WigWag" feature that helps significantly

increase recognition in broad daylight as well as night operations to help avoid midair collisions and bird strikes while drawing half the current. The SunSpot™ 36-4000 Series Taxi Lights will fit all PAR36 configurations. Available for 12V and 24V systems

- Lumens 11,000 - Candela 50,000 - Power consumption: 100 watts max - Simple drop-in replacement - Approvals: FAA-PMA/STC - 5-year warranty

Description	Part No.	Price
SunSpot 36-4587 Taxi Light (24v)	11-14573	\$650.00
SunSpot 36-4314 Taxi Light (12v)	11-17128	\$655.00
SunSpot 36-4587-H Taxi Light w/Pulse (24v)	11-17133	\$695.00
SunSpot 36-4314-H Taxi Light w/Pulse (12v)	11-17131	\$696.00
SunSpot Synchronizer Circuit (-H Models Only)	11-14028	\$17.00



SUNSPOT™ 46 LX/HX LANDING LIGHT

SunSpot™ 46 LX/HX Landing Light is designed as an LED drop-in replacement for existing legacy lights. HX version includes an integrated Pulse or "WigWag" feature that helps significantly increase recognition in broad daylight as well as night operations to help avoid midair collisions and bird strikes while drawing half the current. The

SunSpot™ 46 LX/HX Landing Lights will fit all PAR46 configurations. Wide input voltage range (9-38VDC) - Lumens 9900 - Candela 150,000 - Power consumption: 90 watts max - Simple drop-in replacement - Approvals: FAA-PMA/STC - 5-year warranty

Description	Part No.	Price
SunSpot 46 LX Landing Light	11-11744	\$349.00
SunSpot 46 HX Landing Light w/Pulse	11-11411	\$449.00
SunSpot Synchronizer Circuit (HX Models Only)	11-14028	\$17.00

SUNSPOT™ 46-4000 SERIES LANDING LIGHT

Highest performance in the industry. SunSpot™ 46-4000 Series Landing Lights are designed as an LED drop-in replacement for existing legacy lights. -H version includes an integrated Pulse or "WigWag" feature that helps significantly increase recognition in broad daylight as well as night operations to help avoid midair collisions and bird strikes while drawing half the current. The SunSpot™ 46-4000 Series Landing Lights will fit all PAR46 configurations. Available for 12V and 24V systems - Simple drop-in replacement - Approvals: FAA-PMA/STC - 5-year warranty.

- 12V - 140w, 15,400lm, 180,000cd
- 24V - 175w, 19,250lm, 250,000cd

Description	Part No.	Price
SunSpot 46-4580 Landing Light (24v)	11-15868	\$850.00
SunSpot 46-4580-H Landing Light w/Pulse (24v)	11-17134	\$889.00
SunSpot Synchronizer Circuit (-H Models Only)	11-14028	\$17.00

SUNSPOT™ 46-4000 SERIES TAXI LIGHT

Highest performance in the industry. SunSpot™ 46-4000 Series Taxi Lights are designed as an LED drop-in replacement for existing legacy lights. -H version includes an integrated Pulse or "WigWag" feature that helps significantly increase recognition in broad daylight as well as night operations to help avoid midair collisions and bird strikes while drawing half the current. The SunSpot™ 46-4000 Series Taxi Lights will fit all PAR46 configurations. Available for 24V systems - Lumens 19,250 - Candela 100,000 - Power consumption: 175 watts max - Simple drop-in replacement - Approvals: FAA-PMA/STC - 5-year warranty

Description	Part No.	Price
SunSpot 46-4554 Taxi Light (24v)	11-15869	\$850.00
SunSpot 46-4554-H Taxi Light w/Pulse (24v)	11-17136	\$889.00
SunSpot Synchronizer Circuit (-H Models Only)	11-14028	\$17.00

SUNSPOT™ 64-4000 SERIES LANDING LIGHT

Highest performance in the industry. SunSpot™ 64-4000 Series Landing Lights are designed as an LED drop-in replacement for existing PAR64 lights. The SunSpot™ 46-4000 Series Landing Lights will fit all PAR64 configurations. Available for 24V systems - Lumens 22,000 - Candela 420,000 - Power consumption: 200 watts max - Simple drop-in replacement - Approvals: FAA-PMA - 5-year warranty

SunSpot 64-4559 (24) Landing Light.....P/N 11-16454\$1,650.00

AEROLEDS SUNSPOT 36 EQUINOX DUAL-FUNCTION LANDING / TAXI LIGHTS

AeroLEDs SunSpot 36 Equinox is the industries first true dual function LED Landing and Taxi light. In landing mode, it will output a 20°X20° bright white beam angle for high-speed take-offs and landings to greatly improve visibility both on the ground and in the air from up to 30 miles away.

While in taxi mode, the light produces a wider beam spread (20°X45°) that outputs a solid and evenly distributed light pattern for unmatched illumination of the runway/taxiway without impairing the vision of other pilots. All lights in the SunSpot Equinox Series come standard with integrated Pulse or WigWag feature. This feature takes advantage of an LEDs ability to illuminate instantaneously, providing a very immediate and distinct visual cue to other aircraft.

12VP/N 11-19188\$850.00
24VP/N 11-19189\$850.00

VISIT OUR WEBSITE OR CALL US FOR ADDITIONAL PART NUMBERS OR ACCESSORIES.

WWW.AIRCRAFTSPRUCE.COM

AEROLEDs LED AVIATION LIGHTING



SUNSPOT™ PCX SERIES LANDING/TAXI LIGHT (FOR PILATUS)

The SunSpot™ 36 PCx series replacement LED's utilize existing Pilatus mounting configurations and electrical connections, making installation a true drop-in replacement. This PAR36 light is compatible with models: PC-7, PC-7 MKII, PC-9, PC-12 and PC-21. Available for 24V systems - Lumens 11,000

- Candela 150,000 - Power consumption: 100 watts max - Simple drop-in replacement - Approvals: FAA-PMA/STC - 5-year warranty

Description	Part No.	Price
SunSpot PCx Landing Light (24v)	11-18443	\$1,100.00
SunSpot PCx Taxi Light (24v)	11-18444	\$1,100.00



AEROSUN™ LANDING/TAXI LIGHT

AeroSun™ is an experimental wing-mounted LED landing and taxi light with an integrated Pulse or "WigWag" feature that significantly increases recognition in broad daylight as well as night operations to help avoid midair collisions and bird strikes while drawing half the current. This light is ideal for installations in aluminum aircraft/composite aircraft, where some airflow within the wing cutout exists. Wide input voltage range (9-40VDC) - Lumens 4,290 - Candela 54,000 - Power consumption: 39 watts max - 5-year warranty

Description	Part No.	Price
SunSpot PCx Landing Light (24v)	11-11359	\$325.00
SunSpot PCx Taxi Light (24v)	11-08144	\$45.00



AEROLEDs QUASAR CX LED WINGTIPS FOR CESSNA

Cessna QUASAR CX integrated LED lighting system. Wingtip integrating state-of-the-art LED landing, taxi, and recognition lighting technology for Cessna aircraft. Designed for easy installation of existing Cessna nav/strobes lights or upgrade to latest LED nav/strobe/position light solutions. No brighter feature rich LED light on the market. Brighter than any currently available FAA approved incandescent, LED, or HID light. Does NOT require an external device to control recognition mode. Recognition mode is built into the light assembly. Optional Installation kit includes shielded wire, connectors, switches, and breaker.

Description	Part No.	Price
14/28 Volt Right and left (Late Cessna)	05-15082	\$3,283.00
14/28 Volt Right and left (Early Cessna)	05-15084	\$3,168.00



AEROSUN™ VX LANDING/TAXI LIGHT

AeroSun™ VX Landing and Taxi Light is designed specifically for Vans RV wingtips. In addition to its standard operation as a landing/taxi light, the AeroSun™ VX features integrated Pulse or "WigWag" significantly increasing recognition in broad daylight as well as night operations to help avoid midair collisions and bird strikes while drawing half the current. Ideal for installations in aluminum aircraft/composite aircraft, where some airflow within the wing cutout exists. Wide input voltage range (9-40VDC) - Lumens 13,300 - Candela 120,000 - Power consumption: 120 watts max (per pair) - 5-year warranty

Description	Part No.	Price
SunSpot PCx Landing Light (24v)	11-07779	\$1,100.00
SunSpot PCx Taxi Light (24v)	11-16655	\$1,100.00

Vans Aircraft Model Eligibility

RV6	RV7/8	RV9	RV12	RV10/14
•	•	•	NOT ELIGIBLE	•
•	Requires W-715-1 Wingtip			
•	Requires Conversion Kit 01-2500-KT-1 Note: Window (VA-166) supplied from Vans WILL NOT work for the conversion kit so new part (01-2500-KT-1A) must be used.			
•	Requires Conversion Kit 01-2500-KT-2 Note: The existing wingtip window (VA-193) from Vans WILL work with conversion kit.			

Description	Part No.	Price
AeroSun VX Landing/Taxi/Recognition Light	11-12921	\$895.00
AeroSun VX Conversion Kit w/Lens - RV9/9A	11-13272	\$220.00
AeroSun VX Conversion Kit - RV10/14	11-13273	\$174.95

SUNTAIL™ LED STROBE/ POSITION LIGHT (CERTIFIED OR EXPERIMENTAL)



SunTail™ serves as an LED Anti-Collision Strobe and Position Light designed for the tail of the aircraft. SunTail™ can synchronize its strobe with any of AeroLEDs™ LED lighting products. SunTail™ does not require an external power supply and will retrofit the mounting footprint of legacy lighting. It is TSO-C30c Type III and TSO-C96a Class II approved. Available for 12V and 24V systems - No external power supply needed - Low power consumption - 5-year warranty

Description	Part No.	Price
SunTail Strobe/Position Light (12v) - Certified	11-15266	\$495.00
SunTail Strobe/Position Light (24v) - Certified	11-15267	\$495.00
SunTail Strobe/Position Light (12v) - Experimental	11-15268	\$395.00
SunTail Strobe/Position Light (24v) - Experimental	11-15269	\$395.00



SUNBEAM™ LANDING LIGHT

SunBeam™ LED landing light is manufactured under FAA-PMA standards in a rectangular format to fit a variety of experimental aircraft and LSAs. It features integrated Pulse or "WigWag" significantly increasing recognition in broad daylight as well as night operations to help avoid midair collisions and bird strikes while drawing half the current. Aircrafts that use this landing light include: Diamond DA-40, the Cessna Columbia, the Liberty XL, some Cirrus models, and some Grumman models. Wide input voltage range (9-40VDC) - Lumens 3,300 - Candela 91,000 - Power consumption: 35 watts max - 5-year warranty

Description	Part No.	Price
SunBeam Landing/Recognition Light	11-11225	\$395.00



MICROSUN™ TAXI/ RECOGNITION LIGHT

The ultra-powerful MicroSun™ LED is very versatile, with the ability to be mounted almost anywhere on an aircraft. In addition to its standard operation as a taxi light, the MicroSun™ features integrated Pulse or "WigWag" significantly increasing recognition in broad daylight as well as night operations to help avoid midair collisions and bird strikes while drawing half the current. The light-weight of the MicroSun™ makes them the trusted light for lighter weight Experimental or Kit Planes. Wide input voltage range (9-40VDC) - Lumens 2,640 - Candela 15,000 - Power consumption: 24 watts max - 5-year warranty

Description	Part No.	Price
SunSpot PCx Landing Light (24v)	11-07779	\$1,100.00
SunSpot PCx Taxi Light (24v)	11-16655	\$1,100.00



SUNRAY™ PLUS LANDING LIGHT

The SunRay™ LED is a high-powered, compact experimental landing light. This wing-mounted LED features integrated Pulse or "WigWag" significantly increasing recognition in broad daylight as well as night operations to help avoid midair collisions and bird strikes while drawing half the current. The versatility in placement of the SunRay™ makes it perfect for most airplane types. This light is small enough to fit in the wingtip cutout found in Van's RV kits. Wide input voltage range (9-40VDC) - Lumens 1,100 - Candela 25,000 - Power consumption: 10 watts max - 5-year warranty

Description	Part No.	Price
SunRay Plus Landing/Recognition Light	11-09348	\$295.00
SunRay Plus Mounting Kit	11-12037	\$35.00

VISIT OUR WEBSITE OR CALL US FOR ADDITIONAL PART NUMBERS OR ACCESSORIES.

WWW.AIRCRAFTSPRUCE.COM

Prices Subject to Change Without Notice - Valid as of June 3, 2022.

AEROLEDs LED AVIATION LIGHTING

PULSAR™ NAVIGATION/STROBE/POSITION LIGHT (CERTIFIED OR EXPERIMENTAL)



Pulsar Series LED Navigation Lights serve as a three-in-one light—a navigation light for directional red and green positioning, a strobe light increases visibility in both daylight and night, and a rear-facing white position light. Designed with an industry-standard mounting footprint, an aerodynamically low drag profile,

standard three-position mounting screw pattern with a patented mounting bracket, they are ideal for replacing legacy light installations. The lights are TSO approved and meet or exceed C-30c, Type I, II and III, and C-96a, Class II. Available for 12V and 24V systems - No external power supply needed - Low power consumption - 5-year warranty • **Mounting Brackets Included With Purchase**

Description	Part No.	Price
Light PAIR (12v) - Certified	11-15567	\$1,250.00
Light PAIR (24v) - Certified	11-15568	\$1,250.00
Light PAIR (12v) - Experimental	11-17138	\$996.00
Light LEFT (12v) - Experimental	11-18435	\$497.50
Light RIGHT (12v) - Experimental	11-18436	\$497.50
Light LEFT (24v) - Experimental	11-18437	\$497.50
Light RIGHT (24v) - Experimental	11-18438	\$497.50
Pulsar Mount Kit (single bracket)	11-18432	\$32.50

PULSAR N™ NAVIGATION LIGHT (CERTIFIED)



Pulsar N is part of our Pulsar N Series™ LED Navigation Lights. Pulsar N serves as a navigation light for directional red and green positioning. Designed with an industry-standard mounting footprint, an aerodynamically low drag profile, standard

three-position mounting screw pattern with a patented mounting bracket, they are ideal for replacing legacy light installations. TSO approved and meet or exceed C-30c, Type I, II. Available for 12V and 24V systems - Low power consumption - 5-year warranty • **Mounting Brackets Included With Purchase**

Description	Part No.	Price
Light Pair (12v) - Certified	11-15999	\$695.00
Light Left (12v) - Certified	11-15870	\$347.50
Light Right (12v) - Certified	11-15871	\$347.50
Light Pair (24v) - Certified	11-15271	\$695.00
Light Left (24v) - Certified	11-15872	\$575.00
Light Right (24v) - Certified	11-15873	\$575.00
Pulsar N Series Mounting Bracket	11-18433	\$45.00

PULSAR N SERIES COMPARISON CHART

NAVIGATION



PULSAR N ● ●
Navigation Red
Navigation Green

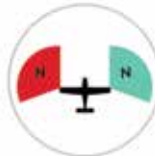

ANTI-COLLISION STROBE



PULSAR NS ● ● ● ●
Navigation Red
Navigation Green + Anti-Collision Strobe

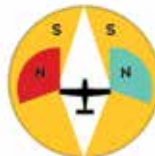

POSITION



PULSAR NSP ● ● ● ● ●
Navigation Red
Navigation Green + Anti-Collision Strobe + Rear White Position



PULSAR NS™ NAVIGATION/STROBE/POSITION LIGHT (CERTIFIED OR EXPERIMENTAL)



Pulsar NS is part of our Pulsar N Series™ LED Navigation Lights. Pulsar NS serves as a two-in-one light—a navigation light for directional red and green positioning, and a strobe light to increase visibility in both daylight and night flight. Designed with an industry-standard mounting footprint, an

aerodynamically low drag profile, standard three-position mounting screw pattern with a patented mounting bracket, they are ideal for replacing legacy light installations. The lights are TSO approved and meet or exceed C-30c, Type I, II, and C-96a, Class II. Available for 12V and 24V systems - No external power supply needed - Low power consumption - 5-year warranty • **Mounting Brackets Included With Purchase**

Description	Part No.	Price
Light Pair (12v) - Certified	11-15272	\$1,150.00
Light Left (12v) - Certified	11-15874	\$575.00
Light Right (12v) - Certified	11-15875	\$575.00
Light Pair (24v) - Certified	11-15273	\$1,150.00
Light Left (24v) - Certified	11-15876	\$575.00
Light Right (24v) - Certified	11-15877	\$575.00
Light Pair (12v) - Experimental	11-15278	\$895.00
Light Left (12v) - Experimental	11-15859	\$447.50
Light Right (12v) - Experimental	11-15860	\$447.50
Light Pair (24v) - Experimental	11-15279	\$929.00
Light Left (24v) - Experimental	11-15862	\$447.50
Light Right (24v) - Experimental	11-15863	\$447.50
Pulsar N Series Mounting Bracket	11-18433	\$45.00

PULSAR NSP™ NAVIGATION/STROBE/POSITION LIGHT (CERTIFIED OR EXPERIMENTAL)



Pulsar NSP is part of our Pulsar N Series™ LED Navigation Lights. Pulsar NSP serves as a three-in-one light—a navigation light for directional red and green positioning, a strobe light increases visibility in both daylight and night, and a rear-facing white position light. Designed with an industry-

standard mounting footprint, an aerodynamically low drag profile, standard three-position mounting screw pattern with a patented mounting bracket, they are ideal for replacing legacy light installations. The lights are TSO approved and meet or exceed C-30c, Type I, II and III, and C-96a, Class II. Available for 12V and 24V systems - No external power supply needed - Low power consumption - 5-year warranty • **Mounting Brackets Included With Purchase**

Description	Part No.	Price
Light Pair (12v) - Certified	11-15274	\$1,195.00
Light Left (12v) - Certified	11-15878	\$597.50
Light Right (12v) - Certified	11-15879	\$597.50
Light Pair (24v) - Certified	11-15275	\$1,195.00
Light Left (24v) - Certified	11-15880	\$597.50
Light Right (24v) - Certified	11-15881	\$597.50
Light Pair (12v) - Experimental	11-15280	\$929.00
Light Left (12v) - Experimental	11-15864	\$464.50
Light Right (12v) - Experimental	11-15865	\$464.50
Light Pair (24v) - Experimental	11-15281	\$929.00
Light Left (24v) - Experimental	11-15866	\$464.50
Light Right (24v) - Experimental	11-15867	\$464.50
Pulsar N Series Mounting Bracket	11-18433	\$45.00

EL

VISIT OUR WEBSITE OR CALL US FOR ADDITIONAL PART NUMBERS OR ACCESSORIES.

WWW.AIRCRAFTSPRUCE.COM

AEROLEDs LED AVIATION LIGHTING



POLARIS™ POSITION LIGHT BULB

Polaris™ Position Light Bulb serves as an LED replacement for traditional incandescent position lighting. They are to be installed behind a green or red forward-facing navigation lens. Available for 12V and 24V systems - BAY15s socket - Lumens 720 - Power consumption: 7 watts max - Approvals: FAA-PMA - 5-year warranty

Description	Part No.	Price
Polaris Position Light (12v)	11-17571	\$119.00
Polaris Position Light (24v)	11-17572	\$119.00



SUNBEACON II™ SERIES NAVIGATION LIGHT

SunBeacon II™ provides a 360-degree flash pattern around its vertical axis. This compact beacon comes standard with a clear lens - available with either white or red LEDs. The SunBeacon II™ is a direct replacement for standard rotating beacons and flashing beacons, with significantly more light output for less power.

The SunBeacon II™ requires zero maintenance and has an extremely low profile for reduced drag. Red TSO C96a Class I & III, White TSO C96a Class II. Available for 12V and 24V systems - No external power supply needed - Low power consumption - 5-year warranty - MOUNTING HARDWARE SOLD SEPARATELY

Description	Part No.	Price
SunBeacon II Strobe Light RED (12v) - Certified	11-15882	\$695.00
SunBeacon II Strobe Light RED (24v) - Certified	11-15883	\$695.00
SunBeacon II Strobe Light WHITE (12v) - Certified	11-15884	\$695.00
SunBeacon II Strobe Light WHITE (24v) - Certified	11-15885	\$695.00
SunBeacon II Twist Mount Kit	11-13537	\$45.00
SunBeacon II 3.75" Cup Mount Adapter	11-17387	\$79.00

STARLIGHT™ WING ICE LIGHT



Low-lying clouds and sub-zero temperatures can create hazardous ice formations on the wings of your aircraft.

StarLight™ was engineered with your safety in mind. This LED Ice Light (or wing inspection/wing scan light) provides optimum illumination of your wing to check for the formation of ice. It offers more total light output (Lumens) and a wider beam spread to give you the optimum amount of light needed. It also provides added visibility to your aircraft for collision avoidance and recognition.

StarLight Ice serves as an easy LED replacement for incandescent 7079 light bulbs. Available for 24V systems - BAY15s socket - Lumens 550 - Power consumption: 5 watts max - Approvals: FAA-PMA - 5-year warranty

Description	Part No.	Price
StarLight Wing Inspection Light (24v)	11-16661	\$179.00

ACCESSORIES



11-18431



11-18430

Description	Part No.	Price
Pulsar/Pulsar N Series Adapter Plate (Aeroflash Conversion)	11-18431	\$120.00
Pulsar NS Cessna Wingtip Fairing Adapter	11-18430	\$150.00

VAN'S RV LIGHTING KITS

Four different kits from which to choose. All kits do not require power supply.

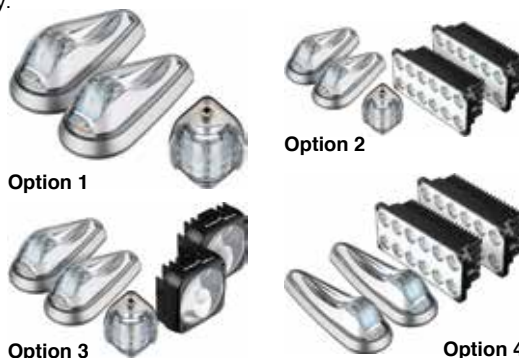

Description	Part No.	Price
Van's RV Kit Option 1:		
Pulsar NS Pair (12v), SunTail (12v)	11-09921	\$1,245.00
Pulsar NS Pair (24v), SunTail (24v)	11-17268	
Van's RV Kit Option 2:		
Pulsar NS Pair (12v), SunTail (12v), Two (2) AeroSun Landing/Taxi/Recognition Lights	11-09922	\$1,895.00
Pulsar NS Pair (24v), SunTail (24v), Two (2) AeroSun Landing/Taxi/Recognition Lights	11-17267	
Van's RV Kit Option 3:		
Pulsar NS Pair (12v), SunTail (12v), Two (2) SunRay Plus Landing/Recognition Lights	11-09923	\$1,835.00
Pulsar NS Pair (24v), SunTail (24v), Two (2) SunRay Plus Landing/Recognition Lights	11-17266	
Van's RV Kit Option 4:		
Pulsar Pair (12v), Two (2) AeroSun Landing/Taxi/Recognition Lights	11-09924	\$1,489.00

KING AIR LIGHTING KITS



11-18447

11-18448

Aeroleds King Air LTL Complete Light Kits 28V (33,000 Lumen) / 9-36V (14,850 Lumen).

Description	Part No.	Price
SunSpot 36-4000 Series Landing/Taxi Light Kit (100w)	11-18447	\$1,800.00
SunSpot 36 LX Series Landing/Taxi Light Kit (45w)	11-18448	\$1,000.00

CESSNA CARAVAN (C208) LIGHTING KITS



Aeroleds Cessna Caravan LTL complete Light Kit (30,250 Lumens).

Description	Part No.	Price
SunSpot Landing/Taxi Light Kit	11-18446	\$1,500.00

PILATUS LIGHTING KITS



The SunSpot 36 PCx (Landing light for Pilatus) series replacement LED's utilize mounting configurations and electrical connections, making installation a true drop-in replacement for your Pilatus Aircraft. This PAR36 landing light will work with models: PC-7, PC-9, PC-12 and PC-21. AeroLEDs

SunSpot 36 series lights consume less power, are not affected by vibration and output a solid, even light beam that provides exceptional color rendition when compared to the grayed out images from legacy incandescent lamps.

Description	Part No.	Price
SunSpot PC12 Landing/Taxi Light Kit (24v)	11-18445	\$3,300.00

VISIT OUR WEBSITE OR CALL US FOR ADDITIONAL PART NUMBERS OR ACCESSORIES.

BEACONS – DIMMERS

SKYSPORTS BRIGHT STAR STROBE



Measuring only 4" high by 2 3/4" diameter, it weighs less than 5 ounces! Special dual xenon flashtube arrangement provides ultra-bright flash visible for over 3000' in daylight, much more at dusk and dawn. No separate power pack is required, all electronics are fully contained in the strobe itself. Lens is available in clear, red or green. Each strobe draws less than 300ma.

Mounting bracket included. Buy two for wing-tip installation. Must be run from 12 volt battery. Dimensions: 4"x 2.75"(dia) Weight: 4.5 ounces.
Features: • Operates on 12VDC (12' lead is hardwired to unit) • Completely self-contained • Water-resistant • Ultra-compact • Meets FAR 103 • Bright 8 joule flash • 40 flashes/minute
 Strobe 12VDC Clear.....P/N 11-07769\$57.75

ACCESSORIES

Strobe Lens Clear.....P/N 11-07772\$4.75
 Strobe Lens Red.....P/N 11-07770\$4.75
 Strobe Lens Green.....P/N 11-07771\$4.75

ELECTRONIC ANTI-COLLISION LIGHT - ACL4



The electronic anti collision light 4 (ACL4) is a highly innovative product which contributes to saver airspace. The new LED technology allows an incredibly excellent, red light with only approx. 10% of the input power compared with conventional lights. The casting in a high-optical plastic makes the ACL absolutely insensitive against water, vibrations and other environmental influence. The efficiency of the output is much higher, than with conventional electric light bulbs. The self-warming of the ACL is low and can be determined as safe. To avoid overheating, the heat balance is controlled electronically P/N 11-10678\$396.00

RECESSED MOUNT LED LIGHT FIXTURES



Recessed mount convenience light. 3 Bright LEDs behind a frosted panel. Recessed mount with hardware. Dimensions: 2.25" x 2.25" x .5" depth. #6 mounting holes with snap on cover. 12 Volt DC or 24 Volt DC, very low power drain (0.1mA). Applications: Mounts flush into foot wells, door panels, and side panels. Ideal as a convenience light, mp light, or chart light.

Description	Part No.	Price	Description	Part No.	Price
12V White	11-09266	\$13.90	24V White	11-09268	\$13.90
12V Red	11-09267	\$13.90	24V Red	11-09269	\$13.90
12V Blue	11-09642	\$12.90	24V Blue	11-09644	\$12.90



OPTIMUS LED AUX LIGHTS

Utilizing an all new proprietary IRIS Reflector Technology, the Long Range series provides the ultimate focus for long range lighting by producing 693 ft. of usable light from a single 3.5" tall, 10-watt LED.

Compared to a standard 55 watt low beam headlight reach of 88 ft. and a standard 65 watt high beam reach of 153 ft. Optimus lights also feature Cyclops Prime Drive technology for integrated thermal management and dimming capabilities. **Pulse Width Modulation** The Optimus Prime utilizes integrated Pulse Width Modulation (PWM) dimming circuitry to manage heat levels. PWM works by flashing the LED at a frequency faster than the human eye can detect, reducing the time that the LED is operating while still delivering 100% light output. Round.....P/N 11-12266\$298.95

BLACK FLUTED CONTROL KNOB



Black Bakelite knob. Fluted grip. 1/4" brass bushing with set screw. 3/4" in diameter x 7/16" high. Fits potentiometers for Superior Panel Technology dimmers.

P/N 11-07344\$4.90

XEVISION® XETREME™ LED LANDING/TAXI LIGHTS



The benefit of the combination of the XV36-LED-7UN landing light and the XV36-LED-7EL taxi light is enormous, providing a far reach of central illumination

(7UN) and a superb uniform illumination to the sides (7EL). These characteristics combined, provide optimal benefits for ground and flight operation safety. Too bright? Just choose 50% light intensity, simply selected in the cockpit on the fly. XeVision's proprietary strobe mode, dubbed XeStrobe™, is purposely designed by their engineers for better recognition. The XeStrobe™ pattern and high brightness light beam of this LED landing light is a perfect solution to mitigate bird strikes. Used together with the LED taxi light version, the wider taxi projecting angle helps to reach flocks of birds over a wider range. By using both Landing and Taxi fixtures with the XeStrobe™ pattern selected "To be seen" is a no-brainer even for birds. XeStrobe™ is far superior to the traditional wig-wag pattern. **Specifications:** • Input power: 100 watt • Form Factor: par 36 (Also, serves par 46 using the optional generic mounting adapter/bracket for individual installation) • LED output power: 92 watt
 Landing Light.....P/N 11-19030\$897.75
 Taxi Light.....P/N 11-19031\$897.75

SINGLE / 2 CHANNEL PWM DIMMERS

The two dimmers include a single channel model. Both use pulse wave modulation, or PWM electronic design for precise control of LED lighting such as LED instrument panel lighting, baggage, utility, map or post lights. The self-contained products are designed for easy installation and feature integrated on/off switches on each rheostat. Rated at 18 Watts per dimmer channel, the dimmers are capable of operating a large number of interior lighting products and are engineered to provide additional over-current, over-voltage and reverse polarity protection.



SINGLE CHANNEL PILOT'S LIGHT DIMMER

Single Channel PWM (pulse wave modulation) dimmers are ideal for operating LED Light Strips and other interior incandescent or LED lighting, such as map lights, convenience, footwell or baggage compartment lighting. Features include reverse-polarity protection and over-

voltage protection as well as an integrated on/off switch (in the fully counterclockwise position).

12 Volt DC (14VDC systems) version has 7 Amps of capacity (97W)
 24 Volt DC (28VDC systems) version has 4 Amps of capacity (112W)

Just 1.25" x 1.6". Shaft diameter is 17/64" (6.75mm)

Screw-down terminals for easy connection of input and output wires

Powerful enough to operate a wide range of lighting products

High-quality push-on knob. Shaft length accommodates panel widths to 5mm.

2-CHANNEL PILOT'S LIGHT DIMMER

2 Channel PWM (pulse wave modulation) dimmers are ideal for controlling more than one bank of LED or incandescent lighting, such as 2-color LED light strips or any combination of lighting (panel lighting, overhead map lights, foot well lighting, etc.). Each rheostat controls a separate lighting channel and contains its own On/Off switch

(in the fully counterclockwise position). 1.5 Amp per channel version (12-14VDC systems) controls up to 18W per channel. 7 Amp per channel version (12-14VDC systems) control up to 97W per channel and adds over-current protection and dual independent heat sinks. Ideal for LED or incandescent lighting. Dual rheostat shafts permit independent control of each channel. Screw-down terminals for easy connection of input and output wires. Powerful enough to operate a wide range of lighting products. High-quality push-on knob. Shaft length accommodates panel widths to 5mm

Description	Part No.	Price
Single Channel PWM Dimmer 12V	11-06674	\$39.50
Single Channel PWM Dimmer 24V	11-07286	\$35.90
Dual Channel Dimmer 12V	11-10783	\$53.75
Dual Channel Dimmer 24V	11-14109	\$49.95

PWM DIMMER



Extremely powerful PWM Dimmer - 7 Amps capacity. Perfect for controlling interior lighting inside your Aircraft. Easy-to-install with smooth control rheostat. High quality fluted knob included. (Note: Rheostat does not have an integrated on/off switch - in full counterclockwise it is OFF). Designed to

control both LED and Incandescent lighting - 7 Amps per channel. 12 OR 24 Volt Pulse Wave Modulation (PWM) Electronic Dimmer for DC Lighting Applications.

12V.....P/N 11-14107\$35.75
 24V.....P/N 11-14108\$35.75

HIGH POWER 30 AMP (30A) PWM DIMMER



Extremely powerful PWM Dimmer - 30 Amps capacity. Perfect for controlling large banks of LED lighting.. Easy-to-install, on/off switch on rheostat. Push-on knob included. Designed to control both LED and Incandescent lighting - 30 Amps maximum. 12V or 24V Pulse Wave Modulation (PWM)

Electronic Dimmer for DC Lighting Applications. Over-current protection, reverse polarity protection and over-voltage protection. On board ATM fuse for additional protection.

12V.....P/N 11-16081\$97.75
 24V.....P/N 11-16082\$97.75

COCKPIT LIGHTS

754 SERIES LED COCKPIT LIGHTS



Parts Sold Separately

These versatile cockpit lights can be used to illuminate the instrument panel. They can be repositioned to illuminate your charts with their 110 degrees of angle adjustment while being able to rotate a full 360 degrees. Dimensions: 3/4" diameter, 1-5/8" tall fully-extended, 7/8" tall at 90 degrees.

The mounting stud is 1/4" in diameter and can be mounted onto a surface up to .200" thick. Switchable models facilitate wiring an SPDT switch (not included) to the light, allowing either red or white operation. We also offer a flush-mount flange to mount the light if the back side of the light is unreachable. Flush Mount - (Pictured above) This part is for mounting and LED light Model 754 from the front side. The adapter base is 1-1/2" in diameter, stands 1-2" tall, and has a 1" bolt hole circle.

Model	Description	Body	Part No.	Price
754R-14V	4 Red 14V L.E.D.s	Alum.	11-04393	\$55.75
754R-28V	4 Red 28V L.E.D.s	Alum.	11-04394	\$55.75
754W-14V	4 White 14V L.E.D.s	Alum.	11-07481	\$52.75
754W-28V	4 White 28V L.E.D.s	Alum.	11-07482	\$52.75
754RW-14V	2 Red 2 White 14V L.E.D.s	Alum.	11-04395	\$52.75
754RW-28V	2 Red 2 White 28V L.E.D.s	Alum.	11-04396	\$52.75
754R-14V	4 Red 14V L.E.D.s	Black	11-07483	\$53.75
754R-28V	4 Red 28V L.E.D.s	Black	11-07484	\$55.75
754W-14V	4 White 14V L.E.D.s	Black	11-07485	\$52.75
754W-28V	4 White 28V L.E.D.s	Black	11-07486	\$52.75
754RW-14V	2 Red 2 White 14V L.E.D.s	Black	11-07487	\$52.75
754RW-28V	2 Red 2 White 28V L.E.D.s	Black	11-07488	\$52.75

Accessories	Body Color	Part No.	Price
Flush Mount	Aluminum	11-04397	\$15.85
Flush Mount	Black	11-07502	\$16.50



LED MAPLIGHTS

The body of the maplight is constructed of aircraft grade 6061 T6 aluminum and black anodize treated for protection from corrosion. The LED bulbs and internal components are high quality components, and are engineered to withstand 150% of their rated voltage

without damage. The wire is tefzel coated mil-spec wire used in certified aircraft and the component potting material is a two part epoxy making this maplight highly vibration and shock resistant. The average bulb life of the LED used in this product in excess of 20,000 hours of use and the maplight draws only 20 millamps of power with virtually no heat produced. The red LED used in this maplight gives the most light available in environments where night vision must be retained. This "LED Maplight" is built to be durable, simple to operate, lightweight and compatible with dimming systems. Each "LED maplight" is tested twice during production for maximum quality and customer satisfaction. The "LED maplight" is intended for use in Experimental, Amateur-Built aircraft only.

MAPLIGHT I - 4 LEDES			
Color	Voltage	Part No.	Price
Red	12	11-04387	\$80.10
Green	12	11-04388	\$80.10
White	12	11-04389	\$80.10
Red	24	11-04390	\$81.75
Green	24	11-04391	\$80.10
White	24	11-04392	\$80.10
MAPLIGHT II - 6 LEDES			
Color	Voltage	Part No.	Price
Red	12	13-06620	\$100.75
White	12	13-06621	\$100.75
Blue	12	13-06622	\$100.75
Green	12	13-06623	\$100.75
Red	24	13-06624	\$100.75
White	24	13-06625	\$100.75
Blue	24	13-06626	\$100.75
Green	24	13-06627	\$100.75
MAPLIGHT II - 6 LEDES Dual Color			
White/Red	12	13-06628	\$100.75
White/Blue	12	13-06629	\$100.75
White/Green	12	13-06630	\$100.75
White/Red	24	13-06631	\$100.75
White/Blue	24	13-06632	\$100.75
White/Green	24	13-06633	\$100.75

Accessories

Surface Mount Adapter SMA/MMII P/N 13-06651 \$19.50

1512 SERIES LED EYEBALL COCKPIT LIGHTS



These lights work great in overhead consoles and tight spaces. 30 degree adjustable angle, 360 degree adjustable rotation. LED technology draws less current (40 mA max.) and last much longer, (20,000+ hours.) and are fully dimmable.

The light is available in three light color version, two housing colors, and two voltages. The light colors are four red LED's, four white LED's, and two red/two white LEDs that can be lit separately with a SPDT switch (not included.) The housing colors are black or clear anodize. There are two voltages: 14 and 28. The light has a 1.45" flange and mounts in a 1.25" hole. The light requires 1" behind the mounting surface and is only 5/8" in front. It will accept up to 0.2" thick mounting surface.

Model	Description	Body	Part No.	Price
1512R-14V	4 Red 14V LEDs	Alum.	11-07489	\$112.95
1512R-28V	4 Red 28V LEDs	Alum.	11-07490	\$116.85
1512W-14V	4 White 14V LEDs	Alum.	11-07491	\$116.95
1512W-28V	4 White 28V LEDs	Alum.	11-07492	\$108.95
1512RW-14V	2 Red 2 White 14V LEDs	Alum.	11-07493	\$116.95
1512RW-28V	2 Red 2 White 28V LEDs	Alum.	11-07494	\$116.95
1512R-14V	4 Red 14V LEDs	Black	11-07495	\$114.75
1512R-28V	4 Red 28V LEDs	Black	11-07496	\$116.85
1512W-14V	4 White 14V LEDs	Black	11-07497	\$116.95
1512W-28V	4 White 28V LEDs	Black	11-07498	\$116.95
1512RW-14V	2 Red 2 White 14V LEDs	Black	11-07499	\$108.95
1512RW-28V	2 Red 2 White 28V LEDs	Black	11-07501	\$116.95

FIXED LED COCKPIT LIGHTS



Cockpit and/or baggage compartment light that mounts in a 1.250 hole. This light is fixed (does not swivel) and is great for lighting a specific area. It has 4 L.E.D.s that are fully dimmable and only draws 30ma current. It is available in 2 light colors and 2 housing colors.

Voltage	Light Color	Housing Color	Part No.	Price
14	White	Silver	05-08303	\$69.75
14	Red	Silver	05-08298	\$70.99
14	White/Red	Silver	05-08301	\$69.75
14	White	Black	05-08304	\$69.75
14	Red	Black	05-08299	\$71.75
14	White/Red	Black	05-10634	\$69.75
28	White	Silver	05-08352	\$69.75
28	Red	Silver	05-08343	\$70.99
28	White/Red	Silver	05-08347	\$69.75
28	White	Black	05-08353	\$69.75
28	Red	Black	05-08346	\$70.99
28	White/Red	Black	05-08302	\$69.75

LED CABIN LIGHTING



This light can be used for a wide variety of applications.

It has a 110° angle adjustment while being able to rotate 360° and are fully dimmable. The light end is 1 1/2" in diameter, 2 3/4" tall fully extended and 1 1/2" high at 90°. The mounting stud is 3/8" and can be mounted to a surface up to 1/2" thick. This light has 12 LEDs that draw amps max.

Voltage	Light Color	Housing Color	Part No.	Price
14	Red	Silver	05-08306	\$114.75
14	White	Silver	05-08314	\$113.75
14	Red	Black	05-08307	\$114.75
14	White	Black	05-08316	\$113.75
28	Red	Silver	05-08309	\$114.75
28	White	Silver	05-08318	\$109.00
28	Red	Black	05-08312	\$113.75
28	White	Black	05-08321	\$113.75

LED SUPER DOME LIGHT



The Superior Panel Technology Super Dome Light (SPTSDL) is an ultra-bright dome light that can be used in a variety of aircraft locations: Cabin, Baggage, Door entry, etc. The SPTSDL super dome provides a bright, wide angle, cool-white flood light. A dimmer is highly suggested for use with this light. The recommended dimmer is the Superior Panel Technology dimmer model SPTPWMLSDS. This pulse-width-modulating dimmer that will provide even, full range dimming from barely visible to full bright. This dimmer has a built in circuit breaking off switch which allows you to connect directly to a battery with an inline fuse so that you can turn on the light without turning on the master switch (if desired). The precision machine aluminum bezel on the light is available either in black (SPTSDLB) or clear (SPTSDLC) anodizing.

Specifications: • Input Voltage: 14-VDC • Input Power: 4 watts max; .25 amps @ 14 VDC • Weight: 1.41 oz • Dimensions: (not including connector) 2 inches wide X 3.33 inches long X .25 inches thick.

Black Anodized (No Dimmer) P/N 11-17445 \$149.00
 Clear Anodized (No Dimmer) P/N 11-17446 \$170.75
 Black Anodized (Dimmer with Built-In Internal Circuit Breaking Switch) P/N 11-17447 \$248.00
 Clear Anodized (Dimmer with Built-In Internal Circuit Breaking Switch) P/N 11-17448 \$248.00

STROBES – MAP LIGHTS – LED LIGHTS



OPLITE FAA-PMA SINGLE COLOR 4 LED MAPLIGHTS

Easily installed, dimmable, unobtrusive and efficient, the LED Maplight 4 series consists of four LEDs of the same color that illuminate simultaneously. The LED Maplight 4 series is compatible with all dimming systems. Each LED Maplight 4 is manufactured and tested

in accordance with FAA-PMA-approved protocols for quality assurance and customer satisfaction. Precision CNC Machined • Mil-Spec Anodized • 20,000 Hours LED Life.

Specifications:

- 12-volt model; maximum 15 volts DC 30 milliamps
- 24-volt model; maximum 30 volts DC 15 milliamps
- Fully adjustable in two directions
- Total installed height when extended is 2.125 inches
- Mounts in 15/32" thru hole; surface mount adapter available

Color	Volts	Part No.	Price
Red	12V	11-13846	\$186.75
Green	12V	11-13847	\$186.75
White	12V	11-13848	\$186.75
Red	24V	11-13849	\$186.75
Green	24V	11-13850	\$186.75
White	24V	11-13851	\$186.75



OPLITE FAA-PMA SINGLE COLOR 6 LED MAPLIGHTS

The Maplight 6 series is available either with all six LEDs of your color choice operating simultaneously, or three white LEDs and three LEDs of your color choice operating independently of the other color. The Maplight 6

series is compatible with all dimming systems. Each LED Maplight 6 is manufactured and tested in accordance with FAA-PMA-approved protocols for quality assurance and customer satisfaction.

Color	Volts	Part No.	Price
Red	12V	11-13852	\$191.15
White	12V	11-13853	\$191.15
Blue	12V	11-13854	\$191.15
Green	12V	11-13855	\$191.15
Red	24V	11-13856	\$191.15
White	24V	11-13857	\$191.15
Blue	24V	11-13858	\$191.15
Green	24V	11-13859	\$191.15



OPLITE FAA-PMA DUAL COLOR 6 LED MAPLIGHTS

The Maplight 6 series is available either with all six LEDs of your color choice operating simultaneously, or three white LEDs and three LEDs of your color choice operating independently of the other color. The

Maplight 6 series is compatible with all dimming systems. Each LED Maplight 6 is manufactured and tested in accordance with FAA-PMA-approved protocols for quality assurance and customer satisfaction.

Color	Voltage	Part No.	Price
White/Red	12V	11-13860	\$201.25
White/Blue	12V	11-13861	\$201.25
White/Green	12V	11-13862	\$201.25
White/Red	24V	11-13863	\$201.25
White/Blue	24V	11-13864	\$201.25
White/Green	24V	11-13865	\$201.25

Surface Mount Adapter for MapLights.....P/N 13-06651**\$19.50**



PILOT LIGHT PRO

Pilot Light Pro serves two main functions. It provides hands free panel lighting, as well as map lighting. using the latest in LED technologies it delivers 19 hours of continuous use. Pilot Light Pro is delivered with two AA Procell 1500 batteries installed, and may also optionally be installed using ships power. The internal circuit board will cut off the internal battery source once ships power is turned on. Loss of ships power will

return the unit back to it's battery source, leaving you with light to work by in the advent of any problem i.e. loss of alternator.

Quick Installation: Installation is quick and easy if using battery only option, simply peel and stick using 3M power lock. The panel light is fully adjustable see our web site for installation instructions. Wiring to ship's power will require a Licensed A&P and a 337 Form, field approval may be required by local Fisdco.

Blue	P/N 11-07819	\$124.95
Red	P/N 11-07836	\$124.95
Green.....	P/N 11-07837	\$124.95



TASKLIGHT 600 COLOR LED COCKPIT LIGHTS

The TaskLight 600 series is available either with all 6 LEDs of your color choice operating simultaneously, or three White LEDs and three LEDs of your color choice operating independently of the other color. The TaskLight 600 series has an intensity knob and on/off switch built in and operates with input voltages ranging from 10v to 30 volts. Made in the USA, each LED Tasklight

600 is manufactured and tested to AS9100C quality standard and Traceability for quality assurance and customer satisfaction.

Single Color	Part No.	Price
Gooseneck Blue	11-15387	\$248.15
Gooseneck Green	11-15388	\$248.15
Gooseneck Red	11-15389	\$248.15
Gooseneck White	11-15390	\$248.15
Thru Panel Blue	11-15394	\$248.15
Thru Panel Green	11-15395	\$248.15
Thru Panel Red	11-15396	\$248.15
Thru Panel White	11-15397	\$248.15

Dual Color	Part No.	Price
Gooseneck Blue/White	11-15391	\$248.15
Gooseneck Green/White	11-15392	\$248.15
Gooseneck Red/White	11-15393	\$248.15
Thru Panel Blue/White	11-15398	\$248.15
Thru Panel Green/White	11-15399	\$248.15
Thru Panel Red/White	11-15400	\$248.15

Gooseneck Surface Mount AdapterP/N 11-15403**\$19.20**



PSA NAVIGATIONAL AND TAIL LIGHTS COMBINATION

Green/Clear or Red/Clear, 14 Volt, Navigational and Tail Light combination units. They have a mounting footprint of 1.88" to 1.75" cc. They each come in a complete assembly and are sold as a set. They are easy to install and manufactured and tested to meet FAR section 23.183-23.191 and all applicable requirements of D0160G for EMC, EMI, vibration & thermals under normal operating conditions for position lights.

Meets or exceeds AS8037 REV B, AC20-74 and FAR specifications for all color coordinates and minimum intensities. Made in the USA. No RFI. Non-PMA. Weigh in at 1.6 oz. and draw .25 amps each.

Green/Clear	P/N 11-14398	\$110.00
Red/Clear	P/N 11-14399	\$110.00
Red/Green	P/N 11-16300	\$198.00

LED LIGHTING - INSTRUMENT LIGHTING



LED CABIN LIGHTS

12 Very Bright LEDs in an ABS Housing. 12or 24 Volt; Very low current draw (under 80 mA) Red, White, Blue, and Green LED colors available. Compact Size - Just 3"x2"x1" with side mounting flanges for easy installation. Broad, "flood" lighting distribution. Extremely resistant to vibration, shock and moisture. Ideal for baggage area and utility light illumination.

Light Color	12V	12V Price	24V	24V Price
Red	11-05521	\$44.90	11-08404	\$49.85
White	11-05522	\$48.50	11-08406	\$49.85
Blue	11-05524	\$44.90	11-08405	\$49.85
Green	11-08408	\$49.85	11-08407	\$49.85



CABIN LIGHTS

Designed for use in experimental aircraft, these LED lights are excellent for cabin lighting, work station lighting, interior lighting, or cargo space illumination. They feature small size (2" x 3"), low power draw (less than 95ma, and weigh less than 3 ounces.

the basic module consists of 3 rows of LED's potted with epoxy in a strong plastic housing. This makes it extremely resistant to vibration and moisture. The modules are very efficient, and are available in 12 or 24V and in super bright white or red colors. Furnished with a diffused light pattern and a 3 ft. cable length. No on-off switch.

12V Red LED.....P/N 11-02880\$127.80

LED MAP LIGHT, DOME, AND BAGGAGE AREA LIGHTS INTERIOR CONVENIENCE AND MAP LED LIGHTING



Three very bright LEDs in an ABS housing. Compact size, just 2" long. #4 holes for horizontal mounting. 12 volts, low current draw (under 40 mA). Ideal for map lighting or utility installations.

RedP/N 11-05527\$7.95
GreenP/N 11-09650\$7.95

DOME AND BAGGAGE AREA LIGHTS



Four (4) very bright LEDs. Compact size, just 1.5" long. #4 mounting holes 12 or 24 volts. "Flood" type wide area lighting. Ideal for map lighting, dome or utility installations. Black or Chrome Base. Chrome Base only comes in White and Red 12V. For experimental aircraft only

Case	Light	Volt	Part No.	Price	Volts	Part No.	Price
Black	White	12V	11-09651	\$7.95	24V	11-09654	\$7.95
Black	Red	12V	---	---	24V	11-09655	\$7.95
Black	Green	12V	11-09652	\$7.95	24V	---	---
Black	Blue	12V	11-09653	---	24V	11-09656	\$7.95
Chrome	Red	12V	11-05526	\$7.90	24V	---	---

FLEXIBLE LED LIGHT STRIP GLARE-SHIELD LIGHTING AND DIMMER BY SPT



Superior Panel Technology has developed a brighter, wide-angle LED Light strip for aircraft panel illumination. The 39" LED light strip includes 60 wide-angle white LEDs. The LED light strips are adaptable for both 14V and 28V aircraft can be cut as needed.

When on full power, it produces a nice flood light that is amazingly bright and produces enough light to read charts. The LEDs are fully dimmable using the SPT Pulse-Width-Modulation (PWM) dimmer that was specifically designed for the low current draw LEDs.

Description	Part No.	Price
SPT White Light Strip and Dimmer Switch	11-10599	\$147.75
SPT White Led Light Strip Dimmer w/o Switch	11-10598	\$143.75
SPT White Led Light Strip 14V or 28V	11-10597	\$49.85
SPT Green Light Strip and Dimmer with Switch	11-17261	\$149.00
SPT Green Led Light Strip Dimmer w/o Switch	11-17263	\$139.75
SPT Green Led Light Strip 14V or 28V	11-17259	\$51.85
SPT Red Light Strip and Dimmer with Switch	11-17260	\$147.75
SPT Red Led Light Strip Dimmer w/o Switch	11-17262	\$139.75
SPT Red Led Light Strip 12V or 28V	11-17258	\$51.85



LED INTERIOR DOME LIGHTS

Interior Dome Light - 12VDC. 18 or 24 LED Dome light.
18 LEDP/N 13-15806\$21.95
24 LEDP/N 13-15803\$24.95



LED RAIL LAMPS

2-color Red/White LED lights.
12 inchesP/N 13-15804\$32.70
18 inchesP/N 13-15805\$44.95



LED WATERPROOF STRIP LIGHTS

LED Waterproof Strip Lights. Cool White LED 12VDC.
4 inchesP/N 13-15807\$11.95
6 inchesP/N 13-15808\$16.95
8 inchesP/N 13-15809\$18.95

INSTRUMENT PANEL LIGHT STRIP



Flexible LED Instrument Lights

Dimmable LEDs encased in a flexible resin strip. Ideal for mounting under glare shields for instrument panel lighting. Available in White, Red and Blue LEDs. Can be trimmed every 2-1/2 inches (every 3 LEDs). Easy-to-install, waterproof, shockproof and requires no inverter to operate. Draws only 83 mA, 12 volts DC, and has a service life of over 10,000 hours. 35" length, 3/8" width and 1mm high. Installs in minutes with double-sided tape

Description	Part Number	Price
12V LED Light Strip - Red	11-05224	\$37.90
12V LED Light Strip - Blue	11-05225	\$37.90
12V LED Light Strip - White	11-05226	\$37.90
24V LED Light Strip - Red	11-06828	\$37.90
24V LED Light Strip - Blue	11-06829	\$37.90
24V LED Light Strip - White	11-08409	\$37.95

FLEXIBLE LED INSTRUMENT LIGHTS - DUAL COLOR

Dual Color - Red/White



- Dimmable LEDs encased in a flexible resin strip.
- Identical to standard Flexible LED strips but with twice the LEDs.
- Permits independent control of the RED and White or Blue and White colors.

Dual Color - Blue/White



- Ideal for using White lights for loading/unloading or in cloudy conditions and MIX or use of colored lighting during dusk or night conditions.

• 35" length, 3/8" width and 1mm high. Installs in minutes with double-sided tape
Power consumption no greater than 160mA.

Description	Part Number	Price
12V Dual Flexible LED W001-Dual Red	11-05511	\$55.95
12V Dual Flexible LED W001-Dual Blue	11-05512	\$55.75
24V Dual Flexible LED W001-Dual Red	11-08410	\$55.95
24V Dual Flexible LED W001-Dual Blue	11-08411	\$55.80

FLEXIBLE LED INSTRUMENT LIGHTS - WITH CIGARETTE LIGHTER AND DIMMER



For production aircraft OR experimental aircraft

- The same quality Dimmable LEDs as our standard Flexible LED instrument Lights but with a Cigarette Lighter plug and in-line dimmer control
- Ideal for non-permanent installation in aircraft and other vehicles
- Power is supplied by the Cigarette Lighter plug (12 Volt systems only)

- In-line dimmer controls lighting level
 - Available in Red, White or Blue LEDs.
 - Ideal for mounting under glare shields for instrument panel lighting
 - Can be trimmed every 2-1/2 inches (every 3 LEDs)
 - Easy-to-install, waterproof, shockproof and require no inverter to operate.
 - Draws only 83 mA, 12 volts DC, and has a service life of over 10,000 hours
 - LED is 35" length, 3/8" width and 1mm high.
- W003- CLA RedP/N 11-05513\$51.75

CRAZEDPILOT LED COCKPIT LIGHTING SYSTEM KITS



Weights ONLY 2.5 ounces installed! The digital dimmer control uses pulse technology to prevent heat generation and current draw commonly found in inferior designs. This light system does not generate bulb heat - you will never get burned or melt anything! This interior lighting system is very easy to install - trim the light strips to the desired length at 2 inch intervals, wire as shown in the instructions, and light will not only glow softly on your instrument panel but can be turned up bright enough to illuminate clear to the flap controls or the floorboards to find that chart you dropped!

RedP/N 11-11201\$47.65
WhiteP/N 11-11202\$47.65
BlueP/N 11-12907\$47.65

EL

COCKPIT LIGHTS – RUNWAY/TAXI LIGHTS

MINI EYEBALL LED LIGHTS



Mini Eyeball LED spotlight. Powerful & Dimmable 1 Watt LED. Adjustable eyeball directs light beam at 30 degree angle. Designed for overhead consoles or side panels. Mounts using spring loaded retainers. Dimensions: 1.75" diameter - mounts in 1 1/8" diameter hole - depth is just 3/4". Satin black aluminum housing. 12 Volt DC, very low power drain (200mA). 24 Volt DC, very low power drain (240mA) Applications: Overhead panel, sidewall panels or anywhere a compact powerful LED light is needed.

Light	Volts	Part No.	Price	Volts	Part No.	Price
White	12V	11-09271	\$43.85	24V	11-09274	\$41.90
Red	12V	11-09272	\$42.65	24V	11-09276	\$41.90
Green	12V	11-09645	\$41.90	24V	11-09646	\$45.85
Blue	12V	11-09273	\$41.90	24V	11-09277	\$41.90

MINI LED SPOT LIGHTS



• For experimental aircraft • High intensity, dimmable multi-LED lamps • Easy to install • Flexible pivot mounts • 1.75" length, 1" wide (at lens), 1.75" height (with base) • 160-180 Lumens • 0.15 amps @ 13.8 volts • 12 volts, less than 50mA • Metal housing available in Black or Aluminum • Available in multiple LED color.

Black/White

Case	Light	Volts	Part No.	Price	Volts	Part No.	Price
Black	Red	--	--	--	24V	11-08771	\$39.50
Black	White	12V	11-05520	\$45.75	24V	11-08772	\$45.75
Black	Blue	12V	11-09285	\$45.75	24V	11-09289	\$45.75
Silver	White	12V	11-05518	\$45.75	24V	11-05517	--
Silver	Red	--	--	--	24V	11-10577	\$45.75

SURFACE MOUNT LED LIGHTS



Surface mount convenience light. 2 Bright LEDs behind a frosted panel. Surface mount with hardware. Dimensions: 2.5" x 1.25" x 5/8". #6 mounting holes. 12 Volt DC or 24 Volt DC, very low power drain (0.1mA). Applications: foot wells, door panels, side panels, map light, chart lights or anywhere a dimmable, bright LED light is needed.

Light	Volts	Part No.	Price	Volts	Part No.	Price
White	12V	11-09255	\$11.90	24V	11-09258	\$11.90
Red	12V	11-09256	\$11.90	24V	11-09259	\$11.90
Green	12V	11-09640	\$11.90	24V	11-09641	\$11.90
Blue	12V	11-09257	\$11.90	24V	11-09261	\$11.90

FLUSHMOUNT WATERPROOF LED UTILITY LIGHT



Applications: Side panels, overhead consoles, door panels, exterior application (waterproof) Features: Bright LED fixtures with 1/4 Watt LEDs Powerful & Dimmable, Installs in a 3/4" hole with self-locking nut, Designed for overhead consoles or side panels, Mounts in panels up to 3/4" thickness Dimensions: 1.25" length x 1 1/4" top flange; mounts in 3/4" diameter hole; depth is just 1 1/8"; installed flush height is 1/8" Fresnel lens and clear plastic housing Waterproof and vibration resistant 12 Volt DC, very low power drain (0.1 mA)
 12V WhiteP/N 11-09278 \$8.95
 12V RedP/N 11-09279 \$9.50
 12V BlueP/N 11-09280 \$9.50

LED PANEL MOUNT INDICATORS



Specifications: Mounting Hole Dia: 6.35mm. Forward Current If: 20mA. Forward Voltage: 12V or 24V, your choice. Luminous Intensity: 10mcd. Viewing Angle: 60°. Bulb Size: 5.08mm. Lens Width: 7. RoHS Compliant: Yes.

Color	Volts	Part No.	Price	Volts	Part No.	Price
Red	12V	11-18196	---	24V	11-07839	\$9.70
Green	12V	11-07841	\$9.95	24V	11-07840	\$8.75

SOLAR BLUE LED AIRPORT TAXIWAY MARKER



Emits blue LED light from both sides. Poly Carbonate, Poly Crystalline Silicon fixture. Maintenance Free. LED Visibility over 1/2 mile. Nickel Metal Hydride Batteries. Secures to asphalt or concrete w/2 part epoxy. Approximately: 4 3/4" x 4 3/4" x 3/4". Designed to withstand 20 tons PSI. Built for extreme weather conditions. Three (3) to five (5) year life span, Maintenance FREE Batteries charge in approximately four (4) hours using the suns energy. Operate all night (8 or more hours on a full charge). LED brightness equates to 35 lumens.
 Blue BSL05DTWP/N 11-09385 \$68.75

SOLAR GREEN LED CENTERLINE TAXIWAY MARKER



Emits green LED light from both sides. Poly Carbonate, Poly Crystalline Silicon. Maintenance Free. LED visibility over 1/2 mile Nickel Metal Hydride Batteries Secured to asphalt or concrete w/epoxy. Approximately: 4 3/4" x 4 3/4" x 3/4". Designed to withstand 20 tons PSI. Built for extreme weather conditions. Three (3) to five (5) year life span, Maintenance FREE Batteries charge in approximately four (4) hours using the suns energy. Operate all night (8 or more hours on a full charge). LED brightness equates to 35 lumens.
 Green BSL-05DCLP/N 11-09394 \$58.95

SOLAR GREEN LED THRESHOLD MARKER



Emits Green/Red LED light. Poly Carbonate, Poly Crystalline Silicon. Maintenance Free LED visibility over 1/2 mile Nickel Metal Hydride Batteries Secures to asphalt or concrete w/epoxy. Approximately: 4 3/4" x 4 3/4" x 3/4". Designed to withstand 20 tons PSI. Built for extreme weather conditions. Three (3) to five (5) year life span, Maintenance FREE Batteries charge in approximately four (4) hours using the suns energy. Operate all night (8 or more hours on a full charge). LED brightness equates to 35 lumens.
 Green BSL-05DTHP/N 11-09387 \$55.95

SOLAR WHITE LED AIRPORT EDGE MARKER

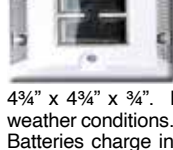

Emits White LED light from both sides. Poly Carbonate, Poly Crystalline Silicon. Maintenance Free. LED visibility over 1/2 mil. Nickel Metal Hydride Batteries. Secured with 2 part epoxy Approximately: 4 3/4" x 4 3/4" x 3/4". Designed to withstand 20 tons PSI. Built for extreme weather conditions. Three (3) to five (5) year life span, Maintenance FREE Batteries charge in approximately four (4) hours using the suns energy. Operate all night (8 or more hours on a full charge). LED brightness equates to 35 lumens.
 White BSL-05DELP/N 11-09386 \$55.95

SOLAR RED LED AIRPORT OBSTRUCTION MARKER

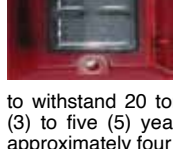

Emits Red LED light from one single side. Poly Carbonate, Poly Crystalline Silicon. Maintenance Free Nickel Metal Hydride Batteries. Secures with 2 part epoxy. Approximately: 4" x 4" X 3/4". Designed to withstand 20 tons PSI. Built for extreme weather conditions. Three (3) to five (5) year life span, Maintenance FREE Batteries charge in approximately four (4) hours using the suns energy. Operate all night (8 or more hours on a full charge). LED brightness equates to 35 lumens.
 Red BSL03AOMP/N 11-09389 \$64.75

SOLAR LED BEACON MARKER RED



Emits light from all sides. Poly Crystalline Silicon, ABS Plastic. Super Bright Red LED light. Mounted to post or pipe. Approximately: 9" circumference x 6" height. Designed to withstand 20 tons PSI. Built for extreme weather conditions. Three (3) to five (5) year life span, Maintenance FREE Batteries charge in approximately four (4) hours using the suns energy. Operate all night (8 or more hours on a full charge). LED brightness equates to 35 lumens.
 Red Beacon VRH-4704P/N 11-09384 \$61.95

RUNWAY MARKER ADHESIVE PADS



The Adhesive Epoxy Pads are a non toxic, zero V.O.C., performance thermoplastic adhesive designed to adhere raised pavement markers to the concrete or asphalt surface. When heated with a propane heat torch, a Pad liquefies and fuses with the surface and the marker providing a bond that will last throughout the marker's lifetime. Size: 5" x 5".
 P/N 13-10451 \$5.00

EL

DIMMING SYSTEMS - COCKPIT LIGHTS

SOLID STATE LIGHT DIMMING KIT



Economical solution for the dimming of aircraft interior lighting. This heavy-duty solid state dimming kit by Superior Panel Technology includes a potentiometer with built-in off switch and 115W power transistor mounted to a heat sink. The supplied colored Mil Spec wire and very easy to follow wiring diagram allows the aircraft builder to customize the wiring harness to fit individual needs. When compared to rheostats, this unit provides more even dimming when a combination of LEDs, incandescent bulbs and electroluminescent lamps (such as SPT's Glow Strips) are used. Appropriate for both 14V and 28V systems.

Knob sold separately.....P/N 11-00846**\$78.75**
Control KnobP/N 11-07344**\$4.90**

LC-40E/LC-40 LIGHTING CONTROLLERS



The LC-40e comes in an anodized brushed aluminum chassis. Features extra control knob sensitivity at dim end of the lighting range where it is needed most. It is microcontroller controlled and has continuous over voltage, current limit & fault protection. Each channel can handle 1.5 amps. LC-40E

P/N 11-03366**\$126.95**

LC-50 LIGHTING CONTROLLER



- Rate and Offset adjustments for each channel allows exact matching of dimming behavior of each channel.
- Multiple channels can then be joined and controlled by a single knob.
- Two Analog outputs for dimming these devices:
 - Garmin LCD Displays G3X, G900X, etc.
 - Garmin 400/500/600/700 series Radios
 - Garmin GTX 327/330 Transponders

• Garmin GMA 347 Audio Panel
• Tru-Trak ADI Pilot
• Tru-Trak Pictorial Pilot
• Newer PS Engineering Audio Panels.....P/N 10-06621**\$178.00**

PWM DIMMER BY SPT



Superior Panel Technology has developed three new, compact solid state Pulse-Width-Modulation (PWM) dimmers to meet all aircraft dimming needs.

They are extremely easy to install (one terminal screw for power in, one for ground and the third for power out), minimal heat dissipation,

and by choosing the right dimmer (EL/LED Dimmer, Heavy Duty or Extreme Heavy Duty) you avoid the "dimming steps" in brightness often found in other PWM dimmers.

The EL/LED Dimmer would be used for LED's and electroluminescent lighting such as SPT's Glow Strips. The Heavy Duty dimmer can handle up to 100 watts. The Extreme Power can be used for up to 400 watt @28V or 200 watt @14V. These dimmers have the smallest footprint on the market for a PWM dimmer with a switch.

Description	Part No.	Price
LED/EL Dimmer with Off Switch	11-10603	\$119.65
LED/EL Dimmer without Off Switch	11-10604	\$103.75
Heavy Duty Dimmer with Off Switch	11-10606	\$122.65
Heavy Duty Dimmer without Off Switch	11-10608	\$99.95
EXTREME DUTY Dimmer without Off Switch (Only Available with out)	11-10612	\$128.95

CRAZEDPILOT LED LIGHTING FLEXIBLE WATERPROOF STRIP



This flexible 15 ft LED Lighting strip is powered by 12volts, is adhesive backed and waterproof - allowing you to install it in any location you want light to glow. This LED Lighting strip can be powered directly with 12v as a light source for footwells, dome lighting, passenger areas, etc. LED Lighting comes in Red, White, and Blue with a black flexible PC Board technology, and clear silicone-based flexible covering.....P/N 11-14143**\$19.75**

VAL AVIONICS CLA 500 COCKPIT LIGHTING ASSEMBLY



The CLA 500 is a Multiple Circuit, Solid State Cockpit Lighting Assembly that will accommodate (4) independent dimmer lighting circuits such as instruments, sub panels, avionics, eyebrow, overhead, flood, and post lamps etc. The CLA 500 unit itself measures 5"l x 4.7" w x 1.5" h; wt: 0.8 lbs. The unit is rated at 14/28VDC input at 2.5 amps max per circuit. The CLA 500 comes complete with 4 on/off dimmer control switches and connector assembly. The CLA 500 carries a full 1 yr factory warranty. **Not TSO'D**

14VP/N 11-05700**\$236.95**
28VP/N 11-04592**\$250.00**

COCKPIT LIGHTS



TYPE C4A - A multi-purpose light providing narrow spotlight or floodlight beam. Rotate dial for red or white lens. Push-button for instant full light. Adjustable rheostat. Coiled cord & snap-in mounting base makes light portable in cockpit area. New mtg. Most suitable for larger aircraft.

12VP/N 11-03921**\$237.95**
24VP/N 11-03922**\$245.00**

MINIATURE EYEBALL COCKPIT LIGHTS



MOD1 OVERHEAD CONSOLE - The Mod1 Overhead Console is mounted to top of cabin or top wing skin with four stainless steel screws into the four standoffs or posts on Console. All lights are ordered separately. Weight: 3.8 oz.P/N 11-06003**\$27.65**

EYEBALL COCKPIT LIGHTS



These high quality cockpit lights are engineered to match the eyeball swivel vents on the page on Air Vents in this catalog. Simple twist on/off operation provides white beam for cockpit lighting. Made from 2024T351 aluminum. Diameter: 2.75". Has 4 mounting holes (1/8" dia.) which are spaced 2-3/8" apart on a mounting plate with a thickness of .71". Made in USA.

Black (no bulb)P/N 05-01401**\$71.90**
Gray (no bulb)P/N 05-01402**\$71.90**
28VP/N 11-04172**\$2.95**

Order 14V or 28V bulb separately

PANEL POST LIGHT



Panel Post Light. Compact design, just 3/4" x 1/2" (6mm shaft diameter). 2 super-bright LEDs. Ideal for panel lighting or map lighting.

12V White.....P/N 13-15801**\$17.80**
12V RedP/N 13-15816**\$17.80**
12V Green.....P/N 13-22027**\$17.80**
12V Blue.....P/N 13-22028**\$17.80**
12V Amber.....P/N 13-22030**\$17.80**
24V White.....P/N 13-15802**\$17.80**
24V RedP/N 13-15817**\$17.80**
24V Green.....P/N 13-22029**\$17.80**

LED TASK LIGHT MODULE 24V WHITE



The LED task light features a rain and brake light, two separate functions in the same package. The LED task light module has a high flash rate which is important in attracting attention in low visibility conditions. This is a three wire unit with wires for Brake, Rain and battery negative. It uses LOW power, so minimal that you can power it from a single 9 volt battery. Operating voltage range 5vdc to 18vdc, Dimensions: 2.7"x2.5"x0.89"P/N 11-02881**\$74.95**

MINI GOOSENECK LAMP



This mini gooseneck lamp is a versatile, flexible-shaft lamp designed as a map light, chart light, and panel light. The flexible shaft permits the lamp to stand-off and illuminate a larger panel surface, or double as a flexible chart light or map light. When mounted on instrument panels or consoles, the lamp provides a bright and directional lighting source. The 1/4" shaft is flexible yet rigid enough to retain its shape during use.

Length	Color/Volts	Part No.	Price
5-7/8	Red 12V	11-14112	\$21.95
	Red 24V	11-14116	\$5.70
	White 12V	11-14114	\$21.95
	White 24V	11-14118	\$21.95
10-1/2	Red 12V	11-14113	\$25.75
	Red 24V	11-14117	\$26.50
	White 12V	11-14115	\$23.95
	White 24V	11-14119	\$23.95

EL

DIMMERS

LIGHT DIMMING KIT



Kit includes a Mil.Spec Potentiometer, Mil. Spec Power transistor mounted to a heatsink and a wiring harness. Breaker Size: 2A @ 14V, 1.5A @ 28V, Operating Range: 0-32 VDC, Current: 1.4A @ 14V, .7A@28V, Power: 20W.

P/N 11-02082\$169.95

4-CHANNEL LED DIMMER



Easy-to-install, 7 Amps per channel. High quality knobs and wiring kit with stand-offs. 12VDC. Control up to Four (4) different LED or Incandescent light circuits independently.

P/N 13-15799\$69.95

PANEL LIGHT DIMMING RHEOSTATS



These high-quality rheostats are used in production aircraft to dim instrument panel lights. Size: 1-9/16" dia. x 2-1/4" long. Mounts in 3/8" dia. panel hole. Shaft is 1/4" dia. w/flat for knob set screw. New manufacture. Power Rating: 25 Watts.

0-8 OHM Panel light dimming retrostat.....P/N 0144\$59.75

0-15 OHM Panel light dimming retrostat.....P/N 0146\$63.90

FINGER GRIP KNOB



Finger grip knob or rheostats. 1-1/2" Diameter, 1/4" Hole.....P/N 11-07967\$13.50

MULTIPLE CIRCUIT SOLID STATE LIGHT DIMMERS



Choose from 2, 3, or 4-circuit heavy-duty 115W light dimming systems by Superior Panel Technology. Circuit board design with pin connector allows for easy and neat wiring. Mil Spec Tefzel color-coded wire is included. Unlike rheostats, this system will provide even dimming of incandescent lights, electroluminescent lamps (such as the SPT Glow Strips) and LEDs when used in combination on the same circuit. A separate control switch (with circuit breaking off position) is included for each circuit. Knobs sold separately. For 12 or 24 volt as long as there have been no modifications

2 CircuitP/N 11-02046\$148.65

3 CircuitP/N 11-02047\$257.95

4 CircuitP/N 11-02049\$305.00

Control KnobP/N 11-07344\$4.90

K11 AIRCRAFT PANEL DIMMER



Features: • 3 outputs with a tracking capability - One output is the "Master", and the other two can be set to track the master from 0 to any set voltage behind the master. This allows items on the dimmer bus to be grouped according to their relative brightness. Photocell light sensor automatic control capability • Low cost • Performance: • Voltage range: 0 to Input supply - .6V • Output current - Depends on ventilation - Each channel is capable of 5 amps, practical dissipation limitation is ~ 5 amps total for all channels. (For 28 volt systems, current limit is 1 A per channel) Unit connections are made through a DB15 connector, and are easy to integrate into the rest of the aircraft wiring.P/N 11-02244\$149.95

MICROPULSE LANDING LIGHT CONTROL



This Micropulse Landing Light Control has 12 to 35 VDC, 0-8 A per channel, Control over 224 Watts per channel in a .9" Inch square by 1.9" Package. Complete compact, light weight, powerful, solid state Landing light controller. The MicroPulse has all the functions you should need. MicroPulse Function Modes: Switch Positions: • OFF Both Circuits Off • L Left on only (CKT1) • R Right on only (CKT2) • L&R Both circuits On • A44 Alternate 44 PPM (STD) • B44 Both Flash 44 PPM • A88 Alternate 88 PPM • A120 Alternate 120 PPM. Capacity: • 96 Watts @12 VDC each channel • 224 Watts @28 VDC each channel.

P/N 11-11886\$295.00



MAX DIM DIMMER CONTROL UNIT

5-35 VDC 0-12.5A Control 350 Watts in a 1-1/4" Diameter package. Complete compact, light weight, powerful, solid state dimmer. Great for light wedges. FAA STC Approved. PMA'd . Features: • Aircraft Lighting Boat Cruiser Cabins. • Instrument Panels. • Hundreds of DC Lighting Control applications.

P/N 11-05738\$249.00



MAXPULSE LANDING LIGHT CONTROL/ PULSER - (STC'D)

Extreme long life, low temperature operation, high current capability, noise free operation and small size makes it a ideal landing light controller for all aircraft. This new STC version sports eight functional pulse, flash and steady state modes of operation. It is also an ideal replacement for old technology controllers requiring large heavy heat sinks and or noisy relays as part of the installation. STC'd.....P/N 11-06998\$298.00



MAXPULSE LANDING LIGHT CONTROLLER MODEL - B

12-35 volts @ 10 Amps per channel - 2 channels, Ring Connectors, Controlled Output: 0 to 12-35 VDC , 0 to 10 A per channel. No outboard heat sinks, rheostats, or other packages. STC, PMA, RTCA/DO-160E SEC 21: qualified. Configure for Wig Wag or Wing and taxi light pulsing, single light pulsing etc. Increased safety for your passengers and yourself. Hundreds of DC Lighting Applications. Emergency Vehicles. Assembled in the USA.....P/N 11-08175\$298.00

MAXDIM DIMMER CONTROLLER MODEL - B

Specifications: 5-35 volts @ 15 Amps. Ring Connectors. Controlled Output: 0 to 5-35 VDC - 0 to 15 A Capacity: 75 Watts @5 VDC. 180 Watts @12 VDC. 360 Watts @24 VDC. 420 Watts @28 VDC. 700 Watts @35 VDC Includes: MaxDim unit, installation instructions, color coded terminals, reference panel label, STC printout for your logs, installation template, and knob.....P/N 11-08176\$289.00



MAXDIM DUO DUAL DIMMER CONTROLLER MODEL - C

12 to 35 VDC, 0-15 A per channel, Control 1050 Watts In a 1-1/4 Inch Diameter Package. Complete compact, light weight, powerful, solid state dimmer. Model C accepts spade terminals.

P/N 11-12421\$389.00



MAXDIM DUO DUAL DIMMER CONTROLLER MODEL - D

12 to 35 VDC, 0-15 A per channel, Control 1050 Watts In a 1-1/4 Inch Diameter Package. Complete compact, light weight, powerful, solid state dimmer. Accepts ring terminals.....P/N 11-08177\$396.00

For Complete info on Dimmers and MaxDim Mini Control Units please visit our website at www.aircraftspruce.com

MICRODIM DUAL DIMMER

5 to 35 VDC, 0-7.5 A per channel, Control over 224 Watts per channel in a .9" Inch square by 1.9" Package. Complete compact, light weight, powerful, solid state Dimmer and switch controller.

Microdim Dual Dimmer Revision SWP has all the functions you will need. Dimming on one channel and switching on channel 2 for the position lights/navigation lighting is activated any time there is output on the dimming channel.....P/N 11-11887\$295.00

MICRODIM SINGLE CHANNEL DIMMERS

5 to 35 VDC, 0-7.5 A per channel, Control over 210 Watts In a 0.9" Inch square by 1.9" Package. Complete compact, light weight, powerful, solid state PWM dimmer. Sized for those tight panels with smaller dimensions and depth of 1.9.

Applications and features: • SINGLE CHANNEL control of aircraft Lighting • Aircraft instrument panel lighting • Excellent control of Nulite instrument lighting • LED PWM dimmer, low range enhanced • RTCA/DO-160E SEC 21: RFE Qualified • Instrument Panels • Nulite dimmers • UMA dimmer • LED Glare shields, overheads • Avion Glare shield dimmer • LED lit panels • Hundreds of DC Lighting Control applications • Assembled in the USA

SINGLE

LED 6 mm Bushing	11-15244	\$289.00
LED 11 mm Bushing	11-15246	\$315.00
Incandescent 6 mm Bushing	11-11191	\$269.95
Incandescent 11 mm Bushing	11-15245	\$297.00

DUAL

Incandescent Only 6 mm Bushing	11-11192	\$295.00
Incandescent Only 11 mm Bushing	11-15249	\$340.00
Incandescent Only 6 mm Bushing	11-15248	\$340.00
Incandescent Only 11 mm Bushing	11-15250	\$325.00
LED/ Incandescent 11 mm Bushing	11-15251	\$295.00



INSTRUMENT LIGHTING

UMA INSTRUMENT LIGHTING - PMA'D



The UMA EL Light Bezel System replaces instrument post-lights, provides a uniform light around the dial of each instrument using a solid-state electro-luminescent element rather than an incandescent bulb. The bezels have a design life of 5,000 operating hours. The system consists of a bezel or "wedge", DC to AC inverter, and a connector kit. The bezel fits over the instrument face, and is available in a variety of configurations to accommodate various adjusting knobs. The bezel mounts either between the instrument face and the panel, or between the panel and the overlay. The bezel is held in place by the instrument mounting screws. The DC to AC inverter provides power for as many as 12 bezels or about 25 sq. inches of lighting. To facilitate installation and maintenance a connector kit is supplied with each bezel. Colors are White, Aviation Green, and red, **with white being the only FAA approved color.** The PMA is based on a STC for Beechcraft King Air 90s. To assist you in filing a FAA form 337, the approved data package used for the King Air installation is available from UMA, or can be downloaded on or website. Copies of previously issued 337s are available upon request. * Inverter is required. Must be ordered separately.

Model No.	Size	Cut-Out	Light	Part No.	Price
2-30-W	3-1/8"	Single (Left Or Right)	White	10-00794	\$73.75
2-30-G	3-1/8"	Single (Left Or Right)	Green	10-02089	\$72.75
2-30-R	3-1/8"	Single (Left Or Right)	Red	2-30-R	\$72.75
2-31-W	3-1/8"	None	White	2-31-W	\$72.75
2-31-G	3-1/8"	None	Green	10-02090	\$72.75
2-31-R	3-1/8"	None	Red	2-31-R	\$73.75
2-33-W	3-1/8"	Center	White	2-33-W	\$72.75
2-33-G	3-1/8"	Center	Green	10-02091	\$72.75
2-33-R	3-1/8"	Center	Red	2-33-R	\$72.75
2-34-W	3-1/8"	Double	White	2-34-W	\$86.75
2-34-G	3-1/8"	Double	Green	10-02092	\$85.80
2-34-R	3-1/8"	Double	Red	2-34-R	\$85.80
2-35-W	3-1/8"	None W/Undercut for VSI	White	11-02095	\$72.75
2-20-W	2-1/4"	Single (Left Or Right)	White	10-00792	\$73.75
2-20-G	2-1/4"	Single (Left Or Right)	Green	10-02087	\$72.75
2-20-R	2-1/4"	Single (Left Or Right)	Red	2-20-R	\$72.75
2-21-W	2-1/4"	None	White	2-21-W	\$73.75
2-21-G	2-1/4"	None	Green	10-02088	\$72.75
2-21-R	2-1/4"	None	Red	10-00793	\$72.75

INVERTERS FOR UMA LIGHTING -

14VP/N 10-02083\$87.75
 28VP/N 10-00986\$87.75

Each inverter will run up to 12 lighting wedges.

RheostatP/N 6002\$55.75
 Elec. Wire Kit*P/N 10-02085\$17.80

*Contains AMP connector and connecting pins

UMA ELECTRO-LUMINESCENT LIGHT STRIPS



UMA, Inc. now offers an ultra-thin (0.006") flexible self-adhesive long-life light strip based on the same technology that is used in our EL Light Bezel. Since there is no filament, these light strips are not bothered by vibration or rapid changes in temperature. Perfect for use under a glare shield, or for any other interior lighting need (both aircraft and automotive). Length may be cut as needed. Available colors are Aviation Green & White/Blue. Power Inverter required.

Dimensions	Color	Part No.	Price
0.5"W x 25"L	White/Blue	10-00321	\$89.75
0.5"W x 25"L	Aviation Green	10-00322	\$89.75
1.5"W x 18"L	White/Blue	10-00323	\$109.80
1.5"W x 18"L	Aviation Green	10-00324	\$109.75

FIBERLITE INSTRUMENT LIGHTING SYSTEM



FiberLites, by Superior Panel Technology, offer an innovative instrument lighting system that uses fiber optics to evenly illuminate aircraft instruments with easily accessible, long lasting, LED light sources. Select up to 8 of any Bezel combination of 3-1/8", **3-1/8" with cut-out (DG,VSI,ALT) and 2-1/4" instruments light bezels. **The FL318CO has a cut-out in one corner. Use this for directional gyros, altimeters, vertical speed indicators and other Instruments with corner knobs.

Use the standard FL318 for the attitude indicator. The FiberLite package includes 3 LEDs which can light up 12 instruments. The FiberLite Instrument Light Bezels are FAA approved for certified aircraft. Look in the document section for the Approved Make and Model List. If your aircraft is not on the list then you would need a 337.

Aircraft spruce and spt have worked together to offer a discount on the fiberlites and pwm dimmer when ordered as a package.

Instrument Package -without dimmerP/N 11-04009\$287.95
 FiberLite Instrument Package with PWM dimmer with built in circuit-breaking off switchP/N 11-10601\$397.00

Individual Parts Pricing:

2-1/4" inst.P/N 11-04000\$34.85
 3-1/8" inst.P/N 11-04002\$34.85
 3-1/8" inst w/cut out (DG, VSI, ALT)P/N 11-04003\$34.85
 14V LED Light Source.....P/N 11-03999\$19.95
 28V LED Light Source.....P/N 11-07838\$19.95
 LED EL Dimmer with off switch.....P/N 11-10603\$119.65
 LED EL Dimmer without off switch.....P/N 11-10604\$103.75
 LED Heavy Duty Dimmer with off switchP/N 11-10606\$122.65
 LED Heavy Duty Dimmer without off switch.P/N 11-10608\$99.95
 Extreme Duty Dimmer without off switchP/N 11-10612\$128.95

LED COCKPIT LIGHTING SYSTEM KITS



The simplest and best priced LED cockpit lighting and interior lighting system on the market - the CRAZEDPilot LED Cockpit Lighting System includes over 5 feet of adhesive-backed flexible LED light strip (AVAILABLE IN PURE WHITE) which can be trimmed to any length (or multiple lengths, read on!) The system also contains a digital dimmer control with black panel-mount knob, and detailed installation instructions and clear wiring diagram. Weighs ONLY 2.5 ounces installed! The digital dimmer control uses pulse technology to prevent heat generation and current draw commonly found in inferior designs.

The LED light strips are 8mm wide by 3mm thick made using flexible PC-board technology - with a clear vinyl coating over a black background, these light strips nearly disappear when not illuminated. The strips are capable of curves and contours of a 2 inch radius, which will fit nicely into the corner of your glare shield or custom panel (see photographs on this page). The 3M adhesive backed light strips bond and stay bonded once placed permanently.

RedP/N 11-11201\$47.65
 WhiteP/N 11-11202\$47.65
 BlueP/N 11-12907\$47.65

CRAZEDPILOT LED LIGHTING FLEXIBLE WATERPROOF STRIPS



This flexible 15 ft LED Lighting strip is powered by 12volts, is adhesive backed and waterproof - allowing you to install it in any location you want light to glow. This LED Lighting strip can be powered directly with 12v as a light source for footwells, dome lighting, passenger areas, etc. LED Lighting comes in Red, White, and

Blue with a black flexible PC Board technology, and clear silicone-based flexible covering.

RedP/N 11-14143\$19.75
 WhiteP/N 11-14144\$19.75
 BlueP/N 11-14145\$19.75

EL

PILOT LIGHTS - INSTRUMENT LIGHTING

NULITE INSTRUMENT LIGHTING SYSTEM



Replace your existing lighting system of post lights or indirect lighting using the latest technological developed in optical enhancements. The NULITE uses dual incandescent bulbs with a rated life of 10,000 hours in a translucent material designed to look like an internally lighted unit. Nulites are easily installed by anyone in just minutes and are pre-cut to fit all standard instruments operating on 14, or 28 Volts. NULITE light

wedges can be installed over the instrument or between the panel and the instrument. One wire is connected to ground and the other to a dimmable buss. Installation takes about 30 minutes for each unit and does not require any special tooling. The instrument is not altered in any way therefore only a log book entry is required. FAA/PMA approved.

Will not work with DC to AC inverted systems

Volts	Description	Model No.	Part No.	Price
14v	2-1/4" No Cutout	LW2014	11-03851	\$65.75
14v	2-1/4" with Left Cutout	LW2014A	11-01257	\$65.75
14v	2-1/4" with Right Cutout	LW2014B	11-04373	\$65.75
14v	3-1/8" No Cutout	LW3014	11-02572	\$65.75
14v	3-1/8" with Left Cutout	LW3014A	11-02673	\$65.75
14v	3-1/8" with Right Cutout	LW3014B	11-02574	\$65.75
14v	3-1/8" with Left + Right Cutout	LW3014AB	11-00818	\$65.75
14v	3-1/8" for Altimeters	LW3014AA	11-02573	\$65.75
14v	3-1/8" for VSI	LW3014V	11-01099	\$65.75
14v	4" Light Bar	LB4014	11-02788	\$65.75
28v	2-1/4" No Cutout	LW2028	11-02571	\$65.75
28v	2-1/4" with Left Cutout	LW2028A	11-04374	\$65.75
28v	2-1/4" with Right Cutout	LW2028B	11-04375	\$61.75
28v	3-1/8" No Cutout	LW3028	11-03852	\$65.75
28v	3-1/8" with Left Cutout	LW3028A	11-02762	\$65.75
28v	3-1/8" with Right Cutout	LW3028B	11-03853	\$65.75
28v	3-1/8" with Left + Right Cutout	LW3028AB	11-01352	\$61.75
28v	3-1/8" for Altimeters	LW3028AA	11-02851	\$65.75
28v	3-1/8" for VSI	LW3028V	11-01230	\$65.75
28v	Replacement Bulb	LIGHTBAR-28	11-18998	\$25.94



NULITE NV6 LIGHTING

Features: • Daytime Readability: Because Nulites utilize an open ring bezel, there are no daytime readability issues • Ease of Installation: A typical aircraft installation takes approximately 8 hours and can be done in the field by an A&P mechanic • Color Shifting: Nulites uses NVIS White Technology that does not shift any color and illuminates what is on the instrument • Upgrades the Panel Not The Instrument: Nulite nvg does not alter the instrument in any way and reduces the need for rotables • Lower Cost: A Nulite nvg conversion cost a third of what traditional filtered conversions cost • Reduce Training Time: With an open ring bezel, there is no need for additional training for Daytime Operations. **Specifications:** • NVIS White long lasting LED • Pulse type dimming circuit • 28 volt systems with lower power consumption (40ma average per unit) • Nulites are FAA approved and STC's are available, .220" thick and tight tolerances of .005" • Meets all FAR burn tests • NVIS radiance per MIL-STD-3009

White Light 28V 3-1/8" Round.....	P/N 11-08774	\$549.00
White Light 28V 3-1/8" Left Cutout.....	P/N 11-08775	\$548.00
White Light 28V3-1/8" Altimeter Cutout.....	P/N 11-08776	\$551.00
White Light 28V Left & Right Cutout.....	P/N 11-08777	\$549.00
White Light 28V 3-1/8" Right Cutout.....	P/N 11-08778	\$549.00
White Light 28V 3-1/8" VSI Cutout.....	P/N 11-08779	\$549.00
White Light 28V 2-1/4" Round.....	P/N 11-08780	\$539.00
White Light 28V 2-1/4" Left Cutout.....	P/N 11-08781	\$539.00
White Light 28V2-1/4" Right Cutout.....	P/N 11-08782	\$535.00

NULITE LED INSTRUMENT LIGHT BUNDLES



This LED light wedge and dimmer starter kit from Nulite includes two (2), 3-1/8-inch LW3034 and one (1), 3-1/8 inch LW3034AA light wedges, plus one (1) MaxDim 9100-001-A Dimmer controller from Seaton Engineering and operates on 14 volts. Nulite LED aircraft instrument lights use bright, long-lasting LEDs inside of a special bezel that focuses light toward the instrument, rather than towards the pilot's eyes. The MaxDim Dual controller from Seaton Engineering is the perfect option for controlling lighting and instrument panels in new or existing aircraft.

14V LED Bundle.....	P/N 11-13951	\$492.00
28V LED Bundle.....	P/N 11-13956	\$479.00
14V LED Dual Bundle.....	P/N 11-13957	\$638.00
28V LED Dual Bundle.....	P/N 11-13958	\$648.00

GLOW STRIPS - GLARE SHIELD LIGHTING



Superior Panel Technology has developed a brighter, more uniform and longer lasting Glare Shield lighting system. The 18" x 1" Glow Strip electroluminescent lamps provide a beautiful fluorescent-like aviation green or a white light output. The ultra-thin lamps (.065 including the adhesive backing) are very flexible and conform to the curves of the

underside of the glare shield. The Glow Strips meet the FAA 23.853 burn test. Inverters ARE included with the kit. A solid state dimmer and battery back-up system is available and recommended (see part numbers below).

Green		
Description	Part No.	Price
Single Glow Strip 14V No Dimmer	11-00847	\$142.75
Two Glow Strip 14V No Dimmer	11-00848	\$192.75
Two Glow Strip 28V No Dimmer	11-00849	\$192.75
Single Glow Strip 14V Dimmer with Switch (Recommended)	11-10617	\$235.95
Single Glow Strip 14V Dimmer without Switch	11-10613	\$225.95
Single Glow Strip 28V Dimmer with Switch (Recommended)	11-17533	\$227.95
Single Glow Strip 28V Dimmer without Switch	11-17532	\$216.95
Single Glow Strip 28V No Dimmer	11-17531	\$143.75
Two Glow Strip 14V Dimmer with Switch (Recommended)	11-10618	\$274.95
Two Glow Strip 14V Dimmer without Switch	11-10614	\$266.95
Two Glow Strip 28V Dimmer with Switch (Recommended)	11-10619	\$274.95
Two Glow Strip 28V Dimmer without Switch	11-10616	\$267.95
White		
Description	Part No.	Price
Single Glow Strip 14V No Dimmer	11-10525	\$142.75
Two Glow Strip 14V No Dimmer	11-10528	\$189.95
Two Glow Strip 28V No Dimmer	11-10529	\$189.95
Single Glow Strip 14V Dimmer with Switch (Recommended)	11-10633	\$226.95
Single Glow Strip 14V Dimmer without Switch	11-10624	\$215.95
Single Glow Strip 28V Dimmer with Switch (Recommended)	11-17536	\$226.95
Single Glow Strip 28V Dimmer without Switch	11-17535	\$216.95
Single Glow Strip 28V No Dimmer	11-17534	\$143.75
Two Glow Strip 14V Dimmer with Switch (Recommended)	11-10634	\$274.95
Two Glow Strip 14V Dimmer without Switch	11-10622	\$264.95
Two Glow Strip 28V Dimmer with Switch (Recommended)	11-10636	\$275.95
Two Glow Strip 28V Dimmer without Switch	11-10626	\$264.95

Accessories

Solid State Dimmer P/N 11-00846 \$78.75

NULITE INSTRUMENT LED LIGHTING SYSTEMS



NULITES are a revolutionary lighting system for aircraft instruments. They give the same lighting appearance as internal lighting kits at a fraction of the cost. NULITES have a special bezel that focus light toward the instrument, preventing light from reflecting into the pilot's eyes. When sandwiched between the instrument and panel, NULITES reduce glare and "hotspots" by concentrating 60% of the light on the upper half of the instrument.

Volts	Description	Model No.	Part No.	Price
14v	2-1/4" LED round	LW2034	11-13932	\$79.95
14v	2-1/4" LED with Left Cutout	LW2034A	11-13933	\$79.95
14v	2-1/4" LED with Right Cutout	LW2034B	11-13934	\$76.75
14v	3-1/8" LED round	LW3034	11-13935	\$79.95
14v	3-1/8" LED with Left Cutout	LW3034A	11-13936	\$79.95
14v	3-1/8" LED Altimeter Cutout	LW3034AAA	11-13937	\$79.95
14v	3-1/8" LED with Left + Right Cutout	LW3034AB	11-13938	\$79.95
14v	3-1/8" LED with Right Cutout	LW3034B	11-13939	\$79.95
14v	3-1/8" LED for VSI Cutout	LW3034V	11-13940	\$79.95
28v	2-1/4" LED round	LW2038	11-13941	\$79.95
28v	2-1/4" LED with Left Cutout	LW2038A	11-13942	\$79.95
28v	2-1/4" LED with Right Cutout	LW2038B	11-13943	\$76.75
28v	3-1/8" LED round	LW3038	11-13944	\$79.95
28v	3-1/8" LED with Left Cutout	LW3038A	11-13945	\$79.95
28v	3-1/8" LED Altimeter Cutout	LW3038AA	11-13946	\$79.95
28v	3-1/8" LED with Left + Right Cutout	LW3038AB	11-13947	\$80.75
28v	3-1/8" LED with Right Cutout	LW3038B	11-13948	\$79.95
28v	3-1/8" LED for VSI Cutout	LW3038V	11-13949	\$79.95

INSTRUMENT LIGHTING – LED LANDING LIGHTS



LIGHTSAVER

The Lightsaver prevents this massive inrush allowing the filament to draw the rated current even at turn on with no change in typical light output performance. The filament life increases up to 10 times due to reducing the stress induced by inrush current. This is something the lamp manufacturers don't want you to know. After all they are in the business of manufacturing replacement lamps for your aircraft. Installation is simple.

Description	Part No.	Price
24 V 100W	11-07317	\$39.75
24 V 150W	11-07318	\$38.75



PANEL INDICATOR LAMPS

Screw-in terminals, easy retrofit installation. 12mm 12V LED, dimmable, no resistor required. Model: Pilot-12mm-Series

Color	Part No.	Price
White	13-15811	\$12.95
Red	13-15812	\$12.95
Green	13-15813	\$13.00
Blue	13-15814	\$12.95
Yellow	13-15815	\$12.95



FIBER-OPTIC PANEL BACKLIGHTING KIT

Backlight the lettering on reverse engraved panels using FiberLites fiber-optic panels. The panels can be cut to width and normally one fiber-optic panel can illuminate all the text for switches and breakers on a panel.

The fiber-optic panels are 3" x 8.5" and come with the needed connectors and three LEDs (either green or white). The panels can also be used as mini flood lights over breakers and switches.

Fiber-Optic Back Light Kit Green.....P/N 11-08561\$149.95
 Fiber-Optic Back Light Kit White.....P/N 11-08562\$149.95

SR 10 INCH SPOT LANDING LIGHT NON TSO



• Landing • 4x4x14 • 2.1lb • 35 Watts 2.4 AMP Draw • 10 LEDs • 3400 Raw Lumens • 676 Lux at 10m • 603.3 Beam Distance • 91000 Peak Beam Intensity.
 Black.....P/N 11-11223\$329.99

SR SPECTOR 10 INCH LANDING / TAXI LIGHT NON TSO



• Landing • 4x4x14 • 2.1lb • 53 Watts 3.7 AMP Draw • 15 LEDs • 5100 Raw Lumens • 345 Lux at 10m • 364.4 Beam Distance • 33200 Peak Beam Intensity.
 Black.....P/N 11-11224\$419.99

HYBRID SR-Q SPOT LANDING



• Landing • 1 lb. • 20 Watts 14.45 AMP Draw • 4 LEDs • 1360 Raw Lumens • 151.1 Lux at 10m • 246 Beam Distance • 15111 Peak Beam Intensity.
 White.....P/N 11-14954\$199.99



AML Q-4509 LED PAR 36 LANDING / TAXI LIGHT

LED Q4509(Non-Polarity Applicable from 9V-36V), approximately 15,000 lab life hours, specialized structure for heat emission. High brightness (960LM) at low temperature: The temperature of lamp housing stays under 50°C even after continuous lighting for two hours. Non-polarity, applicable from 9V~36V. 15,000 lab life hours.

P/N 11-11513\$98.75



NORMAN LAMP 4572

Specifications:

• Lamp No.: 4572 • Voltage: 28V • Wattage: 60W • Type: PAR36 Sealed Beam • Base Type: Screw Terminal Base • Life Hours: 800 • Length: 2.75 in. • Candela: 2,000
 P/N 08-17132\$8.50



LEADING EDGE LANDING LIGHT KIT

Kit consists of (2) GE #4509 12V, 100W sealed beam lamps, brackets for installation, switch, switch plate, 60 ft. of 2-conductor hookup wire & instructions. Size: 4.5"hx5.25"w x2.25"d w/ bulbs installed.

Complete Kit.....P/N 11-08000\$130.95
 Replacement #4509 Bulbs.....P/N 11-03796\$12.70
 Switch Plate only.....P/N 11-14900\$3.90

SR-M2 LANDING / TAXI NON TSO



• Landing/Taxi • 10x7x3 • 7 oz • 16 Watts 1.1 AMP Draw • 3 LEDs • 1050 Raw Lumens • 135 Lux at 10m. 224 Beam Distance • 13500 Peak Beam Intensity.
 Black.....P/N 11-11222\$199.99

SR-M SPOT LANDING LIGHT NON TSO



• Landing • 10x7x3 • 7 oz • 10 Watts .63 AMP Draw • 2 LEDs • 700 Raw Lumens • 296 Lux at 10m • 298 Beam Distance • 29625 Peak Beam Intensity.
 Black.....P/N 11-11221\$149.99
 White.....P/N 11-14956\$149.99

SPECTOR SR-Q2 DRIVING LANDING / TAXI



• Landing • 1 lb. • 34.5 Watts 2.5 AMP Draw • 6 LEDs • 3030 Raw Lumens • 178.2 Lux at 10m • 267 Beam Distance • 17824 Peak Beam Intensity.
 Black.....P/N 11-11220\$229.99

EL

GRIMES LIGHTING PARTS – LANDING LIGHTS

FAA-PMA REPLACEMENT PARTS FOR GRIMES LIGHTING



Evolution Aerospace understands the prohibitively high cost of maintaining Grimes® legacy lighting systems. That's why they have developed an extensive, high quality line of alternative parts for your lighting requirements. From motors to capacitors, from transformers to flash tubes, they have dozens of cost effective, high quality, FAA Approved replacement components.

FAA-PMA Approved parts for the most common lighting requirements

OEM Part No.	MFG Part Number	Description	Part Number	Price
25-0491-1	TR-25-0491-1	Lens	11-15326	\$98.75
31-2106-1	TR-31-2106-1	Insulator	11-15327	\$133.75
31-4059-1	TR-31-4059-1	Insulator	11-15328	\$66.00
31-4851-1	TR-31-4851-1	Lens	11-15329	\$329.00
31-4852-1	TR-31-4852-1	Lens	11-15330	\$329.00
41-0261-1	TR-41-0261-1	Cam & Worm Wheel	11-15331	\$475.00
55-0069-1	TR-55-0069-1	Motor	11-15332	\$800.00
55-0073-11	TR-55-0073-11	Trigger Coil	11-15333	\$665.00
55-0073-5	TR-55-0073-5	Trigger Coil	11-15334	\$162.75
55-0221-1	TR-55-0221-1	Flash Tube	11-15335	\$219.95
55-0257-1	TR-55-0257-1	Battery Pack	11-15336	\$1,400.00
55-0295-1	TR-55-0295-1	Contact	11-15337	\$66.00
55-0339-101G6C2	TR-55-0339-101G6C2	Capacitor	11-15338	\$325.00
55-0339-151H6F2	TR-55-0339-151H6F2	Capacitor	11-15339	\$520.00
55-0339-321G2C2	TR-55-0339-321G2C2	Capacitor	11-15340	\$347.00
55-0339-421G2D2	TR-55-0339-421G2D2	Capacitor	11-15341	\$330.00
55-0743-641L2D8	TR-55-0743-641L2D8	Capacitor	11-15342	\$700.00
55-0753-1	TR-55-0753-1	Capacitor	11-15343	\$121.00
55-0834-641L2D2	TR-55-0834-641L2D2	Capacitor	11-15344	\$408.00
55-0834-751L2E2	TR-55-0834-751L2E2	Capacitor	11-15345	\$520.00
55-2198-1	TR-55-2198-1	Battery Pack	11-15346	\$1,046.00
A1233A2	TR-A1233A2	Lens	11-15347	\$154.00
A1233A3T	TR-A1233A3T	Lens	11-15348	\$163.75
A1257A	TR-A1257A	Gasket	11-15349	\$45.50
A1280-2	TR-A1280-2	Lens	11-15350	\$219.85
A1280-3	TR-A1280-3	Lens	11-15351	\$199.75
A6458	TR-A6458	Motor	11-15352	\$725.00
A6532	TR-A6532	Motor	11-15353	\$936.00
A6580	TR-A6580	Worm Wheel Assembly	11-15354	\$398.00
A6582	TR-A6582	Worm Wheel Assembly	11-15355	\$398.00
A6932	TR-A6932	Insulator	11-15356	\$117.75
A6947	TR-A6947	Switch Actuator	11-15357	\$122.75
A6948	TR-A6948	Switch Actuator	11-15358	\$123.75

ELL60 ELECTRONIC LANDING LIGHT



The landing light ELL60 is the logical evolution of ELL50 with even more power. Despite its small size (diameter 60 mm) this headlight has an input power of 60 watts, which corresponds to a usual halogen headlight of 180 - 200 watts. For the first time we have designed a new cooling system for the ELL60. In the new developed central cooling, the cooling air is passed through the landing light directly to the heatsink. With this new system it is possible to implement this high performance on such a small space. Of course, the ELL60 is through its complete socketing absolutely vibration inured and can be installed anywhere on the aircraft. The peculiarity of our landing light based on light-emitting diodes is the integrated anti-collision light (ACL). In this technique, the LEDs of the landing light can be controlled as an anti-collision light and is therefore integrated into our system of "intelligent synchronization". Thus, the ELL acts both as a normal landing light as well as anti-collision light in flight direction (ie forward) and increases the visibility of the aircraft in flight significantly. The ELL is pre-wired for easy connection to a cable with at least 1.5 mm² conductor cross section of 0.5 mm² flexible high. The assembly instructions and the shrink tubing required are attached.

Description	Part No.	Price
ELL60 Electronic Landing Light	11-13565	\$496.00
ELL60 Mount Cup	11-13568	\$36.00

ELL50 ELECTRONIC LANDING LIGHT



The Thiesen landing light, the ELL50, with it's 50 mm (approx 2") diameter, and less than 80 gram (2.8 ounces) is much more compact than it's forerunner model ELL80, but has a much greater luminous efficiency. Power input of the ELL50 is only 30 watts, with the light output equal to a 90 watt halogen lamp. Again, Thiesen's state of the art molding techniques guaranties weather resistance and therefor can me mounted virtually anywhere on your aircraft including even the wheel pants!

The integrated anti-collision lighting of the ELL50 is also prepared for the intellegent synchronization. The ELL50 can be easily connected to a cable of minimum 1.5 mm² cross section and is prewired with a 0.5 mm² highly flexible cord. An instructions manual and the required shrink tubing are included in the package.

Thanks to its advanced construction the ELL50 is water and seawater resistant and, therefore, ideally suited for use in seaplanes. It has temperature controls and is corrosion and UV resistant.

Description	Part No.	Price
ELL50 Electronic Landing Light	11-13564	\$365.00
ELL50 Mount Cup	11-13567	\$36.00

ELL80IS - ELECTRONIC LANDING LIGHT - INTELLIGENT SYNCHRONIZATION



By using the ELL, the Electronic Landing Light, ultralight aircraft are better perceived even during the day. The special feature of the light-emitting diode-based landing light is the integrated anti-collision light (ACL). Thus, the ELL functions both as a normal landing light and as anti-collision light in the direction of flight (ie forward). This significantly increases the visibility of the aircraft in flight.

Landing Lights ELL80is is the logical evolution of the proven ELL80 for integration into the family of "intelligent synchronization". With the specially selected LEDs, the ELL80is achieves four times the light output of its predecessor. Mounting and weight are identical to its predecessor, so that it can be replaced 1:1.

The ELL80is is pre-wired for easy connection to a cable with at least 1.5 mm² conductor cross-section with 0.5 mm² highly flexible stranded wire and has a separate connection for the landing light and for the ACL. The installation instructions and the required shrink tubing are enclosed.

Due to the forward-looking construction, the ELL is water and seawater resistant and therefore ideally suited to be used in seaplanes. It is temperature controlled and corrosion and UV resistant.

P/N 11-15985 **\$410.00**

PULSE LIGHT SYSTEMS - LANDING/TAXI LIGHTS

XEVISION LANDING & TAXI LIGHTS



XeVision™ super bright Xenon metal halide arc discharge landing & taxi lights for experimental aircraft. Light so bright and white you'd swear it's daylight; 500,00 candle power (3200 lumens) for our 35 Watt and more than 750,000 candle power (5400 lumens) for our 50 Watt systems – up to more than 8 times brighter than a standard 100 watt incandescent sealed beam. High HID efficiency means less than half the current draw and about ½ of the radiated heat of standard or Halogen lamps.

XeVision™ offers reliable HID pulsing capability based on the proprietary XeStrike™ series ballasts and the patented XePulse and new XePulse II™ pulsing module. All XeVision HID lighting systems are tested up to 100,000 feet altitude. XeVision systems are warranted up to 35,000 feet for continuous fail-safe operation.

XeVision offers retrofit kits for direct replacement or complete lighting system kits for new aircraft installation, different lamp shapes/sizes available. Many installation locations are possible now with a variety of lamp shapes and sizes, extremely small form factor, and lower lamp housing temperatures. They are

especially suited for tight spaces in composite aircraft. XeVision reflectors are made of metal, not plastic. High Intensity Discharge (HID) lighting is the most significant breakthrough in aviation lighting since the development of modern sealed beam lamps.

XeVision offers highest quality at a very competitive price with a 5 year warranty and up to 3,000 hour typical lamp life. XeVision HID aviation lighting systems are DO-160E certified (35,50, and 75 watt models)

The XeStrike™ proprietary ballasts XV1D or XV4D are an integral part of all XeVision aircraft lighting systems with the following features: 12 or 24 VDC voltage input., Designed for pulsing or dimming of HID Xenon bulbs with the XePulse™ HID control module., Designed for 35 watt or 50 watt output, 75 watt for special applications only., Extremely low EMI/RFI in combination with third generation D1S bulbs with integrated igniter and double shielded silicone cables., Digital power control for pre-programmable start-up algorithm.

XeVision conversion kit & components	Key features & other information
 <p>XeVision XV-36-SL • Standard landing light conversion kit. With XV1D or XV4D ballast and D1S bulb.</p>	Beam angle 9° horizontal & vertical. PAR 36 size. Preferred Application - PAR 36 conversion, lamp diameter 4-5/16"
XV-36-SL 35 Watt	P/N 11-01760 \$545.00
XV-36-SL 50 Watt	P/N 11-05038 \$595.00
 <p>XeVision XV-36-ST • Standard taxi light conversion kit. XV1D or XV4D ballast and D1S bulb.</p>	Beam angle 55° horizontal & 10° vertical. Preferred Application - PAR 36 conversion, lamp diameter 4-5/16"
XV-36-ST 35 Watt	P/N 11-01761 \$545.00
XV-36-ST 50 Watt	P/N 11-05037 \$595.00
 <p>XeVision XV-46-SL • Landing light conversion kit. XV1D or XV4D ballast and D1S bulb.</p>	Beam angle 10° horizontal & vertical. Preferred Application - PAR 46 conversion, lamp diameter 5-11/16"
XV-46-SL 35 Watt	P/N 11-01762 \$545.00
XV-46-SL 50 Watt	P/N 11-05204 \$595.00

XeVision conversion kit & components	Key features & other information
 <p>XV-46-ST - Taxi light conversion kit. XeVision XV-46-ST taxi light conversion kit XV1D or XV4D ballast and D1S bulb.</p>	Beam angle 50° horizontal & 8° vertical. Preferred Application - PAR 46 conversion, lamp diameter 5-11/16"
XV-46-ST 35 Watt	P/N 11-01763 \$545.00
XV-46-ST 50 Watt	P/N 11-05208 \$595.00
 <p>XV-22 - Landing or taxi light for external use like gear struts. XV1D or XV4D ballast and D1S bulb.</p>	15° horizontal & 10° vertical. Landing/taxi light conversion designations. Preferred Application - Lamp fixture, rectangular, only 2.25" high 4.7" wide, and 4.2" deep.
XV-22 35 Watt	P/N 11-01765 \$581.00
XV-22 50 Watt	P/N 11-05209 \$635.00
 <p>XV-23 - Landing or taxi light in wing area or externally as on a gear structure. With XV1D or XV4D ballast and D1S bulb.</p>	20° horizontal & 8° vertical. Preferred Application - Lamp fixture, rectangular, only 2.25" high 4.7" wide, and 4.2" deep.
XV-23 35 Watt	P/N 11-01764 \$581.00
XV-23 50 Watt	P/N 11-05210 \$635.00

EL

FOR MORE MODELS PLEASE VISIT
www.aircraftspruce.com

NAVIGATION / POSITION LED LIGHT BULBS



An affordable, long life, super-bright LED replacement for high-current demand incandescent bulbs for Whelen/Grimes position lights and other applications.

This glass dome LED is an exact replacement for BAY15s-base incandescent bulbs (P/N: 13-15810). Super bright 3W design. Very low power consumption. Green LEDs are designed to work behind an existing Green position light lens.

Features: • Replaces common Grimes / Whelen incandescent reflector bulbs (12V or 24V) • Sealed glass dome for superior dust/moisture resistance • Super bright 3W design – brighter than incandescent it replaces • Low current consumption – about 12% of a similar incandescent • Exact fit replacement for common Grimes /

Whelen navigation lights • Experimental Aircraft Only (for Certified aircraft - these bulbs meet FAA illumination guidelines but have no STC/PMA - ask your IA/A&P to consider these as a "minor alteration")
Clear White.....P/N 13-22035**\$28.50**

LED REPLACEMENT BULB FOR BEACONS



An affordable, long life, super-bright LED replacement for high-current demand incandescent bulbs for Whelen/Grimes Rotating Beacons and position lights.

This glass dome LED is an exact replacement for BAY15s-base incandescent bulbs. Super bright 3W design. Mirror-gloss reflector concentrates and directs lighting.

Very low power consumption. Cool white LEDs are super-bright (300 lumens). Mirror-reflector mimics OE bulb function and ensures a bright rotating-light effect. Exact fit replacement in most older rotating beacons

Note: Not suitable for flash-tube type strobes.

Features:

- Super bright cool white output
 - Replaces common Grimes / Whelen incandescent reflector bulbs (12V or 24V)
- Cool WhiteP/N 13-22036**\$31.70**
RedP/N 13-22437**\$27.95**
Green.....P/N 13-22438**\$31.70**

REPLACEMENT LAMPS

UNIVERSAL REPLACEMENT LAMPS

Our long life incandescent and halogen lamps offer greater light output with increased life and reduced costs. All lamps feature heavy filament construction. Improved design and manufacturing techniques produce a lamp far superior in service with lower cost to the user and packaging provides maximum protection in shipping, handling and storage.



Universal	Grimes	Whelen	General Electric	Cessna	Piper	Aeroflash	Our P/N	Price
24V150W	-	-	-	-	-	40-0003	040-0003	\$12.50
U303	-	-	GE-303	303	-	-	11-01948	\$0.65
U330	-	-	GE-330	330	-	-	11-01950	\$0.45
U1163	11631	-	-	-	-	-	11-01953	\$15.70
U1512	1512	-	-	1512	-	-	11-01954	\$21.75
U1524	1524	-	-	1524	-	-	11-01955	\$19.75
U1940	1940	WRM-1940	GE-1940	1940	-	-	11-01958	\$8.95
U1982-SP	LP-1982SP	-	GE-1982SP	-	761-214	-	11-01960	\$18.50
UA-7079B-12	1-7079B-12	-	-	A-7079B-12	-	-	11-01962	\$18.95
UA-7079B-24	A-7079B-24	-	-	A-7079B-24	-	-	11-01963	\$54.75
UA-7512-12	A-7512-12	W1290-14	-	A-7512-12	-	-	11-01964	\$21.75
UA-7512-24	A-7512-24	W1290-28	-	A-7512-24	753-478	-	11-01965	\$21.75

GALAXY LANDING LIGHT BULBS

Bulb #	Volts	Watts	Par #	Part No.	Price ea
4509Q	13	100	36	11-02220	\$19.65
4570	28	150	46	11-03528	\$14.85
4581	28	250	46	11-03530	\$17.35



WAMCO 4509 PAR36 LANDING LIGHT BULB

Wamco 4509 Par36 Landing Light Bulb.
P/N 11-18422\$9.50



AML Q4509 SEALED BEAM

This sealed beam is 30 volt, 100 watts and is 4 1/2" in Diameter. **Features:** • 13 Volts • 100 Watts • 4 1/2" Diameter • 114 MM.....P/N 11-12157\$9.95

GE PAR 46 HALOGEN SEALED BEAM Q4681

Voltage: 28V, Wattage: 450W, Type: PAR46 Sealed Beam, Base Type : Screw-Terminals, Life Hours: 50, Depth: 2.65 in., Sealed Beam, Quartz Halogen
Normal Q4681 BulbP/N 08-13147\$33.85
GE-Q4681 BulbP/N 11-03101\$45.50
Amglo Q4681 BulbP/N 11-18677\$184.95



CESSNA BULB S3353-1

Cessna Bulb S3353-1 replacement bulb.....06-03542\$69.95

GRAIN OF WHEAT INSTRUMENT BULBS

Replace burnt out Grain of Wheat Bulbs that are used to illuminate many instrument panels & instruments.

These blue-white silicone booted lamps are filtered for illuminating integrally white-lighted aircraft instruments and panels as called out in MIL-L-27160. Available in 14/28V.

14VP/N 11-02052\$6.50
28VP/N 11-02053\$6.50

GRIMES LAMPS FOR EXTERIOR LIGHTS

Lamp No.	Volts	Application	Price
11-02601	12	Wing Tip Lights, Model E	\$27.65
11-02603	24	Wing Tip Lights, Model E	\$106.90

WHELEN LAMPS FOR EXTERIOR LIGHTS

Lamp	Part No.	Application	Price
A427	11-03219	Wing Tip Strobe, Xenon Flash	\$244.95
A435	11-03697	Tail Strobe, Xenon Flash	\$233.95
A469B	11-03225	Flash Tube for SA & A450	\$199.95
A506	11-03274	Flash & Socket for A500	\$374.00
A508-14	11-03216	Halogen Lamp, A500 / A555 / A600	\$55.80
-	11-02602	Replacement bulb (14V)	\$113.75
-	11-02604	Replacement bulb (28V)	\$106.90
-	11-03897	(12V) Rotating Beacon	\$11.75

WHELEN FLASH TUBE FOR GRIMES STROBES

This flash tube replaces Grimes P/Ns 30-0467, 30-1467, 30-1331, 30-1172-5, & 30-0515 series. Used on many Cessna aircraft.
W55-0221-1P/N 11-02780\$208.95



3 WATT LED NAVIGATION LIGHT BULBS

High-Output 3 Watt LED navigation light bulbs. LED retro-fit for older Grimes navigation lights. Models: 1156, 1157 and 10761P/N 13-15810\$26.50

LED MIDGET FLANGED BI-POLAR LAMP T1-3/4 (5-28 VOLTS)

Replaces miniature lamps: # 328, 345, 350, 7335 (5/6V), 330, 382, 394 (12/14V), 327, 376, 387 (24/28V). Attention: Not intended for use with Post Light Assemblies
P/N 11-09629\$6.95



MINIATURE BAYONET BASED T3 1/4 LED LAMP

Replaces miniature lamp: # 6MB, 44, 47, 755, 1302, 1847 (5/6v); 12MB, 57, 386, 756, 1445, 1815, 1889, 1893 (12/14v); 1437, 24MB (24V); 28MB, 313, 757, 1819, 1829 (28V); 48MB (48V); 60MB, 1835 (60V); 120MB, NE51H, 967 (120VAC); 130MB (130V).....P/N 11-09628\$6.95

MARTEK AIRCRAFT 4509 LANDING LIGHT LAMP

Lamp	Part No.	Price	Lamp	Part No.	Price
4580	11-08435	\$24.75	Q4509	11-08432	\$15.85
4591	11-08438	\$15.85	4587	11-08436	\$15.85
4626	11-08440	\$13.50	4596	11-08439	\$16.50

WHELEN REPLACEMENT REFLECTOR LAMPS

Whelen Replacement Reflector Lamps: W678, W1512, W1524, WA7079B12.



Description	Part No.	Price
Wing Tip Strobe, Xenon Flash	11-03219	\$244.95
Tail Strobe, Xenon Flash	11-03697	\$233.95
Flash Tube for SA & A450	11-03225	\$199.95
Flash & Socket for A500	11-03274	\$374.00
Halogen Lamp, A500/A555/A600	11-03216	\$55.80
Halogen Lamp, A500/A555/A600	11-03208	\$56.90
Rotating Beacon	11-03897	\$11.75
Replacement lamp 28V / 75W W1982SP	11-13906	\$69.75

MARTEK ML-1986 28V- 250W

Miniature lamp for cockpit / wing / tail lights ML-1986 28V-250W.....P/N 11-18199\$88.75

WINGTIP AND TAIL LED BULB SET

Finally a powerful LED replacement for the expensive RA-7512 (14V) and W-1290 (28V) reflector-type navigation bulbs found on many General Aviation aircraft.

Set of 2 bulbs (Red and Green).....P/N 11-14885\$46.50
Set of 3 bulbs (Red, Green, and Clear)P/N 11-14884\$69.75

ITC LAMP ASSEMBLY 84-10015

ITC lamp assembly 84-10015 equivalent to Cessna Bulb S3353-1 replacement bulb.

OEM equivalents: Cessna S3353-1 | Cirrus 0105S00034
Externally Replaceable Bulbs (BLUE-WHITE) 1/4 turn to remove replaceable lampP/N 11-18451\$52.50

REPLACEMENT LAMPS



GE Lamp No.	Volts/Amps/Watts	WAMCO P/N	AML P/N	Price
43	2.5V 500mA	11-10886	11-12699	\$0.50
44	6.3V 250mA	11-10974	11-12702	\$0.38
53	14.4V 120mA	11-11039	11-12388	\$0.65
55	7V 410mA	11-10978	11-12724	\$0.50
67	13.5V 590mA	11-10979	11-12705	\$0.70
81	6.5V 1020mA	11-10957	11-12712	\$0.45
85	28V 40mA	11-10945	11-12707	\$0.55
93	12.8V 1040mA	11-11040	11-12411	\$0.45
94	12.8V 1040mA	11-11041	11-12412	\$0.85
209	6.5V 1780mA	11-11062	11-12768	\$1.30
301	28V 170mA	11-10990	11-12729	\$0.95
303	28V 300mA	11-11042	11-12679	\$0.75
304	28V 300mA	11-11043	11-12689	\$0.70
305	28V 510mA	11-11008	11-12418	\$0.80
306	28V 510mA	11-11044	11-12396	\$0.95
307	28V 670mA	11-11024	11-12380	\$0.95
308	28V 670mA	11-11013	11-12398	\$0.80
309	28V 900mA	11-11045	11-12693	\$1.25
311	28V 1290mA	11-11027	11-12683	\$1.20
313	28V 170mA	11-10953	11-12377	\$0.45
315	28V 900mA	11-11046	11-12756	\$0.72
316	6V 700mA	11-10954	11-12694	\$0.80
327	28V 40mA	11-10946	11-12662	\$0.55
327R	28V .04Amp	----	11-14291	\$1.20
328	6V 200mA	11-10952	11-12382	\$0.50
330	14V 80mA	11-10968	----	----
334	28V 40mA	11-10965	11-12387	\$0.55
336	14V 80mA	11-10993	11-12690	\$0.55
356	28V 170mA	11-10955	11-12401	\$0.55
382	14V 80mA	11-10969	11-12402	\$0.50
385	28V 40mA	11-10982	11-12726	\$0.70
386	14V 80mA	11-10984	11-12417	\$0.50
387	28V 40mA	11-10944	11-12383	\$0.40
388	28V 40mA	11-10970	11-12416	\$0.45
425	5V 500mA	11-10949	11-12710	\$0.85
623	28V 370mA	11-10971	11-12722	\$0.85
685	5V 60mA	11-11010	11-12738	\$0.85
715	5V 115mA	11-10975	11-12626	\$0.40
718	5V 115mA	11-11011	11-12739	\$0.95
757	28V 80mA	11-10947	11-12709	\$0.38
1251	28V 230mA	11-11063	11-12682	\$0.70
1252	28V 230mA	11-11064	11-12770	\$1.20
1309	28V 520mA	11-11073	11-12842	\$1.35
1315	2.5V 1000mA	11-11047	11-12757	\$1.32
1317	6V 510mA	11-11069	11-12775	\$1.50
1385	28V 720mA	11-11094	11-12678	\$4.95
1495	28V 300mA	11-10976	11-12390	\$0.75
1512	14V 21W	11-15187	----	----
1524	28V 21W	11-15183	----	----
1665	28V 800mA	11-11056	11-12467	\$2.80
1680	6V 4100mA	11-11057	11-12765	\$1.30
1691	28V 610mA	11-11058	11-12687	\$0.60
1769	2.5V 200mA	11-10958	11-12713	\$0.86
1815	14V 200mA	11-10985	11-12680	\$2.00
1819	28V 40mA	11-10966	11-12395	\$0.45
1820	28V 100mA	11-10950	11-12378	\$0.45
1829	28V .07Amp	----	11-14331	\$0.40
1864	28V 170mA	11-10972	11-12391	\$0.45
1873	28V 200mA	11-11000	11-12695	\$0.70
1982SP	28V/75w	----	11-15185	\$26.50
1982	28V 75W T-3	11-11115	----	----
1987	28V 150W	11-11128	11-12468	\$22.85
2182	14V 80mA	11-10948	11-12687	\$0.60
2232	28V 640mA	11-11080	11-12783	\$1.68
2233	28V 770mA	11-11081	11-12784	\$1.50
3011	28V 1290mA	11-11082	11-12686	\$1.60
3071	5V 60mA	11-11051	11-12685	\$1.20
3150	5V 60mA	11-11028	11-12629	\$1.30
3335	28V 16mA	11-11061	11-12384	\$1.15
4009	28V 40mA	11-11029	11-12748	\$0.90
6832	5V 60mA	11-11016	11-12393	\$1.15
6838	28V 24mA	11-11025	11-12386	\$0.70
6839	28V 24mA	11-11001	----	----
7009	28V 20mA	11-11078	11-12385	\$3.35
7132	5V 75mA	11-11030	11-12749	\$0.90
7152	5V 115mA	11-10980	11-12389	\$0.95
7153	5V 115mA	11-11009	11-12691	\$0.72
7265	5V 60mA	11-11017	11-12628	\$1.02
7267	5V 115mA	11-11049	11-12760	\$0.96
7327	28V 40mA	11-10986	11-12419	\$0.90
7382	14V 80mA	11-10987	11-12463	\$0.60
7387	28V 40mA	11-10956	11-12624	\$0.60
7715	5V 115mA	11-11067	11-12773	\$1.18
7839	28V 24mA	11-11018	11-12784	\$1.50
8552	28V 20mA	11-11095	11-12795	\$4.35
8623	28V 40mA	11-11088	11-12789	\$3.00

GE Lamp No.	Volts/Amps/Watts	WAMCO P/N	AML P/N	Price
8628	6V 200mA	11-11019	11-12743	\$0.80
8918	14V 100mA	11-10998	11-12706	\$0.76
16870	6.2V 40W	11-11126	11-12814	\$31.50
1044-1	28V 40mA	11-11070	11-12776	\$3.85
1044-06	28V 40mA	11-11065	11-12771	\$1.20
1044-08	28V 40mA	11-11068	11-12774	\$1.18
1098BPEG- PL	10V 27mA	11-11020	11-12744	\$0.80
120MB	120V 25mA	11-11071	11-12777	\$1.30
1280-01	28V 24mA	11-11075	11-12779	\$1.38
1280-08	28V 24mA	11-11076	11-12780	\$1.38
1280-481	28V 24mA	11-11052	11-12762	\$1.00
1309IF	28V 520mA	11-11083	11-12785	\$1.70
1495X	28V 300mA	11-10999	11-12708	\$2.10
1665AF (1665IF)	28V 800mA	11-11084	11-12698	\$1.56
1970X	28V 100W	11-11122	11-12813	\$17.90
1978X	10V 100W	11-11114	11-12812	\$26.50
1982SP	28V 75W	11-11118	11-01960	\$18.50
2059X	12V 10W	11-11108	11-12799	----
2232SB	28V 640mA	11-11096	11-12796	\$3.85
305AF (WL-305IF)	28V 510mA	11-11048	11-12758	----
3071AS15	5V 60mA	11-11077	11-12781	\$1.44
3071BPE	5V 60mA	11-11031	11-12750	\$0.95
3071BPEG- PL	5V 60mA	11-11002	11-12621	\$0.78
3071F	28V 670mA	11-11060	11-12697	\$1.08
376AS15	28V 60mA	11-10988	11-12627	\$1.58
382AS10	14V 80mA	11-11014	11-12741	\$0.78
385AS15	28V 40mA	11-11026	11-12747	\$0.88
387AS15	28V 40mA	11-10981	11-12725	\$1.10
387BPGPL	28V 40mA	11-11050	11-12761	\$1.20
4009BPE	28V 40mA	11-11032	11-12751	\$1.10
4009BPEG- PL	28V 40mA	11-11012	11-12740	\$0.76
565-101	28V 24mA	11-11111	11-12803	\$7.60
6180AS15	5V 60mA	11-11004	11-12736	\$2.80
6832AS15	5V 60mA	11-10994	11-12684	\$1.25
6833AS15	5V 60mA	11-10983	11-12727	\$1.22
6838-1001	28V 24mA	11-11074	11-12466	\$1.45
6838AS15	28V 24mA	11-11033	11-12752	\$0.90
6839AS15	28V 24mA	11-11034	11-12754	\$1.45
6839BPE	28V 24mA	11-11005	11-12413	\$1.20
683AS15	5V 60mA	11-10992	11-12730	\$0.62
685AS15	5V 60mA	11-11066	11-12772	\$1.16
7009AS15	28V 20mA	11-11085	11-12786	\$3.35
7132AS15	5V 75mA	11-11021	11-12703	\$1.34
7132AS15T- PL	5V 75mA	11-11022	11-12745	\$0.80
713AS15	5V 75mA	11-10977	11-12723	\$0.50
7152AS15	5V 115mA	11-11035	11-12704	\$1.36
7153AS15	5V 115mA	11-11036	11-12755	\$1.36
7153SAS15	5V 115mA	11-11059	11-12766	\$1.04
715AS15	5V 115mA	11-11037	11-12696	\$0.90
718AS15	5V 115mA	11-11038	11-12701	\$0.90
737AS15	28V 50mA	11-11079	11-12782	\$1.95
7715AS15	5V 115mA	11-11015	11-12742	\$0.78
8GH003912-06	6V 12W	11-11107	11-12798	\$11.70
8GH004554-28	28V 11.5W	11-11109	11-12802	\$4.50
8GH005448-28	28V 11.5W	11-11110	11-12848	\$5.40
8GH005597- 12	12V 25W	11-11113	----	----
8GH005678- 06	6V 10W	11-11106	11-12797	\$6.60
8GH007429- 28	28V 11.5W	11-11112	11-12843	\$11.50
A1G	65VAC 90VDC Max	11-11086	11-12787	\$1.70
A1H	95VAC 135VDC Max	11-11089	11-12790	\$1.90
A1H-R18	95VAC 135VDC Max	11-11090	11-12791	\$2.10
A3C	95VAC 135VDC Max	11-10989	11-12728	\$0.60
A-4174-24	28V 40W	11-11123	11-12845	\$14.80
A-4174-24X	28V 40W	11-11130	11-12816	\$40.95
A-7512-12	14V 26W	11-04366	----	----
A-7512-24	28V 26W	11-04367	----	----
A-7079B-12	14V 40W	11-11124	----	----
A-7079B-24	28V 40W	11-15189	----	----
A9A	65VAC 90VDC Max	11-10959	11-12715	\$40.00
B1A	65VAC 90VDC Max	11-11006	11-12737	\$0.70
B2A	95VAC 135VDC Max	11-11023	11-12746	\$0.80
C7A	65VAC 90VDC Max	11-11091	11-12792	\$2.10
C9A	95VAC 135VDC Max	11-11087	11-12788	\$1.70
DT1673A	5V 21mA	11-11093	11-12794	\$2.50
G9B	95VAC 135VDC Max	11-11092	11-12793	\$2.20
KPR102	2.4V 700mA	11-10995	11-12731	\$0.64
KPR103	3.6V 700mA	11-10996	11-12732	\$1.90
KPR104	2.2V 470mA	11-10997	11-12734	\$0.64
PR12	5.95V 500mA	11-10960	11-12716	\$0.40
PR18	7.2V 550mA	11-10967	11-12721	\$0.42
PR2	2.38V 500mA	11-10961	11-12717	\$1.20
PR3	3.57V 500mA	11-10962	11-12718	\$0.56
PR6	2.47V 300mA	11-10963	11-12719	\$0.40
PR7	3.7V 300mA	11-10964	11-12720	\$0.40
1308	28V 560mA	11-17218	----	\$9.50

EL

NORMAN AIRCRAFT LAMPS



Since 1985 Norman Lamps, a U.S. based corporation, has been a valued supplier of certified aircraft lamps to the U.S. Defense Department (DOD), Naval Air Systems Command (NAV-AIR), and the Federal Aviation Administration (FAA). We are specialists in design, development, production and worldwide distribution of high quality, long life lighting products

Lamp No.	Size	Volts/Amp	Part No.	Price
53	G 3-1/2	14.4/.12	08-12244	\$0.65
75	T4	28/2.67	11-13902	\$31.75
90	G 6	13/.58	08-12245	\$1.30
93	S 8	12.8/1.04	08-12246	\$0.95
94	S 8	12.8/1.04	08-12247	\$1.25
100	T1	28/.024	08-14671	\$0.90
194	T 3-1/4	14/.27	08-12248	\$0.45
259	T 3-1/4	6.3/.25	08-12249	\$0.84
302	G 5	28/.17	11-16624	\$0.50
305	S 8	28/.51	08-12250	\$0.99
306	S 8	28/.51	08-12251	\$1.25
307	S 8	28/.67	08-12252	\$1.45
308	S 8	28/.67	08-12253	\$1.75
313	T 3-1/2	28/.17	08-12254	\$0.85
316	T 3-1/4	6/.70	08-12255	\$0.95
328	T 3-1/4	6/.20	08-12256	\$0.80
335	T 3-1/4	28/.04	08-12257	\$1.10
337	--	--	08-12259	\$0.95
382	T 1-3/4	14/.08	08-16167	\$0.50
387	T 1-3/4	28/.04	08-12260	\$0.95
1004	B6	12.8/.94	08-12261	\$0.82
1141	S 8	12.8/1.44	08-12263	\$0.55
1142	S 8	12.8/1.44	08-12264	\$1.30
1143	RP 11	12.5/1.98	08-12265	\$1.95
1383	R 12	13/1.54	08-12266	\$3.25
1414	T 4-1/2	14/.46	08-12267	\$0.85
1495	T 4-1/2	28/.61	08-12268	\$1.15
1683	S 8	28/1.02	08-12269	\$0.95
1813	T 3-1/4	14.4/.1	08-12270	\$0.55
1818	T 3-1/4	28/.17	08-12271	\$0.65
1819	T 3-1/4	28/.04	08-12272	\$0.55
1820	T 3-1/4	28/.10	08-12273	\$0.90
1829	T 3-1/4	28/.07	08-12274	\$0.90
1864	T 3-1/4	28/.17	08-12275	\$0.75
1891	T 3-1/4	14/.24	08-12276	\$2.75
1893	T 3-1/4	14/.33	08-12277	\$0.85
1940	T 7	14/.50	08-12278	\$6.85
4559	PAR 64	28/600	08-12280	\$28.50
4570	PAR 64	28/150	08-12281	\$9.50
4580	PAR 64	28/450	08-12282	\$19.75
4591	PAR 36	28/100	08-12283	\$12.90
4596	PAR 36	28/250	08-12284	\$13.50
4626	PAR 36	28/150	08-12285	\$14.85
6838	T 1	28/.024	08-12287	\$1.10
1816R	T 3-1/4	13/.33	08-12298	\$1.80
1939X	T 7	28/50	08-12300	\$4.75
313R	T 3-1/4	28/.17	08-12311	\$0.95
678	T 3	6/1.67	08-12397	\$48.65
Q4509	PAR 36	13/100	08-12451	\$14.95

Lamp No.	Size	Volts/Amp	Part No.	Price
1073	S 8	12.8/1.8	08-13110	\$1.15
1144	RP 11	12.5/1.98	08-13111	\$12.94
1308	B 6	28/.056	08-13112	\$1.10
1309	B 6	28/.52	08-13113	\$1.65
1315	G 5	2.5/1.00	08-13114	\$1.66
1385	R 12	28/.71	08-13115	\$2.95
1692	S 8	28/.61	08-13116	\$1.45
1777	S 8	12.8/1.52	08-13465	\$0.95
1816	T 3-1/4	13/.33	08-13117	\$0.60
1828	T 3-1/4	37.5/.05	08-13118	\$11.75
1982	T 3	28/75	08-13119	\$24.75
1982SP	T 3	28/75	08-13120	\$11.85
1991	T 3-1/4	14/25	08-13469	\$18.75
1999	T 3-1/4	2/25	08-13998	\$16.95
2232	S 8	28/.64	08-13121	\$1.70
3150	T 1-3/4	5/.06	08-16180	\$1.60
303	G 6	28/.30	08-13122	\$1.10
304	G 6	28/.30	08-13123	\$0.80
309	S 11	28/.90	08-13124	\$1.16
311	S 11	28/1.29	08-13125	\$0.96
327	T 3-1/4	28/.04	08-13126	\$0.90
334	T 3-1/4	28/.06	08-13128	\$1.00
336	T 3-1/4	14/.08	08-13129	\$0.75
4313	PAR 36	12/12	08-13130	\$23.85
4509	PAR 36	13/100	08-13131	\$8.75
4522	PAR 46	13/250	08-13132	\$25.65
4537	PAR 46	13/100	08-13133	\$13.50
4553	PAR 46	28/250	08-13134	\$22.50
4581	PAR 46	28/450	08-13135	\$21.85
4582	PAR 46	28/450	08-13136	\$23.00
4587	PAR 36	28/250	08-13137	\$13.50
4589	PAR 36	28/50	11-16625	\$10.85
4593	PAR 36	28/50	08-13138	\$11.50
4594	PAR 36	28/100	08-13139	\$13.50
4595	PAR 36	13/100	11-16626	\$26.70
67	G 6	13.5/.59	08-13140	\$8.06
6839	T 1	28/.024	08-13141	\$1.20
685	T 1	5/.06	08-13142	\$0.90
89	G 6	13/.58	08-13143	\$1.15
7079-24	GG-12A1	28/1.54	08-13468	\$39.75
7512-12	--	14/28	08-13464	\$37.50
7512-24	--	28/28	08-13466	\$38.50
7604	--	--	08-13144	\$9.50
PR6	--	--	08-13145	\$1.08
Q4559	PAR 64	28/600	08-13146	\$39.65
Q4681	PAR 64	28/450	08-13147	\$33.85
--	T 4 14/25	12V	08-13463	\$20.85
A508-14	T 3-1/4	14/25	11-16627	\$17.50



GE REPLACEMENT LAMPS

GE MINIATURE LAMPS FOR COCKPIT/WING/TAIL LIGHTS

Lamp No.	Primary/Application	Volts	Amps/Watts	Part No.	Price
B-31/2 Bulb 7/16" (11mm) Diameter					
GE-PR3	Flashlight-3D Cells	3.57	.50A	11-03071	\$0.65
GE-PR6	Flashlight-2D Cells	2.47	.30A	11-03070	\$0.54
GE-PR7	Flashlight-3D Cells	3.70	.30A	11-03072	\$0.74
GE-PR12	Flashlight-5D Cells	5.95	.50A	11-03073	\$0.58
GE-PR18	Flashlight-6D Cells	7.20	.55A	11-03074	\$0.78
B-6 Bulb 3/4" (19mm) Diameter					
GE-1308	Reading Light	28	.56A	11-03076	\$1.25
GE-1309	Aircraft Interior	28	.52A	11-04162	\$1.75
GE-1317	Emergency Landing	6	.51A	11-03075	\$2.65
G-31/2 Bulb 7/16" (11mm) Diameter					
GE-356	Map Light	28	17A	11-04184	\$2.95
GE-1450	Indicator	24	.035A	11-03077	\$6.95
G-41/2 Bulb 9/16" (14mm) Diameter					
GE-55	Panel Indicator	7	2 CP	11-04194	\$1.60
GE-57	Panel Indicator	14	2 CP	11-04195	\$0.90
G-5 Bulb 5/8" (16mm) Diameter					
GE-1315	Emergency Lighting	2.5	1.0A	11-03037	\$3.35
G-6 Bulb 3/4" (19mm) Diameter					
GE-303	Cockpit Light	28	.30A	11-04172	\$2.95
GE-304	Cockpit Light	28	.30A	11-04173	\$3.20
GE-623	Aircraft - 2 Filaments	28	.37A	11-03041	\$2.65
GE-1251	Aircraft - 2 Filaments	28	.23A	11-03039	\$0.55
GE-1252	Aircraft - 2 Filaments	28	.23A	11-03040	\$1.80
S-8 Bulb 1" (25mm) Diameter					
GE-305	Wing/Tail	28	.51A	11-04174	\$3.55
GE-306	Wing/Tail	28	.51A	11-04175	\$4.95
GE-307	Wing/Tail	28	.67A	11-04176	\$3.35
GE-308	Wing/Tail	28	.67A	11-04177	\$3.35
GE-315	Wing/Tail	28	.90A	11-04180	\$3.95
GE-1619	Instrument	6	4.1A	11-03025	\$3.85
GE-1665	Aircraft	28	.80A	11-03034	\$8.50
AML-1665AF	Aircraft	28	.80A	11-10813	\$2.35
GE-1680	Wing/Tail	6	4.1A	11-04165	\$3.95
GE-1691	Aircraft - 2 Filaments	28	.61A	11-03029	\$8.75
GE-1692	Marine - 2 Filaments	28	.61A	11-03030	\$9.45
GE-1777	Aircraft Tail Light	12.8	1.52A	11-04014	\$5.85
S-11 Bulb 1-3/8" (35mm) Diameter					
GE-309	Aircraft	28	.90A	11-03036	\$5.70
GE-311	Wing/Tail	28	1.29A	11-04178	\$4.50
T-1 Bulb 1/8" (3mm) Diameter					
GE-685	Aircraft	5.0	.06A	11-03042	\$1.25
GE-718AS15	Aircraft - 1 Filament	5.0	.115A	11-03043	\$1.65

Lamp No.	Primary/Application	Volts	Amps/Watts	Part No.	Price
T-13/4 Bulb 7/32" (5.5mm) Diameter					
GE-85	Indicator	28	.04A	11-03044	\$1.95
GE-327	Eyebrow/Post Lt.	28	.04A	11-04015	\$0.50
GE-328	Panel Indicator	6	.20A	11-04181	\$1.50
GE-330	Eyebrow/Post Lt.	14	.08A	11-04016	\$0.95
GE-334	Panel Indicator	28	.04A	11-04182	\$1.35
GE-387	Panel Indicator	28	.04A	11-04185	\$1.15
T-21/4 Bulb 9/32" (7.5mm) Diameter					
GE-786	Emergency-Halogen	6	2.0A	11-03046	\$10.85
T-3 Bulb 3/8" (9.5mm) Diameter					
T-31/4 Bulb 13/32" (10mm) Diameter					
GE-44	Panel Indicator	6.3	.25A	11-04186	\$0.90
GE-316	Instrument	6	.70A	11-03050	\$3.50
GE-323	Aircraft	3	.19A	11-13900	\$9.85
GE-400	Aircraft	28	.10A	11-03054	\$1.65
GE-757	Indicator	28	.08A	11-03053	\$1.50
GE-1813	Wing/Tail-All Frosted	14.4	.10A	11-04166	\$1.85
GE-1816	Map/Dome Light	13	.33A	11-04167	\$4.35
GE-1818	Panel Indicator	24	.17A	11-04168	\$2.85
GE-1819	Panel Indicator	28	.04A	11-04169	\$1.70
GE-1820	Panel Indicator	28	.10A	11-04170	\$1.88
GE-1873	Aircraft	28	.17A	11-03056	\$5.60
GE-464	Aircraft	28	.17A	11-03055	\$1.80
GE-1864	Panel Indicator	28	.17A	11-04171	\$1.65
T-5 Bulb 5/8" (16mm) Diameter Electric Discharge Lamps					
GE-5004CW	Cool White	A.C.	4W	11-03060	\$8.50
GE-5008CW	Cool White	A.C.	8W	11-03063	\$7.05
GE-5104WW	Warm White	A.C.	4W	11-03062	\$5.35
GE-5108WW	Warm White	A.C.	8W	11-03065	\$6.85
GE-5113WW	Warm White	A.C.	13W	11-03068	\$6.65
T-7 Bulb 7/8" (20mm) Diameter					
GE-1940	Rotating Beacon	14	3.57A	11-03794	\$11.75
Cockpit & Wing/Tail Lights					
GE-53	Panel Indicator	14.4	1 CP	11-04193	\$0.95
GE-67	Clock, tail, cargo area	13.5	8	11-01394	\$2.85
GE-93	Wing/Tail	12.8	15 CP	11-04199	\$2.25
GE-313	Cockpit Light	28	.17A	11-04179	\$1.60
GE-336	Post Light	14	.08A	11-04183	\$0.83
GE-356	Map Light	28	.17A	11-04184	\$2.95
GE-1073	Illuminator Lights	12.8	1.80A	11-04012	\$2.45
GE-1141	Wing/Tail	12.8	1.44A	11-04161	\$1.95
GE-1495	Panel Indicator	28	.30A	11-04164	\$2.95

Note: GE is no longer producing lamps. Martek is producing this line utilizing the original GE molds. Packaging may vary, but all shipped lamps will be equivalent and meet the same specifications.

GE SEALED BEAM LAMPS FOR LANDING & TAXI LIGHTS

Lamp Diameter	Lamp No.	PAR	Design Volts	Watts	Part No.	Price
4 1/2" (114mm)	GEH-7604	36	12.8	50	11-04023	\$16.90
4 1/2" (114mm)	GE-4509	36	13	100	11-03796	\$12.70
4 1/2" (114mm)	GE-4700	36	13	100	11-03807	\$59.95
4 1/2" (114mm)	GE-Q4631	36	13	250	11-03083	\$69.50
4 1/2" (114mm)	GE-4313	36	13	250	11-03795	\$34.85
4 1/2" (114mm)	GE-4537	46	13	100	11-03798	\$18.75
4 1/2" (114mm)	GE-4502	36	28	50	11-04187	\$20.50
8" (203mm)	GE-4552	64	28	250	11-04189	\$98.75
8" (203mm)	GE-4557	64	28	400	11-04190	\$58.75
8" (203mm)	GE-4559	64	28	600	11-04017	\$34.85
4 1/2" (114mm)	GE-4627	36	28	100	11-03088	\$53.85
4 1/2" (114mm)	GE-4626	36	28	150	11-04191	\$31.75
4 1/2" (114mm)	GE-4589	36	28	50	11-03084	\$17.50
4 1/2" (114mm)	GE-4593	36	28	50	11-03085	\$23.85
4 1/2" (114mm)	GE-4594	36	28	100	11-03803	\$14.85
4 1/2" (114mm)	GE-4713	36	28	150	11-03089	\$125.00

Lamp Diameter	Lamp No.	PAR	Design Volts	Watts	Part No.	Price
4 1/2" (114mm)	GE-4587	36	28	250	11-03090	\$25.95
5 3/4" (146mm)	GE-4551	46	28	250	11-03093	\$24.50
5 3/4" (146mm)	GE-4553	46	28	250	11-03799	\$19.95
5 3/4" (146mm)	GE-4554	46	28	450	11-03095	\$26.50
5 3/4" (146mm)	GE-4571	46	28	150	11-03092	\$31.50
5 3/4" (146mm)	GE-4581	46	28	450	11-03097	\$43.50
5 3/4" (146mm)	GE-Q4681	46	28	450	11-03101	\$45.50
5 3/4" (146mm)	GE-4582	46	28	450	11-03098	\$59.75
5 3/4" (146mm)	GE-Q4597	46	28	450	11-03099	\$189.75
7" (178mm)	GE-4541	56	28	450	11-03102	\$47.50
8" (203mm)	GE-4559X	64	28	600	11-03104	\$57.75
4 1/2" (114mm)	GE-4505	36	28	50	11-04188	\$17.95
5 3/4" (146mm)	GE-4580	46	28	450	11-03901	\$38.65
5 3/4" (146mm)	GE-4570	46	28	150	11-03801	\$14.95