

# COMPRESSED AIR | CHILLER & COOLING BEST PRACTICES<sup>®</sup>

[airbestpractices.com](http://airbestpractices.com)

[coolingbestpractices.com](http://coolingbestpractices.com)

April 2022

## Energy Conservation

30 SHOW REPORT  
AHR EXPO

- 14 **Compressed Air Supports Growth at Roush Yates Manufacturing Solutions**
- 18 **Show Report: The 2022 International Production & Processing Expo**
- 26 **Energy Saving and Air Changes**
- 38 **Pro-Refrigeration Helps California Dairy with CO<sub>2</sub> Chillers**





Atlas Copco

# Air, Gas, Vacuum and a Whole Lot More!

Solutions that are made to work together.  
Solutions that are made to work for you.

- 24/7 Remote Monitoring
- Centralized Control System
- Family-Style Controllers Across Models and Technologies
- Single Service Contract for Multiple Machines
- Nationwide Support by Factory-Trained Service Technicians

## The Connected Efficiency Journey



Audit



Design/Install



Optimize



Monitor



Service & Support

Call 866-546-3588 or visit [atlascopco.com](http://atlascopco.com)

## COMPRESSED AIR SYSTEM FEATURES

- 6 Compressed Air Technology & Industry News**
- 14 Compressed Air Supports Growth at Roush Yates Manufacturing Solutions**  
By Mike Grennier, Compressed Air Best Practices® Magazine
- 18 Show Report: The 2022 International Production & Processing Expo**  
By Roderick Smith, Compressed Air Best Practices® Magazine



## COOLING SYSTEM FEATURES

- 26 Energy Saving and Air Changes**  
By Raul Simonetti, Carel Industries
- 30 Chiller & Cooling Tower Technology Win Big at 2022 AHR Expo**  
By Bill Smith, Chiller & Cooling Best Practices Magazine
- 38 Pro-Refrigeration Helps California Dairy with CO<sub>2</sub> Chillers**  
By Tom Savas, Danfoss
- 41 Chiller & Cooling System Technology & Industry News**

## EVERY ISSUE

- 4 From the Editor**
- 49 Advertiser Index**
- 49 The Marketplace | Jobs and Technology**



Compressed Air Best Practices® (USPS# 17130) is published monthly except January-February combined by Smith Onandia Communications LLC, 37 McMurray Rd., Suite 104, Pittsburgh, PA 15241. Periodicals postage paid at Pittsburgh, PA and additional mailing offices. POSTMASTER: Send address changes to: Compressed Air Best Practices®, 37 McMurray Rd, Suite 104, Pittsburgh, PA 15241.

Compressed Air Best Practices® is a trademark of Smith Onandia Communications, LLC. Publisher cannot be held liable for non-delivery due to circumstances beyond its control. No refunds. SUBSCRIPTIONS: Qualified reader subscriptions are accepted from compressed air professionals, plant managers, plant engineers, service and maintenance managers, operations managers, auditors, and energy engineers in manufacturing plants and engineering/consulting firms in the U.S. Contact Patricia Smith for subscription information at tel: 412-980-9902 or email: patricia@airbestpractices.com. REPRINTS: Reprints are available on a custom basis, contact Patricia Smith for a price quotation at Tel: 412-980-9902 or email: patricia@airbestpractices.com. All rights are reserved. The contents of this publication may not be reproduced in whole or in part without consent of Smith Onandia Communications LLC. Smith Onandia Communications LLC. does not assume and hereby disclaims any liability to any person for any loss or damage caused by errors or omissions in the material contained herein, regardless of whether such errors result from negligence, accident, or any other cause whatsoever. Printed in the U.S.A.

# FROM THE EDITOR



When industry allows specialists to partner with them to ensure reliable, efficient and high-quality compressed air systems to power automation – great things happen. Our own Mike Grennier has written an article on how Roush Yates Manufacturing Solutions has partnered with Atlas Copco to support their significant growth.

We hope you enjoy our show reports from the 2022 installments of the International Production & Processing Expo and from AHR Expo.

Thanks go to Raul Simonetti, from Carel Industries, for his article titled, “Energy Saving and Air Changes.” We would also like to thank Tom Savas, from Danfoss, for his article titled, “Pro-Refrigeration Helps California Dairies with CO<sub>2</sub> Chillers.”

Lastly, we are accepting speaker abstracts for the Best Practices 2022 EXPO & Conference being held October 4-6, 2022 at Cobb Galleria in Atlanta. Abstracts can be sent to Clare Heintz at [clare@airbestpractices.com](mailto:clare@airbestpractices.com). Save the date and visit <https://cabpexpo.com> for more information!

Thank you for investing your time and efforts into *Compressed Air and Chiller & Cooling Best Practices*.

**RODERICK M. SMITH**

Editor

tel: 412-980-9901

[rod@airbestpractices.com](mailto:rod@airbestpractices.com)



COMPRESSED AIR BEST PRACTICES® EDITORIAL ADVISORY BOARD			
Industrial Energy Managers	Doug Barndt	Energy Manager	Danone North America
	John Bilsky	Facilities Maintenance	Gentex Corporation
	Bhaskar Dusi	Corporate Energy Manager	CEMEX USA
	Richard Feustel	Senior Energy Advisor	Leidos
	William Jerald	Energy Manager	CalPortland
	Michael Jones	Director Corporate Energy	Intertape Polymer Group
	Robert Kirts	GTS Energy Manager	Stanley Black & Decker
	Brett Rasmussen	Senior Utilities Engineer	Nissan North America
	Brad Runda	Director Energy & Utilities	Purdue University
Cooling & Compressed Air System Assessments	David Andrews	VP, Global Marketing & Communications	Sullair
	Steve Briscoe	President	Compressed Air Challenge
	Tim Dugan	President	Compression Engineering Corp.
	Tilo Fruth	President	Beko USA
	Paul Humphreys	VP Communications	Atlas Copco
	Frank Melch	Vice President	Zorn Compressor & Equipment
	Wayne Perry	Sr. Technical Director	Kaeser
	David Robertson	Sr. Sales Engineer	Arizona Pneumatic
	Mark Rogan	Senior Energy Engineer	2RS Consulting Engineers
	Nitin Shanbhag	President	Mikropor Americas
	Matt Smith	VP Channel Partner Sales	FS-Curtis & FS-Elliott
	Derrick Taylor	Manager	PneuTech Products
	Hank van Ormer	Technical Director	Air Power USA
Bert Wesley	Sr. Principal-Industrial Plant Engineering Practice Leader	Woodard & Curran	



Enviro/Tech is a registered trademark.



## 2022 MEDIA PARTNERS





Meet the new

# MCHILL

## Mikropor Water Process Chillers

- With air- and water-cooled models ranging from 2-70 tons, the Mikropor MCHILL fits a wide range of process cooling applications.
- Available in open- or closed-circuit configurations.
- MCHILL is equipped with:
  - Brazed Plate Stainless Steel Evaporator,
  - Aluminium Microchannel Condenser,
  - Scroll Compressors with R-410A Refrigerant,
  - Microprocessor controls and several optional features.



For more information, please contact us at [support@mikroporamerica.com](mailto:support@mikroporamerica.com)

# COMPRESSED AIR TECHNOLOGY & INDUSTRY NEWS

## Ingersoll Rand Acquires Houdstermaatschappij Jorc B.V.

Ingersoll Rand Inc., a global provider of mission-critical flow creation and industrial solutions, acquired Houdstermaatschappij Jorc B.V. (“Jorc”) for an all-cash purchase price of €27 million. Jorc will join the Industrial Technologies and Services (ITS) segment.

Jorc is a world-leading manufacturer of condensate management products, primarily condensate drains, oil/water separators and air-saving equipment. The company is based in Heerlen, Netherlands and has additional facilities in the US and Slovenia. Jorc has approximately €13 million in 2021 annual sales and 2021 Adjusted EBITDA margins in excess of the ITS segment.

“The addition of Jorc fills a strategic gap in our portfolio that enables us to provide a more end-to-end solution to our customers,” said Enrique Minarro Viseras, senior vice president and general manager of the ITS EMEA business. “From their energy-saving electronic drain to oil/water separators compliant with environmental regulatory agencies, Jorc’s family-built business and focus on sustainability is a natural fit with our values and purpose to Lean on Us to Help You Make Life Better. I am excited to welcome the Jorc team into the Ingersoll Rand family and look forward to the great things we can do together.”

### About Ingersoll Rand Inc.

*Ingersoll Rand Inc., driven by an entrepreneurial spirit and ownership mindset, is dedicated to helping make life better for our employees, customers and communities. Customers lean on us for our technology-driven excellence in mission-critical flow creation and industrial solutions across 40+*

*respected brands where our products and services excel in the most complex and harsh conditions. Our employees develop customers for life through their daily commitment to expertise, productivity and efficiency. For more information, visit [www.IRSCO.com](http://www.IRSCO.com).*

## TM.I.C. Expands into the North American Marketplace

TM.I.C., Termomeccanica Industrial Compressors, is expanding its presence in compressed air & gas, through its existing North American Distribution, OEMs, & Specialty Direct Accounts while developing more of the same channels to the marketplace.

With core focus on oil-injected compressors that range from 3 to 1,300 hp, the line consists of their SCA Series, ITA Series, and SCI Integrated Screw Compressors for air applications. The SCA & ITA series incorporate ten different models offered in direct and geared configurations to meet a varied range of customer’s compressed

air needs. Some of the many important features of the TM.I.C. compressors are an optimized compact design, reduced speed operation, high efficiency, and low noise. The compact SCI Rotary Screw Compressors consist of an integrated rotary screw airend with inlet controls, air filter, compressor oil filter, & separator element. Models are offered in both direct and gear driven configurations to meet many applications. In addition, TM.I.C. offers a patented aluminum version of their SCI Integral Compressor “SCI10ALG” that reduces operating weight significantly.

The company also offers a range of Gas Compressors. TM.I.C.’s NG & SCG Rotary Screw Gas Compressors can manage different types of gases including natural gas, methane, and biogas as well as many others such as hydrogen and vinyl chloride that are listed amongst the most “problematic” ones.

TM.I.C. Industrial NG series gas compressors are equipped with a mechanical shaft seal that minimizes the risk of any possible leakage into the atmosphere. Further, upon request, the NG compressor series is also available with a magnetic joint, which is requested for ATEX classified areas (Up to Zone 1) and by API-619 Standard. The high level of flexibility of TM.I.C. enables them to tailor its products to every/any customer need for customized features. The NG Compressor Series Range in capacity from 7 – 3,300 cfm, Power: 30 – 1,300 hp, Inlet Pressure: - 14,5 psig, Discharge Pressure: 290 psig.

In the last year TM.I.C. developed an ITA-HP series for gas with an inlet pressure up to 116 psig and discharge pressure up to 360 psig. There is also a two stage machine “ITA-TS” that reaches important energy savings.



*Termomeccanica Rotary Screw Gas Compressors for Special Projects.*



### About Termomeccanica Industrial Compressors

Termomeccanica Industrial Compressors, part of an Italian industrial group, founded in 1912, is amongst the main players of both the Environmental and Mechanical sectors. T.M.I.C. carries out its various business activities in Italy and abroad through its operational companies, each specialized in one of the group's key market areas. For more information contact, Ray Rasnack, North American Sales Manager at [r.rasnack@termomeccanica.com](mailto:r.rasnack@termomeccanica.com) or visit <https://www.tmic.termomeccanica.com/>.

### BOGE Converts Refrigerant Dryer to New Refrigerant

Meeting the European climate objectives set out in the Kyoto protocol means finding solutions that are environmentally friendly and, most importantly, reduce greenhouse gases. This applies to the compressed air industry too. To optimize the CO<sub>2</sub> footprint of its refrigerant dryers, BOGE will be using a new refrigerant. From now on, they will be using refrigerant R 513A instead of R134a for its DS-2 series in the power range up to 10 m<sup>3</sup>/min. This reduces the GWP value by around 60%: from 1,430 to 573. The CO<sub>2</sub> equivalent, i.e., the impact the substance has on the climate compared to carbon dioxide, also decreases accordingly. The greenhouse effect of the new refrigerant over the 100-year period studied is much lower than before. Furthermore, BOGE refrigerant dryers generally require less refrigerant than similar models by other manufacturers, which also has a positive effect on the environment. Another advantage of the DS-2 series: the refrigerant circuit is hermetically sealed. This means that the mandatory testing stipulated in F-Gas Regulation EU 517/2014 is not required. Which, in turn, means that the refrigerant dryer not only offers environmental benefits, but financial ones too.



THAT'S THE TRUE MEANING OF **RELIABILITY**



EXPLORE THE BROAD RANGE OF NEW SULLAIR COMPRESSORS AT [SULLAIR.COM](http://SULLAIR.COM)

 **SULLAIR**<sup>®</sup>

A Hitachi Group Company

## Compressed Air Technology & Industry News



BOGE will be using refrigerant R 513A instead of R134a for its DS-2 series.

The F-Gas Regulation aims to reduce emissions from the industrial sector by 79% by 2030. One of its focal points is reducing the emissions of fluorinated greenhouse gases (F-gases) in the EU. A phase-down process is underway, whereby the fluorinated greenhouse gases emitted in the EU are to be reduced from 100% (based on the annual average from 2009 to 2012) to 21% by 2030. During the first phase, refrigerants with a GWP value greater than 2,500 have been prohibited since January 2020. In the second phase, F-gases with a GWP value over 750 may not be used from 2022; in the third phase F-gases with a GWP value above 150 must not be used from 2030. As refrigerant dryers fall into the category of stationary refrigeration equipment, special rules apply to them. For example, the refrigerants currently used must only have a GWP value below 2,500. However, by converting to R 513A, BOGE is getting ahead of the game and replacing the old refrigerant before it is legally obliged to do so. The regulation also stipulates if and how often the stationary refrigeration equipment must undergo a leak tightness test. Depending on the category, this ranges from quarterly to annually and can be costly. As BOGE DS-2 refrigerant dryers both feature a hermetically sealed refrigerant circuit and have a CO<sub>2</sub> equivalent below 10 t, they are not subject to mandatory testing.

The heavy-duty aluminum heat exchanger is highly efficient. The coolant circuit is also designed to the highest quality standards. Low losses together with a low coolant requirement means low operating costs that are unmatched. This makes the refrigerant dryers from the DS-2 series the most energy-efficient on the market compared to systems with the same flow capacity by other manufacturers. Conclusion: by converting to refrigerant R513A, BOGE has

**ASSURED AUTOMATION** We Make **Valve Automation** Easy!

### Compact, Fast-Acting, High-Cycle Switching Valves for Desiccant Dryers



**VA Series**



**Angle Valves**



**VAX Series**

Try Our **Easy to Use** Online **Valve Configurators**



**assuredautomation.com**



demonstrated its clear commitment to climate protection and sustainability. The approx. 60% lower global warming potential of its DS 4-2 to DS 100-2 refrigerant dryers speaks for itself. Moreover, operators will not have to compromise on performance. This means they can guarantee the future supply of compressed air of the highest quality.

**About BOGE Compressors**

*BOGE America is the USA based American subsidiary of BOGE KOMPRESSOREN Otto Boge GmbH & Co. KG based in Bielefeld, Germany. Whether for centrifugal compressors, screw compressors, high-pressure piston compressors, scroll compressors, controls, air treatment equipment, complete systems or individual devices, BOGE meets the most diverse requirements and highest standards – in a precise and customer-oriented manner. BOGE solutions are used by all sectors of industry to supply compressed air for a wide range of manufacturing processes. The USA Operations of BOGE America stock the various technologies of high-quality compressors and spares for immediate support. Compressed air systems are designed, sold and serviced through a dedicated network of over 50 distributors in North, Central, and South America. The USA Operations is also the "Center of Excellence" for Technical Trainings for our partners to ensure Top Level Support for the consumer. For more information, visit [www.boge.com/en](http://www.boge.com/en).*

**Gardner Denver Announces New Electra Saver G2 200-300HP**

Gardner Denver is excited to announce the release of the new Electra Saver G2 200-300HP compressors to its oil lubricated product portfolio. This release rounds out the introduction of the Electra Saver G2 products 75-300HP which have taken place over the last few years. Founded on slow-speed, 1800rpm design principles, the Electra Saver G2 products



The new Electra Saver G2 200-300HP compressors rounds out the introduction of the Electra Saver G2 products 75-300HP.



**Condensate Management—Engineered for Life**

Sales@cleanresources.com • 800-566-0402

## 30-Day Supply at all Times

Same or Next Day Shipping

\*Super-Pak units require a custom build—shipping is two weeks from the order date.



COMPRESSED AIR  
**BEST PRACTICES**  
airbestpractices.com



Learn from Leading  
Industry Experts  
**FREE\* Live  
Webinars**

Receive 1.0 PDH Credit by attending our Expert Webinars.

**Upcoming Webinars**

- **April 28, 2022:** Air Compressor Cooling, Water- or Air-Cooled? – Tom Taranto, Owner, Data Power Services
- **June 9, 2022:** Sizing and Maintaining Compressed Air Systems – Loran Circle, Senior Consultant, Circle Training & Consulting
- **June 23, 2022:** Compressed Air System Design for Lowest kW/100scfm – Tom Taranto, Owner, Data Power Services

\*Included with your free magazine subscription

**Get FREE Instant Access\* to Webinars >>>**  
<https://www.airbestpractices.com/webinars>

**Compressed Air Technology & Industry News**

build on the thousands of hours of reliability that were established by the first generation of these products more than two decades ago.

These new G2 compressor packages feature the legendary TurnValve (variable speed) technology, stainless steel control lines and enclosed/unenclosed options the Electra Saver is known for. The state-of-the-art Governor Controller and iConn module are also featured in these premium compressor packages for convenient control and monitoring. The Electra Saver G2 continues to be a staple in the market delivering best in class performance and efficiency with a strong reputation of quality and longevity.

**About Gardner Denver**

*Gardner Denver is a leading provider of mission-critical flow control and compression equipment and associated aftermarket parts, consumables and services, which it sells across multiple attractive end-markets within the industrial, energy and medical industries. Its broad and complete range of compressor, vacuum and blower products and services, along with its application expertise and over 160 years of engineering heritage, allows Gardner Denver to provide differentiated product and service offerings for its customers' specific uses. Gardner Denver supports its customers with sales, service and technical support through an extensive network of factory-trained and authorized local distributors. For more information, visit [www.gardnerdenver.com](http://www.gardnerdenver.com).*

**Nano Introduces Pneumatic Desiccant Dryer**

Suitable for use in any classified location where NEMA 7 explosion-proof controls are necessary or remote locations where power is either limited or unavailable, nano D<sup>213</sup> pneumatic desiccant air dryers provide clean,



nano D<sup>213</sup> pneumatic desiccant air dryer.

dry compressed air to the most challenging environments.

Pneumatically controlled, the dryers deliver compressed air purity in accordance with ISO 8573.1:2020, Class 2 dirt and Class 2 water (-40°F PDP). Featuring lower life cycle costs, low energy costs and simplified maintenance, the units come standard with pre and after filtration.

With a compact design allowing installation in spaces too small for a traditional dryer, applications include oil & gas rigs, land-based drilling rigs, lumber mills and explosion-proof areas.

*For more information, contact: nano-purification solutions at 704.897.2182, [marketing@n-psi.com](mailto:marketing@n-psi.com) or [www.n-psi.com](http://www.n-psi.com).*



**FS-Curtis Launches FS-SmartConnect IoT Monitoring**

FS-Curtis announced the new and improved IoT monitoring feature, the FS-SmartConnect. Providing customers with peace of mind, the FS-SmartConnect is changing the way data is tracked. This intuitive monitoring tool will ensure each compressor's system performance, efficiency, and health status are always being optimized. Unlike other monitoring systems, customers will have instant access to their compressor's performance via the Cloud, which will also provide warnings, scheduled maintenance, and customized reports to ensure a more reliable operation.

“SmartConnect represents a significant step for FS-Curtis and our distribution network. It opens the door for our compressors to become part of the smart facilities enabled by Industry 4.0, and consequently opens new doors for our Channel Partners. It not only provides insight into the operation, health, and energy efficiency of FS-Curtis compressors for end-users, but also provides a golden opportunity for the distributor to provide predictive maintenance and expand their footprint into these smart factories,” said Matthew Smith, Vice President of Channel Partner Sales.

The FS-SmartConnect will be available in three servicing options: SmartConnect Insight, SmartConnect Energy, and SmartConnect Premium, where the SmartConnect Insight will be offered as a free option for all compressors 60 HP and above. All three options will come

with customer access to the Cloud, mobile alerts, and FS-Curtis Technical Support as standard features and depending on the option selected will come with customized reports to show a full, in-depth analysis of the compressor's operation and performance.

We at FS-Curtis are excited to share this innovative technology and are committed to offering a world-class portfolio of products. Through the dependability of our employees and our quality-focused manufacturing, FS-Curtis will continue to be the most trusted and dependable name in compressed air, serving even more markets through our ever-growing global presence. For more information on FS-SmartConnect, contact one of your trusted channel partner managers today.

**About FS-Curtis**

*FS-Curtis is committed to offering a world-class portfolio of products. Through the dependability of our people and our quality-focused manufacturing, FS-Curtis will continue to be the most trusted and dependable name in compressed air serving even more markets through our ever-growing global presence. For more information find us online at [www.fscurtis.com](http://www.fscurtis.com).*

**Atlas Copco Appoints Chief Communications Officer**

Atlas Copco has appointed Sara Hägg Liljedal Senior Vice President, Chief Communications Officer and member of Atlas Copco's Group Management. Sara Hägg Liljedal joined Atlas Copco in February 2018 as Media Relations



FS-SmartConnect is changing the way data is tracked.

**CLEAN - RELIABLE - CONSISTENT**

**Protect the Quality of Your Processes, Components, & Products by Ensuring the Quality of Your Compressed Air**

**Desiccant & Refrigerated Air Dryers**  
0.40 - 3000 SCFM

*Pressure Dew Points  
Down to -100°F / -79°C*

*Available ISO 8573-1  
Filtration Class 1.2.1*

*Dry, Contaminant-Free Air  
When You Need It*

**1-800-521-5351**      **www.AltecAIR.com**

## Compressed Air Technology & Industry News



Sara Hägg Liljedal, Senior Vice President, Chief Communications Officer and member of Atlas Copco's Group Management.

Manager for the Group. Before joining Atlas Copco, she held several leading communication roles in both the private and public sector.

"I'm very happy to welcome Sara as the new Chief Communications Officer," said Mats Rahmström, President and CEO of the Atlas Copco Group. "She is an appreciated and engaged colleague with solid experience and strong capabilities. I look forward to having her on the team."

Sara Hägg Liljedal is a Swedish citizen, born in 1980. She has a degree in Journalism and Political Science from Stockholm University, Sweden. Cecilia Sandberg, who was appointed acting Chief Communications Officer, in addition to being Senior Vice President, Chief

Human Resources Officer, will resume her regular responsibilities.

### About Atlas Copco Group

*Our industrial ideas empower our customers to grow and drive society forward. This is how we create a better tomorrow. Atlas Copco is a global industrial group, founded in 1873 in Stockholm. In 2020 we had revenues of BSEK100 and at year end about 40,000 employees. For more information, visit [www.atlascopcogroup.com](http://www.atlascopcogroup.com).*

### Xebec Announces Succession Plan to Next Generation Leadership

Xebec Adsorption Inc. ("Xebec"), a global provider of sustainable gas technologies, announced that Kurt Sorschak will retire as Chairman, President and CEO effective May 12, 2022, at the company's 2022 annual meeting of shareholders. Jim Vounassis will concurrently be appointed President and CEO of Xebec. At the same time, Xebec's current VP Global Operations, Mike Munro, will assume the role of COO.

Mr. Sorschak will remain a member of the Board of Directors to enable a smooth transition and for Xebec to continue benefiting from his experience as the company's founder and alignment as a meaningful shareholder. This plan will ensure continuity while supporting management in executing the next phase of the company's strategic growth plan.

In preparation for this transition to new leadership, Mr. Vounassis and Mr. Munro joined Xebec in May 2021 as senior executives with a credible history in driving organizational performance.

Mr. Vounassis has a proven track record in leading global and complex organizations in meeting their transformational vision and

AST

APPLIED SYSTEM TECHNOLOGIES™

Complete high quality, high performance aluminum piping systems



goals. He was most recently COO at Bombardier Transportation, now part of Alstom, one of the world's largest rail equipment manufacturing companies. Mr. Vounassis was responsible for the operations aspects of the \$8 billion revenue business and empowered over 15,000 employees to deliver innovative rail solutions across global markets. Prior to this, he held executive positions at Pharmascience, Baker Hughes, and Pratt and Whitney.

Mr. Munro is an award-winning senior executive with a record in managing North American based businesses with strong expertise in business development, operations and strategic planning. With a longstanding career at GE in the Energy, Oil & Gas, and Power businesses, as Vice President and General Manager of several business units, Mr. Munro is highly recognized for his seamless approach in driving organizational transformation and establishing solid ground for turnarounds that heighten business performance.

“On behalf of Xebec’s employees, management team, and Board of Directors, I want to sincerely thank Kurt for his 18 years of dedication and service as President and CEO in which he oversaw Xebec become the cleantech success it has become today,” said Bill Beckett, Lead Director of the Board at Xebec Adsorption Inc. “Under Kurt’s leadership over the last almost two decades, the company has evolved from a small Québec-based manufacturing outfit to a global renewable gas player with thousands of customers, a physical presence across four continents and most importantly, a commercial ready technology portfolio to transition us to a clean energy future.”

“Xebec is launching off a solid foundation for its next leg of growth, and we are excited to see

Jim and Mike thrive in their new roles as they both ensure an orderly transition and prepare to leverage their experience as proven executives. The management team looks forward to building off the cleantech vision that Kurt instilled when he founded the company 2004,” he said.

“It has been an honor to serve Xebec as its first President and CEO,” said Kurt Sorschak, Chairman, President and Chief Executive Officer at Xebec Adsorption Inc. “I have really enjoyed my time helping the team execute our vision to build a worldwide sustainable gas technology leader that will make an impact in the fight against climate change. I look forward to supporting Xebec’s new leadership from the Board level and would like to thank all our employees, customers and investors

in their continued support throughout our journey,” he continued.

#### **About Xebec Adsorption Inc.**

*Xebec is a global provider of sustainable gas solutions used in energy, mobility and industrial applications. The company specializes in deploying a portfolio of proprietary technologies for the distributed production of hydrogen, renewable natural gas, oxygen and nitrogen. By focusing on environmentally responsible gas generation, Xebec has helped thousands of customers around the world reduce their carbon footprints and operating costs. Headquartered in Québec, Canada, Xebec has a worldwide presence with eight manufacturing facilities, thirteen Cleantech Service Centers and five sales offices spanning over four continents. For more information, visit [www.xebecinc.com](http://www.xebecinc.com).*



# Zero Operating Cost Instrument Quality Air

**SAHARA  
AIR PRODUCTS**

**Sahara Air Products**  
A Div. of Henderson Engineering Co., Inc.  
95 North Main Street  
Sandwich IL 60548  
800-544-4379 • 815-786-9471  
Fax 815-786-6117  
[www.saharahenderson.com](http://www.saharahenderson.com)

# Compressed Air Supports Growth at Roush Yates Manufacturing Solutions

By Mike Grennier, Compressed Air Best Practices® Magazine

*Roush Yates Manufacturing Solutions opened an 88,000-square-foot facility in Mooresville, North Carolina, as part of its strategic plan for strong growth.*

► One certainty about Roush Yates Manufacturing Solutions is this: It's in the midst of rapid growth. Another is their ability to manage growth, as well as the compressed air systems powering their operations.

Roush Yates Manufacturing Solutions' growth is evidenced by its strategic building plans. In 2018, it moved from a 30,000-square-foot plant to a newly built 88,000-square-foot, state-of-the-art manufacturing facility for the production of precision-machined parts – only to expand again this year with a new 55,00-square-foot manufacturing plant to outpace growing demand for its quality products. All three facilities are in Mooresville, North Carolina. Roush Yates Manufacturing Solutions is a division of Roush Yates Engines.

Todd English, Vice President of Business Development, Roush Yates Engines, said a key component to successful growth is to maintain peak production at all times, especially given the fast-paced world in which the company operates. Toward that end, the machining company has taken the necessary steps to equip its plants with compressed air systems designed to get the job done – while importantly – operating without the slightest cause for concern.

“I’ll say this politely. At the end of the day, we shouldn’t have to worry about compressed air, right? We’ve got more important things to worry about,” English said, adding how a recent partnership with Atlas Copco Compressors and other decisions associated with compressed air have hit the mark. “Without clean, compressed air we wouldn’t be able to complete our day-to-day activities. We’re relieved it’s something we don’t need to worry about.”

## A Winning History

Roush Yates Manufacturing Solutions ([www.roushyatesmfg.com](http://www.roushyatesmfg.com)) originally started

out machining high-performance engine components to support Roush Yates Engines ([www.roushyates.com](http://www.roushyates.com)), which was formed in 2003. That’s when Jack Roush and Robert Yates partnered with Ford Motor Company to serve as the exclusive Ford Engine Builder for NASCAR. The partnership resulted in as many as 420 combined wins in the NASCAR, International Sports Association (IMSA) and Federation Internationale de l’Automobile (FIA) Series.

Over time, Roush Yates Manufacturing Solutions parlayed its passion for CNC manufacturing excellence for race car engines into machining



*Among the precision components machined by Roush Yates Manufacturing Solutions are those used in Ford NASCAR engines.*



components for the aerospace, military, medical, and automotive industries. Diversification beyond race car engines alone has been pivotal to the company’s strategic growth, said English.

“In 2018, the majority of our work was really feeding our engine shop,” English said. “But business has dramatically shifted. Now, 90% of the work is external where we’re supplying parts for other high-tech industries. The growth has been fantastic, but it’s also been manageable.”

**Facility Operates 58 CNC Machines**

Roush Yates Manufacturing Solutions specializes in CNC machining of complex geometry parts that require precision and robust process control. Working 24 hours a

day, seven days per week, the company’s 100 employees leverage an array of advanced processes and technologies including four- and five-axis mills, automation centers, waterjets, and multi-axis mill turn, as well as Swiss turn machines. The company also offers post-machine surface, secondary treatment processes, and sub-series services through a network of validated suppliers.

The high-tech operation is AS 9100 Rev D certified, which meets the aerospace industry’s quality management system requirements. Its quality management system is also appropriate and effective for the safety and efficacy of medical devices given its ISO 13485 certification. Additionally, it is registered through the Department of State as a company

that adheres to International Traffic in Arms Regulations (ITAR) regulations.

In 2018, the new plant boasted a total of 26 CNC machines to meet production goals. Today, the same facility operates 58 CNC machines, all of which typically operate near maximum capacity to meet demand. In addition to diversification, English said dedication to quality has driven the company’s growth.

“Companies will typically send us a CAD drawing or print,” he said. “We then look at the part and determine the best way to machine it. From there, we’re responsible for all machining and the quality control, making sure we meet their expectations to print.”



**See Unipipe For Yourself!**  
Request a Demo Kit Today

**unipipe<sup>®</sup>**  
ALUMINUM PIPING SYSTEM

- Fast Installation
- No Special Tools Needed
- Pressures up to 1015 PSI
- 13 Pipe Sizes Available
- Exceptionally Secure Joints



UnipipeSolutions.com

**Seeking Distributors and Resellers Across the United States**

## Compressed Air Supports Growth at Roush Yates Manufacturing Solutions

### Compressed Air System Sized for Growth

Originally, the 88,000-square-foot plant's compressed air system consisted of two, 50-horsepower (hp) Atlas Copco GA 37 VSD+ FF rotary screw air compressors. Each Variable Speed Drive (VSD) air compressor is rated to deliver up to 240 scfm of air at 102 psig.

One air compressor would operate at approximately 70% to satisfy the plant's load during normal operation and the initial years of production. The second air compressor

served primarily as a backup machine, given the importance of full redundancy. As the plant began to add CNC machines, however, the second machine operated more often to meet increased demand for air. As needs for air grew, plans took shape for additional compressed air capacity.

To develop a plan for additional air – and meet the plant's need for clean and dry air – the team at Atlas Copco Compressors ([www.atlascopco.com/air-usa](http://www.atlascopco.com/air-usa)) conducted a full assessment of the plant's compressed air use and analyzed how much air the facility

consumes and when – with an eye toward continued increases in production and demand for air.

Armed with data, the Atlas Copco team recommended the installation of two, 100-hp Atlas Copco GA 75 VSD+ FF rotary screw air compressors to replace the smaller, 50-hp machines. The smaller machines are earmarked for use at a Roush Yates Engines facility. Each 100-hp air compressor is rated to produce up to 540 scfm of air at 110 psig, effectively meeting the plant load – and allowing the second unit to provide full redundancy. As VSD units, the air compressors automatically adjust to deliver only the air needed for optimal efficiency.

### Clean, Dry Air Needs Met

Roush Yates Materials Solutions Building Supervisor Jeff Smith said the new air compressors provide an ample amount of air today and well beyond, noting his appreciation for an appropriately sized compressed air system.

“We’re not compressed air people. We’re good at machining parts and building engines,” Smith said. “Atlas Copco did a lot of legwork to help us decide what we need now and for future growth. Those guys did a really good job helping us out with that.”

As with the original air compressors, the 100-hp machines feature integrated refrigerated dryers rated to provide air at a Pressure Dew Point (PDP) of 36°F (2.2°C). The system also includes a 400-gallon dry receiver tank, as well as DD+ and PD+ oil-coalescing filters and an EWD 50 zero-loss drain. Each CNC machining center at the plant is also equipped with a dedicated refrigerated dryer to meet the individual machine's PDP specification. An aluminum piping system routes air throughout the plant.



Advanced CNC machines are at the heart of Roush Yates Manufacturing Solutions' operations.



Roush Yates Engines relies on Atlas Copco Compressors to power their manufacturing and engine build facilities.



The compressed air system’s ability to consistently provide clean, dry air – at the proper volume and pressure – is vital to Roush Yates Materials Solutions ongoing success, said Smith.

“If there is moisture of any kind in the air, it’s going to corrode the CNC machines’ solenoid valves and measurement scales,” adding proper air pressure is equally important. “Every machine requires whatever the OEM says it needs for compressed air. If we drop below that pressure, the machine will alarm out. We’ve got to have the correct compressed air volume, psi and cleanliness at every machine.”

for compressed air, Atlas Copco Compressors also maintains the system. Yet another measure that eliminates concerns regarding compressed air, said English.

“We’ve built with Atlas Copco since 2018 and there’s a lot of trust there,” he said, noting Atlas Copco Compressors is working with the company to install a compressed air system at the newest facility.

English said the team at Roush Yates Materials Solutions is proud of the company’s growth and appreciates the ability to work with business partners on the challenges that go with it. He expects the path of ongoing success to continue.

“We’re very bullish on the future and we’re excited about the opportunities in front of us,” English said. “The future looks very bright.” **BP**

All photos courtesy of Roush Yates Manufacturing Solutions.

**Bullish on the Future**

In addition to designing a system capable of meeting Roush Yates Materials Solutions’ goals

To read similar *Automotive Industry* articles, visit <https://www.airbestpractices.com/industries/auto>



For expert presentations, visit our Webinar Archive Section dedicated to *Air Compressor Technology* at <https://www.airbestpractices.com/magazine/webinars>

# Setting the standard since 1854



Howden manufactures the world-renowned Roots™ rotary positive displacement blowers and centrifugal compressors in Connersville, IN and Springfield, MO.

Designed and fabricated to unique applications within a wide array of industries including pneumatic conveying, gas separation, wastewater treatment, steam compression, and petrochemical production. Maintain optimized production levels with Howden factory maintenance and repair services available worldwide.



Universal RAI Bi-lobe Blower



RGS-J Gas Compressor



Centrifugal Compressor



TRI-NADO™ Tri-lobe Exhauster



EasyAir™ Rotary Factory Blower packages

For more information contact:

Tel: 1 800 55 ROOTS (76687) | Email: [inquiries.USA@howden.com](mailto:inquiries.USA@howden.com)

**Revolving Around You™**



## Show Report: The 2022 IPPE

By Roderick Smith, Publisher, Best Practices Magazines

► The 2022 International Production & Processing Expo (IPPE), was held January 25-27, 2022 in Atlanta with more than 500,000 square feet of exhibit space and 1,140-plus exhibitors. Attendee numbers had not been released when this was written. Sponsored by the U.S. Poultry & Egg Association, American Feed Industry Association and the North American Meat Institute, IPPE is the world's largest annual poultry, meat and animal food industry event of its kind.

"In one word, our business has been strong," said a 32-year exhibitor at IPPE, reflecting the sentiment expressed by many.

"We are pleased with the excitement displayed by this year's attendees and exhibitors and their enthusiasm in reconnecting with their colleagues from around the world. The trade show floor and attendee and exhibitor numbers continue to complement IPPE's unparalleled education sessions, invaluable

networking opportunities and extensive exhibits highlighting the latest innovative technology, equipment and services for our industries," remarked the three organizations.

The large trade show floor remains the central attraction. Numerous companies are showcasing their new products at IPPE, with all phases of the animal food, meat and poultry industries represented, from live production and processing to further processing and packaging.



**Booth Visits: Wash-down Motors, Drives and Vacuum Egg Lift Systems**

I visited the booth of Kuhl Corporation to examine their “SPEED VAC” Osuva Vacuum Egg Lift System. The product literature states, “one operator can handle 1,000 to 1,400 dozen eggs per hour depending on type and size of case used.” The OSUVA systems feature an overhead suspension system with different vacuum pump model and size options along with the necessary vacuum lift accessories to connect to up to four “head assemblies”. The head assembly is a lifter assembly with suction cups able to safely lift and transport up to 30 eggs. Three vacuum pump configurations, using the Thomas Piccolino model, are offered and are able to operate one to four “heads”, with multiple options including filters, pressure gauge, relief valve, tanks and tank drains.

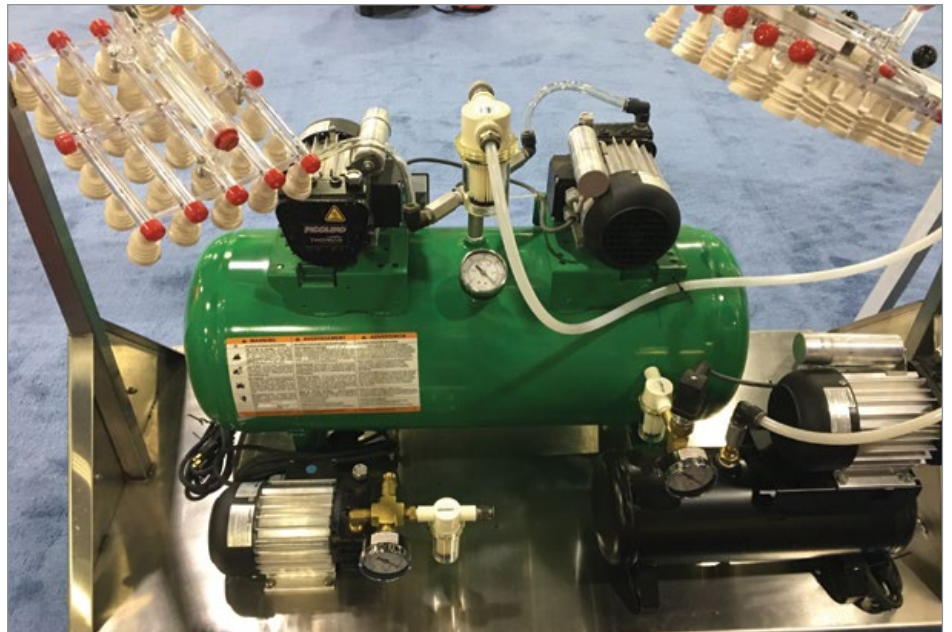

*A display of three different types of vacuum pumps used to power the Kuhl Vacuum Lift Systems used to safely and efficiently transport eggs. Hanging above the pumps are the egg lifter head assemblies.*

At the WEG booth, I was shown the Hydroduty IP69K washdown application motor manufactured in the former Franklin Electric plant in Bluffton, Iowa. The EZ Connect system is unique and considered a top feature on the motor. It is suitable for 460 and 230 V operation and TEFC with a multi-mount terminal box. It is also TENV with the conduit box on “Opposite Drive End” allowing for cleaner installation.

At the ABB booth, Dave Felt was kind enough to review their EC-Titanium unit featuring an integrated motor and drive configuration. Manufactured in Fort Smith, Arkansas, there are two different configurations/models covering 30 hp and below applications. The efficiency rating is IE5.



# LONE STAR

## BLOWER AND COMPRESSOR

# RENTALS

- Air, Gas, Pressure, Vacuum • Emergency (24/7)
- Drop-In Replacements • Rent-to-Own, Leases
- Remote Monitoring • Custom Solutions
- Complete Packages • PLC Controls w/Starters

[www.LoneStarTurbo.com](http://www.LoneStarTurbo.com) • 832-532-3112



**WE ARE ALWAYS LOOKING FOR INDUSTRIAL REPS**



## Show Report: The 2022 IPPE



### Booth Visits: Food Safety and Software for Safety Audits

The larger booths featuring all the food processing automation equipment were of course (who isn't?) talking about their "IIoT" Industrial Internet of Things solutions to increase productivity, reliability and efficiency. At one booth I asked them how they are monitoring quality with their IIoT solutions. One major OEM said that if a customer wants to add on "Quality Audits" to the solution, they were "bolting-on" a software solution from a firm called SafetyChain – so off I went to their booth.

I had a great visit at the SafetyChain booth speaking with and learning from poultry

Brandon Cook showing the WEG Hydroduty motor with EZ Connect technology.



# BEST PRACTICES

2022 EXPO OCTOBER 4-6 ATLANTA  
COMPRESSED AIR / VACUUM / COOLING

**ON-SITE UTILITY**  
Education, Certification  
and Networking!

## Four Reasons to Send the Team to the EXPO!

Projects get done by sales engineers working with engineering firm and manufacturing personnel. Affordably priced at only \$25 per person, the EXPO is designed to motivate the whole team!

Network, solve problems and view the latest technologies from leading global manufacturers! Technologies include: air compressors, compressor automation software, compressed air dryers, filtration, aluminum piping & storage, flow/pressure/dew point meters, leak detectors, motors & drives, nitrogen generation, chillers, water treatment, cooling towers, blowers and vacuum pumps.

**#1. New Technology EXPO**

**#2. New Technology EXPO Classroom**

**#3. Daily EXPO \$1,000 Energy Treasure Hunt RAFFLE!**

**#4. Two Catered Networking Events**

Register at [cabpexpo.com](http://cabpexpo.com)

Sponsored by



Exhibition Booth Inquiries: [bill@airbestpractices.com](mailto:bill@airbestpractices.com)



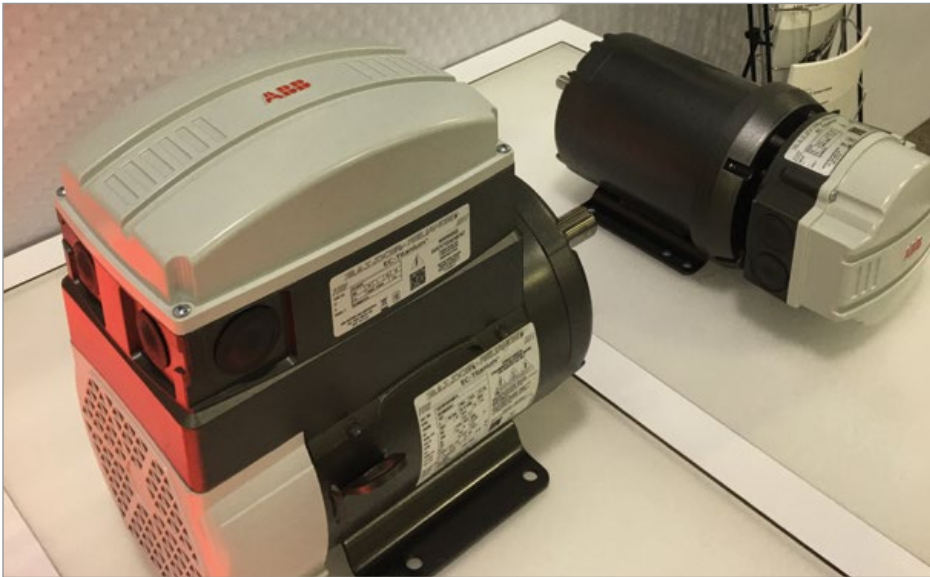

The two ABB EC-Titanium units featuring an integrated motor and drive.



Dustin Cheatham at the SafetyChain booth.

industry veteran Dustin Cheatham. By the way, do you know what a “broiler” is? I can rest easy now having learned to properly refer to that type of chicken. Anyways, Dustin explained that firms like Chick-fil-A are very demanding on their suppliers when it comes to Quality and Quality Audit Systems. I was personally pleased to hear this! He went on to say it’s not unusual

for them to demand Safety Audit Reports, on a slew of quality metrics, once per week, per production line, per plant.

Referencing Tyson as a major client, Dustin showed me the SafetyChain Quality Management Software (QMS) and the Environmental Health & Safety (EHS) package.

# Filtration

For Every Application



From applications with standard conditions to those with high temperature and high pressure ratings, ZEKS filtration solutions make delivery of high quality compressed air possible. Contact your local ZEKS Distributor to learn more.

**ZEKS**  
COMPRESSED AIR SOLUTIONS<sup>®</sup>  
1302 Goshen Parkway  
West Chester, PA 19380  
Phone: 800-888-2323

Sales And Service Through  
Authorized Distributors Located  
Across North America.

[www.zeks.com](http://www.zeks.com)

## Show Report: The 2022 IPPE

The former focuses on program management for compliance with third-party certifications like ISO, GFSI, SQE, FSSC, BRC and HACCP. I thought an interesting comment he made was that in the poultry industry, SQE is used by more than half of the firms with BRC being the second-most used quality system used.

I asked Dustin, who is a specialist in the poultry and protein market, if compressed air, pneumatic conveying blower air, vacuum or cooling water quality is ever integrated into the quality reporting systems he's worked on and he said "no". He said he was familiar with these on-site utilities and that it would be simple to add some folders to their QMS software to monitor quality metrics for these plant utilities.

### Vacuum, Cooling, Compressed Air: Quality is the Responsibility of the Plant

The OSSID booth was quite large and I zeroed in on their E40 REEPACK Line featuring a built-in chiller, a built-in vacuum pump and compressed air powered vacuum venturis for the suction cups. Service technicians at the booth told me the closed-circuit chiller provides cooling water at room temperature for the seal bars and reduces water use for clients. The rotary vane vacuum pump powers the vacuum seal and wrap process and the compressed air was "prepared" by an inlet filter and pressure regulator.

I asked the OSSID technicians if the machine had a compressed air quality specification

and they said they tell clients the units require "clean, dry compressed air" and that compliance is the responsibility of the plants where they place their machines. I want to note that as far as I could tell, compressed air did not enter into direct contact with food in this OSSID machine.

It makes sense that compressed air quality should be the responsibility of the plant, since the plant owns and operates the system. Yet, if a machine is designed to package food, and compressed air enters into direct or indirect contact with food, shouldn't it have an alarm function (like a compressed air dew point monitor) to ensure no moisture (water or oil) is entering into contact with the food? This train of thought made me think of that old article I wrote titled, "Oil in the Wurst." I wonder if anybody remembers that story?

The Cryovac booth had vacuum pumps on prominent display with both a Busch R5 RA 0840Plus and an Atlas Copco GHS 900 VSD+. The firm is placing a major emphasis on IIoT solutions and monitoring of all key performance indicators.

Schmalz is making real inroads with ergonomic handling systems. Focusing on worker safety and health, these systems move goods weighing up to 660 lbs (300 kg) quickly and safely. Using a vacuum tube lifter, workers can move cardboard boxes, bags, barrels, wooden boards, packaging and a variety of other applications. The team explained they have moved towards on-board vacuum pumps to power the tube lifter or suction cups – and have moved almost entirely away from compressed air powered vacuum venturi systems. **BP**

## Host a CAC L1 Training ONLINE TODAY

Interested in hosting the Fundamentals of Compressed Air Systems (L1) training online? CAC instructors are now able to provide the L1 training online! Contact us today to get your training scheduled! CAC will work with hosts to identify dates, times and available instructors.

Like the popular in-person class, the web-based workshop is designed to teach facility engineers, operators, and maintenance staff how they can achieve 15-25 percent cost savings through proper operation and controls, system maintenance, and appropriate uses of compressed air. Both the in-person and web-based classes utilize the same basic content and adhere to the CAC's principles of product-neutrality and a focus on the systems approach to managing compressed air.

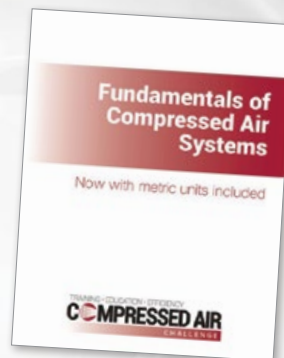

For more information, please contact CAC Executive Director, Tracey Kohler at [tkohler@compressedairchallenge.org](mailto:tkohler@compressedairchallenge.org).

TRAINING • EDUCATION • EFFICIENCY  
**COMPRESSED AIR**  
CHALLENGE

/CACKnowPressure

/company/compressed-air-challenge

/CACKnowPressure





The OSSID E40 REEPACK Line featuring a built-in chiller, vacuum pump and compressed air powered vacuum venturis for the suction cups.

**ABOUT IPPE**

The International Production & Processing Expo (IPPE) is a collaboration of three shows – International Feed Expo, International Meat Expo and the International Poultry Expo – representing the entire chain of protein production and processing. The event is sponsored by the American Feed Industry Association (AFIA), North American Meat Institute (NAMI) and U.S. Poultry & Egg Association (USPOULTRY).

**ABOUT AFIA**

Founded in 1909, the American Feed Industry Association (AFIA), based in Arlington, Va., is the world's largest organization devoted exclusively to representing the business, legislative and regulatory interests of the U.S. animal food industry and its suppliers. The organization's membership is comprised of more than 650 domestic and international companies that represent the total feed industry – manufacturers of commercial and

# Don't Get Left Behind – Get Certified!

Are you an expert in the compressed air industry? Holding the status of being a Certified Compressed Air System Specialist demonstrates that you have the knowledge and expertise in compressed air systems that sets you apart and gives confidence to the customers you serve.

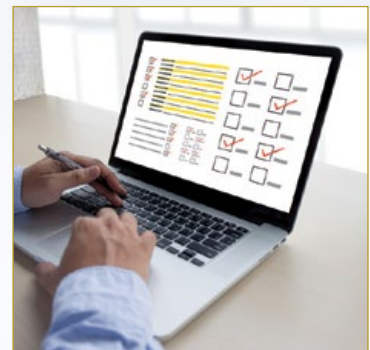

Take the exam and get certified. Learn more and find how to get certified at the Compressed Air & Gas Institute's (CAGI) website:

[www.cagi.org/personnel-certification](http://www.cagi.org/personnel-certification)



## Show Report: The 2022 IPPE

integrated feed and pet food, ingredient suppliers, pharmaceutical companies, industry support and equipment manufacturers. AFIA's members manufacture more than 75% of the feed and 70% of the non-whole grain ingredients used in the country. AFIA is also recognized as the leader on international industry developments and holds membership in the International Feed Industry Federation (IFIF).

### ABOUT NAMI

The North American Meat Institute (NAMI) is the leading voice for the meat and poultry industry. Formed from the 2015 merger of the American Meat

Institute (AMI) and North American Meat Association (NAMA), the Institute has a rich, century-long history and provides essential member services including legislative, regulatory, scientific, international and public affairs representation. NAMI's mission is to shape a public policy environment in which the meat and poultry industry can produce wholesome products safely, efficiently and profitably. Together, the Institute's members produce the vast majority of U.S. beef, pork, lamb and poultry and the equipment, ingredients and services needed for the highest quality products.

### ABOUT USPOULTRY

U.S. Poultry & Egg Association (USPOULTRY) is the All Feather Association progressively serving its poultry and egg members through research, education, communications and technical services. Founded in 1947, USPOULTRY is based in Tucker, Georgia.



The Cryovac booth had vacuum pumps on prominent display with both a Busch R5 RA 0840Plus and an Atlas Copco GHS 900 VSD+.



The team at Schmalz next to an ergonomic handling system.

To read similar **Food Industry** articles visit  
<https://www.airbestpractices.com/industries/food>



Visit our Webinar Archives to listen to expert presentations on **Compressed Air Systems** at <https://www.airbestpractices.com/magazine/webinars>





**#1 Manufacturer of  
Automation Components**

*For Industrial Automation*

High precision temperature control for every industry

# Temperature Control Equipment



- Floor mount and Rack mount styles
- Refrigerant and Peltier models
- Temperature Stability:  $\pm 0.01^{\circ}\text{C}$  to  $\pm 0.1^{\circ}\text{C}$
- Air cooled / Water cooled
- Voltages: 110VAC / 230VAC / 460 VAC
- Cooling Capacity: 200W to 28KW

*Providing Sustainable, Energy Efficient and CO<sub>2</sub> Reducing Components for Industrial Automation*

**SMC Corporation of America** 800-762-7621  
**SMC Automation Canada Ltd.** 800-762-7621  
Email: [sales2smcusa.com](mailto:sales2smcusa.com)



[www.smcusa.com](http://www.smcusa.com)  
[www.smcautomation.ca](http://www.smcautomation.ca)



# Energy Saving and Air Changes

By Raul Simonetti, HVAC/R Corporate Business Manager, Carel Industries

► Current ventilation guidelines recommend maintaining ventilation with 100% outdoor air 24/7, or as much as possible if that is not feasible, as an effective way to keep airborne pathogen concentration under control. Obviously, outdoor air needs to be filtered and conditioned to guarantee the indoor temperature and humidity set points; this, in turn, implies a higher HVAC-related primary energy consumption, because more outdoor air needs to be conditioned compared to the pre-COVID-19 situation, when the flow of outdoor air was typically 20% of the total supply air entering the space.

Is it possible then to minimize primary energy consumption to reasonable levels, and even to values that are similar to the pre-COVID-19 situation?

It appears so, based on simulations carried out in four different European climates: Athens, Berlin, Madrid, and Milan.

In order to save energy, recovering as much as possible from the exhaust air is of paramount

importance. Therefore, a heat exchanger between the exhaust and the supply air flows is a big plus in the AHU used to simulate the four cities.

Evaporative cooling, both direct and indirect, helps to reduce the energy consumption related to cooling.

Modulation of all devices in the AHUs (coils, evaporative coolers, blowers, etc.) brings an additional advantage, as operation of the devices is modulated so as to provide no more than necessary, i.e. exactly the required heating/cooling, or the supply air flow based on actual occupancy.

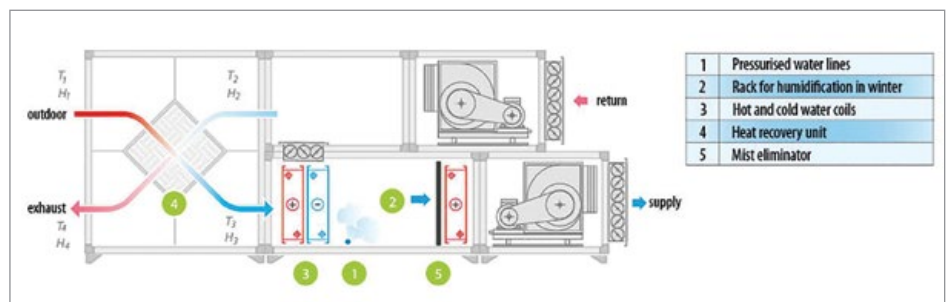

Figure 1. Pre-pandemic scenario.

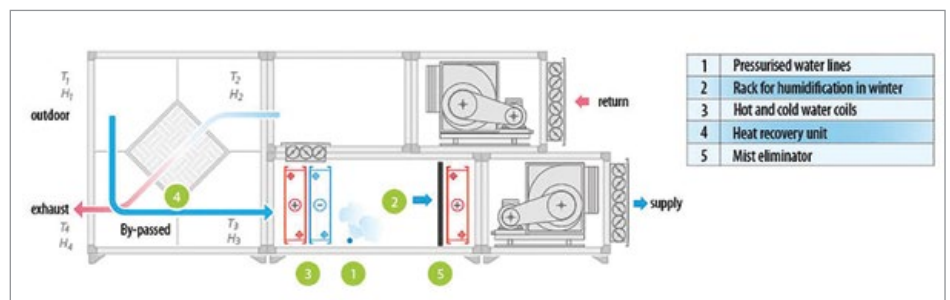

Figure 2. Pandemic scenario.



The AHU used in the simulation is illustrated in the following three images. The AHU is the same; what differs is the way the supply air is generated:

- Pre-pandemic scenario: ventilation is on duty 12 hrs/day; supply air (constant flow) is composed of outdoor air (20%) and recirculated air (80%); humidification is by steam (electric); the heat exchanger is not bypassed; no indirect evaporative cooler is installed.
- Pandemic scenario: ventilation is on duty 24/7; supply air (constant flow) is composed of **100%** outdoor air; humidification is by steam (electric);

the heat exchanger is bypassed as per ventilation guidelines; no indirect evaporative cooler is installed.

- Post-pandemic scenario: ventilation is on duty 24/7; supply air (**variable** flow) is composed of 100% outdoor air; humidification is by direct evaporative cooler; the heat exchanger is not bypassed and it is assumed there is no cross-flow contamination; an indirect evaporative cooler is installed and running.

**Pre-pandemic scenario (Figure 1)**

- Air flow  $Q = 31,600 \text{ m}^3/\text{h}$
- Heat recovery  $\zeta = 73\%$  sensible, bypass on/off

- Isothermal humidification from electrical source
- Percentage of outside air = 20%
- Percentage of recirculated air = 80%
- Constant air flow management (CAV)
- Operation 12 hours/day

**Pandemic scenario (Figure 2)**

- Airflow  $Q = 31,600 \text{ m}^3/\text{h}$
- By-passed heat recovery
- Isothermal humidification electric source
- Percentage of Outside Air = 100%
- Percentage of Recirculated Air = 0%
- Constant airflow management (CAV)
- Operation 24 hours/day



# First-Class Service & Global Support

You deserve nothing less than the best and EVAPCO offers it all!



Top Quality Products



Best Lead Times in the Industry



Great Customer Service

## Energy Saving and Air Changes

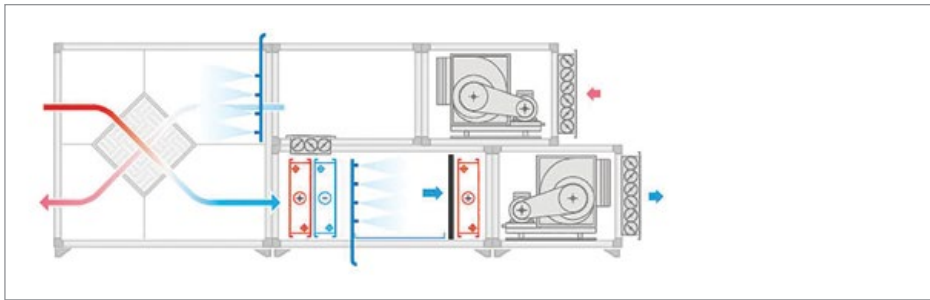

Figure 3. Post-pandemic scenario.

### Post-pandemic scenario (Figure 3)

- Air flow  $Q = 31,600 \text{ m}^3/\text{h}$
- Heat recovery  $\zeta = 73\%$  sensible, bypass modulating
- Adiabatic humidification
- Percentage of outside air = 100%
- Indirect evaporative cooling with heat recovery unit dampening
- Percentage of recirculated air = 0%
- Variable air flow management (VAV)
- Operation 24 hours/day

### In all four cities, the simulations generate similar results:

- Pre-pandemic scenario: baseline.
- Pandemic scenario: there is a large increase in primary energy consumption, as the amount of outdoor air to be conditioned increases from 20% in the pre-pandemic scenario to 100%.
- Post-pandemic scenario: primary energy consumption is reduced dramatically compared to the pandemic scenario, reaching values similar to those in the pre-pandemic situation, due to modulation, heat recovery and evaporative coolers.

Once the current pandemic is over, we will return to normal. Yet, depending on the climate, it will be possible to have ventilation with 100% outdoor air, but with primary energy consumption close to the pre-pandemic scenario; and the same will be true for running costs. This will be possible thanks to fully-modulating ventilation systems, with energy recovery, evaporative coolers, and control and monitoring systems capable of getting the most from the devices they drive. **BP**

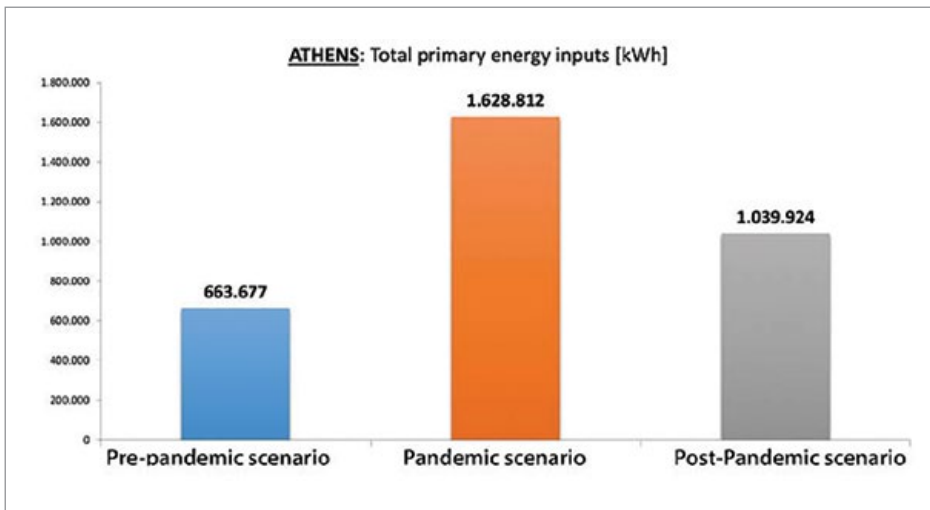

Simulation of primary energy requirements in the three AHU configurations for the climatic conditions in the city of Athens.

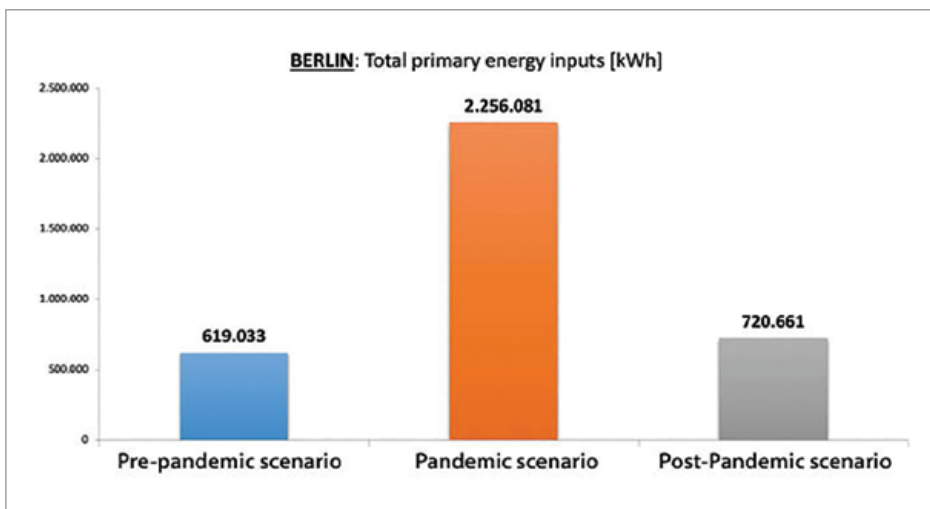

Simulation of primary energy requirements in the three AHU configurations for the climatic conditions in the city of Berlin.



**About the Author:**

Raul Simonetti joined CAREL INDUSTRIES S.p.A. in 2000 as a Product Specialist for humidification. He dealt with sales support and training for several years, making presentations at specialist events.



**Raul Simonetti**

Following a period as Application Manager at the Climate Business Unit (humidification and evaporative cooling systems), since 2014 he has been HVAC/R

Corporate Business Manager for all CAREL businesses. His role involves active participation as CAREL's representative at ASHRAE Conferences in USA; he is also directly involved in associations that represent the industry in dealings with the institutions, either directly (via EPEE and EUROVENT in Europe) or indirectly through other colleagues (EUROVENT again, AHRI in USA, CRAA in China).

**About CAREL INDUSTRIES S.p.A.**

CAREL is a world leader in control solutions for air-conditioning, refrigeration and heating, and systems for humidification and evaporative cooling. Our products are designed to bring energy savings and reduce the environmental impact of machinery and systems. Our solutions are used in commercial, industrial and residential applications.

Founded in 1973, in 2020 CAREL had a turnover of more than 331 million euros, with over 1700 employees, 29 subsidiaries and 9 production sites, in addition to partners and distributors in a further 75 countries. Research & Development are the heart of our commitment. A total of approximately 6% of consolidated sales is regularly reinvested in Research & Development, in order to anticipate

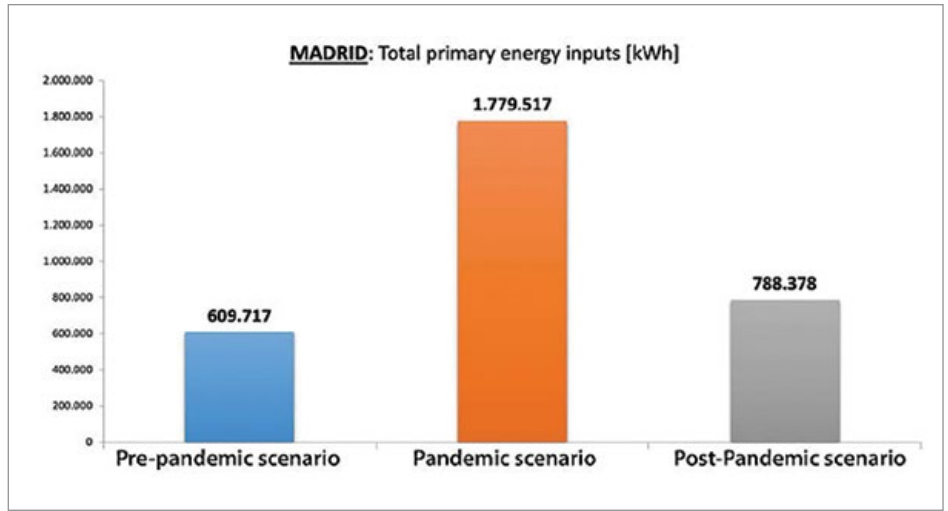

Simulation of primary energy requirements in the three AHU configurations for the climatic conditions in the city of Madrid.

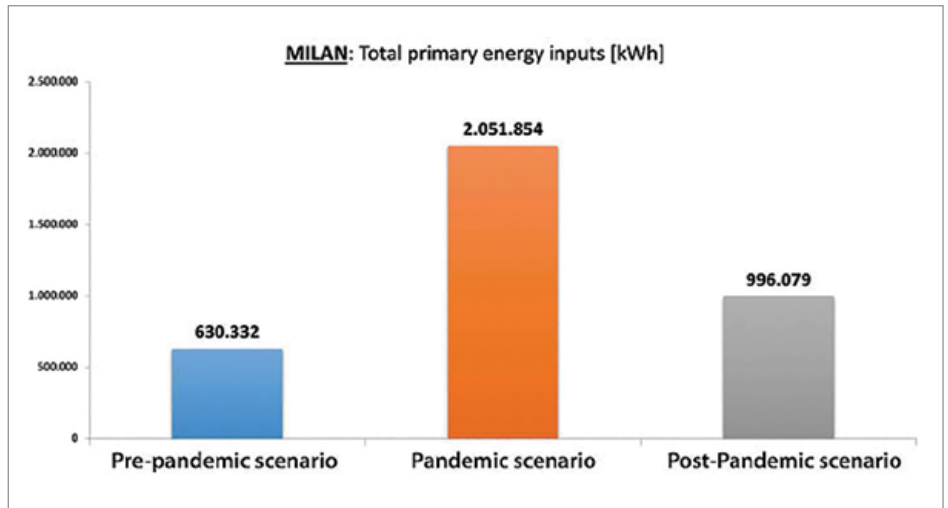

Simulation of primary energy requirements in the three AHU configurations for the climatic conditions in the city of Milan.

customer needs and supply advanced solutions. CAREL also operates two research laboratories, one focused on thermodynamics and the other

on humidification, true points of excellence in their respective fields.

To read similar **Cooling System** articles visit <https://coolingbestpractices.com>



Visit our Webinar Archives to listen to expert presentations on **Chiller Technology** at <https://coolingbestpractices.com/magazine/webinars>

# Chiller & Cooling Tower Technology Win Big at 2022 AHR Expo

By Bill Smith, Chiller & Cooling Best Practices Magazine

► The 2022 AHR Expo co-sponsored by ASHRAE and AHRI was held Jan. 31 – Feb. 2, at the Las Vegas Convention Center. A total of 1,573 exhibitors (281 international) spread out over 440,000 square-feet, and 80 free sessions in the Education Program drew more than 30,000 attendees to the event. Common trends discussed amongst exhibitors focused on energy efficiency, operational reliability, connectivity and new chiller refrigerant transitions spurred by approaching regulatory transition dates in the AIM Act enacted by US Congress in late 2020. This report focuses on select chiller, heat pump, cooling tower, refrigeration compressor, motor, hydronic pump and instrumentation technology on display at the 2022 AHR Expo for process cooling and commercial HVAC systems.

## Compressors and Refrigerants

Honeywell manufacturers modern refrigerants for centrifugal, screw and scroll compressors installed in chillers. Sunita Rai Singh, Honeywell Performance Materials and Technologies General Manager, Fluorine Products was present discussing Honeywell's hydrofluoroolefin (HFO) and HFO blend refrigerants offering for new equipment. For centrifugal chillers, Honeywell offers its Solstice zd (R-1233zd, HFO), a nonflammable replacement for R-123 with a global warming potential (GWP) of 1. For screw chillers, Honeywell offers three Solstice refrigerants – 513A (R-513A, HFO), N15 (R-515B, HFO blend) and ze (R-1234ze, HFO blend). Lastly, for scroll chillers, Honeywell again offers three Solstice refrigerants – 454B (R-454B, HFO blend), N15 and ze.

The new Danfoss Turbocor VTCA400 Compressor won the 2022 AHR Expo Innovation Award for product of the year – Cooling category. The Danfoss Turbocor VTCA400 is an oil-free, two-stage, variable speed, magnetic bearing centrifugal compressor, utilizing a hybrid compression design for use with low-GWP refrigerant R-1233zd. The patented hybrid compressor design uses a mixed flow impeller with both axial and radial components in the first stage, while the second stage impeller uses a radial design. This hybrid design allows for a compressor footprint that is half the physical size and weight of a conventional radial-only design,



Informational session on Solstice N<sub>15</sub> (R-471A, HFO blend) occurring at the Honeywell booth.



while reducing costs and allowing chiller OEMs to integrate multiple compressors for redundancy. The VTCA400 has a nominal capacity of 400 TR/1,400 kW and is designed for water-cooled chiller applications.

**Chillers & Heat Pumps**

Carrier brought three large chiller models to the show. First, a 600-ton model (capacity range: 300-700 tons) of its all-new AquaEdge 19MV Centrifugal Chiller available with R-513A or R-134a. The 19MV achieves <0.52 kW/ton and <0.31 kW/Ton integrated part load value (IPLV) at AHRI conditions. Carrier’s EquiDrive two-stage, back-to-back, magnetic bearing centrifugal compressor provides “More Operating Range” (MORe), allowing the 19MV to take advantage of cold condenser water, chiller water reset and other energy-saving practices. Also displayed was a similar unit with a lower pressure refrigerant, R-1233zd(E), the AquaEdge with Greenspeed 19DV Water-Cooled Centrifugal Chiller with VFD and free cooling capability. Lastly, Carrier’s 30XV Variable Speed Air-Cooled Screw Chiller on display is available with R-134a, and has a



Frank D. Ford, P.E., and Eddie Rodriguez, Danfoss Turbocor Compressors (left to right).

capacity range of 140-500 nominal tons. Typically, Carrier’s waterside economizer for free cooling is installed as a separate module, versus a stacked coil arrangement.

aee<sup>®</sup> ENERGY CONFERENCE & EXPO

**West**

aewest.org

**June 15-16, 2022**

Washington State Convention Center | Seattle, WA

Delivering **Energy Efficiency** for **Strategic Impact**

**PSE** PUGET SOUND ENERGY  
Event Host

## Chiller & Cooling Tower Technology Win Big at 2022 AHR Expo



Tom Franaszek with the Carrier AquaEdge 19MV Centrifugal Chiller.

Mikropor was present at AHR displaying its atmospheric air filtration products, its Mia Air indoor air purifier and its MCHILL-US Series Water Process Chillers. The MCHILL's cooling capacity ranges from 2–73 tons, is available in air- and water-cooled designs, comes standard with a 45 psi water pump (75 psi optional) and operates with R-410A. It's equipped with a hermetic scroll compressor, aluminum microchannel refrigerant condenser, brazed plate stainless steel evaporator, variable speed EC fan motor, cold water storage tank and several customizable features. Designed for the global market, this chiller can operate efficiently in the highest ambient temperatures, while maintain noise levels below 80 dBA across the product range. The MCHILL is designed for long list of mission-critical process cooling applications across many industries.



Ken Schiefer, Ryan Loeffler, Nitin Shanbhag and Jeff Thibodeau at the Mikropor booth (left to right).

This year, Daikin Applied is introducing a WMT magnetic bearing centrifugal chiller with low-pressure and low-GWP HFO refrigerant R-1233zd (E). The compressor's motor is installed between the first- and second-stage impellers to mitigate thrust loads. "Once we launch it, this will be the most efficient chiller in the market with the smallest footprint," said Arthur Rizoli, Director of Centrifugal Products, Daikin Applied Americas. One unique reliability feature in this product called RideThrough, was designed to maintain cooling capacity in the event of a facility power outage. Since most generators take 15 seconds to kick in, Daikin designed the WMT to maintain cooling capacity for 17 seconds while the generator is turning on, so mission critical facilities maintain uninterrupted cooling.



Arthur Rizoli with Daikin Applied's virtual reality chiller display.

On display at the Multistack booth was an assortment of its combination chiller and heat pump units. First, an MSF\_H Water-Cooled Dedicated Heat Recovery Chiller (DHRC) MagLev flooded with R-515B refrigerant (pictured below), equipped with oil-free, magnetic bearing, high-lift centrifugal compressors deliver peak energy efficiency at heat recovery conditions. Next, an ARZ Air-to-Water Modular Scroll Heat Recovery with Multi-Mode Source/Sink unit available in R-410A (in transition to R-454B) was displayed. To produce hot water, the ARZ has the capability to source heat from ambient air or geothermal bore fields. This multi-mode source/sink technology allows the users to source heat based on highest efficiency. Lastly, a 60-ton MSH\_VY DHRC Scroll Modular with R-454B refrigerant was on display equipped with fixed speed and True-Variable speed scroll compressors. "Something we do very well, is we are great listeners. A lot of our product development centered around electrification is a result of interacting with customers. *Customer Driven*



*Innovation* is something we take very seriously,” said Scott Degier, Vice President of Sales, Multistack.

On display at the Johnson Controls (JCI) booth was the YORK YVAA Variable Speed Air-Cooled Screw Chiller. Available with R-134a or R-513A, a capacity range of 150-500 TR, the YVAA is driven by screw compressors designed and manufactured by JCI. It’s apparent JCI is evolving with the trends in today’s HVAC industry. “We are trending towards HVAC systems that require less power in more compact physical footprints, systems operating on low-GWP refrigerants, and more connected, cyber secure HVAC systems,” said Rob Tanner, Marketing Director, Applied Equipment at JCI. Members of JCI’s Connected Chiller Support Team were on-site displaying the OpenBlue dashboard where users can monitor any KPI in the machine. YORK brand chiller products are compatible with other control systems as well as OpenBlue.

SWEP displayed its D650 True Dual brazed plate heat exchanger (BPHE) range for chiller and heat pump applications. This range includes the DFX650 evaporator and DB650 condenser, designed for efficient operation at part and full loads, covering applications from 250-700 kW.

**Cooling Towers and Components**

Baltimore Aircoil Company (BAC) understands how critical cooling tower reliability is. At AHR, the BAC team highlighted two of its cooling tower features designed to provide operators with peace of mind – the ENDURADRIIVE Fan System, and TriArmor Corrosion Protection System. First, the ENDURADRIIVE is a direct-drive fan system, engineered for maximum reliability. Its simpler direct-drive design is free of failure-prone gears and transmission parts, reducing maintenance hours and costs. Next, its permanent magnet motor can withstand severe operating temperatures, while operating efficiently and keeping critical components dry with its double O-ring seal and condensate management system. Lastly, the ENDURADRIIVE is CTI certified for thermal performance and shake table vibration tested for IBC (International Building Code) compliance. Next, the TriArmor Corrosion Protection System protects the cold-water basin from corrosion and leaks. The system is formed with a base layer of galvanized steel, followed by a thermosetting hybrid polymer permitting the final polyurethane barrier (similar to truck bed liner) to adhere properly to the basin and provide cold water basin protection in the harshest environments.



Scott Degier, Vice President of Sales, alongside the MSF\_H Water-Cooled DHRC.



Rob Tanner, Marketing Director, Applied Equipment, JCI alongside the YORK YVAA Variable Speed Air-Cooled Screw Chiller.



Nathan Thomas, Business Engineer Team Manager, alongside SWEP’s D650 True Dual BPHE.

## Chiller & Cooling Tower Technology Win Big at 2022 AHR Expo



Neal Walsh and Kevin Deliman at the BAC booth (left to right).



Gary Hennis, Adrielle Einto and Jay Poggi at the American Cooling Tower booth (left to right).



Jay Harris and Mathu Solo at the Tower Tech booth (left to right).

American Cooling Tower (ACT) has provided cooling tower engineering, design and construction services since the 1920s. ACT offers CTI-certified packaged and field erected counterflow and crossflow designs in stainless, galvanized or fiberglass materials constructed in single or multiple cells. “What sets us apart is our ability to custom build and repair towers in place. For repairs in older installations inaccessible by crane or helicopter, we have the capability to disassemble a tower, manufacturer new parts, and complete an entire rebuild,” said Jay Poggi, Area Sales Manager. In addition, ACT offers customers complete access to any after-market part regardless of manufacturer. “Everyone is experiencing supply-chain issues. Thanks to our great relationships with local suppliers, we’re currently building towers in ten weeks lead time,” shared Poggi. ACT also offers proprietary coatings to prevent leaks and corrosion.

Tower Tech displayed its TTXR Series Factory Assembled Modular Cooling Tower. “We have turned the cooling tower industry upside down with our bottom mounted fans and patented water collection system,” said Mathu Solo, President, Tower Tech. The TTXR’s bottom mounted fans are easily accessible for maintenance, receive a cool, dry intake air stream from below, plus provide redundancy with its modular, multi-fan design. First, warm return water is dispensed through variable-flow 2" spray nozzles. Then water flows through the fill media down into the water collection system (chevron veins). In between each chevron vein, that collects the water, is an opening where cool air passes through into the fill where the heat transfer occurs. Cooled water then runs through its Fully Enclosed Flow-through Basin. A benefit of the Flow-through Basin is water doesn’t accumulate at the bottom, where biological growth can occur. The modular design is equipped with a pre-engineered substructure system allowing each tower to be safely installed in less than 30 minutes. It’s built with non-corrosive Fiber Reinforced Composite rated for 200 mph wind loads and is OHSPD approved for all seismic zones.

REYMSA Cooling Towers has been providing cooling solutions for the HVAC and industrial market for over 50 years. They exhibited one of its thousands of CTI-certified models, a non-corrosive structural fiberglass cooling tower, manufactured with high grade, fiberglass reinforced polyester (FRP). REYMSA Cooling Towers offer a 15-year warranty on casing and structure with no basin leakage problems, capable of operating in the most severe environments, such as desert with high UV concentrations, coastal and sub-freezing climates. Certain models are offered with IBC-compliant, seismic certification. Towers are available in single or multi-fan, direct-drive Models with sound sensitive options.



Additionally, the standard design parameters specify permanently bonded UV protection which provides minimum maintenance and a life expectancy of 30+ years. It is clear REYMSA Cooling Towers understands the efficiency, reliability and sustainability needs of its customers.

Delta Cooling Towers, a leader in non-corroding technology, showcased its Delta Engineered Plastic Cooling Tower models known for their 20-year warranty, high-efficiency, lightweight and heavy-duty designs, and more. One of many product ranges, Delta's Pioneer Series (forced draft, counter flow design), available in 10-to-100-ton single modules, features an air moving system – a totally enclosed premium efficiency cooling tower motor powering a centrifugal blower. Additional features for the Pioneer Series include high efficiency spiral wound PVC fill material, PVC drift eliminator, leak-proof sump, a water distribution system with non-clog large orifice removable nozzles and more, all protected by a non-corroding HOPE plastic shell backed by a 20-year warranty.

Brentwood Industries, a leading provider of cooling tower fill and drift eliminator products, displayed its all-new Separator System. This product can be installed directly into a cooling tower basin or cooling loop to remove troublesome solids, dirt and debris using an efficient centrifugal separator. Accumulation of organics and sediment causes early fill replacement, poor tower performance, and downstream equipment efficiency losses. Additional features include 80 TDH radial pump & enclosed fan-cooled motor, no filters or cartridges to replace, crossflow or counterflow compatibility, control panel and more. "Clean water is cold water," Brentwood Industries reminds us.

Cooling Tower Duty Motors from US Motors, a Nidec brand, are engineered for cooling tower, evaporative condenser and other commercial applications requiring protection from harsh and humid operating conditions. Enclosure options include totally enclosed air over (TEAO) and totally enclosed fan cooled (TEFC) with double-sealed bearings. Optional space heaters (115V) are available to reduce condensation and extend life of the motor.

Infinitum Electric displayed its IEs Series Integrated Motor & Drive. The IEs is built with copper-etched PCB stator instead of a traditional iron core and copper windings, increasing efficiency by eliminating high-loss eddy currents, while giving the IEs Series a 50% smaller, lighter footprint. Available from 5-15 hp, the IEs Series reaches speeds from 1,800-4,200 RPM.



Carl Barday, Michael Mulligan, Lucia Treviño, Ricardo Cavazos and Mike Poland at the REYMSA Cooling Towers booth (left to right).



David Blodgett alongside the Anti-Microbial Cooling Tower display at the Delta Cooling Towers booth.



Anthony Lou and Bhavnes Patel at the Infinitum Electric booth (left to right).

## Chiller & Cooling Tower Technology Win Big at 2022 AHR Expo



Dylan Ziegler hosting an informational session on the Brentwood Industries Separator System.



Tim Albers alongside a World Motor display at the Nidec booth.

### Pumps, Hydronic Systems and Instrumentation

Armstrong Fluid Technology displayed its new 50 hp Design Envelope Permanent Magnet pump with integrated VFD designed for efficient and reliable fluid distribution in large commercial HVAC and process cooling systems. After receiving demand from its customers for larger horsepower, Armstrong introduced this new medium range line (15 – 50 hp) to operate at NEMA Ultra-Premium Efficiency levels. These pumps feature a compact footprint and are less expensive to purchase and install because permanent magnet motors offer a substantial reduction in both size and weight. To make the units even more compact, Armstrong integrated its variable VFD into the pump, saving space by

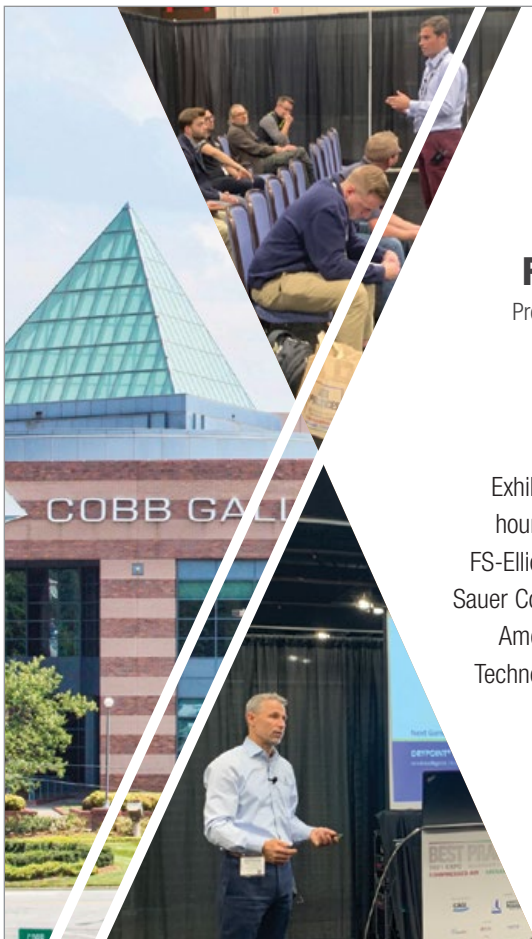

**BEST PRACTICES**  
2022 EXPO OCTOBER 4-6 ATLANTA  
COMPRESSED AIR / VACUUM / COOLING

**ON-SITE UTILITY**  
Education, Certification  
and Networking!

### Four Reasons to Send the Team to the EXPO!

Projects get done by sales engineers working with engineering firm and manufacturing personnel. Affordably priced at only \$25 per person, the EXPO is designed to motivate the whole team!

**#1. New Technology EXPO**

**#2. New Technology EXPO Classroom**

**#3. Daily EXPO \$1,000 Energy Treasure Hunt RAFFLE!**

**#4. Two Catered Networking Events**

Exhibitors present new technologies during EXPO hours. 2021 presentations were from: FS-Curtis/FS-Elliott, Asahi-America, Energair, Kingston Valves, Sauer Compressors, VPIinstruments, PneuTech, BOGE America, HydroThrift, Aerzen Rental, SMC, BEKO Technologies, Tamturbo, Fluke, UE Systems, Sullair, Hertz Kompressoren, Van Air Systems

Register at [cabpexpo.com](http://cabpexpo.com)

Sponsored by



Exhibition Booth Inquiries: [bill@airbestpractices.com](mailto:bill@airbestpractices.com)



avoiding wall mounted VFD cabinets. Additional features include Armstrong’s patented Parallel Sensorless Control and advanced connectivity via Armstrong’s Pump Manager.

Grundfos showcased its Distributed Pumping System, designed to replace control valves and balancing valves throughout the plant/building with smaller pumps. This allows for reduction in size of primary pumps and energy savings by reducing overall horsepower, and provides chillers and air handling units with targeted flow to meet exact demands of the application. By generating flow and pressure only when and where it’s needed, users can reduce commissioning time, improve Delta T and create a balanced distribution of chilled water into the various terminal units located at each loop. The system consists of five key components working together to deliver chilled water efficiently throughout the facility: distributed pumps, primary pumps, primary pump controls, check valves and sensors.

On display at the Fluke booth was an assortment of its test, measurement and monitoring products and software for HVACR technicians and engineers. The Fluke Ti480

PRO Infrared Camera’s LaserSharp Auto Focus technology uses a built-in laser so users can easily point, shoot and receive accurate temperature readings in real time with no calibration required. The Ti480 has a temperature measurement range from -4°F to 1,832°F. Next, the Fluke 378 FC Non-Contact Voltage True-rms AC/DC Clamp Meter with iFlex measures voltage and current with a clamp jaw. It provides fast, safe testing – all without touching a live wire. The power quality indicator shows whether equipment is acting



Danny Staerk and Dennis Sindholdt displaying the Grundfos Distributed Pumping System (left to right).



Armstrong Fluid Technology’s 50hp Design Envelope Permanent Magnet Pump.



Sean Silvey with the Fluke 378 FC Non-Contact Voltage True-rms AC/DC Clamp Meter with iFlex.

faulty, and completes 3-phase voltage and current tests in three quick steps. **BP**

For more information on the AHR Expo, visit [www.ahrexpo.com](http://www.ahrexpo.com).

To read similar **Chiller or Cooling Tower Technology** articles visit <https://coolingbestpractices.com/technology>



Visit our Webinar Archives to listen to expert presentations on **Chiller or Cooling Tower Technology** at <https://coolingbestpractices.com/magazine/webinars>

# Pro-Refrigeration Helps California Dairy with CO<sub>2</sub> Chillers

By Tom Savas, Regional Key Account Manager, Danfoss



▶ With the approaching HFC phasedown, the demand for environmentally friendly cooling systems is driving chiller manufacturers to innovate. Washington-based Pro-Refrigeration, Inc., a leading manufacturer and supplier of chillers for the industrial and beverage processing market, including the dairy, beer and wine industries, recognized an opportunity with CO<sub>2</sub> chillers. Since, as a natural substance, CO<sub>2</sub> has nearly zero impact on global warming, the company knew that demand would increase in the coming years as their customers look to reduce their environmental impact and comply with local, state and federal regulations.

Most of Pro-Refrigeration's traditional chillers use R404A, which has a GWP rating of 3922. In comparison, CO<sub>2</sub>, the baseline for GWP, has a rating of 1. CO<sub>2</sub> also allows refrigeration systems to recover 100% – three times that of chillers using synthetic refrigerants – of the heat rejected from their systems, generating hot water at up to 200 degrees. For Pro-Refrigeration, heat recovery capability is an essential product feature. Dairy farms in particular use a high amount of natural gas

or propane to heat water for sanitizing and wash-down. Heat recovery technology lowers both their costs and climate impact.

## Building the Product

When the company made the decision to move forward with manufacturing, they investigated controls and valves from several major manufacturers. Danfoss control valves had the combination of higher capacities and safety ratings that were required to meet the needs of the project. Danfoss had been supplying components for the company's industrial chillers for nearly 30 years, so Pro-Refrigeration was confident in Danfoss' ability to meet their production needs. While the global supply chain disruption extended the production timetable, the companies worked together to produce and procure the necessary components.

The Danfoss components utilized in the CO<sub>2</sub> chiller include the AK-SM850A system manager, AK-CC 750A case controller, AK-PC781A pack controller, as well as the CCM 20 and CCMT 30 electric regulating valves,

BC 5100 pressure switches, pressure and temperature sensors, and other accessories such as AK-PS 250 power supply and GDC gas detector. All of the parts work together to monitor the cooling system, gather data from the sensors, control when the compressors cycle on and off and ensure the fans and expansion valves are working correctly.

"The Danfoss components provide the brains of the system," explained Jim VanderGiessen, Pro-Refrigeration's co-founder and CEO. "They keep the system running in an optimal manner." As part of its constant monitoring and adjustment to external conditions, the system manager generates alerts and alarms, so that the facilities staff can immediately identify and address potential mechanical problems. The refrigeration control system also allows Pro-Refrigeration engineers to access the data remotely for improved customer support and troubleshooting capabilities.

## Putting Innovation into Practice

While using CO<sub>2</sub> as a refrigerant pays dividends for the environment, VanderGiessen noted that



it does come at a premium. The chiller costs nearly 30% more to produce than a traditional chiller. While VanderGiessen projected that the cost will come down as the technology becomes mainstream and is deployed across more industries, the current cost presents a barrier to adoption. Fortunately, one of the company's customers, a California dairy farm, was excited about blazing a new trail and was confident the new chiller would meet its needs.

Installation of the CO<sub>2</sub> chiller was a smooth process, VanderGiessen reported. Pro-Refrigeration installers placed the chiller alongside the current system, on the opposite side of the barn, and when the new chiller was ready to begin operating, the crew was able to easily connect the chiller to the rest of the refrigeration system. Pro-Refrigeration crews remained on-site to monitor the new chiller around the clock for the first week, until everyone was confident the new chiller was performing as expected.

The chiller, operating at 100 HP, is now fully operational, chilling milk after it passes through a heat exchanger and arrives at a tank for cooling and storage. The chiller has the capacity to service dairy farms of any size, enabling farms to utilize heat recovery on top of the benefits of energy efficiency and low-GWP refrigerants. VanderGiessen noted that the farm has reported the CO<sub>2</sub> chiller "consistently produces colder and higher-quality milk" than its previous 120 HP R404A chiller.

In order for dairy farmers to earn a quality bonus of up to 10% above market rate from milk processors, the milk must be cooled to a temperature below 40 degrees Fahrenheit and run a high temperature CIP (Clean in Place) system every 24 hours to ensure proper system



*The CO<sub>2</sub> chiller is installed at a California dairy farm.*

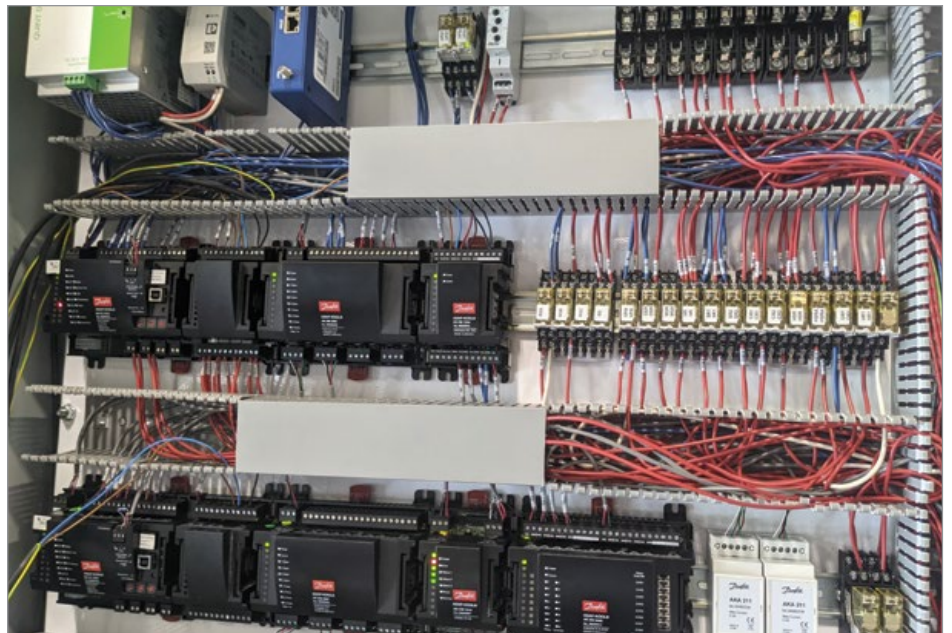

*The Danfoss components provide the brains of the CO<sub>2</sub> chiller.*

sanitation. Since the CO<sub>2</sub> chiller was installed, the milk temperature has averaged 37.1°F, whereas their previous chiller was unable to cool below 40 F. As a result, the dairy farm was able to see revenue increases in the range of \$1,400 to \$2,800 per day.

The chiller also recovers the waste heat from the chiller system to heat the wash water, heating 3000 gallons of well water per day from 70°F to 140°F and eliminating the need to use fossil fuels (propane) as a heating source. Early results tracking indicates that the heat recovery

## Pro-Refrigeration Helps California Dairy with CO<sub>2</sub> Chillers

operation is saving the farm 30 gallons of propane each day, totaling about \$2,100 in savings per month.

### The Future of CO<sub>2</sub>

VanderGiessen is optimistic about the future adoption of CO<sub>2</sub> as a refrigerant, noting that the technology is applicable to any industry with a constant cooling load. Pro-Refrigeration has received more inquiries about its latest technology and plans to increase production on CO<sub>2</sub> chillers in the years ahead.

Referencing the pending changes in the industry, VanderGiessen noted that the CO<sub>2</sub> chiller is “a future-proof solution. Our design will evolve and improve over time but we won’t

need to build new equipment.” He also noted that while “the price differential needs to ease,” he is confident that “the technology will be considered in all industries. We see a huge opportunity to offer CO<sub>2</sub> chillers across many vertical markets.” **BP**

### About Danfoss

Danfoss engineers advanced technologies that enable us to build a better, smarter and more efficient tomorrow. In the world's growing cities, we ensure

*the supply of fresh food and optimal comfort in our homes and offices, while meeting the need for energy-efficient infrastructure, connected systems and integrated renewable energy. Our solutions are used in areas such as refrigeration, air conditioning, heating, motor control and mobile machinery. Our innovative engineering dates back to 1933 and today Danfoss holds market-leading positions, employing 28,000 and serving customers in more than 100 countries. We are privately held by the founding family. For more information, visit [www.danfoss.com](http://www.danfoss.com).*

To read similar **Chiller Technology** articles visit <https://coolingbestpractices.com/technology/chillers>



Visit our Webinar Archives to listen to expert presentations on **Chiller Technology** at <https://coolingbestpractices.com/magazine/webinars>



## BEST PRACTICES

2022 EXPO OCTOBER 4-6 ATLANTA  
COMPRESSED AIR / VACUUM / COOLING

**ON-SITE UTILITY**  
Education, Certification  
and Networking!

### Four Reasons to Send the Team to the EXPO!

Projects get done by sales engineers working with engineering firm and manufacturing personnel. Affordably priced at only \$25 per person, the EXPO is designed to motivate the whole team!

Designed to reward the people who make Energy Treasure Hunts in manufacturing plants happen! This is why only distributor sales engineers and service technicians, auditors/consultants/engineers and manufacturing plant personnel are eligible to win. Network at the Welcome Reception and the Official Networking Event!

*2021 Winners: Shawn Anderson, Ring Power Corp. • John Bilsky, Gentex Corp. • Clint Hill, National Compressor Services • Matt Brockman, Atlantic Compressors • Manuel Elizalde, Tunna Industrial • Brian Coder, Tate Engineering*

- #1. New Technology EXPO
- #2. New Technology EXPO Classroom
- #3. Daily EXPO \$1,000 Energy Treasure Hunt RAFFLE!
- #4. Two Catered Networking Events

Register at [cabpexpo.com](http://cabpexpo.com)

Sponsored by



Exhibition Booth Inquiries: [bill@airbestpractices.com](mailto:bill@airbestpractices.com)



# CHILLER & COOLING SYSTEM TECHNOLOGY & INDUSTRY NEWS

## New Carrier Software Compares Chillers from Different OEMs

To help consulting engineers make more objective and informed decisions about their chiller plant designs, Carrier has introduced PLV Pro, a new software tool to provide fast, easy life cycle cost analysis at no charge for water-cooled chillers from different manufacturers. Carrier is a part of Carrier Global Corporation, the leading global provider of healthy, safe, sustainable and intelligent building and cold chain solutions.

“Many engineers and facility managers know that full load and integrated part load value (IPLV) may not provide a complete and accurate picture of the performance of multi-chiller central plants in the real world, but they often fall back on them because detailed energy modeling analyses can be costly and time-consuming,” said Scott McDonough, Associate Director of Product Management, Carrier Commercial Global Equipment. “PLV Pro offers a free alternative that’s fast, easy and accurate.”

PLV Pro calculates custom part-load weighting factors and condenser water temperatures based on site-specific weather profiles, U.S. Department of Energy building occupancy profiles, chiller staging and system design. Criteria include geographical location, building type, quantity of chillers, chiller staging method, design temperatures and chiller plant capacity and design. Custom PLV weighting factors and condenser water temperatures generated by the software are suitable for inclusion in equipment schedules.

“While some of the new application’s speed comes from its intuitive and simple user interface, what’s going on under the hood is even more important,” said McDonough. “Engineers and contractors can now use and independent software to provide custom PLV values to show the performance of all chillers under local job conditions.”

PLV Pro uses load profiles generated with Carrier’s Hourly Analysis Program energy modeling software for thousands of building types and locations worldwide, using detailed building modeling and 8,760-hour-by-hour analysis. By leveraging a large library of pre-calculated, precisely detailed load profiles, PLV Pro can deliver both fast analysis and credible results for local job specifications.

PLV Pro aligns with Carrier’s 2030 Environmental, Social & Governance (ESG) goals of reducing customers’ carbon footprint

by more than 1 gigaton. The data provided by PLV Pro will contribute to lower building energy use and indirectly lower carbon dioxide emissions. PLV Pro is available for immediate download at [www.carrier.com/commercial/en/us/software/hvac-system-design/plv-pro](http://www.carrier.com/commercial/en/us/software/hvac-system-design/plv-pro).

### About Carrier

*Founded by the inventor of modern air conditioning, Carrier is the world leader in high-technology heating, air-conditioning and refrigeration solutions. Carrier experts provide sustainable solutions, integrating energy-efficient products, building controls and energy services for residential, commercial, retail, transport and food service customers. Carrier is a part of Carrier Global Corporation, the leading global provider of innovative healthy, safe, sustainable and intelligent building and cold chain solutions. For more information, visit [www.carrier.com](http://www.carrier.com).*

## Danfoss Introduces VTCA400 and TGS380 Oil-Free Compressors

Danfoss, the pioneer of oil-free compressor technology, has expanded the oil free compressor portfolio with the introduction of the VTCA400 and the TGS380 models.

The new Danfoss Turbocor VTCA400 is the world’s first oil-free, variable-speed, magnetic bearing centrifugal compressor utilizing a hybrid compression design that is optimized for use with low-GWP refrigerant R-1233zd. The 400 ton/1400 kW nominal capacity rating provides unparalleled performance for water-cooled chiller applications.

The VTCA400 is the world’s first compressor to incorporate a hybrid compression configuration

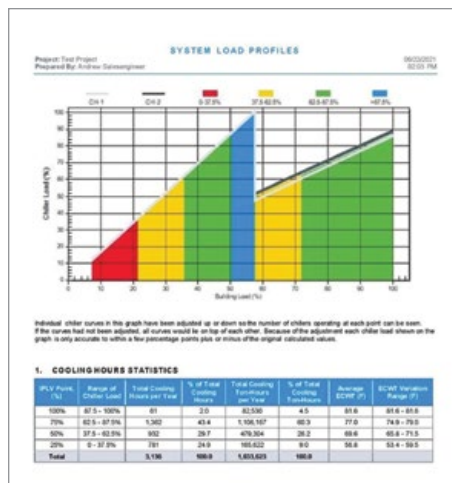

Carrier has introduced PLV Pro, a new software tool to provide fast, easy life cycle cost analysis at no charge for water-cooled chillers from different manufacturers.

## Chiller & Cooling System Technology & Industry News



The Danfoss Turboacor VTCA400 and TGS380 oil-free, variable speed, magnetic bearing centrifugal compressors (left to right).

using a mixed flow and radial impeller design, optimized for use with low-GWP refrigerant R-1233zd. This results in a compact compressor design that reduces footprint and weight by up to 50% compared to traditional designs, giving users the benefits of more mechanical room space along with the ability to incorporate multiple compressors in a single chiller for built-in redundancy and improved part load performance.

The new Danfoss Turboacor TGS380 is a further extension of the TGS series compressors, the world's first oil-free, variable speed, magnetic bearing centrifugal compressors qualified for the use with R-515B refrigerant. R-515B has an AR5 GWP of 299 and an ASHRAE A1 safety classification for lower toxicity and no flame propagation. As an extension of the existing Danfoss Turboacor TGS series of compressors, it also is qualified to use HFO-1234ze, an environmentally friendly refrigerant with a GWP less than one.

The TGS380 builds on the innovation of the other models in the TGS series and features an expanded operating map to support applications with pressure ratios up to 5.7. This includes not only comfort cooling, water-cooled chiller applications but also higher lift

applications such as air-cooled chillers in hot ambient climates up to 125 degrees Fahrenheit and water-cooled heat recovery generating up to 145 degrees Fahrenheit process water.

“The new Danfoss Turboacor VTCA400 compressor represents a significant evolution in oil-free compressor technology that gives customers not only industry-leading performance but also the most compact footprint of any low-pressure compressor design,” said Ricardo Schneider, president and CEO of Danfoss Turboacor. “In addition, the TGS380 expands the capacity range of our TGS series of compressors and gives customers more options to use environmentally friendly refrigerants for both air and water-cooled chiller applications.”

Additionally, the new Danfoss Turboacor VTCA400 and TGS380 models, like all Danfoss Turboacor compressors, feature oil-free, magnetic bearing compressor technology that offers the benefits of industry-leading efficiency, reduced maintenance and simplified design through the elimination of the traditional oil management system. Oil-free, magnetic bearing technology also incurs no performance degradation or mechanical wear over the life of the compressor.

The Danfoss Turboacor VTCA400 was selected by a panel of third-party ASHRAE member judges to receive a prestigious Innovation Award and was also awarded Product of the Year during the 2022 AHR Expo in Las Vegas, Nevada.

### About Danfoss

*Danfoss engineers advanced technologies that enable us to build a better, smarter and more efficient tomorrow. In the world's growing cities, we ensure the supply of fresh food and optimal comfort in our homes and offices, while meeting the need for energy-efficient infrastructure, connected systems and integrated renewable energy. Our solutions are used in areas such as refrigeration, air conditioning, heating, motor control and mobile machinery. Our innovative engineering dates back to 1933 and today Danfoss holds market-leading positions, employing 37,000 and serving customers in more than 100 countries. We are privately held by the founding family. Read more about us at [www.danfoss.com](http://www.danfoss.com).*

### Daikin Launches SiteLine Building Controls for HVAC Equipment

Daikin Applied introduced SiteLine Building Controls – a portfolio of scalable, cloud-based technologies to effortlessly connect, monitor and manage both individual pieces of HVAC equipment and integrated building systems. With SiteLine, building owners and operators have the tools and insights to optimize performance, improve indoor air quality, and trim energy use and carbon emissions.

The new controls portfolio provides complete transparency into the entire HVAC ecosystem to help create comfortable and sustainable environments where people work and live. Intuitive dashboards keep facility personnel connected to their operations at all times, and



arms them with data to drive efficiency and lower costs while maintaining comfort.

Unlike most control systems, which require a high degree of configuration and programming, SiteLine offers out-of-the-box functionality for easy setup. It also seamlessly links many makes of equipment, helping alleviate integration challenges that contractors and engineers face every day.

“Controls are often the domain of specialized engineers and technicians,” said Shinya Nishi, senior vice president, aftermarket, Daikin Applied. “And that comes with a considerable price tag. SiteLine, however, is designed to provide effortless insights. The hardware and software are flexible and user-friendly, able to be installed and used by almost anyone in the field.”

The SiteLine portfolio currently includes three offerings to meet a range of needs:

**SiteLine for Wireless BAS** combines the power of wireless technology and the cloud to integrate light-commercial, applied and VRV equipment into one, easy-to-manage building automation system (BAS) for both retrofits and new construction. Plus, the controls feature



The SiteLine portfolio currently includes three offerings to meet a range of needs including: SiteLine for Dedicated Equipment, SiteLine for Wireless BAS (Building Automation System) and SiteLine for Pre-Programmed BAS.

advanced security to protect user data and scalability to accommodate future expansion.

**SiteLine for Dedicated Equipment** delivers 24/7 monitoring and control for standalone equipment, including rooftop units and chillers. A direct connection to hundreds of data points – from any connected device, anywhere in the world – provides precise insights for easier decision making. Preventative alerts also help reduce downtime and emergency service calls.

**SiteLine for Pre-Programmed BAS** helps users enhance performance and efficiency throughout an entire facility with a BAS that links and optimizes Daikin equipment. This pre-engineered system offers configurable control without the need for custom programming. Local and cloud-based connectivity provides additional flexibility.

“It’s not just the technology,” said Nishi. “Users also get access to our technical resource center and controls engineers for ongoing support. Controls and customer care – we’re bringing the best of both worlds together to deliver an exceptional experience.”

#### About Daikin Applied Americas

*Daikin Applied, a member of Daikin Industries, Ltd., designs and manufactures advanced commercial and industrial HVAC systems for customers around the world. The company’s technology and services play a vital role in creating comfortable, efficient and sustainable spaces to work and live – and in delivering quality air to workers, tenants and building owners. Daikin Applied solutions are sold through a global network of dedicated sales, service and parts offices. For more information, visit [www.daikinapplied.com](http://www.daikinapplied.com).*

### Johnson Controls Energy Conservation Initiatives in Arkansas

Johnson Controls, the global leader for smart, healthy and sustainable buildings, is now projected to successfully cut more than one million metric tons of carbon dioxide through energy efficiency and renewable energy public projects across the state of Arkansas. Since 2010, Johnson Controls has partnered with 22 public organizations to implement decarbonization solutions that are expected to deliver the same air quality results as taking a quarter million vehicles off the roads for one year while saving Arkansas taxpayers a combined \$229M.

“Our partnerships across Arkansas are a perfect example of how public entities can support ambitious sustainability goals,” said Nate Manning, president of Building Solutions North America at Johnson Controls. “Through creative funding solutions, public organizations can make much-needed infrastructure updates that enrich their communities while reducing costs and meeting decarbonization goals. We are eager to see how these customers innovate and inspire similar organizations to join the race to cut emissions and save capital.”

Twenty-two public organizations throughout Arkansas have engaged with Johnson Controls under performance contracts to implement energy-efficient and renewable infrastructure solutions. These contracts help empower organizations to make critical infrastructure improvements to deliver guaranteed outcomes while preserving capital. Johnson Controls projects throughout Arkansas are leading the way in energy conservation and tax-dollar preservation.

## Chiller & Cooling System Technology & Industry News

### City of Rogers

When city leadership in Rogers, Arkansas, first engaged with Johnson Controls, they knew they needed to reduce their energy consumption to save capital and meet citizens' rising sustainability expectations. Johnson Controls experts proposed the construction of three ground-mounted solar photovoltaic (PV) arrays totaling 4.6 megawatts. The project is set to build the largest publicly owned solar facility in the state and expected to generate more than 157M kilowatt-hours (kWh) of electricity – worth more than \$15M in total utility and operations and maintenance (O&M) savings alone – for the Rogers taxpayers. By working under a 20-year performance contract with a 30-year generation warranty on the solar hardware, the city will fix its long-term electricity costs despite local electrical providers' increasing rates.

### Arkansas State University (ASU)

After a successful project completion at the Arkansas State University (ASU) System's flagship institution in Jonesboro, the ASU System engaged Johnson Controls to address deferred maintenance and provide sustainable solutions across eight other ASU System campus locations. The combined \$39M in capital improvements included installing LED lighting throughout campuses, implementing energy management controls, upgrading water conservation solutions in residence halls and other facilities, upgrading HVAC and central plant technologies and investing in solar PV facilities at ASU-Newport. In addition, Johnson Controls worked with the Arkansas State College of Engineering & Computer Science to streamline campus waste collection processes with intelligent trash compactors, solving a maintenance and aesthetics concern for

campus leadership. The updates are expected to save the ASU System more than 611M kWh-worth of electricity and \$110M in total utility and O&M costs.

### Washington County

As the first county in Arkansas to invest in solar through a performance contract, Washington County is moving toward 100% renewable energy. Working with Johnson Controls, the county installed two solar PV arrays, a 1.6-megawatt ground mount and a half-megawatt solar rooftop array – the largest in the state. To further support the county's dedication to sustainability, Johnson Controls also retrofitted more than 3,200 lighting fixtures with LED lights, replaced 53 HVAC assets and installed energy management controls countywide. Washington County is expected to reduce its energy consumption by over 161M kWh and save almost \$21M in energy and O&M costs.

### About Johnson Controls

*At Johnson Controls, we transform the environments where people live, work, learn and play. As the global leader in smart, healthy and sustainable buildings, our mission is to reimagine the performance of buildings to serve people, places and the planet. With a history of more than 135 years of innovation, Johnson Controls delivers the blueprint of the future for industries such as healthcare, schools, data centers, airports, stadiums, manufacturing and beyond through its comprehensive digital offering, OpenBlue. With a global team of 100,000 experts in more than 150 countries, Johnson Controls offers the world's largest portfolio of building technology and software, as well as service solutions with some of the most trusted names in the industry. For more information, visit [www.johnsoncontrols.com](http://www.johnsoncontrols.com).*

### ASHRAE Recognizes 2022 Member Achievements

ASHRAE recognized the outstanding achievements and contributions of members to the Society and the built environment industry during its 2022 Winter Conference in Las Vegas.

“Congratulations to all of ASHRAE's Honors and Awards recipients,” said 2021-22 ASHRAE President Mick Schwedler, P.E., Fellow ASHRAE, LEED AP. “Your service to the global built environment and our Society is appreciated.” A list of the awards and recipients are below:

### Fellow ASHRAE

Fellow ASHRAE is a membership grade that recognizes members who have attained distinction and made substantial contributions in HVAC&R and the built environment such as education, research, engineering design and consultation, publications, presentations and mentoring. The Society elevated 25 members to the grade of Fellow:

- Edward A. Arens, Ph.D., Life Member ASHRAE, director, Center for the Built Environment, University of California Berkeley, Berkeley, Calif.
- Robert Bean, President, Indoor Climate Consultants Inc., Calgary, Alberta, Canada
- Don Brandt, Life Member ASHRAE, Retired from Trane Co., in Phoenix, Ariz.
- James F. Butler, CTO, Cimetrics Inc., Boston, Mass.
- Pieter De Wilde, Professor, University of Plymouth, Plymouth, United Kingdom
- Titu R. Doctor, Life Member ASHRAE, Retired, Marietta, Ga.
- W. Stuart Dols, Mechanical Engineer, National Institute of Standards and Technology (NIST), Gaithersburg, Md.



- Brian A. Fricke, Ph.D., Group Leader, Building Equipment Research, Oak Ridge National Laboratory, Oak Ridge, Tenn.
  - Shih-Cheng Hu, Ph.D., Distinguished Professor, Department of Energy, Refrigeration, and Air-Conditioning, and Director, Center for Clean Technology Research, National Taipei University of Technology, Taipei, Taiwan
  - Joe Huang, BEMP, Owner, White Box Technologies, Inc., Moraga, Calif.
  - Luke C. H. Leung, P.E., P.Eng., BEMP, Director, Skidmore, Owings & Merrill LLP, Chicago, Ill.
  - Igor Y. Maevski, Ph.D., P.E., Manager of Engineering, Global Tunnel Fire & Life Safety Lead, Jacobs Engineering, New York, N.Y.
  - Hugh Magande, Technical Principal, Research, Southface Institute, Atlanta, Ga.
  - Tim McGinn, P.Eng., HBDP, Principal, McGinn Technical Services, Calgary, Alberta, Canada
  - Janice K. Means, P.E., Life Member ASHRAE, Professor Emerita, Lawrence Technological University, Southfield, Mich.
  - Amy V. Musser, Ph.D., P.E., BEMP, Partner, Vandemusser Design, Asheville, N.C.
  - Zheng O'Neill, Ph.D., P.E., Associate Professor, J. Mike Walker '66 Department of Mechanical Engineering, Texas A&M University, College Station, Texas
  - Ryoza Ooka, Professor, Institute of Industrial Science, The University of Tokyo, Tokyo, Japan
  - Chun-cheng Piao, Ph.D., President, Daikin Open Innovation Lab Silicon Valley, Santa Clara, Calif.
  - Lee Riback, Life Member ASHRAE, Project Director – Commissioning, McKinstry Co – South Region, Dallas, Texas
  - Charles Roos, CPEng, Senior Technical Director, Beca Ltd., Auckland, New Zealand.
  - William A. Ryan, Ph.D., P.E., Clinical Associate Professor and Director of the Master of Energy Engineering Program, Department of Mechanical and Industrial Engineering, University of Illinois Chicago, Chicago, Ill.
  - Roger R. Schmidt, Ph.D., Traugott Distinguished Professor, Mechanical and Aerospace Engineering Department, Syracuse University, Syracuse, N.Y.
  - Celso Cardoso Simões Alexandre, P.Eng., Life Member ASHRAE, President, TROX Americas Extended Board, and Member, TROX GROUP Extended Board, TROX GmbH, São Paulo, Brazil
  - Filza H. Walters, Professor of the Practice in Architectural Engineering, Department of Multidisciplinary Engineering, College of Engineering, Texas A&M University, College Station, Texas
  - Brad C. Cochran, P.E., Senior Principal, CPP Wind Engineering, Windsor, CO.
  - Wade H. Conlan, P.E., BCxP, Commissioning and Energy Discipline Manager, Hanson Professional Services, Inc., Maitland, FL
  - Jason DeGraw, Ph.D., R&D Staff Member, Oak Ridge National Laboratory, Knoxville, TN
  - Traci Hanegan, P.E., HFDP, Fellow Member ASHRAE, Principal Mechanical Engineer, Coffman Engineers, Inc., Spokane, WA
  - Richard D. Hermans, P.E., HFDP, Life Member ASHRAE, Retired Mechanical Department Manager, AECOM, Minneapolis, MN
  - Luke Leung, P.E., P.Eng, BEMP, Director, Skidmore, Owings & Merrill, Chicago, IL
  - Stephen B. Martin, Jr., Ph.D., P.E., Senior Research Engineer, Respiratory Health Division, Field Studies Branch, National Institute for Occupational Safety and Health (NIOSH), Morgantown, WV
  - John L. McKernan, Sc.D., Chief, Emerging Contaminants and Technologies Branch, US EPA, Cincinnati, OH
  - Corey B. Metzger, P.E., Principal, Resource Consulting Engineers, LLC, Ames, IA
  - Jim Ridenhour, Life Member ASHRAE, Retired, Greer, SC
  - Max H. Sherman, Ph.D., Fellow Life Member ASHRAE, Retired Senior Staff Scientist, Lawrence Berkeley National Laboratory, Berkeley, CA
  - Stephanie Taylor, M.D., President and Founder, Building 4 Health, Inc., Keswick, Va.
  - Pawel Wargocki, Ph.D., Associate Professor, International Centre for Indoor Environment and Energy, Department of Civil Engineering, Technical University of Denmark, Kongens Lyngby, Denmark
- Presidential Certificate of Honor**
- The Presidential Certificate of Honor is presented as a special honor by the ASHRAE President to recognize a member who has made a unique contribution to the growth and well-being of the Society. The ASHRAE Epidemic Task Force was recognized. Members are as follows:
- Bill Bahnfleth, Ph.D., P.E., Presidential Fellow Member ASHRAE, Professor of Architectural Engineering, The Pennsylvania State University, University Park, PA
  - Dennis Knight, P.E., BEMP, Fellow Life Member ASHRAE, Principal, Whole Building Systems, LLC, Mt. Pleasant, SC
  - Walid Chakroun, Ph.D., P.E., Fellow Member ASHRAE, Professor, Kuwait University, Kuwait

## Chiller & Cooling System Technology & Industry News

### The ASHRAE Technology Awards

The ASHRAE Technology Awards recognize outstanding achievements by ASHRAE members who have successfully applied innovative building designs. Their designs incorporate ASHRAE standards for effective energy management and indoor air quality and serve to communicate innovative systems design. Winning projects are selected from entries earning regional awards.

First place recipients for the ASHRAE Technology Award are:

- Hermes Silva Flores, existing commercial buildings category, Hotel Mandarin Oriental, Santiago, Chile.
- Donald R. Hartdegen, Jr., P.E., Asfandyar Khan, P.E., HBDP and Sudesh Saraf, P.E., new educational facilities category, Adlai E. Stevenson High School East Building, Lincolnshire, IL
- Jason Volz, P.E., Matt Branham, P.E., Brian Duvall, P.E. and Braydi McPherson-Hathaway, EBCx educational facilities category, Kentucky Community and Technical College System, Louisville, KY.
- Lincoln Pearce, P.E., BEAP, existing educational facilities category, Marston Hall Renovation, Ames, IA.
- Nicholas Rogers, P.E., Tracy Steward and David Mayer, new health care facilities category, Norton Novak Center for Children's Health, Louisville, KY.
- Shana Scheiber, P.E. and Rick Flock, P.E., new industrial facilities or processes category, Exact Sciences Lab, Madison, Wis. The building is owned by Exact Sciences.
- Leighton W. Deer, P.E., HBDP and Brad Grubb, P.E., new public assembly category, Westwood Hills Nature Center, St. Louis Park, MN.

- Dennis C. McKale, P.E., Bradley Herbeck and Ryan Cowan, existing industrial facilities or processes category, Stellantis – Sterling Heights Assembly Plant, Sterling Heights, MI
- Dustin Langille, BEMP, HBDP and Donald McLauchlan, residential facilities category, 3833 North Broadway, Chicago, IL

### First Place and Award of Engineering Excellence

The Award of Engineering Excellence was created in 1989 to recognize a first-place winner of the Society-level Technology Award competition for an outstanding application of innovative design and effective energy utilization. The recipient of the Award of Engineering Excellence will have demonstrated the best overall compliance with the judging criteria.

First place and recipients of the Award of Engineering Excellence are: Shiro Tsukami, P.E., Kitaro Mizuide, Ph.D., P.E. and Hiroataka Kubo, P.E., new commercial buildings category, DaiyaGate Ikebukuro, Tokyo, Japan. The building is owned by Seibu Properties Inc.

**E.K. Campbell Award of Merit:** Thomas M. Lawrence, Ph.D., P.E., Fellow Member ASHRAE, received the E.K. Campbell Award of Merit. The award honors an individual for outstanding service and achievement in teaching and is presented by the Life Members Club. Lawrence is professor of practice, mechanical engineering program lead, University of Georgia, Athens, Ga.

**John F. James International Award:** Karine Leblanc, received the John F. James International Award. The award recognizes a member who has done the most to enhance the Society's international presence. Leblanc is sales engineer, US Air Conditioning Distributors, City of Industry, Calif.

YEA Inspirational Leader Award: Badri Patel, BEAP, received the YEA Inspirational Leader Award. The award recognizes a Young Engineer in ASHRAE (YEA) member who has gone above and beyond to make considerable contributions to the industry and community. Patel is commercial market account executive, Johnson Controls Canada, Toronto, Ontario, Canada.

### ASHRAE Award for Distinguished Public Service

**Service:** Steven J. Williams, received the ASHRAE Award for Distinguished Public Service. The award recognizes members who have performed outstanding public service in their community and, in doing so, have helped to improve the public image of the engineer. Williams is mechanical project manager, James Posey Associates, Owings Mills, Md.

**Honorary Member:** William "Bill" Nye, known as Bill Nye the Science Guy, was elected as an Honorary Member of ASHRAE. Honorary Members, elected by the Board of Directors, are defined as notable persons of preeminent professional distinction. Nye is CEO, The Planetary Society, Pasadena, CA.

### ASHRAE Hall of Fame

Raymond G. Alvine, P.E., Fellow Life Member ASHRAE (1926-2005) and Alwin B. Newton, Fellow Life Member ASHRAE (1907-1985), were inducted into the ASHRAE Hall of Fame. The ASHRAE Hall of Fame honors deceased members of the Society who have made milestone contributions to the growth of ASHRAE-related technology or the development of ASHRAE as a society.

### F. Paul Anderson Award

James E. Braun, Ph.D., Fellow Life Member ASHRAE, received the F. Paul Anderson Award. The award, ASHRAE's highest honor, for



technical achievement, is named in memory of Presidential Member F. Paul Anderson, who was a pioneer in the study of environmental conditions for comfort.

#### About ASHRAE

Founded in 1894, ASHRAE is a global professional society committed to serve humanity by advancing the arts and sciences of heating ventilation, air conditioning, refrigeration and their allied fields. For more information, visit [www.ashrae.org](http://www.ashrae.org).

### New Armstrong Medium Range Permanent Magnet Pumps

Armstrong Fluid Technology has introduced a new size range of Design Envelope Permanent Magnet pumps that are engineered to deliver 20% lower operating costs than variable speed pumps with standard induction motors.

The new pumps are available with motors ranging from 15 hp to 50 hp, and operate at NEMA Ultra-Premium Efficiency levels that exceed the efficiency targets of both the US Department of Energy and the European Union.



Design Envelope Permanent Magnet Pump from Armstrong Fluid Technology.

“Better performance at higher RPMs means that in some cases a smaller Design Envelope Permanent Magnet Pump can deliver the same flow and pressure as a larger, more expensive competing model,” said David Lee, Offering Manager, Armstrong Fluid Technology. “These new pumps also feature smaller dimensions and are less expensive to purchase and install because permanent magnet motors offer a substantial reduction in both size and weight.”

Beyond the motor efficiency, a number of additional design innovations make the new Design Envelope pumps more energy-efficient and cost-effective:

- Armstrong’s patented Parallel Sensorless Control stages multiple pumps and regulates output for best efficiency across the entire pump array, saving 10-30% in operating costs
- Adjustable design points and setpoint based on the actual on-site conditions
- A quadratic pressure control curve that provides more efficiency than a linear pressure control curve
- A constant-flow function for maintaining a desired flow rate in recirculation applications
- Advanced connectivity via Armstrong’s Pump Manager, a cloud-based performance tracking service, provides industry-leading analytics and insights along with alerts, alarms and data storage

#### About Armstrong Fluid Technology

With eight manufacturing facilities on four continents, and employees around the world, Armstrong Fluid Technology is known as an innovator in the design, engineering and manufacturing of intelligent fluid flow equipment, control solutions and digital technologies.

*In the shift toward digitalization and integration of fluid-flow systems, Armstrong leads the industry, bringing edge computing to mechanical systems, approaching energy optimization as a whole-building challenge and advancing the practice of full lifecycle management of mechanical systems. Focusing on HVAC, Plumbing, Gas Transmission and Fire safety applications, we provide energy-efficient and cost-effective solutions to building and facility professionals around the world. For more information, visit [www.armstrongfluidtechnology.com](http://www.armstrongfluidtechnology.com).*

### New SWEP Hypertwain Suction Gas Heat Exchanger Technology

SWEP’s Hypertwain is a revolutionary new technology that optimizes both cooling and heating and keeps the need for space, electricity and refrigerants to a bare minimum. Hypertwain is the answer to the rising demand for comfortable indoor climate – and the absolute necessity of using fewer resources.

Unlike a standard BPHE, Hypertwain features an integrated suction gas heat exchanger (“iSGHX”) that improves the evaporator performance. This leads to Hypertwain’s main benefit which is allowing OEMs to design and bring products to market with unrivalled seasonal efficiency in both heating and cooling mode, while additional benefits are reduced refrigerant charge and footprint. The integrated iSGHX also enables control stability compared with an external SGHX. In addition, Hypertwain also improves freeze resistance and reduces water pressure drop.

SWEP is now launching its first brazed plate heat exchanger (BPHE) based on its novel Hypertwain technology. It’s called the FTW250AS and primarily targets reversible chillers and heat pumps.

## Chiller & Cooling System Technology & Industry News



With Hypertwain, SWEP introduces a new heat exchanger that combines the SGHX with the evaporator into one.

Hypertwain integrates several functions critical for evaporator and condenser duties in chiller and heat pump applications. The FTW250AS covers a capacity span up to around 70 USRt while the Hypertwain platform is being extended with additional BPHEs aiming for capacities up to 200 USRt with both single and dual circuit. Focus refrigerants are all high-pressure refrigerants such as R32, R410A, R454B, R452B, as well as being verified for R290 (Propane)

For more information, visit [www.swep.net](http://www.swep.net).

### New Infinitum Electric High-Efficiency Motors for Canada

Infinitum Electric, creator of the breakthrough air-core motor, announced a new product line specifically built to support Canadian HVAC fan, pump and general-purpose applications.

The new product line is an extension of Infinitum Electric's IEs Series motors and will be available in the 575V, 5-15 horsepower range in 2H 2022. With the addition of the Canadian products, Infinitum Electric is delivering the most comprehensive range of power and frame sizes for the North American HVAC market. The IEs Series offers 10% more efficiency and IoT capabilities in a package that is 50% lighter and smaller, and significantly quieter than traditional motors.

To date, Canadian HVAC applications requiring 575V power have largely relied on suboptimal motor configurations due to a lack of focus on the specific needs of the Canadian market. HVAC applications have therefore used either an EC motor and a transformer to convert power, which adds costs and reduces overall efficiency, or a conventional, lower efficiency AC induction motor and VFD.

“Having a motor designed specifically for Canada greatly simplifies our engineering process and will ultimately help us deliver better products,” said Larry Hopkins, chief technology officer, XNRGY. “Infinitum Electric's

integrated motor and VFD gives us the breakthrough levels of efficiency our customers want, while its smaller size and light weight open new possibilities for our development team.”

“Infinitum Electric's advancements in motor efficiency have the potential to spur innovation and reduce energy demand in Canadian HVAC and pump applications,” said Ivan Campos, research analyst, Omdia. “As supply chain issues continue, Infinitum Electric's simple motor design, materials and PCB stator technology make it easier to source, produce and assemble motors close to their target market, reducing lead times.”

“We're excited to expand our footprint and bring our proven IEs Series product line to Canada,” said Ben Schuler, founder and chief executive officer, Infinitum Electric. “We look forward to working with product manufacturers who are looking to achieve new levels of sustainability for fan, pump and general-purpose applications.”

### About Infinitum Electric

Infinitum Electric has raised the bar for a new generation of motor that is better for the planet and people. The company's patented air-core motors offer superior performance in half the weight and size, at a fraction of the carbon footprint of traditional motors, making them pound for pound the most efficient in the world. Infinitum Electric motors open up sustainable design possibilities for the machines we rely on to be smaller, lighter and quieter, improving our quality of life while also saving energy. Based in Austin, Texas, Infinitum Electric is led by a team of industry experts and pioneers. For more information, visit [www.infinitumelectric.com](http://www.infinitumelectric.com).

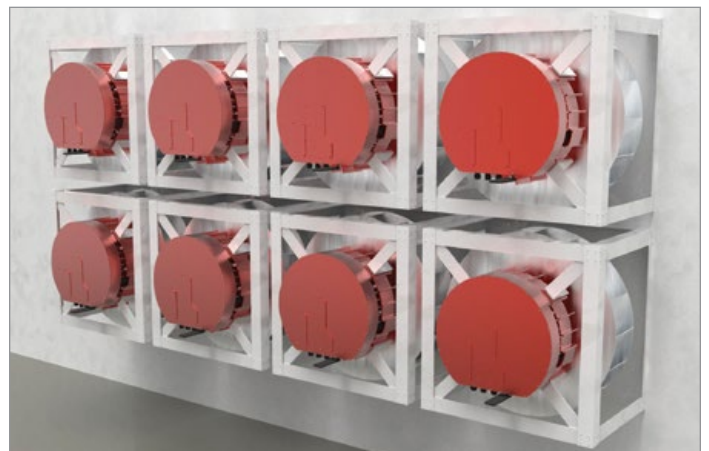

Air-core motors purpose-built for Canada deliver breakthrough efficiencies and simplify design for HVAC fan, pump and general-purpose applications.



# THE MARKETPLACE

**COMPRESSED AIR BEST PRACTICES®**  
www.airbestpractices.com

## ADVERTISER INDEX

Company	Page	Web Site
Kaeser Compressors	Outside Back Cover	https://us.kaeser.com/cabp
Atlas Copco	Inside Front Cover	www.atlascopco.com/air-usa
BEKO Technologies	Inside Back Cover	www.bekousa.com
Mikropor	5	www.mikroporamerica.com
Sullair	7	www.sullair.com
Assured Automation	8	www.assuredautomation.com
Clean Resources	9	www.cleanresources.com
Best Practices Webinars	10	www.airbestpractices.com/webinars
Altec AIR	11	www.AltecAIR.com
Applied System Technologies	12	www.appliedsystemtech.com
Sahara Air Products	13	www.saharahenderson.com
Unipipe	15	www.unipipesolutions.com
Howden	17	www.howden.com
Lone Star	19	www.LoneStarTurbo.com
Best Practices 2022 EXPO	20, 36, 40	https://cabpexpo.com/
ZEKS	21	www.zeks.com
Compressed Air Challenge	22	www.compressedairchallenge.org
Compressed Air and Gas Institute	23	www.cagi.org/personnel-certification
SMC	25	https://www.smcusa.com/
Evapco	27	www.evapco.com
AEE West	31	www.aeewest.org

## TECHNOLOGY & JOBS

### Job & Product Marketplace Advertising Information

Reach 16,200+ readers of **Compressed Air Best Practices® Magazine with Marketplace Ads every month!** Job Marketplace ads are also placed for one month on [www.airbestpractices.com](http://www.airbestpractices.com) and promoted in our three monthly e-newsletters.

Ad dimensions are 2.36" wide x 3.91" tall. We can help you design the ads. Send us your logo, product photo, and text to [rod@airbestpractices.com](mailto:rod@airbestpractices.com). We recommend 20-50 total words of text.

Prices are \$625 per Job or Product Marketplace Ad (\$440 if 6 or more ads are placed). Contact Rod Smith at [rod@airbestpractices.com](mailto:rod@airbestpractices.com) to schedule your Marketplace Ads.



**Advertising/Editorial** Rod Smith • [rod@airbestpractices.com](mailto:rod@airbestpractices.com) • Tel: 412-980-9901  
**Subscriptions Administration** Patricia Smith • [patricia@airbestpractices.com](mailto:patricia@airbestpractices.com) • Tel: 412-980-9902  
 A Publication of **Smith Onandia Communications LLC**  
 37 McMurray Rd., Suite 104, Pittsburgh, PA 15241

# THE MARKETPLACE

## TECHNOLOGY & JOBS

### High Efficiency Compressor Controllers

Control Rotary Screw, Vane, Scroll or Recip Compressors

Save Energy controlling up to FOUR compressors and qualify for Utility Rebates.



- Automatic Lead/Lag Control-up to FOUR Compressors
- Accurate Pressure Control with Pressure Transducers
- Compressors and Vacuum Pumps from 1 to 250 hp
- Automatic Lead/Lag Control for Chillers & Heat Exchangers

**Standard Pneumatic Products, Inc.**  
Tel: 203-270-1400 • Toll free: 800-979-9156  
Email: sales@stdpneumatics.com

[www.stdpneumatics.com](http://www.stdpneumatics.com)



CONNECTED TO INNOVATION

**prevost**  
Quick Safety Couplings



**Decompress and disconnect with one simple push of a button**



- Eliminate hose whip
- Consistent flow rates
- Lightweight, anti-scratch body
- Anti-static, silicone free
- Multiple profile connections
- Available in body sizes from 1/4" to 1/2"



Prevost CORP - 74 Brookfield Oaks Drive Ste. 3 - Greenville, SC 29607  
(800) 845-7220 - sales.corp@prevostusa.com - www.prevostusa.com



Acoustic Camera

Leak Detection with  
**SONASCREEN**

[Learn More](#)

Join our EXCLUSIVE Members Only  
DISTRIBUTOR TO DISTRIBUTOR NETWORK



- Easily connect from your mobile device
- Direct access to members local or nationwide
- 30 day free trial

Locate Machines For Re-Rent, Hard-To-Find Specialty Units, Obsolete Parts, Etc.

Easily create your posts including images, videos and text from your smart phone.

Sign up at [compressortrader.com/join](http://compressortrader.com/join)



SYNTHETIC FLUIDS  
SINCE 1975

- OEM CALIBER SYNTHETIC AIR COMPRESSOR LUBRICANTS
- TECHNICAL SUPPORT
- GENEROUS FREIGHT POLICY
- COMPLIMENTARY OIL ANALYSIS
- SHIP NEXT DAY IN MOST CASES

CALL PAT SCHRIDER  
1-850-543-5490



### Job & Product Marketplace Advertising Information

Reach 16,200+ readers of Compressed Air Best Practices® Magazine with Marketplace Ads every month!



Prices are \$625 per Job or Product Marketplace Ad (\$440 if 6 or more ads are placed).

Contact Rod Smith at [rod@airbestpractices.com](mailto:rod@airbestpractices.com) to schedule your Marketplace Ads.



**We** proudly  
provide **you**  
with the  
**best**  
solutions



## QWIK-PURE® / ÖWAMAT® Oil-water Separators

The disposal of air compressor lubricant carryover in condensate is a concern, as is the variety of regulations across the country.

Installation of an oil-water separator is simple. The oily condensate from each drain valve is individually piped to a depressurization chamber to reduce pressure to atmospheric. The clean water is then piped into a waste water drain. The separated oil is contained within the cartridge and/or held in a collection vessel for proper disposal.

### Features and Benefits

- Simplified Service
- Unique Adsorption Material
- Reliable Operation
- Environmentally Safe
- Future Proof

**Our promise** ✓



+1 (800) 235-6797



[www.bekousa.com](http://www.bekousa.com)

**Truth in Compressed Air**  
Reliable | Efficient | Innovative





**KAESER**  
**COMPRESSORS**®  
*Built for a lifetime.*

## Be the hero. Get a SAM 4.0.

**C**ompressors cycling faster than a speeding bullet? Energy costs growing by leaps and bounds? Maintenance bills more powerful than a locomotive? It's time to call on a compressed air master controller that's built to save the day.

Our Sigma Air Manager 4.0 monitors compressors and steps in before there's trouble. It eliminates compressors fighting for control, restores peace to the system with a steady pressure, and reduces energy waste from idling and cycling.

Beyond saving energy, SAM 4.0 lowers maintenance costs by minimizing run time which extends service intervals. Reduced cycling and idling means less wear and tear on the motor, starter, valves, etc. SAM 4.0 also provides full time energy monitoring and easy integration into plant control/IIoT systems.

Get a SAM 4.0 today and be the superhero of your plant (red cape sold separately).



*Kaeser's Sigma Air Manager 4.0 (SAM) compressed air management system brings the IIoT to industrial plants with its adaptive control, data storage, analysis, and predictive maintenance capabilities, and it does it all while ensuring a reliable, consistent supply of compressed air.*

**Kaeser Compressors, Inc. • 866-516-6888 • [customer.us@kaeser.com](mailto:customer.us@kaeser.com)**  
*Built for a lifetime* is a trademark of Kaeser Compressors, Inc. ©2022 Kaeser Compressors, Inc.

