

# CLEVELAND WHEELS & BRAKES

## CLEVELAND WHEELS & BRAKES FOR HOMEBUILTS



Wheels with matching hydraulic disc brakes are made from magnesium alloy castings to give a lightweight, durable unit. Wheels complete with bearings and wheel covers. Brake assembly has linings installed. Sold in pairs only.

**500 x 5**, Wt. 5.75 Lbs. Each (Wheel P/N 40-78B, Brake P/N 30-9)

Kit P/N 199-102 (Standard Disc).....**\$1,895.00/pr**  
 Kit P/N 199-102C (Chrome Disc).....**\$4,193.00/pr.**  
 Use Lining P/N 66-106. Fits 1-1/4" dia. axles.

**600 x 6**, Wt. 7-3/4 Lbs. Each (Wheel P/N 40-59A, Brake P/N 30-59A)  
 Kit P/N 199-104 (Standard Disc).....**\$5,245.00/pr.**  
 Kit P/N 199-104C (Chrome Disc).....**\$3,126.00/pr.**  
 Use Lining P/N 66-112. Fits 1-1/2" dia. axles.

**600 x 6**, with Master Cylinders for Defiant  
 Special set consists of (2) P/N 40-75B wheels, (2) P/N 30-52 brake assemblies and (2) P/N 10-34 master cylinders.  
 P/N 199-133X.....**\$6,336.00**

**500 x 5 NOSE WHEEL** - Magnesium, with bearings.  
 For 1-1/4" dia. axle.....P/N 40-77C.....**\$1,412.00**

**600 x 6 NOSE WHEEL** - Anodized aluminum, with bearings.  
 For 1-1/2" dia. axle.....P/N 40-56.....**\$3,077.00**

## HEAVY-DUTY CLEVELAND WHEELS & BRAKES FOR HOMEBUILTS



The heavier-duty brake discs, linings and hardware in these kits will increase braking capacity for the heavier, faster-landing aircraft now being designed & built.

**#199-93 UPGRADE KIT**  
 For #199-102 standard wheels and brakes. Upgrades current 40-78B/30-9 to new 40-230/30-181 specs. Consists of #66-106 linings, discs, shims, bolts, rivets and nameplates for 2 wheels & brakes.  
 P/N 199-93.....**\$1,052.00**

**#199-156 KIT (AIRCRAFT TO 1500 LBS)**  
 Kit consists of two 40-230 wheel assemblies and two 30-181 brake assemblies. Uses #66-106 linings. Fits 1-1/4" dia. axles.  
 Used on Vari-eze.....P/N 199-156.....**\$3,598.00**

**#199-152 KIT FOR LONG-EZ & COZY (AIRCRAFT TO 2200 LBS)**  
 Kit contains two 40-151 wheel assemblies and two 30-133 brake assemblies. Uses #66-105 linings. Fits 1-1/4" dia. axles.  
 P/N 199-152.....**\$4,191.00**

## CLEVELAND WHEELS & BRAKES FOR AMPHIBIANS



Although magnesium wheels and brakes are considerably lighter, magnesium is subject to corrosion and should not be used for amphibious operation. Only organic linings should be used on all brakes. All parts of the 500 x 5 size wheels and brakes for amphibians are constructed of anodized aluminum

for water resistance. Although a special 40-74 series of 600 x 6 wheels and brakes are manufactured for amphibious use, with chrome plated bearings and brake disc and water drainage holes, they are too costly for use on homebuilt aircraft.

The use of standard Cleveland aluminum wheels with standard bearings on amphibian aircraft is suggested. If bearings are kept well greased, reasonable service can be expected, but earlier bearing replacement should be anticipated.

**500 x 5 (Anodized Aluminum)**  
 Kit P/N 199-103 (Std. Disc).....**\$4,804.00/pr.**  
 Kit P/N 199-103C (Chrome Disc).....**\$2,765.00/pr.**  
**600 x 6 (Anodized Aluminum)**  
 Kit P/N 199-105 (Std. Disc).....**\$3,914.00/pr.**  
 Kit P/N 199-105C (Chrome Disc).....**\$3,578.00/pr.**

**500 x 5 ALUMINUM NOSE WHEEL**.....P/N 40-87C.....**\$2,066.00**

## CLEVELAND HOMEBUILDERS SPECIAL WHEEL & BRAKE SET PACKAGES



**PACKAGE NO. 1**  
 Includes 2 Cleveland 5.00-5 magnesium wheels & brakes plus (2) 6 ply tires & tubes. (Wt. approx. 28 lbs.)

A w/STA Air Trac Tires & Tubes.....P/N 06-00100.....**\$2,315.00**  
 B w/Goodyear Flight Custom II Tires (Goodyear's latest design)  
 P/N 06-00200.....**\$2,815.00**  
 C w/Lamb Tires & Tubes (11.400 x 5).....P/N 06-00300.....**\$2,003.00**

**PACKAGE NO. 2**  
 Package No. 1 plus 2 Cleveland #10-35 master cylinders. (Wt. approx. 30 lbs.)  
 A w/STA Air Trac Tires & Tubes.....P/N 06-00400.....**\$4,423.00**  
 B w/G.Year Flight CustomII Tires & Tubes..P/N 06-00500.....**\$4,923.00**  
 C w/Lamb Tires & Tubes (11.400x5).....P/N 06-00600.....**\$4,111.00**

**PACKAGE NO. 3**  
 Includes 2 Cleveland 6.00-6 magnesium wheels and brakes plus two 4 ply tires and tubes. (Wt. approx. 32 lbs.)  
 A w/STA Air Trac Tires & Tubes.....P/N 06-00700.....**\$5,661.00**  
 B w/G.Year Flight Custom II Tires & Tubes..P/N 06-00800.....**\$6,127.00**

**PACKAGE NO. 4**  
 Package No. 3 plus 2 Cleveland #10-35 master cylinders. (Wt. approx. 34 lbs.)  
 A w/STA Air Trac Tires & Tubes.....P/N 06-00900.....**\$7,769.00**  
 B w/G.Year Flight Custom II Tires & Tubes...P/N 06-01000.....**\$8,235.00**

**PACKAGE NO. 5**  
 Includes 2 Cleveland 6.00-6 magnesium wheels & brakes plus two low-profile lightweight 6-ply 15x6.00-6 tires & tubes. (Wt. approx. 32 lbs.)  
 A w/STA Air Trac Tires & Tubes.....P/N 06-01100.....**\$5,771.00**  
 B w/G.Year Flight Custom II Tires & Tubes...P/N 06-01200.....**\$6,135.00**

**PACKAGE NO. 6**  
 Package No. 5 plus 2 Cleveland #10-35 master cylinders. (Wt. approx. 34 lbs.)  
 A w/STA Air Trac Tires & Tubes.....P/N 06-01300.....**\$7,879.00**  
 B w/G.Year Flight Custom II Tires & Tubes....P/N 06-01400.....**\$8,243.00**

**PACKAGE NO. 7 FOR DEFIANT**  
 Includes 2 Cleveland 6.00-6 magnesium wheels & brakes (P/N 199-133X) plus (2) 6.00-6 STA 6 ply tires & tubes plus 2 master cylinders.  
 P/N 06-01500.....**\$6,909.00**



## AEROSHELL GREASE FOR WHEEL BEARINGS

Aeroshell #22 grease is recommended for lubrication of Cleveland wheel bearings and is also applicable to other similar wheel bearings. Meets Mil-G-81322.  
 14 oz. tube.....P/N 08-05490.....**\$17.50**

LG

# WHEELS & BRAKES

## CLEVELAND WHEEL & BRAKE CONVERSION KITS

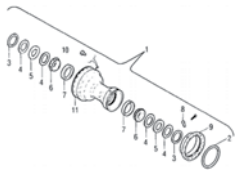

### REPLACE 800 x 4 WHEELS ON PIPER AIRCRAFT

A bolt-on 600 x 6 wheel and brake conversion kit for Piper models: J3, J5C, PA11, PA12, PA14, PA15, PA16, PA17, PA18 & PA20 PA18-150 & PA18A-150 with Form 337. The 199-71-STC kit comes complete

with STC paperwork. Accommodates tire sizes 600 x 6, 700 x 6, 800 x 6. No landing gear modifications required. Minor modification of hydraulic line required. Uses double puck brakes. Fits 1-1/4" diameter axle size only. Fits Piper J4/J5 but STC does not cover these aircraft.

#### Magnesium Model for general use

P/N 199-71 ..... \$4,163.00  
 P/N 199-71-STC (w/full STC paperwork)..... \$4,785.00  
 Aluminum Model for "AG" Service..... P/N 199-71A..... \$5,465.00

### REQUEST QUOTATION ON UNLISTED MODELS

### PIPER AZTEC - BRAKE

P/N 199-63 ..... \$5,025.00

Description	Part No.	Qty.
Brake Assembly	30-96	2
Brake Disc	164-57	2
Nameplate	166-74	2
Installation Instructions	E.S.B. 7000-4	1



Important Note: Image is for reference only. Individual components may vary by kit.

### CESSNA - WHEEL & BRAKE

P/N 199-46 ..... \$2,739.00  
 (6.00x6) FOR CESSNA MODELS: 120, 140, (SN 8004 thru 13399), 140A (SN 13400 and up), 170, 170A, 170B, 172, 172A thru 172E, 175, 175A, 175B, 175C, P172D, 180, 180A thru 180E, 182, 182A thru 182G.

Description	Part Number	Qty.
Wheel Assembly	040-09701	2
Brake Assembly	030-06301	2
Bushing	145-02200	8
Bushing	145-01000	4
W & B Assembly Dwg.	20-134	1
Installation Instructions	50-24	1
Installation Instructions	50-25	1
Installation Instructions	50-26	1
Supplemental Type Certificate		1

### GLOBE SWIFT

P/N 199-48C (Chrome) ..... \$7,717.00  
 Wheel and Brake Conversion Kit (6 00 X 6) for Globe Swift Models GC-IA, GC-IB.  
**NOTE: It will be necessary to change master cylinders and obtain the necessary axle hardware for conversion, Ref. dwg. 50-28. These parts can be obtained through Beech aircraft.**

Description	Part Number	Qty.
Brake Assembly	030-07902	2
Wheel Assembly	040-11303	2
Spacer	067-02400	2
W & B Assembly Drawing	20-130	1
Installation Drawing	50-23	1
Supplemental Type Certificate		1

### BEECH - WHEEL & BRAKE

P/N 199-49 ..... \$4,874.00  
 P/N 199-49C (Chrome) ..... \$8,549.00  
 (6.00x6) FOR BEECH AIRCRAFT MODELS: 35, A35 thru G35, 35R 35-33, 35-A33, 35-B33, 35-C33, 35-C33A, E33, E33A E33C, F33, F33A, F33C, G33, H35, J35, K35, M35, N35, P35, S35, V35, V35A, V35B, 36, A36.

Description	Part Number	Qty.
Brake Assembly	030-05400	2
Wheel Assembly	040-08300	2
Spacer	067-02600	2
W & B Assembly Drawing	20-69	1
Installation Drawing	50-28	1
Supplemental Type Certificate		1

### BEECH - WHEEL & BRAKE

P/N 199-50 ..... \$8,449.00  
 (7.00x8) FOR BEECH AIRCRAFT MODELS: 35, A35 thru G35, 35R, H35, J35, K35, M35, N35, P35, S35, D55, D55A, E55, E55A 95, B95, B95A, D95A, E95, 95-55, 95-A55, 95-B55A, 95-B55B, 95-C55, 95-C55A.

Description	Part Number	Qty.
Brake Assembly	030-06600	2
Wheel Assembly	040-09800	2
Spacer	067-02500	2
Spacer	067-02700	2
W & B Assembly Drawing	20-135	1
Installation Drawing	50-27	1
Supplemental Type Certificate		1

**NOTE: It will be necessary to change master cylinders and obtain the necessary axle hardware for conversion, Ref. dwg. 50-27. These parts can be obtained through Beech aircraft.**

Part No.	Description	Qty
040-09804	Wheel Assembly	2
030-06602	Brake Assembly	2
067-02900	Spacer	2
067-03200	Spacer	2
040-07602	Nose Wheel Assembly	1
067-03100	Spacer	2
157-01000	Dust Shield	2
102-00600	Screws	6
095-15100	Washers	6
207-00300	Hydraulic Line	2
50-29	Installation Drawing NLG	1
50-30	Installation Drawing MLG	1
	Supplemental type cert.	1

### #199-52 NAVION CONVERSION KIT

Complete kit for conversion to Cleveland 700 x 8 main gear and 600 x 6 nose wheel on Navion Models - A, B, C, D, E, F, G & H.  
 P/N 199-52 ..... \$12,437.00

### #199-52A NAVION CONVERSION KIT

Kit for conversion of main gear only.  
 P/N 199-52A ..... \$9,901.00

### CESSNA - WHEEL & BRAKE

P/N 199-60 ..... \$3,198.00  
 (6.00x6) For Cessna Models: 180, 180A, B, C, D, E, F, H, J, 185, 185A, B, A185E, A185F, 206E, 206F, TU206E, TU206F, 210, 210A, B, C, 210K, L, T210K, T210L.

Description	Part Number	Qty.
Wheel Assembly	040-07502	2
Brake Assembly	030-05200	2
Installation Drawing (210 series)	50-34	1
Installation Drawing (180,185,206 Series)	50-35	1
Supplemental Type Certificate (210 series)		1
Supplemental Type Certificate (180,185,206 Series)	20-64	1

**NOTE: Kit to be used only on aircraft with 6.00 x 6 tires.**

### CESSNA - WHEEL & BRAKE

P/N 199-62 ..... \$3,088.00  
 P/N 199-62C (Chrome) ..... \$3,278.00  
 (8.00x6) FOR CESSNA MODELS: 180, 180A, B, C, D, E, F, H & J. 185, 185A, B, A185E, A185E, A185F, 206E, F, TU206E, TU206F.

Description	Part Number	Qty.
Wheel Assembly	040-07504	2
Brake Assembly	030-05213	2
Installation Drawing	50-36	1
Supplemental Type Certificate		1

**NOTE: Kit to be used only on aircraft with 6.00 x 6 tires.**

### CESSNA - WHEEL & BRAKE

P/N 199-84 ..... \$2,987.00  
 CESSNA APPROVED RETROFIT FOR THE FOLLOWING AIRCRAFT:  
 150, F150, A150, FA150, 152, A152, F152, FA152, 177, 177RG, F177RG, 182, A182, F182

Description	Part Number	Qty.
Wheel Assembly	030-07500(1)	2
Brake Assembly	040-11300(2)	2
Installation Drawing	50-36	1

#### NOTE CESSNA CROSS REFERENCE NUMBERS

(1) C-163030-113(LH) C-163030-114(RH) (2) C-163001-0104

### CESSNA - WHEEL & BRAKE

P/N 199-84A ..... \$2,865.00  
 P/N 199-08413 (chrome) ..... \$4,497.00  
 CESSNA APPROVED RETROFIT FOR THE FOLLOWING AIRCRAFT: 172, F172, R172, FR172

Description	Part Number	Qty.
Wheel Assembly	030-07501(1)	2
Brake Assembly	040-11300(2)	2
Installation Drawing	50-37	1

#### NOTE CESSNA CROSS REFERENCE NUMBERS

(1) C-163030-011(LH) C-163030-112(RH) (2) C-163001-0104

### WE CARRY ALL CLEVELAND CONVERSION KITS

Cessna P210N ..... P/N 199-60A ..... \$4,580.00  
 Cessna 310, 320 ..... P/N 199-64 ..... \$8,778.00  
 Cessna 421, 340, 401, 402, 414 ..... P/N 199-76 ..... \$9,029.00  
 Ercoupe ..... P/N 199-69 ..... \$5,190.00  
 Beech Duke ..... P/N 199-73 ..... \$9,537.00  
 Beech Musketeer ..... P/N 199-124 ..... \$5,503.00  
 Beech 1900C, 1900D Nose Wheel Conversion  
 P/N 06-02550 ..... \$13,908.00  
 Luscombe(8 Series) Kit with STC ..... P/N 06-02951 ..... \$4,185.00  
 Stinson ..... P/N 199-87 ..... \$3,949.00  
 Hawker D18C, D18S, E18S, etc. (See website) . P/N 06-01909 ..... \$3,357.00  
 Raytheon ..... P/N 199-123 ..... \$23,154.00  
 Raytheon ..... P/N 199-124C ..... \$4,229.00  
 Raytheon ..... P/N 199-90 ..... \$16,598.00  
 Twin Otter DHC6-1, -100, -200, -300 ..... P/N 199-92 ..... \$28,464.00  
 Pilatus PC-7 MK-1 ..... P/N 05-21695 ..... \$15,952.00  
**SEE OUR WEBSITE FOR COMPLETE CONVERSION KIT LISTING**

# WHEELS & BRAKES

## FAA-APPROVED CLEVELAND WHFFI S & BRAKES

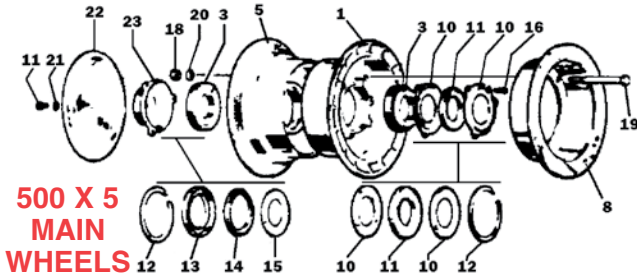

**500 X 5  
MAIN  
WHEELS**

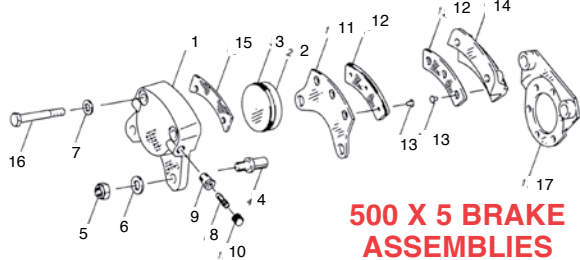

**500 X 5 BRAKE  
ASSEMBLIES**

FIG	Cleveland P/N	Part No.	Description	Assembly Number	Qty. Per Assembly						Price Each
					40-12	40-12A	40-12B	40-19	40-19A	40-19B	
1	161-5	161-00500	Inner Wheel Half Assy.	1	1	1					\$1,204.00
	161-03100	161-03100	Inner Wheel Half Assy.							1	\$717.00
	161-04100	161-04100	Inner Wheel Half Assy.							1	\$1,356.00
3	08231	214-00300	Cup-Bearing	1	1	1	1	1	1	1	\$45.50
5	162-00500	162-00500	Outer Wheel Half Assy.	1	1	1					\$1,480.00
	162-02800	162-02800	Outer Wheel Half Assy.							1	\$689.00
	162-03900	162-03900	Outer Wheel Half Assy.							1	\$1,511.00
3	08231	214-00300	Cup-Bearing	1	1	1	1	1	1	1	\$45.50
*	217-00100	217-00100	Grommet							1	\$15.50
*	101-07200	101-07200	"O" Ring	1	1	1					\$382.00
8	164-00400	164-00400	Brake Disc Assy.	1	1	1	1	1	1		\$425.00
	164-17	164-01700	Brake Disc Assy.							1	\$244.95
*	08125	214-00400	Cone-Bearing	2	2	2	2	2	2	2	\$82.75
19	AN4-31A	103-10800	Bolt	3	3	3	3	3	3		\$0.80
	AN4-22A	103-10500	Bolt							3	\$0.56
20	AN960-416	095-10400	Washer	6	6	6	6	6	3	3	\$0.09
18	AN365-428A	094-10300	Nut	3	3	3	3	3	3	3	\$0.19
10	153-00800	153-00800	Ring-Grease Seal	2	2	4	2	4	4	4	\$24.60
12	155-00200	155-00200	Ring-Snap	2	2	2	2	2	2	2	\$30.60
11	154-00600	154-00600	Felt-Grease Seal	1	1	2	1	2	2	2	\$18.55
23	158-00500	158-00500	Cap-Hub	1	1	1	1				\$558.00
17	102-25100	102-25100	Screw	1	1	1	1	1			\$18.80
21	095-15400	095-15400	Washer-Lock	1	1	1	1	1			\$15.50
22	157-00500	157-00500	Shield-Dust	1		1					\$197.75

**MODEL NO. 05-13459** wheel with brake disc and 1-1/4" dia. bearings as used on Cessna 150.....P/N 05-13459.....\$2,974.00

**MODEL NO. 40-78B**.....P/N 40-78B.....\$2,245.00

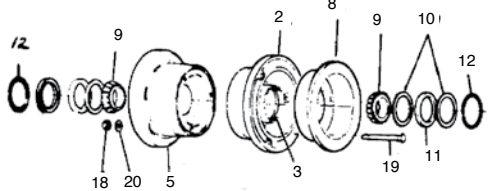

**600 X 6 MAIN WHEELS**

FIG	Cleveland P/N	Part No.	Description	Assembly Number	Qty. Per Assembly				Price Each
					30-9	30-9A(2)	30-9C	30-9D	
	91-00702	06-01203	Cylinder Assembly		1			1	\$1,074.00
	91-04800	06-01204	Cylinder Assembly			1	1		---
	91-17401	06-01205	Cylinder Assembly					1	\$950.00
1	61-00601	061-00601	Cylinder		1			1	\$892.00
	61-03901	061-03901	Cylinder			1	1		---
	92-00200	06-01206	Piston		1	1	1	1	\$188.75
2	79-00300	062-00300	Piston		1	1	1	1	\$170.80
3	101-02300	AN6227B-23	O-ring (MS28775-218)		1	1	1	1	\$2.13
4	069-00400	069-00400	Anchor bolt		2	2	2	2	\$48.90
5	94-10300	AN365-428A	Nut (MS21044-N4)		2	2	2	2	\$0.19
6	95-10400	095-10400	Washer (AN960-4-16)		2	2	2	2	\$0.09
7	95-10200	095-10200	Washer (AN960-416L)		2	2	2	2	\$0.04
8	079-00300	079-00300	Screw-Bleeder		1	1	1	1	\$21.50
9	081-00100	081-00100	Seat-Bleeder		1	1	1	1	\$38.70
10	183-00100	183-00100	Cap-Bleeder		1	1	1	1	\$7.85
	073-00300	073-00300	Pressure Plate Assy.		1	1	1	1	\$274.95
11	063-00500	063-00500	Pressure Plate		1	1	1	1	\$197.75
12	066-10600	066-10600	Lining		1	1	1	1	\$15.75
13	15-00200	105-00200	Rivet		3	3	3	3	---
	074-00200	074-00200	Back Plate Assembly		1	1	1	1	\$442.00
14	064-00500	064-00500	Back Plate		1	1	1	1	\$203.95
12	66-106	066-10600	Lining		1	1	1	1	\$15.75
13	15-00200	105-00200	Rivet		3	3	3	3	---
15	68-00401	06-01196	Shim					1	\$705.00
16	06-00011	103-12100	Bolt		2	2	2	2	\$1.25
		103-11500	Bolt					2	---
17	075-00800	075-00800	Torque Plate Assembly		1	1	1	1	\$465.00
	75-19300	06-01201	Torque Plate Assembly					1	\$998.00

**MODEL NO. 30-9** used with wheel 40-78..P/N 30-9.....\$946.00

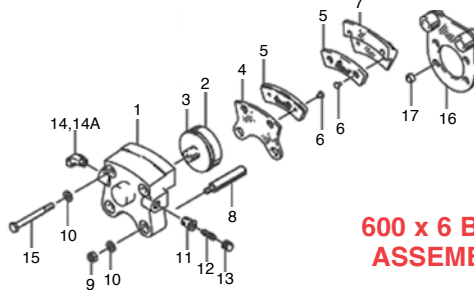

**600 X 6 BRAKE  
ASSEMBLIES**

FIG	Cleveland P/N	Part Number	Description	Assembly Number	Qty. Per Assembly					Price Ea.
					40-97	40-97A	40-97B	40-97C	40-97D	
2	161-03000	161-03000	Inner Wheel Half Assy.	1	1	1	1	1	1	\$568.00
	161-02100	161-02100	Inner Wheel Half Assy.						1	\$1,616.00
3	13836	214-00100	Cup-Bearing	1	1	1	1	1	1	\$49.85
5	162-02700	162-02700	Outer Wheel Half Assy.	1	1	1	1	1		\$575.00
	162-01900	162-01900	Outer Wheel Half Assy.						1	\$1,868.00
	13836	214-00100	Cup-Bearing	1	1	1	1	1	1	\$49.85
8	164-26A	164-02601	Brake Disc Assy.	1	1	1	1	1	1	\$183.75
	164-02800	164-02800	Brake Disc Assy.						1	\$337.00
9	214-00200	214-00200	Cone-Bearing	2	2	2	2	2	2	\$162.75
19	AN5-35A	103-20400	Bolt	3	3	3	3	3		\$1.19
	AN4-37A	103-11200	Bolt						6	\$1.21
20	AN960-516	095-10500	Washer	3	3	3	3	3		\$0.08
	AN960-416L	095-10200	Washer						6	\$0.04
18	AN365-524A	094-10400	Nut	3	3	3	3	3		\$0.27
	AN365-428A	094-10300	Nut						6	\$0.19
10	153-00400	153-00400	Ring-Grease Seal	2	2	2	2	2		\$25.50
	153-00300	153-00300	Ring-Grease Seal	1	1	2	1	1		\$25.50
	153-01500	153-01500	Ring-Grease Seal	1	1	2	1	1		\$31.85
	158-00300	158-00300	Cap-Hub						1	\$113.75
11	154-00300	154-00300	Felt-Grease Seal	1	1	1	1	1	1	\$15.95
	154-01300	154-01300	Felt-Grease Seal	1	1	2	1	1		\$15.95
12	155-00100	155-00100	Ring Snap	2	2	2	2	2	2	\$18.50
	154-12400	06-01778	Molded Grease Seal						1	\$42.85
	154-12000	06-01782	Molded Grease Seal						1	\$47.90

**MODEL NO. 40-97A** wheel with brake disc and 1.5" dia. bearings fits Cessna 172, 182.....P/N 40-97A.....\$1,159.00

FIG	Part No.	Cleveland No.	Description	Assembly No. & qty. per assembly				Price
				30-56	30-56A	30-63	30-63A	
	091-02200	091-02200	Cylinder Assy.	---	---	1	1	\$1,028.00
1	061-01900	061-01900	Cylinder	1	1	1	1	\$457.00
2	062-01600	062-01600	Piston	1	1	1	1	\$137.80
3	101-05200	101-05200	"O" Ring	1	1	1	1	---
	073-01100	073-01100	Press. Plate Assy.	1	1	1	1	\$174.75
4	063-01200	063-01200	Plate-Press.	1	1	1	1	\$148.75
5	66-105	66-155	Lining	1	1	1	1	\$17.75
6	105-00200	105-00200	Rivet - Cleveland 9/32" Long	2	2	2	2	\$0.85
	074-01000	074-01000	Back Plate Assy.	1	1	1	1	\$272.95
7	064-01500	064-01500	Plate-Back	1	1	1	1	\$163.75
8	069-00400	069-00400	Bolt-Anchor	2	2	2	2	\$48.90
9	AN365-428A	094-10300	Nut	2	2	2	2	\$0.19
10	AN960-416L	095-10200	Washer	4	4	4	4	\$0.04
11	081-00100	081-00100	Seat-Bleeder	1	1	1	1	\$38.70
12	079-00300	079-00300	Screw Bleeder	1	1	1	1	\$21.50
13	183-00100	183-00100	Cap-Bleeder	1	1	1	1	\$7.85
14	AN823-4D	104-00500	Fitting Tube	1	1	---	---	\$11.60
15	AN4H-17A	103-11600	Bolt-Lock	2	2	2	2	\$0.87
16	075-03700	075-03700	Torque Plate Assy.	---	1	1	1	\$470.00
17	145-01000	145-01000	Bushing	2	---	2	2	\$47.60

**MODEL No. 30-63A** used with wheel 40-97A..P/N 30-63A.....\$919.00

**MODEL No. 30-52** Brake Assy.....P/N 30-52.....\$1,323.00

**MODEL No. 30-52N** Brake Assy.....P/N 06-00106.....\$1,395.00

# CLEVELAND WHEEL & BRAKE PARTS

## CLEVELAND WHEEL ASSEMBLIES

Assembly No.	Part No.	Price
40-166	05-11658	\$9,454.00
40-60	05-11660	\$3,515.00
40-77B	05-11661	\$1,296.00
40-90	05-11662	\$2,834.00
161-05500	05-11630	\$1,106.00
40-75D	06-00105	\$1,398.00
40-140C	06-02822	\$5,682.00
40-56B	05-13441	\$2,152.00
040-07702	05-11661	\$1,296.00
040-0860	05-13470	\$1,549.00
40-87A	05-13472	\$1,485.00
40-97D	05-13480	\$2,145.00
40-97E	05-13481	\$2,787.00
40-98	05-13483	\$4,127.00
40-98A	05-13484	\$4,254.00
40-98G	05-13485	\$4,777.00
40-102	05-13488	\$6,799.00

## CLEVELAND BRAKE ASSEMBLIES

Assembly No.	Part No.	Price
30-52N	06-00106	\$1,395.00
30-83A	05-13391	\$2,175.00
30-164	05-14982	\$1,988.00
30-182A	05-13419	\$2,923.00
30-65	06-03065	\$1,779.00
30-63E	05-13370	\$1,424.00
30-84	06-02789	\$6,682.00

## CLEVELAND INSULATORS

Description	Part No.	Price
088-03500 Insulator Pin	06-02557	\$242.95
088-00100 Insulators	10-00091	\$32.65
088-00200 Insulators	05-13903	\$53.75
088-01400 Insulators	05-13906	\$298.95

## CLEVELAND BOLTS

Description	Part No.	Price
103-22600 Bolt/ Ms21250-05016	05-11597	\$164.75
103-31500 Bolt/ Nas6606-56	05-11598	\$112.90
103-11800 Bolt	06-01307	\$11.75
103-19000	05-14152	\$27.85

## CLEVELAND BRAKE CYLINDERS

Description	Part No.	Price
061-01800 Brake Cylinder 61-18	05-11556	\$569.00
061-01801 Brake Cylinder	05-11557	\$1,613.00
061-02400 Clev Cylinder	06-01207	\$698.00
061-02500 Brake Cylinder	05-11558	\$929.00
061-07000 Brake Cylinder	05-11559	\$3,114.00
061-07001 Brake Cylinder	05-11560	\$3,087.00
061-11800 Brake Cylinder	05-13606	\$1,045.00

## CLEVELAND BRAKE PISTONS

Description	Part No.	Price
062-03100 Brake Piston	05-11561	\$329.00
062-10800 Brake Piston	06-02554	\$195.75
092-02100 Brake Piston Assembly	05-11586	\$550.00
062-04100 Piston	05-13633	\$374.00
062-05600 Piston	05-13638	\$254.95
062-05700 Piston	05-13639	\$336.00
062-10800 Piston	06-02554	\$195.75
092-02000 Brake Piston Assembly	05-13960	\$143.85
092-03300 Brake Piston Assembly	05-13965	\$373.00
092-06700 Brake Piston Assembly	05-13977	\$299.95
139-20000 Piston Boot	05-14249	\$18.50

## CLEVELAND PRESSURE PLATES

Description	Part No.	Price
063-00600 Pressure Plate	05-11562	\$220.95
063-01400 Pressure Plate	05-11563	\$335.00
063-01500 Pressure Plate	05-11564	\$331.00
063-03500 Pressure Plate	05-11565	\$615.00
063-30025 Pressure Plate	05-11566	\$244.95
073-01300 Pressure Plate Assembly 73-13	05-11581	\$346.00
073-02700 Pressure Plate	05-11582	\$642.00
063-01100 Pressure Plate	06-01208	\$109.85
063-08200 Pressure Plate	06-02555	\$2,135.00
073-07100 Pressure Plate Assy	06-02556	\$2,368.00
063-01300 Pressure Plate	05-13657	\$345.00
063-03500 Pressure Plate	05-11565	\$615.00
063-08200 Pressure Plate	06-02555	\$2,135.00
073-08500 Pressure Plate Assembly	05-13766	\$321.00
073-09800 Pressure Plate Assembly	05-13769	\$1,996.00

## CLEVELAND BACK PLATES

Description	Part No.	Price
064-01600 Back Plate	05-11567	\$225.95
064-03200 Back Plate	05-11568	\$518.00
064-04300 Back Plate	05-11569	\$4,892.00
074-03400 Back Plate Assembly 74-34	05-11583	\$412.00
074-01000 Back Plate	074-01000	\$272.95
074-02300 Back Plate Assembly	05-13780	\$432.00
074-02900 Back Plate Assembly	05-13783	\$344.00
074-04800 Back Plate Assembly	05-13789	\$687.00
074-06600 Back Plate Assembly	05-13794	\$243.95
069-01900 Anchor Bolt	05-13722	\$95.75

## CLEVELAND SHIMS

Description	Part No.	Price
068-02700 Shim 68-27	05-11574	\$129.75
068-02800 Shim 68-28	05-11575	\$127.75
068-03000 Shim	05-11576	\$183.80
068-03100 Shim	05-11577	\$187.75
068-03300 Shim 68-33	05-11578	\$137.75
068-04000 Shim 68-40	05-11579	\$377.00
068-04100 Shim 68-41	05-11580	\$120.75
068-01600 Shim	06-01198	\$128.75
068-01700 Shim	06-01199	\$107.85
068-05300 Shim	06-80530	\$346.00
068-04600 Shim	05-13716	\$179.75

## CLEVELAND RIVETS

Description	Part No.	Price
105-00100 Rivet	05-11599	\$12.60
105-00900 Rivet	05-11600	\$3.35
105-00901 Rivet	05-11601	\$6.95
105-01100 Rivet	05-11602	\$5.35
105-01200 Rivet	05-11603	\$9.50
105-01300 Rivet	05-11604	\$5.35
105-06700 Rivet	05-11605	\$1.90
105-00200 Rivet	06-02808	\$0.85
Oval Head Rivet - Tubular	105-02401	\$16.50
105-08701 - Over Head Rivet - Tubular	05-14204	\$16.50
Rivet 105-08700	105-08700	\$19.50
105-06800	05-14203	\$4.65

## CLEVELAND BLEEDER SEAT

Description	Part No.	Price
081-00200 Bleeder Seat 81-2	05-11584	\$55.80
081-30169 Bleeder Seat	05-11585	\$227.95

## CLEVELAND SPACERS

Description	Part No.	Price
067-04100 Spacer 67-41	05-11572	\$611.00
067-06200 Spacer	05-11573	\$81.75
Spacer 067-30076	06-01195	\$132.65

## CLEVELAND PREFORMED PACKING

Description	Part No.	Price
101-61900 Preformed Packing	06-02559	\$18.95
101-60800 Packing	05-11595	\$53.90
101-62700 Packing	05-14110	\$71.75
101-60800 Packing	05-11595	\$53.90

## CLEVELAND BRAKE ASSEMBLY 30-59A

MFR Part No.	Qty. Rqd	Description	Part No.	Price/Ea.
30-59A / 030-05901	-	Complete Cleveland 30-59A Assy	30-59A	\$3,139.00
091-09600	1	091-09600 Cylinder Assy	06-01952	\$1,716.00
061-07500	1	061-07500 Cylinder	06-01953	\$772.00
092-04000	1	092-04000 Piston Assy	06-01954	\$130.99
062-03900	1	062-03900 Piston	06-01955	\$239.95
069-00400	2	069-00400 Bolt Anchor	069-00400	\$48.90
095-10200	4	095-10200 Washer AN960-416L	95-10200	\$0.04
079-00300	1	Bleeder Screw 079-00300	079-00300	\$21.50
081-00100	1	Bleeder Seat #081-00100	081-00100	\$38.70
183-00100	1	Bleeder Cap 183-00100	183-00100	\$7.85
073-04600	1	073-04600 Pressure Plate Assy	06-01956	\$291.95
063-03400	1	063-03400 Pressure Plate	06-01957	\$284.95
066-11200	2	Brake Lining # 66-112	66-112	\$36.25
105-00200	4	#105-2 4X4 Brake Lining Kit	105-00200	\$0.85
074-03600	1	074-03600 Back Plate Assy	06-01958	\$384.00
064-02900	1	064-02900 Back Plate	06-01959	\$414.00
103-11700	2	Bolt 103-11700	06-00078	\$16.50
075-03700	1	Torque Plate Assy	075-03700	\$470.00
145-01000	2	Bushing # 145-01000	145-01000	\$47.60

SEE WEBSITE FOR COMPLETE LISTING OF COMPLETE PARTS

[WWW.AIRCRAFTSPRUCE.COM](http://WWW.AIRCRAFTSPRUCE.COM)

Prices Subject to Change Without Notice - Valid as of June 1, 2023.

LG

# CLEVELAND WHEEL & BRAKE PARTS

## CLEVELAND GREASE SEALS

Description	Part No.	Price
153-04200 Grease Seal Ring	05-11612	\$97.85
154-00800 Grease Seal Felt	05-11613	\$38.50
154-01200 Grease Seal Felt	05-11615	\$88.75
154-02600 Grease Seal Felt	05-11616	\$59.75
154-02800 Grease Seal Felt	05-11617	\$42.65
154-03200 Grease Seal	05-11618	\$198.95
154-03500 Grease Seal	05-11619	\$221.95
154-03600 Grease Seal	05-11620	\$182.75
154-07500 Grease Seal	05-11621	\$352.00
154-30010 Grease Seal Felt	05-11622	\$19.80
154-00400 Clev Felt Seal	154-00400	\$28.50
154-01400 Clev Felt Seal	154-01400	\$20.90
154-00500 Clev Felt Seal	06-01193	\$31.80
153-00500 Clev Grease Ring	153-00500	\$37.50
153-00900 Clev Grease Ring	06-01192	\$34.85
154-13100 Grease Seal, Molded	05-12775	\$56.85
Molded Grease Seal 40-77, 40-77A, 40-77B	06-02819	\$67.75
199-507 Seal Repair Kit	05-14563	\$69.75
199-53500 Seal Repair Kit	05-14571	\$86.75
199-53801 Seal Repair	05-14572	\$383.00

## CLEVELAND BEARING CONE/CUPS

Description	Part No.	Price
214-00200 Bearing Cone	05-14605	\$162.75
214-00300 Bearing Cup	05-14606	\$79.85
214-00400 Bearing Cone	05-14607	\$123.75
214-00600 BRG Cone/Timken L21549	05-14608	\$591.00
214-00700 Bearing Cup	05-14609	\$257.95
214-00800 Bearing Cone	05-14610	\$308.00
214-00900 Bearing Cup	05-14611	\$67.75
214-01000 Bearing Cone	05-14612	\$183.80
214-03300 Bearing Cone	05-11639	\$198.65
214-03400 Bearing Cup	05-14625	\$107.95
214-13200 Bearing Cone	05-14642	\$196.75
214-00100 Cup Bearing	06-03305	\$74.85
214-01100 BRG Cup, Corrosion Resistant	05-14613	\$326.00
214-01200 BRG Cone, Corrosion Resistant	05-14614	\$3,163.00
214-01400 Bearing Cone	05-14615	\$135.75
214-01600 Bearing/ Torrington #BH1616	05-14616	\$189.75
214-01700 BRG Cup/Timken 19268 CP	05-14617	\$795.00
214-01800 BRG Cone/Timken 19150 CP	05-14618	\$3,053.00
214-01900 BRG Cup/Timken 07196 CP	05-14619	\$673.00
214-02000 BRG Cone/Timken 07100 CP	05-14620	\$2,138.00
214-02800 Cone, Bearing	05-14621	\$219.95
214-02900 Cup, Bearing	05-14622	\$118.75
214-03000 Bearing Cup	05-14623	\$605.00
214-03100 Bearing Cone	05-14624	\$370.00
214-03400 BRG Cup/Timken 07204	05-14625	\$107.95
214-03800 Bearing/ Timken 13600LA-902A3	05-14626	\$410.00
214-04300 Bearing Cone	05-14627	\$524.00
214-04400 Bearing/Timken LM29700LA-902A1	05-14628	\$414.00
214-04500 BRG Cone/Timken LM503349	05-14629	\$203.95
214-04600 BRG Cup/Timken LM503310	05-14630	\$117.75
214-04700 BRG Cone/Timken 18690	05-14631	\$312.00
214-04800 BRG Cup/Timken 18620	05-14632	\$176.75
214-04900 BRG Cone/Timken 18685	05-14633	\$312.00
214-05100 BRG Cup/Timken 08231 CP	05-14634	\$498.00
214-06300 BRG Cup/Timken 13830	05-14635	\$224.95
214-09200 Bearing Cone	05-14636	\$382.00
214-12300 Cone, Bearing	05-14637	\$436.00
214-12400 Cup, Bearing	05-14638	\$897.00
214-12900 Cup, Bearing	05-14639	\$329.00
214-13000 Cone, Bearing	05-14640	\$820.00
214-13100 Cup, Bearing	05-14641	\$95.75
214-13200 Cone, Bearing	05-14642	\$196.75
214-18200 BRG Cone - Chrome Plated	05-14643	\$3,526.00
214-18337 BRG Cup - Chrome Plated	05-14644	\$2,093.00
214-30371 Bearing	05-14645	\$283.95
214-39250 BRG Cone - Chrome Plated	05-14646	\$1,636.00
214-39412 BRG Cup/Timken 39412	05-14647	\$278.95
214-39422 BRG Cup - Chrome Plated	05-14648	\$1,955.00
214-80900 Spherical Bearing	05-14649	\$342.00
214-83500 Bearing, Spherical	05-14650	\$597.00

## CLEVELAND STATORS

Description	Part No.	Price
232-00300 Cleveland Stator	06-02564	\$1,798.00
232-00400 Cleveland Stator	06-02565	\$1,150.00

## CLEVELAND HOSE ASSEMBLIES

Description	Part No.	Price
207-00600 Hose Assembly	05-14589	\$725.00
207-01600 Hose Assembly	05-14595	\$523.00

## CLEVELAND SNAP RINGS

Description	Part No.	Price
155-00600 Cleveland Snap Ring 155-6	05-11623	\$54.75
155-02900 Snap Ring	05-11624	\$58.75
155-04400 Snap Ring	05-11625	\$54.75
155-04800 Cleveland Snap Ring T5304-15	06-02562	\$27.50
155-14300 Snap Ring	05-14375	\$103.85

## CLEVELAND WEAR PADS

Description	Part No.	Price
109-00100 Wear Pad	05-11607	\$33.95
109-00200 Wear Pad	05-11608	\$48.50
109-02800 Cleveland Wear Pad	06-02561	\$127.85
109-03000 Cleveland Wear Pad	109-03000	\$48.60
109-01500 Wear Pad	06-02795	\$45.70
109-00100 Wear Pad	05-11607	\$33.95
109-00201 Wear Pad	05-14214	\$21.85

## CLEVELAND WHEEL AND BRAKE PARTS

Description	Part No.	Price
065- . Torque Plate Assembly	05-11570	\$1,746.00
30-182. Brake Assembly	06-02566	\$4,116.00
30-54C Brake Assembly	05-11654	\$2,327.00
091-11900 Brake Cylinder Assembly	06-02820	\$1,749.00
162-00600 Outer Wheel Half	06-00015	\$1,804.00
162-02100 Outer Wheel Half	06-02100	\$1,533.00
161-044700 Inner Wheel Half	05-14419	\$652.00
162-04500 Outer Wheel Half	05-14476	\$749.00
162-04700 Outer Wheel Half	06-00114	\$977.00
075-17100 Torque Plate Assembly	05-13855	\$1,458.00
075-20301 Tube, Torque, Assembly	05-13860	\$4,625.00
103-11700 Anchor Bolt	06-00078	\$16.50
069-00200 Anchor Bolt	069-00200	\$82.75
177-00300 Pin	07-00003	\$25.75
068-01100 Insulating Shim	06-01197	\$84.65
199-516 O-Ring Kit	08-00353	\$39.75
214-01300 Bearing Cup	05-11637	\$129.75
095-01100 Washer	095-01100	\$31.85
111-08200 Adjuster Assembly	05-11610	\$326.00
107-03700 Wiper	107-03700	\$98.75
107-00500 Wiper Ring	05-11606	\$51.75
107-03100 Wiper Ring	05-14213	\$98.75
MS35266-61 Screw for 102-07100	06-02560	\$21.50
095-02600 Seal for Master Cylinder	05-11587	\$10.80
110-15300 Bumper Heat Shield	05-14218	\$7.85
095-03000 Washer	05-11588	\$25.85
094-10401 MS21045-5S Nut	06-02558	\$17.65
158-01300 Hubcap	05-11626	\$155.75
158-00300 Hubcap	158-00300	\$113.75
159-02700 Hubcap	05-11626	\$155.75
177-00400 Pin	06-01194	\$41.90
177-01600 Pin	05-11632	\$28.65
160-01100 Valve Stem	05-14404	\$363.00
160-01200 Valve Assembly	05-14405	\$312.00
106-01900 Inflation Valve	05-11629	\$360.00
082-02000 Spring	05-13887	\$19.95
102-33300 Screw	05-14119	\$12.60
102-00600 Screw 8-32X.250 Zinc	05-14113	\$12.65
094-91500 Nut MS21045-6S	05-14006	\$19.80
094-13800 Nut	05-13996	\$45.80
094-13200 Nut 42FLW-524	05-13995	\$64.75
1J2-2 Airborne Filter	05-11636	---
700-8 Dustshield Size	157-01000	\$447.00
106-02000 Inflation Valve Assembly	160-02000	\$243.95
199-52 Repair Kit	06-00834	\$54.75
ID Plate	166-21600	\$21.50
082-02000 Clev Spring	05-13887	\$21.50
082-05300 Clev Spring	05-13890	\$21.50

## CLEVELAND DRIVE KEY

Description	Part No.	Price	Description	Part No.	Price
205-00700 Drive Key	05-14581	\$98.75	205-05201 Drive Key	05-14587	\$280.95
205-04400 Drive Key	05-14585	\$113.75	205-00600 Key Liner	05-14580	\$158.75
205-05000 Drive Key	05-14586	\$83.75			

## CLEVELAND O-RINGS

Description	Part No.	Price	Description	Part No.	Price
101-50353	05-06395	\$19.90	101-61800	05-11596	\$35.80
101-27900	05-11591	\$20.80	101-60001	05-11593	\$37.80
101-28000	05-11592	\$25.85	101-24900	05-14076	\$16.50
101-60001	05-11593	\$37.80	101-24600	05-14075	\$14.85
101-60100	05-11594	\$9.90	101-24200	05-14073	\$20.65

SEE WEBSITE FOR COMPLETE LISTING OF COMPLETE PARTS

[WWW.AIRCRAFTSPRUCE.COM](http://WWW.AIRCRAFTSPRUCE.COM)

# NOSE WHEELS

## MATCO NOSE WHEELS

Matco Part No.	Our Part No.	Dia. (in.)	Bearing Axle dia.	Bearing Type Sealed	Width	Static Capacity (lbs.)	Load Limit (lbs.)	Weight (lbs.)	Price
<b>MATERIAL: SPUN ALUMINUM</b>									
MH6N	06-00537	6	0.625	Ball	5.325	660	2000	2.6	\$178.75
MH6N-S	06-00539	6	0.625	Ball	5.325	660	2000	2.6	\$178.75
MH6N.75	06-00538	6	0.75	Ball	5.325	660	2000	2.6	\$178.75
<b>MATERIAL: CNC CAST ALUMINUM</b>									
NW40B	06-00541	4	6.25	Ball	3	660	2000	2.25	\$130.75
NW40B.75	06-00542	4	0.75	Ball	3	660	2000	2.25	\$126.95
NW40R	06-00543	4	0.75	Taper/Roll	3	1185	3560	2.25	\$185.75
NW50	06-00544	5	0.75	Taper/Roll	3.88	1185	3560	3.24	\$212.95
NW51	06-00545	5	0.75	Taper/Roll	3.88	1185	3560	3.24	\$212.95
NW501.25	06-00546	5	1.25	Taper/Roll	3.88	1420	4260	3.24	\$204.95
NW511.25	06-00547	5	1.25	Taper/Roll	3.88	1420	4260	3.6	\$208.95
NW60	06-00548	6	1.25	Taper/Roll	3.5	1420	4260	3.24	\$196.75
NW600	06-00549	6	1.25	Taper/Roll	4.5	1420	4260	3.24	\$241.95
<b>MATERIAL: DIE CAST ALUMINUM</b>									
NW40EE	06-00550	4	0.625	Ball	3.25	660	2000	1.8	\$75.75
NW50CC	06-00551	5	0.625	Ball	4.38	660	2000	2.7	\$124.75
NW50CC.75	06-00552	5	0.75	Ball	4.38	660	2000	2.7	\$124.75
NW51CC	06-00553	5	0.625	Ball	4.38	660	2000	2.7	\$124.75
NW51CC.75	06-00554	5	0.75	Ball	4.38	660	2000	2.7	\$124.75
NW50CC.75R	06-00555	5	0.75	Taper/Roll	4.38	1185	3560	2.8	\$197.75
NW51CC.75R	06-00556	5	0.75	Taper/Roll	4.38	1185	3560	2.8	\$197.75
NW60CC	06-00557	6	0.625	Ball	4.38	660	2000	3.22	\$132.75
NW60CC.75	06-00558	6	0.75	Ball	4.38	660	2000	3.22	\$132.75
NW60CC.75R	06-00559	6	0.75	Taper/Roll	4.38	1185	3560	3.52	\$183.75
NW600CC	06-00560	6	0.625	Ball	5.38	660	2000	3.47	\$141.75
NW600CC.75	06-00561	6	0.75	Ball	5.38	660	2000	3.47	\$147.75
NW600CC.75R	06-00562	6	0.75	Taper/Roll	5.38	1185	3560	3.52	\$215.95
NW800CC-Z	06-00563	8	0.625	Ball	3	660	2000	5.02	\$149.75

### MATCO 6 INCH PNEUMATIC NOSE WHEEL ASSEMBLY



Matco mfg produces the WHLTW35 inch nosewheel for use with aircraft requiring less than 660 pounds nosewheel load. Dimensions: The WHLTW35 uses 0.625 inch Sealed Ball bearings. It is 1.78 wide and weighs approximately 0.91 lbs. Performance: The WHLTW35 is designed for the following standards: • Static Capacity: 660 • Load Limit: 1980 • Also used in WHLT-6P Tailwheel • This wheel uses the TIRT6X2ASY tire & tube assembly. The wheel is rated at 660 lbs static but the tire is only rated at 250 lbs static. This is the lightest weight 6 inch pneumatic wheel available! .....P/N 06-01658 .....\$126.85

### MATCO NOSEWHEEL



Matco mfg produces the WHLTW40R nosewheel for use with aircraft requiring less than 1185 pounds nosewheel load. Dimensions: The WHLTW40R uses .75 inch tapered roller bearings. It is 2.6 wide and weighs approximately 2.1 lbs. Static Capacity: 1185. Load Limit: 3555. Tapered Roller Bearings: .75 inch. Wheel Assembly Width: 2.6. Weighs: appr. 2.1 lbs. P/N 06-02571 .....\$193.90

### GROVE 400X4 NOSE WHEEL



The perfect nose wheel for light sport aircraft such as the KR and Soneri. • Static Load Rating 900lbs • Genuine Timkin Bearings • Uses 3/4" Axle • Felt Seals • Weight 1.98 lbs Model 49-1A..... P/N 06-00843. \$416.00 **TIRE:** Uses 400 x 8 ply tire.. P/N 06-00844...\$97.75 **TIRE:** Uses 4.10 x 3.50 x 4 ply tire P/N 06-08102...\$43.75

### GO-CART WHEELS



Cast aluminum wheels with 4" hub, for homebuilts and sailplanes. Used on Tri-Q conversion as nose-wheel. 3-1/4" wide. Complete with 5/8" dia. ball bearings. Wt. 1-1/2 Lbs.....P/N 06-00550 ..... \$75.75 Ea.

### HEGAR 6" NOSE WHEEL



The 6" Spun Aluminum nose wheel with 5/8 bearings. Comes centered when using the MX o-ring standard wheel hub but can also be purchased with the MX offset hub (no o-ring with offset hub. Requires the use of a tube. Comes complete with nuts, bolts, washers, valve stem, o-rings if required and the MX hub. May also be used as main wheels. P/N 06-01274 .....\$112.75

### CLEVELAND NOSE WHEELS 500X5

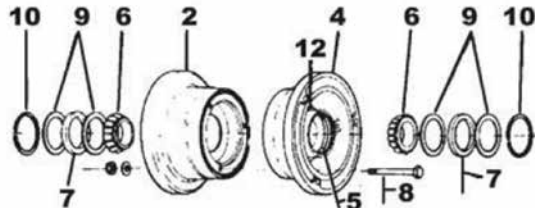

#	Old Part No.	Part No.	Description	Qty Per Assy.				Price Each	
				40-77	40-77A	40-85	40-87		40-87A
2	162-28	162-02800	Outer Wheel	1	1	-	1	-	\$689.00
	162-36	162-03600	Outer Wheel	-	-	-	-	1	\$912.00
	08231	214-00300	Cup Bearing	1	1	1	1	1	\$79.85
12	217-1	217-00100	Grommet	1	1	1	1	1	\$15.50
4	161-31	161-03100	Inner Wheel Half Assy.	1	1	-	1	-	\$717.00
	161-38	161-03800	Inner Wheel Half Assy.	-	-	-	-	1	\$1,043.00
5	08231	214-00300	Inner Cup Bearing	1	1	1	1	1	\$79.85
8	103-1050	AN4-22A	Bolt	3	3	3	3	3	\$0.56
*	095-10400	AN960-416	Washer	6	6	6	6	6	\$0.09
*	094-10300	AN365-428A	Nut	3	3	3	3	3	\$0.19
9	153-8	153-00800	Ring-Grease Seal	4	4	-	-	-	\$24.60
	21-104	153-00200	Ring-Grease Seal	-	-	4	-	-	\$29.50
10	155-2	155-00200	Ring-Snap	2	2	2	2	2	\$30.60
7	154-6	154-00600	Felt-Grease Seal	2	2	-	-	-	\$18.55
6	08125	214-00400	Cone-Bearing	2	2	2	2	2	\$123.75

500 X 5 NOSE WHEEL dimensions: 6.625 in. x 6.625 in. x 7 in. P/N 40-77 .....\$897.00

500 X 5 NOSE WHEEL with 1-1/4" dia. bearings. Used on some models of Cessna 150, is typical of nose wheels used on general aviation aircraft. FAA-approved.....P/N 40-77A.....\$1,098.00

500 X 5 NOSE WHEELS 1-1/2" Dia. Bearings used on Mooney Model 40-77B .....P/N 05-11661 .....\$1,296.00 Model 40-87 .....P/N 06-00417 .....\$1,558.00 Model 40-87C.....P/N 06-00962 .....\$2,066.00

600 X 6 NOSE WHEEL with 1-1/2" dia. bearings. (not illustrated) is used on some models of Cessna 172 and 182. FAA approved. P/N 40-76A .....\$972.00

600X6 Nose Wheel 40-76B.....P/N 05-13057 .....\$1,695.00

LG

# MATCO WHEELS & BRAKES



P/N 06-00448



P/N 06-00456



P/N 06-00462



P/N 06-01660

NOTE: Our prices include 2 wheels and 2 brakes (set)

Matco Part No	Aircraft Spruce	Bearing Axle Dia. BB=Ball TRB=Taper Roll	Load Limit (lbs.)	Static Capacity (lbs.)	Brake Reline Kit	Weight (lbs.)	Tire Size	Tire Type	Price
<b>CNC SPUN WHEELS: INTERNAL CALIPER</b>									
MH6B	06-16810	0.625BB	2000	660	BRL-2	4.4	6"	any 6"	\$692.00
MH6B-S	06-00447	0.625BB	2000	660	BRL-2	4.4	6"	any 6"	\$694.00
MH6B.62D	06-00448	0.625BB	2000	660	BRL-3	4.65	6"	any 6"	\$794.00
MH6B.62D-S	06-00449	0.625BB	2000	660	BRL-3	4.65	6"	any 6"	\$795.00
MH6B.75	06-00450	0.75BB	2000	660	BRL-2	4.4	6"	any 6"	\$685.00
MH6B.75-S	06-00453	0.75BB	2000	660	BRL-2	4.4	6"	any 6"	\$686.00
MH6B.75D	06-00451	0.75BB	2000	660	BRL-3	4.65	6"	any 6"	\$794.00
MH6B.75D-S	06-00452	0.75BB	2000	660	BRL-3	4.65	6"	any 6"	\$794.00
MH6BD.62	06-00454	0.625BB	2000	660	2BRL-2	5.18	6"	any 6"	\$876.00
MH6BD.62-S	06-00455	0.625BB	2000	660	2BRL-2	5.18	6"	any 6"	\$877.00
MH6BD.75	06-00456	0.75BB	2000	660	2BRL-2	5.18	6"	any 6"	\$889.00
MH6BD.75-S	06-00457	0.75BB	2000	660	2BRL-2	5.18	6"	any 6"	\$876.00
<b>CNC SPUN WHEELS: EXTERNAL CALIPER</b>									
MHE6B1.25	06-00444	1.25TRB	2700	900	BRL-1	5.8	6"	up to 6.00-6	\$859.00
MHE6B1.25-C	06-00443	1.25TRB	2700	900	BRL-1	5.8	6"	up to 6.00-6	\$848.00
<b>CENTRIFUGALLY CAST WHEELS: INTERNAL CALIPER</b>									
W40B	06-00458	0.625BB	2000	660	BRL-2	4.05	4"	any 4"	\$700.00
W40-BDXT	06-00459	0.75BB	3560	1185	BRL-2	3.8	4"	2.80/2.50x4	\$734.00
W40R	06-02210	0.75BB	3560	1185	BRL-2	4.05	4"	any 4"	\$797.00
W50L	06-01860	0.625BB	2000	660	BRL-1	6.6	5"	11.0x4.05	\$731.00
W50L.75	06-00833	0.75BB	2000	660	BRL-1	6.6	5"	11.0x4.05	\$754.00
W50LD	06-00411	1.25BB	4260	1420	2BRL-1	8.9	5"	11.0x4.05	\$862.00
W50LT	06-00461	1.25BB	4260	1420	BRL-6	9.2	5"	11.0x4.05	\$875.00
W50LXT-Pair	06-00462	1.25BB	1420	4260	BRL-6	9.2	5"	11.0x4.05	\$1,044.00
W50S1.25	06-01660	1.25BB	4260	1420	BRL-1	6.6	5"	11.0x4.05	\$724.00
W50S.75	06-00463	0.75BB	4260	1185	BRL-1	6.6	5"	11.0x4.05	\$751.00
W51L	06-01710	1.25BB	4260	1420	BRL-1	6.6	5"	5.00x5	\$687.00
W51LD	06-00464	1.25BB	4260	1420	2BRL-1	8.9	5"	5.00x5	\$814.00
W51LT	06-00079	1.25BB	4260	1420	BRL-6	9.2	5"	5.00x5	\$877.00
W51LXT	06-00412	1.25BB	4260	1420	BRL-6	9.2	5"	5.00x5	\$968.00
W50LXT-Single	06-00412-1	1.25BB	1420	4260	BRL-6	9.2	5"	11.0x4.05	\$490.00
W51S1.25	06-01960	1.25BB	4260	1420	BRL-1	6.6	5"	5.00x5	\$722.00
W62	06-02110	0.75BB	3560	1185	BRL-1	7	6"	any 6"	\$699.00
F602	06-00465	0.75BB	3560	1185	BRL-1	7.8	6"	any 6"	\$912.00
W60	06-02160	1.25BB	4260	1420	BRL-1	7.1	6"	any 6"	\$699.00
F600	06-00466	1.25BB	4260	1420	BRL-1	7.8	6"	any 6"	\$834.00
W600	06-00467	1.5TRB	5580	1860	BRL-6	11.9	6"	any 6"	\$934.00
W600XT	06-00413	1.5TRB	5580	1860	BRL-6	11.9	6"	any 6"	\$1,059.00
W600XLT	06-00468	1.5TRB	5580	1860	BRL-6	10.2	6"	any 6"	\$1,046.00
W323A	06-00469	1.5TRB	5580	1860	BRL-323	13.75	6"	any 6"	\$1,446.00



# MATCO WHEELS & BRAKES

## MATCO DIECAST WHEELS

NOTE: Our prices include 2 wheels and 2 brakes (set); Bearing Axle: BB=Ball TRB=Taper Roll



P/N 06-00471



P/N 06-00485



P/N 06-00486



P/N 06-00489

Matco Part No.	Our Part No.	Bearing Axle Diameter	Load Limit	Static Capacity	Brake Reline Kit	Weight	Tire Size	Tire Type	Price
<b>CENTRIFUGALLY CAST WHEELS: EXTERNAL CALIPER</b>									
WE51	06-00445	1.25TRB	4260 lbs.	1420 lbs.	BRL-1	7.5 lbs.	6"	5.00x5	\$821.00
W50CC	06-00470	0.625BB	2000 lbs.	660 lbs.	BRL-2	4.57 lbs.	5"	11.0 x 4.05	\$693.00
W50CC.62D	06-00471	0.625BB	2000 lbs.	660 lbs.	BRL-3	4.82 lbs.	5"	11.0 x 4.05	\$795.00
W50CC.75	06-00472	0.75BB	2000 lbs.	660 lbs.	BRL-2	4.57 lbs.	5"	11.0 x 4.05	\$718.00
W50CC.75D	06-00473	0.75BB	2000 lbs.	660 lbs.	BRL-3	4.82 lbs.	5"	11.0 x 4.05	\$794.00
W50CCD.75	06-00474	0.75BB	2000 lbs.	660 lbs.	2 BRL-2	5.35 lbs.	5"	11.0 x 4.05	\$876.00
W51CC	06-00476	0.625BB	2000 lbs.	660 lbs.	BRL-2	4.57 lbs.	5"	5.00-5	\$742.00
W51CC.75	06-00478	0.75BB	2000 lbs.	660 lbs.	2 BRL-2	4.57 lbs.	5"	5.00-5	\$692.00
W51CC.75D	06-00479	0.75BB	2000 lbs.	660 lbs.	2 BRL-3	4.82 lbs.	5"	5.00-5	\$876.00
W51CCD.75	06-00480	0.75BB	2000 lbs.	660 lbs.	2 BRL-2	5.35 lbs.	5"	5.00-5	\$707.00
W600CC	06-00484	0.625BB	2000 lbs.	660 lbs.	BRL-2	5.85 lbs.	6"	any 6 "	\$721.00
W600CC.75	06-00485	0.75BB	2000 lbs.	660 lbs.	BRL-2	5.85 lbs.	6"	any 6 "	\$361.00
W600CCD.75	06-00489	0.75BB	2000 lbs.	660 lbs.	2 BRL-2	5.85 lbs.	6"	any 6 "	\$905.00
W600CC.75R	06-00491	0.75TRB	2000 lbs.	1185 lbs.	BRL-2	6.15 lbs.	6"	any 6 "	\$833.00
W600CCD.75R	06-00493	0.75TRB	2000 lbs.	1185 lbs.	2 BRL-2	6.55 lbs.	6"	any 6 "	\$935.00
W80CC-Z	06-00494	0.625BB	2000 lbs.	660 lbs.	BRL-1	8.75 lbs.	6"	4.80-8	\$717.00

LG

## MATCO AXLE CHART

Matco P/N	Aircraft Spruce P/N	Dia. (In.)	Used on Models	Axle Assy.	Comment	Axle Price	Assy. Price
A1	06-00495	1.25	W50, W51, WE51L	AXLE1	AL Flange Mount	\$91.99	118.75
A1A	06-00496	1.25	W50LD, W51LD, W50LT, W50LXT, W51LT, W51LXT	AXLE1A	AL Flange Mount	\$94.75	\$119.75
A1B	06-00497	1.25	WE51	AXLE1B	AL Flange Mount	\$93.75	\$119.75
A2	06-00498	1.25	W50S, W51S	AXLE2	AL Flange Mount	\$91.95	\$118.75
A3	06-00499	1.25	W60, W160, W160L	AXLE3	AL Flange Mount	\$89.75	\$117.75
A3A	06-00501	1.25	MHE51, MHE6B, MHE8B, MHE10B, MHE12B	AXLE3A	AL Flange Mount 5" Cessna bolt pattern	\$99.75	\$113.75
A3C	06-00502	1.25	MHE51-SC, MHE6B-SC, MHE8B-SC, MHE10B-SC, MHE12B-SC	AXLE3C	AL Flange Mount 6" Cessna bolt pattern	\$95.75	\$117.75
A4	06-16830	0.625	MHE6B, W50CC, W60CC, W40B	AXLE4	Steel Tube	\$71.75	\$75.75
A5	06-00503	0.75	W40BD	AXLE5	AL Flange Mount	\$101.75	\$106.75
A5G	06-00504	20mm	W40M	AXLE5G	Steel Flange Mount	\$105.75	\$113.75
A6	06-00505	1.5	W600, W600XT, WW600XLT	AXLE6	AL Flange Mount	\$121.95	\$142.75
A6M	06-00506	1.5	W600, W600XT, WW600XLT	AXLE6M	A6 Alternate Mount Ver.	\$121.95	\$148.75
A7	06-00507	0.75	MH6B, W50CC, W60CC, W40B	AXLE7	Steel Tube Mount	\$86.75	\$102.80
A8	06-00508	0.75	W62, MH6B.75, W50CC.7, MH6B5, 260CC.75	AXLE8	Steel Tube	\$83.75	\$91.99
A13	06-00509	0.625	W80CC-Z	AXLE13	Steel Tube for Fork Mount	\$82.75	\$91.99
A15	06-00510	1.5	W323A	AXLE15	For W323A Compound W&B	\$165.75	\$205.95
A15M	06-00511	1.5	W323SA	AXLE15M	For W3238A Compound W&B	\$163.95	\$199.85
A16	06-00512	0.75	F602	AXLE16	Steel Tube for W62 w/F602 Spacer	\$83.75	\$89.75
A17	06-00513	0.75	W600CC.75	AXLE17	Steel Tube	\$83.75	\$89.75
A19	06-00514	0.75	W50CC.75, W51CC.75, W51CC.75R ONLY	AXLE19	Steel Tube	\$83.75	\$89.75
A20	06-00515	0.75	NW50.75R, NW51.75R	AXLE20	Steel Tube w/Spacers for Zenith 601	\$77.75	\$86.75



# WHEELS & BRAKES



## HEGAR WHEEL KITS

Spun aluminum wheel kit includes aluminum wheel halves, hubs, 5/8 bearings, valve, tubeless kit and all necessary hardware, Compatible with Hegar brakes.

**Note: Order tires separately.**  
4X6 Symmetrical (Quicksilver®)

- P/N 06-00319 .....\$89.75
- 6X6 Offset rim .....P/N 06-00322 .....\$90.80
- 6X6 Symmetrical (Quicksilver®).....P/N 06-00323 .....\$112.75
- The following Hegar wheels are designed to fit Quicksilver® nose gear allowing clearance for the steering fork.
- 3.5X5 MX(L) Nose Wheel .....P/N 06-00324 .....\$112.75

## 6S X 6 SPUN ALUMINUM WHEEL WITH BRAKE KIT



6" Spun Aluminum Wheel kit includes, 2 – 6" spun aluminum wheels, 2 – 6" calipers and 4-1/2" rotors, all lines and fittings, axles included 5/8". 5/8" precision ball bearings are 800 GVW. To be run tubeless, but tubes may be used. Total weight per caliper, wheel, rotor and hub combined 3-3/4 lbs. Overall wheel width: 6.00 x 6" (3.5 rim w/stem & 2.5" no stem)  
P/N 06-01270 .....\$699.00

## HEGAR BRAKE ACCESSORIES

Order the type of master cylinder(s) & actuator best suited to your aircraft. Standard keyed axles for all aircraft, except Quicksilver®.

Description	Part No.	Price
Heel-Operated Master Cylinder	06-00328	\$121.75
Joystick-Mounted Master Cylinder	06-00329	\$204.95
Foot Linkage	06-00330	\$99.95
Hand Linkage	06-00331	\$90.25
Axles, 5/8" Standard, Set Of 2	06-00332	\$28.50
Axles, 5/8" Quicksilver® Set Of 2	06-00333	\$63.25
Axles, 3/4" Standard, Set Of 2	06-00334	\$36.50
Master Cylinder 5" Complete Single Lever 1/2" Bore	06-01277	\$132.75
Master Cylinder 5" Complete Single Lever 5/8" Bore	06-01671	\$134.75
Master Cylinder 5" Complete Dual T-Lever 1/2" Bore	06-01278	\$227.95
Master Cylinder 5" Complete Dual T-Lever 5/8" Bore	06-01611	\$226.95
Master Cylinder 7" Complete Dual T-Lever 1/2" Bore	06-01280	\$227.95
Master Cylinder 7" Complete Dual T-Lever 5/8" Bore	06-02812	\$227.95
Master Cylinder Complete 1/2" Bore MCT Motor Cycle	06-00329	\$204.95
Master Cylinder Complete 3/4" Bore MCT Motor Cycle	15-05690	\$138.75
Master Cylinder Only Rod End Type 1/2" Bore	15-04621	\$106.80
Master Cylinder Only Motor Cycle Type 3/4" Bore	15-06337	\$105.80
Master Cylinder Complete Heel Type 1/2 Bore	06-00328	\$121.75
Master Cylinder 7" Complete Single T-Lever 1/2" Bore	06-01279	\$89.75
Master Cylinder 7" Complete Single T-Lever 5/8" Bore	06-01775	\$134.80

## HEGAR 6 INCH BRAKE ASSEMBLY KIT WITHOUT WHEELS



Kit comes complete with two sets of hubs, 4.5" rotors, calipers, brake pads as shown along with two 8" axles with hardware, 15 feet of high pressure brake line and one bleeder kit. 5/8" or 3/4" bearing options.  
5/8 Bearing .....P/N 15-05703 .....\$564.00  
3/4 Bearing .....P/N 15-08293 .....\$586.00

## TRUE-LOCK FASTENER SYSTEMS

LG

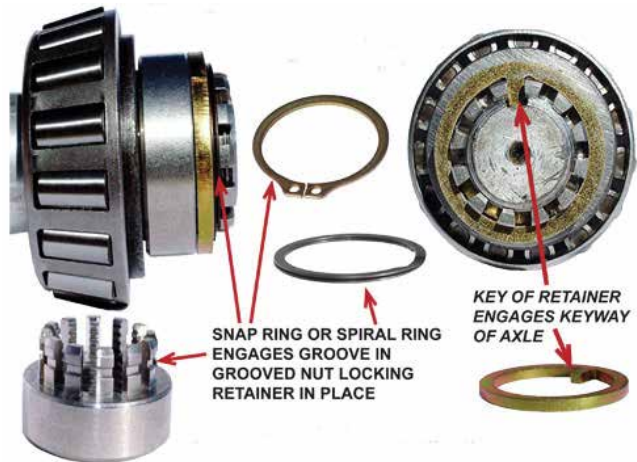

True-Lock aviation fastener systems reduce premature wear on your wheel-end assembly parts (brakes, bearings, axles, including tires and wheels). The True-Lock system eliminates the conventional axle nut system's inherent inferior torque setting characteristics imposed by the castle nut and cotter pin (end-play).

True-Lock is the only patented aviation wheel fastener system in the world that has been awarded an STC (Supplemental Type Certificate) by the FAA for axle nut technology. True-Lock LLC holds over 1,000 FAA certifications for aviation fastener design. All True-Lock fastener systems are guaranteed for the life of your aircraft and pay for themselves over time by reducing downtime and fewer replacement parts. So, If you want a wheel fastener system for your aircraft that sets the industry standard for vibration mitigation and cost reduction, then True-Lock is what you need.

The True-Lock fastener system is the next generation of fastener technology:

- FAA Certification on over 1,000 aircrafts.
- Significantly increases safety and reliability.
- Reusable & cost effective.
- Maintenance Free - requires no cotter pins or safety wire!

**SEE [WWW.AIRCRAFTSPRUCE.COM](http://WWW.AIRCRAFTSPRUCE.COM) FOR COMPLETE PRICE LIST OF TRUE-LOCK FASTENER SYSTEMS.**

# WHEELS & BRAKES

## MATCO HUB CAP KIT FOR MH SERIES WHEELS



Responding to customer inquiries for a kit to allow installation of the current WHLWC wheel cover on MH series wheels, MATCO mfg has introduced the MHWC hub cap kit. The kit includes wheel covers and mounting hardware for 2 wheels. The WHLWC wheel covers are made from durable ABS polymer. The wheel covers can be painted to match customer requirements. Installation can be accomplished without removing the wheel. Installation on MH wheels using the CNC spun wheel halves (introduced in early 2001) can be accomplished in about 10 minutes. On earlier MH series wheels using stamped wheel halves, some trimming of the wheel cover may be required and installation may require about 30 minutes. Furnished unpainted. 2 wheel kit. For 5" Wheels.....P/N 06-02913 .....\$46.70 For 6" Wheels.....P/N 06-00446 .....\$47.75

## MATCO BRAKE RELINE KITS



Matco Part No.	Our Part No.	Lining Model Used	Price each
BRL-1*	06-00571	4 of M66-106	\$46.85
BRL-2*	06-00572	4 of M66-103	\$45.50
BRL-3*	06-00573	4 of M66-1052	\$53.75
BRL-6*	06-00574	4 of M66-1052	\$95.75
BRL-323	06-00575	4 of DR323	\$383.00

\*Reline kits include linings and rivets for 2 calipers.

## MATCO TUBING & FITTINGS

Matco Part No.	Our Part No.	Description	Price
MSCNNR4/035	06-01133	Nylon II Tube .25	\$1.95
MSC261P	06-01134	Ferrule and Nut	\$3.35
MSC262P	06-01135	Union, Brass Fitting	\$5.85
MSC264P	06-01136	T-Fitting, 1/4" Compression.	\$10.50
MSC268P	06-01137	Straight fitting, 1/8" NPT - 1/4" Compression	\$3.95
MSC268P-04X01	06-01138	Straight Fitting 1/16"	\$16.90
MSC269P	06-01139	Brass Elbow, 90° 1/8" NPT - 1/4" Compression	\$4.35
MSCNNR2/026	06-01140	Nylon II Tube, .125	\$1.15
MSC164P	06-01142	T-Fitting, 1/8" NPT - 1/8" Compression	\$18.60
MSC168P	06-01143	Straight Fitting, 1/8" NPT - 1/8" Compression	\$7.50
MSC169P	06-01144	Brass Elbow, 90°, 1/8" NPT - 1/8" Compression	\$8.50

## GROVE CONVERSION KITS FOR PIPERS

Conversion kits are STC approved for Piper models listed below with 1-1/4" axles. No landing gear modifications required. The existing Scott master cylinders provide adequate pressure and volume for this conversion kit and need not be replaced. Comes complete with STC paperwork, 2 wheel and brake assemblies, mounting hardware, brake line extensions and fittings. Approved tire sizes include 6.00-6, 7.00-6, 8.00-6, 8.50-6 and 26x10.5-6. Brake caliper body is aluminum, wheels are available in either aluminum or lighter weight magnesium.

Model No.	Piper Models:	Description	Part No.	Price
28-4001	PA-12, PA-14, PA-16, PA-18, PA-19, PA-20	Magnesium Wheels	06-02906	\$2,913.00
28-4001A	PA-12, PA-14, PA-16, PA-18, PA-19, PA-20	Aluminum Wheels	06-02907	\$2,816.00
28-4002	J-3, J-4, J-5, PA-11, PA-15, PA-17	Magnesium Wheels	06-02904	\$2,913.00
28-4002A	J-3, J-4, J-5, PA-11, PA-15, PA-17	Aluminum Wheels	06-02905	\$2,816.00

## MATCO 6" WHEELS & BRAKES FOR ULTRALIGHTS

This top quality wheel and brake set is excellent for use on high-performance ultralights. Set includes: 2 aluminum wheels & brakes with 5/8" bearings, 2 axles, 2 spacers, 2 brake bleeder seats & valves, 4 brake line fittings, 12 ft. of 1/4" dia. x .035 wall brake line & 1 vertical master cylinder..... P/N 06-16800 .....\$978.00 Same as set #06-16800 except with 2 vertical master cylinders P/N 06-16840 .....\$1,097.00 Same as set #06-16800 except with 1 laydown style master cylinder P/N 06-16850 .....\$975.00 Same as set #06-16800 except with 2 laydown style master cylinders P/N 06-16860 .....\$1,099.00

### AVAILABLE SEPARATELY:

6" Wheel & Brake.....P/N 06-16810 .....\$692.00  
A-4 Axle, 9.75" Long, 5/8" Dia.....P/N 06-16830 .....\$71.75

## AZUSA LITE NYLON WHEELS 4, 5 AND 6 INCH MODELS



Azusalite wheels are made from engineering grade Nylon which combines high tensile and compressive strengths and good impact resistance. Excellent for many homebuilt and ultralight aircraft applications since they weigh 60-70% less than aluminum wheels. Azusalite wheels are offered in 4", 5" and 6" models. Replacement parts and unlisted accessories available on request.

**AZUSALITE 5" WHEEL** - Used as the main wheels on the Mohawk ultralight, this 5" wheel features 5/8" I.D. sealed ball bearings. Uses 4.10 / 3.50 x 5 or 5.00 x 5 tire & tube. Max Load: 475 lbs, or the load rating of the tire. Whichever is lower.....P/N 06-02500 .....\$38.50  
**AZUSALITE 4" WHEEL** - A 4 inch Azusalite wheel featuring 5/8" sealed ball bearings. Uses a 4.10 / 3.50 x 4 tire and tube. Max Load: 440 lbs, or the load rating of the tire. Whichever is lower.....P/N 06-02600 .....\$32.50  
**AZUSALITE 6" WHEEL** - A 6" Azusalite wheel; comes complete w/ 5/8" sealed ball bearings. Uses 4.10 / 3.50-6 or a 6.00-6 tire & tube. Max Load: 565 lbs, or the load rating of the tire. Whichever is lower. P/N 06-02700 .....\$51.75

## AZUSA TIRES & TUBES (SAWTOOTH TREAD)



4.10 / 3.50 x 4 Tire & Tube P/N 06-02800 ..... \$26.75 Ea  
 4.10 / 3.50 x 5 Tire & Tube P/N 06-02900 ..... \$32.25 Ea  
 4.10 / 3.50 x 6 Tire & Tube P/N 06-03000 ..... \$34.00 Ea

## AZUSA RIBBED TIRE ROUND PROFILE RIBBED ROUND PROFILE

4.80 x 4.00 x 8 Tire & Tube .....P/N 06-03010 .....\$35.00 Ea

## AZUSA ALUMINUM WHEELS



**5" AZUSA ALUMINUM WHEEL** - Complete with 5/8" I.D. sealed bearing.....P/N 1144 .....\$45.65  
**5" AZUSA ALUMINUM WHEEL & BRAKE KIT** - Kit consists of (2) #1144 wheels with 5/8" sealed bearings, (2) #2270 aluminum Azusa brakes, (2) #2211 brake drums (2) 11.400-5, 6-ply Lamb tires and Azusa #7131 (2) 340/300 x 5 tubes. P/N 06-03100 .....\$328.00

## 5" AZUSA ALUMINUM WHEEL

Complete with 3/4" bearing.....P/N 06-00376 .....\$51.75

## 6" AZUSA ALUMINUM WHEEL

Complete with 5/8" I.D. sealed bearings. Wt. 3.9 lbs.....P/N 06-03200 .....\$54.75

## 6" AZUSA ALUMINUM WHEEL

Complete with 5/8" I.D. Timken bearings. Wt. 4.1 lbs.....P/N 06-03300 .....\$72.75

## 6" AZUSA ALUMINUM WHEEL

Complete with 3/4" I.D. Timken bearings. Wt. 4.2 lbs.....P/N 06-03400 .....\$69.95

## 8" AZUSA ALUMINUM WHEEL & BRAKE KIT

Kit consists of (2) #1175 wheels, (2)#2530 brakes, (2)#2542 drums, (2)4.80 x 4.00 tires and tubes, & hardware..P/N 06-03410 .....\$325.95

## AZUSA BRAKES FOR AZUSA 5" & 6" WHEELS

These 4.5" brakes have a long actuating arm, 5/8" mounting hole, and bonded lining. Available in anchor style w/ built-in anchor & 2 cable mounting ears, or round style which features a round aluminum backing plate. Platform required w/5" Azusalite.

Part No.	Description	Price	Part No.	Description	Price
06-03415	Anchor Style Brake #2208	\$51.90	06-03430	Spring #2264	\$1.14
06-03420	Round Style Brake #2270A	\$49.75	06-03435	Cam #8235	\$6.75
01-00169	Brake Assy, 2272A (Right)	\$46.50	06-03440	Platform #2259A	\$12.75
01-00306	Brake Assy, 2272A (Left)	\$46.50	06-03445	Lined Shoes (1/side) #2260	\$26.50
06-03425	Brake Arm #2263	\$2.76	06-03557	Brake Arm #2263-L	\$2.85

## AZUSA BRAKES FOR AZUSA 8" WHEELS

These 5" brakes are used on Azusa #1175 wheels only. Features a round aluminum backing plate and actuating arm which allows for 8 positions.

Part No.	Description	Price
06-03450	Round Style Brake #2530	\$49.50
06-03455	Brake Arm #2537	\$4.75
06-03460	Spring #2539	\$0.75
06-03465	Cam #2533	\$7.95
06-03470	Lined Shoes (1/side) #2538	\$20.50
2542	Brake Drum (For 8"Wheel)	\$16.75



## AZUSA 4-1/2 BRAKE DRUM

Azusa 4-1/2" Brake Drum, No Flange, Machined OD Three sets of mounting holes: 3 Hole for Tri-Star wheels 4 hole on a 3.75" diameter bolt circle 4 hole on a 3.228 bolt circle to match the mini-hub.....P/N 2211 .....\$17.60

## AZUSA MINI AXLES

5/8-18 x 2" threads both ends, 3/16" keyway (full length of axles) black oxide plate x 8" Long.....P/N 06-01776 .....\$13.90  
 5/8-18 x 2" threads both ends, 3/16" keyway (full length of axles) black oxide plate x 10" Long.....P/N 06-01777 .....\$14.55

LG

# GROVE WHEEL & BRAKES

## 4 INCH WHEELS & BRAKES



P/N 40-101 Shown

Manufactured from aerospace grade aluminum

These 4" wheels are manufactured to the same exacting standards as the Grove 5" & 6" wheels.

They feature genuine Timken tapered roller bearings with felt grease seals.

40-1 wheel has 2-3/4" tire bead width.

40-3 wheel has 2-1/4" tire bead width.

## GROVE WHEELS & BRAKES FEATURES:

- Aerospace grade materials
- Precision CNC machined
- Timken tapered roller bearings
- Felt grease seals
- Tubeless Option



From the chart below, select the proper static load rating, kinetic energy rating and brake torque for your aircraft.

Choose from Aluminum or Magnesium — Magnesium wheels weigh less than aluminum, but aluminum is more corrosion resistant. Both metals have similar strengths.

## 5 INCH WHEELS & BRAKES



P/N 57-124 Shown

Available in Aluminum or Magnesium

**50 SERIES** — Grove's basic 5" wheel.

**51 SERIES** — Lighter weight version of the 50 series.

**55, 56 & 57 SERIES** — Same wheel as the 50 series, but with heavier discs for greater kinetic energy and larger calipers for greater braking torque

## 6 INCH WHEELS & BRAKES



P/N 66-152 Shown

Available in Aluminum or Magnesium

**60 SERIES** — Grove's basic 6" wheel for 1-1/2" axles.

**61 SERIES** — Lighter weight version of the 60 series.

**65 SERIES** — Same as the 61 series, but for use with 1-1/4" axles.

**66 SERIES** — Same as the 60 series but with heavier discs for greater kinetic energy and larger calipers for greater braking torque.

LG

GROVE KIT NO.	OUR PART NO.	WHEEL NO.	STATIC LOAD RATING POUNDS	KINETIC ENERGY FT-LBS.	DISC THICKNESS (INCHES)	BRAKING TORQUE INCH-LBS.	CALIPER NO.	PISTON DIA. (INCHES)	BRAKE PAD NO.	AXLE DIA. (INCHES)	WEIGHT LBS. (SEE REF. 1)	PRICE/SET (SEE REF. 2)
<b>FOUR INCH WHEELS AND BRAKES</b>												
40-101	06-00858	40-3A	700	72,000	0.160	1,384	39-1A	1x1.250	66-106	0.75	4.05	\$1,109.00
40-102	06-00859	40-1A	700	72,000	0.160	1,832	39-2A	1x1.438	66-106	0.75	4.16	\$689.00
<b>FIVE INCH WHEELS AND BRAKES</b>												
50-101	06-00094	50-1A	1,285	120,149	0.190	2,364	30-1A	1x1.500	66-106	1.25	7.10	\$1,839.00
50-201	06-00860	50-1M	1,285	120,149	0.190	2,364	30-1M	1x1.500	66-106	1.25	6.10	\$1,945.00
51-101	06-00589	51-1A	800	120,149	0.190	2,364	30-1A	1x1.500	66-106	1.25	6.60	\$1,818.00
51-201	06-00862	51-1M	800	120,149	0.190	2,364	30-1M	1x1.500	66-106	1.25	5.60	\$1,945.00
55-112	06-00863	55-1A	1,285	162,315	0.250	3,283	31-2A	2x1.250	66-111	1.25	7.60	\$2,038.00
55-212	06-00864	55-1M	1,285	162,315	0.250	3,283	31-2M	2x1.250	66-111	1.25	6.45	\$2,231.00
56-113	06-00095	56-1A	1,285	205,146	0.313	3,283	31-3A	2x1.250	66-111	1.25	7.90	\$2,213.00
56-213	06-00867	56-1M	1,285	205,146	0.313	3,283	31-3M	2x1.250	66-111	1.25	6.80	\$2,335.00
57-124	06-00096	57-1A	1,285	246,175	0.375	4,345	32-4A	2x1.438	66-111	1.25	8.30	\$2,312.00
57-224	06-00870	57-1M	1,285	246,175	0.375	4,345	32-4M	2x1.438	66-111	1.25	7.20	\$2,524.00
<b>SIX INCH WHEELS AND BRAKES</b>												
60-162	06-00101	60-1A	1,750	206,406	0.250	5,052	36-2A	1x2.000	66-105	1.50	10.50	\$2,499.00
60-262	06-00798	60-1M	1,750	206,406	0.250	5,052	36-2M	1x2.000	66-105	1.50	9.20	\$2,740.00
61-111	06-00590	61-1A	1,200	170-149	0.190	3,947	31-1A	2x1.250	66-111	1.50	9.20	\$2,476.00
61-211	06-00799	61-1M	1,200	170-149	0.190	3,947	31-1M	2x1.250	66-111	1.50	8.10	\$2,709.00
65-203	06-01805	65-1M	1,250	170-149	0.190	3,868	30-3M	1X1.750	066-106	1.25	7.40	\$2,690.00
65-207	06-00879	65-1M	1,250	170-149	0.190	3,868	30-7M	1x1.750	66-106	1.25	7.43	\$2,699.00
65-211	06-00881	65-1M	1,250	170-149	0.190	3,947	31-5M	2x1.250	66-111	1.25	7.64	\$2,699.00
65-222	06-00883	65-5M	1,250	206,406	0.250	5,219	32-6M	2x1.438	66-111	1.25	7.90	\$2,743.00
66-152	06-00885	60-1A	1,750	206,406	0.250	7,735	35-6A	2x1.750	66-106	1.50	11.15	\$2,718.00
66-154	06-00886	60-5A	1,750	280,188	0.375	7,735	35-4A	2x1.750	66-106	1.50	11.82	\$2,961.00
66-252	06-00888	60-1M	1,750	206,406	0.250	7,735	35-6M	2x1.750	66-106	1.50	9.90	\$3,080.00
66-254	06-00890	60-5M	1,750	280,188	0.375	7,735	35-4A	2x1.750	66-106	1.50	11.82	\$3,176.00
67-174	06-00892	67-1A	2,500	280,188	0.375	7,735	37-8A	2x1.750	66-105	1.50	14.25	\$4,080.00
67-274	06-00894	67-1M	2,500	280,188	0.375	7,735	37-4M	2x1.750	66-105	1.50	12.25	\$4,253.00

NOTE: Braking torque calculated at 600 psi brake line pressure. Ref 1: Weight for one wheel, disc and caliper assy. Ref 2: Set includes two wheel assys. "A" in wheel No. = Aluminum "M" in wheel No. = Magnesium

# GROVE WHEELS & BRAKES

## NOSE WHEELS

**Genuine Aircraft Quality!**

- Cast from aerospace grade materials
- Precision CNC Machined
- Timken Tapered Roller Bearings
- Felt Grease Seals



"GROVE P/N"	"OUR P/N"	WHEEL SIZE	STATIC LOAD RATING	AXLE DIA.	WEIGHT	PRICE
49-1A	06-00843	4 Inch	1,000 lbs	0.75"	1.98 lbs	<b>\$416.00</b>
59-1A	06-00102	5 Inch	1,285 lbs	1.25"	3.90 lbs	<b>\$614.00</b>
59-1M	06-00911	5 Inch	1,285 lbs	1.25"	2.90 lbs	<b>\$701.00</b>
59-2A	06-00912	5 Inch	800 lbs	1.25"	3.40 lbs	<b>\$624.00</b>
59-2M	06-00913	5 Inch	800 lbs	1.25"	2.40 lbs	<b>\$681.00</b>
69-1A	06-00103	6 Inch	1,750 lbs	1.50"	6.00 lbs	<b>\$702.00</b>
69-1M	06-00915	6 Inch	1,750 lbs	1.50"	4.80 lbs	<b>\$731.00</b>

## GROVE BRAKE LININGS



All Grove Brake Pads are components of FAA-TSO brake assemblies. Grove Brake Pads are FAA-PMA for many popular certificated aircraft.

Individual pads do not include rivets. Pad kits include 4 pads and all necessary rivets

Description	Part No.	Price
Brake Lining Rivet	06-02966	<b>\$0.35</b>
Brake Lining 066-105	06-02968	<b>\$9.75</b>
Brake Lining 066-106	06-02969	<b>\$9.75</b>
Brake Lining 066-108	06-02970	<b>\$15.50</b>
Brake Lining 066-111	06-02971	<b>\$14.95</b>
Brake Pad Kit 066-105K	06-03022	<b>\$36.95</b>
Brake Pad Kit 066-106K	06-03023	<b>\$37.75</b>
Brake Pad Kit 066-108K	06-03024	<b>\$56.75</b>
Brake Pad Kit 066-111K	06-03025	<b>\$61.85</b>

## 800X4 DISC BRAKE CONVERSION



**STC Approved FAA-PMA APPROVED MODELS INCLUDE:**

J-3, J-4, J-5, PA-11, PA-12 PA-14, PA-15 PA-16, PA-17PA-18, PA-19 PA-20

Good news for owners of early Piper aircraft. Say good-bye to brake expander tube problems forever!

- No more soft brake pedal
- Easy Installation

• Improved braking and ground handling  
Maintain the classic cub look by installing modern disc brakes on your existing 800x4 wheels and tires. Use your existing wheels, tires, tubes, master cylinders and brake lines.

STC Kit comes complete with all parts, special tools and STC documentation. Installation requires only standard hand and rivet tools. No modifications are required to be made on the gear leg, or any other part of the aircraft.

P/N 06-00837..... **\$999.00**

LG

## AXLE SHIMS

Reduce Tire Wear  
Improve Ground Handling



## TOE-IN/OUT REALIGNMENT SHIMS

Install these axle shims between your landing gear and axles to insure that your tires track true. Correct any misalignment of toe-in or out in 1/4° increments. Precision machined from 6061-T6 aluminum..... **Price \$32.50 each.**

Correction	500X5	600X6
1/4°	06-00925	06-00928
1/2°	06-00926	06-00929
3/4°	06-00927	06-00930

## CAMBER ADJUSTMENT SHIMS

Adjust the vertical alignment of your wheels with these camber adjustment shims. Precision machined from 6061-T6 aluminum.  
**Price: \$32.50 each.**

Correction	500X5	600X6
1/2°	06-00931	06-00934
1°	06-00932	06-00935
2°	06-00933	06-00936

## 500X5 STANDARD AXLE

Precision CNC machined from 2024-T3 aluminum with clear anodized protective finish Weight 0.92 lbs. 1.25" diameter Static Load Rating 1,285 lbs.



Use with Grove 50, 51, 52, 55, 56, 57, & 58 and Cleveland 500x5... P/N 06-00917 .. **\$109.95**

## 500X5 STANDARD AXLE WITH WHEEL PANT STUB

Same as the 500x5 standard axle but with 1" extension to attach wheel pant. End tapped for 1/4-28 screw Weight 0.95lb.



Use with all Grove 5" wheels with 1-1/4" bearings..... P/N 06-00601 .. **\$114.75**

## 600X6 STANDARD AXLE

Precision CNC machined from 2024-T3 aluminum with clear anodized protective finish Weight 1.28 lbs. 1.50" diameter Static Load Rating 1,750lbs



Use with Grove 60, 61, & 66 and Cleveland 600x6 wheels P/N 06-00919 .. **\$144.75**

## 600X6 STANDARD AXLE WITH WHEEL PANT STUB

Same as the 600x6 standard axle but with 2" extension to attach wheel pant. End tapped for 1/4-28 screw Weight 1.43lb.



Use with Grove 60, 61, & 66, and Cleveland 600x6 wheels. .... P/N 06-00602 .. **\$139.75**

## 400X4 AXLES

Use with Grove 40-1A Wheel Weight 0.37 lbs. P/N 06-00921 .. **\$108.75**  
Use with Grove 40-3A Wheel Weight 0.38lbs P/N 06-00922.. **\$108.75**



Solid 7075-T6 aluminum with clear anodized finish. Diameter 0.75" Static Load Rating 700 lbs.

## 1-1/4" DIAMETER 600X6 AXLES

Same construction as the above axles, but with 1.25" diameter Use with Grove 65 Series Wheels.



With wheel pant stub.... P/N 06-00923 .. **\$119.75**  
Without stub ..... P/N 06-00924 .. **\$137.75**

# GROVE MASTER BRAKE CYLINDERS



Clevis End—3/16" hole, 1/4" wide slot



Eye Bolt End—3/16" hole, 1/2" head diameter



Eye Bolt End - 3/16" hole, 3/8" head diameter

These master cylinders are the perfect choice for all Grove brake systems as well as use with other major brands that require a high pressure master cylinder. Consider the following when selecting the proper master cylinder for your aircraft:

1. The style (with or without integral reservoir, etc.)
2. The pin-to-pin length—this is the length between the upper and lower attach holes.
3. The attach type for the upper end (clevis, or eye bolt)
4. The attach type for the lower end (cross drilled, slotted, etc.)

## REMOTE BRAKE FLUID RESERVOIRS

Quality machined from 6061 billet. Top is retained by snap ring with O-ring seal. Supplied with vented 1/8" NPT cap plug. Anodized for corrosion resistance.

2.75" high 1.75" diameter. Holds 2.42 fluid ozs. Weighs 3.6 ounces.

Designed to attach to firewall or other remote location. Adequate capacity to serve both master cylinders. Outlet has 1/8" female NPT thread at bottom of reservoir.

Normal installation requires two (one for each master cylinder.) Supplied with 1/8" NPT fitting. Attaches directly to your master cylinder.

1.98" high; 1.38" diameter Holds 1.10 fluid ounces Weighs 1.5 ounces. 067-050

067-054 ..... P/N 06-00819..... **\$74.85** P/N 06-00818 ..... **\$59.80**



Cross Drilled - 3/16" holes inline with fitting and also 90° to fitting



90° Offset - 3/16" hole drilled 90° to fitting. Tab is inline with fitting.



Inline -3/16" hole drilled inline with fitting. Tab is offset 90° to fitting



Slotted -0.090" slot inline with fitting. 3/16" hole drilled 90° to fitting.



Right Offset Tab 3/16" hole drilled 90° to fitting



Left Offset Tab 3/16" hole drilled 90° to fitting

Grove P/N	Our Part No.	Pin-to-Pin Length	Upper Attachment	Lower Attachment	Weight	Price
670-1	06-00594	7.5"	Clevis	Inline	5.9 oz.	<b>\$368.00</b>
670-2	06-00866	8.0"	Clevis	Inline	6.2 oz.	<b>\$375.00</b>
670-3	06-00104	7.5"	Clevis	90° Offset	5.9 oz.	<b>\$374.00</b>
670-4	06-00869	8.0"	Clevis	90° Offset	6.2 oz.	<b>\$368.00</b>
670-8	06-01286	7.25"	Clevis	90° Offset	5.9 oz.	<b>\$375.00</b>
670-13	06-00871	8.0"	3/8" Eye Bolt	90° Offset	6.2 oz.	<b>\$368.00</b>
670-14	06-00872	8.0"	3/8" Eye Bolt	Inline	6.2 oz.	<b>\$368.00</b>
670-15	06-00596	8.0"	1/2" Eye Bolt	90° Offset	6.2 oz.	<b>\$368.00</b>
670-16	06-00873	7.5"	1/2" Eye Bolt	90° Offset	5.9 oz.	<b>\$368.00</b>
670-17	06-00597	8.0"	1/2" Eye Bolt	Inline	6.2 oz.	<b>\$368.00</b>
670-18	06-00875	7.5"	1/2" Eye Bolt	Inline	5.9 oz.	<b>\$368.00</b>
670-19	06-00877	7.5"	3/8" Eye Bolt	90° Offset	5.9 oz.	<b>\$368.00</b>
670-20	06-00878	7.5"	3/8" Eye Bolt	Inline	5.9 oz.	<b>\$368.00</b>

Grove P/N	Our Part No.	Pin-to-Pin Length	Upper Attachment	Lower Attachment	Weight	Price
671-20	06-00880	7.5"	1/2" Eye Bolt	Cross Drilled	5.9 oz.	<b>\$368.00</b>
671-21	06-00882	7.5"	3/8" Eye Bolt	Cross Drilled	5.9 oz.	<b>\$369.00</b>
671-22	06-00884	8.0"	1/2" Eye Bolt	Cross Drilled	6.2 oz.	<b>\$372.00</b>
671-23	06-00887	8.0"	3/8" Eye Bolt	Cross Drilled	6.2 oz.	<b>\$368.00</b>

Grove P/N	Our Part No.	Pin-to-Pin Length	Upper Attachment	Lower Attachment	Weight	Price
672-1	06-00889	5.0"	Clevis	Cross Drilled	4.0 oz.	<b>\$368.00</b>
672-2	06-00891	5.5"	Clevis	Cross Drilled	4.2 oz.	<b>\$368.00</b>
672-3	06-00893	6.0"	Clevis	Cross Drilled	4.5 oz.	<b>\$372.00</b>

Grove P/N	Our Part No.	Pin-to-Pin Length	Upper Attachment	Lower Attachment	Weight	Price
673-9	06-00895	7.5"	Clevis	Cross Drilled	5.9 oz.	<b>\$368.00</b>
673-10	06-00896	8.0"	Clevis	Cross Drilled	6.2 oz.	<b>\$368.00</b>
673-11	06-00897	7.5"	1/2" Eye Bolt	Left Offset	5.9 oz.	<b>\$368.00</b>
673-12	06-00898	7.5"	1/2" Eye Bolt	Right Offset	5.9 oz.	<b>\$368.00</b>
673-13	06-00899	7.5"	1/2" Eye Bolt	Slotted 90°	5.9 oz.	<b>\$368.00</b>
673-14	06-00901	7.5"	1/2" Eye Bolt	Slotted Inline	5.9 oz.	<b>\$368.00</b>

Grove P/N	Our Part No.	Pin-to-Pin Length	Upper Attachment	Lower Attachment	Weight	Price
674-1	06-00902	7.5"	Clevis	Cross Drilled	5.0 oz.	<b>\$368.00</b>
674-2	06-00903	8.0"	Clevis	Cross Drilled	5.0 oz.	<b>\$368.00</b>
674-3	06-00904	7.0"	Clevis	Cross Drilled	5.0 oz.	<b>\$369.00</b>

Grove P/N	Our Part No.	Pin-to-Pin Length	Upper Attachment	Lower Attachment	Weight	Price
675-1	06-00097	8.0"	Clevis	Inline	8.1 oz.	<b>\$408.00</b>
675-2	06-00905	7.5"	Clevis	Inline	7.9 oz.	<b>\$408.00</b>
675-3	06-00593	8.0"	Clevis	90° Offset	8.1 oz.	<b>\$415.00</b>
675-4	06-00906	7.5"	Clevis	90° Offset	7.9 oz.	<b>\$415.00</b>

Grove P/N	Our Part No.	Pin-to-Pin Length	Upper Attachment	Lower Attachment	Weight	Price
676-1	06-00907	8.0"	Clevis	Inline	9.3 oz.	<b>\$446.00</b>
676-2	06-00908	7.5"	Clevis	Inline	9.0 oz.	<b>\$445.00</b>
676-3	06-00909	8.0"	Clevis	90° Offset	9.3 oz.	<b>\$448.00</b>
676-4	06-00910	7.5"	Clevis	90° Offset	9.0 oz.	<b>\$438.00</b>

All master cylinders have a 5/8" bore, 1/8" NPT outlets, are rated at 1,000 psi for use with MIL-H-5606 hydraulic fluid.



P/N 670-1



P/N 671-21



P/N 672-1



P/N 673-9



P/N 674-1



Reservoir Volume 2.0 cu-in P/N 675-1

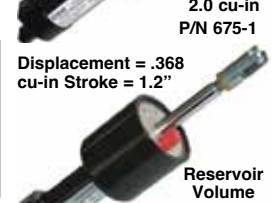

Reservoir Volume 3.05 cu-in P/N 676-1



# ABI WHEELS & BRAKES – RAPCO BRAKES

## ALASKAN BUSHWHEEL CONVERSION KITS



ABI-199-71



ABI-199-62

**ABI-199-71** - Wheel and Brake kit for Piper Aircraft J3, J5C, PA-11, PA-12, PA-14, PA-15, PA-16, PA-17, PA-18 "150", PA-18A "150", and PA-20. FAA-PMA Approved. Approved for Aviat Husky per Aviat Type Certificate .....P/N 06-02831 .....**\$3,100.00**

**ABI-199-62/62A** - Wheel and Brake kit for Cessna Aircraft Aeries: 180, 185, 206. Also approved for Cessna Aircraft Series 170 and 172 and on Piper Aircraft Series: J-3, J3C, PA-11, PA-12, PA-14, PA-16 and PA-18 with F. Atlee Dodge STC SA02231AK available separately. Please inquire with your order if needed. FAA-PMA Approved. American Champion 7GCBC, 7GCAA, 7ECA and 8GCBC. Maule M-4 , M-5, M-6, M-7 and M-9ABI-199-62(3 bolt).....P/N 06-02830 .....**\$2,299.00**  
ABI-199-62A(6 bolt).....P/N 06-02829 .....**\$3,095.00**

## ABI WHEEL AND BRAKE PARTS

Description	Part No.	Price
Bearing Cone ABI-08125	06-02859	\$59.65
Bearing Race ABI-08231	06-02860	\$25.50
Bearing Race ABI-13836	06-02861	\$22.50
Torque Plate Bushing Reducer 3/8 To 5/16 Bolt	06-02864	\$9.50
Seal Ring ABI-153-00200	06-02865	\$13.99
Seal Ring ABI-153-00300	06-02866	\$14.95
Seal Ring ABI-153-00400	06-02867	\$15.70
Seal Cup ABI-153-01500	06-02868	\$21.65
Outer Felt Grease Seal AABE-154-00200	06-02869	\$6.95
Felt Grease Seal ABI-154-00300	06-02870	\$9.95
Felt Grease Seal ABI-154-01300	06-02871	\$11.50
Inner Felt Grease Seal ABI-154-02800	06-02872	\$7.75
Retaining Snap Ring ABE-155-00100	06-02873	\$13.50
Retaining Ring ABI-155-00200	06-02874	\$10.85
Brake Piston ABI-62-00500	06-02875	\$94.75
Brake Pressure Plate ABE-63-00600	06-02876	\$67.75
Brake Pressure Plate ABE-63-01100	06-02877	\$45.50
Brake Anchor Bolt ABI-69-01900	06-02878	\$41.75
Brake Anchor Bolt ABI-69-02600	06-02879	\$90.75
Brake Piston ABI-92-00600	06-02881	\$22.90
Brake Pad Rivet APS-105-00200	06-02882	\$0.20
Inner Wheel Half ABI-161-03000	06-02883	\$415.00
Inner Wheel Half ABI-161-07000	06-02884	\$445.00
Inner Wheel Half ABI-161-08700	06-02885	\$564.00
Outer Wheel Half ABI-162-02700	06-02886	\$415.00
Outer Wheel Half ABI-162-06500	06-02887	\$446.00
Outer Wheel Half ABI-162-08100	06-02888	\$588.00
Brake Assy 1.5" ABI-30-52n	06-02889	\$932.00
Brake Caliper 1.5" Only ABI-30-52nbc	06-02890	\$804.00
Brake Caliper 1.25" Only ABI-30-60a	06-02891	\$937.00
Brake Caliper 1.25" Only ABI-30-60abc	06-02892	\$877.00
Wheel Assy 1.25" Axle, 6 Bolt ABI-40-60	06-02893	\$1,073.00
Wheel Assy 1.5" Axle, 3 Bolt ABI-40-75-d	06-02894	\$1,042.00
Wheel Assy 1.5" Axle, 6 Bolt ABI-40-75t	06-02895	\$1,170.00
Brake Cylinder ABI-61-01800	06-02896	\$271.95
Brake Cylinder ABI-61-06701	06-02897	\$352.00
Brake Backing Plate ABI-64-00500	06-02898	\$119.85
Brake Backing Plate ABI-64-01500	06-02899	\$122.75
Brake Anchor Plate ABI-75-12500	06-02901	\$185.75
Brake Anchor Plate ABI-75-13600	06-02902	\$297.95

## ABI BRAKE BLEEDER



Alaskan Bushwheel Brake Bleeder Screw (OEM: 220-0627) is a direct replacement brake bleeder screw for Alaskan Bushwheels brand 30-52N and 30-60A brake assemblies..P/N 06-03552 .....**\$24.65**

## RAPCO SHIM INSULATORS

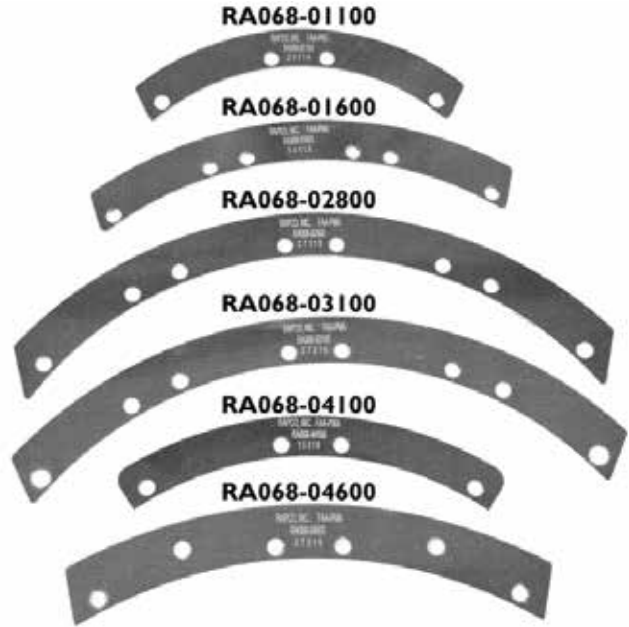

Model No.	Description	Part No.	Price
RA068-01100	Replaces: Cleveland P/N 068-01100	06-02845	\$47.85
RA068-01600	Replaces: Cleveland P/N 068-01600	06-02846	\$51.90
RA068-02800	Replaces: Cleveland P/N 068-02800	06-02847	\$65.75
RA068-03100	Replaces: Cleveland P/N 068-03100	06-02848	\$113.75
RA068-04100	Replaces: Cleveland P/N 068-04100	06-02957	\$43.50
RA068-04600	Replaces: Cleveland P/N 068-04600	06-02849	\$52.75
RA068-01700	Replaces: Cleveland P/N 068-01700	06-03073	\$59.95
RA068-02700	Replaces: Cleveland P/N 068-02700	06-03074	\$65.75
RA068-02900	Replaces: Cleveland P/N 068-02900	06-03075	\$177.90

## RAPCO PRESSURE PLATES

Description	Part No.	Price
Rapco Pressure Plate RA063-01100	06-02850	\$67.95
Rapco Pressure Plate RA063-01200	06-02851	\$72.75
Rapco Pressure Plate RA063-01300	06-02852	\$128.75
Rapco Pressure Plate RA063-30025	06-02853	\$98.80
Replaces: Cleveland P/N: 073-02600	06-03478	\$156.75
Replaces: Cleveland P/N: 073-02600	06-03479	\$183.75

## RAPCO PMA BRAKE PARTS

RAPCO Part No.	Our Part No.	Description	OEM Part No.	Price
RA063-02500	06-03072	Pressure Plate	063-02500	\$180.75
RA068-01700	06-03073	Shim Insulator	068-01700	\$59.95
RA068-02700	06-03074	Shim Insulator	068-02700	\$65.75
RA068-02900	06-03075	Shim Insulator	068-02900	\$177.90
RA073-08500	06-03076	Pressure Plate Assembly	073-08500	\$180.75
RA088-01800	06-03077	Insulator	088-01800	\$79.75
RA109-00200	06-03078	Wear Pad	109-00200	\$20.50
RA109-00201	06-03079	Wear Pad	109-00201	\$13.50
RA109-01500	06-03080	Wear Pad	109-01500	\$29.85
RA205-02900	06-03082	Key Drive	205-02900	\$250.95

## RAPCO KEY DRIVE



FAA-PMA Key Drive - Approved replacement for Cleveland 205-02900. Installation Eligibility: Daher Aerospace TBM 700 P/N 06-03082 .....**\$250.95**

## RAPCO DRIVE KEY - RA205-05201



Rapco offers PMA approved replacement drive key for: Pilatus Aircraft Ltd - PC-12/47E and With STC SA01376CH installed: PC-12, PC-12/45 & PC-12/47E.....P/N 06-03502 .....**\$186.75**

LG

# BERINGER WHEEL & BRAKE KITS

Upgrade your aircraft and save up to 9 lbs with high performance BERINGER® wheels and brakes. Complete main wheel and brake sets are designed to mount directly, replacing original equipment. Wheels are aluminum red anodized, fully CNC machined, with O-rings for Tubeless mounting.

Brake calipers use sintered metallic pads and stainless steel discs for increased lifetime.

The kit includes: 2 main wheels with brakes and stainless steel discs, tubeless tires (mounted and pressure tested), bolt-on axles, master cylinders, fluid reservoirs, hydraulic anti-skid, stainless steel brake lines and fittings and detailed installation manual.

If your aircraft is not listed below, please ask for a special quotation, we can equip 99% of the existing aircraft.



COMPLETE WHEEL AND BRAKE KITS						
Beringer Part No.	Our Part No.	Aircraft Type	Wheel Assembly	Standard Tire (Other Size and Quality Available)	Price	
<b>FOR EXPERIMENTAL AIRCRAFT</b>						
SLC02	06-01093	Lancair 320/360 (retractable LG)	5.00-5	TL 11x4.00-5" 8 PLY Aero Classic	\$3,194.00	
SLC01	06-01094	Lancair Legacy (retractable LG)	5.00-5	TL 5.00-5"10 PLY Michelin Aviator	\$3,407.00	
SGL02	06-01622	Glascir III (retractable LG)	5.00-5	TL 5.00-5"10 PLY Michelin Aviator	\$3,361.00	
SFA01	06-01623	Falco	5.00-5	TL 5.00-5"10 PLY Michelin Aviator	\$3,413.00	
SLE01	06-02026	Long'Ez	5.00-5	TL 5.00-5"10 PLY Michelin Aviator	\$3,580.00	
SLE02	06-03052	Vari'Ez	4.00-5	TL 11x4.00-5" 8 PLY Aero Classic	\$3,185.00	
SJU01	06-03084	Jabiru J400/430	5.00-5	TL 5.00-5"10 PLY Michelin Aviator	\$3,680.00	
<b>FOR ULTRALIGHT AIRCRAFT AND LSA</b>						
SSJ01	06-03086	JUST Aircraft SuperStol + Dual brake	6.00-6	w/o tires	\$5,096.00	
SRA02	06-01626	RANS Coyote (axle bolted with screws)	6.00-6	w/o tires	\$3,490.00	
SRA01	06-01627	RANS Coyote (axle bolted with flange)	6.00-6	w/o tires	\$3,304.00	
SPP01	06-01628	Pipistrel Sinus, Virus	4.00-6	4.00-6" 6 PLY Sava	\$3,285.00	
SSK01	06-01629	Skyranger - Nynja	4.00-6	4.00-6" 6 PLY Sava	\$2,765.00	
SSA01	06-01097	Zlin Savage (tire < 29 ")	6.00-6	w/o tires	\$3,589.00	
SSA02	06-01759	Zlin Savage (tire > 29 ") + Dual brake	6.00-6	w/o tires	\$4,222.00	
SEU01	06-01761	Evektor Eurostar/Sportstar	4.00-6	4.00-6" 6 PLY Sava	\$2,943.00	
SBR01	06-01762	Breezer	5.00-5	TL 5.00-5"10 PLY Michelin Aviator	\$2,808.00	
SFD01	06-01763	Flight Design CTSW	4.00-6	TL 15x6.00-6" 6 PLY Sava	\$2,636.00	
STP01	06-01764	Tecnam P92	4.00-6	4.00-6" 6 PLY Sava	\$2,358.00	
STP02	06-01765	Tecnam P2008	5.00-5	TL 5.00-5"10 PLY Michelin Aviator	\$3,419.00	
SZH05	06-01766	Zenair (all type)	6.00-6	TL 15x6.00-6" 6 PLY Sava	\$3,208.00	
SSC01	06-02025	TL Sting Carbon	4.00-5	TL 11x4.00-5" 8 PLY Aero Classic	\$3,437.00	
SJU03	06-03087	Jabiru J170	4.00-6	4.00-6" 6 PLY Sava	\$2,876.00	
<b>FOR VAN'S AIRCRAFT</b>						
SRVFU01	06-01767	Fuselage kit-RV6,7,8,9,10,14-Basic set	-	-	\$1,224.00	
SRVFU02	06-01768	Fuselage kit-RV6,7,8,9,10,14-Basic set + copilot brakes	-	-	\$2,056.00	
SRVFU03	06-01769	Fuselage kit-RV6,7,8,9,10,14-Basic set + parking brake	-	-	\$1,700.00	
SRVFU04	06-01770	Fuselage kit-RV6,7,8,9,10,14-Basic set + parking brake + copilot brakes	-	-	\$2,585.00	
SRVFI02	06-01772	Finishing kit-RV6,7,8,9-Main wheels	5.00-5	TL 5.00-5"10 PLY Michelin Aviator	\$2,363.00	
SRVFI03	06-01773	Finishing kit-RV8 Grove LG-Main wheels	5.00-5	TL 5.00-5"10 PLY Michelin Aviator	\$2,335.00	
SRVFI04	06-03088	Finishing kit-RV14-Main wheels	5.00-5	TL 5.00-5"10 PLY Michelin Aviator	\$2,662.00	
SRVFI05	06-03139	Finishing kit-RV10-Main wheels	6.00-6	TL 15x6.00-6" 6 PLY Aero Classic	\$4,364.00	
SRVCO03	06-03089	Complete Wheel And Brake Kit-RV3	5.00-5	TL 11x4.00-5" 8 PLY Aero Classic	\$3,424.00	
<b>OPTIONS - CAN BE ORDERED SEPARATELY</b>						
Beringer Part No.	Our Part No.	Option	Description		Price	
PKG01N	06-02012	Parking brake valve kit	Provided with extra hose and fittings		\$479.00	
INOBE	06-03092	Amphibian use	Stainless steel ball bearing for one wheel		\$223.95	
<b>FRONT WHEEL / TAIL WHEEL KITS – SPECIAL AXLE FOR EACH AIRCRAFT</b>						
Beringer Part No.	Our Part No.	Description	Wheel Assy.	Standard Tire (Other Size and Quality Available)	Weight (lbs.)	Price
SST10	06-02018	Tailwheel for replacement on Matco fork	3.50-4	2.80/2.50-4" 4 PLY Kenda	2.53	\$379.00
SST11	06-02019	Tailwheel for replacement on Scott fork	3.50-4	2.80/2.50-4" 4 PLY Kenda	2.53	\$402.00
JC-01	06-00957	Tailwheel for Pipistrel Sinus/Taurus	200x50	200x50 with tube	1.83	\$253.95
<b>SUPPLEMENTAL TYPE CERTIFICATE – DELIVERED WITH AN EASA FORM1</b>						
Beringer Part No.	Our Part No.	Description				Price
STC-013	06-03093	Complete wheel and brake kit for Diamond DA42				\$8,986.00
STC-012.1	06-03094	Complete wheel and brake kit for Extra 300/330 – Single seater				\$4,425.00
STC-012.2	06-03095	Complete wheel and brake kit for Extra 300/330 – Two seater				\$6,572.00
STC-003	06-02020	Complete wheel and brake kit for Centrair Pegasus				\$2,150.00
STC-005	06-02022	Complete wheel and brake kit for Schleicher ASW20				\$1,843.00
STC-007	06-02023	Complete wheel and brake kit for Schempp-Hirth Ventus/Discus 2				\$1,827.00

LG



## BERINGER NOSE WHEEL RA-015 (A)

Beringer Nose Wheel RA-015 (A)..... P/N 06-04181..... \$460.00

# BERINGER MASTER BRAKE CYLINDERS

The seals inside the brake master cylinders are specific for each type of brake fluid.

- It is not possible to put DOT4 brake fluid in a master cylinder with seals for MINERAL (MIL) fluid and it is not possible to put MINERAL brake fluid in a master cylinder with seals for DOT4 brake fluid.

**To Order use "Base Part No." followed by the dash number of desired brake fluid below.**

- E is for DOT4 brake fluid (Example: 06-03098-E)
- N means for MINERAL (MIL) brake fluid (Example: 06-03098-N)

## RUDDER MASTER CYLINDER ASSEMBLY

Beringer Part No.	Our Part No.	Attachments	Pin-to-Pin Length				Bore		Weight		Price
			Min		Max		Inch	mm	oz	g	
			Inch	mm	Inch	mm					
MP-001	06-03098	CHP-001	7.441	189	8.189	208	3/16	14.5	5.89	167	\$275.95
MP-001.2	06-03100	CHP-007	7.441	189	8.189	208	3/16	14.5	5.82	165	\$328.00
MP-002	06-03104	--	-	-	-	-	1/2	12.2	3.53	100	\$258.95
MP-002.1	06-03105	ZM-001	5.433	138	5.630	143	1/2	12.2	4.15	118	\$284.95
MP-002.2	06-03106	CHP-003	5.512	140	5.669	144	1/2	12.2	3.96	112	\$282.95
MP-002.3	06-03107	CHP-003 - ZM-001	6.457	164	6.929	176	1/2	12.2	4.81	136	\$306.00
MP-002.4	06-03108	CHP-003 - CHP-003	6.654	169	6.929	176	1/2	12.2	4.62	131	\$304.00
MP-002.5	06-03109	ZM-001 - ZM-001	6.496	165	6.969	177	1/2	12.2	5.00	142	\$295.95
MP-002.6	06-03125	PGT-002+ZM-001 - ZM-001	6.535	166	6.929	176	1/2	12.2	4.81	136	\$305.00
MP-002.7	06-03126	CHP-006	5.118	130	5.433	138	1/2	12.2	3.72	105	\$314.00
MP-002.8	06-03127	CHP-003	5.512	140	5.669	144	1/2	12.2	3.76	107	\$282.95
MP-003	06-03128	CHP-002	7.32	186	7.56	192	1/2	12.2	4.30	122	\$268.95
MP-003.1	06-03129	CHP-002	8.07	205	8.31	211	1/2	12.2	4.80	136	\$293.95
MP-003.2	06-03130	CHP-005	7.32	186	7.56	192	1/2	12.2	4.41	125	\$348.00
MP-003.3	06-03131	CHP-002	7.32	186	7.56	192	1/2	12.2	4.27	121	\$348.00

LG

## LEVER KIT FOR MP-XXX BRAKE MASTER CYLINDER

Beringer Part No.	Our Part No.	Brake master cylinder (not included)	Weight Oz.	Price
MP-004.1	06-01754	MP-002.3	8.77	\$147.85
MP-004.2	06-01755	MP-002.3	16.06	\$202.95
MP-004.3	06-01756	MP-002.8	9.30	\$126.99
MP-004.4	06-01757	MP-002.8	17.11	\$231.95
MP-004.5	06-03117	MP-002.8	9.58	\$110.75
MP-004.6	06-03118	MP-002.8	10.33	\$201.95
MP-004.7	06-03119	MP-002.8	8.48	\$142.99

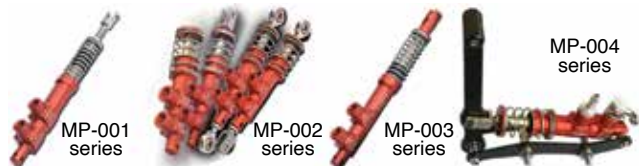

## ATTACHMENTS

Beringer Part No.	Our Part No.	Description	Weight Oz.	Price
CHP-001	06-03135	Clevis	0.83	\$23.50
CHP-002	06-01748	Clevis	0.23	\$25.50
CHP-003	06-01749	Clevis	0.40	\$25.50
CHP-004	06-01750	Clevis	0.39	\$85.75
CHP-005	06-01751	Clevis	0.32	\$25.50
CHP-005.1	06-03136	Clevis	0.37	\$41.60
CHP-007	06-03137	Clevis	0.79	\$21.55
CHP-008	06-03110	Clevis	0.27	\$20.55
CHP-009	06-03112	Clevis	0.80	\$25.50
CHP-010	06-03113	Clevis	0.77	\$68.75
ZM-001	06-01747	Clevis	0.792	\$29.50
BGE-011	06-01752	Clevis	0.159	\$9.50

## INTEGRAL BRAKE FLUID RESERVOIR



- Vertical or horizontal mounting • Available for DOT4 or MIL Fluid • CNC machined from aluminum billet • Incorporates tight bellows • Attached directly to the master cylinder • 100% tight, no leak, perfect for aerobatic use

Beringer Part No.	Our Part No.	Weight (oz)	Price
HFA02N	06-01644	1.94	\$103.85

## BERINGER REPLACEMENT VALVE STEM

Beringer Replacement Valve Stem A-001 for the Nose Wheel Assembly 4.00-6 SL..... P/N 06-03039 ..... \$23.80

**BERINGER SPARE CLIPS**  
Stainless steel clips between wheel rim and disc.  
Includes: 10 left and 10 right (set for 1 wheel), procedure.  
Set of 20..... P/N 06-01111 ..... \$42.99

**BERINGER WHEEL CLIP CLP-001(B)**  
Beringer Wheel Clip CLP-001(B)..... P/N 06-04182 ..... \$2.85

## BERINGER TIRE CHANGING TOOL

Specific tire change tool for Beringer wheels with conical aluminum spacer to insert tire on wheel half. Plywood flanges maintain tire while positioning second wheel half with the O-ring. Includes: Plywood flanges, bolts with butterfly nut and conical aluminum spacer.



Beringer 5" wheels.... P/N 06-01109..... \$189.00  
Beringer 6" wheels.... P/N 06-01110..... \$199.95

## BERINGER WHEEL O-RINGS

These O-rings need to be replaced at each tire changing. Includes: 2 large O-rings and 1 small O-ring. \*Important note: The KDF series are for non-certified aircraft and older Beringer wheels in three parts. New Beringer wheels are 2 parts, and need only one O-ring of the J-JTR series. EASA Form 1 is available if required for J-JTR series only, at an additional charge of \$10 per document.

5" Wheel O-Rings KDF01..... P/N 06-01112 ..... \$19.95  
Classic 6" Wheel O-Rings KDF02C..... P/N 06-01113 ..... \$19.95  
4" Wheel O-Rings KDF03..... P/N 06-01992 ..... \$5.95  
O-Ring J-TR-006N\* ..... P/N 06-01994 ..... \$37.60  
O-Ring J-TR-007N\* ..... P/N 06-01995 ..... \$35.50  
O-Ring J-TR-017N\* ..... P/N 06-01996 ..... \$24.75

**BERINGER BRAKE PADS**  
Friction material: sintered metal. High coefficient of friction, very long life time, no fading till very high temperatures: 1100° F  
Includes: 2 brake pads (for 1 brake caliper), bolts and procedure

Description	Model	Part No.	Price
Pads for BERINGER standard caliper EA-006 or EA-001	ZEA01	06-01103	\$82.75
Pads for BERINGER caliper EA-002N(A), EA-002E(A), EA-002.2N(A) & EA-002.2E(A)	PQT-009(A)*	06-03027	\$119.85
Pads for BERINGER caliper EA-003N and EA-003.4N	PQT-010*	06-01991	\$133.75



# CLEVELAND BRAKE DISCS

## CLEVELAND BRAKE DISCS



If your aircraft is flown a lot (more than 200 hours a year) and is not exposed to exceptionally corrosive atmospheres, Cleveland Standard discs are the ideal replacement when normal brake wear requires it.

Cleveland Chrome brake discs are the answer for owners of aircraft that are exposed to the elements (moisture, salt, industrial chemicals) and are not flown frequently enough to rub off corrosion. If you fly less than 200 hours a year, your aircraft spends more than 8,500 idle hours exposed to the elements. Standard and Chrome Cleveland brake discs are fully FAA approved as replacements on virtually all popular single engine aircraft.

Aircraft Model	Main Wheel Ass'y	Standard Disc	Price Each	Chrome Disc	Price Each
Homebuilts	500x5 40-78B	164-17	\$244.95	164-117	\$641.00
Homebuilts	600x6 40-59A	164-75	\$347.00	164-175	\$1,309.00
General (High Energy)	40-151A	164-08500	\$336.00	---	---
General (Increased Energy)	40-230	164-09900	\$376.00	---	---
Aerotek (Pitts) S-1 Series, S-2A	500x5 40-78B	164-17	\$244.95	164-117	\$641.00
Bonanza F33A, F33C, A36, A36TC, B36TC	600x6 40-83A, 40-83B	164-02505	\$256.95	164-125B	\$1,476.00
Bellanca Citabria, Decathlon	600x6 40-28D	164-5	\$247.95	164-105	\$932.00
Bellanca Champ	600x6 40-78B	164-17	\$244.95	164-117	\$641.00
Viking 300A	600x6 40-75E	164-15A	\$242.95	164-115A	\$463.00
Cessna 150C	600x6 40-57	164-5	\$247.95	164-105	\$932.00
Cessna 150D,E	500x5 40-78	164-17	\$244.95	164-117	\$641.00
Cessna 150F,G,H,J	600x6 40-97A	164-26A	\$183.75	164-126A	\$452.00
Cessna 150K	600x6 40-97A	164-26A	\$183.75	164-126A	\$452.00
Cessna A150K, F150, FA150	600x6 40-113	164-40	\$189.90	164-140	\$477.00
Cessna 152, F152, FA152	600x6 40-113	164-40	\$189.90	164-140	\$477.00
Cessna 172	600x6 40-97A	164-26A	\$183.75	164-126A	\$452.00
Cessna 172	600x6 40-113	164-40	\$183.75	164-140	\$477.00
Cessna 177,177RG, F177RG	600x6 40-113	164-40	\$189.90	164-140	\$477.00
Cessna 177A, B	600x6 40-97A	164-26A	\$183.75	164-126A	\$452.00
Cessna 180	600x6 40-75B	164-15A	\$242.95	164-115A	\$463.00
Cessna 180	600x6 40-75D	164-63	---	164-163	---
Cessna 180H, J, K, L, M, N	600x6 40-66	164-7	\$353.00	164-107	\$674.00
Cessna 182H	600x6 40-97A	164-26A	\$183.75	164-126A	\$452.00
Cessna 182N	600x6 40-113	164-40	\$189.90	164-140	\$477.00
Cessna 182J, K, L, N,	600x6 40-97A	164-26A	\$183.75	164-126A	\$452.00
Cessna 185, A, B	600x6 40-32	164-7	\$353.00	164-107	\$674.00
Cessna 185, A, B	600x6 40-66	164-7	\$353.00	164-107	\$674.00
Cessna 185C, D, E	600x6 40-75B	164-15A	\$242.95	164-115A	\$463.00
Cessna A185E 1966 & Up	600x6 40-75B	164-15A	\$242.95	164-115A	\$463.00
1969 & Up	600x6 40-75D	164-36	\$264.95	164-136	\$600.00
1967, 1968	600x6 40-66	164-7	\$353.00	164-107	\$674.00
Cessna 188, A188	600x6 40-75B	164-15A	\$242.95	164-115A	\$463.00
Cessna 205, 205A	600x6 40-67	164-7	\$353.00	164-107	\$674.00
Cessna 205, 205A	600x6 40-75B	164-15A	\$242.95	164-115A	\$463.00
Cessna 206, U206A, TU206A & Turbo	600x6 40-75	164-15A	\$242.95	164-115A	\$463.00
Cessna U206D, D & Turbo	600x6 40-75D	164-36	\$264.95	164-136	\$600.00
Cessna P206, A, TP206A	600x6 40-75	164-15A	\$242.95	164-115A	\$463.00
Cessna P206, A, B, C, D, & Turbo	600x6 40-75B	164-15A	\$242.95	164-115A	\$463.00
Cessna P206D, E, Turbo & Super Skylane	600x6 40-75D	164-36	\$264.95	164-136	\$600.00
Cessna 207, T207	660x6 40-75B	164-15A	\$242.95	164-115A	\$463.00
Cessna 207, T207	600x6 40-75D	164-36	\$264.95	164-136	\$600.00

Aircraft Model	Main Wheel Ass'y	Standard Disc	Price Each	Chrome Disc	Price Each
Cessna Caravan 1, & 208B	40-179	164-22201	\$387.00	---	---
Cessna 210C	600x6 40-21	164-9	\$319.00	164-109	\$575.00
Cessna 210 series P210, T210	600x6 40-75B	164-15A	\$242.95	164-115A	\$463.00
Cessna 210N, P210N	600x6 40-75B	164-15A	\$242.95	164-115A	\$463.00
Cessna 336 Series	600x6 40-67	164-7	\$353.00	164-107	\$674.00
1963-1965	600x6 40-75B	164-15A	\$242.95	164-115A	\$463.00
Gulfstream AA-1, A, B, AA-5,	600x6 40-86A	164-20	\$179.95	164-120	\$430.00
Gulfstream AA-1, A, B, AA-5, AA-5B, TR2	600x6 40-88C	164-20	\$179.95	164-120	\$430.00
Helio H-295, 395,	600x6 40-75E	164-15A	\$242.95	164-115A	\$463.00
391	600x6 40-75D	164-36	\$264.95	164-136	\$600.00
Maule M4, M5 Series	600x6 40-97D	164-26A	\$183.75	164-126A	\$452.00
Mooney M20A, M20B	600x6 40-24	164-9	\$319.00	164-109	\$575.00
Mooney 20C	600x6 40-86	164-20	\$179.95	164-120	\$430.00
Mooney 20D, E	600x6 40-24	164-9	\$319.00	164-109	\$575.00
Mooney 20D, F, G, J, K	600x6 40-86	164-20	\$179.95	164-120	\$430.00
Piper PA22-108	600x6 40-28	164-5	\$247.95	164-105	\$932.00
Piper PA24-180, 250	600x6 40-58	164-9	\$319.00	164-109	\$575.00
Piper PA24-260	600x6 40-84	164-19	\$249.95	164-119	\$613.00
Piper PA-24, 30, 32, 34, 39	600x6 40-90	164-22A	\$262.95	---	---
Piper PA25	600x6 40-84A	164-33	\$334.00	164-133	\$1,930.00
Piper PA28 Series Cherokee/ Warrior	600x6 40-28	164-20	\$179.95	164-120	\$74.99
Piper PA32 Series	600x6 40-120C (1)	164-21600	\$239.95	---	---
Piper PA32 Series	600x6 40-90A	164-23	\$269.95	---	---
Piper P34 Series	600x6 40-90A	164-23	\$269.95	---	---
Piper PA38-112	500x5 40-78B	164-17	\$244.95	164-117	\$641.00
Piper PA44	600x6 40-90A	164-23	\$269.95	---	---
(1) Heavy duty	600x6 40-120(1)	164-21600	\$239.95	---	---
Archer	600x6 40-86	164-20	\$179.95	164-120	\$430.00
Pathfinder	600x6 40-86B	164-20	\$179.95	164-120	\$430.00
Cherokee	600x6 40-58	164-9	\$319.00	164-109	\$575.00
Cherokee/Arrow	600x6 40-84	164-19	\$249.95	164-119	\$613.00
Dakota	600x6 40-86	164-20	\$179.95	164-120	\$430.00
Dakota	600x6 40-86B	164-20	\$179.95	164-120	\$430.00
Rockwell Int. 112, 112A, B	600x6 40-113A	164-43	\$336.00	164-143	\$1,393.00
112B, TC, TCA114	600x6 40-75H	164-15A	\$242.95	164-115A	\$463.00
Schweizer SGS-1-34	500x5 40-78B	164-17	\$244.95	164-117	\$641.00
Socata TBM 700/850	8" Int. Brake	159-02700	\$1,394.00	---	---
Spencer Amph. S12E	600x6 40-74	164-7	\$353.00	164-107	\$674.00
Taylorcraft F-19	600x6 40-86	164-20	\$179.95	164-120	\$430.00
Varga 2150A	600x6 40-97E	164-26A	\$183.75	---	\$452.00
Waco	600x6 40-97A	164-26A	\$183.75	164-126A	\$452.00
Wing Derringer	600x6 40-84	164-19	\$249.95	164-119	\$613.00



## REPLACEMENT DISCS & LININGS FOR CESSNA/MCCAULEY WHEELS & BRAKES

Cessna Aircraft Model	Cessna/McCauley Wheel Assembly	Cessna/McCauley Brake Disc Assy.	Cleveland Brake Disc Assy.	Price
150, 150A	C163004-0104 C163003-0101 or C163001-0102 C163002-0101	B-30440	164-09200	\$286.95
		B-30195	164-09300	\$242.95
		B-30007	164-09400	-----
152, A152, F152, FA152	C163005-0101 or C163006-0101	-----	-----	-----
		C30615-1	164-08800	\$183.75
172, F172, R172, FR172	C163004-0104 C163003-0101 or C163003-0102 or C163004-0104 C163002-0101	B-30440	164-09200	\$286.95
		-----	-----	-----
		B-30195	164-09300	\$242.95
		B-30007	164-09400	-----
172, F172, 172RG	C163006-0101	C30615-1	164-08800	\$183.75
177	C163005-0101	C30615-1	164-08800	\$183.75
177RG	C163005-0101 or C163006-0101	-----	-----	-----
		C30615-1	164-08800	\$183.75

Cessna Aircraft Model	Cessna/McCauley Wheel Assembly	Cessna/McCauley Brake Disc Assembly	Cleveland Brake Disc Assembly	Price	
180, 185	C163004-0103	-----	-----	-----	
		C163004-0101	C30388	164-09700	\$282.95
		C163006-0103 Std.	C30615-3	164-9	\$319.00
		C163006-0102 HD	C30615-2	164-08900	\$308.00
182, F182	C163006-0101	-----	-----	-----	
		or C163006-0103	C30615-1	164-08800	\$183.75
R182, FR182, TR 182	C163006-0103	C30615-3	164-9	\$319.00	
U206-TU206	C163004-0102	C30398	164-09600	\$308.00	
		C30388	164-09700	\$282.95	
		C163006-0103 Std.	C30615-3	164-9	\$319.00
		C163006-0102 HD	C30615-2	164-08900	\$308.00
210, T210, P210	C163006-0103	C30398	164-09600	\$308.00	
	C163006-0103	C30615-3	164-9	\$319.00	

## CLEVELAND BRAKE DISCS

Model No.	Part No.	Price	Model No.	Part No.	Price
159-01200	06-02563	\$1,263.00	159-02700	06-02796	\$1,394.00
159-03500	05-11628	\$1,368.00	159-02900	05-14401	\$1,440.00
159-07100	159-07100	\$2,077.00	164-02201	164-22A	\$262.95
164-20900	06-01843	\$486.00	164-22201	06-01146	\$387.00
164-22400	06-01850	\$854.00	164-05806	06-01819	\$825.00

# RAPCO BRAKE DISCS

## RAPCO BRAKE DISCS



RAPCO FAA-PMA approved replacement brake disc for Cleveland and McCauley brake assemblies offer premium quality in a direct replacement disc. All discs are one piece forged for optimum strength and resistance to cracking, then heat treated to a specific hardness for a long service life. They are precision CNC machined, laser etched with permanent identification markings and then nickel

plated for corrosion resistance. A final machining on the wear surface assures trueness and offers an optimum absorption of kinetic energy for performance braking. When installing new brake discs always use new linings. For application guide, cross reference or product guide photos, please visit our web site at [www.aircraftspruce.com](http://www.aircraftspruce.com).

LG

RAPCO P/N	OEM P/N	Superseded	Our P/N	Price Ea.
<b>Cleveland Style Brake Disc</b>				
RA164-00206	164-00206	164-2F	06-00610	\$231.95
RA164-00300	164-00300	164-3	06-01682	\$152.75
RA164-00400	164-00400	164-4	06-00118	\$157.75
RA164-00500	164-00500	164-5	06-00612	\$167.85
RA164-00700	164-00700	164-7	06-00613	\$154.75
RA164-00806	164-00806	164-8F	06-01520	\$308.00
RA164-00900	164-00900	164-9	06-00614	\$158.75
RA164-01000	164-01000	164-10	06-00615	\$172.75
RA164-01300	164-01300	164-13	06-01683	\$154.75
RA164-01406	164-01406	164-14F	06-01685	\$306.00
RA164-01501	164-01501	164-15A	06-00616	\$153.75
RA164-01506	164-01506	164-15F	06-01686	\$150.75
RA164-01600	164-01600	164-16	06-00617	\$152.75
RA164-01700	164-01700	164-17	06-00618	\$157.65
RA164-01900	164-01900	164-19	06-00619	\$145.75
RA164-02000	164-02000	164-20	06-00620	\$135.75
RA164-02201	164-02201	164-22A	06-00621	\$164.75
RA164-02300	164-02300	164-23	10-03107	\$157.75
RA164-02504	164-02504	164-25A	06-00622	\$155.80
RA164-02505	164-02505	164-25C	10-03106	\$151.75
RA164-02601	164-02601	164-26A	06-00623	\$135.80
RA164-02706	164-02706	164-27F	06-01496	\$242.95
RA164-02707	164-02707	164-27G	06-01687	\$279.85
RA164-02800	164-02800	164-28	06-00624	\$152.80
RA164-03006	164-03006	164-30F	06-00414	\$316.00
RA164-03106	164-03106	164-31F	06-01129	\$343.00
RA164-03206	164-03206	164-32F	06-00625	\$219.95
RA164-03300	164-03300	164-33	06-00626	\$158.75
RA164-03506	164-03506	164-35F	06-01688	\$314.00
RA164-03601	164-03601	164-36A	06-00627	\$158.75
RA164-03906	164-03906	164-39F	06-01689	\$358.00
RA164-04000	164-04000	164-40	06-00628	\$133.75
RA164-04300	164-04300	164-43	06-00629	\$155.75
RA164-04406	164-04406	164-44F	06-01691	\$311.00
RA164-04800	164-04800	164-48	06-01692	\$360.00
RA164-05006	164-05006	164-50F	06-01693	\$288.95
RA164-05500	164-05500	164-55	06-01694	\$324.00
RA164-05700	164-05700	164-57	06-00630	\$237.95
RA164-05806	164-05806	164-58F	06-01128	\$277.95
RA164-06106	164-06106	164-61F	06-01695	\$289.95

RAPCO P/N	OEM P/N	Superseded	Our P/N	Price Ea.
RA164-06306	164-06306	164-63F	06-01696	\$347.00
RA164-06406	164-06406	164-64F	06-01697	\$347.00
RA164-06506	164-06506	164-65F	06-01698	\$340.00
RA164-06700	164-06700	164-67	06-01699	\$161.75
RA164-06900	164-06900	164-69	06-00631	\$158.75
RA164-07200	164-07200	164-72	06-01701	\$416.00
RA164-07400	164-07400	164-74	06-01703	\$417.00
RA164-07500	164-07500	164-75	06-00632	\$161.90
RA164-07700	164-07700	164-77	06-01704	\$329.00
RA164-07800	164-07800	164-78	06-00633	\$190.75
RA164-07906	164-07906	164-79F	06-01705	\$320.00
RA164-08100	164-08100	164-81	06-01706	\$252.95
RA164-08200	164-08200	164-82	06-01707	\$203.95
RA164-08300	164-08300	164-83	06-01708	\$161.75
RA164-08406	164-08406	164-84F	06-01709	\$276.95
RA164-08500	164-08500	164-85	06-01711	\$156.75
RA164-09100	164-09100	164-91	06-01712	\$321.00
RA164-09900	164-09900	164-99	06-01311	\$207.95
RA164-20206	164-20206	164-202F	06-01713	\$323.00
RA164-20306	164-20306	164-203F	06-01714	\$336.00
RA164-20500	164-20500	164-205	06-01715	\$171.75
RA164-20600	164-20600	164-206	06-01716	\$414.00
RA164-20700	164-20700	164-207	06-01717	\$408.00
RA164-20806	164-20806	164-208F	06-01718	\$291.95
RA164-20900	164-20900	164-209	06-01719	\$399.00
RA164-21000	164-21000	164-210	06-01720	\$310.00
RA164-21100	164-21100	164-211	06-01721	\$400.00
RA164-21200	164-21200	164-212	06-01722	\$159.95
RA164-21600	164-21600	164-216	06-02798	\$166.80
RA164-21900	164-21900	164-219	06-01723	\$330.00
RA164-22000	164-22000	164-220	06-01724	\$415.00
RA164-22201	164-22201	164-222A	06-01725	\$267.95
RA164-22202	164-22202	164-222B	06-01566	\$425.00
RA164-22400	164-22400	164-224	06-01726	\$615.00
RA164-22900	164-22900	164-229	06-01727	\$414.00
RA164-23000	164-23000	164-230	06-01728	\$599.00
RA164-23001	164-23001	---	06-01852	\$1,528.00
RA164-23002	164-23002	---	06-01853	\$1,307.00
RA164-24200	164-24200	---	06-01595	\$157.75
RA164-24400	164-24400	---	06-01594	\$167.75
RAPCO P/N	OEM P/N	Superseded	Our P/N	Price Ea.
<b>McCauley Style Brake Disc</b>				
RA164-30195	164-30195	B-30195	06-00579	\$152.75
RA164-30388	164-30388	C-30388	06-00584	\$152.75
RA164-30398	164-30398	C-30398	06-00588	\$152.75
RA164-30414	164-30414	C-30414	06-01732	\$152.75
RA164-30440	164-30440	B-30440	06-00578	\$152.75
RA164-30615-1	164-30615-1	C30615-1	06-00580	\$145.75
RA164-30615-2	164-30615-2	C30615-2	06-00586	\$163.75
RA164-30615-3	164-30615-3	C30615-3	06-00585	\$163.75

# APS BRAKE DISCS



APS brake discs are state-of-the-art CNC machined from a one-piece forging. When the metal is forged it creates a directional grain flow that follows the contour of the disc. This allows for a much stronger disc that has a reduced risk of the cracking and catastrophic failures associated with the inferior welded design. The APS "Black Steel" advantage is a proprietary heat treatment with a two-fold purpose. The heat treatment strengthens the steel by bonding the carbon, oxygen and nitrogen in the top layer of the metal. This is not a coating that can wear off. The steel itself is transformed. The heat treatment gives the steel its aesthetically pleasing black appearance and provides a surface with a high resistance to the corrosion and oxidation associated with the extreme thermal cycling experienced in aircraft braking systems. This makes it an excellent choice for agricultural aircraft that work in a harsh, chemical environment, as well as anyone who leaves their plane outside for most of its life.

**SEE OUR WEBSITE FOR AIRCRAFT APPLICATION CHART!**

APS Part Number	OEM Part Number	Description	Part Number	Price
APS164-00300	164-00300	APS164-00300 Blacksteel Brake Disc	07-20106	\$154.85
APS164-00400	164-00400	APS164-00400 Blacksteel Brake Disc	07-20107	\$158.75
APS164-00500	164-00500	APS164-00500 Blacksteel Brake Disc	07-20108	\$169.95
APS164-00700	164-00700	APS164-00700 Blacksteel Brake Disc	07-20109	\$154.75
APS164-00806	164-00806	APS164-00806 Blacksteel Brake Disc	07-20110	\$322.00
APS164-00900	164-00900	APS164-00900 Blacksteel Brake Disc	07-20111	\$154.75
APS164-01000	164-01000	APS164-01000 Blacksteel Brake Disc	07-20112	\$170.75
APS164-01501	164-01501	APS164-01501 Blacksteel Brake Disc	07-20115	\$154.75
APS164-01600	164-01600	APS164-01600 Blacksteel Brake Disc	07-20117	\$154.85
APS164-01700	164-01700	APS164-01700 Blacksteel Brake Disc	07-20118	\$158.75
APS164-01900	164-01900	APS164-01900 Blacksteel Brake Disc	07-20119	\$155.75
APS164-02000	164-02000	APS164-02000 Blacksteel Brake Disc	07-20120	\$135.75
APS164-02201	164-02201	APS164-02201 Blacksteel Brake Disc	07-20121	\$171.75
APS164-02300	164-02300	APS164-02300 Blacksteel Brake Disc	07-20122	\$154.75
APS164-02504	164-02504	APS164-02504 Blacksteel Brake Disc	07-20123	\$171.75
APS164-02505	164-02505	APS164-02505 Blacksteel Brake Disc	07-20124	\$155.75
APS164-02601	164-02601	APS164-02601 Blacksteel Brake Disc	07-20125	\$135.75
APS164-02706	164-02706	APS164-02706 Blacksteel Brake Disc	07-20126	\$257.95
APS164-03006	164-03006	APS164-03006 Blacksteel Brake Disc	07-20129	\$320.00
APS164-03206	164-03206	APS164-03206 Blacksteel Brake Disc	07-20131	\$215.95
APS164-03300	164-03300	APS164-03300 Blacksteel Brake Disc	07-20132	\$154.75
APS164-03506	164-03506	APS164-03506 Blacksteel Brake Disc	07-20133	\$321.00
APS164-03601	164-03601	APS164-03601 Blacksteel Brake Disc	07-20134	\$154.75
APS164-03906	164-03906	APS164-03906 Blacksteel Brake Disc	07-20135	\$353.00
APS164-04000	164-04000	APS164-04000 Blacksteel Brake Disc	07-20136	\$135.75
APS164-04700	164-04700	APS164-04700 Blacksteel Brake Disc	07-20138	\$284.95
APS164-05006	164-05006	APS164-05006 Blacksteel Brake Disc	07-20139	\$287.95
APS164-05500	164-05500	APS164-05500 Blacksteel Brake Disc	07-20140	\$319.00
APS164-05700	164-05700	APS164-05700 Blacksteel Brake Disc	07-20142	\$230.95
APS164-05806	164-05806	APS164-05806 Blacksteel Brake Disc	07-20143	\$282.95
APS164-06106	164-06106	APS164-06106 Blacksteel Brake Disc	07-20144	\$286.95
APS164-06700	164-06700	APS164-06700 Blacksteel Brake Disc	07-20147	\$154.75
APS164-07200	164-07200	APS164-07200 Blacksteel Brake Disc	07-20150	\$411.00
APS164-07400	164-07400	APS164-07400 Blacksteel Brake Disc	07-20151	\$411.00
APS164-07700	164-07700	APS164-07700 Blacksteel Brake Disc	07-20153	\$325.00
APS164-07800	164-07800	APS164-07800 Blacksteel Brake Disc	07-20154	\$189.99
APS164-07906	164-07906	APS164-07906 Blacksteel Brake Disc	07-20155	\$332.00
APS164-08300	164-08300	APS164-08300 Blacksteel Brake Disc	07-20156	\$154.75
APS164-08500	164-08500	APS164-08500 Blacksteel Brake Disc	07-20158	\$158.75
APS164-20306	164-20306	APS164-20306 Blacksteel Brake Disc	07-20160	\$332.00
APS164-20700	164-20700	APS164-20700 Blacksteel Brake Disc	07-20163	\$412.00
APS164-20900	164-20900	APS164-20900 Blacksteel Brake Disc	07-20164	\$409.00
APS164-21000	164-21000	APS164-21000 Blacksteel Brake Disc	07-20165	\$325.00
APS164-21600	164-21600	APS164-21600 Blacksteel Brake Disc	07-20167	\$186.75
APS164-22000	164-22000	APS164-22000 Blacksteel Brake Disc	07-20169	\$412.00
APS164-22201	164-22201	APS164-22201 Blacksteel Brake Disc	07-20170	\$269.95
APS164-22202	164-22202	APS164-22202 Blacksteel Brake Disc	07-20171	\$413.00
APS164-22900	164-22900	APS164-22900 Blacksteel Brake Disc	07-20173	\$412.00
APS164-23001	164-23001	APS164-23001 Blacksteel Brake Disc	07-20174	\$616.00
APS164-24200	164-24200	APS164-24200 Blacksteel Brake Disc	07-20175	\$157.75
APS164-24400	164-24400	APS164-24400 Blacksteel Brake Disc	07-20176	\$170.75
APS164-24500	164-24500	APS164-24500 Blacksteel Brake Disc	07-20177	\$199.95
APS164-30007	164-30007	APS164-30007 Blacksteel Brake Disc	07-20178	\$236.95
APS164-30195	164-30195	APS164-30195 Blacksteel Brake Disc	07-20179	\$155.75
APS164-30398	164-30398	APS164-30398 Blacksteel Brake Disc	07-20181	\$155.75
APS164-30440	164-30440	APS164-30440 Blacksteel Brake Disc	07-20183	\$155.75
APS164-30615-2	164-30615-2	APS164-30615-2 Blacksteel Brake Disc	07-20184	\$163.75
APS164-30615-3	164-30615-3	APS164-30615-3 Blacksteel Brake Disc	07-20185	\$163.75
APS164-30615-4	164-30615-4	APS164-30615-4 Blacksteel Brake Disc	07-20186	\$143.75
APS164-23002	164-23002	APS164-23002 Blacksteel Brake Disc	07-20697	\$894.00



# CLEVELAND BRAKE LININGS

## CLEVELAND STANDARD ORGANIC BRAKE LININGS



66-02  
(66-106)



66-141



66-4  
(66-111)



(66-30)

Order by NEW Cleveland part number.  
All Linings Include Rivets

LG

Aircraft Make & Model	Old Cleveland P/N	# Req.	New Cleveland P/N	Price
AEROTEK - Pitts S-1, S-2A	66-2	2	66-106	\$17.75
BEECH - Musketeer	66-55	2	66-105	\$17.75
Sierra Sport Sundowner B-19; C-23, 24R	66-55	2	66-105	\$17.75
Debonair CD-1 thru CD-387	66-4	2	66-111	\$35.25
Debonair B-33	66-2	2	66-106	\$15.75
Skipper	66-71	2	66-112	\$36.25
BELLANCA - Citabria, Champ	66-2	2	66-106	\$15.75
Scout	66-3	1	66-106	\$15.75
Decathlon, Scout 8GCBC	66-2	2	66-106	\$15.75
Viking, Aries 250	66-55	2	66-105	\$17.75
CESSNA - 150A, B, C, D, E	66-2	2	66-106	\$15.75
	66-56	2	66-106	\$15.75
150F, G, H, J, K, 152, F-152, FA-152	66-55	2	66-105	\$17.75
All Cessnas using Cessna/McCauley Brakes	B-30026	2	66-109	\$26.50
Skyhawk 172, Cardinal 177 All	66-55	2	66-105	\$17.75
Skywagon 180	66-55	4	66-105	\$17.75
Skylane 182 H, J, K, L, M, N	66-55	2	66-105	\$17.75
185A, B	66-2	2	66-106	\$15.75
185C, D, E	66-55	2	66-105	\$17.75
185 with crosswind gear	66-2	2	66-106	\$15.75
AGWagon	66-55	4	66-105	\$17.75
Stationair-6 205, 205A	66-2	2	66-106	\$15.75
Stationair-6 205, 205A (s/n 205-0481 & up)	66-55	4	66-105	\$17.75
206, U206A, D, E & Turbo models	66-55	4	66-105	\$17.75
207, T207	66-55	4	66-105	\$17.75
210C	66-4	2	66-111	\$35.25
210, P210, T210, 210N, P210N	66-55	4	66-105	\$17.75
303, T303	66-44	4	66-44	\$22.65
305A, B, C, D, E, F	66-55	4	66-105	\$17.75
310, 335	66-33	6	66-33	\$21.50
Skymaster 336	66-2	2	66-106	\$15.75
337, T337, 337B,C,D,E, T337B,C,D,E	66-55	4	66-105	\$17.75
All Cessnas using Cessna/McCauley Brakes	B-30026	2		
<b>CIRRUS</b>				
SR-20	066-14100	4	66-141	\$36.50
<b>GRUMMAN</b>				
AA-1, A, B, AA-5, AA-5A, AA-5B, Tiger, TR-2	66-55	2	66-105	\$17.75
AG-CAT	66-3	1	66-106	\$15.75
	66-56	2	66-106	\$15.75
G-154	66-2	2	66-106	\$15.75
G21, G21A	66-113	2	66-113	\$80.75
Widgeon G44, G44A, Scan Type 30	66-11700	2	66-11700	\$92.75

Aircraft Make & Model	Old Cleveland P/N	# Req.	New Cleveland P/N	Price
MAULE - Jetasen/Rocket, Lunar/Rocket	66-55	2	66-105	\$17.75
MOONEY - Most M20, A, B, D, E	66-4	2	66-111	\$35.25
PIPER - Colt PA22-108	66-2	2	66-106	\$15.75
	66-56	2	66-106	\$15.75
Apache PA-23-150, 160	66-2	2	66-106	\$15.75
	66-56	2	66-106	\$15.75
Apache/Aztec PA-23-235, 250 Series	66-2	4	66-106	\$15.75
	66-3	4	66-106	\$15.75
Comanche PA-24-180, 250, 260	66-2	2	66-106	\$15.75
Pawnee C PA-25	66-2	2	66-106	\$15.75
Cherokee/Cruiser PA-28-140	66-2	2	66-106	\$15.75
PA-28-140 s/n 28-20521 & up	66-55	2	66-105	\$17.75
Cherokee PA-28-150	66-2	2	66-106	\$15.75
Cherokee PA-28-160 s/n 28-1761 & up	66-55	2	66-105	\$17.75
Cherokee Warrior PA-28-151	66-55	2	66-105	\$17.75
Cherokee PA-28-160	66-2	2	66-106	\$15.75
Cherokee/Warrior II PA-28-161	66-55	2	66-105	\$17.75
Cherokee/Archer PA-28-180 to 28-1760	66-2	2	66-106	\$15.75
Cherokee/Archer PA-28-180 28-1761 & up	66-55	2	66-105	\$17.75
Cherokee/Pathfinder PA-28-181, PA-28-236	66-55	2	66-105	\$17.75
PA-28R-180, PA-28-200	66-2	2	66-106	\$15.75
PA-28R-180 s/n 28R-7130006 & up	66-55	2	66-105	\$17.75
PA-28-200 s/n 28R-7135110 & up	66-55	2	66-105	\$17.75
PA-28R-201T, 201, PA-28RT-201, 201T	66-55	2	66-105	\$17.75
Early PA-28-235	66-56	2	66-105	\$17.75
Early PA-28R-180, 200	66-56	2	66-105	\$17.75
Twin Comanche PA-30 Serial # 30-845 and on	66-19	2	66-62	\$35.50
Twin Comanche PA-30 Serial # 30-2 thru 30-845	66-19	2	66-65	\$43.85
Navajo B, PA31-300, 310, Turbo Navajo	66-33	6	66-33	\$21.50
Chieftain, PA-31-350	66-33	6	66-33	\$21.50
Cherokee/Six-260 PA-32-260	66-55	4	66-105	\$17.75
PA-32-300 s/n 32-40000 thru 7200029	66-55	4	66-105	\$17.75
PA-32R-300, 32RT-300	66-55	4	66-105	\$17.75
PA-38-112 (6" wheel)	66-71	2	66-112	\$36.25
PA-38-112 (5" wheel)	66-56	2	66-106	\$15.75
PA-39	66-19	1	66-62	\$35.50
PA-39, PA-39-1 & up	66-3	1	66-106	\$15.75
PA-44-180	66-55	4	66-105	\$17.75
<b>TAYLORCRAFT</b>				
Sportsman 100	66-55	2	66-105	\$17.75

Advise aircraft make, model and serial number to assure that correct brake lining part number is furnished Extra rivets, P/N 105-2, for all models listed in table.

### CLEVELAND BRAKE LINING KITS



Pack of 4 linings  
66-105.....P/N 06-01309.....\$67.45  
66-106.....P/N 06-01310.....\$59.50

### CLEVELAND BRAKE LININGS

066-10000.....P/N 06-01792.....\$95.75  
066-15300.....P/N 05-13686.....\$27.60  
066-13100.....P/N 06-01796-1.....\$41.60

### BRAKE LINING TOOLS



Designed especially to economically reline brakes, this riveting set is a handy tool for many other jobs where rivets are used to fasten leather, canvas, plastic and metal parts. Deluxe tool is screw-down type.

Deluxe Brake Lining Tool #404 (Threaded).....P/N 12-20810.....\$29.50  
Brake Lining Rivets 4-6.....P/N 06-02300.....\$0.06

# RAPCO/APS BRAKE LININGS – BRAKE PARTS

## RAPCO BRAKE LININGS



RAPCO FAA-PMA approved quality replacement linings for Cleveland and McCauley\* brake assemblies. Most organic linings include an exclusive built in wear indicator.

RAPCO P/N	Cleveland P/N	Our P/N	Price Ea.
<b>Organic Linings</b>			
RA066-10500	066-10500	06-16955	<b>\$9.75</b>
RA066-10600	066-10600	06-16956	<b>\$9.75</b>
RA066-10800	066-10800	06-16959	<b>\$11.75</b>
RA066-11000	066-11000	06-01734	<b>\$17.50</b>
RA066-11100	066-11100	06-16958	<b>\$9.00</b>
RA066-11200	066-11200	RA66-112	<b>\$12.50</b>
RA066-13100	066-13100	06-02833	<b>\$29.50</b>
RA066-14100	066-14100	RA66-141	<b>\$17.75</b>
RA066-14800	066-14800	06-01738	<b>\$16.25</b>
RA066-30026	066-30026 *	06-16987	<b>\$12.50</b>
<b>Metallic Linings</b>			
RA066-02200	066-02200	06-16922	<b>\$15.50</b>
RA066-03300	066-03300	06-16933	<b>\$14.95</b>
RA066-04400	066-04400	06-16944	<b>\$14.65</b>
RA066-06200	066-06200	06-16962	<b>\$15.75</b>
RA066-06400	066-06400	06-01563	<b>\$22.60</b>
RA066-06500	066-06500	06-16965	<b>\$17.90</b>
RA066-06600	0066-06600	06-16966	<b>\$14.50</b>
RA066-06700	066-06700	06-01562	<b>\$22.90</b>
RA066-06800	066-06800	06-16968	<b>\$21.50</b>
RA066-07300	066-07300	06-01558	<b>\$37.55</b>
RA066-09000	066-09000	06-01556	<b>\$33.65</b>
RA066-09100	066-09100	06-01559	<b>\$139.85</b>
RA066-09200	066-09200	06-01560	<b>\$257.95</b>
RA066-09700	066-09700	06-01561	<b>\$16.60</b>
RA066-10000	066-10000	06-16955	<b>\$9.75</b>
RA066-15300	066-15300	06-01557	<b>\$29.95</b>

## BRAKE LINING KITS

RAPCO FAA-PMA approved for Cleveland and McCauley\* brake assemblies. The kits come with linings and rivets. The -4K, -8K, -12K refers to the number of linings in a kit.

RAPCO P/N	Description	Our P/N	Price/Kit
RA066-10500-4K	Lining Kit	06-00643	<b>\$39.70</b>
RA066-10500-8K	Lining Kit	06-00650	<b>\$77.90</b>
RA066-10600-4K	Lining Kit	06-00651	<b>\$37.50</b>
RA066-10600-8K	Lining Kit	06-00652	<b>\$74.95</b>
RA066-10800-8K	Lining Kit	06-00681	<b>\$89.75</b>
RA066-10800-12K	Lining Kit	06-01739	<b>\$129.75</b>
RA066-11100-4K	Lining Kit	06-00683	<b>\$34.50</b>
RA066-11200-4K	Lining Kit	06-01740	<b>\$46.75</b>
RA066-30026-4K	Lining Kit	06-00653	<b>\$45.60</b>
RA066-30026-8K	Lining Kit *	06-00682	<b>\$91.95</b>



## RAPCO RA154-03000 MOLDED GREASE SEAL

P/N 06-03081 ..... **\$58.95**



## BRAKE TORQUE PLATE FOR AERONCA

Brake Torque Plate. 7A, 7BCM, 7CCM, 7EC, 7FC, 7GC, 7HC, 11A 11BC. Code 4.

P/N 05-06315 ..... **\$26.65**



## BRAKE PUCK - MAIN ROTOR BRAKE

FAA-PMA approved quality replacement main rotor brake puck for Bell 206A, 2067B, 206L, 206L-1, 206L-3, 206L-4. RAPCO: RA5009212 • OEM: 5009212

P/N 06-01306 ..... **\$208.95**

## RAPCO BRAKE RIVET TOOL KIT



The RAPCO rivet tool kit offers quality tooling for professional results with brass or steel rivets. The kit comes with punch to remove old rivets and screw style set and anvil to properly install new rivets.

RAPCO P/N	Description	Our P/N	Price
RA825	Rivet Tool Kit	10-02065	<b>\$43.50</b>
RA825AP	Anvil & Punch	10-02066	<b>\$8.95</b>

## RAPCO BRAKE RIVETS

FAA-PMA approved tubular rivets for the installation of aircraft brake linings. Use with RA825 Rivet Tool Kit.



RAPCO P/N	Head, Shank	Our P/N	Price Ea.
RA105-00200	5/16, 5/32	06-00351	<b>\$0.20</b>
RA105-06700	5/16, 3/16	06-02834	<b>\$0.80</b>

## BRAKE MOUNTING PINS

FAA-PMA approved quality stainless steel mounting pins for metallic brake linings.



RAPCO P/N	Head, Shank	Our P/N	Price Ea.
RA177-00300	5/16, 5/32	06-01215	<b>\$4.45</b>
RA177-00400	5/16, 3/16	06-01499	<b>\$4.45</b>
RA177-01600	3/8, 3/16	06-01501	<b>\$4.45</b>

## APS PILATUS PC-12 BRAKE OVERHAUL KIT

The Pilatus PC-12 Overhauled Kit is cost-effective replacement brake parts for the PC-12 with Cleveland Brakes. **Features:** • All parts are PMA'D • Longer Wear Life • Parts offered individually or as a brake overhaul kit ..... P/N 06-03466 ..... **\$2,858.00**

## RAPCO PILATUS PC-12 BRAKE OVERHAUL KIT

RAPCO Inc. Brake Overhaul Kits contain FAA-PMA and EASA approved quality replacement parts for Cleveland multi-rotor brake assemblies. The parts have undergone rigorous dynamometer and flight testing by experienced designers, engineers and test pilots. Each kit offers quality and performance at a very competitive price..... P/N 06-03546 ..... **\$2,973.00**

## APS 30-244 OVERHAULED MAIN BRAKE ASSEMBLY FOR PILATUS PC-12

APS Overhauled 30-244 Main Brake Assembly – 10" Internal. Single Cylinder, Six Piston. P/N 06-03537 ..... **\$3,625.00**

## RAPCO 30-244 OVERHAULED MAIN BRAKE ASSEMBLY FOR PILATUS PC-12

Rapco Overhauled 30-244 Main Brake Assembly – 10" Internal. Single Cylinder, Six Piston. FAA-PMA and EASA approved quality replacement parts for Cleveland multi-rotor brake assemblies. The parts have undergone rigorous dynamometer and flight testing by experienced designers, engineers and test pilots. **Eligibility:** Pilatus Aircraft Ltd. PC-12, PC-12/45, PC-12/47, PC-12/47E with Parker Cleveland Brake Assembly P/N: 30-244..... P/N 06-04174 ..... **\$3,736.00**

## APS CESSNA CARAVAN BRAKE KIT

APS Caravan Kit. The APS "Black Steel" advantage. APS Brake Pad lining pin APS177-00300. Compatible with the following metallic linings: APS66-06200, APS66-06500, APS66-02200, APS66-04400, APS66-09700, APS66-01500, APS66-01900 and APS66-03300

**Kit Includes:** • APS164-22201 Blacksteel Brake Disc • APS177-00300 APS (M) Brake Lining Pin • APS66-15300 APS Brake Lining (M)

P/N 07-24462 ..... **\$994.00**

## GOODYEAR BRAKE PARTS

Most replacement parts are available for aircraft still equipped with Goodyear wheels and brakes. We provide prompt shipment on replacement parts such as brake linings, brake discs, clips, etc. Request quotation on any unlisted Goodyear part numbers.

Brake 5.00 x 5, Cessna 150, Assy. No. 9532302	
Piston Lining.....	P/N 9524161-1 ..... <b>\$62.50</b> ea.
Brake 6.00 x 6, Cessna 120, 140, Aeronca 7AC, 11AC, Swift, Lus., Assy. No. 9520517	
Disc Clips.....	P/N 9523482 ..... <b>\$46.50</b> ea.
Brake 6.00 x 6, Cessna 170, 172, 175, 180, 182, 210 Assy. No. 9530839	
Aeronca 7AC, 11AC, 15AC, Stinson 150, 165, Assy. No. 951239 & 9532181	
Disc Clip.....	P/N 9523482 ..... <b>\$46.50</b> ea.
Brake 6.00 x 6, Ercoupe Forney, Assy. No. 9520285	
Disc Clip.....	P/N 9523482 ..... <b>\$46.50</b> ea.
Brake 6.50 x 8, Beech T34, 35, Camair, Assy. No. 511731	
Piston Lining.....	P/N 9510713-1 ..... <b>\$63.75</b> ea.
Disc Clip.....	P/N 9523937 ..... <b>\$84.75</b> ea.
Brake 6.50 x 10, Cessna 190, 195, 310, 320 Assy. No. 951731	
Piston Lining.....	P/N 5009853 ..... <b>\$108.75</b> ea.



# APS BRAKE LININGS



APS BlackSteel offers semi-metallic (organic) and metallic linings for your specific application. The semi-metallic linings are impregnated with Kevlar® fibers for optimum performance. APS metallic linings are constructed from an innovative design and from more durable materials than other brands so you get longer wear and superior stopping power for greater safety.

**SEE OUR WEBSITE FOR AIRCRAFT APPLICATION CHART!**

## APS BRAKE LININGS

APS Part Number	OEM Part Number	Description	Part Number	Price
APS66-02200	66-02200	APS Brake Lining (M)	07-20191	\$14.50
APS66-03300	66-03300	APS Brake Lining (M)	07-20192	\$14.50
APS66-04400	66-04400	APS Brake Lining (M)	07-20193	\$14.50
APS66-06200	66-06200	APS Brake Lining (M)	07-20194	\$14.85
APS66-06400	66-06400	APS Brake Lining (M)	07-20195	\$22.50
APS66-06500	66-06500	APS Brake Lining (M)	07-20196	\$16.70
APS66-06600	66-06600	APS Brake Lining (M)	07-20197	\$13.75
APS66-06800	66-06800	APS Brake Lining (M)	07-20198	\$19.95
APS66-07300	66-07300	APS Brake Lining (M)	07-20199	\$37.50
APS66-09000	66-09000	APS Brake Lining (M)	07-20200	\$33.50
APS66-09100	66-09100	APS Brake Lining (M)	07-20201	\$142.75
APS66-09200	66-09200	APS Brake Lining (M)	07-20202	\$264.95
APS66-09700	66-09700	APS Brake Lining (M)	07-20203	\$15.60
APS66-10500	66-10500	APS Brake Lining (O)	07-20204	\$9.95
APS66-10600	66-10600	APS Brake Lining (O)	07-20205	\$9.95
APS66-10800	66-10800	APS Brake Lining (O)	07-20206	\$11.75
APS66-10900	66-10900	APS Brake Lining (O)	07-20207	\$11.90
APS66-11000	66-11000	APS Brake Lining (O)	07-20208	\$16.70
APS66-11200	66-11200	APS Brake Lining (O)	07-20210	\$11.85
APS66-13100	66-13100	APS Brake Lining (O)	07-20211	\$26.75
APS66-14100	66-14100	APS Brake Lining (O)	07-20212	\$16.90
APS66-15300	66-15300	APS Brake Lining (M)	07-20213	\$15.90
APS66-15300	66-15300	APS Brake Lining (M) - Box of 10	07-20213-10	\$157.75

## APS BRAKE SHIMS

APS Part Number	Description	Part Number	Price
APS68-01100	Brake Shim	07-25594	\$30.80
APS68-01600	Brake Shim	07-25596	\$51.75
APS68-01700	Brake Shim	07-25598	\$54.75
APS68-02700	Brake Shim	07-25600	\$60.75
APS68-02800	Brake Shim	07-25599	\$47.85
APS68-02900	Brake Shim	07-25616	\$130.75
APS68-03000	Brake Shim	07-25602	\$67.95
APS68-03100	Brake Shim	07-25611	\$97.75
APS68-03300	Brake Shim	07-25601	\$61.75
APS68-03900	Brake Shim	07-25612	\$134.99
APS68-04000	Brake Shim	07-25617	\$184.75
APS68-04100	Brake Shim	07-25595	\$42.50
APS68-04600	Brake Shim	07-25597	\$52.75



### APS BRAKE PAD LINING RIVETS

APS105-00200-100	P/N 07-20100	\$17.95
APS105-06700-100	P/N 07-20101	\$39.50
APS105-00200	P/N 06-02882	\$0.20
APS105-00200-PKG	P/N 07-20700	\$4.75



### APS BRAKE PAD LINING PINS

APS177-00300	P/N 07-20187	\$4.35
APS177-00400	P/N 07-20188	\$4.35
APS177-01600	P/N 07-20189	\$4.35

# OMEGA BRAKE REPLACEMENT PARTS

## CLEVELAND

OEM Part No.	Description	Part No.	Price
063-01100-OAA	Pressure Plate	06-03383	\$43.80
063-01200-OAA	Pressure Plate	06-03387	\$46.85
064-01500-OAA	Back Plate	06-03394	\$55.75
064-00500-OAA	Back Plate	06-03396	\$56.75
063-30025-OAA	Pressure Plate	06-03399	\$72.75
063-01300-OAA	Pressure Plate	06-03412	\$109.75
064-03200-OAA	Back Plate	06-03432	\$166.75
063-03500-OAA	Pressure Plate	06-03434	\$225.95
063-05800-OAA	Pressure Plate	06-03446	\$328.00

## TBM

OEM Part No.	Description	Part No.	Price
105-00900-OAA	Rivet - (Sold In Bags of 100)	06-03371	\$145.75
109-00200-OAA	Wear Pad	06-03380	\$21.50
30-191-OSK-OAA	Standard Kit	06-03456	\$810.00

## PC-12

OEM Part No.	Description	Part No.	Price
93-909-1-OAA	Wear Pad (PC-12 BFG Steel)	06-03385	\$43.55
173-80-OAA	Pin (PC-12 BFG Steel)	06-03402	\$79.80
74-973-OAA	Piston (PC-12 BFG Steel)	06-03436	\$188.75
133-1513-OAA	Stationary Disc (PC-12 BFG Steel)	06-03449	\$397.00
2-1674-1-OSK-OAA	Standard Kit (PC-12 BFG Steel)	06-03458	\$1,977.00
45-246-1-OAA	Swage Tube (BFG Steel)	06-03404	\$78.75

## KING AIR

OEM Part No.	Description	Part No.	Price
105-00901-OAA	Rivet (King Air Cleveland) (Sold In Bags Of 100)	06-03370	\$1.45
109-00200-OAA	Wear Pad (King Air Cleveland)	06-03378	\$15.50
20-191-OAA	Return Pin (King Air BFG Standard)	06-03389	\$43.55
74-645-OAA	Piston (King Air BFG Standard)	06-03393	\$50.99
259-80-OAA	Wheel Clip (King Air BFG Standard)	06-03397	\$61.75
9534915-1-OAA	Insulator (King Air Meggit High Float And Dornier 228)	06-03417	\$138.75
43-1171OAA	Bolt (King Air BFG Standard)	06-03419	\$123.75
9536788-OAA	Piston (King Air Meggitt High Float)	06-03424	\$138.75
115-210-2-OAA	Insulator (King Air BFG Standard)	06-03431	\$158.75
60-438-OAA	Axle Spacer (King Air BFG Standard)	06-03433	\$176.75
30-162-OSK-OAA	Standard Kit (King Air Cleveland)	06-03444	\$224.95
184-443-OAA	Back Plate (King Air BFG Standard)	06-03459	\$1,741.00
5002289-OAA	Brake Housing (King Air Meggit High Float)	06-03462	\$7,540.00

## PREMIER JET

OEM Part No.	Description	Part No.	Price
78-265-OAA	Rivet (Premier Jet) (Sold In Bags Of 100)	06-03372	\$2.25
S11065-13-1-OAA	Scrapper (Beechjet and Premier)	06-03377	\$9.50
93-989-OAA	Wear Pad (Premier Jet)	06-03398	\$59.85
45-255-OAA	Swage Tube (Premier Jet)	06-03427	\$137.85
5003096-7-OKS-OAA	Stationary Disc (Premier Jet)	06-03454	\$835.00
390-388103-OSK-OAA	Standard Kit (Premier Jet)	06-03461	\$4,474.00

## EMB-500

OEM Part No.	Description	Part No.	Price
90005153-1	Swage Tube	06-03386	\$37.50
90005124-OAA	Drive Key	06-03407	\$82.99

## BEECHJET

OEM Part No.	Description	Part No.	Price
GYR6B11-OAA	Rivet (Beechjet) (Sold In Bags Of 100)	06-03362	\$0.37
GYR6B6-OAA	Rivet (Beechjet) (Sold In Bags Of 100)	06-03364	\$0.87
GYR6A16-OAA	Rivet (Beechjet) (Sold In Bags Of 100)	06-03365	\$1.16
5010702-OAA	Wear Pad (Beechjet)	06-03375	\$6.50
S11065-13-1-OA	Scrapper (Beechjet and Premier)	06-03377	\$9.50
5010754-OAA	Swage Tube (Beechjet)	06-03392	\$50.75
GYN186-OAA	Nut (Beechjet)	06-03395	\$55.75
5005129-OAA	Piston (Beechjet)	06-03441	\$225.95
5011104-OAA	Wear Pin (Beechjet)	06-03443	\$242.95
400-8002-97-OSK-OAA	Standard Kit (Beechjet)	06-03457	\$1,256.00
5010704-1-OAA	Wheel Channel (Beech Jet)	06-03451	\$341.00

## HAWKER

OEM Part No.	Description	Part No.	Price
AHO089645-OAA	Wear Pin (Hawker 800)	06-03379	\$17.50
AHO89768-OAA	Wear Pin (Hawker 1000)	06-03405	\$109.75
AHO89576-OAA	Piston (Hawker 700)	06-03409	\$92.80
AHO88411-OAA	Piston (Hawker 800)	06-03429	\$152.75

## LEARJET

OEM Part No.	Description	Part No.	Price
GY18A15-OAA	Rivet (Lear Jet) (Sold In Bags Of 100)	06-03366	\$1.16
GY18B7-OAA	Rivet (Lear Jet) (Sold In Bags Of 100)	06-03367	\$1.24
9Y18B9-OAA	Rivet (Lear Jet) (Sold In Bags Of 100)	06-03368	\$1.24
GY18B15-OAA	Rivet (Lear Jet) (Sold In Bags Of 100)	06-03369	\$1.30
GYR8A23-OAA	Rivet (Lear Jet) (Sold In Bags Of 100)	06-03373	\$2.38
5006029-OAA	Wear Pad (Lear Jet)	06-03374	\$5.85
9535042-1-OAA	Insulator (Lear 25, 31, 35, 36 Series)	06-03382	\$25.50
9536273-OAA	Piston (Lear Jet)	06-03384	\$36.65
5005119-OAA	Wear Pad (Lear Jet)	06-03390	\$42.50
5006895-1-OAA	Insulator (Lear Jet 55, 55B, 55C, 60)	06-03391	\$50.80
90002647-OAA	Insulator (Lear Jet 60)	06-03411	\$123.75
5007328-OAA	Wear Pad (Lear Jet)	06-03423	\$127.75
5011739-OAA	Drive Key (Lear 60)	06-03439	\$225.95
5003096-6-OSK-OAA	Standard Kit (Lear Jet)	06-03452	\$450.00
5003096-7-OKS-OAA	Standard Kit (Lear Jet)	06-03453	\$745.00
5012943-OAA	Swage Tube (Learjet)	06-03463	\$22.90

## DORNIER

OEM Part No.	Description	Part No.	Price
5008490-OAA	Swage Tube (Dornier 228)	06-03403	\$82.95
2610750-OAA	Swage Tube (Dornier 228)	06-03416	\$123.75
5006521-OAA	Piston (Dornier 228)	06-03437	\$192.75

## G-150

OEM Part No.	Description	Part No.	Price
5006747-OAA	Swage Tube (G-150)	06-03381	\$32.55
5002894-1-OAA	Insulator (G-150)	06-03401	\$64.75
5006729-OAA	Piston (G-150)	06-03418	\$137.85
5006727-OAA	Wear Pin (G-150)	06-03448	\$276.95

LG

# SHIMMY DAMPERS

## PIPER SHIMMY DAMPER SERVICING KIT

Finally, a shimmy damper servicing kit. One of the most neglected components on Piper aircraft is the shimmy dampener. The shimmy damper aids nose wheel steering by reducing the shimmy of the nose wheel during takeoff and landing, and during high-speed taxiing. Even minor shimmying can lead to serious damage to the nose gear and engine mount and affect the airworthiness of the aircraft. The shimmy damper is a sealed unit that, until now, could not be serviced and required costly replacement. The STC and accompanying servicing kit allows the MAECO shimmy damper to be modified and serviced, restoring the shimmy damper to like-new condition and enabling it to perform as originally designed Important: Enter Piper Aircraft Model, Serial number, and "N" number at time of order.....P/N 06-00846 .....**\$175.95**

**SEE WEBSITE FOR AIRCRAFT ELIGIBILITY!**

## SHIMMY DAMPENER REPAIR KITS



TSDK-1 & TSDK-2 Shimmy Dampener Repair Kits. Replaces the Cleveland 199-535 kit.

### Specifications:

Kits Service the: 15-2, 15-8 (456-015), 15-9 (456-016), 15-10 (456-017), 15-11 (456-018), 15-13, 15-14 (456-014) and 15-16.

TSDK-1 .....P/N 04-04055 .....**\$24.50**  
TSDK-2 with Glyd Ring.....P/N 04-04056 .....**\$86.75**

## MC0442512-1 SHIMMY DAMPENER ASSEMBLY FOR CESSNA



Direct replacement for part numbers 0442512-1 and 0542119-1. It's everything the original should have been and more than the rubber units ever could be!

- Improved design for consistent dampening action!
- Oversize shaft for rigid strength
- Wear resistant hard anodized housing
- Better shimmy dampening
- Totally repairable
- Self lubricating
- Costs less than the throw away rubber dampener
- Temperature compensated hydraulics
- Almost no service required
- Even the first minor movements are dampened
- Consistent dampening action
- No oil leaks.

P/N 05-22192 .....**\$859.00**

**SEE WEBSITE FOR AIRCRAFT ELIGIBILITY!**

## SEAL KITS FOR CESSNA SHIMMY DAMPENERS



Shimmy dampener seal kits contain the industry standard o-rings required to reseal the Cessna shimmy dampener.

Visit our website for application information.

Economy Kit.....P/N 06-01679 .....**\$5.00**

LG



## LORD MAINTENANCE-FREE SHIMMY DAMPERS

This high performance shimmy damper is designed to last at least 10 yrs without maintenance and contains no hydraulic fluid, so it cannot leak. Priced at about half the cost of equivalent Cessna factory dampers. 5-year pro-rated warranty. All dampers are STC'd and PMA approved. **Features: No Hydraulic Fluid:** No periodic leaks or loss of damping. No servicing required. Reduced wear of nose gear linkages. Lower operating costs. **Consistent damping from -30° to 150°F:** No loss of damping at temperature extremes. Reduced wear of nose gear linkages. Lower operating costs. **No performance degradation over time and use:** Reduced wear of nose gear linkages. Lower operating costs. **Large diameter shaft:** Increased durability. Lower operating costs. **Simple Design:** High reliability. Lower operating costs. **Form, fit and function compatible:** Simplicity of use (one-for-one replacement). Compatibility with existing installation. **Note: Installation hardware not included.**

Part No.	Lord Part No.	Aircraft Eligibility	Price
<b>CESSNA</b>			
05-00443	SE-1051-2 Approved Replacement For Cessna # 0442512-1, 0542119-1	150G, H, J, K, L, M F150G, H, J, K, L, M, A150K, L, M, FA150K, L FRA150L, FRA150M 152 (ALL) 1978 thru 1985 (no letter designators) F152 (ALL) 1978 thru 1984 (no letter designators) A152 (ALL) 1978 thru 1985 (no letter designators) FA152 (ALL) 1978 thru 1984 (no letter designators) 172, 172 A, B, C, D, E, F, G, H, I, K, L, M, N, P, Q, R, S F172D, E, F, G, H, K, L, M, N, P P172D, FR172E, F, G, H, J (REIMS ROCKET) R172K, FR172K, 175, 175A, B, C, 182B, C, D	<b>\$889.00</b>
05-00444	SE1051-3 Approved Replacement for Cessna # 0442512-2, 0542119-2	150, 150A, B, C, D, E, F	<b>\$2,295.00</b>
05-02610	SE-1068-5 Approved Replacement for Cessna # 0743624-1	182K, L, M, N, P, Q, R, S, T, T182T	<b>\$1,095.00</b>
05-00446	SE-1069-3 Approved Replacement for Cessna # 0743624-2	206H, U206B, U206C, U206D, U206E, U206F, U206G, TU206B, TU206C, TU206D, TU206E, TU206F, TU206G, TU206H, P206B, P206C, P206D, P206E, 207, 207A, T207, T207A, 210G, 210H, 210J, 210K, 210L, 210M, 210N, 210R, T210K, T210L, T210M, T210N, P210N, P210R	<b>\$926.00</b>
05-03382	SE-1070-7 Approved Replacement for Cessna # 2643090-3	C208, C208A, C208B	<b>\$3,093.00</b>
05-04185	SE-1090-1 Approved Replacement for Cessna # 0842410-2 for selected models, 0001-0710 for 182 Models	310, 310B, 310C, 310D, 310F, 310G, 310H, 310I, 310J, 310K, 310L, 310N, 310P, T310P, 310R, T310R, 320, 320A, 320B, 320C, 320D, 320E, 320F, 335, 340, 340A, 401, 401A, 401B, 402, 402A, 402B, 402C, 411, 411A, 414, 414A, 421, 421A, 421B, 421C, 425, 404, 406, 441, R182, TR182, FR182	<b>\$2,975.00</b>
<b>TEXTRON AVIATION (FORMERLY BEECHCRAFT)</b>			
05-03421	SE-1076-1 Replaces Beech #s: 35-825145, 35825145-2, and 35-825145-6	58P, 58TC, 35-33, 35-A33, 35-C33A, E33C, F33, F33A, F33C, G33, H35, J35, K35, M35, N35, P35, S35, V35, V35A, V35B, 36, A36, A36TC, B36TC, 95-55, 95-A55, 95-B55, 95-C55, 95-C55A, G58, D55, D55A, E55, 58, 35, A35, B35, C35, D35, E35, F35, G35	<b>\$1,227.00</b>
<b>PIPER</b>			
05-12930	SE-1508-2 Replaces Piper 456-015 Supercedes SE-1508-1	PA-28, PA-28-140, PA-28-140B, PA-28-140C, PA-28-140D, PA-28-140E, PA-28-140 Cruiser, PA-28-150, PA-28-150B, PA-28-150C, PA-28-151, PA-28-160, PA-28-160B, PA-28-160C, PA-28-161, PA-28-161 Warrior II, PA-28-161 Warrior III, PA-28-180, PA-28-180B, PA-28-180C, PA-28-180D, PA-28-180E, PA-28-180F, PA-28-180G, PA-28-180 Challenger, PA-28-180 Archer, PA-28-181, PA-28-181 Archer II, PA-28-181 Archer III, PA-28-181 Archer LX, PA-32-301 Saratoga, PA-32-301T Saratoga, PA-32-301XTC, PA-32-301FT 6X	<b>\$1,395.00</b>



# HUB CAPS – BLACK MAX – GOODRICH



## METAL HUB CAPS

These FAA approved metal hub caps are designed for older Pipers using the 800x4 Goodrich (Hayes) brakes such as the J-3 and PA-18. A larger cap for 600 x 6 conversions are also available below. The caps are available with "CUB" stamped in raised letters or plain.

Cub 800x4 Goodrich hub cap .....P/N 06-00010 .....**\$44.80 ea.**  
(Identical in size and appearance to Cleveland #157-9)  
Cub 600x6 Cleveland hub cap .....P/N 06-00020 .....**\$41.99 ea.**  
Plain 800x4 Goodrich hub cap .....P/N 06-00030 .....**\$34.90 ea.**  
Plain 600x6 Cleveland hub cap .....P/N 06-00040 .....**\$39.60 ea.**



## GROVE HUB CAPS

### GROVE HUB CAP 5"

For Grove, Cleveland and Gerdes wheels. Includes mounting screws. 011-012  
P/N 06-01363 .....**\$26.50**



### GROVE HUB CAP 6"

For Grove, Cleveland and Gerdes 600x6 wheels. Includes mounting screws. 011-013  
P/N 06-00845 .....**\$29.50**



## WHEEL COVERS

For Gerdes, McCauley, Cleveland, Hayes, Goodyear, Rosenhan and Matco wheels as listed. Furnished with mounting screws and lock washers.

157-8

Part No.	Wheel Size	Application	Price ea.
157-8	5.00-5*	Cleveland, McCauley, Gerdes	<b>\$279.65</b>
157-9	6.00-6**	Cleveland, McCauley, Gerdes	<b>\$198.75</b>
06-03705	6.00-6	All Goodyear Wheels	<b>\$56.75</b>
06-03900	5" Dia.	Rosenhan Matco Wheels	<b>\$11.50</b>



## ECONOMY WHEEL COVER

For 600-6 Cleveland wheels  
P/N 06-03710 .....**\$19.75 ea.**  
For 500-5 Cleveland wheels  
P/N 06-00073 .....**\$22.75 ea.**

Furnished with screws for installation

## BX-1000 BLACK MAX HYDRAULIC BRAKE SYSTEM

(Everything you need in one package)

This system has a full floating rotor which compensates for alignment giving you a smooth feeling brake action. The master cylinder has a built in reservoir which allows you to add oil and bleed from the top down. Maximum holding pressure to allow for a good run up. Uses standard brake fluid. Gross rating 1000 lbs. **Rims Included.**

### Features:

• Master Cylinder w/reservoir and brake handle • 2 - 6" polished aluminum wheels • 2 - Hubs w/bearings • 2 - Tires • 2 - Rotors • 2 - Calipers • 5/8" axle with keyway • Brake Pads • 14' of Hydraulic Brake Line • Fittings and Hardware.



Part No.	Model	Rim Type	Rim Size	Gross Weight	Includes tires	Axle Size	Part No.	Price
BX44708	BX1000	Welded	4"W X 6" D	1000 lbs.	Yes	5/8" X 8"	06-00707	<b>\$548.00</b>

LG

## BLACK MAX AXLE ADAPTERS

Description	Part No.	Price
Challenger Metal Gear Leg	06-00973	<b>\$74.85</b>
Adapter for Challenger w/ Fiberglass Left Gearleg	06-00974	<b>\$81.75</b>
Adapter for Challenger w/ Fiberglass Right Gearleg	06-00975	<b>\$81.75</b>
Hawk Left Axle Assembly	06-00976	<b>\$68.75</b>
Titan Gear LED Adapter	06-00994	<b>\$68.75</b>
Axle 3/4" x 8 w/Woodruff Key	06-01005	<b>\$53.75</b>

## BLACK MAX REPLACEMENT PARTS

Mfg. P/N	Description	Part No.	Price
44766	Caliper Assembly 5/8	06-00996	<b>\$161.75</b>
44766-3/4	Caliper Assembly 3/4	06-00997	<b>\$156.75</b>
44764	Master Cylinder Assembly	06-00995	<b>\$126.75</b>
44747	Brake Handle	06-01017	<b>\$19.95</b>
44771	Brake Handle Grip	06-01037	<b>\$3.95</b>
-	Replacement Valve System	06-01013	<b>\$1.75</b>
44743	Black Max Nylon Brake Line 1/8" O.D.	06-01006	<b>\$0.85</b>
44848	Replacement O-Seal Kit (For Split Rims)	06-01012	<b>\$15.00</b>

See [www.aircraftspruce.com](http://www.aircraftspruce.com) for more Brake Max Parts

## GOODRICH 800X4 WHEEL PARTS

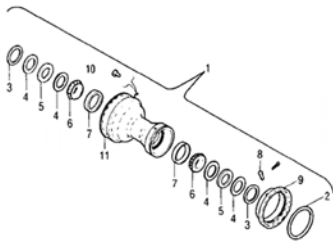

Figure No.	Part No.	Description	Price
5	B227-52	Felt, Grease Retaining	<b>\$1.65</b>
6	08125	Cone, Bearing	<b>\$82.75</b>
7	08231	Cup, Bearing	<b>\$45.50</b>
9	B11-5	Casting, Side	<b>\$60.80</b>
10	AN441-6-6P	Rivet, Brake Drum	<b>\$1.15</b>
11	B13-4	Drum, Brake (I.D. Must be turned after installation.)	<b>\$269.95</b>

## GOODRICH WHEEL & BRAKE O-RINGS

Manufacturer	Dimensions (WxLxH)	Part No.	Price
68-448	0.19 in. X 4.07 in. X 0.19 in.	06-02273	<b>\$41.50</b>
68-559	3.88 in. X 3.88 in. X 0.07 in.	06-02274	<b>\$33.50</b>
68-1413	7.63 in. X 10 in. X 2 in.	06-02807	<b>\$296.95</b>
68-1318	8 in. X 10.188 in. X 0.25 in.	06-02806	<b>\$299.95</b>
68-216	8.25 in. X 10.25 in. X 0.11 in.	06-02567	<b>\$69.75</b>

## 4-1/2 INCH BRAKE BANDS WITH PINS



Band Brakes are simple, effective and economical for a variety of small, light-duty small vehicles, or as parking brakes. They were designed to work with either 4" or 4-1/2" diameter drums, but may work well with drums ranging in size from 3-7/8" through 4-5/8" O.D. • 2 Piece Bonded Lining • Comes with 1 band and 1 pin. • Riveted End/Mounting Brackets • Steel Brake Pin with Cable Hole Included • Band Brake for 4.5" drum - Packaged P/N 2555 .....P/N 06-00662 .....**\$20.50**



## SCOTT TYPE DIAPHRAGM FOR BRAKE CYLINDER

Master cylinder diaphragm for Piper J-3/PA-11.  
**Specifications:** • Maximum Working Pressure: 350 lbs • Pedal Pressure: 100 lbs • Recommended Hydraulic Fluid: MIL-H-5606 • Weight as Shown: 21 ounces dry .....P/N 2844 .....**\$47.85**



06-00013



06-00430



06-01042

## GOODRICH BRAKE ASSEMBLY PARTS FOR ALL PIPERS WITH 8.00 X 4 WHEELS

Brake Block (750-033) .....P/N 06-00013 .....**\$84.80**  
Spring (750-029) .....P/N 06-00430 .....**\$10.70**  
Shield (750-093) .....P/N 06-01042 .....**\$34.50**

# AIRCRAFT TIRE APPLICATION CHART

Tires/Tubes Certified Aircraft Application Chart - Tires are low speed unless designated. Tires are tube-type unless otherwise indicated. Consult aircraft manual for individual tire pressure. - IMPORTANT: READ THIS LEGEND FIRST -

Code: TL = Tubeless; SC = Smooth Contour; DT = Deflector Type; DDT = Dual Deflector Type

**APPLICATION CHARTS** - The application information presented within this manual is based on the most current information available and is intended for use as a **GENERAL REFERENCE ONLY**. Any inquiries regarding specific model aircraft should be directed to the applicable airframe manufacturer. Your requirements may vary depending on the actual configuration of your aircraft. All Goodyear aircraft tires are manufactured in accordance with TSO-C62, MIL-T-5041 or AIR8505A and/or applicable airframe manufacturer specifications. Additionally, all tire sizes included in this manual may not necessarily be available from Goodyear. Contact your Goodyear Representative for specific tire information and availability. **Failure to make this verification and to install unapproved tires on an aircraft may result in tire failure causing property damage, serious injury, or loss of life.**

\* Please visit our website for the "Select by Aircraft" shopping tool.

## CESSNA

Model	Name	Main Tire		Auxiliary Tire	
		Tire Size	Ply	Tire Size	Ply
120, 140	—	6.00-6	4	5.00-5	4
150, 152	Commuter, Aerobat	6.00-6	4	5.00-5	4
172	Skyhawk	6.00-6	4	5.00-5	4
R172	Hawk XP	6.00-6	4	5.00-5	4
172 Q	Cutlass	6.00-6	6	5.00-5	4
172 RG	Cutlass RG	15x6.00-6	6	5.00-5	4
175	Skylark	6.00-6	4	5.00-5	4
177	Cardinal	6.00-6	6	5.00-5	4
177 RG	Cardinal RG	15x6.00-6	6	5.00-5	4
180	Skywagon	6.00-6	6	8.00"SC	6
182, T182	Skylane	6.00-6	6	5.00-5	6
182RG, T182RG	Skylane	15x6.00-6	6	5.00-5	4
185	Skywagon	6.00-6	6	8.00 SC	6
188	AG Wagon	22x8.00-8	8	10.00 SC	6
188	AG Wagon(optional)	8.50-10	6	10.00"SC	6
205	—	6.00-6	6	5.00-5	6
206	Station Air	6.00-6	6	5.00-5	6
206, 207	Optional	8.00-6	6	6.00-6	4
207	Skywagon	6.00-6	8	6.00-6	8
208 (FLO)	Caravan	8.50-10	8	22x8.00-8	8
208 (STA)	Caravan	6.50-10	8	6.50-8	8
210	Centurion	6.00-6	8	5.00-5	6
T210, P210	Turbo, Centurion	6.00-6	8	5.00-5	10
T303	Crusader	6.00-6	8	6.00-6	6
T303	Optional	6.50-8	8	6.00-6	6
310, T310	—	6.50-10	6	6.00-6	4
320, 340	—	6.50-10	6	6.00-6	4
336	—	6.00-6	6	15x6.00-6	6
337	Super Skymaster	18x5.5	8	15x6.00-6	6
401, 402	—	6.50-10	8	6.00-6	6
404	Titan	22x7.75-10	10TL	6.00-6	6
411	—	6.50-10	8	6.00-6	6
414	Chancellor	6.50-10	8	6.00-6	6
421	Golden Eagle	6.50-10	8	6.00-6	6
425	Conquest I	6.50-10	10	6.00-6	6

## BELLANCA

Model	Name	Main Tire		Auxiliary Tire	
		Tire Size	Ply	Tire Size	Ply
260A	Bellanca	6.00-6	6	6.00-6	4
17-30A	Viking	6.00-6	6	15x6.00-6	6/8
17-31A	Super Viking	6.00-6	6	15x6.00-6	6/8
17-31ATC	Turbo Viking	6.00-6	6	15x6.00-6	6/8
7GCAA	Citabria	6.00-6	4	5.00-5	4
7KCAB	Citabria	7.00-6	4	5.00-5	4
8KCAB	Decathlon	8.00-6	4	5.00-5	4
8GCBC	Scout	8.50-6	4/6	5.00-5	4

## MOONEY

Model	Name	Main Tire		Auxiliary Tire	
		Tire Size	Ply	Tire Size	Ply
MO-20	Ranger	6.00-6	6	5.00-5	4/6
MO-21C	Super	6.00-6	6	5.00-5	4/6
MO-22	Mustang	6.00-6	6	15x6.00-6	6
MO-20E	Chapparral	6.00-6	6	5.00-5	4
MO-20F	Executive	6.00-6	6	5.00-5	6
MO-20J	201	6.00-6	6	5.00-5	6
MO-20K	Turbo 231	6.00-6	6	5.00-5	6
M-20K	TSE	6.00-6	6	5.00-5	4
M-20M	Bravo	6.00-6	6	5.00-5	6
M-20S	Eagle	6.00-6	6	5.00-5	6
M-20R	Ovation	6.00-6	6	5.00-5	6

## COMMANDER AIRCRAFT

Model	Name	Main Tire		Auxiliary Tire	
		Tire Size	Ply	Tire Size	Ply
112	Commander	6.00-6	6	5.00-5	4
112B	—	7.00-6	6	5.00-5	4
112TC, TCA	—	7.00-6	6	5.00-5	6
114	—	7.00-6	6	5.00-5	6
114A, B	—	6.00-6	6	5.00-5	6

## BEECH

Model	Name	Main Tire		Auxiliary Tire	
		Tire Size	Ply	Tire Size	Ply
C-17R	Staggerwing	7.50-10	6	10.00SC	—
BE 18	Twin Beech	11.00-12	8 TL	14.50SC	8TL
BE 18H	Twin Beech	8.50-10	8 TL	8.50-10	8TL
BE 19	Musketeer Sport	6.00-6	4	6.00-6	4
BE 23	Musketeer	6.00-6	4	6.00-6	4
BE23C, BE-A24	Sundowner	6.00-6	4	6.00-6	4
BE 24-R	Super Sierra	6.00-6	4	5.00-5	4
BE 33A	Bonanza	7.00-6	6	5.00-5	4
BE 35	Bonanza	7.00-6	6	5.00-5	4
BE 36	Bonanza	7.00-6	6	5.00-5	4
BE 50	Twin Bonanza	8.50-10	6	6.50-10	4
BE B55	Baron	6.50-8	8	5.00-5	6
BE C55	Baron	6.50-8	8	5.00-5	6
BE E55	Baron	6.50-8	8	5.00-5	6
BE 58	Baron	6.50-8	8	5.00-5	4
BE 60	Duke	19.5x6.75-8	10TL	15x6.00-6	4
BE 65	Queen Air	8.50x10	8TL	6.50-10	6TL
BE-80	Queen Air	8.50-10	8TL	6.50-10	6TL
BE-C90B	King Air	8.50-10	8TL	6.50-10	6TL
BE-B200	Super King Air	18x5.5	10TL	22x6.75-10	8TL
BE-200T	Super King Air	22x6.75-10	8TL	22x6.75-10	8TL
BE-99	—	18x5.5	8 TL	6.50-10	6TL
BE-300/350	Super King Air	22x6.75-10	8TL	19.5x6.75-8	10TL
BE-2000	Starship 1	19.5x6.75-10	8 TL	19x6.75-8	10TL

## PIPER

Model	Name	Main Tire		Auxiliary Tire	
		Tire Size	Ply	Tire Size	Ply
J3	Cub	8.00-4	4	8.00"SC	Solid
PA18-135	Super Cub	6.00-6	4	8.00"SC	Solid
PA18-150	Super Cub	6.00-6	4	6x2.00	Solid
PA22	Tri Pacer	6.00-6	6	6.00-6	6
PA23, 160-235	Apache	7.00-6	6	6.00-6	4
PA23-250	Aztec	7.00-6	8	6.00-6	4
PA24-180	Commanche	6.00-6	4	6.00-6	4
PA24, 250, 260, 400	Commanche	6.00-6	6	6.00-6	4/6
PA25-150	Pawnee	7.00-6	4	8x3.00-4	4
PA25, 236, 260	Pawnee	8.00-6	4	8x3.00-4	4
PA28R-201	Arrow	6.00-6	6	5.00-5	4
PA28-140	Cherokee	6.00-6	4	6.00-6	4
PA28-150	Cherokee	6.00-6	4	6.00-6	4
PA28-151, 161	Warrior	6.00-6	4	5.00-5	4
PA28-160	Cherokee	6.00-6	4	6.00-6	4
PA28-180	Cherokee	6.00-6	4	6.00-6	4
PA28-181	Archer	6.00-6	4	5.00-5	4
PA28-235	Cherokee	6.00-6	4	6.00-6	4
PA30	Twin Commanche	6.00-6	4	6.00-6	6
PA31	Navajo	6.50-10	8	6.00-6	6
PA31	Chieftain	6.50-10	8	6.00-6	6
PA31T	Navajo	6.50-10	10	6.00-6	6
PA31P	Pressurized Navajo	6.50-10	8	6.00-6	8
PA31T-500	Cheyenne 1A	6.50-10	10	6.00-6	6
PA32	6-300	6.00-6	6	6.00-6	6
PA32RT300	Lance	6.00-6	8	6.00-6	4
PA31P-350	Mojave	6.50-10	8	17.5x6.25-6	10
PA34-220	Seneca	6.00-6	8	6.00-6	6
PA36	Brave	8.50-10	6	10x3.5-4	6
PA38	Tomahawk	6.00-6	6	5.00-5	6
PA42	Cheyenne IIIA	6.50-10	12 TL	17.5x6.25-6	10
PA44-180	Seminole	6.00-6	6	6.00-6	6
600/601B (PA60)	Aerostar	6.50-8	8TL	6.00-6	6
601P (PA60-601P)	Aerostar	6.50-8	8 TL	6.00-6	6
602P (PA60-602P)	Aerostar	6.50-8	8 TL	6.00-6	6
700P (PA60-700P)	Aerostar	6.50-8	8 TL	6.00-6	6
PA46-350P	Malibu Mirage	6.00-6	8	5.00-5	6
PA34-270T	Seneca V	6.00-6	8	6.00-6	8
PA44-180	Seminole	6.00-6	8	5.00-5	6
PA32R-301	Saratoga II HP	6.00-6	8	5.00-5	6
PA32R-301T	Saratoga II TC	6.00-6	8	5.00-5	6
PA28-181	Archer III	6.00-6	4/6	6.00-6	4
PA28-161	Warrior III	6.00-6	4	5.00-5	4

## MAULE

Model	Name	Main Tire		Auxiliary Tire	
		Tire Size	Ply	Tire Size	Ply
MX-7-160	—	7.00-6	4/6	280/250-4	4
MXT-7-160	—	7.00-6	4/6	280/250-4	4
M-8-235	—	7.00-6	4/6	280/250-4	4
MX7-420	—	7.00-6	4/6	280/250-4	4

LG

# GOODYEAR TIRES & TUBES



**Flight Custom III™**

**Goodyear Flight Custom III™ Tires are the ONLY General Aviation tires with Kevlar®:**

- Antioxidant formulation to help reduce cracking.
- Deeper Tread Depth.
- Wide Aquachannels®.
- Kevlar® belt package.
- Premium Wingstay® formulation.
- Dual polymer tread compound.
- Get up to 20% more landings.
- Superior wet traction, enhanced treadwear.
- The Goodyear® Flight Custom III® offers up to 20% more landings to removal than its predecessor. Dupont tm and Kevlar (circleR) are trademarks or registered trademarks of E.I. du Pont de Nemours and Company. Results may vary based on proper maintenance, runway and operating conditions.



**Flight Special II™**

A popular replacement tire for light aircraft, the Flight Special is an unsurpassed combination of value and performance. Designed for long treadlife, this tire is built to last. Every strand of nylon cord in the casing has been triple tempered with time, tension and temperature to provide the ultimate in tire construction, uniformity and strength.

**FEATURES:**

- Wide rib tread design and large footprint
- Enhanced tread compound for uniform wear and extended service life
- Triple-tempered nylon casing cord.

**BENEFITS:**

- Enhanced traction
- Uniform wear and extended

**SERVICE LIFE:**

- Excellent Treadwear.



**TIRE TALC**

Eases installation of tubes in tires. Size: 13oz.

DISCOUNT: LESS 15% ON 12

P/N 17-250 ..... **\$7.85**



**SILICONE BASE TUBE TALC**

16 oz. Shaker bottle of Silicone Base Tube Talc Adds Extra Life and Prevents Pinching & Chafing on rubber tubes.

P/N 05-11180 ..... **\$25.85**

A "B" at the end of a description means BENT valve stem. An "S" at the end of a description means STRAIGHT valve stem.

- (1) For use in both 5.00-5 and G380x150-5 (15x6.00-5).
- (2) For use in both 6.00-6 and 15x6.00-6 tires.
- (3) For use in both 7.00-6 and 8.00-6 tires.
- (4) For use in 6.50-8, 19.5x6.75-8 & 22x8.00-8 tires.
- (5) Discontinued, call for Special Pricing.

-Natural rubber aircraft tubes comply with the requirements of Goodyear QAI 2525, which the U.S. Military has accepted in lieu of MIL-I-5014.

-Flight Mate (Butyl) tubes comply with the requirements of SAE document AS 50141.

**GOODYEAR TIRES – TUBE TYPE**

Tire Size	PR	Description	Speed (MPH)	Avg. Weight (lbs.)	Part No.	Price ea.
5.00-4	6	RIB	120	4	06-04700	\$559.00
15X6.00-5 / G380-150-5	6	RIB	120	7	06-01078	\$304.00
5.00-5	4	Flight Custom III	160	7	06-04900-3	\$278.00
5.00-5	4	Flight Special II	120	5	06-07110	\$163.00
5.00-5	6	Flight Custom III	160	7	06-05100-3	\$293.00
5.00-5	6	Flight Special II	120	5	06-07100	\$149.00
5.00-5	10	Flight Special II	120	6	06-00208	\$297.00
15X6.00-6	6	Flight Custom III	160	9	06-05500-3	\$316.00
15x6.00-6	6	Flight Special II	160	8	06-07340	\$219.95
6.00-6	4	Flight Custom III	160	11	06-05200-3	\$312.00
6.00-6	4	Flight Special II	120	9	06-07200	\$185.00
6.00-6	6	Flight Custom III	160	11	06-05400-3	\$367.00
6.00-6	6	Flight Special II	120	9	06-07300	\$195.00
6.00-6	8	Flight Custom III	160	11	06-05410-3	\$374.00
6.00-6	8	Flight Special II	120	9	06-07310	\$196.00
6.50-8	6	Flight Custom III	160	14	06-05600-3	\$447.00
6.50-8	8	Flight Custom III	160	14	06-05800-3	\$495.00
6.50-8	8	Flight Special II	120	12	06-07320	\$319.00
6.50-10	8	Flight Custom III	160	16	06-06100-3	\$529.00
6.50-10	8	Flight Special II	120	14	06-00209	\$410.00
6.50-10	10	Flight Custom III	160	17	06-06110-3	\$593.00
7.00-6	6	Flight Custom III	160	13	06-06200-3	\$416.00
7.00-6	6	Flight Special II	120	10	06-07330	\$307.00
7.00-6	8	Flight Custom III	160	13	06-06210-3	\$444.00
8.00-4	4	RIB	120	9	06-06600	\$543.00
8.00-6	6	Flight Special II	120	13	06-01145	\$325.00
8.00-6	8	Flight Special II	120	12	06-00212	\$359.00
8.50-6	6	RIB - Tubeless	120	12	06-02568	\$539.00
8.50-10	8	Flight Custom III	160	24	06-06900-3	\$560.00
6.00-6.5 / 420X150	4	RIB	120	6	06-01088	\$538.00
18X5.5	8	Flight Special II	120	11	06-00203	\$397.00
22X8.00-8	6	Flight Special II	120	14	06-00205	\$407.00

**GOODYEAR TIRES – TUBELESS**

Tire Size	PR	Description	Speed (MPH)	Avg. Weight (lbs.)	Part No.	Price ea.
5.00-4	14	RIB	120	7	06-01057	\$698.00
6.00-6	8	Flight Custom III	160	12	06-01058	\$385.00
17.5X6.25-6	10	Flight Special II	160	11	06-00202	\$542.00
6.50-8	8	Flight Custom III	160	15	06-01060	\$500.00
6.50-10	6	Flight Custom III	160	17	06-05900-3	\$487.00
6.50-10	12	Flight Special II	160	21	06-00210	\$566.00
7.00-6	10	Flight Custom II	120	12	06-01061	\$527.00
7.00-8	10	RIB, All Weather	120	15	06-01062	\$662.00
7.50-14	12	RIB	160	36	06-01063	\$1,330.00
8.50-10	8	Flight Custom III	160	27	06-01064	\$673.00
8.50-10	10	Flight Custom III	160	28	06-01065	\$698.00
8.90-12.50	6	RIB, All Weather	160	24	06-01067	\$1,182.00
9.00-6	10	RIB	120	22	06-01068	\$1,168.00
9.25-12 / 28X9.0-12	12	RIB	160	38	06-01069	\$1,034.00
11.00-12	10	RIB	160	45	06-01070	\$1,248.00
13X5.0-5	8	Smooth	120	7	06-01071	\$703.00
14.5X5.5-6	14	RIB	120	10	06-01072	\$1,240.00
15X6.0-6	10	Flight Custom II	160	9	06-01073	\$544.00
22X6.75-10	8	Flight Custom III	160	20	06-01074	\$686.00
26X10.5-6	6	Smooth	120	23	06-01075	\$1,230.00
27	10	RIB	120	-	06-03040	\$1,236.00
29X11.00-10	10	RIB	120	36	06-00206	\$1,086.00
15.00-12	14	RIB	160	59	06-01076	\$2,438.00
15.00-16	16	RIB	120	95	06-01077	\$3,582.00
67/210-12	10	RIB	160	12	06-02219	\$1,174.00

**GOODYEAR TUBES**

Tube Size	Description	Avg. Weight (lbs.)	Part No.	Price ea.
5.00-4 Flight Mate	Butyl Tube TR 67, B	1	06-04800	\$235.95
5.00-5 Flight Mate	Butyl Tube TR 67A (1), B	1	06-05000	\$167.00
6.50-10 Flight Mate	Butyl Tube TR 25, S	2	06-06000	\$148.75
7.00/8.00-6 Flight Mate	Butyl Tube TR 20, (3), S	2	06-06300	\$139.75
7.50/8.50-10 Flight Mate	Butyl Tube TR 25, S	3	06-07000	\$206.95
8.50-6 Flight Mate	Butyl Tube TR 20, S	3	06-01050	\$283.00
8.90-12.50 Flight Mate	Butyl Tube TR 25, S	6	06-01051	\$292.95
G15/6.00-6 Flight Mate*	Butyl Tube TR 67A, B	1	06-05305	\$259.00
G15/6.00-6 Flight Mate*	Butyl Tube TR 20, (2), S	1	06-05300-1	\$129.95
G19.5X6.75-8 Flight Mate	Butyl Tube TR 15, (4), S	2	06-05700	\$147.00

\* ALSO FOR 600 X 6 TIRES.



# GOODYEAR FLIGHT EAGLE TIRES



## GOODYEAR FLIGHT EAGLE TIRES

With over 100 years of brighter ideas about lighter flight, it's only natural that Goodyear lights the way with LJs and VLJs.

Goodyear Flight Eagle LT is a new tire, but it's already been chosen for the Embraer Phenom 100 and Phenom 300 aircraft. The LT stands for Light Turbine... a new generation of aircraft tires for demanding high speed take-offs and landings.

**Features:** • Computer-aided design • Special inner-liners • Enhanced bead compounds and construction • Sidewalls with a reservoir of antioxidants • **Benefits:** • Maximum number of landings • Enhanced air retention • Great serviceability and resistance to wheel damage • Special wear-resistant tread compounds Low cost-per-landing • Excellent resistance to weather effect of sunlight and ozone

### BUSINESS BIAS AIRCRAFT TIRES

Tire Size	PR	Description	Speed (MPH)	Avg. Wt. (lbs.)	Aircraft	Part No.	Price
5.00-5	10	Flight Eagle LT	190	11	TBM900	06-02499	\$312.00
18X4.25-10	6	Flight Eagle, DT	210	12	Hawker 125	06-01316	\$832.00
16X4.4	4	Flight Eagle	210	8	Westwind 1124	06-01317	\$1,080.00
16X4.4	6	Flight Eagle, DT	210	10	Westwind 1125, SJ30-2, AstraSPG100	06-01319	\$963.00
16X4.4	10	Flight Eagle	210	11	Citation X	06-01320	\$1,544.00
16X4.4	12	Flight Eagle	190	9	SJ-30-2	06-01321	\$858.00
18X4.4	6	RIB,DDT	190	11	Cit 525, CJ,CJ-1,CJ-2	06-01322	\$835.00
18X4.4	10	Flight Eagle, DT	210	12	Dash8, CL-600	06-01323	\$703.00
18X4.4	10	RIB, DDT	210	13	Cessna CIT I/II, Lear	06-01324	\$843.00
18X4.4	10	RIB, DDT	190	13	Cessna CIT II, CJ-3	06-01325	\$916.00
18X4.4	10	RIB, DDT	210	14	Diamond I/II, Beech Jet, CIT II, III, V, VI, VII	06-01358	\$943.00
18X4.4	12	Flight Eagle, DT	210	13	Jetstar II, CL600/601	06-01326	\$599.00
18X5.5	8	Flight Leader	210	12	Saab 2000	06-02224	\$731.00
14.5X5.5-6	LR2800	Flight Eagle, DT	210	11	Falcon 20	06-01327	\$1,914.00
18X5.5	8	Flight Eagle	190	13	Lear23, KingAir, CE-337	06-01328	\$699.00
18X5.5	10	Flight Eagle	210	14	Lear23/24/25, EMB120	06-01329	\$743.00
18X5.5	10	Flight Leader	210	15	Challenger 300	06-01330	\$1,065.00
19.5 X 6.75	8	Flight Leader	210	17	Embraer:ERJ 135/140/145 ER Regional Jet Embraer: ERJ 145LR Regional Jet	06-02972	\$924.00
24X7.25	12	Flight Leader	190	27	Aero - L-39 Albatros Embraer - EMB 120 Brasilia	06-03013	\$1,048.00
17.5X5.75-8	12	Flight Eagle	210	15	Learjet 30 Series	06-01331	\$892.00
17.5X5.75-8	17	Flight Eagle	210	17	Learjet 55, 60	06-01332	\$1,217.00
21x7.25-10	14	Flight Eagle	225	--	Gulfstream G650	06-02843	\$1,085.00
18X5.75-8	8	Flight Eagle, DDT	190	13	Falcon 10	06-01333	\$1,411.00
22X5.75-12	10	Flight Eagle	190	20	CITII,VI,VII,F-10, Lear 45	06-01334	\$1,158.00
15X6.00-6	10	Flight Eagle LT DDT	160	11	EMB Phenom	06-01336	\$666.00
17.5X6.25-6	8	RIB, DDT, TT	190	11	Corvette	06-01337	\$696.00
21X6.50-10	12	Flight Eagle LT	160	18	EMB Phenom 100	06-01338	\$845.00
26X6.6	14	Flight Eagle	210	31	CL-600/601, Jetstar I/II, Corvette, Falcon 20, 50, 200	06-01339	\$2,075.00
26X6.6	14	Flight Eagle	210	31	CL-600/601, Jetstar I/II, Corvette, Falcon 20, 50, 200	06-01334	\$1,158.00
25.75X6.75-14	14	RIB	210	33	CL-600/601	06-01340	\$1,768.00
26.6.75-14	16	Flight Eagle	190	38	Sabre 60, 65	06-01341	\$2,622.00
23X7.00-12	12	Flight Eagle	210	28	Hawker 125 Astra SP G100	06-01342	\$1,142.00
21X7.25-10	12	Flight Eagle, DT	225	20	GII,III,IV,V,G300, 350, 400, 450, 550, Global Express	06-01343	\$898.00
24X7.7	16	Flight Leader	210	32	Beechjet 400	06-01344	\$1,331.00
24x7.7	16	Flight Leader	225	32	Boeing 737-100, Boeing 737-200	06-02230	\$1,346.00
24x7.7	10	Flight Leader	225	32	Nextant 400XT, Twin 690D Jetprop 1000	06-03533	\$1,125.00
Twin 690D	10	RIB	190	20	1, CJ1+	06-01345	\$963.00
22X7.75-10	12	RIB	190	25	CIT C-2, CJ-2+	06-01346	\$916.00
22X8.00-10	10	Flight Eagle	190	24	CIT I/II	06-01347	\$1,174.00
22X8.00-10	12	Flight Eagle	190	28	CIT II, V	06-01348	\$1,305.00
H26.5X8.0-14	14	Flight Leader	210	32	Challenger 300	06-02220	\$1,785.00
H22X8.25-10	12	Flight Eagle	190	22	CJ-3	06-01350	\$1,265.00
H22X8.25-10	14	Flight Eagle	190	31	Citation 550/560	06-01351	\$1,693.00
30X9.5-14	16	Flight Leader	210		Embraer	06-02482	\$2,025.00
34X9.25-16	18	Flight Eagle	210	68	GII, III, IV	06-01352	\$2,491.00
H34X9.25-18	18	Flight Eagle	225	58	GIV-SP, G300,350, 400,450	06-01353	\$2,995.00
B24X9.5-10.5	18	RS700	210	40	Westwind 1124	06-01354	\$3,379.00
29X9.0-15	16	Flight Eagle LT	210	44	CRJ100 Regional Jet, CRJ200 Challenger 800/850, CRJ200 Regional Jet	06-02235	\$1,676.00
H35X11.0-18	20	Flight Eagle	335	82	GV, G500, 550	06-01355	\$3,297.00
H38X12.0-19	20	Flight Eagle	210	87	Global Express	06-01356	\$3,775.00
21X7.25R10	14	Flight Radial	225	--	G600, Global 7500	06-03355	\$1,158.00
H34X9.5R18	18	Flight Radial	225	--	G500	06-03356	\$4,603.00
26X6.6R14	14	Flight Radial	225	26	Falcon 20/50/200	06-02569	\$2,705.00
26X6.6R14	14	Flight Radial	225	26	Falcon 20/50/200	06-01357	\$2,365.00
32x8.8R16	12	Flight Radial	190	43	ATR 42	06-03547	\$2,581.00
BUSINESS RADIAL AIRCRAFT TIRES							
450x190-5	10	Flight Leader	190	15	ATR42, ATR72	06-03548	\$995.00
34x10.75-16	16	Flight Leader	210	55.8	Bombardier Q400 (HDC-8 Series 400)	06-03012	\$1,670.00
22x6.5-10	8	RIB	190	19	Bombardier Q400 (HDC-8 Series 400)	06-03011	\$902.00
26X6.6R14	14	Flight Radial	225	26	Falcon 20/50/200	06-01357	\$2,365.00
H34x10.0R16	14	Flight Radial	190	55.7	ATR72	06-01951	\$2,858.00
H25X8.0-12	16	Flight Eagle LT	210	--	EMB Phenom 300	06-02570	\$1,857.00
H37.5x12.0R19	20	Flight Radial	225	--	See website for application information	06-02844	\$3,999.00
H39X12.0R19	22	Flight Radial	225	--	See website for application information	06-03532	\$4,685.00
29X9.0-15	16	Flight Leader	210	-	CRJ100 Regional Jet, CRJ200 Challenger 800/850, CRJ200 Regional Jet	06-02235	\$1,676.00

LG

# SPECIALTY TIRES & TUBES

## SPECIALTY TIRES & TUBES

Manufactured by  
Specialty Tires of America  
(Formerly McCreary)



These fine nylon cord tires with rib tread design are rigidly tested to meet FAA Standard TSO-C62. The Air Trac® is an excellent choice for single engine, piston aircraft. It is ideal for aircraft operated on grass strips while being perfectly usable on hard surfaces. This unique, narrow-ribbed, oval shaped tire is designed for soft field applications.

The 7.00/8.00-6 tube can be utilized in both 7.00-6 and 8.00-6 tires.

## AIR TRAC TIRES & TUBES

Tube-Type Tire Size	Ply Rating	Wt./Lbs.	Tire Pressure PSI (a)	Max. Load Rating Lbs.(a)	Tire		Tube	
					Part No.	Price	Part No.	Price
5.00-5	4	4.4	31	800	06-08210	\$96.75	06-08300	\$112.75
5.00-5	6	4.3	50	1285	06-08200	\$98.00	06-08300	\$112.75
6.00-6	4	6.8	29	1150	06-08400	\$109.00	06-08700	\$99.85
6.00-6	6	7.0	42	1750	06-08500	\$118.00	06-08700	\$99.85
6.00-6	8	7.3	55	2350	06-08600	\$124.95	06-08700	\$99.85
15x6.00-6	4	6.3	45	1250	06-08800	\$164.00	06-08901	\$98.00
15x6.00-6	6	6.6	68	1950	06-08900	\$165.00	06-08901	\$98.00
6.50-8	6	9.3	51	2300	06-02973	---	06-09200	\$102.85
6.50-8	6	9.5	51	2300	06-09000	---	06-09200	\$102.85
6.50-8	8	10.0	75	3150	06-07914	\$257.00	06-09200	\$102.85
6.50-10	6	10.7	60	2770	06-02552	---	06-09500	\$102.85
6.50-10	8	12.0	80	3750	06-09400	\$303.00	06-09500	\$102.85
6.50-10	10	15.2	100	4750	06-09410	---	06-09500	\$102.85
7.00-6	6	9.0	38	1900	06-09600	\$206.95	06-09800	\$98.75
7.00-6	8	9.4	54	2550	06-09700	\$223.00	06-09800	\$98.75
7.50-10	6	14.3	46	3000	06-09710	\$587.00	06-09810	\$152.75
8.00-6	4	10.0	23	1350	06-09900	\$247.00	06-09800	\$98.75
8.00-6	6	10.3	35	2050	06-10000	\$238.00	06-09800	\$98.75
8.50-6	6	16.5	30	2275	06-10100	\$357.00	06-10200	\$182.75
8.50-10	6	17.5	41	3250	06-02975	\$429.00	06-10500	\$155.75
8.50-10	6	16.5	41	3250	06-10300	---	06-10500	\$155.75
8.50-10	8	19.5	55	4400	06-10400	\$473.00	06-10500	\$155.75
6.50-10	6	10.9	60	2770	06-02552	---	06-09500	\$102.85
12.5x4.5	10	--	--	--	06-02976	\$410.00	06-02497	\$145.75
14.5	8	--	--	--	06-02977	\$605.00	---	---
3.50 X 4.10-4	--	--	--	--	---	---	06-08102	\$43.75
29 X 11	--	--	--	--	---	---	06-02986	---

The 7.00/8.00-6 tube can be utilized in both 7.00-6 and 8.00-6 tires.

## AIR HAWK TIRES

Tube-Type Tire Size	Ply Rating	Wt./Lbs.	Part No.	Price
5.00-5	4	3.8	06-07710	\$103.00
5.00-5	6	4.3	06-07700	\$103.00
5.00-5	10	6.2	06-07720	\$119.75
6.00-6	4	6.8	06-07800	\$115.00
6.00-6	6	7.0	06-07900	\$119.00
6.00-6	8	7.8	06-07910	\$159.00
6.50-8	6	10.5	06-07912	\$259.00
6.50-8	8	10.5	06-07914	\$257.00
6.50-10	6	11.5	06-07916	\$289.00
6.50-10	8	11.8	06-07918	\$298.00
6.50-10 Special	8	14.5	06-00416	\$187.00
6.50-10	10	16.2	06-07920	\$375.00
7.00-6	6	9.5	06-07922	\$214.00
7.00-6	8	9.4	06-07924	\$234.00
8.00-6	4	10.4	06-07926	\$237.00
8.00-6	6	10.7	06-07928	\$275.00
8.00-6	8	11.8	06-07929	\$279.00
8.50-10	6	19.9	06-07932	\$502.00
8.50-10	8	23.3	06-07934	\$533.00
17.5/625-6	10	--	06-00309	\$335.00
18-5.5	8	--	06-00310	\$246.95
22/800-8	6	--	06-00311	\$371.00
29/1100-10	10	--	06-00312	\$579.00

## SUPER HAWK TIRES

Designed to handle higher landing speeds and heavier loads, the Super Hawk® offers advanced design. The result is a premium belted aircraft tire that surpasses FAA specifications and matches the performance levels of far more expensive brands.

Part No.	Tire Size	Ply Rating	Price Ea.	Part No.	Tire Size	Ply Rating	Price Ea.
06-17000	5.00-5	6	\$209.95	06-17510	6.50-10	10	\$458.00
06-18000	6.00-6	6	\$291.95	06-17515	7.00-6	6	\$314.00
06-17500	6.50-10	8	\$409.00	06-17520	7.00-6	8	\$326.00
06-17505	6.00-6	8	\$309.00	06-17525	6.50-8	8	\$329.00

Call for pricing on other sizes of Hawk Tires.

## AERO TRAINER TIRES

Tube Type Tire Size	Ply	Part No.	Price Each
5.00-5	6	06-01700	\$98.00
6.00-6	6	06-01800	\$109.00

Aero Trainer Tires use standard Specialty Tires tubes listed above

## NYLON TUBELESS TIRES

Nylon Tubeless Tires: Designed especially for classic planes including warbirds, DC-3's and Beech 18's. The Aero Classic® is also great for many foreign and European aircraft. Many sizes of the Aero Classic® come in both historical diamond tread or in the more current rib tread for work uses.

Tire Size	Ply	Part No.	Price	Tire Size	Ply	Part No.	Price
27" Diamond Tread	10	06-00080	\$967.00	8.9 X 12.5 Rib	6	06-00083	\$769.00
27" Rib	10	06-00081	\$1,121.00				



## SPECIALTY TIRE & TUBE PACKAGES

**600 X 6, 4 PLY KIT** - Consists of three 600 x 6 4 ply tires and tubes. Fits PA-24-180 Comanche, PA-28 Cherokee, Beech Musketeer, Musketeeer Sport, and Sundowner.

W/Air Trac tires.....P/N 06-21200 .....\$625.00  
W/Air Hawk tires.....P/N 06-21205 .....\$643.00

**600 X 6, 6 PLY KIT** - 600 X 6 - 6 Ply Package. Fits Piper PA-32 6-300, Lance, PA-44 Seminole, PA-30 Twin Comanche, and Cessna 337.

W/Air Trac tires.....P/N 06-21300 .....\$652.00  
W/Air Hawk tires.....P/N 06-21305 .....\$655.00

**6.00 X 6, 6 PLY / 5.00 X 5, 6 PLY KIT** - Two Specialty Tires 6.00 x 6, 6 ply tires and tubes and one 5.00 x 5, 6 ply tire and tube. Fits Cessna 182, 182N; all 206 Skylane, Skywagon, and Station Air 207; Mooney 201, 220; Waco 250 260, PA-32 6-300 Lance.

W/Air Trac tires.....P/N 06-21100 .....\$645.00  
W/Air Hawk tires.....P/N 06-21105 .....\$604.00

**6.00 X 6, 4 PLY KIT** - Two Specialty Tires 6.00 x 6, 4 ply tires and tubes. Fits Bellanca Citabria 7ECA, 7GCA-A, 7GCBC and 7KCA-B.

W/Air Trac tires.....P/N 06-21110 .....\$416.95  
W/Air Hawk tires.....P/N 06-21115 .....\$428.95

**6.00 X 6, 4 PLY / 5.00 X 5, 4 PLY KIT** - Two Specialty Tires 6.00 x 6, 4 ply tires and tubes and one 5.00 x 5, 4 ply tire and tube. Fits Beech Super/Musketeer Sierra; Cessna 150, 172, 175, 177; Grumman AA1B, AA5; PA-28, 151, 180R, 200R.

W/Air Trac tires.....P/N 06-21120 .....\$626.00  
W/Air Hawk tires.....P/N 06-21125 .....\$644.00

**6.00 X 6, 6 PLY / 5.00 X 5, 4 PLY KIT** - Two Specialty Tires 6.00 x 6, 6 ply tires and tubes and one 5.00 x 5, 4 ply tire and tube. Fits Beech Debonair 33, 33A; Bonanza 33; Mooney 200, Mark 21C; Rockwell Commander.

W/Air Trac tires.....P/N 06-21130 .....\$644.00  
W/Air Hawk tires.....P/N 06-21135 .....\$652.00

**6.00 X 6, 6 PLY / 6.00 X 6, 4 PLY KIT** - Two Specialty Tires 6.00 x 6, 6 ply tires and tubes and one 6.00 x 6, 4 ply tire and tube. Fits Bellanca 206, Viking; PA-24-250, 260, PA-32-260, 300.

W/Air Trac tires.....P/N 06-21140 .....\$643.00  
W/Air Hawk tires.....P/N 06-21145 .....\$651.00

**6.50 X 10, 8 PLY / 6.00 X 6, 6 PLY KIT** - Two Specialty Tires 6.50 x 10, 8 ply tires & tubes & one 6.00 x 6, 6 ply tire and tube. Fits Cessna 340, 401, 402, 411, 414, 421; PA-31-300, 310, 350, PA-31P-425.

W/Air Trac tires.....P/N 06-21155 .....\$1,028.00  
W/Air Hawk tires.....P/N 06-21160 .....\$1,019.00

**7.00 X 6, 6 PLY / 6.00 X 6, 4 PLY KIT** - Two Specialty Tires 7.00 x 6, 6 ply tires and tubes and one 6.00 x 6, 4 ply tire and tube. Fits PA-23, 160, 235, 250.

W/Air Trac tires.....P/N 06-21165 .....\$819.00  
W/Air Hawk tires.....P/N 06-21170 .....\$839.00

**8.50 X 6, 6 PLY KIT** - Two Air Trac 8.50 x 6, 6 ply tires and tubes. Fits Bellanca Decathlon 8KCA-B and Scout 8GCBC.

W/Air Trac tires.....P/N 06-21175 .....\$1,078.00

# MICHELIN® TIRES



## MICHELIN® AIR® & AVIATOR® GENERAL AVIATION TIRES

**Michelin® AIR®:** The tire for demanding pilots. The sidewall compound is optimized to provide maximum ozone and ultraviolet light protection, while the MX2000 tread compound is Michelin's toughest. In addition, the new Air Cushion Inner Liner provides a protective cushion over the casing plies which guards against inner tube chafing. And the Posi-Fit bead construction reduces movement between the tire and the wheel for improved lateral stability.

**Michelin® Aviator®:** A Michelin quality tire at a great price. Like the Michelin AIR, the Aviator offers exceptional balance, a new sidewall configuration and an extra strong nylon casing. It also features the tough MX1000 tread compound for long life, and a specialized sidewall compound to protect against ultraviolet light.

Size	Ply	Speed (MPH)	Brand	Avg W (lbs)	Applications	Part No.	Price
11.00-12	10	160	Michelin Aviator	46	IAI 201, Bombardier DHC6, Casa 212, 235 (MLG)	06-01397	\$1,337.00
15x6.0-6	6	160	Michelin Air	7	Cessna 172, 177, 182 - Cirrus SR20, SR22 (MLG) - Cessna 336, 337 (NLG)	06-01398	\$233.95
16x4.4	8	160	Michelin Aviator	9	Raytheon T6A Texan - Pilatus PC9 - Embraer Xingu - Fairchild SA226 (NLG)	06-01399	\$469.00
16x4.4	8	160	Michelin Air	9	Cessna Mustang (NLG)	06-01401	\$688.00
17.5x5.75-8	12	210	Michelin Aviator	14	Learjet 20, 31, 35, 36 (MLG)	06-01402	\$968.00
17.5x6.25-6	10	120	Michelin Air	11	Piper PA31, 42 (NLG)	06-01403	\$544.00
17.5x6.25-6	8	160	Michelin Air	11	Pilatus PC-12 (NLG)	06-01404	\$497.00
18x4.25-10	6	210	Michelin Air	11	Hawker 700, 800, 800XP, 1000 (NLG)	06-01405	\$713.00
18x4.4	6	190	Michelin Air	9	Hawker Premier 1 (NLG)	06-01413	\$815.00
18x4.4	6	190	Michelin Air	13	Cessna CJ, CJ1, CJ1+, CJ2 (NLG)	06-01411	\$777.00
18x4.4	6	160	Michelin Aviator	8	Fairchild SA226, 227, Piper PA31 (NLG)	06-01414	\$388.00
18x4.4	10	210	Michelin Air	12	Hawker Beechjet 400A - Cessna CJ2+, CJ3, Citation I, II, III, V, VI, VII, Bravo, Encore, Encore+, Excel, XLS (NLG) - Learjet 40, 45	06-01407	\$810.00
18x4.4	12	210	Michelin Air	13	Bombardier Challenger 600, 601, 604 (NLG)	06-01408	\$589.00
18x5.5	10	210	Michelin Air	14	Beech King Air 200, 55 (MLG) - Socata TBM 700, 850 (MLG)	06-01415	\$698.00
18x5.5	8	190	Michelin Aviator	12	Beech King Air 200, 99, 100 - Cessna 337 - Socata TBM700 (MLG) - Bombardier DHC8 - Embraer EMB120, Fairchild SA226 (NLG)	06-01416	\$697.00
19.5x6.75-8	10	160	Michelin Aviator	14	Beech King Air 300, Baron 58, 60 - Fairchild SA226, 227 (MLG)	06-01417	\$463.00
19.5x6.75-8	10	190	Michelin Aviator	17	Beech 1900, C, D (NLG)	06-01418	\$494.00
20x4.4	8	160	Michelin Aviator	13	Pilatus PC9 (MLG)	06-01419	\$483.00
22x6.75-10	10	190	Michelin Air	18	Beech King Air 200 (NLG), Beech 1900D (MLG), IJT36 (MLG)	06-01422	\$685.00
22x6.75-10	8	160	Michelin Aviator	16	Beech 1900C (MLG), King Air 300 & 200 (NLG) - Tucano S312 (MLG) - Cessna Mustang (MLG)	06-01423	\$629.00
22x7.75-10	12	190	Michelin Air	20	Cessna CJ, CJ1, CJ1+, CJ2, CJ2+ (MLG)	06-01424	\$925.00
23x7.0-12	12	210	Michelin Air	27	Gulfstream G150 (MLG), Hawker 800, 800XP, 1000 (MLG)	06-01429	\$1,168.00
23x7.0-12	12	210	Michelin Air	27	Gulfstream G150 (MLG), Hawker 800, 800XP, 1000 (MLG)	06-01430	\$1,244.00
24X7.7	14	190	Michelin Air	--	Pilatus PC-24	06-04173	\$1,466.00
450X190-5	8	190	Michelin Nose Tire	--	Pilatus PC-24	06-04172	\$1,137.00
29x11.0-10	10	160	Michelin Air	35	Cessna 208 (MLG)	06-01432	\$1,017.00
34x9.25-16	18	210	Michelin Air	72	Gulfstream II, IIB, III, IV (MLG)	06-01433	\$2,487.00
380x150-5	6	120	Michelin Air	7	Robin	06-01434	\$268.00
5.00-5	8	160	Michelin Air	6	Eclipse 500 (NLG)	06-01436	\$269.00
5.00-5	6	120	Michelin Air	6	Cirrus SR20, SR22 (NLG)	06-08052	\$193.00
5.00-5	10	120	Michelin Aviator	6	--	06-01437	\$238.00
5.00-5	8	160	Michelin Aviator	7	Eurocopter Tigre (TLG)	06-01438	\$263.00
5.00-5	4	120	Michelin Air	6	--	06-01439	\$179.00
6.00-6	8	120	Michelin Air	9	--	06-08058	\$262.95
6.00-6	4	120	Michelin Air	9	--	06-01441	\$209.00
6.50-10	8	120	Michelin Air	16	Cessna 208, 310, 335, 401, 402, 414, 421, 425, Piper PA-30, 31 (MLG)	06-08065	\$390.00
6.50-10	6	120	Michelin Air	16	Beech King Air 90 (NLG)	06-01447	\$369.00
6.50-10	12	160	Michelin Aviator	17	Piper PA-42 (MLG)	06-01448	\$587.00
6.50-10	10	120	Michelin Air	16	Cessna 425 Conquest I (MLG)	06-01450	\$430.00
6.50-10	10	160	Michelin Air	16	--	06-01450	\$430.00
6.50-8	8	160	Michelin Air	13	Beech Baron 55,56 (MLG)	06-08070	\$455.00
7.00-6	6	120	Michelin Air	11	Beech 33, 35, 36 (MLG)	06-08059	\$299.00
6.00-6	6	160	Michelin Aviator			06-01442	\$335.00
8.00-6	6	120	Michelin Aviator	13	Cessna 140, 185, 206, 207, 305, 01E, Socata Rallye	06-01456	\$373.00
8.50-10	8	160	Michelin Air	25	Beech 18, 50, 65, 70, 80, 88, King Air 90 - Cessna 188, 208, 308, 406 - Gulfstream 500, 560, 680, 681, 685, 720 - Mitsubishi MU2 - Piaggio 149, 166, 136 - Rockwell Int'l 500, 560, 680, 520 (MLG)	06-01458	\$546.00
8.50-10	10	160	Michelin Air	25	Gulfstream 690, 680T - Rockwell Int'l 685, 690, 695, 700, 840 (MLG)	06-01459	\$668.00
8.50-6	6	120	Michelin Air	--	High flotation, fixed gear	06-01461	\$476.00
6.50	10	160	Michelin Air	14	--	06-03021	\$548.00
H22x8.25-10	12	190	Michelin Air	20	Cessna CJ3 (MLG) - Hawker Premier 1 (MLG)	06-01463	\$1,359.00
H22x8.25-10	14	190	Michelin Air	22	Cessna Citation Encore, Encore+, 560 (MLG)	06-01464	\$1,547.00
H27x8.5-14	16	210	Michelin Air	40	Bombardier Challenger 604 (MLG)	06-01465	\$912.00

LG

# MICHELIN® TIRES & TUBES



## MICHELIN® AIR X® GENERAL AVIATION RADIAL TIRES

Michelin® AIR X® radials typically weigh 20–30% less than comparable bias tires, and they operate at cooler temperatures. Helps provide measurable fuel savings, more landings per tread, longer wear characteristics and a more stable contact patch than bias tires, as well as shorter turnaround times and reduced carcass fatigue. Extra Strong Carcass Michelin's carcass design helps restrict tire growth and the stretching of rubber. Durable cut-resistant tread includes deep skid depth and specially-designed circumferential grooves. Sidewall is optimized for both ozone and ultraviolet light protection which helps reduce ozone cracking in key areas of the tire. The Michelin® AIR X® casing is more flexible than casings used in bias tires.

Size	Ply	Speed (MPH)	Brand	Avg W (lbs)	Applications	Part No.	Price
14.5x5.5R6		225	Michelin Air X	8	"Falcon 20, 50, 200, 2000 (NLG)"	06-01382	\$1,918.00
14.5x5.5R6	10	225	Michelin Air X	8	Falcon 2000EX (NLG)	06-01383	\$2,077.00
16x4.4R8	10	210	Michelin Air X	10	"Cessna Sovereign, Citation X (NLG) - Gulfstream G150 (NLG)"	06-01384	\$1,798.00
16x4.4R8	12	190	Michelin Air X	10	Pilatus PC21 (NLG)	06-01385	\$2,490.00
16x6.0R6	12	225	Michelin Air X	11	Falcon F7X (NLG)	06-01387	\$2,530.00
17.5x5.75R8		225	Michelin Air X	11	Falcon 900 (NLG)	06-01388	\$2,463.00
20x4.4R12	14	190	Michelin Air X	14	Pilatus PC21 (MLG)	06-01390	\$2,782.00
23.5x8.0R12	14	190	Michelin Air X	24	"Cessna Citation Excel, XLS (MLG)"	06-01391	\$2,583.00
26x6.6R14	14	225	Michelin Air X	22	"Falcon 20, 50, 200, 2000, 2000EX, Gulfstream G200 (MLG)"	06-01392	\$2,056.00
26x6.6R14	12	210	Michelin Air X	24	"Cessna Sovereign, Citation X (MLG)"	06-01393	\$2,267.00
26x6.6R14	14	225	Michelin Air X	22	Hawker 4000 (MLG)	06-01394	\$2,149.00
29x7.7R15		225	Michelin Air X	31	Falcon 900 (MLG)	06-01395	\$3,740.00
H32x10.5R16.5	16	225	Michelin Air X	44	Falcon F7X (MLG)	06-02581	\$4,131.00
1400 x 530R23	36	235	Michelin Air X	32	Airbus Industries	06-03036	\$3,766.00
1050 x 395R16	28	225	Michelin Air X	32	Falcon 900 (MLG)	06-03037	\$2,691.00
26X6.6R14	14	225	Michelin Air X	-	Cessna 700 Longitude	06-03496	\$2,298.00
16X4.4R8	10	225	Michelin Air X	-	Cessna 700 Longitude	06-03497	\$1,749.00

## MICHELIN REGIONAL RADIAL AIRCRAFT TIRES AIR X

Size	Ply Rating	Speed (MPH)	Avg W (lbs)	Application	Part No.	Price
24X7.7R10	16	225	24	Embraer 190 (NLG)	06-01522	\$1,119.00
32X8.8R16	12	90	41	ATR 42 (MLG)	06-01523	\$2,035.00
H34X10.0R16	14	190	55	ATR 72 (MLG)	06-01524	\$2,127.00
H41X16.0R20	22	225	129	Embraer 190 (MLG)	06-01526	\$4,381.00
16x4.4R8	10	-	-	-	06-02996	\$2,308.00
17.5x5.75R9	12	-	-	-	06-02997	\$1,940.00

## MICHELIN REGIONAL BIAS AIRCRAFT TIRES

Size	Ply Rating	Speed (MPH)	Special	Avg W (lbs)	Application	Part No.	Price
17.5x6.25-6	8	190	-	11	Saab 340	06-01530	\$275.00
18x4.4	12	210	CH	13	Bombardier CRJ100/200	06-01406	\$394.00
18x4.4	10	210	CH	13	Fairchild Metro	06-01409	\$659.00
18x5.5	10	210	-	14	Embraer EMB120ER	06-01415	\$698.00
19.5x6.75-8	10	190	-	15	Fairchild Metro	06-01540	\$385.00
20.5x6.75-10	12	225	CH	19	Bombardier CRJ700/900	06-01541	\$678.00
24x7.7	14	190	-	25	Saab 340	06-01543	\$640.00
32x8.8	14	210	-	46	Saab 2000	06-01549	\$1,047.00
450x190-5	10	190	-	14	ATR 42, 72	06-01550	\$675.00
670x210-12	10	160	-	30	Embraer EMB110, 121, Xingu	06-01551	\$748.00
H29x9.0-15	16	210	-	45	Bombardier CRJ100/200	06-01552	\$1,210.00
H31x9.75-13	12	190	-	39	Bombardier DHC8 - 100/200	06-01554	\$1,135.00
H36x12.0-18	18	225	0	89	Bombardier CRJ700/900	06-01555	\$2,094.00

## AIRCRAFT WHEEL BALANCER



The Aircraft Wheel Balancer uses the same static balancing method that is used to balance helicopter rotors. The patent pending design features a pivot point that is easily adjustable on-the-fly for maximum sensitivity, and includes bushings to accommodate both 1 1/4" and 1 1/2" axle sizes.

You now have an extremely portable wheel balancer that is small enough to fit in a tool box and does not require a bulky stand. The McFarlane design is more precise than other static balancing methods, and allows the wheel to be balanced while the bearings and seals are installed.

It's fast and easy! Due to the horizontal balancing and orientation, test weights can be temporarily set in place and easily adjusted while balancing. This eliminates the need to tape the test weights. The McFarlane wheel balancer is precision machined with a black, hard anodized finish, and comes in an oiled wooden case. This is a lifetime tool that fits almost all light aircraft wheel/tire assemblies.

### Features:

- Adjustable pivot point for maximum sensitivity (Patent Pending)
- More accurate than "bubble" or "axle and bearing" style balancers
- Portable - small enough to fit in your tool box
- Does not require removal of bearings or seals
- High quality wooden case
- Less than half the price of bulky axle and bearing type balancers

Description	Part No.	Price
Wheel Balancer for 1", 1-1/4", and 1-1/2" axles, including Cessna 300 and 400 Series tapered axles with 1-1/2" and 1" bearing bores.	05-12922	\$346.00
Tool129 Large Axle Bushing Kit	05-12923	\$214.95
Tool108 Large Axle Bushing Kit	05-12924	\$214.95
Aircraft Wheel Balancer Tool For 3/4 Axles	05-12921	\$266.95

# MICHELIN® TIRES – RETREAD TIRES



## CONDOR AIRCRAFT TIRES

Strong sidewalls for exceptional durability, even after frequent hard landings. Tough treads compounded for high abrasion resistance, low heat generation and extra long life. Smooth liners to help prevent tube chafing. Full FAA qualification based on thorough static and dynamic testing. Each production tire is subject to final inspection and a check for weight and balance. Limited warranty guarantees that each Condor tire is free from any manufacturing defects. Condor tires are available in a variety of sizes for light to medium general aviation aircraft.

Size	Ply	Speed (MPH)	Brand	Avg W (lbs)	Part No.	Price
15x6.0-6	6	120	Condor	7	06-08040	\$223.00
29x11.0-10	10	160	Condor	31	06-01379	\$825.00
5.00-5	6	120	Condor	6	06-08010	\$148.00
5.00-5	4	120	Condor	6	06-08005	\$142.00
6.00-6	6	120	Condor	9	06-08020	\$197.00
6.00-6	8	120	Condor	9	06-08025	\$209.00
6.00-6	4	120	Condor	9	06-08015	\$174.90
6.50-10	8	120	Condor	16	06-00197	\$354.00
6.50-10	10	120	Condor	16	06-00198	\$362.00
6.50-8	8	120	Condor	13	06-00199	\$313.00
7.00-6	8	120	Condor	11	06-08035	\$275.00
7.00-6	6	120	Condor	11	06-08030	\$275.00
8.00-6	8	120	Condor	13	06-08050	\$317.00
8.00-6	6	120	Condor	13	06-08045	\$295.00
8.50-10	8	120	Condor	24	06-00201	\$466.00
8.50-10	10	120	Condor	24	06-01381	\$519.00

LG

## MICHELIN® PILOT® TIRES

The MICHELIN® PILOT® high performance bias tire is designed to be the best tire money can buy for propeller driven aircraft. Reflecting their proven history of developing ultra high performance tires, the MICHELIN PILOT tire offers the latest state-of-the-art features.



Size	Ply	Speed	Brand	Avg W (lbs)	Part No.	Price
15x6.0-6	6	160	PILOT	8.6	06-03067	\$314.00
5.00-5	6	160	PILOT	6.6	06-03068	\$294.00
7.00-6	6	160	PILOT	13.7	06-03490	\$395.00
6.50-8	8	160	PILOT	13.9	06-03492	\$475.00
8.50-10	10	160	PILOT	12.4	06-03493	\$784.00

## MICHELIN® AIRSTOP® AIRCRAFT INNER TUBES

MICHELIN® AIRSTOP® Aircraft Tubes provide long-lasting, dependable performance you can rely on in just about any operating condition. Because they're made with advanced materials, MICHELIN® AIRSTOP Aircraft Tubes offer extended air retention and can sustain temperatures as low as minus 50°C. So when you fly with MICHELIN® AIRSTOP Aircraft Tubes, you fly with confidence.



Size	Valve Stem	Avg W (lbs)	Part No.	Price
15x6.0-6	TR-20 / Straight	1	06-01373	\$152.75
22x8.0-8	TR-15 / Straight	3	06-01374	\$190.75
29x11.0-10	---	-	06-03360	\$283.00
5.00-5	TR-67A / Bent 90°	1	06-00019	\$188.75
6.00-6	TR-20 / Straight	1	06-00021	\$149.95
6.50-10	TR-25 / Straight	2	06-00849	\$151.75
6.50-8	TR-15 / Straight	2	06-00851	\$152.65
7.00-6	TR-20 / Straight	2	06-00848	\$158.75
7.00-8	TR-15 / Straight	2	06-00851	\$152.65
8.00-6	TR-20 / Straight	2	06-00848	\$158.75
8.50-10	TR-25 / Straight	3	06-00850	\$189.75
8.90-12.50	TR-15 / Straight	5	06-01378	\$263.95
355 x 150-4	Bent 90°	2	06-01487	\$151.75
7.00-6	TR-20 / Straight	2.5	06-00848	\$158.75
6.50-8	TR-15 / Straight	2.5	06-00851	\$152.65

## RETREAD TIRES

500-5 10 ply high performance retreaded tires \*Subject To Limited Core Availability\*

Their premium retreads are produced by: Aero Wheel & Brake Service Corp. Aero WBS holds FAA certification to retread high speed aircraft tires up to 225 MPH.

Their sizes range from small piston engine aircraft through Regional Jet aircraft. 95% of the world's airlines depend on retreads not only for cost control, but for the extended life they provide over most new tires.



Size	Ply	Part No.	Price
600-6 Standard	6	06-01472	\$113.00
600-6 - Monster retread. Almost 12/32nds tread Depth	6	06-01473	\$139.00
600-6 - Elite Premium 2 Groove Top of the line. 2 Wide Hydro-Grooves	6	06-01474	\$124.00
15/600-6 Standard	6	06-01471	\$117.00
700-6 Standard	6	06-01475	\$139.00

\*Subject To Limited Core Availability\*

\*\*Tire cores are of various makes and models\*\*

## SMOOTH TUNDRA FAA TSO TIRE

Aero Classic Tundra 22 x 8.50-6 4 Ply "Pillow Soft" 22 x 8.50-6 4 Ply stands 22 inches tall and weighs in "featherlight" at under 10 lbs. Compare that to a standard 850-6 6 Ply which average 15 lbs. each. The load rating is 1,600 lbs. per tire. Tube Type. FAA TSO



Tire .....P/N 06-02501 .....\$349.00  
 Tube .....P/N 06-00765 .....\$205.00



# AERO CLASSIC TIRES & TUBES

## AERO CLASSIC TIRES

Aero Classic is a proprietary line of over 50 aircraft tires and tubes made to meet or exceed the original specifications.



Size	Ply	Description	Part No.	Price
10/350-4	4	Aero Classic Premium	06-01238	\$79.00
10/350-4	6	Aero Classic Premium - HD	06-01239	\$86.00
11/400-5	8	Aero Classic Flat Rib Tire	06-01240	\$107.00
12.5-4.5	10	Aero Classic Channel	06-01241	\$357.00
15/600-6	6	Aero Classic Rib	06-03028	\$229.00
200-50	6	Aero Classic Rib	06-01243	\$72.85
280/250-4	4	Aero Classic Premium	06-01244	\$79.00
280/250-4	6	Aero Classic Premium - HD	06-01245	\$88.00
380/150-5	6	Aero Classic Rib	06-01249	\$246.00
400-6	6	Aero Classic Rib	06-00944	\$96.75
400-4	8	Aero Classic Rib	06-00844	\$97.75
420-150	4	Aero Classic Rib	06-01250	\$323.00
550-4	8	Twin Contact	06-03199	\$563.00
500-5	6	Aero Classic All Weather	06-01252	\$128.00
500-5	10	Aero Classic All Weather	06-01253	\$226.00
6 x 2		Aero Classic Solid Tailwheel	06-01044	\$117.75
600-6	4	Aero Classic All Weather	06-01254	\$229.00
600-6	6	Aero Classic All Weather	06-01255	\$229.00
700-7.5	6	Aero Classic All Weather	06-01258	\$612.00
700-8	6	Aero Classic Diamond Tread	06-01126	\$394.00
800x6	4	Aero Classic Tube Type / Tubeless Light Sport Tundra	06-03186	\$176.00
8.9 x 12.5	6	Aero Classic Diamond (Stearman)	06-01518	\$907.00
27	10	Aero Classic Rib Tread Tire	06-03539	\$799.00
30"	8	Aero Classic Rib	06-02984	\$2,012.00
10.00 SC	8	Aero Classic Channel Rib	06-02958	\$327.00
15/600-6		Aero Classic Butyl Easy Valve GL-1587	06-03185	\$56.85
15/600-6	10	Aero Classic Tubeless (Cirrus)	06-03043	\$339.00
1100/12	10	Air Tractor, Twin Beech and Twin Otter	06-03171	\$948.00

## AERO CLASSIC RIB / SAWTOOTH TIRES



Size	Ply	Description	Part No.	Price
300-4	4	Rib Tire	06-00361	\$34.95
800-6	4	Sawtooth Tire	06-00366	\$136.75

## AERO CLASSIC SMOOTH TUNDRA TIRES



Size	Ply	Description	Part No.	Price
8.50-6	4	22x8-50	06-02501	\$349.00
27.5x10-8	4	For 8" Wheels	06-02964	\$745.00
31x11-10	4	For 10" Wheels	06-02965	\$1,343.00



## LEAKGUARD TUBES

EASY INFLATE Valve Makes Inflation Less Of A Chore. Valve Is Angled Toward You, Easier To Inflate, Easier To Check The Pressure. WILL NOT WORK WITH HUBCAPS "LEAKGUARD" Inner Tubes Are Blended With A Proprietary Leak Resistant Compound For Less Maintenance.

Size	Valve	Model	Part No.	Price
Tube, Natural	TR-87	Tube, Leakguard Butyl	06-00761	\$44.60
1100-12	TR-13	Tube, Low Temp. Natural	06-01218	\$189.00
13/500-6	TR-87	Tube, Heavy Duty	06-03559	\$57.75
12.5-4.5	TR-67	Tube, Leakguard Butyl	06-00762	\$123.90
15/600-6	TR-20	Tube, Leakguard Butyl	06-00770	\$107.85
18-5.5	TR-15	Tube, Leakguard Butyl	06-01221	\$189.95
19.5/675-8	TR-15	Tube, Leakguard Butyl	06-01222	\$114.75
22/800-8	TR-15	Tube, Leakguard Butyl	06-01223	\$173.75
280/250-4	TR-87	Tube, Leakguard Butyl	06-00760	\$33.75
29/1100-10	TR-150	Tube, Leakguard Butyl	06-01224	\$235.95
29/1100-10	TR-25	Tube, Natural	06-03290	\$297.95
500-4	TR-67	Tube, Low Temp. Natural	06-01227	\$177.75
500-5	TR-67	Tube, Leakguard Butyl	06-00755	\$108.95
600-6	TR-20	Tube, Leakguard Butyl	06-00754	\$92.50
600-6	TR-15	Tube, Natural	06-03289	\$149.00
600-6.5	TR-67A	Tube, Low Temp Natural 90°	06-01229	\$158.75
6.50-10	TR-25	Tube, Natural	06-03181	\$95.00
6.50-10	TR-25	Tube, Butyl	06-00767	\$121.85
650/700-8	TR-15	Tube, Leakguard Butyl	06-00766	\$96.85
700/800-6	TR-20	Tube, Leakguard Butyl	06-00764	\$118.75
750-10	TR-25	Tube, Leakguard Butyl	06-00768	\$99.65
800-4	TR-12	Tube, Low Temp. Natural	06-00821	\$329.00
850-10	TR-25	Tube, Leakguard Butyl	06-00769	\$152.85
890-12.50	TR-25	Tube, Low Temp. Natural	06-01237	\$230.95
600-6	TR-87	Tube, Leakguard Butyl	06-03303	\$92.75

LG

## AERO CLASSIC TUBES

Aero Classic Tubes Tested to MIL-I-5014F  
\*Can be used with Tundra Tires.



Size	Valve	Part No.	Price
11 x 4.00 x 6	TR-87	06-00716	\$43.50
10/350-4	TR-87	06-00761	\$44.60
400-6	TR-87	06-00945	\$36.70
200-50	TR-87	06-01368	\$14.95
380/150-5	TR-67A	06-02787	\$77.85
410/350-5	TR-87	06-00714	\$11.95
480/400-8	TR-87	06-00720	\$12.85
700/800-6	TR-87	06-00358	\$34.65
800-4	TR-12	06-00821	\$329.00
*850-6	TR-20	06-00765	\$205.00
*850-10	TR-20	06-01236	\$207.95
10.00 SC	Straight	06-02959	\$149.00
27" SC	Straight	06-02955	\$245.95

## AZUSA 4 PLY TURF SAVER TIRE 16-650 X 8



Azusa Turf Saver Tire 16-650 x 8.4 ply.  
Width: 6.4 in. OD:16.4  
Tire 16-650x8..... P/N 06-01579...\$55.95  
Tube #7118 16-650/750x8.. P/N 06-01593...\$15.95

# AERO CLASSIC TIRES & TUBES



## HOMEBUILT TIRES & TUBES

These industrial tires and tube assemblies are used on a unique variety of homebuilt and ultralight aircraft airplanes. Sold as set of tire and tube only.

Dimensions	Ply	Part No.	Price
4.10 x 3.50 x 4	4 PLY	06-10830	\$61.75
3.40 x 3.00 x 5	4 PLY	06-10840	\$28.80
11 x 4.00 x 5	2 PLY	06-10860	\$76.00
13.5 x 6.00 x 6	2 PLY	06-10870	\$42.75
4.80 x 4.00 x 8	4 PLY	06-10880	\$35.25
400x6 Bent Stem	--	06-00945	\$36.70
400X6 Straight Stem	--	06-00945	\$36.70
4.10 x 3.50 x 5	--	06-00714	\$11.95
11 x 400 x 5	--	06-00716	\$43.50
4.80 x 4.00 x 8	--	06-00720	\$12.85

\*2008 tire superseded by Carlisle.

## 11.400 X 5 TIRES & TUBES

This tire fills the size gap between the 5.00-5 aircraft tire and the 3.40-5 industrial tire. Looks like a scaled-down 5.00-5. Fits VariEze, KR's and most experimentals using 5" wheels. These tires require tubes. (tube-type). Formerly known as Lamb tires.

11.400-5 (6 Ply) Tire	P/N 06-02952	\$43.50
11.400-5 (8 Ply) Tire	P/N 06-01573	\$43.85
11.400-5 Tube	P/N 15-04651	\$10.50
11.400-5 (2 Ply) Tire	P/N 06-01571	\$32.50
11.400-5 (4 Ply) Tire	P/N 06-00362	\$27.50
11.400-5 (8 Ply) Tire	P/N 06-01240	\$107.00

## CST SLICK NOSE TIRE & TUBE 2.80X4

This tire has a smooth tread design suitable for professional grounds crew / maintenance machines as well as a wide variety of experimental aircraft, including utilization as a nose tire on the Long-EZE.

### Specification:

Tire Size: 2.80/2.50-4	
Rim Size (inch): 4X2.15	
Ply Rating: 4	
Overall Diameter (mm/in): 224.0 / 8.8	
Overall Width (mm/in): 69 / 2.70	
Tire Pressure (kpa/psi): 345 / 50	
Max Load (kg/lbs): 134 / 295	
Tread Depth (mm/in): 0.00 / 0.00	
Slick Nose Tire	P/N 06-02809 .....\$23.75
Tube for Slick Nose Tire 2.80 X 4 w/90° Bent Stem	P/N 06-02810 .....\$9.85

## 20X700-8 2PLY KITFOX TIRE

20x700-8 2 Ply Kitfox tire (buffed smooth) aircraft tire. Max load 195 lbs at 5 PSI. 15 PSI max to seat beads.. P/N 06-01596 .....\$146.00

## TIRES & TUBES FOR ULTRALIGHTS

### TIRES

Part No.	Nom. Size	W	Dia.	Price
06-00361	300 x 4	3.2"	10.0"	\$34.95
06-00362	400 x 5	3.9"	10.5"	\$27.50
06-00365	15-600 X 6	5.9	14.8	\$45.50
06-00366	800 x 6	6.0"	16.3	\$136.75

### TUBES

Part No.	Size	Angle Degree	Price
06-00761	300x4	90°	\$44.60
06-00355	3.50x5	0	\$12.95
06-00356	600x6	90°	\$57.75
06-00358	800x6	90°	\$34.65



## RIBBED / FLAT PROFILE TIRES

Ribbed/Flat Profile Tires. Price per tire.

**Note:** These are not automotive tires, extra inflation precautions are required.

Size / Tire	Ply / Width	OD* / Innertube	Part No.	Price
11-400 X 5 / 7164	2 / 3.2"	10.5" / 7131	06-01571	\$32.50
11-400 X 5 / 7046	4 / 3.9"	10.5" / 7131	06-00362	\$27.50
11-400 X 5 / 7046-8	8 / 4"	10.8" / 7131	06-01573	\$43.85
13-500 X 6 / 7168	2 / 4.8"	12.6" / 7133	06-01568	\$33.50
410/350 x 6	4 / 4.0"	12.5" / 7039	06-00074	\$24.75
13-500 X 6 / 7018	4 / 4.8"	12.6" / 7133	06-01572	\$27.75
13-650 X 6 / 7031	4 / 6.0"	12.5" / 7141	06-01575	\$41.50
15-600 X 6 / 7169	2 / 5.9"	14.8" / 7125	06-01576	\$38.90
800 X 6 / 7007	4 / 8.0"	16.0" / 7138	06-00366	\$136.75
16-650 x 8 / 7024-2	2 / 6.4"	16.4" / 7118	06-01609	\$55.95
16-650 X 8 / 7024-2	2 / 6.4"	16.4" / 7118	06-01579	\$55.95
18-850 X 8 / 7002	4 / 8.0"	16.5" / 7120	06-01580	\$88.75
18-950 X 8 / 7027	4 / 8.0"	17.4" / 7120	06-01581	\$83.75
13-500 x 6 / 7018	2 / 4.8"	12.6" / 7133	06-01568	\$33.50



## TUBES FOR ULTRALIGHTS

Inner Tubes for most Azusa variety tires.

Tubes	Valve Stem	Part No.	Price
Tube #7133 410/350X6	90°	06-00075	\$9.55
Tube #7130 410/350 X 4	90°	06-00773	\$9.70
Tube #7132 410/350 X 5	90°	06-00775	\$9.95
Tube #7131 340/300 X 5	90°	06-00822	\$9.95
Tube #7129 280/250 X 4	90°	06-01288	\$8.50
Tube #7141 410/350X6	Straight	06-01590	\$12.75
Tube #7138 800 X 6	90°	06-01592	\$23.50
Tube #7118 16-650/750 X8	Straight	06-01593	\$15.95
Tube #7125 15-600 X 6	90°	15-04869	\$15.50
Tube #7116 11-600 X 5	90°	15-06300	\$16.50
Tube#7120 18-950 X 8	Straight	15-04731	\$25.50
Tube #7121 480/400 X 8	Straight	7121	\$12.60
Aero Classic Tube 400 X 6	90°	06-00945	\$36.70
Azusa Inner Tube 13-500 X 6	90°	06-01988	\$12.50



## SAWTOOTH TREAD TIRES AND TUBES

Description	Ply / Width	OD	Part No.	Price
Tire 4.10/350 X 4	4 / 3.5"	10.5"	06-00772	\$17.50
Tire 4.10/350 X 5	4 / 3.5"	11.5"	06-00774	\$22.75
Tire 280/250 X 4	4 / 2.8"	8.8"	06-01287	\$14.50
Tire #7038 3.40 X 3.00 X 5	4 / 3.5"	10.5"	06-01655	\$18.85
Tire #7039 410/350X6	4 / 4"	12.5"	06-00074	\$24.75
Azusa Sawtooth 480/800 X 8	4 / 4.6"	16"	06-01948	\$27.50
4.10 x 3.50 x 5 Tire and Tube Kit	4 / 3.5"	---	06-01659	\$34.70
Tube #7130 410/350 X 4	4 / 3.5"	10.5"	06-00773	\$9.70
Tube #7132 410/350 X 5	4 / 3.5"	11.5"	06-00775	\$9.95
Tube #7129 280/250 X 4	4 / 2.8"	8.8"	06-01288	\$8.50
Tube #7131 340/300 X 5	4 / 3.5"	10.5"	06-00822	\$9.95
Tube #7133 410/350 X 6	4 / 4"	12.5"	06-00075	\$9.55
Tube #7121 480/400 X 8	4 / 4.6"	16.0"	7121	\$12.60

# MASTER BRAKE CYLINDERS



## BERINGER REPAIR/OH KIT

Repair kits are available for the following BERINGER® parts: Hand master cylinder, Rudder pedal master cylinder, 2 and 3 piston brake caliper. Includes all wear parts: pistons, seals, screws, grease, repair procedure.  
 Mineral Oil.....P/N 06-03550 .....**\$164.80**  
 DOT4 .....P/N 06-03551 .....**\$99.99**

## CLEVELAND MASTER BRAKE CYLINDERS



### MODEL 10-35

This model has a built-in reservoir and is used in production aircraft. Cast aluminum construction. 5/8" bore, 1.2" stroke, 0.36 cu. in. displacement. Outlet 1/8" NPT. Pin center length 8". Designed to mount on rudder pedal. Formerly Gerdes Model A-049.....P/N 10-35.....**\$1,054.00**  
 Model 10-35 O-Ring Kit.....P/N 199-513 .....**\$44.50**



### MODEL 10-20

Spring-loaded piston type assembly without reservoir. Simple design assures long troublefree service. Pin center length 7-1/2". Bore 9/16". Stroke 1.25". Weight: 10 oz. Used on Pitts Special, Acro-Sport and other homebuilts.  
 Model 10-20 & 10-19 O-ring kit.....P/N 06-10600 .....**\$34.50**



### MODEL 10-19

Used on Pitts and other homebuilts. Similar to Model 10-20 except with ports aligned differently.  
 Model 10-20 & 10-19 O-ring kit.....P/N 06-10600 .....**\$34.50**



### MODEL 10-5B

This Cleveland master brake cylinder has the same type construction as Model 10-20. Model 10-5B does not have a parking brake feature. 1/8" NPT ports, on opposite sides of cylinder, have AN823-4D fittings for use with 1/4" brake line. Pin center length 8". Wt. 9.5 oz. Bore 0.562". Stroke 1.25". Used on Piper PA25 and homebuilts. O-Ring kit is Cleveland part No. 199-502. Stroke 1.25". Used on Piper PA25 and homebuilts. O-Ring kit is Cleveland part No. 199-502.  
 Model 10-5B O-Ring kit (199-503).....P/N 06-00708 .....**\$92.95**  
 Model 10-5 O-Ring kit (199-502).....P/N 06-10700 .....**\$85.75**  
 Model 10-22 .....P/N 05-13316 .....**\$1,227.00**  
 Model 10-30 .....P/N 05-13319 .....**\$652.00**  
 Model SSFA232-5 .....P/N 05-13328 .....**\$1,513.00**



### MODEL 10-54

Spring-loaded piston type assembly without reservoir. Simple design assures long troublefree service. Pin center length 7.88". Bore 5/8". Stroke 1.62". Wt. .45 oz. Ports in-line, no fittings.  
 P/N 06-01214 .....**\$675.00**

## CLEVELAND 199-512 MASTER CYLINDER REPAIR KIT



Elastomeric cure date required per ESP3620. This Service Kit will overhaul one 10-30, 10-30A, 10-30C, or 10-300 Master Cylinder Assembly. CM10-30 Overhaul Instructions for 10-30, 10-30A, 10-30C, & 10-300.....P/N 06-01130 .....**\$48.80**

**VISIT OUR WEBSITE FOR MASTER CYLINDER SEAL KITS**

## MATCO MASTER CYLINDERS



### MATCO MC-4 MASTER CYLINDER

MATCO mfg's MCMC-4 master cylinder uses a REMOTE reservoir. The MCMC-4 can be used in individual or dual brake applications. Buna-n o-rings are used in this assembly. Mil-H-5606 aircraft hydraulic fluid or compatible fluids are recommended. DOT5 may be used but not DOT5.1 which contains glycol. DOT3 and DOT4 may not be used and will cause immediate damage to the seals. The MCMC-4 master cylinder measures 8.05 +0.25 inches from end to end and 7.5 +0.25 inches from mounting hole to mounting hole. A 0.625 inch diameter piston is used. Available stroke is approximately 1.388 inches and displacement is 0.43 cubic inches. The ports on all MATCO mfg master cylinders are 1/8 inch NPT (except the MC-4E). Has an adjustable clevis.

### UNIVERSAL - Vertical or horizontal mounting with exterior reservoir.

MC-4.....P/N 06-11150 .....**\$155.75**  
 MC-4A (0.50" shorter than the MC-4) .....P/N 06-11100 .....**\$162.75**



MC-5 VERTICAL

### MATCO MC-5 MASTER CYLINDER

MATCO mfg's MCMC-5 master cylinder uses an INTERNAL reservoir. The MCMC-5 can be used in individual or dual brake applications. Buna-n o-rings are used in this assembly. Mil-H-5606 aircraft hydraulic fluid or compatible fluids are recommended. DOT5 may be used but not DOT5.1 which contains glycol. DOT3 and DOT4 may not be used and will cause immediate damage to the seals. The MCMC-5 master cylinder measures 8.25 inches from end to end and 7.7 inches from mounting hole to mounting hole. A 0.625 inch diameter piston is used. Available stroke is approximately 1.388 inches and displacement is 0.43 cubic inches. The ports on all MATCO mfg master cylinders are 1/8 inch NPT (except the MC-4E). The MC-5 has an adjustable clevis. The MC-5 can not be used in series with a second MC-5 or MC-5A

### VERTICAL STYLE - Cylinder for vertical mounting, with steel housing and reservoir.

MC-5.....P/N 06-11000 .....**\$163.85**  
 MC-5A (0.50" shorter than the MC-5) .....P/N 06-00375 .....**\$172.75**



### MC-7 MASTER CYLINDER

The black anodized MC-6 is designed to attach to a 1" diameter control stick and function similar to a motorcycle brake. Designed for ultralight aircraft, it is completely self-adjustable as the lining wears and draws additional fluid from the cylinder. The 6:1 mechanical leverage allows the average pilot to generate 1,500 PSI in the system.  
 P/N 06-00014 .....**\$275.95**

## MATCO MASTER CYLINDER REBUILD KITS



Buna-n orings are used in the original assembly, these rebuild kits are of same quality.

Description	Part Number	Price
MC-4 Rebuild Kit	06-02998	<b>\$17.85</b>
MC-4A Rebuild Kit	06-03003	<b>\$18.60</b>
MC-5 Rebuild Kit	06-02999	<b>\$18.65</b>
MC-5A Rebuild Kit	06-03002	<b>\$18.65</b>
MCMC-7/MCMC-7s Universal Rebuild Kit	06-03001	<b>\$23.50</b>

# SHOCK CORDS - SHOCKS RINGS

## MIL FRESH SHOCK RINGS



An endless elastic ring composed of multiple strands of natural rubber, wound into a circular skein. Braided cover is high grade yarn. Manufactured to meet specification MIL-C-5651B, Type II. Shock cord is used in landing gear to reduce shock transmitted to fuselage while landing and taxiing and on other shock mounting applications. Color coded to insure fresh stock.

Ring No.	Ring Size* (In.)	Test (Lb.)	Aircraft	# Req.	Part No.	Price Ea.
9044	9/16x4-1/2	400	Hatz Bi-Plane	4	9044	\$36.60
9090	9/16x9	425	Taylorcraft B	4	9090	\$32.80
9010HD	9/16x10	475	Taylorcraft BC	4	06-00829	\$31.95
9010HDX	9/16x10		Taylorcraft F-19/ F-21	4	06-01132	\$37.90
1080	5/8x8	750	Stolp Starduster, Rans S4/5	4	1080	\$44.70
1080HD	5/8x8	900	PA-16, PA-18	4	06-00823	\$43.50
			PA-20, PA-22, PA-25	4		
1174	11/16x7-1/2	730	Piper J-2, Early J-3, J-5	4	06-00756	\$39.85
1192	11/16x9-1/4	750	Taylorcraft D	4	1192	\$54.75
11104	11/16x10-1/2	750	Taylorcraft L-2	4	11104	\$52.75
1280	3/4x8	750	Stolp Starduster Too	4	1280	\$36.50
1280-HD	3/4x8	950	Piper J-3 (S/N8277 up),	4	06-00826	\$35.50
			PA-11, PA-12, PA-14	4		
			PA-18 (thru S/N18-3013) Rans	4		
			S10 Acrosport, Pitts S-2			
8097	1/2x9-7/8	400	PA-24, PA-30	2	8097	\$27.80
1286	3/4x8-3/4	750	Aeronca (S/N330 up)	4	1286	\$44.55
1286HD	3/4x8-3/4	950	Skybolt	6	06-00827	\$86.75
1380	13/16x8	1160	PA-20 (before 1952) Pitts (S-1, S-1C, S-1S) Husky, Acrosport 2, Rans S9	2	1380	\$41.65
				4		
1380HD	13/16 x 8	1460	Rans 57	1	06-00828	\$89.95

### SEE OUR WEBSITE FOR MORE APPLICATIONS INFORMATION.

\*1st dimension is cross section; 2nd dimension is inside dia. of ring.  
HD - Heavy Duty, higher test rings. \*\*\*6 Rings for J-5. HDX - Extra Heavy Duty.

CW (Cold Weather) shock rings available on Special Order basis. Prices are approx. twice that of standard shock rings. Add "-CW" to standard part number when ordering.



## SHOCK CORD FASTENERS

These cone spring hooks and locking rings are used as terminal fasteners. Insert cord through small end of cone. Apply and crimp locking ring about 1/2" from end of cord, pull cord back until locking ring contacts inside of fastener. Cut ends of cord may be sealed by dipping in rubber cement. Set includes cord and locking ring.

Shock Cord Size	Fastener P/N	Price/Set
1/4"	06-12800	\$0.99
3/8"	06-12900	\$1.60
1/2"	06-13000	\$2.75

## SHOCK ABSORBER COIL RINGS

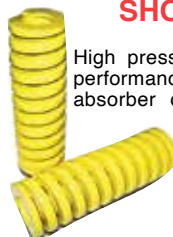

High pressure springs fabricated from alloy steel for top performance and long spring life. The Claude Gray shock absorber design has been service-proven on the EAA Biplane, Miniplane, Pitts and others. Over 1,000 pair in use. Length 6", 2" O.D., 1" I.D.. Wt. 4-1/2 lbs. per pair. Spring deflection 0.7" per 1,000 lb. force.

Single spring .....P/N 06-01367 .....\$79.75

Discount 10% on 6, 15% on 12

## BOGERT AVIATION PA-24/30 BUNGEE TOOL



• Lower damage risk with the right tool • Complete control of bungee shock cords coming off • Complete control of bungee shock cords going on • E-Z instructions with detailed drawings • Safe landings depend on new cords every few years. Comanche Owners: 30 minutes to change bungees.....P/N 06-00419 .....\$217.00

## BOGERT AVIATION COMANCHE GEAR RETRACTION TOOLS



Retract landing gear using only retraction tool & torque wrench.

**Straight** - Fits: PA-24, SN 24-1 through 24-4782 & 24-4784 through 24-4803 .....P/N 12-02095 .....\$109.95

**Angled** - Fits: All PA-30's, PA24, Serial number 24-4783, 24-4804 & up  
P/N 12-02094 .....\$163.00

## SHOCK CORD



MIL-C-5651D TYPE I SHOCK CORD: This cord has a double cover of glazed cotton over natural cotton. It has 3 markers: 2 for the year and 1 for the quarter.

The certifiable cord sizes of Type I are: 1/4", 3/8", 1/2", 5/8"

### TYPE 1

Dia. (In.)	Part No.	Price/Ft. Less Than 100 Ft.	100 Ft.	Dia. (In.)	Part No.	Price/Ft. Less Than 100 Ft.	100 Ft.
1/8	06-12100	\$0.45	\$40.50	3/8	06-12400	\$1.70	\$153.00
1/4	06-12200	\$0.90	\$81.00	1/2	06-12500	\$2.75	\$247.50
5/16	06-12300	\$0.95	\$85.50	5/8	06-12600	\$6.50	\$585.00

LG

# MASTER BRAKE CYLINDERS

## HEGAR MASTER CYLINDERS

### 5" SINGLE LEVER MASTER CYLINDER

5" single lever, foot operated. Designed for single braking.

1/2" Bore.....P/N 06-01277 .....**\$132.75**  
5/8" Bore.....P/N 06-01671 .....**\$134.75**

### 5" DUAL LEVER MASTER CYLINDER

5" dual lever, foot operated. Designed for differential braking. Comes in your choice of 1/2", 5/8" and 3/4" bore sizes.

1/2" .....P/N 06-01278 .....**\$227.95**  
5/8" .....P/N 06-01611 .....**\$226.95**

### 7" SINGLE LEVER MASTER CYLINDER

7" single lever, hand operated. Designed for single braking. Comes in your choice of 1/2", and 5/8" bore sizes .....P/N 06-01279 .....**\$89.75**

### 7" DUAL LEVER MASTER CYLINDER

7" dual lever, hand operated. Designed for differential braking. Comes in your choice of 1/2", 5/8" and 3/4" bore sizes .P/N 06-01280 .....**\$227.95**

## STANDARD MASTER CYLINDER WITH 2 INCH ROUND PEDAL



16982 STANDARD master cylinder with 2" round pedal cylinder. STANDARD master cylinder with 2" round pedal. Can be used for hand or foot operation. Comes with mounting bracket as shown. P/N 06-00328 .....**\$121.75**



### MASTER CYLINDER PLUG

Master cylinder plug 1/8" NPT for Black Max. P/N 06-01028 .....**\$0.75**

### O-RING KIT FOR HEGAR BRAKES



Replacement o-ring for 6.375" or 6" brake caliper. Simply remove the piston, clean, lube and install the new o-ring for a perfect seal. Kit comes with two o-rings for one set of calipers (one aircraft). P/N 15-05062 .....**\$4.95**

### MASTER CYLINDER O-RING KIT



O-Ring Kit is for use with 5/8" bore cylinders in the 670, 671, 672, 673, and 674 Series. For use with MIL-H-5606 fluid only. O-Ring kit contains 1 ea of the following O-Rings: • Spruce P/N: AN6227B-3 (MS28775-008) • Spruce P/N: AN6227B-7 (MS28775-012). Spruce P/N: AN6227B-9 (MS28775-111) • Spruce P/N: AN6227B-10 (MS28775-112) P/N 06-00805 .....**\$5.95**

## BONANZA & BARON BRAKE MASTER CYLINDER UPGRADE / REPAIR KIT



The Marsh Brothers Aviation Bonanza brake master cylinder upgrade kit contains all of the hardware to repair/upgrade your Baron brake master cylinder. Additionally, the kit also includes tooling to aid in the re-assembly. The piston rod seal (Thorseal®) provided is a Marsh Brothers Aviation proprietary lip seal design and is manufactured from a proprietary elastomeric polymer. The Marsh Brothers Aviation Thorseal® replaces both the OEM O-ring and rod wiper. The kit also includes installation instructions, instructions for continuing airworthiness and an authorized release certificate. P/N 05-26909 .....**\$122.00**

### PIPER PA32 / PA44 SERIES BRAKE MASTER CYLINDER SERVICE KIT



TCBM-PA32 brake master cylinder kit for the Piper PA28 and PA32 series with the Cleveland 10-30 / 455-968 master cylinder. P/N 04-04069 .....**\$30.65**

## BEECH BRAKE MASTER CYLINDER UPGRADE/ REPAIR KIT FOR KING AIR / 1900 / MODEL 99

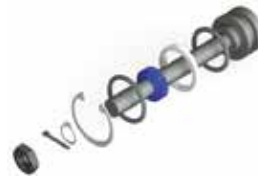

Marsh Brothers' Brake Master Cylinder upgrade & repair kit is a proactive solution that will eliminate the risk of failure due to leaks at the piston rod seal. By eliminating typical O-ring failure modes, this upgrade kit will increase mean time between unscheduled maintenance events keeping your aircraft in the air longer, while reducing maintenance costs associated with your brake master cylinder.

Installation of the Marsh Brothers brake master piston rod seal offers the opportunity to practice preventative maintenance, by eliminating the risks associated with the typical failure modes of traditional O-rings used in dynamic seal applications.

Kit contains all of the hardware to repair/upgrade your King Air brake master cylinder. Additionally, the kit also includes tooling to aid in the re-assembly. The piston rod seal (AeroLas™-Flex) provided is a Marsh Brothers Aviation proprietary lip seal design and is manufactured from a proprietary elastomeric polymer. Thorseal® replaces both the OEM O-ring and rod wiper. The kit also includes installation instructions, instructions for continuing airworthiness and an authorized release certificate.

**Note:** The Piston is not included in this kit.

**Caution:** Thorseal® is made from AeroLas™-Flex. AeroLas™-Flex is not compatible with phosphate ester hydraulic fluid, commercially known as Skydrol. Exposure to phosphate ester hydraulic fluid contamination will damage the seals.

**Features:** • Applicable to OEM P/N 90-380001-23, 90-380001-29, 90-380001-33 series brake master cylinders. • Piston Rod Lip Seal eliminates risk of typical failure modes associated with traditional O-rings used in dynamic applications. • The proprietary elastomeric polymer offers improved lower pressure sealing performance and overall cold weather performance. • Installation Tooling included - Seal compression ring, thread sleeve, and push tube. • Delivery documentation includes copies of all STC certificates and a Transport Canada Form One (authorized release certificate) to keep your logbook up-to-date. P/N 05-26910 .....**\$173.00**

## CIRRUS PIPER / MOONEY CLEVELAND BRAKE MASTER CYLINDER UPGRADE /REPAIR KIT



**Note:** The Piston is not included in this kit.

The Marsh Brothers Aviation Cirrus (Aerostar / Mooney) Cleveland Brake Master Cylinder upgrade kit contains all of the hardware to repair/upgrade your Mooney Cleveland Brake Master Cylinder. Additionally, the kit also includes tooling to aid in the re-assembly. The piston rod seal (AeroLas™-Flex) provided is a Marsh Brothers Aviation proprietary lip seal design and is manufactured from a proprietary elastomeric polymer. AeroLas™-Flex replaces both the OEM O-ring and rod wiper. The kit also includes installation instructions, instructions for continuing airworthiness and an authorized release certificate.

**Caution:**

Piston Rod Lip seal is made from Marsh Brothers proprietary material known as AeroLas™-Flex. AeroLas™-Flex is not compatible with phosphate ester hydraulic fluid, commercially known as Skydrol. Exposure to phosphate ester hydraulic fluid contamination will damage the seals.....P/N 05-27283 .....**\$198.00**

### PIPER PA28 / PA32 SERIES HAND BRAKE MASTER CYLINDER KIT



TCBM-PA28 brake master cylinder kit for the Piper PA28 and PA32 series with the Cleveland 10-22 / 455-938 master cylinder. P/N 04-04043 .....**\$36.50**

### PIPER PA28 / PA32 / PA44-180 SERIES GAR-KENYON BRAKE MASTER CYLINDER KIT



Gar Kenyon 17000 TCBM-17000 brake master cylinder kit for the Piper PA28 and other models with the 17000 / 455-944 master cylinder. P/N 04-04044 .....**\$32.50**

LG

# BRAKE RESERVOIRS - BRAKE BLEEDERS

## CLEVELAND BRAKE LINE BLEEDER 87-5



A unique tool which simplifies the brake bleeding job. This brake line bleeder can be used to service all brake assemblies utilizing the bleeder screw assembly pictured above.....P/N 06-01202.....**\$279.95**

## ACS BRAKE BLEEDER ASSEMBLY

Universal brake bleeder fitting. Fits all standard brake systems. 1/8" male NPT Seat is brass. Bleeder screw is stainless steel. P/N 11225.....**\$16.50 Ea.**

## HYDRAULIC BRAKE BLEEDER TANK

This Deluxe Brake Bleeder Tank has been completely redesigned to resist the solvent effects of most types of aviation brake fluids. The high-impact plastic reservoir and specialized seals are compatible with 5606 and Skydrol. The hand operated pressurizing pump has also been totally re-engineered to deliver more pressure with fewer strokes. Includes a Cleveland adapter and the universal adapter which will fit most brake receptacles. 12 lbs (5.5Kg) shipping weight.225DX

Economy Bleeder Tank.....P/N 06-11413-1.....**\$109.95**  
Option Adapter for Brake Bleeder.....P/N 06-11414.....**\$29.90**

## HOMEBUILDERS BRAKE BLEEDER

Quickly and easily bleed and flush your brakes without the aid of another person. By using a reverse flow system, combined with slow fluid flow, one person can fill an empty brake system in less than 15 minutes without having air in the brakes. This is a gravity fed brake bleeder and does not require compressed air. This system is so easy that once you start the process you can walk away; come back in 15 minutes later and the job is done. Commonly used for Cleveland & Matco brakes. Not FAA approved.....P/N 06-00120.....**\$87.75**

## BRAKE BLEED VALVES FOR CLEVELAND & MCCAULEY WHEELS



The bleeder valves consist of a bleeder needle, bleeder seat, needle cap, and in some cases an O-ring. Bleeder seats are precision manufactured from stainless steel for corrosion resistance, and cadmium plated to prevent galvanic corrosion with the magnesium housing. The bleeder needle is made from strong, heat treated 17-4 stainless steel. Two kits are required per aircraft. FAA Approved.

Model	Part No.	Price
MCBB-KT-1: (1) Bleeder Seat 081-00100, (1) Bleeder Needle 079-00300, (1) Needle Cap 183-00100	05-06974	<b>\$42.65</b>
MCBB-KT-2: (1) Bleeder Seat 081-00200, (1) Bleeder Needle 079-00300, (1) Needle Cap 183-00100, (1) O-Ring MS28775-012	05-06975	<b>\$59.75</b>
MCBB-KT-3: (1) Bleeder Seat 081-00500, (1) Bleeder Needle 079-00300, (1) Needle Cap 183-00100, (1) O-Ring MS28775-011	05-06976	<b>\$74.75</b>
MCBB-KT-4: (1) Bleeder Seat 081-00600, (1) Bleeder Needle 079-00300, (1) Needle Cap 183-00100, (1) O-Ring NAS1612-4A	05-06977	<b>\$87.75</b>
MCBB-KT-5: (1) Bleeder Seat 081-30169, (1) Bleeder Needle 079-00300, (1) Needle Cap 183-00100, (1) O-Ring MS28775-011	05-06978	<b>\$115.75</b>

## BLEEDER SCREW PLUG



Steel set screw with nylon flat point 1/4-28x3/8" Bleeder screw plug.....P/N 06-01674.....**\$2.40**

## 90 DEG COMPRESSION FITTING



90° Compression fitting 1/8" NPT x 1/8" Tube. P/N 06-01673.....**\$24.50**

## ACS MODEL A-315 RESERVOIR



Machined from 6061-T6 billet and anodized for improved corrosion resistance. Available with choice of filler port location for firewall or floor mounting. Capacity 5 oz. Size: 2-1/4" dia. x 2-1/2" long. Wt: 7oz. Specify style.  
Firewall Mounting.....P/N A-315.....**\$75.75**  
Floor Mounting.....P/N A-315-1.....**\$43.50**

## ACS MODEL A-600 RESERVOIR



Machined from 6061T6 billet. Cap is threaded into body and sealed with a Viton o-ring for easy filling and cleaning. Cap and body have 1/8" female threads. 1-3/8" dia. x 2-3/8" high. Capacity 1.8 oz. Can be threaded directly into master cylinder port. Two units required on most installations (one per master cylinder). Supplied with vented plug in cap and 1/8" NPT male fitting in body....P/N 06-00391.....**\$35.75 ea.**

## ACS MODEL A-650 RESERVOIR



Machined from 6061 T6 billet and anodized for improved corrosion resistance. Attaching bracket is included for firewall or other installation. Extra capacity of 70 ml. Supplied with vented plug in cap and outlet has a female 1/8 NPT thread." P/N 06-01480.....**\$39.65**

## PETRO BRAKE BLEEDER



Clean and test carburetors and more. Bleed power steering systems. Bleed aircraft brakes. Pressure test fuel systems to 100 psi. Reverse, pressure, and vacuum bleed. Test automatic transmissions. Test pressure and vacuum sensors. Patented. Use for all petroleum fluids. **NOT for automotive brake fluid!**.....P/N 12-03214.....**\$179.99**



## MATCO BRAKE BLEEDER VALVE ASSEMBLY

Matco brake bleeder valve assembly MSCBBS(S)S. Latest generation bleeder assembly provides a seal and wrenching feature for either US or metric sizes.....P/N 06-02801.....**\$25.80**

## MATCO BRAKE FLUID RESERVOIR



This brake fluid reservoir from Matco features a clear plastic bowl for easy inspection of reservoir fluid. Furnished with pre-drilled aluminum flange for easy mounting. Small and compact, this reservoir mounts almost anywhere. Temperature limit is 250°F

Reservoir only.....P/N 06-11225.....**\$47.85**  
Reservoir Kit (includes reservoir, tubing, & fittings for installation) P/N 06-11230.....**\$71.75**

## MATCO MCR-100A AEROBATIC REMOTE RESEVOIR



This Remote Reservoir is designed for both aerobatic or nonaerobatic flight and includes mount bracket, cap, check valve, and bowl. Reservoir has approximately 2 oz. volume and has valve incorporated for checked flow to the vent when inverted or negative g's. Reservoir includes 1/8 NPT adapter fitting and seal for connection to poly bowl and easy open top.....P/N 06-01662.....**\$77.75**

## GROVE BRAKE FLUID RESERVOIRS



**067-050** - Grove remote reservoirs are quality machined from 6061 billet. Top is held in place with a snap ring with O-ring seal. Supplied with vented 1/8" NPT cap plug. Anodized for corrosion resistance. Normal installation requires two (one for each master cylinder). Supplied with 1/8" NPT Fitting. Attaches directly to the master cylinder. Holds 1.10 fluid ounces. 1.98" High. 1.38" Dia. 1.5 oz P/N 06-00818.....**\$59.80**



**067-067** - Grove remote reservoirs are quality machined from 6061 billet. Top is held in place with a snap ring with O-ring seal. Supplied with vented 1/8" NPT cap plug. Anodized for corrosion resistance. Attaches to firewall or other remote location with integral 10-32 tapped holes. 1/8" Female NPT thread at side of reservoir and hold 3.25 fluid ounces. 2.63" High. 2.00" Dia. 3.3 oz.....P/N 06-01744.....**\$83.75**



**067-054** - Grove remote reservoirs are quality machined from 6061 billet. Top is held in place with a snap ring with O-ring seal. Supplied with vented 1/8" NPT cap plug. Anodized for corrosion resistance. Attaches to firewall or other remote location. Adequate capacity to serve both master cylinders. 1/8" Female NPT thread at bottom of reservoir and hold 3.6 fluid ounces. 2.75" High. 1.75" Dia. 3.6 oz P/N 06-00819.....**\$74.85**



**067-065** - Grove remote reservoirs are quality machined from 6061 billet. Top is held in place with a snap ring with O-ring seal. Supplied with vented 1/8" NPT cap plug. Anodized for corrosion resistance. Attaches to firewall or other remote location with integral 10-32 tapped holes. 1/8" Female NPT thread at bottom of reservoir and hold 3.38 fluid ounces. 2.75" High. 2.00" Dia. 3.3 oz. P/N 06-01743.....**\$79.00**

## BERINGER PARKING BRAKE VALVE



Lightweight parking brake valve, aluminum anodized, fully CNC machined, for dual brake installations. Available for mineral-based fluid type MIL-H-5606 or DOT4 brake fluid. Complete with fittings, Wt. 6 oz.

Max. operating pressure: 1450 PSI

**Features:** • Lightweight parking brake valve, Aluminum anodized • Available for mineral-based fluid like MIL-5606 or synthetic DOT4 fluid • Machined from billet on CNC • Max. input pressure: 1450 PSI

Description	Part No.	Price
Beringer parking brake valve for DOT4 brake fluid, dash-3 fittings (3/8X24), red anodizing color.	06-01107	<b>\$416.00</b>
Beringer parking brake valve for mineral-based fluid MIL-H-5606, dash-4 fittings (7/16x20), blue anodizing color.	06-01108	<b>\$416.00</b>

LG

# BRAKE FLUID – BRAKE VALVES

## AEROSHELL 41 MIL-PRF-5606H HYDRAULIC FLUID



Mineral oil based "super clean" hydraulic fluid for use with brake and hydraulic systems with synthetic rubber seals. Meets specifications MIL-PRF-5606H. Colored red. Note: Containers are cans and are non-resealable. For reduced pricing on large volume orders, please contact sales.

Quart.....P/N 09-27000-QT .....**\$12.65**  
 Case of 24 Quarts.....P/N 09-27000-1 .....**\$299.00**  
 Gallon.....P/N 09-27100 .....**\$44.50**  
 Case of 6 Gallons.....P/N 09-27100-2 .....**\$283.00**  
 55 Gallon.....P/N 09-27100-55 .....**\$2,495.00**

## AEROSHELL 41 HYDRAULIC FLUID MIL-H-5606A



MIL-H-5606A Mineral oil based hydraulic fluid for use with brake and hydraulic systems with synthetic rubber seals. Colored red.

Pint with screw cap.....P/N 09-27110 .....**\$5.95**  
 Quart with screw cap.....P/N 09-27000 .....**\$10.95**

## AEROSHELL 31 MIL-PRF-83282D HYDRAULIC FLUID



A synthetic hydrocarbon hydraulic fluid with greatly improved fire resistance characteristics when compared with conventional petroleum products. Specially developed base stock that provides a relatively high flash point, excellent low temperature properties, and good oxidation and thermal stability. In addition, additives are incorporated to further enhance stability and lubricity.

Gallon.....P/N 08-14635-1 .....**\$77.85**  
 Case of 6 Gallons.....P/N 08-14635 .....**\$456.00**

## PHILLIPS 66 X/C MIL-PRF-5606H HYDRAULIC FLUID



A mineral-based hydraulic oil with low temperature characteristics capable of operating over a wide range of temperatures. Can be used in both aviation and non-aviation systems with synthetic rubber components, but should not be used in systems that incorporate natural rubber.

Quart.....P/N 09-00774 .....**\$11.80**  
 Case of 24 Quarts.....P/N 09-00773 .....**\$226.00**  
 Gallon.....P/N 08-13851-1 .....**\$44.00**  
 Case of 6 Gallons.....P/N 08-13851 .....**\$243.00**  
 55 Gallon Drum.....P/N 08-13852 .....**\$1,798.00**

## ANDEROL ROYCO 756 HYDRAULIC FLUID



MIL-PRF-5606H - ROYCO 756 is a red-dyed, mineral oil based hydraulic fluid developed for the severe duty demands of aerospace and industrial service. USES: ROYCO 756 is designed for use in aircraft, missiles, auto pilots, shock absorbers, cherry pickers, boom trucks, robotics, and auto wreckers requiring all-weather performance. ROYCO 756 can be used in unpressurized systems operating at temperature ranges from -54 to 90°C (-65 to 195°F) and in pressurized systems from -54 to 135°C (-65 to 275°F) at pressures up to 3000 p.s.i.

Size	Part No.	Price	Size	Part No.	Price
Quart	08-12080-1	<b>\$18.50</b>	Case of Quarts	08-12080	<b>\$418.00</b>
Gallon	08-12119-1	<b>\$99.75</b>	Case of Gallons	08-12119	<b>\$599.00</b>
5 Gallon	08-12121	<b>\$367.00</b>	55 Gallons	08-15970	<b>\$2,210.00</b>

## DOT4 BRAKE FLUID



The racing grade has a minimum boiling point of 600°F which assures fade-free operation under the most severe use • Exceeds current SAE J1703, J1S K2233 and U.S. and FMVSS116 DOT 3 & 4 specifications • Recommended for all U.S., U.K., Japanese and European motor cycles • Anti-vapor lock formula • Mixes with other DOT 3 and DOT 4 brake fluids.....P/N 06-01497 .....**\$11.50**

## SKYDROL LOW DENSITY HYDRAULIC FLUID LD-4



Skydrol LD-4 features low density, excellent thermal stability, valve erosion prevention, and deposit control.

Quart.....P/N 08-12239 .....**\$49.95**  
 Gallon.....P/N 08-12241 .....**\$185.75**  
 5 Gallon.....P/N 08-12240 .....**\$837.00**

## SKYDROL FIRE RESISTANT HYDRAULIC FLUID



500B-4 is the most worker friendly of the aviation phosphate esters; it is least irritating to skin and less prone to form mists. Quart.....P/N 08-12463 .....**\$52.80**



## SKYDROL TYPE V HYDRAULIC FLUID

Skydrol 5 offers higher temperature capability than Type IV fluids, the lowest density, and better paint compatibility.

Quart.....P/N 08-12242 .....**\$49.85**



## SKYDROL HYDRAULIC ANALYSIS KIT

Skydrol Hydraulic Test Kit. Testing includes chlorine content, elemental contamination, Karl Fisher water, specific gravity, total acid number, viscosity, particle count, and wear metals....P/N 08-13479 .....**\$322.00**



## MATCO PARKING BRAKE VALVE

Ideal for installation in a wide variety of homebuilt aircraft applications. The arm actuates the valve in approximately a 45 degree arc allowing for ease of installation. In-line installation can be used in conjunction with either a single or dual parking brake system setup. Body is made from 6061 anodized aluminum for lasting durability.....P/N 06-17200 .....**\$209.95**



## MATCO SINGLE SIDED PARKING BRAKE VALVE

Light weight, and easy in-line installation The overall dimensions of this product are a slim 2.3" X 0.75" X 0.75". P/N 06-01267 .....**\$159.75**

## SCOTT TYPE PARKING 4500-A1 BRAKE VALVES



A fine quality valve for applications in parking brake systems, helicopter rotor braking systems, pneumatic pressure controls and other hydraulic uses. Molded rubber valve seat designed for use with MIL-H-5606BB petroleum base hydraulic fluid. Maximum working pressure. Mounting holes extend through entire body. 1/8" NPT ports. Valve assembly for Piper and Stinson. Visit our website for a complete application guide.

Model No.	Port A / Port B	Part No.	Price
4500-A1	1/8 ANPT	06-00393	<b>\$510.00</b>
4500S-A1	7/16-20 NF	06-00949	<b>\$515.00</b>

## MANUAL PARKING BRAKE VALVE



Miniature inline hydraulic manually operated ball valve. Fits in the bottom of the Master cylinder. Just pull the brake handle and hold the pressure and turn the lever on the ball valve. Let go of the handle and the ball valve holds the pressure until you release the lever back. 1/8"NPT Female x 1/8"NPT Male Chrome Plated Brass Valve 1.7" overall length.

P/N 06-00971 .....**\$19.95**

## CLEVELAND PARKING BRAKE VALVE



Aluminum valve as used in production aircraft with Model A-110 master cylinders for dual brake installations. Complete w/AN flare fittings.

P/N 60-5 .....**\$1,011.00**

## GROVE INLINE PARKING BRAKE VALVE



Innovative design allows control lever to be attached in any of four positions as well as on either side of valve body. Internal poppet valves insure easy, secure operation. Body is drilled for mounting with two 3/16" bolts. Valve body dimensions: 1.5"x2.0"x0.75". Control arm has 45° of travel. Max operating pressure: 1,200 psi. For use with MIL-H-5606 Hydraulic Fluid. Weight: 0.32 lbs. Side or top inlet ports: 1/8"NPT \* Outlet ports: 1/8" Female NPT or -4 Flare.

Part No.	Inlet	Outlet	Price
06-01260	Top	1/8" NPT	<b>\$388.00</b>
06-01261	Side	1/8" NPT	<b>\$388.00</b>
06-01262	Top	-4 Flare	<b>\$398.00</b>
06-01263	Side	-4 Flare	<b>\$388.00</b>

## BRAKE BLEEDER COUPLER



This adapter will couple firmly to the 079-00300 (FC-6446) type bleeder screw used in Cleveland and Matco brake systems so that you can properly bleed and charge the aircraft's brake lines and cylinder. The other end connects to any hose having a 1/4 NPT male thread. It will work with all bleeder tanks (such as our model 225 Economy Bleeder Tank) or other pressurized fluid systems. It locks firmly in place around the nipple and forms a high pressure seal, so there is absolutely no chance of leaking fluid.

P/N 12-05623 .....**\$32.85**



# STRUT SEAL KITS

## TRIMCRAFT STRUT SEAL KITS FOR CESSNA



Cessna Nose Strut Seal Kit Fits: 150, 152, 172, 172RG, 175, 182, R182, 205, 206, 210, P210, T210, 310 - 3500 thru 310Q thru 1160, 320, 336, and 337.....P/N 04-03468 .....**\$19.85**

## TRIMCRAFT STRUT SEAL KITS FOR PIPER



LG

Kits contain Mil-Spec & Industry Standard Seals and Components required for various Piper Strut application. Seal kit for nose or main strut for Piper Apache/Aztec.....P/N 06-00126 .....**\$21.75**  
 Strut seal kit for Piper PA-24 main gear .....P/N 06-00127 .....**\$19.85**  
 Strut seal kit for Piper PA24 nose gear.....P/N 06-00128 .....**\$19.85**  
 Strut seal kit for Piper PA30 main gear.....P/N 06-00129 .....**\$25.85**  
 Strut seal kit for Piper PA30 nose gear.....P/N 06-00130 .....**\$25.50**  
 Main Strut seal kit for Piper PA28 140, 150, 151, 160, 161, 180, 181, 235, & PA32-260, 300.....P/N 06-03975 .....**\$19.95**  
 Nose strut seal kit for PA28-140, 150, 151, 160, 161,180, 181, 235, & PA32-260, 300 .....P/N 06-03965 .....**\$19.95**  
 Main strut seal kit for PA28R & PA32R-300, 301, 301T, & PA32RT-300, 300T .....P/N 06-03980 .....**\$18.70**  
 Nose strut seal kit for PA28R & PA32R-300, 301, 301T, & PA32RT-300.....P/N 06-03970 .....**\$19.85**  
 Nose strut seal kit for PA PA22 Series .....P/N 06-01370 .....**\$14.95**  
 Piper PA34 Strut Seal Kit for main or nose for Seneca I, Seneca II & Seminole 180/180T .....P/N 05-03603 .....**\$18.65**

## TRIMCRAFT STRUT SEAL KITS FOR BEECHCRAFT

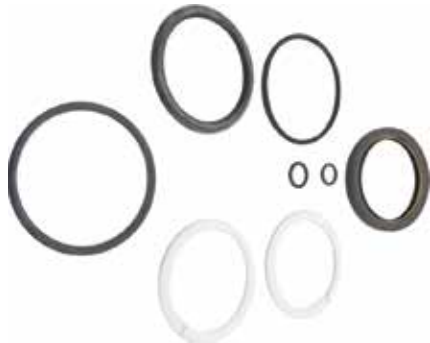

Main strut seal kit for Beechcraft, fits B-33, F-33, V-35B, & 36, A36, G-36, A36TC, B36TC (s/n A0001 thru A9999 & E0001 thru E9999) .....P/N 06-02802 .....**\$39.95**  
 Nose Strut Seal Kit for Beechcraft.....P/N 06-02803 .....**\$35.75**  
**Note:** These kits may fit other models. It DOES NOT fit earlier model Bonanza & Debonair.  
 Main Strut Seal Kit. Kit contains Mil-Spec & Industry Standard Seals and Components required for Beech 55 Strut application. ....P/N 05-12280 .....**\$38.70**



## J & M CESSNA NOSE STRUTS

For Cessna models 150, 152, 172, 175, 182, R182, 205, 206, 210, T210, P210, 310-310Q, 320, 336, & 337.  
**Includes:** 5 O-Rings, 2 Back-Up Rings, Scraper Ring .....P/N 06-03960 .....**\$28.95**



## J&M PIPER STRUT SEAL KITS FOR PIPER

Kits contain Mil-Spec & Industry Standard Seals and Components required for various Piper Strut application.

Description	Part No.	Price
PA23 Nose or Main Strut Seal Kit for Apache or Aztec Kit includes seals for one strut	05-22254	<b>\$13.50</b>
PA24 Main Strut Seal Kit for 180 & 250 Commanche	05-22255	<b>\$13.95</b>
PA24 Nose Strut Seal Kit for 180 & 250 Commanche	05-22256	<b>\$15.50</b>
PA30 & PA39 Main Strut Seal Kit for Twin Commanche	05-22257	<b>\$12.95</b>
PA30 & PA39 Nose Strut Seal Kit for Twin Commanche	05-22258	<b>\$15.90</b>
PA28 & PA32 Main Strut Seal Kit for 140, 150, 151, 160, 161, 180, 181, 235 & PA32-260, 300	05-22259	<b>\$29.50</b>
PA28 & PA32 Nose Strut Seal Kit for 140, 150, 151, 160, 161, 180, 181, 235 & PA32-260, 300	05-22260	<b>\$14.75</b>
Main Strut Seal Kit for PA28R & PA32R-300, 301, 301T & PA32RT-300, 300T	05-22261	<b>\$15.75</b>
Nose Strut Seal Kit for PA28R & PA32R-300, 301, 301T & PA32RT-300, 300T	05-22262	<b>\$15.85</b>
PA22 Nose Strut Seal Kit for Colt & Tri-Pacer SN: 22-1 thru 22-7642 & 22-8000 thru 22-9000	05-22263	<b>\$15.65</b>
PA34 Strut Seal Kit for main or nose for Seneca I, Seneca II & Seminole 180/180T	05-22264	<b>\$13.80</b>



## J&M STRUT SEAL KITS FOR BEECHCRAFT

Description	Part No.	Price
Main strut seal kit, fits B-33, F-33, V-35B, & 36, A36, G-36, A36TC, B36TC (s/n A0001 thru A9999 & E0001 thru E9999)	05-22266	<b>\$38.50</b>
Nose Strut Seal Kit for Beechcraft	05-22267	<b>\$38.50</b>



## MCFARLANE CESSNA NOSE STRUT SEAL KIT

Australian Nose Strut Seal Kit Solves the Problem! FAA-PMA. Features a double edge ("X" style) seal that will not twist and leak. It solves the continuous leak and re-service problems with the Cessna nose strut, allowing you to go years without servicing.  
 • FAA-PMA direct replacement for Cessna P/N SK172-1F • Also includes AN901-5A gasket • Improved lock rings are made of 304 stainless steel for better corrosion resistance .....P/N 05-03602 .....**\$72.90**  
 Quad Ring 1100 .....P/N 05-22285 .....**\$69.95**



## GRANVILLE'S STRUT SEAL

Landing gear strut packing seals shrink due to fluctuating weather conditions and age. This specially engineered hydraulic chemical additive leaves a protective coating on the strut shaft and allows the seal to expand to its normal size. It will stop strut leaks and is an excellent lubricant and corrosion preventative. Application is fast and easy - any owner or pilot can do the job in minutes. FAA approved.  
 Single-Strut Kit .....P/N 06-13300 .....**\$56.80**  
 3-Strut Kit (Single Engine).....P/N 06-13400 .....**\$98.75**  
 3-Strut Kit (Medium Twins).....P/N 06-13500 .....**\$122.95**  
 Large Twin kit (16 oz).....P/N 06-00110 .....**\$149.95**  
 Granville Strut Additive (Pt.).....P/N 06-00111 .....**\$132.75**  
 Granville Strut Additive (Quart).....P/N 06-03048 .....**\$193.75**  
 Granville Strut Additive (1/2 Gallon) .....P/N 06-03049 .....**\$355.00**  
 Granville Strut Additive (Gallon) .....P/N 06-03050 .....**\$645.00**



# AXLES

## HOMEBUILDERS MAIN GEAR AXLES ACS AXLES - BOLT-ON TYPE



**500X5 AXLE** - Machined from 2024T3 aluminum. Gold anodized per specification MIL-A-8625C, Type II for improved corrosion resistance. Length 5-3/4". Mounting bolt pattern is four equally spaced 1/4" dia. holes on 1-15/16" dia. bolt circle. Thread size: 1-1/4 x 16.

P/N 11701..... **\$89.75 Ea.**

**500X5 AXLE** - For 199-152 heavy duty discs (as used in Cozy). Same as #11701 axles above except 6" long and without undercut between bearings.....P/N 11701-2 .....**\$95.75**

**SPACERS FOR 500 X 5 AXLE** - 2 required per axle when used with Cleveland wheels. Not required on 600x6 size.

P/N 11716..... **\$9.99 Ea.**

**EXTRA WIDE SPACER FOR 500X5 AXLE** - 7/16" wide as used on 199-152 heavy duty discs. 1 required per axle with P/N 11716 (Use Axle # 11701-2) .....P/N 11716-2 ..... **\$7.95 Ea.**

## ACS AXLES - WELD-ON TYPE

**500 X 5 AXLE** - For use on welded type gear. Fabricated from 1-1/4" O.D. x .120 wall 4130N steel tubing. Precision ground for proper bearing fit. One end threaded 1-1/4 x 12 for round axle nut. 12" long.

P/N 11703-1 ..... **\$48.95 Ea.**

**600 X 6 AXLE** - For use on welded type gear. Fabricated from 1-1/2" O.D. x .120 wall 4130N steel tubing. Precision ground for proper bearing fit. One end threaded 1-1/2 x 16 for round axle nut. 12" long.

P/N 11704-1 ..... **\$55.75 Ea.**



06-11800  
06-11900

## AXLE NUTS

Castle type nuts manufactured to MIL Specification MS21025 using 4140 steel. Mild steel nuts are not acceptable for use on certificated aircraft. 1-1/4" dia. nuts for 500 x 5 axles, 1-1/2" dia. nuts for 600 x 6 axles.

Nut Type	Thread	Axle Type	Part No.	Price
Matco	Castle	5/8-18	Matco 06-11815	<b>\$4.35</b>
---	Castle	1-1/4-16	Cessna 06-11800	<b>\$17.75</b>
---	Castle	1-1/2-16	Cessna 06-11900	<b>\$14.50</b>
ACS	Round	1-1/4-12	Piper 11725	<b>\$18.70</b>
ACS	Round	1-1/2-16	Piper 11726	<b>\$18.70</b>
Grove	Round	1-1/4-12	Piper 06-00937	<b>\$41.75</b>

## TAPER SHIMS

For wheel alignment. Ideal setting is zero toe-in and zero camber at normal operating weight. Shims may be rotated to any one of four positions to obtain desired result.



0441157-1

Axle Size	Shim Part No.	Approx. correction value		Price Each
		Camber	Toe-In	
500x5	0441157-1	1/2°	0.06"	<b>\$71.75</b>
	0441157-3	1°	0.12"	<b>\$47.50</b>
	0441157-2	2°	0.006"	<b>\$135.95</b>
600x6	0441139-5	1/2°	0.12"	<b>\$153.75</b>
	0441139-6	1°	0.20-0.25"	<b>\$103.75</b>
	0541111-2	2-1/2°	0.10-0.25"	<b>\$300.95</b>

## AXLE WITH WOODRUFF KEY



Axle 5/8" x 8" with Woodruff Key (Cotter Pin hole) .....P/N 06-01004 .....**\$39.50**

## GROVE AXLES

For 500X5 Wheels with Wheel Pant Stub  
• Diameter: 1.25" • Material: Solid 2024-T3 aluminum w/anodized finish • Hole Pattern: 1-15/16" bolt circle; 1/4" dia. holes. Requires (2) P/N5710 spacers per axle.

P/N 06-00601 .....**\$114.75**



For 600X6 Wheels with Wheel Pant Stub  
• Diameter: 1.5" • Material: Solid 2024-T3 aluminum w/anodized finish • Hole Pattern: 2.25" bolt circle; (2) 2-15/16" dia. bolt holes & (2) 2-3/8" dia. bolt holes.

P/N 06-00602...**\$139.75**



## GROVE AXLE SPACER 5712

I.D.: 1.25", O.D.: 1.438", Thickness: 0.360", Used with 5015 axle, 1 (one) required per axle.

P/N 06-01504 .....**\$7.50**



## GROVE AXLE SPACER 5710

I.D.: 1-1/4" • O.D.: 1-3/4", Thickness: 1/4", Used with 500x5 axle, 2 required per axle .....P/N 06-00852 .....**\$7.50**



## GROVE ALUMINUM WHEEL PANT AXLE NUTS



Model	Axle	Thread	Part No.	Price
5512	500x5	1-1/4x16	06-01677	<b>\$41.50</b>
5513	600x6	1-1/2x16	06-01678	<b>\$46.60</b>
--	400x4	3/4x16	06-01742	<b>\$37.90</b>

## CESSNA MAIN GEAR AXLE

For use on flat spring landing gear, Cessna models 180, 182, 185 and 206. It is highly recommended to replace aluminum axles with these much stronger steel axles when operating on rough conditions, with larger wheels or on skis. FAA-PMA approved.

Steel .....P/N 05-00481 .....**\$463.00**  
Titanium.....P/N 05-12478 .....**\$1,502.00**



## GROVE HOMEBUILT AIRCRAFT LANDING GEAR

These custom landing gear are fabricated from aircraft grade 2024T3 aluminum. After cutting and milling, they are annealed to "O" condition for bending, and then heat-treated to "T6" condition for exceptional strength and durability. Top quality landing gear at exceptional pricing.

Aircraft Type	Part No.	Price
KITFOX - Mod 3&4 TD	06-04025	<b>\$2,599.00</b>
PITTS - S1	06-03915	<b>\$2,119.00</b>
S1-11B SuperStinker	06-04035	<b>\$2,519.00</b>
Baby Lakes	06-04070	<b>\$1,839.00</b>
VP1 - 1100B Free Standing No Cables	06-04040	<b>\$1,809.00</b>
Zenair CH701	06-00058	<b>\$1,896.00</b>

NOTE: Request landing gear layout sheet when placing order or quotation Request for custom landing gear to verify correct gear for application.

**NOTE: ALL GROVE AIRCRAFT LANDING GEAR IS  
NON-CANCELLABLE / NON-RETURNABLE.**

# RUDDER PEDALS

## ACS RUDDER PEDALS



Professionally made black powder coated aluminum pedals as used in production aircraft. Approved by Rutan Aircraft Factory for use on the Defiant. 5"W x 6"L. Wt. 3/4 lb. ea. P/N 06-00392.. **\$104.75 Pr.**  
**Discount Less 10% on 6 Pr.,**  
**15% on 12 Pr., 20% on 20 Pr.**

## ACS RUDDER PEDAL/ TOE BRAKE ASSEMBLY



For use with any standard master brake cylinders. 2-piece design. Completely finished, assembled, ready for installation. Wt. 2 lbs. each. Set of 2 .....P/N 11350 .....**\$97.75**  
**Discount Less 10% on 6 Pr.**  
**15% on 12 Pr., 20% on 20 Pr.**

## AZUSA STEEL PEDAL SET



This rugged pedal set (left & right) features built-in stops, (4) 1/4" pre-drilled holes to allow adjustable rod connections and a 5/16"-18 x 1-3/4" long mounting bolt. W t 7oz. ea. length 6.5' .....P/N 06-00107 ... **\$18.50 /set**

## RUDDER PEDAL RETURN SPRINGS



4-1/2" Long

P/N 01-27300 ..... **\$6.50 ea.**

## DELUXE HOMEBUILDERS / RUDDER PEDAL KITS



Designed for single or two place tandem seating experimental aircraft. The pedals are aluminum castings and the hinge bracket and pedal pivot pin are constructed from 4130 steel tubing. The pedals have an attachment point (1/4" hole) at the top to link the toe brake from the rear cockpit to the front cockpit only 2 master cylinders required). To mount the pedals the builder will need 2 steel bushings 3/4" long to weld through the fuselage and a tube to put through the bushings and the bottom tube of the hinge bracket. Will work well in almost any homebuilt aircraft. Single Place Kit .....P/N 06-17015 .....**\$396.00**  
 Two Place Tandem Kit.....P/N 06-17025 .....**\$485.00**

## VANS RV RUDDER PEDAL EXTENSIONS

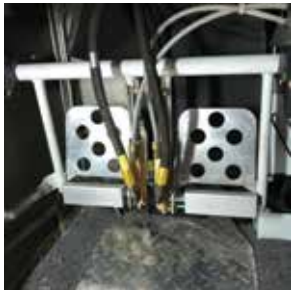

These very high-quality parts add considerable structure, feel and comfort to the Vans Rudder pedals. Pedals are cut from very strong and tough, type 6061 T-6 high tensile aircraft grade aluminum extrusion, with a very durable clear anodized finish. Pedals measure 4.5" X 1.5" X .75", are very light, 5 oz. each, feature simple and easy installation with only one bolt, and are very inexpensive as well.

Model	Part Number	Price	Model	Part Number	Price
RV6	05-21798	<b>\$39.00</b>	RV9	05-21802	<b>\$39.95</b>
RV7	05-21799	<b>\$39.95</b>	RV10	05-21803	<b>\$42.75</b>
RV8	05-21801	<b>\$39.00</b>	RV14	05-21804	<b>\$39.00</b>

## RUDDER ARMS

### SCOTT TYPE



Scott Type Rudder Arm. Cast aluminum brackets with reinforced chain mounting holes. 3/4" diameter post between mounting holes. FAA/PMA'd P/N 1140.....**\$209.00**

### HOMEBUILDERS MODEL



Home style as Scott model. 3/4" dia. post and 3/4" arm (width) FAA/PMA'd.....P/N 06-15900 .....**\$49.95**

### RUDDER ARM 1" SHANK



Originally designed for J-3 through PA-18 series, but adapts nicely to most homebuilts. Code 1.....P/N 06-01045 .....**\$49.95**

### SCOTT TYPE TAILWHEEL ARM ASSEMBLY



FAA/PMA approved; for the Scott 3250 8-inch tailwheel assembly. P/N 3214T .....**\$395.00**

### HOMEBUILDERS TAIL SKID



The skid is 1" wide and 6" long. It is made out of 3/16" thick 347 Stainless Steel. It will accept up to a 1-3/4" O.D. 3/8" thread tie down ring. This skid will eliminate bending of the tie down ring and damage to the tail. This a must have for training aircraft. The skid is currently mounted on several experimental and certified aircraft .....P/N 05-04383 .....**\$70.75**

### CESSNA 120 / 140-140A TAILWHEEL BRACKET



FAA/PMA Approved for Cessna 120, 140, & 140A. Cessna ID 0412139-1. P/N 05-06994 .....**\$1,094.00**

### SCOTT TYPE BRAKE BRACKET - RH



These economical brake brackets fit the popular Scott brake master cylinders and are cast from 356-6 aluminum. These brackets are not PMA'd and are recommended for experimental aircraft only. Scott Type 1220 Brake Bracket RH P/N 1220 .....**\$339.00**

### PIPER AEROSTAR LANDING GEAR CONTACTING BUMPERS

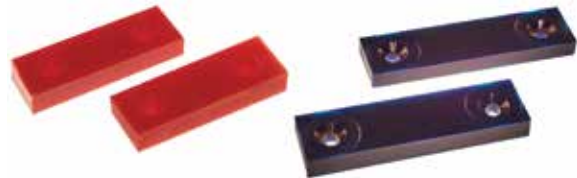

These are the contacting bumpers for the landing gear upstops and downstops on the Piper Aerostar. It's not unusual for them to be in pretty bad shape. When they're worn out, there is risk of damage as the landing gear extends and retracts beyond its normal limits, imposing concentrated loads on the airframe which are normally cushioned and distributed by the bumpers. Our bumpers are made from a tough, high-tech polymer that should last as long as the airframe. They will never crack or bulge. And they're easy to install! Package of 2. Upper Blue Bumper M1018 .....P/N 05-14952 .....**\$263.95**  
 Lower Red Bumpers M1019 .....P/N 05-14953 .....**\$263.95**

LG

# TAILWHEELS

## LANG TAILWHEEL PARTS

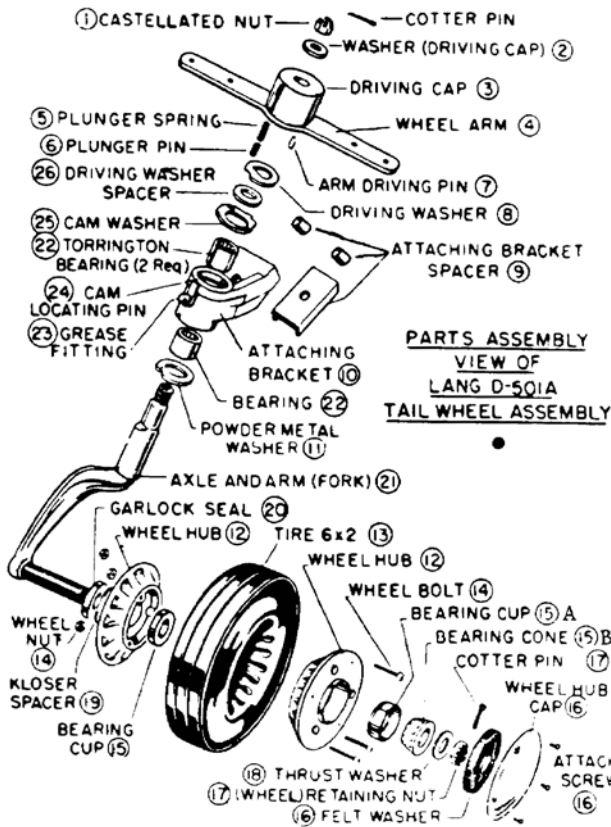

Ref No.	Lang No.	Part No.	Qty	Price Each	Ref No.	Lang No.	Part No.	Qty	Price Each
1&2	A-501, A521	06-13601	1	\$4.95	16	A-522, A-523 & A-524	--	--	--
3,5,6,7	A503, A507, A-505, A506	06-01570	1	\$18.90			06-13600	1	\$21.50
4	A-504	06-13604	1	\$15.90	17	A-521	06-13617	1	\$2.45
					18	A-531	06-13618	1	\$0.08
8	A-509	06-13608	1	\$5.90	19	A-546	06-13619	1	\$3.20
9	A-512, A560-1, A560-2	06-13609	1	\$11.50	20	A-547	06-13620	1	\$18.80
10	C-501	06-13610	1	--	21	C-503	06-13621	1	\$158.95
11	A-516	06-13611	1	\$5.95	22	A-554	06-13622	2	\$13.95
12	A-544, A545	06-13800	2	\$127.95	23	A-525	06-13623	1	\$2.35
13	A-590	06-15800	1	\$104.85	24	A-508	06-13624	1	--
14	A-548, A549	06-13614	3	\$12.50	25	A-511	06-13625	1	\$5.95
15A	A-518	13287	2	\$82.75	26	A-510	06-13626	1	\$1.45
15B	A-519	13286	2	\$84.85					

Hub Ass'y (2 #12 Hub Halves, 3 #14bolts & Nuts) ..P/N 06-13800 .... \$127.95  
 Hub Ass'y w/Bearing Cups.....P/N 06-13900 .... \$152.95  
 Wheel Ass'y (Hub Ass'y & 2 Bearing Cups & Cones) ..P/N 06-14000 .... \$263.50  
 Wheel & Tire Ass'y (Wheel Ass'y & 6 x 2 Tire).....P/N 06-14100 .... \$398.00



### THE LANG TAILWHEEL – FAA APPROVED STEERABLE – FULL SWIVEL

**THE ONLY TAILWHEEL TO MEET THE EXACTING REQUIREMENTS OF THE CHRISTEN EAGLES** - The Lang Model D-501-A Tailwheel is full swivel, fully automatic and steerable. It is impossible to throw the Lang tailwheel into full swivel unintentionally regardless of rough field conditions or cross winds. This tailwheel will not lock in any position except steerable, but releases easily when plane is pushed sideways or backwards by hand or when maneuvering plane on ground using brakes. The Lang tailwheel fits both 1-1/4" and 1-1/2" leaf springs. Drop forged, heat-treated 4130 chromoly steel fork of single arm type. The cast aluminum wheel is grease packed for 100 hours service. The 6 x 2.00 solid rubber tire has interior wire reinforcement for added strength. Manufactured by ACS Products Co. under FAA-PMA. All replacement parts available. The Lang tailwheel is FAA-approved for installation on many light aircraft including Aeronca 7AC, Piper J-3 and PA-12, Cessna 140, Luscombe and Taylorcraft. Comparable to Scott Model 2000. Wt. 6 Lbs. **OEM & DISTRIBUTOR PRICING AVAILABLE**

P/N 06-00398 ..... \$1,045.00



### SHIMMY DAMPENER 3400 STRAIGHT ASSEMBLY

Compact and lightweight assembly that hydraulically dampens oscillations in the tailwheel to eliminate tailwheel shimmy and stabilize your tailwheel.

**Features:**

- Smoother landings
- Reduced aircraft wear and tear
- No headache installation & maintenance
- Includes STC
- Not compatible with the T3 Tailwheel Suspension
- A long pawl tailwheel assembly

ABI Straight .....P/N 05-27237 .....\$1,095.00  
 ABI Bent .....P/N 05-27235 .....\$1,095.00  
 Scott Straight.....P/N 05-27238 .....\$1,095.00  
 Scott Bent.....P/N 05-27236 .....\$1,095.00



### SHIMMY DAMPENER 3450-23 STRAIGHT ASSEMBLY

Compact and lightweight assembly that hydraulically dampens oscillations in the tailwheel to eliminate tailwheel shimmy and stabilize your tailwheel.

**Features:**

- Smoother landings
- Reduced aircraft wear and tear
- No headache installation & maintenance
- Includes STC
- Not compatible with the T3 Tailwheel Suspension
- A long pawl tailwheel assembly

.....P/N 05-27239 .....\$1,095.00



### RE-BUILD KIT FOR 3400 SERIES TAILWHEEL

Re-Build Kit for 3400 Series Tailwheel  
 P/N 05-27228 .....\$359.00



### TAILWHEEL BOLT FOR ABI 3200 / 3224A / 3200B SERIES

Bracket assembly is compatible with: 3200, 3224A, and 3200B series.  
 P/N 05-27215 .....\$64.90



### SPACER PLATE FOR ABI 3400B FORK

Spacer Plate; Compatible only on a ABI F2 3400B fork. 3 screws that hold this in place are MS24693S272.....P/N 05-27216 .....\$68.75



### AIRFRAME ALASKA LONG PAWL

Compatible with 3200, 3224A, 3200-3, 3200B, 3200-3B, 3400, 3425-5, 3425-13, 3450(T), 3450-3, 3450-17, 3450-23, and 3400B series.

ABI-3200 AND ABI-3224A tailwheel assemblies and parts are direct replacements for the Scott 3200/3200A. Our assemblies and parts are FAA-PMA'd products and have STC's for well over 35 makes of Aircraft available .....P/N 05-27213 .....\$49.65



### TAILWHEEL SPRING NON-PMA PART

ABI-3239-1 Scott 3200 tailwheel spring. Non-PMA part.....P/N 05-27212 .....\$27.85



# TAILWHEELS

## ALASKAN BUSHWHEEL INC. 3200/3400 TAILWHEEL ASSEMBLY

The Alaskan Bushwheel Tailwheel Assembly is an FAA-PMA (PMA # PQ1557NM, Supplement 9) replacement part for the Scott 3200 assembly and parts contained therein, includes Heavy Duty Steering Arm. One Year Warranty.

ABI-3200 Standard Tailwheel Assembly(3214 Standard Arm).....	P/N 06-00836 .....	\$1,765.00
ABI-3200-3 direct replacement for the Scott 3200-3.....	P/N 06-01313 .....	\$1,775.00
ABI-3224A Standard Tailwheel Assembly(3214T Heavy Duty Arm) .....	P/N 06-00722 .....	\$1,866.00
ABI-3200B Tailwheel Tundra Assembly.....	P/N 06-00723 .....	\$2,095.00
ABI-3400 8" Bent Steering Arm Tailwheel.....	P/N 06-02914 .....	\$3,100.00
ABI-350 10" Bent Steering Arm Tailwheel.....	P/N 06-02915 .....	\$2,025.00
1154.R Baby Bushwheel.....	P/N 05-15215 .....	\$556.00
ABI-800613-00 Pawnee 2-bolt Tailwheel Head.....	P/N 06-00820 .....	\$473.00
ABI-2600A 4" wheel halves with 2.80x2.50x4 tire & tube mounted and ready to go.....	P/N 06-01190 .....	\$549.00

LG

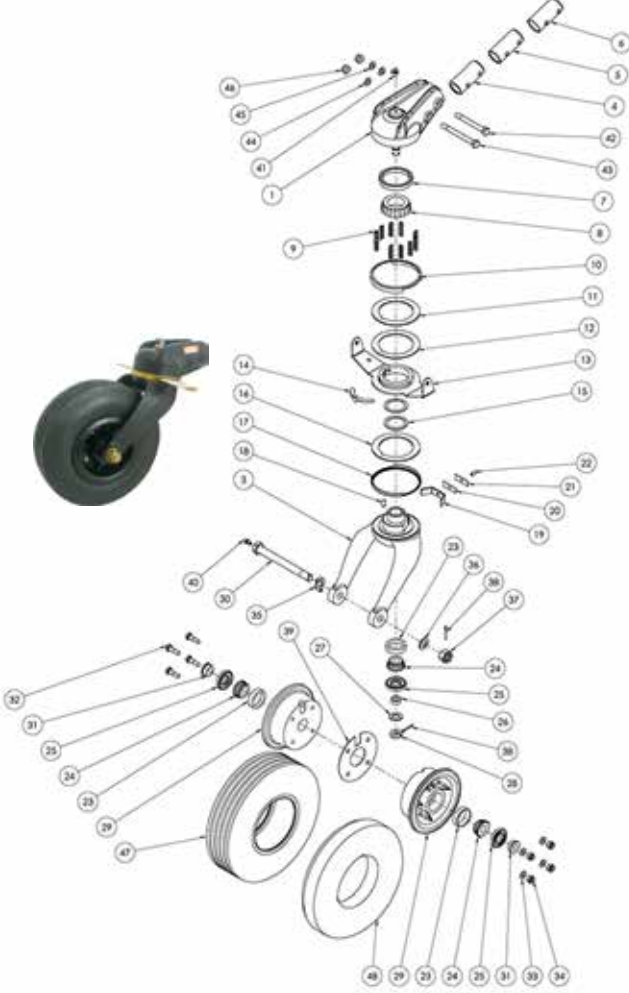

#	ABI P/N	Description	Part No.	Price
----	ABI-3400-00	8" Tailwheel Assembly	06-01147	\$1,995.00
----	ABI-3450-00	10" Tailwheel Assembly	06-01148	\$2,152.00
----	ABI-3450-23 (S)	2-Bolt, 10" Tailwheel Assembly Straight Arm	06-01149	\$2,243.00
----	ABI-3450-23 (T)	2-Bolt, 10" Tailwheel Assembly Bent Arm	06-01741	\$2,243.00
----	ABI-3400B	Bushwheel Tailwheel Assembly	06-01150	\$2,389.00
1	ABI-3412MK	Tailwheel Head	06-01151	\$592.00
1A	ABI-3450-23-M	2-Bolt Tailwheel Head	06-01152	\$544.00
2	ABI-3423-01**	10" Fork	06-01153	\$574.00
2A	ABI-3413-01**	8" Fork	06-01154	\$420.00
2B	ABI-F2*****	Wide Fork	06-01155	\$742.00
4	ABI-3412-S.875***	7/8" Head Spacer	06-01156	\$112.75
5	ABI-3412-S.937***	15/16" Head Spacer	06-01157	\$112.75
6	ABI-3412-S1.00***	1" Head Spacer	06-01158	\$123.85
7	8231	Bearing Race	06-01162	---
8	8118	Bearing	06-01163	\$55.75
9	ABI-3233-00	Compression Spring	06-00728	\$4.75
10	ABI-3411-02	Dust Cap, Upper	06-01166	\$39.95
10A	ABI-3411-07*	Dust Cap, Upper (For Locking Tailwheels)	06-01167	\$44.75
11	ABI-3408-00	Thrust Washer	06-01168	\$21.80
12	ABI-3408-01	.036 Fiber Thrust Washer	06-01170	\$21.50
12A	ABI-3479-01*	Fiber Thrust Washer	06-01169	\$19.50
13	ABI-3410-03	Steering Arm Bent (Bent)****	06-01171	\$368.00
13A	ABI-3410-05	Straight Steering Arm	06-01172	\$344.00
14	ABI-3219-00	Short Pawl	06-00732	\$49.75
15	ABI-3407-00	Spacer	06-01164	\$5.95
16	ABI-3408-02	.065 Fiber Thrust Washer	06-01173	\$20.65
17	ABI-3411-02	Dust Cap, Lower	06-01174	\$37.50
17A	ABI-3411-05*	Dust Cap, Lower (For Locking Tailwheels)	06-01175	\$42.50
18	ABI-232-046	Pin	06-00749	\$16.95
19	ABI-3432-00	Compression Spring	05-15222	\$17.65
20	ABI-3258-01	Spacer	06-00739	\$2.95
21	ABI-3258-00	Spacer	06-00738	\$2.95
22	ABI-3257-00	Pin	06-00740	\$10.85
23	A4138	Bearing Race	06-01183	\$21.95
24	A4050	Bearing	05-15223	\$49.90
25	ABI-1863	Grease Retainer	06-00746	\$14.50
26	ABI-2504-01	Spacer	06-01178	\$21.75
27	AN960-816	Washer (Axle)	05-15224	\$0.06
28	AN320-8	Nut	05-15225	\$4.35
29	ABI-3244-00	Wheel Half	06-00745	\$179.85
29A	ABI-S2	Wide Spacer (ABI-3400-B Tailwheels)	06-00744	\$127.75
30	ABI-3236-C2**	10" Axle Bolt	06-01186	\$67.75
30A	ABI-872	Wide Fork Axle Bolt (ABI-3400-B Tailwheels)	06-00741	\$62.75
31	ABI-3227-00	Spacer	06-00743	\$28.50
32	AN4-7A	Wheel Bolt	05-15226	\$0.17
32A	AN4-34A	Wide Wheel Bolt (ABI-3400-B Tailwheels)	05-15227	\$0.93
33	AN960-416	Washer (Wheel)	05-15228	\$0.09
35	ABI-3225-00	Tab Lock Washer	06-00742	\$7.85
36	AN960-816L	Washer (Axle)	05-15232	---
37	AN310-8	Nut	05-15233	---
38	MS246655-283	Cotter Pin	05-15234	---
39	ABI-2602	Gasket	06-00750	\$5.65
40	T7201	Zerk Fitting	06-00753	\$2.60
41	T7208	Zerk Fitting	06-01184	\$3.65
44	AN960-516	Washer (Wheel)	05-15236	\$0.08
45	AN960-516L	Washer	05-15237	---
46	MS21044-N5	Locknut	05-15238	---
47	280X2.50X6	8" Tire (Scott/ABI-3400 Tailwheels)	05-15239	\$116.75
47A	10X3.50-4	10" Tire (Scott/ABI-3425 and 3450 Tailwheels)	05-15240	\$103.75
47B	1154.R	Baby Bushwheel (ABI-3400-B Tailwheels)	05-15241	---
48A	280X2.50X4 TUBE	8" Tube	05-15242	---
-	3400MBK-01	Miscellaneous Mounting Bolt Kit	05-15243	\$9.95

\* Parts not included in ABI-3200/ABI-3224A Assembly  
 \*\* Parts not included in ABI-3200B Assembly  
 \*\*\*\* Parts not included in assemblies.  
 Parts in red are not sold individually.

## ALASKAN BUSHWHEEL 3400 TAILWHEEL

Item	ABI Part No.	Description	Part No.	Price
----	ABI-3400-00	8" Tailwheel Assembly	06-01147	\$1,995.00
----	ABI-3450-00	10" Tailwheel Assembly	06-01148	\$2,152.00
----	ABI-3450-23 (S)	2-Bolt, 10" Tailwheel Assy Straight Arm	06-01149	\$2,243.00
----	ABI-3450-23 (T)	2-Bolt, 10" Tailwheel Assy Bent Arm	06-01741	\$2,243.00
----	ABI-3400B	Bushwheel Tailwheel Assembly	06-01150	\$2,389.00
1	ABI-3412M	Tailwheel Head	06-01151	\$592.00
1A	ABI-3450-23-M	2-Bolt Tailwheel Head	06-01152	\$544.00
2	ABI-3423-01**	10" Fork	06-01153	\$574.00
2A	ABI-3413-01**	8" Fork	06-01154	\$420.00
2B	ABI-F2*****	Wide Fork	06-01155	\$742.00
3	ABI-3412-S.875***	7/8" Head Spacer	06-01156	\$112.75
4	ABI-3412-S.937***	15/16" Head Spacer	06-01157	\$112.75
5	ABI-3412-S1.00***	1" Head Spacer	06-01158	\$123.85

Item	ABI Part No.	Description	Part No.	Price
6	ABI-3412-02	Head Bolt	06-01159	\$101.75
6A	ABI-3412-05	Head Bolt	06-01160	\$95.75
8	8231	Bearing Race	06-01162	---
9	8118	Bearing	06-01163	\$55.75
10	ABI-3407-00	Spacer	06-01164	\$5.95
11	ABI-3219-00	PAW	06-00732	\$49.75
12	ABI-3411-02	Dust Cap, Upper	06-01166	\$39.95
12A	ABI-3411-07*	Dust Cap, Upper	06-01167	\$44.75
13	ABI-3408-00	Thrust Washer	06-01168	\$21.80
13A	ABI-3479-01*	Fiber Thrust Washer	06-01169	\$19.50
14	ABI-3408-01	.036 Fiber Thrust Washer	06-01170	\$21.50
15	ABI-3410-03	Steering Arm Bent (Bent)****	06-01171	\$368.00

SEE WWW.AIRCRAFTSPRUCE.COM FOR DIAGRAM AND ITEM #.

## 3200/3400 SERIES TAILWHEEL FORK CONVERSION KITS

Use this kit to modify an existing Scott or Alaskan Bushwheel Series Tailwheel for use with an Alaskan Baby Bushwheel. This is a less expensive option than purchasing a whole new tailwheel.

3400 Kit with Tire.....P/N 05-22009 .....	\$1,357.00	3200 Kit with Tire.....P/N 06-03531 .....	\$1,852.00
3400 Kit without Tire.....P/N 05-15210 .....	\$799.00	3200 Kit without Tire.....P/N 06-03144 .....	\$821.00



# TAILWHEELS

## REPLACEMENT PARTS FOR SCOTT 3200 TAILWHEEL

The Scott Model 3200 tailwheel, with 8" pneumatic tire, is designed to give years of trouble-free service. The swivel mechanism is sealed to keep out water, sand and mud. Grease fittings are provided for lubrication. Bracket fits 1-3/4" wide tailwheel leaf spring. Wt. 7-1/2 lbs. Attaching hardware not furnished.

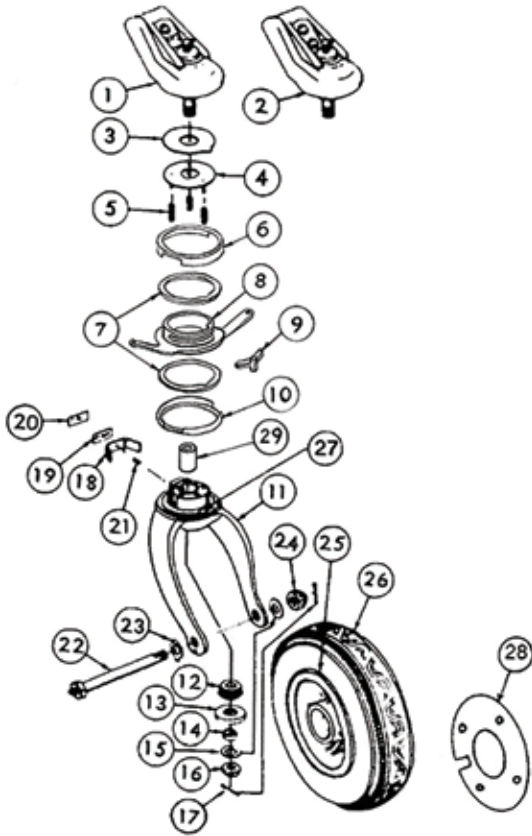

Item No.	Description	No Req'd	Part No.	Price
2	Bracket Assembly ABI-800613	1	06-01291	\$472.00
3	Washer, Thrust	1	3207	\$7.55
4	Thrust Plate Ass'y	1	3234	\$45.85
5	Spring, Compression	5	3233	\$5.65
6	Dust Cap	1	3235-2	\$38.50
7	Washer, Thrust	2	3206	\$20.50
8	Arm Assembly	1	3214	\$320.00
9	Pawl	1	3219	\$41.85
10	Dust Cap	1	3235-1	\$39.60
11	Fork Assembly, ABI-3244K	1	06-00736	\$413.00
12	Cone Bearing	1	13286	\$84.85
13	Retainer, Grease	1	1863	\$11.80
14	Spacer	1	2504-1	\$22.75
15	Washer, AN960-816	2	AN960-816	\$0.10
16	Nut, Shear AN320-8	1	AN320-8	\$2.27
17	Pin, Cotter	2	18482	\$0.23
18	Spring	1	3222	\$15.55
19	Spacer	1	3258	\$3.90
20	Spacer	1	3258-1	\$3.65
21	Pin	1	3257	\$12.50
22	Axle Ass'y	1	3236	\$59.80
23	Washer, Lock	1	3225	\$8.95
24	Nut, Castle, AN310-8	1	AN310-8	\$4.90
25	Wheel Assembly, ABI-3244-00		06-00745	\$179.85
27	Pin, 3226	1	3226	\$11.85
28	Gasket	1	2602	\$6.95
29	Bushing	1	3205	\$32.55
--	Adapter D306-007	1	05-09044	\$18.55



## SCOTT MODEL 2600 8-INCH PNEUMATIC TIRE

The Model 2600 8" pneumatic tire and wheel assembly is used on the 3200, 3250, 3400 and 3425 Series tailwheel assemblies. The Model 3245-1 10" pneumatic tire and wheel assembly is used on the 3425 & 3450 Series tailwheel assemblies. Total Wt. 3 lbs. 13 oz.

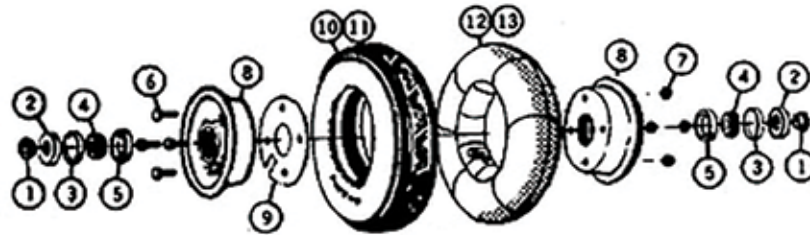

Item No.	Part No.	Description	8" Assembly P/N 2600	10" Assembly P/N 3245-1	Price Each
1	3227	Spacer	2	2	\$33.85
2	1863	Retainer, Grease	2	2	\$11.80
3	1862	Spacer	2	2	\$13.75
4	13286	Bearing Cone (A-4050)	2	2	\$84.85
5	13287	Bearing Cup (A-4138)	2	2	\$82.75
6	18438	Bolt	4	4	\$0.23
7	33478-202	Nut, Self Locking	4	4	\$0.19
9	2602	Gasket	1	1	\$6.95
10	3228	8" Tire	1		\$76.75
11	06-08100	10" Tire		1	\$87.75
12	3223	8" Tube	1		\$38.50
13	3247	10" Tube		1	\$44.60

## SCOTT LEAF SPRING SPACERS AND SPRING KITS

3241-3S - Spacer Only.....	P/N 06-00406 .....	\$27.60
3243-2 - Spacer Only .....	P/N 06-00407 .....	\$86.75
3241-1S - Adapter Kit - Converts 1-3/4" 3216 (1 3/4") bracket to 1-1/2" width. ....	P/N 06-00408 .....	\$84.75
3239 - Heavy Duty Tension Spring Kit.....	P/N 06-00008 .....	\$112.75
3243-01 - Converts 1-3/4" Bracket to 1-1/4" Bracket. Used on 3200 Tailwheel.....	P/N 06-00421 .....	\$131.75

# TAILWHEELS

## MAULE MODEL SFSA SOLID TAILWHEELS

The SFSA tailwheel assembly is of the same type construction as the SFS-P8A unit except for the tire, which is a 6.50 x 2.50 soft rubber solid tire. Spring connector kit not furnished with this model. FAA-approved. Wt. 6 lbs.

- SFSA-1-4, for 1-1/4" Spring .....P/N 06-16710 .....**\$949.00**
- SFSA-1-2, for 1-1/2" Spring .....P/N 06-16720 .....**\$949.00**
- Replacement Tire & Bearings .....P/N TW-23A .....**\$345.00**

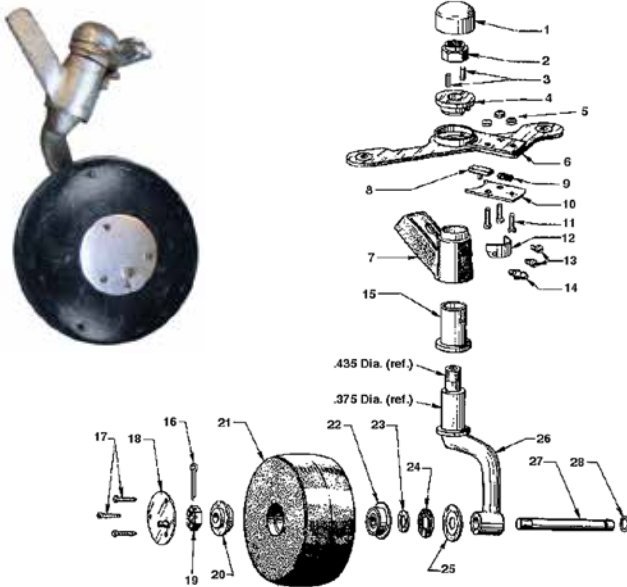

## MAULE MODEL SFS-P8A PNEUMATIC TAILWHEELS

An inexpensive 8" pneumatic tailwheel assembly which is steerable and full swiveling, with new improved single arm shimmy-free fork. All working parts heat treated. FAA approved. Wt. 7 lbs.

- Maule Tailwheel #SFS-P8A-1-4\* .....P/N 06-16730 .....**\$959.00**
  - Maule Tailwheel #SFS-P8A-1-2\*\* .....P/N 06-16740 .....**\$916.00**
  - Specialty Tire 2.80/2.50-4 4 Ply .....P/N 06-08000 .....**\$76.75**
  - Specialty Tube 280 X 250 X 4 .....P/N 06-08101 .....**\$38.50**
- \* - For 1-1/4" Leafspring      \*\* - For 1-1/2" Leafspring

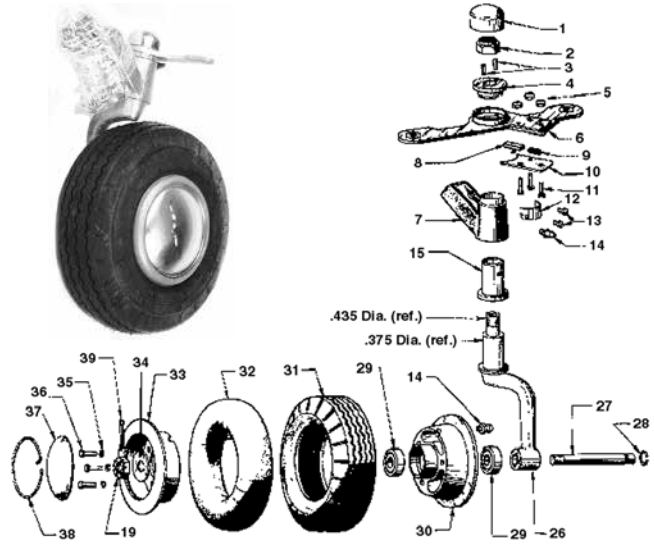

LG

## MAULE P8B TUNDRA TAILWHEEL

A new tailwheel with 8" pneumatic tire designed and engineered to meet the toughest conditions on all types of airports and landing fields.

- SFS-P8B-1-4 ..... For 1-1/4" Leaf Spring Width .....P/N 06-16750 .....**\$982.00**
- SFS-P8B-1-2 ..... For 1-1/2" Leaf Spring Width .....P/N 06-16760 .....**\$982.00**
- SFS-P8B-3-4 ..... For 1-3/4" Leaf Spring Width .....P/N 06-16770 .....**\$1,010.00**

## MAULE TAILWHEEL PARTS LIST

#	Description	Part Number	Part Number	Qty. Req.	Price Each
1	Cover Cap	TW-18 (1-1/4")	TW-63A (1-3/8")	1	\$15.50
2	Nut	AN364-720A or AN365-720	AN364-720A or AN365-720	1	\$1.68
3	Lock Ring Pin	TW-17	TW-60AB	1/2	\$11.55
4	Lock Ring	TW-16	TW-57	1	\$49.85
5	Nut	AN364-440A	AN364-440A	3	\$0.44
6	Steering Arm Assembly*	TW-15 (TW-13 & TW-16 are included in this Assembly)	TW-15A	1	\$225.95
7	Bracket Assembly, 1-1/4"	06-16101	06-16201	1	\$233.95
7	Bracket Assembly, 1-1/2"	06-16102	06-16202	1	\$212.95
8	Lock Pin	TW-13	TW-13	1	\$37.50
9	Steering Arm Spring	TW-14	TW-14	1	\$7.35
10	Lock Cover Plate	TW-12	TW-12	1	\$16.50
11	Screw	MS35206-217	MS35206-217	3	\$0.06
12	Cam	TW-10	TW-10	1	\$42.50
13	Screw	AN501-A10-4	AN501-A10-4	2	\$0.38
		AN520-10-4	AN520-10-4		
14	Zerk Fitting	TW-7-A14	TW-7-A14	1	-----
15	Oilite Bearing	TW-7 (3/4" I.D.)	TW-59A (7/8" I.D.)	1	\$33.50
Items 16 through 25 are for the solid rubber tire assembly only.					
16	Cotter Pin	AN380-3-3	AN380-3-3	1	\$0.14
17	Screw	TW-A18	TW-A18	3	\$0.15
18	Hub Cap	TW-27	TW-27	1	\$25.50
19	Axle Nut	AN320-8	AN320-8	1	\$2.27
20	Bearing	TW-3	TW-3/A15	1	\$41.85
21	Tire—solid, no bearings	TW-23	TW-23	1	\$297.00
21	Tire—solid, with bearings	TW-23A	TW-23A	1	\$345.00

#	Description	Part Number	Part Number	Qty. Req.	Price Each
22	Bearing (with washer)	TW-A15	TW-A15	1	\$41.85
23	Washer	TW-28	TW-28	1	\$2.35
24	Felt Seal	TW-26	TW-26	1	\$2.75
25	Retainer Washer Fork (with axle)	TW-64	TW-64	1	\$6.95
27	Axle	TW-5	TW-5	1	\$72.80
28	Axle Sircilip Ring	TW-6	TW-6	1	\$6.95
29	Bearing	TW-A7	TW-A7	2	\$166.95
30	Inboard Wheelhalf, with bearings	TW-30	TW-30	1	\$394.00
31	Tire, 8-inch			1	-----
32	Tube			1	-----
33	Outboard Wheelhalf	TW-31	TW-31	1	\$179.85
34	Washer	TW-A6	TW-A6	1	\$1.40
35	Lock Washer	AN935-516	AN935-516	3	\$0.07
36	Bolt	TW-A12	TW-A12	3	-----
37	Hub Cap	TW-32	TW-32	1	\$46.50
38	Hub Cap Sircilip Ring	TW-33	TW-33	1	\$4.35
39	Cotter Pin	AN380-3-3	AN380-3-3	1	\$0.14
Items 40 through 44 are used on the "Old" style & pneumatic tailwheel that have a shimmy dampener.					
40	Adjusting Screw	TW-40		1	-----
41	Dampener Spring	TW-41		1	-----
42	Friction Block	TW-42		1	-----
43	Hex Housing	TW-43		1	-----
44	Bracket Assembly, 1-1/4 inch drilled	TW-44-1-4		1	-----
	Bracket Assembly, 1-1/2 inch drilled	TW-44-1-21			-----

## MAULE ARM ASSEMBLIES

Fig. No.	Description	Style	Qty Req.	Part No.	Price
26	Arm Assembly .375 Dia. (Pneumatic)	Old	1	TW-58A	\$159.75
26	Arm Assembly without Axle .435 Dia. (Solid Rubber)	New	1	TW-61A	\$239.25
26	Arm Assembly with Axle .435 Dia. (Solid Rubber)	New	1	TW-61A	\$239.25
26	Arm Assembly .375 Dia. (Pneumatic)	New	1	TW-58A-1	\$206.75
26	Arm Assembly .375 Dia. (Solid Rubber)	Old	1	TW-21-1	---

# TAILWHEELS

## MATCO SINGLE ARM TAILWHEELS



Matco tailwheels use a fiberglass reinforced nylon wheel with an operating load of 450 lbs. It takes over 5000 lbs to fail the wheel and it will hold up in the most rigorous conditions. Can be used with 1-1/4" or 1-1/2" leaf spring. These tailwheels are steerable, and are available with a 6 inch hard rubber solid tire or with 8" Shin pneumatic tire and tube for heavier aircraft. Tailwheel construction is anodized aluminum. Weight: 5 lbs.

Item	Part No.	Price
Matco solid rubber tire Tailwheel Assembly	06-01615	\$263.95
Replacement Tire (solid rubber) for T-6	06-00004	\$125.75
Matco 6" Pneumatic the Tailwheel Assembly	06-00831	\$308.00
Replacement 6" Pneumatic Tire * Tube	06-00832	\$31.75
Matco 8" pneumatic wide Tailwheel Assembly Overall length of 11.20". Max fully splayed arms is 9.29" and overall height is 11.7". weight 7 lbs.	06-01620	\$369.00
Matco 8" pneumatic wide Tailwheel Assembly Overall length of 12.51". Max fully splayed arms is 9.29" and overall height is 15.7". Weight 8lbs.	06-01361	\$409.00
Specialty Replacement 8" Tire 2.80/2.50-4 4PLY	06-08000	\$76.75
Specialty Replacement Tube 8" 280 X 250 X 4	06-08101	\$38.50

## MATCO DUAL ARM TAILWHEELS



### DUAL ARM TAIL WHEEL ASSEMBLY 8 INCH PNEUMATIC TIRE

The T-8LD tail wheel utilizes a dual fork configuration and incorporates a geometric release mechanism that allows the wheel to caster after reaching a steered angle of 40 degrees. The WHLTW37 wheel used on the WHLT-8LD has a .625 precision sealed ball bearing which is rigorously tested and designed to resist bearing fatigue providing a long bearing life. The arms and wings of the tail wheel fork assembly are composed of 4130 which is heat treated to a Rockwell 38-43 to ensure strength and are irridited to prevent corrosion. The tail wheel base and forks are cast and then black anodized to prevent corrosion as well. The wheel halves are die cast aluminum for light weight and superior strength. The T-8LD features split rims for ease of mounting and dismounting its 200x50 (8"x2") tire and tube assembly. **Specifications:** 8 inch pneumatic tire, Overall length of 10.8 inches, Maximum width of this tail wheel with fully splayed arms: 7 inches, Overall height: 10.8 inches, This cast aluminum tail wheel weighs 5.4 pounds. P/N 06-01528 .....\$689.00



### LIGHTWEIGHT DUAL ARM TAIL WHEEL ASSEMBLY 8.5 INCH PNEUMATIC TIRE

The T-8D tail wheel utilizes a dual fork configuration and incorporates a geometric release mechanism that allows the wheel to caster after reaching a steered angle of 40 degrees. The WHLTW40EE wheel used on the WHLT-8D has a .625 precision sealed ball bearing which is rigorously tested and designed to resist bearing fatigue providing a long bearing life. The arms and wings of the tail wheel fork assembly are composed of 4130 which is heat treated to a Rockwell 38-43 to ensure strength and are irridited to prevent corrosion. The tail wheel base and forks are cast and then black anodized to prevent corrosion as well. The wheel halves are die cast aluminum for light weight and superior strength. The T-8D features split rims for ease of mounting and dismounting its 2.80/2.50-4 tire and tube assembly. **Specifications:** 8.5 inch pneumatic tire, Overall length of 11.6 inches, Maximum width of this tail wheel with fully splayed arms: 7 inches, Overall height is 11.8 inches, This cast aluminum tail wheel weighs 6.7 pounds. P/N 06-01529 .....\$746.00

## MATCO DUAL ARM TAILWHEELS

### DUAL ARM TAIL WHEEL ASSEMBLY 8.5 INCH PNEUMATIC TIRE



The T-8WD tail wheel utilizes a dual fork configuration and incorporates a geometric release mechanism that allows the wheel to caster after reaching a steered angle of 40 degrees. The WHLNW40EE wheel used on the WHLT-8WD has a .625 precision sealed ball bearing which is rigorously tested and designed to resist bearing fatigue providing a long bearing life. The arms and wings of the tail wheel fork assembly are composed of 4130 which is heat treated to a Rockwell 38-43 to ensure strength and are irridited to prevent corrosion. The tail wheel base and forks are cast and then black anodized to prevent corrosion as well. The wheel halves are die cast aluminum for light weight and superior strength. The T-8WD features split rims for ease of mounting and dismounting its 9x3.50-4 tire and tube assembly. **Specifications:** 8.5 inch pneumatic tire, Overall length of 11.7 inches, Maximum width of this tail wheel with fully splayed arms: 7 inches, Overall height is 11.9 inches, This cast aluminum tail wheel weighs 8.3 pounds. P/N 06-01531 .....\$728.00

### DUAL ARM TAIL WHEEL ASSEMBLY 10 INCH PNEUMATIC TAIL WHEEL



This wheel features split rims for ease of mounting and dismounting its 10 x 3.50-4 tire and tube assembly. The tail wheel assembly is both steerable and full swiveling and provides easy installation with variant spring tension. This wheel has been designed to release with light spring tension and fits a 1.75 wide spring. Adapter plates can accommodate either a 1.25 or 1.50 inch wide spring. The base unit that mounts to the spring is also machined from extrusion. It is available with a two hole mounting option. The assembly should be mounted on the flat spring so that the pivoting axle is as close to vertical as possible when the plane is loaded. All assembly bushings are made of oil impregnated brass so no lubrication is needed during the life of the tail wheel. In addition, the shaft has been redesigned to .625 for added strength and durability. **Specifications:** • Tail wheel has a 10 inch pneumatic tire, overall length of 11.4 inches• Max width of tail wheel with fully splayed arms is 7 inches, overall height of 13.1 inches• Weight: 8.5 pounds. P/N 06-01781 .....\$1,082.00

### DUAL ARM TAIL WHEEL ASSEMBLY 11 INCH PNEUMATIC TIRE



The T-11D tail wheel utilizes a dual fork configuration and incorporates a geometric release mechanism that allows the wheel to caster after reaching a steered angle of 40 degrees. The MH5N-S wheel used on the WHLT-11D has a .625 precision sealed ball bearing which is rigorously tested and designed to resist bearing fatigue providing a long bearing life. The arms and wings of the tail wheel fork assembly are composed of 4130 which is heat treated to a Rockwell 38-43 to ensure strength and are irridited to prevent corrosion. The tail wheel base and forks are cast and then black anodized to prevent corrosion as well. The wheel halves are die cast aluminum for light weight and superior strength. The T-11D features split rims for ease of mounting and dismounting its 11x6-5 tubeless tire assembly. **Specifications:** 11 inch pneumatic tire, Overall length of 13.5 inches, Maximum width of this tail wheel with fully splayed arms: 7 inches Overall height: 14 inches, This cast aluminum tail wheel weighs 9.6 pounds.....P/N 06-01537 .....\$1,045.00



# TAILWHEELS



## STEEL TAILWHEEL LEAF SPRINGS

Set No.	Spring Width	Hole Dia. Fuselage End	Hole Dia. Tailwheel End	Distance Between Bolt Centers	Original Application	Wt. Lbs.	No. of Springs	Part No.	Price
1	1-1/4"	7/16"	3/8"	12-1/2"	Piper J-3 (serial numbers 10339 and up), L-4, PA-11, PA-12, PA-14 (up to serial number 204)	3-1/8	3	06-14200	\$188.75
2	1-1/2"	3/8"	3/8"	11-1/4"	T-Craft BC-12D	2-3/4	3	06-14300	\$211.95
3	1-1/2"	3/8"	7/16"	14-1/4"	Aeronca 7AC, 11AC	3-1/2	3	06-14400	\$193.75
4	1-1/2"	3/8"	3/8"	14-7/8"	Homebuilts	1-3/4	1	06-14500	\$85.75
5	1-1/4"	5/16"	3/8"	11-3/4"	Luscombe	3-1/2	4	06-14600	\$269.95
6	1-1/4"		Main Leaf Only	11-3/4"	Luscombe	1-1/2	1	06-14700	\$67.80
7*	1-1/2"	5/8"		13-1/2"	Cessna 120-140	4	4	06-14800*	\$294.95
8	1-1/2"		Main Leaf Only	13-1/2"	Cessna 120-140	1-1/2	1	06-14900	\$88.75
9	1-1/2"	5/8"	7/16"	13-1/2"	Cessna 170	5	5	06-15000	\$385.00
10	1-1/2"		Main Leaf Only	13-1/2"	Cessna 170	1-3/4	1	06-15100	\$127.80

DISCOUNTS LESS 10% ON 6, 15% ON 10 (ASSORTED) \*P/N 06-14800 has two bends

LG

### MAULE ANTI-SHIMMY CONNECTOR SPRING KITS

A high and low frequency spring is used to upset the natural frequency of the tailwheel. The lighter spring is used on the left side.. P/N 06-15150 .....\$109.75

### TENSION TYPE CONNECTOR SPRING KITS

Kit consists of two tension type springs, two chains and two connector links.

Lightweight Spring Kit Scott.. P/N 2151 .....\$112.75 ea.  
Connector Links..... P/N 06-15400...\$3.95 ea.  
Chain..... P/N 06-15500.... \$1.37/ft.

### COMPRESSION TYPE CONNECTOR SPRING KIT

Replace conventional springs with new compression type. Original tension type springs keep rudder post under continuous tension which wears the hinges. Compression type springs keep rudder neutral - no tension on post. Assures more effective steering action.

Set of 2 stainless steel springs, (2) 1' chains, 4 connector clips:  
P/N 06-15600 ..... \$47.75  
Springs Only..... P/N 06-15700 .....\$14.85 ea.  
Connector Clips..... P/N 06-15400 .....\$3.95 ea.  
Chain..... P/N 06-15500 ..... \$1.37/ft.

### FAA/PMA TENSION SPRING KIT

Attaches tailspring to tailwheel. Includes 2 springs, 2 connector clips and 2 linkage chains.

P/N 05-11457 ..... \$42.95

### FAA/PMA COMPRESSION SPRING KIT

Keeps rudder neutral - no tension on the post. Complete with 2 springs, 4 connector clips and 2 linkage chains.

P/N 05-11458 ..... \$46.50

### HUSKY TAILSPRING

The Husky Tailspring is now available. The 3-leaf tailspring, mounting bracket & hardware is all included. This is a direct replacement for all of Sky International (Aviat Husky) tailsprings and eligible on all Husky aircraft, the A1, A1-A, A1-B and the new A1-C. .... P/N 06-01364 .....\$955.00

### SONEX TAILWHEEL

This sand-cast aluminum cores combine weight, economy and long life with maximum strength. The single-wall construction offers a light yet durable wheel with the ability to absorb impact. Engineered to transmit loads directly to the bearing surface for smoother action.

Diameter & Width: 4" x 1-1/2". Bearing ID or Axle Size: 3/8, 1/2, 5/8, 3/4. Hub Length std. 1-1/2". Aprox Wt. 1lb. Load Rating: 225. Less Bearing 1-3/8..... P/N 06-01665 .....\$45.50

### PIPER TAILWHEEL SPRINGS



Description	Part No.	Price
PA-15/17 Tailwheel Spring Assembly PA17TWS	05-21946	\$146.75
PA-16 Tailwheel Spring Assembly SN 1 TO 272 PA16TWS4L	05-21947	\$214.95
PA-16 Tailwheel Spring Assembly SN 273 AND UP PA18TWS4L	05-21948	\$203.95

### TAILWHEEL TIRES

**6X2 AERO CLASSIC SOLID TIRE** - Used on Scott 2000. Replaces Goodyear 6x2 tire.  
P/N 06-01044 .....\$117.75

**6X2 GENERAL SOLID TIRE** - A flexible rubber tire with four knobs on center hole. This is Scott P/N 1879 used on Scott Model 2000 tailwheels and some Scott 3-24B tailwheels. Replaces Goodyear 6x2 (11 knobs) solid tailwheel tire..... P/N 06-15800 .....\$104.85



**6.50 X 2.50 SOLID TIRE** - Maule P/N 23 for Model SFSA tailwheels.  
Tire Only..... P/N 06-00409 .....\$297.00  
Tire w/ Bearings..... P/N 06-00410 .....\$345.00

**2.80/2.50 X4 SPECIALTY PNEUMATIC TIRE** - Used on Scott Model 2600 8" wheel assembly.

Tire..... P/N 06-08000 .....\$76.75  
Tube..... P/N 06-08101 .....\$38.50

### 2.80/2.50 X4 AZUSA TIRE

Tire..... P/N 06-01287 .....\$14.50  
Tube..... P/N 06-01288 .....\$8.50

**10 X 3.50 X 4 SPECIALTY PNEUMATIC TIRE** - Used on Scott Model 3450 tailwheel and Scott Model 3245-1 10" wheel assembly.

Tire..... P/N 06-08100 .....\$87.75  
Tube..... P/N 06-08102 .....\$43.75

**400 X 4 AERO CLASSIC** - used on Grove Model 49-1A; Tire: 11.5" Dia. Looks like scaled down 500x5 tire.

Tire..... P/N 06-00844 .....\$97.75  
Tube..... P/N 06-08102 .....\$43.75

**400X6 AERO CLASSIC** - The New Light Sport Tire, 400-6 6 Ply with a Deep Aircraft Type Tread.

Tire..... P/N 06-00944 .....\$96.75  
Tube..... P/N 06-00945 .....\$36.70

### REPLACEMENT TAILWHEEL FOR VAN'S TAILWHEEL ASSEMBLY



This is a replacement tail wheel for the Van's tail wheel assembly. The hub is made from 6061-t6 aircraft aluminum with a tire molded from 65 durometer SBR rubber. The design includes precision sealed bearings. 5-1/2" Diameter X 1-1/2" tire x 2" hub thickness..... P/N 06-01284 .....\$147.75



# SHIMS – VALVE CORES



## GOOSENECK HOSE COUPLING

Used on high pressure strut pump hose. High pressure connection with a swivel nut and female 1/8" NPT port on other end.

P/N 06-11700 ..... **\$19.50**  
Replacement Seal...P/N SK2043-5 ..... **\$0.58**

## STRUT VALVE



AN6287-1 strut valve for operating pressures up to 3000 PSI. Consists of a 3-piece stainless steel body, high-pressure valve core and MS20813-1B cap.....P/N 06-00395 ..... **\$28.95**

## HIGH PRESSURE VALVE CORES



#9914B (Short Type, Length 7/8") Same operating range as #2300HV, but doesn't conform to AN809-1. ....P/N 06-00396 ..... **\$5.65**

## AIRCRAFT TIRE VALVE CORES



Valve Core to replace the existing valve core in tires.

Opening Pressure PSIG	Max Working Pressure PSIG	Temp. Range (°F)	Cup Seal Material	Part No.	Price
60	300	-40 - 225	Nitrile	05-11589	<b>\$0.45</b>
80	225	-65 - 250	Silicone	6035	<b>\$2.35</b>



## 2525 VALVE CAP (MS20813-1B)

A heat-resisting cap designed to withstand high pressure conditions. Has special rubber sealing washer.

P/N 2525 ..... **\$2.64 Ea.**



## TIRE VALVE EXTENSION

This tire valve extension allows you to fill your tire with air without removing your wheel pants. Simply screw in to your existing valve, and fill your tire. The valve extension attaches securely and won't leak air.

P/N 06-03064 ..... **\$23.95**



## WHEEL SPEED COVER KIT

U.S. Patented wheel covers enjoying performance improvements you only dreamed about, even better. Kits are available for all serial numbers for Cessna 402C, 414A, 421C Note: You must measure both the right and left side wheel nuts prior to order. Complete kit will install in 2-3 hours! ..... P/N 06-01779 ..... **\$2,499.95**

## BEECH NOSE GEAR DOOR HINGE UPGRADE KIT

This kit covers the nose gear door hinge bushings for the Beech Bonanza and Baron. Baron .....P/N 05-15104 ..... **\$348.00**



## MALIBU MIRAGE NOSE GEAR SPRING COMPRESSOR

Aerotar NLG Spring Compressor And Nose Gear Spring Removal Install Tool. For PA-46-350 Malibu Mirage.....P/N 08-15782 ..... **\$790.00**



## NOSE GEAR SPRING FORK NEEDLE BEARING

Nose Gear Spring Fork Needle Bearing. Fits all Cessna 208 models. Two required per aircraft. Save 30% .....P/N 05-15144 ..... **\$157.75**

## TIMKEN TAIL WHEEL FORK BEARING CUPS AND CONES



Wheel Bearing Cups and Cones. FAA-PMA approved Timken wheel bearings for Goodyear, Cleveland, and McCauley wheels. Class 2 aviation grade FAA-PMA bearings (Timken designates these with a -20629 suffix) Tighter tolerance and higher quality control than Class 4 automotive bearings. Save \$\$

Bearing Cup....P/N 05-15147 ..... **\$27.50**  
Bearing Cone..P/N 05-15148 ..... **\$110.75**

## TIMKEN NOSE GEAR SHOCK STRUT CUPS AND CONES FOR CARAVAN



Nose Gear Shock Strut Cups and Cones for Caravan. FAA-PMA approved Timken wheel bearings for Goodyear, Cleveland, and McCauley wheels. Class 2 aviation grade FAA-PMA bearings (Timken designates these with a -20629 suffix). Tighter tolerance and higher quality control than Class 4 automotive bearings. Save \$\$. Bearing Cup....P/N 05-15145 ..... **\$212.95**

Bearing Cone..P/N 05-15146 ..... **\$312.00**

## RV-10 | RV-14 NOSE WHEEL SPACER



This spacer is a part specified by Vans in the RV-10 and RV-14 instruction manual. We CNC machine this part to the specifications set by Vans to give you a perfectly dimensionally accurate part to hold on your nose gear wheel pants. You are probably getting toward the end of your project if you are

looking at this part. Go ahead and spend a few hours finishing up some other items on your aircraft and this part can be made for you. After we CNC machine this part, we also deburr all edges so it is ready to bolt right onto your aircraft.....P/N 05-12907 ..... **\$47.50**

## NITROGEN TIRE INFLATION SYSTEM 20CU, 40CU NITROGEN ACCESSORY KIT NOT FOR STRUT USE



GENTEC® Nitrogen aircraft tire inflation systems allow for easy, cost effective filling of General Aviation aircraft tires with pure Nitrogen. The **GKNAT20-TC** is a 20 cubic foot high pressure nitrogen tank (empty) with stand, ten foot hose; pressure reducing single stage regulator and tire inflator with resettable dial pressure gauge. The **GKNAT40-TC** is a 40 cubic foot high pressure nitrogen tank (empty) with stand, ten foot hose; pressure reducing single stage regulator and tire inflator with resettable dial pressure gauge. **Visit our website to locate a filling station near you.**

Nitrogen Tire Inflation System 20CU.....P/N 12-01586 ..... **\$424.00**  
Nitrogen Tire Inflation System CU40.....P/N 12-01587 ..... **\$535.00**  
Nitrogen Accessory Kit- (This kit is for someone who may already have a nitrogen cylinder and only needs the accessories)

P/N 12-01588 ..... **\$239.00**

