

2021
VOL. 49



BUYERS GUIDE
CONVERSION PARTS CATALOG



BUYER'S GUIDE NO. 49

May 1, 2021



This *Forty Ninth* edition of the Advance Adapters Buyer's Guide has been revised with every consumer in mind. The general catalog format is designed for auto parts stores, mechanics, technical salesmen, and home mechanic; although it may not always answer specific questions presented by the consumer. This catalog is directed towards the most popular engine and transmission conversion requirements. The Buyer's Guide is not intended to be a technical guide with specific requirements and alternatives, although it will supply you with the latest information that is available at Advance Adapters. If you have additional questions or your vehicle is not listed, then we suggest that you contact our sales staff for further assistance. This catalog is updated every 12-16 months. Advance Adapters has made every effort to inform you of all of the necessary modifications required for each of the conversions. Due to various vehicle production changes, Advance Adapters cannot always be absolutely positive on all the conversion requirements for each vehicle, especially vehicles less than 3 years old. Prices listed are subject to change so we suggest that you verify pricing if your Buyer's Guide is more than 12 months old. We are pleased to receive your inquiry indicating your interest in the Advance Adapters product line. Our organization is proud to serve you and ready to help with your automotive needs. If you should have any questions or comments, please feel free to contact our sales staff.

Terms & Conditions

PRODUCT LIMITATIONS: All of the conversion components that Advance Adapters lists are intended for offroad use. Advance Adapters cannot be held liable for any vehicle modifications since all conversion components and kits are intended for off-highway application use only. Before using any of our products, we recommend that you check your local and state vehicle regulations to be sure that you are within the laws concerning your specific vehicle modifications. Exhaust systems are not legal for sale or use on pollution controlled motor vehicles. They are legal only for racing vehicles which may never be used upon a highway. They are not applicable or intended for street or highway use.

WARRANTY: Advance Adapters warranties all of the products sold and distributed by our company without exception, even those used in competition-type vehicles. Warranty is limited to repair or replacement. Advance Adapters *does not offer* any type of labor allowance, and all warranty claims are subject to inspection by Advance Adapters. We have different warranties on the several products that we manufacture and they are as follows:

All Adapters, Motor Mounts, Headers, & Miscellaneous Accessories: These products have a warranty good for ninety (90) days from the date of shipping. These products will be free from defects in material and workmanship under customary and normal installation, use, and service. *We do not warranty the chrome plating on the exhaust headers. The use of aftermarket header wrap products WILL VOID the header warranty.*

RubiCrawler, Saturn, Ranger Torque Splitter O.D., Transmissions & Orion T/C: These units have a warranty for 1 year from the date of shipping. These products will be free from defects in material and workmanship under the customary and normal installation, use, and service. We will not warranty any units that have not had adequate oil and maintenance. If at anytime within the one year warranty period you have a problem or claim, simply return the unit prepaid to Advance Adapters and it will be completely rebuilt or replaced free of charge--*provided the proper installation procedures were followed.*

Atlas T/C: Atlas transfer cases are guaranteed against defects in workmanship and materials *for the life of the original purchaser* and is non-transferable. This lifetime guarantee covers and is limited to gear sets and castings. The remainder of the unit (i.e. shafts, bearings, gaskets, hardware) is covered by our limited 1-year warranty. Warranty begins from the date the unit is shipped from Advance Adapters.

Lifetime & limited warranties are void if (as determined by Advance Adapters) misuse, abuse, alterations of the product, improper install or if the proper gear lubricants are not

used, proper oil levels are not maintained, *and* installation and maintenance instructions have not been followed. These guarantees DO NOT cover any labor, shipping, normal wear or any other unforeseen event that may occur due to failure of a unit.

At the discretion of Advance Adapters, the products in question can be repaired or replaced when found defective. *Prior to any replacement or repair, written authorization must be obtained from Advance Adapters.* Failure to contact us prior to having warranty work performed will immediately void all applicable warranties; and it is then the sole responsibility of the customer to remit any payment incurred.

CATALOG CONTENTS: This Buyer's Guide has been put together with the best possible information available. Advance Adapters cannot accept the responsibility for vehicles, applications & OEM part numbers that may have changed. The contents of this brochure has been proofread before printing to minimize errors. We cannot be held responsible for errors overlooked.

The artwork and copy is the property of Advance Adapters, LLC and any use in part or in whole, must obtain written permission from Advance Adapters. All contents of this catalog have a copyright and are reserved for Advance Adapters only.

TRADE MARKS: The word Jeep & Jeep grille as used in the contents of this brochure have been recognized as a registered trademark of the Chrysler Corporation. Usage of the trademark name Cummins™ and Cummins™ 2.8L Turbo Diesel allowed by permission.

ORDERING INFORMATION: To place an order for items listed in this catalog, we suggest that you call for current pricing & freight charges. All major Credit Cards & PayPal accepted or a check for the full amount may be mailed to us prior to shipping. Personal checks are subject to be held 10 days to clear before product is shipped. *Therefore, we recommend sending a Cashiers check or Money order.* C.O.D. shipments are Certified or money order funds only.

TERMS OF SALE:

1. Visa, Mastercard, AMEX or Discover charge cards and PayPal accepted.
2. Merchandise is F.O.B. Paso Robles, California.
3. *Buyer agrees by acceptance of merchandise to be bound by these terms and conditions.*

Advance Adapters Gift Certificates obtained through giveaways, raffles & sponsored events have *no cash value* and *only* good for the purchase of AA branded products. Certificates purchased through Advance Adapters have *no limitations* and can be used toward any product.

Contact information on following page

TABLE OF CONTENTS

<u>JEEP & SCOUT VEHICLE SECTION:</u>	
Transfer Case Information	
Jeeps 1941-79.....	5-8
Saturn Overdrive.....	7-8
Jeeps 1980-86.....	9-11
Jeeps 1987 & Up.....	12-15
NP231 Fixed Yoke Kit.....	15
Jeep 42RLE Reduction Box "The RubiCrawler".....	22-23
Atlas Transfer Case.....	16-21
Drivetrain Yokes.....	87
Complete Transmissions.....	51-54
AX15, Automatics, NV4500 & NV3550	
T/Case Adapter Selection & Trans Data Charts.....	24-26
Bellhousing Adapters for Stock Jeep Transmissions:	
Jeep Transmissions 1941-79.....	27-28
Jeep Transmissions 1980-86.....	29
Jeep Transmissions 1987 & Up.....	29-30
Scout Transmissions.....	31
Jeep Transmission Retrofits.....	31-32
Special Conversion Bellhousings.....	33-34
Jeep Bellhousing Chart.....	34
Clutch Linkages.....	35-36
Clutch Release Arms & Bearings and Crank Bushings.....	36-37
Clutch Selection Chart.....	37
Radiators.....	38 & 78-79
Engine Mount Selection Chart & Additional Mounts.....	39-40
Exhaust Headers & Header Chart.....	40-41
Miscellaneous Brackets & Linkages.....	40 & 84-85
Saginaw Steering Conversions.....	41-44
Moses Ludel Jeep Bibles.....	84
<u>S10/S15 2WD & 4WD CONVERSIONS:</u>	
Engine & Transmission Adapters.....	45-46
<u>GM BLAZERS & FULL SIZE TRUCKS:</u>	
Transfer Case & Bellhousing Adapters.....	47-50
NV4500 CONVERSION PARTS.....	52-54
<u>COMPLETE TRANSMISSIONS AX15, NV4500:</u>	
AX15 & NV3550 CONVERSION PARTS.....	51-52
NV4500 CONVERSION PARTS.....	52-54
<u>DODGE GETRAG REPLACEMENTS:</u>	
NV4500 Adapters Dodge Getrag & Dodge NP205.....	55-56

<u>FORD FULL SIZE TRUCKS:</u>	
Transfer Case & Bellhousing Adapters.....	57-58
NV4500 CONVERSION PARTS.....	52-54
<u>FORD BRONCOS 1966-77:</u>	
Transfer Case Adapters.....	59-61
Atlas Transfer Case-Broncos.....	16-21
AX15 & NV3550 CONVERSION PARTS.....	51-52
<u>FORD BRONCO II & RANGER TRUCKS:</u>	
Engine & Transmission Adapters.....	62-63
Atlas Transfer Case-Rangers, Bronco II & Explorers.....	16-21
<u>TOYOTA 4WD TRUCKS & 4-RUNNERS:</u>	
Stock Transfer Cases.....	64-65
Transfer Case Adapter Chart.....	66
Engine Conversion & Bellhousing Adapters.....	67-68
Dual Transfer Case Crawler Box & Toyota Gears.....	68-69
<u>TOYOTA LAND CRUISERS:</u>	
General Conversion Information.....	70-72
Transmission Retrofits - SM465.....	72
NV4500 CONVERSION PARTS.....	52-54
Transfer Case Selection Chart.....	73
Bellhousing Adapters.....	74-75
Orion Transfer Case & Rock Crawling Options.....	76-77
Saginaw Steering Conversions.....	41-44
Mark's 4WD Adaptors.....	72
<u>LAND ROVER:</u>	
Transfer Case Adapters.....	83
<u>MISCELLANEOUS:</u>	
TRANSMISSION DATA CHART.....	26
Rad-a-Kool Radiators.....	78-79
Moses Ludel Jeep, GM, Ford & Toyota Bibles.....	84
Lokar Products, Shift Components & Starters.....	84-85
Gen III & IV Engine Information.....	80-81
Cummins™ 2.8L Turbo Diesel & Engine Information.....	82
Vehicle Speed Sensor Information (VSS).....	86
Drivetrain Yokes.....	87
Yoke Tool.....	87
SUZUKI SAMURAI GEARS.....	56
Apparel.....	88

(Terms & Conditions con't)

RETURN OF MERCHANDISE: **No merchandise may be returned without prior permission from Advance Adapters.**

Each shipment being returned must have an **Return Goods Authorization Number (RGA#)** listed on the outside of the package. Please contact our sales department to obtain an RGA number. Refunds or credits on merchandise *after 30 days* of purchase at the discretion of Advance Adapters, and **ALL returns may be subject up to a 30% restocking fee.** When returning merchandise, shipment must be **PREPAID. Freight is not refundable.** Products purchased through our distributors should be returned to them for refunds; exchanges and warranties can be dealt directly with us depending on components, and proof of purchase may be required.

PLEASE USE RETURN ADDRESS: 4320 Aerotech Center Way, Paso Robles, CA 93446.

Freight Policy Refunds for Shipping Errors & Defective Parts:

1. Advance Adapters will reimburse up to 3-day shipping, unless otherwise prearranged.
2. Upon verification of an error or defect, freight charges (when noted on your packing slip or freight bill) will be credited.

Refused Shipments: Advance Adapters has the option of back charging for any freight charges incurred from a refused shipment.

Lost or Damaged Shipments: It is the responsibility of the carrier if merchandise is lost or damaged while in transit. *Damage claims or shortages should be filed promptly.* Please contact us for proper assistance and for all necessary shipping information for you to trace or file a claim.

SALES DEPARTMENT CONTACT INFORMATION:

TELEPHONE (805) 238-7000
FAX (805) 238-4201
TOLL FREE (Nationwide) (800) 350-2223

WEB PAGE www.advanceadapters.com
E-MAIL ADDRESS sales@advanceadapters.com

BUSINESS HOURS (Pacific Time)
Monday 7:00 a.m. to 3:30 p.m.
Tuesday 7:00 a.m. to 3:30 p.m.
Wednesday 7:00 a.m. to 3:30 p.m.
Thursday 7:00 a.m. to 3:30 p.m.
Friday 7:00 a.m. to 3:30 p.m.
Closed Saturday & Sunday

Phones are on and open for calls at: 8am to 11am and then 12:30pm to 3:15pm

CALLING IN FOR SALES, TECHNICAL or CUSTOMER SERVICE

Customer service is very important to us. We have set up our phone system with the options listed below to streamline phone support for the type of help you are looking for. We have a well trained staff that has great product knowledge here to help you.

SALES (Press 1) - Our sales department is ready for sales questions, help, product applications or placing orders.

CUSTOMER SERVICE (Press 2) - Our customer service department is here for order shipping, tracking info, or issuing RGAs etc.

TECHNICAL SERVICE (Press 3) - Our technical service department can help with fitment questions, conversion issues or any other product problems you may be experiencing.

OUR WEBSITE & FEATURES

We are continually working on and making improvements to the Advance Adapters website because it is one of your direct sources for the most current, up-to-date information on our products. We have several features that will help you in the proper selection of products.

Features:

TECH VAULT - For more than 45 years now, we have been collecting data and doing drivetrain conversions on various four wheel drive vehicles. At one time in our print history, we use to publish six different vehicle specific manuals from our knowledge base; however, these are now all part of our Tech Vault. The Tech Vault has a link from our home page, but now we are linking relevant information on the Tech Vault to each product number. The important fact is that we want YOU to be informed & educated as much as possible on your project. If, for any reason you don't see the information you are looking for, we are just a phone call or email away. Please let us know.

REWARDS PROGRAM - We realize that web shopping is a competitive market place and most on-line shoppers are looking for a special price or a reason to purchase at a particular store. For this reason we offer a simple rewards program that is easy to redeem and you are automatically signed up with your first order.



The points program is exclusive to purchases made on-line and can only be redeemed through advanceadapters.com. We will reward points in the amount equivalent to 5% of your purchase (excluding shipping cost). These points are stored on your account and can be used like cash on your next on-line purchase from Advance Adapters. Points can be used to pay for some or all of your next order.

Example of points: A \$350.00 order today would earn 17.5 points towards your rewards account and those points could be used towards your next order.

SOCIAL NETWORKING - Like us on Facebook or follow us on Twitter for new products, latest news or to just see what's going on with us here at Advance Adapters. We post weekly information to keep you informed.

PRODUCT NAVIGATION - We offer two search windows on the home page for key word searches plus several main category drop downs to navigate to the products you are looking for. Once you have the product page up that you are looking for, there are linked instruction sheets, related items that you may also want, and the Tech Vault related information.

The products page also offers you an option to save money on salvage items that may be available for that product. We sometime get machine blem parts or parts that were damaged in shipping. They are always numerically correct but cannot be sold as 'new'. If available, you will see a mustard color box indicating that we have this as an option.

JEEP 1941-UP & SCOUT

Transfer Case Adapters

This section of the Buyer's Guide deals with transfer case adapters in Jeeps 1941 to current models, and International Harvester Scouts. On the Jeep Transfer Case Selection chart you will find numerous listings of both transfer cases and the most popular GM, Ford, and Chrysler automatic & manual transmissions. By using this chart, you will be able to identify the specific adapter for your application. Most of these adapters will require additional components to complete your conversion needs. (i.e. motor mounts for engine swaps, crossmember mount, transfer case & transmission shifter components, transfer case alignment retainers, etc.)

In addition, most transmission swaps will normally require driveline modifications. We have listed both transmission and adapter lengths for your reference. The paragraphs to follow are listed by year of vehicle and transfer case application.

1941-79 JEEPS & SCOUTS (Dana Spicer 18 & 20 T/C) and SCOUTS (1980 Dana 300):

These transfer cases, although used in different vehicles, all have the same bolt pattern. When considering a new transmission for one of these transfer cases, there are just a few things you must confirm: the transfer case indexing to the new adapter and the female splines on the transfer case input gear.

INDEXING: The Dana Spicer transfer cases were indexed to the stock transmission by either a bearing or a bearing retainer. Early Jeeps that were equipped with the T90 or T84 transmissions used a bearing to index the transmission to the transfer case. We classify this transfer case as a *small hole* transfer case. This small hole transfer case will require a bearing when you adapt to this transfer case. In addition to this bearing, our adapter will also require a thin bearing support retainer. This support retainer is necessary to align our adapter to the transfer case. This support retainer can be purchased from us or be obtained off of a stock T90 transmission.



Small Hole transfer case (3-1/8")



Large Hole transfer case (4")

All other Jeep transmissions were indexed to the transfer case by either a retainer housing or an index hub which was part of the stock transmission case. These transfer cases are classified as *large hole* transfer cases. Our adapters will require this indexing retainer to obtain proper alignment. This retainer can be purchased from us or you can also use a retainer from a Jeep T86 transmission. All large hole transfer cases require this retainer. (Scout Dana 300s are also a large hole transfer case). When utilizing either one of these retainers, we also recommend that a new 307 sealed bearing be used.



Small Hole T90



Large Hole T86

- P/N 716002 - Small hole index retainer (T90) Dana 18
- P/N 716001 - Large hole index retainer (T86) Dana 20
- P/N 716302 - Sealed bearing (307)



SPLINES: These transfer cases all require a male shaft to extend from the rear of the stock transmission or the new adapter housing. The transmission output shaft fits into the drive gear of the transfer case. Jeep standardized most drive gears with a 6 tooth female spline; however, there were some exceptions. Between the years 1969 to 1971, Jeeps equipped with a T14 transmission used a 10 spline female drive gear; and Scout transfer cases used with an automatic were always a 23 spline female drive gear. *(Note: On Scouts, we recommend that you verify your input spline count before ordering parts.)* Jeeps that were equipped with an AMC TH400 used a 15 tooth female drive gear. We manufacture transfer case adapters to fit most of the different splines that Jeep used. The transfer case adapter selection chart on Pages 24 & 25 will help you to identify the proper adapter for your transfer case. If for some reason we do not offer the adapter for your female spline count, you can change out the transfer case drive gear. Please check with a qualified transfer case rebuilder when changing your drive gear, since there were some external gear tooth differences.



6 10 23 15
Four different female spline transfer case drive gears

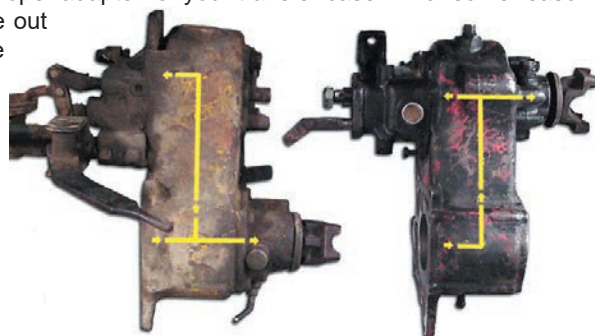

Power flow of a Dana 20 (left) & Dana 18 (right)

FRONT DRIVESHAFT CLEARANCE: On most vehicles, we have tried to allow for proper clearance. However, we are unable to compensate for this with some automatic transmissions. These applications will require the centerline of the drivetrain to be offset 1" to the driver's side and you will be limited on your driveshaft diameter. On some 1965 and earlier Jeeps, the front yoke can also present some interference problems on both the automatic & manual transmissions. If the front yoke is interfering, than we do offer a small front yoke replacement kit, [P/N 716009](#).

TRANSFER CASE SHIFTERS: The 1941 to 1979 transfer cases use several designs of shifters. These shifters are always supported off the front of the stock transfer case. On some of the truck 4 speed adapters and the NV4500 adapters, you may need to modify your stock shifter. The instruction sheets provided with the kits will give you this information.

CROSSMEMBER SUPPORT: All of the adapters we manufacture offer a support pad machined on the casting. The location of this pad will normally require you to relocate your crossmember on your frame rails. We offer a few options to aid you in this area.

- [P/N 716003](#) - New rubber support (Jeeps 1941-79) *(photo right)*
- [P/N 716003-HD](#) - New prothane support (Jeeps 1941-79)
- [P/N 716021](#) - New rubber support (Jeeps 1972-79)



JEEP DANA 20, 32 SPLINE OUTPUT SHAFT KIT:



The Dana 20 transfer case is a good, strong cast iron transfer case; however, with the introduction of the various low gear options for this unit and the popularity of rock crawling, a growing concern for drivetrain reliability has materialized. Since low gear kits increase the torque to the output shaft and rock crawling usually demands tire size, we've developed a heavy-duty rear output shaft kit for the Dana 20 transfer case to add strength and reliability to your drivetrain. Our kit fits all Dana 20 transfer cases with or without a low gear kit installed. The stock Dana 20 output shaft is a 1-1/8" diameter 10 spline, and our new output shaft is a larger 1-3/8" diameter 32 spline output. The output shaft kit is approximately 1.5" longer than your stock tailhousing; however, you do gain the option of calibrating your speedometer to compensate for a different axle ratio and/or larger tires. Our kits come complete with a new tailhousing, output shaft, tapered roller bearings, yoke, and speedometer drive. When you require strength and reliability, install the Advance Adapters H.D. Dana 20 output shaft kit.

- [P/N 50-3020A](#) - Heavy duty 32 spline Dana 20 output shaft without a yoke (See yoke options listed on Page 18).

JEEP DANA 18/20 INTERMEDIATE GEAR KIT:

These kits are available for Jeep transfer cases 1946-53 (with an 1-1/8" intermediate shaft), or Jeeps 1953-79 (1-1/4") to fit the stock cluster gear. These kits use tapered roller bearings and a new shaft that aid in the noise reduction of your stock transfer case. Machining is required on your cluster gear.

- [P/N 716005](#) - 1-1/4" Kit
- [P/N 716006](#) - 1-1/8" Kit



WINDSHIELD LATCHES: The CJ5 & CJ6 Jeep vehicles (up to 1975) always had a problem with the stock windshield. The stock latches had a tendency of loosening up and allowing the windshield to fall forward.

We remedied this problem by designing aluminum castings that would replace the stock dash & windshield brackets. This kit is available with a polished aluminum finish and is directly interchangeable with your stock latching mechanism. [P/N 716127](#)

JEEP DANA 18 GEAR KNOBS KIT:

We offer replacement knobs for the Dana 18 twin stick transfer case. [P/N 715643](#)



JEEP 1941-72 Hydraulic Clutch Linkage:

We offer the components to upgrade your Jeep to hydraulic clutch linkage, see Page 35.

SATURN OVERDRIVE

This all-range overdrive is a great addition to any of the early model Jeeps from 1940 to 1971, and I.H. Scouts 1961 to 1965 with the Model 18 transfer case. The addition of this 25% overdrive unit offers you the needed gearing that the early Jeeps were lacking. The Saturn overdrive is a fully synchronized unit that can be shifted-on-the-fly. When installing the unit, only minor modifications are required to the floorboard for the shifter. The Saturn is built to handle up to 300 ft.-lbs. of torque, well within the range of a stock V8.

The Saturn is the original unit designed and developed by Warn Industries. Advance Adapters purchased the tooling, engineering data, and inventory from Warn in 1991. The components we manufacture today are the same as the old Warn components. We have incorporated a few upgrades on the units we sell today, but these units are all still interchangeable with the original Warn overdrive. (Note: The Saturn is not compatible with the Husky unit.)

APPLICATION INFORMATION:

To select the proper overdrive model, find your vehicle model and transmission type listed below. The Saturn overdrive will only fit the vehicles listed that have a Dana 18 transfer case.

Part #	Description	Vehicle Models
P/N 915670	26T X 6 spline	M38, M38-A1, CJ2A, CJ3A, some CJ3B, 4-63 4X4, 4-73 4X4
P/N 915672	29T X 6 spline	CJ5, CJ5A, CJ6, CJ6A, 4-74 4X4, some CJ3B, 6-266, 6-230
P/N 915674	29T X 10 spline	(T14 trans) CJ5, CJ5A, CJ6, CJ6A
P/N 915678	27T X 6 spline	
P/N 915676	31T X 10 spline	(Mitsubishi Jeep only)

UNIT PRICE \$1102.29

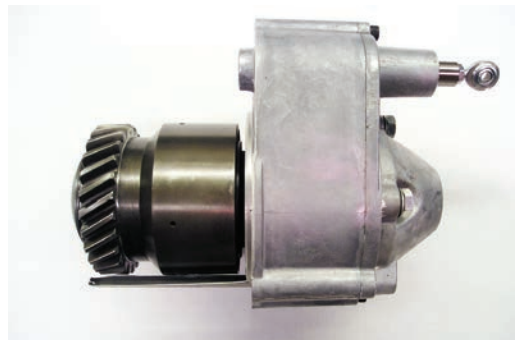

SHIFTER APPLICATION: Shifters are sold separately.

Part #	Description
P/N 920000	T90 Dual Handle T/C
P/N 920001	T90 Single Handle T/C
P/N 920003	Universal Saturn Shifter
P/N 920013	T14 Shifter

SHIFTER PRICE \$88.45

The complete installation instructions and parts are listed online at www.advanceadapters.com under the Tech Vault.



SATURN ASSEMBLY KITS

COMPONENTS

911349 SEAL AND GASKET KIT
KIT INCLUDES ALL GASKET SEALS & SEAL WASHERS

912821 THRUST BEARING KIT
KIT INCLUDES: (2) 911099
(2) 911094
(2) 911100

918963 4-PC PLANETARY GEAR SETS
KIT INCLUDES: (8) 911341
(8) 911342
(4) 911316
(4) 911090
(4) 911338

911362 SPLINED SHAFT KIT
KIT INCLUDES: (1) 911043
(1) 915132
(1) 911143
(1) 911147
(1) 911330

911317 SYNCHRO RING SERVICE KIT
KIT INCLUDES: (2) 911067
(3) 911069
(3) 911071

911318 SYNCHRO ASSEMBLY KIT
KIT INCLUDES: (2) 911067
(3) 911069
(3) 911071
(1) 911078
(1) 911346

911223 26 TOOTH PLANETARY HSG. KIT
KIT INCLUDES: (1) 911092
(2) 911091
(1) 919869

911224 29 TOOTH PLANETARY HSG. KIT
KIT INCLUDES: (1) 911093
(2) 911091
(1) 919869

911837 PLANETARY ASSEMBLY (6 SPL.)
INCLUDES: (1) 914232
(4) 911090
(1) 911095
(1) 911137
(4) 911316
(4) 911338
(8) 911341
(8) 911342
(1) 911731
(2) 919866
(1) 916779
(1) 911143

Part No.	Qty. Req.	Description	Part No.	Qty. Req.	Description
911043	1	HEX NUT	911731	1	DRIVE NUT
911067	2	BRASS SYNCHRO-RING	911731-S	1	METRIC DRIVE NUT
911069	3	SYNCHRO DOG	911806	1	LOCKWASHER
911071	3	SYNCHRO SPRING	911838	1	RETAINER RING
911078	1	SHIFTER SLIDER RING	912388	1	ROLL PIN
911090	4	PIN, PLANETARY GEAR	913296	1	SHIFTER SHAFT
911091	2	NEEDLE BEARING	913297	1	SHIFTER GUIDE PIN
911092	1	26-TOOTH GEAR	914231	2	SCREWS 6-32 X 1/4
911093	1	29-TOOTH GEAR	914232	1	PLANET HUB - 6 SPL
911094	2	THRUST RACE	914384	1	PLANET HUB -10 SPL
911095	1	THRUST WASHER	914384-S	1	PLANET HUB 10 SPL
911096	1	31-TOOTH GEAR	914862	1	CAP SHIFTER
911097	1	27-TOOTH GEAR	915132	1	COTTER PIN
911098	1	TERA LOW BOWL GEAR	915204	1	SATURN CASE
911099	2	NEEDLE BEARING	916779	1	SNAP RING
911100	2	THRUST WASHER	919866	1	RETAINING RING
911103	1	SHIFTER FORK	919869	1	RING OIL SLINGER
911105	1	SPRING, SHIFT DETENT			
911106	1	SHIFT DETENT BALL			
911107	1	SHIFT RAIL SEAL NEW STYLE			
911108	1	SHIFT RAIL O-RING SEAL			
911109	1	SPACER WASHER			
911130	1	GASKET CASE			
911131	1	GASKET BODY			
911133	1	OIL SCOOP			
911137	1	O-RING			
911143	1	NEEDLE BEARING			
911147	2	RETAINER RING SUN GEAR BEARING			
911236	1	SPECIAL SNAP RING			
911313	1	ROLLER BEARING			
911316	4	THRUST WASHER			
911326	1	BEARING CAP			
911328	1	CASE COVER			
911330	1	6 SPLINE SHAFT			
911334	1	SPACER WASHER			
911336	1	GASKET CAP			
911337	1	STATIONARY MEMBER			
911338	4	14-TOOTH GEAR			
911341	8	THRUST WASHER			
911342	8	NEEDLE BEARING STRIP			
911346	1	DRIVE MEMBER			

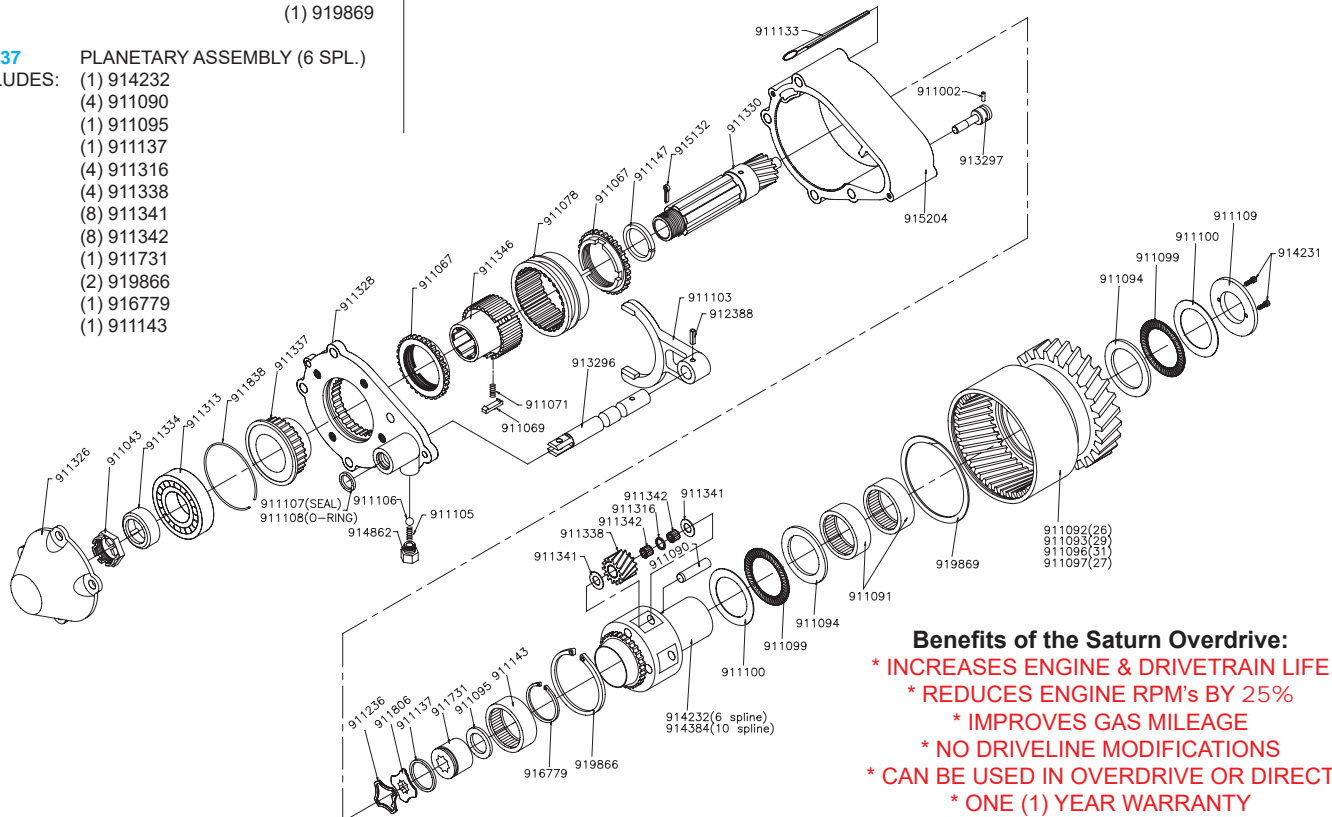

Benefits of the Saturn Overdrive:
 * INCREASES ENGINE & DRIVETRAIN LIFE
 * REDUCES ENGINE RPM's BY 25%
 * IMPROVES GAS MILEAGE
 * NO DRIVELINE MODIFICATIONS
 * CAN BE USED IN OVERDRIVE OR DIRECT
 * ONE (1) YEAR WARRANTY

1980-86 JEEPS (Dana 300):

In 1980, the transfer case in Jeep vehicles changed to the Dana 300 transfer case. This was a good improvement over the Dana 20, and it seems to handle V8 horsepower without any problems. We manufacture several adapters that will bolt different transmissions to this stock transfer case. These adapters are manufactured to fit a 23 spline input sleeve in Dana 300 transfer cases. These adapters should be used when replacing the SR4, T4, T5, T176, and Torqueflite transmissions.

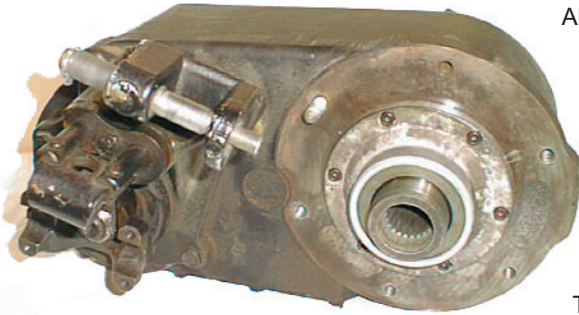

All Jeep Dana 300s are a right-hand drop. They have a circular bolt pattern, 23 tooth input spline, case length of 12", and main case material of cast iron. The transfer case uses an aluminum retainer that indexes this transfer case to the transmission. The stock low gear ratio is 2.62:1. The power to the rear axle is in line with the transmission. This is a good gear-driven transfer case to retain when doing an engine or transmission swap.

Jeep Dana 300s all use a 23 spline input. We manufacture various Dana 300 input shafts which include 10, 21, 23 (stock replacement), long 23 (.750" longer than stock engagement), 27, 29, 31, 32, and 35 splines. Therefore, if you obtained a Dana 300 from a salvage yard, please verify the input spline. The aluminum index retainer incorporates a front seal to protect the transfer case fluid from entering the transmission. The Dana 300 has a stock rotation of approximately 35 degrees. All of the adapters we manufacture for this transfer case have the provisions for this rotation.

DANA 300 INPUT SHAFT:

- P/N 52-0203** - 35 spline Dana 300 input
- P/N 52-0208** - 32 spline Dana 300 input
- P/N 52-0229** - 29 spline Dana 300 input
- P/N 52-0432** - 27 spline Dana 300 input (short)
- P/N 52-2910** - 31 spline Dana 300 input
- P/N 52-3001** - 23 spline Dana 300 input Stock replacement
- P/N 52-3002** - 23 spline Dana 300 input .750" longer
- P/N 52-3021** - 21 spline Dana 300 input
- P/N 52-6309** - 27 spline Dana 300 input
- P/N 52-9810** - 10 spline Dana 300 input



DANA 300 OUTPUT SHAFT KITS:

About the only weakness we've seen on the Dana 300 is the output shaft. The stock Dana 300 output shaft is a 1-1/8" diameter, 26 spline. We now offer a new, larger 1-3/8" diameter 32 spline output shaft for this transfer case. The Dana 300 has two different stock tailhousing lengths (approximately 4.25" "long tail" and 3.25" "short tail"). The bolt patterns on these two tail housings are different when bolting to the Dana 300 case.

We offer kits to fit both lengths of the Dana 300 transfer case tail housings. Dana 300s equipped with the shorter 3.5" version tailhousing will require driveshaft modifications since our kit is 1.5" longer than your stock tailhousing. Kits come complete with a new tailhousing, output shaft, taper roller bearings, and yoke.

If you require strength and reliability, the Advance Adapters H.D. Dana 300 output shaft kit is a must have.

DANA 300 LONG TAILHOUSING OUTPUT SHAFT KITS:

- P/N 50-3032A** - Heavy duty 32 spline Dana 300 output shaft without a yoke (See yoke options listed on Page 18)

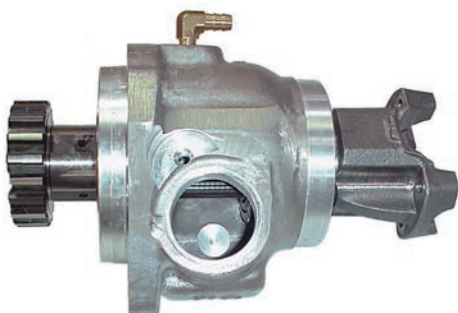

DANA 300 SHORT TAILHOUSING OUTPUT SHAFT KITS:

- P/N 50-3034A** - Heavy duty 32 spline Dana 300 short output shaft without a yoke (See yoke options listed on Page 18)

(The short tailhousing kits also include a new speedometer drive provision that can now be simply calibrated for tire or axle changes. Speedometer drives sold separately.)

TRANSFER CASE TWIN STICK SHIFTERS:

Another option for the Dana 300 transfer case is a twin stick shifter. This twin stick shifter application requires the installation of two new shift rails. This kit is securely mounted off of the stock aluminum shifter housing. The new shifter kit contains a heim joint linkage for a smooth, positive shifter motion.

P/N 403300 - Twin Stick kit
(Kit includes new shift rails and shifter boot included)

P/N 303150AA - Aluminum Knobs
(Black anodized knobs for the twin stick kit)

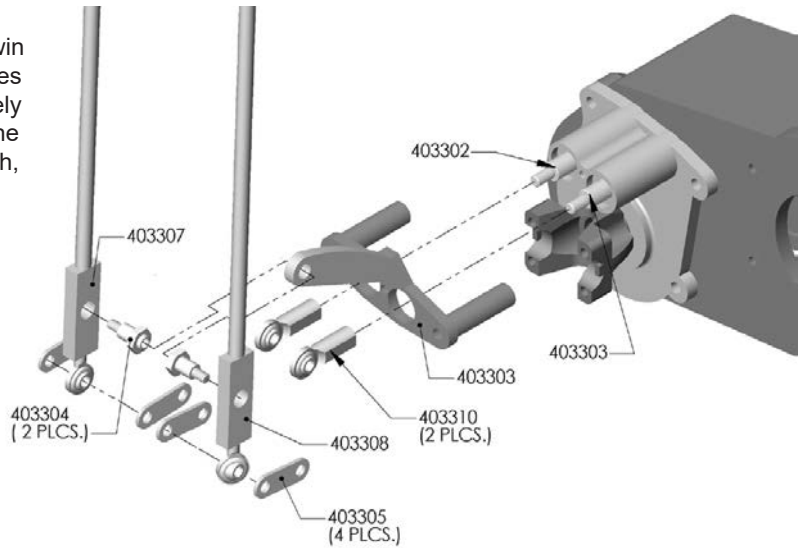
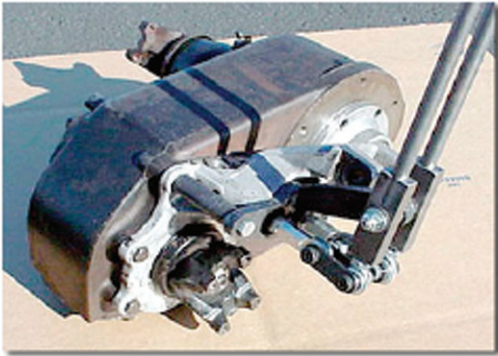

TRANSFER CASE STOCK SHIFTERS:

Dana 300 shifters are always supported off the front of the stock transfer case. On some of the truck 4 speed and NV4500 adapters, the shifter support and pivot shaft may need to be modified to fit to these transmissions. Most applications will not require any modifications.

DANA 300 REBUILT KITS:

We offer complete rebuild kits for the Dana 300 transfer case. Our kit comes complete with bearings, seals, shift fork pads, and intermediate shaft. This kit is ideal when installing one of our new 32 spline output shaft kits, **P/N 400300R**.

DANA 300 LOW GEAR OPTION:

Most 4WD vehicle owners today are always looking for a lower gear advantage. We offer a NP203 reduction box for the Dana 300. This kit bolts a NP203 gear box in front of the Dana 300 providing a 2.0:1 reduction. A twin stick shifter is required with this kit.

P/N 50-8811 - Dana 300 to NP203 reduction box adapter

DANA 300 ROTATION KIT:

Since ground clearance is a concern for most vehicles, we have developed a rotation kit to allow the Dana 300 to be clocked at a higher than stock rotation. Our kit allows up to three different rotations than stock. The adapter is .750" thick and includes a new, longer input shaft for the Dana 300. Our kit retains the proper spline engagement and proper indexing for the Dana 300 transfer case. Floorboard and shifter modifications may be required.

P/N 50-8604 - Fits transmission with a flush output shaft stickout (Jeep automatics & NV3550)

P/N 50-8603 - Fits transmission with a .438" output shaft stickout (Jeep AX15)

(Note: This adapter is not designed to flip the Dana 300 upside down.)

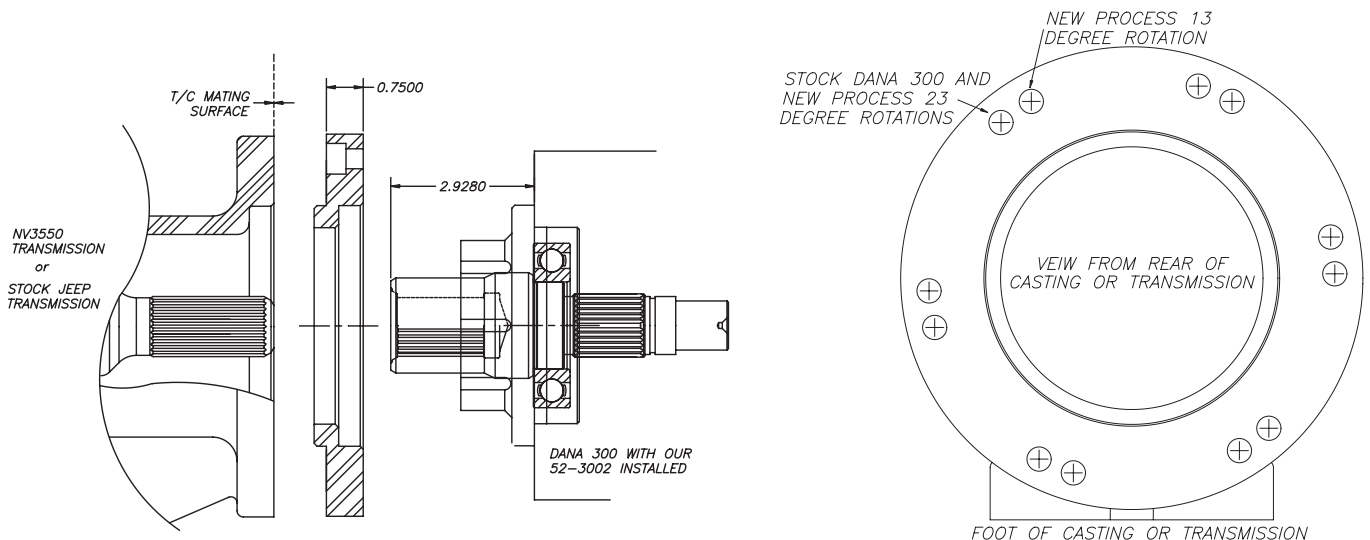

TRANSMISSION / TRANSFER CASE SUPPORT PLATE:

All of the adapters we manufacture offer a support pad machined on the casting. In most cases, this pad will not line up with your original skid plate mounting slots. If you are planning to reuse your stock rubber support or our new support, we suggest that you retain your skid plate in the stock location and add two new holes to your skid plate to fasten the rubber support. The kit below can be used to fasten our adapter to your stock skid plate.

P/N 716021 - New rubber support (Jeeps 1980-86)

Some vehicle applications may require a spacer between the adapter crossmember foot and the rubber mount. This is to provide ample clearance between the transmission and the skid pan. We offer a 2" spacer that works well. Since all applications differ, it's hard to recommend when this additional mount is needed.

P/N 716048 - 2.0" spacer between adapter foot and crossmember

FRONT DRIVESHAFT CLEARANCE:

On most vehicles, we have tried to allow for proper clearance. However, we are unable to allow for this with some automatic transmissions. These applications will require the centerline of the drivetrain to be offset 1" to the driver's side, and you will be limited on your driveshaft diameter.



P/N 716021



Stock rubber mount



P/N 716021 and P/N 716048

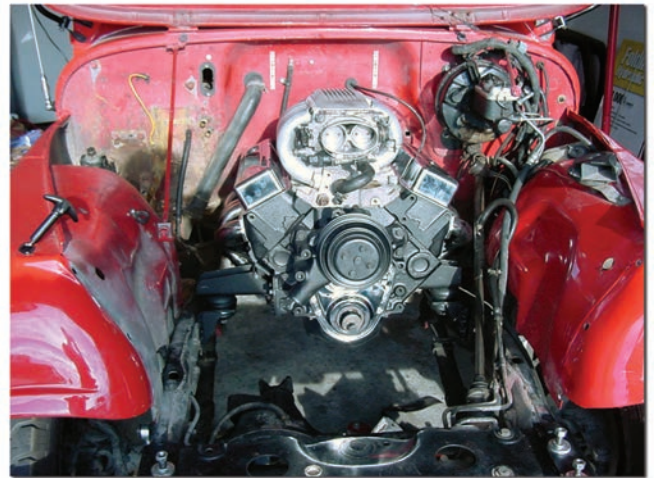

713089 bolt-in mounts with engine off-set

1987 & Up JEEPS

(NP200 Series Transfer Cases):

The New Process transfer cases used in late model Jeeps are always a left-hand drop configuration and have the same circular bolt pattern as the Dana 300. One of the differences between the Dana 300 and New Process transfer case is the rotation. The stock rotation on the New Process transfer case depends on the year of the vehicle and the stock transmission used. The rotations are approximately 13 or 23 degrees. Most of our adapter housings will have both sets of six adapter-to-transfer case mounting holes. The illustration (on previous page) shows both rotations.

The input splines on these transfer cases vary from 21 to 23 splines, and the transmission that is mated to these transfer cases had either a long or flush output shaft length. **It is crucial that you identify the correct spline length and tooth count before ordering any adapters.**

There are numerous styles of New Process transfer cases and you must be very careful in making your identification of such. The first units were the NP207s, and they were used in the early model Cherokee Jeeps. The full size Jeep trucks and Grand Wagoneers used the NP208. Jeep soon added the NP231 which replaced the Model 207 in 1987. A Model NP242 was also added for the full time 4WD models.

SPLINES: With all of the variations in model numbers, the only variation that we see concerning transmission adaption is the size and tooth count of the transfer case input spline. As mentioned in the second paragraph, the New Process transfer case has two basic spline counts and each spline count has two different lengths. Most New Process transfer cases were available with these two different input splines. The input splines of the transfer case can be changed if necessary, but the complete transfer case will need disassembly.

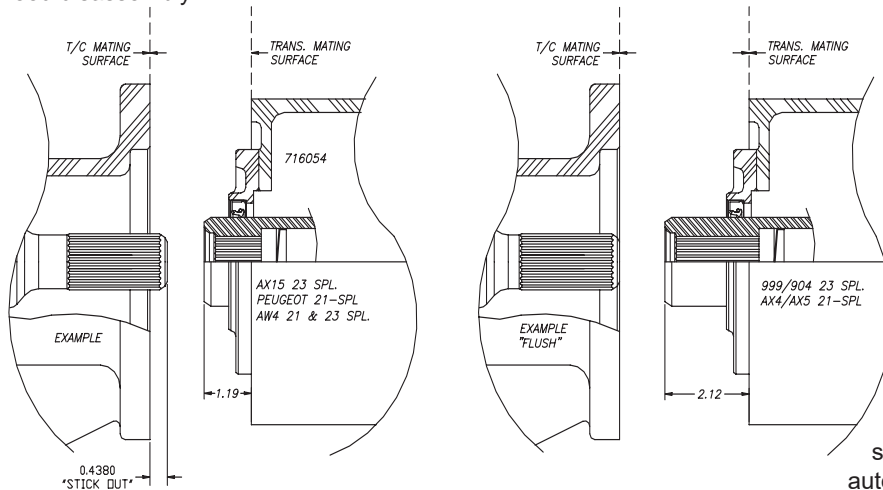

The easiest way that we have found to identify the proper transfer case input is by identifying the stock transmission that Jeep used. The 21 and 23 spline output shafts vary on different transmission models. The AX15 transmission is always 23 spline and protrudes 1/2" beyond the face of the transmission. The Torqueflite and NV3550 are normally a flush 23 spline. The AX4 & AX5 always had 21 splines and were flush with the back of the transmission adapter up to 1996; and then in 1997 were the same as the Peugeot transmission which is always 21 splines and protrudes 1/2" beyond the back of the transmission adapter housing. We have seen the AW4 automatic transmission in both a long 21 & 23 spline.

On the Transfer Case Selection Chart, we have listed the stock Jeep transmissions used with each transfer case. You can also refer to the Stock Jeep Transmission & Bellhousing section for additional transmission identifications. If you have a 21 spline transfer case, you will notice that some transmission applications are not available. On these applications and on high horsepower applications, we recommend changing your input gear to a 23 spline. This will allow you to use the transmissions listed for the 23 spline applications and will also give you added strength.

- P/N 716053** - New Process T/C 23TH input (used for **flush** output shaft stickout on transmission)
- P/N 716054** - New Process T/C 23TH input (used for long output shaft stickout on transmission)

On Jeeps 1995 & newer, New Process used a different planetary assembly. The two part numbers previously listed will not work with these transfer cases. To the best of our knowledge, this transfer case can be identified by one of three case model numbers: 5209-7894, 5209-8361 & 5209-8540. If you have one of these model transfer cases and wish to change to a 23 spline input, the input gear required is **P/N 716095**.

The gears listed above will not work with the NP207 transfer case. If you have a 1987 Jeep equipped with the NP207 21 spline input gear and wish to add some strength to your drivetrain, you can purchase a new 23 spline input gear (**P/N 716096**). This new input gear was designed for transmissions with a flush output shaft stickout. Transmissions having a .500" stickout past the adapter housing will require the input gear length to be modified. On certain applications the transmission output will have to be trimmed.



DRIVESHAFT CLEARANCE: When converting to a new transmission, driveshaft modifications are normally necessary. Jeeps with the NP231 now have the advantage of gaining needed length for suspension travel. We offer a new short shaft "Fixed Yoke" kit that will add 4" of rear driveshaft length on a YJ, and up to 6" on a TJ. Regarding front driveshaft clearance, this is not usually a problem. Care should be given on some manual transmissions with reference to the clutch release arm and slave cylinder mounting.

TRANSMISSION/TRANSFER CASE SUPPORT PLATE: All of the adapters we manufacture offer a support pad machined on the casting. In most cases, this pad will not line up with your original skid plate mounting slots. If you are planning to reuse your stock rubber support or one of our new supports, we suggest that you retain your skid plate in the stock location and add two new holes to your skid plate to fasten the rubber support. The supports below can be used to fasten our adapter to your stock skid plate.

- P/N 716008** - New rubber support (Jeeps 1987 & Up)
- P/N 716055** - Transmission support (limited applications)



Some vehicle applications may require a spacer between the adapter crossmember foot and the rubber mount. This is to provide ample clearance between the transmission and the skid pan. We offer a 2" spacer that works well. Since all applications differ, it's hard to determine or recommend when this additional mount is needed. **P/N 716048**

TRANSFER CASE SHIFTERS: There are several configurations used on the New Process transfer cases. We manufacture several brackets to assist you in retaining your stock shifter; however, some applications are not available. You may be required to fabricate your own brackets to work with our adapters. The stock brackets pictured below are the most common brackets we've found on New Process series transfer cases. Some of these brackets were used in specific applications, while others were interchanged. The photos below will help you identify the stock linkage your vehicle may have. This will assist you as to whether or not we offer additional brackets to mount your linkage.



(Brkt. #1)

Jeep# 53004280

This bracket bolts the adapter to the transfer case flange and is the most universal of the 4 brackets. If you are having trouble mounting your transfer case linkage, obtain this bracket to simplify your installation. No additional brackets are necessary. This bracket is sometimes hard to find. Our **Part No. 715545** is very close to the same as this bracket.



(Brkt. #2)

Jeep# 53005371

This bracket is normally found on Jeep AX15 transmissions.



(Brkt. #3)

Jeep# 53004278

This bracket is normally used with the AX4 & AX5 transmission.



(Brkt. #4)

This bracket (used mostly in TJs and some Cherokees) is by far, the hardest linkage to retain when doing any type of conversion. The outside of the bracket is bolted to the frame rail or floorboards, thus causing difficulty adjusting for different transmission lengths.

We offer assistance on mounting some of the above stock transfer case shifters. If we do not offer a bracket for your application, we suggest that you purchase Bracket #1. The part numbers listed below refer to the stock bracket referencing numbers.

AA Part #	Fits AA Casting # or Application	Fits Stock Bracket #
715523	50-6300, 6800, 9100 kit series	Brkt. #2 & 3
715542	TJ with 13 degree T/C rotation	Brkt. #4
715545	NV3550 & AX15 to NP transfer case	New Brkt.

Replacement transfer case handle & black anodized aluminum shift knob.

P/N 715545H



P/N 715523



P/N 715542



P/N 715545



Adjustable connector rod with rod ends between the transfer case shifter lever and gated shifter.

P/N 715545C

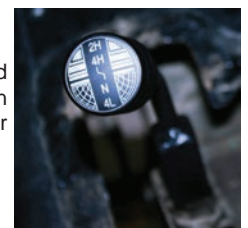

JEEP TJ DELUXE CABLE LINKAGE

Our Deluxe Cable Shifter alleviates the problematic shifting mechanism of Jeep TJ Transfer cases. This heavy duty shifter was designed to correct the binding, hard shifts, and slipping-out-of-gear inherent when lifting a Jeep TJ or altering the drivetrain components. Both kits replace the body mounted mechanical system with a robust cable actuated design that creates a crisp and carefree transfer case shifting experience.

- P/N 715543-231** - Jeep TJ cable shifter for NP231 T/Cs
- P/N 715543-241** - Jeep TJ cable shifter for NP241 T/Cs

Jeep TJ Cable Shifter Kit
(Installation videos available Online)



JK CABLE LINKAGE:

This whole new heavy duty design was created for the off roader who is consistently shifting the transfer case in and out of various ranges. The improved cable and mounting system offers both a durable and dependable system that removes the easily worn out or broken factory shifter system. **P/N 715596**

Jeep JK Cable Shifter Kit
Sema New Products Award Winner

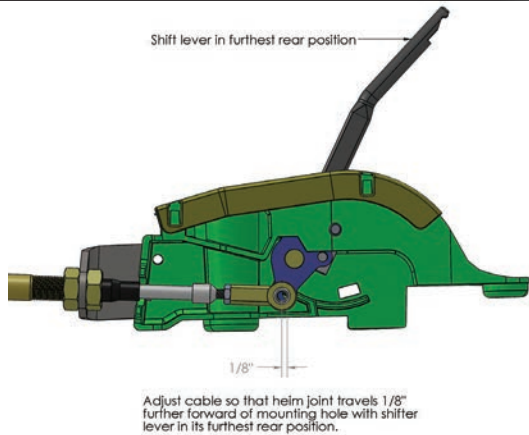

JK TRANSFER CASE SHIFTER KNOBS:

These are two transfer case shift knob designs for the 2007-2018 Jeep JKs. We offer them in a variety of colors and they are easy to install.



P/N 715598

P/N 715597

Jeep NP231 Fixed Yoke Kit (Slip Yoke Eliminator)(S.Y.E)

Kit 50-7906 (Driveshaft modifications required) CALL FOR PRICING!

The Jeep NP231 is one of the most commonly used transfer cases today. It is a chain-driven, planetary designed gear box with a low ratio of 2.72 to 1. For the average 4-wheeler, this is a good transfer case. One of the biggest faults of this transfer case is the overall length. At 20+ inches, this creates an extremely short rear driveshaft in the Jeep YJ & TJ Wranglers, which becomes even more crucial when the vehicle is lifted or a transmission swap is performed. In addition to a lift kit installation, larger tires are usually the next upgrade. Strength and driveline angle of the output shaft then becomes a concern.

To make the NP231 better suited for these upgrades, we have designed our "Fixed Yoke" kit with the best features available. We manufacture a new one-piece tailhousing that will add 3-1/2" to 4" to your rear driveline length on a YJ, and up to 6" on a TJ. This will allow you to obtain a better driveshaft angle and eliminate driveline vibrations. We also manufacture a new 32 spline output shaft that is over 50% stronger than stock. This kit, along with a new 1310 series C.V. yoke, makes the NP231 a better transfer case for trail use. A full set of installation instructions is provided to assist in the installation of this kit.

If you're looking for a non C.V. yoke or a flanged yoke option, kit **P/N 50-7907** allows for these options. This kit can be ordered with a 1310 or 1350 non-C.V. yoke or a flange yoke can be added (See yoke options listed on Page 18).

We also offer S.Y.E kits with a Tom Woods Custom Drive Shaft.

Overall, NP231 is a good chain-driven transfer case. For the ultimate in strength, reliability, and low gear ratio, consider a *gear-driven* "Atlas" transfer case as the superior choice.

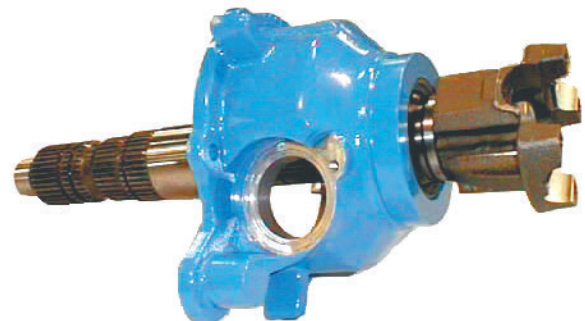
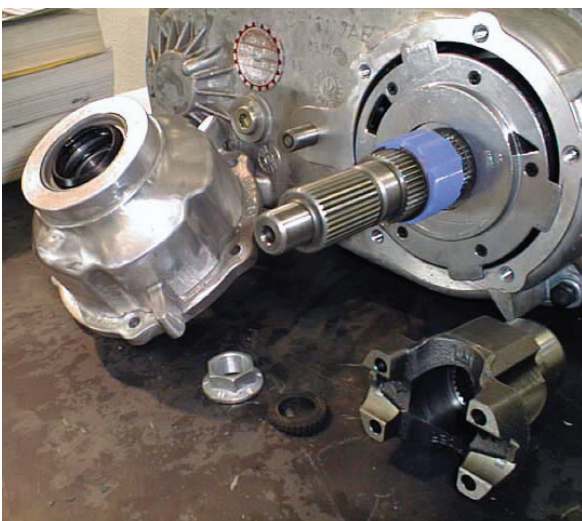
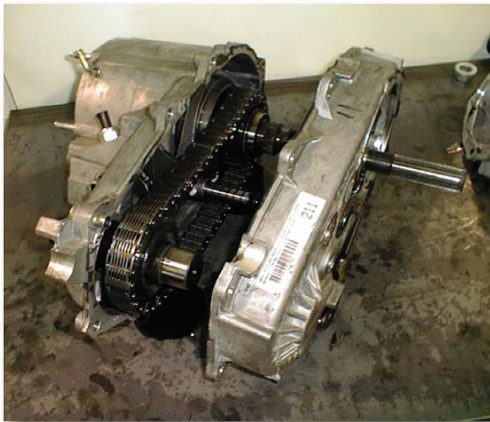

THE ATLAS TRANSFER CASE

The Advance Adapters Atlas heavy duty gear-driven transfer cases are the ultimate in gearing and strength. These units are the solution for combining both on and offroad performance. From its inception in 1996, we have received numerous inquiries to fit the Atlas into a wide spectrum of vehicles. To date the Atlas has been installed into a multitude of different vehicles such as Jeeps, Broncos, Explorers, Dodge, Chevy & Ford Trucks. These units can be found in daily driven vehicles, extreme rock crawling vehicles, all the way up to the Ultra 4 race rig. When you want or need peace of mind on the trail, in the rocks, on the sand, or in the mud, the Atlas is the transfer case for you.

The [Atlas 2 Speed](#) is 2-1/2" shorter than a NP231 with a fixed yoke conversion kit. Applications with a NP231 will have to lengthen the rear driveshaft and shorten the front driveshaft. Applications with a Dana 300 transfer case or Bronco Dana 20 will have to shorten the rear driveshaft and lengthen the front driveshaft. Most applications will require crossmember modifications.

(2SP) Atlas, 13.8" & Atlas (with AST32 short tailhousing), 11.8"

The [Atlas 4 Speed](#) is 1-3/4" to 3-3/4" shorter than a standard NP231 transfer case (length depends on which tailhousing is used). Applications replacing a NP231 will have to lengthen the rear driveshaft and shorten the front driveshaft. Applications replacing a Dana 300 transfer case or Bronco Dana 20 will have to shorten the rear driveshaft and lengthen the front driveshaft. The Atlas 4 speed offers you the ultimate multiple-use vehicle, The several low gearing options allow you to gear your rig for the daily driver as well as the extreme rock crawler.

(4SP) Atlas, 18.75" & Atlas (with AST32 short tailhousing), 16.75"

Stock transfer case lengths: **NP 231 Series, 20-1/2"; NP Rock Trac T/C, 15-1/4"; Dana 300, 12"**

Design of the Atlas:

Through the analysis of other successful transfer case designs, we have manufactured a rugged, all gear-driven transfer case. Combining the latest in CAD/CAM technology and years of in-house CNC machining capabilities, the Atlas transfer case is sure to bring you the utmost in dependability and performance.

The Atlas is available for both left and right hand vehicle applications with centered rear differentials. The solid, one-piece case design is manufactured from 356-T6 heat-treated aluminum alloy. This material is also used for the structural access cover and all other exterior components. The massive gears are helical cut and synchro-equipped for quiet performance and "shift-on-the-fly" capability. These gears are supported by needle bearing elements, precision matched to strong 8620 shafts. The ruggedly designed output shafts are amply supported by large taper roller bearings. The Atlas also features a unique twin stick shifter. This shifting mechanism offers you the availability to engage the rear axle or front axle independently in low range. The shifter is also designed to deliver crisp and quiet operation.

With any of the Atlas ratios equipped in your 4WD, you have the opportunity to select a sensible ring and pinion gear ratio for great street performance. Combined with a low-geared crawl ratio of your choice, your vehicle will have the ultimate combination. This allows you to compete with the most well-equipped offroad vehicles, but then cruise comfortably down paved roads. If you're serious about on and offroad performance and dependability, then demand one of the Advance Adapters Atlas transfer cases.

Jeep JK and JL ATLAS:

Both the Jeep JK's and JL's are prime candidates for the Atlas. There are certain features that these Jeeps need and to make sure you get the proper components, we offer pre-configured units which include all the necessary components for the proper installation.

For the Jeep JK's the Atlas units listed below only require you to pick a **gear ratio** and the **yokes** needed. NOTE: JK & JL owners that have manual transmissions will need to configure the Atlas via the custom build option on the next page.

JK's 2SP Atlas to 2007-11 Auto Transmission:

ATLAS-2SP-JK Std tail(Trail rated)
ATLAS-PS-JK Std tail(G2 gears)
ATLAS-PSF-JK Flat tow tailhousing(G2)

JK's 4SP Atlas to 2007-11

Auto Transmission:

ATLAS-4SP-JK Std tail (G2 gears)

JK's 2SP Atlas to 2012-18 Auto Transmission:

ATLAS-2SP-JKA Std tail(Trail rated)
ATLAS-PS-JKA Std tail(G2 gears)
ATLAS-PSF-JKA Flat tow tailhousing(G2)

JL's 2SP Atlas to 2018 & Newer Auto Transmission:

ATLAS-PS-JL Std tail(G2 gears)
ATLAS-PSF-JL Flat tow tailhousing(G2)

We went one step further on the Jeep JL's and offer complete pre-configured units. These units are offered with a short or flat tow tailhousing. The yokes are the GKN flange yokes that retain the factory drive shafts.

JL's 2SP Atlas Short tail to 2018 & Newer Auto Trans:

ATLAS-PS-JL30 3.0:1(G2)
ATLAS-PS-JL38 3.8:1(G2)
ATLAS-PS-JL43 4.3:1(G2)

JL's 2SP Atlas Flat Tow to 2018 & Newer Auto Trans:

ATLAS-PSF-JL30 3.0:1 (G2)
ATLAS-PSF-JL38 3.8:1 (G2)
ATLAS-PSF-JL43 4.3:1 (G2)

Complete units

See more information on the Jeep JL on Page 20.

ORDERING YOUR ATLAS:

Each Atlas transfer case is custom built for your vehicle requirements. All Atlas orders consist of several subassemblies that makes your transfer case unique to your vehicle. There are also several optional items that can be added to the Atlas while the unit is being built.

The Atlas part numbers are generated by the gear ratio, input spline, case drop, tailhousing configuration, yokes, and twin stick shifter options. **The following steps will guide you through the process. Select an option for your Atlas under each numbered heading listed on the next few pages or just give us a call to discuss your Atlas build.**

1. Atlas 2 & 4 GEAR RATIO Part Numbers: We offer the Atlas gear sets two ways. Our trail rated gears are a perfect fit for most vehicles and our G2/G3 heavy duty gears work well for the vehicles that are a bit more extreme. Our sales department can assist you in deciding the gear option for your needs. Note: all Atlas 4 speeds and Flat tow Atlas's use the G2/G3 gear set.

TRAIL RATED SETS

Atlas30 (3.0:1)

Atlas38 (3.8:1)

Atlas43 (4.3:1)

Atlas50 (5.0:1)

(5.0 ratios are not an option for Atlas 4 speeds)

G2 HD RATED SETS

Atlas15-G2 (1.5:1)

Atlas30-G2 (3.0:1)

Atlas38-G2 (3.8:1)

Atlas43-G2 (4.3:1)

G3 HD RATED SETS

Atlas20-G3 (2.0:1)

G3 gears have an improved shifting design and gear finish for smoother shifting and less gear noise.

The Atlas G2 & G3 gears offer:
109% increase in beam strength
7% dynamic
15% static load rating bearing sets
25% thrust surface area increase
7% reduction in weight
These gears can also be ordered with as super finished which add additional benefits.

2. Atlas INPUT SPLINE Options: The inputs we offer are to mate to the numerous transmission outputs. Our web site as well as our Atlas sales manual show detailed options for these inputs.

Atlas 2 speed inputs options: **10, 21, 23, 25, 26 (2012 & newer JK auto's), 27, 28, 29, 31, 31S, 32, 34, 35, 43, A-DIV(divorced)**

Atlas 4 speed inputs: **23, 27, 29, 31, 32, 34**

3. Atlas FRONT OUTPUT DROP & ROTATION Options: When coupling an Atlas to one of the various transmissions, you have a number of choices as to the degree of rotations which includes a zero degree (or flat) rotation on most application.

TRAIL RATED

P/N ALC-T - Left (driver's side)

P/N ALC-D - Left Divorced unit

P/N ALC-T-GM - Left, GM TRANS 7,20,27

P/N ARC-T - Right (passenger side)

P/N ARC-D - Right Divorced unit

P/N ARC-T-GM - Right, GM TRANS 0,39,46

G2 HD RATED

P/N ALC-G2 - Left G2 Series Case

P/N ALC-G2-FT - Left G2 FLAT TOW

P/N ALC-G2-D - Left G2 Divorced unit

P/N ALC-G2-GM - Left G2 GM TRANS 7,20,27

P/N ARC-G2 - Right G2 Series Case

P/N ARC-D - Right G2 Divorced unit

P/N ARC-G2-GM - Right G2 GM TRANS 0,39,46

Atlas 4SP G2 HD RATED

P/N A4-LC-G2 - Left drop 4SP G2

P/N A4-RC-G2 - Right drop 4SP G2

G2 Atlas upgrades include an idler pin of 1.50" diameter, a universal case design, and integrated rear bearing cap with better oil flow.

4. Atlas SHIFT CONTROL Options: The Atlas shifter control is the assembly that allows the shifting functions like 2WD low range. It also prevents the transfer case from being shifted into high range on the rear output and low range on the front output at the same time.

P/N 301510A- Left drop case control

P/N 301511A- Right drop case control

P/N 301515- Left drop case designed for a single stick shifter

5. Atlas REAR TAILHOUSING Options: The Atlas transfer case can be ordered with several tailhousing options and a couple shaft materials.

Standard tailhousing:

P/N ALT-T - Tailhousing

P/N ALT-G2 - Tailhousing 300M OUTPUT

Tailhousing accepts a stock Jeep speedometer from Jeep vehicles 1982 & newer. We offer the electronic version or the mechanical drive version. The speedometer provision on the Atlas also allows you to calibrate your speedometer for tire and gearing changes.

Short tailhousing:

P/N AST-T - Tailhousing

P/N AST-G2 - Tailhousing 300M OUTPUT

This new tailhousing is 2" shorter than the standard Atlas tailhousing. It was only designed for trail or competition use since it does not provide provisions for any type of speedometer.

VSS signal tailhousing:

P/N AVT-T - GM VSS Tailhousing

P/N AVT-G2 - GM VSS Tailhousing 300M OUTPUT

The VSS tailhousing kits provide a 40 tooth reluctor and sensor in the Atlas tailhousing. See Page 86 for more VSS information and these kits.

Flat Tow tailhousing:

P/N AFT-JP - FLAT TOW w/ Jeep speed sensor

P/N AFT-GM - FLAT TOW GM VSS Tailhousing

P/N AFT-STD - FLAT TOW no speed sensor (Jeep JKs)

The Flat Tow tailhousing comes with or without a speed sensor for Jeeps or GMs. This tailhousing is approximately the same length as the standard Atlas tailhousing. This tailhousing is designed to provide oil to the rear bearings while flat towing.

Note: The 300M or G2 output shaft kits have an increased strength of 79% stronger than our standard output.

6. Atlas YOKES Options: With the Atlas transfer case being such a diverse case fitting into such a wide variety of vehicles, naturally we needed a variety of available transfer case yokes. The following yokes are the ones we offer which are for the 32 spline front and rear outputs shafts. If you have your own yoke(s), then we offer a seal kit that includes a sleeve to retain the tapered bearing for shipping purposes. You will need either kit **A1399CV** with a sealing diameter of 1.875" or kit **A1399** with a sealing diameter of 2.125". Anytime you replace a yoke, the yoke nut should be replaced (**P/N 300476**).

P/N A1310	1310 series (non-C.V.)
P/N A1310CV	1310 series (C.V.)
P/N A1330CV	1330 series (C.V.)
P/N A1350	1350 series (non-C.V.)
P/N A1350CV	1350 series (C.V.)
P/N A1399	No yoke, seal installed for 2.125" yoke
P/N A1399CV	No yoke, seal installed for 1.875" yoke
P/N A1410	1410 series (non-C.V.) Straps
P/N A1410U	1410 series (non-C.V.) U-bolt
P/N 300486	Flange NISSAN PATROL
P/N AF1300	Flange 1310/1330/1350 (CV & non-C.V.)(2" male index)
P/N AF1350	Flange 1350/1410 (C.V.)(3.125" male index)
P/N AF1410	Flange 1350/1410 (non-C.V.)(2.75" female index 12MM)
P/N AF1410STD	Flange 1350/1410 (non-C.V.)(2.75" female index 7/16-20)
P/N AF1480	Flange 1480 (3.75" female index)
P/N AFJL	GKN Flange to retain the stock JL drivelines
P/N AFTOY	Toyota Flange yokes

YOKE REMOVAL TOOL:

For the quick and easy removal of transfer case yoke, this is a trail tool and/or shop tool that makes it easy. Fits most yoke types. **P/N 716400 \$54.20**



7. SPEEDOMETER Options: We offer mechanical or electronic speedometer drive options that fit the standard Atlas tailhousing. The speedometer drives we offer do not come with the speedometer pinion gear which is sold separately and are listed on the next page.

The late model Rubicon Jeep TJs with the Rock Trac 241J transfer case used a tone ring and sensor for the speedometer pickup source. That combination is not able to be used on the Atlas tailhousing. The Atlas only accepts the mechanically driven TJ Speedometer. This NP231 style speedometer will work the same as the later model tone ring and sensor. One advantage is the mechanical unit is easy to modify when larger tires or different ring and pinions are used.

- P/N 301506** - Mechanical drive Speedometer housing
- P/N 300640** - Jeep TJ Electronic Speedometer housing
- P/N 300621** - Speedometer Hole Plug

Toyota Trucks and FJ Cruisers Speedo / VSS. **1995-1997** Fully mechanical speedo. **P/N 300613**
1998-2004 VSS speedometer kit that retains your stock VSS sending unit **P/N 300605**

8. Atlas SHIFTER Options: We have designed several shifters for the Atlas transfer case. The part numbers listed on the next page are designed to fit with minimal modifications.

Jeep TJs have the option for either a cable shifter or a ridged linkage mounted to the front of the new case. Both systems retain the stock console and the factory look. We offer one universal TJ kit adjustable for various transmission lengths and to fit the linkage up through the floor board.

Jeep JKs are a must for a cable shifter. The JK had a stock linkage that was cable, so the only access to the transfer case is a small hole in the floor board. The linkage bolts a new twin stick bracket to the floorboard and allows the two handles to come up through the stock console access hole.

Jeep JLs are a newly designed twin stick application. The design of this shifter allows the vehicle to retain the factory look but gain the low 2WD option. The shifter also incorporates the Jeep shift indicator module which feeds the computer the correct information when shifting the transfer case.



2 Speed Shifter Part numbers are:

- P/N 303000L - 5.5" Left & Right Universal shifter
- P/N 303000HD - Shifter 2.5" heim joints
- P/N 303000HD1 - Shifter 5.5" heim joints
- P/N 303002L - TJ Automatic 97-02 shifter
- P/N 303002U - TJ AUTO 03-06 & Universal shifter
- P/N 303003L - TJ Manual Atlas shifter
- P/N 303004L - Bronco shifter
- P/N 303005L - ZJ 6" Left shifter
- P/N 303006L - Explorer/Bronco II shifter
- P/N 303007L - XJ with AW4 transmission
- P/N 303008 - JK Cable shifter (Auto trans.)
- P/N 303008L-M - JK Cable shifter (Man. trans.)
- P/N 303012 - Jeep WJ cable shifter
- P/N 303009 - Universal Cable shifter
- P/N 303020 - Jeep TJ Cable shifter
- P/N 303030 - Jeep JL/JT Cable shifter

2 Speed Shifter single stick shifters:

- P/N 303017L - Single Stick Shifter Left Drop
- P/N 303018R - Single Stick Shifter Right Drop

4 Speed Shifter Part numbers are:

- P/N 344000 - Universal shifter
- P/N 344000HD - Universal shifter w/ heim joints
- P/N 344002 - TJ Automatic 97-02 shifter
- P/N 344003 - TJ Manual & 03-06 Auto shifter
- P/N 344004 - Bronco shifter
- P/N 344005 - ZJ 6" Left shifter
- P/N 344006 - Explorer/Bronco II shifter
- P/N 344007 - XJ with AW4 transmission
- P/N 303008L-M - JK Cable shifter (Man trans.)
- P/N 303009 - Universal Cable shifter
- P/N 303020-4 - Jeep TJ Cable shifter

4 Speed Reduction Housing Shifter

Part numbers are:

- P/N 344020 - Reduction Cable shifter
- P/N 344025 - Jeep JK Reduction Cable shifter

Atlas Shifter Linkage Upgrade:

The connection rods for the Atlas were designed to be universal so they could be adjusted for the various drivetrain lengths. The stock linkage works well for the majority of applications and vehicles. The extreme racers and rock crawlers, on the other hand, were looking for a linkage that would withstand the abuse that they are putting their rigs through. The two kits offered are upgrades that work with the standard handles and use heim joints that are bolted to the Atlas linkage. Anyone can upgrade to these kits as they will work on all Atlas ridged mounted twin stick applications, [P/N 303040](#) or [P/N 303041](#). Application descriptions available on-line.

9. Atlas SITE TUBE Option: The Atlas was sold for years with an oil site tube as part of the standard build. With some of the recent updates to the rear bearing cap which now has a oil level weep hole, we have now made the site tube an optional item. We still have a lot of the units being shipped with this component; however, we wanted to make sure that this was a part that was preferred and not discarded.

- P/N 301603 - Current production Site Tube Kit
- P/N 301602 - Replacement Site Tube without case fittings
- P/N 301600 - Atlas Site Tube kit 1/4 Fittings

OPTIONAL Atlas Items:

- Option 1.* The Atlas is shipped with a set of standard black shift knobs, but we also offer an aluminum knob upgrade as listed below.
- Option 2.* Most installations will require a new breather and breather hose to properly vent an Atlas 2 or 4 speed transfer case. We now offer these items along with additional Atlas oil for your first oil change.
- Option 3.* It's been our experience that most driveshafts don't include the u-bolt needed to connect driveshafts to the Atlas yokes. You can now order them ahead of time with your Atlas.

	P/N 303150 Aluminum knobs Std. pattern P/N 303150AA Black knobs Std. pattern P/N 303150BL Blue knobs Std. pattern P/N 303150GN Green knobs Std. pattern P/N 303150RD Red knobs Std. pattern
	P/N 303152 Aluminum knobs Rev. pattern P/N 303152AA Black knobs Rev. pattern P/N 303152BL Blue knobs Rev. pattern P/N 303152GN Green knobs Rev. pattern P/N 303152RD Red knobs Rev. pattern
	P/N 303155 2 Speed Std. "Sport" labeled (Black) P/N 303157 2 Speed Rev. "Sport" labeled (Black)
	P/N 303155BL 2 Speed Std. "Sport" labeled (Blue) P/N 303157BL 2 Speed Rev. "Sport" labeled (Blue)
	P/N 303155RD 2 Speed Std. "Sport" labeled (Red) P/N 303157RD 2 Speed Rev. "Sport" labeled (Red)
	P/N 303155GN 2 Speed Std. "Sport" labeled (Green) P/N 303157GN 2 Speed Rev. "Sport" labeled (Green)

	Atlas 4 speed shifter knob kits P/N 303156 4 Speed Std. "Sport" (Black) P/N 303158 4 Speed Rev. "Sport" (Black) P/N 303156BL 4 Speed Std. "Sport" (Blue) P/N 303158BL 4 Speed Rev. "Sport" (Blue) P/N 303156RD 4 Speed Std. "Sport" (Red) P/N 303158RD 4 Speed Rev. "Sport" (Red) P/N 303156GN 4 Speed Std. "Sport" (Green) P/N 303158GN 4 Speed Rev. "Sport" (Green)
	P/N 303159 - 2.75" H-N-L standard labeled knobs flats milled on both sides
	P/N 303159-C - 2.75" L-N-H Cable shifter Black knobs reverse pattern
	P/N 303159-4 - Single knob Atlas 4 speed reduction box

2. Breather & Breather hose:

- P/N X11320** 2SP Atlas kit
- P/N X11324** 4SP Atlas kit

3. U-Bolt kits (includes two u-bolts):

- P/N X11340** 1310/1330 U-Bolt kit
- P/N X11341** 1350/1410 U-Bolt kit
- P/N X11342** 1410 Strap kit

Atlas LOW RANGE SWITCHES or 4WD LIGHT:

A low range switch and pigtail is also available from us for the Atlas transfer case. This switch is from a stock Jeep TJ. The switch can be used for an indicator light or a low range switch. The sensor is [P/N 300364](#) and Pigtail [P/N 300378-C](#).

Jeep TJs & JKs: In essence, the Low-Range switch tells the computer what mode the transfer case is in. To operate the needed functions on these vehicles, we only need one of four normal mode positions and that is the "Low-Range" mode. This mode allows the factory lockers (and electric sway bar if equipped) to work on the Rubicon series TJ, JKs & Liberty's. The other necessity is the ESP (ELECTRONIC STABILITY PROGRAM) in the JK series of Jeeps. By installing the Low-Range switch in the JK it will automatically turn the ESP to its lowest setting possible allowing front digs in low range, tire slippage without engine hesitation or braking feedback. It will also change the fly-by-wire throttle sensitivity to take away the side effects that usually consist of jerky throttle response that occurs as a result of running low range without the Low-Range switch hooked up.

- [P/N 300378X](#) - Low range pigtail for Jeep (will not light up 4WD indicator in high range) (FITS UNITS BUILT BEFORE 7/2014)
- [P/N 300378A](#) - Low range pigtail for Jeep (will not light up 4WD indicator in high range) (FITS UNITS BUILT AFTER 8/2014)
- [P/N 300377](#) - Control module for Jeep JKs (retains all stock features when an Atlas is installed) (FITS UNITS BUILT BEFORE 7/2014)
- [P/N 300377A](#) - Control module for Jeep JKs (retains all stock features when an Atlas is installed) (FITS UNITS BUILT AFTER 8/2014)

JK 2012 & newer Jeeps equipped with an automatic transmission will also require a Transmission Control Module flash to operate correctly with the new Atlas transfer case. Jeep coded the stock transfer case ratio of either the 2.72:1 or the 4.0:1 into this module and any different ratio in the transfer case will put the vehicle into a limp mode. A Jeep programmer like an A.E.V. Procal or the Bully Dog with the transfer case ratio option is needed and we sell both of these programmers. Unfortunately, the Atlas 4 speed is not an option in these newer JKs with the automatic. The exact ratios for the Atlas are required for reprogramming the module. We round up or down to the decimal on our ratios; however, the Jeep computer module will accept the three places right of the decimal. The ratios are as follows: 2.0:1 is exactly 2.11:1, 3.0:1 is 3.030:1, 3.8:1 is 3.824:1, 4.3:1 is 4.286:1, and 5.0:1 is 5.048:1.

Speedometer Gear Tooth Counts:

TIRE DIAMETER	AXLE GEAR RATIOS							
	5.38	5.13	4.88	4.56	4.10	3.73	3.55	3.07
44"	32T	31T	29T	27T				
42"	34T	32T	30T	28T				
40"	35T	34T	32T	30T	27T			
39"	36T	34T	33T	31T	28T			
38"	37T	35T	34T	31T	28T	26T		
37"	38T	36T	35T	32T	29T	26T		
36"	39T	37T	36T	33T	30T	27T	26T	
35"	40T	38T	37T	34T	31T	28T	27T	
33"		41T	39T	36T	33T	30T	28T	
32"			40T	37T	34T	31T	29T	
31"			41T	39T	35T	32T	30T	26T
30"				40T	36T	33T	31T	27T
29"				41T	37T	34T	32T	28T
28"					38T	35T	33T	29T



Once you have selected the proper pinion tooth count for your tire size and axle ratio, you must then determine which one of the two style gears for the Atlas speedometer housings you'll need. The long shaft pinion gears for the mechanical drive units are [P/N 300620](#)-(the number of teeth needed) and the short shaft pinion gears for the electronic speedometer drive units are [P/N 300637](#)-(the number of teeth needed).

Special Atlas ADAPTERS:

Jeep JL, automatic to Atlas 2 speed: The Jeep JL with the 850RE 8-speed automatic is coupled to a Magna transfer case. This is the first year Jeep went away from its standard circular bolt pattern when coupling these two gear boxes. So this required us to manufacture a new adapter housing to couple the Atlas to the 8 speed automatic. [P/N 50-9900](#) is the new adapter kit that provides the connection to a new Atlas. The 7.75" adapter also provides the needed length to clear the transmission cooling system.

The JL presented several other challenges for installing the Atlas such as the stock transfer case shifter for example. The factory shifter is very small and fits into a compact location in the new Jeep. Having this lack of room required a redesign of the Atlas shifting system for the JLs. We incorporated the Jeep factory electronic sending unit which now allows the Atlas to work the same as the factory transfer case. The new twin stick shifter includes new cables and allows the vehicle to have all the shifting features the Atlas is famous for.

The last update to finish the install into the Jeep JLs was new flange yokes. We have manufactured new yokes to retain the factory GKN yokes. The adapter puts the Atlas in a similar location as factory, allowing you to retain the factory driveshafts. These yokes can be swapped out for any Spicer yoke down the road, but it now allows the Jeep equipped Atlas to be back on the road within a day. The complete install of the transfer case is approximately 6 hours and the shifter 1 to 2 hours. The pre-configured unit we offer comes complete with the parts listed above. The Atlas is built with a 23 spline standard input.

Jeep JL, D478 manual 6 speed to Atlas 2sp: The manual transmission used in the JL will require the same adapter housing as the automatic with the same shifter components; however, it will need a different spud shaft which has not been manufactured as of this printing.

Special Atlas ADAPTERS:

4L60E Atlas Adapter Atlas 2 & 4 Speed: This kit supplies you with a new 23 spline 300M output shaft for the 4L60E transmission. The Atlas adapter provides a VSS in the 1.625" adapter housing. **Part No. 50-9305** Note: should not be used on 2speed right drop units due to yoke clearance on the transmission.

4L80E Atlas Adapter Atlas: This adapter kit, **P/N AS-6450**, allows the 4L80E to couple to the Atlas 2 speed transfer case. The adapter is 2.75" thick. The tone ring mounts to the front of the Atlas and the casting has the sensor hole to match up to the tone ring. This adapter provides the length allowing the stock 4WD output shaft to be used, but it also gives the computer a true output signal. We offer the same type of kit for the Atlas 4 speed **P/N AS-6455**. The tone wheel has a smaller I.D. to fit the 4 speed input gear.

For the 2WD transmission, we do offer Adapter kit **P/N AS-0401**, This kit is 4.25" long allowing you to retain the stock output shaft. The stock shaft will need to be shortend, but leaves enough splines to couple to the Atlas. The 2WD shaft needs to be the 6.5" stickout with the slip yoke.

GM 6L80E & 6L90E Atlas Adapter Atlas: This adapter kit, **P/N 50-9600**, allows the 6L80 and 6L90 to couple to the Atlas transfer case. The 6L80 4WD transmission is normally a 32 spline output and the 6L90 4WD is normally a 29 spline output. The casting has the stock GM crossmember foot bolt pattern to retain the factory rubber support.

TH400 Atlas Adapter Atlas: This adapter kit, **P/N AS-6440**, allows the TH400 to couple to the Atlas transfer cases. The adapter is 2.75" thick. The adapter does have a VSS option for applications with newer engines.

Powerglide Atlas Adapter: The GM Powerglide automatic has become a popular transmission for the rock crawling rigs. We offer a new cast aluminum adapter and crossmember mount. **Part No. 50-9200** is designed to couple the Powerglide to the 27 spline Atlas transfer case. When coupling the Powerglide to the Atlas, the adapter kit requires a shorty 27 spline output shaft to be used.

SM465 3.5" 32 Spline: We offer an adapter & shaft combination that offers you a short 3.5" adapter with a new 32 spline output shaft. The two parts are sold separately but together gives you a very strong combination. **P/N 51-9807** is the 3.5" adapter. **P/N 50-4732** is the output shaft kit.

Ford 6R80 to Atlas Adapter: Ford's 6 speed automatic is a great performance upgrade to an Atlas. This 6 speed with a double overdrive and a 4.17:1 first gear offers plenty of gearing options. The Atlas requires the short 31 spline input and a 4WD transmission. **Part No. 50-3900**

C4 to Atlas Adapter: This kit was also designed for the rock crawling industry. This short C4 adapter kit makes the C4 a manually shifted transmission. This 2.9" long adapter is ideal for vehicles requiring a short drivetrain. **Part No. 50-2905** comes complete with a new output shaft and two castings. The output shaft in this kit is made out of 300M material. Some machining is required to the transmission.

Spacer Ring: Certain transmissions to the Atlas transfer case will require a spacer to prevent the transmission output from bottoming out. We offer 4 different length spacers to aid in bolting to the Atlas. **Part No. AS-0404** is a 1" spacer plate. **Part No. AS-8603** is a 3/4" spacer plate which also allows for some additional rotation options. **Part No. AS-8610** is a 1/2" spacer plate. **Part No. AS-0402** is a 1" Ford spacer plate.

Toyota Tacoma, Tundra, T100, FJ Cruiser Adapter: Toyota applications can install an Atlas transfer case with a choice of 4 different adapter options. We use a 3/8" adapter plate that couples the Atlas to your transmission. We offer the Atlas in either a left or right drop, left being for stock installations. The Toyota transmission either had a 22, 23 or 26 spline stock output shaft and two different bolt patterns. Our spud shafts couple to a 23 spline Atlas input. **P/N 50-5710**, **P/N 50-5711**, **P/N 50-5715** or **P/N 50-5716**.

Divorce Mounted Atlas Transfer Case: This kit has been created to give you all of the great gearing options, parts availability, and strength features to vehicles that require a remote mounted transfer case. Early vehicles sometimes ran this type of independent transfer case. It was attached to the powertrain by a small drive shaft coming from the transmission. This transfer case functioned identical to others and had a front and rear driveshaft. The entire transfer case assembly was hung from the frame on a crossmember type mount. The Divorced Atlas can be built as either a right or left drop unit. The shifters and crossmember are sold as a separate kit to fit the t-case.

1966-77 Bronco Atlas: When ordering an Atlas with a 28 spline input, the unit comes with an adapter plate to couple to the new input ring making the Atlas a direct bolt-up to the stock transmission. The adapter to the Atlas input allows for a few rotation options for the Bronco installation. The stock rotation is 42 degrees. For additional ground clearance, the unit can be installed at 35 degrees. If you are planning to install a new transmission such as a C6 or NP435, it is possible for the Atlas to be configured to bolt directly to a stock 4WD Ford transmission using the stock Ford adapter. You can still maintain the correct Atlas rotation for your vehicle and this is usually very cost effective.

Ford Ranger, Bronco II, & Explorer Atlas: The Atlas can also replace a stock Borg Warner 1350 transfer case. This 25 spline transfer case option outfits the Atlas with an input ring machined for the stock Ford transmission found in these vehicles. To install an Atlas in these vehicles, you will need to consider clearance for the Atlas case. You will either be required to have a body lift (1" minimum) or else be prepared to do crossmember modifications and/or considerable underbody modifications.

Dodge 8HP870 8-speed to Atlas adapter: The Dodge 1500 series pick-ups used a similar transmission to what was used in the Jeep JL's. Adapter kit **P/N 50-9900** will adapt to this transmission giving you the circular pattern. The adapter have a few holes that are slotted to fit both the Jeep and Dodge application.

ADVANCE ADAPTERS

RUBI CRAWLER



This unit fits Jeeps 2003 to 2011 with the 42RLE automatic overdrive transmission. This new reduction unit replaces the stock 42RLE tailhousing with a 6 gear planetary reduction box featuring a 2.72 low range. This is a true bolt-in doubler that couples to the stock Jeep transfer case or an existing Atlas transfer case.

Features:

The RubiCrawler increases your available gear ratios allowing you to gear your Jeep to the terrain in which you're wheeling on. The various ratios will allow you more control of the vehicle which results in extreme off road performance while maintaining a fun and safe offroading experience.

Ratios with a Stock New Process 231/241 are a 2.72:1 and a 7.40:1

Ratios with a Stock NP Rocktrac are a 2.72:1, 4.0:1 and a 10.88:1

Stock Transfer Case Functions (all Jeeps):

With the RubiCrawler installed in any Jeep, the Normal 2WD feature of your Jeep does not change. The city or rural road handling of your Jeep is the same as it was the day you bought the Jeep.

Stock Transfer Case Functions with the RubiCrawler in High Gear (all Jeeps):

RubiCrawler in high range and the transfer case in 4WD high range (all Jeeps). The gear ratio of the transmission does not change. This feature gives you power to all four wheels.

RubiCrawler in high range and the t-case in 4WD low range (non Rubicon Jeeps):

The final gear ratio with the transmission in any gear is reduced 2.72 times lower. This feature gives you power to all four wheels.

RubiCrawler in high range and the t-case in 4WD low range (Rubicon Jeeps):

The final gear ratio with the transmission in any gear is reduced 4.0:1 times lower. This feature gives you power to all four wheels.

Stock Transfer Case Functions with the RubiCrawler in Low Gear (all Jeeps):

RubiCrawler in low range and the transfer case in 2WD (all Jeeps). The final gear ratio with the transmission in any gear is reduced 2.72 times lower. This feature does not give you power to all four wheels but provides slower speeds and more throttle response for easy trail use. The nice feature about this is that you have more torque and better handling.

RubiCrawler in low range and the transfer case in 4WD high range (all Jeeps):

The final gear ratio with the transmission in any gear is reduced 2.72 times lower. This feature give you power to all four wheels and provides a shift-on-the-fly option for four wheel drive. The New Process transfer case can be shifted into high ratio on the fly; so if you're in sand, mud or on an offroad trail and need power to all four wheels, this is a great option.

RubiCrawler in low range and the transfer case in 4WD low range (non Rubicon Jeeps):

The final gear ratio with the transmission in any gear is reduced 7.40 times lower. This feature gives you power to all four wheels. This is an extreme crawl ratio that provides a slow controlled approach to an obstacle.

RubiCrawler in low range and the transfer case in 4WD low range (Rubicon Jeeps):

The final gear ratio with the transmission in any gear is reduced 10.88 times lower. This feature gives you power to all four wheels. This is an extreme crawl ratio that provides a slow controlled approach to an obstacle.

Key Installation Points:

No Driveline Modifications.

No Crossmember Modifications.

Most installations can be done in 8 hours.

Clean factory look upon completion.



Shifting the RubiCrawler: The RubiCrawler shifting mechanism utilizes push/pull cable technology for a smooth and easy shift. All RubiCrawlers are sold and shipped with a shifter kit. These kits are designed to fit the stock Jeep TJ and JK consoles. These shifters are best suited for most installations.

The Jeep TJ twin stick shifter replaces the standard mechanical linkage. We have designed a twin stick shifter that comes through the stock console for a clean installation that operates both the RubiCrawler and the stock NP231 or NP241 transfer case.

The twin stick JK shifter also provides a twin stick shifter through the stock console. This kit upgrades the stock transfer case cable to a new cable assembly and adds the addition handle and cable for the new RubiCrawler control.

The universal kit is designed for floorboard mounting.

- P/N RUBI-JKAD** JEEP JK (STOCK TRANSFER CASE) *Includes: Twin Stick Shifter w/ upgraded T/C Cable & Control Module*
- P/N RUBI-TJ** JEEP TJ (STOCK 231 or 241 TRANSFER CASE) Twin Stick Shifter
- P/N RUBI-UNIV** JEEP TJ or JK (ATLAS TRANSFER CASE) Universal Shifter RubiCrawler



Jeep TJ console (left) with the RubiCrawler twin stick shifter installed.



Jeep JK console (right) with the RubiCrawler twin stick shifter installed.

Additional Accessories:

- P/N 42R360** - 1 quart A.T.F. *(4 quarts recommended)*
- P/N 42R711** - NP241 shifter knob when using a Tera Low kit
- P/N 42R712** - NP231 shifter knob when using a Tera Low kit

We've also designed an electronic interface assembly that integrates the RubiCrawler into the Jeep Wrangler electronics. The primary function of the RubiCrawler Control Module is to allow the Rubicon locking differentials and disconnecting sway bar (JK only) to operate when the RubiCrawler Low is engaged. **P/N 42R800** *(included in JK kits)*



ADVANCE ADAPTERS, LIMITED WARRANTY

The RubiCrawler is guaranteed against defects in workmanship and materials for one year. This warranty begins from the date the unit is shipped from Advance Adapters. We log all units with a serial number at time of shipping. The warranty is void (as determined by Advance Adapters) by misuse, abuse, improper maintenance, installation and/or alterations to the product. Warranty will be voided if the proper transmission fluid levels are not maintained, if any transmission fluid other than ATF+4 is used or the product has not been properly installed and instructions have not been followed. Do not disassemble or attempt to repair the RubiCrawler as doing so will void the warranty. Please return the product as further described below.

These guarantees do not cover any outside labor, shipping, towing, normal wear or any other unforeseen events that may occur due to failure of a unit. Advance Adapters reserves the right to repair or replace any product.

All returns must have a returned goods authorization (RGA#) prior to shipping the product, and returns are to be sent prepaid freight. Please call 1-800-350-2223 and the sales department can assist you.

JEEP TRANSFER CASE ADAPTER SELECTION CHART

JEEP TRANSFER CASE SELECTION CHART GM , FORD & DODGE MANUAL TRANSMISSIONS	DANA 18/20 6 SPL. 1941-79 10 Spl. 1969-71 <i>JEEP AND SCOUTS</i> 10.5" long NOTE 11	DANA 300 23 SPLINE 1980-86 <i>NP208 T/C & (84-86 downsize Cherokee (10)</i>	NP T/C FLUSH 23 1987-06 <i>(999/904 & NV3550)</i> 20.5" long	NP T/C LONG 23 1989-99 <i>(AX15)</i> 20.5" long	NP T/C 21 Spl. 1987-02 <i>(AX4/AX5, PEUGEOT SOME AW4)</i>	Atlas Transfer Case
GM SM420 4 SPEED <i>10.5" CASE LENGTH</i>	50-2401 (3) 4" ADAPTER 50-2402 (3 & 33) 4.5" ADAPTER	50-9702 5.25" ADAP.	50-9702 5.25" ADAP.	50-9702 5.25" ADAP.	50-9702 (32) 5.25" ADAP.	50-9702 5.25" ADAP.
GM SM465 4WD 10 SPL. <i>12" CASE LENGTH</i>	50-4702 4.625" ADAPTER 50-4701 (33) 4.625" ADAPTER 50-4703 (12) .875" ADAPTER	50-9810 (26) 3.5" ADAPTER	50-9808 (1,29) 5.25" ADAP.	50-9808 (29) 5.25" ADAP.	50-9808 (29, 32) 5.25" ADAPTER	51-9807 3.5" ADAPTER
GM SM465 2WD 35 SPL. <i>12" CASE LENGTH</i>	50-4703 .875" ADAPTER	50-9807 (26) 3.5" ADAPTER	50-9812 (1) 5.25" ADAP.	50-9812 5.25" ADAP.	50-9812 (32) 5.25" ADAP.	51-9807 3.5" ADAPTER
GM SM465 32SPL. 4"(STICKOUT) <i>Output Shaft only</i>		50-4732	50-4732	50-4732		
FORD TRUCK OD (RTS) 4SD <i>10.25" CASE LENGTH (TOP SHIFTED)</i>	CALL A.T.V. 1.25" ADAPTER					Stock 4WD
FORD & JEEP T98 4 SPEED <i>11.87" CASE LENGTH</i>		50-7503 (6) 3.25" ADAP.	50-7503 (6) 3.25" ADAP.	SPECIAL	50-7503 (6,32)	50-7503
JEEP T18 4 SPEED <i>11.87" CASE LENGTH</i>	50-8705 (5) 1.0"	50-7502 (6) 3.25" ADAP.	50-7502 (6) 3.25" ADAP.	SPECIAL	50-7502 (6,32)	50-7502
FORD T18 4 SPEED <i>11.87" CASE LENGTH</i>	50-7202 (4) 1.0" 50-7201 (5) 1.0"	50-7500 3.25" ADAP.	50-7500 3.25" ADAP.		50-7500 (32)	50-7500
FORD T19 4 SPEED <i>11.87" CASE LENGTH</i>		50-6501 (1) 3.25" ADAP.	SPECIAL	SPECIAL	50-6600 (31) 50-6600A (31)	51-7500 & 52-6501
FORD NP435 4 SPEED <i>10.87" CASE LENGTH</i>	50-6102 3.325" ADAP.	50-3801 4.25" ADAP.	50-3801 (29) 4.25" ADAP.	50-3801 (29) 4.25" ADAP.	50-3801 (29,32) 4.25" ADAP.	50-3801
DANA 300 & ROTATION KIT <i>"THIS IS NOT A FLIP KIT"</i>		50-8604 (9) 50-8603				
AMC 1980 & NEWER TRANS <i>21 SPL. OR 23 SPL.</i>	50-8601 (23) 50-8602 (24)	50-3021 (23,26) 50-8603 /04 (24)				Stock
GM NV4500 4WD 32 SPL. <i>12.375" CASE LENGTH</i>	50-0210 5.87" ADAP. (25)	50-0205 6.3" ADAPTER	50-0212 5.87" ADAP (20)	50-0212 5.87" ADAP. (20)	50-0212 (32) 5.87" ADAP. (20)	51-0205 & 51-0220
DODGE NV4500 4WD 23 SPL. <i>12.375 CASE LENGTH</i>		STOCK & 716221	50-0204 5.87" ADAP (20)	50-0204 5.87" ADAP. (20)	50-0204 (32) 5.87" ADAP. (20)	Stock
DODGE NV4500 4WD 29 SPL. 2001 TRANS NOTES 9 & 28		52-0229 (8,26) & 716221	50-0231 (27) 50-0231A (31)	50-0231 (27) 50-0231A (31)	50-0231 (27) 50-0231A (31)	Stock
JEEP NV3550 4WD TRANS.	50-8602	50-8604 (9)				Stock
JEEP AX15 5 SPEED .750" ADAP.	50-8602	50-8603				Stock
FORD ZF 4WD TRANS.		50-9925 (9)				Stock
GM MUNCIE 4 SPEED <i>10.5" CASE LENGTH</i> NOTE 21	50-0100 6"ADAPTER	50-6000 5" ADAPTER				50-6000
GM SAGINAW 3 & 4 SPEED NOTE 21	50-1000					
GM AUTOMATIC TRANSMISSIONS						
GM TH350 2WD TRANS. <i>21.5" CASE LENGTH</i> NOTE 12	50-3000 50-3100 (33) 1.85" ADAP.	**50-6300 3.65" ADAP.	50-6300 50-6801/2 (9,31) 1.5" ADAP.	50-6307 50-6801/2 (9,31) 1.5" ADAP.	50-6305/A (9,31) 50-6801/2 (9,31) 3.65" & 1.5" ADAP.	50-6300 50-6802
GM TH350 4WD TRANS. <i>21.5" CASE LENGTH</i>	50-3001 50-3101 (33) 1.85" ADAP.	**50-6304 3.65" ADAP.	50-6304 50-6804/5 (9,15,31) 1.5"	50-6308 50-6804/5 (9,15,31) 1.5"	50-6306/A (9,31) 50-6804/5 (9,15,31) 3.65" & 1.5" ADAP.	50-6304 AS-6800

NP refers to New Process transfer cases 231, 207 & 241.

JEEP TRANSFER CASE ADAPTER SELECTION CHART

JEEP TRANSFER CASE SELECTION CHART GM, FORD AUTOMATIC TRANSMISSIONS	DANA 18/20 6 SPL. 1941-79 10 Spl. 1969-71 JEEP AND SCOUTS 10.5" long NOTE 11	DANA 300 23 SPLINE 1980-86 NP208 T/C 84-86 DOWNSIZE CHEROKEE	NP T/C FLUSH 23 1987-06 (999/904 & NV3550)	NP T/C LONG 23 1989-99 (AX15)	NP T/C 21 Spl. 1987-02 (AX4/AX5, PEUGEOT SOME AW4	Atlas Transfer Case
GM TH400 2 & 4WD TRANS. 24.25" CASE LENGTH	50-1300 (12) 50-0500 (13,14) 50-1400 (12,33)	**50-6400 (12) **50-6404 (13) 4.25" ADAPTERS	50-6402/A 1.2" ADAP. (1,12)	50-6403 4.2" ADAP. (12) 50-6402/A 1.2" ADAP. (12)	50-6402/A 1.2" ADAP. (31)	AS-6440 2.75" ADAP. AS-6401 1.25" ADAP.
GM 4L80 & 4L80E 4SP TRANS.	50-6905 (16) 6.25" ADAP. (13)	**50-0401 (1,9) 50-0440 (15,9)	50-0442 4L80 to JK NP241 (2.72:1 ONLY)			AS-6450 ATLAS 2 SP AS-6455 ATLAS 4 SP AS-6408 1.25" ADAPTER
GM 700R / 4L60 O/D 4 SPEED 23.375" CASE LENGTH 2WD OR 4WD		**50-6303 3.65" ADAP. (12)	50-9102 1.5" ADAP. (12)	50-9102 1.5" ADAP. (12)	50-9103/A 1.5" ADAP.(12,31)	50-9102
GM 700R / 4L60 O/D 4 SPEED 4WD TRANSMISSION ONLY		**50-6309 3.65" ADAP.(15,26)	50-9104/5 2.5" (9,15,31)	50-9104/5 2.5" (9,15,31)	50-9104/5 2.5" (9,15,31)	AS-9111
GM 4L60E 2 & 4WD TRANS. 700R/4L60 With VSS NOTE 12		**50-0404 4.65" ADAP.	50-0402 1.50" ADAP.	50-0402 1.50" ADAP.		50-0404 AS-9111 (4WD)
GM 4L60E 2 & 4WD TRANS. W / REMOVABLE BELLHOUSING (31)		**50-0432 4.1" ADAP. (15)	50-0430 3" ADAP. (19)	50-0430 3" ADAP. (19)	50-0431/A 3" ADAP. (19)	AS-9300 (4WD)
GM 4L60E 4WD TRANS.		50-0432	50-0434/5	50-0434/5	50-0434/5	50-9305
GM 6L80 TRANS. 32 SPL. (9)		50-9620 3.7"ADAP.				50-9600
GM 6L90 TRANS. 29 SPL. (9)		50-9621 3.7"ADAP.				50-9600
AMC 1980 & NEWER TRANS.	50-8601 (23) 50-8602 (24)	50-3021 (23) 50-8603 & 04				Stock
FORD C4 3 SPEED TRANS.	50-2900 5" ADAP. (12)	50-8100 (1) 6.25" ADAP. (12)	50-8100 (1) 6.25"ADAP. (12)	50-8100 6.25" ADAP.(12)		50-8100 50-2905
FORD C6 3 SP. TRANS. 20" CASE LENGTH	50-3300 5" ADAP. (12)	50-9925 .75" ADAP. (1, 9,15)				Stock
FORD 6R80 6 SP.						50-3900 (31 short input required)
FORD 6R140						50-6140 50-6142
SCOUT DANA 300 23 SPL.	TH350 transmission to Scout Dana 300 P/N 50-3102 (2WD) or P/N50-3103 (4WD) 1.85" Adap. thickness. TH400 transmission to Scout Dana 300 P/N 50-1401 2.87" Adapter thickness.					
Jeep Quadra-Trac 10 SPL.	700R 4WD transmission to Jeep Quadra-Trac P/N 50-2501 (output shaft must be cut)					

NOTES:

- (1) OUTPUT SHAFT MAY NEED TO BE SHORTENED OR A 1" SPACER ADAPTER MAY NEED TO BE USED (P/N 51-0404)
- (3) THIS KIT USES A SPUD SHAFT
- (4) THIS KIT FITS SMALL HOLE T/Cs
- (5) THIS KIT FITS LARGE HOLE T/Cs
- (6) TRANSMISSION CASE NEEDS MACHINE WORK
- (7) ADAPTER LENGTH IS PART OF TRANS. MEASUREMENT
- (9) THESE KITS COME WITH A NEW T/C INPUT GEAR
- (10) ADAPTERS FOR CHEROKEES REQUIRE FLOOR & SHIFTER MODS.
- (11) THESE ADAPTERS REQUIRE A NEW BEARING & RETAINER
- (12) NEW TRANSMISSION OUTPUT SHAFT MUST BE INSTALLED
- (13) USES STOCK 2WD OUTPUT SHAFT
- (14) USES 15 TOOTH JEEP GEAR
- (15) USES STOCK 4WD OUTPUT SHAFT
- (16) LONG WHEEL BASED VEHICLES ONLY
- (19) COMPLETE TRANSMISSION TO TRANSFER CASE ADAPTER
- (20) THESE ADAPTERS ARE SUPPLIED WITH A TRANSFER CASE BRKT.
- (21) THESE TRANSMISSIONS ARE SIDE SHIFTED. BELOW ARE THE SHIFTER BRACKETS, ROD KITS & HURST SHIFTER WE OFFER:

715501	MUNCIE BRACKET	715631	FORD T&C ROD KIT
715506	SAGINAW & FORD T&C SHFT.BRKT.	715600	HURST SHIFTER
715625	MUNCIE ROD KIT (MALE STUDS)	715643	JEEP T/C KNOBS
715626	MUNCIE ROD KIT (FEMALE STUDS)	715644	OFFSET HANDLE
715628	SAGINAW ROD KIT		

- (23) FOR USE ON A 21 SPLINE TRANSMISSION
- (24) FOR USE ON A 23 SPLINE TRANSMISSION
- (25) STOCK OUTPUT SHAFT MUST BE SHORTENED. KITS USE THE 31 TOOTH PORTION OF OUTPUT SHAFT
- (26) THIS KIT WILL NOT WORK ON A NP208 TRANSFER CASE.
- (27) KIT 50-0231 IS A 29 SPLINE INPUT GEAR THAT FITS NP231 T/Cs
- (28) THIS KIT WORKS IN CONJUNCTION WITH THE ADAPTER LISTED UNDER DODGE 23 SPL. NV4500
- (29) THE CASTING IN THIS KIT ONLY HAS ONE ROTATION AVAILABLE
- (31) THESE KITS FIT THE NP231 T/C ONLY. TRANSFER CASES UP TO 1994 USE A DIFFERENT INPUT GEAR THAN THE 1995 & LATER MODEL NP231. KITS LISTED WITH THE FULL PART NUMBER FIT THE EARLY MODEL; KITS ENDING WITH AN "/5" OR "/A" & OR "/2" ARE LATE MODEL.
- (32) THESE KITS REQUIRE THE PURCHASE OF A NEW T/C INPUT GEAR
- (33) THESE KITS ARE DESIGNED FOR THE 10 SPLINE DANA 18 TRANSFER CASE 1969 TO 71

****SEE BACK COVER FOR
COMPLETE CONVERSION KITS**

TRANSMISSION DATA

TRANSMISSIONS	CASE LENGTH	BELLOUSING	STOCK TRAINER CASE ADAPTER	PILOT TIP LENGTH & DIAMETER	INPUT SHAFT SPLINE DATA	OUTPUT SHAFT SPLINE DATA	1ST GEAR RATIO	2ND GEAR RATIO	3RD GEAR RATIO	4TH GEAR RATIO	5TH & 6TH GEAR RATIO	B/H ADAPTERS	T/C ADAPTERS
JEEP T-86 3 SPEED	8.00"	9.00"		1.1"X.590"	1-1/8-10	1-3/8"-6	2.88	1.68	1.00			Y	N
JEEP T-90 3 SPEED	8.12"	9.00"		1.5"X.629"	1-1/8-10	1-3/8"-6	2.98	1.66	1.00			Y	N
JEEP T-14 V6 3 SPEED	8.75"	9.00"		1.1"X.590"	1-1/8-10	1-3/16"-10	3.10	2.61	1.00			Y	N
JEEP T-14 STR 6 3 SPEED	8.75"	8.00"		1.1"X.590"	1-1/8-10	1-3/16"-10	3.10	2.61	1.00			Y	N
JEEP T-15 3 SPEED	9.125"	8.00"		1.1"X.750"	1-1/8-10	1-3/8"-6	2.97	1.55	1.00			Y	N
JEEP T-150 3 SPEED	9.25"	6.625"		2"X.673"	1-1/16-10	1-3/8"-6	2.99	1.75	1.00			Y	N
JEEP T-18	11.875"	Varies	.875	1"X.627/670	1-1/8-10	1-3/8"-6	4.03	2.42	1.41	1.00		Y	Y
JEEP T-98	11.875"	10.75"	.875	1"X.627/670	1-1/8-10	1-3/8"-6	6.40	3.09	1.69	1.00		Y	Y
JEEP T176 4 SPEED	10.25"	6.625"	2.625"	1.5"X.590"	1-1/8-10	23	3.52	2.27	1.46	1.00		Y	Y
JEEP T4, T5, SR4 (*4Cyl. are 1"-14)	9.18"	6.625"	5.937"	1.5"X.590"	1-1/8-10*	23	4.03	2.37	1.50	1.00	.76(T5)	Y	Y
JEEP PEUGEOT 5 SPEED	13.50"	7.25"	3.50"	1.5"X.590"	1-1/8-10	21	3.39	2.33	1.44	1.00	.79	Y	Y
JEEP AX4, AX5	15.750"	6.75"		1"X.590	1"-14	21	3.93	2.33	1.44	1.00	.85	Y	Y
JEEP AX15 5 SPEED	16.75"	7.375"		1.5"X.590/750	1-1/8-10	23	3.83	2.33	1.44	1.00	.79	Y	Y
JEEP NV3550 5 SPEED	16.75"	7.375"		1.5X.750"	1-1/8-10	23	4.01	2.32	1.40	1.00	.78	Y	Y
JEEP NSG 370	25.25"			.750"	1-1/8-10	23	4.46	2.61	1.72	1.20	1.00/.83	N	Y
GM MUNCIE CAR 4SP	10.43"	6.375"		1"X.590"	1-1/8-10	27	2.20	1.64	1.27	1.00		Y	Y
GM SAGINAW 3 & 4SP	9.62"	6.375"		1"X.590"	1-1/8-10	27	2.84/3.11	1.68/2.20	1.00/1.47	1.00		Y	Y
GM SM420	10.43"	6.375"		1"X.590"	1-1/8-10	10,35	7.05	3.57	1.70	1.00		Y	Y
GM SM465	12.00"	6.375"	8.50"	1"X.590"	1-1/8-10	10,35,32	6.54	3.57	1.57	1.00		Y	Y
FORD 4 SPEED RTS	10.12"	6.25"		1"X.670"	1-1/16-10	28, 31	3.25	1.92	1.00	.78		Y	Y
FORD 4 SPEED T18	11.875"	6.25"		1"X.670"	1-1/16-10	28, 31	6.32	3.09	1.69	1.00		Y	Y
FORD 4 SPEED T19	11.875"	6.25"		1"X.670"	1-1/16-10	28, 31	5.11, 4.02	3.03, 2.41	1.79, 1.41	1.00		Y	Y
FORD 4 SPEED NP435	10.875"	6.25"/7.25"	8.00"	1"X.670"	1-1/16-10	28, 31	6.69	3.34	1.97	1.00		Y	Y
GM NV4500 92-94	12.375"	6.375"	8.25"	1"X.590"	1-1/8-10	32	6.34	3.44	1.71	1.00	.73	Y	Y
GM NV4500 95 & UP	12.375"	6.375"	8.25"	1"X.590"	1-1/8-10	32	5.61	3.04	1.67	1.00	.73	Y	Y
DODGE NV4500 4WD GAS	12.375"	7.50"	6.375"	1"X.750"	1-1/8-10	23, 29	5.61	3.04	1.67	1.00	.73	Y	Y
DODGE NV4500 4WD DIESEL	12.375"	7.50"	6.375"	1"X.750"	1-1/4-10	29	5.61	3.04	1.67	1.00	.73	Y	Y
JEEP TH400 (1974 & NEWER)	24.375"		2.50"			10, 32	2.48	1.48	1.00			Y	Y
JEEP 727 T.FLITE (1980 & UP)	17.00"		6.625"			23	2.45	1.45	1.00			Y	Y
JEEP 904 (30RH) T.FLITE	16.00"		6.625"			23	2.74	1.54	1.00			N	Y
JEEP 999 (32RH) T.FLITE	16.00"		6.625"			23	2.74	1.54	1.00			Y	Y
JEEP 42RLE	17.00"		7" TJ 7.4 JK			23	2.84	1.57	1.00	.69		N	Y
CHEVY POWERGLIDE	16.25"					27	1.76	1.00				Y	Y
CHEVY AUTOMATIC TH350	21.50"					27	2.52	1.52	1.00			Y	Y
CHEVY AUTOMATIC TH400	24.375"		2.5"			32	2.48	1.48	1.00			Y	Y
CHEVY AUTO 700R/4L60	23.375"		3.25"			27	3.059	1.625	1.00	.696		Y	Y
CHEVY AUTOMATIC 4L60E	23.375"					27	3.059	1.625	1.00	.696		Y	Y
CHEVY 4L60E W/ REM. B/H	15.50"	6.3"/6.9"				27	3.059	1.625	1.00	.696		Y	Y
CHEVY AUTOMATIC 4L80E	26.00"					32	2.482	1.482	1.00	.750		Y	Y
CHEVY AUTOMATIC 6L80E	16.50"	6.812"				32	4.03	2.36	1.53	1.15	.85/.67	N	Y
CHEVY AUTOMATIC 6L90E	17.90"	6.812"				29	4.03	2.36	1.53	1.15	.85/.67	N	Y
FORD C4	11.187"	6.00"				28	2.46	1.46	1.00			N	Y
FORD C6	20.00"		5.75"			31	2.46	1.46	1.00			N	Y
FORD AOD, AODE	20.50"		6.375"			28, 31	2.40	1.47	1.00	.67		N	Y
FORD 4R70W / 75W	20.50"					31	2.84	1.55	1.00	.70		N	Y
FORD 6R80	23.50"					31	4.17	2.34	1.52	1.00	.87/.69	N	Y

The chart listed above is general transmission information that we have gathered over the years. Some lengths are rounded and some transmissions have several gear ratio options. We have just listed the most popular for doing drivetrain conversions.

STOCK JEEP TRANSMISSION & BELLHOUSING ADAPTER INFORMATION

JEEPS 1941 & UP

Over the past 75 years, Jeep vehicles have been equipped with over 25 different transmissions making it difficult to identify the specific transmission by the year of the vehicle. Listed on the following pages are the stock Jeep transmissions and the corresponding bellhousing adapters we manufacture. Additional detailed information can be found in our Tech Vault area of our website.

(Note: The engine blocks referenced are as follows: Chevy includes all V8s, 229 & 4.3 V6. Ford includes 289, 302, 351W. AMC includes 258, 304, 360, 401, 4.2L, 4.0L - each manufacturer group having the same block bolt pattern. The newer Chevy Generation III Vortec engines require a few additional considerations.)

Using a bellhousing adapter is usually the easiest and least expensive way of converting to a new engine. When considering the use of either a stock manual or automatic transmission, strength and durability should be the first area of concern. The stock transmissions were designed to handle the horsepower and torque of the stock engine that the vehicle was equipped with. Having this in mind, consider your driving habits, tire size, and the intended use of the vehicle. You may incur more expenses in the long run if your transmission is not adequate to handle the new engine of your choice.

When starting a conversion, there are many things to consider. Whether you use a transfer case adapter listed on the previous pages or choose a stock bellhousing adapter in this section, there are other essential engine and drivetrain swap components that we also provide. Between Pages 27 through 44, you'll find everything from **Bellhousing Adapters, Transmission Retrofits, Special Conversion Bellhousings, Clutch Components, Motor Mounts, Radiators, Exhaust Headers, and Saginaw Steering Conversions.**

BELLHOUSING ADAPTERS

JEEP TRANSMISSIONS 1941-79

Most of the early transmissions used a long transmission input shaft. We manufacture adapter plates that make the stock Jeep transmission look just like a Chevy or Ford. This enables us to bolt a Chevy or Ford engine and stock bellhousing to this adapter plate. With these adapter plates, we utilize a new front bearing retainer to obtain proper bellhousing alignment. On Chevy bellhousing kits, we use a small index of 4.686". (For larger index bellhousings, [P/N 716078](#) can be added to the kit. This is an index ring that increases the 4.686" retainer to a 5.125" diameter). On Ford bellhousings, a bearing index of 4.848" is used.

- T84** (1941-45) - Transmission case length of 6.750". We do not manufacture any adapters to retain this 3 speed.
- T90** (1946-72) - Transmission case length of 8.000". T90 will normally be stamped on the case. It was used with both the 4 & 6 cylinder applications. If your T90 was originally fitted to a 4 cylinder, you will be required to purchase a 6 cylinder style input shaft, [P/N 716014](#). This shaft has a gear tooth count of 18 teeth. On some Jeep (and Scout) vehicles, the input shaft that you are replacing may be 16 tooth. On these applications, you will also need to purchase a new cluster gear, [P/N 716018](#).
[P/N 712502A](#) - Chevy bellhousing to T90
[P/N 712505](#) - Ford bellhousing to T90
- T86AA** (1966-68) - Transmission case length of 8". T86 will normally be stamped on the case.
[P/N 712506](#) - Chevy bhsg. to T86
[P/N 712508](#) - Ford bhsg. to T86
- T14A** (1968-75) - Transmission case length of 8.375". T14A or 1302 is normally cast on the side of the case. This transmission was used up against two different engines; and two different input shaft lengths were used. The description below designates the stock engine application:
[P/N 712506](#) - Chevy bhsg. to T14A (replacing V6 engine)
[P/N 712510*](#) - Chevy bhsg. to T14A (replacing straight 6 engine)
[P/N 712508](#) - Ford bhsg. to T14A (replacing V6 engine)
[P/N 712511*](#) - Ford bhsg. to T14A (replacing straight 6 engine)
- T15A** (1972-75) - Transmission case length of 10.000". T15 or 1307 is normally cast on the side of the case.
[P/N 712510](#) - Chevy bhsg. to T15A
[P/N 712511](#) - Ford bhsg. to T15A



**Requires additional item
[P/N 716089](#)*

T150 (1976-79) - Transmission case length of 9.250". A casting number of 2603983 can be found on the case under the oil fill hole. We manufacture two types of GM adapters for this application. This transmission bolt pattern is the same as a standard Ford. The Ford bellhousing can bolt directly to the T150. No adapter is necessary.

- P/N 712548** - Full Conversion bellhousing, Chevy engine to T150. (*11" clutch recommended*)
- P/N 712527** - Adapter plate to accept a standard Chevy bhsg.

The next section covers both the T98 & T18 transmissions. Since these two gear boxes are almost identical, we have grouped and listed the conversion components together.

T98A (1955-73) - This 4 speed transmission can be identified by a case length of 11.875", and a casting number of T98. The shift cover is mounted on the top of the case with 6 bolts. This is an excellent transmission to mate to any V8. For the necessary adapter, you will need to determine your front input shaft stickout length. There are several various lengths and it is critical that you determine this measurement prior to ordering the necessary components for your vehicle.

Jeep T18 (1965-79) - This 4 speed transmission has a case length of 11.875". The casting number is T18, 1301, or shifter top cover casting T98. There are over 14 variations of this 4 speed transmission. These transmissions can have either a 4:1 or 6.32:1 1st gear ratio. This transmission is an excellent choice for Chevy and Ford conversions. The biggest problem that we have with this transmission is the various lengths of the front input shaft. To select the correct adapter, you will be required to determine your stock input shaft stickout length. (**Transmissions with long input shafts will not work in short wheel base vehicles**).

In order to assist you in determining the necessary adapter plates for both the T98 and T18 transmissions, we have listed the adapters that correspond to the transmission stickout length. **The stickout length is usually 2-5/8" less than the O.A.L.**



Stickout	O.A.L. Of Input Shaft	GM Kit Number	Ford Kit Number
7-3/8"	10"		712529
7-3/4"	10-3/8"	712512	712514
9-3/8"	12"	712521	712522
10-1/4"	12-7/8"	712517	712518
11-3/8"	14"	N/A	N/A
13-1/8"	15-3/4"	712516	N/A
13-1/4"	15-7/8"	712516	N/A
13-3/8"	16"	712516	N/A
14-1/8"	16-3/4"	712516	N/A

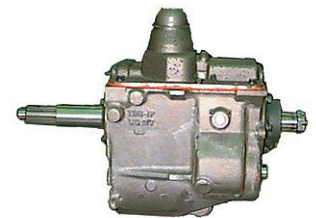

On any transmission that has a 17 tooth input shaft, you have the option of installing a new shorter input shaft. If you are using a T98 or T18 in a short wheel base vehicle, drivetrain length is crucial. These input shafts have a 17 tooth gear and allows us to use a 1/2" thick adapter plate. **P/N 712512** for a T18 and **P/N 712512-T98** for the T98 transmission is to a Chevy engine. **P/N 712514** for a T18 and **P/N 712514-T98** for the T98 transmission is to a Ford engine. These adapters are 1/2" thick adapter plates (thin design) that come complete with a new input shaft for your transmission.

- P/N 712549** - Chevy bhsg. Full Bellhousing kit (input shaft stickout 7.375", 1-1/16" 10 spl. *normally used in 1977-79*)
- P/N 712521** - Chevy bhsg to kit (input shaft stickout 9.375")
- P/N 712522** - Ford bhsg. to kit (input shaft stickout 9.375")
- P/N 712517** - Chevy bhsg. to kit (input shaft stickout 10.250")
- P/N 712518** - Ford bhsg. to kit (input shaft stickout 10.250")
- P/N 712516** - Chevy bhsg. to kit (13 to 14" input shaft stickout)
- P/N 712512** or **712512-T98** - Chevy bhsg. to kit (input shaft stickout 7.750")
- P/N 712514** or **712514-T98** - Ford bhsg. to kit (input shaft stickout 7.750")

AMC TH400 (1972-79) - Transmission case length of 24.500". In 1971, this transmission was introduced in Jeeps; however, this early transmission used a cast iron adapter plate to fit this tranny to the AMC block. In 1974, the case was redesigned and eliminated the cast iron adapter. *We manufacture an adapter to mate only the 1974 & newer transmissions to Chevy blocks.*

- P/N 716133** - AMC TH400 plate to Chevy block



JEEP TRANSMISSIONS 1980-86:

Between 1980-86, the Jeep transmission clutch input shaft was designed shorter than the earlier year transmissions. This presented a problem with clutch & pilot bushing engagement when trying to use an adapter plate. For these year Jeep vehicles, we manufacture a full bellhousing. These bellhousings are designed to bolt directly to the stock 4 or 5 speed transmission and retain the stock clutch linkage. We utilize the original bearing retainer to align the stock transmission to a new bellhousing on Chevy or Ford engine conversions.

- T176, T177** (1980-83) - Transmission case lengths of 10.250". Casting number of 2604203. This transmission bolt pattern is the same as a standard Ford. We manufacture two types of adapters for this application. (Note: On some T177 transmissions, Jeep used a long input shaft. These adapters will not work on this application.)
- (highly recommended) **P/N 712548** - Full conversion bellhousing, Chevy engine to T176 (**11" clutch recommended**)
P/N 712534 - Adapter plate to accept a standard Chevy bhsg. (with 4.686" index)
P/N 712599 - Stock AMC T176 Bellhousing

SEE BACK COVER FOR COMPLETE CONVERSION KITS

- T4, SR4 & T5** (1980-86) - Transmission case lengths of 15.187". These transmissions were used with the AMC 258 6 cylinder, AMC 150 4 cylinder, and the GM Iron Duke 4 cylinder. The input shafts on these transmissions are normally 1-1/8" 10 spline; however, 1984-86 AMC 2.5 4 cly's we have found a 1" 14 spline. When converting to these transmissions, we offer two options.



- P/N 712548** - Full conversion bellhousing, Chevy engine to T4, SR4 & T5 (highly recommended) (**11" clutch recommended**) When replacing an AMC 4 cylinder and using the 712548 bellhousing, you will need to purchase a few additional items; Part numbers **716332** T/O arm boot, **716333** internal return spring, **716334** clutch release arm & **716336** slave cylinder.
- P/N 712533** - Adapter plate to accept a standard Chevy bhsg. (with 4.686" index)
P/N 712599-T5 - Stock AMC T4/T5/SR4 Bellhousing

SEE BACK COVER FOR COMPLETE CONVERSION KITS

NOTE: When replacing the Iron Duke 2.5 GM, no adapter is required.

- 999 / 727 Torqueflite** (1980-86) - This transmission can be identified by a case length of 16", and a transfer case adapter housing length of 6-5/8". These transmissions can be found behind a 258 6 cylinder or AMC V8 engine. These transmissions were coupled to both the Dana 300 and New Process transfer cases. We have developed an adapter plate that bolts to the front side of the transmission case, adapting it to a Chevy V6 or V8 engine. The kit also includes an internal adapter for the torque converter. This adapter ring indexes to the Jeep torque converter and then has a standard GM bolt pattern to couple to a factory GM flexplate. This ring also takes care of the spacing of the converter with the new engine and adapter housing.

- P/N 716131-A** Chevy block
P/N 716131-V Chevy Gen III Vortec V8 block

JEEP TRANSMISSIONS 1987-UP:

The transmissions used in Jeeps 1987 & UP changed once again. The indexing of these transmissions to the bellhousing was no longer done by a bearing retainer. Dowel pin alignment was then introduced. Along with this new type of indexing, Jeep also changed the design of their clutch mechanism. In these early year series Jeeps (1987-93), Jeep used an internal hydraulic throw-out bearing design, then changed to an external design on 1994 & newer models. For these transmissions, we still manufacture a full bellhousing due to the overall length of the input shaft. When using these transmissions, it is crucial to identify the exact transmission and the type of linkage it is equipped with.

- AX4 & AX5** (1985-2002) - The overall transmission length is 22.500", 15.625" case. The output shaft of these trannys are a flush 21 spline in vehicles up to 1996, and then switched to a 1/2" stickout past the tailhousing in 1997 & newer Jeeps. They are normally found coupled to an AMC 4 cylinder engine and had either an internal or external slave cylinder. The conversion bellhousings we manufacture require a new slave cylinder, **P/N 716213**, which is mounted externally. The input shaft on the AX5 is 1"-14 spline, so all conversions will require the use of a special 10-1/2" clutch disc, **P/N 716104**.



SEE BACK COVER FOR COMPLETE CONVERSION KITS

- P/N 712565** - Full conversion bellhousing, Chevy to AX4 & AX5
P/N CF360056 - 10-1/2" High profile pressure plate
P/N 712565V - Full conversion bellhousing using 168 tooth Flywheel, Chevy to AX4 & AX5
P/N CF165552 - 11" High profile pressure plate (**must use P/N 22-0001**)
P/N N1430 - Flat-face throw out bearing



Peugeot 5 speed (1987-89)

SEE BACK COVER FOR COMPLETE CONVERSION KITS

-The overall transmission length is 24.000", 16.875" case. This transmission is also called BA10/15. The output shaft on this transmission is a long 21 spline and is normally found coupled to an AMC 4.2L 6 cylinder engine. It always used an internal slave cylinder. The conversion bellhousing kit we manufacture provides a new internal slave cylinder. (**Note:** This is a very light-duty transmission.)

P/N 712566 - Full conversion bellhousing, Chevy to Peugeot 5 speed



AX15 (1989-99) -

The overall transmission length is 24.250", 16.750" case. The output shaft on this transmission is a long 23 spline. It is normally found coupled to an AMC 4.0L high output 6 cylinder engine. It uses both an internal and external slave cylinder. The GM conversion bellhousings we manufacture require a new slave cylinder mounted externally (**P/N 716213**). In 1994, the pilot diameter of this transmission was increased to .750"

P/N 712567 - Full conversion bellhousing using **153 tooth Flywheel, Chevy to AX15**
P/N CF360056 - 10-1/2" High profile pressure plate
P/N 383271 - 10-1/2" clutch disc

P/N 712567V - Full conversion bellhousing using **168 tooth Flywheel, Chevy to AX15**
P/N CF165552 - 11" High profile pressure plate (**must use P/N 22-0001**)
P/N 383735 - 11" 1-1/8 inch, 10 spline clutch disc

P/N N1430 - Flat-face throw out bearing
P/N 712543 - Adapter plate fitting the AX15 to a Ford bhsg. (with a 4.848" index)
P/N 716210 - Stock AX15 bearing retainer.

SEE BACK COVER FOR COMPLETE CONVERSION KITS



Torqueflite 999 (32RH) (1987-2002)

- The overall transmission case length is 16.000". The output shaft on this transmission is a flush 23 spline. They are normally found coupled to an AMC 6 cylinder engine. Transmission identification numbers are stamped on the left side of the case just above the oil pan gasket surface. We have developed an adapter plate that bolts to the front side of the transmission case, adapting it to a Chevy V6 or V8 engine. The kit also includes an internal adapter for the torque converter. This adapter ring indexes to the Jeep torque converter and then has a standard GM bolt pattern to couple to a factory GM flexplate. This ring also takes care of the spacing of the converter with the new engine and adapter housing.

P/N 716131-A Chevy block
P/N 716131-V Chevy Gen III Vortec V8 block



NV3550 (2000-04) -

This transmission was used in TJ Wranglers equipped with the 4.0L 6 cylinder engine. The overall transmission length is 24.250", 16.750" case, a 1-1/8" 10 spline input shaft, and a pilot tip diameter of .750". The output shaft of this transmission is a flush 23 spline. The shifter handle location is 12" from the face of the transmission to the center of the shifter handle. The GM conversion bellhousings we manufacture require a new slave cylinder mounted externally (**P/N 716213**).

P/N 712591 - Chevy V8 to NV3550, full conversion bellhousing using **153 tooth Flywheel**
P/N CF360056 - 10-1/2" High profile pressure plate
P/N 383271 - 10-1/2" clutch disc

P/N 712591V - Chevy V8 to NV3550, full conversion bellhousing using **168 tooth Flywheel**
P/N CF165552 - 11" High profile pressure plate (**must use P/N 22-0001**)
P/N 383735 - 11" 1-1/8 inch, 10 spline clutch disc
P/N N1714 - Flat-face throw out bearing
P/N 712544 - Ford Engine to NV3550, adapter plate

SEE BACK COVER FOR COMPLETE CONVERSION KITS

Aisin AW4 (1989-2002)

- This transmission is an overdrive automatic similar to the GM 700R tranny. The transmission output shaft was both 21 & 23 splines. Due to the complex computer controls, we do not offer any adapters to retain this transmission with a new engine.

NSG 370 (2005-2009)

- This Jeep 6 speed was used in both the TJ and JK with a 23 spline output spline, we do not offer any adapters to retain this transmission with a new engine.

42RLE 4 Speed (2003-2011)

This transmission is a 4 speed overdrive automatic. We do not offer any adapters to retain this transmission with a new engine. See the RubiCrawler, Pages 22 & 23.

W5A580 (NAG1) (2012-2018)

We do not offer any adapters to retain this transmission with a new engine. We can couple an Atlas to the back of this transmission.



SCOUT TRANSMISSIONS:

Torqueflite -

On Scout vehicles that were equipped with the Torqueflite 3-speed automatic transmission, we offer a kit that will bolt a Chevy V8 to this automatic replacing the stock I.H. 304 or 345 engine. This kit comes complete with an adapter plate, crank bushing, and flexplate. This kit is not compatible with the small block 400.

P/N 712572-A Torqueflite to Chevy V8 (up to 1985)

Scout T18 & T19 - These Borg Warner 4 speed transmissions have the long 10-1/4" stickout with an 1-1/4" 10 spline input shaft. We have developed two kits to use these transmissions. The original clutch linkage will need to be modified and relocated forward from the firewall, which is the most difficult part of this particular conversion.

P/N 712530 - T18, T19 or T98 to Chevy adapter plate

P/N 712531 - T18, T19 or T98 to Ford adapter plate (new input shaft provided-17 tooth gear)

P/N CF165473S - Centerforce 11" Pressure Plate (*recommended for GM conversions*)

JEEP TRANSMISSION RETROFITS

(JEEPS RETAINING STOCK AMC ENGINE & STOCK TRANSFER CASE)

On many of the late model Jeeps, the stock engines that were used were adequate for horsepower and torque. An example of these engines include the 4.0L, 4.2L, 258 6 cyl., 304, 360, and 401. The weak link is normally the stock transmission up against these power plants. We manufacture bellhousing adapters to retain these stock AMC-Jeep engines with new, stronger transmissions. The part numbers listed below are just the bellhousing components required. A transfer case adapter will also be necessary. The Transfer Case Selection Charts are located on Pages 24 & 25.

Ford T18 & NP435: These transmissions are popular to retrofit into these vehicles. They are a heavy-duty 4 speed with a granny low 1st gear. The transfer case adapter can be found in the transfer case chart for your application. When converting to AMC blocks (except the 4.0L), a stock AMC bellhousing can be used - Jeep P/N 8133951, 3236291 or **AA P/N 712599**.

P/N 716156 - AMC pilot bushing (required for all applications)

P/N 712569 - AMC 4.0L to Ford truck transmission

P/N 384180 - AMC clutch disc (required when the stock tranny has 1-1/16" 10 spline)

SM420 & SM465: GM truck 4 speeds with a granny low 1st gear. Ideal for rock-crawling.

P/N 712570 - AMC engines to SM420 (4.686" bellhousing index)

P/N 712571 - AMC engines to SM465 (5.125" bellhousing index)

NV3550/AX15: Jeep 5 speed with a 4.01:1 first gear ratio and 22% overdrive. We offer a full bellhousing to fit both the 4.0L & 4.2L stock 6 cylinder (with hydraulic clutch linkage) and also an adapter plate for 1980-86 CJs. See Pages 51 & 52 for more information.

NV4500: GM & Dodge truck 5 speeds with a 5.61 first gear ratio and 27% overdrive. The first two bellhousing kits listed are for GM NV4500s. The input shaft of the Dodge transmission can be changed to a GM style input, and then the 712568 bellhousing can be used with a Dodge NV4500.

P/N 712571 - AMC engines to GM NV4500 (up to 1995)

P/N 712568 - AMC engines to GM NV4500 (1996 & up)

The following adapter plates are designed around the Dodge gas NV4500. The Dodge transmission input shaft has a stickout length of 7-1/2". This allows us to use an adapter plate to couple to the stock AMC bellhousing.

P/N 712553 - AMC engines (using Jeep bhsg. 8133951 or **P/N 712599**) to Dodge NV4500

P/N 712555 - AX5 bhsg. to Dodge NV4500 (internal release bearing only)

P/N 712559 - AX5 bhsg. to Dodge NV4500 (external slave cylinder only)

We offer full adapter packages for the NV4500, NV3550 & AX15 transmissions. See Pages 51 through 54.



AX15 to Jeep 4Cyl: This Jeep 5 speed was originally coupled to the Jeep 6 cylinder engine. Compared to the AX5 transmission, the gear ratios of the AX15 are very similar; however, the AX15 is a heavy-duty 5 speed. We have designed two kits that make the AX15 a nice and easy retrofit. The kits we offer will work for either the external or internal slave cylinder. Both kits are an adapter plate design, retaining the stock 4 cylinder bellhousing. Kits include a new clutch disc. A new Centerforce pressure plate is available if needed. Depending on what model transfer case you have, a new input gear (sold separately) will be required.

- [P/N 712563](#) - External slave cylinder kit
- [P/N 712564](#) - Internal slave cylinder kit
- [P/N CF361914](#) - 4 cylinder pressure plate

GM TH350, TH400 & 700R: This adapter kit was designed to allow the use of a GM TH350, TH400 or 700R transmission to the stock AMC straight 6 cylinder & V8s. This 5/8" thick steel plate allows you to couple any one of these transmissions to a stock Jeep flexplate and retain the GM torque converter.



- [P/N 716138](#) - AMC engines to GM automatic (*needs a modified flexplate from list below*)
- [P/N 716138-1](#) - 1991-2004 4.0L & 1988-90 4.2L engines to GM automatic uses stock flexplate

Aftermarket flexplates we carry for this conversion:

- [P/N 716138-A](#) AMC flexplate 304 & 360 (1972-87)
- [P/N 716138-C](#) AMC flexplate 360 (1988-91)
- [P/N 716138-D](#) AMC flexplate 401 (1972-76)
- [P/N 716138-E](#) AMC flexplate 258 (1972-87)

When installing an automatic into a Jeep, some additional parts will need to be considered. A transmission shifter will be required and most applications need a flexible dipstick. We also carry a 52" long 700R T.V. cable under [P/N 716138-KD](#) or a kickdown cable for the TH350 52" long under [P/N 716138-KD1](#).

When using the 716138 adapter kit on a **4.0L Jeep 6 cyl. engine**, we offer two options for retaining the flywheel sensor: [Part No. 716138-M](#) and [716138-N](#). These kits do require you to modify the GM bellhousing, but they retain the sensor on the flexplate as it was factory. The "M" kit is for 1991-96 Jeeps and the "N" kit fits 1997-2004 Jeeps. We no longer offer a harmonic balancer kit, but you can get the parts from Mopar if you don't want to modify the GM bellhousing.

SPECIAL CONVERSION BELLHOUSINGS

NV4500 Bellhousing Adapters to GM ENGINES:

The NV4500 transmission is a popular combination when installing a Chevy engine into a Jeep. Since the NV4500 was offered from General Motors or Dodge, the stock GM & Dodge bellhousing is not always compatible with the original Jeep clutch linkage. Depending on the model NV4500 you obtain, the full bellhousing kits have provisions to utilize your stock hydraulic or mechanical clutch linkage, while the adapter plate kit may require additional clutch linkage items to be purchased. If using one of our bellhousings with a Vortec engine, you may be limited on clutch linkage due to the exhaust manifolds. See also Pages 52 & 53.

- GM NV4500:** [P/N 712577](#) - GM NV4500/SM465 (1993-1995) to GM block, full bellhousing
- [P/N 712576](#) - GM NV4500 (1996 & up) to GM block, full bellhousing

- DODGE (Gas) NV4500:** [P/N 712550](#) - Dodge NV4500 to GM 5.125" indexed adapter plate



NV4500 Bellhousing Adapters to FORD ENGINES:

The NV4500 transmission has also become a popular combination when installing a Ford engine into a Jeep. The adapter listed below are necessary to perform this conversion. This adapter plates utilize a stock Ford bellhousing 4.848" index. We do not offer brackets to install either hydraulic or mechanical clutch linkages for these applications. Some fabrication on your part will be required.

- DODGE NV4500:** [P/N 712551](#) - Dodge NV4500 to Ford 4.848" indexed adapter plate

BUICK Bellhousing Adapters:

Automatic: The Buick V6 has always been a popular engine to swap into Jeep vehicles. When installing the Buick V6 to an automatic transmission, we recommend using a Buick automatic. When this option is not available we offer an adapter, [P/N 716134](#). This plate will mate a Chevy automatic (TH350, TH400, 700R) to the Buick engine block. If you've obtained a Buick transmission and would like to adapt it to a Chevy block, we offer adapter plate [P/N 716129](#).

SPECIAL CONVERSION BELLHOUSINGS (CON'T)

BUICK to Manual Transmissions: Due to the limited availability of stock bellhousings, a problem exists when trying to adapt the Buick engine to a manual transmission. Jeep was the only large volume manufacturer that ever used a manual transmission to a Buick engine. Needless to say, these bellhousings are extremely hard to locate. So in the early 1990s, we decided to design and manufacture a Buick V6 bellhousing to fit the 231, 225, and the rear-wheel drive 3.8L V6 engine for a manual transmission. To meet the various transmission requirements, we had to manufacture three different styles.

P/N 712581 - Buick V6 to Chevy transmission bolt pattern with a 4.686" index

P/N 712582 - Buick V6 to Chevy transmission bolt pattern with a 5.125" index

P/N 712583 - Buick V6 to Jeep T4, T5, SR4, T176 & Ford transmissions

(These bellhousings are limited to a stock Buick 10-1/2" clutch assembly & 160 tooth flywheel)

(These bellhousings are not compatible with 3.8L transverse engines)

Bellhousing P/N 712581 can be used in conjunction with many of the adapter plates on the previous pages.

FORD Truck 4SP Transmission to GM V6/V8 ENGINE:

In some of the short wheel-based vehicles, doing an engine & transmission swap is a game of inches when trying to retain the longest possible rear driveshaft length. In many cases, it's easier to accomplish this by coupling a GM engine to a Ford transmission to a Jeep transfer case.

We've designed a bellhousing that can retain the stock hydraulic or mechanical clutch linkage on most Jeep vehicles. The bellhousing requires an 168T Chevy flywheel and pressure plate with a Ford Clutch disc (Centerforce **P/N 281226**), and release bearing (**N1714**). The bellhousing comes complete with a new Chevy release arm, pilot bushings, and necessary hardware.

P/N 712549 - Ford Truck 4sp (T18, T19 & NP435) to Chevy V6/V8 engine

GM 700R, TH350 & TH400 Transmissions to FORD 302 ENGINE:



We offer an adapter plate and flywheel adapter to couple the GM automatics (TH350, TH400 & 700R) to the stock Ford engine. This kit is 3/8" thick and provides an excellent way of combining the GM transmission into a Ford-powered Jeep.

P/N 712588-A GM Transmission to Ford 302 1968-80 (28 oz. balance)

P/N 712588-B GM Transmission to Ford 302 1982-97 (50 oz. balance)

P/N 712588-C GM Transmission to Ford 302 1981

GM GEN III/IV Bellhousing Components:

The Gen III engines have the same block bolt pattern as the early GM with the exception of one bolt hole. When bolting an earlier GM transmission or one of our bellhousings to the Gen III block, you will only be able to use 5 bolts. The Gen III engine used a different crank stickout from the back of the block and a different crank bolt pattern. This means the early style flywheels and flexplates will not bolt to the new Gen III blocks. The stock flywheels and flexplates from the Gen III blocks are also unique with regard to the clutch bolt pattern and the torque converter bolt pattern. We have designed two kits for either a manual transmission or an automatic.

Early GM manual transmissions adapting to late GM engines is kit **P/N 712500M**. This kit includes a flywheel, flywheel bolts, 11" **Luk pressure plate & disc**, bolts for the pressure plate, pilot bushing spacer, release bearing, and metric bolts & washers for the bellhousing.

Early GM manual transmissions adapting to late GM engines is kit **P/N 712500M-CF**. This kit includes a flywheel, flywheel bolts, 11" **Centerforce pressure plate & disc**, bolts for the pressure plate, pilot bushing spacer, release bearing, and metric bolts & washers for the bellhousing.

Early GM Automatic adapting to late GM engines is kit **P/N 712500A**; and for the TH400/4L80E transmission, **Part No. 712500A4**. These kits include a modified flexplate (drilled for a early GM torque converter), flexplate bolts, and crank spacer bushing.

NOTE: The 4L80E will only use 3 of the 6 torque converter bolts to the flexplate.



JEEP BELLHOUSING CHART

JEEP MANUAL TRANSMISSIONS	GM V8 & V6	FORD 302 V8	BUICK V6	AMC 4.0L	AMC V8 & 4.2L	AMC 4 CYL.
T-84 3 SPEED	N/A	N/A	N/A			
T-90 3 SPEED (REPLACING 4 CYL.) NOTE 1	712502A (4)	712505 (4)	712502A (3,4)			
T-90 3 SPEED (REPLACING 6 CYL.)	712502A (4)	712505 (4)	712502A (3,4)			
T-89 3 SPEED	N/A	N/A	N/A			
T-86 3 SPEED	712506 (4)	712508 (4)	712506 (3,4)			
T-14 3 SPEED (REPLACING V6)	712506 (4)	712508 (4)	712506 (3,4)			
T-14 3 SPEED (REPLACING STRAIGHT 6)	712510 (4)	712511 (4)	712510 (3,4)			
T-15 3 SPEED	712510 (4)	712511 (4)	712510 (3,4)			
T-150 3 SPEED	712527 (4)	FORD B/H	712527 (3,4)			
T-150 3 SPEED	712548 (2)	FORD B/H	712583 (2)			
T-18 (STICKOUT 7.375")	712549 (4)		712583 (4)			
T-18 & T-98 (STICKOUT 7.750")	712512 (4)	712514 (4)	712512 (3,4)			
T-18 (STICKOUT 9.375")	712521 (4)	712522 (4)	712521 (3,4)			
T18 & T-98 (STICKOUT 10.250")	712517 (4)	712518 (4)	712517 (3,4)			
T18 (STICKOUT 13-14")	712516 (4)		712516 (3,4)			
T176 4 SPEED	712548 (2)	FORD B/H		712569 (2)	STOCK / 712599	
T176 4 SPEED	712534 (4)	FORD B/H	712534 (3,4)	712569 (2)	STOCK / 712599	
T4, T5, SR4	712548 (2)			712569 (2)	STOCK / 712599	
PEUGEOT 5 SPEED	712566 (2)		712566 (2)		STOCK	
AX4, AX5	712565 (2,7,13)		712565 (2,13)	N/A	N/A	STOCK
AX15 5 SPEED	712567 (2,7)	*712543 (4,8)	712567 (2)	712590 & -M (2)	712543J	712563/64
NV3550 5 SPEED	712591 (2,7)	*712544 (4,8)	712591 (2)	712590 & -M (2)	712545	
				(-M) is 05 & 06 JEEPS		
JEEP AUTOMATIC TRANS.						
AMC TH400 (1974 & NEWER)	716133					
727 TORQUEFLITE	716131 (6)					
904 TORQUEFLITE						
999 TORQUEFLITE	716131 (6)					
AW4						
SCOUT MANUAL & AUTOMATICS						
T18,T19,T98 4-SPEED	712530 (4)	712531 (4)	712530 (4)			
T-90 3 SPEED NOTE 1	712502A (4)	712505 (4)	712502A (3,4)			
727 TORQUEFLITE	712572-A (12)					
MISC. GM, FORD, DODGE TRANS.						
GM SM420 *ALSO REQUIRES 716041	STOCK/712577*		712581 (2)	712570 (2)	712570 (2)	
GM SM465	STOCK/712577		712582 (2)	712571 (2)	712571 (2)	
FORD 4 SPEED (T18,T19 & NP435)	712549 (2)	STOCK	712583 (2)	712569 (2)	712569 (2)	
GM NV4500 (6.34:1 1ST GEAR)	712577 (2)			712571 (2)	712571 (2)	
GM NV4500 (PRE-96 / 5.61:1 GEAR RATIO)	712577 (2)	712552 (4)		712571 (2)	712571 (2)	
GM NV4500 (1996 +)	712576 (2)			712568 (2)	712568 (2)	
DODGE NV4500 4WD GAS VERSION	712550 (5)	712551 (4)	712550 (3,5)		712553 (4)	712555 (9)
DODGE NV4500 4WD GAS VERSION	712550 (5)	712551 (4)	712550 (3,5)			712559 (10)
CHEVY AUTOMATIC (TH350,400,700R)	STOCK	712588 (14)	716134	716138-1	716138 (11)	

NOTES:

1. REQUIRES A NEW INPUT SHAFT 716014
2. THIS KIT IS A FULL BELLHOUSING
3. OUR BUICK B/H CAN BE USED WITH THIS ADAPTER
4. GM & BUICK KIT USES 4.686" B/H INDEX AND FORD, JEEP KIT USES A 4.848" B/H INDEX
5. GM & BUICK KIT USES A 5.125" B/H INDEX
6. THIS KIT HAS TWO VERSIONS REF. PAGE 29 or 30.
7. THIS KIT IS SOLD FOR EITHER A EARLY (-B) OR LATE (-A) GM V8

8. WE CAN SUPPLY A BRACKET FOR THE JEEP SLAVE 716336
9. FOR USE WITH AX5 BELLHOUSING, INTERNAL HYDRAULIC
10. FOR USE WITH AX5 BELLHOUSING, EXTERNAL HYDRAULIC
11. SEE PAGE 32 FOR OPTIONS
12. THIS KIT ONLY WORKS ON 1985 & EARLIER BLOCK (NO 400CI)
13. THE TRANSMISSION FOR THIS BHSG. HAS A 1"-14 SPL. INPUT SHAFT WHICH REQUIRES A SPECIAL CLUTCH DISC
14. THERE ARE 3 VERSIONS OF THIS KIT. THE CORRECT KIT DEPENDS ON THE YEAR OF YOUR FORD BLOCK.

CLUTCH LINKAGE (Manual Transmissions Only):

Jeep has used both hydraulic and mechanical clutch linkages over the years. When doing an engine conversion, it is not uncommon to have clutch linkage changes. Many of these stock linkages can be retained with a few modifications. However, if you would like to improve your clutch linkage, we offer many upgrades from these stock linkages.

Jeeps 1941-1971 - These Jeeps used a torque tube that pivots off the stock transfer case. The clutch pedal & bellhousing arm used rods that connected to this torque tube. We offer a new assembly that removes the torque tube & rods and replaces them with a sprocket and chain. This controller utilizes the stock pedal and clutch arm. It can be easily installed and offers a great mechanical advantage on any vehicle whether stock or converted (**Part No. 716640**). *Will not work on a stock 4cyl. application.*

Jeeps 1970-1972 (**Cable linkage**) - This linkage was only used by Jeep for a short time. This linkage proved to be very inadequate. We've never manufactured an upgrade linkage kit to replace this type of linkage, but it can be retained when doing a conversion.

Jeeps 1941-1972 (**Hydraulic linkage**) - Although these year Jeeps never came with this type of linkage, we have designed a new dual pedal and master cylinder assembly to upgrade your vehicle to a hydraulic linkage. These components cannot be used on vehicles with disc brakes.

P/N 716117 -	Dual Swing Pedals	P/N 716116 -	Slave Cylinder Kit
P/N 716118 -	Dual Master Cylinder	P/N 716287 -	Slave Cylinder Bracket (GM block only)

Jeeps 1972-1986 (**Mechanical**) - These Jeeps use the same type of clutch torque tube as the earlier models, except the torque tube pivots off the bellhousing instead of the transfer case. This linkage uses a ball design pivot bracket that bolts to the stock bellhousing. When using one of our Chevy conversion bellhousings, the stock bracket can be retained. If you are using a GM bellhousing, we offer **Part No. 716638** which will provide you with an adjustable pivot location. If you would like to upgrade your clutch linkage, we offer a chain-operated clutch linkage. This kit is mounted to the original push rod that extends out of the firewall. (**P/N 716639**)



Jeeps 1980-1986 (**Hydraulic linkage**) - Jeep first started using a hydraulic linkage in the 1980-82 CJ7s with the 151 Iron Duke engine. This slave cylinder bolts to the bellhousing using the same two holes as the mechanical linkage ball pivot bracket. If you are using one of our Chevy conversion bellhousings, this slave cylinder can easily be installed. If you wish to change to a hydraulic linkage, replacing the mechanical linkage, 1980-86 Jeeps had provisions to bolt a stock Jeep master cylinder to the firewall (Jeep master cylinder AA **P/N 40CJ8086**). We offer the stock slave cylinder assembly to work for this application (**Part No. 716331**).

Jeeps 1987-2006 (**Hydraulic linkage**) - These year series Jeeps all had hydraulic linkages and use both internal and external release mechanisms. When installing a new engine and retaining the stock 5 speed transmission, we normally use an external slave cylinder - except on Peugeot 5 speeds where the stock internal slave cylinder must be retained. The external slave cylinder for AX5, AX15 & NV3550 transmissions is found off of a 1975 Toyota Land Cruiser, **P/N 716213**. The bellhousing kits for the AX5, AX15 & NV3550 includes a slave cylinder fitting to adapt this slave cylinder to a #3 or AN3 37 degree fitting, which is the same size fitting that Jeep used on the master cylinder. **P/N 716130-60** can be used to couple the slave cylinder & master cylinder together.

Jeeps 1987-1991 (**Hydraulic linkage**)

New Engine & Transmissions Swaps & Transmission Retrofits:

When you are installing a new drivetrain using one of our full conversion bellhousings, we offer a slave cylinder that bolts directly to our bellhousing. This Jeep Iron Duke slave cylinder works well with the 1987 to 1991 master cylinder (11/16" bore). This slave cylinder is **P/N 716331** and fits both the GM and Jeep conversion bellhousing we manufacture.

Jeeps 1992-2006 (**Hydraulic linkage**) New Engine & Transmissions Swap Combos:

When you are installing a new drivetrain using one of our full conversion bellhousings, Jeeps 1992 & newer used a master cylinder with a 3/4" cylinder bore. We offer a slave cylinder bracket that bolts to our bellhousing and allows the use of a Toyota Land Cruiser slave cylinder. This bellhousing does have the provision to use a Jeep Iron Duke slave cylinder; however, this slave cylinder is marginal when used with this YJ and TJ master cylinder. The recommended method of using the Land Cruiser slave cylinder would require the following: **P/N 716288** slave cylinder bracket (A.A. bellhousing), **P/N 716119S** TLC slave cylinder, **P/N 716215** slave cylinder fitting, and **P/N 716130H** slave cylinder hose. You will also require a special master cylinder fitting depending on the year of your vehicle. This assembly only works on our GM conversion bellhousing. The Jeep bellhousing will need a special bracket to be manufactured. If you are using a stock Chevy bellhousing, the slave cylinder bracket should be **P/N 716287**.

Jeep TJ 1997-2006 - Jeep TJs have a hard plastic hydraulic hose assembly. We offer a replacement stainless braided hose assembly with two fittings for the master and slave cylinders, **P/N 716130TJH**.

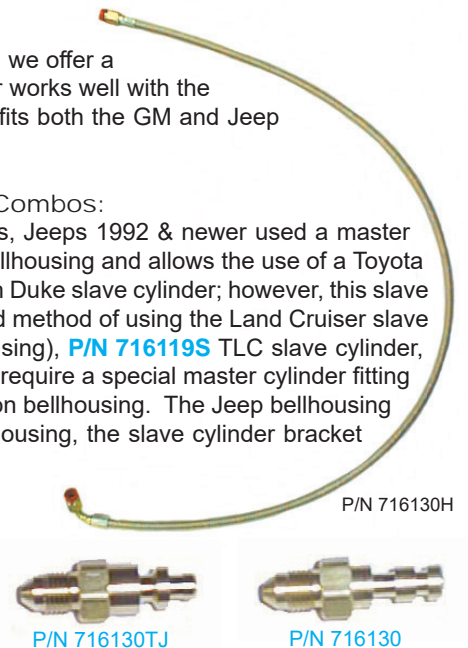

Jeeps 1980-2006 (**Master cylinders**) - Jeep master cylinders up to 1991 have threaded fittings, and 1992 & newer Jeep master cylinders have a pin-type connection. We offer hydraulic fittings to couple the stock master cylinder to the steel braided hose that we offer. The early master cylinders require **P/N 716130F**, which is a threaded connector. On later model master cylinders, you will have two options. We have found that Jeep used two types of pin-style connectors. The difference seems to be between the YJ & TJ models. The photos on the previous page will assist you in the identification process. We suggest you check the fitting on your vehicle by matching it to one of these examples. To assist you with connecting these fittings to the slave cylinder, we also offer a 42" long stainless braided hose with #3 female fittings, **P/N 716130H**. In some cases the 42" hose is not long enough; therefore, we can carry a 12" extension hose, **P/N 716130E** OR 60" hose **P/N 716130-60** for when you're just short of the proper fit.

P/N 716130H - 42" hose with dash 3 fitting
P/N 716130-60 - 60" hose with dash 3 fitting

P/N 716130E - 12" hose with dash 3 fitting
P/N 716130F - dash 3 fitting

Jeeps 1987-1993 (**Internal Hydraulic Release Bearings**) - We have had several requests for both a stainless braided hose kit for a replacement for the stock clutch hose line as well as a conversion one for those of you upgrading to a larger engine. The nice thing on these kits is they will work on either application. Our hose assembly kits offer two master cylinder fittings to ensure you have the correct application. Also included is a new 42" stainless braided hose and then a new adapter fitting to couple to the factory Jeep internal hydraulic release bearing.

P/N 716130IR - 1987-1992 Jeeps master cylinder hose kit with internal release bearing

P/N 716130IR-93 - 1993 Jeeps master cylinder hose kit with internal release bearing

CLUTCH RELEASE ARMS & BEARINGS:

On the clutch chart (next page), we have listed all Centerforce & Luk high diaphragm pressure plates that we stock. By using these pressure plates, we can standardize on just a few release arms and bearings.

The GM arm we use is the straight cast iron style that accepts the groove-type throw out bearing, **P/N 716176**. On most of our conversion bellhousings and adapter plates, we recommend this part number (except on P/N 712548 bellhousing assembly).

On Ford bellhousing applications we have found a wide variety of release arms. The release arm that your stock Ford bellhousing has is your best choice. (The only Ford bellhousing we manufacture comes complete with a new release arm). The release arm normally accepts one of two types of release bearings: Up to 1981, Ford used a clip-type. On 1982 & newer, Ford (like GM) uses a groove-type.



Jeeps are similar to the early Fords in that they use a clip-type release bearing. The only application that we retain the stock Jeep throw out arm is with our conversion bellhousing P/N 712548 (vehicles 1976-86). When using this bellhousing on vehicles that were originally equipped with a 4 cylinder, you will need to purchase: **Part No. 716332** (boot), **716333** (spring) & **716334** (T/O arm).

The Centerforce pressure plates (listed on the Jeep Clutch chart) require a flat-faced release bearing. There are two things to consider regarding this: First, how does the bearing attach to the release arm? (Clip or Groove). Second, the external dimension of the transmission snout that the bearing rides on. (The GM retainer snout is 1.37", and Ford, Jeep & Dodge NV4500 is 1.43").

P/N N1430 - 1.37" I.D. groove-type release bearing

P/N 716311 - 1.43" I.D. clip-type release bearing

***P/N N1714** - 1.43" I.D. groove-type release bearing

**(When using this bearing with a GM arm, the GM arm will require slight modifications)*



FLYWHEELS & STARTERS:

GenIII Flywheel Kits we offer:

P/N 712500M Flywheel w/ Luk clutch

P/N 712500M-CF Flywheel with Centerforce

P/N 712500T Flywheel w/ Luk clutch for TLC

P/N 22-0002 High torque starter Gen III

P/N CF53005524 JEEP 4.0 1991 & UP (CAST STEEL) 1" Thick

P/N CF700010 BUICK V6 160T Flywheel 231 for EVEN-FIRE 1977 and Up (*BILLET STEEL*)

P/N CF700100 153T GM Flywheel Up to 85 (*BILLET STEEL*) **P/N 22-0003** High torque starter

P/N CF700120 168T GM Flywheel Up to 85 (*BILLET STEEL*) **P/N 22-0003** (straight pattern) or **P/N 22-0001** (staggered) High torque starter

P/N CF785168 168T GM Flywheel Up to 1985 (CAST STEEL) **P/N 22-0003** (straight pattern) or **P/N 22-0001** (staggered) High torque starter

P/N CF700170 153T GM Flywheel 1986 & Up (*BILLET STEEL*) **P/N 22-0003** High torque starter

P/N CF700160 168T GM Flywheel 1986 & Up (*BILLET STEEL*) **P/N 22-0003** (straight pattern) or **P/N 22-0001** (staggered) High torque starter

P/N CF786168 168T GM Flywheel 1986 & Up (CAST STEEL) **P/N 22-0003** (straight pattern) or **P/N 22-0001** (staggered) High torque starter

P/N CF720000 Flywheel (Iron Head 6.0L 99 & 00) & (4.8L 99-03 Manual Trans.) NON RECESSED Crank W/ Early P/P bolt pattern (*BILLET STEEL*)
P/N 22-0002 High torque starter Gen III

CRANK PILOT BUSHINGS:

In most of the bellhousing adapters we sell, the crank pilot bushings are included. The bushings below list the outside & inside dimension and the overall length. **NOTE: Late model Jeeps used a 2-piece bearing. The first piece is a bushing/bearing; the second piece is a steel sleeve that looks like part of the crank. This steel sleeve must be removed when doing a conversion.**

Part No.	O.D.	x	I.D.	x	Length	Application	Part No.	O.D.	x	I.D.	x	Length	Application
716120	1.818		.590		.870	Jeep / GM	716122	1.377		.750		.500	Ford /
716156	1.818		.670		.500	Jeep / Ford	716153	1.377		.590		.359	Ford / GM
716156GM	1.818		.590		.600	Jeep / GM	716172	1.377		.629		.500	Ford / Jeep
716164	1.818		.750		.500	Jeep /	716173	1.377		.670		.500	Ford/Ford
716166	1.818		.750		.750	Jeep /	716169	1.377		.750		.350	Ford
716149-NS	1.090		.471		1.50	GM / Toy	716159	1.050		.590		.625	Jeep T176
716148	1.090		.670		1.50	GM / Ford	716167	.947		.750			Jeep 4cyl. / AX15
716154	1.090		.590		1.00	GM / GM	716167A	.947		.670			Jeep 4cyl. / Ford
716158	1.090		.670		.750	GM / Ford							
716168	1.090		.750		.750	GM /	716171	1.090		.629		.750	GM / Jeep
716170	1.090		.590		.750	GM / GM	716193	1.090		.670		1.250	GM / Ford



Clutch Alignment Tools: These are great tools for installing a new clutch assembly. It allows you to align the clutch disc splines to the pilot bushing while bolting down the pressure plate to the flywheel. When it comes time to bolt the transmission to the bellhousing, you'll know you will have the correct alignment.

- 716228 1-1/8" 10 spline .590 pilot tip
- 716229 1-1/16" 10 spline .670 pilot tip
- 716230 1" 14 spline .590 pilot tip
- 716231 1-1/8" 21 spline .460 pilot tip
- 716232 1-1/8" 10 spline .750 pilot tip.



JEEP CLUTCH SELECTION CHART

The Centerforce or Luk clutches and flywheels listed below are recommended when using Advance Adapters conversion components. We design our adapter kits around these clutch designs. **If clutch components from other manufacturers are used, we cannot guarantee proper clutch operation.** When selecting a clutch assembly for one of our full conversion bellhousings, refer to the Bellhousing Adapter Information section starting on Page 27 for the clutch diameter recommendations.

	1-1/8" 10 SPLINE ALL GM TRANS. NV4500, JEEP T5, T176, T90, T86, T14, T15, T18	1-1/16" 10 SPLINE ALL FORD TRANS. JEEP T150 JEEP T18 1976-79		1-1/8" 10 SPLINE ALL GM TRANS. NV4500, JEEP T5, T176, T90, T86, T14, T15, T18	1-1/16" 10 SPL. ALL FORD TRANS. JEEP T150 JEEP T18 1976-79
GM 10-1/2" CLUTCH PRESSURE PLATE CLUTCH DISC 153 FLYWHEEL UP TO 85 153 FLYWHEEL 86 & UP	**LC360056 CF360056 383271 CF700100 CF700170	CF360056 381021 CF700100 CF700170	FORD 10" CLUTCH PRESSURE PLATE (3 sets of 2) CLUTCH DISC 157 FLYWHEEL	CF360030 383303 STOCK	CF360030 280490 STOCK
GM 11" CLUTCH PRESSURE PLATE CLUTCH DISC 168 FLYWHEEL UP TO 85 168 FLYWHEEL 86 & UP	**LC165552 CF165552 383735 CF700120 CF700160	**LC281226 CF165552 281226 CF700120 CF700160	FORD 11" CLUTCH PRESSURE PLATE (3 sets of 2) (6 bolts evenly spaced) CLUTCH DISC 164 FLYWHEEL	CF260000 CF360049 383735 STOCK	CF260000 CF360049 281226 STOCK
AMC 10-1/2" CLUTCH PRESSURE PLATE CLUTCH DISC FLYWHEEL	CF361675 (MECH) CF361897 (80-85 HYD) CF361890 (86&up HYD) 384193 STOCK	CF361675 (MECH) CF361897 (80-85 HYD) CF361890 (86&up HYD) 384180 STOCK	BUICK 10-1/2" CLUTCH PRESSURE PLATE CLUTCH DISC 160 FLYWHEEL SPECIAL PRESSURE PLATE FOR RECESSED 225 FLYWHEEL	CF360056 383271 *CF700010 CF361662 383271 (disc) N1178 (release brg.)	CF360056 381021 *CF700010

*This flywheel is designed for a Buick even fire block. Before installing, the flywheel should be balanced to the Buick engine crank.

**This is a Luk clutch assembly. The kit includes a pressure plate, disc, bearing, and alignment tool.

Jeep Centerforce II Pressure Plate - 4.0L & 4.2L (P/N CFT361890)
Jeep DUAL FRICTION - Jeep 4.0L 1986-2006 (P/N DF193890)



When installing a larger engine into any Jeep vehicle, the radiator is normally an area that needs attention. We offer our Rad-A-Kool aluminum radiator. For radiator specifications, cooling tips along with additional cooling components, see Pages 78-79.

Chevy to 1972-1986 Jeep CJ

- P/N 716692-AA** - Conversion Radiator w/Manual Transmission **(Aluminum)**
- P/N 716692-LS** - Conversion Radiator or GM LS1/Gen 3 & 5 engine w/Manual Transmission **(Aluminum)**
- P/N 716692-LT** - Conversion Radiator for GM LT1 w/Manual Transmission **(Aluminum)**
- P/N 716690-AA** - Conversion Radiator w/Automatic Transmission **(Aluminum)**
- P/N 716690-LS** - Conversion Radiator for GM LS1/Gen 3 & 5 engine w/Automatic Transmission **(Aluminum)**
- P/N 716690-LT** - Conversion Radiator for GM LT1 w/Automatic Transmission **(Aluminum)**

Chevy to 1987-2006 Jeep Wrangler

- P/N 716693-AA** - Conversion Radiator w/Manual Transmission **(Aluminum)**
- P/N 716693-LS** - Conversion Radiator for GM LS1/Gen 3 & 5 engine w/Manual Transmission **(Aluminum)**
- P/N 716693-LT** - Conversion Radiator for GM LT1 w/Manual Transmission **(Aluminum)**
- P/N 716691-AA** - Conversion Radiator w/Automatic Transmission **(Aluminum)**
- P/N 716691-LS** - Conversion Radiator for GM LS1/Gen 3 & 5 engine w/Automatic Transmission **(Aluminum)**
- P/N 716691-LT** - Conversion Radiator for GM LT1 w/Automatic Transmission **(Aluminum)**

Spal Fan Kits: The Spal fans we offer are high performance curved bladed pusher or puller fans. These 16" fans are 16.3" tall, 15.75" wide, and 3.39" deep at the fan's motor. The fans are rated at 2070 CFM and being that they are pre-shrouded, they are ideal for cooling larger engines. Our fan kits come complete with the needed wiring harness, which is compatible with both positive and negative ground vehicles. The 3/8" pipe thread sending unit is designed to turn the fan on at 185 degrees and off at 170 degrees. Kits come with a 40 amp relay, a fuse holder, and all other necessary hardware. In addition, our kits also include mounting brackets for the fan to the radiator. The mounting brackets are designed for our aluminum radiators; however, we can also supply you with brackets to fit some of our copper/brass radiators upon request.

- 716670** - Puller Fan Kit
- 716671** - Pusher Fan Kit

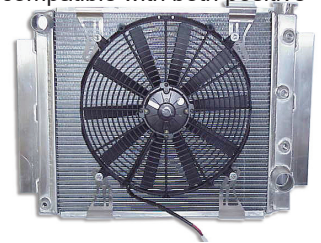

Transmission Cooler Lines Kit: We offer a flexible stainless steel transmission cooler line hose kit. These hoses are simple to route and easily installed onto the radiator. The seven foot long hoses are long enough to fit most applications while having a bit of extra hose to allow for body and frame flex. Our kit includes two 7' stainless steel outer braid lines with Teflon inner tubing. The ends have dash 6 female A.N. fittings that are pre-crimped to the hose ends. The kit also includes two 1/4" MPT to dash 6 Male fittings for aluminum Rad-a-Kool radiators, and two 5/16" inverted flare to dash 6 Male fittings for TH350 / TH400 / 700R4 transmissions. **NOTE:** We also offer these in shorter line lengths of 24", 36", 48" & 60". The shorter length kits are the same part number as listed below with a dash and the length in inches.



- P/N 23-1500** - Transmission Cooler Lines Kit 7' to work with our Rad-A-Kool radiator
- P/N 23-1501** - Transmission Cooler Lines kit 7' to work with radiators with a 5/16 inverted flare

JEEP ENGINE MOUNT SELECTION CHART

AdvanceAdapters has been doing engine conversions long before most of our competitors were even born. We learned the hard way to count only on top-quality, proven design installations. Our mounts are secured with a 5/8" diameter bolt between the engine brace and frame bracket. No rubber vulcanization failure will let you down. To assure that you have the premier engine mounts that we offer, make sure our name is on the box. Do not accept look-a-like takeoffs. We are the "4-Wheel Drive Experts" and have the quality to prove it.

	1941-1971 JEEP UNIVERSALS	1972-1986 JEEP & SCOUT UNIVERSALS	1941-1984 JEEP WAGON & TRUCKS	1987-1996 JEEP YJ WRANGLERS	1997-2006 JEEP TJ WRANGLERS	1984-2001 JEEP CHEROKEES XJ 4WD
CHEVY V8 ALL SMALL BLOCKS	713001 NOTE 1	713001 (1) or 713089 (2,6,11)	713007 NOTE 1	713001 (1) or 713087 (2,4,6,7,8)	713090 (2,3,6,9) or 713091 (1,3,6,7)	713109 NOTE 2,4,6
GM GEN. III V8 & LS1 BLOCKS		713088 NOTE 1	713088-W NOTE 1	713088 NOTE 1	713092 (1,3,6,7,9) 713093 (1,3,6,7,9,10)	
GM GEN. 5 V8		713085 (1)	713085-W (1)	713085 (1)		
CHEVY V8 LT1 SMALL BLOCKS	713005 NOTE 1	713005 NOTE 1	713005 NOTE 1	713005 NOTE 1		
CHEVY V6 4.3 & 229 BLOCKS	713001 NOTE 1	713001 NOTE 1	713007 NOTE 1	713001 NOTE 1		
BUICK V6 231 & 3.8 BLOCKS	713003 (1,5) or 713011 (1)	713011 NOTE 1	713011 NOTE 1	713011 NOTE 1		Jeep TJ mount
FORD V8 ALL SMALL BLOCKS	713002 NOTE 1	713006 NOTE 1	713006 NOTE 1	713006 NOTE 1		
AMC V8 304, 360 & 401	713120 NOTE 1	713120 NOTE 1	713120 NOTE 1	713120 NOTE 1		
DODGE HEMI N1	713097	713097	713097	713097	713098	
DODGE 318/360 BLOCKS		713095 NOTE 1	713095 NOTE 1	713095 NOTE 1	713094 NOTE 1,6,7,9	

NOTES:

- (1) REMOVE STOCK MOUNTS & WELD-IN NEW MOUNTS
- (2) REMOVE STOCK MOUNTS & BOLT-IN NEW MOUNTS
- (3) A 1" BODY LIFT NEEDED
- (4) SUSPENSION LIFT IS REQUIRED
- (5) REQUIRES STOCK RUBBER MOUNTS (NOT SUPPLIED IN KIT)
- (6) DRIVELINE MODS. MAY BE REQUIRED
- (7) REPLACES A JEEP 6 CYLINDER
- (8) WILL NOT WORK WITH AFTER MARKET OIL PANS
- (9) REPLACES A JEEP 4 CYLINDER
- (10) ENGINE W/ A/C REQUIRES FRAMES MODS. & WELDING
- (11) JEEP CJ7 MOUNT ONLY

Mounts 713002 & 713006: These motor mounts fit the Ford V8. The mounts are a complete frame-to-block mounting system that uses a dual rubber donut design locked together with a hardened bolt. This combination offers a positive means of securing the engine for the most severe offroad conditions. Our universal motor mounts can be adjusted to accommodate the best possible engine location.

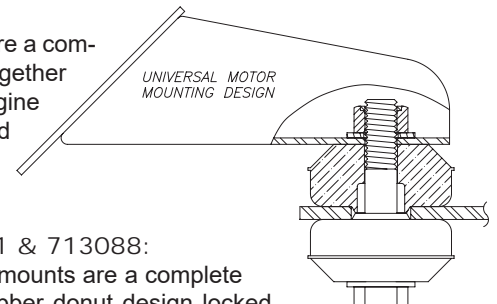

"SlideLock" Mounts 713001, 713007, 713011 & 713088:

These motor mounts fit the Chevy & Buick V6s. The mounts are a complete frame-to-block mounting system that uses a dual rubber donut design locked together with a hardened bolt. This is great for securing the engine for the most severe offroad conditions. We recently redesigned the adjustment feature on these motor mounts. We had always had holes 1" apart for the 5/8" bolt-to-bolt through, but on some frames widths you ended up having to elongate the hole on our mount. Now the new "Slide Lock" allows you to have complete side-to-side adjustment for the perfect engine placement without any modifications needed.

You can now fine tune your engine placement for steering clearance, oil pan clearance, and of course the engine height which had always been adjustable. Once the new mounts are in the desired location they can be locked in place by a bolt or a small tack weld. Don't be forced into an engine location that is not right for your vehicle. Use the new "Slide Lock" system and see how easy an engine conversion can be.

713087 mounts: This bolt-in saddle mount kit is designed to be used with 1987-95 YJ Wranglers. This mount fits GM V8s with the stock GM oil pan *only*. This mount is engineered to position your new engine in the best location possible, allowing for up to 1-1/4" of lateral adjustment. Driveshaft modifications may be necessary depending on your application. An electric fuel pump is required for ALL applications. This motor mount will not work with LT1 or 383 Stroker motors.



Jeep TJ Hemi Mounts: We now offer motor mounts for the Hemi engines, **P/N 713098**. These mounts are designed to replace both the stock 4 & 6 cylinder Jeep engines. A 1" body lift is required. The mounts are a weld-in set; however, we give you the exact location for placement.

MISCELLANEOUS BRACKETS & LINKAGES

LOKAR PERFORMANCE PRODUCTS:

Listed on Pages 84 & 85 are the performance components we carry from Lokar Industries. Items such as flexible dipsticks, backup light & neutral safety switches, kickdown / throttle cables, and brackets are available.



P/N 717038-NP

JEEP EXHAUST HEADERS

Ninety percent of our product line covers engine conversion applications; and since we are known as the "4-Wheel Drive Experts", naturally we had to design & manufacture our own quality header systems that complement the engine conversion business.

Our header flanges are 3/8" thick, and all of our primary tubes are constructed with 16 gauge tubing with a 2-1/2" 3 bolt collector ring. Each design is available in a non-plated version only, ready for your painting or custom coating. **NOTE: Our headers will not fit Chevy small blocks with angle plug heads.**

Our written guarantee states that if the headers do not fit your engine conversion exactly as you see fit, then simply return them for a full refund. You will only be responsible for the freight charges. **We do not warranty the chrome plating on our exhaust systems, and the use of aftermarket header wrap products will void the header warranty.** Over 44 years of continual fine tuning and adjustments have made the Advance Adapters headers a choice for all engine conversion installations.

SPECIAL HEADERS: We now offer a universal header like our 717011 headers that work with angle plug and D-port heads.

- P/N 717015-NP** - Fits blocks with a std port head with angle plugs.
- P/N 717016-NP** - Fits D-port heads with angle plugs.



P/N 717056-NP



P/N 717090-NP

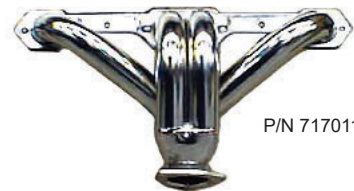

P/N 717011-NP

We also carry small block Chevy & Ford header gaskets as well as Buick V6 & Chevy V6 gaskets.

- P/N 716550** - Chevy V8 gasket (pair)
- P/N 716551** - Chevy V6 gasket (pair)
- P/N 716552** - SB Ford V8 gasket (pair)
- P/N 716554** - Buick V6 gasket (pair)
- P/N 716562** - 2-1/2" collector gasket (pair)

JEEP EXHAUST HEADERS CHART

	CHEVY V8 S.B.ENGINES (note 3)	CHEVY V6 4.3 & 229 (note 3)	VORTEC GEN III V8 (note 3)	BUICK V6 225 & 231 (note 3)	FORD V8 S.B.ENGINES (note 3)
JEEP UNIV. SQUARE FENDER CJ2A, CJ3B, MB & M38	717001-NP (1) **717011 (2)	717019-NP (1)		717005-NP (1)	717012-NP (2,5)
JEEP UNIV. ROUND FENDER CJ5 & M38A1	717001-NP (1) **717011 (2)	717002-NP (1)		717020-NP (1)	717012-NP (2,5)
JEEP WAGON & TRUCKS 1941-1986	**717011 (2)				717012-NP (2,5)
JEEP UNIV. 1972-75 CJ5	**717011 (2)	717056-NP (2,6)			717012-NP (2,5)
JEEP UNIV. 1976-86 CJ7 & CJ8	**717011 (2) 717038-NP (1)	717056-NP (2,6) 717056-NP (2,6)	717040-NP (1) 717043-NP (2, 7)		717012-NP (2,5)
JEEP YJ WRANGLERS 1987-96 YJ	717011 (2) 717039-NP (1)	717056-NP (2,6) 717056-NP (2,6)	717043-NP (2, 7)		717012-NP (2,5)
JEEP TJ WRANGLERS 1997-05 TJ	**717011 (2) 717090-NP (2)		TRUCK MANIFOLDS		
JEEP CHEROKEE 1984-95 XJ, ZJ	717053-NP (2)				

NOTES:

- (1) FENDERWELL HEADER. SOME MINOR MODIFICATIONS TO THE FENDERWELL ARE REQUIRED.
- (2) INSIDE THE FRAME RAIL HEADER.
- (3) THESE HEADERS ARE NOT LEGAL FOR USE ON POLLUTION-CONTROLLED VEHICLES.
- (5) FOR STARTER CLEARANCE, YOU MAY NEED TO USE A 157 TOOTH FLYWHEEL.
- (6) THIS HEADER WILL INTERFERE WITH MOST RELEASE ARMS ON MANUAL TRANSMISSIONS.
- (7) THIS HEADER IS OFFERED IS A CERAMIC COATED FINISH P/N 717043
- ** This header is offered in Ceramic coated P/N 717011Z, or Plain steel P/N 717011-NP

SAGINAW STEERING CONVERSIONS FOR JEEPS & TOYOTA LAND CRUISERS

Since the steering conversion for both Jeeps and Toyota Land Cruisers are similar, this section will cover both applications.

The Saginaw steering conversions for these vehicles is a proven advantage. The problem with the stock steering on both of these vehicles is excessive play or backlash. In addition to offering a sound positive means of controlling your vehicle, it can be performed at a reasonable cost. Additional advantages include exhaust clearance, engine positioning, and custom steering columns.

Before you consider this conversion we recommend that you thoroughly read and understand the complete installation procedure. For detailed procedures, call for a set of installation instructions or view them on line at www.advanceadapters.com in the Tech Vault. **Do not take shortcuts on steering installations.** We recommend that these conversions be installed by a qualified technician. The control of your vehicle depends on your steering performance. Failure of your steering system can result in severe damage and possible injury.

SAGINAW STEERING KITS:

Jeeps prior to 1971 & Toyota Land Cruiser FJ40 series (up to 1980) both had basically the same stock steering configuration. It is simply a gear box at the base of the steering column which controls a drag link towards the front of the vehicle. The bell crank is mounted on the front crossmember or axle and uses a push-pull affect for steering. Because there are many motions and joints on this system, excessive free play and backlash develops.

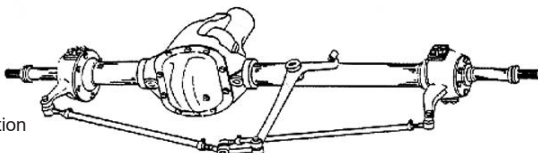

Stock Illustration

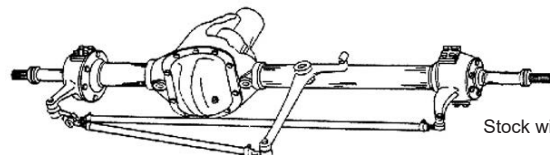

Stock with long tie rod

The Saginaw steering system requires the elimination of the stock gear box and bell crank. The new steering box is mounted on the inside of the left front frame rail, just behind the bumper. Although this sounds simple, there are several things that must be considered before the installation can be completed. Such things include power or manual steering, steering column type, steering box location, motor mount clearance on steering shaft, tie rod size & length, and winch clearance.

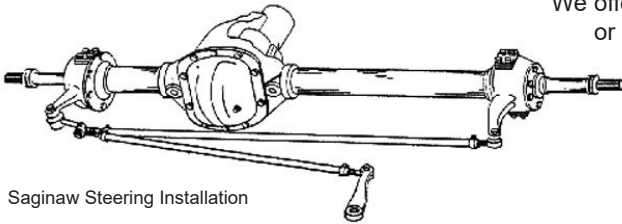

Saginaw Steering Installation

We offer multiple conversion kits for each vehicle. These kits are either power or manual steering conversions. None of these kits supply the steering box (manual or power), or steering pump and hoses (power applications). To help identify the kit necessary for your conversion, please consider the following information. **Note: Full steering kits should not be ordered when converting Jeep Pickups & Wagons, since special tie rods will be required.**

POWER & MANUAL STEERING BOX SELECTION:

Make sure the box that you select has the same basic configuration as the ones illustrated. Both Power & Manual boxes can be found in the 1960s & early 1970 GM cars or Jeep vehicles 1972 & newer. We also carry new power boxes & pumps which are as follows.

We stock Saginaw power & manual steering boxes for the steering kits we offer. Power steering boxes are ideal for the offroad enthusiast that uses their vehicle as a daily driver. These units use a large piston and most have a 16/13:1 turning ratio. The valving is designed for a more firm and precise steering effort. This gives you more stability and control at highway speeds, and less oversteer offroad. These units also help stabilize larger tires giving the vehicle a more stable feel on the highway.

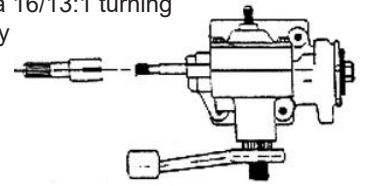

Manual Steering Box

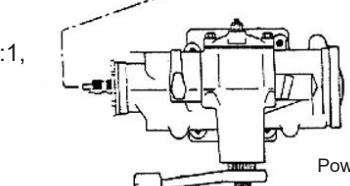

Power Steering Box

P/N 716880 - Power Steering Box .800" X 36T Flare Fitting Pre '80, 16/13:1 variable, also fits 72-79 CJs

P/N 716881 - Power Steering box .800" X 36T O-ring fittings 16/13:1, also fits 80-86 CJs

P/N 716882 - Triton power steering box .730 X 30T O-ring fittings 16/13:1, also fits 80-86 CJs

P/N 716877 - Manual steering box 525 16:1 .730 36T (new box)

P/N 716878 - Manual steering box 525 24:1 .730 30TH (new box)

We also offer a complement power steering pump. These pumps work well when combined with the steering boxes mentioned above. Larger cam packed with a larger rotor and vanes enables these pumps to flow 3.4 gallons per minute, and produce 1500 psi. The custom ported housing makes for less flow restriction, allowing the pump to run stronger and cooler.

P/N 716885-P - Power steering pump w/ o-ring fitting, (does not include pulley)

P/N 716886-P - Power steering pump w/ o-ring fitting and remote reservoir, (does not include pulley)

P/N 716887-P - Power steering pressure hose kit for o-ring box

P/N 716888-P - Power steering return hose kit for o-ring box

P/N 716889-P - Power steering heat sink cooler kit

For 1975 to 1981 Land Cruisers keeping the stock 6 cylinder engine, there is now the option of installing a power steering pump onto the stock 6 cylinder. We offer bracket **P/N 716842** to install the Saginaw pump to the Toyota straight 6 cylinder.

POWER & MANUAL STEERING BOX SPUD SHAFTS:



The Saginaw steering box gets mounted just behind the front bumper. This requires a clearance hole to be cut in the stock support located under the radiator for the steering shaft. Since the Saginaw steering shaft has a short stickout from the box, a spud shaft (or extension shaft) must be added to the steering box to extend the steering shaft into the engine compartment. There are three different spline sizes on the different Saginaw power and manual boxes. Both Power and Manual boxes have two spline sizes that mate to our spud shaft. Our complete manual steering kits are supplied with a .730" dia. 30 spline female spud shaft, and on our power steering kits, we supply the most common spud shaft which is a .800" dia. 36 spline female.

P/N 716834-30 - Spud shaft .730" dia. 30 spline female x 1" DOUBLE D MALE (power & manual boxes)

P/N 716834-36 - Spud shaft .730" dia. 36 spline female x 1" DOUBLE D MALE (power & manual boxes)

P/N 716835 - Spud shaft .800" dia. 36 spline female x 1" DOUBLE D MALE (power boxes only)

STEERING COLUMNS:

The stock steering column is the easiest option when installing the Saginaw steering. Our kits include the necessary column bushings and firewall mounting plates for your installation. If you are planning to use a custom steering column, some fabrication will be necessary for mounting a custom column on a Jeep. We now offer a custom column mount for the Toyota Land Cruisers.

P/N 716865 and **716866** fit GM 2" and 2-1/4" columns.

When using a new steering column you will need a different yoke assembly to connect a custom steering column shaft to our Saginaw steering components.

- P/N 716848** - 1" 48 spline Universal yoke (GM columns)
- P/N 716849** - 1" DD Universal yoke (GM and Ford)
- P/N 716850** - 3/4" x 36 spline Universal yoke (GM and Ford)

(The dimensions represent the column side of these yokes only. The opposite side of these yokes is a 3/4" DD)



Pre-1972 column

Land Cruiser Columns ONLY:

There are 3 different column configurations used on FJ40 Land Cruisers. The steering kits that we offer provide coverage to retain the stock column by supplying either a support bushing (for vehicles up to 1972), or a 4-bolt support bearing (for vehicles 1973 to 1979). On FJ40s 1980 & newer, we have seen a change on the column mounting to a 3-bolt mount and an increase in the steering shaft diameter. We currently do not offer a support bushing or bearing to fit these model years.



Pre-1972 column bushing



1973-79 column plate



1980 & up column plate



BORGESON / FLAMING RIVER:

These kits are the newest and most recommended style that we manufacture. The steering shaft assembly connects directly to our steering spud shaft. This collapsible slip steering shaft extends to the firewall and can be adjusted to any length. With a 3/4" DD connection (round shaft having 2 flat surfaces), it is easily coupled to any of the yokes supplied in the kit or listed under the Custom Steering Column subheading. These kits require welding on the steering box mounting plate, frame enclosures, and firewall mounting plate.



- P/N 716805** - Jeep conversion kit, Manual Saginaw box

- P/N 716806** - Jeep conversion kit, Power Saginaw box (shown)

- P/N 716806A** - Jeep conversion kit, Power Saginaw box
(does not include column yoke and steering spud shaft.)

- P/N 716807** - Land Cruiser kit, Manual Saginaw box

- P/N 716808** - Land Cruiser kit, Power Saginaw box

- P/N 716808A** - Land Cruiser kit, Power Saginaw box

(does not include column yoke, steering spud shaft and center socket tie rod end.)
(These kits do not include boxes or pumps)

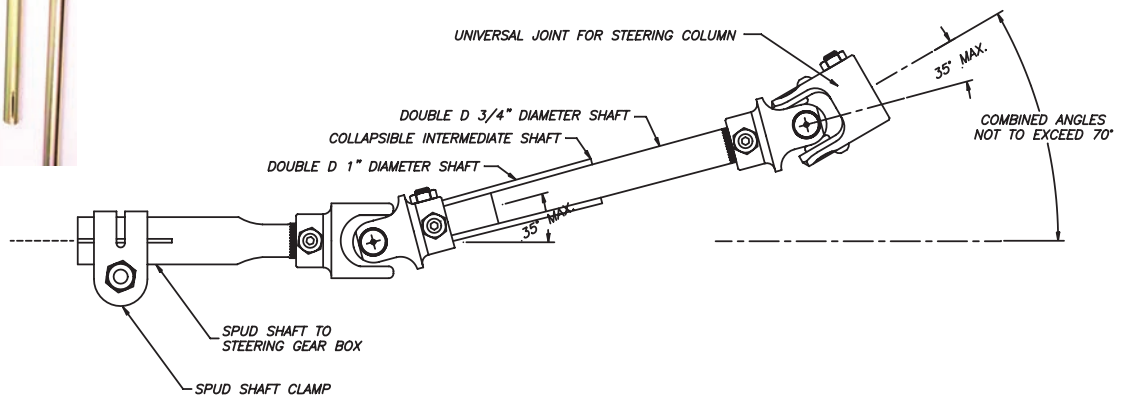

STEERING COMPONENTS:

Although we manufacture and sell complete kits for Saginaw steering conversions, we do offer the individual components.

- P/N 716810** - Stock Jeep column bushing
 - P/N 716811** - Stock Land Cruiser column bushing (up to 1972)
 - P/N 716812** - Tie rod clamp
 - P/N 716814** - Spud shaft clamp
 - P/N 716816** - Manual pitman arm
 - P/N 716817** - Power pitman arm
 - P/N 716819** - Center socket tie rod end
 - P/N 716820** - Left hand thread tie rod end
 - P/N 716821** - Right hand thread tie rod end
 - P/N 716822** - Land Cruiser column mounting plate
 - P/N 716823** - Jeep column mounting plate
 - P/N 716824** - Jeep frame enclosures
 - P/N 716826** - Manual steering box mounting plate (Jeeps)
 - P/N 716829** - Jeep tie rod 22-1/2"
 - P/N 716830** - Jeep tie rod 35-1/2"
- (Custom tie rods can be made for longer lengths)*
- P/N 716831** - Land Cruiser tie rod 25-1/2"
 - P/N 716832** - Manual box mounting plate gusset
 - P/N 716833** - Land Cruiser column bushing (1972 - 1979)
 - P/N 716834-30** - Spud shaft .730" dia. x 30T (manual & power)
 - P/N 716834-36** - Spud shaft .730" dia. x 36T (manual)
 - P/N 716835** - Spud shaft .800" dia. x 36T (power)
 - P/N 716838** - Power steering mounting plate for Jeeps
 - P/N 716839** - Power & manual steering box mounting plate for L/C
 - P/N 716841** - Universal Joint 1" DD x 1" DD
 - P/N 716842** - Land Cruiser 6 cylinder power steering pump bracket
 - P/N 716843** - Universal Joint 1" DD x 7/8"
 - P/N 716844** - Universal Joint 3/4" x .800 36 Spline
 - P/N 716845** - Universal Joint 1" DD x 3/4" - 36 Spline
 - P/N 716846** - Universal Joint 1" DD x .800 36 Spline
 - P/N 716847** - Jeep column shaft x 3/4" DD
 - P/N 716848** - Universal Joint 3/4" DD x 1"-48 GM
 - P/N 716849** - Universal Joint 3/4" DD x 1" DD
 - P/N 716850** - Universal Joint 3/4" DD x 3/4"-36
 - P/N 716851** - Land Cruiser column shaft 3/4" x 3/4" DD
 - P/N 716852** - Universal Joint 3/4"-36 x 3/4"-36

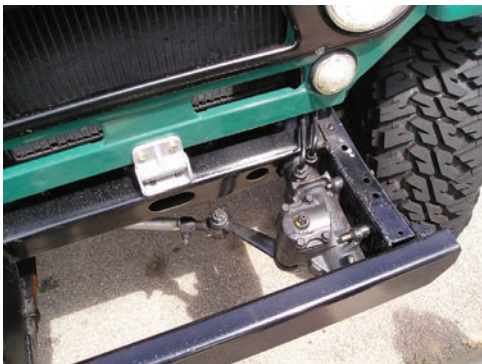
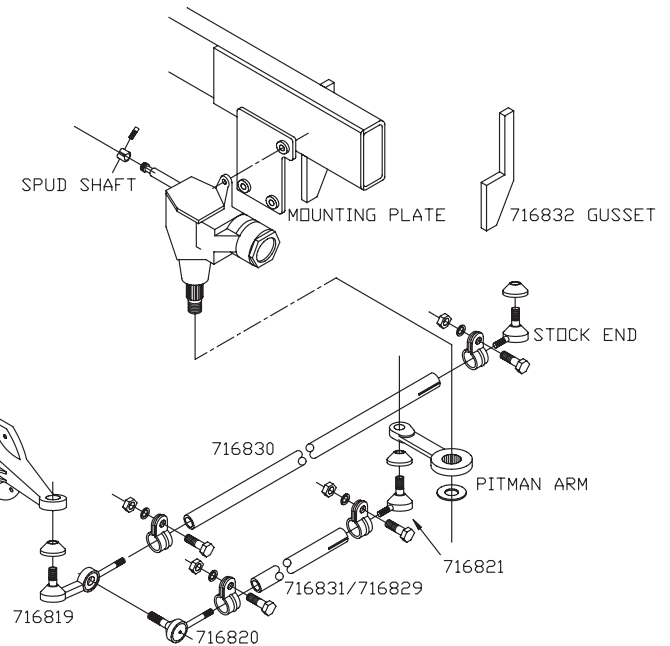

- P/N 716853** - Universal Joint 3/4" DD x 3/4"-30
- P/N 716854** - Universal Joint 1" DD x 3/4"-30
- P/N 716855** - Jeep YJ steering box mount
- P/N 716860** - Steering shaft support bushing
- P/N 716862** - Borgeson slip yoke steering shaft & yoke assembly
- P/N 716865** - 2" dia. steering column floor mount (TLC only)
- P/N 716863** - Steering shaft, slip, 3/4" DD x 1" DD (no yoke)
- P/N 716866** - 2-1/4" dia. steering column floor mount (TLC only)

1987-95 YJ Steering Box Mounting Plate: Steer your Jeep YJ easy without interference. This new mounting plate moves the YJ steering box 1" forward, increasing the clearance between the tie rod and drag link. This provides more clearance making it less likely to have steering bind. This mounting plate is made with 1/2" steel for strength and reliability. **P/N 716855**

1975-95 Steering Shaft Assemblies: Jeep's original steering shaft assembly was not designed for the added stress of body lifts and oversize tires. We carry Borgeson replacement assemblies which have a telescoping shaft with two precision needle bearing u-joints. The steering assembly is easy to install with common hand tools. Once installed, you will experience much tighter and more responsive steering.

- P/N 716869** - 75-86 CJ Steering Shaft assembly for MANUAL BOX
- P/N 716870** - 75-86 CJ Steering Shaft assembly for POWER BOX
- P/N 716871** - YJ Steering Shaft assembly for POWER & MANUAL BOXES

S10/S15 ENGINE & TRANSMISSION CONVERSIONS



The parts we manufacture are available for either Chevy V8 or Chevy 4.3 V6, retrofitting the stock S10/S15 2.8L V6, 4 cylinder and stock 4.3 V6. We have grouped the conversion components by applications. Many of our components are necessary when converting your engine and or transmission. Items such as exhaust and radiators can be modified or sourced elsewhere.

GENERAL CONVERSION INFORMATION:

The S10 2WD was first introduced in 1982, and the 4WD model became available in 1983. These vehicles came stock with a 2.8L V6 or 4 cylinder, which proved to be underpowered. The transmissions used in these vehicles were either the 700R (60 degree bolt pattern) or T5. We offer the necessary components to install the Chevy 4.3 V6 or Chevy V8, utilizing either the TH350, 700R, or stock T5. These conversions for both the 2WD and 4WDs are very popular and can normally be performed without driveline modifications.

In 1988, the S-series pickups offered a 4.3 V6, and still utilized the 700R or the NV3500 transmission. These engine and transmission combinations seemed to be an excellent upgrade, but many people still wanted V8 power. In 1996, the NV1500 was introduced behind 4 cylinder motors. (No adapters available to retain this transmission).

Engine Selection:

First check your local Department of Motor Vehicles for smog & engine requirements. Certain states, such as California, require the same year or newer engine as the vehicle. (The engine should be complete, retaining all smog equipment). Both the Chevy V6 & V8 fit well in these vehicles. All Chevy V8 blocks (pre-Gen III) have the same physical dimensions and use the same motor mounts. Choosing the right block depends on the intended use of your vehicle and your state regulations. See Page 82 for additional engine information.

Motor Mounts:

We manufacture bolt-in motor mounts for the early S10/S15. They work in conjunction with the stock 2.8L frame mounts. If your vehicle was equipped with a 4 cylinder, it is necessary that you purchase and install a set of stock 2.8L V6 frame mounts, GM Part No. 22188284. If your vehicle is a later model S10/S15 that came equipped with a 4.3 V6 and are planning to upgrade to a V8, we manufacture a bolt-on mount for this installation.

- P/N 713111** - Chevy V8 to 2.8L stock frame mounts (2WD)
- P/N 713123** - Chevy V8 to stock 4.3 V6 motor mounts (2WD)(used also on Astro Vans)
- P/N 713107** - Chevy V8 to 2.8L stock frame mounts (4WD)
- P/N 713123** - Chevy V8 to stock 4.3 V6 motor mounts (4WD)

These motor mounts listed above are slotted for fine-tune adjustments. On vehicles retaining the air conditioning, the engine must be set to the furthest rear position available on the motor mount. When this is done, clearance on the A.C. evaporator housing becomes crucial on the passenger side exhaust manifold. We manufacture a sheet metal cover that will allow the necessary ample clearance between the manifold and housing. **P/N 716421** - A.C. Evaporator housing cover

Transmission Selection:

700R: We commonly deal with two types of GM 700R transmissions. The S10/S15 used a 700R up against a 2.8L V6. This transmission differs in two areas from a 700R that was originally bolted to a V8. The first difference is the bellhousing bolt pattern. The 2.8L 700R version is commonly known as the 60 degree bolt pattern, and the 700R V8 version is known as the 90 degree bolt pattern. The bellhousing and transmission cases are integral (one unit). The second difference is the 2.8L 700R uses less clutch packs than the V8 700R. If you want to retain your 700R, you will need to switch your 2.8L 700R transmission casing to a V8 700R casing. (**Note:** S10/S15 equipped with a 700R and a 4.3 V6 have the 90 degree bolt pattern which will not need to be changed.)

T5: The T5 equipped in these vehicles are not recommended for bolting up to the Chevy V6 or V8; however, we do carry a bellhousing for customers that wish to retain this transmission on 1984 and newer vehicles. On 2WD vehicle applications, you should never retain this 5 speed. On 4WD vehicle applications 1982-83 having a mechanical clutch or manual transmission and used with a 4 cylinder engine, you should consider switching to an automatic transmission due to the cable-operated clutch linkage. The stock T5 transmission can be retained with a new bellhousing, **Part No. 712547**. The bellhousing is designed to fit an 11" clutch assembly. The bellhousing is outfitted to use a McLeod internal release bearing. Due to tight internal clearances, we also recommend a 11" McLeod pressure plate designed to work with the release bearing. The input shaft on this transmission is a 1" 14 spline. We offer a special 11" clutch disc to fit this application, **P/N 716102**. The pressure plate is offered under **P/N 716102-P**. **NOTE:** Manual transmission conversions are NOT compatible with vehicles 1982-83 that are equipped with cable clutch controls. Will not work on a 1994 & newer T5 from a 2.2 4 cyl. On 1993 applications, the bolt pattern will need to be verified.

NV3500: This tranny is normally found up against the stock 4.3 V6 and does not require an adapter when converting to the V8.

TH350: This is the most popular transmission to be installed in combination with a V6 or V8 engine selection. On 2WD vehicles, a TH350 with a 9" tailhousing can be installed without driveshaft modifications. On 4WD vehicles, a TH350 replacing the 700R (using our adapter) can be installed without driveshaft modifications. When replacing a T5, no driveshaft modifications are necessary, but a stock adapter housing and transfer case shifter components are required. Our adapter kit for the TH350 comes with an output shaft and adapter housing to retain the stock transfer case in its original location. On vehicles that were previously equipped with a 5 speed, it is necessary to purchase the following GM items: GM# 14049551 (shifter bracket) and GM# 15681328 (stock adapter).

P/N 50-8500 - TH350 to stock S10/S15 NP207 & NP231 T/C

Suspension Requirements:

The installation of a V8 is about 175 lbs. heavier than stock. On 2WD applications, your front suspension will normally drop about an inch. We recommend using a heavy duty shock which will compensate for this drop, or you can change to an extended cab front coil spring which has a greater load rating. On 4WD applications, the suspension is normally equipped to handle the extra weight. Once completing any one of these vehicles, your front end alignment should be checked. A body lift is not required on both the 2WD & 4WD versions; however, a body lift will always add additional tunnel & hood clearance.

Oil Pans & Oil Filter Adapters:

The 4WD applications require a special rear sump oil pan when converting to a Chevy V8. Depending on the year and style of the block, we offer three different oil pans for the V8 replacing the 2.8 V6, and the 4.3 V6. All pans come with a new pickup screen and oil plug. **The 1986 & newer pans will work on LT1 & LT4 engines, but the pickup screen will not fit the LT1 & LT4 oil pump and we do not offer oil level sensor provisions. These pans do not work on LS1 engines.**

Replacing the 2.8L & 4.3L:
P/N 716410A - 1985 & earlier Chevy block, driver side dipstick 2.8L (shown)
P/N 716411A - 1985 & earlier Chevy block, passenger side dipstick
P/N 716420A - 1986 & up Chevy block, 1 piece rear main seal

These conversions require a remote oil filter adapter to provide front driveshaft clearance.

P/N 716083 - Chevy V8 oil filter adapter **P/N 716085** - Chevy 4.3 V6 oil filter adapter

Cooling Requirements:

When replacing a 2.8L or 4 cylinder, a radiator upgrade is normally required. On vehicles that were originally equipped with a 4.3L and converting to a V8, we recommend trying your stock radiator first. Please refer to Page 78 for more radiator options.

Exhaust:

We offer headers for Chevy V8 2WD and 4WD applications. When using a newer block and retaining the smog equipment, stock Chevy manifolds off of a 1982 or newer low performance car work the best. These manifolds are very compact and the main exhaust remains level with the exhaust ports. Our headers are manufactured with a 3/8" header flange and 16 gauge tubing. Headers use a slip type exhaust connection which aids in additional clearance when exiting from the engine compartment. These headers are available in Non-plated (NP) only. We do not offer headers for the 4.3 V6 application.

P/N 717052-NP - SlickFit headers, Chevy V8 2WD (shown)
P/N 717053-NP - SlickFit headers, Chevy V8 4WD



CONVERSION PACKAGES: These are a one part number item that offers you a complete package for some of the most popular conversion applications.

P/N CP-S1001 GM S10 2WD V8 T5 TRANS// (Includes 713111, 716421, 712547, 716102 & 716102-P) - **\$1023.12**
P/N CP-S1003A GM S10 2WD/V8 AUTO FOR 2.8/2.5// (Includes 713111 & 716421) - **\$141.12**

P/N CP-S1002A - GM S10 4WD/V8 T5 PRE86 DS OIL Includes, 713107, 716083, 716421, 712547, 716102, 716102-P & an Oil Pan
P/N CP-S1002B - GM S10 4WD/V8 T5 PRE86 P.S OIL These kits vary slightly in price but average about **\$1430.00**

P/N CP-S1002C - GM S10 4WD/V8 T5 86UP OIL PAN
P/N CP-S1004A - GM S10 4WD/V8 TH350 PRE86 DS OIL Includes, 50-8500, 713107, 716083, 716421 & an Oil Pan
P/N CP-S1004B - GM S10 4WD/V8 TH350 PRE86 PS OIL These kits vary slightly in price but average about **\$700.00**
P/N CP-S1004C - GM S10 4WD/V8 TH350 86UP OIL PAN

Advance Adapters 2WD & 4WD S10/S15 Part Pricing:

Motor Mounts:	713107 - \$165.95	Oil Filter Adapter:	716083 - \$ 92.87
	713111- \$111.81		716085 - \$ 90.19
	713123 - \$ 79.35	Headers:	717052-NP \$326.85
A/C Housing:	716421 - \$ 43.60		717053-NP \$326.85
Oil Pans:	716410A - \$282.89	T/C Adapter:	50-8500 - \$169.55
	716411A - \$282.89	B/H Adapters:	712547 - \$634.74
	716420A - \$282.89	Clutch P.P.	716102-P - \$188.19
		Disc	716102 - \$148.16

FULL SIZE GM BLAZERS & GMC TRUCKS

We offer numerous adapters for GMC vehicles. Whatever transmission and/or transfer case combination you're looking for, whether it be upgrading a 4 speed manual to a 5 speed manual, or a 3 speed automatic to a 4 speed overdrive automatic, there is a good chance that we offer the necessary components to accommodate your needs. For more detailed conversion installation procedures, we recommend you download our GM & Chevy instruction manual located at www.advanceadapters.com under the **Tech Vault**.

The transfer case selection chart in this section lists all the possible adapter combinations; however, before you can select the proper adapter you'll need to properly identify your stock drivetrain and the new prospective drivetrain.

Once you have identified your transmission, you will then need to identify the stock transfer case and/or the new transfer case. If you are keeping the stock transfer case that your vehicle was equipped with and you have already identified the stock transmission, then identifying the transfer case should be easy. If you're swapping your transfer case with a different one, this could be a challenge.

Over the past 30 years, GM has offered numerous transmission and transfer case combinations. Some of these combinations have similar spline counts or bolt patterns - allowing the combination of a transmission to a transfer case that may have never been offered as stock. To add even more to the possibilities, the components that you are looking at using might have already been converted. The following information is put together with the best information we have on file. If your application varies or you have something different, please call and let us know.

GM TRANSMISSION AND TRANSFER CASE INFORMATION:

The early GMs used a Dana 20 style transfer case and no adapters are available for these vehicles.

In 1971, New Process introduced a model NP203 (chain-driven), and NP205 (gear-driven) transfer case. Both of these transfer cases used various input splines. As a general rule, all of the transfer cases that couple to a TH350 automatic are normally a 27 spline input; when coupled to a manual transmission a 10 spline input; and when coupled to a TH400 a 32 spline input.

The NP203 was used from 1971 to 1979. This transfer case was mated to the TH350, TH400, and SM465 transmission.

The NP205 was used from 1971 to 1991. The 1971-79 NP205 was only found mated to the TH350 and the SM465 transmission. For 1-ton vehicles between 1979 to 1984, GM used a TH400 and the SM465. The TH400 was equipped with a female 32 spline input, while the SM465 retained the male 10 spline input. These model transfer cases had a figure-eight front bolt pattern. In 1985 to 1991 vehicles, GM started using a different version of the NP205. The input spline for both the TH400 and the SM465 transmissions was a female 32 spline, and the front bolt pattern changed to a circular bolt pattern.

In 1981, GM introduced the NP208 chain-driven transfer case. The NP208 also has a circular bolt pattern, and had either a 27 or 32 spline input. In 1988, GM next introduced the NP241 chain-driven transfer case. This transfer case, as far as bolt patterns and splines are concerned, is identical to the NP208.

The chart on Page 50 will help you identify the necessary transfer case adapters for these swaps.



Front view (NP203)



NP205 T/C
figure-8 bolt pattern



NP205 stock adapter



NP208 stock adapter

The NP205 is sometimes hard to identify. The data plate for this transfer case is located on the upper front of the case; but many times this information has been worn off, and subsequently a NP205 gets confused with a NP203 transfer case. The easiest way to identify the NP205 is by the rear 3 bolt cover on the idler shaft.

NP205 TWIN STICK SHIFTERS:

We offer a twin stick shifter kit for the NP205 transfer cases. Our kit, [P/N 715595](#), fits the figure eight bolt pattern 205 transfer cases when coupled to the GM TH350, TH400, and SM465.

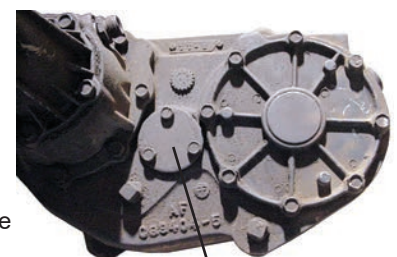

3 bolt cover found on
NP205 transfer cases

STOCK GM ADAPTERS and COUPLERS:

The early GM transmission-to-transfer case adapters were mostly cast iron. These stock adapters were strong; however, years of off road use, weather elements, and vehicle abuse have taken their toll on these adapter housings. Ordering a replacement GM casting was an easy fix until GM started discontinuing these older housings. The other option was to search salvage yards, but these parts are becoming harder to find and/or were damaged also. To remedy this problem, we began to re-manufacture these GM discontinued items. The adapters we are manufacturing are cast out of Aluminum rather than cast iron. These high tensile cast aluminum replacement housings offer you a durable, quality option. We've reproduced most of the popular stock adapter housings.



50-5302 - GM TH350 to the the figure-eight GM NP205



50-4705 - GM SM465 to the NP208 transfer cases



50-4708 - GM SM465 to the figure-eight GM NP205



51-3202 - GM TH400 to the figure-eight GM NP205

51-7000 - GM TH400 to NP208 Short foot on casting

51-7002 - GM TH350 to NP208 Short foot on casting

(Photo not shown, but looks similar to 51-7000)



51-3210 - GM TH400 or TH350 to the GM NP203 transfer case



51-7010 - GM TH400 to NP208 Long foot on casting

Most of the early GM adapters used a coupler to connect the transmission output shaft to the transfer case input. We also offer these replacement couplers. There were normally two couplers GM offered: a 27 spline and a 10 spline.

52-9503 - Fits the GM TH350 27 spline to the GM NP205 27 spline.

52-9504 - Fits the GM SM465 10 spline to the GM NP205 10 spline.

Adapter Couplers: These are couplers that we have designed for coupling the different transfer case inputs to the opposite transmission.

52-9502 - Fits the GM SM465 10 spline to the GM NP205 27 spline (use 716728 seal)

50-5304 - Fits the GM TH350 27 spline to the GM NP205 10 spline.



NP205 Input Gears: We manufacture the NP205 input gears. Our gears are a bit different than OE (original equipment) in that they are engineered in a two component design that not only expedites production time, but also reduces material waste & expenses. These two piece gears sets come with the correct snap rings and instructions for installation into any NP205 gear box.

- 716044** NP205 GEAR GM 32 SHORT
- 716044-A** NP205 GEAR GM 32 LONG
- 716044-B** NP205 GEAR Divorced
- 716044-D** NP205 GEAR Dodge Male 29
- 716044-F** NP205 GEAR FORD 31
- 716044-G** NP205 GEAR GM 27 MALE
(one piece gear)

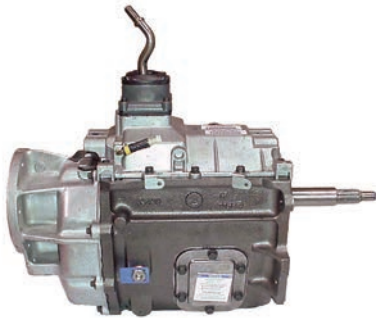

NV4500 Adapters: If you are considering a NV4500, we offer conversion bellhousings transfer case adapters and complete transmission packages for the Chevy trucks. Page 52 & 54 has additional NV4500 transmissions information.

P/N 26-0007R - 32 spline output with a std. GM input shaft

P/N 27-0030 - GM 4WD (26-0007R). GM 10 spl. NP205 1971-84/85 V8 engine full bellhousing. **O.A.L. 26.250"**

P/N 27-0031 - GM 4WD (26-0007R). GM 27 spl. NP205 1971-1979 V8 engine full bellhousing. **O.A.L. 26.750"** (photo shown)

P/N 27-0032 - GM 4WD (26-0007R). GM 32 spl. NP205 1971-84/85 V8 engine full bellhousing. **O.A.L. 26.250"**



Gen III & IV ENGINES with Early GM Transmissions:

The Gen III/IV engines have the same block bolt pattern as the early GM with the exception of one bolt hole. When bolting an earlier GM transmission or one of our bellhousings to the Gen III block, you will only be able to use 5 bolts on some bellhousing kits. The Gen III engine used a different crank stickout from the back of the block and a different crank bolt pattern. This means the early style flywheels and flexplates will not bolt to the new Gen III blocks. The stock flywheels and flexplates from the Gen III blocks are also unique with regard to the clutch bolt pattern and the torque converter bolt pattern. We have designed two kits for either a manual transmission or an automatic.

Early GM manual transmissions adapting to late GM engines is kit **P/N 712500M**. This kit includes a flywheel, flywheel bolts, 11" **Luk pressure plate & disc**, bolts for the pressure plate, pilot bushing spacer, release bearing, and metric bolts & washers for the bellhousing. For the same kit with a **Centerforce pressure plate & disc**, use **P/N 712500M-CF**.

There are some Gen III blocks that do not have the recessed crank. This kit will not work on these blocks. One block that we know of is the 6.0L with cast iron heads and the 4.8 engines coupled only to a stock manual transmission in 1999 to 2003. A custom flywheel would have to be made to work on these block, **P/N CF720000**.

Early GM Automatic adapting to late GM engines is kit **P/N 712500A**; and for the TH400/4L80E transmission **Part No. 712500A4**. These kits include a modified flexplate (drilled for a early GM torque converter), flexplate bolts, and crank spacer bushing. **NOTE: The 4L80E will only use 3 of the 6 torque converter bolts to the flexplate.**

Gen III/IV Engine Mounts: These mounts are designed to be used in conjunction with a stock triangular 3 bolt pattern mount. These plates will allow the new Vortec to be installed into the same location as the earlier Chevy you're replacing. The back of the block will line up to your transmission and the triangular mount will not need to be modified. **P/N 713088-P**

GM TRANSFER CASE ADAPTERS



	NP205 1971-79 27 SPL. MALE (ORIG. TH350) fig.8 pattern	NP205 1971-84/85 10 SPL. MALE (ORIG. SM465) fig.8 pattern	NP205 1979-84/85 32 SPL. FEMALE (1 TON TH400) fig.8 pattern	NP205 1985-91 32 SPL. FEMALE (SM465 & TH400) cir.6 pattern	NP208 & NP241 1981-00,32 SPL. (ORIG. SM465) (TH400 & 4L80E) cir.6 pattern
GM NV4500 4WD 1993-2001 (12.375" CASE)	50-0218 (1) 7.875" ADAP. OR 50-0206 (1,2,6,11)	50-0217 (1,6) 7.375" ADAP. OR 50-0206 (1,2,6,11)	50-0206 (1,6) 7.375" ADAP.	50-6911	STOCK ADAPTER
DODGE NV4500 4WD 29 SPL	50-9551 (2,6)	50-9551 (2,6)	50-9551 (2,6)	50-9552 (6)	
GM MUNCIE (M21,M22)	50-3500 (10)	50-3400 (10)			
GM MUNCIE (SM465)	52-9502 (7)	52-9504 (7)	51-4708	51-4705	51-4705
GM TH350 AUTOMATIC CASE LENGTH 21.5"	STOCK ADAP. or 50-5302	50-5304 (7A)			50-5306 (7)
GM TH400 AUTOMATIC CASE LENGTH 24.25"	50-3200 (6,8) or 50-3202 or 03 (2)	50-3202 (2) 2WD 50-3203 (2) 4WD	STOCK or 51-3202	50-7001 (9,13,14) 50-7010 (9,13,14)	50-7001 50-7010 Long foot
GM 700R & 4L60 AUTO O.D. CASE LENGTH 23.375"	50-6900 (7A,8)	50-6906 (7A)	50-6902 (8) 1.00" ADAP.	50-6901 (7,13,14) 1.00" ADAP.	50-6901 (8) 1.00" ADAP.
GM 4L60E AUTO O.D. CASE LENGTH 23.375" NOTE 5	50-6900 (8) STOCK ADAP.	50-6906 (7A) 3.50" ADAP.	50-6902 (8) 1.00" ADAP.	50-6901 (7,13,14) 1.00" ADAP.	50-6901 (8) 1.00" ADAP.
GM 4L60E REMOVABLE B.H. CASE LENGTH 22.00"	50-5310 5.00" ADAP.	50-5311 5.00" ADAP.	50-0405 (4) 1.50" ADAP.	50-0405 (4) 1.50" ADAP.	50-0405 (4) 1.50" ADAP.
GM 4L80E AUTOMATIC CASE LENGTH 26.00"	50-0410 (2) 2WD 50-0411 (2) 4WD 4.00" ADAP.	50-0410 (2) 2WD 50-0411 (2) 4WD 4.00" ADAP.	50-0410 2WD 50-0411 4WD 4.00" ADAP.	50-6912 Long input needed	
GM 6L80 AUTOMATIC 32SPL	50-9551B (2)	50-9551B (2)	50-9551B	50-9552B	
GM 6L90 AUTOMATIC 29SPL	50-9551A (2)	50-9551A (2)	50-9551A	50-9552A	



	NP203 1971-79 27 SPL. (ORIG. TH350)	NP203 1971-79 10 SPL. (ORIG. SM465)	NP203 1973-77 32 SPL. (TH400)	NP208 & NP241 1981-00, 27 SPL. (ORIG. 700R, 4L60, 4L60E)
GM MUNCIE (M21,M22)	50-3400 (10) 4.5" ADAP.	50-3400 (10) 4.5" ADAP.		
GM POWERGLIDE				50-9212 2.375" ADAP. (15)
GM TH350 AUTOMATIC CASE LENGTH 21.5"	STOCK or 51-3210		STOCK or 51-3210	50-7100 (3,8) or 50-8606
GM TH400 AUTOMATIC CASE LENGTH 24.25"	50-3200 (6,8) .590 ADAP.	50-3201 (6,8) .75"ADAP.&4.0"ADAP.	51-3210 52-7002	50-7000 2.50" ADAP.
GM 700R & 4L60 AUTO O.D. CASE LENGTH 23.375"	50-6900 (8) & STOCK ADAP. or 50-8505			SPECIAL (16)
GM 4L60E AUTO O.D. CASE LENGTH 23.375"	50-6900 (5,8) & STOCK ADAP. or 50-8505			SPECIAL (16) 51-7102
GM 4L60E REMOVABLE B.H. CASE LENGTH 22.00"	50-0405 (4) 1.50" ADAP.		50-0405 (4) 1.50" ADAP.	SPECIAL (16)

NOTES:

- (1) MUST SHORTEN STOCK OUTPUT SHAFT.
- (2) NEW T/C INPUT GEAR MUST BE INSTALLED (MACHINING REQ'D).
- (3) NO DRIVESHAFT MODIFICATIONS.
- (4) THIS KIT REQUIRES THE USE OF A 700R KIT ALSO, IF A 4L60E SHAFT IS USED THEN KIT 50-0405E SHOULD BE ORDERED.
- (5) THIS KIT REQUIRES A RELUCTOR KIT, P/N 716073.
- (6) KIT COMES WITH A T/C LINKAGE BRACKET.
- (7) THIS KIT REQUIRES A STOCK ADAPTER HOUSING FROM G.M.
- (7A) KIT REQUIRES EITHER A STOCK TH350 ADAP. OR OUR 50-5302 KIT.
- (8) THIS ADAPTER WORKS TOGETHER WITH YOUR STOCK ADAPTER. IF THE ADAPTER CAME OFF A 4L80E OUR MATING ADAPTER PLATE MUST BE MODIFIED FOR THE PROPER INDEX DIAMETER.

SEE PAGE 86 FOR VSS INFORMATION

- (9) KIT NOT NEEDED WHEN REPLACING A TH400.
- (10) 715501 SHIFT BRKT., 715625 OR 715626 ROD KIT & 715600 HURST SHIFTER IS NEEDED.
- (11) P/N 716038 MUST BE PURCHASED.
- (13) THE ADAPTER HOUSING MAY NEED TO BE MODIFIED FOR THE TRANSFER CASE LINKAGE OR A SPACER ADAPTER CAN BE USED, P/N 50-6910.
- (14) THIS ADAPTER IS DESIGNED FOR A SHORT NP205 INPUT GEAR. IF YOU HAVE THE LONGER INPUT STICKOUT, YOU MAY NEED TO REPLACE OR MODIFY THIS GEAR OR USE OUR SPACER ADAPTER 50-6910.
- (15) THIS ADAPTER REQUIRES A CUSTOM CROSSMEMBER TO BE FABRICATED.
- (16) WE OFFER SEVERAL WAYS TO ADAPT THIS. PLEASE CALL FOR OPTIONS.

COMPLETE TRANSMISSIONS

AX15 TRANSMISSION: *(New Transmission)*

The AX15 transmission has always been a great transmission able to handle the torque and horsepower of most V8s. The biggest problem has always been the availability of new units. With the lack of availability of a new NV3550, we revisited the possibility of obtaining the Aisin Warner AX15 transmission and were successful. Although the torque specifications are not listed on this transmission in any service manual, we feel it's similar enough to the NV3550. The NV3550 was the transmission that superseded the AX15; and Jeep used the same engine with the same vehicle ratings. With the availability of AX15 transmissions, we can now offer some additional transmission retrofit applications. Shift handles are sold separately.

New AX15 transmissions (23 spline output) that come with a 1 year warranty. [P/N 26-AX15](#)

We offer rebuilt AX15 transmissions (23 spline output) that come with a 1 year warranty. [P/N 26-AX15R](#)

The AX15 can be used in multiple vehicles. The most common are the Jeep and Bronco; however, this transmission is easily adapted to most transfer cases we work with.

JEEP APPLICATIONS for the AX15 & NV3550:

Direct Replacement Jeep YJ & TJ: The AX15 was used in Jeep vehicles used between 1988 to 1999, and the NV3550 between 2000 to 2004. With these Jeeps getting up in mileage a new AX15 or a NV3550 would be your direct replacements. The AX15 is available in both an internal and external release bearing design. And because the AX15 and NV3550 are the exact same dimensions, you can replace a NV3550 with a AX15 and the same goes for the NV3550 for the AX15.

Replacing the AX5 (AX15 Only): This kit is for all 4 cylinder Jeeps 1987 to 2002. The AX5 is considered a light duty transmission compared to the AX15. Jeeps equipped with larger tires and lower gears in the axle & transfer case may find the weak link in the drivetrain is the stock transmission. You can now install the AX15 in place of the AX5 to gain some drivetrain strength. The nice thing is that when you're ready to replace the 4 cylinder with a larger V6 or V8, the AX15 is an ideal transmission for the power increase. We offer 5 complete kits to fit the different Jeep applications:

27-AX15A	AX15 TO 4CYL YJ NP207 TC INTERNAL RELEASE
27-AX15B	AX15 TO 4CYL YJ NP231 TC INTERNAL RELEASE
27-AX15C	AX15 TO 4CYL YJ NP231 TC EXTERNAL SLAVE
27-AX15D	AX15 TO 4CYL YJ LATE MODEL NP231 TC EXTERNAL SLAVE
27-AX15E	AX15 TO 4CYL TJ NP231 TC EXTERNAL SLAVE

Replacing the Peugeot 5sp. The AX15 & NV3550 are ideal replacements for this light-duty transmission. The kits we offer include a new input gear for either the New Process 231 or 207 transfer case. Due to vehicle variances, some applications may require transfer case linkage modifications. The adapter kits are sold either with or without a transmission. Kits include a new bellhousing, transfer case shifter linkage, crossmember adapter mount that retains the stock Peugeot rubber mount, slave cylinder kit, and an input gear for your transfer case.

27-3507AX15	AX15 TO BA10 NP207 (Trans Included)
27-3510AX15	AX15 TO BA10 NP231 (Trans Included)
27-3507AA	NV3550 & AX15 TO BA10 NP207 KIT
27-3510AA	NV3550 & AX15 TO BA10 NP231 KIT

1980-86 Jeep Replacements: We offer the adapters for replacing the stock Jeep T5, T4, SR4 and T176 transmissions found in Jeeps 1980-86. The overall length of the new transmissions are 16.75" long, and most bellhousings we offer for this transmission are 7.500" long. Therefore, most applications will require driveline modifications. When installing the Dana 300 you may be required to modify your transfer case shifter. The adapter plates use a stock T150/T176 bellhousing or [AA P/N 712599](#).

P/N 27-3531AA -	NV3550 to AMC Block and DANA 300 Transfer case adapter kit
P/N 27-3531R -	AX15 to AMC Block and DANA 300 Transfer case adapter kit

P/N 712543J -	AX15 adapter plate to 1976-86 AMC bellhousing
P/N 712545 -	NV3550 adapter plate to 1976-86 AMC bellhousing

AX15/NV3550 4.0L & 4.2L Jeep Bellhousing:

We offer a full bellhousing to fit both the 4.0L & 4.2L stock 6 cylinder (with hydraulic clutch linkage).

- P/N 712590** - AMC 4.0L & 4.2L engine to AX15/NV3550 (This bhsg. will only work with the slave cylinder listed below)
- P/N 712590-M** - AMC 4.0L engine **2005 & 06** to AX15/NV3550 (This bhsg. will only work with the slave cylinder listed below)
- P/N 716340** - Slave cylinder kit for the AX15/NV3550 using 712590 bellhousing
- P/N 716210** - Stock AX15 bearing retainer with snout for release bearing.

Bronco Dana 20 Applications for the AX15 & NV3550:

These transmissions are ideal transmission swaps for the early Broncos. The weight of these 5 speeds is similar to the stock 3 & 4 speed transmissions. The overall size and length make it an ideal fit. The gearing of these 5 speeds is as follows:

AX15 is 1st 3.83:1; 2nd 2.33:1; 3rd 1.44:1; 4th 1.00:1; 5th 0.79:1, and Reverse 4.76:1.

NV3550 is 1st 4.01:1; 2nd 2.32:1; 3rd 1.40:1; 4th 1.00:1; 5th 0.78:1, and Reverse 3.57:1.

The transfer case adapters we manufacture for these transmissions use an adapter plate and spud shaft. The adapter plate offers two rotation options for the Dana 20 transfer case: the stock rotation which is 42 degrees and a higher rotation of 34 degrees. The higher rotation may require a body lift for proper clearance. The transfer case adapter comes with a transfer case shifter linkage bracket which only fits the "T" style shifter.

The stock Ford bellhousing will also need to be adapted. The NV3550 and the AX15 have a 7-1/2" long input shaft. We manufacture an adapter plate that bolts to the front of this transmission. This adapter provides you with the proper indexing and bolt pattern to couple to the stock bellhousing. When bolting to the NV3550, the stock bellhousing requires some slight modifications. The stock pressure plate and release bearing are retained and a new 1-1/8" 10 spline clutch disc is used.

The new crossmember for the NV3550/AX15 transmission must also be used. Since these 5 speeds do not offer the angular support pads, and our adapter is too short to have these provisions, we designed a new crossmember support for the new transmission. Our new crossmember bolts to the stock crossmember frame hole and includes a new rubber support. The crossmember is designed to fit both stock exhaust and header applications.

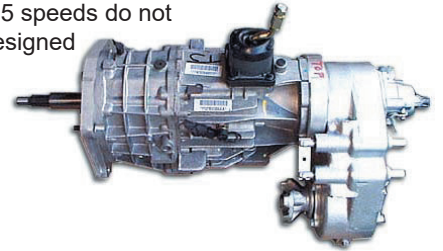

- *P/N 50-9920A** - AX15 to Bronco Dana 20 T/C adapter (1.40" long)
- *P/N 712543** - AX15 to Ford bellhousing 4.848" index (adapter length 7/8")
- *P/N 383735** - 1-1/8" 10 spline clutch disc
- *P/N 716000A** - AX15 Crossmember support
- P/N 27-3520AX15** - AX15 BRONCO DANA 20 KIT (*includes all parts listed above plus a shift handle)
- P/N 27-3525** - AX15 TRANSMISSION & BRONCO DANA 20 ADAPTER KIT (Trans Included)

- *P/N 50-9920** - NV3550 to Bronco Dana 20 T/C adapter (1.40" long)
- *P/N 712544** - NV3550 to Ford bellhousing 4.848" index (includes clutch)
- *P/N 716000** - NV3550 Crossmember support
- P/N 27-3520AA** - NV3550-BRONCO DANA 20 KIT (*includes all parts listed above plus a shift handle)
- P/N 27-3520R** - NV3550-BRONCO DANA 20 REBUILD (Trans Included)

NV4500:

We offer rebuilt NV4500 transmissions that come with a 1 year warranty. These transmissions are built in several configurations for simpler installations or to fit your specific vehicle needs. All the transmissions we offer come with a GM shift tower/thread for the GM handle we manufacture.

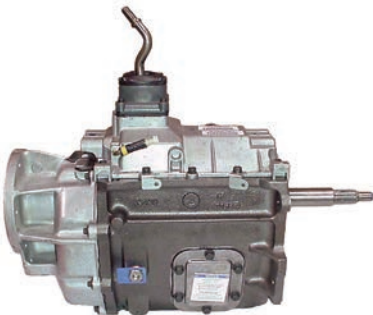

- *P/N 26-0007R** - 32 spline output with a std. GM input shaft
- P/N 26-0016R** - 23 spline output with a std. Dodge input shaft
- P/N 26-0016RGM** - 23 spline output with a std. GM input shaft
- P/N 26-0020R** - 29 spline output with a Dodge 1-1/4" input
- *P/N 26-0029R** - 29 spline output with a std. Dodge input shaft
- *P/N 26-0029RGM** - 29 spline output with a std. GM input shaft
- P/N 45-0104** - 32 spline output with a std. Dodge input shaft
- P/N 45-0105** - 32 spline output with a std. GM input shaft (6.34:1 first gear)

*These are the most common transmission we sell for conversions.

NV4500 Bellhousing Adapters: If you are considering a NV4500, we offer conversion bellhousings & adapter plates for these applications. The bellhousing bolt pattern changed on the Chevy NV4500 transmission in 1996. The full bellhousings will require a GM input shaft in the transmission while the adapter plates are designed around the longer Dodge gas input shaft. An adapter plate will allow you to use the bellhousing needed for your application.

- Chevy** **P/N 712576** - Chevy block to Chevy NV4500 full bellhousing (1996 & up) (Chevy input)
P/N 712577 - Chevy block to Chevy NV4500 full bellhousing (up to 1995) (Chevy input)
P/N 712580 - NEW VENTURE 4500/CHEVY TRUCK 92 to 95 BHSG * **2WD trucks only**
P/N 712550 - Chevy bellhousing to Dodge NV4500 (adapter plate)(5.125" index) (Dodge input)
- Ford** **P/N 712551** - Ford bhsg to Dodge NV4500 (4.848" index) (Dodge input)
- Jeep** **P/N 712568** - AMC engines to GM NV4500 (1996 & up) (Chevy input)
P/N 712571 - AMC engines to GM NV4500 (up to 1995) (Chevy input)
P/N 712553 - AMC engines to Dodge NV4500 (adapter plate)using Jeep bhsg. 8133951 or **P/N 712599** (Dodge input)
P/N 712555 - Jeep AX5 bhsg. to Dodge NV4500 (internal release bearing only) (Dodge input)
P/N 712559 - Jeep AX5 bhsg. to Dodge NV4500 (external slave cylinder only) (Dodge input)

To install a NV4500 into a vehicle having a mechanical or hydraulic linkage, you have a few options. The bellhousings we manufacture offer brackets to retain both these linkages.

CLUTCH LINKAGE & COMPONENTS:

- P/N 715534** - GM truck mech. clutch pivot boss
P/N 716332 - Bellhousing boot
P/N 383735 - Centerforce 11" clutch disc
Jeep Linkages - See Pages 35-36
- P/N 715535** - GM truck hyd. clutch slave brkt.
P/N CF165552 - Centerforce 11" pressure plate
P/N N1430 - Throw out bearing
Land Cruisers Linkages - See Page 70

NV4500 Transfer Case Adapters: The transfer case adapters are listed under each specific vehicle. We have provided charts or listings in most vehicle sections within this book to aid in the selection of the correct transfer case adapter: *Jeep* Page 24, *Chevy* Page 50, *Ford* Page 58, *Ford Bronco* Page 60, and *Toyota Land Cruiser* Page 73.

NV4500 Stock Shafts, 5th Gears & Adapters: The NV4500 is best suited for most 4WDs in its shortest length. The best way is to mix the input and outputs of these transmissions for your best setup. In addition, many NV4500 transmissions were used in UPS or bread delivery trucks which were mainly 2WD. The shafts listed will allow you to custom configure a transmission for your needs.

- Main Shafts** **P/N 52-0204** - Main shaft GM 4WD 32 spline output
P/N 52-0205 - Main shaft Dodge 4WD 23 spline output
P/N 52-0206 - Main shaft Dodge 4WD 29 spline output
P/N 45-0013 - 2WD main shaft Dodge diesel and V10. Main shaft is a 31 spline for slip yoke, upgraded full spline for 5th gear with special lock collar design and spline for speedometer gear.

- Input Shafts** **P/N 52-0219** - Input shaft Dodge 1-1/8"-10 spline
P/N 52-0221 - Input shaft GM 1-1/8"-10 spline 5.61:1
P/N 52-0228 - Input shaft Dodge 1-1/4"-10 spline

- Gears** **P/N 45-0010** - 5th gear for 94 & up GM and 23 spline Dodge gas mainshafts - 22 teeth, 31 ID spline, 5:61 ratio.
P/N 45-0011 - Spacer GM 4x4 mainshaft between the lock nut and 5th gear when a vibration damper is not used.
P/N 45-0012 - 5th gear for 29 spline Dodge diesel and V10 gas mainshafts - 22 teeth, 35 ID spline, 5:61 ratio.

Tailhousing **P/N 51-0205A**- Adapter Dodge stock cast iron

- NV4500 Front Bearing Retainers:** **P/N 716067** - 5.60" index retainer (Dodge) modified with a GM snout 1.37"
P/N 716068 - 5.60" index retainer Dodge stock 1.43
P/N 716068G - 5.60" index retainer GM aluminum no snout for a bearing
P/N 716080 - 5.60" index retainer Dodge HD 1.50" snout

NV4500 5th Gear Locking Nuts: These aftermarket nuts have the upgraded set screw design to prevent the nut from backing off.

- P/N 716460** - Main shaft nut for GM and Dodge standard duty transmissions.
P/N 716460A - Main shaft nut for Dodge diesel and V10 transmissions.

NV4500 Shifter Parts & Handles:

- P/N 45-0001** - This vulcanized rubber spacer plate acts as an isolator and is required for all late model 4 bolt, square shift covers for both Dodge and GM transmissions.
- P/N 45-0002** - Shifter top cover fits 1998 & up Dodge and 1995 & up GM. This square 4-bolt tower model comes assembled with forks, rails, springs and balls. *Vent and backup light switch are not included.*
- P/N 45-0003** - Shift tower assembly for 1995 & up GM transmissions
- P/N 45-0004** - These bushings (4) are required in order to index the shift tower to the spacer plate
- P/N 716050C** - NV4500 SHIFTER HANDLE-CHEVY
- P/N 716050D** - NV4500 SHIFTER HANDLE-DODGE
- P/N 716050D1** - NV4500 DODGE 99 & UP HANDLE ASSY.

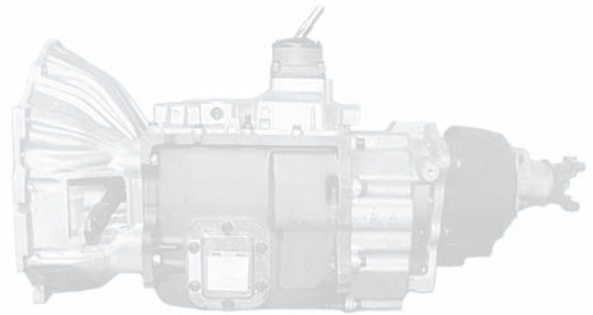

NV4500 Yokes, Oil, Rebuild Kits & Misc Parts:

- P/N 715690** - OIL-NV4500 5 QTS.
- P/N 715690A** - REDLINE-NV4500 5 QUARTS
- P/N 715691** - REBUILD Kit NV4500 DODGE Transmission
- P/N 715691-C** - REBUILD Kit NV4500 GM 92-95 Transmission
- P/N 715691-D** - REBUILD Kit NV4500 GM 96+ Transmission
- P/N 716087** - Yoke-1410 DODGE HD NV4500 2WD Output
- P/N 716101** - CHEVY/NV4500 Trans Rubber Mt.
- P/N 45-0020** - Middle (fiber-lined) 1st/2nd friction synchro ring for GM & Dodge. This is 1 of the 3 that make up the synchro.
- P/N 45-0030** - 1350 series yoke for GM NV4500 2WD for nut retained short tailhsg (GM# 12548124; NVG# 18741).
- P/N 45-0031** - YOKE-GM 2WD NV4500 1410 SERIES 35 SPLINE BOLT ON

COMPLETE NV4500 KITS:

We distribute complete kits for the NV4500 transmission. Most kits include the bellhousing adapter, transfer case adapter, crossmember mount, clutch linkage, and the necessary transfer case linkage components. If we do not offer a transmission package specifically for your application, more than likely we offer the individual components to convert your vehicle. A complete transmission package from Advance Adapters is a cost effective way to order. The kits listed below are designed around the stock NV4500 transmissions.

- JEEPS:**
- P/N 27-0000T** - Stock Dodge 29 spl. Dana 300 & Chevy V8 engine adapter plate **O.A.L. 26.00"**
 - P/N 27-0000TA** - Using NV4500 **26-0029R**. Dana 300 & Chevy V8 engine adapter plate **O.A.L. 26.00"**
 - P/N 27-0001** - Stock Dodge 23 spl. Dana 300 & Chevy V8 engine full bellhousing **O.A.L. 25.28"**
 - P/N 27-0001A** - Using NV4500 **26-0016RGM**. Dana 300 & Chevy V8 engine full bellhousing **O.A.L. 25.28"**
 - P/N 27-0001T** - Stock Dodge 29 spl. Dana 300 & Chevy V8 engine full bellhousing **O.A.L. 25.280"**
 - P/N 27-0001TA** - Using NV4500 **26-0029RGM**. Dana 300 & Chevy V8 engine full bellhousing **O.A.L. 25.280"**
 - P/N 27-0003BT** - Stock Dodge 29 spl. Dana 300 & AMC Jeep Eng. full bellhousing **O.A.L. 25.430"**
 - P/N 27-0003BTA** - Using NV4500 **26-0029RGM**. Dana 300 & AMC Jeep Eng. full bellhousing **O.A.L. 25.430"**
 - P/N 27-0003T** - Stock Dodge 29 spl. Dana 300 & AMC Jeep Eng. adapter plate **O.A.L. 26.00"**
 - P/N 27-0003TA** - Using NV4500 **26-0029R**. Dana 300 & AMC Jeep Eng. adapter plate **O.A.L. 26.00"**
 - P/N 27-0011** - Stock Dodge 23 spl. NP231 & Chevy V8 engine full bellhousing **O.A.L. 24.85"**
 - P/N 27-0011A** - Using NV4500 **26-0016RGM**. NP231 & Chevy V8 engine full bellhousing **O.A.L. 24.85"**
 - P/N 27-0011T** - Stock Dodge 29 spl. NP231 & Chevy V8 engine full bellhousing **O.A.L. 24.85"**
 - P/N 27-0011TA** - Using NV4500 **26-0029RGM**. NP231 & Chevy V8 engine full bellhousing **O.A.L. 24.85"**
 - P/N 27-0012T** - Stock Dodge 29 spl. NP231 & AMC Jeep Eng. full bellhousing **O.A.L. 25.00"**
 - P/N 27-0012TA** - Using NV4500 **26-0029RGM**. NP231 & AMC Jeep Eng. full bellhousing **O.A.L. 25.00"**
 - P/N 27-0019T** - Stock Dodge 29 spl. NP231 & keeping AMC 4 cyl. (AX5) plate design **O.A.L. 25.25"**
 - P/N 27-0019TA** - Using NV4500 **26-0029R**. NP231 & keeping AMC 4 cyl. (AX5) plate design **O.A.L. 25.25"**

-
- Toyota** **P/N 27-0020G** - Stock GM 4WD. Land Cruiser 10 spline T/C & V8 engine full bellhousing **O.A.L. 25.350"**
- L/C:** **P/N 27-0021G** - Stock GM 4WD. Land Cruiser 16 spline T/C & V8 engine full bellhousing **O.A.L. 25.350"**
- P/N 27-0022G** - Stock GM 4WD. Land Cruiser 19 spline T/C & V8 engine full bellhousing **O.A.L. 25.350"**

-
- Fords:** **P/N 27-0040T** - Stock Dodge 29 spl. Ford NP205 Ford V8 engine adapter plate. **O.A.L. 27.500"**
- P/N 27-0040TA** - Using NV4500 **26-0029R**. Ford NP205 Ford V8 engine adapter plate. **O.A.L. 27.500"**
- P/N 27-0044T** - Stock Dodge 29 spl. Bronco Dana 20 Ford V8 engine adapter plate. **O.A.L. 27.00"**
- P/N 27-0044TA** - Using NV4500 **26-0029R**. Bronco Dana 20 Ford V8 engine adapter plate. **O.A.L. 27.00"**

For Dodge kits, continue next page. GM kits are listed on page 49

DODGE GETRAG REPLACEMENT

Between the years of 1989-1993, Dodge used a German made Getrag 5 speed transmission coupled to the Cummins™ diesel engine. These transmissions were used in both 2WD and 4WD vehicles. The availability of re-manufactured transmissions and replacement parts have been extremely difficult to locate. We have developed a new bellhousing that will permit the use of the newer heavy-duty NV4500 transmission.

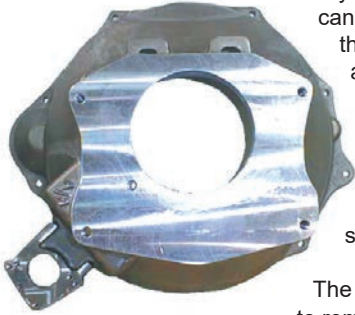

Many customers (aware that the NV4500 is currently available with the Cummins™ diesel) reason that they can simply use a stock New Venture bellhousing from Chrysler. Although this may be true, as was our initial thought, these original components from Chrysler proved to be extremely expensive. Not only would a new bellhousing be required, but also new clutch components, slave cylinder, engine intermediate plate, and considerable labor.

The bellhousing we manufacture bolts to the Cummins™ 5.9 diesel and utilizes the stock slave cylinder, clutch arm, and release bearing. This bellhousing comes with a new pilot bushing for both the 2WD and 4WD applications. The 4WD kits also include a crossmember mount and transfer case shifter bracket.

The stock clutch arms have become very hard to come by when doing the Getrag replacement. We decided to remanufacture this arm to the factory specifications. **P/N 712584C** is a direct replacement arm.

2WD APPLICATIONS:

On 2WD installations, the new transmission is approximately 6-1/2" longer than the stock Getrag transmission. This conversion will require driveline and crossmember modifications. A new rear output yoke will need to be purchased and we offer this item as **Part No. 716087**. Not all Dodge 2WD transmissions have a speedometer option on the tailhousing. The 1998 & newer transmissions used a speedometer located in the rear axle, thus these transmissions do not have any way of connecting a speedometer cable to them. A GPS speedometer may be the only way to accommodate a speedometer in your vehicle with the newer transmission. Floorboard modifications may be necessary because of the new shifter handle location.

- P/N 712585** - Dodge H.D. NV4500 bellhousing for replacing the Getrag 5 speed
- P/N 27-0055** - Dodge H.D. NV4500 2WD tranny assembly

4WD APPLICATIONS:

On 4WD installations, the new transmission is a direct replacement for the Getrag 5 speed. You will have minor floorboard modifications for the new shifter handle location. The bellhousing kit comes with a crossmember adapter block and transfer case shifter bracket. The stock Dodge NV4500 transfer case adapter housing bolts directly to the stock transfer case. Most applications will require the stock adapter seal to be removed. We offer rebuilt NV4500 transmissions which are the only units available today.

This transmission can be ordered from us under **P/N 26-0020R**.

- P/N 712584** - Dodge H.D. NV4500 bellhousing replacing the Getrag 5 speed
- P/N 27-0055** - Dodge H.D. NV4500 4WD tranny assembly
(Assembly includes the bellhousing kit and shift handle)

1992 & 1993, Dodge used a gated transfer case shifter. This shifter bracket is not included in the bellhousing or transmission kits listed above. If your vehicle has this shifter as illustrated, you will need to purchase this bracket or you can order bellhousing kit **P/N 712584A** which includes this bracket.

- P/N 715540** - 1991-93 Getrag Gated transfer case shifter bracket

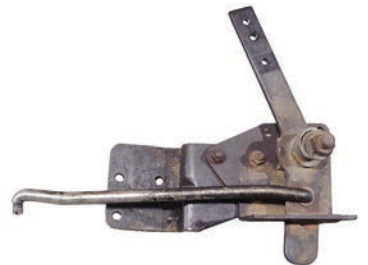
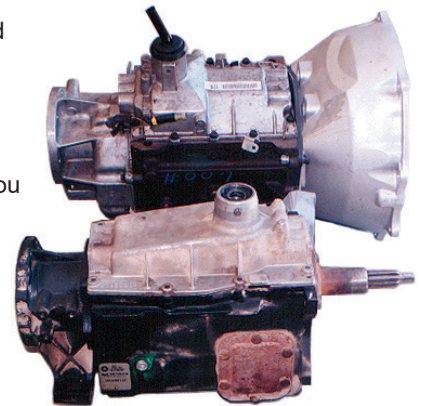

Stock Dodge Cummins™ to NV4500 bellhousing:

These bellhousings were discontinued from Dodge in 2012; therefore, we started making them soon after. The bellhousings are stock replacement housings, not heavy-duty housings built for more torque. If you have a Cummins engine that is built, you may want to limit the twisting on the drivetrain if you purchase one of these bellhousings.

- P/N 712586** - Stock Dodge NV4500 bellhousing.
- P/N 712586A** - Stock Dodge NV4500 bellhousing replacing an automatic.

Dodge NP205:

Dodge used two versions of the NP205. 1971 to the mid 70's they offered divorced units as well as a married unit in the mid-70's to 1993. The married unit was a right drop with a figure 8 bolt pattern. Dodge used an adapter between the 205 and stock transmission, this adapter took the figure 8 pattern to a circular 6. This adapter also provided the room to couple the two male shafts together.

All married units except the Cummins diesel Getrag 5 speed 89-93 had 23 spline inputs and used a coupler sleeve like Chevy. They used an adapter casting fig 8 on transfer case side to circle 6 transmission bolt pattern and uses the small input bearing like the Chevy male inputs.

1989-93 Getrag 5 speed diesel only 29 spline male inputs and fig 8 to circle 6 adapters. This adapter is special to this t-case due to the use of the large input bearing like a Ford 31 spline or Chevy 32 spline. This HD 205 also had a special heavy duty fixed yoke rear output shaft. The design of the shaft makes it stronger than any other 205 rear output and commonly swapped into Ford and Chevy cases for extreme duty use.

In recent years the availability on the stock adapter housings has dwindled. We are now offering the stock replacement adapters for both the 23 spline and the 29 spline transfer cases. These adapters are a two-piece billet combination that is the exact same length as the stock adapter.

P/N 50-2800 Stock Dodge adapter fits the small bearing(6307)

P/N 50-2801 Stock Dodge adapter fits the large bearing(6210).

We also offer the stock 29 spline input gears for the NP205 transfer case **P/N 716044-D**

We offer the stock couplers between the male transfer case spline and the male transmission splines.

P/N 52-9541 23 X 23 spline coupler

P/N 52-9540 29 X 29 spline coupler

The developed a hybrid coupler also that will take the 23-spline male shaft from the transfer case and then couple it to a 29 spline from a NV4500 or Getrag. The coupler uses the seal that the stock New Venture tail housing has and requires that the output shaft is either flush or slightly recessed with the end of the transmission adapter.

P/N 52-9542 23 X 29 spline coupler

Dodge NP205 Transfer Case to Transmission Adapters:

P/N 50-9551 - Dodge NP205 to NV4500 29 spline transmission.

(This is not a factory replacement adapter. Not recommended for stock 89-93 applications)

P/N 50-9551A - Dodge NP205 to GM 4WD 6L90 29 spline transmission

P/N 50-9551B - Dodge NP205 to GM 6L80 32 spline transmission



Dodge Ram 2500 68RFE Transmission to Transfer Case Clocking ring:

When lifting the Dodge Ram 2500 the front driveshaft angle become an issue. We have designed a transfer case clocking kit to rotate the transfer case down 14 degrees improving the front drive shaft angle.

P/N 50-6810 - 14 degree clocking kit Ram 2500



SUZUKI SAMURAI GEARS:

We now offer three different sets of Suzuki Samurai low range gears. The kits come with three gears, one shaft & gear, a new cluster pin, thrust washers, cluster gear needle bearings, and a new gasket set. These gears are manufactured in Japan and are of the highest quality.

P/N 48-4160 is a 4.16:1 low range with a 12% high gear reduction *

P/N 48-4900 is a 4.90:1 low range with a 16% high gear reduction *

P/N 48-6400 is a 6.40:1 low range with a 17% high gear reduction *

**(See the PDF instructions online for case modifications and gear installations).*

SUZUKI Vitara

(GM Sidekick, GEO Tracker)

Along with the Samurai gears, The Sumo Gear Company also manufactures a 4.2:1 gear set for the Vitara, GM Sidekick or Geo Tracker. The stock transfer case was a 1.8:1 and low range and these new 4.2:1 low gears bring life to these SUV's. This gear set is made out of 4320 chrome moly steel.



FORD FULL SIZE TRUCKS

Full size Ford trucks have never been a very popular truck for transmission upgrades. Over the years, we've only had a few requests for certain adapters. Most of the early Ford trucks produced had either a single gear ratio Dana 21 transfer case or they had a divorced New Process transfer case. The Dana 21 was very light-duty and, therefore, not very popular to adapt to. The divorced New Process transfer cases were good gear boxes; however, no adapters were required when changing transmissions, just a custom driveshaft did the job.

Around 1977, the first Ford married transfer cases came on the scene. From 1977 to 1979, both the NP205 & NP203 transfer cases were found in Ford trucks. Both New Process transfer cases used a 31 spline input; however, the bolt patterns were different. Since the NP203 was discontinued in 1979, we have never made any adapters for this transfer case. In 1980, Ford changed transfer cases to the New Process 208 and the 6 bolt Borg Warner transfer cases. At that time, Ford still offered the NP205 on special order applications. The transfer cases (NP205, NP208, and the 6 bolt B/W transfer case) found in these vehicles are all basically treated the same when it comes to adapting to them. They all have a circular 6 bolt pattern, a 31 spline input, and the same index diameter. The New Process 205 has one difference that does play a part with our adapters. The adapter requires a clearance notch for the stock transfer case shifter linkage. Since these Ford transfer cases all have the same basic configuration, the task of swapping a Ford 4WD transmission with another Ford 4WD transmission can normally be accomplished with the stock adapter.

The adapters we manufacture are designed to couple the different Chevy automatic transmissions and the NV4500 5 speed transmissions to the Ford transfer cases. We've also designed bellhousing adapters to couple the Chevy automatics and the NV4500 transmission to the stock Ford engines. *(Note: In reference to the transfer case adapters, we have seen different transmission output shaft stickouts on the Fords. The transfer case adapters we manufacture are designed around a 1" long stickout from the adapter. If your stock transmission had a flush output shaft stickout, then our kit may require the shaft to be shortened accordingly or a spacer plate to be used).*

FORD TRUCK BELLHOUSING ADAPTERS:

P/N 712588-A	GM automatic to Ford 302 bhsg. adapter plate	<i>(28 oz. balance)</i>
P/N 712588-B	GM automatic to Ford 302 bhsg. adapter plate	<i>(50 oz. balance)</i>
P/N 712551 -	Dodge NV4500 adapter plate to standard Ford bhsg.	<i>(4.848" index)</i>
P/N 712549 -	GM engine to Ford transmission	<i>(Full bellhousing)</i>

FORD TRUCK TRANSFER CASE ADAPTERS:

700R or 4L60E to NP205 / NP208 / B.W.: The kit comes with a new output shaft that must be installed into the transmission. We then uses a 31 spline spud shaft supported with a bearing in the adapter to couple to the transfer case.

- P/N 50-6904** - GM 700R to Ford NP transfer case adapter. 3.625" long
- P/N 50-6924** - GM 4L60E to Ford NP transfer case adapter. 5.125" long

TH350 to NP205 / NP208 / B.W.: This adapter is 3.625" long. The kit comes with a new output shaft that must be installed into the transmission. We then uses a 31 spline spud shaft supported with a bearing in the adapter to couple to the transfer case.

- P/N 50-6908** - GM TH350 to Ford NP transfer case adapter.

TH400 2WD to NP205: This kit uses a stock 2WD output shaft. The Ford NP205 has a 31 spl. input and the kit comes with a new 32 spl. input that must be installed. Once the new input is installed the Stock TH400 shaft will couple the two together.

- P/N 50-3204** - GM TH400 2WD to Ford NP205. Adapter housings is 4.25" long.

TH400 4WD to NP205 / NP208 / B.W.: This kit uses the TH400 with a 2.4" output stickout from the rear of the case. The shaft will need to be shortend before installing the adapter. The kit comes with a spud shaft 32 spl. x 31spl. that couples to the shortened 4WD output up to the 31 spline transfer case.

- P/N 50-3206** - GM TH400 4WD to Ford NP205 / 208 or B.W. transfer case adapter. Adapter housings is 4.25" long.

4L80E 2WD to NP205: This kit uses a stock 2WD (full spline) output shaft. The Ford NP205 has a 31 spl. input and the kit comes with a new 32 spl. input that must be installed. Once the new input is installed the Stock 4L80E shaft will couple the two together.

- P/N 50-3205** - GM 4L80E 2WD to Ford NP205. Adapter housings is 4.25" long.

GM 6L80 4WD & some 2WD to NP205: The Ford NP205 has a 31 spl. input and the kit comes with a new 32 spl. input that must be installed. The kit is designed for the 4WD transmission, however, some long splined 2WD transmission can work. the 2WD outputs must be shortend.

P/N 50-9550B - GM 6L80 32 spl. to Ford NP205 T/C adapter. Adapter is 5.325" long

GM 6L90 4WD to NP205: The Ford NP205 has a 31 spl. input and the kit comes with a new 29 spl. input that must be installed. The kit is designed for the 4WD transmission, however, we have seen two length of 4WD output shafts. The ideal shaft stickout is approxamatly 3.25".

P/N 50-9550A - GM 6L90 29 spl. to Ford NP205 T/C adapter. Adapter is 4.70" long

NV4500 29 spl. 4WD to NP205: This adapter is based on the stock Dodge NV4500 4WD with a 29 spline output shaaft. The stock tailhousing is 6.3" long couples to an adapter ring 1". The kit has a new 29 spline input gear that needs to be installed into the Ford transfer case.

P/N 50-9550 - Dodge NV4500 29 spl. to Ford NP205 T/C adapter. Adapter is 7.30" long

NV4500 4WD to NP205 / NP208 / B.W.: The adapters listed below use the stock Dodge tailhousing 6.3" coupled to an adapter ring that is 1.625". These are spud shaft kits and one fits the 23 spline Dodge output and the other fits the 29 spline. Both spud shafts have a male 31 spline to fit the stock Ford transfer case.

P/N 50-0207 - Dodge NV4500 23 spl. to Ford NP205 / 208 or B.W. T/C adapter

P/N 50-0220 - Dodge NV4500 29 spl. to Ford NP205 / 208 or B.W. T/C adapter

FORD TRUCK NV4500 TRANSMISSION KITS: See Pages 54 & 55 for NV4500 options.

6R140 6 Speed Automatic: These adapter kit allows the 6R140 to be coupled to the Atlas 2 speed transfer case. Adapters are available for either the 2WD or 4WD transmissions with a 43 spline output. Converting a Ford Van or any other 2WD Ford vehicle can now be done with this adapter.

P/N 50-6140 - 6R140 TO 4X4 TO ATLAS

P/N 50-6140 - 6R140 4X4 A.T. (EXTENDED)

P/N 50-6140 - 6R140 4X2 A.T. (EXTENDED) No output shaft modifications

NP205 INPUT GEARS:

We manufacture the NP205 input gears. Our gears are a bit different than OE (original equipment) in that they are engineered in a two component design that not only expedites production time, but also reduces material waste & expenses. These two piece gear sets come with the correct snap rings and instructions for installation into any NP205 gear box.

P/N 716044-F - NP205 GEAR FORD 31



The various Ford engine blocks used three different bolt patterns. When replacing an engine in a vehicle that originally had a manual transmission, the bellhousing will need to be changed. When converting vehicles with automatics, the entire transmission casing will need to be replaced. The following blocks are grouped together by block bolt pattern configuration. More detailed information can be found in the Ford section of our Tech Vault located at www.advanceadapters.com.

SMALL BLOCK FORDS: 289, 302 and 351 Windsor all have the same block bolt pattern.

FORD BLOCKS: 332, 352, 360, 390, 406, 427 and 428 all have the same block bolt pattern.

FORD BLOCKS: 429, 460, 351M and 400 all have the same block bolt pattern.

1966-77 FORD BRONCOS

The early Ford Broncos have always been a popular vehicle for conversions. These vehicles were normally equipped with a 6 cylinder or V8 engine up to a 3 speed manual transmission. On this transmission, Ford used two different lengths of adapter housings when coupling this 3 speed to the stock transfer case. The adapter housing is either 6-1/2" or 9-3/8". Vehicles equipped with a V8 had a 9-3/8" tailhousing which set the bellhousing further into the engine compartment. Vehicles with the 6 cylinder had the 6-1/2" tailhousing. This shorter adapter compensated for the longer engine. In 1973, Ford began offering the C4 automatic. A special tailhousing and output shaft was manufactured to couple this transmission to the stock transfer case. (Ford no longer makes the C4 adapter).

The 1966-77 vehicles were equipped to a Bronco Dana 20 transfer case. This transfer case, unlike the Jeep Dana 20, has the front driveshaft on the driver's side of the vehicle. The input gear of this transfer case is 6 spline. Ford always used a spud shaft that coupled this 6 spline transfer case to the transmission 28 spline output shaft. The transmission-to-transfer case adapters used both a dowel pin and alignment retainer. The spud shaft is supported in this retainer with a bearing. The adapter kits we manufacture utilize this type of design. In some applications, we also retain the stock spud shaft*. This transfer case has a 2.46:1 low gear ratio. In early 1973, Ford switch to a 2.34:1 low gear ratio. These transfer cases used two different shifter designs known as either the "T" handle or "J" pattern. The "T" handle was used from 1966 to 1972, and the "J" pattern from 1973 to 1977.

We manufacture over 10 different transfer case adapters for the early Ford Broncos; and since the conversion business is market-driven, we've developed over the years a variety of applications to meet consumer needs. For more detailed information and conversion procedures, we recommend that you download our Ford instruction manual located at www.advanceadapters.com under the **Tech Vault**.

*We offer a stock Bronco replacement spud shaft under [P/N 52-2710](#).

TRANSFER CASE ADAPTERS:

T & C 4 speed: This transmission has the same bolt pattern and is 1" longer than the stock 3 speed transmission. This conversion kit consists of a new output shaft, shift rod bushing, and gasket kit. The 9-3/8" stock adapter housing is used and some machining is required. Your stock tailhousing must be drilled and reamed for the shift rail. The counter bore on the adapter housing must be machined to accept the larger 307 bearing. This kit utilizes the stock Bronco spud shaft. This transmission is side shifted and will require additional shifter components. Floorboard modifications will be necessary for shifter clearance and driveshaft modifications may be required.

- [P/N 50-1900](#) - Ford T & C 4 speed to Bronco Dana 20
- [P/N 715503](#) - Hurst Competition Plus shifter bracket
- [P/N 715630](#) - Shifter rod kit
- [P/N 715600](#) - Hurst Competition Plus shifter & handle



T & C 4 Speed Overdrive: The bolt pattern & length of this transmission is 1" longer than the stock 3 speed transmission. This kit includes a new output shaft, shift rod bushing, and gasket kit. The 9-3/8" stock adapter housing is used and some machining is require. Your stock tailhousing must be drilled and reamed for the shift rail. The counter bore on the adapter housing must be machined to accept the larger 308 bearing. This kit utilizes the stock Bronco spud shaft. This transmission was used in both cars and trucks. Our kit only fits the truck-style transmission. The truck-style transmission is top shifted and does not require any additional shifter components.

The car-style transmission can be used if the main case is machined to accept the larger 308 bearing. This transmission is side shifted, which will require the same shifter components listed above. Floorboard modifications will be required.

- [P/N 50-5601](#) - Ford (RTS)T & C Overdrive to Bronco Dana 20 (truck-style transmission 1984-89 F150s)



ZF 5 Speed: We offer an adapter and shaft assembly to adapt the Bronco Dana 20 transfer case to the ZF 4WD 5-speed transmission. This adapter kit is 1.50" long and comes with a new spud shaft and alignment retainer.

- [P/N 50-4303](#) - Ford ZF 5 speed to Bronco Dana 20 transfer case

Custom Twin Stick Kits for Broncos: Our adapter kits for the AOD, NV3550, and ZF don't provide transfer case linkage options for the "J" shifter. JB Custom Fab manufactures a custom twin stick linkage kit that works well for these transmissions as well as the other transmission options. Please contact them at 503-932-6978 for more information.

Ford NP435 & T18: These truck transmissions are a very popular choice for the early Bronco drivetrain. The kit includes an adapter housing, alignment retainer, seals and gaskets. The kit utilizes the stock 2WD transmission output shaft (28 spline) and the stock Bronco spud shaft. The adapter housing is drilled for both the NP435 & T18 transmissions. When installing the NP435 in a V8 application, this combination will not require any driveshaft modifications. The T18 is 1" longer than the NP435, requiring driveshaft modifications. Both trannys will require some floorboard and shift handle modifications.



P/N 50-2700 - NP435 & T18 to Bronco Dana 20 (adapter length of 7.500", transmission 10.875")

NV3550 & AX15 5 speeds: See Page 51 & 52.

Dodge NV4500 5 speed: The NV4500 was introduced in 1993 and has been recognized as the ultimate manual transmission of choice. With a 5.61:1 low gear ratio, 27% overdrive and a synchro-reverse, this transmission works well with the early Broncos. The adapters we manufacture only fit the Dodge gas version. The transfer case adapter is supplied with an adapter housing, a special spud shaft, and the necessary bearings and seals. Your Ford bellhousing will also need to be adapted. The Dodge NV4500 has a 7-1/2" long input shaft. We manufacture an adapter plate that bolts to the front of this transmission. This compensates for the long input shaft and provides the necessary Ford bellhousing bolt pattern. Another consideration is the clutch disc spline. The stock Ford is 1-1/16" 10 spline, and the NV4500 is 1-1/8" 10 spline; therefore, a new clutch disc will be required. When installing these components, driveline and floorboard modifications will be required.

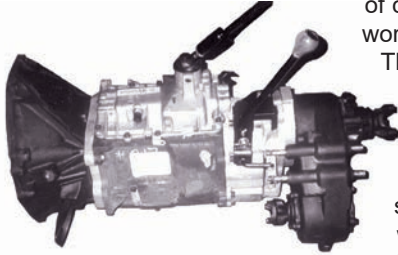

- P/N 50-0209** - Dodge 23 spl. NV4500 to Bronco Dana 20 T/C adapter (adapter 7.300", tranny 12.375")
- P/N 50-0230** - Dodge 29 spl. NV4500 to Bronco Dana 20 T/C adapter (adapter 7.300", tranny 12.375")
- P/N 712551** - Dodge NV4500 to Ford bellhousing 4.848" index (adapter length 7/8")
- P/N 383735** - 11" Centerforce clutch disc
- P/N 716101-2** - Rubber crossmember mount
- P/N 716000-4** - Crossmember support for the NV4500

We offer a complete kit to use the Dodge NV4500 transmission. This assembly consists of a new transfer case adapter, transfer case linkage, crossmember mount, bellhousing or bellhousing adapter plate, clutch disc (on some applications), and shifter handle. This complete adapter package from us is a cost effective way to order. We offer rebuilt NV4500 transmissions which are the only units available today. This transmission can be purchased under **P/N 26-0029R**.

P/N 27-0044T - Dodge NV4500 29 spl. transmission assembly to Ford Dana 20

C4 3 speed automatic: Even though Ford used this transmission stock in vehicles from 1973-77, stock parts are no longer available. We manufacture a new aluminum adapter housing and a custom output shaft that is identical to the original Ford C4. This kit uses the stock Bronco spud shaft, which may need to be shortened in some applications. No driveline modifications are required when replacing a manual 3 speed that was originally mated to a V8. The automatic shifter can be obtained from either 1973-77 Bronco, or a B & M cable operated sport shifter can be used, **P/N 715680**.



P/N 715680

- P/N 50-4200** - C4 auto to Bronco Dana 20. Kit supplies a new casting & C4 main shaft, retaining the stock spud shaft.
- P/N 50-4200A** - C4 auto to Bronco Dana 20. Kit supplies a new casting, mainshaft and spud shaft in the kit.
(Both adapter kit lengths 7.375", transmission 17.000")

AOD & AODE: This automatic overdrive transmission has become very popular among Bronco owners. The gear ratio found in this transmission is great for trail and highway use. We manufacture adapters for both AOD & AODE (4R70E) transmissions. This transmission assembly is 1-1/2" longer than the stock V8 assembly. It requires relocation and modifications to your stock crossmember. The "T" handle transfer case shifter is the easiest linkage to use, having only minor modifications. The "J" pattern can be used - but with a little ingenuity. The adapter kit comes complete with an adapter housing, main shaft, spud shaft, bearings and seals. Transmission length 20.375".



- P/N 50-2704** - All AOD (1980 & up) to Bronco Dana 20 (adapter length of 6.000")
- P/N 50-2704A** - AOD 4WD to Bronco Dana 20 (adapter length of 7.400")
- P/N 50-2704E** - AODE to Bronco Dana 20 (adapter length of 6.000")

C6 3 speed automatic: If you are installing a high horsepower V8 and want to use an automatic, this transmission is your best choice. The C6 tranny and adapter housing will be 2-1/2" longer than your factory setup. Driveline & crossmember modifications are necessary. The stock transfer case linkage will need minor modifications to fit on this adapter housing. This kit uses a stock 4WD C6 tailshaft with 31 splines. This kit also includes a new 8" adapter housing, spud shaft, and necessary bearings and seals. *(Note: At one time, this kit included a custom C6 output shaft with 28 splines and used the stock spud shaft. This design was discontinued in 1998).*

P/N 50-4301 - C6 to Bronco Dana 20 (adapter length of 8.000", transmission 20.000")

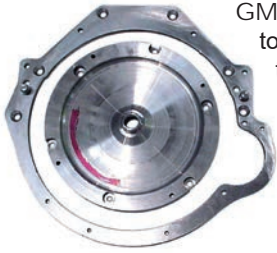

GM Automatic transmission to Ford small blocks: We offer an adapter plate and flywheel adapter to couple the GM automatics (TH350, TH400 & 700R) to the stock Ford engine. These adapters are 3/8" thick and provide an excellent way of combining the GM transmission into your Bronco. These kits have become very popular for the rock crawling enthusiast. It provides the ability to install the popular 700R transmission, which has a good reliable reputation and a great low 1st gear for an automatic.

- P/N 712588-A** GM Transmission to Ford 302 1968-80 (28 oz. balance)
- P/N 712588-B** GM Transmission to Ford 302 1982-97 (50 oz. balance)
- P/N 712588-C** GM Transmission to Ford 302 (no flexplate)

GM TH400: The kit includes two adapter housings, a main shaft, a spud shaft, and the necessary bearings and seals. Driveline and floorboard modifications are required.

- P/N 50-3601** - TH400 to Bronco Dana 20
(adapter length of 2.250", transmission 24.250")

GM 700R: This transmission conversion is becoming very popular. As mentioned above, the 700R is an ideal transmission for the Broncos. The 3.06:1 1st gear is great for rock crawling, and the .70:1 overdrive is excellent for mileage. The kit includes two adapter housings, a main shaft, a spud shaft, and the necessary bearings and seals. Driveline and floorboard modifications are required.

- P/N 50-2706** - 700R to Bronco Dana 20 (adapter length of 2.500")

COYOTE V8 & 6R80 TRANSMISSIONS FOR BRONCOS:

The new Ford blocks 4.6, 5.0 & 5.4 have gained popularity for swapping into the early Broncos. We have designed a bellhousing system for the manual transmissions and a transfer case adapter for the 6R80 automatic transmission.

Ford 6R80 Automatic transmission: This newer automatic overdrive transmission is very popular choice for the Broncos. The gear ratio's starting out with a 4.17:1 and a double overdrive, this transmission is great for trail and highway use. We manufacture adapters for the 4WD version of this transmission. This transmission is 27" long and the adapters adds 4.625". It requires a new crossmember which we manufacture for this application. We currently do not have a transfer case linkage bracket, but check with us as one will be offered sometime in the future. The adapter kit comes complete with an adapter housing, spud shaft, bearings, bearing retainer and seals.

- P/N 50-3901-** 6R80 TO Bronco Dana 20 Adapter
- P/N 50-3900-** 6R80 TO Atlas T/C Adapter
- P/N 716040** - Crossmember support for the 6R80

Bellhousing Adapter to Modular Ford "Coyote" Engine: This is a full Ford bellhousing that has been modified for a hydraulic clutch linkage. The bellhousing comes with the slave cylinder & bracket, clutch arm, pivot ball, starter index plate and crank bushing with a .750" I.D. This bellhousing has a 4.848" index and can be coupled to any early Ford transmission with a pilot bearing change or we suggest using it on a NV4500, or AX15. These transmissions along with the 1" adapters to make them look like a Ford are a perfect fit for these engines.

- P/N 712546** - COYOTE 4.6 / 5.0 / 5.4 BELLHOUSING KIT W/ HYDRAULIC

ATLAS TRANSFER CASE:

When replacing the Bronco Dana 20 transfer case, the Atlas is the ideal upgrade. The Atlas comes with a new adapter to mate to the a new input that exactly matches the Dana 20 transfer case bolt pattern and case rotation. Most adapters kit listed in the Bronco section can be used when coupling to the Atlas.

We offer 6 low gear ratios: **Atlas15** **Atlas20** **Atlas30** **Atlas38** **Atlas43** **Atlas50**
And numerous input splines to fit the various transmissions. We do not offer a Atlas 4 speed with a 28 spline input. The Atlas offers the same rotation as stock plus some higher ones; however, the frame rails will need some modifications.



For all Atlas options, please see Pages 16-21 or on-line under the Atlas Transfer Cases Category.



2WD & 4WD FORD BRONCO II, RANGER TRUCKS & EXPLORERS

The parts we manufacture are available for small block Ford V8s retrofitting stock engines. Because of the diversity of applications, we do **not** offer complete conversion packages. We have grouped the conversion components by application. Many of our components are necessary when converting your engine and/or transmission.

GENERAL CONVERSION INFORMATION:

The Rangers & Bronco IIs were first introduced in 1983, and come stock with either a 2.8 V6 or 4 cylinder. They later came equipped with a 2.9L, 3.0L or 4.0L V6 engine. Ford used various transmissions. The manual transmissions consisted of the Toyo Koygo, Mitsubishi or Mazda. These transmissions are all light-duty 4 & 5 speeds. The automatics that Ford used were the C3, C5 and A4LD. The conversion components we manufacture fit all Bronco II & Rangers. Currently, engine conversions using our components have been performed on Ranger pickups as new as 1997. In 1991, the Ford Explorer was introduced, retiring the Bronco II models. This vehicle came stock with a 4.0L V6, and the A4LD transmission. The adapters we manufacture fit Explorers 1991-94.

Engine Selections: First check your local Department of Motor Vehicles for smog & engine requirements. Certain states, such as California, require the same year or newer engine as the vehicle. (The engine should be complete, retaining all smog equipment). The most recommended engine is the Ford 302. If your engine choice is a 351 Windsor, extra consideration should be given regarding exhaust clearance. A special oil pan must also be purchased.

We manufacture bolt-in motor mounts for these 2WD vehicles. These mounts are designed to utilize the stock Ford crossmember and stock V8 rubber mounts. The Ford rubber mount is a common V8 support, but we offer them for your convenience. When installing a small block into 2WD vehicles, we recommend using either the C4 or AOD transmission. The 713015A mounts bolt to the stock frame hole and are slotted to customize the best engine location for your vehicle.

P/N 713015A - Ford V8 adapter mounts for 2WD vehicles

P/N 713017 - Stock Ford rubber mounts

We offer a one piece motor mount for 4WD vehicles. These mounts require that you drill two holes into your existing crossmember to secure the block. These rubber insulated mounts can then be bolted to the crossmember, and then the block set in. These mounts will place the engine high enough for oil pan clearance.

P/N 713018 - Ford V8 mounts for 4WD vehicles

Transmission Selections: On most of the stock Ford transmissions, we have listed a transmission identification code. This number is found of the driver's side door of your vehicle. This will help you identify the stock transmission equipped in your vehicle.

C4: The C4 automatic transmission is the most practical transmission to choose. It is durable and very easy to find. Due to design changes, we advise that you select a 1970 or newer C4. The C4 has a removable bellhousing, so make sure the bellhousing pattern is compatible with the new engine and flexplate. We recommend a 157 tooth flexplate. Be sure the starter motor engages the flexplate correctly with this bellhousing.

C5: The C5 was used in Ranger / Bronco II vehicles 1984-85. It has the same dimensions as the C4. If you have the C5, you simply need to change your bellhousing, torque converter, and valve body. This is to prevent having to bother with the computer module. Failure to change these parts will cause the torque converter to lock up.

C3: The C3 is identified by a "V" transmission code. The overall length of this tranny is 24". We do not offer any adapters to retain this transmission.

A4LD: The A4LD is identified by a "T" transmission code. The overall length of this tranny is 28.687". We do not offer any adapters to retain this transmission.

Toyo Koygo 4 speed: Transmission code "X", with an O.A.L. of 24". We offer a bellhousing adapter to retain this transmission.

Toyo Koygo 5 speed: Transmission code "5", with an O.A.L. of 25.937". We offer a bellhousing adapter to retain this transmission.

Mitsubishi 5 speed: Transmission code "D", with an O.A.L. of 28.687". We offer adapters to retain this transmission.

Mazda 5 speed: This transmission can normally be found in late model vehicles. The bellhousing and transmission are integral (one piece). We do not offer any adapters to retain this transmission.

STOCK MANUAL TRANSMISSIONS: On vehicles 1983-87 & Rangers 1988-91 with the 2.9L (both having a removable bellhousing), we manufacture an adapter plate that bolts to the stock transmission and allows the use of a standard Ford bellhousing. We recommend that you use a 1987 F150 truck bellhousing. This bellhousing is for use with a 164 tooth flywheel, which may cause tunnel clearance problems (a body lift is recommended). This bellhousing has an external slave cylinder that works well with the Bronco II / Ranger master cylinder. *Later model vehicles used an integral bellhousing & transmission. We do not offer any adapters to retain this transmission.*

P/N 712541 - 1983-88 & Rangers '88-91 w/ 2.9L stock trans adapter plate to 302 bhsg.

P/N CF260000 - Centerforce (bolts to flywheel 3 sets of 2)

P/N 384070 - Centerforce 11" Disc 1", 23 spline

P/N CF360049 - Centerforce (bolts to flywheel even spaced)

P/N N1714 - Clutch release bearing

Axle Strength: These vehicles are equipped with one of three different rear axles. Up to 1984, Ford used a 6.75 rear end, which would be marginal with the added torque. Vehicles 1985-89 had a 7.5 rear end, and 1990 & newer vehicles had a 8.8 rear end. These '85 and up axles are usually sufficient to handle the power of a V8.

Transfer Case: These Ford vehicles used a Borg Warner 1350 transfer case. This transfer case is a chain driven unit and is strong enough to handle the torque of a 302 engine. All of the transfer case adapters that we manufacture have the mounting bosses for the stock transfer case linkage.

C4: The C4 is 17" long. Combined with the new adapter length, use the best adapter suited for your application.

P/N 50-8401 - C4 to Borg Warner 1350 T/C. Adapter length of 11.5" O.A.L. 28.500".

P/N 50-8402 - C4 to Borg Warner 1350 T/C. Adapter length of 8.75" O.A.L. 25.750".

AOD: The AOD is 20-1/2" long. Combined with the new adapter length, use the best adapter suited for your application. These kits come with a modified AOD output shaft, a new transfer case adapter and necessary hardware. The adapter housings have provisions for the stock rubber crossmember mount and the stock linkage (some applications may require linkage modification to fit our adapter). This kit will work with a AODE transmission with the addition of kit **P/N 716057**.

P/N 50-8403 - **AOD (up to 1987) to Borg Warner 1350 T/C**

P/N 50-8404 - **AOD (1988 & up) to Borg Warner 1350 T/C**

Suspension Requirements: The installation of a V8 is about 175 lbs. heavier than stock. On 2WD applications, the suspension will normally drop about 1". We recommend using a heavy-duty shock which will compensate for this drop. On 4WD applications, the suspension is equipped to handle the extra weight. Once completing any one of these vehicles, the front alignment should be checked.

Firewall Modifications: The body seam between the floorboard and firewall will normally need to be bent over. This is where a body lift will aid in clearance. In addition, the heater box on the passenger side will need to be trimmed and patched in order to clear the valve cover.

Cooling Requirements: The V6 radiator used from the factory on Bronco II & Rangers is not large enough to cool even the mildest V8 engine. We manufacture a 2 row aluminum radiator. This radiator can be installed while retaining the air conditioning condenser in the stock location; however, for the best fan clearance, the condenser can be moved forward and the radiator tucked under the grille. Radiators fit 2WD and 4WD vehicles. See Page 78 & 79 for more radiator information.

P/N 716696-AA - BRONCO II ALUM.2CORE W/TRANS

Exhaust: We offer headers for the Ford V8 on both the 2WD & 4WD applications. These headers are conversion headers designed to fit the 302 & 289 blocks within the engine compartment. Vehicles retaining smog equipment can use the stock manifolds off of a Maverick or Comet, or manifolds off of a 1996 & newer Ford Explorer with a 302.

P/N 717044-NP - Ford small block header for 4WD Ranger / Bronco II (non-plated)

Remote Oil Filter: Ford V8 installations on both 2WD & 4WDs require a special remote oil filter. Many of the oil relocation kits on the market have the lines coming straight out. These kits will not clear the steering sector on the chassis. We offer a special remote oil filter kit with lines coming out at a 90 degree angle. This kit comes complete with mounting brackets and hoses.

P/N 716084 - Ford remote filter adapter

Oil Pans: A special dual sump oil pan is required for all 2WD & 4WD conversions. This pan is normally found on 1983 & newer Mustang V8s. This pan will not fit the 351 Windsor block.

P/N 716412 - 302 oil pan and pick up tube

Fuel Pump: In most cases, a mechanical fuel pump will interfere with the steering box and frame rail. We offer an inverted mechanical fuel pump that clears these areas. On newer injected blocks, an in-line electric fuel pump should be used.

P/N 716052 - Mechanical inverted fuel pump

Average Installation Hours: The average conversion time on most vehicles is 40-50 hours.

Advance Adapters 2WD & 4WD Ranger/Bronco II Part Pricing:					
Motor Mounts 2WD:	713015A -	\$ 111.81	Fuel Pump:	716052 -	\$ 89.30
Rubber Mounts for 2WD:	713017 -	\$ 72.17	Bellhousing Adapter:	712541 -	\$ 303.04
Motor Mounts 4WD:	713018 -	\$ 212.24	Clutch pressure plate:	CF260000 -	\$ 182.95
Oil Pan:	716412 -	\$ 182.96		CF360049 -	\$ 175.95
Radiators:	716696-AA -	\$ 596.57	Clutch disc:	384070 -	\$ 103.95
Headers:			Release bearing:	N1714 -	\$ 42.00
4WD not-plated	717044-NP	\$ 359.55	C4 T/C Adapters:		\$ 541.16
Oil Filter Adapter:	716084 -	\$ 92.87	AOD T/C Adapters:		\$ 584.40

TOYOTA 4WD TRUCKS & 4-RUNNERS

Toyota 4WD engine conversions are extremely popular. Whether you are retaining the stock transmission or converting to a Chevy or Ford transmission, we offer the adapters necessary. This section will cover transmission-to-transfer case adapters. In order to identify the different transfer cases Toyota used, we reference to the stock transmissions in these vehicles. These transmission codes are normally found in the engine compartment on vehicles 1979-83, or the driver's side door jam on vehicles 1984 & newer.



Throughout the years Toyota used basically two types of transfer cases: chain-driven or gear-driven. All gear-driven cases have the same bolt pattern with a 2.28:1 low gear ratio. They did, however, use two input splines which were 21 and 23. The chain-driven transfer case offered two input splines which were 23 and 26. The bolt pattern on these cases differed from the gear-driven transfer case. These chain-driven transfer cases have a 2.57:1 low gear ratio. The chart on Page 66 lists the different adapters available for these 4 different transfer cases. One of the easiest ways to identify the difference between a chain or gear-driven transfer case is by looking under your vehicle. The transfer case rear cover is either bolted on with 5 bolts (chain) or 7 bolts (gear).



1979-1980 4-SPEED with GEAR-DRIVEN 21 SPLINE TRANSFER CASE:

The first Toyota 4WD was produced in 1979. 1979-80 vehicles used a manual 4 speed (tranny code L43). This transmission was coupled to a gear-driven 21 spline transfer case. The input shaft on this transfer case was odd because it did not have a standard spline relief as did all other Toyota 21 spline gear-driven transfer cases. On these transfer cases, some grinding is required on the input shaft for proper fit. When adapting to this transfer case, the shifter linkage will stay mounted on the transfer case.

1981-1983 5-SPEED with GEAR-DRIVEN 21 SPLINE TRANSFER CASE:

1981-82 tranny code L45 4-speed, 1981-82 tranny code L50 5-speed, and 1983 tranny code L52 5-speed.

All three transmissions used in these years were all integral (one piece bellhousing and transmission). The overall length of these transmissions varied. When adapting a new engine & transmission on these year vehicles, driveline modifications should be expected. These transmissions were coupled to a gear-driven 21 spline transfer case. Although there were three different transmissions used, there was only one model transfer case used. The transfer case shifter is mounted on the top of this transfer case. The gears on this transfer case are categorized as "noisy run gears".

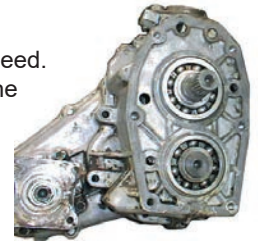

1984-1988 (Carbureted) 5-SPEED with GEAR-DRIVEN 21 SPLINE TRANSFER CASE:

1984-88 tranny G52 & G54 5-speed. These transmissions were normally coupled to a carbureted 4 cylinder. These transmissions offered a removable bellhousing, allowing these transmissions to be retained for engine swaps. These transmissions were coupled to a gear-driven 21 spline transfer case. Although there were two different transmissions used in these years, only one model transfer case was used. The transfer case shifter was mounted on the stock 5-speed tailhousing. Our adapters will allow you to retain this same shifter configuration.

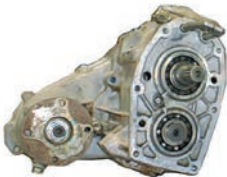

1985-1988 (E.F.I. 4 cylinder) 5-SPEED with GEAR-DRIVEN 21 SPLINE T/C:

1985-88 tranny code W56 5 speed. This transmission was normally coupled to an electronic fuel injected 4 cylinder. The bellhousing on this transmission is removable, allowing this transmission to be retained for engine swaps. This transmission was coupled to a gear-driven 21 spline transfer case. The transfer case shifter linkage is mounted on the top of this transfer case. The gears on this transfer case are categorized as "quiet run gears".

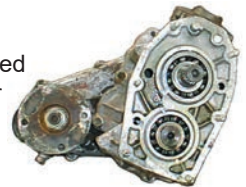

1989-1995 (E.F.I. 4 cylinder) 5-SPEED with GEAR-DRIVEN 21 SPLINE TRANSFER CASE:

1989-95 tranny code W56 5 speed. This transmission was normally coupled to an electronic fuel injected 4 cylinder. The bellhousing on this transmission is removable, allowing this transmission to be retained for engine swaps. This transmission was coupled to a gear-driven 21 spline transfer case.



In 1989, the transfer case shifter linkage was relocated on the 5 speed tailhousing. The shifter mechanism for both the transfer case and the transmission were one unit. When using this transfer case with any of our transfer case adapters, you must either modify or replace your transfer case. To modify your transfer case to work with our adapters, you can change the shifter rods out to a set of rods from a 1984-88 (Carbureted 4 cyl.) transfer case or purchase a new set of shift rods, Toyota part numbers 36314-35020 (high-low rod) and 36313-35020 (front drive rod). Installing the different shift rods will allow you to retain your stock transfer case.

1986-1987 (Turbo E.F.I. 4 cylinder) 5-SPEED with GEAR-DRIVEN 23 SPL. TRANSFER CASE:

The transmission code is R151F, and this unit is used in conjunction with the turbo-charged 4 cylinder. This 5-speed has a removable bellhousing, allowing this transmission to be retained for engine swaps. This transmission was coupled to a gear-driven 23

spline transfer case. This transfer case is identical to the 21 spline transfer case except Toyota used a larger diameter 23 spline input. This input can be interchanged with any of the 21 spline cases. On high horsepower engines or vehicles with large tires, you can interchange this 23 spline input into a 21 spline case if you are concerned about strength. The transfer case shifter is located on the transmission tailhousing. Our transfer case adapter housings will allow you to retain this stock shifter configuration.

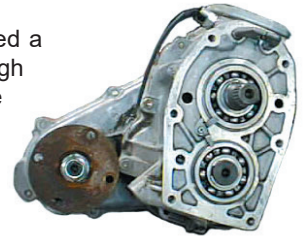

CHAIN-DRIVEN 23 SPLINE TRANSFER CASE 1988-1994:

This 23 spline transfer case is most common in late model Toyotas. It is normally used in conjunction with a V6 or turbo-charged 4 cylinder engine. The transmission code is R150F. We offer a full bellhousing adapter to couple a GM engine to this transmission. The chain drive transfer case is also a popular choice to couple up to a GM transmission. Due to the stock drivetrain length, driveshaft modifications are normally required.

There are no reduction box adapters nor are there any low gear option for this transfer case. We do, however, offer an adapter to install a 23 spline Toyota gear-driven transfer case to the R150F transmission. This adapter plate then allows you to use a gear-driven transfer case with either a low gear set installed or a reduction box installed behind your stock drivetrain. [P/N 50-5707](#).

CHAIN-DRIVEN 26 SPLINE TRANSFER CASE 1989-1995:

This 26 spline transfer case is not real common. It is normally found in Toyotas with 4 cylinders having a transmission code of G58. This vehicle also has a vacuum disconnect differential (VDD). Driveshaft modifications are normally required.

TOYOTA AUTOMATIC TRANSMISSIONS:

In the mid-'80s, Toyota used a 4 speed automatic. This automatic was computer operated and had an integral transfer case (one case transmission & transfer case). We do not manufacture any transfer case or bellhousing adapters for this drivetrain assembly. When attempting to convert a vehicle with this drivetrain, we recommend that you obtain a 1979-88 (Carbureted 4 cyl.) transfer case.

OTHER CONSIDERATIONS:

Most of the adapters we manufacture are designed around the 1984 to 1988 21 spline gear-driven transfer case. The stock transmissions used in these years all measured 25-1/4". We try to maintain the same O.A.L. with a new transmission assembly. On the transfer case chart, we reference both adapter and transmission lengths. This will aid in determining your new transmission overall length.

A rubber mount on the transfer case supports the transmission & transfer case assembly. Due to the length of the transmission, vehicles 1979-83 retrofitting the stock 4 or 5 speed must relocate the stock crossmember. When retrofitting vehicles having a chain-driven transfer case with a V6 engine, our Chevy V8 motor mounts are supplied with an additional crossmember block that relocates the stock crossmember. Both gear & chain-driven Toyota transfer cases use an internal type shifter linkage. This linkage is located either on the stock 5 speed tailhousing or the top stock transfer case. The adapter housings we manufacture will allow you to retain either location. To obtain the proper body clearance when installing a Chevy or Ford transmission, we recommend a 1" to 2" body lift.

TOYOTA TACOMA, TUNDRA, T100, and FJ Cruisers

STOCK TRANSMISSIONS to ATLAS Transfer Case:

These kits are designed to adapt the Atlas transfer case to a Toyota transmissions. The plates work with either a right or left hand front output drop. The left hand drop (driver's side) is the same as stock.

No crossmember modifications are needed. The stock mount and location are retained. Some floorboard modifications are needed. Driveshaft modifications are required and some grinding may be required on the Atlas tailhousing and shifter tower.

We offer flange yokes for the Toyota [P/N AFTOY](#). These will mate to most Toyota drive shafts. Cable shifters are recommended [P/N 303009](#). These allow the shifters to be placed in the most desirable location. There is also some wiring needed on later Tacoma models with VSS and/or push button shifting.

Cable Speedometer 1995-1997: Fully mechanical speedo. We offer an adapter cable that adapters the Atlas to the stock cable [P/N 300613](#)

VSS Speedometer 1998 & UP: We offer a cable/VSS sender that couples to the Atlas speedometer drive. This unit provides the stock VSS signal that the Toyota transfer case did. The Atlas speedometer can be calibrated to tire size and axle ratio when doing these upgrades. [P/N 300605](#)

For more detailed information.

Check out the Atlas Toyota Tech Vault section on-line.

Toyota Applications with Adapter needed:

Tacoma 1996-04 w/ 3.4L V6 & 2.7L automatic [P/N 50-5710](#)

Tacoma 1996-04 w/ 2.7L manual [P/N 50-5711](#)

Tacoma's 2005 & up with a 4.0L manual [P/N 50-5715](#)

Tacoma's 2005 & up with an automatic [P/N 50-5716](#)

4 Runner 1996-02 w/ 3.4L V6 & 2.7L automatic [P/N 50-5710](#)

4 Runner 1996-02 w/ 2.7L manual [P/N 50-5711](#)

4 Runners 2003 & up with an automatic [P/N 50-5716](#)

Tundra 1999-06 4.7L automatic [P/N 50-5710](#)

The FJ Cruiser 2007 & up with a 4.0L manual [P/N 50-5715](#)

The FJ Cruiser 2007 & up with an automatic [P/N 50-5716](#)

Adapter information:

[50-5710](#) - Couples Toyota 23 spline output to a Short Atlas 23

[50-5711](#) - Couples Toyota 26 spline output to a Short Atlas 23

[50-5715](#) - Couples Toyota 22 spline output to a Standard Atlas 23

[50-5716](#) - Couples Toyota 23 spline output to a Short Atlas 23

TOYOTA TRANSFER CASE ADAPTER CHART



Gear-driven T/C



7 bolts (gear T/C)



Gear drive T/C shifter



Chain-driven T/C



5 bolts (chain T/C)

TOYOTA TRUCKS & 4 RUNNERS TRANSFER CASE ADAPTER SELECTION CHART	21 SPLINE T/C GEAR-DRIVEN 1979-95 4 cyl. HAVING STOCK TRANNY CODE L43,L45,L50,L52, G52,G54,W56	23 SPLINE INPUT GEAR-DRIVEN 1986-87 Turbo 4 cyl. HAVING STOCK TRANNY CODE R151F	26 SPLINE INPUT CHAIN-DRIVEN 1989-95 4 cyl. VDD HAVING STOCK TRANNY CODE G58
AUTOMATICS			
GM TH350 4WD TRANS. CHEVY V6 & V8 CONVERSIONS 21.5" CASE LENGTH	50-5702 (5) 3.50" ADAPTER	50-5704 (5) 3.50" ADAPTER	
GM TH350 2WD TRANS. CHEVY V6 & V8 CONVERSIONS 21.5" CASE LENGTH	50-5700 (3,5) 3.50" ADAPTER	50-5703 (3,5) 3.50" ADAPTER	
GM 700R/4L60 O/D 4 SPEED 23.375" CASE LENGTH	50-5705 (3,5) 3.50" ADAPTER	50-5706 (3,5) 3.50" ADAPTER	50-3703 (3) 3.600" ADAPTER
GM 4L60E 2 & 4WD TRANS. 23.375" CASE LENGTH	50-5705 (3,5,6) 3.50" ADAPTER	50-5706 (3,5,6) 3.50" ADAPTER	50-3703 (3,6) 3.600" ADAPTER
GM 4L60E 2 & 4WD TRANS W/REMOVABLE BELLHOUSING	50-5760 5.00" ADAPTER	50-5761 5.00" ADAPTER	50-0405 (4) 1.5" ADAPTER
FORD C4 3SD TRANS 11.180" CASE LENGTH	50-4400 (3,5) 8.25" ADAPTER	50-4401 (3,5) 8.25" ADAPTER	
MANUALS			
FORD T18 4 SPEED 11.87" CASE LENGTH	50-5801 (3,5) 5.50" ADAPTER	50-5802 (3,5) 5.50" ADAPTER	
FORD NP435 4 SPEED 10.87" CASE LENGTH	50-5804 (3) 5.50" ADAPTER	50-5803 (3) 5.50" ADAPTER	
DUAL CRAWLER REDUCTION BOX 4.125" TOYOTA BOX	50-5905D 2.375" ADAPTER	50-5906D 2.375" ADAPTER	
TOYOTA R150F TO GEAR DRIVE T/C	50-5708	50-5707	

NOTES:

- (3) THIS KIT COMES WITH A NEW OUTPUT SHAFT THAT MUST BE INSTALLED
- (4) THIS KIT REQUIRES THE USE OF A 700R KIT ALSO. IF A 4L60E SHAFT IS USED THEN KIT 50-0405E SHOULD BE ORDERED
- (5) IN VEHICLES 1984 & NEWER, THIS KIT NORMALLY WILL NOT REQUIRE DRIVESHAFT MODIFICATIONS
- (6) THIS KIT REQUIRES A RELUCTOR KIT, P/N 716073

SEE PAGE 86 FOR VSS INFORMATION



DANA 300 & ATLAS to TOYOTA CRAWLER BOX:
 The Toyota transfer case does not allow the option of controlling the power distribution to the front or rear axles independently. Our kit, [P/N 50-5915](#), now allows you to couple the Dana 300 transfer case to the Toyota drive-train with the crawler box option giving you some great low range options; and when used in conjunction with a twin stick linkage kit, you will love the shifting ability your Toyota never had.

TOYOTA 4WD ENGINE CONVERSIONS & ADAPTERS

As noted in the transfer case section, Toyota used many 4 & 5 speed transmissions. We manufacture full bellhousing adapters to retain most of these stock Toyota trannys. These bellhousings adapt to the popular Chevy 4.3 V6 & V8, and the Buick V6. The transmissions we **do not** offer any bellhousing adapters for are the 4 & 5 speed transmissions (1979-83) with tranny codes L43, L45, L50 and L52. The L43 & L45 4 speeds were only used for a short time and not strong or popular enough to warrant an adapter. The L50 & L52 5 speeds were an integral (one piece) bellhousing and transmission, which makes it very difficult to adapt to.

TOYOTA 4WD TRUCKS 1984-1995 (Tranny Codes G52, G54, W56 & G58):

These transmissions are normally coupled to the Toyota 4 cylinder. They all have the same input shaft length, spline, and bolt pattern. We manufacture one bellhousing that will adapt these transmissions to the Chevy 4.3 V6, V8, and Buick V6. This bellhousing utilizes a Toyota Land Cruiser slave cylinder. The kit includes a new GM throw out arm and special pilot bushing.

- P/N 712560** - Chevy 4.3 V6, V8 & Buick V6 bellhousing to Toyota G52, G54, W56 & G58 transmissions
- P/N 716213** - Land Cruiser slave cylinder for the 712560 bellhousing

This bellhousing is designed for a 153 tooth flywheel with a 10-1/2" clutch assembly. Since some of the later model GM blocks only have a 168 tooth flywheel option, we also provide our bellhousing with clearance to accept a 168 tooth flywheel and clutch components. The only requirement when using a 168TH flywheel is that a hi-torque starter with no nose cone *must* be used. Since this bellhousing kit is slightly different, when ordering you will need to add a "V" to the kit number.

- P/N 712560V** - Chevy 4.3 V6 & V8 with 168TH flywheel to Toyota G52, G54, W56 & G58 transmissions
- P/N 716213** - Land Cruiser slave cylinder for the 712560V bellhousing

TOYOTA 4WD TRUCKS 1986 - 1995 (Tranny Codes R151F & R150F):

The R151F is normally coupled to the Turbo-charged 4 cylinder, and the R150F to a V6. Both of these transmissions have the same input shaft length, spline and bolt pattern. We manufacture one bellhousing that will adapt these two transmissions to the Chevy 4.3 V6, V8, and Buick V6. This bellhousing utilizes a Toyota Land Cruiser slave cylinder. The kit includes a new GM throw out arm and special pilot bushing.

- P/N 712561** - Chevy 4.3 V6, V8 & Buick V6 bellhousing to Toyota R151F & R150F transmissions
- P/N 716213** - Land Cruiser slave cylinder for the 712561V bellhousing

This bellhousing is designed for a 153 tooth flywheel with a 10-1/2" clutch assembly. Since some of the later model GM blocks only have a 168 tooth flywheel option, we also provide our bellhousing with clearance to accept a 168 tooth flywheel and clutch components. The only requirement when using a 168TH flywheel is that a hi-torque starter with no nose cone *must* be used. Since this bellhousing kit is slightly different, when ordering you will need to add a "V" to the kit number.

- P/N 712561V** - Chevy 4.3 V6 & V8 with 168TH flywheel to Toyota R151F & R150F transmissions
- P/N 716213** - Land Cruiser slave cylinder for the 712561 bellhousing

The Toyota transmissions use a 1-1/8" 21 spline input shaft which requires a custom clutch disc. This clutch disc is a 10-1/2" diameter disc. We also recommend the Centerforce or Luk pressure plate for proper clutch disengagement in the bellhousing. If clutch components from other manufacturers are used, we cannot guarantee proper clutch operation.

Clutch Components:

- P/N CF360056** or **LC360056-PP** - 10-1/2" High profile pressure plate
- P/N CF165552** or **LC165552-PP** - 11" High profile pressure plate (must use P/N 22-0001)
- P/N 716105** - 10-1/2" 1-1/8 inch, 21 spline clutch disc
- P/N N1430** - Flat-face throw out bearing
- P/N 716231** - Clutch alignment tool 1-1/8" 21 spl.

Flywheels:

- P/N CF700100** - 153 tooth GM flywheel
- P/N CF700170** - 153 tooth GM flywheel (1986 & up blocks)
- P/N CF700010** - 160 tooth Buick flywheel
- P/N CF700120** - 168 tooth GM flywheel (up to 1985 blocks)
- P/N CF700160** - 168 tooth GM flywheel (1986 & up blocks)

Hi Torque Starters:

- P/N 22-0001** - 168TH starter, staggered bolt pattern 4.3 V6
- P/N 22-0003** - 153/168TH starter, straight bolt pattern V6 or V8



Conversion bellhousing

MOTOR MOUNTS: Toyota used a straight axle on 4WDs 1979-85, and started using an independent front suspension on 4WDs 1986 to 1995. Our motor mounts are designed for different engine blocks as well as the different front axle considerations. These mounts are for both transmission and transfer case adapters. Since clearance may be an issue when performing an engine swap, a 2" body is recommended. Asterisk "*" mounts will require driveline modifications.

- | | | |
|---------------|---|--|
| Chevy V8: | <p>P/N 713001-S
 P/N 713013 -
 *P/N 713125 -</p> | <p>Chevy V8 mounts to Toyota 1979-85 (weld-in)
 Chevy V8 mounts to Toyota 1986 & up replacing a 4 cylinder (bolt-in)
 Chevy V8 mounts to Toyota 1988 & up replacing a V6 (bolt-in)</p> |
| Chevy 4.3 V6: | <p>P/N 713001-S
 P/N 713013 -
 *P/N 713126 -</p> | <p>Chevy 4.3 V6 mounts to Toyota 1979-85 (weld-in)
 Chevy 4.3 V6 mounts to Toyota 1986 & up replacing a 4 cylinder (bolt-in)
 Chevy 4.3 V6 mounts to Toyota 1988 & up replacing a V6 (bolt-in)</p> |
| Buick V6: | <p>P/N 713011 -</p> | <p>Buick V6 mounts to Toyota 1979-85 (weld-in)</p> |
| Ford V8: | <p>P/N 713002-S</p> | <p>Ford V8 mounts to Toyota 1979-85 (weld-in)</p> |

RADIATOR: The stock radiator used in the 4 cylinder Toyotas is not sufficient to cool the V6 & V8 engines. The stock V6 radiator is marginal for cooling. We offer a few aluminum radiator for the Buick V6, Chevy 4.3 V6 & V8.

- P/N 716698-AA** or **AB** - Toyota 79-95 GM V8 radiator ((AA) automatic & (AB) Manual) 1 3/8 single core downflow
- P/N 716698-AAV6** or **ABV6**- Toyota 79-95 GM V6 radiator ((AA) automatic & (AB) Manual) 1 3/8 single core downflow
- P/N 716698A-LS** or **M-LS**- Toyota 79-95 LS1 radiator ((A) automatic & (M) Manual) 1 3/8 single core downflow
- P/N 716698A-LT** or **M-LT** - Toyota 79-95 LT1 radiator ((A) automatic & (M) Manual) 2 row 1" crossflow

OIL PANS (FOR VEHICLES WITH I.F.S. SUSPENSION): Although a suspension lift is not mandatory on these vehicles, we highly recommend a 3" suspension lift when installing a Chevy 4.3 V6, V8 & Ford V8. This lift drops the front axle and allows for proper oil pan clearance. For customers wanting to keep their vehicles the stock height, you will be required to modify your stock oil pan.

EXHAUST HEADERS: We manufacture conversion headers for V6 & V8 blocks. These headers are not smog legal. Vehicles retaining emissions equipment should use late model stock manifolds. These headers are available in Non-plated (NP) only.

- P/N 717011** - Chevy V8 center dump headers (vehicles 1979-85 only)
(Available in Stainless, Ceramic coated and Non-Plated on this header)
 - *P/N 717053-NP**- Chevy V8 rear dump manifold style headers (for vehicles replacing the V6 engine)
 - *P/N 717054-NP**- Chevy V8 rear dump manifold style headers (for vehicles replacing a 4 cylinder)
 - P/N 717056-NP** - Chevy 4.3 V6 headers (vehicles 1979 & up)
 - P/N 717012-NP** - Ford V8 center dump headers (vehicles 1979-85 only)
 - *P/N 717044-NP**- Ford V8 rear dump manifold style headers (vehicles 1979 & up)
- *Headers will have interference problems with the release arm when used with a manual transmission.*

R150/R151 Transmission to Toyota 4 Cylinder: The R150F & the R151F were coupled to the Toyota V6 and the Turbo-charged 4 cylinder. These transmissions were built to handle more torque and horsepower than the stock 4 cylinder transmissions. This adapter plate is 5/8" thick and comes with a crank spacer to retain input shaft support. **P/N 712562**

TOYOTA TRANSFER CASE HEAVY DUTY FRONT HOUSING:

For aftermarket Toyota low gears, the case must be machined or ground to provide clearance for the cluster gear. You can grind the necessary clearance; however, it is recommended to machine the case for this clearance.

If your not sure about this grinding or the machining process, we now offer a new heavy duty front Toyota housing. Our new Toyota HD housing can be used as a crawler box with stock Toyota gears or with a low gear sets. This housing will save you time and money. When installing our low gears into a stock Toyota housing, grinding & machining on the stock case is required. Our housing has been engineered with additional clearance for our gear sets. Thus, hours of grinding & expensive machining labor are eliminated. A "stock" housing is die cast aluminum and only has an average wall thickness of .200". This housing is made from 356-T6 heat-treated aluminum alloy with an average thickness of .550". **P/N 51-5911**

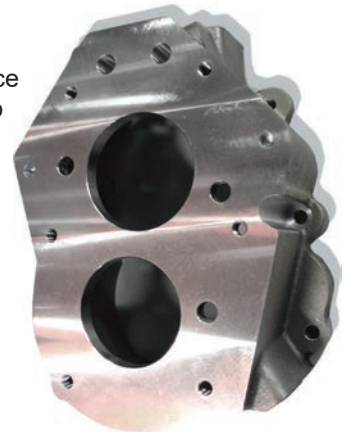

“Sumo Gears” New JAPANESE Made TOYOTA Low Gears:

These new 4.7:1 Toyota Truck gears are made in Japan at one of the original gear cutters that supplied many of the gear components on your Toyota Truck. Sumo Gears are of the highest quality and not to be compared to anything else sourced from overseas. These are a direct replacement for your stock gear-driven Toyota transfer case gears. There are no driveline modifications required. Average installation time between 6-8 hours, less time when using our 51-5911 casting. The kit includes the gear set, bearings, seals and gaskets.



Part No. 48-4721 - 21 tooth 4.7:1 GEAR SET
Part No. 48-4723 - 23 tooth 4.7:1 GEAR SET

We also offer complete rebuild kits for your Toyota Truck transfer case. Our rebuild kits are superior to the other kits on the market today. They are assembled with quality gaskets which come from KP, an O.E. supplier. The bearings are brand name O.E. bearings and the seals are NOK, the choice of all the big Japanese manufacturers.

Part No. 400107 - REBUILD KIT-Toyota T/C gear drive
Part No. 400105 - Needle Bearing Kit
Part No. 400104 - Complete Rebuild kit Toyota T/C

The Sumo Gear company makes gears for numerous applications and we import these on a regular basis. The Sumo Gears are also made for the **Toyota Land Cruiser FJ60, 62 and 80s**, and we carry gear sets for **Suzuki Samurai's** as well as the **GM Sidekicks**.

DUAL TRANSFER CASE CRAWLER BOX (TX2):

Because of larger tires with a stock drivetrain, most Toyota trucks are not geared low enough. A double transfer case crawler adapter can be an easy solution to your gearing problems. Low gearing allows you to control crawl over obstacles; and keeping the vehicle under control saves on wear & tear and, in many cases, less breakages.

Designed for 1979-95 Toyota truck gear-driven transfer cases (21 or 23 spline), this new double bearing design is ideal to help with gear support and deflection. Tx2 kits have a casting length of only 2.375" long.

This gear box takes the stock Toyota transfer case from a low gear ratio of 2.28:1, to a 5.20:1 low gear ratio. The stock gear-driven Toyota transfer case is assembled from the factory in 3 basic portions. By using the front section of the transfer case as a donor box, our adapter will allow you to install this reduction box between your transmission and transfer case. When installing this unit, driveline and floorboard modifications are required. Since the stock transfer case is also being relocated further back, an extended speedometer cable will be necessary. The kits we offer fit both the 21 & 23 spline gear-driven transfer cases.

P/N 50-5905D - Tx2 Crawler Adapter for 21 spline gear-driven T/C
P/N 50-5906D - Tx2 Crawler Adapter for 23 spline gear-driven T/C
P/N 716186-C - Speedometer cable extension

1979-83 Carbureted and the 1985-88 EFI T/Cs have the shifter on the transfer case with a 4 bolt cast iron base of 3-1/8" x 4-3/8". When using one of these cases as a donor box, your shifters would measure 6-1/2" apart.

1984-88 Carbureted and 1986-87 EFI Turbo T/Cs have the T/C shifter located on the transmission tailhousing with a 4 bolt aluminum base of 3-1/4" x 4". When using one of these cases as a donor box, your shifters would measure 11" apart.

The 1989-95 EFI T/C shifter is located on the transmission tailhousing. This transfer case has a 6 bolt aluminum base that houses both the transfer case & transmission shift handles. This aluminum base is 4" x 8". When using one of these cases as a donor box, your shifters would measure 10" apart.

Note #1 - The rear T/case must be a top shifting style (1979-83 Carbureted or 1985-88 EFI).

Note #2 - Reduction gear box can retain the original T/C shift rod location to match to the existing transmission, or the reduction box can be changed out to the 1979-83 carbureted or 1985-88 EFI box (T/C shift lever on reduction box).

Note #3 - Shift rods, forks & driveshaft flanges are interchangeable between all years shown.

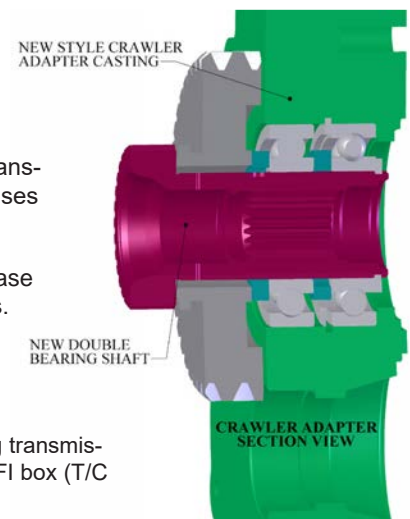

TOYOTA LAND CRUISERS

As far as strength is concerned, Toyota Land Cruisers are probably one of the best designed vehicles. The durability of the chassis and transfer case components offers a great opportunity for the installation of new engine & transmission assemblies. Whether your vehicle was previously equipped with a 3 or 4 speed, we offer a full line of engine & transmission conversion parts. We also manufacture components for steering upgrades, overdrives, and transmission retrofits. The following pages will cover the components that we offer for Land Cruisers. For more detailed conversion installation procedures, we recommend you download our Toyota Land Cruiser instruction manual located at www.advanceadapters.com under the **Tech Vault**.

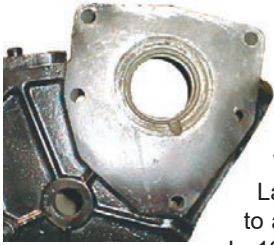

GENERAL INFORMATION:

We offer conversion components for the 1963 to 1990 Land Cruiser models. Land Cruisers produced before 1963 used a small cast iron transfer case coupled to a manual 4 speed transmission. No adapters are available for this drivetrain. In 1963, Toyota began using a one piece aluminum transfer case coupled to a 3 speed manual transmission. This transfer case had a 10 spline input gear. Beginning in 1974, Toyota changed the transmission to a 4 speed manual. Although they continued using the same transfer case, they changed the input gear to 16 splines. In August of 1980, Toyota once again changed the drivetrain. The manual 4 speed was still being used; however, the transfer case had been upgraded to a split-case design with a 19 spline input gear. In 1990, Toyota switched to a new transfer case called the HF2A. All of these transfer cases work well when coupled to a Chevy or Ford drivetrain. The Transfer Case Adapter Chart on Page 72 highlights the various transmission-to-transfer case options. The adapters we manufacture require a few considerations.



SEALED BEARING: Most of the adapters on the L/C Transfer Case Selection chart come with a new 307 sealed bearing. On some of the manual transmission adapters, this bearing is not provided because the two gear boxes use the same type of lubrication. If you would rather isolate your gear box fluids, a sealed bearing can be purchased, [P/N 716301](#).

PTO Spacer: [P/N 716160](#) is a bushing that can be used in place of a PTO gear or if the original spacer on 10spl T/C is lost (2 req.).

TRANSFER CASE REBUILD KITS: All of the transfer case adapters we manufacture require you to access the stock transfer case. Since most of these kits are dealing with this important gear box and its performance, and the transfer case is normally removed from the vehicle to install one of our kits, it's only natural that we offer transfer case rebuilding kits. Our rebuild kits are superior to the other kits on the market today. They are assembled with quality gaskets which come from KP, and is a O.E. supplier. The bearings are brand name O.E. bearings and the seals are NOK the choice of all the big Japanese manufacturers.

- | | |
|---|--|
| P/N 401310 - 3 speed transfer case rebuild kit | P/N 401416 - 4 speed 16 spl. transfer case rebuild kit |
| P/N 401418 - 4 speed 19 spl. T/C rebuild kit 34MM | P/N 401419 - 4 speed 19 spl. T/C rebuild kit 38MM |

TRANSFER CASE LINKAGE: The 10 spline transfer case used either a vacuum or mechanical linkage. A shifter bracket for both of these linkages is not supplied in our adapter kits. On 10 spline transfer cases that are mechanical, the T/C shifter brackets listed below can be used. (**Note:** These brackets are designed around the 4-speed applications. Some modifications to your stock linkage may still be necessary). On vacuum operated linkages, we offer a pivot bracket, [P/N 716024](#). The 16 & 19 spline transfer cases are both mechanical. Most of these transfer cases brackets are include with our adapter kits to retain the mechanical linkages.

- | | |
|---|---|
| P/N 715520 - TH400 linkage bracket | P/N 715521 - TH350/700R linkage bracket |
| P/N 715527 - SM420 linkage bracket | P/N 715530 - SM465 linkage bracket |
| P/N 715532 - NV4500 linkage bracket | P/N 715539 - NV4500 linkage bracket (19 spline T/C) |

TWIN STICK LINKAGE FJ40: We offer new twin stick shifter kits for the Toyota Land Cruiser transfer case. The new linkage will allow the transfer case to shift into High and Low range, and in-and-out of 4WD easily. This new product simplifies the stock Land Cruiser complex linkage. The twin stick benefits include: no linkage binding, no shifter gating, low 2WD option, smooth operation, and a universal fit. Some applications will require welding. (These kits will not fit the split-style case. See Page 77).

- | |
|--|
| P/N 715571 - GM V8, SM420 or SM465 & AA T-case adapter / GM V8 with 4sp AA bellhousing |
| P/N 715572 - Stock 6 cyl. with stock 4 speed/GM V8 with a Marks bhsg. Adapter |
| P/N 715573 - GM V8, TH350, 700R, 4L60 & our transfer case adapter |
| P/N 715573B - GM V8, TH400, 4L80 & our transfer case adapter |

- | |
|--|
| P/N 715584 - Aluminum shifter knobs |
| P/N 715584-AA - Black anodized shifter knobs |

Note: Vehicles that were previously equipped with a vacuum T/C linkage may require additional stock Toyota L/C transfer case parts.



ENGINE TEMPERATURE SENSOR:

When installing a Chevy engine, we offer a couple of options depending of the year of your block. Our **P/N 716023** temperature bushing will allow you to retain your stock sensor on the GM intake as long as the GM block has a 1/2" bung. The newer GM blocks changed the intake thread size to a smaller thread diameter. On these applications, we offer two options, a upper radiator hose adapter or a adapter bushing for the Gen III's. Both options allows you to retain your vehicles stock temperature sending unit and stock gauge. The In-Line units are offered in either 1-3/8" or 1-1/2" hose diameter to fit most block and radiator configurations. The sensor hole is 1/2" which fits the 716023 bushing list above. Additional in-line adapters are listed on Page 79. The bushing to the Gen III block is **P/N 716023-LS**

- P/N 716673A** - 1-3/8" with 1/2" sensor hole
- P/N 716674** - 1-1/2" with 1/2" sensor hole

EXHAUST:

We design and manufacture our own header systems that complement the engine conversion business. The headers listed below are for Chevy & Ford V8 engine conversions. The Chevy headers are offered in both a "fender well" or "inside-the-frame rail" design. For smog legal conversions, stock manifolds off of a late model Chevy passenger car work the best. (*Note: If your Land Cruiser has stock steering, these rear dump manifolds may interfere.*)

- P/N 717006-NP** - Fender well Chevy V8 headers
- P/N 717011** - Ram horn style Chevy V8 headers (inside-the-frame rail)
- P/N 717012-NP** - Inside the frame rail Ford V8 header
- P/N 717015-NP** - Fits blocks with a std port heads and angle plugs
- P/N 717016-NP** - Fits D-port heads with angle plugs
- P/N 717043-NP** - Gen III center dump headers

RADIATOR: Most FJ40 applications can retain the stock radiator.

CROSSMEMBERS 1963-1980:

Land Cruisers have the stock transmission & transfer case supported by using bellhousing mounts. When installing a new transmission, a new crossmember is mandatory. We offer two types of crossmember designs. The most popular design bolts on the back of the stock transfer case. There is a 6 bolt cover that must be removed and our new crossmember bolted in its place. This crossmember extends to the inner frame rails. It is supported by L-brackets that must be welded to the frame rail. These components are insulated on rubber cushions.



- P/N 716022** - T/C crossmember support
- P/N 716022-TSW** - T/C support for FJ55s & long tranny assemblies

We also manufacture another option for transmission support, **P/N 716004**. This crossmember is designed for the TH350, 700R & TH400. This mount bolts to the bottom of the adapter housing using a stock GM rubber mount. This tubular crossmember extends to the inner frame rails. It is supported by L-brackets that must be welded to the frame rail. This mount only fits the one piece Land Cruiser transfer case.



CROSSMEMBERS 1981-1990:

Land Cruisers with the split style 19 spline transfer case used a crossmember that was located underneath the stock transmission. This crossmember is a weld-in unit that comes with two new L-brackets for your frame rails and works with the stock rubber support. The crossmember works with the TH350 and 700R transfer case adapters.

- P/N 716183** - fits FJ60 & FJ62 Land Cruisers

MOTOR MOUNTS:

The motor mounts we offer are for the Chevy V6/V8 and Ford V8. The V6/V8 mounts are a complete frame-to-block mounting system that uses a dual rubber donut design locked together with a hardened bolt. This offers a great means of securing the engine for the most severe offroad conditions.

Our universal motor mounts can be adjusted to accommodate the best possible engine location. Our universal Chevy and Ford side mounts are your best choice for Land Cruisers. The universal mounts are designed to be welded into position. When you position your engine (with the weld-in mounts), you must take into consideration such things as oil pan, steering box, and firewall clearances. Our Chevy V6/V8 mounts include new scab plates that should be welded to the inner frame rails. This will allow a better weld for the engine support bracket to the frame. On Ford V8 & Gen III universal mounts, the frame enclosures can be ordered under **P/N 713124-PLT**. (not needed on FJ60's)

- P/N 713124** - Chevy V6/V8 motor mounts
- P/N 713088** - Chevy LS1 and Gen III V8 motor mounts (see Page 80 & 81 for additional adapter information)
- P/N 713002** - Ford V8 motor mounts

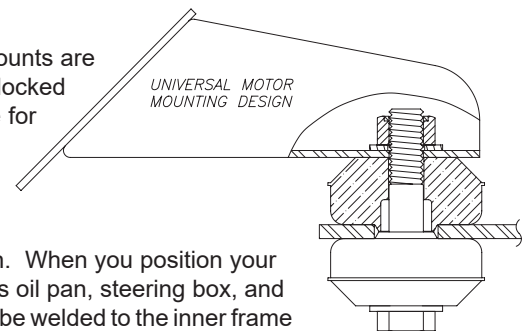

SAGINAW STEERING: We offer complete Saginaw steering kits for Toyota Land Cruisers. The stock steering often had excessive play and backlash. The Saginaw system is a proven advantage for these vehicles. The Saginaw steering conversions and components are listed on Pages 41 through 44. Saginaw steering will provide your Land Cruiser with a more responsive steering system, more engine compartment space, and easier exhaust clearance.

DISTRIBUTOR CLEARANCE: A V8 engine fits well in the Land Cruiser engine compartment. Most applications do not require any firewall modifications. On some applications using a large H.E.I. distributor cap, firewall modifications may be required.

VEHICLE SPEED SENSORS: See Page 86 for information on VSS.

ALUMINUM BILLET SHIFTER KNOBS: We offer new black anodized shift knobs for both the stock Land cruiser 4 speed and 5 speed manual transmission. **P/N 715592** fits the 4 speed and **P/N 715593** fits the 5 speed.



Photo illustrates motor mount installed with Saginaw steering conversion

TRANNY RETROFITS:

SM465: Some customers prefer not to replace the stock Land Cruiser engine. For these applications we offer the SM465 transmission option. By using a 1963-73 Land Cruiser 3 speed bellhousing, we are able to adapt the popular SM465 transmission to your stock engine. This kit is a custom machined new transmission retainer which allows the use of the stock Land Cruiser bellhousing. This kit adapts the new transmission to the bellhousing. A transfer case adapter kit will also be required.

- P/N 712519** - SM465 to Land Cruiser 6 cylinder
- CF043518** - Aug.1974-1987 stock 6 cylinder clutch assembly (2 F engines)

NV4500 with CHEVY V8 (TRANSMISSION PACKAGES):

- P/N 27-0020G** - Stock GM 4WD. Land Cruiser 10 spline T/C & V8 engine full bellhousing **O.A.L. 25.350"**
- P/N 27-0020T** - Stock Dodge 29 spl. Land Cruiser 10 spl. T/C & V8 eng. full bellhousing **O.A.L. 25.350"**
- P/N 27-0020TA** - Using NV4500 **26-0029RGM**. Land Cruiser 10 spl. T/C & V8 eng. full bellhousing **O.A.L. 25.350"**
- P/N 27-0021G** - Stock GM 4WD. Land Cruiser 16 spline T/C & V8 engine full bellhousing **O.A.L. 25.350"**
- P/N 27-0022G** - Stock GM 4WD. Land Cruiser 19 spline T/C & V8 engine full bellhousing **O.A.L. 25.350"**
- P/N 27-0022T** - Stock Dodge 29 spl. Land Cruiser 19 spl. T/C & V8 eng. full bellhousing **O.A.L. 25.350"**
- P/N 27-0022TA** - Using NV4500 **26-0029RGM**. Land Cruiser 19 spl. T/C & V8 eng. full bellhousing **O.A.L. 25.350"**

These transmission packages include a transfer case adapter, full bellhousing, slave cylinder bracket, release bearing and a new shifter handle. These kits do not include motor mounts, rear crossmember or clutch components. See Pages 52 & 54 for more information.

MARKS 4WD ADAPTORS:

Advance Adapters is proud to be the U.S. distributor for Mark's 4WD Adaptors of Melbourne, Australia. Mark's 4WD has been manufacturing adapters since 1979. Their product line coverage overlaps ours on some vehicles like the Toyota pickup and the Toyota Land Cruisers; however, they offer some adapters for these vehicles that we do not. A large part of their product line ventures into vehicles that are popular over there, but are in limited supply here in the United States. The drivetrain on Australian vehicles are configured for the driver location on the right side of the vehicle, whereas the U.S. is on the left side. Caution should be used in this area only when dealing with motor mounts. Some mounts may offset the engine to obtain steering clearance for their vehicles, but it will cause clearance problems on ours. Other than the engine position, all other components seem to be interchangeable.

Marks 4WD offers adapters for: **Toyota Land Cruisers** **Land Rovers** **Range Rovers**
Mitsubishi trucks **Isuzus** **Plus many accessories**

Items we stock at various time during the year:

- 716921** - 8% overdrive and a 2.81:1 low range FJ60s with the 34mm/38mm cluster pin
- 716920/21UD** - 8% underdrive and 3.05:1 low range FJ60s with the 34mm/38mm cluster pin
- 6245-001** - NISSAN PATROL T/C Low Range Gears 3.7:1
- 6245-004** - LANDCRUISER 80 SERIES H.D. PART TIME CONVERSION KIT
- 6245-010** - NISSAN-HYDRAULIC UPGRADE KIT FOR GM V8
- 6245-012** - LS V8 TO NISSAN PATROL MANUAL
- 6245-017** - MARKS- LS (GEN3) V8 TO Range Rover 4&5 SPEED MANUAL
- 6245-018** - 4L80E TO LAND ROVER LT230 TRANSFER CASE
- 6245-020** - MARKS PART TIME 4WD 80 SERIES W/O HUBS
- 6245-022** - MARKS GM DIESEL 6.2/ 6.5 TO 2F SERIES 4 & 5 SPEED
- 6245-023** - MARKS GM V8 TO Range Rover 4&5 SPEED
- 6245-024** - MARKS GM V8 TO Range Rover ZF AUTO
- 6245-025** - MARKS GM V8 LATE TO Range Rover ZF AUTO

Their product line is continually growing. Information on their product can be obtained through us, or you can check their complete catalog online at: **www.marks4wd.com**.

TOYOTA L/C SELECTION CHART GM AND FORD	TOYOTA 3 SPEED TRANSFER CASE 10 SPLINE 1963-1973	TOYOTA 4 SPEED TRANSFER CASE 16 SPLINE 1974- JULY 1980	TOYOTA 4 SPEED T/Case 19 SPLINE AUG. 1980 to 1990 SPLIT-CASE DESIGN	TOYOTA L/C HF2A T/C 1990-2002 REPLACING AUTO
MANUAL TRANSMISSIONS				
GM SM420 4 SPEED 10" CASE LENGTH	50-2601 (3) 4.625" ADAPTER	50-2602 (3) 4.5" ADAPTER		
GM SM465 4WD 10 SPL. 12.0" CASE LENGTH	50-4601 (3) 4.625" ADAPTER	50-4602 (3) 4.625" ADAPTER		
GM SM465 2WD 35 SPL. 12.0" CASE LENGTH	50-4901 (3) 4.625" ADAPTER	50-4902 (3) 4.625" ADAPTER		
FORD T18 4 SPEED 11.87" CASE LENGTH		50-8000 3.75" ADAPTER		
GM NV4500 4WD 31 SPL. 12.375" CASE LENGTH	50-0211 (2,3) 6.375" ADAP.	50-0213 (2,3,5) 6.375" ADAP.	50-0214 (2,3,5) 6.375" ADAP.	
DODGE NV4500 4WD 23 SPL. 12.375 CASE LENGTH			50-0227 (3,5) 6.375" ADAP.	
DODGE NV4500 4WD 29 SPL. 12.375" CASE LENGTH	50-0222 (3) 6.375" ADAP.		50-0224 (3,5) 6.375" ADAP.	
AUTOMATIC TRANSMISSIONS				
GM TH350 2 & 4WD TRANS. 21.5" CASE LENGTH NOTE 6	50-7300 (1,3) 5.25" ADAP.	50-7400 (1,3,5) 5.25" ADAP.	50-7401 (1,3,5) 6.75" ADAP.	
GM TH400 2 & 4WD TRANS. 24.25" CASE LENGTH (THICK HUB) NOTE 6	50-1500 (3,5) 2.68" ADAP.	50-1600 (3,5) 2.68" ADAP.	50-1700A 3.187" ADAP.	
GM 700R / 4L60 O/D 4 SPEED 23.375" CASE LENGTH NOTE 6	50-8901 (1,3) 6.75" ADAP.	50-8902 (1,3,5) 6.75" ADAP.	50-8903 (1,3,5) 6.75" ADAP.	50-8904A (1,2) 9.17" ADAP.
GM 4L60E 2WD 23.375" CASE LENGTH NOTE 6	50-0406 (3,5) 6.75" ADAP.	50-0407 (3,5) 6.75" ADAP.	50-0408 (3,5) 6.75" ADAP.	50-0409 (1,2) 9.17" ADAP.
GM 4L60E 2WD TRANS. W/REMOVABLE BELLHOUSING NOTE 6	50-0406A 8.25" ADAP.	50-0407A 8.25" ADAP.	50-0408A 8.25" ADAP.	50-0420 (1,2) COMPLETE KIT
GM 4L80E 4WD TRANS. 26.000" CASE LENGTH	50-1501 (3,5) 2.68" ADAP.	50-1601 (3,5) 2.68" ADAP.	50-1701 (3,5) 3.187" ADAP.	50-1702 5.24" ADAP.
GM 6L80 TRANS. 4.75" ADAP	50-9610 4.75" ADAP	50-9611 4.75" ADAP	50-9612	
FORD C4 3 SP. TRANS. 11.180" CASE LENGTH	50-8200 (3) 7.25" ADAP.	50-8300 (3) 7.25" ADAP.		
NP203 REDUCTION BOX 5.50" CASE LENGTH	50-8801 1.59" ADAP.	50-8802 1.59" ADAP.		

NOTES:

- (1) THIS KIT USES A 2WD OUTPUT SHAFT (6" STICKOUT)
- (2) THE STOCK OUTPUT SHAFT MUST BE SHORTENED
- (3) THESE ADAPTERS COME WITH A NEW SEALED BEARING
- (4) THESE ADAPTERS ARE SUPPLIED WITH A TRANSFER CASE BRKT.
- (5) THESE TRANSMISSIONS ARE SIDE SHIFTED. (con't next column)
- (6) TO ALLOW ADDITIONAL FRONT DRIVESHAFT CLEARNANCE, WE OFFER 3 YOKE
KITS: P/N 716370 (Coarse spline), P/N 716371 (Fine spline), P/N 716369 (19 spl.)

SEE PAGE 86 FOR VSS INFORMATION



FJ40 & FJ55 NP203 REDUCTION BOX:

These kits offer a 2:1 reduction for your Land Cruiser. They are designed to be used with the stock Land Cruiser 3 & 4 speed transfer cases. These kits are designed to use the front half of the GM NP203 transfer case, which houses the low gear set. These kits only work with a TH350, 700R-4, TH400 or SM465. Transfer case linkage, crossmember, and floorboard modifications are necessary. Due to the added length, driveshaft modifications will be necessary. Moving the engine forward may compensate for some of the added length; and by removing your mechanical fan and going with an electric pusher fan, you may be able to save up to 4" of your driveline.

- P/N 50-8801 - Toyota Land Cruiser 3 speed transfer case to NP203 reduction box
- P/N 50-8802 - Toyota Land Cruiser 4 speed transfer case to NP203 reduction box

TOYOTA LAND CRUISER BELLHOUSING ADAPTERS

Land Cruiser engine conversions are extremely popular due to the cost and availability of stock GM and Ford engine parts. The components covered in this section are for retaining the stock transmission. The components listed on these pages are offered individually or as part of a conversion kit. The bellhousing conversions below will list our products as well as products we import from Australia. Motor mounts, crossmember, and other conversion information listed on the previous pages will also need consideration.

RETAINING THE STOCK 3 SPEED TRANSMISSION:

This transmission was offered in both column and floor shifted models. Our kit is only compatible with the floor shifted transmission. If your transmission is column shifted, you can either upgrade to a floor shifted 3 speed or use a different transmission.



The stock 3 speed transmission can be retained when using a Chevy V8 only. The adapter kit for mating this stock 3 speed is a simple spacer plate and bearing retainer, which does not require any transmission modifications. To obtain the proper firewall clearance, the transmission and transfer case assembly will need to be relocated a minimum of 3-1/2" forward. On many of these applications, you can simply reverse the driveshafts (front to rear, rear to front).

Land Cruisers utilize a hydraulic clutch mechanism. When using the Chevy adapter, we offer a bracket that will retain your stock slave cylinder on the Chevy bellhousing.

Chevy V8 conversion kit 713028-EK: (This kit consist of the following items which are available individually.)

- | | |
|---|--|
| P/N 712523 - Bhsg. adapter plate (fits GM bellhousing w/ 4.686" index) | P/N 716024 - T/C pivot shifter |
| P/N 713124 - Motor mounts | P/N 716176 - GM release arm |
| P/N 716022 - Crossmember | P/N 716287 - Slave cylinder brkt. |
| P/N 716023 - Temperature bushing | P/N 716316 - Release bearing |

RETAINING THE STOCK 4 SPEED TRANSMISSION:

The stock 4 speed transmission can be retained when using a Chevy V8 or GEN III V8. There are two styles of adapter kits for mating the stock 4 speed to these engines.

We manufacture a new bellhousing that bolts the Chevy V8 to the Land Cruiser 4 speed. Our bellhousing will require the transfer case to be relocated forward a minimum distance of 3-1/2". This relocation is required for clearance necessary around the Chevy V8 distributor. This kit also requires driveshaft & floorboard modifications. Be aware that placing the engine too far forward can cause excessive clearance issues with the 4 speed shifter and heater vent. Also, most shifter handles will need to be modified to provide heater vent clearance.

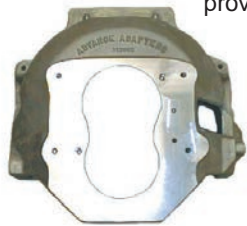

Chevy V8 conversion kit **P/N 713024-EK**
(This kit consist of the following items which are available individually)

- | |
|---|
| P/N 712532 - Bhsg. adapter |
| P/N 713124 - Motor mounts |
| P/N 716022 - Crossmember |
| P/N 716023 - Temperature bushing |

(These parts should not be used on FJ60 vehicles due to crossmember modifications)

Another option to retain the stock 4 speed is to use a Mark's 4WD adapter kit. They offer a conversion bellhousing for the Chevy engines. This bellhousing adapter is 4-7/8" thick and mounts directly onto the engine side of the original Land Cruiser bellhousing. Although the Mark's 4WD kit is slightly more expensive than our design, their special housings provide a very distinct advantage of retaining the drivetrain in the stock location eliminating any relocation of the transfer case. The Mark's 4WD kits retain the stock clutch linkage & slave cylinder and includes a new release bearing.

Chevy V8 conversion kit **P/N 713025-EK**
(This kit consist of the following items which are available individually)

- | |
|-----------------------------------|
| P/N 712525 - Bhsg. adapter |
| P/N 713124 - Motor mounts |
| P/N 713038 - Bhsg. mount |

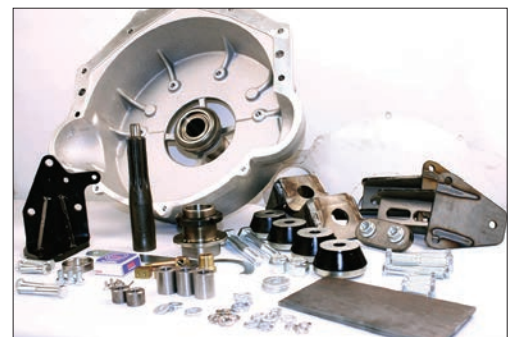

GEN III KITS:

We offer two kits like the ones above for the Vortec GEN III V8 engines. These kits are similar to the Gen 2 V8 kits with the exception of the motor mounts and the addition of a new flywheel, pressure plate, clutch disc and release bearing. These kits also include the metric fasteners needed and an in-line temperature sensor kit for the Land Cruisers.

GEN III V8 conversion kit **with AA Bellhousing P/N 713026-EK**
GEN III V8 conversion kit **with Mark's 4WD Bellhousing P/N 713027-EK**



LAND CRUISER AUTOMATICS (A440F & A440L):

These transmissions were found in the FJ60, 62, 80 & 100 series Land Cruisers coupled to either a 3F or diesel engine. Mark's 4WD offers kits for either an early or late model Chevy V8 to fit directly to these transmissions. These kits use a stock GM flywheel on the engine, a crank spacer, and then a special adapter ring which bolts to the stock Land Cruiser torque converter. The kit sets the engine in the right location so that driveline modifications should be avoided.



P/N 712535-A Land Cruiser FJ60 & 62 Automatic to GM V8 1985 & earlier
P/N 712535-B Land Cruiser FJ60 & 62 Automatic to GM V8 1986 & up Gen I & II
P/N 712535-C Land Cruiser FJ80 & 100 series Automatic to GM V8 1985 & earlier
P/N 712535-D Land Cruiser FJ80 & 100 series Automatic to GM V8 1986 & up Gen I & II
Kits for Gen III & IV engines are available, please call.

NV4500 BELLHOUSINGS:

The NV4500 has become a popular transmission when installing a Chevy or Ford engine in a Land Cruiser. The adapters listed below are necessary to perform this conversion. Additional information on Pages 52 & 53

P/N 712577 - GM NV4500 (1993-95) to GM block, full bellhousing (**11" clutch recommended**)
P/N 712576 - GM NV4500 (1996 & up) to GM block, full bellhousing (**11" clutch recommended**)
P/N 712550 - Dodge Gas NV4500 to GM 5.125" bellhousing indexed adapter plate
P/N 712551 - Dodge Gas NV4500 to Ford 4.848" bellhousing indexed adapter plate
(Dodge NV4500s can use bellhousing P/N 712576 by installing a new input shaft, **P/N 52-0221**.)



716288 bracket

CLUTCH COMPONENTS:

Whether you are retaining your stock 3 or 4 speed transmission or upgrading to a new 4 or 5 speed, clutch considerations will need to be addressed. We highly recommend retaining the stock Land Cruiser slave cylinder. Whether you are using a stock GM or a conversion bellhousing, we offer the brackets to retain this slave cylinder.

P/N 716287 - Chevy bellhousing to Land Cruiser slave cylinder bracket
P/N 716288 - Conversion bellhousing to Land Cruiser slave cylinder bracket
P/N 716286 - Conversion bellhousing to Land Cruiser GEN III slave cylinder bracket

We offer a new Land Cruiser slave cylinder, **P/N 716119**. This slave cylinder has a very short release. When converting to a V8 engine and using an aftermarket clutch assembly, you play havoc attempting to get your clutch to release properly. We highly recommend using Centerforce or Luk clutch components. Centerforce & Luk use a low diaphragm pressure plate that works in conjunction with a large diameter, radius-face bearing. This combination is proven to work with the Land Cruiser hydraulic release system.

Chevy Engines: **P/N CF165473S** Centerforce 11" low profile pressure plate
P/N 383735 - Centerforce 11" clutch disc
P/N CF700120 Centerforce 168 tooth flywheel (up to 1985 blocks)
P/N CF700160 Centerforce 168 tooth flywheel (1986 & up blocks)
P/N 716316 - Release bearing for stock Chevy transmissions & Land Cruiser

3 Spd. Transmission: **P/N 716314** - Release bearing for Land Cruiser stock 4 speeds
P/N 716176 - Stock GM release arm

Gen. III Vortec Engines: **P/N 712500T** 11" Flywheel (includes a LC165473s)

Ford Engines: **P/N CF260000** Centerforce 11" pressure plate (3 sets of 2 bolt pattern)
P/N CF360049 Centerforce 11" pressure plate (6 bolts evenly spaced)
P/N 281226 - Centerforce 11" clutch disc
P/N 716311 - Release bearing for stock Ford transmissions & Land Cruiser 3 spd. transmission



Orion Low Range Transfer Case:

Advance Adapters is proud to offer the Orion transfer case. This transfer case has a low ratio of 4.0:1, it is a cast iron designed transfer case that is sure to capture the attention of the Land Cruiser enthusiast. Advance Adapters is not the manufacturer of this new transfer case; however, we are the exclusive distributor.

The Orion kits come with a new cast iron case, four new gears, a new 34mm cluster pin, and a complete gasket bearing and seal kit. This transfer case, however, is not a complete "ready-to-bolt-in" unit like the Atlas. The transfer case does require the use of your stock front and rear output shafts and housing. The new unit also requires the use of the stock P.T.O. gear and inspection covers.

ORION4 4.0:1 fits vehicles with 10 or 16 spline inputs

ORION PRICING:

4.0:1 Low Gear 10 or 16 Spline - **Starting at \$1687.74**

When ordering an Orion, 3 part numbers make up the transfer case for your application.

1st is the case and gear assembly **P/N Orion4**

2nd is the input spline count (**P/N O70010** 10 spline or **P/N O70016** 16 spline)

3rd is the bolt pack needed (**P/N O10220** stock 3 spd., **P/N O10221** stock 4 spd., **P/N O10222** AA adapter kit)

The installation instructions online at www.advanceadapters.com. Search Orion and look at the technical info link.

We also carry replacement output shafts for the Orion transfer case. We have found that most stock transfer case output shafts have excess wear on the gear journals. These new shafts provide a closer tolerant installation for the Orion gears.

- P/N O40500** - T/Cs up to 4/1975
- P/N O40501** - T/Cs 4/1975 to 7/1980

We also carry replacement Hi/Low shifter sliders for the Orion transfer case. These are also prone to excess wear and should be replaced. **P/N O50010**.

In addition, we have a replacement PTO cover (**P/N O51062**), a replacement shifter cover (**P/N O51060**), and an actuator shaft and lever for the shifter cover (**P/N O60042**).

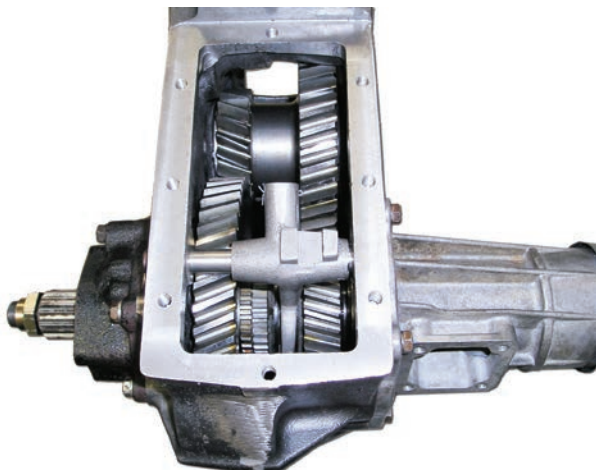

TOYOTA LAND CRUISER ROCK CRAWLING OPTIONS:

FJ60, FJ62 TRANSFER CASE LOW GEARS:

We offer gearing options for the 19 spline split transfer case. All gear sets require a small amount of internal case modifications to clear the new gear diameters; however, the installation of any gear set **does not** require any floorboard, driveshaft or crossmember modifications.

The FJ60 & FJ62 used two different cluster pin diameters on the idler gears: 34mm cluster pin transfer cases were used from August 1980 to October 1985, and 38mm cluster pin transfer cases from October 1985 to January 1990.

The 4:1 low gear set offers you some gearing options without swapping axles or drivetrain components and requires no driveshaft modifications. The kit does not include bearings or new seals. We recommend obtaining a Toyota service manual for the proper disassembly procedures and the proper torque specifications during reassembly.



The installations of the 4:1 gears requires some machining to the rear half of the Toyota transfer case. The machining should be performed at a machine shop to ensure that proper case clearance is obtained without removing too much case material thus weakening the case.

Note: This gear set will also alter your high range ratio. The high range ratio will now result in a 10% underdrive.

716938 - 4.0:1 low range FJ60/62 with the **38mm cluster pin**

716934A - Idler pin kit for 4:1 low range FJ60/62 with the **34mm cluster pin (must also use 716938 kit)**



Our rebuild kits are superior to the other kits on the market today. They are assembled with quality gaskets which come from KP, an O.E. supplier. The bearings are brand name O.E. bearings and the seals are NOK, the choice of all the big Japanese manufacturers.

401420 - T/C REBUILD KIT FJ60/62

REPLACEMENT CLUSTER PINS with THRUST WASHERS

401418 - IDLER PIN KIT FJ60/62 34MM

401419 - IDLER PIN KIT FJ60/62 38MM

716934A - Idler pin kit for use with 716938 kit (FJ60/62)

FJ80 TRANSFER CASE LOW GEARS:

This new gear set gives you a 3.1:1 low range from your stock 2.48:1. The Sumo Gears are made in Japan and are the highest in quality. This new gear set will get you a 25% lower range to help safely crawl your rig through the trail.

716940 - 3.1:1 low range FJ80



TWIN STICK LINKAGE FJ60/62:

We offer a new twin stick shifter kit for the Toyota Land Cruiser 34mm and 38mm transfer cases. The new linkage will allow the transfer case to shift into High and Low range, and in-and-out of 4WD easily. This new product simplifies the stock Land Cruiser complex linkage. The twin stick benefits include: no linkage binding, no shifter gating, low 2WD option, and smooth operation.

P/N 715569 - Universal twin stick kit for FJ60 and FJ62 (34mm & 38mm cases).

P/N 715584 - Aluminum shifter knobs

P/N 715584-AA - Black anodized shifter knobs



Most engine conversions are done to add horsepower, performance or reliability along with part availability. Whatever the case may be, engine swaps will normally require cooling upgrades. Over the years, we have tested different radiators and cooling options. The information listed below describes the types of radiators that work well in converted vehicles.

We do offer some cooling accessories that work that help cool the larger engines. We offer electric fan systems, high flow water pumps, and automatic transmissions cooler lines. These additional products are listed after the radiator information in this catalog.

Aluminum Radiator Features that work well:

*1" wide core tubes

*Cross Flow Design

*16 Fins per inch

Inside the radiator, the engine's heated water/coolant flows into the radiator and flows across the numerous tubes. From there the heat is transferred to the fins of the radiator. The fins are air cooled by the airflow of the fan and vehicle speed, which is the only way to dissipate the heat from the fins - thus cooling the water before reentering the engine. Aluminum radiators with the 1" wide tubes and 16 fins per inch provides excellent heat dissipation.

Our radiators use a common 3/8" NPT fitting located in the cold side of the tank. This location provides for an accurate temperature reading of the fluid as it enters the engine. Our filler neck requires a standard GM overflow system style cap (3/4" depth). We recommend a 15 lbs. to 22 lbs. cap pressure. A higher pressure cap increases the boiling point and keeps the fluid in the cooling system, not the recovery tank.

A cross flow designed radiator will allow the radiator cap to be on the low-pressure side (cold side or water outlet) of the tank. Water drops in pressure as it is cooled; allowing recovered fluid back into the radiator during normal operation. On a down flow radiator, the top tank is always the hot side and is under constant pressure. Under sustained high RPM, this can force the fluid past the filler cap, out the overflow tube, and into the recovery tank even at normal operating temperatures.

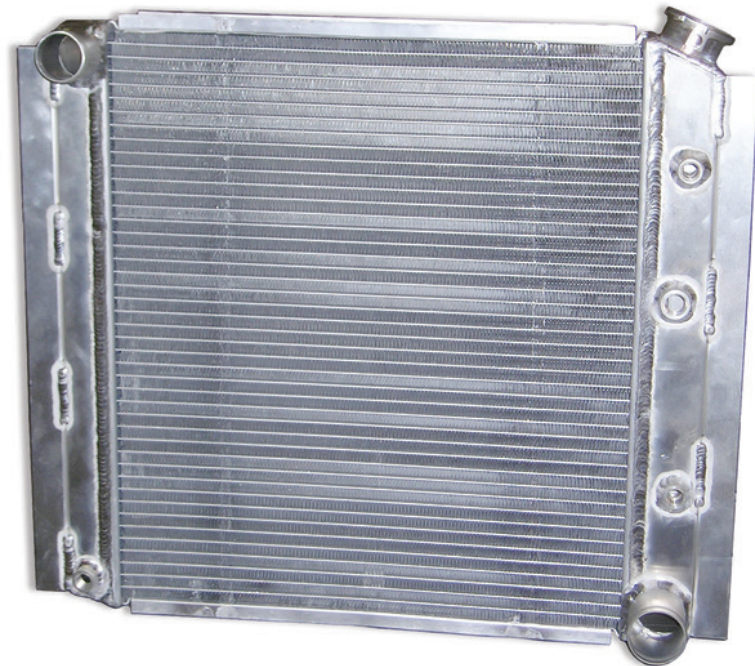

Our radiators have an aluminum angle for the mounting flange. This angle is TIG welded to the tanks. The aluminum angle has no mounting bolt holes. The customer determines the mounting pattern and location. This allows height adjustment for the radiator to center up to the water pump with the new engine location. This will also assist a desired height location if a body lift is to be installed.

Most radiators can be ordered with or without a transmission cooler. The radiator, if equipped for an automatic, will have two 1/4" NPT fittings welded into the tank. A benefit of the transmission cooler in the radiator is the heat exchange between the radiator and the tranny cooler. The radiator brings the transmission fluid up to a safe and constant operating temperature.

Most radiators are designed to fit standard GM engines. Newer blocks such as the LT1, LS1, and Vortec Gen 3 blocks will require some additional features to be added to the radiator. A steam return option and smaller water inlets and outlets must be incorporated to the radiator when using it to a newer block.

Radiator Recovery Can: This canister will accumulate any "overflow" from the radiator cap. The accumulated fluid will then be pulled back into the radiator once the engine has cooled. [P/N 716672](#).

Radiator In-Line Temperature Sensor Adapters: We offer three upper radiator hose in-line temperature sensor adapters. These adapters allow you to retain your vehicles stock temperature sending unit and stock gauge. These units are offered in either 1-3/8" or 1-1/2" hose diameter as to fit most block and radiator configurations. The sensor hole is either 3/8" or 1/2" on the 1-3/8" adapters or 1/2" on the 1-1/2" adapter.



- [P/N 716673](#) - 1-3/8" with 3/8" sensor hole
- [P/N 716673A](#) - 1-3/8" with 1/2" sensor hole
- [P/N 716673B](#) - 1-1/2" with 3/8" sensor hole
- [P/N 716674](#) - 1-1/2" with 1/2" sensor hole



Radiator Cap: The normal operating temperatures on most engines range from 180 to 200+ degrees which generates a pressure of 8-12 pounds. This is true for both carbureted and fuel injected engines. For added protection, we offer a new 22 lb. radiator pressure cap. This 22 lb. cap will increase the boiling point but keep your engine coolant in the radiator and not in the recovery tank. This cap works on all of our radiators. [P/N 716679](#).

Spal Fan Kits: The Spal fans we offer are the high performance curved bladed pusher or puller fans. These 16" fans are 16.3" tall, 15.75" wide, and 3.39" deep at the fan's motor. The fans are rated at 2070 CFM and being that they are pre-shrouded, they are ideal for cooling larger engines. Our fan kits come complete with the needed wiring harness, which is compatible with both positive and negative ground vehicles. The 3/8" pipe thread sending unit is designed to turn the fan on at 185 degrees and off at 170 degrees. The kit comes with a 40 amp relay, a fuse holder, and all other necessary hardware. In addition, our kit also includes mounting brackets for the fan to the radiator. The mounting brackets are designed for our aluminum radiators, however; we can supply you with brackets to fit some of our copper/brass radiators upon request.

- [716670](#) - Puller Fan Kit
- [716671](#) - Pusher Fan Kit

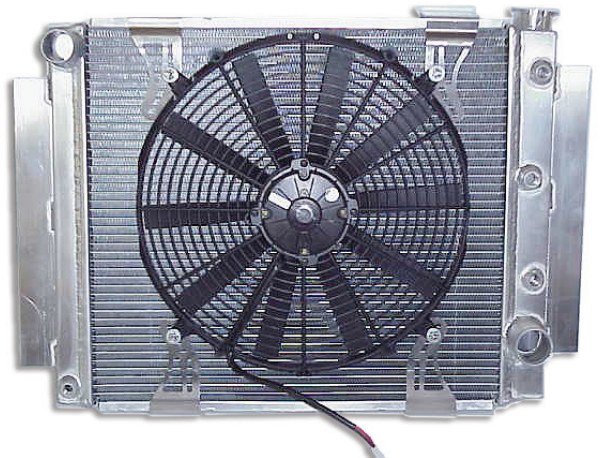

Transmission Cooler Lines Kit: As you finish up a drivetrain conversion, there are always a few last minute items that need attention. One of these is the transmission cooler lines. You can surely bend up custom ridged cooler lines and route them up to the radiator or splice into your old lines if your vehicle had a stock automatic. We've found that the ridged lines are sometimes a pain to fit properly, and splicing into your stock lines may not always be the cleanest installation. We now offer a flexible stainless steel hose kit. These hoses are simple to route and easily installed onto the radiator. The seven foot long hoses are long enough to fit most applications while having a bit of extra hose to allow for body and frame flex. Our kit includes two 7' stainless steel outer braid lines with Teflon inner tubing. The ends have dash 6 female A.N. fittings that are pre-crimped to the hose ends. The kit also includes two 1/4" MPT to dash 6 Male fittings for aluminum Rad-a-Kool radiators, and two 5/16" inverted flare to dash 6 Male fittings for TH350 / TH400 / 700R4 transmissions.



NOTE: We also offer these in shorter line lengths of 24", 36", 48" & 60". The shorter length kits are the same part numbers as listed below with a dash and then the length in inches.

- [P/N 23-1500](#) - Transmission Cooler Lines kit 7' to work with our Rad-A-Kool radiator
- [P/N 23-1501](#) - Transmission Cooler Lines kit 7' to work with radiators with a 5/16 inverted flare

GENIII & IV ENGINE INFORMATION

Installation Considerations: The GM Generation III & IV blocks are classified as a 4.8L, 5.3L, 5.7L(LS1), and 6.0L. These blocks have gained popularity because of the emission controls required when performing an engine swap. A few things to consider when using a Generation III* V8 block are as follows: All fasteners are metric. The heads of a Gen III are wider than an early GM V8, so the exhaust manifolds are tough to fit between the frame rails on most vehicles. The exhaust on the driver's side can be a problem for mechanical clutch linkages. The oil pan is aluminum and cannot be modified. This can cause some problems on vehicles requiring oil pan modifications.

We recommend the installation of a Gen III into the following vehicles: Jeep TJ, YJ, and CJ7 (CJs may be required to use a header system), Toyota Land Cruiser, full size Chevys, and any other vehicle with a minimum of a 25" inside frame width.

Transmission Combinations: The Gen III engines have the same block bolt pattern as the early GM with the exception of one bolt hole. When bolting an earlier GM transmission or one of our bellhousings to the Gen III block, you will only be able to use 5 bolts on some bellhousing kits. The Gen III engine used a different crank stickout from the back of the block and a different crank bolt pattern. This means the early style flywheels and flexplates will not bolt to the new Gen III blocks. The stock flywheels and flexplates from the Gen III blocks are also unique with regard to the clutch bolt pattern and the torque converter bolt pattern. We have designed two kits for either a manual transmission or an automatic.

There are some Gen III blocks that do not have the recessed crank. This kit will not work on these blocks. One block that we know of is the 6.0L with cast iron heads and the 4.8 engines coupled only to a stock manual transmission in 1999 to 2003. A custom flywheel would have to be made to work on these block, [P/N CF720000](#).

The kit designed to fit a manual transmission is [P/N 712500M](#). This kit includes a flywheel, flywheel bolts, 11" Luk pressure plate & disc, bolts for the pressure plate, pilot bushing spacer, release bearing, and metric bolts & washers for the bellhousing. [P/N 712500M-CF](#) is for the Centerforce version clutch assy. Both kits work with our bellhousing kits P/N 712525, 712548, 712549, 712567V, 712576, 712577, and 712591V. A special starter, [P/N 22-0002](#), is required if using bellhousings 712567V and 712591V.

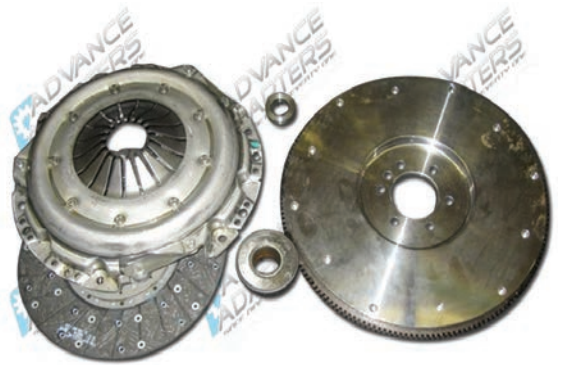

The kit designed to fit the TH350 or 700R automatic transmission is [P/N 712500A](#); and for the TH400 transmission [Part No. 712500A4](#). These kits include a modified flexplate (drilled for an early GM torque converter), flexplate bolts, crank spacer bushing. Transmissions such as the 700R4 will require a TV cable kit, [P/N 718000](#). Transmissions like the TH350 and TH400 will require a Lokar kickdown cable.

Exhaust: The truck manifolds fit the majority of applications with the exception of the Jeep CJ. The Jeep CJ can use a 2010 & newer Camaro manifold or exhaust headers that we manufacture. On our NV4500 bellhousing kits, the truck manifolds also have some clearance issues with the slave cylinder. We sell a slave cylinder bracket for a NV4500 and Gen III engine application.

- [P/N 717040-NP](#) Jeep CJ Gen III Fenderwell Header
- [P/N 717043-NP](#) Gen III Center Dump Header
- [P/N 716286](#) Slave Cyl. Brkt. (NV4500 w/ truck manifolds)

Vacuum Lines: You will notice that the Gen III block has no provision for vacuum lines. There is a small port on the back of the intake manifold that can be used. First, pull out the black plug on the intake manifold by holding pressure on the gray ring. Once the plug is out, drill and tap the black plug for a 1/8" pipe thread. Use a 90 degree 1/8" pipe by 3/8" barb adapter and thread it into the tapped plug. Press the plug back into the manifold and attach the hose.

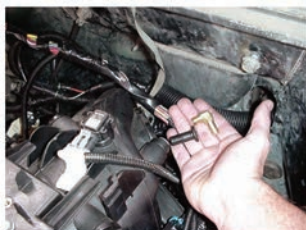

* When we refer to Gen III we are also including the Gen IV.



Radiators: The Gen III requires a steam release port which is a standard feature on our radiators indicated with part numbers ending with a “-LS”. The Gen III also require smaller water inlets and outlets on the radiators. A 50/50 mixture of Dex-cool and water is recommended for the Gen III engines.

Fan: We recommend using an electric fan in most installations. Our Spal fans allow for ample clearance in the engine compartment providing for good air circulation. We offer a Spal fan kit (to fit our radiator) under [P/N 716670](#). This fan is rated at 2070 CFM.

Wiring: Installing the Gen III is fairly simple; however, depending on the year of the vehicle, coupling to the stock gauges may require a vehicle service manual. For example, on a Jeep TJ we retained the stock Jeep sending units and attached them to the GM block (oil pressure, temperature, and fuel level). All of them work fine except the tachometer (in which we installed an aftermarket one). Since we used the stock sending units and because the Jeep TJ had a computer controlled stock engine, the Jeep computer thinks that the original engine is still sending information. Vehicles that were not originally computer controlled may just need new dash gauges coupled to the Gen III sending units.

Throttle Linkage: The throttle cable that comes on most Gen III engines has a standard cable connection which can be fitted to most gas pedals. A new, larger access hole may need to be drilled in the firewall where the stock cable was originally located.

Fuel: The Gen. III fuel rails have anywhere between 50-60 pounds of fuel pressure! *Only approved high pressure hose and fittings should be used.* The Gen III engines need a minimum diameter of 3/8” line on the pressure side, and a minimum of 5/16” on the return side (3/8” is best for the return line).

Depending on the year, model, and make of your vehicle, you will need to find out what type of fuel delivery system your vehicle was equipped with and what type of pressure it was running. For example, a Jeep TJ used a fuel pump that was internally regulated in the fuel tank at 46 psi. Since the Jeep regulated the pressure at the tank, it did not run a return fuel line. On this installation, we opted to run two new 3/8” lines; one pressure and one return. The pressure line needed to be installed by drilling and installing a bulkhead-type “AN” fitting alongside the stock Jeep pump assembly. A fuel tank pickup also had to be installed. The old “pressure” line out of the Jeep tank was used as a return line from the Gen III. To use this connection, we had to remove the stock internal regulator. This is just an example of one application we encountered.

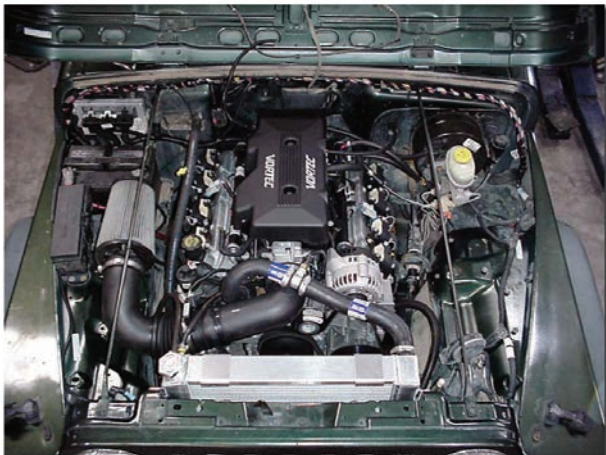

Crank stickout is almost flush with the back of the block

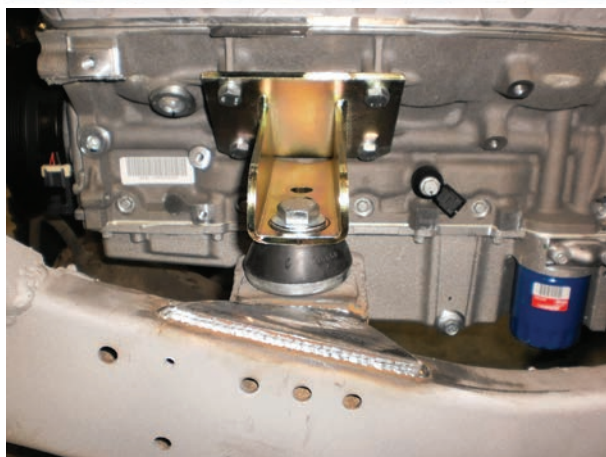

CUMMINS™ 2.8L TURBO DIESEL ENGINE SWAPS



For years we have been asked to offer a diesel engine swap and for years we had been looking for the perfect candidate. We have worked with some imported engines and the 4BT and 6BT Cummins™; however, the imports were not D.O.T. approved and the 4BT or 6BT were just hard to get and just too large for most applications. Well, our patience paid off. Earlier this year (2016), we were contacted by one of the magazine editors along with a representative from Cummins™. They were looking for help on a conversion project for a new diesel that has been used overseas for several years but is now being certified to be run here in the states. The new "2.8L Turbo Diesel" is approximately 500 pounds, has a torque rating of 270 lb.-ft. @ 1800RPM and 161 H.P. @ 3600. The Diesel is a turbo-charged intercooled common rail engine that you can get more low end torque which helps with driveability all the while vastly improving fuel economy.

Adapting to the Cummins™ The adapters we offer come with a new Cummins ring gear and flex plate for the starter and adapter plate and crank adapter for coupling to the new transmission. The adapter kits do require the use of the stock transmissions flex plate or flywheel.

- P/N 712593-A** - CUMMINS 2.8L TO JEEP 6CYL. DRIVETRAIN
- P/N 712594-A** - CUMMINS 2.8L TO GM LS (GEN III & IV) TRANSMISSIONS
- P/N 712595-A** - CUMMINS 2.8L TO Rover LT77, LT77S & R380 U.S. transmissions

Note: Since the Cummins has an electronic throttle, the GM automatic transmissions should only be electronically shifted.

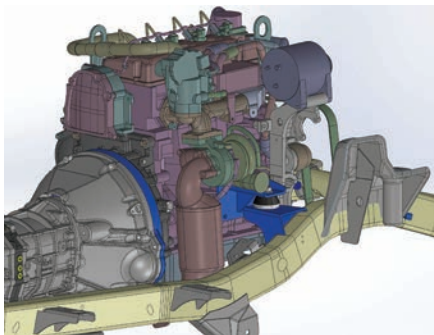
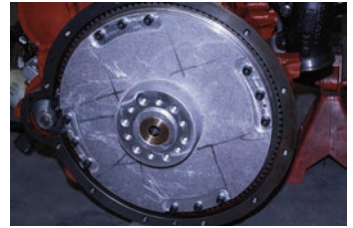

Along with the adapter we designed for this project we also designed a weld-in set of motor mounts. These were specific for the Jeep TJ and our design set the engine in the perfect location. No firewall modifications were needed and no body lift was required.

- P/N 713130** Jeep TJ motor mounts to Cummins™ 2.8L Turbo Diesel
- P/N 713131M** Block & Rubber motor mount to Cummins™ 2.8L Turbo Diesel

Note: Images shown are for marketing purposes only - actual product may vary.

GENERAL ENGINE INFORMATION

Being a manufacturer of engine and transmission conversion components, we receive numerous questions regarding engine specifications. We are not experts with the internal workings of these engines; however, we are very familiar with the bolt patterns, motor mounts, flywheels, etc. This section is intended to help identify engine use and interchangeability.

CHEVY V8: When it comes to bellhousing bolt patterns, the small & big block Chevys are the same. (This is known as the 90 degree bolt pattern). These engines use a dowel pin alignment. The stock starter bolts to the bottom of the block except on some early blocks like the 265. (**Note: These early blocks, in which the starter bolts to the bellhousing, should not be used for conversions**). The flywheel can either be 153 tooth measuring 12-3/4" in diameter, or 168 tooth measuring 14" in diameter. The 1985 & earlier flywheels are not interchangeable with the 1986 & later flywheels due to a change on the flywheel crank bolt pattern and balancing. GM used two different starter bolt patterns on the bottom of the block. The straight bolt pattern is normally used with the 153T flywheel, and the offset or staggered starter bolt pattern is normally used with the 168T flywheel. Many Chevy blocks today offer both starter bolt patterns on the block. Some of our conversion bellhousings may require you to grind on the bellhousing a bit to fit the stock starter nose cone or purchase a hi-torque starter which does not have a nose cone.

The oil pans on Chevy blocks have gone through a few changes. 1985 & earlier blocks are all the same except the dipstick access is either on the driver's side or passenger side. In 1986, GM changed their gasket design to a one piece rear main seal. The earlier style oil pans will not fit the newer blocks. The computer controlled blocks in the '90s added oil level sensors.

Most GM blocks used a triangular motor mount bolt pattern, however; GM switched to a square pattern on the LS1 and Gen. III V8 blocks. We offer a full selection of conversion mounts for all of these GM blocks. GM also changed the crank flange stickout location on the LS1 and Generation III V8 blocks. This crank is recessed .400" closer to the block. When these blocks are used in a conversion, the torque converter or clutch components will need to be adjusted. LT1, LT4, ZZ4, LS1, and Gen III blocks all use angle port heads which are not compatible with most of our header systems. We offer some specialized headers for these blocks. These blocks also require a steam release port on the radiator. The radiator we offer can be ordered with this steam release provision.

LAND ROVER TRANSFER CASE ADAPTERS:

Land Rover "Series" T-case

We offer 3 different adapters that couple the Land Rover "Series" transfer case to several different transmissions. The adapters are all the same in that they adapt the "Series" transfer case to a circular transmission bolt pattern. This circular pattern is what Jeep used beginning from 1980 to newer Jeep drivetrains. Being that we offer a full line of GM, Ford & Dodge transmission options for Jeeps, using the Jeep adapter with the new Land Rover adapter offers limitless choices. There are three Land Rover adapters because of the different transmission output spline options. The kits are as follows:

- P/N 50-9000** - 23 spline kit fits most stock Jeep transmissions as well as and transmissions we offer Jeep transfer case adapters for. For transmissions like the Ford T18 & NP435, you will need to purchase a Jeep adapter also.
- P/N 50-9001** - Fits only the Dodge NV4500 transmission with a 29 spline output shaft.
- P/N 50-9002** - Fits only the SM465 10 spline transmission.

These adapters have been designed for the series I,II,IIA,IIB and III transfer cases, including both the rare 1 ton and the aftermarket overdriven versions. Essentially, this adapter is installed on the front side of the "series" transfer case. This adapter is used in conjunction with one of our Dana 300 adapters or a stock tailhousing. The adapter is constructed of 356-T6 heat-treated aluminum alloy. The spud shaft is a precision machined shaft made of 8620 material. The spud shaft is supported by two large ball bearings and has an external seal. By manufacturing the adapter this way the shaft is supported very well. The adapter has provisions to cover the relocated idler pin in the overdrive, aftermarket version. The stock drive gear train is retained and reused in the transfer case. The front side if the adapter is modeled after the Atlas and Dana 300 transfer case. The mounting surface is a circular six with multiple rotation options. This allows the installer to fine tune the installation of the replacement transmission and engine combination. The adapter is 1.750" thick.

Chassis modifications:

The battery tray structure will have to be removed to allow the fitment of a "V" type engine. The original motor mounts need to be cut off the frame. The front cross member will require a notch or scallop made for front driveshaft clearance, similar to the military LWB. On some series I,II,IIA, it is advisable to remove the web on the front crossmember. The web is on the driver's side (LHD). This provides clearance for the exhaust to pass over the crossmember and down the inside of the chassis. The transmission crossmember will also need modifying. Depending upon your mounting method, you can retain the crossmember if mounting from the transfer case using the original studs. It may need to be moved on the chassis depending upon engine placement. If using the mounting surface provided on our adapters, a new crossmember will need to be fabricated. The park brake bell crank will also have to be modified to maintain the correct geometry to operate well. The cross shaft may also need to be modified due to the height of engine placement. On LWB models, the crossmember behind the transfer case (where the original driveline passed through) will need to be removed and replaced with a section of rectangular tubing similar to the removable crossmember of a Discovery or a Range Rover.

Necessary sheet metal modifications:

To maintain the original external appearance of the vehicle and allow for ample cooling capacity, the "breakfast" or headlight panel will need to be modified. The original radiator will not be adequate to keep the replacement engine cool. To make room for a larger radiator, the original radiator support structure needs to be removed. The original radiator overhangs past the first crossmember. The panel is easily modified by drilling through the spot welds and gently levering the two pieces apart. The latch is no longer used. You will need to purchase military hood latches. This provides the space for a radiator on top of the first crossmember. It is advisable to convert to power steering. When converting to power steering, the steering relay is removed allowing greater room for a new radiator. To provide room for a "v" type of engine and maintain the original look of the vehicle, it is also necessary to widen the firewall or "bulkhead" to accept the wider engine. This is easily done by drilling out the spot-welds that hold the center panel to the foot well. Remove the panels individually and save them for reuse. Now, drill out the spot-welds out of the inner kick panel. The goal is to match the foot well dimensions to the driver's side (LHD), essentially creating a large factory appearing opening. Fabricate a new center panel, keeping in mind the bellhousing size, engine, transmission and placement.

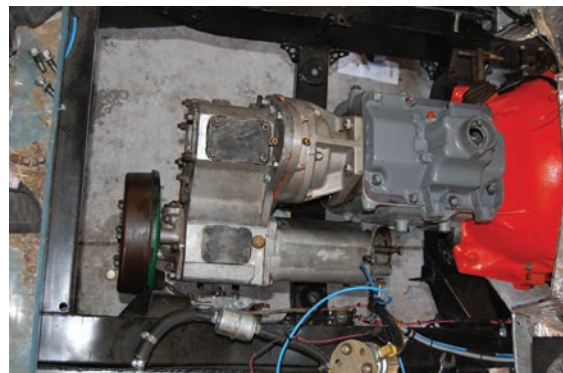
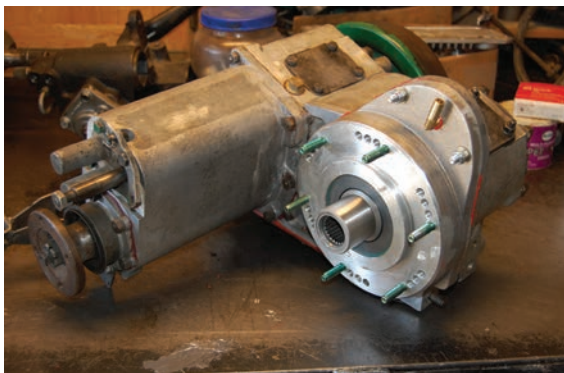

MOSES LUDEL OWNERS BIBLES:

The Owners Bibles are a great addition in educating yourself regarding your vehicle. These books are a hands-on guide to getting the most from your vehicle by providing information on high-performance modifications, accessories, vehicle history, and tips you should know when buying a new or used vehicle - just a few of the many topics covered by the well known technical writer Moses Ludel.

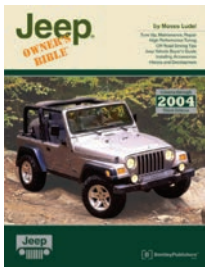

Part # **JOB**



Part # **COB**

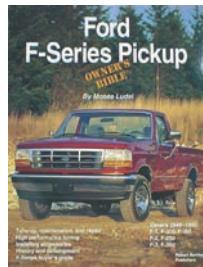

Part # **FOB**



Part# **TLCB**

Owners Bibles & Rebuilder's Manuals are priced at **\$39.95**

Moses Ludel Rebuilder's Manuals: Is it time to rebuild your Jeep axles or install a locking differential? Does your CJ need a frame-off restoration? Between the covers of these two volumes you'll find the unit repair and overhaul steps for complete Jeep CJ rebuilding.

Having talked with hundreds of enthusiasts, Moses Ludel discovered that hobbyists & professional Jeep mechanics alike want heavily illustrated, step-by-step 'how-to' manuals. In each volume, Moses photographs each step in the process. From disassembly of each powertrain, geartrain, and axle component to rebuilding & upgrading - every step is thoroughly explained.



Part # **CJ46-71**

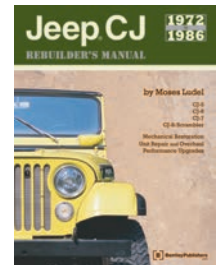

Part # **CJ72-86**

LOKAR PERFORMANCE PRODUCTS & MISC. COMPONENTS:

Lokar is a manufacturer of accessory components such as flexible dipsticks for engines and transmissions, universal cable throttles, kickdown cables, and a neutral safety backup switch.

FLEXIBLE ENGINE DIPSTICKS: These slim designed, flexible dipsticks are great for engine conversions with little to no room to spare.

- P/N 23-0005** - Small block Chevy Passenger side (1980 & up)
- P/N 23-0006** - Small block Chevy Driver's side (1979 & earlier)
- P/N 23-0007** - Ford 302 small block engine
- P/N 23-0009** - Flexible engine dipstick LS1

FLEXIBLE TRANSMISSION DIPSTICKS: These flexible dipsticks work ideally with many of the different transmission conversions we offer. This teflon-lined, braided stainless transmission dipstick easily mounts to the firewall or the transmission.

- P/N 23-0001** - All TH350 & TH400 transmissions
- P/N 23-0002** - All 700R transmissions
- P/N 23-0003** - All C4 transmissions
- P/N 23-0004** - Hi-Tech Dipstick transmission mounted 4L60E
- P/N 23-0004A** - Dipstick flexible 4L80E

UNIVERSAL CABLE THROTTLES: The throttle cable linkages adapt to factory and aftermarket pedals. These cut-to-fit assemblies work great with most conversions.

- P/N 23-0010** - 24" SS Hi-Tech throttle cable
- P/N 23-0011** - 24" Universal black throttle cable
- P/N 23-0011-36** - 36" Universal black throttle cable
- P/N 23-0012** - Tuned Port SS throttle cable 24"
- P/N 23-0012-LS1** - Tuned Port LS1 throttle cable 36"
- P/N 23-0012-TP1** - Tuned Port VORTEC throttle cable 36"
- P/N 23-0015** - Stainless Steel Carburetor bracket

We have additional Lokar products listed on-line

KICKDOWN CABLES: An adjustable kickdown with stainless mounting bracket.

- | | | | |
|----------------------|------------------------|-----------------------|--------------------------|
| P/N 23-0017 - | Cable KIT TH350 | P/N 23-0017A - | Hardware kit for 23-0017 |
| P/N 23-0018 - | GM TH350 Hi-Tech | P/N 23-0019 - | GM 700R Hi-Tech |
| P/N 23-0022 - | Ford C6 Hi-Tech | P/N 23-0023 - | Chrysler 727 Hi-Tech |
| P/N 23-0024 - | Chrysler 904 universal | P/N 23-0025 - | Chrysler 727 universal |

T.V. CABLES 700R/4L60: When installing a 700R or 4L60, a T.V. cable is necessary for the transmission to work correctly. Vehicles driven without the proper cabling will cause severe transmission damage. We carry a T.V. cable and bracketry for the 700R/4L60 transmission to the Vortec Gen. III engines under **P/N 718000**.

GAS PEDAL: This large gas pedal is spring loaded like an OEM pedal. **P/N 23-0013**

LOKAR AUTOMATIC SHIFTERS: Lokar shifters are completely adjustable so you can mount them in a number of locations front-to-rear. The shifter bolts directly to the top of your transmission. They come complete with a 12" handle, and brushed aluminum mushroom knob.



- | | |
|-----------------------|-------------------------|
| P/N 23-T350 - | TH350 automatic shifter |
| P/N 23-T400 - | TH400 automatic shifter |
| P/N 23-R700 - | 700R automatic shifter |
| P/N 23-4L60 - | 4 bolt 4L60E shifter |
| P/N 23-4L60E - | 6 bolt 4L60E shifter |
| P/N 23-4L80E - | 4L80E shifter |



B & M SPORT SHIFTER: This sport shifter fits the GM TH350, 700R, TH400, 4L60, 4L60E, 4L80E and Ford C4 & C6 transmissions. This is a console mounted, cable-operated shifter that works well for most conversions using automatics. **P/N 715680**



GATED SHIFTER: This cable shifter is ideal for rock crawling rigs. These shifters fit the GM TH350, 700R, TH400, Powerglides, Ford C4, C6 & AOD transmissions. They are a console mounted shifter that works well for most applications.

- | | |
|-------------------------|-----------------------------|
| P/N 715681-TH350 | P/N 715681-700R |
| P/N 715681-TH400 | P/N 715681-PG |
| P/N 715681-C4 | P/N 715681-C6 |
| P/N 715681-AOD | P/N 715681-TF904/999 |
| P/N 715682-4L80E | P/N 715681-4L60E |

REVERSE GATED SHIFTER: We also offer a complete line of reverse gated shifters. These are perfect for rigs that have had their transmission built with a reverse valve body. The part numbers are **715682**-(Transmission type). Check out the complete list of these products on-line.

700R LOCK UP: Now you can control the lock-up function on your 700R4 overdrive transmission with your carbureted engine without having to buy expensive computer controlled equipment. A vacuum controlled switch and a 4th gear pressure switch controls the torque converter lock up solenoid. The kit comes complete with everything to complete the installation and fits any 700R4 GM transmission. The Painless Performance Products kit includes: Vacuum switch, 4th gear pressure switch, Brake switch, Torque converter lock-up solenoid, Wire harness, New transmission pan gasket and mounting hardware. **P/N 24-700R**

HIGH TORQUE STARTERS: We offer mini-high torque starters.

- | | |
|----------------------|---|
| P/N 22-0001 - | 168 Tooth V6 & V8 High Torque Starter (<i>staggered bolt pattern blocks only</i>) |
| P/N 22-0002 - | Vortec Gen. III High Torque Starter |

These starters fit either the staggered bolt pattern of the Chevy V6 & V8 engines with a 168 tooth flywheel or the new Vortec Gen. III engines. These starters offer the highest torque at 200 ft.-lbs. Features include: No heat soak problems, clears all headers, they're a billet aluminum adapter block, a 4.4:1 gear reduction ratio, cranking power for up to 18:1 compression, and includes new mounting bolts.

We also offer a universal straight bolt pattern starter. **P/N 22-0003** fits either the 153 tooth or the 168 tooth flywheels. This starter only fits GM blocks that have the straight bolt pattern option on the block. This starter features a 3.7:1 gear reduction. It does not work with oversized kickout oil pans.

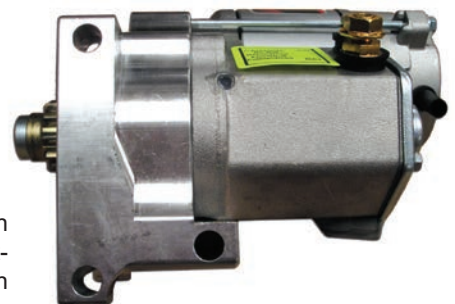

VEHICLE SPEED SENSOR INFORMATION

Computer Controlled engines and/or transmissions require a Vehicle Speed Sensor (VSS). Although there are a couple of different styles of sensors, they all perform the same type of purpose - to tell the computer (or PCM) how fast the vehicle is traveling. Using this data, the computer can determine how to adjust for freeway driving, fuel economy, transmission shift points (automatic only), and how to get the best performance at any given moment. Power and fuel economy will be lost if the VSS is not functioning properly. Different styles of VSS are shown below.

Application	Signal type	Pulse count per driveshaft revolution	Mechanical Speedometer driven signal available
1986-1992 GM TBI engines 1985-1989 GM TPI engines	Square wave signal - two wire sensor "Pulse Generation"	2	Yes
GM trucks (1993-current)	Sine wave signal - two wire sensor "Voltage Generation"	40	No See voltage generation chart
Jeep (1987-current)	Square wave signal - three wire sensor "Pulse Generation"	3	Yes

As can be seen above, some Vehicle Speed Sensor signals can be created from a standard mechanically driven speedometer. These drivetrains are much easier for swapping because it allows the use of almost any transmission or transfer case combination.

For the 40 pulse GM VSS, there are much fewer options. Please refer to the flowchart below to determine the correct location for the GM 40 pulse VSS in your application.

We do not offer any type of mechanical speedometer driven VSS units; however, these types of units (pulse generation / square wave) are available from most companies that supply engine wiring harnesses or custom speedometer shops such as Nevada Speedometer, Tel# (775) 358-7422.



LATE MODEL GM ENGINE VOLTAGE GENERATION

GM 40 pulse Vehicle Speed Sensor - Proper Location Flowchart:

Computer Controlled GM engine with a computer controlled automatic transmission.	Computer Controlled GM engine with non computer controlled automatic or manual transmission.	Computer Controlled GM engine & drivetrain in a GM 4WD vehicle (Atlas T/C install)
Transmission Output VSS	VSS is needed, but location is not critical	Transfer case tailhousing VSS
<p>Transmission:</p> <p>700R/4L60 - See the adapters listed under 700R/4L60 in your specific vehicle year.</p> <p>Early 4L60E - All vehicles can use Part No. 716073. For Jeeps and Toyota Land Cruisers, you can also use the adapters listed under the 700R/4L60.</p> <p>Late 4L60E - See the adapters listed under 4L60E in your specific vehicle year.</p> <p>4L80E - Most early transmissions have an internal tone ring for VSS. The 1997 & later 4WD transmission did not. If you are using a 1997 & later transmission, you need to install a tone ring. On later model transmissions coupled to an Atlas, we offer kit 50-6409 which will provide a rear reluctor ring.</p>	<p>The VSS can be in the transmission or transfer case and still function properly. We offer a reluctor kit that fits on all of our tailhousing kits for the Jeeps. This kit is an external mounted unit that provides a Tru 40 Pulse required for the computer system. The reluctor ring gets mounted to the transfer case yoke. The kit is offered in several yoke styles except a flange yoke. Our Tru-Pulse kit fits the Dana 20, 300, NP, and Atlas transfer cases with 32 spline outputs.</p> <p>P/N 50-5040 is a 1310 non C.V. P/N 50-5041 is a 1310 C.V. P/N 50-5042 is a 1350 non C.V. P/N 50-5043 is a 1410 non C.V.</p>	<p>Atlas transfer case Kit #AVT32L provide a VSS tailhousing with the provision for a low-range switch. (See the Tech Vault for more info.). If the Atlas T/C is not being used, then a GM transfer case that came behind the donor engine can be used. All other transfer cases will require a custom fabricated VSS.</p>
		<p>P/N 716073 fits in the main case of a 4L60E transmission and provides a voltage signal.</p>

DRIVETRAIN YOKES:

10 SPLINE x 1.125"

P/N 716407 - 1100 & 1210 (U-Bolt) Fits Dana 18 T/C front output shaft

P/N 716298 - 1310 (C.V.) Fits Dana 18/20 in both Jeep and Bronco transfer cases

26 SPLINE X 1.146"

P/N 300477 - 1310 (U-Bolt) Fits Dana 300 front & rear, Dana 20 T/C w/ fine spline, Jeep NP231 front output & Dana 35 & 44 axles with a 26 Spline pinion shaft

P/N 300481 - 1310 (C.V.) Fits Dana 300 front & rear, Dana 20 T/C w/ fine spline & Jeep NP231 front output

32 SPLINE X 1.401" -----Fits NP203/205 with 32 splines

P/N 716295 - 1310 (U-Bolt)

P/N 300484 - 1310 (Strap)

P/N 300475 - 1310 (C.V.)

P/N 300369 - 1330 (C.V.)

P/N 300472 - 1350 (U-Bolt)

P/N 300485 - 1350 (C.V.)

P/N 300483 - 1410 (Strap)

P/N 300488 - 1410 (U-Bolt)

P/N 300470 - 1310-1350 Series Flange (2" male index)

P/N 300468 - 1350 Series Flange holes drilled out (2" male index)

P/N 300471S - 1350-1410 Non C.V. Flange (2.75" female index)

P/N 300450 - 1350-1410 C.V. Flange (3.125" male index)

P/N 716294 - 1480 Flange (3.75" female index)

P/N 300465 - TOYOTA Flange

P/N 300466 - DIN120 Flange

P/N 300467 - DIN150 Flange

P/N 300486 - NISSAN PATROL Flange

DANA 60 PINION YOKES

P/N 716291 - 1310 Series 29 spline yoke

P/N X11385 - *1310 yoke kit

P/N 716293 - 1350 Series 29 spline yoke

P/N X11390 - *1350 yoke kit

*includes yoke, seal, washer, nut & u-bolts

GM 14-BOLT CORP. 30 SPLINE

P/N 716299 - Chevy Corp. 1350 Series 30 spline yoke

X11394 - Full Floater kit (yoke, seal, washer, nut & u-bolt)

Jeep NP241 & Rocktrac Rear Yoke

P/N 29-2006 - 1350 Flange yoke

U-Bolts and Straps:

P/N X11340 - 1310/1330 U-Bolt kit

P/N X11341 - 1350/1410 U-Bolt kit

P/N X11342 - 1350/1410 Strap kit



*Ford NP205: The seal will need to be changed when using one of our yokes.
Non-C.V. & Flange yokes = National Seal# 473468
C.V. Yokes = C/R Seal# 18872 (A.A. P/N 716737)*



YOKE REMOVAL TRAIL TOOL:

For the quick and easy removal of differential pinion yokes or transfer case yoke, this is a trail tool and/or shop tool that makes it easy. Fits yoke types: 1310 Non-CV, 1310 CV, 1330 Non-CV, 1330 CV, 1350 Non-CV, 1350 CV, 1410, 1480, DIN 120, DIN 150, Toyota Truck & Land Rover.

P/N 716400 **\$54.20**



CONVERSION PACKAGES:

These are one part number items that offers you a complete package for some of the most popular conversion applications.

CJ 1980-86 T4/T5 V8 KITS

P/N CP-CJ001 (WELD IN)

P/N CP-CJ002 (BOLT IN)

INCLUDES: V8 MOUNTS, 712548, 716692-AA, 716311, 716679 & LC165552 (does not work with 4 cly applications)

CJ 1980-86 TH350 V8 KITS

P/N CP-CJA010 (2WD)

P/N CP-CJA011 (4WD)

INCLUDES: 713089, T/C ADAP., 716690-AA, 716021, 716679 & 23-1500

CJ 1980-86 TH400 V8 KITS

P/N CP-CJA012 (2WD)

P/N CP-CJA013 (4WD)

INCLUDES: 713089, T/C ADAP., 716690-AA, 716021, 716679 & 23-1500

CJ 80-86 700R/4L60 V8 KITS

P/N CP-CJA014 (2WD)

P/N CP-CJA015 (4WD)

INCLUDES: 713089, T/C ADAP., 716690-AA, 716021, 716679 & 23-1500

CJ 80-86 4L60E V8 KITS

P/N CP-CJA016 (SQ BOLT)

P/N CP-CJA017 (HEX BOLT)

INCLUDES: 713089, T/C ADAP., 716690-AA, 716021, 716679 & 23-1500

CJ 80-86 4L80E V8 KIT

P/N CP-CJA018 (2/4WD)

INCLUDES: 713089, T/C ADAP., 716690-AA, 716021, 716679 & 23-1500

YJ V8 KITS 10.5" FLYWHEEL

P/N CP-YJ001 (PEUGEOT 5SP)

P/N CP-YJ002 (AX15 5 SPEED)

P/N CP-YJ003 (AX5 5 SPEED)

INCLUDES: Bellhousing Adapter, 713001, 716779, 716693-AA & Clutch Assy. Kits 002 & 003 also supply 716130-60, 716130, 716130F, 716213 & N1430.

TJ V8 KITS 10.5" FLYWHEEL

P/N CP-TJ001 (NV3550 TRANS)

P/N CP-TJ002 (AX15 TRANS)

P/N CP-TJ003 (AX5 TRANS)

INCLUDES: Bellhousing Adapter, Motor Mounts, 715542, 716130-60, 716130TJ, 716213, 716679, 716693-AA, Clutch Assembly & Release Bearing

YJ V8 KITS 11" FLYWHEEL

P/N CP-YJ001A (PEUGEOT 5SP)

P/N CP-YJ002A (AX15 5 SPEED)

P/N CP-YJ003A (AX5 5 SPEED)

INCLUDES: Bellhousing Adapter, 713001, 716779, 716693-AA & Clutch Assy. Kits 002A & 003A also supply 716130-60, 716130, 716130F, 716213 & N1430.

TJ V8 KITS 11" FLYWHEEL

P/N CP-TJ001A (NV3550 TRANS)

P/N CP-TJ002A (AX15 TRANS)

P/N CP-TJ003A (AX5 TRANS)

INCLUDES: Bellhousing Adapter, Motor Mounts, 715542, 716130-60, 716130TJ, 716213, 716679, 716693-AA, Clutch Assembly & Release Bearing

YJ LS GEN III KIT

P/N CP-YJ002B (AX15 5 SPEED)

INCLUDES: 22-0002, 712500M, 712591V, 713088,, 716130-60, 716130, 716130F, 716213, 716779 & 716693-AA

TJ LS GEN III/IV KIT

P/N CP-TJ001B (NV3550 TRANS)

P/N CP-TJ002B (AX15 TRANS)

INCLUDES: 22-0002, 712500M, Bellhousing Adapter, 713093, 713093P, 715542, 716130-60, 716130TJ, 716213, 716679 & 716693-AA

APPAREL:

We are constantly updating and adding new apparel. Most items have an Advance Adapters or Atlas Transfer Case logo. We buy quality apparel products since they represent our name. Check out our new apparel online at www.advanceadapters.com under the Apparel Category.

Most apparel is stocked in sizes ranging from Medium to XXXL. The apparel size is included in the part numbers (XLG is used for Extra large).

P/N 716051HL-LOGO - Flexfit® Large AA logo hat

P/N 716051HL - Snap back logo hat

P/N 716051-45_ - 50th Anniversary logo T-shirts (indicate size)

Hooded Sweatshirts

P/N 716051SS-USA-____(indicate size)



4320 Aerotech Center Way
Paso Robles, CA 93446
800-350-2223 or 805-238-7000

www.advanceadapters.com