

ENGLISH



# WEIGHT TRANSMITTER T200F

with RS232 serial, analog 4-20 mA 0-10V

Fieldbus OPTION : MODBUS TCP, PROFINET, PROFIBUS, ETHERNET IP, CAN OPEN, ETHERCAT

## Installation and User Manual



Pesage, Dosage, Machine de Conditionnement

ADN Pesage: 7 Rue du bois Malhais, 78990 Saint Germain de la Grange France  
Tél.: 33(0) 1 48 63 00 76 - Télécopie: 33(0) 1 48 63 72 06 - Mail: [contact@adnpesage.fr](mailto:contact@adnpesage.fr)

## TABLE OF CONTENTS

PRECAUTIONS .....	Page	2
INTRODUCTION .....	Page	3
TECHNICAL FEATURES .....	Page	5
INSTALLATION .....	Page	6
FRONT PANEL OF THE INSTRUMENT .....	Page	14
USING THE KEYBOARD .....	Page	15
INFO DISPLAY .....	Page	18
OPERATING FUNCTIONS .....	Page	19
SETTING .....	Page	23
DIAGRAM OF THE MENU .....	Page	27
CONFIGURATION PARAMETERS .....	Page	28
CALIBRATION.....	Page	28
ANALOG PARAMETERS .....	Page	33
SERIAL PARAMETERS .....	Page	35
INPUT/OUTPUT PARAMETERS .....	Page	44
WEIGHING PARAMETERS .....	Page	48
FILTER - SETTING FILTER PARAMETERS .....	Page	50
SETTING FUNCTIONAL FEATURES .....	Page	52
SET DATE AND TIME .....	Page	55
UPLOAD/DOWNLOAD FUNCTION .....	Page	56
ACCESS VIEWING .....	Page	57
ALIBI MEMORY .....	Page	58
SERIAL COMMUNICATION PROTOCOLS .....	Page	59
FIELDBUS PROTOCOL .....	Page	71
TROUBLESHOOTING .....	Page	84

## PRECAUTIONS

READ this manual BEFORE operating or servicing the instrument.

FOLLOW these instructions carefully.

KEEP this manual for future use.



### WARNING

The purpose of this manual is to provide the operator with explanatory text and figures, the requirements and basic criteria for the installation and correct use of the instrument.

The installation, maintenance and repair should only be carried out by specialised personnel who have read and understood this manual. "Specialised personnel" means personnel who, because of their training and professional experience have been expressly authorised by the plant Safety Officer to carry out the installation.

Power the instrument with a voltage whose value is within the limits specified in the specifications.

The user is responsible for ensuring that the installation complies with the provisions in force.

Any attempt to dismantle or modify the instrument which is not expressly authorised will invalidate the warranty and will relieve ADN Pesage from all liability.

Installation and maintenance of this instrument must be entrusted to qualified personnel only.

Be careful when performing inspections, tests and adjustments with the instrument on.

Perform the electrical connections with the instrument unplugged from the mains

Failure to observe these precautions may be dangerous.

DO NOT allow untrained personnel to work, clean, inspect, repair or alter this instrument.

## INTRODUCTION

The T200F is a weight transmitter to be combined with the load cells to detect the weight in every situation.

The module is easy to install and must be mounted on a 35 mm DIN rail or OMEGA bar. The weight, the status of the instrument, the setting parameters and any errors are all clearly shown on the display.

The 4 capacitive keys below the display permit easy use of these functions: ZERO-SETTING, TARE, GROSS/NET switching, setting of the weight set-points, configuration, and both theoretical and real calibration.

The T200F uses the RS232 serial port with ASCII protocols, in order to be connected to a PC, PLC and remote units with a maximum distance of 15m, above which you must use the serial port RS422/RS485 which also allows connection with the MODBUS RTU protocol up to 32 addressable instruments.

Availability of the most widespread fieldbuses, as an alternative to port RS485, also makes it possible to interface the transmitter with any supervision device currently offered by the market.

There is also a USB 2.0 port for easy interfacing with the PC via a utility software which can be provided with it.

They are always 2 programmable weight set-points and control of the maximum weight value reached (peak).

In addition you can have the analog output in current or voltage even with a FIELDBUS.

Available versions:

- **T200F:** weight transmitter with RS232 serial output, USB, RS485 and peak function. Supported protocols are Modbus RTU, continuous, slave and on demand. Two programmable set points, 2 inputs and Peak function.
- **T200F/A:** version with the analog output.
- **T200F/PROFINET:** weight transmitter with RS232 serial output, USB and PROFINET.
- **T200F/ETHERNET IP:** weight transmitter with serial output RS232 and ETHERNET IP.
- **T200F/ETHERCAT:** weight transmitter with serial output RS232 and ETHERCAT.
- **T200F/ETHERNET :** weight transmitter with serial output RS232 and ETHERNET.
- **T200F/PROFIBUS:** weight transmitter with serial output RS232 and PROFIBUS.
- **T200F/CANOPEN :** weight transmitter with serial output RS232 and CANOPEN.

## IDENTIFICATION PLATE OF THE INSTRUMENT

Always cite this data when requesting information or instructions concerning the instrument, as well as the program number and version that are shown on the cover of the manual and on the display when the instrument is switched on.

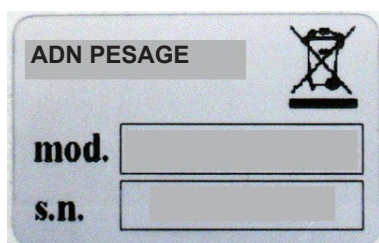

### WARNINGS

The following procedures must be entrusted to qualified personnel.

All connections must be made with the instrument turned off.

## TECHNICAL FEATURES

Power supply	12 ÷ 24 Vdc ± 15 %
Max. absorption	5 W
Isolation	Class II
Installation category	Cat. II
Operating temperature	-10°C ÷ +50°C (max humidity 85% without condensate)
Storage temperature	-20°C ÷ +70°C
Weight display	6 digit 7-segment red LEDs (h 14 mm)
Led	4 3mm indicator LEDs
Keyboard	4 capacitive keys
Overall dimensions	106 mm x 63 mm x 110 mm (l x h x d)
Assembly	On support for DIN profile or OMEGA bar
Container material	Self-extinguishing Noryl (UL 94 V1)
Connections	Removable terminal boards pitch 5.08.
Load cells power supply	5 Vcc/120 mA (max 8 cells x 350Ω in parallel) short-circuit protected
Input sensitivity	0.02 µV min.
Linearity	< 0.01% of full scale
Temperature drift	< 0.001% of full scale / C°
Internal resolution	24 bit
Displayed weight resolution	Up to 999,999 divisions on useful capacity
Measuring range	From -3,9 mV/V to +3,9 mV/V
Weight acquisition frequency	12 Hz - 1000 Hz
Digital filter	Selectable 0,5 ÷50 Hz (up to 1000 Hz in manual)
Weight decimal number	from 0 to 4 decimal digits
Zero calibration and full scale	Automatic (theoretical) or executable from the keyboard.
Logic outputs	2 optoinsulated (free contact) max 24Vdc / 100 mA ea.
Logic inputs	2 optoinsulated 24 Vdc PNP (external power supply)
Serial port (n° 2)	RS232C and RS422/485
Maximum cable length	15m (RS232C) and 1000m (RS422 and RS485)
Serial protocols	ASCII, Modbus RTU
Baud rate	1200, 2400, 4800, 9600, 19200, 38400, 57600, 115200 selectable
USB port device:	complies with USB 2.0; up to 12 Mbps speed
Analogue output (optional)	optoinsulated 16 Bit Voltage: 0÷5/10 V (R min10 K Ohm), Current: 0/4÷20 mA (R max 300 Ohm)
Analogue output calibration	From keyboard
Linearity	< 0,02% FS
Thermal drift	0,001% FS / °C
Microcontroller:	ARM Cortex M0+ to 32 bit, 256KB Flash reprogrammable on-board by USB.
Data storage	64 Kbytes expandable up to 1024 Kbytes
Fieldbus (alternative to RS485)	PROFINET, ETHERNET IP, ETHERCAT, ETHERNET, PROFIBUS, CANOPEN
Regulatory Compliance	EN61000-6-2, EN61000-6-3 , EN61010-1 EN45501

## INSTALLATION

### GENERAL DATA

The T200F comprises a motherboard, to which various options can be added; the motherboard is housed in a plastic 35mm DIN rail mount enclosure.



The T200F should not be immersed in water, subjected to jets of water, and cleaned or washed with solvents.

Do not expose to heat or direct sunlight.

Do not install the instrument near power equipment (motors, inverters, contactors, etc.) or anyhow equipment that does not comply with CE standards for electromagnetic compatibility.

The connection cable for the load cells must have a maximum length of 140m/mm<sup>2</sup>.

The RS232 serial line must have a maximum length of 15 meters (standard EIA RS-232-C).

The recommendations given for connecting the individual devices must be adhered to.

### OVERALL DIMENSIONS

#### ELECTRICAL INSTALLATION

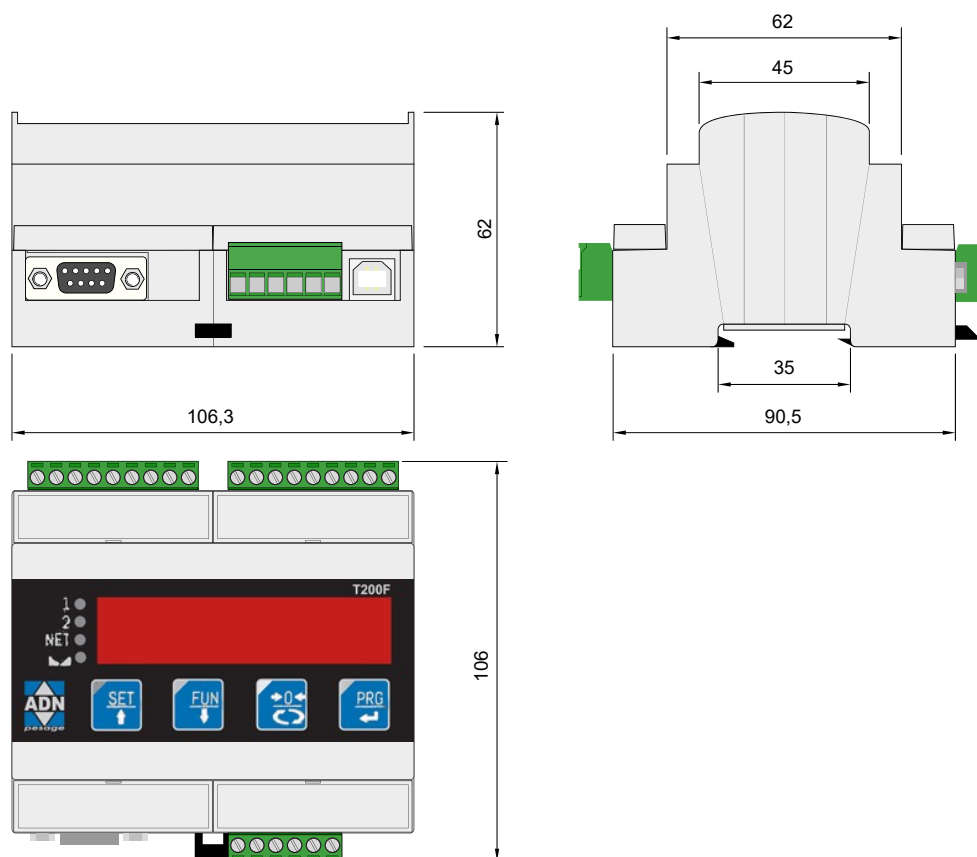

The transmitter T200F uses removable screw terminal boards with a pitch of 5.08 mm, for electrical connection. The load cell cable must be shielded and channelled away from power cables to prevent electromagnetic interference.

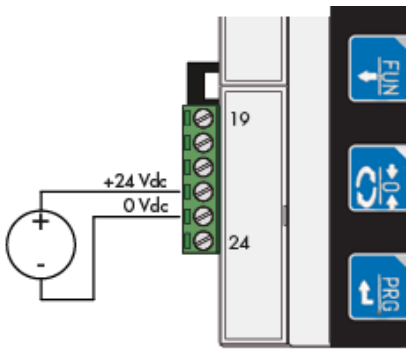

The instrument is powered via terminals 22 and 23. The power cord must be channelled separately from the other cables.

The instrument is in insulation class II (double insulation) and there is no ground terminal provided, which is however necessary to

Make sure you have a valid ground connection.

Power supply voltage:  $12 \div 24 \text{ Vcc} \pm 15\%$ , max 5W

### LOAD CELL(S) CONNECTIONS

The cable of the cell(s) must be channelled separately, and not with

A maximum of 8 load cells of 350 ohm can be connected to the instrument in parallel. The supply voltage of the cells is 5 Vdc and has temporary short circuit protection.

The measuring range of the instrument permits the use of load cells with a sensitivity of up to 3.9 mV/V.

The cable of the load cells must be connected to terminals 11-18.

In the case of a 4-wire load cell cable, jumper the terminals 11 to

Connect the cell cable shield to terminal 10.

In the case of two or more load cells, use special junctionboxes (CEM4/C or CSG4/C). The connection of these is shown below.

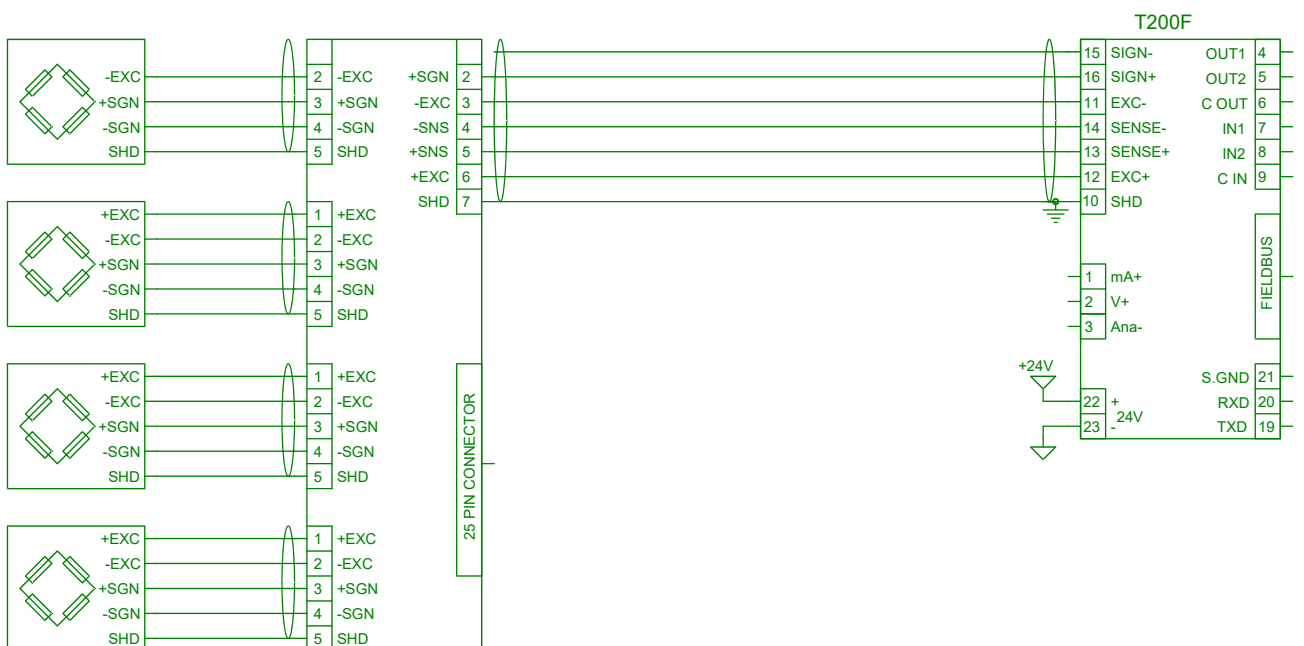
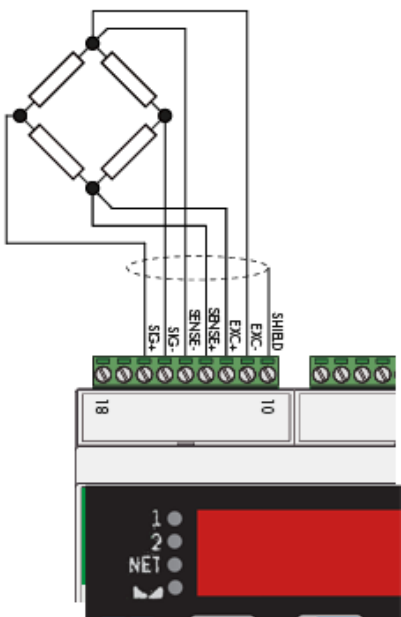



### LOGIC INPUTS

The two logic inputs are opto-isolated.



The cable connected to the logic input should not be channelled with the power cables.

Minimise the length of the connecting cables.

The function of the two inputs is selectable from Set-up:

The two functions are activated by connecting the 24 Vdc external power supply to the relative terminals as shown in the figure.

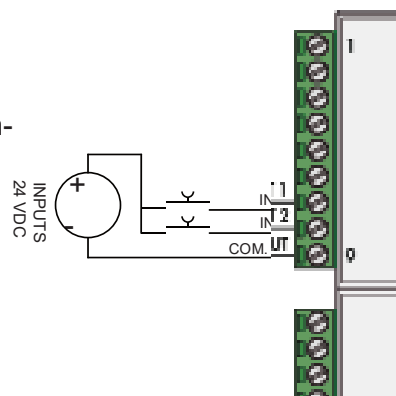

### LOGIC OUTPUTS

The two opto-isolated relay outputs are of the type with normally open contacts.



The capacity of each contact is 24 Vdc, 100 mA max. The output connection cable does not have to be channelled with power cables. The connection should be as short as possible.

The environment where the equipment is installed can normally be subject to strong magnetic fields and electrical disturbances caused by the machinery present, therefore it is advisable to adopt the normal precautions in order to prevent them affecting the typical signals of an electronic precision apparatus. (filters on the remote control switches, diodes on the 24 VDC relays, etc.)

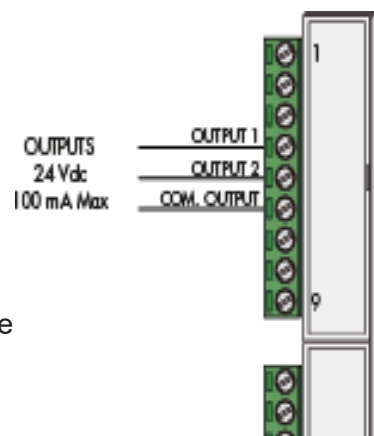

### SERIAL COMMUNICATION

#### RS232:

The RS232 serial port is normally used for connections to PCs, printers and repeaters.

To make the serial connection, use a suitable shielded cable, making sure to ground the shield to just one of the two ends.



The cable must not be channelled with power cables; the maximum length is 15 metres (EIA RS-232-C). In the case of a longer cable, use of the optional RS485 interface is required.

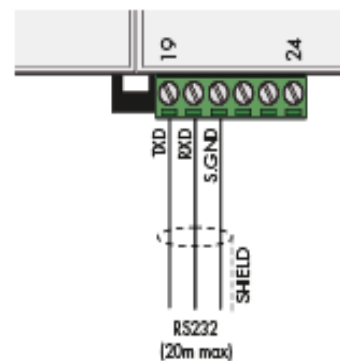

#### RS485:

The RS485 serial connection is of the 2-wire type, and allows you to connect up to 32 instruments to a single MASTER unit (PC, PLC etc.) by means of a shielded twisted cable, making sure to connect the shield to the ground of one of the two ends.

The cable should not be ducted with power cables.



NOTE: Links 6-7 and 4-9 are made within the instrument (are used only for compatibility with the cables of the DAT 400).

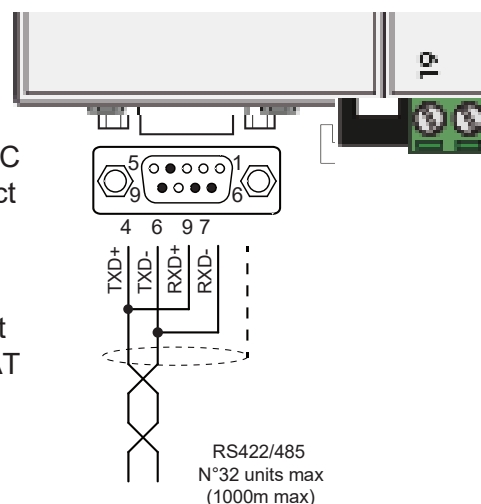

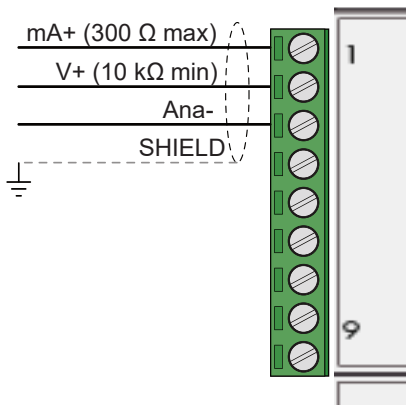

The transmitter provides an analogue output in current or voltage.

Analogue output in voltage: range from 0 to 10 Volt or from 0 to 5

Analogue output in current: range from 0 to 20 mA or from 4 to 20

Analogue transmission can be sensitive to electromagnetic interference, it is therefore recommended that the cables are as short as possible and that they follow their own route.

To make the connection, use a suitable shielded cable, making sure to connect the shield to the ground in one of the two ends.

Caution: do not connect the analogue output to active devices.

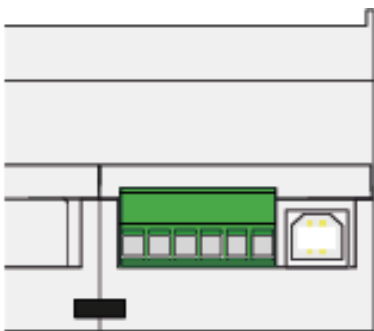

#### USB DEVICE

( SPECIFICATION 2.0 COMPLIANT; FULL-SPEED 12 MBPS)

Use this communication port to directly interface a PC via a USB port.

Use a standard USB cable for the connection.

To connect the instrument via the USB device, you must install a driver on the PC which is suitable for the operating system used.

For installation please follow the specific instructions.

#### FIELDBUS CONNECTIONS

As an alternative to the RS485 serial port some of the most common fieldbuses are available. You can use a single fieldbus which must be specified when ordering.

#### ETHERNET CONNECTION

On the lower left part of the instrument there is a RJ45 connector for Ethernet.

Features:

Trasmission speed 10 Mbps

Network compatible with 10/100/1000 Base-T

TCP Ethernet protocols, Modbus/TCP, UDP, IP, ICMP, ARP

TCP server communication mode

LED indicators (2) Presence of Ethernet and communication/diagnostics line

Buffer size 256 bytes

Connection Time-out Min 30 seconds - Max 90 seconds

Link Time-out (cable disconnected) 30 seconds

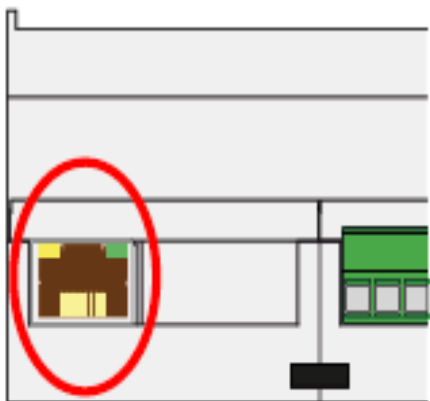

To connect to the MASTER, use a standard twisted pair Ethernet cable with RJ45 connector.

The RJ45 Ethernet connection cable has a variable maximum length, depending on the type of cable. A common Cat5 shielded cable can have a maximum length of about 180 m.

- You can connect the Ethernet communication port directly to the PC, without having to go through other network devices (routers, switches, hubs, LAN-bridge or the like), but special RJ45 cables must be used, called “crossover.”

- Normally cables are the “direct” type and allow connection to network devices such as routers or hubs, but not direct connection to two PCs (even if there are currently network cards with auto-sensing technology, which recognize the type of cable and the type of connection, allowing direct PC-PC connections as well as using non cross-over cables).

- On side are diagrams of the two types of cables mentioned and their connection diagram.

PIN	DESCRIPTION
1	TX+
2	TX-
3	RX+
4	
5	
6	RX-
7	
8	

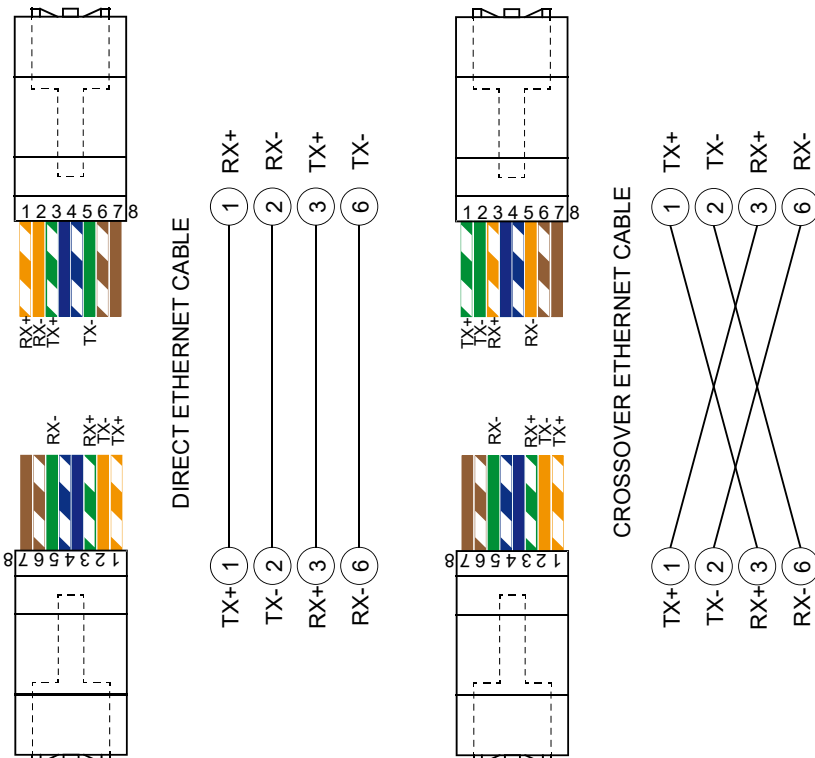

### ETHERNET / IP CONNECTION

Ethernet / IP is a real-time industrial protocol which is based on the Ethernet network.

There are two RJ45 connectors to allow connection of multiple instruments in the same network.

Refer to the previous page for connection notes and warnings.

Features:

10 and 100 Mbit operation, Full and Half Duplex

Modbus-TCP server

Up to 128 bytes of I / O fieldbus in every direction.





### PROFINET CONNECTION

The Profinet connector is RJ45, the same as the Ethernet interface.

There are two RJ45 connectors to allow connection of multiple instruments in the same network.

Refer to the previous page for connection notes and warnings.

Features:

PROFINET IO Real Time (RT) communications

Modbus-TCP server

Up to 128 bytes of I/O fieldbus in every direction.



### ETHERCAT CONNECTION

EtherCAT is a real-time industrial protocol which is based on the Ethernet network.

EtherCAT The protocol requires that the RJ45 connectors have the function of IN and OUT.

Putting more DAT1400 instruments in series, the MASTER will be connected to the IN connector of the first DAT1400, whose OUT connector will be connected to the IN connector of the next etc ...

Refer to the previous page for connection notes and warnings.



### MAC ADDRESS IN INSTRUMENTS WITH INDUSTRIAL FIELDBUS ETHERNET.

Instruments which install Hilscher modules with Industrial Ethernet Protocol (Profinet, EthernetIP, EtherCAT, etc.) have a label under the connectors, as shown.

This label shows the MAC address of the module (red box), the identification number of the module (blue box) and a QR code that contains the MAC address. The latter can be read using a smartphone app for reading QR codes (eg. on Google Play store, "QR Code Reader").



PROFIBUS DP CONNECTION

Pin	Signal	Description
1	-	-
2	-	-
3	B line	+RxD/+TxD, level RS485
4	RTS	Request to send
5	GND	Ground (isolated)
6	+ 5V Bus Output	+5V termination (isolated)
7	-	-
8	A line	-RxD/-TxD, level RS485
9	-	-
Housing	Cable shield	Internally connected to protective earth according to Profibus specification

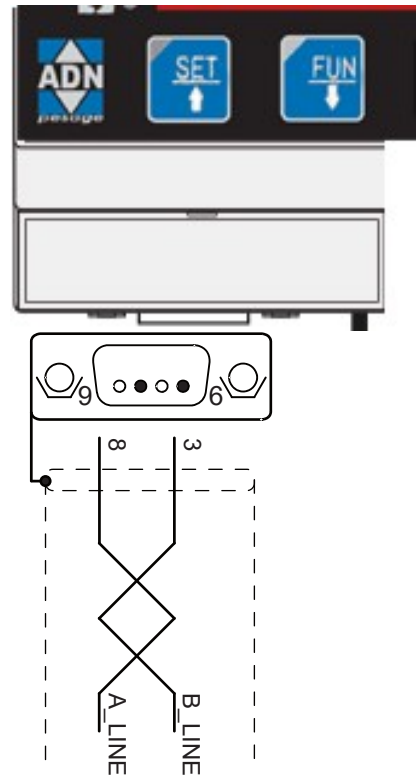

For connection to the Profibus Master, use a standard Profibus cable.

The typical impedance of the cable should be between 100 and 130 Ohms ( $f > 100$  kHz). The cable capacity (measured between conductor and conductor) should be less than 60 pF / m and the minimum cable cross section should not be less than 0.22 mm<sup>2</sup>

In a Profibus-DP network, you can use either cable type A to type B cable, depending on the required performance. The following table summarizes the features of the cable to be used:

Specification	Type A Cable	Type B Cable
Impedance	from 135 to 165 ohm ( $f = 3 - 20$ MHz)	from 100 to 300 ohm ( $f > 100$ kHz)
Capacity	< 30 pF/m	< 60 pF/m
Resistance	< 110 ohm/km	-
Conductor cross section	> 0,34 mm <sup>2</sup>	> 0,22 mm <sup>2</sup>

The following table shows the maximum length of the wires line with cable type A and type B, function of the different communication speed required:

Baud rate (kbit/s)	9.6	19.2	187.5	500	1500	3000	6000	12000
Cable A lenght (m)	1200	1200	1000	400	200	100	100	100
Cable B lenght (m)	1200	1200	600	200	-	-	-	-

For a reliable operation of the Fieldbus, should be used a line termination at both ends.

In the case of multiple T200F instruments, use the line termination at only one instrument.

For configuring the instrument, the GSD file is available (hms\_1810.gsd) that must be installed in the master.

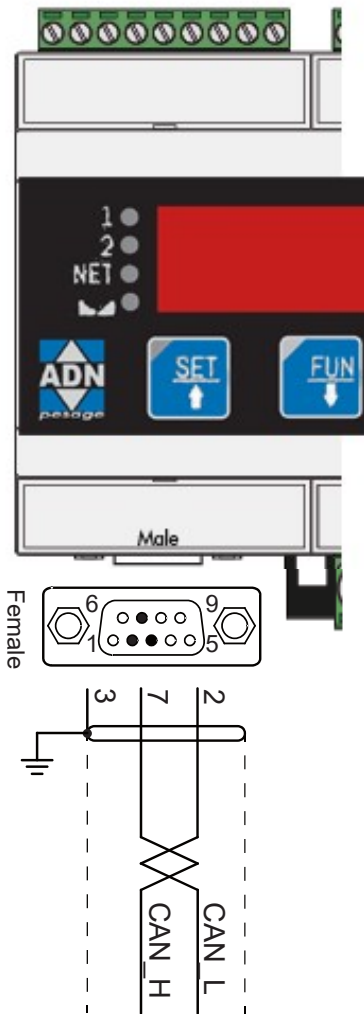

Pin	Signal	Description
2	CAN_L	CAN low bus line
3	CAN_GND	
7	CAN_H	CAN high bus line

CANopen is an higher-layer communication protocols based on a CAN seria bus system.

For the connection using a cable with a twisted pair differential and common return in accordance with ISO 11898. The length of the bus is limited by the speed of communication chosen according to

Bit Rate	Max. Bus lenght
1 Mbit/sec	25 m
500 Kbit/sec	100 m
250 Kbit/sec	250 m
125 Kbit/sec	500 m
50 Kbit/sec	1000 m

The CAN line must have the resistance of 120Ω termination.

The reference CAN\_GND must be connected to earth at one point of the line.

The cable can not be channeled with power cables.

For the configuration of the card is available ESD file that must be installed in the master.

## FRONT PANEL OF THE INSTRUMENT

The T200F has a 6-digit lit display, 4 status LEDs and four keys with corresponding LEDs for confirming pressing of the key.

In operating mode, the display shows the weight and the LEDs indicate the status of weight and the set-points.

The set-up parameters are easily accessed and modified using the three buttons on the front to select, edit, confirm and save the new settings.

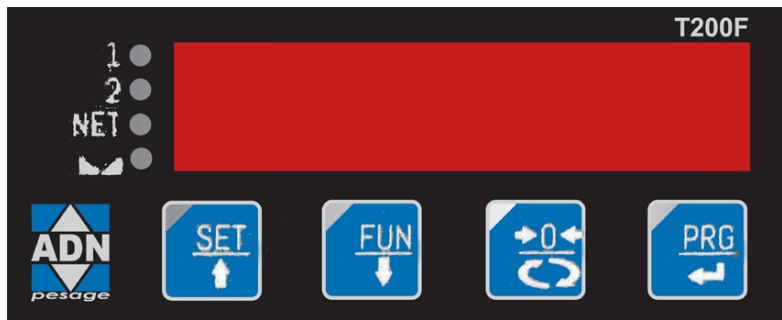

### DISPLAY

The 6-digit display normally shows the weight on the scale. According to the various programming procedures, the display is used for programming the parameters to be stored in the memory, i.e. the messages that indicate the type of operation in progress and, therefore, help the Operator to manage and program the instrument.

### STAND-BY FUNCTION

The display can take on the stand-by mode, during which time the display brightness is reduced and the keypad is locked. All other functions of the instrument are up and running.

See the paragraph on the activation / deactivation of the stand-by mode.

### LED INDICATORS

To the left of the display there are 4 LED indicators:

1 State of the logic output 1 (ON = closed contact OFF = open contact)





2 State of the logic output 2 (ON = closed contact OFF = open contact)

NET The displayed value is the net weight



> < indicates the condition of stable weight.

Next to each button is also a LED that indicates when the button is pressed.







## USING THE KEYPAD

The instrument is programmed and controlled via the capacitive keypad consisting of 4 keys, all with dual function. The selection of one of the two key functions is automatically established by the instrument based on operation in progress. In general, the programming menus are managed using keys  and  to scroll through the items; the  to access the relevant submenu or programmable setting, whereas key  is used to exit the menu or go back to the higher level.









You can also use the keyboard by sliding your finger from left to right and back again as with a regular smartphone.













SYMBOL	DESCRIPTION
	Short press on the single key. The corresponding LED will flash briefly
	Long press on a single key. The corresponding LED will flash briefly and then lights up until released.









The red LED at each key signals its activation.

KEY	FUNCTIONS DURING WEIGHT DISPLAY
	Access to the set points value programming menu
	Display selection (gross weight, net weight). (Press and hold) Weight / peak display selection
	Resetting the displayed value (gross weight, net weight or peak).
	Sending the weight string via the serial line. (Press and hold) Access to quick set-up menu.
 or 	(Press for 3 sec) Access to set-up menu.  (Press for 6 sec) Access to set-up menu.









KEY	FUNCTION DURING THE PROGRAMMING MENU NAVIGATION
 	It selects the next menu.
 	It selects the previous menu.
 	It exits the programming menu or returns to the upper level.
 	It accesses the relative sub-menu or programming or confirms the selected parameter.

KEY	FUNCTION DURING SETTING OF THE NUMERICAL VALUES
 	It increases the value of the selected digit.
 	It decreases the value of the selected digit.
 	It selects the most-right digit.
 	It resets all the digits.
 	It ends composition and saves the value.
 	It exits without saving the changes.



KEY	FUNCTION WHILE SETTING SUGGESTED VALUES
 	It selects the next value.
 	It selects the previous value.
 	It confirms and stores the displayed value.
 	It exits without saving the changes.

Pressing the key  always results in a return to the previous menu.

KEYBOARD LOCKING/UNLOCKING FUNCTIONS

OPERATION	DESCRIPTION
  + 	Keyboard Lock - The keys are disabled until released. The display goes into low power mode. The instrument is locked by simultaneously pressing the ZERO + PRG keys for 5 seconds. By switching the instrument on and off the instrument automatically unlocks.
  + 	Keyboard Unlock - By simultaneously pressing the ZERO + PRG keys for 5 seconds, the keys are reactivated and the brightness of the display returns to standard.

EXITING THE CONFIGURATION MENU

Press the key  to return to the main menu. Press the key again . "StorE?" is displayed.

Keep the key pressed  until the message "sEtUP" appears. Press the key  to return to the weight display.

## INFO DISPLAY

**PdAt01** When the instrument is switched ON, a display test is run followed by the identification code and then the version of the software, in that order. These codes are to be cited when requesting assistance

When is not in progress a programming procedure, the display shows the weight measured in kilograms. Under certain conditions, the following messages are reported:

### NOTIFICATION OF ERRORS

In operating mode, the following error codes may appear on the display.



















#### Fixed message

<b>P &lt;picco&gt;</b>	Display of peak value.
<b>rENotE</b>	Communication with "Optimization" PC utility software.
<b>222222</b>	Overload. The load applied to the load cells exceeds by over 9 divisions the maximum capacity of the weighing system.
<b>O-L</b>	Signal that the load cells are absent or outside of the measuring range mV/V. Flashing message, alternating with the weight measured.
<b>No CAL</b>	Calibration weight not performed)
<b>No CoN</b>	Fieldbus network disconnected
<b>E-F.buS</b>	Fieldbus interface absent or not working.

## OPERATING FUNCTIONS

Once calibrated, the display shows the current weight whenever it is switched on.

The following are the possible operations that can be carried out from the keyboard when viewing the weight of the instrument.

KEY	OPERATION	FUNCTION
		Display of Gross Weight to Net Weight.
		Display of the peak.
		Net Weight being displayed: Auto-tare.
		Gross Weight being displayed: Semi-Automatic zero.
		Transmission of a string from serial (only protocol on-demand)
		Set-Point function programming.
 +  Or 		Entry into the Programming Menu
  + 		Keyboard Lock - The keys are disabled until released. The display goes into low power mode. The instrument is locked by simultaneously pressing the ZERO + PRG keys for 5 seconds. By switching the instrument on and off the instrument automatically unlocks.
  + 		Keyboard Unlock - By simultaneously pressing the ZERO + PRG keys for 5 seconds, the keys are reactivated and the brightness of the display returns to standard.

### GROSS WEIGHT / NET WEIGHT DISPLAY

Press the  key to toggle between the gross weight and the net weight and vice versa. The value displayed is signalled by the NET LED (lit: net weight). If the tare is not entered, the net weight is equal to the gross weight.

In the case of negative weight, the minus sign is shown before the digit.

### RESETTING THE WEIGHT AND AUTO-TARE

These two functions are performed by the 0 key 

When the instrument is in the "Net" operating mode ("NET" LED on) the 0 key  performs the auto-tare function.

When the instrument is in the "Gross" operating mode ("NET" LED off) the 0 key  performs the gross weight resetting function.

## ZERO SETTING

The reset command of the gross weight is used to correct for small zero shifts of the weighing system during normal operation.

Normally these zero shifts are due to thermal drifts or to residues of material that accumulate on the weighing system over the time.

To run the command, it is necessary for the instrument to be under "Gross" conditions ("NET" LED off) and for the deviation of the weight with respect to the zero of the scale (the one performed with the zero calibration procedure) does not exceed (in positive or negative) the number of divisions set in the "0 BAND" parameter (within the PARAM menu).

The reset command of the gross weight is not executed if occurs even one of the following conditions:

- Unstable weight (with weight stability control enabled). In this case, the reset command takes effect only if the weight stabilises within 3 seconds or if the the weight stability control is disabled ("MOTION " parameter equal to zero).
- Gross weight greater (in positive or negative) than the number of divisions set in the "0 BAND" parameter, when the auto-zero set-point is not programmed.

The zero obtained with the gross weight resetting operation is retained in memory even after the instrument is turned off.

The gross weight reset operation can be repeated several times, but the number of divisions reset to zero is added from time to time, so when the total exceeds the limit value set in parameter "0 BAND", zero setting can no longer be executed. In this case, it is necessary to calibrate the Zero.

Any automatic zero parameter setting when switching on (AUTO 0) reduces (or clears, in the case of "AUTO 0"> "0 BAND") the range of action of the reset command.

## AUTO-TARE

Auto-tare is possible in the following conditions:

- Instrument in "Net" conditions ("NET" LED on)
- Positive gross weight.
- Gross weight not exceeding maximum capacity.
- Stable weight.
- Unstable weight. In this condition 2 cases must be distinguished:
  1. The weight stability control is enabled (the "MOTION" parameter (\*) must be other than zero): the command executed while the weight is unstable only has an effect if the weight stabilizes within 3 seconds after the command was given.
  2. The weight stability control is disabled (the "MOTION" parameter (\*) is equal to zero): the executed command takes effect immediately, even with unstable weight.

(\*) *The operating modes of the "MOTION" parameter are described in the relevant paragraph.*

The auto-tare is retained in memory even after the instrument is turned off.

PEAK FUNCTION

The instrument continuously memorises the peak value of the gross weight.

This function is available only if the peak calculation function is enabled via the corresponding parameter in the set-up menu of the instrument. The peak display is shown by the letter P on the left of the display. The peak value is detected at the same frequency of acquisition of the weight (see table on filters). The peak value can also be used for the following functions:

FUNCTION	DESCRIPTION
LOGIC OUTPUTS	The set-points can be set to have the peak value as a reference. (See the procedure for setting operation of the logic outputs).
SERIAL PORT	Acquisition of the peak value (peak hold) using the CONTIN, AUTO, DEMAND, and MODBUS SLAVE protocols.
ANALOGUE OUTPUT	The analogue output value can assume the peak value (peak hold). (See the analogue output configuration procedure).

FREEZING THE ACQUIRED WEIGHT

You can freeze the weight in the face of a variation of the logic inputs, if any of these is set in the HOLD mode.

TEST FUNCTIONS - RS232 AND RS485

The test consists of sending the string received from its serial line (echo) and the display of the number of strings received and the number of characters received in the last string.

00C= 00

TEST FUNCTIONS - ANALOGUE OUTPUT TEST

Once in the test out function **out. An**, , the following message will appear:

**out 0** out 0 where 0 indicates the output value (in current or voltage based on that selected) expressed as a % of the full scale.

You can change this value from 0 to 100, with an interval of 10%, by pressing the 0 key.

Press the SET key to exit the function.

INPUT / OUTPUT TEST FUNCTIONS

Once in the IN OUT test function, the following **1n 00** 1n 00 will appear where 00 depends on the logic inputs mode, as shown in the table:

VALUE	MEANING
<b>00</b>	No active input
<b>01</b>	Input 1 active
<b>10</b>	Input 2 active
<b>11</b>	Inputs 1 and 2 active

In the same menu you can enable or disable the outputs by repeatedly pressing the ZERO key.

The status of the two outputs is shown by the first 2 status LEDs.

Press the SET button to exit the function.

## PROGRAMMING THE WEIGHT SET-POINTS

The set-points are compared with the weight to drive the relative logic output. The comparison criteria is defined during set-up of the logic inputs/outputs (see the relevant section).

To access the Set points setting, press the SET key while viewing the weight

MENU	MESSAGE	DESCRIPTION	TYPE	DEFAULT	RANGE	IND.FIELD BUS
Set-point	<b>SEtP. 1</b>	Sets value of Set-point 1	Com.	0	0÷Capacity	201(MSB) 202(LSB)
	<b>SEtP. 2</b>	Sets value of Set-point 2	Com.	0	0÷Capacity	203 (MSB) 204 (LSB)

The set-points are compared with the weight to drive the relative logic output. The comparison criteria is established in the set-point set-up procedure.

When the weight is not detectable or out of range, all the outputs are disabled (contact open or closed depending on the MODE; see the relevant chapter).

During the step of setting the set-points, both outputs are disabled. If the set-point value in the memory is 0, the relative output is never enabled, regardless of the set-up of the selected set-points.

## WEIGHT ACQUISITION

The weight can be printed or sent to the serial port / fieldbus (depending on the setting of the communication ports), in the following ways:

- In automatic mode (in the event of selecting the “automatic” serial communication protocol).
- Through the instrument keyboard (pressing the PRG key, in the event of selecting the “on demand” serial communication protocol).
- From the external input (in the event of selecting the “on demand” serial communication protocol and the “data transmission on demand” operation selected on at least one input).
- Through the serial line (in the event of selecting the “slave” serial communication protocol), by sending the weighing execution command.
- Through the fieldbus, using the weighing execution command in the register command.

The following are the conditions for weight acquisition:

- Stable weight (or stabilised within 3 seconds from the command).
- Since the last acquisition carried out, the weight has undergone a change of at least 20 divisions (weight difference).
- Gross weight equal or greater than the minimum weight (20 divisions) and less than the maximum capacity.
- Net weight not zero.

In METRIC operation, if the alibi memory is configured, the transaction is recorded. The net weight and the weight identification code are also stored in a memory register which can be read on a request from the fieldbus.

Only in FREE operation and print executed by key or ester-no input, the weighing is permitted even with the gross weight less than the minimum weight or with the net weight at zero.

## CALIBRATION JUMPER

In the event of metrological use, the enabling to the setting of the metric parameters can be done with the internal bridge towards the board.

## SETTING

### GENERAL DATA





All functions of the T200F are activated and modified by accessing a simple setup menu, shown on the next page. All settings that are selected or activated remain in the memory even after the transmitter has been switched off.



The T200F is preconfigured with a default setting. The following pages shows the “Default” values of each parameter.





With the first field installation some parameters have to be changed in order to obtain a correct indication of the displayed weight (Theoretical calibration).

This may be required when you first purchase the T200F.

The settings of the setup menu can be changed using the keys on the front or the “OPTIMATION” utility software provided.

KEY	FUNCTION WHILE MAIN MENU PROGRAMMING
	It selects the next menu.
	It selects the previous menu.
	It exits the programming menu or returns to the upper level.
	It accesses the relative sub-menu or programming or confirms the selected parameter.

KEY	FUNCTION WHILE SETTING SUGGESTED VALUES
	It selects the next value.
	It selects the previous value.
	It confirms and stores the displayed value.

KEY	FUNCTION WHILE SETTING NUMERIC VALUES
	It increases the value of the flashing digit.
	It decreases the value of the flashing digit.
	It goes to the next digit.
	It confirms and stores the displayed value.



CHANGING AND ENTERING THE PARAMETERS:

The procedure for accessing the menu depends on the operating mode selected: FREE or METRIC.

MENU ACCESS IN FREE OPERATION MODE.

In the event of FREE operation all instrument parameters can be changed by the operator.

MENU ACCESS IN METRIC OPERATION MODE.

In the event of METRIC operation programming of weighing parameters and the weight calibration settings are only permitted to personnel authorised by law, through password-protected access.



For this procedure you need the password table.

1d	To access the menu the operator's identification code is requested. The "ID" timed message is displayed and then you are prompted to enter the code.
0000	Enter the identification code of the operator who has authorised access, corresponding with the number of the password table and confirm with PRG. If the value 0000 is confirmed or if the procedure is cancelled with the ZERO key access to the menu parameters will be limited (you will not be able to access the programming of the weighing parameters and the calibration settings of the weight).
Cod..000	The display shows a 3 digit number randomly selected. Locate on the table the corresponding password (4 digits) and press PRG to access the password setting.
0000	Enter the password obtained from the table and confirm with the PRG key. If 0000 is confirmed or if the procedure is cancelled with the ZERO key access to the menu parameters will be limited (you will not be able to access the programming of the weighing parameters and the calibration settings of the weight).



Each authorised personnel access is recorded in the memory which contains the last 5 accesses.



Turn on the instrument with the bridge for enabling calibration in the CALIBRATION position in order to go directly to the programming menu (when the calibration bridge is on, you cannot exit the programming menu).

1nfo will appear on the display. Use the arrow keys until the menu appears where you want to group the instrument parameters in a number of main menus.

The first to appear is that of 1nfo that allows you to view the information for instrument identification and configuration.

The second menu is that of tEst concerning procedures for functional testing of the instrument.

The third is that of SEtup which allows you to program the parameters which determine the operation of the instrument

To access the setup menu, press the PRG key and then the SET key and hold them down simultaneously for 3 seconds or press and hold the PRG key for at least 6 seconds .

Access by confirming your choice with the PRG key.

MESSAGE	NAME	DESCRIPTION
<b>1nFo</b>	Information	Parameter menu can be viewed for identification of the instrument and its configuration.
<b>tEst</b>	Test	Menu of test procedures for operation of the instrument hardware.
<b>SEtuP</b>	Setup	Menu of programmable parameters which determine the operation of the instrument

INFO MENU

MENU	MESSAGE	NAME	DESCRIPTION	TYPE
<b>1nFo</b>	<b>Cod. FN</b>	Firmware code	Indication of installed Firmware code	Vis.
	<b>rEL. FN</b>	Firmware revision	Indication of revision of the Firmware installed	Vis.
	<b>F.SCALE</b>	Full scale of the instrument	Indicates the full scale set	Vis.
	<b>F. bUS</b>	Fieldbus present	Indicates the type of Fieldbus configured	Vis.
	<b>Addr.</b>	Fieldbus address	Indicates the Fieldbus address set. This menu item is displayed only in the RS485 configurations.	Vis.
	<b>1P</b>	Fieldbus IP address	Indicates the IP Fieldbus address set. This menu item is displayed only in the ETHERNET, PROFINET and ETHERNET/IP configurations.	Vis.
	<b>SubnEt.</b>	Subnet Mask Fieldbus	Indication of the subnet mask Fieldbus set. This menu item is displayed only in the ETHERNET, PROFINET and ETHERNET/IP configurations.	Vis.
	<b>oUt.. An</b>	Analog Output Configuration	Indicates the presence and type of analogue output (Not present - Unipolar - Bipolar)	Vis.
	<b>NENory</b>	Optional Memory Configuration	Indicates the presence and type of memory (None - Alibi memory - µSD card)	Vis.

In the case of PROFINET field bus: the parameters IP address and Subnet Mask are programmable by PLC and are updated in this menu only when the instrument is switched on. Following a change in these parameters from the PLC, the instrument must be switched off and on again to display the correct value.



It is important to remember that even if you set the parameters IP address and subnet mask in Temporary mode, these parameters are not automatically updated in the instrument. Moreover, when the instrument is switched off and then on again, these parameters will all be set to 0.0.0.0.

## TEST MENU

MENU	MESSAGE	NAME	DESCRIPTION	TYPE
tEst	S1GnAL	Cell signal	Display of the signal in mV/V in input to the instrument	Vis.
	H1 rES.	Resolution x10	Display of the weight with a resolution 10 times greater than that set	Vis.
	PSupPL.	Power supply voltage	Display of the supply voltage measured by the instrument	Vis.
	NENory	Test of the memory (Only with configured memory)	Automatic operation test of the additional memory	Test.
	1n oUt.	I/O test	I/O test with simultaneous display of inputs and outputs (See specific description)	Test.
	rS 232	Test RS232	Transmission and receipt test (See specific description)	Test.
	rS 485	Test RS485	Transmission and receipt test (See specific description)	Test.
	oUt.. An	Analogue output test	Test procedure with manual activation of the output value (See specific description)	Test.

## SETUP MENU

MENU	SUB MENU	NAME
SEtuP	CAL1br.	Calibration Settings (*)
	AnALoG	Analog output settings (Only with analog output configured)
	CoN.Por..	Serial ports and fieldbus settings
	1n-oUt.	Logic Output and Input settings
	PArAN	Weighing meteorological parameter settings
	F1LtEr	Filter Settings
	FUnCt	Functional Features settings
	CLock	(**)
	uPL.dow	Upload/Download function of saved setup data
	accEss	Showing the last 5 accesses of the Authorized Staff (***)
ali.NEN	Aliby memory consultation (***)	

(\*) These menu items are displayed only when operating in FREE mode or if accessed using the password of authorised personnel (if operating in METRIC mode).

(\*\*) This menu is displayed only in case of hardware with calendar clock.

(\*\*\*) This menu items are only displayed when operating in METRIC mode.

On exiting the setup menu, if changes were made to the parameters, the message **StorE**, is displayed which is confirmed with PRG



## CONFIGURATION PARAMETERS

All the parameters that can be set are described in the following pages. At the end of each parameter description, where present, the fieldbus address corresponding to the parameter is shown. If the parameter is the selectable type, the value to be entered in the register for the desired selection is shown between “[ ]”.

### CALIBRATION MENU

Access to this menu is only allowed when operating in FREE mode or when operating in METRIC with access using the password of authorised personnel.

#### rESoLU

##### DIVISION VALUE [1101÷1102]

Value of a single division, expressed in kg. The ratio between the capacity of the system and the division value represents the resolution of the system (number of divisions).

Following the change of the division value, if the maximum capacity is not changed, calibration of the weight is corrected automatically.

*Values that can be selected:*

*0.0001 - 0.0002 - 0.0005*

*0.001 - 0.002 - 0.005*

*0.01 - 0.02 - 0.05*

*0.1 - 0.2 - 0.5*

*1 - 2 - 5*

*10 - 20 - 50*

*Default: 1*

#### L.C. CAP.

##### CAPACITY OF THE LOAD CELLS [1103-1104]

It defines the value corresponding to the sum of the rated capacity values of the load cells expressed in kg. In the case of systems with only one load cell and “N” fixed supports, enter the capacity value of the cell for the total number of supports. This figure represents the full scale value of the weighing system. Following the change of the parameter value, the theoretical weight value is recalculated.

*Values: from 1 to 999999*

*Default: 0*

#### L.C. SEn..

##### SENSITIVITY OF THE LOAD CELLS [1105]

Set the value corresponding to the average sensitivity of the loadcells, in mV / V. The instrument accepts values between 0.0 and 4 mV / V. If no value is programmed, 2mV/V is set by default.

Following the change of the sensitivity value, the theoretical weight value is recalculated.

*Values: from 0.0000 to 4.0000 mV/V*

*Default: 2.0000*

## SySt.FS

### CAPACITY OF THE WEIGHING SYSTEM [1301-1302]

Programming the useful capacity (net) of the weighing system.

*Values: from 0 to Load Cell Capacity*

*Default: 0*

## dEAd L.

### FIXED TARE OF WEIGHING SYSTEM [1106-1107]

Programming the fixed tare value of the weighing system

*Values: from 0 to Capacity Value*

*Default: 00000*

## CAL.tyP

### SELECTING THE CALIBRATION TYPE

Selecting the calibration type. On confirmation one of the following procedures is started.

## dEAd W

### DEAD WEIGHT TYPE CALIBRATION [501÷503]

Zero Calibration and Full Scale up to 5 linearisation points using Sample weights.

## tAbLE

### TABLE TYPE CALIBRATION [1151÷1172]

Allows you to manually program up to 5 calibration points. The values corresponding to those resulting from the linearisation procedure with sample weights. In this way you can copy the calibration values made with sample weights.

### PARAMETERS DISPLAYED ONLY DURING METRIC OPERATION

## G-CAL

### CALIBRATION LOCATION GRAVITY [1108-1109]

Programming of the force of gravity of the location where the calibration takes place.

*Values: from 9.77000 to 9.84000*

*Default: 0*

## G-uSE

### GRAVITY OF LOCATION OF USE [1110-1111]

Programming of the force of gravity of the location where the instrument will be used.

*Values: from 9.77000 to 9.840000*

*Default: 0*

## CONFIGURATION/CALIBRATION EXAMPLE

Set the parameters listed above to perform theoretical calibration of the Full Scale of the T200F. This procedure must be completed with calibration of the zero-point as described later on. The procedure ensures good precision of the system (maximum error <1% FS) when there are no mechanical problems.

When you change the rESOLU selection, calibration of the full-scale is automatically recalculated. Selections incompatible with the calibration parameters or with the calibration value saved in the memory are not accepted.

A tank must be weighed, of an unladen weight of 750 Kg and capacity 1000 litres, containing a product with specific weight 1.3 Kg/dm<sup>3</sup> the weight of which needs to be read with a display resolution 0.2 Kg.

Before proceeding with configuration it is required to ensure the load cells are connected correctly to the unit and the tank is empty, the parameters may then be set.

Use:

3 load cells 1000 Kg capacity

Sensitivity respectively 2.0015, 2.0008 and 1.9998 mV/V (average value = 2.0007 mV/V)

Set the following figures in configuration parameters:

**L.C. CAP** = 3000

**L.C. SEr** = 2.0007

**SySt.FS** = 1500

**dEAd L.** = 0

**rESoLU** = 0.2

Ensure the value read in parameter S1GNAL of the menu TEST corresponds to the tare weight of the system according to the following proportion:

$$3000:2.0007=750:X$$

Where X is the value of the signal expressed in mV/V corresponding to the theoretical value of the empty tank weight- The value should be about 0.5 mV/V

At this stage one may proceed with calibration described in the following paragraph or exit the configuration menu saving the data entered.

The instrument should indicate the value corresponding to the unladen tank weight (e.g. 756.8).

It is possible to enter the configuration menu again and enter the value of the weight read in parameter dEad L and enter 756.8

Exit the configuration menu again after saving the data.

For greater precision arrange sample weights or pre-weighed material on a certified scale and proceed with calibration as described in the following paragraph.

## CALIBRATION OF SAMPLE WEIGHTS

The calibration procedure described below should be carried out using sample weights and/or a sample product pre-weighed on a weighing system.

Before proceeding with calibration of the full scale, always perform zero calibration.

During the calibration phase, the weight is shown on the display in alternation with the text CAL.

**WARNING:** Switching off the instrument without exiting the set-up menu cancels any changes made during the programming process.

N.B. If linearity errors are shown after calibration, verify that the weighed structure is completely free of mechanical constraints.

### ZERO CALIBRATION

Perform this operation with the scale unloaded (including the fixed tare), and when the weight is stable. The zero value of the system is set by pressing the key 0.

The weight displayed is reset and the display shows CAL and 0. in alternation. This operation can be repeated at will.

### CALIBRATION OF THE FULL SCALE

Before calibration, put the sample weight on the scale and wait for stabilisation; the display shows a weight value.

To correct the displayed weight press the SET key. All the digits to 0 appears on the display with the the first digit on the left flashing. Using the arrow keys, enter the actual weight loaded on the scale starting with the first flashing digit. Move to the next digit by pressing PRG. Pressing the PRG key to confirm the last digit (far right) corrects the weight. SAVE and then CAL are shown in alternation to the actual weight value entered on the display.

If the set value is higher than the resolution offered by the instrument, the weight is not accepted and an error message appears on the display for a few seconds.

This procedure can be repeated.

Press and hold the PRG key to return to the CaL1br... menu.

### LINEARISATION PROCEDURE

Sample weights linearisation: (SET key long press) Up to 5 linearisation points are possible on positive scale. The progression of linearisation points is displayed alternately to the current weight. Press the SET key to set the sample weight value loaded and stabilised. On confirmation you go to the next point. If 0 is set the value is not saved. To end the procedure press and hold the PRG key. It is possible to save a number of points less than 5.

The calibration operations can always be repeated.

When programming the sample weight, values greater than the full scale, or lower than the previous point, or when the weight is not stable, are not accepted. If the entered value is accepted, the next step is shown, otherwise still the same.

The linearisation points are automatically reset by any change of the theoretical calibration data or if a full-scale calibration is performed.



## TABLE CALIBRATION

It allows you to manually program up to five calibration points, in addition to zero. The values corresponding to those resulting from the linearisation procedure with sample weights. This way you can view the values automatically determined with this procedure or modify and program them in accordance with predetermined values.

BELOW MENU	MESSAGGIO	NAME	DESCRIPTION	TYPE
tAbLE	0 S1G.	Zero signal	Signal value in mV / V corresponding to the zero scale	Com.
	P1 JAL.	Weight point 1	Weight value corresponding to the 1st calibration point	Com.
	P1 S1G.	Signal point 1	Signal value in mV/V corresponding to the 1st calibration point	Com.
	P2 JAL.	Weight point 2	Weight value corresponding to the 2nd calibration point	Com.
	P2 S1G.	Signal point 2	Signal value in mV/V corresponding to the 2nd calibration point	Com.
	P3 JAL.	Weight point 3	Weight value corresponding to the 3rd calibration point	Com.
	P3 S1G.	Signal point 3	Signal value in mV/V corresponding to the 3rd calibration point	Com.
	P4 JAL.	Weight point 4	Weight point 4 Weight value corresponding to the 4th calibration point	Com.
	P4 S1G.	Signal point 4	Signal point 4 Signal value in mV/V corresponding to the 4th calibration point	Com.
	P5 JAL.	Weight point 5	Weight point 5 Weight value corresponding to the 5th calibration point	Com.
	P5 S1G.	Signal point 5	Signal point 5 Signal value in mV/V corresponding to the 5th calibration point	Com.
	GEt 0	Acquire the Zero Signal	Acquisition function of the signal corresponding to the zero scale expressed in mV/V	

The programmed to zero are not considered. The calibration data sheet is automatically cancelled when a new theoretical calibration is carried out or with sample weights.

After the execution of the zero signal acquisition function, using  key, the signals in the table are recalculated. At each signal value an offset is added, obtained from the difference between the new acquired zero signal and the old zero signal value.

### EXITING THE CALIBRATION MENU

To exit the CAL1b press the menu key , press until the text storE? appears on the display.

Press PRG to save calibration and exit the setup menu.

It is possible to clear the zero and full scale calibrations.



+



delete zero calibration.



+



delete the full scale calibration.

## ANALOG - ANALOG OUTPUT PARAMETERS (OPTIONAL)

**rAnGE..**

ANALOG OUTPUT RANGE [1506]

Select the analogue output range.

*Selectable setting:*

0÷10 Vdc [0]

0÷5 Vdc [1]

4÷20 mA [2]

0÷20 mA [3]

*Default: 0÷10 Vdc***NodE..**

ANALOG OUTPUT OPERATION MODE [1505]

Selection of the value to be associated to the analogue output, corresponding to the net weight, gross weight or peak value.

*Selectable setting:*

NET [0]

GROSS [1]

PEAK [2]

HOLD [3]

*Default: NET***An 0..**

ANALOG OUTPUT ZERO VALUE [1501-1502]

Analogue value to be subtracted referred to the full scale of the analogue output.

**An FS..**

FULL SCALE [1503-1504]

It is the weight corresponding to the analog output full scale.

*Value settable from 0 to Capacity**Default: Capacity***0 AdJ..**

ZERO OFFSET REGULATION

Measure the analogue output value with a multimeter to perform the zero (0) calibration.



Use the keys  and  to regulate the analogue output. Press and hold the key for rapid change.

Press key  to go back to the ANALOG menu.

## FS.AdJ..

### FULL SCALE OFFSET REGULATION

Measure the analogue output value with a multimeter to perform the full scale (FS) calibration.

Use the keys  and  to regulate the analogue output. Hold the key for a quick change.

Press key  to go back to the ANALOG menu.

This procedure is available to the user for adjustment, for each selectable range. In the case of a full reset of the setup memory (PC Configurator), they are restored values to the factory calibration.SERIAL

## SERIAL COMMUNICATIONS PARAMETERS

This menu makes it possible to configure the COM1 and COM2 serial ports and the communication parameters. The instrument has two independent serial ports:

COM1 always with interface RS232 ; COM2 can be fitted with either of the following interfaces: RS485, ETHERCAT, ETHERNET, ETHERNET IP, PROFINET.

### C1 Nod..

#### RS232 OUPUT MODE

Selecting the value transmitted on output RS 232.

*Values that can be selected:*

*nEt*

*GroSS*

*PEAk*

*Default: nEt*

### C1Prot...

#### COM1 PROTOCOL

It defines how to use the RS232 serial port:

*Values that can be selected:*

*None: Serial communication OFF*

*Contin: Continuous transmission of the weight string. It can be used, for example, to drive a weight repeater. See details in the relevant section.*

*on deM: When the Operator presses the relative button on the front or uses Input 2, a weight string is sent. The command is accepted if the weight is stable. Between two consecutive transmissions, variation of the weight must be at least equal to 20 divisions.*

*Autom: A weight string is sent automatically when the weight stabilises at a value above the minimum weight (20 divisions).*

*Slave: ASCII protocol. See details in the relevant section.*

*Print: When the operator presses the key on the front or by Input, a weight string is transferred. The command is accepted if the weight is stable. Between two successive transmissions, the weight must have a variation of at least 20 divisions.*

*Default: Slave*

## C1baud.

### COM1 BAUD RATE

Defines the baud rate of serial port RS232.

The value must be set at the same value as PC/PLC or remote display.

*Values that can be selected:*

1200

2400

4800

9600

19200

38400

57600

115200

*Default: 9600*

## C1ForN

### COM1 PROTOCOL

Type of frame. For the SLAVE protocol you cannot select 7-bit data format (E-7-1 e O-7-1):

*Values that can be selected:*

n-8-1

n-8-2

E-7-2

E-8-1

o-7-2

o-8-1

*Default: n-8-1*

## COM 2 PARAMETERS WHEN PRESENT RS485

### C2 Nod..

#### COM2 OUTPUT MODE

Selecting the value transmitted on output RS 485.

*Values that can be selected:*

*nEt*

*GroSS*

*PEAk*

*Default: nEt*

### C2Prot...

#### COM2 PROTOCOL

It defines how to use the RS485 serial port:

*Values that can be selected:*

*None: Serial communication OFF*

*Contin: Continuous transmission of the weight string. It can be used, for example, to drive a weight repeater. See details in the relevant section.*

*on deM: When the operator presses the relevant front key or via Input 2, a weight string is transmitted. The command is accepted if the weight is stable. Between two subsequent transmissions the weight must undergo a variation of 20 divisions.*

*Autom: A weight string is sent automatically when the weight stabilises at a value above the minimum weight (20 divisions). Variation of the weight between two consecutive transmissions must be at least 20 divisions.*

*Slave: ASCII protocol. See details in the relevant section.*

*Modbus: MODBUS RTU Protocol See details in the relevant section.*

*Default: Slave*

### C2baud.

#### COM2 BAUD RATE

Defines the baud rate of serial port RS485.

The value must be set at the same value as PC/PLC or remote display.

*Values that can be selected:*

*1200*

*2400*

*4800*

*9600*

*19200*

*38400*

*57600*

*115200*

*Default: 9600*

## C2ForN

### COM2 PROTOCOL

Type of frame. For the SLAVE or MODBUS protocol you cannot select 7-bit data format (E-7-1 e O-7-1):

*Values that can be selected:*

*n-8-1*

*n-8-2*

*E-7-2*

*E-8-1*

*o-7-2*

*o-8-1*

*Default: n-8-1*

## C2Addr.

### COM2 ADDRESS

Communication address of the serial port:

*Values from 1 to 32*

*Default: 1*

## COM 2 PARAMETERS WHEN PROFINET / ETHERCAT IS PRESENT

### En.FbuS.

#### FIELD BUS ENABLING

Enabling PROFINET / ETHERCAT fieldbus, if OFF error messages concerning FIELD BUS communication are never displayed:

*Values that can be selected:*

OFF

ON

*Default: OFF*

### InP.rEG..

#### INPUT AREA DIMENSION

Input area dimension for fieldbus (value expressed in Bytes).

*Values that can be selected:*

32, 64, 96, 128

*Default: 128*

### oUt.rEG..

#### OUTPUT AREA DIMENSION

Output area dimension for fieldbus (value expressed in Bytes).

*Values that can be selected:*

32, 64, 96, 128

*Default: 128*

In case of PROFINET fieldbus, the XML configuration file "GSDML-V2.3-HILSCHER-NIC 50-RE PNS 32-20160122.xml" is provided. The size of the input and output areas set in the PLC (possible selections: 32, 64, 96 or 128 bytes) must correspond to the size of the input and output areas selected in the instrument (parameters "INP.REG." and "OUT.REG. ").

The instruments are supplied with the parameter "Profinet Name" not configured and IP address set at 0.0.0.0.

In case of ETHERCAT fieldbus: the devices will be connected with ring type (according to EtherCAT specification), refer to the installation manual for the use of INPUT and OUTPUT ports.

4 different XML configuration files are provided:

"Hilscher NIC 50-RE V2.2 ECS Byte.xml 32" (32 bytes Input Area, 32 bytes of Output area).

"Hilscher NIC 50-RE V2.2 ECS 64 Byte.xml" (64 bytes Input Area, 64 bytes of Output area).

"Hilscher NIC 50-RE V2.2 ECS Byte.xml 96" (96 bytes Input Area, 96 bytes of Output area).

"Hilscher NIC 50-RE V2.2 ECS 128 Byte.xml" (128 bytes Input Area, 128 bytes of Output area).

In the PLC must be imported the file that matches the size of the input and output areas selected in the instrument (for example, if the instrument is set to InP.rEG.=128 and oUt.rEG.=128, the PLC has to be imported file "Hilscher NIC 50-RE V2.2 ECS 128 Byte.xml"). It could be import multiple files with different size, but in this case you can not run the automatic search function and configuration of the devices on the network.



## PARAMETERS COM 2 WHEN ETHERNET IP IS PRESENT

**En.FbuS.**

## FIELD BUS ENABLING

Enabling ETHERNET IP fieldbus, if OFF error messages concerning Fieldbus communication are never displayed:

*Values that can be selected:*

OFF

ON

*Default: OFF*

**1P**

## IP ADDRESS

ETHERNET IP protocol address

*Values from 0.0.0.0 to 255.255.255.255*

*Default: 0.0.0.0*

**SubnEt**

## SUBNET MASK

ETHERNET IP protocol Subnet Mask.

*Values from 0.0.0.0 to 255.255.255.255*

*Default: 0.0.0.0*

**InP.rEG..**

## INPUT AREA DIMENSION

Input area dimension for fieldbus (value expressed in Bytes).

*Values that can be selected:*

32, 64, 96, 128

*Default: 128*

**oUt.rEG..**

## OUTPUT AREA DIMENSION

Output area dimension for fieldbus (value expressed in Bytes).

*Values that can be selected:*

32, 64, 96, 128

*Default: 128*

In the case of IP ETHERNET fieldbus, the EDS configuration file "HILSCHER NIC 50-RE EIS V1.1.EDS" is provided. The size of the input and output areas set in the PLC (possible selections: 32, 64, 96 or 128 bytes) must correspond to the size of the input and output areas selected in the instrument (parameters "INP.REG." and "OUT.REG. ").

## COM 2 PARAMETERS WHEN ETHERNET IS PRESENT

### 1P

#### IP ADDRESS

ETHERNET protocol IP address

*Values from 0.0.0.0 to 255.255.255.255*

*Default: 192.168.0.201*

### SubnEt

#### SUBNET MASK

ETHERNET protocol Subnet Mask.

*Values from 0.0.0.0 to 255.255.255.255*

*Default: 255.255.255.0*

### GatE

#### GATEWAY

ETHERNET protocol gateway.

*Values from 0.0.0.0 to 255.255.255.255*

*Default: 192.168.0.1*

### Port

#### PORT

Communication port for ETHERNET protocol.

*Values from 1 to 65535*

*Default: 1800*

### Eth.Pro..

#### ETHERNET COMMUNICATION PROTOCOL

Selecting communication type for Ethernet protocol.

*Values that can be selected:*

*None: Serial communication OFF*

*Contin: Continuous transmission of the weight string. It can be used, for example, to drive a weight repeater. See details in the relevant section.*

*on deM: When the Operator presses the relative button on the front or uses Input 2, a weight string is sent. The command is accepted if the weight is stable. Between two consecutive transmissions, variation of the weight must be at least equal to 20 divisions.*

*Autom: A weight string is sent automatically when the weight stabilises at a value above the minimum weight (20 divisions).*

*Slave: ASCII protocol. See details in the relevant section.*

*Modbus: Modbus TCP protocol.*

*Default: Slave*

## COM 2 PARAMETERS WHEN PROFIBUS DP IS PRESENT

### En.FbuS.

#### FIELD BUS ENABLING

Enabling PROFIBUS DP fieldbus, if OFF error messages concerning Fieldbus communication are never displayed:

*Values that can be selected:*

OFF

ON

*Default: OFF*

### Addr.Pr

#### PROFIBUS ADDRESS

Programming the address used in the PROFIBUS protocol.

*Values: from 0 to 126*

*Default: 01*

### InP.rEG..

#### INPUT AREA DIMENSION

Input area dimension for fieldbus (value expressed in Bytes).

*Values that can be selected:*

32, 64, 96, 128

*Default: 128*

### oUt.rEG..

#### OUTPUT AREA DIMENSION

Output area dimension for fieldbus (value expressed in Bytes).

*Values that can be selected:*

32, 64, 96, 128

*Default: 128*

In the case of PROFIBUS fieldbus, the GSD configuration file "hms\_1810.gsd" is provided. The size of the input and output areas set in the PLC (possible selections: 32, 64, 96 or 128 bytes) must correspond to the size of the input and output areas selected in the instrument (parameters "INP.REG." and "OUT.REG.").

COM 2 PARAMETERS WHEN CANOPEN IS PRESENT

**En.FbuS.**

FIELD BUS ENABLING

Enabling CANOPEN fieldbus, if OFF error messages concerning Fieldbus communication are never displayed:

*Values that can be selected:*

OFF

ON

*Default: OFF*

**Addr.Co**

CANOPEN ADDRESS

Programming the address used in the CANOPEN protocol.

*Values: from 0 to 126*

*Default: 1*

**Baud.Co..**

CANOPEN BAUD RATE

Defines the baud rate of the Canopen protocol.

The value must be set to the same value as the PC / PLC.

*Values that can be selected (expressed in Kbit/sec.):*

10

20

50

125

250

500

1000

*Default: 20*

## INPUT/OUTPUT PARAMETERS

### FUn.1n.1

#### INPUT 1 FUNCTION

Selecting the function associated with input 1 [1401]

*Values that can be selected:*

Zero: *It calibrates to zero. [0]*

Tare: *It executes the automatic tare. [1]*

Del.Tar: *It cancels the tare. [2]*

Peak: *Reset of the peak function. [3]*

Hold: *Holds Acquired Weight. [4]*

Send: *Data transmission on demand. [5]*

Log: *Activates the datalogger function. [6]*

*Default: Zero*

### FUn.1n.2

#### INPUT 2 FUNCTION

Selecting the function associated with input 2. [1402]

*Values that can be selected:*

Zero: *It calibrates to zero. [0]*

Tare: *It executes the automatic tare. [1]*

Del.Tar: *It cancels the tare. [2]*

Peak: *Reset of the peak function. [3]*

Hold: *Holds Acquired Weight. [4]*

Send: *Data transmission on demand. [5]*

Log: *Activates the datalogger function. [6]*

*Default: Zero*

### NodE 1

#### SET-POINT 1 OPERATING MODE

Select in sequence 4 operating criteria of set-point 1: [1403]

Comparison with net weight, with gross weight or with peak. In the latter case the comparison is carried out with the last acquired peak value, even when the peak function is not active.

**NET**        *The relay output is active in Net Weight mode. [0]*

**GROSS**    *The relay output is active in Gross Weight mode. [1]*

**PEAK**      *The relay output is active in Peak mode. [2]*

**PROCESS** *The relay output is active when the instrument is working normally. [3]*

*Default: GROSS*

Selecting the output status if normally open or closed: [1404]

*n.oPEn.* Relay 1 is normally open. [0]

*n.CLoSE* Relay 1 is normally closed. [1]

*Default: n.oPEn.*

Select if positive or negative values have to be compared. [1405]

*PoSIt..* The output is operative with positive weight. [0]

*nEGAt.* The output is operative with negative weight. [1]

*ALL:* The output is operative both with positive and negative weight. [2]

*Default: PoSIt*

Select whether only stable weight values are to be compared or also unstable: [1406]

*norMAL* Output 1 is active with unstable weight. [0]

*StAbLE* The output is active with stable weight. [1]

*Default: norMAL*

### HySt. 1

SET-POINT 1 HYSTERESIS [1407]

Hysteresis value with respect to the set-point

*Value: from 0 to Capacity*

*Default: 2*

### t1NEr1

SET-POINT 1 TIMING [1408]

Value of time, in tenths of a second, during which, when the weight value set is exceeded, the output associated with set-point 1 remains enabled.

After this time, even if the weight value is still above the set-point, the output is automatically disabled.

The function is not active with programmed time equal to zero.

*Values: from 000 to 999*

*Default: 0*

### dELAy1

SET-POINT 1 DELAY [1409]

Value of time, in tenths of a second, after which, when the set weight value is exceeded, the output associated with set-point 1 is enabled.

The function is not active with programmed time equal to zero

*Values: from 000 to 999*

*Default: 0*

## NodE 2

### SET-POINT 2 OPERATING MODE

Select in sequence 4 operating criteria of set-point 2: [1410]

Comparison with net weight, with gross weight or with peak. In the latter case the comparison is carried out with the last acquired peak value, even when the peak function is not active.

*NET*        *The relay output is active in Net Weight mode. [0]*

*GROSS*     *The relay output is active in Gross Weight mode. [1]*

*PEAK*       *The relay output is active in Peak mode. [2]*

*PROCESS*   *The relay output is active when the instrument is working normally. [3]*

*Default: GROSS*

Selecting the output status if normally open or closed: [1411]

*n. oPEn.*    *Relay 2 is normally open. [0]*

*n.CLoSE*   *Relay 2 is normally closed. [1]*

*Default: n. oPEn.*

Select if positive or negative values have to be compared. [1412]

*PoSIt.*      *The output is operative with positive weight. [0]*

*nEGAt.*     *The output is operative with negative weight. [1]*

*ALL:*        *The output is operative both with positive and negative weight. [2]*

*Default: PoSIt*

Select whether only stable weight values are to be compared or also unstable: [1413]

*norMAL*    *Output 2 is active with unstable weight. [0]*

*StAbLE*    *Output 2 is active with stable weight. [1]*

*Default: norMAL*

## HySt. 2

### SET-POINT 2 HYSTERESIS [1414]

Hysteresis value with respect to the set-point

*Value: from 0 to Capacity*

*Default: 2*

## t1NEr2

### SET-POINT 2 TIMING [1415]

Value of time, in tenths of a second, during which, when the weight value set is exceeded, the output associated with set-point 2 remains enabled.

After this time, even if the weight value is still above the set-point, the output is automatically disabled.

The function is not active with programmed time equal to zero.

*Values: from 000 to 999*

*Default: 0*

## dELAy2

SET-POINT 2 DELAY [1416]

Value of time, in tenths of a second, after which, when the set weight value is exceeded, the output associated with set-point 2 is enabled.

The function is not active with programmed time equal to zero

*Values: from 000 to 999*

*Default: 0*



## WEIGHING PARAMETERS

The parameters in this menu permit adjustment of the times for acquisition and updating of the display and manual or automatic resetting by the transmitter.

### uSE

#### INSTRUMENT OPERATION

Selecting the operation of the instrument. In case of a change from FREE operation to METRIC operation, to confirm the setting authentication is required through the password of authorised personnel.

<i>Value</i>	<i>Variation</i>
<i>Free</i>	<i>Free operation. [0]</i>
<i>Trade</i>	<i>METRIC instrument operation. [1]</i>

*Default: Free*

### Not1on

#### STABILITY OF WEIGHT [1303]

This parameter defines the number of divisions needed to consider the weight stable.

A high number of divisions allows the transmitter to quickly detect stability of the weight, which is needed when executing tare and print commands.

<i>Value</i>	<i>Variation</i>
<i>0</i>	<i>Weight always stable</i>
<i>1</i>	<i>Stability determined quickly</i>
<i>2</i>	<i>Stability determined with medium parameters</i>
<i>3</i>	<i>Stability determined accurately</i>
<i>4</i>	<i>Stability determined with the highest accuracy</i>

*Default: 2*

### AUto-0

#### AUTOZERO WHEN SWITCHING ON [1304-1305]

This parameter defines the value of maximum weight that can be reset when the instrument is switched on.

This operation corresponds to zero calibration of the system and is executed only if the weight is stable and below the set value.

*Value: from 0 to Capacity.*  
*Default: 0*

## 0-trAC

### ZERO TRACKING [1306]

This function allows you to perform temporary zero calibration compensating for the temperature drift of the weight.

Switching off the transmitter automatically restores the previous zero calibration.

The maximum weight that can be reset by this parameter is 2% of the capacity of the system.

To disable this function, set the value 0.

<i>Value</i>	<i>Variation</i>
0	<i>Control excluded</i>
1	<i>0.5 div/sec</i>
2	<i>1 div/sec</i>
3	<i>2 div/sec</i>
4	<i>3 div/sec</i>

*Default: 0*

## 0-bAnd

### ZERO BAND [1307]

This parameter defines the number of divisions that can be reset by pressing the zero button on the front or the associated Input.

*Values: from 0 to 200.*

*Default: 100*

## FILTER - SETTING FILTER PARAMETERS

### d1G.bAn.

#### WEIGHT FILTER VALUE [1201]

This parameter adjusts not only the refresh rate of the display, but specially the serial and analogue output. The maximum refresh rate of the display is limited to 25 Hz

High filter values speed up the weight update.

Low values of the filter slow down the weight update.

Factor (Hz)	Settling Time (mS)	ADC Freq (Hz)	N readings	Monotony Time (mS)	Oscillation time (mS)	Oscillation range (div)
MANUAL [0]		Selectable	Settable	Settable	Settable	Settable
50 [1]	20	250	5	20	4000	10
25 [2]	40	100	5	40	3000	12
10 [3]	100	50	5	80	2500	16
5 [4]	200	50	10	100	2000	20
2 [5]	500	50	25	250	1500	25
1,25 [6]	800	12,5	10	300	1500	25
1 [7]	1000	12,5	12	400	1500	25
0,7 [8]	1500	12,5	19	500	1200	30
0,5 [9]	2000	12,5	25	600	1000	30

*Default: 2 Hz*

The following parameters are visible and therefore can be set, only if the parameter selection is MANUAL.

### C. rAtE.

#### ADC SPEED [1202]

With this parameter, the frequency of weight acquisition is adjusted. If the parameter changes to values higher than 12.5 Hz, the weight must be stable. In case of instability the instrument will immediately indicate an error message.

Selectable Values:

12,5 [0]

50 [1]

100 [2]

250 [3]

1000 [4]

### AJErAG.

#### NUMBER OF READINGS ON AVERAGE [1203]

With this parameter you set the number of readings that the filter will use to establish the average weight value.

*Values: from 0 to 50.*

**Nonot.**

MONOTONY TIME [1204]

Parameter used to stabilize the weight when continuous variation of the last digit is detected. Normally used in case of resolution of the weight exceeding 10,000 divisions or with low sensitivity of the input signal. Value expressed in mS.

*Values: from 0 to 999.*

**t.oSC1L..**

OSCILLATIONS TIME [1205]

Parameter used in conjunction with oscillation Range to reduce the lens weight changes and repetitive typical in lifting systems. Enter the value of the oscillation time expressed in mS.

*Values: from 0 to 999.*

**r.oSC1L.**

OSCILLATIONS RANGE [1206]

As for the parameter Oscillation time, used to reduce the oscillations. Enter the value of the oscillation expressed in weight divisions.

*Values: from 0 to 99.*

## SETTING FUNCTIONAL FEATURES

### Std. by.

#### STAND BY [1001]

Idle time beyond which the instrument automatically assumes a low brightness status and keypad lock.

0 = deactivated function.

*Values: from 0 to 999.*

*Default: 0*

### LoCk.

#### KEYPAD LOCK [1002]

Set of 4 binary values that correspond to the 4 keys.

0 → key not locked

1 → key locked

(e.g. 0101 corresponds to locking the 2nd and 4th key).

*Values from 0000 to 1111.*

*Default: 0000*

### P1n.Cod..

#### PASSWORD SETTING [1003]

If programmed, to access the programming menu you must enter the password. In the event of subsequent accesses it is no longer necessary to type the password until the stand-by intervenes or the instrument is powered off.

*Values from 0 to 9999.*

*Default: 0000 (no Password)*

### PEAk.

#### PEAK FUNCTION [1004]

Allows the peak function to be available or not and refers it to the net or gross weight.

If the application does not provide this feature you can disable it.

*Selectable setting:*

*NONE [0]*

*NET [1]*

*GROSS [2]*

*Default: NONE*

## DISPLAYED PARAMETERS ONLY IF OPTIONAL MEMORY INSTALLED

**dAt.LoG.**

## DATALOGGER [1005]

Allows you to save the weight and I/O status in the optional memory in Excel format. The logging can be a single measurement or a continuous series of measurements from the start of storage (max 1000 measurements). The memory can contain a maximum of 60000 records, after which the oldest records are overwritten.

*Selectable setting:*

NONE [0]

SINGLE [1]

CONTIN. [2]

*Default: NONE*

**LoG.trG.**

## TRIGGER DATALOGGER [1006]

If the datalogger is enabled, select whether storage is done manually (by button or input), or on activation of output 1 or 2. To start storing by key, press and hold the SET button. Storage can be interrupted at any time by pressing the ZERO key.

*Selectable setting:*

MANUAL [0]

OUT1 [1]

OUT2 [2]

*Default: MANUAL*

**LoG.FrQ.**

## DATALOGGER FREQUENCY [1007]

If the datalogger is enabled, select the storage frequency of data (datalogger). The maximum frequency corresponds to that of weight acquisition (maximum frequency 250 Hz).

*Selectable setting:*

10 MIN. [0]

5 MIN. [1]

1 MIN. [2]

10 SEC. [3]

5 SEC. [4]

2 SEC. [5]

1 HZ [6]

5 HZ [7]

10 HZ [8]

HIGH [9]

*Default: 10 MIN.*

## LoGdnL.

### DOWNLOAD LOG

Log download function, the records are transmitted through the USB key of the instrument. This function can be interrupted at any time by pressing the ZERO key.

At the end of the transmission you are prompted to delete the log, confirm by pressing PRG or cancel by pressing the ZERO weight key.

## LoGErS.

### LOG DELETION

Log delete function, confirm with the PRG key or cancel with the ZERO key.

*NOTE:* In the download function of the log the records are transmitted in the followings format (starting from the oldest record):

*<Tempo>; <Gross>; <Net>; <Peak>; <Inputs>; <Outputs> CR LF*

Or in case of Date and Time option

*<Date> ; <Time> ; <Lordo> ; <Netto> ; <Picco> ; <Ingressi> ; <Uscite> CR LF*

*Where:*

*Tempo:* field consists of six ASCII characters with the value of the recording time justified to the right (value in seconds from 0 to 999999, without insignificant zeros) If the LOG function is configured to store a single record at a time, this field is always 0.

*Date:* field consists of eight ASCII characters with the value of the recording date, in the format "dd/mm/yy".

*Time:* field consists of eight ASCII characters with the value of the recording time, in the format "hh:mm:ss".

*Gross Net Peak:* fields consisting of 8 ASCII characters with the weight value justified to the right (without insignificant zeroes, with decimal points and negative signs).

*Inputs:* two ASCII characters, "0" (30h, input disabled) or "1" (31h, input enabled). Which indicate the status of input 1 and the status of input 2.

*Outputs:* two ASCII characters, "0" (30h, output disabled) or "1" (31h, output enabled). Which indicate the status of output 1 and the status of output 2.

## SET DATE AND TIME



This menu is shown only with clock hardware installed.

**dAtE**

### SET DATE

Parameter for the adjustment of the current date

Format of selectable value: dd.mm.yy

*dd from 01 to 31*

*mm from 01 to 12*

*yy from 00 to 99*

*Default: actual date*

**t1NE**

### SET TIME

Parameter for the adjustment of the current time

Format of selectable value: hh:mm

*hh from 00 to 23*

*mm from 00 to 59*

*Default: actual time*



## UPLOAD/DOWNLOAD FUNCTION



The TESTER 1008 must be connected to the serial COM1 (RS232) of the instrument.

This feature allows you to download or upload the setup configuration and calibration data stored in the instrument.

- Download function: The instrument setup parameters are stored in a file.
- Upload function: the instrument is configured with the setup parameters read from a file.

To use these functions it is necessary to activate the procedure ( "receive" files or "transmit file") in 1008 TESTER instrument.

## ACCESS VIEWING



This menu only appears in case of METRIC functioning.

SUB MENU	MESSAGGE	NAME	DESCRIZIPTION	TYPE
ACCEss	ACC-01	Access 01	Procedure for wiewing last access of authorized personnel.	Spc
	ACC-02	Access 02	Procedure for wiewing last but one access of authorized personnel.	Spc
	ACC-03	Access 03	Procedure for wiewing last but two access of authorized personnel.	Spc
	ACC-04	Access 04	Procedure for wiewing last but three access of authorized personnel.	Spc
	ACC-05	Access 05	Procedure for wiewing last but four access of authorized personnel.	Spc

## PROCEDURE FOR ACCES VIEWING

Press PRG to enter: you will see the operator code used to access the programming of the instrument and the sequential number of accesses as indicated below:

**1d.0000**

The display shows the ID code used for access (the password table). In the case where access is made through calibration jumper, it displays the identification code 0000.

Press the PRG key to continue with the visualization of the progressive access number.

**Pr.0000**

The display shows the sequence number of access (this value is incremented at each access and is never reset). Press the PRG key to exit the access viewing procedure.

## ALIBI MEMORY CONSULTATION



This menu only appears in case of METRIC functioning.

SUB MENU	MESSAGE	NAME	DESCRIPTION	TYPE	RANGE
ALi.NEN	SEE.NEN.	Aliby memory consultation	Procedure for consulting weigh stored in aliby memory.	Spc	0-959999

In case of METRIC functioning and with aliby memory enabled:

- Each executed weigh is stored in the aliby memory.
- For each weighing it is associated an identification code, with value range from 0 to 959999
- The identification code of the weighing is transmitted to the serial port at the time of weighing.

## ALIBI MEMORY CONSULTATION PROCEDURE

**000000**

Enter the ID code of the weighing and confirm with the PRG key.

**0.000**

The display shows the weight associated with the required identification code. Press the ZERO key to exit the consultation procedure of the alibi memory.

**no Cod.**

If the required identification code is not present in the alibi memory, a timed message "NO CODE" is showed.

## SERIAL COMMUNICATION PROTOCOLS

### CONTINUOUS, AUTOMATIC AND MANUAL ASCII PROTOCOLS

The continuous transmission is carried out at the refresh rate of the weight, consistent with the serial transmission baud rate. In case of communication on the ethernet port, the continuous transmission frequency is limited to 12.5 Hz.

In case of FREE mode, the string is transmitted with Continuous, On Demand and Automatic protocols:

STX	<status>	<weight>	ETX	<chksum>	EOT
-----	----------	----------	-----	----------	-----

In case of METRIC mode, the string is transmitted with On Demand and Automatic protocols:

STX	<status>	<weight>	Weighing ID	ETX	<chksum>	EOT
-----	----------	----------	-------------	-----	----------	-----

Where:

STX (start of text) = 0x02h

ETX (end of text) = 0x03h

EOT (end of transmission) = 0x04.

<status> = character encoded as per the following table (bit = 1 if condition TRUE):

Bit 7	Bit 6	Bit 5	Bit 4	Bit 3	Bit 2	Bit 1	Bit 0
0	0	1	1	Tare Entered	Zero band	Stable weight	Centre zero

<weight> = field consisting of 8 ASCII characters with the weight value justified to the right (without insignificant zeroes, with decimal points and negative signs).

The weight value transmitted may be the net weight, the gross weight or the peak value, depending on the transmitted data selected (parameter MODE) in the configuration menu of the serial communication ports (see related paragraph).

In conditions of overweight the field assumes the value: "^^^^^^^^".

In conditions of underweight greater than 999999, the field assumes the value: " \_ \_ \_ \_ \_ \_ \_ \_".

In conditions of weight reading error the field assumes the value: " O-L ".

<weighing ID> = field consisting of seven ASCII characters with the identifier code of the weight justified to the right (without insignificant zeros).

<chksum> = checksum of the string data. It is calculated by performing the exclusive OR (XOR) of all the characters between STX (or from <Addr>) and ETX, with the exclusion of the latter two; the result of the XOR is broken up into 2 characters considering the upper 4 bits (first character) and the lower 4 bits (second character) separately; the 2 characters obtained are then ASCII encoded;

(example: XOR = 5Dh; <csum> = "5Dh" i.e. 35h and 44h).



*In the case of automatic and manual communication protocols, between 2 successive transmissions the weight must have a variation of at least 20 divisions.*

## SLAVE TRANSMISSION PROTOCOL

## LIST OF THE CONTROLS AVAILABLE:

1. Request for the net and gross weight and current peak.
2. Execution weighing command
3. Autotare command
4. Zero command
5. Peak reset command
6. Programming two weight setpoints
7. Requesting the programmed setpoints.
8. Logic output activation
9. Request Input status
10. Command of setpoints storage in permanent memory.
11. Change in net weight.
12. Change in gross weight.
13. DeleteTare command.
14. Request for Net weight.
15. Request for Gross weight.

The unit connected to the instrument (typically a personal computer) acts as a MASTER and is the only unit that can start a process of communication.

The process of communication must be made by the transmission of a string by the MASTER, followed by a reply from the SLAVE concerned.

## CONTROLS FORMAT DESCRIPTION:

The double quotes enclose constant characters (observe upper and lower case); the < and > symbols contain variable numeric fields. The <addr> is the instrument identification. In case of communication on the RS485 port, is obtained by adding 80h to the instrument's address value (for example with address 3 <addr> = 80h + 03h = 83h). In case of communication on the RS232 port, the <addr> must always be equal to 81h, or, in case of communication on the Ethernet port, the <addr> must always be equal to FFh

## 1.REQUEST FOR THE NET AND GROSS WEIGHT AND CURRENT PEAK

Master: <Addr> "N" EOT

DAT 400: "N" <Addr> <status> <net> <gross> <peak> ETX <chksum> EOT

## 2 EXECUTION WEIGHIN COMMAND

This command is only available in case of METRIC operation. The possible use conditions are:

- Stable weight.
- Since the last executed weigh, the weight has undergone a change of at least 20 divisions (delta weight).
- Gross weight equal to or greater than the minimum weight (minimum of 20 divisions) and less than the maximum capacity.
- Net weight not null. Between two successive requests, the weight must have a variation of 20 divisions; if the weight is unstable the command is not executed.

Master: <Addr> "P" EOT

T200F: <Addr> "P" <status> <weight> <ID weight> ETX <chksum> EOT  
or <Addr> NAK EOT

3 AUTO-TARE COMMAND

Master: <Addr> "A" EOT

T200F: <Addr> "A" ACK EOT or <Addr> NAK EOT

4. SEMI-AUTOMATIC ZERO COMMAND

Master: <Addr> "Z" EOT

T200F: <Addr> "Z" ACK EOT or <Addr> NAK EOT

5. PEAK VALUE RESET COMMAND

Master: <Addr> "X" EOT

T200F: <Addr> "X" ACK EOT or <Addr> NAK EOT

6. PROGRAMMING TWO WEIGHT SET-POINTS

Master: <Addr> "S" <s1> <s2> ETX <csum> EOT

T200F: <Addr> "S" ACK EOT or <Addr> NAK EOT

7. REQUESTING PROGRAMMED SET-POINTS

Master: <Addr> "R" EOT

T200F: <Addr> "R" <s1> <s2> ETX <csum> EOT or <Addr> NAK EOT

8. ACTIVATION OF LOGIC OUTPUTS.

Master: <Addr> "U" <outputs> EOT

T200F: <Addr> "U" ACK EOT or <Addr> NAK EOT

9. STATUS REQUEST OF LOGIC INPUTS

Master: <Addr> "I" EOT

T200F: <Addr> "I" <inputs> ETX <csum> EOT or <Addr> NAK EOT

10. COMMAND FOR STORING SET-POINTS IN THE PERMANENT MEMORY.

Master: <Addr> "E" EOT

T200F: <Addr> "E" ACK EOT or <Addr> NAK EOT

*In the case of a communication error or a command that is not recognised, T200F responds with the following string:*

T200F: <Addr> NAK EOT

<s1> and <s2>: formatted as weight field.

<outputs> and <inputs>: single ASCII character encoded as per the following table (bit = 1 if input/output enabled).

BIT 7	BIT 6	BIT 5	BIT 4	BIT 3	BIT 2	BIT 1	BIT 0
0	0	1	1	0	0	Input 2 / output 2	Input 1 / output 1

11. CHANGE FROM GROSS TO NET WEIGHT

Master: <Addr> "CN" EOT

T200F: <Addr> "C" ACK EOT or <Addr> NAK EOT

12. CHANGE FROM NET TO GROSS WEIGHT

Master: <Addr> "CL" EOT

T200F: <Addr> "C" ACK EOT or <Addr> NAK EOT

13. DELETE TARE COMMAND

MASTER: <Addr> "DT" EOT

T200F: <Addr> "D" ACK EOT or <Addr> NAK EOT

14. REQUEST FOR NET WEIGHT (used for repeater program PDAT06)

MASTER: <Addr> "W" "N" EOT

T200F: <Addr> "W" <rip status> <net> ETX <csum> EOT or <Addr> NAK EOT

15. REQUEST FOR GROSS WEIGHT (used for repeater program PDAT06)

MASTER: <Addr> "W" "G" EOT

T200F: <Addr> "W" <rip status> <gross> ETX <csum> EOT or <Addr> NAK EOT

where:

<rip status>: character encoded as per the following table (bit = 1 in case of true condiction).

Bit 7	Bit 6	Bit 5	Bit 4	Bit 3	Bit 2	Bit 1	Bit 0
0	0	1	1	Displayed weight 0 = net 1 = gross	Zero band	Stable weight	Zero center

<net> <gross> =field consisting of 8 ASCII characters with the net and gross weight value justified to the right (without insignificant zeroes, with decimal points and negative signs).

In overweight conditions the field assumes the value: "^^^^^^^^".

In conditions of underweight (negative weight greather of 999999), the field assumes the value: " \_ \_ \_ \_".

Under weight reading error conditions, the field assumes the value: " O-L ".

## PRINTER PROTOCOL

Data transmission protocol to Plus Printer

Printing can be started by pressing a key (see section FUNCTION OPERATIONAL) or by input (see paragraph SETTING I/O).

Here is an example of printer.

216/06/16	15:32
Net	209.0 kg
Gross	211.5 kg
Tare	2.5 kg
Peak	268.5 kg
Code	212456



- Date is printed only in case of hardware with time clock.
- The peak value is only printed if the peak function is enabled.
- The identification code of the weighing is printed only in case of METRIC operation and alibi memory configured.

The conditions to printing are:

- Stable weight (or stabilized within 3 seconds from command).
- Since the last executed weigh, the weight has undergone a change of at least 20 divisions (delta weight).
- Gross weight equal to or greater than the minimum weight (20 divisions) and less than the maximum capacity.
- Net weight not null.

Only in case of FREE functioning, printing is permitted even with gross weight less than the minimum weight or with zero net weight.



## MODBUS RTU PROTOCOL

The addresses set out in the tables follow the standard routing specified in the reference guide of Modicom PI-MBUS-300 an extract of which is provided below to help the user communicate with the instrument.

*“All data addresses in Modbus messages are referenced to zero. The first occurrence of a data item is addressed as item number zero. For example:*

*The coil known as ‘coil 1’ in a programmable controller is addressed as coil 0000 in the data address field of a Modbus message.*

*Coil 127 decimal is addressed as coil 007E hex (126 decimal).*

*Holding register 40001 is addressed as register 0000 in the data address field of the message. The function code field already specifies a ‘holding register’ operation. Therefore the ‘4XXXX’ reference is implicit.”*

To confirm a new value entered in E2prom, run the MAKE – BACKUP function. If this function is not performed, by switching off, the T200F, the value before the change will be restored.

Unless otherwise specified, the numerical values (such as addresses, codes and data) are expressed as decimal values.

The MODBUS RTU protocol is available only on COM2 RS485.

## HANDLING OF COMMUNICATION ERRORS

The CRC (Cyclic Redundancy Check) is carried out to check the communication strings. In the case of a communication error, the slave does not respond with a string. The master must consider a timeout for receipt of the response. If it does not receive a response, a communication error has occurred

## HANDLING OF RECEIVED DATA ERRORS

In the case of a string that has been received correctly but cannot be executed, the slave responds with an EXCEPTIONRESPONSE as indicated in the table below.

CODE	DESCRIPTION
1	ILLEGAL FUNCTION (The function is not valid or not supported)
2	ILLEGAL DATA ADDRESS (The address of the specified data is not available)
3	ILLEGAL DATA VALUE (The values of the received data are invalid)

## FUNCTIONS SUPPORTED:

FUNCTION	DESCRIPTION
01	READ COIL STATUS (Reading the status of the logic outputs)
02	READ INPUT STATUS (Reading the status of the logic inputs)
03	READ HOLDING REGISTERS (Reading the programmable registers)
04	READ INPUT REGISTERS (Reading the “read only” registers)
05	FORCE SINGLE COIL (Writing the status of each output)
06	PRESET SINGLE REGISTER (Writing a programmable register)
15	FORCE MULTIPLE COILS (Multiple writing of outputs)
16	PRESET MULTIPLE REGISTERS (Multiple writing of registers)
Funct + 80h	EXCEPTION RESPONSE

## LIST OF THE MODBUS PROTOCOL HOLDING REGISTERS

The instrument parameters that can be read or programmed via the communication interfaces available on the instrument, depending on the hardware configuration, are listed in the following table.

R type registers are readable while W type are writeable.

In case of Modbus TCP protocol, the address of the instrument (the "Unit Identifier" field) must always be FFh.

If a fieldbus is used (different from the Modbus), only the R or R/W registers will be in the input area and only the W or R/W registers will be in the output area.

The registers are 16 bit in size.

Address	Holding Register	R/W	Notes
0001	Status Register	R	See relevant table.
0002	Gross weight (MSB)	R	INT. value - Most significant word
0003	Gross weight (LSB)	R	INT. value - Less significant word
0004	Net weight (MSB)	R	INT. value - Most significant word
0005	Net weight (LSB)	R	INT. value - Less significant word
0006	Peak (MSB)	R	INT. value - Most significant word
0007	Peak (LSB)	R	INT. value - Less significant word
0008	Digital Inputs	R	See relevant table
0009	Digital Outputs	R	
0101	Weighted Net weight (MSB)	R	INT. value - Most significant word
0102	Weighted Net weight (LSB)	R	INT. value - Less significant word
0103	Weight code (MSB)	R	INT. value - Most significant word
0104	Weight code (LSB)	R	INT. value - Less significant word
0201	Set-Point 1 (MSB)	R/W	INT. value - Most significant word
0202	Set-Point 1 (LSB)	R/W	INT. value - Less significant word
0203	Set-Point 2 (MSB)	R/W	INT. value - Most significant word
0204	Set-Point 2 (LSB)	R/W	INT. value - Less significant word
0501	Data Register (MSB)	W	INT. value - Most significant word (See relevant table)
0502	Data Register (LSB)	W	INT. value - Least significant word (See relevant table)
0503	Command Register	W	See relevant table.
1001	Stand-by function	R/W	INT. value
1002	Keypad Lock function	R/W	See relevant table
1003	Password function	R/W	INT. value
1004	Peak function	R/W	See correspondence on page 47
1005	Data-Logger function	R/W	See correspondence on page 48
1006	Data-Logger Trigger	R/W	See correspondence on page 48
1007	Data-Logger function	R/W	See correspondence on page 48
1101	Weight division value (*)	R/W	See relevant table.
1102	Decimals (*)	R/W	
1103	Capacity of load cells (MSB) (*)	R/W	INT. value - Most significant word
1104	Capacity of load cells (LSB) (*)	R/W	INT. value - Less significant word
1105	Sensitivity of load cells (*)	R/W	INT. value
1106	Fixed Tare (MSB) (*)	R/W	INT. value - Most significant word
1107	Fixed Tare (LSB) (*)	R/W	INT. value - Less significant word
1108	Gravity Calibration (MSB) (*)	R/W	INT. value - Most significant word
1109	Gravity Calibration (LSB) (*)	R/W	INT. value - Less significant word

1110	Gravity zone of use (MSB) (*)	R/W INT. value - Most significant word
1111	Gravity zone of use (LSB) (*)	R/W INT. value - Less significant word
1151	Cal. table Zero signal (MSB) (*)	R/W INT. value - Most significant word
1152	Cal. table Zero signal (LSB) (*)	R/W INT. value - Less significant word
1153	Cal. table P1 signal (MSB) (*)	R/W INT. value - Most significant word
1154	Cal. table P1 signal (LSB) (*)	R/W INT. value - Less significant word
1155	Cal. table P2 signal (MSB) (*)	R/W INT. value - Most significant word
1156	Cal. table P2 signal (LSB) (*)	R/W INT. value - Less significant word
1157	Cal. table P3 signal (MSB) (*)	R/W INT. value - Most significant word
1158	Cal. table P3 signal (LSB) (*)	R/W INT. value - Less significant word
1159	Cal. table P4 signal (MSB) (*)	R/W INT. value - Most significant word
1160	Cal. table P4 signal (LSB) (*)	R/W INT. value - Less significant word
1161	Cal. table P5 signal (MSB) (*)	R/W INT. value - Most significant word
1162	Cal. table P5 signal (LSB) (*)	R/W INT. value - Less significant word
1163	Cal. table P1 value (MSB) (*)	R/W INT. value - Most significant word
1164	Cal. table P1 value (LSB) (*)	R/W INT. value - Less significant word
1165	Cal. table P2 value (MSB) (*)	R/W INT. value - Most significant word
1166	Cal. table P2 value (LSB) (*)	R/W INT. value - Less significant word
1167	Cal. table P3 value (MSB) (*)	R/W INT. value - Most significant word
1168	Cal. table P3 value (LSB) (*)	R/W INT. value - Less significant word
1169	Cal. table P4 value (MSB) (*)	R/W INT. value - Most significant word
1170	Cal. table P4 value (LSB) (*)	R/W INT. value - Less significant word
1171	Cal. table P5 value (MSB) (*)	R/W INT. value - Most significant word
1172	Cal. table P5 value (LSB) (*)	R/W INT. value - Less significant word
1201	Filter factor	R/W See correspondence on page 48
1202	Output rate ADC	R/W See correspondence on page 48
1203	Number of readings on average	R/W INT. value
1204	Monotony Time	R/W INT. value
1205	Oscillations Time	R/W INT. value
1206	Oscillations Range	R/W INT. value
1301	Full Scale (MSB) (*)	R/W INT. value - Most significant word
1302	Full Scale (LSB) (*)	R/W INT. value - Less significant word
1303	Weight stability (*)	R/W See correspondence on page 46
1304	Auto zero when switching on (MSB) (*)	R/W INT. value - Most significant word
1305	Auto zero when switching on (LSB) (*)	R/W INT. value - Less significant word
1306	Zero tracking (*)	R/W See correspondence on page 47
1307	Resettable Divisions (MSB) (*)	R/W INT. value - Most significant word
1308	Resettable Divisions (LSB) (*)	R/W INT. value - Less significant word
1401	Input 1 function	R/W See correspondence on page 43
1402	Input 2 function	R/W See correspondence on page 43
1403	Output mode 1— Function	R/W See correspondence on page 43
1404	Output mode 1— Logic	R/W See correspondence on page 43
1405	Output mode 1— Polarity	R/W See correspondence on page 44
1406	Output mode 1— Stability	R/W See correspondence on page 44
1407	Hysteresis output 1	R/W Valore INT.
1408	Timing output 1	R/W Valore INT.
1409	Delay output 1	R/W Valore INT.

1410	Output mode 2—F unction	R/W	See correspondence on page 44
1411	Output mode 2— Logic	R/W	See correspondence on page 45
1412	Output mode 2— Polarity	R/W	See correspondence on page 45
1413	Output mode 2 — Stability	R/W	See correspondence on page 45
1414	Hysteresis output 2	R/W	INT. value
1415	Timing output 2	R/W	INT. value
1416	Delay output 2	R/W	INT. value
1501	Analogue Tare (MSB	R/W	INT. value - Most significant word
1502	Analogue Tare (LSB)	R/W	INT. value - Less significant word
1503	Analogue Full Scale (MSB	R/W	INT. value - Most significant word
1504	Analogue Full Scale (LSB)	R/W	INT. value - Less significant word
1505	Analogue Output Mode	R/W	See correspondence on page 35
1506	Analogue Output Range	R/W	See correspondence on page 35
1507	Regulation of analogue zero	R/W	INT. value Analogue output zero points, to end the regulation procedure it is necessary to send the data storage command to the permanent memory in the Command Register.
1508	Regulation of analogue full scale	R/W	INT. value Analogue output full scale points, to end the regulation procedure it is necessary to send the data storage command to the permanent memory in the command register.
2000	Monitor register	W	The programmed value is automatically copied in the Monitor Register R (2100).
2100	Monitor register	R	

*(\*) These registers can only be modified in FREE mode or if in METRIC mode with a calibration bridge enabled.*

TABLE A - REGISTER STATUS CODING

BIT	15	14	13	12	11	10	9	8
Description	Setup (***)	Weight difference	Output 2	Output 1	Input 2	Input 1	Run Backup	Hold function
BIT	7	6	5	4	3	2	1	0
Description	Not calibrated	Weight error	Over-load	Under-load	Tare entered	Zero band	Stable weight	Zero centre

TABLE B - KEYPAD LOCK CODING

BIT	15÷4	3	2	1	0
Description	Not used	SET Key	FUN Key	0 Key	PRG Key

*ATTENTION: the bits from 15 to 4 are not managed and are always equal to 0.*

TABLE C - INPUTS/OUTPUTS CODING

BIT	15÷2	1	0
Description	Not used	IN/OUT 2 Active	IN/OUT 1 Active

*ATTENTION: the bits from 15 to 4 are not managed and are always equal to 0.*

TABLE D - DECIMALS AND DIVISION VALUE CODING

ADDRESS	DESCRIPTION	ACCEPTED VALUES
1104	Division value	1 - 2 - 5 - 10 - 20 - 50
1105	Number of decimals	0 - 1 - 2 - 3 - 4

TABLE E - DATA REGISTER / COMMAND REGISTER CODING

REGISTER VALUE	COMMAND REGISTER FUNCTION	FUNCTION DATA REGISTER
0x0001	Semiautomatic zero	
0x0002	Auto-tare	
0x0003	Peak Reset	
0x0004	Zero calibration (**)	
0x0005	Full scale calibration (**)	Sample weight value in MSB and LSB
0x0006	Analogue Test	Value between 0 and 100 at intervals of 10 LSB
0x0007	Saving the data in the permanent memory	
0x000A	Run command.	
0x000B	Change from gross to net	
0x000C	Change from net to gross	
0x000D	Acquisition of the zero signal (calibration table)	
0x3FFF	Enabling Output Data Area (*)	

(\*) The instrument parameters managed in the Fieldbus Output Data Area are not changed until this command is sent. When the instrument is switched on the Output Data area is completely reset, the master fieldbus must read the parameter values from the Input Data Area and copy them in the relevant registers of the Output Data Area, then it must send the enable command in the Command Register. Otherwise all parameters managed in the Output Data area would be reset when switched on.

(\*\*) Function only available in FREE mode or if in METRIC mode with a calibration jumper enabled.

(\*\*\*) The instrument is undergoing configuration (TRUE flag during access to the SETUP menu of the instrument or during connection with PC "Optimation" software).

## EXAMPLES

### ZERO CALIBRATION

In condition of stable and unloaded scale write hexadecimal value 0004 in Command Register (0503). To permanently store in the memory the new Zero value, write hexadecimal value 0007 in Command Register (0503).

### FULL SCALE CALIBRATION

Put a sample weight on the scale, i.e 1256 kg.

Write in Data Register (0501 and 0502) the hex value of the sample weight: 04E8.

Write to the Command Register (0503), the hexadecimal value 0005.

You can write at the same time the Command Register and Data Register using the multiple registers function.

To permanently store in the memory the new value, write hexadecimal value 0007 in Command Register (0503).

INSTRUMENT RESPONSE TIMES

The instrument, to satisfy most requests, uses a variable time in accordance with the programming of the instrument parameters and the type of request as per table:

Update frequency of measurements	12,5 Hz	50 Hz	100 Hz	250 Hz	1000 Hz
Analogue output update frequency	12,5 Hz	50 Hz	100 Hz	250 Hz	1000 Hz
Fieldbus memory area reading and update update frequency.	125 Hz	125 Hz	125 Hz	125 Hz	125 Hz
Update frequency of logic outputs.	12,5 Hz	50 Hz	100 Hz	250 Hz	1000 Hz
Status and weight acquisition cycle from Modbus RTU (*)	$ffffffffff = \frac{11}{\left( \left( \frac{nnnnnnnnnn}{1111bbbbbbbb} \right) + 88 * 00,00 \right) 00000}$				
Status and weight acquisition cycle from ASC11 protocol (*)	$ffffffffff = \frac{11}{\left( \left( \frac{nnnnnnnnnn}{bbbbbbbb} \right) + 88 * 00,00 \right) 111100000}$				

(\*) nchar = sum of characters which make up the request string of the master (Query) and the response string of the T200F (Response).

Example of status request, net weight and gross weight (5 registers) at baud rate = 115,2 kbit/sec:

$$1 / (((8 + 15 + 8) * 10) / 115200) + 0,004 = 149 \text{ Hz}$$

Exceptions are:

- the Backup E2prom command (max time = 350mSec.)
- writing of the registers of Cells capacity, Cells sensitivity, Net weight, System tare, Filter (max time = 550mSec).

## USE OF SERIAL APPLICATIONS VIA THE USB PORT

PC software "OPTIMIZATION" allows:

- total configuration of all the setup parameters;
- testing of the different hardware sections;
- consultation of the instrument documentation
- updating of instrument firmware
- storage over time of the weight values acquired by the instrument using the Datalogger function;
- saving and loading of the configuration parameters of the instrument on file.

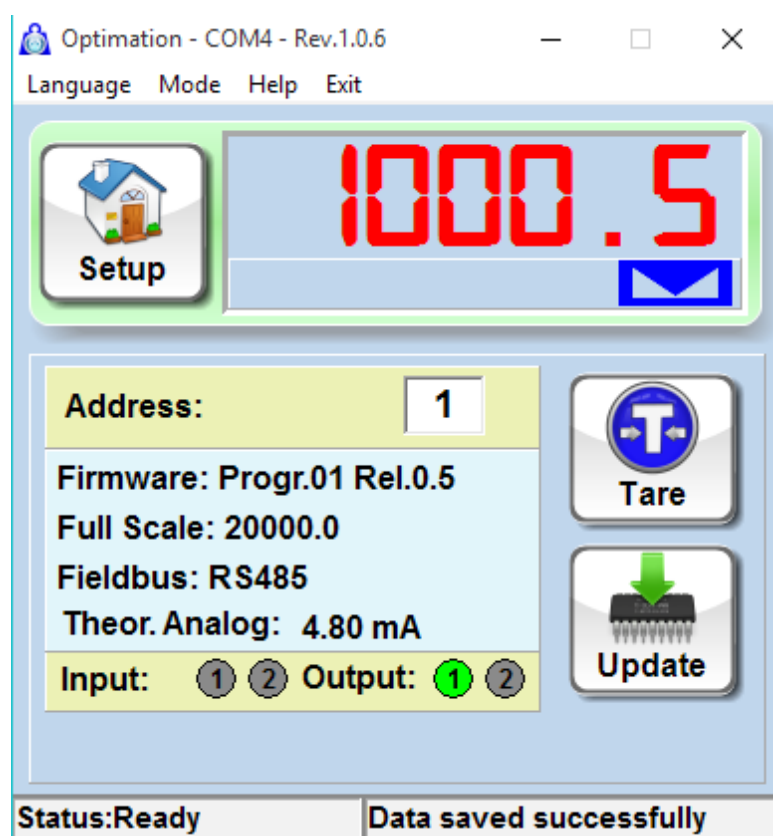

## FIELDBUS PROTOCOL

The following table lists the registers of the input area (produced from the instrument and read by the master), common to all PROFIBUS, PROFINET, ETHERCAT, ETHERNET/IP fieldbuses.

The registers are 16 bit in size. The input area is updated at a fixed frequency of 150 Hz (80 Hz in case of PROFIBUS).

The size of the output area configured in the master fieldbus must match the size configured in the instrument.

### INPUT DATA AREA

Byte	Register address	INPUT AREA REGISTER	Notes
1-2	0	Status Register	See relevant table.
3-4	1	Gross weight (MSB)	INT. value - Most significant word
5-6	2	Gross weight (LSB)	INT. value - Less significant word
7-8	3	Net weight (MSB)	INT. value - Most significant word
9-10	4	Net weight (LSB)	INT. value - Less significant word
11-12	5	Peak (MSB)	INT. value - Most significant word
13-14	6	Peak (LSB)	INT. value - Less significant word
15-16	7	Digital Inputs	See relevant table.
17-18	8	Digital Outputs	
19-20	9	Monitor register	This value corresponds to the same register in the output area.
21-22	10	Net weight weighing (MSB)	INT. value - Most significant word
23-24	11	Net weight weighing (LSB)	INT. value - Less significant word
25-26	12	Code weighing (MSB)	INT. value - Most significant word
27-28	13	Code weighing (LSB)	INT. value - Less significant word
29-30	14	Set-Point 1 (MSB)	INT. value - Most significant word
31-32	15	Set-Point 1 (LSB)	INT. value - Less significant word
33-34	16	Set-Point 2 (MSB)	INT. value - Most significant word
35-36	17	Set-Point 2 (LSB)	INT. value - Less significant word
37-38	18	Capacity of load cells (MSB)	INT. value - Most significant word
39-40	19	Capacity of load cells (LSB)	INT. value - Less significant word
41-42	20	Sensitivity of load cells	INT. value
43-44	21	Weight division value	See relevant table.
45-46	22	Decimals	See relevant table.
47-48	23	Fixed Tare (MSB)	INT. value - Most significant word
49-50	24	Fixed Tare (LSB)	INT. value - Less significant word
51-52	25	Stand-by function	INT. value
53-54	26	Keypad Lock function	See relevant table.
55-56	27	Password function	INT. value
57-58	28	Peak function	See correspondence on page 50
59-60	29	Data-Logger function	See correspondence on page 51
61-62	30	Data-Logger Trigger	See correspondence on page 51
63-64	31	Data-Logger function	See correspondence on page 51
65-66	32	Filter factor	See correspondence on page 48
67-68	33	Output rate ADC	See correspondence on page 48



69-70	34	Number of readings on average	INT. value
71-72	35	Monotony Time	INT. value
73-74	36	Oscillations Time	INT. value
75-76	37	Oscillations Range	INT. value
77-78	38	Full Scale (MSB)	INT. value - Most significant word
79-80	39	Full Scale (LSB)	INT. value - Less significant word
81-82	40	Weight stability	See correspondence on page 46
83-84	41	Auto zero when switching on (MSB)	INT. value - Most significant word
85-86	42	Auto zero when switching on (LSB)	INT. value - Less significant word
87-88	43	Zero tracking	See correspondence on page 47
89-90	44	Input 1 function	See correspondence on page 43
91-92	45	Input 2 function	See correspondence on page 43
93-94	46	Input 1 mode —Function	See correspondence on page 43
95-96	47	Input 1 mode —Logic	See correspondence on page 43
97-98	48	Input 1 mode —Polarity	See correspondence on page 44
99-100	49	Input 1 mode —Stability	See correspondence on page 44
101-102	50	Hysteresis input 1	INT. value
103-104	51	Timing input 1	INT. value
105-106	52	Delay input 1	INT. value
107-108	53	Input 2 mode —Function	See correspondence on page 44
109-110	54	Input 2 mode —Logic	See correspondence on page 45
111-112	55	Input 2 mode —Polarity	See correspondence on page 45
113-114	56	Input 2 mode —Stability	See correspondence on page 45
115-116	57	Hysteresis input 2	INT. value
117-118	58	Timing input 2	INT. value
119-120	59	Delay input 2	INT. value
121-122	60	Analogue Fixed Tare (MSB)	INT. value - Most significant word
123-124	61	Analogue Fixed Tare (LSB)	INT. value - Less significant word
125-126	62	Analogue Full Scale (MSB)	INT. value - Most significant word
127-128	63	Analogue Full Scale (LSB)	INT. value - Less significant word

#### READING EXAMPLE

To read the gross weight on the T200F it is needed to read the addresses from 3 to 6 of the Input Area.

To read the net weight is needed to read the addresses from 7 to 10 of the Input Area.

When the display shows the gross weight value of 12351 in the corresponding bytes there will be:

	Byte 3	Byte 4	Byte 5	Byte 6
Hex	00	00	30	3F

The following table lists the registers of the output area (written by the master and acquired by the instrument), common to all PROFIBUS, PROFINET, ETHERCAT, ETHERNET / IP Fieldbuses.

The registers are 16 bit in size. The registers written by the master in the output area, are read by the instrument at a fixed frequency of 150 Hz. (80 Hz in case of PROFIBUS)

The size of the output area configured in the master fieldbus must match the size configured in the instrument.

#### OUTPUT DATA AREA

Byte	Register address	OUTPUT AREA REGISTER	Note
1-2	0	Command Register	See relevant table.
3-4	1	Data Register (MSB)	INT. value - Most significant word (See Table)
5-6	2	Data Register (LSB)	INT. value - Least significant word (See Table)
7-8	3	Monitor register	This value corresponds to the same register in the input area.
9-10	4	Set-Point 1 (MSB)	INT. value - Most significant word
11-12	5	Set-Point 1 (LSB)	INT. value - Less significant word
13-14	6	Set-Point 2 (MSB)	INT. value - Most significant word
15-16	7	Set-Point 2 (LSB)	INT. value - Less significant word
17-18	8	Capacity of load cells (MSB)	INT. value - Most significant word
19-20	9	Capacity of load cells (LSB)	INT. value - Less significant word
21-22	10	Sensitivity of load cells	INT. value
23-24	11	Weight division value	See relevant table.
25-26	12	Decimals	See relevant table.
27-28	13	Fixed Tare (MSB)	INT. value - Most significant word
29-30	14	Fixed Tare (LSB)	INT. value - Less significant word
31-32	15	Stand-by function	INT. value
33-34	16	Keypad Lock function	See relevant table.
35-36	17	Password function	INT. value
37-38	18	Peak function	See correspondence on page 50
39-40	19	Data-Logger function	See correspondence on page 51
41-42	20	Data-Logger Trigger	See correspondence on page 51
43-44	21	Data-Logger function	See correspondence on page 51
45-46	22	Filter factor	See correspondence on page 48
47-48	23	Output rate ADC	See correspondence on page 48
49-50	24	Number of readings on average	INT. value
51-52	25	Monotony Time	INT. value
53-54	26	Oscillations Time	INT. value
55-56	27	Oscillations Range	INT. value
57-58	28	Full Scale (MSB)	INT. value - Most significant word
59-60	29	Full Scale (LSB)	INT. value - Less significant word
61-62	30	Weight stability	See correspondence on page 46
63-64	31	Auto zero when switching on (MSB)	INT. value - Most significant word
65-66	32	Auto zero when switching on (LSB)	INT. value - Less significant word
67-68	33	Zero tracking	See correspondence on page 47
69-70	34	Resettable Divisions (key >0<)	INT. value
71-72	35	Input 1 function	See correspondence on page 43
73-74	36	Input 2 function	See correspondence on page 43
75-76	37	Input 1 mode —Function	See correspondence on page 43

77-78	38	Input 1 mode —Logic	See correspondence on page 43
79-80	39	Input 1 mode —Polarity	See correspondence on page 44
81-82	40	Input 1 mode —Stability	See correspondence on page 44
83-84	41	Hysteresis input 1	INT. value
85-86	42	Timing input 1	INT. value
87-88	43	Delay input 1	INT. value
89-90	44	Input 2 mode —Function	See correspondence on page 44
91-92	45	Input 2 mode —Logic	See correspondence on page 45
93-94	46	Input 2 mode —Polarity	See correspondence on page 45
95-96	47	Input 2 mode —Stability	See correspondence on page 45
97-98	48	Hysteresis input 2	INT. value
99-100	49	Timing input 2	INT. value
101-102	50	Delay input 2	INT. value
103-104	51	Analogue Fixed Tare (MSB)	INT. value - Most significant word
105-106	52	Analogue Fixed Tare (LSB)	INT. value - Less significant word
107-108	53	Analogue Full Scale (MSB)	INT. value - Most significant word
109-110	54	Analogue Full Scale (LSB)	INT. value - Less significant word
111-112	55	Analogue Output Mode	See correspondence on page 35
113-114	56	Analogue Output Range	See correspondence on page 35

*(\*) These registers can only be modified in FREE mode or if in METRIC mode with a calibration bridge enabled.*

#### WRITING EXAMPLES

To write the set-up parameters following the example:

In the bytes 1-2 (Command Register) write value Hex 3FFF. This value opens the writing area of the T200F.

Example: to change the default values of the T200F like the Capacity of the load cells, the Sensitivity and Division value to 15000, 2.9965 and 2:

Capacity	Byte 17	Byte 18	Byte 19	Byte 20
Hex	00	00	3A	98
Dec	15000			

Sensitivity	Byte 21	Byte 22
Hex	75	0D
Dec	29965	

Division	Byte 23	Byte 24
Hex	00	0D
Dec	13	

Save the data by writing the value Hex 7 in Command Register.

N.B. The T200F does not accept writing of the same values already written.

To perform Zero and FS Calibration it is not needed to abilitate the internal Writing Area of the DAT 1400.

Zero Calibration:

Whit empty system put Hex 4 in Command Register (bytes 1-2). The new Zero value is stored.

Full Scale Calibration:

Put a know weight on the system and write its value in the Data Register (from byte 3 to 6). Put value Hex 5 in Command Register. The weight value will be displayed.

## CANOPEN - DESCRIPTION

The protocol supports the CiA DS301 "communication profile area".

Network Management (NMT) manages Pre-Operational, Operational, Stopped, Reset and Reset Communication states with its protocols.

The Heartbeat protocol is supported, setted by default at 1 second, and can be switched off by programming at 0 the intervention time. (Index = 1017h).

The Emergency Message Management intervenes when the following events occur or cease:

- Fault Sensor (code = 5030h according to CiA DS404) when the load cell signal is not detected due to failure or incorrect connection or failure of the hardware of the instrument.
- Sensor Calibration (code = 6310h based on CiA DS404), when no weight calibration was performed.
- Input Overload (code = F001h according to CiA DS404), when the load cell signal is out of the instrument reading range.

Two transmission PDO's are handled with the following transmission types:

- Synchronous acyclic (00h): The data is transmitted in response to the SYNC signal only if the data has been updated with respect to the previous transmission.
- Synchronous cyclic (01h): The data is transmitted in response to the SYNC signal even though it has not been updated yet.
- Asynchronous (FFh): This is the default operation that involves the transmission of the PDO to a predetermined frequency programmable in communication parameters (default = 0, transmission disabled).

The PDO1 is mapped to transmit the following values (updated at 125 Hz frequency):

- Gross weight (Index = 2001h), formatted as 32-bit Signed.
- Net weight (Index = 2002h), formatted as 32-bit Signed.

The PDO2 is mapped to transmit the following values (updated at 125 Hz frequency):

- Peak (index = 2003h), formatted as 32-bit Signed.
- Status Register (index = 2000h), formatted as 16-bit Signed.
- Digital input (index = 2004h), formatted as 8-bit Unsigned.
- Output (index = 2005h), formatted as 8-bit Unsigned.

SPECIFICATION

NMT	NMT slave
Error Log	Heartbeat producer
Boot-up	Yes
Range ID nodo	1 - 127
CANopen bit-rates	10 – 1000 kbit/sec
Numero di PDO	1 TPDO
Modalità PDO	Event-triggered (timer)
	Synchronous (cyclic)
	Synchronous (acyclic)
Mappatura PDO	Si (6 obj/PDO)
Emergency message	Si (Producer)
Numero di SDO	1 SDO server (“expedited” and “segmented” transferred)
	No SDO client
Sync	Sync producer: no
	Sync counter: no
Time stamp	No
Funzioni aggiuntive	-
Application layer	CiA 301 V 4.0.2
Frameworks supportati	-
Profili supportati	-
Certificato	No

## CANOPEN - OBJECT DICTIONARY - COMMUNICATION PROFILE AREA

## GENERIC PARAMETERS

Index	Sub-Index	Name	Description	Type	Attribute
1000h	0	DEV_TYPE	Device type information (*)	U32	R
1001h	0	ERR_REG	Error log	U8	R
1005h	0	COB_ID SYNC	COB_ID Sync message (80h)	U32	R/W
1010h	0	STORE_PAR	Sub-index number(4)	U8	R
	1		Store all parameters (**)	U32	R/W
	2		Store communication parameters (**)	U32	R/W
	3		Store application parameters (**)	U32	R/W
1011h	0	RESTORE_PAR	Sub-index number(4)	U8	R
	1		Restore default parameters (***)	U32	R/W
	2		Restore communication parameters (***)	U32	R/W
	3		Restore application parameters (***)	U32	R/W
1014h	0	COB_ID EMCY	COB_ID Emergency message (80+Node_ID)	U32	R
1017h	0	HBT_TIME	Heartbeat time (expressed in ms, default 1000 mS)	U16	R/W
1018h	0	OBJ_ID	Sub-index number (4)	U8	CONST
	1		ID Vendor	U32	CONST
	2		Product code	U32	CONST
	3		Version number	U32	CONST

(\*) 00070194h (according to CiA DS404 for measurement device).

(\*\*) 65766173h ('a','v','e','s').

(\*\*\*) 64616F6Ch ('d','a','o','l').

## SDO SERVER PARAMETERS

Index	Sub-Index	Name	Description	Type	Attribute
1200h	0	SDO_PAR	SDO record number(2)	U8	R
	1		COB_ID Client->Server (rx) ( = 600h + Node_ID )	U32	R
	2		COB_ID Server->Client (tx) ( = 580h + Node_ID )	U32	R

T\_PDO COMMUNICATION PARAMETERS

Index	Sub-Index	Name	Description	Type	Attribute
1800h	0	AI_T_PDO_CPAR	Sub-index number(5)	U8	R
	1		COB_ID used from PDO (180h + Node_ID )	U32	R
	2		Transmission type PDO (*)	U8	R
	3		Inhibition time (0)	U16	R/W
	4		Reserved	U8	R/W
	5		Event timer (expressed in ms, default 8 ms)	U16	R/W

(\*) PDO Transmission type:

00h = synchronous acyclic (PDO is transmitted following the receipt of SYNC, but only if a new measurement has been acquired).

01h = synchronous cyclic (PDO is always transmitted after receiving SYNC).

FFh = asynchronous (default) (PDO is periodically transmitted according to the set time, setting “event timer” to zero, transmission is disabled).

Other types of transmission provided by the CIA DS-301 are not supported.

T\_PDO MAPPING PARAMETERS

Index	Sub-Index	Name	Description	Type	Attribute
1A00h	0	T_PDO_MPAR1	Number of “application objects” mapped in the PDO (2)	U8	R
	1		Applic.Obj.map 1 (*)	U32	R
	2		Applic.Obj.map 2 (*)	U32	R

Below is the sub-index structure from 1h to 6h.

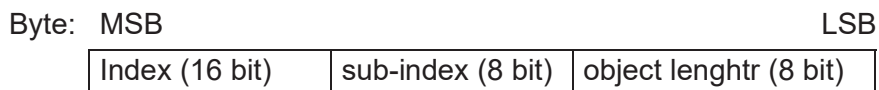

(\*) The following default values are defined:

- Sub-index 0 = 6h.
- Sub-index 1 = 2001 0120h ( Index = 2001h, sub-index 01, 32 bit length).
- Sub-index 2 = 2002 0120h ( Index = 2002h, sub-index 01, 32 bit length).



## T\_PDO COMMUNICATION PARAMETERS

Index	Sub-Index	Name	Description	Type	Attribute
1801h	0	AI_T_PDO_CPAR2	Sub-index number(5)	U8	R
	1		COB_ID used from PDO (180h + Node_ID )	U32	R
	2		Transmission type PDO (*)	U8	R
	3		Inhibition time (0)	U16	R/W
	4		Reserved	U8	R/W
	5		Event timer (expressed in ms, default 8 ms)	U16	R/W

(\*) PDO Transmission type:

00h = synchronous acyclic (PDO is transmitted following the receipt of SYNC, but only if a new measurement has been acquired).

01h = synchronous cyclic (PDO is always transmitted after receiving SYNC).

FFh = asynchronous (default) (PDO is periodically transmitted according to the set time, setting "event timer" to zero, transmission is disabled).

Other types of transmission provided by the CIA DS-301 are not supported.

## T\_PDO MAPPING PARAMETERS

Index	Sub-Index	Name	Description	Type	Attribute
1A01h	0	T_PDO_MPAR2	Number of "application objects" mapped in the PDO (2)	U8	R
	1		Applic.Obj.map 1 (*)	U32	R
	2		Applic.Obj.map 2 (*)	U32	R
	3		Applic.Obj.map 3 (*)	U32	R
	4		Applic.Obj.map 4 (*)	U32	R

Below is the sub-index structure from 1h to 6h.

Byte: MSB LSB

Index (16 bit)	sub-index (8 bit)	object length (8 bit)
----------------	-------------------	-----------------------

(\*) The following default values are defined:

- Sub-index 0 = 6h.
- Sub-index 1 = 2003 0120h ( Index = 2003h, sub-index 01, 32 bit length).
- Sub-index 2 = 2000 0110h ( Index = 2000h, sub-index 01, 16 bit length).
- Sub-index 1 = 2004 0120h ( Index = 2004h, sub-index 01, 8 bit length).
- Sub-index 2 = 2005 0120h ( Index = 2005h, sub-index 01, 8 bit length).

PARAMETERS DEFINED BY THE MANUFACTURER

<b>Index</b>	<b>Sub-Index</b>	<b>Name</b>	<b>Description</b>	<b>Type</b>	<b>Attribute</b>
2000h	0	UD_STATUS	Sub-index number(1)	U8	R
	1		Status Register	U16	R/W
2001h	0	UD_LORDO	Sub-index number(1)	U8	R
	1		Gross weight	S32	R
2002h	0	UD_NETTO	Sub-index number(1)	U8	R
	1		Net weight	S32	R
2003h	0	UD_PICCO	Sub-index number(1)	U8	R
	1		Peak	S32	R
2004h	0	UD_IN	Sub-index number(1)	U8	R
	1		Digital input	U8	R
2005h	0	UD_OUT	Sub-index number(1)	U8	R
	1		Digital output	U8	R
2006h	0	UD_COMMAND	Sub-index number(1)	U8	R
	1		Command Register	U16	R/W
2007h	0	UD_DATA	Sub-index number(1)	U8	R
	1		Data Register	U32	R/W
2008h	0	UD_MONITOR_R	Sub-index number(1)	U8	R
	1		Monitor Register (reading)	U16	R
2009h	0	UD_MONITOR_W	Sub-index number(1)	U8	R
	1		Monitor Register (writing)	U16	W
200Ah	0	UD_W_VAL	Sub-index number(1)	U8	R
	1		Net weight weighing	S32	R
200Bh	0	UD_W_CODE	Sub-index number(1)	U8	R
	1		Weighing code	S32	R
200Ch	0	UD_SET_1	Sub-index number(1)	U8	R
	1		Set-Point 1	S32	R/W
200Dh	0	UD_SET_2	Sub-index number(1)	U8	R
	1		Set-Point 2	S32	R/W
200Eh	0	UD_PORTATA	Sub-index number(1)	U8	R
	1		Load cells capacity	S32	R/W
200Fh	0	UD_SENS	Sub-index number(1)	U8	R
	1		Load cells sensitivity	U16	R/W
2010h	0	UD_DIV	Sub-index number(1)	U8	R
	1		Weight division value	U8	R/W

Index	Sub-Index	Name	Description	Type	Attribute
2011h	0	UD_DEC	Sub-index number (1)	U8	R
	1		Decimal	U8	R/W
2012h	0	UD_TARA_F	Sub-index number (1)	U8	R
	1		Fixed tare	S32	R/W
2013h	0	UD_STAND_B	Sub-index number (1)	U8	R
	1		Stand by function	U16	R/W
2014h	0	UD_BLOCCO_T	Sub-index number (1)	U8	R
	1		Keypad lock function	U8	R/W
2015h	0	UD_PASS	Sub-index number (1)	U8	R
	1		Password function	U16	R/W
2016h	0	UD_PICCO	Sub-index number (1)	U8	R
	1		Peak function	U8	R/W
2017h	0	UD_LOG	Sub-index number (1)	U8	R
	1		Datalogger function	U8	R/W
2018h	0	UD_FILT	Sub-index number (1)	U8	R
	1		Filter factor	U8	R/W
2019h	0	UD_RATE	Sub-index number (1)	U8	R
	1		Output rate ADC	U8	R/W
201Ah	0	UD_N_MEDIA	Sub-index number (1)	U8	R
	1		Number of readings on average	U8	R/W
201Bh	0	UD_T_MON	Sub-index number (1)	U8	R
	1		Monotony Time	U16	R/W
201Ch	0	UD_T_OSC	Sub-index number (1)	U8	R
	1		Oscillations Time	U16	R/W
201Dh	0	UD_R_OSC	Sub-index number (1)	U8	R
	1		Oscillations Range	U8	R/W
201Eh	0	UD_FS	Sub-index number (1)	U8	R
	1		Full Scale	S32	R/W
201Fh	0	UD_STAB	Sub-index number (1)	U8	R
	1		Weight stability	U8	R/W
2020h	0	UD_AUTO_Z	Sub-index number (1)	U8	R
	1		Auto zero when switching on	S32	R/W
2021h	0	UD_INS_Z	Sub-index number (1)	U8	R
	1		Zero tracking	U8	R/W

Index	Sub-Index	Name	Description	Tipo	Attribute
2022h	0	UD_FUN_IN1	Sub-index number (1)	U8	R
	1		Input 1 function	U8	R/W
2023h	0	UD_FUN_IN2	Sub-index number (1)	U8	R
	1		Input 2 function	U8	R/W
2024h	0	UD_FUN_OUT1	Sub-index number (1)	U8	R
	1		Output mode 1— Function	U8	R/W
2025h	0	UD_LOG_OUT1	Sub-index number (1)	U8	R
	1		Output mode 1— Logic	U8	R/W
2026h	0	UD_POL_OUT1	Sub-index number (1)	U8	R
	1		Output mode1— Polarity	U8	R/W
2027h	0	UD_STAB_OUT1	Sub-index number (1)	U8	R
	1		Output mode 1— Stability	U8	R/W
2028h	0	UD_IST_OUT1	Sub-index number (1)	U8	R
	1		Hysteresis input 1	S32	R/W
2029h	0	UD_T_OUT1	Sub-index number (1)	U8	R
	1		Timing input 1	U16	R/W
202Ah	0	UD_R_OUT1	Sub-index number (1)	U8	R
	1		Delay input 1	U16	R/W
202Bh	0	UD_FUN_OUT2	Sub-index number (1)	U8	R
	1		Output mode 2— Function	U8	R/W
202Ch	0	UD_LOG_OUT2	Sub-index number (1)	U8	R
	1		Output mode 2— Logic	U8	R/W
202Dh	0	UD_POL_OUT2	Sub-index number (1)	U8	R
	1		Output mode 2— Polarity	U8	R/W
202Eh	0	UD_STAB_OUT2	Sub-index number (1)	U8	R
	1		Output mode 2— Stability	U8	R/W
202Fh	0	UD_IST_OUT2	Sub-index number (1)	U8	R
	1		Hysteresis input 2	S32	R/W
2030h	0	UD_T_OUT2	Sub-index number (1)	U8	R
	1		Timing input 2	U16	R/W
2031h	0	UD_R_OUT2	Sub-index number (1)	U8	R
	1		Delay input 2	U16	R/W
2032h	0	UD_ANA_T	Sub-index number (1)	U8	R
	1		Analogue Fixed Tare	S32	R/W
2033h	0	UD_ANA_FS	Sub-index number (1)	U8	R
	1		Analogue Full Scale	S32	R/W
2034h	0	UD_ANA_M	Sub-index number (1)	U8	R
	1		Analogue Output Mode	U8	R/W
2035h	0	UD_ANA_R	Sub-index number (1)	U8	R
	1		Analog output range	U8	R/W

## TROUBLESHOOTING

PROBLEM	POSSIBLE CAUSE	SOLUTION
The display shows the O-L message	The weight cannot be detected because the cell is not available or has been connected incorrectly.	Check the connections of the cells.
The hyphen is shown in the top display.	The acquired weight cannot be shown because it exceeds the available five digits or is greater than the capacity of the cells.	Configure setup parameters that are compatible with system features
The number of decimal places is wrong.	Incorrect division value selected.	Select the correct division value in the main menu.
The Instrument remains switched off	Wrong supply voltage	Power up the instrument with the correct supply voltage
Weight display is frozen	The load cell is not functioning properly or has not been properly connected	Use a multimeter and measure 5Vdc between EXC+ and EXC- and a lower value between SENSE+ and SENSE- (greater are the distance between the instrument and the load cells and lower will be the SENSE voltage) and check the variation in millivolt between SGN+ and SGN- when loading or unloading the load cells
Inputs and / or outputs does not work properly	Wiring or Software Setup Errors	Use the I / O Test Function to verify the correct operation of inputs and outputs and verify the settings of the specific program
The serial communication does not work properly.	Installation has been completed properly. Selection of operation of the serial interface is incorrect.	Check the connections as described in the installation manual. Select the settings as appropriate.
The semi-automatic zero-setting function does not work.	The gross weight exceeds the action limit of semi-automatic zero-setting. The weight doesn't stabilise.	To re-establish the zero, calibrate the weight. Wait for the weight to stabilise or adjust the weight filter parameter.
The semi-automatic tare function does not work.	The gross weight is negative or exceeds the maximum capacity. The weight doesn't stabilise.	Check the gross weight. Wait for the weight to stabilise or adjust the weight filter parameter.

## EU Declaration of conformity (DoC)

We **ADN Pesage**  
7 Rue du Bois Malhais  
F-78640 St-Germain-De-La-Grange  
FRANCE

declare that the DoC issued under our sole responsibility and belongs to the following product:

Apparatus model/Product: T200F  
Type: Weighing instrument

The object of the declaration described above used as indicated in the installation manual and use, is in conformity with the relevant Union harmonisation legislation:

Directive EMC 2014/30/EU Electromagnetic Compatibility

The following harmonized standards and technical specification have been applied:

EN 61000-6-2:2005  
EN 61000-6-3:2007 + A1 2011

Directive LVD 2014/35/EU Low Voltage Directive

The following harmonized standards and technical specification have been applied:

EN 61010-1:2011

Directive EMC 2014/32/EU Measuring Instruments

The following harmonized standards and technical specification have been applied:

EN 45501:2015

Signed for end on behalf of:

Concorezzo: 16/01/2019



# PRODUCT RANGE

## Weight indicator MS100



## Weight processor MS300



## Lite weight indicator T16F



## Process transmitter T200F



## Junction box for load cell

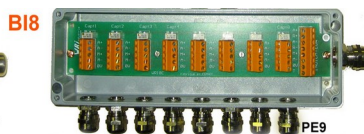
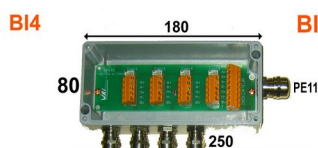

Aluminium or plastic junction box for load cell

Stainless steel junction box

## load cell and mounting kit



**Capteur de pesage en flexion**  
Capteur extrêmement précis et économique pour les applications de pesage et mesure de force.



**Capteur de pesage à appuis central**  
Capteurs conçus pour les plateformes de pesage mono-capteur et petites trémies.



**Capteur de pesage en cisaillement**  
Capteur conçu pour les charges moyennement élevées de 500 à 5000 kg.



**Capteur de pesage en traction**  
Capteur fonctionnant en traction ou compression pour la mesure de force et les dynamomètres.



**Capteur de pesage en compression**  
Capteur de compression idéal pour les fortes charges et le pont-basculés.



**Capteur de pesage double cisaillement**  
Capteur à double cisaillement extrêmement robuste et stable même pour les fortes charges 10 à 50 t



VPG Transducers  
Celtron • Revore • Sensorfronics • Tedeo-Huntleigh

