

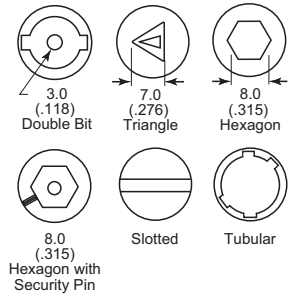

## LCPA Series Adjustable Compression Latch

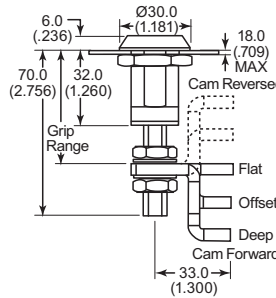

Chrome Plated    Black Powder Coated



### Specifications:

- Material: Die Cast Zinc with Steel Cam & Rubber O-Ring

### Features:

- 6mm (0.236") Compression
- Adjustable grip range by adjustable bolts
- Used for tight sealing, noise isolation, and vibration

See page 127 for keys and pages 182 - 185 for gaskets.

Item No.		Head Style	Pack Qty.	Bulk Pack Qty.
Chrome Plated	Black Powder Coated			
LCPACORE000A	LCPACORE000B	3mm Double Bit	1	50
LCPACORE100A	LCPACORE100B	Tubular	1	50
LCPACORE200A	LCPACORE200B	8mm Hex	1	50
LCPACORE300A	LCPACORE300B	8mm Hex with Security	1	50
LCPACORE400A	LCPACORE400B	2x4 Slotted	1	50
LCPACORE500A	LCPACORE500B	7mm Triangle	1	50

Item No.	Cam Style	Grip Range				Pack Qty.	Bulk Pack Qty.
		Cam Reversed		Cam Forward			
		In	mm	In	mm		
CAM-001A	Flat	1.575 - 2.244	40.0 - 57.0	1.575 - 2.244	40.0 - 57.0	1	50
CAM-002A	Offset	1.102 - 1.732	28.0 - 44.0	2.106 - 2.795	53.5 - 71.0	1	50
CAM-003A	Deep	0.433 - 1.142	11.0 - 29.0	2.657 - 3.346	67.5 - 85.0	1	50

Note: Core & Cams Sold Separately: Select the core item number with desired head style and finish & your Cam item number with desired grip range.

## LCPM Series Mini Adjustable Compression Latch



Chrome Plated    Black Powder Coated

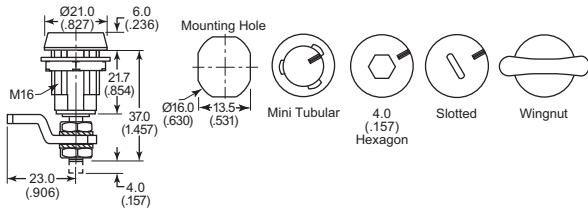

### Specifications:

- Material: Die Cast Zinc with Steel Cam & Rubber O-Ring

### Features:

- 4mm (0.157") Compression
- Adjustable Grip Range by adjustable bolts
- Used for tight sealing, noise isolation, and vibration

See page 127 for keys.

Core Item No.		Head Style	Pack Qty.	Bulk Pack Qty.
Chrome Plated	Black Powder Coated			
LCPMCORE100A	LCPMCORE100B	Slotted	1	10
LCPMCORE200A	LCPMCORE200B	4mm Hex	1	10
LCPMCORE300A	LCPMCORE300B	Tubular	1	10
LCPMCORE400A	LCPMCORE400B	Wing Knob	1	10

Cam Item No.	Grip Range		Pack Qty.	Bulk Pack Qty.
	In	mm		
CAM-022A	0.992 - 1.110	25.2 - 28.2	1	10
CAM-023A	0.882 - 1.008	22.4 - 25.6	1	10
CAM-024A	0.756 - 0.882	19.2 - 22.4	1	10
CAM-025A	0.630 - 0.756	16.0 - 19.2	1	10
CAM-026A	0.504 - 0.630	12.8 - 16.0	1	10
CAM-027A	0.378 - 0.504	9.6 - 12.8	1	10

Note: Core & Cams Sold Separately: Select the core item number with desired head style and finish & your Cam item number with desired grip range.

## Compression Latches with Adjustable Cam



Tool Activated

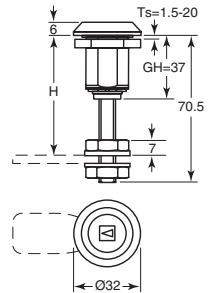

Wing Knob

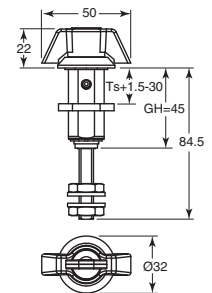

Handles and housing are black powder coated zinc alloy. Each locking handle has one silver steel key with black nylon grip. Nema 4 and IP65 rated.

See page 127 for keys.

Item No.	Description	Pack Qty.	Bulk Pack Qty.
<b>Vibration Proof</b>			
ELH-1200*	8mm Tool Activated w/ M6 Thread	1	25
ELH-1201	2 x 4 Tool Activated Slotted Insert	1	25
<b>Wing Knob</b>			
ELH-1202	Wing Knob Non-Locking	1	25
ELH-1203	Wing Knob Locking w/ Key ELH-333	1	25

\*Activation tool #KEYS070A for 8mm is sold separately.



**LCPF Series  
Fixed Compression Latch**



**Chrome Plated**



**Black Powder Coated**

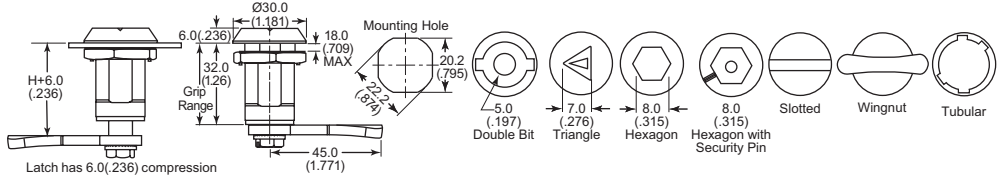

**Specifications:**

- Material: Die Cast Zinc with Steel Cam & Rubber O-Ring

See page 127 for keys.

**Features:**

- 6mm (0.236") Compression
- Used for tight sealing, noise isolation, and vibration

Core Item No.		Head Style	Pack Qty.	Bulk Pack Qty.
Chrome Plated	Black Powder Coated			
LCPFCORE100A	LCPFCORE100B	5mm Double Bit	1	50
LCPFCORE200A	LCPFCORE200B	7mm Triangle	1	50
LCPFCORE300A	LCPFCORE300B	2x4 Slotted	1	50
LCPFCORE400A	LCPFCORE400B	8mm Hex	1	50
LCPFCORE500A	LCPFCORE500B	8mm Hex with Security	1	50
LCPFCORE600A	LCPFCORE600B	Tubular	1	50
LCPFCORE700A	LCPFCORE700B	Wing Knob	1	50

Cams Item No.	Grip Range		Pack Qty.	Bulk Pack Qty.
	In	mm		
CAM-005A	0.787	20.0	1	50
CAM-006A	0.866	22.0	1	50
CAM-007A	0.945	24.0	1	50
CAM-008A	1.102	28.0	1	50
CAM-009A	1.260	32.0	1	50
CAM-010A	1.378	35.0	1	50
CAM-011A	1.496	38.0	1	50

**Note:** Core & Cams Sold Separately: Select the core item number with desired head style and finish. Then select your Cam item number with desired grip range.

**Vise Action Compression Latch  
Single Hole Mount**

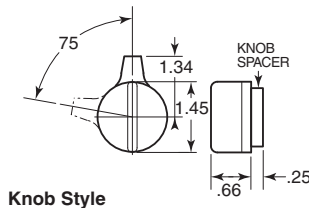

**Knob Style**



**Key Operated**

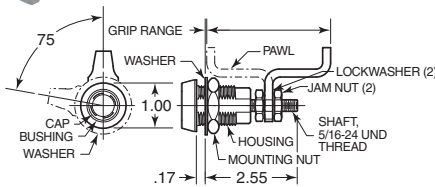

**Tubular Key**



Item No.	Southco	Description	Pack Qty.	Bulk Pack Qty.
SC-7430	E3-5-15	Tubular Key	1	50

Easy to install. Locks door then pulls them tight with one half turn. Internal O-ring gasket provides consistent compression. Maximum working load 100 lbs. Black powder coated die cast zinc housing with black knobs or caps. Easy to install. Key #SC-7430 must be ordered separately for key operated style.

Item No.	Southco	Description	Grip Range	Pack Qty.	Bulk Pack Qty.
SC-7355	E3-10-505-50	Knob Style	.95 - 2.65	1	50
SC-7356*	E3-55-715-50	Key Operated	1.00 - 2.70	1	50

\*Grip Range is 1.00 to 1.70 pawl forward. 2.00 to 2.70 pawl reversed

**Vise Action Compression Latch  
Single Hole Mount**



**Knob Style**



**Key Operated**

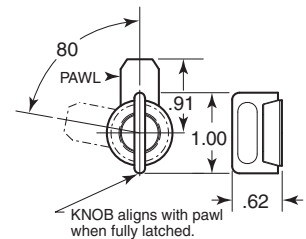

**Key**



Easy to install. Locks door then pulls them tight with one half turn. Internal O-ring gasket provides consistent compression. Maximum working load 100 lbs. Black powder coated die cast zinc housing with black knobs or caps. Easy to install. Key #SC-732 must be ordered separately for key operated style.

Item No.	Southco	Pack Qty.	Bulk Pack Qty.
SC-732	E3-26-819-15	1	50

Knob Style		Key Operated Style		Grip Range	Pack Qty.	Bulk Pack Qty.
Item No.	Southco	Item No.	Southco			
SC-737	E3-57-15	SC-735	E3-55-15	.125-.250	1	50
SC-7372	E3-57-25	SC-7352	E3-55-25	.250-.375	1	50
SC-7373	E3-57-35	—	—	.375-.500	1	50
SC-7374	E3-57-45	—	—	.500-.625	1	50
SC-7375	E3-57-55	—	—	.625-.750	1	50
SC-7377	E3-57-75	—	—	.875-1.000	1	50
SC-7378	E3-57-85	SC-7358	E3-55-85	1.000 - 1.125	1	50

LQTS Series  
Quarter Turn Spring Latches

Chrome Plated



Black Powder Coated

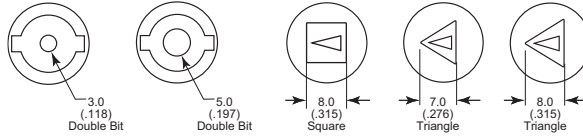
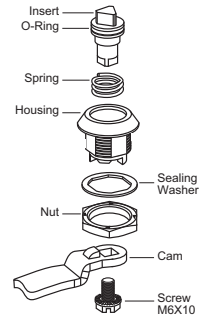
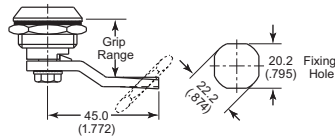

## Specifications:

- Material: Die Cast Zinc Alloy

See page 127 for keys.

Item No.		Head Style	Grip Range		Pack Qty.	Bulk Pack Qty.
Chrome Plated	Black Powder Coated		In	mm		
LQTS010A	LQTS010B	3mm Double Bit	0.335	8.5	1	50
LQTS020A	LQTS020B	3mm Double Bit	0.571	14.5	1	50
LQTS030A	LQTS030B	3mm Double Bit	0.728	18.5	1	50
LQTS040A	LQTS040B	3mm Double Bit	0.965	24.5	1	50
LQTS050A	LQTS050B	3mm Double Bit	1.043	26.5	1	50
LQTS060A	LQTS060B	3mm Double Bit	1.122	28.5	1	50
LQTS070A	LQTS070B	5mm Double Bit	0.335	8.5	1	50
LQTS080A	LQTS080B	5mm Double Bit	0.571	14.5	1	50
LQTS090A	LQTS090B	5mm Double Bit	0.728	18.5	1	50
LQTS100A	LQTS100B	5mm Double Bit	0.965	24.5	1	50
LQTS110A	LQTS110B	5mm Double Bit	1.043	26.5	1	50
LQTS120A	LQTS120B	5mm Double Bit	1.122	28.5	1	50
LQTS130A	LQTS130B	8mm Square	0.335	8.5	1	50
LQTS140A	LQTS140B	8mm Square	0.571	14.5	1	50
LQTS150A	LQTS150B	8mm Square	0.728	18.5	1	50
LQTS160A	LQTS160B	8mm Square	0.965	24.5	1	50
LQTS170A	LQTS170B	8mm Square	1.043	26.5	1	50
LQTS180A	LQTS180B	8mm Square	1.122	28.5	1	50

Item No.		Head Style	Grip Range		Pack Qty.	Bulk Pack Qty.
Chrome Plated	Black Powder Coated		In	mm		
LQTS200A	—	7mm Triangle	0.335	8.5	1	50
LQTS210A	—	7mm Triangle	0.571	14.5	1	50
LQTS220A	—	7mm Triangle	0.728	18.5	1	50
LQTS230A	—	7mm Triangle	0.965	24.5	1	50
LQTS240A	—	7mm Triangle	1.043	26.5	1	50
LQTS250A	—	7mm Triangle	1.122	28.5	1	50
LQTS300A	LQTS300B	8mm Triangle	0.335	8.5	1	50
LQTS310A	LQTS310B	8mm Triangle	0.571	14.5	1	50
LQTS320A	LQTS320B	8mm Triangle	0.728	18.5	1	50
LQTS330A	LQTS330B	8mm Triangle	0.965	24.5	1	50
LQTS340A	LQTS340B	8mm Triangle	1.043	26.5	1	50
LQTS350A	LQTS350B	8mm Triangle	1.122	28.5	1	50
LQTS360A	LQTS360B	Slotted	0.335	8.5	1	50
LQTS370A	LQTS370B	Slotted	0.571	14.5	1	50
LQTS380A	LQTS380B	Slotted	0.728	18.5	1	50
LQTS390A	LQTS390B	Slotted	0.965	24.5	1	50
LQTS400A	LQTS400B	Slotted	1.043	26.5	1	50
LQTS410A	LQTS410B	Slotted	1.122	28.5	1	50

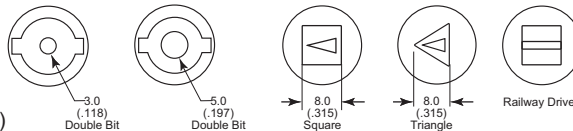
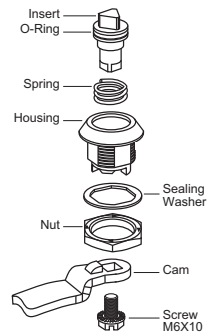
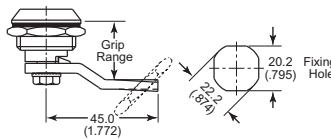
LQTS Series  
Stainless Steel Quarter Turn Latches with Spring

## Specifications:

- Material: Stainless Steel (AISI 304)

See page 127 for keys.

Item No.	Head Style	Grip Range		Pack Qty.	Bulk Pack Qty.
		In	mm		
LQTS010A	5mm Double Bit	0.571	14.5	1	50
LQTS020A	5mm Double Bit	0.728	18.5	1	50
LQTS030A	5mm Double Bit	0.965	24.5	1	50
LQTS040A	5mm Double Bit	1.043	26.5	1	50
LQTS050A	3mm Double Bit	0.571	14.5	1	50
LQTS060A	3mm Double Bit	0.728	18.5	1	50
LQTS070A	3mm Double Bit	0.965	24.5	1	50
LQTS080A	3mm Double Bit	1.043	26.5	1	50
LQTS090A	8mm Square	0.571	14.5	1	50
LQTS100A	8mm Square	0.728	18.5	1	50

Item No.	Head Style	Grip Range		Pack Qty.	Bulk Pack Qty.
		In	mm		
LQTS110A	8mm Square	0.965	24.5	1	50
LQTS120A	8mm Square	1.043	26.5	1	50
LQTS130A	8mm Triangle	0.571	14.5	1	50
LQTS140A	8mm Triangle	0.728	18.5	1	50
LQTS150A	8mm Triangle	0.965	24.5	1	50
LQTS160A	8mm Triangle	1.043	26.5	1	50
LQTS170A	Railway Driver	0.571	14.5	1	50
LQTS180A	Railway Driver	0.728	18.5	1	50
LQTS190A	Railway Driver	0.965	24.5	1	50
LQTS200A	Railway Driver	1.043	26.5	1	50



**LQTW Series**  
**Quarter Turn Latches with Wing Knob**

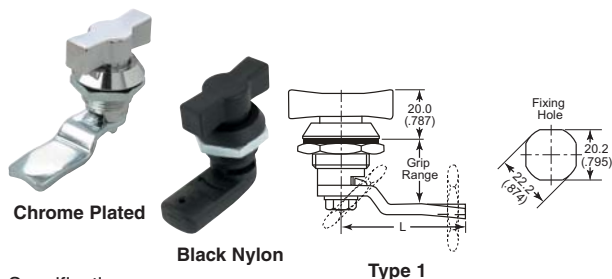

Specifications:

- Material: Die-Cast Zinc Alloy Body with Steel Cam or Black Nylon Body & Cam

Features:

- Supplied with Rubber Gasket for sealing
- IP65 for Type 2 only

**Die-Cast Zinc Alloy Body, Steel Cam – Type 1**

Item No.		Grip Range		L		Pack Qty.	Bulk Pack Qty.
Chrome Plated	Black Powder Coated	In	mm	In	mm		
LQTW010A	LQTW010B	0.355	8.5	1.772	45.0	1	50
LQTW020A	LQTW020B	0.571	14.5	1.772	45.0	1	50
LQTW030A	LQTW030B	0.728	18.5	1.772	45.0	1	50
LQTW040A	LQTW040B	0.965	24.5	1.772	45.0	1	50
LQTW050A	LQTW050B	1.043	26.5	1.772	45.0	1	50
LQTW060A	LQTW060B	1.122	28.5	1.772	45.0	1	50

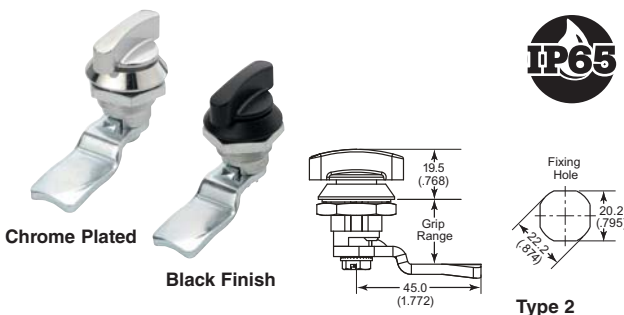

**Die-cast Zinc Alloy, Steel Cam – Type 2**

Item No.		Grip Range		L		Pack Qty.	Bulk Pack Qty.
Chrome Plated	Black Powder Coated	In	mm	In	mm		
LQTW500A	LQTW500B	0.355	8.5	1.772	45.0	1	50
LQTW510A	LQTW510B	0.571	14.5	1.772	45.0	1	50
LQTW520A	LQTW520B	0.728	18.5	1.772	45.0	1	50
LQTW530A	LQTW530B	0.965	24.5	1.772	45.0	1	50
LQTW540A	LQTW540B	1.043	26.5	1.772	45.0	1	50
LQTW550A	LQTW550B	1.122	28.5	1.772	45.0	1	50

**30% CF Nylon Body and Cam – Type 1**

Item No.	Grip Range		L		Pack Qty.	Bulk Pack Qty.
	In	mm	In	mm		
LQTW100A	0.728	18.5	1.378	35.0	1	50
LQTW110A	0.965	24.5	1.378	35.0	1	50
LQTW120A	0.886	22.5	1.772	45.0	1	50
LQTW130A	0.728	18.5	0.984	25.0	1	50

**LQTP Series**  
**Plastic Quarter Turn Latches**



Specifications:

- Material: Black 30% GF Nylon

Features:

- Supplied with metal nut
- Lightweight alternative to metal

See page 127 for keys.

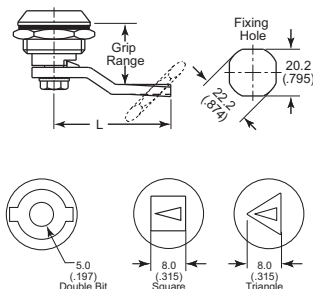

**Optional Parts**  
**Plastic Lock Nut**

Item No.	Pack Qty.	Bulk Pack Qty.
LQTP999A	1	300

Item No.				Grip Range		L		Pack Qty.	Bulk Pack Qty.
5mm Double Bit	8mm Square	8mm Triangle	Slotted	In	mm	In	mm		
LQTP010A	LQTP210A	LQTP410A	LQTP610A	0.728	18.5	1.378	35.0	1	50
LQTP020A	LQTP220A	LQTP420A	LQTP620A	0.965	24.5	1.378	35.0	1	50
LQTP030A	LQTP230A	LQTP430A	LQTP630A	0.886	22.5	1.772	45.0	1	50
LQTP040A	LQTP240A	LQTP440A	LQTP660A	0.728	18.5	0.984	25.0	1	50

**LOMCW Series**  
**Mini Cam Latch with Knob**



Specifications:

- Material: Die-Cast Zinc Alloy

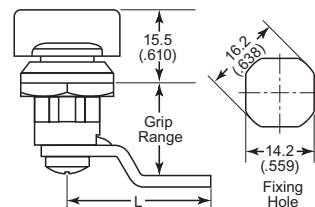

Item No.		Grip Range		L		Pack Qty.	Bulk Pack Qty.
Chrome Plated	Black Powder Coated	In	mm	In	mm		
LOMCW010A	LOMCW010B	0.531	13.5	1.299	33.0	1	50
LOMCW020A	LOMCW020B	0.807	20.5	1.181	30.0	1	50
LOMCW030A	LOMCW030B	0.768	19.5	0.984	25.0	1	50



## LQPL Series

## Wing Knob Latches with Pad Lockable Fitting

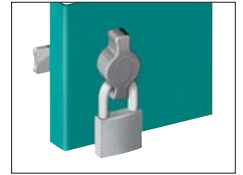
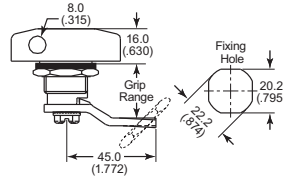

## Specifications:

- Material: Chrome Plated Die-Cast Zinc Alloy

## Features:

- Supplied with Rubber Gasket for sealing
- Max lock diameter of 6mm (0.236")

Item No.		Grip Range		Pack Qty.	Bulk Pack Qty.
Right Hand Door	Left Hand Door	In	mm		
LQPL010RA	LQPL010LA	0.335	8.5	1	50
LQPL020RA	LQPL020LA	0.571	14.5	1	50
LQPL030RA	LQPL030LA	0.728	18.5	1	50
LQPL040RA	LQPL040LA	0.965	24.5	1	50
LQPL050RA	LQPL050LA	1.043	26.5	1	50
LQPL060RA	LQPL060LA	1.122	28.5	1	50

## LOP Series

## Finger Grip Plastic Locking Knob

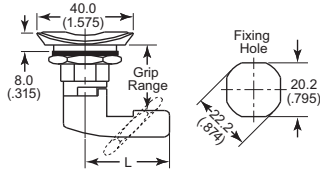

## Specifications:

- Material: Black Nylon

## Features:

- Designed with finger grips for easy opening

See pages 127 for keys.

Lock Nut Style

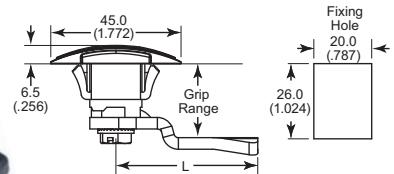

## Lock Nut Style

Item No.	Grip Range		L		Pack Qty.	Bulk Pack Qty.
	In	mm	In	mm		
LOP010A	0.728	18.5	1.378	35.0	1	50
LOP020A	0.965	24.5	1.378	35.0	1	50
LOP030A	0.886	22.5	1.772	45.0	1	50
LOP040A	0.728	18.5	0.984	25.0	1	50

## Snap In Style

Item No.	5mm Double Bit	E Key	Grip Range		L		Pack Qty.	Bulk Pack Qty.
			In	mm	In	mm		
LOP210A		LOP410A	0.728	18.5	1.378	35.0	1	50
LOP220A		LOP420A	0.965	24.5	1.378	35.0	1	50
LOP230A		LOP430A	0.886	22.5	1.772	45.0	1	50
LOP240A		LOP440A	0.728	18.5	0.984	25.0	1	50

## Snap In Style

## LOC Series

## Cover Locks for Thick Doors



## Specifications:

- Material: Chrome Die Cast Zinc Alloy
- All part numbers use 5mm Double Bit Key

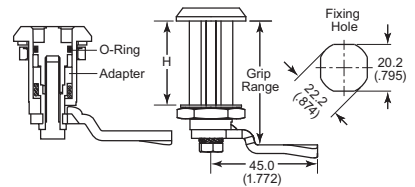

See pages 127 for keys.

Item No.	Max Panel Thickness		Grip Range		Pack Qty.	Bulk Pack Qty.
	In	mm	In	mm		
LOC010A	0.787	20.0	1.181	30.0	1	50
LOC020A	0.787	20.0	1.339	34.0	1	50
LOC030A	0.787	20.0	1.417	36.0	1	50
LOC040A	0.787	20.0	1.496	38.0	1	50
LOC050A	0.787	20.0	1.575	40.0	1	50
LOC060A	1.181	30.0	1.575	40.0	1	50
LOC070A	1.181	30.0	1.732	44.0	1	50
LOC080A	1.181	30.0	1.811	46.0	1	50
LOC090A	1.181	30.0	1.890	48.0	1	50
LOC100A	1.181	30.0	1.969	50.0	1	50

Item No.	Max Panel Thickness		Grip Range		Pack Qty.	Bulk Pack Qty.
	In	mm	In	mm		
LOC110A	1.575	40.0	1.969	50.0	1	50
LOC120A	1.575	40.0	2.126	54.0	1	50
LOC130A	1.575	40.0	2.205	56.0	1	50
LOC140A	1.575	40.0	2.283	58.0	1	50
LOC150A	1.575	40.0	2.362	60.0	1	50
LOC160A	1.969	50.0	2.362	60.0	1	50
LOC170A	1.969	50.0	2.520	64.0	1	50
LOC180A	1.969	50.0	2.598	66.0	1	50
LOC190A	1.969	50.0	2.677	68.0	1	50
LOC200A	1.969	50.0	2.756	70.0	1	50



# QUARTER TURN TOOLS, KEYS & ACCESSORIES

## KEYS Series Keys & Tools



**Specifications:**

- Material: Chrome Plated Zinc Alloy or Nylon

**Features:**

- Style A: For Quarter Turn Locks Only
- Style B: For Mini Cam locks & Quarter Turns

Item No.	Head Style	Style	Material	Pack Qty.	Bulk Pack Qty.
KEYS010A	3mm Double Bit	A	Chrome Plated	1	50
KEYS020A	5mm Double Bit	A	Chrome Plated	1	50
KEYS030A	8mm Square	A	Chrome Plated	1	50
KEYS040A	8mm Triangle	A	Chrome Plated	1	50
KEYS140A	8mm Hex Security Key	A	Chrome Plated	1	50
KEYS050A	3mm Double Bit	B	Chrome Plated	1	50
KEYS060A	5mm Double Bit	B	Chrome Plated	1	50
KEYS110A	6mm Square	B	Chrome Plated	1	50
KEYS070A	8mm Square	B	Chrome Plated	1	50
KEYS120A	7mm Triangle	B	Chrome Plated	1	50
KEYS080A	8mm Triangle	B	Chrome Plated	1	50
KEYS090A	5mm Double Bit	C	Polyamide	1	50
KEYS100A	5mm Double Bit	D	Polyamide	1	50
KEYS160A	Tubular	E	Chrome Plated	1	10
KEYS170A	Mini Tubular	F	Chrome Plated	1	10
KEYS180A	4mm Hex	G	Polyamide/Steel	1	10
KEYS200A	Hex/Allen	G	Polyamide/Steel	1	10
KEYS150A	E Key	-	Chrome Plated	1	50

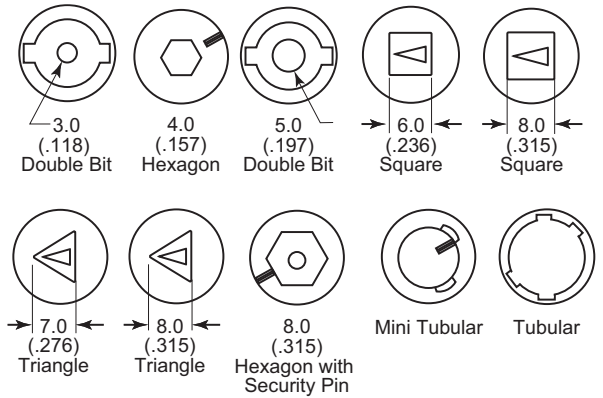

## LQTA Series Quarter Turn Accessories

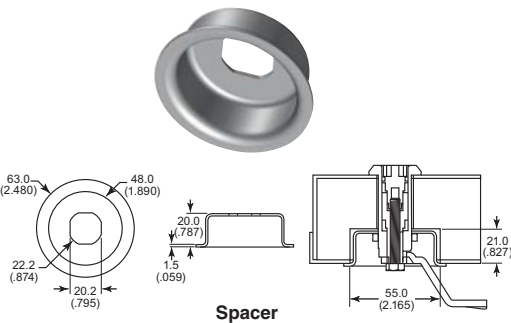
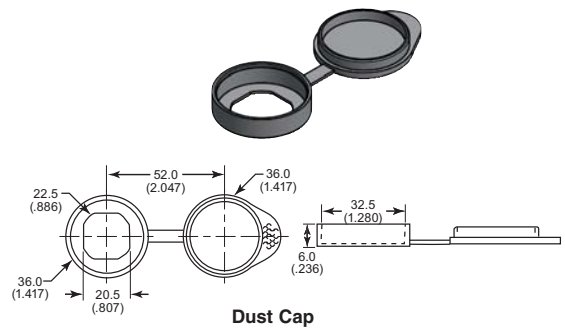
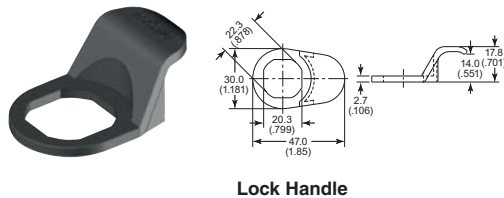
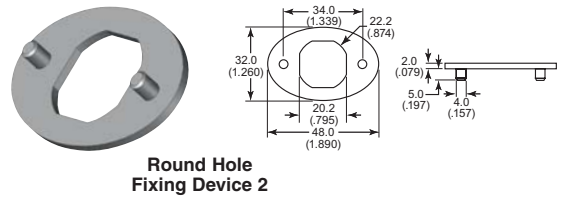
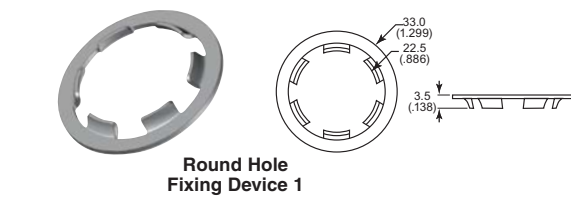

**Specifications:**

- Material: See Chart
- Use Fixing Devices 1 & 2 for mounting into round holes

Item No.	Type	Material	Pack Qty.	Bulk Pack Qty.
LQTA100A	Lock Handle	Polyamide	1	100
LQTA200A	Fixing Device 1	Spring Steel	1	100
LQTA300A	Fixing Device 2	Die Cast Zinc	1	100
LQTA400A	Spacer	Zinc Plated Steel	1	50
LQTA500A	Dust Cap	Polyurethane	1	50

LOMC Series  
Mini Cam Latches & Locks

Type 1

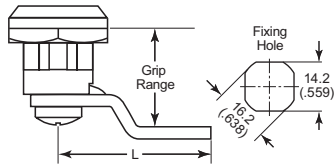

Type 2

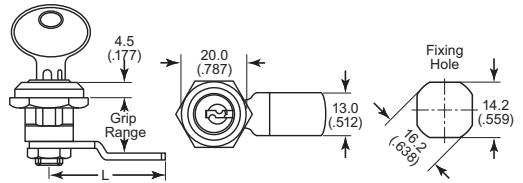

Type 3

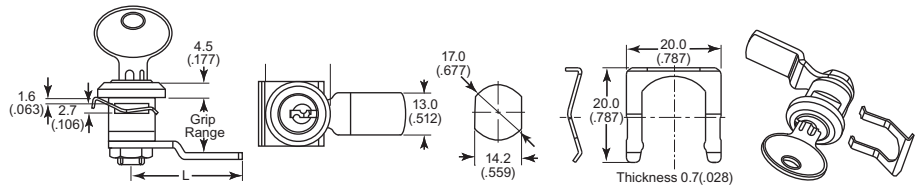

## Specifications:

- Material: Die-Cast Zinc Alloy

## Features:

- Offered in 3 different styles
- Each Type 2 & 3 supplied with 2 E-Keys, Type 1 requires option tool

See page 127 for keys.

## Type 1 – With Spring Action

Item No.		Type	Head Style	Grip Range		L		Pack Qty.	Bulk Pack Qty.
Chrome Plated	Black Powder Coated			In	mm	In	mm		
LOMC010A	LOMC010B	1	6mm Square	0.531	13.5	1.299	33.0	1	50
LOMC020A	LOMC020B	1	6mm Square	0.807	20.5	1.181	30.0	1	50
LOMC030A	LOMC030B	1	6mm Square	0.768	19.5	0.984	25.0	1	50
LOMC040A	LOMC040B	1	7 mm Triangle	0.531	13.5	1.299	33.0	1	50
LOMC050A	LOMC050B	1	7 mm Triangle	0.807	20.5	1.181	30.0	1	50
LOMC060A	LOMC060B	1	7 mm Triangle	0.768	19.5	0.984	25.0	1	50
LOMC070A	LOMC070B	1	Slotted	0.531	13.5	1.299	33.0	1	50
LOMC080A	LOMC080B	1	Slotted	0.807	20.5	1.181	30.0	1	50
LOMC090A	LOMC090B	1	Slotted	0.768	19.5	0.984	25.0	1	50

## Type 2 &amp; 3 – Without Spring Action

Item No.		Type	Grip Range		L		Pack Qty.	Bulk Pack Qty.
Chrome Plated with E Key			In	mm	In	mm		
LOMC210A		2	0.512	13.0	1.220	31.0	1	100
LOMC220A		2	0.630	16.0	1.181	30.0	1	100
LOMC230A		2	0.787	20.0	1.024	26.0	1	100
LOMC240A		3	0.512	13.0	1.220	31.0	1	100
LOMC250A		3	0.630	16.0	1.181	30.0	1	100
LOMC260A		3	0.787	20.0	1.024	26.0	1	100

LOCC Series  
Cylinder Cam Locks

## Specifications:

- Material: Die Cast Zinc Alloy with or without 30% GF Nylon Housing

## Features:

- Each lock supplied with 2 E-Keys
- Quarter turn
- IP65 for Zinc Alloy versions only
- Keyed alike

See page 127 for keys.



Chrome Plated

Black Powder Coated

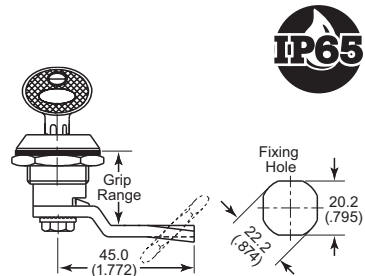

## Die-Cast Zinc Alloy Housing

Item No.		Type	Grip Range		Pack Qty.	Bulk Pack Qty.
Chrome Plated	Black Powder Coated		In	mm		
LOCC010A	LOCC010B		0.335	8.5	1	50
LOCC020A	LOCC020B		0.571	14.5	1	50
LOCC030A	LOCC030B		0.728	18.5	1	50
LOCC040A	LOCC040B		0.807	20.5	1	50
LOCC050A	LOCC050B		0.965	24.5	1	50
LOCC060A	LOCC060B		1.043	26.5	1	50

## Nylon 30% Glass Fiber Reinforced Housing

Item No.	Grip Range		Pack Qty.	Bulk Pack Qty.
	In	mm		
LOCC500A	0.335	8.50	1	50
LOCC510A	0.571	14.5	1	50
LOCC520A	0.728	18.5	1	50
LOCC530A	0.807	20.5	1	50
LOCC540A	0.965	24.5	1	50
LOCC550A	1.043	26.5	1	50



**LOCCW Series  
Cylinder Cam Locks with Knob**

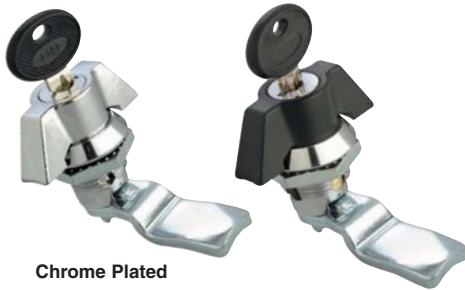

Chrome Plated

Black Powder Coated

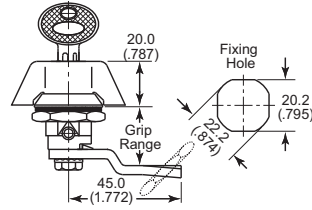

Specifications:

- Material: Die Cast Zinc Alloy with or without Black Nylon Housing

Features:

- Each lock supplied with 2 E-Keys
- Supplied with Rubber Gasket
- Quarter turn

Die-Cast Zinc Alloy

Item No.		Grip Range		Pack Qty.	Bulk Pack Qty.
Chrome Plated	Black Powder Coated	In	mm		
LOCCW010A	LOCCW010B	0.335	8.5	1	50
LOCCW020A	LOCCW020B	0.571	14.5	1	50
LOCCW030A	LOCCW030B	0.728	18.5	1	50
LOCCW040A	LOCCW040B	0.965	24.5	1	50
LOCCW050A	LOCCW050B	1.043	26.5	1	50
LOCCW060A	LOCCW060B	1.122	28.5	1	50

Die-Cast Zinc Alloy with Black Nylon

Item No.	Grip Range		Pack Qty.	Bulk Pack Qty.
	In	mm		
LOCCW500A	0.335	8.5	1	50
LOCCW510A	0.571	14.5	1	50
LOCCW520A	0.728	18.5	1	50
LOCCW530A	0.965	24.5	1	50
LOCCW540A	1.043	26.5	1	50
LOCCW550A	1.122	28.5	1	50

**LOCCC Series**

**Chrome Cam Locks**



Request Info

1-800-453-1692

[www.aboveboardelectronics.com](http://www.aboveboardelectronics.com)

Specifications:

- Material: Chrome Die Cast Zinc Alloy

Features:

- Supplied with 2 E-Keys
- Key rotation of 90°

Item No.		Grip Range		L		Pack Qty.	Bulk Pack Qty.
Keyed Alike	Keyed Different	In	mm	In	mm		
LOCCC010A	LOCCC015A	0.787	20.0	1.299	33.0	1	100
LOCCC020A	LOCCC025A	0.787	20.0	1.693	43.0	1	100
LOCCC030A	LOCCC035A	1.063	27.0	1.575	40.0	1	100

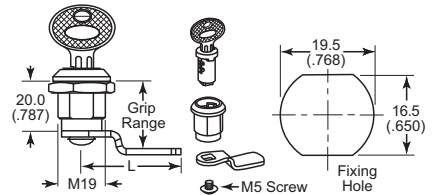

**CABLE GLANDS, GROMMETS & CONDUIT**



Pages 640 - 652

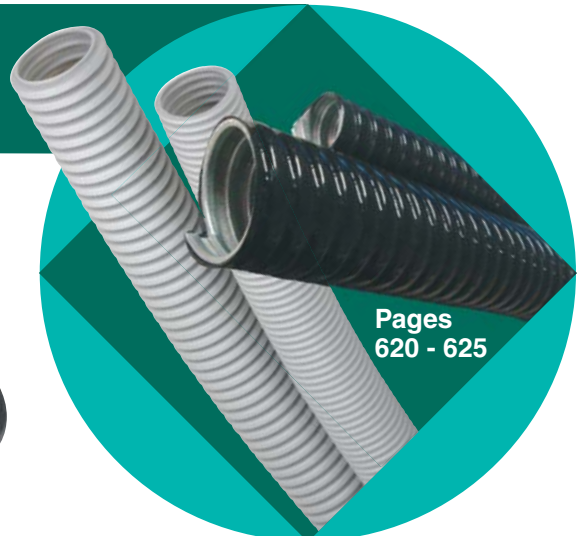

Pages 620 - 625





**Slotted Cam Latches**



NEMA 4 rated cam quarter turn latches are shipped assembled and include the following components: housing, insert, rubber seal, hex nut and cam. Available in zinc die cast with chrome or black finish or type 304 stainless steel. Grip ranges are approximate.

Item No.	Approx. Grip Range	Pack Qty.	Bulk Pack Qty.	Item No.	Approx. Grip Range	Pack Qty.	Bulk Pack Qty.
<b>Chrome</b>				<b>Black</b>			
ELH-1	1/4	1	50	ELH-18	1/2	1	50
ELH-2	5/16	1	50	ELH-20	3/8	1	50
ELH-3	3/8	1	50	ELH-28	13/16	1	50
ELH-4	1/2	1	50	<b>Stainless</b>			
ELH-6	5/8	1	50	ELH-30	3/8	1	50
ELH-8	3/4	1	50	ELH-31	9/16	1	50
ELH-9	7/8	1	50	ELH-34	7/8	1	50
ELH-10	15/16	1	50	ELH-35	19/16	1	50
ELH-11	1	1	50	ELH-36	1 1/16	1	50
ELH-12	1 1/16	1	50	ELH-37	1 1/8	1	50
ELH-13	1 1/8	1	50				
ELH-14	1 3/8	1	50				

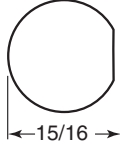
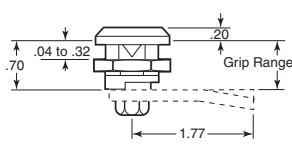

**Recommended Hole Profile**

**Alternate Hole Profile**

**Wing Handle Cam Latches with and without Padlock Option**



**Chrome Finish Without Padlock Option**

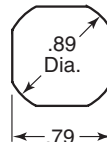
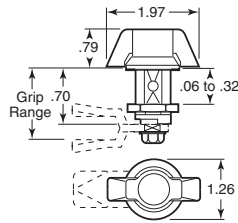

**Recommended Hole Profile**

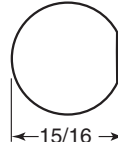

**Alternate Hole Profile**

NEMA 4 rated wing handle cam latches are shipped assembled and include the following components: housing, insert, rubber seal, hex nut and cam. Available in zinc die cast with chrome or black finish. Grip ranges are approximate. ELH-68 and ELH-76 have an option that allows a padlock to be installed, making the latch inoperable. Padlock not included.

Item No.	Approx. Grip Range	Pack Qty.	Bulk Pack Qty.	Item No.	Approx. Grip Range	Pack Qty.	Bulk Pack Qty.
<b>Chrome</b>				<b>Black</b>			
ELH-38	1/4	1	50	ELH-52	1/4	1	50
ELH-40	3/8	1	50	ELH-54	3/8	1	50
ELH-41	1/2	1	50	ELH-68*	3/8	1	50
ELH-45	3/4	1	50	ELH-55	1/2	1	50
ELH-47	15/16	1	50	ELH-56	9/16	1	50
				ELH-60	7/8	1	50
				ELH-76*	1	1	50
				ELH-65	1 3/16	1	50

\*Padlock option



**Black Finish With Padlock Option**

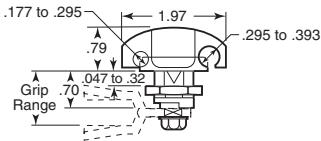

# GASKETING & SEALS

Pages 182 - 185



**Non-Locking Chrome**



Item No.	Approx. Grip Range	Pack Qty.	Bulk Pack Qty.
ELH-868	1/4	1	50
ELH-869	1/2	1	50
ELH-870	3/4	1	50

**Non-Locking Black Powder Coat Finish**



Item No.	Approx. Grip Range	Pack Qty.	Bulk Pack Qty.
ELH-871	1/4	1	50
ELH-872	1/2	1	50
ELH-873	3/4	1	50

**Locking Chrome**



Item No.	Approx. Grip Range	Pack Qty.	Bulk Pack Qty.
ELH-883	1/4	1	50
ELH-884	1/2	1	50
ELH-885	3/4	1	50

**Locking Black Powder Coat Finish**



Item No.	Approx. Grip Range	Pack Qty.	Bulk Pack Qty.
ELH-886	1/4	1	50
ELH-887	1/2	1	50
ELH-888	3/4	1	50

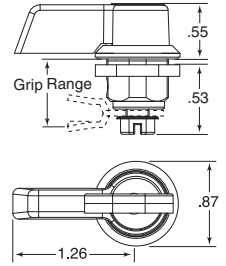

Note: Includes key ELH-333

Note: Includes key ELH-333

**Non-Locking Black Polyamide**



Item No.	Approx. Grip Range	Pack Qty.	Bulk Pack Qty.
ELH-1022	1/4	1	50
ELH-1023	5/16	1	50
ELH-1024	3/8	1	50
ELH-1025	1/2	1	50
ELH-1026	5/8	1	50
ELH-1027	3/4	1	50
ELH-1028	7/8	1	50
ELH-1029	1	1	50
ELH-1030	1 1/16	1	50
ELH-1031	1 1/8	1	50
ELH-1032	1 1/4	1	50
ELH-1033	1 3/8	1	50
ELH-1034	1 1/2	1	50

**Locking Chrome**



Item No.	Approx. Grip Range	Pack Qty.	Bulk Pack Qty.
ELH-983	1/4	1	50
ELH-984	5/16	1	50
ELH-985	3/8	1	50
ELH-986	1/2	1	50
ELH-987	5/8	1	50
ELH-988	3/4	1	50
ELH-989	7/8	1	50
ELH-990	1	1	50
ELH-991	1 1/16	1	50
ELH-992	1 1/8	1	50
ELH-993	1 1/4	1	50
ELH-994	1 3/8	1	50
ELH-995	1 1/2	1	50

**Locking Black Polyamide**



Item No.	Approx. Grip Range	Pack Qty.	Bulk Pack Qty.
ELH-1009	1/4	1	50
ELH-1010	5/16	1	50
ELH-1011	3/8	1	50
ELH-1012	1/2	1	50
ELH-1013	5/8	1	50
ELH-1014	3/4	1	50
ELH-1015	7/8	1	50
ELH-1016	1	1	50
ELH-1017	1 1/16	1	50
ELH-1018	1 1/8	1	50
ELH-1019	1 1/4	1	50
ELH-1020	1 3/8	1	50
ELH-1021	1 1/2	1	50

**Locking Black Powder Coat Finish**



Item No.	Approx. Grip Range	Pack Qty.	Bulk Pack Qty.
ELH-996	1/4	1	50
ELH-997	5/16	1	50
ELH-998	3/8	1	50
ELH-999	1/2	1	50
ELH-1000	5/8	1	50
ELH-1001	3/4	1	50
ELH-1002	7/8	1	50
ELH-1003	1	1	50
ELH-1004	1 1/16	1	50
ELH-1005	1 1/8	1	50
ELH-1006	1 1/4	1	50
ELH-1007	1 3/8	1	50
ELH-1008	1 1/2	1	50

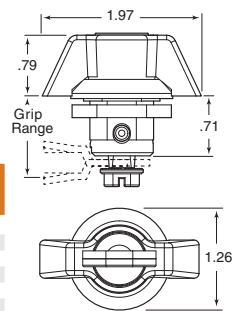

Note: Includes key ELH-333

Note: Includes key ELH-333

Note: Includes key ELH-333

**Non-Locking Chrome**



Item No.	Approx. Grip Range	Pack Qty.	Bulk Pack Qty.
ELH-862	1/4	1	50
ELH-863	1/2	1	50
ELH-864	3/4	1	50

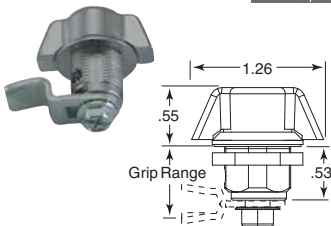

**Non-Locking Black Powder Coat Finish**

Item No.	Approx. Grip Range	Pack Qty.	Bulk Pack Qty.
ELH-865	1/4	1	50
ELH-866	1/2	1	50
ELH-867	3/4	1	50

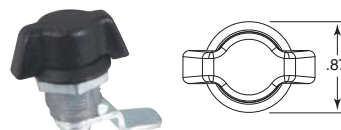

**Locking Chrome**



Item No.	Approx. Grip Range	Pack Qty.	Bulk Pack Qty.
ELH-877	1/4	1	50
ELH-878	1/2	1	50
ELH-879	3/4	1	50

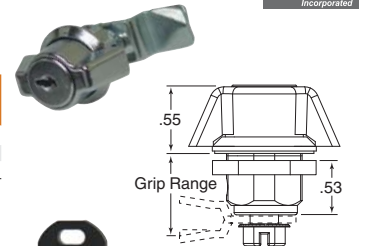

**Locking Black Powder Coat Finish**

Item No.	Approx. Grip Range	Pack Qty.	Bulk Pack Qty.
ELH-880	1/4	1	50
ELH-881	1/2	1	50
ELH-882	3/4	1	50

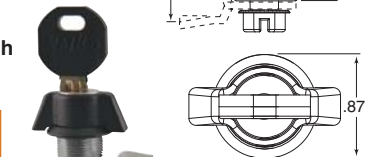

Note: Includes key ELH-333

**304 Stainless Steel**

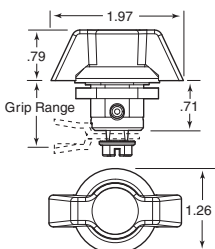

Item No.	Approx. Grip Range	Pack Qty.	Bulk Pack Qty.
ELH-791	1/4	1	50
ELH-793	3/8	1	50
ELH-795	5/16	1	50
ELH-797	3/4	1	50
ELH-798	7/8	1	50
ELH-799	1 1/16	1	50
ELH-801	1 1/8	1	50
ELH-802	1 1/4	1	50

**Non-Locking Black Polyamide**



Item No.	Approx. Grip Range	Pack Qty.	Bulk Pack Qty.
ELH-874	1/4	1	50
ELH-875	1/2	1	50
ELH-876	3/4	1	50

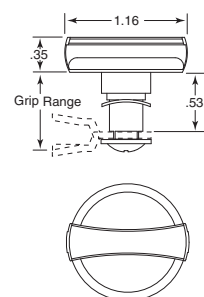



**Locking Chrome**



Item No.	Approx. Grip Range	Pack Qty.	Bulk Pack Qty.
ELH-942	1/4	1	50
ELH-943	5/16	1	50
ELH-944	3/8	1	50
ELH-945	1/2	1	50
ELH-946	9/16	1	50
ELH-947	5/8	1	50
ELH-948	3/4	1	50
ELH-949	7/8	1	50
ELH-950	15/16	1	50
ELH-951	1	1	50
ELH-952	1 1/16	1	50
ELH-953	1 1/8	1	50
ELH-954	1 3/16	1	50

Note: Includes key ELH-333

**Locking Black Powder Coated**



Item No.	Approx. Grip Range	Pack Qty.	Bulk Pack Qty.
ELH-955	1/4	1	50
ELH-956	5/16	1	50
ELH-957	3/8	1	50
ELH-958	1/2	1	50
ELH-959	9/16	1	50
ELH-960	5/8	1	50
ELH-961	3/4	1	50
ELH-962	7/8	1	50
ELH-963	15/16	1	50
ELH-964	1	1	50
ELH-965	1 1/16	1	50
ELH-966	1 1/8	1	50
ELH-967	1 3/16	1	50

Note: Includes key ELH-333

**Locking Black Polyamide**



Item No.	Approx. Grip Range	Pack Qty.	Bulk Pack Qty.
ELH-968	1/4	1	50
ELH-969	5/16	1	50
ELH-970	3/8	1	50
ELH-971	1/2	1	50
ELH-972	9/16	1	50
ELH-973	5/8	1	50
ELH-974	3/4	1	50
ELH-975	7/8	1	50
ELH-976	15/16	1	50
ELH-977	1	1	50
ELH-978	1 1/16	1	50
ELH-979	1 1/8	1	50
ELH-980	1 3/16	1	50

Note: Includes key ELH-333

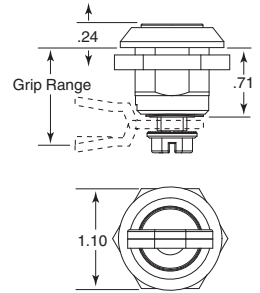

**Quarter Turn Cam Latches Padlockable Railroad Style**



Zinc die cast black powder coating with slotted insert and padlockable.



Item No.	Approx. Grip Range	Pack Qty.	Bulk Pack Qty.
ELH-1088	5/16	1	50
ELH-1089	3/8	1	50
ELH-1090	1/2	1	50
ELH-1091	9/16	1	50
ELH-1092	5/8	1	50
ELH-1093	3/4	1	50
ELH-1094	7/8	1	50
ELH-1095	15/16	1	50
ELH-1096	1	1	50
ELH-1097	1 1/16	1	50
ELH-1098	1 1/8	1	50
ELH-1099	1 3/16	1	50

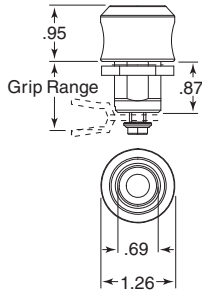

**Quarter Turn Latch Accessories**

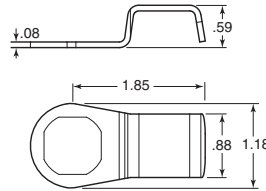

ELH-1100

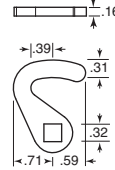

ELH-1101

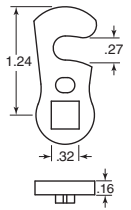

ELH-1102

Item No.	Description	Pack Qty.	Bulk Pack Qty.
ELH-1100	Latch Finger	1	50
ELH-1101	Latch Hooked	1	50
ELH-1102	Latch Hooked	1	50

**Quarter Turn Cam Latches**

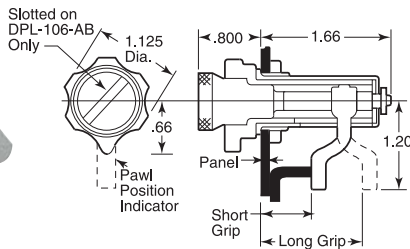

An ideal fastener for gasketed doors and access panels subject to wide thickness or misalignment tolerances. Grip length is variable from 1/8" to 1 1/16" and is set by rotating the center spindle. The DPL-106-KB grip length can be adjusted by hand and the DPL-106-AB grip length is set with a screw driver. The latch can be opened with a quarter turn of the outer ring. Made of steel with black plastic outer ring. Panel thickness .048" min. to .128" max. Installation hole diameter is .765". Installation instructions included.

Item No.	Description	Pack Qty.	Bulk Pack Qty.
DPL-106-KB	Pawl Latch - Manual	1	50
DPL-106-AB	Pawl Latch - Slotted	1	50

**EMKA Product Keys**



Type A



Type B



Type C



Type D



Type E



Type F

Item No.	Type	Description	Pack Qty.	Bulk Pack Qty.
ELH-1149	A	Square Female 7mm Zinc Die	1	50
ELH-1150	A	Square Female 8mm Zinc Die	1	50
ELH-1151	A	Triangular 7mm Zinc Die	1	50
ELH-1152	A	Triangular 8mm Zinc Die	1	50
ELH-1153	B	Double Bit 3 Zinc Die	1	50
ELH-1154	B	Double Bit 5 Zinc Die	1	50
ELH-1155	C	Square Female 6mm Zinc Die	1	50
ELH-1156	D	Crown Type Zinc Die	1	50
ELH-1157	E	Double Bit 5 Black Poly Blk	1	50
ELH-1158	E	Double Bit 3 Black Poly Blk	1	50
ELH-333	F	Replacement Key	1	50



**Adjustable Knob Handle**



Die cast zinc with black powder coated knob handle. Maximum working load 150 lbs. Average ultimate load 340 lbs. Gasket available separately. Optional .885" round installation hole may be used with spur washer, sold separately.

Item No.	Southco	Grip Range Cam Forward		Grip Range Cam Reversed		Pack Qty.	Bulk Pack Qty.
		Min.	Max.	Min.	Max.		
SC-7341	E3-17-15	.45	1.07	2.61	3.00	1	50
SC-7342	E3-17-25	1.00	1.62	2.07	2.69	1	50
SC-7343*	E3-17-35	1.53	2.15	1.53	2.15	1	50
SC-733	E3-24-201-18	Gasket for Gasketed Applications				1	50
SC-734	90-6-875	Spur Washer for Optional Round Hole Installation				1	50

\*Straight cam

**Tubular Key Operated Stainless Steel**

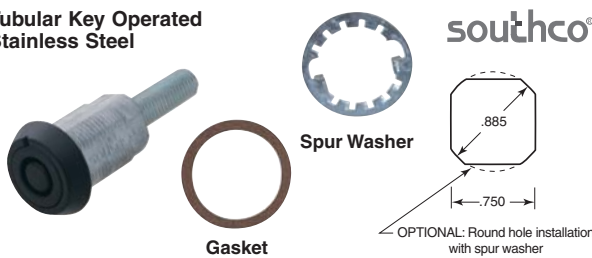

Stainless steel with black powder coated cap. Maximum working load 150 lbs. Average ultimate load 340 lbs. Gasket available separately. Optional .885" round installation hole may be used with spur washer, sold separately.

Item No.	Southco	Grip Range Cam Forward		Grip Range Cam Reversed		Pack Qty.	Bulk Pack Qty.
		Min.	Max.	Min.	Max.		
SC-7431	E3-15-15	.45	1.07	2.61	3.00	1	50
SC-7432	E3-15-25	1.00	1.62	2.07	2.69	1	50
SC-7433*	E3-15-35	1.53	2.15	1.53	2.15	1	50
SC-7430	E3-5-15	Tubular Key				1	50
SC-733	E3-24-201-18	Gasket for Gasketed Applications				1	50
SC-734	90-6-875	Spur Washer for Optional Round Hole Installation				1	50

\*Straight cam

**Explosion Proof Latches**

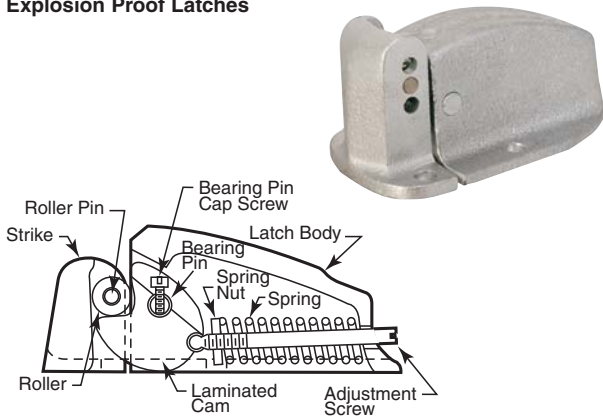

These pressure release latches provide venting in the event of internal explosion and maintain a seal in order to prevent loss of heat and/or escape of gasses under normal conditions. Latches have an adjustable strike and the release force is adjustable. EP-22 is cast iron and EP-32 is investment cast steel. Instructions included.

Item No.	OAL	Latch Lgth.	Strike Lgth.	Adjustable Release Force Lbs.	Pack Qty.	Bulk Pack Qty.
EP-22	5	3 3/4	1 1/2	10 - 45	1	25
EP-32	7	5 1/2	1 1/2	43 - 180	1	25

**Miniature Adjustable Grip Latches**

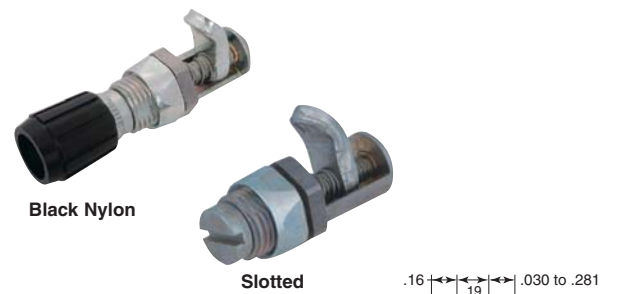

Rugged construction. Single hole installation. Made of zinc plated steel. Maximum working load 35 lbs. Ultimate load 90 lbs. Available with black nylon knob (shown in line drawing) or low profile slotted head.

Item No.	Southco	Knob Type	Direction to Latch	Pack Qty.	Bulk Pack Qty.
SC-2713	27-10-311-10	Black Nylon	Clockwise	1	50
SC-2715	27-10-501-10	Slotted	Clockwise	1	50
SC-2723	27-20-311-10	Black Nylon	Counter Clockwise	1	50

**Arrowhead Adjustable Grip Latch**

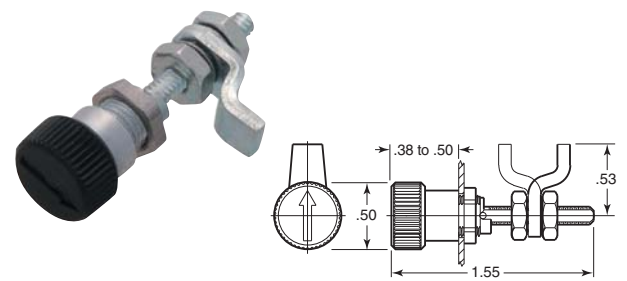

Arrow designates position of the cam. Latch operates through 90 degree rotation with a positive click stop at both extremes. Use in either clockwise or counterclockwise applications. Panel thickness ranges from .063 to .188. Knob height is adjustable. Grip range .16 to 1.11 with cam reversed. Made of low carbon steel with aluminum ferrule and stainless steel mounting nut, spring, pin and washers. Knob is black nylon. Shaft thread size is 6-32 UNC.

Item No.	Southco	Description	Pack Qty.	Bulk Pack Qty.
SC-691	69-10-301-11	Adjustable Grip Arrowhead Latch	1	25

**Adjustable Grip Latches**

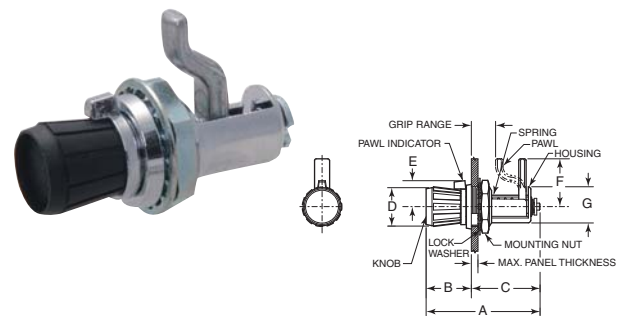

Made of carbon steel with black nylon knob. A quarter turn latches or unlatches. Knob includes indicator to make sure cam is in proper position. Compress gaskets, resist vibration.

Item No.	Southco	A	B	C	D	E	F	G	Grip Range	Max. Panel Thickness	Pack Qty.	Bulk Pack Qty.
SC-164	16-10-411-14	1.56	.64	.92	.53	.36	.75	.45	.063 - .344	.09	1	50
SC-163	16-10-311-14	2.16	.86	1.30	.75	.50	1.06	.61	.063 - .500	.19	1	50



## Low Profile Cabinet Latches



Slotted

Hex

Knob

Designed mainly for use on light cabinet doors and panels. A distinctive "snap" lets user know that the latch is fully open or fully closed. The dead bolt latches each come with a hex nut for mounting them to a door or panel. The cam is held in place with a lock washer and screw. Plug barrel and hex nut are zinc die cast. Cam, lock washer and screw are made of steel. Nickel plated finish. Hex accepts 1/4" hex tool. For use on panels up to 1/4" thick. Cams are straight.

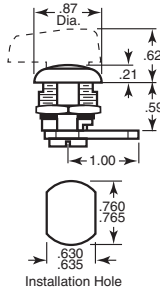

Item No.	Style	Pack Qty.	Bulk Pack Qty.
LOK-520	Slotted	1	50
LOK-521	Hex	1	50
LOK-522	Knob	1	50

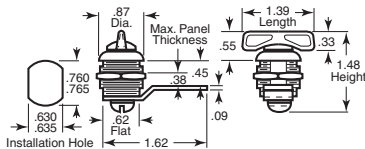
Quarter Turn Cam Latches  
Die Cast Plated Knob

Quarter turn latch with .20" offset cam. Cam may be reversed for increased grip range. Includes detent in body, which signals positive open or closed position.

Item No.	Style	Pack Qty.	Bulk Pack Qty.
LOK-524	Wing Knob Lock	1	50

## Key Locking Cam Latches



Straight



Offset

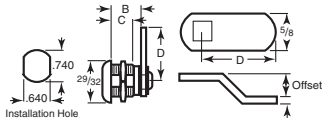

90 degree cam rotation. Zinc alloy die cast housing and cylinder. Five disc tumblers. Stainless steel bezel. Cams are available offset or straight, 5/8" wide and 3/32" thick. Brass keys are keyed alike.

Item No.	B	C	D	Cam Type	Pack Qty.	Bulk Pack Qty.
LOK-600	7/16	1/4	7/8	Straight	1	50
LOK-601	5/8	1/2	7/8	Straight	1	50
LOK-602	5/8	1/2	2	Straight	1	50
LOK-603	5/8	1/2	1 1/8	Offset	1	50
LOK-604	5/8	1/2	2	Offset	1	50
LOK-605	7/8	3/4	7/8	Straight	1	50
LOK-606	7/8	3/4	2	Straight	1	50
LOK-607	7/8	3/4	1 1/8	Offset	1	50
LOK-608	7/8	3/4	2	Offset	1	50
LOK-609	1 1/8	1	7/8	Straight	1	50
LOK-610	1 1/8	1	2	Straight	1	50
LOK-611	1 1/8	1	1 1/8	Offset	1	50
LOK-612	1 1/8	1	2	Offset	1	50
LOK-614	1 3/8	1 1/4	2	Straight	1	50
LOK-616	1 3/8	1 1/4	2	Offset	1	50

## Spring Latches - Knob Style

Smooth latching action. Action of spring cam provides wide grip ranges. Specify one size for several applications. Black nylon with stainless steel spring. Housing is bright chromate zinc alloy plated steel with sealer. Designed to be riveted or screwed in place.

Item No.	Southco	A	B	C	D	E	F	G	H	Max. Panel Thickness	Installation Hole Dia.	Grip	Pack Qty.	Bulk Pack Qty.
SC-57341	57-30-401-10	.58	.59	.44	.031	1.56	.416	1.312	.106	.188	.406	.05 to .25	1	50
SC-57141	57-10-401-10	.97	.75	.69	.047	2.31	.620	1.940	.136	.250	.625	.06 to .38	1	50

## Arrowhead Latches

southco®

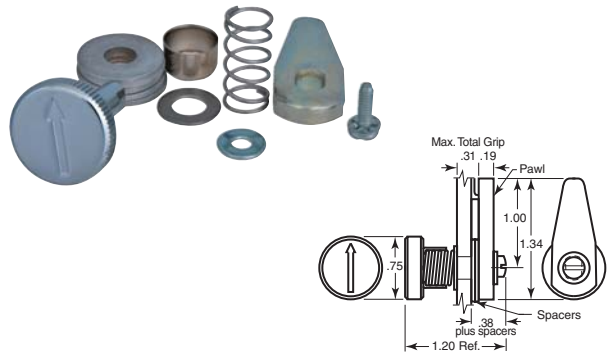

Arrow designates position of the cam. Spring loaded cam creates slight pressure against frame to eliminate rattles and movement. Has die cast zinc knob, steel cam nickel plated brass ferrule and aluminum spacers. Simple one hole installation. Spacers supplied for various panel thicknesses.

Item No.	Southco	Max. Total Grip	Max. Working Load Lbs.	Avg. Ultimate Load Lbs.	Pack Qty.	Bulk Pack Qty.
SC-492	49-2	.310	50	200	1	50

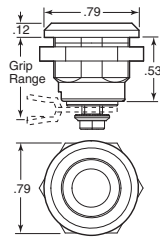
Cabinet Latches  
Quarter Turn - Slotted  
ChromeEMKA  
Incorporated

Item No.	Approx. Grip Range	Pack Qty.	Bulk Pack Qty.
ELH-856	1/4	1	50
ELH-857	1/2	1	50
ELH-858	3/4	1	50

## Push Button Latches Chrome

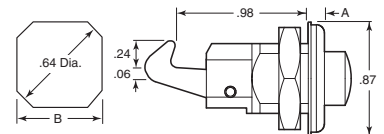
EMKA  
Incorporated

Item No.	A	B	Pack Qty.	Bulk Pack Qty.
ELH-981	.12	.56	1	50
ELH-982	.10	.52	1	50

southco®

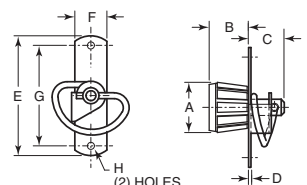



**Recessed Link Lock**

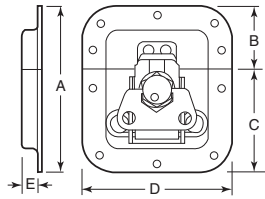

Recessed dish latch and catch are zinc plated steel. Utilizes spring loaded link lock latches.

Item No.	Mounting Holes					Rectangular Installation Opening	Bulk Pack Qty.	Bulk Pack Qty.
	A	B	C	D	E			
NSH-240	4.09	1.50	2.59	4.00	.56	3.0 x 3.1	1	50

**Butt Joint Panel Fastener**

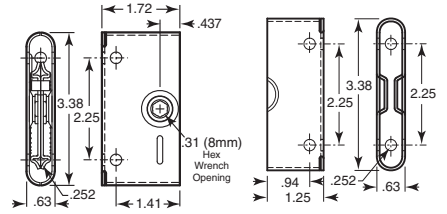

Progressively draws panels together. Helps provide airtight or water tight seal. Adjustability for manufacturing tolerances and gasket shrinkages. Uses 8mm hex to actuate. Bright chromate dipped, zinc plated carbon steel. Ultimate tensile load 1,400 lbs., ultimate shear load 2,000 lbs. Receptacle not included and must be purchased separately.

Item No.	Southco	Description	Pack Qty.	Bulk Pack Qty.
SC-225	R2-0055-02	Latch	1	50
SC-222	R2-0002-02	Receptacle	1	50

**LOHX Series Hex Key Locks**

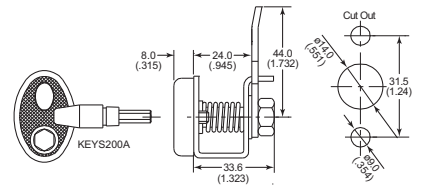
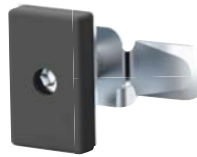

Specifications:

- Material: Steel body & cam with Black Plastic cover

Features:

- Spring loaded panel lock
- Opens with Hex/Allen Key (Part # KEYS200A), sold separately, or allen wrench

See page 127 for keys and 182 - 185 for gaskets.

Item No.	Type	Grip Range		Cam Length		Pack Qty.	Bulk Pack Qty.
		In	mm	In	mm		
LOHX100RA	Right Handed	0.945	24.0	1.732	44.0	1	50
LOHX100LA	Left Handed	0.945	24.0	1.732	44.0	1	50

**LOTL Series T & L Shaped Handle Locks**



Black

Chrome

T Type

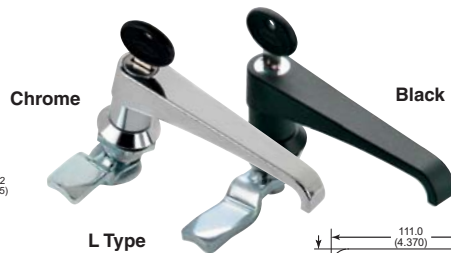
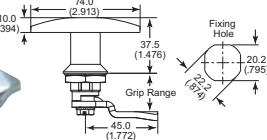

Chrome

Black

L Type

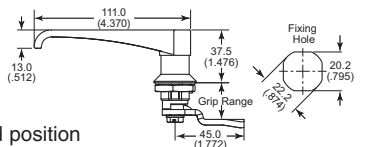

Specifications:

- Material: Chrome Plated or Black Nylon Overmolded Die Cast Zinc Alloy Body with Steel Cam

Features:

- Supplied with two E Keys per part
- Quarter turn
- Keys can only be removed in locked position

**T Handle Locks**

Item No.	Grip Range	Pack Qty.	Bulk Pack Qty.	Grip Range	
				In	mm
LOTL010A	0.335	8.5	1	25	25
LOTL020A	0.571	14.5	1	25	25
LOTL030A	0.728	18.5	1	25	25
LOTL040A	0.965	24.5	1	25	25
LOTL050A	1.043	26.5	1	25	25
LOTL060A	1.122	28.5	1	25	25

**L Handle Locks**

Item No.	Grip Range	Pack Qty.	Bulk Pack Qty.	Grip Range	
				In	mm
LOTL070A	0.335	8.5	1	25	25
LOTL080A	0.571	14.5	1	25	25
LOTL090A	0.728	18.5	1	25	25
LOTL100A	0.965	24.5	1	25	25
LOTL110A	1.043	26.5	1	25	25
LOTL120A	1.122	28.5	1	25	25



FIBER, WIRE & CABLE  
**MANAGEMENT**

Pages 566 - 659

FREE SAMPLES AVAILABLE!





All latches are NEMA 4 and IP65 rated. Each latch is shipped assembled and includes the following components: housing, insert, rubber seal, foam in place, gasket, hex nut and cam. Grip range is calculated as the door flange with compressed gasket and cabinet flange. All grip ranges are approximate.

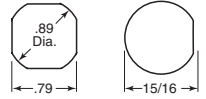

T-Handle



Non-Locking Black Polyamide



Locking Black Polyamide

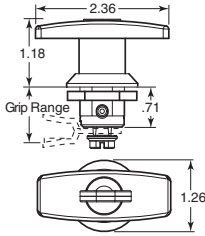

Non-Locking Black Polyamide

Locking Black Polyamide

Item No.	Approx. Grip Range	Pack Qty.	Bulk Pack Qty.
ELH-700	1/4	1	25
ELH-701	5/16	1	25
ELH-702	3/8	1	25
ELH-703	1/2	1	25
ELH-704	5/8	1	25
ELH-705	3/4	1	25
ELH-706	7/8	1	25
ELH-707	1	1	25
ELH-708	1 1/16	1	25
ELH-709	1 1/8	1	25
ELH-710	1 1/4	1	25
ELH-711	1 3/8	1	25
ELH-712	1 1/2	1	25

Item No.	Approx. Grip Range	Pack Qty.	Bulk Pack Qty.
ELH-713	1/4	1	25
ELH-714	5/16	1	25
ELH-715	3/8	1	25
ELH-716	1/2	1	25
ELH-717	5/8	1	25
ELH-718	3/4	1	25
ELH-719	7/8	1	25
ELH-720	1	1	25
ELH-721	1 1/16	1	25
ELH-722	1 1/8	1	25
ELH-723	1 1/4	1	25
ELH-724	1 3/8	1	25
ELH-725	1 1/2	1	25

Note: Includes key ELH-333

L-Handle With Padlock Option



Coin Proof Slotted Black Die Cast



Blank Black Die Cast

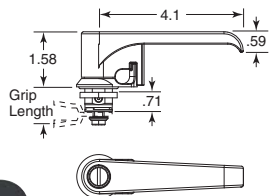

Water and Dust Resistant IP65 Rated Electrical Use

Coin Proof Slotted Black Die Cast

Blank Black Die Cast

Item No.	Approx. Grip Range	Pack Qty.	Bulk Pack Qty.
ELH-726	1/4	1	25
ELH-727	5/16	1	25
ELH-728	3/8	1	25
ELH-729	1/2	1	25
ELH-730	5/8	1	25
ELH-731	3/4	1	25
ELH-732	7/8	1	25
ELH-733	1	1	25
ELH-734	1 1/16	1	25
ELH-735	1 1/8	1	25
ELH-736	1 1/4	1	25
ELH-737	1 3/8	1	25
ELH-738	1 1/2	1	25

Item No.	Approx. Grip Range	Pack Qty.	Bulk Pack Qty.
ELH-739	1/4	1	25
ELH-740	5/16	1	25
ELH-741	3/8	1	25
ELH-742	1/2	1	25
ELH-743	5/8	1	25
ELH-744	3/4	1	25
ELH-745	7/8	1	25
ELH-746	1	1	25
ELH-747	1 1/16	1	25
ELH-748	1 1/8	1	25
ELH-749	1 1/4	1	25
ELH-750	1 3/8	1	25
ELH-751	1 1/2	1	25

Heavy Duty L-Handle with Defeater For Two Hand Operation Padlockable Black Powder Coating

Slotted Insert



Item No.	Approx. Grip Range	Pack Qty.	Bulk Pack Qty.
ELH-778	1/4	1	25
ELH-779	5/16	1	25
ELH-780	3/8	1	25
ELH-781	1/2	1	25
ELH-782	5/8	1	25
ELH-783	3/4	1	25
ELH-784	7/8	1	25

Item No.	Approx. Grip Range	Pack Qty.	Bulk Pack Qty.
ELH-785	1	1	25
ELH-786	1 1/16	1	25
ELH-787	1 1/8	1	25
ELH-788	1 1/4	1	25
ELH-789	1 3/8	1	25
ELH-790	1 1/2	1	25

Heavy Duty L-Handle With or Without Key Black Powder Coating



Plain



Key Locking

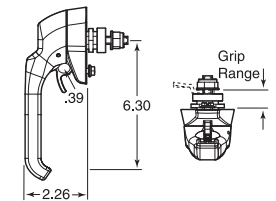

Plain

Key Locking

Item No.	Approx. Grip Range	Pack Qty.	Bulk Pack Qty.
ELH-752	1/4	1	25
ELH-753	5/16	1	25
ELH-754	3/8	1	25
ELH-755	1/2	1	25
ELH-756	5/8	1	25
ELH-757	3/4	1	25
ELH-758	7/8	1	25
ELH-759	1	1	25
ELH-760	1 1/16	1	25
ELH-761	1 1/8	1	25
ELH-762	1 1/4	1	25
ELH-763	1 3/8	1	25
ELH-764	1 1/2	1	25

Item No.	Approx. Grip Range	Pack Qty.	Bulk Pack Qty.
ELH-765	1/4	1	25
ELH-766	5/16	1	25
ELH-767	3/8	1	25
ELH-768	1/2	1	25
ELH-769	5/8	1	25
ELH-770	3/4	1	25
ELH-771	7/8	1	25
ELH-772	1	1	25
ELH-773	1 1/16	1	25
ELH-774	1 1/8	1	25
ELH-775	1 1/4	1	25
ELH-776	1 3/8	1	25
ELH-777	1 1/2	1	25

Note: Includes key ELH-333

GASKETING & SEALS



Pages 182 - 185



# NEMA & COMPRESSION, T & L LATCHES



## Compression Latches with Adjustable Cam

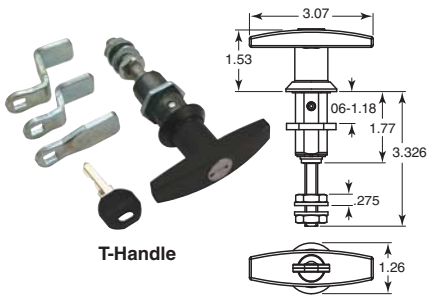

T-Handle

## L-Handle Pawl Latch with Padlock Option

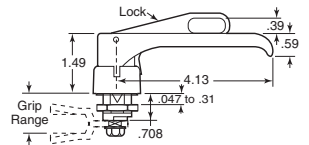

Zinc die cast with chrome finish. Padlock can be installed making the latch inoperable. Padlock not included.

Item No.	Approx. Grip Range	Pack Qty.	Bulk Pack Qty.
ELH-174	1	1	25

## Large Size Vise-Action Compression Latches Single Hole Mount T-Handle

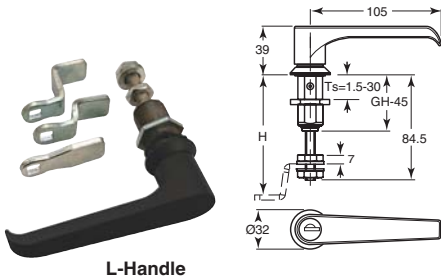

L-Handle

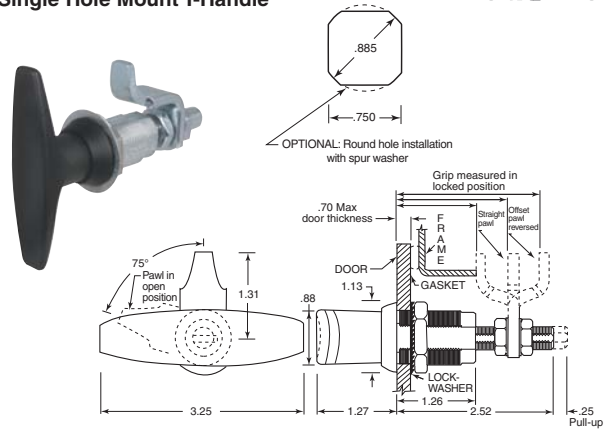

Handles and housing are black powder coated zinc alloy. Each locking handle has one silver steel key with black nylon grip. NEMA 4 and IP65 rated.

Item No.	Description	Pack Qty.	Bulk Pack Qty.
<b>T-Handle</b>			
ELH-1204	T-Handle Non-Locking	1	25
ELH-1205	T-Handle Locking w/ Key ELH-333	1	25
<b>L-Handle</b>			
ELH-1206	L-Handle Non-Locking	1	25
ELH-1207	L-Handle Locking w/ Key ELH-333	1	25

## T-Handle Pawl Latches with or without Locks

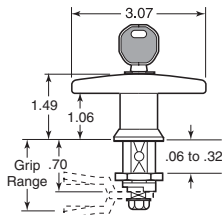

Available in zinc die cast with chrome or black finish. Available with or without keyed locks. All locks are keyed alike. Keys included.

Item No.	Approx. Grip Range	Pack Qty.	Bulk Pack Qty.	Item No.	Approx. Grip Range	Pack Qty.	Bulk Pack Qty.
<b>Chrome</b>				<b>Black</b>			
ELH-80	1/4	1	25	ELH-96	3/8	1	25
ELH-83	1/2	1	25	ELH-97	1/2	1	25
ELH-85	5/8	1	25	ELH-101	3/4	1	25
ELH-88	7/8	1	25	ELH-102	7/8	1	25
ELH-90	1	1	25	ELH-104	1	1	25
ELH-92	1 1/8	1	25	ELH-107	1 1/8	1	25
ELH-93	1 1/16	1	25	ELH-124	3/4	1	25
<b>Chrome with Lock</b>				<b>Black with Lock</b>			
ELH-110	3/8	1	25	ELH-129	3/4	1	25
ELH-121	1 3/16	1	25	ELH-130	7/8	1	25
<b>Black</b>				<b>Replacement Key</b>			
ELH-94	1/4	1	25	ELH-135	1 1/8	1	25
ELH-95	5/16	1	25	ELH-333	—	1	50

Black powder coated die cast zinc. Keys included with locking models. Gaskets available for gasketed applications. Maximum working load 150 lbs. Average ultimate load 340 lbs. Optional .885" round installation hole may be used with spur washer, sold separately.

Item No.	Southco	Lock	Grip Range Pawl Forward		Grip Range Pawl Reversed		Pack Qty.	Bulk Pack Qty.	
			Min.	Max.	Min.	Max.			
SC-7331	E3-11-15	No	.45	1.07	2.61	3.00	1	25	
SC-7332	E3-11-25	No	1.00	1.62	2.07	2.69	1	25	
SC-7333*	E3-11-35	No	1.53	2.15	1.53	2.15	1	25	
SC-7334	E3-18-15	Yes	.45	1.07	2.61	3.00	1	25	
SC-7335	E3-18-25	Yes	1.00	1.62	2.07	2.69	1	25	
SC-7336*	E3-18-35	Yes	1.53	2.15	1.53	2.15	1	25	
SC-733	E3-24-201-18	Gasket for Gasketed Applications						1	50
SC-734	90-6-875	Spur Washer for Optional Round Hole Installation						1	50

\*Straight cam

## L-Handle Pawl Latches with or without Locks Zinc Die Cast or Stainless Steel

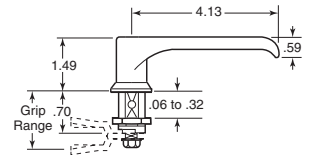

Available in zinc die cast with chrome or black finish and Type 304 stainless steel. Available with or without keyed locks. (Stainless is only available without lock). The locked type are all keyed alike. Keys included.

Item No.	Approx. Grip Range	Pack Qty.	Bulk Pack Qty.	Item No.	Approx. Grip Range	Pack Qty.	Bulk Pack Qty.
<b>Chrome</b>				<b>Stainless</b>			
ELH-136	1/4	1	25	ELH-206	3/8	1	25
ELH-141	5/8	1	25	ELH-209	3/4	1	25
ELH-143	3/4	1	25	ELH-213	1 1/8	1	25
ELH-146	1	1	25	<b>Replacement Key</b>			
ELH-148	1 1/8	1	25	ELH-333	—	1	50
ELH-149	1 3/16	1	25				
<b>Black</b>							
ELH-151	5/16	1	25				
ELH-157	3/4	1	25				
ELH-204*	1 1/8	1	25				
ELH-163	1 3/16	1	25				

\*With lock





T-Handle Latches

Wide grip range, restricted 90 degree rotation, mounts from inside panel. No visible mounting hardware. Turn clockwise to open. Die cast zinc. Available either chrome plated or with chemical protective film. Average ultimate load 250 lbs. for small and medium series, 300 lbs. for large series.

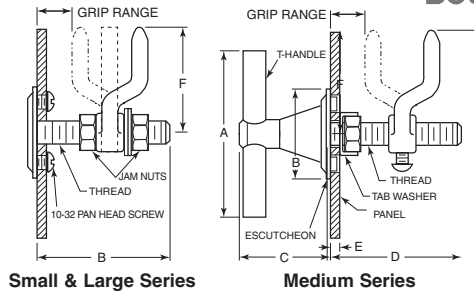

southco®

Item No.	Southco	Finish	Grip Range		Thread	A	B	C	D	(Min.) E	F	Pack Qty.	Bulk Pack Qty.
			Pawl Forward	Pawl Reversed									
<b>Small Series</b>													
SC-6851	68-50-301-10	Film	0-.50	1.00-1.50	5/16-24	2.19	1.06	1.23	1.38	.05	1.34	1	25
SC-6852	68-50-301-20	Chrome	0-.50	1.00-1.50	5/16-24	2.19	1.06	1.23	1.38	.05	1.34	1	25
SC-6853*	68-50-302-10	Film	.50-1.00	—	5/16-24	2.19	1.06	1.23	1.38	.05	1.34	1	25
SC-6854*	68-50-302-20	Chrome	.50-1.00	—	5/16-24	2.19	1.06	1.23	1.38	.05	1.34	1	25
<b>Medium Series</b>													
SC-681	68-10-101-10	Film	.13-1.00	1.00-2.00	3/8-16	3.00	1.50	1.73	1.83	.03	1.75	1	25
SC-682	68-10-101-20	Chrome	.13-1.00	1.00-2.00	3/8-16	3.00	1.50	1.73	1.83	.03	1.75	1	25
<b>Large Series</b>													
SC-6871	68-70-301-10	Film	0-.75	1.00-2.25	7/16-20	4.25	2.13	2.38	2.00	1.38	1.88	1	25
SC-6872	68-70-301-20	Chrome	0-.75	1.00-2.25	7/16-20	4.25	2.13	2.38	2.00	1.38	1.88	1	25
SC-6873*	68-70-302-10	Film	.25-1.50	1.00-2.25	7/16-20	4.25	2.13	2.38	2.00	1.13	2.56	1	25

\*Straight pawl

L-Handles

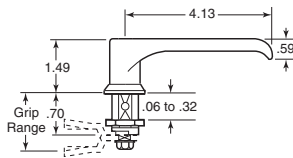

Locking



Non-Locking

Locking  
Black Polyamide  
Clear Zinc Coated

Non-Locking  
Black Polyamide  
Clear Zinc Coated

Item No.	Approx. Grip Range	Pack Qty.	Bulk Pack Qty.
ELH-1074	1/4	1	25
ELH-1075	5/16	1	25
ELH-1076	3/8	1	25
ELH-1077	1/2	1	25
ELH-1078	9/16	1	25
ELH-1080	3/4	1	25
ELH-1081	7/8	1	25
ELH-1082	15/16	1	25
ELH-1084	1 1/16	1	25
ELH-1085	1 1/8	1	25
ELH-1086	1 3/8	1	25
ELH-1079	5/8	1	25

Item No.	Approx. Grip Range	Pack Qty.	Bulk Pack Qty.
ELH-1061	1/4	1	25
ELH-1062	5/16	1	25
ELH-1063	3/8	1	25
ELH-1064	1/2	1	25
ELH-1065	9/16	1	25
ELH-1066	5/8	1	25
ELH-1067	3/4	1	25
ELH-1068	7/8	1	25
ELH-1069	15/16	1	25
ELH-1070	1	1	25
ELH-1071	1 1/16	1	25
ELH-1072	1 1/8	1	25
ELH-1073	1 3/8	1	25

Note: Includes key ELH-333

T-Handles



Locking

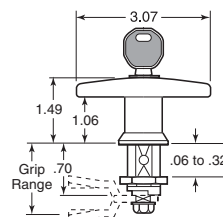

Non-Locking

Locking  
Black Polyamide  
Clear Zinc Coated

Non-Locking  
Black Polyamide  
Clear Zinc Coated

Item No.	Approx. Grip Range	Pack Qty.	Bulk Pack Qty.
ELH-1048	1/4	1	25
ELH-1049	5/16	1	25
ELH-1050	3/8	1	25
ELH-1051	1/2	1	25
ELH-1052	9/16	1	25
ELH-1053	5/8	1	25
ELH-1054	3/4	1	25
ELH-1055	7/8	1	25
ELH-1056	15/16	1	25
ELH-1057	1	1	25
ELH-1058	1 1/16	1	25
ELH-1059	1 1/8	1	25
ELH-1060	1 3/8	1	25

Item No.	Approx. Grip Range	Pack Qty.	Bulk Pack Qty.
ELH-1035	1/4	1	25
ELH-1036	5/16	1	25
ELH-1037	3/8	1	25
ELH-1038	1/2	1	25
ELH-1039	9/16	1	25
ELH-1040	5/8	1	25
ELH-1041	3/4	1	25
ELH-1042	7/8	1	25
ELH-1043	15/16	1	25
ELH-1044	1	1	25
ELH-1045	1 1/16	1	25
ELH-1046	1 1/8	1	25
ELH-1047	1 3/8	1	25

Note: Includes key ELH-333

T-Handle and L-Handle Latches

Bright chrome. Available with or without lock. T-handle or L-handle. Turn clockwise to latch. Average ultimate load is 415 lbs.



T-Handle

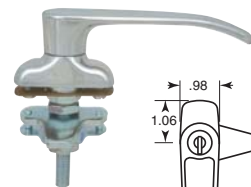
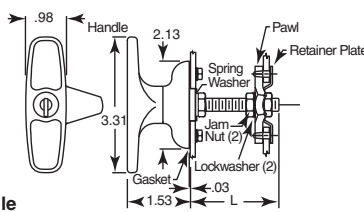

L-Handle

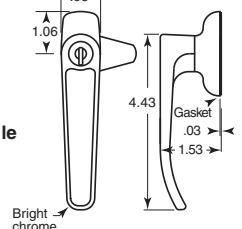

Bright chrome

southco®

Item No.	Southco	Handle	Locking	Grip Range			Pack Qty.	Bulk Pack Qty.
				Min.	Max.	L		
SC-9211	92-21-121	T	Yes	.63	1.25	1.75	1	25
SC-9213	92-11-131	T	No	.63	1.75	2.25	1	25
SC-9221	92-41-131	L	Yes	.63	1.75	2.25	1	25
SC-9223	92-31-131	L	No	.63	1.75	2.25	1	25



**Adjustable T-Handle Latches**

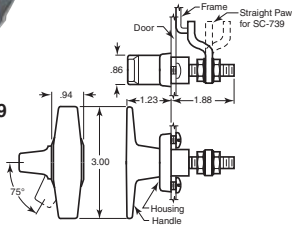

Made of die cast zinc with matte black polyester powder coated and zinc alloy plated steel parts. Maximum working load 100 lbs. Average ultimate load 200 lbs. Three hole mount installation. No. 8-32 screw/lockwasher assemblies supplied for .16" max. door thickness.

Item No.	Southco	Grip Range Pawl Forward		Grip Range Pawl Reversed		Pack Qty.	Bulk Pack Qty.
		Min.	Max.	Min.	Max.		
SC-738	E3-41-15	1.25	1.95	—	—	1	25
SC-739*	E3-41-25	.75	1.45	.75	1.45	1	25

\*SC-739 has a straight pawl

**Folding T-Handle**

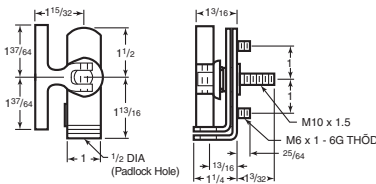

Item No.	Description	Pack Qty.	Bulk Pack Qty.
HH-111	Folding T-Handle	1	25

Gold zinc finished steel/die cast construction. 5/16" square shank. 360 degree rotation. Blind mount. Padlockable.

**Locking T-Handle**

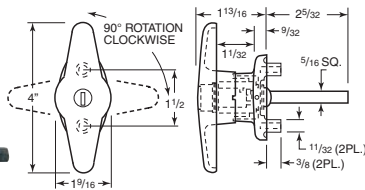
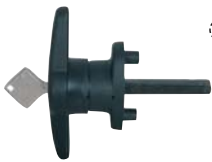

Item No.	Description	Pack Qty.	Bulk Pack Qty.
HH-120	Locking T-Handle	1	25

90 degree clockwise rotation. Made of weatherable black nylon handle and steel parts. Includes one key. May be used with rod kit for 2-point locking.

**T-Handle**

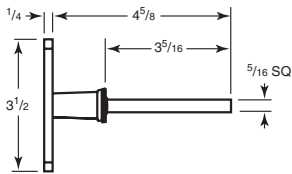

Item No.	Description	Pack Qty.	Bulk Pack Qty.
HH-112	T-Handle	1	25

Zinc plated steel. 5/16" square shank. Handle is 3 1/2" long by 3/4" wide.

**Locking L-Handle**

Chrome finished zinc die-cast construction. 360 degree handle rotation. HH-119 comes with gasket. All locks are keyed alike. Keys included. May be used with rod kit for 2-point locking.

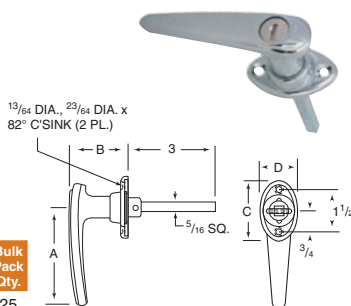

Item No.	A	B	C	D	Pack Qty.	Bulk Pack Qty.
HH-119	3 1/2	1 3/32	2 1/8	1 1/32	1	25

**Padlocking Handle**

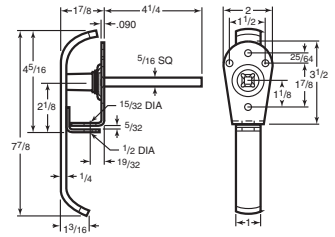

Zinc finished iron/steel construction. Has 5/16" square shank.

Item No.	Description	Pack Qty.	Bulk Pack Qty.
HH-109	Padlocking Handle	1	25

**Tool Box Lock**

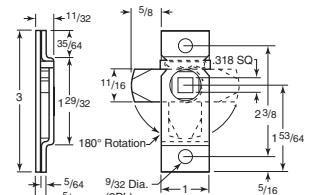

Zinc finished steel. Accepts 5/16" square shank.

Item No.	Pack Qty.	Bulk Pack Qty.
HH-110	1	25

**Cab Locks**

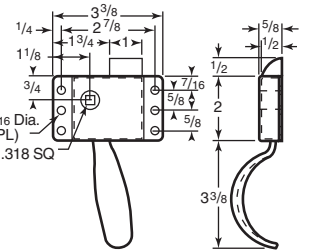

Zinc finished steel. Accepts 5/16" square shank. Inside handle, right or left hand. (Right hand shown)

Item No.	Description	Pack Qty.	Bulk Pack Qty.
HH-107	Right Hand Cabinet	1	25
HH-108	Left Hand Cabinet	1	25

**2-Point Locking Rod Kit**

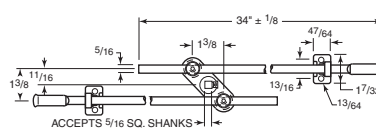

Kit can be used with any 5/16" square shanked handles for two point locking. Kit includes two gold zinc plated steel rods, two plastic rod guides, steel cam, two steel bushings, two wave washers, and three set screws.

Item No.	Description	Pack Qty.	Bulk Pack Qty.
HH-121	Two-Point Locking Rod Kit	1	25

**Rod Assemblies**



Rod assemblies for two and three point installations of flush recessed latches. Rod assemblies include guide, keeper and rod. Aluminum rods are .34" diameter. Rod assemblies have a .75" throw. Guide and keeper brackets are 1010 steel with black nylon inserts. Latch is not included and must be purchased separately.

See page 143 for flush release latches.

Item No.	Southco	Length	Pack Qty.	Bulk Pack Qty.
SC-151	A5-31-120-10	12	1	50
SC-152	A5-31-240-10	24	1	50
SC-153	A5-31-360-10	36	1	50
SC-154	A5-31-480-10	48	1	50

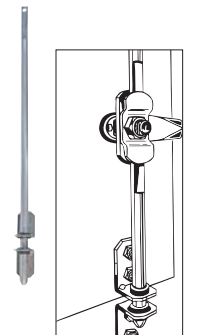

**Lift and Turn Compression Latches**

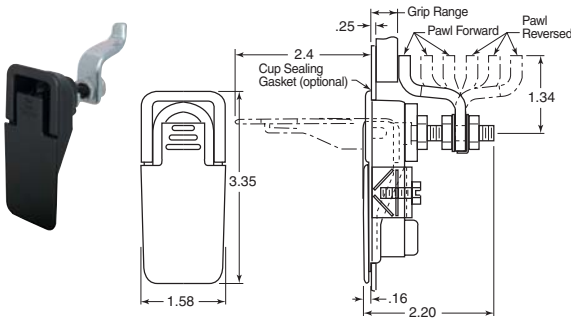

Lift handle to relax compression and then turn to open. Handle and sleeve are die cast zinc with either polished chrome or black powder coat finish. Comes with mounting hardware. Maximum working load is 100 lbs. Mounting screws are M5 thread. For panels thicker than .25" a longer screw lockwasher combination will be needed (not supplied).

Item No.	Southco	Grip Range				Finish	Pack Qty.	Bulk Pack Qty.
		Pawl Forward		Pawl Reversed				
SC-62011	62-40-111-3	.23	.63	2.20	2.59	Polished	1	50
SC-62015	62-40-151-3	.23	.63	2.20	2.59	Black Powder	1	50
SC-62021	62-40-211-2	1.02	1.41	1.41	1.81	Polished	1	50
SC-62025	62-40-251-3	.63	1.02	1.81	2.20	Black Powder	1	50
SC-62031	62-40-311-3	1.02	1.41	1.41	1.81	Polished	1	50

**Swell Latches**

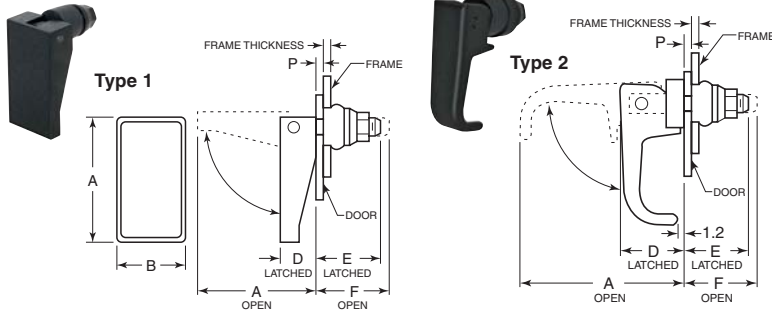

Item No.	Frame Thickness	Frame Diameter	Short Term Rated Load Lbs.
SC-1908	Up to .13	.375	40
SC-1909	.13 to .19	.547	75
SC-1912	.0 to .05	.530	90
	.05 to .10	.530	150
	.10 to .13	.550	140
	.13 to .19	.550	43
SC-1910, SC-1911	.05 to .13	.750	75
	.13 to .19	.766	150
	.19 to .25	.781	125
	.25 and Up	.797	50

Latches in any frame thickness, blind application, glass or plastic. Latches accommodate misalignment between door and frame. Black nylon handle and nut. Black rubber bushing provides sound deadening effect. When handle is lifted bushing diameter decreases allowing it to pass through the hole in the frame to unlatch door.

Item No.	Southco	A	B	D	E	F	P (Max.)	Frame Thickness	Pack Qty.	Bulk Pack Qty.
SC-1908	19-81-10	1.09	.47	.31	.52	.61	.13	Up to .13	1	50
SC-1909	19-91-10	1.53	.66	.45	.75	.89	.19	Up to .19	1	50
SC-1912	19-54-01	1.53	.66	.45	.75	.91	.19	Up to .19	1	50
SC-1910	19-10-101-10	2.19	1.13	.64	1.05	1.23	.25	.05 and Up	1	50
SC-1911	19-14-10	2.48	.63	1.10	1.15	1.32	.25	.05 and Up	1	50

**LALT Series  
Lift & Turn Cam Latches**

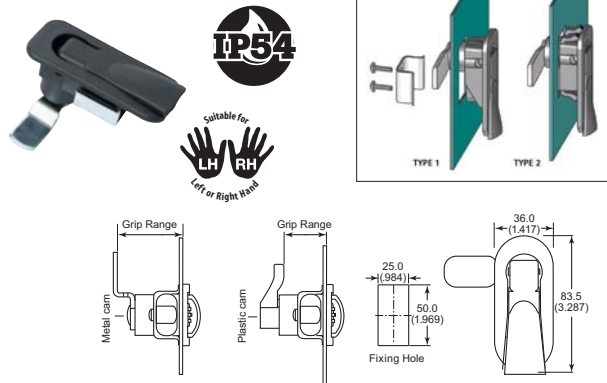

**Specifications:**

- Material: Black 30% Glass Filled Nylon Body with Steel or Nylon Cam

**Features:**

- Quarter Turn
- Low profile stow away handle
- Fits 0.032" to 0.079" (0.80-2.00 mm) thick panels

See page 182 - 185 for gaskets.

Item No.	Grip Range		Cam Length		Cam Type	Pack Qty.	Bulk Pack Qty.		
	Right Handed	Left Handed	Type	In mm	In mm				
LALT100RA	LALT100LA	1	0.984	25.0	0.984	25.0	Plastic	1	50
LALT110RA	LALT110LA	1	1.142	29.0	1.142	43.0	Steel	1	50
LALT120RA	LALT120LA	1	1.417	36.0	1.417	40.0	Steel	1	50
LALT130RA	LALT130LA	1	1.535	39.0	1.535	37.0	Steel	1	50
LALT200RA	LALT200LA	2	0.984	25.0	0.984	25.0	Plastic	1	50
LALT210RA	LALT210LA	2	1.142	29.0	1.142	43.0	Steel	1	50
LALT220RA	LALT220LA	2	1.417	36.0	1.417	40.0	Steel	1	50
LALT230RA	LALT230LA	2	1.535	39.0	1.535	37.0	Steel	1	50

**Lift and Turn Latches**

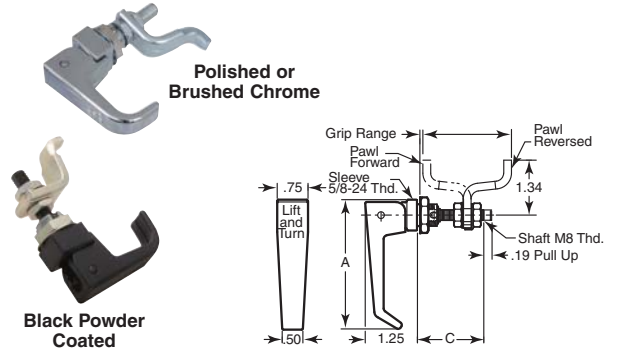

Lift handle to relax compression and then turn to open. Handle and sleeve die cast zinc with either polished chrome, brushed chrome or black powder coat finish. Stainless steel spring and long pin. Other parts are zinc plated steel. Provides consistent compression. Positioning pin assures proper latching. Maximum panel thickness .234".

Item No.	Southco	Finish	Grip Range				Working Load Lbs.	A	C	Pack Qty.	Bulk Pack Qty.
			Pawl Forward		Pawl Reversed						
SC-6211	62-10-21	Polished	.08	.47	1.25	1.66	125	2.25	1.53	1	25
SC-6215	62-10-25	Powder	.08	.47	1.25	1.66	125	2.25	1.53	1	25
SC-62131	62-10-31	Polished	.47	.87	.87	1.25	125	2.25	1.53	1	25
SC-62135	62-10-35	Powder	.47	.87	.87	1.25	125	2.25	1.53	1	25
SC-62111*	62-10-11	Polished	—	—	1.66	2.05	125	2.25	1.53	1	25
SC-62115*	62-10-15	Powder	—	—	1.66	2.05	125	2.25	1.53	1	25
SC-62311	62-30-11	Polished	0	.20	1.77	2.16	150	3.16	1.65	1	25
SC-62312	62-30-12	Brushed	0	.20	1.77	2.16	150	3.16	1.65	1	25
SC-62315	62-30-15	Powder	0	.20	1.77	2.16	150	3.16	1.65	1	25
SC-6231	62-30-21	Polished	.20	.59	1.37	1.77	150	3.16	1.65	1	25
SC-6232	62-30-22	Brushed	.20	.59	1.37	1.77	150	3.16	1.65	1	25
SC-62325	62-30-25	Powder	.20	.59	1.37	1.77	150	3.16	1.65	1	25
SC-62331	62-30-31	Polished	.59	.98	.98	1.37	150	3.16	1.65	1	25
SC-62332	62-30-32	Brushed	.59	.98	.98	1.37	150	3.16	1.65	1	25
SC-62335	62-30-35	Powder	.59	.98	.98	1.37	150	3.16	1.65	1	25

\*Straight pawl



**LATH Series**  
Flush Trigger Compression Latches

Specifications:

- Material: Black Powder Coated Die-Cast Zinc

Features:

- Supplied with 2 keys
- Available in two adjustable grip ranges

See page 182 - 185 for gaskets.

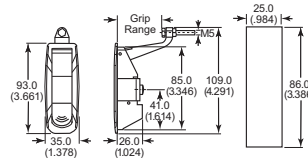

Item No.	Grip Range		Max		Max Door Thickness		Locking Mechanism	Pack Qty.	Bulk Pack Qty.
	In	mm	In	mm	In	mm			
LATH010A	0.000	0.0	0.945	24.0	0.079	2.0	N/A	1	40
LATH020A	0.000	0.0	0.945	24.0	0.079	2.0	Keyed Alike	1	40
LATH030A	0.000	0.0	0.945	24.0	0.079	2.0	Different Keys	1	40
LATH040A	0.945	24.0	1.811	46.0	0.079	2.0	N/A	1	40
LATH050A	0.945	24.0	1.811	46.0	0.079	2.0	Keyed Alike	1	40
LATH060A	0.945	24.0	1.811	46.0	0.079	2.0	Different Keys	1	40

**LCPL Series**  
Off-Set Trigger Compression Latches

Specifications:

- Material: Black Powder Coated Die-Cast Zinc

Features:

- Raised trigger design
- Each supplied with 2 keys per lock
- Fits panels up to 0.079" (2 mm)

See page 182 - 185 for gaskets.

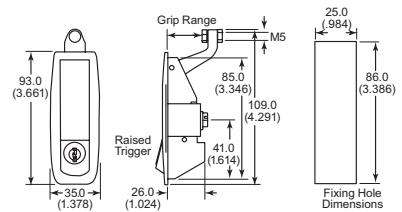

Item No.	Grip Range		Max Door Thickness	Locking Mechanism	Pack Qty.	Bulk Pack Qty.
	In	mm				
LCPL100A	0.000 - 0.945	00.0 - 24.0	.079 (2mm)	N/A	1	40
LCPL200A	0.000 - 0.946	00.0 - 24.0	.079 (2mm)	Keyed Alike	1	40
LCPL300A	0.000 - 0.947	00.0 - 24.1	.079 (2mm)	Different Keys	1	40
LCPL400A	0.945 - 1.811	24.0 - 46.0	.079 (2mm)	N/A	1	40
LCPL500A	0.945 - 1.811	25.0 - 46.0	.079 (2mm)	Keyed Alike	1	40
LCPL600A	0.945 - 1.811	26.0 - 46.0	.079 (2mm)	Different Keys	1	40

**Adjustable Lever Latches**

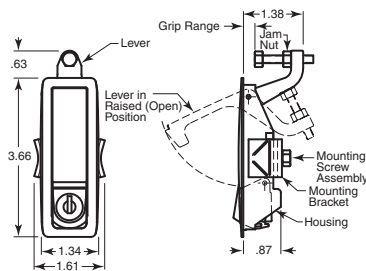

Die cast zinc with stainless steel springs and roll pins. Available in textured chrome or matte black powder coat. Working load 300 lbs. Ultimate load 488 lbs. M5 screws with lock washer supplied. Single hole installation.

Item No.	Southco	Locking	Grip Range	Finish	Pack Qty.	Bulk Pack Qty.
SC-42215	C2-32-15	No	.04 to .95	Black	1	50
SC-42211	C2-32-11	No	.04 to .95	Chrome	1	50
SC-42221	C2-32-21	Yes	.04 to .95	Chrome	1	50
SC-42315	C2-33-15	No	.91 to 1.81	Black	1	50
SC-42311	C2-33-11	No	.91 to 1.81	Chrome	1	50
SC-42321	C2-33-21	Yes	.91 to 1.81	Chrome	1	50

**Paddle Latch**

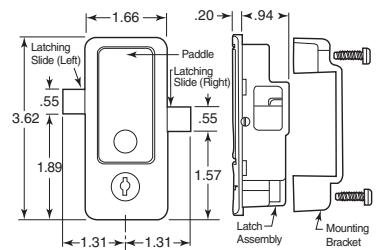

Push-to-close latch accommodates left or right side latching. Corrosion resistant polycarbonate/ABS black resin housing and paddle. Paddle serves as door handle, quick easy installation into 1.45" x 3.33" rectangular hole. Lock plug is glass reinforced acetal with brass wafers. Other parts are glass reinforced nylon. Key lockable with locked/unlocked indicators. Keys are brass. Two M4.2 x 1.4 stainless steel self tapping screws included. Total grip left or right is .25". Maximum working load 112 lbs.

Item No.	Southco	Description	Pack Qty.	Bulk Pack Qty.
SC-2125	M1-2F-2-25	Push-to-Close Paddle Latch	1	50



Slam-Action Latches

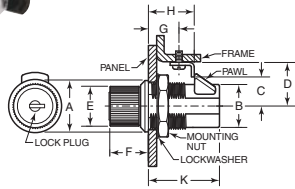

Knob Style

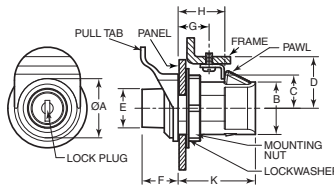

Push Lock

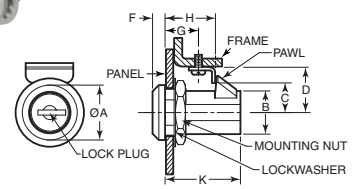

Key Activated

Single hole mounting. Latches by simply pushing door closed. Housing ring is made from die cast zinc chrome plated steel. Knob style has plastic knob. Push lock and knob style are available with or without locks and can be operated without key when left in the unlocked position. Knob style and key activated style will unlatch with a 90 degree turn. Push lock style has plastic body that provides corrosion resistance and unlatches by just pushing the button.

Table with columns: Item No., Southco, Style, A, B, C, D, E, F, G, H, K, Max. Lbs. Working Load, Max. Panel Thickness, Pack Qty., Bulk Pack Qty. Rows include Knob Style (SC-9323, SC-9312, SC-9313), Push Lock (SC-9333, SC-9334, SC-9337, SC-9338), and Key Activated (SC-9321).

Push-To-Close Latches

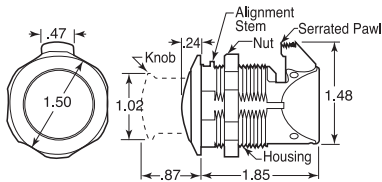

Self-Adjusting Grip

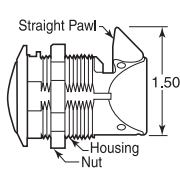

Fixed Grip

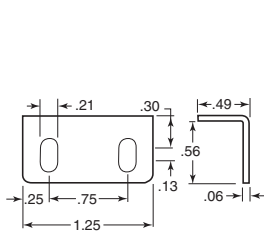

Perpendicular Door / Frame Configuration

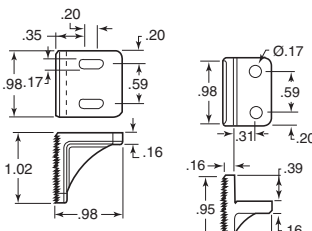

Flush Door / Frame Configuration

Overlapping Doors

Knob stores flush, pops out at a touch. Turn the knob to open, push to close. Latches securely with knob in or out. Accommodates misalignment. Use on flush, surface mount, or perpendicular doors. Quick 1.25" diameter round hole installation. Polycarbonate/ABS blended material with glass filled black nylon keepers, nut and pawl. Corrosion and UV resistant. Chrome plated. Internal springs are Type 304 stainless steel. Maximum working load 50 lbs. Available with serrated pawl for self adjusting grip or regular pawl for fixed grip. Keepers included. Keeper for fixed grip is stainless steel.

Table with columns: Item No., Southco, Description, Pack Qty., Bulk Pack Qty. Rows include SC-2102, SC-2101, and SC-2103.

\*Stainless steel keeper

LOPB Series Push Button Locks

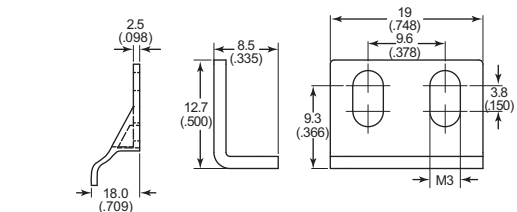
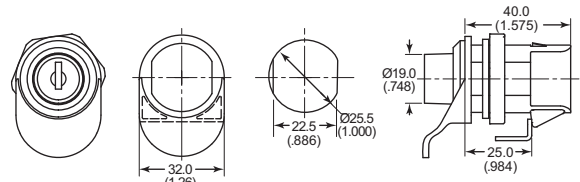

Specifications:

- Material: Black ABS with Steel Catch Plate

Features:

- Slam shut operation
Supplied with 2 keys per lock optional catch plate and finger grip
Fits panel thicknesses up to 0.630" (16mm)

See page 182 - 185 for gaskets.

Table with columns: Item No., Pack Qty., Bulk Pack Qty. Row for LOPB100A.



**Slam Action Slide Latches**



**Tab**

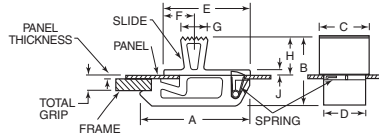

**Flush**

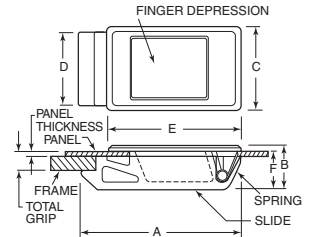

Fast snap in installation. Made of non-corrosive materials; black ABS plastic and stainless steel spring. Push to close latching.

Item No.	Southco	Panel Style	Panel Thickness	Total Thickness	Hole LxW	A	B	C	D	E	F	G	H	J	Working Load (Lbs.)	Pack Qty.	Bulk Pack Qty.
SC-1320	A3-20-412-12	Tab	.040	.120	.500 x .307	.87	.61	.37	.30	.70	.26	.22	.33	.06	20	1	50
SC-1330	A3-30-519-12	Tab	.050	.190	.875 x .562	1.41	.88	.64	.55	1.13	.41	.34	.50	.08	30	1	50
SC-1340	A3-40-625-12	Flush	.060	.250	1.500 x 1.00	2.23	.58	1.11	.99	1.84	.50	—	—	.08	40	1	50

**LOS Series Sliding Slam Latches**



**Mini Tab**

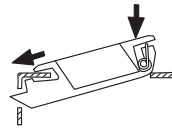
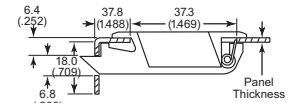
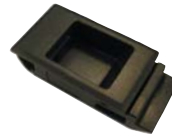
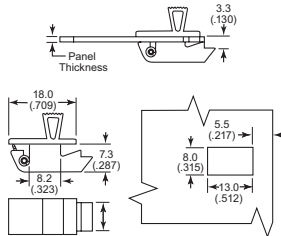

**Flush**

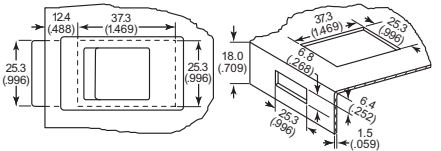

Specifications:

- Material: ABS Body with Stainless Steel Spring

Features:

- Quick Slide movement to release catch

Item No.	Style	Panel Thickness		Bulk Pack Qty.
		In	mm	
LOS010A	Tab	0.031 - 0.059	0.8 - 1.5	1 250
LOS500A	Flush	0.031 - 0.047	0.80 - 1.20	1 250
LOS510A	Flush	0.047 - 0.059	1.20 - 1.50	1 250

**Flush Recessed Latches**

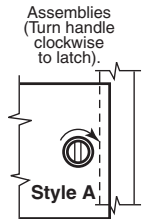

Handle shown parallel to edge of door when latched.

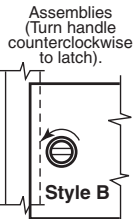

Handle shown perpendicular to edge of door when latched.

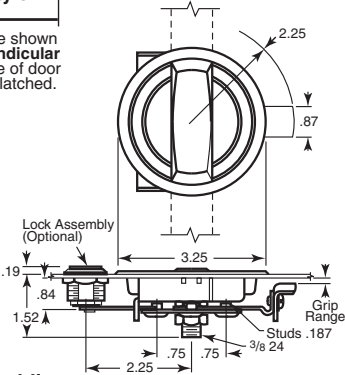

Single, two point or three point latch assemblies. Latches are available in bright chrome plated or matte black finish with a key lock option. Maximum working load 50 lbs. Ultimate load 160 lbs. Rods for two and three point assemblies must be ordered separately.

See page 139 for rod assemblies.

Chrome Plated Steel		Black Matte Finish		Assemblies	Style	Lock	Grip Range	Pack Qty.	Bulk Pack Qty.
Item No.	Southco	Item No.	Southco						
SC-0101	01-13-11	SC-0111	01-13-15	1 or 3 Point	A	No	Up to .5	1	50
SC-0101-L	01-33-11	SC-0112	01-13-25	1 or 3 Point	B	No	Up to .5	1	50
SC-0102-L	01-33-21	—	—	1 or 3 Point	A	Yes	Up to .5	1	50
SC-0104	01-13-41	—	—	1 or 3 Point	B	No	.5 to 1.13	1	50
SC-0103-L	01-33-31	SC-0114	01-13-45	1 or 3 Point	A	Yes	.5 to 1.13	1	50
SC-0104-L	01-33-41	—	—	1 or 3 Point	B	Yes	.5 to 1.13	1	50
SC-0105	01-13-51	SC-0115	01-13-55	2 Point	A	No	—	1	50
SC-0106-L	01-33-61	—	—	2 Point	B	Yes	—	1	50

Note: Locks are keyed alike.

**Flush Pull Latches**



**Non-Locking**



**Locking**

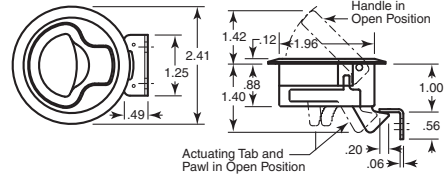

Low profile. Corrosion resistant. Simple 2" round hole installation. Mounts in panels up to .875" thick. Includes M5 Phillips pan head mounting screws. Includes tab for inside actuation. Maximum working load 60 lbs. Ultimate load 120 lbs. Black polycarbonate with stainless steel spring, keeper and screws.

Non-Locking		Locking		Panel Thickness Min.	Panel Thickness Max.	Mtg. Bracket Hgt.	Mtg. Screw Lgth.	Pack Qty.	Bulk Pack Qty.
Item No.	Southco	Item No.	Southco						
SC-211*	M1-61	SC-215*	M1-41	.075	.275	.55	.63	1	50
SC-212	M1-62	SC-216	M1-42	.275	.475	.55	.81	1	50
SC-213	M1-63	SC-217	M1-43	.475	.675	.15	.63	1	50
SC-214	M1-64	SC-218	M1-44	.675	.875	.15	.81	1	50

\*Latch can be mounted in a min. panel thickness of .040, but requires shorter mounting screws than supplied.



## LHD Series

## Heavy Duty Push To Close Panel Locks



Lock Type 1 &amp; 2

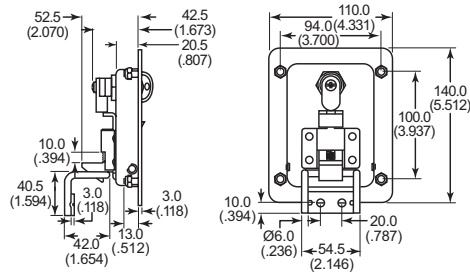

Lock Type 1

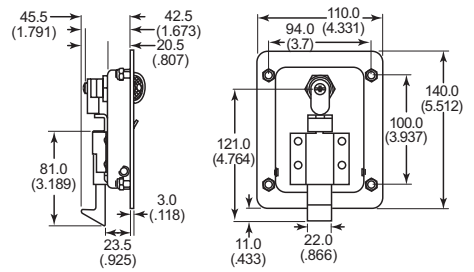

Lock Type 2



Lock Type 3

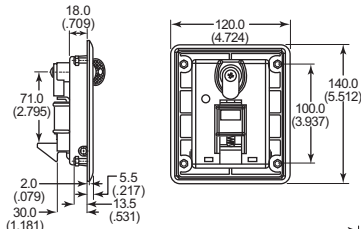

Lock Type 3

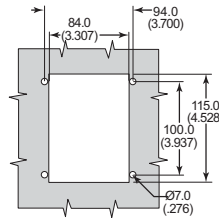

Mounting Hole for all Types



Optional Locking Catch

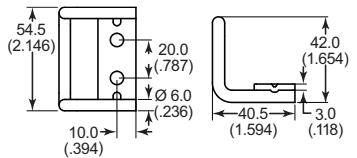

## Specifications:

- Material: Powder Coated Black Steel with Brass or Steel Cam and Polyurethane seal

## Features:

- Slam shut operation
- Supplied with 2 keys per lock
- Can be opened from inside by sliding cam

Item No.		Type	Require Locking Device	Seal	Pack Qty.	Bulk Pack Qty.
Keyed Alike	Keyed Different					
LHD100A	LHD150A	1	Yes	Yes	1	10
LHD300A	LHD350A	2	No	Yes	1	10
LHD400A	LHD450A	3	Yes	No	1	10

## Locking Catch

Part Number	Pack Qty.	Bulk Pack Qty.
LHD999A	1	10

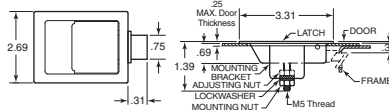
Flush Paddle Latches  
Large Size

Flush mounting, available either all stainless steel or black powder coated with bright zinc plated slide. Maximum working load is 125 lbs.

Item No.	Southco	Finish	Installation Hole		Pack Qty.	Bulk Pack Qty.
			Length	Width		
SC-6420	64-21-10	Stainless Steel	2.81	2.19	1	50
SC-6421	64-21-11	Black Powder Coat	2.81	2.19	1	50

southco®

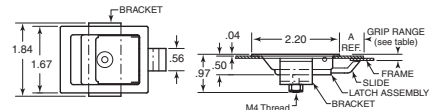
Flush Paddle Latches  
Medium Size

Flush mounting, cup, paddle and cover are Type 304 stainless steel. Slide is 1010 steel, chrome plated. Three grip ranges available. Maximum working load is 50 lbs.

Item No.	Southco	Grip Range	A	Installation Hole		Pack Qty.	Bulk Pack Qty.
				Length	Width		
SC-6411	64-11-10	.05 to .08	.45	1.88	1.44	1	50
SC-6412	64-11-20	.08 to .11	.47	1.88	1.44	1	50
SC-6413	64-11-30	.11 to .14	.48	1.88	1.44	1	50

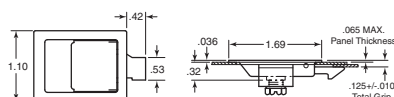
Flush Paddles Latches  
Miniature Size

Flush mounting and made of stainless steel with plastic slide. Spring loaded paddle won't rattle. Smooth, push to close latching. Quick one-screw mounting.

Item No.	Southco	Installation Hole		Max. Load Lbs.	Pack Qty.	Bulk Pack Qty.
		Length	Width			
SC-6401	64-01-10	1.53	.96	20	1	50

southco®



**LHDM Series**  
Mini Heavy Duty Push to Close Panel Locks

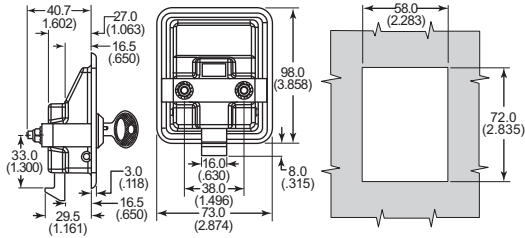

**Specifications:**

- Material: Black 30% GF Nylon with Delrin Cam (Mounting Bracket is Steel)

**Features:**

- No locking device needed
- Supplied with 2 keys per lock
- Can be opened from inside by sliding cam

Item No.	Type	Pack Qty.	Bulk Pack Qty.
LHDM100A	Locking	1	10
LHDM200A	Non- Locking	1	10

**Hidden Panel Latches**

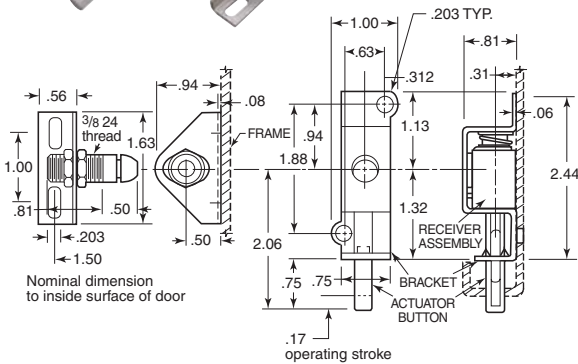
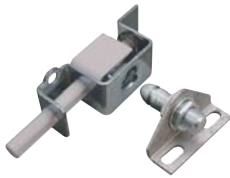

For near edge applications. Provides clean, unblemished panel surfaces. Push the panel to latch. Floating keeper option includes U-bent washer to assist alignment of hinged panels. Stud of floating keeper will float .16" total movement. Steel latch with stainless steel spring with white thermoplastic actuator button.

Item No.	Southco	Working Load (Lbs.)	Keeper	Pack Qty.	Bulk Pack Qty.
SC-522	E2-50-101-20	170	Floating	1	50
SC-521	E2-50-101-10	300	Fixed	1	50

**Flush Cup Latches**



Non-Locking

Locking

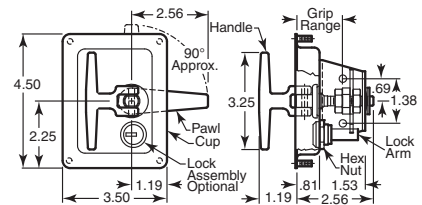

Polished stainless steel cup and bracket. Handle is die cast zinc, chrome plated. Set grip during installation. Includes mounting studs, mounting nuts and lockwashers. Grip range 1.09" to 1.56". Maximum working load 100 lbs. Ultimate load 250 lbs. Turns clockwise to latch.

Item No.	Southco	Lock	Pack Qty.	Bulk Pack Qty.
SC-248	24-20-812-35	Yes	1	50
SC-243	24-20-302-35	No	1	50

**LHDP Series**

Pad Lockable Heavy Duty 'T' Handle Lock

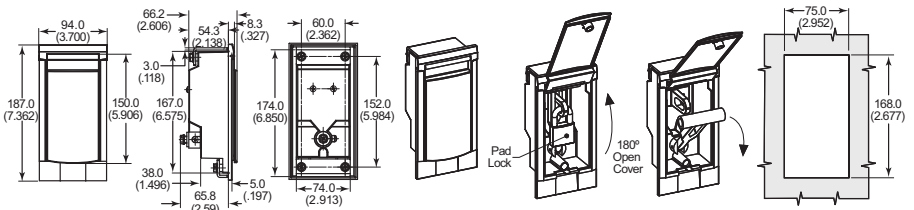
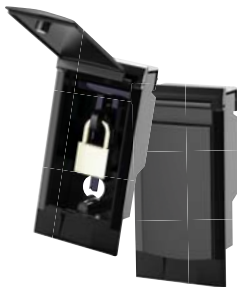

**Specifications:**

- Material: Black Aluminum body & Cover with Die-Cast Zinc Handle

**Features:**

- Designed for medium voltage panels
- Supplied with foam sealing gasket & stainless pin
- Can fit 0.350" (9mm) diameter pad lock

Item No.	Pack Qty.	Bulk Pack Qty.
LHDP100A	1	10





Vantage-Downunder Latches



Concealed Base

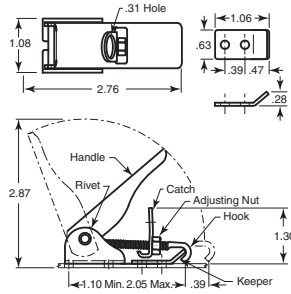

Exposed Base

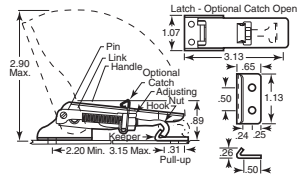

Under center latch adjusts up to one inch. Available with concealed or exposed bases. Padlock or secondary catch option. Kick out feature moves unlatched hook from keeper. Available in zinc plated steel and bright or black powder coat. Type 300 series stainless steel.

Concealed Base		Exposed Base		Description	Color/Material	Pack Qty.	Bulk Pack Qty.
Item No.	Southco	Item No.	Southco				
SC-91307	91-512-07	SC-911	91-552-07	Latch	Zinc Plated Steel	1	25
SC-91352	91-512-52	SC-912	91-552-52	Latch	Bright Stainless	1	25
SC-910	91-512-25	SC-913	91-552-25	Latch	Black Stainless	1	25
SC-91527	91-522-07	SC-915	91-562-07	Latch w/ Secondary	Zinc Plated Steel	1	25
SC-914	91-522-52	SC-916	91-562-52	Latch w/ Secondary	Bright Stainless	1	25
SC-91537	91-532-07	SC-918	91-572-07	Latch w/ Padlock	Zinc Plated Steel	1	25
SC-917	91-532-52	SC-919	91-572-52	Latch w/ Padlock	Bright Stainless	1	25
SC-91607	91-600-07	SC-841	K4-2338-07	Keeper	Zinc Plated Steel	1	25
SC-91652	91-600-52	SC-845	K4-2338-52	Keeper	Bright Stainless	1	25
SC-91663	91-600-63	SC-846	K4-2338-63	Keeper	Black Stainless	1	25

Note: Keepers not included and must be purchased separately. Average ultimate load 350 lbs.

LAAD Series Adjustable Draw Latch

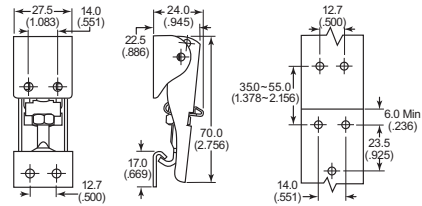

Specifications:

- Material: Zinc Plated Steel or Stainless Steel

Features:

- Adjustable design
- Secondary lock button to prevent accidental opening
- Designed for M4 fitting (not supplied)

Item No.	Type	Pack Qty.	Bulk Pack Qty.
LAAD100S	Stainless Steel	1	10
LAAD100A	Zinc Plated Steel	1	20

LAOC Series Over Center Compression Latches

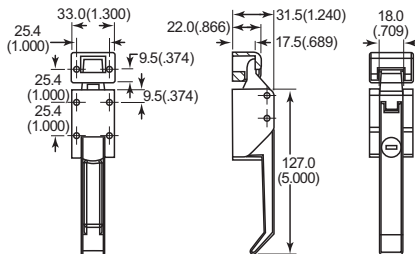

Specifications:

- Compression
- Material: Black Powder Coated Die-Cast Zinc with Stainless Steel Pin

Features:

- Easy to use for good gasket compression
- Keyed versions supplied with 2 keys
- Designed for M5 fittings (not supplied)

Item No.	Type	Pack Qty.	Bulk Pack Qty.
LAOC100A	Locking	1	4
LAOC200A	Non-Locking	1	4

Aerolatch™ Lever Assisted

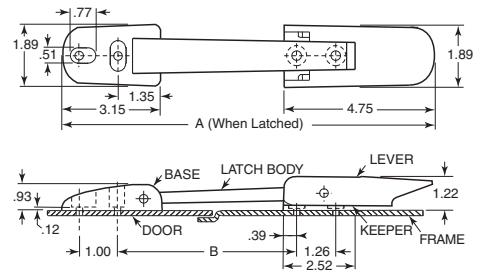

Non-corrosive and UV resistant lever assisted draw latch. To operate, align pivot bosses on lever with slots in keeper. Snap lever over keeper detent. Overcenter action and detent keep latch closed. Latch absorbs and reduces vibration. Base, lever and keeper are made of black glass filled nylon. Latch body is black EPDM Rubber. Four mounting holes are designed for #10 screws (not included). Clamp forces listed are for average steady state at room temperatures.

Item No.	Southco	A	B	Clamp Force	Pack Qty.	Bulk Pack Qty.
SC-3734	37-30-294-60	10	3.82	25	1	50
SC-3735	37-40-295-60	12	5.67	79	1	50



Over Center Draw Latches



A Style Keeper



B Style Keeper

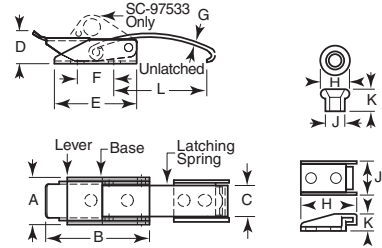

Case hardened steel and passivated stainless steel. Latches mount with M4 or No. 8 screws or 5/32" rivets. For type B keeper use a counter sunk screw.

Item No.	Southco	Keeper Style	A	B	C	D	E	F	G	H	J	K	L	Clamping Strength Lbs.	Pack Qty.	Bulk Pack Qty.
<b>Light Duty - Steel</b>																
SC-973611	97-30-161-11	A	.50	1.08	.33	.31	.85	.380	.035	.56	.42	.14	.89	30	1	25
SC-973631	97-30-163-11	B	.50	1.08	.33	.31	.85	.380	.035	.30	.20	.14	.89	30	1	25
SC-975111	97-50-111-11	A	.89	1.91	.59	.56	1.50	.687	.042	.97	.75	.25	1.16	70	1	25
SC-975211	97-50-121-11	A	.89	1.91	.59	.56	1.50	.687	.042	.97	.75	.25	1.66	70	1	25
SC-975231	97-50-123-11	B	.89	1.91	.59	.56	1.50	.687	.042	.44	.31	.25	1.66	70	1	25
<b>Heavy Duty - Steel</b>																
SC-975511	97-50-151-11	A	.89	1.91	.59	.56	1.50	.687	.062	.97	.75	.25	1.16	150	1	25
SC-975611	97-50-161-11	A	.89	1.91	.59	.56	1.50	.687	.062	.97	.75	.25	1.66	150	1	25
SC-975631	97-50-163-11	B	.89	1.91	.59	.56	1.50	.687	.062	.44	.31	.25	1.66	150	1	25
SC-975711	97-50-171-11	A	.89	1.91	.59	.56	1.50	.687	.062	.97	.75	.25	2.16	150	1	25
SC-975731	97-50-173-11	B	.89	1.91	.59	.56	1.50	.687	.062	.44	.31	.25	2.16	150	1	25
<b>Light Duty - Type 300 Series Stainless Steel</b>																
SC-97361	97-30-161-12	A	.50	1.08	.33	.31	.85	.380	.035	.56	.42	.14	.89	30	1	25
SC-97363	97-30-163-12	B	.50	1.08	.33	.31	.85	.380	.035	.30	.20	.14	.89	30	1	25
SC-975112	97-50-111-12	A	.89	1.91	.59	.56	1.50	.687	.042	.97	.75	.25	1.16	70	1	25
SC-975132	97-50-113-12	B	.89	1.91	.59	.56	1.50	.687	.042	.44	.31	.25	1.16	70	1	25
SC-97511	97-50-121-12	A	.89	1.91	.59	.56	1.50	.687	.042	.97	.75	.25	1.66	70	1	25
SC-97513	97-50-123-12	B	.89	1.91	.59	.56	1.50	.687	.042	.44	.31	.25	1.66	70	1	25
SC-97533*	97-50-323-12	B	.89	1.91	.59	.56	1.50	.687	.042	.44	.31	.25	1.66	70	1	25
SC-975312	97-50-131-12	A	.89	1.91	.59	.56	1.50	.687	.042	.97	.75	.25	2.16	70	1	25
SC-975332	97-50-133-12	B	.89	1.91	.59	.56	1.50	.687	.042	.44	.31	.25	2.16	70	1	25

\*Hole for padlock

Adjustable Draw Latches

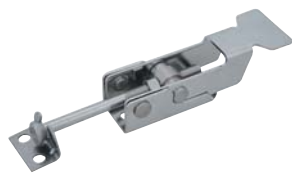

With Keeper

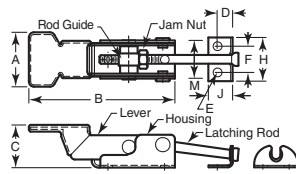

With Hook

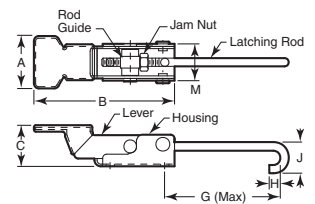

Threaded rod allows periodic adjustments where gasketing and material tolerances may vary. All are passivated Type 300 series stainless steel, except SC-1511 and SC-1722 which are zinc plated steel. SC-1722 has a yellow vinyl grip.

Item No.	Southco	A	B	C	D	E	F	G Max.	H	J	M	Working Load Strength Lbs.	Ultimate Load Lbs.	Adjustment	Pack Qty.	Bulk Pack Qty.
<b>With Keeper</b>																
SC-1511	A1-10-501-10	1.06	2.66	.78	.31	.203	.50	—	.88	.56	.82	40	75	.75	1	50
SC-1514	A1-10-501-40	1.06	2.66	.78	.31	.203	.50	—	.88	.56	.82	40	75	.75	1	50
SC-1714	A1-10-701-40	1.56	4.45	1.25	.44	.265	.75	—	1.21	.75	1.21	200	400	1.31	1	50
<b>With Hook</b>																
SC-1722*	A1-11-702-20	1.69	4.52	1.31	—	—	—	4.44	.36	1.00	1.21	700	1,100	1.31	1	50
SC-1724	A1-11-702-40	1.56	4.45	1.25	—	—	—	4.44	.36	1.00	1.21	700	1,100	1.31	1	50

\*With yellow vinyl grip



**Straight Loop Latches**

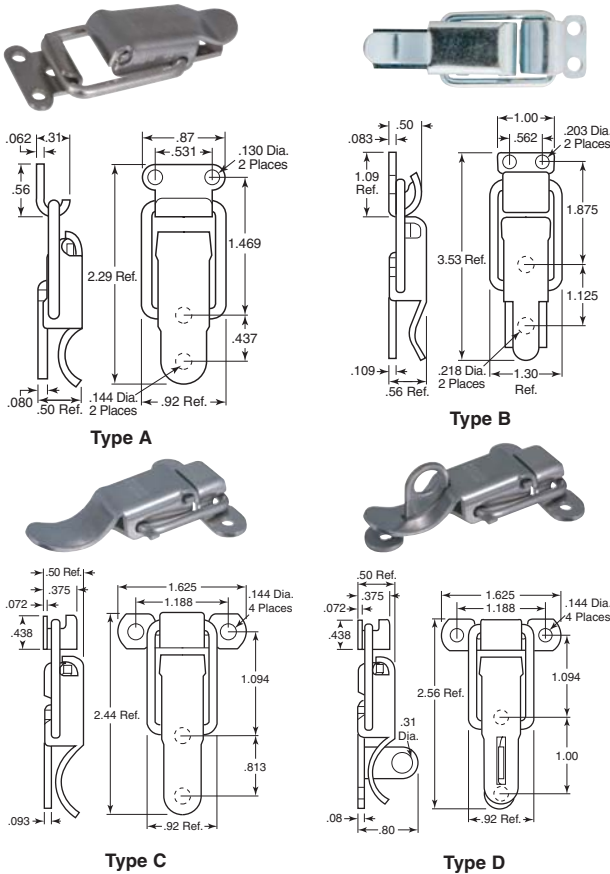

High strength overcenter catch and strike. Economical and compact. Available in plain steel, zinc plated steel and Type 304 stainless steel, with or without mounting holes. Strike is included. Dimensions are as mounted. To increase tension, increase catch/strike separation.

Item No.	Type	Holes	Material/ Finish	Pack Qty.	Bulk Pack Qty.	Item No.	Type	Holes	Material/ Finish	Pack Qty.	Bulk Pack Qty.
NSH-2041	A	Yes	Zinc	1	50	NSH-2241	C	Yes	Zinc	1	50
NSH-2042	A	No	Plain	1	50	NSH-2242	C	No	Plain	1	50
NSH-2043	A	Yes	Stainless	1	50	NSH-2271	D	Yes	Zinc	1	50
NSH-2051	B	Yes	Zinc	1	50	NSH-2272	D	No	Plain	1	50
NSH-2052	B	No	Plain	1	50	NSH-2273*	D	Yes	Stainless	1	50

\*Padlockable

**Lorenz Clamps**

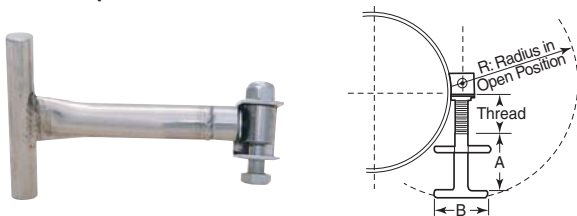

Patented quick clamp is ideal for door openings on bins, hoppers, tanks and manholes. T-handle allows torque without tools. The one piece unit is made of highly polished Type 304 stainless steel. Full 2" adjustment. 180 degree pivot when disengaged, leaving access doorway unobstructed. Will not loosen through vibration. Brackets supplied for easy installation.

Item No.	Thread	A	B	R	Pack Qty.	Bulk Pack Qty.
LZ-250	1/4	3 1/2	3	6 1/2	1	25
LZ-312S	3/16	2 1/2	3	4 3/4	1	25
LZ-312	3/16	3 1/2	3	6 1/2	1	25
LZ-375S	3/8	2 1/2	3	4 3/4	1	25
LZ-375	3/8	3 1/2	3	6 1/4	1	25
LZ-500	1/2	3 1/2	3	6 1/4	1	25

**Catchbolt® Adjustable Latches**

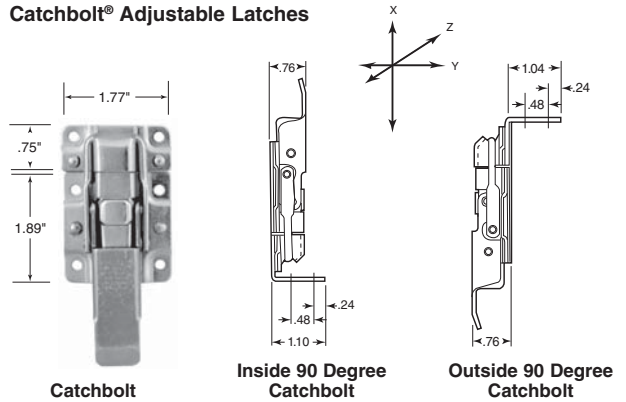

Holds firmly in three directions. Initial action pulls two parts together. As lever is latched an integral deadbolt slides into keeper forcing a panel or door to stay firmly in place with no movement in any direction. Six mounting holes are .16" diameter. Latch height when closed is .71". Material is Type 302 / 304 stainless.

Item No.	Description	Ultimate Strength lbs.			Pack Qty.	Bulk Pack Qty.
		X	Y	Z		
PX-880	Catchbolt	882	1,984	882	1	50
PX-11	Inside 90 Degrees Catchbolt	882	1,984	882	1	50
PX-12	Outside 90 Degrees Catchbolt	882	1,984	882	1	50
PX-881	Stainless Catchbolt	1,323	1,984	1,323	1	50

**Adjustable Latches**

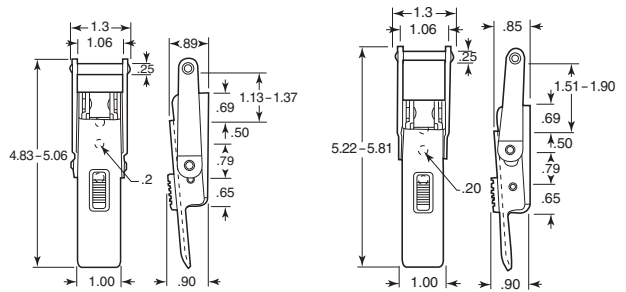
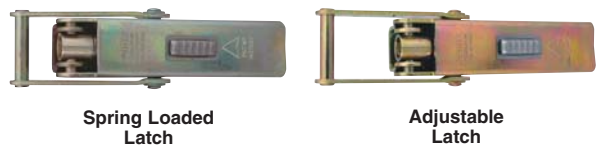

**Wide Keeper**

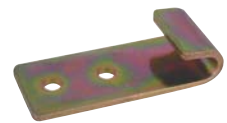
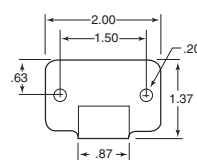

**J Keeper**

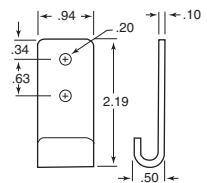

These latches can be used in applications where variances occur. Latches are zinc plated steel. Keepers must be ordered separately. Either keeper can be used with either latch listed below.

Item No.	Description	Pack Qty.	Bulk Pack Qty.
PX-19	Spring Loaded Latch	1	50
PX-22	Adjustable Latch	1	50
PX-20	Wide Keeper	1	25
PX-21	J Keeper	1	25



**LAWB Series  
Stainless Steel Wire & Bail Latches**

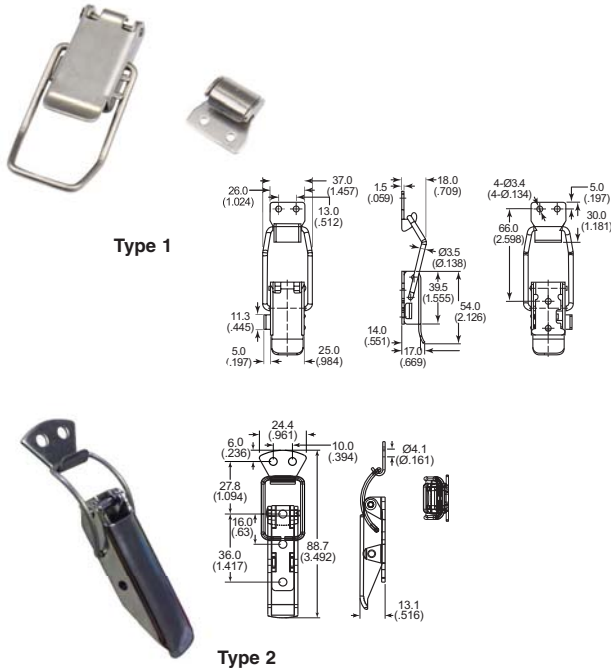

**Specifications:**

- Material: Stainless Steel

**Features:**

- Secondary lock button to prevent accidental opening

Item No.	Type	Pack Qty.	Bulk Pack Qty.
LAWB100S	1	1	25
LAWB200S	2	1	50

**Draw Pull Catches**

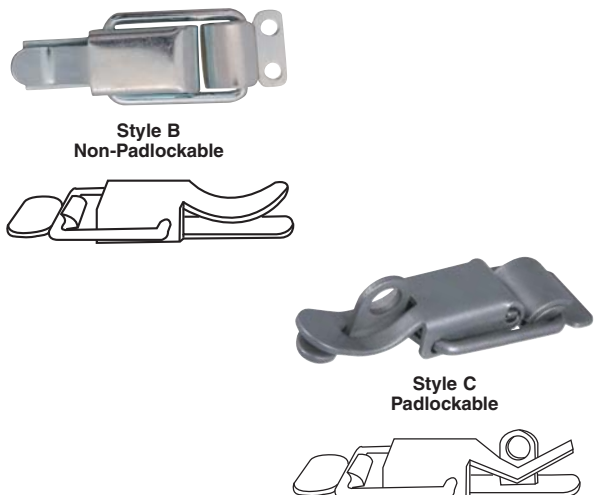

Draw pull catches are available in two sizes. Available in zinc finished steel, and Type 304 stainless steel. HG-83341-R is padlockable. Strike included.

Item No.	Style	OAL	Overall Width	Mounting Holes	Material	Finish	Pack Qty.	Bulk Pack Qty.
HG-83323	B	2.25	.93	.130	Type 304 Stainless Steel	None	1	25
HG-83332	B	3.93	1.03	.195	Steel	Zinc	1	25
HG-83333	B	3.93	1.03	.195	Type 304 Stainless Steel	None	1	25
HG-83341-R*	C	3.93	1.03	None	Steel	None	1	25

\*Padlockable

**Compression Spring Catches**

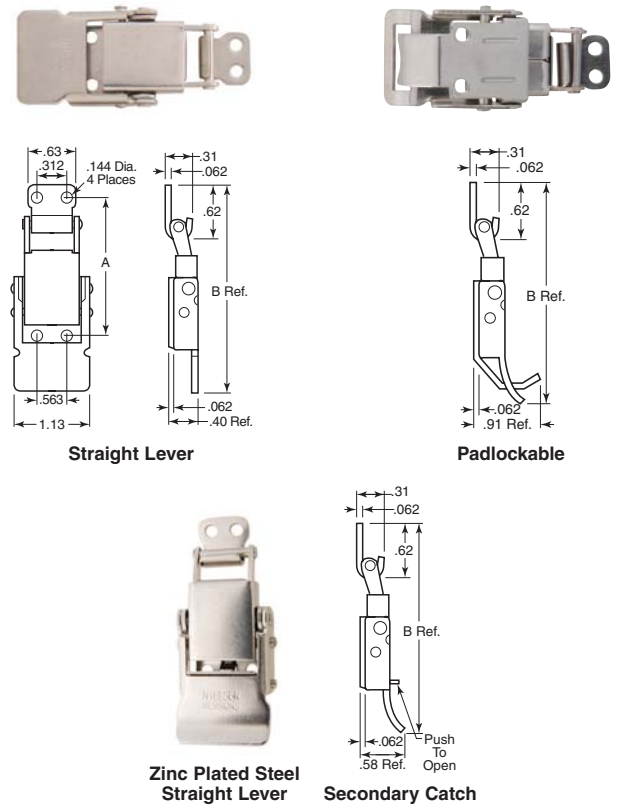

Lbs.	Mounting For Desired Tension	
	A	B
30	1.813	2.79
50	1.875	2.85
70	1.938	2.91

Three internal compression springs supply up to 70 pounds of spring tension. Available as padlockable or with secondary catch. Spring tension compensates for gasket set. Provides exact tension for water tight and air tight seals. All are Type 304 stainless steel except NSH-8331 which is zinc plated steel. To increase tension, increase catch/strike separation.

Item No.	Description	Pack Qty.	Bulk Pack Qty.
NSH-8331*	Straight Lever	1	50
NSH-8332	Straight Lever	1	50
NSH-8333	Padlockable	1	50
NSH-8334	Secondary Catch	1	50

\*Zinc plated steel

**MORE CHOICE!**

We have over 1 billion components in stock—available for same day shipping!





**Link Lock Rotary Action Draw Latches**

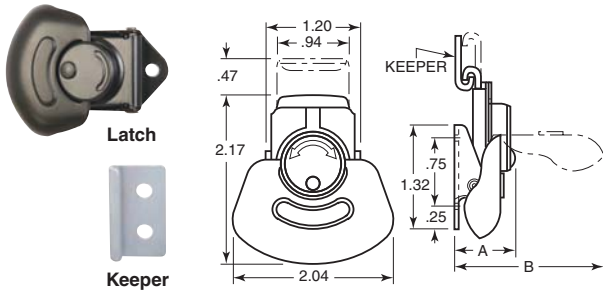

Draws panels together with overcenter clamping force and slide travel of .47". Simply lift wing and twist to disengage. Available with spring loaded option for mounting hole irregularities or shock and vibration. Type 300 series stainless steel or steel with black UV resistant powder coat. Working load for stainless is 190 lbs., steel is 275 lbs. Keepers not included and must be purchased separately.

Item No.	Southco	Material	Description	A	B	Pack Qty.	Bulk Pack Qty.
SC-K258	K2-3005-89	Steel	Springloaded Latch	.73	1.89	1	25
SC-K255	K2-3005-51	Stainless	Latch	.73	1.89	1	25
SC-K259	K2-3001-89	Steel	Fixed Latch	.71	1.85	1	25
SC-841	K4-2338-07	Steel	Keeper	—	—	1	25
SC-842	K4-2338-89	Steel	Keeper	—	—	1	25
SC-843	K4-2338-51	Stainless	Keeper	—	—	1	25

**Draw Latches Adjustable Style**

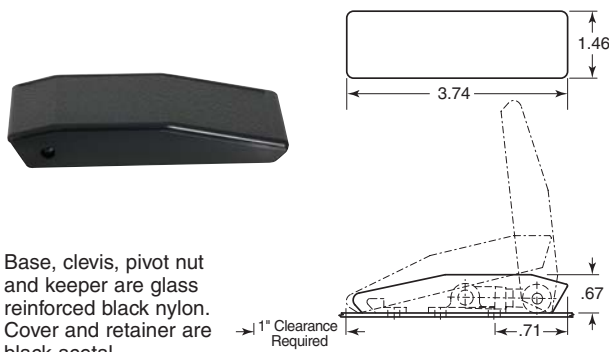

Base, clevis, pivot nut and keeper are glass reinforced black nylon. Cover and retainer are black acetal. Adjustment nut is passivated stainless steel. Maximum working load 350 lbs. Average ultimate load 500 lbs. Keeper included.

Item No.	Southco	Description	Pack Qty.	Bulk Pack Qty.
SC-7522	E8-10-502-20	Non-Corrosive Adjustable Draw Latch	1	25

**Versa Latch™ Tension Latches**

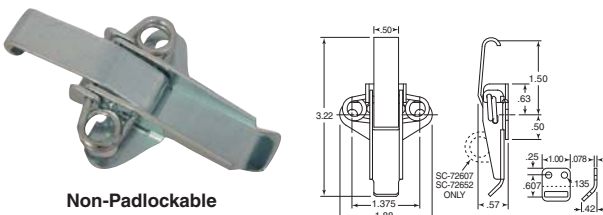

Latches		Keepers		Average Ultimate Load (Lbs.)	Pack Qty.	Bulk Pack Qty.
Item No.	Southco	Item No.	Southco			
<b>Steel</b>						
SC-72507	V2-0025-07	SC-7207	V2-0025-07	400	1	25
SC-72607*	V2-0026-07	SC-7207	V2-0026-07	400	1	25
SC-74602	V4-0006-02	SC-7402	V4-0006-02	800	1	25
<b>Type 300 Series Stainless Steel</b>						
SC-72552	V2-0025-52	SC-7252	V2-0025-52	380	1	25
SC-72652*	V2-0026-52	SC-7252	V2-0026-52	380	1	25
SC-74652	V4-0006-52	SC-7452	V4-0006-52	800	1	25

\*Similar to SC-72507 and SC-72552 but padlockable

**ProLatch™**

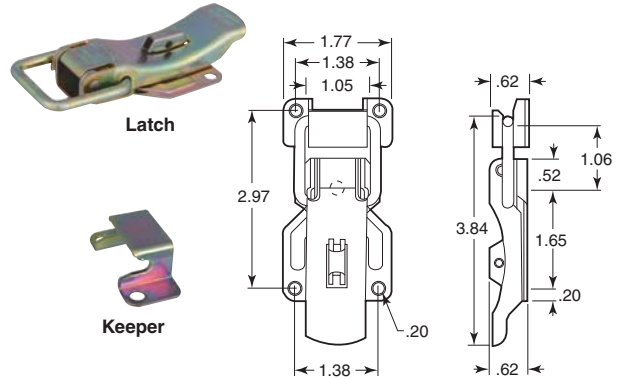

ProLatch is ideal for gasketed applications. The latch forces a panel against a seal and holds firmly in two planes. A safety catch is incorporated. The keeper for the PX-14 must be ordered separately. Made of zinc plated steel. Ultimate strength is 715 lbs.

Item No.	Description	Pack Qty.	Bulk Pack Qty.
PX-14	ProLatch	1	50
PX-15	Keeper for PX-14	1	25

**Junior ProLatch™**

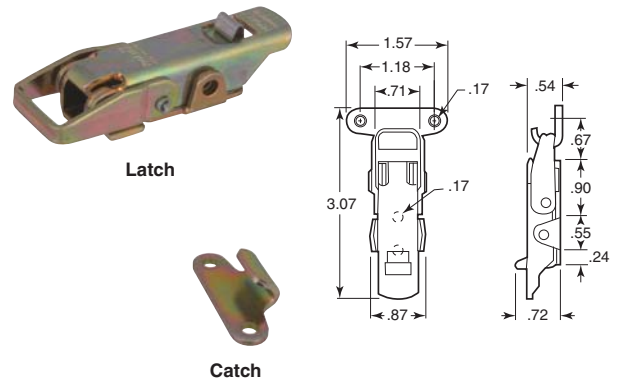

Similar to above ProLatch but for smaller applications. Ultimate breaking strength is 325 lbs. Keeper for PX-17 must be ordered separately.

Item No.	Description	Pack Qty.	Bulk Pack Qty.
PX-17	Junior ProLatch	1	50
PX-18	Keeper for PX-17	1	25



Torsion springs compensate for application irregularities. Easy to grasp handle design. Steel is zinc plated carbon steel with bright chrome dip. Type 300 series stainless steel are passivated. Keepers not included and must be purchased separately. SC-72607 and SC-72652 are padlockable.



**Draw Latches  
T-Handle**



southco®

Black rubber T-handle with metal bracket and keeper. Shipped assembled. Installs with .1875" rivets or #10 screws. Can be welded. Keeper is included.

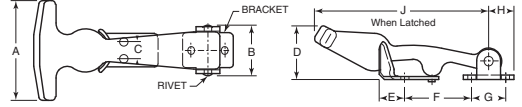

Zinc Plated Steel		Stainless Steel		A	B	C	D	E	F	G	H	J	Avg. Ultimate Load (Lbs.)	Pack Qty.	Bulk Pack Qty.
Item No.	Southco	Item No.	Southco												
SC-37711	37-10-071-10P	SC-37712	37-10-071-20P	1.88	.95	.50	.75	.50	1.25	.63	.47	2.94	32	1	50
SC-37861	37-10-086-10P	SC-37862	37-10-086-20P	2.44	1.25	.44	1.25	.72	1.50	.88	.66	4.00	64	1	50
SC-37011	37-10-101-10P	SC-37012	37-10-101-20	3.13	1.55	.50	1.25	1.02	2.00	1.00	.75	5.13	82	1	50

Note: Holes are parallel with latch rather than perpendicular as pictured and install with .125 rivets or #5 screws.

**LAF Series  
Flexible Over Center Latch**



Type 1

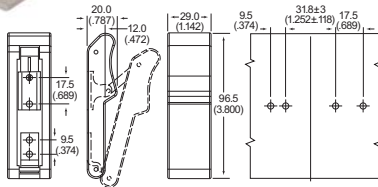

Type 2

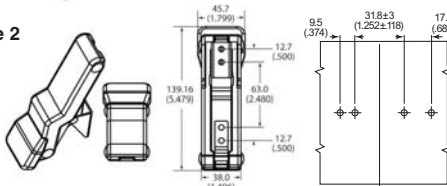

**Specifications:**

- Material: Black Rubber with Stainless Steel keeper & bracket

**Features:**

- Low profile design
- Non-corrosive
- Designed for M4 or #8 Screws (not included)

Item No.	Pack Qty.	Bulk Pack Qty.
LAF100A	1	20
LAF200A	1	20

**Soft Latch®**

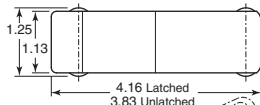
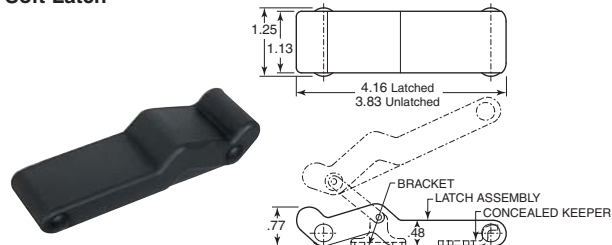

southco®

**Flexible T-Handle  
Non-Conductive**

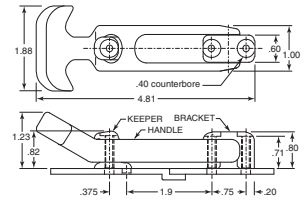

southco®

No metal parts. UV resistant, self aligning. Built in drag prevents handle flopping. Steady state clamp force 10 lbs. Mounts with M5, #10 screws or 3/16" rivets. Keeper included. Thermoplastic elastomer.

Item No.	Southco	Description	Pack Qty.	Bulk Pack Qty.
SC-1753	F7-53	Flexible Draw Latch	1	50

**Spring Loaded Latches  
Hood Latches**



90 Degrees

Straight

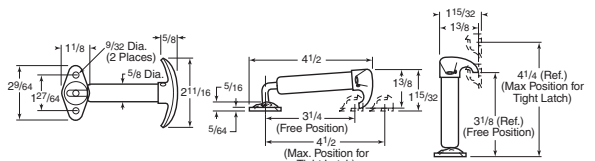

Steel construction with either black enamel or chrome finish. 90 degree or straight mounting options. Keeper included.

Item No.	Item No.	Mounting	Pack Qty.	Bulk Pack Qty.
HH-361	HH-363	90 degrees	1	25
HH-362	HH-364	Straight	1	25

southco®

Tolerates misalignment. UV resistant thermoplastic elastomer body, glass reinforced nylon link and bushings, stainless steel rivet, pins, keeper and bracket. Cushions impact absorbs vibration. Keeper included.

Item No.	Southco	Description	Pack Qty.	Bulk Pack Qty.
SC-4710	C7-10	Soft Latch	1	50



These versatile, medium size toggle latches are built for tough use on chests, cabinets, etc. Steel latches and strikes are zinc plated with a bright chromate finish. Stainless latches and strikes are made from Type 300 series stainless. All mounting holes on latches and strikes will accept .156" dia. rivets or #6 round head screws. Latches that do not require strikes are designed to latch on notches, corners, lips, etc. The secondary latch prevents accidental opening. Note: Strikes are not included with the latch and must be purchased separately.

800 Series

Strength: Ultimate: 700 Lbs.

Working: 100 Lbs.

Pull Up Ability: .6"

Technical drawings and photos of 800 Series latches (DTL-800A, DTL-800B, DTL-800G, DTL-800DA, DTL-800DB) with dimensions and link contact ranges.

Table with 8 columns: Item No., Material, Secondary Lock, Pack Qty., Bulk Pack Qty., Item No., Material, Secondary Lock, Pack Qty., Bulk Pack Qty. Lists items DTL-800DB, DTL-800BX, DTL-800DA, DTL-800DAX, DTL-800G, DTL-800GX, DTL-800GSS, DTL-800A, DTL-800ASS, DTL-800AXSS.

803 Series

Strength: Ultimate: 220 Lbs.

Working: 45 Lbs.

Pull Up Ability: .2"

Technical drawings and photos of 803 Series latches (DTL-803G, DTL-803B, DTL-803DA, DTL-803DB) with dimensions and link contact ranges.

Table with 8 columns: Item No., Material, Pack Qty., Bulk Pack Qty., Item No., Material, Pack Qty., Bulk Pack Qty. Lists items DTL-803DB, DTL-803DA, DTL-803B, DTL-803BSS, DTL-803G, DTL-803GSS.

806 Series

Strength: Ultimate: 220 Lbs.

Working: 45 Lbs.

Pull Up Ability: .2"

Technical drawings and photos of 806 Series latches (DTL-806DB, DTL-806DA) with dimensions and link contact ranges.

Table with 8 columns: Item No., Material, Pack Qty., Bulk Pack Qty., Item No., Material, Pack Qty., Bulk Pack Qty. Lists items DTL-806DB, DTL-806DBSS, DTL-806DA, DTL-806DASS.

802 Series

Strength: Ultimate: 700 Lbs.

Working: 100 Lbs.

Pull Up Ability: .6"

Technical drawings and photos of 802 Series latches (DTL-802A, DTL-802G, DTL-802DA, DTL-802DB) with dimensions and link contact ranges.

Table with 8 columns: Item No., Material, Pack Qty., Bulk Pack Qty., Item No., Material, Pack Qty., Bulk Pack Qty. Lists items DTL-802DB, DTL-802DA, DTL-802G, DTL-802GSS, DTL-802A.

200 Series - Heavy Duty w/Pad Lock Hole

Strength: Ultimate: 1,500 Lbs.

Working: 600 Lbs.

Technical drawings and photos of 200 Series latches (DTL-200B, DTL-200-5) with dimensions and pad lock hole details.

Table with 5 columns: Item No., Description, Pull Up, Pack Qty., Bulk Pack Qty. Lists items DTL-200B, DTL-200-5.

400 Series - Miniature

Locked Tension: 30 Lbs.

Technical drawings and photos of 400 Series latches (DTL-400, DTL-400-1) with dimensions and mounting hole details.

Table with 5 columns: Item No., Description, Pull Up, Pack Qty., Bulk Pack Qty. Lists items DTL-400, DTL-400-1.

Strikes

Steel and Stainless

Technical drawings and photos of various strikes (DTL-802-2, DTL-800-5, DTL-800-7, DTL-800-9) with dimensions.

Any of these strikes may be used with any 800, 802, 803 and 806 latch. All mounting holes are .167" dia.

Table with 6 columns: Item No., Pack Qty., Bulk Pack Qty., Item No., Pack Qty., Bulk Pack Qty. Lists items DTL-802-2, DTL-800-5, DTL-800-7, DTL-800-9, DTL-802-2SS, DTL-800-7SS.

# DRAW LATCHES & KEEPERS



These adjustable grip toggle latches allow you to easily adjust both the grip length and locking tensions. The optional secondary latch prevents accidental opening. Made from cold rolled steel, zinc plated with a bright chromate finish.

**100 Series - Adjustable Grip**  
**Strength: Ultimate: 800 Lbs.**  
**Working: 600 Lbs.**

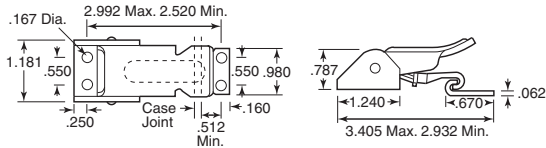
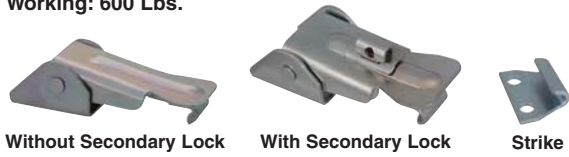

Item No.	Description	Secondary Lock	Pull Up	Adjustment	Pack Qty.	Bulk Pack Qty.
DTL-100A	Latch	No	.16	.45	1	25
DTL-100AX	Latch	Yes	.16	.45	1	25
DTL-100-5	Strike	—	—	—	1	25

**Note:** Strikes are not included with latches and must be purchased separately.

**110 Series - Adjustable Grip**  
**Strength: Ultimate: 326 Lbs.**  
**Working: 270 Lbs.**

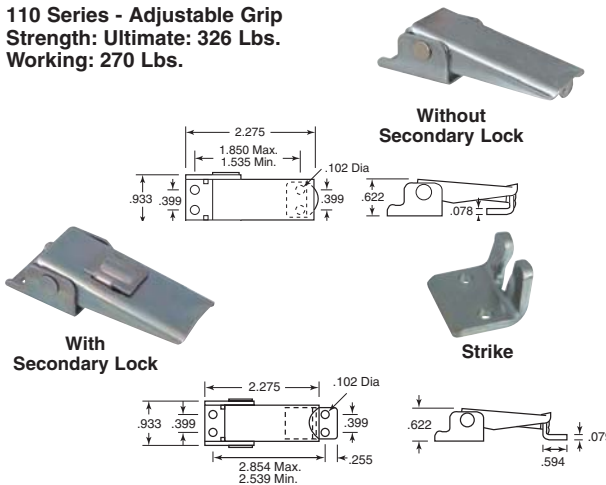

Item No.	Description	Secondary Lock	Pull Up	Adjustment	Pack Qty.	Bulk Pack Qty.
DTL-110A	Latch	No	.31	.31	1	25
DTL-110AX	Latch	Yes	.31	.31	1	25
DTL-110-5	Strike	—	—	—	1	25
DTL-110-15	Strike	—	—	—	1	25

**Note:** Strikes are not included with latches and must be purchased separately.

**300 Series - Adjustable Grip**  
**Strength: Ultimate: 800 Lbs.**  
**Working: 600 Lbs.**

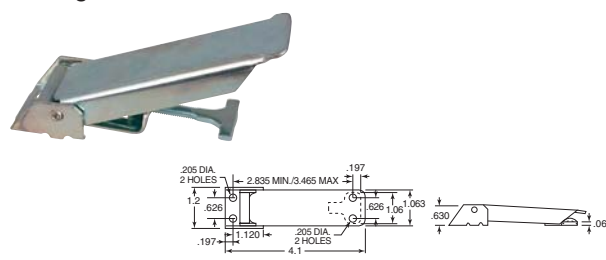

Item No.	Description	Pull Up	Adjustment	Pack Qty.	Bulk Pack Qty.
DTL-300A	Latch	.20	.625	1	25
DTL-300-8	Strike	—	—	1	25

**Note:** Strikes are not included with latches and must be purchased separately.

## Slam Locks

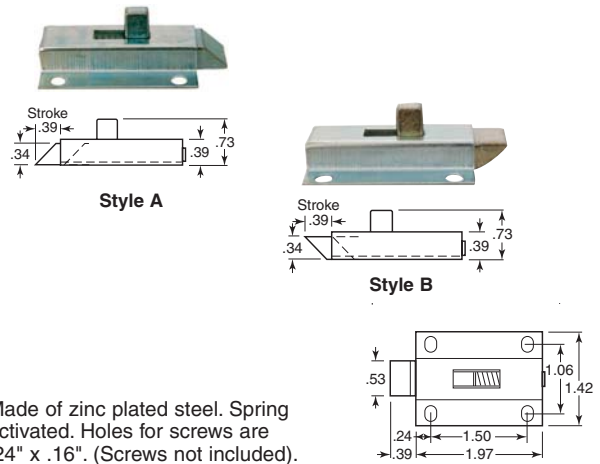

Made of zinc plated steel. Spring activated. Holes for screws are .24" x .16". (Screws not included).

Item No.	Style	Pack Qty.	Bulk Pack Qty.
ELH-500	A	1	25
ELH-501	B	1	25

## Barrel Bolts

304 Stainless Steel  
Satin Finish

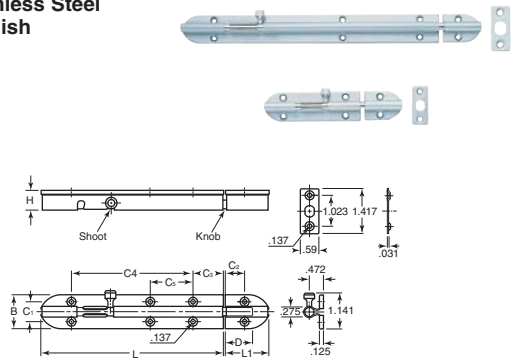

Barrel bolt body and plates are made of 304 stainless steel with satin finish while bolt and knob are nickel-plated brass. Simply lift the knob, slide it over and drop it into notch for secure latching. Attractive and ideal for corrosive environments.

Item No.	L	L1	H	B	C1	C2	C3	C4	C5	D	Pack Qty.	Bulk Pack Qty.
SUG-504	3 <sup>39</sup> / <sub>64</sub>	1 <sup>27</sup> / <sub>64</sub>	.649	1 <sup>1</sup> / <sub>16</sub>	.629	.590	0.570	2.283	—	.944	1	10
SUG-505	5 <sup>29</sup> / <sub>64</sub>	1 <sup>27</sup> / <sub>64</sub>	.649	1 <sup>1</sup> / <sub>16</sub>	.629	.590	0.984	3.937	—	.944	1	10
SUG-506	9 <sup>29</sup> / <sub>64</sub>	1 <sup>27</sup> / <sub>64</sub>	.649	1 <sup>1</sup> / <sub>16</sub>	.629	.590	0.728	7.559	2.795	1.181	1	10

## Gate Latches

304 Stainless Steel  
Satin Finish

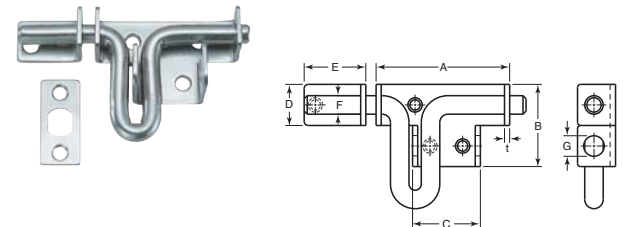

Made from 304 stainless steel with satin finish, gate latches are designed to accommodate a padlock (not included) security in corrosive environments.

Item No.	A	B	C	D	E	F	G	t	Pack Qty.	Bulk Pack Qty.
SUG-541	1 <sup>25</sup> / <sub>32</sub>	1 <sup>3</sup> / <sub>32</sub>	.984	.551	5 <sup>9</sup> / <sub>64</sub>	.236	.275	.078	1	10
SUG-542	2 <sup>9</sup> / <sub>16</sub>	1 <sup>15</sup> / <sub>16</sub>	1.299	.787	1 <sup>1</sup> / <sub>16</sub>	.354	.393	.098	1	10
SUG-543	3 <sup>1</sup> / <sub>32</sub>	1 <sup>9</sup> / <sub>16</sub>	1.653	1.023	1 <sup>3</sup> / <sub>8</sub>	.472	.393	.118	1	10