

[Home \(/s/\)](#)[TECHNICAL SUPPORT \(/s/contactsupport\)](#)[FORUMS \(/s/forums\)](#)[TRAINING \(/s/cpu\)](#)[NETCLOUD \(/s/NetCloud\)](#) [Log in](#)

Search (Knowledge Base, Forums, Cases)

Search

## AER2200 Branch Router Quick Start Guide

Sep 16, 2020 · Knowledge

### Content

## AER2200 Branch Router Quick Start Guide

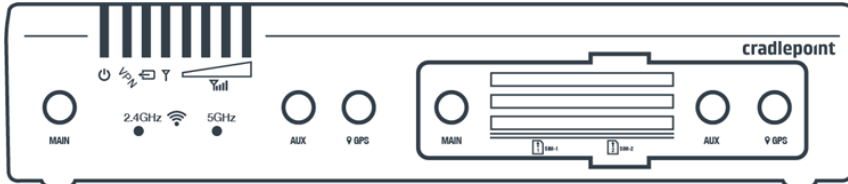

### Introduction

This document provides basic setup and installation instructions for the AER2200 Branch Router.

### Navigation

Use the following links to quickly navigate through this document.

[AER2200 Branch Router Models](#)[Before You Begin](#)[Location Considerations](#)[SIM Card for Wireless Connectivity](#)[Installing an External Modem](#)[Required Tools for Setup](#)[Setup](#)[STEP 1: Check box contents.](#)[Accessories](#)[STEP 2: Remove the modem door.](#)[STEP 3: Insert a SIM card into the embedded modem slot\(s\).](#)[STEP 4 \(Optional\): Setup and install the MC400 modular modem.](#)[STEP 5: Reinstall the modem door.](#)[STEP 6: Attach the 4G LTE cellular antennas.](#)[STEP 7: Attach the Wi-Fi antennas.](#)[STEP 8: Mount the router.](#)[DESK](#)[RACK](#)[STEP 9: Connect the Ethernet cable.](#)[STEP 10: Power up the router.](#)[Connecting to NetCloud](#)[Understanding LEDs](#)[Troubleshooting](#)[Resources](#)[Help and Support](#)[Terms of Service](#)

### AER2200 Branch Router Models

This document applies to all of the following AER2200 models.

CRADLEPOINT AER2200-1200M-B    MODEL: S5A845A

CRADLEPOINT AER2200-1200M	MODEL: S5A845A
CRADLEPOINT AER2250-1200M	MODEL: S5A850A
CRADLEPOINT AER2250-600M	MODEL: S5A808A

## **Before You Begin**

Read the following before setting up the AER2200 Branch Router.

*NOTE: Cradlepoint recommends that all branch devices be installed by a professional. For assistance with installation or in locating a professional installer, refer to our [Contact Us](https://cradlepoint.com/about-us/gdpr-privacy-policy/) (<https://cradlepoint.com/about-us/gdpr-privacy-policy/>) page.*

## **Location Considerations**

To ensure the AER2200 operates efficiently, do the following:

- Ensure the device is positioned to receive optimal signal. Avoid positioning near concrete walls, metal or reflective surfaces, or any other objects that may interfere with RF reception.
- Ensure plenty of ventilation. Avoid installing the device in enclosed spaces.
- Do not install the device in direct exposure to the elements. Extreme heat or cold can and will impact the router's performance.
- Refer to the AER2200 Safety, Regulatory, and Warranty Guide (included with your hardware) for more information about location considerations.

## **SIM Card for Wireless Connectivity**

A wireless broadband data plan must be added to your AER2200 for wireless broadband connectivity. Wireless broadband data plans are available from wireless carriers such as Verizon, AT&T, Sprint, and T-Mobile. The SIM card must be activated and provisioned by the carrier. Contact your carrier for details about selecting a data plan and about the process for provisioning your SIM.

## **Installing an External Modem**

The AER2200 includes a slot for an additional MC400 modem. This enhanced capability allows for redundancy, advanced configuration, failover, and upgradability. The AER2200 supports both the MC400-600M or the MC400-1200M. Refer to the following for more information:

[Insert Optional MC400 External Modem](#)

[MC400 Webpage \(https://cradlepoint.com/product/accessories/mc400-modular-modem/\)](https://cradlepoint.com/product/accessories/mc400-modular-modem/)

[MC400 Spec Sheet \(https://resources.cradlepoint.com/product-docs/mc400-spec-sheet-01202020\)](https://resources.cradlepoint.com/product-docs/mc400-spec-sheet-01202020)

[MC400 Quick Start Guide \(https://customer.cradlepoint.com/s/article/MC400-Getting-Started\)](https://customer.cradlepoint.com/s/article/MC400-Getting-Started)

## **Required Tools for Setup**

The following tools are recommended for proper, basic setup and installation of your Cradlepoint AER2200 Branch Router.

- #0 Philips-head screwdriver (for modem door cover)

## **Setup**

The following instructions walk you through basic setup of your Cradlepoint AER2200 Branch Router. For more advanced setups, contact a professional installer.

### **STEP 1: Check box contents.**

The contents of the box vary depending upon the Cradlepoint AER2200 model purchased. Refer to the following to ensure you received all items included with your hardware:

#### **AER2200-600M**

- [1] AER2200-600M Branch Router
- [2] 4G LTE cellular antennas
- [4] 2.4/5GHz Wi-Fi antennas
- [1] Power supply (54VDC 1.2A 2x2 2M)
- [1] Region-specific line cord
- [1] Modem door screw (M3.0x4mm)
- [1] Rubber feet pack (4 pieces)
- [1] Cat 5e Ethernet cable
- [1] Quick Start Reference sheet
- [1] Safety, Regulatory, and Warranty guide

#### **AER2200-1200M-B**

- [1] AER2200-1200M-B Branch Router
- [4] 4G LTE cellular antennas
- [4] 2.4/5GHz Wi-Fi antennas
- [1] Power supply (54VDC 1.2A 2x2 2M)
- [1] Region-specific line cord
- [1] Modem door screw (M3.0x4mm)
- [1] Rubber feet pack (4 pieces)
- [1] Cat 5e Ethernet cable
- [1] Quick Start Reference sheet
- [1] Safety, Regulatory, and Warranty guide

## **Accessories**

To enable cellular connectivity, you will also need at least one activated 2FF-sized SIM card with an active cellular data plan.

Additionally, the AER2200 Branch Router models may be enhanced with a [Cradlepoint MC400 Modular Modem](https://cradlepoint.com/product/accessories/mc400-modular-modem/) (<https://cradlepoint.com/product/accessories/mc400-modular-modem/>) as well as with additional external antennas. Refer to the [AER2200 Product Page](https://cradlepoint.com/product/endpoints/aer2200/) (<https://cradlepoint.com/product/endpoints/aer2200/>) for more information.

**STEP 2: Remove the modem door.**

Remove the modem door covering the SIM slots.

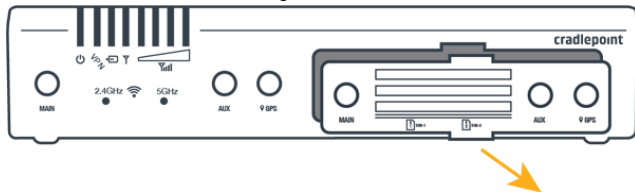

**STEP 3: Insert a SIM card into the embedded modem slot(s).**

- Insert an activated 2FF SIM card into the SIM1 slot (metal contacts face up, notch in). It will click into place. Depress again to remove, if necessary.
- Insert a secondary/backup, activated SIM card into the SIM2 slot, if desired.

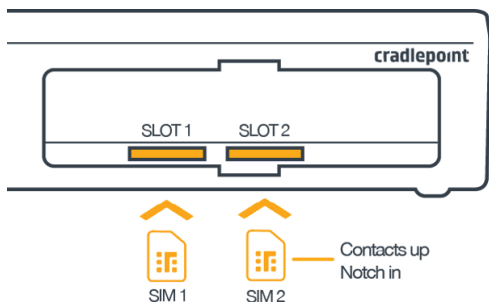

**STEP 4 (Optional): Setup and install the MC400 modular modem.**

The AER2200 has a slot for a second, removable modem (MC400). If you are using the MC400 with the AER2200, the additional modem must be installed before the router can be set up. To install this modem, do the following:

- Insert an activated 2FF SIM card into the SIM1 slot (metal contacts down, notch in). It will click into place. Depress again to remove, if necessary.

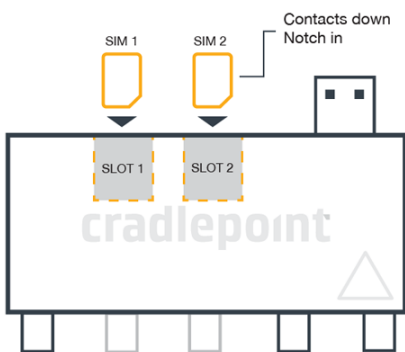

- Slide the MC400 into the modem slot, USB plug first, with the Cradlepoint logo facing up.

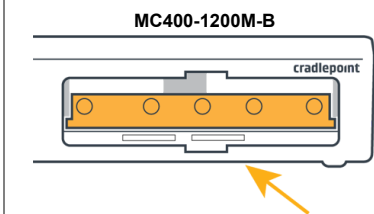
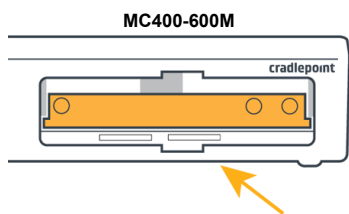

**STEP 5: Reinstall the modem door.**

- If installing the optional MC400 modem, remove the plastic SMA covers from the modem door cover for the additional antenna ports.
- Replace the door on the AER2200.

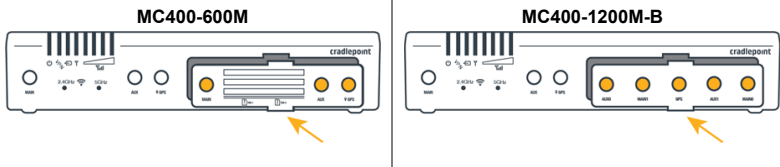

- Secure with the door cover screws (beneath the device).

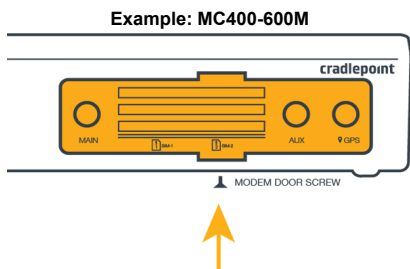

NOTE: The modem door cover must be completely installed on the device or the embedded modem will not power on.

**STEP 6: Attach the 4G LTE cellular antennas.**

- Attach the antennas to the ports marked MAIN and AUX.

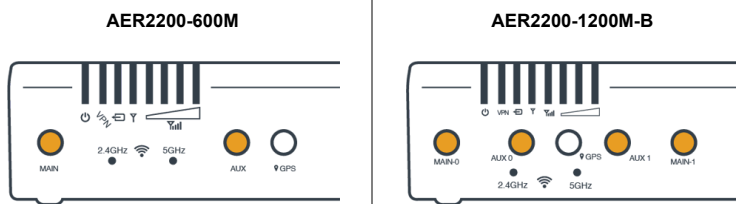

- Hold the antenna straight and twist the base to thread onto the device.
- Tighten with fingers only (maximum torque not to exceed 4 in-lbs). Do not over-tighten.
- Angle the antennas for optimal signal reception.

NOTE: The number of cellular antennas varies by model and optional removable modem type. Refer to the images below for optional antenna positioning.

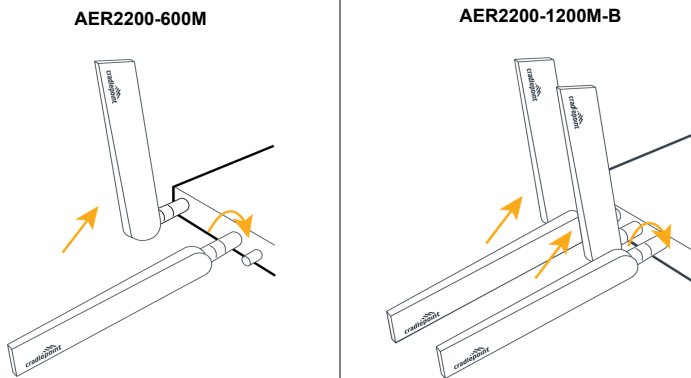

- Attach the cellular antennas to the MC400 removable modem, if installed.

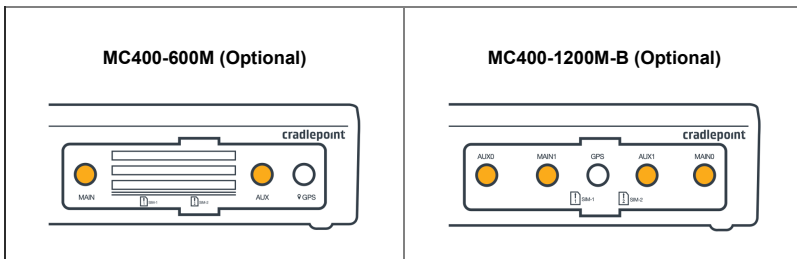

**STEP 7: Attach the Wi-Fi antennas.**

- Attach the Wi-Fi antennas to the ports marked 2.4/5GHz and 5GHz.
- Hold the antenna straight and twist the base to thread onto the device.
- Tighten with fingers only (maximum torque not to exceed 4 in-lbs). Do not over-tighten.

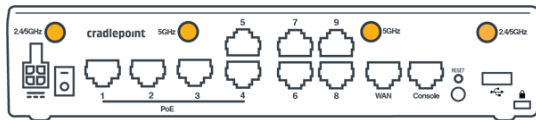

**STEP 8: Mount the router.**

The AER2200 may be mounted in a number of ways, including on a desk, affixed to a wall or ceiling, or to a rack. Refer to the following for mounting best practices.

**DESK**

- Install the rubber feet (included) on the bottom of the router.
- Place the router on a flat surface away from objects that cause RF interference, including concrete, reflective and metal surfaces, microwaves, and so on.

**RACK**

- The AER2200 may be mounted within a rack using the [AER2200 Rack Mount Kit \(Part #170749-001\)](https://cradlepoint.com/product/accessories/aer2200-rack-mount-kit/) (<https://cradlepoint.com/product/accessories/aer2200-rack-mount-kit/>).
- Screw the rack mounts onto the sides of the AER2200.
- Slide the AER2200 into the rack and secure using the rack mount screws, provided with the Rack Mount Kit.

**STEP 9: Connect the Ethernet cable.**

Connect the Ethernet cable to the port marked WAN on the back of the AER2200. Connect the other end to your WAN source.

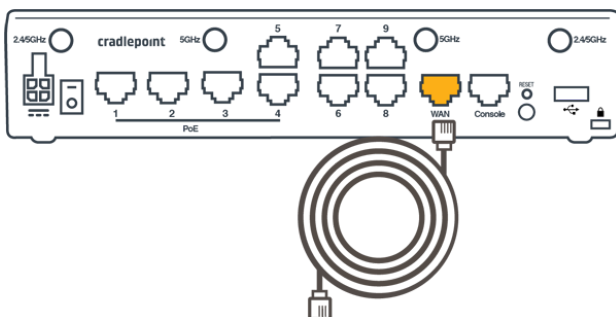

**STEP 10: Power up the router.**

- |   |   |
|---|---|
| <ul style="list-style-type: none"> <li>• Connect the power supply to the router and then plug the other end into an electrical outlet.</li> </ul> | <ul style="list-style-type: none"> <li>• Switch the device to the ON position (O = Off, – = ON).</li> </ul> |
|---|---|

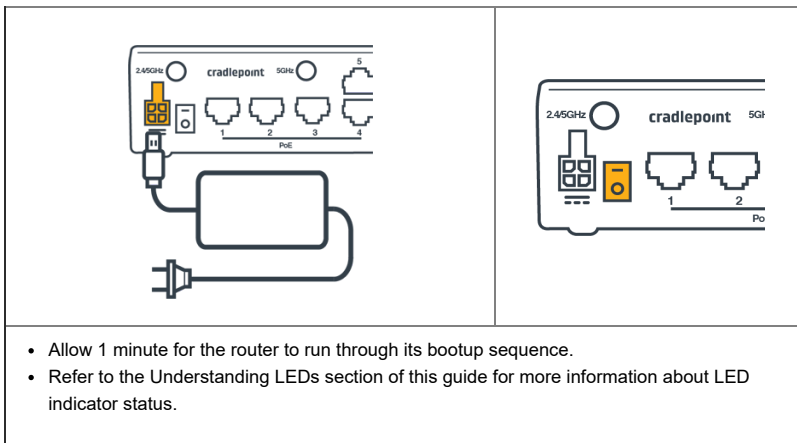

- Allow 1 minute for the router to run through its bootup sequence.
- Refer to the Understanding LEDs section of this guide for more information about LED indicator status.

[Return to top](#)

### Connecting to NetCloud

Activate your device through NetCloud Manager (NCM). Your device is packaged with NetCloud services and activation requires that you log into your NetCloud account. Refer to [Getting Started with NetCloud Manager \(/s/article/Getting-Started-with-NetCloud-Manager?r=82&ui-knowledge-components-aura-actions.KnowledgeArticleVersionCreateDraftFromOnlineAction.createDraftFromOnlineArticle=1\)](https://article/Getting-Started-with-NetCloud-Manager?r=82&ui-knowledge-components-aura-actions.KnowledgeArticleVersionCreateDraftFromOnlineAction.createDraftFromOnlineArticle=1) for more information.

### Understanding LEDs

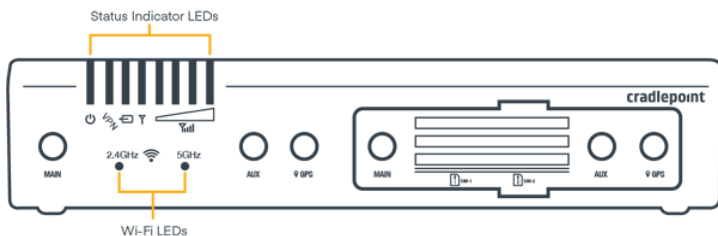



















Image of AER2200-1200M

INDICATOR	BEHAVIOR
	<b>POWER:</b> The Cradlepoint AER2200 must be powered using an approved 54 VDC power source.
	<ul style="list-style-type: none"> <li>• Green = Powered On.</li> </ul>
	<ul style="list-style-type: none"> <li>• No Light = Not receiving power. Check the power switch and the power source connection.</li> </ul>
	<ul style="list-style-type: none"> <li>• Amber = Attention. Open the administration pages and check the router status.                             <ul style="list-style-type: none"> <li>◦ The LED will be amber during the bootup sequence of the endpoint.</li> <li>◦ The status will remain amber until the default password is changed or the device license needs to be renewed.</li> </ul> </li> </ul>
<b>VPN</b>	<b>VPN:</b> Indicates status of VPN connection.
	<ul style="list-style-type: none"> <li>• Blue = Connected to an active VPN</li> </ul>
	<ul style="list-style-type: none"> <li>• No Light = Not connected to an active VPN.</li> </ul>

INDICATOR	BEHAVIOR
	<p><b>REMOVABLE MODEM:</b> Indicates the status of removable modem(s).</p>
	<ul style="list-style-type: none"> <li>Green = Modem has established an active connection.</li> </ul>
	<ul style="list-style-type: none"> <li>Blinking Green = Modem is connecting.</li> </ul>
	<ul style="list-style-type: none"> <li>Blinking Amber = Data connection error. No modem connection is possible.</li> </ul>
	<ul style="list-style-type: none"> <li>Blinking Red = Modem is in the process of resetting.</li> </ul>
	<p><b>EMBEDDED MODEM:</b> Indicates information about the embedded modem.</p>
	<ul style="list-style-type: none"> <li>Solid Green = Modem has established an active connection.</li> </ul>
	<ul style="list-style-type: none"> <li>Blinking Green = Modem is connecting.</li> </ul>
	<ul style="list-style-type: none"> <li>Solid Amber = Modem is not active.</li> </ul>
	<ul style="list-style-type: none"> <li>Blinking Amber = Data connection error. No modem connection possible.</li> </ul>
	<ul style="list-style-type: none"> <li>Blinking Red = Modem is in the process of resetting.                             <ul style="list-style-type: none"> <li>NOTE: If this indicator is blinking red in time with the Signal Strength LEDs = SIM door is not installed, modem is off.</li> </ul> </li> </ul>
	<ul style="list-style-type: none"> <li>No Light = Modem not connected.</li> </ul>
	<p><b>SIGNAL STRENGTH:</b> Blue LED bars indicate the active modem's signal strength (only for integrated and removable modems).</p>
	<ul style="list-style-type: none"> <li>4 Solid Bars = Strongest signal.</li> </ul>
	<ul style="list-style-type: none"> <li>1 Blinking Bar (half a bar) = Weakest signal.</li> </ul>
	<ul style="list-style-type: none"> <li>4 Blinking Bars = SIM door is not installed, modem is off.</li> </ul>
<p><b>2.4GHz</b> <b>5GHz</b></p>	<p><b>Wi-Fi BROADCAST:</b> These two LEDs indicate activity on the Wi-Fi broadcast.</p>

INDICATOR	BEHAVIOR
	<ul style="list-style-type: none"> <li>• 2.4 GHz (green) = 2.4 GHz WiFi is on and operating normally.</li> </ul>
	<ul style="list-style-type: none"> <li>• 5 GHz (blue) = 5 GHz WiFi is on and operating normally.</li> </ul>
<p><b>Other</b></p>	<p><b>ADDITIONAL LED INDICATIONS</b></p> <ul style="list-style-type: none"> <li>• Several LEDs blink when the factory reset button is pressed.</li> <li>• Two LEDs blink red in unison for 10 seconds when there is an error during NCOS upgrade.</li> </ul>

[Return to Top](#)

### Troubleshooting

If the device takes longer than 5 minutes to connect to the Internet, you may need to log into the local UI of the device to make configuration changes or to start the troubleshooting process. You must be physically co-located with the device in order to do this. Refer to the following document for additional help:

[How to Troubleshoot Connection Issues \(https://customer.cradlepoint.com/s/article/NCOS-No-Internet-or-Connection-Issues\)](https://customer.cradlepoint.com/s/article/NCOS-No-Internet-or-Connection-Issues)

Once the device connects to the Internet, it should then connect to your NetCloud Manager account and start its configuration download.

### Resources

[AER2200 Spec Sheet \(https://resources.cradlepoint.com/product-docs/spec-sheet-aer2200\)](https://resources.cradlepoint.com/product-docs/spec-sheet-aer2200)

[AER2200 Webpage \(https://cradlepoint.com/product/endpoints/aer2200/\)](https://cradlepoint.com/product/endpoints/aer2200/)

[How to Position 1200M Antennas \(https://customer.cradlepoint.com/s/article/How-To-Position-1200M-Antennas\)](https://customer.cradlepoint.com/s/article/How-To-Position-1200M-Antennas)

### Help and Support

[Cradlepoint Customer Connect Community \(https://customer.cradlepoint.com/s/\)](https://customer.cradlepoint.com/s/)

[Cradlepoint Support Services \(https://cradlepoint.com/support/\)](https://cradlepoint.com/support/)

### Terms of Service

[Cradlepoint Terms of Service & License Agreement \(https://cradlepoint.com/terms-of-service\)](https://cradlepoint.com/terms-of-service)

[Privacy Policy \(https://cradlepoint.com/privacy-policy/\)](https://cradlepoint.com/privacy-policy/)

[GDPR Privacy Policy \(https://cradlepoint.com/about-us/gdpr-privacy-policy/\)](https://cradlepoint.com/about-us/gdpr-privacy-policy/)

[Return to Top](#)

---

**Title**

AER2200 Branch Router Quick Start Guide

---

**URL Name**

AER2200-Getting-Started

---





No related lists to display

Follow



Ask a Question

## Related Articles

- 
- [AER1600 Series Micro Branch Router Quick Start Guide \(/s/article/AER1600-Series-Micro-Branch-Networking-Router\)](/s/article/AER1600-Series-Micro-Branch-Networking-Router)  9.92K
- 
- [E300 Series Enterprise Branch Router Quick Start Guide \(/s/article/E300-Series-Enterprise-Branch-Router-Quick-Start-Guide\)](/s/article/E300-Series-Enterprise-Branch-Router-Quick-Start-Guide)  2.65K
- 
- [E3000 Series Enterprise Branch Router Quick Start Guide \(/s/article/E3000-Series-Enterprise-Branch-Router-Quick-Start-Guide\)](/s/article/E3000-Series-Enterprise-Branch-Router-Quick-Start-Guide)  1.85K
- 
- [Quick Start Guide Index \(/s/article/Quick-Start-Guides\)](/s/article/Quick-Start-Guides)  1.54K
- 
- [NCOS: VPN Quick Start Guide for Capable Cradlepoint Products \(/s/article/NCOS-VPN-Quick-Start-Guide-for-capable-Cradlepoint-products\)](/s/article/NCOS-VPN-Quick-Start-Guide-for-capable-Cradlepoint-products)  37.18K
- 

## Trending Articles

- [Accessing the Setup Pages of a Cradlepoint Endpoint \(/s/article/NCOS-Accessing-the-Setup-Pages-of-a-CradlePoint-router\)](/s/article/NCOS-Accessing-the-Setup-Pages-of-a-CradlePoint-router)
- 
- [How to Do Port Forwarding To Multiple Devices on the Same Port \(/s/article/How-to-Do-Port-Forwarding-To-Multiple-Devices-on-the-Same-Port\)](/s/article/How-to-Do-Port-Forwarding-To-Multiple-Devices-on-the-Same-Port)
- 
- [IBR600C Series Quick Start Guide \(/s/article/COR-IBR600C-Series-Quick-Start-Guide\)](/s/article/COR-IBR600C-Series-Quick-Start-Guide)
- 
- [Getting Started with NetCloud Manager \(/s/article/Getting-Started-with-NetCloud-Manager\)](/s/article/Getting-Started-with-NetCloud-Manager)
- 
- [How To Set Custom DNS Servers Over a Routed OpenVPN Tunnel \(/s/article/How-To-Set-Custom-DNS-Servers-Over-a-Routed-OpenVPN-Tunnel\)](/s/article/How-To-Set-Custom-DNS-Servers-Over-a-Routed-OpenVPN-Tunnel)
-