

REV	DESCRIPTION	DATE	PREP	APPD
F	EC20973	7/10/23	SM	LT/AJ

--

 MOUNT HOLLY SPRINGS, PA 17065	Oscillator Specification, Hybrid Clock For Hi-Rel Standard, 300krad Tolerant CMOS			
THE RECORD OF APPROVAL FOR THIS DOCUMENT IS MAINTAINED ELECTRONICALLY WITHIN THE ERP SYSTEM	CODE IDENT NO	SIZE	DWG. NO.	REV
	00136	A	DOC206379	F
UNSPECIFIED TOLERANCES: N/A			SHEET 1 OF 17	

1. SCOPE

1.1 General. This specification defines the design, assembly and functional evaluation of high reliability, hybrid clock oscillators produced by Vectron. Devices delivered to this specification represent the standardized Parts, Materials and Processes (PMP) Program developed, implemented, and certified for advanced applications and extended environments.

1.2 Applications Overview. The designs represented by these products were primarily developed for the MIL-Aerospace community. The lesser Design Pedigrees and Screening Options imbedded within DOC206379 bridge the gap between Space and COTS hardware by providing custom hardware with measures of mechanical, assembly and reliability assurance needed for Military or Ruggedized COTS environments.

2. APPLICABLE DOCUMENTS

2.1 Specifications and Standards. The following specifications and standards form a part of this document to the extent specified herein. The issue currently in effect on the date of quotation will be the product baseline, unless otherwise specified. In the event of conflict between the texts of any references cited herein, the text of this document shall take precedence.

Military

MIL-PRF-55310 Oscillators, Crystal Controlled, General Specification For
MIL-PRF-38534 Hybrid Microcircuits, General Specification For

Standards

MIL-STD-202 Test Method Standard, Electronic and Electrical Component Parts
MIL-STD-883 Test Methods and Procedures for Microelectronics

Other

DOC206411 Test Specification, 300KRad CMOS Hybrid XO, Hi-Rel Standard
QSP-90100 Quality Systems Manual, Vectron
DOC011627 Identification Common Documents, Materials and Processes, Hi-Rel XO
DOC203982 DPA Specification
QSP-91502 Procedure for Electrostatic Discharge Precautions
DOC208191 Enhanced Element Evaluation for Space Level Hybrid Oscillators
DOC220429 Packaging Standards, Hi-Rel Series

3. GENERAL REQUIREMENTS

3.1 Classification. All devices delivered to this specification are of hybrid technology conforming to Type 1, Class 2 of MIL-PRF-55310. Primarily developed as a Class S equivalent specification, options are imbedded within it to also produce Class B, Engineering Model and Ruggedized COTS devices. Devices carry a Class 2 ESDS classification per MIL-PRF-38534.

3.2 Item Identification. Unique model number series are utilized to identify device package configurations as listed in Table 1.

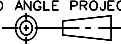
SIZE A	CODE IDENT NO. 00136	THIRD ANGLE PROJECTION 	UNSPECIFIED TOLERANCES N/A	DWG NO. DOC206379	REV. F	SHEET 2
------------------	--------------------------------	---------------------------------------------------------------------------------------------------------------	--------------------------------------	-----------------------------	------------------	-------------------

3.3 Absolute Maximum Ratings.

- a. Supply Voltage Range ($V_{CC} = 3.3V$ or $5V$): -0.5Vdc to +7.0Vdc
Supply Voltage Range ($V_{CC} = 1.8V$ or $2.5V$): -0.3Vdc to +4.8Vdc
- b. Storage Temperature Range (T_{STG}): -65°C to +125°C
- c. Junction Temperature (T_j) [$V_{CC} = 3.3V$ or $5V$]: +175°C
Junction Temperature (T_j) [$V_{CC} = 1.8V$ or $2.5V$]: +150°C
- d. Lead Temperature (soldering, 10 seconds): +300°C
- e. Output Source/Sink Current: ±50mA

3.4 Design, Parts, Materials and Processes, Assembly, Inspection and Test.

3.4.1 Design. The ruggedized designs implemented for these devices are proven in military and space applications under extreme environments. Designs utilize 4-point crystal mounting in compliment with Established Reliability (MIL-ER) componentry. When specified, radiation lot acceptance testing up to 300krad(Si) (RHA level F) can be included without altering the device's internal topography.

3.4.1.1 Design and Configuration Stability. Barring changes to improve performance by reselecting passive chip component values to offset component tolerances, there will not be fundamental changes to the design or assembly or parts, materials and processes after first product delivery of that item without notification.

3.4.1.2 Environmental Integrity. Designs have passed the environmental qualification levels of MIL-PRF-55310. These designs have also passed extended dynamic levels of at least:

- a. Sine Vibration: MIL-STD-202, Method 204, Condition G (30g pk.)
- b. Random Vibration: MIL-STD-202, Method 214, Condition II-J (43.92g rms, three-minute duration in each of three mutually perpendicular directions)
- c. Mechanical Shock: MIL-STD-202, Method 213, Condition F (1500g, 0.5ms)

3.4.2 Prohibited Parts, Materials and Processes. The items listed are prohibited for use in high reliability devices produced to this specification.

- a. Gold metallization of package elements without a barrier metal.
- b. Zinc chromate as a finish.
- c. Cadmium, zinc, or pure tin external or internal to the device.
- d. Plastic encapsulated semiconductor devices.
- e. Ultrasonically cleaned electronic parts.
- f. Heterojunction Bipolar Transistor (HBT) technology.
- g. 'getter' materials

3.4.3 Assembly. Manufacturing utilizes standardized procedures, processes and verification methods to produce MIL-PRF-55310 Class S / MIL-PRF-38534 Class K equivalent devices. MIL-PRF-38534 Group B Option 1 in-line inspection is included on radiation hardened part numbers to further verify lot pedigree. Devices are handled in accordance with Vectron document QSP-91502 (Procedure for Electrostatic Discharge Precautions). Element replacement will be as specified in MIL-PRF-38534 Rev. L.

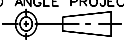
SIZE A	CODE IDENT NO. 00136	THIRD ANGLE PROJECTION 	UNSPECIFIED TOLERANCES N/A	DWG NO. DOC206379	REV. F	SHEET 3
------------------	--------------------------------	---------------------------------------------------------------------------------------------------------------	--------------------------------------	-----------------------------	------------------	-------------------

- 3.4.4 Inspection. The inspection requirements of MIL-PRF-55310 apply to all devices delivered to this document. Inspection conditions and standards are documented in accordance with the Quality Assurance, ISO-9001 and AS9100 derived, System of QSP-90100.
- 3.4.5 Test. The Screening test matrix of Table 5 is tailored for selectable-combination testing to eliminate costs associated with the development/maintenance of device-specific documentation packages while maintaining performance integrity.
- 3.4.6 Marking. Device marking shall be in accordance with the requirements of MIL-PRF-55310. In addition, when devices are identified with laser marking, the Resistance to Solvents test specified in MIL-PRF-55310 Group C, Mil-PRF-55310 Qualification or MIL-PRF-38534 Group B Inspection will not be performed.
- 3.4.7 Ruggedized COTS Design Implementation. Design Pedigree “D” devices (see ¶ 5.2) use the same robust designs found in the other device pedigrees. They do not include the provisions of traceability or the Class-qualified componentry noted in paragraphs 3.4.3 and 4.1.

4. DETAIL REQUIREMENTS

4.1 Components

4.1.1 Crystals. Cultured quartz crystal resonators are used to provide the selected frequency for the devices. The optional use of Premium Q swept quartz can, because of its processing to remove impurities, be specified to minimize frequency drift when operating in radiation environments. In accordance with MIL-PRF-55310, the manufacturer has a documented crystal element evaluation program.

4.1.2 Passive Components.

4.1.2.1 For Design Pedigree E, where available, resistors shall be Established Reliability, Failure Rate R (as a minimum) and capacitors shall be Failure Rate S. Where resistors and capacitors are not available as ER parts, and for all other passive components, the parts shall be from homogeneous manufacturing lots that have successfully completed the Enhanced Element Evaluation of DOC208191 which meets the requirements of Mil-PRF-38534 Revision L for Class K.

4.1.2.2 For Design Pedigree F and V, where available, resistors shall be Established Reliability, Failure Rate R (as a minimum) and capacitors shall be Failure Rate S. Where resistors and capacitors are not available as ER parts, and for all other passive components, the parts shall be from homogeneous manufacturing lots that have successfully completed the Class K Element Evaluation of Mil-PRF-38534 Revision K for Class K.

4.1.2.3 For Design Pedigree D, the passive elements will be COTs level or higher.

4.1.2.4 When used, inductors may be open construction and may use up to 47-gauge wire.

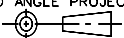
SIZE A	CODE IDENT NO. 00136	THIRD ANGLE PROJECTION 	UNSPECIFIED TOLERANCES N/A	DWG NO. DOC206379	REV. F	SHEET 4
------------------	--------------------------------	---------------------------------------------------------------------------------------------------------------	--------------------------------------	-----------------------------	------------------	-------------------

- 4.1.3 Microcircuits. The AC MOS microcircuit die is sourced in accordance with Standard Microcircuit Drawing 5962F8760901V9A, 5962F1820201V9A, and/or 5962F8974902V9A, Class V (MIL-PRF-38535) qualified device, except for Design Pedigree D, which will use COTs level or higher.
- 4.1.4 Semiconductors
- 4.1.4.1 For Design Pedigree E, the semiconductors shall be from homogeneous wafer lots that meet the Enhanced Element Evaluation requirements in DOC208191.
- 4.1.4.2 For Design Pedigree F and V, semiconductors shall be from homogeneous wafer lots that have successfully completed the MIL-PRF-38534, Revision K Lot Acceptance Tests for Class K devices as a minimum.
- 4.1.4.3 For Design Pedigree D, semiconductors can be COTs level or higher.
- 4.1.5 Radiation. Devices are assembled with bipolar semiconductors and an AC MOS chip used to provide the AC MOS output. All active devices are acceptable for use in environments of up to 300 krad(Si) total dose by Radiation Lot Acceptance Testing of the individual components. TID/ELDRS tolerance on the bipolar transistors is verified by performing High Dose Rate (HDR) and/or Low Dose Rate (LDR) Total Ionizing Dose to 300 krad(Si) at 42 mrad/s. The 5962F8760901V9A device is guaranteed to have no SEL or SEU occurrences up to 93 MeV-cm²/mg. The 5962F1820201V9A device is SEL immune up to 125 MeV-cm²/mg and SET immune up to 62.5 MeV-cm²/mg. The 5962F8974902V9A device is SEL immune up to 93 MeV-cm²/mg. Prompt dose (dose rate) testing of devices that use 5962F8760901V9A show that the part is immune to latch-up/burnout up to at least 1.32E10 rad(Si)/s and +125°C. The parts exhibited no transients at a dose rate of 1E9 rad(Si)/s. At dose rates up to 1.32E10, all parts recovered to pre-shot function and supply current within three to four microseconds. Bipolar semiconductors are considered insensitive to Single Event Effects.
- 4.1.6 Packages. Packages are procured that meet the construction, lead materials and finishes as specified in MIL-PRF-55310. All leads are Kovar with gold plating over a nickel underplate. Package lots are evaluated in accordance with the requirements of MIL-PRF-38534. Vectron will not perform Salt Spray testing as part of MIL-PRF-55310 Group C/Qualification. In accordance with MIL-PRF-55310, package evaluation results for salt atmosphere will be substituted for Salt Spray testing during MIL-PRF-55310 Group C/Qualification.
- 4.1.7 Traceability and Homogeneity. All design pedigrees except option D have active device lots that are homogenous and traceable to the manufacturer's individual wafer; all other elements and materials are traceable to their manufacturer and incoming inspection lots. Design pedigrees E, F, and V have homogeneous material. In addition, swept quartz crystals are traceable to the quartz bar and the processing details of the autoclave lot. A production lot, as defined by Microchip, is all oscillators that have been kitted and built as a single group. The maximum deliverable quantity with a single lot date code is 150 units. Order quantities that exceed 150 units will be delivered in multiple lot date codes with deliveries separated by 3 weeks. If applicable, each production lot will be kitted with homogeneous material which is then allocated across multiple lot date code builds to satisfy the deliverable order quantity.

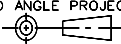
SIZE A	CODE IDENT NO. 00136	THIRD ANGLE PROJECTION 	UNSPECIFIED TOLERANCES N/A	DWG NO. DOC206379	REV. F	SHEET 5
------------------	--------------------------------	---------------------------------------------------------------------------------------------------------------	--------------------------------------	-----------------------------	------------------	-------------------

MICROCHIP CONFIDENTIAL

When ordered, Group C Inspection, lot qualifications, and/or DPA will be performed on the first build lot within the production lot unless otherwise stated on the purchase order.

4.2 Mechanical.

4.2.1 Package Outline. Table 1 links each Hi-Rel Standard Model Number of this specification to a corresponding package style. Mechanical Outline information of each package style is found in the referenced Figure.

4.2.2 Thermal Characteristics. The calculated thermal resistance and resulting junction temperature rise is found in Table 4.

4.2.3 Lead Forming. When the lead forming option is specified, the applicable leak test specified in screening will be performed after forming.

4.3 Electrical.

4.3.1 Input Power. Devices are available with an input voltage of either +5.0 Vdc ($\pm 10\%$), +3.3 Vdc ($\pm 10\%$), +2.5 Vdc ($\pm 5\%$), or +1.8 Vdc ($\pm 5\%$). Current is measured, no load, at maximum rated operating voltage.

4.3.2 Temperature Range. Operating range is -55°C to $+125^{\circ}\text{C}$.

4.3.3 Frequency Tolerance. Initial accuracy at $+23^{\circ}\text{C}$ is ± 15 ppm maximum. Frequency-Temperature Stability is ± 50 ppm maximum from $+23^{\circ}\text{C}$ reference. Frequency-Voltage Tolerance is ± 4 ppm maximum.

4.3.4 Frequency Aging. Aging limits, and when tested in accordance with MIL-PRF-55310 Group B inspection, shall not exceed ± 1.5 ppm the first 30 days, ± 5 ppm Year 1 and ± 2 ppm per year thereafter.

4.3.4.1 Frequency Aging Duration Option. For Screening Option S, the Aging test will be terminated after 15 days if the measured aging rate is less than half of the specified aging rate. This is a common method of expediting 30-Day Aging without incurring risk to the hardware and used quite successfully for numerous customers. It is based on the ‘least squares fit’ determinations of MIL-PRF-55310 paragraph 4.8.35. The ‘half the time/half the spec’ limit is generally conservative as roughly $2/3$ of a unit’s Aging deviation occurs within that period of time. Vectron’s automated aging systems take about 6 data points per day, so a lot of data is available to do very accurate projections, much more data than what is required by MIL-PRF-55310. The delivered data would include the Aging plots projected to 30 days. If the units would not perform within that limit, then they will continue to full 30-day term. For all other screening options, please advise by purchase order text if this is an acceptable option to exercise as it assists in Production Test planning.

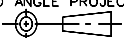
SIZE A	CODE IDENT NO. 00136	THIRD ANGLE PROJECTION 	UNSPECIFIED TOLERANCES N/A	DWG NO. DOC206379	REV. F	SHEET 6
------------------	--------------------------------	---------------------------------------------------------------------------------------------------------------	--------------------------------------	-----------------------------	------------------	-------------------

- 4.3.5 Operating Characteristics. Symmetrical square wave limits are dependent on the device frequency and are in accordance with Tables 2A and 2B. Waveform measurement points and logic limits are in accordance with MIL-PRF-55310. Start-up time is 10.0 msec. maximum.
- 4.3.6 Output Load. AC MOS (10kΩ, 15pF). Test load configurations are in accordance with MIL-PRF-55310.

5. QUALITY ASSURANCE PROVISIONS AND VERIFICATION

5.1 Verification and Test. Device lots shall be tested prior to delivery in accordance with the applicable Screening Option letter as stated by the 15th character of the part number. Table 5 tests are conducted in the order shown and annotated on the appropriate process travelers and data sheets of the governing test procedure. For devices that require Screening Options that include MIL-PRF-55310 Group A testing, the Post-Burn-In Electrical Test and the Group A Electrical Test are combined into one operation.

5.1.1 Screening Options. The Screening Options, by letter, are summarized as:

- A Modified MIL-PRF-38534 Class K
- B Modified MIL-PRF-55310 Class B Screening & Group A Quality Conformance Inspection (QCI)
- C Modified MIL-PRF-55310 (Rev E) Class S Screening & Group A QCI
- D Modified MIL-PRF-38534 Class K with Group B Aging
- E Modified MIL-PRF-55310 Class B Screening, Groups A & B QCI
- F Modified MIL-PRF-55310 (Rev E) Class S Screening, Groups A & B QCI
- G Modified MIL-PRF-55310 Class B Screening & Post Burn-in Nominal Electricals
- S MIL-PRF-55310 (Rev F) Class S Screening & Groups A & B QCI
- X Engineering Model (EM)

5.2 Optional Design, Test and Data Parameters. The following is a list of design, assembly, inspection, and test options that can be selected or added by purchase order request.

- a. Design Pedigree (choose one as the 5th character in the part number):
 - (E) Enhanced Element Evaluation, (MIL-PRF-38534 Rev L for Class K components as specified in DOC208191) 300krad die, Premium Q Swept Quartz
 - (F) Hi-Rel design w/ 300krad Class K die, Premium Q Swept Quartz
 - (V) Hi-Rel design w/ 300krad Class K die, Non-Swept Quartz
 - (D) Hi-Rel design w/ Non-Swept Quartz and commercial grade components
- b. Input Voltage, (A) for +5.0V, (B) for +3.3V, (C) for +2.5V, (D) for +1.8V as the 14th character
- c. Not Used
- d. Radiographic Inspection
- e. Group C Inspection: In accordance with MIL-PRF-55310, Rev E (requires 8 destruct specimens)
- f. Group C Inspection: MIL-PRF-55310, Rev F (requires 8 destruct specimens, includes Random Vibration, MIL-STD-883, Method 1014 Leak Test and Life Test)

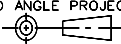
SIZE A	CODE IDENT NO. 00136	THIRD ANGLE PROJECTION 	UNSPECIFIED TOLERANCES N/A	DWG NO. DOC206379	REV. F	SHEET 7
------------------	--------------------------------	---------------------------------------------------------------------------------------------------------------	--------------------------------------	-----------------------------	------------------	-------------------

- g. Group C Inspection: In accordance with MIL-PRF-38534, Table C-Xc, Condition PI (requires 8 destruct specimens – 5 pc. Life, 3 pc. RGA) Subgroup 1 fine leak test to be performed per MIL-STD-202, Method 112, Test Condition C.
- h. Internal Water-Vapor Content (RGA) samples and test performance
- i. MTBF Reliability Calculations
- j. Worst Case Analysis (unless otherwise specified, MIL-HDBK-1547)
- k. Derating and Thermal Analysis (unless otherwise specified, MIL-HDBK-1547 with Tj Max = +105°C; Derated Maximum Operating Temp = Tj Max – ΔTj)
- l. Process Identification Documentation (PID)
- m. Customer Source Inspection (pre-crystal mount pre-cap, post-crystal mount pre-cap and final). Due to components being mounted underneath the crystal blank, pre-crystal mount pre-cap inspection should be considered.
- n. Destruct Physical Analysis (DPA): MIL-STD-1580 with exceptions as specified in Vectron DOC203982.
- o. Qualification: In accordance with MIL-PRF-55310, Rev F, Table IV (requires 16 destruct specimens). Includes Group III, SG1 through SG6 only. ESD (SG7) not performed.
- p. Qualification: In accordance with EEE-INST-002, Section C4, Table 3, Level 1 or 2 (requires 11 destruct specimens)
- q. High Resolution Digital Pre-Cap Photographs (20 Megapixels minimum)
- r. Hot solder dip of leads with Sn63/Pb37 solder prior to shipping.
- s. As Designed Parts, Materials and Processes List

5.2.1 NASA EEE-INST-002. A combination of Design Pedigree R, Option S Screening, and Qualification per EEE-INST-002, Section C4, Table 3, meet the requirements of Level 1 and Level 2 device reliability.

5.3 Test Conditions. Unless otherwise stated herein, inspections are performed in accordance with those specified in MIL-PRF-55310. Process travelers identify the applicable methods, conditions, and procedures to be used. Examples of electrical test procedures that correspond to MIL-PRF-55310 requirements are shown in Table 3.

5.3.1 When MIL-PRF-55310, Revision F was being reviewed for release by manufacturers and users, Vectron and other organizations recommended that burn-in delta limits not be applied to logic level measurements due to the inconsistency in attempting to measure small changes in logic levels which inherently have ringing in the signal. This is especially true in higher frequency oscillators measured in automated test systems that are affected by cable length that is not representative of the user’s application and contact resistance in test fixtures that do not provide a consistent Vcc or Ground connection. The exact test setup conditions may vary slightly from pre-burn-in to post-burn-in and cause small artificial deltas in logic level measurements that are not indicative of an issue. Any significant changes in logic levels will be reflected in supply current deltas and/or logic levels that exceed the min/max limits. As a result, we take exception to MIL-PRF-55310, Revision F, Para. 4.4.5 and the delta limit for Output Low Level as specified in 4.4.5(c) shall not be applied to Burn-in PDA.

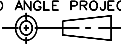
SIZE A	CODE IDENT NO. 00136	THIRD ANGLE PROJECTION 	UNSPECIFIED TOLERANCES N/A	DWG NO. DOC206379	REV. F	SHEET 8
------------------	--------------------------------	---------------------------------------------------------------------------------------------------------------	--------------------------------------	-----------------------------	------------------	-------------------

- 5.4 Deliverable Data. The manufacturer supplies the following data, as a minimum, with each lot of devices:
- a. As applicable to the Screening Option chosen, completed assembly and screening lot travelers,-screening data, including radiographic images, and rework history.
 - b. Electrical test variables data, identified by unique serial number.
 - c. Special items when required by purchase order such as Group C, DPA, and RGA data.
 - d. For Design Pedigrees E, F, and V, traceability, component LAT, enclosure LAT, and wafer lot specific RLAT data for non-SMD active devices (if applicable).
 - e. Certificate of Conformance.
- 5.5 Discrepant Material. All MRB authority resides with the procuring activity.
- 5.6 Failure Analysis. Any failure during Qualification or Group C Inspection will be evaluated for root cause. The customer will be notified after occurrence and upon completion of the evaluation.
6. PREPARATION FOR DELIVERY
- 6.1 Packaging. Devices will be packaged in a manner that prevents handling and transit damage during shipping. Devices will be handled in accordance with MIL-STD-1686 for Class 1 devices. Devices will be packaged for transport in accordance with DOC220429. Please note that “one unit per package” is available for a fee; however, this service must be requested as part of the official RFQ.
7. ORDERING INFORMATION
- 7.1 Ordering Part Number. The ordering part number is made up of an alphanumeric series of 15 characters. Design-affected product options, identified by the parenthetic letter on the Optional Parameters list (¶ 5.2a and b), are included within the device part number.

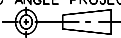
SIZE A	CODE IDENT NO. 00136	THIRD ANGLE PROJECTION 	UNSPECIFIED TOLERANCES N/A	DWG NO. DOC206379	REV. F	SHEET 9
------------------	--------------------------------	---------------------------------------------------------------------------------------------------------------	--------------------------------------	-----------------------------	------------------	-------------------

MICROCHIP CONFIDENTIAL

The Part Number breakdown is described as:

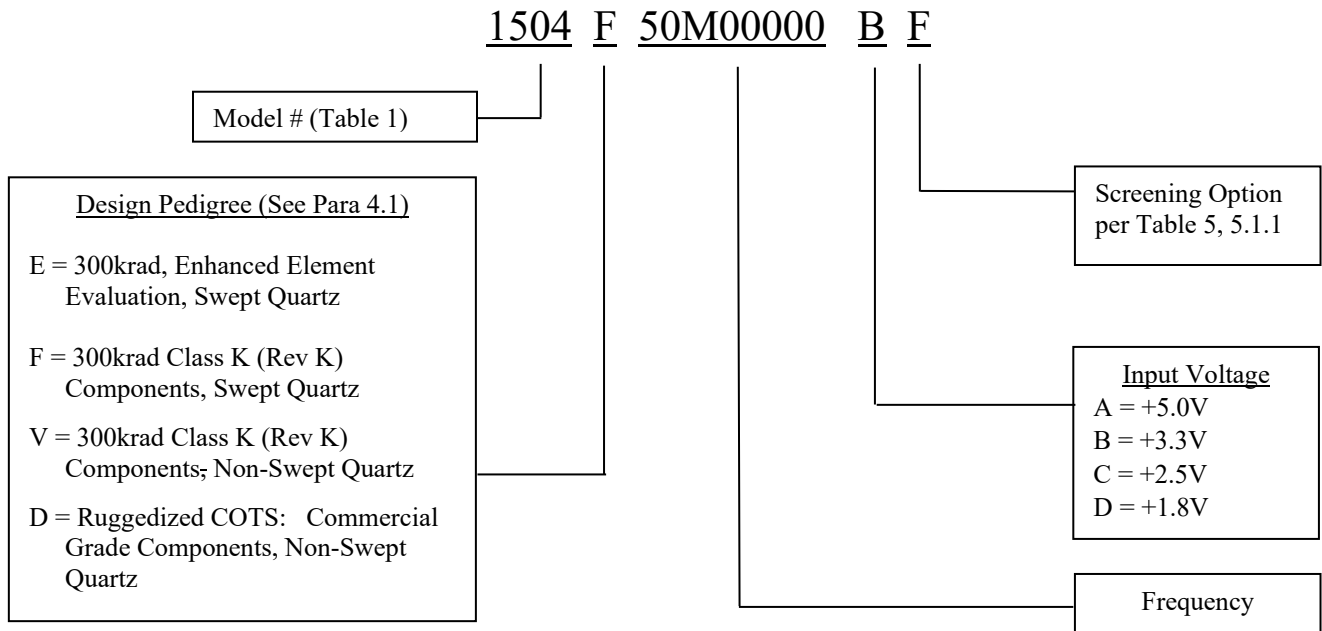

- 7.1.1 Model Number. The device model number is the four (4) digit number assigned to a corresponding package and output combination per Table 1.
- 7.1.2 Design Pedigree. Class S variants correspond to either letter “E”, “F” or “V” and are described in paragraph 5.2a. Ruggedized COTS, using commercial grade components, corresponds to letter “D”.
- 7.1.3 Input Voltage. Voltage is the 14th character, letter “A” representing +5.0V, “B” representing +3.3V, “C” representing +2.5V, and “D” representing +1.8V.
- 7.1.4 Output Frequency. The nominal output frequency is expressed in the format as specified in MIL-PRF-55310 utilizing eight (8) characters.
- 7.1.5 Screening Options. The 15th character is the Screening Option (letter A thru G, S or X) selected from Table 5.
- 7.2 Optional Design, Test and Data Parameters. Optional test and documentation requirements shall be specified by separate purchase order line items (as listed in ¶ 5.2c thru s).

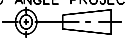
SIZE A	CODE IDENT NO. 00136	THIRD ANGLE PROJECTION 	UNSPECIFIED TOLERANCES N/A	DWG NO. DOC206379	REV. F	SHEET 10
------------------	--------------------------------	---------------------------------------------------------------------------------------------------------------	--------------------------------------	-----------------------------	------------------	--------------------

HI-REL STANDARD MODEL #	PACKAGE	OUTPUT	PIN I/O			MECHANICAL OUTLINE
			Vcc	Out	Gnd/Case	
1504	20 Lead Flatpack	ACMOS	13, 20	11	10	FIGURE 1
1520 <u>2/</u>	20 Lead Flatpack	ACMOS	13, 20	11	10	FIGURE 2

1/. All unassigned pins have no internal connections or ties.

2/. Model 1520 is the lead formed version of Model 1504. See Appendix A for the recommended land pattern.

TABLE 1 - Item Identification and Package Outline

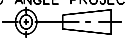
SIZE A	CODE IDENT NO. 00136	THIRD ANGLE PROJECTION 	UNSPECIFIED TOLERANCES N/A	DWG NO. DOC206379	REV. F	SHEET 11
------------------	--------------------------------	---------------------------------------------------------------------------------------------------------------	--------------------------------------	-----------------------------	------------------	--------------------

MICROCHIP CONFIDENTIAL

Frequency Range @ 5.0V Operation: 750kHz to 100MHz					
Frequency Range @ 3.3V Operation: 750kHz to 125MHz					
Temperature Range: -55°C to +125°C					
Frequency Tolerance, Initial Accuracy @ +23°C: ±15 ppm max.					
Frequency-Temperature Stability from +23°C ref.: ±50 ppm max.					
Frequency-Voltage Tolerance: ±4 ppm max. (Vcc ±10%)					
Frequency Aging: ±1.5 ppm max. 1 st 30 days, ±5 ppm max. Year 1, ±2 ppm max. Year 2+ (Estimated maximum aging for 20 years will be <10 ppm due to the non-linear characteristics of crystal aging)					
Start-up Time: 10.0 ms max.					
Frequency Range (MHz)	Current (mA) (max. no load)		Rise / Fall Times (ns max.)	Duty Cycle (%)	Load
	+3.63V	+5.5V			
0.75 – 11.999	10	15	5	45 to 55	10KΩ 15 pF
12 - 30	15	25	5	40 to 60	10KΩ 15 pF
>30 - 65	20	35	5	40 to 60	10KΩ 15 pF
>65 - 80	25	40	5	40 to 60	10KΩ 15 pF
>80 - 100	25	45	3	40 to 60	10KΩ 15 pF
>100 - 125	27	N/A	3	40 to 60	10KΩ 15 pF

1/. Waveform measurement points and logic limits are in accordance with MIL-PRF-55310, Para 3.6.20.3.

TABLE 2A - Electrical Performance Characteristics

Frequency Range @ 1.8V or 2.5V Operation: 12MHz to 125MHz					
Temperature Range: -55°C to +125°C					
Frequency Tolerance, Initial Accuracy @ +23°C: ±15 ppm max.					
Frequency-Temperature Stability from +23°C ref.: ±50 ppm max.					
Frequency-Voltage Tolerance: ±4 ppm max. (Vcc ±5%)					
Frequency Aging: ±1.5 ppm max. 1 st 30 days, ±5 ppm max. Year 1, ±2 ppm max. Year 2+ (Estimated maximum aging for 20 years will be <10 ppm due to the non-linear characteristics of crystal aging)					
Start-up Time: 10.0 ms max.					
Frequency Range (MHz)	Current (mA) (max. no load)		Rise / Fall Times (ns max.)	Duty Cycle (%)	Load
	+1.890V	+2.625			
12 - 30	10	10	5	40 to 60	10KΩ 15 pF
>30 - 65	12	12	5	40 to 60	10KΩ 15 pF
>65 – 80	15	15	5	40 to 60	10KΩ 15 pF
>80 – 100	15	15	3	40 to 60	10KΩ 15 pF
>100 - 125	17	17	3	40 to 60	10KΩ 15 pF

1/. Waveform measurement points and logic limits are in accordance with MIL-PRF-55310, Para 3.6.20.3.

TABLE 2B - Electrical Performance Characteristics

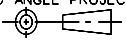
SIZE A	CODE IDENT NO. 00136	THIRD ANGLE PROJECTION 	UNSPECIFIED TOLERANCES N/A	DWG NO. DOC206379	REV. F	SHEET 12
------------------	--------------------------------	---------------------------------------------------------------------------------------------------------------	--------------------------------------	-----------------------------	------------------	--------------------

OPERATION LISTING	REQUIREMENTS AND CONDITIONS
@ all Electrical tests	
Input Current (no load)	MIL-PRF-55310, Para 4.8.5.1
Initial Accuracy @ Ref. Temp.	MIL-PRF-55310, Para 4.8.6
Output Logic Voltage Levels	MIL-PRF-55310, Para 4.8.21.3
Rise and Fall Times	MIL-PRF-55310, Para 4.8.22
Duty Cycle	MIL-PRF-55310, Para 4.8.23
@ Post Burn-In Electrical only	
Overvoltage Survivability	MIL-PRF-55310, Para 4.8.4
Initial Freq. – Temp. Accuracy	MIL-PRF-55310, Para 4.8.10.1
Freq. – Voltage Tolerance	MIL-PRF-55310, Para 4.8.14
Start-up Time (fast/slow start)	MIL-PRF-55310, Para 4.8.29

TABLE 3 - Electrical Test Parameters

Model #	Thermal Resistance Junction to Case θ_{jc} ($^{\circ}\text{C} / \text{W}$)	Δ Junction Temp. T_j ($^{\circ}\text{C}$ @ max. I_{cc})	Weight (Grams)
1504/1520	11.60	2.87	3.0

1/. The maximum current and voltage from Table 2 is used to calculate the worst case Δ junction temperature.

TABLE 4 – Typical Thermal Characteristics and Weight

SIZE A	CODE IDENT NO. 00136	THIRD ANGLE PROJECTION 	UNSPECIFIED TOLERANCES N/A	DWG NO. DOC206379	REV. F	SHEET 13
------------------	--------------------------------	---------------------------------------------------------------------------------------------------------------	--------------------------------------	-----------------------------	------------------	--------------------

MICROCHIP CONFIDENTIAL

Frequency Range (MHz)	Vcc = +5V			Vcc = +3.3V		
	Period Jitter 1 sigma (ps)	Period Jitter pk-pk (ps)	Phase Jitter 12kHz - 20MHz (ps)	Period Jitter 1 sigma (ps)	Period Jitter pk-pk (ps)	Phase Jitter 12kHz - 20MHz (ps)
12 to 40	6	48	0.22	10	85	0.33
>40 to 80	5	40	0.16	8	60	0.20
>80 to 100	4	40	0.08	4	40	0.12
>100 to 125	N/A	N/A	N/A	3.5	28	0.10

TABLE 4A – Typical Jitter Performance

Frequency Range (MHz)	Vcc = +2.5V			Vcc = +1.8V		
	Period Jitter 1 sigma (ps)	Period Jitter pk-pk (ps)	Phase Jitter 12kHz - 20MHz (ps)	Period Jitter 1 sigma (ps)	Period Jitter pk-pk (ps)	Phase Jitter 12kHz - 20MHz (ps)
125	2.5	18	0.072	4.5	32	0.124

TABLE 4B – Typical Jitter Performance

SIZE A	CODE IDENT NO. 00136	THIRD ANGLE PROJECTION 	UNSPECIFIED TOLERANCES N/A	DWG NO. DOC206379	REV. F	SHEET 14
------------------	--------------------------------	---------------------------------------------------------------------------------------------------------------	--------------------------------------	-----------------------------	------------------	--------------------

OPN. NO.	OPERATION LISTING	REQUIREMENTS AND CONDITIONS	Option A	Option B	Option C	Option D	Option E	Option F	Option G	Option S	Option X
	SCREENING	MIL Class Similarity (MIL-PRF-55310, Class S/B or MIL-PRF-38534, Class K)	K 100%	B- 100%	S- 100%	K+ 100%	B 100%	S (Rev E) 100%		S (Rev F) 100%	EM 100%
1	Non-Destruct Bond Pull	MIL-STD-883, Meth 2023	X	NR	X	X	NR	X	NR	X	NR
2	Internal Visual	MIL-STD-883, Meth 2017 Class K, Meth 2032 Class K	X	X	X	X	X	X	X	X	X
3	Stabilization (Vacuum) Bake	MIL-STD-883, Meth 1008, Cond C, 150°C	X 48 hrs.	X 24 hrs.	X 48 hrs.	X 48 hrs.	X 24 hrs.	X 48 hrs.	X 24 hrs.	X 48 hrs.	X 24 hrs.
4	Random Vibration	MIL-STD-883, Meth 2026, Cond I-B, 15 mins in each axis	NR	NR	NR	NR	NR	NR	NR	X	NR
5	Thermal Shock	MIL-STD-883, Meth 1011, Cond A	NR	NR	X	NR	NR	X	NR	X	NR
6	Temperature Cycle	MIL-STD-883, Meth 1010, Cond. B (except Option S), 10 cycles min.	X	X	X	X	X	X	X	X Cond. C	NR
7	Constant Acceleration	MIL-STD-883, Meth 2001, Cond A, Y1 plane only, 5000 g's	X	X	X	X	X	X	X	X	NR
8	Particle Impact Noise Detection	MIL-STD-883, Meth 2020, Cond B (except Option S)	X	X	X	X	X	X	NR	X Cond. A	X
9	Electrical Testing, Pre Burn-In	Perform tests in Table 3. Nominal Vcc, nominal temperature	X	X	X	X	X	X	X	X	X
10	1 st Burn-In	MIL-STD-883, Meth 1015, Condition B	X 160 hrs.	X 160 hrs.	X 240 hrs.	X 160 hrs.	X 160 hrs.	X 240 hrs.	X 160 hrs.	X 240 hrs.	NR
11	Electrical Testing, Intermediate	Perform tests in Table 3. Nominal Vcc, nominal temperature	X	NR	NR	X	NR	NR	NR	NR	NR
12	2 nd Burn-In	MIL-STD-883, Meth 1015, Condition B	X 160 hrs.	NR	NR	X 160 hrs.	NR	NR	NR	NR	NR
13	Electrical Testing, Post Burn-In (Group A) <u>4/</u>	Perform tests in Table 3. Nominal Vcc & extremes, nominal temperature & extremes	X	X	X	X	X	X	X nom. Vcc	X	NR
14	Seal: Fine Leak Seal: Gross Leak	MIL-STD-202, Meth 112, Cond C (5 x 10 ⁻⁸ atm cc/sec max) MIL-STD-202, Meth 112, Cond D	X	X	X	X	X	X	X	NR	X
15	Seal: Fine Leak Seal: Gross Leak	MIL-STD-883, Meth 1014, Cond A2 or B1 MIL-STD-883, Meth 1014, Cond B2 or B3	NR	NR	NR	NR	NR	NR	NR	X	NR
16	Radiographic Inspection	MIL-STD-883, Meth 2012	X	AR	AR	X	AR	X	NR	X	NR
17	Solderability	MIL-STD-883, Meth 2003	<u>1/</u>	<u>1/</u>	<u>1/</u>	<u>1/</u>	<u>1/</u>	<u>1/</u>	<u>1/</u>	<u>1/</u>	NR
18	External Visual & Mechanical	MIL-STD-883, Meth 2009	X <u>2/</u>	X <u>2/</u>	X <u>2/</u>	X <u>2/</u>	X <u>2/</u>	X <u>2/</u>	X <u>2/</u>	X <u>2/</u>	X <u>2/</u>
19	Aging, 30 Day <u>3/</u> (M55310 Group B)	MIL-PRF-55310, para. 4.8.35.1	NR	NR	NR	X	13 pcs.	X	NR	X	NR
20	Group C Inspection (optional)	See Para 5.2 herein for details of supplier recommended Group C Inspection options	5.2(g)	5.2(e)	5.2(e)	5.2(g)	5.2(e)	5.2(e)	5.2(e)	5.2(f)	NR

LEGEND: X = Required, NR = Not Required, AR = As Required

TABLE 5 - Test Matrix

1/ Performed at package LAT. Include LAT data sheet.

2/ When specified, RGA samples will be removed from the lot after completion of this operation. Use of Screening failures requires customer concurrence.

3/ See paragraph 4.3.4.1 herein.

4/ See paragraph 5.3.1 herein.

SIZE A	CODE IDENT NO. 00136	THIRD ANGLE PROJECTION 	UNSPECIFIED TOLERANCES N/A	DWG NO. DOC206379	REV. F	SHEET 15
------------------	--------------------------------	---------------------------------------------------------------------------------------------------------------	--------------------------------------	-----------------------------	------------------	--------------------

MICROCHIP CONFIDENTIAL

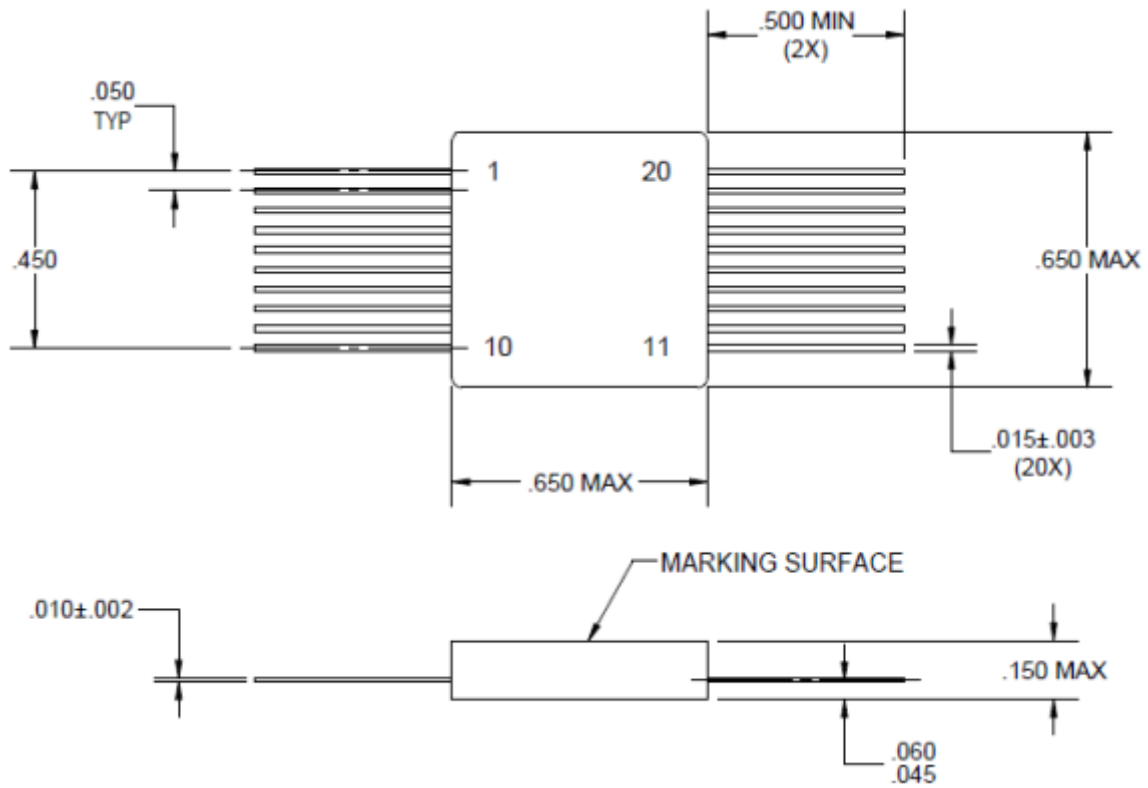

FIGURE 1
Model 1504 Package Outline

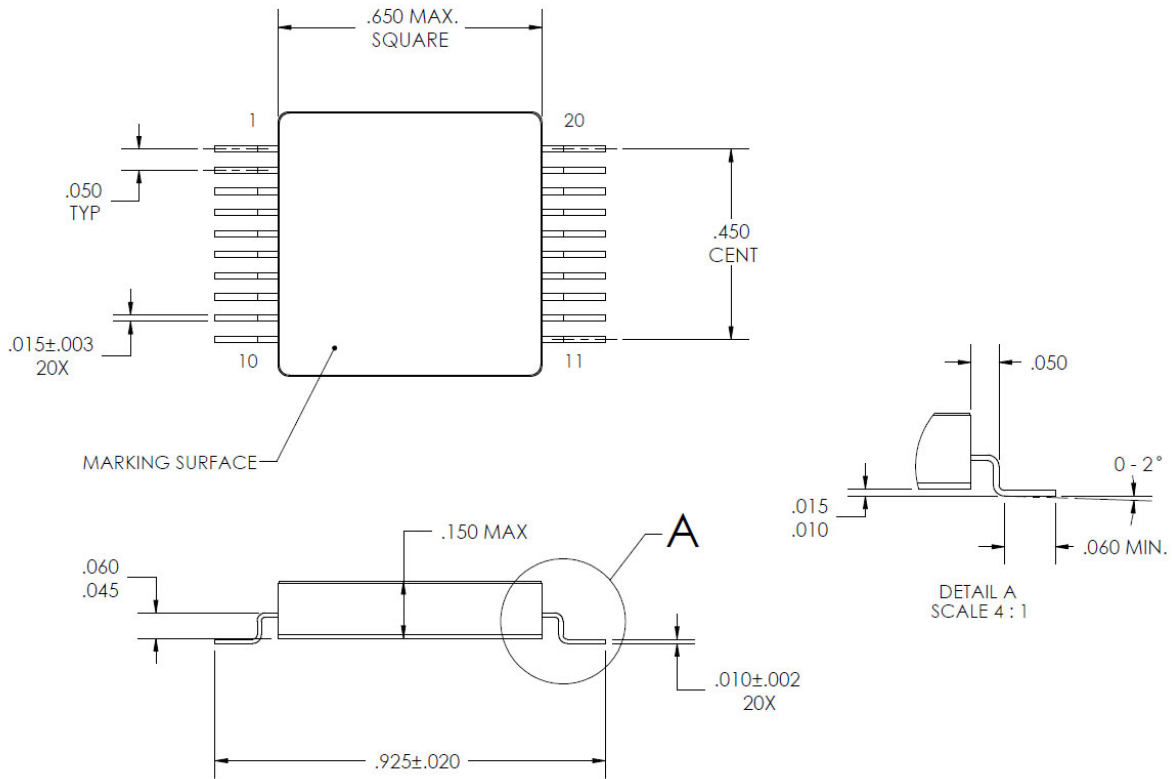
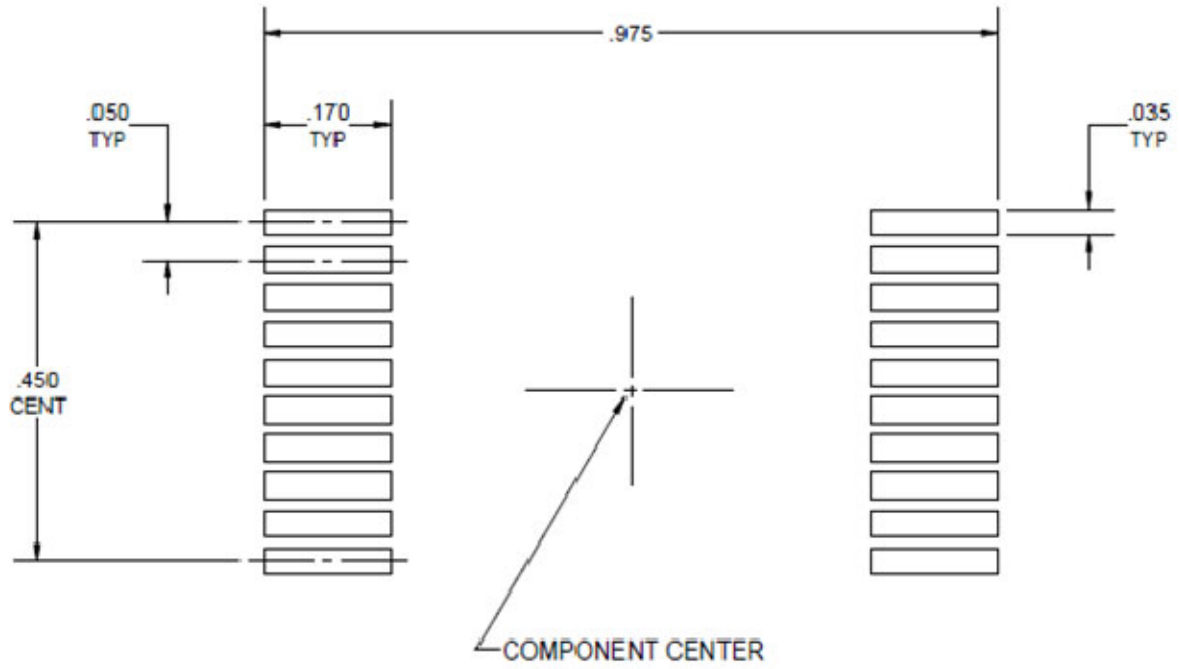

FIGURE 2
Models 1520 Package Outline

SIZE	CODE IDENT NO.	THIRD ANGLE PROJECTION	UNSPECIFIED TOLERANCES	DWG NO.	REV.	SHEET
A	00136		N/A	DOC206379	F	16

APPENDIX A
Recommended Land Pattern



Model 1520

SIZE A	CODE IDENT NO. 00136	THIRD ANGLE PROJECTION 	UNSPECIFIED TOLERANCES N/A	DWG NO. DOC206379	REV. F	SHEET 17
------------------	--------------------------------	---------------------------------------------------------------------------------------------------------------	--------------------------------------	-----------------------------	------------------	--------------------