PoE Midspans Multi-Port User Guide

Introduction

Microchip's family of Power over Ethernet (PoE) Midspans PD-90XXG series inject power over data-carrying Ethernet cabling. Employing these devices reduces the need for AC outlets, local UPS, and AC/DC adapters near Powered Devices (PDs).

PD-9006G/9012G/9024G Midspans support 6, 12, or 24 ports in a 10/100/1000BaseTx Ethernet network respectively, over TIA/EIA-568 category 5/5e/6 cabling. The PD-90XXG family can provide up to 30 W (or 36 W in Extra Power mode) according to the new PoE standard, IEEE[®] 802.3at. DC power is supplied over the spare pairs of wires within a cable (4/5 and 7/8) to terminal units.

PoE Midspan normally powers devices that are PoE enabled or are equipped to receive PoE. These devices are called PDs.

PoE Midspans offer the following important features.

- Safe and reliable power over an existing Ethernet infrastructure
- Remote management using web control and/or SNMPv3.
- High-level of network security.
- Safe solution that protects network infrastructure.
- Standards compliant: IEEE 802.3af and IEEE 802.3at.
- Provides safe Power and Data over a single RJ45 cable.

Table of Contents

Introduction.....	1
1. Standards and Safety Guidelines.....	4
1.1. Part Number Definition.....	4
1.2. Electrical Compatibility Approvals.....	4
1.3. Safety Standard Approvals.....	4
1.4. CE Marking.....	4
1.5. Safety Information.....	4
2. Information en matière de sécurité.....	6
2.1. Directives générales.....	6
2.2. Mises en garde.....	6
3. 10/100/1000BASE-TX Ports Definition.....	7
3.1. Data Input Ports.....	7
3.2. Data and Power Output Ports.....	7
3.3. Indicators.....	7
3.4. Connectors.....	9
4. PoE Midspan Installation.....	10
4.1. Background Information.....	10
4.2. Verifying Kit Contents.....	10
4.3. Rack Mounting Brackets.....	11
4.4. Installation Factors.....	11
4.5. Connecting Ethernet Cables.....	11
4.6. Connecting Power Cables.....	11
4.7. Powering Up the Unit.....	12
5. Troubleshooting.....	13
5.1. Preliminary Steps.....	13
5.2. Troubleshooting Steps.....	13
6. Specifications.....	14
6.1. Physical Specifications.....	14
7. Microchip's PowerView Pro.....	16
8. Power Backup and Power Redundancy Connection.....	17
8.1. Power Redundancy.....	17
8.2. Power Backup.....	18
8.3. Connectors.....	18
8.4. Connecting Backup and Redundancy Connectors.....	19
8.5. Power Backup and Power Redundancy Indications.....	20
9. Technical Support.....	22
10. Revision History.....	23
The Microchip Website.....	24

Product Change Notification Service.....24

Customer Support..... 24

Microchip Devices Code Protection Feature..... 24

Legal Notice..... 25

Trademarks..... 25

Quality Management System..... 26

Worldwide Sales and Service.....27

1. Standards and Safety Guidelines

The following sections mention the standard and safety guidelines for the product.

1.1 Part Number Definition

- PD-90xxG/ACDC/M/F: 2 pairs AC and DC input family
- PD-90xxG/DC/M: 2 pairs DC input family

Table 1-1. Part Number Definition

Symbol	Description
xx	Represents number of ports (6, 12, or 24).
AC	Midspan has AC input.
DC	Midspan has DC input, current sharing, and power backup features between two Midspans.
M	Midspan includes PowerView Pro (see 7. Microchip's PowerView Pro).
F	Midspan enables full power on all ports.

1.2 Electrical Compatibility Approvals

Microchip PD-90XXG series complies with the following standards:

- FCC Part 15: Class B with FTP cabling, Class A with UTP cabling
- EN 55032: Class B with FTP cabling, Class A with UTP cabling
- EN 55024 (CISPR 24)
- Canadian ICES-003, Class B

1.3 Safety Standard Approvals

Microchip meets the following safety standards:

- UL/IEC/EN 62368-1
- Consult Microchip for a complete list of safety certifications

1.4 CE Marking

CE marking on this product indicates that this product complies with EMC directive and low voltage directive.

1.5 Safety Information

Read the safety information before using the PoE Midspan unit.

1.5.1 General Guidelines

Read the following safety information before carrying out any installation, removal, or maintenance procedure on the PoE Midspan. Warnings contain directions to be followed for the safety of personal and product.

1.5.2 Warnings

- Read installation instructions in [4. PoE Midspan Installation](#) before connecting Midspan to its power source.
- Read instructions in [4. PoE Midspan Installation](#) before connecting Midspan-to-Midspan power backup.
- Only trained and qualified personnel must be allowed to install, replace, and service this equipment.

- Midspan must be connected using a grounded power cord, as defined in [1.5.3 Power Cord](#).
- This ITE device must be connected to PoE (power supply over Ethernet) networks only, without routing to other networks.
- The power cord must not be attached to the surface of the building or pass-through walls, ceilings, floors, and similar openings in the building structure.
- Steps must be taken to prevent physical damage to the power cord, including proper routing.
- This product relies on building installation for short-circuit (over-current) protection. Use only a fuse or circuit breaker not higher than 15 A for 120 V_{AC} (U.S.) or 10 A for 230 V_{AC} (international).
- All wiring and connections must conform to NFPA 70 (NEC).
- Do not work on the system or connect/disconnect cables during lightning storms.
- A voltage mismatch can damage the equipment and can pose a fire hazard. If voltage indicated on the label is different from the power outlet voltage, do not connect Midspan to this outlet.
- For shelf-mounted equipment, verify that surface is stable and strong enough to support the equipment. Do not stack more than **four** Midspan units.
- When disposing this product, follow all local laws and regulations.
- **Data** and **Data and Power** ports of the Midspan are shielded RJ45 data sockets. They cannot be used as Plain Old Telephone Service (POTS) sockets. Only connect RJ45 data connectors to these sockets.
- Associated Ethernet wiring must be limited to the inside of the building.

1.5.3 Power Cord

Power cord replacement must meet the local requirements.

- To ensure a reliable connection to an AC mains supply, equipment provides an appliance IEC60320 inlet to connect a detachable power supply cord.
- Power socket outlet must be located near Midspan and easily accessible.
Note: The only way to power off the unit is to disconnect the power cord from the outlet.
- This unit operates under Safety Extra Low Voltage (SELV) conditions, according to IEC/EN60950-1 or ES1 according to IEC/EN 62368-1.
Conditions are maintained only if the equipment to which the unit is connected also operates under SELV/ES1 conditions.

1.5.4 Country-Wise Power Cord Specifications

U.S.A. and Canada	<ul style="list-style-type: none"> • Cord must be UL-approved or CSA certified. • Minimum specification for flexible cord is: <ul style="list-style-type: none"> – No. 18 AWG – Type SV or SJ – Three-conductors • Cord set must have a rated current capacity of at least 13A for 9024G/ACDC/M/F and PD-9024G/AC/F; and 10A for PD- 9024G/ACDC/M, PD-9024G/AC, PD-9012G/ACDC/M, PD-9012G/AC, PD-9006G/ACDC/M, and PD-9006G/AC. • The attachment plug must be an earth-grounding type with a NEMA 5-15P (15 A, 125 V) or NEMA 6-15P (15 A, 250 V) configuration.
Denmark	Supply plug must comply with section 107-2-D1, standard DK2-1a or DK2-5a.
Switzerland	Supply plug must comply with SEV/ASE 1011.
France and Peru	IT supplies cannot power this unit. If your supplies are an IT type, unit must be powered by 230 V (2P+T) via an isolation transformer with a 1:1 ratio, and with secondary connection point labeled Neutral and connected directly to the ground.
U.K	PoE Midspan is covered by General Approval NS/G/12345/J/100003, for indirect connection to a public telecommunications system.

2. Information en matière de sécurité

Lire les informations suivantes en matière de sécurité avant d'utiliser d'activer l'alimentation sur votre appareil Ethernet Midspan.

2.1 Directives générales

Lire les informations suivantes en matière de sécurité avant d'installer ou enlever quoi que ce soit, ou procéder à l'entretien de l'alimentation de votre appareil Ethernet Midspan. Les mises en garde contiennent des instructions qui doivent être suivies pour la sécurité des personnes et du produit. Suivre les instructions soigneusement.

2.2 Mises en garde

- Lire les instructions d'installation dans la cette [PoE Midspan Installation](#) avant de connecter le Midspan à une source d'alimentation.
- Lire les instructions d'installation dans la cette [PoE Midspan Installation](#) avant de connecter le Midspan à une source de sauvegarde Midspan.
- Seul du personnel formé et qualifié doit être autorisé à installer, remplacer et entretenir cet équipement.
- Le Midspan doit être connecté au moyen d'une corde d'alimentation avec prise de terre, comme précisé à la [Power Cord](#).
- Cet ITE appareil doit être branché à des réseaux PoE (alimentation électrique par Ethernet) seulement, et ce, sans routage vers d'autres réseaux.
- Le cordon d'alimentation ne doit pas être fixé à la surface du bâtiment ni traverser les murs, les plafonds, les planchers et les ouvertures similaires de la structure du bâtiment.
- Des mesures doivent être prises pour éviter tout dommage physique au cordon d'alimentation, y compris un acheminement approprié.
- Ce produit dépend de l'installation électrique de l'immeuble pour une protection contre les courts-circuits (surcharges de courant). Utiliser seulement un fusible ou un disjoncteur dont la puissance ne dépasse pas 15A pour 120VAC (É.-U.), ou 10A pour 230VAC (international).
- Tout le câblage et les connexions doivent être conformes à la norme NFPA 70 (NEC)
- Ne pas exécuter de travaux sur le système, connecter ou déconnecter des câbles pendant les orages.
- Une disparité de voltage peut endommager l'équipement et constituer un risque d'incendie. Si le voltage indiqué sur l'étiquette est différent du voltage de la source d'alimentation, ne pas connecter le Midspan à cette prise.
- Pour un équipement monté sur une tablette, vérifier que la surface est stable et suffisamment solide pour le supporter. Ne jamais empiler plus de **quatre** unités Midspan.
- Pour disposer/jeter ce produit, suivre les lois et règlements locaux.
- Les ports **Data** et **Data et Power** du PoE Midspan sont des prises de données blindées RJ45. Elles ne peuvent pas être utilisées comme prises de service téléphonique traditionnel. Connecter seulement des connecteurs de données RJ45 à ces prises. Le câblage Ethernet connexe doit être limité à l'intérieur de l'immeuble.
- Le câblage Ethernet associé doit être limité à l'intérieur du bâtiment.

3. 10/100/1000BASE-TX Ports Definition

The following sections detail PD9000G ports, and their functions.

3.1 Data Input Ports

Midspan has 6, 12, or 24 10/100/1000Base-T **Data In** ports, located on PoE front panel ([Figure 3-1](#)), configured in a non-crossover manner (straight-wired).

These ports are designed to carry Ethernet data only (Tx/Rx) over:

- Standard 4-wire pairs (pins 1/2, 3/6, 4/5, and 7/8) (1000Base-T)
- 2-wire pairs (pins 1/2 and 3/6) (10/100Base-T)

3.2 Data and Power Output Ports

Midspan has 6, 12, or 24 10/100/1000Base-T **Data & Power Out** ports, located on the front panel as shown in the following figure. These ports are configured in a non-crossover manner (straight-wired) and carry Ethernet data over:

- Standard 4-wire pairs (pins 1/2, 3/6, 4/5, and 7/8) (1000Base-T)
- 2-wire pairs (pins 1/2 and 3/6) (10/100Base-T)
- PD-90xxG series carry DC power over 2-wire pairs (pins 4/5 and 7/8)

Note: Power over Ethernet Midspan is not a repeater. Therefore, the maximum distance from Ethernet switch must not exceed 100 meters (328 ft). Power over Ethernet Midspan is guaranteed to work only within this distance, as specified in IEEE 802.3at standard.

Figure 3-1. Front View (PD-9024G) of PoE Midspan

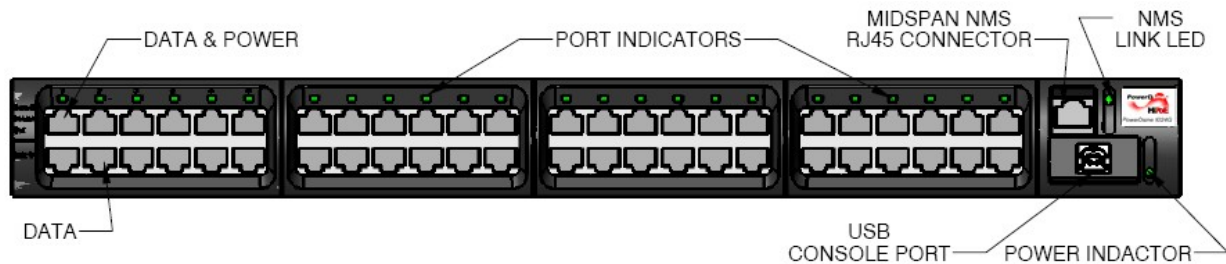

3.3 Indicators

A set of indicators displays the status of the PoE Midspan and its ports. For more information about the status information during operation, see [Table 3-1](#) and [Table 3-2](#).

3.3.1 Power Indicator LED

Power Indicator LED on the front panel displays power status of PoE Midspan. When the LED is illuminated in green, it indicates that the Midspan is receiving AC power. For more information, see [Table 3-1](#).

3.3.2 Port Indications

The following sections detail PD-90XXG port indicators.

3.3.2.1 PD-90xxG Midspan Series

One uni-color indicator (green) per port displays port status:

- Green indicates terminal unit (PD) has been identified as **Power over Ethernet Enabled**, it is active and receiving power.
- Blinking green indicates port does not supply power and is inactive.

Table 3-1. Power Status Indications

Indicator	Color	Main Power Status	Remarks
Power Indicator	Off	Power supply unit is unplugged.	—
	Green	Power input is active.	Power supply voltage is within limits.
	Green light blinks once every second (only if power backup is connected).	Midspan power supply failure (disconnected or out of voltage range).	Unit receives backup power and continues to function normally. Maintenance measures must be taken whenever possible.

Table 3-2. Port Status Indications for PD-90XX Series

Port LED Color	Port Load Conditions	Port Voltage
Off	Inactive load or unplugged port.	Power to port is disconnected. No DC voltage present on port output lines.
Green	Active load is plugged in and complies with normal load conditions.	Continuous nominal DC voltage is present on spare pairs.
Green blinks once every second.	Overload or short circuit.	Power to port is disconnected. No DC voltage is present on port output lines.
Green blinks once every 0.5 seconds.	Valid load.	Power is not connected to port.
	Total aggregated power exceeds predefined power budget.	No DC voltage is present on port output lines.

3.4 Connectors

On the front panel of Midspan, there is a Console port. Using a standard USB cable, users can connect a terminal to this port and load software.

Note: USB connection requires CP210x Driver.exe installation. To install the USB driver, see: www.silabs.com/developers/usb-to-uart-bridge-vcp-drivers.

Console port is set to 38,400-baud for managed units and 19,200-baud for unmanaged units, 8 data bits, no parity, and 1 stop bit.

Figure 3-2. Connecting to Midspan

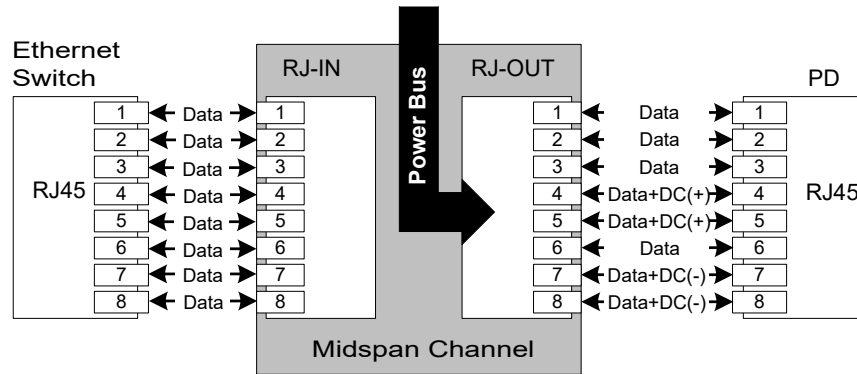

Each data port is configured, as data **Pass-Through** ports for all data pins (pins 1, 2, 3, 6, 4, 5, 7, and 8). Make sure you are using cabling of Category 5 or higher.

4. PoE Midspan Installation

The following sections describe how to install PoE Midspan.

4.1 Background Information

As shown in the following figure, Midspan is connected in series to an Ethernet switch/hub. Switch's data output terminals are connected to Midspan. Midspan delivers power over the spare twisted pairs (pins 7/8 and pins 4/5) in PD-90XXG series of Category 5 cabling, without degrading data quality. Most installations require Midspan to be rack-mounted.

Figure 4-1. Typical Installation

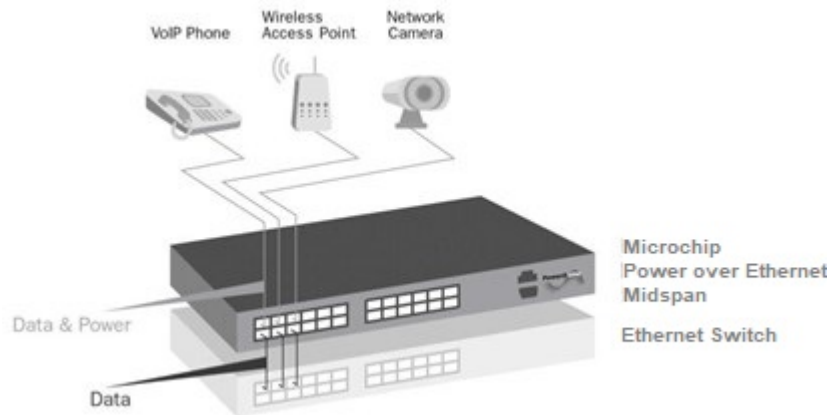

4.2 Verifying Kit Contents

Unpack kit and verify that the following items are included.

- PoE Midspan
- Mounting brackets (for 19-inch racks) and plastic cover
- Screws for assembling mounting brackets
- Self-adhesive rubber feet
- User guide

Before proceeding, record the serial number of the unit in the following rectangle for future reference. Serial number is found on the information label at the back of the PoE Midspan.

Serial Number

4.3 Rack Mounting Brackets

Midspan comes with 19-inch mounting brackets and screws. To install Midspan into a 19-inch rack:

1. Remove self-adhesive rubber feet from the bottom surface.
2. Install brackets using three screws on each side.

Note: Rack-mounting screws are not provided.

Figure 4-2. Installing Mounting Brackets

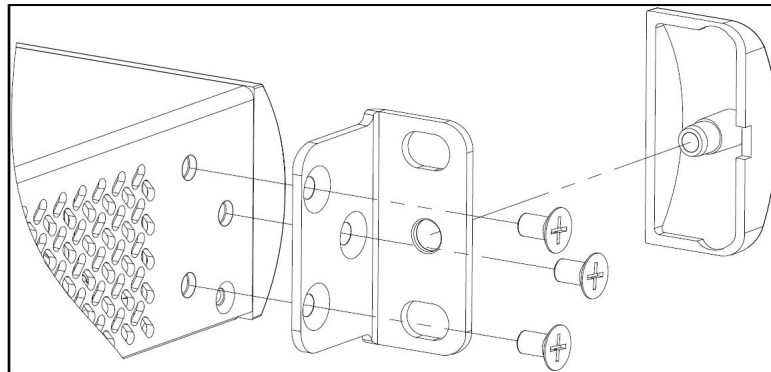

4.4 Installation Factors

Follow the installation factors carefully:

- **Elevated Operating Ambient Temperature:** If installed in a closed or multi-unit rack assembly, operating ambient temperature in rack environment may be greater than room ambient temperature. Therefore, install the equipment in an environment compatible with manufacturer's maximum rated ambient temperature (T_{mra}).
- **Reduced Air Flow:** Install the equipment in a rack in a manner that does not compromise the amount of airflow required for safe operation of the equipment.
- **Mechanical Loading:** While mounting the equipment in a rack, ensure that the mechanical loading is even.
- **Circuit Overloading:** Consider the connection of the equipment to a supply circuit and the effect overloading of the circuits might have on over-current protection and supply wiring. Appropriate consideration of the equipment nameplate ratings must be given while addressing this concern.
- **Reliable Grounding (Earthing):** Maintain reliable earthing of rack mounted equipment. Pay attention to supply connections, other than direct connections to branch circuit (for example, the use of power strips).

4.5 Connecting Ethernet Cables

The ports on the front panel of Midspan are configured as **Pass Through** ports for eight (1, 2, 3, 6, 4, 5, 7, and 8) conductors of RJ45 connectors. Use Category 5 cabling while making connections.

1. Connect cables from Ethernet switch to data in ports (lower row on front panel).
2. Connect cables from IEEE 802.3at or IEEE 802.3af ready terminals (PDs) to corresponding **Data & Power Out** ports (upper row on front panel).

4.6 Connecting Power Cables

While using an AC source to power Midspan, plug in the provided power cord to back of the AC connector.

4.7 Powering Up the Unit

PoE Midspan has no on/off switch. To apply or remove power from Midspan, insert or remove power cable to receptacle (AC) on the back panel of the unit.

With power applied;

- Midspan powers-up.
- Internal fan operates.
- Device runs its Power-On Self-Test (POST), which takes less than 10 seconds. During POST, all ports are disabled and indicators illuminate in the following sequence:
 - Port indicators and power indicators illuminate in green.
 - Power indicator remains illuminated in green; port indicators are off.

Ports are now ready (enabled) for normal operation.

If LEDs are not lit, refer to [5. Troubleshooting](#).

5. Troubleshooting

The following sections describe the troubleshooting procedures to address any problems with a unit.

5.1 Preliminary Steps

If you have a problem, verify:

- Power is applied to Midspan.
- A crossover-type Ethernet cable has not been used.
- Ethernet cable from network is connected to DATA port.
- Ethernet cable to PD is connected to **Data & Power** port.
- Cable pairs are attached to their corresponding ports.

5.2 Troubleshooting Steps

The following table provides a problem and resolution sequence to assist in troubleshooting of minor operating problems. If steps given do not solve your problem, call the local dealer for further assistance.

Table 5-1. Troubleshooting Steps

Problem	Corrective Steps
Midspan does not power up	<ol style="list-style-type: none"> 1. Make sure power cord is properly connected. 2. Verify voltage at power inlet is between 100 and 240 VAC. 3. Remove and reapply power to the device and check indicators during power-up sequence.
A port indicator is not lit and corresponding PD does not operate.	<ol style="list-style-type: none"> 1. Verify port is enabled (Midspan did not detect a PD). 2. Verify PD is designed for PoE operation. 3. Verify you are using a standard Category 5/5e/6, straight-wired cable, with four pairs. 4. If an external power splitter is in use, replace it with a viable splitter. 5. Verify PD is connected to Data & Power Output port. 6. Try to reconnect the same PD to a different port on the same Midspan or on another midspan. If it works, there is probably a faulty output port or RJ45 connection. 7. Verify port shutdown command was not issued through web management. 8. If PD is an old PD, set the Port to Legacy mode through the port management.
End device operates, but there is no data link.	<ol style="list-style-type: none"> 1. Verify port indicator on front panel is continuously lit. 2. If an external power splitter is in use, replace it with a viable splitter. 3. Verify that for this link you are using a standard UTP/FTP Category 5 straight (non-crossover) cabling, with all four pairs, and that link is 100 meters long or less. 4. Try to reconnect the same PD to a different port on the same Midspan or on another one. If it works, there might be a faulty port or faulty RJ45 connection.

6. Specifications

The following sections detail unit specifications.

6.1 Physical Specifications

Dimensions (H x W x D): 44 x 438 x 272 mm (1.75" x 17.3" x 10.8")

Table 6-1. Physical Specifications

P/N	Weight
PD-9006G	4.74 Kg
PD-9012G	4.94 Kg
PD-9024G	5.34 Kg

Table 6-2. Environmental Specifications

Parameter	Value
Operating Temperature	0° C to 40° C (32° to 104°F)
Storage Temperature	-20° C to 70° C (-4° to 158° F)
Operating Humidity	90% max (Non-condensing)
Storage Humidity	95% max (Non-condensing)

Table 6-3. Electrical Specifications for PD-9024G/ACDC/M

Parameter	Value
AC Input Voltage	100 to 240 VAC at 50/60 Hz
Input Current @ 100 VAC	12 A max
Input Current @ 240 VAC	6 A max
Nominal Output Voltage	50 to 57 VDC
Total Output Power	1000 W max
Maximum Output Power per Port	PD-90XX series: 36 W

Table 6-4. Electrical Specifications for PD-9012G/ACDC/M and PD-9006G/ACDC/M

Parameter	Value
AC Input Voltage	100 to 240 VAC at 50/60 Hz
Input Current @ 100 VAC	5.5 A max
Input Current @ 240 VAC	2.75 A max
Nominal Output Voltage	50 to 57 VDC
Total Output Power	450 W max
Maximum Output Power per Port	PD-90XX series: 36 W

Table 6-5. Electrical Specifications for PD-9024G/ACDC/M, PD-9012G/ACDC/M, and PD-9006G/ACDC/M

Parameter	Value
DC Input Rated Voltage	53-57 VDC 
Input DC Maximum Current	20 A

7. Microchip's PowerView Pro

Microchip's PowerView Pro is a secure remote management system offering real time monitoring and control, with graphical representation, status indicators, and alarms. PowerView Pro manages Midspans through an Internet browser interface or through a Network Management System (NMS). Some of the most important features is remote power enable/disable functionality on each Midspan port, supporting "hard resets" of remote terminals such as WLAN Access Points and VoIP Phones, and enabling to monitor and control at network and Element levels, as shown in the following figure. For further details, refer to *Microchip's PowerView Pro Web Manager User Guide*.

Figure 7-1. Management Deployment

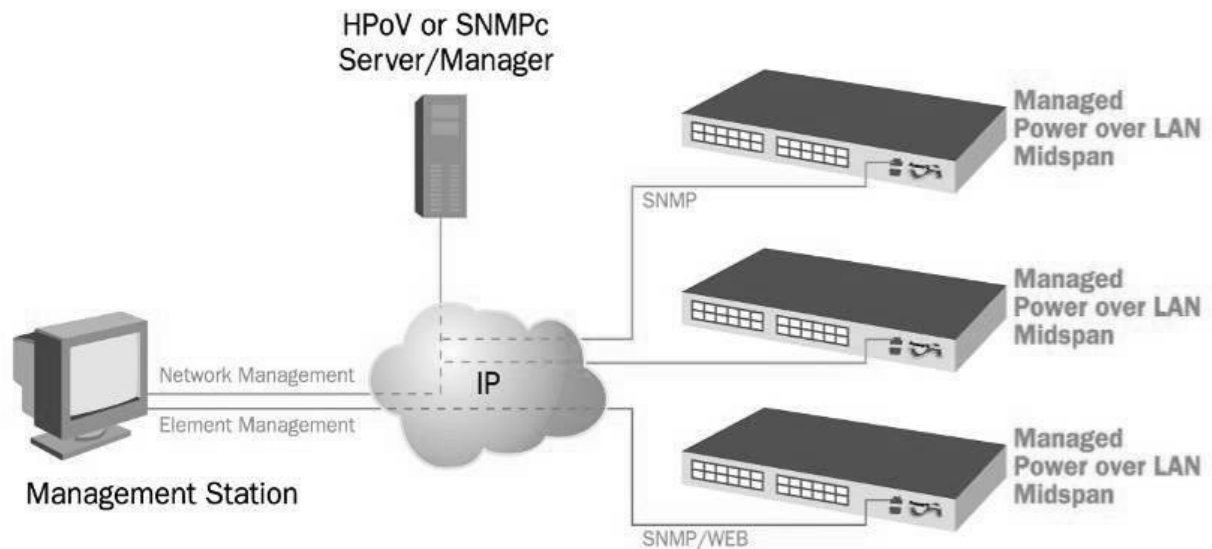

PowerView Pro provides a number of unique features for Midspan management:

- Remote Web Management of PoE for monitoring and configuration.
- Configuration using graphical representations of remote devices.
- Real-time monitoring and configuration with visual status indicators and alarms.
- Multi-manager capabilities.
- Event and performance data recording.
- Runs on a PC platform with Windows GUI.

Note:

The PD-90xxG Midspan comes with the PowerView Pro software pre-installed. In case the software needs to be re-installed or updated, the latest version is located in [Microchip's Software Library](#).

8. Power Backup and Power Redundancy Connection

PD-90xxG has two options for ensuring continuous power supply:

- Power Redundancy
- Power Backup

8.1 Power Redundancy

Microchip's power redundancy mode is available in the PD-90XXG Midspan series. This mode enables internal power supply backup for two inter-connected Midspans. This mode provides seamless failover between two Midspans. If internal power supplies of one of the two Midspans fails, it is detected automatically and a working power supply provides power to the Midspan. Both the Midspans are ensured continuous uptime and all the active ports continue to operate without any effect on the connected PDs.

Power redundancy mode is available in the following midspans.

- PD-9024G/ACDC/M/F
- PD-9024G/ACDC/M
- PD-9012G/ACDC/M
- PD-9006G/ACDC/M
- PD-9524G/ACDC/M
- PD-9512G/ACDC/M
- PD-9506G/ACDC/M
- PD-5524G/ACDC/M

Note: While using power redundancy option, connect only units that share the same power supply:

- 1 Kw power supply units
 - PD-9024G/ACDC/M/F
 - PD-9524G/ACDC/M
 - PD-9512G/ACDC/M
 - 450W power supply units
 - PD-9024G/ACDC/M
 - PD-9012G/ACDC/M
 - PD-9006ACDC/M
 - PD-9506G/ACDC/M
 - PD-55XXG/ACDC/M



While connecting the power redundancy connectors, make sure that the AC power in both the Midspans is disconnected from the AC mains.

8.2 Power Backup

If one of Midspans' power supplies fails, unit maintains full functionality by using an optional backup power supply.

Table 8-1. Power Backup of PDs

Midspan Unit	Redundant Power Supply
PD-9024G/ACDC/M/F	PD-9024G/ACDC/M/F
PD-9524G/ACDC/M	PD-9524G/ACDC/M
PD-9012G/ACDC/M	PD-9012G/ACDC/M
PD-9024G/ACDC/M/F	PD-9024G/ACDC/M/F
PD-9524G/ACDC/M	PD-9524G/ACDC/M
PD-9012G/ACDC/M	PD-9012G/ACDC/M

8.3 Connectors

Power backup and power redundancy connectors are located on the back panel of the Midspan.

PD-90xxG power backup and power redundancy have two connectors as shown in the following figure.

- Power Backup and Power Redundancy Control Signal connector, COM D-Sub: 15 pins, 3 rows female connector.
- DC Voltage Terminal Block Connector has two positive (+) terminals and two negative (-) terminals.

Figure 8-1. PD-90xxG Rear Panel Connectors

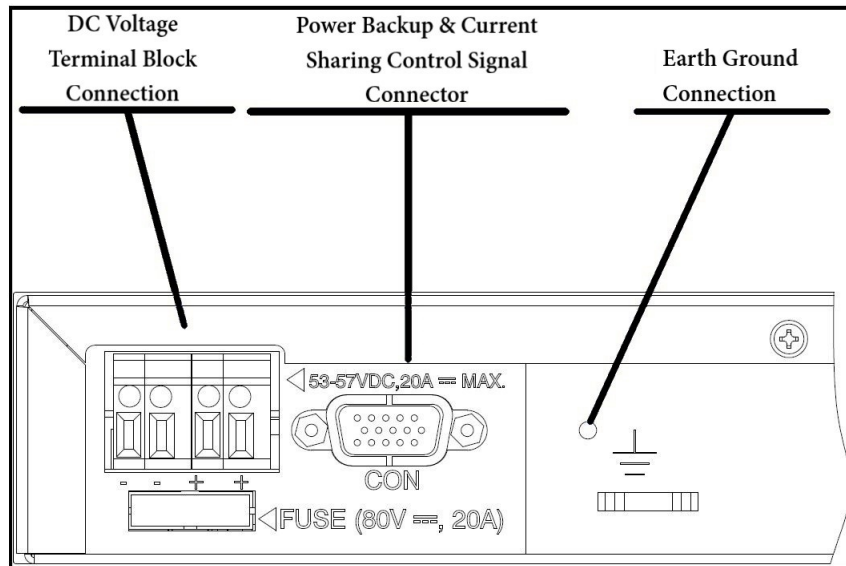

8.4 Connecting Backup and Redundancy Connectors



Before connecting one Midspan to another, disconnect both Midspans from AC main.

Implement Power Backup and Power Redundancy modes by using Cable kit which includes DC Cable and signal COM.

To connect the connectors:

1. Verify Midspans are mounted securely on the rack.
2. Verify Midspans are not connected to AC mains.
3. Connect DC cable*; two red wires (+), two black wires (-), and one yellow/green wire, as shown in [Figure 8-2](#).
4. Connect COM cable*.
5. Connect Midspans to AC outlet.
6. Verify Power Indicator LED is ON (Green LED).

Note: When connecting a midspan to midspan, connect the earth ground cable between both units Earth Ground connection.

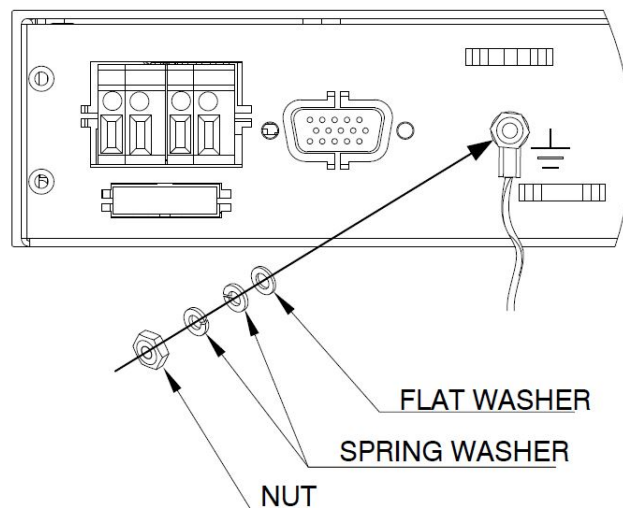

Notes:

- If power indicator LED is not lit, refer to [5. Troubleshooting](#).
- Backup functionality can be monitored through NMS as described in [Figure 8-3](#).
- *Consult Microchip for information on DC and COM cables.

Figure 8-2. PD-90XXG Rear Panel Connections

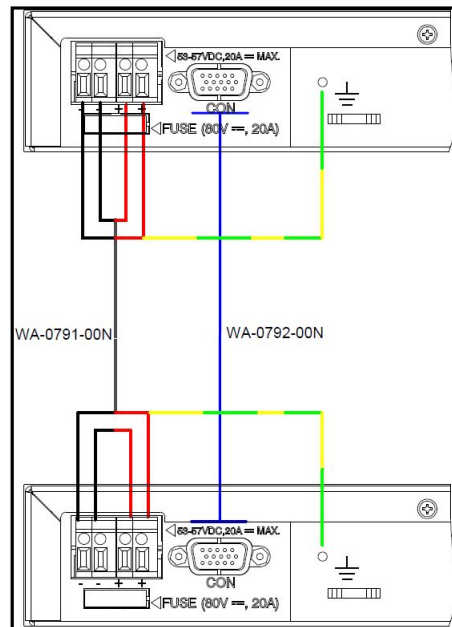

8.5 Power Backup and Power Redundancy Indications

For information on NMS configuration, see *PowerView Pro User Guide*. During Power Backup and Power Redundancy, NMS View-Status window displays **Power Source Status** field. The **Power Source Status** field shows both internal and external power supply statuses (green indication for **OK** and red indication for **Fail**).

Figure 8-3. PD-90XXG View Status in NMS

#	1	2	3	4	5	6	7	8	9	10	11	12	13	14	15	16	17	18	19	20	21	22	23	24
Power (W)	0	0	0	0	0	0	0	0	0	0	0	0	0	0	0	0	0	0	0	0	0	0	0	0
Description																								

Midspan Status	
Total Power Consumption (Watt)	0
Maximum available Power (Watt)	430
System Voltage (Volt)	55.1
PD Detection Method	IEEE802.3af + IEEE802.3at + Legacy
Midspan Status	Active

Power Source Status	
Internal (430W) Power Source	OK
External (430W) Redundancy Power Source	OK

Note: Midspan provides another power fail indication through Midspan's Power Indicator LED; whenever unit's internal power supply fails, Power Indicator LED blinks once every second (Green LED).

Figure 8-4. PD-90XXG Front Panel LED Indication

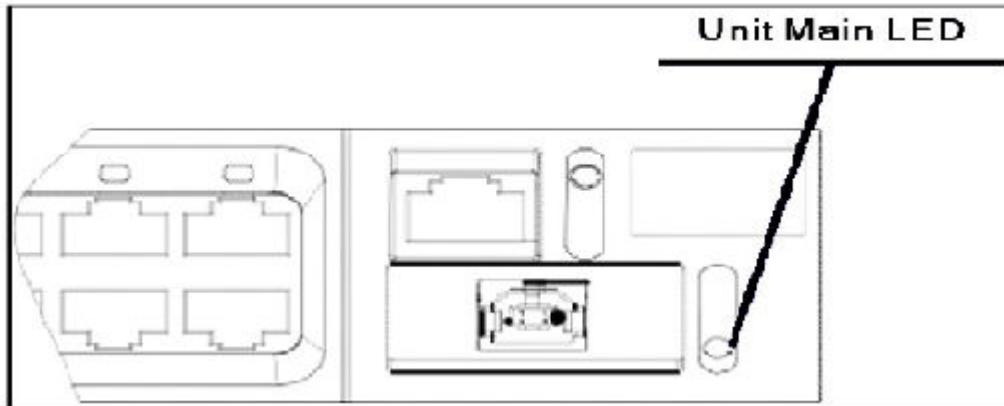

9. Technical Support

If you encounter any problems while installing or using this product, visit the Microchip website at: www.microchip.com/support or call USA/Canada: +1 877 480 2323.

10. Revision History

Revision	Date	Description
B	06/2021	Added 2. Information en matière de sécurité section. Updated Figure 3-2 . Updated dimension and Midspans PD Part numbers in 6.1 Physical Specifications .
A	04/2021	Initial Revision

The Microchip Website

Microchip provides online support via our website at www.microchip.com/. This website is used to make files and information easily available to customers. Some of the content available includes:

- **Product Support** – Data sheets and errata, application notes and sample programs, design resources, user's guides and hardware support documents, latest software releases and archived software
- **General Technical Support** – Frequently Asked Questions (FAQs), technical support requests, online discussion groups, Microchip design partner program member listing
- **Business of Microchip** – Product selector and ordering guides, latest Microchip press releases, listing of seminars and events, listings of Microchip sales offices, distributors and factory representatives

Product Change Notification Service

Microchip's product change notification service helps keep customers current on Microchip products. Subscribers will receive email notification whenever there are changes, updates, revisions or errata related to a specified product family or development tool of interest.

To register, go to www.microchip.com/pcn and follow the registration instructions.

Customer Support

Users of Microchip products can receive assistance through several channels:

- Distributor or Representative
- Local Sales Office
- Embedded Solutions Engineer (ESE)
- Technical Support

Customers should contact their distributor, representative or ESE for support. Local sales offices are also available to help customers. A listing of sales offices and locations is included in this document.

Technical support is available through the website at: www.microchip.com/support

Microchip Devices Code Protection Feature

Note the following details of the code protection feature on Microchip devices:

- Microchip products meet the specifications contained in their particular Microchip Data Sheet.
- Microchip believes that its family of products is secure when used in the intended manner and under normal conditions.
- There are dishonest and possibly illegal methods being used in attempts to breach the code protection features of the Microchip devices. We believe that these methods require using the Microchip products in a manner outside the operating specifications contained in Microchip's Data Sheets. Attempts to breach these code protection features, most likely, cannot be accomplished without violating Microchip's intellectual property rights.
- Microchip is willing to work with any customer who is concerned about the integrity of its code.
- Neither Microchip nor any other semiconductor manufacturer can guarantee the security of its code. Code protection does not mean that we are guaranteeing the product is "unbreakable." Code protection is constantly evolving. We at Microchip are committed to continuously improving the code protection features of our products. Attempts to break Microchip's code protection feature may be a violation of the Digital Millennium Copyright Act. If such acts allow unauthorized access to your software or other copyrighted work, you may have a right to sue for relief under that Act.

Legal Notice

Information contained in this publication is provided for the sole purpose of designing with and using Microchip products. Information regarding device applications and the like is provided only for your convenience and may be superseded by updates. It is your responsibility to ensure that your application meets with your specifications.

THIS INFORMATION IS PROVIDED BY MICROCHIP "AS IS". MICROCHIP MAKES NO REPRESENTATIONS OR WARRANTIES OF ANY KIND WHETHER EXPRESS OR IMPLIED, WRITTEN OR ORAL, STATUTORY OR OTHERWISE, RELATED TO THE INFORMATION INCLUDING BUT NOT LIMITED TO ANY IMPLIED WARRANTIES OF NON-INFRINGEMENT, MERCHANTABILITY, AND FITNESS FOR A PARTICULAR PURPOSE OR WARRANTIES RELATED TO ITS CONDITION, QUALITY, OR PERFORMANCE.

IN NO EVENT WILL MICROCHIP BE LIABLE FOR ANY INDIRECT, SPECIAL, PUNITIVE, INCIDENTAL OR CONSEQUENTIAL LOSS, DAMAGE, COST OR EXPENSE OF ANY KIND WHATSOEVER RELATED TO THE INFORMATION OR ITS USE, HOWEVER CAUSED, EVEN IF MICROCHIP HAS BEEN ADVISED OF THE POSSIBILITY OR THE DAMAGES ARE FORESEEABLE. TO THE FULLEST EXTENT ALLOWED BY LAW, MICROCHIP'S TOTAL LIABILITY ON ALL CLAIMS IN ANY WAY RELATED TO THE INFORMATION OR ITS USE WILL NOT EXCEED THE AMOUNT OF FEES, IF ANY, THAT YOU HAVE PAID DIRECTLY TO MICROCHIP FOR THE INFORMATION. Use of Microchip devices in life support and/or safety applications is entirely at the buyer's risk, and the buyer agrees to defend, indemnify and hold harmless Microchip from any and all damages, claims, suits, or expenses resulting from such use. No licenses are conveyed, implicitly or otherwise, under any Microchip intellectual property rights unless otherwise stated.

Trademarks

The Microchip name and logo, the Microchip logo, Adaptec, AnyRate, AVR, AVR logo, AVR Freaks, BesTime, BitCloud, chipKIT, chipKIT logo, CryptoMemory, CryptoRF, dsPIC, FlashFlex, flexPWR, HELDO, IGLOO, JukeBlox, KeeLoq, Klear, LANCheck, LinkMD, maXStylus, maXTouch, MediaLB, megaAVR, Microsemi, Microsemi logo, MOST, MOST logo, MPLAB, OptoLyzer, PackeTime, PIC, picoPower, PICSTART, PIC32 logo, PolarFire, Prochip Designer, QTouch, SAM-BA, SenGenuity, SpyNIC, SST, SST Logo, SuperFlash, Symmetricom, SyncServer, Tachyon, TimeSource, tinyAVR, UNI/O, Vectron, and XMEGA are registered trademarks of Microchip Technology Incorporated in the U.S.A. and other countries.

AgileSwitch, APT, ClockWorks, The Embedded Control Solutions Company, EtherSynch, FlashTec, Hyper Speed Control, HyperLight Load, IntelliMOS, Libero, motorBench, mTouch, Powermite 3, Precision Edge, ProASIC, ProASIC Plus, ProASIC Plus logo, Quiet-Wire, SmartFusion, SyncWorld, Temux, TimeCesium, TimeHub, TimePictra, TimeProvider, WinPath, and ZL are registered trademarks of Microchip Technology Incorporated in the U.S.A.

Adjacent Key Suppression, AKS, Analog-for-the-Digital Age, Any Capacitor, AnyIn, AnyOut, Augmented Switching, BlueSky, BodyCom, CodeGuard, CryptoAuthentication, CryptoAutomotive, CryptoCompanion, CryptoController, dsPICDEM, dsPICDEM.net, Dynamic Average Matching, DAM, ECAN, Espresso T1S, EtherGREEN, IdealBridge, In-Circuit Serial Programming, ICSP, INICnet, Intelligent Paralleling, Inter-Chip Connectivity, JitterBlocker, maxCrypto, maxView, memBrain, Mindi, MiWi, MPASM, MPF, MPLAB Certified logo, MPLIB, MPLINK, MultiTRAK, NetDetach, Omniscient Code Generation, PICDEM, PICDEM.net, PICKit, PICtail, PowerSmart, PureSilicon, QMatrix, REAL ICE, Ripple Blocker, RTAX, RTG4, SAM-ICE, Serial Quad I/O, simpleMAP, SimpliPHY, SmartBuffer, SMART-I.S., storClad, SQL, SuperSwitcher, SuperSwitcher II, Switchtec, SynchroPHY, Total Endurance, TSHARC, USBCheck, VariSense, VectorBlox, VeriPHY, ViewSpan, WiperLock, XpressConnect, and ZENA are trademarks of Microchip Technology Incorporated in the U.S.A. and other countries.

SQTP is a service mark of Microchip Technology Incorporated in the U.S.A.

The Adaptec logo, Frequency on Demand, Silicon Storage Technology, and Symmcom are registered trademarks of Microchip Technology Inc. in other countries.

GestIC is a registered trademark of Microchip Technology Germany II GmbH & Co. KG, a subsidiary of Microchip Technology Inc., in other countries.

All other trademarks mentioned herein are property of their respective companies.

© 2021, Microchip Technology Incorporated, Printed in the U.S.A., All Rights Reserved.

ISBN: 978-1-5224-8294-9

Quality Management System

For information regarding Microchip's Quality Management Systems, please visit www.microchip.com/quality.

Worldwide Sales and Service

AMERICAS	ASIA/PACIFIC	ASIA/PACIFIC	EUROPE
<p>Corporate Office 2355 West Chandler Blvd. Chandler, AZ 85224-6199 Tel: 480-792-7200 Tel: 480-792-7277 Technical Support: www.microchip.com/support Web Address: www.microchip.com</p> <p>Atlanta Duluth, GA Tel: 678-957-9614 Fax: 678-957-1455</p> <p>Austin, TX Tel: 512-257-3370</p> <p>Boston Westborough, MA Tel: 774-760-0087 Fax: 774-760-0088</p> <p>Chicago Itasca, IL Tel: 630-285-0071 Fax: 630-285-0075</p> <p>Dallas Addison, TX Tel: 972-818-7423 Fax: 972-818-2924</p> <p>Detroit Novi, MI Tel: 248-848-4000</p> <p>Houston, TX Tel: 281-894-5983</p> <p>Indianapolis Noblesville, IN Tel: 317-773-8323 Fax: 317-773-5453 Tel: 317-536-2380</p> <p>Los Angeles Mission Viejo, CA Tel: 949-462-9523 Fax: 949-462-9608 Tel: 951-273-7800</p> <p>Raleigh, NC Tel: 919-844-7510</p> <p>New York, NY Tel: 631-435-6000</p> <p>San Jose, CA Tel: 408-735-9110 Tel: 408-436-4270</p> <p>Canada - Toronto Tel: 905-695-1980 Fax: 905-695-2078</p>	<p>Australia - Sydney Tel: 61-2-9868-6733</p> <p>China - Beijing Tel: 86-10-8569-7000</p> <p>China - Chengdu Tel: 86-28-8665-5511</p> <p>China - Chongqing Tel: 86-23-8980-9588</p> <p>China - Dongguan Tel: 86-769-8702-9880</p> <p>China - Guangzhou Tel: 86-20-8755-8029</p> <p>China - Hangzhou Tel: 86-571-8792-8115</p> <p>China - Hong Kong SAR Tel: 852-2943-5100</p> <p>China - Nanjing Tel: 86-25-8473-2460</p> <p>China - Qingdao Tel: 86-532-8502-7355</p> <p>China - Shanghai Tel: 86-21-3326-8000</p> <p>China - Shenyang Tel: 86-24-2334-2829</p> <p>China - Shenzhen Tel: 86-755-8864-2200</p> <p>China - Suzhou Tel: 86-186-6233-1526</p> <p>China - Wuhan Tel: 86-27-5980-5300</p> <p>China - Xian Tel: 86-29-8833-7252</p> <p>China - Xiamen Tel: 86-592-2388138</p> <p>China - Zhuhai Tel: 86-756-3210040</p>	<p>India - Bangalore Tel: 91-80-3090-4444</p> <p>India - New Delhi Tel: 91-11-4160-8631</p> <p>India - Pune Tel: 91-20-4121-0141</p> <p>Japan - Osaka Tel: 81-6-6152-7160</p> <p>Japan - Tokyo Tel: 81-3-6880-3770</p> <p>Korea - Daegu Tel: 82-53-744-4301</p> <p>Korea - Seoul Tel: 82-2-554-7200</p> <p>Malaysia - Kuala Lumpur Tel: 60-3-7651-7906</p> <p>Malaysia - Penang Tel: 60-4-227-8870</p> <p>Philippines - Manila Tel: 63-2-634-9065</p> <p>Singapore Tel: 65-6334-8870</p> <p>Taiwan - Hsin Chu Tel: 886-3-577-8366</p> <p>Taiwan - Kaohsiung Tel: 886-7-213-7830</p> <p>Taiwan - Taipei Tel: 886-2-2508-8600</p> <p>Thailand - Bangkok Tel: 66-2-694-1351</p> <p>Vietnam - Ho Chi Minh Tel: 84-28-5448-2100</p>	<p>Austria - Wels Tel: 43-7242-2244-39 Fax: 43-7242-2244-393</p> <p>Denmark - Copenhagen Tel: 45-4485-5910 Fax: 45-4485-2829</p> <p>Finland - Espoo Tel: 358-9-4520-820</p> <p>France - Paris Tel: 33-1-69-53-63-20 Fax: 33-1-69-30-90-79</p> <p>Germany - Garching Tel: 49-8931-9700</p> <p>Germany - Haan Tel: 49-2129-3766400</p> <p>Germany - Heilbronn Tel: 49-7131-72400</p> <p>Germany - Karlsruhe Tel: 49-721-625370</p> <p>Germany - Munich Tel: 49-89-627-144-0 Fax: 49-89-627-144-44</p> <p>Germany - Rosenheim Tel: 49-8031-354-560</p> <p>Israel - Ra'anana Tel: 972-9-744-7705</p> <p>Italy - Milan Tel: 39-0331-742611 Fax: 39-0331-466781</p> <p>Italy - Padova Tel: 39-049-7625286</p> <p>Netherlands - Drunen Tel: 31-416-690399 Fax: 31-416-690340</p> <p>Norway - Trondheim Tel: 47-72884388</p> <p>Poland - Warsaw Tel: 48-22-3325737</p> <p>Romania - Bucharest Tel: 40-21-407-87-50</p> <p>Spain - Madrid Tel: 34-91-708-08-90 Fax: 34-91-708-08-91</p> <p>Sweden - Gothenberg Tel: 46-31-704-60-40</p> <p>Sweden - Stockholm Tel: 46-8-5090-4654</p> <p>UK - Wokingham Tel: 44-118-921-5800 Fax: 44-118-921-5820</p>