

wireless world

SEPTEMBER 1982 80p

Australia A\$ 2.70
Canada C\$ 3.25
Denmark DKR. 33.25
Germany DM. 7.00
Greece DRA. 190.00
Holland DFL. 8.50
Italy L 3700
New Zealand NZ\$ 3.00
Norway NKR. 26.00
Singapore M\$ 5.50
Spain PTS 275.00
Switzerland FR. 7.00
U.S.A. \$ 3.75

Eprom emulator/programmer

C.b. selective call unit

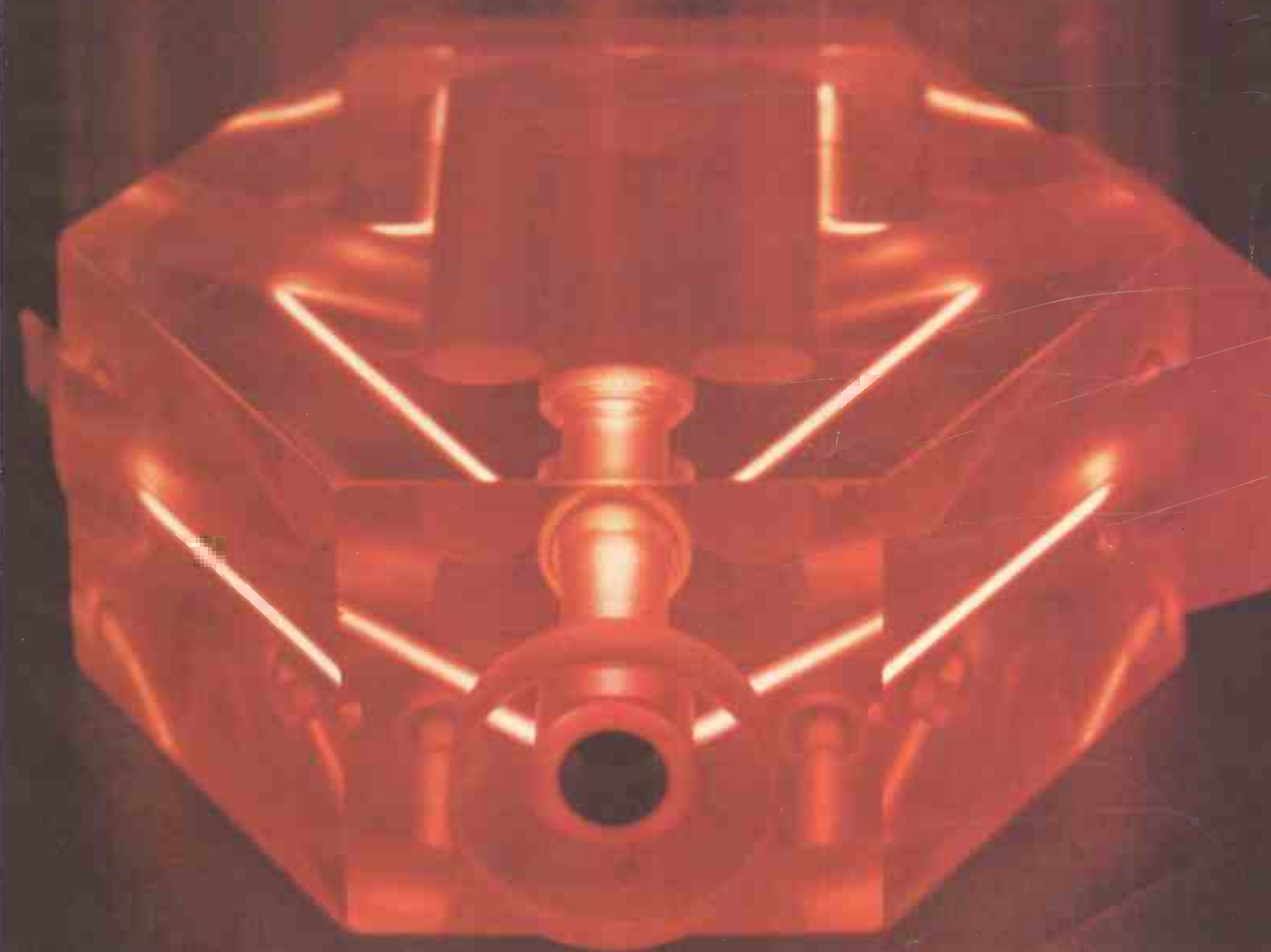

TRANSMITTER TEST SET, TTS520

Tests transmitters up to 100 watts rating

For testing base stations: mobile or fixed radios: pocket phones: pagers, etc

Instrument incorporates: r.f. counter • modulation meter • directional power meter • a.f. voltmeter • a.f. synthesizer • distortion analyser • a.f. counter • weighting filters • r.f. power load/attenuator

Transmitter measurements include: frequency • power • modulation (a.m. or f.m.) level, frequency, distortion, sensitivity, bandwidth, capability • call tone modulation check • aerial efficiency

Many measuring functions automatic—fewer controls, easier to understand and operate

Helps speed up test throughput

Reduces operator error and fatigue

Compatible with Farnell SS6520 synthesized signal generator to provide full transceiver testing facilities

Split concept (receiver/transmitter testing) offers distinct advantages over dedicated test set or discrete instruments

Programmable. Also IEEE488 option available for low cost computer controlled A.T.E.

Releases skilled engineers from routine tests. More time for repairs and other tasks

Pre-service diagnostic tool. Use printer to record condition of radio as received and to verify performance to specification after repair or recalibration

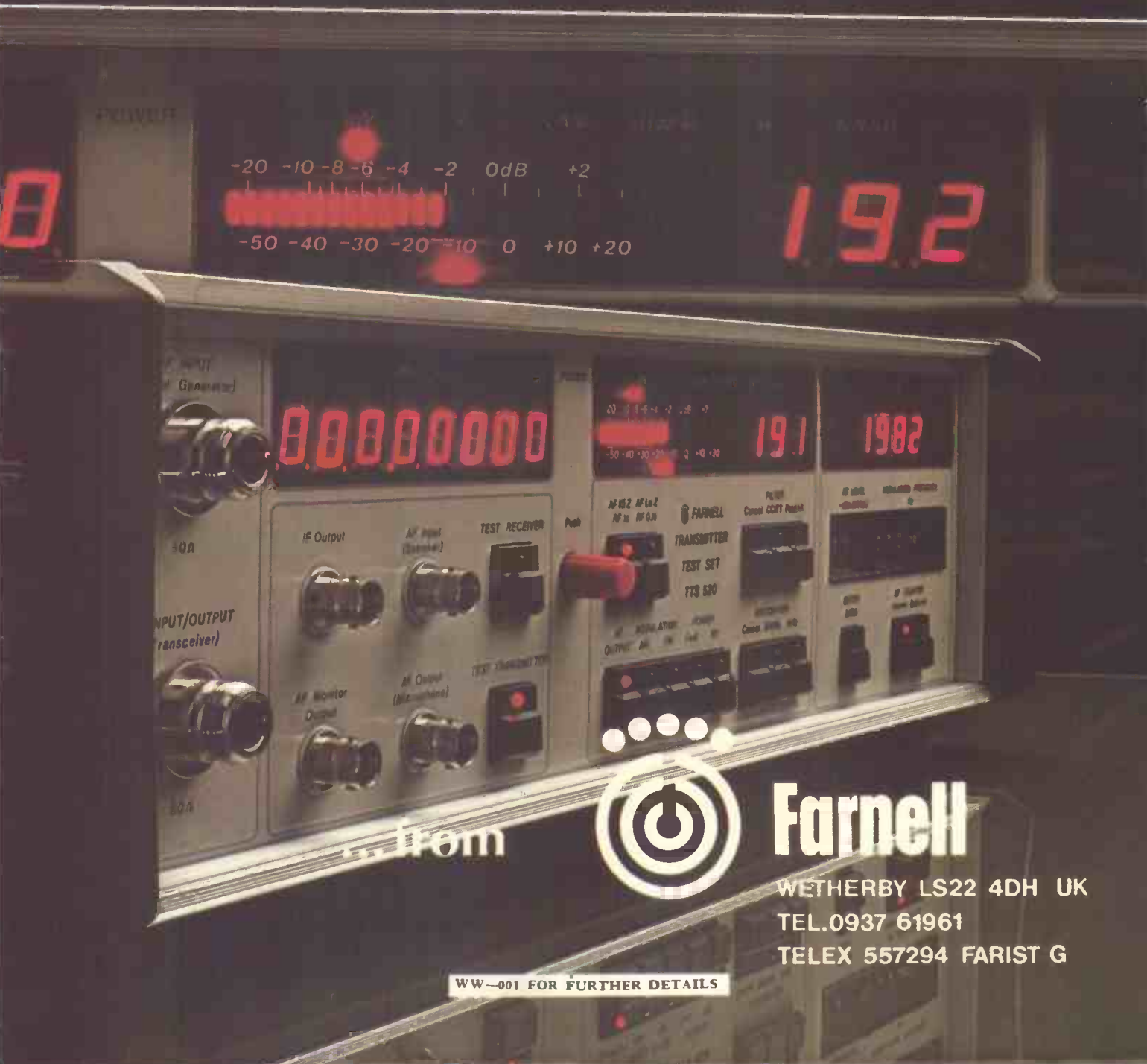

... from



Farnell

WETHERBY LS22 4DH UK
TEL.0937 61961
TELEX 557294 FARIST G

WW-001 FOR FURTHER DETAILS

wireless world

Eprom emulator/programmer
C. b. selective call unit



Front cover is a laser gyro, used in strap-down inertial navigation systems. Picture supplied by SFENA, Villacoublay, France.

NEXT MONTH

Modular preamplifier. The first of three articles in which John Linsley Hood describes his new preamplifier, which is modular in form and which features several novel ideas.

Electronic compass. Design by Neil Pollock for all-solid-state compass for small boats, using a flux-gate sensor. A microprocessor will process the sensor output or a hard-wired system, which is described, can be used.

Low-frequency oscillator. A sine-square oscillator, with tone-burst switching, which covers the 10Hz-250KHz frequency range.

Current issue price 80p, back issues (if available) £1, at Retail and Trade Counter, Units 1 & 2, Bankside Industrial Centre, Hopton Street, London SE1. Available on microfilm; please contact editor.

By post, current issue £1.23, back issues (if available) £1.80, order and payments to EEP General Sales Dept., Quadrant House, The Quadrant, Sutton, Surrey SM2 5AS.

Editorial & Advertising offices: Quadrant House, The Quadrant, Sutton, Surrey SM2 5AS.

Telephones: Editorial 01-661 3500. Advertising 01-661 3130.

Telegrams/Telex: 892084 BISPRS G.

Subscription rates: 1 year £14 UK and £17 outside UK.

Student rates: 1 year £9.35 UK and £11.70 outside UK.

Distribution: Quadrant House, The Quadrant, Sutton, Surrey SM2 5AS. Telephone 01-661 3500.

Subscriptions: Oakfield House, Perry-mount Road, Haywards Heath, Sussex RH16 3DH. Telephone: 0444 59188. Please notify a change of address.

USA: \$39 surface mail, \$98.30 airmail. US subscriptions from IPC B.P., Subscriptions Office, 205 E.42nd Street, NY 10017.

USA mailing agents: Expeditors of the Printed Word Ltd, 527 Madison Avenue, Suite 1217, New York, NY 10022. 2nd class postage paid at New York.

© IPC Business Press Ltd. 1982 ISSN 0043 6062.

ELECTRONICS
BROADCASTING
AUDIO

wireless world

COMMUNICATIONS
COMPUTING
VIDEO

Vol 88 No 1560

SEPTEMBER 1982

- 31 I.T. and M.I.S.S.**
- 32 DIGITAL FREQUENCY STABILIZATION OF A V.F.O.**
by W. Trapman
- 38 CLASS 'S'**
by A. Sandman
- 40 LETTERS**
- 45 DIGITAL PHASE CONTROL OF THYRISTORS**
by B. H. Pardoe
- 46 DIFFERENTIAL DIRECT CONVERSION**
by P. E. Gill
- 49 SIMPLE LOW-FREQUENCY OSCILLOSCOPE**
by R. Taylor
- 51 SELECTIVE CALLING UNIT**
by B. Drury
- 57 NEWS**
- 61 TRANSMITTING AERIALS**
by J. Wiseman
- 64 CES Chicago**
by G. Tillett
- 67 COMMUNICATIONS**
- 69 CIRCUIT IDEAS**
- 71 NETWORK ANALYSIS BY ZX81**
by L. E. Weaver
- 73 DISC DRIVES**
by J. R. Watkinson
- 77 DIGITAL FILTERS FOR SOUND REPRODUCTION**
by Y. Hirata
- 80 RCA 3140 AND TI TL071**
by J. L. Linsley Hood
- 83 EPROM EMULATOR**
BY P. Nicolis
- 88 NEW PRODUCTS**
- 90 RANDOM ECHOES**

The simple answer to all your power supply problems.



As supplied to International Telecommunications Companies
Uninterruptible Power Supplies - UPS CVT Reliability
 125va to 50kva, 50 or 60hz.

■ **STANDBY POWER.** Invaluable for winding down a computer programme on mains failure and wherever continuous power is essential.

■ **STABILISATION.** $\pm 5\%$ Vital to combat mains voltage fluctuations and ensure the operation of equipment at peak efficiency. Frequency stabilised $\pm 0.1\%$ 47 to 65Hz.

■ **TRANSIENT ATTENUATION.** Provides suppression of mains born interference (spikes).

An unbeatable power package at a price to suit all budgets from Galatrek International, UPS are DOWN to unbeatable prices.

For more information, cut the coupon.
 Galatrek International, FREEPOST, Scotland Street, Llanrwst, nr. Llandudno, Gwynedd LL26 0AL, BRITAIN, Tel No: 0492-640311/641298, Telex: 617114 A/B Galahu. Made and Designed in Britain by Galatrek.



Please send me full details of your range of voltage stabilisers, filters, cutouts, generators and CVT's

Please send me full details of UPS

Please send me a requirement check sheet

Consultation with Galatrek Engineer

Name

Position

Company

Address

Tel No Telex

Trade OEM (please tick where appropriate) ww 2/9

WW - 072 FOR FURTHER DETAILS

pantechnic

THE POWERFET SPECIALISTS

POWERFET AMPLIFIER MODULES

The people at Pantechnic have been designing with powerfets since they first became commercially available. Their experience of powerfet amplifiers, coupled with their insight into the sources of non-linearity often neglected by others, has resulted in a new range of powerfet amplifiers that are fast, tough, linear and cheap.

MODEL	POWER RANGE (Continuous RMS)	TYPICAL LOADS	NOTES
PFA 100	50W-150W	4 Ω , 8 Ω	Physically small 30mm x 79mm x 108mm
PFA 200	100W-300W	4 Ω , 8 Ω	High Watts per Ω ratio
PFA 500	250W-600W	2 Ω , 4 Ω , 8 Ω	25A continuous output current
PFA HV	200W-300W	4 Ω , 8 Ω , 16 Ω	5dB dynamic headroom Drives 70V line direct

Key features:

- **RELIABLE** - Powerfet freedom from thermal runaway and secondary breakdown
- **LINEAR** - TID zero, IM/THD < 0.01% full power, (mid band THD down to 0.0015%)
- **FAST** - Slew rate > 30V/ μ S, (45V/ μ S typical)
- **QUIET** - Signal to noise ratio 120dB
- **BRIDGEABLE** - (100, 200, 500 without extra circuitry)
- **STABLE** - Unconditionally
- **LOW COST** - 10watts to 20watts per Ω , depending on model and quantity

As they stand these modules suit most P.A. and industrial applications and satisfy all foreseeable audiophile requirements. (The HV is aimed at digital audio.) Where aspects of performance fail to meet specific requirements (e.g. in speed or power) low cost customising is often a possibility. Alternatively entirely new boards can be produced.

Pantechnic make more than just PFAs. Loudspeaker protection boards and the quietest, lowest distortion preamp boards currently available are just two of an ever-expanding range.

Pantechnic sell high quality power supply and other components at excellent prices.

CHECK US OUT

Price and Delivery
PANTECHNIC (Dept WW7)
 17a WOOLTON STREET
 LIVERPOOL L25 5NH
 Tel. 051-428 8485

Technical Enquiries
 contact
 Phil Rimmer
 on
 01-800 6667

WW - 039 FOR FURTHER DETAILS

ERASERS FOR THE DEVELOPMENT LAB



UVIT

Powerful, compact unit to erase up to six EPROMs quickly and safely. 10-60-minute electronic timer.

£59.13 + V.A.T.

UVIB

As above but without timer.

£46.95 + V.A.T.

Carriage paid (U.K.)

Send cheque or official order for prompt delivery.

Also available in London from:
 Technomatic Ltd
 Henrys Radio
 Ambit International

IN USE IN DESIGN
 LABS & EDUCATIONAL
 ESTABLISHMENTS
 AROUND THE WORLD

NORTHERN ELECTRONICS

51 Arundel Street, Mossley, Lancashire Tel: Mossley (04575) 4119

WW - 040 FOR FURTHER DETAILS

RADIATION DETECTORS

BE PREPARED

VIEW THRU LENS

- Ideal for the experimenter
- THIS DOSIMETER WILL AUTOMATICALLY DETECT GAMMA AND X-RAYS
- UNIT IS SIZE OF FOUNTAIN PEN & CLIPS ONTO TOP POCKET
- PRECISION INSTRUMENT
- MANUFACTURERS CURRENT PRICE OF A SIMILAR MODEL OVER £25 EACH
- 0-5 R

British design & manufacture
 Tested and fully guaranteed. Ex-stock delivery.
 As supplied to Fire Services/Civil Defence

HENRY'S

Official Orders welcome

01-723 1008/9

CALLERS: 404 EDGWARE ROAD, LONDON W2 1ED
 Mail Orders/Export Enquiries to: 11-12 Paddington Green, London W2

FREE RECHARGE SERVICE AFTER PURCHASE

£6.95

Add. VAT, Post & Packing

COMPLETE WITH DATA



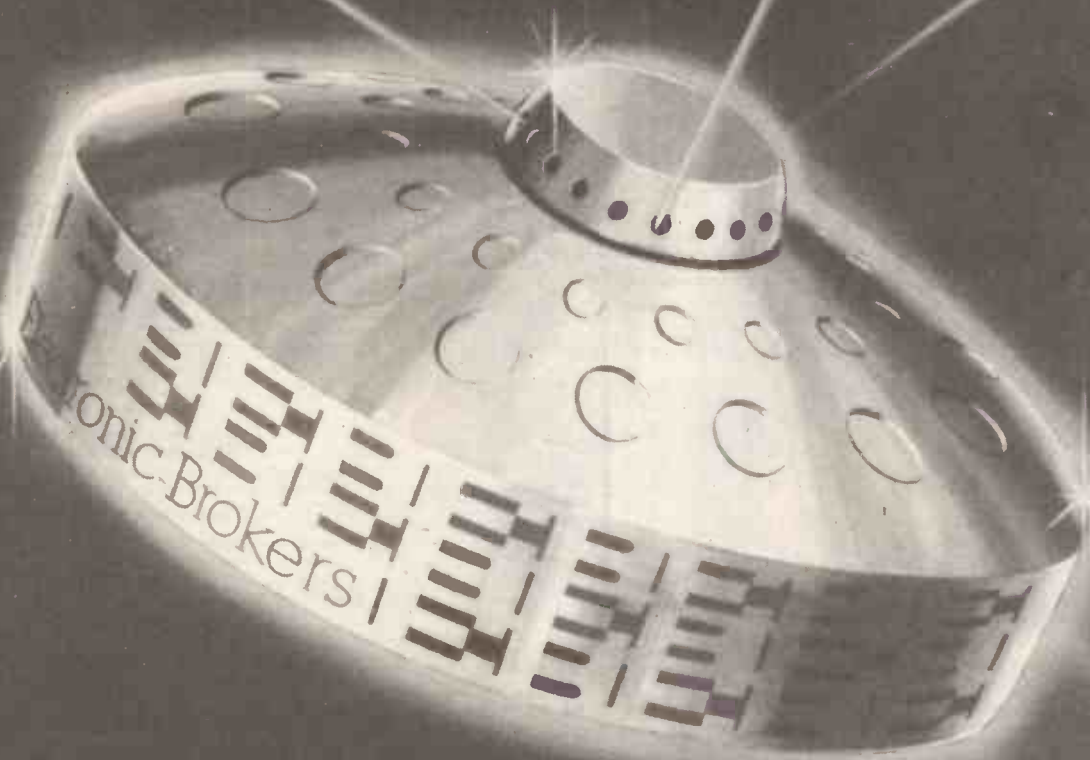

THE SOURCE OF ALL HIGH QUALITY USED TEST EQUIPMENT



Electronic Broker's new catalogue of current Used Test Equipment is hot off the press.
Send for your FREE copy now!

Name

Company

Address

Position

Department Tel No

Post To: Electronic Brokers Ltd., 61/65 Kings Cross Road, London WC1X 9LN. Tel: 01-278 3461. Telex 298694



WW-200
FOR FURTHER DETAILS

TED RULE

LINSLEY-HOOD AMPLIFIERS



J. L. Linsley-Hood Amplifier designs have always led the field. The latest and greatest is the new 100 watt MosFet power amplifier recently described in this magazine. We are of course preparing kits for this and the matching separate Pre-amplifier to be described later. Our present range is the "300 Series" consisting of a 30 watt Darlington output version and a 35 and 45 watt variant with MosFet output. A matching FM tuner will be available shortly.

30 watt Amplifier Kit.....£72.00
35 watt MosFet Kit.....£87.40
45 watt MosFet Kit.....£94.80

'P. W. WINTON' TUNER & AMP.



Snaazy matching slimline tuner and amplifier in beautiful wooden cabinets. These Ted Rule designs are for the enthusiast. Tuner covers LW, MW, SW, FM and TV sound! Digital frequency readout with clock and timer features. FM has 6 section front end and switchable bandwidth for exceptional fringe area performance. Amplifier has Toroidal transformer, Mosfet output stages, 50 watts per channel and got a cracking review from Gordon King.

Tuner, Complete Kit.....£163.00
Amplifier, Complete Kit.....£109.90

LINSLEY-HOOD CASS. REC.



We have done two kits to this design, one using the original car cassette mechanism and the newer version using a very high quality front loading deck. This new deck has an excellent W & F performance and fitted with our latest Sensus Alloy Super Head gives an incredible frequency range (with good tape you can see 23kHz on ours!).

Linsley-Hood Cassette Recorder 1.....£75.00
Linsley-Hood Cassette Recorder 2.....£94.90
Reprints of "WW" Articles.....70p. No VAT



Telephone: Oswestry (0691) 2894

Personal callers are always very welcome but please note that we are closed all day Saturday

LINSLEY-HOOD PEAK DRIVE INDICATOR



A very useful device, connected to loudspeakers giving a 4 light readouts of peak power delivered for the protection of both the loudspeaker and the perceived quality of sound. Gives instant indication even for peaks of only five microseconds' duration. Unit uses CMOS technology, is self-contained and battery powered. Complete Kit except batteries. Only £17.40 plus VAT. Reprint of Article 25p. No VAT. Post free.

VERTICAL FRONT LOADING CASSETTE DECK VFL910



This deck is used in our Linsley-Hood Cassette Recorder 2 and has every possible feature to ensure top notch performance. Recently featured in this magazine in a "Digital Multi-Track Tape Recorder" by A. J. Ewins.

12v DC Servo Feedback Motor.
VFL910 Deck. Fitted with HS16 Sensus Alloy Super Head £31.99

FEED YOUR MICRO BYTES WITH OUR SOLENOID CONTROLLED CASSETTE DECK



Front loading deck with full solenoid control of all functions including optional read in fast wind modes. 12 volt operation. Fitted 3-digit memory counter and Hall IC Motion Sensor. Standard erase and stereo R/P Heads. Cheapest price ever for all these features. Only £38.90 plus VAT. Full technical specification included.

HIGH QUALITY REPLACEMENT CASSETTE HEADS



Do your tapes lack treble? A worn head could be the problem. Fitting one of our replacement heads could restore performance to better than new! Standard mountings make fitting easy and our TC1 Test Cassette helps you set the azimuth spot-on. We are the actual importers which means you get the benefit of lower prices for prime parts. Compare us with other suppliers and see! The following is a list of our most popular heads, all are suitable for use on Dolby machines and are ex-stock.

HC20 Permalloy Stereo Head. This is the standard head fitted as original equipment on most decks.....£4.25
HM90 High Beta Permalloy Head. A hard-wearing, higher performance head with metal capability.....£8.20
HS16 Sensus Alloy Super Head. The best head we can find. Longer life than Permalloy, higher output than Ferrite, fantastic frequency response.....£8.20
HG551 4-Track Head for auto-reverse or quadrophonic use. Full specification record and playback head.....£7.40
Please consult our list for technical data on these and other Special Purpose Heads.

SPECIAL OFFER

Replacement heads for SONY machines.
First Quality Stereo head with special base to fit Sony decks
These are only available while stocks last, so buy now to keep in. Only £5.95
Trade price available on 10 or more.

HART TRIPLE-PURPOSE TEST CASSETTE TC1

One inexpensive test cassette enables you to set up VU level, head azimuth and tape speed. Invaluable when fitting new heads. Only £3.80 plus VAT and 50p postage.

Tape Head De-magnetiser. Handy cassette size mains operated unit prevents build up of residual head magnetisation causing noise on playback.....£8.88

Full details of the entire range of HART products is contained in our illustrated lists.

Ask for your FREE copy NOW.
Enquiries for lists are also welcome from overseas but please let us have three IRCs to cover the cost of surface post or 5 IRCs for airmail.

In a hurry? A telephone order with credit card number placed before 3 p.m. will be despatched THAT DAY!

Please add part cost of post, packing and insurance as follows:

INLAND
Orders up to £10 - 50p
Orders £10 to £49 - £1
Orders over £50 - £1.50

OVERSEAS
Postage at cost plus £2 documentation and handling

ALL PRICES PLUS VAT

TED RULE

HART ELECTRONIC KITS. LTD.
OSWESTRY, SHROPSHIRE

TV TUBE REBUILDING

Faircrest Engineering Ltd. manufacture a comprehensive range of equipment for processing all types of picture tubes, colour and mono. Standard or custom built units for established or new businesses. We export world-wide and have an excellent spares service backed by a strong technical team.

Full training courses are individually tailored to customers requirements.

For full details of our service contact Neil Jupp

FAIRCREST ENGINEERING LTD.

4 Union Road, Croydon, CR0 2XX
01-684 1422/01-684 0246

WW - 050 FOR FURTHER DETAILS

P.&R. COMPUTER SHOP

IBM GOLFBALL PRINTER 3982, £70 EACH + VAT

NEW CENTRONIC 779 PRINTERS, £325 + VAT
NEW CENTRONIC 781 PRINTERS, £350 + VAT
LA DECK WRITERS MODS. 35, 36 & 180, FROM £325 + VAT. ALL NEW
NEW CIFA VDUs. 1 ONLY £300 + VAT
POWER UNITS 5 VOLT 6 AMP, £20 EACH
FANS, PCBs, KEYBOARDS AND LOTS OF ODDS & ENDS

COME AND LOOK AROUND

SALCOTT MILL, GOLDHANGER ROAD
HEYBRIDGE, ESSEX.
PHONE MALDON (0621) 57440

WW - 36 FOR FURTHER DETAILS

METER PROBLEMS?

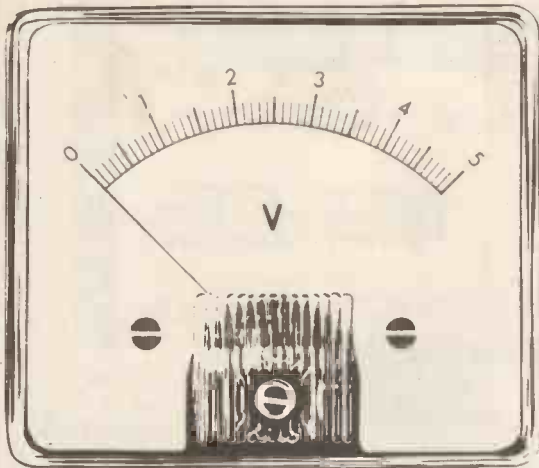

137 Standard Ranges in a variety of sizes and stylings available for 10-14 days delivery. Other Ranges and special scales can be made to order.

Full Information from:

HARRIS ELECTRONICS (London)

138 GRAY'S INN ROAD, W.C.1

Phone: 01-837/7937
Telex: 892301

RADIOCODE CLOCKS

are powerful and comprehensive instruments which receive, decode and analyse time-coded standard frequency transmissions to provide accurate, secure and completely automatic time/calendar or synchronisation systems.



Applications

- Automatic master clock and slave controller.
- Synchronisation of separate equipment and events.
- Programmable energy management system.
- Computer clock/calendar with battery backup.
- Data logging and time recording.
- Process and equipment control.
- Broadcasting, Astronomy, Navigation.
- Satellite tracking.

If you have a time or synchronisation problem, write or phone for further details of our portable and new microcomputer-controlled Radiocode Clocks.

Circuit Services, 6 Elmbridge Drive
Ruislip, Middlesex. Ruislip 76962

WW - 026 FOR FURTHER DETAILS

WIRELESS WORLD SEPTEMBER 1982

New Fluke 4½ Digit Hand-held D.M.M.s

Now in Stock

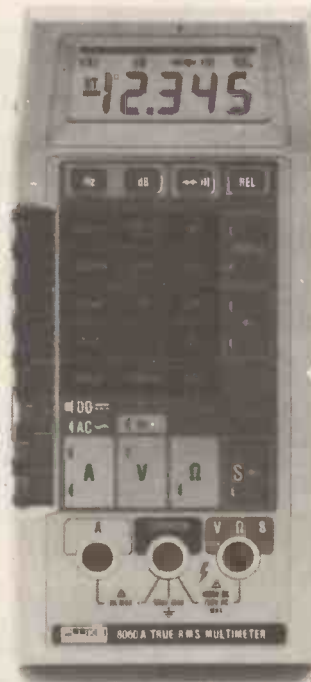

Basic dc accuracy 0.04%; 10 μ V, 10 nA and 10 m Ω sensitivity.
Display annunciators for low battery (BT) and special functions: frequency (kHz), dB, continuity (\rightarrow), and relative reference (REL).
Autoranging M Ω measurements from 2 M Ω to 300 M Ω .
Conductance functions for resistance measurements to 10,000 M Ω .
Separate constant-current source diode-test function for checking semiconductor junctions.
Full range capability for voltage, current, resistance (200 μ A, 200 mV and 200 Ω ranges).
Wideband True RMS AC measurements to 100 kHz.
Overload protection to 750 VAC or 1000 VDC on voltage inputs and 500 V on resistance. Protection on current inputs provided by a 2A/250V fuse in line with a heavy-duty 3A/600V fuse.
Sophisticated self-diagnostics provided for all range and function selections plus LCD display, battery and CMOS circuitry.
Fluke's 8062A makes many of the same measurements as the 8060A, at a lower price.
Continuity and relative reference functions identical to 8060A.
True RMS measurements to 30 kHz.
Basic dc accuracy 0.05%; 10 μ V, 10 nA and 10 m Ω sensitivity.

Fluke 8060A £275.00
Fluke 8062A £210.00

Fluke 8022B. With 2 year warranty	£85.00
Fluke 8021B. With 2 year warranty	£95.00
Fluke 8020B. With 2 year warranty	£125.00
Fluke 8024B. With 2 year warranty	£155.00
Fluke 8050A	Mains Model £255.00 Mains Battery £285.00
Fluke 8012A	Mains Model £229.00 Mains Battery £257.00
Fluke 8010A	Mains Model £175.00 Mains Battery £203.00

ACCESSORIES

A81-230 Battery eliminator	£14.00
C90 Carry case for hand held	£10.00
801-600 Amp clamp	£68.00
80J-10 Current shunt 10A	£22.00
80K-40 H.V. probe 40kV	£56.00
80K-6 H.V. probe 6kV	£40.00
80T-150 Temperature probe	£72.00
80T-H Touch hold probe	£36.00
83RF R.F. probe 100MHz	£40.00
85RF R.F. probe 500MHz	£69.00
Y8102 Thermocouple probe	£41.00
Y8103 Bead thermocouple	£18.00
Y8104 K type thermocouple termination	£8.00
Y8133 Deluxe test leads	£14.00

Full Specs. on Request.

The above prices do not include carriage or VAT (15%).

**EXPRESS
DELIVERY
SERVICE**

Simply Phone or
Telex your order for
Immediate dispatch.

Electronic Brokers Ltd
61/65 Kings Cross Road
London WC1X 9LN
Telephone: 01-278 3461
Telex: 298694 Elebro G

WW - 201 FOR FURTHER DETAILS

Electronic Brokers

PORTABLE MAINS DISTRIBUTION NOW WITH EARTH LEAKAGE

OLSON

**FOR INSTANT MAINS DISTRIBUTION IN
OFFICES, LABORATORIES, WORKSHOPS
AND FOR MAXIMUM SAFETY**



BEL 5SW
£61, £2.25 P&P + VAT



PEL 1
£44.50, £1.50 P&P + VAT



N13A/6
£23.40, £1.50 P&P + VAT



13A/4SW
£22.40, £1.50 P&P + VAT



13A/5/R £25.30, £1.50 P&P + VAT

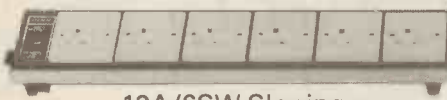

13A/6SW Sloping
£26, £1.50 P&P + VAT



PEL 3
£65, £2.25 P&P + VAT



WEL 2
£52.80, £2.25 P&P + VAT



TR9 £38.75, £2.50 P&P + VAT



T13A/5
£21.75
£1.50 P&P + VAT

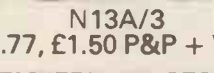

N13A/3
£16.77, £1.50 P&P + VAT

DELIVERY EX-STOCK

OLSON Electronics Ltd. FACTORY NO. 8, 5-7 LONG STREET
LONDON E2 8HJ Tel: 01-739 2343



WW - 067 FOR FURTHER DETAILS

*Keep those
Contacts CLEAN*

BY USING A

DIACROM SPATULA

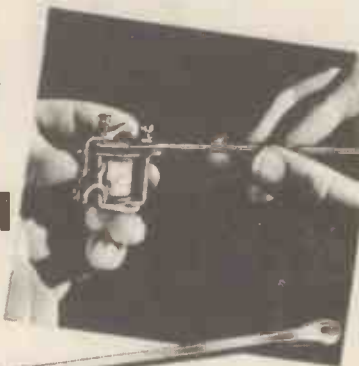

*Manufactured in France
British Patents applied for*

No other cleaner has all these advantages:—

1. Only 100% pure, natural diamond grains are utilised.
 2. Blades are treated with hard chrome to reinforce the setting of the diamond grains, to obviate loosening or breakaway during use. This process also prevents clogging of the diamond surface by residues resulting from use.
 3. All diamond blades are rectified to ensure an absolutely smooth surface by eliminating diamond grains which may rise above the surface. This eliminates all excessive scratching during use.
 4. All diamond grains are rigidly calibrated to ensure a perfectly uniform grain size of either 200, 300 or 400.
 5. The chrome gives a very weak co-efficient of friction and the rigidity of the nylon handle is calculated to permit proper utilisation and yet pliant enough to avoid undue pressures on highly delicate relays.
- Grain size 200, thickness 55/100 mm., both faces diamonded. For quick cleaning of industrial relays and switching equipment, etc.
 - Grain size 300, thickness 55/100mm., both faces diamonded. For smaller equipments, like telephone relays, computer relays, etc.
 - Grain size 400, thickness 25/100 mm., one face diamonded. For sensitive relays and tiny contacts. Two close contacts facing each other can be individually cleaned, because only one face of the spatula is abrasive.

**Sole Distributors for the United Kingdom
SPECIAL PRODUCTS (DISTRIBUTORS) LTD**

81 Piccadilly, London W1V 0HL. Phone: 01-629 9556

As supplied to the M.O.D., U.K.A.E.A., C.E.G.B. British Rail and other Public Authorities; also major industrial and electronic users throughout the United Kingdom.

WW - 066 FOR FURTHER DETAILS

EV88 - A low-cost evaluation system for the 8088 microprocessor

EV88 is a single board microcomputer that is ideal for evaluating the 8088 8-bit/16-bit microprocessor. EV88 can also be used as a powerful controller, and, with a suitable cross-assembler running on a standard microcomputer, and an EPROM programmer, for low-cost development of 8088-based systems.

EV88 is supplied fully assembled and tested, with comprehensive documentation, and a copy of The 8086 Book, by Rector and Alexy. All you need is a 5V 1A power supply and a terminal or a suitable microcomputer.

- ★ 8088 microprocessor in minimum mode (software compatible with the 8086 16-bit microprocessor).
- ★ Comprehensive monitor in 2K EPROM.
- ★ 2K CMOS RAM.
- ★ Cassette interface.
- ★ 24 lines of I/O.
- ★ Eight levels of interrupt.
- ★ RS-232 compatible serial interface (300 baud to 9600 baud).
- ★ Three-channel counter/timer.
- ★ Buffered data, address and control lines.
- ★ Double Eurocard.
- ★ On-board expansion to 16K EPROM/RAM (sockets provided).
- ★ Breadboarding area.
- ★ All bus signals available on 64-way DIN 41612 connector.
- ★ Single 5V supply.
- ★ Price £300 plus VAT. Includes delivery.

8088/8086 design service available (software and hardware).

LFH Associates Ltd.
40A High Street
Stony Stratford
Milton Keynes
(0908) 564271

WW-065 FOR FURTHER DETAILS

The lightweight mast with 101 applications

25
years in this
specialist field



The smoothly operated QTM Mast comes fitted with handpump or can be vehicle mounted with 'Power Pack' for extension and retraction. Available in a range of heights up to 15 metres, the QTM mast can provide the ideal answer for:

- Mobile Radio Telephone
- Police Mobile HQ (UHF)
- Field Telecommunications
- Floodlighting
- Anemometer and Wind Measurement
- Environmental - gas sampling collector
- High level photography
- Meteorology
- And a host of other uses

CLARK MASTS

Find out more about the QTM series by writing or phoning:-

U.K.
CLARK MASTS LTD. (W.W.),
Evergreen House, Ringwood Road,
Binstead, Isle of Wight,
England PO33 3PA
Tel: Isle of Wight (0983) 63691
Telex: 86686

EUROPE
GENK TECHNICAL PRODUCTS N.V. (W.W.)
Woudstraat 21, 3600 Genk,
Belgium.
Telefoon 011-380831
Telex 39354 Genant B.

WW - 021 FOR FURTHER DETAILS

We supply HAMEG for Industry



HM 307 OSCILLOSCOPE

Single trace. DC to 10MHz. Risetime 35nS. 5mV/cm to 20V/cm. Timebase 0.5μS-0.2S. Built in component tester. LPS technique provides stable and reliable triggering up to 30MHz **£138.00**



HM 203 PORTABLE OSCILLOSCOPE

Dual Trace. DC to 20MHz. 8 x 10cm display. Risetime 17.5nS. Sensitivity 5mV/cm-20V/cm. Timebase 0.5μS-0.2S. x 5 magnifier. X-Y operation. Auto or variable trigger. Channel 1, Channel 2, line and external. Coupling AC, or TV low pass filter. Weighs only 6Kg. Size [m.m.] H. 145, W. 285, D. 380 **£220.00**



HM412-5

Dual Trace. DC to 20MHz 8 x 10cm display with internal graticule. Rise time 17.5nS. Variable input 2mV-20V/cm. Add and invert modes. Timebase 0.5μS-0.2S with sweep delay 100nS-1S x 5 expansion. X-Y operation Z modulation. Trigger CH1, CH2, CH1/2, Line or EXT. **£350.00**



HM705

Dual Trace DC-70MHz 8 x 10cm display with internal graticule. Risetime 5nS. Variable input 2mV-20V. Add and invert modes. 95nS Signal Delay Line. Timebase 50nS-1S/cm with Sweep delay 100nS-1S x 10 expansion. XY operation. Z modulation. Trigger CH1, CH2, CH1/2 line or EXT. **£580.00**

The above prices do not include carriage or VAT (15%).

Simple Phone or Telex your order for immediate dispatch.

Electronic Brokers Ltd
61/65 Kings Cross Road
London WC1X 9LN
Telephone: 01-278 3461
Telex: 298694 Elebro G

WW - 202 FOR FURTHER DETAILS



Electronic Brokers

STOP WASTING TIME TESTING BOARDS

MD will pin-point microtroubles in seconds. Portable and simple to use by non-technical staff in the REPAIR SHOP or on the PRODUCTION LINE. MD tests ROM, RAM & I/O and prints diagnostic reports. MICRODOCTOR can be plugged into an unknown system to perform a general diagnostic and print a MEMORY-MAP. The ENGINEER may enter sequences of CHECKSUMS and RAMTESTS, READS and WRITES to specific MEMORY and I/O locations. SHORTING tests on DATA and ADDRESS LINES. PRINT-OUTS of memory in ASCII or HEX. These sequences are retained in CONTINUOUS MEMORY, available always at the push of a key.

★ **FREE Z80 DISASSEMBLER** with each MD (other disassemblers soon to retrofit at low cost). Get a **DISASSEMBLER LISTING** of ROM in any microsystem! **MICRODOCTOR — £295.00**

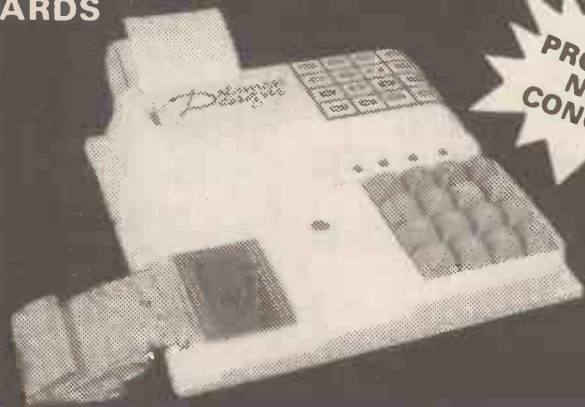

**NEW
PRODUCT
NEW
CONCEPT**

INTELLIGENT EPROM PROGRAMMER

Good tools need not be expensive. **SOFTY 2** is the latest version of the engineer's favourite **EPROM HANDLER** for anybody who uses 2516, 2716, 2532 and 2732 EPROMS.

SOFTY will program any of these EPROMS or copy any type into another.

SOFTY puts out a TV picture of memory contents, with many code-manipulating and editing facilities.

There is also a fast cassette data storage system. **SOFTY** is also a **ROMULATOR** (a lead is supplied which may be inserted into a board under development to emulate the ROM using **SOFTY's** internal RAM. This procedure can also be used on the single-chip piggy-back type MPU.) **SOFTY** is complete in itself as a **PRODUCT DEVELOPMENT SYSTEM**.

Code may be entered in **HEXADECIMAL** via the keyboard also **SERIAL** and **PARALLEL** inputs and outputs allow downloading of object code from your computer or printing **EPROM** contents on your printer.

SOFTY 2 — £169.00 **TEX UV EPROM ERASER — £39**



Z80 DEVELOPMENT SYSTEM

MENTA puts out a TV PICTURE of memory in hexadecimal. The 40 key keyboard will accept inputs, both in hexadecimal and Z80 mnemonics; there is a quick cassette data storage system, a powerful editor which permits program debugging by showing contents of registers and stack. Also there are 24 bits of I/O for external control. A Z80 disassembler is also available which outputs to any RS232 device such as a printer or terminal.

MENTA was designed as a low-budget device for teaching microprocessing in schools; professional course-material is available to teachers together with add-on boards for a variety of control functions and robotic applications.

MENTA — £115.00 **SERIAL DISASSEMBLER — £19.50**



Manufactured by Dataman Designs, sold by dealers in UK, USA, France, etc. TRADE ENQUIRIES INVITED — TELEX 418442 DATAMAN

NEC PC 8000 PERSONAL COMPUTER.



The brand-leader in Japan; gaining ground rapidly in America; this beautifully made, reliable system has all the features you could want at the right price. See it! Try it!

- 8001 Keyboard Unit (24K BASIC, 32K RAM, colour graphics, function keys etc.) **£599**
 - 8011 Expansion Unit (32K RAM, RS232, IEEE-488, CLOCK, 34 pin I/O etc.) **£489**
 - 8023 Dot Matrix Printer (100 CPS, up to 136 columns, proportional spacing, greek and math) **£399**
 - 8031 Dual Disk Drive **£669** 8043 Colour Monitor **£579**
- All CPM software is available

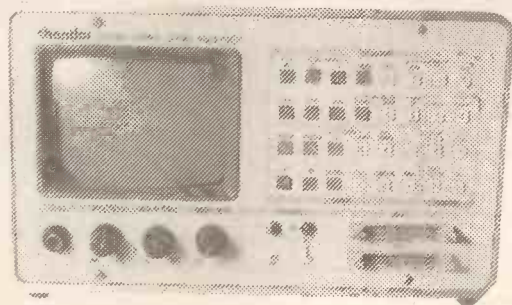

THANDAR TA2080 — £1950

20MHZ LOGIC ANALYSER

A value-for-money instrument with both **TIMING** and **STATE** capture and display and excellent triggering from 23 bits.

We are designing RS232 and IEEE interfaces, Z80 and 8048 disassemblers for our own use, which will be available when tried and approved by Thandar.

PLEASE PHONE FOR PRICES

LOMBARD HOUSE, CORNWALL ROAD, DORCHESTER, DT1 1RX

Telephone: Dorchester (0305) 68066

Prepaid or credit card orders normally shipped by return. Prices include first-class recorded post in UK. Securicor, Red Star, etc. at extra cost. VAT should be added at current rates.

*Dataman
Designs*



Bigger and Better for 1982
the colourful Wilmslow Audio brochure
— the definitive loudspeaker catalogue!

Everything for the speaker constructor — kits, drive units, components for HiFi and PA.

50 DIY HiFi speaker designs including the exciting new dB Total Concept speaker kits, the Kef Constructor range, Wharfedale Speakercraft, etc.

Flatpack cabinet kits for Kef, Wharfedale and many others.

- ★ Lowest prices — Largest stocks ★
- ★ Expert staff — Sound advice ★
- ★ Choose your DIY HiFi Speakers in the comfort of our ★
two listening lounges
(Customer operated demonstration facilities)
- ★ Ample parking ★

Send £1.50 for catalogue
(cheque, M.O. or stamps — or phone with your credit card number)

★ Access — Visa — American Express accepted ★
also HiFi Markets Budget Card.



0625 529599

35/39 Church Street, Wilmslow, Cheshire SK9 1AS



Lightning service on telephoned credit card orders!



WW — 032 FOR FURTHER DETAILS

Quartz Oscillators



DIL compatible configurations
CMOS and TTL outputs
Wide temperature ranges
Frequencies one pulse per day to 60 MHz
Many standard frequencies from stock

More details of specifications from

IQD

Interface
Quartz
Devices
Limited

29 Market Street
Crewkerne
Somerset TA18 7JU
Crewkerne (0460) 74433
Telex 46283 inface g

Electronic Brokers

DEC SALE

a selection from our huge stocks

All items reconditioned unless otherwise stated

DISK DRIVES		PDP8A	
RK05J2.5 meg	£975	PDP8A-205 Processor 10 1/2"	£1,750
RK05F5 meg fixed	£1,250	32KW MOS (NEW)	£1,750
RK11D RK05 and Ctl	£1,870	PDP8A-400 Processor, 8KW	£1,500
RK06 14 meg (NEW)	£2,200	Core, KM8AA, DKC8AA	£275
RK611 RK06 and Ctl (NEW)	£3,950	KC8AA Programmers Console	£275
RK07 28 meg	£3,500	KM8AA Option Module	£275
RK711 RK07 and Ctl	£5,250	MM8A8KW Core Memory	£500
RL01 5 meg	£995	MM8A8 16KW Core Memory	£995
RL11 RL01 and Ctl	£1,745	MS8C832KW MOS Memory	£750
RL02 10 meg	£1,450	RX8E Dual Floppy & Ctl (NEW)	£995
RL211 10 meg and Ctl	£2,200	RX28 Dual Floppy & Ctl	£1,250
RM02 67 meg	£8,500		
RJM02 RM02 and Ctl	£11,500		
RM03 67 meg	£8,250		
RWM03 67 meg and Ctl	£11,250		
RWM05 256 meg and Ctl	£24,500		
RP04 80 meg	£4,950		
RJP04 RP04 and Ctl	£7,950		
RP06-AB 167 meg	£12,500		
*RX1 180 Dual Floppy and Ctl	£995		
*RX2 1180 Dual Floppy and Ctl	£1,450		
* Available in either rack mounting or desk top version.			
PROCESSORS		OPTIONS	
PDP8A-205 32KW MOS (NEW)	£1,750	AA110 D/A + Backplane	£125
PDP8A-400 8KW Core	£1,500	AR11 16 channel A/D	£750
PDP11/04 10 1/2" 32KB MOS	£3,625	BA11ES expander box	£750
PDP11/34A 128KB MOS	£5,000	BA11FE expander box	£995
PDP11/34A 256KB MOS	£6,250	BA11KF expander box	£1,325
PDP11/40 96KW Core, KT11D	£4,650	BA11LF expander box	£825
PDP11/44 256KB MOS	£11,500	OB1 1A Unibus Repeater	£525
PDP11 X44-CB 256KB TUS8	£12,750	OB1 1B Unibus Repeater	£525
PDP11/70 512KB MOS (NEW)	£43,000	DD1 1A Backplane	£125
KMC11A Auxiliary Processor	£875	DD1 1CK 4-slot Backplane	£275
		DD1 1DK 9-slot Backplane	£375
PRINTERS/TERMINALS		DH1 1AC Multiplexor	£3,250
LA36 20mA	£450	DH1 1AD Multiplexor	£4,000
LA36 RS232	£495	DJ1 1AA Multiplexor E1A (NEW)	£1,250
LA34 RS232	£425	DL11 Serial Interface	£250
LA38 RS232	£495	DL11W Asynchronous Interface	£395
LA120-DA (NEW)	£1,225	DM1 1DA Line Adaptor	£525
LA180-PD Parallel (NEW)	£495	DR1 1C Gen Purpose I/O	£250
LA180-ED RS232 (NEW)	£670	DR1 1K Digital I/O	£425
LP04 Drum Printer (NEW)	£5,500	DR1 1W DMA Interface	£825
VT50 20mA	£199	DU1 1DA Synchronous Interface	£525
VT50 RS232	£225	DUP11 DA Synchronous Interface	£750
		DZ1 1A Multiplexor	£1,395
		DZ1 1B Multiplexor	£995
		FP11A Floating Point	£1,500
		FP11E Floating Point [11/60]	£1,975
		H720 Power Supply	£175
		H744 Power Supply	£125
		H745 Power Supply	£90
		H754 Power Supply	£175
		H775BB Battery Back-up	£495
		H775CB Battery Back-up [11/34]	£695
		H7750BD Battery Back-up [11/44]	£695
		KE1 1A Extended Arithmetic	£625
		KE1 1B Extended Arithmetic	£595
		KG1 1A CRC module	£465
		KIT1 1H Bus Interface	£250
		KK1 1A Cache Memory	£1,500
		KT1 1D Memory Management (NEW)	£750
		KW1 1L Real Time Clock	£150
		KW1 1P Programmable Clock	£345
		LP11 Printer Control module	£325
INTERFACES			
DL11 W Asynchronous I/F	£395		
DJ1 1 DA Synchronous I/F	£525		
DUP1 1 DA Synchronous I/F	£750		
KL8E Asynchronous (8E)	£175		
KL8JA Asynchronous (8E, 8A)	£275		
M7258 Printer I/F (PDP11)	£325		
M8207 Printer I/F (LSI 11)	£175		
M8342 Printer I/F (8E, 8A)	£225		

DAISY WHEEL PRINTERS

NEW LOW PRICE



Scoop purchase of factory refurbished Anderson Jacobson AJ832 daisy wheel printers complete with full keyboard, integral stand, and RS232 interface. Utilising the famous QUME Printer Mechanism.
NOW ONLY £750

HAZELTINE VDUS

SAVE UP TO 51%



HAZELTINE 1510
(MLP £880)

..... Only **£550**

HAZELTINE 1520
(MLP £1050)

..... Only **£625**

HAZELTINE 1552
(MLP £800)

..... Only **£395**

HAZELTINE 1410
(MLP £475)

..... Only **£295**

Manufacturer's surplus — ALL BRAND NEW BOXED

ADD 15% VAT TO ALL PRICES

Carriage and Packing extra

Electronic Brokers Ltd., 61/65 Kings Cross Road, London WC1X 9LN. Tel: 01-278 3461. Telex 298694

Electronic Brokers

TEST COMPONENTS ON THIS NEW OSCILLOSCOPE

OSCILLOSCOPE DTC12

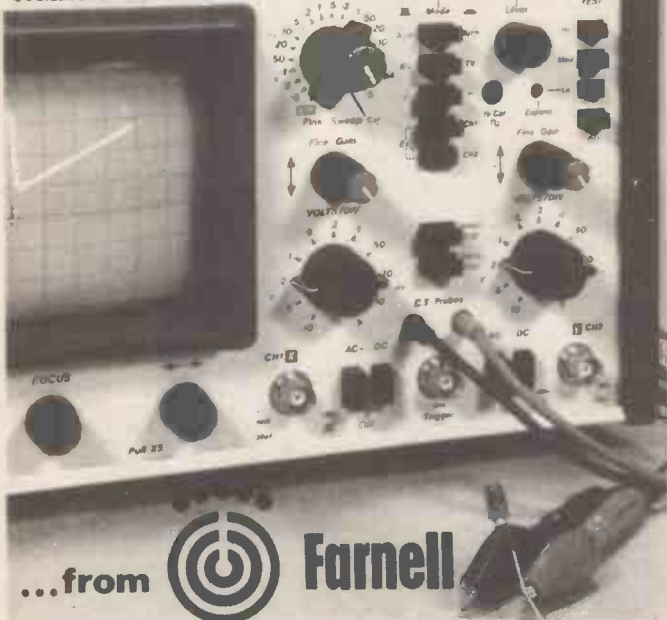

...from  Farnell

USE READER CARD FOR DETAILS
WW - 027 FOR FURTHER DETAILS

PRODUCTION TESTING

DEVELOPMENT

SERVICING

POWER UNITS
Now available with
3 OUTPUTS



Type 250VRU/30/25

OUTPUT 1: 0-30v, 25A DC
OUTPUT 2: 0-70v, 10A AC
OUTPUT 3: 0-250v, 4A AC

ALL
Continuously
Variable

Valradio

VALRADIO LIMITED, BROWELLS LANE, FELTHAM
MIDDLESEX TW13 7EN
Telephone: 01-890 4242/4837

WW - 031 FOR FURTHER DETAILS

Box Clever!

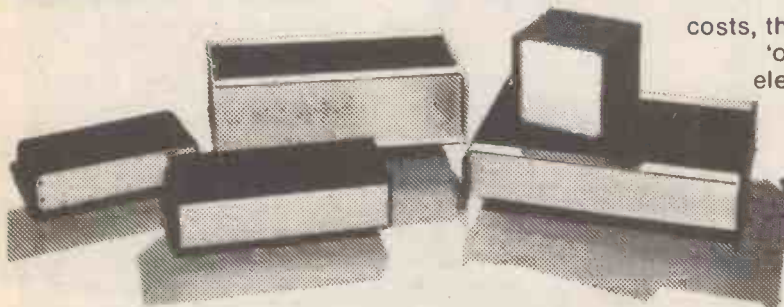

With 1,100 instrument cases in over 750 sizes, and some 250,000 case parts currently in stock, we certainly enable you to *box clever*. A practical solution to every electronic packaging requirement, without the problem of high tooling costs, that's our aim at West Hyde. By being able to supply an 'off the shelf' enclosure for just about any electronic or electrical instrument, we can certainly make sure when it comes to enclosing your particular product, we can help you to *box clever!* For more information send for our catalogue, price £1.00 inc. P&P.

WEST HYDE

West Hyde Developments Ltd., Unit 9,
Park Street Industrial Estate, Aylesbury, Bucks. HP20 1ET.
Telephone: Aylesbury (0296) 20441. Telex: 83570 W HYDE G.

WW - 053 FOR FURTHER DETAILS

THE MOST
ECONOMICALLY - PRICED
PROFESSIONAL EPROM
PROGRAMMERS AROUND

SUITABLE FOR EPROMS:
2708, 2516, 2716, 2532, 2732, 2732A
plus option for 2564, 2764

DATAPROM

STARTING AT £395 + VAT

Albetros (Products) Limited Frances Road Basingstoke Hampshire RG21 3DA
Telephone (0256) 57551



WW - 038 FOR FURTHER DETAILS

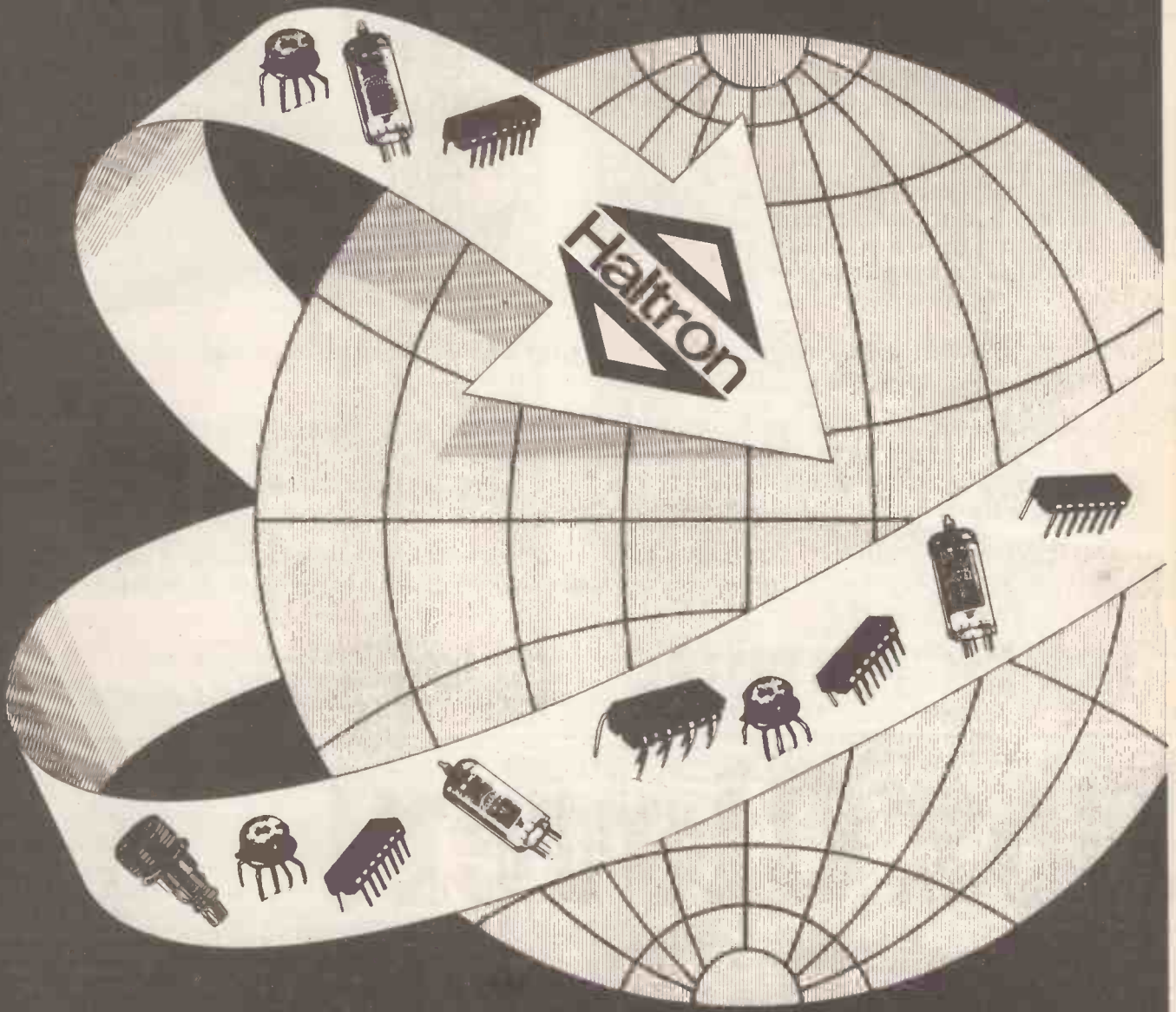

The Professionals

VALVES, SEMICONDUCTORS
& COMPONENTS for:-

Communications, Displays,
Radar, Computer,
Audio etc.

Hall Electric Limited
Electron House
Cray Avenue, St. Mary Cray
Orpington, Kent BR5 3QJ
Telephone: Orpington 27099
Telex: 896141

MIN DEF APPROVAL 0529/0531

CX80 COLOUR MATRIX PRINTER

New low price-
£795 + V.A.T.

At last a low-cost Colour Matrix Printer for Text, Graphics, Histograms, Colour VDU Dumps, etc.

Colour printout is quickly assimilated, makes graphics more understandable and is an ideal medium for the presentation of complex data or concepts.



Compatible with most microprocessors, prints in 7 colours – sophisticated internal programme makes the CX80 easy to use.

Dot Addressable + 15 user programmable characters, 96 ASCII and 64 graphics characters in rom. Centronics interface with RS232 and IEEE488 options. Apple II interface gives dot for dot colour dump. New viewdata interface prints out two pages side by side in full colour. See Prestel 200650.

The CX80 is a product of our own design and development laboratories. It represents a British breakthrough in colour printer technology. Colour brochure on request. OEM pricing available.

INTEGREX LIMITED

Portwood Industrial Estate, Church Gresley.
Burton-on-Trent, Staffs DE11 9PT
Burton-on-Trent (0283) 215432. Telex: 377106

DAROM SUPPLIES Dept. AW - Tel: (0925) 64764
4 Sandy Lane, Stockton Heath,
Warrington, Cheshire WA4 2AY

SAFGAN British Made Scopes
A range of high-performance,
economically priced scopes
featuring:



- ★ Dual Trace
- ★ 5mV/div Sensitivity
- ★ X Y Facility
- ★ Z Modulation
- ★ Solid Trigger with Auto., Normal and TV
- ★ Portable/Lightweight

DT 410 10MHz£179.00
DT 415 15MHz£185.00
DT 420 20MHz.....£198.00
X1-REF-X10 probe.....£11.50

OSCILLOSCOPES THE FUTURE SERIES

BY LEADER

All Models feature:

- ★ Dual Trace
- ★ 6-inch rectangular CRT
- ★ Max. sensitivity 500µV
- ★ TV-V, TV-H sync.
- ★ ALT trigger
- ★ Hold OFF variable
- ★ X Y Facility
- ★ Preset Sync.
- ★ Z Modulation
- ★ Includes 2 XI/XIO Probes

LBO 524 features Delayed Sweep and Dual Time Base



LBO 522 20MHz..... £298
LBO 523 35MHz..... £425
LBO 524 35MHz..... £540

Add 15% V.A.T. on all prices – prices correct at 1-5-82 – E&OE cash with order or credit card – Carriage £5 for Express Delivery

WW – 077 FOR FURTHER DETAILS

TWIN PPM BOX



High quality Ernest Turner TWIN movement in a mains powered unit. The illuminated coaxially mounted pointers of the TWIN offer an unrivalled method of monitoring stereo Left and Right, or Sum and Difference controlled by a front panel switch. Meets IEC65-2, BS415 safety. Also single version and boards for building into equipment.

PPM2 and PPM3 drive circuits Ernest Turner movements 640, 642, 643 and TWIN with flush mounting adaptors and illumination kits ★ Peak Deviation Meter ★ Programme and Deviation Chart Recorders ★ Stereo Disc Amplifier 2 and 3 ★ Moving Coil Pre-amplifier ★ 10 Outlet Distribution Amplifier ★ Stabilizer ★ Fixed Shift Circuit Boards ★ Broadcast Monitor Receiver 150kHz – 30MHz.

SURREY ELECTRONICS LTD
The Forge, Luicks Green, Cranleigh
Surrey GU6 7BG. Tel: 0482 221007

ELECTRONIC VALVES WANTED

All Types Receiving, Transmitting, Industrial

PL504 – PL802 – PCL805 – CV131 – CV136 –
CV138 – CV329 – CV345 – CV450 – 805 – 807 –
813 – 2K25, etc.

Phone/write to:

PYPE HAYES RADIO LTD.
606 Kingsbury Road
Birmingham, B24 9PJ
021-373 4942

WW – 058 FOR FURTHER DETAILS

An entire range of low-cost high-performance instruments



sabtronics

'Making Performance Affordable'

- | | |
|--------------------------------------|---|
| 5020A 1Hz-200KHz Function Generator | 8000B 1GHz 9-Digit Frequency Meter |
| 2033 3 1/2-Digit L.C.D. Hand DMM | PSC-65 600MHz Prescaler |
| 365-S Proto-board | AT-001 x1 Passive Probe |
| LP-10 10MHz Logic Probe | AT-010 x10 Passive Probe |
| 8110A 100MHz 8-Digit Frequency Meter | AT-110 x1x10 Passive Probe (Switchable) |
| 8610B 600MHz 9-Digit Frequency Meter | |

Also Oscilloscopes 15-30MHz Single or Dual trace.

Test our low priced test equipment. It measures up to the best. Compare our specs and our prices—no-one can beat our price/performance ratio.



Illustrated brochure and price list from:

BLACK STAR LTD
9a Crown Street, St. Ives, Cambs. PE17 4EB
Tel: (0480) 62440. Telex: 32339

WW - 013 FOR FURTHER DETAILS



PARABOLIC DISHES

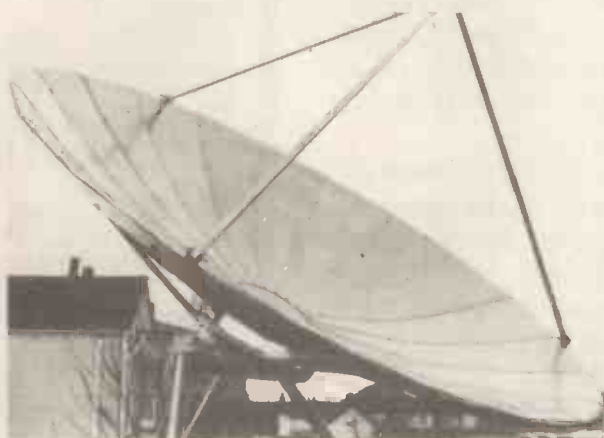

6ft dia. for use in satellite reception and microwave transmissions. Please send S.A.E. for full details and data sheet.

Harrison Bros.

Electronic Distributors

22 Milton Road, Westcliff-on-Sea, Essex SS0 7JX
Tel. Southend (0702) 332338

WW - 029 FOR FURTHER DETAILS

MICROCOMPUTER COMPONENTS

LOWEST PRICES - FASTEST DELIVERY

MEMORIES ★★ NEW LOWER PRICES ★★

2114 Low power 200ns	0.80	4116 200ns	0.70
2708 450ns	2.79	4116 150ns	1.10
2716 450ns (5v)	2.10	4118 150ns	3.38
2716 350ns (5v)	3.59	4164 200ns (TI)	4.65
2716 (3 rail) 450ns	5.95	4518/4816 100ns	3.25
2732 450ns	3.90	5516 200ns	9.38
2732 350ns	4.40	6116P3 150ns	4.30
2532 450ns	3.60	6116LP3 150ns	5.75

BBC MICRO UPGRADE KITS ★★ NEW LOWER PRICES ★★

As some parts are still in short supply please check availability before ordering.

BBC1 4516/4816 x 8 100ns	25.50	BBC21 Printer cable complete	13.00
BBC2 Printer/User I/O kit (IC69, 70 + PL9, 10)	8.00	BBC22 Connector for user port with 36in cable	2.00
BBC4 Analogue input kit (IC73, 77 + SK6)	6.70	BBC44 Analogue input plug with cover	2.25
BBC5 Serial I/O and RGB kit (IC74, 75 + SK3, 4)	11.45	BBC55 5 and 6 pin DIN plugs for Serial I/O and RGB input	0.99
BBC6 Expansion bus and tube kit (IC71, 72, 76 + PL11/12)	6.25	BBC66 Connector for Bus port with cable	3.50

We've done it again! Massive price reductions on LPS and CMOS

DEVICE	PRICE	DEVICE	PRICE	DEVICE	PRICE	DEVICE	PRICE	DEVICE	PRICE
Z80 FAMILY		FLOPPY DISC CONTROLLERS		CRYSTALS		40	0.12	DIL JUMPERS SINGLE ENDED	
Z80 CPU	3.15	FD1771	17.12	1 MHz	2.90	42	0.27	24in	
Z80A CPU	3.50	WD1391 kit	45.50	1.008 MHz	2.90	47	0.34	14-pin	1.40
Z80A CTC	2.95	WD1393 kit	45.50	1.8432 MHz	2.20	51	0.14	16-pin	1.60
Z80A DART	5.70	WD1395 kit	45.50	3-6864 MHz	2.95	54	0.14	24-pin	2.35
Z80A DMA	11.95	WD1397 kit	45.50	4 MHz	1.45	74	0.16	40-pin	3.25
Z80 PIO	2.75	(Kits include F D 1 7 9 X + W D 2 1 4 3 + W01691)		6 MHz	1.45	75	0.19		
Z80A PIO	2.95			8 MHz	1.70	76	0.17		
Z80A SIO-0	11.99			CMOS 4000 'B' SERIES		83	0.34	DOUBLE ENDED	
Z80A SIO-1	11.99			4000	0.10	86	0.15	6in	
Z80A SIO-2	11.99			4001	0.10	90	0.28	14-pin	1.90
MK3886	11.00			4002	0.12	92	0.31	16-pin	2.05
MK3886-4	14.47			4007	0.15	93	0.25	24-pin	3.10
		MISCELLANEOUS SUPPORT CHIPS		4011	0.11	109	0.27	40-pin	4.85
		AY3-1015	2.99	4012	0.15	122	0.35		
		AY3-1270	7.95	4013	0.24	123	0.35	DOUBLE ENDED	
		AY3-8910	5.99	4015	0.49	125	0.24	12in	
		AY5-1013	2.99	4016	0.19	126	0.25	14-pin	2.00
		AY5-3600	7.95	4017	0.37	132	0.29	16-pin	2.15
		AY5-2376	5.99	4020	0.49	136	0.31	24-pin	3.25
		DP8304	4.50	4023	0.15	139	0.31	40 pin	5.10
		MC1488	0.55	4024	0.31	148	0.69		
		MC1489	0.55	4025	0.16	151	0.39		
		MC3446	2.95	4027	0.23	153	0.28	DOUBLE ENDED	
		MC3448A	4.25	4028	0.49	155	0.34	18in	
		MC3480	7.95	4040	0.49	156	0.34	14-pin	2.05
		MC3487	2.95	4042	0.44	157	0.25	16-pin	2.25
		MC14411	6.94	4046	0.64	158	0.29	24-pin	3.40
		MC14412	7.99	4047	0.49	161	0.35	40 pin	5.25
		RO3-2513L	6.99	4049	0.24	163	0.34		
		RO3-2513U	5.99	4050	0.24	164	0.39	ZERO INSPECTION FORCE SOCKETS	
				4051	0.44	165	0.54	24-pin	5.95
				4052	0.59	166	0.63	28-pin	7.40
		DVM CHIPS		4060	0.59	166	0.63	40-pin	8.80
		ZN450E	7.61	4066	0.29	173	0.64		
		ZN450 Kit	17.35	4069	0.15	174	0.40	25 WAY 'D' CONNECTORS	
				4070	0.14	175	0.44	Male-female (36in cable)	10.15
				4071	0.14	191	0.44	Male-female (36in cable)	10.13
		LINEARS		4073	0.14	192	0.44	Male S-ended (18in cable)	5.83
		LM301AN	0.25	4075	0.14	193	0.44	Female S-ended (18in cable)	6.25
		LM308N	0.89	4081	0.15	194	0.34		
		LM311N	0.69	4093	0.25	195	0.34	OIL SOCKETS	
		LM319N	2.14	4508	1.29	221	0.54	Low profile	
		LM324N	0.30	4511	0.44	240	0.64	8 07 22 25	
		LM348N	0.59	4512	0.49	241	0.64	14 09 29 35	
		LM555N	0.16	4518	0.39	242	0.64	16 09 31 42	
		LM555CN	0.45	4520	0.49	243	0.64	18 13 33 52	
		LM741 (8 pin)	0.14	4526	0.69	244	0.59	20 14 35 60	
				4528	0.69	245	0.69	22 17 40 70	
		LM747CN	0.64	4541	0.99	251	0.29	24 19 42 70	
		LM748 (8 pin)	0.34	4543	0.79	257	0.34	28 25 54 80	
				N.B. Other devices available.		259	0.57	40 29 81 99	
		LM725CN	3.20	74LS SERIES		266	0.19		
				00	0.10	273	0.59		
		BUFFERS		D1	0.11	279	0.29		
		81LS95	0.90	7805	0.39	283	0.39		
		81LS96	0.90	7812	0.39	365	0.29		
		81LS97	0.90	7815	0.39	366	0.29		
		81LS98	0.90	78105	0.29	367	0.29		
		81LS99	0.90	78112	0.29	368	0.39		
		8T26A	1.20	78115	0.29	373	0.59		
		8T28A	1.20	7905	0.55	374	0.64		
		8T95	1.35	7912	0.55	377	0.69		
		8T97A	1.35	7915	0.55	390	0.49		
		8T98	1.45	7915	0.55	393	0.44		
				LM309K	0.99	13	0.15		
				LM317K	3.20	14	0.33		
				LM323K	4.95	15	0.12		
				LM338K	POA	20	0.12		
		DATA CONVERTERS		21	0.12	21	0.12		
		ZN425	3.45	26	0.12	26	0.12		
		ZN427	5.99	27	0.12	27	0.12		
		ZN428	4.75	28	0.12	28	0.12		
		ZN432	13.00	6 MHz UM1111	3.70	30	0.12		
		ZN433	25.90	8 MHz UM1233	37	32	0.12		
		ZN447/8/9	POA			38	0.12		
		UPD7002	4.35						

OFFICIAL ORDERS WELCOME **VISA** 24 HOUR TELEPHONE SERVICE FOR CREDIT CARD USERS **QUANTITY DISCOUNTS AVAILABLE**

* Free Reply Paid Envelope with every order *
* All prices exclude VAT & P & P (0.75) (Free on CWO's over £10) *
* All orders despatched on day of receipt with full refund on out of stock items if requested *
Data sheets available on most higher cost items. Please telephone for prices and details

MIDWICH COMPUTER CO. LTD.

DEPT WW, HEWITT HOUSE, NORTHGATE STREET,
BURY ST. EDMUNDS, SUFFOLK IP33 1HQ
TELEPHONE: (0284) 701321 TELEX: 817670

WW - 074 FOR FURTHER DETAILS

Carston

Used test equipment, calibrated to Manufacturer's original specification.

ACOUSTIC & VIBRATION

BRUEL & KJAER	
1621 Tunable Band Pass Filter	550
2113 Audio Frequency Spectrometer	1400
2215 Sound Level Meter Inc. Oct. Filter	1050
2218 Sound Level Meter inc. Leq.	1475
2305B Level Recorder inc. 50 dB pot.	1350
2625 Vibration pick-up amplifier	350
2808 Power Supply/Mains Adapter	90
2972 Tape Signal Gate	200
4423 Noise Dosimeter	350
4424 Noise Dosimeter	375
CASTLE ACOUSTICS	
CS181 Sound Level Meter & Calibrator	295
C.E.L.	
144 Environmental Noise Analyser	500
DAWE	
419C Audio White Noise Generator	190
1461CV Vibration Analyser	350
1463B 1/2 Octave Filter	200
1465 Octave Band Filter	150
WAYNE KERR	
B731B Vibration Meter inc. probe	270
BRIDGES & V and I STANDARDS	
HEWLETT PACKARD	
4261A Digital Automatic LCR Bridge	975
4342 QLC Meter 22 KHz-70 MHz	2600
MUIRHEAD	
D30A DC Bridge 0.15%	180
WAYNE KERR	
B224 RCL Bridge 0.1%	500
B521 LCR Bridge	115

COMMS & CABLE TEST EQUIPMENT

DYMAR	
BC282 Battery charger for 883 Radio Telephone	40
883 Radio Telephone - VHF band - hand held	120
MARCONI	
TF2091 White Noise Generator (exc. filters)	1000
TF2092 White Noise Receiver (exc. filters)	1000
TF2809 Data Line Analyser	600
NORTHEAST ELECTRONICS	
TT537B Psophometer/VU Meter	200
SEIMENS	
U2033 Psophometer	475
S.T.C.	
74106 Bridge Unit	135
74184B Selective Level Measuring Set	600
74216A Noise Generator	300
74261A Psophometer	300
74262B White Noise Generator & Receiver	2000
74307C Level Measuring Set	175
74834C Distortion Measuring Set	500
96016 Selective Null Detector	200
GTA-2 Quantization Distortion Tester	800
GTA4B Pattern Generator	900

COMPUTER EQUIPMENT

(90 day guarantee)	
CENTRONICS	
702 matrix printer	500
HEWLETT PACKARD	
9835A Desktop Computer 64K + expanded I/O ROM + HP - IB interface. Includes C.R.T. Cartridge Tape Drive - Full documentation test tapes etc.	5900

TEKTRONIX

4610-1 Hard copy printer for 4010 series computer display terminals	1150
COUNTERS & TIMERS	
FLUKE	
1912 520 MHz 7 digit Counter	375
1912A01 As 1912A but inc. re-charging batteries	430
1920A 520 MHz 9 digit Counter inc. Brst. mode	575
HEWLETT PACKARD	
5300A/5305B 1300 MHz 6 Digit Counter	425
5345 500 MHz 11 Digit Counter Timer	2000
MARCONI	
TF 2432 560 MHz 8 Digit Counter	275
PHILIPS	
PM6614/02 520 MHz 9 Digit Counter TCXO	480
PM6624/02 520 MHz 9 Digit Counter Timer TCXO	750
PM6661 80 MHz 8 Digit Counter	180
RACAL-DANA (E.I.P.)	
371 18 GHz 11 Digit Counter with Source Locking facility	4950
8110 50 MHz 8 Digit Counter Timer	320
9025 1 GHz 8 Digit Counter	450

MAINS TEST EQUIPMENT

DATALAB	
DL019 Mains Interface for DL905	300
DRANETZ	
606 3ch Volts Av/ Spike/ Time/ Printer	3500
616 2ch AC 1ch DC Volts/Av/Spike/ Time/ Printer	3500
ELLIOTT	
500 Dynamometer - measures Volts, Amps, Watts on mains	180
MISCELLANEOUS	
A.I. INDUSTRIES	
TCS General Purpose Gas Leak Detector - intrinsically safe	290
BRADLEY	
192 Oscilloscope Calibrator	825
COMARK	
1601BLS Thermom 10ch B7 + 1000°C type K	50
<i>N.B. Thermocouples not included</i>	
CROWCON	
71P Inflammable Gas Detector/ Alarm	125
DATALAB	
DL905 Digital Transient Recorder/ Display Storage	1050

RADIOMETER

SMG1 Stereo FM Generator	4
ROHDE & SCHWARZ	
BN252 Transistor Y Parameter Test Set	150
SCHLUMBERGER	
4010A VHF/UHF Radio Telephone Test Set	550
S.T.C.	
74600J Attenuator 0-9 dB 50Ω in 1 dB steps	12
74616A Attenuator 0-100 dB 600Ω in 0.1 dB steps	10
TEKTRONIX	
184 Time Mark Generator	23
521PAL Vectorscope	275
528 TV Waveform Monitor	7
575 Semiconductor Curve Tracer	4
1485C TV Waveform Monitor PAL/NTSC	310

TELONIC

6001 RF Detector with Log Amplifier - Analogue display & recorder O/P. 0.4-130 MHz - 80 dB range	2
--	---

YELLOW SPRINGS

YS157 Water Pollution Measurement System	1
--	---

NETWORK ANALYSERS/ PHASEMETERS

DRANETZ	
301A Analogue Phasemeter 5 Hz-500 KHz	7
HEWLETT PACKARD	
8405A Vector Voltmeter 1-1000 MHz	29
8407A/8412A/8601A 100 KHz-110 MHz complete Network Analyser system comprising Analyser, Phase/Magnitude display and Sweep Generator. 50Ω or 75Ω system available. 80 dB dynamic range	65
8745A S Parameter Test Set 0.1-2 GHz	31
11570A Accessory Kit for 8405A	1
11600A Transistor Test Fixtures	1
T018/TO-72	1
11602A Transistor Test Fixtures	1
T05/TO-12	1

OSCILLOSCOPES & ACCESSORIES

BIOMATION	
350 Compact XYZ Display	4
GOULD ADVANCE	
OS1000B 20 MHz 5mV 2 Trace	3
HEWLETT PACKARD	
1740A 100 MHz 5mV 2 Trace 2TB	13
182C 100 MHz Mainframe	13
182T 100 MHz Mainframe with digital normaliser interface	15
1804A 50 MHz 20mV 4 Trace Plug-in	16
1825A Dual Timebase Plug-in	3
1805A 100 MHz 5mV 2 Trace Plug-in	6
PHILIPS	
PM3207 15 MHz 5mV 2 Trace TV trig	2
PM3211 15 MHz 2mV 2 Trace 2T trig	2
PM3212 25 MHz 2mV 2 Trace TV trig	4
PM3233 10 MHz 2mV 2Ch fixed delay Dual Beam	2
PM3244 50 MHz 5mV 4 Trace 2T base	12
PM3260 120 MHz 5mV 2 Trace 2T base	14
PM3262 100 MHz 5mV 2 Trace 2T base Tr View	11
TEKTRONIX	
465 100 MHz 5mV 2 Trace 2TB	15
465B 100 MHz 5mV 2 Trace 2TB	16
475 200 MHz 2mV 2 Trace 2T base	17
475A 250 MHz 2mV 2 Trace 2T base	22
485 350 MHz 5mV 2 Trace 2T base	36
5B42 2 T/base plug-in 50 MHz Trig for 5000 series Mainframe	3
661/4S3/5T1A 1 GHz Sampling scope	5
7A18 75 MHz 5mV 2 Trace Plug-in	4
7A22 1 MHz 10μV Differential Plug-in	7
7A26 200 MHz 5mV 2 Trace Plug-in	6
7B53A 2 Timebase Plug-in 100 MHz Trig	2
7403N 75 MHz 3 slot M/Frame	13
7603 100 MHz CRT r/out 3 slot M/Frame	19
TELEQUIPMENT	
D63/V1/V1 15 MHz 2 Trace 1mV	3
D63/V5/V5 15 MHz 5mV 2 Trace & fixed delay	3
D1010 10 MHz 5mV 2 Trace	2
S61 5 MHz 5mV 1 Trace	1
TEXSCAN	
DUI20 Large CRT XY Display with z modulation	2

Note: we hold a range of cameras

OSCILLOSCOPES (STORAGE)

HEWLETT PACKARD	
181A 100 MHz Mainframe 5cm/μs	25
1703A 35 MHz 10mV 2 Tr 2TB 1000 Div/ms	18

SPECIAL OFFER

GUIDO GAY Model MTA

Memory Voltmeter/Transient Monitor

For peak voltage measurements of single or repetitive pulses down to 50ns or less. Ideal for measuring fast transients, spikes, noise and interference, on AC or DC lines. 1V to 1KV ranges (protected to 3KV). Fully variable threshold level. Measurements can be gated.

Complete with compact strip printer that records data that is above the user adjustable threshold level. Prints peak voltage, day, hour, min, second. Max print rate 40 l.p.m.

£1500

9903 50 MHz 7 Digit Counter Timer	310
9905 200 MHz 8 digit Counter Timer	360
SYSTRON DONNER	
6053 3 GHz 9 digit Counter BCD O/P	790
6103B Strip Printer for 6053/6054	375
TEKTRONIX	
DC501 7 Digit 100 MHz Counter - TM500 Plug-in	180
DIGITAL TESTING EQUIPMENT	
HEWLETT PACKARD	
1600A Logic Analyser 16 ch 20 MHz	1150
1600S Logic Analyser 32 ch 20 MHz	2250
1602A Logic Analyser 16 ch 10 MHz	900
1615A Logic Analyser 24 ch 20 MHz	4850
TEKTRONIX	
832 Datacom Tester R5232/V24	1150
833 As 832 plus BERT/BLERT feature	1300

FLANN	
16/11 Rotary Vane Attenuator WG16	295
HEWLETT PACKARD	
342A Noise Figure Meter	500
X382A Rotary Vane Attenuator WG16	175
536A 0.96-4.2 GHz Cavity Frequency Meter	300
MEGGER	
BM6 500V 0 - 200 mΩ tester. Batt op.	70
MJ4 1 kV 0 - 200 mΩ tester. Hand Drive	160
MULTIMETRICS	
AF120 Dual H/Pass L/Pass active filter 20 Hz - 2 MHz	475
PHILIPS	
PM 5501 Colour TV Pattern Generator	199
PM 5519 Colour TV Pattern Generator	635
PM 6456 Stereo FM Generator	190

Carston Electronics Ltd
01-267 5311

Shirley House, 27 Camden Road, London NW1 9NR. Telex: 23920.

All items have a 12 month guarantee unless otherwise stated.

practical, authoritative books

from Prentice-Hall International

Alan Clements

Microcomputer Design and Construction: Building Your Own System with the Motorola 6800

Both the theory and practical aspects of designing and constructing a general-purpose microcomputer are explained in this book in an informal and lively style. It describes the design of a microprocessor system in detail, with full circuit diagrams using the Motorola 6800 as an example. Since much of the text is processor independent it will be of value to designers of systems based on other CPU's.

£18.95 600 pages July 1982
A Motorola Approved Product 

Ed Klingman

Microprocessor Systems Design, Volume 1

This thorough introduction covers information devices, CPU's, memory, languages, structure and microprocessor architecture. Detailed diagrams and design sections are provided.

£22.35 416 pages 1977

Microprocessor Systems Design, Volume 2

Volume 2 gives full details on the concepts and techniques required to utilize array logic devices or bit slice devices for the architectural design of a special purpose digital system.

Three complete design examples are included: a two-dimensional filtering problem; a floating-decimal-point computation system; a facsimile transmission system.

£22.00 368 pages July 1982

Book Orders

These books can be ordered from your usual bookseller or in case of difficulty from:
Department 30, Prentice-Hall International,
66 Wood Lane End, Hemel Hempstead,
Hertfordshire, HP2 4RG, England.

Please mark the number of books you wish to order in the boxes beside each title and return the advertisement to the address above.

Name _____

Address _____

I enclose a cheque/P.O. for £

Please add £1.00 per book for postage and packing. Payment should be made out to **International Book Distributors**. Please allow 28 days for delivery.

Prices and publication dates are correct at the time of going to press but may be subject to change.

WW9

Prentice-Hall  International

WW - 037 FOR FURTHER DETAILS

SAFGAN DT-400 Series BRITISH MAKE DUAL TRACE 'SCOPES

NEW
20MHz

LOW COST

DT-410 £179*
DT-415 £189*
DT-420 £199*
* Ex V.A.T.



RELIABLE
WITH
18 months'
GUARANTEE

DT-410, 10 MHz

DT-415 15MHz

DT-420 20MHz

- ★ CH1, CH2: 5mV/div - 20V/div.
- ★ Time Base: 1 sec/div - 100ns/div.
- ★ XY Facility: Matched XY inputs.
- ★ Trigger: Level control, \pm Slope selection.
- ★ Auto, Normal, TV Triggering.

- ★ External Trigger
- ★ Z-Modulation.
- ★ CAL output 1v 1kHz.
- ★ Graticule blue ruled 8x10 div. (4in. CRT)
- ★ Size: H215mm, W165mm, D280mm.
- ★ Weight: 4kg.

PROBE (XI-REF-X10) £11.50

SAFGAN ELECTRONICS LTD.

OMEGA ROAD, WOKING, SURREY TEL. WOKING (04862) 69560/24731

Carriage: England & Wales £7.50 + V.A.T.; Scotland £10.50 + V.A.T.



London Stockist: Audio Electronics - Tel: 01-724 3564
North-West Stockist: Darom Supplies, Warrington, Ches. - Tel: Warrington 64764
Avon Stockist: L. F. Harney, Bath - Tel: Bath 24811

Cardiff Stockist: Steve's Electronics Supply Co., Cardiff - Tel: (0222) 41905
Chesterfield Stockist: Kays Electronics, Chesterfield - Tel: (0246) 31696
Newcastle Stockist: Aitken Bros. & Co., Newcastle - Tel: 0632 26729
Birmingham Stockist: P.A.T.H. Electronic Services - Tel: 021-327 2339
Derby Stockist: RTS, Derby - Tel: (0332) 41235



WW - 073 FOR FURTHER DETAILS

"Sympathy, Love and Understanding are not enough"

Sir Douglas Bader C.B.E., D.S.O., D.F.C.



The Wings Appeal Fund helps to maintain the RAF Association Home for Disabled and Chronic Sick. Care is essential for those who have served their country and who are in need. So please help by giving all you can for an emblem in WINGS WEEK in September or send a donation to show that you care.



To: Royal Air Forces Association, Appeals Dept., (DS) Portland Rd., Malvern, Worcs. WR14 2TA.

I enclose a donation of _____ for the Wings Appeal Fund.

Name _____

Address _____

Please tick if receipt is required.

Space donated by 'Wireless World'

The Professional Choice



AMCRON 

Since the introduction of the DC300 in 1967, AMCRON amplifiers have been used worldwide — wherever there has been a need for a rugged and reliable amplifier. Their reputation amongst professional users, throughout industry, has made the name of AMCRON synonymous with power amplification. For power you can depend on - choose AMCRON, the professional choice.

For further details contact the UK Industrial distributor:

G.A.S.

G.A.S. ELECTRONICS

16, ST. ALFEGE PASSAGE, LONDON SE10

TELEPHONE: 01-853 5295

TELEX: 923393 LASER G

WW - 056 FOR FURTHER DETAILS



HF COMMUNICATIONS RECEIVERS

FOR

POINT TO POINT/TRANSPORTABLE

AND

MARINE SYSTEMS

DESIGNED AND MANUFACTURED TO HIGHEST INTERNATIONAL SPECS

FULLY SYNTHESISED – 10Hz or 100Hz STEPS

CONTINUOUSLY TUNED – 50KHz to 30 MHz

MODES: – LSB/USB/CW/AM/FSK or TELEX

STABILITY – ± 1 PART IN $10^7/^\circ\text{C}$

TUNING – SPIN WHEEL or DECADE

POWER SUPPLIES – 110/240 A.C. and 24V D.C.

SEND FOR TECHNICAL BROCHURES TO:

VIGILANT COMMUNICATIONS LTD, UNIT 5, PONTIAC WORKS, FERNBANK ROAD, ASCOT, BERKS, ENGLAND

TELEPHONE: (0344) 885656

OUTSTANDING PERFORMANCE

AND RELIABILITY

HIGHLY

COMPETITIVE PRICES

WORLD WIDE AGENTS NOW

BEING ESTABLISHED

WW – 059 FOR FURTHER DETAILS

FYLDE

TRANSDUCER and RECORDER
AMPLIFIERS and SYSTEMS



reliable high performance & practical controls. individually powered modules— mains or dc option single cases and up to 17 modules in standard 19" crates small size—low weight—realistic prices.

FYLDE

49/51 Fylde Road Preston
PR1 2XQ
Telephone 0772 57560

Fylde
Electronic
Laboratories
Limited.

WW – 028 FOR FURTHER DETAILS

IN VIEW OF THE EXTREMELY RAPID CHANGE TAKING PLACE IN THE ELECTRONICS INDUSTRY, LARGE QUANTITIES OF COMPONENTS BECOME REDUNDANT. WE ARE CASH PURCHASERS OF SUCH MATERIALS AND WOULD APPRECIATE A TELEPHONE CALL OR A LIST IF AVAILABLE. WE PAY TOP PRICES AND COLLECT.

BROADFIELDS & MAYCO DISPOSALS

21 Lodge Lane, N. Finchley, London, N.12. 5 mins. from Tally Ho corner
Telephone 445 2713/0749 (9461)

WW – 033 FOR FURTHER DETAILS

TIME WRONG?

MSF CLOCK is ALWAYS CORRECT – never gains or loses, SELF-SETTING at switch-on, 8 digits show Date, Hours, Minutes and Seconds, auto GMT/BST, leap year and parallel BCD (including WEEKDAY) output, receives Rugby 60KHz atomic time signals, built-in antenna, 1000Km range, GET the TIME RIGHT, £69.60.

LOSING DX? Make them HEAR YOU with a Speech Compressor, between your microphone and transmitter, BOOST your POWER up to four times, 60dB agc, MORE DX, £15.30.

60KHz Receiver £22.20, 10Hz-200KHz Signal Generator £19.70, 10-150KHz Receiver £19.40, 200KHz Converter £19.80.

Each fun-to-build kit (ready made to order) includes all parts, printed circuit, case, postage, etc., instructions, money back assurance so GET yours NOW.

CAMBRIDGE KITS

45 (WJ) Old School Lane, Milton, Cambridge. Tel. 860150



Constructor Series Speakers

IT'S
SO
EASY

Have fun, save money, building a Kef design with a Wilmslow Audio CS Total kit.

No electronic or woodworking knowledge necessary and the end result is a proven top-quality design that you'll be proud of.

Each kit contains all cabinet components, accurately machined for easy assembly, speaker drive units, crossovers, wadding, grille fabric, terminals, nuts, bolts, etc.

The cabinets can be painted or stained or finished with iron-on veneer or self adhesive woodgrain vinyl.

Easy foolproof assembly instructions supplied. Set of constructor leaflets sent free on receipt of large S.A.E.

Prices: CS1 (As 101)	£110 pr. inc. VAT, plus carr./ins. £ 5.50
CS1A (simplified LS3/5A)	£103 pr. inc. VAT, plus carr./ins. £ 5.50
CS3 (as 103.2)	£129 pr. inc. VAT, plus carr./ins. £10.00
CS5 (as Carlton II)	£192 pr. inc. VAT, plus carr./ins. £15.00
CS7 (as Cantata)	£250 pr. inc. VAT, plus carr./ins. £18.00



☎
0625 529599

35/39 Church Street, Wilmslow, Cheshire SK9 1AS

1982 Catalogue — £1.50 post free



Lightning service on telephoned credit card orders!



WW — 063 FOR FURTHER DETAILS

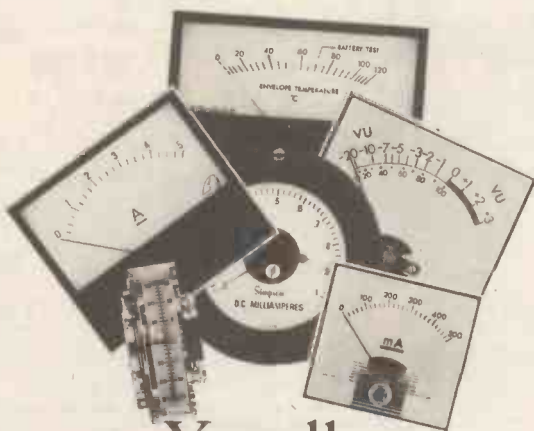

You tell us
we'll deliver!

We have the UK manufacturing facilities, experience and skills to give you the panel meter you want. With all aspects of panel meter construction under our control it means you can specify and get the sensitivity, movement, ballistics and scale you want. It all adds up to greater flexibility and a wider choice. You want them quickly? — of course! Low quantities or large quantities present no problems. Next time why not give us a call — ask for Colin Williams, tell him what you want — you could be surprised at what he may have to tell you!



Bach-Simpson

Bach-Simpson (U.K.) Limited,
Trenant Estate, Wadebridge, Cornwall, PL27 6HD.
Telephone: (020881) 2031 Telex: 45451

WW — 009 FOR FURTHER DETAILS

The Keithley 179A

NEW!

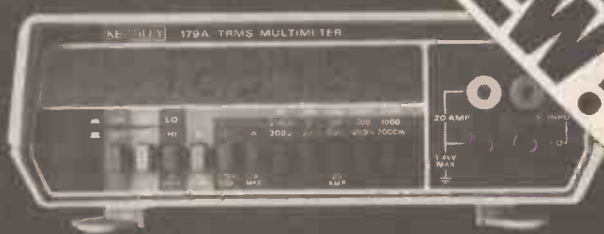

A MEASURE OF ACHIEVEMENT.

Specification . . . Versatility . . . Accuracy . . . Price. In almost every major area the new 179A — a 4½ digit bench/portable DMM — from Keithley Instruments sets some pretty impressive standards:

- 20 amp capability
- Full function: 27 ranges including true RMS AC Measurement
- Year's guarantee on spec
- 0.04% DC accuracy
- IEEE option
- Large display and 10µV dc resolution.

For those requiring 10 times more sensitivity and an analogue output there's the 177, a unit with similar specification to the 179A. Both models are part of a vast range of test equipment from one of the world's leading manufacturers.

For more information fill in the coupon at the bottom of the page.

☎ Alternatively, phone our Instant Information Service on 0734 864784 now.



KEITHLEY

Keithley Instruments Ltd
1 Boulton Road Reading Berkshire RG2 0NL
Telephone (0734) 861287
Telex 847047

I'd like to know more . . .

Name _____

Position _____

Company _____

Address _____

Telephone _____

(WW9)

WW — 023 FOR FURTHER DETAILS

Testing...
Testing...
Testing...

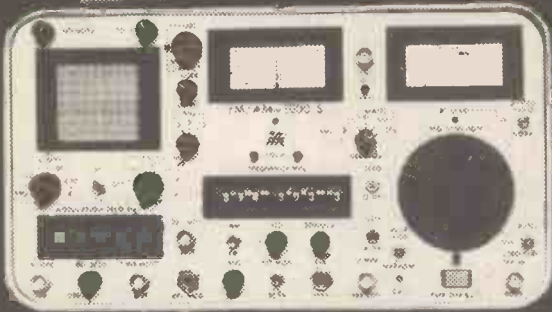

anywhere!

FM/AM 1000s with Spectrum Analyser – we call it the SUPER – S

A portable communications service monitor from IFR, light enough to carry anywhere and good enough for most two-way radio system tests. The FM/AM 1000s can do the work of a spectrum analyser, oscilloscope, tone generator, deviation meter, modulation meter, signal generator, wattmeter, voltmeter, frequency error meter—and up to five service engineers who could be doing something else!

**A PRACTICAL TOP UP!
MM-100 MULTI-METER**

Simply replaces the protective lid of the FM/AM 1000s. It includes a modified probe, PB-114, and a built in speaker unit with independent volume control for audible response to signal measurement. This practical 'top up' will perform the following functions.

Sinad: Measurements for 1 kHz tone (± 20 Hz)

Distortion: To 30%
DC Volts: Up to 300 volts and up to 800 volts when the X10 probe is used

AC Volts: 600 VRMS maximum for frequencies between 25 Hz and 25 kHz

Ohms: Using the modified probe, part number PB-114, Ohms can be measured on scales X1 to X10 K
% AM Measured on the RF signal applied to the FM/AM-1000 unit

OPTIONAL ACCESSORIES

A choice of R.F. power attenuators and protective carrying cases.



For further information contact Mike Taylor



**Fieldtech
Heathrow**

Fieldtech
Heathrow Ltd.
Huntavia House
420 Bath Road
West Drayton
Middlesex UB7 0LL
Tel: 01-897 6446
Telex: 23734
FLDTEC G

IFR precision simulators

WW – 014 FOR FURTHER DETAILS

FIRST IN THE WORLD

The ICM-12, synthesized, marine hand-portable radio



FEATURES:

- 12 channels – 6 and 16 fitted as standard.
- No waiting for crystals, can be diode programmed between 156-164MHz.
- Automatic semi-duplex for private and link calls.
- Slide-on nicad pack recharges from mains or 12V.
- Lots of options, speaker mics, alternative battery packs, 12V leads, and desk chargers.
- Complete with nicad battery pack, mains charger, belt clip, earphone, rubber antenna.
- Home Office type approved. RTD HP 105.
- PRICE £199.13 + VAT. Free carriage.

Trade enquiries very welcome – Ask for Phil Hadler



We can also supply the ICOM IC100E and IC410A VHF & UHF. PMR Base and Mobile transceivers. Fully approved, very compact, built-in CTCSS and at very competitive prices.

Also the first synthesized hand portable – ICH2. Two channels, high band, Simplex or Duplex.

Dealer outlets required, ask for Dave Stockley.

Thanet Electronics  **ICOM**

143 Reculver Road, Herne Bay, Kent
Tel: 02273 63859. Telex 965179

WW – 16 FOR FURTHER DETAILS

Time's running out...
for Ni-Cads!

**NEW
NEC
SUPERCAPS**



Available from stock NOW!

1.0 FARAD SUPERCAP + 5101 C.MOS R.A.M. <u>1 MONTH</u>	1.0 FARAD SUPERCAP + 1703 Programmable Tuner Chip <u>1 WEEK</u>	1.0 FARAD SUPERCAP + 7507 C.MOS Microcomputer <u>1 DAY</u>
--	--	---



Only part of the Anglia range of **NEC** components

**Anglia
COMPONENTS**

Burdett Road, Wisbech,
Cams, PE13 2PS
Telephone 0945 63281
Telex 32630 ANGLIA G

**THE PARTS YOU NEED
– fast!**

WW – 041 FOR FURTHER DETAILS



"...the quality of the colour display is excellent". Popular Computing Weekly.
"The graphics facilities are great fun". Personal Computer World.
"...the Spectrum is way ahead of its competitors". Your Computer.

"The world's best personal computer for under £500."

Chris Sinclair

Sinclair ZX Spectrum 16K RAM £125, 48K RAM £175.

This is the astonishing new ZX Spectrum – a powerful professional's computer in everything but price!

There are two versions – 16K or a really powerful 48K. Both have a full 8 colours, sound generation, a full-size moving-key keyboard and high-resolution graphics. Plus established Sinclair features such as 'one-touch' keyword entry, syntax check and report codes!

Key features of the Sinclair ZX Spectrum

Full colour – 8 colours plus flashing and brightness-intensity control.

Sound – BEEP command with variable pitch and duration.

Massive RAM – 16K or 48K.

Full-size moving-key keyboard – all keys at normal typewriter pitch, with repeat facility on each key.

High resolution – 256 dots horizontally x 192 vertically, each individually addressable for true high-resolution graphics.

ASCII character set – with upper- and lower-case characters.

High speed LOAD & SAVE – 16K in 100 seconds via cassette, with VERIFY and MERGE for programs and separate data files.

The ZX Printer – available now

The printer offers ZX Spectrum owners the full ASCII character set – including lower-case characters and high-resolution graphics.

Printing speed is 50 characters per second, with 32 characters per line and 9 lines per vertical inch.

ZX Microdrive – coming soon

Each Microdrive will hold up to 100K bytes on a single interchangeable microfloppy – with a transfer rate of 16K bytes per second. And you'll be able to connect up to 8 ZX Microdrives to your ZX Spectrum – they're available later this year, for around £50.

How to order your ZX Spectrum

BY PHONE – Access, Barclaycard or Trustcard holders can call 01-200 0200 for personal attention 24 hours a day, every day.

BY FREEPOST – use the coupon below. You can pay by cheque, postal order, Access, Barclaycard or Trustcard.

EITHER WAY – please allow up to 28 days for delivery. And there's a 14-day money-back option, of course. We want you to be satisfied beyond doubt – and we have no doubt that you will be.

sinclair ZX Spectrum

Sinclair Research Ltd,
Stanhope Road, Camberley, Surrey,
GU15 3PS. Tel: Camberley (0276) 685311.

To: Sinclair Research, FREEPOST, Camberley, Surrey, GU15 3BR.				Order
Qty	Item	Code	Item price £	Total £
	Sinclair ZX Spectrum – 16K RAM version	100	125.00	
	Sinclair ZX Spectrum – 48K RAM version	101	175.00	
	Sinclair ZX Printer	27	59.95	
	Printer paper (pack of 5 rolls)	16	11.95	
	Postage and packing: orders under £100	28	2.95	
	orders over £100	29	4.95	
			TOTAL £	

FREEPOST – no stamp needed. Prices apply to UK only. Export prices on application. WRW809

Please tick if you require a VAT receipt

*I enclose a cheque/postal order payable to Sinclair Research Ltd for £.

*Please charge to my Access/Barclaycard/Trustcard account no. Please print.

*Please delete/complete as applicable.

Mr/Mrs/Miss _____

Address _____

WW – 042 FOR FURTHER DETAILS

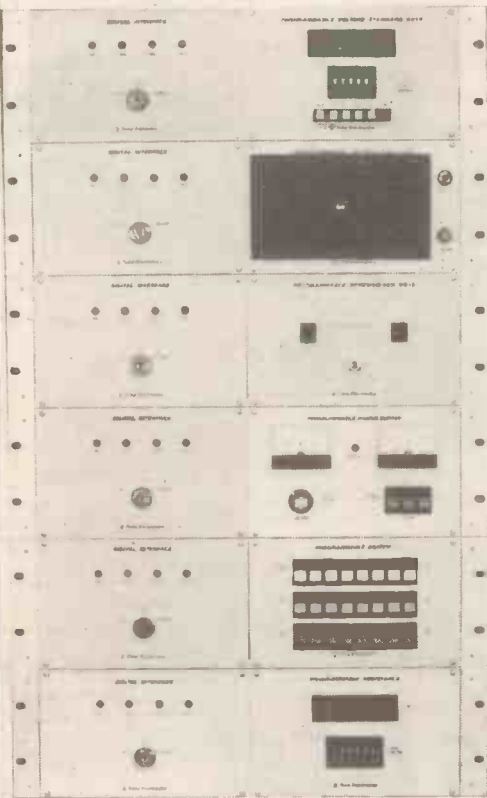

IEEE PROGRAMMABLES from TIME

9814 IEEE PROGRAMMABLE VOLTAGE STANDARD

A high performance voltage standard with 4 ranges from 0.1 volt to 10 volt output. Accuracy is 0.01% and the resolution of setting is 1 in 200,000. Output resistance is less than 0.01 ohms, and output current adjustable 20mA-200mA. Temperature coeff is less than 20ppm/°C and long term stability better than 50ppm per year. Full manual control is available via front panel controls. Available for benchtop use or 19" rack mounting.

9816 IEEE PROGRAMMABLE VOICE

A high quality speech synthesizer which has a 280 word vocabulary. By suitable programming via the IEEE bus it is possible to output single words, phrases and sentences. The vocabulary has been chosen to be applicable to many ATE applications.

9815 IEEE PROGRAMMABLE SCREWDRIVER

The unit has been designed to overcome the problems of adjusting large numbers of multi-turn trimmers in ATE systems. The screwdriver is fully programmable via the IEEE bus with 3 speeds of rotation and 2 selectable torque values available. The unit is supplied complete with a flexible drive shaft and drill chuck into which various adjusting tools can be located.

9810 IEEE PROGRAMMABLE POWER SUPPLY

0-33V in 0.1V steps. Local or remote (IEEE) operation. Fully programmable on the IEEE bus with 3 settable current limits 1mA, 10mA and 1.1A. A dual version of the 9810 is also available. The unit is 3 Euro units high and standard 19" rack mounting width.

9812 IEEE PROGRAMMABLE SWITCH

24 double pole changeover switches are available with full IEEE control. Each switch is rated at 1 Amp, 30V dc or 100V ac. Thermal emfs have been minimised to less than 1µV per switch. All outputs are on the rear panel along with the IEEE address selector switch and bus connector. Manual control of the switches is also provided via a set of front panel switches which also incorporate LED indicators.

9811 IEEE PROGRAMMABLE RESISTANCE

0-1 Megohm in 1 Ohm steps, fully programmable via the IEEE bus. Accuracy is 0.1% over most of the resistance range. Resistors are rated at 1 watt each. An attractive feature is the option to switch to local operation when the output resistance can be set up manually via front panel switches.

TIME ELECTRONICS LTD, Botany Industrial Est., Tonbridge, Kent, England TN9 1RS. Tel: (0732) 355993. Telex: 95481

WW - 024 FOR FURTHER DETAILS

Toroidal Transformers

THE COTSWOLD "BUDGET RANGE" OFFERS BUILT-IN QUALITY COUPLED TO A RELIABLE DELIVERY SERVICE MOST TYPES FROM STOCK

IEC 65
VDE 0550
BS 415
TO ORDER

PHONE
TELEX, WRITE
FOR DATA SHEET
AND PRICE LIST

Budget Range Stockist
BARRIE ELECTRONICS LTD.
3 The Minories, London EC3N 1BJ. 01-488 3316

Cotswold Electronics LTD.

Unit T1, Kingsville Road, Kingsditch Trading Estate, Cheltenham GL51 9NX

Tel: 0242-41313

Telex: 897106

WW - 025 FOR FURTHER DETAILS

O.I.L. MINIATURE ON-OFF SWITCHES Gold-plated contacts. Sealed base. Ideal for programming. 6-position at less than half manufacturer's price. ONLY 75p Will fit into 14-pin DIL socket. Ten at 65p ea.; per 100 55p ea.	HONEYWELL PROXIMITY DETECTOR integral amplifier, 5v D.C., £3.50 ea. PHOTO CONDUCTIVE CELL , £1.25 High-power CdS cell, 500MW, for control circuits. Resistance 800 ohm to 4K. Max. volts 240. Size 1 1/2 x 1/2in. RIBBON MICROPHONE with pre-amp. on chassis, £1.75.	MULLARD MODULES LP1171 1F Strip AM, FM Front end Pair £3.75 Complete with Data LP1186 varicap LP1157 Med. & Long Tuner £2.50 CRYSTALS COLOUR TV 4433619 mc/s £1.25 Miniature type sealed	ULTRA SONIC TRANSDUCERS 40KCS. Complete on 18in. Screened cable, £1.75 each; pairs £2.95. ULTRA SONIC TRANSMITTER . Complete unit (uncased requires 1.5V), £3.25. FOSTER DYNAMIC MICROPHONES . 200 ohm impedance. Moving coil. Complete on chassis, £1.75 pair.
U.H.F. MODULATORS Latest type, adjustable, ideal for computers. with data circuit Size 3x2 1/2 x 1 inch Only £3.50 In screened case	LM380 Amplifier 85p LM318N Hi-Stew Op. Amp. £1.50 LM323K , 5v, 3-amp, reg. £3.50 LM310N Volt. follower Amp. £1.20 LM311H High Perf. Volt. Comparator. £1.00 LM384N , 5-watt Amp. £1.20 LM393N Dual Com. 60p 7905 Reg. -5v 75p	MINIATURE HIGH-QUALITY FANS "Whisper Model" by Roton. Low-power consumption (less than 10 watts). Silent running. 115v. (two in series for 230v.). 50/60Hz. Size 4 1/2 x 4 1/2 x 1 1/2in. ONLY £6.50 EACH incl. V.A.T. BRAND NEW 50% less than manufacturer's price	STEREO CASSETTE MECHANISMS 6 or 12 volt. Complete with Heads + Erase and Solenoid. Brand new £3.50 ea. TV COUNTERMEASURE POTS (LJN) 50 ohm ALL 100 50p 200 5K ea.
MONSANTO Half-inch +1 Display High Intensity £1 each set of 4 £3.50 Common anode 14 Pin DIL Package	STEREO CASSETTE TAPE HEADS. Quality replacement for most recorders with mounting plate. Record/Replay £2.80 MARRIOTT TAPE HEADS Quarter track. Type XRPS18 Record/Replay (each) £2.00 XRPS36 Record/Replay (each) £3.00 XES11 Erase (each) £1.00	NEWLETT-PACKARD DISPLAYS 5062-7650 HIGH EFFICIENCY AND VERY BRIGHT Only £1.00 each Set of 6 for £5 Half-inch red common anode will replace DL70/14-pin DIL.	EX-MOTOROLA 5 + 5-WATT CAR STEREO AMPLIFIERS Complete and tested units Medium and Long Wave. Supplied as two built units (5 x 2 x 2in) with circuit and data. Only £5 pair. Includes pre-amp.
BRIDGE RECTIFIER 830 PIV 35 amps 1 1/2 x 1 1/2 x 1/2in £3.50	NATIONAL P.808DA Chips £2.95 8216 £1.75 IN4148 DIODES Full spec. but no polarity band. Per 1,000 £10 MINIATURE M.P.C. POTENTIOMETERS , Model M2. High-quality, 5% tolerance, 2-watt, with lin spindles. All values, 47 ohms-47k, only 60p each per 10; 50p each per 100, 40p each.	RECHARGEABLE BATTERIES VARTA 36 volts DEAC, M/AH 225 £1.50 DRYFIT 6-volt, 4.5 amp £7.50 XTAL FILTER 10.7 mc/s 12.5dB separation, 1 1/2 x 1 1/4 x 1 inch £7.00 100KCS + 1 meg, 3-pin £7.00	"CHERRY" ADD-ON KEYPAD A compact 12-button keypad suitable for use with Keyboard extend its functions plus four extra keys. Supplied brand new A 3 x 4 non-encased single mode keyboard LIST PRICE £22.00 OUR PRICE ONLY £7.50 incl. V.A.T.

QUANTITY DISCOUNTS on ALL items (unless stated), 15% per 10, 20% per 50, 25% per 100. All items BRAND NEW (unless otherwise stated). DELIVERY from stock - Add post 35p per order.

HENRY'S

EXPORT enquiries invited

TELEX 262284
Transonics
Mono 1400

01-723 1008/9

Callers to: 404 EDGWARE ROAD, LONDON W2 1ED
ALL MAIL ORDERS/EXPORT ENQUIRIES 11/12 PADDINGTON GREEN, LONDON, W2

AUDIO ELECTRONICS

ALL PRICES INCLUDE VAT

RETAIL-MAIL ORDER-EXPORT INDUSTRIAL-EDUCATIONAL

TEST EQUIPMENT CENTRES

CALL IN AND SEE FOR YOURSELF OPEN SIX DAYS A WEEK ALL MODELS ON DISPLAY

DIGITAL MULTIMETERS

All models complete with leads and batteries

- | | |
|---|---|
| <p>Hand Held Models 3½ digit LCD (UK C/P 65p)</p> <p>601 26 range push button 2A AC/DC Basic 0.5% £36.50</p> <p>2033A Similar to above by Sabtronics £39.95</p> <p>703 As 601 but 0.2% basic £54.00</p> <p>188m/6011A 15 range + Hfe tester push button 10A DC £43.50</p> <p>189m 30 range plus Hfe tester. Rotary switch 10A AC/DC £69.95</p> <p>2035A 28 range 0.1% basic 2A AC/DC push button (Sabtronics) £71.00</p> <p>2037A As 2035A plus 2-temp. ranges £77.00</p> <p>129 25 range 0.8% basic 10A AC/DC rotary switches (Keithley) £79.35</p> <p>130 As model 129 but 0.5% basic £102.35</p> | <p>Bench Models 3½ digit LCD unless stated (UK C/P 90p)</p> <p>2010A LED 31 range. 10A AC/DC basic 0.1% (Sabtronics) £81.50</p> <p>TM353 LCD 27 range 2A AC/DC basic 0.15% (Sinclair) £86.25</p> <p>2015A LCD 31 range 10A AC/DC basic 0.1% (Sabtronics) £89.50</p> <p>TM351 LCD 29 range 10A AC/DC basic 0.1% (Sinclair) £113.85</p> <p>2001 LCD 28 range plus 5 range capacitance meter 10A AC/DC Basic 0.1% (Pantec) £108.00</p> <p>1503A 4½ digit LCD 30 ranges 10A AC/DC 4 MHz counter, 4 KHZ osc. 0.05% basic (Thurby) £171.00</p> <p>1503HA As above but 25A and 0.03% basic £189.75</p> |
|---|---|

- ACCESSORIES**
- AC Adaptors (2010A & 2015A only) **£5.69** Cases TM351/353 **£6.84**
- 2001 **£7.50** 1503 **£20.45** Touch and hold probe THP20 **£14.95**

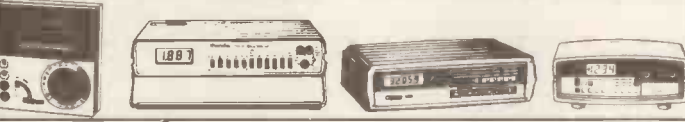

OSCILLOSCOPES

TRID CS1566A

- 20 + 20 MHz dual trace triggered sweep. 5mV/0.5 us/CHZ Inv/V x 10 mag. 19 sweep ranges. Limited offer. WAS £363.40 NOW **£320.00** (UK C/P £4.00)
- HM307 Single trace 10 MHz 5mV/0.5 micro sec. Plus built in component tester 6 x 7cm display (HAMEG) **£158.70** Optional case **£18.40**
- 3030 Single trace 15 MHz. 5mV/0.5 micro sec. Plus built in component tester. 95mm tube. Trig. to 20 MHz (CROTECH) **£172.50**
- 3035 Single trace 15 MHz. 5mV. Trig to 20 MHz plus built in component tester 0.2 µSec. 130mm tube (CROTECH) **£189.75**
- HM203 Dual 20 MHz. Trig to 30 MHz 5mV/0.5 micro sec. 8 x 10cm display. (HAMEG) **£253.00**
- CS1562A Dual 10 MHz 10mV. 1 µSec. 140mm tube (TRIO) **£267.95**
- 3131 Dual trace 15 MHz Trig. to 35 MHz 5mV/0.5 micro sec. 130mm tube. plus component tester. **£276.00**
- CS1575 Dual 5 MHz 1mV/0.5 µSec. 140mm tube. Phase display audio scope. (TRIO) **£312.80**
- CS1560A11 Dual 15 MHz 10mV. 0.5 µSec. (TRIO) **£341.55**
- 3034 Battery-mains dual trace 15 MHz. Trig to 20 MHz built in Nicads. 5mV/0.5 micro sec. (CROTECH) **£356.50** (Eliminator charger optional) **£28.75**

SAVE £43

(UK C/P Single trace £3 ea. Safgan £3 ea. Dual trace £4 ea. SC110 £1.00)

- HM412-5 Dual 20 MHz delayed sweep. Trig to 40 MHz. 5mV/0.1 micro sec 8 x 10cm display (HAMEG) **£402.50** (Optional case **£21.85**)
- SC110A New Model 10 MHz battery portable. 10mV/0.1 µSec 2" trace All facilities (THANDAR) **£171.00** (Options: Carry case **£6.84**, AC Adaptor **£5.69**, Nicads **£12.65**)
- CS1820 Dual 20 MHz 2.5mV/0.1 µSec. Delay sweep. 140 mm tube (TRIO) **£483.00**
- CS1577A Dual 35 MHz. 2mV. 0.1 µSec. Single sweep facility. 140mm tube. (TRIO) **£523.25**
- CS1830II 30 MHz. 2mV 0.2 µSec (flitted delay line). Delay sweep 140mm tube (TRIO) **£626.75**
- HM705 Dual 70 MHz delayed sweep. Single sweep Delay line: Trig to 70 MHz. 2mV/0.1 micro sec. 8 x 10cm display (HAMEG) **£667.00**
- Range of low cost Dual Trace Scopes mains operated. Made in UK to exacting standards. Available as 10 MHz, 15 MHz, or 20 MHz. All feature 5mV sensitivity, 0.5 micro sec. 6.4 x 8cm display. (SAFGAN)
- OPTIONS HM203/412/705**
- View Hoods **£6.90**
- Component Tester **£28.75**
- DT410 Dual 10 MHz **£205.85**
- DT415 Dual 15 MHz **£217.35**
- DT420 Dual 20 MHz **£228.85**
- Scope probes all models - see below.

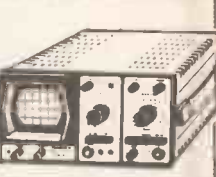
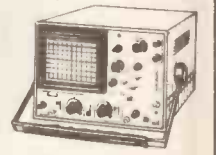
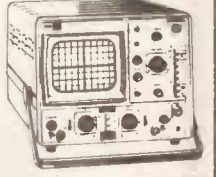

GENERATORS

- R-C Pulse RF Function Audio (UK C/P £1)
- All models 220/240 V AC
- AUDIO 4 band Sine/SQ output TE220 Max distortion 1% 20Hz/200KHz **£69.95**
- LAG27 Max distortion 0.5-1% (LEADER) 10Hz-1MHz **£86.25**
- AG202A Max distortion 0.5% (TRIO) 20Hz-200KHz **£78.20**
- LAG120A 5 band 10 Hz - 1MHz. Sine/SQ 0.05-0.8% dist. **£146.00**
- LAG125 As LAG120A but 0.02% dist. (LEADER) **£273.00**
- AG203 10 Hz - 1 MHz 5 band 0.1% Sine/SQ (TRIO) **£126.50**
- RF (All with Int/Ext mod. variable output)
- TE200 100 KHz - 100 MHz 6 band (300 MHz harm) **£59.95**
- LS617 100KHz-130MHz (390MHz harm) LEADER **£71.30**
- SG402 100 KHz - 30 MHz 6 band (TRIO) **£68.00**
- FUNCTION (All sine/SQ/Triangle/TTL etc.)
- 5020A 1 Hz - 200 KHz (SABTRONICS) **£90.00**
- TG100 1 Hz - 100 KHz (THANDAR) **£90.85**
- TG102 0.2 Hz - 2 MHz (THANDAR) **£166.75**
- PULSE
- TG105 5 Hz - 5 MHz Various outputs (THANDAR) **£97.75**
- 4001 Ultra-variable 0.5Hz-5MHz (GSC) **£113.85**



FREQUENCY COUNTERS

- (All models battery operated) (UK C/P £1)
- PFM200A Pocket 8 digit LED 200 MHz 10 mV (THANDAR) **£67.50**
- Max 50 50 MHz 6 digit LED Pocket (GSC) **£56.35**
- Max 550 6 digit LED Pocket (GSC) **£97.75**
- 8110A 8 digit LED 2 range 100 MHz. Bench (SABTRONICS) **£77.00**
- 8610A 8 digit LED 3 range 600 MHz Bench (SABTRONICS) **£94.00**
- Max 100 5Hz-100MHz 8 digit bench LED (GSC) **£97.75**
- 8610B 9 digit LED 3 range 600 MHz Bench (SABTRONICS) **£113.85**
- 8000B 9 digit LED 3 range 1000 MHz Bench (SABTRONICS) **£178.00**
- TF040 8 digit LCD 40 MHz (600 MHz with TP600) (THANDAR) **£126.50**
- TF200 8 digit LCD 2 range 200 MHz (600 MHz with TP600) (THANDAR) **£166.75**
- TP600 600 MHz precaler (THANDAR) **£43.13**
- OPTIONS**
- TF series carry case **£6.84**
- AC adaptors **£5.69**
- 8' series AC Adaptors **£5.69**
- All models probe kits **£7.95**

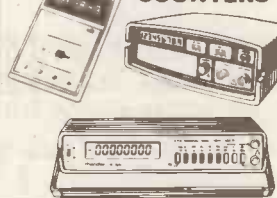

INSULATION AND CLAMP METERS

- Multi-range clamps all with resistance range carry case and leads. Also digital and DC clamp in stock. (UK C/P 75p)
- ST300 300A 600V AC. 9 ranges. **£28.95**
- K2606 300A 600V AC. 8 ranges (Optional temp. probe £13.80) **£49.50**
- K2903 900A 750V AC. 9 ranges. **£77.50**

ELECTRONIC INSULATION TESTERS

- Battery operated complete with carry case. (UK C/P £1)
- YF501L 500V/100 Meg Plus 0-100 ohm **£65.00**
- K3103 600V/100 Meg. Plus 0-2.5k ohm **£109.00**
- K3106 500V & 1000V. 1000 & 2000 Meg **£119.00**
- K4101 Earth resistance tester **£149.00**
- M500 Hand cranked insulation tester 500V/100 Meg **£79.50**
- K6031 110V/600V phase tester **£23.50**

AMATEUR RADIO AND CB TESTING

- (Full lists send S.A.E.)
- KDM6 1.5 to 250 MHz 6 range DIP meter (illus) **£47.95**
- RC1000 3 meters 0/10/100/1000 watts. SWR etc. 150 MHz max. illus) **£45.00**
- CB20 SWR/Power twin meter to 30 MHz. 1KW (illus) **£8.95**
- HM20 20K/Volt multirange multimeter. Plus SWR/Power meter 150 MHz Detachable Coupler **£22.95**
- LPM880 RF Power meter 5/20/120W. 1.8 - 500 MHz **£84.00**
- LPM885 SWR/Power. 20/200/1000W. 1.8 - 54 MHz (illus) **£54.00**

HAVE A BANANA!

- Low cost reliable meters (All supplied with bats/leads) (UK C/P 55p)
- BANANA 15 range pocket 20K/ Volt plus cont. buzzer (illus) **£20.64**
- T10L 12 range 1K/Volt + overload **£5.75**
- NH55 10 range pocket 2K/Volt **£6.50**
- ST5 11 range pocket 4K/Volt **£7.50**
- NH56R 22 range pocket 20K/ Volt **£11.50**
- YN360T 19 range plus Hfe test 20K/Volt **£14.95**
- KRT5001 18 range 10 amp DC range double 50K/Volt **£17.95**
- ST303TR 21 range plus Hfe Test 20K/Volt **£18.95**
- TMK500 23 range plus 12A DC plus cont. buzzer 30K/Volt **£24.50**
- 168m 36 range large scale 10A AC/DC 50K/Volt **£28.50**
- 360TR 23 range large scale 10A AC/DC Hfe test 50 meg ohm. 1KV AC/DC 100 K/Volt **£39.95**
- Choose from UK's largest range

TOP QUALITY ANALOGUE MULTIMETERS

- (UK C/P £1.20)
- All featuring AC/DC Volts/Current and Ohms ranges.
- MAJOR 20K 29 range 20k/V. 2½A DC. 12½A AC (PANTEC) **£33.90**
- MAJOR 50K 29 range 50K/V. 2½A DC. 12½A AC (PANTEC) **£40.25**
- PAN3001 34 range 40K/V. 5A AC/DC 50 Meg. (PANTEC) **£59.80**
- Also 500KHz. 500 MHz signal injector and 3 range cap. meter.
- PAN3003 42 range 1 Meg/V. 5A AC/DC. 1µA FSD (PANTEC) **£66.70**
- (NOTE 3001 & 3003 Electronic Protection Mirror Scales)
- K1400 26 range large scale 20K/Volt 10A AC/DC. 20 Meg ohm. 5KV AC/DC **£95.00**
- K200 39 range 10 Meg. ohm input. 25 Hz - 1 MHz **£105.00**
- M1500 43 range 20k/V. 9 range AC - 10A 12 range DC - 10A **£67.50**

DIRECT READ HV PROBE

- (UK C/P 65p)
- 0/40 KV. 20K/Volt **£18.40**

OSCILLOSCOPE PROBE KITS

- (UK C/P 50p per 1 to 3) BNC plug X1
- X10 **£7.95**
- X1 - X10 **£9.45**
- X100 **£10.50**
- X100 **£16.95**

DECADE BOXES

- RSB2 32 value Resis. box. 1 ohm to 4 Meg. **£18.50**
- CSB20 20 Value Cap. box. 470 pt to 1 µF **£21.00**

PORTABLE TV COLOUR GENERATOR

- MC101
- 8 patterns/dots/lines etc. Built in Nicads. Pat B UNF only. Complete with charger, case and leads. **£162.50**

DIRECT READ TEMPERATURE

- TH301 -50°C to +750°C. LCD readout. Complete with battery and thermocouple. **£68.43**

LOGIC PROBES/MONITOR

- Sabtronics LP10 10 MHz probe **£28.50**
- GSC LP2 15 MHz probe **£19.95**
- LEADER LDP076 50 MHz (with case) **£56.90**
- GSC LM1 monitor (8 to 16 pin IC's) **£33.00**
- GSC DPI Digital pulsar. Single/100 pps **£58.50**

VARIABLE POWER SUPPLIES

- Mains input. Volts/Amps meter (UK C/P £1)
- PP241 0/12. 12/24 Volt. 0/1 amp **£35.00**
- PP243 0/12. 12/24 Volt. 0/3 amp **£59.95**
- PS1307S twin meter 8-15V 2-7A **£35.95**

'SCOPE ADD ON UNITS

- LTC905 Semiconductor curve tracer (illus) (LEADER) **£95.45** (UK C/P 85p)
- MZ65 Component tester (HAMEG) (UK C/P 85p) **£27.95**

AUDIO ELECTRONICS CUBEGATE LIMITED

301 EDGWARE ROAD, LONDON, W2 1BN, ENGLAND. TEL 01-724 3564
ALSO AT HENRY'S RADIO, 404/406 EDGWARE ROAD, LONDON W2

WE ARE OPEN 6 DAYS A WEEK - CALL IN AND SEE FOR YOURSELF!

Order by Post with CHEQUES/ACCESS/VISA or Telephone your order

Allow up to 10 days for delivery (unless advised)

Send large SAE (20p UK) Schools, Companies, etc. Please write in.

ALL PRICES INCLUDE VAT

EP4000

EPROM EMULATOR PROGRAMMER



The microprocessor controlled EP4000 will emulate and program all the popular EPROMs including the 2704, 2708, 2716(3), 2508, 2758, 2516, 2716, 2532 and 2732 devices. Personality cards and hardware changes are not required as the machine configures itself for the different devices. Other devices such as bipolar PROMs and 2764 and 2564 EPROMs are programmed with external modules.

The editing and emulation facilities, video output and serial/parallel input/output provided as standard make the EP4000 very flexible to allow its use in three main modes:

- As a stand alone unit for editing and duplicating EPROMs.

Items pictured are: ● EP4000 Emulator Programmer - £545 + £12 delivery; ● BSC buffered simulator cable - £39; ● MESA 4 multi EPROM simulator cable - £98; ● 2732A Programming adaptor - £39; ● 2764 Programming adaptor - £64; ● 2564 Programming adaptor - £64; ●

- As a slave programmer used in conjunction with a software development system or microcomputer.
- As a real time EPROM emulator for program debugging and development (standard access time of the emulator is 300ns).

Data can be loaded into the 4k x 8 static RAM from a pre-programmed EPROM, the keypad, the serial or parallel ports and an audio cassette. Keypad editing allows for data entry, shift, move, delete, store, match and scroll, and a 1k x 8 RAM allows temporary block storage. A video output for memory map display, as well as the built-in 8 digit hex display allows full use of the editing facilities to be made.

BP4 (TEXAS) Bipolar PROM Programming module - £190

Also available (not shown): ● VM10 Video monitor - £99; ● UV141 EPROM Eraser with timer - £78; ● GP100A 80 column Printer - £225; ● PI100 interface for EP4000 to GP100A - £65.

VAT should be added to all prices

DISTRIBUTORS REQUIRED

EXPORT ENQUIRIES WELCOME

GP Industrial Electronics Ltd.

Tel: Plymouth (0752) 332961
Telex: 42513

Unit E, Huxley Close, Newnham Industrial Estate, Plymouth PL7 4JN

P8000 — THE PRODUCTION PROGRAMMER THAT HANDLES ALL NMOS EPROMS



**NEW
PRODUCT**

- Checks, Programs, Compares up to 8 devices simultaneously
- Handles all NMOS EPROMS up to projected 128K designs with no personality modules or characterisers — See list
- Easy to use, menu driven operation for blankcheck, program, verify, illegal bit check, checksum, self-test
- Constant display of device type, mode and fault codings
- Individual socket LED indicators for EPROM status
- Comprehensive EPROM integrity checks — Illegal bit check, data and address shorts, constant power line monitoring
- Full safeguard protection on all sockets
- Automatic machine self-test routine
- Powered down sockets
- Cost effective price — £695 + VAT
- Available from stock

2704
2708
2716(3)
2508
2758A
2758B
2516
2716
48016
2532
2732
2732A
68732-0
68732-1
68766
68764
2764
2564
MK2764

Write or phone for more details

DISTRIBUTORS REQUIRED

EXPORT ENQUIRIES WELCOME

GP Industrial Electronics Ltd.

Tel: Plymouth (0752) 332961
Telex: 42513

Unit E, Huxley Close, Newnham Industrial Estate, Plymouth PL7 4JN

WW — 071 FOR FURTHER DETAILS

RADIO AND TELEVISION SERVICING

1981-82 MODELS

Editor: R. N. Wainwright, T. Eng (CEI), F.S.E.R.T.

This latest volume in the series covers more makes than ever before and continues to provide an invaluable reference book for all service engineers. The first section contains circuit diagrams and service information for a wider group of colour and monochrome TV receivers than previously attempted, the second contains a selection from an enormous range of available audio equipment, including portable and clock radios, tape recorders, audio centres and in-car entertainment.

Price: £19.50
Publication Date: 26th August

Previous volumes are still available. Enquiries to the Publicity Department, Macdonald & Co.

From booksellers, or in case of difficulty, please use the coupon below:-

To: Cash Sales Dept. Macdonald & Co., Maxwell House, Worship Street, London EC2A 2EN.

Please send me . . . copy(ies) of RADIO AND TELEVISION SERVICING 1981-82 MODELS.

I enclose a cheque/PO made out to Macdonald & Co (Publishers) Ltd for

Name

Address

.

. WW

MACDONALD

A division of Macdonald & Co (Publishers) Ltd
WW - 060 FOR FURTHER DETAILS

Three of the best in test

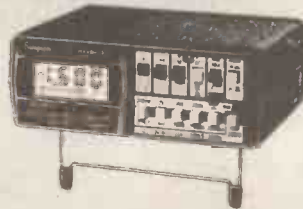

Model 467

The 3½ digit hand portable True RMS DMM with LCD digital and analogue display — another Simpson first in the UK.

Model 260

The Simpson analogue multimeter that is the world's largest selling AMM. 27 ranges cover AC and DC volts, DC current, resistance and dB.



Clamp-on Testers

The new 296-2 for faster testing of motors, transformers and circuits. All models measure up to 300 Amps AC RMS.



now see the rest

Write now for technical information on our full range of precision instruments

Bach-Simpson

Bach-Simpson (U.K.) Limited,
Trenant Estate, Wadebridge, Cornwall, PL27 6HD.
Telephone: (020881) 2031 Telex: 45451

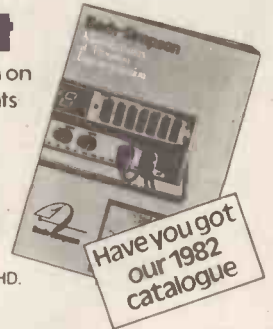

WW - 052 FOR FURTHER DETAILS

PRINTED CIRCUITS FOR WIRELESS WORLD PROJECTS

Audio compressor/limiter—Dec. 1975—1 s.s. (stereo)	£4.25
Cassette recorder—May 1976—1 s.s.	£5.00
Audio compander—July 1976—1 s.s.	£4.25
Audio preamplifier—November 1976—2 s.s.	£8.50
Additional circuits—October 1977—1 s.s.	£4.00
Stereo coder—April 1977—1 d.s. 2 s.s.	£8.50
Low distortion disc amplifier (stereo)—September 1977—1 s.s.	£2.00
Low distortion audio oscillator—September 1977—1 s.s.	£3.50
Synthesized f.m. transceiver—November 1977—2 d.s. 1 s.s.	£12.00
Morsemaker—June 1978—1 d.s.	£4.50
Metal detector—July 1978—1 d.s.	£3.75
Oscilloscope waveform store—October 1978—4 d.s.	£18.00
Regulator for car alternator—August 1978—1 s.s.	£2.00
Wideband noise reducer—November 1978—1 d.s.	£5.00
Versatile noise generator—January 1979—1 s.s.	£5.00
200MHz frequency meter—January 1979—1 d.s.	£7.00
High performance preamplifier—February 1979—1 s.s.	£5.50
Distortion meter and oscillator—July 1979—2 s.s.	£5.50
Moving coil preamplifier—August 1979—1 s.s.	£3.50
Multi-mode transceiver—October 1979—10 d.s.	£35.00
Amplification system—Oct. 1979—3 preamp 1 poweramp	£4.20 each
Digital capacitance meter—April 1980—2 s.s.	£7.50
Colour graphics system—April 1980—1 d.s.	£18.50
Audio spectrum analyser—May 1980—3 s.s.	£10.50
Multi-section equalizer—June 1980—2 s.s.	£8.00
Floating-bridge power amp—Oct. 1980—1 s.s. (12V or 40V)	£4.00
Nanocomp 6802 or 6809—Jan., July, 1981—1 d.s. 1 s.s.	£9.00
Cassette interface—July, 1981—1 s.s.	£1.50
Eprom programmer—Jan., 1982—1 d.s.	£4.50
Logic probe—Feb., 1981—2 d.s.	£6.00
Modular frequency counters—March, 1981—8 s.s.	£20.00
Opto electronic contact breaker (Delco)—April, 1981—2 s.s.	£4.00
CB synthesiser—Sept.—1 d.s.	£8.00
Electronic ignition—March, 1982—1 s.s.	£4.00

Boards and glassfibre roller-tinned and drilled. Prices include VAT and UK postage. Airmail add 30%, Europe add 10%. Insurance 10%. Remittance with order to:

M. R. SAGIN, NANCARRAS MILL, THE LEVEL CONSTANTINE, FALMOUTH, CORNWALL

WW - 030 FOR FURTHER DETAILS

GET YOUR HANDS ON A KEITHLEY 130

The pocket Digital Multimeter by which others are judged.

£89 PLUS VAT

And generous discounts start at 10 units; 5%.

Everything about the 130 is right. Easy to operate, large clear read-out. Compact, robust and reliable. With a specification few can equal in machines costing twice the price:

- Only one calibration adjustment.
- One year guarantee on spec.
- 25 ranges and five functions: ohms, DC and AC volts and amps.
- 10 amp range.
- 100 V, 1 A, 0.1 Ω sensitivity.
- 20,000 hour M.T.B.F.

All this is backed by the immense know-how of a specialist company with an enviable reputation for test equipment spanning almost all requirements from 3½ to 5½ digits.

How do you get one?

Simple. Just send off the coupon enclosing cheque or postal order. And see for yourself how the 130 measures up.

The Keithley 130 – the D.M.M. that won't stretch your pocket!

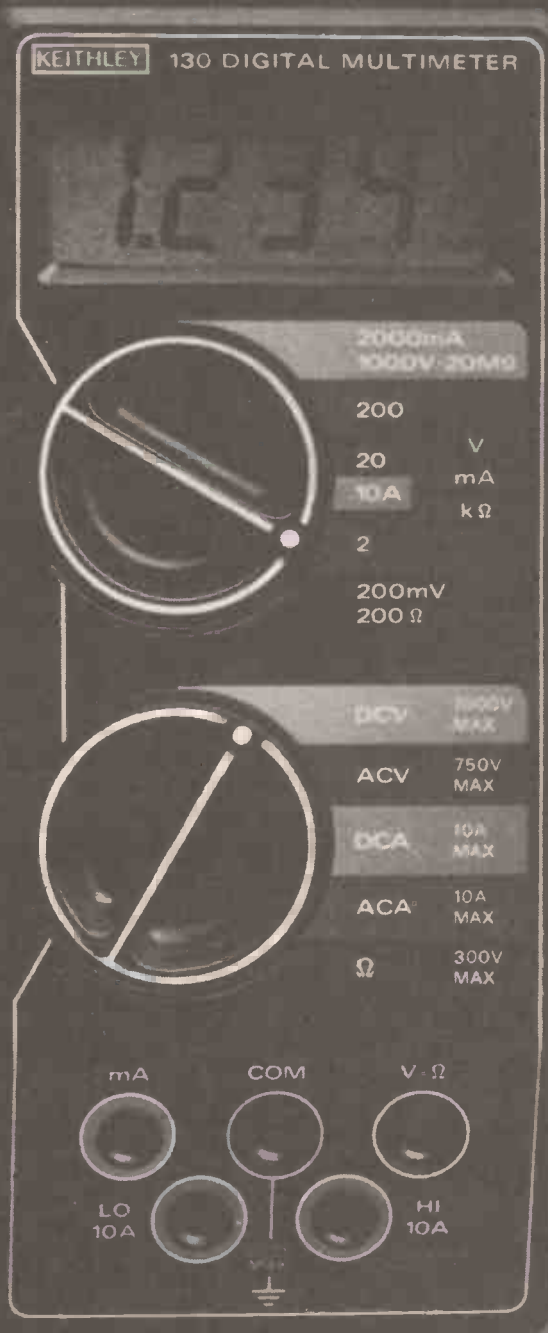

KEITHLEY

Keithley Instruments Ltd
1 Boulton Road Reading Berkshire RG2 0NL
Telephone 01235 86128

WW - 008 FOR FURTHER DETAILS

Please send me To Keithley Instruments Ltd, 1 Boulton Road, Reading, Berkshire.
 Keithley 130(s) at £102.35 including V.A.T. each.
 I enclose a cheque/postal order for _____
 Name _____
 Address _____
 Allow 21 days for delivery.
 This offer includes postage and packaging in the United Kingdom only.



AMCRON INDUSTRIAL MUSCLE

- ★ POWER RESPONSE DC - 45KHz ± 1dB.
- ★ OUTPUT POWER IN EXCESS OF 1.5KW INTO 2.75 Ohm LOAD (CONTINUOUS R.M.S.)
- ★ D.C. OUTPUT 20 AMPS AT 100 VOLTS OR 2KVA.
- ★ HARMONIC DISTORTION LESS THAN 0.05% DC-20KHz AT 1KW INTO 6 OHMS.
- ★ PLUG-IN MODULES: CONSTANT VOLTAGE/CURRENT, PRECISION OSCILLATORS.
- ★ UNIPOLAR AND BIPOLAR DIGITAL INTERFACES, FUNCTION GENERATORS, AND MANY OTHERS.
- ★ OUTPUT MATCHING TRANSFORMERS AVAILABLE TO MATCH VIRTUALLY ANY LOAD.
- ★ FULL OPEN AND SHORT CIRCUIT PROTECTION GUARANTEED STABLE INTO ANY LOAD.
- ★ TWO UNITS MAY BE CONNECTED TO PROVIDE UP TO 4kW.
- ★ INTERLOCK CAPABILITY FOR UP TO EIGHT UNITS.
- ★ 3-YEAR PARTS AND LABOUR WARRANTY.
- ★ UNITS AVAILABLE FROM 100VA-12KVA.

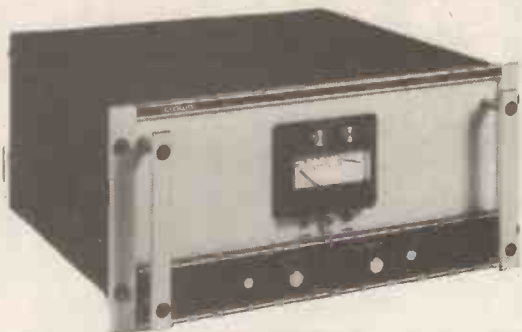

Model - M600

For full details on all Amcron Products write or phone Chris Flack

P.O. BOX 3
ATTLEBOROUGH
NORFOLK NR17 2PF
Tel: 0953-452477

Analogue Associates

PROFESSIONAL INDUSTRIAL ELECTRONICS

WW - 020 FOR FURTHER DETAILS



L & J COMPUTERS

192 HONEYPOT LANE, QUEENSBURY, STANMORE, MIDDX HA7 1EE. 01-204 7525

THE "PET" SPECIALISTS



4016 16K Computer	£460
4032 32K Computer	£575
2031 171K Single Drive Floppy Disk	£350
4040 343K Dual Floppy Disk	£575
4022 Tractor Feed Printer	£350
8032 32K Computer	£750
8096 96K Computer	£995
8050 950K Dual Drive Floppy Disk	£750
8023 Tractor Feed Printer	£750
8422 22 Megabyte Winchester Disk	£3250
9000 SuperPet 134K Multilanguage Computer	£1295

TOOL KITS (BASIC 2 & 4). SUPERCHIPS
AND ALL SORTS OF OTHER CHIPS

WE HAVE A DAZZLING ARRAY OF CONNECTIONS WITH THE OUTSIDE WORLD! D TO A CONVERTERS (8, 12 & 16 BIT A TO D CONVERTERS RESOLUTIONS X/Y PLOTTERS (A3 SIZE UPWARDS) DIGITAL INPUTS/OUTPUTS RS 232: IEEE: CENTRONIC INTERFACES

AS WELL AS BUSINESS SOFTWARE, WE ALSO CAN SUPPLY ENGINEERING REQUIREMENTS, LIKE: DATA ANALYSIS/STATISTICAL PACKAGES TAPEPREP FOR CNC MACHINE TOOLS SECTION CALCULATIONS FOR DRAWING OFFICES ANALYSIS FOR CONTROL SYSTEMS

COME AND SEE THE NEW VIC-20 £165

VIC-20

FULLY WORKING AND OPERATIONAL ASK US ABOUT ALL THE ADD-ON-GOODIES THAT GO WITH THE VIC

MASSSES OF BOOKS ON THE PET & VIC + INTERFACING & CONTROL

SEND US A LARGE STAMPED ADDRESSED ENVELOPE (12x9) AND WE WILL BE DELIGHTED TO SEND YOU ALL OUR CURRENT INFORMATION!

* PRICES DO NOT INCLUDE VAT

PERSONAL SHOPPERS WELCOME
Phone & Mail Orders accepted

ALL GOODS SENT SAME DAY WHEREVER POSSIBLE
LARGE S.A.E. FOR LISTS ETC.



WW - 047 FOR FURTHER DETAILS

CLEF ELECTRONIC MUSIC

PIANOS

SPECIALISTS SINCE 1972
DOMESTIC OR STAGE
SIX OR 7 1/4 OCTAVES
KITS OR MANUFACTURED



The most advanced form of touch-sensitive action simulating piano key inertia by patented technique.

Four mixable voices for serious tone variation plus electronic chorus and flanger effects.

DOMESTIC PRICES

E	SIX	7 1/4
Comp	234	266
Full	398	442
MFD	620	695

Component Kits include Keyboard.

Full Kits further contain: Cabinets, Harness, Power Amp, and Speaker.



Kit BAND-BOX
£314 An Electronic Backing TRIO. Drums, Bass & Chord Instrument.
Mfd £439 User Programmable for 50-100 scores, using microprocessors.



MASTER RHYTHM
User Programmable DRUM MACHINE.
Twenty-four patterns. Eight parallel tracks. Twelve instruments sequence operation.



£79 KIT £119 BUILT

Write or Phone for full details of our range of high quality Kit and manufactured Electronic Musical Instruments. Prices include V.A.T., Carr., & Ins. and we operate Telephone BARCLAYCARD/ACCESS. Competitive EXPORT Quotations given.

CLEF PRODUCTS (ELECTRONICS) LIMITED
Dept. W, 44a Bramhall Lane South
Bramhall, Stockport, Cheshire SK7 1AH
061-439 377

NOW!
FROM SESCOM

ORDER YOUR FAVOURITE
AUDIO ACCESSORIES BY MAIL

SEND FOR YOUR FREE COPY
OF OUR 1982 CATALOG



48
PAGES
8 1/2" x 11"

OVER 250 ITEMS

INCLUDING DIRECT BOXES, MIC-SPLITTERS, SIGNAL PROCESSING, AUDIO MODULES, TRANSFORMERS & MANY OTHER ACCESSORIES

WITH TECHNICAL DATA & USE DIAGRAMS

We Ship the fastest & most convenient way for you! Most Shipments From Stock



SESCOM, INC.
RETAIL SALES DIVISION
1111 Las Vegas Blvd. North
Las Vegas, NV 89101-1197 U.S.A.

(702)384-0893
(800)834-3457
TWX (910)397-8996

WW - 051 FOR FURTHER DETAILS

WW - 048 FOR FURTHER DETAILS

WIRELESS WORLD SEPTEMBER 1982



No hangover!

Hangover, a rather loose term to describe the stored energy resonance in a loudspeaker, the principal cause of colouration that immediately tells you you're listening to a loudspeaker.

Take it away and there's a new world – the loudspeakers have nothing more to say – instead there's just the orchestra and the magic of the music.

If music is an important part of your life, then a pair of ESL-63 loudspeakers could be the best investment you've ever made.

Perhaps even something to celebrate about.



For further details and the name and address of your nearest Quad ESL-63 retailer write or telephone The Acoustical Manufacturing Co. Ltd., Huntingdon, Cambs., PE18 7DB. Telephone: (0480) 52561.

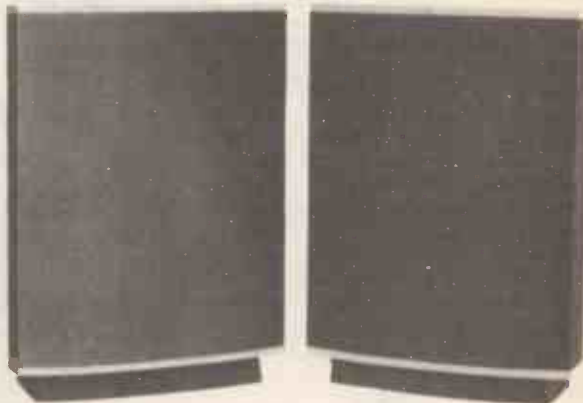

QUAD 
for the closest approach
to the original sound

WW - 018 FOR FURTHER DETAILS

ONLY HB ELECTRONICS OFFER SUCH A HIGH QUALITY RANGE AT SUCH UNBEATABLE PRICES

Whatever your requirements in soldering and desoldering equipment, you won't find better value at such competitive prices.

Just take a look at these:

UNGARmatic
24V TEMPERATURE
CONTROLLED
SOLDERING IRON
UNBEATABLE PRICE
£16.00 ONLY
Inc Heater & Tip
(+ £2.40 VAT)

SOLDERING ACCESSORIES

HANDLE (71)

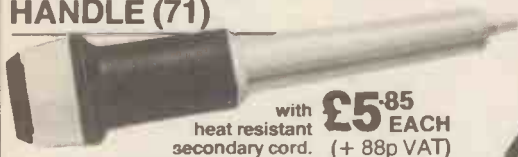

with heat resistant secondary cord. **£5.85** EACH (+ 88p VAT)

HEATER (76/77/78)

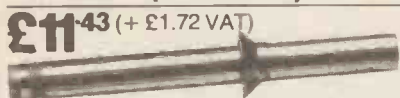

Temperature Ranges **77 370°C (700°F)**
76 315°C (600°F) **78 430°C (800°F)**

TIPS Long Life interchangeable

Iron-clad, chrome plated and pre-tinned.

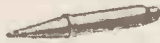

£1.30 EACH (+ 20p VAT)

	80. Long Screwdriver 3.17mm
	81. Screwdriver 5.95mm
	82. Spade .79mm
	83. Screwdriver 2.38mm
	84. Long Screwdriver 1.98mm
	85. Stepped Spade 1.19mm
	86. Needle Tip 1.19mm
	87. Screwdriver 1.59mm
	88. Long Screwdriver 1.19mm
	92. Screwdriver 3.17mm
	93. Screwdriver .79mm
	94. Short Conical .79mm
	95. Adaptor

DESOLDERING SYSTEMS & ACCESSORIES

DESOLDERING PUMP (7872)

DESOLDERING PUMP
£5.99
(+ 90p VAT)

Lightweight Anodised Aluminium

Designed for operation with one hand.

DESOLDERING KIT (50DK)

Kit includes: **95** Tip Adaptor **6948** Slotted DIP desoldering bar tip
6982 Spring loaded extractor **5013** Super-Wick T.M. desoldering braid.

4000E DESOLDERING STATION
£285
(+ £42.75 VAT)

DESOLDERING KIT
£9.43
(+ £1.42 VAT)

HEAT GUN (6966G)

240 V HEAT GUN
£44.00
(+ £6.60 VAT)

Lightweight Heat Gun complete with stand and set of 4 push-on baffle adaptors

ORDER TODAY - 24 HOUR DESPATCH



For further details and comprehensive literature on all our products contact this number today **0204 386361** or fill in the coupon.

HB Electronics

Lever Street, Bolton, Lancs.

CANNING
THE W CANNING GROUP

Please add VAT to prices shown

Post to HB Electronics (DEPT D.S.) Lever St, Bolton, Lancs.

QUANTITY	PRODUCT NO.	UNIT PRICE	TOTAL PRICE

CHEQUE POSTAL ORDER TOTAL

NAME _____
ADDRESS _____

ALL PRICES INCLUDE POST AND PACKING

Editor:

PHILIP DARRINGTON
01-661 3128

Deputy Editor:

GEOFF SHORTER, B.Sc.
01-661 8639

Technical Editor:

MARTIN ECCLES
01-661 8638

News Editor:

DAVID SCOBIE
01-661 8632

Design Editor

ALAN KERR

Drawing Office Manager:

ROGER GOODMAN

Technical Illustrator:

BETTY PALMER

Advertisement Manager:

BOB NIBBS, A.C.I.I.
01-661 3130

DAVID DISLEY

01-661 8641

BARBARA MILLER

01-661 8640

Northern Sales:

HARRY AIKEN
061-872 8861

Midland Sales:

BASIL McGOWAN
021-356 4838

Classified Manager:

BRIAN DURRANT
01-661 3106

OPHELIA SMITH

01-661 3033

Production:

BRIAN BANNISTER
(Make-up and copy)
01-661 3500 X3561

I.T. and M.I.S.S.

One of the aims of Information Technology Year and the Microelectronics Education Programme is to involve schoolchildren in the use of microcomputers and related electronic devices. There are the M.E.P., the Micros in Schools Scheme, exhibitions and events throughout the year and beyond. It is, perhaps, fortunate that Mr Callaghan happened to be watching television on the evening the programme "Now the Chips are Down" was broadcast and was spurred into action then, or we would probably find the propaganda even more frenetic than that now being put out by the energetic Mr Baker, the prophet of IT.

Information Technology is a curiously diffuse name for a Year. The official definition, "the acquisition, processing, storage, dissemination and use of vocal, pictorial, textual and numerical information by a microelectronics-based combination of computing and telecommunications" appears to encompass most of the activities of the average person, except eating and one or two other processes, although the use of a computer is not often considered essential to the more basic of these.

So far as its involvement of schoolchildren is concerned, the publicity is decidedly shrill, the Minister's aim being to have a computer in every secondary school by the end of the year and even to think about providing them for primary schools.

There can be no argument that young people must be aware of computers and how to use them, but it does seem possible that the present blaze of publicity tends to obscure the point that computers are a means, not an end. There is also the question of how the micros are to be used in schools.

According to the fifth edition of the Concise Oxford Dictionary (now, admittedly, modified), a computer is "a calculator — an electronic calculating machine" — an unfortunate description, taken too literally by at least some of those responsible for introducing youngsters to

computing, with the result that the school micro is often given to the senior maths teacher to guard with his life, presumably on the grounds that computers are electronically mathematical and possess no relevance to any other subject.

In other schools, the computer is treated as a kind of totem, and the pupils are taught "Computer Studies". As a subject, computing (meaning programming) is a singularly empty one, unless the pupil learning it intends to become a programmer. A computer is an aid to the process in which it is used — in this instance, learning — and an element of transparency to the user rather than an obscuring of the subject by undue attention to the computer must be the aim.

Clearly, an overnight transformation, after which every teacher would be using a micro as to the manner born, is hardly feasible. But, until the school micro (or one of its terminals or even a micro owned by a pupil or teacher) can be used naturally, as is a dictionary or pocket calculator or a video recorder, it will dominate the learning process. Utmost priority should be given to teachers from all disciplines, from home economics to athletics, to use the computer as an aid, rather than as a distraction, so that pupils who are not to specialize in science or engineering can see that it is of advantage to them to be at ease with computers, but no more than that.

The Inner London Education Authority is aware of these problems and is educating teachers in the use of computers so that, even though there may be only one micro or terminal in the classroom, the pupils will learn the place of a computer by, to use ILEA's word, "osmosis". However, there is evidence aplenty that education authorities in other areas are either hypnotized or revolted by the new equipment and, accordingly, either enshrine it or pass it to the school computer fanatic to impress people with.

In short, a computer is a useful tool, but that is all it is: it can help or it can dangerously hinder learning, and only the education of teachers in its natural use as an aid can decide which.

DIGITAL FREQUENCY STABILIZATION OF A V.F.O.

Using a single crystal, the unit stabilizes the output of a variable-frequency oscillator at a large number of points by means of a counting technique. This article traces the development of the design and points out further avenues to explore

Most radio receivers and transmitters use at least one variable oscillator, coupled with the turning dial. Such an oscillator, usually called a v.f.o., must be easily tuned, exhibit high frequency stability and provide a pure sinusoidal output. For s.s.b. communication, the stability requirement cannot be met with LC oscillators, at least not in the higher h.f. bands or the v.h.f. frequencies. Use is often made of a mixing scheme, the variable oscillator running at a lower frequency, but purity of output and simplicity suffer with this method. Ease of tuning has always been the hall-mark of good communication receivers, leading to the familiar looks and appreciable cost of a very long tuning dial, with very fine divisions, coupled to the tuning capacitor by means of slip-free reduction gear without backlash.

Of course, a digitally-set frequency is very useful in a test-oscillator, but useless when one wants to tune in with the 'handwheel'.

A simple stabilizer

Proposals have therefore been made to accomplish the old-fashioned continuous tuning while stabilizing the generated frequency at discrete spots. A simple method, now well known to amateurs, is given in Fig. 1. Since we are not interested in displaying the frequency digitally, only the first decade from the usual chain of counters is needed and its output used to correct the v.f.o. frequency.

To get a good mental picture of what happens, consider an example. The measuring period is exactly one second, the v.f.o. frequency is about 5 MHz, say, 5,123,456.78 . . Hz. The counter, being reset before the measuring time starts, contains after one second a 6 or 7. Because the digital output is taken from the fourth flipflop, a 1 only results when the counter contains an 8 or a 9, all other numbers giving a 0 at this point. The 1 may be regarded as the 'too high' signal, the 0 standing for 'too low'. This digit is stored in a buffer, so the counter can be reset and a new measurement initiated. A large time-constant smoothes the control signal from the buffer to the Varicap v.f.o. In the working system, the frequency of the oscillator is kept around 5,123,457/8 MHz and wobbles around this value. The next points for stabilization are 5,123,467/8 when tuning upwards and 5,123,447/8 when going downwards. Any drift of the v.f.o. is taken care of by changing the ideal equal number of ones and zeros to some

by W. Trapman, jr.

other proportion, for instance five ones against four zeros in a sequence like 01010110101, etc. (To say *any* drift is compensated for is fine, so long as it is taken to mean 'any small drift'. A very bad oscillator equipped with the stabilizer will not 'creep' but 'jump'. It is a very simple system, compared with other possibilities.

Besides a crystal-controlled (one-second interval) time-base, few i.c.s are required and its elegant simplicity appeals to constructors.

There are drawbacks, however, all connected with the long measuring time: to get a reasonably smoothed control signal, the integrating time-constant has to be very large. A further point to think about is the delay in the system — even if the large RC product could be avoided, the information about the frequency becomes available every second and this is a somewhat elusive way of saying that some of it is almost one second old. The system just described needs at least several seconds to stabilize after the tuning knob is touched.

So, the first thing one tries to do is to shorten the measuring time to 0.1s. This is

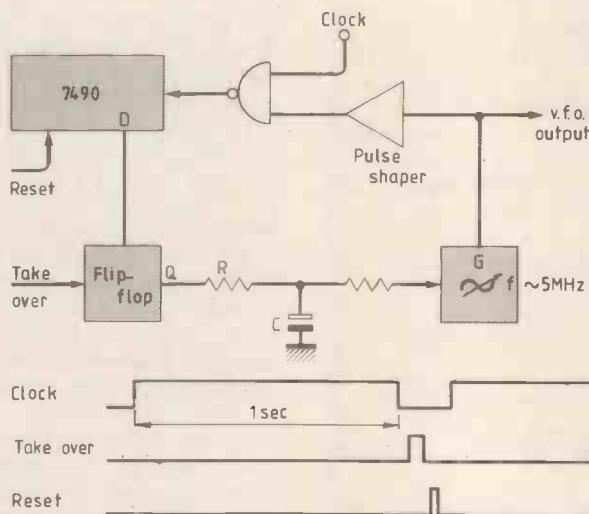

Fig. 1. Simple frequency-stabilized v.f.o.. When crystal-derived one-second period ends, 'high' or 'low' information from the decade counter is stored in the flip flop until next measuring period is completed. Clock and logic to provide the timing and controlling pulses not shown. R and C give large time constant.

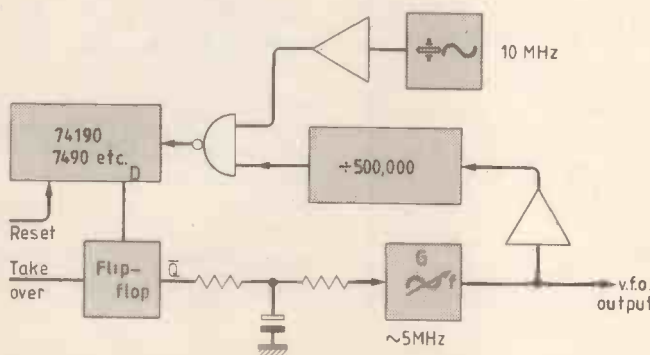

Fig. 2. Connecting high-frequency clock directly to gate and dividing v.f.o. output down gives a varying distance between successive stabilized frequencies on the dial. Because high-frequency crystal oscillators give no problems, resolution and stability can be high. Integrator is now connected to \bar{Q} on storage flip flop. Speed of logic elements forms limit for higher clock frequencies.

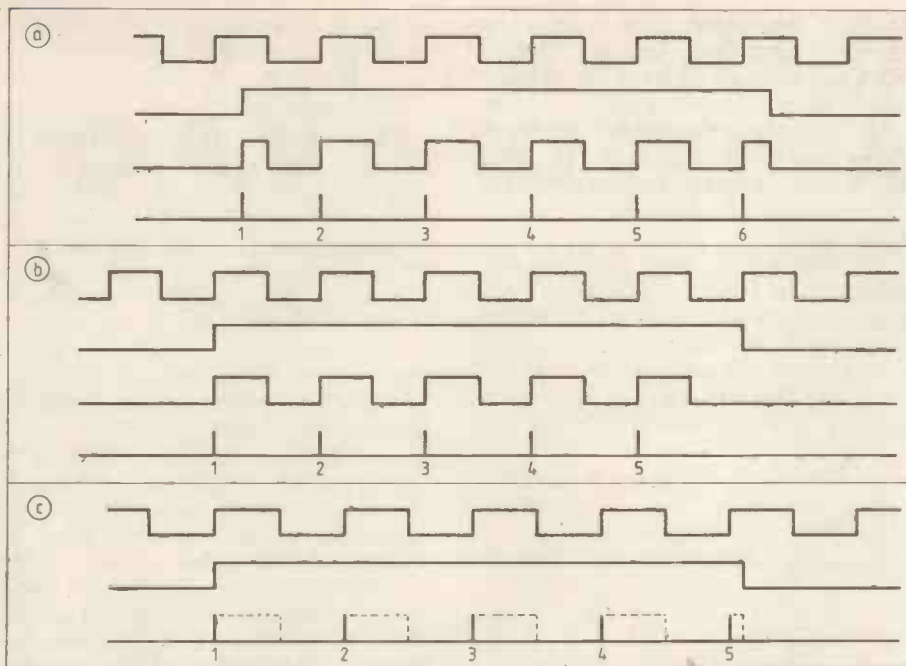

Fig. 3. (a) Shows 5 Hz square wave giving six positive going slopes per second, seen as pulses by the counter. In (b) only five pulses are seen. With some regularity this situation may alternate or not with (a). All depends on the relative position of the two waveforms. (c) shows that even an input frequency of 4.1 Hz gives five pulses to counter.

not a good idea, however, because the digit now contained in the buffer store represents not Hertz but tens of Hertz. In our example, with an initial frequency of 5,123,456.789... Hz, the counter contains that five and the feedback will arrange to make it alternate between 7 and 8 as before. The next higher stabilization (centre) point will be 5,12357/8, which is no less than 100 Hz from the previous one. The resolution of measurement is ten times reduced and the 'ripple' on the v.f.o. frequency is the same factor enlarged. The integrator time-constant can be ten times smaller now and the speed of response is subjectively very much improved — the only benefit of the change in measuring time.

The problem still remains: how to improve the resolution without lengthening the time for each measurement. When discussing this point with friends (one of them the prototype of *Homo digitalis*) one answer came up again and again: raise the frequency, so that the relative accuracy remains high enough when you shorten the gate time. In theory this is a way-out, because the high and stabilized frequency of, say, 51 MHz is divided by ten to get our original 5.1 MHz and the frequency variations are divided too. In practice, if you can build an oscillator that does not drift 10 Hz in 0.1 second at 50 MHz, frequency stabilization is probably not necessary. This approach did not seem attractive. Instead I pondered for some time, wondering whether it is at all possible to measure a frequency with an accuracy of 1 Hz in less than a second.

Period counting

Just to be complete, one may recall the 'period counting' method of measuring low frequencies. When the rôles of the clock and the unknown frequency in a

frequency counter are reversed the unknown period is measured in units of the clock period and this takes only one period of the unknown frequency. If the unknown is about 5 MHz we could count off 500 000 periods in about 0.1 second, during which time the gate would be open. The single decade connected to its output would receive the clock signal, let us say 10

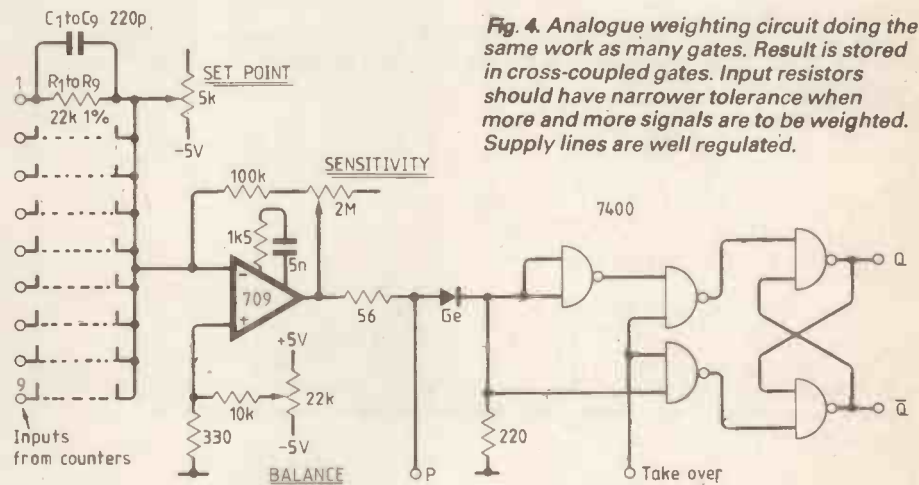

Fig. 4. Analogue weighting circuit doing the same work as many gates. Result is stored in cross-coupled gates. Input resistors should have narrower tolerance when more and more signals are to be weighted. Supply lines are well regulated.

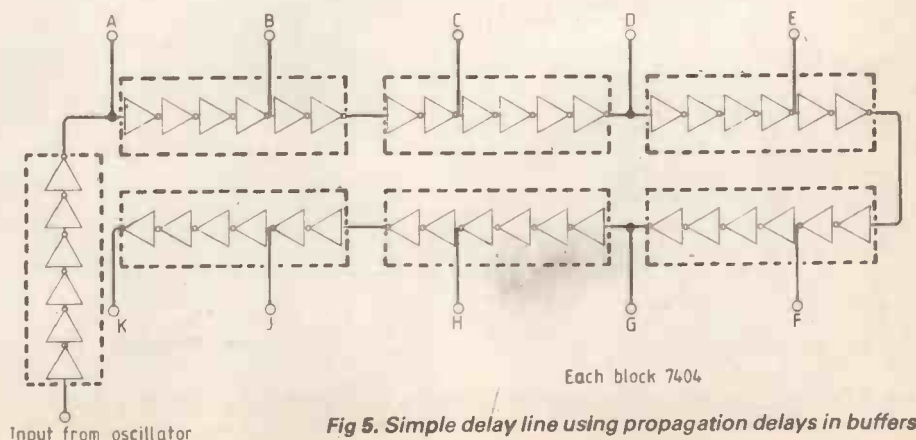

Fig. 5. Simple delay line using propagation delays in buffers.

MHz. The resolution is still plus or minus one pulse in (about) a million and the grid of stabilization frequencies is now nonlinear: the distance between grid points at 5 MHz is 50 Hz. This is twice as good as the 100 Hz grid obtained with 0.1 second measuring time when counting the frequency direct and solely due to the clock frequency being twice as high as the v.f.o. frequency: a block diagram is given in Fig. 2. This is a good set-up when high-speed logic is used and the clock frequency can be raised to 20 or preferably 50 MHz (no prescaling: the gate and the counter following it must discriminate between those fast pulses).

To conclude the period-counting line of thought, the change of the distance between stable points over the dial is often not important. The ratio of the divider between oscillator and gate might well be a power of 2. Frequencies like $f/2$, $f/4$ are then available, all stabilized.

Counting reviewed

The above stabilizations work well, but there is an extra irregularity not yet described, which is caused by the counting process itself. The specifications of commercial counters usually give the measurement error as ± 1 count + time base error. The time base is not important for this discussion: the reference crystal oscillator drifts a little, but presents no problem. The real problem is with the last digit of the counter, which in successive counts (if it were provided with a display) would show two values — it would 'jitter'. The stabilizing counter does the same thing,

even when the incoming frequency is perfectly stable since there is no phase relationship between the reference oscillator and the v.f.o. This is most disturbing and leads to noise on the correcting voltage to the oscillator.

To get a clear picture I drew a few pulses on graph paper, as in Fig. 3, which represents a 5 Hz signal as it appears before and after the gate of a frequency counter. The flip-flops in the counter toggle on the positive-going slope. When a window of exactly one second moves over the 5 Hz pulse train, we see immediately what happens: half a pulse has just the same positive-going slope, which is what is counted,

when the two waveforms glide past each other. Only when the situation is exactly stable (no gliding) do we get consistent answers from the counting process. Figure 3 (c) shows that stretching the pulses out (by lowering the frequency to 4.5 Hz) does not produce a different result; even 4.1 Hz does not make the fifth pulse 'fall out of the window'.

The only way to make this one-pulse ambiguity less important is to count more pulses, for instance by counting during ten seconds or by making ten, separate, one-second counts and averaging the answers. The last method was used very often when counters had no switch position for

'multiple frequency' and the resolution was just one decimal place too low.

A new method

All this may be interesting but does not look very promising for our v.f.o., until a new idea is brought in. It is not necessary to do the individual one-second measurements one by one: the measuring times may overlap. The aim is to average out the one-pulse variation and obtain the high resolution that may be expected from a long counting time, but before placing endless rows of decades on the breadboard it might well be asked why one should use four flip-flops to get a single 0 to 1 out of them? Well, it depends largely on the stability of the oscillator when the controlling loop is disabled, and on the nature and magnitude of any impulsive noise that might enter the system. With a simple four-bit counter there is plenty of margin on both sides of the dividing line between 7 and 8, but with a decade counter one side is limited; two pulses extra make a zero from that 8 to give a 'correction' in the wrong direction.

Because the decade on the breadboard worked well once the starting time was over, I decided that two-bit counters were all I needed. There were times I wished I had used the SN 7493 four-bit counter, but some of the problems turned out to be hardware-oriented and not so much a system fault.

Voting logic

The majority-vote is taken by the analogue circuit of Fig. 4, which works easily with 21 inputs - an odd number to get a majority in all situations. The input resistors are of the carbon-film type, selected for close tolerances for a larger batch with the circuit of Fig. 4 itself (without R₁-R₉). A voltmeter at point P indicates output voltage during the selection; the setpoint and sensitivity potentiometers are partly incorporated for this occasion. Even this circuit is a simplification from the breadboard circuit, where the digital outputs of the counters were stored by 'buffer' flip-flops. These buffers are not required if a reasonable amount of time is available for the voltage at P to take on the proper value. If take over and reset must take place in 1 or 2 μ s, it becomes necessary to use the buffer store.

Counting in the parallel, but delayed, counting operation, it is immaterial

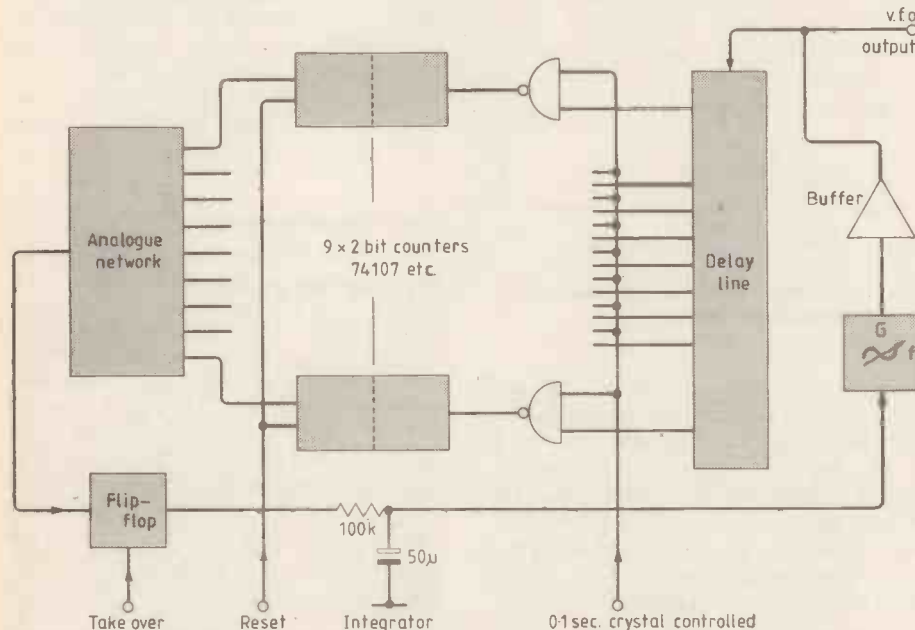

Fig. 6. Block diagram of frequency-stabilized v.f.o. Each of odd number of counters gets a slightly different 'cut' from continuous pulse train from the oscillator. Counters work simultaneously.

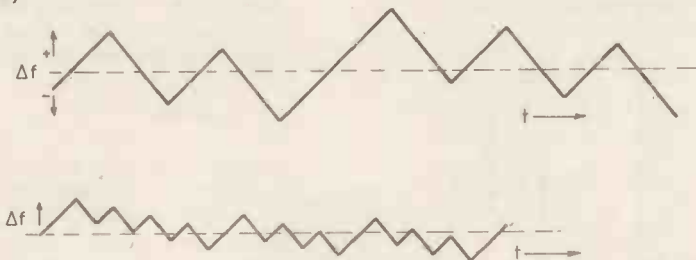

Fig. 7. Frequency variation of output is reduced when corrections come faster, drift being equal in both cases. Even a three times faster correction rate is a worthwhile improvement.

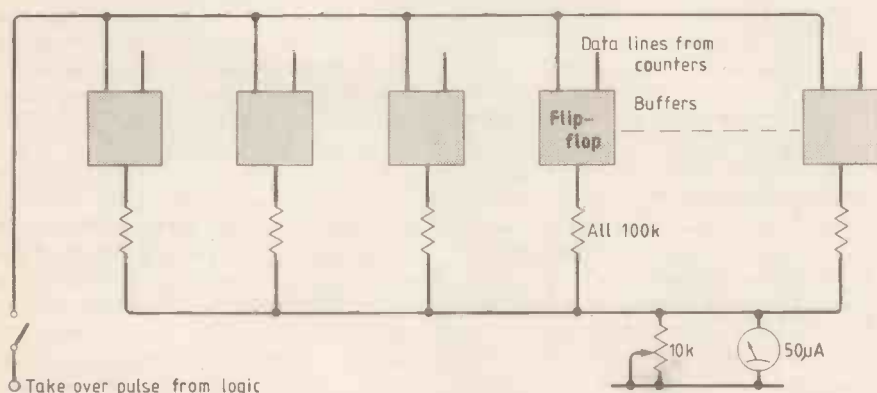

Fig. 8. Adding digital information without clipping is much better. Digital store is 'frozen' when switch is open.

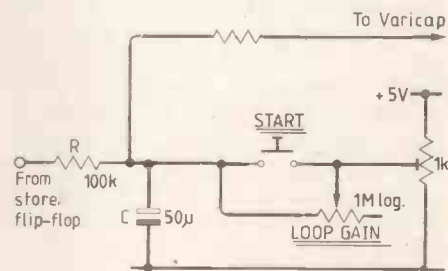
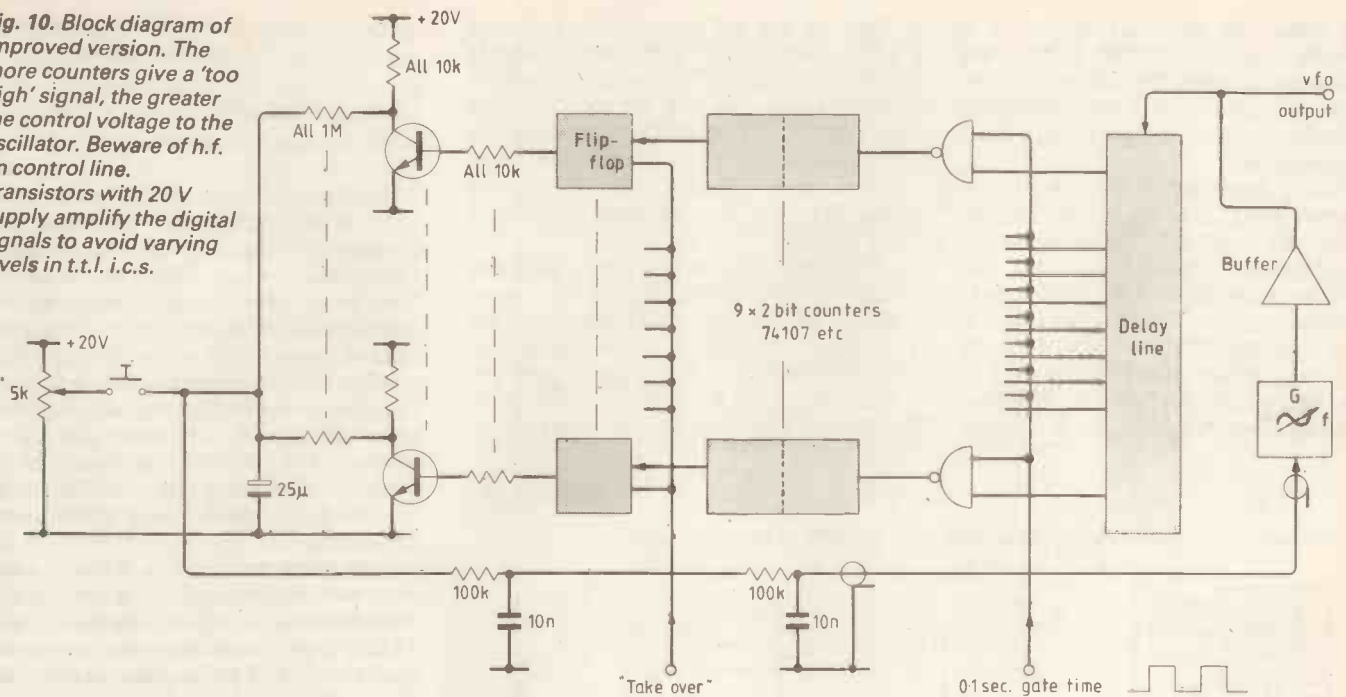

Fig. 9. Push button is pressed 10 seconds after power is switched on, reducing loop gain while charging capacitor to average value. H.f. decoupling of control line not shown.

Fig. 10. Block diagram of improved version. The more counters give a 'too high' signal, the greater the control voltage to the oscillator. Beware of h.f. on control line. Transistors with 20 V supply amplify the digital signals to avoid varying levels in t.t.l. i.c.s.



whether the clock is delayed or the v.f.o. signal. For oscilloscope testing, it is very pleasant to be able to delay the highest frequency (the v.f.o.): it would take a storage oscilloscope or one with dual timebase to display 10 Hz signals with small delays. The end of the counting, take over and reset and start can now be the same for all counters, which keeps matters simple. The last question to resolve is, with a 5 MHz v.f.o., over what period must the delays be extended and how many counting systems are needed? In a practical system, with cheap t.t.l. building blocks, there are only two possibilities for building a delay line. The first one to think of is a series of 'monostable' delays, SN 74121 being the monostable block. A second way to achieve delay is the use of the intrinsic propagation delay of logic elements, the standard inverter SN7404 giving, in pairs, a delay of about 20 nanoseconds, according to the data sheet, although measurement shows the delay of n pairs often to be shorter than n times 20ns. To get a maximum delay of at least one period of the 5 MHz, the delay line consists of a series string of inverters with outputs every two pairs, which takes six blocks, one more being used to make sure the input to the delay line has the appropriate switching times.

Complete system

A block diagram of a complete system gives Fig. 6. The v.f.o. frequency of 5,123,456.789 Hz is counted during 0.1 second in a modulo-four counter which is another way of saying that it contains, when the counting is over, the remainder of the division-by-four of the number of input pulses. If the remainder is 0 or 1 a 0 level is presented to the analogue weighing network, a count of 2 or 3 producing a 1. The nine counters get a 0.1 second gate signal, the closing of the gates immediately being followed by storing a 0 or 1 in the flipflop, depending on the dominance of the counts 0 and 1 ('too low' signal) or 2

and 3 ('too high' signal). The integration time constant is related to the repetition rate of the measurements, which is ten per second.

The stabilization points (the grid on the tuning dial) have such frequency values that the average remainder in the counters wobbles between 1 and 2. The next grid point is one cycle of the counters further, or four more counts. Four counts in one tenth of a second means 40 in a second, so the grid points have 40 Hz spacing: the +0/+1 irregularities are not so well averaged out as I had hoped. A little calculation and comparison with other processes where a random disturbance is reduced in prominence by a form of averaging leads to the unpleasant conclusion that these variations are reduced by \sqrt{N} , where N is the number of counters. This is disappointing and means that the nine counting systems give only three-fold reduction in 'randomness'.

This should be regarded as a by-product of the process, the main advantage being the faster response of the loop. In the system of Fig. 6, drift of the oscillator leads to all counters giving the same signal, e.g. 'too high', and this leads to a consistent 1 in the buffer, which is something different from the random 1 appearing occasionally. Before examining this more closely, it is necessary to remember that the v.f.o. stabilizer is not perfect — not only is the number of counters N very low, but the delay-line sections do not have equal delays. Then there is the question of the length of the delay line: one feels by intuition that the discrete length of the line is important, and the same intuition tells us that when N is really high, this discreteness is not quite so important.

Another point to remember is the fact that the 'feel' of the turning knob is so much better, because of the improvement in response speed, compared with a one-second gate period. The ripple on the frequency is probably as shown in Fig. 7 and even a $3\times$ improvement looks good.

Further development

At this stage of the experiments a set of flipflops was in place, and for a reason I cannot remember now these storage flipflops were reinserted between the counters and the weighting network. Instead of the v.f.o. a crystal oscillator was connected to the input and a digital-to-analogue converter with a set of equal resistors feeding an indicator in the form of a 50 μ A meter (Fig. 8). The frequency of this oscillator can be varied slightly by varying the supply voltage so, by breaking the line controlling take-over of information at certain times by means of the switch and changing the oscillator frequency by small amounts, the effects of a drifting oscillator can be seen on the meter. There is no closed loop and we see just the information-gathering part of the process.

The demonstration was set up without thinking very much of it, but it became apparent that this 'analogue' method of adding the information from the counters is very good; the occasional +0/+1 variation is much smaller than the swing of the pointer when a small frequency shift occurs, several counters responding in the same direction. It really came down to the fact that the limiting applied by the 709 in Fig. 4 to the sum signal should be avoided. What is needed is linear amplification, which can be done with the left-hand part of Fig. 4, the storage in the right-hand part now being redundant. The control line to the v.f.o. may not go negative, but little d.c. amplification is required.

Some amplification can be had before the d-to-a conversion takes place by providing a higher voltage difference between logic levels. The SN 7406 or discrete transistors may be used, connected between the buffer flip-flops and the summing resistors. This was not tried, but seems an easy way to get some gain when a well-regulated supply of 20 V or more is already available. This method gives well-defined voltage levels for 'high' and 'low', but the system is very tolerant of faults in

to get the command pulses at the right times was avoided by taking the exact repetition frequency used from the divider in question (e.g. 0.1 Hz, 0.2 Hz, 0.4 Hz, etc.), and triggering a 74121 monostable block with it. The time between monostable pulses is used as the gate time. A few more monostables produce the command pulses 'take over' and 'reset' as in Fig. 12. The gate time is now not exactly 0.1 second, etc., but this is unimportant. The stability of the gate time is still good, as the 1 μ s from the 74121 is only a small part of it and a drift to 1.1 μ s is unlikely to happen in a short time.

Further possibilities

Next to waiting for the proper integrated circuit to appear on the market, containing a large number of fast gates and counters, the most straightforward approach would be to use a number of nominally equal crystals, as in the scheme of Fig. 13. This is especially attractive in countries where ex-second world war supplies are available and cheap. Of course, very efficient decou-

pling and buffering is necessary to prevent the oscillators from locking on to each other. The v.c.o. frequency may be chosen freely, taking into account the division ratio N of the divider chain.

This should preferably be a power of 2, providing symmetrical output waveforms from all intermediate tap points. The number of flip flops in the divider should be such that the output frequency of the divider is, say, 10 to 20 Hz. As outlined before, there is no need for separate flip-flops controlling the gates, this being done just as easily with monostable circuits.

The use of 27 MHz crystals was not successful, these being probably less stable than the surplus types, which were around 5 MHz. The lower oscillator frequency makes the isolating problem less severe, too. It is not necessary to make the frequencies of the crystal oscillators very nearly equal when the weighing network is large, as it is here. Starting from a nominal v.c.o. frequency (e.g., the one that gives exactly 0.1s gate time) it is easy to find out what is the maximum allowable spread in

crystal frequencies, the limits being given by the size of the counter. Obviously, one requirement is that all counters overflow the same number of times, as can be expected, a better alignment of the crystal oscillators makes it possible to reduce the number of resistors in the network.

Reducing the size of the counter from modulo 16 or modulo 10 to modulo 4 or even modulo 2 is worth thinking over, if the v.c.o. is extremely good. Starting up and locking is going to be much more troublesome; this makes other components necessary (automatic loop gain reduction when turning the v.c.o. wheel). With modulo 2 counting no working system is obtained, however, because in theory no frequency difference is allowed that leads to a zero in some counters and a one in the others. In this case there is no discrimination between a higher and a lower v.c.o. frequency. For some frequencies, or grid points, this is not true, a form of stabilization is taking place near certain points of the dial — more a drift reduction than true stabilization.

WW

BOOKS

Computing

Apple Interfacing, by J. G. Titus, D. G. Larsen and C. A. Titus. 206 pp., paperback. Prentice-Hall International, £7.65. ISBN 0-672-21862-3.

Interface control signals between the Apple II and external devices are thoroughly explained in theory and practice by the use of experiments. A general-purpose breadboard assists in circuit construction and there is enough information to enable the experimenter to build a printed-board type. Only a nodding acquaintanceship with digital electronics is assumed.

The Logic Design Of Computers, by M. P. Chinitz. 413 pp., paperback. Prentice-Hall International, £11.15. ISBN 0-000-218-006.

Neither hardware nor software are the province of this book, but rather the logical processes which are performed by the former when instructed by the latter. A short historical section and a piece on number representation are followed by chapters on programming and switching theory. Logic elements are treated in outline and the final chapter deals with microprogramming.

The 6809 Companion, by M. James. 88 pp., paperback. Bernard Babani, £1.95. ISBN 0-85934-077-5.

A discussion of the characteristics of the 6809 microprocessor from the programmer's point of view. This is a small book, but nonetheless a very useful contribution. A slight drawback is that the text was produced by a Centronics printer, which is good for its purpose but not, perhaps, for a book.

16-bit Microprocessor User's Manual. 231 pp., paperback. Prentice-Hall International, £11.20. ISBN 0-13-566695-3.

This is the third edition of what is effectively Motorola's handbook for the MC68000

series of microprocessors. Full information on all aspects of instruction, signal and bus operation and memory management are provided, with all characteristics.

The Explorer's Guide to the ZX81, by M. Lord. 120 pp., paperback. Timedata, £4.95.

In the words of the author, this "attempts to carry the reader on from where the ZX 81 manual leaves off". There is no introduction to Basic or the ZX81, although the first chapter does provide some programming aids which help to use the limited r.a.m. available more economically. A number of games are included as illustrations of techniques. There is a chapter on machine language, which is included to help the inexperienced, and the final section deals with practical matters, such as loading from cassettes and connecting a monitor. Timedata Ltd, 57 Swallowdale, Essex SS15 5BZ.

Analogue design

Analog Instrumentation Fundamentals, by V. F. Leonard, jr. 318 pp., paperback. Prentice-Hall International, £13.95. ISBN 0-672-21835-6.

Anyone looking for an explanation of the principles of a.c. and d.c. pointer-type instruments, bridges, transducers, RC filters and attenuators will probably find this book useful. Those needing practical help will not find it here since, as the title clearly states, these are fundamentals, which are attractively treated in a readable style.

Applications and Design with Analog Circuits, by J. M. Jacob. 498 pp., hardback. Prentice-Hall International, £22.45. ISBN 0-8359-0245-5.

Essentially practical design information on the use of operational amplifiers in most of their relevant roles, including power supplies, active filters and non-linear circuits. Although written for engineering degree students, the treatment is such that less advanced readers will find it accessible.

Operational Amplifiers and Linear Integrated Circuits, by R. F. Coughlin and F. F. Driscoll. 376 pp., hardback. Prentice-Hall International, £16.45. ISBN 0-13-637785-8. Written at a slightly less advanced level than the previous book, this is even more practical and a little wider in scope. It is intended for a one year course, all the circuits described having been tested. Students not specializing in electronics will find the book helpful and the practical approach is ideal for amateurs.

Radio frequencies

Introduction to Radio Frequency Design, by W. H. Hayward. 383 pp., hardback. Prentice-Hall International, £20.95. ISBN 0-13-494021-0.

Students and amateur electronics engineers commonly find their way into electronics by way of digital circuitry and components, r.f. design being well in the background. This is an attempt to do for r.f. what thousands of texts at this level do for digital design. It is practical, with many examples, mathematics up to about A level being used. A working knowledge of simple circuit theory is needed to make full use of the book. All the components of a modern receiver are described in detail, including a chapter on transmission lines and the Smith chart.

H. F. Antennas for All Locations, by L. A. Moxon, G6XN. 260 pp., hardback, RSG1. £5.00. (£6.67 by post, from RSGB, 35 Doughty Street, London WC1N 2AE. ISBN 0-900612-57-6.

This is a remarkably helpful book, which deals with a subject often regarded as being akin to black magic, in a thoroughly practical manner. That is not to say that theory is neglected — it is not — but it is kept in its place. The author has been well served by his publishers, who have turned out a well-produced book at an extremely low price — well under half the price of many technical paperbacks of half the size.

CLASS 'S'

A novel approach to amplifier distortion

If the load presented to the voltage amplifier by the power output stage appears very high, crossover distortion can be reduced and the voltage amplifier is much easier to design.

A basic cause of distortion in power amplifiers is quite simply that they have to drive loads, something which is clearly seen in Fig. 1 (b), when the higher resistance load of 2.4Ω can have ± 25 volts of swing generated across it whilst the low resistance load of 0.8Ω can have only ± 10 volts across it before it limits. Another way of looking at the situation is to try and generate ± 25 volts across the 0.8Ω resistor, when severe distortion in the form of limiting will occur. In other words, it is much easier to drive a high-resistance load than a low-resistance one.

The object of Class 'S' is to perform the task of making a low-resistance or impedance load appear to the voltage amplifier as a high, ideally infinite impedance.

Basic configuration

Let V_o (Fig. 2) represent the voltage output of the voltage amplifier and I_L the

by A .M. Sandman,
M.Phil.(London), M.I.E.R.E.

output of the subsidiary current amplifier which also provides load power. R_m is a small resistor which develops a voltage V_m proportional to the load current I_L . R_L is the load resistance.

If V_m is used to make the subsidiary amplifier develop a current I_L' as close in value to I_L as possible then $I_L - I_L' = 0$ and Z_{in} will tend to infinity.

This is the simple idea behind a whole family of circuits, one of which will now be described.

Basic circuit

This consists, as seen in Fig. 3, of a voltage amplifier, comprising a standard operational amplifier with feedback (A_1, R_1, R_2)

and a voltage-controlled, high-impedance-output current amplifier (A_2 with its associated bridge of R_m, R_m', R_G, R_G').

As the non-inverting (+) and inverting (-) inputs to A_2 are virtually at the same potential, irrespective of what this potential is (a basic property of operational amplifiers), it follows that the bridge must be in balance and that, ideally, since $I_L = I_L'$, A_1 sees an infinite load.

Demonstration circuit

The circuit of Fig. 4 works on the principle of the basic circuit, with the addition of a complementary push-pull pair at the output (Tr_1, Tr_2) to provide more current than the second 741 and its voltage follower Tr_3 is capable of.

During the crossover region time when, say, Tr_1 stops conducting and Tr_2 has not yet started to conduct, Tr_3 provides the output voltage and the impedance it sees

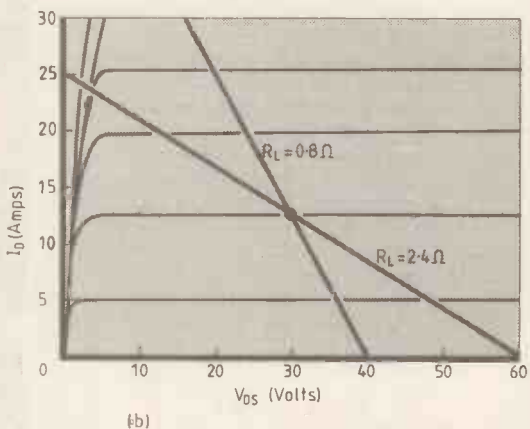
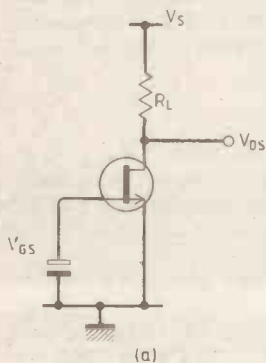

Fig. 1. In the basic voltage-amplifier stage, a high-resistance load provides a larger swing with less distortion.

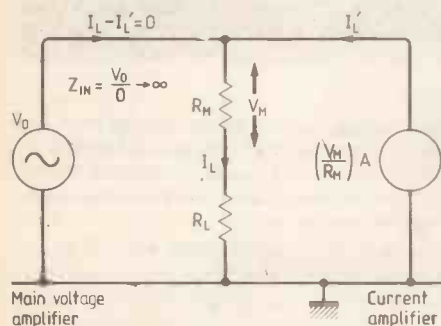

Fig. 2. If the current from the current amplifier equals that into the load R_L , the voltage amplifier sees an infinite impedance. Voltage V_M controls the current amplifier.

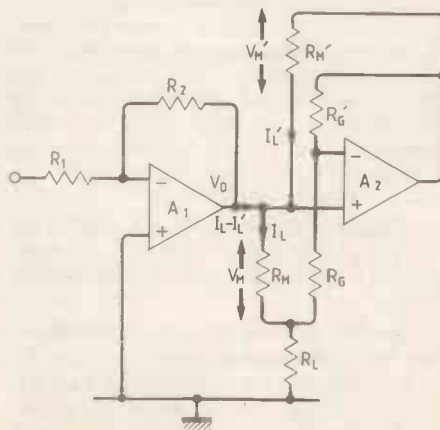

Fig. 3. Basic circuit of Class A amplifier. A_2 is current amplifier.



The author

Mr Sandman was born in 1933 of Jewish parents and almost become a tailor! After gaining City and Guilds Full Technological Certificate in 1957, he obtained his M.Phil. degree from London University in 1978.

Many years ago, he published a scheme for automating the railways as part of a scheme for road traffic automation - he tells us that his chief pleasure lies in the invention of new schemes such as a bandwidth compression system, currently in the pipeline, and "Error Take Off," a method of reducing amplifier distortion published in Wireless World in October 1974.

A deeply held, though hardly novel, belief is that we shall never resolve our problems as a country until, we pay our engineers about twice as much as we do now.

drops from, ideally, infinity to 122Ω. However, this is only for a small excursion voltage and current and so Tr₃ can easily handle it. What is more important is that when the transition is completed, the impedance seen switches from low to high impedance, which will produce a voltage spike at the output.

However, this spike is of very low amplitude due to the low output impedance of the first 741 and its voltage follower and, more to the point, at least one other class 'S' circuit, which will not be described at this time, exists in which this minor problem does not occur to a measurable degree.

Resistor R₂ may be taken to the junction of the 22Ω, 100Ω and 6.2kΩ resistors, so reducing the output impedance to zero.

The crossover distortion of A₂, Tr₂, Tr₁ (W1) has a very small effect on the output (W2) and this effect (W3) is less than 6mV (spike voltage) at the virtual earth of A₂, corresponding to 12mV at the output (allowing for attenuation by the two 10kΩ resistors). That is 12mV in 24V p-p, or 0.05%.

Circuit analysis

Referring to Fig. 3,

$$V_{M'} = V_M \left(\frac{A_2}{1 + A_2\beta} \right) - V_M$$

where $\beta = \frac{R_G}{R_G + R_G'}$, (1)

whence $V_{M'} = V_M \left(\left[\frac{1}{\beta \left(1 + \frac{1}{A_2\beta} \right)} \right] - 1 \right)$

and $I_L' = \frac{V_{M'}}{R_{M'}}$
 $= V_M \left(\left[\frac{1}{\beta \left(1 + \frac{1}{A_2\beta} \right)} \right] - 1 \right) \left(\frac{1}{R_{M'}} \right)$

But $V_M = V_0 \left(\frac{R_M}{R_M + R_L} \right)$,

therefore $I_L' = V_0 \left(\frac{R_M}{R_M + R_L} \right)$

$$\left(\left[\frac{1}{\beta \left(1 + \frac{1}{A_2\beta} \right)} \right] - 1 \right) \left(\frac{1}{R_{M'}} \right)$$

Now $I_L = \frac{V_0}{R_M + R_L}$

and $R_{in} = \frac{V_0}{I_L - I_L'}$

whence $R_{in} = \frac{R_M + R_L}{1 - \left(\frac{R_M}{R_{M'}} \right) \left(\left[\frac{1}{\beta \left(1 + \frac{1}{A_2\beta} \right)} \right] - 1 \right)}$ (2)

Approximations

$A_2\beta \gg 1$

$$\beta = \frac{R_G}{R_G + R_G'}$$

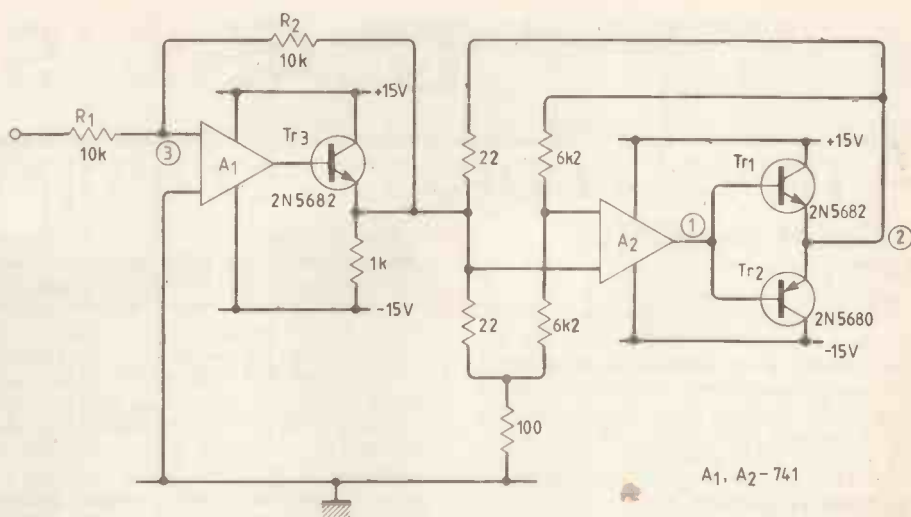

Fig. 4. Addition of power stage to augment A₂ output current forms working circuit.

Let $R_G = R_G'$ and $R_M = R_M'$

whence $R_{in} = \frac{R_M + R_G}{1 - \left[\left(\frac{1}{\frac{1}{2} \left(1 - \frac{2}{A_2} \right)} \right) - 1 \right]}$ (3)

Therefore $R_{in} \approx \frac{A_2(R_M + R_L)}{4}$ (4)

from (3), and applying Binomial Theorem.

$A_2 \rightarrow \infty$

$R_M R_G' = R_M' R_G$ (5)

$R_{in} = \frac{R_M + R_L}{1 - \left(\frac{R_M}{R_L'} \right) \left[\left(\frac{1}{\beta} \right) - 1 \right]}$ from (2),

whence $R_{in} = \frac{R_M + R_L}{1 - \frac{R_M R_G'}{R_M' R_G}}$

therefore $R_{in} \rightarrow \infty$

$A_2 \rightarrow \infty$

$R_G = R_G'(1 + \Delta)$

$R_M = R_M'(1 + p)$

whence, from (1) and (2),

$$R_{in} = \frac{R_M + R_L}{1 - \left(\frac{R_M'(1+p)R_G'}{R_M'R_G'(1+\Delta)} \right)}$$

and thus, by binomial approximation,

$$R_{in} \approx \frac{R_M + R_L}{\Delta - p}$$
 (6)

which, for $\Delta = -p = 0.01$ (1% resistors), gives $R_{in} \approx (R_M + R_L)/0.02 = 50(R_M + R_L)$, so that for $R_M + R_L = 8 + 1 = 9\Omega$, the load appears as 450Ω to A₁. The formulae (4) (5) and (6) are useful as initial design guides, but the full formula (2) should be used for the final calculations.

The circuit is a stable one and has the great advantage of dealing with the problem of crossover distortion whilst not needing any setting-up, even though a class B amplifier is employed in the sub-

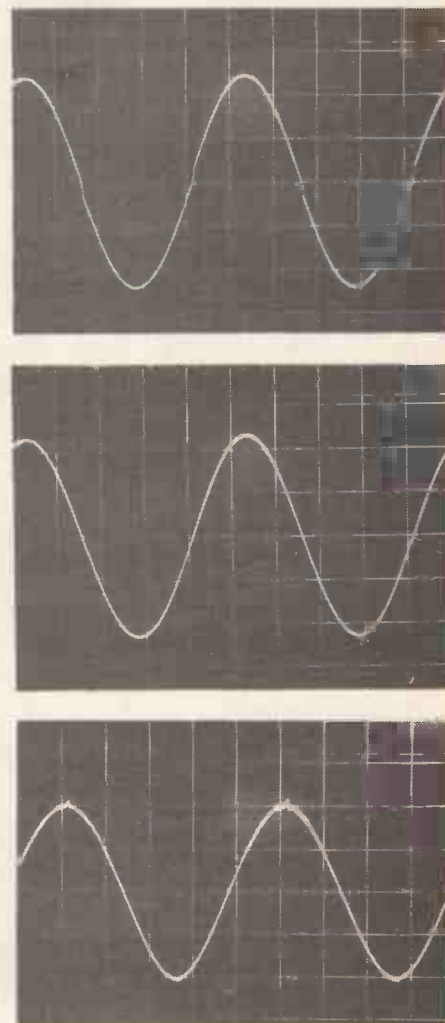

Fig. 5. Waveforms in circuit of Fig. 4. Top shows crossover distortion at output of driver stage, middle picture showing that output of current amplifier is clear. Bottom trace shows small spike at input of voltage amplifier caused by both output transistors coming back into conduction after being cut off during crossover.

sidary amplifier. It is also insensitive to the effects of temperature, specimen and ageing variations on cross-over performance, unlike the standard class B amplifier.



LETTERS

TOUCH-SENSITIVE V.D.U.

I read with interest News of the Month, *Wireless World*, p.69, July 1982, to be informed that Tony Booth and his engineering staff of British Telecom, London, have 'invented the system' called City Business System, described as a v.d.u. terminal with a touch-sensitive screen, the sensitivity being obtained using a matrix of infra-red beams which can sense which part of the screen is being touched.



Worthy of note as this may be, I feel I should bring to your attention that an identical system to that described was designed and built (invented?) by myself as part of a computer-controlled system on a large research particle accelerator called Nimrod back in 1971, and was in use until the machine shut down in 1978.

A report containing sufficient information to make such a device was available to anyone, price 20p., from HMSO or through any good bookseller entitled:

A Transparent Touch-Screen Device for Interactive Computer-Graphic Displays. R.H.E.L./R 248 1972.

Sorry, it's all been done before.

E. M. Mott
Rutherford and Appleton
Didcot Laboratories
Oxfordshire

LAWS OF MOTION

Mr Frost (July 'Letters') should consider the difference between science and poetic imagination. The views of Lucretius were unsupported by experiment, not open to test by others, (there being in any case no instruments about at the time to test them with) and, as matters of opinion, have in fact about the same scientific status as the views of flying saucer nuts; perhaps less. If Mr Frost will read Aristotle he will rapidly realise that sloppy theorizing is sloppy even when 2,000 years old, and that good science is good even when five hundred years older still.

I suggest that the briefest survey of human history shows up the truth that an idea may be said to have arrived when the engineers stop using rule of thumb and apply mathematics. Cannon had been around for hundreds of years before Newton, demonstrating all three of his laws with classical elegance. The ballistics experts had it all in front of them but missed it. Newton didn't. Newton was a genius. Even so, he needed an intellectual climate in which to function; Galileo, perhaps the greater scientist, just missed it.

Newton's great work is called the Mathematical Principles of Natural Philosophy, and that is the indicator of his achievement; he synthesized the known physical world in mathematical terms. It may be that the central problem of modern physics is either that 1) we are thinking about everything all wrong, or 2) the right maths has not yet come along, or 3) the right maths is available but lying about unnoticed. For Mr R. G. Young, however, the rot has already set in. He doubts Special Relativity because he thinks of electrons as peas in a drain-pipe bouncing around at c. Peas aren't charged, electrons are.

M. D. Bacon
New Milton
Hants

DESIGN EXHIBITION

I have been asked to help organize an exhibition of 'Design Since 1945', and as one of the exhibits, I require a 1948 Ekco P63 'Princess' personal portable valve radio in green plastic case. I wonder if any of your readers could perhaps help me to locate one of these radios.

Gordon Bussey,
64 Pampisford Road,
Purley,
Surrey.

LEAKY FEEDER RADIO SYSTEMS

I have read with interest the recent articles on underground radio systems by my former colleague, Dr David Martin.

Whilst I am in general agreement with most of his paper, I feel that it would be desirable to clarify the position of the National Coal Board.

There are about 130 leaky feeder radio systems installed underground, the majority of which are of the daisy-chain type. This technique, which requires separated transmitter and receiver, and which makes spurs difficult to achieve is now considered obsolescent. Over the past few years, experimental installations have been made of a number of alternatives, including the BDR system (one installation) the back-i.f. system (one installation) and the forward-drive system (two installations). The two-way repeater is, however, now being installed routinely, and there are currently 15 installations of this type operating successfully underground, the largest being at Easington Colliery with a total length of about 10 km. The repeaters used are more expensive than comparable unidirectional repeaters, but the difference does not significantly effect total system costs; and their performance is entirely adequate even in terms of cumulative noise and intermodulation distortion for any NCB requirement expected over the next few years. In addition, the technique is conceptually simple and needs only two types of line module; a normal repeater, and a splitting repeater at each branch point.

In the medium term (say 5 to 10 years) underground mobile communications systems may need to provide additional services such as high speed data or vision signals. Such requirements

would involve considerable changes to our current systems, which fully meet present needs. It is our intention to embark on further development as future needs become clearer.

R. J. Parsons,
Head of Communication
Applications Group,
National Coal Board.

3D TELEVISION

The publication of your article on 3D tv, following the 'Real World' programme on TVS on May 4th prompts me to write and reiterate that this country could have had 3D tv 30 years ago, without the need for colour spectacles.

You published a letter of mine on the subject some three years ago when I mentioned that my father (the late Granville Bradshaw who, though designing in many fields, was better known in that of the internal-combustion engine, examples of which are to be seen in the Science and other museums) had developed in the 1930s a system of 3D photography, which was widely used in advertising displays.

With this system in mind I designed for him a system for television. Both the BBC and the ITA were extremely interested but had to admit in the end that they had no brief to proceed with 3D, let alone the money with which to experiment.

The result - another British invention stifled at birth for being, so it would now appear, at least 30 years ahead of its time.

Geoffrey Bradshaw
Leatherhead
Surrey

INTENTIONAL LOGIC SYMBOLS

Referring to the latest Letter (July '82), why keep bickering about old BS symbols, now defunct or otherwise unknown this side of the Channel? There exists a set of ANSI/IEEE/IEC approved logic symbols, that provides throughout diversification, ease of drawing (no circles, no bows) and intentionality if one wishes. Please refer to e.g. the 1981 Supplement to The TTL Data Book by Texas Instruments (2nd edition), pp. 318/343.

Of course, in a manufacturer's handbook, all of the functions provided should be fully documented, so the schematics look a bit weird. But practice shows that a little pruning here and there yields drawings that are very intentional indeed, and easy to read.

Ing. J. Eyckmans
St.-Truiden,
Belgium.

S-100 BUSES

Do you know if anyone has made a comparison chart between the various S100 computers in terms of the bus definition? Some of the early 'S100' equipment differs with that designed after the specification was finalised. Can your readers help?

S. B. Hayes,
Toltec Computer,
Cambridge.

IT'LL DO — OR WILL IT?

I am involved in various aspects of electronics including design, application, trouble-shooting, repair and construction. Like many people who have a general knowledge of the subject, I have an appreciation of the principles of each aspect and a respect for experts in each field. Some of my spare time is given to private repair work, tv, calculators, electronic musical instruments, hi-fi, etc, so that I consider myself not inexperienced in the area of consumer electronics. Recently I completed two jobs that provided real food for thought.

The first was a Goodman's 'One-Ten' tuner amplifier, which sports a very elaborate power amplifier with several transistor stages in d.c. connection. Only the output pair proved to be damaged, but the underlying cause was the fuse-holders, one of which had become high resistance, due to oxidation. This is not incomparable to a safety belt causing a car crash.

The other job involved a Ferguson (Thorn) 'Revolver' radio/cassette player, given as a Christmas present only six months ago. This had become erratic and finally stopped altogether. The problem was simply traced to the amplifier power switch, which had simply burnt itself out. The machine boasts a very large power-output stage requiring (I calculate) about an amp. of current, but this was switched by a small-signal switch just not up to the job.

These exemplify the Great British "It'll do" attitude that has made Japan what it is today. While years of soak testing are clearly not feasible for such products, only a little more care would result in machines as dependable as the valve radios of the '50s that I still use, and worthy of the remarkable development that has gone into the i.cs that are put into products of amateurish design.

Mike Feeney
North Gosforth
Newcastle-upon-Tyne

Presumably Mr Feeney is aware that depending upon environment, possible mis-use of equipment and any number of other variable factors, it is possible for oxidation to occur in similar situations which have nothing to do with "amateurish design". This is the only such case that we have been made aware of on this product and many thousands are still in operation, providing excellent performances to their very satisfied users.

I would further point out that the last One-Ten tuner/amplifier was manufactured some eight years ago.

T. E. W. Bennett
Goodmans Loudspeakers Ltd

I have total sympathy with the point that Mr Feeney is making. The recent sad contraction of the British consumer electronics industry is generally acknowledged as having been considerably influenced by lack of attention to quality matters. By the same token I believe it is also widely acknowledged that Ferguson were one of the first to read the signs and, later with their 'Queen's Award for Technological Achievement', were one of the more successful in reversing the trend. At least we are still here to respond to his letter!

Having said this, I do not feel that Mr Feeney illustrates his case well. The Goodmans unit to which he refers was engineered by one of the country's leading hi-fi designers of the period, the late Frank Rodwell, no less than 12 years ago. Perhaps more significantly the last ones were actually made about 8 years ago. If corroded fuse holders were a general fault on these models, then it would worry me more, but they are not, and I am sure that there must be many reasons apart from intrinsic bad quality why isolated cases of contamination might emerge over so long a period.

The 'Revolver' falls into an entirely different category. This is an o.e.m. product sourced for Ferguson by a leading Japanese-owned manufacturer. This is not to say that we divorce ourselves from its technical standards; quite the reverse, and as it happens power and switch areas always get particular scrutiny for safety reasons apart from anything else.

It is quite impossible to judge the rating of a switch merely by looking at it. Approval specifications run to many pages, and tests take hundreds of hours to conduct over tens of thousands of cycles of operation. A switch handling an amp. or so on low voltage in a small audio product would very likely be lighter in appearance than a television mains component which could be rated at over 100 A surge; but it should not be condemned for it.

This failure may well be a symptom of Far Eastern manufacturers having chinks in their armour too!

D. R. Topping
Director of Engineering
Thorn EMI Ferguson Ltd.

THEORIES AND MIRACLES

My initial reaction to the article by Dr Murray in the June issue of *Wireless World* was 'Why all the fuss?'. All scientific theories can be shown to generate anomalies if pushed far enough, indeed one would be suspicious of one that did not. Anomalies are not the catastrophe that Dr Murray seems to think, they serve only to indicate the limits of present theories and are therefore the starting point for the next development. Dr Murray also attacks 'pragmatism' in science; as I shall show below it is the only measure, of which we can be certain, that can be applied to a scientific theory.

Dr Murray seems to believe that there is an absolute truth or ultimate scientific theory towards which we should be moving, that we can measure our theories against the real world, and so improve and up-grade them, that one day we will achieve this absolute truth. In this he is sadly mistaken, for two reasons. Firstly in testing our current theories we must observe the world, and in doing so we must also accept as true other theories that explain the operation of our observing apparatus (including the physical bases of our own sense organs), and those theories may in turn depend on the truth of other theories, including in some cases, the theory we are testing. Secondly (and much more fundamentally) not only must we observe via our senses (and other apparatus) but we must also interpret what we observe, and these interpretations are, at base, limited by our human psycho-

logy, we are, as it were, bounded by our humanness. We can never observe the world directly, but only a human version of it.

There is nothing we can do about this limitation, no advance in our observing apparatus can affect it. Any interpretation we care to put on our observations, no matter how obtained, must be human centred, but there will always be the possibility that the same observations could be interpreted by a non-human thinking entity in another but equally valid way. Even if we extend our mental capacities by building artificial or machine intelligences that can interpret observations of the world in other ways, they could not explain what they perceived directly to us without translating it into human terms.

Dr Murray may have, if he wishes, his belief in the simple truths of nature, but as I have shown above, they are (and must always be) limited and biased truths.

John W. T. Smith
Hatfield
Herts

RF RADIATION HAZARDS

I read with interest the two articles referring to r.f. radiation hazards; the first, *WW*, October 1981, page 42 and the more recent article *WW*, April 1982, page 58.

There are, in Australia, many hundreds of small craft fitted with microwave radar. The majority would be professional fishing boats. However, privately owned pleasure craft are being equipped in increasing numbers. Many of the installations that I have seen have been installed with the rotating antenna barely above the head of the helmsman. This applies in particular to those vessels which have a fly bridge above the main super-structure.

I would be interested to know if any of your readers have observed, or have knowledge of, any adverse effects resulting from exposure to micro-wave radiation in the situation outlined above.

John Allan, VK5UL
Ovingham
South Australia

NIKOLA TESLA

Nikola Tesla is a fascinating subject for study and I join with Desmond Thackeray (May 'Letters') in the toast "Tesla Lives!". But surely the centennial for Tesla was in 1956 and wasn't the Tesla Society formed for the celebration?

As for Tesla's claim to having invented wireless telegraphy, his patent 645,576 was upheld by the US Supreme Court against the claims of the Marconi Wireless Telegraph Company of America on June 21st 1943. Ironically, Tesla had died in January of that year.

A factual account of what Tesla accomplished, particularly towards the wireless transmission of power would make most interesting reading; may we hope for an article along these lines?

Martin W. Berner 9Y4TAM
Trinidad, W.I.

COST EFFECTIVE IGNITION

Far from being criticised (Letters, June), Mr Cooper is to be congratulated on producing a design for electronic ignition using components that can be obtained by the home constructor.

Wireless World has never claimed to be a magazine merely catering for the amateur constructor and in the course of demonstration the latest technology has, quite rightly, published circuits using components not generally available, and requiring alignment equipment found in only the privileged laboratories.

However, certain designs are still clearly intended to be built even though articles with the constructional detail of, for example, the Dinsdale high-quality audio amplifier of January/February 1965 are no longer published. Designers should therefore consider carefully whether any component they are fortunate enough to have available may not be available to the majority of readers.

Before quoting past numbers, Mr Pickavance should consider the attitude of many firms, and perhaps also his, to requests from private individuals for the less-common components in small quantities.

C. G. Gardiner
Chelmsford
Essex

I have read Mr Cooper's article on electronic ignition in March *Wireless World* and wonder if I might be permitted to summarize my own experiences and views on alternative ignition systems?

If the cause of bad starting is not in the ignition system but, say, in the fuel supply, as it often is, no alternative form of ignition system will help. Unless you want to be able to start your car with a nearly flat battery, I do not think changing the ignition system will help. It is not in starting the car that the failings of the Kettering system have most effect.

As Mr Cooper points out, if your engine only has a 6,000-6,500 r.p.m. maximum (as most have), there is nothing the Kettering system can't achieve if kept in good order.

I have used many different systems for many years but have never really noticed any significantly better fuel consumption. I have not made any detailed tests but over say a tank full, no change is noticeable. I would love to think that better consumption resulted — it is a tangible and worthwhile benefit in these days of high fuel costs — but I have grave doubts whether it exists.

In their freedom from maintenance, alternative systems can, I think, produce benefits. The first task is to relieve the contact breaker of the high current demanded by the Kettering system. Contrary to Mr Cooper's opinion, I believe this alone is worthwhile. If the system chosen also obviates adjustment of the dwell angle, so much the better. This leaves any residual mechanical weaknesses of the ordinary contact breaker. These do not manifest themselves under say 7,000 r.p.m. — probably more — save for wear. The contacts may not wear but the fibre block on the cam can and does and this wear is not compensated for by contact wear. The contact gap may not be important in alternative systems but there must be one! Do alternative systems affect the plugs? Those which produce more energy in the spark (i.e. C.D. systems) do but only in the sense that the plugs

will go on working long after they would misfire with the Kettering system. I have never noticed any reduced wear and it would be interesting if Mr Cooper could elaborate on the short paragraph in his article on this aspect (what is an electronic spark?) I have noticed that wide gaps (up to 60-70 thou) still work and so do sooted plugs — due, I have always assumed, to the greater energy available with C.D. Incidentally, has anyone noticed smoother running at minimum throttle openings just to maintain speed, with wide plug gaps?

On the subject of current consumption, does it really matter (within limits) how much current the ignition system uses unless you are in the habit of leaving it on without the engine running?

C. E. H. Benson
Market Drayton
Shropshire

I had to abandon any idea of constructing Watkins's Opto-electronic contact breaker (*WW*, April 1981) simply because I was unable to obtain the i.c. specified through normal retail channels. In the light of Rod Cooper's remarks about using readily available components contained in your letter in the June issue, I approached the construction of his ignition system with more hope. Alas, I have come up against the same problem of supply in respect of the Mullard FX 3720 ferrite power transformer.

Of two main stockists tried, Phillips and Marshalls, the former would only supply for their own equipments, and the latter, whom I rang, said they did not stock the item! So far as I can see none of the usual suppliers who advertise in *WW* and elsewhere stocks the FX 3720, and I am beginning to suspect that it is again one of those desirable components available only to industrial users and electronic engineers through privileged channels of supply.

As to the circuit itself, this seems to have suffered somewhat in the reproduction process for publication and I would appreciate your help in my difficulties of interpretation. You will have noticed that D₇, unlike D₁₋₆, has not been specified. This may be a misprint for a 3A fuse, or possibly a decoupling capacitor. The capacitor values in the multivibrator have been omitted. Perhaps Mr Cooper would confirm that ½W resistors were intended throughout the circuit.

J. E. Stevenson,
Purley, Surrey.

The author replies:

I agree with Mr Stevenson's comments about components for construction articles: such components should be available through accessible supply channels and not just to professionals, but it's a fact that some of the most interesting items remain relatively obscure because they are only available via the privileged channels, which I think is a pity. It needs a change of heart on the part of certain British component suppliers and manufacturers to alter this situation.

However, this is not the case with the FX3720, which is a Mullard ferrite available through their stockists. My local Mullard stockist is Hawnt Electronics Ltd., Firswood Road, Garretts Green, Birmingham B33 0QT, and they will be pleased to supply this ferrite, which they stock in depth. The FX3720 is 44p per piece (you need two pieces to make a transformer) and the bobbin DT2723 to suit is 35p. This firm has a minimum charge of £2, which

should cover a transformer, bobbin, v.a.t. and postage.

There is a world of difference between the non-availability of silicon diodes as discussed in the *WW* 'Letters' column and the limited availability of a more specialized component through manufacturers' selected agents, such as Hawnt Electronics. Unfortunately it is all too easy for an author to slant his constructional project towards the professional supply channel without realising it. In this case, I checked that the FX3720 was available without spotting that there might be a problem for people like Mr Stevenson who may not know the supply channel.

Regarding the other comments, corrections appeared in the August issue. As for resistors, I did not give wattage ratings for resistors because I think most readers of *WW* will see at a glance what is needed; it is quite easy to use the formula V^2/R and then make an allowance for ambient temperature and duty cycle. My view is that a constructional project should not be a cookery-book type recipe to be followed blindly, but should involve at least a little thought by the constructor about what he is doing. In the same vein, I hope you will read about r.f. suppression before winding a transformer, as suggested in the article.

The 3 A rectifier diode, D₇, was not specified because it is non-critical; its only function is to provide reverse-polarity protection and it can be by-passed with a shorting link once the unit is installed and working correctly.

POOR DEAL FOR AMATEUR RADIO

I feel I must reply to G3DRN's letter criticising my own letter 'A poor deal for amateur radio'. Like him, I shall endeavour to answer and comment on his 'points in turn'.

Firstly, his 'All Fools' comment — Is this the best he can manage? Likewise, his claims to impartiality can be dismissed with little (or better still) no comment.

As a member of the RSGB (fighting from within) I feel that I have every right to question its actions and expect a reply. As regards my claims to speak for many others, for three evenings after the publication of my first letter I was inundated with 'phone calls agreeing with my comments, including four suggestions that I should stand for a Regional Rep. post.

His comments on the RSGB's neutrality are no more valid to me than mine are to him. As I see the facts, the RSGB is an anti-c.b.; they will not even allow the advertising of c.b. sets in *Rad Com*.

The fact that 70 MHz is a national allocation is hardly relevant to the morse argument — and what about 28 MHz? I acknowledge the introduction of the new u.h.f. bands and one of the new h.f. bands. With regard to the American case, G3DRN is comparing bad with worse — never a good defence. Remember, the Americans have 220MHz and 50 MHz, easy repeater licencing, sel. call, third-person message rights etc., etc.

His analogy of 'phone abuse and repeaters is quite amusing. We, as a society, have come to need 'phones: we do not need repeaters, nice as some of them are.

His comments on the RAE, in general reinforce my own. However, his attack on my standing as a licenced amateur is quite unjustified. Firstly, my RAE was obtainable under the

old system and I am an engineer by profession. Many A licencees (possibly G3DRN included) never took the RAE, which was introduced in about 1947. Any person who held an experimental licence before the war (as G3DRN said he did) was exempted from the RAE. His contention that morse makes you a better operator defies comment – the first ‘Squeaky’ on GB3LO was a G3. Japan has no morse test and few would disagree that the Japanese are impeccable operators.

Amateur radio is a technical hobby and a statement implying this is included in the licence. I do not say that amateurs must build their own equipment, but I do believe they should take a serious interest in how it works. The RAE (even now) does not include p.i.s and it certainly did not in 1947. In my view, some amateurs have their licences under false pretences.

I do not deny that the RSGB is strong and vigilant, but I also believe it does not pursue the interests of the majority of amateurs, just the select few who run it. His ‘wood and trees’ comment – well soon, if not already, the majority of amateurs in this country will be B licencees, many of them discontented. Soon, the new trees will outnumber the old.

B. Reay, B.Sc., G8OSN
Woolwich
London S.E.18

From recently published letters it would seem that a number of RSGB members are becoming sufficiently frustrated with the Society to consider recording their dissatisfaction elsewhere, in journals unaffected by RSGB inertia. Surely the Society’s behaviour has been at its most astonishing, but probably most revealing, over the lamentable, and inexcusable radio regulations farce. One might have expected that the Society journal, *Radio Communication*, would have been filled with expressions of disgust that the Home Office should perpetrate such a blunder. Many a society in such circumstances would demand that heads should roll. However, in the pages of “*Rad Com*” there was not to be found the gentlest rebuke; instead they were filled with much mutual back slapping and an account of the splendid way the Society machine sprang into action, to rectify the faults of the Home Office. One might well ask why a society watching over the interests of its membership was not making itself involved with production of regulations from the outset. The Society gives the impression of a lackey who fears to offend his master.

The Society seems constantly to proselytize for new members, stressing the great benefit membership will confer. The new RAE is producing vast numbers of amateurs, but since most will continue to operate on v.h.f. they will, in general, find little use for a QSL card bureau. Moreover, the majority may be expected to use “black boxes” and would make little use of the constructional projects found in *Rad Com*. In its present form it would seem that the Society will be seen by new amateurs as benefitting them only by producing a journal containing a few advertisements, which could probably be found elsewhere.

We are told that a country gets the government it deserves. It certainly looks as if the Radio Society of Great Britain has got the Government Department it deserves.

Peter Naish
Reading
Buckinghamshire

THE RIGHT FORMULA

Two points of information. First, regarding Mr Young’s letter in the July issue “The Right Formula”, the super-luminal velocities he mentions in astronomical objects are adequately explained as illusions created by high-energy beam phenomena (see, for example, *Scientific American* June 1982).

Secondly, having consulted several dictionaries of a range of authorship, even one dating back to 1932 (Nuttall’s Popular Dictionary of the English Language), I find that every one gives the pronunciation of “patent” as being acceptable with either long or short “a”. I object to Mr Fox’s tone in his article in the same issue and will continue to pronounce “patent” similar to “latent”.

K. Wood,
Ipswich,
Suffolk

Ronald G. Young of Peacehaven asks in his July 1982 Letter to you “How come wires don’t weigh heavier when current flows?” In Einstein’s Special Theory of Relativity one of the end results is that mass is energy, gravity is acceleration and time is space. Units of mass and units of energy are therefore related and it comes about that 1 gram is 9×10^{20} ergs.

Now, if one passes 1 amp through a wire of resistance 1 ohm with a potential difference of 1 volt the energy required to do so is 1 watt, which is equal to 10^7 ergs per second.

According to physicists, 1 gram is equivalent to 9×10^{20} ergs. Now 10^7 ergs are expanded by 6.2×10^{18} electrons per second and this corresponds to a mass of 1.1×10^{14} grams per second. The confusion between mass, amps and ergs lies in their “Relativity” and different frames of reference perhaps. One may measure the distance of a star from earth in feet, miles, seconds or light years or even angles. Mass is a measure of resistance to a change of velocity.

O. B. Balean,
Chatham,
Kent

In July, R. G. Young wrote, “. . . all such ‘theories’ [e.g. Theory C, *WW* Dec. 1980] are purely human artifacts, designed to make predictions of the way things work!”

Young is describing the reigning philosophy in science today, called “instrumentalism” by Karl Popper, see “Conjectures and Refutations”, RKP, 1963, p100. As Popper says on page 101, instrumentalism is used in a defensive mood – to rescue the existing theory. The instrumentalist view is that the winning theory is the theory which has produced practical results, and that since there is no such thing as absolute truth (which last remark is held to be absolutely true!), we should not modify our theories if they are serving well enough.

The flaw in the instrumentalist argument is that the decision on whether the old theory serves well enough is a value judgement based on experience, and if (as is the case) the guardians of the faith – professors, lecturers, Nobel prize winners and text book writers – have no experience of high speed logic (and have never used a sampling oscilloscope), they will reject (and in my case suppress) theories which help in that field. Instrumentalism is the philosophical rationale for a general clamp-down on progress in science into new fields by those whose exper-

ience, careers and prestige are based on the old (analogue) experience.

Young writes, “Does Mr Catt find his theories enable him to do better design work?”

The pre-Catt pot-pourri which served as electromagnetic theory (see for instance D. B. Jarvis, “The effects of interconnections on high-speed logic circuits,” *IEEE Trans. Electronic Computers*, vol. EC-12, pp476-487, Oct. 1963), could not help me to successfully design high speed systems (see Fall Joint Computer Conference, 1966). The new Catt theories were developed in order to make possible the reliable interconnection of high speed (1 ns) logic gates.

The refusal to publish my theories by instrumentalists in the IEE, the Institute of Physics and elsewhere led to a collapse in the use of fast (1 ns) logic gates already available in 1964 and a decline back to slower t.t.l., and then to the very slow microprocessors of today. The computer industry has paid a heavy price for the suppression of theoretical advances by means of instrumentalist arguments. Still today, hardly anyone can successfully assemble 1 ns logic as I did in 1964.

Similarly, in the field of computer architecture, the suppression of the content addressable memory by instrumentalists who only know (and who live off) von Neumann has blocked advance towards more practical machines for a third of a century.

References.

1. I. Catt et al., “A High-Speed Integrated Circuit Scratchpad Memory”, Proceedings – Fall Joint Computer Conference, 1966, pp315-331
2. M. H. and B. R. MacRoberts, “The Scientific Referee System”, *Speculations in Science and Technology*, Vol. 3, No. 5 (1980) – p573-578
3. I. Catt, “The scientific reception system as a servomechanism”, *Journal of Information Science* 2 (1980) pp 307-308

Ivor Catt
St Albans
Herts.

FIRE SHIPS

The Falklands conflict has shown up a fire problem in some of our war ships. Part of the trouble is caused, we are told, by the p.v.c. insulation on the cables. This must mean the multi-core signal cables, since the power cables would be mineral insulated.

Silicone rubber would clearly be better than p.v.c. It remains an insulator after it is burnt, and it contains no chlorine, so cannot produce phosgene.

However, it occurs to me that it might be possible to use fibre optics for communications between the different locations in the ship. This may seem at first a silly suggestion for distance of a few metres, because the cost of the terminations would be large. But if the idea proved practicable, there would be great advantages. A single fibre could carry all the signals for the whole ship, and there could be many parallel routes, so that if several were damaged, the signals could still get through. And of course the fibre cannot burn, though it would melt in a fire.

C. Q. Keiller
Heathfield
Sussex

MICROCHIPS AND MEGADEATHS

As both an electronics engineer and occasional disarmament activist, I have been following the correspondence in *WW* on military electronics and the responsibility of the engineer, both before and since the November 1980 editorial, with more than a passing interest. The Falklands/Malvinas crisis has thrown the issues raised in your May 82 editorial into sharp focus.

10% of Argentina's armaments, including a great deal of radar and communications equipment, came from British companies. In the media this is usually described as "ironic" — but it is no irony, merely the logic of the international arms trade. The Defence Sales Organisation, a 400-strong government department, exists purely to ensure that whenever someone is blown up, burned, drowned or maimed, it's done with quality British equipment and none of your foreign rubbish. And still it goes on, with *WW* readers (unless they've all cancelled their subscriptions) making their own contribution — for example, Plessey, Racal-Decca and Ferranti between them supplying systems for four new Brazilian corvettes, and Marconi selling China £14m of electronics for their fighter aircraft.

Much of the correspondence opposing the theme of the 'Microchips and megadeaths' editorial has dwelt on the well-worn bogey of the Perceived Soviet Threat, with various refinements such as Defending our Democracy (what democracy?) and Maintaining Technological Superiority. In fact, the motivation which keeps these people beavering away at improving their killing capacity, and which keeps their opposite numbers in the U.S. and the Soviet Union doing the same, has little to do with any of these. It has to do with lack of imagination. They cannot imagine the reality of a full-scale nuclear war, or even a full-scale "conventional" one; the most they can stretch to is a brace of foreign tanks rolling down the High Street, and they cling to this image with patriotic fervour. The Russians (or any other aggressor) can have no desire for Britain powerful enough to justify invading it. We have enough trouble managing it ourselves, and we live here; imagine how a foreigner would fare.

Where do engineers stand in all this? The usual prescription — to refuse as a matter of principle to work on military electronics — is glib, and not so easy to put into practice. (Though the if-I-don't-do-it-someone-else-will argument is no more than a cop-out, at individual or national level.) Where do you draw the line between military and non-military work? Does the manufacture of Mil-spec components count as a crime? How about production control systems for weapons factories? Or for the nuclear fuel cycle, which has a dual-purpose role?

This is not to denigrate those (of whom I am one) who will not work in overtly military industry. But it should be realised that often the main effect of such an individual stand is simply the amelioration of the individual's conscience — and to achieve an end to the technological arms race we need much more than that.

One aspect that needs constant effort is information. Much, if not most, military work is shrouded in secrecy, some of which may be justifiable but a great deal of which is not. For example, how many people know that France is still conducting nuclear weapons tests on the Mururoa atoll in the Pacific (the most recent on

December 8, 1981) and that in March 1981 several pounds of plutonium and other radioactive wastes were swept out to sea by a tropical storm? This information was leaked to the Australian press by a group of French engineers working on the island, who were concerned about their government's apparent decision to ignore the problem. Closer to home, Jock Hall's letter in June 1981 *WW* cites another example of this kind of action; part of the social responsibility we are talking about is a willingness to take the risk in exposing such harmful activities.

Another aspect that needs more work is conversion — the conversion of military companies to manufacturing socially useful products, with a concomitant increase in job security and job satisfaction. The classic example here is the Lucas Aerospace Shop Stewards Combine, who devised a detailed plan for such a move for their company. Predictably perhaps, the management were uncooperative, eventually sacking the most active figure in this project. This has not deterred employees of other firms from producing similar plans.

Finally, there is the most positive action of all — applying your engineering skills to relieve the real needs of the world and the human race. H. M. Butterworth, in November 1981 letters, described agricultural electronics as an order of magnitude more difficult, and two orders of magnitude more satisfying, than military electronics. Professor Meredith Thring, in his recent James Clayton lecture Engineering for Humanity, argued that planners of the future can only plan with the machines that engineers have already developed; he went on to say that "it is the prime responsibility of the engineer to envisage the machines that will be needed to give our grandchildren a stable peaceful world in the twenty-first century." (Digital watches and video games?) He identified appropriate technologies for the energy, food and transport requirements of the Third World to be the urgent priority.

There is no shortage of prognoses. Why then, since the problem is generally accepted, do we still have the arms race, are there still starving billions? From the engineering point of view, a clue can be found in Dr Peter Hartley's excellent piece "Educating engineers" in December 1981 *WW*, where he argues that engineering has been dominated by humanist values which are inherently antisystemic — the system in this case being global in nature. In the context of the arms race and the North/South divide, political and technical forces have concentrated on fragmented solutions, usually nationalist or economic, without reference to the global system in which they are embedded — as a direct result of the humanist world-view. But the solution he proposes, that of educating future engineers towards an ecological outlook, is far too long-term. The problems are with us now. If we do not face them now, by educating ourselves towards ecology and a systemic view and acting from that perspective, we won't have to worry about educating a future generation.

Tim Williams,
Wadhurst,
East Sussex

As a subscriber to *Wireless World* for over 30 years, I read with interest the correspondence on Microchips and Megadeaths, but had no intention of entering into the debate, but the

letter in your April issue from R. Whitehead was more than I could take without reply.

Perhaps I could plead in mitigation for my unreasonableness, the excuse, that I was born soon after the first world war, and in common with most of my generation, watched the rise of Hitler and Mussolini, and then served in the 39-45 war albeit in a non-combative job with the R.A.F.

I doubt if any member of my generation would subscribe to the view that the Japanese were on the point of surrender when the atom bomb was dropped. We all thought, perhaps wrongly in Mr Whitehead's view, that we were fighting for our survival, and there were times when I wondered if we would win or be subjugated. It should also be remembered that in 1945, that our enemies were also working on the atomic bomb — recall our raids on Norway to destroy heavy water plants — and a delay in ending the war might have given Japan the advantage in dropping the bomb first.

However, my main point is that I believe there is no record, official or otherwise, which pointed to the possibility of the Japanese being on the point of surrender. This word was not in their dictionary, and though they treated many of our prisoners most cruelly, their own courage and patriotism was never in doubt. If they fought well on foreign soil their tenacity in defending their homeland was expected to far greater. It should also be recalled that they did not sue for peace when the first bomb was dropped. Despite its devastation, it took another bomb to convince them to surrender.

G. S. Curry,
Ashley, New Milton,
Hampshire.

The wisdom of your editorial ('Arms and the Man', May 1982) is not to be doubted by anyone who has an intelligent concern about the future of our species and the environment we inhabit. But how are we to escape from the senseless militarist cycle which our society, East and West, is caught in? You suggest that it is the responsibility of engineers to refuse to work on the production of armaments. This proposition misses the fundamental problem of our present social order which is that engineers, and other producers of wealth, do not own or control the means of production and distribution, i.e. factories, mines, farms, docks, offices, etc. Wealth producers can only begin to seriously use productive machinery for rational uses when we commonly own and democratically control it. Such a transformation of society (which I would call a socialist revolution) would have two direct consequences: firstly, it would put an end to rivalries over the possession of property and thus eliminate one of the principal causes of war; secondly, it would allow humanity to produce wealth solely for use, not for profit. Political organisation to establish a society of common ownership and free access seems to be a more scientific and less risky course than to rebel against employment in the armaments industry and gain for oneself a place in the dole queue.

Stephen Coleman
Clapham
London

This correspondence is now closed. — Ed.

DIGITAL PHASE CONTROL OF THYRISTORS

Easy computer interfacing for power control devices is provided by this digital circuit. Adjusters are eliminated and a definite off-case ensures no motor creep or light flicker.

Phase control of thyristor and triac devices using analogue techniques is a well-established method. The input analogue signal may be generated by a rheostat or a digital-to-analogue converter. This input is compared with a ramp and a pulse generated when the ramp voltage is greater than the input. Such circuits are usually provided with two adjustments, one for absolute level of the ramp and one for the rate of rise. This circuit eliminates these potentiometers and makes the control circuit easy to interface to a computer.

The power supply circuit, see diagram, is a conventional design, except for D_1 , giving a stabilized 12V output. Diode D_1 ensures a full-wave rectified signal appears at the output of the bridge rectifier. This is attenuated by R_7 and R_8 with R_9 also acting as a current limiter to an input of IC_6 . The output at IC_6 pin 3 is broad pulse with long rise and fall time. This signal is differentiated by the next two gates combined with R_6 and C_3 . The output, IC_6 pin 10, is a positive-going pulse with duration τ where $\tau \approx C_3 R_6 \log_2 2$. The duration must be sufficient for gate output IC_5 pin 10 to discharge capacitor C_1 . The discharge takes time $\approx 1000C_1$ in a c.m.o.s. circuit running on 12 volts. The sync-generator and power supply are only required once per line phase in a system

by **B. H. Pardoe**
Ph.D., M.I.E.E.

where there could be many triacs running off each line phase.

The sync-generator pulse occurs every 10 ms on the zero crossing of the mains supply and clears bistable IC_{5a} which removes the reset signal from the counter IC_2 and the hold signal from the oscillator. The oscillator drives counter IC_2 whose eight least-significant bits are connected to an eight-bit comparator made up from two four-bit comparators. A second eight-bit input to the comparator comes from the eight-bit store IC_1 . The input to this is fed in asynchronously and may give an incorrect pulse in the first half cycle in which the data has been placed in the store by the external strobe pulse.

The counter output value rises until it equals the store output. This creates a one on the equal line which turns on the transistor TIP121 and sets the bistable IC_{5a} . The bistable clamps the oscillator thereby holding the equal signal at the comparator output. The bistable output causes the reset to IC_2 signal to rise exponentially. When the reset passes the threshold, the counter output goes to zero and the equal signal disappears. The

output to the power amplifier is switched for a time set by R_1 and C_1

$$t_{on} = R_1 C_1 \log_e 2.$$

The counter IC_2 remains reset until the next sync pulse arrives at the end of the half cycle. This hold ensures only one pulse is generated per half cycle.

The case of zero in the store is used as turn-off guarantee. When the counter reaches zero for the first equality a positive transition is sent to the power amplifier. The bistable IC_{5a} stops the oscillator and after a delay a reset level appears on the input to IC_2 . This tries to create zero which already exists and reinforces the equal signal. The sync pulse removes the reset at the end of each half cycle, but not for long enough to give one half clock cycle. The counter therefore remains at zero and there is no output as the d.c. signal is blocked by C_7 and R_{10} .

The clock must go through 256 cycles in 10ms which sets the frequency at 25.6kHz and the standard values for R_2 and C_2 are given by*

$$R_2 C_2 = 1/2.2 \times 25600.$$

The choice of both triac and pulse transformer require some care. The pulse length required on the triac gate depends on the holding current of the device and the load. This circuit was designed to handle 500 to 2000 watt loads. The supply voltage and load can be used to predict the time taken from the zero crossing for the current to rise to the holding current. This gives a worst case figure and turns out to be about 135 μ s, set by $R_1 C_1$.

The pulse transformer connections are arranged to give the most sensitive operation of the triac device. The pulse transformer has 12 volts switched across it by Darlington transistor TIP121 for a time equal to t_{on} . The final current in the primary is

$$I_{max} = \frac{12}{2r} (1 - e^{-t/\tau L})$$

where $\tau L = 4\pi/2\tau L$ is the inductance of one primary winding and r its resistance. For the coil specified I_{max} is 133mA, whilst the saturation current is 200 mA which ensures there is no excessive collector current. Collector current of the TIP121 will be 133 mA plus half the gate current. The value of R_5 can be fixed by the minimum gain of the TIP121 and its maximum collector current. Components C_7 and R_{10} are only used for d.c. blocking and should be chosen to be transparent to a 135 μ s pulse feeding the load R_5 . 

*RCA Data Handbook, 1977.

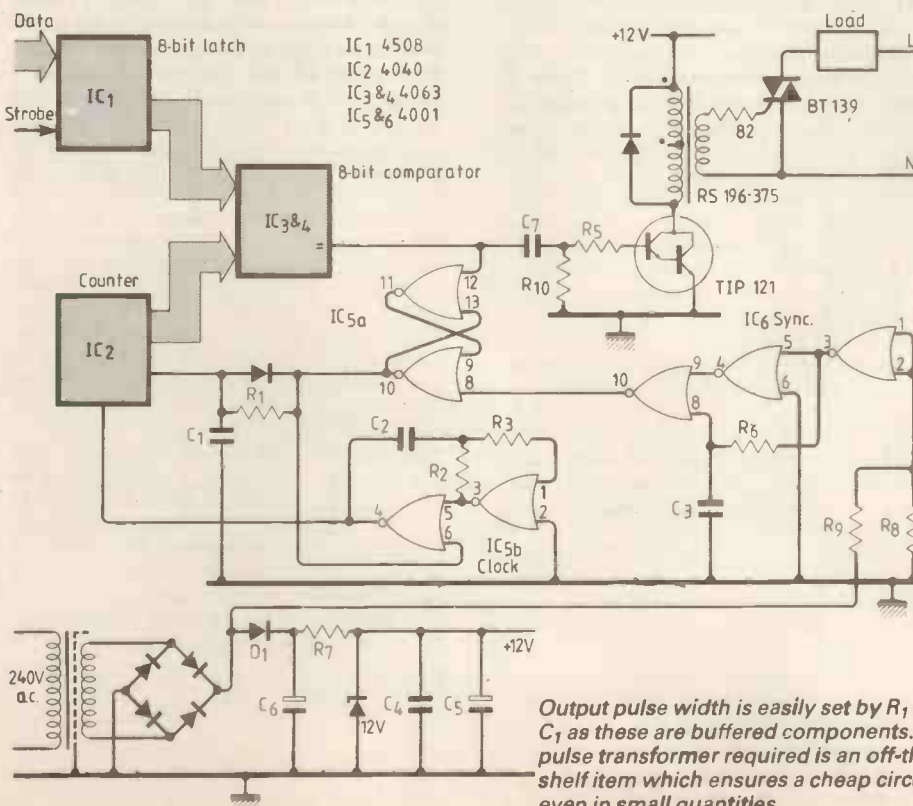

Output pulse width is easily set by R_1 and C_1 as these are buffered components. The pulse transformer required is an off-the-shelf item which ensures a cheap circuit even in small quantities.

DIFFERENTIAL DIRECT CONVERSION

Poor pre-detection selectivity, second-order mixer intermodulation and high-gain amplification problems are all reduced by using differential circuitry for direct frequency conversion

In single-ended transmission systems, the signal voltage is taken with respect to a reference (usually "ground") which is assumed common to all stages of the receiver. Unfortunately this assumption cannot be realized in practice. In the differential mode, by which I mean that connections from one stage to the next are made with two wires and the signal information is contained in their voltage difference, with proper device selection and circuit design, push-pull type circuits naturally evolve which reduce second-order intermodulation products and untuned signal detection. Induced hum and power supply ripple can similarly be reduced by using the high common-mode rejection ratios available in modern op-amps. The beneficial side-effects are at least these three

- a balanced receiving antenna such as a small directional loop can be directly interfaced to the receiver without the phase and gain inaccuracies attendant with baluns
- r.f. circuit layout problems are drastically reduced because in a differential mode we don't worry about maintaining a constant impedance to ground (there is no "ground")
- if we ever cared about transmitting with a balanced antenna we would need both + and - drive signals - these are automatically available with a differential layout.

I have built the receiver whose block diagram appears in Fig. 1, and found that it does indeed achieve all of the advantages outlined above. I wouldn't waste your time describing something that doesn't work, so at this point you can either go ahead and duplicate my circuit, shown in Fig. 2, or read on and find out why it works.

I used a tuned-loop antenna to differentially drive the balanced inputs to IC₁, an MC1590 untuned video amplifier with a voltage gain of about 10 and a 10k Ω differential input impedance. A collection of small loop-antenna design equations is given in the appendix, which also explains why you should be using a loop antenna on the h.f. bands. The receiver's first stage performs two functions: it provides constant input and output impedances and acts as a buffer between antenna and mixer, and it provides about 20dB gain for the inefficient loop antenna. Due to atmospheric noise in the h.f. bands for which this receiver was designed, noise figure and antenna efficiency or G/T are unimportant factors. The important consideration is dynamic range, and for the direct

by Paul E. Gili, WA1WQH

conversion receiver, second-order intermodulation products. They must be low to reduce untuned signal detection. In the circuit, the MC1590 operates in a push-pull mode which suppresses this type of non-linearity by generating two equal and opposing non-linearities (when the device is driven non-linear) and cancels even-order harmonics.

After the antenna is amplified, it is differentially converted to the audio frequency range by a doubly balanced mixer circuit incorporating a CA3049. In fact, this circuit could be considered "triply-balanced" as there are no unbalanced ports at all (don't fall over on that one). The CA3049, to be described later, operates as a differential amplifier with its outputs switched in polarity at the local oscillator rate. The fact that gain is available in the upper switching transistors whose bases are at pins 1, 4, 7 and 10 and also the fact that the l.o. signal is a square wave ensures fast switching transitions from positive gain to exactly the same but negative gain. Lack of symmetry during the short switching transition time is known to cause intermodulation products. At h.f. relatively faster switching can be achieved with active devices using squared-up drive waveforms than can be achieved with diode ring-type balanced mixers. Up to 30 MHz, therefore, I think that the integrated bipolar transistor type of balanced mixer driven by a square wave is superior to other types of mixers. It will, however,

respond to signals at odd harmonics of the l.o. almost as well as it does to the fundamental; these can be easily filtered out as they are widely separated in frequency.

At points C and D of Fig. 2, then, there is a differential audio signal which is amplified differentially by IC₂. These are the two op-amps connected in the classical differential instrumentation amplifier configuration with a differential gain of 40dB. This is where power line hum gets rejected and the amount of rejection depends on how closely you can match the gains to maximize common-mode rejection. You might want to make the gain of IC_{2(b)} slightly variable ($\pm 10\%$) by using a 910-ohm feedback resistor in series with a 200-ohm potentiometer instead of the fixed 1k Ω resistor shown. Residual power supply ripple from the 6.2-volt zener diode is in-phase at the inputs to IC₂ but the desired signals are 180° out of phase with each other at these points. With the circuit shown, differential signals get amplified by 40dB, whereas changes in the zener diode reference voltage come through unchanged. A 40dB improvement in signal-to-ripple ratio over a single-ended design is therefore effected.

At the output of IC₂ the signal has been amplified and filtered to a level where it is relatively impervious to the interference effects important to a direct-conversion receiver. From here on, we can use standard single-ended operational amplifier circuitry with one input, one output, and ground as a reference. I used a three-section Tchebychev 0.1dB ripple lowpass active filter with cutoff at 500Hz for c.w.

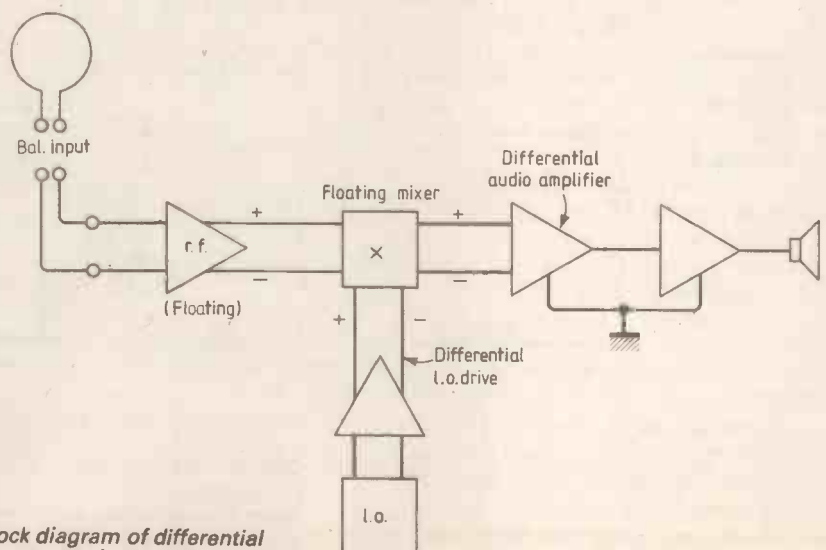
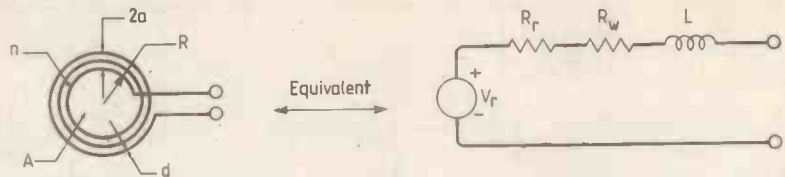

Fig. 1. Block diagram of differential direct conversion receiver

menclature of points A, B, C, etc, on the mixer of Fig. 2 has been generated mainly to reduce the clutter which would appear on a detailed circuit schematic, but which is much more simple in an actual physical realization, as Fig. 4 shows.)

Appendix

Small loop antennas are useful for receiving systems in the h.f. band because their dipole-like directional characteristics are preserved even though their size is orders of magnitude smaller than an actual dipole at these frequencies. Their efficiency is extremely low, but at h.f. where most of the receiver noise is due to random atmospheric disturbances, it doesn't matter if you have a lossy, noisy receiver front end. A small loop's main attribute is its ability to easily null out a coherent man-made interfering signal by simple physical re-orientation of the loop. A 3.5MHz receiving loop antenna can be as small as two feet in diameter and have the same directional properties as a rotatable 80-metre dipole which would be about 130 feet long. Null depths of around 20dB can be achieved if phase and gain of the balanced antenna output are preserved. Naturally, you'll need a differential direct conversion receiver to do a good job at this.



For convenience in building small loop antennas, I've put together a number of design equations from various sources, shown on the right. Included is one relationship assembled by me which allows you to calculate the approximate r.f. voltage received from a transmitter as a function of the transmitter's range, power, frequency, and your receive loop antenna parameters. Of course the range depends on how the signal got to you, i.e. how many ionospheric bounces it took and how high the reflecting ionospheric layer was at the time. Polarization of the received wave also plays a part, as does the angle of arrival from the sky with respect to the loop's orientation (elevation as opposed to azimuth). One can easily get carried away trying to account for more variables than can be measured or even defined; however, the equation does give an answer which probably is within an order of magnitude of the actual number.

The small loop antenna has an equivalent circuit which may be derived from its physical parameters.

$$R_r = 31,200 (nA/\lambda^2)^2 \text{ ohms}$$

$$R_w = 2.61 \times 10^{-7} \sqrt{f(2nR/d)} \text{ ohms for copper}$$

$$L = n^2 \mu_0 R (\log_e(8R/a) - 2) \text{ nanohenries}$$

$$V_r \approx (\lambda/4\pi D) \sqrt{8P_t R_r} \text{ volts}$$

Definitions

- R mean radius of loop
- A area of loop, πR^2
- d wire diameter
- n number of turns in loop
- a radius of bundle of wires in loop or $d/2$ if $n=1$
- V_r peak amplitude of received signal
- R_r radiation resistance
- R_w conductor loss resistance with skin effect
- L inductance of loop (nH)
- f frequency (Hz)
- λ free space wavelength
- μ_0 12.56 nH/cm
- P_t transmitted power (watts)
- D range (same units as λ)

WW

LITERATURE RECEIVED

"Phase-locked Upconverters for Pulse-compression Radar" is the title of a booklet containing three re-printed papers by Microwave Associate's principal engineer. The articles are extremely well presented and form a useful collection of information on the subject. Publication available free from Microwave Associate Ltd, Dunstable, Bedfordshire LU5 4SX.

WW401

Timers, controllers, relays and connectors are all fully illustrated and described in a 60-page Tempatron catalogue, now freely obtainable from the Sales Department, Tempatron Ltd, 6 Portman Road, Reading, Berkshire. WW402

Characteristics and mechanical details of microwave and r.f. power transistors, working in the range 1MHz to 4GHz at up to 500W peak pulse power are given by a catalogue for Acrian. There are, in addition, pages on reliability, testing and a glossy of transistor terms. March Microwave Ltd, 112 South Street, Braintree, Essex. WW403

A leaflet on relays and timers of all types, which provides both electrical and mechanical information, is available from Appliance Components Ltd, Cordwallis Street, Maidenhead, Berkshire SL6 7BQ. WW404

A selection guide giving brief details of all transistors and integrated circuits made by Raytheon can be obtained from Raytheon distributors and sales offices. Raytheon Semiconductor UK, Howard Chase, Pippas Hill Industrial Area, Basildon, Essex SS14 3DD. WW405

The Philips LDK 14SL colour television camera system is briefly described in a colour leaflet, available from Pye TVT Ltd, P.O. Box 41, Coldhams Lane, Cambridge CB1 3JU. WW406

Semiconductors made by Plessey are listed, with salient characteristics, in a short catalogue, obtainable from Plessey Semiconductors Ltd, Cheney Manor, Swindon, Wiltshire SN2 2QW.

WW407

Test signals for audio equipment are described in a Standard from the International Electrotechnical Commission. A weighted noise test signal with a mean power spectral density is close to the average mean power of programme signals is described. The Standard includes the specification of the frequency weighting, together with filters for deriving signals from pink-noise and white-noise sources. Publication 268-1C available from IEC, 1 Rue de Varembe, 1211 Geneva 20, Switzerland. WW408

National Semiconductors have issued a leaflet describing their NSC 800 P²CMOS microprocessor and associated devices. The double layer of polysilicon connections (hence the P² are claimed to provide very high speed at low power consumption for the 8-bit m.p.u. family. Details from ITT Electronic Services, Edinburgh Way, Harlow, Essex. WW409

The Pro-Audio Yearbook 1982/83 contains 686 pages of information and pictures to do with the various aspects of professional recording and sound broadcasting. Link House Magazines, Dingwall Avenue, Croydon CR9 2TA. WW410

High power thyristors in small packages are detailed in Bulletins E2515 and E2516 from International Rectifier. Bulletin E2746A describes the IRK series of thyristor/diode combinations. Details from IR, Holland road, Hurst Green, Oxted, Surrey. WW411

Electrically-Small HF Transmitting Antennas is the title of a Technical Note from Technology for Communications International Ltd, Kingston House, Stephenson Way, Three Bridges, West Sussex RH10 1TN. WW412

Wilmslow Audio charge £1.50 for their new catalogue which includes details of their d-i-y loudspeaker kits and components as well as a range of ancillary equipment. There is a lot of useful information about loudspeakers and enclosures. Wilmslow Audio Ltd, D.A.T.A. books have published new editions of their Transistor, Diode and Thyristor D.A.T.A. books, along with the listings of the available devices and their characteristics, there is a new section which lists the replacements for components. Any replacement listed can, of course, be compared in detail in the device listings. Other recent additions to the 24-volume D.A.T.A. series are ones on Modules and hybrid i.c.s and others on discontinued linear devices. D.A.T.A. International Inc., Portman House, 16-20 Victoria Road, Romford, Essex RM1 2JH. WW414

BS 6204 is a new British Standard for Safety of Data Processing Equipment. It specifies the requirements of data processing and associated electronics units intended to be connected to a supply system having a maximum nominal system voltage of 600V and designed for continuous operation. The Standard has been drafted to avoid the risk of personal injury or damage to equipment or buildings arising from electric shock, fire, energy hazards, mechanical and heat hazards, radiation and chemical hazards associated with the installation of such equipment. British Standard Institution, 2 Park Street, London W1A 2BS. WW415

A massive catalogue of Linear Integrated Circuits lists the products of Precision Monolithics Inc. It includes op. amps, comparators, voltage reference, d-to-a converters, multiplexers, telecommunications chips and much more. Each entry gives a full specification, a schematic diagram and applications notes. The PMI 1982 Catalogue is available in the UK from Bourns Electronics, 17 High Street, Hounslow TW3 1TE. WW416

SIMPLE, LOW-FREQUENCY OSCILLOSCOPE

A simple oscilloscope based on the old ex-Government radar tube VCR517, which is still available together with its variations VCR97 and small screen VCR138.

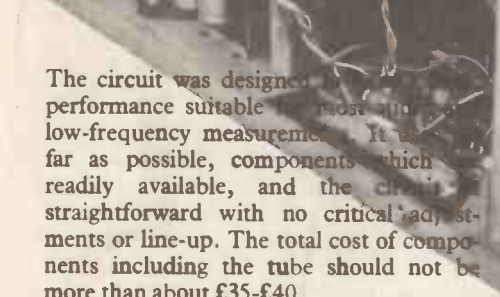

by R. J. Taylor

20MHz unity gain bandwidth and fet input impedance. The gain from the Y input to the output of each operational amplifier is $\times 12$ and to each Y plate $\times 300$.

The input attenuator gives accurate input attenuation with a constant $1\text{ M}\Omega$ input impedance using a moulded, single-pole, 10 position switch. This type of switch, which is also used for the X speed control, is available in a plastic moulded form which gives good insulation resistance. A ring on the fixing bush is used to limit the rotation to 10 positions for the Y attenuator, or is left off if all 12 positions are used, as in the X sweep circuit. Non-standard resistor values can be made up from two resistors, for example, 470 k and 33 k give $500\text{ k}\Omega$, using 2% tolerance if possible.

Note that the simple input attenuator has no high-frequency correction, which this results in the full Y amplifier bandwidth only being obtainable at the 0.05 V/cm setting. At other settings of the attenuator (except 0.1 V/cm) the bandwidth is between 200 and 300 kHz. At 0.1 V/cm the bandwidth is 100 kHz.

The Y amplifier gain may be adjusted by the $1\text{ k}\Omega$ resistor between the inverting inputs of the two operational amplifiers.

Sawtooth generator and X amplifier

The sawtooth oscillator is based on a CA3130 operational amplifier which has a c.m.o.s. output stage and permits the output voltage to reach the rail voltages (0 or +12 V). The basic sawtooth oscillator is shown in Fig. 1, in which the operational amplifier operates in a switching mode with the output at either ground or positive rail potential.

At switch-on, the capacitor is discharged and the output (A) will be at +12 V. The positive input of the amplifier will therefore be at +8 V and the transistor will be supplying current to the capacitor. The current will be defined by V_e/R_T where V_e is the voltage across R_T . In the basic circuit, this will be about 3.3 V when the amplifier output is at +12 V.

The capacitor charges up linearly until the voltage on the negative input of the amplifier equals that on the positive input (+8 volts). At this point the output will rapidly fall to ground potential, turning the transistor off and turning the fet on,

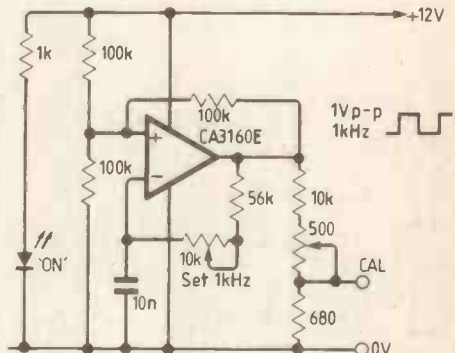

Fig. 3. Square-wave calibration oscillator.

discharging the timing capacitor through the $1\text{ k}\Omega$ hold-off resistor. The positive input of the amplifier is now at +4 V. At the point at which the negative input is the same as the positive input the output voltage switches to the positive rail again and the whole cycle repeats. In the final circuit, a logic gate is used between points A and B, so that the sawtooth oscillator can be inhibited, ready to trigger.

The emitter resistor R_T is used to set the sweep speed and is replaced in the final circuit by the sweep-speed switched resistors, which vary the current supplied by the transistor into the timing capacitor between about 0.8 mA to $0.2\mu\text{A}$.

The X amplifier takes the same form as the Y amplifier. There is a voltage gain of 2 to the output of each operational amplifier (8 V p-p sawtooth) and a further gain of about 30 to each X plate (240 volts p-p).

Trigger circuit

This circuit, comprising the three integrated circuits 4011, 4070 and 4013, takes

continued on p.87

Circuit description

The tube is run at about 2000 V e.h.t., which gives adequate brightness and spot size and at the same time eases the deflection-plate drive requirements. The X and Y amplifiers drive the deflection plates directly at a mean voltage of +100 V and the tube cathode is at a potential of -2000 volts.

For good focus, the potential on A_3 of the tube must be the same as the deflection plate potential and therefore a preset control is used to set A_3 potential, and acts as a second focus control.

The e.h.t. is generated by a voltage tripler, driven by a 500 V transformer winding.

The A_2 and A_3 focus controls are preset potentiometers. A_2 focus should be suitably insulated, since it is at about -1500V. Similarly, the brightness control should have a nylon spindle and the body should be fixed to an insulating mounting.

Y amplifier and input attenuator

The Y amplifier is a fully balanced, d.c.-coupled circuit with the Y input connected to one side and the Y shift to the other. The LF357 operational amplifier was chosen to drive the long-tailed pair, as it has a

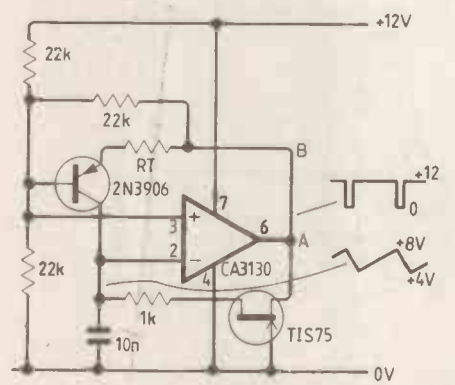

Fig. 1. Basic form of sawtooth generator. Circuit is seen in final form in main circuit diagram, where logic gates are used to inhibit free-running mode for triggering.

Specification

Sweep speeds 5 $\mu\text{s/cm}$ to 20 ms/cm.

Vertical 0.05 V/cm to 50 V/cm ac/dc

bandwidth: 1 MHz at 0.05 V/cm

100 kHz at 0.1 V/cm

200-300 kHz at other settings

Input impedances: $1\text{ M}\Omega // <20\text{ pF}$

Triggering free run or trigger from +ve or -ve edge of input

Calibrate waveform 1 volt p-p square-wave, 1 kHz

* The bandwidth could be improved to 1 MHz on all settings using a more complex input attenuator with compensating capacitors. However, the simple input attenuator shown gives accurate low-frequency performance.

Fig. 2. Complete circuit diagram, less calibration oscillator.

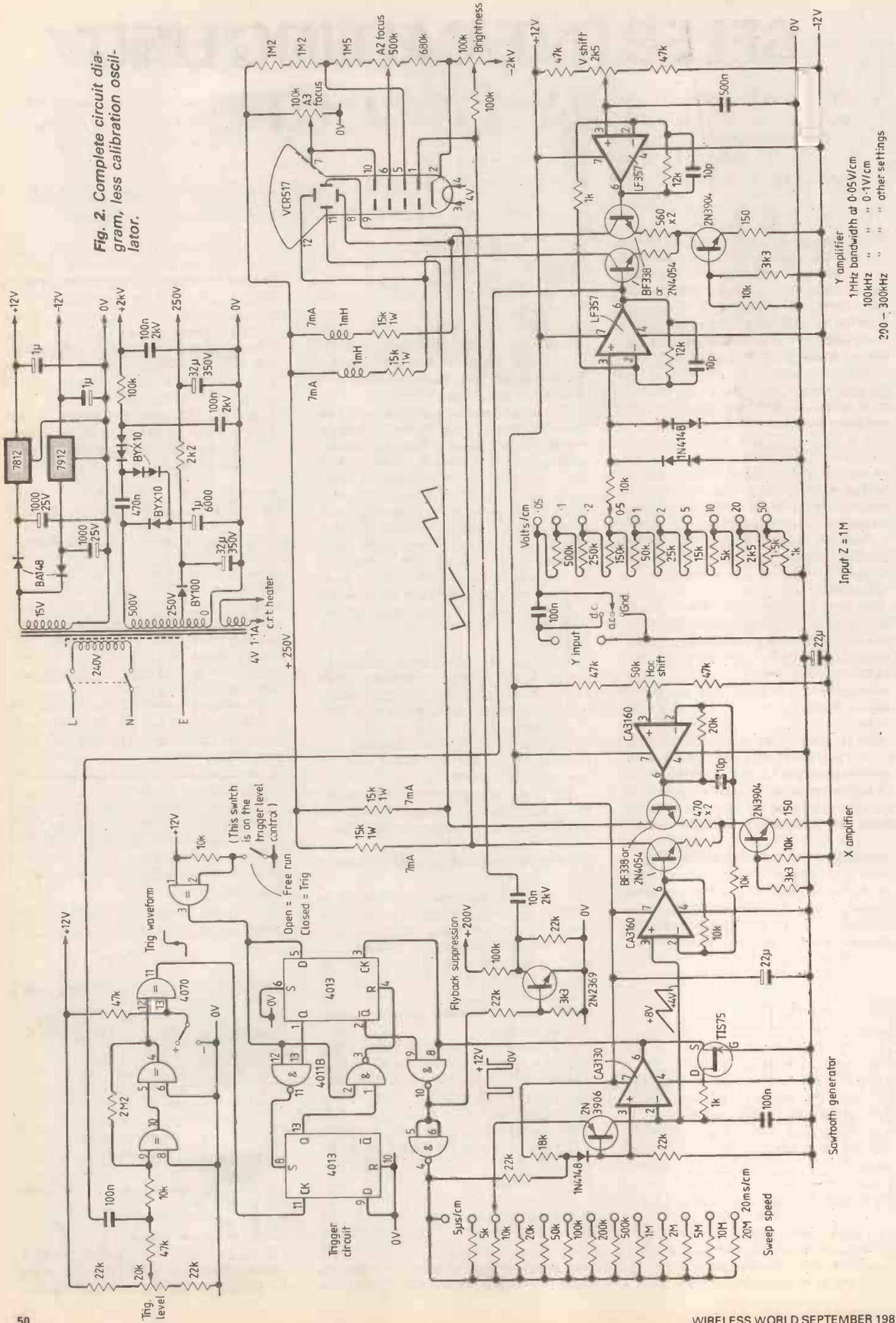

Y amplifier
 1MHz bandwidth at 0.05V/cm
 100kHz " " 0.1V/cm
 200 - 300kHz " " other settings

Input Z = 1M

X amplifier

Sawtooth generator

Sweep speed

SELECTIVE-CALLING UNIT

Designed for use with citizens'-band radio, this pocket-sized unit can be programmed to accept one of 65 536 different four-digit codes, and can call as many individual stations from values entered on a hexadecimal keypad. Coupling to the transceiver may be acoustical in both directions or through the radio's external loudspeaker socket for receiving. This unit could be adapted for use in electronic combination-lock applications.

The concept of selective calling for private-mobile, citizens'-band and amateur radio is not new, but existing systems are usually incorporated in the transceiver and often use expensive components. Also, the number of individual codes available is more often than not inadequate, especially where citizens' band is concerned.

Described here is a unit housed in a calculator-sized case, which can handle up to 65,536 different codes and uses readily available components. The received signal can be acoustically coupled to the selective-call unit by placing the latter near to the receiver's speaker, should the preferable method of connecting the unit directly to the receiver's external loudspeaker socket be undesirable.

Basically, a four-character hexadecimal number entered on the unit's keypad results in the generation of a sixteen-bit serial signal which is used to modulate the transceiver's carrier. This allows the user to selectively call any of up to 16^4 receivers, and means that potential recipients only need to listen for a 'bleep'—rather than having to constantly monitor conversations on what may be a busy shared channel.

All the i.c.s used are c.m.o.s. types, the main element being the Intersil IM6402 uart (universal asynchronous receiver/transmitter), so operation from nickel-cadmium cells small enough to fit into the calculator-sized case is practical. Also, the components used are readily available and at moderate cost. The unit was designed to be small and versatile to allow it to be modified for other purposes, particularly in security applications, where it might be used to permit access to information, or to a telephone-answering machine, or, say, to unlock a garage door. In transpond mode, the unit may also be used for remote data interrogation.

Circuit description

Board A. This board, shown in Fig. 1, provides an interface between the keyboard and main logic board, board B, which is described separately. Hexadecimal codes are entered on a 16-key matrix-type keypad which is connected directly by eight wires to a keyboard encoder, IC₂. This i.c. responds to closed-contact resistances of up to 5k Ω , and provides a contact-debounce period proportional to the value of C₁; here, 1 μ F is used, giving a debounce period of around 1ms.

A clock signal applied to pin 5 of the keyboard encoder determines the keyboard-scan rate. The frequency at pin 5 in this case is 3.2768kHz, derived from a

by Brian Drury

crystal oscillator, IC₅, and divide-by-ten circuit, IC₁. Half of a dual D-type flip-flop, IC₄, further divides this signal to provide the main 1.6384kHz clock used on the second board. The remaining half of IC₄ is used to steer the keyboard encoder's strobe output either into the 4-bit latch, IC₃, or off board A as STB.

When the unit is switched on, circuit elements R₂, D₁ and C₃ ensure that the steering logic starts out in the correct state, and provide a system-reset signal, RST,

for the second board. Immediately after power-up, the first hexadecimal character entered on the keypad will be held at the Q outputs of IC₃. Entry of the second character will result in an eight-bit byte being shifted off board A by the STB signal. This board, while specifically designed for use with the 6402 uart, could be used in any application requiring manual entry of an eight-bit-wide data byte.

Board B. The main component on this board, shown in Fig. 3, is the previously mentioned 6402 uart, IC₆, which is used in its eight-bit mode, with even parity and

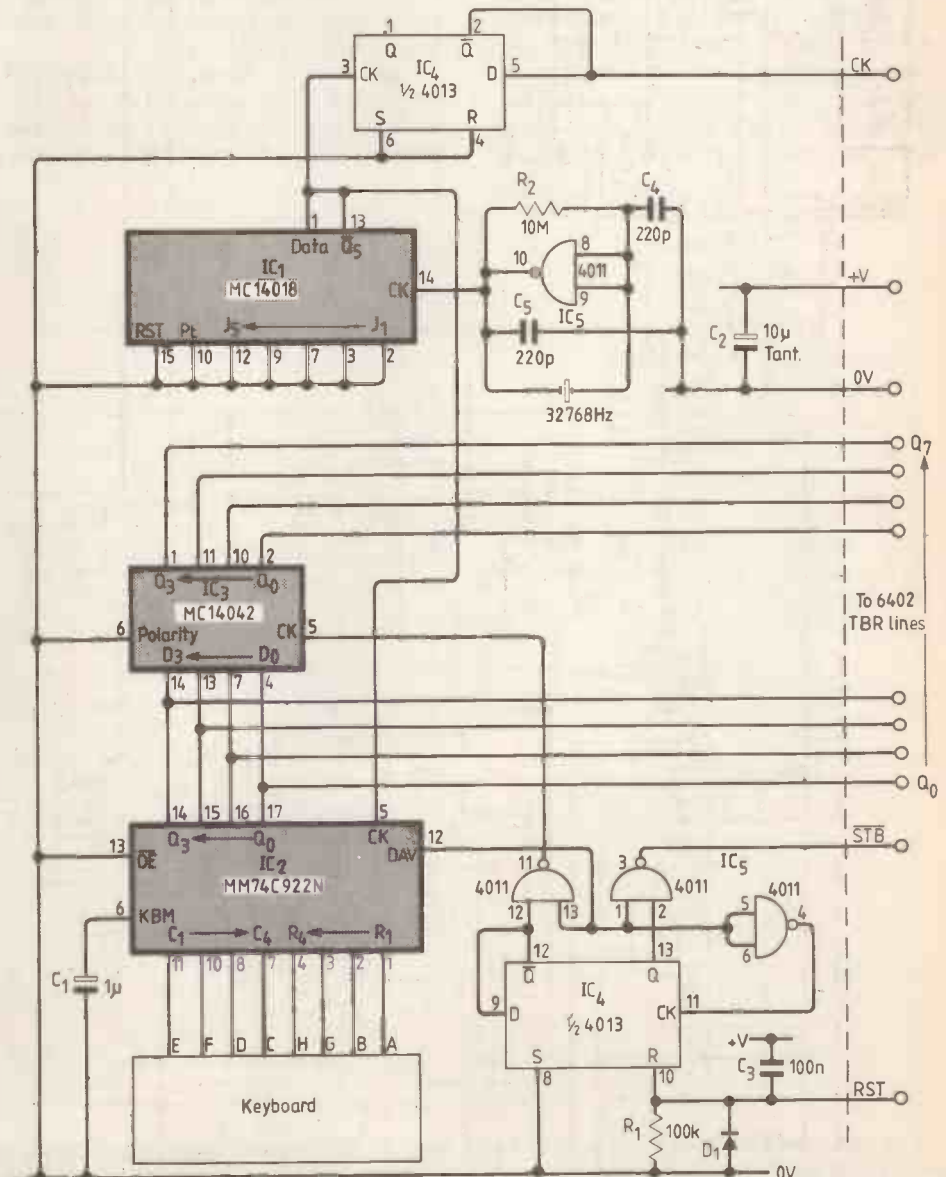

Fig. 1 Board A. This board produces an eight-bit parallel word from two entries on a hexadecimal keypad and may be used in any application requiring such. IC₁ divides by ten and IC₄ by two, to produce a clock signal of 1.638kHz for use on board B, Fig. 2.

one stop bit. More information on this can be obtained from the appropriate Intersil data book.

IC₄ divides the 1.638kHz clock signal from board A by two to provide receiver and transmitter clocks for the uart. Within the 6402, these clocks are divided by 16, giving a bit rate of 51.2 baud.

In transmit mode, a zero at the buffer-register load input, pin 23, transfers data at inputs TBR₁-TBR₈ to the transmitter buffer register. A low-to-high transition on pin 23 results in a request to transfer data to the transmitter register. If the register is free, the two hexadecimal characters are sent to the TRO output, pin 25, in the form of an 11-bit frame consisting of eight data bits, one parity bit and two framing bits.

For receiving, the unit may be electrically coupled to the loudspeaker output of a radio, or acoustically coupled, when the unit is placed near to the radio's loudspeaker. As an aid to testing both transmitting and receiving functions, the unit may also be connected so that it monitors its own transmissions.

Although the signal source may vary, amplification in each case is provided by Tr₁ and IC₅. Tr₁, used as a grounded-base voltage amplifier, has a low input impedance well matched to the moving-coil transducer and its parallel resistor, R₉. When a jack plug is inserted in socket 2, however, switch S₂ opens and the source

impedance rises, reducing the gain of the amplifier.

Capacitor C₅ couples the output of Tr₁ to the inputs of one quarter of a c.m.o.s. Nand gate, IC₅, used as a linear amplifier. The resulting modulated square-wave version of the carrier signal is then applied to Tr₂, where data is recovered by removal of the carrier.

Recovered serial data is fed directly into the serial input of IC₆, pin 20. When a complete frame has been received, a data-available signal, DR, appears at pin 19. This signal is used to gate the parity and framing error signals, hence, if a valid, errorless frame is received, pin 10 of IC₁ will go high while DR is high; in practice, this period is around 10ms long, determined by R₁₈ and C₄.

A monostable, half of IC₃, is triggered by the 10ms pulse to give an output for 2.2s. This signal, the duration of which was found by experiment to be the most convenient, is required in the event that a valid two-character data frame is received, but not followed by a second within 2.2s. The Q output at pin 6 of IC₃ is connected to one clock input of a dual D-type flip-flop, IC₄. On the rising edge of the signal at this input, the D input's state is transferred to the Q output, pin 1.

Logic used to compare a 'call number' stored in a diode memory with the first-received, valid data byte determines states at the flip-flop's D input. Figure 3 is used

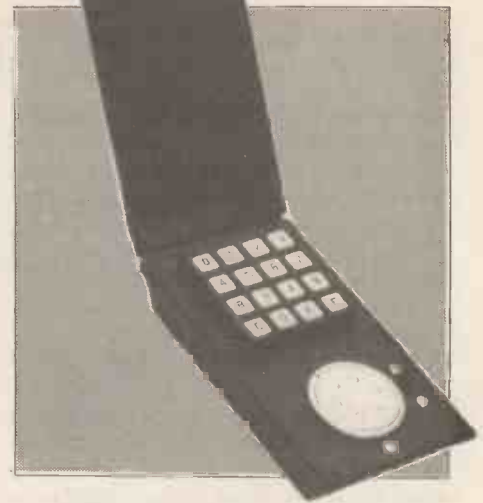

to help explain how the comparison circuit works. In the example, the diodes are drawn to represent a stored call number of 55 hexadecimal, and any binary-bit pattern other than 55 applied to the data input will result either in a logic 1 at point A or a logic 0 at point B. In either case the output will be 0. But when 55 is applied, point A will be at 0 and point B at 1, resulting in a 1 at the output.

Two such roms are used to store the 16-bit call word. If the first byte of the selective-call signal is equal to the value stored in the first rom, which has its output connected to point X, Fig. 2, the Q output of IC₄, pin 1, will go high. If a

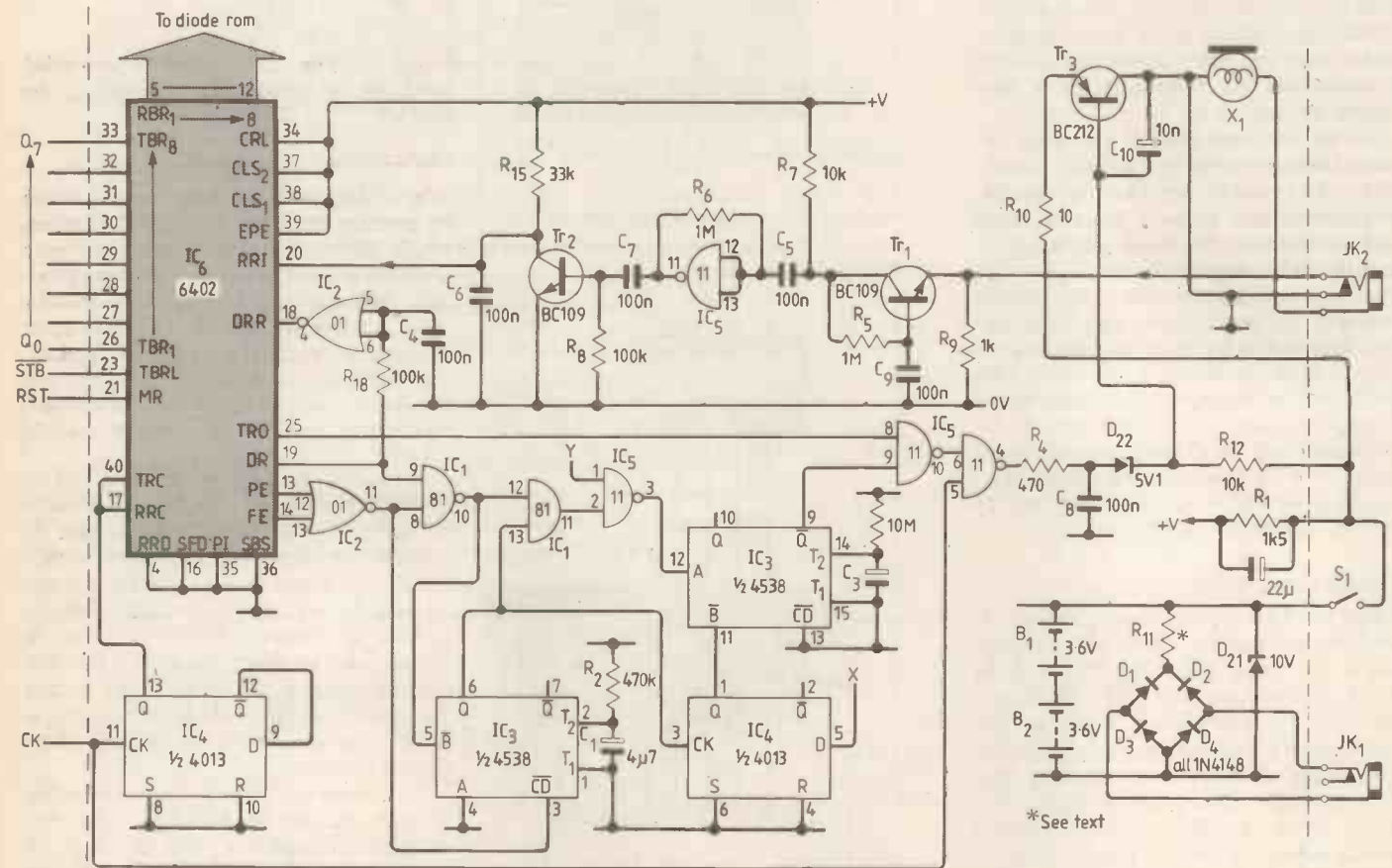

Fig. 2. Main board B, based on the 6402 u.a.r.t. Here, eight-bit parallel words are turned into serial words and used to modulate an audio carrier in transmit mode. On receive, serial words are demodulated, converted to parallel and compared with hexadecimal values set on diode roms. If two received eight-bit words correspond with two words stored in diode roms, an audible alarm is sounded for 10s (C₃). Pins 5-12 of IC₆ should be reversed.

second byte is received within 2.2s of the first, it will be compared with the second diode rom, whose output is connected to point Y of Fig. 2. Where the stored and received bytes are equal, the second monostable of IC₃ will be triggered for around 10s and gate the 1.638kHz carrier to produce an alarm.

Power for the rechargeable batteries is supplied through a jack socket to a bridge rectifier, so that a.c. or either polarity of d.c. may be used. R₁ provides current limiting and D₂₁ overvoltage protection.

Construction

A small, calculator-sized plastic case is used to house various components of the unit, as shown in Fig. 4. An aluminium fascia, supplied with the case specified, must be accurately drilled according to the dimensions given in Fig. 5, especially in the case of the retaining-stud holes, as the studs are only 1mm away from the keypad. A position for an on/off switch is not given since the type of switch used and its placing are not critical. If rechargeable batteries are not used, the on/off switch may be omitted.

The moving-coil transducer is pressed into place and fixed using one or two drops of an epoxy-type adhesive applied from behind. A 1/4in drill was used to remove the plastic supporting pillars in the plastic case and the keypad was fixed in place on the fascia by 'riveting' the retaining studs using a warm soldering iron. Dimensions for the jack-socket holes are given in Fig. 6 and for board A in Fig. 7. Board B measured 4.15in by 2.35in.

Components on board A must be mounted as close to the board as possible, otherwise, problems will be encountered when attaching the fascia assembly. When assembling board B, the batteries should be mounted last because an accidental short will probably cause damage to either the batteries or components.

When determining diode positions for the roms, it is best to write the bit pattern of the chosen number with the most signi-

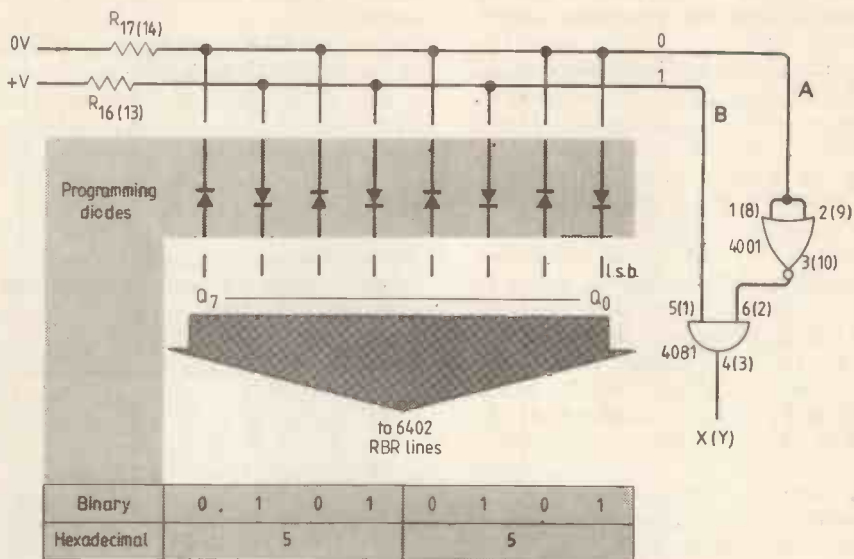

Fig. 3. Diode roms for storing two eight-bit words in hexadecimal form. Two of these circuits are used, with their outputs connected to the appropriate points on board B, Fig. 2.

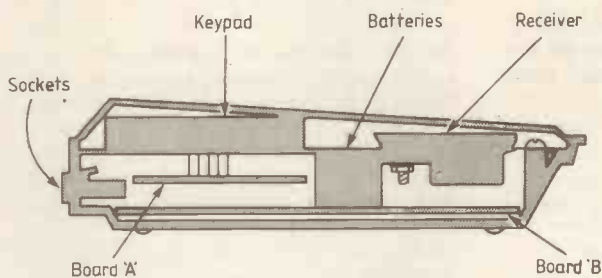

Fig. 4. Cross section of the selective-calling unit. Components on board A must be carefully mounted as height is limited.

ficant byte on the right. In my version, only 5mm was available between the surface of the board at the position where the diode roms were situated, and the moving-coil transducer. Internal wiring is best done with flat cable since it gives a neat finished product. It is practical to wire the two boards together before mounting the keyboard and fascia plate.

Finally, current consumption is measured and should be approximately 1.5mA in standby mode and over 20mA when an alarm is given. If the alarm is triggered each time that power is applied to the unit, an additional tantalum-bead capacitor should be connected in parallel with R₁₁ on

board B. The alarm may be cancelled manually by momentarily switching the unit off.

Operation

When completed, the unit is easily tested by entering its own selective-call number, which should result in the alarm being given for around 10s. If two units are available, they may be placed side by side and a rigid reflector positioned directly in front of the two transducers to provide acoustical coupling: each unit's selective call number is entered on the other's keypad, whereupon the relevant alarm should sound.

Normally, the unit will be used with a transceiver and be coupled electrically through JK₂. Sufficient voltage gain is provided to cope with the lowest anticipated input signal so in most cases, a resistor will be needed in the signal line to provide a potential divider with R₉. A typical value for this resistor when the unit is connected to a loudspeaker output, and the radio's volume control is set at 50%, is 100kΩ, but some experimenting will probably be required.

If a call is unsuccessful, it is not possible to judge whether the failure is due to the potential recipient not being at home, or due to the signal not reaching its intended destination. This problem may be overcome using a third jack socket to tap the alarm monostable's signal, pin 10 of IC₃, which may be used to activate the potential recipient's transmitter in transpond mode. Modulation is provided

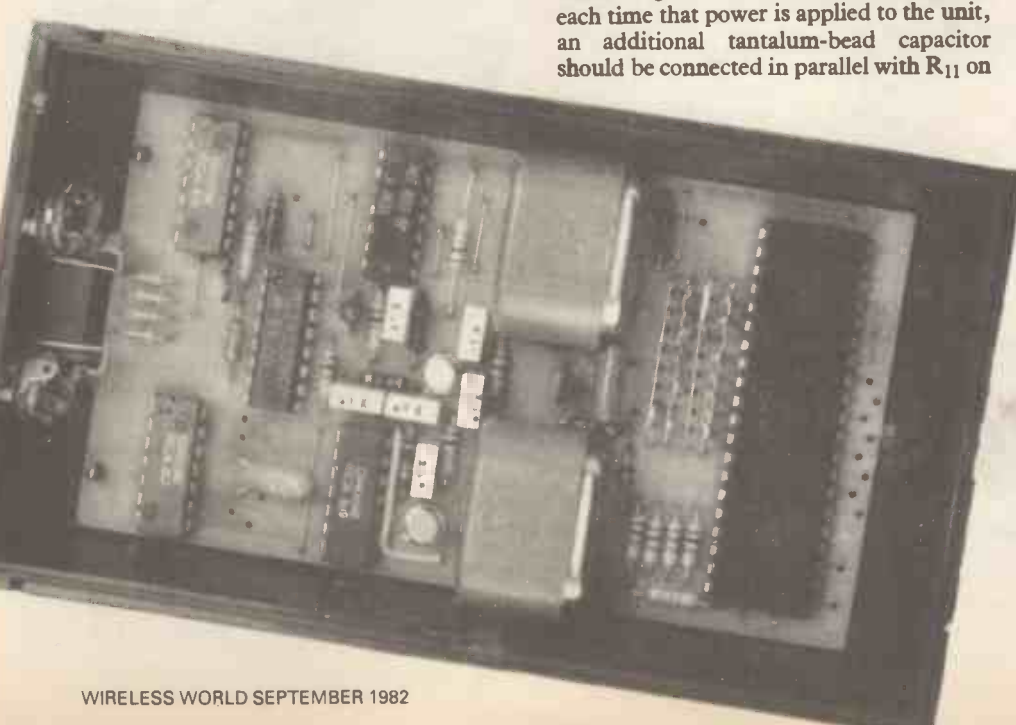

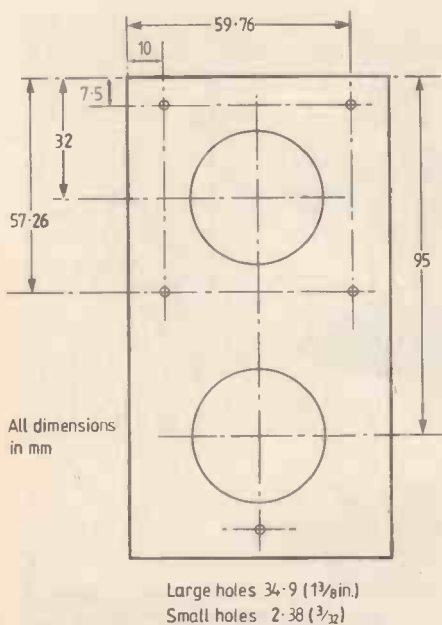
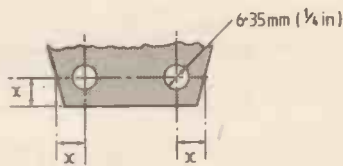

Fig. 5. Dimensions for the facia are critical. Four of the small holes are for the keyboard's mounting studs, which are riveted using a warm soldering iron. The transducer should preferably be a push fit in its hole, and fixed from behind using one or two drops of epoxy adhesive.

by the alarm signal.

This additional socket could be used to activate any remotely controlled device requiring a high degree of security. A transpond signal could be used to relay information relating to the status of the remote device.

During tests, whether or not squelch was used made no difference to the unit's operation. It is advisable to radiate an unmodulated carrier for about 3s during transmission to ensure that the first-monostable section is clear. Modulation depth and deviation will be determined by the distance between the unit and the radio's microphone, so some experimentation may be required to determine optimum positions.



$x = 7.15\text{mm} (\frac{1}{2}\text{in})$

Fig. 6. Dimensions for the jack-socket holes. A third jack socket may be used, as described in the text.

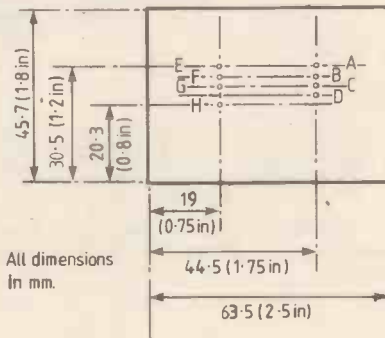

Fig. 7. Dimensions for board A and positions of the keyboard connection holes. Board B measures 4.15in by 2.35in.

Although it is not advisable to use the unit when the background-noise level is high, a degree of success has been obtained under adverse conditions, including operating the unit from a noisy mini-van using simple moving-coil microphones.

If microphones with automatic-gain controls are used, it is possible that noise during the 'quiet' period preceding the first data byte will be sufficient to trigger the uart. Should the noise initially provide the correct parity and framing signals, it is unlikely that further noise will follow with the same correct parity and framing signals, in which case, the monostable will be reset through a negative-going signal at its CD input. Such a microphone was not available to test this theory.

Table 1. Mnemonics for the 6402 universal asynchronous receiver/transmitter.

VCC	positive supply
N/C	no connection
GND	ground
RRD	receiver register disable
RBR	receiver buffer register outputs
PE	parity error
FE	framing error
OE	overrun error
SFD	status flags disable
RRC	receiver register clock
DRR	data received reset
DR	data received
RRI	receiver register input
MR	master reset
TBRE	transmitter buffer register empty
TBRL	transmitter buffer register load
TRE	transmitter receiver empty
TRO	transmitter register output
TBR	transmitter buffer register inputs
CRL	control register load
PI	parity inhibit
SBS	stop bit select
CLS	character length select
EPE	even parity enable
TRC	transmitter register clock

Comments

This selective call unit was designed with the sure knowledge that the facility it would provide could not be relied upon in the same way that the telephone service can. However, tests so far conducted suggest that the unit is useful even in less than ideal conditions, and generally the operational range is the same as that achieved with normal speech. Further improvement could no doubt have been achieved had a filter been added to bandpass the 1.638kHz carrier signal, but this idea was rejected because of the extra test equipment needed to align the unit. Also, the bulky components required for a passive filter would not fit in such a small case. A phase-locked-loop was rejected because of the need for passive pre-filtering and power-supply dependent oscillator frequency problems.

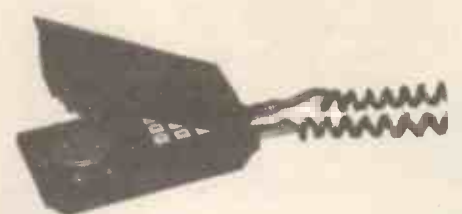

The design was based upon a standard c.m.o.s. uart in view of its low cost and availability; also, the use of eight-bit bytes provides for easy interface to microcomputers should the need arise. Modular construction allows the unit to be used as a byte-wide parallel-data entry terminal for microprocessor applications when board B is omitted. Alternatively, the unit may be used for serial data-entry applications using both logic boards, but with some components omitted.

Photo-copies of the p.c.b.-foil patterns and components positions can be obtained by sending a s.a.e. to Wireless World, Selcall, Room L303, Quadrant House, The Quadrant, Sutton, Surrey SM2 5AS. Requests for printed-circuit, boards, whose price will depend on demand, should be sent to the same address.

Components

Board A	Board B		
Resistors	Resistors	5	4011
1 10M	1 1.5k	6	1M6402IPL
2 100k	2 470k		Diodes
Capacitors	3 10M	1-20	1N4148
1 1μ tantalum	4 470	21	10V zener, 400mW
2 10μ tantalum	5,6,13, 14,16,17 1M	22	5.1V zener, 400mW
3 100n	7,12 10k		Transistors
4,5 220p	8,18 100k	1,2	BC109C
Integrated circuits	9 1k	3	BC212
1 4018	10 10		Other components
2 MM74C922N	11 see below		Batteries, MP3-100 from Ever Ready
3 4042	15 33k		Case, 75-3018C from Verospeed Ltd
4 4013	Capacitors		Moving-coil transducer, 3T from Besson, Hove, Sussex
5 4011	1 4.7μ tantalum		Keypad, Grayhill 83BB1-002
Diodes	2 10μ tantalum		Highland Electronics Ltd, 8 Old Steine, Brighton.
1 1N914	4-9 100n		3.5mm jack sockets
Crystal	10 10n		For continuous charging, R11 should be chosen to provide 1mA charge current, or 10mA for rapid charging.
1 32768Hz type QRT-38 from Interface Quartz Devices	Integrated circuits		
	1 4081		
	2 4001		
	3 4538		
	4 4013		



At last the message has come through, all you old solderers can throw away the soldering irons and the perforated circuit boards. NOW you can use PROTO-BOARDS from GSC. Despite daily breakthroughs in components and packaging, designing and testing new circuit concepts is often a lot more manual work than creative work. Not surprising, if you are using old-fashioned perforated boards and time-consuming soldering. With PROTO-BOARDS any component can be plugged in, tested, removed, and used again. Circuits can often be designed from component pinouts and the circuit diagram does not need to be drawn until after the circuit is working properly. PROTO-BOARD designing is very much like careful single-sided printed circuit design in terms of the effects of parasitics and in terms of operation at high frequency or low levels. Well-planned grounds and judicious use of shielded cable can permit operation through VHF frequencies. So, you old solderers, stop soldering on! Send off for our FREE 40 page catalogue; we have a PROTO-BOARD to fit any size budget.

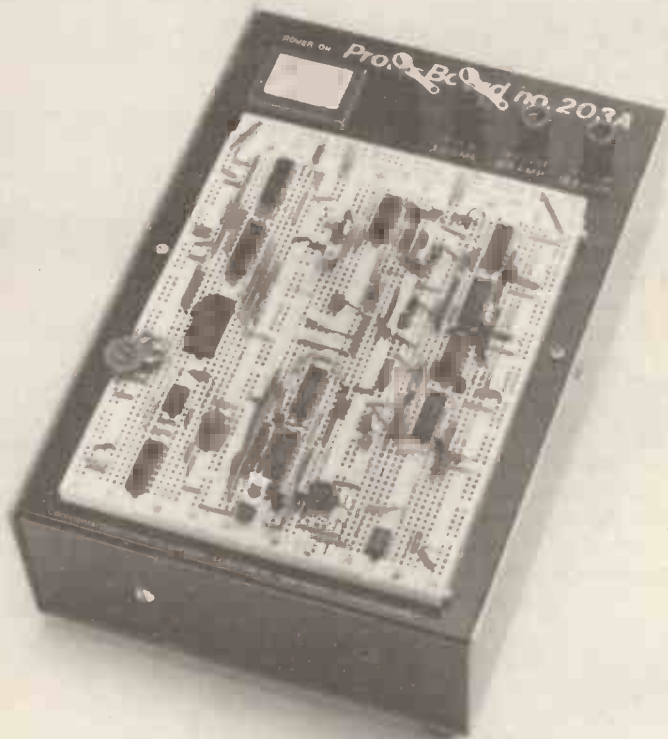

PROTO BOARDS

Models PB 203, PB 203A and PB 203AK offer a large breadboarding area and a built in regulated power supply housed in a rugged metal cabinet. Models PB6 to PB105 offer various breadboarding areas screw mounted onto sturdy back plates with non-slip, non-scratch vinyl feet. Red and black binding posts are included, the red being electrically insulated from the back plate, the black being electrically connected for ground.

PB 203

Includes 5VDC, 1 amp power supply, available at binding posts; two binding posts (V1, V2) remain uncommitted. The perfect board for TTL and other 5 volt logic designs.

PB 230A

Every development engineer should have one of these. Includes 5VDC, 1 amp power supply. Also includes separate +5.5 to 18 VDC and -5.5 to 18 VDC power supplies, each capable of supplying 500 mA at 15 VDC. Power supplies are factory preset to +/- 15 VDC but can be independently adjusted.

PB 203AK

Identical to PB 203A but in kit form.

PB 6

A kit form breadboard with 4 binding posts, 630 contact points and includes non-slip rubber feet.

PB 100

Another kit form breadboard with 760 contact points.

PB 101

A robust laboratory breadboard accepts up to 10 IC's, 940 contact points.

PB 102

A fully assembled breadboard with 1240 contact points.

PB 103

With 2250 contact points this board is perfect for prototyping and custom circuit applications.

PB 104

A total IC capacity of 32 with 3060 contact points makes this the ultimate electronics development engineers breadboard.

PB 105

The newest Protoboard, 4560 contact points, 48 IC capacity.

G.S.C. (UK) LIMITED
 UNIT 1, SHIRE HILL INDUSTRIAL ESTATE
 SAFFRON WALDEN, ESSEX CB11 3AQ
 Telephone: Saffron Walden (0799) 21682
 Telex: 817477

GLOBAL SPECIALTIES CORPORATION

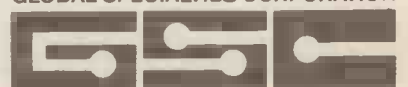

Labgear Low-cost UHF Sound and Vision Modulators

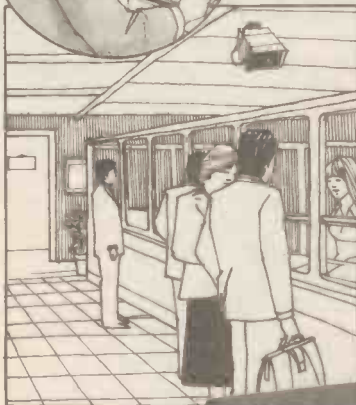
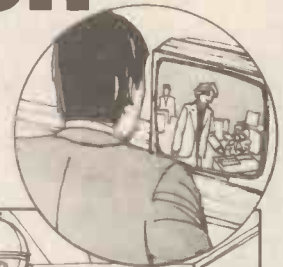

For use with low-cost cameras allowing video source to be modulated to RF for display on standard TV receivers

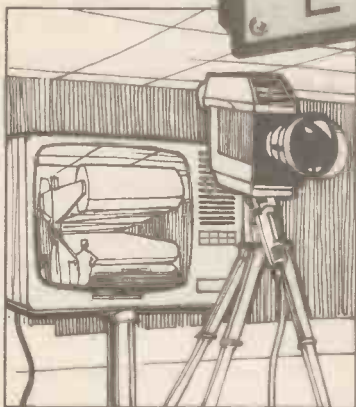
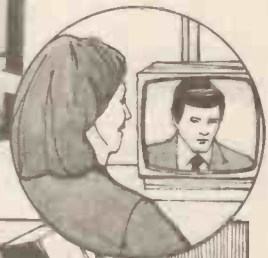
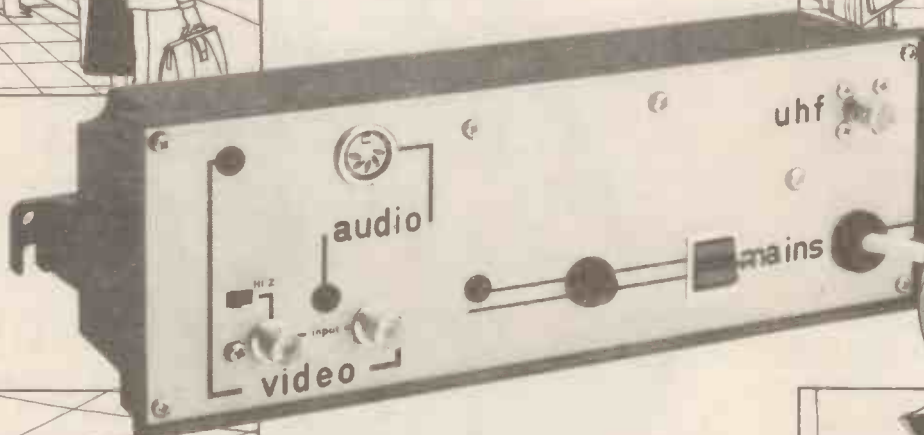
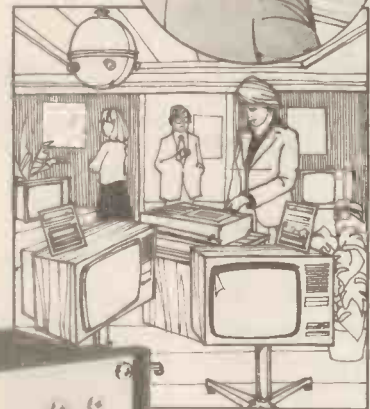

Sole Distributors
in Scotland: AES Glasgow.
in Eire: Aerials & Electronics, Dublin.
in Northern Ireland: Edwards & Edwards, Belfast.



For further information & specification
please contact:—

Labgear Limited

Abbey Walk, Cambridge CB1 2RQ, England.
Telephone: (0223) 66521. Telex: 817705 (LABCAL)
Telegrams: Labgear, Cambridge

A member of the Cambridge Electronic Industries Group

WW - 070 FOR FURTHER DETAILS

Fifth-generation computers

The government has recently announced that it will be financing research into the development of 'Fifth generation computers'. The need for this is illustrated by the peculiar effect of the tumbling cost of large-scale integrated circuits. The very cheapness of the hardware means that we are using computers to solve bigger and more difficult problems and this results in an escalating cost in the writing of the programs. The situation has been referred to as the 'software crisis'.

The principal reason for the software crisis is that the internal structure of the computer allows it to operate on one piece of data at a time, using only one instruction at a time — the von Neumann architecture. The next step is to allow the computer to operate by overlapping the various stages that make up the execution of an instruction, so that a number of consecutive instructions are simultaneously active in various stages of partial execution. This is called 'pipelining', first used in Manchester University and is employed in large, fast computers such as the Cray 1. From a programmer's point of view there is little difference — it just runs faster.

An 'array processor' uses an array of similar processing elements but still has a single stream of instructions emanating from a central point. Each instruction is simultaneously carried out by all the processing elements in the array. Finally in this catalogue of existing computer archi-

ture, we come to the multi-processor multi-instruction machine. These are still at the experimental stage. The CYBA-M computer, built at UMIST has a number of independent processors arranged around a common memory. Each processor has its own tasks to perform and is coordinated with the others through the shared memory. The shared memory when built normally can cause a bottleneck as it can only be accessed by one processor at a time. This may be overcome by having a number of separate memory elements, connected to the processors through a switching network.

This brings us to the Dataflow computer, the next, 5th, generation. The basic plan for a dataflow machine is that there are two main components; a block of processing units and an activity store (where the program is kept). They are interlinked by a high bandwidth communications path in the form of a ring. At any given time the processing units will be performing a number of tasks, each of which might be quite simple such as a multiplication. A packet of data complete with its instruction arrives at the processor from the activity store. The processed result is transmitted back to the activity store and its arrival there triggers the release of further tasks to be transmitted to the processing units. Many of the tasks may be performed independently and therefore asynchronously, the only time

that operations need to be sequential is when one operation depends on the results of another. A program consists of a very large number of small tasks, coordinated only through their data dependencies.

As all the existing program languages are based on von Neumann architecture, completely new programs need to be developed. One such is KRC, The Kent Recursive Calculator, developed at the University of Kent. An interesting distinction is that once a value is assigned to a variable (i.e. $X=A+B$), this cannot be altered as there is no sequential order. So an assignment such as $X=X+1$ is not valid. The left-hand side of each assignment equation must be unique. In KRC there is a SORT operation and if we want to sort the elements of list X we could write $Y=$ SORT X. Y is the name for the new sorted list while X remains unaltered. All data structures are built using lists including such elements as 'infinite lists' for example (1,3..), the list of all odd numbers. Many such lists constitute mathematical sets so elements of the language can be built by obeying the rules of set theory.

Such languages have still a long way to go as at the moment they actually take longer than conventional programs.

Much of the above has been extracted from a paper presented by David Turner of the University of Kent, presented at a recent seminar on the Fifth Generation.



This micro-cassette drive comes from Hungary and is a low-cost alternative to many rivals. Each 2½-inch disc is housed in a rigid plastic cassette which offers some advantages in that it is better protected from the environment and can be provided with a solid core to improve the drive. It is claimed that the single-sided disc can hold up to 200Kbytes of data and can read or write its entire contents in less than a second. The bare drive costs £60 for one-off or is available in an applications kit with five discs, a head tuning disc, instructions and an interface cable for £100 (+v.a.t.). The UK agents are BATS-NCI Ltd, in London.

For QWERTY read QPYCB

After an exhaustive computer analysis of the frequency of the use of letters in keyboard operations, and of the ease finger movements, PCD Maltron Ltd. have rearranged the positions of letters on the keyboard. They claim that their keyboard has 90% of the letters of the 100 most commonly used words on the 'home' row, which on the usual typewriter is ASDFGHJKL. On the Maltron keyboard this becomes ANISFDTHOR. The analysis also suggested that the distribution of the letters could be arranged so that the same finger is used less often successively and that there could be a lot less hopping up and down the rows of keys. In these two respects the improvement claimed is in the ratios of 9:1 and 256:1 respectively. Not only are the keys altered in their relative positions but they have been arranged so that the keys operated by each hand are physically separated and instead of being on a single plane are adjusted so that the keys operated by the longer fingers are sunk into the plane of the keyboard and all the keys require a

Peter Wheeler, one of the National Co-ordinators of the Microelectronics Education Programme, is seen using an ergonomically designed Malton Keyboard with an RM 380Z computer.



minimum of movement to be operated.

New learners can be trained faster than on traditional keyboards, according to trial tests. Even those already skilled in QWERTY operation can be supplied with the ergonomically moulded keyboard but with the traditional order of the keys. Er-

ror rates have been shown to be reduced to one tenth while speed can be increased by up to 40%. This could be very important as the keyboards for computers seem to be invading every aspect of our lives, at least until there is an efficient voice recognition system.

BT up for sale

As predicted in our May issue, the Government has at last announced its plans for the 'privatization' of British Telecom. The process started with the granting of a licence to Project Mercury. Then there was the opening of the doors to allow private-sector selling of telephone apparatus direct to the public. Patrick Jenkins, in a Statement to the House of Commons, said that the liberalisation of telecommunications had started and that he intended to see it through.

He pointed out that 90% of BT's investment programme was financed by BT, or rather by their customers. Consequently, costs to the customer had risen to an 'unacceptable level'. Selling BT would generate capital for investment: the proposed sale would take place after the next General Election. Any legislation would keep BT as a single enterprise.

The Board of British Telecom has been very cautious in its response. Until detailed proposals are put forward, the Board is unwilling to express any general view on the proposals. They welcomed the Secretary of State's commitment to full consultation and would be seeking to ensure that BT would have a stable basis for future development.

Engineers surveyed

The Institution of Electrical and Electronics Incorporated Engineers (formerly the IEETE) have conducted a salary survey of their members which showed that there has been an average increase in income of 30% over their last survey two years ago. The most noticeable difference is that the difference between salaries in the public and private sectors of industry has increased with Incorporated Engineers now taking home an average of £1,190 more than their counterparts in the private sector, compared with a difference of £410 in 1980. For the technician who was better off by £50 in the private sector, he is now worse off by £300 compared with his publicly employed peer.

Incorporated engineers can expect to break the five-figure barrier. Technician Associates on average get £8,000 in the public domain and for graduates the figure is £8,400 (their private-sector counterparts get £1,000 less).

The best paid members work in General Administration, the next best in Broadcasting, Telecommunications and Postal Services. After them come the workers in Electricity Generation and Distribution (and for technicians the Armed Forces). Where they used to earn most, in the chemical and processing industries, they have now been relegated to fourth place.

The predominant qualification for members is still the HNC.

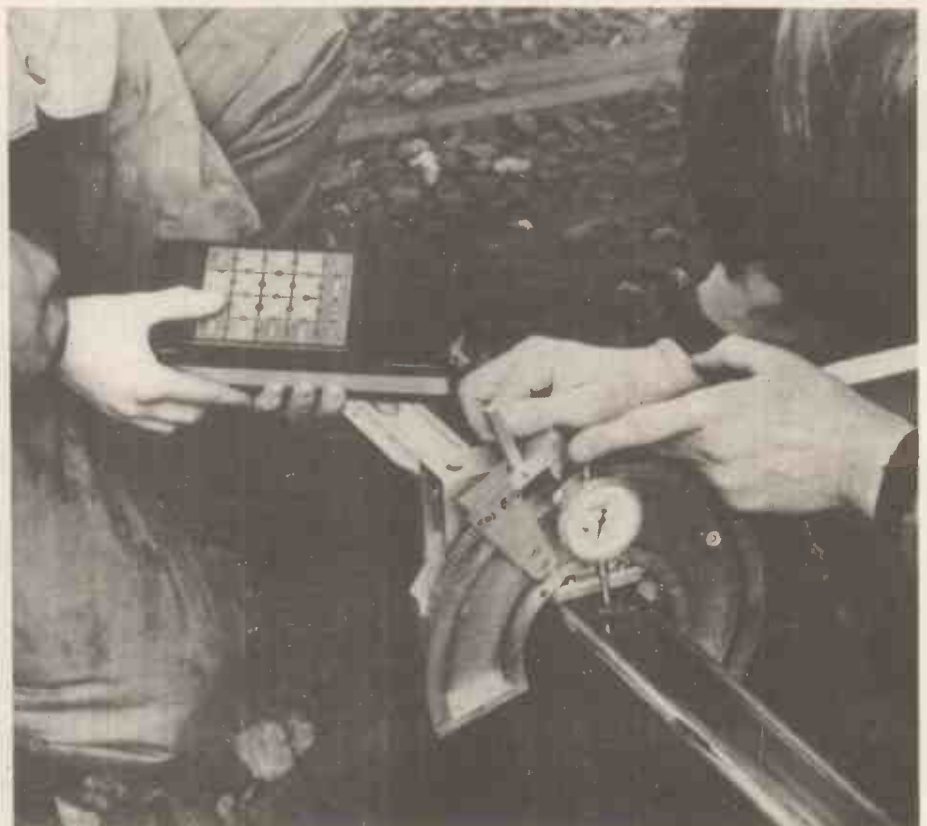

British Rail's R&D Division at Derby is using a Dataport 5 hand-held microcomputer to record the measurements of the effects that vehicles have on rails. The Dataport can retain the data and then at a later stage transmit it to a host computer, by telephone if needed. It is hoped that the research will lead to improved passenger comfort and into a better understanding of rail and wheel maintenance. The Dataport 5 is produced by Data Recognition in Earley, Berkshire.



The 50th ACR 430 airfield control radar has been installed by Plessey at the British Aerospace private airfield in Hatfield. The cost-effective X-band system is easy to install and maintain and will be used in connection with the flight testing programme of the new BAe HS 146 Feeder aircraft.

24-track digital recorder

Sony have launched their PCM 3324 recorder which offers many of the advantages usually associated with analogue machines. Spliced joins or punch-in recordings are simplified by means of a computer-generated cross-fade over the join to give a continuous signal round the insert or edit point.

At a recent demonstration, Sony transferred a recording from the first track to the second and then to each of the 24 tracks in turn and then played the 24th

recording in stereo with the original. There was no audible difference. In addition to the 24 digital tracks there is a stereo pair of analogue tracks, a control track and a time-code track. There is a long catalogue of features and operations; one that appealed to us was the ability to rehearse an edit; to be able to hear what it would sound like without losing the originals.

There is a claimed dynamic range in excess of 90dB and all 28 tracks fit onto 1/2in tape.

The head configuration of a Sony PCM 3324 digital tape recorder. The heads from left to right are 1. Advance digital recording head. 2. Digital play-back head. 3. Analogue erase head. 4. Analogue record and playback head, and 5. The synchronised digital recording head.

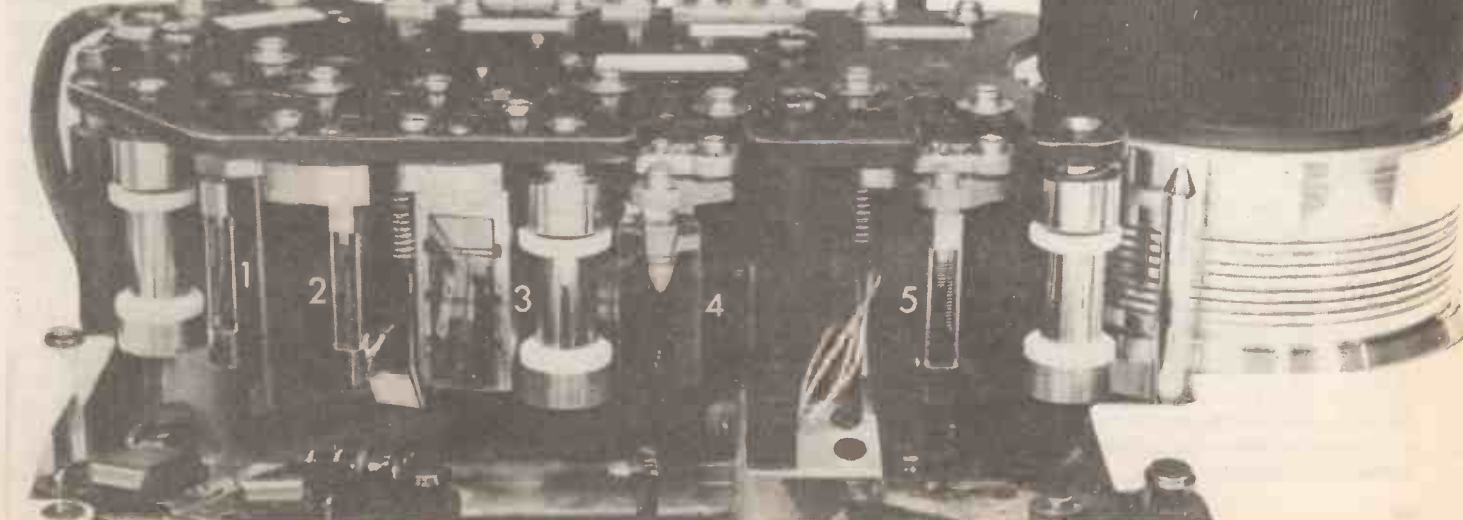

Micros in primary schools

At last Clive Sinclair has a foot in the door. The ZX Spectrum microcomputer has been accepted as suitable for use in primary schools. This is an extension of the 'Micro in schools' project which is part of Information Technology campaign of the Government, through the Department of Industry. Like the scheme for secondary schools the DoI is offering 50% of the cost of the computer to schools which can raise the other 50%.

Other systems selected for the scheme are the BBC Model B and the Research Machines Link 480Z.

Recording medium

The needle-like particles used in magnetic recordings have a limitation. Because of their physical length, there is a minimum distance between the two points where a change of magnetic flux can be recorded. The current maximum density for data storage is about 15,000 bits per inch; with multi-track recorders it is possible to get a large amount of information onto the magnetic medium. However there is a limitation and any attempt to increase bit-density can lead to a loss of data. One solution has already been mentioned in these columns; the EMI Watermark system orients the magnetic needles across the magnetic track - transverse instead of longitudinal. Another system proposed by Vertimag of Minnesota, USA (co-incidentally the home of 3M), is to get the magnetic particles to stand on end, perpendicular to the surface.

With the vertical system, each particle can be shorter and thinner without losing its magnetic coercivity. In fact by some

quirk of nature it is found to improve the coercivity.

This leads to a tenfold increase in the bit density. 100,000 bits per inch is already achieved and experiments have shown that 400,000 will be possible. This may be compared with 25k b.p.i. for an optically read laser disc and in terms of bits per square inch can even compare favourably with a 64K, random-access memory, which can hold 10^6 bits in a square inch while the vertical magnetic recording can have 10^{10} .

Vertimag are concentrating their development into the production of computer memory discs. First the 'floppy' variety where a disc will offer three to five times the capacity of an equivalent conventional

disc. One drawback is that the medium is produced by using a sputtering technique to deposit the chromium cobalt crystals on to the backing. This is expensive and discs are likely to cost up to 75% more than the conventional ones.

Further advantages will become apparent when the technique is applied to hard disc memories of the Winchester type. With their sealed environment and more precise mechanisms it is possible not only to improve the linear density but also the number of tracks on the disc. Similar advantages will accrue to digital tape and disc recording for audio and video applications.

The vertical magnet idea was developed

in Japan but Vertimag are hoping to beat the Japanese at their own game and be able to sell products ahead of them.

News in Brief

British Aerospace has been appointed prime contractor for the European Space Agency's Giotto scientific satellite which will intercept Halley's Comet in 1986. Giotto will be Europe's first space explorer when it begins its eight month journey to the interception some 150 million km from Earth. Data will be transmitted back in the S and X bands.

Other news from the ESA is that the Marecs-B Inmarsat satellite and Sirio-2 the Italian communications satellite are to be launched together from Ariane L5 - the first fully operational launch of Ariane. The two satellites will be put into orbit by a dual launch system developed by Aerospaziale known as Sylta.

Video coverage of the attempt at the land speed record is to be provided by lightweight tv colour camera and a portable tape recorder to be installed in the cockpit of the jet-powered Thrust 2 car, driven by Richard Noble. The equipment supplied by Sony will be subjected to forces up to $6\frac{1}{2}G$ and it is not yet known if it can stand up to it. Sony are quietly confident.

Two fibre-optics experts, Dr George Newns and Dr Keith Beales have been awarded the Martlesham Method by their employers, British Telecom. They developed a method of cladding one type of glass in a sheath of another type to improve its internal reflectivity along the fibre. Their 'double-crucible' technique is a versatile process, capable of producing most types of fibre.

After seven years of producing professional audio equipment Monogram are seeking a buyer. Don Purkis, the company's founder, says the unexpectedly high development costs, spent on an as yet unexploited new product, have led to the downfall of Monogram. Now Mr Purkis is looking for a buyer prepared to spend, we believe, around £12 000. He can be contacted by ringing London 573 3362.

The Home Office has set up an Independent Review of the Radio Spectrum under the chairmanship of Dr. J. H. H. Merriam. The first area of enquiry is to be the use of tv Bands I and III once the 405 line services are withdrawn.

Channel 4 commences broadcasting in November and already some 31 transmitters are ready to provide the service to about 87% of the population. The task of converting all the main IBA transmitter and 600 relay station will not be completed until 1984.

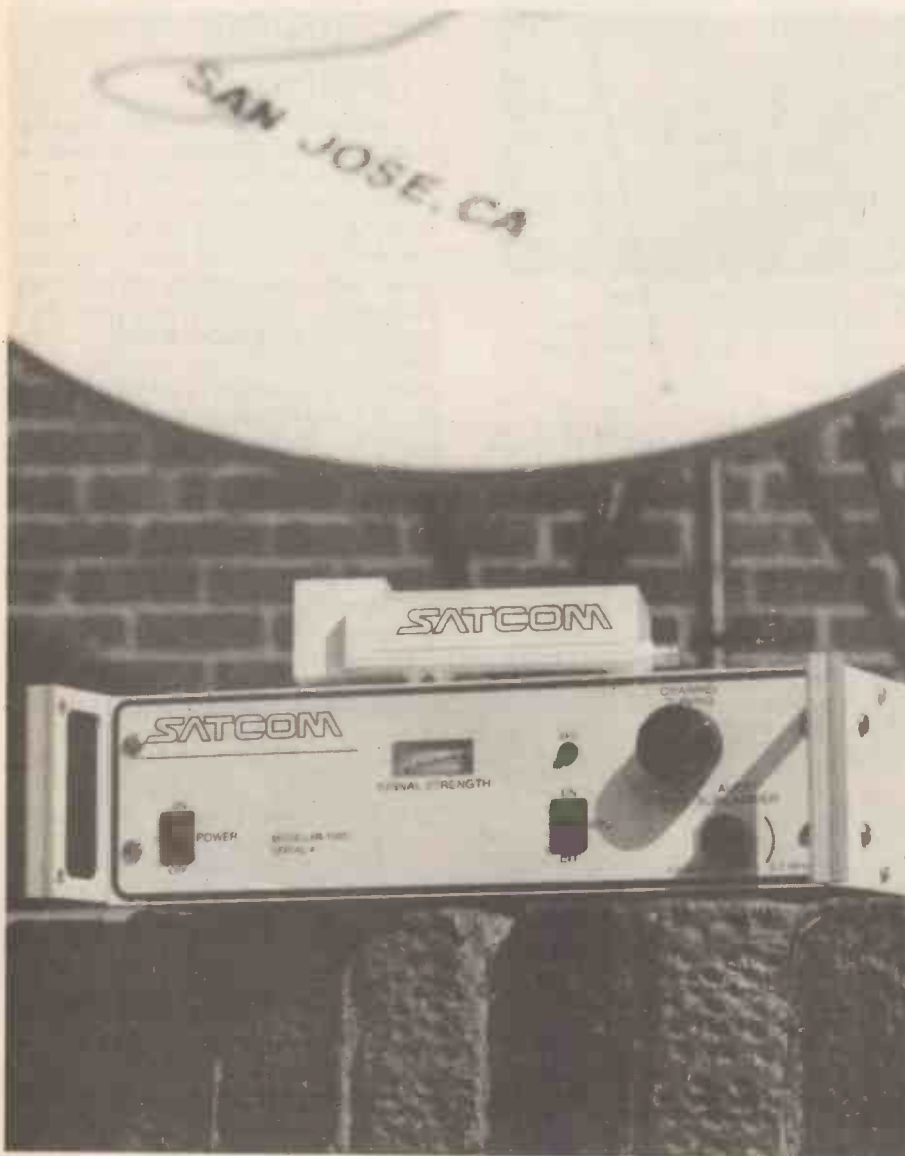

Satcom 1200 is a 12GHz receiver for direct broadcasts from satellites. Signals received from the dish aerial are amplified by a low noise downconverter using Gallium Arsenide fetts and hybrid i.cs. To give a stable low-drift performance across a minimum 500MHz bandwidth. The signals are fed to an indoor tuner with a further downconversion to normal broadcast frequencies, which are demodulated to PAL - G/625 line standard. For use on future DBS the dish size may be as small as 700mm but for current satellite transmissions, dishes of 2 to 3 metres are offered. The system is marketed by March Microwave in Braintree, Essex.

TRANSMITTING AERIALS ON MODERN MERCHANT SHIPS

Following a lengthy correspondence in our Letters pages on the deficiencies of modern marine communications, John Wiseman presents photographic evidence of what he calls "the insanities of ships' aerials".

by J. Wiseman

Mr Wiseman is a freelance marine radio officer

In the early days of marine radio, almost every merchant ship had two tall masts for the very practical purpose of supporting the cargo derricks, the principal method of cargo handling of those days. This fortunate circumstance provided, at no extra cost, a ready made means of supporting a transmitting antenna for operation in the band 400 to 525 kHz, a band chosen to take advantage of the 24 hour, long-distance, ground-wave propagation characteristic of low frequencies, while still permitting the erection of a reasonably efficient aerial in the space available on-board ship.

The aerial provided was invariably a capacitive "flat-top", inverted "L" or "T", resonating with the transmitter tank inductance at the transmitted frequency, heaviest current up, and omni-directional radiation from, the vertical section, rising to a good height and clear of the super-structure.

Textbooks of those days had whole chapters on antenna theory. For example, the Textbook of Wireless Telegraphy, by Rupert Stanley, 1919, makes the following observations: "... the range of transmission, or the energy radiated, depends on the (height)² for a given aerial current ..." and "... the greater the capacity of the aerial the less will be the maximum voltage strain on its insulation for a given

aerial current and frequency . . . the capacity of the aerial is increased by having two or more wires in parallel . . . the greater the capacity of the aerial, the more energy it will take from the closed circuit for a given voltage strain . . .".

The wisdom of Stanley's words is echoed by the Admiralty Handbook of Wireless Telegraphy, 1931, according to which: "... the greater the capacity of the aerial, the less inductance will be required for tuning to any particular wave, and consequently the less will be the oscillatory potential of the aerial above that of the deck insulator. $V = I\sqrt{L/C}$. . ." and "... defective insulation will account for a considerable loss in efficiency, especially on long wave . . . leakage to earth in this way is equivalent to having a resistance in parallel across the aerial capacity, and this can be replaced by an equivalent series resistance, whose value (approx) is given by $1/\omega^2 C^2 R$, where R is the resistance of the leakage path . . .".

The following table will illustrate that aerials of low capacity are less tolerant to problems of parallel leakage. It is compiled for antennas of 500,250 and 150 pF operating at 500 kHz.

parallel leakage	series equivalent at 500p	series equivalent at 250p	series equivalent at 150p
10kΩ	40.5Ω	162Ω	450Ω
100kΩ	4.05Ω	16.2Ω	45Ω
1MΩ	0.405Ω	1.62Ω	4.5Ω
10MΩ	0.0405Ω	0.162Ω	0.45Ω

I only mention these elementary matters to show that all necessary information on good aerial design has been readily available for 50 or 60 years.

Times have changed: only passenger ships have long aerials now. Since the early



Australian flag, 21,731 g.r.t. B.1974, pictured Yokohama, October 1981. "... a few years ago a ship would be fitted with a good T or inverted L aerial, often extending the entire length of the ship and as high as the masts would allow. Nowadays, we are lucky to have 80 feet of wire round the funnel . . .". (Letter to the Editor, Nov. 1979). Insert shows size of ship in relation to space for aerials.

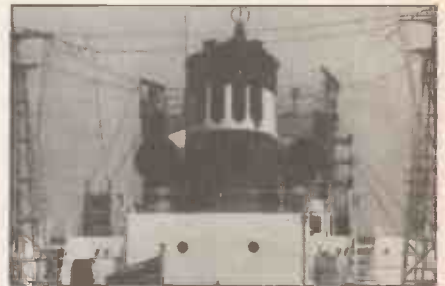

Liberian flag, 10,430 g.r.t. B.1974. Photograph W. Africa, March 1981. Efforts to increase capacitance offset by wet weather leakage offered by 11 insulators on one aerial and seven on the other. Does not rise above funnel, a vertical ground.

Five mast aerials. From the left: Greek flag, 14,383 g.r.t., B.1966, taken W.Africa, Sept. 1980; Japanese flag, 15,967 g.r.t., B1979, taken W.Africa, Sept. 1981; U.S.A. flag, 11,000 g.r.t., B.1963, photographed W.Africa, Sept. 1981; German flag, taken W.Africa, Aug. 1981; Liberian flag, 20,713 g.r.t., B.1972, taken Nagoya, Oct. 81. Latter is of Japanese design, perhaps inspired by a Japanese lantern - note the rope propping it up. Other aerials in this strip have extraneous ropes or wires hanging from their radiating parts.



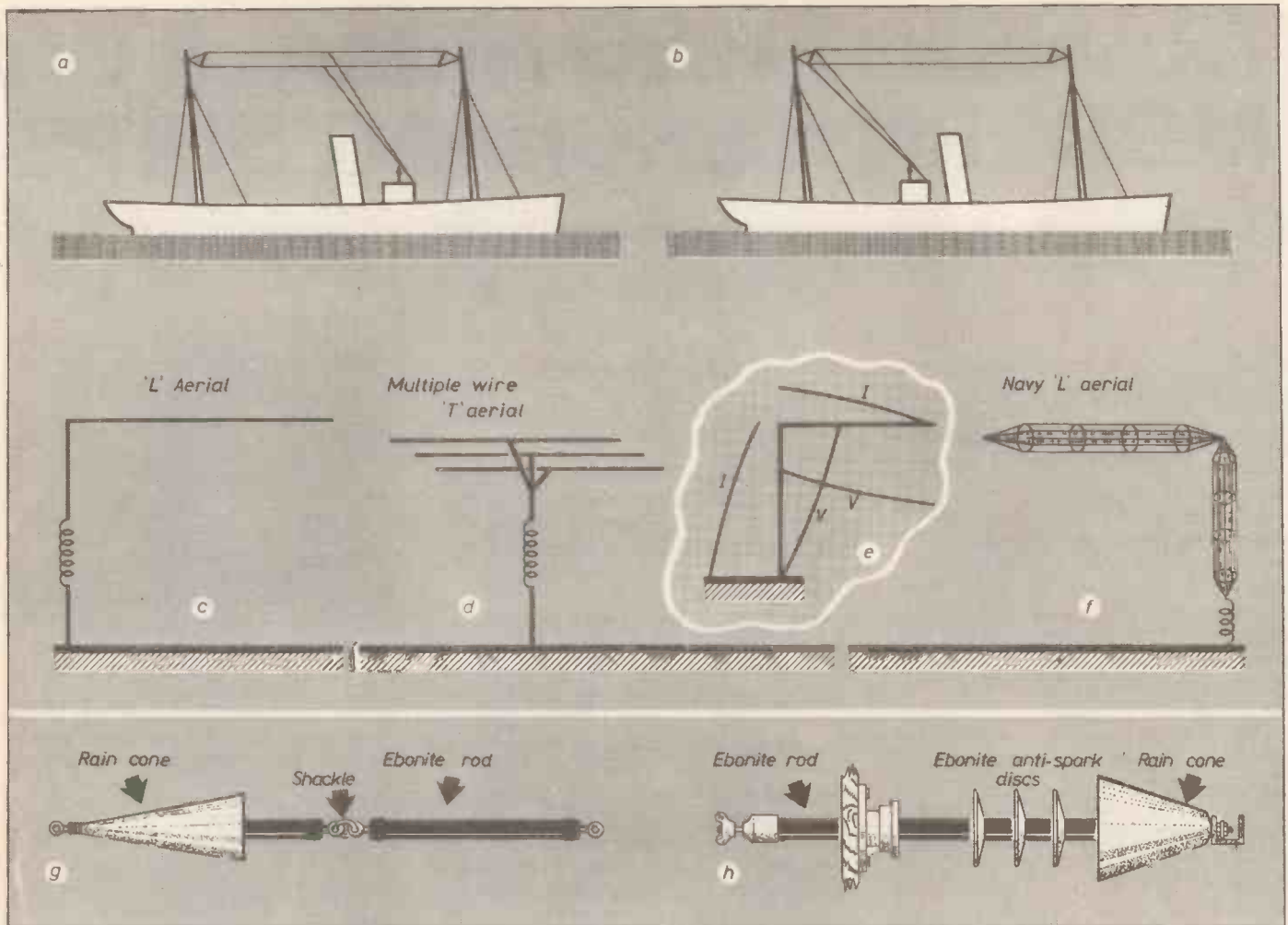
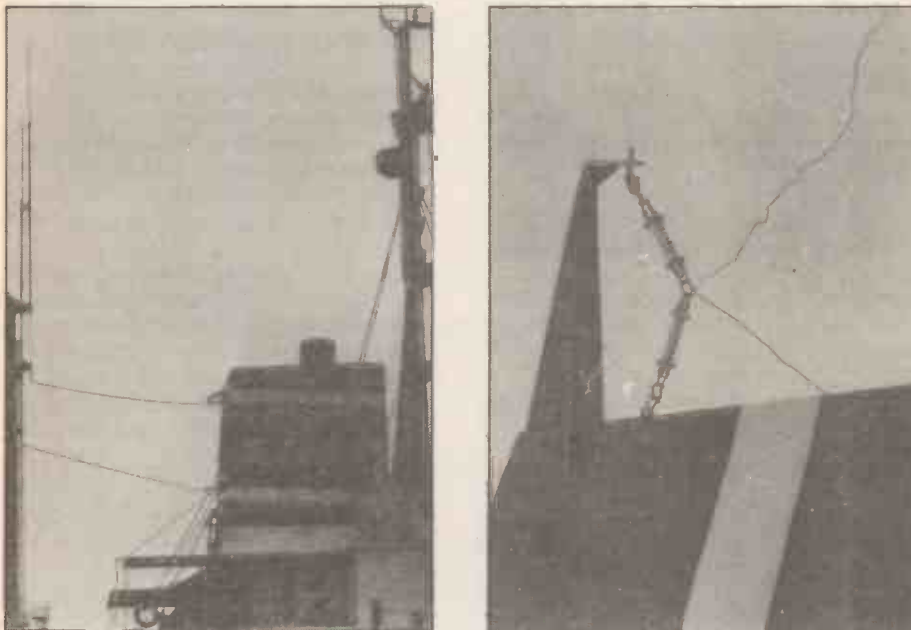

Fig 1. Collection of diagrams on sound marine aerial design from early textbooks. Inverted L and T aerials at (a) and (b) are from "The Maintenance of Wireless Telegraph Apparatus", P.W. Harris, 1917. Diagrams (c) to (f) show 'capacity aerials', taken from "Wireless Principles and Practice", L. S. Palmer, 1928, and the insulators at (g) and (h) come from "Handbook of Instruction for Wireless Telegraphists", Hawkhead and Dowsett, 1918.



British flag, 11,897 g.r.t., B.1973, taken at Kobe, Oct. 1981. Parts of aeriels radiating most are two horizontal wires, hanging from bottoms of whips below funnel and optimistically described as 'feeders'. Whips look very 'modern'. Insulators are inaccessible for inspection and maintenance. These are really mini inverted L aeriels rotated through 90 degrees. To obtain sufficient capacity for full power operation, both are operated in parallel, frustrating the concept of main and reserve aeriels. No use is made of signal mast to obtain good aerial height. Works well at h.f.

been discussed in the Letters to the Editor columns of *WW* over the past three years, under the heading "Failure of distress signals at sea". The photographs reproduced here have not been specially selected. They are by no means an exhaustive collection, but they are typical enough. There is a 'Murphy's Law' about photographing aeriels: the most interesting and splendid examples sail past during a tropical thunderstorm, or are seen in ports where persons with telephoto lenses are likely to be shot on sight.

There are neither "good" flags nor "bad" flags. The "designers" of these aeriels appear to be (a) d.i.y. enthusiasts, (b) practitioners of black magic, (c) persons who have not heard of Rupert Stanley, and who believe that "a more powerful transmitter will compensate for an inefficient aerial", or, in too few cases, (d) real radio engineers.

The commentary accompanying the photographs will refer in general to operation at 500 kHz. The Home Office 'Code of Practice for Ships' Wire Antenna Systems for Radio Telegraphy Transmissions in the Frequency Band 405 to 535 kHz', MPT 1270, published 1974, gives, as the "major objectives at the design stage", the following criteria: "... in order that the required antenna shall



From left: British flag – plywood lead-in-trunk for minimum shunt capacitance – brass bells shield lead through insulators from spray and rain, but they are shunted by unprotected strain insulators; Italian flag – steel mesh offers neither protection from weather nor reduction in shunt capacitance; British flag – no trunk at all – cheaper and quicker to cut holes in wall, but efficiency of shielding bells on horizontal insulators is doubtful – bells shunted by unprotected strain insulators (seems to be universal practice).

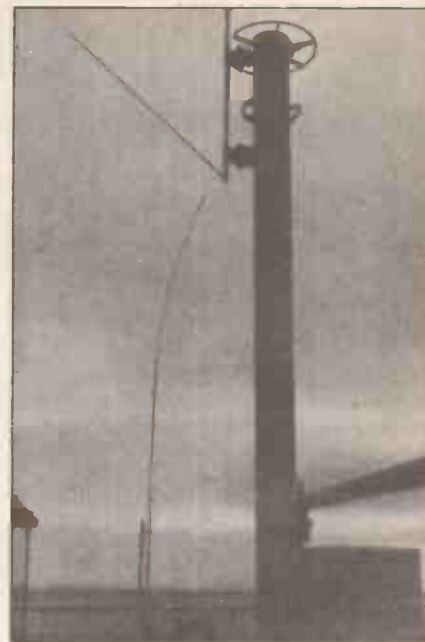

British flag. Receiving whip bends in strong wind, almost touching transmitting aerial.

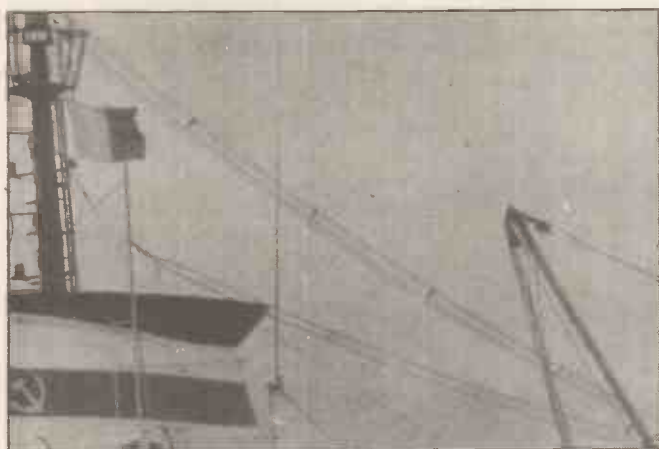

USSR flag, 3236 g.r.t., B.1963. Photographed in W.Africa, Sept. 81. Maximized capacity, minimized leakage on a 19-year-old ship. Return to the basic principles, of 1919 and rational design.

current at the radio transmitter could be misleading and would not give a good indication of the radiation from the antenna.

(10) the radio installation is efficiently earthed to the ship's hull.

How would the aerials depicted measure up to these requirements?

WWW

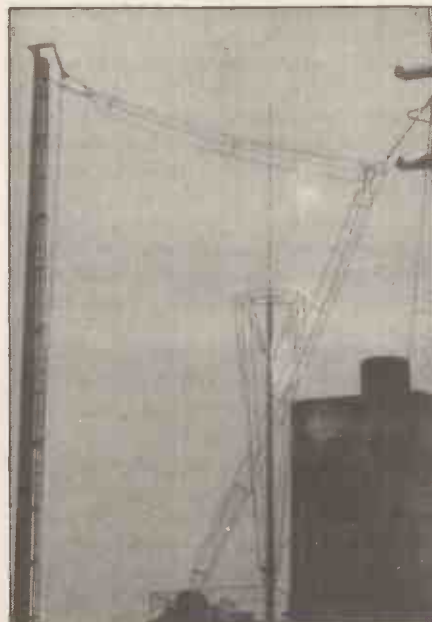

East German flag, 11,127 g.r.t., B.1976. Photographed at Yokohama, Oct. 81. High capacity 'sausage' aerial with good height and only three possible points of leakage. Many splendid examples of this type can also be found on French, Belgian and Soviet vessels. The mast aerial in the background is a standard model widely used on eastern bloc merchant ships.

radiate efficiently, it is necessary that:

- (1) It should be suitably dimensioned.
- (2) The electrical connection between the radio transmitting apparatus and the antenna is of such design that only a small part of the radio energy is 'lost'.
- (3) a principal part of the antenna is vertical or near vertical.
- (4) the principal part of the antenna is not in close proximity to any substantial part of the ship's superstructure.
- (5) the uppermost part of the antenna is of adequate height above the topmost deck or superstructure.
- (6) the antenna is not shielded unduly by parts of the ship's superstructure.
- (7) the radioroom be situated on the top deck or second deck so the feeder connecting the radio apparatus to the effective part of the antenna is short.
- (8) the vertical part of the antenna, which is of principal importance for radiating energy, is close to the radio room.
- (9) attention be especially given to the means necessary to avoid the high loss of radio energy which can occur when the lower part of the antenna includes a substantial amount of open conductor in close proximity to metallic portions of the ship. In such cases the measurement of antenna

Linsley Hood 100W amplifier – corrections

Several errors and omissions made the circuit diagrams of the amplifier – given on p.28 of the August issue – misleading. We apologize for them and give the corrections below.

Ordinary small-signal transistors (high-voltage, where necessary) are suitable for the early stages, and it was not intended to tie them down too specifically, but the types used in the prototype are: Tr₁–BC447; Tr_{5,6}–MPSA93; Tr_{4,7}–MPSA43; Tr₁₃–BC212; Tr₁₀–BC182; Tr₁₁–2SK134; Tr₁₂–2SJ49. The output transistors should be n-channel (Tr₁₁) and p-channel (Tr₁₂).

The negative supply to Tr₃ should be negative, the Zener and C₃ being shown upside down. Capacitors C₉ and C₁₀ can be reduced to 100µF.

Resistor values in Fig. 25 are not shown, since they are the same as those in Fig. 24: R_{5,8} are 1M5, R_{6,7} are 3M9 and R_{1,4} are 2M2. Care should be taken to connect the pins of Tr₃ to the correct pads on the p.c.b., since the case outline is shown 'twisted' from the correct position.

CES CHICAGO

A thousand exhibitors demonstrated the consumer electronics they will sell to America this year

This year, a record number of well over 72,000 visitors attended the Consumer Electronics Trade Show in Chicago. There were more than 1,000 exhibitors dispersed in the huge McCormick Center and various hotels in the city. In general, the mood was one of cautious optimism and most dealers were looking for increased business in the future when the political and economic climate improves.

As with the last three Shows, the emphasis was very much on video — which in this context includes computer-based electronic games, many now embellished with “speech”.

Video discs

Big news from RCA was the introduction of a new video disc player which features an infra-red remote control, a fast search speed (16x) in both directions, rapid access (120x) and stereo audio tracks with CX noise reduction. Similar models using the RCA CED system were being demonstrated by Zenith, Toshiba and Hitachi. RCA's Vice-President, Thomas Kuhn said: “Despite the recession, US consumers spent more than \$90 million for CED players and discs in the product's first year”. Although the VHD players were being heavily promoted by Panasonic and JVC with programs in NTSC, Pal and Secam formats, release has been postponed-again. Rumour has it that work is proceeding on a recordable disc although many experts believe this is unlikely. However, it is known that the Japanese broadcasting Corporation (NHK) has developed a video disc that can be recorded and erased any number of times. It uses a thermomagnetic principle for recording and the Kerr optomagnetic effect for laser playback. Prototypes have a carrier-to-noise ratio of only 38 dB but work is proceeding on methods of improving it.

The third system-LaserVision, was represented by Pioneer and Magnavision among others and the new models also use CX noise suppression. At the January Show in Las Vegas, Kenwood caused a minor sensation with the introduction of the first audio-video amplifier which features a video enhancer circuit, switching for VCR's and V-Disc players, provision for mic dubbing and more, all combined with a 50 watt integrated amplifier. This model really heralded the coming audio-video ‘marriage’ caused by the enormous number of potential video program sources and the need for better sound quality.

Television

Although as yet there is no stereo tv in the US, apart from some cable systems, most of the new VCR's and video disc players have this facility, usually with some kind of noise reduction system, so the tv set

By G. W. Tillett

with its poor quality loudspeaker is just not good enough. In addition there are the electronic games, computers and satellite tv signals — all requiring connections to the tv. There is no question that the tv of the future, the near future, will be just a monitor, part of a component system needing only a video signal for direct application to the tube. Sony's Profeel system is one of the first and similar units were shown by nearly all the other tv manufacturers. Some have amplifiers built in to the monitor while others like Jensen, offer a combined audio-video receiver. Model AVS-1500 combines a a.m.-f.m. digital tuner, a 133-channel tv tuner and a stereo 50 watt amplifier with a microprocessor controlled switching unit — all in a single unit. There is a choice of 51cm or 67cm colour monitors. The smallest monitor comes from Hitachi: it has a 10cm screen and there are two built-in 6.5cm loudspeakers.

There is a definite trend towards larger tv screen sizes: Sony were showing a prototype with a new 80cm picture tube and there were a number of new projection models. GE unveiled a 110cm rear projection model which has a built-in stereo amplifier rated at 10 watts per channel — plus two loudspeaker systems. A switch panel allows connection to external video sources. Other rear projection systems with similar size screens were shown by RCA, Sony and RCA. Pioneer's LS-501 is a forward projection model and the screen size is about 130cm. Zenith claim to eliminate picture distortion in their 100cm projection models. The red, green and blue tubes are mounted side by side but the faceplates of the left and right tubes are tilted to cancel out distortion caused by the angle of projection.

Video cassettes

Now for a look at some of the new video cassette recorders. With the appearance of the T-160 long-playing tapes, most of the

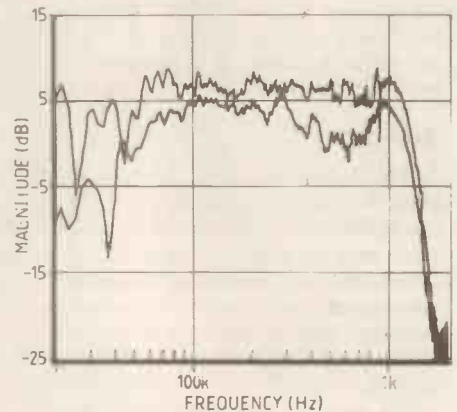

Fig 2. Before and after curves for the AR room acoustic adjuster below

new VHS recorders can record up to eight hours. At the other extreme, a number of mini-portables were seen using a new format called UCM, for Ultra Compact Machine. These mini-VHS models were shown by RCA, Sharp and JVC, the average weight being only 4½lbs. Playing time of the cassettes — which are slightly smaller than a cigarette pack — is 20 minutes. Adaptors permit them to be used with standard VHS machines as ½ inch tape is used. Apparently the UCM format was developed to meet competition from Grundig, Funai and Technicolor who make small portables using 6mm tape. Discussions are being held among some Japanese manufacturers concerning an entirely new format employing 8mm tape for portables but production might be two, or even three years away.

Marantz were demonstrating a Beta VCR which was specially designed for high quality sound reproduction and among the features is Dolby C and stereo sound. Panasonic's VHS model PV-1780 also has a similar specification with Dolby and Stereo but, like many VHS models it employs four video heads. This means that field-by-field scanning is used for the “still” mode instead of frame-by-frame.

Sony had a new Video Special Effects Kit which includes an effects generator, a monochrome video camera which, when

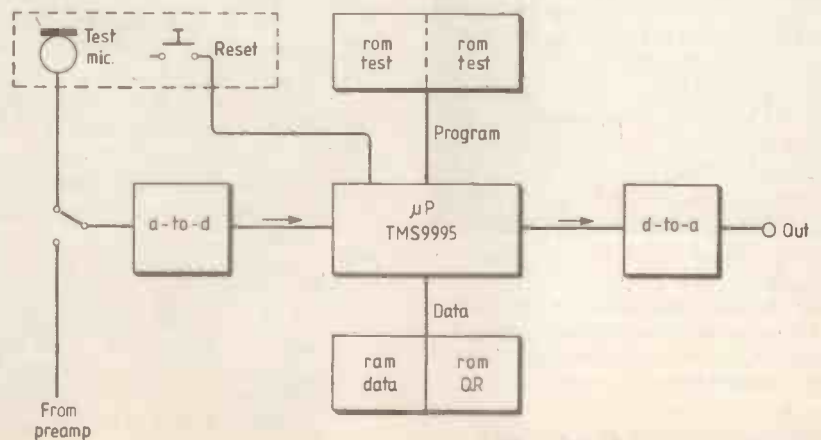

Fig 1. The AR room-acoustic adjuster

combined with a colour camera and VCR can provide such effects as superimposition, colour keying alteration in up to six colours, monochrome reversal, plus remote control of VCR transport functions. The kit also has a close-up lens, camera stand and title holder. For the professional, Sony introduced a waterproof "marine pack" designed to protect portable Betamax video equipment during under water shooting. It is equipped with a built-in microphone.

Audio

Although audio seems to be taking second place to the more glamorous video products, there were plenty of new items in all price ranges. Here are some of the most interesting: AR were demonstrating their new digital signal processor which compensates for loudspeaker-room acoustic deficiencies. Figure 1 shows the basic circuit: the listener presses the re-set button and a random noise-like signal from the m.p.u. memory is sent to the loudspeakers via the a-to-d convertor. This signal is picked up by a microphone located in the remote hand-held module and stored as ram data under control of the m.p.u. The data is analyzed and compared with the original to produce a filter which is then inserted into the preamp circuit. Each channel is analyzed separately so there are really two filters. The system operates to 1 kHz and a typical pair of before-after response curves are shown in Figure 2.

Last year Onkyo introduced a double cassette deck, this has now been joined by a "second generation" model with other twin decks from Sansui, Hitachi, Sharp, JVC and Technics. Most offer a fast speed for dubbing so a single side of a C.60 can be copied in 15 minutes. Perhaps the most significant development in cassette decks is a revival of interest in microcassettes. Panasonic make a miniature model using dbx, while Sony's TC-MR3 is described as "the first home microcassette deck." One of its advertised functions is to make tapes for the Sony Walkman and similar models. Few pre-recorded microcassettes are available at present but this situation is likely to change soon. Meanwhile, blank cassettes using metal formulations are being marketed by Sony, Fuji, and TDK among others.

Denon were showing a 'Pure Class A, No-Feedback' 200 watt amplifier last year and now they have a matching preamplifier. This is the PRA-6000 which also uses no feedback. Equalization and tone controls use passive circuits while input switching is electronic. The price is pretty steep at \$3,000. Another interesting amplifier comes from Harman-Kardon, the Citation XX which was designed by the Finnish engineer, Matti Ojala. It includes an instantaneous current capability of 200 amps so the amplifier can deliver 14,000 watts per channel into a 0.35 ohm resistor under transient conditions; a low value of negative feedback; dual power supply with a total capacitance of 80,000 mfd; three thick copper plates are used to form a low impedance transmission line from the power supply to the output transistors.

Fig. 3. The Southern linear tracking arm is driven by the groove without motors

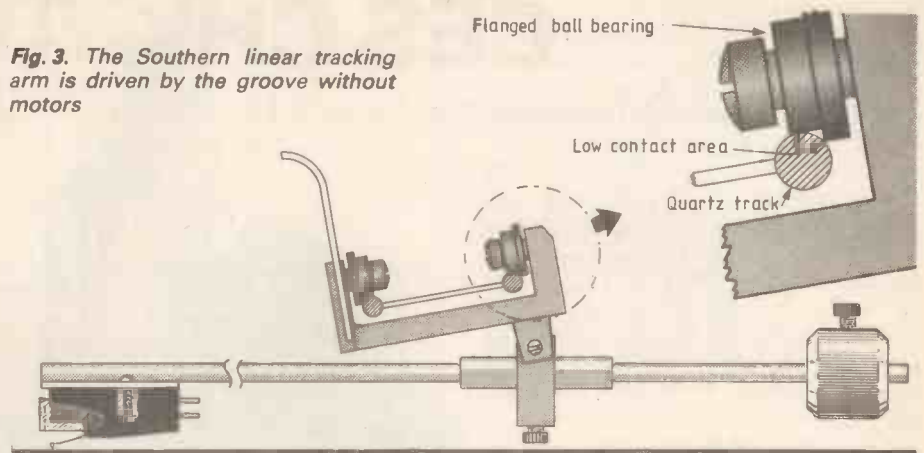

Rated output is 440 watts per channel into 4 ohms with no more than 0.1% THD. A special feature is a three-position switch for bias so the current can be adjusted according to the power level desired.

The new Quad ESL was attracting a lot of attention - so was the latest electrostatic loudspeaker from Acoustat, the Model Eight which stands 94 inches high. It has a radiating area of over 23 square feet and is capable of a s.p.l. of 125 dB at a distance of 25 feet. The impedance is said to be "an extremely peaceful 6 ohms". At the other extreme; in terms of size B & W were making some impressive sound with a new mini system measuring 240mm by 155mm by 190mm which was designed for domestic or car use.

New turntables caused no great excitement among dealers; although there were several new linear tracking designs from manufacturers like Sansui, Luxman, JVC and Technics. The most unusual was a precision linear arm from Southern: unlike all the other models now on the market, it doesn't use a servo-drive mechanism as the record groove pulls the cartridge across, just like a conventional pivoted arm. In order to do this, arm friction needs to be very low indeed, as does the mass. The arm is actually made from a glass composition and weighs only 1¼ grams. A three-point suspension is used with stainless steel and sapphire bearings and it runs on pure quartz rods. Price is about \$600. Yet another unusual arm was the Townsend Elite which is a pivoted design with a difference. An extension section near the cartridge floats on an arc-shaped trough filled with silicone to provide damping and the turntable base can be hit quite hard before mistracking occurs.

Radio

One of the issues causing some arguments among engineers is the proposed a.m. stereo transmissions. There are no less than five systems contending for acceptance: Magnavox, Kahn, Belar, Harris and Motorola. All employ some kind of phase modulation but the Kahn system has independent left-right sidebands. The Belar approach is to frequency modulate the carrier while the other three systems phase modulate the carrier. Most of the Japanese manufacturers appear to favour the Magnavox system although the Harris system which was demonstrated at the Show has

several advantages. These include a wider bandwidth, separation up to 15 kHz and the smallest occupied bandwidth. As shown in the block diagram, (fig 4) the Harris system amplitude modulates two RF carriers separated by 30 degrees and 90 degrees phase difference. The left channel modulates one of the signals while the right modulates the other. A pilot tone is varied from 55 to 96Hz to enable the receiver to track this varying phase difference and provide normal stereo decoding. Although this means that channel separation can only be maintained down to 200 Hz, this is not considered a serious drawback. The block diagram shows the decoder arrangement: unmodulated i.f. is generated with the phase locked loop to quadrature detect the l-r stereo difference information. After attenuating the L+R to match the L-R, both are fed to an audio matrix to recover the left and right audio channels. The basic circuit will be available in a 24 pin ceramic DIP (HS-3604) later this year. Harris say that orders for over 150 transmitter adaptors have already been received, but these will obviously be cancelled if one of the other systems is adopted. It is now up to the broadcasters to make a decision. At the Show, Sansui were demonstrating a receiver equipped to receive signals from a local transmitter in the Kahn, Harris and Magnavox modes.

Arguments are still going on concerning the compatibility of the CBS CX noise reducing system. Fewer than two dozen CX records have been released although some 200 are promised by the end of the year. Several receivers were to be seen featuring CX and a number of decoders are now available while the system is being used in video disc players and VCR's.

I counted 17 compact digital disc players at the Show but only one company, Cybernet, claim that units are being actually produced. The software situation is not too clear although Polygram claim that they will release 200 to 300 records by the end of the year.

Electronic music

Casio's new musical keyboard lets the user create 1000 different sounds which are stored in 10 memories. Arpeggio patterns can be programmed to match the music by reading in up to 127 steps, 9 note pitches and rests. There is a built-in "sequencer" which allows the user to program a series

of notes, play the sequence and create other sounds — all at the same time. Other features include digital frequency display, vibrato, sustain, delayed vibrato and pre-set sounds for such instruments as a bassoon, pipe organ and flute. The keyboard is a full-size 61-key model and the instrument has a built-in loudspeaker. Another musical instrument from Casio is the CT-701 computerized electronic player piano. It uses a "miracle scanner" and the user just passes a wand over a printed bar code music sheet and the tune is instantly put into the keyboard's memory for instant playback. The instrument can store up to 345 melody notes and up to 201 accompaniment chords.

Home computers

The Commodore MAX machine uses a new m.p.u., the 6510, to produce a variety of music and sound effects. There are three "voices" each with a 9 octave range and the instrument is said to, "command amazing orchestration when used with a good quality audio system" With a BASIC language cartridge, MAX users can learn the fundamental language of computing and write their own programs which can include maths functions. Commodore also introduced a home computer, the Model 64, which the American Express said, "could be the m.p.u. industry's outstanding new product introduction since the birth of the industry" It can use VIC 20 peripherals and the addition of an IEEE-48 cartridge will enable it to run other peripherals including CBM printers and disc drives. Another feature is its capability of using a Z-80 add-on processor board to run CPM. The 40 column by 25 line screen and 16 colours, plus its 64K of RAM help to give it one-third more computer power than the Apple II at \$595.00 — less than half the price.

The most inexpensive computer at the Show was the Timex-Sinclair, which sells at less than \$100. It is a modification of the Sinclair ZX81 and manufactured in Scotland.



An interesting telephone adaptor was shown by International Mobile Machines Corporation and it is intended to screen phone calls, tell you who is calling and it also features a memory. It works like this: whenever someone dials your number, the phone will not ring but a pleasant synthesized female voice asks the caller to enter their personal access code by pressing the appropriate buttons. If the code you've authorised is entered, the number appears on a digital display so you know who is calling and who the caller wants to speak to. A touch of a button and the Access codes of all those callers who tried to reach you will be displayed. The system is called "Privencode" and one of its uses is to stop people from being bothered with wrong numbers, obscene calls and slick salesmen.

Mitsubishi were demonstrating what they called a "Micro Robot Minicomputer system" which consisted of a keyboard computer with display, plus a "mechanical arm". This was a jointed structure mounted on a base and powered by six

drive motors. There are five degrees of freedom with independent rotation around six independent axes and a multi-location memory. The device, called a Move-Master can be controlled by a number of standard computers but the Mx-6000 was specially designed to interface. It has a 5 inch green display, 64K dynamic RAM, floppy disc, 640 character display and an impact type dot matrix printer. Programming languages include BASIC, assembler and a new robot-oriented language called M-Roly. What can this robot be used for? Well, the makers say it is useful for getting practical experience in robotics either for the hobbyist or for educational.

Etc.

Do you play golf? If so, Mitsubishi have just the gadget for you — the GL-500 Golf Trainer. It consists of a computerized display unit mounted on an artificial grass



mat base. As the club passes over this base, the shot is detected by four sensors and the data displayed. This includes head speed, head angle, hitting area of club, shot direction and the difference in distance between the aimed and actual point at which the ball would land. Now if they would only make a similar device for cricket . . . Prize for the smallest radio must go to Sony's wrist watch model which uses on-chip technology. A four-function LCD displays time, alarm time and AM station frequency. Loudspeaker is a one-inch model . . . Marantz were demonstrating the "Sing Along System" which uses a cassette deck with special tapes so the lyrics of popular songs are displayed on a screen . . . Texas Instruments were showing the "Magic Wand" reader designed for young children. It features an optical scanner built into a "Magic Wand" to read talking book codes which are translated into "human-like" voices. The vocabulary consists of 200,000 words and there are various sound effects and music songs.

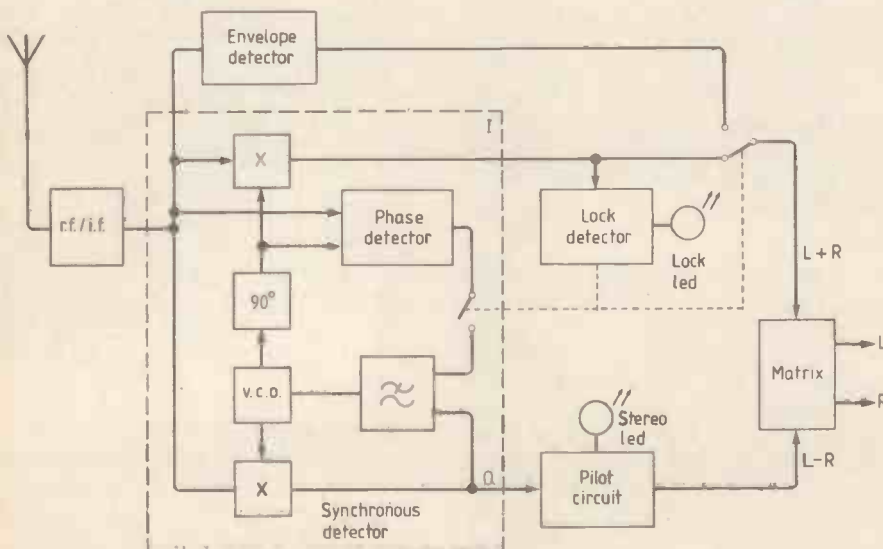

Fig 4. The Harris system for receiving stereo a.m. radio

COMMUNICATIONS

Air data links

During recent years there have been several major disasters that appear to have been brought about, or at least assisted to happen, by misunderstanding of air traffic control messages in circumstances which suggest that poor speech intelligibility may have played some part. The hazard, if hazard there is, occurs less on routine messages than where there is some marked departure from message formats that follow a pattern familiar to the pilot.

Voice communication with aircraft involves achieving intelligibility in a very difficult environment, and it is this factor rather than basic distortion that appears to account for some of the problems. Whatever the cause, aircraft communications still fall a long way short of high fidelity.

One approach would be to replace voice communications with a data link, provided that this would not add to the load already imposed on the eyes of a pilot. An alternative would be voice assisted by data. G. Bennelli of Florence University has put forward proposals for simultaneous voice-data links over a simple radio channel by using combined amplitude-phase modulation of a single carrier, rather akin to some of the proposals for medium-wave stereo broadcasting in America. He suggests (*Electronics Letters*, June 24, 1982) that this could provide a simple and economic method of introducing a certain degree of automation into air-traffic-control functions without the need for entirely new equipment, so opening the way to extend data-link operations to small as well as large aircraft.

Computer studies suggest that problems of mutual interference between voice and data in a narrow bandwidth need not be excessive with AM-MSK (m.s.k. - minimum shift keying, or in other words f.f.s.k. - fast frequency shift keying) modulation systems which, it is suggested, have greater potential than AM-PSK (p.s.k. - phase shift keying).

Engineers at the Nippon Telegraph & Telephone Public Corporation have reported the fabrication of a single-chip c.m.o.s. coherent demodulator for m.s.k./f.f.s.k. working at an i.f. of 455 kHz at bit rates up to 32 Kb/s, a considerably higher bit rate than proposed by the Italian team for ground-air-ground communications, for which bit rates of from 300 to 2400 b/s were considered in the simulation tests.

E.m.c. and c.b.

The Home office radio interference report for 1981 underlines the large increase of complaints made by viewers and listeners during the year, many relating to the operation of illegal 27 MHz amplitude-modulated transceivers in the months leading up to the licensing of 27 MHz f.m. equipment. However, a reading of the re-

port shows that many of the arguments publicly used for a number of years by the Home Office to oppose allocating 27MHz for c.b. were based on the false premise that the prime cause of r.f.i. to domestic equipment is harmonic radiation. The report shows that not harmonics but "direct audio break-in arising from the close proximity of the c.b. transmitters" is the main problem. It could thus be argued that c.b. operators have been (and still are being) blamed for the poor electromagnetic compatibility of modern domestic electronic equipment.

Of the 14,359 complaints ascribed after investigation to illicit c.b.; over 3000 referred to m.f. radio and more than 9200 to Band IV-V u.h.f. television - few of these appear likely to have been caused by "harmonic radiation". The statistics do, however, lend support to the view that f.m. transmissions cause less problems than a.m. (though listening in the London area reveals that widespread use of illegal a.m. is continuing).

There can be no doubt that there are many home-entertainment equipments, such as cassette recorders, that are vulnerable at distances up to 50-100 ft or so to interference from low-power a.m. (or s.s.b.) transmitters of the type marketed for c.b. operation. The vulnerability undoubtedly increased significantly when solid state devices replaced valves in domestic equipment; it was also made worse by "unit" audio equipment with interconnecting leads that act as aerials. Yet there is also little doubt that domestic equipment could have much improved electromagnetic compatibility at relatively little added cost. For many years, British and American manufacturers have resisted suggestions that tv sets could be made far more resistant to r.f.i., although some European firms have been more responsive.

The recent showing at CETEX of "unit-video" systems by Sony and Phillips may raise the question once more, since there is evidence that a number of separate units tends to be more vulnerable to r.f.i. than a single unit; for example the combination of a video recorder with a tv set tends to increase e.m.c. problems.

Interference complaints in 1981 rose sharply over 1980 - from 35,790 to 70,452. This near doubling in numbers appears to have overwhelmed the system with 28,490 uncompleted cases carried over to 1982. Nevertheless the number of completed investigations rose by 47 per cent from 41,086 to 60,571. Although much of this large increase is due to 27 MHz c.b. operation, there appears to have been a general increase in complaints of interference from other causes, although there was a significant drop of 16.57 per cent in complaints identified as due to contact devices, from 10,584 in 1980 to 8,914 in 1981 - almost wiping out the

very large jump in such interference recorded in 1979.

Despite the increase, the complaints amounted to less than one for every 500 tv licence holders; on the other hand, over 11 per cent of licence holders for the two-way land mobile radio services reported interference, though it should be stressed that 18,048 licences cover 340,830 l.m.r. receivers.

Radio complaints were sharply up (24,648 compared with 20,345) but this puts radio back on the ascending curve of the past decade with 1980 the odd-man-out. The v.h.f./f.m. service accounts for about half the number relating to l.f./m.f.

In the news

British Aerospace are building the largest solar generator yet announced for non-military space applications. Designed to provide 5 kW of electrical energy, using almost 50,000 solar cells made by AEG-Telefunken, it represents a cost of about £300,000 per kilowatt, underlining the limitations on the number of d.b.s television channels that could be provided in the near future on a single satellite.

The firm of Daini Seikosha, Tokyo, is reported to have developed a new photolithographic technique for the manufacture of GT-cut quartz crystals to provide tiny crystal resonators in the megahertz region.

With a number of British communications and electronics firms noticeably absent from the 1982 British Army Equipment Exhibition (more from megacost than megadeath considerations) it is interesting to note that Racalex '82, the private exhibition of the Racal Electronics Group, is to be opened by the Secretary of State for Defence, John Nott, MP, next October. But Racal continue their unbroken record of expansion, announcing a pre-tax profit to March 1982 of over £100 million from a turnover that has climbed in ten years from £25 million to £644 million.

The recent joint presentation by NHK and RTE (with encouragement from CBS) of the NHK-developed high-definition television system having 1115 lines, 5:3 aspect ratio and 60 fields per second undoubtedly impressed all those who saw the excellent quality pictures at Killarney. It should encourage the use of electronic techniques in the production of cinema material (remember the 1000-line black-and-white system developed by High Definition Films in 1951?) but it would set broadcast engineers the almost impossible task of finding spectrum space transmitting 20MHz of luminance plus 7MHz and 5.5MHz of chrominance - and keeping these as separate components! Electronic production for cinemas could undoubtedly reduce costs but it may prove difficult to convince film production teams that they should switch to video.

AMATEUR RADIO

Solar upset

Sunspot Cycle 21 developed a square wheel during June that gave a very bumpy ride on the h.f. bands – and posed the interesting question once again of what triggers off Sporadic-E propagation conditions. From early to mid-June there was a succession of solar flares, sudden ionospheric disturbances, magnetic storms and the largest X-ray event for several years. These gave rise predictably to very disturbed h.f. conditions including some daylight “black outs”.

This period also witnessed two Sporadic-E openings extending up to 144 MHz, the first on May 25 when Scandinavian amateurs, including many in Finland, were heard and worked by British amateurs. The second on June 5 when the 144 MHz band opened to the Central Mediterranean area, including Malta, Sicily, Southern Italy, Corsica etc. Although it is not common for Sporadic-E conditions to extend as high as 144 MHz, there seems little reason to link these openings with the solar disturbances on h.f.

50MHz

Long-distance openings in a generally north-south direction continued to occur in early June on 50 MHz, including reception by Gordon Pheasant, G4BPY of the Brazilian beacon station PY2AA, in the afternoon of June 4 and the FY7THF beacon on June 5. A number of South African signals also continue to come through on 50 MHz.

British amateurs have for long sought use of the 50 MHz band available in the other WARC Regions, and have recognised that such an opportunity could arise in the UK with the phasing out of the BBC 405-line television service in Band 1 (due to be completed about 1986). This objective has become a live issue with the setting up of the independent review, under the chairmanship of Dr J. H. H. Merriman, charged with producing an interim report by September on the future use of Bands 1 and 111 “taking account not only the need to provide for expansion of the land mobile services but also of various possibilities for the continued use of these bands for broadcasting”. The main review, by June 1983, is to examine the present occupancy and utilization of frequencies from 30 to 960 MHz, and thus covers the 70 MHz, 144 MHz and 430 MHz amateur bands. The RSGB will make a submission to the Merriman committee.

Less formally, it is hoped by many amateurs that the committee will note how much more generous are the frequency allocations to amateurs and broadcasters in

North America than in Europe, with not only the 50 to 54 MHz band but also the allocation of 220-225 MHz and the much wider 430 MHz band; yet at the same time extending the v.h.f./f.m. broadcast band right up to 108 MHz and continuing to use Band 1 (except Channel 1) and Band 111 as the main television bands plus 55 u.h.f. television channels. The sometimes-heard premise that the valid needs of the land mobile service can be satisfied only by whittling away the frequencies allocated to existing non-military users needs to be challenged.

CQ out?

Those who, like myself, operate c.w. on h.f. bands normally listen until we hear a reasonable signal calling CQ and then reply. It is considered bad form to reply to European stations calling “CQ DX” or “CQ Africa” etc. Just occasionally one puts out a CQ call.

On s.s.b. much the same procedure applies although the growth of multistation “nets” means that there are far fewer CQ calls than on c.w.

But from an editorial by Gary O’Neil, N3G0 in *Ham Radio* one learns that launching a CQ call on 144 MHz f.m. is now regarded in the States as an unusual and peculiar event. Instead a station announces it is listening “on channel” in a rather forbidding manner that does not invite a random reply but suggests only a wish to be called by known friends or members of a particular organization or someone with a positive reason for seeking contact. The tendency for amateurs to form élitist coteries, cold-shouldering all outsiders, is not entirely unknown this side of the Atlantic.

Here and there

The effects of inflation, the less-strong exchange rates, the growing use of frequency synthesizers, up-conversion, digital readout and the like have all combined to push up the price of amateur radio equipment. The Yaesu “FT-ONE” h.f. transceiver retails around £1300, the latest Trio (Kenwood) TS930S is over £1000, and some American-built models such as the KWM380 and the Signal/One (built to a military specification) tend to be well over £2000. One notes that more and more advertisers, particularly in the USA, are becoming very coy about disclosing prices and this appears to conceal substantial discounting as the market becomes rather more sluggish. Though it would seem that sales of the lower cost transceivers, both h.f. and v.h.f., are suffering more than the “top-of-the-range” models.

The GB3SWH 10.368 GHz beacon at Bushey, North London, has been rebuilt and now provides 22mW output to an omnidirectional aerial (6dBi gain). It has been heard in Hampshire over a difficult 80 km

path. The 10 GHz beacon at Martlesham, like the British Telecom Research laboratories with which it is associated, is changing away from GB3BPO that linked it with the British Post Office.

A Scottish Amateur Convention will be held at Aberdeen University (Nat.Phil.Dept), St. Machar Drive, Aberdeen, on September 11, from 10 a.m. to 5 p.m., with trade stands. Among the speakers will be Professor R. V. Jones, M. C. Hatley, GM3HAT, John Nelson G4FRX and members of the Moray Firth Amateur Television Group.

A Midlands VHF Convention is planned for October 9 and will be at Wolverhampton Polytechnique, near the centre of the town.

Reminder of the British Amateur Television Club convention at The Post House, Leicester on September 5 and the British Amateur Radio Teleprinter Group rally at Sandown Park Racecourse, Esher, Surrey on August 29.

In brief

Launch date for the Phase 3B satellite could be any time between September and March 1983 depending on the completion of the main load for the Ariane launcher . . . Proposals for five amateur television repeaters in Leicester, Luton, Stoke-on-Trent, Bath and Worthing are being put to the Home Office. . . The Home Office is introducing an annual fee for “experimental v.h.f. licences” which permit holders to use powers up to 1kW and are considering the provision of other forms of experimental licence . . . Members of the Barry College of Further Education Radio Society are to operate GB2F1 on Flat-holme island in the Bristol Channel from August 27 to 30. Flat-holme was the site of Marconi’s first radio transmission across water in 1897. Since the island is administered from South Glamorgan it also represents the southernmost point of the Principality . . . Mobile rallies: August 22 Avoncroft Art Centre Bromsgrove. August 29 ITT Social Centre, Old Brixham Road, Paignton. September 12 Telford New Town Centre Malls, Telford, Shropshire and Nicholas School, Basildon, Essex. September 19 Werrina Sports Stadium, Bishops Road, Peterborough. . . Chris Chisholm, G2CX, who died recently, played a prominent role in R.S.G.B. activities in the 1930s including a long spell as QSL Manager and also as a Council Member. He was also one of a number of radio amateurs who played a role in secret radio activities during World War II. He was licensed in the 1920s. Another loss has been Jack Box, G6BQ for long an outstandingly successful 1.8MHz contest operator.

PAT HAWKER, G3VA

CIRCUIT IDEAS

Simple divider

The GAP-01 general-purpose analogue processor, primarily intended for synchronous demodulation, may be used as the basis of a versatile divider.

In the first circuit diagram, two CA3080 transconductance amplifiers are shown, each with a g_m of $I_B/2V_T$, where I_B is the bias current and V_T , the thermal voltage at 23°C, is 26mV. Given that $I_{B1}=aV_1$ and $I_{B2}=aV_2$, and further, $V_{x1}=V_{in} k/(k+1)$ and $V_{x2}=V_{out} k/(k+1)$, where a and k are constants, the equation

$$g_{m1}V_{x1} + g_{m2}V_{x2} = 0$$

yields

$$\frac{V_{in}}{V_{out}} = -\frac{I_{B2}}{I_{B1}} = -\frac{V_2}{V_1}$$

and hence

$$V_{out} = -V_{in} \frac{V_1}{V_2}$$

This equation demonstrates the advantages of this circuit over others, i.e., that errors resulting from temperature variations do not influence the output voltage.

The first circuit may be simplified by replacing the two amplifiers by a GAP-01, as shown in the second diagram. This i.c. consists of two differential-input transconductance amplifiers, two 'low-glitch' current-mode switches, an output buffer and a comparator. Values for R_1 and R_2 are 50 and 15kΩ respectively and k is 0.01.

Kamil Kraus
Rokycany
Czechoslovakia

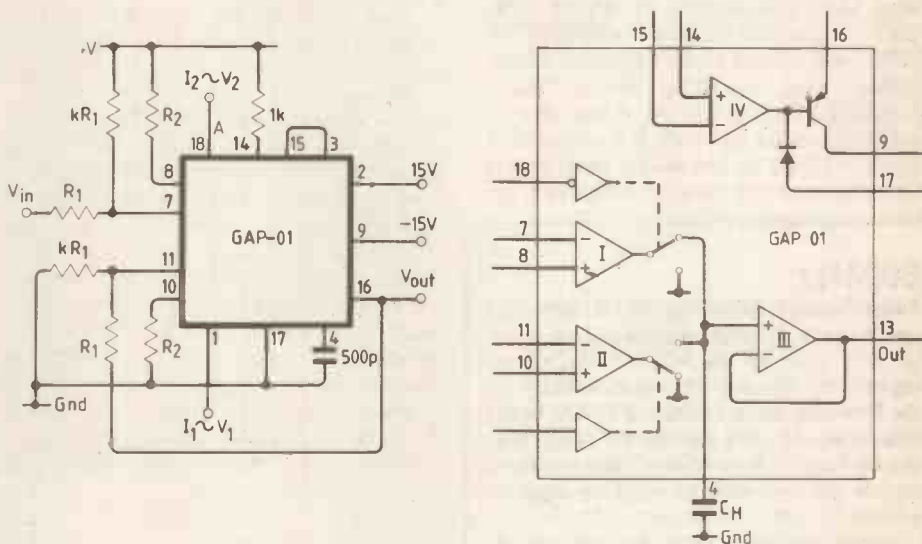
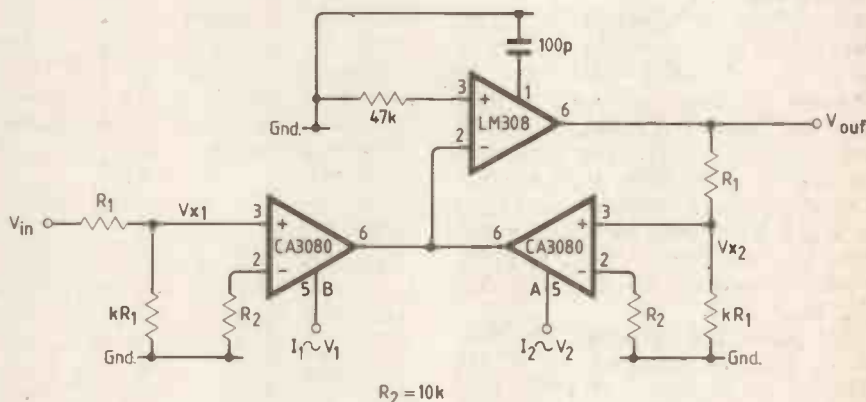

10+1 MHz comb generator

A 1 MHz frequency comb with every tenth spectrum line raised by 10 dB is very convenient for use as a spectrum analyser calibrator or sweep generator marker. It can be generated using the simple logic and pulse shaping shown, by gating out every tenth pulse of the incoming 10MHz clock. The resulting pulses, of nearly 1.4 ns duration, ensure an essentially flat spectrum to 250MHz into 50 ohms. A faster, larger-signal p-n-p transistor such as BF479 or MM4018 and a higher supply voltage for the second transistor might raise this limit to 400 or 500MHz.

The principle works for any other ratio N , with the exception of $N=2$, by having the counter divide by N and selecting its outputs to enable gate 3 during $N-1$ clock pulses.

J. C. Baumeister
Chantraine, France

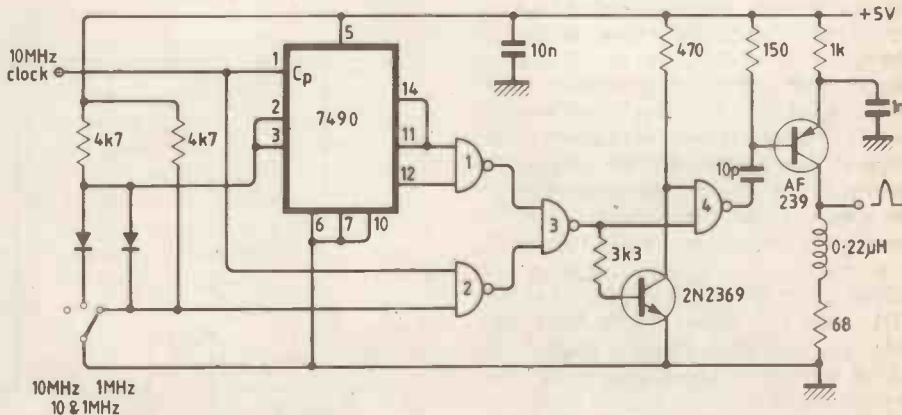

NETWORK ANALYSIS WITH A ZX81

This second part details the method used to compute insertion loss and group delay of a network.

by L. E. Weaver

Equation 1 can be written in matrix form

$$\begin{bmatrix} e_i \\ i_i \end{bmatrix} = \begin{bmatrix} a_{11} & a_{12} \\ a_{21} & a_{22} \end{bmatrix} \times \begin{bmatrix} e_o \\ i_o \end{bmatrix}$$

The array of a's is known as the A-matrix of the system. Its particular virtue is that the combined response of two networks in series is given by the product of their individual A-matrices.

In the simplest case this second network can take the form of a single series or parallel network branch. Then for a network with an A-matrix having coefficients z_{11} , z_{12} , z_{21} , z_{22} :

addition of a series branch z_s

$$\begin{bmatrix} z_{11} & z_{12} \\ z_{21} & z_{22} \end{bmatrix} \times \begin{bmatrix} 1 & z_s \\ 0 & 1 \end{bmatrix} = \begin{bmatrix} z_{11} & z_{12} + z_s \cdot z_{11} \\ z_{21} & z_{22} + z_s \cdot z_{21} \end{bmatrix} \quad 3$$

addition of a shunt branch z_p

$$\begin{bmatrix} z_{11} & z_{12} \\ z_{21} & z_{22} \end{bmatrix} \times \begin{bmatrix} 1 & 0 \\ 1/z_p & 1 \end{bmatrix} = \begin{bmatrix} z_{11} + z_{12}/z_p & z_{12} \\ z_{21} + z_{22}/z_p & z_{22} \end{bmatrix} \quad 4$$

The A-matrices of a single series or shunt arm can be determined by inspection from equations 1. The method of matrix multiplication appears in a wide range of standard texts.

Equations 3 & 4 can now be considered as recurrence relationships from which z_{11}

Nevertheless the input impedance is not always needed, and if the computation of the insertion loss only can be accepted then a considerable simplification can be introduced. Equations 3 and 4, reveal that the lower row of the A-matrix does not enter in any way into the calculation of z_{11} . It can therefore be removed entirely with a consequent halving of the amount of complex arithmetic which needs to be performed.

Equations 3 & 4 now reduce to the extremely simple recurrence algorithms

addition of series arm z_s

$$(z_{11}, z_{12}) \rightarrow (z_{11}, z_{12} + z_s \cdot z_{11})$$

addition of shunt arm z_p

$$(z_{11}, z_{12}) \rightarrow (z_{11} + z_{12}/z_p, z_{12})$$

Incidentally, even including the complex arithmetic the first only occupies two program lines and the last three lines.

Now that the basic algorithm has been established, it becomes possible to examine the actual program listing. Although the number of REM statements has been kept small for obvious reasons, some notes have been added to the listing which should make it possible to follow most of the procedure without too much difficulty.

The component values of the ladder are stored in sequences as L(N) and C(N) where N is the branch number. The auxiliary arrays G(N) and T(N) indicate the type of impedance in branch N, and direct execution to the appropriate one of the four routines contained in lines 900 through 1140. The output in each case is in the form $Re + jIm$, where these are the real and imaginary parts of the branch impedance.

The single reduced matrix row corresponds to the two-dimensional array A(I,4), i.e. $z_{11} = A(I,1) + jA(I,W)$, and $z_{12} = A(I,3) + jA(I,4)$ where $I=1$ and $W=2$. Accordingly the initial matrix line has $A(1,3)=RI$ and $A(1,1)=I$ (lines 750,760). The indispensable information on whether the first network branch is series or parallel is provided by M(N) being I or -I respectively. Subsequently, M(N) reverses sign with successive values of N so as to ensure alternating series and parallel branches.

The next step after N has reached its maximum value MN is the addition of the output termination RO (lines 1330, 1340), which completes the computation of z_{11} and allows the insertion loss in dB to be derived in lines 1400, 1410. The insertion phase shift is also available in the form of $\arctan \beta = A(I,W)/A(I,1)$, and is stored in the array P(S) as this is only part of the necessary information.

The group delay is defined as $d\beta/d\omega$ which is not calculable by purely numeri-

First it is desirable to define what is meant by insertion loss. The concept arose in communication engineering where there is a frequent need to break a circuit to insert a filter or other network. More recently, it has given its name to a class of filters designed so that the response when inserted between the correct resistive terminations can be accurately predicted. Because of the great advantages this brings, many of the filters for video purposes, for example, belong to this type.

For the sake of simplicity assume that the input and output terminations are equal. Although this is not necessary, it is by far the most common situation. A more complete treatment will be found in chapter 2 of Skwirzynski³.

Now consider the illustration in which a generator with e.m.f. e_i and source resistance R feeds a network also terminated in R. The loss from input to output is $|e_i/e_o|$, but if the network is removed and the junctions reconnected the output is $e_i/2$. Hence

$$\begin{aligned} \text{insertion loss} &= 20 \log_{10} |e_i/2e_o| \\ \text{insertion phase shift} &= \angle e_i/e_o. \end{aligned}$$

The use of the reciprocal ratio to determine the phase shift has no effect other than to make a lagging angle positive instead of negative, as is the more usual convention.

For computational purposes the circuit shown needs to be considered in terms of

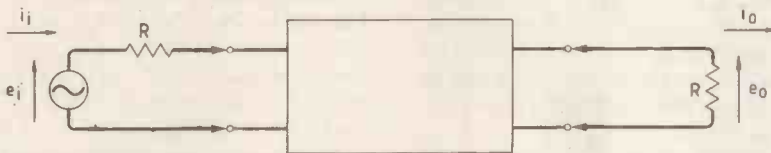

the input and output voltages and currents, in fact it is completely described by the Kirchhoff equation

$$\begin{aligned} e_i &= a_{11}e_o + a_{12}i_o \\ i_i &= a_{21}e_o + a_{22}i_o \end{aligned} \quad 1$$

provided the system is linear. In general, the a's are complex numbers. The next step is to consider the output termination as forming an integral part of the network, which is perfectly justifiable. Then the system is open-circuited at the output making $i_o=0$, and the above equations reduce to

$$\begin{aligned} e_i &= a_{11}e_o \\ i_i &= a_{21}e_o \end{aligned} \quad 2$$

It follows that the insertion loss and phase angle are now

$$\begin{aligned} \text{insertion loss} &= 20 \log_{10} |a_{11}/2| \\ \text{insertion phase} &= \angle a_{11}. \end{aligned}$$

and z_{21} may be determined, starting from the input termination R_i . As this is always in series, see illustration, its A-matrix is

$$\begin{bmatrix} 1 & R_i \\ 0 & 1 \end{bmatrix} \quad 5$$

The process can be continued for any number of branches, limited only by the capacity of the program. Finally, the output termination R_o must be added as a shunt branch, otherwise equations 2 become invalid.

Although it has not so far been mentioned specifically, the coefficient z_{21} is not unimportant for some purposes. From equations 2 we have $z_{11}/z_{21} = e_i/i_i$, that is the input impedance as seen through R_i , giving the input impedance of the terminated network. The original program listing in fact included this facility.

```

10  REM LADDER
15  LET CHECK = 2040
20  LET LOSS = 700
25  LET EQU = 1770
30  LET I = VAL "I"
35  LET M = I+I
40  PRINT "P0" (P_min)
50  INPUT P0
60  CLS
70  PRINT "P1" (P_max)
80  INPUT P1
90  CLS
100 PRINT "DP" (step in P)
110 INPUT DP
120 PRINT "D" (dissipation)
130 INPUT D
140 CLS
150 PRINT "FD" (frequency of max.D)
160 INPUT FD
180 LET PD = PD*M*PE
190 CLS
200 DIM L(20)
210 DIM C(20)
220 LET O = I+I
230 DIM P(N+1)
240 LET N = 0
250 DIM M(1)
260 DIM R(10)
270 PRINT "R1" (input termination)
280 INPUT R1
290 CLS
300 PRINT "R0" (output termination)
310 INPUT R0
315 CLS
320 PRINT "NO OF BRANCHES?"
330 INPUT NB
340 DIM H(10)
350 DIM G(10)
360 CLS
370 LET M = M+I
380 PRINT TAB 1: "LACT" TAB 16: "M = "; M
390 INPUT M1
400 IF M1 = "NO" THEN GOTO 545
410 PRINT "SER OR PAR?"
420 INPUT M2
430 IF M2 = "SER" THEN LET C(N) = I
440 IF M2 = "PAR" THEN LET C(N) = -I
440 PRINT "L?"
470 INPUT L
475 PRINT
480 LET L(N) = L
485 PRINT TAB 16: "L = "; L(N)
490 PRINT "C?"
500 INPUT C
505 LET C(N) = C
510 PRINT TAB 16: "C = "; C(N)
520 PAUSE 12
530 IF N <= 20 THEN GOTO 360
540 IF N = 20 THEN GOTO 650
545 CLS
550 PRINT TAB 1: "L?"; TAB 16: "M = "; M
555 PRINT
560 INPUT L
565 LET L(N) = L
570 PRINT TAB 16: "L = "; L(N)
575 PRINT "C?"
580 INPUT C
585 LET C(N) = C
590 PRINT TAB 16: "C = "; C(N)
600 PAUSE 12
610 IF C = 0 THEN LET T(N) = -I
620 GOTO 530
640 LET M = M+I
650 PRINT "SHOW?"
660 INPUT W
670 IF W = "YES" THEN LET M(I) = -I
680 IF W = "NO" THEN LET M(I) = I
695 LET N = N
690 CLS
695 STOP
700 LET M = M+I
710 DIM R(10)
715 LET R = I
720 LET P = P0
730 LET S = I
735 LET A = M*PI*P
740 DIM A(2,4) (start matrix)
745 LET A(I,3) = R1
760 LET A(I,2) = I
765 FOR N = I TO 20
770 IF T(N) = 1 THEN GOTO 940
780 IF T(N) = -1 THEN GOTO 900
790 IF C(N) = 1 THEN GOTO 1020
840 IF C(N) = -1 THEN GOTO 1070
900 REM L ONLY
910 LET RE = PD*(N)*D/M (real part)
920 LET IM = L(N)*A (imaginary part)
930 GOTO 1150
940 REM C ONLY
950 IF A = 0 THEN GOTO 990
960 LET RE = D/(M*PD*C(N))
970 LET IM = -I/(A*C(N))
980 GOTO 1150
990 LET RE = D/(M*PD*C(N))
1000 LET IM = -I
1010 GOTO 1150
1020 REM SERIES LC
1030 LET H = SQRT(L(N)*C(N))
1040 LET X = A/H
1050 IF A = 0 THEN LET X = 1E-8
1055 LET RE = M*DE*(N)
1060 LET IM = M*(N)* (X - I/X)
1065 GOTO 1150
1070 REM PARALLEL LC
1085 IF L(N) = 0 THEN GOTO 2150
1090 LET H = SQRT(L(N)*C(N))
1095 LET X = A/H
1100 IF A = 0 THEN LET X = 1E-8
1110 LET J = (X-I/X)*(X-I/X) + D*I
1120 LET LI = H*(N)
1130 LET RE = LI*D/J
1140 LET IM = -LI*(X-I/X)/J
1150 IF M(N) = 1 THEN GOTO 1250
1160 IF M(N) = -1 THEN GOTO 1370
1170 LET DE = RE*RE + IM*IM
1180 LET A(I,3) = A(I,3) + (A(I,3)*RE + A(I,4)*IM)/DE
1190 LET A(I,4) = A(I,4) + (A(I,4)*RE - A(I,3)*IM)/DE
1220 LET M(N+1) = -M(N)
1230 GOTO 1300
1240 STOP
1250 LET A(I,3) = A(I,3) + A(I,3)*RE - A(I,4)*IM
1260 LET A(I,4) = A(I,4) + A(I,3)*IM + A(I,4)*RE
1280 LET M(N+1) = -M(N)
1300 NEXT W
1310 LET RE = R0
1320 LET DE = RE*RE
1330 LET A(I,3) = A(I,3) + A(I,3)*RE/DE
1340 LET A(I,4) = A(I,4) + A(I,4)*RE/DE
1400 LET LO = A(I,3)*A(I,3) + A(I,4)*A(I,4) (insertion loss)
1410 LET R(1) = 10*(LN(LO/M*M))/LN 10 (dB)
1420 LET P(1) = A(I,3)/A(I,3) (tan beta)
1430 LET S = S+I
1440 IF S = M+I THEN GOTO 1500
1450 IF S = M THEN LET P = P + .001 (add frequency increment)
1460 LET A = M*PI*P (repeat computation)
1480 GOTO 740
1500 LET P = P + .001
1510 LET P = (ATN(D*(M) - P(1))/(1+P(1)^2))/PI*(.001)^2 1dB/dw
1520 LET R(N) = P
1530 PRINT "P="; P; " MZ "; R(1); " DB "; R(1); " US"
1540 LET R = R+I
1550 PRINT
1560 LET P = P+DP
1570 IF P > PM THEN GOTO 1590
1580 GOTO 730
1590 STOP
1600 LET DISS = 2100
1620 CLS
1630 DIM S(20) (group delay values)
1640 DIM R(15)
1650 DIM P(5)
1660 LET N = I
1670 PRINT "V?" (number of sections)
1680 INPUT V
1685 PRINT TAB 16: "M = "; M
1690 PRINT "P?" (resonant frequency)
1700 INPUT P
1710 LET P(N) = P
1720 PRINT "K?" (shape factor K)
1730 INPUT K
1740 LET R(N) = R
1745 CLS
1750 LET M = M + I
1760 IF M <= V THEN GOTO 1685
1770 FOR R = I TO 15
1780 LET R(N) = R(R) (group delay values into array R(R))
1790 NEXT R
1800 LET A = E
1810 LET P = P0
1820 LET M = I
1830 IF R(N) <= 0 THEN GOTO 1860 (if 2nd order section)
1840 LET T = P/P(N)
1850 LET S = PE*(N)*(1+T*T) (1st order section)
1860 LET R(N) = R(N) + I/S
1870 LET M = M + I
1875 IF M = V THEN GOTO 1840 (2nd order sections)
1880 LET T = P/P(N)
1890 LET D = (1 - T*T)*(1 - T*T)
1900 LET S = (1+T*T)*R(N)/(D*(M)*R(N)*T*T)
1910 LET R(N) = R(N) + S/S*(1+M)
1920 LET M = M + I
1930 IF M <= V THEN GOTO 1880
1940 LET R = R + I
1950 LET P = P+DP
1960 IF P > PM THEN GOTO 1980
1970 GOTO 1620
1980 PRINT "D(0) = "; R(1); " US"
1990 FOR R = I TO 15
2000 LET P = PD*(R-1)*DP
2010 PRINT P; " MZ "; R(1) - R(1); " DB" (delay differences)
2020 NEXT R
2030 STOP
2040 PRINT TAB 1: "R1 = "; R1; TAB 16: "R0 = "; R0 (subroutine CHECK)
2050 PRINT
2060 FOR I TO 10
2070 PRINT "N = "; N; " L = "; L; " C(N) = "; C(N); " U?"
2080 PRINT
2090 NEXT W
2100 FOR R = I TO 15
2110 LET P = PD*(R-1)*DP
2120 PRINT P; " MZ "; R(1) - R(1); " DB"
2130 PRINT
2140 NEXT R
2150 LET RE = 0
2160 LET IM = 0
2170 GOTO 1350
(CORRECTION)
90 should read LET I=I
2060 should read FOR N=I TO PM

```

cal methods. The best one can do is to replace it by the approximation $\Delta\beta/\Delta\omega$, where $\Delta\beta$ is the change in insertion phase shift resulting from a small increment in angular frequency $\Delta\omega = 2\pi\Delta f$, achieved by adding a small quantity to the current frequency value and computing $\beta + \Delta\beta$ (line 1450). The fact that this doubles the running time is unfortunate but inevitable, and it is a credit to the ZX81 that nevertheless the total execution time is still remarkably short.

The choice of the frequency increment poses a difficult problem. In principle one would like to make it extremely small, but too small a value would be self-defeating because the accuracy gained by approaching the theoretically infinitesimal $d\omega$ would certainly be outweighed by the arithmetical limitations of the ZX81. When two almost equal numbers are subtracted, rounding-off errors can result in a very large percentage error in the difference quality. On the other hand, too large an increment will give rise to inaccuracies where the rate of change of the group delay is high.

The compromise adopted was a frequency increment of 0.001, i.e. a 1kHz difference when frequencies are in MHz. It was checked by comparing the com-

puted group delay with the calculated values in some special cases where it is available in closed form. This suggested a likely accuracy of 1 or 2 nanoseconds, which would be acceptable. Nevertheless, such a compromise cannot be optimum for all cases, and simple modifications can be made to lines 1450, 1500 and 1510 to suit individual needs.

One possible source of inaccuracy could however be avoided. Truncation errors in the ATN algorithm might have a large effect on the value of $\Delta\beta$ if it were derived from expressions of the form $\arctan A - \arctan B$ where A and B differ only slightly. It was replaced by $\arctan(A-B) = \arctan(\tan A - \tan B)/(1 + \tan A \cdot \tan B)$, executed in line 1510.

Such difficulties do not arise with the group delay equalizer sections whose group delay is available as closed expressions. These are

first order

$$d\beta/d\omega = 1/\pi f_r(1+x^2)$$

second order

$$d\beta/d\omega = 1/\pi f_r K(1+x^2)/((1-x^2)^2 + K^2x^2)$$

where in each case $x = f/f_r$. These correspond to lines 1840 to 1860 and lines 1880 to 1900 respectively.

Furthermore, they are constant-resis-

tance all-pass networks, so that in principle it should be possible to connect them between the filter and a termination with no change in loss, only added group delay. For convenience the filter group delay is held in the array X(R) and transferred to the working array Z(R) each time the EQU subroutine is called by GOTO EQU. Each pass is therefore executed very quickly.

The performance of these equalizer sections deviates from the ideal for two reasons. Assuming the component values are correct and that strays are negligible, the alignment may not be correct and the components will not be dissipationless. In point of fact the strays are usually by no means negligible, but this is too extensive a topic to be entered into here.

However, the extra loss due to dissipation in the delay equalizer components can easily be calculated by a little known, but extremely useful theorem due to Mayer⁵. This states that provided the dissipation is reasonably small, say no greater than about 0.02, then the loss is

$$\Delta\alpha \approx 8.686D \cdot d\beta/d\omega \cdot \omega \text{ decibels.}$$

As in the loss program, D is the sum of the capacitive and inductive dissipations, assumed to be equal, but in practice this condition need not be obeyed at all rigidly.

Continued on page 79

DISC DRIVES

Winchester technology

Winchester drives are totally-sealed, high-density storage units, as opposed to floppy disc drives that provide low-cost data storage on a medium similar to ordinary magnetic tape. Electronic, electrical and mechanical aspects of these two quite different types of drive are discussed in two sections, starting with Winchester technology.

These offshoots of the conventional exchangeable-pack disc drive described in five preceding articles satisfy quite different requirements, as will be seen. First, Winchester technology is covered, followed by a description of floppy-disc drives in the next article.

Servo-surface disc drives, as dealt with in last month's article, permit a great reduction in disc-track spacing since the read/write head's position is determined by information on the disc's surface, rather than by an external reference. Winchester technology — initially developed near the Hampshire town of Winchester — is the next step forward.

Briefly recapping, there are two ways in which storage density may be increased

- by increasing the number of bits stored per unit length of track
- by increasing the number of tracks within a given radius.

It was shown in the second article (April) that an increase in writing density must be accompanied by a reduction in the head's flying height. But reducing the flying height magnifies the problem of providing a contaminant-free environment. A conventional disc is well protected while in its drive, but outside the drive, even when the disc is protected by a cartridge, the effects of contamination become intolerable.

In last month's article it was explained that the difficulty of aligning the heads increases as the tracks become closer together. There comes a time when it is not physically possible to make a mechanism which can provide the microscopic adjustments necessary, and compatibility between drives could not be achieved.

The essence of Winchester technology is that each disc pack has its own set of read/write and servo heads, with an integral positioner. The whole is protected by a dust-free enclosure, and the unit is referred to as a head/disc assembly, or h.d.a.

As the h.d.a. contains its own heads, compatibility problems do not exist, and no head alignment is necessary or provided for. It is thus possible to reduce track spacing to about one half that of exchangeable servo-surface drives. The totally enclosed assembly can ensure a clean environment for the heads and disc, permitting a reduction in flying height without loss of reliability, which leads in turn to an increase in the number of bits which can be

by J. R. Watkinson*

recorded per unit track length. If the rotational speed is maintained, this increase in density leads to an increase in the data transfer rate. Ways in which high transfer rates are accommodated will be covered in a subsequent article.

The h.d.a. is completely sealed except for a small port covered by a filter, which equalizes pressure changes due to temperature and/or air transport. Into this sealed volume of air the drive motor delivers the majority of its power, and the resulting heat is generally dissipated by fins on the h.d.a. casing, in conjunction with an external fan. The disc is designed to circulate the air inside the h.d.a., Fig 1. Some h.d.as have a temperature sensor to monitor this dissipation. An alternative, for where it is not intended that the h.d.a. be exchanged by the operator, is to use a conventional blower and absolute filter for cooling. An exhaust filter is also necessary to protect the h.d.a. when no power is applied, Fig 2.

An exchangeable-pack drive must retract the heads so that the disc can be removed. With an h.d.a., retraction is not necessary as the heads are integral. An area of the disc surface is reserved as a landing strip for the heads. The disc surface is lubricated, and the heads are designed to withstand landing and take-off without damage. When the term retraction is used in this context, it refers to the process of positioning the heads over the landing area.

Disc rotation must be started and braked as quickly as possible to minimize the time for which the heads are in sliding contact. A motor with good starting characteristics is required. On small units, an extra winding may be used for starting, whereas on large units a three-phase motor will be necessary, consuming perhaps 10A per phase during startup. Running current will, of course, be much less — of the order of 1A per phase. Eddy-current braking cannot be used, since in the event of a power failure, the unbraked discs would turn for an extended period with the heads in sliding contact, resulting in damage. A mechanical friction brake is commonly used, actuated by a spring. The brake is held off by a solenoid, which makes the system failsafe in the event of a power failure. Figure 3 shows motor-brake assembly.

An advantage of contact start/stop technology is that the provision of more than

one head per surface is easier in the absence of mechanisms for retraction and alignment. This leads to two gains, firstly that travel of the positioner is reduced in proportion to the number of heads per surface, reducing the average access time, and secondly that more data can be stored at a given detented position of the carriage, increasing efficiency on long transfers.

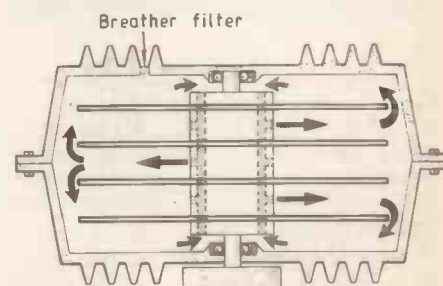

Fig. 1. The sealed-head disc-assembly has to dissipate the power of the spindle motor. The hollow disc stack in this design circulates the air and brings it into contact with the finned case, whose exterior is fan cooled. Note the vent which allows the internal pressure to equalise. The vent contains a filter to prevent dust ingress.

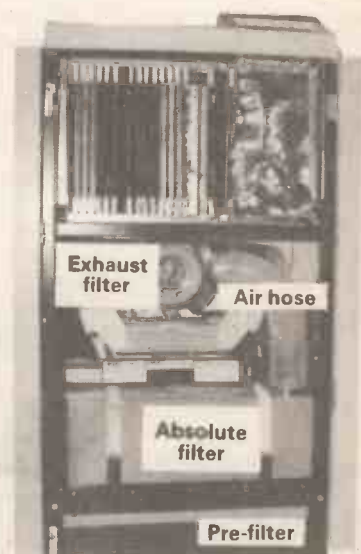

Fig 2. A contact start/stop drive utilising a full flow air cooling system. The exhaust filter protects the medium from dust ingress when no power is applied.

*B.Sc., M.Sc., Digital Equipment Co.

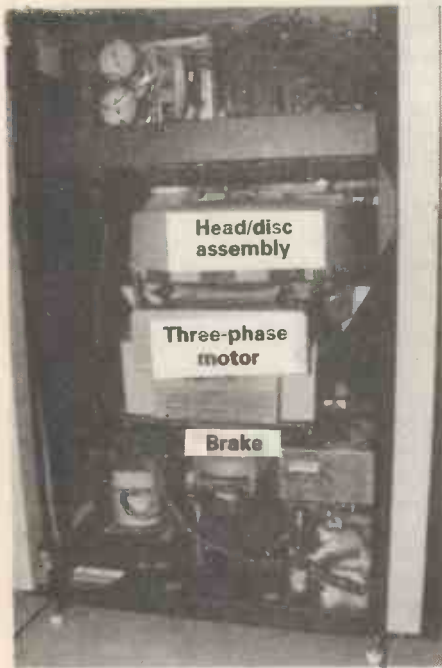

Fig. 3. Contact start/stop drives require mechanical brakes to prevent damage to the disc or heads in the event of a power failure. The h.d.a. of this unit has a capacity of 500 megabytes, and is turned by a three-phase motor which has on the lower end of the shaft a brake.

Figure 4 illustrates the relationship between various areas of servo and read/write surfaces.

Positioning velocity and rotation sensing. In preceding articles, several types of transducer used to monitor the velocity of the positioner and the rotation of the disc have been described. Whatever the principle of operation, these devices all share the drawback that they require both mechanical adjustment and electrical cali-

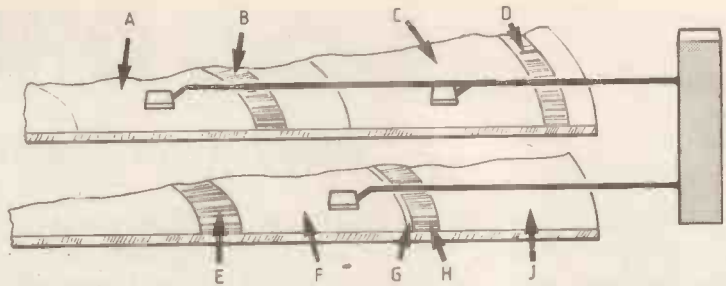

Fig. 4. When more than one head is used per surface, the positioner still only requires one servo head. This is often arranged to be equidistant from the read/write heads for thermal stability.

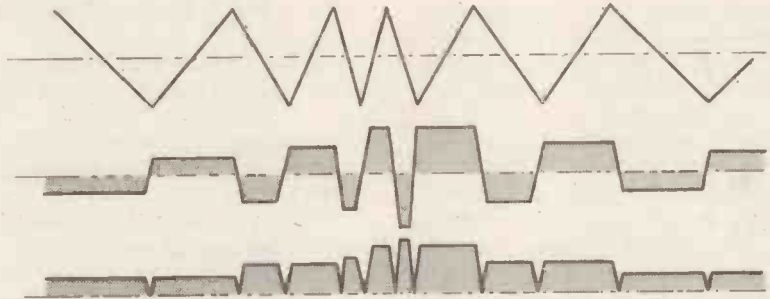

Fig. 5. To generate a velocity signal, the position error from the servo head is differentiated and rectified.

bration, with consequent demands upon the skill and training of those who maintain them. With contact start/stop technology, the servo head is always over the disc surface, and can be used for positioner-velocity and disc rotation sensing.

Figure 5 shows the position-error signal generated by servo circuitry during a seek, which rises and falls as the servo head crosses servo information, and that the position-error signal's slope is proportional to the positioner velocity. The position error signal is differentiated and rectified, the resulting signal representing the magnitude of the positioner velocity. The process of differentiation exaggerates any

h.f. noise present, and a low-pass filter is placed before the input to the differentiator to combat this. At high seek velocities, however, the filter would attenuate the position-error signal, and is therefore switched out when the velocity exceeds a certain threshold; since the differentiated signal is large at this time, the absence of the filter is of no consequence.

Owing to the sign change of the differentiated signal, the output waveform contains troughs where the position-error slope falls to zero at the peaks. These troughs prevent direct use of the signal by the velocity-feedback loop during a seek, as they would be interpreted by the servo amplifier as momentary, large-velocity errors, causing saturation of the output. The troughs cannot be filtered out, since this would introduce an extra pole into the open-loop response of the servo, causing instability.

In April's article covering read/write heads, it was shown that the area under a graph of electromagnetic actuator (e.m.a.) current against time represents the energy put into the positioner. As the mass of the positioner is almost constant, the velocity of the positioner is proportional to the integral of the e.m.a. current, neglecting losses due to friction and air resistance. Despite errors resulting from these effects, integrated e.m.a. current is sufficient to carry over the velocity signal when the troughs in the differentiated position error occur. Figure 6 shows that the e.m.a.-current integrator has a finite output impedance, whereas the differentiator has low output impedance in series with an analogue switch. When the position-error signal exceeds a reference voltage, the switch is opened and the trough is blocked. Now, the integrator signal is used. When the position error falls below the reference, the switch is enabled, and

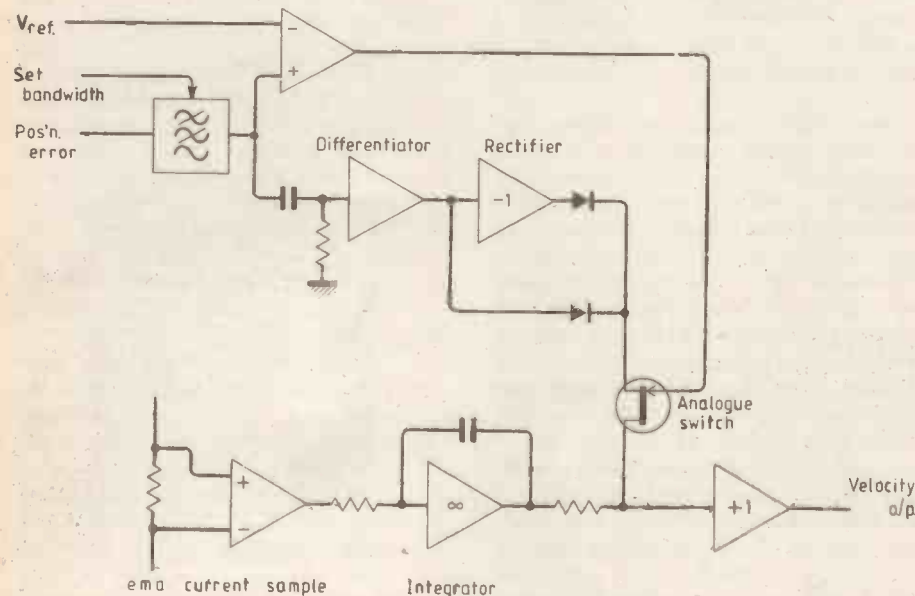

Fig. 6. The intermittent nature of the differentiated position error is eliminated from the output by the use of the integrated e.m.a. current signal which is less accurate, but continuous. At high seek velocities, the bandwidth of the input filter must be raised. The control signal for this purpose can be derived from the cylinder difference.

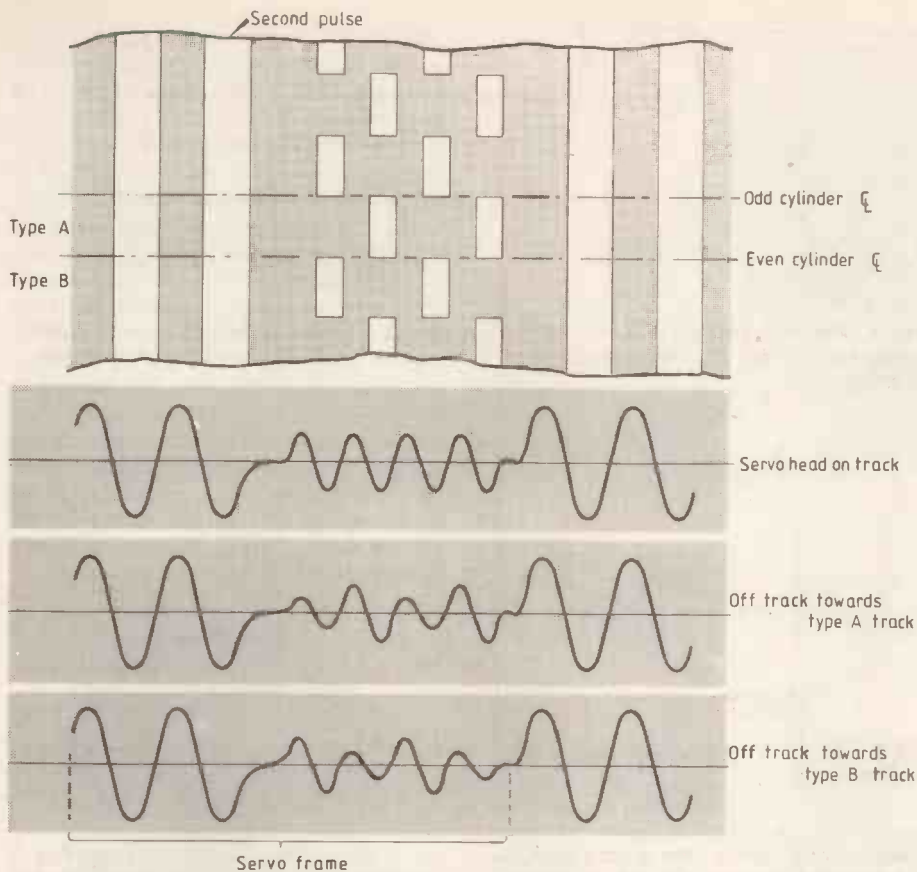

Fig. 7. This type of servo surface pattern has a second pulse which may be omitted to act as a data bit. This is used to detect the guard bands and index.

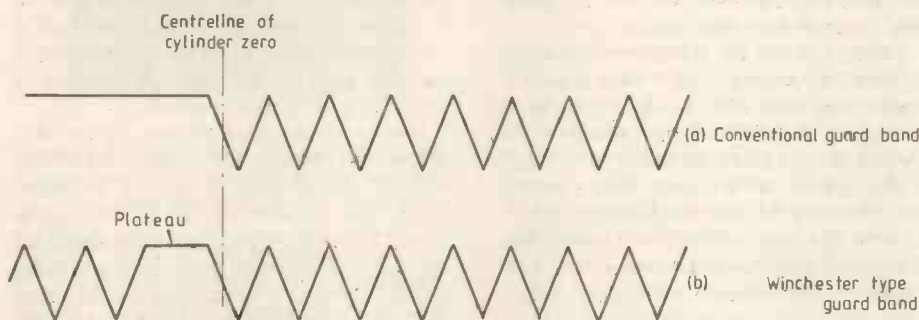

Fig. 8. The plateau in the position error known as the reference gap which is used to locate cylinder zero.

the differentiated position-error signal overrides the integrated e.m.a.-current signal by virtue of its low output impedance. Any difference between the two signals appears across the integrator's output impedance.

Having obtained velocity information from the servo surface, it is necessary to ensure that velocity feedback is available over the entire positioner travel. In the last article, it was shown that conventional servo-surface guard bands result in steady-maximum position-error signals at the extremities of the data area. Clearly this approach cannot be used when velocity feedback is derived from the servo surface, as there is no slope to differentiate in the guard band. With contact start/stop, the head landing area is defined by a guard band, and the servo must be capable of operating there and identifying its position.

A modification of the usual servo surface is used, shown in Fig. 7, where there are extra transitions, identical in both type A

and type B servo tracks, along with the familiar dibits. The repeating set of transitions is known as a frame, in which the first dibit is used for synchronization, and a phase-locked oscillator is made to run at a multiple of the sync. signal rate. The p.l.o. is used as a reference for the write clocks, to open windows to extract a position error from the composite waveform and to provide a window for the frame's second dibit, which may or may not be present. Each servo frame thus contains one data bit, and successive frames are read to build up a bit pattern in a shift register. The parallel output of the shift register is examined by a decoder which recognises a number of unique patterns. In the guard bands, the decoder will repeatedly recognise the guard-band code as the disc revolves. An index* is generated in the same way, by recognizing a different pattern. In a contact start/stop drive, the repetition rate of index pulses is used to monitor safe rotational speed, eliminating a further transducer. It must, however, be

possible to detect index anywhere in the travel of the positioner, if speed errors are to be avoided. For this reason, index is still found in the guard bands, simply by replacing the guard-band identification pattern with the index pattern once per revolution.

An exchangeable-pack servo-surface drive locates cylinder zero using the steady position-error generated in the guard bands. In a contact start/stop drive, this form of guard band has been abandoned because of conflict with the requirements of velocity feedback, so the cylinder-zero position has to be established by different means.

A common solution uses a unique area of the servo surface known as the reference gap.

In the reference gap, which is adjacent to cylinder zero, there is a servo track which is three times the width of all others. In the reference gap and in several servo tracks outside it, is a third data pattern which is decoded by the index/guard-band circuits to indicate that the reference gap is close. Figure 8 shows position error in the cylinder zero area, which is generated as the servo head crosses that part of the disc. Note that there is a plateau in the position-error waveform. During the head load, which in the context of contact start/stop refers to the process of positioning the heads at cylinder zero, the heads move inward at fixed speed away from the head-landing area. When the reference code is detected, positioner velocity is reduced to typically 2in/s, and the position error is sampled repeatedly. When successive samples of position error are the same, the plateau due to the reference gap has been found, and if the servo is put into track following mode, the positioner will detent at cylinder zero.

Rotary positioners. Figure 9 shows the geometry of a rotary positioner with two heads per surface. As the positioner moves, the spacing between tracks will be different from one head to the other, and there will be a certain amount of skew between the flux gap in the head and a true radius of the disc. The tolerances involved in the manufacture of the cantilever are such that no two would generate the same pattern on the disc surface with both heads. None of these effects is of consequence with contact start/stop drives, since data is always read by the heads that wrote it; they are however reasons why exchangeable-pack drives are not found with rotary positioner, as compatibility would be impossible.

Having established that rotary positioners have no fundamental drawbacks for contact start/stop drives, advantages can be detailed. Firstly size — the rotary positioner can be tucked into a corner of the h.d.a. where it can easily be cooled by air thrown out by the disc. Secondly cost — a rotary positioner requires only two ballraces on the shaft, compared to six or more on a linear positioner, and a precision

*The term index refers to a once-per-revolution signal used to locate sector positions on the disc and was fully described in the July issue of WW.

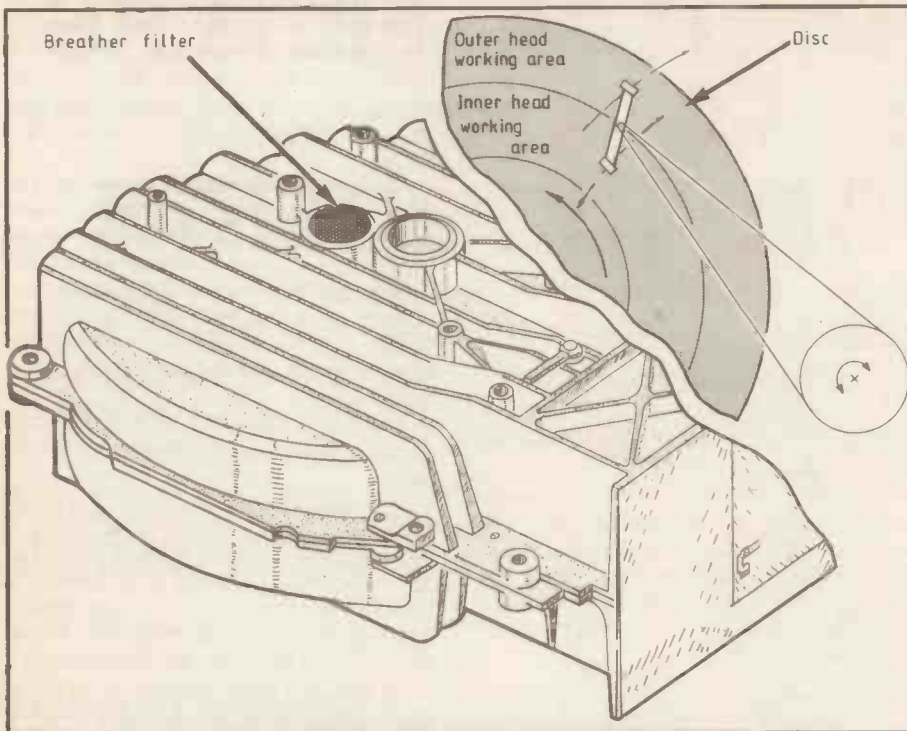

Fig. 9. A Mini-Winchester disc drive having a capacity of nearly 10 megabytes shown with a rotary positioner having two heads per surface. The tolerances involved in the spacing between the heads and the axis of rotation means that each arm records data in a unique position. That data can only be read back by the same heads, which rules out the use of a rotary positioner in exchangeable pack drives. In a head disc assembly the problem of compatibility does not arise.

carriageway is unnecessary. Figure 10 shows an h.d.a. with a rotary positioner, which functions in the same way as a moving-coil ammeter. Other aspects of the associated circuits are almost identical to those required by a linear positioner, with the exception that rotary positioners suffer from windage due to the spinning disc having a component which tries to turn the positioner inwards. In linear positioners, windage is almost at right angles to the positioner axis, and can be neglected. Windage is overcome in rotary positioners by feeding the current cylinder address to a r.o.m. which sends a word to a d-to-a

converter for inserting an offset voltage into the track-following circuit.

As has been stated, it is possible to make a Winchester-type disc drive with an operator exchangeable h.d.a. The h.d.a. is ejected by a motorized mechanism, and a system of levers disengages the drive belt from the stack pulley and removes electrical connections. The machinery involved adds to the unit cost, and to avoid this, many drives have fixed h.d.as, only replaceable by an engineer. Head/disc assemblies, like all human artefacts, can fail, but unlike a conventional disc pack, which can often be put in another drive, a failure can

take place in electronic circuitry inside the h.d.a., which means that the data is essentially lost. This places added emphasis on the necessity to back up data stored on disc. Back-up is however made more difficult by a fixed h.d.a. and it is necessary to use high-speed magnetic tapes or conventional disc drives to perform the necessary copying. One useful technique is known as 'journaling', where a permanently mounted magnetic tape records all of the changes made to the disc since it was last backed up. In the case of a failure, the tape and the backup disc can be merged to create an up to date working disc. Contact start/stop technology offers extremely low cost per bit, rapid access and high transfer rate with the inherent reliability of the sealed medium. It is these desirable features which override the above problems in many cases.



Fig. 10. A head disc assembly with a rotary positioner. The adoption of this technique allows a very compact structure.

Last month's article showed that the introduction of the servo surface permitted a great reduction in the cylinder spacing, but that each read/write head was assumed to be at the same temperature as the servo head. At extremely small cylinder spacings, small differences in head temperature become significant, and it is necessary to combine the principle of the servo surface with that of the embedded servo. In this approach, the servo head generates velocity feedback and coarse positioning information for the carriage, but when in the vicinity of the desired track, the selected head adjusts itself perfectly to the embedded servo information on each surface. This permits several thousand tracks to be accommodated on one surface.

At the small end of the capacity scale, the mechanical simplicity of contact start/stop yields a low cost product. The nature of the market rules out advanced positioners such as have been described, on grounds of cost. Current 'Mini-Winchester' have simple open-loop stepping positioners, in conjunction with moderate track spacing. Despite this, the price-to-performance ratio of these drives is still impressive. Figure 9 shows a typical Mini-Winchester disc drive with a capacity of almost 10 megabytes. The disc diameter is about five inches.

Previous articles in this series.

Introduction, the drive's role in a computer system, March 1982.

Read/write head assemblies, April 1982.

Read/write head positioning systems, May 1982.

Motors, mountings, bearings and cooling/filtration, July 1982.
 Servo-surface and embedded-servo disc drives, August 1982.
 Subsequent articles planned cover floppy-disc drives, disc control logic and data integrity.

SIMPLE DIGITAL FILTERS FOR SOUND REPRODUCTION

Filters for disc recording equalization, tone control, channel dividing and notch filtering, as well as graphic equalization can be obtained by combining first-order digital filters

Many methods of designing digital filters have been proposed, but most from the point of computer-based filtering for speech-signal processing. In audio, digital techniques have entered the field of recording and p.c.m. recorders are being developed, and it is expected that digital processing such as filtering will be incorporated. For this purpose, digital filters using second-order digital filters as the basic building block have been described by McNally¹, but the realization requires a large table for storing filter coefficients and a large filter word length, i.e. more than 30 bits for the arithmetic operation of digitized audio input signals to avoid errors occasioned by overflow and coefficient truncation. What is needed is a digital filter of least filter word length and the minimum number of coefficients to obtain the desired spectrum shaping of input signals².

Basic filter

The design of digital filters is simplified by the z transfer function which can be realized using adders, coefficient multipliers and delay elements. The z transform operator, which corresponds to a unit delay in the discrete time sequence, is related to a frequency f by

$$z^{-1} = e^{-j2\pi f/F}$$

where $j = \sqrt{-1}$ and F is the sampling frequency. As usual, suppose in the following discussion that the frequency response of the digital filter is considered in the region $f < F/2$ and that the frequency of an input signal is limited to half the sampling frequency.

Figure 1 (a) shows the structure of a basic digital filter for low-frequency shelving, which consists of a non-recursive filter with a coefficient A and a first-order recursive filter which comprises a coefficient B. The transfer function is

$$\frac{1 - Az^{-1}}{1 - Bz^{-1}}$$

in which the numerator corresponds to the non-recursive filter and the denominator to the recursive filter.

The processing required to implement the basic digital filter is two adders, two multipliers and one unit delay element. But to avoid overflow, the digital filter structure shown in Fig. 1 is preferable, with impulse and frequency response of the filter shown in (b) and (c). The maximum slope of the frequency response is +6 dB/octave when B = 1 and the minimum slope is -6 dB/octave when A = 1.

by Yoshimutsu Hirata

Figure 2(a) shows the structure of another basic digital filter for high-frequency shelving. This consists of a non-recursive filter which comprises a coefficient G, a first-order recursive filter which comprises a coefficient H, and two multipliers which multiply the input signal by (1 - H) and 1/(1 - G). The transfer function is

$$\frac{1 - H}{1 - G} \cdot \frac{1 - Gz^{-1}}{1 - Hz^{-1}}$$

Impulse and frequency responses of the filter are shown in (b) and (c). The maximum level is given by H = 0 and the

minimum by G = 0, provided that a turnover frequency f_2 is kept constant.

Tone controller

A tone controller can be obtained by the serial combination of the first and second basic digital filter shown in Figs 1 & 2. The transfer function of the tone controller is

$$D(z) = \frac{1 - Az^{-1}}{1 - Bz^{-1}} \cdot \frac{1 - Gz^{-1}}{1 - Hz^{-1}} \cdot \frac{1 - H}{1 - G} \quad (1)$$

with the low-frequency shelving characteristic defined by two coefficients A and B, and the high-frequency shelving by two coefficients G and H. For example, when the sampling frequency is 44kHz and the turnover frequency f_1 is chosen as 500Hz,

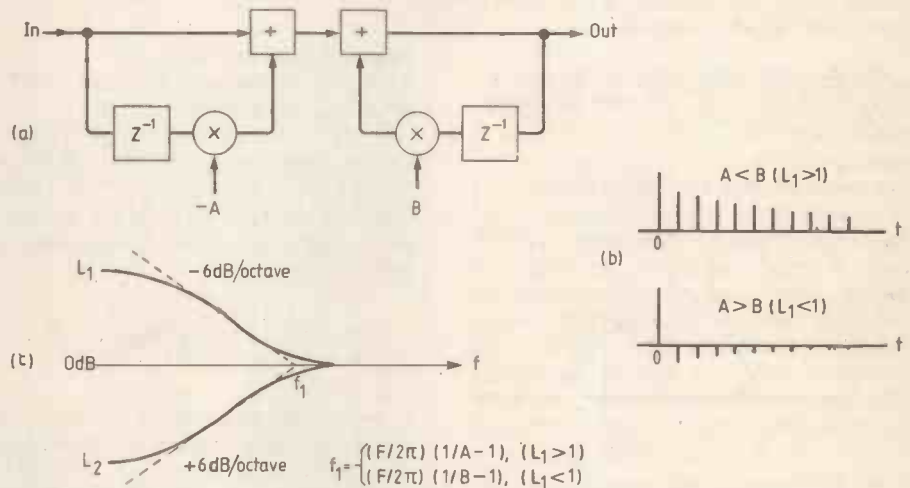

Fig. 1. Basic digital filter for low-frequency shelving comprises two adders, two multipliers and two unit delay elements (a), impulse response (b), and amplitude response (c).

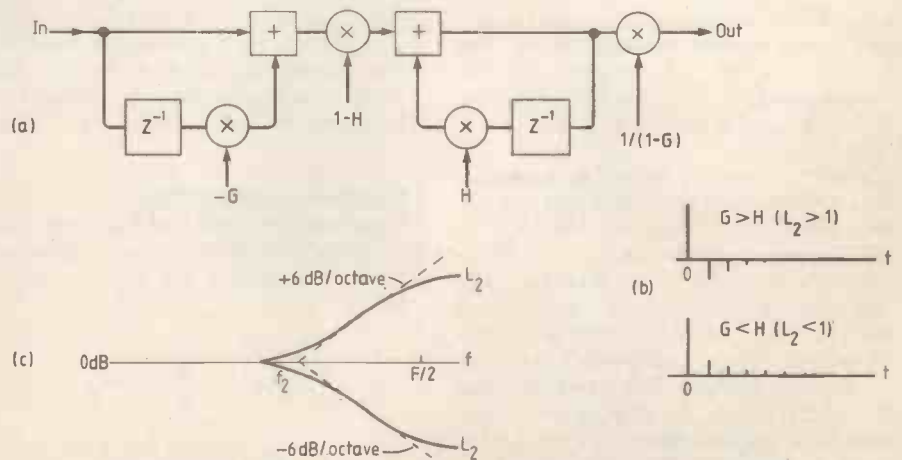

Fig. 2. Basic digital filter for high-frequency shelving comprises two adders, four multipliers and two unit delay elements (a), impulse response (b), and amplitude response (c).

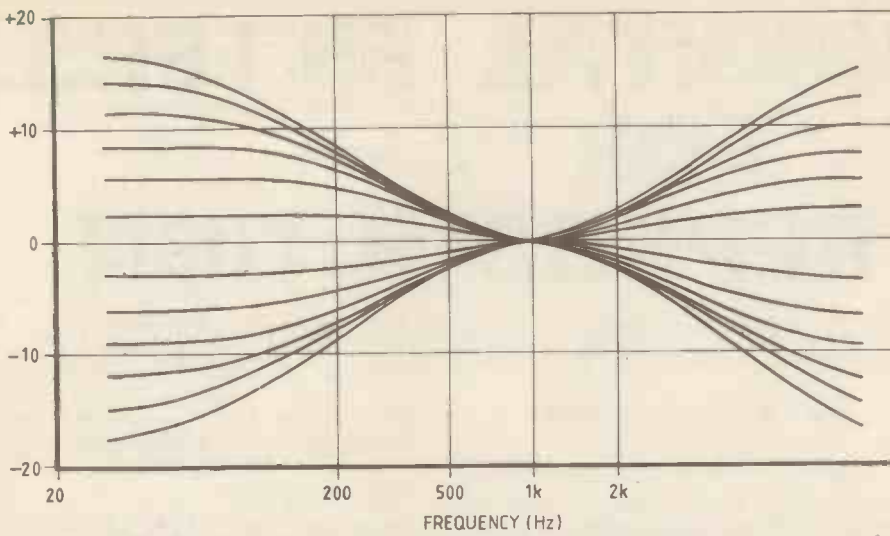

Fig. 3. Family of measured curves obtained by tone controller implemented as hardware.

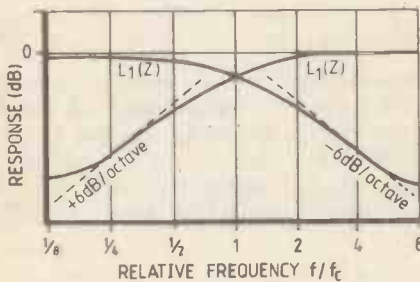

Fig. 4. Amplitude response of complementary low and high-pass filters expressed by equations 1.

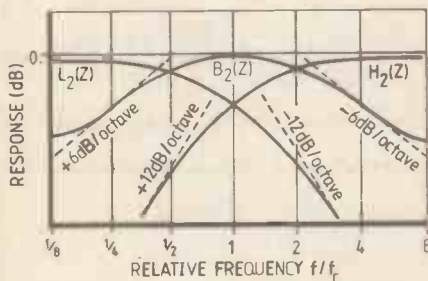

Fig. 5. Frequency response of complementary low, band and high-pass filters expressed by equations 3.

a low-frequency boost is obtained by putting $A=0.93$ and selecting B so that $L_1=0.07/(1-B)>1$. Similarly, a low-frequency attenuation is obtained by putting $B=0.93$ and selecting A so that $L_1=(1-A)/0.07<1$.

Figure 3 shows a family of measured curves obtained by the digital tone controller. When $f_1 \approx 500\text{Hz}$, $f_2 \approx 2\text{kHz}$, $F = 44\text{kHz}$, and $-18\text{dB} < L_1, L_2 < +18\text{dB}$, the addition of four bits (experimentally three bits) in the arithmetic operation of the tone controller can prevent overflow. In practice, selecting the level steps L_1 and L_2 and the turnover frequencies suitable for binary values, the additional ten bits, four for headroom and six for the coefficient word-length (filter word-length is given by ten bits plus the input signal bits), will be sufficient to avoid overflow and coefficient truncation.

The digital tone controller discussed above is well suited for a digital audio system based on microprogramming where minimum instruction steps and a maximum dynamic range for a given word length are required. The filter of equation 1 has been accomplished by hardware controlled by the microprogram of six instructions using about $1 \mu\text{s}^3$.

Record equalization

The recording characteristic is specified by three time constants $T_1 = 3180$, $T_2 = 318$ and $T_3 = 75 \mu\text{s}$ which correspond to turnover frequencies 50.05, 500.5 and 2122Hz. For example, when $F = 44\text{kHz}$, applying 88kHz as the sampling frequency of the high-frequency shelving process, the RIAA coefficients are

$$\begin{aligned} A &= FT_1/(1 + FT_1) = 0.993 \\ B &= FT_2/(1 + FT_2) = 0.933 \\ G &= 2FT_3/(1 + 2FT_3) = 0.868 \\ H &= 0. \end{aligned}$$

In practice the quantization error of coefficients will cause certain deviations from the ideal curve. For $F = 44.056\text{kHz}$ (88.112kHz for the high-frequency shelving), we have $A = 0.9921875$ (binary 0.1111111), $B = 0.9296875$ (0.1110111), $G = 0.875$ (0.111) and $H = 0$. In this case, the deviation from the ideal curve is within $\pm 0.5\text{dB}$ and the additional ten bits (three bits for headroom and seven bits for coefficient word-length) are sufficient to avoid both overflow and coefficient truncation.

Channel dividing filter

Complementary low and high-pass filters in a parallel combination have a linear response in amplitude and phase, expressed by

$$\begin{aligned} L_1(z) &= \frac{1-B}{2-B} \cdot \frac{1}{1-Bz^{-1}} \\ H_1(z) &= \frac{1}{2-B} \cdot \frac{1-Az^{-1}}{1-Bz^{-1}} \end{aligned} \quad (2)$$

$$(1 > A > B > 0 \text{ and } A = 2B - B^2)$$

respectively. $L_1(z)$ and $H_1(z)$ satisfy the identity

$$L_1(z) + H_1(z) = 1.$$

Figure 4 shows the frequency response of $L_1(z)$ and $H_1(z)$, whose crossover is

$$f_c \approx (F/2\mu)(1-B).$$

These complementary digital filters can be used for a digital two-way limiter analogous to the conventional analogue two-way limiter. Incidentally, a digital limiter can be realized by either a variable coefficient multiplier, where a digital input signal is multiplied by a coefficient whose magnitude varies with an appropriate time constant according to the amplitude of an input signal, or an s-type non-linearity which can be realized by a simple arithmetic operation of the input signal⁴.

Squaring the identity $L_1(z) + H_1(z) = 1$, we have complementary low, band and high-pass filters

$$\begin{aligned} L_2(z) &= L_1^2(z) \\ B_2(z) &= 2L_1(z)H_1(z) \\ H_2(z) &= H_1^2(z) \end{aligned} \quad (3)$$

respectively. They satisfy the identity

$$L_2(z) + B_2(z) + H_2(z) = 1.$$

Figure 5 shows the amplitude response of these three filters, while the phase response of $L_1(z)$, $H_1(z)$, ... and $H_2(z)$ is shown in Fig. 6.

Notch filter

The z transfer function of the simplest notch filter is

$$N(z) = 1 - \frac{N(1-z^{-1})}{(1-Bz^{-1})^2}, \quad N = 2(1-B)$$

which is realized by the digital structure shown in Fig. 7. If $B \approx 1$, the response of this equation is approximately

$$N(f) = 1 - \frac{1}{1 + (j/2)(f_d/f - f/f_d)} \quad (4)$$

$$\text{where } f_d = (F/2\pi)(1/B - 1)$$

Graphic equalizer

The z transfer function of the simplest filter which can control a mid-band level is expressed by

$$M(z) = 1 + \frac{K(1-B)(1-Az^{-1})}{(1-Bz^{-1})^2}, \quad (5)$$

$$(1 > A > B > 0)$$

where K is a variable coefficient. If $A = 1$, a peak-level occurs at

$$f_p \approx (F/2\pi)(1/\sqrt{B} - \sqrt{B}), \quad (K > 0)$$

and a dip-level occurs at the frequency f_p of equation 4 when $0 > K > -4$. The dip-

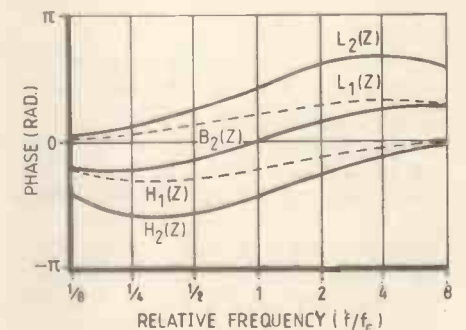

Fig. 6. Phase response of $L_1(z)$, $H_1(z)$, ... and $H_2(z)$.

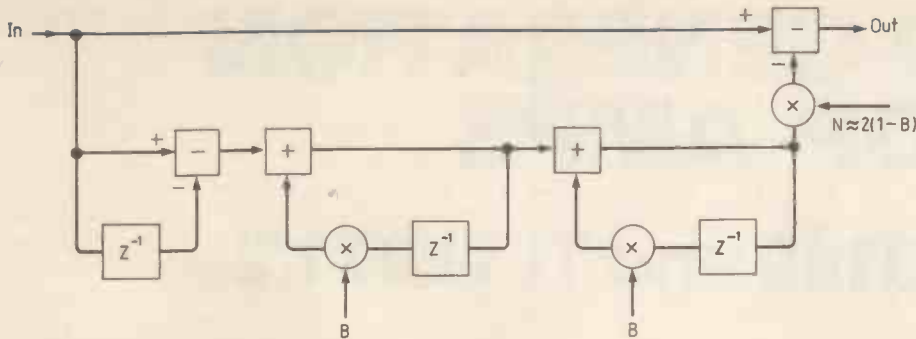

Fig. 7. Digital filter structure of $N(z)$.

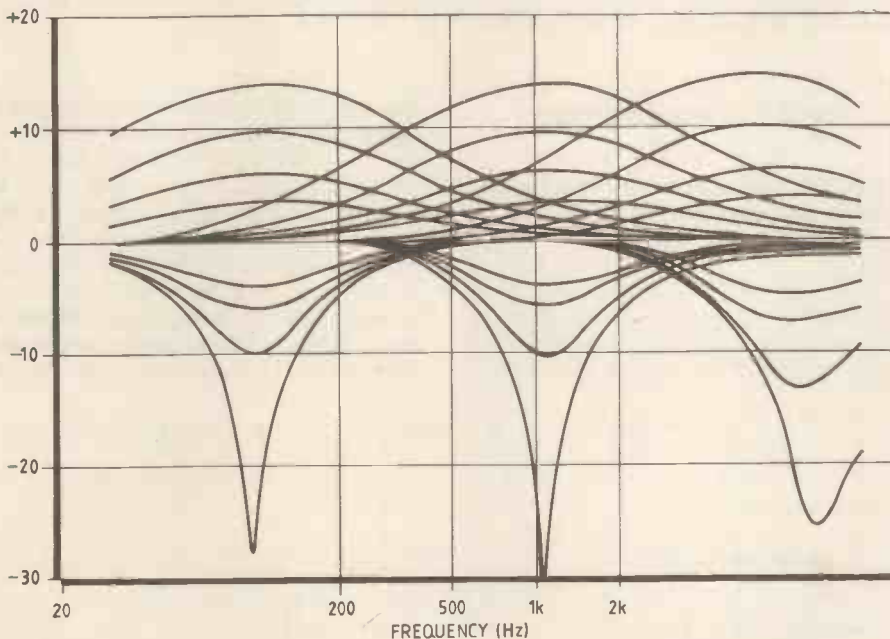

Fig. 8. Measured curves obtained by the simple graphic equalizer whose transfer function is given by equation 5.

level becomes minimum at $K \approx -2$ (notch filter). When $B \approx 1$ and ≈ -4 , the amplitude of $M(z)$ is approximately equal to 1 (all-pass filter). Adjusting $A = 2B/(1 + B^2)$, gives $f_p = f_d = (F/2\mu) \cos^{-1}(A + 1/A - B/2 - 1/2B)$.

The mid-band level is controlled by the single variable coefficient K .

A family of measured curves of equation 5 obtained by a hardware filter is shown in Fig. 8, where $F = 44.056\text{kHz}$ and $A = 1$. The difference between f_p and f_d at $f_d = 10\text{kHz}$ is theoretically given by 3.58kHz . If the maximum level is limited to 15dB , for example, the additional two bits (theoretically and experimentally) can prevent overflow.

The z transfer function capable of control for a narrow-band level using a single variable coefficient can be obtained also by the combination of first-order digital filters. This allows implementation of the filter as hardware with a relatively small word-length, i.e. the additional bits are less than eight. WW

References

1. McNally, G. Computer-based mixing and filtering system for digital sound signals, BBC RD 1979/4.
2. Hirata, Y. Digitalization of conventional analogue filters for recording use, *J. Audio Eng. Soc.*, vol. 29, no. 5, 1981, p. 333-7. Ishida, S., Nagatani, S., Hirata, Y. & Itow, T. Digital filter for tone control and spectrum shaping, Acoust. Soc. Japan Convention Report, May 1981, p. 577-8.
3. Sekiguchi, K., Ishizaka, K., Matsudaira, T. K. & Nakajima, H. New approach to high-speed digital signal processing based on microprogramming, *Audio Eng. Soc.*, 70th Convention Report, 1841(A-1), 1981.
4. Hirata, Y. Digital limiter, IECE Japan, Technical Report EA79-67, Dec. 1979.

EVENTS

September 6-12

SBAC Show - 25th air show and exhibition, society of British Aerospace Companies Ltd, 29 Kings Street, St Janes, London SW1Y 6RD.

September 8-10

Auditorium Acoustics and Electro Acoustics Conference at the David Hume Tower, Edinburgh University. Details from Institute of Acoustics, 25 Chambers Street, Edinburgh EH1 1HV.

September 13-17

12th European Micro Wave Conference in Helsinki. Details from LPL, Convex House, 43 Dudley Road, Tunbridge Wells, Kent TN1 1LE.

September 14

Power Control Seminar. A one-day event on Motorola solid-state power control. Cavendish Conference Centre. Details from Motorola Ltd, York House, Wembley, Middlesex HA9 0PL.

September 21-23

International Conference on Electromagnetic Compatibility. IERE Conference at University of Surrey, Guildford, on radio interference problems. Details from Conference Department, IERE, 99 Gower Street, London WC1E 6AZ.

September 28

7th Sound Broadcasting Show. Albany Hotel, Birmingham. Details from Audio and Design Recording, North Street, Reading, Berkshire RG1 4DA.

September 19-24

Human Aspects of Computer Systems. Course on Ergonomics and Computers Systems in commercial organizations, at Loughborough University. Details from Rachel Shattock on Loughborough (0509) 212041.

October 5-6-7

Electronic Displays '82. Conference and exhibition on displays at Kensington Exhibition Centre, London. Details from Network Exhibitions Ltd, Printers Mews, Market Hill, Buckingham MK18 1JX.

October 6

Radio and TV interference. IEEIE. At Royal Star Hotel, High Street, Maidstone, at 7.30pm. Details from IEEIE, 2 Savoy Hill, London WC2R 0BS.

October 7

Auto Electronics. IEEIE meeting at Conference Centre, Friargate Hill, Preston, at 6.30pm. Details from IEEIE, 2 Savoy Hill, London WC2R 0BS.

Publication delays

Production problems have meant the late publication of *Wireless World* in July and August. We apologise for the delays and expect to be on time in September with the October issue.

Continued from page 72

The theorem is useful not only quantitatively, but also qualitatively. For example it predicts that a second-order delay corrector should have a loss maximum in the neighbourhood of its resonant frequency, which is true.

The corresponding subroutine is called up by GOTO DISS, which in the listing starts at line 2100. WW

References

- 3 J. K. Skwirzynski, Design theory and data for electrical filters. Van Nostrand, 1965.
- 4 J. W. Head, Mathematical techniques in electronics and engineering analysis. Iliffe, 1964.
- 5 H. F. Mayer, Über die Dämpfung von Siebketten im Durchlässigkeitsbereich. *E.N.T.*, vol. 10, no. 2, pp. 335-8.

THIRD-GENERATION OP-AMPS

RCA CA3140 and TI TL071/2

John Linsley continues his series of articles on i.c. design with a look at the operational amplifiers which succeeded the versatile 741. The TL072 is the type used in the modular preamplifier, to be described in the next three issues.

by J. L. Linsley Hood

I made the comment in the first article of this series, last October, that I felt the advent of the 741 integrated-circuit operational amplifier was the turning point in the conversion of many linear circuit engineers to the use of i.c.s. However, useful though the 741 and other similar contemporary i.c. op-amps were, they were relatively slow and their input impedance was low enough to make it necessary to consider the likely effects of the flow of the input bias current in the input circuitry.

CA3140

It is understandable, therefore, that the advent of the RCA 'mosfet-input' op-amp, the CA3140, with an input impedance of more than $10^{12}\Omega$ and a slew-rate of some $9V/\mu s$ in comparison with that of the $0.5V/\mu s$ typical of the 741 in the mid-1970s, should have been greeted with great enthusiasm by the industrial electronic-engineering fraternity, for whom a lot of rather awkward jobs now became very much easier to accomplish. Examination of the circuit, drawn in simplified form in Fig. 1, shows a very great similarity in general structure to that of the 741, except that the complementary-pair output stage emitter followers have been replaced by a single emitter-follower Darlington pair ($Tr_{17,18}$) with an active emitter load built up from $Tr_{15,16}$ and Tr_{21} .

The input stage is conventional, consisting of an input long-tailed pair of p-channel mosfets driving a current mirror ($Tr_{11,12}$) and a single class-A amplifier (Tr_{13}) with a constant-current source as its collector load. High-frequency compensation is again conventional in form, with a collector-base capacitor (C_c) connected across Tr_{13} to impose a dominant-lag type reduction in h.f. gain.

The major advantage of this circuit arrangement stems from the replacement of the relatively poor 'lateral' p-n-p transistors which would have to be used in a conventional, bipolar only type of i.c., with p.m.o.s. devices, which have an exceedingly high input impedance and very good h.f. characteristics. Unfortunately, in this circuit, there is an inevitable load mismatch so that, in spite of the current-mirror load, the gain of this input stage is only about $10\times$. Also, the need to protect the input gates from inadvertent breakdown due to electrostatic charges

forces the use of internal Zener diodes, whose leakage currents effectively limit the input impedance to some 1.5×10^{12} ohms at $25^\circ C$.

In order, therefore, to get the gain up to the 100,000 mark expected from his type of device, some ingenuity has been applied to the design of the second class-A gain

stage and the output circuitry, shown in full in Fig. 2. In this, the most obvious feature, apart from the four p.m.o.s. devices ($Tr_{8,9,10,21}$), is the most elaborate biasing circuitry, with its ladder of current-mirrors built up from D_1 , Tr_1 , Tr_6 and Tr_7 , all fed from Tr_8 , whose geometry is organized to make it act as a current source. This ladder of current-mirrors is used to control the cascade-connected current sources (Tr_2 and Tr_5) in the 'tail' of

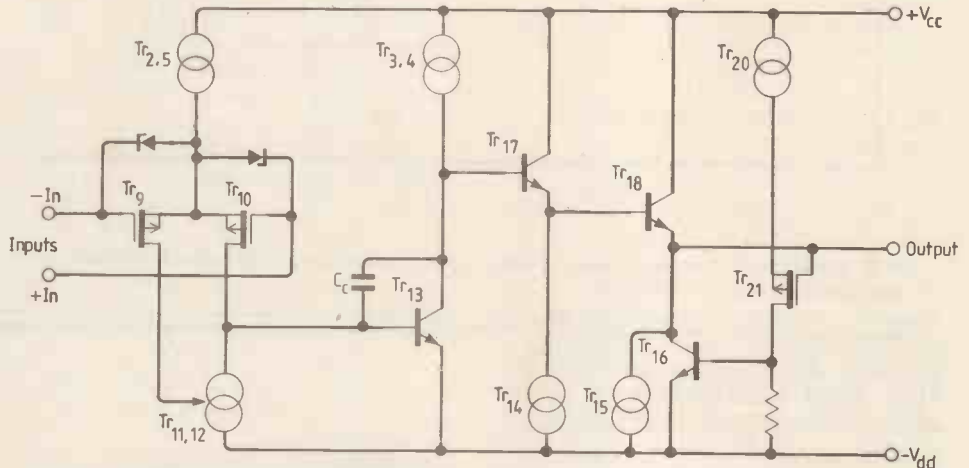

Fig. 1. Simplified CA3140 circuit, showing general similarity to 741 structure.

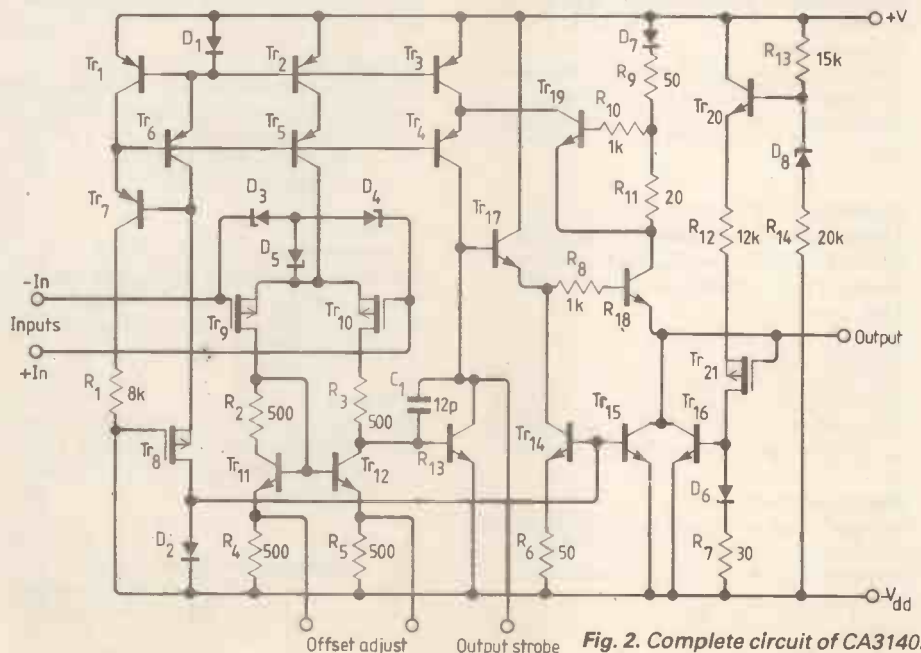

Fig. 2. Complete circuit of CA3140.

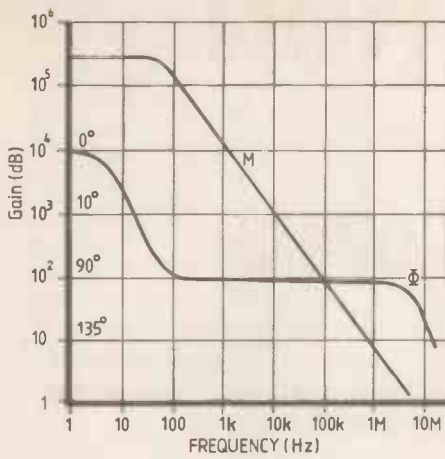

Fig. 3. Gain/frequency plot for CA3140.

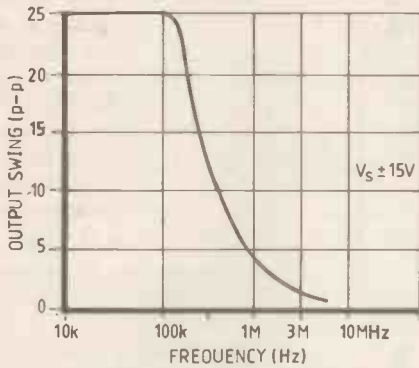

Fig. 4. Output swing plotted against frequency for CA3140.

the input long-tailed pair (Tr_9 and Tr_{10}) and in the load circuit (Tr_3 and Tr_4) of the class-A amplifier transistor (Tr_{13}). This second pair of cascade-connected current sources is used as an ingenious output overload protection device, in that if the current through the output transistor (Tr_{18}) exceeds some 30mA at 25°C (or less at higher temperatures), Tr_{19} will be turned on, and will steal the current from the driver stage.

The maximum current available from the lower half of the output stage ($Tr_{16,15}$) is already limited by the current fed into the two output current-mirrors ($Tr_{15}+D_2$, $Tr_{16}+D_6$ and R_7) from Tr_8 and R_{12} , which is itself fed from a semi-fixed voltage source arranged around the zener diode D_8 and Tr_{20} .

All in all, it is a rather elaborate circuit arrangement, which has always been somewhat expensive to produce and has demanded a relatively large chip size. Nevertheless, the performance of the i.c. is very satisfactory, and it has retained its place in instrumentation use, where its good high-frequency performance, its high input impedance, and its ability to operate over the supply voltage range $\pm 2V - \pm 18V$ has made it a useful circuit component. Characteristic gain/frequency and output swing/frequency graphs are shown in Figs. 3 and 4.

TL071

From the point of view of the audio circuit engineer, the remaining requirements which remained to be satisfied in the field

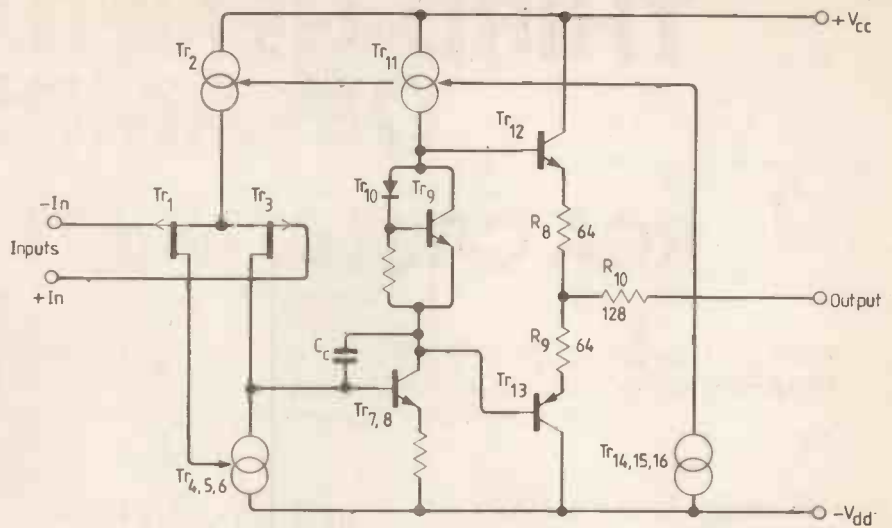

Fig. 5. TL071 in simplified form, showing return to complementary-pair output and apparently rudimentary short-circuit protection.

of i.c. operational amplifiers were guaranteed low noise and low distortion parameters. These residual requirements were amply met in mid-1977 when Texas Instruments introduced their TL0** series of 'BiFET' devices, based on a combination of bipolar and junction fet technologies, which were now capable of fabrication on the same chip.

Of these, for reasons of personal interests, the one which was most immediately attractive was the TL071, 072, 074 series of single, dual and quad op-amps which are characterized for use in audio circuitry, with a noise specification of $18nV/\sqrt{Hz}$ and a total harmonic distortion, just below clipping, of typically less than 0.01%. In addition, the typical input impedance was still of the order of 10^{12} ohms, and the unity-gain slew rate was typically $13V/\mu s$. The use of junction fet input devices has also allowed a somewhat simpler circuit configuration, shown in its basic form in Fig. 5.

Once again, the circuit architecture is of

familiar form, with an input long-tailed pair of p-channel junction fets driving a current mirror to add the signal components of both halves, a single class A amplifier stage (actually a Darlington-pair connected stage), and a complementary pair of n-p-n and p-n-p output transistors biased into class AB1 operation. The only curious feature to the professional op-amp watcher is the apparently complete absence of any formal positive-excursion output short-circuit protection, other than the use of an output resistor, R_{10} , and the adoption of relatively high-value emitter resistors for the output emitter-follower pair. However, the makers claim that such an output short-circuit can be sustained indefinitely.

I have shown the full circuit of the TL071 in Fig. 6, in which there are a few further details not apparent from the simplified diagram. It will be seen that the input circuit load is formed from a more highly developed form of current-mirror $Tr_{4,5,6}$ and $R_{1,3,4}$) than the simple, two-

Fig. 6. Full circuit diagram of TL071

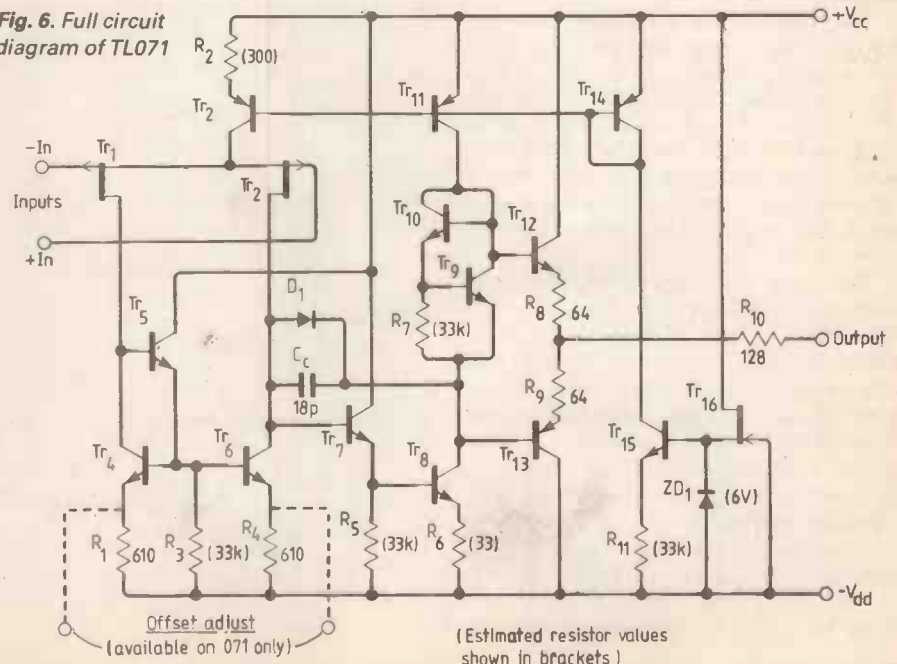

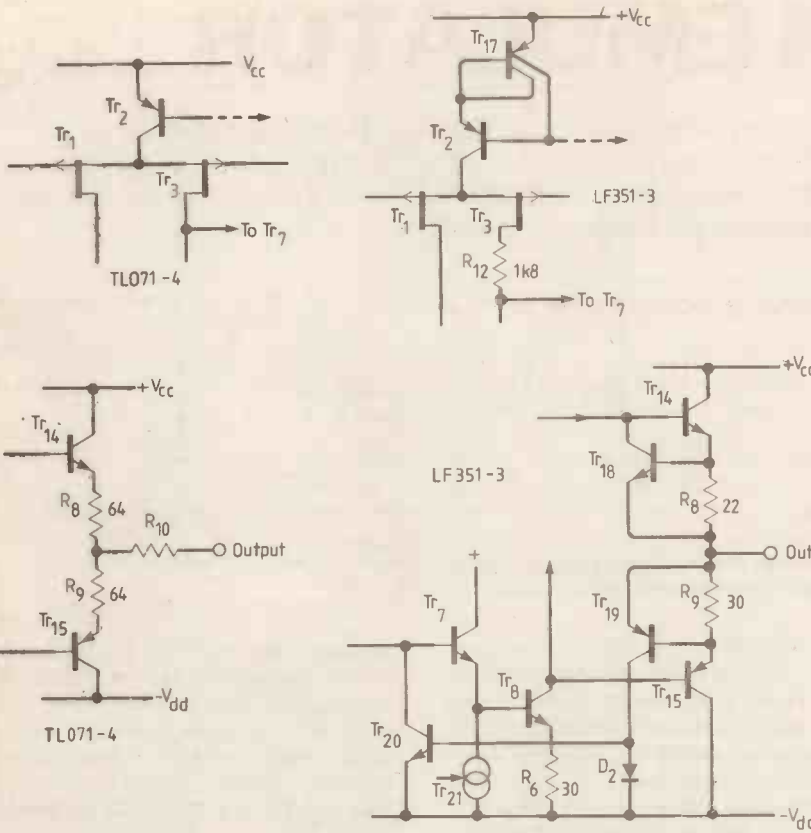

Fig. 7. Comparison between TL071 and LF351 from National Semiconductor, showing variations in input stage and overload protection.

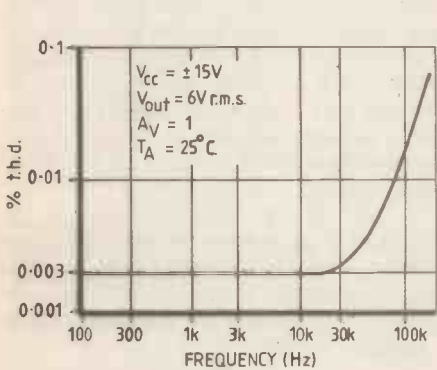

Fig. 10. Harmonic distortion plotted against frequency.

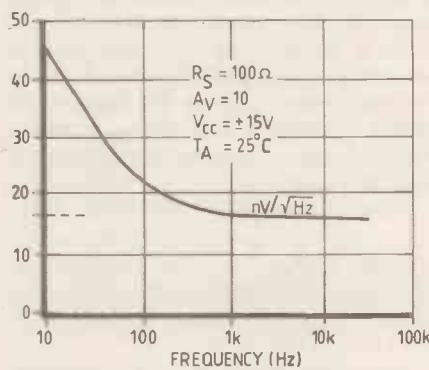

Fig. 11. Equivalent input noise voltage.

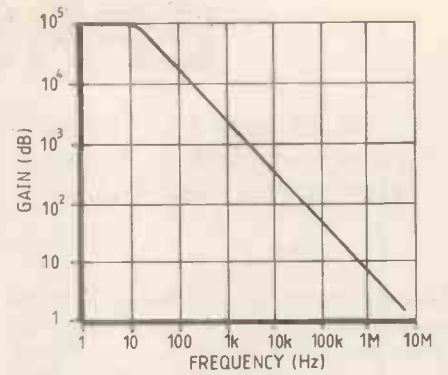
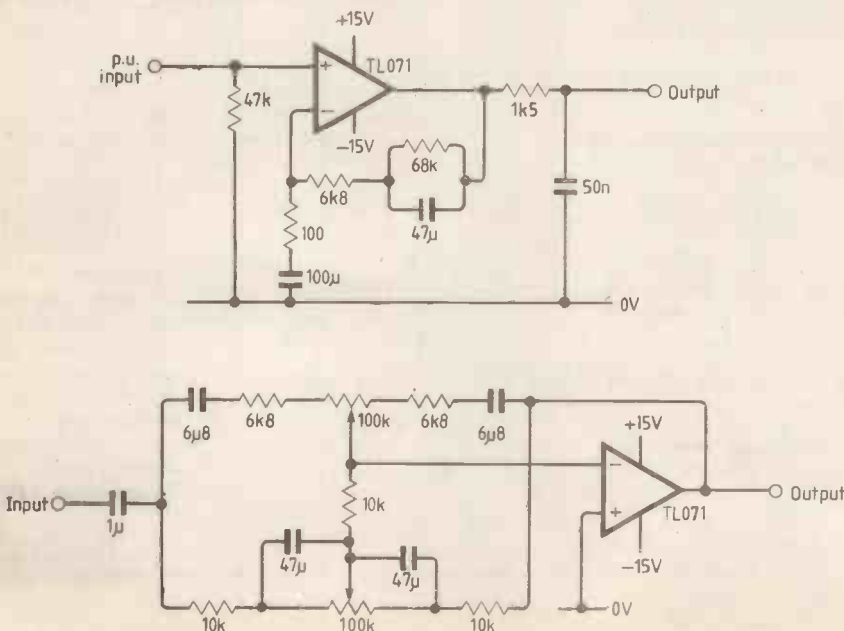

Fig. 8. Open-loop gain and phase characteristics of TL071-4.

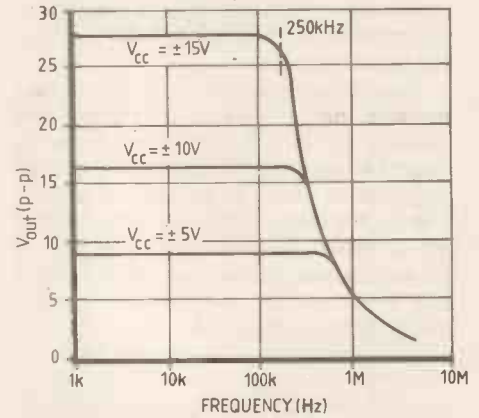

Fig. 9. Output voltage swing as function of supply voltage and frequency in TL071.

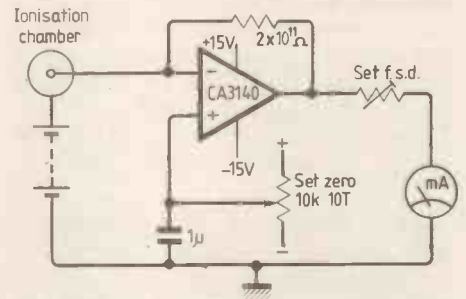

Fig. 12. Typical application of CA3140 is as ionization chamber amplifier at high impedance.

transistor circuit employed in the 3140, and a catch-diode is connected across the compensation capacitor (D_1) to bypass the amplifier stages Tr_7 and Tr_8 if Tr_{13} is driven into saturation. This assists in output overload protection, and also speeds up recovery from any swing which drives the circuit into negative line clipping.

Transistors $Tr_{2,11,14}$ form a current-mirror group fed from the constant current source $Tr_{16,15}, R_{11}$, with transistors 2 and 11 acting as the input 'tail' and the class 'A' stage load, respectively. The transistor pair Tr_{10} and Tr_9 , are merely a passive biasing network for the output emitter followers, in which Tr_{10} acts simply as a forward-biased diode. Because of the relatively large proportion of the total (1.5-2mA) quiescent current consumption

Continued on page 87

◀ Fig. 13. Low noise and low distortion of TL071 make it very useful in small-signal audio circuitry.

EPROM EMULATOR

A 2K-byte 2516/2716 emulator to aid software development. Designed for use in a secondary school, the unit is simple yet provides eight control functions, including two for storing and recalling data on cassette. A directly compatible eprom programmer is to be described in a subsequent article.

by Peter Nicholls, M.A.

Microprocessor system design requires some facility for transferring software from paper to semiconductor memory. Often, an eprom programmer is used, but it is extremely useful to be able to evolve and test a piece of software without having to repeatedly erase and reprogram an eprom — a process required even if only one byte needs altering.

An emulator provides the facility to load software into ram using a keyboard and display, and then to use that software to control an external microprocessor system. Any byte in ram may be changed at will, making for easy testing and correction of the software and breakpoint insertion. A 24-way jumper and 'header' plug connects the emulator to the external system through its eprom socket.

This article describes an emulator for 2516/2716 eproms, designed for use in secondary schools with cheapness and simplicity in mind. At the same time a range of useful facilities are provided making the emulator suitable for the 'serious' system designer. Manual input to the emulator is through eight control keys and a hexadecimal keypad. A description of the control key functions should help one understand how the circuit operates, Table 1.

The eighth control key is spare and may be used to add another function, such as a

print command, which might allow the emulator ram's contents to be recorded on a printer. At present, the unmodified monitor program, to be shown, causes a jump to the start when the eighth key is pressed, resulting in a display of 'a', 000, XX.

To make the unit easier to use, the following features have been added to supplement the single-character prompts for constantly monitoring the emulator's operating mode.

- If ↑ is pressed at addresses 7FF or 000, resulting in an attempt by the system to go to an illegal address, an error message is displayed for one second, after which the monitor jumps to the start.

- When recording of the memory contents on tape is finished, the display 'sent' is given until the 'a' key is pressed.

- The cassette-recorder interface used is not RS232, but a software interface called Transwift. With this, a check-byte is included at the end of each transmission and checked when the data is read back. If the received parity is correct, the display will show 'read', and if incorrect, will give an error message. This display is held until the 'a' key is pressed.

- When eprom programming is com-



plete, the display shows 'burnt'.

If the software to be programmed does not fill an eprom, further data bytes sent by the emulator must be FF if remaining eprom locations are to be left free. Without software this is a tedious business but it was felt that a separate function key for filling superfluous locations would lead to students losing their software by accidentally pressing the wrong key.

So, to overcome this, the software is designed so that if the 'e' key is pressed within one second of a first depression, the prompt will show 'f' and all ram displayed from the address when 'e' was pressed will be filled with FF.

Table 1. Control-key functions and prompts

Control key	Prompt	Function
A	a	Address entry. When display shows this character, an address may be entered on the keypad. This address is displayed together with ram contents at the address.
D	d	Data entry. This function allows data to be entered at the displayed address.
↑		Increment address. With this function, the system remains in data-entry mode.
↓		Decrement address. Here, again the system remains in data-entry mode.
T	T	Transmit to tape. On display of this character, ram contents are transmitted to cassette recorder through a 'software interface'.
R	R	Receive from tape. Reads data recorded using previous function.
E	E	Eprom program. This function programs a 2716 with the emulator contents using a small external board.



Fig. 1. A typical display. The 8086 processor has only 12 address lines, hence the hexadecimal address display consists of only three digits.

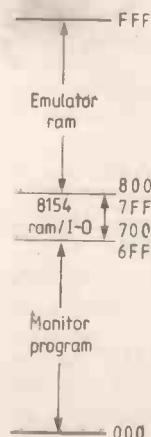

Fig. 2. The emulator's memory map in load mode. Additional logic is used to rearrange the memory map so that an external system addresses the emulator between 000 and 7FF.

Table 2. The 24-way jumper lead that plugs into the external system's eprom socket should be connected to the emulator board by a transition socket to provide strain relief. A 26-way socket was used with the following pin assignments.

Point on board	Pin number	Pin name (2716)
1	24	+5V
2	1	A7
3	23	A8
4	2	A6
5	22	A9
6	3	A5
7	21	Vpp (+5V)
8	4	A4
9	20	(DE to CS on emulator)
10	5	A3
11	19	A10
12	6	A2
13	18	CE (0V)
14	7	A1
15	17	D7
16	8	A0
17	16	D6
18	9	D0
19	15	D5
20	10	D1
21	14	D4
22	11	D2
23	13	D3
24	12	GND
25 not used		
26 not used		

The reset button functions in the usual way and can be useful when, for example, a badly corrupted data transfer from tape occurs, the error message will not be displayed until 16K-bits of data of some sort have been received. A Schmitt trigger inverter is used to provide a clean pulse for 8060's reset input.

Operation of the load/emulate switch should be self explanatory.

Use of the emulator

Normally, the emulator is operated as follows.

- With the header plug disconnected from the external system and the load/emulate switch in the load position, the required software is loaded into the emulator.

- After loading, the system is switched to emulate mode.

- Now the header is connected to the external microprocessor system, which may need resetting so that it fetches from the emulator's first location.

Care must be taken with power supplies. For example, if the system connected to the emulator has to be powered by the emulator, it is not advisable to use the 24-way connecting cable for this purpose. Generally, if the external circuit has its own supply, it may be connected to the emulator's supply, provided that both are regulated and nominally 5V.

If the system under development has a microprocessor that will relinquish its buses in response to a control command, this facility may be used so that the two systems may remain connected together while the emulator is in load mode. An appropriate control command could be de-

rived from the load/emulate switch and connected through a separate lead to the microprocessor of the system under development.

Circuit description

As stated, the prime considerations for a piece of school equipment are complexity and cost, so an attempt was made to eliminate the need for buffers on the buses. This influenced the choice of processor for the emulator; the 6502, for example cannot be switched to a high-impedance state on all its buses. The INS-8060 can, and also has the following features that make it suitable for this application.

- no external clock is required
- the device may be rendered static for 50ms in the eprom-programming cycle
- control lines are available that simplify implementation of the emulator's 't, r, e' and 'p' functions:

Referring to the main circuit diagram, Fig. 4, the processor is linked to an 8154 parallel-interface adapter - which provides 128 bytes of 'scratch-pad' ram and two sets of 8-bit input/output lines for display and keypad control - to a 2716 eprom containing the monitor program, and to a 2K by 8-bit cmos ram. This static ram, the HM6116, is more compact than the slightly cheaper equivalent of four 4114s, simplifying p.c.b. design, and it consumes only 20µA in standby mode. A p.c.b.-mounting nickel-cadmium battery will power the 6116 in standby mode for some 200 days. This makes the emulator more reliable and allows one to develop a piece of software over extended periods with minimal use of the cassette-storage facility.

When the main-power supply is used, Tr₁ conducts, allowing the ram's chip-select input to be controlled by the NAND gate. When the main supply is removed, R₁₃ holds the input high without excessive battery drain. Provided that the board is used on average for about a half an hour each day, the back-up batteries will be sufficiently trickle charged through R₁₂.

Figure 2 shows the memory map, which is implemented by most of the low-power Schottky gates. When the ram is addressed by the outside world through the header, data appears in memory between addresses 000 and 7FF. Since the processor only has

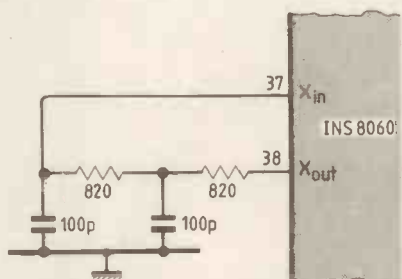

Fig. 3. To keep costs to a minimum, the crystal section controlling the 8060's clock may be replaced by an RC circuit as shown.



Peter Nicholls studied natural sciences at Trinity College, Cambridge in the middle of a "thick sandwich" apprenticeship with AEI Telecommunications. In 1967, after a brief period engaged in quality control on a production line for early electronic telephone exchanges, he left to set up an electronics department at Oundle School in Northants. Then, in 1973, Peter moved to Belper High School to establish electronics at all levels in the new school's curriculum, subsequently becoming head of the sixth form. Recently, he left to work for the Microelectronics Education Programme in the East Midlands.

12 address lines, which is adequate addressing capability for this application, a fourth hexadecimal digit is not found in either the display or the memory map.

A further small economy may be made when the crystal used for the 8060 clock is replaced by an RC circuit as shown in Fig. 3. The only section of the emulator likely to be affected by the small reduction in timing accuracy caused by this modification is the cassette interface.

Switch S₁ on the main circuit diagram, the load/emulate switch, applies either or logic 1 or a logic 0 to the processor's NE-NIN input. At this input a logic 1 disables the processor, setting all the address and data lines and control lines NRDS and NWDS to their high-impedance state. In this condition, the external system may control the emulator buses without impediment. The signal at NENIN is also used to rearrange the memory map so that the 6116 appears at the bottom of the map as far as the external system is concerned.

Tape interface Data is sent to the tape by the processor as a series of 16K bits preceded by a header and ended by a parity-check byte. The value of each bit is conveyed as the time interval between two successive changes in magnitude of the output signal. When reading, the signal from the tape is squared using two Schmitt trigger inverters, and the data is then recovered by software.

Transwift, the name given to this interface by its designer, Barry Savage, requires very few components, yet it is relative-

vely insensitive to changes in tape speed and output level and is fast, taking about nine seconds to load the emulator's 2K ram contents.

Keyboard/display. Functioning of the display and keyboard is straightforward, as the second circuit diagram shows. A 7445 decodes three bits of port B and provides sufficient current to drive the multiplexed-display cathodes. Seven bits of port A control the display anodes through a dar-

lington driver i.c., IC₃. This technique is slightly wasteful of current, but it is a practical solution as p-n-p - driver i.c.s are difficult to obtain.

The keypad is connected to port B in such a way that no software decoding is necessary. Lines B₃ to B₀ carry the hexadecimal value of the key pressed. Depression of a control key results in a low transition on B₇, which is easily detected by the software using a jump if positive command.

Diodes one to seven may be replaced by wire links if the emulator is to be kept basic, but they were included in my design to allow printer heads to be driven by IC₃.

Construction and testing

Wire wrapping was used for the prototype, resulting in a compact unit, and later, a single-sided board was made measuring 233 by 220mm. A 26-way transition connector was used to join the 24-way rib-

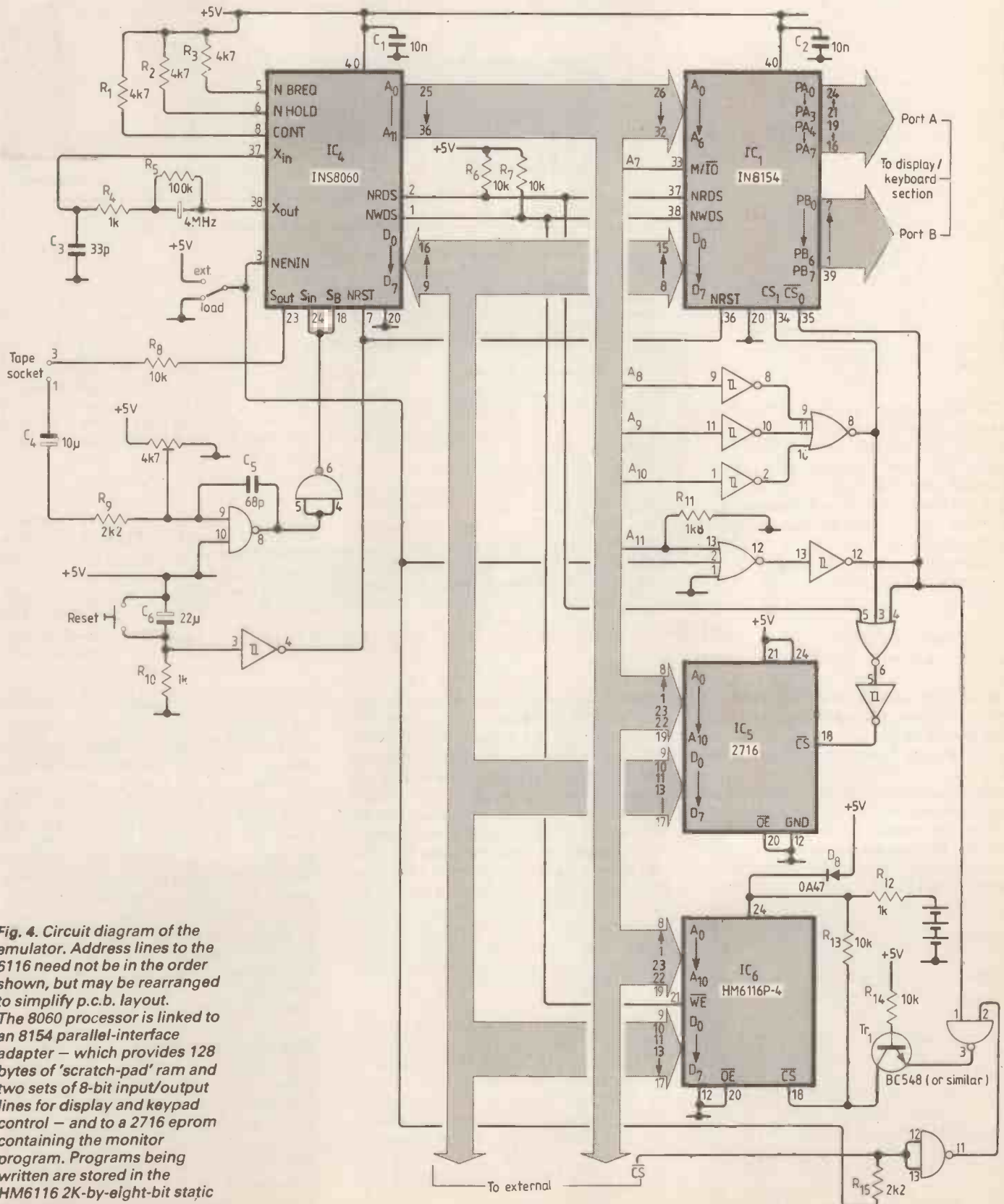
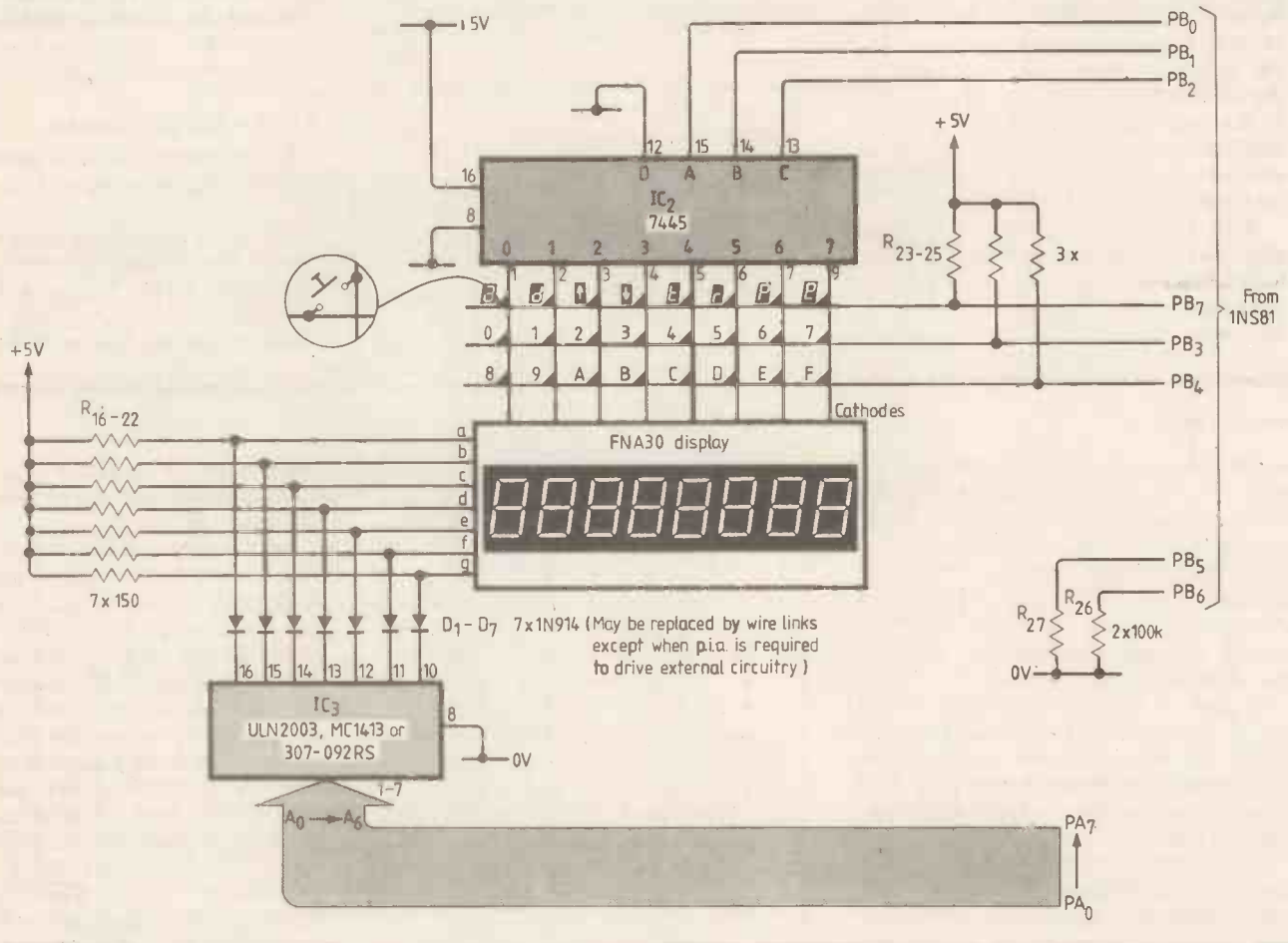

Fig. 4. Circuit diagram of the emulator. Address lines to the 6116 need not be in the order shown, but may be rearranged to simplify p.c.b. layout. The 8060 processor is linked to an 8154 parallel-interface adapter - which provides 128 bytes of 'scratch-pad' ram and two sets of 8-bit input/output lines for display and keypad control - and to a 2716 eeprom containing the monitor program. Programs being written are stored in the HM6116 2K-by-eight-bit static cmos ram.

Fig. 5. Diagram of display/keyboard section. Port B and the keyboard are connected such that no software decoding is necessary and the hexadecimal value appears on lines B3 to B0. A logic 0 on B7 indicates to the software that a control key is pressed.



bon cable to the board. This method is preferred since the transition connector provides strain relief.

When construction is complete, the load/emulate switch should be set to the load position and the power applied. If the display is blank, pressing reset should result in a display of 'a', 000, XX. If this does not happen, a fault must be assumed as there are no adjustment points on the board. Should a close visual inspection fail to reveal the fault, checking the circuit from i.c. pin to i.c. pin with an analogue multimeter which uses a 1.5V battery for its resistance range will usually locate the fault, without risking the semiconductors.

Operation of the address and data entry and address increment and decrement functions may easily be checked by referring to the previous description of functions. Next, connect a cassette recorder to the interface, set the displayed address to 000 and press the 'e' key twice (if an eprom programmer board is to be used with the emulator it should not be connected for this test). This should fill the whole of the ram with FF and after a few seconds, the display will show 'burnt'. Now, when 'a' is

pressed, the usual display will be restored.

Set up the cassette recorder for recording, then press 't'. When the display shows 'ent' the recording is complete, and should consist of a steady tone of about 1.3kHz for a few seconds after a short leader. This recording can be used to set up the tape interface using an oscilloscope. First, connect the oscilloscope to pin 18 of the 8060 and start replaying the tape. Play back the recorded data and adjust the 4.7kΩ variable resistor on the main circuit diagram to give a 1:1 mark-to-space ratio. After pressing the 'r' function key, a further replay of the recorded data should result in the acceptance message 'recd' being displayed.

Should 'error' appear, or the display continue to show the 'r' prompt, it should first be checked that the whole message has been sent and received, and that part of it has not been lost on the cassette's leader. Minor adjustments to the cassette recorder volume control and to the setting of the variable resistor may be made to ensure that the signal at pin 18 of the 8060 is 5V peak-to-peak.

Without an oscilloscope, the voltage at

pin 18 of the 8060 may be set to 2.5V using an analogue meter, provided that the cassette recorder input is grounded and that one is certain that noise is not falsifying the reading.

As a final test of the cassette interface, switch off the emulator-power supply and touch pin 24 of IC₆ to ground. This will fill the 6116 with random data which can then be recorded on tape and played back again, the display confirming accurate reception and transmission.

Single-sided printed-circuit boards (233 by 220mm) and monitor eproms for the emulator, at £8 and £5 respectively, will be available from PKG Electronics, Oak Lodge, Tansley, Derbyshire.

Acknowledgements

The Transwift interface, designed by Barry Savage and incorporated in Softy I and Softy II, is used by kind permission and is the subject of a patent. Acknowledgements also go to the Microelectronics Education Program, without whose financial support this project would not have been possible, and to Denys Gaskell for his patience and skill.



the vertical signal from the Y amplifier and triggers the sawtooth oscillator if the switch on pin 2 of the 4070 is in the 'Trig' position (closed). In the 'Free Run' position, the sawtooth oscillator runs continuously.

Two exclusive-Or gates form the clipper circuit, the 2.2 MΩ feedback resistor across the two gates preventing the trigger waveform having multiple edges due to noise on the vertical signal. The polarity of the trigger waveform may be inverted by the following ex-Or gate when the switch is in the negative position. The first of the two Nand gates in the feedback path of the sawtooth oscillator is used to inhibit the oscillator when Q of the 4013 is logic 0.

With the circuit waiting for a trigger edge, and the switch in the 'Trig' position, logic levels are:

- 4011 pin 8 - logic 1
- 4011 pin 9 - logic 0

- 4011 pin 1 and 2 - logic 1
- 4011 pin 12 and 13 - logic 1
- 4070 pin 3 - logic 1
- 4013 pin 4 - logic 0 (reset is off)
- 4013 pin 8 - logic 0 (set if off)

When a positive-going trigger edge clocks pin 11 of the 4013, the Q output pin goes to logic 0, the 4011 pin 3 goes to logic 1 and resets the 4013, Q pin 2 to a logic 1; this allows the sawtooth oscillator to run. Further trigger waveform edges cannot now inhibit the oscillator until it has reset and the positive-going edge following flyback clocks the 4013 at pin 3. The circuit is then ready to accept a further trigger pulse.

Note that when the sawtooth generator is waiting for a trigger edge, the CA3130, pin 6, is at +12 V (the fet is therefore off) and the 4011 pin 4 is logic 0, so that the current transistor is off. The timing capacitor therefore floats from a starting voltage of +4 V and, depending on the

leakage, would gradually drift over a period of tens of seconds. However, this drift has no effect when the circuit is operating normally.

Flyback suppression

This is a.c. coupled to simplify the coupling to the tube grid, which is at about -200V. The pulse amplitude is about 35V negative-going at the collector of the 2N2369. A.c. coupling results in a spot at the left-hand side of the trace when the circuit is waiting to trigger.

Calibration oscillator

The squarewave oscillator generates an accurate 1 kHz squarewave at 1 volt p-p.

Cathode-ray tubes for this design can be obtained from: Colomor (Electronics) Ltd, 170 Goldhawk Road, London W12; Langrex Supplies Ltd, Climax House, Fallsbrook Road, Streatham, London SW16 6ED.

which is routed through the last class 'A' stage (Tr₈-Tr₁₁), a very high slewing rate (13V/μs) is attained in spite of the relatively large value of C_c. An offset nulling adjustment, for the output d.c. level, is provided on the TL071 only, by which an adjustment may be made with a centre-tapped trimmer potentiometer between the 'offset adjust' pins and the -V_{dd} line.

In spite of the relatively simple circuit layout (for an i.c.) the performance of this device is excellent, and is becoming adopted as the industry standard for low-noise, low-distortion, high-input-impedance amplifiers of this type.

As is fairly typical, the National Semiconductors design engineers have 'second-sourced' this device with their own version (known as the LF351 and LF353 for the single and dual units) incor-

porating a few design improvements, which I have shown in side-by-side comparison in Fig. 7. Although these design changes allow a somewhat improved published specification, my own tests suggest that the performance differences between the TI and NS units are less than the small random variations between one device and the next, so the performance characteristics for the TL07* devices shown in Figs. 8-11 can be taken as representative of the LF351-353 as well. The basic differences in the circuitry concern the 'tail' of the input stage, and in the output stage overload protection, which is done much more formally in the NS design by the addition of the protection transistors Tr₁₈ and Tr₁₉. Because Tr₁₉ is a low gain 'lateral' type of device, it is used to rob base current from Tr₇ by way of an addi-

tional amplifier transistor Tr₂₀. Other circuit differences between these two types of i.c. are trivial.

As examples of the types of circuit which can be built very satisfactorily using these types of op-amp i.c., I have shown two typical applications in Figs. 12 and 13. In particular, the low noise and very low distortion of the TL07* family makes its use in high quality audio preamplifier systems a very natural development. It is unlikely that developments of such i.c.s., in this type of TO99 or DIL package, will rest at this level of performance, and straws in the wind are the Mullard/Signetics NE5532-5534 series and the Precision Monolithics OP-27, which have noise figures in the range 3-5nV/√Hz, though as yet, only with relatively low input impedance characteristics. WWW

Next month

Modular preamplifier.

John Linsley Hood begins his description of a new, modular preamplifier, designed for use with the 100W power amplifier recently featured. Among its features are a noise-blanker stage to minimize scratch 'clicks', a push-button, eight-octave tone-control, a four-input mixer, a rumble filter with a 22dB/octave cut and a signal-strength

meter.

Electronic compass.

This is a 'no-moving part' design, by Neil Pollock which uses a flux-gate sensor, the construction of which is described. The output of the sensor can be processed by a microprocessor to provide a numerical display, or the hard-wired circuit shown in the article can be used.

Low-frequency oscillator. A sine-plus-square

oscillator, working in the 10-Hz to 250KHz range, which provides a tone-burst output for loud-speaker testing. There is octave switching and a RIAA pre-emphasis network, and the instrument is built in the modular manner.

**On sale
Sept 15.**

NEW PRODUCTS

500MHZ FREQUENCY SYNTHESIZER

Internal or external references may be used to determine output frequencies from 1 to 500MHz in steps of 0.1Hz on the PTSS500 synthesized-signal generator. All functions may be programmed using either binary-coded decimal signals or the IEEE488 bus. Switching between frequencies takes from 5 to 20 μ s, output levels are between +3 and +13dBm, and resolution may be selected. Wessex Electronics, the manufacturer's representatives, say that the instrument introduces little phase noise (-63dBc from 0.5Hz to 15kHz) and that the simple synthesizing method used involves fewer components than competitive instruments do, resulting in a reduction in power consumption of up to 50%. A wideband-h.f. linear amplifier from RF Power Labs is since recently also available from Wessex Electronics. This 150W instrument may be used at frequencies from 1 to 30MHz with an average gain of 50dB, within ± 1.5 dB. Comprehensive circuit protection is incorporated in the design. Wessex Electronics Ltd, 114-116 North Street, Downend, Bristol BS16 5SE.

WW301

MONITORS FOR PORTABLE USE

An uncased 5in monitor from Kent Modular Electronics has 25MHz bandwidth and is claimed to be suitable for displaying up to 80 columns by 36 lines. Designated the MC500, this monitor is suitable for displaying characters, in point-of-sale terminals and computers for instance, or for use in picture-display applications including surveillance and closed-circuit tv. It requires a 12V d.c. supply, may be driven by either composite video or separate t.t.l.-level signals, and has line and field-scan rates of 15.6kHz and 50 or 60Hz respectively. Resolution is 700 lines at screen centre and 500 lines at the corners. Different phosphors can be obtained. Kent Modular Electronics Ltd, Maidstone Road, Rochester, Kent ME1 3QL.

WW302

12-by-12-BIT MULTIPLIER

What is claimed to be the fastest unsigned-magnitude 12-by-12-bit



WW301

multiplier, the MPY112K from TRW LSI Products, multiplies in under 50ns. This 48-pin device, available through MCP Electronics, has dual-input registers, a multiplier array and a 16-bit output-product register with three-state t.t.l.-compatible output buffers. Applications include real-time video-signal processing, digital filtering, FFT calculations and geometric transformations. MCP Electronics Ltd, 38 Rosemont Road, Alperton, Wembley, Middx HA0 4PE.

WW303

enable input while the programming-pulse input is held at 21V. The erase/write cycle is similar to that of the industry-standard 2716 eeprom. To erase or write a byte takes 10ms, or alternatively the whole device may be erased at once in 10ms. Apart from the difference mentioned, the devices are pin and function compatible with each other. Prices for 250ns and 450ns versions are between £30 and £40 for small quantities. National Semiconductor (UK) Ltd, 301 Harpur Centre, Horne Lane, Bedford MK40 1TR.

WW304

MICROWAVE TRIMMERS

Four microwave trimming capacitors from Waycom cover 0.3 to 1.2, 0.4, to 2.5, 0.6 to 4.5 and 0.8 to 8pF ranges respectively and have minimum-Q values of between 1000 and 5000 at 250MHz. Self-resonant frequencies are between 5 and 13GHz. The MTRX2X series can directly replace the company's MTMX0X trimmers. Waycom Ltd, Wokingham Road, Bracknell, Berkshire RG12 1ND.

WW305

BYTE-ERASABLE EEPROM

Limited samples of National Semiconductor's 2K-by-eight electrically-erasable prom can be obtained for evaluation purposes. Two versions are available, the NMC2816 and the NMC9716, the difference being that the latter device may be erased or written using a t.t.l. pulse on the chip-

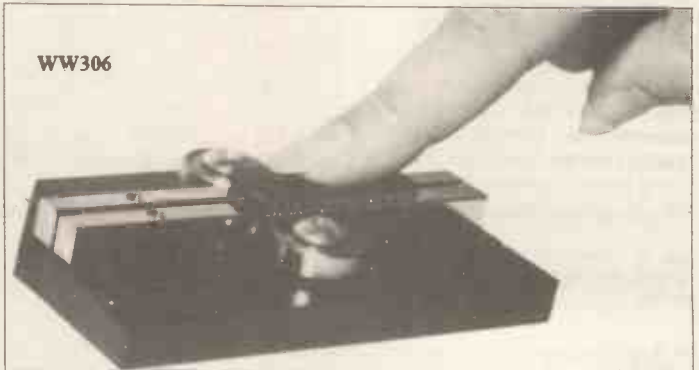

WW306



WW302

DIL PREFORMING TOOL

As many readers will be aware, integrated-circuit pins are intentionally splayed so that the device stays in place when mounted on a board by an automatic-insertion machine or tool. If manual insertion is preferred, the pins must be preformed in some way. Kam Circuits sell two small preforming fixtures, one for 0.3in-wide devices and one for 0.6in-wide types, which can quickly preform i.c. pins. One-off prices are £15 for the DHPT3 and £18 for the DHPT6, excluding vat. Kam Circuits Ltd, Porte Marsh Road, Calne, Wilts SN11 9BW.

WW306

LED MOUNTINGS

Glass-filled polycarbonate holders for mounting 5mm leds either horizontally or vertically on a p.c.b. are available from Zaerix Electronics Ltd. These holders may be end or stack mounted on a 3mm pitch, used between -50 and $+125^{\circ}\text{C}$ and serve as a guide for led lead forming. Zaerix Electronics Ltd, Electron House, Cray Avenue, St Mary Cray, Orpington, Kent BR5 3QJ.

WW307

CONTROL COMPUTER

This single-board microcomputer which, it is claimed, can function as its own development system, uses the Zilog Z8671 'single-chip microcomputer' - a microprocessor with a Basic interpreter, two timers, a uart, four i/o ports, vectored interrupts and 144 bytes of ram. The Arc computer, designed for control applications, can be set to initiate itself on power up so that it may be used as a stand-alone controller. Built on a Eurocard, by Arcom Control Systems, the computer has a real-time clock/calender with battery back-up, 4Kbytes of ram and a 2Kbyte eprom containing demonstration programs written in Basic, and an RS232 interface, rate selectable from 110 to 19200 bit/s. Space is available on the board to extend the memory capacity to 20K. Excluding vat, the Arc's price is £135. Arcom Control Systems Ltd, 38 Grantchester Road, Newnham, Cambridge CB3 9ED.

WW308



WW309

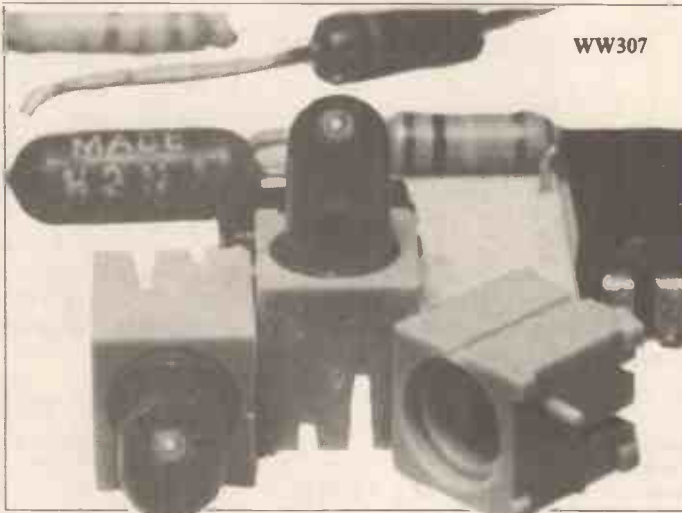

WW307

COMPUTER SPEECH

Keyboard entries may be converted into speech on most computers using the Votrax Type-and-Talk, claim Intelligent Artefacts (a company name). Typewritten words are translated into electronic speech by the unit's microprocessor-based text-to-speech algorithm. Suggested applications include education for, say, spelling tests, and in aiding blind and dumb persons. Communication with the computer is through an RS232 link and the device gives its verbal response according to the English language, but possibly with an American accent since it originated in the US. It can be obtained for £275 excluding vat. Intelligent Artefacts, Cambridge Road, Orwell, Royston, Herts SG8 5QD.

WW309



WW310

LARGE G.T.O. THYRISTOR

A gate turn-off thyristor capable of handling 50 to 150kW in uninterruptible power supplies, inverters, variable-speed a.c. motor drive circuits etc., is manufactured by International Rectifier. The 160PFT is a 250A r.m.s., 600A peak device with a 1200V maximum repetitive peak off-state rating and a turn-off time of 8us. International Rectifier Co. (GB) Ltd, Hurst Green, Oxted, Surrey RH8 9BB.

WW310

CONTINUITY TESTER

Some find it difficult to imagine what a continuity tester costing £54.40 might feature. The Buzzbox, from Kelvin Electronics, can locate p.c.b. short circuits since, claim its makers Kelvin Electronics, it is possible to resolve resistances lower than $10\text{m}\Omega$ with the aid of the unit's ten-turn potentiometer and audible-signal

generator. A similar method using a medium-resistance range of 0.5 to 30Ω can be used to identify and check multiple cables. Here, a built-in intercom may be of use should the cable ends be far apart. The instrument is also claimed to give consistently more reliable indications than most multimeters where general continuity testing is concerned. Internal calibration resistors are included, and the unit may be used to check capacitor leakage current, as a simple signal generator for audio-amplifier testing, and for alternating and direct voltage checks. In short-circuit location mode, current through the circuit under test is about $20\mu\text{A}$ and the alternating test voltage too low to turn on a silicon junction. Kelvin Electronics, 18 Exeter Close, Tilgate, Crawley, Sussex RH10 5HW.

WW311

POLYPHONIC-SOUND GENERATOR

An integrated circuit for simplifying the construction of polyphonic keyboard instruments, the M112, is manufactured by SGS. The device contains a microprocessor interface, eight sound-generating channels and output-control logic. Each generator consists of gating logic to select required tones and harmonics, and an a.d.s.r.-envelope shaper to determine the sound's dynamics. Twelve-bit words are sent to the i.c. through a six-bit data bus to determine pitch, a.d.s.r. and output options such as 'hold' and 'pedal'. The device has fifteen outputs in all and includes an input to provide a percussion effect. Cascading of the M112 is possible. Sample quantities of the device should be available in September. SGS recently introduced a 28-pin version of the M3870 microprocessor, the M2870, which will sell in large quantities at 'significantly' under \$3. The device is identical to the 3870, except in the number of i/o lines. Both have a 2K rom, 64 bytes of ram, a counter/timer, programmable i/o, external-interrupt facility, internal clock, and require a single 5V supply. SGS-ATES (UK) Ltd, Walton Street, Aylesbury, Bucks.

WW312

Professional readers are invited to request further details on items featured here by entering the appropriate WW reference number(s) on the mauve reply-paid card.

RANDOM ECHOES

By Chirp

THREE DIMENSIONS

There is an advertisement in my paper for one of those new Sony television outfits made up from a set of separate units. It has a separate picture monitor, a separate receiver/demodulator, teletext unit, video cassette unit, etc. It's the logical video extension of the audio hi-fi philosophy, and I'm sure it will be a winner with the "video" enthusiast. It makes good sense in terms of flexibility and must have considerable prestige value.

It is clear from the advertisement picture that Sony intends the tv sound to be handled by the hi-fi stereo system, a small loudspeaker being shown placed at each side of the picture monitor. Of course, British tv sound does not come in stereo, so the system would have to operate in mono for broadcast entertainment. Perhaps some video cassettes have two-track sound, and broadcast television with stereo sound is being developed in Germany.

Personally I have my doubts about the advantages of stereo sound on television. Even with a very large picture tube, I find it hard to believe that the stereophonic illusion can pinpoint the sound source image to coincide with the visual image accurately enough to improve the realism. But I'm probably wrong. Even with real sound sources I find it difficult to locate them aurally. I have very little aural sense of direction, and I am usually unable to tell whether a two-speaker system is providing stereo sound or just doubling up on the monophonic.

Had I not made this admission, however, I am sure I could pursue the argument on the futility of the combination of television and stereo sound and convince a significant following. But there is bound to be a large number of viewer/listeners who can locate the direction of a sound source within a tenth of a second of arc or even less. Indeed, I'm probably the only person who can't do it.

I made the mistake some years ago after a demonstration 3D film at the local cinema. It was based on the use of a different colour filter for the left and the right eye, with appropriately coloured images on the screen.

I found that the stereoscopic effect was far greater than I was accustomed to in real life, and I was easily able to persuade a large number of my colleagues that we were only able to detect the three dimensions visually to a range of about 10 feet. I frequently heard my opinion voiced by others, and each occasion reinforced my conviction of the truth of the statements.

Then I got some new spectacles. The moment I put them on out-of-doors my

whole flat world leapt into 3D, and I realized that my disciples were preaching a false doctrine. I was not too penitent, for some were, presumably, normally sighted and should have known that the 10-foot limit was nonsense, even if the film's stereoscopic effect was somewhat exaggerated.

The moral of this story is that, if you believe what you are saying, you can probably fool some of the people most of the time, even in contradiction to the evidence of their eyes.

MARKING TIME

Quite recently a kind lady gave me an electronic ball-point-pen – all-solid-state with quartz-crystal frequency control – a high-technology writing instrument if ever there was one.

Actually it was not really intended as a gift so much as a prize for ordering more stationery than one really needs. It is what our supplier calls a "promotion"; and there are, I know, folk who regard the acceptance of such gifts as not quite proper, especially as they are nearly always received by somebody else. Anyway I'm quite pleased with mine. It is not everyone who has an electronic ball-point pen.

It's just the same as any other ball-point pen really, except that it has a tiny digital clock built into its upper half, with an l.c.d. readout on the side giving the time in hours and mminutes. It has been quite well engineered – in Hong Kong – and it has some attractive features; e.g., it takes Parker refills, which are readily available outside Hong Kong, and it is fat enough to hold comfortably when writing.

I'm not too fond of digital timepieces in general. I find it easier to relate time intervals to distance round the circumference of my wrist watch than to do the arithmetic with digital information. This is particularly true first thing in the morning, when it comes to the nice assessment of time for a final doze before crawling out of bed. Although the digital characters on our clock radio are large and bright, the concentration needed to subtract 6:33 from a quarter to seven is such that I find I'm wide awake and the pleasure is lost; so I still squint bleary-eyed at my old fashioned watch.

Of course, my analogue mind lasts all day and, in common with the rest of the human race, I find it easier to absorb diagrammatic information than to interpret characters. But that little digital timepiece in the stem of my ball-point has one important advantage over the wrist watch. It is easy to read when holding the pen in the

normal writing position.

This means that, when I get involved in one of those boring office meetings, I am able to keep track of the time without the more obvious frequent reference to my wrist watch. It is perfectly natural to look in the direction of one's pen when taking notes, and I can look as often as I like without upsetting anyone.

Terry Wogan has just announced that it is coming up to eighteen minutes to ten. Is that later than 9:41?

STRANGER THAN FICTION

So it's arrived at last. There it is on the front page of the *Financial Times* complete with a full-size photograph – the world's first wristwatch television. Needless to say, it's Japanese; and I must admit it upstages my electronic ball point pen. It must have impressed the *FT*, because I cannot recall ever having seen a new-product photograph on the front page before.

According to the paper it is all made possible by the development of a liquid-crystal display with a matrix of 32,000 dots covering a 1.2-in screen. It says, "the tv is part of a slightly oversized electronic wristwatch with digital time display, calendar, stop-watch and alarm."

Fantastic; but how do they manage to pack the receiver circuit and all the video signal processing etc. into the wristwatch case? Well, actually, they don't. The watch tv is connected by a thin cable to a pocket-sized receiver unit, weighing just under half a pound, complete with batteries and all the normal controls. An ear-phone is also attached by a lightweight cable; so it seems that the wearer of the wristwatch tv must be wired for vision and sound.

The manufacturer expects to start mass production in Japan in six months' time, and perhaps we shall see them here in time for Wimbledon 1982. It should be fairly easy to spot the wristwatch television viewer out of doors watching the tennis. With a viewing screen about half the size of a 35mm negative, it will be necessary to hold it about eight inches from one's eyes to keep an eye on the ball; and, no doubt, an aerial will be needed for all but the highest field-strength areas, suggesting some interesting headgear.

So if, next July, you should see a man in the park with a deaf-aid and an antenna on his hat, staring intently at his wristwatch, you'll know what he's doing, won't you? You could be wrong, of course. If he talks to his wristwatch and then slowly fades away to nothing, it could mean that he's been "beamed up" to a 25th century space ship.

C.B. Radio

Can you afford NOT to STOCK IT THIS XMAS?



You may be under the impression that the hoped for CB boom was a damp Squib. Since it was legalised well over 300,000 radio's have been sold worth well over 30 million pounds (plus accessories). Some damp Squib!

As no one originally had any experience selling legal CB in the UK it would have been surprising if retailers bought the right stock — in fact many didn't. Luckily for us and our customers, as one of the fastest growing CB importers/wholesalers in the country we guessed right.

Now is the time to use our experience and get the right products inc many brand names, at the right prices (e.g. a 40ch radio around £20 wholesale) direct from us for Xmas.

Pan
INTERNATIONAL

Send for literature and a trade price list today. Clip this advert to your card or letterhead, post to our Head Office and find out the facts.



LUTON BRANCH (HEAD OFFICE):
201 Dunstable Road, Luton, Bedfordshire, LU1 1DD.
Tel: (0582) 425722/3
Telex: 826623 KNIGHT G.
BIRMINGHAM BRANCH:
Unit 7, Vernon Trading Estate, New John Street, Halesowen, Birmingham, W. Midlands B62 8HT
Tel: (021) 561 3181/2

WW - 017 FOR FURTHER DETAILS

Chiltern Electronics

HIGH ST, CHALFONT ST. GILES, BUCKS
Telephone: 02407 71234

MICROPROCESSOR SYSTEMS

A complete Microprocessor subsystem on single PC card, complete with 2650A CPU, four 2758 EPROMS and 12 RAM chips, all in DIL sockets. Loads of other components including TTL chips, xtal, ribbon connectors. Unfortunately we have no circuit or data, so we are offering the complete units with ribbon cables and plugs for only£23 each

SELF-SCAN DISPLAY UNITS

These state-of-the-art displays can replace a VDU, and measure only 12 x 4 x 2 inches. Display all ASCII set 40 characters by 6 lines. As used on latest mainframe terminals. But again no data or circuit so only £23 ea.

MEMORY CARDS

A full size circuit board ex new equipment containing 64 4K Dynamic RAM chips in sockets, and complete with all decoding circuitry. Organised as 32K x 8 bits. A complete memory system for your micro, but again we have no data, so it will be necessary to spend an hour circuit tracing..... Only £11.50 ea.

POWER SUPPLY UNITS

Ideal for your micro system, and at a quarter of usual price, these units give a fully regulated and filtered DC 5v supply, complete with over voltage protection and standard mains input.

5v 3-amp £11.50 5v 6-amp £23

AMPHENOL 36-WAY CENTRONICS PLUGS

Genuine Amphenol plugs with gold-plated contacts that are standard for all parallel printers and usually cost around £6 each. New ex-equipment. With cable top and clamp.

Our price £11.50 for 6, or £115 for 100

ALL ABOVE PRICES INCLUDE VAT AND POSTAGE. SAME-DAY DESPATCH

We also stock full range of DEC Systems from PDP11/04 to VAX 11/780, and full range of spare cards — please telephone for details or catalogue.

WW - 080 FOR FURTHER DETAILS

REDCLIFFE magtronics

ARE PLEASED TO ANNOUNCE

A

MAGNETIC EQUIPMENT EXHIBITION

AT THE

CREST HOTEL, BRISTOL

2nd November 1982

On show will be -

Magnet chargers



Magnet processors

Instrumentation



Special Test and Analysis Systems

BRING YOUR MAGNETICS PROBLEMS TO US FOR PROMPT SOLUTION

For further details please write to
REDCLIFFE MAGTRONICS LTD.,
24, EMERY RD, BRISLINGTON,
BRISTOL. (0272) 771404

WW - 061 FOR FURTHER DETAILS

Six months in the life of someone like you

April 29 Forced to enter hospital for tests to discover root of illness

May 1 Doctor tells of a suspected tumour. An operation is needed

May 4 Operation successful, but warning given of several months incapacity

June 18 Progress is slow. Wife finding it hard to make ends meet safely on Sickness and Supplementary Benefits

July 4 Hospital recommends a recuperative holiday. More anxiety over where the money will come from

July 16 A colleague contacts EEIBA

July 23 An EEIBA welfare officer visits family to discuss the problems

August 7 EEIBA pays for holiday

August 21 Return to find a pile of unpaid bills. Inability to cope causes desperation

August 29 EEIBA welfare officer comes to see how things are going. She offers reassurance and the promise of help

August 30 Bills paid by EEIBA

October 29 Full recovery effected. Return to work and draw up letter of thanks

This is just one type of case out of the 800 EEIBA deals with every year. We exist to help people like you, and we need your help in two ways. To tell us of any cases you might know where help is required. And to help us with regular donations. We're not asking for a fortune, we're simply asking you to appreciate how lucky you are and to send what you can spare.



With your help we can help

The Electrical and Electronics Industries Benevolent Association
8 Station Parade, Balham High Road, London SW12 9BH. Telephone 01-673 0131
43 branches throughout the country

"Sympathy, Love and Understanding are not enough"

Sir Douglas Bader C.B.E., D.S.O., D.F.C.

The Wings Appeal Fund helps to maintain the RAF Association Home for Disabled and Chronic Sick. Care is essential for those who have served their country and who are in need. So please help by giving all you can for an emblem in WINGS WEEK in September or send a donation to show that you care.



To: Royal Air Forces Association, Appeals Dept., (DS) Portland Rd., Malvern, Worcs. WR14 2TA.

I enclose a donation of for the Wings Appeal Fund.

Name
Address

Please tick if receipt is required.

Space donated by 'Wireless World'



PM COMPONENTS LTD VALVE & COMPONENTS SPECIALISTS

INTEGRATED CIRCUITS

AN124	2.50	ML231B	1.75
AN214Q	2.50	ML232B	1.75
AN240P	2.80	ML237B	1.95
AN7150	2.95	ML238B	4.20
BA521	3.35	ML920	4.12
ETT6016	1.75	ML928	1.85
HA1151P	2.50	MSM5807	6.75
HA1366W	1.95	PL02A	5.75
LA4031P	2.70	SA41025	7.25
LA4102	2.95	SA5000A	3.05
LA4400	4.15	SA5010	6.35
LA4422	2.50	SA5560S	1.60
LC7120	3.25	SAS570S	1.60
LC7150	3.50	SAS580	2.85
LC7131	5.50	SL490	1.95
LC7137	5.50	SL901B	4.85
LM324N	0.45	SL917B	6.65
LM380N	0.95	SL1310	1.80
LM383T	2.95	SL1327	1.10
LM390N	1.95	SL1327Q	1.10
M51513L	2.30	SN76003N	1.65
M51515L	2.95	SN76013N	1.65
MB3712	2.00	SN76013ND	1.65
MC1307P	1.00	SN76023N	1.65
MC1310P	1.50	SN76033N	1.65
MC1327	0.95	SN76110N	0.89
MC1327Q	0.95	SN76131N	1.30
MC1330P	0.76	SN76226DN	1.55
MC1349P	1.20	SN76227N	1.05
MC1350P	0.76	SN76532N	1.40
MC1351P	1.50	SN76533N	1.30
MC1352P	1.00	SN76544N	1.30
MC1357	2.35	SN76650N	1.05
MC1495	3.00	SN76660N	0.80
MC14011BCP	0.32	SN76666N	0.70
MC1723	0.50	TA7061AP	3.95
MC3357	2.25	TA7108P	1.00

TA7120P	1.65
TA7130P	1.50
TA7203	2.95
TA7204P	2.15
TA7205AP	1.50
TA7222AP	1.80
TA7227P	4.25
TA7310P	1.80
TA7313AP	2.95
TAA550	0.25
TAA570	1.80
TAA661B	1.20
TAA700	1.70
TBA120B	0.70
TBA120S	0.70
TBA125Q	0.70
TBA120T	0.70
TBA120U	1.00
TBA231	1.25
TBA395	1.50
TBA396	0.75
TBA440N	2.55
TBA480Q	1.25
TBA510	1.65
TBA510Q	1.65
TBA520	1.10
TBA520Q	1.10
TBA530	1.10
TBA530Q	1.10
TBA540	1.25
TBA540Q	1.35
TBA550Q	1.45
TBA550	0.95
TBA560C	1.45
TBA570	1.00
TBA641A12	2.50
TBA641B1X1	3.00
TBA641-B11	3.00

TBA651	1.75
TBA720A	2.45
TBA750Q	1.85
TBA800	0.89
TBA810AS	1.35
TBA810Q	1.45
TBA890	2.50
TBA920	1.65
TBA920Q	1.65
TBA950	2.35
TBA9502X	2.35
TBA990	1.49
TBA990Q	1.49
TBA1441	2.15
TCA270	1.10
TCA270SQ	1.10
TCA550	2.50
TCA800	2.15
TCA830S	1.40
TCA940	1.65
TDA440	2.20
TDA1004A	2.20
TDA1006A	2.50
TDA1010	2.15
TDA1035	2.50
TDA1037	1.95
TDA1170	1.95
TDA1170S	1.95
TDA1190	2.15
TDA1270C	3.95
TDA1327	1.70
TDA1352B	1.43
TDA1412	0.85
TDA1524	2.85
TDA2020	2.45
TDA2030	2.80
TDA2522	1.95
TDA2523	1.95
TDA2530	5.4
TDA2532	1.95

TD2540	2.15
TD2541	2.15
TD2560	2.15
TD2581	1.15
TD2590	2.95
TD2591	2.95
TD2593	2.95
TD2600	3.15
TD2610	2.50
TD2611A	1.95
TD2640	2.60
TD2690	3.35
TD2690	3.95
TD2690	3.95
TD2690	3.95
UPC566H	2.95
UPC575C2	2.75
UPC1011H	2.50
UPC1156H	2.75
UPC1182H	2.95
UPC1185H	3.95
UPC1350C	2.95
UPC2020H	1.95
ZTK33B	0.50
555	0.35
723	0.50
741	0.35
747	0.50
748	0.35
4042	5.00
7805	0.60

I.C. DATA BOOKS
LIN 1 covering Op Amps
LIN 2 covering Regulators
£4.95 each

SEMICONDUCTORS

AA112	0.25	BC172C	0.10
AC126	0.22	BC173B	0.10
AC127	0.20	BC174	0.09
AC128	0.20	BC174A	0.09
AC128K	0.32	BC175	0.15
AC141	0.28	BC178	0.15
AC141K	0.34	BC182	0.10
AC142K	0.30	BC182LB	0.10
AC176	0.22	BC183	0.12
AC178K	0.31	BC183L	0.09
AC187	0.25	BC194B	0.10
AC187K	0.28	BC204	0.10
AC188	0.22	BC207B	0.13
AC188K	0.37	BC208B	0.13
AD142	0.90	BC212	0.09
AD143	0.82	BC212L	0.09
AD149	0.70	BC212LA	0.09
AD161	0.39	BC213	0.09
AD162	0.39	BC213L	0.09
AD161/2	0.90	BC214	0.09
AF115	0.75	BC214C	0.09
AF124	0.34	BC214L	0.09
AF125	0.32	BC237	0.09
AF126	0.32	BC237A	0.09
AF127	0.32	BC237B	0.09
AF139	0.42	BC238	0.09
AF150	0.42	BC239	0.12
AF239	0.42	BC251A	0.12
AU106	2.00	BC252A	0.15
AU107	1.75	BC258	0.39
AU110	2.00	BC258A	0.39
AU113	1.85	BC284	0.30
BC107	0.10	BC300	0.30
BC107A	0.10	BC301	0.30
BC107B	0.10	BC303	0.26
BC108	0.10	BC307	0.09
BC108A	0.10	BC307A	0.09
BC108B	0.10	BC307B	0.09
BC109	0.10	BC327	0.10
BC109B	0.10	BC328	0.10
BC109C	0.10	BC338	0.09
BC114	0.11	BC347A	0.13
BC116A	0.13	BC461	0.35
BC117	0.19	BC478	0.20
BC119	0.24	BC527	0.20
BC125	0.12	BC547	0.10
BC140	0.31	BC548	0.10
BC141	0.25	BC549A	0.08
BC142	0.21	BC550	0.08
BC143	0.24	BC557	0.08
BC147	0.09	BC557A	0.08
BC147B	0.09	BC557B	0.08
BC148A	0.09	BC558	0.08
BC148B	0.09	BC558A	0.08
BC149	0.09	BC558B	0.08
BC157	0.10	BCY33A	1.60
BC158	0.09	BD115	0.30
BC159	0.09	BD116	0.52
BC160	0.28	BD124P	0.59
BC161	0.28	BD131	0.32
BC170B	0.10	BD132	0.35
BC171	0.08	BD133	0.40
BC171A	0.10	BD135	0.30
BC171B	0.10	BD136	0.30
BC172	0.10	BD137	0.28
BC172B	0.10	BD138	0.30

BD139	0.32	BF338	0.32
BD140	0.30	BF355	0.37
BD144	1.10	BF362	0.38
BD159	0.65	BF363	0.38
BD165	0.46	BF371	0.20
BD179	0.72	BF394	0.19
BD182	0.70	BF457	0.23
BD201	0.83	BF458	0.28
BD202	0.65	BF459	0.36
BD203	0.78	BF460	0.35
BD204	0.70	BF461	0.35
BD223	0.48	BF492	0.25
BD225	0.48	BF493	0.25
BD232	0.35	BF494	0.28
BD233	0.35	BF495	0.28
BD236	0.45	BF496	0.28
BD237	0.40	BF497	0.28
BD238	0.40	BF498	0.28
BD241	0.40	BF499	0.28
BD242	0.50	BF500	0.28
BD246	0.80	BF501	0.21
BD376	0.32	BF502	0.21
BD410	0.55	BF503	0.27
BD434	0.55	BF504	0.27
BD437	0.50	BF505	0.27
BD438	0.60	BF506	0.27
BD508	0.40	BF507	0.27
BD520	0.65	BF508	0.27
BD538	0.65	BF509	0.27
BD597	0.75	BF510	0.27
BD687	1.10	BF511	0.27
BD698	1.10	BF512	0.27
BD707	0.75	BF513	0.27
BDX32	1.50	BF514	0.27
BF115	0.35	BF515	0.27
BF127	0.24	BF516	0.27
BF154	0.12	BF517	0.27
BF158	0.18	BF518	0.29
BF160	0.27	BF519	0.29
BF167	0.24	BF520	0.29
BF173	0.22	BF521	0.29
BF177	0.38	BF522	0.29
BF178	0.28	BF523	0.29
BF179	0.34	BF524	0.15
BF180	0.29	BF525	0.28
BF181	0.29	BF526	0.28
BF182	0.29	BF527	0.28
BF183	0.29	BF528	0.28
BF184	0.28	BF529	0.28
BF185	0.28	BF530	0.28
BF194	0.11	BF531	0.28
BF195	0.11	BF532	0.28
BF196	0.11	BF533	0.28
BF197	0.11	BF534	0.28
BF198	0.10	BF535	0.28
BF199	0.14	BF536	0.28
BF200	0.40	BF537	0.28
BF241	0.15	BF538	0.28
BF245	0.30	BF539	0.28
BF246	0.28	BF540	0.28
BF256/LC	0.28	BF541	0.28
BF257	0.28	BF542	0.28
BF258	0.28	BF543	0.28
BF259	0.28	BF544	0.28
BF271	0.26	BF545	0.28
BF273	0.13	BF546	0.28
BF336	0.34	BF547	0.28
BF337	0.29	BF548	0.28

RC416335	1.80
SKESF	0.45
TIP29	0.40
TIP29C	0.42
TIP30C	0.43
TIP31C	0.42
TIP32C	0.42
TIP33B	0.75
TIP34B	0.75
TIP41A	0.45
TIP41C	0.45
TIP42C	0.47
TIP47	0.65
TIP120	0.60
TIP142	1.75
TIP146	1.75
TIP161	2.95
TIP2955	0.80
TIP3055	0.50
TIS91	0.20
TU106/2	1.50
TU106/3	0.28
2N2805	0.40
2N3053	0.40
2N3054	0.59
2N3055	0.52
2N3070	0.12
2N3071	0.12
2N3072	0.12
2N3073	0.12
2N3074	0.12
2N3075	0.12
2N3076	0.12
2N3078	0.12
2N3079	0.12
2N3080	0.12

PCI 1002 IEEE THERMOCOUPLE CONVERTER

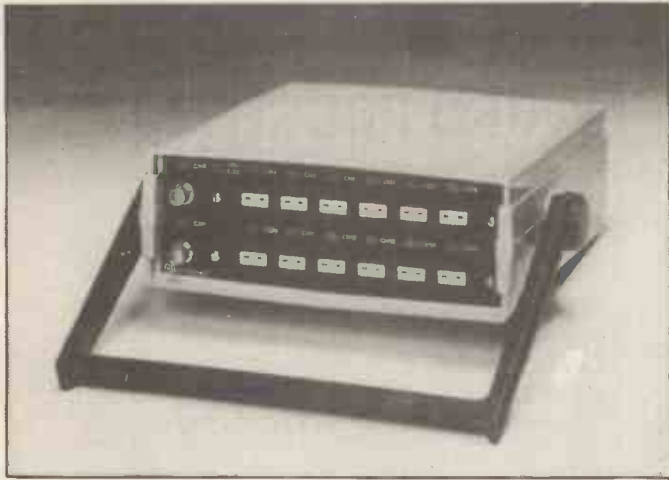

The PCI 1002 is a 12 Channel IEEE compatible thermocouple converter having two input ranges of $\pm 10\text{mV}$ or $\pm 100\text{mV}$ F.S.D. selected by an internal switch. It has 12 Bit resolution of the A to D converter giving a resolution of 0.06 deg. C on 10mV range and covers all common thermocouple types.

Cold Junction Compensation is provided giving a resolution of 0.2°C on 100mV range and 0.02°C on 10mV range.

Linearising software in Basic using optimised coefficients for ranges and thermocouple types.

Two other channels are provided via BNC input sockets on the front panel. Input ranges are $1/\text{V}$ for 10 mV range and $\pm 10\text{V}$ for 100mV range.

CIL MICROSYSTEMS LTD
DECOY ROAD, WORTHING, SUSSEX.
TEL: 210474.



WW - 097 FOR FURTHER DETAILS

ELECTRONICS EMPORIUM

Vast range of bargains in stock includes Diodes, Heat Sinks, Thyristors, Bridge Rectifiers, Resistors, Capacitors, Terminals, Connectors, Relays, Switches, Wire and Cable, PCBs, Transformers, Measuring Instruments, Nibbler and other Hand Tools.

Ex-M.O.D., British Aerospace Surplus: Cambridge A.C. Test Sets, Marconi Moisture Testers, Savage Amplifiers, Digital Voltmeters, Oscilloscopes, Oscillators, Power Supplies, Gyroscopes, Propeller Test Rigs.



EASILY REACHED BY READERS IN YORKS & LANCS

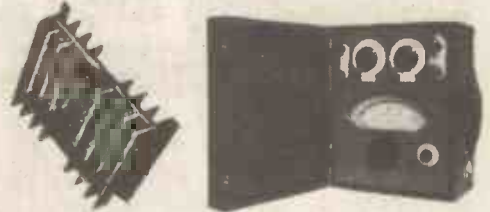

A. C. TOWNLEY LTD.

Harehill, Todmorden, Lancs, OL14 5JY
off the A646 Todmorden-Burnley Road
Open Monday to Friday, 8.30 a.m. to 5.30 p.m.
Saturday by arrangement
Tel: Todmorden 4931 (070-681 4931)

WW - 076 FOR FURTHER DETAILS

NEW OFF THE SHELF QUALITY ENCODER DISCS

Veco Electroforming Photo-etching Limited, one of the largest European suppliers of custom-designed electroformed and photo-etched components is now offering a range of "off the shelf" encoder discs.

These will enable small users to purchase at highly competitive prices and larger users to carry out initial development work and prototype manufacture prior to purchase of production quantities. In addition, these "off the shelf" designs can also be supplied in larger quantities for production with a relatively short delivery time.

The initial range is as follows:

1. Diameter 30mm 120 slots - Price 1-5 off £5 each
 2. Diameter 60mm 120 slots - Price 1-5 off £7 each
 3. Diameter 60mm 240 slots - Price 1-5 off £9 each
 4. Diameter 60mm 360 slots - Price 1-5 off £12 each
- Price reductions available according to quantity.

Specification:

Material Hard Nickel 0.08 to 0.09mm thick.

Centre Hole 10mm ± 20 microns.

Slot Width Tolerance ± 7 microns.

Mark Space ratio 1 to 1.

Angular Tolerances ± 20 seconds.

General Tolerances ± 20 microns.

Delivery is from stock.

Contact: VECO ELECTROFORMING/PHOTO-ETCHING LTD

36 Essendene Road

Caterham, Surrey CR3 5PA

Tel: Caterham (0883) 46062

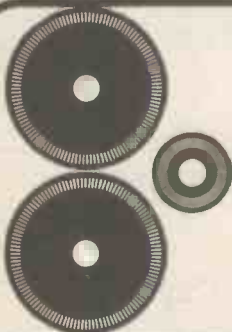

Please send further details without obligation to:

Name _____ Job Title _____

Company Name and Address _____

Tel. No. _____

WW - 044 FOR FURTHER DETAILS

UNITS EX-STOCK FOR IMMEDIATE DESPATCH

TYPE 9054	VMOS LINEAR POWER AMPLIFIER. 20 watts RF output, 2 watts RF input + 24, supply. Specify required frequency in the range 1-250 MHz.....	£85.00
	POST AND PACKING.....	£4.00
TYPE 9050	VMOS WIDEBAND LINEAR POWER AMPLIFIER. 20-200 MHz without tuning. 4 watts max. RF output. Increases power output by 10 times and may be used in series for more gain and lower drive level.....	£49.50
	POST AND PACKING.....	£2.00
TYPE 9045	VMOS WIDEBAND LINEAR POWER AMPLIFIER. 30 KHz-60 MHz without tuning. 4 watts max. RF output.....	£49.50
	POST AND PACKING.....	£2.00
TYPE 9056	1500 MHz. FREQUENCY DIVIDER BY 10. Divides input frequencies in the range 100-1500 MHz by 10. May be used ahead of frequency meters and counters to increase the frequency of measurement. Enables UHF oscillators to be phased-locked to a lower frequency high stability reference.....	£59.50
	POST AND PACKING.....	£1.50
TYPE 9030	WIDEBAND RF PREAMPLIFIER. 1 KHz-100 MHz without tuning. N.F. 3.0 dB. Gain 40 dB. Increases sensitivity of instruments by 100 times.....	£29.50
	POST AND PACKING.....	£1.50
TYPE 9025/FM	BAND II. 88-108 MHz N.F. 1.0 dB. Gain 40 dB, adjustable -40 dB. Masthead/lab. use.....	£29.50
	POST AND PACKING.....	£1.50
TYPE 9025	RF PREAMPLIFIER. Specify required frequency in the range 1-250 MHz. N.F. 1.0 dB. Gain 40 dB adjustable -40 dB. Masthead/lab. use.....	£29.50
	POST AND PACKING.....	£1.50

PLEASE ADD V.A.T. 15% ON TOTAL

COMPONENTS EX-STOCK FOR IMMEDIATE DESPATCH

GASFET transistors NEC NE 72089 N.F. 0.6 dB. at 500 MHz. 0.8 dB. at 1.3 GHz. 1.3 dB. at 4 GHz.....	£30.00
UHF dual-gate mosfet BF 960 N.F. 2.8 dB. at 800 MHz. Gain 18 dB.....	£3.50
RCA 40673 Mosfet.....	80p
BF181.....	50p
2N5460.....	60p
TIS88A.....	30p
Signetics NE560B PLL.....	£4.50
Plessey SL6600C.....	£5.00
SL1612C.....	£2.00
SL624C.....	£3.50
SL670C.....	£3.00
SL1640C.....	£2.00
SL1610C.....	£2.00
SL1621C.....	£2.50
SL621C.....	£4.50
SL613C.....	£3.50
SL502B.....	£5.00
SL640C.....	£4.00
Siliconix U350.....	£11.00
E430.....	£3.50
E177.....	£1.20
Motorola MC1590G.....	£3.00
National LM370.....	£4.00
LM380.....	£1.00
Varicaps:	
Thomson-CSF BB204.....	80p
Motorola MV104.....	80p
Shottky Diodes:	
Motorola MBD101.....	60p
Pin Switching Diodes:	
Thomson-CSF BA182.....	50p
BA244.....	70p
Voltage Regulators:	
12V 1A 7812.....	80p
12V 5A 78H12.....	£6.00
15V 5A 78H15.....	£6.00
Variable Voltage Regulator:	
1.5A 1.2 to 37V LM317K.....	£3.00
Synthesizer Signetics:	
HEF 4750VD.....	£25.00
Universal Divider:	
HEF 4751VD.....	£25.00
Opto-Isolators Darlington.....	£1.50
Electronic Attenuators.....	£1.00
Mullard 808 Film Dielectric Trimmers 2-22 pF.....	20p

POST AND PACKING 50p : PLEASE ADD V.A.T. 15% ON TOTAL

RESEARCH COMMUNICATIONS LTD

UNIT 3, DANE JOHN WORKS, GORDON ROAD, CANTERBURY, KENT, CT1 3PP
TELEPHONE: CANTERBURY (0227) 56489

WW - 081 FOR FURTHER DETAILS

A.B. Dick Magna II

WORD PROCESSORS

at £850 plus V.A.T.

45 cps Qume Printer
8K Working Store
Thin Window Display
Permanent Storage on Magnetic Cards

Limited stock of ex-demonstration machines factory reconditioned by manufacturer to 'as new' standard

AUTOTYPE (The 2nd-User W.P. Specialists)
1 Church Street
Cuckfield, Sussex
Haywards Heath (0444) 414484 and 454377

WW - 068 FOR FURTHER DETAILS

Largest range? Superior paint finish? Best ex-stock delivery?

Familiar claims? Study the Sarel range and decide for yourself. You'll find answers to all your own questions on enclosures — small, large, metal, plastic, glass-fibre reinforced polyester, monobloc, modular, with every imaginable accessory from gaskets to swing racks, chassis to brackets, locks, handles, glands and ventilators.

Sarel's range answers all your questions. No fuss, no bother, no compromise. Contact us for a quotation.



Think big - think Sarel
Sarel Electric Limited
Cosgrove Way, Luton, Beds. Tel: Luton 20121
Telex: 8265551 Sarel G

Send me my free copy of the new Sarel Electric catalogue, fast!

Name _____

Position _____

Company _____

Address _____

Telephone _____

WW9



WW - 069 FOR FURTHER DETAILS

HEMMINGS ELECTRONICS AND MICROCOMPUTERS

16 BRAND ST
HITCHIN
HERTS
SG5 1JE

Tel: (0462) 33031
Shop open Mon.-Sat. 9 a.m.-5.30 p.m.
Closed all day Wednesday



Professional quality electronic components, brand new and fully guaranteed. Mail order by return of post. Cash/Cheque/POs or Banker's Draft with order, payable to Hemmings Electronics Ltd.

Official orders from schools, colleges and universities welcome. Trade and export enquiry welcome.

P.&P. add 60p to all orders under £10. Telephone your Access orders, using our 24-hr. Answerphone service. Please send SAE for full price list.

VAT - All prices exclusive of VAT - Please add 15% to total cost including P.&P. No VAT on export orders or books.

LINEAR ICs 709 35p BC177 25p 741 25p BC178 25p 741 25p BC179 25p 741 25p BC182 10p 747 55p BC182A 10p 748 35p BC182B 10p CA390E 70p BC183A 10p LA4422 295p BC183C 10p LF355 80p BC184 10p LF356 90p BC184C 10p LF357 100p BC212 10p LM301A 10p BC212A 10p LM308A 95p BC212B 10p LM311N 65p BC213A 10p LM324 45p BC213C 10p LM339 55p BC214 10p LM348 80p BC214C 10p LM358 60p BC237A 12p LM380 90p BC237C 12p LM393 95p BC238 12p LM3909 85p BC238A 12p MC1310P 210p BC238B 12p MC1455 85p BC238C 12p MC1456 135p BC239 12p MC1458 45p BC237A 12p MC3242A 630p BC307C 15p MC3302 95p BC308 15p MC3340P 135p BC308A 15p MC3401 65p BC308B 15p MC3403 70p BC308C 15p MC3456 107p BC308 15p MC34001 58p BC309C 15p NE555 16p BC327 15p 555CMOS 90p BC328 15p NE556 45p BC337 18p NE556 155p BC338 15p NE567 140p BCY70 18p TA7205AP 125p BCY71 20p TB4540Q 95p BCY72 20p TB4800 90p BD135 42p TCA850 390p BD136 45p TCA910 180p BD139 40p TL061 40p BD140 40p TL062 60p BD165 45p TL064 90p BD166 45p TL071 30p BD169 45p TL072 50p BD170 45p TL074 100p BD538 95p TL081 25p BD677 60p TL082 45p BD678 60p TL084 95p BD679A 60p uPD7002 450p BD680A 65p		TRANSISTORS BC107 12p BFY90 85p BC107B 15p BF244A 30p BC108 12p ME4102 30p BC108B 15p ME5002 15p BC109 12p MJ2955 95p BC109B 15p MJE241 80p BC109C 15p MJE251 80p		COMPUTER ICs 6502 350p 2N1711 25p 6800 290p 2N1712 25p 6800 450p 2N1713 25p 6802 345p 2N1714 25p 6803 845p 2N1715 25p 6809 1350p 2N1716 25p 6809E 1295p 2N1717 25p 6810 120p 2N1718 25p 6821 160p 2N1719 25p 6821 215p 2N1720 25p 6840 390p 2N1721 25p 6844 1295p 2N1722 25p 6845 795p 2N1723 25p 6850 140p 2N1724 25p 6852 250p 2N1725 25p 6854 680p 2N1726 25p 6875 420p 2N1727 25p 79L05 120p 2N1728 25p 79L06 30p 2N1729 25p 79L12 35p 2N1730 25p 79L15 35p 2N1731 25p 7905 60p 2N1732 25p 7906 70p 2N1733 25p 7907 70p 2N1734 25p 7912 60p 2N1735 25p 7915 60p 2N1736 25p 7918 70p 2N1737 25p 7924 65p 2N1738 25p		MEMORIES 2114L-200ns 90p 2114-450ns 90p 2716-450ns 210p 2732-200ns 440p 4116-200ns 85p 4164-200ns 500p 6116-150ns 500p		SCR THYRISTORS BT106 150p BT116 175p C106D 45p TIC44 30p TIC45 30p 2N5062 30p 2N5064 38p 2N4444 125p		TRIACS TIC206D 55p T2800D 95p		BRIDGE RECTIFIERS 1A/100V 25p 1A/400V 30p 1A/800V 40p 2A/100V 40p 2A/400V 50p 2A/800V 70p 6A/400V 95p 10A/400V 280p 35A/400V 315p BY154 52p		CRYSTALS 32.768kHz 100p 1.000MHz 320p 1.8432MHz 240p 2.000MHz 225p 2.4576MHz 225p 3.000MHz 240p 3.5795MHz 120p 3.8864MHz 240p 4.1943MHz 150p 4.000MHz 190p 5.0688MHz 240p 6.000MHz 180p 6.1440MHz 180p 6.8800MHz 240p 8.000MHz 160p 10.000MHz 170p 16.000MHz 190p 18.4320MHz 250p 19.6608MHz 240p 20.000MHz 200p 27.000MHz 170p 48.000MHz 170p		SWITCHES Toggle: Standard 240V 1A SPST DPDT 40p Subminiature 240V 2A 50p Rotary SPST 60p SPDT 65p DPDT 75p SPDT Centre off 85p DPDT Centre off 90p		ALUMINIUM BOXES Bright aluminium, folded construction, 0.5" deep lid and screws. Length, width, height 3" x 2" x 1" 70p 4" x 2", 5" x 2" 100p 4" x 4" x 1.5" 104p 5.25" x 2.75" x 1.5" 109p 5.25" x 4" x 1.5" 117p 6" x 4" x 2" 143p 7" x 5" x 2.5" 170p 8" x 6" x 3" 204p		SPECIAL OFFER VIC-20 Colour computer C2N Cassette Deck Introduction to Basic (Part 1) P Programmers Reference Guide 10 Blank Cassettes Demonstration Tape (6 programs) Vic Computing Magazine £239.95 inc. VAT + £5 carr.	
PRINTERS EPSON MX80 Printer Friction and Tractor feed 80 cps Bidirectional MX80 FT/1 £350 + £5 carr. MX80 FT/2 £360 + £5 carr.		NEC PC8023 Printer Friction and Tractor feed 100 cps Bidirectional High Res. Proportional spacing £350 + £5 carr.		MONITORS 12" Prince Monitor (24MHz BW) £98.50 + £5 carr. BMC Colour Monitor (RGB TTL) £240 + £6 carr.		BBC MICROCOMPUTER ADD-ONS Analogue Port IC73, SK6 £6.75 Printer Port IC69, P19 £8.50 Printer Cable (Centronics) £14.50 PL8, 9, 10, 11, 12 £9.50		PANEL METERS W-50mm x H-40mm x D-34mm 37mm Diameter Cut-Out FSD Resistance 50uA 3.5K 343p 100uA 3.5K 343p 30V 1K 343p		ELECTRONIC DESIGN WORK Undertaken by qualified Engineers. Analogue/Digital/Microprocessor. Prototypes built. PCB artwork prepared. Documentation/Test Specs. prepared to your specification. Please ring for further details.											

10% DISCOUNT ON ANY ORDER OVER £50 (Components Only) SEE AUGUST ADVERT FOR PRICES NOT LISTED

WW - 015 FOR FURTHER DETAILS

THE RELAY RACE IS ON!

We have relays of all types, to cater for most of your requirements. Listed is a selection.

PLUG-IN (BPO 3000), BPO 1000 MINIATURE LEVER KEYS, CRADLE TYPE DIL REED, PC SERIES 65 POWER RELAY MR16 SERIES, PCB MOUNTING RP SERIES, SR26 TYPE, B15 TYPE, 07 + 12 SERIES, KL SERIES, 5G SERIES, 35 SERIES CRADLE TYPE, 29 SERIES.

SAFELOC 250V. A.C. (single phase mains) ONLY £5.45 - NO EXTRAS!

Contact us for detailed stocklist
Trade and Export enquiries welcome



Access and Barclaycard Accepted



BAYDIS

7 William Street
Herne Bay, Kent
Tel: 02273 64586

WW - 067 FOR FURTHER DETAILS

LOW DISTORTION AUDIO SIGNAL GENERATORS

Model 149 ba

£41.60 (P&P £2.25)



DISTORTION .002% (1KHz)
Range 10Hz - 100 kHz
Output 1v rms (600 ohms)
Sine/Square
Coarse/Fine Attenuation

Based on a Linsley Hood design

Also available in kit form and alternative versions, i.e.: battery or mains. With or without frequency meter.

Literature on these units, R.F. Sig. Gen., T.H.D. meters, MVMT, Function Generators and many other instruments is available on request.

TELERADIO ELECTRONICS, 325 FORE STREET, LONDON N9 0PE
Telephone 01-807 3719 Closed Thursdays



Audio Measuring Instruments, Audio Amplifiers, Loudspeakers and Loudspeaker Components for the professional and enthusiast

RADFORD AUDIO LTD.

10 BEACH ROAD
WESTON-S-MARE, AVON BS23 2AU
TEL. 0934 416033

WW - 049 FOR FURTHER DETAILS

Professional Two-way radio in your vehicle for less than a gallon a day

PYE Private Mobile Radio systems can start as low as £1.50 per vehicle. Manufactured purely to professional specifications, and supplied solely for bona-fide business or industrial users they offer real benefits to those who *really need* good coverage and interference-free communications. If you've experienced some of the fun of C.B. radio (and some of its hang-ups!) but, would now like your business to benefit from *instant*, clear communications, get in touch now!

PYE Telecom Europe's leading manufacturer and supplier of two-way radio systems.

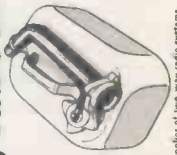

Feedback's latest!



Feedback's new Sweep Function Generator SFG611 is a high-performance instrument offering many versatile facilities:

- Frequency range 0.01Hz to 12MHz
- Sine, square and triangular outputs from 500V
- Comprehensive mark-space facilities
- Logarithmic and linear sweep
- Wide sweep-frequency range 50Hz-0.001Hz
- Single-shot facilities
- Effective bright-up marker

Professional Two-way radio in your vehicle for less than a gallon a day

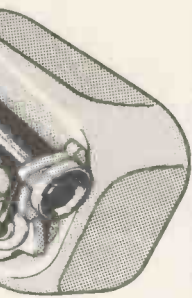

PYE Private Mobile Radio systems can start as low as £1.50 a day per vehicle. Manufactured purely to professional specifications, and supplied solely for bona-fide business or industrial users they offer real benefits to those who *really need* good coverage and interference-free communications. If you've experienced some of the fun of C.B. radio (and some of its hang-ups!) but, would now like your business to benefit from *instant*, clear communications, get in touch now!

PYE Telecom Europe's leading manufacturer and supplier of two-way radio systems.

Please let me have a free copy of your Brochure 'A look at Business Communications Costs' Arrange for me to have a mobile radio test drive

Name Position
 Company & Address Telephone 115/WW/9

Feedback's latest!



Feedback's new Sweep Function Generator SFG611 is a high-performance instrument offering many versatile facilities:

- Frequency range 0.01Hz to 12MHz
- Sine, square and triangular outputs from 500V
- Comprehensive mark-space facilities
- Logarithmic and linear sweep
- Wide sweep-frequency range 50Hz-0.001Hz
- Single-shot facilities
- Effective bright-up marker

GOULD OSCILLOSCOPES SET A HIGHER STANDARD

The Gould OS300 Dual Trace 20MHz 'Scope

A tough professional instrument you can trust - at a price you can afford!

- Max. sensitivity 2mV/cm
- Stepped and continuously variable attenuator and timebase controls
- D.C. coupled triggering and "active" T.V. sync separator
- "Add" and "invert" for differential measurements
- X-Y facility

 Built to do more - safely, reliably and for longer. Ask for our 8-page data sheet for full details and applications information.

Name Position
 Company Name and Address Tel. No.

GOULD OSCILLOSCOPES SET A HIGHER STANDARD

The Gould OS300 Dual Trace 20MHz 'Scope

A tough professional instrument you can trust - at a price you can afford!

- Max. sensitivity 2mV/cm
- Stepped and continuously variable attenuator and timebase controls
- D.C. coupled triggering and "active" T.V. sync separator
- "Add" and "invert" for differential measurements
- X-Y facility

 Built to do more - safely, reliably and for longer. Ask for our 8-page data sheet for full details and applications information.

Name Position
 Company Name and Address Tel. No.

INTERNEPCON / UK '82

Brighton, England

CAHNER'S EXPOSITION GROUP S.A.
 Cavriety House, Ladymead,
 Guildford, Surrey UK
 Tel: 0483-38085
 Telex: 859486

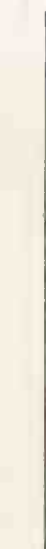

INTERNEPCON / UK '82

Brighton, England

CAHNER'S EXPOSITION GROUP S.A.
 Cavriety House, Ladymead,
 Guildford, Surrey UK
 Tel: 0483-38085
 Telex: 859486

Name Position
 Company Name and Address Tel. No.

12-14th October, 1982
 The 15th exposition covering production equipment, materials, tools, hardware, pcb's, test systems, chemicals and components for total electronics production technology.

My company may be interested in exhibiting. Please send details.
 I wish to attend. Please send free ticket and conference programme.

Please send further details without obligation to:

Name Position
 Company Name and Address Tel. No.

GOULD OSCILLOSCOPES SET A HIGHER STANDARD

The Gould OS300 Dual Trace 20MHz 'Scope

A tough professional instrument you can trust - at a price you can afford!

- Max. sensitivity 2mV/cm
- Stepped and continuously variable attenuator and timebase controls
- D.C. coupled triggering and "active" T.V. sync separator
- "Add" and "invert" for differential measurements
- X-Y facility

 Built to do more - safely, reliably and for longer. Ask for our 8-page data sheet for full details and applications information.



Name Position
 Company Name and Address Tel. No.

Postage
will be
paid by
Licensee

Do not affix Postage Stamps if posted in
Great Britain, Channel Islands or N. Ireland

BUSINESS REPLY SERVICE
Licence No KE 1731

BOB NIBBS
L305
QUADRANT HOUSE
SUTTON
SURREY SM2 5AS

Postage
will be
paid by
Licensee

Do not affix Postage Stamps if posted in
Great Britain, Channel Islands or N. Ireland

BUSINESS REPLY SERVICE
Licence No EDO 1033

SALES DEPT
GOULD ADVANCE LIMITED
ROEBUCK ROAD
HAINAULT
ESSEX IG6 3UE

Postage
will be
paid by
Licensee

Do not affix Postage Stamps if posted in
Great Britain, Channel Islands or N. Ireland

BUSINESS REPLY SERVICE
Licence No CB7

PYE TELECOMMUNICATIONS LIMITED
ST ANDREWS ROAD
CAMBRIDGE CB4 1BR

AFFIX
STAMP
HERE

MARKETING SERVICES DEPARTMENT
FEEDBACK INSTRUMENTS LIMITED
PARK ROAD
CROWBOROUGH
SUSSEX TN6 2QR

THE CASE FOR



It's the chance every constructor wants

Did you know



POWER AMPS



P.S.U's



PRE-AMP
MODULES

It's something you have always wanted... something to build your equipment into that's smart, modern, strong, adaptable to requirement and not expensive. The 'UniCase' is yet another triumph of I.L.P. design policy. It presents totally professional appearance and finish, ensuring easier and better assembly to make it equal to the most expensive cased equipment. The all-metal 'UniCase' is enhanced by precision aluminium extruded panels engineered for speedy and perfect aligned assembly within a mere five minutes. Designed in the first case to accommodate I.L.P. power amps with P.S.U.'s, the range will shortly be extended to house any other modular projects.

WHAT WE DO FOR CONSTRUCTORS

Our product range is now so vast we cannot possibly hope to show it all in our advertisements without overcrowding or abridging information to the point of uselessness. So we have devised a solution which we invite you to take advantage of without delay. ALL YOU NEED DO IS FILL IN AND FORWARD THE COUPON BELOW TO RECEIVE OUR NEWEST COMPREHENSIVE I.L.P. CATALOGUE POST FREE BY RETURN. It gives full details of all current I.L.P. products for the constructor together with prices, full technical and assembly details, wiring and circuit diagrams etc. and it's yours, FREE. You don't even have to stamp the envelope if you address it the way we tell you.

I.L.P. are the world's largest designers and manufacturers of hi-fi audio modules?

I.L.P. pioneered encapsulated power amps and pre-amps for enhanced thermal stability, mechanical protection and durability?

There are TWENTY power amplifiers from 15 to 240 watts RMS including the very latest super-quality Mosfets to choose from?

TWENTY pre-amp modules allow you to incorporate exciting professional applications to your equipment never before available to constructors and experimenters?

I.L.P. are suppliers to the B.B.C., I.B.A., N.A.S.A., British Aerospace, Marconi, Racal, Ferranti, G.E.C., Rolls Royce etc?

Goods are despatched within 7 days of your order reaching us and covered by our 5 year no-quibble guarantee?



FREEPOST 5
GRAHAM BELL HOUSE, ROPER CLOSE, CANTERBURY CT2 7EP
Telephone Sales (0227) 54778 Technical Only (0227) 64723 Telex 965780

FREEPOST
Mark your envelope clearly **FREEPOST 5** and post it **WITHOUT** a stamp to I.L.P. at address above. We pay postage when your letter reaches us.

SEND COUPON
(NO STAMP NECESSARY)
FOR YOUR FREE
I.L.P. CATALOGUE
AND OPEN UP
TO A
NEW WORLD OF
QUALITY & VALUE

To: I.L.P. ELECTRONICS LTD.
PLEASE SEND ME I.L.P. CATALOGUE,
POST PAID BY RETURN

Name: _____

Address: _____

I HAVE/HAVE NOT PREVIOUSLY
BUILT WITH I.L.P. MODULES

I.L.P. products are available also from Henry's, Marshall's, Technomatic & Watford.

WW - 019 FOR FURTHER DETAILS

HF ANTENNAS



- ★ **MODE;** Full half wave operation.
- ★ **BANDS;** Up to 4 spot frequencies.
- ★ **POWER;** Receive to 800W (PEP).
- ★ **SWR;** Better than 1.5:1 on channel.



THE SMC TRAPPED DIPOLE ANTENNA

has been developed to satisfy the needs of commercial and military users. It is capable of operation between 2 and 30 MHz on as many as four spot frequencies — each capable of accommodating many channels. Excellent matching and efficiency with a single coaxial feed is offered by the use of SMC H1Q traps and the incorporation of a ferrite balun in a full half wave design. NB: Power absorbing terminating resistors are not employed. The antenna may be deployed using one or two support masts, installation (incorporating SMC light duty portable masts) can be easily effected by two people in half an hour.

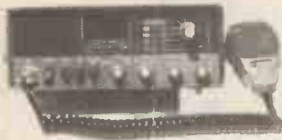

FT180 "PIONEER" HF SSB TRANSCEIVER. 1.8-18MHz, 6 channels 100 watts RF output measuring only 95(H) x 240(W) x 310(D) mm and weighing 6kg. May be operated as a base or mobile transceiver, complementing our trap dipole and HW4 mobile aerials. Prices start at £500, making this unit not only very attractive but highly competitive.

SOUTH MIDLANDS COMMUNICATIONS LTD.

OSBORNE ROAD, TOTTON
SOUTHAMPTON SO4 4DN

Telex: 477351 SMCOMM G
Tel: Totton (0703) 867333

WW - 094 FOR FURTHER DETAILS



Dwight Cavendish

So why do we put a protection circuit indicator on our amplifiers?



Well you see, the amplifier is inherently so robust that you might never know that it was operating into an adverse load, in fact it copes with anything in between a dead short and open circuit. And once you have corrected the load the amplifier automatically reverts to "normal" working.

This is just one of many features on our new range of 19" rack mounted or stand alone audio power amplifiers. The system comes complete in powers up to 500W with a variety of options and at a price which won't shock you.

For further details about our new range of f.e.t. amplifiers, drop us a line or phone 0480-215778.

Dwight Cavendish Company Limited,
Paxton Hall, Gt North Rd, Lt Paxton, Huntingdon Cambs PE19 4EL
Tel 0480 215778 215753 Telex 32744 DWICAV G

Designers and manufacturers of electronic equipment, control systems and devices.

WW - 082 FOR FURTHER DETAILS

TECHNOMATIC TECHNOMATIC TECHNOMATIC

CONNECTOR SYSTEMS

I.D. CONNECTORS (Speedblock Type)				D CONNECTORS				DIP PLUGS		FLAT CABLE (Grey)			
No. of Ways	Header	Recep	Edge Conn.	9 way 15way 25way 37way				Solder Type	IDC Type	10 way	60p		
10	90p	90p	200p	MALE				14 pin	40p	14 way	80p		
20	145p	125p	240p	FEMALE				16 pin	50p	18 way	90p		
26	175p	150p	300p	Solder	125p	200p	230p	400p	24 pin	100p	175p	34 way	220p
34	200p	160p	380p	Angled	175p	240p	275p	500p	40 pin	200p	225p	40 way	265p
40	220p	190p	550p	Hood	100p	100p	100p	125p				50 way	300p
50	235p	200p	600p	IDC Type	25 way	M £4.50	P £5.00					64 way	370p

JUMPER LEADS				EDGE CONNECTORS		EURO CONNECTORS				
24" Cable with DIP Headers				0.1" 0.156"		DIN41612 2 x 32				
1 End	145p	165p	240p	380p	2 x 18 way	140p	Plug	Sk1		
Z Ends	210p	230p	345p	540p	2 x 22 way	200p	2 x 32 Angled	260p	330p	
Cable with Sockets						Pins		330p	400p	
No. of Ways	20	26	34	40	2 x 23 way	210p	Ipsc specify a+b+c+d			
1 End	160p	210p	270p	300p	2 x 25 way	225p	3 x 32 way	295p	400p	
Cable with D Connectors						2 x 43 way	260p	IDC 2 x 32 way	a+b 475p	a+c 525p
24" Single End Male £5.50 Female £6						2 x 43 way	395p	DIN 41617 31 way	180p	180p
36" Double End Male £11 Female £11.50						1 x 77 way	700p	21 way	170p	170p
36" Male/Female £11.00						S 100 £6.00				

★ SPECIAL OFFER ★

2114L-200nS	1-24	25-99
2114L-450nS	100p	90p
2716 (+5v)	85p	80p
2532	250p	225p
2732	375p	350p
6116P-3	375p	350p
	410p	375p

OFFICIAL BBC STOCKIST

UPGRADE KIT MODEL A → MODEL B £65

MEMORY PACK
8 x 4816AP-100nS
£21.60

PRINTER & USER PORTS
IC69,70 PL9, 10 £9.50
36" Printer Lead Complete £13.50

ANALOGUE PORT
IC73, SK6 £7.30

ALL BBC CONNECTORS AVAILABLE IN STOCK
SEND FOR OUR LEAFLET

Telephone for availability of Models A & B

PRINTERS

SEIKOSHA GP100A Dot Matrix Printer, Full Graphics, double-width characters, up to 10" wide paper, self-testing parallel interface. £189+£6 Carr.

EPSON MX80 F/III. This is an upgrade of F/12 featuring improved graphics, auto underline, super and subscripts. £340+£8 carr.

NEC PC 8023 BE-C 80 Cols. 100 CPS bi-directional, Logic seeking printer with forward reverse line feed, Hi-Res & Block Graphics, International and Greek charc. Auto-underline. £375+£8 carr.

FULL DETAILS ON REQUEST

FLOPPY DISC DRIVES

Single TEAC FD 50A in cabinet with PSU £190+£6 Carr.
Two TEAC FD-50A in cabinet with PSU £360+£8 Carr.

Single Drive for Apple II

Siemens FDD 100-5 Drive housed in attractive case. Drive complete with track zero micro switch, motor control pcb, read, write and control electronics + cable £270+£6 carr.

MONITORS

BMC 12" Green Screen 18MHz Bandwidth £99+£6 Carr.
BMC 14" Colour Monitor (25 x 40 chars.) £240+£6 Carr.

SOFTY II EPROM PROGRAMMER

The complete microprocessor development system for both Engineers and Hobbyists. You can develop programs, debug, verify and commit them to EPROMs. Will accept most +5V EPROMs. Can also be used as a ROMULATOR. Full review in September, 1981 P.E. Built unit complete with PSU and TV lead £169.

MENTA

A sophisticated Z80 development system and trainer. Direct interface to TV & cassette recorder. Powerful keyboard assembler and program debugging facility — ideal for both engineers and students. Audible feedback on keyboard input. Menta + PSU + TV Lead £115.

UV ERASERS

UV1B up to 6 Eproms £47.50 UV1T with Timer £60
UV140 up to 14 Eproms £61.50 UV141 with Timer £78
(Carr. £2/eraser)

All erasers are fitted with mains switches and safety interlocks.

TECHNOMATIC TECHNOMATIC TECHNOMATIC

THE COMPUTER SHOW FOR EVERYONE!

CITY HALL, GLASGOW
September 7-9, 1982

COMPEC SCOTLAND '82



As a professional computer user, or first time user, you need to see and compare the whole range of equipment and services available for today's specifiers and purchasers – and what better way is there than spending a day at the first Compec exhibition in Scotland – COMPEC SCOTLAND – the most effective way of bringing yourself up to date with everything the computer industry can offer.

COMPEC SCOTLAND offers a truly comprehensive range: mini- and micro-computers, small business systems, printers, software, terminals and other peripherals, telecom equipment, word processors – as well as the many ancillary services and equipment available.

For computer users, suppliers, systems and software houses, the OEM industry, consultants – and particularly those considering the use of a computer system for the first time – this must be *the* exhibition for you.

Apply now for as many FREE advance registration tickets that you will need. Clip the coupon now!

Please sendFREE advance registration tickets for COMPEC SCOTLAND to:

Name

Job title

Company

Address

Return to: COMPEC SCOTLAND '82 Tickets, IPC Exhibitions,
Surrey House, Throwley Way, Sulton, Surrey SM14QQ.

W.W

DAROM SUPPLIES Dept. AW - Tel: (0925) 64764

4 Sandy Lane, Stockton Heath
Warrington, Cheshire, WA4 2AY

sabtronics 

FREQUENCY METERS

8 digit:

- ★ Convenient single input for entire range
- ★ Big easy to read LED display
- ★ Excellent sensitivity
- ★ 10MHz crystal controlled timebase
- ★ Battery or mains operated
- ★ 3 switch selectable gate times
- ★ Leading zero suppression

8110A..... 20Hz-100MHz£67
8610A..... 20Hz-600MHz£82

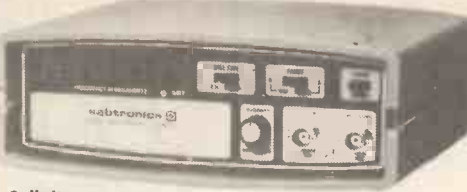

9 digit:

- ★ 9 digit resolution for more precise readings
- ★ Excellent 30mV sensitivity up to 1GHz
- ★ 3 switch selectable gate times
- ★ 10 MHz crystal controlled timebase
- ★ 2 separate inputs for added versatility
- ★ Front panel sensitivity control
- ★ Battery or mains operated

8610B 10Hz-600MHz£99
8000B 10Hz-1000MHz.....£155

WW - 078 FOR FURTHER DETAILS

I.C.E. Multitester

Only
£32.00



2000V. DC	2500V. AC
10 Amps DC	5 Amps AC
100 M Ω	20,000μF

Add 15% VAT on all prices correct at 1-5-82 E & OE cash with order or credit card Carriage £1 for all orders

SOUND INVESTMENT



QUALITY REEL TO REEL & CASSETTE TAPE HEADS

FITTING A NEW TAPE HEAD CAN TRANSFORM THE PERFORMANCE OF YOUR TAPE RECORDER. OUR FULL CATALOGUE (PRICE 50p) ALSO INCLUDES TAPE TRANSPORTS, DISC DRIVES, PRE-AMPLIFIERS AND ACCESSORIES

POPULAR UNIVERSAL CASSETTE HEADS TO EIAJ STANDARDS

C21RPS18 MONO R/P	£4.82	Hole Centres 17mm Apart, 12mm From Head Face
B24-02 STEREO R/P	£7.66	C42RPH20 STEREO R/P SENDUST FOR CHROME/METAL TAPES ..
B24-07 STEREO R/P FOR DOLBY SYSTEMS	£9.05	C42RPH04 STEREO R/P GLASS FERRITE THE ULTIMATE LONG LIFE, HIGH PERFORMANCE HEAD
C21ES18 MONO/STEREO ERASE HEAD	£2.13	£13.34

POST AND PACKING 40p EX STOCK DELIVERIES, ALL PRICES INCLUDE V.A.T.

The Monolith Electronics Co. Ltd.,
5/7 Church Street, Crewkerne,
Somerset TA18 7HR
Tel: 0460 74321.
Telex: 46306 MONLTH G.

MONOLITH
electronic products

WW - 034 FOR FURTHER DETAILS

RECHARGEABLE BATTERIES

PRIVATE & TRADE ENQUIRIES WELCOME

Full range available to replace 1.5 volt dry cells and 9 volt PP type batteries, SAE for lists and prices. £1.45 for booklet, "Nickel Cadmium Power," plus catalogue.

★ New sealed lead range now available ★

Write or call at:

SANDWELL PLANT LTD.
2 Union Drive, Boldmere
Sutton Coldfield, West Midlands, 021-354 9764
After Hours 0977 84093

WW - 035 FOR FURTHER DETAILS

MARKETING Ltd.

Bullet

LOUDSPEAKER COMPONENTS

N-4500 FILTER KIT

A 12 dB/octave, 3 component, high pass filter kit especially designed for the K-3050 Super Tweeter. 50 Watts, 8 Ohms, -3 dB point at 4,500 Hertz. Comes complete with full connection instructions.

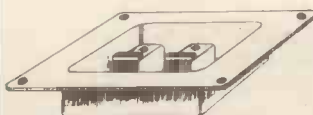

T-8065 TERMINAL PANEL

The two recessed, colour coded, terminals will allow easy connection of any loudspeaker cable by simply inserting the stripped cable ends into the spring loaded terminals.

D.S.N. Marketing is a newly established subsidiary company, part of a group of companies centred around one of the U.K. market leaders in electro-acoustic equipment, established for over 50 years. We make use of the extensive research facilities on our premises, which include a large anechoic chamber and B & K measuring equipment, to ensure the highest quality of our products.

K-3050 SUPER TWEETER

This is a highly efficient horn loaded mid and high frequency tweeter with a large magnet system, a mylar diaphragm and a cast aluminium horn. Power rating with a 12 dB/octave filter at 5,000 Hertz is 15 Watts (sine wave), 50 Watts (programme), impedance 8 Ohms, frequency response 2,000-20,000 Hertz, S.P.L. 100 dB (1W @ 1m), dimensions 78 x 78mm front, 69mm depth.

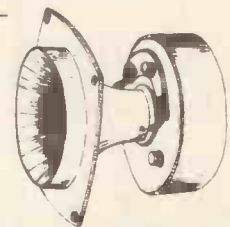

AT-SERIES L-PAD CONTROLS

A range of constant impedance loudspeaker level controls. By employing a twin-track wire wound power potentiometer in an L-circuit configuration a constant impedance of 8 Ohms within ± 25% is achieved over the whole attenuation range of 0 to -40 dB. The 'H' models are standard potentiometers with a 10mm long M9 threaded shaft. The 'S' models come complete with a recessed indication panel and control knob.

AT-40H/S - 15 Watts (- dB), 10 Watts (-6 dB), 6 Watts (-12 dB)
AT-50H/S - 30 Watts (-2 dB), 25 Watts (-6 dB), 15 Watts (-12 dB)
AT-60H - 50 Watts (-2 dB), 35 Watts (-6 dB), 25 Watts (-12 dB)

Use one AT-40H/S for each K-3050, or one AT-60H for four K-3050. For heavy duty applications, use one AT-50H/S for each K-3050 Super Tweeter.

To order: send this coupon together with cheque/postal order, payable to D.S.N. Marketing Ltd, or give Access/Visa card number. Access/Visa card holders also can phone their orders through for extra fast service. All prices include VAT @ 15%, subject to availability.
Please supply the following:

quantity	product	unit price	total price
	K-3050 Super Tweeter	5 00	
	N-4500 Filter Kit	2 20	
	T-8065 Terminal Panel	1 00	
	AT-40H L-Pad Control	1 10	
	AT-40S L-Pad Control	2 45	
	AT-50H L-Pad Control	2 55	
	AT-50S L-Pad Control	3 40	
	AT-60H L-Pad Control	4 15	
	Tick for further details	UK P&P	2 00
		TOTAL	

NAME: _____
Address: _____

Signature: _____
Access/Visa Number: _____

WW/9/82

D.S.N. MARKETING LTD, Westmorland Road, London NW9 9RJ
Telephone: 01-204 7246. Telex: 895 4243.
Trade, Wholesale, O.E.M. & Export enquiries welcome.



VISA

WW - 046 FOR FURTHER DETAILS

ambit[®] INTERNATIONAL

THE MOST COMPREHENSIVE RANGE OF COMPONENTS, KITS AND MODULES IN THE WORLD & THERE'S ONLY ROOM FOR A FRACTION HERE, GET THE CATALOGUE AND FIND THE REST.

CMOS-TTL :

4001	0.11	4515	1.25	74LS10	0.12	74LS138	0.30
4007	0.13	4516	0.60	74LS11	0.12	74LS139	0.30
4009UB	0.25	4518	0.35	74LS12	0.12	74LS145	1.20
4010	0.30	4520	0.60	74LS13	0.20	74LS151	0.30
4011	0.11	4521	1.20	74LS14	0.30	74LS153	0.27
4012	0.14	4522	0.89	74LS20	0.12	74LS154	0.99
4013	0.25	4526	0.80	74LS21	0.12	74LS155	0.35
4016	0.22	4527	0.80	74LS22	0.12	74LS156	0.37
4017	0.40	4528	0.65	74LS26	0.14	74LS157	0.30
4019	0.38	4529	0.70	74LS27	0.12	74LS158	0.30
4020	0.85	4531	0.65	74LS28	0.15	74LS160	0.37
4021	0.55	4532	0.80	74LS30	0.12	74LS161	0.37
4022	0.55	4534	4.00	74LS32	0.12	74LS162	0.37
4023	0.15	4536	2.50	74LS33	0.15	74LS163	0.37
4024	0.33	4538	1.20	74LS38	0.14	74LS164	0.40
4025	0.15	4539	0.80	74LS40	0.13	74LS165	0.60
4027	0.26	4543	0.80	74LS42	0.30	74LS168	0.70
4030	0.35	4549	3.50	74LS47	0.35	74LS169	0.85
4043	0.50	4553	2.70	74LS48	0.45	74LS170	0.90
4044	0.33	4554	1.20	74LS49	0.30	74LS173	0.40
4046	0.60	4555	0.35	74LS51	0.13	74LS174	0.40
4049UB	0.24	4556	0.40	74LS54	0.14	74LS175	0.40
4050	0.24	4557	2.30	74LS55	0.14	74LS181	1.05
4051	0.55	4558	0.80	74LS73	0.21	74LS190	0.60
4060	0.30	4559	3.50	74LS74	0.15	74LS191	0.80
4066	0.30	4560	2.50	74LS75	0.22	74LS192	0.45
4068	0.18	4561	1.00	74LS76	0.20	74LS193	0.42
4069UB	0.14	4562	2.50	74LS78	0.19	74LS194	0.35
4070	0.18	4566	1.20	74LS83	0.40	74LS195	0.35
4071	0.18	4568	1.40	74LS86	0.50	74LS196	0.55
4072	0.16	4569	1.70	74LS86	0.14	74LS221	0.50
4073	0.16	4581	0.18	74LS90	0.28	74LS240	0.80
4075	0.16	4572UB	0.22	74LS92	0.31	74LS241	0.80
4076	0.65	4580	3.25	74LS93	0.31	74LS242	0.70
4077	0.18	4581	1.40	74LS95	0.40	74LS243	0.70
4078	0.18	4582	0.70	74LS96	1.20	74LS244	0.60
4081	0.12	4583	0.80	74LS107	0.25	74LS245	0.80
4093	0.30	4584	0.27	74LS109	0.20	74LS287	0.40
4175	0.80	4585	0.45	74LS112	0.20	74LS258	0.37
4502	0.15	40174	1.05	74LS113	0.20	74LS260	0.50
4503	0.50	40195	1.08	74LS114	0.19	74LS266	0.22
4506	0.70	74LS00	0.10	74LS122	0.35	74LS273	0.70
4507	0.37	74LS01	0.10	74LS124	1.80	74LS279	0.35
4508	1.50	74LS02	0.11	74LS123	0.35	74LS365	0.32
4510	0.55	74LS03	0.11	74LS125	0.20	74LS366	0.34
4511	0.45	74LS04	0.12	74LS126	0.24	74LS367	0.32
4512	0.55	74LS05	0.13	74LS132	0.42	74LS368	0.35
4514	1.25	74LS08	0.12	74LS133	0.24	74LS373	0.70

Memory Micros Linears:

LM10CN	3.88	SL1611	1.60	KB4433	1.52	U265	3.16
L149	1.86	SL1612	1.60	KB4433	1.95	U266	2.43
U237B	1.28	SL1613	2.05	KB4436	2.53	727137	7.50
U247B	1.28	SL1620	2.17	KB4437	1.75	ICM7216B	19.50
U257B	1.28	SL1621	2.17	KB4445	1.29	ICM7216C	19.95
U267B	1.28	SL1623	2.44	KB4446	2.75	ICM7217A	9.50
LM324	0.45	SL1625	2.17	NE5044	2.26	SPB647	6.00
LM339N	0.66	SL1630	1.62	MC5229	9.60	95H90	7.80
LF347	1.60	SL1640	1.89	SL6270	2.03	HD10551	2.45
LM348	0.90	SL1641	1.89	SL6310	2.03	HA12009	6.00
LF351	0.45	TD42002	1.25	SL6440	3.38	HD44015	4.45
LF353	0.76	ULN2242	3.05	SL6800	3.75	HD44752	8.00
LM380N	1.00	ULN2283	1.00	SAS6610	1.48	MC145151P	6.00
ZN419CE	1.98	CA3089	1.84	SL6640	2.75	Z80A	3.75
ZN427E/B	6.28	CA3130E	0.80	SL6690	3.20	Z80A P10	3.50
NE544	1.80	CA3130T	0.90	SL6700	2.35	Z80A CTC	4.00
NE555N	0.20	CA3140E	0.95	SAS6710	1.48	Z80A DMA	9.95
SL580C	1.98	CA3189E	2.20	LS7225	3.65	Z80A DART	7.50
NE564	4.29	CA3240E	1.27	ICM7555	0.94	Z80A I/O1	11.00
NE567	1.30	MC3357	2.85	ICL8038CC	4.50	Z80A I/O2	11.00
uA741CN	0.20	ULN3859	2.95	TK10170	1.87	Z80A I/O9	9.95
TBA820M	0.78	LM3900	0.60	TK10321	2.75	Z8001	65.00
ZNA1034	2.10	LM3909N	0.68	HA11223	2.15	8255	2.58
LM1035	4.50	LM3914N	2.80	HA11225	1.45	6800P	2.90
TDAl062	1.95	KB4412	1.95	HA12002	1.2	6809	8.75
TDAl083	1.95	KB4417	1.80	HA12402	1.95	6802	3.60
TDAl090	3.05	KB4420B	1.09	HA12411	1.20	68A00P	4.25
HA1197	1.00	KB4423	2.30	HA12412	1.55	68B00P	4.65
MC1350	1.20	KB4424	1.65	LF13741	0.33	2114-L2	1.49
HA1370	1.90	KB4430	2.30	MK60375	3.85	4116-2	1.89
HA1388	2.75	KB4431	1.95	MM53200	3.90	2732	4.00
SL1610	1.60	KB4432	1.95	U264	2.27	2716	3.00

AND THERE'S PLENTY MORE IN THE CATALOGUE 70p inc.

Coils, Filters: Toko, Murata, NTK, Cathodeon.

SFE6.0MA	0.80	CDA10.7MA	0.70	10M15D	14.50
CFSE10.7	0.80	SFE27MA	0.94	LFB4	1.95
SFE10.7MA	0.45	SAF10.7MC-Z	3.75	LFB6/CFU455H	1.95
CFSB10.7	0.50	MF45510AZ12118.65		LFB8	1.95
SFE10.7MJ	0.50	MFL45501L	11.95	LFB10	1.95
SFA10.7MF	0.75	10M15A	1.99	LFB12/CFU455F	1.95
SFE10.7ML	0.70	21M15A	3.45	LFH6S/	
SFE10.7MX	0.95	45M15A	5.95	CFW455HT	2.45
CFSH10.7M1	0.50	10M22D	17.20	LFH8S	2.45
CFSH10.7M2	0.50	10M8D	15.50	LFH12S/	
CFSH10.7M3	0.50			CFW455FT	2.45

TOKO FIXED VALUE CHOKES (E12 Values)

7BA - 1 to 1000uH	16p	10RB - 1 to 120mH	33p
8RB - 1 to 33mH	19p	10RB - 15 to 15H	43p

RETAIL SHOP OPENING HOURS

Monday to Thursday 8.30-6.30
Friday 8.30-8.30 Saturday 9.00-5.30
(Access + Barclaycard orders accepted)

NOW IN STOCK
MF10 - National's new Dual
Switched Capacitor Filter:
Price £5.05

ALL PRICES SHOWN EXCLUDE VAT. P&P 50p per order.

AMBIT INTERNATIONAL DEPT. WW
200 North Service Road, Brentwood, Essex
TELEPHONE (STD 0277) 230909 TELEX 995194 AMBIT G POSTCODE CM14 4SG

WW - 089 FOR FURTHER DETAILS

DIGITAL MULTIMETERS FROM ONLY £39 (plus VAT, p&P)



Get your hands on a low-cost, high-performance digital multimeter. Choose from these three models:

EDM-101, at £39 (+VAT, p&P), has 5 functions and 19 ranges, plus diode test (200mV to 1000Vdc; 200 and 600Vac; 200µA to 2Aac; 200 Ω to 20M Ω).

T100 (illustrated), at £49 (+VAT, p&P), incorporates 7 functions and 29 ranges including diode test and a direct 10A input. (200mV to 1000Vdc or 750Vac; 200µA to 10Aac or dc; 200 Ω to 20M Ω).

T110, at £59 (+VAT, p&P), has an additional buzzer for fast continuity testing. Send your order in today!

VAKO DISPLAY SYSTEMS LTD

Pass Street, Werneth, Oldham, Lancs OL9 6HZ
Tel: 061-652 5111 Telex: 668250

Please send me:

- EDM-101 multimeters at £46.60 (incl.VAT, p&P)
- T100 multimeters at £58.10 (incl.VAT, p&P)
- T110 multimeters at £69.50 (incl.VAT, p&P)

Cheque/P.O. enclosed payable to Vako Display Systems Ltd. for: £

Name:

Address

Please allow 14 days for delivery.

TRADE COUNTER CALLERS WELCOME.

BSR DE LUXE AUTOCHANGER £18

Plays 12", 10" or 7" records, Auto or Manual. A high quality unit backed by BSR reliability. Stereo Ceramic Cartridge. AC 200/250V. Size 13 1/2 x 11 1/4 in. 3 speeds. Above motor board 3 3/4 in. Below motor board 2 1/2 in. Post £2 Cut Metal £1 extra



HEAVY METAL PLINTHS Post £2

Cut out for most BSR or Garrard decks. Silver grey finish, black trim. Size 16x13 3/4 in. **£4**

DECCA TEAK VENEERED PLINTH Post £1.50

Superior finish with space and panel for small amplifier. Board is cut for B.S.R. 18 3/4 in. x 14 1/4 in. x 4 in. Black/chrome fascia trim. Also with boards cut out for Garrard £3. **Tinted plastic cover £6**

TINTED PLASTIC COVERS Post £2

17 7/8 x 13 1/8 x 3 1/4 in.	£5	18 1/4 x 12 1/2 x 3 in.	£5
17 1/4 x 9 3/8 x 3 1/2 in.	£3	14 3/8 x 12 1/2 x 2 7/8 in.	£5
13 3/4 x 12 x 2 1/4 in.	£5	16 3/8 x 13 x 4 in.	£5
15 1/4 x 13 1/2 x 4 in.	£5	14 1/2 x 13 3/8 x 2 3/4 in.	£5
17 x 12 1/8 x 3 1/2 in.	£5	17 1/4 x 13 3/4 x 4 1/8 in.	£5

Callers Only (not suitable for post)
21 1/2 x 14 1/4 x 2 1/2 in. **£5** 21 x 13 7/8 x 4 1/8 in. **£5**
23 3/4 x 14 x 3 7/8 in. **£5** 30 3/4 x 13 3/8 x 3 1/4 in. **£5**

BSR SINGLE PLAYER DECKS

BSR P170 RIM DRIVE QUALITY DECK **£20** Post £2

Manual or automatic play. Precision ultra slim arm. Black with silver trim, stereo ceramic cartridge



BSR P204 SINGLE PLAYERS SPECIAL OFFERS
Two speed 33/45 r.p.m. hi-fi decks with stereo cartridges, cueing device and snake arm. Ceramic - 240V AC £15 or 9V DC £18
Magnetic - 240V AC £20 or 12V DC £24 **Post £2 ea**

GARRARD 6-200 SINGLE PLAYER DECK £22 Post £2

Brushed Aluminium Arm with stereo ceramic cartridge and Diamond Stylus, 3-speeds. Manual and Auto Stop/Start. Large Metal Turntable. Cueing Device. Ready cut mounting board £1 extra.

GARRARD SP25 Mk 4. Less cartridge. Balanced arm. Few only. 3-speed single player **£30** Post £2

BATTERY ELIMINATOR MAINS TO 9 VOLT D.C.

Stabilised output, 9 volt 400 mA. U.K. made in plastic case with screw terminals. Safety overload cut out. Size 5x3 1/4 x 2 1/2 in. Transformer Rectifier Unit. Suitable Radios, Cassettes, models, **£4.50**. Post 65p.

DE LUXE SWITCHED MODEL STABILISED. £7.50. PP £1.

3-6 1/2-9 volt 400mA DC max. Universal output plug and lead. Pilot light, mains switch, polarity switch.

DRILL SPEED CONTROLLER/LIGHT DIMMER KIT. Easy to build kit.

Controls up to 480 watts AC mains. £3. Post 65p.
DE LUXE MODEL READY-BUILT 800 watts. Front plate fits standard box. £5. Post 65p.

EMI 13 1/2 x 8 in. LOUSPEAKERS

Model 450, 10 watts R.M.S. with moving coil tweeter and two-way crossover; 3 ohm or 8 ohm. "Final Clearance". Sale Price **£8** Post £1.50
SUITABLE BOOKSHELF CABINET **£6.50**. Size 18x11x6in. Post £1.50.



RELAYS. 6V DC 95p. 12V DC £1.25. 18V £1.25. 24V £1.30

BLANK ALUMINIUM CHASSIS. 6x4-£1.45; 8x6-£1.80; 10x7-£2.30; 12x8-£2.60; 14x9-£3; 16x6-£2.90; 16x10-£3.20. 14x3x1.80. All 2 1/2 in. deep. 18 swg.

ANGLE ALL. 6x3 1/4 x 3/4 in. 18 swg. 30p.
ALUMINIUM PANELS, 18swg. 6x4-45p; 8x6-75p; 14x3-75p; 10x7-95p; 12x8-£1.10; 12x5-75p; 16x6-£1.10; 14x9-£1.45; 12x12-£1.50; 16x10-£1.75.

PLASTIC AND ALI BOXES IN STOCK. MANY SIZES
ALUMINIUM BOXES. 4x4x1 1/2 £1. 4x2 1/2 x 2 £1. 3x2x1 £1. 6x4x2 £1.80. 7x5x3 £2.40. 8x6x3 £2.50. 10x7x3 £3. 12x5x3 £2.75. 12x8x3 £3.60. All with lids.

BRIDGE RECTIFIER 200V PIV 2a £1. 4a £1.50. 6a £2.50.
TOGGLE SWITCHES SP 40p. DPST 50p. DPDT 60p.

MINIATURE TOGGLES SP 40p. DPDT 60p.
RESISTORS. 100 to 10M. 1/4W, 1/2W, 1W, 2W 20 10p.

HIGH STABILITY. 1/2w 2% 10 ohms to 1 meg. 10p.
Ditto 5%. Preferred values, 10 ohms to 10 meg. 3p.

WIRE-WOUND RESISTORS 5 watt, 10 watt, 15 watt 20p.
PICK-UP CARTRIDGES SONOTONE 9TA £2.50.

BSR Stereo Ceramic C7 Medium Output £2. SC12 £3.
PHILIPS PLUG-IN HEAD. Stereo Ceramic. AU1020 (G306 - GP310 - GP233 - AG3306. £2. A.D.C. QLM 30/3 Magnetic £5.

LOCKTITE SEALING KIT DECCA 118. Complete £1.
ANTIX SOLDERING IRON 240V 15W 3mm bit £5.25.

JACK PLUGS Mono Plastic 25p; Metal 30p.
JACK PLUGS Stereo Plastic 30p; Metal 35p.

JACK SOCKETS Mono Open 20p; Closed 25p.
JACK SOCKETS Stereo Open 25p; Closed 30p.

FREE SOCKETS - Cable end 30p. Metal 45p.
2.5mm and 3.5mm JACK SOCKETS 25p. Plugs 25p.

DIN TYPE CONNECTORS
Sockets 3-pin, 5-pin 15p. Free Sockets 3-pin, 5-pin 25p.

Plugs 3-pin 20p; 5-pin 25p; Speaker plugs 25p; Sockets 15p.
PHONO PLUGS and SOCKETS ea. 20p.

Free Socket for cable end 20p. Screened Phono Plugs 25p.
300 ohm TWIN RIBBON FEEDER 10p yd.

U.H.F. COAXIAL CABLE SUPER LOW LOSS, 25p yd.
COAX PLUGS 30p. COAX SOCKETS 20p.

NEON INDICATORS 250V, round 30p. Rectangular 45p.

POTENTIOMETERS Carbon Track

5kΩ to 2MΩ. LOG or LIN. L/S 50p. DP 90p. Stereo L/S £1.10. DP £1.30. Edge Pot 5K. SP 45p.

MINI-MULTI TESTER NEW

De luxe pocket size precision moving coil instrument. Impedance + Capacity - 4000 o.p.v. Battery included. 11 Instant ranges measure: DC volts 5.25, 250, 500, AC volts 10, 50, 500, 1000, DC amps 0-250µa, 0-250mA. **£6.50** Post 50p
Continuity and resistance 0 to 600K ohms

De Luxe Range Doubler Model, 50,000 o.p.v. £18.50. 7x5x2in. Post £1

NEW PANEL METERS £4.50

50µa, 100µa, 500µa, 1ma, 5ma, 50ma, 100ma, 500ma, 1 amp, 2 amp 25 volt, VU Meter. **2 1/4 x 2 x 1 1/4** Post 50p



RCS SOUND TO LIGHT CONTROL KIT

Kit of parts to build a 3 channel sound to light unit. 1,000 watts per channel. Suitable for home or disco. Easy to build. Full instructions supplied. Post 95p **£15**

Cabinet £4.50 extra. Operates from 200MV to 100V. 200 Watt Rear Reflecting White Light Bulbs. Ideal for Disco Lights, Edison Screw. 6 for £4, or 12 for £7.50. Post 65p. Suitable panel mounting holders 85p.

RCS "MINOR" 10 watt AMPLIFIER KIT £14

This kit is suitable for record players, guitars, tape playback, electronic instruments or small PA systems. Two versions available: Mono. £14; Stereo. £20. Specification 10W per channel; size 9 1/2 x 3 x 2 in. SAE details. Full instructions supplied. 240V AC mains. Post £1.

RCS STEREO PRE-AMP KIT. All parts to build this pre-amp. Inputs for high, medium or low imp per channel, with volume control and PC Board

Can be ganged to make multi-way stereo mixers **£2.95** Post 65p

MAINS TRANSFORMERS

250-0-250V 70mA, 6.5V 2A	Post £4.50
1 amp, 6, 8, 10, 12, 16, 18, 20, 24, 30, 36, 40, 48, 60	£5.00
2 amp, 6, 8, 10, 12, 16, 18, 20, 24, 30, 36, 40, 48, 60	£10.50
3 amp, 6, 8, 10, 12, 16, 18, 20, 24, 30, 36, 40, 48, 60	£12.50
5 amp, 6, 8, 10, 12, 16, 18, 20, 24, 30, 36, 40, 48, 60	£16.00
5-8-10-16V. 1/2 amp.	£2.50
8-12 amp.	£2.00
6-0-6V. 1/2 amp.	£3.50
9V. 250mA.	£1.50
9-0-9V. 50mA	£3.50
10-0-10V. 2 amps	£3.00
10-30-40V. 2 amps	£3.50
12-0-12V. 100mA	£1.50
12V. 750 mA	£2.00
12V 3 amps	£3.50
12-0-12V. 2 amps	£3.50

GENERAL PURPOSE LOW VOLTAGE

Tapped outputs available	Price Post
2 amp, 3, 4, 5, 6, 8, 9, 10, 12, 15, 18, 25 and 30V	£8.00
1 amp, 6, 8, 10, 12, 16, 18, 20, 24, 30, 36, 40, 48, 60	£8.00
2 amp, 6, 8, 10, 12, 16, 18, 20, 24, 30, 36, 40, 48, 60	£10.50
3 amp, 6, 8, 10, 12, 16, 18, 20, 24, 30, 36, 40, 48, 60	£12.50
5 amp, 6, 8, 10, 12, 16, 18, 20, 24, 30, 36, 40, 48, 60	£16.00
5-8-10-16V. 1/2 amp.	£2.50
8-12 amp.	£2.00
6-0-6V. 1/2 amp.	£3.50
9V. 250mA.	£1.50
9-0-9V. 50mA	£3.50
10-0-10V. 2 amps	£3.00
10-30-40V. 2 amps	£3.50
12-0-12V. 100mA	£1.50
12V. 750 mA	£2.00
12V 3 amps	£3.50
12-0-12V. 2 amps	£3.50

CHARGER TRANS

6-12 volt 3a	£4.00+£2	Post £1.10+80p
6-12 volt 4a	£6.50+£2	Post £2.00+80p

RECTIFIERS

6-12 volt 2a	£1.10+80p
6-12 volt 4a	£2.00+80p

OPUS COMPACT SPEAKERS £22 pair Post £2

TEAK VENEERED CABINET 11x8 1/2 x 7 in, 15 watts

50 to 14,000 cps. 4 ohm or 8 ohm

OPUS TWO 15x10 1/2 x 7 3/4 in 25 watt

2-way system **£39 pair**. Post £3.

LOW VOLTAGE ELECTROLYTICS Wire ends

1mf, 2mf, 4mf, 8mf, 10mf, 16mf, 25mf, 30mf, 50mf, 100mf, 250mf. All 15 volts. 22mf/60V/10v; 25mf/60V/10v; 47mf/10v; 50mf/16v; 50mf/22v; 68mf/16v/10v/16v/25v; 100mf/10v; 150mf/6v/10v; 200mf/10v/16v; 220mf/4v/10v/16v; 330mf/4v/10v; 500mf/16v; 680mf/6v/10v/16v; 1000mf/2.5v/4v/10v; 1500mf/6v/10v/16v; 2200mf/6v/10v; 3300mf/6v; 4700mf/4v. 5000mf 12V 15p; 25V 20p; 50V 30p. 1200mF 76V 86p. 1000mF 12V 20p; 25V 35p; 50V 50p; 100V 70p. 2000mF 6V 25p; 25V 42p; 40V 60p; 1200mF 76V 80p. 2200mF 63V 90p. 2500mF 50V 70p; 3000mF 50V 65p; 4500mF 64V £2. 4700mF 63V £1.20. 2700mF/76V £1.

HIGH VOLTAGE ELECTROLYTICS

2/500V	45p	8+8/450V	75p
8/450V	45p	8+8/500V	£1
16/350V	45p	8+16/450V	75p
32/500V	75p	32+32/350V	50p
32/350V	50p	32+32/500V	£1.80
50/450V	95p	50+50/300V	50p

CAPACITORS WIRE END High Voltage

.001, .002, .003, .005, .01, .02, .03, .05 mfd 400V 5p.
.1MF 200V 5p. 400V 10p. 600V 15p. 1000V 25p.
.22MF 350V 12p. 600V 20p. 1000V 30p. 1750V 50p.
.47MF 150V 10p. 400V 20p. 630V 30p. 1000V 60p.
VALVE OUTPUT Transformers (small) 90p.
TRIMMERS 30pF, 50pF, 10pF, 100pF, 150pF 20p. 500pF 30p.
MICROSWITCH SINGLE POLE CHANGEOVER 40p.
SUB-MIN MICROSWITCH, 50p, Single pole changeover.
TWIN GANG, 120pF 50p. 500 plus 200pF £1.
GEARED TWIN GANGS 25pF 95p.
GEARED 365+365+25+25pF £1.
TRANSISTOR TWIN GANG, Japanese Replacement £1
SOLID DIELECTRIC 100pF £1.50, 500pF £1.50

HEATING ELEMENTS, WAFER THIN

Size 11x9x1/8 in. Operating voltage 240V, 250W approx. Suitable for Heating Pads, Food Warmers, Convector Heaters, Propagation, etc. Must be clamped between two sheets of metal or ceramic, etc. **ONLY 60p EACH (FOUR FOR £2) ALL POST PAID.**

NEW baker Star sound

high power full range quality loudspeakers produced to give exceptional reproduction. Ideal for Hi-Fi, music P.A. or discotheques. These loudspeakers are recommended where high power handling is required with quality results. The high flux ceramic magnet ensures clear response.



MODEL	INCHES	OHMS	WATTS	TYPE	PRICE	POST
MAJOR	12	4-8-16	30	HI-FI	£14	£2
DELUXE MK II	12	8	15	HI-FI	£14	£2
SUPERB	12	8-16	30	HI-FI	£24	£2
AUDITORIUM	12	8-16	45	HI-FI	£22	£2
AUDITORIUM	15	8-16	60	HI-FI	£34	£2
GROUP 45	12	4-8-16	45	PA	£14	£2
GROUP 75	12	4-8-16	75	PA	£18	£2
GROUP 100	12	8-16	100	Guitar	£24	£2
DISCO 100	12	8-16	100	Disco	£24	£2
GROUP 100	15	8-16	100	Guitar	£32	£2
DISCO 100	15	8-16	100	Disco	£32	£2



BAKER 150 WATT MIXER/POWER AMPLIFIER £89 Post £2

For Discotheque, Vocal, Public Address. Three speaker outlets for 4, 8 or 16 ohms. Four high gain inputs, 20 mv, 50K ohm. Individual volume controls "Four channel" mixing. 150 watts 8 ohms R.M.S. Music Power. Slave output 500 M.V. 25K ohm. Response 25 Hz - 20kHz ± 3dB. Integral Hi-Fi preamp separate Bass & Treble. Size - 16" x 8" x 5 1/2". Wt - 14lb. Master volume control. British made. 12 months' guarantee. 240v A.C. mains or 120v to order. All transistor and solid state.
MONO SLAVE VERSION £75. 100 Volt Line Model £104.
New Stereo Slave Model 150 + 150 watt £125. Post £4.
BAKER'S NEW PA150 MICROPHONE PA AMPLIFIER £129. PP £3.
4 channel 8 inputs, dual impedance, 50K-600 ohm 4 channel mixing, volume, treble, bass. Presence controls, Master volume control, echo/send/return socket. Slave input/output sockets.

BAKER £69 50 WATT AMPLIFIER Post £2

Ideal for PA systems, Discos and Groups. Two inputs, Mixer, Volume, Controls, Master Bass, Treble Gain.



RCS offers MOBILE PA AMPLIFIERS. Outputs 4-8-16 ohms

20-watt RMS 12V DC, AC 240v, 3 inputs. 50K	£46 PP £2
40-watt RMS 12V DC, AC 240v, 4 inputs. 50K	£75 PP £2
Mic 1; Mic 2; Power; aux. outputs 4 or 8 or 16 and 100v line	
60-watt RMS, Mobile 24 volt DC & 240-volt AC mains. inputs 50K	
3 mics + 1 mic. Outputs 4-8-16 ohm + 100 volts line	£95 PP £2

Battery only Shoulder PA Amplifier 10w max. Includes mike and speaker, OK for meetings, crowd control, stalls, fetes, traders, etc. Batteries included (6 of U2) £27.50 post £1.50.

FAMOUS LOUSPEAKERS "SPECIAL PRICES"

MAKE	MODEL	SIZE	WATTS	OHMS	PRICE	POST
SEAS	TWEETER	4in	50	8	£3.50	£1
GOODMANS	TWEETER	3 1/2 in	25	8	£4	£1
AUDAX	TWEETER	4in	30	8	£6.50	£1
SEAS	MID-RANGE	4in	50	8	£7.50	£1
SEAS	MID-RANGE	5in	80	8	£12	£1
SEAS	MID-RANGE	4 1/2 in	100	8	£12.50	

WHAT ARE YOU DRIVING?

INDUCTION LOOP TRANSMITTERS
VIBRATOR/SHAKERS
SERVOMOTORS
MAGNETS

CRIMSON ELEKTRIK POWER AMP MODULES HAVE DONE IT ALL

CHOOSE our acclaimed Bipolar Modules for the best in Hi-Fi. These modules have been widely used by professional bodies. They are high slew, low t.h.d. devices without need for the output fuses that spoil fidelity. They have instantly resettable 'electronic fuse' and are L-bracket mounting for flexi installation.

CHOOSE Our Mosfet Modules for the most difficult loads. These modules are rugged and make ideal line step-up transformer drivers. They respond down to d.c. and make excellent servo-driving devices. They have low d.c. offset drift due to jfet inputs.

BIPOLAR	TYPE	MAX. O/P POWER	SUPPLY TYP.	VOLTAGE MAX.	THD TYP.	PRICE INC. V.A.T. & POST
	CE 608	60W/8Ω	± 35	± 40	< .01%	£21.50
	CE 1004	100W/4Ω	± 35	± 40	< .018%	£25.00
	CE 1008	120W/8Ω	± 45	± 50	< .01%	£28.00
	CE 1704	200W/4Ω	± 45	± 63	< .015%	£35.50
	CE 1708	180W/8Ω	± 60	± 63	< .01%	£35.50
	CE 3004	320W/4Ω	± 60	± 63	< .02%	£49.50
MOSFET	FE 908	90W/8Ω	± 45	± 60	< .01%	£30.00
	FE 1704	170W/4Ω	± 45	± 60	< .025%	£39.00

Export - no problem. Please write for quotation or quote your Visa/Master Charge card number.

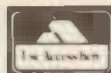

Crimson Elektrik

FREEPOST, 9 Claymill Road, Leicester, LE4 7JJ, England

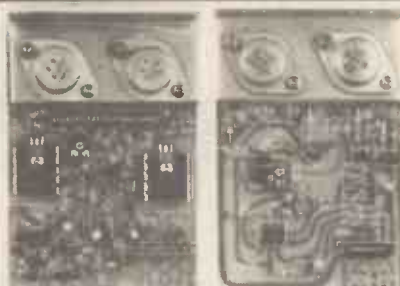

POWER AMPLIFIERS

POWER AMPLIFIERS

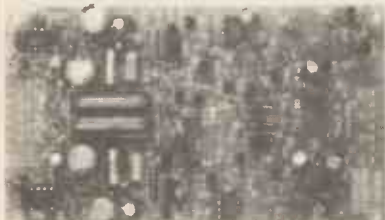

PRE-AMPLIFIERS



ACTIVE CROSSOVERS

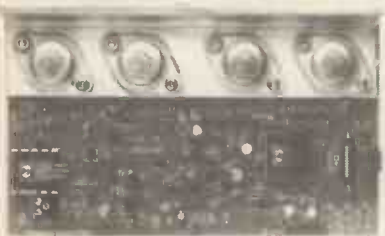

HEAVY DUTY POWER AMPLIFIERS

INSTANT PRINTED CIRCUITS!!

Make your own - to professional standards - within minutes using either "Fotolak" Light-sensitive Aerosol Lacquer or Pre-coated board. No Darkroom or Ultra-violet source needed!

Fotolak aerosol.....£2.50 (30p)	Developer.....£0.30 (15p)
Ferric Chloride.....£0.60 (45p)	Acetate Sheet.....£0.15 (15p)
Copper-clad Fibre-glass Boards:	Single-sided.....£2 ft. sq. (45p)
	Double-sided.....£2.25 ft. sq. (60p)
Pre-coated Fibre-glass Board:	
8"x4 1/2".....£1.75 (25p)	16"x9".....£7 (60p)
8"x9".....£3.50 (45p)	24"x12".....£13 (£1.20)
	Eurocard £1.25 (25p)

Double-sided Board (all sizes) add 20%
Postage individual items in brackets. Maximum charge £2 per order.

WHITE HOUSE ELECTRONICS
P.O. Box 19, Praa Sands, Penzance TR20 9TF
Telephone: Germoe (073-676) 2329

ScheTronics Limited

For repair and calibration of test equipment. We also have the following second user LF/HF equipment for sale.

Siemens including Pegamat - W & G - H.P. - Hatfield
Anritsu - Marconi - Fluke - STC - etc ...

Unit 10, Dunstall Estate
Crabtree Manorway
Belvedere, Kent DA17 6AW
Telephone: 01-311 9657

WW - 093 FOR FURTHER DETAILS

★ DISCOUNT STRUCTURE FOR MULTIPLE USERS ONLY



Teoman Products Ltd
"Wychwood", 2 Abbots Ripton Rd., Sapley, Cambridgeshire PE17 2LA. Tel: (0480) 57758

Please send
TLW4 Toolwallet £13.75 + £1.50 P&P
TL100 Professional Toolcases at £43.70 each
TL99 £39.90. Both inc. VAT (P&P £2.60 extra)

Enclosed my cheque for £
Name
Company
Address

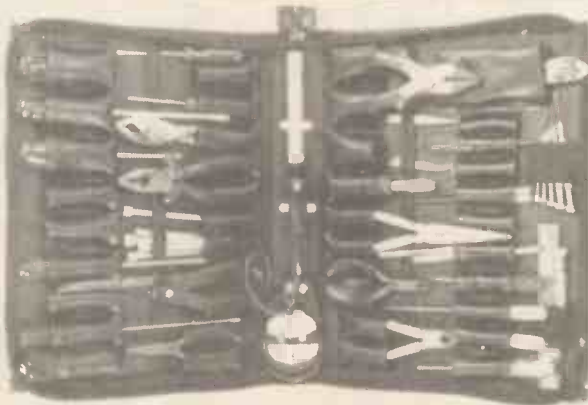

TLW4

TLW4 TOOLWALLET MEASURES 11"x14"x2 1/2" WHEN CLOSED. MADE FROM REINFORCED PVC WITH A HEAVY DUTY INDUSTRIAL ZIP

LANGREX SUPPLIES LTD

Climax House, Fallsbrook Rd., Streatham, London SW16 6ED

RST Tel: 01-677 2424 Telex: 946708 RST

SEMICONDUCTORS

AA119	0.12	ASZ15	1.38	BC172	0.13	BD131	0.51	BF257	0.31	GEX541	5.75	OAZ207	1.73	OC205	3.16	ZTX504	0.24	2N1671	5.75	2N3819	0.35
AA130	0.20	ASZ16	1.21	BC173	0.13	BD132	0.55	BF258	0.31	GJM38	1.73	OC16	2.88	OC206	3.16	ZTX531	0.28	2N1893	0.37	2N3820	0.45
AA132	0.20	ASZ17	1.21	BC174	0.13	BD133	0.46	BF259	0.31	KS1030	2.02	OC207	2.88	OC207	2.88	ZTX550	0.28	2N2147	4.90	2N3823	0.69
AA133	0.48	ASZ18	1.15	BC175	0.32	BD137	0.46	BF336	0.39	MJE300A	0.52	OC208	2.88	OC208	2.88	ZTX550	0.29	2N2148	4.31	2N3866	1.15
AA134	0.17	ASZ20	2.44	BC178	0.16	BD138	0.55	BF338	0.41	MJE301	0.69	OC209	2.88	OC209	2.88	ZTX550	0.29	2N2149	4.31	2N3904	0.20
AA135	0.17	ASZ21	2.88	BC179	0.32	BD139	0.55	BF339	0.41	MJE302	0.84	OC210	2.88	OC210	2.88	ZTX550	0.29	2N2150	4.31	2N3905	0.20
AA136	0.17	ASZ22	2.88	BC180	0.32	BD140	0.58	BF340	0.41	MJE303	0.84	OC211	2.88	OC211	2.88	ZTX550	0.29	2N2151	4.31	2N3906	0.20
AA137	0.63	AYU10	3.48	BC181	0.13	BD141	2.30	BF341	0.41	MJE304	0.84	OC212	2.30	OC212	2.30	ZTX550	0.29	2N2152	4.31	2N4059	0.23
AC125	0.29	BA110	2.58	BC184	0.13	BD181	1.38	BF342	0.41	MJE305	0.84	OC213	2.30	OC213	2.30	ZTX550	0.29	2N2153	4.31	2N4060	0.18
AC126	0.29	BA145	0.15	BC212	0.13	BD182	1.36	BF343	0.41	MJE306	0.84	OC214	2.30	OC214	2.30	ZTX550	0.29	2N2154	4.31	2N4061	0.18
AC127	0.29	BA148	0.17	BC213	0.13	BD183	0.62	BF344	0.41	MJE307	0.84	OC215	2.30	OC215	2.30	ZTX550	0.29	2N2155	4.31	2N4062	0.18
AC128	0.35	BA154	0.12	BC214	0.13	BD238	0.62	BF345	0.41	MJE308	0.84	OC216	2.30	OC216	2.30	ZTX550	0.29	2N2156	4.31	2N4124	0.18
AC141	0.32	BA155	0.13	BC217	0.13	BDX10	1.05	BF346	0.41	MJE309	0.84	OC217	2.30	OC217	2.30	ZTX550	0.29	2N2157	4.31	2N4126	0.18
AC141K	0.40	BA156	0.12	BC230	0.13	BDX32	2.30	BF347	0.41	MJE310	0.84	OC218	2.30	OC218	2.30	ZTX550	0.29	2N2158	4.31	2N4286	0.17
AC142	0.32	BA162	0.86	BC301	0.38	BDY20	1.73	BF348	0.41	MJE311	0.84	OC219	2.30	OC219	2.30	ZTX550	0.29	2N2159	4.31	2N4288	0.21
AC142K	0.40	BA163	0.07	BC303	0.39	BDY60	3.16	BF349	0.41	MJE312	0.84	OC220	2.30	OC220	2.30	ZTX550	0.29	2N2160	4.31	2N4289	0.21
AC176	0.35	BA166	0.07	BC307	0.13	BF115	0.40	BF350	0.41	MJE313	0.84	OC221	2.30	OC221	2.30	ZTX550	0.29	2N2161	4.31	2N4547	0.37
AC187	0.32	BC107	0.18	BC308	0.13	BF152	0.18	BF351	0.41	MJE314	0.84	OC222	2.30	OC222	2.30	ZTX550	0.29	2N2162	4.31	2N4548	0.37
AC188	0.32	BC108	0.18	BC327	0.14	BF153	0.18	BF352	0.41	MJE315	0.84	OC223	2.30	OC223	2.30	ZTX550	0.29	2N2163	4.31	2N4549	0.37
AC191	1.50	BC109	0.18	BC328	0.14	BF154	0.20	BF353	0.41	MJE316	0.84	OC224	2.30	OC224	2.30	ZTX550	0.29	2N2164	4.31	25017	11.50
AC198	1.32	BC113	0.17	BC337	0.14	BF155	0.20	BF354	0.41	MJE317	0.84	OC225	2.30	OC225	2.30	ZTX550	0.29	2N2165	4.31	25019	13.80
AC199	1.27	BC114	0.17	BC338	0.14	BF160	0.20	BF355	0.41	MJE318	0.84	OC226	2.30	OC226	2.30	ZTX550	0.29	2N2166	4.31	25026	28.75
AC199	1.27	BC115	0.21	BCY30	1.44	BF167	0.28	BF356	0.41	MJE319	0.84	OC227	2.30	OC227	2.30	ZTX550	0.29	2N2167	4.31	25103	1.73
AC199	1.27	BC116	0.22	BCY31	1.73	BF173	0.35	BF357	0.41	MJE320	0.84	OC228	2.30	OC228	2.30	ZTX550	0.29	2N2168	4.31	25103	1.73
AC199	1.27	BC117	0.26	BCY32	1.73	BF177	0.40	BF358	0.41	MJE321	0.84	OC229	2.30	OC229	2.30	ZTX550	0.29	2N2169	4.31	25103	1.73
AD140	0.86	BC118	0.21	BCY33	1.27	BF178	0.40	BF359	0.41	MJE322	0.84	OC230	2.30	OC230	2.30	ZTX550	0.29	2N2170	4.31	25103	1.73
AD161	0.40	BC125	0.21	BCY34	1.15	BF179	0.40	BF360	0.41	MJE323	0.84	OC231	2.30	OC231	2.30	ZTX550	0.29	2N2171	4.31	25103	1.73
AD162	0.40	BC126	0.21	BCY39	3.91	BF180	0.32	BF361	0.41	MJE324	0.84	OC232	2.30	OC232	2.30	ZTX550	0.29	2N2172	4.31	25103	1.73
AF106	0.40	BC135	0.17	BCY40	3.22	BF181	0.32	BF362	0.41	MJE325	0.84	OC233	2.30	OC233	2.30	ZTX550	0.29	2N2173	4.31	25103	1.73
AF114	0.86	BC136	0.22	BCY42	0.35	BF182	0.35	BF363	0.41	MJE326	0.84	OC234	2.30	OC234	2.30	ZTX550	0.29	2N2174	4.31	25103	1.73
AF115	0.86	BC137	0.22	BCY43	0.35	BF183	0.32	BF364	0.41	MJE327	0.84	OC235	2.30	OC235	2.30	ZTX550	0.29	2N2175	4.31	25103	1.73
AF116	0.86	BC138	0.22	BCY44	0.35	BF184	0.32	BF365	0.41	MJE328	0.84	OC236	2.30	OC236	2.30	ZTX550	0.29	2N2176	4.31	25103	1.73
AF117	0.86	BC139	0.22	BCY45	0.35	BF185	0.35	BF366	0.41	MJE329	0.84	OC237	2.30	OC237	2.30	ZTX550	0.29	2N2177	4.31	25103	1.73
AF139	0.38	BC149	0.15	BCY71	0.21	BF194	0.16	BF367	0.41	MJE330	0.84	OC238	2.30	OC238	2.30	ZTX550	0.29	2N2178	4.31	25103	1.73
AF186	1.15	BC157	0.15	BCY72	0.20	BF195	0.14	BF368	0.41	MJE331	0.84	OC239	2.30	OC239	2.30	ZTX550	0.29	2N2179	4.31	25103	1.73
AF239	0.45	BC158	0.15	BCZ11	2.01	BF196	0.16	BF369	0.41	MJE332	0.84	OC240	2.30	OC240	2.30	ZTX550	0.29	2N2180	4.31	25103	1.73
AFZ11	4.60	BC159	0.15	BD115	0.48	BF197	0.12	BF370	0.41	MJE333	0.84	OC241	2.30	OC241	2.30	ZTX550	0.29	2N2181	4.31	25103	1.73
AFZ12	4.60	BC167	0.13	BD121	0.46	BF198	0.12	BF371	0.41	MJE334	0.84	OC242	2.30	OC242	2.30	ZTX550	0.29	2N2182	4.31	25103	1.73
ASV26	1.61	BC170	0.13	BD123	3.22	BF224	0.29	BF372	0.41	MJE335	0.84	OC243	2.30	OC243	2.30	ZTX550	0.29	2N2183	4.31	25103	1.73
ASV27	1.04	BC171	0.12	BD124	2.30	BF244	0.32	BF373	0.41	MJE336	0.84	OC244	2.30	OC244	2.30	ZTX550	0.29	2N2184	4.31	25103	1.73

VALVES

A1834	10.35	E180F	7.83	EF91	2.07	GXU1	16.10	PC97	1.38	QV5-3000A	1.38	UL84	1.38	4B32	29.16	6CW4	8.83	12BE6	2.79	5670	5.18
A2087	13.58	E182CC	18.80	EF92	6.68	GXU2	28.43	PC900	1.38	QV6-3000A	356.66	UM80	1.15	4C35	74.75	6D24	1.01	12BH7	1.29	5675	21.47
A2134	20.13	E186F	12.58	EF93	6.58	GXU3	30.49	PC884	1.15	QV6-20	34.16	UY41	1.44	4CX250B	51.75	6DK6	3.00	12BY7	3.11	5687	6.31
A2293	8.26	E294C	2.94	EF94	1.15	GXU5	17.25	PC859	1.38	R10	5.75	YV831	1.20	4CX50A	80.50	6D06B	4.69	12E18T	18.27	5696	4.35
A2426	17.63	E280F	25.88	EF95	6.27	GZ32	1.44	PC889	1.56	R18	4.89	XG1-2500	58.02	4E150D	24.41	6EA8	3.38	12E11TT	19.26	5707	5.75
A2521	24.28	E283CC	9.02	EF98	1.44	GZ33	4.60	PC885	1.51	R19	1.38	XG2-6400		4E150D	28.75	6EB8	2.44	12E14	34.50	5725	5.62
A2900	14.43	E288CC	18.54	EF183	0.92	GZ34	2.88	PC806	2.07	R20	1.66	XG5-500	28.23	5B254M	23.12	6EW6	1.73	12E14	123.05	5726	3.62
A3343	51.75	EAS2	28.18	EF184	0.96	GZ37	4.60	PC882	2.07	R20	1.66	XG5-500	28.23	5B255M	23.12	6F6	2.02	19H4	28.75	5727	6.47
A3343	51.75	EAS2	28.18	EF184	0.96	GZ37	4.60	PC882	2.07	R20	1.66	XG5-500	28.23	5B255M	23.12	6F6	2.02	19H4	28.75	5727	6.47
A3343	51.75	EAS2	28.18	EF184	0.96	GZ37	4.60	PC882	2.07	R20	1.66	XG5-500	28.23	5B255M	23.12	6F6	2.02	19H4	28.75	5727	6.47
A3343	51.75	EAS2	28.18	EF184	0.96	GZ37	4.60	PC882	2.07	R20	1.66	XG5-500	28.23	5B255M	23.12	6F6	2.02	19H4	28.75	5727	6.47
A3343	51.75	EAS2	28.18	EF184	0.96	GZ37	4.60	PC882	2.07	R20	1.66	XG5-500	28.23	5B255M	23.12	6F6	2.02	19H4	28.75	5727	6.47
A3343	51.75	EAS2	28.18	EF184	0.96	GZ37	4.60	PC882	2.07	R20	1.66	XG5-500	28.23	5B255M	23.12	6F6	2.02	19H4	28.75	5727	6.47
A3343	51.75	EAS2	28.18	EF184	0.96	GZ37	4.60	PC882	2.07	R20	1.66	XG5-500	28.23	5B255M	23.12	6F6	2.02	19H4	28.75	5727	6.47
A3343	51.75	EAS2	28.18	EF184	0.96	GZ37	4.60	PC882	2.07	R20	1.66	XG5-500	28.23	5B255M	23.12	6F6	2.02	19H4	28.75	5727	6.47
A3343	51.75	EAS2	28.18	EF184	0.96	GZ37	4.60	PC882	2.07	R20	1.66	XG5-500	28.23	5B255M	23.12	6F6	2.02	19H4	28.75	5727	6.47
A3343	51.75	EAS2	28.18	EF184	0.96	GZ37	4.60	PC882	2.07	R20	1.66	XG5-500	28.23	5B255M	23.12	6F6	2.02	19H4	28.75	5727	6.47
A3343	51.75	EAS2	28.18	EF184	0.96	GZ37	4.60	PC882	2.07	R20	1.66	XG									

BRITAIN'S BETTER BARGAIN STILL IN WORLD-WIDE DEMAND

WIRELESS WORLD CIRCARDS at 1976 prices 10% discount for 10 sets! Most sets are still available even though the companion volumes CIRCUIT DESIGNS 1, 2 and 3 are out of print. (CIRCARDS SETS 1 to 30).

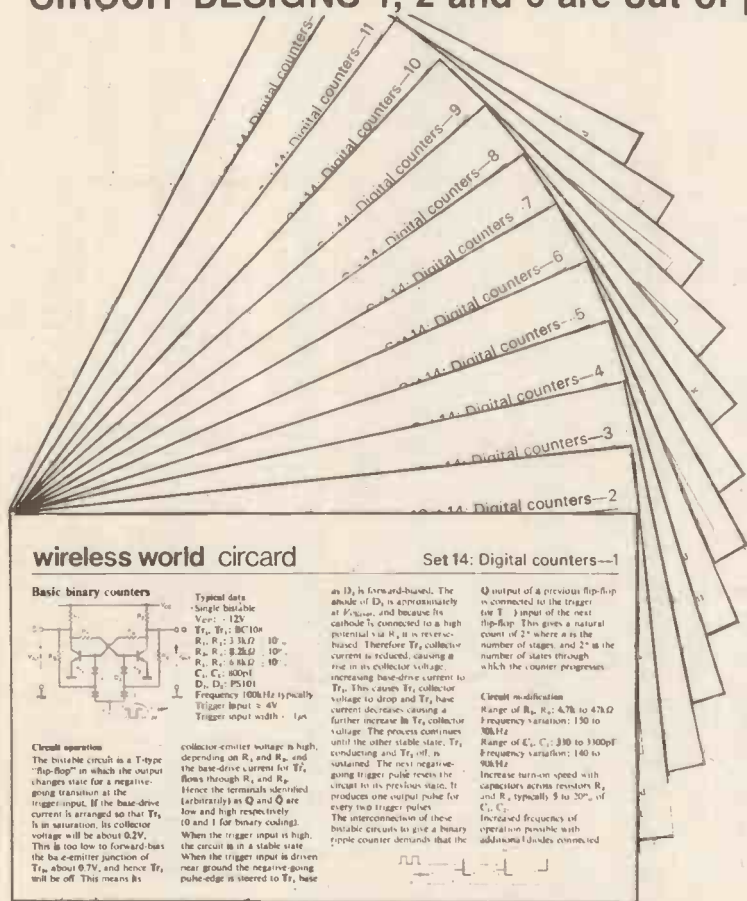

Fill gaps in your circuit files with these sets of 127 x 204 mm cards in plastic wallets. These unique circuit cards normally contain descriptions and performance data of 10 tested circuits, together with ideas for modifying them to suit special needs.

- 1 Basic Active filters 2 Switching Circuits, comparators and Schmitts (But these gaps cannot be filled)
 6 Constant current circuits 7 Power amplifiers 8 Astable circuits 9 Optoelectronics 10 Micro power circuits 11 Basic logic gates 12 Wideband amplifiers 13 Alarm circuits 14 Digital Counters 15 Pulse modulators 16 Current differencing amplifiers—signal processing 17 Current differencing amplifiers—signal generation 18 Current differencing amplifiers—measurement and detection 19 Monostable circuits 20 Transistor pairs 21 Voltage-to-frequency converters 22 Amplitude modulation and detection 23 Reference circuits 24 Voltage regulators 25 RC oscillators—1 26 RC oscillators—2 27 Linear cmos—1 28 Linear cmos—2 29 Analogue multipliers 30 Rms/log/power laws 31 Digital multipliers 32 Transistor arrays 33 Differential and bridge amplifiers 34 Analogue gate applications—1 35 Analogue gate applications—2.

To IPC Electrical—Electronics Press Ltd.
 General Sales Department,
 Room 205,
 Quadrant House,
 Sutton,
 Surrey SM2 5AS

Company registration in England
 Quadrant House, The Quadrant,
 Sutton, Surrey SM2 5AS
 Reg. No 677128

Please send me the following sets of
 Circards:..... £2 each,
 £18 for 10 post free.
 Remittance enclosed..... payable
 to IPC BUSINESS PRESS LTD.

Name (Please print).....

Address (Please print).....

.....

MULTIPURPOSE DIGITAL THERMOMETER

£59 EX-WORKS

Sensors are £5 to £14 for Air, Liquid Immersion, Surface and Penetration measurements.



Total range -50 to 1100°C with 1.0°C resolution. Type K Ni-Cr/Ni-Al Thermocouple input. Suitable for applications from the workshop to the laboratory. Solder Baths, Soldering Irons, Ovens, Components are only a few of the many temperatures needing to be measured. Send for Product Details. Calibration Certificates can be supplied, details on request.

Phone our Technical Enquiry Service for Assistance No. 02434-77743. We have many other products and sensors including Non-contact Infra-red Thermometers.

PROLAB INSTRUMENT COMPANY

GREENSIDE HOUSE, LISLE WAY
EMSWORTH, HAMPSHIRE, ENGLAND
Telephone: 02434-77743
Telex: 86626 Mynews G

WW - 079 FOR FURTHER DETAILS

Happy Memories

Part type	1 off	25-99	100 up
4116 200ns	.83	.72	.66
4116 250ns	.75	.65	.60
4816 100ns for BBC comp	2.95	2.70	2.50
4164 200ns	6.15	5.25	4.65
2114 200ns Low Power	1.15	1.00	.90
2114 450ns Low Power	.95	.85	.80
4118 250ns	3.25	2.85	2.65
6116 150ns CMOS	4.25	3.65	3.35
2708 450ns	2.60	2.25	2.10
2716 450ns 5 volt	2.60	2.25	2.10
2716 450ns three rail	5.75	5.00	4.65
2732 450ns Intel type	3.95	3.45	3.25
2532 450ns Texas type	3.95	3.45	3.25

Z80A-CPU £4.35	Z80A-PI0 £3.25	Z80A-CTC £3.25
6522 PIA £3.98	7805 reg .50	7812 reg .50

Low profile IC sockets: Pins.....8 14 16 18 20 22 24 28 40
Pence.....9 10 11 14 15 18 19 25 33

Soft-sectored floppy discs per 10 in plastic library case:
5-inch SSSD £17.00 5-inch SSDD £19.25 5-inch DSDD £21.00
8-inch SSSD £19.25 8-inch SSDD £23.65 8-inch DSDD £25.50

74LS series TTL: Large stocks at low prices with D.I.Y. discounts starting at a mix of just 25 pieces. Write or phone for list.

Please add 30p post and packing to orders under £15 and V.A.T. to total. Access and Barclaycard welcome. 24-hour service on (054-422) 618. Government and Educational orders welcome; £15 minimum. Trade accounts operated - phone or write for details.

HAPPY MEMORIES (WW)
Gladestry, Kington
Herefordshire HR5 3NY
Tel: (054-422) 618 or 628

TRANSFORMERS

Despatch by return

CONTINUOUS RATINGS

MAINS ISOLATORS

Pri 0-120; 0-100-120V. Sec 0-CT-115V x2.

Ref. VA (Watts)	£	P&P
07★	20	5.32
149	60	8.84
150	100	10.06
151	200	13.69
152	250	16.31
153	350	20.34
154	500	25.02
155	750	35.91
156	1000	45.89
157	1500	60.52
158	2000	72.43
159	3000	101.12
161	6000	203.65

★115 or 240v sec only. State volts required. Pri 0-220-240V.

12 or 24-VOLT RANGE

Separate 12V windings Pri 220-240V

Ref.	12v Amps	24v	£	P&P
242	300mA	150mA	2.41	.90
213	1	0.5	3.19	1.20
71	2	1.0	4.25	1.20
18	4	2.0	4.91	1.60
85	5	2.5	6.78	1.50
70	6	3.0	7.69	1.40
108	8	4.0	8.98	1.64
72	10	5.0	9.82	1.80
116	12	6.0	10.89	1.90
17	16	8.0	12.97	2.12
115	20	10.0	17.46	2.44
187	30	15.0	21.69	2.64
226	60	30.0	44.45	OA

30 VOLT RANGE

Sec. Volts available 3, 4, 5, 6, 8, 9, 10, 12, 15, 18, 20, 24, 30V or 12V-0-12V or 15V-0-15V

Ref.	30v	15v	£	P&P
112	0.5	1	3.19	1.20
79	1	2	4.32	1.40
3	2	4	6.99	1.60
20	3	6	8.10	1.85
21	4	8	9.67	1.90
51	5	10	11.95	2.00
117	6	12	13.52	2.02
88	8	16	18.10	2.26
89	10	20	20.88	2.24
90	12	24	23.20	OA
91	15	30	26.60	3.00
92	20	40	35.64	4.83

50 VOLT RANGE

2x25V tapped secs. Volts available 5, 7, 8, 10, 13, 15, 17, 20, 25, 30, 33, 40 or 20V-0-20V or 25V-0-25V

Ref.	50v	25v	£	P&P
102	0.5	1	4.13	1.40
103	1	2	5.03	1.40
104	2	4	8.69	1.84
105	3	6	10.36	1.90
106	4	8	14.10	2.12
107	6	12	18.01	1.84
118	8	16	24.52	2.70
119	10	20	30.23	OA
109	12	24	36.18	OA

60 VOLT RANGE

Pri 0-120V x2
2x30V tapped secs volts available 6, 8, 10, 12, 16, 18, 20, 24, 30, 36, 40, 48, 60V, or 24V-0-24V or 30V-0-30V

Ref.	60v	30v	£	P&P
124	0.5	1	4.70	1.50
126	1	2	7.15	1.50
127	2	4	9.20	1.90
125	3	6	13.31	2.02
123	4	8	15.15	2.26
40	5	10	19.16	2.24
120	6	12	21.86	2.64
121	8	16	30.72	OA
122	10	20	35.78	OA
189	12	24	41.22	OA

400/440V ISOLATORS

400/440 to 200/240V

VA	Ref.	£	P&P
60	243	8.11	1.50
250	246	16.07	OA
350	247	19.88	OA
500	248	24.77	OA
1000	250	50.53	OA
2000	252	74.79	OA
3000	253	104.86	OA
6000	254	207.92	OA

CASED AUTOS

240V cable input USA 115V outlets

VA	Price	P&P	Ref
20	£7.21	1.25	56W
80	£9.35	1.50	64W
150	£12.10	1.84	4W
250	£14.73	1.60	69W
500	£22.14	2.24	67W
1000	£33.74	2.80	84W
2000	£60.47	OA	95W

INVERTERS

Cased 12V input 240V a.c., 13 amp socket outlet. Continuous 100W.

£46 + p&p £2 + VAT 15%. (Tool rating 150W.)

SCREENED MINIATURES Pri 240V

Ref.	mA	Sec Volts	£	P&P
238	200	3-0-3	3.11	.90
212	1A, 1A	0-6-0-6	3.45	1.20
13	100	9-0-9	2.59	.80
235	330, 330	0-9-0-9	2.41	.90
207	500, 500	0-8-9, 0-8-9	3.36	1.20
208	1A, 1A	0-8-9, 0-8-9	4.27	1.40
236	200, 200	0-15, 0-15	2.41	.90
239	50MA	12-0-12	3.11	.90
214	300, 300	0-20, 0-20	3.39	1.20
221	700 (DC)	20-12-0-12-20	4.13	1.20
206	1A, 1A	0-15-20, 0-15-20	5.60	1.60
203	500, 500	0-15-27, 0-15-27	4.83	1.50
204	1A, 1A	0-15-27, 0-15-27	7.30	1.60

AUTO TRANSFORMERS

Volts available 105, 115, 190, 200, 210, 220, 230, 240. For step up or step down.

Ref.	VA (Watts)	TAPS	£	P&P
113	15	0-10-115-210-240V	2.39	1.20
64	80	0-10-115-210-240V	4.84	1.40
4	150	0-10-115-200-220-240V	6.48	1.60
67	500	0-10-115-200-220-240V	13.30	2.24
84	1000	0-10-115-200-220-240V	22.70	2.80
93	1500	0-10-115-200-220-240V	28.17	OA
95	2000	0-10-115-200-220-240V	42.14	OA
73	3000	0-10-115-200-220-240V	71.64	OA
80	4000	0-10-115-200-220-240V	93.01	OA
57	5000	0-10-115-200-220-240V	108.30	OA

CONSTANT VOLTAGE TRANSFORMERS
For 'clean' mains to computers, peripherals.
250VA £137.36 (+ p&p)
500VA £159.43 (+ p&p)
1kVA £213.12 (+ VAT)

COTSWOLD TOROIDALS OFF THE SHELF

30VA, 60VA, 100VA, 160VA, 230VA, 330VA, 530VA
Send for list

PLEASE ADD 15% VAT AFTER P&P
Overseas post extra

OTHER PRODUCTS

AVO TEST METERS

8Mk. 5 Latest Model	£122.10
71 (Electronics & TV Service)	£48.30
MM5 Minor	£68.90
DA211 LCD Digital	£58.50
DA212 LCD Digital	£81.90
DA116 LCD Digital	£131.30
Megger 70143 500v	£101.50
Megger Battery BM7	£71.60
DA117 Autorange LCD	£157.00

Avo Cases and Accessories P&P £1.60 + VAT 15%

BRIDGE RECTIFIERS

200v	2A	45p
400v	2A	55p
100v	25A+	£2.10
100v	35A	£2.60
200v	4A	65p
400v	4A	85p
400v	6A	£1.40
500v	12A	£2.85

P&P 20p. VAT 15%
Send 20p for catalogue. Prices correct at 20/3/81

MAINS BATTERY ELIMINATORS

No wiring, ready to plug into 13A socket. 3, 4.5V, 6, 7.5V 9, 12V DC @ 300mA £5.10 + £1.20 p&p + VAT 15%

ANTEX SOLDERING IRONS 15W CCN240 or C 55.
Safety stand.....£1.75 25W X25.....£5.30
12V 25W car soldering kit.....£5.30
P&P 50p + VAT

PANEL METERS £6.70 ea + 76p P/P + VAT
43 x 43mm or 82 x 78mm V.U. Indicator
50µA, 500µA, 1mA, 30V d.c. etc. £1.95 + 30p P&P + VAT
Educational Meter 10A8 30V £4.50 + VAT

Precision De-Solder Pumps - Spring loaded quick action button release for one hand working. Large £5.86 P&P 35p - VAT. Small £5.17 P&P 30p - VAT. Replacement tips: Small 85p - VAT. Large 86p - VAT.

Telephones: Trimphone £28 + £1.20 p&p + VAT.
Desk phones 746 £11.50 + £1.20 p&p + VAT.
Wall phones £14.50 + £1.20 p&p + VAT.

METAL OXIDE RESISTORS £1/100 + VAT
Special Offer TR4 5% Electrofil (100s only). Use in place of c.film. 47Ω - 75Ω - 180Ω - 360Ω - 390Ω - 430Ω - 470Ω - 510Ω - 560Ω - 820Ω - 1K - 1K2 - 1K3 - 1K6 - 1K8 - 2K - 2K4 - 3K - 16K - 20K - 22K - 24K - 27K - 47K - 82K - 100K - 110K - 120K - 130K - 180K - 220K - 270K - 300K. P&P 30p + VAT

Barrie Electronics Ltd.
3, THE MINORIES, LONDON EC3N 1BJ
TELEPHONE: 01-488 3316/7/8
NEAREST TUBE STATIONS: ALDGATE & LIVERPOOL ST

Item No	Description	Price
1	HEWLETT PACKARD RMS VOLTMETER type 3400A 1mV-300V, 10HZ-10MHZ	£150
2	BOONTON SIGNAL GEN POWER AMPLIFIER type 230A 10-500MHZ	£50
3	HEWLETT PACKARD AUDIO SIGNAL GENERATOR type 205AG	£25
4	CLAUDE LYONS AUTOMATIC VOLTAGE STABILISER 2.88KVA Compact	£30
5	TEKTRONIX AMPLIFIER type 1121	£40
6	SES ABSORPTION WATTMETER type T62600 2-1000MHz, 100 Watts 50 ohm	£100
7	TEKTRONIX PLUG-IN type D Single Trace High Gain DC Differential	£20
8	TEKTRONIX PLUG-IN type E Single Trace Low Level AC Differential	£20
9	TEKTRONIX PLUG-IN type G Single Trace Wide Band DC Differential	£25
10	TEKTRONIX PLUG-IN type L Single Trace 30MHz High Gain	£25
11	TEKTRONIX PLUG-IN type M 4 Trace DC-20MHz	£125
12	TEKTRONIX PLUG-IN type O Operational Amplifier	£35
13	TEKTRONIX PLUG-IN type Q Transducer & Strain Gauge	£75
14	TEKTRONIX PLUG-IN type R Transistor Rise Time	£75
15	TEKTRONIX PLUG-IN type W Differential Comparator	£125
16	TEKTRONIX PLUG-IN type Z Differential Comparator	£75
17	HEWLETT PACKARD LCR BRIDGE type 4261A	£75
18	HEWLETT PACKARD AMPLIFIER type 462A	£35
19	HEWLETT PACKARD DC CURRENT SOURCE type 6181B 0-100V; 0-250MA	£125
20	FAST RESPONSE RECORDER type H3020-3 (3 channel) Brand new	£50
21	HEWLETT PACKARD AUDIO OSCILLATOR type 200J	£35
22	HEWLETT PACKARD PULSE GENERATOR Model 212A	£40
23	HEWLETT PACKARD DC MICRO VOLT AMMETER type 425A	£40
24	HEWLETT PACKARD OSCILLOSCOPE 182A with 1825A and 1825A 75MHZ Dual Trace Delayed Sweep	£750
25	AVO VALVE TESTER type CT160 (22 valve bases)	£20
26	AVO TRANSISTOR ANALYSER type CT446	£20
27	MARCONI UNIVERSAL BRIDGE type TF868A	£50
28	GENERAL RADIO DIGITAL TIME & FREQUENCY type 1151-A	£45
29	MARCONI (SANDERS) MICROWAVE POWER METER type 6598	£150
30	MARCONI UHF SIGNAL GENERATOR type TF1060	£95
31	MARCONI FM SIGNAL GENERATOR type TF1077/1197-102.5MHZ	£30
32	MARCONI SUPPRESSED ZERO VOLTMETER type TF1377	£15
33	MARCONI VARIABLE ATTENUATOR type TF1073A/25 (CT421)	£30
34	ERNST TURNER 20KV ELECTROSTATIC VOLTMETER 6 inch	£20
35	MARCONI AM/FM SIGNAL GENERATOR TF995A/3/S (CT402) 1.5-220MHZ	£160
36	MARCONI AC MILLIVOLTMETER type TF2600 10HZ-5MHZ; 1mV-300V	£95
37	B & K ACCELEROMETER PREAMPLIFIER type 2620	£50
38	B & K DEVIATION BRIDGE type 1503	£30
39	B & K DEVIATION BRIDGE type 1504	£35
40	B & K MICROPHONE AMPLIFIER type 2602	£35
41	B & K MICROPHONE AMPLIFIER type 2605	£30
42	B & K BEAT FREQUENCY OSCILLATOR type 1013	£95
43	B & K BEAT AUTOMATIC VIBRATION EXCITER CONTROL type 1018	£25
44	B & K EXCITER CONTROL PRE AMPLIFIER type 1608	£20
45	B & K FREQUENCY RESPONSE TRACER type 4707	£200
46	SOLIARTRON/SCHLUMBERGER SYNTH. SSB GENERATOR type SSB30 with MODULATOR MA30 10HZ-32MHZ	£950
47	TEXAS SILENT 700 PRINTER Model KSR733 - 300 baud	£225
48	BRADLEY MULTIMETER type CT471C	£35
49	MOSELEY WAVEFORM TRANSLATOR type 101	£50
50	HOUSTON INSTRUMENTS LOG VOLTMETER-CONVERTOR Model HLVC150	£30
51	POLARAD FIELD STRENGTH METER type FIM-62 with RF Tuning Unit FIM-X2 7360-10,000MHZ	£95
52	HEWLETT PACKARD DIGITAL VOLTMETER type 3460B with AC CONVERTER type 3461A +/- 0.004%	£100

Item No	Description	Price
53	SANDERS OSCILLATOR type CLC2-4	£75
54	B & K ELECTRONIC VOLTMETER type 2409 2HZ-200KHZ	£95
55	GENERAL RADIO MICROWAVE OSCILLATOR type 1380B 1.7-4.1GHZ	£225
56	GENERAL RADIO FREQUENCY/DISCRIMINATOR METER type 1142A 0-1.5MHZ	£95
57	HEWLETT PACKARD MEMORY DISPLAY type 5480A with CONTROL type 5486B and Two Channel Input type 5485A	£225
58	GENERAL RADIO DECADE CAPACITOR type 1413 with ANALOG LIMIT COMPARTMENT 1782 and IMPEDANCE COMPARATOR 1654	£150
59	STOODART RADIO INTERFERENCE & FIELD INTENSITY METER type N-M 52A	£195
60	KEITHLEY REGULATED HIGH VOLTAGE SUPPLY type 241	£145
61	BRANDENBURGH HIGH VOLTAGE GENERATOR type MR50	£75
62	BRANDENBURGH HIGH VOLTAGE P.U. Model 705 Metered 0-15KV +/-	£100
63	BELX POWER UNIT type CM13001 +/-	£125
64	PLESSEY TELEGRAPH SIGNAL GENERATOR TSG10 with TDMS type 70. Speed 50-75 100 (12 units)	£80
65	As Above but SPEED 45.5-50-75	£80
66	RACAL H.F. SELECTIVE ANALYSER type 9056	£235
67	RACAL UHF FREQUENCY METER type 9639 10-5600MHZ	£225
68	RACAL 500MHZ DECADE DIVIDER type 9010	£40
69	RACAL AUTO FREQUENCY CONVERTOR type 803R 500MHZ	£50
70	RHODE & SCHWARZ NOISE GENERATOR SKTU BN4151/2/60 3-1000MHZ	£75
71	R & S UHF TEST RECEIVER BN1523 280-940MHZ	£50
72	R & S FREQUENCY METER VHF-UHF 30-300MHZ type W10 BN442	£40
73	R & S ATTENUATOR type DR BN1804/50	£25
74	R & S RESONANCE FREQUENCY METER 30-5000MHZ WAM BN4312/2	£50
75	R & S WIDE BAND SIG GEN type SBR BN4061 10HZ-10MHZ	£50
76	R & S SIGNAL GENERATOR type SMR BN4123 30HZ-30MHZ	£50
77	R & S CAPACITANCE METER BN5201	£50
78	ISOLATING TRANSFORMER 240V Input 240V Output 1300 Watts	£15
79	AUTO TRANSFORMER 1.4 KVA Pri Volts 30/240 Sec Volts 115	£15
80	DC SERVO MOTOR 110V 2.5A Cont. Double Shaft 4 wire 4 brush New	£15
81	JLT TRANSISTOR A.C. VOLTAGE REGULATOR Model LT-11000-2S Rating 1000V 40A	£15
82	WAYNE KERR AUTOBALANCE CAPACITANCE BRIDGE type B541	£75
83	PHILIPS VIDEO COLOUR TEST GENERATOR type PM5522 No case	£145
84	PHILIPS FM STEREO GENERATOR type PM5456. Separate L & R Signals Carrier Freq 100MHz +/- 1% RF O/P 3mV pk-pk	£30
85	PHILIPS COMPARATOR 278XHZ	£20
86	PHILIPS AUTOMATIC ELECTRONIC VOLT OHM METER type PM2405	£50
87	B & K AUTOMATIC VIBRATION EXCITER CONTROL type 1016	£20
88	HEWLETT PACKARD DC POWER SUPPLY type 6448B, 0-600 Volts 0-1.5 Amps	£295
89	BRANDENBURGH REGULATED HIGH VOLTAGE P.U. type 928R 0-1000KV; 0-1MA	£150
90	ADVANCE PULSE GENERATOR type P950020	£20
91	GAUMONT-KALEE FLUTTER METER type 1740	£20
92	ADVANCE SIGNAL GENERATOR LF type 81A 15HZ-200KHZ	£25
93	ADVANCE BATCH COUNTER type 4B41	£20
94	ADVANCE AUDIO SIGNAL GENERATOR type J1	£30
95	ADVANCE SIGNAL GENERATOR type E2 100KHZ-100MHZ	£45
96	PYE SCALAMP 40kV RMS Max ELECTROSTATIC VOLTMETER	£55
97	PYE SCALAMP 20kV RMS Max ELECTROSTATIC VOLTMETER	£35
98	RANK ABENA E.H.T. METER 0-30KV	£35
99	SINE & SQUARE WAVE AUDIO GENERATOR type TE-22 20HZ-200KHZ	£35
100	BLACK & WHITE 20" MONITOR by Ikegami type PM701TS. Solid State	£85

PLEASE CHECK AVAILABILITY BEFORE ORDERING
COMPONENT LIST AVAILABLE S.A.E. OR PHONE

MARCONI AM/FM SIGNAL GENERATOR type TF1066B/6S 10-470 MHZ in 5 bands £250 each. Carriage £6.

WAYNE KERR COMPONENT BRIDGE type B521 (CT 375) Resistance 1mOhm - 1000 MegOhm Capacitance. 1pF - 5000Kuf Inductance 1uH - 500KH. With copy of manual ONLY £40 each. Carriage £6.

AVO VALVE TESTER type CT160 (22 valve bases) with copy of manual £20 each. Carriage £6.

AVO TRANSISTOR ANALYSER type CT446 with copy of manual £20 each. Carriage £6.

AVO SIGNAL GENERATOR No. 2 AM/FM AM 0.45-225MHZ; FM 20-100MHZ with copy of manual £75 each. Carriage £6.

MARCONI COUNTER/FREQUENCY METER TF1417/2 with Converter type TF 2400/MT7265 - 500MHZ £35 each. Carriage £6.

TELETYPE PRINTERS KSR33 - ASCII Keyboard £50. ASR 33 - as above with 8-bit Punch and Reader £75. Carriage £6 each unit.

MULTIMETER Russian Type 4324 AC/DC volts; AC/DC current; ohms, etc. Brand new, boxed. £12.50 each. P&P £2.50	SINE & SQUARE WAVE AUDIO GENERATOR type TE-22, 20HZ- 200KHZ. Portable as new ONLY £35 each. P&P £4
--	---

ISOLATING TRANSFORMER 240V input 240V Output 1300 Watts £15 each. Carr. £6	IKEGAMI MONITOR 20" Black & White Solid state. Video in, int. ext. Sync. £65 each. Carriage £6
--	--

PLEASE NOTE:
WE WILL BE CLOSED TO CALLERS MONDAY,
AUGUST 9th UNTIL SATURDAY, AUGUST
21st INCLUSIVE

BARCLAYCARD (VISA) and ACCESS taken. Official orders welcome
CALLERS VERY WELCOME STRICTLY BETWEEN 9am-1pm and 2-5pm Monday to Saturday inc. All units £6 carriage. Plus V.A.T. on total

CHILTMHEAD LTD

NORWOOD ROAD, READING

TELEPHONE NO. READING 669656

(2nd turning left past Reading Technical College In King's Road then first right - look on right for door with "Spoked Wheel")

JOYSTICK CONTROLS



We specialise in joystick mechanisms in a very wide range of types and price

- * SINGLE, DUAL or TRIPLE AXIS
- * SPRING-CENTRED or DETENT MODES
- * CONTACTLESS, POTENTIOMETER, WAFER SWITCH or MICROSWITCH TYPES
- * AVAILABLE IN THOUSANDS, HUNDREDS, TENS or ONES
- * NO MINIMUM ORDER. NO PROHIBITIVE SMALL QUANTITY PRICES
- * RAPID DELIVERY (usually 1-3 days for samples)
- * SCHEDULED ORDERS OVER 12 MONTHS GAIN FULL DISCOUNTS
- * SPECIALS AND PROTOTYPES IN DAYS, EVEN IN 1 OFF
- * PRICES FROM £1 (TV game types) to £50

Tens of thousands of our joysticks are in use worldwide in applications such as electric wheelchairs, flight simulators in machine tool controls, computer graphics, servo controls, CCTV controls. 15 years' experience of joysticks is available to you at the cost of a phone call

RECENT ADDITIONS to our range include **Dual axis inductive contactless joystick** (see photo) giving infinite resolution zero noise and mechanical life exceeding 10 million full cycles. Ideal for any application where incessant cycling or vibration limits life of potentiometer types.
VERY HEAVY-DUTY TYPES. The full PQ CONTROLS range of controllers for electrically-controlled hydraulic valves, etc., with rugged construction for outdoor, dockside and construction sites

Specialising in joysticks, and producing substantial quantities, we are able to offer unbeatable prices and delivery. Contact us immediately for a quotation
NEW! Electronic level sensor/alarms

New Contactless inductive dual axis joystick £17.50 less quantity discounts.

DISTRIBUTORS APPOINTED IN: America/Canada, Austria, Holland, Sweden and Comecon Countries. Addresses on request.

Applications invited for distributorships in other countries

FLIGHT LINK CONTROL LTD.
UNIT 12, THE MALTINGS
TURK STREET, ALTON, HANTS, GU34 1DL
Tel. 0420 87241 (24 hours). Telex: 858623 TELBURG

WW - 100 FOR FURTHER DETAILS

A REAL TIME SAVER FOR ONE-OFFS AND SHORT RUNS NEW STICKY TEMPLATES (Pat. Pending)

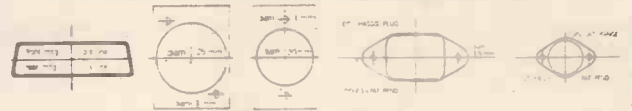

STICKY OUTLINES

INEXPENSIVE self-adhesive clear acetate TEMPLATES - especially designed to ELIMINATE TEDIOUS MARKING OUT of panels and instrument cases when mounting POPULAR CONNECTOR TYPES. Simply peel off protective backing and APPLY DIRECTLY to the surface to be worked, then cut and drill to outlines and centres shown. SAVES HOURS of work - PLUS - makes LINING UP MULTI-CONNECTOR ARRAYS so EASY, as vertical and horizontal centres are printed on Stickers. Will not harm existing finishes, in fact PROTECTS AREA around cut-out and PREVENTS punches and drills skidding. INVALUABLE on LAYOUT SKETCHES and drawings too.

Send £5.40 incl. VAT P&P for selection pack (90 templates) or ask for leaflet, sample and order form to:

FUTRONICS TECHNOLOGY (UK) Ltd.
15 North Avenue, London W13 8AP
Or telephone 01-991 0070 (Answerphone service)

WW - 95 FOR FURTHER DETAILS

NEUTRIK XLR CONNECTORS

Line Female A3F	£1.59	Chassis Female D3F	£2.04
Line Male A3M	£1.36	Chassis Male D3M	£1.19

4, 5, 6 and 7-pin versions and large selection audio adaptors available

NEUTRIK	XLR CONNECTORS		
Latchless Chassis NC3-FZ	£0.67	Latchless Chassis Male NC3-MZ	£0.59
Line Female NC3-FCC	£1.34	Line Male NC3-MC	£1.15
Female Chassis NC3-FP	£1.65	Chassis Male NC3-MP	£0.87

4.5-pin, PCB and black versions and large selection of audio adaptors available

XLR LNE MAIN SERIES

XLR LNE 11C	£3.87	XLR LNE 12C	£3.76
XLR LNE 32	£2.89	XLR LNE 31	£4.14

BELCLERE AUDIO TRANSFORMERS

EN6422 Ratio +1.2 +2 Freq. 40MHz-35KHz. PRI 150/6000, sec. 600/2.4KΩ	£4.15
EN423 Ratio 1 + 1:6.45 + 6.45. Freq. 40HZ - 25KHZ. PRI 150/6000I. sec. 6.25K/25KΩ	£4.15
SKT-723 MuMetal Screening can, 39dB reduction 50KHz ext. field	£1.30

Trade enquiries welcome: quantity discounts available. All prices subject to V.A.T. Call, write or telephone. Minimum order £10. Please add £2 postage. Access, Amex, Barclaycard.

KELSEY ACOUSTICS LTD.
28 POWIS TERRACE, LONDON W11 1JH
01-727 1046/0780

WW - 101 FOR FURTHER DETAILS

LEADER

instruments set the pace

TV & FM Test

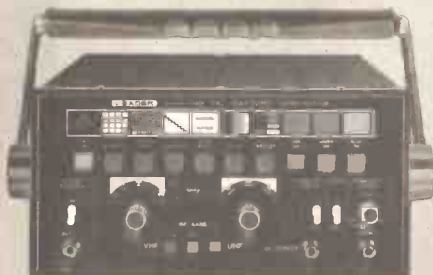

- Colour Bar Pattern Generators
- Sweep and Marker Generator
- CRT Tester
- Field Level Checker
- Signal Level Meter
- High Voltage Metered Probe
- Signal Generators

Audio Test

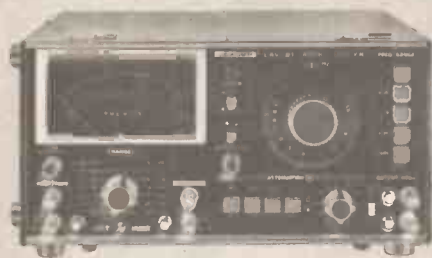

- Generators
- Attenuators
- System Analyser
- Audio Tester
- Distortion Meter
- Equaliser Amp
- Wow and Flutter Meter
- Frequency Response Recorders
- Millivoltmeters
- Log Amplifier
- Speaker Analyser

When you select an instrument from the Leader range, you get more than just sound engineering. That's guaranteed – by rigorous quality assurance at manufacture, and a one year warranty. A broad range that covers most areas of test, measurement and calibration, with advanced features and high specification as standard. Prices that are lower than you'd expect are the bonus. Probes, covers, hoods and pouches are all available to enhance the application potential and ensure that Leader instruments set the pace for others to follow.

 **thandar**
ELECTRONICS LIMITED

Oscilloscopes



- 4 to 50MHz
- Single, Dual and Quad trace
- Delayed sweep
- Wide bandwidth
- High sensitivity
- High accuracy
- Battery operated

General Test

- LCR Bridge
- Semiconductor Curve Tracer
- Transistor Testers
- Logic Probe



Power Supplies

- Laboratory bench type
- 5 models
- 500mA to 5A
- Overload Protected

Thandar Electronics Ltd,
London Road, St. Ives,
Huntingdon,
Cambridgeshire
PE17 4HJ England.
Tel: (0480) 64646.
Telex: 32250.

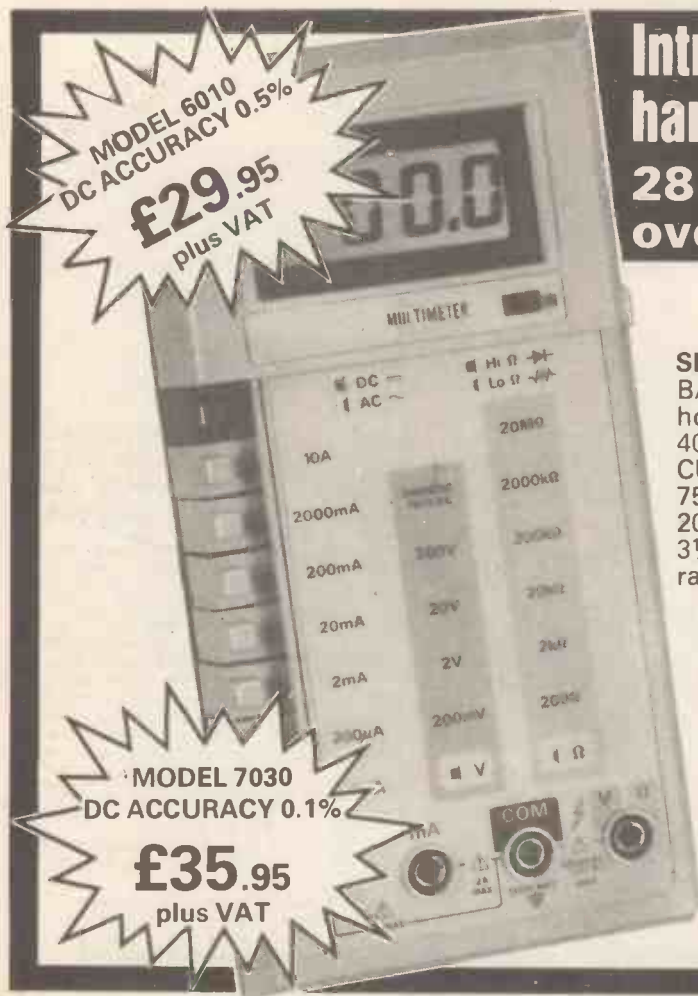

Introducing two new hand-held digital multimeters

28 Ranges, each with full overload protection

10 amp AC/DC

SPECIFICATION 6010 & 7030

BATTERY: Single 9v dry cell. BATTERY LIFE: 200 hours. DIMENSIONS: 170 x 89 x 38mm. WEIGHT: 400g inc. battery. MODE SELECT: Push button. AC DC CURRENT: 200µA to 10A. AC VOLTAGE: 200mV to 750V. DC VOLTAGE: 200mV to 1000V. RESISTANCE: 200Ω to 20MΩ. INPUT IMPEDANCE: 10MΩ. DISPLAY: 3½ Digit 13mm LCD. O/LOAD PROTECTION: All ranges.

OTHER FEATURES:

Auto polarity, auto zero, battery-low indicator, ABS plastic case with tilt stand, battery and test leads included, optional carrying case.

Please add 15% to your order for VAT. Postage and packing is free of charge. Trade prices available on application.

ARMON ELECTRONICS LTD.

Cottrell House, 53-63 Wembley Hill Road
Wembley, Middlesex HA9 8BH, England
Tel. 01-902 4321 (3 lines). Tlx: No. 923985



WW - 086 FOR FURTHER DETAILS

Electricity Supply Handbook

- Your Guide to the Industry!

An up-to-date copy of the Electricity Supply Handbook is the best reference for knowing who's who and what's what in the electricity industry.

The 1982 edition contains:-

- * Over 2,000 names and locations of executive personnel in the Electricity Council, C.E.G.B., Area Boards and other organisations.
- * Major authorities, government departments associated with the electrical industry.
- * U.K. power stations, Area Board statistics, electricity tariffs, electrical associations.
- * Pull out map of C.E.G.B. regions, power stations and transmission lines.
- * Bound in maps of Area Boards.

Famous for its total coverage, detail and accuracy, it always sells out fast so make sure of your copy today, using the coupon below.

**1982
edition
out now!
Price
£7.00
post free**

To: General Sales Department, Room 205, Quadrant House, The Quadrant, Sutton, Surrey SM2 5AS.

Please send me copies of Electricity Supply Handbook 1982 at £7.00 per copy, incl. p&p

I enclose cheque/P.O. for £ made payable to IPC Business Press Ltd.

Name Address

Company registered in England No. 677128. Reg office: Quadrant House, The Quadrant, Sutton, Surrey SM2 5AS. WWO

LOOK
SENSATIONAL
SCOOP OFFER

OPUS SUPPLIES RGB COLOUR MONITOR

BRING YOU AN
YOU CAN AFFORD

LOOK
A COLOUR
MONITOR FOR
LESS THAN A TUBE

LIMITED QUANTITY
AVAILABLE
FOR USE WITH
B.B.C., MICRO,
VIC, APPLE,
DRAGON, etc

Specification: The VMC 22 Colour Monitor is designed to meet the high reliability and performance standards associated with the games, data and computer colour graphics industries.

Input levels: Video-TTL compatible either +ive or -ive going for RGB (IC37416 -ive going 7417 +ive going).

Composite Sync: TTL compatible either +ive or -ive going set by PCB link. Separate sync: (Frame and line) TTL compatible +ive going = video response 10 MHz.

Deflection: Scanning systems, 625 line 50 Hz and 525 line 60 Hz.

Scan linearity: Errors less than 5%.

Scan geometry: Errors less than 3%.

High voltage: 25KV.

X radiation: Less than 0.5MR/h.



FOR ONLY

99.95

+ CARRIAGE & VAT

FREE

**ISOLATING
TRANSFORMER
ON FIRST 100
ORDERS**

A fabulous 22 inch colour monitor. Featuring: Mullard 22 inch 110° C.C.R.T.

Controls: Brightness, RGB video amp bias, height, width, vertical hold, horizontal hold, linearity, east-west correction, phase, focus, H.T. adjust, beam cut-off switch, convergence controls.

De Gaussing: Automatic on switch on. Power requirements: 155 VAC, 44-60Hz 120VA (Isolated supply).

Temperature: Storage -10°C to +70°C. Operating 0°C to 50°C.

Overall sizes: Height 40.3 cm, width 51.0 cm, depth 39.5 cm (inc. tube neck P.C.B.). Weight 19 kgrms.

After months of negotiation we have finally secured the computer user's dream. We have bought the complete manufacturer's production of these superb British made R.G.B. Colour Monitors and can offer them to you at this unrepeatable price. This offer, available to readers of "Wireless World" also includes a **FREE** isolating transformer. So with a little of your time and our buying power - you can save pounds. For shipping purposes the C.R.T. and scan coil assembly are separate from the chassis. The lugs of the C.R.T. allow it to be mounted in a standard 22" colour TV cabinet or a unit of your own design. The unit is assembled by plugging the wires from the chassis to the tube, soldering the input connector, power connector and isolating transformer. The monitor has been fully tested and adjusted prior to packing this simplifying assembly. A comprehensive instruction sheet will be supplied with each unit.

OPUS

A computer supplies company have established an enviable reputation for reliable service and value for money - so pick up your telephone and discuss your supplies requirement with us.

STOP PRESS

JUST ARRIVED FROM JAPAN:

NEC DOT MATRIX PRINTER

OUTSELLS OKI & EPSON IN USA

CALL FOR PRICE & DELIVERY

LOCKABLE DISC FILING BOXES:

To hold 40 Minis £16.00

80 Minis £21.00

To hold 40 8" Discs

£21.00

80 8" Discs

£28.00

DISC MAILERS:

Mini 60p

8" 90p

DESK TOP LECTERN - ADJUSTABLE WITH MOVABLE CURSOR

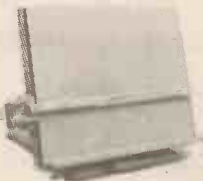

ONLY £19.95

HOW TO ORDER

Carriage should be added to prices at the following rates: Monitor £10; Discs 85p; Rams 50p; Filing Boxes/Lecturns £2; Desks £10. Please add carriage as applicable and then VAT at 15% to total and send Cheque/P. Order payable to "Opus Supplies" to Dept. W.W., Opus Supplies, 10 Beckenham Grove, Shortlands, Kent BR2 0JU. Telephone order Hotline: 01-464 5040 (24-hour service) or 01-464 1598. Access and Barclaycard accepted. If you are not completely satisfied return the goods within 14 days and your money will be refunded.

ATHANA FLOPPY DISCS

MINIS WITH FREE PLASTIC LIBRARY CASE & HUB RINGS

S/S S/D £17.95 for 10

S/S D/D £19.95 for 10

D/S D/D £23.50 for 10

S/S 77 Track £26.50 for 10

S/S 96 Track £28.50 for 10

8" DISCS

S/S S/D £15.50 for 10

S/S D/D £24.50 for 10

D/S D/D £25.50 for 10

HARD SECTORED AND ALL OTHER DISCS AVAILABLE

RAM BARGAINS

PART 1 off 25-99 100

4116-200ns .80 .75 .68

4116-250ns .75 .70 .55

2114-300ns .85 .80 .75

2114-450ns .80 .75 .70

2114-L-200ns .95 .87 .83

4516-100ns

BBC RAM 3.10 2.95 2.80

4164-200ns 4.80 4.60 4.20

6116-150ns 4.20 3.95 3.50

2716-5v-450ns 2.40 2.15 2.00

2716 Triple

Rail 6.00 - -

2732-450ns 3.95 3.75 3.25

2532-450ns 3.95 3.75 3.25

8080A 1.90 1.70 -

8212 1.40 1.30 -

25-WAY D SOLDER CONNECTORS

25P £1.30 each

25S £1.50 each

OTHER DEVICES AVAILABLE

PLEASE RING FOR QUOTE

OPUS DESKS

MANUFACTURED BY OPUS IN U.K. AVAILABLE FROM OUR CENTRAL WAREHOUSE

- ★ 5 MODELS AVAILABLE - CHOOSE WITHIN YOUR BUDGET ★
- ★ CREAM & BROWN CO-ORDINATING PANELS ★

- ★ DRAWER FOR DISC STORAGE ★

- ★ MOBILE ★

- ★ AMPLE SPACE FOR HARDWARE AND PERIPHERALS ★

- ★ THROUGH SHELF FOR DISC DRIVES, PAPER FEED, FILES ★

SEND S.A.E. FOR YOUR FREE COLOUR BROCHURE



For business or home use - each Desk is supplied with castors - two of which have lockable brakes

See us at the

Personal Computer World Show, Stand 255

The Barbican 9-12 Sept, 1982



TRADE ACCOUNTS OPERATED - GOVT. AND EDUCATIONAL ORDERS WELCOMED



PORTABLE COMPUTERS

plus FREE software

SHARP PC-1500
Approaches the Personal Computer in ability

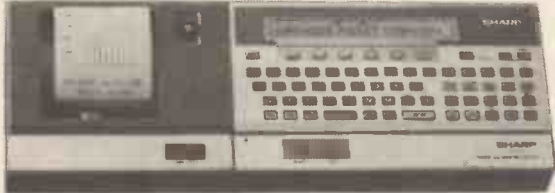

With 16K bytes of ROM and up to 11.5K bytes of RAM memory, with battery protection. Up to 36 program storage capacity. BASIC program language with two dimensional arrays and variable strings. QWERTY keyboard with upper and lower case. Full range of science and math functions (statistics with MICROL software). Alarm clock and calendar; multi-tone generator; mini graphic 7 x 156-dot matrix display; all under BASIC program control. Line width 26 characters.

CE-150 Four-colour Graphic Printer/Two Cassette Interface (for saving/loading) has 8K bytes of Graphics BASIC. Prints virtually any drawing, with complete control of up, down, left and right printing. Variable line length from 4 to 36 characters. With rechargeable battery and mains adaptor. Dimensions: PC-1500; 195 x 25.5 x 86mm (7-11/16 x 1 x 3 3/8). Wt 375g CE-150; 330 x 50 x 50 x 115mm (13 x 2 x 4 1/2). Weight 900g (1.98lb.).

Optional add-ons include: CE-151 4K memory module, CE-155 8K memory module CE-153 140-key custom keyboard (summer '82), RS232C communications interface (Autumn '82), CE-152 custom cassette recorder (Autumn '82), custom system briefcase (Autumn '82).

COLOUR BROCHURE ON REQUEST

PRICES including VAT:
PC-1500 COMPUTER £169.95. Plus FREE £20 software voucher.
CE-150 PRINTER £149.95. Plus FREE £20 software voucher.
CE-151 4K RAM MODULE £49.95. Plus FREE £10 software voucher.
CE-155 8K RAM MODULE £79.95. Plus FREE £10 software voucher.
Vouchers on request with order only

PC-1500 PROFESSIONAL SOFTWARE ON TAPE

SHARP CE-15A Fourteen Applications Programs £14.95.
MICROL 1500 PROCOS 'Visicalc-type' system £34.95.
MICROL 1500 I.M.S. Information Management System £34.95.
MICROL 1500 STATIX Adds statistics to the 1500 £9.95.

THE SCIENTIFIC PORTABLE COMPUTER

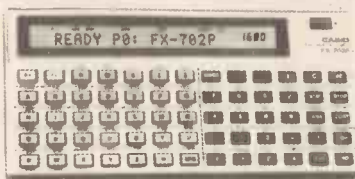

CASIO FX-702P only £99.95

Plus FREE MICROL Professional Programming Pack (RRP £9.95) or we will beat any lower price by 5%

The widest range of math, science and statistics (55 in all, including Regression and Correlation), BASIC programming. Up to 1,680 program memory steps, up to 226 data memories. Subroutines; 10 levels. FOR/NEXT looping; 8 levels. Edit, debug and trace modes. 240 hours lithium battery life. Dimensions: 17 x 165 x 82mm. Weight 176g.

MICROL 702 PROCOS

Professional computing solutions on tape. Save up to 90% of programming time with this electronic equivalent of pen and paper. 'Visicalc-type' system answers 'what if...' questions and analyses trends. £24.95.

Peripherals for the FX-702P, 602P, 601P and 502/501P

FA-2 Remote control cassette interface £19.95

FP-10 Permanent hard copy printer, mains or battery powered £44.95

702 PACKAGE DEALS

PACK A: FX-702P + MICROL PPP £99.95

PACK B: FX-702P + FA-2 + MICROL PPP + MICROL PROCOS £129.90

PACK C: FX-702P + FP-10 + FA-2 + MICROL PPP + MICROL PROCOS £164.85

THE WORLD'S FASTEST PROGRAMMABLE?

CASIO FX-602P

Only £74.95

With FREE MICROL Professional Programming Pack (R.R.P. £9.95)

Or we will beat any lower price by 5%

50 scientific functions. Up to 512 program steps, up to 88 memories, all protected when switched off. 10 programs, PO to P9. GOTO, up to 10 pairs. Up to 9 subroutines, nestable up to 9 levels. 33 parentheses at 11 levels.

Peripherals

FA-2 Interface £19.95

FP-10 Printer £44.95

CASIO FX-601P

Now Only £39.95

Similar to the FX-602P but with 128 program steps; 11 memories; 18 (), up to 6 levels; up to 9 subroutines, nestable up to 4 levels.

Price Includes VAT, P. & P. : Delivery normally by return post

Send cheques, P.O., or phone your Access/Visa/Barclaycard number to:

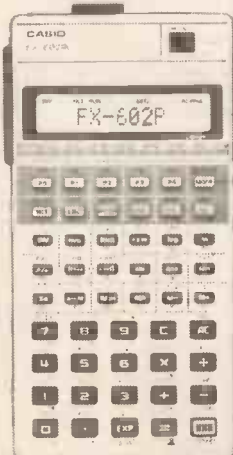

Dept. WW, 38 Burleigh Street
Cambridge, CB1 1DG
Tel: 0223 312866

TEMPUS

WW - 075 FOR FURTHER DETAILS

WIRELESS WORLD SEPTEMBER 1982

TOROIDALS

The toroidal transformer is now accepted as the standard in industry, overtaking the obsolete laminated type. Industry has been quick to recognise the advantages toroidals offer in size, weight, lower radiated field and, thanks to I.L.P., PRICE.

Our large standard range is complemented by our SPECIAL DESIGN section which can offer a prototype service within 7 DAYS together with a short lead time on quantity orders which can be programmed to your requirements with no price penalty.

- ★ 294 TYPES TO CHOOSE FROM!
- ★ ORDERS DESPATCHED WITHIN 7 DAYS OF RECEIPT FOR SINGLE OR SMALL QUANTITY ORDERS
- ★ 5 YEAR NO QUIBBLE GUARANTEE

TYPE	SERIES No.	SECONDARY Volts	RMS Current	PRICE
30 VA 70x30mm 0.45kg Regulation 18%	1x010	6+6	2.50	£5.12 +P/P £1.04 -VAT £0.92 TOTAL £5.08
	1x011	9+9	1.56	
	1x012	12+12	1.25	
	1x013	15+15	1.00	
	1x014	18+18	0.83	
	1x015	22+22	0.68	
	1x016	25+25	0.63	
1x017	30+30	0.50		
50 VA 80x35mm Regulation 13%	2x010	6+6	4.16	£5.70 +P/P £1.38 -VAT £1.05 TOTAL £5.03
	2x011	9+9	2.77	
	2x012	12+12	2.08	
	2x013	15+15	1.66	
	2x014	18+18	1.38	
	2x015	22+22	1.13	
	2x016	25+25	1.00	
2x017	30+30	0.83		
2x028	110	0.45		
2x029	220	0.22		
2x030	240	0.20		
80 VA 90x30mm 1 Kg Regulation 12%	3x010	6+6	6.64	£6.08 +P/P £1.67 -VAT £1.16 TOTAL £5.91
	3x011	9+9	4.44	
	3x012	12+12	3.33	
	3x013	15+15	2.66	
	3x014	18+18	2.22	
	3x015	22+22	1.81	
	3x016	25+25	1.60	
3x017	30+30	1.33		
3x028	110	0.72		
3x029	220	0.36		
3x030	240	0.33		
120 VA 90x40mm 1.2 Kg Regulation 11%	4x010	6+6	10.00	£6.90 +P/P £1.67 -VAT £1.29 TOTAL £5.96
	4x011	9+9	6.66	
	4x012	12+12	5.00	
	4x013	15+15	4.00	
	4x014	18+18	3.33	
	4x015	22+22	2.72	
	4x016	25+25	2.40	
4x017	30+30	2.00		
4x018	35+35	1.71		
4x028	110	1.09		
4x029	220	0.54		
4x030	240	0.50		
160 VA 100x40mm 1.8 Kg Regulation 8%	5x011	9+9	8.89	£7.91 +P/P £1.67 -VAT £1.44 TOTAL £6.94
	5x012	12+12	6.66	
	5x013	15+15	5.33	
	5x014	18+18	4.44	
	5x015	22+22	3.63	
	5x016	25+25	3.20	
	5x017	30+30	2.66	
5x018	35+35	2.28		
5x026	40+40	2.00		
5x028	110	1.45		
5x029	220	0.72		
5x030	240	0.66		

TYPE	SERIES No.	SECONDARY Volts	RMS Current	PRICE
225 VA 110x45mm 2.2 Kg Regulation 7%	6x012	12+12	9.38	£9.20 +P/P £2.00 -VAT £1.68 TOTAL £7.86
	6x013	15+15	7.50	
	6x014	18+18	6.25	
	6x015	22+22	5.11	
	6x016	25+25	4.50	
	6x017	30+30	3.75	
	6x018	35+35	3.21	
	6x026	40+40	2.81	
	6x025	45+45	2.50	
	6x033	50+50	2.25	
6x028	110	2.04		
6x029	220	1.02		
6x030	240	0.93		
300 VA 110x50mm 2.6 Kg Regulation 6%	7x013	15+15	10.00	£10.17 +P/P £2.00 -VAT £1.63 TOTAL £8.00
	7x014	18+18	8.33	
	7x015	22+22	6.82	
	7x016	25+25	6.00	
	7x017	30+30	5.00	
	7x018	35+35	4.28	
	7x026	40+40	3.75	
	7x025	45+45	3.33	
	7x033	50+50	3.00	
	7x028	110	2.72	
7x029	220	1.36		
7x030	240	1.25		
500 VA 140x60mm 4 Kg Regulation 4%	8x016	25+25	10.00	£13.53 +P/P £2.25 -VAT £2.38 TOTAL £11.25
	8x017	30+30	8.33	
	8x018	35+35	7.14	
	8x026	40+40	6.25	
	8x025	45+45	5.55	
	8x033	50+50	5.00	
	8x042	55+55	4.54	
8x028	110	4.54		
8x029	220	2.27		
8x030	240	2.08		
625 VA 140x75mm 5 Kg Regulation 4%	9x017	30+30	10.41	£16.13 +P/P £2.50 -VAT £2.79 TOTAL £13.42
	9x018	35+35	8.92	
	9x026	40+40	7.81	
	9x025	45+45	6.94	
	9x033	50+50	6.25	
	9x042	55+55	5.68	
	9x028	110	5.68	
9x029	220	2.84		
9x030	240	2.60		

IMPORTANT: Regulation—All voltages quoted are FULL LOAD. Please add regulation figure to secondary voltage to obtain off load voltage.

The benefits of ILP toroidal transformers

ILP toroidal transformers are only half the weight and height of their laminated equivalents, and are available with 110V, 220V or 240V primaries coded as follows:

For 110V primary insert "0" in place of "X" in type number.

For 220V primary (Europe) insert "1" in place of "X" in type number.

For 240V primary (UK) insert "2" in place of "X" in type number.

How to order Freepost:

Use this coupon, or a separate sheet of paper, to order these products, or any products from other ILP Electronics advertisements. No stamp is needed if you address to Freepost. Cheques and postal orders must be crossed and payable to ILP Electronics Ltd. Access and Barclaycard welcome. All UK orders sent within 7 days of receipt of order for single and small quantity orders.

Also available at Electrovalue, Maplin and Technomatic.

Please send

Total purchase price

I enclose Cheque

Postal Orders

Int. Money Order

Debit my Access/Barclaycard No.

Name

Address

Signature

Post to: ILP Electronics Ltd., Freepost 5, Graham Bell House, Roper Close
Canterbury CT2 7EP, Kent, England.
Telephone Sales (0227) 54778: Technical (0227) 64723: Telex 965780.

ILP TRANSFORMERS

(a division of ILP Electronics Ltd)

WW - 022 FOR FURTHER DETAILS

ambit[®] INTERNATIONAL

THE MOST COMPREHENSIVE RANGE OF COMPONENTS, KITS AND MODULES IN THE WORLD & THERE'S ONLY ROOM FOR A FRACTION HERE, GET THE CATALOGUE AND FIND THE REST.

BAND 2 TUNERHEADS (Varicap Tuning)

EF5804

2 MOSFET of stages MOSFET mixer, JFET IF preamp, with internally amplified PIN diode AGC. Tuning voltage for 88-108MHz is 2-8V. Buffered LO output. AGC input
145 x 70 x 24mm.
Stock No. 1-24 25+
40-05804 Bit 24.95 19.65

7255 The latest complete FM tunerhead from RF input to stereo output. MOSFET RF stage, HA11225 IF and
KB4437 stereo decoder. 7255 special offer price: £30.00 plus VAT

KB4437 stereo decoder. 7255 special offer price: £30.00 plus VAT

911225A The 911225A is the 7230 'edited' and shrunk into a screened metal case 97 x 56 x 24mm. The unit is ideally suited to use with synthesised tuner systems.

Stock No. 1-24 25+
40-91225 Built 20.82 16.25

944378 'Hyper' series decoder module with the TOKO KB4437 pilot cancel PLL IC birdy filter and the KB4438 muting stereo audio preamp with 26/38kHz pilot tone filtering.

Stock No. 1-24 25+
40-04378 Built 19.95 18.05

DFCM500 Wide range digital frequency/capacitance meter. Frequency ranges:

0-1MHz, 1-50MHz and 80-500MHz. 8 digit LED display, mains or Ni-Cad battery operation
Stock No. 1-24 25+
40-01500 Kit 95.95 86.50

AUTOBRIDGE

An Automatic power tracking VSWR and self-ranging power meter. Complete Kit: All PCBs, board mounted components, meters, case (undrilled), transformer etc.
Stock No: 40-40400 £52.96 + £1.50 P&P

FET DIP OSCILLATOR

An essential piece of test equipment for the RF constructor. GDO or WM function covering 1.6-215MHz in five ranges. Audio and meter indication. Kit includes: fibre glass PCB, all components, all hardware, punch, painted and screen printed case, wire etc. for coils and printed scale.
Stock No: 1-24 25+
40-16215 Kit 17.90 16.20

10.MHz SSB GENERATOR

PCB. All components, eight-pole crystal filter.
Stock No. 40-10700 Price £29.65

R&W PROJECT AND OATABRIEF PCBs: High quality glass fibre printed circuit boards for projects and Databriefs published in Radio & Electronics World.

27MHz Deviation Meter	£1.98
PA105	£3.39
TV Pattern Generator	£5.70
MC145151	£2.57
2m Pre-amp	£0.97
KB4417 (Undrilled)	£0.60
0.30V PSU	£3.92
2m PA Mk II	£5.14
ULN3859 (Undrilled)	£0.84
SSB Exciter	£3.37
HA12017	£2.16
Up Converter	£4.75

2m PRE-AMP

Very compact low-noise MOSFET 2m pre-amp. Gain 22dB. Noise figure; less than 1.5dB. I/p and o/p impedance; 50 ohm size; 34 x 9 x 15mm. From April '82 R&W.
Stock No. 1-24 25+
40-14400 Kit 2.55 2.30

70cm PRE-AMP

Compact low-noise pre-amp. Gain at 433MHz; 13dB. I/P and O/P impedance 50 ohms. Size 50 x 10 x 17mm. From March '82 R&W.
Stock No. 1-24 25+
40-07000 Kit 3.90 3.60

2m POWER AMP

20 watt 144MHz linear power amplifier. 10dB gain, 2W input - 20W output. Automatic switched relay. By-passes power amp in receiver mode. Developed from original class C version in Dec 81 R&W. High power output relay. Pre-drilled heatsink, optional RX pre-amp. Kit only.
Stock No. 1-24 25+
40-14421 Less Preamp 28.50 25.65
40-14422 With Preamp 30.40 27.36

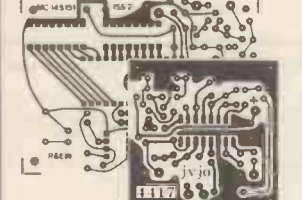
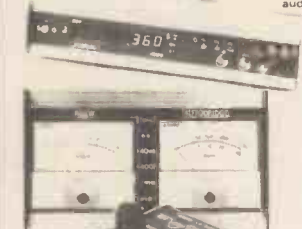
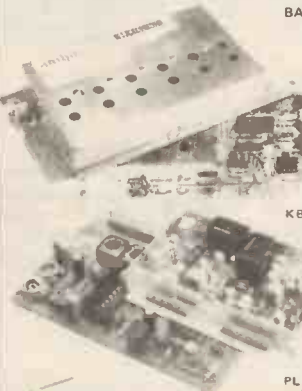

AND THERE'S PLENTY MORE IN THE CATALOGUE 70p inc.

RETAIL SHOP OPENING HOURS

Monday to Thursday 8.30-6.30
Friday 8.30-8.30 Saturday 9.00-5.30
(Access + Barclaycard orders accepted)

NOW IN STOCK

MF10 - National's new Dual Switched - Capacitor Filter: Price £5.05

ALL PRICES SHOWN EXCLUDE VAT. P&P 50p per order.

AMBIT INTERNATIONAL DEPT. WW

200 North Service Road, Brentwood, Essex

TELEPHONE (STD 0277) 230909 TELEX 995194 AMBIT G POSTCODE CM14 4SG

WW - 090 FOR FURTHER DETAILS

ANY MAKE-UP OR COPY

QUERIES CONTACT BRIAN BANNISTER

01-661 8648

reprints

If you are interested in a particular article / special Feature or advertisement published in this issue of

WIRELESS WORLD

why not take advantage of our reprint service.

Reprints can be secured at reasonable cost to your own specifications providing an attractive and valuable addition to your promotional material. (Minimum order 250.)

For further details contact Michael Rogers, IPC Electrical-Electronic Press Ltd. Phone 01-661 3036 or simply complete and return the form below.

To Michael Rogers, Reprints Department
Quadrant House, The Quadrant
Sutton, Surrey SM2 5AS

I am interested in _____ copies of the article / advertisement headed _____ featured in

WIRELESS WORLD

on page(s) _____ in the issue dated _____

Please send me full details of your reprint service by return of post.

Name _____

Company _____

Address _____

Tel. No. _____

REMEMBER - THE LOWEST PRICED NICADS: AA 80p; C £2.35; Sub D £2.15; D £3.05; PPS £3.70

COMPUTER WAREHOUSE

THE 'ALLADINS' CAVE OF COMPUTER AND ELECTRONIC EQUIPMENT

HARD DISK DRIVES

Diablo/DRE Series 30 2.5 mb. fully refurbished DEC RK05 media and software compatible. Front load **£550**. Top load **£295**. PSU for 2 drives **£125**.
Diablo-Dre 44A-4000A or 4000B 10 mb 5+5 removable pack new and refurbished from **£995**.
CDC 80 mb removable pack DEC RM03 media and software compatible brand new from **£2,950**.
Honeywell 5+5 10 mb drives **£450** good s/h condition. For more information on controllers, expansions and ready to go sub systems contact sales office.

DISTEL ©

The UK's **FIRST** free of charge, 24 hr. public access data base. Get information on 1000's of stock items and order via your computer and credit card. On line now, 300 baud. CCITT tones, full duplex, fully interactive.

DON'T MISS THOSE BARGAINS CALL NOW, IT'S FREE!

01-683 1133 7 days per week 24 hrs. per day

COMPUTER 'CAB'

All in one quality computer cabinet with integral switched mode PSU. Mains filtering and twin fan cooling. Originally made for the famous DEC PDP8 computer system costing 1000's of pounds, and designed to run 24 hours per day. The PSU is fully screened and will deliver a massive +5v DC at 17 amps, +15v DC at 1 amp and -15v DC at 5 amps. The unit is fully enclosed with removable top lid, twin fan cooling, mains filtering, trip switch, 'power on' and 'run' LED's, aluminium front panel and rear cable entries. Give your system that professional finish for only **£49.95 + £9.50** carr. — Dim. 19" wide 16" deep 10.5" high. Usable area 16" w. 10.5" h. 11.5" d. Units are in good but used condition 240 or 110 working — complete with data. Large stocks of PDP8 spares — enquire.

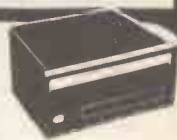

COOLING FANS

Keep your 'Hot Parts' cool and reliable with our range of professional fans.
ETRI 99XU01 Miniature equipment fan 240 vac working DIM 92 x 25 mm BRAND NEW complete with finger guard. Makers price £16 our price **£9.95**
BUHLER 69.11.22 micro miniature 8-16 v DC reversible fan. Measures only 62 x 62 x 22 mm. Uses a brushless DC servo motor almost silent running ideal portable equipment, life in excess of 10,000 hours. BRAND NEW manufactures price **£32.00** our price **£12.95**
MUFFIN/CENTAUR cooling fans DIM 120 x 120 x 38 mm tested ex equipment 240v **£6.25** 115v **£4.95** + p&p **£1.90**
KOOLTRONICS Powerful small type blower gives massive air movement with centrifugal rotor DIM as a cube 8" x 8" x 6" air aperture 2.5" x 2.5" with flange fixing. BRAND NEW 110v 50Hz ac working **ONLY £9.95 + £1.90** p&p



8" FLOPPY DISK DRIVES

Unbelievable value the DRE 7100 & 7200 8" disk drives utilise the finest technology to give you 100% bus compatibility with most drives available today, the only difference being our PRICE and the superb manufacturing quality. The 7100 single sided & 7200 double sided drive accept hard or soft sectoring. IBM or ANSI standard giving a massive 0.8 MB (7100) & 1.6 MB (7200) of storage. Absolutely SHUGART, BASF, SIEMENS etc compatible. Supplied BRAND NEW with user manual and 90 day warranty.
7100 single sided **£225.00 + 9.50 + vat**
7200 double sided **£295.00 + 9.50 carr + vat**
full technical manual **£20.00** alone **£9.00** with drive, refund of difference on purchase of drive.
SHUGART s/h 800-2 8" Drive's 110v 50Hz motor **£160 + £9.50** carr. Removed from working equipment but untested. SA120 Alignment disk's **£9.95**

9" Monitors

DT10 Monitor a complete **MOTOROLA 9"** video monitor housed in an attractive metal case DIM approx. 10" deep 16" wide and 11" high. The monitor has a 75 ohm composite video input with a bandwidth of 18 mhz. A separate internal PSU delivers 5v dc for external use and 12v DC for video monitor. The case has sufficient room inside for mounting other units such as 5" disk drives etc. Internal pots give full control over all monitor functions. Supplied in a tested, as new or little used condition. 240v AC operation **£55.00** Carriage and Insurance **£10.50**
MOTOROLA 9" open chassis monitor. Standard 240 v AC with composite 75 ohm video input, bandwidth in excess of 18 mhz. Monitors are ex equipment and although unguaranteed they are all tested prior to despatch, and have no visible burns on the screens. Dim approx. 9" x 9" x 9". Supplied complete with mains and input lead. Ideal ZX81 etc or giving the tele bag to the family!!
Black and White phosphor **£35.00 + £9.00** Carr.



SUPER SCOOP

CENTRONICS 739-2

The "Do everything Printer" at a price that will NEVER be repeated. Standard Centronics interface, full graphics, 4 type fonts with high definition & proportional spacing for word processor applications, 80-132 columns, single sheet, roll or sprocket paper handling plus much more. Available only from DISPLAY ELECTRONICS at a ridiculous price of only **£299.00**. Options: carriage & insurance **£10.00** Interface Cable **£10.00** RS232 Converter **£45.00**

SAVE £250



TELETYPE ASR33 I/O TERMINALS

FROM **£195 + CAR. + VAT**
Fully fledged industry standard ASR33 data terminal. Many features including ASCII keyboard and printer for data I/O auto data detect circuitry. RS232 serial interface. 110 baud, 8 bit paper tape punch and reader for off line data preparation and ridiculously cheap and reliable data storage. Supplied in good condition and in working order
Options: Floor stand **£12.50 + VAT**
KSR33 with 20ma loop interface **£125.00 +** Sound proof enclosure **£25.00 + VAT**



SOFTY 2

The amazing SOFTY 2. The complete "toolkit" for the open heart software surgeon. Copies, Displays, Emulates ROM, RAM and EPROMS of the 2516, 2532 variety. Many other features include keyboard, UHF modulator, Cassette interface etc. Functions exceed capabilities of units costing 7 times the price! Only **£169.00** pp **£1.95** Data sheet on request

MAINS FILTERS

Professional type mains filters as used by "Main Frame" manufacturers. Ideal for curing those unerving hang ups and data glitches — fit one now and cure your problems.
Suppression Devices SA5A upto 5 amp load **£5.95**
Corcom Inc F1886 up to 20 amp load **£9.50**
Corcom Inc F1900 upto 30 amp load **£12.25**

RECHARGEABLE BATTERIES

CYCLON type D001 sealed lead acid maintenance free 2v 2.5 ah. will deliver over 300 amps on short circuit!! Brand new at only **£2.95**
SAFT VR2C size 'C' 1.2v 2 ah nickel cadmium **£1.50** each 10 for **£11.50**

D.C. POWER SUPPLY SPECIALS

Experimentors PSU Ex-GPO unit all silicon electronics. Outputs give +5v @ 2 amps. +12v @ 800 ma. -12v @ 800 ma. +24v @ 350 ma. 5v @ 50 ma. floating. Dim 160 x 120 x 350 mm. All outputs fully regulated and short circuit proof. Removed from working equipment, but untested. Complete with circuit. Transformer guaranteed. Only **£14.50 + £2.50** pp.
POWER ONE CP143 super compact unit giving continuous output of 5v @ 5 amps. dim. 215 x 67 x 80 mm. BRAND NEW and guaranteed Only **£21.00 + £1.50** pp.
CUSTOM POWER CO55 5v @ 3 amp. Very compact unit dim. approx 60 x 90 x 190 mm. Semi open chassis, full crowbar overvoltage protection. Tested Ex Equipment. **£11.95 + pp £1.25**
MINI SYSTEM PSU Ex equipment unit ideal for the small micro. Outputs give 5v @ 3 amps. +12v @ 1 amp and -12v @ 300 ma. Crowbar overvoltage protection and current limit. Fully tested. Dim 70 x 165 x 320 mm. Complete with Circuit only **£12.95 + £2.00** pp.
PERIPHERAL SYSTEM SUPPLY. Fully cased unit supplied in a Brand new or little used condition. Outputs give 5v @ 11 amps. "+ 15-17v @ 8 amps. "-" 15-17v @ 8 amps and "+ 24v @ 4 amps. All outputs are crowbar protected and the 5 volt output is fully regulated. Fan cooled. Supplied tested, with circuit **£55.00 + £8.50** carr.
MAIN FRAME SUPPLY. A real beefy unit designed for MINI or MAINFRAME use outputs give 5 volts @ 50 amps. +12v @ 5 amps. -12v @ 10 amps. All output are fully regulated with crowbar overvoltage protection on the 5v output. Supplied with circuit and tested. Ex-Equip. 110v AC input. Only **£49.95 + carr. £10.50**.

300 BAUD DATA MODEMS

Join the communications revolution with our standard EX GPO 2a/b data MODEMS. Modem operates on standard CCITT tones with full auto answer facilities. Will switch to ANSWER or ORIGINAL. Standard RS232 i/o connections. Ideal networks. DISTEL etc. Complete with data. Untested but good condition **£55.00** carr. **£8.50**.

1200 BAUD DATA PUMP MODEMS

Compact unit for use with private or "Dial up lines" Designed to work in pairs at any baud rate upto 1200 full duplex (4 wire circuit) or half duplex (2 wire circuit). Features include remote test facilities. RS232 i/o lines etc. Supplied with data in working order, but less case cover **£65.00 + £4.50** carr.

RCA FULLY CASED ASCII CODED KEYBOARDS

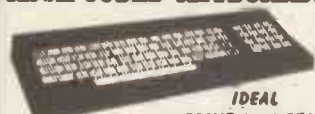

IDEAL TANGERINE OHIO ETC.

Straight from the USA made by the world famous RCA Co., the VP600 Series of cased freestanding keyboards meet all requirements of the most exacting user, right down to the price! Utilising the latest in switch technology. Guaranteed in excess of 5 million operations. The keyboard has a host of other features including full ASCII 128 character set, user definable keys, upper/lower case, rollover protection, single 5V rail, keyboard impervious to liquids and dust, TTL or CMOS outputs, even an on-board tone generator for keypress feedback and a 1 year full RCA backed guarantee.
VP601 7 bit fully coded output with delayed strobe, etc. **£43.95**
VP611 Same as VP601 with numeric pad **£54.95**
VP506 Serial, RS232, 20MA and TTL output with 6 selectable Baud Rates **£64.26**
VP616 Same as VP606, with numeric pad **£84.34**
Plug and cable for VP601, VP611 **£2.25**
Plug for VP606, VP616 **£2.10**
Post, Packing and Insurance **£1.95**
ORDER NOW OR SEND FOR DETAILS

66% DISCOUNT

Due to our massive bulk purchasing programme which enables us to bring you the best possible bargains, we have thousands of I.C.'s, Transistors, Relays, Cap's, P.C.B.'s, Sub-assemblies, Switches, etc. etc. surplus to our requirements. Because we don't have sufficient stocks of any one item to include in our ads, we are packing all these items into the "BARGAIN PARCEL OF A LIFETIME" Thousands of components at giveaway prices! Guaranteed to be worth at least 3 times what you pay plus we always include something from our ads. For unbeatable value!! Sold by weight.

2.5kls **£4.25 + pp £1.25**
10kls **£10.25 + pp £2.25**

ELECTRONIC COMPONENTS & EQUIPMENT

5kls **£5.90 + pp £1.80**
20kls **£17.50 + pp £4.75**

DISPLAY ELECTRONICS

All prices quoted are for U.K. Mainland, paid cash with order in Pounds Sterling PLUS VAT. Minimum order value **£2.00**, Minimum Credit Card order **£10.00**. Minimum BONA FIDE account orders from Government depts., Schools, Universities and established companies **£20.00** Where post and packing not indicated please ADD **60p + VAT** Warehouse open Mon-Fri 9.30 — 5.30. Sat. 10.15 — 5.30. We reserve the right to change prices and specifications without notice. Trade, Bulk and Export enquiries welcome.

64-66 Melfort Road, Thornton Heath, Near Croydon, Surrey
01-689 7702 — 01-689 6800 Telex 27924



WW — 099 FOR FURTHER DETAILS

METERS

Large range of types in stock; also probes, leads, accessories, etc

PANEL MOUNTING in 50, 100, 500µA; 1, 5, 10, 50, 100 500mA; 1A either model.



T Range
60 x 45mm
£5.95



MU Range
50 x 45mm
£2.88

MULTIMETERS

NH56A
N E W -
20KΩ/V
A C / D C / V
RES / dB
in 2 3
ranges:
130 x 88 x
37mm
£11.20N



YN 360TR
20 KΩ/V
A C / D C / V
dB/Transistor Test:
i n 2 1
ranges:
145 x 96 x
45mm
£16.45N



DMM
00601
LCD 3 1/2 digit (1999)
Push button
26 ranges
170 x 80 x
38mm
£32.00N

SOLDERING IRONS

Also large stocks of bits, desoldering devices, accessories, etc.
ANTEX C-240V £4.60N; X-25-240V £5.30N; CSBP £5.45N; XSBP £5.55N; S14 Stand £1.70N.
ORYZ 50 watt temp. controlled £13.75N; Stand £4.00N.
SOLDER 500cm/18SWG £7.60N; Desolder braid 1.5m 54p.

SWITCHES

Wavechange
Type CK - 1P/12 way; 2P/6W; 3P/4W; 4P/3W 48p.
MIN. TOGGLES - S7101, SPDT 57p; S7201 DPDT 80p; S7301 3PDT £1.64; S7401 4PDT £2.75; 7211 1P3W £1.40; Centre off S7103 SPDT 71p; S7203 DPDT 96p.
Push button min 8531 make/8533 break 62p; 8225 DPDT £1.34 - DUAL IN LINE ERM colour coded 0.3"x0.1" format. On/Off single throw 2P SDS2 54p; 4P SDS4 95p; 6P SDS6 £1.36; 8P SDS8 £1.87; 10P SDS10 £2.10.
LOW COST D-I-L 4P DNSO4 60p; 8P DNSO8 £1.

PROFESSIONAL KEYBOARD FOR USE WITH ZX81 £31.30N
Keyboard Case £13.46N

NICAD CHARGERS

For PP3 - NC75 £4.95N; for AA, C or D - NC1230 £8.20N; Power Units MW88 3/4.5/6/7.5/9/12V; 13A fitting 300mA out £3.45; HC244R DC Stabilised 3p/7.5/9V 400mA out £6.25.

BOXES

High quality Black ABS plastic or diecast plain or stove grey.

L	W	D	ABS	PLAIN	STOVE GR
50	50	25	5001P	88p	5001 118p
100	80	25	2002 67p	5002P	67p
113	83	31	2003 200p	5003P	130p
121	86	40	2004 106p	5004P	150p
152	82	50	2005 123p	5005P	185p
192	113	61	2006 216p	5006P	305p



VERO RANGE plastic boxes			G RANGE professional Instrument Cases		
L	W	D	L	W	D
72	47	25	21024	50p	134
120	50	35	21390	78p	224
180	110	55	21391	145p	302
			134	90	44
			21089	£7.28N	
			21090	£11.02N	
			21091	£14.96N	

ELECTROVALUE

FOR SERVICE YOU CAN TRUST

VEROBOX CASES

ABS, lt. grey top; dk. grey bottom + 2 slt. panels

L	D	H	TYPE	PRICE
205	140	40	21034	£4.52
205	140	75	21035	£5.02
205	140	110	21036	£6.54
180	120	39	21037	£4.11
180	120	65	21038	£4.40
180	120	90	21039	£4.69
155	85	39	21040	£3.31
155	85	60	21041	£3.61
155	85	80	21042	£4.30
125	65	30	21047	£2.22
125	65	39	21048	£2.82
125	65	50	21049	£3.18

ALL ITEMS BRAND NEW AND GUARANTEED TO SPEC.

CAPACITORS

POLYSTYRENE, SIEMENS 5% Tolerance. 160V
5, 7, 10, 12, 15, 18, 22, 27, 33, 39pF 12p; 47, 56, 68, 82, 100, 120, 150, 180, 220, 270, 330, 390, 470, 560, 680, 820pF; 1n, 1n2, 1n5, 1n8, 2n2, 2n7, 3n3, 3n9, 4n7 8p; 5n6, 6n8, 8n2, 10n 9p.

CERAMIC Very small 1.8, 2.2, 2.7, etc. up to 1n 5p each. 1n5, 2n2, 3n3, 4n7, 6n8 5p; 10n, 22n 6p. 33n, 47n 7p; 100n 8p.

POLYESTER, SIEMENS LAYER-TYPE 7.5mm lead spacing 100V
1n, 1n5, 2n2, 3n3, 4n7, 6n8, 8n2, 10n, 12n, 15n, 18n, 22n, 27n, 33n, 39n, 47n 7p; 56n, 68n 8p; 82n, 100n 9p; 120n, 150n, 11p; 180n, 220n, 12p; 270n, 330n, 15p; 390n, 470n 17p; 560n, 680n 24p; 1000mm spacing 1µF 26p; 15mm spacing 2µF 35p; 22.5mm spacing 1µF 40V 47p; 3.3µF 100V 50p; 1N-depth stocks.

ELECTROLYTICS Non-polar (for LS X-overs) 50V peak 2µF 26p; 4µF 28p; 6, 8, 10, 16µF 32p; 25µF 37p; 40, 60µF 59p; 100µF 69p.

POLARISED, SIEMENS OR MULLARD FOR QUALITY
(µF/V) 10/40, 22/25, 47/10 11p; 47/25 12p; 100/10 13p; 10/63, 22/40, 100/18 14p; 22/63, 47/40, 100/25, 100/40 15p; 220/10, 220/16 16p; 220/25 18p; 220/40 20p; 470/10, 470/16, 470/25, 100/10 19p; 470/40, 1000/16 27p; 1000/25 36p; 1000/40, 2200/16 44p; 1000/63 76p; 2200/40, 4700/16 73p.

PLUGGABLE SIEMENS single ended
1/63, 2/2/63, 4/7/63 10p; 10/63, 22/63 12p; 22/40, 47/16 10p; 47/40 12p; 47/63 15p; 100/16, 100/25 12p; 100/40 15p; 100/63 20p; 220/10 13p; 220/16, 220/25 13p; 470/6.3 15p; 470/10 16p; 470/16 18p; 470/25 22p; 470/40 25p; 1000/10 22p; 1000/16 23p.

LARGE CANS - SIEMENS
2200/63 £1.77; 4700/40 £1.78; 4700/63 £2.96; 4700/100 £5.54; 10000/16 £1.53; 10000/25 £2.78; 22000/16 £3.20; 22000/25 £4.73.

TANTALUM
0.1/35, 0.22/35, 0.47/35, 1/35, 2.2/16 13p; 2.2/35, 4.7/16 18p; 10/6.3 18p; 4.7/35, 10/16, 22/6.3, 10/25 18p; 22/16, 22/25, 33/10, 47/6.3, 100/3 30p.

LOW LEAKAGE All single ended
0.1/50, 0.22/50, 0.47/50, 4.7/35 10p; 1/50, 2.2/50, 4.7/50 12p; 10/16, 22/16, 10p; 10/35, 22/10, 22/16, 22/35, 47/6, 47/10 12p; 47/16, 100/6 12p.

CATALOGUE 82, 70p POST FREE INC. 70p REFUND VOUCHER

RESISTORS

1/4, 1/3, 1/2, 3/4 watt - all 2p each, 10 of one value 15p.
2% Mullard metal film 5.1 ohms - 300K 5p each, 10 of one value 40p.
5% wire wound 3W or 7W, most £12 value 1.2 ohms to 8K2 9p each, 10 for 70p.

POTENTIOMETERS

Carbon rotary (P20) 100 ohms - 4M7 lin, 220 ohms - 2M2 log 35p or w. switch - 90p; Dual gang (JP20) 4K7 - 2M2 lin. or log 85p or w. switch £1.44.

SLIDERS 58mm, low cost 10K - 1M log only 29p; Std 58mm mono 4K7 - 1M lin or log 79p, stereo matched £1.29; Graduated bezels 34p. PRESET min. 10mm dia. horizontal or vert. 100 ohms - 1M ea. £1.06; Plessey MPWT moulded carbon 47 ohms 2M2 ea. 59p.

DISCOUNTS ON ALL PRICES EXCEPT PRICES MARKED N

CMOS SUPER SAVERS!

4000	14p	4015	55p	4027	32p	4089	16p
4001	13p	4016	25p	4028	50p	4070	22p
4002	14p	4017	42p	4029	67p	4071	18p
4006	59p	4018	55p	4030	50p	4072	18p
4007	14p	4019	36p	4041	60p	4081	18p
4008	15p	4020	53p	4042	52p	4082	18p
4009	35p	4021	50p	4043	55p	4093	36p
4010	35p	4022	18p	4044	55p	4510	59p
4011	14p	4023	18p	4046	75p	4511	55p
4012	15p	4024	44p	4049	25p	4516	53p
4013	29p	4025	18p	4050	28p	4518	45p
4014	80p	4026	104p	4060	90p	4520	68p

ACCESS, VISA

accepted via mail order or by telephone.
GIRO A/C NO. 38/671/4002

VAT - additional at 15% on all U.K. orders
FREE POSTAGE and packing on U.K. C.W.O. orders £5.75 inc. V.A.T. and upwards. Under add 40p inc. V.A.T.
DISCOUNTS on orders over £23.00 - 5%
on orders over £57.50 - 10%
Discounts do not apply to 'Net' items (shown by N after the price, or orders paid by credit card)

Headquarters for mail orders and shop

ELECTROVALUE LTD

28a St. Jude's Road, Enfield Green, Engham, Surrey TW20 0HB

Telephone Engham (STD 0784; London 87) 33603; Telex 264475

Northern Branch (Personal shoppers only)

580 Burnage, Manchester M13 1NA

Computing at:

700 Burnage Lane, Manchester (061-431 4866)

Hitachi Oscilloscopes

performance, reliability, exceptional value and immediate delivery!

Hitachi Oscilloscopes provide the quality and performance that you'd expect from such a famous name, in a newly-extended range that represents the best value for money available anywhere.

V-152F	15MHz Dual Trace	V-353F	35MHz Sweep Delay
V-202F	20MHz Dual Trace (illustrated)	V-650F	60MHz Dual Timebase, Trigger View
V-203F	20MHz Sweep Delay	V-1050F	100MHz Quad Trace, Dual Timebase
V-302F	30MHz Dual Trace	V-209	20MHz Dual Trace, Mini-Portable
V-352	35MHz Dual Trace	V-509	50MHz Dual Timebase, Mini-Portable

Prices start from under £250 (ex. V.A.T.) including 2 high-quality probes and a 2-year warranty. We hold the range in stock for immediate delivery.

For colour brochure giving detailed specifications and prices ring (0480) 63570.

Reltech Instruments, 46 High Street, Solihull, W. Midlands, B91 3TB

WW - 098 FOR FURTHER DETAILS

LAST CHANCE AT THIS PRICE.

METALFILM RESISTORS 1% Tolerance, 1/4 Watt

100R	1k	10k	100k
110R	1k1	11k	110k
120R	1k2	12k	120k
130R	1k3	13k	130k
150R	1k5	15k	150k
160R	1k6	16k	160k
180R	1k8	18k	180k
200R	2k	20k	200k
220R	2k2	22k	220k
240R	2k4	24k	240k
270R	2k7	27k	270k
300R	3k	30k	-
330R	3k3	33k	330k
360R	3k6	36k	-
390R	3k9	39k	-
430R	4k3	43k	-
470R	4k7	47k	470k
510R	5k1	51k	-
560R	5k6	56k	560k
620R	6k2	62k	-
680R	6k8	68k	680k
750R	7k5	75k	-
820R	8k2	82k	820k
910R	9k1	91k	1M

ONLY 3p EACH

High Quality High Stability.

Huge Strength.

Minimum order £20

Minimum 5 pcs per value

89 Values (£24)

VAT, p&p inclusive.

SPECIAL OFFER
10 PCS OF EACH (89 RESISTORS)
£23.00

ORION SCIENTIFIC PRODUCTS LTD. 4 GOLDEN SQ LONDON W1

WW - 083 FOR FURTHER DETAILS

VIDEO TECHNIQUES

AN INTRO. TO THYRISTORS AND THEIR APPLICATIONS by Gordon White Price: £12.00

by M. Ramamoorthy DIGITAL ICs - HOW THEY WORK AND HOW TO USE THEM Price: £7.50

by A. W. Barber SERVICING RADIO, HI-FI AND TV EQUIPMENT Price: £6.50

by G. J. King H/B OF PRACTICAL ELECTRONIC CIRCUITS Price: £7.50

by J. D. Lenk ELECTRONIC TEST EQUIPMENT OPERATION AND APPLICATION Price: £17.45

by A. M. Rudkin ELECTRONIC COMPONENTS AND SYSTEMS Price: £21.00

by W. H. Dennis TOWERS' INTERNATIONAL TRANSISTOR SELECTOR Price: £13.50

by T. D. Towers ELECTRONIC CIRCUITS AND APPLICATIONS Price: £10.50

by B. Grob INTRODUCTION TO RADIO FREQUENCY DESIGN Price: £17.00

by W. H. Hayward ★ PRICES INCLUDE POSTAGE AND PACKING ★ Price: £22.00

THE MODERN BOOK CO.

Specialist in scientific and technical books

15/21 PRAED ST., LONDON W2 1NP

PHONE: 01-402 9176 - Closed SATURDAY 1 p.m.

Please allow 14 days for reply or delivery

WW - 092 FOR FURTHER DETAILS



AP DIP JUMPERS LOWEST PRICE IN THE UK.
NEW AP LOW-PROFILE "D" SUB MINIATURE JUMPERS
ALL RS232 COMPUTER LINK UP PROBLEMS SOLVED
FREE TC16 WITH EVERY SUPERSTRIP SOLD



	PART NO	CONTACTS	LENGTH INCHES	DESCRIPTION	PRICE
MALE-END	924 229-18	25	18	25 PIN MALE SINGLE END 18" LONG	5.97
	924 222-18	25	18	25 PIN FEMALE SINGLE END 18" LONG	6.04
	924 269-36	25	36	25 PIN MALE TO MALE DOUBLE END 36"	11.73
	924 299-36	25	36	25 PIN MALE TO 24 PIN DIP 36"	8.35
	924 339-36	25	36	25 PIN MALE TO 26 PIN SOCKET 36"	10.50
FEMALE-END	924 262-36	25	36	25 PIN FEMALE TO FEMALE DOUBLE END 36"	11.50
	924 292-36	25	36	25 PIN FEMALE TO 24 PIN DIP 36"	8.75
	924 332-36	25	36	25 PIN FEMALE TO 26 PIN SOCKET	8.75
	924 382-36	25	36	25 PIN FEMALE TO 25 MALE 36"	11.50

ALSO WITH 9, 15, 37 CONTACTS ANY STYLE HUGE DISCOUNTS FOR QUANTITY

AP sub-miniature "D" jumpers have the lowest front to back profile in the world and come to you fully assembled, tested and ready to use. They are directly replaceable with existing "D" connections.

DIP-DIP-DIP-DIP-DIP JUMPERS

AP DIP JUMPERS ARE THE LOWEST PRICE IN THE UK



- EX STOCK DELIVERY
- 5 STANDARD LENGTHS
6, 12, 18, 24, 36"
- WITH 14, 16, 24, 40 CONTACTS
- FULLY ASSEMBLED AND TESTED
- INTEGRAL MOULDED ON STRAIN RELIEF
- LINE BY LINE PROBEABILITY

SINGLE-ENDED		DOUBLE-ENDED all prices 1-9 off. Huge discounts for quantity					
CONTACTS	24"	CONTACTS	6"	12"	18"	24"	36"
14	£1.67	14	£2.11	£2.21	£2.31	£2.43	£2.63
16	£1.89	16	£2.33	£2.45	£2.58	£2.66	£2.97
24	£2.74	24	£3.45	£3.62	£3.78	£3.94	£4.30
40	£4.38	40	£5.31	£5.61	£5.91	£6.22	£6.81

We can supply DIP, SOCKET, PCB, CARD-EDGE RS232, assemblies made-up, tested, ready for use, cheaper than you can buy the parts, ask for quote.

TEST-CLIP TEST-CLIP



Clip an AP TEST-CLIP over an IC and you immediately bring up all the leads from the crowded board into an easy working level.

22 NEW AP TEST-CLIPS TO PICK FROM

examples:	TC 14	923695	£2.76
	TC 16	923700	£2.91
	TC 24	923714	£8.50
	TC 40	923722	£12.88

ADVENTURES ON THE IC'S

A SPECIAL £6 OFF OFFER



EBBO DISCRETE STARTER PACK
Normal Price £6.67.



ADVENTURES WITH ELECTRONICS
Normal Price £2.30.

ALL COMPONENTS TO BUILD ALL 16 PROJECTS

Normal Price £17.25

TOTAL PRICE ONLY £19
incl VAT post & packing

ANYBODY CAN BUILD ELECTRONIC PROJECTS WITH EBBO BOARDS.

We supply EBBO block, adventures with electronics book which gives step by step instructions to build 16 projects including: chip radio, two transistor radio, electronic organ etc. and every component needed. Nothing else to buy.

SUPERSTRIP SS2 THE BIGGEST SELLING BREADBOARD IN THE WORLD

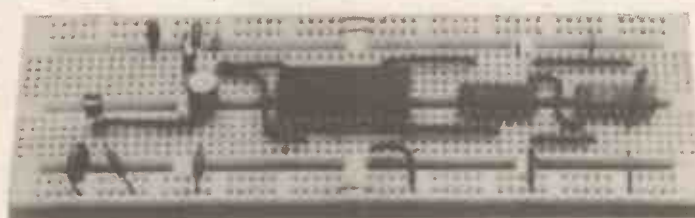

When you buy a SUPERSTRIP BREADBOARD you buy a breadboard to last you for ever, we give you a LIFETIME guarantee. SUPERSTRIP is the most used breadboard by hobbyists, professionals and educationalists because it gives you more for your money... With 840 contact points SUPERSTRIP accepts all DIP's and discrete components and with eight bus bars of 25 contact points each SUPERSTRIP will take up to nine 14-pin DIP's at any one time. You should only buy a breadboard once so buy the biggest seller with a lifetime guarantee. SUPERSTRIP SS2 923252 PRICE INCL VAT £9.78



All prices shown are recommended retail incl. VAT
 In difficulty send direct, plus 50p P & P.
 Send S.A.E. for a free copy of colour catalogues detailing our complete range.

AP PRODUCTS, PO BOX 19, SAFFRON WALDEN, ESSEX, (0799) 22036

Appointments

Advertisements accepted up to 12 noon Wednesday, August 25th, for October issue, subject to space being available.

DISPLAYED APPOINTMENTS VACANT: £15.50 per single col. centimetre (min. 3cm).
LINE advertisements (run on): £3 per line, minimum £20 (prepayable).
BOX NUMBERS: £3 extra. (Replies should be addressed to the Box Number in the advertisement, c/o Quadrant House, The Quadrant, Sutton, Surrey SM2 5AS).
PHONE: IAN FAUX, 01-661 3033 (DIRECT LINE)

Cheques and Postal Orders payable to IPC Business Press Ltd.



ecm

ALWAYS AHEAD WITH THE BEST! £5,000-£15,000

- ★ **Experienced in:** Mini/Microprocessor hardware or Software; Digital and Analogue circuitry; RF and Microwave techniques?
- ★ **Where does your interest lie:** Image processing; Automation; Datacomms; Radar; Nav-Aids; Video; Medical; Telemetry; Simulation; Satcom; Local Area Nets?
- ★ **There are opportunities in:** Design; Test; Service; Sales; Systems; Production; Quality and Research.
- ★ **First call:** Contact MIKE GERNAT on 076 384 676/7 (usually until 8 p.m.)

ELECTRONIC COMPUTER AND MANAGEMENT APPOINTMENTS LIMITED
148-150 High St., Barkway, Royston, Herts SG8 8EG.

(1750)

ENGINEER TV or Telecomms

We have a vacancy for an experienced television or telecomms engineer to work in the central apparatus area at our Birmingham studio centre: this area forms the technical centre of the station, and the interface with British Telecom and the I.B.A. network. The work involves the operation, monitoring and maintenance of equipment concerned with pulse generation, signal switching and distribution, quality control and testing.

Applicants must have a good knowledge of the PAL 625 system, and the application of advanced technology in video and audio signal processing and transmission. Education to HNC/HND or TEC Higher Diploma standard would be an advantage.

The salary will be at an appropriate point on an automatic scale, up to about £11,000 p.a. (under review). The work pattern involves a seven day fortnight.

Application forms are available, in writing, from:-
The Head of Staff Relations,
Central Independent Television plc.,
Central House, Broad Street, Birmingham B1 2JP.
Please quote Vacancy No: 36 (WW)



CENTRAL

(1743)

TEST ENGINEERS

Required by professional audio manufacturers.

Applicants must be aged between 24 and 35 years approx, and have a proven background in analogue and digital electronics. As we are a rapidly expanding company we are looking for persons who are self-motivated and able to work under pressure.

We offer an excellent salary and good prospects. Write to Mick Newman with career details and salary.

Soundcraft Magnetics Ltd

5-8 Great Sutton Street, London EC1

(1753)

A small but expanding S. Worcestershire based company specialising in C.C.T.V. research and production requires the following staff:

★ **Production Manager**

who will be expected to organise a production team of approx. 6. Previous experience in a small batch electronic production is essential.

★ **Electronic Test & Service Engineer**

with a good understanding of analogue and digital techniques. In particular a thorough knowledge of C.C.T.V. and some broadcast video is required.

Applicants should be able to work off their own initiative and to set up their own work procedures. Salaries will be commensurate with experience.

Please apply in writing, enclosing C.V. to
Box No. 1755

DIGITAL EXPERIENCE?

FIELD SUPPORT
R & D AND SALES
VACANCIES IN COMPUTERS
NC, COMMS., MEDICAL
VIDEO, ETC.

For free registration ring
0453 883264
01-290 0267

LOGEX

ELECTRONICS RECRUITMENT SERVICE
LOGEX HOUSE, BURLEIGH, STROUD
GLOUCESTERSHIRE GL5 2PW
TEL. 0453 883264, 01-290 0267

(321)

Opportunities in Professional Audio

World leaders in the marketing and distribution of professional broadcast equipment throughout Europe, the Middle East and Africa, we are currently undergoing a significant planned expansion programme. Applications are now invited for the following challenging opportunities within our Audio Department.

Sales Engineer

A young and dynamic sales professional is required to join a small team engaged in the sale of digital audio equipment, analogue tape machines, mixing consoles and RF communication products. Applicants should have a proven track record in audio sales, a high degree of self motivation and an ability to work on their own initiative. Candidates must be prepared to undertake overseas travel when necessary.

Audio Support Engineer (RF/Analogue Products)

This new position would suit an engineer experienced in RF communications. The successful applicant will provide in-depth technical sales support on a wide range of audio products. Particular emphasis will be on wireless microphone systems but will also include microphones, analogue tape machines and mixing consoles. This will involve travel throughout our marketing area and full product training will be given. Candidates should be qualified to Degree/HNC level Electronics although direct relevant experience is equally as important.

Service Engineer (Professional Audio Products)

To be responsible for the service and repair of an expanding range of high technology products. Applicants should be experienced engineers who ideally have a background in sound recording or broadcast equipment, together with a relevant qualification in Electronics. Some travelling to customers will be involved and full product training will be given where necessary.

We offer attractive salaries, first class conditions of employment and considerable prospects for personal development.

If you are interested please write, giving brief details of experience and current salary, to Mike Jones, Senior Personnel Officer, Sony Broadcast Limited, City Wall House, Basing View, Basingstoke, Hants RG21 2LA. Tel: 55011.



Sony Broadcast Ltd.
City Wall House
Basing View, Basingstoke
Hampshire RG21 2LA
United Kingdom
Telephone (0256) 55 0 11

The Polytechnic of North London

Department of Electronic and Communications Engineering.

LABORATORY TECHNICIAN Grade V (Electronics)

Applications are invited for the above post in one of our specialist laboratories for microprocessors.

The work is interesting and varied involving the construction, development and maintenance of electronic equipment, mainly in a laboratory associated with Z80, 8085 and 8086 microprocessors. Candidates must be experienced in fault finding on digital equipment.

Qualifications: HNC or HND or Advanced City & Guilds or equivalent. At least 7 years' relevant experience (including training period). Salary scale: £6,782-£7,737 inclusive of London Weighting.

Further details and application form from Mr. E. W. Bowman, Departmental Superintendent, Department of Electronic and Communications Engineering, The Polytechnic of North London, Holloway Road, London N7 8DB.

(1641)

Electronic Engineering

Dolby Laboratories, the world famous audio noise reduction company, was founded by an engineer. We are a company that believes in engineers and engineering. Small enough for you to make a contribution, we have the minimum bureaucracy, are well established, and have a track record of innovation and quality.

A graduate with experience of audio electronics, or a related discipline, is needed to lead a small section auditing product quality. There is considerable scope for initiative and innovation in this position, which will involve all aspects of the manufacture of our professional products.

An excellent benefits package is offered, including a salary in the range of £8-10,000.

For more information about the position and the company, contact: Steve Matta.

Dolby Laboratories Inc.,
346 Clapham Road,
London SW9 9AP
01-720 1111



Radio/ Electronic Technician

London based organisation seeks enthusiastic Radio-Electronic Technician with a broad knowledge of Communication Techniques and associated systems. Applicants should preferably be aged between 25 and 40 with desirable qualifications of City and Guilds Certificate/T.E.C. in Telecommunications or equivalent in experience. Some overseas travel is a possibility in this position.

Salary according to qualifications and experience but not less than £7,300.

Please write with personal and career details to Confidential Reply Service, Ref. AMR 8482, Austin Knight Limited, London W1A 1DS.

Applications are forwarded to the client concerned, therefore companies in which you are not interested should be listed in a covering letter to the Confidential Reply Supervisor.

Austin Knight Advertising



(1754)

Research and Development Engineers

Your opportunity to advance broadcast television technology to the era of the 'all digital television studio'.

The Advanced Developments department of Sony Broadcast Ltd is part of an international R&D team committed to pioneering new techniques and technologies. Established four years ago, the department has already made significant contributions to digital television development.

Further expansion is planned to broaden the range of our activities. Applications are invited from well qualified engineers to contribute to the following:-

- Digital Video/Audio Processing
- Digital Recording
- Theoretical Analysis
- Analogue Video Processing
- Digital Filtering
- Picture Storage & Manipulation
- Error Correction & Detection
- Coding Techniques

As a successful candidate you will join a department of highly skilled engineers responsible for projects from concept to realisation. This highly innovative work requires good theoretical knowledge coupled with the application of the most up-to-date techniques and devices. These developments will influence the future of television broadcasting.

Whilst directly relevant experience is advantageous, candidates working with digital signal processing techniques applied to other fields are encouraged to apply. Appointments will be made at all levels and applicants should have a good honours degree or equivalent qualification.

Attractive salaries are offered together with first class conditions of employment and a pleasant working environment. Relocation assistance will be given where appropriate.

Please apply, giving brief details of career to date and present salary, to Mike Jones, Senior Personnel Officer, Sony Broadcast Limited, City Wall House, Basing View, Basingstoke, Hants RG21 2LA. Tel: 55011.



Sony Broadcast Ltd.
City Wall House
Basing View, Basingstoke
Hampshire RG21 2LA
United Kingdom
Telephone (0256) 55 011

Professional Television Engineers

RCA is seeking engineers to work in the field servicing operation of the Broadcast Division.

The work will involve travel in the Europe, Africa and Middle East region, and will be with one inch 'C' format V.T.R.s and the new exciting "Hawkeye" VTR/Camera combination.

If you are looking for a stimulating job with high technical content and a lot of travel and you have HND or equivalent qualifications then find out more about it by phoning Des Chalkley, Manager of Broadcast Field Services on Sunbury on Thames 85511 Extension 3150.

If you want to "Go places" why not do it with RCA?

(1744)

LABORATORY ENGINEERS/TECHNICIANS

The BBC Engineering Designs Department in Central London requires Laboratory Engineers and Technicians, male or female, to assist engineers in the design, development, construction and testing of sound and television broadcasting equipment.

LABORATORY TECHNICIANS who will probably be in their mid 20's, will have a keen interest in electronics with one to two years' practical experience. They will have at least TEC Certificate, ONC or C&G Part II. Salary according to qualifications and experience in the range £5,451-£6,418 p.a. More experienced technicians may be appointed at a salary scale in the range £6,538-£7,044 p.a.

LABORATORY ENGINEERS will have had several years' experience of electronic development work and will have an appropriate degree, TEC Higher Certificate, H.N.C., or C&G Full Technological Certificate (271, Telecommunications or 281, Electrical Technicians). Salary in the range £7,454-£8,044 p.a., progressing to £10,573.

These are pensionable posts and re-location expenses will be considered.

Requests for application form to: the **Engineering Recruitment Officer, BBC Broadcasting House, London W1A 1AA** quoting reference 82.E.4047/WW. For further information please contact **Mr. I. Millar on 01-580 4468 Ext 4593.**

Completed forms should be received within fourteen days of publication date.

1638

The Polytechnic of North London

Department of Electronic and Communications Engineering

LABORATORY TECHNICIAN (Grade 4)

Applications are invited for the above post. The duties involve assistance in our Teaching Laboratories.

Applicants will be required to construct, modify and maintain experiments and electronic equipment. Greater consideration will be given to those with experience in servicing equipment to component level.

Qualifications: OND or ONC or 2 'A' levels or Ordinary City and Guilds or equivalent. At least 7 years' relevant experience (including training period).

Salary Scale: £6,371-£7,165 inclusive of London Weighting.

Further details and application form from Mr. E. W. Bowman, Departmental Superintendent, Department of Electronic and Communications Engineering, The Polytechnic of North London, Holloway Road, London N7 8DB.

Closing date for the receipt of applications 14 days from the appearance of this advertisement.

(1739)

Electronics Design Engineers

Take your career a step in the right direction

Having introduced an extended new product range, many of which are microprocessor based, Marconi Instruments has once again confirmed itself as Europe's leading manufacturer of test equipment and measurement systems. Our products are selling throughout the world to all leading users in the Telecommunications and Aerospace industries and we are naturally developing further innovative designs. That is why we are now looking for more Design Engineers with experience in any of the following areas:

RF, Microwave, Analogue, Digital, Software, ATE, Microprocessor Applications.

Whatever your level of experience we would like to hear from you. We offer excellent salaries plus a wide range of large company benefits including relocation expenses where appropriate.

marconi instruments



NAME _____ AGE _____

ADDRESS _____

TEL. NO. WORK _____ HOME _____

YEARS OF EXPERIENCE: 0-1 1-3 3-6 OVER 6

PRESENT SALARY: £5,500 £8,000 £10,000 OVER
to to to
£8,000 £10,000 £12,000 £12,000

QUALIFICATIONS: HNC DEGREE OTHERS

PRESENT JOB: _____

So take a positive step in the right direction and join us in developing tomorrow's technology today. Cut the coupon and send it to John Prodder, Recruitment Manager, Marconi Instruments Limited, FREEPOST, St. Albans, Herts AL4 0BR. Tel: St. Albans (0727) 59292.

(1234)

A GOOD MAN NOWADAYS IS HARD TO FIND BUT OUR CLIENTS WILL APPRECIATE HIM (SORRY, OR HER)

DESIGN/DEVELOPMENT ENGINEERS

To design microprocessor systems, VLSI and analyse CAD systems for process control. New graduates considered, and experienced men appreciated up to the tune of £14,000 pa in rural Berkshire.

PROGRAMMER

To write process control software for on-line manufacturing systems in Fortran and Basic for DEC LSI 11. Graduate with relevant software experience for up to £10,000 pa in Wiltshire.

SENIOR PROGRAMMER

To program hand held 64kbram 8 bit micros based on 8080 and Z80 and do it in classic fashion with elegance. Degree or equivalent, at least four years' experience to include assembler level and knowledge of Basic interpreters would be helpful around £10,000 pa in Hampshire.

SENIOR PROGRAMMER

To lead a team designing software and hardware for wire and wireless data communications based on Z80 and junior to write machine code. Senior must be graduate with at least 3 years' data communications experience, junior graduate with some experience. For the senior up to £11,000 pa in Wiltshire.

Charles Airey Associates

Tempo House, 15 Falcon Road, Battersea, London SW11 2PJ
 Tel: 01-223 7662 or 228 6294

(1357)

CAPITAL

APPOINTMENTS LTD.

THE UK'S No. 1 ELECTRONICS AGENCY

Design, Development and Test to £14,000
 Ask for Brian Cornwell

SALES to £15,000 plus car
 Ask for Maurice Wayne

FIELD SERVICE to £12,000 plus car
 Ask for Paul Wallis

We have vacancies in ALL AREAS of the U.K.

Ask for a Free Jobs List

Telephone: 01-637 5551 (3 lines)

(291)

CAPITAL HOUSE
 29-30 WINDMILL
 STREET
 LONDON W1P 1HG
 TEL: 01-637 5551



RECRUITMENT

WE SPECIALISE IN THE RECRUITMENT OF

QUALIFIED STAFF

for

ENGINEERING, MARKETING

&

MANAGERIAL POSITIONS

IN

TELECOMMUNICATIONS, BROADCASTING & ELECTRONICS WORLDWIDE

ADVERTISING, SEARCH AND SELECTION IS CARRIED OUT BY OUR TEAM OF PROFESSIONAL EXPERTS ALL QUALIFIED AND EXPERIENCED IN THEIR PARTICULAR SPHERES.

WE WELCOME ENQUIRIES FROM QUALIFIED PEOPLE SEEKING A CHANGE OF EMPLOYMENT.

WE EMPLOY DIRECTLY FOR OUR OWN INTERNATIONAL OPERATIONAL CONTRACTS AND OUR SERVICES ARE AVAILABLE BOTH FOR THE EMPLOYER SEEKING STAFF FOR SHORT AND LONG TERM CONTRACTS OR FOR PERMANENT APPOINTMENTS.

FOR FURTHER PARTICULARS CONTACT:

PERSONNEL & ELECTRONICS LTD

Triumph House, 1096 Uxbridge Road
 Hayes, Middlesex UB4 8QH, England, UK

Telephone: 01-573 8333

Telex: 934271

(1746)

Assistant Chief Telecommunications Technicians (two posts)

ZIMBABWE

Required to provide on-the-job training for Technician Staff on the maintenance of Radio Communication Systems, Navigational Aids and Radar. Applicants should be UK citizens holding Part II City and Guilds Telecommunications Certificate or equivalent with at least 7 years' experience in Civil Aviation equipment.

Appointments:

2 years, posting Harare Airport. Salary will be in accordance with qualifications and experience subject to UK income tax plus a variable tax-free overseas allowance.

The posts are wholly financed by the British Government under Britain's programme of aid to the developing countries.

In addition to basic salary and overseas allowances other benefits normally include paid leave, free family passages, children's education allowances and holiday visits, free accommodation and medical attention.

Application Details:

For full details and application form please apply, quoting ref. AH372/AL stating post concerned, and giving details of age, qualifications and experience to:

Appointments Officer,
Overseas Development Administration,
Room 351, Abercrombie House,



Eglesham Road,
EAST KILBRIDE,
Glasgow G75 8EA.

OVERSEAS DEVELOPMENT

BRITAIN HELPING NATIONS
TO HELP THEMSELVES

HULL COLLEGE OF HIGHER
EDUCATION

MARITIME TECHNICIAN VACANCIES

Following a major review, applications are now invited for the following posts:

PRINCIPAL TECHNICIAN £7,371-£7,875

This is a key appointment to manage technical support staff and services. Applicants will have considerable experience and a high level of expertise, preferably in the area of Marine Electronics.

SENIOR TECHNICIAN £5,652-£7,137

To lead a small group of technical staff dealing specifically with aspects of marine electronics. Applicants must have considerable experience and will hold relevant qualifications, e.g. ONC or Tech. Cert. in Electronics or Electrical Engineering or MRGC or equivalent.

TECHNICIAN – ELECTRONICS TECHNICIAN – NAVIGATION/SIMULATOR £5,064-£5,526

To work specifically in areas of marine electronics and with the College's advanced computer navigation simulator. Applicants must hold relevant qualifications, e.g. DoT Radar Maintenance Certificate.

Application forms and further details from:

The Personnel Office
Hull College of Higher Education
Inglemire Avenue
Hull HU6 7LU

Tel: (0482) 446506

Closing date for receipt of completed applications – 6th September 1982

(1642)

Electric Circuit C.A.D.

We are currently engaged in setting up engineering CAD facilities for use by University and Polytechnic R. & D. groups. An important part of this provision concerns the design and small-scale production of electronic devices and systems to be realised as printed circuits or as integrated circuits using the Laboratory's electron beam microfabricator.

A considerable amount of modern circuit-analytic software is a necessary background to this activity and we need a circuit analyst to run the section that provides it.

The successful candidate will:

- (1). Lead a small section concerned with the implementation of recommendations to set up and run a network-based suite of programs for the analysis of electrical, electronic and microelectronic devices and systems.
- (2). Interact with University and Polytechnic R. & D. groups who will use this software on the SERC computer network.
- (3). Supervise the running of short courses in the use of this developing software provision.

Applicants for this post should have a degree or equivalent qualification, in electrical/electronic engineering or physics. Experience in the analysis of electrical or electronic networks – preferably by means of digital computers – is essential.

The appointment will be in the grade of Senior Scientific Officer within the salary range £8,599 to £10,967. Some assistance with house sale/purchase may be available.

The Rutherford Appleton Laboratory is a friendly community with its own restaurant and sports facilities nearby. Benefits include a local transport service, generous holidays and a non-contributory pension scheme.

Application forms from: Recruitment Office, RAL, Science and Engineering Research Council, Chilton, Didcot, Oxon OX11 0QX. Tel: Abingdon (0235) 21900 Ext. 510, quoting ref. VN. 069.

Closing date: Closing Date: 8th September, 1982

serc  Rutherford Appleton Laboratory

UNIVERSITY OF KEELE
COMPUTER CENTRE
JUNIOR

MICROPROCESSOR ENGINEER

Required for the Microprocessor Unit. This unit provides a general support service for all academic departments. The appointee will be required to collaborate with researchers on the installation and commissioning of microprocessor systems, to give hardware and software support for such systems and to contribute to the project work and teaching within the unit.

Applicants should hold a degree or equivalent qualification. It is expected that this post will be most suited to someone recently qualified.

The appointment will be on Grade 1B within the salary scale £6,070-£6,880.

Application forms and further particulars from the Registrar, The University, Keele, Staffs, ST5 5BG. (1741)

Occasional Freelance Work

available revising short technical articles about Computers, Electronic Circuits, Device Fabrication, Power Switchgear, etc. Please send details of your qualifications to:

Box No. 1752

(1732)

Engineers & Scientists

£9,126

Communications R & D...
...the leading edge

At HM Government Communications Centre, we're applying the very latest ideas on electronics and other technologies to the problems of sophisticated communications systems, designed to enable and protect the flow of essential information.

The work is of the highest technical challenge, offering full and worthwhile careers to men and women of high ability, on projects covering the following areas of interest:—

RADIO - from HF to microwave, including advanced modulation systems, propagation studies, applications of Microcircuitry.

ACOUSTICS **SIGNAL ANALYSIS**
MAGNETICS **SYSTEMS ENGINEERING**

Applicants, under 30 years of age, should have a good honours degree or equivalent qualification in a relevant subject, but candidates about to graduate may also apply.

Appointments are as Higher Scientific Officer (£6,840-£9,126) or Scientific Officer (£5,422-£7,399) according to qualifications and experience. Promotion prospects.

For an application form, please write to the Recruitment Officer, (Dept. W/W8), HM Government Communications Centre, Hanslope Park, Milton Keynes, MK19 7BH.

TRAINEE RADIO OFFICERS

First-class, secure career opportunities.

A number of vacancies will be available in 1982/83 for suitable qualified candidates to be appointed as Trainee Radio Officers.

If your trade or training involves Radio Operating, you qualify to be considered for a Radio Officer post with the Composite Signals Organisation.

Candidates must have had at least 2 years' radio operating experience or hold a PMG, MPT or MRGC certificate, or expect to obtain this shortly.

On successful completion of between 36 and 42 weeks specialist training, promotion will occur to the Radio Officer grade.

Registered disabled people may be considered.

SALARY & PROSPECTS

TRAINEE RADIO OFFICER: £4,357 at 19 to £5,203 at 25 and over. On promotion to Radio Officer: £5,968 at 19 to £7,814 at 25 and over. Then by four annual increments to £10,662 inclusive of shift working and Saturday and Sunday elements.

For full details please contact our Recruitment Officer on Cheltenham (0242) 21491 Ext. 2269 or write to her at:

Recruitment Officer, Government Communications Headquarters, Oakley, Priors Road, Cheltenham, Gloucestershire GL52 5AJ

(1531)

THE OPEN UNIVERSITY
FACULTIES OF SCIENCE
AND TECHNOLOGY



MICROPROCESSOR MAINTENANCE ENGINEER

Applications are invited for the post of microprocessor maintenance engineer in the Interfaculty Electronics Facility.

The successful candidate will be a senior member of a team of electronic engineers and technicians in the facility. He/she will complement the team by providing the major input for maintenance and servicing of micros. There is both analogue and digital expertise in the team, the latter including microprocessor experience. The successful applicant will work largely on his/her own on the servicing of micros, with back-up where possible. The work will appeal to someone who is keen and interested in keeping up to date in the fast moving world of micros and associated technologies.

Appropriate training will be arranged as necessary. Qualifications of HNC level or equivalent are expected, although proven experience will be given full consideration.

Salary will be on the T7 scale: £7,605-£8,542 per annum.

Further particulars and an application form are available from Mrs S. McBrearty (4355/1), Faculty of Technology, The Open University, Walton Hall, Milton Keynes, MK7 6AA, or telephone Milton Keynes (0908) 653941: there is a 24-hour answering service on Milton Keynes 653868.

Closing date for applications: 14th September.

(1635)

2-WAY RADIO SERVICE TECHNICIAN

Experienced in servicing V.H.F. and U.H.F. Land Mobile Equipment, required for expanding COMMUNICATIONS COMPANY in STAINES.

SALARY: Commensurate with experience.

CONTACT: Chris Turner,

FRANK CODY ELECTRONICS LTD
STAR HOUSE, GRESHAM ROAD,
STAINES, MIDDLESEX

Or telephone Staines 62682 for an appointment.

(1701)

Electronic Engineers salaries up to £13k

VIDEO is one of the World's fastest growing industries, and McMichael Ltd. is in the forefront of advanced video technology. We need young dynamic electronic engineers at all levels to join prestige high technology project teams.

As an analogue or digital video engineer, you would be involved in such projects as, video conferencing, broadcast effects, laser video transmission, precision displays, and other projects.

Our project teams are based at our new research and development Laboratories in Stoke Poges, Bucks., set in 37 acres of ground, with extensive sports and social facilities.

If you are experienced in high speed digital processing or analogue video, write or phone for an application form today.

McMICHAEL LIMITED

Sefton Park, Bells Hill, Stoke Poges, Slough SL2 4DY
Telephone Fulmer (02816) 2777 Telex 849212

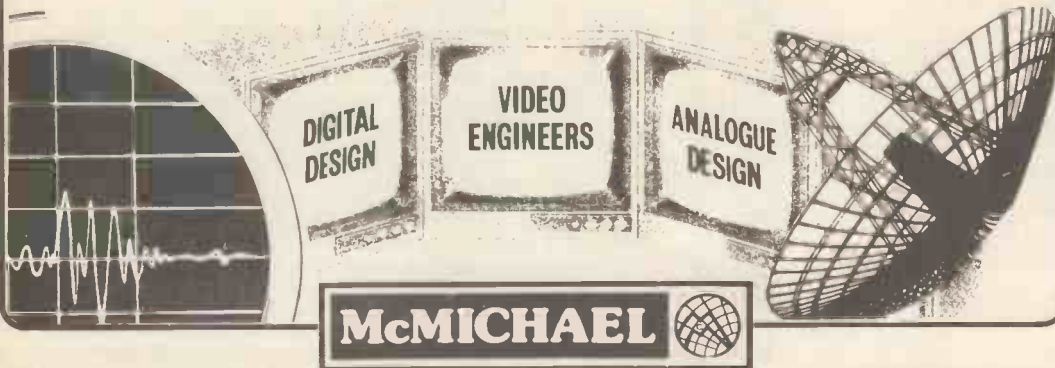

McMICHAEL 

£25,000?

- 1. PROJECT MANAGER**
To lead the development of a programmable controllers - Intel based. Circa £12,000.-Berks.
 - 2. RF DESIGN ENGINEER**
To develop software packages for PDP11-LS111 Computers as part of ATE Systems. Experience in Macro, Fortran, Pascal needed. Circa £10,000.-Herts.
 - 3. PROJECT LEADER**
To lead team with background of radar, sonar or EW systems. To £16,000 + overseas allowance.-Holland.
 - 4. DEVELOPMENT ENGINEER**
Design and develop communications systems with RF, Analogue and Digital experience. Circa £12,000.-Essex.
 - 5. SOFTWARE ENGINEER**
To develop software packages for PDP11-LS111 Computers as part of ATE Systems. Experience in Macro 11, Fortran, Pascal needed. Circa £10,000.-Herts.
 - 6. ELECTRONIC ENGINEERS**
To develop and test analogue circuits with digital computer interface for electron microscopes. Circa £11,000.-Sussex.
100s of other electronic and computer vacancies to £25,000.
- Phone or write: Roger Howard
C.Eng., M.I.E., R.E., M.I.E.E.
CLIVEDEN CONSULTANTS
87 St. Leonard's Road Windsor, Berks.
Windsor (07535) 57818/58022
24-hour service (1640)

CLIVEDEN

ARTICLES FOR SALE

THE SCIENTIFIC WIRE COMPANY

P.o. Box 30, London, E.4

SWG	ENAMELLED COPPER WIRE			
	1lb.	8oz.	4oz.	2oz.
8 to 29	2.76	1.50	.80	.60
30 to 34	3.20	1.80	.90	.70
35 to 40	3.40	2.00	1.10	.80
41 to 43	4.75	2.60	2.00	1.42
47	8.37	5.32	3.19	2.50
48 to 49	15.96	9.58	6.38	3.69

SILVER PLATED COPPER WIRE				
14 to 30	6.50	3.75	2.20	1.40

TINNED COPPER WIRE				
14 to 30	3.38	2.36	1.34	.90

Prices include P&P, VAT and Wire Data
SAE for list. Dealer enquiries welcome.
Reg Office: 22 Coningsby Gardens. (9063)

STOCK SURPLUS

35,000 0.2 inch red leds available as 1 lot or in 1000s.

Offers to:

Box No. 1760

(1760)

TELEVISION SERVICE ENGINEER

We are an expanding Television Rental and Retail company with a vacancy for an additional Television Service Engineer.

Suitable applicant will preferably hold an R.T.E.B. certificate or be training towards this qualification.

The post is directly responsible to the Service Manager.

A clean driving licence is essential.

A spacious flat is available if required.

Hydes of Chertsey Ltd., 56/60 Gullford Street, Chertsey, Surrey. KT16 9BE. Chertsey 63243.

(1434)

APPOINTMENTS IN ELECTRONICS to £15,000

MICROPROCESSORS
COMPUTERS - MEDICAL
DATA COMMS - RADIO

Design, test, field and support engineers - for immediate action on salary and career advancement, please contact.

Technomark
Engineering and Technical Recruitment

11, Westbourne Grove
London W2. 01-229 9239 (1296)

ARTICLES FOR SALE

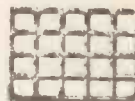

Alleinvertrieb:
Willy Kronhagel KG
John-F.-Kennedy-Pl. 10. 3300 Braunschweig. Tel. (05 31) 4 55 35

1738

Vollgummi-Gittermatte

Die beste Werktafelauflage
antistatisch, 2MΩ/cm
Modell I 540×380 Gitter 90×100
Modell II 625×375 Gitter 45×50
Modell III 700×450 Gitter 45×50
Dicke 25 bzw. 20 mm

John-F.-Kennedy-Pl. 10. 3300 Braunschweig. Tel. (05 31) 4 55 35

Z80A USERS. Compare our prices. All items ex-stock cwo: Z80 AC PL1, £2.95; Z80ACTC, £2.50; Z80 APIO, £2.50; Z80A SIO/O, £9.95. INSTINCT ELECTRONICS, No. 7 Hogarth Ave., Ashford, Middx. 51519. Plus VAT and 50p P&P.

LIGHT METRE, 'Centronic' Model 110. New-unused. Cost £678.50, sell £350 or nearest offer. - Ring Mr Sturgess on Dartford (0322) 77457. (1751)

RTTY/CW DECODER - Low cost kit with alphanumeric LED display, 45 and 50 baud, 5-30 wpm. Parts available separately, construction data £2.95 (refundable). See enquiries, Macritchie Micros, 100 Drakies Ave, Inverness. (1736)

BRIDGES, waveform/transistor analysers. Calibrators, Standards, Millivoltmeters, Dynamometers, KW meters, Oscilloscopes, Recorders. Signal generators - sweep, low distortion, true RMS, audio, FM, deviation. Tel. 040 376326. (1627)

SITUATIONS VACANT

GARDLINE SURVEYS SEISMIC ENGINEERS

Required for high resolution shallow seismic work with this leading Hydrographic and Marine Geophysical Company.

Must be experienced on:
DFS III, DAS 1A or MDS 10

Good salary, sea-going allowances, leave arrangements and Company Pension Scheme Benefits.

EXCELLENT PROSPECTS

Golden opportunity to join a dynamic, fast-growing Company.

Please write, quoting WW200, to:

**The Managing Director, Gardline Surveys
Admiralty Road, Great Yarmouth
or telephone 0493 50723, ext 200, Monica Goff**

(1761)

ELECTRONICS TECHNICIAN

Required for the routine maintenance and repair of electro-medical equipment in the Westminster Unit, based in the Department of Clinical Measurement, Westminster Hospital. Opportunities also exist for the development of equipment. Applicants should have experience of electronics and be prepared to work with clinical and non-clinical staff.

Salary is on the Medical Physics Technician III grade: £5,536-£7,155 per annum plus £932 per annum London Weighting Allowance. (increase pending).

Application forms from the Secretary:

Department of Clinical Measurement, Westminster Hospital, 65 Romney Street, London, SW1 or phone 01-828 9811 Ext 2640

(1749)

R & D OPPORTUNITIES. Senior level vacancies for Communications Hardware and Software Engineers, based in West Sussex. Competitive salaries offered. Please ring David Bird at Redifusion Radio Systems on 01-874 7281. (1162)

WEST YORKSHIRE METROPOLITAN COUNTY COUNCIL

The Directorate's radio communication system presently consists of a network of approximately 650 vehicle-mounted radios, 5 VHF transmitter sites and numerous land lines.

A RADIO ENGINEER (Post ref: ES76 006)

is required to work from Chantry House, Wakefield, to be responsible for the planning and maintenance of the system. Applicants should have an appropriate professional qualification, (e.g. M.I.E.R.E.), and experience in design, maintenance and repair of radio communication equipment is essential.

Salary £9,528-£10,581 (award pending)

2 RADIO TECHNICIANS (Post ref: ES37 010/011)

are also needed to assist the Engineer in providing an effective service of operation, maintenance and repair of the system. Applicants should hold a technician qualification and experience in the maintenance and repair of radio communication equipment is essential.

Salary £6,501-£7,137 (award pending)

Further information from Mr J. H. James, tel: Wakefield 367111, ext 4406.

Applications welcome from disabled people.

Application forms from the:
Directorate of Traffic, Highways and Engineering, Room 238, County Hall, Wakefield WF1 2QW
to be returned by 10 September, 1982.

(1761)

*Royal Marsden Hospital
Fulham Road, London SW3*

Medical Physics Technician GRADE IV

required in the Radiotherapy and Physics Electronics Workshop of the above hospital.

The person appointed will work in a small group responsible for the maintenance of radiotherapy equipment, including three Cobalt units, a Philips 10 MeV Linear Accelerator and orthovoltage X-ray equipment. Applicants should have experience in electronics or in electrical and mechanical servicing.

They should hold ONC, HNC or similar qualification in electrical engineering or electronics to obtain salary on scale £5,600-£7,069.

Application form and job description available from Mrs. E. M. Latham, Group Personnel Officer, Royal Marsden Hospital. Tel: 01-352 8171, Ext. 446.

(1637)

ARTICLES FOR SALE

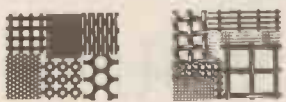

Perforated Metals - Screens, Plastics, Wire Meshes, Sifting Media, Cable Tray, Gratings, direct from Manufacturer's Stock. We can cut to size.

We specialise in one-offs or large quantities.

GRAEPEL PERFORATORS LTD.

Unit 1-B, Charles Street, Dept. WS, Walsall, Staffs WS2 9LZ. Tel. 0922 611644/611414. Telex 335291.

INSTRUMENT BARGAINS

SCALE AMP Multi Range Galvo, £15; MICROMETER SOLID DIELECTRIC TESTER, Teak case, type, type Marconi T2228, £75; PYE VERNIER MICROSCOPE, £35; Quartz MARINE CHRONOMETER, £35; 0.43 inch 7-SEG. CC LED DISPLAYS TYPE HP DL 7653. Price 85p. NEW HALF-PRICE BANKRUPT STOCK. See for details. CTC DEW POINT HYGROMETER PRT Non optical, £295; LCD PLAT Res THERM Hand-held 2/3 wire, £55; DPM PLAT Res THERM LINEARISER, Integral PSU, £65; DPM 2V 3 1/2 digit PSU and Temp Option, £35; 9-digit 7-seg CC multiplexed LED Displays, £1.50
10% P&P all orders
Instruments, Old Hall,
Thriplow, Cambs, SG8 7QY
Tel: Fowimere (076-382) 440 (1737)

TELERADIO

For low cost instruments. Freq meters, audio & RF generators. Distortion analysers, etc. Assembled & kits. Illustrated lists sent on request.

325 Fore Street, Edmonton
London N9 0PE

Tel: 01-807 3719

(1762)

ARTICLES FOR SALE

80 x 24 VDU

All the electronics for a 24 lines by 80 characters visual display unit on one assembled and tested printed circuit board measuring 8.75 inch x 6.50 inch.

You provide: power supply +5v at 1.2 amps +12v/-12v at 25mA, ASC11 encoded keyboard, video monitor.

The VDU-1 will talk to the R.S.232 serial port on your computer, at up to 19,200 Baud 56 features including cursor (X, Y) addressing.

VDU-1 Assembled and tested PCB £135
PSU-1 VDU-1 power supply £32
All prices subject to £2.50 registered delivery, plus VAT.

SIRIUS CYBERNETICS

Comyn Lodge, 66 Holly Walk
Leamington Spa, Warwickshire
Tel. (0926) 316110 (1648)

PRINTED CIRCUITS. Make your own simply, cheaply and quickly. Golden Fotolak Light Sensitive Laquer - now greatly improved and very much faster. Aerosol cans with full instructions, £2.25. Developer 35p. Ferric Chloride 55p. Clear Acetate sheet for master 14p. Copper-clad Fibreglass Board approx. 1mm thick £1.75 sq. ft. Post/Packing 60p. White House Electronics, Castle Drive, Praa Sands, Penzance, Cornwall. (714)

HYDROKIT Hydraulic Flypress Conversion



Complete Hydraulic Kits comprising: Power Pack, Control Valve, Ram, Hoses and Fittings. Suitable for many applications including Flypress Conversions. Working pressure 2,000 p.s.i. 2-10 tons. Stroke 4in. Adjustable relief valve. Power pressure and return.

PRICE FROM £428

"HYDROKITS" ARE COMPLETE
Just remove arm of press and operate screw shaft, fit hydraulic ram assembly with manual valve (all supplied), fill with hydraulic oil and connect to power source, 13 amp or 3-phase. Send details of press or ask for questionnaire.



TAVSHELM HYDRAULICS INTERNATIONAL LIMITED
Hypress House, Station Close, Potters Bar, Herts. EN6 1TL. Tel. Potters Bar (0707) 43434 (1735)

ARTICLES FOR SALE

**TO MANUFACTURERS, WHOLESALERS
BULK BUYERS, ETC.**
**LARGE QUANTITIES OF RADIO, TV AND
ELECTRONIC COMPONENTS FOR DISPOSAL**
SEMICONDUCTORS, all types, INTEGRATED CIRCUITS, TRANSISTORS,
DIODES, RECTIFIERS, THYRISTORS, etc. RESISTORS, C/F, M/F, W/W, etc.
CAPACITORS, SILVER MICA, POLYSTYRENE, C280, C296, DISC CERAMICS,
PLATE CERAMICS, etc.
ELECTROLYTIC CONDENSERS, SPEAKERS, CONNECTING WIRE,
CABLES, SCREENED WIRE, SCREWS, NUTS, CHOKES, TRANSFORMERS,
etc.
ALL AT KNOCKOUT PRICES — Come and pay us a visit ALADDIN'S CAVE
TELEPHONE: 445 0749/445 2713
BROADFIELDS & MAYCO DISPOSALS
21 Lodge Lane, North Finchley, London, N.12
(5 minutes from Tally Ho Corner) (1613)

PARAMETRON 477 Spectrum Analyser Freq. 200KHz-50MHz.....£375
HEWLETT-PACKARD 3500 Attenuator DC-1MHz 600 Ohm.....£75
MARCONI 866B Universal Bridge 1% 1KHz & 10KHz £190
WAYNE KERR B901/S261/R261 Admittance Bridge 50-250MHz.....£120
MARCONI TF2424 VHF/UHF Freq. Meter 4 Digit DC-512MHz.....£100
GAUMONT KALEE Flutter Meter.....£45
MARCONI TF 893 Power Meter.....£65
MARCONI TF 2600 Sens. Valve Voltmeter 10V-300V 1 s.d. ± 1%.....£95
WAVETEK 740 Phase meter 10Hz-2MHz.....£225
TEKTRONIX 564 Storage Scope DC-10MHz c/w 3A6 & 3B3 Plug-ins.....£275
ADVANCE SG.62B Signal Generator 150KHz-220MHz A.M. to 30%.....£80
ADVANCE HIE Signal Generator 15Hz-50KHz Sine/Sq. D/P.....£50
ADVANCE SG65A Oscillator 10Hz-100KHz Sine/Sq. 0/P, 0-6V.....£65
MARCONI TF 2950 Mobile Radio Test Set.....£395
MARCONI TF 1066B AM/FM Signal Generator 10MHz-470MHz.....£590
MARCONI TF 1101 R-C Oscillator 20Hz-200KHz.....£60
PHILIPS PM 6456 Stereo Generator.....£185
PROSSER A100/A340 Wave Form Generator.....£375
TAYLOR SG.62A AM/FM Signal Generator.....£125
TEKTRONIX L09 Pulse Generator.....From £120
KORTING 82515 Colour TV Service Generator.....£200
I.C.I. ULY 2318 Ultra Sonic Cleaner, 3 Compartments.
Filtration, Cont. distillation.....OFFERS OVER £2500
BPL CZ457/4 Component Comparator and CZU 457/4 3 Channel Automator.....£125
FERROGRAPH RTS.2 Recorder Test Set.....£225

Send SAE for list to:

MARTIN ASSOCIATES
PARTHA, BECKHAMPTON
NEAR MARLBOROUGH, WILTS
TEL AVEBURY (067-23) 219
(1384)

BRAND NEW ALUMINIUM

storage cases, 2 sizes available: 26" x 15" x 13" and 30" x 14" x 16"

Many uses from £49.95 including VAT. Carriage £5 per box.

Tel: Southampton (0703) 431 323
(1759)

POWER V MOS-FET TECHNOLOGY

We specialise in all aspects of this important subject. A comprehensive service is offered to individual or OEM users, including:

- ★ Hitachi Supertex and RCA V MOS-FET from stock.
 - ★ V MOS-FET power modules from stock.
 - ★ Competitive prices (120 watt modules £15.45, 1 off).
 - ★ Printed circuits and kits.
 - ★ Data books and application notes.
 - ★ Design, evaluation and advice service.
 - ★ Catalogue/sample data sent free (50p stamp appreciated towards post and packing).
- Phone 02514 22303 and ask Richard Walsh about your application requirement or write:

AUDIO TECHNOLOGY
Freeport, Church Crookham
Aldershot, Hants. GU13 0BR

WORLD'S BIGGEST INFORMATION SERVICE

By return post — service/workshop manuals. Over 2,000 Sony — over 300 different CTV plus huge stocks VCR/TV Audio/foreign and UK.
Any single service sheet £1 + s.ee. Repair data named TV £6.50 (with circ. £8.50). SAE brings free — 50p magazine/price lists/bargain offers/quotations — unique TV publications.
TISWW, 76 Church Street, Larkhall 10698 8833341, Lanarkshire ML5 1HE. (16337)

Quartz Crystal Units
ACCURATE
RELIABLE



Private enquiries, send 1/3p in stamps for brochure

THE QUARTZ CRYSTAL CO. LTD.
Q.C.C. WORKS, WELLINGTON CRESCENT
NEW MALDEN, SURREY 01-942 0334 & 2988
(8493)

EXIDY SURPLUS SALE

We have thousands of these parts for 1/2 PRICE & UNDER
NO REASONABLE OFFER REFUSED

ALL ITEMS BRAND NEW

74LS04	74LS167	3130 OP AMP
74LS05	74LS373	6850 ACIA
74LS32	74LS373	6502 Processor
74LS10	74LS365	4027 RAM

7805 1 AMP 5V REG

LSI Breakout TV Game Chip

PCB for Breakout TV Game

4700 MFD 10V 1K Resistors 1/4W

Sockets: 40 PIN, 24 PIN, 20 PIN, 16 PIN, 14 PIN

Joystick Plastic Holders (Over 1,000 sets)

Transformers for Commodore Pet: 8:0:8 SAMP.

16V 1 AMP, 22V 1 AMP, 240V Primary

Telephone Answering Machines — All faulty

TEL: 01-440 7033 (1696)

INVERTERS

High quality DC-AC. Also "no break" (2ms) static switch, 19" rack. Auto Charger.



COMPUTER POWER SYSTEMS
Interport Mains-Store Ltd.
POB 51, London W11 3BZ
Tel: 01-727 7042 or 0225 310916
(9101)

STYLI ALL TYPES supplied, send SAE for price list. Watts Radio, 8 The Apple Market, Kingston, Surrey. (1709)

ENCAPSULATING EQUIPMENT For coils, transformers, components, degassing silicone rubber, resin, epoxy. Lost wax casting for brass, bronze, silver, etc. Impregnating coils, transformers, components. Vacuum equipment, low cost, used and new. Also for CRT regunning metallising. Research & Development. Barratts, Mayo Road, Croydon CR0 2QP. 01-684 9917. (9678)

ARTICLES WANTED

WANTED!

all types of scrap and
**REDUNDANT
ELECTRONIC &
COMPUTER
MATERIALS**
with precious metal content

**TRANSISTORS
& PRINTED
CIRCUIT BOARDS
TO COMPLETE
COMPUTERS**

**THE COMMERCIAL
SMELTING &
REFINING Co. Ltd.**
171 FARRINGTON ROAD
LONDON EC1R 3AL
Tel: 01-837 1475
Cables: COMSMELT, EC1
Works: FLECKNEY, Nr. LEICESTER
(205)

RACAL COMMUNICATIONS RECEIVERS

500 Kc/s — 30Mc/s 1MHz wide. RA17L — £175. RA117E — £225. A few sets available as new at £75 extra. All receivers are air tested and calibrated in our workshop, supplied with full manual, dust cover, in fair used condition. New black metal louvered cases for above sets £25 each. RA980 — ISB — SSB — £75. RA218 — SSB — ISB and fine tune for RA117 — £50. TRANSMITTER DRIVE UNIT RA79. 1.5mc/s — 30mc/s — SSB — ISB — DSB — FSM — CW — £150. AERIAL TUNING UNIT and protection unit MA197B — £25 to £50. DECADE FREQUENCY GENERATOR MA350B Solid state synthesiser for MA79 or RA117 — RA217 — RA1217 — £150 to £200. MA250 — 1.6mc/s to 31.6mc/s — £150 (New). MA259G — precision frequency standard — 5mc/s 1mc/s 100kHz — £100 to £250. RACAL MA152 — Standing wave ratio indicator. FX2mc/s — 25mc/s Power up to 1000watts — 50 ohms — Auto trip switch — Transistor mains 100 — 250AC, new and boxed — £40. RACAL COUNTER 836 (9036) 32mc/s TTL circuit design — tested with manual — £50 to £75. OSCILLOSCOPES COSSOR COU150 — 35mc/s — Twin Beam — Solid State — £175 with manual. TEKTRONIC OSCILLOSCOPE 647 and 647A Solid State — 50mc/s and 100mc/s bandwidth — £250 and £350. Tested, circuit and instructions. RACAL counter 801 M-125 Mc-S £50. IMAGE INTENSIFIER ASSEMBLY — XX 1060 (Mullard). Very high-gain self-focusing image intensifier for night vision systems. Minimum luminance gain 35,000. £12 (used).

All items are bought direct from H.M. Government, being surplus equipment. Price is ex-works. SAE for all enquiries. Phone for appointment for demonstration of any item. John's Radio, Whitehall Works, 84 Whitehall Road East, Birkenshaw, Bradford BD11 2ER. Tel. (0274) 684007. V.A.T. and Carriage extra. (848)

CAPACITY AVAILABLE

TW ELECTRONICS LTD. THE PCB ASSEMBLERS

More and more companies are investigating the advantages of using a professional subcontractor. Such an undertaking requires certain assurances.

TW are able to satisfy all of them — quality, competitive pricing, firm delivery, and close co-operation with the customer.

Assembled boards are 100% inspected before flow soldering and reinspected after automatic cropping and cleaning.

Every batch of completed boards is issued with a signed certificate of conformity and quality — our final assurance.

For further details, contact us at our new works:

Blenheim Industrial Park
Bury St. Edmunds
Suffolk IP33 3UT
Tel: 0284 3931 (1466)

BATCH PRODUCTION wiring and assembly to sample or drawings. McDeane Electricals Ltd, 19b Station Parade, Ealing Common, London W5. Tel: 01-992 8976. (169)

PCB ASSEMBLY/wiring from drawings or sample. Very competitive rates, free delivery and collection. Swift, quality service. — Ring Julie 01-603 7311.

ELECTRONIC DESIGN SERVICE. Immediate capacity available for circuit design and development work, PC artwork, etc. Small batch and prototype production welcome. — E.P.D.S. Ltd., 1A Eva Road, Gillingham, Kent. Tel: Medway (0634) 577854. (9667)

WANTED

Scrap and re-usable mainframe computer and industrial electronic equipment.

E.M.A. Telecommunications Engineers, Orford, Woodbridge, Suffolk. Tel. 039-45 328. (1720)

WANTED: Redundant test equipment — receiving and transmitting equipment — valves — plugs and sockets — syncros, etc. Phone: John's Radio, 0274 684007, 84 Whitehall Road East, Birkenshaw, Bradford BD11 2ER. (1723)

WANTED FOR CASH: 7F7, 7N7, 53, 6L6 metal, 304TL, 4CX1000A, all transmitting, special purpose valves of Eimac/Varian. DCO, INC, 10 Schuyler Avenue, North Arlington, New Jersey 07032, USA. (1625)

**PHONE YOUR
CLASSIFIEDS
TO IAN FAUX
ON 01-661 3033**

SERVICES

CIRCOLEC THE COMPLETE ELECTRONIC SERVICE

Artwork, Circuit Design, PCB Assembly, Test & Repair Service, Q.A. Consultancy, Prototypes, Final Assembly.

Quality workmanship by professionals at economic prices.
Please telephone 01-767 1233 for advice or further details.

1 FRANCISCAN ROAD
TOOTING, LONDON SW17

(1391)



Micro Processor Design

Our team of experts offer the complete service from Design to Manufacture

- Artwork ● Prototype Development ● Testing
- Board Manufacture ● Assembly ● Packaging

For more information contact: Micro Control, 1 Cherrywood Drive, Aspley, Nottingham NG8 3NN. Telephone 0602 298281 (24 hour service). (1597)

Design Engineers **DIGI-TEL ELECTRONICS**

- Video character & image generation systems
- Microprocessor-controlled video systems
- Prototype & small batch production capacity

20 Trenches Road,
Crowborough, Sussex.
Tel. (08926) 5069

FOR THE BEST PCB SERVICE AVAILABLE

- ★ Circuit Design & Development Digital and Analogue
- ★ Artwork Layout
Work of the highest standard by experienced draughtsmen. No minimum charge.

- ★ Board Manufacture
Prototype to semi-production, excellent rates, 24-hour prototype service from filmwork.

- ★ Wiring & Assembly
PCB assembly, wiring and cable forming by qualified staff.

- ★ Test
Full test facilities available.

One or all services available, no order too small. Please telephone Chelmsford (0245) 357935, or write to HCR Electronics, The Industrial Unit, Parker Road, Chelmsford.



(1169)

ELECTRONIC SUB-CONTRACTING SERVICES

A small Company with experienced staff can offer the following sub-contract services:

- ★ Printed circuit board assembly from free issue components, or component procurement
- ★ Flow soldering
- ★ Hand soldering
- ★ Chassis wiring and cable harnesses
- ★ Circuit design and development
- ★ Printed circuit layout and artwork production
- ★ Testing facilities
- ★ Modifications and repairs
- ★ Small or large production quantities

Let us know your requirements - we'll show you our quality.

LONGBOW ELECTRONICS LTD
21 Clifford Road, London SE25 5JJ

(1742)

BOARDRAVEN LTD.

PRINTED CIRCUIT BOARDS

Manufactured to your specifications. Single/double sided. Very speedy deliveries on prototypes and quantity. Master layouts if required.

Contact:
J. K. Harrison, Carney Industrial Estate, Bridlington, North Humberside YO15 3QY. Tel. (0262) 78788.

(1168)

SHEET METAL WORK, fine or general front panels chassis, covers, boxes, prototypes, 1 off or batch work, fast turnround. - 01-449 2695. M. Gear Ltd., 179A Victoria Road, New Barnet, Herts. (812)

AGENTS

AGENTS/DISTRIBUTORS REQUIRED

Leading manufacturer of digital multimeters seeks agents/distributors for new low cost range of instruments.

Attractive margins available. Coverage required for all areas of UK and Ireland.

Ideal products for hobbyist/electrical outlets.

Please apply for detail to:

Box No 1747

Wireless World Classified
Quadrant House, The Quadrant
Sutton, Surrey SM2 5AS

(Vacancy also exists for direct sales person)

(1747)

SPECIALIST

manufacturer of electrical and electro-mechanical joystick controls seeks UK representation.

Flight Link Control
Alton (0420) 87241
Unit 12, The Maltings
Turk St, Alton

(1740)

30,000 SERVICE SHEETS IN STOCK
COLOUR MANUALS ALSO AVAILABLE
TV Monos £2, Transistor Radios £2,
Tuners £2, Tape Recorders, Record
Players and Stereograms £2. Stamped
addressed envelopes with all quotations.
Also colours available. Car Radios
£3 + stamped addressed envelope. All
valve radios £2. Stamped addressed
envelope please. Quote advert. no. with
order.

C. CARANNA

71 Beaufort Park, London NW11 6BX
01-458 4882 (Mail Order) (1325)

PROTOTYPE PLASTIC CASINGS, vacuum
formed to your requirements. Four-D Ltd., 25
Burnett Park, Harlow, Essex. Phone 0279 29246.
(1725)

DESIGN SERVICES. Electronic design development and production service available for digital and analogue instruments. RF Transmitters and receivers, telemetry and control systems. 20 years' experience. R.C.S. Electronics, Wolsey Road, Ashford, Middlesex. Phone Mr Falkner 53661. (8341)

DESIGN AND DEVELOPMENT. ANALOGUE, DIGITAL, RF AND MICROWAVE CIRCUIT AND SYSTEM DESIGN. Also PCB design, mechanical design and prototype/small batch production. - Adenmore Limited, Unit 103 Liscombe, Bracknell, Berks. Tel: Bracknell 52023. (656)

SMALL BATCH PCBs produced from your artwork. Also DIALS, PANELS, LABELS. Camera work undertaken. FAST TURNAROUND. Details: Winston Promotions, 9 Hatton Place, London EC1N 8RU. Tel. 01-405 4123/0960. (9794)

CLASSIFIED ADVERTISEMENTS

Use this Form for your Sales and Wants

PLEASE INSERT THE ADVERTISEMENT INDICATED ON FORM BELOW

To "Wireless World" Classified Advertisement Dept., Quadrant House, The Quadrant, Sutton, Surrey SM2 5AS

- Rate £3 PER LINE. Average six words per line. Minimum £20 (prepayable)
- Name and address to be included in charge if used in advertisement
- Box No. Allow two words plus £3
- Cheques, etc., payable to "IPC Business Press Ltd." and cross "& Co."

NAME.....

ADDRESS

.....

.....

REMITTANCE VALUE..... ENCLOSED

PLEASE WRITE IN BLOCK LETTERS. CLASSIFICATION..... NUMBER OF INSERTIONS.....

CROTECH OSCILLOSCOPES NATIONWIDE AVAILABILITY LOCAL TO YOU.

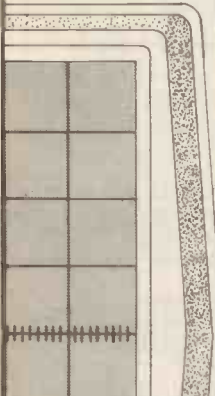

KENTWOOD ELECTRONICS
Reading
Tel: 0734 698040

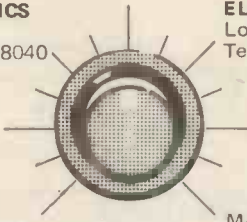

AUDIO ELECTRONICS
London W2
Tel: 01-724 3565

GLEVUM INSTRUMENTS
Gloucester
Tel: 0452 31620

PIL
London SE15
Tel: 01-639 4461

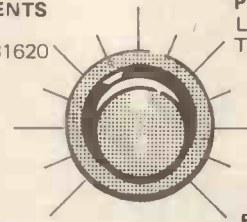

CARSTON ELECTRONICS
London NW1
Tel: 01-267 5311

NORTHERN INSTRUMENTS
Leeds
Tel: 0532 791054

MARSHION ELECTRONICS
Ipswich
Tel: 0473 75476

RT & I ELECTRONICS
London E11
Tel: 01-539 4986

BURDON INSTRUMENTS
Stoke-on-Trent
Tel: 0782 616631

Crotech Instruments Limited 5 Nimrod Way · Elgar Road · Reading · Berkshire · RG2 0EB
Telephone: (0734) 866945 Telex: 847073 POWLIN G

WW - 062 FOR FURTHER DETAILS

INDEX TO ADVERTISERS SEPTEMBER

Appointments Vacant Advertisements appear on pages 118-127

PAGE		PAGE		PAGE	
Acoustical Mfg. Co. Ltd.	29	Faircrest Engineering Ltd.	4	Northern Electronics	2
Albetros (Products) Ltd.	10	Farnell Instruments	Cover ii, 10 Reader Card	Olson Electronics Ltd.	6
Ambit International	102, 114	Feedback Instruments	Product Card	Opus Supplies	111
Analogue Associates	28	Fieldtech Heathrow Ltd.	20	Orion Scientific Products Ltd.	116
Anglia Components	20	Futronics Tech	108	Pantechinc	2
Antex (Electronics) Ltd.	Cover iii	Fylde Electronic Laboratories Ltd.	18	PM Components	92, 93
AP Products	117	Galatrek International Ltd.	2	P. & R. Computer Shop	4
Armon Electronics Ltd.	110	GAS Electronics	17	Prentice Hall International	16
Audio Electronics	23	Global Specialities Corp. (UK) Ltd.	55	Prolab Instruments Co.	107
Autotype	95	Gould Instruments Division	Product Card	Pye Telecommunication	Product Card
Avel Lindberg (Cotswold Electronics)	22	GP Industrial Electronics Ltd.	24, 25	Pype Hayes Radio Ltd.	12
Bach-Simpson (UK) Ltd.	19, 26	Greenwood Electronics Ltd.	Cover iv	Radford Laboratory Ind.	96
Barrie Electronics Ltd.	107	Hall Electric Ltd.	11	Radio Components Specialists	103
Baydiss	96	Happy Memories	107	Redcliffe Magtronics Ltd.	91
Beckman Instruments	102	Harris Electronics (London)	5	Reprints	114
Black Star Ltd.	13	Harrison Bros Electronic Distributors	13	Research Communications Ltd.	95
Broadfield & Mayco Disposals	18	Hart Electronic Kits Ltd.	4	R.S.T. Valves	105
Cambridge Kits	18	H.B. Electronics	30	Safgan Electronics Ltd.	16
Carston Electronics Ltd.	14, 15	Hemmings Electronics and Microcomputers	96	Sagin, M. R.	26
Chiltern Electronics	91	Henry's Radio	2, 22	Sandwell Plant Ltd.	101
Chiltmead Ltd.	108	House of Grolier	Loose Insert	Sarel Electric Ltd.	95
CIL Microsystems	94	ILP Electronics Ltd.	97, 113	Sche Tronics Ltd.	104
Circuit Services	5	Interface Quartz Devices Ltd.	9	Sescom Inc.	28
Clark Masts Ltd.	7	Intergrex	12	Sinclair Research Ltd.	21
Clef Products (Electronics) Ltd.	28	Keithley Instruments Ltd.	19, 27	South Midlands Communication	98
Compec Scotland	100	Kelsey Acoustics	108	Special Products (Distributors) Ltd.	6
Crimson Elektrik	104	Knight CB Specialists	91	Surrey Electronics Ltd.	12
Crotech Instruments Ltd.	128	Labgear Ltd.	56	Technomatic Ltd	98, 99
Daram Supplies	12, 101	Langrex Supplies Ltd.	105	Teleradio Electronics Ltd.	96
Dataman-Designs	8	LFH Associates	6	Teloman Products Ltd.	104
Display Electronics	115	Lion Viewdata TV	92	Tempus	113
DSN Marketing Ltd.	101	L&J Computers	28	Thandor Electronics Ltd.	109
Dwyatt Cavendish Co. Ltd.	98	MacDonald & Co. (Pub) Ltd.	26	Thanet Electronics	20
Electricity Supply Hand Book	110	Midwich Computer Co. Ltd.	13	Thurlyb Electronics (Reltech Instruments)	116
Electronic Brokers Ltd.	3, 5, 7, 9	Modern Book Co.	116	Time Electronics Ltd.	22
Electrovalue Ltd.	116	Monolith Electronics Co. Ltd.	101	Townley, A. C. Ltd.	94
Electrical Review Shock Cards	112	Japan: Mr. Inatsuki, Trade Media - IBPA (Japan), B.212, Azabu Heights, 1-5-10 Roppongi, Minato-ku, Tokyo 106. Telephone: (03) 585 0581.		Valradio Ltd.	10
Essex Electronics	108	United States of America: Ray Barnes, IPC Business Press, 205 East 42nd Street, New York, NY 10017 - Telephone: (212) 867-2080. Telex: 238327.		Veco Electroforming/Photo-Etching Ltd.	94
OVERSEAS ADVERTISEMENT		Mr Jack Farley Jnr., The Farley Co., Suite 1584, 35 East Walker Drive, Chicago, Illinois 60601 - Telephone: (312) 63074.		Vigilant Communications	18
AGENTS:		Mr Victor A. Jauch, Elmatex International, P.O. Box 34607, Los Angeles, Calif. 90034, USA - Telephone (213) 821-8581 - Telex: 18-1059.		West Hyde Developments Ltd.	10
France & Belgium: Norbert Hellin, 50 Rue de Chemin Veat, F-9100, Boulogne, Paris.		Canada: Mr Colin H. MacCulloch, International Advertising Consultants Ltd., 915 Carlton Tower, 2 Carlton Street, Toronto 2 - Telephone (416) 364 2269.		Wilmslow Audio	9, 19
Hungary: Mrs Edit, Bajusz, Hungexpo Adverting Agency, Budapest XIV, Varosliget. Telephone: 225 008 - Telex: Budapest 22-4525 INTFOIRE		* Also subscription agents.		Wings Appeal	16, 92
Italy: Sig C. Epis, Etas-Kompass, S.p.a. - Servizio Estero, Via Mantegna 6, 20154 Milan. Telephone: 347051 - Telex: 37342 Kompass.				Wireless World Circards	106
				Which? Magazine	Loose Insert
				White House Electronics	104

Printed in Great Britain by QB Ltd., Sheepen Place, Colchester, and Published by the Proprietors IPC ELECTRICAL-ELECTRONIC PRESS LTD., Quadrant House, The Quadrant, Sutton, Surrey SM2 5AS, telephone 01-661 3500. *Wireless World* can be obtained abroad from the following: AUSTRALIA and NEW ZEALAND: Gordon & Gotch Ltd. INDIA: A. H. Wheeler & Co. CANADA: The Wm. Dawson Subscription Service Ltd, Gordon & Gotch Ltd. SOUTH AFRICA: Central News Agency Ltd: William Dawson & Sons (S.A.) Ltd. UNITED STATES: Eastern News Distribution Inc., 14th floor, 111 Eighth Avenue, New York, N.Y. 10011.

KARILINS

ORYX



the new name in quality solder

Now there is another choice in high quality solder. The new Oryx resin cored solder. Try it and you will find it spreads easier than the solder you are using.

Specially formulated for fast precision solder work, it is 60% tin, 40% lead alloy with quality flux construction and melts at 183°C. Two gauges are available—18 SWG (1.2mm) and 22 SWG (0.71mm) in 2.5 Kg, 500g, 250g and 100g reels. Pocket size dispenser with 10 feet of Oryx 1mm solder is also available at only 68p (+VAT).

Oryx is competitively priced—write now for details and technical information.

Greenwood Electronics

Greenwood Electronics Limited, Portman Road, Reading, Berkshire RG3 1NE. Telephone: (0734) 595844. Telex: 848659

The TC82—a significant development in temperature controlled soldering



The new Oryx TC82 has features unique to any temperature controlled precision soldering iron. Available in 24 V, 50 V, 115 V and 210/240 V models, the TC82 has a facility allowing the user to accurately dial any tip temperature between 260°C and 420°C by setting a dial in the handle without changing tips.

This eliminates the need for temperature measuring equipment. You get faster and better soldering.

For 24 V models a special Oryx power unit connects directly to the iron and contains fully isolated transformer to BS3535, a safety stand, tip clean facility and illuminated mains socket switch.

The Oryx TC82 is also **extra-safe**. Removing the handle automatically disconnects the iron from power source. Other TC82 features include: Power-on Neon indicator in handle; burn proof cable; choice of 13 tip styles.

And more good news

The Oryx TC82 iron costs only £13.00 (+VAT) and the power unit for 24 V operation £23.00 (+VAT).

The TC82 240 volt is also available as a 30 watt general purpose iron at only £4.95 (+VAT).

Greenwood Electronics

Greenwood Electronics Limited, Portman Road, Reading, Berkshire RG3 1NE. Telephone: (0734) 595844. Telex: 848659

YOU'RE LOOKING AT 31 ANTEX SOLDERING IRONS!

The secret is in the range of bits for each model, from 19mm down to 0.5mm! No screws to seize up — push-on bits which cover the elements to save time and energy.

The new range of Antex irons come with or without safety plugs fitted. They are tougher than ever, and about twice as efficient as conventional designs.

Specify low wattage, low leakage Antex Irons now.



Made in England

WW-002 FOR FURTHER DETAILS

Our products are widely distributed by wholesalers and retailers throughout the UK. Please try your local dealer. Please send literature and price list to:

ANTEX (Electronics) Ltd.
Mayflower House, Plymouth, Devon.
Tel: (0752) 667377/8 Telex: 45296

Name Address

Telephone

WW 9