

Electronics World's renowned news section starts on page 5

# ELECTRONICS WORLD

JULY 2002 £2.95



**Capacitor sound?**

**Observing lightning**

**Spectrum pricing comes of age**

**Phase noise in  
frequency synthesisers**

**Headphone clarifier**

**Circuit ideas:**

Battery charger timer, Active antenna,  
Simple 1pF to 100nF capacitor tester





# Telnet

## Quality second-user test & measurement equipment

<b>Fluke 5700A Multifunction Calibrator with 5725A Amplifier</b>	<b>£17,000</b>
<b>Hewlett Packard 3314A Function Generator 20MHz</b>	<b>£1250</b>
<b>Hewlett Packard 3324A synth. function/sweep gen. (21MHz)</b>	<b>£2250</b>
<b>Hewlett Packard 3325B Synthesised Function Generator</b>	<b>£3250</b>
<b>Hewlett Packard 3326A Two-Channel Synthesiser</b>	<b>£3000</b>
<b>Hewlett Packard 4191A R/F Impedance Analyser (1-1000MHz)</b>	<b>£4995</b>
<b>Hewlett Packard 4192A L.F Impedance Analyser (5Hz-13MHz)</b>	<b>£4000</b>
<b>Hewlett Packard 4193A Vector Impedance Meter (4-110MHz)</b>	<b>£3000</b>
<b>Hewlett Packard 4278A 1kHz/1MHz Capacitance Meter</b>	<b>£3750</b>
<b>Hewlett Packard 53310A Modulation Domain Analyser (opts 1&amp;31)</b>	<b>£6750</b>
<b>Hewlett Packard 8349B (2 - 20 GHz) Microwave Amplifier</b>	<b>£2500</b>
<b>Hewlett Packard 8508A (with plug-in 85082A-2GHz) Vector Voltmeter</b>	<b>£2500</b>
<b>Hewlett Packard 8904A Multifunction Synthesiser (opt 2+4)</b>	<b>£1950</b>
<b>Hewlett Packard ESG-D3000A (E4432A) 250 kHz-3GHz) Signal Gen.</b>	<b>£6995</b>
<b>Marconi 6310 - programmable sweep generator (2 to 20GHz) - new</b>	<b>£2500</b>
<b>Marconi 6311 Prog'ble sig. gen. (10MHz to 20GHz)</b>	<b>£2995</b>
<b>Marconi 6313 Prog'ble sig. gen. (10MHz to 26.5GHz)</b>	<b>£4750</b>
<b>R&amp;S SMG (0.1-1GHz) Sig. Generator (opts B1+2)</b>	<b>£2750</b>
<b>Rohde &amp; Schwarz SM1Q-03B (opt11,12,14,20,B42) Vector Signal Generator (300kHz-3.3GHz)</b>	<b>£8500</b>

### OCSILLOSCOPES

Gould 400 20MHz - DSO - 2 channel	£695
Gould 1421 20MHz - DSO - 2 channel	£425
Gould 4068 150MHz 4 channel DSO	£1250
Gould 4074 100MHz - 400 Ms/s - 4 channel	£1100
Hewlett Packard 54201A - 300MHz Digitizing	£750
Hewlett Packard 54502A - 400MHz - 400 MS/s 2 channel	£1600
Hewlett Packard 54520A 500MHz 2ch	£2750
Hewlett Packard 54600A - 100MHz - 2 channel	£675
Hewlett Packard 54616B 500MHz - 2Gs/s 2 Channel	£2500
Hewlett Packard 54810A 'Infinium' 500MHz 2ch	£3500
Hitachi V152/V212/V222/V302B/V302F/V353F/V550BV650F	from £100
Hitachi V1 100A - 100MHz - 4 channel	£750
Intron 2020 - 20MHz. Dual channel D.S.O (new)	£450
Iwatsu SS 5710/SS 5702 -	from £125
Kikusui COS 5100 - 100MHz - Dual channel	£350
Lecroy 9314L 300MHz - 4 channels	£2750
Meguro MSO 1270A - 20MHz - D.S.O. (new)	£450
Philips 3295A - 400MHz - Dual channel	£1400
Philips PM3070 - 100MHz - 2 channel - cursor readout	£650
Philips PM3392 - 200MHz - 200Ms/s - 4 channel	£1750
Philips PM3094 - 200MHz - 4 channel	£1500
Tektronix 464/466 - 100MHz - (with AN. storage)	£295
Tektronix 465 - 100MHz - Dual channel	£295
Tektronix 468 - 100MHz D.S.O.	£500
Tektronix 475/475A - 200MHz/250MHz	from £400
Tektronix 2213/2215 - 60MHz - Dual channel	£300
Tektronix 2220 - 60MHz - Dual channel D.S.O	£850
Tektronix 2221 - 60MHz - Dual channel D.S.O	£850
Tektronix 2235 - 100MHz - Dual channel	£500
Tektronix 2245A - 100MHz - 4 channel	£700
Tektronix 2430/2430A - Digital storage - 150MHz	from £1250
Tektronix 2440 - 300MHz/500MS/s D.S.O.	£2100
Tektronix 2445 - 150MHz - 4 channel +DMM	£850
Tektronix 2445/2445B - 150MHz - 4 channel	£800
Tektronix 2465/2465A /2465B - 300MHz/350MHz 4 channel	from £1250
Tektronix 7000 Series (100MHz to 500MHz)	from £200
Tektronix 7104 - 1GHz Real Time - with 7A29 x2, 7B10 and 7B15	from £1950
Tektronix TAS 475 - 100MHz - 4 channel	£850
Tektronix TDS 310 50MHz DSO - 2 channel	£750

### SPECTRUM ANALYSERS

Advantest 4131 (10kHz - 3.5GHz)	£3750
Advantest 93272 Spectrum Analyser (9kHz-26.5GHz)	£12000
Advantest/TAKEDA RIKEN - 4132 - 100kHz - 1000MHz	£1350
Ando AC 8211 - 1.7GHz	£1500
Anritsu 54111A Scalar Network Analyser (0.001-3GHz) +dets+SWR	£7000
Anritsu 54154A Scalar Network Analyser (2-32GHz)+detectors+SWR	£9950
Avcom PSA-65A - 2 to 1000MHz	£750
Hewlett Packard 182T Mainframe + 8559A Spec.An. (0.01 to 21GHz)	£2000
Hewlett Packard 853A Mainframe + 8559A Spec.An. (0.01 to 21GHz)	£2500
Hewlett Packard 3582A (0.02Hz - 25.5kHz) dual channel	£1500
Hewlett Packard 8560A (50MHz-2.9GHz) High performance with Tracking Generator option (02)	£5500
Hewlett Packard 8567A -100Hz - 1500MHz	£3400
Hewlett Packard 8590A (opt 01, 021, 040) 1MHz-1.5MHz	£2500
Hewlett Packard 8596E (opt 41, 101, 105, 130) 9kHz - 12.8GHz	£9950
Hewlett Packard 8713C (opt 1 E1) Network An. 3 GHz	£6000
Hewlett Packard 8752A - Network Analyser (1.3GHz)	£4995
Hewlett Packard 8753A (3000KHz - 3GHz) Network An.	£3250
Hewlett Packard 8753B+85046A Network An + S Param (3GHz)	£6500
Hewlett Packard 8754A - Network Analyser 4MHz -1300MHz)	£1500
Hewlett Packard 8756A/8757A Scalar Network Analyser	from £900
Hewlett Packard 70001A/70900A/70906A/70902A/70205A - 26.5 GHz Spectrum Analyser	£7000
IFR A7550 - 10kHz-GHz - Portable	£1750
Meguro - MSA 4901 - 30MHz - Spec Analyser	£600

### Radio Communications Test Sets

Anritsu MT 8801C Radio Comms Analyser 300kHz - 3GHz (opt 1,4,7)	£6500
Hewlett Packard 8920B (opts 1,4,7,11,12)	£6750
Marconi 2955	£1250
Marconi 2955A	£1750
Marconi 2955B/60B	£3500
Marconi 2955R	£1995
Racal 6103 (GSM) Digital Radio Test Se	£6250
Racal 6111 (GSM)	£1250
Racal 6115 (GSM)	£1750
Rohde & Schwarz CMT 55 (2GHz)	£7500
Rohde & Schwarz CMD 57 GSM test set (opts B1/34/6/7/19/42/43/61)	£7995
Rohde & Schwarz CMT 90 (2GHz) DECT	£3995
Rohde & Schwarz CMTA 94 (GSM)	£4500
Schlumberger Stabilock 4031	£2750
Schlumberger Stabilock 4040	£1300
Wavetek 4103 (GSM 900) Mobile phone tester	£1500
Wavetek 4106 (GSM 900, 1800, 1900) Mobile phone tester	£2000

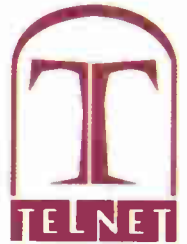

Meguro - MSA 4912 - 1MHz - 1GHz Spec Analyser	£750
Tektronix 492P (opt1,2,3) 50kHz - 21GHz	£3500
Willtron 6409 - 10-2000MHz R/F Analyser	£1250

### MISCELLANEOUS

Ballantine 1620A 100Amp Transconductance Amplifier	£1750
Bias unit 3220 and 3225L Cal.Coil available if required.	(P.O.A)
EIP 545 Microwave Frequency Counter (18GHz)	£1000
EIP 548A and B 26.5GHz Frequency Counter	from £1500
EIP 575 Source Locking Freq.Counter (18GHz)	£1200
EIP 585 Pulse Freq.Counter (18GHz)	£1200
Gigatronics 8541C Power Meter + 80350A Peak Power Sensor	£1750
Gigatronics 8542C Dual Power Meter + 2 sensors 80401A	£2500
Hewlett Packard 339A Distortion measuring set	£750
Hewlett Packard 436A power meter and sensor (various)	from £750
Hewlett Packard 3335A - synthesiser (200Hz-81MHz)	£1995
Hewlett Packard 3457A multi meter 6 1/2 digit	£850
Hewlett Packard 3784A - Digital Transmission Analyser	£3750
Hewlett Packard 37900D - Signalling test set	£2950
Hewlett Packard 4276A LCZ Meter (100MHz-20KHz)	£1400
Hewlett Packard 5342A Microwave Freq.Counter (18GHz)	£850
Hewlett Packard 5350B 20KHz Microwave Freq.Counter	£2000
Hewlett Packard 5351B (pt 1 & 6) Microwave Freq.Counter (26.5GHz)	£3000
Hewlett Packard 5385A - 1 GHz Frequency counter	£495
Hewlett Packard 6033A - Autoranging System PSU (20v-30a)	£750
Hewlett Packard 6622A - Dual O/P system p.s.u	£1250
Hewlett Packard 6624A - Quad Output Power Supply	£2000
Hewlett Packard 6626A / 6629A Quad O/P Power Supply	£3500
Hewlett Packard 6632A - System Power Supply (20v-5A)	£695
Hewlett Packard 8350B - Sweep Generator Mainframe	£1500
Hewlett Packard 8603A B and E - Distortion Analyser	from £1000
Hewlett Packard 8642A - high performance R/F synthesiser (0.1-1050MHz)	£2500
Hewlett Packard 8656A - Synthesised signal generator	£750
Hewlett Packard 8656B - Synthesised signal generator	£995
Hewlett Packard 8657A - Synth. signal gen. (0.1-1040MHz)	£1500
Hewlett Packard 8657B - 100MHz Sig Gen - 2060 MHz	£3950
Hewlett Packard 8657D - XX DQPSK Sig Gen	£3950
Hewlett Packard 8901B - Modulation Analyser	£2250
Hewlett Packard 11729B/C Carrier Noise Test Set	from £2500
Hewlett Packard 53131A Universal Frequency counter (3GHz)	£850
Hewlett Packard 53151B Microwave Freq. Counter (26.5GHz)	£3400
Hewlett Packard 85024A High Frequency Probe	£1000
Keithley 237 High Voltage - Source Measure Unit	£4500
Keithley 238 High Current - Source Measure Unit	£4500
Keithley 486/487 Picoammeter (+volt.source)	£1350/£1850
Keithley 8006 Component Test Fixture	£1750
Marconi 2840A 2 Mbit/s Transmission Analyser	£1100
Marconi 6950/6960/6960B Power Meters & Sensors	from £400
Philips 5515 - TN - Colour TV pattern generator	£1400
Philips PM 5193 - 50 MHz Function generator	£1350
Leader 3216 Signal generator 100KHz -140MHz - AM/FM/CW with built in FM stereo modulator (as new) a snip at	£650
Rohde & Schwarz FAM (opts 2,6 and 8) Modulation Analyser	£3750
Rohde & Schwarz NRV dual channel power meter & NAV Z2 Sensor	£1000
Tektronix ASG100 - Audio Signal Generator	£750
Wavetek 178 Function generator (50MHz)	£750
Wayne Kerr 3245 - Precision Inductance Analyser	£1850
Wayne Kerr 3260A + 3265A Precision Magnetics Analyser with Bias Unit	£5500
Wayne Kerr 6245 - Precision Component Analyser	£2250

All equipment is used - with 30 days guarantee and 90 days in some cases  
Add carriage and VAT to all goods.

Telnet, 8 Cavans Way, Binley Industrial Estate,  
Coventry CV3 2SF.

Tel: 02476 650 702

Fax: 02476 650 773

Web: [www.telnet.uk.com](http://www.telnet.uk.com)

Email: [sales@telnet.uk.com](mailto:sales@telnet.uk.com)

## 3 COMMENT

Reasons to be cheerful...

## 5 NEWS

- Software designs analogue chips
- Breakthrough in nanotubes
- Biotech sensor
- New ARM handles AV
- Electronic tongue
- 2.4GHz UK wireless network
- 2GHz number cruncher
- Towcester firm wins \$3m contract
- New user interface research
- Robot interacts with humans

## 12 CAPACITOR SOUND

As a first step in breaking new ground in relation to how capacitors can contribute to the 'sound' of a hi-fi amplifier, **Cyril Bateman** has designed a spot-frequency oscillator with sub-ppm distortion.

## 20 HEADPHONE CLARIFIER

**John Woodgate** has devised a very simple circuit that enhances the listening experience of people with impaired hearing when using headphones.



## 24 SPECTRUM PRICING COMES OF AGE

Twenty years after it was first conceived, spectrum pricing has achieved universal respect as the principal tool for managing the radio spectrum. But its essential principles have still not been fully grasped by the Government or its economic advisers. **David Rudd** reports.

## 26 BUDGET T&M ON A PC

In his second article on analysing signals using a PC with some low-cost software, **Richard Black** discusses using Fourier transforms to reveal spectral information.

## 30 WHITE NOISE

**Hot Electron** takes a sideways look at the world of electronics.

## 32 CIRCUIT IDEAS

- Electronic fuses as liquid level sensors
- Active antenna with noise suppression
- Timer for battery chargers
- Push-button controlled power supply
- Capacitance meter for 1pF to 100nF
- Variable over-current trip

## 39 NEW PRODUCTS

The month's top new products, selected and edited by **Richard Wilson**.

## 46 PHASE NOISE AND FREQUENCY SYNTHESISERS

Ian Poole explains how phase noise affects a synthesiser's performance, and offers tips on how to minimise it.

## 50 OBSERVING LIGHTNING

**Joe Carr** presents a backgrounder on the complex effects of lightning and offers ideas for making your own electronic observations in relative safety.

## 56 LETTERS

- Equality?
- Making your own PCBs
- Stuck in a time warp...
- Shock hazard reduced?

## 60 WEB DIRECTIONS

Useful web addresses for electronics engineers.

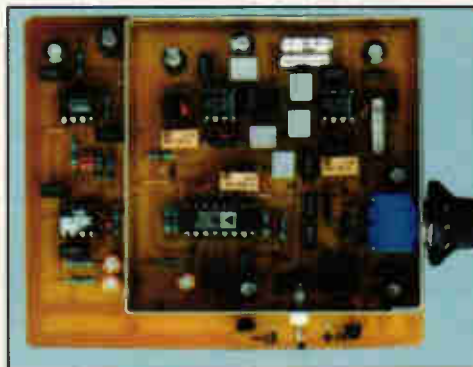

*Does a capacitor in a hi-fi circuit affect the sound perceived by the listener? There have been many mystical and florid claims about capacitor sound, but few authors have attempted quantitative explanations. In the first of this unique set of articles, capacitor guru Cyril Bateman sets out to rectify that. Find out how on page 12.*



Cover photography Mark Swallow

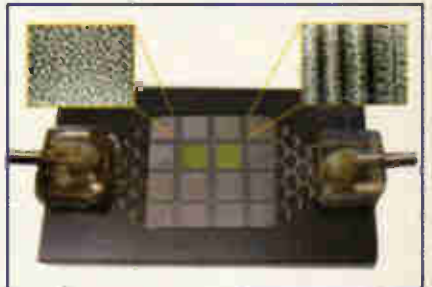

*Featured in News on page 6, this electronic tongue can detect chemical changes. If development work gets underway again, it could be developed further so that it can recognise classes of chemicals.*



*Joe Carr describes lightning and discusses how to observe its effects in relative safety – page 50.*



# PROTEUS

## VSM

Virtual System Modelling

Build It In Cyberspace

[www.labcenter.co.uk](http://www.labcenter.co.uk)

CIRCLE NO. 105 ON REPLY CARD

**Develop and test complete micro-controller designs without building a physical prototype. PROTEUS VSM simulates the CPU and any additional electronics used in your designs. And it does so in real time. \***

- CPU models for PIC and 8051 and series micro-controllers available now. 68HC11 coming soon. More CPU models under development. See website for latest info.
- Interactive device models include LCD displays, RS232 terminal, universal keypad plus a range of switches, buttons, pots, LEDs, 7 segment displays and much more.
- Extensive debugging facilities including register and memory contents, breakpoints and single step modes.
- Source level debugging supported for selected development tools.
- Integrated 'make' utility - compile and simulate with one keystroke.
- Over 4000 standard SPICE models included. Fully compatible with manufacturers' SPICE models.
- DLL interfaces provided for application specific models.
- Based on SPICE3F5 mixed mode circuit simulator.
- CPU and interactive device models are sold separately - build up your VSM system in affordable stages.
- ARES Lite PCB Layout also available.

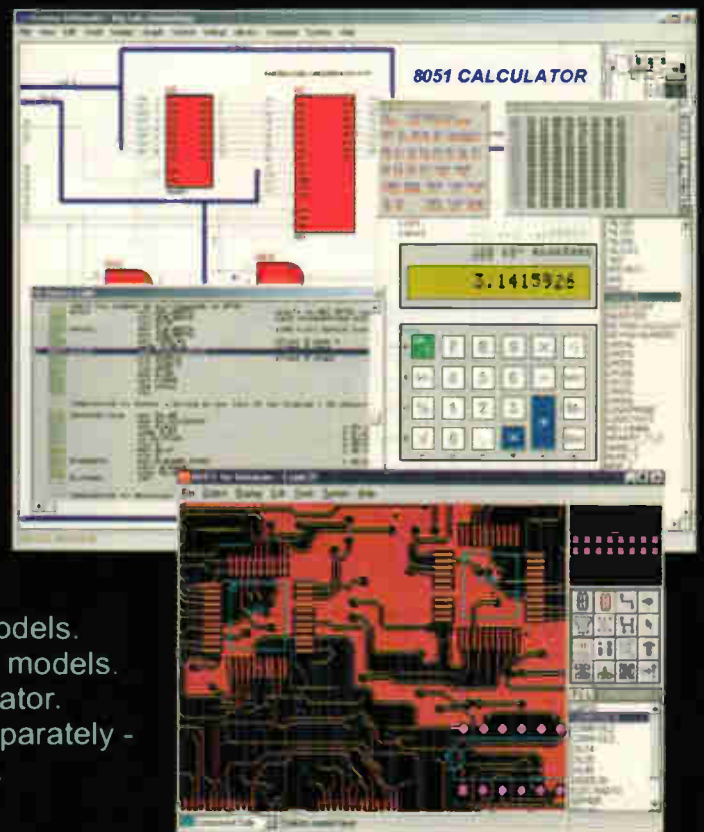

labcenter  
Electronics

\*E.g. PROTEUS VSM can simulate an 8051 clocked at 12MHz on a 300MHz Pentium II.

Write, phone or fax for your free demo CD - or email [info@labcenter.co.uk](mailto:info@labcenter.co.uk).  
Tel: 01756 753440. Fax: 01756 752857. 53-55 Main St, Grassington. BD23 5AA.



**EDITOR**  
Martin Eccles

**CONSULTANT**  
Ian Hickman

**EDITORIAL  
ADMINISTRATION**  
Jackie Lowe  
020 8722 6054

**EDITORIAL E-MAILS**  
J.lowe@cumulus  
media.co.uk

**GROUP SALES**  
020 8722 6028

**ADVERTISEMENT  
E-MAILS**  
j.thorpe@cumulus  
media.co.uk

**EDITORIAL FAX**  
020 8722 6098

**CLASSIFIED FAX**  
020 8770 2016

**PUBLISHING DIRECTOR**  
Tony Greville

**MANAGING DIRECTOR**  
Roy Greenslade

**NEWSTRADE ENQUIRIES**  
020 7907 7777

**ISSN 0959-8332**  
**SUBSCRIPTION HOTLINE**  
Tel (0) 1444 475662  
Fax (0) 1444 445447

**SUBSCRIPTION QUERIES**  
rbp.subscriptions@rbi.co.uk  
Tel (0) 1444 445566  
Fax (0) 1444 445447

## Reasons to be cheerful...

Work, as the old saying goes, is the curse of the drinking classes. But work has to be done to pay the bar bills, the mortgage and everything else. At least for some the worry these days is finding the work, even whether we'll be granted the privilege of a job. What will the prospects be for designers – and everyone else in the high-tech industries? What will you be doing in eight years' time? Have you any idea?

The truth is, you don't know and nor does anyone else, even though our jobs are all at stake.

In fact the future is famously unpredictable. You can never eliminate uncertainty, which has the power to wreck well-honed business plans – as the events of 11 September did for the air travel industry and all its dependents. It's clear too that collapse was never envisaged when ITV Digital was launched.

Unpredictable events can also bring blessings and for firms that can handle such eventualities, they can be highly beneficial. Experts say you cannot plan for unpredictability, but you can at least align your business process to recognise it and then react positively. The trick is to allow for uncertainty without descending into anarchy, so you can turn uncertainty to your commercial advantage.

In other words, the winners will be those who can manage uncertainty the best. That must be encouraging for those working for enlightened employers but will the rest of us still have jobs in 2010? Two reports provide a pointer...

A study by BT, 'Everyday Life in 2010', predicts that automation will eliminate jobs not dependent on human creativity. Computers will become intelligent personal assistants, greatly boosting the productivity of those with jobs.

Some of today's service industries will no longer exist and firms performing broker or intermediary-type services will be replaced by computer programs providing the same functions for nothing. Only for skilled programmers and computer manufacturers will this be good news.

Big business will not eliminate small companies, however. Some companies may be truly global, with workers on every continent, picked specifically for the task in hand. But their exclusive concentration on 'core activities' will make them more reliant than ever on small and local companies.

Personal motivation will be vital; by 2010 the notion of the job for life will be totally extinct. Most workers will change jobs frequently, working for virtual companies composed of a core of mission-critical project leaders, augmented by skill providers employed on short-term contracts. To avoid the need to move location each time they change job most people will telework but not at home like a few manage today.

Because of the distractions and the fact that most houses are not built with space for a dedicated office, many of us will 'go to work' in communal local telework centres, equipped with all the technology and facilities we need.

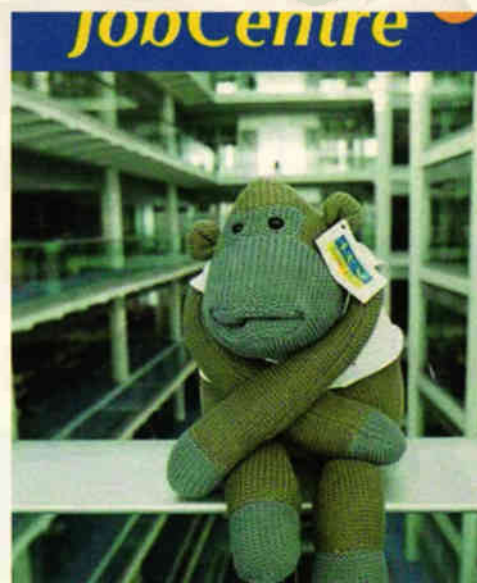

People have social needs at work, which these centres will provide, doubling in the evenings as community centres for education and entertainment. It sounds almost utopian – we shall actually work next to our neighbours, strengthening the local community while reducing commuter stress. Fantastic!

More of the same can be found in the report 'Tomorrow's Work', written for employment company Kelly Services by Institute of Directors Chief Economist Graeme Leach. Looking a decade further at the year 2020, the study predicts major change across the job market, both in structure and in attitudes.

Continued outsourcing will mean a quarter of the workforce will be temporary workers, up from 6% today, with self-employed people accounting for another 20-25% of the workforce. The gurus, freelance consultants with high skill levels and experience working for clients on a freelance basis, will be in strong demand. For the remainder of workers, a good recruitment consultant will be as essential as a good accountant is now.

In technical professions expertise will figure highly and companies will have greater difficulty retaining their best staff. Performance-related pay and flexible reward packages will increase, with employees able to make up their pay from a whole range of benefits from extra holiday to childcare. Many staff will work a six-hour day with flexibility to work earlier or later in the day to suit their lifestyle and family commitments.

Higher, rather than lower, skill sets will be demanded and because knowledge will be obsolete within a few years, short courses and refresher sessions will become part and parcel of normal work. For their part, workers will have to commit to life-long learning if they want to retain pole position in the job market and take maximum advantage of changes on the way.

If this sounds encouraging, then I'm extremely happy. On the other hand the forecast could be flawed. Either way, it's our job to use uncertainty to our advantage! ■

Andrew Emmerson

*Electronics World* is published monthly. Orders, payments and general correspondence to Jackie Lowe, Highbury Business Communications, Anne Boleyn House, 9-13 Ewell Road, Cheam, Surrey, SM3 8BZ.

Newstrade: Distributed by COMAG, Tavistock Road, West Drayton, Middlesex, UB7 7QE Tel 01895 444055. Subscriptions: Quadrant Subscription Services, Oakfield House Perrymount Road,

Haywards Heath, Sussex RH16 3DH. Telephone 01444 475631. Please notify change of address. Subscription rates 1 year UK £38.00 2 years £61.00 3 years £76.00. Europe/Eu 1 year £54.00 2 years £86.00 3 years £108.00 ROW 1 year £63.00 2 years £101.00 3 years £126

Overseas advertising agents: France and Belgium: Pierre Mussard, 18-20 Place de la Madeleine, Paris 75008. United States of America: Roy Barnes, Reed Business

Publishing Ltd, 475 Park Avenue South, 2nd Fl New York, NY 10016 Tel; (212) 679 8888 Fax; (212) 679 9455

USA mailing agents: Mercury Airfreight International Ltd Inc, 10(b) Englehard Ave, Avenel NJ 07001. Periodicals Postage Paid at Rahway NJ Postmaster. Send address changes to above.

Printed by Polestar (Colchester) Ltd, Filmsetting by G&E 2000 A1 Parkway, Southgate Way, Orton Southgate, Peterborough, PE2 6YN



**HIGHBURY**  
**Business Communications**

A SUBSIDIARY OF HIGHBURY HOUSE COMMUNICATIONS PLC





®

# 19" RACK MOUNTING DISTRIBUTION PANELS WITH IEC 320 SOCKETS AND REAR CABLE MANAGEMENT

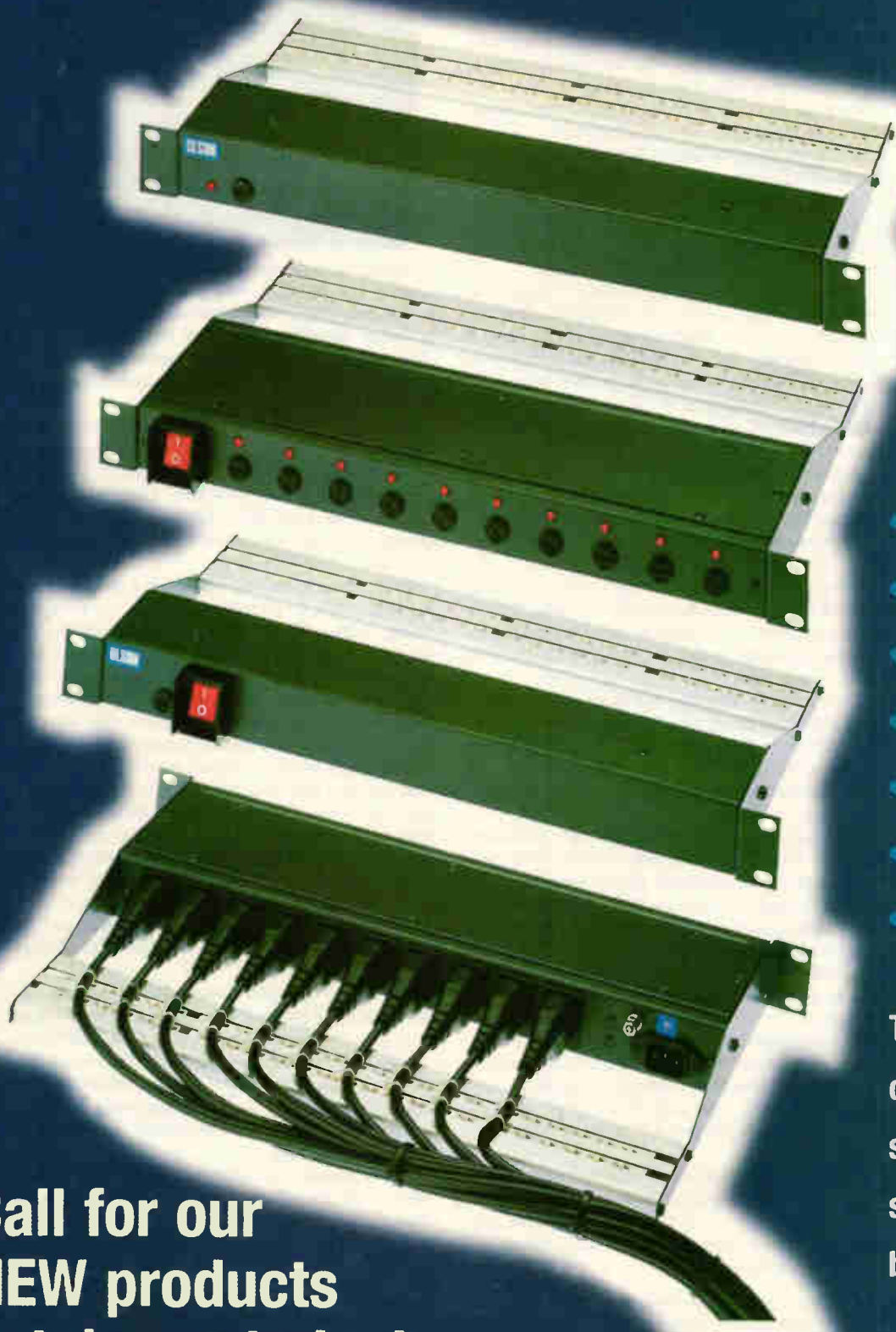

- 19" Front Panel 1U HIGH
- Sockets on the back
- 10A inlet on the back
- New Colour
- Up to 12 Sockets
- 22 Different types
- With cable support

This unique design offers cable tie slots for instant snap-in installation and stops plugs accidentally being disconnected.

Call for our  
NEW products  
catalogue today!

020 8905 7273

24 HOUR SERVICE. VISA, MASTERCARD AND SWITCH ACCEPTED



## ELECTRONICS LIMITED

OLSON HOUSE, 490 HONEYPOT LANE,  
STANMORE, MIDDX HA7 1JX  
TEL: 020 8905 7273 FAX: 020 8952 1232  
e-mail: sales@olson.co.uk  
web site: <http://www.olson.co.uk>



1961-2001

## Software automatically designs analogue chips

Firms from Canada and the US have developed software that can automatically generate analogue chip designs.

Canadian firm Analog Design Automation (ADA) calls its two products Creative Genius and Explorer Genius.

The creation tool takes a circuit topology including a transistor level net list, test benches, process information and environmental data. Raw circuit data for the tool comes from standard analogue design software such as that from Cadence and Mentor Graphics.

The designer inputs the circuit objectives, such as output impedance, slew rate, area and power, and the tool creates multiple circuit solutions that meet the goals.

The software can take account of many variables, such as process

variations, temperature ranges, voltages and transistor parameters.

"It would take a designer several months to come up with all the circuits Creative Genius can produce in a matter of hours," said Amit Gupta, a co-founder of ADA. "Since our algorithms can handle all the values simultaneously, we can push the limits of the designer's objectives."

The Explorer tool is used to sort the output from the Creation tool, examining design trade-offs. Once the final design is selected, component parameters are automatically back-annotated into the schematic.

● Barcelona Design has unveiled a synthesis tool for analogue chip design.

Called Prado, the software is a platform for combining analogue

circuit engines, said the firm. Each engine focusses on a specific topology or circuit type, such as phase-locked loops or op-amps.

Prado includes placement and routing of the completed analogue circuit design.

"Barcelona provides a radical new alternative for implementing analogue circuits," said Thomas Heydler, CEO of Barcelona Design.

The firm said the software could reduce design time from months to hours, and would be particularly useful when designing mixed signal ICs.

Mitsubishi has already started using the tools at its System LSI division. "It is clear their approach to analogue circuits offers unprecedented speed and flexibility," said Yasuyuki Nakamura, engineering manager at Mitsubishi.

## Breakthrough in nanotube research

Carbon nanotubes are being touted as future components in next-generation integrated circuits and micromachines.

Unfortunately they are difficult to grow on demand and virtually impossible to grow in a set direction.

Now workers at the Rensselaer Polytechnic Institute in the US claim to have achieved controlled nanotube growth, perpendicular to a prepared silica-coated substrate.

"This is the first step toward making complex networks comprised of molecular units. By manipulating the topography of silica blocks, and utilising the selective and directional growth process, we have been able to force

nanotubes to grow in predetermined, multiple directions, with a very fine degree of control. No one else has done this," Ganapathiraman Ramanathboth.

Ramanathboth, with fellow materials scientists Pulickel Ajayan, have combined formerly disparate areas of research to grow their nanotubes. With the shaped silica surface they use gas phase delivery of a metal catalyst, essential for nanotube growth which, they claim, makes their process more flexible and more easily scalable than conventional methods.

"It's a simple and elegant process that provides unprecedented control over nanotube growth," said Ajayan.



Workers at the Rensselaer Polytechnic Institute in the US claim to have achieved controlled nanotube growth, perpendicular to a prepared silica-coated substrate.



**Biotech sensor...** US scientists at the Ames Laboratory and the University of Michigan have developed a fluorescence-based chemical sensor that integrates its own organic LED.

The compact device could have uses in biomedical and biochemical research, monitoring gasses, organic compounds and biological organisms.

Conventional sensors use a laser or inorganic LED as a light source, which makes the resulting device bulky and expensive. The Ames/Michigan combines the organic components in a single device.

"Integration and miniaturisation of fluorescence-based chemical sensors is highly desirable, as it is the first step towards the development of fluorescence-based sensor arrays that could be used for analysis of living cells and organisms, and biochemical compounds," said Joseph Shinar, a senior physicist at Ames.



## New ARM device has audio and video handling instructions

Cambridge-based ARM, whose processors dominate the mobile phone market, has revealed details of its first v6 architecture processor.

v6 adds video and audio handling instructions to ARM's CPUs which will suit it to consumer and wireless applications, including videophones, said the company.

Called ARM11, the new processor will yield 350 to 500MHz processors on a 0.13µm process, said Dave Cormie, ARM CPU product manager. "0.10µm parts should work at over 1GHz."

The company's Jazelle Java instruction decoder and Thumb 16-bit instruction decoder will come as

standard with ARM11 as will some DSP capability.

The processor has an eight-stage pipeline and will be available with and without a floating point co-processor.

The pipeline includes dynamic branch prediction. "It is a single-issue design, so it has simple instruction decoding to keep power consumption well under control," said Cormie.

Consumption is projected to be 0.4mW/MHz at 0.13µm and with two 32kbyte caches, ARM11 will fit into 7mm<sup>2</sup> on a 0.13µm process.

It will be available in the last quarter of this year, with high-performance variants from ARM partners out before the end of 2003.

● ARM also announced ARM1026EJ-S. Based on v5 architecture, it is the first synthesisable ARM10 and the first ARM10 to include a Jazelle Java instruction decoder.

This processor should operate at between 270 and 325MHz – giving 400 Dhrystone Mips – and occupy around 260 000 gates.



**Bright dyes for CDs...** Just to make CDs and DVDs more striking, GE Plastics has developed Edge Glow, a combination of fluorescent dyes, licenced from Fujitsu Component of Japan, and a polycarbonate resin. GE also produces coloured resins for CDs, so you can chose the colour of your glow.  
[www.geplastics.com](http://www.geplastics.com)

*This electronic tongue can detect chemical changes. If development work gets underway again, it could be developed further so that it can recognise classes of chemicals.*

## Electronic tongue has a taste for chemicals

An electronic 'tongue' that could be used to monitor rivers or factories' pipes for dangerous chemicals has been developed by scientists at Cardiff University.

The tongue uses porous silicon to create a solid-state chromatograph. "We've borrowed technology from chromatography and

transferred that onto the surface of oxidised silicon," said Professor David Barrow, a biologist at Cardiff.

Barrow's team etched a series of porous areas into a silicon dioxide layer on a chip. Each spot of porous silicon has a slightly different layout of pores, so different

chemicals will be absorbed to a different extent into the surface.

"We look at the electrochemical impedance of the interface between the porous silicon and the fluid," said Barrow. "We would see changes in impedance due to different chemical species."

The sensor cannot identify specific compounds, but can see when the chemical makeup of the fluid is changing. The fluid could then be analysed by more traditional means to find the exact compounds involved.

This could be used to spot when, for example, pesticides are introduced into a river, or when industrial effluent contains anything out of the ordinary. "The application range is diverse," said Barrow.

The project has stopped for now as the initial funding from the EPSRC has dried up, but Barrow hopes to attract further funding and continue development.

The next step, he said, would be to add a neural network to try and recognise classes of chemical – something he has already tried with phenol.

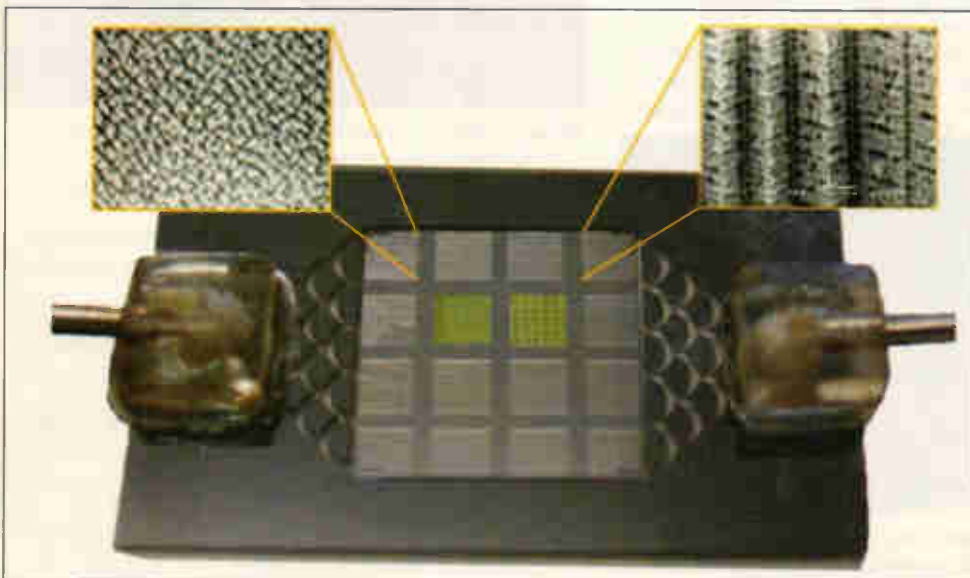



## 2.4GHz UK wireless network planned for WWW access

BT plans to build a 2.4GHz wireless LAN network with 400 base stations by June next year. Within three years, the firm expects to have 4000 sites in public areas such as hotels, railway stations, airports and bars.

The decision to build the network is conditional on the Radiocommunications Agency allowing commercial services in the unlicensed 2.4GHz band – a move it is expected to make soon.

"We intend to build a national network of access points around key public sites... all within reach of business travellers, commuters

and other users," said Pierre Danon, CEO of BT Retail.

Anyone within a 100m range of one of BT's 'hot-spots' will gain access to the Internet if they have the firm's software on their PC or PDA. Access speeds will be up to 500kbit/s, BT claimed.

"One of the advantages of Wireless LAN is the simplicity of its adoption, requiring no additional cabling and no digging. By only modest investment, we'll achieve a high-speed network and be able to exploit BT's existing and growing broadband network," Danon added.

BT Wholesale has also announced

plans to trial high-speed Internet access over satellite.

Aimed at small businesses and residential customers, the service would be attractive to people outside of cable and DSL equipped areas.

"It is not true broadband, but it will give much faster internet access to many people who could otherwise be denied," said Paul Reynolds, chief executive of BT Wholesale.

A 65cm dish would deliver the 256kbit/s service, with the return path via a slower phone modem line. Up to 4Mbit/s could be available at higher cost.

## US start-up produces 2GHz number cruncher

This is FastMATH – a 2GHz MIPS processor-based number cruncher from a US start-up company called Intrinsicity.

Aimed at 'adaptive signal processing', it includes a 2GHz matrix/vector processor, 1Mbyte level 2 cache and two 2Gbyte/s RapidIO ports. Performance will be 32Gmacs – 64Gops, claims Intrinsicity.

"FastMATH is six-times faster than a Texas Instruments' C6416 running at 600MHz," said Company v-p marketing Scott Gardner – comparing 1024-point radix-4 FFT times.

To get the speed, Intrinsicity uses dynamic logic implemented in an 0.13µm process and designed using its proprietary Fast14 tools. A 0.10µm 4GHz version is planned.

Potential applications include calculation-intensive tasks in mobile communication and image processing. Gardner takes the example of MUD – multi-user detection – in mobile phone masts. "64 users can be supported in two FastMATH

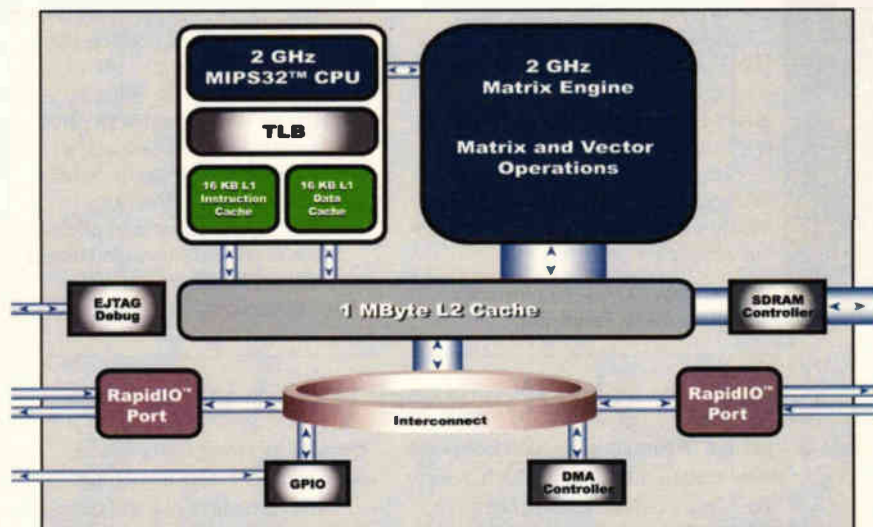

chips versus eight desktop processors and an FPGA," he said.

Power dissipation at full speed will be "well under 20W", claimed Gardner.

Samples are due in the last quarter of this year with production at the

end of next year. Software tools should be out this summer.

Intrinsicity is also planning FastMIPS; a version of the chip without a matrix processor which should also be out at the end of this year.

## Towcester company wins \$3m computer contract

Towcester-based VME-based computer-maker Radstone Technology has won a \$3m contract to supply computers for the Abrams Battle Tank M1A2.

As part of the tank's continuous electronics enhancement program, Radstone is integrating its latest-generation rugged COTS (commercial off-the-shelf) Power-PC processor. Called General Purpose Processor (GPP), it supports on-board mezzanines and will allow for improved capabilities in both crew operations and vehicle diagnostics, said Radstone.

This is an initial order covering around 50 tanks. Over 2000 M1A2 tanks are currently in service with the US Army and other nations.

The Abrams is the US Army's main battle tank. The update includes a distributed data and power architecture and a radio interface unit which allows transfer of digital battle situational data.

[www.radstone.co.uk](http://www.radstone.co.uk)



Radstone Technology has won a \$3m contract to supply computers for the Abrams Battle Tank M1A2.

## Researchers to develop new user interfaces for PCs and PDAs

The UK's Central Research Laboratories (CRL) is running a two year, £3.4m project to develop new user interfaces for PCs, PDAs and other computing devices.

Physical objects will be used to indicate to the computer what information the user is seeking.

"It's about enabling people to use information sources in a more intuitive way," said John Holden, director of the multimedia group at CRL.

Called Webkit, the project will use an object-based interface and radio-frequency tags. When a tagged object, such as a model car, is placed near the reading device, the PC or PDA could use information in the object to search the Web or other database.

"It's perfect for education, when a teacher wants students to learn about specific things," Holden pointed out. It could also be used in marketing

or advertising, sending an object to people that their Web browser would use to link direct to a company web site.

This use of physical objects to communicate is being dubbed a tangible user interface (TUI). The Middlesex-based research group is being joined by the Universities of Cambridge and Warwick in the project.

## Robot interacts with humans

US company ActivMedia Robotics has designed a robot for interaction with humans.

Called PeopleBot, it is a mechanical base on which owners can overlay complex behaviours.

ActivMedia sees it being programmed as a waiter, a tour guide, a mobile security camera or an advertising gimmick among other applications.

Various models are sold and features can include a gripper, table-sensing infra-red detectors and a pan-tilt zoom camera.

*Harry, from its maker ActivMedia Robotics, meets PeopleBot.*



The robot can play sound and speech, recognise phrases or sounds, transmit video images and navigate, using upper and lower sonar rings, without running over toes or into furniture, claims the company. Power cables and other low obstacles are said to be no problem.

The key to using the robot is developing suitable software. It is programmed in C or C++ and a development environment called ARIA (ActivMedia Robotics Interface Application) is available.

ARIA is a multi-threaded object oriented API (application programming interface) usable under

Linux or Win32.

PeopleBot comes with demo software which allows it to recognise a coloured object, fetch it from one table and place it on another. [www.activrobots.com](http://www.activrobots.com)

### PeopleBot specification

47x38x112cm aluminium body  
19cm drive wheels  
13kg payload  
1% accurate wheel encoders for dead-reckoning  
0.8m/s unloaded speed  
Climbs 5% slopes and 1.5cm steps  
Siemens C166 processor

## Aiwa plant saved from closure

Axiom Manufacturing Services is the new name for the plant which used to be Aiwa's manufacturing centre in Wales. Trevor Wilkinson, MD of Axiom looks over one of the firm's circuit boards with James Liu of new owners Sen Hong.

The future of Aiwa's 200-worker Welsh manufacturing plant at Newbridge is brighter following a

buy-out by Hong Kong-based industrial investors Sen Hong.

"This agreement is good news for the business, its staff and our customers. It secures our future as a provider of contract manufacturing in the UK and Europe," said Trevor Wilkinson, MD at the plant which will now be known as Axiom Manufacturing Services.

Aiwa was bought recently by Sony and Aiwa's Welsh facility looked set to be closed as part of Sony restructuring.

The Welsh Development Agency brokered the Sen Hong deal which will see Axiom continue to act as a contract manufacturer – which it has been since June 2001 when it stopped making Aiwa-branded products, said a spokesman for the company.

Financial support has come from the Welsh Assembly Government.

"The Regional Selective Assistance grant from the Assembly

Government will help to safeguard the jobs at the Newbridge plant and support the continuing development of the Welsh electronics industry," said Andrew Davies, economic development minister for the Welsh Assembly Government.

Due largely to its long association with Japan, said Axiom, the Newbridge site boasts some of the most advanced equipment and manufacturing techniques in the European CEM market. It claims to be thriving in contract manufacture and estimates it will generate sales of nearly £20m in 2003.

The Regional Selective Assistance grant scheme is run by the Welsh Assembly Government. Grants are offered businesses towards the costs of investments that help to produce or protect jobs in areas of Wales which have been designated as 'assisted areas'.

The Aiwa brand name remains with Sony.

*Axiom Manufacturing Services' Trevor Wilkinson (right), MD, with James Liu of new owners Sen Hong.*





# B<sup>2</sup> Spice AD v4

Try the full version risk free for 30 days

**NEW  
VERSION**

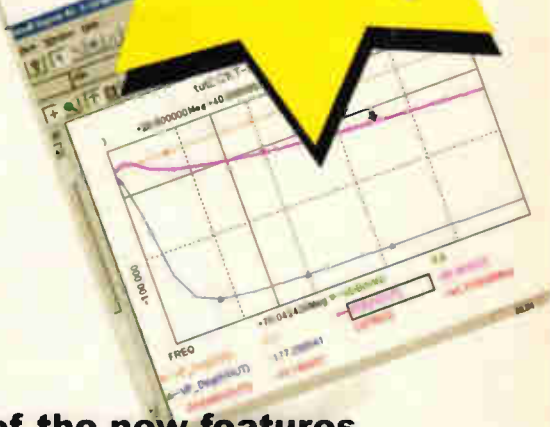
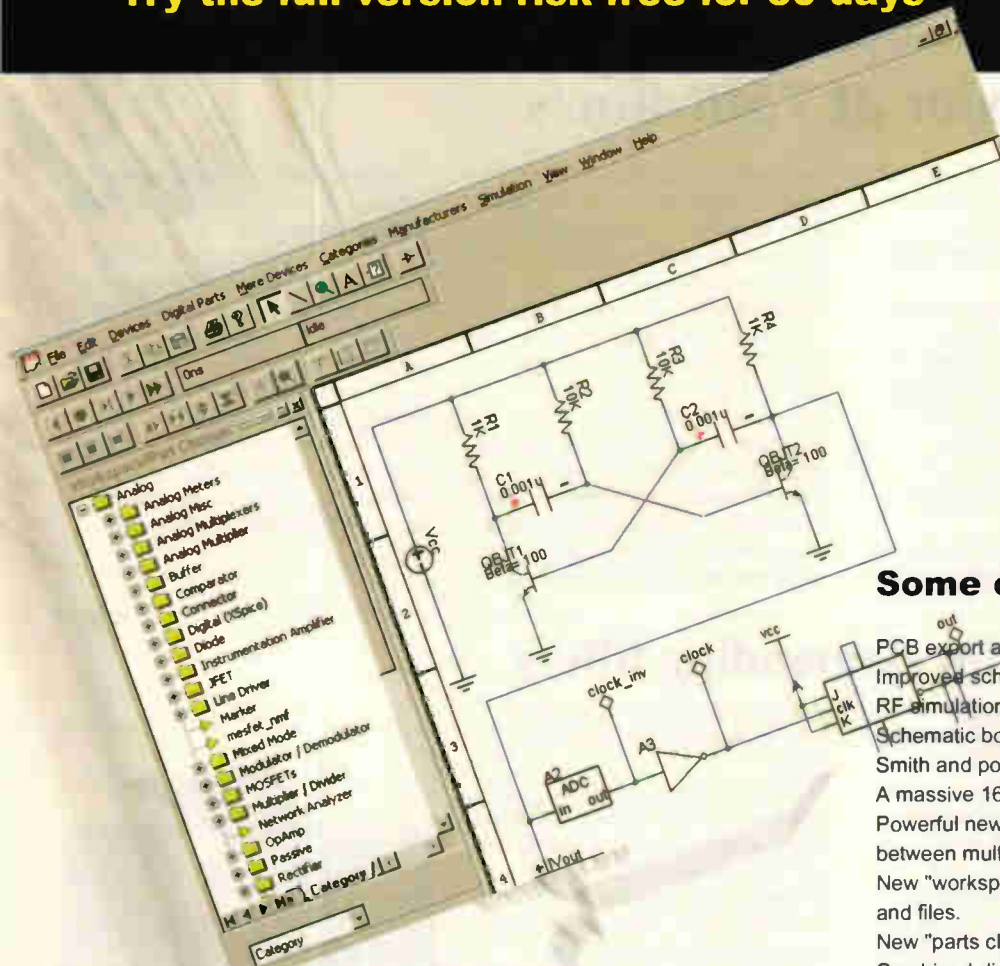

## Some of the new features

- PCB export and bill of materials.
- Improved schematics with DIN and ANSI symbols.
- RF simulations and network analysis.
- Schematic borders and title-box for professional output.
- Smith and polar plots.
- A massive 16,000 parts as standard.
- Powerful new graphing and plotting - display & switch between multiple graphs easily.
- New "workspace" window to manage your projects and files.
- New "parts chooser" window to easily pick and place parts.
- Combined digital and analogue graphs.
- Even faster simulations.
- Unlimited undo / redo.
- Many new simulation models.
- Create new parts.
- Create and edit symbols.
- Create new PCB layout parts.
- New fully featured schematic editor.

## Results you can rely on

B<sup>2</sup> Spice's ease of use and above all, accuracy, is why it is used by dozens of universities and thousands of professional designers in the UK and US. B<sup>2</sup> Spice delivers simulations that accurately behave like the end result. This new version contains a plethora of additional features, from Radio Frequency simulation to PCB capabilities.

## More features and simulation options than ever before

Sinusoidal, constant, periodic pulse, exponential, RF, single frequency, FM, AM, DC voltage, AC voltage, VCO, Vcc, piecewise linear, polynomial / arbitrary source, voltage-controlled voltage, voltage-controlled current, current-controlled voltage, current-controlled current, lossy and ideal transmission line, MESFET, uniform RC, current and voltage controlled switches are all available.

Fully mixed mode, single / dual parameter DC sweep, AC sweep, transient analysis, small signal transfer function, Fourier analysis, AC & DC sensitivity, Smith charts, pole zero, Monte Carlo analysis, noise, distortion operating point, temperature change, as well as generating component faults.

## There are NO limits

We set no limit on the size of your design or the number of nodes or parts. It can be as large or as complex as you want. The high quality graphics ensure that your results are easy to understand and interpret. Everything can be customised to suit your needs and preferences.

**30 Day no risk trial with free ongoing technical support. If it doesn't do what you want, then simply return it.**

From just £159 ex VAT for the standard version.  
Normal price - professional version £229 ex VAT.  
Upgrades from earlier versions £179 ex VAT.  
All libraries included - no hidden extra costs.  
Education discounts and site licences available.

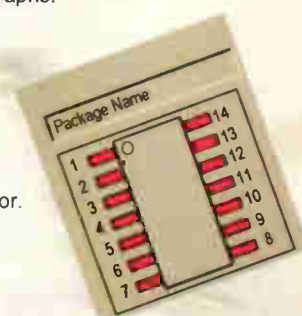

**Tel: 01603 872331**



Research House, Norwich Road, Eastgate  
Norwich. NR10 4HA. Fax: 01603 879010  
Email [info@looking.co.uk](mailto:info@looking.co.uk) [www.spice-software.com](http://www.spice-software.com)



Also order on-line through **GREY MATTER**  
[www.greymatter.com/mcm/rdresearch](http://www.greymatter.com/mcm/rdresearch)

## Holographic drives could hold 500Gbyte and transfer at 750Mbit/s

A Cambridge University spin off is developing holographic data storage techniques that could lead to 500Gbyte discs with read and write speeds of 750Mbit/s.

Polight's first generation product will be called Holodisc, and is expected to be available by 2004. In comparison, a DVD offers 4.7Gbyte capacity and read/write speeds of around 3Mbyte/s. The memory density will be five times that of conventional magnetic hard disks, said the firm.

"Holographic data storage is the next big step forward for the

removable data storage industry. Polight's materials put the company in the unique position of holding a key that will enable holographic data storage to become reality," said Michael Ledzion, Polight's CEO.

The firm's technology derives from research carried out by Professor Stephen Elliott of Cambridge University. His research led to chalcogenide glass materials that are changed both physically and optically when exposed to laser light. Information is stored in the material using optical interference patterns inside the photosensitive material.

Furthermore, no processing is required after the laser stage to 'fix' the data in the glass.

Each interference pattern stores a hologram, and hence large amounts of data in one go. Ledzion reckons that 1Mbyte of data can be stored per hologram. Indeed, it is this that leads to the very high data rates when reading and writing data.

If Polight is successful in bringing products to market, initial applications for the storage medium are expected in archiving and data backup.

## FFT cores for demanding filters

If you have a very demanding filter application, Isle of Wight-based RF Engines may have the answer.

It has released details of its 'vectis' family of multi-radix architecture, pipelined, complex fast Fourier transform (FFT) cores. The first family member, vectis4000R2, can continuously process data at a up to 200Msample/s, which the company believes is one of the world's fastest FFT cores of its type.

vectis4000R2 is a complex 4096-point FFT processor licensable as intellectual property that fits into a one million gate Xilinx Virtex/E FPGA.

It is intended for applications including high-speed networking subsystems, VDSL communication

systems, electronic warfare, radar and signals intelligence systems design.

"One of the most important points is that we have a fully implemented design working in silicon, rather than just vapourware," said John Lillington, the company's chief technical officer. "The design uses a high degree of parallelism; the multipliers used are optimised for the target device allowing flexibility to use a mixture of embedded and logic built multipliers. We confidently expect to further refine further the upcoming cores in this family, achieving significantly faster performances, over 800MHz, with higher radix architectures in VirtexII devices."

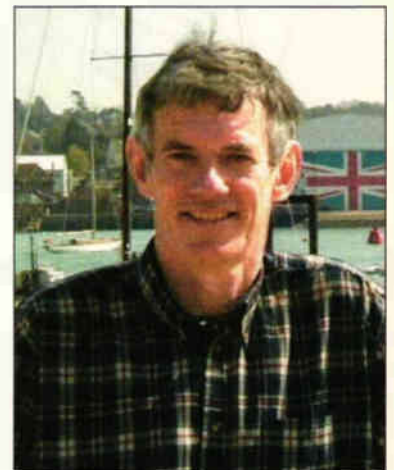

RF Engines' John Lillington.

Plot 1

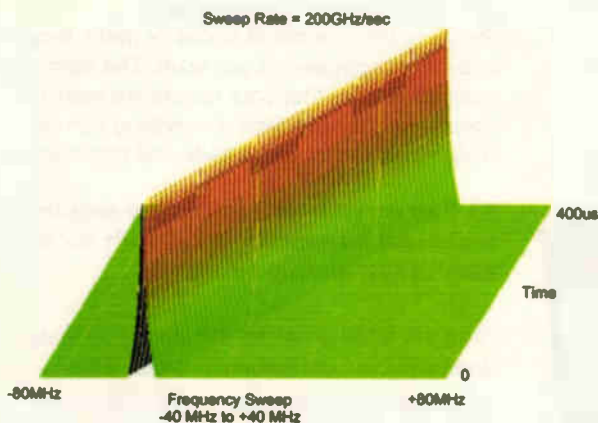

This is the output of the pipelined FFT core running at an input complex rate of 160Msample/s. A sweeping signal running at 200GHz/s has been injected into the core and can clearly be identified across its sweep range, said RF Engines.

Plot 2

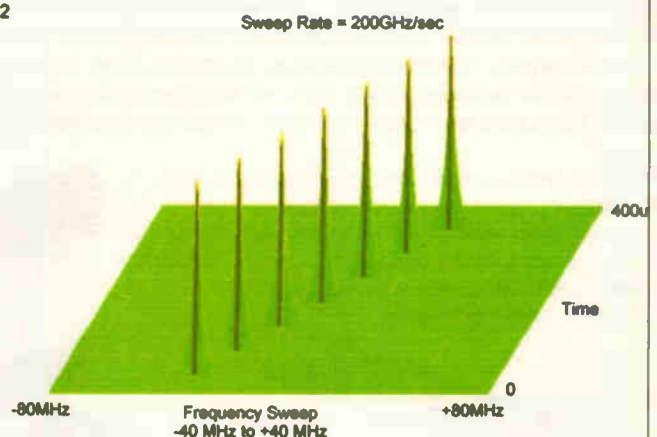

A conventional 'recycling architecture core' misses some incoming data as its hardware has to be used several times to process each set of samples.



## QUASAR ELECTRONICS LIMITED

(Dept EW), PO Box 6935, Bishops Cleeve, CM23 4WP  
**TEL: 01279 467799 FAX: 07092 203496**

ADD £2.00 P & P to all orders (1<sup>st</sup> class Recorded £4, Next day (Insured £250) £7, Europe £5.00, Rest of World £10.00). We accept all major credit cards. Make cheques/PD's payable to Quasar Electronics. Prices include 17.5% VAT. MAIL ORDER ONLY FREE CATALOGUE with order or sent 2 x 1" class stamps (refundable) for details of over 150 kits & publications.



### Enhanced 'PICALL' ISP PIC Programmer

Kit will program virtually ALL 8 to 40 pin\* serial and parallel programmed PIC microcontrollers. Connects to PC parallel port. Supplied with fully functional pre-registered PICALL DOS and WINDOWS AVR Software packages, all components and high quality DSPTH board. Also programs certain ATMEL AVR, SCENIX SX and EEPROM 24C devices. New devices can be added to the software as they are released. Blank chip auto detect feature for super-fast bulk programming. Hardware now supports ISP programming. \*A 40 pin wide ZIF socket is required to program 0.3" devices (Order Code AZIF40 @ £15.00).



Order Ref	Description	inc. VAT ea
3144KT	Enhanced PICALL ISP PIC Programmer	£64.95
AS3144	Assembled Enhanced PICALL ISP PIC Programmer	£74.95
AS3144ZIF	Assembled Enhanced PICALL ISP PIC Programmer c/w ZIF socket	£89.95

### ATMEL 89xxxx Programmer

Powerful programmer for Atmel 8051 micro controller family. All fuse and lock bits are programmable. Connects to serial port. Can be used with ANY computer and operating system. 4 LEDs indicate programming status. Programs 89C1051, 89C2051, 89C4051, 89C51, 89LV51, 89C52, 89LV52, 89C55, 89LV55, 89S8252, 89LS8252, 89S53 & 89LS53 devices. NO special software needed - uses any terminal emulator program (built into Windows).

Order Ref	Description	inc. VAT ea
3123KT	ATMEL 89xxxx Programmer	£29.95
AS3123	Assembled 3123	£44.95

Atmel 89Cx051 and AVR programmers also available.

### PC Data Acquisition & Control Unit

Use a PC parallel port as a real world interface. Unit can be connected to a mixture of analogue and digital inputs from pressure, temperature, movement, sound, light intensity, weight sensors, etc. (not supplied) to sensing switch and relay states. It can then process the input data and use the information to control up to 11 physical devices such as motors, sirens, other relays, servo motors & two-stepper motors.



#### FEATURES:

- 8 digital Outputs: Open collector, 500mA, 33V max
- 16 Digital Inputs: 20V max. Protection 1K in series, 5.1V Zener to ground.
- 11 Analogue Inputs: 0-5V, 10 bits (5mV/step)
- 1 Analogue Outputs: 0.25V or 0-10V. 8 bit (20mV/step.)

All components provided including a plastic case (140mm x 110mm x 35mm) with pre-punched and silk screened front/rear panels to give a professional and attractive finish (see photo). with screen printed front and rear panels supplied. Software utilities & programming examples supplied.

Order Ref	Description	inc. VAT ea
3093KT	PC Data Acquisition & Control Unit	£99.95
AS3093	Assembled 3093	£124.95

### ABC Mini 'Hotchip' Board



ABC Starter Pack

Currently learning about microcontrollers? Need to do something more than flash a LED or sound buzzer? The ABC Mini 'Hotchip' Board is based on Atmel's AVR 8535 RISC technology and will interest both the beginner and expert alike. Beginners will find that they can write and test a simple program, using the BASIC programming language, within an hour or two of

connecting it up. Experts will like the power and flexibility of the Atmel microcontroller, as well as the ease with which the little Hot Chip board can be "designed-in" to a project. The ABC Mini Board 'Starter Pack' includes just about everything you need to get up and experimenting right away. On the hardware side, there's a pre-assembled micro controller PC board with both parallel and serial cables for connection to your PC. Windows software included on CD-ROM features an Assembler, BASIC compiler and in-system programme. The pre-assembled boards only are also available separately.

Order Ref	Description	inc. VAT ea
ABCMINISP	ABC MINI Starter Pack	£59.95
ABCMINIB	ABC MINI Board Only	£34.95

### Advanced 32-bit Schematic Capture and Simulation Visual Design Studio

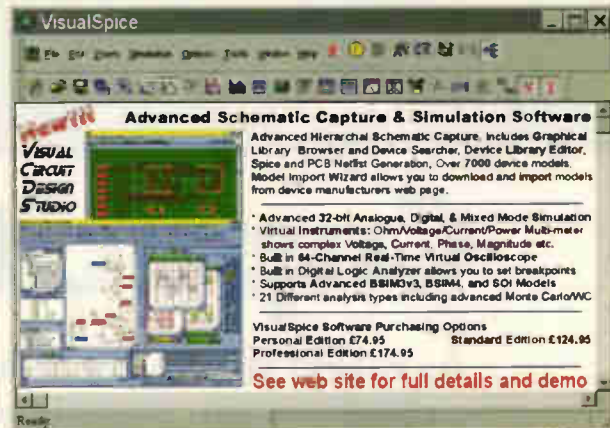

### Serial Port Isolated I/O Controller

Kit provides eight relay outputs capable of switching 5 amps max and four optically isolated inputs. Can be used in a variety of control and sensing applications including load switching, external switch input sensing, contact closure and external voltage sensing. Programmed via a computer serial port, it is compatible with ANY computer & operating system. After programming, PC can be disconnected. Serial cable can be up to 35m long, allowing 'remote' control. User can easily write batch file programs to control the kit using simple text commands. NO special software required - uses any terminal emulator program (built into Windows). Screw terminal block connections. All components provided including a plastic case with pre-punched and silk screened front/rear panels to give a professional and attractive finish (see photo).



Order Ref	Description	inc. VAT ea
3108KT	Serial Port Isolated I/O Controller Kit	£54.95
AS3108	Assembled Serial Port Isolated I/O Controller	£69.95

Full details of these items and over 200 other projects can be found at [www.QuasarElectronics.com](http://www.QuasarElectronics.com)







# Capacitor sound?

**As a first step in breaking new ground in relation to how capacitors can contribute to the 'sound' of a hi-fi amplifier, Cyril Bateman has designed a spot-frequency oscillator with sub-ppm distortion.**

**M**any capacitors introduce distortions onto a pure sine wave test signal. In some instances this distortion results from the unfavourable loading that the capacitor imposes on its valve or semiconductor driver. In others, the capacitor generates the distortion within itself.

Most properly designed power amplifiers measure less than 0.01% distortion when sine wave tested at 1kHz. This distortion percentage equates to 100 parts per million. Such small distortions are believed to be inaudible, yet people often claim to hear distortions from these amplifiers when listening to music.

Many authors claim to have identified differences in sound between different capacitor types. These differences have been ascertained not by measurements though, but by listening tests. This has led to a retrofit upgrade market supplying 'better' audio grade capacitors at substantially elevated prices compared to mass market types.

A common subjectivist claim is that oil-impregnated paper capacitors sound better than film types in valve amplifiers. Others claim that a PET capacitor sounds 'tubby' while a polypropylene sounds 'bright', and that all ceramics sound

awful. Naturally these claims have no supporting measurements.

Many writers on this topic even decry measurements, presumably in case such measurements disprove their subjectivist claims.

I have regularly received requests for advice about capacitors from readers who have read the many, often conflicting, subjectivist views about capacitor types. Over the years, these pages have also echoed to disputes between amplifier designers and music enthusiasts regarding capacitor sound distortion. These disputes culminated in a particularly acrimonious debate a year ago, during which I offered to perform some comparative measurements.

As a long term capacitor designer and measurement engineer, I believe that any truly audible differences must be both understandable and measurable. Understanding should be in terms of the capacitor constructions. Measurements may however require a change in measuring techniques.

In order to develop suitable test methods, I have measured large numbers of capacitors of many types. From these measurements, I have determined the distortion differences between capacitor constructions.



What I did not expect to find – and I find this rather disturbing – is that within a small batch of capacitors, some exhibit abnormally higher distortions. These anomalous capacitors typically exhibit some ten times greater distortion than others taped on the same card strip.

In this, the first of a set of articles, I begin to honour my commitment to quantify capacitor distortion.

### What the tests involved

Using a scheme involving a test signal at 1kHz, it is possible to differentiate between capacitor types and between good or bad capacitors within a type, Figs 1, 2.

In all performance plots, the 1kHz fundamental has been attenuated some 65dB using a twin-tee notch filter. The test capacitors for this article were each subjected to a three volts test signal, as measured across the capacitor terminals.

Rather than perform measurements using sophisticated equipment, I decided to develop a low-cost method that could be easily replicated by any interested reader. In doing so, I hope to improve understanding of capacitors and reduce the number of capacitor disputes in the letters pages.

### Initial investigations

Spectrum analysers capable of measuring small distortion components are prohibitively expensive for most people. I wanted to make sure that performance measurements could be made using readily available test gear like the Picoscope ADC-100 A-to-D converter or a computer sound card with FFT software.

I started by carrying out some initial capacitor intermodulation tests<sup>2</sup>. Experiments involving simple harmonic distortion testing revealed easily interpreted differences when testing less good capacitors. Testing good capacitors however confirmed that my existing signal generators introduced far too much distortion.

### A much better signal generator...

Having reviewed past low-distortion oscillator designs, I bread-boarded the more promising ones. Using these I tested a number of capacitors but with only partial success.

From these results it became clear that I needed an extremely low distortion 1kHz sinewave. I had to be able to drive at least 3 volts into a 100Ω/1μF near perfect, low distortion capacitive load, and do so without this load distorting my test signal, Fig. 3.

To test this near perfect capacitor, measured distortions of my complete equipment needed to be less than 1ppm, or 0.0001%. This is approaching the order of oscillator distortion produced by expensive measuring instruments such as those made by Audio Precision.

So began the design of a suitable test oscillator with a price that would be within the reach of most of you. The design of this oscillator forms the subject of this first article, Fig. 4.

### Initial researches

My attention was caught by a remark about “future Wien bridge oscillator design” in John Linsley Hood’s 1981 description of a 0.001% Wien bridge oscillator<sup>3</sup>. Most Wien bridge oscillators use a single amplifying stage. John suggested a method spreading the capacitor/resistor elements over two stages. This reduced the drive into his first amplifier and thus reduced its distortion.

I ran some simulations that supported John’s earlier views about lower distortion using this configuration. These simulations also suggested a possible improvement. Usually, the two Wien bridge arms use equal value components. With John’s new arrangement this results in his second amplifier having double the voltage output of his first.

I decided to double the capacitance and halve the resistance of the series combination. This would provide equal output

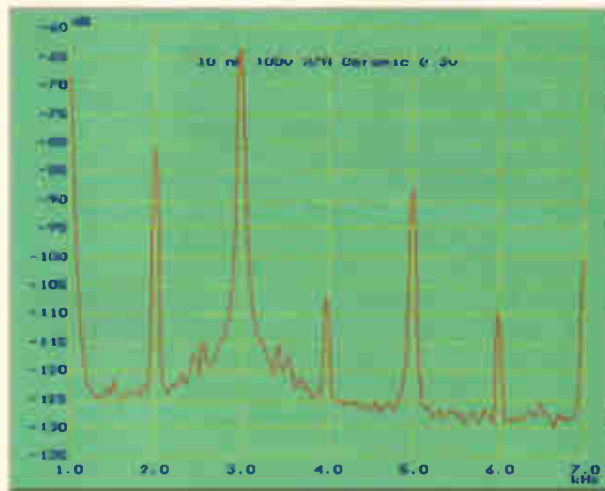

Fig. 1. Some capacitors distort even a pure 1kHz sinewave test signal. This 10nF X7R ceramic was made by a CECC approved, European manufacturer. It was tested at 1kHz and 3 volts, in series with a 10kΩ current limiting resistor. Measurable distortion exists at all voltages down to 0.5 volts – my lowest test voltage.

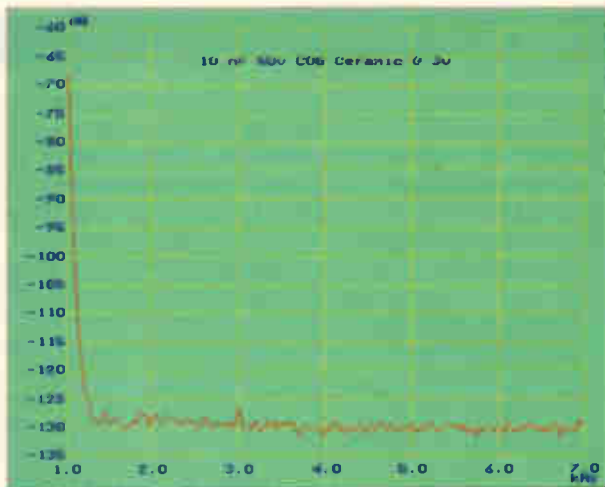

Fig. 2. Some capacitors distort very little. This 10nF COG ceramic was made by the same maker as Fig. 1 and co-purchased from the same distributor. Both were tested at 1kHz under identical conditions, within a few seconds of each other.

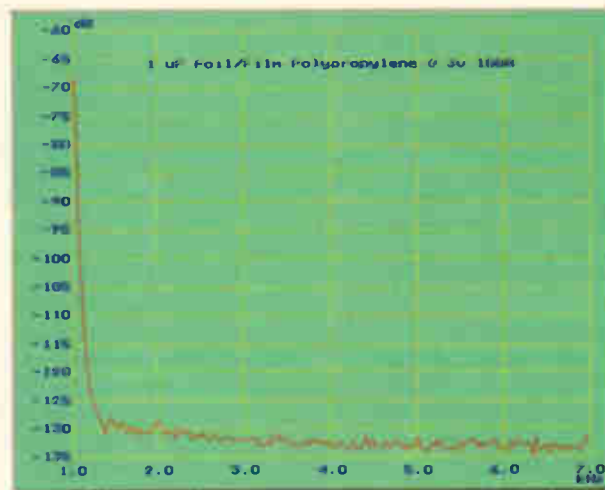
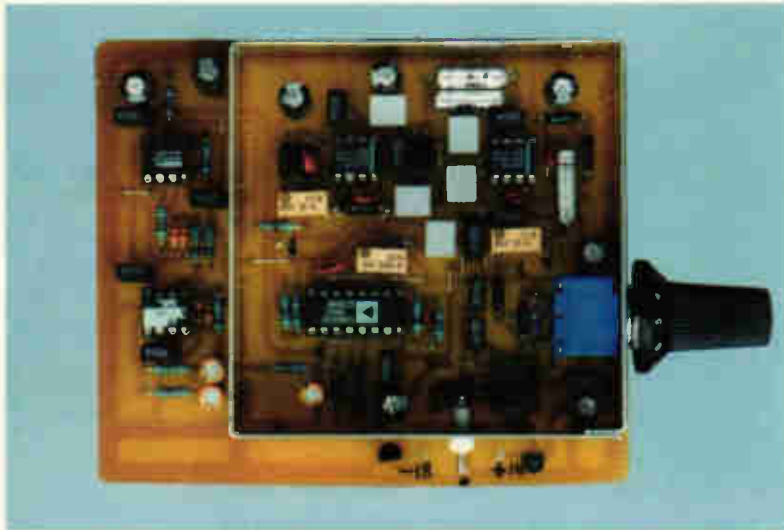

Fig. 3. Plot of a near perfect 1μF foil/film polypropylene capacitor, tested at 3V in series with a 100Ω current limiting resistor. It clearly shows my target test specification has been attained. This excellent result depends as much on my output amplifier design as on the oscillator. Combined distortions of my test system and 1μF load are buried in the noise floor at -130dB.



**Fig. 4.** Final design for the 1kHz test oscillator, with its screening lid removed. Fitted with its lid but no other shielding and with normal fluorescent room lighting, it was used on my bench within 1 metre of the test PC for all measurements.

voltage from each amplifier with no change in oscillator frequency. With two equal voltage output stages, I could take the amplitude control voltage from one amplifier, leaving the other able to provide my output signal.

I needed 200 $\mu$ V drive into the negative inputs of both amplifiers to produce a 3 volts output, and this arrangement promised a high 'Q' and low distortion.

Many oscillators use a thermistor to control oscillator amplitude. Distortion is then mostly third harmonic, which has been blamed on the thermistor. For my needs, third harmonic had to be minimised as much as possible. I needed a different amplitude control.

After some catalogue searching, I choose to design my amplitude control system around the Analogue Devices SSM2018P. This IC was expressly designed as a low-distortion, audio-frequency, voltage-controlled amplifier. Its lowest distortion of 0.006% at 1kHz is produced with a 3 volt input and 0dB gain. For 0dB gain, a control voltage a few millivolts above 0V is needed.

Provided that this IC's output was used to supply only a tiny portion of that drive needed to maintain oscillation, its 0.006% distortion should contribute little to the circuit's output.

I bread-boarded the circuit using a manual control voltage and with NE5534A ICs for the oscillator. Encouraged by the

### Alternative ICs and components

While I used ultra-low distortion, but expensive, AD797 ICs for  $U_1$  and  $U_2$  when building my final 1kHz oscillator, almost all its circuit development was done using low-cost NE5534A ICs. I found some 6dB difference in distortion between these two IC types in my oscillator.

I have tried other ICs for the oscillator, including the low-distortion OPA134 and OPA604. To facilitate evaluating ICs I used Harwin turned pin sockets for each position.

When using the AD797 for  $U_1$  and  $U_2$ , it is preferable to fit a 50pF capacitor between pins 6 and 8. If you are using NE5534A ICs, it is preferable to fit a 22pF capacitor instead between pins 5 and 8. Neither capacitor is needed when using OPA134 or OPA604 ICs.

The oscillator tuning capacitors must be low-distortion types, preferably 1% extended foil with polystyrene, as shown in the photograph. However I have also built satisfactory working prototypes with 1% extended foil with polypropylene and 1% metallised polypropylene, in order of preference.

Obviously a good COG ceramic capacitor would work almost as well as my first choice of polystyrene, provided the COG capacitor is available selected to 1% tolerance. My PCB provides mountings for a variety of suitable capacitors.

The value of  $VR_1$  needed to minimise distortion will vary depending on which type IC and tuning capacitors are used. I found that only the NE5534A IC provided low distortion when used for the output buffer,  $U_5$ . For this low/unity gain

position, the 22pF capacitor is essential. Also for its gain control, I found only one satisfactory variable resistor. That was a Bourns 91 series conductive plastic, obtained as 148-557 from Farnell.

Similar types may be OK too, but I have not tried them. Don't use either cermet or wirewound controls for this position though. I have tried several and they certainly do not work acceptably.

The 50pF/22pF capacitors must be low-loss, low-distortion types. Polystyrene parts are preferable, but disc ceramics – COG only – can be used. Similarly for the remaining picofarad capacitors used. I used COG ceramics for my prototypes. The PCB drawing provides for both alternatives.

In each case, my preferred IC choice is the first type listed on the schematic drawing. To produce such a low distortion oscillator it is important to use resistors having a small voltage coefficient of resistance. To ensure an easily reproducible design, I used only 0.5% Welwyn RC55C metal film resistors in the signal path. These are the black components in the photograph. These are marked as 0.5% on the schematic.

These resistors use plated steel end caps, which I prefer for reliable long term end contact stability. Many subjectivists claim non-magnetic end caps are better. I do not subscribe to that belief.

Undoubtedly, some of the oscillator output distortion is generated inside the three multi-turn Cermet trimmers. For two positions, these trimmers are essential. However the printed board does provide mounting pads for a fixed resistor, which could be substituted for  $VR_1$ , once its

value has been determined during calibration. So far I have retained use of the trimmer on my versions.

While these RC55C types could be used throughout, for economy I used my standard, inexpensive 1% metal-film resistors, for all other positions.

Three bi-polar electrolytic capacitors are used in the gain control circuits. These are the yellow-cased 'Nitai' types visible in the photograph. Equally suitable are the slightly larger Panasonic BP types. Both are stocked by Farnell. Do not use a conventional polar electrolytic capacitor for these positions.

For such a low-distortion oscillator, it is essential to use good quality capacitors to decouple the power supplies. For the 0.1 $\mu$ F value, black in the photograph, I used Evox-Rifa SMR, metallised polyphenylene-sulphide film. I consider this film produces the best, small, low cost, universal capacitor. They were obtained from RS, but unfortunately the company has since stopped supplying them.

Alternatively, a good metallised PET capacitor, such as the Evox-Rifa MMK or BC Components (Philips) 470 series, should be satisfactory. I used many of both these types, in my tan $\delta$  meter project.

For the larger capacitors, I used BC Components' 1 $\mu$ F 470 series, grey in the photograph, and Rubycon YXF polar electrolytics. Again, other types should be OK but they have not been tried in the circuit.

In use the oscillator is powered from my laboratory supply, set to output  $\pm 18$  volts.



results, I designed a simple rectifier and DC control amplifier and tested the composite assembly.

With a 3 volt drive, this set up produced the desired near 0V control voltage to the SSM2018P. Distortion however was far worse than my simulations had suggested. Time for a rethink, Fig. 5.

### Accident or design?

I returned once more to my simulations. To approximate the actual ESR losses of the tuning capacitors, I had inserted some resistance in series with each device. At some time during my many simulation runs, I had mistyped the entry of this ESR estimate for the shunt feedback capacitor. Instead of 10.0 $\Omega$  I had input 100 $\Omega$ . Could this explain my differing results?

Going back to my breadboard, I inserted a 1k $\Omega$  ten-turn variable resistor, set to its minimum value. I adjusted it to replicate my typographical error while measuring the circuit. To my amazement, as I increased the resistance value above 100 $\Omega$ , the distortions rapidly disappeared. Why?

Certain that I had made a mistake. I repeated this adjustment and measurement many times. The results were consistent. Even better, with the variable resistor left above this value, the oscillator could be powered down and restarted, and each time it settled to the new lower distortion output, Fig. 6.

I decided to re-read the data sheet for the AD797 amplifier, which I hoped to use in my final implementations. This IC is claimed to have the lowest distortion figures of all the popular audio op-amps, but costing some £7, it is expensive.

After re-reading more carefully, I spotted a paragraph I had previously ignored. This dealt with using a small feedback capacitor ' $C_L$ ' in parallel with the feedback resistor ' $R_2$ '. "When  $R_2$  is greater than 100 $\Omega$  and  $C_L$  is greater than 33pF, a 100 $\Omega$  resistor should be placed in series with  $C_L$ ".

As one would with many Wien bridge and Sallen and Key filter designs, I was using a much higher feedback resistor of 15911 $\Omega$  in parallel with a very high feedback capacitor of 10nF. I re-examined the data sheets for the NE5534 and several other ICs I had considered using, but did not find the same recommendation. I found that this added resistance worked well in the circuit with my NE5534A. It also worked well with all other ICs I tried in the circuit, virtually eliminating all third harmonic distortions.

### Proving the design

Accidents easily happen when bread-boarding and testing prototype designs. To avoid expensive mistakes, I used the inexpensive NE5534A devices while developing my printed circuit layout.

To stand any chance of attaining my desired low distortion, the circuit would need screening, good earthing between sections and careful supply rail decoupling. Perancea makes a 75 by 75mm PCB solder mount screening can with removable lid. It's available from Farnell. This size could accommodate just the oscillator components. The next size can was much too large. Using the smaller option required leaving my amplitude control components unshielded.

The prototype PCB layout worked extremely well, except for the output amplifier. Driven with 3 volts, my original output amplifier distorted badly. Following more breadboard experiments, the board was modified to accept another NE5534A. This was arranged as a variable gain, inverting amplifier, driving into a 600 $\Omega$  load, Fig. 7.

### Choosing a gain-control pot

Choice of the gain control potentiometer was crucial. I evaluated four types, wirewound, cermet and two different conductive plastic types.

Wirewound alternatives created intolerable distortion;

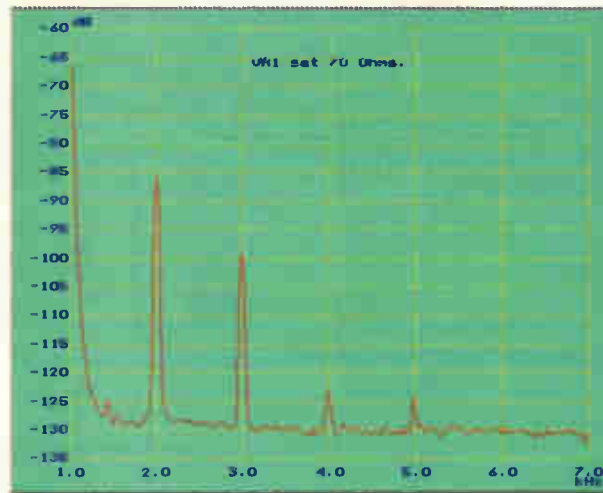

Fig. 5. Oscillator output with VR1 set to 70 $\Omega$  – well below the optimum value when using NE5534A ICs. Distortion at 3 volts output measured 57ppm or 0.0057%.

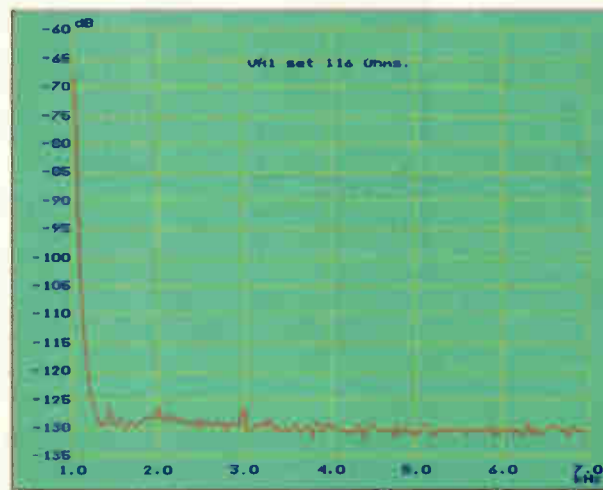

Fig. 6. Increasing VR1 to 116 $\Omega$ , still slightly below optimum, distortion is now mostly third harmonic and at -126dB is well below 1ppm.

Cermets were better, but not adequate. The Bourmes 91 type shown in the photograph, combined with a selected NE5534A IC, contributed almost no additional distortion when set to produce a 3 volts output, Fig. 4.

With a 600 $\Omega$  load, distortion was now much lower than I could measure using either the ADC-100, my computer sound card or a Hewlett Packard 331A distortion analyser. Equipped with a passive twin-tee pre-notch filter and the above instruments I re-measured the oscillator output. Making allowance for the notch filter's reduction of the second harmonic, I estimated that at 5 volts output, distortion was approximately 1-2ppm, Fig. 8.

### Final design

Having attained what seemed a satisfactory distortion figure, I updated the printed board to accommodate this revised output amplifier. Five Vero pin test points were added to facilitate calibration. Space was provided for a couple of 'adjust-on-test' resistors and links to allow the SSM2018P to be set to either class A or AB operation, Fig. 9.

While class AB is the recommended mode and my PCB's default mode, simply linking the free end of  $R_{2A}$  to  $R_{22}$  sets the SSM2018P into class A. Set to class AB, it provides both low noise and low distortion. Reset to class A it produces a higher noise level but slightly lower distortions.

Output stage distortion of the AD797 IC can be cancelled by connecting a 50pF capacitor between its pins 6 and 8. For minimum distortion using this amplifier, the 50pF capacitor should be fitted.

If you are using the NE5534A, this 50pF capacitor must not be used. Instead, a 22pF capacitor can be connected

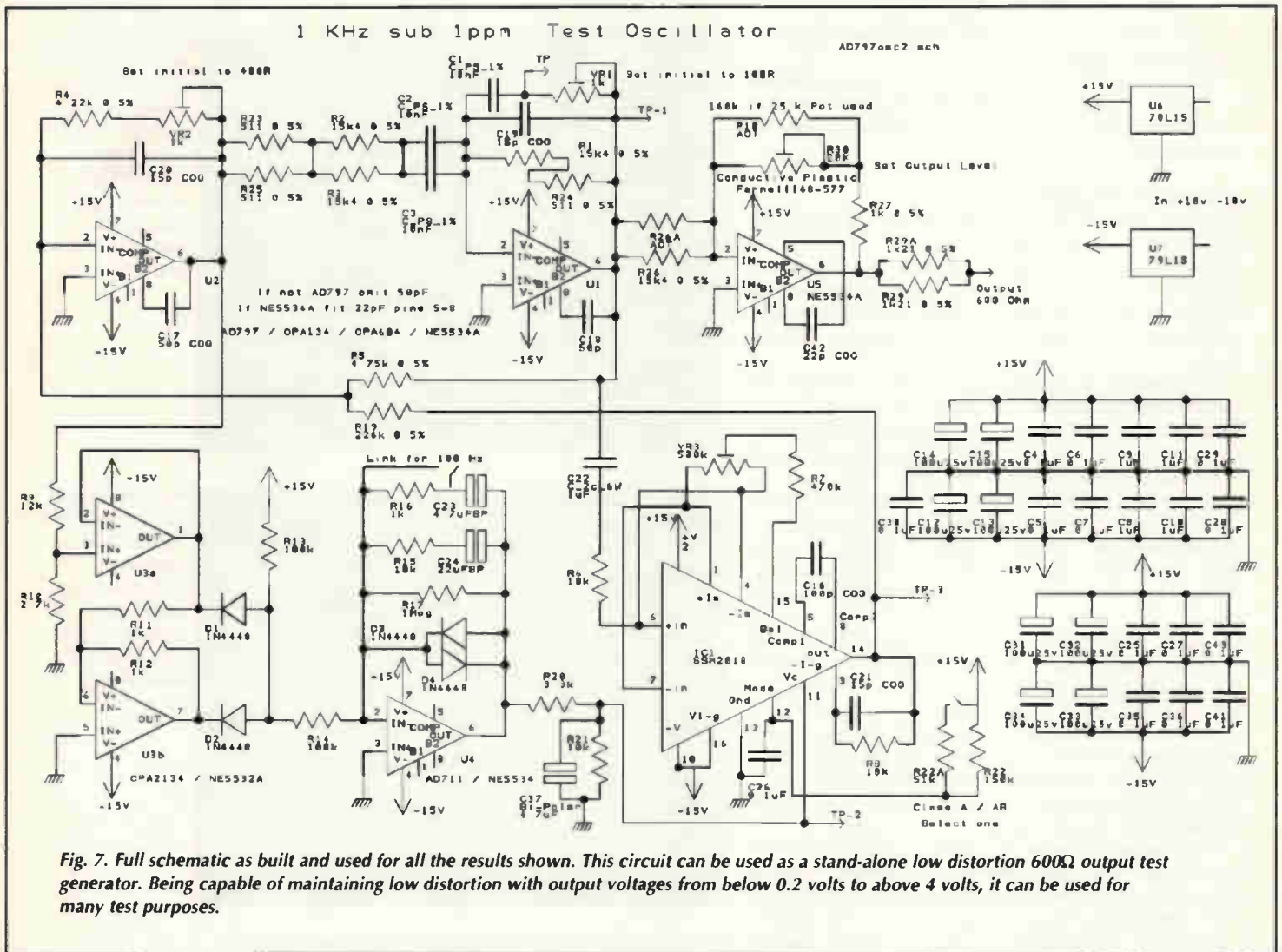

Fig. 7. Full schematic as built and used for all the results shown. This circuit can be used as a stand-alone low distortion 600Ω output test generator. Being capable of maintaining low distortion with output voltages from below 0.2 volts to above 4 volts, it can be used for many test purposes.

**Other measuring methods**

Early carbon-film resistors were trimmed to their final value by grinding a spiral groove into a resistive element coating on a ceramic former. Resistor noise and non-linearity was significantly reduced, compared to the older composition resistor. Incomplete or badly ground spirals frequently resulted in component failures under load.

In the sixties, engineers at Ericsson believed that non-linearities in capacitors and resistors could be detected. They measured the level of third-harmonic distortion generated in a component subjected to a very pure sinewave test signal<sup>4</sup>. Non-linearities were believed to result from badly ground resistor spirals, poor electrical contacts and the use of non-linear materials.

The engineers' original non-linearity detector design produced low-distortion test signals at 10 and 50kHz. Third harmonic distortion generated by the component under test was passed

through bandpass filters for measurement. Subsequently the 50kHz test frequency was dropped and a commercial instrument – the CLT1 component linearity tester – was produced by Radiometer of Denmark<sup>1</sup>.

To accommodate the range of component impedances and test voltages needed, a low distortion output transformer was used. Having seven adjustable tapings, it was used to tightly couple the instrument to the component under test. Component impedances from 3Ω to 300kΩ could be measured.

Today, an updated version can be obtained from Danbridge A/S, Denmark – a specialist manufacturer of capacitor test instruments. Using such equipment makes testing resistors quick and easy; however the extremely low impedance of many capacitors at 10kHz requires using extremely small test voltages. Bad and oxidised connections can be discovered. From my work though, I find detection of certain capacitor distortion

effects – especially with electrolytic types – requires a much increased test voltage.

These capacitor distortions cannot be measured at very low voltages. To avoid overstressing the test capacitor or the equipment, this increased voltage test must be performed at lower frequencies.

Extremely tight coupling between the test capacitor and the linearity tester is implicit in the CLT1 equipment design. From my early work measuring capacitors, I found it necessary to loosen this coupling in order to clearly reveal anomalies found in many modern capacitors, Fig. 1.

Using trial and error when measuring known good and bad capacitors at 1kHz, I found that 100Ω in series with a 1μF capacitor provided the best compromise between measuring current and capacitor voltage. This resistance value needs to be adjusted according to the capacitor's impedance at the test frequency used.



between pins 5 and 8. The revised circuit board provides for both options.

Note that it is crucial to use only close tolerance and low distortion capacitors for both these positions. Preferred types are 1% foil/polystyrene or COG disc ceramic.

### Final testing

To permit accurate measurements of this oscillator's distortion and facilitate calibration using either the ADC-100 or a sound card, a pre-notch filter is essential. The ADC-100 in its spectrum-analyser mode provides selectable peak input levels up to 20 volts. Its 0dB reference is fixed nominally at 1 volt.

Having 12-bit resolution, the ADC-100's dynamic range is limited to just 70dB. Most sound card a-to-d converter inputs are limited to 2 volts peak or less, but having 16 or more bits, they can provide more dynamic range.

To measure down to -130dB below 3 volts with either of the above, the fundamental should first be reduced by some 60 to 65dB. To minimise the influence of ambient interfering noise and attain a more easily measured signal, this reduced fundamental and the harmonic voltages must be pre-amplified by some 40dB.

Using a 3 volts test signal, this amplified fundamental and distortions results in a measurement voltage of around 0.3 volts RMS. To minimise wideband noise and extraneous pickup from AC mains or your PC, the signal should also be band-pass filtered.

### Making measurements

I have designed a second printed circuit board that houses a low-distortion, passive twin-tee notch filter. To permit matching the notch frequency to that of the oscillator output, the notch is tuneable by some  $\pm 10\%$  from its nominal frequency.

Nominal input impedance of the filter is 10k $\Omega$ . A high impedance unity gain, low noise pre-amp can be switched into circuit, should this passive notch loading be excessive.

Four stages of low-noise, low-distortion, amplification and bandpass filtering follow the notch filter. All measurements shown in this article were made using this pre-notch filter/pre-amplifier as the input into my ADC-100 converter.

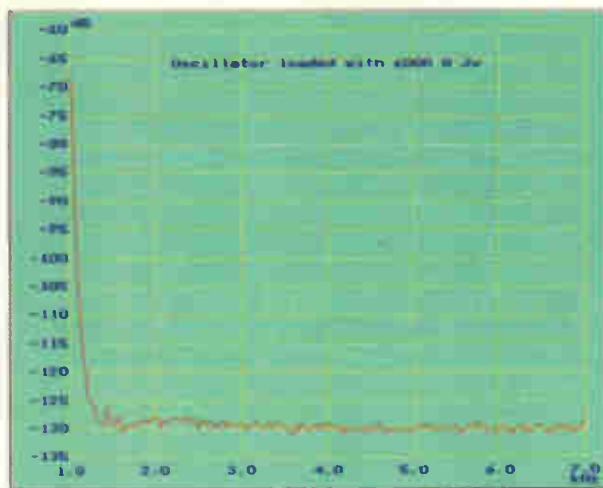

Fig. 8. Output distortion of the complete oscillator design shown in Fig. 7. Outputting 3 volts into a 600 $\Omega$  load, distortion of this prototype measured using my pre-notch filter/amplifier is buried in the measurement noise floor at -128dB – or less than 0.5ppm.

While I took care to minimise noise and distortion in this amplifier/filter, obviously its contribution is included in my results. Using this method, the distortion of my oscillator into 600 $\Omega$  load when built with AD797 ICs, measured less than -128dB, or less than 0.5ppm, Fig. 8.

Less expensive alternative ICs can also be used. By selecting from a batch of 10, I was able to attain an output distortion of -126 dB using the much less expensive NE5534As. There's more on this in the panel entitled, 'Alternative ICs and components'.

### Increasing signal drive

This excellent quality signal driving into 600 $\Omega$  can be used to measure amplifiers, etc. However a more powerful output buffer amplifier providing increased drive current must be used when testing capacitors.

## Jung-Curl test

Some twenty years ago, a simple capacitor test method used an instrument amplifier to compare the differences between a test and reference capacitor<sup>5</sup>. These capacitors were connected in series with each of the instrumentation amplifier inputs, then subjected to a rectangular test wave, Fig. A.

This circuit formed a traditional Wheatstone bridge. Using a sine wave stimulus, a test capacitor was compared with a known reference capacitor. When a rectangular wave test signal is used though, interpretation of the output waveform was impracticable, unless both capacitors were of similar value, dielectric and construction.

For most capacitor constructions, capacitance does vary with test frequency and test voltage. For all capacitors, using dielectrics other than air or vacuum, equivalent series resistance is totally frequency dependent. Usually, ESR reduces with frequency, reaching a minimum at the capacitor's series self-resonant frequency.

Differing dielectrics and constructions thus result in small differences in ESR and impedance with test voltage and frequency. The differences simply cannot be adequately resistively nulled. This imbalance led to a variety of unsatisfactory explanations and interpretations, often

involving dielectric absorption.

Having tried and failed to reconcile the output waveforms when using previously characterised capacitors, my advice is to use this circuit only with a sine wave test signal, as a resistance or capacitance bridge.

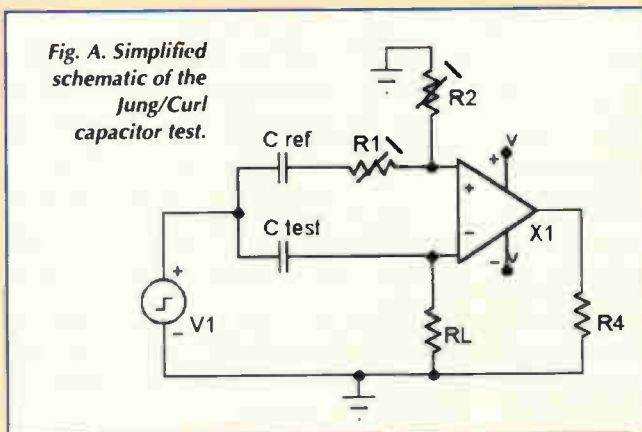

Fig. A. Simplified schematic of the Jung/Curl capacitor test.

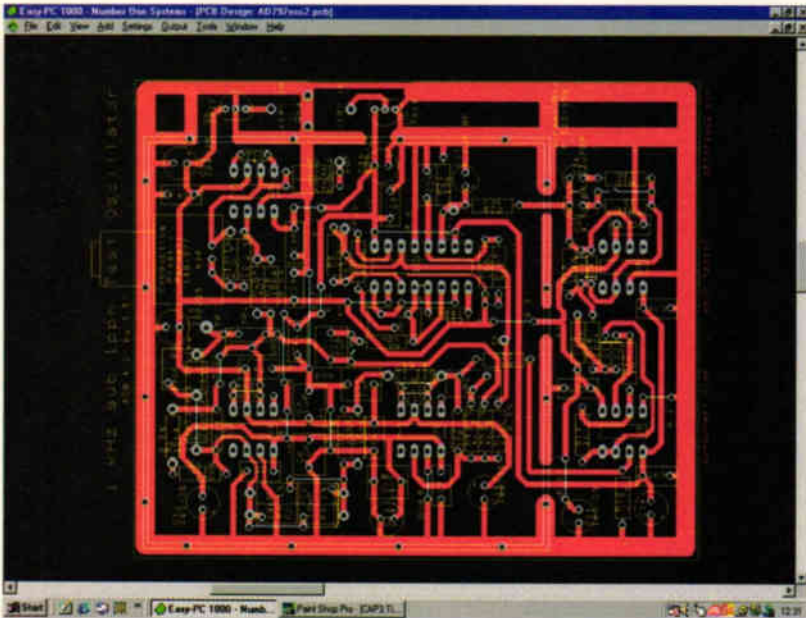

Fig. 9. Version II of the PCB design, as used for this article. The board can be assembled using a variety of oscillator ICs, and is pierced allowing a choice of oscillator capacitor styles and values. The PCB tracks have been arranged for easy one-off PCB etching and assembly.

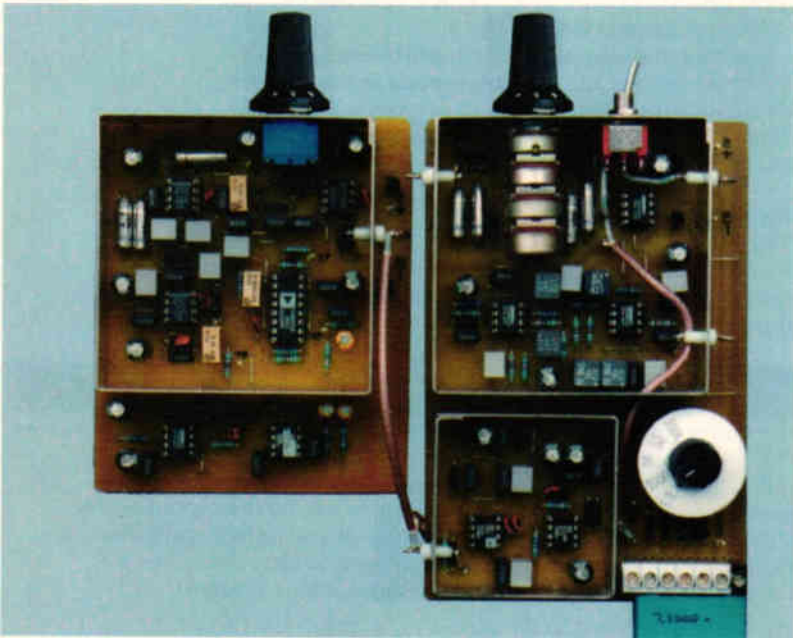

Fig. 10. Full measurement system displayed, with the test oscillator on the left and the low output impedance amplifier and pre-notch filter/amplifier on the right. This design has been used down to 100Hz and up to 10kHz by changing the Wien bridge and filter capacitor values.

Designing a suitable buffer power amplifier capable of driving into a series resistor/capacitor load without increased distortion proved difficult. It required almost as much development time as was needed for the oscillator itself.

After evaluating many potential buffer amplifier configurations, I have designed a very low distortion circuit having a gain of two and capable of driving 7V RMS or 40mA into a 100Ω/1μF capacitor combination. I have found this buffer circuit sufficient to measure distortions produced by capacitors from a few hundred picofarads up to 1μF, at 1kHz, Fig. 10.

Capacitors above 1μF are usually electrolytic types, either tantalum or aluminium. To avoid overstressing these capacitor types and maintain similar test voltages, a reduced test frequency must be used.

I have also developed an alternative buffer amplifier for measuring electrolytics. It is able to drive up to 7 volts and

400mA at 100Hz, albeit with slightly greater distortion than for my 1kHz design. Since electrolytic capacitors distort more than the lower value, better quality film and ceramic types this small increase in distortion is acceptable.

My 1kHz pre-notch filter/pre-amplifier (top box) and output buffer amplifier (lower box) can be seen in the photograph. Both will be fully described in my next article, Fig. 10.

**Calibration**

Calibrating this oscillator requires a suitable spectrum analyser, distortion meter or preferably my low cost pre-notch filter/40dB preamplifier. This is shown in Fig. 10 and will be detailed in my next article.

Prior to inserting the SSM2018P, trimmer VR<sub>3</sub> should first be set to its mid value. Similarly, prior to inserting U<sub>1</sub> and U<sub>2</sub>, trimmers VR<sub>1</sub> and VR<sub>2</sub> should be set to the starting values shown on the diagram. These values give a good starting point and should ensure the oscillator starts reliably. Output at the test point adjacent to VR<sub>1</sub>/R<sub>26</sub> should be around 3 volts.

Monitor test point 2 adjacent to C<sub>37</sub> using a DC millivoltmeter. Adjust VR<sub>2</sub> only to attain near zero volts. With the top screening cover fitted in place, allow the circuit to fully warm up for at least 20 minutes.

Observing the output spectrum at the test point 1 adjacent to VR<sub>1</sub>/R<sub>26</sub> using the high impedance preamplifier, you will probably see significant distortion products, Fig. 5.

Slowly increase the resistance of VR<sub>1</sub> and simultaneously adjust trimmer VR<sub>2</sub> to maintain near zero volts on the test point adjacent to C<sub>37</sub>. This adjustment affects mostly the third and higher odd harmonic components.

Adjusting VR<sub>1</sub> and VR<sub>2</sub> will also slightly change the oscillator frequency. If you are using a pre-notch filter, re-adjust this filter tuning to maximise notch depth. Distortion products should suddenly and dramatically reduce as you approach the optimum resistance value for VR<sub>1</sub>, Fig. 6.

Relocate your test probe to the test point 3 adjacent to R<sub>8</sub> and adjust VR<sub>2</sub> to minimise the second harmonic component only. This adjustment has little effect on the higher harmonics which should be ignored.

Return to monitoring the test point 1 adjacent to VR<sub>1</sub>/R<sub>26</sub> and slowly adjust all three trimmers as above to minimise distortion. This completes the oscillator calibration, Fig. 8.

Test or select U<sub>5</sub>. Attach a 600Ω resistor load to the 'out' test point and adjust the conductive plastic potentiometer to give a 3 volts output. Monitor the distortion spectrum at this 'out' test point, and compare it with that previously attained at the test point adjacent to VR<sub>1</sub>/R<sub>26</sub>. Both should be almost identical. If not replace U<sub>5</sub> and retest.

While monitoring the 'out' test point, you may be able to slightly reduce the overall output distortion by making small adjustments of the three variable trimmers, as above. Distortion with 3 volts output into 600Ω, should be considerably less than 1ppm, Fig. 8.

By varying the output potentiometer, the output voltage should range from less than 0.2V to more than 4V. 'Adjust on test' resistor positions have been provided for R<sub>26A</sub> also R<sub>18</sub> to ensure attaining this output voltage range. ■

**References**

1. CLT1 Component Linearity Test Equipment data sheet, RE Instruments AS, Copenhagen.
2. 'Trial by three tones', Ivor Brown, *Electronics World* February 1991, p. 131.
3. 'Wien-bridge oscillator with low harmonic distortion', J. L. Linsley Hood, *EW* May 1981 p. 51.
4. 'Harmonic testing pinpoints passive component flaws', V. Peterson & Per-Olof Harris, *Electronics*, July 11, 1966.
5. 'If the Cap Fits', W. Jung and J. Curl, *Hi Fi News & Record Review*, April 1986.



# Easy-PC For Windows V5.0, now available with SPICE based A/D mixed mode simulator

From Only

**£97**

## NEW Easy-PC V5.0

Easy-PC for Windows is one of the biggest selling PCB systems in Europe. With prices starting from as little as £97 it represents exceptional price performance.

Only

**£295**

## SPICE Based Simulator

Easy-Spice is a substantially enhanced version of SPICE3 and XSPICE with the underlying algorithms being reworked to significantly improve convergence and add new functionality.

Easy-Spice is integrated with Easy-PC Schematics and is supplied ready to use with SPICE libraries and models.

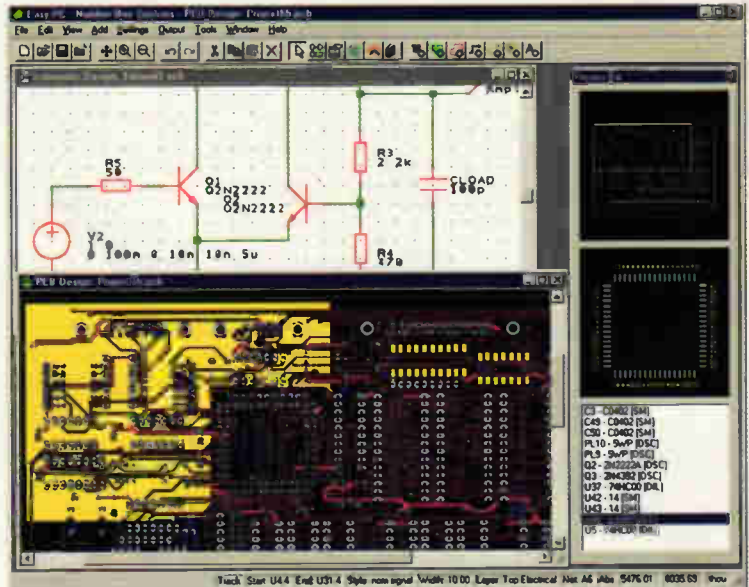

For more information or for a demo copy call us on +44 (0)1684 773662 fax +44 (0)1684 773664 or E-mail [info@numberone.com](mailto:info@numberone.com)

or download a demo copy from [www.numberone.com](http://www.numberone.com)

Number One Systems, Oak Lane, Bredon, Tewkesbury, Glos, GL20 7LR

## WATCH SLIDES ON TV MAKE VIDEOS OF YOUR SLIDES DIGITISE YOUR SLIDES

(using a video capture card)



"Liesgang diatv" automatic slide viewer with built in high quality colour TV camera. It has a composite video output to a phono plug (SCART & BNC adaptors are available). They are in very good condition with few signs of use. For further details see [www.diatv.co.uk](http://www.diatv.co.uk)

Board cameras all with 512x582 pixels 8.5mm 1/3 inch sensor and composite video out. All need to be housed in your own enclosure and have fragile exposed surface mount parts. They all require a power supply of between 10 and 12v DC 150mA.

47MIR size 60x36x27mm with 6 infra red LEDs (gives the same illumination as a small torch but is not visible to the human eye)..... £37.00 + vat = £43.48

30MP size 32x32x14mm spy camera with a fixed focus pin hole lens for hiding behind a very small hole..... £35.00 + vat = £41.13

40MC size 39x38x27mm camera for 'C' mount lens these give a much sharper image than with the smaller lenses..... £32.00 + vat = £37.60

Economy C mount lenses all fixed focus & fixed iris

VSL1220F 12mm F1.6 12x15 degrees viewing angle..... £15.97 + vat = £18.76

VSL4022F 4mm F1.22 63x47 degrees viewing angle..... £17.65 + vat = £20.74

VSL6022F 6mm F1.22 42x32 degrees viewing angle..... £19.05 + vat = £22.38

VSL8020F 8mm F1.22 32x24 degrees viewing angle..... £19.90 + vat = £23.38

Better quality C Mount lenses

VSL1614F 16mm F1.6 30x24 degrees viewing angle..... £26.43 + vat = £31.06

VWL813M 8mm F1.3 with iris 56x42 degrees viewing angle..... £77.45 + vat = £91.00

1206 surface mount resistors E12 values 10 ohm to 1M ohm 100 of 1 value £1.00 + vat 1000 of 1 value £5.00 + vat

866 battery pack originally intended to be used with an orbital mobile telephone it contains 10 1.6Ah sub C batteries (42x22dia the size usually used in cordless screwdrivers etc.) the pack is new and unused and can be broken open quite easily..... £7.46 + vat = £8.77



Please add 1.66 + vat = £1.95 postage & packing per order

### JPG ELECTRONICS

Shaws Row, Old Road, Chesterfield, S40 2RB

Tel 01246 211202 Fax 01246 550959 Mastercard/Visa/Switch  
Callers welcome 9:30 a.m. to 5:30 p.m. Monday to Saturday

# Springboard

remote control via the Internet  
or dial up connection

Low cost development board  
For domestic or industrial monitoring and control applications.

Ideal for educational establishments teaching telematics etc.

Students, be the first to count the beer cans in your fridge on line.



- 8 x digital inputs
- 8 x open drain high current outputs
- 3 x analogue inputs (8 bit)
- 2 x 0 to 5 volt analogue outputs (8 bit)
- 1 x RS232 (TTL level) Tx/Rx
- 1 x LCD interface (serial)
- Power Supply - 7 to 24 volts
- Accepts all Parallax 24 pin Stamps
- Accepts BASICMICRO ATOM
- Accepts NetMedia BX24
- Note:- Processor not supplied

**£39.99**  
including Delivery & VAT

Example software for Springboard includes a web server (written in Java to run on a PC or Dallas Semiconductor Tini) plus typical control applet allowing a web site to be established that will send control datagrams to "Springboard" and display received results.

Contact Jeff Thorpe

### Pinecone Associates Ltd

office@pinecone.fsbusiness.co.uk

Call: 0161 776 4405 Fax: : 0161 776 4407

Carrington Business Park, Carrington, Manchester M31 4DD



**John Woodgate\* has devised a very simple circuit that enhances the listening experience of people with impaired hearing when using headphones.**

# Headphone clarifier

**S**ome 14% of the British population has significant hearing impairment. Headphones – particularly cordless infra-red (IR) or radio headphones – are very helpful in allowing people to hear radio and TV without needing excessive sound levels in the room.

But wearing headphones and a hearing aid simultaneously can be uncomfortable or ineffective or both. Without the hearing aid, however, its frequency response correction is missing.

The passive circuit described here provides the necessary response correction for typical sensori-neural impairment, which causes a loss of high-frequency sensitivity. It takes advantage of the gain reserve available in most headphone amplifiers and cordless systems.

This device was developed primarily to improve the results obtained by people with age-related deafness who use radio or infra-red headphones to listen to radio or television. It can also be used between a preamplifier or a power amplifier with a headphone output and a headphone amplifier.

## Hearing

The human ear, Fig. 1, consists of an outer flap, the *pinna*, which gives directional properties and affects the frequency response, the ear canal, which leads to the ear-drum, a mem-

brane forming the first mechanical part of the system. The vibrations of this drum are passed through three tiny bones, the *malleus* (hammer), *incus* (anvil) and *stapes* (stirrup), to another drum, the oval window.

A muscle system attached to the bones acts literally as an input attenuator – loud sounds cause the muscles to contract and alter the velocity ratio of the bones, thus reducing the movement of the oval window.

The oval window is in the wall of a liquid-filled cavity, part of which is the organ of balance and part is a complex, snail-shaped structure called the *cochlea*. Within the cochlea is the *basilar membrane*, which acts as a mechanical frequency analyser. Unrolled, it would have the shape of a long, thin triangle, and the broad part resonates at low frequencies while the narrow tip resonates at high frequencies.

Attached to the membrane are two sets of *hair-cells*, which have many hairs each, stretching up to another membrane, the *tectorial membrane*. Some of the workings of these minute structures are still not well understood, but it seems that vibrations of the basilar membrane due to sounds cause the hairs of the *inner hair cells* to move and that in turn caus-

\*John M. Woodgate, B.Sc.(Eng) C. Eng. MIEE FAES FInstSCE



es the associated hair cells to emit pulses of electricity into nerve fibres that are joined to it. These nerve fibres are part of the *auditory nerve*, which leads to the brain.

The other set of hair cells, the *outer hair cells*, mostly have attached to them nerves coming from the brain. The attached hairs appear to alter the shape and mechanical properties of the tectorial membrane in such a way as to alter the sensitivity of the inner hair cells.

It is very likely that this is a feedback system and is responsible for the logarithmic response of the ear to sound pressures: the ratio of the loudest to the quietest sound powers that we can (safely) hear is some 140 dB, or  $10^{14}$ . In fact, it is useful to look at the whole ear and brain system in electronic terms.

We have an acoustic filter (the pinna) followed by a transmission line (the ear-canal), which leads to an acousto-mechanical transducer, the ear-drum. This is part of a variable transformer (the ear-drum, bones and oval window), and the oval window re-converts the signal to the acoustic form but in a liquid, not air.

The basilar membrane and the inner hair cells then act as a frequency analyser and an analogue-to-digital converter, feeding a massively parallel – some 3500 bits wide – interface (part of the auditory nerve) with the brain computer. This computer feeds signals back through an even wider parallel interface to the outer hair cells, which convert the nerve impulses into analogue mechanical movement, forming an amplitude compression and automatic gain control system.

If, like Nature, you had to make a filter, a microphone, an amplifier and an analogue/digital compressor, out of bone and jelly, could you do better?

### Not hearing so well

There's a number of ways in which the hearing system can be faulty from birth, or become faulty later. The proper terms are *hard of hearing*, meaning that you can't hear so well as other people, *deaf*, meaning that you have great difficulty in hearing, and *Deaf*, with a capital 'D', meaning that you can hear almost, or completely, nothing.

The human ear has quite a lot in reserve; most hard-of-hearing people do not notice a problem until they have more than 20dB loss of sensitivity compared to that of the average young person (not deafened by pop-concerts) over a substantial part of the audio spectrum, usually the high end.

There are two broad categories of fault. One is *conductive deafness*, which is usually due to the mechanical system being clogged up with the after-effects of an infection, resulting in a loss of sensitivity which is often quite uniform over most of the audio frequency range. The other is *sensori-neural deafness*, which is due to degradation of the basilar membrane system and usually exhibits as a dramatic loss of sensitivity to high frequencies.

The accepted method of combating hearing loss is to provide electronic amplification, with a frequency response tailored so as to compensate for the loss. It might be thought that 'shouting louder' would cause further loss of hearing, similar to that experienced due to exposure to high sound levels in the workplace.

In fact, any such effect is at worst tolerable, and there is no other real alternative, unless (intricate) corrective surgery can alleviate conductive loss. No such remedy is at present available to alleviate sensori-neural loss.

### Electronic help

The use of headphones to listen to radio and television eliminates the need to have the sound volume in the room annoyingly high for other listeners. In addition, using headphones is often more satisfactory than listening with a hearing aid. This is because the omnidirectional microphone of the aid picks up room reverberation and extraneous noises.

### Take care of your hearing

Don't deafen yourself! Prolonged listening at high sound levels will cause a progressive loss of hearing, especially at high frequencies. If you get 'ringing in the ears', you should definitely cut down both the volume and the time spent listening, because the ringing is a sure sign of damage being caused.

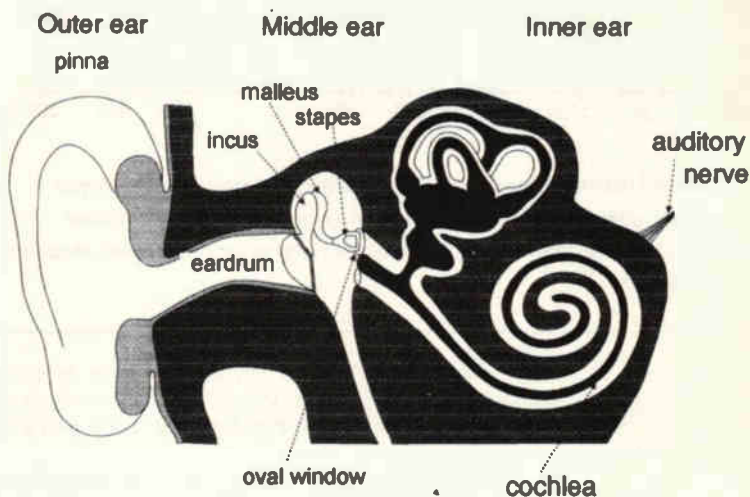

Fig. 1. Cross-section of a human ear

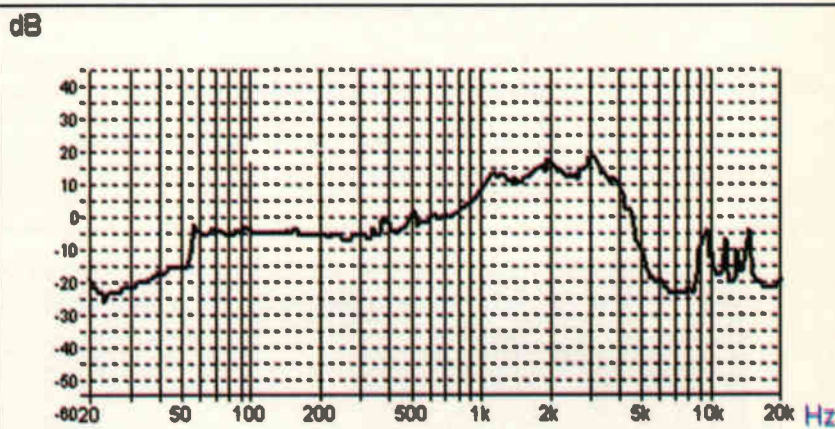
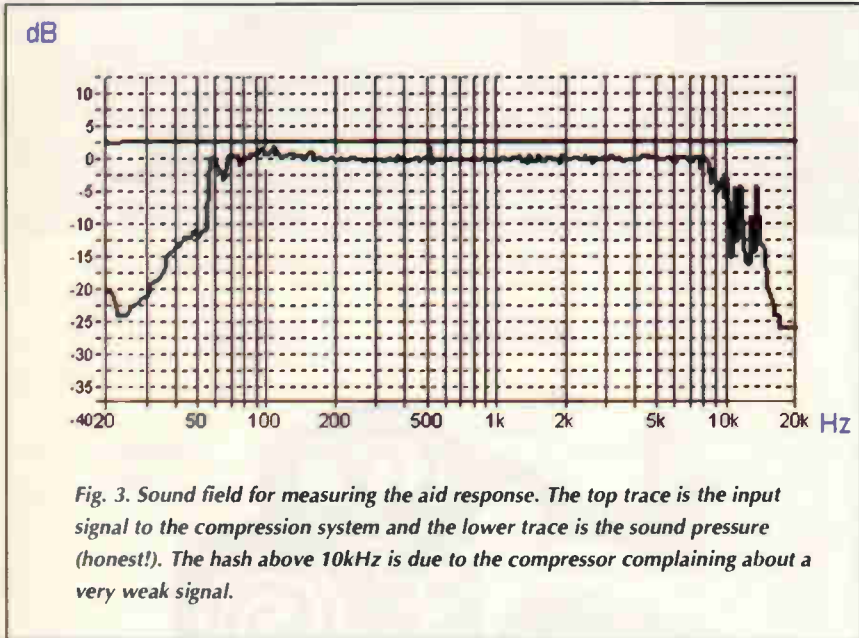

Fig. 2. Frequency response of a hearing aid. Note that the vertical scale covers 100dB. It's not at all easy to measure such a response, because the microphone must 'hear' a sound field with a flat frequency response, and loudspeakers are not very good at producing those. We have to use another microphone to sense the sound pressure and activate a compression loop to keep the sound pressure constant. The result, in my experiment is shown in Fig. 3, and the set-up is shown in Fig. 4.

Modern digital aids are greatly improved in this respect but are very costly to buy and are available only to a very limited extent from the National Health Service (NHS) at present. However, simply connecting the headphones normally deprives the user of the frequency response correction provided by the hearing aid.

Figure 2 shows the frequency response of an analogue NHS aid set to compensate for sensori-neural loss at high frequencies, typical of that of a man notably older than me. (I



have the ears of an 85 year old, and they are at the sides of my head, not in a jar in the fridge.) Figure 3 shows an aid's sound pressure levels and Fig. 4 the test set up used for the measurements.

This frequency response doesn't look very dramatic until you realise that the rise above 400Hz achieves a slope of well over 40dB/decade, which corresponds to the very steep loss of response of the ear. This is achieved in the hearing aid by a succession of three overlapping low-Q mechanical resonances in the microphone and earphone, each causing a peak in the response.

We could reproduce this electronically with three active band-pass filters using op-amps, which in turn require a power supply. But we can do it quite well with a single, low-Q LC tuned circuit, which has the considerable advantage of needing no power supply. This is possible, in spite of the insertion losses of this passive circuit, because most infra-

red and radio headphone systems have a considerable reserve of gain which is not normally used.

Circuits using inductors have traditionally been unpopular, because off-the-shelf components in standard values, like those of resistors and capacitors, were not available. You had to design, and quite possibly make, your own. This is no longer the case, although the range of components is still less than those of either resistors or capacitors. Luckily, components suitable for our application can be obtained from Farnell, and probably other sources.

**The circuit design**

Figure 5 shows the circuit diagram. The (assumed) 120Ω source impedance of the headphone output of the signal source, the 390Ω resistor and the d.c. resistance of the inductor (70Ω) form an approximately 8:1 voltage attenuator (18dB) at low frequencies. This circuit is intended to work between a preamplifier or power amplifier headphone output, which has a source impedance of 120Ω approximately, and an amplifier or IR or radio transmitter input with an impedance of more than 5kΩ.

The tuned circuit resonates at 2kHz, with a Q of just under 0.7. The frequency response is shown in Fig. 6. Note that the vertical scale is very different from that of Fig. 2.

The input connector is a three-contact 3.5mm jack, wired for mono, as is now conventional. For a stereo system, you need two of these circuits, of course, one for each channel. The output is conveniently provided with a flying lead terminated in a three-contact 3.5mm jack plug for connection to the headphone amplifier, IR or radio transmitter.

The whole thing can be built on a piece of stripboard, or a real printed board if you wish, that will fit inside a 35mm

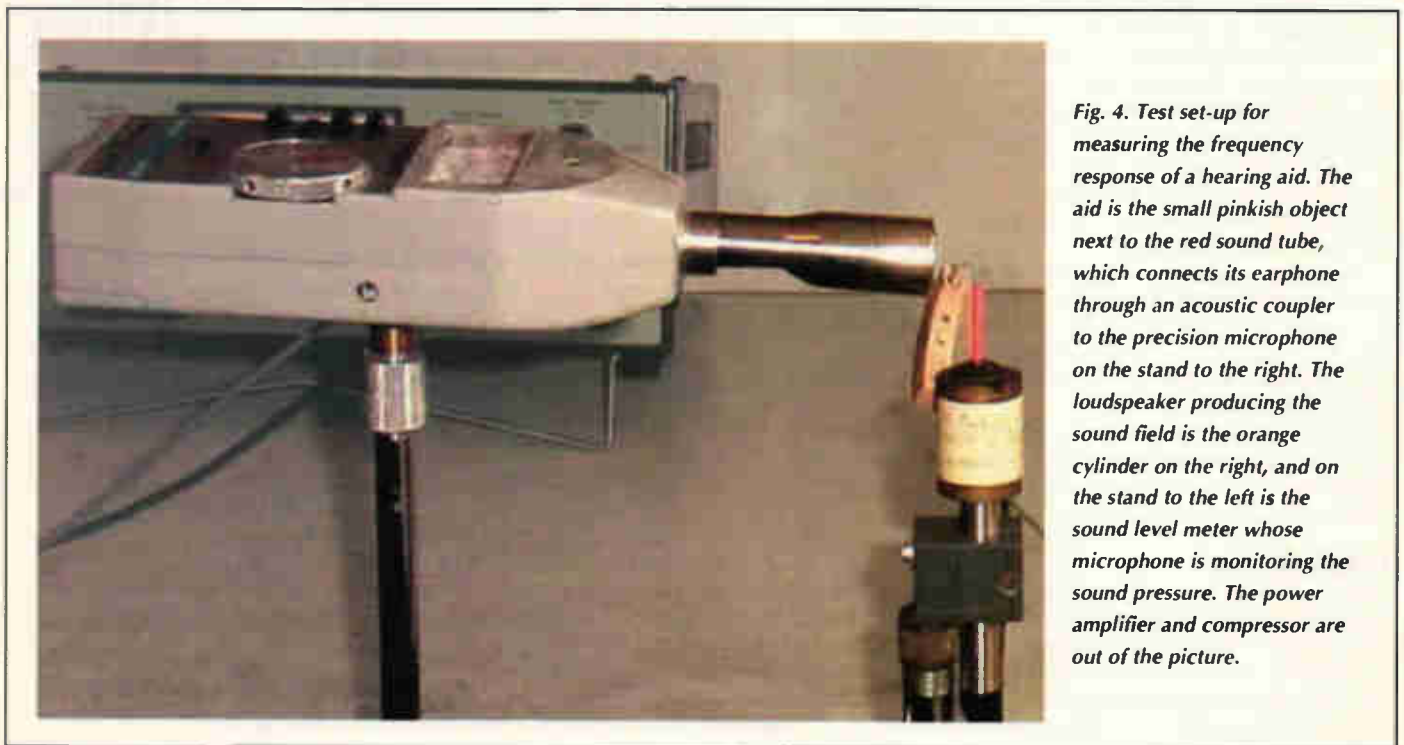
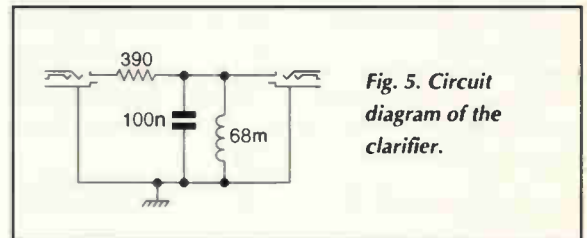



**Parts details**

The following parts list refers to parts from Farnell Electronic Components, which will accept credit card orders for small quantities. Rapid Electronics is another good source of parts at attractive prices and will also accept credit-card orders. Unfortunately, the 68mH inductor offered by Rapid is not so good, because it has about 200 $\Omega$  resistance instead of the 70 $\Omega$  of the Farnell part. You could try increasing the 390 $\Omega$  resistor to 1.2k $\Omega$ , but the Q will increase. This may not be disastrous, though: the application is very tolerant.

Farnell: [www.farnell.com/uk](http://www.farnell.com/uk), 08701200 200

Rapid: [www.rapidelectronics.co.uk](http://www.rapidelectronics.co.uk), 01206 751166

Part	Value	Order code
Capacitor	100nF $\pm$ 10% 100V	545-879
Inductor	68mH	148-878
Resistor	390 $\Omega$ $\pm$ 1% 0.25W	513-921
3.5mm 3-contact jack		152-204
3.5mm 3-contact plug		152-203

film can. But it is so simple that a 'bird's nest' is also possible.

**Using the clarifier**

The insertion of the clarifier into an infra-red or radio headphone system will naturally result initially in a reduction of sound level from the headphones.

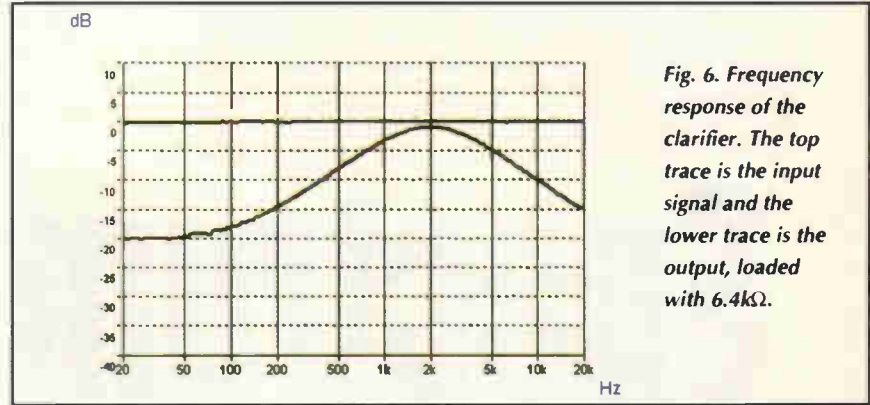

Fig. 6. Frequency response of the clarifier. The top trace is the input signal and the lower trace is the output, loaded with 6.4k $\Omega$ .

To correct this, adjust the volume control on the headphones to about three-quarters full, and then increase the output into the headphone amplifier or transmitter, using the 'headphone volume control' or equivalent, on the signal source to restore the correct sound level.

If the clarifier, followed by a simple low-gain headphone amplifier, is connected to a properly-designed headphone output on a power amplifier, in place of 8 $\Omega$  headphones, there will probably be a slight increase in sound level. This is because a 'properly designed' headphone output provides a 'full output' 5V signal through a resistance of 120 $\Omega$ .

The slight impedance difference doesn't upset the frequency response; headphones are not the same as loudspeakers in that respect. With an 8 $\Omega$  load, the voltage at the headphones is 325mV, whereas with the 460 $\Omega$  load of the clarifier at low frequencies, a whole 4 V is present. ■

## Easy-PC For Windows V5.0, now available with SPICE based A/D mixed mode simulator

From Only

£97

### NEW Easy-PC V5.0

Easy-PC for Windows is one of the biggest selling PCB systems in Europe. With prices starting from as little as £97 it represents exceptional price performance.

Only

£295

### SPICE Based Simulator

Easy-Spice is a substantially enhanced version of SPICE3 and XSPICE with the underlying algorithms being reworked to significantly improve convergence and add new functionality.

Easy-Spice is integrated with Easy-PC Schematics and is supplied ready to use with SPICE libraries and models.

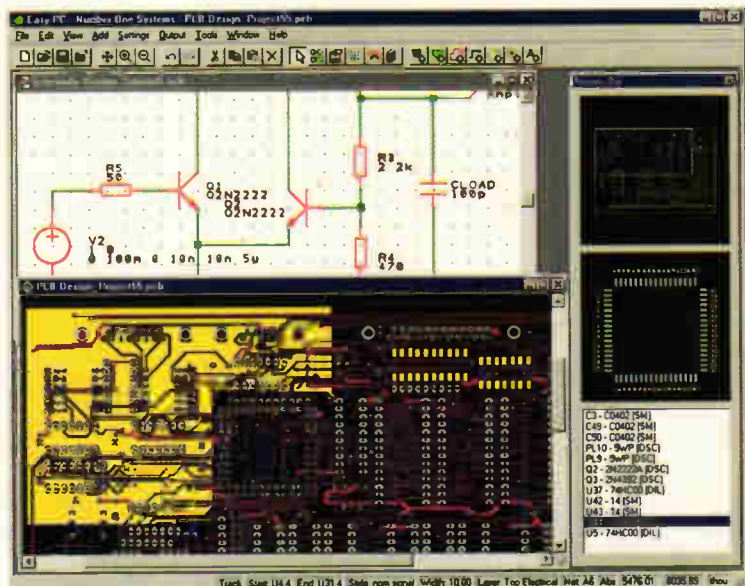

For more information or for a demo copy call us on +44 (0)1684 773662 fax +44 (0)1684 773664 or E-mail [info@numberone.com](mailto:info@numberone.com)

or download a demo copy from [www.numberone.com](http://www.numberone.com)

Number One Systems, Oak Lane, Bredon, Tewkesbury, Glos, GL20 7LR

# Spectrum pricing comes of age

**Twenty years after it was first conceived, spectrum pricing has achieved universal respect as the principal tool for managing the radio spectrum. But its essential principles have still not been fully grasped by the Government or its economic advisers. David Rudd\* reports.**

David Rudd Ph.D. F.I.E.E. C.Eng. is an engineering and economics consultant. He can be contacted at 14 Colcocks Road, Banstead, Surrey SM7 2EW, telephone 01737 356427.

## **Panel 1 - Parameters of the spectrum charges**

The proposed parameters of the charges were: bandwidth, effective power, position in the spectrum, i.e. specified frequency or channel and geographical location.

**J**une 2002 marks the twentieth birthday of spectrum pricing. This article traces at first hand its history over those years: how it came to be conceived and got its name but was then discarded; how it was revived 13 years later; but also how governments and their economic advisers failed to understand its underlying principles.

That failure brought part of the radio communication industry to the brink of disaster in 2000, as will be relayed in next month's issue. But it is evident from the latest review of spectrum management<sup>1</sup> that little has been learned from that episode, as will also be recounted next month.

Spectrum pricing was first conceived in 1982 in response to a shortage of spectrum in some bands, which had begun to appear in the 1970s. The first service to be hit by the shortage in Britain was civil land mobile radio (CLMR), as it was then known. Applicants were having to wait years for licences and many never got them.

The Home Secretary commissioned an independent review under the chairmanship of Dr J. H. H. Merriman F.Eng. in June 1982. He straight away recommended – as interim measures – the withdrawal of Bands I and III from broadcasting use and the accelerated closure of the 405-line television service in favour of CLMR.

The Government accepted those recommendations, but Merriman's final report in July 1983<sup>2</sup> made it clear that he expected shortages would recur and persist across wide swathes of spectrum unless the regulatory procedures, which he said were "arcane" and "detached from the realities of service and manufacturing industry", were reformed.

In Merriman's view, the procedures would, "have to include some capability for the making of value judgements, since demand may often exceed supply". But he did not know how to go about it.

The Department of Transport was concerned about the shortage of spectrum for land transport applications and its Transport Science Policy Unit (TSPU) submitted a proposal to that review for 'A Renting System for Radio Spectrum'. It was included in the final report alongside papers from the Home Office Radio Regulatory Department (RRD) and some economists in the DTI<sup>3</sup>.

## **Charging rents to reflect scarcity value**

I conceived and wrote that submission. As far as I know it was the first published proposal in the world – it was certainly the first in Britain – for charging spectrum users at rates to reflect its scarcity value ('opportunity cost' in the economic jargon). It had three main principles:

- Gradually to introduce a system of charging for spectrum at rates that would reduce the demand for spectrum in any band and geographical location until it no longer exceeded the availability of spectrum there.
- Not to try and maximize the revenue, indeed to charge no more than enough



to provide that any applicant could get an allocation or assignment in any band at the going rent without undue delay, and to charge no more than the bare administration cost in any band where the demand was less than the long-term supply (larger charges would discourage the best use of spectrum).

- To have full regard for international obligations and for users competing against foreign users receiving free assignments from foreign administrations, but gradually to bring the established British users, principally the broadcasters, the Department of Defence and the emergency services, into the charging scheme.

The proposal was intended as a long-term solution to be put in place before more shortages developed. It would effectively guide future applicants for licences into making the most economical – not necessarily the most efficient – use of their allocations or assignments.

A set of parameters was put forward in the proposal for calculating the rents to be charged to the users (see panel 1) and the options they would have to avoid or reduce their charges and so release spectrum in the congested bands (panel 2). I gave a lecture on the proposal at the Institution of Electrical Engineers (IEE) in 1985 and it was published in 1986<sup>4</sup>.

The proposal not to exempt even the emergency services was instinctively opposed by nearly everybody. It often still is today although the arguments have been published several times. They are therefore repeated in panel 3 for readers who still have that instinct.

The RRD denigrated the proposal as “likely to be ineffective and contentious”. The DTI economists opined that charging an economic rent for spectrum would not be an attractive solution unless the allocations could be deregulated and made subject to competition. And the economists concerned with subsequent reviews (including the last) still seem to be imbued with those opinions.

### Feasibility study recommended

Merriman made no formal recommendation on ‘spectrum pricing’ – as he and the RRD preferred to call the proposal – but inclined to the view that “it may well be impracticable”. However he suggested that if the Government thought spectrum pricing should be pursued it should commission a feasibility study.

The term ‘pricing’ has been universally substituted for ‘renting’ ever since, probably because ‘renting’ retains unwarranted connotations of ‘the unacceptable face of capitalism’ and so on in the public mind, but the change contributed to the subsequent confusion.

Two years after the Merriman report, the DTI, which had taken over spectrum management, commissioned such a study from CSP International, who reported in March 1987<sup>5</sup>. But CSP departed radically from the Department of Transport’s proposal in first excluding defence and television broadcasting (by far the largest users) from the scope of the study and then allowing revenue maximization to become the guiding principle instead of matching the demand to the supply.

CSP’s literature review cut out the relevant part of the Merriman report and did not mention the IEE lecture, both of which have been absent from the reports of subsequent reviewers. I criticized that study in *Electronics and Wireless World* later that year<sup>6</sup>.

### Panel 2 - Options for the users

The options for the users were: more spectrum-efficient technology, such as trunking, greater sharing with other users, migration to less congested bands, modifying operating procedures, using different means of communication, such as cable or optical fibre.

### Panel 3 - Allocations to emergency services

Police, fire and ambulance services require and pay for large ranges of equipment and materials. They also pay salaries which are at least large enough to retain their work forces and they trade off the costs of equipment and materials against each other and against the cost of personnel like any other employer. The commercial environment is generally beneficial to those services and raises their standards, compared with countries where that price mechanism is suppressed.

Having to pay for spectrum would not undermine their ability to catch criminals, put out fires or treat injured people any more than having to pay for police cars, fire engines and ambulances, which nobody suggests should be provided free of charge.

### A belated revival

Nine years after that, during which time the situation worsened, the DTI published a white paper: ‘Spectrum Management into the 21st Century’<sup>7</sup>. It followed a two-year consultation of more than 400 spectrum users and it proposed that spectrum pricing should become government policy.

It has been claimed that the DTI itself identified the necessity for spectrum pricing, but in fact the paper was mainly a revival of my proposal on behalf of the Department of Transport 13 years earlier. The parameters for charging were the same (see panel 1 again), as were the options whereby the users could avoid or reduce their charges (panel 2) and so release spectrum for other users in the congested bands. ■

In his next article, David will be investigating the uncertain future of spectrum pricing.

### References

1. ‘Review of Radio Spectrum Management for Department of Trade and Industry and HM Treasury’ by Professor Martin Cave, March 2002.
2. Report of the Independent Review of the Radio Spectrum (30-960 MHz), Chairman Dr J. H. H. Merriman C.B. O.B.E. F.I.E.E. F.Eng., July 1983, HMSO Cmnd 9000.
3. Appendix M: Papers on Spectrum Pricing, page 121.
4. ‘A renting system for radio spectrum?’, Proceedings of the Institution of Electrical Engineers, Vol. 133 Pt. A No.1 January 1986.
5. CSP International, ‘Deregulation of the radio spectrum in the U.K.’, March 1987. HMSO.
6. ‘Privatisation of the radio spectrum’, *Electronics & Wireless World*, September 1987.
7. HMSO Cm 3252, 1996.

# Budget T&M on a PC

In his second article on analysing signals using a PC and some low-cost software, **Richard Black** discusses **Fourier transforms**.

**A** lot of the time in electronics, simply being able to visualise a waveform is all one needs. In that case, going to all the trouble of capturing the waveform to a PC is often redundant – use an oscilloscope!

Still, there are situations where the high dynamic range of the 16-bit digital audio format is useful. Suppose you want to look at the decay of a damped oscillation. The initial amplitude may be quite high, but on most analogue or digital scopes it may prove tricky to capture both the waveform at the start and the final disappearance into noise.

Use a digital audio recorder as your digitiser, though, and you can subsequently zoom in as much as you want on the PC's screen and even perform functions like filtering and averaging after the fact to improve resolution further.

But spectral analysis is where PC-based test and measurement scores. Using the combined power of modern hardware and intelligent software, you can look at the spectrum of a waveform in detail and learn a lot about it.

The key to this of course is the famous fast Fourier transform, or FFT. A numerical version of the analytical Fourier transform, it effectively transforms a description of a signal in the amplitude domain to one in the frequency domain. Used correctly, it is a powerful tool, but if used without proper understanding it can create more problems than it solves.

The FFT takes a handful of samples and computes the spectrum that those samples represent. The handful is generally a number which is a factor of 2. The output consists of  $1+2^{(n-1)}$  complex numbers, each representing the amplitude and phase at a discrete frequency.

If you use a mathematical package such as Mathcad to do your FFT, you will have access to real and imaginary parts, but Cool Edit and all other audio programmes (and most data analysis programmes I've seen) return only the amplitude (magnitude).

## FFTs and 'bins'

An essential feature of the FFT is that the frequency 'bins' into which the signal is sorted are equally spaced. In audio terms a 1024-point FFT returns 513 bins each about 43Hz wide (for a total bandwidth of 22.05kHz when sampling at 44.1kHz). This can be a problem especially when working at low frequencies, and longer FFTs have distinct advantages. Cool Edit handles up to 64k points, and Mathcad over 1M points.

Simply selecting 1024 – or however many – data points is not enough, because the sharp discontinuity at the ends of the selection will produce unwanted artefacts in the FFT. The data must be 'windowed' – multiplied by a function which, ideally, has value zero at the start and end points, value 1 in the middle and an FFT which shows a flat frequency response.

Cool Edit offers a selection of windowing functions, including the near-useless triangular, and the very well-behaved Blackman-Harris, which is in most instances the best.

Just occasionally another window such as Blackman or

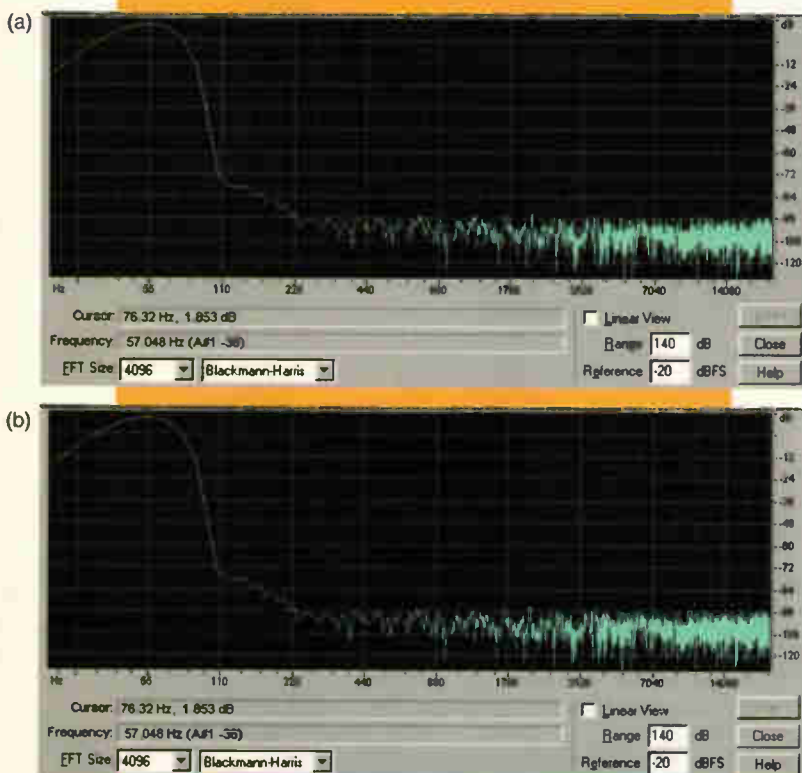

**Fig. 1.** Advantages of a long FFT. In 1a), the signal looks like something in the region of 55Hz when analysed with a 4k-point FFT, but in 1b) it is clearly seen to be two sinusoids at 50Hz and 60Hz thanks to a 64k point analysis.



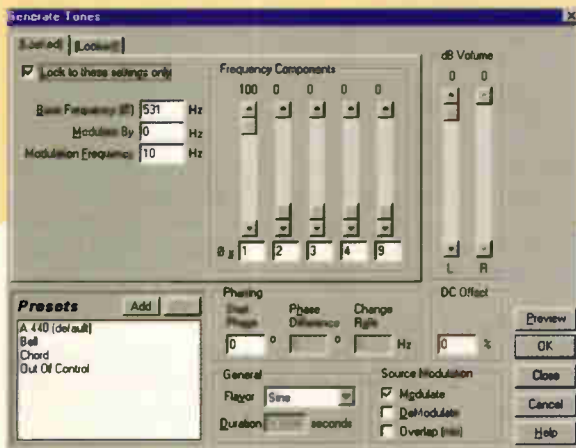

Fig. 2. The 'Generate Tone' window in Cool Edit, set up to modulate by a sinusoid.

Hamming will give more useful frequency resolution at the expense of ultimate noise floor. With Mathcad you must 'roll your own' window: for details of functions see any reference work on digital signal processing.

There will come a time when even a 64k-point FFT in Cool Edit has insufficient resolution for your needs. This can be either because you actually need to examine spectral lines that are very closely spaced or because the graphical display lacks resolution. It is limited by the size of your screen: you can't actually display 32768 points! In logarithmic display mode though, there are several pixels per bin at LF.

In this case, three functions in Cool Edit will help. First, there are two ways of changing frequency: the stretch/compress function and modulation by another signal.

Stretching works just like slowing down an analogue tape recording (there are options to change pitch or speed independently but it doesn't actually work!), altering the frequency of the entire waveform by a factor of up to 20. You'll lose something, either in the bass (when slowing down – the very bottom frequencies fall into the 'DC' bin which is not displayed) or in the treble (when speeding up – CE is smart enough to filter frequencies that would be above the Nyquist limit, avoiding aliasing). But signals of interest can be moved so that their spectral display is more informative.

### Using modulation

Modulation is a powerful feature, but must be used with care. Under the 'Generate' menu is the option to generate a waveform which is used to modulate the existing audio. Just as in RF modulation, this multiplication of one sinusoid by another results in two output frequencies, the sum and difference of the inputs.

Suppose you want to examine a series of spectral spikes centred on a 3kHz tone closely. Modulating by a nearby frequency – maybe 2800Hz – will produce a transposed series of spikes centred on 200Hz, and another centred on 5800Hz.

There's no gain in resolution on an FFT, but on a logarithmic display effective resolution is much increased. If you wish, you can then speed the section up by a factor of ten or so to increase the true FFT resolution.

Before modulation, it is generally necessary to limit the spectrum to avoid aliasing. The third useful CE function is the 'FFT filter'. Technically, this is an FFT implementation of a finite-

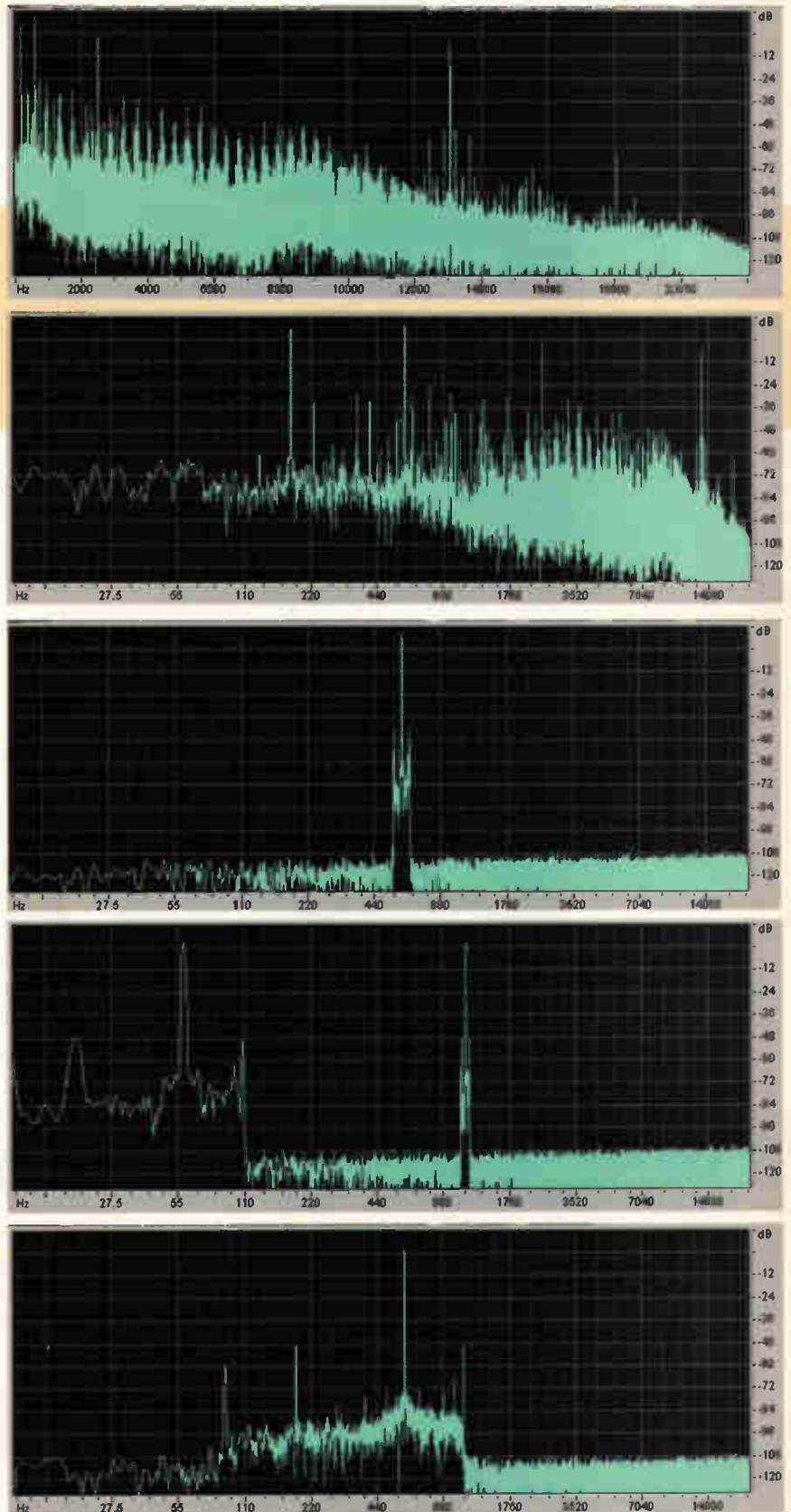

Fig 3 Various views of a spectrum. In 3a, the entire spectrum is viewed with a linear frequency axis, while 3b shows the increased LF resolution of a logarithmic frequency axis. In 3c, a narrow region around 590Hz has been selected using the 'FFT Filter' function, and in 3d it has been further processed by modulating by 531Hz. In 3e, after low-pass filtering, the signal has been compressed by a factor of 10, driving all frequencies upwards and making close-in sidebands clearer to see (at 10 times the offset frequency from the fundamental, itself handily restored to 590Hz thanks to the choice of modulating frequency and frequency scaling).



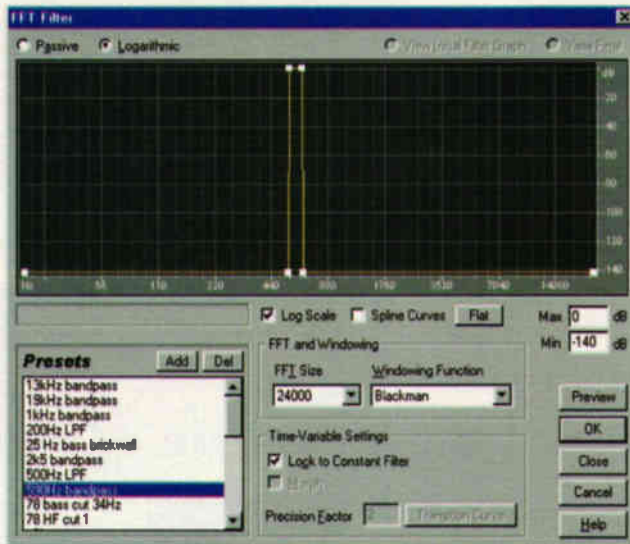
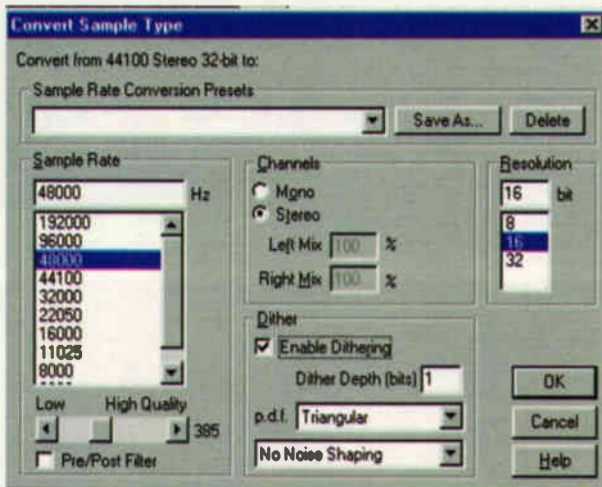

Fig 4 The 'FFT Filter' window, set up for the 590Hz band-pass filter used in Fig 3c. Note that this filter has been saved as a preset: Cool Edit allows presets to be created for most functions.

Fig 5 The 'Convert Sample Type' window.



impulse-response filter. It can give incredibly sharp cut-off in low-pass, high-pass or band-pass form, with no phase shift or other distortion in the passband.

This feature has options for FFT length and window: I normally set window length to maximum and window to Blackman-Harris. I've tested this filter every way I can think of and its behaviour seems to all intents and purposes perfect.

Combining those three functions, it is possible to zoom in to very high resolution on an FFT display. Bear in mind here that you need a fairly long section of data to work on. A 64k-point FFT requires about 1.5 seconds but if you are going to speed up (compress) the signal first by a factor of 10 you'll need at least 15 seconds. In fact, even more can be useful. In Cool Edit's FFT options, there's one that allows you to 'Scan' a selected portion of audio and display an average FFT over the selection. This doesn't actually increase resolution, but it does give a neater display and it gives the operator greater confidence that he or she is looking at real spectral peaks.

**Add-ons for Cool Edit**

Other Cool Edit functions can occasionally come in handy: for instance, as an optional extra (\$49) you can buy a 'Pro EQ' extension pack which adds various filter options to the FFT and 'quick' filters supplied with the standard CE. Included among these is a set of 'Scientific Filters' which mimic – in both amplitude and phase – the classic Bessel, Butterworth and Chebyshev filters of various orders and configurations.

These filters aren't perfect because their performance starts to deviate from ideal above about one-third of the Nyquist frequency. They can be used though, for instance, to integrate (low-pass filter) or differentiate (high-pass) signals.

Mention of that high-frequency departure from ideal behaviour brings up the possibility of converting to a different sample rate. Cool Edit can handle arbitrary sample rates up to 2MS/s – though you won't be able to play such files back through any sound card known to man!

On occasions, it is worth the time and trouble to upsample and then process data. In particular, if you want to compare non-synchronised waveforms side by side, you can upsample to a very high rate (hint: use a small amount of data) and time-shift. This is only done in whole sample periods, to line them up. The 'Quality' slider control can safely be set to around 400.

Another option under 'Convert sample type' (itself found under the 'Edit' menu) is to change the word length of data.

**Fundamental limits: Nyquist's criterion and dither**

The basic maths behind digital audio – indeed any sampled-data system – is fairly simple but not entirely intuitive. It is based on mathematical results dating back to Newton's time, but the first complete statement of sampling theory as we know it was given by Claude Shannon in 1949<sup>1</sup>.

It is Nyquist, however, who is honoured in everyday parlance, marking his realisation that by sampling *N* times a second one could capture faithfully a sinusoidal waveform of less than (not equal to) *N/2*Hz.

Despite many hand-waving attempts to debunk this, particularly in the audio press (and yes, I once made some myself, to my shame), it holds good. Band-limit a signal to less than half the sampling frequency and sampling works

as claimed.

Imperfect band-limiting leads to 'aliasing', where a signal at (*N/2+x*)Hz will appear instead at (*N/2-x*)Hz and so on. On reconstruction, further band limiting is required to prevent aliases: signals at (*N/2-x*)Hz would otherwise appear at (*N/2+x*), (*3N/2+x*), etc., Hz.

Quantisation, the representation of samples by a numeric value, is in fact a separate issue. Because the number has finite precision (1 part in 65536 in CD-format digital audio) there is inevitable distortion generated when quantisation occurs. This distortion can be very unpleasant, but the situation is entirely saved by the seemingly magical properties of properly-applied dither.

Adding a small amount of noise, with

defined statistical properties, can be mathematically shown to decorrelate the distortion from the signal, turning it into relatively harmless noise. This means that it is legitimate to analyse signals way down into the noise floor.

In fact the rule of thumb, that signals below the noise floor are as good as gone, is completely wrong. Dithered 16-bit audio has a maximum signal-to-noise ratio of about 93dB. Perform a 65536-point FFT, though, and that noise is divided into 32768 bins, giving a noise level in each bin of more like -138dB relative to a full-scale sinusoid.

For many analytical purposes, then, dithered 16-bit digital signals have a dynamic range effectively well in excess of 120dB. Undithered, that drops to more like 85dB.



Anything read in off a CD will be in 16-bit format, as will data recorded via most sound cards. For processing though, it can be useful to work in 32-bit mode.

The 32-bit mode uses floating-point storage and processing to give resolution of 144dB (24-bit mantissa) and overall dynamic range of about several hundred decibels. I've yet to find a use for the latter, but the former is genuinely useful in avoiding noise when the final result, or some intermediate stage in the processing, involves much reduced signal levels. Note that 'noise' is not quantisation distortion: it is of paramount importance to ensure that the 'Dither transform results' box is checked (under 'Options/Settings/Data'). A quick summary of what dither is all about is presented in a separate panel.

When dealing with frequencies near the Nyquist limit it can be difficult to see what's going on if the data are shown as points joined by straight lines. Cool Edit has a sensible answer.

At very high zoom levels, individual samples can be clearly seen. Instead of joining them by straight lines, CE calculates a band-limited interpolation, just like any normal CD player. This works well up to about 19kHz. To look really close to the Nyquist limit, just upsample, or filter and modulate downwards.

As I mentioned at the start of this article, sometimes visualising the waveform itself is very useful. In this case, one may wish to employ Cool Edit's various filtering functions to home in on the desired portion of a noisy or distorted waveform.

You can for instance view the distortion residual of a waveform simply by filtering out the fundamental using either the FFT filter or the notch filter. Either of these will let you filter out several fundamentals so you can view the distortion residual of a multi-tone stimulus. You can also boost the level of that residual and listen to it... and so on. The possibilities are endless.

In summary, I should say again that there are certainly many programmes other than Cool Edit that can accomplish most or all of what I have discussed. The principles remain the same. Cool Edit is very cheap though. To an audio-based person like



*Fig 6 1003Hz at -120dB FS, captured using only 16 bits but correctly dithered and clearly visible above white noise in this FFT display. Note that the 'scan' function was used over 18s of audio to give a clearer representation of the true noise floor.*

me, it offers plenty of other attractions. For instance, it is one of the fastest and most versatile MP3 encoders I've seen. And if you've ever tried any audio editing at all in the analogue domain, but never in the digital, I can guarantee you'll be hooked in minutes!

The final article in this set will employ all the tricks mentioned above in a Sherlock Holmes-like search for evidence of 'audio cable sound'.

#### References

1. Claude E. Shannon, 'Communication in the Presence of Noise', Proc. IRE, vol. 37, no. 1, Jan. 1949, pp10-21.

Cool Edit is distributed via the Internet for \$69: [www.syntrillium.com](http://www.syntrillium.com)

## Ten year index: new update

### Hard copies and floppy-disk databases both available

Whether as a PC data base or as hard copy, SoftCopy can supply a complete index of *Electronics World* articles going back over the past nine years.

The computerised index of *Electronics World* magazine covers the nine years from 1988 to 1996, volumes 94 to 102 inclusive and is available now. It contains almost 2000 references to articles, circuit ideas and applications - including a synopsis for each.

The *EW* index data base is easy to use and very fast. It runs on any IBM or compatible PC with 512K ram and a hard disk.

The disk-based index price is still only £20 inclusive. Please specify whether you need 5.25in, 3.5in DD or 3.5in HD format. Existing users can obtain an upgrade for £15 by quoting their serial number with their order.

### Ordering details

The *EW* index data base price of £20 includes UK postage and VAT. Add an extra £1 for overseas EC orders or £5 for non-EC overseas orders

Postal charges on hard copy indexes and on photocopies are 50p UK, £1 for the rest of the EC or £2 worldwide.

For enquires about photocopies etc please send an sae to SoftCopy Ltd. **Send your orders to SoftCopy Ltd, 1 Vineries Close, Cheltenham GL53 0NU.**

Cheques payable to SoftCopy Ltd, please allow 28 days for delivery.

**Photo copies of *Electronics World* articles from back issues are available at a flat rate of £3.50 per article, £1 per circuit idea, excluding postage.**

**Hard copy *Electronics World* index Indexes on paper for volumes 100, 101, and 102 are available at £2 each, excluding postage.**

# WHITENOISE

by Hot Electron

## More and more...

The field of engineering in general, and electronics in particular, continues to expand at an exponential rate. It is long since an electronics engineer could expect to cover the whole subject, it being necessary to specialise in digital or analogue techniques.

Each of these areas has subsequently splintered into a whole gamut of specialisations, and this is mirrored in the plethora of "freebies" or controlled circulation magazines supported entirely by advertising revenue. One that I have been receiving more or less since its first appearance, is *RF innovations* – a publication devoted

entirely to the techniques and applications of RFID – electronic tags for IDENTifying and tracking all sorts of goods from clothing to livestock, by radio frequencies, induction loops or whatever.

The publication has carried an interesting article on Bluetooth entitled 'Application processors'. But despite all the press interest on Bluetooth, the general manager of Intel's Comms Group says the system is a dead duck, having lost out to IEEE 802.11. Odd, as Intel was a founder member of the Bluetooth SIG (Special Interest Group).

Another more recently launched controlled-circulation magazine is *Wireless Europe*, covering longer range wireless systems than those of RFID, such as GSM, 3G, GPRS, wireless

WLANs (wide area networks) etc. All these magazines just seem to start arriving unannounced and unrequested; so much for the Audit Bureaux, which is supposed to ensure that the circulation list of a controlled circulation magazine only includes readers who have specifically requested it.

In practice, circulation lists are widely traded between magazines, inflating the lists and misleading advertisers into thinking that their adverts reach a larger number of potential customers than is actually the case. I even started getting a magazine all about pipework, hydraulic actuators and such: interesting, but really not my field. The result is ever more waste paper and destruction of forests. Ah well, gripe over for today!



## The nerve of it!

A new branch of electronics will surely exist soon, if it does not do so already. I refer to bionics and some bizarre reports are surfacing about some of its stranger manifestations.

One report concerns the bacterium known as *pseudomonas syzyii*. It occasionally somehow gets into semiconductor wafers via water used in the manufacturing process, even though the water is ultra pure.

Ozone, UV light and all other measures fail to eliminate it completely, and it chews its way into the surface of the semiconductor. Apparently it feels at home in both silicon and germanium, and sits in a little protective ring of the material.

Researchers at Buffalo, USA, have shown that electrons can flow across it, and some bacteria are so sensitive to light that the current flowing in the semiconductor may be controlled by the pigment of the bacterium, which can even act as a tiny transistor.

Meanwhile, other researchers at the Max Planck Institute in Munich have grown conducting nerve cells from snails on the surface of a silicon chip, anchoring them in place with microscopic polyimide pegs. The cells then grow interconnections, with each other and the chip.

A stimulator electrode on the chip can send impulses through the nerves and back to other points on the chip, though exactly what end the researchers have in view is not clear at this stage.

Nerve cells are comparatively slow, compared with gigahertz clock rate microprocessors, the human brain only achieving its remarkable results by virtue of its massively parallel processing architecture. ■

## Conundrum

Hot Electron always reads with interest a chat page, rather like this, that regularly appears in one of the better known American freebies. It is written by that famous guru of analogue electronics, and enthusiastic climber of Nepalese mountains, Bob Pease of National Semiconductor. We have corresponded once or twice, but he won't recognise me under this particular pen name.

In one of Bob's recent pages, he included a nice little teaser, which I am sure he won't mind my retailing here. The diagram shows a weight *W* supported by two coil springs *P* and *Q*, tethered together by string *X*.

Strings *Y* and *Z* are slack, but only just. The question is, what happens when string *X* is cut? Does the weight go up, go down or stay put?

Bob's original article also included an electronic analogy of the problem involving resistors and zener diodes, and also one involving wide and narrow roads. This was in aid of his contention that a proposed relief road, in his home state of California, would probably end up making traffic chaos *worse* rather than better.

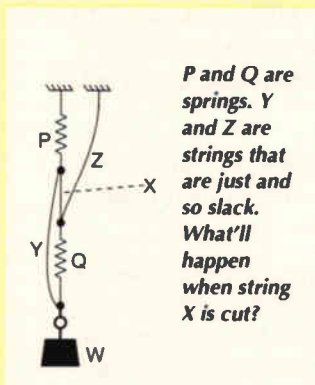

*P and Q are springs. Y and Z are strings that are just and so slack. What'll happen when string X is cut?*



# High Resolution Oscilloscope

- High speed 5GS/s dual channel oscilloscope
- 50MHz, 80dB dynamic range spectrum analyser
- PicoScope & PicoLog software supplied FREE
- Plug into any desktop or laptop PC
- High resolution - 12 bits
- Large 128K memory
- 1% DC accuracy

**NEW**  
Product  
Range

**PICO**  
Technology Limited

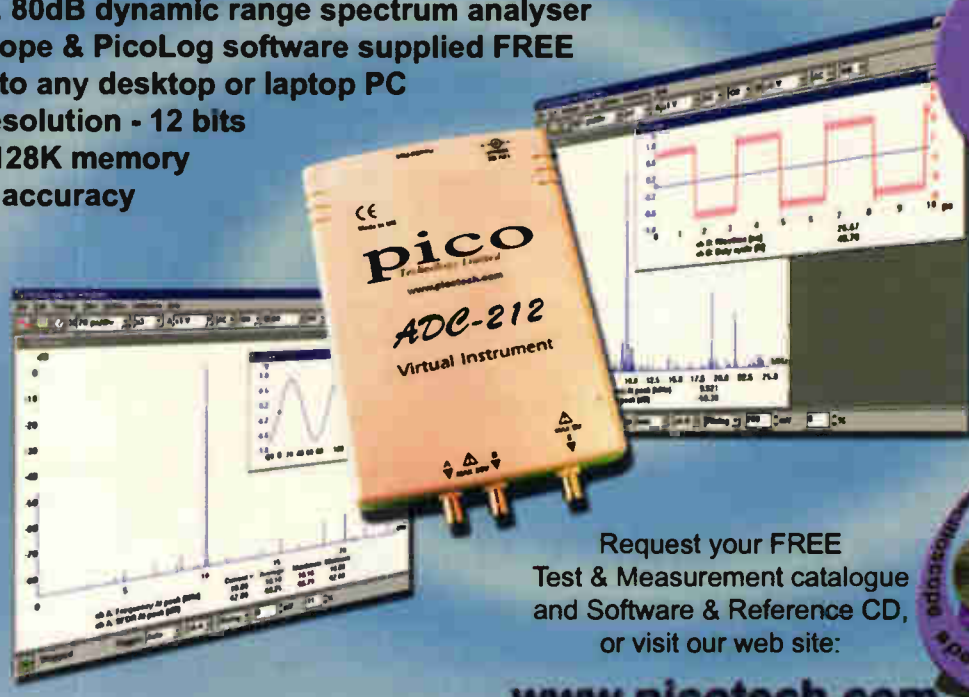

Request your FREE  
Test & Measurement catalogue  
and Software & Reference CD,  
or visit our web site:  
[www.picotech.com](http://www.picotech.com)



Tel: +44 (0) 1480 396395 Fax: +44 (0) 1480 396296 E-mail: [post@picotech.com](mailto:post@picotech.com)

## SPECIAL OFFERS

- TEKTRONIX 2445A 4 Ch 150MHz Delay, Cursors etc Supplied with 2 Tektronix probes** **ONLY £425**
- TEKTRONIX 2232 Digital Storage Scope. Dual Trace 100 MHz 100ms with probes** £525  
**H.P. 54501A Digitizing Oscilloscope 100MHz, 4Ch** £425  
**H.P. 3312A Function Gen 0.1Hz-13MHz AM/FM Sweep/Tr/Gate/Burst etc** £300  
**FARNELL Dual PSU XA35-2T 0-35V 0-2A Twice QMD LCD Display** £180  
**CIRRUS CRL254 Sound Level Meter with Calibrator, 80-120dB, LEO** £150  
**EDDYSTONE 1002 Receiver 150kHz-30MHz + Broadcast FM** £125  
**FARNELL AMM255 Automatic Mod Meter 1.5MHz-2GHz Unused** £300  
**FARNELL DSG1 Low Frequency Syn Sig Gen 0.001Hz to 99.99kHz, Low Distortion TTL/Square/Pulse Outputs etc** £95  
**FLUKE 8060A Handheld True RMS DMM 4 1/2 digit BECKMAN HD110 Handheld 3 1/2 digit DMM, 28 ranges with battery, leads and carrying case** £40
- HP 3310A Function Gen 0.005Hz-5MHz Sine/Sq/Tr/Ramp/Pulse** £125  
**FARNELL FLM4 Sine/Sq Oscillator 10Hz-1MHz low distortion, TTL Output, Amplitude Meter** £125  
**H.P. 545A Logic Probe with 546A Logic Pulsar and 547A Current Tracer** £90  
**FLUKE 77 Multimeter 3 1/2 digit Handheld** £60  
**FLUKE 77 SERIES II** £70  
**HEME 1000 LCD Clamp Meter 0-1000A In Carrying Case** £80
- Racal 9008 Automatic Modulation Meter AM/FM 1.5MHz - 2GHz** **ONLY £95**
- Datron 1061 High Quality 5 1/2 Digit Bench Multimeter True RMS/4 wire Res/Current Converter/IEEE** **£150**
- Datron 1061A High Quality 6 1/2 digit Bench Multimeter True RMS/4 wire/Current Converter** **£225**
- Racal Frequency RA1772 50kHz - 300MHz LED Display Basically Working** **£250**

## MARCONI 2019A

- AM/FM synthesised signal generator 80kHz - 1040MHz NOW ONLY £400**
- MARCONI 893C AF Power Meter, Sinad Measurement. Unused £100 Used £60**  
**MARCONI 893B - No Sinad** £30  
**MARCONI 2610 True RMS Voltmeter Autorangin 5Hz-25MHz** £195  
**GOULD J3B Sine/Sq Osc. 10Hz-100kHz Low distortion Others Avos** £80  
**AVO 8 Mk6 in Ever Ready Case, with leads etc** £80  
**GOODWILL GVT427 Dual Ch AC Millivoltmeter 10mV In 12 Ranges Freq 10Hz-1MHz** £100-£125  
**SOLARTRON 7150 DMM 6 1/2 digit True RMS - IEEE** £95-£150  
**SOLARTRON 7150 PLUS** £200
- HIGH QUALITY RACAL COUNTERS**  
**9904 Universal Timer Counter, 50MHz** £50  
**9916 Counter, 10Hz-520MHz** £75  
**9916 Counter, 10Hz-560MHz, 9-digit** £50  
**WAYNE KERR B424 Component Bridge** £125  
**RACAL/AM 9343M, LCR Databridge, Digital Automeasurements of R.C.L.O.D.** £200  
**HUNTRON TRACKER Model 1000** £125  
**MARCONI TF2015 AM/FM sig gen, 10-520MHz** £175  
**FLUKE 8050A 4.5 Digit, 2A True RMS** £75  
**FLUKE 8012A 3.5 Digit, 2A** £40
- SOLARTRON 7045 Bench Multimeter 4.5 Digit Bright LED with Leads** **ONLY £30**
- Portable Appliance Tester Megger Pat 2** **ONLY £180**
- H.P. 60128 DC PSU 0-60V; 0-50A 1000W** £1000  
**FARNELL AP6V50 1KW Autoranging** £1000  
**FARNELL H60-150 0-60V 0-50A** £750  
**FARNELL H60/25 0-60V; 0-25A** £400  
**Power Supply HPS3010 0-30V; 0-10A** £140  
**FARNELL L30-2 0-30V; 0-2A** £80  
**FARNELL L30-1 0-30V; 0-1A** £60
- Many other Power Supplies available. Isolating Transformer 240V In/Out 500VA** £40

## GOULD OS 300 OSCILLOSCOPE

- DUAL TRACE 20MHz TESTED WITH MANUAL £95**
- OSCILLOSCOPES**  
**TEKTRONIX TDS350 Dual Trace 200MHz 1G/S unused** £1500  
**TEKTRONIX TDS320 Dual Trace 100MHz 500M/S** £1200  
**TEKTRONIX TDS310 Dual Trace 50MHz 200M/S** £950  
**LECROY 9400A Dual Trace 175MHz SG/S** £1500  
**HITACHI VC6523 Dual Trace 20MHz 20M/S etc unused** £600  
**PHILIPS PM3092 2+2Ch 200MHz Delay** £800 As New £950  
**PHILIPS PM3082 2+2Ch 100MHz Delay etc** £700 As New £800  
**TEKTRONIX TA5465 Dual Trace 100MHz Delay etc** £750  
**TEKTRONIX 2465B 4Ch 400MHz Delay Cursors etc** £1500  
**TEKTRONIX 2465 Dual Trace 100MHz Delay Sweep** £325  
**TEKTRONIX 468 Dig Storage Dual Trace 100MHz Overlay** £450  
**TEKTRONIX 466 Analogue Storage Dual Trace 100MHz** £250  
**TEKTRONIX 485 Dual Trace 350MHz Delay Sweep** £550  
**TEKTRONIX 475 Dual Trace 200MHz Delay Sweep** £400  
**TEKTRONIX 465B Dual Trace 100MHz Delay Sweep** £325  
**PHILIPS PM3217 Dual Trace 50MHz Delay** £200-£250  
**GOULD OS1100 Dual Trace 30MHz Delay** £150  
**HAMEG HM303 Dual Trace 30MHz Component Tester** £275  
**HAMEG HN203.7 Dual Trace 20MHz Component Tester** £200  
**FARNELL DTV20 Dual Trace 20MHz Component Tester** £125
- MANY OTHER OSCILLOSCOPES AVAILABLE**  
**MARCONI 2022E Synthesised AM/FM Sig Gen 525 - 1750 10kHz - 1.01GHz LCD Display etc** £2000  
**H.P. 8657A Syn 100kHz - 1040MHz Sig Gen** £2000  
**H.P. 8656B Syn 100kHz - 890MHz Sig Gen** £1350  
**H.P. 8656A Syn 100kHz - 990 MHz Sig Gen** £995  
**R&S APN62 Syn 1Hz - 260kHz Sig Gen** £425  
**Balanced/Unbalanced Output LCD Display** £2000  
**PHILIPS PM5326 Sig Gen 100kHz - 180MHz with 200MHz Freq Counter IEEE** £550
- Freq Counter IEEE**  
**RACAL 9081 Syn AM/FM Sig Gen 5KHz - 1024MHz** £250  
**H.P. 3325A Syn Function Gen 21MHz** £600  
**MARCONI 6500 Amplitude Analyser** £1500  
**H.P. 4192A Impedance Analyser** £5000  
**H.P. 4275A LCR Meter 10kHz - 10MHz** £2750  
**H.P. 8903A Distortion Analyser** £1000  
**WAYNE KERR Inductance Analyser 3245** £2000  
**H.P. 8112A Pulse Generator 50MHz** £1250  
**MARCONI 2440 Freq Counter 20GHz** £1000  
**H.P. 5350B Freq Counter 20GHz** £2000  
**H.P. 5342A 10Hz - 18GHz Freq Counter** £800  
**H.P. 1650B Logic Analyser 80 Channel** £1000  
**MARCONI 2305 Mod Meter 500kHz - 2GHz** £750
- RADIO COMMUNICATIONS TEST SETS**  
**MARCONI 2955/2955A** from £1500  
**Rohde & Schwarz CMT 0.1 - 1000MHz** £2000  
**Schlumberger 4040** £900

## JUST IN

- H.P. 6063B DC Electronic Load 3-240V/0-10A 250W P.O.A** £400  
**H.P. 66312A PSU 0 - 20V/0-2A** £400  
**H.P. 66311B PSU 0 - 15V/0-3A** £400  
**H.P. 66309D PSU Dual 0 - 15V 0-3A/0-12V 0-1.5A** £750  
**H.P. 6632B PSU 0 - 20V/0-5A** £500  
**H.P. 6623A PSU Triple Output ranging from** £850  
**0-7V 0-5A to 0-20V 0-4A**  
**H.P./Agilent 34401A DMM 6 1/2 digit** £400/£450  
**H.P. 3478A DMM 5 1/2 digit** £275  
**FLUKE 45 DMM Dual Display** £400  
**KEITHLEY 2010 OMM 7 1/2 digit** £950  
**KEITHLEY 617 Programmable Electrometer** £1250  
**H.P. 4338B Milliohmmeter** £1500  
**RACAL Counter type 1999 2.6 GHz** £500  
**H.P. Counter type 53131A 3GHz** £850  
**H.P./Agilent 33120A Function Gen/ARB** £900/£1000  
**100microrHz - 15MHz**  
**SONY/TEKTRONIX AFG320 Arbitrary Function Gen** £1250  
**H.P. 8904A Syn Function Gen DC - 600kHz/£1000/£1250**  
**BLACK STAR JUPITOR 2010 Function Gen 0.2Hz - 2MHz with Frequency Counter** £140  
**H.P. 8116A Pulse Generator 1mH-50MHz** £1950  
**H.P. 8657B Syn Signal Gen 0.1-2080MHz** £2500  
**CO-AXIAL SWITCH 1.5GHz** £40  
**IEEE CABLES** £10

## SPECTRUM ANALYSERS

- H.P. 8561B 50Hz - 6.5GHz** £6500  
**H.P. 8560A 50Hz - 2.9GHz Synthesised** £5000  
**H.P. 8569E 9kHz - 2.9GHz** £4500/£5000  
**H.P. 8591E 1MHz - 1.8GHz 75 ohm** £3500  
**H.P. 853A with 8559A 100kHz- 2.1GHz** £2250  
**H.P. 8558B with Main Frame 100kHz - 1500MHz** £1250  
**H.P. 3585A 20Hz - 40MHz** £3000  
**H.P. 3580A 5Hz - 50kHz** £800  
**ADVANTEST R4131B 10kHz - 3.5GHz** £3500  
**EATON/Altech 757 0.001 - 22GHz** £1500  
**MARCONI 2382 100Hz - 400MHz High Res** £2000  
**MARCONI 2370 30Hz - 110MHz** from £500  
**H.P. 182 with 8557 10kHz - 350MHz** £500  
**H.P. 141T Systems**  
**8553 1kHz - 110MHz** from £500  
**8554 500kHz - 1250MHz** from £750  
**8555 10MHz - 18GHz** from £1000  
**TEKTRONIX 491 10MHz - 12.4 GHz** £900  
**H.P. 8443 Tracking Gen/Counter 110MHz** £250  
**H.P. 8444 Opt 059** £750  
**B & K 2033R Signal Analyser** £750  
**H.P. 5372A Frequency & Time Interval Analyser** £2250  
**H.P. 8754A Network Analyser 4MHz - 1300MHz** £1250  
**H.P. 3577A Network Analyser 5Hz - 200MHz** £3000  
**H.P. 53310A Modulation Domain Analyser Opt 001/003** £5000  
**ANO SOKKI Portable FFT Analyser** £1500

## STEWART OF READING

110 WYKEHAM ROAD, READING, BERKS RG6 1PL  
 Telephone: (0118) 9268041 Fax: (0118) 9351696  
[www.stewart-of-reading.co.uk](http://www.stewart-of-reading.co.uk)



Callers welcome 9am-5.30pm Monday to Friday (other times by arrangement)

## USED EQUIPMENT - GUARANTEED. Manuals supplied.

This is a VERY SMALL SAMPLE OF STOCK. SAE or telephone for lists. Please check availability before ordering. CARRIAGE all units £16. VAT to be added to total of goods and carriage.

# CIRCUIT IDEAS

## Fact: most circuit ideas sent to *Electronics World* get published

The best circuit ideas are ones that save time or money, or stimulate the thought process. This includes the odd solution looking for a problem – provided it has a degree of ingenuity. Your submissions are judged mainly on their originality and usefulness. Interesting modifications to existing circuits are strong contenders too – provided that you clearly acknowledge the circuit you have modified. Never send us anything that you believe has been published before though.

Don't forget to say why you think your idea is worthy.

Clear hand-written notes on paper are a minimum requirement: disks with separate drawing and text files in a popular form are best – but please label the disk clearly.

Send your ideas to: Jackie Lowe, Highbury Business Communications, Anne Boleyn House, 9-13 Ewell Road, Cheam, Surrey SM3 8BZ

## Timer for battery chargers

Many devices with NiCd or other types of rechargeable cell specify a time for charging. This is usually several hours and it is very easy to put a battery on charge and then forget about it.

This circuit was developed at the request of my son, who was given a rechargeable strimmer that required a charge time of eight hours.

On operation of the 'On/Start' switch, the output is live for a preset period of from 2 to 12 hours, after which it is off. Timing is reset by switching 'On/Start' off and then on again.

The delay is determined by the ICM7242 timer/counter chip, which is connected as a monostable and triggered by switch on. The timer drives a TLP3063 optically-isolated

triac with zero crossing turn on.

A BC212L p-n-p transistor buffers the output of the timer as its maximum sink current is 3mA and the optical isolator needs about 5mA. The optical isolator, in turn, controls the gate of a TIC 226M triac.

Maximum current for the TLP3063 is 100mA. This current is possibly sufficient for battery chargers up to about 20 watts, but having a larger triac makes the unit more versatile. For example it could be used to switch a light off in the house when unattended.

A jumper allows timing and switching functions to be tested over a short interval of 20 seconds to 2 minutes. By simply changing the value of the 470µF capacitor,

the delay range may be altered.

I mounted the low-voltage components on one pcb and the two triacs on another, with only the led drive connecting the two. The output connector is a panel-mounting 13A socket (RS part number 847-455), with the 'running' neon indicating when that socket is live.

The timer chip, optical isolator and triac are available from RS (parts nos 264-793, 261-0211 and 649-403) and their Application Notes may be downloaded from the RS site.

Other components are from Maplin.  
Tony Meacock  
Norwich

*Some battery chargers can be left charging indefinitely, but for those that can't, this timer should be useful.*

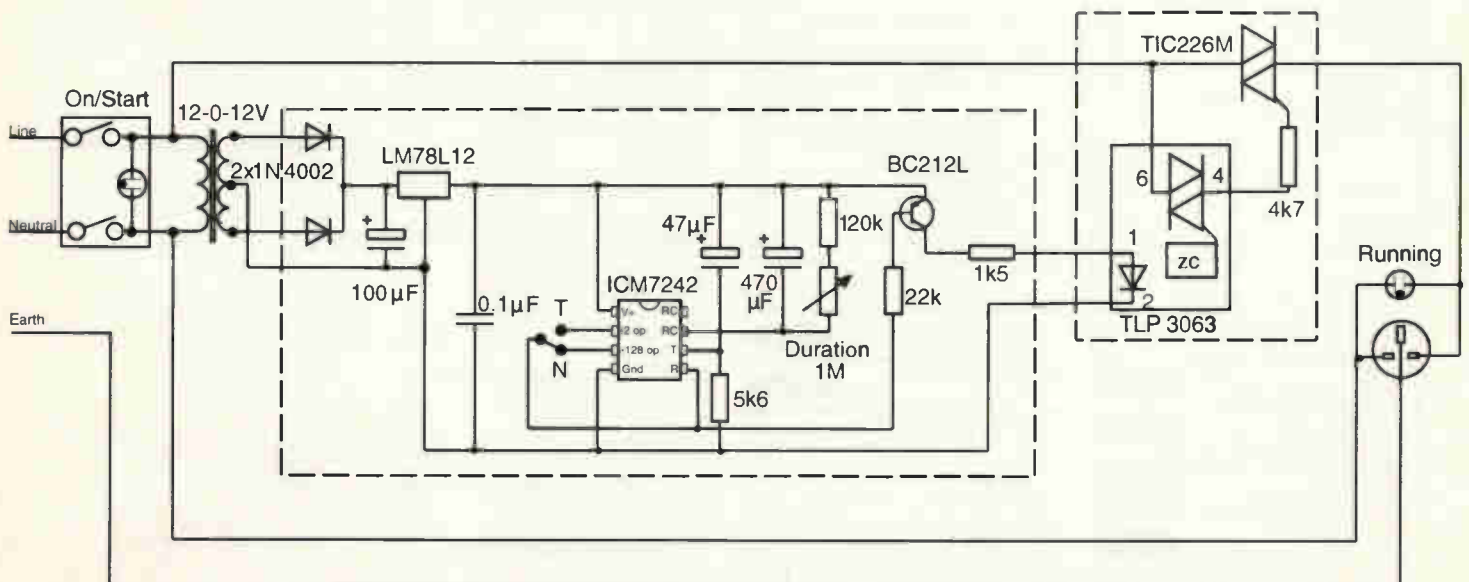





## 20% discount for TV readers

digimess® power supplies from £99.00 inc vat & del



**Vann Draper Electronics Ltd**

The test & measurement specialists

[www.vanndraper.co.uk](http://www.vanndraper.co.uk)

Test equipment from Grundig, digimess, Kenwood, Hameg, Tektronix, Avo and more.

Vann Draper is offering over 20% discount to readers of *Television Magazine* on their new range of low cost digimess® power supplies.

The range includes single, dual, triple and high current output types. All feature LED displays of voltage and current and can be operated in constant voltage or constant current modes. Dual and triple types have switching for independent, series, parallel and tracking modes. All models are supplied complete with mains lead, operating manual and a 1 year guarantee.

Model number	HY3003	HY3003-2	HY3003-3	HY3010	HY3020
Price (inc vat & del)	£99.00	£169.00	£199.00	£275.00	£375.00
No of outputs	Single	Dual	Triple	Single	Single
Output voltage	0-30V	2 x 0-30V	2 x 0-03V, 5V	0-30V	0-30V
Output current	0-3A	2 x 0-3A	2 x 0-3A, 3A	0-10A	0-20A
Load regulation	<0.01%	<0.01%	<0.01%	<0.02%	<0.02%
Ripple & noise	<1mV rms	<1mV rms	<1mV rms	<3mV rms	<3mV rms
Dimensions (mm)	291x158x136	365x265x164	365x265x164	365x265x164	365x265x164

To order, simply post the coupon to:

**Vann Draper Electronics Ltd, Stenson House, Stenson, Derby DE73 1HL.**

Or Tel 01283 704706 Fax 01283 704707 Email [sales@vanndraper.co.uk](mailto:sales@vanndraper.co.uk)

Use this coupon for your order

Please supply me:

(Qty) . . . . (Model) . . . . . (Price) . . . . .  
 (Qty) . . . . (Model) . . . . . (Price) . . . . .

Name:

Address:

Tel No:

Total £

Cheques payable to Vann Draper Electronics Ltd or debit my visa, mastercard or switch card:

Card type:

Card No:

Expiry date:

Switch iss No:

Signature:

Overseas readers can still obtain this discount but carriage charges vary according to country. Please telephone, fax, email or write to Vann Draper.

# PCB-POOL®

SERVICING YOUR COMPLETE PROTOTYPE NEEDS

- Prototypes at a fraction of the cost
- Industry standard quality
- Tooling and setup included
- Follow up series runs
- Any contour
- 24/7 CAD consulting
- Fr4 1.6mm, 35µm Cu

PRICE EXAMPLE:  
 EUROCARD 0.25PTH  
 + Tooling  
 + Photoplots  
 + VAT

= £ 29.89\*

\*Starting rates may vary. Price = € 49

**€49**



Freephone  
**0800-389 8560**

Simply send your files and order ONLINE:

**WWW.PCB-POOL.COM**

Protel orcad EDWIN GraphiCode

## Embedded Ethernet TCP/IP Solutions

**JK microsystems** connects customers with cost-effective embedded solutions. Our DOS based controllers, peripherals and accessories integrate Ethernet, TCP/IP and control capabilities into data acquisition, networking and industrial applications. Consider one of our many solutions, the *LogicFlex*:

- Intel 386Ex @ 25MHz
- 10Base-T Ethernet & TCP/IP
- DOS & Webserver pre-installed
- 46 Digital I/O Lines
- 2 Serial Ports
- Programmable Xilinx CPLD
- 512K SRAM, 512K Flash standard
- Optional M-Systems DiskOnChip
- Expansion Bus for Peripheral Boards
- eRTOS available for Multitasking



Contact our UK distributor  
**Trionyx DSP Systems**

Email: [info@trionyx.co.uk](mailto:info@trionyx.co.uk)

Call: +44 (0)20 8789 8775 Fax: +44 (0)20 8785 0764  
 81 Skeena Hill, Southfields, London, SW18 5PW, UK

• Free technical support available via email •

Visit us on the web at [www.jkmicro.com](http://www.jkmicro.com)

+1 530-297-6073 Fax: +1 530-297-6074 [sales@jkmicro.com](mailto:sales@jkmicro.com)  
 1403 Fifth Street, Suite D, Davis, CA 95616 USA

**JK microsystems**

**£100 winner**

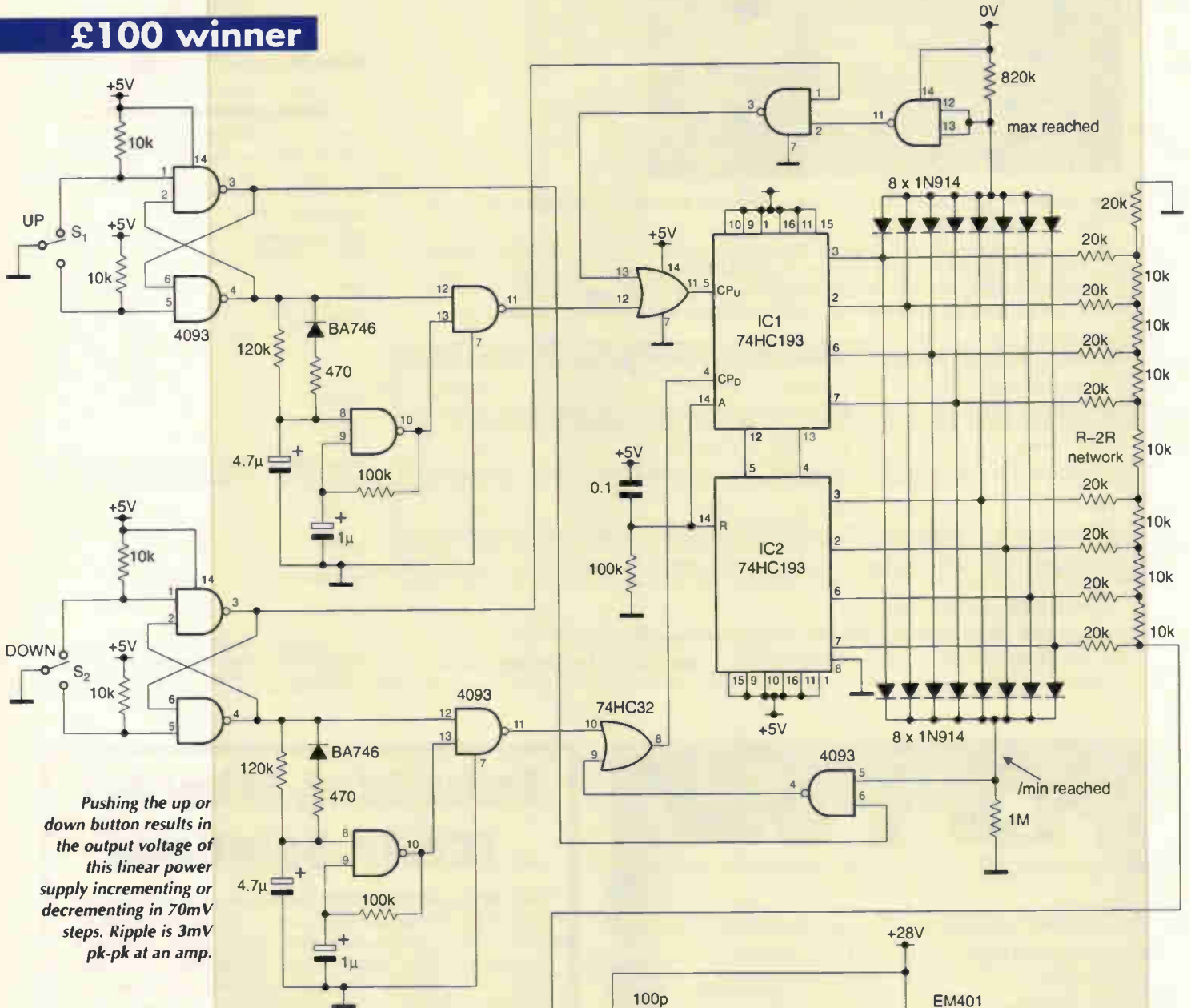

Pushing the up or down button results in the output voltage of this linear power supply incrementing or decrementing in 70mV steps. Ripple is 3mV pk-pk at an amp.

## Push-button controlled power supply

Two push buttons set the output of this power supply. These buttons allow one of 256 voltage levels to be set.

Each push of the up button increments the output by about 70mV and *vice versa* for the down button. If the up button is held down, the voltage increments more rapidly.

Output from the counters passes through an R-2R ladder to provide the reference voltage to a standard linear variable power supply.

The supply always powers up at 0V due to the reset circuitry. If both buttons are pressed, the current count is held. Ripple is 3mV pk-pk at 1A loading.

Gregory Freeman  
Mt Barker  
Australia

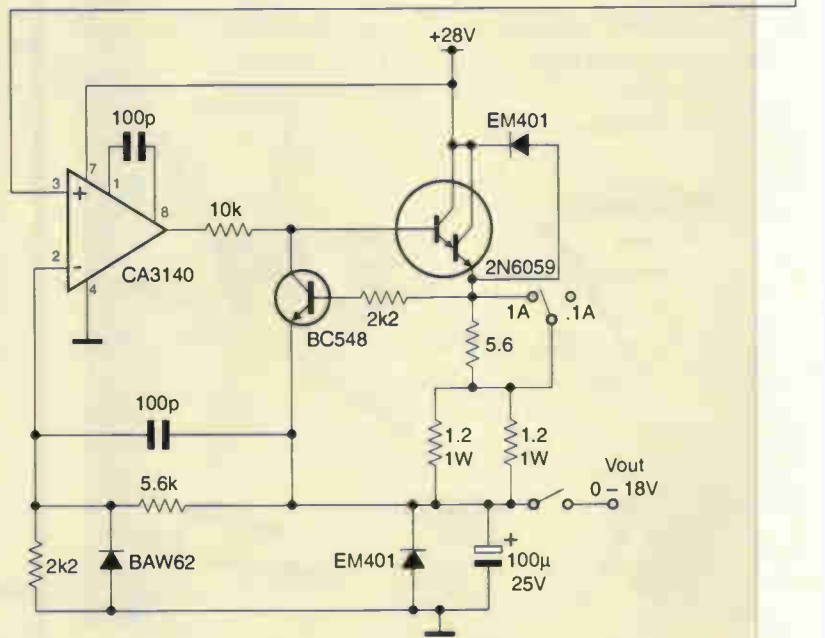



# TELFORD ELECTRONICS

Old Officers Mess, Hoo Farm, Humbers Lane,  
Horton, Telford, Shropshire TF6 6DJ, UK  
Tel: (0044) 01952 605451 / 670178  
Fax: (0044) 01952 677978

E-mail: telfordelectronics@btinternet.com /  
marc.007@btinternet.com / annie.007@btinternet.com

Web: <http://www.telford-electronics.com>

**Shop opening to the public on  
Saturday 7 September 2002  
9am – 2pm**

**Second User –  
Electronic Test and Measuring  
Instruments – DC to 100 GHz**

**FANTASTIC  
BARGAINS  
TO BE HAD**

*Please visit our regularly updated web  
site for all your equipment needs.*

**We have a clearance/graveyard site  
with goods from as little as £15.00!!!**

## The Balance Box

Microphone or line level amplifier for  
balanced or unbalanced signal lines

Professional portable units operating from an internal  
PP3 battery or external mains adaptor



- ★ Precision true floating transformerless balanced input and output at microphone or line level
- ★ Simple interfacing and conversion between balanced and unbalanced signal lines
- ★ Low noise and distortion
- ★ High common mode rejection
- ★ Switchable gain selection
- ★ Extensive RFI protection

**The Phantom Power Box – The Headphone Amplifier  
Box - The OneStop** DIN rail mounting radio  
frequency interference filter and voltage transient protector  
for voltage and current loop process signal lines

**Conford Electronics** Conford Liphook Hants GU30 7QW  
Information line 01428 751469 Fax 751223  
E-mail [contact@confordelec.co.uk](mailto:contact@confordelec.co.uk)  
Web: [www.confordelec.co.uk/](http://www.confordelec.co.uk/)

SCHEMATIC SIMULATION PCB AUTOROUTING CAD/CAM DESKTOP MANUFACTURE

From



**Be The First**  
"a quantum leap"  
Builder 1999

Users all over the world are discovering Electronic Design Studio 3 (EDS 3), with it's modern user interface and powerful tool set. And now with the launch of the Standard version of EDS, prices start at just £49\*.

All versions of EDS include fully integrated schematic and PCB design with autorouting and simulation built in. The powerful editing tool set including the Project management system are also included.

More advanced versions include copper pour with support for unlimited zones, cross-probing, heirarchical and multi-sheet design, rip up and retry routing, extensive CAD/CAM options and our new Desk Top Manufacturing (DTM) system.

Call us now for a free information pack, or try the online trial version at [www.dotqr.com](http://www.dotqr.com)



**electronic  
design STUDIO**

	Standard	Personal	Advance	Ultra
Schematic Design & Capture	✓	✓	✓	✓
SPICE/XSPICE Simulation	✓	✓	✓	✓
Viper II Autorouter	✓	✓	✓	✓
Realtime Connectivity Checking	✓	✓	✓	✓
Power rail and bus support	✓	✓	✓	✓
Multiple Sheet Schematics		✓	✓	✓
CAD/CAM R-247D/X and Drill		✓	✓	✓
Copper Pour with unlimited Zones		✓	✓	✓
Shape based Design Rule Checks		✓	✓	✓
Rip up and retry Autorouter		✓	✓	✓
Cross probing, Net Styles and Tags		✓	✓	✓
Heirarchical Schematics				✓
1nm resolution, Unlimited Layers, auto mitre				✓
Desk Top Manufacturing option				✓
Polyblend system (punch holes in copper, etc)				✓

**Send me** Price inc udes UK P&P and VAT. Other variants available. Pin limits may apply.

- EDS 3 Standard 300 at £65       EDS 3 Personal 300 at £91  
 EDS 3 Advance 1000 at £299       EDS 3 Ultra at £476

**Name/Address**

**Card Number**

**Expiry**

**Signature**



**Phone/FAX 01422 255010/255014**  
**www.dotqr.com**

Copyright © 2002 Quickroute Systems. E.&.O.E.  
\*Price excludes VAT and P&P.



## Capacitance meter for 1pF to 100nF

In this capacitance meter, covering the range 1pF to 100nF, the monostable device a potentiometer sets the width of the timing pulse,  $t_1$ . The counter is fed with the oscillator and monostable outputs and determines the time interval,  $\tau$ , between the falling edges of the A and B inputs.

The counter's LED display is calibrated to display the unknown capacitor with R.

**Davut Celik**  
Ankara  
Turkey

*Simple capacitance meter based on measuring the interval of a pulse whose width is determined by the unknown capacitance.*

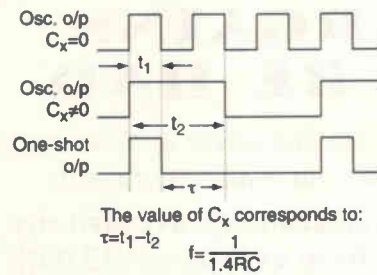
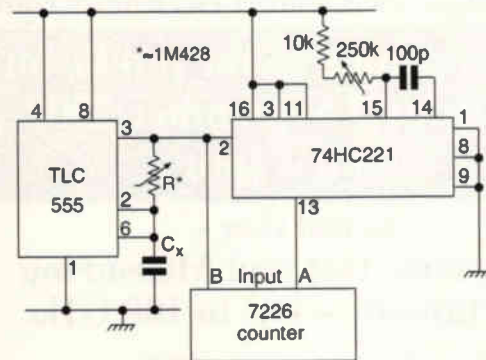

## Electronic fuses as liquid level sensors

There's a lack of cheap electric sensors for detecting liquid levels. Wet electrodes are often used, as in the circuit ideas section of the April and July 1999 issues, to replace mechanical switches. They can suffer from electrolysis and oxidation though.

Electronic fuses, like the Polyswitch from Raychem and the Polyfuse from Bourns, show a heavy positive temperature coefficient. They turn off almost if heated by a current that exceeds their nominal value. Afterwards, they stay off, remaining hot with the leakage current. When they cool, or

as the supply is removed, they return to their original state. For further details see [www.raychem.com](http://www.raychem.com) or [www.bourns.com](http://www.bourns.com).

The cooling effect could be provided by a liquid, opening up the possibility for novel liquid sensing applications. I experimented with the RXE010 Polyswitch from Raychem. It looks a little like a ceramic capacitor and has a nominal current of 100mA. It is guaranteed to switch off at 200mA. Its resistance is 4.5Ω.

Using the usual two sensors to

turn a liquid pump on and off, you can realise the cost-effective circuit shown here. Assuming that the container to be sensed is empty, the relay cannot remain on because the fuses are open due to excessive current. As long as there's no liquid in the container, current consumption is low.

When the liquid reaches the upper sensor, the relay turns on. The pump turns on and continues to run until the lower sensor is dry.

Resistors  $R_1$  and  $R_2$  are chosen to ensure 200mA in the sensors. With the 6V Finder 55 Series relay, whose coil is 40Ω,  $R_1$  will be 30Ω, 2W and  $R_2$  will be 120Ω, 0.5W. This particular relay has enough contacts to switch a three-phase motor.

One more sensor could be added to drive an alarm if the liquid exceeds the maximum level. There is no electrolytic effect with these sensors because the on voltage is too weak. Nevertheless, it is worth insulating the connections of the sensors with epoxy glue for example to prevent oxidation.

**Jean-Marc Brassart**  
Saint Laurent Du Var  
France

**£50 winner**

*A novel use for electronic fuses – liquid level detection.*

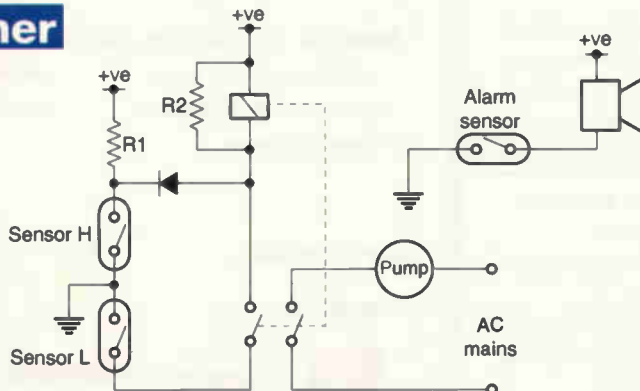



# Over-current relay with auto-variable trip current

Here is a simple circuit that will disconnect an appliance when excessive current flows for a predetermined period. This period varies according to the magnitude of the excessive current.

Figure 1 shows typical time versus overcurrent characteristics. At the heart of the overcurrent relay is an EPROM storing samples of the characteristic curve at successive locations. For a 1K EPROM like the 2716, 1024 samples starting at '0' seconds and ending at '100' seconds are stored.

Figure 2 shows the circuit diagram of the overcurrent relay. The EPROM is addressed by a 10-bit binary counter (3x7493) that is driven by a 10.24Hz clock. Since 1024 samples cover a period of 100 seconds, the clock frequency becomes 10.24Hz.

An eight-bit d-to-a converter connected at the data lines of the EPROM produces the analogue equivalent of the sampled data addressed at any time. Line current is converted into an equivalent voltage,  $V_i$ , using a current-to-voltage converter. It is then compared by  $IC_1$  with the reference voltage  $V_R$ , that represents the rated current that could flow through the appliance.

When normal current flow is exceeded, the binary counter is reset to offer the first sample from the EPROM to the d-to-a converter. After that, successive samples are clocked into the d-to-a converter.

Voltage  $V_i$  is also compared at  $IC_2$ . When it goes above the d-to-a converter voltage, relay  $R$  operates to trip off the system by closing contact  $R_1$ .

Note that the d-to-a converter voltage progressively decreases while clocking is taking place.

**K Balasubramanian**

Dept of Comp. Sci. and Eng  
Mersin  
Turkey  
G53

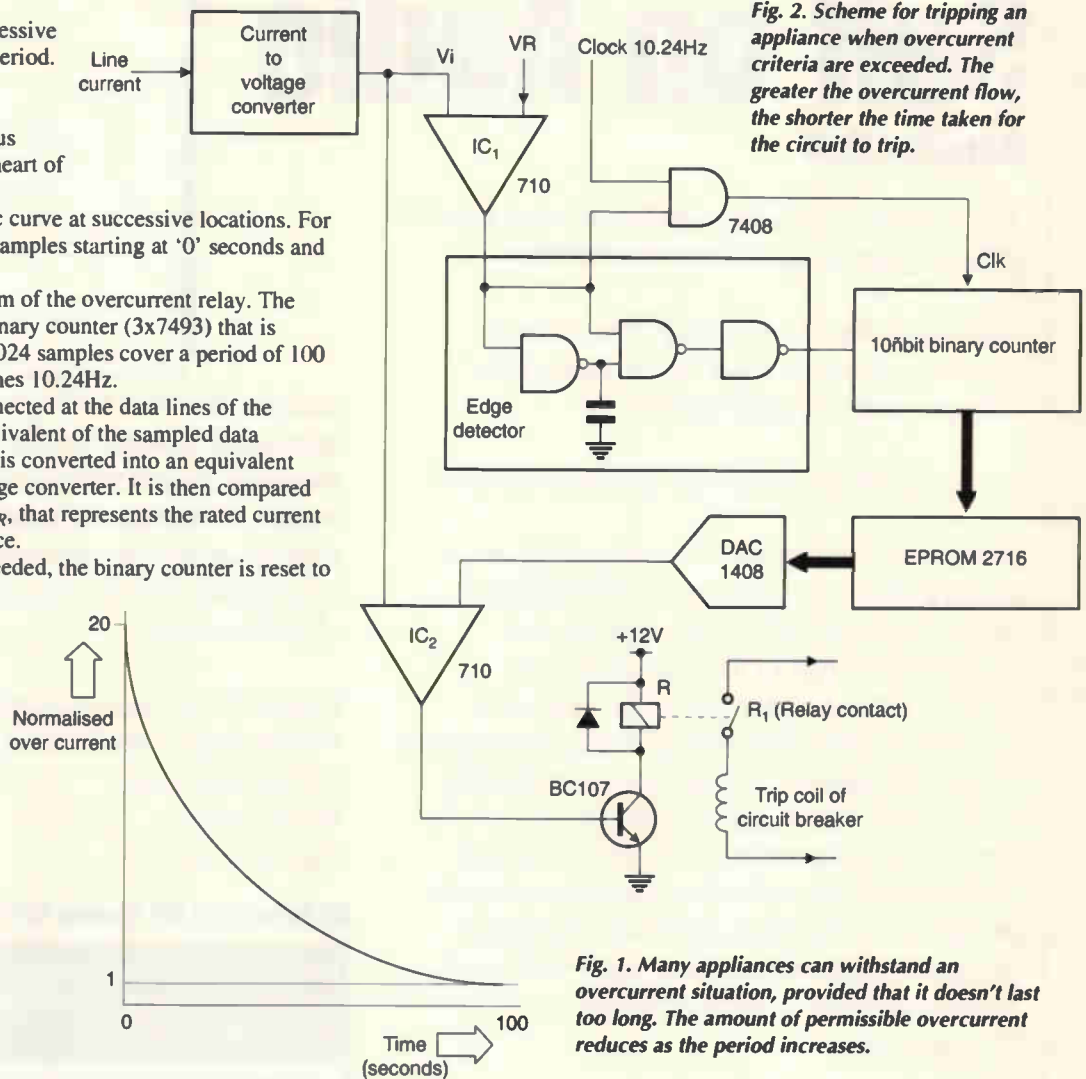

Fig. 2. Scheme for tripping an appliance when overcurrent criteria are exceeded. The greater the overcurrent flow, the shorter the time taken for the circuit to trip.

Fig. 1. Many appliances can withstand an overcurrent situation, provided that it doesn't last too long. The amount of permissible overcurrent reduces as the period increases.

# Active antenna with noise suppression

This circuit is an active antenna with noise suppression properties. The superfet source follower circuit has strong negative feedback. This means that the self-generated noise of the transistors is applied in antiphase to the input, resulting in active noise suppression.

You might think that instability is not possible in such a circuit because the amplification never exceeds one, but parasitic capacitances make a capacitive divider from gate to source to ground. This makes the circuit a Colpitts oscillator. But by manipulating this regenerative effect you can use the effect to advantage.

The best way to make adjustable damping is series connection of a 2.7kΩ resistor and a 5pF trimmer. You can make this a front-panel adjustment if you like.

For lower frequencies, the parasitic capacitances are not large enough, so some additional capacitance may need to be added. Note that both capacitive adjustments interact, but capacitive regeneration adjustment excludes noise, unlike a potentiometer.

Output impedance of the superfet follower is only a few ohms, so a terminated 75Ω coax output is not a problem. Of course due to the outstanding linearity, the third-order intercept properties are good too. This same idea can be modified for ranges other than 14 to 30MHz by the way.

A yellow Amidon 9.5mm core is a good choice. The tap at three turns was found by trial and error. Note that fractional turns are not possible.

The p-n-p transistor must definitely

be a BF type. Audio types in the BC range have much larger capacities, despite their high transition frequency.

**Wim de Ruyter**  
Oudkarspel  
The Netherlands

■ An active antenna featuring noise suppression.

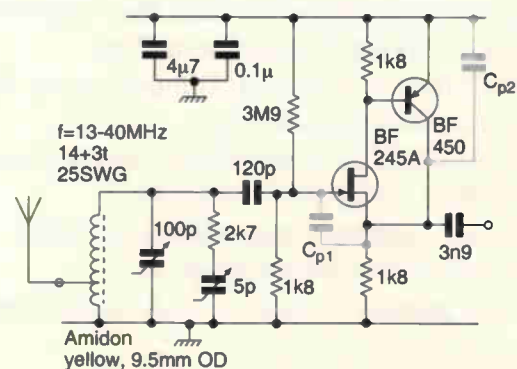



# Self on Audio

DOUGLAS SELF

# Self on Audio

## Douglas Self

The cream of 20 years of Electronics World articles (focusing on recent material)

A unique collection of design insights and projects - essential for all audio designers, amateur and professional alike.

Scientific electronics based on empirical data

Douglas Self has been writing for Electronics World and Wireless World over the past 20 years, offering cutting-edge insights into scientific methods of electronics design.

This book is a collection of the essential Electronics World articles, covering twenty years of amplifier technology but with a very strong bias towards more recent material. The articles include self-build projects as well as design ideas and guidance for the professional audio designer. The result is a unique collection of design insights and projects - essential for all audio designers, whether amateur or professional.

**Contents:** Introduction; PRE-AMPLIFIERS: An advanced preamplifier MRPI; High-performance preamp MRP4; Precision preamp MRP10; Moving-coil head amp; Preamp '96 I; Preamp '96 II; "Overload Matters" (RIAA overload); Balanced line inputs and outputs, part 1; Balanced line inputs and outputs, part 2; POWER AMPLIFIERS: FETs less linear than BJTs; Distortion in power amplifiers 1-8; Distortion residuals; Trimodal part 1, 2; Load-invariant power amp INVAR.DOC; Common-emitter amps; Two-stage amplifiers; SPEAKERS: Excess speaker currents; Class distinction (amp classification); Relay control; Power partition diagrams; Audio power analysis.

Douglas Self has dedicated himself to demystifying amplifier design and establishing empirical design techniques based on electronic design principles and experimental data. His rigorous and thoroughly practical approach has established him as a leading authority on amplifier design.

Readership: Audio electronics enthusiasts;  
Professional amplifier designers;  
Power amp users  
Paperback  
Pages: 416pp

**UK Price: £26.50 Europe £27.50 ROW £28.50**

Return to Jackie Lowe, Highbury Business Communications  
Anne Boleyn House, 9-13 Ewell Road, Cheam,  
Surrey, SM3 8BZ

Please supply the following title:

## SELF ON AUDIO

Total \_\_\_\_\_

Name \_\_\_\_\_

Address \_\_\_\_\_

Postcode \_\_\_\_\_

Telephone \_\_\_\_\_

Method of payment (*please circle*)

Mastercard/Visa/Cheque/PO

**Cheques should be made payable to  
Electronics World**

Credit card no. \_\_\_\_\_

Card expiry date \_\_\_\_\_

Signed \_\_\_\_\_



# NEW PRODUCTS

Please quote *Electronics World* when seeking further information

## EMI gasket material in place

Chomerics has introduced a corrosion-resistant, form-in-place EMI shielding gasket material for dispensing on bare metal electronics housings, such as base-station PCB covers and other electronic equipment with required long service life. Called Cho-form 5541, the material is a single component, electrically conductive silicone elastomer containing nickel-plated graphite particles. Gaskets are dispensed by robot onto customer enclosures or castings and heat-

cured in 30 minutes. The gaskets provide shielding effectiveness above 70dB from 200MHz to 10GHz, and meet UL 94V-0 flammability requirements. It is provided in 6oz (180cc) cartridges containing 350g of compound.

**Chomerics**  
Tel: 01628 404000  
[www.chomerics.com](http://www.chomerics.com)

## 3mm yellow LED with lens

Optosource is stocking a range of 3mm yellow LEDs. Manufactured by Global Light of Germany, the GLE3011-YY14 series has an elliptical lens, offering a viewing angle of 65 degrees in the horizontal

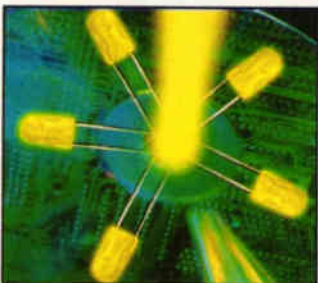

## Chip fuses that are good for the environment

Bussmann Chip fuses from Cooper Electronic Technologies are bonded to a ceramic substrate and are encapsulated in glass to improve reliability and according to the supplier will not burn or char in high temperature environments. Designed to be more reliable than traditional soldered fusing elements which often degrade when subjected to cycling, the fuses use both thick and thin film technology in a solder-free design that improves temperature and pulse cycling capabilities, without causing degradation to the fuse element, said the company. They also comply with demands for board level lead-free components by specifying the lead free plating option, as the fuses will withstand high IR reflow temperatures when using lead free solder pastes due to their high temperature capability.

**Cooper Electronic Technologies**  
Tel: 001 561 742 1178  
[www.cooperet.com](http://www.cooperet.com)

plane and 40 degrees in the vertical, GLI colour grade the LEDs into four separate bins of 1.5nm bandwidth ensuring that there is no colour variation when used in multi-LED arrays, said the supplier. Light intensity is 500mcd at 20mA. The Al-In-GaP chip allows users to drive the LED with a high 50mA maximum forward continuous current, or 150mA peak power pulse current. When driven at

these levels, light output reaches 1000mcd

**Global Light**  
Tel: 01229 582430  
[www.mari.co.uk](http://www.mari.co.uk)

## Detect switches have snap action

ITT Cannon has launched a series of C&K snap acting, detect switches which measure 8.2 x 2.7mm with heights of

## PCB design adds multi-chips

Zuken has announced that its Hot-Stage 4 virtual prototype environment is supported by the company's upgraded PCB and multichip module (MCM) layout tool, VISULA 6.0. According to the firm, this will provide a virtual prototyping environment by enabling both design engineers and layout engineers to solve signal integrity, EMI, thermal and manufacturability issues in the early stages of product development. The schematic-style Scenario Editor within Hot-Stage 4 ensures that realistic constraints are set by enabling 'what if' experimentation with drivers, receivers, terminations and net topologies. Experimentation within the same environment then helps resolve problems in physical design. VISULA 6.0 also features enhancements that include an improved graphical user interface, tools for via manipulation, additional solder mask and silk-screen manufacturing checks, and electrical 'groups' support.

**Zuken**  
Tel: 01454 207800  
[www.zuken.com](http://www.zuken.com)

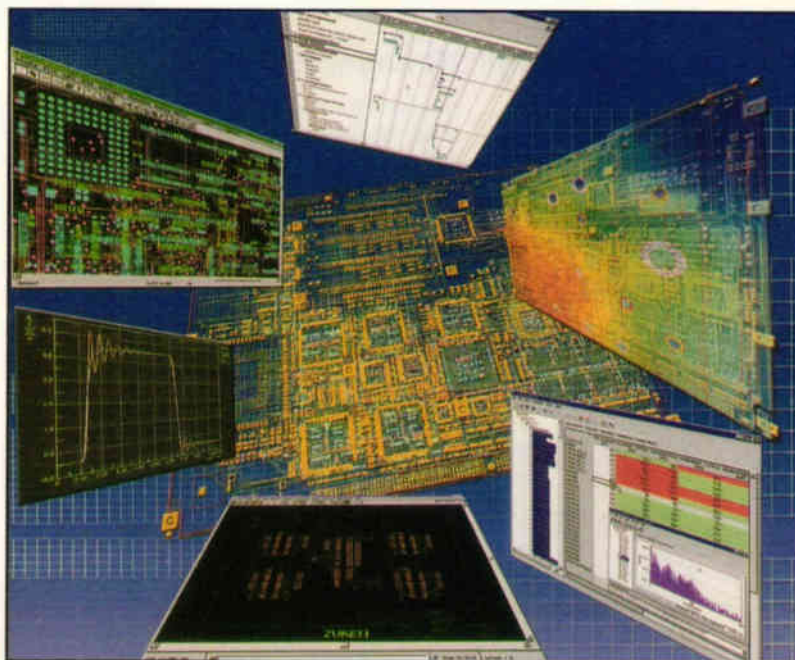



Please quote *Electronics World* when seeking further information

8.2mm for the vertical mount version and 8.4mm for the right angle version, including lever, the MDS switches feature a snapping, tactile feel with a total travel of 2.9mm. Designed to detect the presence of a mechanical device in medical and consumer electronic equipment, the switches are available in vertical or right angle PCB mounting styles. Typical applications include security equipment, consumer electronics, medical devices, and communications equipment. The SPDT range has a contact rating of 0.3A at 6V DC. Mechanical and electrical life is 10000 operations, and operating temperature range is 10 to +60°C.  
**ITT Cannon**  
 Tel: 01273 480661  
 www.ittcannon.com

**Tri-band embedded GPRS module**

TDC is offering next generation GPRS mobile phone developers a GSM tri-band module supporting voice and data transmission via GPRS class 10. Measuring 34x53x3.5mm, the Siemens MC45 module is a tri-band GSM module that has voice, data, fax and SMS abilities. It supports GSM networks in the frequency ranges 900, 1800 and 1900MHz. There is an audio interface, which allows the user

**3V TVS arrays for ESD protection in SOT-23 and SC-70**

Semtech is offering transient voltage suppressors (TVS) featuring a 3.3V operating voltage with low clamping voltage and leakage current values. Designed to guard sensitive, low-voltage circuits against damage or latch-up caused by electrostatic discharge, lightning, and other destructive voltage transients, both the SMS3.3 and the SMF3.3 arrays protect up to four signal lines operating at 3.3V. The device clamping voltage is typically limited to less than 5V. Both arrays feature a leakage current of less than 0.5A, and typical overall capacitance of less than 50pf for the SMF3.3. The SMS3.3 comes in a SOT-23; the SMF3.3 in a SC-70.  
**Semtech**  
 Tel: 02380 769008  
 www.semtech.com

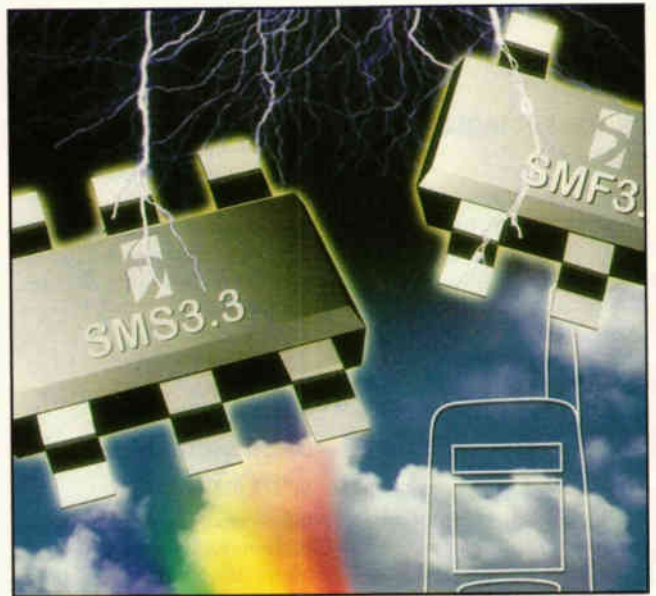

to activate an integrated microphone/loudspeaker unit in notebooks and hand-helds, and so use it as hands-free system for telephone calls. It also allows for simultaneous transmission of data and control of device functions via a standardised AT command set. The MC45 is approved for international R&TTE, FCC, GCF and PTCRB standards.  
**TDC**  
 Tel: 01256 332800  
 www.tdc.co.uk

**3.35Gbit/s telecoms bit error-rate system**

Agilent Technologies has extended its 81250 ParBERT bit error rate test platform by adding modules to include 3.35Gbit/s optical, electrical generator and analyser capabilities. It is a parallel bit-error ratio test (BERT) system for high-speed digital and optical component testing. There is also analysis software to test parallel electrical, optical and electro-

optical converter modules and components. Intended for 10Gbit/s Ethernet testing, characterising cross-point switches and transmission systems, the system performs multiplexer and demultiplexer testing for telecommunications; system area network IC, multiple transmitter and receiver testing in manufacturing; and forward-error-correction device testing. Also, the fast eye-mask measurement offers a quick pass/fail test capability for manufacturing.  
**Agilent**  
 Tel: 07004 666666  
 www.agilent.com

**Radio tester gets full 3G capability**

Rohde & Schwarz has added 3G mobile functionality for the UMTS standard WCDMA to its radio communication tester CMU200. Intended for the development and production of 3G, an option allows a WCDMA downlink signal to be

generated for synchronisation of the mobile phone under test, thus making bit error rate measurement possible, said the company. The platform retains its capability to support various standards like GSM, AMPS, TDMA, CDMA, (TIA/EIA-95),

Bluetooth as well as WCDMA. The tester performs transmitter measurements on terminals for the UMTS standard WCDMA (3GPP/FDD).  
**Rohde & Schwarz**  
 Tel: 01252 81888  
 www.rusk.rohde-schwarz.com

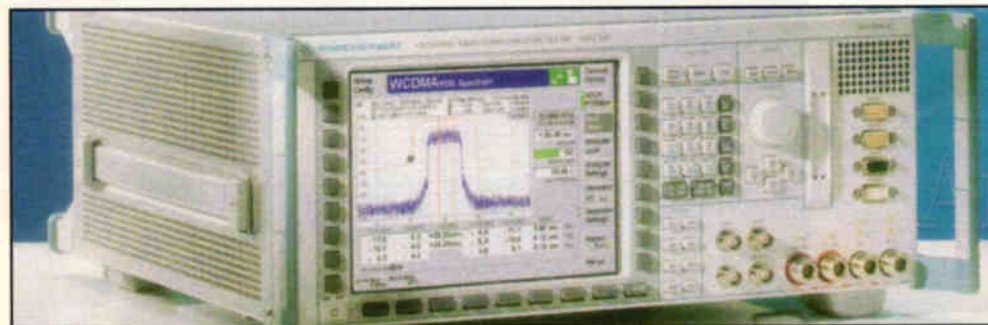

**64-bit Mips processor clocks at 600MHz**

PMC-Sierra has introduced the fourth generation of its RM7000 64-bit Mips-based processor with maximum production clock speeds of 600MHz. The RM7000C and RM7065C use 0.13µm, copper-interconnect technology process, and offer a power consumption of 2.5W at 600MHz. The RM7000C is available at a rate of 533MHz.  
**PMC-Sierra**  
 www.pmc-sierra.com

**AVR design tool supports ICE 200**

IAR Systems has extended support for Atmel's AVR family



Please quote **Electronics World** when seeking further information

of Risc microcontrollers by adding to its Embedded Workbench a toolkit which includes support for the ICE 200 in-circuit emulator and the ATmega64 derivative.

**IAR Systems**  
Tel: 0046 1816 7800  
[www.iar.com](http://www.iar.com)

### Power management IC handles charger

STMicroelectronics has introduced the STw4101 power management chip that integrates the functions required for managing battery power and charger control in a mobile handset. Housed in a 6 x 6mm TBGA package, the device includes six low-dropout (LDO) analogue regulators to supply RF circuits, the baseband chip, audio chip, vibrator and other functions. Two of these LDOs are mask adjustable, two are programmable through an I<sup>2</sup>C bus and two provide general-purpose fixed supply voltages for 3 and 3.3V supplies. The LDOs require a 1µF ceramic capacitor. Also included is a programmable DC-DC step-down converter that can be used to power the baseband and audio LDOs. The battery charging function controls the gate voltage of an external P-channel Mosfet and performs constant voltage and constant current charging for Lithium ion batteries.

**STMicroelectronics**  
Tel: 01628 890800  
[www.st.com](http://www.st.com)

### Fast analyser probes slash input capacitance

Tektronix has introduced a high frequency connectorless probing system for its TLA7Axx logic analyser modules that offers an 8GHz timing acquisition rate. The aim has been to minimise lead capacitance by eliminating the need for connectors. Total input capacitance is specified at 0.7pF. It is possible to make analogue and digital measurements (both timing and state) through a single probe. The P6860 high-density probe for single-ended signals and the P6880 high-density probe for differential signals is designed to eliminate multiple analyser and

### IR transmitter and receiver chip set for stereo wireless

Toshiba Electronics is offering an infrared transmitter and receiver chip set designed to simplify implementing automotive and domestic wireless audio applications. The Toshiba TA2061AF infrared linear audio signal transmitter IC and the TA2056FN 1.5V cordless receiver IC enable stereo transmission of linear audio signals to local loudspeakers and headphones and are suitable for in-car and home entertainment systems. When used with an appropriate infrared LED such as the firm's TLN225, the chip set

enables designers to implement a complete wireless stereo audio system with the minimum of additional discrete components. Featuring two crystal VCO channels, it offers infrared audio signal transmission at typical frequencies of 2.3 and 2.8MHz. It combines two FM receivers for stereo reception at 2.3 and 2.8MHz with two RF amplifiers and operates from a supply of between 0.95 and 2.2V. The device is housed in a 16-pin SSOP package.

**Toshiba**  
Tel: 01276 694730  
[www.toshiba-europe.com](http://www.toshiba-europe.com)



scope connections to the system under test.

**Tektronix**  
Tel: 01344 392400  
[www.tektronix.com](http://www.tektronix.com)

### Step-down regulator for single cell Li-ions

Linear Technology is offering a synchronous, fixed frequency step-down regulator that can deliver up to 1.5A of current at 95 per cent efficiency. The LTC1875's input voltage range of 2.65V to 6V makes it suitable for single cell Li-ion, or multi-cell alkaline/NiMH battery powered applications. It can provide output voltages down to

0.8V to support the latest DSP and microcontroller operating voltages

**Linear Technology**  
Tel: 01276 677676  
[www.linear-tech.com](http://www.linear-tech.com)

### Hall-effect switch for battery-powered applications

The A3212 Hall-effect sensor IC available from Allegro Microsystems is a pole-independent micropower switch with a latched digital output. It includes a Hall-voltage generator, small-single amplifier, chopper stabilisation

circuitry, a latch and Mosfet output. The BiCMOS device's 2.5-3.5V operation, coupled with a clocking scheme, reduces its average operating power requirement to less than 15µW with a 2.75V supply. The device's output can be turned on by either a north or south pole of sufficient strength; in the absence of a magnetic field, the output is off. It uses chopper stabilisation to provide dynamic offset cancellation, which reduces the residual offset voltage normally caused by device overmoulding temperature dependencies, and thermal stress. The device also offers electrostatic discharge

### AC-to-DC converter with insulated transformer

The latest AC-to-DC converter from Rohm Electronics delivers a DC output of 12V and 350mA and can handle an input voltage range of 85V AC to 115V AC. A built-in transformer is designed to reduce component count and board space, while insulation on both primary and secondary windings ensures safe operation and device protection. The BP5710 offers a maximum withstand voltage between transformer primary and secondary windings of 1800V rms for 2s.

**Rohm Electronics**  
Tel: 01908 282666  
[www.rohm.co.uk](http://www.rohm.co.uk)



## NEWPRODUCTS

Please quote *Electronics World* when seeking further information

protection to 5kV. It is available in versions for operation over temperature ranges of -40 to 85°C and -40 to 150°C.

*Allegro Microsystems*  
Tel: 01932 253355  
www.allegromicro.com

### Switches get tactile jogger

Omron is introducing a small form factor jog lever switch that is designed to provide a tactile feel. Type B6J switches, which are designed for applications in consumer electronics, mobile phones, PDAs and voice recorders, provides tactile feedback in up, down and sideways (clockwise/anticlockwise) directions. Measuring 10mm wide and 2.9mm in height, the switch has a capacity of 5V with a 10mA DC resistive load, and offers contact resistance of 1Ω, rated at 5V DC, 1mA. Operating forces are 3.3 newtons in the push direction and 1.2 newtons in the lever direction.

*Omron*  
Tel: 020 8450 4646  
www.omron.com

### Test probes designed for a long life

Beadon is stocking the ranges of long life test probes and sockets from QA Technology. QA's patented rolled design probes incorporate a probe tube and plunger design that reduces radial plunger play at the probe



tube opening. The clearance between the tube and the plunger has been reduced by forming the tube around the plunger itself. According to the supplier, this feature reduces play from side to side and so improves pointing accuracy. The biasing force causes a well-defined wiping action between the plunger and the inner surface of the probe tube to provide improved electrical contact.

*Beading*  
Tel: 01460 62620

### Flexi-connector locks

Incorporating a cable lock option, the 62674 series of 0.5mm pitch vertical connectors from FCI is designed to provide cable retention for flexible printed circuits. Preheld by the connector's slider mechanism, cables are mated in a zero insertion force operation, said the supplier. The cable lock option is also designed to provide cable strain relief and prevents unintentional cable

release in applications susceptible to vibration. The connector has a 2.95mm height profile and it is available with 12, 20, 24, 25, 30, or 33 phosphor bronze, tin alloy plated contacts, with different pin counts available on request.

*FCI*  
Tel: 00331 3949 2082  
www.fciconnect.com

### Battery to mains converter costs £49

Merlin Equipment's latest range of inverters will convert 12V DC battery power to 230V AC mains power. Called Purewatts, the range includes five models with a number of power ratings from 150W to 1500W. All units feature full overload, overheat and short-circuit protection. According to the supplier, the two stage inverters are over 90 per cent efficient. Pricing starts at £49.

*Merlin*  
Tel: 01202 697979  
www.the-merlin-group.com



### Rf meter for 433MHz licence exempt applications

An RF meter from RF Solutions is a hand-held unit designed for validating the signal strength of radio transmitters on installation. It is also able to determine the presence of other RF signals that may cause interference.

The licence-exempt meter detects RF carrier signals at 433MHz. Signal strength is indicated by a ten LED display with one second peak hold function to simplify the reading of measurements. The unit operates from a single 9V PP3 battery and features one minute auto shut-off and battery low indication. The unit has an RF sensitivity of 110dBm and an IF bandwidth of 600kHz.

*RF Solutions*  
Tel: 01273 480661  
www.rfsolutions.com

### SPI/ASI interface converter for DVB

Yokogawa Matron has introduced a serial/parallel interface converter, the Model 70656, to assist with test equipment conversion

requirements in the development of DVB systems. According to the supplier, broadcasting systems are increasingly using serial-based

interfaces for the transmission of MPEG streams, leading to the need for parallel/serial interface conversion units such as the 70656. It carries out

SPI/ASI conversion in either direction, and is available in portable or rack mount form. In addition to serial/parallel conversion, it enables the data rate to be changed by inserting null packets into the transport stream. The packet length can be changed between 188, 204 or 208 bytes. The signal specification complies with ISO/IEC-13818, and the data rate is from 10kbit/s to 80Mbit/s.

*Yokogawa Matron*  
Tel: 01494 459200  
www.martron.com





**SMALL SELECTION ONLY LISTED - EXPORT TRADE AND QUANTITY DISCOUNTS - RING US FOR YOUR REQUIREMENTS WHICH MAY BE IN STOCK**

**Ring for Latest Reduced Prices on this advert**

HP8444A Tracking Generator • 5-1300Mc/s - £450.  
 HP8444A OPT 059 Tracking Gen • 5-1500Mc/s - £650.  
 HP35601A Spectrum ANZ Interface - £300.  
 HP4953A Protocol ANZ - 3400.  
 HP8970A Noise Figure Meter + 346B Noise Head - £3k.  
 HP8755A+B+C Scalar Network ANZ PI - £250 + MF 180C - Heads 11664 Extra - £150 each.  
 HP3709B Constellation ANZ £1,000.  
 FARNELL TVS70MKII PU 0-70V 10 amps - £150.  
 MARCONI 6500 Network Scaler ANZ - £500. Heads available to 40GHz many types in stock.  
 Mixers are available for ANZs to 60GHz.  
 Marconi TF2374 Zero Loss Probe - £200.  
 Rascal/Dana 1250-1261 Universal Switch Controller + 200Mc/s PI Cards and other types.  
 Rascal/Dana 9303 True RMS Levelmeter + Head - £450.  
 TEKA6902A also A6902B Isolator - £300-£400.  
 TEK CT-5 High Current Transformer Probe - £250.  
 HP Frequency comb generator type 8406 - £400.  
 HP Sweep Oscillators type 8690 A+B + plug-ins from 20Mc/s to 18GHz also 18-40GHz.  
 HP Network Analyser type 8407A + 8412A + 8601A - 100Kc/s - 110Mc/s - £500 - £1000.  
 HP 8410-A-B-C Network Analyser 110Mc/s to 12 GHz or 18 GHz - plus most other units and displays used in this unit - 8411A-8412-8413-8414-8418-8740-8741-8742-8743-8744-8650. From £1k.  
 Rascal/Dana 9301A-9302 RF millivoltmeter - 1.5-2GHz - in stock £250-£400.  
 Rascal/Dana Modulation Meter Type 9009-9008 - 8Me/s - 1.5GHz - £150/£250 - 9007-£200.  
 Marconi Microwave 6600A 1 sweep per sec, mainframe with 6650PI - 18-26.5 GHz or 6651PI - 26.5-30GHz-£750 or PI only £600. MF only £250.  
 Gould J3B test generator - manual - £150.  
 B&K Intrinsc Variable Filter EF3 0.1Hz-100Kc/s + High Pass + Low Pass Filters other makes in stock.  
 Rascal/Dana 9300 RMS voltmeter - £250.  
 HP 835A storage normalizer - £400 with lead + S.A. or PL + Marconi mod meters type TF2304 - £250 - TF2305 - £1,000.  
 Rascal/Dana counters-9990A-9905-9906-9915-9916-9917-9918-9919-9921-50Mc/s-3GHz - £100 - £400 - all fitted with FX standards.  
 HP180TR. HP181T, HP182T mainframes £300 - £500.  
 HP432A-435A or B-436A power meters - powerheads to 60GHz - £150 - £1750 - spare heads available.  
 HP3586A or C selective level meter - £500.  
 HP86222A+B Sweep PI 0.1-2 GHz + ATT £1000-£1250.  
 HP86290A+B Sweep PI 2-30GHz - £1000 - £1250.  
 HP8620C Mainframe - £250. IEEE E350.  
 HP8165A Programmable signal source - 1MHz - 50Mc/s - £1k.  
 HP3455/3456A Digital voltmeter - £400.  
 HP5370A Universal time interval counter - £1k.  
 HP5335A Universal counter - 200Mc/s-£1000.  
 TEKTRONIX 577 Curve tracer + adaptors - £500.  
 TEKTRONIX 1502/1503 TDR cable test set - £300.  
 HP8699B Sweep PI YIG oscillator .01 - 4GHz - £300 MF-£250. Both £500.  
 Dummy Loads + Power att up to 2.5 MWatts FX up to 18GHz - microwave parts new and ex stock - relays - attenuators - switches - waveguides - Yigs - SMA - APC7 plugs - adaptors etc. qty. in stock.  
 B&K Items in stock - ask for list.  
 Power Supplies Heavy duty + bench in stock - Famell - HP - Weir - Thurlby - Rascal etc. Ask for list. Large quantity in stock, all types to 400 amp - 100Kv.  
 HP8405A Vector voltmeter - late colour - £400.  
 HP8508A Vector voltmeter - £2500.

**LIGHT AND OPTICAL EQUIPMENT**  
 Anritsu ML93A + Optical Lead Power Meter - £250.  
 Anritsu ML93B + Optical Lead Power Meter - £300.  
 Power Sensors for above MA98A - MA98A - MA913A - Battery Pack MZ95A.  
 Anritsu MW97A Pulse Echo Tester.  
 PI available - MH914C 1.3 - MH915B 1.3 - MH913B 0.85 - MH925A 1.3 - MH929A 1.55 - MH925A 1.3GI - MH914C 1.3SM - £500 + one PI.  
 Anritsu MW98A Time Domain Reflector.  
 PI available - MH914C 1.3 - MH915B 1.3 - MH913B 0.85 - MH925A 1.3 - MH929A 1.55 - MH925A 1.3GI - MH914C 1.3SM - £500 + one PI.  
 Anritsu MZ100A E/O Converter.  
 + MG912B (LD 1.35) Light Source + MG92B (LD 0.85) Light Source £350.  
 Anritsu MZ118A O/E Converter.  
 +MH922A 0.8 O/E unit + MH923 A1.3 O/E unit £350.  
 Anritsu ML96B Power Meter + Charger £450.

Anritsu MN95B Variable Att. 1300 £100.  
 Photo Dyne 1950 XR Continuous Att. 1300 - 1500 £100.  
 Photo Dyne 1800 FA. Att £100.  
 Cossor-Raytheon 108L Optical Cable Fault Locator 0-1000M 0-10kM £200.  
 TEK P6701 Optical Converter 700 MC/S-850 £250.  
 TEK OF150 Fibre Optic TDR - £750.  
 HP8152A Head 150MC/S 950-1700 £250.  
 HP84801A Fibre Power Sensor 600-1200 £250.  
 HP8158B ATT OPT 002+011 1300-1550 £300.  
 HP81519A RX DC-400MC/S 550-950 £250.  
 STC OFR10 Reflectometer - £250.  
 STC OFSK15 Machine jointing + eye magnifier - £250.

**MISCELLANEOUS ITEMS**  
 HP 4261 LCR meter - £650.  
 HP 4274 FX LCR meter - £1,500.  
 HP 3488 Switch Control Unit - PI Booms - £500.  
 HP 75000 VXI Bus Controllers + £1328B-DVM-quantity.  
 HP 83220A GSM DCS/PCS 1900-1990MC/S converter for use with 8922A - £1,000.  
 HP 1630 1631-1650 Logic ANZ's in stock.  
 HP 8754A Network ANZ 4-1300MC/S + 8502A + cables - £1,500.  
 HP 8754A Network ANZ H26 4-2600MC/S + 8502A + Cables - £2,000.  
 HP 8350A Sweeper MF - 1500PI 2-B-4GHz - 8354A PI 5.9-12.4GHz - £3-£3,500.  
 HP MICROWAVE TWT AMPLIFIER 489A 1-2GHz 30DB - £400.  
 HP PRE AMPLIFIER 8447A 0.1-40GHz - £200. Dual - £300.  
 HP PRE AMPLIFIER 8447B 0.01-1.3GHz - £400.  
 HP POWER AMPLIFIER 8447E 0.01-1.3GHz - £400.  
 HP PRE + POWER AMPLIFIER 8447F 0.01-1.3GHz - £100.  
 HP 3574 Gain Phase Measr 1Hz-13MC/S OPT 001 Dual - £1,000.  
 MARCONI 2305 Modulation Meter-50kHz-2.3 GHz - £1,000.  
 MARCONI 2510 True RMS Meter - £450.  
 MARCONI 938B AF Power Meter (opt Sinad filter) - £250-£300.

MARCONI 6950-6960B Power Meters + Heads - £400-£500.  
 MARCONI SIGNAL SOURCE 6655-6056-6057-6058-6059-6060-6061-6062-6063-6064-6065-£250-£400.  
 RACAL 1732 COMMUNICATION RX - £500 early - £1,000 - late model with back lighting and byte test.  
 RACAL 1772 COMMUNICATION RX - £400-£600.  
 TEK MODULE MAINFRAMES TM500 502-503-504-506-507-508-5006.  
 TEK PI 5010-M1 Prog Mod Interface - £250. FG Prog 20MC/S Function Gen - £400. S1 Prog Scanner - £150 - DM Prog LAM - £400.  
 TEK 7600 OSCILLOSCOPE MAINFRAMES - 7603-7623-7633-7634-7635-7636-7637-7638-7639-7640-7641-7642-7643-7644-7645-7646-7647-7648-7649-7650-7651-7652-7653-7654-7655-7656-7657-7658-7659-7660-7661-7662-7663-7664-7665-7666-7667-7668-7669-7670-7671-7672-7673-7674-7675-7676-7677-7678-7679-7680-7681-7682-7683-7684-7685-7686-7687-7688-7689-7690-7691-7692-7693-7694-7695-7696-7697-7698-7699-7700-£100-£1,000.  
 TEK 7000 D's - 7A11-7A12-7A13 7A18-7A19-7A22-7A24-7A26 - A25-7A42-7B10-7B15-7B5A-7B6-7B85-7B92A-7D15-7D20.  
 TEK 7000 - 7S11-7S12-7S14-7M11-S1-S2-S3A-S4-S5-S6-S51-S53-954.  
 HP POWER SUPPLIES - 6621A-6623A-6624A-6632A-6652A. One available. Also 6000 types EPOA.

**WE KEEP IN STOCK HP and other makes of RF Frequency doublers which when fitted to the RF output socket of a S/Generator doubles the output frequency EG.50-1300MC/S to 50-2600MC/S price from £250 - £450 each.**

**SPECTRUM ANALYZERS**  
 HP 2100A 6Hz-50kHz - £750.  
 HP 3102A Dual 0.2Hz-25.5kHz - £1,500.  
 HP 3101A 10Hz-40MC/S - £3,500.  
 HP 3688A 10Hz-150MC/S - £1,500.  
 HP 8568A 100Hz-1.5GHz - £1,500.  
 HP 8568B 100Hz-1.5GHz - £3,500.  
 HP 8590B 1K/C/S - 1.8GHz - £4,500.  
 HP 8593B 1K/C/S - 1.2GHz - £3,500.  
 HP 8553A Signal Analyzer 15Hz-50kHz - £1,000.  
 LK492 10kHz-21GHz OPT 2 - £2,500.  
 TEK492P 10kHz-21GHz OPT 1-2-3 - £3,500.  
 TEK 02AP 50kHz-21GHz OPT 1-2-3 - £4,000.  
 TEK492BP 50kHz-21GHz - £3,000-£4,000.  
 TEK495 100kHz-1.8GHz - £2,000.  
 HP 8557A 0.01MC/S-350MC/S - £500 + MF180T or 180C - £150 - 182T - £500.  
 HP 8558B 0.01-1500MC/S - £750 - MF180T or 180C - £150 - 182T - £500.  
 HP 8559A 0.01-21GHz - £1,000 - MF180T or 180C - £150 - 182T - £500.  
 HP 8901A AM FM Modulation ANZ Meter - £800.  
 HP 8901B AM FM Modulation ANZ Meter - £1,750.  
 HP 8903A Audio Analyzer - £1,000.  
 HP 8903B Audio Analyzer - £1,500.

**MARCONI 2370 SPECTRUM ANALYZERS - HIGH QUALITY - DIGITAL STORAGE - 30Hz-110MC/S Large qty to clear as received from Gov - all sockets in full - complete or add £100 for basic test kit and adjustment - callers preferred - pick your own from over sixty units - discount on qty's of five.**  
**A EARLY MODEL GREY** - horizontal alloy cooling fins - £200.  
**B LATE MODEL GREY** - vertical alloy cooling fins - £300.  
**C LATE MODEL BROWN** - as above (few only) - £500.

**OSCILLOSCOPES**  
 TEK 465-465B 100MC/S + 2 probes - £250-£300.  
 TEK 466 100MC/S storage + 2 probes - £200.  
 TEK 475-475A 200MC/S-250MC/S + 2 probes - £300-£350.  
 TEK 2213-2213A-2215-2215A-2224-2225-2235-2236-2245-60-100MC/S - £250-£400.  
 TEK 2445 4ch 150MC/S + 2 probes - £450.  
 TEK 2445A 4ch 150MC/S + 2 probes - £600.  
 TEK 2445B 4ch 150MC/S + 2 probes - £750.  
 TEK 468 D.S.O. 100MC/S + 2 probes - £500.  
 TEK 468 350MC/S + 2 probes - £550.  
 TEK 2445 4ch 150MC/S - £1,150.  
 TEK 2445A 4ch 150MC/S - £1,550.  
 TEK D.S.O. 2430A -150MC/S + 2 probes - £1,750.  
 TEK D.S.O. 2440 -300MC/S + 2 probes - £2,000.  
 TEK TAS 475-485 -100MC/S-20MC/S-4 ch + 2 probes - £900-£1.1k.  
 HP1740A - 100MC/S + 2 probes - £250.  
 HP 1711A - 100MC/S storage + 2 probes - £200.  
 HP1720A - 1722A - 1725A - 275MC/S + 2 probes - £300-£400.  
 HP1744A - 100MC/S storage - large screen - £250.  
 HP1745A - 1746A - 190MC/S - large screen - £350.  
 HP54100A - 4GHz digitizing - £500.  
 HP54100A - 500MC/S digitizing - £500.  
 HP54071A - 100MC/S digitizing - £500.  
 HP 41100D - 1GHz digitizing - £1,000.

**MICROWAVE COUNTERS - ALL LED READOUT**  
 EIP 351D Autohet 20Hz-18GHz - £750.  
 EIP 371 Micro Source Locking - 20Hz-18GHz - £850.  
 EIP 451 Micro Pulse Counter - 300MC/S-18GHz - £100.  
 EIP 575 Microwave Frequency Counter - 10Hz-16.5GHz - £1,100.  
 EIP 578A Microwave Frequency Counter - 10Hz-16.5GHz - £1,100.  
 EIP 575 Microwave Source Locking - 10Hz-18GHz - £1.2k.  
 EIP 588 Microwave Pulse Counter - 300MC/S-26.5GHz - £1.4k.  
 SD 6054B Alarm Counter 20Hz-24GHz - SMA Socket - £800.  
 SD 6054E Micro Counter 20Hz-18GHz - N Socket - £700.  
 SD 6054D Micro Counter 800MC/S-18GHz - £600.  
 SD 6246A Micro Counter 20Hz-26GHz - £1.2k.  
 SD 6244A Micro Counter 20Hz-4.5GHz - £400.  
 HP5352B Micro Counter OPT 010-005-46GHz - new in box - £1k.  
 HP5340A Micro Counter 10Hz-18GHz - Nixey - £500.  
 HP5342A Micro Counter 10Hz-18-24GHz - £800-£1k - OPTS 001-002-003-004-011 available.  
 HP5342A + 5344A Source Synchronizer - £1.5k.  
 HP5345A 500MC/S 11 Digit LED Readout - £400.  
 HP5345A + 5354A Plug-in - 4GHz - £700.  
 HP5345A + 5355A Plug-in with 5356A 18GHz Head - £1k.  
 HP5385A 1GHz 5386A-5386A 3GHz Counter - £1k-£2k.  
 Rascal/Dana Counter 1991-160MC/S - £200.  
 Rascal/Dana Counter 1992-1.3GHz - £600.  
 Rascal/Dana Counter 9921-3GHz - £350.

**SIGNAL GENERATORS**  
 HP8640A - AM-FM 0.5-512-1024MC/S - £200-£400.  
 HP8640B - Phase locked - AM-FM-0.5-512-1024MC/S - £500-£1.2k. Opts 1-2-3 available.  
 HP8654A - B AM-FM 10MC/S-520MC/S - £300.  
 HP8656A SYN AM-FM 0.1-990MC/S - £900.  
 HP8656B SYN AM-FM 0.1-990MC/S - £1.5k.  
 HP8657A SYN AM-FM 0.1-1040MC/S - £2k.  
 HP8660C SYN AM-FM-PM-0.01-1300MC/S-2600MC/S - £2k.  
 HP8660D SYN AM-FM-PM-0.01-1300MC/S-2600MC/S - £3k.  
 HP8673D SYN AM-FM-PM-0.01-26.5 GHz - £12k.  
 HP3312A Function Generator AM-FM 13MC/S-Dual - £300.  
 HP3314A Function Generator AM-FM-VCO-20MC/S - £600.  
 HP3325A SYN Function Generator 21MC/S - £800.  
 HP3326A SYN 2CH Function Generator 13MC/S-IEEE - £1.4k.  
 HP3336A-B-C SYN Func/Level Gen 21MC/S - £400-£300-£500.  
 Rascal/Dana 9081 SYN S/G AM-FM-PH-5-520MC/S - £300.  
 Rascal/Dana 9082 SYN S/G AM-FM-PH-1.5-520MC/S - £400.  
 Rascal/Dana 9084 SYN S/G AM-FM-PH-.001-104MC/S - £300.

**SPECIAL OFFERS**

MARCONI 2019A SYNTHESIZED SIGNAL GENERATORS - 80KC/S-1040MC/S - AM-FM - £400 inc. instruction book - tested.  
 MARCONI 2022E SYNTHESIZED SIGNAL GENERATOR - 10KC/S-1.01GHz AM-FM - £500 inc. instruction book - tested.  
 R&S APN 62 LF Sig Gen 0.1Hz - 260 kHz c/w book - £250.

MARCONI 2383 S.ANZ 10Hz - 4.2 GHz. £2k  
 H.P. RF AMP 8349A 2-20 GHz microwave. £2k.  
 H.P. RF AMP 8347A 100 kHz - 3GHz £1,500.  
 H.P. 8922 radio communication test sets.  
 G - H - M. options various. £2,000 - £3,000 each.  
 H.P. 4193A VECTOR IMPEDANCE METER + probe kit. 400 kHz. To 110 ML/S. £3,500.

H.P. 83220A - E GMS UNITS for above. £1,000 - £1,500.  
 WAVETECK SCLUMBERGER 4031 RADIO COMMUNICATION TEST SET. Internal Spectrum ANZ. £1,800 - £2,000.  
 ANRITSU MSS55A2 RADIO COMM ANZ. To 1000MC/S. No C.R. tube in this model. £450.  
 TEK 2445A - 4CH - 150ML/S SCOPE + New X1 + X10-probe. Instruction book. £500 each.

ITEMS BOUGHT FROM HM GOVERNMENT BEING SURPLUS. PRICE IS EX WORKS. SAE FOR ENQUIRIES. PHONE FOR APPOINTMENT OR FOR DEMONSTRATION OF ANY ITEMS. AVAILABILITY OR PRICE CHANGE. VAT AND CARRIAGE EXTRA. ITEMS MARKED TESTED HAVE 30 DAY WARRANTY. WANTED: TEST EQUIPMENT-VALVES-PLUGS AND SOCKETS-SYNCRS-TRANSMITTING AND RECEIVING EQUIPMENT ETC.

**Johns Radio, Whitehall Works, 84 Whitehall Road East, Birkenshaw, Bradford BD11 2ER. Tel: (01274) 684007. Fax: 651160**



Please quote *Electronics World* when seeking further information

**8-bit microcontroller with dot LCD driver**

NEC's latest uPD789835 microcontrollers include an on-chip dot LCD driver that can drive a panel of up to 2304 dots. Aiming at the battery-powered applications, the devices feature an operating supply voltage of 1.8 to 3.6V and consumes 15µA (typical) while driving an LCD at 3.6V on a 32.768kHz sub-system clock. The integration on one chip of LCD display and system control functions such as a booster circuit that can boost the voltage up to 5V for LCD display, a freely configurable 16-level volume 3-octave scale audio sound generator, A/D converter, serial interface, and large capacity internal memory (up to 60Kbyte of ROM and 3624 bytes of RAM).  
**NEC**  
 Tel: 01908 691133  
 www.nec.com

**Right-angled M12 connector for rapid termination**

A range of right-angled M12 circular connectors designed for rapid termination has been introduced by Harting. Designed

for use in industrial sensor systems to M12 standards, the connectors are suited to applications where pre-assembled cable would previously have been used. With the design, cable can be terminated quickly, according to the supplier, eliminating the need for fixed-length pre-assembled cable. Called Harex, it uses axial insulation displacement technology to reduce installation, which involves removing the outer insulation of the cable, attaching the connector assembly, and tightening a screw cap. The finished joint offers strain relief as well as sealing to IP67. The right-angled M12 circular connector is available in 3- and 4-pin male and female versions, with maximum voltage and current ratings of 32V and 3A, respectively.  
**Harting**  
 Tel: 01604 766686  
 www.harting.com

**Hardware/software co-design support for ARM**

Celoxia has announced the next version of its Handel-C-to-hardware design suite. DKI.I includes features for system-level HW/SW co-design, co-

**Customised plastic enclosure in 10 days**

Radiatron is offering fully customised plastic enclosures for electronic equipment with a typical sampling time of 7-10 days and volume production available within 8 weeks. Customisation is based on a tooling technique that adapts one of over 350 'standard' parts without requiring completely new tooling. It is possible to add customised fascias, membrane or conventional keyboards, switches, indicators, transparent windows and even EMI shielding to the enclosures.  
**Radiatron**  
 Tel: 01784 439393  
 www.radiatron.com



simulation support for arm and PowerPC embedded processors, improved synthesis, enhanced area and delay analysis, improved VHDL output, 100 times faster simulation, and support for Actel, Altera Excilibur and Xilinx Virtex 11 Pro devices, said the firm. The design suite supports the design, validation, iterative refinement and implementation of complex algorithms in hardware. It includes built-in design entry, simulation, and synthesis - all driven by Handel-C. Handel-C is based on ANSI-C extended with concepts for timing, concurrency, flexible-width variables and resource allocation to implement complex algorithms efficiently in hardware.  
**Celoxia**  
 Tel: 01235 863656  
 www.celoxica.com

ripple current ratings of up to 2.80A rms at +105°C/ 100KHz. Devices can be selected from a range that spans 470µF to 3300µF, with voltage values of 6.3 to 16V DC. Case diameters of 8mm and 10mm are available. NRSK capacitors have an operating temperature range of -40°C to +105°C and a rated load life endurance of 2000 hours at the upper temperature.  
**NIC**  
 Tel: 01280 813737  
 www.niccomp.com

**Stereo headphone amps squeeze into hand-helds**

National Semiconductor is targeting its latest two Boomer stereo headphone amplifiers at applications in small, portable devices such as mobile phones, PDAs and MP3 players. The LM4910 is capable of delivering 35mW of continuous average power to a 32Ω BTL load with less than 1 per cent distortion (THD+N) from a 3.3V DC power supply. It uses a circuit topology that eliminates output coupling capacitors and half-supply bypass capacitors. The device contains advanced pop and click circuitry, which eliminates noises caused by transients that would otherwise occur during turn-on and turn-off. The LM4911 features a low-power consumption shut-down mode and a power mute mode that allow for faster turn-on time with less than 1mV

change at outputs on release. It is capable of delivering 40mW per channel of continuous average power into a 16Ω load, or 25mW per channel into a 32Ω load at 1% THD from a 3V power supply.  
**National Semiconductor**  
 Tel: 0870 242171  
 www.national.com



**Aluminium electrolytic with very low ESR**

The NRSK series of capacitors from NIC Eurotech combines what the supplier calls a low ESR performance with high ripple current ratings and long life, in a radial leaded, aluminium electrolytic device. Intended for low-voltage, high-current applications in power supplies, DC-DC converters and voltage regulator modules, the device has a 100kHz ESR specification of 0.012Ω, with

**Digital audio amps**

STMicroelectronics has introduced a family of digital audio amplifier chips based on Direct Digital Amplification (DDX) technology licensed from US firm Apogee Technology. Parts available today include the STA304A controller plus two power amplifier types: the STA500 and STA505. The STA304A converts two serial digital inputs in IIS or S/PDIF format into five channels of digital drive for DDX power amplifiers. It performs surround sound processing plus volume and tone controls. Other functions can be added by embedding additional software.  
**STMicroelectronics**  
 Tel: 01453 832820  
 www.st.com



Visit our website  
www.distel.co.uk

# THE ORIGINAL SURPLUS WONDERLAND!

THIS MONTH'S SELECTION FROM OUR VAST EVER CHANGING STOCKS

Surplus always  
wanted for cash!

## GIANT 10" 7 SEGMENT DISPLAYS

A bulk purchase enables us to bring to you these GIANT 7 segment digital displays at a now affordable price! The 10" character size gives exceptional readability at long distances and enables a host of applications including, score boards, digital clocks, counters, event timers etc. As the units are a simple electromechanical device and operate from 12 V DC, simple switching via switches, relays, PIC or PC may be used to control single or multiple digits. Units feature integral Zero Power memory which greatly simplifies design. For an excellent DIY practical article, see the May issue of 'Everyday & Practical Electronics' magazine, Ideal School / College construction project. Supplied in good RFE condition, complete with test sheet.



Less than 30% Only £29.95(B) or 4 / £99.00(D) of makers price!  
Order RW44 Order PH26

## THE AMAZING TELEBOX



TV SOUND &  
VIDEO TUNER  
CABLE COMPATIBLE\*

Converts your colour monitor into a QUALITY COLOUR TV!!

The TELEBOX is an attractive fully cased mains powered unit, containing all electronics ready to plug into a host of video monitors or AV equipment which are fitted with a composite video or SCART input. The composite video output will also plug directly into most video recorders, allowing reception of TV channels not normally receivable on most television receivers\* (TELEBOX MB). Push button controls on the front panel allow reception of 8 fully tuneable 'off air' UHF colour television channels. TELEBOX MB covers virtually all television frequencies VHF and UHF including the HYPERBAND as used by most cable TV operators. Ideal for desktop computer video systems & PIP (picture in picture) setups. For complete compatibility - even for monitors without sound - an integral 4 watt audio amplifier and low level Hi Fi audio output are provided as standard. Brand new - fully guaranteed.

TELEBOX ST for composite video input type monitors £36.95  
TELEBOX STL as ST but fitted with integral speaker £39.50  
TELEBOX MB Multiband VHF/UHF/Cable/Hyperband tuner £69.95  
For overseas PAL versions state 5.5 or 6 mHz sound specification.  
\*For cable / hyperband signal reception Telebox MB should be connected to a cable type service. Shipping on all Telebox s, code (B)

**NEW** State of the art PAL (UK spec) UHF TV tuner module with composite 1V pp video & NICAM hi fi stereo sound outputs. Micro electronics all on one small PCB only 73 x 160 x 52 mm enable full tuning control via a simple 3 wire link to an IBM pc type computer. Supplied complete with simple working program and documentation. Requires +12V & +5V DC to operate.  
**BRAND NEW - Order as MY00. Only £39.95 code (B)**  
See [www.distel.co.uk/data\\_my00.htm](http://www.distel.co.uk/data_my00.htm) for picture + full details

## HARD DISK DRIVES 2fi" - 14"

2 \* TOSHIBA MK1002MAV 1.1Gb laptop (12.5 mm H) New £39.95  
2 \* TOSHIBA MK4313MAT 4.3Gb laptop (8.2 mm H) New £105.00  
2 \* TOSHIBA MK6409MAV 6.1Gb laptop (12.7 mm H) New £98.00  
2 \* TOSHIBA MK1814CAV 18 Gb laptop (12 mm H) New £149.95  
2 \* to 3" conversion kit for PC's, complete with connectors £15.95  
3 \* COMPAQ 313706-B21 (IBM) 9 gb ULT/SCSI3 New £199.00  
3 \* FUJI FK-309-26 20mb MFM I/F RFE £59.95  
3 \* CONNER CP3024 20 mb IDE I/F (or equiv.) RFE £59.95  
3 \* CONNER CP3044 40 mb IDE I/F (or equiv.) RFE £69.00  
3 \* QUANTUM 40S Prodrive 42mb SCSI I/F, New RFE £49.00  
5 \* MINISCRIBE 3425 20mb MFM I/F (or equiv.) RFE £49.95  
5 \* SEAGATE ST-238R 30 mb RLL I/F Refurb £69.95  
5 \* CDC 94205-51 40mb HH MFM I/F RFE tested £69.95  
5 \* HP 97458 850 Mb SCSI RFE tested £99.00  
5 \* HP C3010 2 Gbyte SCSI differential RFE tested £195.00  
6 \* NEC D2248 85 Mb SMD Interface, New £99.00  
6 \* FUJITSU M2322K 180Mb SMD I/F RFE tested £195.00  
6 \* FUJITSU M2392K 2 Gb SMD I/F RFE tested £345.00  
Many other floppy & H drives, IDE, SCSI, ESDI etc from stock, see website for full stock list. Shipping on all drives is code (C)

## IC's - TRANSISTORS - DIODES

OBSOLETE - SHORT SUPPLY - BULK  
10,000,000 items EX STOCK  
For MAJOR SAVINGS  
CALL or see web site [www.distel.co.uk](http://www.distel.co.uk)  
COMPUTER MONITOR SPECIALS

Legacy products  
High spec genuine multisync.  
CGA, EGA, VGA, SVGA

Mitsubishi FA3415ETKL 14 SVGA Multisync colour monitor with fine 0.28 dot pitch tube and resolution of 1024 x 768. A variety of inputs allows connection to a host of computers including IBM PC's in CGA, EGA, VGA & SVGA modes. BBC, COMMODORE (including Amiga 1200), ARCHIMEDES and APPLE. Many features: Etched faceplate, text switching and LOW RADIATION MPR specification. Fully guaranteed, in EXCELLENT little used condition. Tilt & Swivel Base £A75

VGA cable for IBM PC included. Only £129 (E) Order as CG73

External cables for other types of computers available - CALL

## Generic LOW COST SVGA Monitors

We choose the make, which includes Compaq, Mitsubishi, IBM, etc. Supplied ready to run with all cables, Standard RTB 90 day guarantee.

14 £59.00 order TD84	15 £69.00 order TG21	17 £79.00 order TJ66
----------------------------	----------------------------	----------------------------

Supplied in good used condition. Shipping code (D)

## VIDEO MONITORS

PHILIPS HCS35 (same style as CM8833) attractively styled 14.62 colour monitor with both RGB and standard composite 15.625 KHz video inputs via SCART socket and separate phono jacks. Integral audio power amp and speaker for all audio visual uses. Will connect direct to Amiga and Atari BBC computers. Ideal for all video monitoring / security applications with direct connection to most concealed camera. High quality with many features such as front concealed flap controls, VCR correction button etc. Good used condition - fully tested - guaranteed  
Only £99.00 (D)  
Dimensions: W14" x H12" x 15" D.

PHILIPS HCS31 Ultra compact 9 colour video monitor with standard composite 15.625 KHz video input via SCART socket. Ideal for all monitoring / security applications. High quality, ex-equipment fully tested & guaranteed (possible minor screen burn). In attractive square black plastic case measuring W10" x H10" x 13" D. 240 V AC mains powered.  
Only £79.00 (D)

## INDUSTRIAL COMPUTERS

Tiny shoebox sized industrial 40 Mhz 386 PC system measuring only (mm) 266 w x 88 h x 272 d. Ideal for dedicated control applications running DOS, Linux or even Windows! Steel case contains 85 to 265 V AC 50 / 60 Hz 70 Watt PSU, a 3 slot ISA passive backplane and a Rocky 318 (PC104) standard, single board computer with 8 MByte NON VOLATILE solid state 'Disk On Chip' RAMDISK. System comprises: Rocky 318 (PC104) SBC ISA card with 40MHz ALJ 386SX CPU, 72 pin SIMM slot with 16 Mbyte SIMM, AMI BIOS, battery backed up real time clock. 2 x 9 pin D 16500 serial ports. EPP/ECP printer port, mini DIN keyboard connector, floppy port, IDE port for hard drives up to 528 MByte capacity, watchdog timer and PC/104 bus socket. The 8 Mbyte solid state 'disk on a chip' has its own BIOS, and can be fiddled, formatted & booted. Supplied BRAND NEW fully tested and guaranteed. For full data see featured item on website. Order as QG36  
100 s of applications inc:  
firewall, routers, robotics etc  
Unless marked NEW, items in this section are pre owned.

HP6030A 0-200V DC @ 17 Amps bench power supply	£1950
Intel SBC 486/125C08 Enhanced Multibus (MSA) New	£1150
Nikon HF-X-11 (Ephiphot) exposure control unit	£1450
PHILIPS PM5518 pro. TV signal generator	£1250
Motorola VME Bus Boards & Components List. SAE / CALL	EPOA
Trio 0-18 vdc linear, metered 30 amp bench PSU. New	£550
Fujitsu M3041R 600 LPM high speed band printer	£1950
Fujitsu M3041D 600 LPM printer with network interface	£1250
Siemens K4400 64Kb to 140Mb demux analyser	£2950
Perkin Elmer 299B Infrared spectrophotometer	£500
Perkin Elmer 597 Infrared spectrophotometer	£3500
VG Electronics 1035 TELETXT Decoding Margin Meter	£3250
LightBand 60 output high spec 2u rack mount video VDA's	£495
Seikonic SD 150H 18 channel digital Hybrid chord recorder	£1995
B&K 2633 Microphone pre amp	£300
Taylor Hobson Tallysurf amplifier / recorder	£750
ADC SS200 Carbon dioxide gas detector / monitor	£1450
BBC AM20/3 PPM Meter (Ernest Turner) + drive electronics	£75
ANRITSU 9654A Optical DC-2.5Gb waveform monitor	£5650
ANRITSU ML93A optical power meter	£990
ANRITSU Fibre optic characteristic test set	EPOA
R&S FTDZ Dual sound unit	£650
R&S SBUF-E1 Vision modulator	£775
WILTRON 6630B 12.4 / 20GHz RF sweep generator	£5750
TEK 2445 150 MHz 4 trace oscilloscope	£1250
TEK 2465 300 MHz 300 MHz oscilloscope rack mount	£1955
TEK TD380 400MHz digital realtime + disk drive, FFT etc	£2900
TEK TD5524A 500MHz digital realtime + colour display etc	£5100
HP3585A Opt 907 20Hz to 40 Mhz spectrum analyser	£3950
PHILIPS PW1730/10 60KV XRAY generator & accessories	EPOA
VARIACS - Large range from stock - call or see our website	
CLAUDE LYONS 12A 240V single phase auto. volt. regs	£325
CLAUDE LYONS 100A 240/415V 3 phase auto. volt. regs	£2900

## 19" RACK CABINETS

Europe's Largest Stocks of  
quality rack cabinets,  
enclosures and accessories.  
Over 1000 Racks from stock

This month's special  
33 / 42 / 47 U - High Quality  
All steel Rack Cabinets

BIG £ SAVER

Made by Eurocraft Enclosures Ltd to the highest possible spec, rack features all steel construction with removable side, front and back doors. Front and back doors are hinged for easy access and all lockable with five secura 5 lever barrel locks. The front door is constructed of double walled steel with a 'designer style' smoked acrylic front panel to enable status indicators to be seen through the panel, yet remain unobtrusive. Internally the rack features fully slotted reinforced vertical fixing members to take the heaviest of 19" rack equipment. The two movable vertical fixing struts (extras available) are pre punched for standard cage nuts. A mains distribution panel internally mounted to the bottom rear, provides 6 x IEC 3 pin Euro sockets and 1 x 13 amp 3 pin switched utility socket. Overall ventilation is provided by fully louvered back door and double skinned top section with top and side louvers. The top panel may be removed for fitting of integral fans to the sub plate etc. Other features include: fitted castors and floor levelers, prepunched utility panel at lower rear for cable / connector access etc. Supplied in excellent, slightly used condition with keys. Colour Royal blue, some grey available - CALL - Can be supplied in many other configurations.



33U Order as BC44 External dimensions mm=1625H x 635D x 603 W. (64 H x 25 D x 23 W) Only £245	42U Order as DT20 External dimensions mm=2019H x 635D x 603 W. (79.5 H x 25 D x 23 W) Only £345	47U Order as RV36 External dimensions mm=2235H x 635D x 603 W. (88 H x 25 D x 23 W) Only £410
--	--	--

Call for shipping quotation

## COLOUR CCD CAMERAS

BIG £ SAVER

Undoubtedly a miracle of modern technology & our special buying power! A quality product featuring a fully cased COLOUR CCD camera at a give away price! Unit features full autolight sensing for use in low light & high light applications. A 10 mm fixed focus wide angle lens gives excellent focus and resolution from close up to long range. The composite video output will connect to any composite monitor or TV (via SCART socket) and most video recorders. Unit runs from 12V DC so ideal for security & portable applications where mains power not available. Overall dimensions 66 mm wide x 117 deep x 43 high. Supplied BRAND NEW & fully guaranteed with user data, 100's of applications including Security, Home Video, Web TV, Web Cams etc. etc.

Order as LK33 ONLY £79.00 or 2 for £149.00 (B)

## SOFTWARE SPECIALS

NT4 WorkStation, complete with service pack 3 and licence - OEM packaged. ONLY £89.00 (B)  
ENCARTA 95 - CDROM, Not the latest - but at this price! £7.95  
DOS 5.0 on 3" disks with concise books c/w QBasic £14.95  
Windows for Workgroups 3.11+ Dos 6.22 on 3.5" disks £55.00  
Windows 95 CDROM Only - No Licence £19.95  
Wordperfect 6 for DOS supplied on 3" disks with manual £24.95  
shipping charges for software is code B

## SOLID STATE LASERS

Visible red, 670nm laser diode assembly. Unit runs from 5 V DC at approx 50 mA. Originally made for continuous use in industrial barcode scanners, the laser is mounted in a removable solid aluminium block, which functions as a heatsink and rigid optical mount. Dims of block are 50 w x 50 d x 15 mm. Integral features include over temperature shutdown, current control, laser OK output, and gated TTL ON / OFF. Many uses for experimental optics, comms & lightshows etc. Supplied complete with data sheet.  
Order as TD91 ONLY £24.95 (A)

## DC POWER SUPPLIES

Virtually every type of power supply you can imagine. Over 10,000 Power Supplies  
Ex Stock - Call or see our web site.

## RELAYS - 200,000 FROM STOCK

Save ££££ by choosing your next relay from our Massive Stocks covering types such as Military, Octal, Crede, Hermetically Sealed, Continental, Contactors, Time Delay, Reed, Mercury Wetted, Solid State, Printed Circuit Mounting etc. CALL or see our web site [www.distel.co.uk](http://www.distel.co.uk) for more information. Many obsolete types from stock. Save ££££

display  
-ELECTRONICS-

ALL MAIL TO  
Dept W, 29 / 35 Osborne Rd  
Thornton Heath  
Surrey CR7 8PD, UK  
Open Mon - Fri 9.00 - 5:30

18 Million Items On Line Now!  
Secure Ordering, Pictures, Information  
www.distel.co.uk  
email = admin@distel.co.uk

ALL ENQUIRIES  
0208 653 3333  
FAX 0208 653 8888



All prices for UK Mainland. UK customers add 17.5% VAT to TOTAL order amount. Minimum order £10. Bonus Fide account orders accepted from Government, Schools, Universities and Local Authorities - minimum account order £100. Cheques over £100 are subject to 7 working days clearance. Carriage charges (A)=£3.50, (B)=£6.50, (C)=£10, (D)=£15.00, (E)=£18.00, (F)=CALL. Allow approx 3 days for shipping - faster CALL. All goods supplied to our Standard Conditions of Sale which can be viewed at our website and unless stated guaranteed for 90 days. All guarantees on a return to base basis. All rights reserved to change prices / specifications without prior notice. Orders subject to stock. Discounts for volume. Top CASH prices paid for surplus goods. All trademarks, tradenames etc acknowledged. Display Electronics 2002. E & O.E.



# Phase noise and frequency synthesisers

Ian Poole explains how phase noise affects a synthesiser's performance, and offers tips on how to minimise it.

**F**requency synthesisers are in widespread use in areas from hi-fidelity tuners to car radios and cellular telephones. They have become an everyday part of radio frequency design because of their flexibility, stability and frequency setting.

Without frequency synthesisers, many of the facilities that are required for today's communications would be far more difficult to achieve. This would severely impact areas such as cellular telecommunications as well as wireless technologies such as Bluetooth and the like. This makes frequency synthesisers critical to today's electronics and radio technology.

There is a number of types of frequency synthesiser, but the type that is in most widespread use today is based on the phase locked loop. It is sometimes referred to as an indirect synthesiser. Such synthesisers offer a considerable amount of flexibility and there are plenty of ICs that are available around which these circuits can be designed.

In another technique, called direct digital synthesis, the waveform is generated completely digitally. Such synthesisers are more expensive to implement. Also, they are not quite as widely used, although their use is increasing as costs fall.

Despite the fact that indirect synthesis has many advantages, it has some disadvantages too. The main one concerns the phase noise that can be generated. Synthesisers have to be carefully designed to ensure that the levels of phase noise fall within the design requirements, otherwise system performance can be degraded.

## Basic synthesisers

Before investigating phase noise any further, I'll present a brief overview of indirect synthesis.

The basic building block is a phase-locked loop as already mentioned. This consists of three main blocks: the phase detector, the loop filter and the voltage controlled oscillator (VCO). A reference signal, from a crystal oscillator or other source enters one input to the phase detector while the other input receives a signal from the voltage controlled oscillator.

The phase detector generates an error voltage proportional to the phase difference between the two input signals. This is passed through the loop which serves a number of functions, one of which is to remove the high frequency signals, and especially the one at the comparison frequency that would give rise to sidebands on the output of the synthesiser.

Having passed through the loop filter, the error voltage is applied to the control input of the VCO. It has the effect of trying to reduce the phase difference and hence the frequency difference between the two signals entering the phase detector.

Eventually a point is reached where a steady phase difference exists between the two signals. As the phase difference is constant this means that the signal from the VCO and the reference are on exactly the same frequency. This basic circuit enables the VCO to produce a signal on the same frequency as the reference, Fig. 1.

A frequency synthesiser is required to produce a signal on a variety of frequencies. To achieve this further circuitry is required in the phase-locked loop. A programmable divider is placed into the loop between the VCO and the phase detector as shown in Fig. 2. In this way, the VCO frequency is divided down by the ratio of the divider.

Now the loop will fight to reduce the phase difference for the two signals at its input. Hence the frequency of the two signals at the input to the phase detector will be the same. With a divider set to a division ratio of  $N$ , this means that the VCO must operate at a frequency  $N$  times the phase comparison frequency, i.e. at  $N$  times the reference frequency. By changing the division ratio the VCO

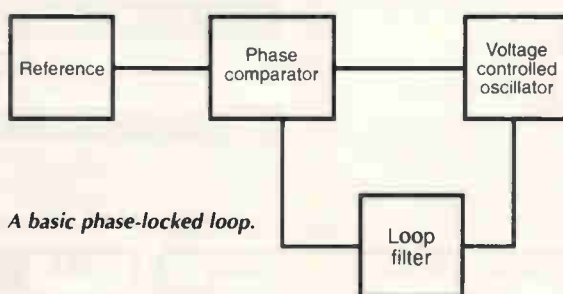

Fig. 1. A basic phase-locked loop.



frequency can be changed.

The synthesiser steps in frequency increments equal to the phase comparator frequency. To have small steps, a low phase comparison frequency is required. This can result in very high division ratios being required – especially if the synthesiser is operating in the VHF or even UHF portion of the radio spectrum.

This is a basic form of synthesiser. More complicated systems using several loops some containing mixers can be devised to keep the division ratios low, and to provide higher levels of performance. However one of the major drawbacks of synthesisers based around phase locked loops is that they can generate large levels of phase noise if they are not designed to avoid this.

### What is phase noise?

Some phase noise appears on all signals to a greater or lesser degree. Crystal oscillators are very good in this respect, generating the lowest levels.

Variable frequency oscillators are not as good. They are not as stable as crystal oscillators or synthesisers. Nevertheless, their performance is acceptable for most applications. A poorly designed frequency synthesiser can be very bad. Some designs do manage to achieve very low levels of phase noise though, but this is often at the price of possibly using several loops and the associated additional cost.

Phase noise can be considered as short-term fluctuations in the phase of a signal: in view of this it is sometimes called phase jitter. It manifests itself as noise modulation on the signal and accordingly it results in sidebands spreading out from the carrier of the signal.

In most cases the noise falls away as the frequency offset from the carrier increases as shown in Fig. 3. However for synthesisers based on phase locked loops the situation is a little more complicated as we shall see later.

### Quantifying phase noise

It is necessary to be able to quantify the level of phase noise on a carrier. Unlike a carrier that occupies a single frequency, noise spreads out over a wide band of frequencies. In order to measure noise a certain bandwidth has to be specified.

In addition to this its position has to be specified as well if the noise varies with frequency. In the case of phase noise it is generally specified in a 1 hertz bandwidth and at a certain offset from the carrier. For example a level of noise may be quoted as being 90dB down on the carrier in a 1Hz bandwidth at 10kHz offset or -90dBc/Hz at 10kHz.

Phase noise can degrade the performance of both receivers and transmitters. In a receiver, an effect known as reciprocal mixing is a cause of degradation. Here the phase noise from the local oscillator can mix with a strong off channel signal to give rise to a signal that can fall within the passband of the IF.

For transmitters the effect of phase noise can be to spread noise either side of the transmission. Phase noise can naturally have a particular effect on phase modulated transmissions where it will introduce errors, degrading the bit error rate when data is transmitted. In view of all these effects it is of paramount importance to ensure that the levels of phase noise are kept to the minimum when designing a synthesiser.

### The loop and phase noise

In order to keep the level of phase noise to a minimum, it is necessary to know how the different elements of the

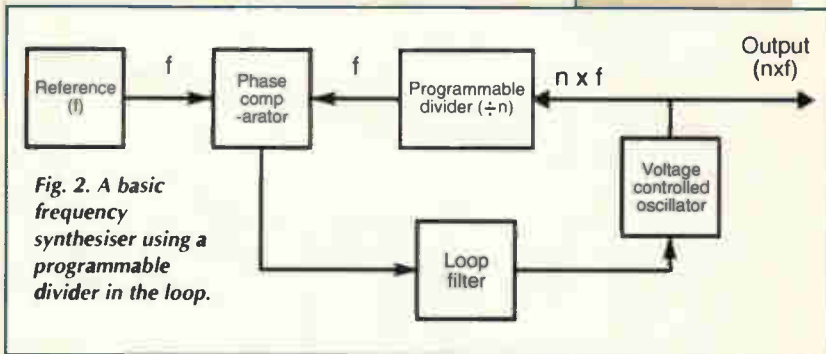

Fig. 2. A basic frequency synthesiser using a programmable divider in the loop.

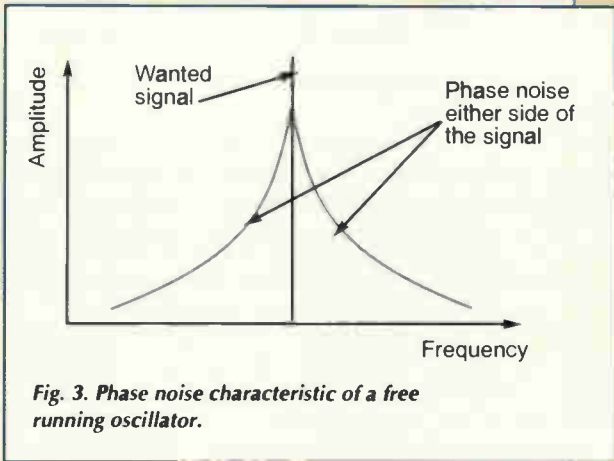

Fig. 3. Phase noise characteristic of a free running oscillator.

loop generate noise and how the action of the loop affects this. For example, phase noise generated by the VCO contributes to the overall phase noise contour in a different way from that generated by the phase detector.

It is necessary to ensure that the noise from each element in the loop is minimised. However the loop filter has the most effect on the final performance because it determines the break frequencies where noise from different parts of the circuit start to affect the output, Fig. 4.

To see how this happens, take the example of noise from the VCO. Noise from the oscillator will be divided by the divider chain and will appear at the phase detector. Here it will appear as small perturbations in the phase of the signal and will emerge at the output of the phase detector.

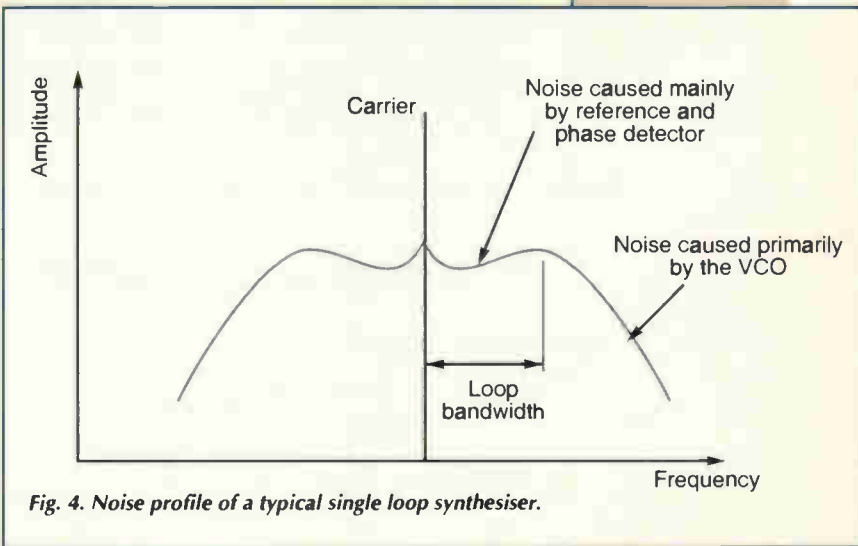

Fig. 4. Noise profile of a typical single loop synthesiser.

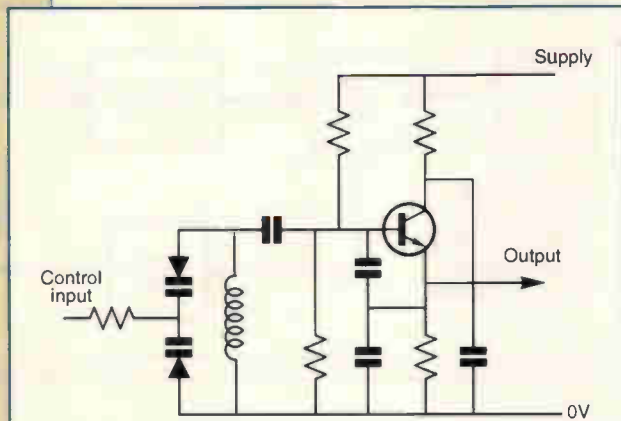

Fig. 5. A typical VCO circuit.

When it comes to the loop filter, only those frequencies that are below its cut-off point will appear at the control terminal of the VCO to correct or eliminate the noise. From this it can be seen that VCO noise which is within the loop bandwidth will be attenuated, but that which is outside the loop bandwidth is left unchanged.

The situation is slightly different for noise generated by the reference. This enters the phase detector and again passes through it to the loop filter where the components below the cut-off frequency are allowed through and appear on the control terminal of the VCO. Here they add noise to the output signal. So it can be seen that noise from the reference is added to the output signal within the loop bandwidth but it is attenuated outside this.

Similar arguments can be applied to all the other circuit blocks within the loop. In practice, the only other block that normally has any major effect is the phase detector. Its noise affects the loop in exactly the same way as noise from the reference. The frequency divider creates some, but often the noise from this source will be combined with that from the phase detector.

Fortunately, noise from the reference and phase detector is generally very low when they are considered on their own. Unfortunately their contribution is often critical in the overall performance because the loop multiplies the frequency of the reference signal.

Also, the level of phase noise is multiplied. In fact, the amount by which it is multiplied is simply  $20 \log_{10} N$ , where  $N$  is the division ratio of the divider. So a loop that has a divider set to 2, and has a multiplication factor of 2, will multiply the noise of the reference and phase detector by 6dB. As multiplication factors increase, so does the noise.

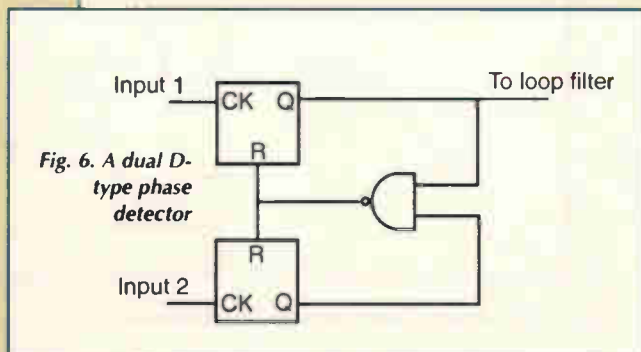

Fig. 6. A dual D-type phase detector

### Keeping the noise down

There are many ways of improving the noise performance of a synthesiser. The first can be seen from the example given above, i.e. to reduce the division ratio within any loop. This reduces the level of noise resulting from the phase detector and the reference that occurs within the loop bandwidth.

Step sizes should be kept as large as possible, but where this is not possible it can be achieved by designing a multi-loop synthesiser. There's a number of ways of designing multi-loop synthesisers, but by doing this it is possible to ensure the division ratio in any loop is kept to reasonable limits.

Another guideline is to keep the loop bandwidth as wide as possible. The noise from the VCO rises towards the carrier. However the loop has the action of cleaning up the VCO noise inside the loop bandwidth. Therefore if the loop bandwidth can be maintained as wide as possible the noise from the VCO can be minimised. This is often a difficult balance. If the step size is small and hence the comparison frequency is low then the loop bandwidth will need to be narrow to prevent the components of the comparison frequency from passing through the loop filter and giving rise to sidebands on the signal.

Apart from addressing the 'system' aspects, it is also possible to design the individual circuits to have the lowest possible noise. Reference oscillators are normally bought in as manufactured items and it is normally a matter of choosing the one with the optimum phase noise performance. If one is being built then many of the guidelines used for a VCO can be followed.

The performance of the VCO can normally be improved. Noise in an oscillator arises in a number of different ways. Naturally, the first point to note is that decoupling should be very good to ensure that no unwanted noise or ripple from the power supply is superimposed on the oscillator signal. This can be effected by local regulation for the oscillator circuit, and good decoupling very close to the oscillator. However it is also necessary to look closer at the different types of noise contribution.

At large offsets from the carrier, the noise profile is relatively flat. This noise depends on factors in the oscillator design such as the noise figure of the active device. It should also be run under the optimum operating conditions for low noise performance.

Another way in which the performance can be improved is to increase the power level of the oscillator. As the noise floor of the oscillator remains substantially the same, increasing the power level gives a significant improvement in the signal to noise ratio. When running oscillators at high power levels beware of spurious signals, or different modes of oscillation resulting in discontinuities in the tuning which are more likely to be present under these conditions, Fig. 5.

Closer in it is again necessary to optimise the oscillator for optimum noise performance. However improvements can also be made by ensuring that the loaded Q of the tuned circuit is as high as possible. Choice of tuning diode plays a large part in this as does the tuning range of the oscillator. Unfortunately the designer does not always have much control over this, although different ranges can be switched in as required.

Very close-in flicker noise dominates. This arises from the  $1/f$  noise that is present on any oscillator. It results in both amplitude and phase modulation of the signal because it modulates such factors as the transconductance and the junction capacitances in the transistor.

This type of noise can be reduced in a number of ways.



One is to increase the low frequency feedback in the oscillator. This is easily effected by introducing a small unby-passed emitter resistor in a bipolar transistor circuit. Using a FET rather than a bipolar transistor is also supposed to help.

While these precautions are focused on the voltage controlled oscillator, most of them are equally applicable to the reference oscillator as well. In this way, one of the contributing components to the noise inside the loop filter can be reduced. The other main contributor to this is the phase detector.

Today, most phase detectors are included within a specially designed synthesiser chip. Optimising the phase noise performance of synthesisers using these chips is difficult because there is no access to the critical areas of the circuit.

Where a phase detector is made from individual chips then it is possible to take a number of steps to improve the performance. A typical circuit arrangement is shown in Fig. 6. It is based on two D-type bistable devices.

Circuit layout is very important. Crosstalk between the two inputs can have a significant effect and therefore input lines should be separated. Also supplies to the ICs should

be decoupled right on the IC itself. Some people even use D-types in different packages to reduce the crosstalk.

Another problem occurs in what is termed the dead zone. When the loop is in lock, the pulses emanating from the Q and Q bar outputs tend to zero, giving the detector zero gain. Accordingly the loop tends to wander slightly, producing noise. To overcome this a small amount of leakage can be added into the loop by placing a high value resistor from the tune line to ground.

#### In summary

Designing a synthesiser is by no means easy. Difficult compromises need to be made. Cost, agility, noise profile, sideband levels, and many more conflicting requirements, all have to be carefully balanced to give an acceptable overall performance. However by having a good understanding of the major contributions to the noise and how they contribute to the overall noise profile, it is easier to make sound judgements. ■

Further information about all aspects of radio and electronics can be found at [www.radio-electronics.com](http://www.radio-electronics.com)

## Build and Upgrade Your Own PC

Second Edition

- Save £100s by making your current PC last longer
- You can have a PC with a spec that matches your needs
- Discover the practical techniques of upgrading a PC and avoid the pitfalls

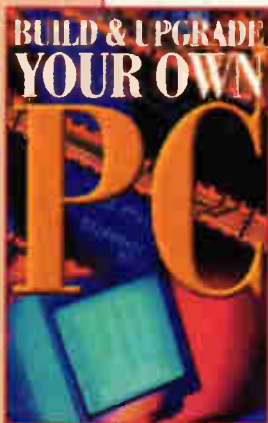

Ian Sinclair's Build Your Own books have established themselves as authoritative and highly practical guides for home PC users and advanced hobbyists alike. All aspects of building and upgrading a PC are covered; making this the book the computer retailers don't want you to read! By getting to grips with the world of PC hardware you can avoid the built-in obsolescence that seems to be part and parcel of the fast moving world of PCs, and escape the need to buy a new PC every year. You can also have a PC that keeps pace with the ever-increasing demands that new software applications place on your system.

The new edition of this book is based round building and upgrading to the latest systems such as Pentium III and dual-processor Celeron motherboards running Windows 95/98 or Windows 2000. As well as guiding you round the inside of your CPU Ian Sinclair also covers monitors, printers, high capacity disk and tape systems, DVD drives, parallel port accessories....

**CONTENTS:** Preface; Preliminaries, fundamentals and buying guide; Case, motherboard and keyboard; About disk drives; Monitors, standards and graphics cards; Ports; Setting up; Upgrading; Multimedia and other connections; Windows; Printers and modems; Getting more; Index

## How to pay

(Build and Upgrade Your Own PC) paperback

I enclose a cheque/bank draft for £ \_\_\_\_\_

(payable to *ELECTRONICS WORLD*)

Please charge my credit/charge card

Mastercard  American Express  Visa  Diners Club

Credit Card No: \_\_\_\_\_

Expiry Date: \_\_\_\_\_

Signature of Cardholder \_\_\_\_\_

Cardholder's statement address: (please use capitals)

Name \_\_\_\_\_

Address \_\_\_\_\_

Post Code \_\_\_\_\_ Tel: \_\_\_\_\_

### Post your completed order form to:-

**Jackie Lowe, Cumulus Business Media,  
Anne Boleyn House, 9-13 Ewell Road, Cheam,  
Surrey, SM3 8BZ**

**Fax your completed order form to 020 8722 6098  
UK Price: £22.50 Europe £24.00 ROW £26.00  
Price includes delivery**



**Joe Carr provides a lightning backgrounder and presents some ideas for doing making your own measurements in safety.**

# Observing lightning

**L**ightning is a familiar and often feared natural phenomenon. Although lightning is seen in all areas of the US, southern Arizona and central Florida are areas of extremely high flash density. This means that there's a high number of cloud-to-ground strikes per square mile per year.

When lightning strikes, property can be damaged, fires started, trees can be split in two – or, oddly, the bark can come off leaving the tree core intact – and, sadly, sometimes people are killed. It's not surprising that the electrical power industry is a leader in lightning research because of the damage done to their power lines by lightning.

## Types of lightning

Cloud-to-ground lightning passes from a cloud overhead to the Earth beneath, Fig. 1. Most cloud-to-ground strikes occur in the higher latitudes, although recent research indicates a more

important variable is cloud top height.

Cloud-to-ground lightning is what causes injury and damages. Cloud-to-cloud or 'inter-cloud' lightning passes from one cloud to another. Intra-cloud lightning appears within a single cloud. The 'jagged' lightning that we see so often is called chain lightning, while sheet lightning is a generalised bright flash.

Other types of lightning may or may not be little more than myths, poor observations – e.g. optical illusions – variations on other types, or real, depending on who you consult. These include ball lightning, tubular lightning, bead lightning, silent lightning, cloud-to-air lightning (as opposed to cloud-to-cloud), and heat lightning.

## Lightning facts

Human casualties are common. The daughter of a former governor of Virginia was struck at the National Guard Camp Pendleton (Virginia) beach in southeast Virginia. Florida saw 298 confirmed lightning deaths in the thirty year period 1959 to 1989.

Between 1940 and 1989, there were 8103 confirmed lightning deaths in the United States (SIRS 1990, 'Earth Science', Article 67). According to the National Oceanic and Atmospheric Administration (NOAA), lightning killed 88 people in 1995.

About 30 percent of the people struck each year are killed. I would have guessed that nearly all of them would have been killed, with only a few survivors. But the statistics apparently suggest otherwise.

Those people who are killed usually succumb to cardiac arrest. The survivors frequently suffer serious heart problems thereafter, and most have to be treated for severe burns.

One source claimed that there are cases on record where

*Fig. 1. Most cloud-to-ground strikes occur in the higher latitudes, although recent research indicates a more important variable is cloud top height.*

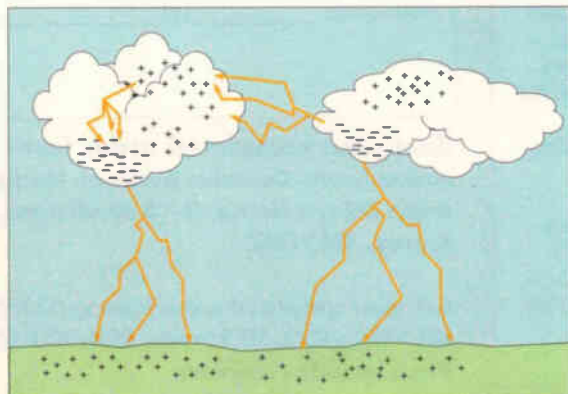



lightning did not even break the skin, but travelled the wet surface of their body to ground. The skin was said to be severely burned, after the manner of scalding.

It is estimated that Earth is struck by lightning 20 million times per year. And if you believe the old myth about 'lightning never strikes the same place twice' then consider the fact that the Empire State Building in New York City takes about twelve strikes per year.

Radio and television antenna towers are also struck frequently. I hasten though to add that they do not 'attract' lightning that would not have come anyway. They tend to act as lightning rods.

The lightning is generated under up to 15 000 000 volts of electrical potential. According to one source there is normally an atmospheric potential cloud-to-ground of 200 000 to 500 000 volts, and a constant but minuscule current of  $10^{-12}$  amperes.

Inside the lightning bolt, the temperature is 15 000 to 60 000 degrees centigrade, which is several times the temperature on the Sun. The lightning bolt travels at speeds up to 100 000, 000 feet per second.

A lightning bolt is actually a series of strokes, averaging about four. Duration varies from a few nanoseconds upward, but about thirty microseconds is said to be average. The average peak power per stroke is  $10^{12}$  watts.

Many people struck by lightning were in unsafe situations. For example, on an open beach or in an open field such as a golf course. It is also not smart to be in a boat on the water. Standing next to a tree or other tall object, such as a radio tower, is also rather dangerous, as the lightning may easily be attracted to that tree.

In one case, a group of golfers was struck when lightning struck a nearby tree and travelled underground, to a covered pavilion where they had taken refuge from the storm. Carrying an umbrella with a metal tip above the canopy has caused lightning injuries, presumably because it looks to the lightning like a lightning rod... and you look like a ground wire!

As a general – but not absolute – rule, as long as you can hear thunder, the danger of strike is small. Lightning travels at the speed of light ( $3 \times 10^8$  meters/second), while sound travels at 331.3 meters per second at  $0^\circ\text{C}$  (sound velocity changes a bit with air temperature), or 1087 feet per second. As a result, the flash of light arrives instantaneously, while the sound of thunder arrives a short time later (measured in seconds).

A 'rule of thumb' is to count the seconds between the flash and thunder clap, and then divide by five, to find the number of miles to the lightning bolt. One reason why I doubt validity of the 'can hear thunder' advice is that I've been under thunderstorms where the lightning flash and thunder were very nearly simultaneous, indicating it was right overhead.

More precise measurements of distance can be done using a good stopwatch to measure the time of arrival of the thunder-clap. From that data you can calculate the distance from  $D=VT$ , where  $D$  is the distance and  $V$  is the velocity (if you use m/s for  $T$  then  $D$  is in meters, but if ft/s is used  $T$  is in feet). You can further refine your measurements by consulting a table of sound velocity related to temperature and atmospheric pressures.

### Some lightning detection history

Before we talk about early lightning research let me hasten to add a caution: **DON'T EVEN THINK ABOUT DOING THESE EXPERIMENTS YOURSELF!** People who've tried to duplicate these experiments have been killed in the attempt.

Electrical phenomenon was researched starting in the early eighteenth century. It was noticed that certain substances when rubbed produced static electricity arcs.

It was also found that a type of capacitor called a Leyden Jar could store electrical charge. It was believed, correctly of

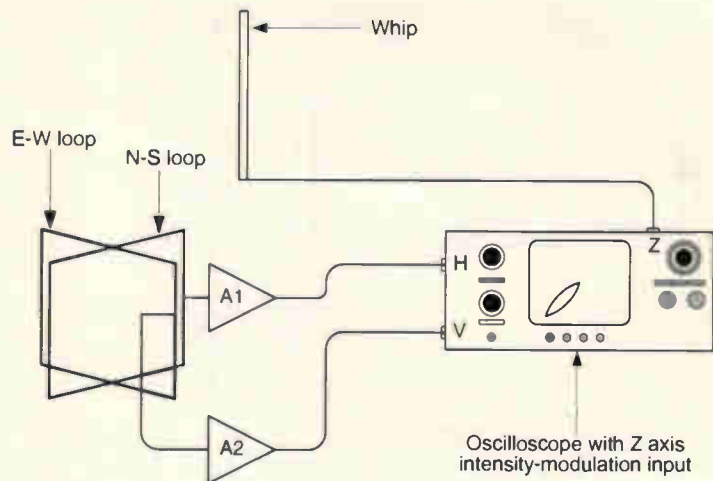

Oscilloscope with Z axis intensity-modulation input

course, that these sparks looked enough like lightning to suggest a connection.

In May 1752, Thomas Francois D'Alibard in France performed an experiment that Benjamin Franklin had failed at the year before. The experimenter stood on an electrical stand, holding an iron rod in one hand. The idea was to produce an electrical arc between that rod and another rod in the other hand connected to a grounded iron wire.

In an attempt to repeat the experiment in July 1753, Swedish physicist G.W. Richmann, working in Russia, was killed by the lightning.

Benjamin Franklin conducted his famous kite experiment in 1752. He used a rain-damped kite string connected to a key at the bottom. The lightning travelled down the string, and jumped from the key to a dry silk ribbon tied to Franklin's knuckles, and then through his grounded body. Others who attempted this experiment were killed.

It's interesting to wonder what the American republic would look like if Franklin, having been killed in 1752, was not alive to provide wisdom to the Constitutional Convention (his compromise suggestion, which reconciled the 'large states versus small states' controversy, is supposedly how we got the bicameral Congress).

When photography and spectroscopy were invented in the nineteenth century additional facts were learned about lightning.

Time-resolved photography was used to count the number of strokes per lightning strike. Current measurements were made by Pockels in Germany during 1897 to 1900. He analysed the magnetic fields induced by the lightning currents to estimate the current level from basic electrical fundamentals.

Around the 1920s, C.T.R. Wilson, who also invented the cloud chamber, used electric field measurements to study lightning. Wilson hypothesised that the electrical fields cause such great ionisation that it's possible for discharges to occur between the clouds and the upper atmosphere. Seeming con-

**Fig. 2.** There are some lightning-effect observation instruments that are easily built and relatively safe to use. The storm scope is one such instrument.

### Most common activities leading to lightning strikes on humans

1. Working, playing or walking in open fields.
2. Boating, fishing, swimming.
3. Working on heavy farm or road construction equipment.
4. Playing golf (!!!)
5. Talking on the telephone.
6. Using electrical appliances.

This list was derived from NASA web site:  
<http://www.thunder.msfc.nasa.gov/primer.html>

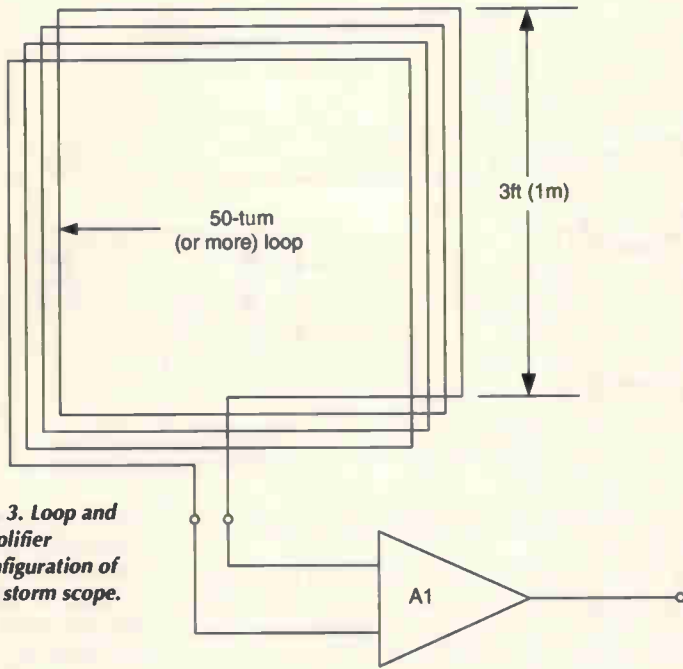

Fig. 3. Loop and amplifier configuration of the storm scope.

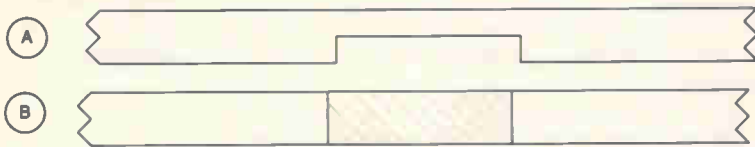

Fig. 4. A loop pair can be constructed using 0.75in by 4in by 36in lumber. A notch, as in a), is cut at the centre of the top and bottom members of each loop. The depth of the notch is the thickness of the lumber, while the width is sufficient to snug-fit the other piece of wood in it, b).

firmation of the 1925 theory was provided on 28 April 1990 when Shuttle mission STS-32 video taped a single luminous discharge in the stratosphere.

Modern lightning research still measures electrical and magnetic fields, but adds other techniques now assist analyses. Cameras with electrically triggered shutters can be used with photosensors to make photographs of lightning strikes. High-speed movie cameras are also used, although the invention of charge coupled device (CCD) sensors (which are used in video cameras) has allowed a number of new instruments to emerge.

Other researchers rely on radio waves – especially the whistlers, spherics and broadband RF noise generated in the ELF/VLF/LF portions of the radio spectrum. This type of research is also easily conducted by amateur scientists.

At a site in Florida, researchers fire three-foot high solid fuel rockets into thunderclouds. The rocket trails a grounded wire that conducts the stroke to earth (AMATEUR ROCKETEERS: DON'T DO THIS!).

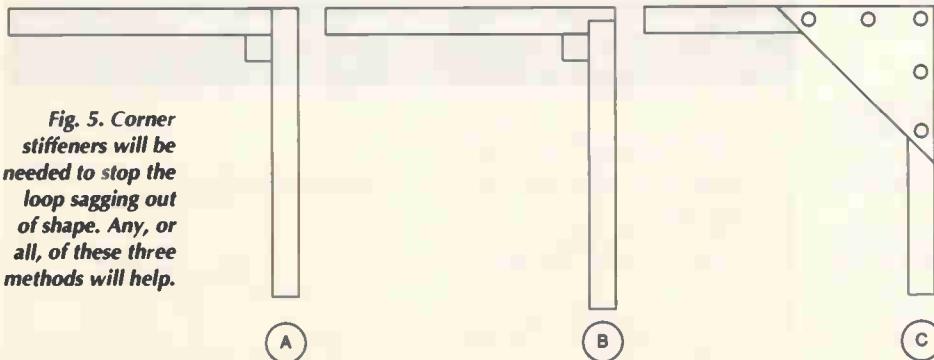

Fig. 5. Corner stiffeners will be needed to stop the loop sagging out of shape. Any, or all, of these three methods will help.

The Space Shuttle and satellites are also being used for lightning research. Some hauntingly beautiful video footage of space shuttle lightning is available from NASA web sites. High-altitude aircraft lightning research revealed newly discovered phenomenon called sprites and jets.

**Storm scope**

Lightning research can be terribly dangerous, especially if it puts you out in the open or if you are foolish enough to mimic professional methods such as ground wire tethered rockets. There are, however, some instruments that are easily build and relatively safe to use. The storm scope is one such instrument.

Figure 2 shows the basic configuration. This project was originally published by Thomas P. Leary in the June 1964 QST magazine. His implementation used vacuum tube amplifiers though.

The storm scope consists of a pair of orthogonal small loop antennas, one oriented north-south (N-S loop) and the other east-west (E-W loop). Keep in mind that a small loop antenna – less than  $0.18\lambda$  wire length for example – shows a figure-of-eight pattern with nulls broadside to the loop plane, and maxima off the ends. Align the ends of the loop (maximum sensitivity direction) in E-W and N-S directions. A compass will make the accuracy better.

The loops are fed through differential amplifiers, with gains in the 20 to 80dB range, to the vertical and horizontal plates of the oscilloscope. The reason for the wide gain scale is that oscilloscopes vary.

The original project connected the amplifier outputs directly to the oscilloscope deflection plates. Modern two-channel oscilloscopes can be used in the X-Y to form a vectorscope, of which the storm scope is a variation on the theme.

Although any two-channel scope with an X-Y mode is usable, a directional ambiguity exists unless the instrument also has a Z-axis input. This input is often present, but hidden on the rear panel of the scope. The Z-axis is used to modulate the intensity of the trace with a signal from a sense whip or vertical antenna near the two-X loop. It may be necessary to amplify the Z-axis input signal, but in that case a single-ended rather than differential amplifier is used.

Figure 3 shows the loop and amplifier configuration. The loop consists of at least fifty turns of small-gauge insulated wire in a three-foot loop. Either square or circular loops can be used, although I find that the square is easier to construct. The loop is untuned. The output of the loop is applied to the input terminals of the differential or push-pull amplifier.

It is critical to shield the loops. Wrap either copper foil or aluminum foil (or tape) over the entire loop, except for a small quarter inch or so gap along the top edge. This prevents the shield from acting like a single-turn shorted loop itself.

The shielded loop will be less prone to pattern distortions from capacitive coupling. In addition, it responds largely to the magnetic component of the lightning electromagnetic field. It is less sensitive to electrical fields, so will not pick up as much locally generated power line and appliance noise.

I constructed a loop pair using 0.75in by 4in by 36in lumber.

Although my own woodworking skills leave something to be desired – polite for 'atrocious' – others are able to make a better job of the method shown in Fig. 4. A notch, Fig. 4a), is cut at the centre of the top and bottom members of each loop. The depth of the notch is the thickness of the lumber, while the width is sufficient to snug-fit the other piece of wood in it, Fig. 4b).

The square loop will tend to 'trapezoid' out of shape if left to its own devices. As a result, some or all of the methods of Fig. 5 are used at the four corners of each loop. In



Fig. 5a) the wood elements are butted together, glued and nailed (or screw fastened).

A small block, about 0.5 inch (12mm) square and as wide as the loop arm, is glued in the corner to give strength. In Fig. 5b) the same method is used, but the joint between the wood members is a bit different. I am told this method is stronger, even though it is more difficult. Finally, a triangular gusset plate cut from a thin sheet of plywood or spruce modelling lumber is shown at Fig. 5c).

Figure 6 shows the wiring of the loop. I used fifty conductor ribbon cable, although one continuous loop of #26 (.4mm diameter) or so enamelled wire could be used as well. It takes more than 600 feet of wire per loop for this approach. You can also use 60 or 64 conductor cable.

The sensitivity of the loop is improved with more turns or a larger length per side. You can, for example, build a four-foot or five-foot loop, or use multiple runs of fifty conductor ribbon cable. In one case, a whistler/spheric hunter used 126 conductors made from intercom cable.

If you opt for the simpler ribbon cable method, then cross connect adjacent turns so that one continuous loop is formed. This is a tedious chore, but it's made a lot easier if you use printed circuit perforated board to make the connections. It is OK to lay the N-S and E-W loops over one another because their orthogonal geometry makes them minimally interactive.

**What to expect**

The original article claimed detection to distances of 500 miles, but I doubt that figure is practicable. I would more likely guess tens of miles, or 100 miles, but further experimentation is needed to confirm the longer distance claim.

Fig. 6. Wiring of the loop. Fifty-conductor ribbon cable can be used, although one continuous loop of 4mm diameter or so enamelled wire could be used instead.

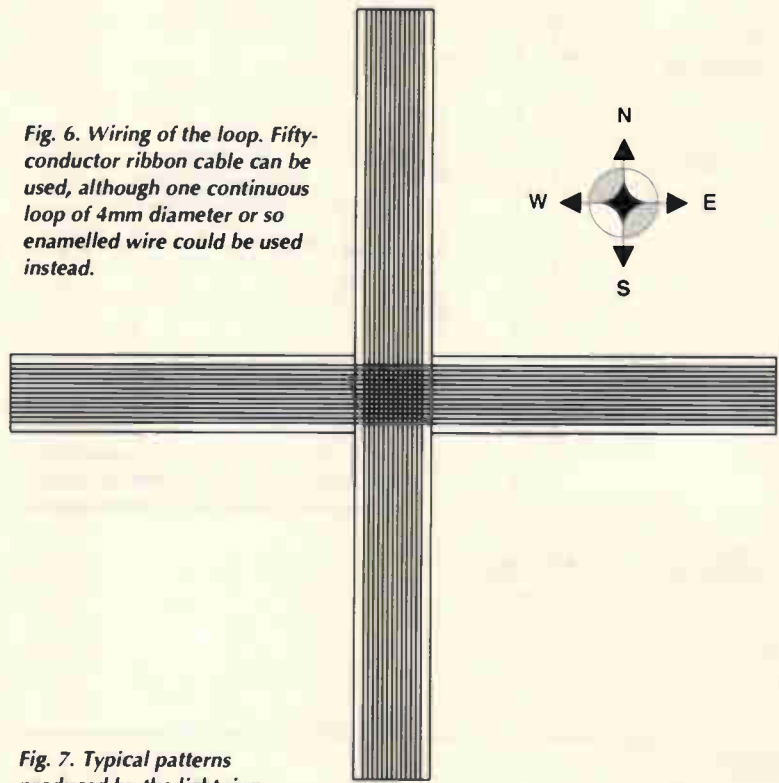
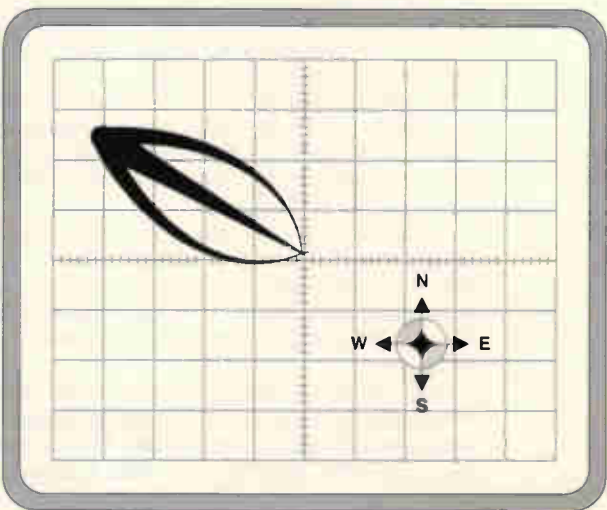
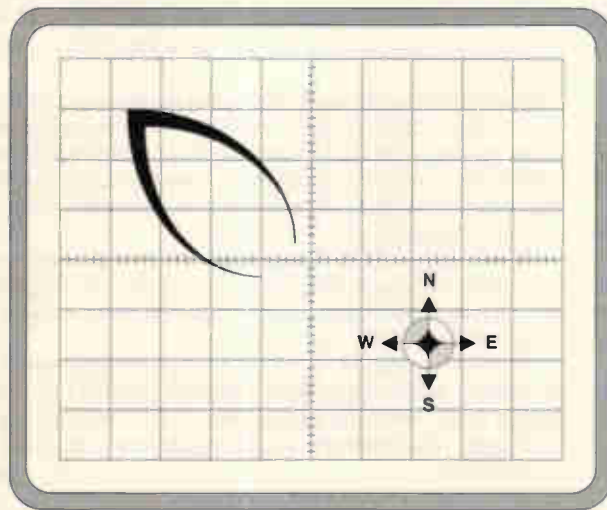
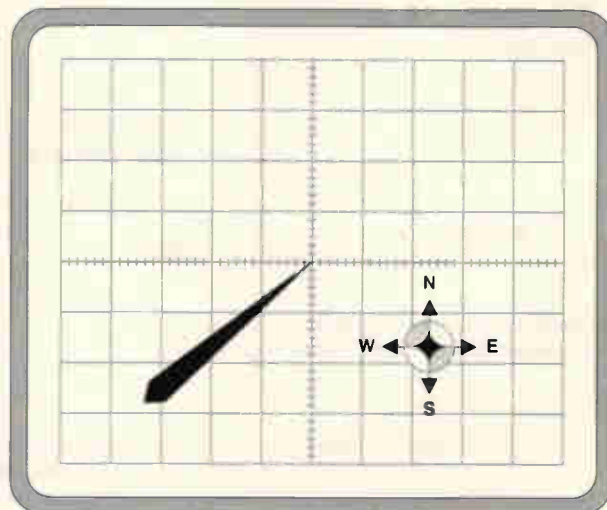
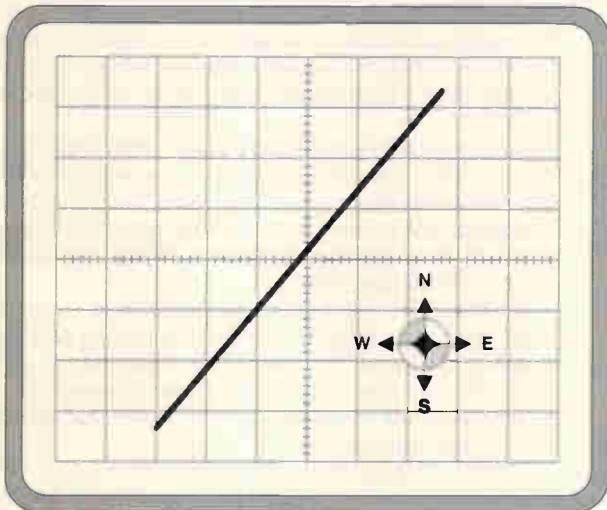

Fig. 7. Typical patterns produced by the lightning monitor.



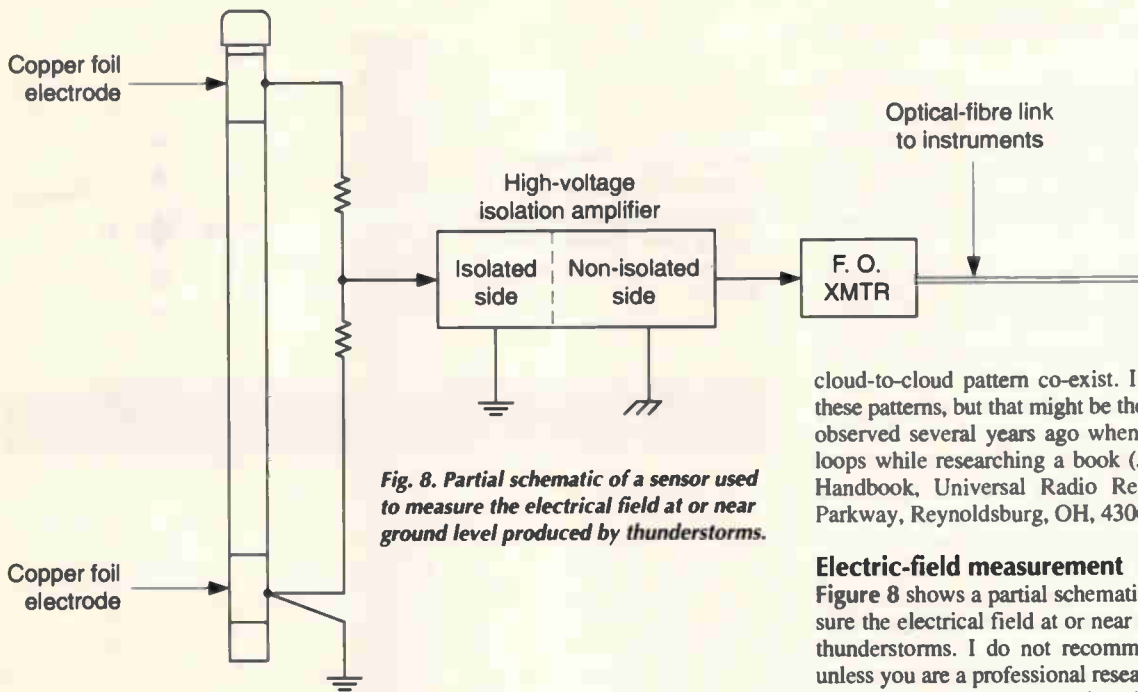

Fig. 8. Partial schematic of a sensor used to measure the electrical field at or near ground level produced by thunderstorms.

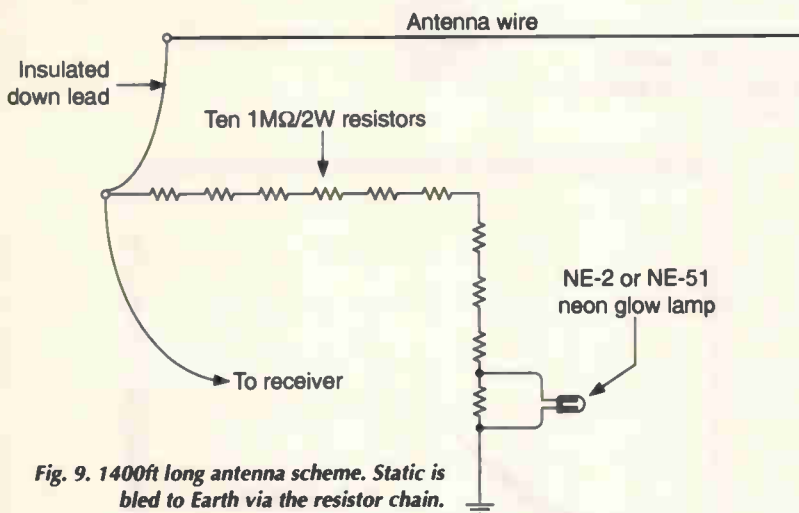

Fig. 9. 1400ft long antenna scheme. Static is bled to Earth via the resistor chain.

Figure 7 shows typical patterns. These patterns are representations of what is observed, but are a bit more distinct and less ragged than actual scope photos (I am no longer able to photograph scope screens... until I find a new hand-held Polaroid scope camera). I was able to create the patterns in Figs. 7a) and 7b), but those of Figs. 7c) and 7d) are cribbed from the Leary article cited earlier.

The pattern in Fig. 7a) is what to expect when there is no Z-axis input to receive the vertical sense antenna signal. It shows the line of the storm, but has the directional ambiguity found on loop antennas. In other words, the storm could be in either direction from the loop.

Figure 7b) shows the pattern to expect when the sense antenna is used, and the Z-axis intensity is correctly adjusted. This is essentially the same concept as a sense antenna producing a cardioid pattern on a radio direction finding (RDF) antenna. The actual pattern will be a lot more ragged than shown here.

Leary claims that patterns like Fig. 7c) are produced with horizontally polarised cloud-to-cloud discharges (the others were essentially ground wave signals). The pattern in Fig. 7d) represents what might be seen when a ground wave and

cloud-to-cloud pattern co-exist. I was not able to confirm these patterns, but that might be the particular thunderstorm I observed several years ago when I was active in building loops while researching a book (Joe Carr's Loop Antenna Handbook, Universal Radio Research, 6830 Americana Parkway, Reynoldsburg, OH, 43068 USA).

**Electric-field measurement**

Figure 8 shows a partial schematic of a sensor used to measure the electrical field at or near ground level produced by thunderstorms. I do not recommend building this project unless you are a professional researcher. And if you do build it, stay a good distance away from it when thunderstorm activity is nearby.

Electrical fields are measured in terms of volts per meter (V/m), or kilovolts per meter. The sensor shown in Fig. 8 uses a pair of 10cm copper electrodes on a centimetre diameter insulated rod, spaced a metre apart.

A pair of resistors is used as a voltage divider to reduce the voltage (thunderstorm fields of 10kV/m are easily observed). The professional sensor I saw used a high-voltage resistor for the upper resistor in the voltage divider (i.e. the type of resistor used inside a high voltage probe for an oscilloscope or voltmeter).

Output from the voltage divider is fed to a high voltage isolation amplifier, and then to a fibre-optic transmitter. Safety dictates that the sensor be far away from humans and the instruments used to record the burst. Fibre optic cable is used to prevent the electromagnetic pulse from inducing a high voltage spike into the wiring.

I saw a primitive variant on this theme at a friend's house in Texas in the early 1980s. My friend was an antenna guru and something of a technical mentor for me. He owned a 43-acre tract of farm land near Austin, mostly for the purpose of erecting antennas at will (but partly to get away from other people – he was semi-hermit).

He had a 1400-foot long wire antenna mounted on telephone poles, trees and whatever else could be commandeered. At the receiver end of the antenna he had a small box, Fig. 9, with a series connected stack of ten 1MΩ carbon resistors. The box, and the bottom end of the resistor chain was grounded.

When I first saw the rig, I noticed that the little light on the box blinking erratically, so I asked what it was. He explained to me that he had to do occasional receiver repairs before he realised that so many burned out RF front-ends could not be due to faulty design. He figured that it was atmospheric electric fields 'charging' the 1400-foot wire.

He was right. A high voltage static charge could build up even when the storms were many miles away. He designed this rig after something he'd seen in his years as an electronics technician in the Navy.

Not shown in Fig. 9 is a second neon glow lamp connected directly across the antenna terminals. It would protect against spikes, while the resistor stack would 'bleed off' static charges. Also, there was a lightning arrester in the antenna downlead.



# BOOKS TO BUY

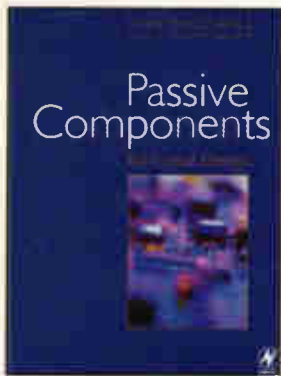

## PASSIVE COMPONENTS FOR CIRCUIT DESIGN

Passive Components for Circuit Design is a unique introduction to this key area of analog electronics designed for technician engineers and anyone involved in circuit design. The coverage encompasses all component types capable of power amplification: resistors, capacitors, transformers, solenoids, motors and transducers. The behaviour of the components is explored along with the different types available and the principles of circuit design. Tolerances, stability, variation with temperature, reliability and manufacturing standards are all covered. Reading this book will improve your skills in component selection and analog circuit design. These are essential skills not only for the analog designer, but for all circuit designers, professional or amateur.

**Contents:** Preface; Fundamentals; Fixed resistors; Variable resistors, potentiometers and diodes; Capacitors; Inductors and inductive components; Inductive devices; Transducing components; SMT; Hardware; Index

**Readership:** Technician engineers, circuit designers, advanced hobbyists  
 Pages: 304pp  
**Price: UK £23.00**  
**Europe £24.00**  
**ROW £27.00**

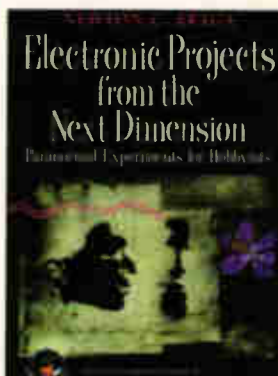

## ELECTRONIC PROJECTS FROM THE NEXT DIMENSION

For years paranormal scientists have explored the detection and documentation of spirits, auras, ESP, hypnosis, and many more phenomena through electronics. Electronic Projects from the Next Dimension provides useful information on building practical circuits and projects, and applying the knowledge to unique experiments in the paranormal field. The author writes about dozens of inexpensive projects to help electronics hobbyists search for and document their own answers about instrumental transcommunication (ITC), the electronic voice phenomenon (EVP), and paranormal experiments involving ESP, auras, and Kirlian photography.

Although paranormal studies are considered esoteric, Electronic Projects from the Next Dimension teaches the technical skills needed to make devices that can be used in many different kinds of experiments. Each section indicates how the circuit can be used in paranormal experiments with suggestions about procedures and how to analyze the results.

**Contents:** White noise generators for use in instrumental transcommunication (ITC) and electronic voice phenomenon (EVP) experiments; Practical circuits for image experimentation, such as a

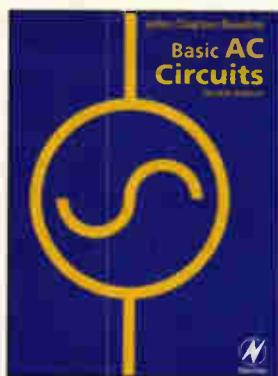

## BASIC AC CIRCUITS

This is the step-by-step approach for beginners. This self-paced individualized learning tool covers concepts, terms, and the mathematics required to understand AC circuit problems. It has been designed to improve analysis techniques for prediction and control development.

**Readership:** Beginners meeting AC circuits for the first time: students; technicians  
 Pages: 92 | pp  
**Price: UK £34.00**  
**Europe £36.00**  
**ROW £38.00**

wireless sparking image generator, horizontal bar generator, brontophic sound, magnetic field generator, high-voltage generators (Kirlian Machine's I & II); Paranormal skills experiments with temperature change, polygraph, electro-shock, random number generation, UFO detection, and ghost-finding.

**Readership:** Hobbyists, Electronics Enthusiasts  
 Pages: 256pp  
**Price: UK £28.00**  
**Europe £30.00**  
**ROW £37.00**



## Interfacing with C

### INTERFACING WITH C

A practical and painless way of becoming an expert C programme New edition also covers C++ and the Windows environment Get up to speed with the essential maths needed for C without having to buy a university maths text!

**Price: UK £20.00**  
**Europe £22.00**  
**ROW £24.00**

Post your completed order form to:-

**Jackie Lowe,  
 Highbury Business Communications,  
 Anne Boleyn House, 9-13 Ewell Road,  
 Cheam, Surrey, SM3 8BZ**

### How to order

Book Title \_\_\_\_\_

I enclose a cheque/bank draft for £ \_\_\_\_\_  
 (payable to **ELECTRONICS WORLD**)

Please charge my credit/charge card

Mastercard  American Express  Visa  Diners Club

Credit Card No: \_\_\_\_\_

Expiry Date: \_\_\_\_\_

Signature of Cardholder \_\_\_\_\_

Cardholder's statement address: (please use capitals)

Name \_\_\_\_\_

Address \_\_\_\_\_

Post Code \_\_\_\_\_ Tel: \_\_\_\_\_

# LETTERS

## to the editor

Letters to "Electronics World" Highbury Business Communications,  
Anne Boleyn House, 9-13 Ewell Road, Cheam Road, Surrey SM3 8BZ  
e-mail j.lowe@cumulusmedia.co.uk using subject heading 'Letters'.

### Equality?

Regarding my leader in the March issue, while I cannot claim to be a huge fan of the medical profession in general, I most emphatically did not treat the profession, as detailed by Dr Wilkins, with any disrespect. I described the behaviour of one of the organizations that claim to represent his profession.

There was an item presented on R4, prior to the ultimatum issued by the BMA. I wrote to the presenter of the programme, contrasting the lives and salaries of GPs with those of engineers working in manufacturing industry - as I have done all my working life. This has included, in my own case, two redundancies.

Several days later, I received a most thoughtful and detailed reply from this presenter. He described in his letter that the criticism of doctors had been such that he'd had to tone down these 'in order to elucidate the doctors' side of the case.' He also made it very clear that he had sympathy with my views.

I was reading the Financial Times a month or so ago and was astounded to read a small article that pointed out that agreement was now

close between the BMA and the government in respect of the annual assessment of GPs competence. I had assumed, post-Shipman, that this was now mandatory.

How many years is it since Shipman; three or four? I'm head of an R&D group and have just carried out the annual assessment of my group; equally my own performance has been assessed. I have undergone this procedure every working year of my life since graduation - as probably have most other Electronics World readers who work in the commercial sector. So why is the medical profession different?

Mr (Dr) Brian Judd made reference to the Boeing 747. Has he ever considered why the 747 actually stays airborne? The reason is, of course, because quite a few talented engineers - which will include many Ph.Ds - have devoted a significant proportion of their lives to ensuring a competent design. What use would the medical doctor be if a 747 went into an uncontrolled spin, with a possibility of crashing? The Ph.D engineer might just save the day!

I did not rehearse this leader - as implied by Dr. Judd. It was written

as a response to Dr Ken Smith's letter and it took approximately twenty minutes to compose. I do not have any chips on my shoulder: facts are not chips.

I am, however, delighted that *Electronics World* chose to publish it. These gentlemen's letters have, quite simply polarised my views about the medical profession even further. If readers want to know about the real income of GPs, then I recommend the reference detailed below (1).

**Lawrence Jones**  
Via e-mail

1. Durham, M., 'Increase takes GPs' earnings to £73K', *The Independent* 14 June 2001, p. 11.

### Making your own PCBs

I read Mr Bateman's article on making PCBs in the May 2002 issue with interest.

I would like to point out another way of printing artwork transparencies, which I have successfully employed. It guarantees a perfect image density in only one pass which avoids the problem of registration of images in multi-pass printing.

I used an ALPS MD-2010 Micro Dry colour printer, which works by dry transferring coloured dots onto the medium. The image is instantly set and the medium does not need to be passed through heated rollers.

The transparency film I used is LaserStar (from Farnell) for making PCB artwork transfers using laser printers: sadly that did not work as intended: it wrinkled and the image contrast was poor. But the LaserStar is smooth enough to pass through the ALPS printer and I got a perfect contrast in only one pass!

The only problem is to keep the film as dust free as possible because dust particles will prevent the dot from sticking. That can be corrected using black ink.

Another good use for Micro Dry

### Shock hazard reduced?

Referring to a letter in the previous issue, Susan is correct to point out the dangers of her circuit, but is misinformed about the danger of 1mA.

The shock hazard depends on the current which, in turn depends on the voltage, source impedance and contact resistance. A milliamp is actually perfectly safe and at approximately the threshold of feeling. It takes tens to hundreds of milliamps to get a shock and 1A plus to interfere with heart operation. Residual-current devices, or RCDs, to protect people are usually set to 30mA which is considered as adequately safe.

Common high-voltage sources such as vehicle ignition and CRT acceleration are low current high impedance so the voltage collapses under the load of being touched.

In the case of mains shocks the current is usually limited by the contact resistance. This is greatly reduced by having wet hands, which is why the danger is so much greater when water is around.

Stored energy in capacitors complicates the picture but again is usually safe enough in 100 to 1000pF range encountered in CRT and electrostatic circuits.

**Paul Bennett**  
Via e-mail



printing is making professional looking replacement analogue meter scales by printing on 0.01 in (ten thou) Plasticard (thickest I can pass through my printer). You can't use ink-jet or laser printers for this purpose!

**Jonathan Wells**  
Saxilby  
Lincoln

Further to Cyril Bateman's article on making double sided PCBs, could I offer a method which we have used with great success for many years? It was suggested by a friend, Mike Fielding, and is almost foolproof.

Assuming that the two pieces of artwork have been printed, the blank PCB is placed on the lower artwork in the correct position. Now superglue two pieces of scrap PCB strip to the artwork to form a corner next to the blank PCB.

When this has set, remove the PCB, locate the top artwork and align it accurately. Make sure that it doesn't move out of position lift the corner and

Superglue it to the top of the strips.

To expose the PCB, remove the protective cover, slide it back into the corner and expose one side. Turn over the PCB and artwork, make sure that the PCB is still located in the

corner of the strips and expose the other side. Develop, etch and drill and that's it!

**Dave Brady**  
Snr. Elec. Eng., Denis Ferranti  
Meters Ltd

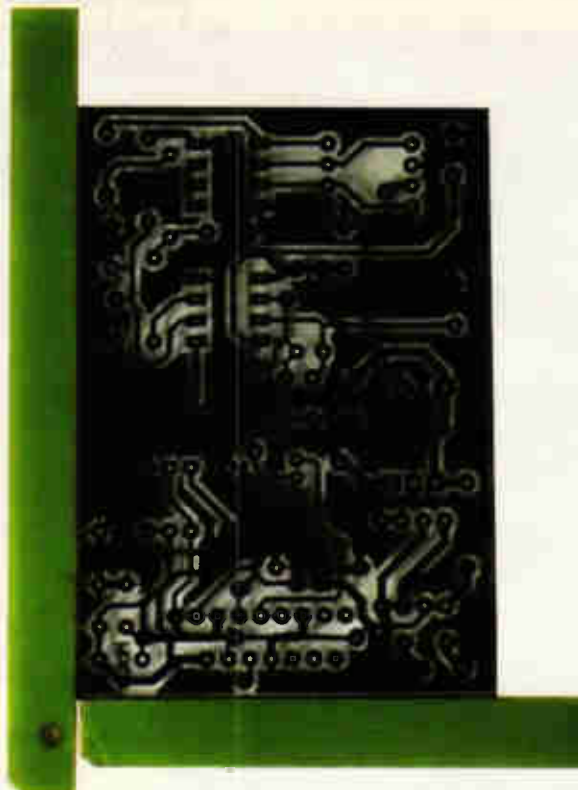

## Stuck in a time warp...

In Update in the April 2000 issue I read that universities and colleges are failing to produce enough electronics graduates to satisfy the demand by industry and that the number of applications for electronics and engineering courses decreases year upon year with students preferring to take media studies or humanities instead.

The real reason for this situation is due to the lack of coverage of science and technology in the secondary school curriculum. Over the past 15 or so years the amount of science and technology in the secondary school curriculum has been cut back on resulting in more of a liberal arts and humanities education.

After GCSEs replaced O Levels the science and mathematics courses have become trivialised, dumbed down and stripped out. In fact the contents of the AS level physics and mathematics courses today are almost identical to that of the O Level courses in the mid 1980s and the intermediate grade GCSE – which now allows students to achieve a grade B rather than a grade C as originally intended – science and mathematics courses contain less subject material than the old CSE courses had in them.

As well a decline in standards in science and maths, the quality of the technology course leaves much to be desired. For a start, apart from the most basic of concepts like lighting up an bulb, electronics is only

ever taught in the final two years at school as an optional GCSE subject.

Electronics needs to be taught at an earlier age and made a compulsory subject if understanding and interest is to be nurtured amongst teenagers.

The availability of GCSE electronics is a post code lottery as not all schools offer it due to a lack of suitable teaching staff or investment in their technology departments and there is little indication of improvements being made in the near future. This situation is quite capable of preventing a student from studying electronics at college or university because they did not have the chance to study it at a more elementary level.

To cap things off the contents of the GCSE electronics course is stuck in a time warp at circa 1975 and fails to take advantage of the exciting developments since then. Even the students fully well know this and an outdated course is an offputting point to some. Satellite communications, mobile phones and Bluetooth interest teenagers. Not crystal radios.

As a result of this situation most school leavers have very little technical understanding and therefore steer clear of engineering and electronics courses at college and university level as they are perceived to be too difficult or feel that they lack the adequate background knowledge to be able to succeed if they chose to

take them.

The article also stated that the newly formed Engineering and technology board proposes to persuade more students to take maths and science at school. What the ETB doesn't seem to realise is that ALL secondary school students have to take maths and science GCSEs by law.

What needs to be done is increase the amount of lesson time devoted to technical subjects and depth of the course material whilst also ensuring that the topics are reasonably up to date concerning the techniques and processes used by today's industry.

Of course changes the school curriculum to introduce more technical materials could be made but one problem is where do schools find the extra teachers? Considering the poor pay compared with industry, lots of red tape and bureaucracy, consistent underfunding (school science and technology departments always seem to bear the brunt of LEA cutbacks), and the general behaviour and lack of discipline of the students then I for one am certainly not going into teaching.

The poor prospects of a career in teaching compared with industry for those with electronics qualifications is another issue that the ETB must address if the decline is to be reversed.

**Riaz Sobrany**  
Surrey



**Electronics World reader offer:**  
**x1, x10 switchable**  
**oscilloscope probes,**  
**only £21.74 a pair,**  
**fully inclusive\***

\*Additional pairs as part of the same order, only £19.24 each pair.

Seen on sale for £20 each, these high-quality oscilloscope probe sets comprise:

- two x1, x10 switchable probe bodies
- two insulating tips
- two IC tips and two sprung hooks
- trimming tools

There's also two BNC adaptors for using the cables as 1.5m-long BNC-to-BNC links. Each probe has its own storage wallet.

*To order your pair of probes, send the coupon together with £21.74 UK/Europe to*  
**Probe Offer, Jackie Lowe, Highbury Business Communications, Anne Boleyn House, 9-13 Ewell Road, Cheam, Surrey, SM3 8BZ**

Readers outside Europe, please add £2.50 to your order.

Please supply the following:

**Probes**

Total \_\_\_\_\_

Name \_\_\_\_\_

Address \_\_\_\_\_

\_\_\_\_\_

\_\_\_\_\_

Postcode \_\_\_\_\_ Telephone \_\_\_\_\_

Method of payment (please circle)

**Cheques should be made payable to ELECTRONICS WORLD**

Access/Mastercard/Visa/Cheque/PO

Credit card no. \_\_\_\_\_

Card expiry date \_\_\_\_\_ Signed \_\_\_\_\_

**Please allow up to 28 days for delivery**

**Specifications**

**Switch position 1**

Bandwidth	DC to 10MHz
Input resistance	1MΩ – i.e. oscilloscope i/p
Input capacitance	40pF+oscilloscope capacitance
Working voltage	600V DC or pk-pk AC

**Switch position 2**

Bandwidth	DC to 150MHz
Rise time	2.4ns
Input resistance	10MΩ ±1% if oscilloscope i/p is 1MΩ
Input capacitance	12pF if oscilloscope i/p is 20pF
Compensation range	10-60pF
Working voltage	600V DC or pk-pk AC

**Switch position 'Ref'**

Probe tip grounded via 9MΩ, scope i/p grounded



For more information, visit:

<http://www.umist.ac.uk/dias/pag/signalwizard.htm>

# Real-time digital filter

**S**ignal Wizard is a unique hardware and software system for designing, downloading and running filters in real-time. Low-pass, high-pass, band-pass, band-stop, comb or any arbitrary shape you like can be designed in seconds. Once a filter is designed, the software interface is used to download the filter to the hardware system via a serial link, where it is executed on demand.

You don't need to know about digital signal processing theory or the maths associated with digital-filter design. But if you're a filter expert, you won't find yourself restricted by the easy-to-use interface. If you want to do it the hard way, you can even design your filter in long-hand then download the filter's frequency response as an ASCII file to the Signal Wizard's control program!

Signal Wizard is a total filter solution. Due to its flexibility, it is ideal for processing audio-bandwidth signals in real time. High-quality analogue signal conditioning and a dual-channel 16/18-bit resolution analogue-to-digital converter and digital-to-analogue converter provide a resolution sufficient for the most demanding applications.

In short, the Signal Wizard brings the power of digital signal processing to any audio-bandwidth domain that requires high-performance electronic signal filtering. Applications include sensor linearisation, audio signal processing, signal analysis, vibration analysis, education and research in electrical, electronic and other physical sciences.

## System requirements:

100 MHz PC running Windows' 95, 98 or ME  
SVGA display (800X600 pixels) or higher  
CD ROM drive  
10 Mbytes of free hard disc space  
Serial port, capable of 19200 bit/s

## Signal Wizard - key features

- Runs under Windows 95, 98 or ME
- Generates FIR filters with a maximum of 1024 coefficients.
- Multiple pass, stop or arbitrary filters.
- Lower -3dB frequency 3.7Hz at 48kHz sample rate and 1.2Hz at 12kHz sample rate.
- Filter operates in single or dual channel modes.
- Import mode - ASCII import of any frequency response.
- Hardware module holds up to 16 filters, instantly selectable with one mouse click.
- Zero-phase distortion in the pass, transition and stop bands, ignoring input and output coupling.
- Choice of rectangular, Bartlett, Hamming, Hanning, Blackman or Kaiser Windows.
- Virtual control panel allowing run-time changes to filter gain and sampling rate.
- Includes frequency and time domain plots of filter performance.
- Frequency response plotted as linear, dB, square, root, real, imaginary or phase.
- Impulse, frequency and phase response exportable in a variety of formats (dB, power etc) as ASCII files for incorporation into standard spreadsheets.
- 18-bit resolution in single, 16-bit in dual-channel mode.
- Normal or turbo speed, software selectable.
- User selectable sample rates of 48kHz, 24kHz, 16kHz, 12kHz, 9.6kHz, 8kHz, 6kHz, 4.8kHz, 4kHz, 3.2kHz or 3kHz.



Each Signal Wizard kit includes: Filter DSP board, Windows filter design software on CD plus demonstration filters, fully-worked help files - featuring tutorial, installation instructions, analogue i/o cables, RS232 COM port download cable, Power supply.

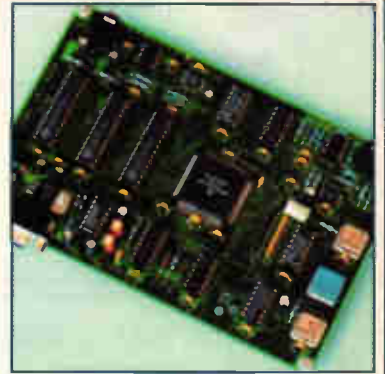

Signal Wizard - a unique, integrated hardware/software system for designing, downloading and running very high performance filters in real time. **Available only from Electronics World.**

## Use this coupon to order your Signal Wizard filter

### Order coupon

Please send me ..... Signal Wizard filter(s) at £499, excluding £7 shipping and UK special delivery and VAT (£594.55 fully inclusive: e-mail [electronics.world@ntlworld.com](mailto:electronics.world@ntlworld.com) for quantity discounts and o/s postage rates).

Name \_\_\_\_\_

Address \_\_\_\_\_  
\_\_\_\_\_  
\_\_\_\_\_

Phone number/fax \_\_\_\_\_

### Total amount £.....

I enclose a cheque \_\_\_\_\_

Please charge to my credit/debit card.

Card type (Mastercard/Visa/Switch etc)

Card No \_\_\_\_\_

Expiry date \_\_\_\_ / \_\_\_\_

Please mail this coupon to *Electronics World*, together with payment. Alternatively fax credit card details with order on **020 8722 6098**  
Address orders and all correspondence relating to this order to Signal Wizard Offer, Electronics World, Anne Boleyn House, 9-13 Ewell Road, Cheam, Surrey, SM3 8BZ  
email [j.lowe@cumulusmedia.co.uk](mailto:j.lowe@cumulusmedia.co.uk)  
Make cheques payable to **Electronics World**.

**TELENET** SPECIAL OFFER

**CONTENTS**

**About Telet**  
Supplier and Buyer of Quality Second-hand Electronic Test and Measurement Equipment at AFFORDABLE Prices.

**How to Buy us**

**Stockroom** To View - please ring for an appointment -  
08 44 2024 7993 6722 - Telephone  
08 44 2024 7993 6722 - Fax  
08 44 2024 688 842 - mobile

**Product Test Kits**

**Measurement**

**Working Information**

**Equipment Wanted**

**Contact Us**

# WEB DIRECTIONS

**PROTELIS VSM Models**

Professional PCB Design Made Easy

Introducing the new VSM 4.0

Professional PCB Design Made Easy

Introducing the new VSM 4.0

Professional PCB Design Made Easy

Introducing the new VSM 4.0

Put your web address in front of 18,000 electronic fanatics.

Electronics World acknowledge your company's needs to promote your web site, which is why we are dedicating over 3 pages in every issue to WEB ADDRESSES.

Linage only will cost £150 + vat for a full year.

Linage with colour screen shot will cost £350 + vat for a full year, this will include the above plus 3cm shot of your web site which we can produce if required.

To take up this offer or for more information  
**Tel 0208 722 6028**

E-mail  
[p.bunce@cumulusmedia.co.uk](mailto:p.bunce@cumulusmedia.co.uk)

**ANASOFT LTD**  
<http://www.anasoft.co.uk>

SuperSpice, the affordable, mixed-mode windows circuit simulator. Wrote by an analogue design engineer for those Teletubbies who like keeping things simple.

**BEDFORD OPTO TECHNOLOGY LTD**  
<http://www.bot.co.uk>

Optoelectronic products UK design development manufacture standard and custom, LED bargraphs, circuit board indicators, stand offs, transmissive/reflective switches, baseeaf optocouplers tubular and surface mount, pannel mount LED assemblies.

**CRICKLEWOOD ELECTRONICS**

<http://www.cricklewoodelectronic.co.uk>

Cricklewood Electronics stock one of the widest ranges of components, especially semiconductors including ICs, transistors, capacitors, all at competitive prices.

**COMPONENT KITS**

<http://www.componentkits.com>



"Component Kits LLC manufactures and distributes Electronic Component Kits used for professional engineering design, prototype, University lab, and hobbyist uses.

Visit our website to review our current product line, request our Free CD-ROM, or join our newsletter."

**COOKE INTERNATIONAL**

<http://www.cooke-int.com>



[info@cooke-int.com](mailto:info@cooke-int.com)

Test & Measuring Equipment  
Operating & Service Manuals.

**CROWNHILL ASSOCIATES LTD**  
<http://www.crownhill.co.uk>



Crownhill supply low cost development tools for use with Micro-Controllers and Smart Cards. Products include Smart Card development tools, Smart cards, Micro Development tools and Bespoke Design Services.

**DB TECHNOLOGY**

<http://www.dbtechnology.co.uk/>



EMC Testing and Consultancy. Anechoic chamber and open area test site.

- Compliance Tests
- Rapid, accurate pre-compliance tests.
- Fixes included. FCC Listed.
- Flexible, hourly booking available.

**DESIGNER SYSTEMS CO.**

<http://www.designersystems.co.uk>



Electronic product design company with over a decade of experience promoting it's own product range and designing and manufacturing innovative products for client companies/individuals.

**EAGLE PCB DESIGN SOFTWARE**

<http://www.puresoft.co.uk>

- Professional PCB design made easy!
- Fully functional freeware download.



- Schematics, Layout & Autorouting.
- Free tech support

**EDAForce**

<http://www.edaforce.co.uk>

EDAForce is a division of the independent specialist recruitment consultancy TelecomForce. We specialise in placing engineers and engineering managers, either contract or permanent, in the role that is right for them. Visit the web site, email us on [ew@edaforce.co.uk](mailto:ew@edaforce.co.uk) or call +44(0)1628 850273 to find out how we could help you.

**EQUINOX TECHNOLOGIES UK LTD**

<http://www.equinox-tech.com>



Equinox Technologies UK Ltd., specialise in development tools for the embedded microcontroller market.

**FELLER UK**

<http://www.feller-at.com>

Feller (UK) Ltd. manufacture Fully approved cordsets (Moulded mains plugs and connectors) and Power Supply Cables for all industrial Countries to National and International Standards

**FIELD ELECTRIC LTD**

<http://www.fieldelectric.co.uk>

Field Electric Ltd has been successfully trading since 1958 in the re-sale of used test & measurement equipment & computer hardware. We buy and sell in small or bulk quantities and can source equipment to particular requirements. Visit our web site or call 44 01837 83736.





## FUTURE TECHNOLOGY DEVICES INTL. LTD.

<http://www.ftdichip.com>

FTDI designs and sells USB-UART and USB-FIFO interface i.c.'s. Complete with PC drivers these devices simplify the task of designing or upgrading USB peripherals

## J W HARDY COMMUNICATIONS

<http://www.jwhardy.co.uk>



R.F. Network Specialist. Shop online - for R.F. network components. We supply a full range of TV, radio reception equipment to receive analogue/digital signals from both terrestrial and satellite sources. We provide a free planning service for your R.F. networks, MATV and SMATV etc

## LABCENTER

<http://www.labcenter.co.uk>



Download evaluation versions of our unique Proteus VSM mixed mode SPICE and CPU simulator, and also the full range of Proteus PCB Design products. Register the Proteus Lite shareware versions online for as little as £20.

## LOW POWER RADIO SOLUTIONS

<http://www.lprs.co.uk>

LPRS markets low power radio transmitters, receivers and transceiver modules manufactured by ourselves, Radiometrix, Circuit Designs, RDT and

Micrel. Applications for telemetry, video and remote control.

## MAGNIFICO (The Magnifier Company)

<http://www.magnifyingglasses.co.uk>



The best online selection of magnifiers and low-vision aids, including hand-held, hands-free, illuminated, magnifying stands, fresnel sheets and inspection loupes.

## MAPLIN ELECTRONICS

<http://www.maplin.co.uk>



A fully secure and interactive internet ordering system from Maplin Electronics, the specialist electronic retail and mail order company to business and retail consumers alike. 15,000 products available on line.

## MATRIX MULTIMEDIA LTD

[www.matrixmultimedia.co.uk](http://www.matrixmultimedia.co.uk)



Matrix Multimedia publishes a number of highly interactive CD ROMs for learning electronics including: Complete electronics course, Analogue filter design, and PICmicro(R) microcontroller programming (C and assembly).

## NORCALL Ltd

<http://www.norcall.co.uk>

e-mail [Norcall@aol.com](mailto:Norcall@aol.com)

Suppliers programmers and repairers of new and refurbished two-way radio equipment. Retuning and recrystalling service available. All types of batteries chargers and aerials supplied.

## QUASAR ELECTRONICS

[www.quasarelectronics.com](http://www.quasarelectronics.com)

Over 250 electronic kits, projects and ready built units for hobby, educational & industrial applications.



TEL: 01279 467799, FAX: 07092 203496 or EMAIL: [ewsales@quasarelectronics.com](mailto:ewsales@quasarelectronics.com)

## PHAEDRUS LTD

[www.phaedrusltd.co.uk](http://www.phaedrusltd.co.uk)

Manufacturer and supplier of low cost general purpose and serial I/O digital modules and accessories. PC based software for data logging and control applications.

## RADIOMETRIX

<http://www.radiometrix.co.uk>



Radiometrix specialises in the design and manufacture of VHF & UHF, RF data modules. We offer a broad range of PCB mounted miniature transmit, receive and transceiver modules for OEM use. They comply with European harmonised standards EN300 220-3 and EN301 489-3 and are CE certified by an independent Notified Body.

## RADIO-TECH LIMITED

<http://www.radio-tech.co.uk>

Radio modules, modems, telemetry, audio transmitters, pagers, antenna, remote controls and much more. All UK designed and manufactured.

## RALFE ELECTRONICS

professional test & measurement



[www.ralfe-electronics.co.uk](http://www.ralfe-electronics.co.uk)

## RIMO-AKD-PP

<http://www.art-decade.com>

We provide the following services: Systems design, test & analysis. Software design & coding. Avionics design. Document technical review, authoring & proof reading. Rig design. Hardware design.



## RD RESEARCH

<http://www.spice-software.com>

B2 Spice offers powerful simulation software for professional engineers and education establishments. All the software is available on a 30 day trial basis and comes with free technical support.

## SOFTCOPY

<http://www.softcopy.co.uk>

As a PC data base or hard copy, SoftCopy can supply a complete index of Electronics World articles over the past ten years. Photo copies of articles from back issues are also available.

## TEMWELL CORPORATION

<http://www.temwell.com.tw>

Manufacturer & Exporter of Heical BPF Filter, 30 Watts BPF Power Filter and Handset/Base Station Duplexers

## TENNET

<http://www.tennet.co.uk>



Top quality second-user Test and Measurement Equipment  
eMail [sales@tennet.co.uk](mailto:sales@tennet.co.uk)

## TELONIC

<http://www.telonic.co.uk>



Telonic, specialists in laboratory AC & DC Power Supplies, Electronic AC & DC Loads, Electrical Safety Testing and complete test systems. Plus RF Filters, Attenuators, Diesel Engine Smoke Measurement, Quartz Crystal Microbalances.  
Tel +44 (0) 118 9786911



### TEST EQUIPMENT SOLUTIONS

<http://www.TestEquipmentHQ.com>  
 Test Equipment for rental or second user sale at the industry's lowest prices. All types of equipment from all leading manufacturers including general purpose, communications and industrial test. Items fully refurbished with 1 year warranty. Rental rebate given on purchases.

### THOSE ENGINEERS LTD

<http://www.spiceage.com>  
 Working evaluations of SpiceAge mixed-mode simulator, Spicycle PCB design tools and Superfilter demo (synthesises passive, active, digital filters). Tech support, sales links and price list.

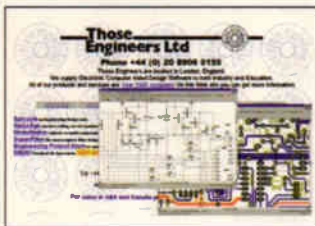

### TECHNICAL AND SCIENTIFIC SUPPLIES

<http://www.technicalscientific.com>  
 Suppliers of pre-1985 equipment and components.  
 - Test/Measurement equipment  
 - Valves and semiconductors  
 - Transducers and pressure gauges  
 - Scientific books and catalogues  
 - Manuals and data sheets

### TOTAL ROBOTS

<http://www.totalrobots.co.uk>  
 Robot Kits and Control Technology products, including OOPic the first Object-Oriented Programmable Integrated Circuit. Secure on-line ordering and fast delivery.

### ULTRACOM

<http://www.ultracom.fi>  
 Ultracom specializes in the design and manufacture of data radio products including Radio Modules, Radio Modems, Filters and Antennas for real-time data communication. In addition to our standard RF-products we provide tailored solutions for customers wireless communications requirements. Our wireless data radios are used in the most varied applications: transferring environmental data in tropical conditions, locating moving targets, remote-control of cranes, controlling pump stations in waterworks, monitoring real estates, transferring data in public transportation information systems.

There are countless applications, what are yours?

### VUTRAX PCB DESIGN SOFTWARE

<http://www.vutrax.co.uk>



Vutrax electronic schematic and pcb design system for Windows 95/98, ME, NT, 2000, XP and Linux. Limited Capacity FREE version downloads available, all upgradeable to various customised level.

### WARWICK WIRELESS LTD

<http://www.radiotelemetry.co.uk>  
 Free data on Radio Modems, Radio Telemetry, Radio Modules and Wireless Video systems. The licence exempt radios can transmit data from 1 to 20Km



at baud rates of 19.2Kbaud to 128Kbaud. The UK based Company can offer customised derivatives of their products as well as turnkey RF Systems.

### WILMSLOW AUDIO

<http://www.wilmslow-audio.co.uk>



'UK's largest supplier of high quality loudspeaker kits and drive units. Comprehensive range of components and accessories, including damping products, connectors and grilles materials. Demonstration facilities available.

## WEB DIRECTIONS

Put your web address in front of 21,000 Electronics fanatics. Electronics World acknowledges your company's need to promote your web site, which is why we are now dedicating page's in every issue to WEB ADDRESSES. This gives our readers the opportunity to look up your company's name, to find your web address and to browse the magazine page to find new sites. We also understand that cost is an important factor, as web sites are an added drain on budgets. I am sure you will agree these rates make all the difference

**FOR 12 ISSUES:**  
 Lineage only will cost £150 for a full year just £12..50 per month. This includes your company's name, web address and a 25 word description.  
 Lineage with colour screen shot will cost £350 for a full year just £29.17 per month. This will include the above plus a 3cm screen shot of your site, which we can produce if required.  
 To take up this offer or for more information ring on 0208 722 6028.  
 E-mail: [j.thorpe@cumulusmedia.co.uk](mailto:j.thorpe@cumulusmedia.co.uk)

Company Name	Web address



As an advertiser you can be certain that your sales message is going to be read by decision-making electronics professionals with the power to purchase your products.

The pre-paid rate for semi-display setting is £17 per single column centimetre (maximum 4cm). Box number £22 extra. All prices plus 17 1/2% VAT. All cheques, postal orders etc to be made payable to Highbury Business Communications Ltd. Advertisements together with remittance should be sent to Electronics World Classified, Highbury Business Communications Ltd, Anne Boleyn House, 9-13 Ewell Road, Cheam, Surrey SM3 8DZ.  
Tel: 020 8722 6028. Fax: 020 8770 2016.

## Service Link

## MISC

### TOP PRICES PAID

For all your valves, tubes, semi conductors and ICs.

### Langrex Supplies Limited

1 Mayo Road, Croydon, Surrey CR0 2QP  
TEL: 020 8684 1166 FAX: 020 8684 3056

## ARTICLES WANTED

### SURPLUS WANTED

WE BUY: ICs, Memory, Relays, Caps, PSUs, Semiconductors, Populated Boards, Computers + Test Equipment

#### ANYTHING CONSIDERED

For our wide range of Semiconductor + Passives List, please ring, fax or email

### MAIL ELECTRONICS

TEL: 0161-761 4520 / FAX: 0161-763 6863

EMAIL: andrew@mailelectronics.com

www.mailelectronics.com

### BEST CASH PRICES PAID

For all valves KT88 PX4 and other audio types

Wide range of valves and CRT stocked

Tel: 01403 784961

Billington Export Ltd.

Fax: 01403 783519

Email: sales@bel-tubes.co.uk

Sussex RH14 9EZ

Visitors by appointment

### 19" Rack Enclosures

New and Used - most sizes 16U to 50U side and rear panels mains distribution 19" Panel mounts optima eurocraft

Prices from £45 + vat

#### M&B Radio

86 Bishopgate Street, Leeds LS1 4BB  
Tel. 0113 2702114 Fax. 0113 2426881

## FOR SALE

### RF DESIGN SERVICES

All aspects of RF hardware development considered from concept to production.

#### WATERBEACH ELECTRONICS

www.rlaver.dial.pipex.com

TEL: 01223 862550

FAX: 01223 440853

## FOR SALE

### PRINTED CIRCUIT BOARDS

DESIGNED & MANUFACTURED

- Prototype or production quantities
- Fast turnaround available
- PCBs designed from circuit diagrams
- Almost all computer files accepted
- PCB assembly - mechanical assembly
- Full product design-manufacture-test-repair

Unit 5, East Belfast Enterprise Park  
308 Albertbridge Rd, Belfast BT5 4GX  
TEL 028 9073 8887 FAX 028 9073 1802  
info@agarcircuits.com



### New PCB Product Magatrix Connectors™

Division of Victor Ignition Ltd  
21<sup>st</sup> Century Battery Connection + Advanced Design Flexibility in a Minimum of Space  
Send for leaflet  
e-mail: sales@victorignition.co.uk  
Tel: 01254 830761. Fax: 01254 830408



Patent No. PCT/GB95/00213  
advanced 4 terminal design  
10,000 F 63 volts pcb mount  
£22.00 + VAT in small quantity full production quantity discounts — trade enquiries welcome  
www.dnm.co.uk follow links to full details T Network Capacitor  
DNM Design, 18 Hartford Road, Huntingdon, Cambs PE29 3QD  
01480-457989 E-mail: denis.m@dnm.co.uk

## FOR SALE

### For Sale - Pre used test equipment in excellent condition

Qty 2 Farnell Power Supply TSV70 mkII 0 - 35 volt 10 amp, 0 - 70 volt 5 amp

Qty 1 Hewlett Packard Power Supply HP 6111A 0 - 20 volt 1 amp

Qty 4 Hewlett Packard Precision Power Supply HP 6114A

0 - 20 volt 2 amp 20 - 40 volt 1amp



**Mushroom**  
COMPONENTS

6a St.Mary's St, Bedford, Bedfordshire, MK42 0AS

Tel: 01234 363611 Fax: 01234 326611

E-mail: sales@mushroomcomponents.com

Internet: www.mushroomcomponents.com

## SERVICES

### P&P ELECTRONICS

Design of Electronic Systems by Degree Qualified Engineer

01924 402931

### POWER SUPPLY DESIGN

Switched Mode PSU  
Power Factor Correction  
designed to your specification

Tel/Fax: 01243 842520

e-mail: eugen\_kus@cix.co.uk

Lomond Electronic Services

### PCBs Conv/PTH/Multi-Layer/Flexible • UK & Far East production

- CAD Layout • Electronic Design • Assembly (prototype & production)
- SMD m/c assy @ 18,500 cps/hr

Deliveries from

24 Hrs

Prototype PTH PCBs from just £40.00

Tel: 01635 40347

Newbury Electronics Ltd

Faraday Road Newbury Berks RG14 2AD

Fax: 01635 36143

e-mail: circuits@newbury.tcom.co.uk

http://www.newburyelectronics.co.uk

Visit

www.pcbtrain.com

The low cost source for prototype PCBs from 1 to 6 layers



Approvals: ISO 9002/UK  
SEE OUR WEB SITES

### From Concept To Production

48 HOUR SERVICE

Electronic design and manufacturing services for the new millennium:

- Embedded monitoring & control
- PSTN telephones and test equipment
- Datacom interfacing, line driving etc.
- Switch Mode & linear PSU and battery management
- Gas detection systems
- Printed Circuit Board design
- Technical documentation, schematic layout & language translation
- Wireless telemetry systems
- Audio & Video processing
- GSM telemetry via SMS or data (TCP/IP)
- DVD player control systems
- GPS positioning systems
- Specialist cable looms
- Small, medium & large scale manufacturing

Email: sales@designersystems.co.uk

Tel/Fax: +44 (0) 1872 223306

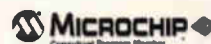

for more information see our web site @ http://www.designersystems.co.uk

**T & M EQUIPMENT**

**AGILENT TECHNOLOGIES (HEWLETT PACKARD)**



8753ES/010 3GHz network analyser. option 010 (TIME-OMAIN) (List over £28000) £15000.  
 8653ES/06/010 network analyser with 006 & 010 (6GHz + time-domain options) (list £32k) £20000  
 All above supplied with new Agilent calibration & 1 year warranty.

**ralfe electronics** *exclusively professional T&M*  
 Unit 1, Olds Close, Olds Approach • WATFORD Herts WD1 8RU • ENGLAND  
 Tel (+44) 0 1923 721396 • Fax (+44) 0 1923 721402

EST  
45  
YRS



**AGILENT TECHNOLOGIES**



8712ET 1.3GHz network analyser (list £8800) £5500  
 16534A digitising oscilloscope card £2500  
 16702A logic analyser system mainframe (£8k5) £4000  
 33120A 15MHz function generator £850

**AGILENT TECHNOLOGIES (HEWLETT PACKARD) an 'as new condition' 8722ET 50mhz - 40GHz NETWORK ANALYSER with /010 & 1D5 Options (time-domain & high-stability). Current list is over £58k, asking £40,000 With new Agilent calibration & 1 year warranty.**



All equipment sold calibration-checked by independent laboratories and carries un-conditional refund and 90-day guarantees.

**TEST EQUIPMENT WANTED.**  
 TOP PRICES PAID FOR PROFESSIONAL HIGH-END UNITS  
**AGILENT TECHNOLOGY SPECIALISTS.**  
 FOR COMPLETE STOCK LISTING PLEASE CHECK OUR WEBSITE  
**www.ralfe-electronics.co.uk**

- 37718B communications analyser /001/12/106/200/602 (>£49k) £15000
- 37724A / 37776A SDH/PDH test set with optical (1310nm) plug-in £2800
- 437B microwave power meter (requires additional sensor) £1000
- 4396B /010/1D6/spectrum/ network/ impedance analyser (£25k) £15000
- 53310A modulation analyser /01/030 (>10k) £5000
- 54835A infinium oscilloscope 5Gsa/sec 4 channel (£16k) £9800
- 6623A quad output power supply unit £850
- 85053B 3.5mm verification kit £2000
- 85056D 2.4mm economy calibration kit (list £4904) £2500
- 85132F 7mm to 3.5mm flexible test port cable set (list £2862) £1750
- 85133F 2.4mm flexible test port cable set (list £4249) £2500
- 89441A 2.65GHz vector signal analyser, many options listing at >50k £call
- 2 in Stock
- 8164A lightwave measurement system with 81680A / 072 tunable laser module £20800
- 8657B synthesized signal generator 0.1 - 2080MHz £4000
- 8903B /10/51 audio analyser £2000
- 86142B /004/006 optical spectrum analyser (>£37k) £20800
- 8904A function generator £1000
- E8358A 300kHz - 9GHz network analyser (48k) £27500
- E4432B 250kHz-3GHz signal gen with /1E5/UN5/UN7/UN8/UND (£26k) £16000
- E4437B 250kHz-4 GHz signal gen with UN8/UN9/UND (27k) £17500
- E5200A broadband service analyser, options £5000
- /02/05/1/122/122/138/138/139/139 £1500
- J2171A ethernet interface module £2000
- J3458A fast ethernet lanprobe option 201 OR 202 and ANS £2000
- J3911A multiprot token-ring Lanprobe £2000
- J3914A E1 WanProbe £2000
- J3921A E3 ATM probe £6500
- J3935A Telegra D analyser /201 / 202 options (list £13250) £6500
- J3972A 3c / STM-1 performance enhanced ATM probe £6500
- N8973A 4GHz noise figure analyser (17k) £12500



Certificate No.: 95/013  
**ISO9002 ACCREDITED STOCKIST**  
**MEASUREMENT & TEST EQUIPMENT**

**FRUSTRATED!**

Looking for ICs TRANSISTORS?  
 A phone call to us could get a result. We offer an extensive range and with a World-wide database at our fingertips, we are able to source even more. We specialise in devices with the following prefix (to name but a few).

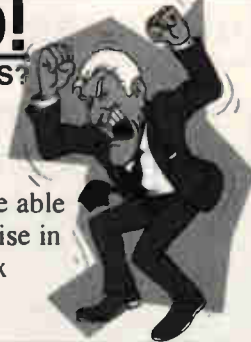

2N 2SA 2SB 2SC 2SD 2P 2SJ 2SK 3N 3SK 4N 6N 17 40 AD  
 ADC AN AM AY BA BC BD BDT BDV BDW BDX BF  
 BFR BFS BFT BFW BFX BFY BLX BS BR BRX BRY BS  
 BSS BSV BSW BSX BT BTA BTB BRW BU BUK BUT BUY  
 BUW BUX BUY BUZ CA CD DX CXA DAC DG DM DS  
 DTA DTC GL GM HA HCF HD HEF ICL ICM IRF J KA  
 KIA L LA LB LC LD LF LM M M5M MA MAB MAX MB  
 MC MDA J MJE MJF MM MN MP5 MPSA M5SH MP5U  
 MRF NJM NE OM OP PA PAL PIC PN RC S SAA SAB  
 SAD SAJ SAS SDA SG SI SL SN SO STA STK STR STRD  
 STRM STRS SV1 T TA TAA TAG TBA TC TCA TDA TDB  
 TEA TIC TIP TIPL TEA TL TLC TMP TMS TPU U UA  
 UAA UC UDN ULN UM UPA UPC UPD VN X XR Z ZN  
 ZTX + many others

We can also offer equivalents (at customers' risk).  
 We also stock a full range of other electronic components.  
 Mail, phone, Fax, Credit Card orders & callers welcome.



**Cricklewood Electronics Ltd**  
 40-42 Cricklewood Broadway, London NW2 3ET  
 Tel: 020 8452 0161 Fax: 020 8208 1441  
 www.cricklewoodelectronics.co.uk  
 E-mail: sales@cricklewoodelectronics.com

**ADVERTISERS INDEX**

COMPANY	PAGE NO:
BETA LAYOUT	33
CONFORD ELECTRONICS	35
CRICKLEWOOD	64
CROWNHILL	IBC
DISPLAY ELECTRONICS	45
JK MICROSYSTEMS	33
JPG	19
JOHNS RADIO	43
LABCENTRE	2
MILFORD	19
OLSON	4
PICO	31
PINWOOD ASSOCIATES	19
QUASAR	11
QUICK ROUTE	35
RALFE ELECTRONICS	64
RD RESEARCH	9
STEWART OF READING	31
TELFORD	35
TELNET	IFC
TIE PIE	OBC
VANN DRAPER	33
WESTDEV	23



# PIC BASIC COMPILERS

Crownhill Associates  
smart electronic solutions

## PIC Basic Plus & PIC Basic Pro Compilers

PIC BASIC Plus, supports the popular 14 bit Microchip PIC-Microcontrollers, allowing the user to write professional programs in BASIC. The compilers produce fast, tight machine code to load directly into the PIC-Microcontroller. The Compiler produces code that is guaranteed 100% compatible with Microchips PASM assembler. The compiler allows direct comparison between the BASIC program and the assembly listing. Two compilers are available, the PIC Basic Pro, entry level compiler and PIC BASIC Plus, professional compiler. Both produce fast assembly code from BASIC. The Compilers run under Windows 95,98,NT,ME and XP and are supplied with a comprehensive, Windows based editor with Syntax highlighting and just two key clicks to compile and program and detailed manuals with worked examples. The Compilers support a range of programmers including the Microchip PICStart-plus and our own development programmers. For a free demo of the Pro compiler visit our web site [www.letbasic.com](http://www.letbasic.com), or join our web based forum to hear what other users think of our compilers and supporting products... (PIC BASIC Pro is supplied with the book "Experimenting with the LET Basic Pro compiler" by Les Johnson, an invaluable guide for the beginner. See the web site for an example chapter).

Technical support is provided online via our web based forum, [www.picbasic.org](http://www.picbasic.org), or to tutors via telephone direct from the Author. Additional support can be provided to tutors using our development system for educational purposes.



### Development system



### Prototype PCB system

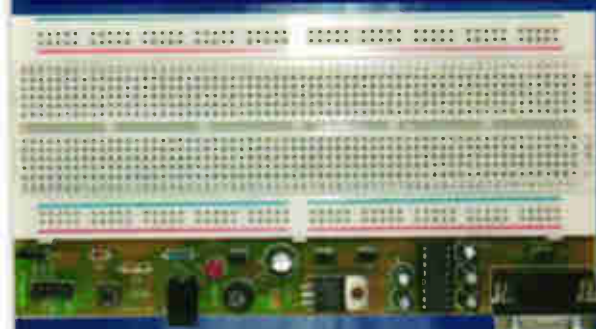

### Programmers



Supplied with source code and documentation for 20 Educational projects. Supports LCD displays from 2x16 Chrs to 128x64 dot matrix Graphics panel

All supporting components stocked at competitive prices  
eg PIC 16F84 04 /P - £1.80 each, PIC 16F877 04 /P £3.95 each  
CD 2x16 Chrs, £7.50 each LCD 128x64 dot matrix £15.95 each  
Many more items stocked, email [sales@crownhill.co.uk](mailto:sales@crownhill.co.uk) for prices

Visit our web sites: [www.letbasic.com](http://www.letbasic.com), [www.picbasic.org](http://www.picbasic.org)

£49.95 - PRO  
£99.95 - PLUS  
Free updates throughout product life

32, Broad Street, Ely  
Cambridge, CB7 4AH

Tel: +44 (0) 1353 666709  
Fax: +44 (0) 1353 666710  
[sales@crownhill.co.uk](mailto:sales@crownhill.co.uk)

All prices exclude:  
VAT, postage and packing



**ARBITRARY WAVEFORM GENERATOR-  
STORAGE OSCILLOSCOPE-  
SPECTRUM ANALYZER-  
MULTIMETER-  
TRANSIENT RECORDER-**

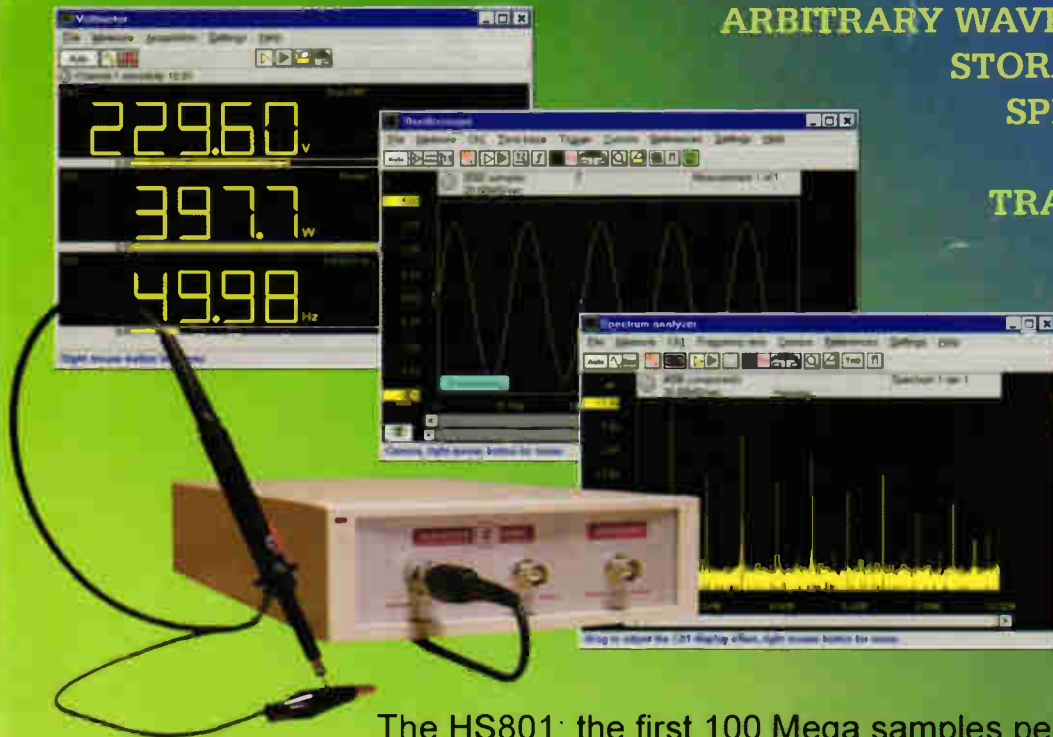

**Reliability**

The HS801: the first 100 Mega samples per second measuring instrument that consists of a MOST (Multimeter, Oscilloscope, Spectrum analyzer and Transient recorder) and an AWG (Arbitrary Waveform Generator). This new MOST portable and compact measuring instrument can solve almost every measurement problem. With the integrated AWG you can generate every signal you want.

- The versatile software has a user-defined toolbar with which over 50 instrument settings quick and easy can be accessed. An intelligent auto setup allows the inexperienced user to perform measurements immediately. Through the use of a setting file, the user has the possibility to save an instrument setup and recall it at a later moment. The setup time of the instrument is hereby reduced to a minimum.
- When a quick indication of the input signal is required, a simple click on the auto setup button will immediately give a good overview of the signal. The auto setup function ensures a proper setup of the time base, the trigger levels and the input sensitivities.
- The sophisticated cursor read outs have 21 possible read outs. Besides the usual read outs, like voltage and time, also quantities like rise time and frequency are displayed.
- Measured signals and instrument settings can be saved on disk. This enables the creation of a library of measured signals. Text balloons can be added to a signal, for special comments.
- The (colour) print outs can be supplied with three common text lines (e.g. company info) and three lines with measurement specific information.
- The HS801 has an 8 bit resolution and a maximum sampling speed of 100 MHz. The input range is 0.1 volt full scale to 80 volt full scale. The record length is 32K/64K samples. The AWG has a 10 bit resolution and a sample speed of 25 MHz. The HS801 is connected to the parallel printer port of a computer.
- The minimum system requirement is a PC with a 486 processor and 8 Mbyte RAM available. The software runs in Windows 3.xx / 95 / 98 or Windows NT / 2000 / XP and DOS 3.3 or higher.

TiePie engineering (UK), 28 Stephenson Road, Industrial Estate, St. Ives, Cambridgeshire, PE17 3WJ, UK  
Tel: 01480-460028; Fax: 01480-460340

TiePie engineering (NL), Koperslagersstraat 37, 8601 WL SNEEK The Netherlands  
Tel: +31 515 415 416; Fax +31 515 418 819

Web: <http://www.tiepie.nl>

