

RADIO & ELECTRONICS

FEBRUARY 1980
55p

CONSTRUCTOR

TELEPHONE BELL REPEATER

GARAGE

WORKSHOP

OUTDOORS

GARDENING

**SIMPLE
SW
SUPERHET**

COVERS 180 TO 20 METRES · NO ALIGNMENT PROBLEMS
ONLY 3 TRANSISTORS · VERY LOW BATTERY CURRENT

**ALSO
FEATURED**

**THE THIEF-PROOF HANDBAG
AUDIO DELAY LINE**

DIRECT SUPPLY SERVICE TO READERS

TOWERS INTERNATIONAL OPAMP LINEAR-IC SELECTOR (JUST PUBLISHED)

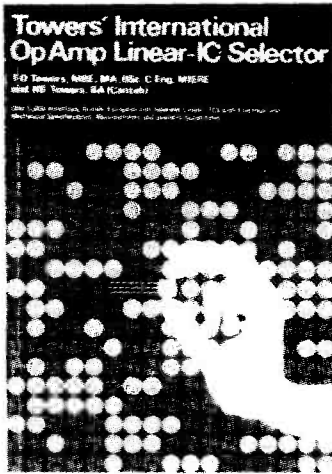

This opamp linear-IC compendium, a comprehensive tabulation of basic specifications for over four thousand opamps, offers information on:

1. Ratings
2. Characteristics
3. Case details
4. Terminal identifications
5. Applications use
6. Manufacturers
7. Substitution equivalents (both European and American)

This work covers not only classical 'pure' opamps, but also several classes of 'quasi-opamps' (i.e. linear-ICs with opamp-like characteristics) such as dc-comparators, operational-trans-conductance-amplifiers, differential-output amplifiers, current-difference amplifiers, and voltage-follower amplifiers.

The more than 4,000 opamps covered in this self-contained volume are a selection of the more common current and widely-used obsolete types.

The coverage is international in scope and includes opamps not only from the USA and Continental Europe, but also from the United Kingdom and the Far East (Japan).

Price **£7.50** inc P&P

(Please allow 21 days for delivery)

TOWERS INTERNATIONAL FET SELECTOR

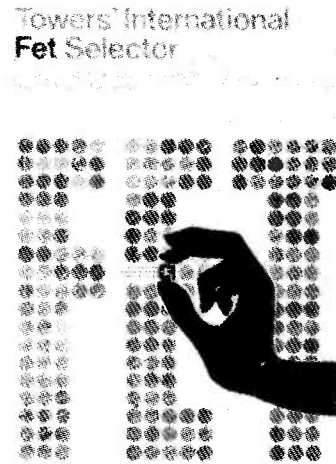

If you deal with field effect transistors, or fet's — whether as a student, a hobbyist, a circuit engineer, a buyer, a teacher or a serviceman — you often want data on a specific fet of which you know only the type number.

Specifications apart, you may be even more interested in where you can get the device in question. And perhaps more important still (particularly with obsolete devices), you may want guidance on a readily available possible substitute.

This fet compendium, a comprehensive tabulation of basic specification offers information on:

1. Ratings
2. Characteristics
3. Case details
4. Terminal identifications
5. Applications use
6. Manufacturers
7. Substitution equivalents (both European and American)

The many fet's covered in this compendium are most of the more common current and widely-used obsolete types.

It is international in scope and covers fet's not only from the USA and Continental Europe, but also from the United Kingdom and the Far East (Japan).

Price **£4.00** inc P&P

**Tower's
International
Op Amp Linear-IC
Selector**

by T. D. Towers
MBE, MA, BSc, C Eng, MIERE
£7.50
inc. post and packing

To:—DATA PUBLICATIONS LTD.
57 MAIDA VALE
LONDON W9 1SN

Please send me copy/copies
to the address shown below

NAME

ADDRESS

.....(Block capitals)

**Tower's
International
FET
Selector**

by T. D. TOWERS
MBE, MA, BSc, C Eng, MIERE
£4.00
inc. post and packing

To:—DATA PUBLICATIONS LTD.
57 MAIDA VALE
LONDON W9 1SN

Please send me copy/copies
to the address shown below

NAME

ADDRESS

.....(Block capitals)

BYPASSING AND DECOUPLING

In the audio frequency amplifier circuit of (a), R1, R2 and R4 are bias resistors and R3 is the transistor collector load. A.F. voltages can develop across R4 and reduce the a.f. gain to a low level. A high-value bypass capacitor is added in (b) and it prevents a.f. voltages appearing across R4 without upsetting d.c. bias conditions. The circuit will then give maximum a.f. gain.

In the 2-stage a.f. amplifier of (c) the input at TR1 base is in phase with the output at TR2 collector. Should the battery develop a high internal resistance (as can occur with aging) a fraction of the output signal will be built up across that internal resistance and be fed back via the positive rail and R1 to TR1 base. The result can be instability. The situation is alleviated by connecting a high-value bypass capacitor across the supply rails, as in (d). The capacitor has a very low reactance at audio frequencies and prevents these appearing on the positive rail.

The situation is further improved in (e) by adding two decoupling components: a series resistor and another high-value capacitor. The resistor and capacitor "decouple" TR1 and its base from TR2. The series resistor has a value which still allows an adequate supply voltage to be available for TR1.

These are simple examples of bypassing and decoupling. At audio frequencies the capacitors will usually be electrolytic with values in the order of $10\mu\text{F}$ to $200\mu\text{F}$. At radio frequencies, bypass and decoupling capacitors are normally non-electrolytic with values ranging from some $1,000\text{pF}$ to $0.1\mu\text{F}$ according to frequency.

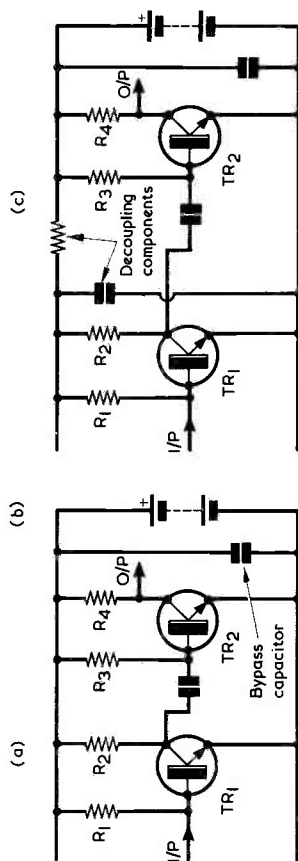
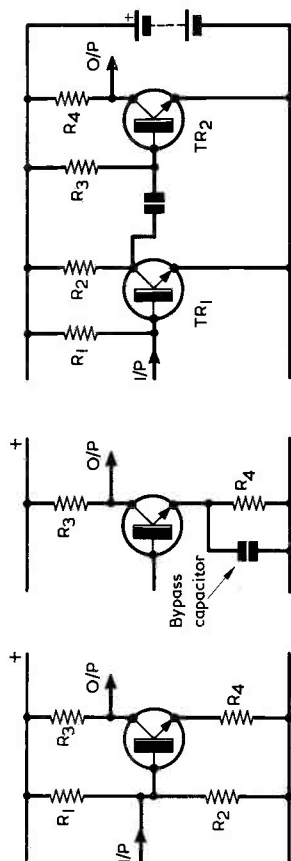

MAPLIN



A 63-key ASCII keyboard with 625-line TV interface, 4-page memory and microprocessor interface. Details in our catalogue.



Our catalogue even includes some popular car accessories at marvellous prices.



A 10-channel stereo graphic equaliser with a quality specification at an unbeatable price when you build it yourself. Full specification in our catalogue.



These are just some of the metal cases we stock. There are dozens of plastic ones to choose from as well. See pages 52 to 57 of our catalogue.



Our bi-monthly newsletter contains guaranteed prices, special offers and all the latest news from Maplin.

A massive new catalogue from Maplin that's even bigger and better than before. If you ever buy electronic components, this is the one catalogue you must not be without. Over 280 pages - some in full colour - it's a comprehensive guide to electronic components with hundreds of photographs and illustrations and page after page of invaluable data.



Mobile amateur radio, TV and FM aerials plus lots of accessories are described in our catalogue.



A digitally controlled stereo synthesiser the 5600S with more facilities than almost anything up to £3,000. Build it yourself for less than £750. Full specification in our catalogue.



A superb range of microphones and accessories at really low prices. Take a look in our catalogue - send the coupon now!



An attractive mains alarm clock with radio switching function and battery back up! Complete kit with case only £18.38 (incl. VAT & p & p) MA1023 module only £8.42 (incl. VAT).

Post this coupon now for your copy of our 1979-80 catalogue price 70p.

Please send me a copy of your 280 page catalogue. I enclose 70p (plus 37p p&p). If I am not completely satisfied I may return the catalogue to you and have my money refunded. If you live outside the U.K. send £1.35 or ten International Reply Coupons. I enclose £1.07.

NAME _____

ADDRESS _____

REC280



A superb technical bookshop in your home! All you need is our catalogue. Post the coupon now!



A hi-fi stereo tuner with medium and long wave, FM stereo and UHF TV sound! Full construction details in our catalogue.

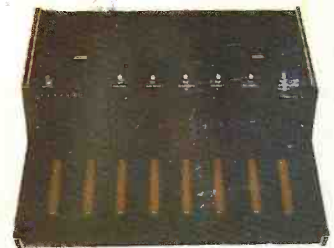

Add-on bass pedal unit for organs. Has excellent bass guitar stop for guitarists accompaniment. Specification in our catalogue.

MAPLIN

ELECTRONIC SUPPLIES LTD

All mail to:-
 P.O. Box 3, Rayleigh, Essex SS6 8LR.
 Telephone: Southend (0702) 554155.
 Shop: 284 London Road, Westcliff-on-Sea, Essex.
 (Closed on Monday).
 Telephone: Southend (0702) 554000.

RADIO & ELECTRONICS CONSTRUCTOR

FEBRUARY 1980
Volume 33 No. 6

Published Monthly

First published in 1947

Incorporating *The Radio Amateur*

Editorial and Advertising Offices
57 MAIDA VALE LONDON W9 1SN

Telephone 01-286 6141 Telegrams
Databux, London

© Data Publications Ltd., 1980. Contents may only be reproduced after obtaining prior permission from the Editor. Short abstracts or references are allowable provided acknowledgement of source is given.

Annual Subscription: £8.00, Eire and Overseas £9.00 (U.S.A. and Canada \$20.00) including postage. Remittances should be made payable to "Data Publications Ltd". Overseas readers, please pay by cheque or International Money Order.

Technical Queries. We regret that we are unable to answer queries other than those arising from articles appearing in this magazine nor can we advise on modifications to equipment described. We regret that queries cannot be answered over the telephone, they must be submitted in writing and accompanied by a stamped addressed envelope for reply.

Correspondence should be addressed to the Editor, Advertising Manager, Subscription Manager or the Publishers as appropriate.

Opinions expressed by contributors are not necessarily those of the Editor or proprietors.

Production— Web Offset.

CMOS C-METER — Suggested Circuit by G. A. French	334
NEWS AND COMMENT	336
CLASS D AMPLIFICATION — A development of the 1960's returns to the audio scene — by John Baker	338
SIMPLE S.W. SUPERHET — Part 1 by R. A. Penfold	342
SHORT WAVE NEWS — For DX listeners by Frank A. Baldwin	348
SAW FILTERS by R. J. Caborn	350
IN NEXT MONTH'S ISSUE	351
TELEPHONE BELL REPEATER by R. A. Penfold	352
INPUTS AND OUTPUTS — Databus Series No. 7 by Ian Sinclair	357
BOOK REVIEW	360
AUDIO DELAY LINE — 'Bucket Brigade' i.e. gives delay for entire audio spectrum by I. M. Attrill	361
TRADE NEWS — Sales and Manufacturing Rights acquired for range of Thermostatic Soldering Irons	367
THE 'WATERSPORT' MEDIUM LONG WAVE PORTABLE — Part 1 — A 3-transistor design with integral wave trap for interfering transmissions by Sir Douglas Hall, Bt., K.C.M.G.	368
NEW PRODUCT — Probe case and associated hardware	371
THE THIEF-PROOF HANDBAG — In Your Workshop	372
RECENT PUBLICATIONS	378
BYPASSING AND DECOUPLING Electronics Data No. 54	iii

Published in Great Britain by the Proprietors and Publishers, Data Publications Ltd, 57 Maida Vale, London W9 1SN.

The *Radio & Electronics Constructor* is printed by Swale Press Ltd.

*The March issue will be published
early in February*

Great 1980 Sale

SUPER SOUND SAVING! DINDY LOW NOISE CASSETTES

SJ30	10 C30 15 min per side	£2.00
SJ55	10 C48 23 minute per side (LP)	£2.50
SJ31	10 C90 45 min per side	£3.50
SJ32	10 C120 40 min per side	£4.50

ALL REDUCED! CAPACITOR PAKS

16201	18 electrolytics	4.7uf-10uf	
16202	18 electrolytics	10uf-100uf	
16203	18 electrolytics	100uf-680uf	
ALL 3 at SPECIAL PRICE of £1.30			
16160	24 ceramic caps	22pf-82pf	
16161	24 ceramic caps	100pf-390pf	
16162	24 ceramic caps	470pf-3300pf	
16163	24 ceramic caps	4700pf-0.047pf	
ALL 4 at SPECIAL PRICE of £1.80			

RESISTOR PAKS

16213	60 1/2w resistors	100ohm-820ohm	
16214	60 1/2w resistors	1K-8.2K	
16215	60 1/2w resistors	10K-82K	
16216	60 1/2w resistors	100K-820K	
ALL 4 at SPECIAL PRICE of £1.80			
16217	40 1/2w resistors	100ohm-820ohm	
16218	40 1/2w resistors	1K-8.2K	
16219	40 1/2w resistors	10K-82K	
16220	40 1/2w resistors	100K-820K	
ALL 4 at SPECIAL PRICE of £1.80			

IC SOCKET PAKS

F.E.T.'s

SJ36	14	8 pin	2N3819	£0.17	
SJ37	12	14 pin	2N5458	£0.18	
SJ38	11	16 pin	2N4220	£0.28	
SJ39	8	18 pin	2N4860	£0.25	
SJ40	7	20 pin			
SJ41	6	22 pin	PROGRAMMABLE		
SJ42	5	24 pin	UNIUNCTION		
SJ43	4	28 pin			
SJ44	3	40 pin	2N6027	£0.25	
ALL at ONLY £1.00 EACH				BRYS6	£0.25

VOLTAGE REGULATORS

Case T0220

Positive	Price each	Negative	Price each
uA7805	£0.65	LM309K T03	£1.10
uA7812	£0.65	uA7905	£0.70
uA7815	£0.65	uA7912	£0.70
uA7818	£0.65	uA7915	£0.70
uA7824	£0.65	uA7918	£0.70
uA723 14 pin DIL	£0.35	uA7924	£0.70

OPTOELECTRONICS

DISPLAYS

1510	707 LED Display	Price each	£0.70
1511	747 LED Display	Price each	£1.50
1512	727 LED Display	Price each (dual)	£1.55

L.E.D.'s

	Price each	
SJ78	.125 LED Diffused RED	£0.08
SJ79	.2 LED Diffused RED	£0.08
SJ20	.235 LED Bright RED	£0.09
SJ21	.2 LED Bright RED	£0.09
1505	.125 LED Diffused GREEN	£0.11
1502	.2 LED Diffused GREEN	£0.11
1503	.125 LED Diffused YELLOW	£0.11
1506	.2 LED Diffused YELLOW	£0.11
SJ80	.2 LED Bright YELLOW	£0.14
SJ82	.2 LED Clear Illuminating RED	£0.10
SJ83	.125 LED Clear Illuminating RED	£0.10

2nd QUALITY LED PAKS

1507	10 assorted colours & size	£0.65
SJ22	10.125 RED	£0.50
SJ23	10.2 RED	£0.50

LED CLIPS

150B/125	.125	5 for £0.10
150B/2	.2	5 for £0.12

SJ81	1 Infra RED emitter - Fairchild FP100	£0.25
SJ98	5 Photo Detector MEL11 + Data	£1.00
ORP12	NORP 12 Cad Cell	£0.45
SJ99	4 IIT 5B70 ST Nixie Tubes	£1.00
SJ29	Texas NPN silicon transistors 2S603=BC108 TO-18 metal can - perfect & coded	

50 off £2.50 - 100 off £4.00 - 1000 off £35.00

SPECIAL OFFER

SJ100	12v Electric Drill 7,500RPM for all your PCB drilling complete with 2 drills - 1 & .15	£5.00
-------	----------------------------------------------------------------------------------------	-------

SUPER DUPER COMPONENT BOX

Min. 3 lbs. in weight consisting of a fantastic assortment of Electronic Components - Pots, Resistors, Condensers, Switches, Relays, Board-Semiconductors, wire, hardware, etc., etc. *This is a large box and is sent separate to your order.
\$140 £2.50 including p&p

METAL CASE DUAL SLIDER POTS: 45mm travel

SJ65	10K log	.25 each
SJ66	1 10K lin	0.25 each
SJ67	Chrome slider knobs to fit	£0.10

TRANSISTORS

Type	Price	Type	Price	Type	Price
AC107	£0.20	BC440	£0.25	TIP29C	£0.34
AC126	£0.14	BC441	£0.25	TIP30	£0.30
AC127	£0.16	BC460	£0.28	TIP30A	£0.30
AC128	£0.15	BC461	£0.28	TIP30B	£0.32
AC128K	£0.24	BC477	£0.15	TIP30C	£0.34
AC176	£0.16	BC478	£0.15	TIP31	£0.30
AC177K	£0.24	BC479	£0.15	TIP31A	£0.30
AC187	£0.16	BC547	£0.08	TIP31B	£0.32
AC187K	£0.26	BC548	£0.08	TIP31C	£0.34
AC188	£0.16	BC549	£0.08	TIP32	£0.30
AC188K	£0.26	BC557	£0.10	TIP32A	£0.30
AD161/162MP	£0.85/pr	BC558	£0.09	TIP32B	£0.32
AD140	£0.50	BC559	£0.10	TIP32C	£0.34
AD149	£0.53	BCY70	£0.13	TIP41	£0.34
AF239	£0.35	BCY71	£0.13	TIP41A	£0.34
BC107	£0.08	BCY72	£0.13	TIP41B	£0.36
BC107A	£0.06	BD115	£0.45	TIP41C	£0.38
BC107B	£0.07	BD131	£0.30	TIP42	£0.34
BC107C	£0.09	BD132	£0.30	TIP42A	£0.34
BC108	£0.06	BD135	£0.28	TIP42B	£0.36
BC108A	£0.06	BD136	£0.28	TIP42C	£0.38
BC108B	£0.07	BD239A/		TIP2955	£0.45
BC108C	£0.09	BD240A/MP		TIP3055	£0.50
BC109	£0.06		£0.80/pr	ZTX107	£0.08
BC109B	£0.07	BF115	£0.20	ZTX108	£0.10
BC109C	£0.09	BF167	£0.20	ZTX300	£0.10
BC113	£0.10	BF173	£0.20	ZTX301	£0.10
BC114	£0.12	BF195	£0.09	ZTX302	£0.12
BC116	£0.16	BF199	£0.09	ZTX500	£0.10
BC118	£0.10	BF197	£0.10	ZTX501	£0.10
BC140	£0.20	BF257	£0.22	ZTX502	£0.12
BC141	£0.20	BF258	£0.22	2N696	£0.10
BC142	£0.18	BF259	£0.22	2N697	£0.09
BC147	£0.07	BF339	£0.20	2N706A	£0.10
BC148	£0.07	BF340	£0.20	2N708	£0.10
BC149	£0.07	BF399	£0.22	2N1302	£0.15
BC157	£0.09	BF400	£0.22	2N1303	£0.15
BC158	£0.09	BF780	£0.22	2N1303	£0.15
BC159	£0.09	BF784	£0.20	2N1613	£0.18
BC189C	£0.08	BF785	£0.20	2N1711	£0.18
BC170	£0.06	BFX29	£0.20	2N1893	£0.25
BC171	£0.07	BFX84	£0.20	2N2218	£0.25
BC172	£0.07	BFY50	£0.15	2N2218A	£0.20
BC173	£0.08	BFY51	£0.15	2N2219	£0.18
BC177	£0.13	BFY52	£0.15	2N2219A	£0.20
BC178	£0.13	8IP19/20MP	£0.70/pr	2N2221	£0.18
BC179	£0.13	MJE340	£0.60	2N2221A	£0.20
BC182	£0.07	MJE2955	£0.75	2N2222	£0.18
BC182L	£0.07	MJE3056	£0.50	2N2222A	£0.18
BC183	£0.07	MPSA05	£0.15	2N2369	£0.12
BC183L	£0.07	MPSA06	£0.15	2N2904	£0.16
BC184	£0.07	MPSA07	£0.15	2N2904A	£0.17
BC184L	£0.07	MPSA55	£0.15	2N2905	£0.18
BC207	£0.08	MPSA56	£0.15	2N2905A	£0.18
BC208	£0.08	OC25	£0.60	2N2906	£0.14
BC209	£0.09	OC26	£0.45	2N2906A	£0.15
BC212	£0.07	OC28	£0.80	2N2907	£0.15
BC212L	£0.07	OC29	£0.55	2N2907A	£0.16
BC213L	£0.07	OC35	£0.55	2N2926G	£0.18
BC214	£0.07	OC36	£0.60	2N3053	£0.15
BC215L	£0.10	OC42	£0.18	2N3054	£0.30
BC261	£0.14	OC44	£0.20	2N3055	£0.35
BC327	£0.12	OC45	£0.18	2N3702	£0.07
BC328	£0.12	OC71	£0.12	2N3703	£0.07
BC337	£0.12	OC72	£0.18	2N3704	£0.06
BC338	£0.12	OC75	£0.18	2N3705	£0.06
		OC81	£0.20	2N3706	£0.07
		TIP29	£0.30	2N3711	£1.00
		TIP29A	£0.30	2N3772	£1.10
		TIP29B	£0.32	2N3773	£1.50

DIODES

Type	Price	Type	Price	Type	Price
AA119	£0.06	0A70	£0.06	IN4004	£0.06
BA100	£0.08	0A79	£0.08	IN4005	£0.07
BA148	£0.13	0A81	£0.08	IN4006	£0.08
BA173	£0.13	0A90	£0.08	IN4007	£0.09
BAK13	£0.05	0A91	£0.08	IN5400	£0.12
BAK16	£0.06	0A95	£0.08	IN5401	£0.13
CA200	£0.06	IN34	£0.08	IN5402	£0.14
CA202	£0.07	IN80	£0.07	IN5404	£0.15
BY100	£0.18	IN4148	£0.05	IN5406	£0.19
BY126	£0.12	IN4001	£0.04	IN5407	£0.23
BY127	£0.14	IN4002	£0.04	IN5408	£0.28
OA47	£0.06	IN4003	£0.05	IS44	£0.03

LINEAR

Type	Price	Type	Price	Type	Price
CA270	£0.95	SL414A	£1.75	TB810	£0.85
CA3099	£1.70	SN76013NE1.85		TB820	£0.65
CA3090	£3.00	SN76023N	£1.60	uA703	£0.20
LM380	£0.80	SN76115	£1.60	uA709C	£0.25
LM381	£1.35	TAA550	£0.30	uA710	£0.25
LM3900	£0.50	TAA621A	£1.80	uA711	£0.28
MC1310P	£0.85	TBA120B	£0.60	7418	£0.16
NE555	£0.18	TBA641A	£1.10	TAA661	£1.25
NE556	£0.55	TBA800	£0.75	TAA661B	£1.25

COMPONENT PAKS

O/N/O	Quantity	£	p
SJ1	200 Resistors mixed values	0.50	
SJ2	200 Carbon resistors 1/2 watt preformed	0.60	
SJ3	100 1/2 watt miniature resistors mixed values	0.50	
SJ4	60 1/2 watt resistors mixed values	0.50	
SJ5	50 1-2 watt resistors mixed pot values	0.50	
SJ6	50 Precision resistors 1-2" tol. mixed	0.50	
SJ7	30 5-10 watt wirewound resistors mixed	0.50	
SJ11	150 Capacitors mixed types & values	0.50	
SJ12	60 Electrolytics all sorts mixed	0.50	
SJ13	50 Polyester/polystyrene capacitors mixed	1.00	
SJ14	50 C280 type capacitors mixed	1.00	
SJ15	40 High Quality electrolytics 100-470Mf	1.00	
SJ16	40 Low volts electrolytics mixed up to 10v	0.50	
SJ17	20 Electrolytics transistor types mixed	0.50	
SJ18	20 Tantulum bead capacitors mixed	0.50	
SJ20	2 Large Croc-clips 25A rated	0.30	
SJ21	Large 7 1/2 mains neon tester screwdriver	0.85	
SJ22			

The Logic Probes

Spend Less

Test More



LP-1 Logic Probe

The LP-1 has a minimum detachable pulse width of 50 nanoseconds and maximum input frequency of 10MHz. This 100 K ohm probe is an inexpensive workhorse for any shop, lab or field service tool kit. It detects high-speed pulse trains or one-shot events and stores pulse or level transistions, replacing separate level detectors, pulse detectors, pulse stretchers and pulse memory devices.

All for less than the price of a DVM

£31.00*



LP-2 Logic Probe

The LP-2 performs the same basic functions as the LP-1, but, for slower-speed circuits and without pulse memory capability. Handling a minimum pulse width of 300 nanoseconds, this 300 K ohm probe is the economical way to test circuits up to 1.5 MHz. It detects pulse trains or single-shot events in TTL, DTL, HTL and CMOS circuits,

replacing separate pulse detectors, pulse stretchers and mode state analysers.

(Available in kit form LPK-1 £11-92)

£18.00*

The logic probes shown are all suitable for TTL, DTL, HTL and CMOS circuits.

*price excluding P.&P. and 15% VAT

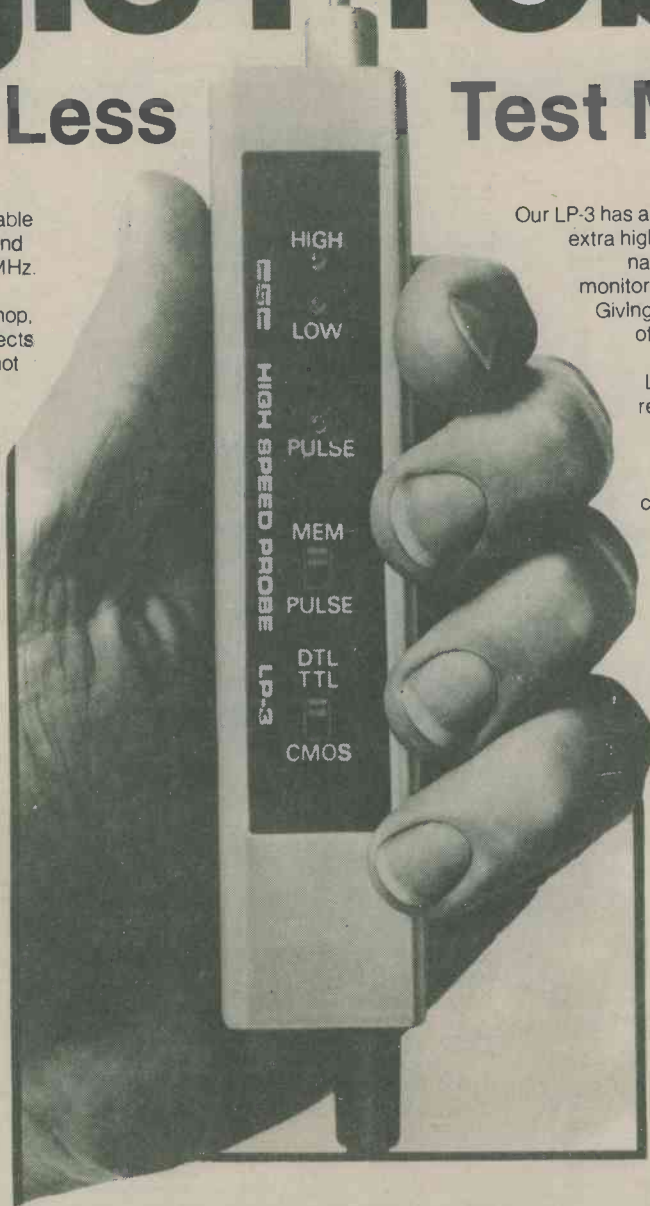

LP-3 Logic Probe

Our LP-3 has all the features of the LP-1 plus extra high speed. It captures pulses as narrow as 10 nanoseconds, and monitors pulse trains to over 50 MHz.

Giving you the essential capabilities of a high-quality memory scope at 1/1000th the cost.

LP-3 captures one shot or low-rep-events all-but-impossible to detect any other way.

All without the weight, bulk, inconvenience and power consumption of conventional methods.

£49.00*



The New Pulser DP-1

The Digital Pulser: another new idea from C.S.C. The DP-1 registers the polarity of any pin, pad or component and then, when you touch the 'PULSE' button, delivers a single no-bounce pulse to swing the logic state the other way. Or if you hold the button down for more than a second, the DP-1 shoots out pulse after pulse at 1000 Hz.

The single LED blinks for each single pulse, or glows during a pulse train. If your circuit is a very fast one, you can open the clock line and take it through its function step by step, at single pulse rate or at 100 per second. Clever! And at a very reasonable price.

£51.00*



CONTINENTAL SPECIALTIES CORPORATION



C.S.C. (UK) Limited,
Dept. 16J, Shire Hill Industrial Estate, Unit 1,
Saffron Walden, Essex CB11 3AQ.
Telephone: Saffron Walden (0799) 21682
Telex: 817477

C.S.C. (UK) Ltd., Dept.16J, Shire Hill Industrial Estate, Unit 1, Saffron Walden Essex CB11 3AQ
Prices include P.&P. and 15% VAT

LP-1	£37.38	Qty.	LP-2	£22.14	Qty.	LP-3	£58.08	Qty.	DP-1	£60.38	Qty.	LPK-1	£14.86	Qty.
------	--------	------	------	--------	------	------	--------	------	------	--------	------	-------	--------	------

Name _____ Address _____

I enclose Cheque/P.O. for £ _____ or debit my Barclaycard/Access/
American Express card no. _____ exp. date _____

FOR IMMEDIATE ACTION — The C.S.C. 24 hour, 5 day a week service.
Telephone (0799) 21682 and give us your Barclaycard, Access, American Express
number and your order will be in the post immediately.

for FREE
catalogue
tick box

THE MODERN BOOK CO

ELEMENTS OF ELECTRONICS By F. A. Wilson

Vol 1: Simple Electronic Circuits £2.45.

Vol 2: A/C Theory £2.45

Vol 3: Semiconductor Technology £2.45

ELECTRONIC PROJECTS IN THE HOME

by O. Bishop **Price £2.50**

ELECTRONIC PROJECTS IN AUDIO
by R. A. Penfold **Price £2.50**

OP-AMPS THEIR PRINCIPLES & APPL.
by J. B. Dance **Price £2.50**

PRINTED CIRCUIT ASSEMBLY
by M. J. Hughes **Price £2.10**

ELECTRONIC SECURITY DEVICES
by R. A. Penfold **Price £1.65**

UNDERSTANDING DIGITAL ELECTRONICS
by Texas Inst. **Price £4.00**

UNDERSTANDING MICRO-PROCESSORS
by Motorola **Price £4.30**

THE FIRST BK OF MICROCOMPUTERS
by R. Moody **Price £3.35**

HOW TO BUILD YOUR OWN SOLID STATE OSCILLOSCOPE
by F. G. Rayer **Price £1.70**

THE OSCILLOSCOPE IN USE
by I. R. Sinclair **Price £2.85**

THEORY & PRACTICE OF MODEL RADIO CONTROL

by P. Newell **Price £4.50**

REPAIRING POCKET TRANSISTOR RADIOS

by I. R. Sinclair **Price £2.55**

MAKING & REPAIRING TRANSISTOR RADIOS

by W. Oliver **Price £2.30**

WORLD RADIO TV HANDBOOK
by J. M. Frost **Price £9.25**

PROJECTS IN RADIO & ELECTRONICS
by I. R. Sinclair **Price £2.50**

ELECTRONIC PROJECTS IN THE HOME
by O. Bishop **Price £2.50**

SIMPLE CIRCUIT BUILDING
by P. C. Graham **Price £2.20**

110 SEMICONDUCTOR PROJECTS FOR THE HOME CONSTRUCTOR
by R. M. Marston **Price £3.20**

HAM RADIO
by K. Ulyett **Price £5.00**

UNDERSTANDING SOLID-STATE ELECTRONICS

by Texas Inst. **Price £1.80**

A SIMPLE GUIDE TO HOME COMPUTERS
by S. Ditlea **Price £4.00**

HOW TO BUILD A COMPUTER-CONTROLLED ROBOT

by T. Loofbourrow **Price £5.30**

THE CATHODE-RAY OSCILLOSCOPE & ITS USE
by G. N. Patchett **Price £4.00**

HOW TO GET THE BEST OUT OF YOUR TAPE RECORDER

by P. J. Guy **Price £1.90**

A GUIDE TO AMATEUR RADIO
by P. Hawker **Price £1.70**

RADIO CONSTRUCTION FOR AMATEURS
by R. H. Warring **Price £2.80**

MAKING TRANSISTOR RADIOS A BEGINNER'S GUIDE

by R. H. Warring **Price £2.90**

We have the Finest Selection of English and American Radio Books in the Country ☆ PRICES INCLUDE POSTAGE ☆

19-21 PRAED STREET (Dept RC) LONDON W2 INP

Telephone: 01 402 9176

AXIAL CAPACITORS

1/25v	4p	150/25v	6p
2.2/63v	4p	160/25v	6p
3.3/50	4p	220/16v	8p
4.7/40v	4p	220/25v	8p
10/25v	4p	220/63v	9p
15/16v	5p	330/10v	9p
22/10v	5p	330/25v	9p
22/16v	5p	330/63v	12p
22/25v	5p	470/6.3v	9p
33/35v	5p	470/16v	12p
33/50v	5p	470/40v	15p
47/25v	5p	680/6.3v	12p
47/16v	5p	1000/6.3v	15p
47/50v	6p	1000/16v	20p
100/10v	5p	1500/25v	20p
100/16v	5p	2200/10v	20p
100/63v	8p	3300/16v	25p
		4700/10v	25p

DIODES

1N4001	4p	1N4005	6p
1N4003	5p	1N4006	6p
1N4004	5p		

AXIAL POLYESTER CAPACITORS

.001uF	400v	3p	.047uF	160v	4p
.0015uF	400v	3p	.1uF	160v	5p
.0022uF	160v	3p	.1uF	400v	5p
.0022uF	400v	3p	.15uF	160v	6p
.0027uF	400v	3p	.18uF	160v	6p
.0068uF	400v	3p	.22uF	160v	6p
.01uF	160v	4p	.22uF	400v	6p
.022uF	160v	4p	.47uF	400v	8p
.033uF	400v	4p	1uF	160v	15p
.039uF	400v	4p			

DISPLAYS

TLR302	.3 inch Common Cathode	70p
TLR306	.6 inch Common Anode	£1.10
DL500	.5 inch Common Cathode	75p
FND507	.5 inch Common Anode	£1.20
Push to make switches		16p
Sub-min DPDT Slide switches		14p
Standard DPDT Slide switches		12p
Standard DPDT Toggle switches		49p
Rotary switches 1p 12w, 2p 6w, 3p 4w, 4p 3w		All 41p each
PP3 battery clips		6p
PP9 battery clips		14p
Din Plugs 5 pin 180°		10p
Din Sockets 5 pin 180°		
Standard metal type		10p
Green Phono Plugs		6p
Latchswitches 2p 2w		10p
20mm chassis mounting fuseholders		6p

RADIAL CAPACITORS

.47/50v	4p	220/50v	9p
1/50v	4p	220/63v	9p
2.2/25v	4p	330/10v	8p
10/40v	4p	330/25v	8p
10/50v	5p	330/50v	9p
15/16v	5p	330/63v	9p
22/25v	5p	470/6.3v	8p
22/50v	6p	470/16v	9p
33/63v	6p	470/25v	10p
47/16v	6p	1000/16v	20p
47/35v	6p	1000/25v	21p
100/35v	6p	1000/35v	23p
220/16v	8p	2200/10v	23p
220/40v	8p	3300/6.3v	24p

DISC CERAMIC CAPACITORS

.047	25v	9mm dia	3p
.1uF	30v	13mm dia	5p

SUB-MIN PRESETS

Horizontal: 100 Ω, 220 Ω, 470 Ω, 1k, 1k5, 2k2, 4k7, 10k, 47k, 100k.
Vertical: 470 Ω, 2k2, 4k7, 47k

ALL PRICE: 5p EACH

TTL

7400	10p	7442	36p	7494	43p
7401	12p	7445	51p	7495	37p
7402	12p	7447	43p	74107	20p
7404	12p	7450	12p	74121	26p
7408	14p	7451	12p	74122	34p
7409	14p	7470	26p	74123	42p
7410	10p	7472	22p	74132	48p
7411	15p	7474	23p	74151	38p
7412	16p	7475	24p	74154	60p
7414	42p	7476	19p	74164	60p
7416	22p	7486	21p	74174	56p
7421	20p	7489	£1.25	74175	56p
7427	20p	7490	32p	74192	48p
7432	17p	7491	30p	74193	48p
7438	19p	7492	30p	74194	43p
7440	12p	7493	25p	74196	48p

All prices include V.A.T. and post and packing. We also stock cable, different types of plugs and sockets, resistors, potentiometers, control knobs, transistors, integrated circuits and many other items. Telephone or write for free pamphlet to:

HARRISON BROS. P.O. BOX 55, WESTCLIFF-ON-SEA, ESSEX, SS0 7LQ.
Telephone: Southend-on-Sea (0702) 32338.

MAPLIN

ELECTRONIC SUPPLIES



SOLDER

A high quality standard solder by Erson Multicore. Ideal for miniature components 22swg. 1/4kg reel, about 163 metres. Order as FY70M Price £7.87



MINIATURE TRANSFORMERS

Good quality mains transformers to BS415. 6V type: secondaries 0-6V at 500mA + 0-6V at 500mA. Order as VB806G Price £2.19
9V type: secondaries 0-9V at 500mA + 0-9V at 500mA. Order as WB11M Price £2.58
12V type: secondaries 0-12V at 250mA + 0-12V at 250mA. Order as WB10L Price £2.19
15V type: secondaries 0-15V at 200mA + 0-15V at 200mA. Order as WB15R Price £2.19.

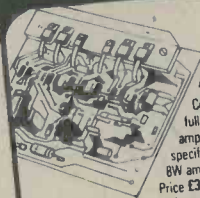

AMP KITS

Complete kits of parts with full instructions to make hi-fi amplifiers with excellent specifications. 8W amp kit: Order as LW36P Price £3.83
50W amp kit: Order as LW35D

Price £13.73
150W amp kit: Order as LW32K Price £14.89

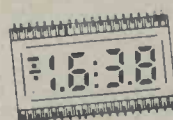

LIQUID CRYSTAL DISPLAY

High quality 3 1/2 digit 12.7mm (1/2 inch) high figures. Display has centre colon for use in 12-hour clocks and decimal points, plus and minus signs and overflow indicator for use in panel meters. Order as FV69W Price £8.89



SIREN

A small, but penetrating siren operating on 12V DC (11.2A) Dia. 75mm. Order as YB25C Price £9.11



McKENZIE POWER SPEAKERS

High quality, high power speakers. 12in. 50W 8Ω Order as XQ79L Price £18.79
12in. 50W 16Ω Order as XQ80B Price £18.79
12in. 80W 8Ω Order as XQ81C Price £26.92
12in. 80W 16Ω Order as XQ82D Price £26.92
15in. 150W 8Ω Order as XQ83E Price £57.80
15in. 150W 16Ω Order as XQ84F Price £57.80



PIEZO HORN TWEETER

Very simply added to any speaker system up to 100W rms. No crossover required. Distortion < 1%. Order as WF09K Price £5.27



20,000 OHM/VOLT MULTIMETER

A 20,000 ohms per volt multimeter at an incredibly low price. DC volts 5, 25, 125, 500, 2,500; AC volts 10, 50, 250, 1,000; DC amps 0 to 0.05mA, 0 to 250mA; Resistance 0 to 50k, 0 to 5M ohms; Decibels -20 to +22dB. Complete with test leads, battery and instruction leaflet. Order as YB83E Price £13.70

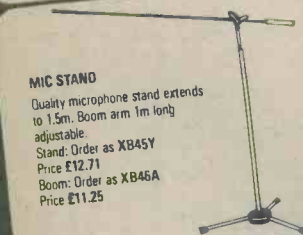

MIC STAND

Quality microphone stand extends to 1.5m. Boom arm 1m long adjustable. Stand: Order as XB45Y Price £12.71
Boom: Order as XB45A Price £11.25



SOLDERING IRONS & KITS

Antex CX iron. 17W miniature. Order as FY62S Price £4.85
Antex XZ5 iron. 25W. Order as FR12N Price £4.85
CX iron with stand in presentation pack. Order as FY68Y Price £6.85
XZ5 iron with stand in presentation pack. Order as FY69A Price £6.85



CLOCK MODULE

Module requires only transformer and two push switches to operate 4 digit, 0.7in red LED display. Alarm and radio outputs. Battery back up when mains fail. Sleep and snooze timer. Seconds display. Just add speaker for alarm tone. Full details on page 267 of our catalogue. Order as XL14Q Price £8.41



QUICK-CHARGE RECHARGEABLE CELL

1.2V. Size AA(HP7). Fully recharged in 5 hours with 150mA. Capacity: 450mAh. Will last for at least 500 full charge-discharge cycles. Change to quick charge cells now! Order as LR74R Price £1.49

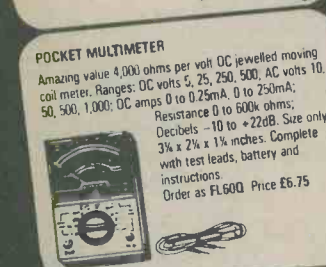

POCKET MULTIMETER

Amazing value 4,000 ohms per volt DC jewelled moving coil meter. Ranges: DC volts 5, 25, 250, 500; AC volts 10, 50, 500, 1,000; DC amps 0 to 0.25mA, 0 to 25mA; Resistance 0 to 500k ohms; Decibels -10 to +22dB. Size only 3 1/4 x 2 1/4 x 1 1/4 inches. Complete with test leads, battery and instructions. Order as FL60Q Price £5.75

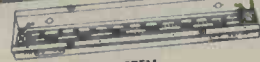

REVERBERATION SYSTEM

The 'concert hall' sound in your living room. Driver module: Order as XB85G Price £6.14
Requires + and - 15V 20mA power supply (ready built) suitable for Driver Module. Order as YL17T Price £4.73
Spring line with 3 sec. reverb time: Order as XL08J Price £4.93
Spring line with 7 sec. reverb time: Order as XB84F Price £11.13

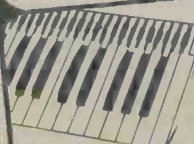

KEYBOARDS

High quality keyboards with hard wearing sloping fronted plastic keys. With keys mounted

on nylon bushed steel levers 49 note C to C. Order as XB15R Price £23.99
61-note C to C. Order as XB16S Price £29.90
With keys pivoted on a hard wearing moulded fulcrum. 49 note C to C. Order as XB17T Price £19.93



MULTIMETER & TRANSISTOR TESTER

Superb high sensitivity multimeter and transistor tester in one. Sensitivity 100,000 ohms per volt DC. Ranges DC volts 0.5, 2.5, 10, 50, 250, 1,000; AC volts 5, 10, 50, 250, 1,000; DC current 0.01, 0.025, 0.5, 5, 50, 500mA, 10A; AC current 10A; Resistance 5k, 50k, 5M, 50M ohms; Decibels -10dB to +62dB. Complete with test leads, three leads for transistor tester batteries and instruction leaflet. Order as YB87U Price £39.30



TURNABLES

Autochanger complete with stereo ceramic cartridge and circuit to make a complete low cost record player ideal for the young pop fan. Order as XQ00A Price £16.30
Single play nm-drive turntable with stereo ceramic cartridge. Order as XB23A Price £24.79
Single-play belt drive turntable 'S' shaped tone arm. Order as XB25C Price £30.63

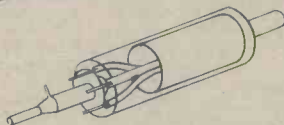

LASER TUBE

A helium-neon 0.5mW laser tube. Full details on page 262 of our catalogue. Order as XL11M Price £104.35

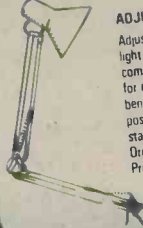

ADJUSTABLE LAMP

Adjustable to get a bright light on miniature components. With bracket for clamping or bolting to bench or wall. Sh-ade and position fully adjustable and stable. Finished in white. Order as XY25C Price £10.90

All prices include VAT and postage and packing, but if total under £4 please add 30p handling charge. Prices guaranteed until February 8th 1980. Export customers deduct 13% and export postage will be charged extra at cost. Please use order code. All items in stock at time of going to press

FOR FULL CATALOGUE DETAILS SEE BACK COVER

MAPLIN

ELECTRONIC SUPPLIES LIMITED

All mail to PO Box 3, Rayleigh, Essex SS6 8LR. Telephone: Southend (0702) 554155. Shop: 284 London Road, Westcliff-on-Sea, Essex (closed on Monday). Telephone: Southend (0702) 554000.

TRADE COMPONENTS

PAY A VISIT — THOUSANDS MORE ITEMS BELOW WHOLESALE PRICE. CALLERS PAY LESS ON MANY ITEMS AS PRICES INCLUDE POSTAGE. PRICES INCLUDE VAT AND ADDITIONAL DISCOUNT IN LIEU OF GUARANTEE. GOODS SENT AT CUSTOMERS RISKS UNLESS SUFFICIENT ADDED FOR REGISTRATION OR COMPENSATION FEE POST. CORRECT AT 28/12/79.

CARTERS MINIMITE SIREN

12/24V £6 for alarms etc.

VALVE BASES

Printed circuit B/G	7p
Chassis B7-B7G	11p
Shrouded Chassis B7G-B8A	13p
B12A tube, Chassis B9A	13p

Speaker 6" x 4" 5 ohm ideal for car radio £1.00
 4 1/2" diam. 30 Ω £1.75. 4" diam. 80 £1.00.
 2 1/2" diam. 8 Ω 75p or 32 £1.07

TAG STRIP—6-way 2 1/2p 5 x 50pF or 1000 +
 9-way 4 1/2p Single 2p 300pF trimmers 35p

C30 Cassette Pre-Programmed TRS80 Electric Pencil 25p or Record/Play

Car type panel lock and key 65p
 Transformer 9V 4A £3.30

Aluminium Knobs for 1/4" shaft. Approx. 1000 x 7/8" with indicator Pack of 5 95p

JAP 4 gang min. sealed tuning condensers 40p

ELECTROLYTICS — Hundreds more in catalogue Value/Voltage

Tant Bead .22, .47/35v 6p. .1, 1/35v, 47/6.3v 8p. .22/20v, 3.3/16v, 4.7/35v, 10/25v, 22/16v 9p. 4.7/16v, 10/3v 10p. 3.3/35v 12p.

Wire End

63v 2.2, 3 1/2p. 4.7, 4p. 10, 33, 5p. 2.5 3p. 1.5, 22 47 6p. 68, 100, 220 8p. 150 7 1/2p. 330 9p. 470 17 1/2p. 1000 29p. 25v 6, 6.4, 10, 12, 16, 22, 25, 30, 33, 40, 47, 50, 64 4p. 100, 150, 160, 330 6p. 220 7p. 250, 300, 470 8p. 1000 11 1/2p. 22/16. 3.3/50, 10/50 4p. 100/10, 47/16 5p. 100/16 100/35, 220/16 6p. 470/6.3, 10/350 470/16 8p. 1000/16 10p. 1500/6.3 7 1/2p. 2200/10 20p. 4700/10 30p. 15/160 7p. CANS 250/300, 45p. 300/450 90p. 100/275 14p. 2000/100 82p. 1000/100 70p. 8+8/450 9p. 10,000/16 36p. 2000/50 35p. 2000 + 2000/50 40p. Full range in catalogue.

RS 100-0-100 micro amp null indicator Approx. 2" x 3/4" x 3/4" £1.85

INDICATORS

Bulgin D676 red, takes M.E.S. bulb £3p
 12 volt, or Mains neon, red pushfit. £23p
 R.S.-Scale Print, pressure transfer sheet £12p

CAPACITORS: up to 500v: Ceramic up to .01 2p. to .1 5p, to .68 8p. Silvermica up to 5000PF 5p. to .01 21p. Poly, etc up to .1 2p, to .2 3p, to .47 5p, to .66 7p:

.1, .22/900v 15p. 3/600v 4p. .97/160v 7 1/2p. 1mFd up to 250v 10p. 2.2mFd up to 100v 14p. 4/16v 25p. 6.8/63, 25/50 19p. 8/20v 40p. CAN 1/350 12p. 8/660 vac £2. 3/660 vac £1.75. 5/150 70p.

Pulse Tube: 8-12kV, 10, 47, 56, 82, 100, 120, 320pF 2p each. Hundreds of others in Catalogue

SONNENSCHNEIN/POWERSONIC DRI-FIT RECHARGEABLE SEALED GEL (Lead Antimony) BATTERY, 6 Volt 6 amp. hr. (4 1/2" x 2" x 3") £4.25
 Ex-equipment, little used.

CONNECTOR STRIP

Belling Lee L1469, 4 way polythene. 9p each

1 1/2 glass fuses 250 m/a or 3 amp (box of 12) 20p

Bulgin 5mm Jack plug and switched socket (pair) 40p

Red Switch 28mm body length 5p

PP3 Battery Leads 8p

Aluminium circuit tape, 1/8 x 36 yards—self adhesive. For window alarms, circuits, etc. 95p

TV MAINS DROPPERS

5 assorted multiple units for 45p

100pF air-spaced tuning capacitor £1.30

5 1/2" x 2 1/2" Speaker, ex-equipment 3 ohm 65p

2 Amp Suppression Choke 10p

3 x 2 1/2" x 1 1/2" PAXOLINE 5 for 35p

4 1/2" x 1 1/2" Nylon clip on MES bulb holder 10 for 15p

VALVE RETAINER CLIP, adjustable 5 for 15p

Sub-miniature Transistor Transformer 35p

Valve type output transformer 90p

POT CORES with adjuster LA2508-LA2519 43p per pair

16 Watt Power Amp. Module

35v 1A power required, giving 16 watt

RMS into 8 Ω £3.45

REGULATED TAPE MOTOR

Grundig 6V approx., 3" x 1 1/2", inc. shock absorbing carrier, or Jap 9V, 1 1/2" diam. £1.05

20mm fuse holder — chassis 4p, panel 17p.

Fane 8 ohm 3" sq. heavy duty communications speaker £1.60

RS neg. volt regulator 103, 306-099 (equiv. MPC900) 10A, 100 watt 4-30 volt. Adjustable sort circuit protection. Sacrifice at £2.00

BOXES — Grey polystyrene 61 x 112 x 31mm, top secured by 4 self tapping screws 57p clear perspex sliding lid, 46 x 39 x 24 mm 10p!

ABS, ribbed inside 5mm centres for P.C.B., brass corner inserts, screw down lid, 50 x 100 x 25mm orange 65p; 80 x 150 x 50mm black 97p; 110 x 190 x 60mm black £1.52.

DIECAST ALI superior heavy gauge with sealing gasket, approx 6 1/2" x 2 3/8" x 1 3/8" £1.55; 3 1/2" x 2 3/8" x 1 3/8" 99p.

VARIABLE CAMM PROGRAMMER 10, 12 or 15 pole 2 way, 50VAC motor — series with 1mf, or 3k 10W or 15W pygmy bulb for mains operation. Ex equipment £3.10.

SWITCHES

Pole	Way	Type	
1	2	Flush Wall Wh. Rocker	35p
6	2	Slide	24p
2	1	Rotary Mains	14 1/2p
2	Alternating	Micro with roller	30p
2	2	Sub-Min Toggle	62p
2	1	Toggle	40p
1	2	Sub-Min Toggle	67p
2	Alternating	2A Mains Push (3/4" hole)	43p
1	3	Slide	12p

S.P.S.T. 10 amp 240v. white rocker switch with neon. 1" square flush panel fitting 39p

1 pole 2-way 10 amp oblong clip in mains rocker appliance switch 36p

Standard thumb-wheel switch 0-9 in 1248N or B.C.D. or Comp. 1242 also 2p co. 85p

Standard Lever Key switch D.P.D.T. locking plus D.P.D.T. and S.P.S.T. Heavy Duty non latching 73p

1 pole 2-way Micro; button, roller, lever or half-trigger 19p

Push to make 15p To break 17p

4-bank of 2PCO independent 40p

5-bank of 2x2PCO, 4PCO, 6PCO, Interlock plus 2PCO independent 48p

6-bank of 4x4PCO+6PCO+2PCO Interlocking. 58p

COMPUTER & AUDIO BOARDS/ASSEMBLIES

VARYING CONTENTS INCLUDE ZENER, GOLD BOND, SILICON, GERMANIUM, LOW AND HIGH POWER TRANSISTORS AND DIODES, HI STAB RESISTORS, CAPACITORS, ELECTROLYTICS, TRIMPOTS, POT CORES, CHOKES, INTEGRATED CIRCUITS, ETC.

3lb for £2.30 7lb for £4.30

1k horizontal preset with knob 10 for 40p

3" Tape Spools 5p

1" Terry Clips 5p

12 Volt Solenoid 40p

ENM Ltd. cased 7-digit counter 2 1/2 x 1 1/2 x 1 1/2" approx. 12V d.c. (48 a.c.) or mains £1.10.

Auto charger for 12v Nicads, ex-new equipment £3.95

RESISTORS

1/4-1/2 watt 1 1/2p 10 same value 10p

1 watt 1 1/2p

1 or 2% 1 1/2p

Up to 15W w/wound 10p, 10 same value 75p

RELAYS

RS/Alma reed relay, 1K12v or 3k Ω 18-30v d.c. coil, normally open 36p

12v d.p.c.o. heavy duty octal £1

600 Ω 4 p/co min sealed 75p. Base 10p. D.I.L. 3-7-12V S.P. £1.00

POTS

Wirewound 38p. Log or Lin rotary 22p, or slide 30p.

With switch 40p, Dual 45p

Dual switch 55p 1.5m Edgetype 10 for 40p.

Skeleton Presets

Slider, horizontal or vertical standard 5p or submin 4p

THERMISTORS and V.D.R.'s

CZ1/2/6/11/14, KR22, KT150, VA1005/6/8/1010/1033/4/7/8/9 1040/1053/5 1066/7/1074/6/7 1082/6/1091/6/7/8 1100/3/8/86D2. Rod with spot blue/fawn/green.

E299DDP120/218/224/338/340/350/352

YF020 E220ZZ/02

KR150 E23 glass bead

YG150-S534 bead KB13

E299 DHP23D, 116-121

401 (TH7, VA1104, OD10), R53 Glass All 7p each

Miniature 0 to 5mA d.c. meter approx 7/8" diameter £1.25

RS Yellow Wander Plug Box of 12 40p

18 SWG multicoe solder 3 1/2p foot

SAPHIRE STYLII, 10 different; dual and single point, current and hard to get types. My mix £1

BRIAN J. REED

161 ST. JOHNS HILL, BATTERSEA, LONDON SW11 1TQ

Open 10 a.m. till 7 p.m. Tuesday to Saturday. VAT receipts on request.

Terms: Payment with order Telephone: 01-223 5016

Digital count unit. Counts in steps of 1, 2, 5 or 10 with total limit switch (2 x D.I.L. BCD), reed relay remote output. Mains power supply, relay and delay unit. UNUSED. £5.60

RELAY 6 amp changeover. Mains coil 200pA F.S.D. level Meter 1 1/2" x 1 1/2" £1.10 £3.25

RECHARGEABLE NICAD 450K. Capacity 6V 450 m.a.h. at 10 hour rate. Ex-new equipment £3.75

DEAC rechargeable NICAD 450K. Capacity 6V 450 m.a.h. at 10 hour rate. Ex-new equipment £3.75

Crouzet 30-minute timer-programmer, multi-variable contacts £7.80

ACOS DUST JOCKEY Automatic record cleaner £1.30

AUDIO LEADS 3 pin din to ocan end, 1 1/2yd. twin screened 45p 5 pin din 180" to 2-phonos 25p 3 pole back plug to tag ends, 4ft. 50p

McMurdo 4 or 8 way plug and socket ex-equipment 50p

"Makaswitch" 1p 10-way wafer 15p Wood cased 8-12V buzzer £2.60

2.5A r.f. thermo-couple and meter 2 1/4" square £3.86

Mullard - 12-0-12V 1A, 4A stabilized, regulated, power supply. £12.50

27V 5A Double section bobbin transformer £4.50

UK - Postal Orders for same day service. Cheques require 8 days from a Monday banking to ensure clearance; export banker's draft (sterling) same day service. Foreign currency money orders etc. can lose value and take 4-6 weeks to clear.

50 ohm BNC plug through connector 70p
 50 ohm BNC plug through connector or round or flanged chassis socket 50p
 TNC plug or N plug or through connector 70p
 C90 Cassette Tape 45p

SEMICONDUCTORS full spec. by Mullard etc. Many others in stock

AC128	5p	BC211 32p	BD113 57p	BFX29	15p	2N706A 12p	2N918 12p	40310	35p		
AC153/176	11p	BD115	35p	BFX30/37	16p	2N929 16p	2N987 45p	OTHER DIODES			
ACY20 30p	ACY29 22p	BD116(BRC116T)	54p	8FX84/88,89	20p	2N1484	£1.15	1N916	2½p		
AD161/2 match pr.	70p	BD131/2	16p	BFX85 14p	BLY10 23p	2N1507	18p	1N4009/4449/662	2½p		
AF116	21p	BD133/5/6/7/8	28p	BFY50/51 13p	BFY90 40p	2N2219 14p	2N2369 10p	1N4148 1p	1N9141 1p		
AF124/6/7	27p	BD137/8 match pr.	60p	BFY75	15p	2N2412 27p	2N2483 28p	BA145	15p		
AF139	23p	BD139 17p	BD142 35p	BRV39/56	29p	2N2904/5/6/7/7A	9p	Cemtercel	28p		
AF178/80	35p	BD140	27p	BR101 20p	BSV64 36p	2N3053	8p	8ZV61/BA148/OA81	12p		
AF181 33p	AF239 35p	BD201/2/3/4	88p	BSV79/80 F.E.T.s	50p	2N3055 R.C.A.	42p	BB110 Varicap	24p		
ASY27/73	36p	BD232 52p	BD234 13p	8SV81 Mosfet	75p	2N3133/4062	24p	BB113 Triple Varicap	43p		
AU110E1.51	AU113 98p	BD233 20p	BD235 35p	BSX20/21	10p	2N3283/3823	25p	BA182/BB 103 Varicap	6p		
BC107/8/9 + A/B/C	6p	BD238 28p	BDX77 97p	BSY40 30p	BSY95A 10p	2N3553 56p	2N4037 30p	OA5/7/10	17p		
BC147/8/9 + A/B/C	5p	BD437 35p	BD438 28p	BU208	£1.85	2N3716	23p	AA133 10p	AA119 7p		
BC157/8/9 + A/B/C	5p	BF115/167/173	18p	CV7042 (OC41/44	ASV63)	2N4918	15p	400MW Zener	5p		
BC178A/B 1798	14p	BF178/9 23p	BF181 8p	GET111/E112	45p	2N5484 FET	37p	1½ Watt Zener	11p		
BC182/184L	8p	BF180/2/3/4/5	18p	MA393	25p	2N6385 Pwr Darl	54p	5 Watt Zener	15p		
BC186 42p	BC187 8p	BF194/5/6/7	5p	MJE371	40p				10 Watt Zener	20p	
BC204 12p	BC173 4p	BF194A, 195C	5p	MJ481 (BDY23)	23p						
BC213L/214B	5p	BF245/266	10p	MPU131/MPF131	15p						
BC238/338	5p	BF200 13p	BF258 17p	OC45(ME2)	13p						
BC327/8/337	8p	BF324 15p	BF262/3 29p	ON222	23p						
BC547/8 + A/B/C	5p	BF336 31p	BF274 8p	R1039(2010)	54p						
BC556/7/8/9	5p	BFS28 Dual Mosfet	50p	R2008B 92p	R2010B 79p						
BCW71R	1p	BFT61	40p	TIP30 22p	TIP48 33p						
BCX32/36	16p	BFW10/11 F.E.T	48p	TIP31 24p	TIP32C 26p						
BCY31	59p	BFW57/58	21p	TIS43 (2N2646)	22p						
BCY40 31p	BCY56 10p	BFX12	23p	µA7805 Reg.T03	55p						
BCY70/1/2	8p				ZT1486	£1.15					

BRIDGE RECTIFIERS

8YX10	34p
OSH01-200	30p
Ex Equip	73p
EC433	20p
Texas	£1.10
LR	48p
B40C 3700	58p

RECTIFIERS

Amp	Volt		
M1	1	6R	5p
1N4002	1	50/100	3p
1N4004/6/8	1	4/6/800	3½p
1N4007/BYX94 1	1	1250	4½p
BY103	1	1,500	21p
SR100	1.5	100	9p
SR400	1.5	400	10p
REC53A	1.5	1,250	16p
LT102	2	30	15p
BYX22-200	1½	300	25p
BYX38-300R	2.5	300	48p
BYX38-600	2.5	600	52p
BYX38-900	2.5	900	60p
BYX38-1200	2.5	1,200	65p
BYX49-300R	3	300	36p
BYX49-600	3	600	42p
BYX49-900	3	900	47p
BYX49-1200	3	1,200	60p
BYX48-300R	6	300	47p
BYX48-600	6	600	60p
BYX48-900	6	900	70p
BYX48-1200R	6	1,200	92p
BYX72-150R	10	150	42p
BYX72-300R	10	300	52p
BYX72-500R	10	500	65p
BYX42-300	10	300	38p
1N5401	3	100	13p
1N5402	3	200	15p
MR856	3	600	24p
BYX42-900	10	900	92p
BYX42-1200	10	1,200	£1.07
BYX46-300R	15	300	£1.19
BYX46-400R	15	400	£1.76
BYX46-500R	15	500	£2.00
BYX46-600	15	600	£2.30
BYX20-200	25	200	72p
BYX52-300	40	300	£2.05
BYX52-1200	40	1,200	£2.90
RAS310AF	1.25	1,250	48p

TRIACS

Amp	Volt		
25	900	BTX94-900	£3.00
25	1200	BTX94-1200	£5.00

Diode Characteristic Equiv., anc. 82p

Substitution Book

Transistor equivalents and substitution Book 1 38p Book 2 82p

Chrome Car Radio facia 28p

Rubber Car Radio gasket 10p

DLI Pal Delavline 90p

Relay Socket 4PCO or 2PCO: 10p

DIL sockets low profile: 8 pin 8p, 16 pin 11p, 28 pin 22p

Ferrite rod 7-8"x½" diam 40p

Earphone 3.5 12p, 2.5 15p, crystal 30p

Colour EHT Tray 3000/3500 £4.05

Nylon self-locking, 3½" tie clips 3p

1.5, 10, 22 or 750 kh choke 12p

Mullard Semiconductor, Valve & Component Data Book 50p

OPTO ELECTRONICS

Photo Diodes

8PX40	36p
8PX42	36p
RPY10	36p
CQY77	36p
CQY17	36p
BPY68	36p
BPY69	36p
BPY77	36p

Wire end neons 4p

Photo transistor

BPX29/43	36p
OC71	40p

LED's

Red .2"	125p
Green 8p	9p
Green 11p	13p
Micro Yellow	13p
LD481	7½p

PHOTO SILICON CONTROLLED SWITCH

BPX66 PNP	10 amp	36p
-----------	--------	-----

3" red 7 segment L.E.D. 14 D.I.L. 0-9 + D.P. display 1.9v 19m/a segment, common anode 55p

HP .43 in yellow £1.50

RS 0.6in. green £1.77

Minitron 0.3in 3015F filament £1.26

Infra red transmit diodes

CQY11B or LD27 High power 1.6-2v or 3-3.5v Pulse 53p

H15B Photon coupled isolator

I.R. diode & NPN Photo-Darlington amp £1.06

Data Sheet 10p

Swivel aerial 8½ to 36" £8.00

Multicore Solder ½kg. 16 or 18 or 20 s.w.g. £5.20

3 inch 8Ω speaker £9.15

New unmarked, or marked ample lead ex new equipment

ACV17-20	10p	TIC44	17p
AS220	10p	2G240	£1.17
ASZ21	35p	2G302	6p
BC186	13p	2G401	6p
BCY30-34	24p	2N711	28p
BCY70/1/2	5p	2N2926	5p
HG126/7	5p	2N598/9	8p
HY1005	12p	2N1091	10p
HG5009	4p	2N1302	10p
HG5079	4p	1N1907	£1.17
L78/9	4p	Germ. diode	2p
M3	12p	2N3055	26p
OA81	2½p	IN 4001	3p
OA47	4p	GET120 (AC128	in 1" sq. heat
OA200-2	4p	sink	22p
OC23	27p	GET872	16p
OC200-5	24p	2S2300	34p
C106 THY	10p	TIS43	15p
BUY 12/13	50p	BDY30	35p

MINIATURE EDGE METERS

100µA i.s.d., scaled 0.5, 12V Illuminated blue perspex front, 35mm x 14mm £3.45

200µA level meter, clear front. 10 x 18mm 65p

TRANSFORMERS

Ferromag C core. Screens 95-105-115-125-200-220-240v

Input output 1.7v ½A x 2 x 24-0-24v, 1.04A x 20v.

1mA. These current ratings can be safely exceeded by 50%. £8.00

Cassette Dynamic Microphone with switch and twin plug £1.35

THYRISTORS

Amp	Volt			Amp	Volt		
1	240	BTX18200	35p	71p	SCR967	6.5	500
1	400	BTX18300	41p	£3.40	BTW92	—	—
1	240	BTX30200	35p	600	—	20	600
4	500	40506	58p	£8.75	BTX95	—	—
15	500	BT107	£1	800R	—	15	800
10	700	BT106	70p	53p	T3N06C00	3	600
6.5	500	BT109	71p	70p	BT121	—	—
				36p	2N3228	4	600

LINEAR I.C.'s

CA3001	86p
CA3028	75p
CA3044	£1.20
CA3046	40p
CA3054	£1.10
CA3086	50p
CA3132em	£2.22
CA3146	90p
CA3085	£1.00
CA3083	65p
CA3183	80p
702 62p	741 16p
710/720 28p	724 20p
7805 (T03)	55p
2102 73p	709 18½p
82S129	£5.00
LM300 86p	LM309 60p
LM1303	97p
LM1458	32p
LM1390	80p
SN15862	40p
SN15862	6p
MC1306P	40p
MC1307P	35½p
MC1312P	40p
TAA263 75p	TBA120 25p
IAA550 Y or G	23p
TAA300	£1.00
TAA320	£1.15
TAA700	£2.30
MT300/305 8p	Yes! 8p
AY58300	36p
C500 (GIMT4)	36p
Calculator chip	37p
SN76396N	35½p
SN76549N	35½p

DIGITAL I.C.'s

7400/1/2/4	8p
7410	8p
74/20/30/60/51	9p
7406	16p
7414	39p
7426 15p	7432 13p
7417 18½p	7442 26p
7437/38/54	12p
1445 42p	74/2/7/8 20p
7473 16p	7474 19p
7480/8280	25p
7482 35p	7483 45p
7486 14p	7489 18p
74107 16p	74118 75p
74122 25p	74123 35p
74132 44p	74141 42p
74151 32p	74165 55p
74154/164/175	36p
74167 23p	74173 44p
74192 33p	74193 38p
74196 38p	74293 80p
74390	£1.30
74H Series	All 26p
0001/1/0A0/50/73	—
74L10/72/74/95	54L95 26p
5406 15p	5486 14p
5476 20p	5490 25p
5480 22p	54123 35p
5413/30/37/73	5413/30/37/73 12p

M.U.S. and Schotky see Catalogue

VEROBOARD

.15 strip approx 6"x4" 65p

3½" x 3½" 34p 4½" x 3½" 44p

Plain 1.1 4x4½" 35p

3½" x 2½" 25p

3½" x 3" 31p

Miniature Axial Lead Ferrite Choke formers 5 for 13p

RS 10 Turn pot 1% 250 500Ω, 1K, £1.70

Copper coated board .181" x 2½" 28p

TBA800 50p NE555 22p

MC1314P 36½p

MC1350P 35½p

MC1349P 36½p

SN76115N 36½p

(TICA270CW 36½p

CATALOGUE

5300 ITEMS AT PRICES YOU WOULD NOT BELIEVE BEFORE INFLATION, YOUR MONEY MUST GO TWICE AS FAR 75p PLUS 27p POST.

TRANSFORMERS

Ferromag C core. Screens 95-105-115-125-200-220-240v

Input output 1.7v ½A x 2 x 24-0-24v, 1.04A x 20v.

1mA. These current ratings can be safely exceeded by 50%. £8.00

Cassette Dynamic Microphone with switch and twin plug £1.35

THYRISTORS

Amp	Volt			Amp	Volt		
1	240	BTX18200	35p	71p	SCR967	6.5	500
1	400	BTX18300	41p	£3.40	BTW92	—	—
1	240	BTX30200	35p	600	—	20	600
4	500	40506	58p	£8.75	BTX95	—	—
15	500	BT107	£1	800R	—	15	800
10	700	BT106	70p	53p	T3N06C00	3	600
6.5	500	BT109	71p	70p	BT121	—	—
				36p	2N3228	4	600

DIGITAL I.C.'s

7400/1/2/4	8p
7410	8p
74/20/30/60/51	9p
7406	16p
7414	39p
7426 15p	7432 13p
7417 18½p	7442 26p
7437/38/54	12p
1445 42p	74/2/7/8 20p
7473 16p	7474 19p
7480/8280	25p
7482 35p	7483 45p
7486 14p	7489 18p
74107 16p	74118 75p
74122 25p	74123 35p
74132 44p	74141 42p
74151 32p	74165 55p
74154/164/175	36p
74167 23p	74173 44p
74192 33p	74193 38p
74196 38p	74293 80p
74390	£1.30
74H Series	All 26p
0001/1/0A0/50/73	—
74L10/72/74/95	54L95 26p
5406 15p	5486 14p
5476 20p	5490 25p
5480 22p	54123 35p
5413/30/37/73	5413/30/37/73 12p

M.U.S. and Schotky see Catalogue

VEROBOARD

.15 strip approx 6"x4" 65p



How to make a hobby

The opportunities in electronics, today, and for the future are limitless — throughout the world. Jobs for qualified people are available everywhere at very high salaries. Running your own business, also, in electronics — especially for the servicing of radio, TV and all associated equipment — can make for a varied, interesting and highly remunerative career. There will never be enough specialists to cope with the ever increasing amount of electronic equipment coming on to the world market.

We give modern training courses in all fields of electronics — practical D.I.Y. courses — courses for City & Guilds exams, the Radio Amateur licence and also training for the new Computer Technology. We specialise only in electronics and have over 40 years experience in the subject.

All the training can be carried out in the comfort of your own home and at your own pace.

A tutor is available to whom you can write at any time for advice or help during your work.

and a career.

COURSES AVAILABLE:—

- CITY & GUILDS CERTIFICATES IN TELECOMMUNICATIONS AND ELECTRONICS.
- RADIO AMATEUR LICENCE.
- COMPUTER TECHNOLOGY WITH HOME TRAINING COMPUTER.
- DIGITAL ELECTRONICS.
- BEGINNERS PRACTICAL COURSE.
- RADIO AND TELEVISION SERVICE.
- AND MANY OTHERS.

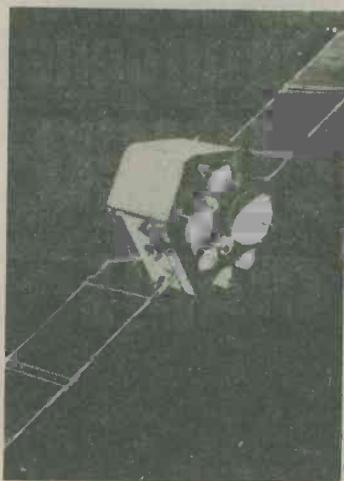

All students enrolling in our courses receive a free circuit board originating from a computer and containing many different components that can be used in experiments and provide an excellent example of current electronic practice.

Free 32 page
Colour Booklet.

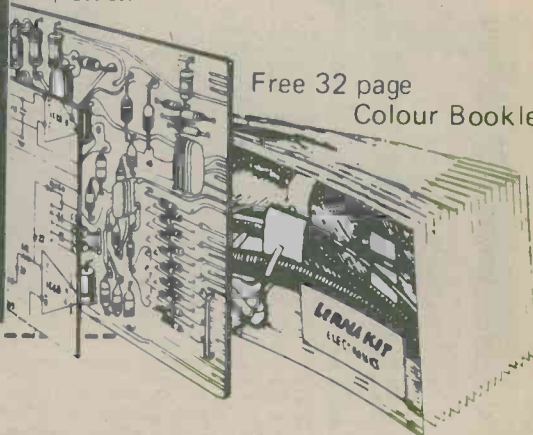

WE ARE AN INTERNATIONAL SCHOOL SPECIALISING IN ELECTRONICS TRAINING ONLY AND HAVE OVER 40 YEARS EXPERIENCE IN THIS SUBJECT

REA2

NAME

ADDRESS

Block Caps Please

Post now, without obligation, to:-

**BRITISH NATIONAL RADIO and
ELECTRONICS SCHOOL**

P.O. Box 156, Jersey,
Channel Islands.

RADIO AND ELECTRONICS CONSTRUCTOR

IT'S HAPPENED AGAIN!

THE PART THREE CATALOGUE IS PUBLISHED & WE HAVE MOVED TO BIGGER PREMISES.

Yes, it's here at last - the all new Part Three Catalogue. Fun for all the family, and the usual update on all that is new, worthwhile and exciting in the world of Radio and Communications. A big section on frequency synthesis techniques covering broadcast tuners, to communication quality transmitter systems. More new products than ever - RADIO CONTROL parts, crystal filters, ceramic filters for 455kHz and the new range of TOKO CFSH low temperature coefficient types for 10.7MHz. Details on new radio ICs, including the new HA11225, the CA3189E lookalike with 84dB signal to noise, and adjustable muting threshold. Radio control ICs - and an updated version of the RCM&E 8 channel FM receiver - now with an Ambit designed screened front end, with 27MHz ceramic bandpass filter. LCD panel clock/timer modules - the neatest and best LCD panel DVM yet (only £19.45 each + VAT), the new 5 decade resolution DFM3 for LW/HF/VHF with LCD readout. The DFM6 with fluorescent display to 10kHz resolution on VHF. 1kHz on SW. A 1kHz HF synthesiser with five ICs - the list is endless. Get your copy of the catalogue now. Post publication price is 60p (inc PP etc). The previous two sections are also required for a complete picture: Parts 1 & 2 £1 the pair, All 3 £1.50. And don't miss our spot the gibbon contest, together with a quiz to see if you can spot the differences between a neolithic cave drawing and a circuit diagram of one of our competitor's tuners. (* Yes, we still haven't learnt how to spell.)

FM radio control RX kit



- 8 Channel RC receiver (FM)
- Single IC RF/IF/Detector
- Single IC decoder
- 27MHz ceramic filter input
- FET RF stage with double tuned bandpass filter
- Dual ceramic filter IF
- Best quality SLM servo connector block
- ONLY £16.10 inc VAT (kit) (includes new SLM case)

DOES YOUR ONE GLOW GREEN IN THE DARK ??

Our DFM4 does, since it uses a vacuum fluorescent display for direct readout of MW/LW/FM. Basically the same as the DFM2, (LCD Version). £24.45 kit (inc VAT) Transformer with all necessary windings for DFM4 - £2.50 inc VAT.

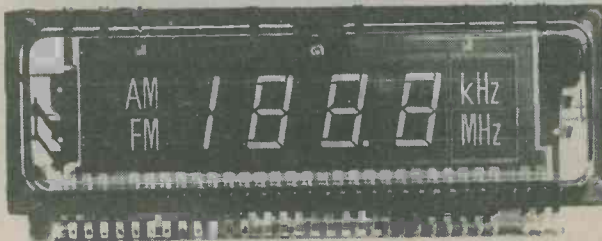

Not illustrated here - but also now available is the DFM6. This is a vacuum fluorescent display version of our immensely popular DFM3 (LCD). Resolution is 100Hz to 3.9999MHz, 1kHz to 39.9999MHz, and 10kHz to 200.000MHz+; all standard IF offsets (inc. 10.7MHz on shortwave) are available via diode programming.

New series of radio modules in fully screened cans:

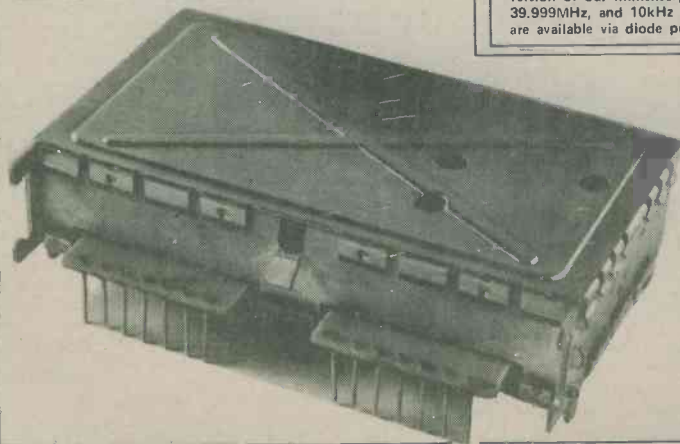

UM1181 VHF band 2 VARICAP TUNERHEAD

5 tuned circuit, with image/spurri better than -80dB, buffered LO output, MOSFET RF stage, FET IF preamp, tunes with only 1½ to 8v, -9dBm 3rd order intercept. 1off price £12.00 inc VAT. (100off/ OA)

911225 FM IF strip with all mod cons for the HiFi tuner:

All types use 80+dB S/N Hitachi IC, with muting, AFC, AGC, meter outputs for signal level and centre zero. IF preamp stage.

'A' Dual linear phase ceramic filters, with MOSFET IAGC'd) IF preamp and a 3rd narrow filter with DC filter selection. Dual tuned FM detector stage. £23.95 inc VAT (built)

'B' Dual ceramic filters, single tuned detector stage £14.95 inc VAT (All 'A' series units are set up with a spectrum analyzer for best THD)

91072 AM RADIO TUNER MODULES - DC TUNED and DC SWITCHED Available February '80

All include buffered LO output, mechanical IF filter (TOKO CFMQ) 1-10v tuning bias, switching by a single pole to earth

A MW/LW (150 to 350kHz LW range) with ferrite rod antenna

B As 'A' but also including SW1 or SW2 (specify.)

SW1 = 1.8 to 4MHz SW2 = 5 to 10MHz

C With both SW ranges

Prices -one off inc VAT

'A' £14.43 'B' £15.90 'C' £17.50 (Custom types OA)

There is a danger - when advertizing in some magazines - that because we do not find space to list everything we sell in every ad., that some readers forget about half the ranges we stock. So to summarize the general ranges:

- TOKO Chokes coils for AM/FM/SW/MPX, Audio filters etc
- Filters: Ceramic for AM/FM, LC for FM, MPX etc.
- Polyvaricons
- ICs for radio, clock LSI, radio control, MPX decoders etc
- Micrometals Dust iron cores for toroids for resonant and EMI filters
- Toroid mounts
- Hitachi Radio/audio/mpx linear ICs
- 100W MOSFETs, small signal FETs, MOSFETs and bipolar

And the following groups of products from a broad range of sources:

Semiconductors -specializing in radio devices, Plessey SL1600, EUROPE's best selection of AM/FM and communications devices. Power MOSFETs, WORLD's LOWEST NOISE AUDIO small signal transistors, BAR graph LED drivers for linear and log. CD4000 series CMOS, TTL/LPSNTTL, standard linears (741, 301, 3080 etc). MPUs, memories. Small signal transistors from AEG BC237/8/9 families etc. (1000 off BC239C : 5.2p ea) LEDs: AEG 3mm/5mm round, 2.5x5mm flat, red, green, orange, yellow. The best prices you will find for quality products. MOSFETs for RF signal processing, including the BF960 UHF device, and 3SK51 for VHF. Varicap diodes for 17:1 capacity ratio tuning

FREQUENCY READOUT LSI from OKL with a one-chip answer to most digital frequency display needs (and various modules).

Crystal and ceramic ladder filters from leading manufacturers, ferrite rods, various ferrite beads and a range of crystals for 'standard' frequencies and both AM and FM radio control at 27MHz. Trimmer capacitors.

METERS - a new range of linear movement types, plus many 'indicator' types for VU, all types of tuning indicators etc.

SOCKETS - a new range that are better quality than Texas low profile, yet better priced.

Modules for AM/FM/STEREO, complete kits for tuners, audio amplifiers from Larsholt.

SWITCHES - complete low cost DIY systems for push button arrays, keyboard switches.

DOUBLE BALANCED MIXERS - MCL SBL1, replacement for MD108 etc. And cheaper.

OUR LATEST MOVING EXPERIENCE :: At last, we have moved to the address below. There is car parking for customers approaching via North Service Road (an extension of North Road Avenue, entrance opposite the Brentwood Fire Station.) Pedestrian access from the High Street (alongside 117 High Street). The new building is six times bigger than our Gresham Road offices, and we will be installing a much expanded sales counter in the fullness of time. NEW TELEPHONE NUMBER (0277) 230909, TELEX NUMBER (as before) 995194 AMBIT G. See you there!

200 North Service Road, Brentwood, Essex.

<p>MOTORS 1.5-8VDC Model Motors 22p. Sub. Min. 'Big Inch' 115VAC 3 rpm Motors 32p. 12VDC 5 Pole Model Motors 37p. 8 track 12V Replacement Motors 55p. Cassette Motors 5-8VDC ex. equip. 70p. Geared Mains Motors (240V) 2.5 rpm 75p. 115VAC 4 rpm Geared Motors 95p.</p>	<p>JUMPER TEST LEAD SETS 10 pairs of leads with various coloured croc clips each end (20 clips) 90p per set.</p>	<p>LOW COST PANEL METERS Dimensions 52 x 52 x 33mm, 50 microamp £4.25 100 microamp £4.10 IMA £3.95, VU meter £4.65. 0-300VAC (60 x 47 x 33mm) £4.25. Ferranti 3.5" square 0-600VAC meter only £2.95.</p>	<p>AEROSOL SERVICE AIDS, SERVISOL Switch Cleaner 226gm 60p. Freezer 226gm 70p. Silicone Grease 226gm 70p. Foam Cleanser 370gm 60p. Plastic Seal 145gm 60p. Excel Polish 240gm 47p. Aero Klene 170gm 55p. Aero Duster 200gm 70p.</p>	<p>TOOLS SOLDER SUCKER, plunger type, high suction, teflon nozzle, £4.99 (spare nozzles 89p each). Good Quality snub nosed pliers, insulated handles, 5" £1.45. Antex Model C 15 watt soldering irons, 240VAC £3.95 Antex Model CX 17 watt soldering irons, 240VAC £3.95. Antex Model X25 25 watt soldering irons, 240VAC £3.95. Antex ST3 iron stands, suits all above models £1.65. Antex heat shunts 12p each. Servisol Solder Mop 50p each. Neon Tester Screwdrivers 8" long 59p each. Miyama IC test clips 16 pin £1.95.</p>
<p>SEMICONDUCTORS C106D 400V 2.5A SCR 20p. 2N5062 100V 800mA SCR 18p. BX504 Opto Isolator 25p. CA3130 95p. TBA800 50p. 741 22p. 741S 35p. 723 35p. NE555 24p. LM3400 40p. AD161/2 70p. 2N3055 38p. ZN414 75p. BD238 28p. BD438 28p. IN4005 10 for 35p. TIL305 alpha numeric displays £2.50. TIL209 Red Leds 8p each. 0.5" 7 segement Led display. Comm. Cathode, green, full spec. 85p each.</p>	<p>TRANSFORMERS All 240VAC Primary (postage per transformer is shown after price). MINIATURE RANGE: 6-0-6V 100mA, 9-0-9V 75mA and 12-0-12V 50mA all 79p each (15p). 0-6V. 280mA £1.20 (20p). 12V 500mA 99p (22p). 12V 2 amp £2.75 (45p). 15-0-15V 3 amp Transformer at £2.85 (54p). 30-0-30V. 1 amp £2.85 (54p). 20-0-20V 2 amp £3.65 (54p). 0-12-15-20-24-30V 2 amp £4.75 (54p). 20V 2.5 amp £2.45 (54p).</p>	<p>CAR STEREO SPEAKERS Shelf mounting in black plastic pods with 5" 5 watt speaker available in 4 ohms only £3.95 per pair.</p>	<p>SURPLUS BOARDS No. 1, this has at least 11 C106 (50V 2.5A) plastic SCR's, one relay a unijunction transistor and tantalum capacitors £1.95. No. 2 I.F. Boards, these are a complete I.F. board assembly made for car radios, 465Khz, full set of I.F.'s and oscillator coils, trimmers etc., 40p each. No. 3 Board with two BDY60 Power Transistors, 45p each.</p>	<p>SWITCHES Sub. miniature toggles; SPST (8 x 5 x 7mm) 52p. DPT (8 x 7 x 7mm) 82p. DPDT centre off 12 x 11 x 9mm 77p. PUSH-SWITCHES, 16 x 6mm, red top, push to make 14p each, push to break version (black top) 16p each.</p>
<p>PROJECT BOXES Sturdy ABS black plast. boxes with brass inserts and lid. 75 x 58 x 35mm 65p. 95 x 71 x 35mm 75p. 115 x 95 x 37mm 85p.</p>	<p>TRIAC/XENON PULSE TRANSFORMERS 1:1 (gpo style) 30p. 1:1 plus 1 sub. min. pcb mounting type 60p each.</p>	<p>MURATA MA401 40kHz Transducers. Rec./Sender £3.50 pair.</p>	<p>CRIMPING TOOL Combination type for crimping red blue and yellow terminations also incorporates a wire stripper (6 gauges) and wire cutter, with insulated handles only £2.30.</p>	<p>G.P.O. Telephone handsets £1.95p. Electrolytic Caps, can type, 2,200mfd and 2,200mfd 50VDC 35p each.</p>
<p>AMP MULTIWAY IN-LINE PLUGS AND SOCKETS, 3 way 35p, 6 way 45p, 12 way 55p, per pair.</p>	<p>MICROPHONES Min. tie pin. Omni, uses dead aid battery (supplied), £4.95. ECM105 low cost condenser, Omni, 600 ohms, on/off switch, standard jack plug, £2.95. EM507 Condenser, uni, 600 ohms, 30-18kHz., highly polished metal body £7.96p. DYNAMIC stick microphone dual imp., 600 ohms or 20K, 70-17kHz., attractive black metal body £7.75p. EM508 dual impedance condenser microphone 600 ohms or 50K, heavy chromes copper body, £12.95. CASSETTE replacement microphone with 2.5/3.5 plugs £1.35. INSERT Crystal replacement 35X10mm 40p. GRUNDIG electric inserts with FET preamp, 3-6VDC operation £1.00.</p>	<p>ELECTRICAL ITEMS 13 amp 3 pin plugs plastic 27p, rubber 62p, 13 amp rubber extension sockets 42p, 12 way flexible terminal blocks; 2 amp 20p, 5 amp 24p, 10 amp 35p, 15 amp 47p. Standard batten (BC lampholders) 27p.</p>	<p>POWER SUPPLIES SWITCHED TYPE, plugs into 13 amp socket, has 3-4.5-6-7.5 and 9 volt DC out at either 100 or 400mA, switchable £3.45. HC244R STABILISED SUPPLY, 3-6-7.5-9 volts DC out at 400mA max., with on/off switch, polarity reversing switch and voltage selector switch, fully regulated to supply exact voltage from no load to max. current £4.95.</p>	<p>MICRO SWITCHES Standard button operated 28 x 25 x 8mm make or break, new 15p each. Roller operated version of the latter, New 19p each. Light action micro, 3 amp make or break 35 x 20 x 7mm, 12p each. Cherry plunger operated micro, normally open, 2 normally closed, plunger 20mm long (40 x 30 x 18mm) 25p each.</p>
<p>CHANGEOVER REED SWITCH 2 1/2" Long 35p. Glass Mercury Switch 1/2" x 3/8", long leads, 35p.</p>	<p>LIGHT DIMMER 240VAC 800 watts max. wall mounting, has built in photo cell for automatic switch on when dark £4.50</p>	<p>VERNIER DIALS 6:1 ratio, scaled 1-10, standard 6.3mm spindle, VD1 36mm diameter £1.95. VD2 50mm diameter £2.85. VD3 70mm diameter £3.75</p>	<p>AMPHENOL CONNECTORS (PL259) PLUGS 47p. Chassis sockets 42p. Elbows PL259/SO239 90p. Double in line male connector (2XPL259) 65p. Plug reducers 13p. PL259 Dummy load, 52 ohms 1 watt with indicator bulb 95p.</p>	<p>PUSH BUTTON UNITS 6 way, 3 DPDT, 3 4 pole c/o 55p, 8 way, 5 DPDT, 3 4 pole c/o 70p. RANK ARENA magnetic cartridge pre-amplifier modules, new with connection details £1.95p.</p>
<p>MULTIMETERS NH55 2,000 o.p.v. 1KV AC/DC, 100ma DC current, 2 resistance ranges to 1meg. £5.95. MODEL 72606 20,000 opv 1,000 volts AC/DC., 250ma DC current, resistance 3 ranges to 3meg, dimensions 127 x 90 x 32mm, mirror scale £11.75p. HANSEN AT210 100,000 opv 1.2KV AC/DC., 12 amps AC/DC current, resistance to 200 meg in 4 ranges, capacitance 200pf-0.2mfd, 1,00pf-1mfd., decibel range, internal safety fuse, dimensions 160 x 105 x 50mm, an excellent meter, £34.50p.</p>	<p>RIBBON CABLE 8 way single strand miniature 22p per metre.</p>	<p>TELEPHONE PICK UP COIL Sucker type with lead and 3.5mm plug 62p.</p>	<p>BUZZERS MINIATURE SOLID STATE BUZZERS, 33 x 17 x 15mm white plastic case, output at three feet 70db (approx), low consumption only 15mA, four voltage types available, 6-9-12 or 24VDC, 80p each. LOUD 12VDC BUZZER, Cream plastic case, 50mm diam. x 30mm high 63p. GPO OPEN TYPE BUZZER, adjustable works 6-12VDC 27p. 12VDC siren, all metal, rotary type, high pitched wail, £7.50.</p>	<p>TAPE HEADS Mono cassette £1.75. Stereo cassette £3.90. Standard 8 track stereo £1.95. BSR MN1330 1/2 track 50p. BSR SRP90 1/4 track £1.95. TD10 tape head assembly — 2 heads both 1/2 track R/P with built in erase, mounted on bracket £1.20.</p>
<p>MORSE KEYS Beginners practice key £1.05. All metal fully adjustable type. £2.60.</p>	<p>SPEAKER BARGAINS All 8 ohms impedance 7" x 4" 4 watts £1.95, 6" round 5 watts £1.75, 8" round 6 watts, twin cone, £2.95. 10" round 6 watts, twin cone, £3.45.</p>	<p>RELAYS Plastic Encap. Reed Relay, 0.1 matrix. 1kΩ coil, 9-12VDC normally open, 35p. Miniature encapsulated reed relay 0.1 matrix mounting, single pole make, operates on 12VDC 50p each. Continental series, sealed plastic case relays. 24VDC 3pole change over 5 amp contacts, new 65p. Min. sealed relay, P.C. mounting, 6-9vdc operation changeover 3 amp contacts, new 85p. Metal Cased Reed Relay, 50 x 45 x 17mm, has 4 heavy duty make reed inserts, operates on 12VDC 35p each. Magnets 1/2" long 1/4" thick with fixing hole, 10 for 40p.</p>	<p>TERMS: Cash with Order (Official Orders welcomed from colleges etc). 30p postage please unless otherwise shown. VAT inclusive. <i>S.a.e. for illustrated lists.</i></p>	<p>STEREO FM/GRAM TUNER AMPLIFIER CHASSIS, VHF and AM. Bass, treble and volume controls, Gram. 8-track inputs, headphone output jack, 3 watts per channel with power supply. £14.95 and £1.20 p&p (CCT supplied).</p>
<p>MINIATURE LEVEL METERS 1 Centre Zero 17 x 17mm 75p. 2 (scaled 0-10) 28 x 25mm 75p. 3 Grundig 40 x 27mm £1.25.</p>	<h1>PROGRESSIVE RADIO</h1> <p>31 CHEAPSIDE, LIVERPOOL 2. ALL ORDERS DESPATCHED BY RETURN POST</p>			
<p>JVC NIVICO STEREO CASSETTE MECHANISM. Music centre type. Rev. counter, remote operation £13.50 and £1.00 p&p.</p>				

GREENWELD

443G Millbrook Road Southampton SO1 0HX

All prices include VAT at 15% — Just add 30p post

BUY A COMPLETE RANGE OF COMPONENTS AND THESE PACKS WILL HELP YOU

*SAVE ON TIME — No delays in waiting for parts to come or shops to open!

*SAVE ON MONEY — Bulk buying means lowest prices — just compare with others!

*HAVE THE RIGHT PART — No guesswork or substitution necessary!

All packs contain Full Spec. Brand New, Marked Devices — Sent by return of post. V.A.T. Inclusive Prices.

K001 50V ceramic plate capacitors, 5%, 10 of each value 22pF to 1000pF. Total 210. £3.69.

K002 Extended range, 22pF to 0.1uF, 330 values £5.53

K003 Polyester capacitors, 10 each of these values: 0.01, 0.015, 0.022, 0.033, 0.047, 0.068, 0.1, 0.15, 0.22, 0.33, 0.47uF, 110 altogether for £5.07

K004 Mylar capacitors, min. 100V type 10 each all values from 1000pF to 10,000pF. Total 130 for £4.05

K005 Polystyrene capacitors, 10 each value from 100pF to 10,000pF, E12 series 5% 180V. Total 370 for £12.67

K006 Tantalum bead capacitors, 10 each of the following: 0.1, 0.15, 0.22, 0.33, 0.47, 0.88, 1, 2.2, 3.3, 4.7, 6.8, all 35V; 10/25, 15/16, 22/16, 33/10, 47/6, 100/3. Total 170 for £14.56

K007 Electrolytic capacitors 25V working, small physical size, 10 each of these popular values: 1, 2.2, 4.7, 10, 22, 47, 100uF. Total 70 for £3.59

K008 Extended range, as above, also including 220, 470 and 1000uF. Total 100 for £6.05

K021 Miniature carbon film 5% resistors, CR25 or similar, 10 of each value from 10R to 1M, E12 series. Total 610 resistors. £6.16

K022 Extended range, total 850 resistors from 1R to 10M £8.60

K041 Zener diodes, 400mW 5% BZY88 etc. 10 of each value from 2.7V to 36V, E 24 series. Total 280 for £16.37

K042 As above but 5 of each value £9.31

£1 BARGAIN PACKS

K101—16 BC239B N.P.N. £1.00

Low Noise

K102—15 BC349B N.P.N. £1.00

Low Noise

K103—10 BC546B N.P.N. £1.00

80 Volt

K104—18 BC182B N.P.N. £1.00

60 Volt

K105—50 IN4148 Silicon Diode £1.00

K106—18 BC184L N.P.N. £1.00

Low Noise

K107—18 BC213L P.N.P. £1.00

General Purpose

K108—8 2N5060 30N .8A SCR £1.00

K109—15 BC114 N.P.N. £1.00

Low Noise

K114—15 XK6116 (8F241) £1.00

N.P.N. 200 MHz

K115—18 SP1218 (2N3702) £1.00

P.N.P. Gen. Purpose

K117—10 BF450 P.N.P. £1.00

T.V. IF Amp.

K118—16 ME4101 N.P.N. £1.00

60V Low Noise

K124—50 .02uF Disc £1.00

Ceramics

K125—200 1k 5% 1/4W. CF £1.00

Resistors

VU METERS

Voo2 Twin type, 2 meters 40x40mm and driver board, supplied with circuit and connexion data. £3.50

Voo3 New type, just in. Twin type moulded in one piece, 80x40mm (No driver board but suitable circuit supplied) £2.50

INVERTER

Prepare for the Power Cuts! Ready built inverter, 24V DC 290x55x37mm in, will power 6x8W fluorescent tubes. Circuit supplied. Only £2.90

THE NEW 1980 GREENWELD CATALOGUE

FEATURES INCLUDE:

- 60p Discount Vouchers
- Quantity prices for bulk buyers
- Bargain List Supplement
- Reply Paid Envelope
- Priority Order Form
- VAT inclusive prices

PRICE 40p + 20p POST

VERO OFFCUTS

Packs of 100 eq lns of good size pieces about 4 x 3" in the following types:

X541 0.1" copper clad£1.50

K542 0.15" copper clad£1.60

K544 0.1" plain£1.50

Also pieces 2½x1" — 10/£1.20 100/£9 17x3½"x0.1" sheets — 10/£16.50

Large range of Standard Veroboard and boxes/cases in stock. Details in catalogue, 45p

SCOOP! Verobox type 2522, unused but has 3 ½" holes in one end and 1 ½" hole the other, so instead of £3.96, we are selling these at £1.85

3W AMP MODULE

Ready built and tested, this handy amplifier will prove very useful around the workshop. Just requires 17V ac source (and 8R spkr) as bridge rect and smoothing cap are mounted on the PCB. The 4 transistor circuit provides enough sensitivity for most applications. Supplied complete with circuit diagram and wiring details. Only £1.75. Suitable transformer £2.20.

BUZZERS & MOTORS

Z401 Powerful 6V DC, all metal construction, 50mm dia x 20mm 70p

Z402 Miniature type, 3-9V, only 22x15x16mm. Very neat 65p

Z450 Miniature 6V DC motor, high quality type 32mm dia x 25mm high, with 12mm spindle. Only £1

Z451 12V high torque motor 30mm dia x 40mm high, with 10mm spindle. 65p

Z452 6V DC motor with gearbox giving final shaft speed 700 rpm. Spindle is threaded O8A. Ex-equip £1

Z453 As above, but 300 rpm and un-threaded spindle £1.

CLOCK CASE BARGAIN

Z472 Oval format, overall size 130x68x87mm deep, with built in stand. Rear panel drilled to accept 4 switches and alarm 80p

74 SERIES PACK

Selection of boards containing many different 74 series IC's 20 for £1; 50 for £2.20; 100 for £4.

PC ETCHING KIT MK III

Now contains 200 sq. ins. copper clad board, 1lb Ferric Chloride, DALO etch-resist pen, abrasive cleaner, two miniature drill bits, etching dish and instructions. £4.85

1A 400V RECTIFIERS

Plastic, like 1N4004, type 388F these diodes have preformed leads for horizontal mntg (15mm FC). Supersvr price — 100 for £2.30; 500/£10 1000/£18.

POWER DARLINGTON PAIR

Plastic power (TOP66 case) transistors type BD695A/BD696A. Just look at the spec! 70W 8A 45V — Hfe 750 at 4A! Special low price — £1.20 per pair.

1,000 RESISTORS £2.50!!

New stock just arrived — Carbon Film 2% and 5%, ¼W and ½W, all brand new, but have pre-formed leads, ideal for PC mntg. Enormous range of popular mixed values for just £2.50/1,000, £11/5,000 £50/25,000.

ELECTROVALUE CATALOGUE 10

Had yours yet?

Our computer has already selected thousands of our customers to whom our new catalogue has automatically been sent. If you would like a copy too, simply send us your name and address. It's

FREE

(You don't even have to pay postage)

IT'S A GOOD DEAL BETTER FROM ELECTROVALUE

● We give discounts

on C.W.O. orders, except for a few items market Net or N in our price lists.

5% on orders, list value £10 or more

10% on orders list value £25 or more.

Not applicable on Access or Barclaycard purchase orders.

● We pay postage

in U.K. on orders list value £5 or over. If under, add 30p handling charge.

● We stabilise prices.

by keeping to our printed price lists which appear but three or four times a year.

● We guarantee

all products brand new, clean and maker's spec. No seconds, no surplus.

● Appointed distributors for SIEMENS, VERO, ISKRA, NASCOM and many others.

OUR NEW CATALOGUE No 10

Over 120 pages. Thousands of items. Improved classification for easier selection. Valuable working information. Illustrations. Separate quick-ref price list.

ELECTROVALUE LTD

HEAD OFFICE (Mail Orders)

28(A) St. Judes Road, Englefield Green, Egham, Surrey TW20 0HB. Phone: 33603 (London prefix 87. STD 0784) Telex 264475.

NORTHERN BRANCH (Personal Shoppers Only)

680 Burnage Lane, Burnage, Manchester M19 1NA Phone: (061) 432 4945.

MARCO TRADING

To obtain a free copy of our 35 page list simply send a 20p postage stamp or a large SAE. This advertisement shows only a part of our range. (Our new list includes Tants, Electrolytics, Disc ceramics, etc.)

TRANSISTORS

AC12B	24p	BC213	10p	BF115	32p	BFY77	22p
AD149	58p	BC213L	10p	BF127	38p	BR101	32p
AD161	45p	BC213L	10p	BF159	25p	BRV39	32p
AD162	44p	BC214	10p	BF164	22p	BSY52	35p
BC107	10p	BC214C	12p	BF166	32p	BU105/02	£1.58
TO5 leg)	6p	BC214L	12p	BF167	26p	BU108	£1.80
BC108	10p	(TO5 lead)	8p	BF178	24p	BU124	£1.82
BC109	10p	BC268A	28p	BF180	29p	BU126	£1.50
BC125	12p	BC301	36p	BF182	29p	BU204	£1.45
BC126	14p	BC307B	13p	BF183	29p	BU205	£1.35
BC147B	8p	BC307B	13p	BF194	10p	BU206	£1.75
8C149	8p	BC308A	13p	8F194A	12p	BU208	£1.75
BC153	10p	BC309-	14p	BF195	10p	GET872	15p
BC161	25p	BC441	36p	8F195C	12p	GET881	15p
BC177	18p	BC460	35p	BF200	28p	OC45	30p
BC178	18p	BC547	12p	BF224J	15p	OC71	25p
BC182	9p	8C558A	13p	BF241	15p	OC72	35p
BC182L	10p	BCY42	30p	BF257	28p	OC76	32p
BC183	9p	BCY70	17p	BF259	30p	TIP29A	44p
BC183B	9p	BCY71	20p	BF262	30p	TIP31A	36p
BC183L	10p	BCY72	20p	BF263	30p	TIP32A	40p
BC184	9p	BD116	54p	BF337	30p	TIP32C	70p
BC184L	10p	BD131	35p	BF41	30p	TIP33A	65p
BC212	10p	BD132	35p	BFX84	22p	TIP41A	45p
BC212B	12p	BD135	34p	BFX89	65p	TIP42A	40p
BC212L	12p	BD136	34p	BFY50	20p	TIP3055	65p
BC212LA	12p			BFY51	20p	TIS43	34p
				BFY52	20p	2N3055	48p

400m/w ZENER DIODES Low Price

3V, 3V3, 3V6, 3V9, 4V3, 4V7, 5V1, 5V6, 6V2, 6V8, 7V5, 8V2, 9V1, 10V, 11V, 12V, 13V, 13V5, 15V, 16V, 18V, 20V, 22V, 24V, 27V, 30V, 33V.
Price: 8p each 100 any mix £8.00

1 watt ZENER DIODES

3V3 to 200V Full range
Price: 15p each 100 any mix £12.50

8 DIL	10p
14 DIL	13p
16 DIL	15p
18 DIL	18p
20 DIL	22p
22 DIL	23p
24 DIL	24p
28 DIL	28p
40 DIL	40p

VEROBOARD (Copper Clad)

Size Inch	0-1"	0.15
2.5 x 1	20p	N/A
2.5 x 5	55p	56p
2.5 x 3.75	46p	50p

Vero Wiring Pen (including spool of wire) £2.84

CONNECTING CABLE

Black, Blue, Green, Grey, Orange, Pink, Red, White, Violet, Yellow, Brown.
Singles 5p per metre
7/0.2mm 5p per metre
16/0.2mm 8p per metre

ROTARY POTS

LOG: 4K7, 10K, 22K, 47K, 100K, 220K, 470K, 1M, 2M2 27p each
LIN: 470Ω, 1K, 2K2, 4K7, 10K, 22K, 47K, 100K, 220K, 470K, 1M, 2M2 10 for £2.50 (Mixed your choice)

RESISTORS Low Noise 5% High Stability

1W at 40C, 1/3W at 70C. E12 series only i.e. 2.2Ω, 2.7Ω, 3.3Ω, 3.9Ω, 4.7Ω, 5.6Ω, 6.6Ω, 8.2Ω, 10Ω etc.

All at 2p each, 10 of one value for 15p, 1,000 mixed in 100's £8.00

Our well known "Special Development" pack. Special Price: £6.00

(This pack consists of 10 off each value 2.2Ω to 2M2. 730 resistors)

1W resistors available. E12 series only. 2.2Ω to 10M 5p each

2W resistors available. E12 series only. 10Ω to 10M 8p each

DIODES

OA47 10p, OA81 14p, OA90 10p, OA91 10p, OA200 5p, 1N4148 4p, 1S44 7p, 1N914 (Formed Leads) 3p, 1N4001 5p, 1N4004 8p, 1N4007 7p, 1N5392 11p, 1N5401 16p, 1N5404 18p, 1N5408 27p.

Many, many more items in stock including our new range of 63V polycarbonate close tolerance capacitors. In 63V we are now able to offer 1%, 1%, 2% and 5%. In 440V the range is still the same. Full details in our FREE list.

SPECIAL OFFERS

Power Amplifier Sanyo STK015 Brand New Full Spec etc. 10 Watts into 8Ω.

Free spec sheet with every order. Our price: £2.50 each.

Radio Spares Edge Meter Type MR100 (259-562). All new and boxed. RS price over £4.00 each. Our price: £2.50 each.

Send your orders to:

DEPT. DP12, MARCO TRADING,
THE OLD SCHOOL, EDSTASTON,
Nr. WEM, SHROPSHIRE SY4 5RJ
Tel: Whixall (094872) 464/465

Please add 25p postage and packing to each order and add 15% VAT to your total order. Export add NO VAT but add postage Air/Sea at cost.

Available Mid-January

LATEST BOUND VOLUME No. 32

of
"Radio & Electronics Constructor"



SEPTEMBER 1978 to AUGUST 1979

Comprising 776 pages PRICED £5.50 P&P £1.05 inc. index

BOUND VOLUME No. 27
(August 1973 to July 1974)
Price £3.00 P&P £1.05

BOUND VOLUME No. 28
(August 1974 to July 1975)
Price £3.20 P&P £1.05

BOUND VOLUME No. 29
(August 1975 to July 1976)
Price £3.50 P&P £1.05

BOUND VOLUME No. 30
(August 1976 to July 1977)
Price £3.70 P&P £1.05

BOUND VOLUME No. 31
(August 1977 to August 1978)
Price £5.20 P&P £1.05

Limited number of these volumes still available.

We regret all earlier volumes are now completely sold out.

Available only from

DATA PUBLICATIONS LTD.,
57 MAIDA VALE, LONDON, W9 1SN

STEVENSON

Electronic Components

CMOS			
4001	13p	4025	13p
4002	13p	4026	90p
4007	13p	4027	78p
4009	30p	4028	45p
4011	13p	4029	50p
4012	13p	4040	55p
4013	28p	4041	55p
4015	50p	4042	55p
4016	28p	4043	50p
4017	47p	4046	90p
4018	55p	4049	25p
4050	25p	4050	25p
4060	80p	4060	80p
4066	30p	4066	30p
4068	13p	4068	13p
4069	13p	4069	13p
4070	13p	4070	13p
4071	13p	4071	13p
4072	13p	4072	13p
4081	13p	4081	13p
4093	36p	4093	36p
4510	60p	4510	60p
4511	60p	4511	60p
451B	65p	451B	65p
4520	60p	4520	60p
4528	60p	4528	60p

FULL DETAILS IN CATALOGUE!

TTL			
7400	10p	7473	20p
7401	10p	7474	22p
7402	10p	7475	22p
7404	12p	7476	20p
7406	22p	7485	55p
7408	12p	7486	20p
7410	10p	7489	135p
7413	22p	7490	25p
7414	39p	7492	30p
7416	55p	7493	25p
7417	55p	7494	45p
7420	12p	7495	35p
7422	20p	7496	45p
7430	12p	74121	25p
7432	18p	74122	35p
7442	38p	74123	38p
7447	45p	74125	35p
7448	50p	74126	35p
7454	12p	74132	45p
74141	55p	74141	55p
74145	55p	74145	55p
74148	90p	74148	90p
74150	55p	74150	55p
74154	40p	74154	40p
74157	40p	74157	40p
74165	55p	74165	55p
74170	100p	74170	100p
74174	55p	74174	55p
74177	50p	74177	50p
74199	50p	74199	50p
74199	50p	74199	50p
74199	50p	74199	50p
74199	50p	74199	50p
74199	50p	74199	50p
74199	50p	74199	50p
74199	50p	74199	50p
74199	50p	74199	50p
74199	50p	74199	50p

OPTO			
LED's	0.125in.	0.2in.	each 100
Red	TIL209	TIL220	9p 7.5p
Green	TIL211	TIL221	13p 12p
Yellow	TIL213	TIL223	13p 12p
Clips	3p	3p	

DISPLAYS			
DL704	0.3 in CC	130p	120p
DL707	0.3 in CA	130p	120p
FND500	0.5 in CC	100p	80p

SKTS			
8pin	8p	18pin	14p
14pin	10p	20pin	16p
16pin	11p	22pin	17p
24pin	18p	28pin	22p
32pin	22p	40pin	32p
3 lead TO18 or TO5 socket. 10p each			
Soldercon pins: 100:50p 1000:370p			

PCBS			
Size in.	0.1in.	0.15in.	Vero
2.5 x 1	14p	-	Cutter 80p.
2.5 x 3.75	45p	45p	
2.5 x 5	54p	54p	Pin insertion tool 108p
3.75 x 5	64p	64p	
3.75 x 17	205p	185p	
Single sided pins per 100 40p 40p			
Top quality fibre glass copper board. Single sided. Size 203 x 95mm 60p each.			
'Data' pens 75p each			
Five mixed sheets of Alfaf. 145p per pack			

RESISTORS			
Carbon film resistors. High stability, low noise 5%.			
E12 series. 4.7 ohms to 10M. Any mix:			
0.25W	each	100+	1000+
0.5W	1p	0.9p	0.8p
0.5W	1.5p	1.2p	1p
Special development packs consisting of 10 of each value from 4.7 ohms to 1 Meg-ohm (650 res) 0.5W £7.50. 0.25W £5.70.			
METAL FILM RESISTORS			
Very high stability, low noise rated at 1/2W 1%. Available from 51ohms to 330k in E24 series. Any mix:			
0.25W	each	100+	1000+
	4p	3.5p	3.2p

PLEASE WRITE FOR YOUR FREE COPY OF OUR 80 PAGE CATALOGUE OF COMPONENTS. OVER 2500 ITEMS LISTED.



LINEAR			
LF356	80p	NE531	98p
LM301AN	26p	NE555	23p
LM308	60p	NE566	60p
LM318N	75p	NE567	100p
LM324	45p	RC4136	100p
LM339	45p	SN76477	230p
LM378	230p	TBA800	70p
LM379S	410p	TBA810S	100p
LM380	75p	TDA1022	620p
LM3900	50p	TL081	45p
LM3909	65p	TL084	125p
LM3911	100p	ZN414	80p
MC1458	32p	ZN425E	390p
MM57160	590p	ZN1034E	200p
ZTX500	16p		
2N697	12p		
2N3053	13p		
2N3054	50p		
2N3055	50p		
2N3442	135p		
2N3702	8p		
2N3703	8p		
2N3704	8p		
2N3705	9p		
2N3706	9p		
2N3707	9p		
2N3708	9p		
2N3819	15p		
2N3820	44p		
2N3904	8p		
2N3905	8p		
2N3906	8p		
2N4058	12p		
2N5457	32p		
2N5459	32p		
2N5777	50p		

TRANSISTORS			
AC127	17p	BCY72	14p
AC128	16p	BD131	35p
AC176	18p	BD132	35p
AD161	38p	BD139	35p
AD162	38p	BD140	35p
BC107	8p	BFY50	15p
BC108	8p	BFY51	15p
BC108C	10p	BFY52	15p
BC109	8p	MJ2955	98p
BC109C	10p	MPSA06	20p
BC147	7p	MPSA56	20p
BC148	7p	TIP29C	60p
BC177	14p	TIP30C	70p
BC178	14p	TIP31C	65p
BC179	14p	TIP32C	80p
BC182	10p	TIP2955	65p
BC182L	10p	TIP3055	55p
BC184	10p	ZTX107	14p
BC184L	10p	ZTX108	14p
BC212	10p	ZTX300	16p
BC212L	10p		
BC214	10p		
BC214L	10p		
BC477	19p	1N914	3p
BC478	19p	1N4001	4p
BC548	10p	1N4002	4p
BCY70	14p	ITT Full spec product	
BCY71	14p	1N4148	£1.40 100

DIODES			
1N914	3p	1N4006	6p
1N4001	4p	1N5401	13p
1N4002	4p	BZY88 ser	8p

CAPACITORS			
TANTALUM BEAD			
0.1, 0.15, 0.22, 0.33, 0.47, 0.68, 1 & 2.2uF @ 35V			each 8p
4.7, 6.8, 10uF @ 25V			13p
22 @ 16V, 47 @ 6V, 100 @ 3V			16p
MYLAR FILM			
0.001, 0.01, 0.022, 0.033, 0.047, 0.068, 0.1			3p 4p
POLYESTER			
Mullard C280 series			
0.01, 0.015, 0.022, 0.033, 0.047, 0.068, 0.1, 0.15, 0.22			5p 7p 10p 14p 17p
0.33, 0.47, 0.68, 1.0uF			

CERAMIC			
Plate type 50V. Available in E12 series from 22pF to 1000pF and E6 series from 1500pF to 0.047uF			
RADIAL LEAD ELECTROLYTIC			
63V	0.47	1.0	2.2
			4.7
			10
			22
			33
			47
			7p
			13p
			20p
25V	10	22	33
			47
			5p
			8p
			10p
			15p
			23p

CONNECTORS			
JACK PLUGS AND SOCKETS			
	unscreened	screened	socket
2.5mm	9p	13p	7p
3.5mm	9p	14p	8p
Standard	16p	30p	15p
Stereo	23p	36p	18p
DIN PLUGS AND SOCKETS			
	plug	chassis socket	line socket
2pin	7p	7p	7p
3pin	11p	9p	14p
5pin 180°	11p	10p	14p
5pin 240°	13p	10p	16p
1mm PLUGS AND SOCKETS			
Suitable for low voltage circuits, Red & black. Plugs 6p each Sockets: 7p each.			
4mm PLUGS AND SOCKETS			
Available in blue, black, green, brown, red, white and yellow. Plugs 11p each Sockets: 12p each			
PHONO PLUGS AND SOCKETS			
Insulated plug in red or black 9p			
Screened plug 13p			
Single socket 7p Double socket 10p			

JANUARY SPECIALS

A range of special offer items valid during January. All orders placed for these items must be received during January.

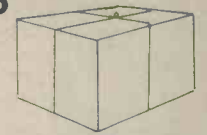

Pack of 3 x LM380	225p	200p
Pack of 30 x 1N4001	120p	100p
Pack of 4 x FND500	400p	350p
Pack of 15 x 2N3702	120p	100p
Pack of 15 x BC107	120p	100p
Special pack of nuts + bolts containing over 600 4BA + 6BA nuts, bolts and washers	330p	250p
Pack of 4 red + 4 black crocodile clips	64p	50p
Mixer control knobs, per 100 (mixed) colours to suit	1400p	1300p

MULTIMETERS

A really smart looking multimeter with an impressive specification for such a small size. The very clean scale in white and green on a black background makes this meter very easy to read. The D.C. Impedance of this meter is 4K ohms per volt which is exceptionally good compared with the vast majority of multimeters of a similar size. £5.95 each.



SPECIFICATION

DC Volts	5V 25V 250V 500V (4K ohms/V)
AC Volts	10V 50V 500V 1000V (2K ohms/V)
DC Current	250uA 250mA
Resistance	0 - 600K (7K ohms centre)

PANEL METERS

High quality 2" wide view meters. Zero adjustment. Back illumination wiring. Available in 50 uA, 100 uA, 500 uA, 1mA, 100mA, 500mA, 1A. £4.95 ea. VU meter similar style. £1.50 ea.



SLIDE POTENTIOMETERS

Good quality 60mm travel slider with 80mm fixing centres. Available from 5k - 500K in log and linear. 55p each. Suitable black knobs 6p ea. Coloured knobs 10p ea.

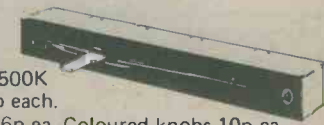

We now offer one of the widest ranges of components at the most competitive prices in the U.K. See catalogue for full details. We welcome callers at our shop in College Rd, Bromley, from Mon-Sat, 9am-6pm (8pm on Weds and Fridays). Special offers always available. We also provide an express telephone order service. Orders received before 5pm are shipped same day. Contact our sales office now with your requirements. TELEPHONE: 01-464 2951/5770.

Quantity discounts on any mix TTL, CMOS, 74LS and Linear circuits: 100+ 10%, 1000+ 15%. Prices VAT inclusive. Please add 30p for carriage. All prices valid to April 1980. Official orders welcome.



BARCLAYCARD & ACCESS WELCOME.

ORDERS DESPATCHED BY RETURN POST

76 College Road, Bromley, Kent BR1 1DE.

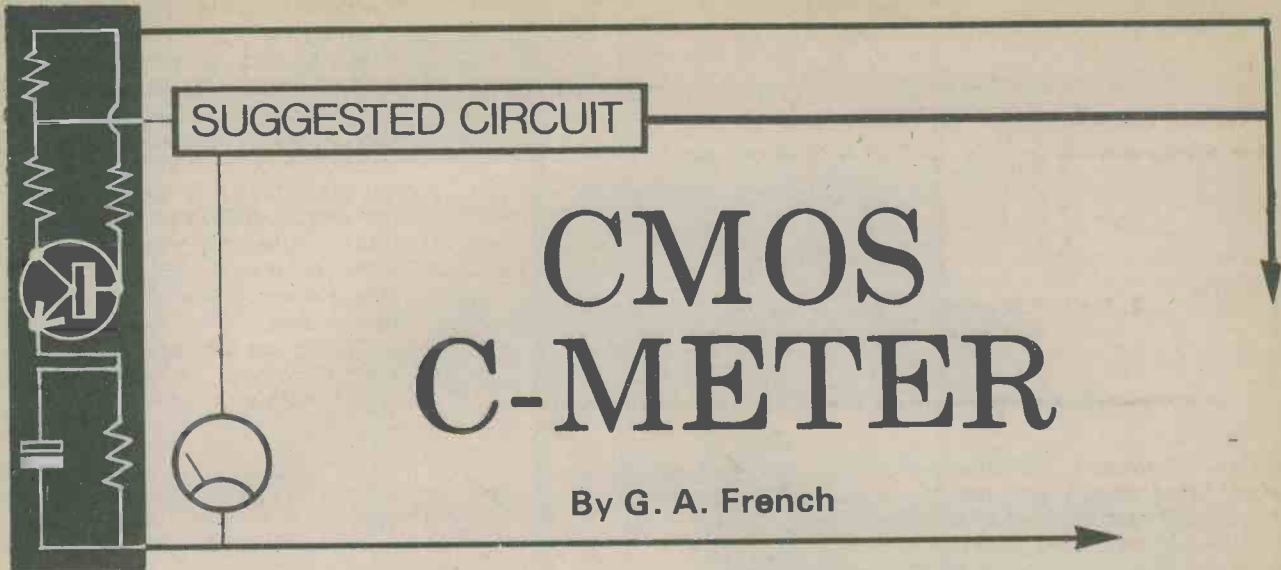

CMOS C-METER

By G. A. French

The very simple and inexpensive capacitance meter to be described is intended for measuring capacitance values from less than 1.5pF to 1,500pF. This range takes in nearly all fixed capacitors likely to be encountered in r.f. circuits including, in particular, ceramic and silvered mica types whose printed value markings are most likely to be blurred or erased due to handling. The meter will also measure maximum and minimum values of variable and trimmer capacitors.

The circuit requires very few components and incorporates an ICM7555, this being the "CMOS 555". In consequence, current consumption from its 9-volt battery is exceptionally low. With the prototype circuit the current drawn was 80µA only, whereupon it becomes possible to use a small battery, such as the PP3, which will have a considerably extended working life. The meter is intended to be employed with a portable medium wave superhet radio having a tuning range of 200 to 550 metres (1,500 to 545kHz).

C-METER CIRCUIT

The circuit of the meter is given in Fig. 1, in which the ICM7555 appears in an astable multivibrator circuit whose frequency is controlled by the values of R1, R2 and C3. The pin connections are exactly the same as would be used with the older bipolar 555 i.c., but supply current is very much smaller. So low is the current drawn by the device that the current flowing through R1 becomes significant in comparison and it is preferable to use a high value resistor here. The value of

1MΩ, chosen means that the current flowing from the battery to the timing components will be in the order of microamps. R1 and R2 are both ¼ watt 5%, and C3 should preferably be a polystyrene or silvered mica component. The circuit produces a rectangular-wave at the pin 3 output having a frequency which is very close to 1kHz.

The output is applied via C2, which has an extremely low capacitance, to C1 and part or all of coil L1 according to the setting of range switch S1. C1 is silvered mica or ceramic. The coil is wound on a 6in. ferrite rod, and the capacitor to be measured is connected to the test terminals. The inductance

selected by S1, and C1 plus the test capacitance, form a parallel tuned circuit, and this is shock-excited to produce damped oscillations at its resonant frequency by the steep pulse edges in the output of IC1. The damped oscillations may be picked up on a medium wave radio whose internal ferrite rod aerial is held parallel with and fairly close to the rod on which L1 is wound, and they are reproduced through the speaker of the radio as a 1kHz tone. The signal peaks very markedly at the resonant frequency and can be tuned in on the radio with the same resolution as an ordinary medium wave broadcast signal. Since the resonant frequency is a function of

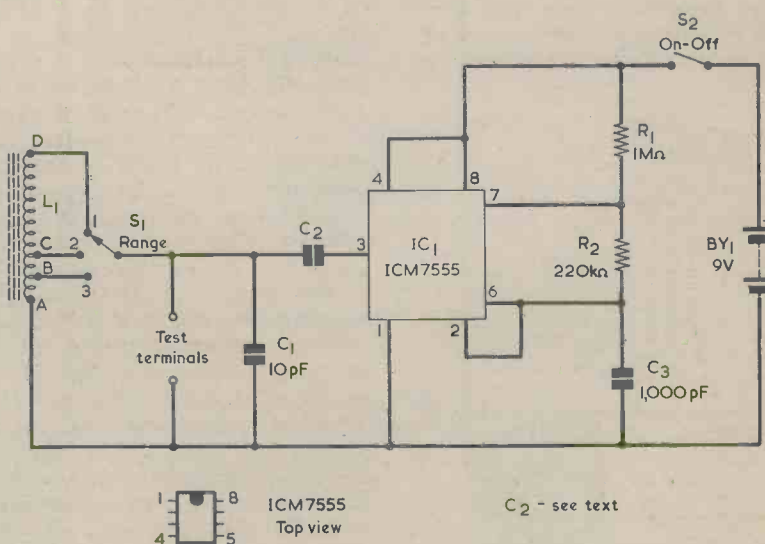

Fig. 1. The circuit of the capacitance meter. Coil L1 is wound on a ferrite rod which radiates an a.m. signal in the medium wave band whose frequency depends on the value of the test capacitance

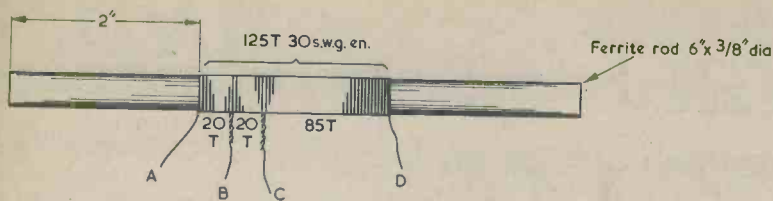

Fig. 2. Details of coil L1. This is close-wound on a ferrite rod with windings, as shown

the test capacitance, the latter may be evaluated, using a table, from the tuning scale reading on the radio.

Details of coil L1 are given in Fig. 2. It has 125 turns overall of 30 s.w.g. enamelled wire close-wound direct onto the ferrite rod. The winding starts 2 in. from one end of the rod and 20 turns are wound on rod before the first tap is made. The coil wire is twisted together at the tap and a further 20 turns are wound on, after which a second tap is reached. The final 85 turns are then wound on the rod. Both the coil ends may be secured by p.v.c. insulating tape. The enamel is scraped off at the two coil ends and at the twisted wires at the taps, and the bared wires are then tinned with solder to enable connections to be made to the coil. The letters "A", "B", "C" and "D" in Fig. 2 correspond with the same letters in Fig. 1.

Capacitor C2 is formed by having two insulated wires about 1 in. long running very close to each other, as in Fig. 3. In this diagram they are shown soldered to two tags of a tagstrip, but any other means of securing the wire ends will be satisfactory.

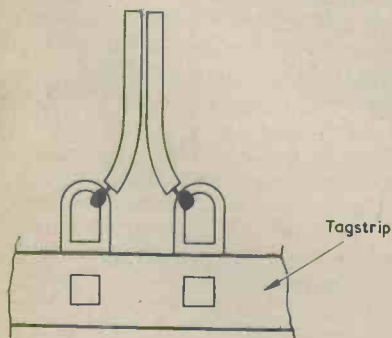

Fig. 3. Capacitor C2 is not a physical component but consists of two short insulated wires positioned close to each other

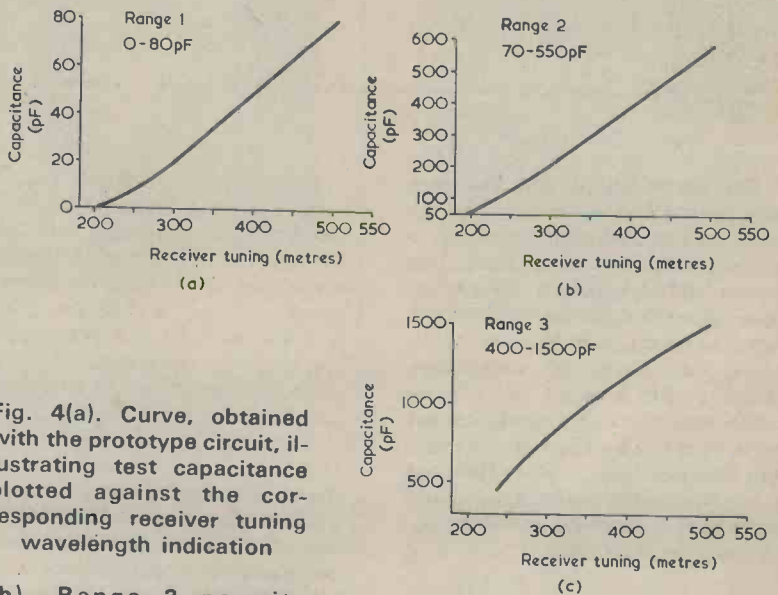

Fig. 4(a). Curve, obtained with the prototype circuit, illustrating test capacitance plotted against the corresponding receiver tuning wavelength indication

(b). Range 2 permits measurement of capacitance between 70 and 550pF

(c). On Range 3, test capacitance between 400 and 1,500pF may be evaluated

METER RANGES

On Range 1, S1 switches in all the turns of L1. This now presents an inductance which is greater than that offered by a normal medium wave ferrite rod aerial coil and, in consequence, resonates at about 600kHz (500 metres) with only some 80pF connected to the test terminals. Range 1 is therefore 0-80pF nominal, and the results obtained with the prototype circuit are illustrated in the curve of Fig. 4(a). Of particular interest in this curve is the left-hand section where the rate of change of capacitance against wavelength is slower than over the rest of the curve. This results in an effective "opening-out" of low capacitance indications. For example, a test capacitance of 5pF compared with zero test capacitance corresponds to a change in wavelength from 200 to as much as 235 metres. The lowest test

capacitance which can be resolved is a little less than 1.5pF. The value of 1.5pF, itself, gives a change from 200 to about 212 metres. In the prototype circuit, zero test capacitance corresponded with 200 metres on the receiver tuning scale, but this is quite fortuitous. All that is required of the circuit is that zero test capacitance should correspond with a point at the low wavelength (high frequency) end of the receiver tuning range.

The internal self-capacitances distributed through coil L1 do not allow reliable shock-excitation to

take place at a single peak frequency when there is no external capacitance connected across it, and this is the reason for having the small capacitor, C1, in circuit. C1 plays no important part on the other two ranges, apart of course from contributing a small part of the parallel tuning capacitance.

On Range 2 only 40 turns of the coil are in circuit, and these permit nominal range limits of 70 to 550pF. The number of turns is reduced to 20 on Range 3, and the values of test capacitance which can be measured range from about 400 to 1,500pF. The curves for Ranges 2 and 3 are given in Fig. 4(b) and (c) respectively. The curve in Fig. 4(c) shows signs of beginning to flatten off at 1,500pF, thereby indicating that the maximum test

Continued on page 341

PORTABLE 3½ DIGIT MULTIMETER INTRODUCED

A portable, high precision 3½ digit multimeter has been introduced by Beckman Instruments. Designed to simplify test and measurement, it has features not found on any other multimeter currently on the world market, such as the Insta-Ohms™ instant continuity test indicator and the 2000 hour battery life. The instrument is available direct from Beckman or through a range of distributors in the UK, the price being £115.

Measurements can be made across five dc voltage ranges from 200mV to 1500V full scale; five ac voltage ranges spanning 200mV to 1000V full scale; five ac and dc current ranges, 200µA to 2A full scale (a separate input extends the range to 10A); and six resistance ranges with full scale values from 200 Ω to 2M Ω.

The low power resistance ranges permit in-circuit resistance measurements to be made without turning on semi conductors, which would affect the measurements. For applications that require testing of diodes and semiconductors, a separate semiconductor test function provides 5mA of test current — enough to verify the operation of most semiconductor junctions — even circuits with as low as 200 Ω

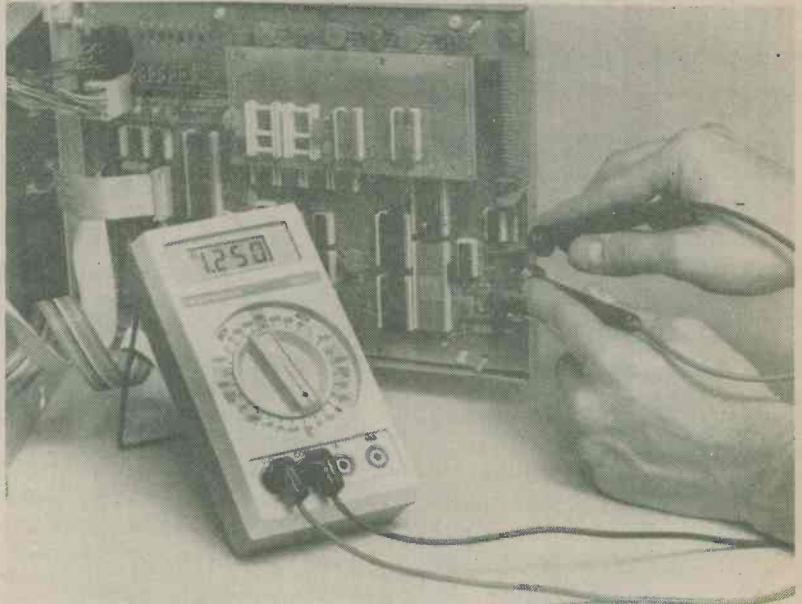

Beckman 3020 digital multimeter being used to check continuity

of equivalent parallel resistance.

The Insta-Ohms™ continuity test indicator allows continuity to be checked simply and speedily. When an in-range resistance is measured an ohms symbol appears on the display in less than one millisecond.

A single 9V transistor battery provides up to 2000 hours of con-

tinuous instrument operation, giving up to 2 years typical use. During the final 200 hours of battery life a decimal point blinks on the display to warn the user to change the battery. Calibration, guaranteed for one year, requires only the simple adjustment of an internal trimming potentiometer.

A NEW BRITISH DESIGNED CASSETTE HOLDER FOR USE IN MOTOR CARS



It is extraordinary to think that the estimated sales in the U.K. alone this year for in-car entertainment equipment will reach £80m. and although motorcar manufacturers and in-car entertainment equipment manufacturers have gone to a lot of trouble on design, there has been little attention paid to the actual storage of the cassettes.

Gilfin International Ltd., has tackled this problem and produced a revolutionary new design and concept in this field.

The "TAPEMATE" cassette holder has been designed to fit behind sun visors, on the roofs, on doors and behind some glove box lids — indeed even on carpeting — giving it a flexibility that no other cassette holder has had. Furthermore, it has a system of locking the tape spindles, which up to now has not been achieved as far as automobile cassette holders are concerned.

If used on the sun visor it has a great safety factor, inasmuch as your attention is still on the traffic ahead whilst selecting the tape.

There is no fixed retail price, but it is estimated that the "TAPEMATE" will sell at between £1.50 and £2.00.

COMMENT

BBC's PUBLICITY FOR AMATEUR RADIO

We read in a recent edition of the BBC's *London Letter*, an article entitled 'The worldwide fellowship of radio hams'.

Although the information contained in the article will be familiar to our radio amateur readers, we feel it is of general interest to publish the following extracts.

"Amateur radio is radio for pleasure: but there's more than one kind of pleasure. For some people, it means pushing their equipment to the limits of its capability — achieving results under conditions which many would regard as impossible. For others, the fun lies in the opportunity amateur radio gives to invent new ways of doing things, to try out ideas. Radio and electronics are among the diminishing group of hobbies where it's still possible for the amateur, working alone with equipment built on his kitchen table, to rival the professionals with their laboratories full of apparatus. As an example, it was the radio amateurs who showed that reliable world-wide communication was possible using short-waves. In the early days of radio, the accepted wisdom had been that the short-waves were useless for all practical purposes since no one had discovered how they worked; and they had accordingly been given to the amateurs as a mere plaything. And innovation still continues. For instance, the amateur radio movement has its own space programme! Through the generous assistance of the space organisations in various countries, several communications satellites built by amateurs have been successfully put into orbit-hitching lifts on rocket launches mainly intended for some other purpose."

"Besides all this, radio amateurs have bounced signals off the moon and off the auroral curtain (the Northern and Southern Lights), they've communicated with each other by radio teleprinter and by colour TV, and they have continued to extend the practical limits of the radio spectrum."

"In addition to the personal pleasure it provides, amateur radio can give public service too. In times of disaster or civil emergency, radio amateurs are often called upon by the relief forces to help co-ordinate their work. So many countries have come to look upon their radio amateurs as a national asset, a corps of trained communicators. Yet the amateurs find themselves continually having to defend their claim to their wavelengths. Their next big test comes as the world's telecommunications administrators meet to thrash out new wavelength allocation plans for the years ahead. There will be stiff competition — nearly every radio user is clamouring for more air-space, the broadcasting stations included. Even today, there's nowhere enough space in the radio bands to satisfy everyone. So amateurs may find it a tough challenge to persuade the administrators that their place on the air should be preserved — even though their activities may seem to have no immediate economic, political or military value."

STEREO SPEAKER FLOOR STANDS

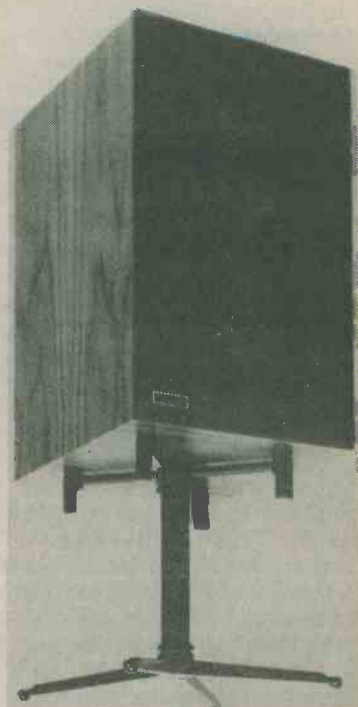

Fidelity Fastenings Ltd., of the Ridgeway, Iver, Bucks., started business in 1977 making a wall mounting bracket system, known as Model FF1.

They have now added a speaker stand, and an adjustable trolley, to the range so that they now offer mountings suitable for most stereo speakers.

Their floor stands are adjustable in height, have a unique speaker tilt device and a fine black satin finish.

The Model FF2 is illustrated above.

RECENT IBA PUBLICATIONS

Publications issued recently by the IBA include an extended edition of "ITV & ILR TRANSMITTING STATIONS — A Pocket Guide" (16pp) and a new four-page illustrated leaflet "500 — The IBA's 500th Transmitter on Air Autumn 1979".

The pocket guide includes brief details of some 500 UHF transmitters (representing 2,000 IBA (ITV), IBA ('Fourth Channel'), BBC1 and BBC2 channels), the 47 ITV/VHF (405-line) transmitters, and 28 different ILR radio services (MF and VHF/FM). Information provided includes channel numbers (or frequencies), polarisation of signals, power, aerial height, and service date (or target service date) and national grid reference of location.

Either or both publications are available on request from IBA Engineering Information Service, Crawley Court, Winchester, Hants.

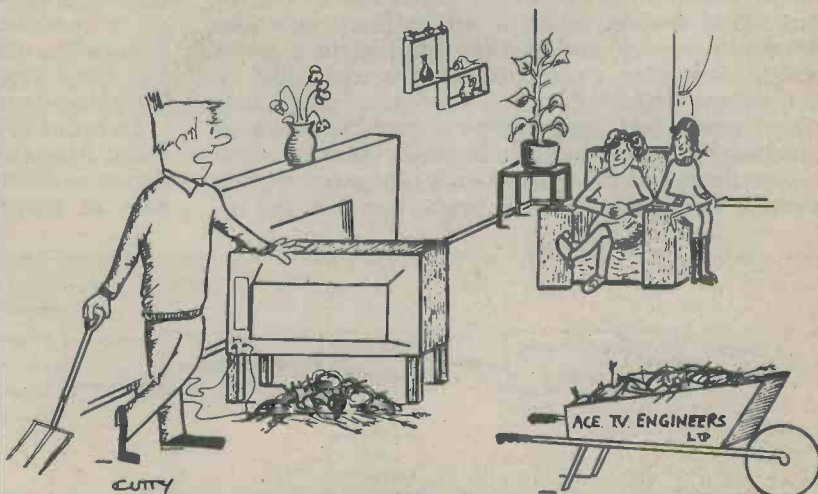

"'Horse of the Year Show', 'Badminton Horse Trials', 'Racing from Wincanton' — The only work I get now is 'mucking out' TV sets!"

CLASS D AMPLIFICATION

By John Baker

A development of the 1960's returns to the audio scene.

While many readers will be familiar with the Class A, B and C modes of amplification employed in the output stages of a.f. amplifiers, Class D is far less well known and quite a few readers may be unaware of its existence. It is sometimes referred to as "digital amplification" (not to be confused with the pulse code modulation method of passing audio signals along a communication channel) and it uses digital techniques to render non-linearity in the amplifier driver and output stages of little consequence. This enables Class D circuits to have inherently low distortion levels which can be reduced further by the use of a comparatively small amount of negative feedback. Another advantage of Class D is the high efficiency that can be obtained in terms of audio output power and supply power. The theoretical maximum is 100% although in practice it is unlikely to be much more than 90%. This is about 20% better than most Class B designs, and something like 3 times as efficient as most practical Class A circuits. The efficiency of Class C amplifiers is roughly comparable with that of Class D types, but Class C is only applicable in practice to r.f. amplifiers, of course, and not to a.f. amplifiers.

OPERATING PRINCIPLE

A Class D amplifier uses the general arrangement shown in the block diagram of Fig. 1. The input signal is first taken to an ordinary analogue amplifying stage and is then applied to a pulse width modulator. Pulse frequency is controlled by a constant frequency clock oscillator. The pulse width modulator produces an output pulse whose mark-space ratio (the ratio between the time when it is positive and the time when it is negative during a clock frequency cycle) is proportional to the in-

put voltage. Thus, under quiescent conditions with zero input voltage the modulator produces a square wave output with a mark-space ratio of exactly 1:1. Positive input voltages cause an increase in the positive pulse length, with peak positive input levels causing the positive pulses to almost merge into one another. Negative-going input signals reduce the mark-space ratio by decreasing the length of the positive pulse within the clock frequency cycle, and peak negative input signals can result in only very brief positive pulses being produced.

The effect is illustrated in the waveforms of Fig. 2. The waveform of Fig. 2(a) is a 1:1 square wave and is that given by a zero level input. That of Fig. 2(b) is given by a high positive input signal level, and that of Fig. 2(c) by a high negative signal input. A pulse output of the type illustrated in Fig. 3 would be given by the analogue input signal shown below it.

The output from the pulse width modulator is fed to what is virtually a conventional Class B driver and complementary output stage. However, this circuit does not need to have good linearity since it is only handling a pulse signal and not an analogue one. It is far more important for it to have a very fast switching time, so that the output pulse lengths are not altered by limitations in switching speed. For the pulse width modulation system to work properly it is necessary for the clock frequency to be higher than the maximum analogue input frequency, and for reasons to be explained shortly the clock frequency should in practice be about 100kHz or more.

In order to obtain the appropriate waveforms at these frequencies it is obviously necessary to use driver and output transistors capable of giving good gain at frequencies well into the r.f. spectrum.

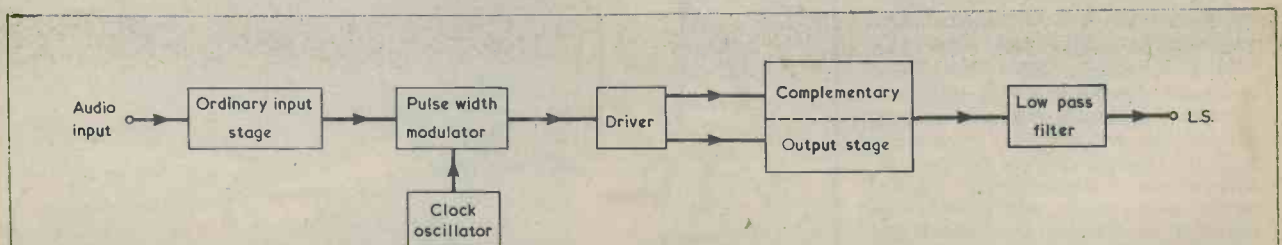

Fig. 1. A Class D amplifier has the basic stage line-up shown here. After the pulse width modulator the driver and output stage amplify pulses and not an analogue audio signal

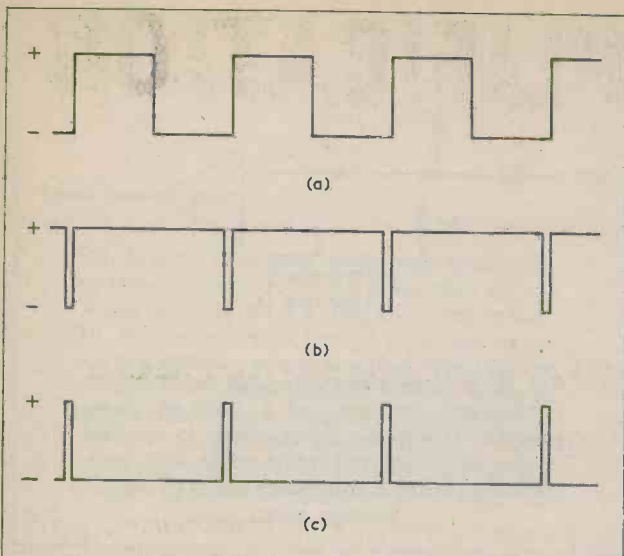

Fig. 2(a). A square wave with a mark-space ratio of 1:1 is produced by the pulse width modulator under quiescent input conditions
 (b). At peak positive signal input the length of the positive pulses is increased considerably, very short negative pulses appearing between them
 (c). A peak negative input signal produces the opposite effect

speaker is not subjected to the pulse frequency as such. This filter is normally an L-C type and, in order for it to give good attenuation at the clock frequency, it is essential for the clock frequency to be several times the maximum audio signal frequency. The filter can then give some 80dB of attenuation to the pulse signal without significantly affecting the upper audio response of the amplifier.

Although the speaker cannot respond to the pulsed output signal due to the inclusion of the low pass filter it will respond to the average output voltage from the amplifier. Under quiescent conditions the average output voltage is obviously half the supply voltage, since the output is fully positive for half the time and fully negative for half the time. Positive audio signals increase the positive output pulse lengths, giving an increase in the average positive output voltage. Negative signals decrease the positive pulse lengths and cause the average output voltage to go negative. Thus, the varying audio signal at the amplifier input produces a corresponding output signal voltage. The speaker is normally fed from the output via a high value d.c. blocking capacitor so that it receives an a.c. signal rather than a varying d.c. signal. Alternatively, if the amplifier has balanced positive and negative supply rails, with a central earth rail, the loudspeaker may be connected directly between the amplifier output and the earth rail.

The efficiency of the Class D system stems from the fact that, for nearly all of the time, each of the output transistors is either fully cut off or is turned hard on. A cut off output transistor passes no significant current and dissipates no significant power. Similarly, when fully turned on an output transistor dissipates little power because there is only a low voltage across it, and power is equal to current multiplied by voltage. The only time that a high voltage-current product appears is during the time when an output transistor is changing from the fully turned on to the fully cut off state, and vice versa. If these transition periods are kept very short, as they can be with transistors having very high switching speeds, the consequent dissipation is low.

The theoretical 100% efficiency of Class D

When Class D designs were first introduced in the 1960's, transistor high frequency performance with power devices was not exceptionally good, and this fact is possibly one reason for the failure of Class D amplifiers to achieve widespread acceptance at that time. At present, high speed silicon and f.e.t. power devices are readily available, and amplifiers having true hi-fi output powers in excess of 100 watts can be produced. The Sony TA-N88 digital audio amplifier is, for example, rated at 2 x 160 watts.

A low pass filter must be incorporated between the output stage and the loudspeaker so that the

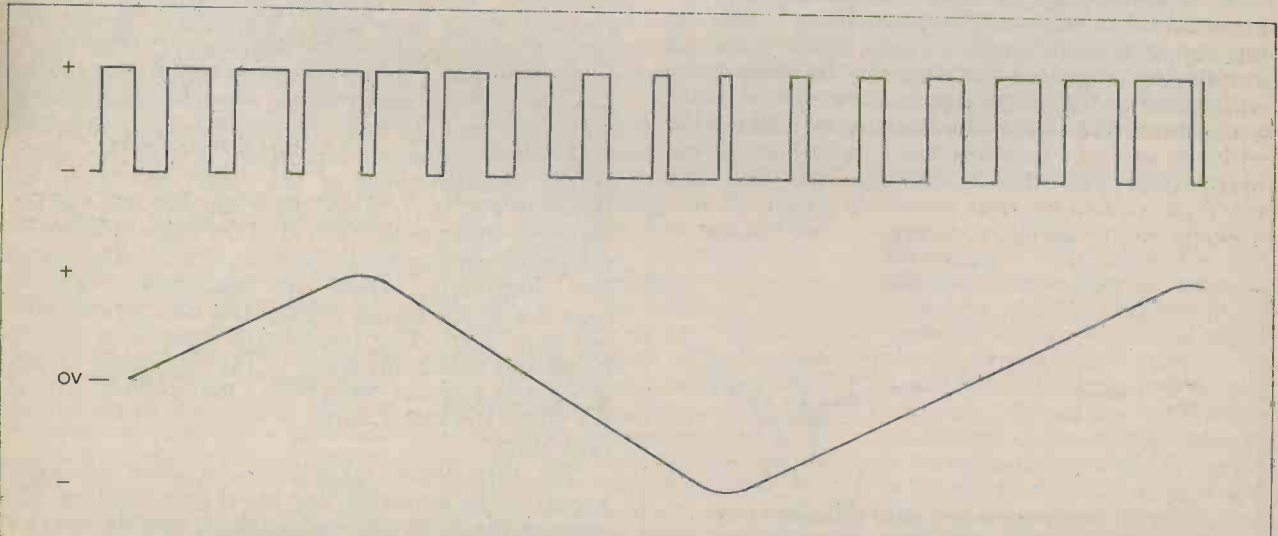

Fig. 3. Illustrating the pulse train produced by the analogue signal shown below it. The average voltage of the pulses corresponds with the voltage of the analogue signal

amplifiers cannot be fully realised in practice for three reasons. The first of these is that some voltage will still be dropped across a fully turned on transistor, even though that voltage is small. Secondly, the transition times between one output state and the other cannot be made infinitely short, and so some power, albeit very small, is still lost here. Finally, there must be some resistance in the low pass output filter, with a consequent small power loss here as well.

Despite these power losses, the basic Class D mode of operation can be made so close to 100% efficient that it is possible to employ smaller output transistors than would be needed in a Class B output stage offering a comparable amount of power. It will be appreciated that the power dissipated in the output transistors of an amplifier is virtually equal to the power provided by the power supply minus the power actually fed into the loudspeaker load.

DISTORTION

Although the linearity of the driver and output stages of a Class D amplifier is relatively unimportant, since they function as switching devices, Class D circuits are not completely distortion free. Heavy output loading, given by an almost continuous positive or negative output over a number of pulses, can result in a drop in supply voltage. Audio output peaks become flattened, with a resultant generation of distortion products. This effect can be minimised by the use of a well stabilized power supply and an output stage having an extremely low output impedance.

Distortion can also be introduced by the pulse width modulator circuit if it fails to govern pulse length correctly, so that the average output voltage is not truly proportional to input voltage. In practice, this will always be the source of a certain amount of distortion, although a well designed circuit will keep the distortion within an acceptable level.

The main source of distortion in most designs is the residual clock pulse signal and, with inadequate low pass output filtering, this can result in the output signal being modulated by the clock pulse in the manner shown in Fig. 4. On high level signals the distortion is unlikely to be as bad as the diagram implies, although for very low level signals it could be even worse. Fortunately, the frequencies introduced by the residual pulses are all well above the upper limit of human hearing as well as the

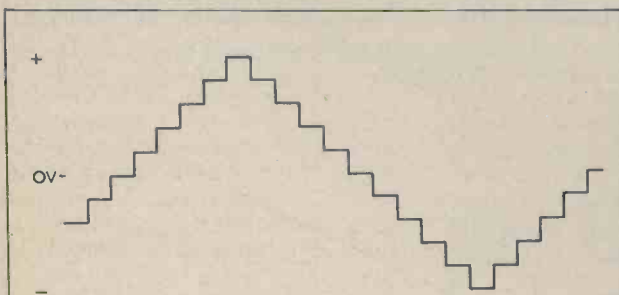

Fig. 4. Inadequate low pass filtering at the amplifier output can allow the clock frequency to modulate the average audio signal, giving a stepped waveform

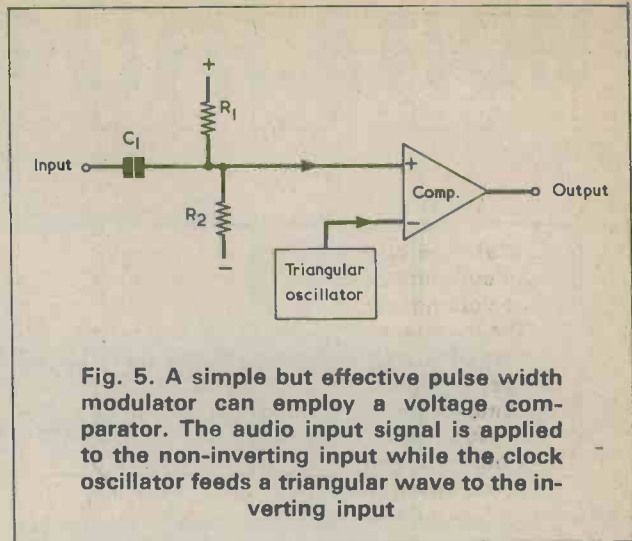

Fig. 5. A simple but effective pulse width modulator can employ a voltage comparator. The audio input signal is applied to the non-inverting input while the clock oscillator feeds a triangular wave to the inverting input

response of the speakers. Apart from the question of distortion the residual pulse contains r.f. components which can be radiated by the speaker leads, possibly causing r.f. interference with adjacent receivers. The radiation could even cause problems when a Class D amplifier is used with an f.m. tuner. It is therefore necessary to attenuate the residual pulse signal by as much as possible.

A well designed Class D circuit has quite low levels of harmonic and intermodulation distortion, and negative feedback can be used in the conventional manner to further improve the distortion performance. The feedback can be taken either from the output via the low pass filter or from the output by way of a separate low pass filter.

PULSE WIDTH MODULATOR

The pulse width modulator can simply consist of a voltage comparator in the basic circuit arrangement of Fig. 5, but there are alternative methods employing a Miller integrator or a monostable. The arrangement of Fig. 5 is commonly employed, though, and is capable of excellent results despite its simplicity.

The clock oscillator must provide a high quality triangular waveform, and this can be readily achieved these days with a function generator i.c. or a discrete component alternative. The clock signal is applied to the inverting input of the comparator and the input signal to the non-inverting input. R1 and R2 bias the non-inverting input so that, under quiescent conditions, it is at the centre of the voltage swing of the triangular wave, as shown in Fig. 6(a). When the triangular wave at the inverting input goes positive of the signal voltage at the non-inverting input the comparator output goes low. Similarly, when the triangular wave is negative of the signal voltage the comparator output goes high. The comparator output is shown below the triangular wave in Fig. 6(a) and, as can be seen, is a square wave with a mark-space ratio of 1:1 when the input signal is zero, i.e. in the quiescent state.

Fig. 6(b) shows what happens when the input signal to the non-inverting input goes positive. The time in the clock cycle when the triangular wave is negative of the input signal voltage increases by a proportionate amount, giving the required increase in the mark-space ratio at the comparator output.

Fig. 6(a). The output pulse train produced by the comparator of Fig. 5 for zero signal input voltage at the non-inverting input (b). The comparator output goes low when the triangular wave is positive of the signal voltage; a highly positive signal voltage thus causes the comparator output to be low for only short periods (c). A highly negative signal voltage results in the comparator output going high for similarly short periods

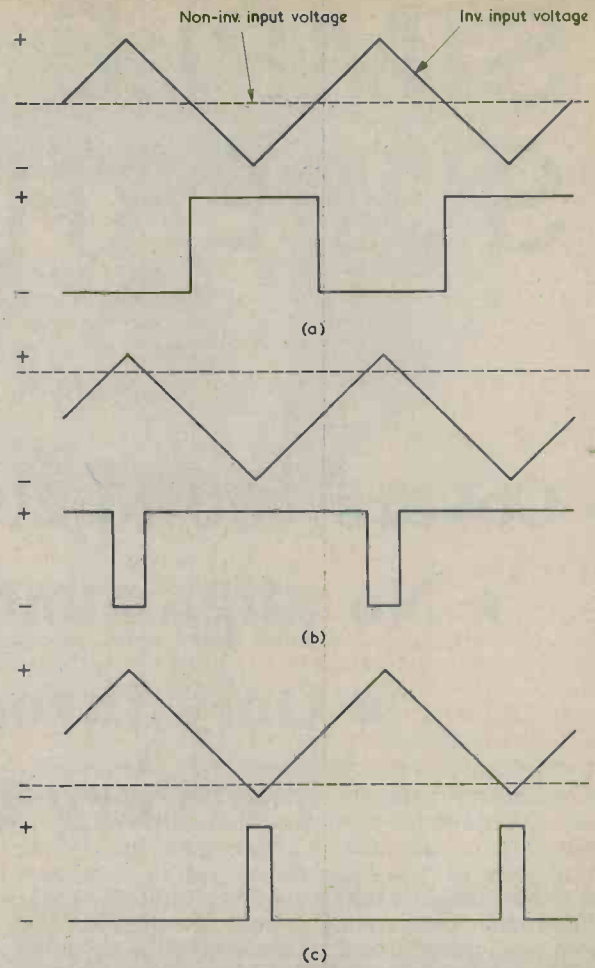

The input signal goes negative in Fig. 6(c), whereupon the length of the positive pulse at the comparator output is reduced by a corresponding amount. It will be seen that the system produces output pulses at clock frequency having an average voltage which is proportional to the analogue input signal.

THE FUTURE

Class D amplifiers have been rather a rarity up to the present time but, with modern components and circuitry, it is now possible to produce high quality amplifiers of this type and they are likely to become more popular. On current showing they would appear to be more complex and expensive

than a simple Class B design of comparable power, but pulse amplifying circuits should be basically easier to design than linear amplifying circuits and the situation could well be changed as development progresses. ■

CMOS C METER — Suggest Circuit *Continued from page 335*

capacitance which can be reliably measured with the present technique is being approached.

None of the three curves of Fig 4 are linear. However, they are smooth and reasonably predictable, and should be capable of being drawn up with as few as four plotting points per range.

Constructors employing the capacitance meter should initially make it up and then calibrate it on all three ranges using known capacitors connected to the test terminals. Curves such as those in Fig. 4 are then drawn up, and the results converted to tables for easy future consultation. The radio receiver employed should have a clear and reasonably well marked out medium wave tuning scale, and it is important that the receiver which is used for calibration is also employed for subsequent measurements. This is because there will be variations in tuning scale readings with different

receivers. If the receiver to be used has a scale marked in frequency rather than wavelength, then the curves and subsequent tables will, of course, be made up in terms of frequency.

The meter may be assembled in a small plastic case wide enough to accommodate the ferrite rod. The only items required on the front panel are the two switches and the test terminals. The capacitor to be measured is connected to the terminals and the medium wave receiver positioned as described earlier. The receiver is then tuned over the medium wave band until the 1kHz tone is picked up with one of the three ranges switched in. It will be found that the radiation on Range 3 is a little weaker than the radiation on the other two ranges.

Because of the relatively high inductance required of L1 on Range 1 there is a slight possibility that, due to the use of a ferrite rod having a

slightly low permeability, some coils wound to the specification of Fig. 2 may still not have sufficient inductance for present requirements. After the meter has been completed it should be switched to Range 1 with a capacitor of between 30 and 50pF connected to the test terminals. The resultant signal from L1 should then be picked up by the receiver at a fairly central setting in the medium wave band. The test capacitor should then be removed, leaving L1 tuned by C1 alone. If the radiation can then be peaked on the receiver at around 200 metres, all is well. Should the signal now be at a frequency just outside the medium wave range of the radio an extra 10 or 20 turns may be added to the coil at the end marked "D" in Fig. 2. The inductance switched in on Ranges 2 and 3 is by no means as critical, and no problems are envisaged here. ■

SIMPLE S.W. SUPERHET — PART 1

By R. A. Penfold

- ★ Covers 180 to 20 metres
- ★ No alignment problems
- ★ Only three transistors
- ★ Very low battery current

A high quality short wave superhet communications receiver can be both complicated and costly, and many people are probably deterred from buying a ready-made set because of the expense. Constructing one's own receiver allows **considerable savings in cost to be made**, but the building of a complex design is not within everyone's capabilities. The very simple set described here has been specifically designed to enable a beginner to assemble a short wave receiver of reasonably good performance at low cost. The circuit is unusual but it gives perfectly satisfactory results in practice.

The set is powered by its own 9 volt battery, and its output is suitable for high impedance magnetic headphones with a resistance of 2,000 Ω or more a crystal earpiece. It needs the usual long wire type of aerial, and an earth connection can also be provided if desired. Denco plug-in coils for Denco Ranges 3 and 4 are used, these covering approximately 1.7 to 5.5MHz (180 to 55 metres) and 5 to 15MHz (60 to 20 metres) respectively. The set is therefore capable of receiving all the low frequency short wave broadcast and amateur bands as well as a good proportion of the high frequency bands. The

completed set requires no r.f. and oscillator alignment whatsoever, as separate tuning controls are employed in these circuits. When correctly adjusted, these enable peak sensitivity to be maintained on all received frequencies. The single i.f. transformer employed is supplied pre-aligned and does not require further adjustment for acceptable operation. If the constructor wishes to fully optimise the i.f. tuning, however, a small adjustment to the appropriate i.f. core may be carried out. The procedure is very simple and requires no test equipment. The set receives normal amplitude modulation (a.m.) signals and can also give quite good resolution of morse (c.w.) and single sideband (s.s.b.) signals, both of which are extensively used in the amateur bands.

STAGE LINE-UP

The basic stage line-up of the receiver is shown in the block diagram of Fig. 1. The aerial is coupled to the aerial tuned circuit, which selects the required signal and attenuates those that are removed from it in frequency. The selected signal is next passed to the mixer-oscillator stage. This incorporates a single transistor which oscillates at a

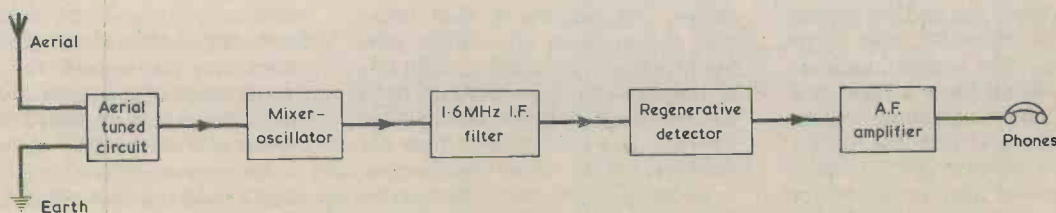

Fig. 1. Block diagram illustrating the stage line-up of the short wave superhet



The use of a ready-made metal case makes the construction of this simple short wave superhet even simpler. Plug-in coils obviate the necessity for a wave band switch

frequency 1.6MHz higher than the signal frequency and which also mixes together the oscillator and signal frequencies. The output of the mixer-oscillator includes the original signal and oscillator frequencies, a frequency equal to the sum of these two frequencies and a frequency equal to their difference. The last frequency is the one which is of importance here and, since the oscillator frequency is 1.6MHz above the signal frequency, the difference is of course 1.6MHz. This is the intermediate frequency (i.f.) for the receiver.

The mixer-oscillator stage does not employ a conventional bipolar transistor circuit. Instead, a dual gate MOSFET device is used with one gate being in the aerial signal circuit and the other in the oscillator circuit. This gives a better performance than is offered by a bipolar transistor circuit and is also less prone to instability.

It is an easy matter to obtain good gain and selectivity with the relatively low 1.6MHz intermediate frequency and this is the reason for using a superhet receiver (as the present type of receiver is known) instead of the simpler type of tuned radio frequency (t.r.f.) set. With the latter, all the gain and selectivity before the detector has to be provided at the reception frequency, which results, in general, in a low level of performance.

The 1.6MHz intermediate frequency next passes through a double tuned 1.6MHz i.f. transformer before it passes to a regenerative detector. Normally, an i.f. filter having only two tuned circuits would not be considered as offering adequate selectivity, but the selectivity provided in the i.f. circuit of this receiver is increased very considerably by the use of a regenerative detector stage in which a positive feedback path is set up by way of the second 1.6MHz tuned circuit in the i.f. transformer. The regeneration also increases the gain at the intermediate frequency to a level which allows good overall receiver sensitivity to be achieved without the necessity for an actual i.f. amplifying stage. The result is a pronounced simplification in the design of the receiver.

The feedback in the regenerative detector circuit can be adjusted by means of a panel control so that it can be taken to a point just below that at which oscillation takes place, and in this condition the receiver is at its most sensitive and selective for the reception of a.m. signals. If the control is taken just beyond the oscillation point the detector oscillation will beat with the signal intermediate frequency to enable c.w. signals to be received or provide a carrier frequency which allows s.s.b. signals to be resolved. The feedback control gives results similar to those obtained with a reaction control in a t.r.f. set.

Some readers may query the choice of an intermediate frequency at 1.6MHz instead of the more conventional frequency of around 470kHz. The 1.6MHz frequency is used because it gives better protection against image interference. When the receiver oscillator is running at 1.6MHz higher than a desired signal it is possible for an unwanted signal 1.6MHz above the oscillator frequency to mix with the oscillator frequency and produce a difference 1.6MHz signal which will also be accepted by the i.f. filter. The unwanted signal is at the "image" frequency for the receiver and is spaced from the required signal frequency by twice 1.6MHz, or 3.2MHz. With an i.f. at 470kHz the image frequency is only 940kHz above the signal frequency. Obviously, an image frequency spaced from the required signal frequency by 3.2MHz can be rejected by the aerial tuned circuit much more effectively than can one spaced away by only 940kHz.

The higher intermediate frequency in a more conventional receiver design would result in a slightly reduced i.f. selectivity and gain. However, these two factors are raised to acceptable levels in the present receiver because of the regenerative detector.

The output from the detector is passed to a standard a.f. amplifier stage, which then feeds the headphones or earpiece.

All in all, this extremely simple receiver offers

very good results. There are obviously one or two drawbacks, such as the lack of automatic gain control (a.g.c.) which cannot be incorporated into the circuit. Nevertheless, when operated correctly the set is capable of world-wide reception.

COMPONENTS

Resistors

(All fixed values $\frac{1}{4}$ watt 5% unless otherwise stated)

R1 1M Ω

R2 330 Ω

R3 2.2M Ω 10%

R4 4.7k Ω

VR1 5K Ω potentiometer, linear, with switch S1

Capacitors

C1 100 μ F electrolytic, 10V. Wkg.

C2 0.015 μ F type C280

C3 1,000pF polystyrene

C4 330pF polystyrene

C5 270pF ceramic plate

C6 0.01 μ F ceramic plate or type C280

C7 2.2 μ F electrolytic, 63V. Wkg.

C8 10 μ F electrolytic, 25V. Wkg.

VC1 365pF variable, type 01 (Jackson)

VC2 365pF variable, type 01 (Jackson)

VC3 10pF variable, type C804 (Jackson)

Inductors

L1 Miniature Dual Purpose coil, Blue, transistor usage, Range 3T and 4T (Denco)

L2 Miniature Dual Purpose coil, White, transistor usage, Range 3T and 4T (Denco)

L3 10mH ferrite cored r.f. choke (see text)

IFT1 1.6MHz double tuned i.f. transformer type IFT18-1.6MHz (Denco)

Semiconductors

TR1 MEM616 or 40673

TR2 2N3819

TR3 BC109C

Switch

S1 s.p.s.t. toggle, part of VR1

Sockets

SK1 insulated wander socket, red

SK2 insulated wander socket, black

SK3 3.5mm. jack socket (see text)

Miscellaneous

Metal instrument case (See text)

2-off B9A valveholders

9-volt battery type PP3

Battery connector

4-off control knobs

20 s.w.g. aluminium sheet (for coilholder bracket)

Veroboard, 0.1 in. matrix (see text)

High impedance magnetic headphones or crystal earpiece with 3.5mm. jack plug.

Nuts, bolts, wire, etc.

CIRCUIT DIAGRAM

The full circuit of the Simple S.W. Superhet is given in Fig. 2. In this, TR1 is the mixer-oscillator transistor, TR2 is the regenerative detector transistor and TR3 is the a.f. amplifier.

Looking at the circuit in greater detail, L1 is in the aerial signal circuit and L2 is in the oscillator circuit. Both L1 and L2 are plug-in Denco coils, and the numbers alongside the ends of the windings indicate the corresponding pin numbers. The tuned winding of L1 connects to pins 1 and 6, and the aerial is coupled to it via the low impedance winding connecting to pins 8 and 9. Aerial signal tuning is adjusted by VC1. As may be seen, the aerial input circuitry is associated only with gate G1 of TR1. The input impedance at this gate is extremely high, whereupon it becomes possible to connect the tuned circuit to it directly.

The oscillator tuned circuit couples to this second gate, G2, of TR1. Feedback to the tuned winding of L2 is provided by inserting the coupling winding (pins 8 and 9) between the drain of TR1 and the primary of the i.f. transformer, IFT1. There are two oscillator tuning capacitors, these being the high value capacitor VC2 and the low value capacitor VC3. The first is the Bandset capacitor, and is used for bringing the receiver tuning to the centre of the band to be searched for signals. Fine tuning is then carried out by adjusting the Bandsread capacitor, VC3. C3 and C4 are padding capacitors, and their function is to ensure that the oscillator frequency range corresponds with the aerial signal frequency range. C4 is the padding capacitor required by the Range 3 oscillator coil and C3 is the capacitor needed on Range 4. The lower end of the tuned winding is brought out to different pins on each oscillator coil, so that the correct padding capacitor is automatically selected when the coil is inserted in its holder. The values specified for the two capacitors are preferred values which are very close to the values quoted for the coils by the manufacturer. Since the tuning of the aerial and

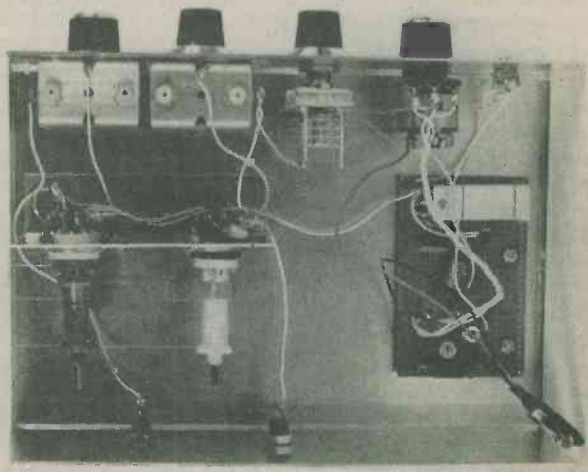

Apart from the front panel components, nearly all the remaining parts are wired up as two modules. These consist of the coilholder bracket assembly, which is dealt with this month, and the Veroboard panel assembly, which will be described next month

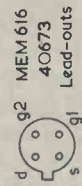
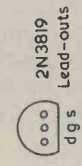
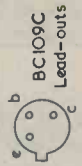
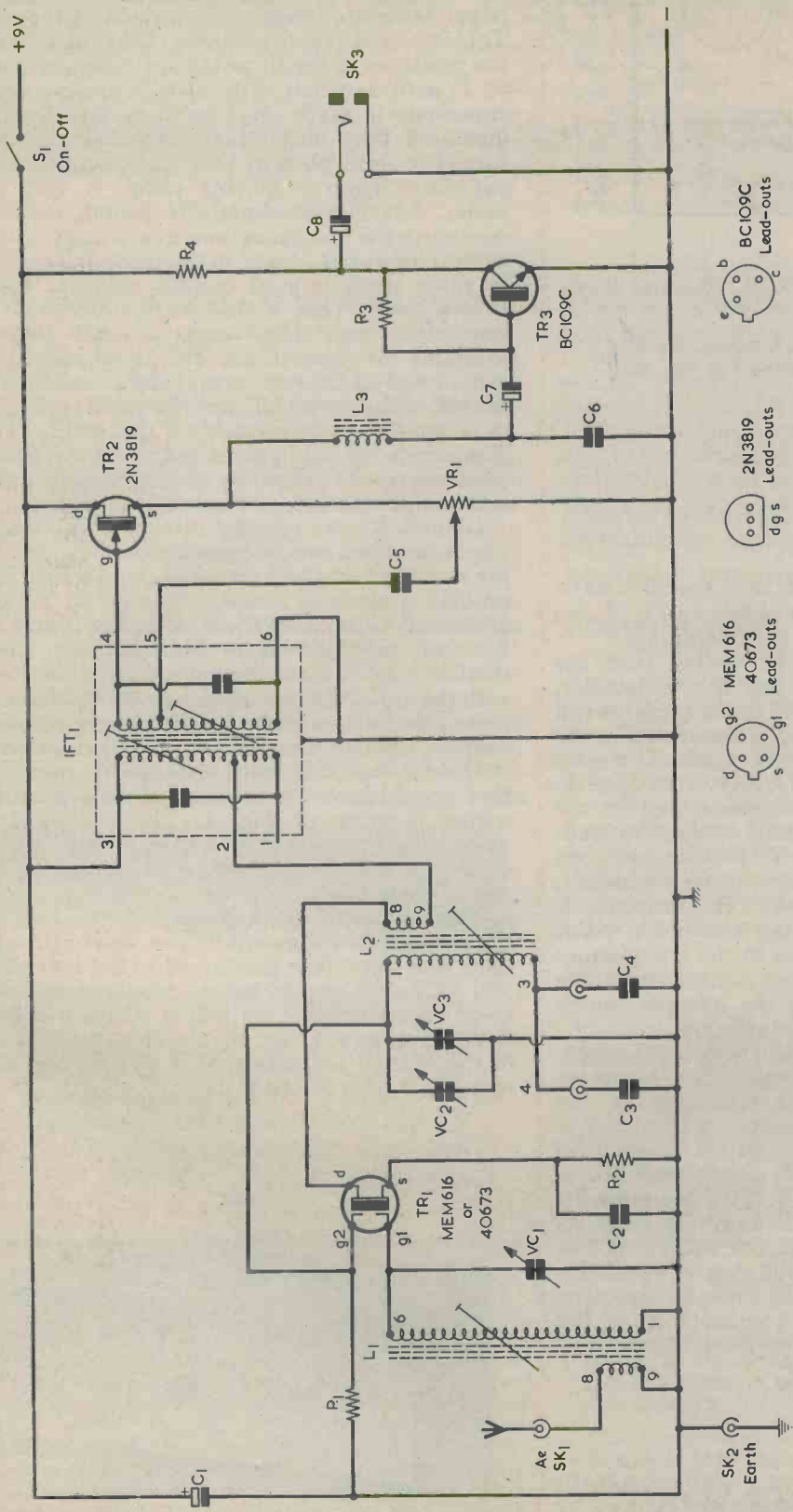

Fig. 2. The circuit of the Simple S.W. Superhet. Although this provides full superhet operation, the components required are minimal

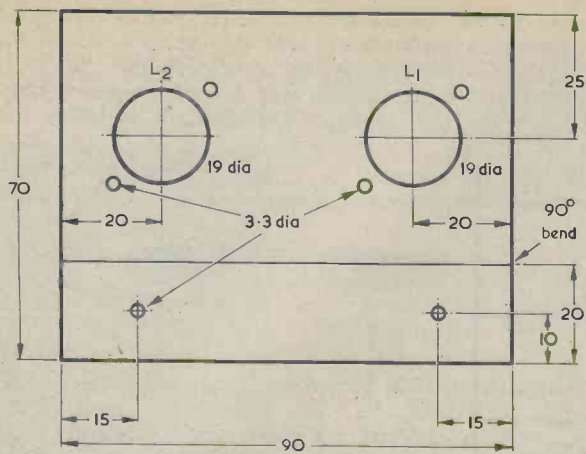

Fig. 3. The coil mounting bracket. Details not shown here are described in the text

oscillator circuits is not ganged there is no necessity to use precisely the manufacturer's recommended values.

Both the aerial and oscillator coils specified have a third winding, which is not shown in Fig. 2. No connections are made to the third winding.

IFT1 selects the 1.6MHz i.f. output from the mixer-oscillator and couples this to the detector, TR2. The gate of TR2 is biased to the negative rail by the secondary of IFT1 and is connected in the common drain, or source follower, mode. This gives a gain of slightly less than unity from gate to source. The track of VR1 provides a load for the source, whilst a variable amount of positive feedback is provided by coupling VR1 slider back, via C5, to a tapping in the i.f. transformer secondary. Despite the unity gain offered by TR2 the feedback can still be taken beyond the oscillation point because of the voltage step-up in the transformer secondary. The two unmarked capacitors in the circuit symbol for IFT1 are the internal tuning capacitors fitted by the manufacturers.

TR2 provides detection due to non-linear operation, in that it gives greater amplification to one set of half-cycles. The effect is enhanced by the positive feedback, and a detected a.f. output is available at TR2 source. L3 and C6 remove the 1.6MHz i.f. signal, and the a.f. signal is applied to the base of TR3 by way of C7. TR3 is a straight-forward common emitter a.f. amplifier, and its collector couples to the phone jack socket via C8.

S1 is the on-off switch, and is ganged with VR1. C1 is the only supply decoupling capacitor required by the circuit. The current consumption of the receiver is about 3 to 4 mA, allowing economic running from the 9 volt battery.

CONSTRUCTION

The receiver is housed in a metal instrument case having approximate dimensions of 8 by 5½ by 2½ in. This is a case type BC3, available from Harrison Bros., P.O. Box 55, Westcliffe-on-Sea, Essex, SS0 7LQ. The simple front panel layout can be seen in the photographs. Looking at the receiver from the front the front panel components, from

right to left, are VC1, VC2, VC3, VR1/S1 and SK3. VC1 and VC2 are each mounted by means of three short 4BA bolts passing through tapped holes in the front plate of the capacitor. The hole positions may be marked on the front panel with the aid of a paper template having a ¼ in. hole in the centre. This is passed over the spindle of the capacitor, and the positions of the three tapped holes are marked on it with a pencil. The 4BA bolts securing the capacitors in place must be short, and their ends must not pass more than marginally inside the capacitor front plate as they will then damage the capacitor fixed or moving vanes. A very much easier, but less mechanically sound, method of mounting the two capacitors is to simply cut out a central hole about 14mm. in diameter and glue them in place using a good quality adhesive such as Bostik No. 1. They should be mounted with their connecting tags uppermost, so that these are available for connections. The aerial socket, SK1, is mounted on the rear panel behind and slightly to the left of the aerial coil, and the earth socket, SK2, in a similar position behind the oscillator coil. These coils are not in place yet, of course, but their positions can be judged by an examination of Fig. 3 and the photograph of the receiver interior.

L1 and L2 are plugged into B9A valveholders, which in effect now become coilholders, and these are mounted on the bracket shown in Fig. 3. The bracket is made of 20 s.w.g. (or slightly thicker, if preferred) aluminium sheet. After the 19mm. holes for each coilholder have been cut out, the two smaller 3.3mm. mountingholes may be marked out with the aid of the coilholder itself. The 20mm. section at the bottom of the bracket is bent through 90 degrees towards the reader. When mounted, the coilholder tags also point towards the reader, and they should have the orientation illustrated in the wiring diagram of Fig. 4. The coilholders are mounted by means of two 6BA or M3 bolts and nuts each, a solder tag being fitted under the lower nut in each case.

The completed bracket is secured to the base of the metal case by means of two short 6BA or M3 bolts and nuts. It is positioned to the rear of VC1 and VC2, but should not be mounted so close to these capacitors that coilholder wiring will be difficult to carry out. Nor should be positioned so far to the rear of the case that it will be difficult to remove or plug in the coils.



The insulated sockets for the aerial and earth connections are mounted on the rear panel of the case. Precise positioning is not important

Fig. 4. The r.f. wiring around TR1

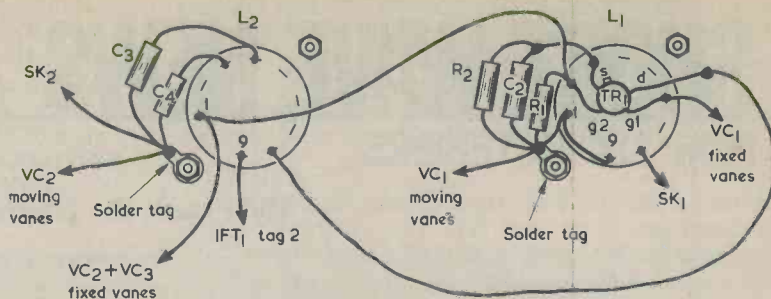

R.F. WIRING

The r.f. wiring is shown in Fig. 4. This is of the point-to-point variety, and all leads should be kept reasonably short. There is a wire from one solder tag to the moving vanes tag of VC1 and another from the second solder tag to the moving vanes tag of VC2. The two wires are essential if these two variable capacitors are glued to the front panel, and are desirable if the two capacitors are bolted to the panel. The chassis connection to VC3 moving vanes is made by way of its mounting bush and nut. A lead from pin 1 and L2 coilholder passes to the fixed vanes tag of VC2, and a second lead from VC2 connects to the nearer fixed vanes tag of VC3. A lead about 6 in. long can be soldered to pin 9 of the L2 coilholder. Its other end, shortened as necessary, will be soldered to tag 2 of 1FT1 later, after this transformer has been mounted in place.

TR1 is a MOSFET device and should be soldered into circuit with an iron having a reliably earthed bit. Many 40673 and MEM616 devices are fitted with integral protective diodes and are not

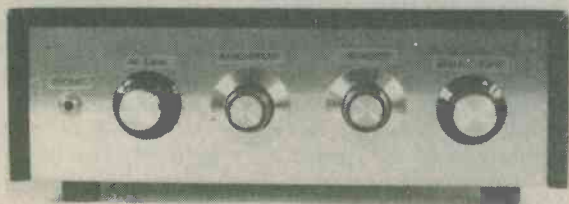

On the front panel, the headphone jack socket is to the left. Next to it is the regeneration control, VR1, followed by the bandspread tuning control, VC3, and the bandset tuning control, VC2. The aerial tuning capacitor, VC1 is at the extreme right

easily damaged by static voltages. If, however, the device is supplied with a small piece of wire short-circuiting together all the lead-outs, it is advisable to leave this short-circuiting wire in place until all the r.f. wiring has been completed, after which it may be removed. A little care is needed with TR1 lead-outs to ensure that they do not touch each other after wiring has been carried out. Pin 2 of L1 coilholder is used as an anchor tag for the connection to the G2 lead-out. Pin 3 is similarly employed as an anchor tag for the source lead-out. The connection to the drain lead-out is made last, and the joint is not supported by any tag.

COMPONENTS

The full Components List appears this month, although some of the components will not be referred to until the concluding article appears. The Veroboard employed in the receiver has 17 copper strips by 30 holes, and is cut down from a larger size board. The 10mH r.f. choke employed for L3 is the component retailed by Maplin Electronic Supplies. The 3.5mm. jack socket required for SK3 should have an open construction, i.e. it should not be an insulated type. The transistor required for TR1 is available from several suppliers including Ambit International.

NEXT MONTH

In next month's concluding article, further constructional details will be given, these applying mainly to the Veroboard component panel on which the remainder of the circuitry is assembled. The article will also deal with the optional i.f. alignment and the operation of the receiver.

(To be concluded)

Mail Order Protection Scheme

The publishers of this magazine have given to the Director General of Fair Trading an undertaking to refund money sent by readers in response to mail order advertisements placed in this magazine by mail order traders who fail to supply goods or refund money and who have become the subject of liquidation or bankruptcy proceedings. These refunds are made voluntarily and are subject to proof that payment was made to the advertiser for goods ordered through an advertisement in this magazine. The arrangement does not apply to any failure to supply goods advertised in a catalogue or direct mail solicitation.

If a mail order trader fails, readers are advised to lodge a claim with the Advertisement Manager of this magazine within 3 months of the appearance of the advertisement.

For the purpose of this scheme mail order advertising is defined as:

"Direct response advertisements, display or postal bargains where cash has to be sent in advance of goods being delivered."

Classified and catalogue mail order advertising are excluded.

SHORT WAVE NEWS

FOR DX LISTENERS



By Frank A. Baldwin

Times = GMT

Frequencies = kHz

Those elusive signals from the Far East are 'in focus' just now and 'observations' tend to show that it will be a good season for Malaysia, Indonesia and all points East etc. Chinese regional stations are featured on the following page.

● SRI LANKA

Colombo on a measured **4902** at 1913, religious chants on a full-moon day. This is the Home Service 1 in Sinhala and is scheduled from 0015 to 0230, 1030 to 1715 but on full-moon days this is extended to 2400. The power is 10kW.

● SINGAPORE

Radio Singapore on a measured **5052** at 1540, YL with identification "This is Radio Singapore" followed by a programme of orchestral music. This is the English Service which operates from 2230 through to 1630 (1700 on Sundays). The power is 20kW.

● INDONESIA

RRI (Radio Republik Indonesia) Banda Aceh, on a measured **4954** at 1543, YL with local-style songs, YL announcer. The schedule is from 2300 to 0015 (Sundays to 0600) and from 0800 to 1600 (during Ramadan has been reported closing as late as 2115) the power is 10kW.

RRI Sorong, on **4875** at 2225, YL with song in Indonesian with local-style orchestral backing, OM announcer. This one has a schedule from 2100 to 2330 and from 0800 to 1400. The power is 10kW.

● SARAWAK

Radio Malaysia, Sibul, Sarawak, on **5005** at 2212, YL with song backed by drums and other local-type percussion instruments. The schedule is from 2200 to 2300, 0400 to 0500 and from 1000 to 1500. The power is 10kW.

AROUND THE DIAL

● BRAZIL

Radio Cultura do Para, Belem, on **5045** at 0259, OM with announcements and identification in Portuguese. Sign-off without the National Anthem at 0301. The close down is sudden, immediately after the announcements — watch the S-Meter drop back when the carrier goes off the air — and then LISTEN CAREFULLY. If you are very lucky, you may hear Radio Altiplano, La Paz, Peru. All other (there are two of them) South American stations also sign-off at 0300 or thereabouts. La Paz has a 24-hour schedule but only broadcasts irregularly, which is a pity. It has, however, been reported by several European Dxers over the past few years. Radio Cultura has a power of 10kW whilst La Paz has only a meagre 1.5kW. Good luck with the Peruvian logging!

● NETHERLANDS ANTILLES

Radio Nederland Relay at Bonaire on **9715** at 0836, OM with news of the Netherlands and the Common Market in the English programme directed to Australia and New Zealand, scheduled from 0830 to 0925. An earlier English programme intended for the same areas is radiated from the Bonaire Relay from 0730 to 0825 on **9715** and in parallel on **9770**.

● PAKISTAN

Karachi on **17910** at 1500, OM with announcements in the World Service Urdu programme intended for the Persian, Gulf and Middle East areas, YL with identification. This programme is scheduled from 1330 through to 1600. According to the schedule, the frequencies used for this transmission should be **17640**, **21485** and **21755** but Radion Pakistan frequencies are often subject to variations — to say the least!

● CZECHOSLOVAKIA

Prague on **11855** at 0830, OM with identification in the English programme beamed to Africa, the Far East, South Asia and the Pacific areas. Followed by a newscast and commentary in the Asian and Pacific Service, the schedule of this transmission is from 0830 to 0900 (to 0925 on Saturday and Sunday). The parallel channels are **17840** and **21700**.

● POLAND

Warsaw on **15120** at 1255, YL with identification, OM with a newscast in the English programme for Africa, scheduled from 1230 to 1300 on this channel and in parallel on **9525**, **9675** and on **11840**.

● HUNGARY

Budapest on **15160** at 1050, YL and OM with the English programme intended for Australia, New Zealand and Japan, scheduled here from 1030 to 1100 and also in parallel on **9585**, **9835**, **11910**, **17785** and on **21525**.

● KUWAIT

Radio Kuwait on **21605** at 1148, YL with songs in local-style, OM announcer in Arabic in the Domestic/External Service, scheduled from 0815 through to 1505 on this frequency.

● WEST GERMANY

"Deutsche Welle — the Voice of Germany", Cologne, on **21590** at 1200, OM with station identification and the commencement of the German programme directed to South America, scheduled

RADIO AND ELECTRONICS CONSTRUCTOR

from 1200 to 1220 on this channel and in parallel on 15245, 17715 from Cologne transmitter and on 11705, 11785 and on 15185 from the relay station at Kigali in Rwanda. For QSL card collectors, listen for the English programme to West Africa, scheduled from 1200 to 1245 on 17875 and 21600 from Cologne and on 15410 and 17765 from Kigali.

● BELGIUM

Brussels on 21475 at 1208, OM with a newscast in the Dutch programme for Africa and South East Asia, scheduled from 1200 to 1230 and in parallel on 17740. This was the programme for Missionaries, radiated on Tuesday, Thursday and Sunday. On Saturdays there is a programme for seamen in Dutch and French on these two channels plus 15210 and 21460.

English programmes from Brussels are currently broadcast as follows — from 0015 to 0100 to the Americas on 11705 and on 15190; from 1610 to 1700 to Africa and Northern Europe on 17740 and on 21475.

● FRANCE

Paris on 21595 at 1310, OM with the French programme for Africa, scheduled on this frequency from 1100 to 1800.

Paris on 21645 at 1313, OM with a talk in French in a relay of the Domestic Service 'France Inter' to North America and the Caribbean, scheduled from 1145 to 1715.

● ISRAEL

Jerusalem on 17630 at 1347, OM with songs, YL announcer in the Domestic Service Network 'B' (in Hebrew) to Europe, the Middle East and North America, scheduled on this frequency from 0400 through to 2310, also being directed to South Africa from 2000.

Jerusalem on 21495 at 1222, OM with a talk about local affairs in the English programme for Europe, the Middle East, South and East Asia, North America, Australia and New Zealand, scheduled from 1200 to 1230 on this channel and in parallel on 7465, 11655, 17565, 17685, 21575, 21675 and on 25640.

● SOCIETY ISLANDS

Papeete, Tahiti, on 15170 at 0325, soft Polynesian songs and lullabies (presumably!), OM with announcements in French. OM news in Tahitian from 0330 to 0340 followed by OM with songs in Tahitian. "Radio Tahiti", France Regions 3, is on the air from 1600 sign-on to 0800 sign-off. The frequencies are 6135 and 9750 (both 4kW) and 11825 and 15170, the latter channel providing the best chance of reception here in the U.K. The listed power of the latter two transmitters is 20kW. According to the schedule, programmes in French are as follows — from 1600 to 2045, 2200 to 0300 and from 0600 to 0800. In Tahitian from 2045 to 2200 and from 0300 to 0600. In English from 1900 to 1915. When logged here however, as will be noticed from the above timings, some announcements in French were being made at 0329.

● COSTA RICA

Faro del Caribe, San Jose, on 5050 at 0307, YL and OM in English with a programme about English folk songs. Identification at 0322 and again at 0338 with the announcement "Faro del Caribe — Lighthouse of the Caribbean" then a religious programme in English. The schedule is from 1055

to 0400 with the English programme listed as being from 0300 to 0400 but the writer has logged them on other occasions prior to 0300 in English, a recent occasion being on a Sunday morning at 0250. The power is 5kW and they are liable to vary in frequency from that shown up to 5055 at times!

● CHINA

Urumqi, Xinjiang, on 4500 at 1800, chimes when opening, id, OM and YL announcers, "Govorit Peking". This is a relay of the Radio Peking Foreign Service in Russian, scheduled on this channel from 1800 to 2100.

Yunnan People's Broadcasting Station, Kunming, on 4760 at 2210, Chinese opera. This is Yunnan 1, scheduled from 2150 to 0600 and from 0920 to 1600 but the writer has heard them much earlier in our evenings, around 1930, when the signal strength is slowly increasing from a mere whisper — and often on a measured 4761. Last year they were often operating on 4759!

Lanzhou, Gansu, on 4865 at 2314, OM with a talk in Chinese. This one has a schedule from 2120 to 0100, 0320 to 0600 and from 1000 to 1600.

Nanning, Guangxi, on 4905 at 2013, YL in Chinese in the Domestic Service 1 Programme, scheduled from 2000 to 2300 and from 1100 to 1735. It relays Peking 1.

Nanning, Guangxi, on 4915 at 2234, OM in Chinese. The schedule is from 2105 to 0005 and from 0845 to 1605.

Hohhot, Inner Mongolia, on 6840 at 2217, OM and YL alternate with announcements (presumably in Mongolian). The schedule of the Inner Mongolia People's Broadcasting Station is from 2145 to 0100, Sundays from 2145 to 0635.

Yunnan, Kunming on a measured 6937 at 2235, Chinese music on piano and flute. The schedule is from 2225 to 0230, 0325 to 0530 and from 1055 to 1605. This is Yunnan 2.

● MONGOLIA

Ulan Bator on 4830 at 2225, classical music on the piano, OM with announcements in Mongolian at 2230. This is the Domestic First Programme scheduled from 2200 to 1500.

● NOW HEAR THIS

Radio Pampas, Pampas-Tayacaja, Huanavelica, Peru, on a measured 4854.5 at 0340, OM announcer in Spanish, YL with ballad, OM with love song. This one may be heard after R.C. do Para, Brazil, on 4855 closes at 0335 (sometimes varies to 0400) usually with 'Anchors Aweigh' and announcements.



SAW FILTERS

By
R. J. Caborn

Surface acoustic wave filters, or SAW filters, are fitted in the i.f. stages of the latest Ferguson colour television receiver, model TX9. These devices can replace all the tuned circuits which would otherwise be required in the television i.f. stages, or they may be used in conjunction with a single tuned coil. The advantages are exceptional. With ordinary TV i.f. tuned circuits all the coils have to be manufactured to high standards of accuracy, after which they have to be carefully aligned on the production line to provide the necessary passband response. Furthermore, if the i.f. tuned circuits fall out of alignment in the field, the service engineer has to re-align them with the aid of quite complex and expensive test equipment. Both the problems of i.f. coil manufacture and subsequent alignment are eradicated at one step with the use of a SAW filter, which is manufactured to provide exactly the required response and which needs no adjustment at all during the working life of the receiver in which it is installed.

How does a SAW filter work? It has a length of flat piezoelectric

ceramic material with an input transducer arrangement at one end and an output transducer arrangement at the other end. It is basically a four terminal device with two input terminals and two output terminals. The input terminals connect to two sets of thin electrode strips deposited on the ceramic which are interleaved with each other in the same way that you can interleave your fingers, with the difference that the number of electrodes is much greater than the number of your fingers. Signals at the input strips disturb the surface of the ceramic material at the input transducer end and these disturbances then travel along the surface towards the output transducer end in much the same way as waves travel along the surface of a liquid. The output transducer is like the input transducer, and when the disturbances reach the output electrode strips the reverse piezoelectric effects creates voltages in them.

The surface waves travel along the surface of the piezoelectric ceramic at a constant velocity. The i.f. selectivity is given first by arranging the spacing between transistor electrodes such that successive

electrodes for one terminal are in phase as the travelling wave passes them at the frequencies it is desired that the filter should pass. The response can then be doctored to the final shape required by judicious control of the length and width of the electrodes. Not an easy process, and it is recalled that work was being carried out on the filters way back in 1971. (See "In Your Workshop" in the issue for May of that year.) Plessey have now overcome the development problems for colour television i.f. applications, and the SAW filter in the Ferguson TX9 receiver is a Plessey type SW153 device. This is housed in a round encapsulation rather smaller than a $\frac{1}{2}$ pence coin.

Unlike tuned circuits, which help to boost the signal, SAW filters incur a loss, but this is to be expected when the mode of operation is considered. In a typical circuit the loss can be of the order of 15dB, or 6 times voltage-wise. This is a mere nothing, with high gain i.c. amplifiers available to recover the loss, when it is compared with the considerable advantages that SAW colour TV i.f. filters provide. ■

EDITOR'S NOTE: For a more extensive treatment of the subject refer to last month's *In Your Workshop*

BACK NUMBERS

For the benefit of new readers we would draw attention to our back number service.

We retain past issues for a period of two years and we can, occasionally, supply copies more than two years old. The cost is 70p inclusive of postage and packing.

Before undertaking any constructional project described in a back issue, it must be borne in mind that components readily available at the time of publication may no longer be so.

IN OUR NEXT ISSUE

STEREO MIXER UNIT



This Unit mixes high impedance dynamic microphone, and music inputs. With modern i.c.'s it gives excellent performance at a low cost.

INFRA-RED INTRUDER ALARM

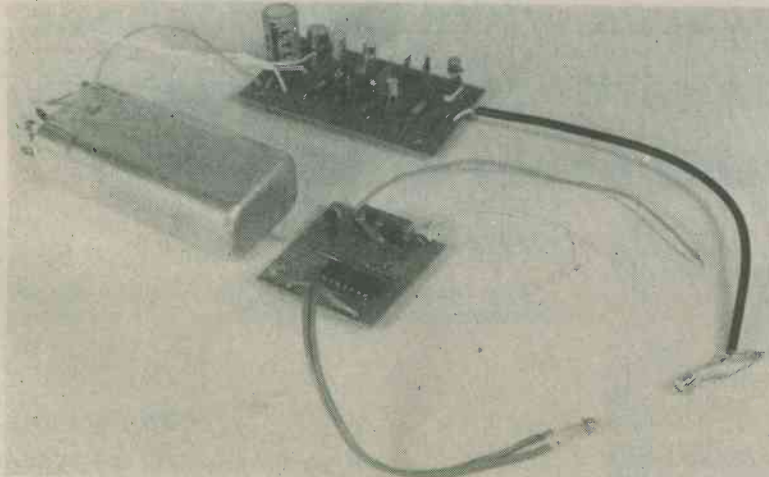

This alarm uses the breaking light beam principle, but in this case the beam is infra-red, and therefore invisible to the human eye. Automatic alarm circuit latching.

IN YOUR WORKSHOP — Questions on Resistors and capacitors for the beginner.

VIDEO A.C. COUPLING — How some black and white TV sets distort picture brightness.

THE 'WATERSPORT' — Part 2 of this popular Medium-Long Wave Portable.

ELECTRONICS DATA — Contact Bounce.

SUGGESTED CIRCUIT — ICM7555 Touch Buttons.

PLUS MANY OTHER ARTICLES

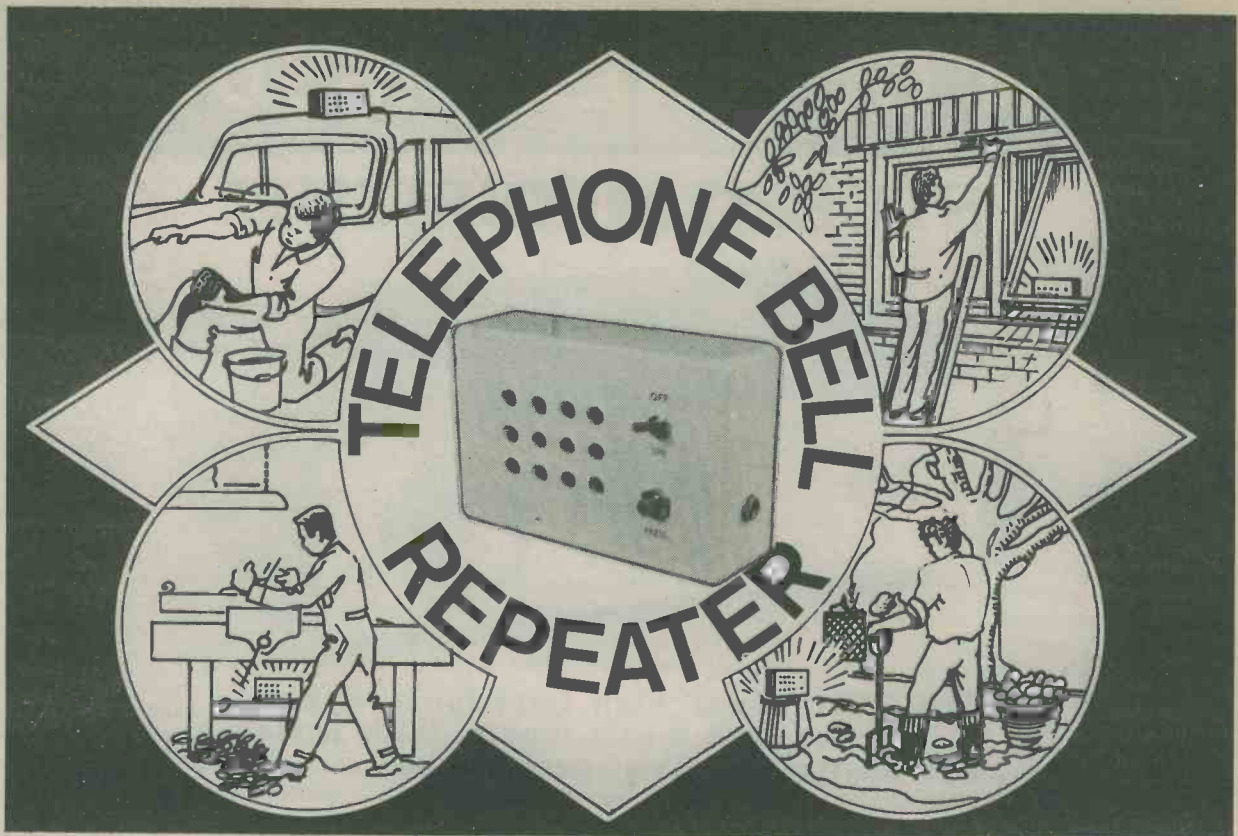

By I. M. Attrill

Remote unit warns when the telephone rings. You can garden happily without missing phone calls.

This simple household device is designed to eliminate the problem of a ringing telephone bell being missed when one is working in an outbuilding or in the garden. Of course, it can also be of value on other occasions when the telephone bell is inaudible for some reason, as occurs when listening to loud music or to a short wave radio using headphones.

The unit consists of a microphone connected to an amplifier and a.f. oscillator circuit via a long 2-way cable. The sound of the telephone bell is picked up by the microphone, amplified and used to trigger on the oscillator, the output of which is coupled to a small loudspeaker. This produces an audible alarm signal which, although less loud than a telephone bell, will still attract the attention of the user because it is in close proximity to him.

A battery powered circuit is used, but this is quite economical to run because the unit has been designed to have a very low stand-by current consumption. Provided the oscillator, when triggered on, is not allowed to run for extended periods, the battery should have a long useful life.

It is necessary to use a microphone to pick up the sound of the telephone bell because, of course, direct connections into telephone equipment are not permitted by the telephone authorities.

OPERATING PRINCIPLE

The block diagram of Fig. 1 shows the general arrangement of the telephone bell repeater. The

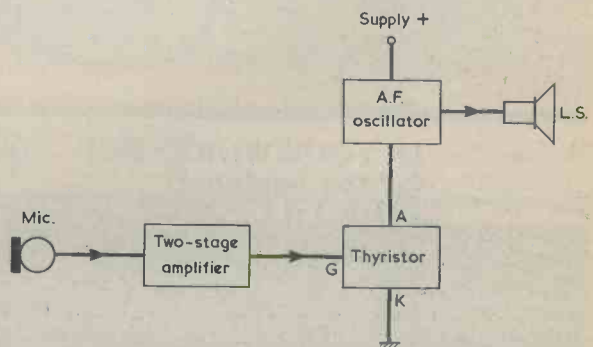

Fig. 1. Block diagram illustrating the basic operation of the telephone bell repeater. The sound of the bell is picked up by the microphone and the amplified signal then triggers the thyristor on, thus completing a supply circuit to the a.f. oscillator

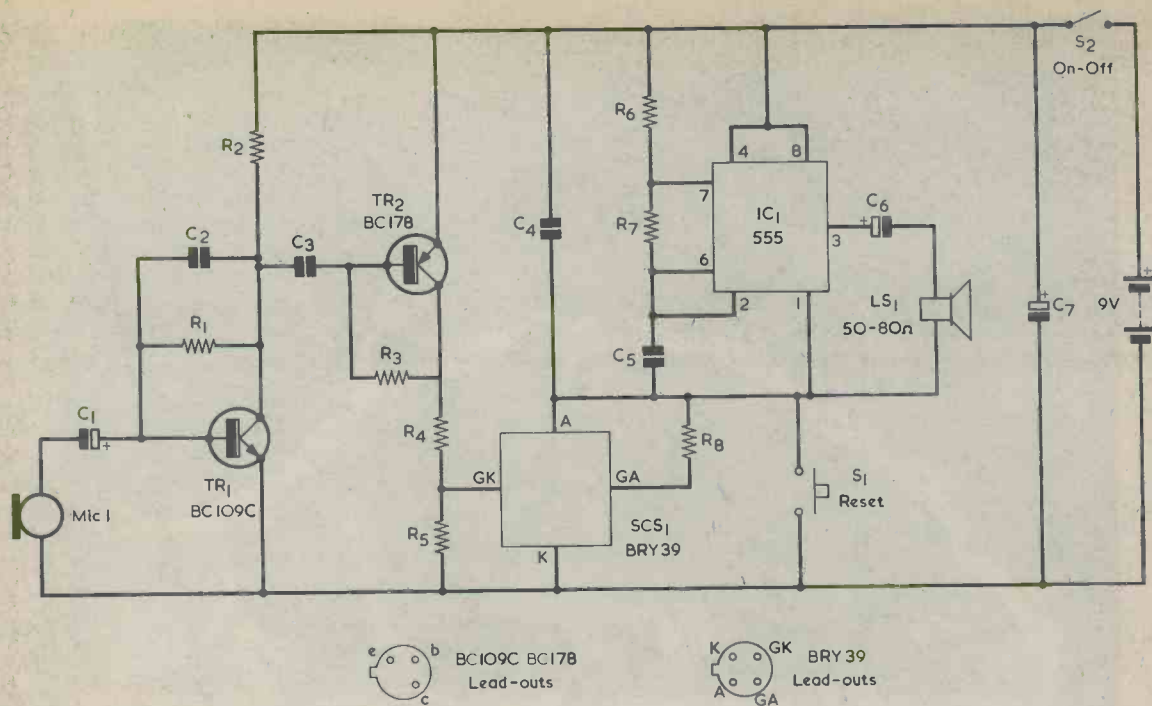

Fig. 2. The circuit of the repeater. The 2-stage amplifier incorporates TR1 and TR2, these feeding into SCS1 which functions as a sensitive thyristor. The a.f. oscillator is given by the 555 i.c. and associated components

microphone is actually a miniature high impedance loudspeaker, which now functions as an inexpensive moving coil microphone. Even though it can be placed quite close to the telephone bell, the output signal level from it is not likely to be more than a few millivolts. It is therefore necessary to considerably amplify the signal to bring it up to a suitable level for turning on the oscillator, and the requisite amplification is provided by a high gain 2-stage common emitter amplifier.

The output of the amplifier is coupled to the gate of a thyristor. Normally, the thyristor is off, but it will be turned on when a positive-going signal half-cycle of sufficient amplitude is applied to the gate. The thyristor will then cause nearly the full supply voltage to appear across the oscillator. Once it has been triggered the thyristor remains turned on until the unit is reset or switched off.

THE CIRCUIT

The full circuit diagram appears in Fig. 2. TR1 and TR2 are in a fairly conventional 2-stage capacitively coupled amplifier, the input signal from the microphone being passed to the base of TR1 via C1, and the amplified output being built up across R4 and R5 in series which provide the collector load for TR2. Both transistors are operated at low collector currents in order that the quiescent current consumption is kept small, thereby allowing economic battery running. The total quiescent consumption of the unit is only about 250µA. C2 rolls off the high frequency response of the input stage to remove the possibility of instability due to stray feedback.

The thyristor is not a 3-terminal silicon controlled rectifier but is, instead, a 4-terminal silicon controlled switch. This is a BRY39 and it has two integrated transistors, one p.n.p. and the other n.p.n., internally connected to form a thyristor type device. The silicon controlled switch has been fully covered earlier in this journal ("Silicon Controlled Switch Circuits" by John Baker in the December 1978 and January 1979 issues) and does not therefore need to be described in detail here. The

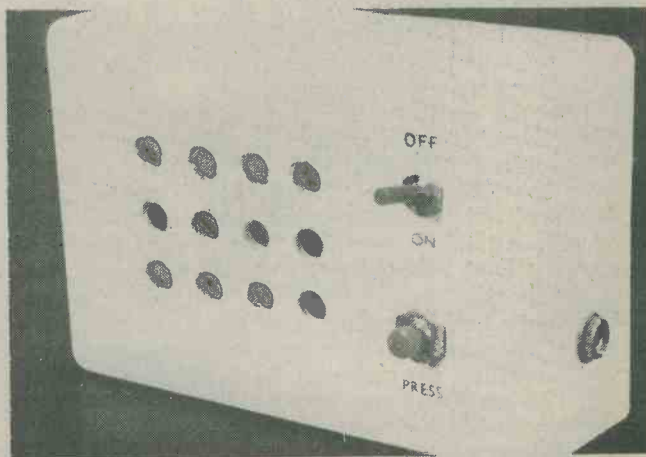

Apart from the microphone, all the repeater circuitry is housed in a small plastic case. The microphone connects to the 2-stage a.f. amplifier via the 3.5mm. jack socket on the right-hand side of the case

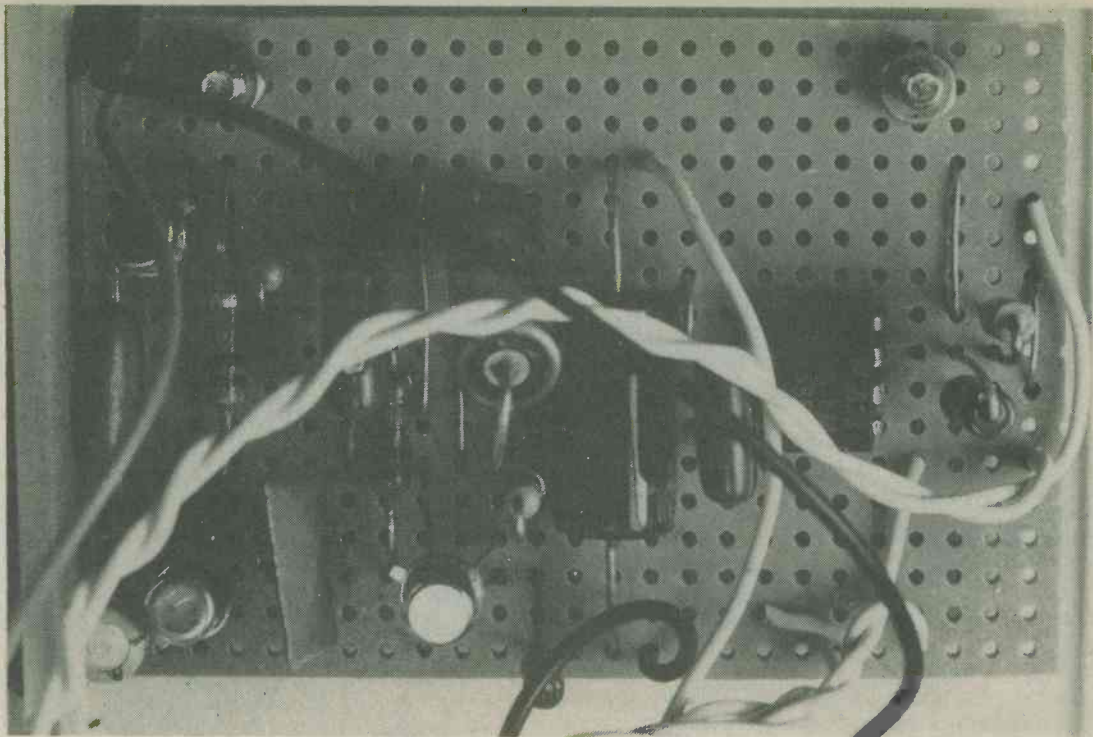

Assembly is simplified by the use of a Veroboard panel on which are mounted nearly all the smaller components

silicon controlled switch has the advantages of high triggering sensitivity and low hold-on current. It can be triggered by a gate current of less than 1mA, and an anode-to-cathode current of this same level is sufficient to hold the device in the on state. The corresponding figures for most 3-terminal thyristors are about 20 times this level.

In the present application, the GA terminal is not required and it is returned to the anode via R8 to prevent spurious triggering. The GK terminal is driven directly from the split collector load of TR2, the quiescent voltage applied to the gate being below the triggering level of about 0.5 volt. When the telephone bell rings, the positive half-cycles of the amplified signal which appear across R5 take the gate above the triggering level.

The a.f. oscillator which forms the anode load of the silicon controlled switch is a straightforward 555 astable multivibrator. Its frequency of operation, controlled by R6, R7 and C5, is approximately 300Hz. It passes a rectangular output waveform via C6 to a high impedance loudspeaker, producing quite a loud and penetrating sound.

After the unit has given warning that the telephone bell is ringing, it is switched off at on-off switch S2 while the user goes to answer the phone. On his return, the unit may be switched on again at S2. The oscillator may also be silenced by pressing S1, which short-circuits the anode and cathode of the silicon controlled switch, thereby reducing to zero the current which flows through it. The silicon controlled switch will then be off when S1 is released. However, since the telephone bell will still be ringing, the silicon controlled switch will then be turned on once more. The main purpose of S1 is to

function as a reset button, and it can be pressed to silence the oscillator if, as may happen, the silicon controlled switch becomes triggered at switch-on.

The main supply decoupling capacitor is C7, with C4 providing decoupling for the 555 section of the circuit. Current consumption when the repeater is sounding is about 30mA.

CONSTRUCTION

An inexpensive plastic box type PB1, available from Maplin Electronic Supplies, is used as a housing for the prototype. This has approximate outside dimensions of 114 by 76 by 38mm. Some constructors may prefer to use a larger 9 volt battery than a PP3, whereupon a larger plastic case will be required to accommodate this and the other components.

The simple front panel layout can be seen in the photographs. Some form of speaker aperture is required, and this merely consists of a matrix of twelve holes about 6 to 7mm. in diameter. The loudspeaker is carefully glued in place behind these holes, using a good quality general purpose adhesive such as Bostik No. 1. The glue should be applied only to the periphery of the speaker, and none must be allowed to get onto the cone or its surround. Be careful to leave sufficient space for the PP3 battery to fit between the speaker and the left-hand side panel of the case. Switches S1 and S2 are mounted on the front panel to the right of the speaker, with S2 above S1. A 3.5mm. jack socket is mounted on the right-hand side panel, and the microphone lead is terminated in a 3.5mm. jack plug for connection to this socket.

COMPONENT PANEL

Most of the components are wired on a Veroboard of 0.1in. matrix having 17 strips by 25 holes. This is a non-standard size and must be cut from a larger Veroboard using a hacksaw. The two mounting holes are then drilled out, after which the six breaks in the copper strips are made. The components and link wires can then be soldered into place. Full details of the board are given in Fig. 3.

Two 6BA clear holes are drilled in the rear panel of the case for mounting the board, and their positions can be marked out with the aid of the board itself. The board is positioned on the right-hand side of the rear panel, behind S2 and S1. The board is finally mounted in place after all the connections between it and the components in the main body of the case have been completed. It is secured by two 6BA bolts and nuts, with spacing washers between the board and the rear panel to give clearance for the soldered connections under the board.

USING THE UNIT

As was mentioned earlier, the microphone connects to the main part of the repeater circuit via a long 2-way cable terminated in a 3.5mm. jack plug. In some locations, where there is little mains wiring, it may be possible to use unscreened 2-way cable but, in general, screened wire is much more preferable as it will prevent spurious triggering due to pick-up of mains hum, mains transients and other noise. The screened wire requires only one lead inside the braiding, and this connects to the tip contact of the 3.5mm. jack plug. The braiding then connects to the sleeve contact of the plug. At the other end the centre lead connects to one tag of the loudspeaker employed as a microphone and the braiding connects to the other tag. Thin flexible screened wire will be quite satisfactory and, since the input circuit is at a fairly low impedance, it can be many metres long.

The Veroboard is bolted to the lid of the plastic case, which now becomes the rear panel of the housing. The board should take up the position illustrated here

COMPONENTS

Resistors

(All $\frac{1}{4}$ watt 5% unless otherwise stated)

- R1 8.2M Ω 10%
- R2 10k Ω
- R3 8.2M Ω 10%
- R4 1k Ω
- R5 1k Ω
- R6 2.2k Ω
- R7 22k Ω
- R8 100k Ω

Capacitors

- C1 1 μ F electrolytic, 63 V. Wkg.
- C2 560pF ceramic plate
- C3 0.1 μ F type C280
- C4 0.1 μ F type C280
- C5 0.1 μ F type C280
- C6 100 μ F electrolytic, 10 V. Wkg.
- C7 100 μ F electrolytic, 10 V. Wkg.

Semiconductors

- IC1 555
- SCS1 BRY39
- TR1 BC109C
- TR2 BC178

Switches

- S1 push-button, press to make
- S2 s.p.s.t., miniature toggle

Transducers

- MIC1 miniature loudspeaker, 50 to 80 Ω
- LS1 miniature loudspeaker, 50 to 80 Ω

Miscellaneous

- Plastic case type PB1 (see text)
- Veroboard, 0.1in. matrix
- 3.5mm. jack socket
- 3.5mm. jack plug
- 9-volt battery type PP3 (see text)
- Battery connector
- 2-way microphone cable (see text)
- Nuts, bolts, wire, etc.

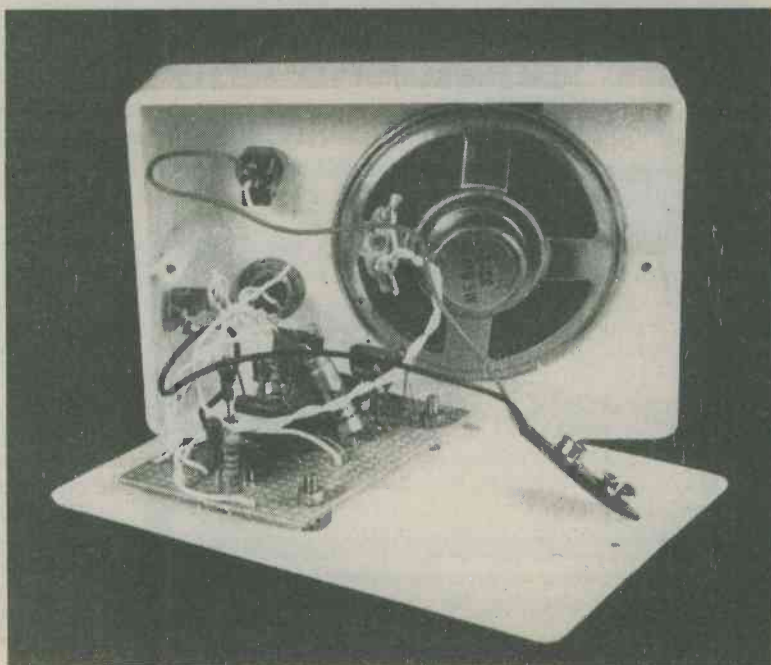

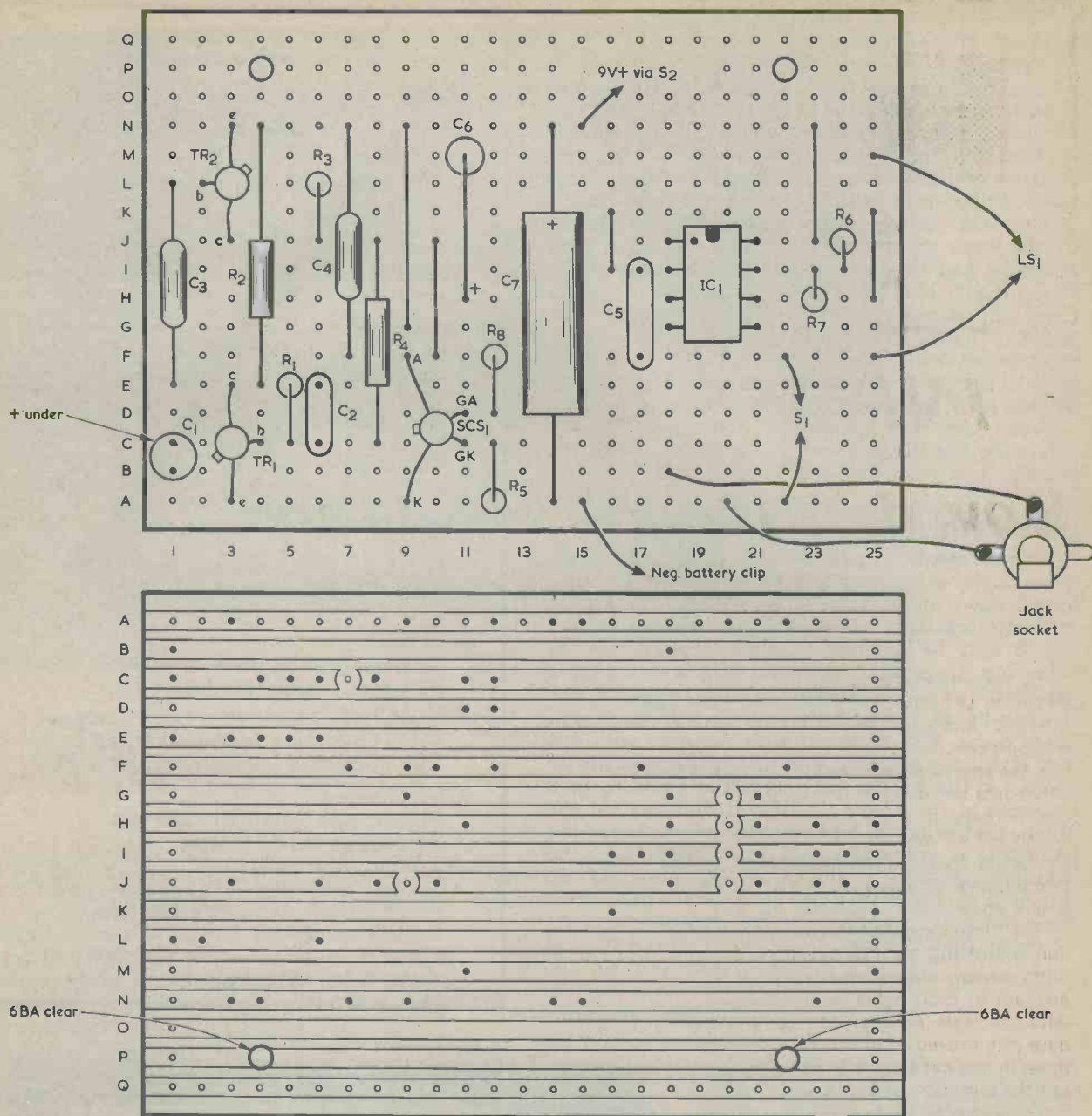
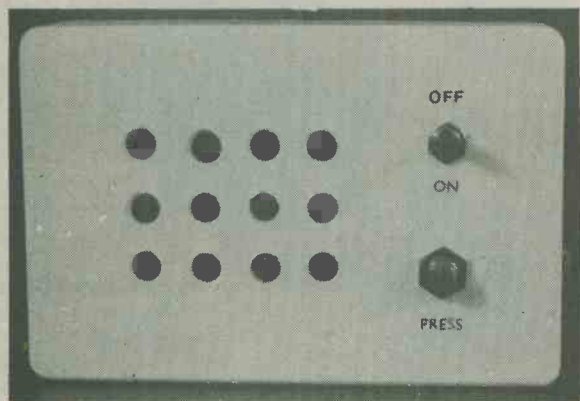

Fig. 3. The layout of components on the Veroboard panel. The microphone couples to the panel by way of a 3.5mm. jack socket, which is viewed here from the rear



The speaker aperture consists of a matrix of 12 holes. To the right of this are S2, above, and S1, below

The loudspeaker acting as the microphone should be mounted in a small case of its own, if only to protect its delicate cone. An aperture in the case will be required so that the sound waves from the bell can reach the cone, and a simple matrix of holes, as used on the main part of the repeater, may be drilled. The unit should be found to trigger reliably with the microphone positioned anywhere within some 300mm. of the telephone, but to be on the safe side it is advisable to place it right next to the telephone.

If the oscillator should happen to trigger on when the repeater is initially switched on, it may be silenced by momentarily pressing S1. ■



series
No. 7

really explains microprocessors

By Ian Sinclair

INPUTS AND OUTPUTS

How data is entered into and acquired from the microprocessor

So far, all the data bytes we've mentioned have been stored in program, for IMMEDIATE loading, or in data memory spaces, usually RAM. This is fine if the microprocessor is being used just to crunch numbers for fun, but any useful application of a microprocessor will involve data being fed in, perhaps from a keyboard, and fed out, perhaps to a display of some sort or to thyristors which will switch motors on. The data might equally well be fed in from a transducer of some sort, perhaps a temperature or distance measurement converted into binary code.

The arrangements that are made for shifting data into and out of the microprocessor system are called in/out ports, usually abbreviated to I/O. Since data is moved in and out in 8-bit bytes, a port must have at least eight data terminals. An alternative arrangement is to have the data bits moved in or out of a port serially — one at a time. In this case, there is only one single in/out terminal, but the bits have to be entered into or clocked out of an 8-bit register so as to assemble or dismantle a complete byte for the CPU.

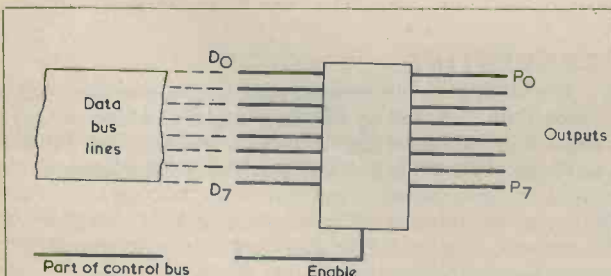

Fig. 1. A simple port. The output lines are connected to the data lines of the CPU when ENABLE is at logic 1. A simple octal latch can be used in this way. The next stage of complexity is to use a 2-way latch, so that inputs or outputs can be connected

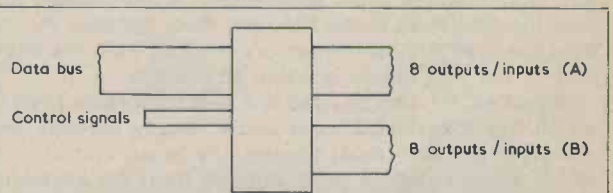

Fig. 2. A more complex port. This example has two sets of output/input lines and a set of control lines which allow programming as inputs or outputs on each set of IN/OUT lines

DESIGN VARIATIONS

The ways in which different types of CPU deal with inputs and outputs vary considerably from one design to another. The Fairchild F8, for example, has two 8-bit I/O ports on the CPU chip. These take up sixteen pins which replace the normal sixteen pin address lines that are used on most other CPUs — the F8 has no built-in memory addressing on the CPU, all the memory addressing is done by another chip which also contains the ROM program. A much more usual method is to connect an I/O port chip to the address bus lines and the data bus lines. The I/O port chip, usually known as PIA (Peripheral Interface Adaptor — how these people love long names!) is a massive chip, the same size as the CPU and also using 40 pins. For its action each part of the PIA has to be addressed, just as if it were a memory location, and in addition the CPU has to send a coded signal to specify whether the port is sending data out or taking it in. All of this must be done under program control, which is why a monitor program in ROM is always needed for any CPU. The stages of a simple input/output would be something like this.

First of all, the program would have a read-from-memory instruction, which would be followed by the address of the PIA port, or a displacement number which can be added to the program count or to the number in an index register to instruct the CPU to put out the correct address on the address bus lines. Because the in-

Fig. 3. Using a serial shift register as a serial IN/OUT port

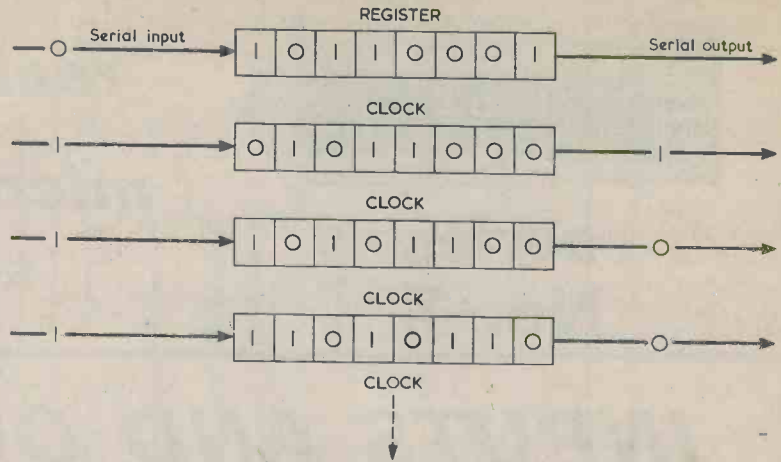

struction is a read-from-memory instruction, the PIA will also have received a signal which gates its circuits to read data bits in. The byte which is on the port input lines will then be transferred to the accumulator register of the CPU, just as if it had been read out of memory. To feed this byte out again through another port, the program has to continue with a write-to-memory instruction, followed by the address of the port which is being used as the output. The data byte in the accumulator is then passed out over the data lines to the PIA, and then, because the instruction was a write-to-memory one, out from the eight pins of the port which is being addressed.

When a CPU is to be used in a microprocessor system which has a keyboard input and a display readout, the operating program must contain the in/out instructions which allow numbers to be entered from the keyboard into the accumulator, and also instruct the accumulator to transfer a byte out to the display. Unless this part of the program is repeated each time a key is pressed, no numbers can be entered, and no display will be seen. Part 8 will go into more details of the most common method of connecting keyboards and displays to the CPU.

IN/OUT LATCHING

Precisely what happens depends very much on the design of the In/Out chip. Many of these chips contain latching so that, for example, when a microprocessor CPU writes out a byte, that byte is stored at the port until cancelled. If we connect the pins of the output port to a set of l.e.d.'s then the l.e.d.'s will remain lit in the pattern of the byte (lit for 1, out for 0) until another different byte is delivered to the output port. Similarly at the input, a byte from the keyboard is held stored at the In/Out chip until a new key is pressed. In all cases, the program of the CPU decides when an output is transferred to the output port, or when an input is taken from the input port.

Several types of I/O port use only a few address lines, and rely on the chip select signals from the CPU to en-

sure correct addressing. A few CPUs reserve certain address numbers exclusively for I/O ports, some types of CPU must therefore use only the PIA chip which is designed to fit them — such a chip is called a "dedicated support chip". Other varieties of CPU have practically no dedicated support chips, and the user is free to select PIAs made by any manufacturer, provided that the necessary operating signals can be obtained to operate the PIA correctly. When adjustments have to be made they usually take the form of some logic gates which are needed to select the chip or correct the addressing.

Not all IN/OUT signals are in the form of 8-bit bytes, however, as we indicated earlier. A simple example is the recording of a program on tape. Unless you happen to be using an 8-track tape recorder, parallel 8-bit outputs are of very little use to you. What is needed is a method of delivering each byte one bit at a time, a serial output. For reading the program in tape form again, a similar serial input is needed. When a signal is converted into serial form it can be transmitted down a single line, instead of needing the eight lines of a parallel output data bus. Serial operation makes it possible to carry digital information along telephone lines, into TV receivers, and to and from tape recorders.

Any shift register will convert from parallel to serial, or serial to parallel, provided it has the necessary inputs and outputs brought out to pins; all that is needed is a method of clocking all the flip-flops of the register. Fig. 3 shows an example of this, loading a register from serial bits or unloading it to a serial output.

CONVERTING

Converting is the easiest part of the exercise, but it takes time. To load or empty a register which contains eight bits will need eight clock pulses into the register (and not every clock pulse of the CPU will be used for the

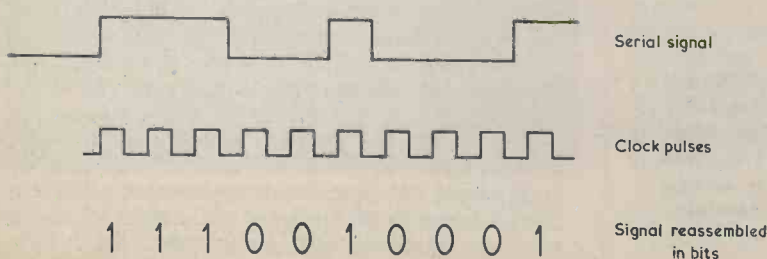

Fig. 4. Using the clock pulses to separate the bits in a serial signal

register) and the CPU must not use this register for any other purpose while loading or unloading is taking place. This problem is nearly solved in the INS 8060 (SC/MP) by providing the serial IN/OUT on the CPU itself. The register which is used is called the extension register and, since a data byte has to be copied from the accumulator into this extension register and then fed out bit by bit under program control, nothing else can upset the loading or emptying of the register. In general, whether the serial/parallel conversion is done in the CPU or by a separate chip, the conversion is under program control.

The next problem is that converting from parallel to serial results in a continuous string of bits coming along one single line. How do we know which bit is the start of

TRANSMISSION SYSTEMS

In a synchronous transmission system the serial output operates all the time, sending out a byte for each eight clock pulses whether there is any data present or not. If data is being clocked out of a register these data bytes are sent out, but if there is nothing to send the signal consists of a "dummy" or "sync" byte which gates the receiver off. Similarly, if such a signal is input to a CPU system, the PIA does not pass the sync bytes to the CPU — if it did, each sync byte would be treated as a number in the usual way. Each transmission of data in a synchronous system starts with two sync bytes (in the commonly-used ASCII code this sync byte is 01101001) and at the receiving end of the serial signals two of these

Fig. 5. Synchronous transmission — bytes are transmitted continually, even when there is no data to transmit. Sync bytes are used to fill the spaces between data bytes

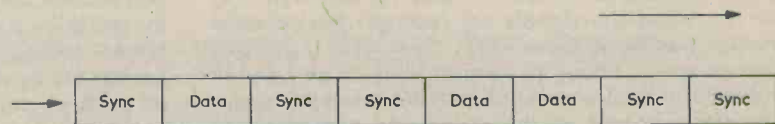

Fig. 6. Asynchronous transmission. Each string of bits is more than a byte long and contains start, stop and parity bits

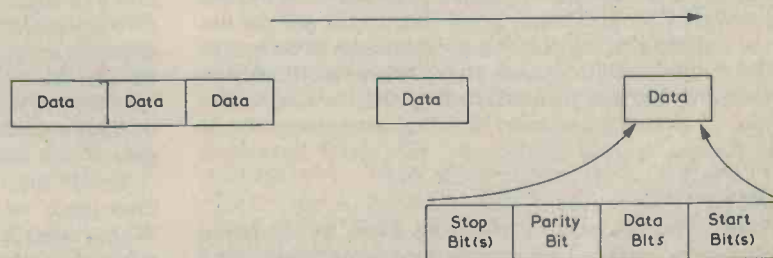
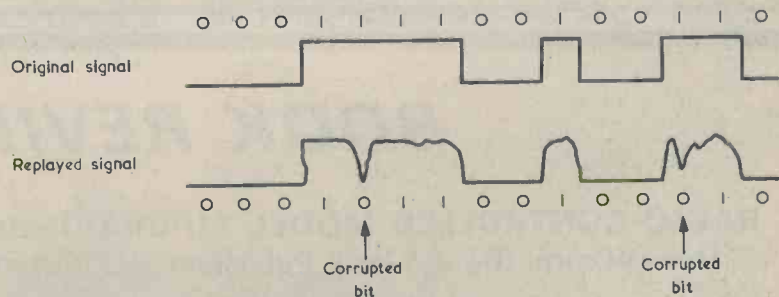

Fig. 7. How tape drop-outs can cause bits to be changed from 1 to 0. Changes like this are referred to as corruption of the signal



a word byte and which is the end? How do we know whether a given pulse is a single 1 bit, two together, or more? The second problem is comparatively easy to solve by using the clock pulses as a guide. If the serial output is high for the time of three clock pulses, then it consists of three 1 bits in a row; if the output is low for two clock pulses, it consists of two 0 digits together. Using clock pulses to gate the serial information thus breaks up the stream into bits which are identified as 1 or 0.

The first problem is not so easy to solve, especially as bits may go missing (for example, because of tape drop-outs) or be added (for example, noise pulses) to a serial stream of pulses. Different methods of dealing with the problem are used according to the way in which the serial data pulses are transmitted — synchronous or asynchronous.

bytes signal that data will be arriving.

Asynchronous transmission is not continuous; the bytes are sent along the line only when there are data bytes to send. In this type of transmission each byte has to be identified by signal bits, one or more start bits (logic 0) at the beginning of each byte, and one or more stop bits at the end. At the receiver, gating has to be able to identify the start bits(s), count out the data bits, and then shut off when the stop bits(s) arrive(s).

In addition to all this, the signals may need still further processing. We use special codes for serial transmission, not the binary code which is used for all the number crunching in the CPU, and some conversion may be needed. In addition, we can't record a string of data bits onto tape without losing a few bits due to drop-outs, and the risk of loss is greater when a lot of 1 bits occur

Fig. 8. Parity. The parity bit is added to a signal byte so as to make the number of 1's in the signal add up either to an even or an odd total, depending on whether even or odd parity is being used. This enables a single fault in a byte to be detected

Signal byte	Parity bit (even parity)	Parity bit (odd parity)
1 1 0 0 0 1 0 0	1	0
0 1 1 1 0 0 1 1	1	0
1 1 0 1 0 0 0 1	0	1
0 1 1 0 0 1 0 1	0	1

together (Fig. 7). For tape recording the logic signals are usually converted into tone signals. For example, the logic zero may be converted to 1,200 Hz and logic 1 to 2,400 Hz; when the signals are replayed the opposite conversion has to be done.

How do we go about it? To start with, some types of CPU will have dedicated serial/parallel converter chips, making the first part of the conversion comparatively easy. For example, the 8080 CPU (Intel) has a corresponding 8251 "communications interface" chip which will carry out either synchronous or asynchronous conversion. This chip is selected by a chip-select signal, and a one-byte program instruction is needed to select what job the chip must carry out. The program instruction will, for example, specify at what rate the serial bits are to be handled, the number of bits in each coded character (from 5 to 8 according to the type of coding that is used), the number of stop bits and start bits, the synchronisation, if used, and parity.

PARITY

Parity? That's a way of detecting a lost or unwanted bit. When we send out a byte, the number of 1 bits in the coded character may be odd or even. The most popular code for serial transmission uses seven bits for each character, and the eighth is a "parity bit". This parity bit is

set so that there will be an even number of 1's in the byte — a system called even parity. When these bytes are played back, gates count the number of logic 1's, and test for parity — even or odd. A single missing or unwanted bit will cause the parity to be wrong. We can't of course correct the byte, because the circuits can't decide which bit is the wrong one, but at least the grouping of the bits into bytes is not upset.

Quite a lot of CPUs have no dedicated chips for this job, so that we need to use a general-purpose one called a UART (Universal Asynchronous Receiver/Transmitter). Similarly if we want to code the serial signals for tape recording, we use a MODEM chip (Modulate/Demodulate). How we connect these up depends very much on the design of the particular chips as well as on the design of the CPU; it boils down to reading the manufacturer's literature rather carefully and making enquiries to their applications department — but only if you are a manufacturer yourself!

So far, we've assumed that each input and output will take place whenever the program decides that it will. What happens if a signal is put in at a time when the program is not ready for it? That's an interrupt, and it will be described in detail in Part 8.

(To be continued)

BOOK REVIEW

RADIO CONTROLLED MODEL AIRCRAFT. By Adrian Vale. 191 pages, 210 x 140mm. (8¼ x 5½in.). Published by Gresham Books. Price (U.K. only) £4.25.

Adrian Vale is a very active radio control enthusiast and runs one of the largest specialist R/C model shops in Britain. After launching his business he soon discovered that much of his time was being taken up in offering advice to newcomers to the hobby, whereupon he produced his own beginner's guide in booklet form. This booklet, which *Aeromodeller* magazine stated "should be compulsory reading for the non-modeller", went through many editions reflecting the author's continuing experience, and it now appears, expanded, updated and illustrated, in its present published form.

The book is packed with common-sense practical advice for anyone starting from the beginning in radio control, and introduces the reader to elementary aerodynamics as well as to the necessity for *learning* to control a model aircraft if it is not to fly itself disastrously into the ground. Engines, fuels and propellers are also dealt with in addition to radio control itself, and the book devotes several pages to legal matters including the obtaining of a radio control licence and insurance. The text is accompanied by photographs and cartoons by "Raf".

The book will be found to be of considerable use to the beginner in R/C aero modelling, and its well written and often humorous contents amply demonstrate the enthusiasm and expertise of its author.

AUDIO DELAY LINE

By I. M. Attrill

"Bucket Brigade" i.c. gives delay for entire audio spectrum

Fairly recently introduced integrated circuits are the "bucket brigade" delay lines, and these offer numerous possible applications to the electronics experimenter. More correctly known as charge couple devices (c.c.d.) or charge transfer devices (c.t.d.), they enable signals covering the full audio bandwidth to be delayed by a few milliseconds with little loss of quality. The signal is delayed purely by electronic means, and there is no need for mechanical or electro-mechanical components such as spring lines or tape loops.

BASIC PRINCIPLE

The basic method by which the delay line i.c. operates is relatively simple, and it relies upon an electric charge being fed along a series of capacitors. This is analagous to buckets of water being passed along a human chain, hence the use of the term "bucket brigade".

The device is controlled by a clock oscillator, and the operating frequency of the clock determines how often the input signal amplitude is sampled by an input gate and capacitor and how often the sampled charges are fed through the device to the output. Obviously, it is not possible for the capacitors in the delay line to pass their charge to the following stage whilst simultaneously receiving a charge from the preceding stage, and so it is necessary to have anti-phase clock signals. One clock phase controls the odd numbered stages (first, third, fifth etc.) whilst the other clock phase controls the even numbered stages (second, fourth, sixth, etc.). Thus, the delay line is arranged so that on one clock half-cycle the even stages are switched to pass on their charges to the odd stages, whilst on the other half-cycle the odd stages are switched to pass on the charges they have just received to the even stages. The charges therefore move one stage

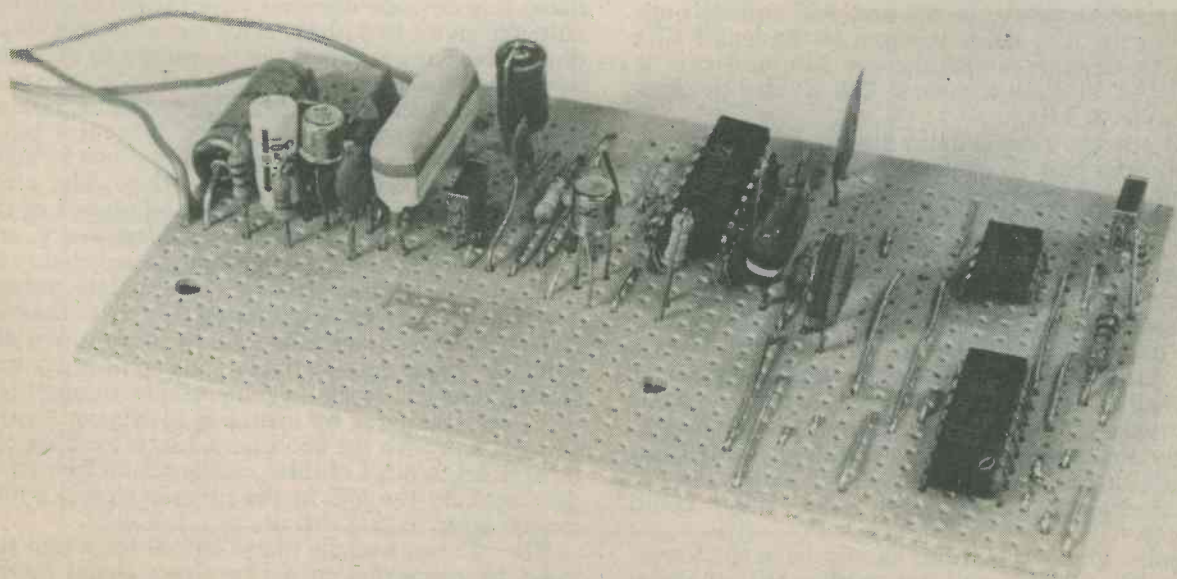

The audio line unit wired up on its Veroboard panel

Looking down on the Veroboard panel. This accepts the components comfortably without excessive crowding

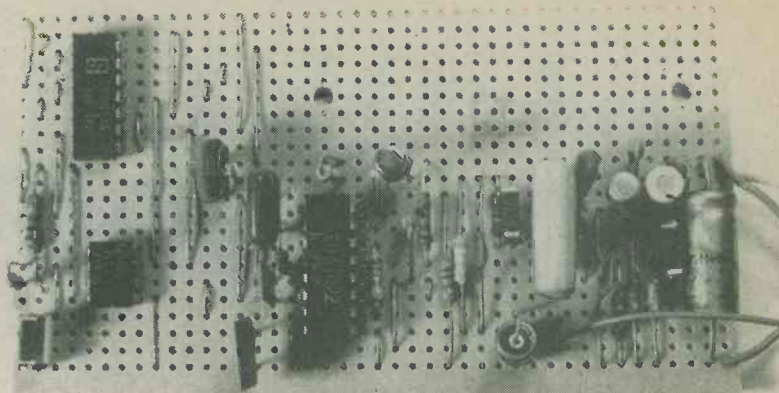

down the line for every clock half-cycle.

The time taken for an input sample to be passed right down the delay line depends upon the clock frequency and the number of stages in the line. The delay line device employed in the present project has 513 stages, although it provides only 512 stages on delay. The function of stage 513 is to maintain the output when stage 512 is switched to receive the charge from stage 511 and is not itself providing an output. Mixing the outputs from stages 512 and 513 provides a continuous output signal, apart from a small and insignificant glitch as the clock signals change state.

It is the clock frequency which is set up to give the desired delay time, and most delay line devices will work using clock frequencies lying between a few kHz and more than 500kHz. However, if the output signal, after the appropriate delay, is to be a good copy of the input signal, it is obviously necessary for the input to be sampled a number of times during each cycle at the highest input frequency. In practice this makes it necessary for the clock frequency to be at least more than twice the maximum input frequency and, ideally, at least three times that frequency. If the full audio bandwidth is to be delayed, minimum clock frequency should be 40kHz or, preferably, 60kHz. With a single delay line device these frequencies correspond to delays of 6.4 and 4.27 milliseconds respectively. The delay is equal to the length of a single clock cycle multiplied by 256, and can be calculated, in milliseconds, as 256 divided by clock frequency in kHz.

The output from a delay line is a stepped frequency and can be looked upon, roughly, as the original input frequency modulated by the clock frequency. This gives a reasonably acceptable audio output as the clock signal will normally be well above the upper frequency limit of human hearing. But the output signal will be improved if the clock frequency can be filtered out as it could have undesirable effects on the equipment into which it is fed (heterodynes in tape equipment, overloading of tweeters in loudspeakers systems, etc.) and so it is normal to remove the clock frequency at the output of the delay line. The output filtering also attenuates the clock switching glitches and the audio background noise these could produce.

Ideally, the output filter should have the lowest acceptable cut-off frequency, with a roll-off above this of 36dB per octave or even more. In practice, when the clock frequency is not much lower than

about 70kHz, a filter having a much lower roll-off rate will give adequate results, with considerably simplified circuitry as a result.

Again, a high slope top cut filter should be used at the input, to remove frequencies which could react with the clock frequency and give audio frequency products at the output. However, it is possible in most instances to obtain good results with relatively uncomplicated input filtering whereupon, once more, circuitry can be considerably simplified.

THE CIRCUIT

There are three delay line i.c.'s available to the amateur user at the time of writing, and the one employed in the unit described here is the TDA1022. This was chosen since it is the least expensive and is the most readily available device. It may be obtained, for instance, from Maplin Electronic Supplies. In passing, it may perhaps be mentioned that the other delay line i.c.'s are the SAD1024 and the SAD512, both of which have n. channel MOSFET circuitry. The SAD1024 has two delay lines whilst the SAD512 has a single delay line. The TDA1022 uses p. channel MOSFET circuitry and contains a single 512 stage delay line.

The complete circuit of the delay line unit is given in Fig. 1. The TDA 1022, like other current delay line devices, does not have the necessary circuitry to give a two-phase clock signal from a single phase clock input, and it is necessary to generate the anti-phase signals externally. The mark-space ratio of the clock signal does not need to be precisely 1:1, or even particularly close to this ratio, but it does need to have a peak-to-peak amplitude virtually equal to that of the supply voltage. The clock signal is generated by IC2, a 555 employed in the astable mode, whereupon the clock frequency, and hence the delay time, can be set quite accurately by using timing components of appropriate values. There is no need for a trimming control to take up frequency errors, as can occur in alternative circuits. In some applications, such as vibrato and similar special effects, it is necessary to modulate the clock oscillator by means of a varying control voltage, and with the 555 such a control voltage can be applied to pin 5 of this i.c. The actual frequency produced by the 555 in the present circuit is discussed later in this article.

The 555 has a single phase output only, and this must be converted to a two-phase signal having suitable characteristics. The conversion is achieved by coupling the output to three CMOS buffer-

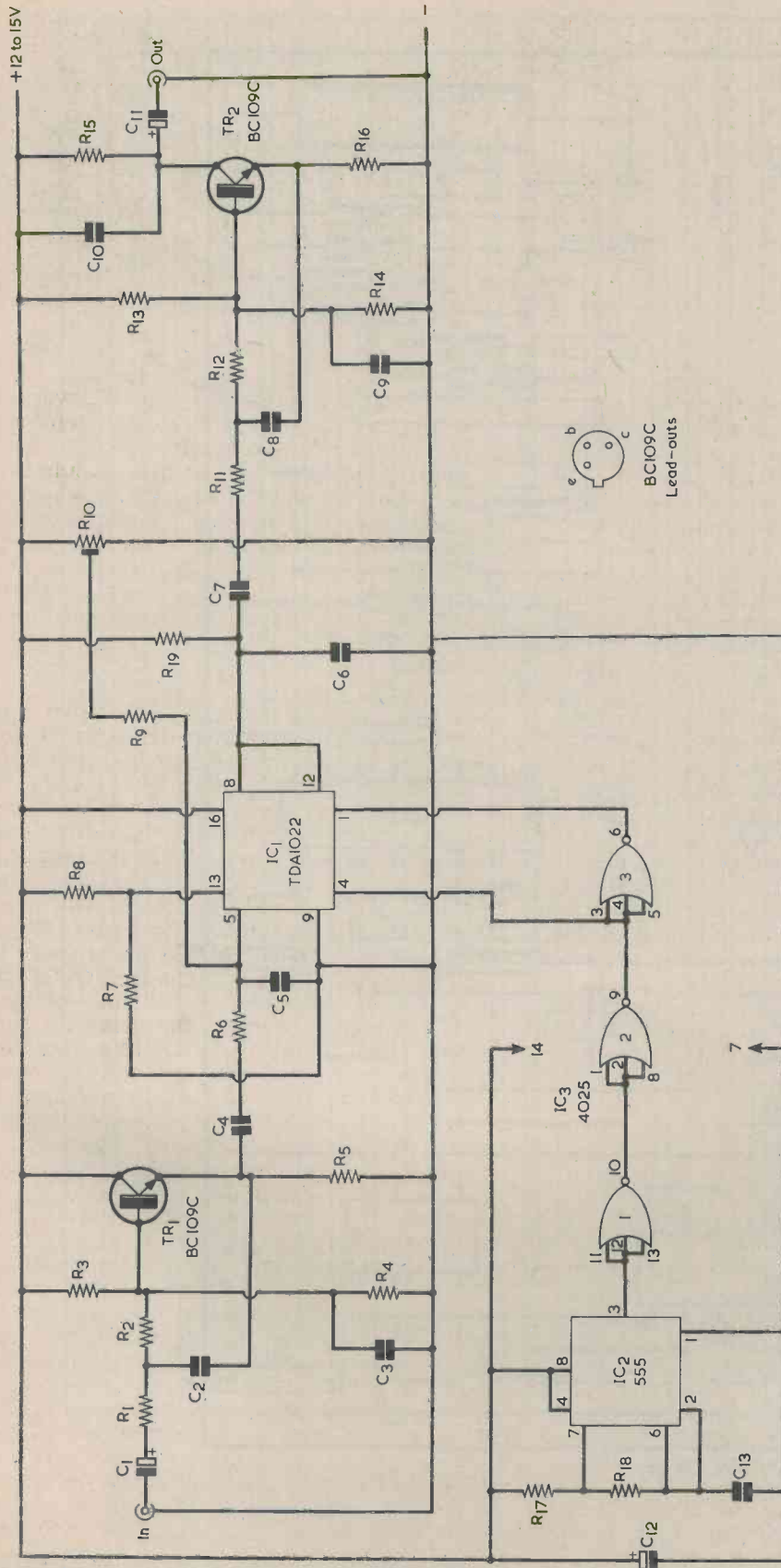
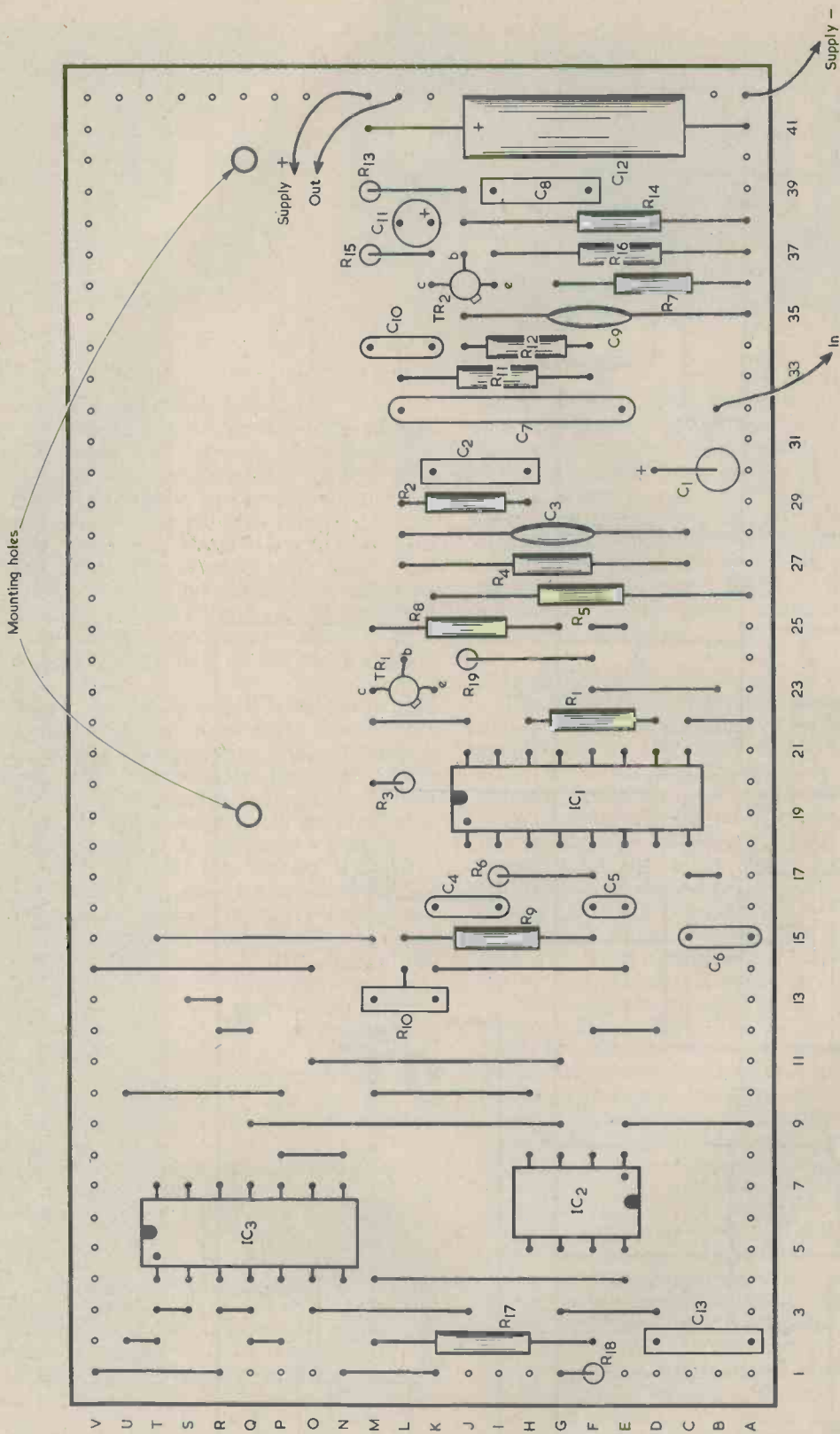

Fig. 1. The full circuit of the audio delay line unit. This offers delays of 1.8 or 2.7 milliseconds according to the value chosen for C13



inverter stages, and then taking the anti-phase signals from the outputs of the second and third stages. Each of the buffer-inverter stages consist of a 3-input NOR gate with the inputs strapped

together. The three NOR gates are in a CMOS i.c. type 4025.

The input filter before the delay line i.c. is based upon TR1, and this is a conventional second order

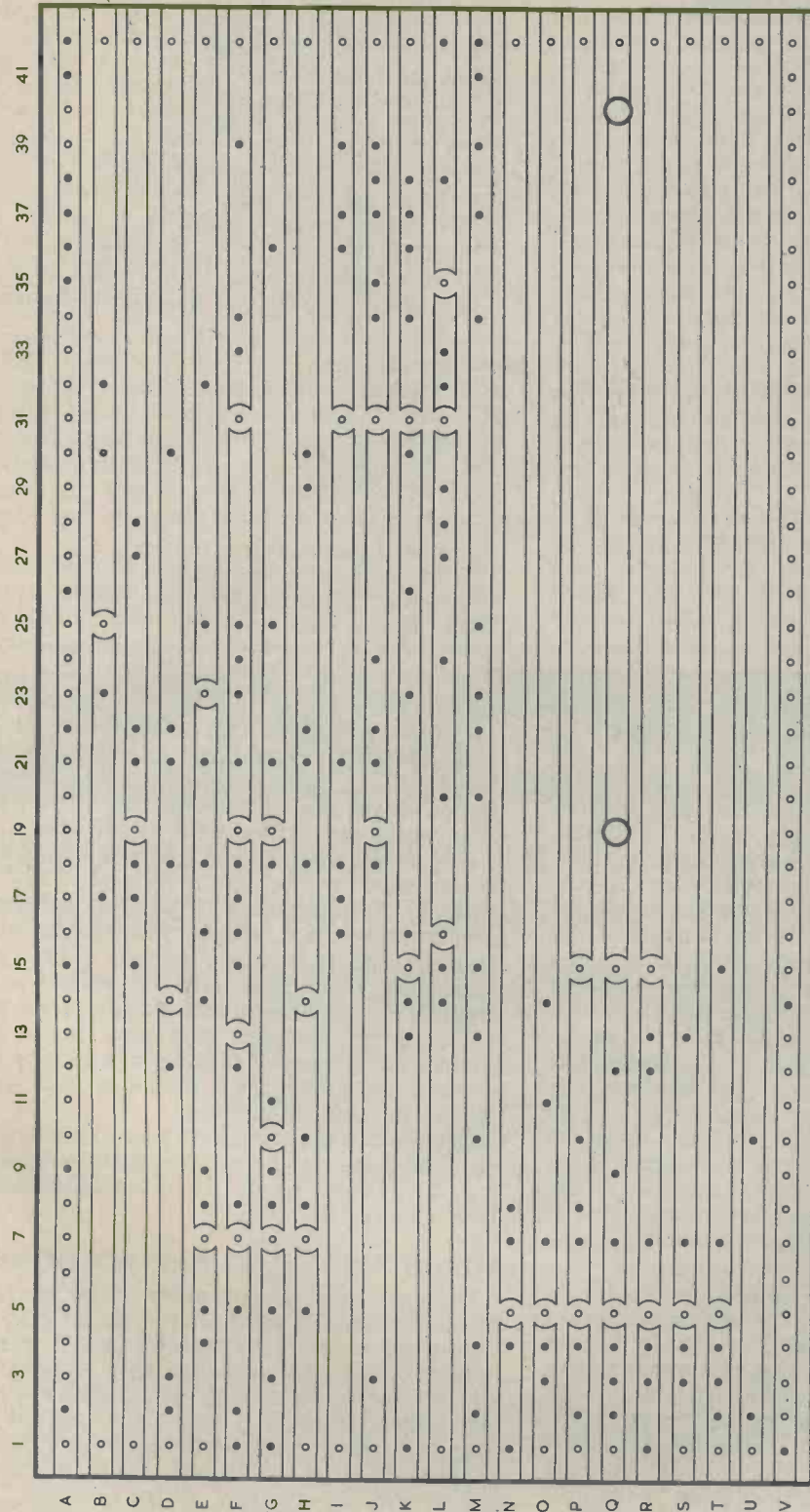

Fig. 2. A Veroboard layout for the delay line unit. IC1 should be the last component to be connected to the board and it should preferably be fitted in an i.c. holder or spider-con sockets

low pass filter giving a nominal roll-off rate of about 12dB per octave. The delay line i.c. is IC1, and the output from TR1 emitter is coupled into its input via d.c. blocking capacitor C4 and a simple

low-pass filter consisting of R6 and C5. The input is biased by R9 and R10, the latter being adjusted to optimise the signal handling capability of the circuit. When R10 is correctly adjusted an input of 2.5

COMPONENTS

Resistors

(All fixed values $\frac{1}{4}$ watt 5%)

- R1 22k Ω
- R2 18k Ω
- R3 390k Ω
- R4 390k Ω
- R5 5.6k Ω
- R6 8.2k Ω
- R7 1.5k Ω
- R8 18k Ω
- R9 120k Ω
- R10 1M Ω pre-set potentiometer, 0.1 watt vertical
- R11 22k Ω
- R12 18k Ω
- R13 1M Ω
- R14 330k Ω
- R15 4.7k Ω
- R16 2.7k Ω
- R17 1k Ω
- R18 4.7k Ω
- R19 47k Ω

Capacitors

- C1 2.2 μ F electrolytic, 16 V. Wkg.
- C2 0.001 μ F polycarbonate
- C3 150pF ceramic plate
- C4 0.1 μ F type C280
- C5 330pF ceramic plate
- C6 220pF ceramic plate
- C7 0.47 μ F type C280
- C8 0.001 μ F polycarbonate
- C9 150pF ceramic plate
- C10 0.001 μ F ceramic plate
- C11 10 μ F electrolytic, 16 V. Wkg.
- C12 100 μ F electrolytic, 16 V. Wkg.
- C13 0.001 μ F or 0.0015 μ F polycarbonate (see text)

Semiconductors

- IC1 TDA1022
- IC2 555
- IC3 4025
- TR1 BC109C
- TR2 BC109C

Miscellaneous

- Veroboard panel, 0.1in. matrix
- 16-wat i.c. holder (see text)
- Input and output sockets (see text)
- Wire, solder, etc.

volts r.m.s. results in an output t.h.d. level of 1%. At lower signal levels the distortion figure is substantially smaller.

R7 and R8 bias internal circuitry in the i.c. by way of pin 13. Pins 8 and 12 are the outputs from stages 513 and 512 respectively of the TDA1022, and these are simply wired in parallel to give a continuous output. R19 is the load resistor for the output stages, and C6 gives the first stage of output filtering. The main output filtering is provided by the active filter circuit around TR2, this being similar to the input filter with the obvious difference that TR2 has a collector load resistor. TR2 functions as an emitter follower so far as the filter circuitry is concerned, and also as a common emitter amplifier to enable an output from the unit to be taken via d.c. blocking capacitor C11. The configuration permits a small amount of voltage gain to be provided by TR2, and this compensates for the attenuation of about 4dB through IC1 plus the small in-band losses given by the filter circuits. The overall gain of the unit, from input to output, is thus made almost exactly equal to unity.

The circuit requires a supply potential of between 12 and 15 volts, the current consumption being in the region of 25mA. The supply voltage must not be in excess of 18 volts. If a mains power supply is used it must have a low ripple and noise content in its output to allow the unit to provide a good signal-to-noise ratio. The TDA1022 is capable of a signal-to-noise ratio of 74dB, but this high figure might not quite be achieved in the present simple circuit and it assumes that the peak input level will drive the device to the threshold of clipping. If the input level is well short of this amplitude, which is about 2.5 volts r.m.s., then it would probably be best to use an external amplifier before the input of the unit to boost the signal to the required level. An attenuator can be connected to the output of the unit to bring the overall voltage gain back to unity.

CONSTRUCTION

The delay line unit can be assembled on a piece of Veroboard of 0.1 matrix, and a suitable layout is shown in Fig. 2. The board has 42 holes by 22 copper strips, and is provided with two mounting holes which are drilled 6BA or M3 clearance.

Both IC1 and IC3 are CMOS devices which can be damaged by high static voltage. They will be supplied in some form of protective package, such as conductive foam, and they should be left in the package until it is time for them to be connected into circuit. IC3, and finally IC1, should be the last components to be wired into circuit, and it is essential that the soldering iron used has a reliably earthed bit. Since IC1 is a fairly expensive i.c., it is worth-while employing a socket or soldercon connectors for this component.

For the benefit of readers who like to trace out a Veroboard layout, it should be mentioned that pins 2, 3, 6, 7, 10, 11, 14 and 15 of the TDA1022 are all "Not Connected" pins.

ADJUSTMENT AND APPLICATIONS

Only one adjustment needs to be made to the finished assembly, and that is to set R10 for optimum signal handling performance. It can be adjoined with the aid of a sine wave signal generator and an oscilloscope. The signal generator should feed a signal of about 3 volts r.m.s. into the input of the unit, with the oscilloscope monitoring the output. R10 is then adjusted to produce a symmetrically clipped output signal. In the absence of suitable test equipment, R10 can quite simply be given any setting that results in a clean-sounding output which is free from serious distortion at peak signal levels.

The timing components for the clock oscillator are R17, R18, and C13. The last may be either 0.001 μ F or 0.0015 μ F. If it is 0.001 μ F the clock frequency is 140kHz, and the time delay is 1.8 milliseconds. With C13 at 0.0015 μ F the clock fre-

quency is 94kHz, giving a time delay of 2.7 milliseconds. Raising the value of C13 increases the time delay and reducing it decreases the time delay. The circuit will not give good results with a clock frequency below about 60kHz, giving a delay of 4.27 milliseconds, and the TDA1022 should not be used with a clock frequency of more than 500kHz, which gives a delay of 0.512 milliseconds. (Clock frequency with C13 at 0.0022 μ F is 64kHz, with a delay of 4 milliseconds, and the clock frequency with C13 at 300pF is 468kHz and the corresponding delay is 0.55 milliseconds).

This article is primarily aimed at the experimenter, who will probably find numerous uses for the delay line unit. One application for units of this nature is in voice control of tape recorders or transmitters. A difficulty with simple voice activated switches is that a short time elapses before the switch turns on the tape recorder or the transmitter, whereupon part or all of the first word may be lost. When a delay line unit is available, a non-delayed signal can be employed to activate the switch whilst a delayed signal is fed to the recorder or transmitter. The controlled equipment is then fully turned on when the delayed message is fed to it.

Another possible application is in stereo simulation with a mono signal. Here, an undelayed mono signal is fed into one channel of a stereo system and

the delayed version is fed into the other. The random phasing of the two signals tends to give a stereo image extending from one speaker to the other, although of course this does not give true stereo reproduction of the conventional type.

Delay lines are much used in special effects equipment, such as reverberation, chorus generator or phasing effects units. An interesting and novel phasing effect can be given simply by mixing a degree of delayed signal with a non-delayed signal. The random phasing results in some frequencies (where the signals are in phase) being boosted and others (where the signals are out of phase) being attenuated. The effect can be enhanced by using a low frequency oscillator to frequency modulate the clock oscillator, so that there is variation in the frequencies that receive most boost and cut.

The author's prototype unit was housed in a metal case which was made common with the negative supply rail and which had input and output coaxial sockets mounted on the front panel. There was then no need to screen the input and output leads to the Veroboard.

If the unit is used in environments where the input and output wiring can pick up hum and noise it is necessary to use screened leads, the braiding of the leads being connected to the negative supply rail. ■

Trade News . . .

SALES AND MANUFACTURING RIGHTS FOR RANGE OF THERMOSTATIC SOLDERING IRONS ACQUIRED



S & R Brewster Limited of 86-88 Union Street, Plymouth, PL1 3HG have announced that they have acquired the manufacturing and sales rights formally held by Cardross Engineering Co. Limited of Dumbarton, of the Ceco Vari-Stat range of thermostatic soldering irons, these irons are now made at the company's Plymouth factory, enabling S & R Brewster Limited to offer the following range of soldering irons.

1) The S.R.B. "Mighty Midget" Type 1 Soldering Iron 18watt, with interchangeable bits, etc. 2) The Ceco Vari-Stat Model 'D' 50watt Temperature Controlled Soldering Iron. 3) The Ceco Vari-Stat

Model 'H' 150watt 'Temperature Controlled Soldering Iron. 4) The Ceco Vari-Stat Model 'I' 500watt Temperature Controlled Soldering Iron.

The S.R.B. 18watt soldering iron is ideally suited for use with modern electronics.

The whole Ceco Vari-Stat range are primarily designed for industrial use, but have a wide variety of uses in the hobby and other retail markets as well. The Model 'D' and the Model 'H' feature a range of four different sized interchangeable bits for each model, while the Model 'I' is fitted with a removable bit suitable for most uses found for this soldering iron.

THE "WATERSPORT" MEDIUM-LONG WAVE PORTABLE Part 1

By Sir Douglas Hall, Bt., K.C.M.G.

3-transistor reflex design with integral wave trap for interfering transmissions

The medium and long wave receiver to be described makes use of a very old but infrequently used device, the acceptor wave trap. The rejector wave trap is quite often met. It can for instance be tuned to the intermediate frequency of a superhet and inserted in the aerial input, whereupon it prevents reception of signals at the intermediate frequency which could otherwise cause interference. The rejector wave trap consists of a

parallel tuned circuit, and presents a very high impedance to signals at the frequency of resonance whilst offering a low impedance to frequencies away from the resonant frequency. If a receiver employs an external aerial the rejector wave trap, again inserted in the aerial input, can be very useful in reducing the signal input from a powerful local station to a level consistent with that from weaker and more distant signals. This reduces blasting or swamping by the powerful signal.

A rejector wave trap is not really practical for use inside a portable receiver having its own self-contained ferrite-rod aerial, and it is here that possible use of the acceptor wave trap can be made instead. The acceptor wave trap has an inductor and capacitor in series, i.e. it is a series tuned circuit, and this offers a very low impedance approaching a virtual short-circuit at its resonant frequency and a medium impedance at other frequencies. At resonance, high signal frequency voltages appear across both the inductor and the capacitor but these are of opposing phase and cancel each other out. Off resonance, the impedance is equal to the difference between the impedance of the capacitor and the impedance of the inductor. With normal medium wave inductance and capacitance values the off-resonance impedance is only of the order of a few thousand ohms. Although much greater than the impedance at the resonant frequency, the relatively low off-resonance impedance prevents the acceptor wave trap from functioning usefully in high impedance circuits.

However, the author's Super Alpha "Spontaflex" reflex circuit has an r.f. point which is at medium impedance, this occurring at the coupling between the two transistors in the Darlington pair. If an acceptor wave trap having an off-tune impedance that is higher than usual is coupled between this point and the receiver negative rail it will have very little effect on signals at off-resonant frequencies but will still present a near short-circuit to a signal at the resonant frequency, bypassing this to the negative rail. The higher off-tune impedance can be produced by giving the wave trap inductor a higher value than is customary and the capacitor a lower value. A further advantage will be given if the wave trap



The completed "Watersport" receiver. The tuning control is at the top and is fitted with a simple home constructed tuning scale

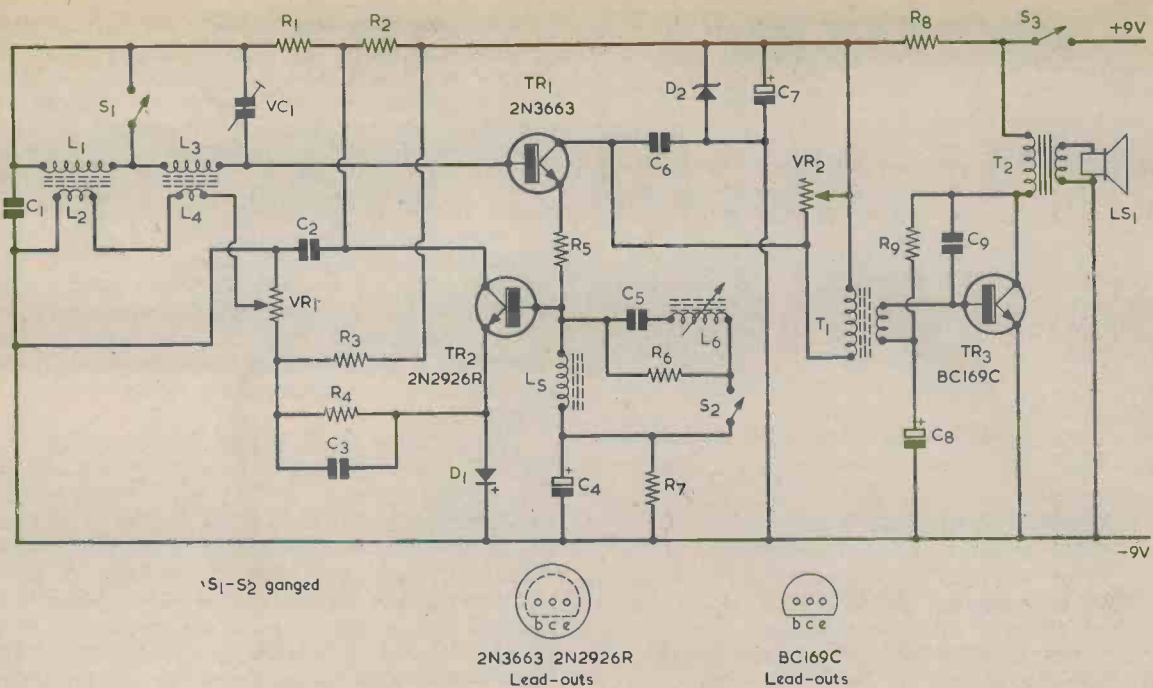

Fig. 1. The circuit of the "Watersport" medium and long wave receiver. L6 and C5 constitute an acceptor wave trap which can be adjusted to suppress any powerful transmission on the medium wave band

resonant frequency can be adjusted by a front panel control in the receiver in which it is fitted, since this will enable it to accept (and bypass to the receiver negative rail) any powerful transmission which is close in frequency to the signal being received.

A tunable acceptor wave trap of this nature is incorporated in the "Watersport" receiver.

THE CIRCUIT

The circuit of the receiver is given in Fig. 1. Regular readers who have retained their back issues will find that the circuit is similar to that employed in the author's "Superalphadyne" receiver (described in the May and June 1976 issues). Apart from some small modifications, the major change is the addition of the wave trap, which consists of C5 and L6 and which can be switched in or out of circuit by S2. Readers who have built the older design and would like to replace it with the present one will find that they have quite a number of the components required.

The circuit functions in the following manner. Signals are picked up by L3 on medium waves, or by L3 and L1 in series on long waves, and are applied to the base of TR1. At r.f. this is the first transistor of a Darlington pair, and its emitter couples via R5 to the base of the second transistor, TR2. The choke L5 provides an intermediate load for TR1 emitter. When the wave trap, C5 L6, is switched into circuit by S2, the trap forms a potentiometer in conjunction with R5, so that only a very low signal voltage is applied to the base of TR2 at the wave trap resonant frequency. S2 is ganged with S1, whereupon both switches are open for long wave reception when the wave trap is not required. In practice, S1 and S2 are the two switches on a

potentiometer, the spindle of which couples mechanically to a ferrite rod moving in and out of coil L6 to vary its inductance and the wave trap frequency. If the wave trap is not required on medium waves the potentiometer spindle is only rotated sufficiently far to operate the two switches. This causes the ferrite rod to be fully inside the coil, whereupon the wave trap has no effect as it is then tuned to above 550 metres. Advancing the potentiometer spindle moves the ferrite rod out of the coil and tunes the trap over the medium wave band. At the extreme end of the spindle rotation the ferrite rod is completely withdrawn and the wave trap resonance is below 200 metres. The potentiometer is employed merely because it offers a very convenient mechanical means of ganging the two switches and the tuning of the wave trap. The potentiometer tags are not connected into the receiver circuit (apart from one tag which is employed as an anchor tag) and it can have any value.

The received signal is next amplified by TR2 and is applied to diode D1. The diode operates at very low impedance due to the current flowing through it from the emitter of TR2 plus a further current through R3 and R4. VR1 is the reaction control and it carries out two functions. As its slider travels down its track it increases the feedback in r.f. signal from the diode to the reaction windings, L4 and L2, which couple to the tuned coils L3 and L1. At the same time it reduces the direct current available for the diode from R3. When the slider of VR1 is moved in the opposite direction, towards the negative rail, it reduces the r.f. feedback to L4 and L2 and allows increased current to flow through R3 to D1. Damping of the diode is thus increased. The combined effect of variable feedback and variable

COMPONENTS

Resistors

(All fixed values $\frac{1}{4}$ watt 5%)

- R1 10k Ω
- R2 47k Ω
- R3 5.6k Ω
- R4 390 Ω
- R5 470 Ω
- R6 4.7k Ω
- R7 3.3k Ω
- R8 680 Ω
- R9 560k Ω
- VR1 2.2k Ω or 2.5k Ω potentiometer, wire-wound, 1 watt
- VR2 22k Ω potentiometer, log, with switch S3, type P20 (Electrovalue)

Capacitors

- C1 1,000pF silvered mica or ceramic
- C2 1,000pF silvered mica or ceramic
- C3 1,000pF silvered mica or ceramic
- C4 22 μ F electrolytic, 3V. Wkg.
- C5 39pF silvered mica or ceramic
- C6 3,300pF silvered mica or ceramic
- C7 1,000 μ F electrolytic, 3V. Wkg.
- C8 10 μ F electrolytic, 3V. Wkg.
- C9 1,000pF silvered mica or ceramic
- VC1 100pF variable, type C804 (Jackson)

Inductors

- L1, L2, L3, L4 see text
- L5 2.5mH r.f. choke (Repanco)
- L6 see text
- T1 Driver transformer type LT44 (Eagle)
- T2 Output transformer type LT700 (Eagle)

Semiconductors

- TR1 2N3663
- TR2 2N2926 Red
- TR3 BC169C
- D1 OA10
- D6 BZY88C6V8

Switches

- S1, S2 d.p.s.t. part of potentiometer of any value (see text)
- S3 s.p.s.t. part of VR2

Speaker

- LS1 3 Ω , 8 x 5in., ceramic magnet (see text)

Miscellaneous

- 9-volt battery type PP9
- Battery connectors
- 3 small knobs (approx $\frac{3}{8}$ in. dia.)
- 1 large knob (see text)
- Ferrite rod x 6in.
- Ferrite rod x 4 $\frac{1}{2}$ in. (see text)
- Ferrite rod x 3 $\frac{1}{2}$ in. (see text)
- 28-way tagstrip (see text)
- 1 $\frac{1}{2}$ in. drive drum (see text)
- Nylon cord
- Materials for "chassis" and case
- Coil winding wire (see text and Fig.3)
- Clips, nuts, bolts, washers, etc.

damping of the diode results in a smooth and easily adjusted control of reaction.

The diode detects the signal, and the resultant a.f. is next amplified by TR2, acting this time in the common base mode with R2 as its collector load. This amplified signal passes via R1, L1 (when S1 is open) and L3 to the base of TR1, which functions as a common emitter a.f. amplifier. Because of TR1's high gain, the low collector

current which passes through it and the negative feedback given by R5, the input impedance at its base is much higher than would usually be the case with a common emitter transistor, and there is good matching to the collector impedance of TR2. It should be added that there is a high r.f. impedance at TR1 base also, this not only enabling the signal tuned circuit to be coupled directly to it but also allowing it to have a high ratio of inductance to capacitance. A variable capacitor of only 100pF maximum tunes the whole of the medium wave band when S1 is closed and the whole of the long wave band when S1 is open. The signal tuned circuit gives a high voltage magnification on consequence, allowing the receiver to have a high sensitivity.

The primary of T1 forms the a.f. collector load for TR1, with VR2 acting as an a.f. volume control. The supply voltage for TR1 and TR2 is stabilized by the zener diode D2. The secondary of T1 couples to the base of the output transistor, TR3, which in turn couples to the speaker by way of T2. The power output is modest but is very adequate for a normal sized room provided a high gauss 8 by 5 in. speaker is used. A fairly large speaker with a strong magnet will offer many times the volume given by a miniature speaker in similar circumstances. The author would much rather have a 50mW from a large speaker than 250mW from a miniature component. A speaker with a ceramic magnet is specified in order to minimise interaction with the two aerial ferrite rods, as could be given by an old fashioned metal magnet with its large external field.

The current drawn by the receiver from the 9 volt battery is about 12mA.

COMPONENTS

Some notes need to be made at this stage concerning components. Dealing first with the semiconductors, the 2N3663 and the 2N2926 Red are available from Electrovalue. The OA10 diode is listed by Bi-Pak Semiconductors. As has already been mentioned, the two switches S1 and S2 are part of a potentiometer which can have any value (or even have a damaged track). The only requirement of this potentiometer is that it should have a spindle length of 1 $\frac{3}{8}$ in. or more. A large knob is required for VC1 and this can be a home-made circular assembly fitted with a tuning scale. It will be dealt with in Part 2. A $\frac{3}{8}$ in. by 6in. ferrite rod is available from Maplin Electronic Supplies, and the two remaining ferrite rods can be 6in. (or longer) rods cut down by filing around the rod at the appropriate point and snapping the excess away. A 8in. ferrite rod, if cut, will provide both the 4 $\frac{1}{2}$ in. and the 3 $\frac{1}{2}$ in. rods. The 1 $\frac{1}{2}$ in. drive drum is available from Home Radio.

The tagstrip employed in the prototype was an RS Components Miniature 28-way strip having a length of 194mm. (or 7.6in.). Readers who do not have access to RS Components parts may obtain a 28-way tagstrip of similar dimensions from Electrovalue. The Electrovalue strip has 0.25in. tag spacing. The speaker is specified as 3 Ω , 8 by 5in. with ceramic magnet. Readers who rely on mail order for obtaining components and have difficulty in obtaining a speaker of precisely these dimensions may employ the 3 Ω , 8 by 4in. speaker with ceramic magnet which is listed by Home Radio.

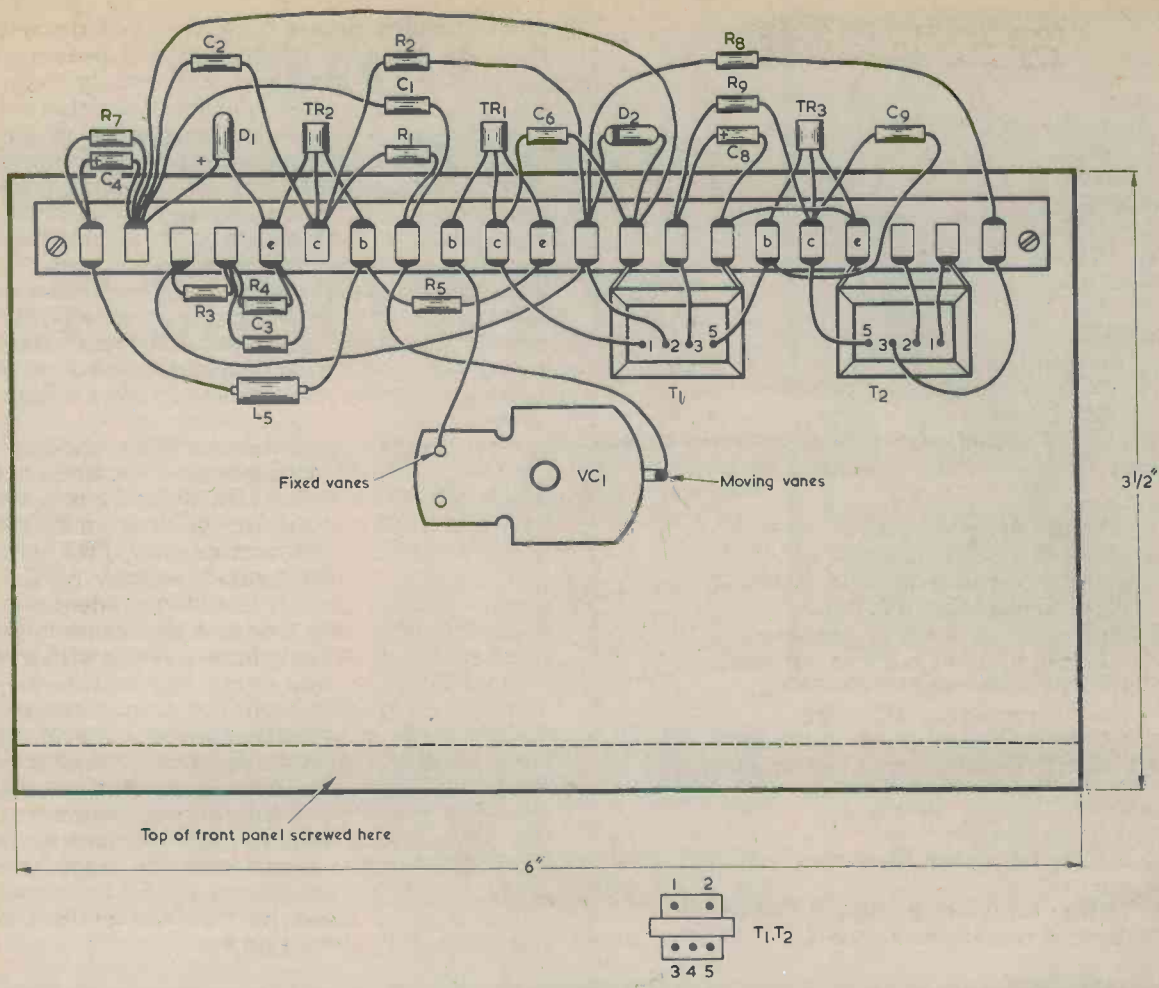
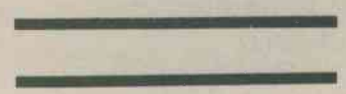

Fig. 2. This component panel appears at the top of the receiver. It is horizontal and is affixed to the receiver front panel in the manner shown here

Constructional details will be given next month

New Product



PROBE CASE AND ASSOCIATED HARDWARE

Now available from Continental Specialties Corporation, of Shire Hill Industrial Estate, Saffron Walden, Essex, the CTP-1 probe case comes complete with associated hardware, and is ideally suited to housing electronic test accessories such as signal injectors, logic probes, small counters, voltage and resistance probes, and continuity checkers. Based on the case used in CSC's LPK-1 logic probe kit, the moulded grey plastic case measures 5.8 x 1.0 x 0.7 inches (147 x 25 x 18 mm), and is supplied complete with a 3ft-long two-wire lead with a moulded strain reliever and alligator clips attached, a nickel-plated screw-in probe tip, a mating tapped hex probe-tip connector, assembly screws, and a blank printed-circuit board pre-cut to size. The probe case is available in customer-specified colours for orders of 1000 or more.

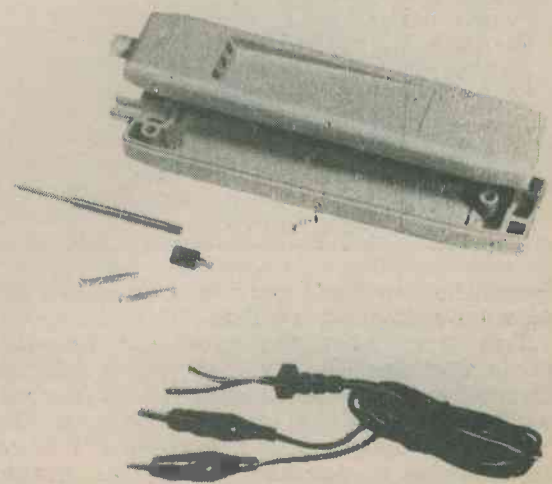

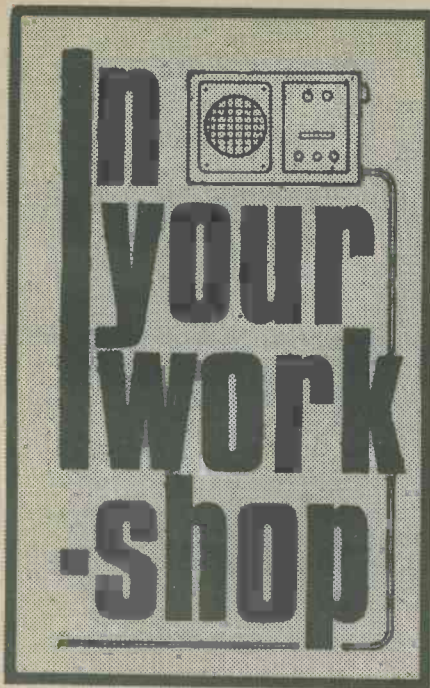

The THIEF-PROOF HANDBAG

"Never out of trouble!"
 Smithy, reaching for his raincoat preparatory to leaving for home, turned round absently.

"Who's never out of trouble?"
 "Joe," said Dick.

"Do you mean Joe of Joe's Caff?"

"That's right."

"I never," sighed Smithy, "cease to marvel at the goings-on in that place. Well, if you don't satisfy my curiosity now I'll be wondering about it all night. Just what *is* happening to Joe?"

"He's got a phantom handbag nicker."

THE ART OF SPIKING

A gleam of intense interest entered Smithy's eye, to be suppressed almost immediately. He assumed an expression of mild interest.

"Perhaps," he remarked, "you'd better start at the beginning."

"Oh, all right. You see, Joe launched this new disco of his a month or so ago."

"Joe's running a *disco*?" queried Smithy incredulously. "In that crummy little place of his?"

"Well, it does get pretty heaving at times," admitted Dick. "But you know what Joe's like, always ready to start something new. So he runs this disco every Tuesday and Friday evening."

"I thought there was a regular disco in the area which opens every night."

"There is," agreed Dick, "but Joe's is cheaper. It's quieter too. In the regular disco they get a bit

careless at times and take the sound level just a decibel or two above the threshold of pain. So Joe operates what you could call a soft disco. His amplifier is a mere 150 watts per channel."

Smithy blanched.

"What has this to do with the handbag stealer?"

"The present difficulty," explained Dick, "is that someone in Joe's disco has started to pinch handbags. When a girl gets up to dance she leaves her handbag on her table. Then, when she gets back again she finds it's been lifted. This has happened three times already and Joe's getting dead worried about it."

Smithy pondered for some moments.

"What you want to do," he said eventually, "is plant a spiked handbag."

"A spiked handbag?" repeated Dick, puzzled. "Do you mean that the handbag should be nailed to the table?"

"Of course not, you idiot. By 'spiked' I mean that the handbag

should be fixed in some way that will incriminate the thief. A good scheme is to put some sort of gadget in the bag which will let everyone around the thief know that something is wrong."

"How do you mean?"

"One obvious idea," said Smithy thoughtfully, "would be to have a loud electric bell in the handbag. If this goes off, say, thirty seconds after the bag has been nicked, it's bound to draw attention to the thief."

"Hey, that's a great idea, Smithy!" said Dick enthusiastically. "How about installing a microswitch in the bottom of the bag which closes when the bag is lifted off the table? This could then turn on the bell directly."

"I'm not keen on the idea of a microswitch," said Smithy. "For one thing it means messing up a perfectly good handbag and for another you'd need an unusual sort of handbag with a hard flat bottom. Also, you don't want the bell to go off immediately the handbag is lifted. The gentle art of spiking con-

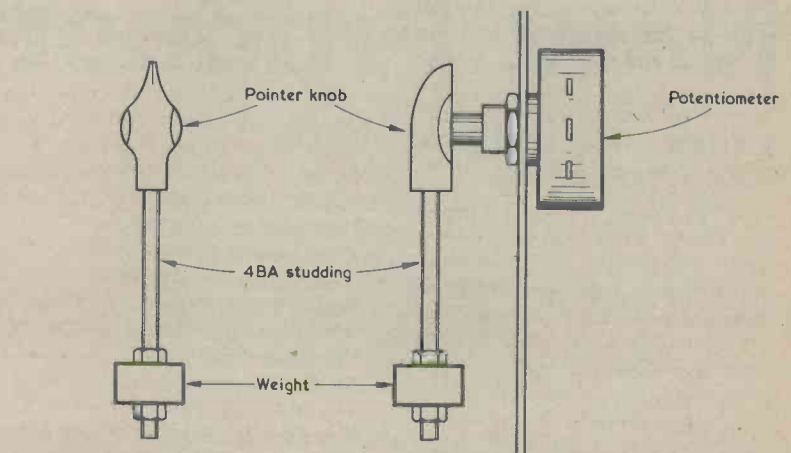

Fig. 1. Fixing a weight to a potentiometer spindle. The potentiometer setting is altered if the panel on which it is mounted is tilted. Other methods of coupling a weight to the potentiometer spindle can be readily devised

sists of *incriminating* the thief, and so you must have a time delay so that, when the bell goes off, the thief has to explain why the handbag is in his or her hands."

"If the microswitch scheme is out," said Dick, suddenly inspired, "how about having a gadget which is set off by the handbag being moved? Like the old 'tilt' warning devices on pin tables."

"Now, that is a good suggestion," said Smithy approvingly. "The whole alarm gadget could then simply be made up in the form of a smallish box which can be placed inside the handbag without having to alter the bag in any way. Let me have a little think about this."

Musingly, he glanced over the surface of his bench. He absently picked up a potentiometer and idly turned its spindle between his fingers. A thought occurred to him and he rummaged in a box of odd items of hardware on the bench. He located a small pointer knob and a two inch length of 4BA brass studding. Removing the knob grub screw he found that this was also 4BA, and he screwed one end of the studding into the knob in its place. He next secured the knob on the potentiometer spindle by tightening the studding and then looked around for a small and fairly weighty object. He found a large steel washer and fastened it to the end of the studding with two nuts. (Fig. 1.)

"Here we are," he said cheerfully, "here's a device for detecting movement of the handbag. If this pot is mounted to a panel on the box in the handbag, the weight will turn the spindle round, so that the pointer nob is always pointing upwards. If the handbag is then picked up, the weight will cause the pot spindle to be turned to different positions as the handbag is moved about."

Smithy held the potentiometer in his hand and rotated its body in the vertical plane. As the body turned round the weight remained in its bottom position, patently turning the potentiometer spindle in relation to its body. The slight stiffness between the spindle and its bush caused the spindle movement to be a little jerky, but the alteration in spindle positioning as the potentiometer's body rotated was, nevertheless, very evident.

"There you are," said Smithy triumphantly. "This basic weight arrangement can be made up by anybody with a little ingenuity and access to odds and ends of hardware. To demonstrate the scheme I've used a knob which happened to accept a length of 4BA

studding, but any other means of attaching a small weight rigidly to a pot spindle could be used instead. For instance, a 6BA clear hole could be drilled through the spindle and a length of 6BA studding used. What is important about the idea is that it is capable of converting movement into an electrical signal."

"Could any pot be used?"

"Well, you'd need to try and select one which has pretty free spindle movement, but most pots fall into this category. A suitable value would be 10k Ω linear."

CIRCUIT DETAILS

"How," asked Dick, "would the pot give a signal when movement takes place?"

"By applying a fixed direct voltage across its track," said Smithy. "After the handbag with the weighted pot in it has been placed on a table the weight will cause the pot spindle to take up a certain position. Obviously, things must be arranged such that the pot slider will be able to move in both directions along its track, and that its slider is not hard up against one end of the track. Picking up the handbag will then cause the pot spindle to be moved and a different voltage to be present at its slider."

Dick frowned.

"I don't like the sound of this," he said. "It seems as though after you've put the handbag on the table you'll have to set up another pot, like in a Wheatstone bridge."

"Oh, the voltage from the pot slider isn't treated as a direct voltage," said Smithy. "It's treated as an alternating voltage. The sort of alarm circuit I'd use would detect a *change* in the pot slider voltage regardless of what the previous voltage was. What I'd do is have a time delay circuit which inhibited detection of the voltage for a period after the alarm device has been switched on. This delay would be necessary for electronic reasons, but it would also offer the advantage that the device could be switched on even *before* the handbag is put on the table. Provided that the pot spindle and its weight are at rest in a final position before the time delay comes to an end, it doesn't matter how much pot spindle movement occurs during the delay period itself. This fact enables the device to be casually switched on whilst the bag is opened for cigarettes to be taken out, or something like that, and the process of switching on would then attract no attention at all."

"Gee," said Dick. "I'd like to see the sort of circuit you have in mind."

THE MODERN BOOK CO.

*Largest selection of English &
American radio and technical
books in the country*

19-21 PRAED STREET
LONDON W2 1NP
Tel: 01-402 9176

SAVE MONEY!



*** NOW ON ***
CASSETTE TAPES

ACADEMY C60 - Super-Low Noise/Hi-output, Cassette Tapes (Ferric Oxide) 2 x 30 mins, Recording/Playing time - 5 for £3.00 P&P included

A.T.Z. C60 - 'Chromium Dioxide' very Low Noise/Hi-output, Cassette Tapes of high quality 2 x 30 mins, Recording/Playing time 5 for £5.00 P&P included

Buy now at lower than pre-Budget prices

SIGTRONIC ELECTRONICS
27 Malvern Street, Stapanhill
Burton-on-Trent, Staffs. DE15 9DY

MORSE MADE EASY



BY THE G3HSC
RHYTHM METHOD!

These courses which have been sold for over 23 years, have been proved many times to be the fastest method of learning Morse. You start right away by learning the sounds of the various letters, numbers, etc., as you will in fact use them. Not a series of dots and dashes which later you will have to transkate into letters and words.

Using scientifically prepared 3 speed records you automatically learn to recognise the code, RHYTHM without translating. You can't help it. It's as easy as learning a tune 18 WPM in 4 weeks guaranteed. The Complete Course consists of three records as well as instruction books. For Complete Course send £5.50 (overseas surface mail £1 extra).

THE G3HSC MORSE CENTRE
Box 8, 45 Green Lane, Purley, Surrey.
I enclose £5.50 or s.a.e. for explanatory booklet.

Name.....

Address.....

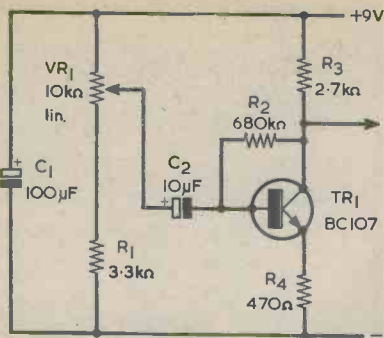

Fig. 2. An amplifying stage coupled to a potentiometer and weight assembly. The potentiometer is shown here as VR1

Smithy pulled his note-pad towards him and, after a little thought, drew out a small circuit. After scribbling a few calculations he marked up the component values, tore off the page and passed it over to his assistant.

"Here's a suitable amplifier circuit to which the pot could connect," he remarked. "I've shown the pot as VR1 and, as I mentioned just now, it can have a value of 10kΩ linear. The amplifier output connects to a voltage detector stage."

"Hey, I could knock this up in lash-up form right away," exclaimed Dick eagerly. (Fig. 2.)

"There's rather more to the complete circuit than just one transistor and a few other components," said Smithy. "Rough check, there'll be three CMOS integrated circuits and another transistor."

"That won't matter," replied Dick keenly. "I've got a piece of 0.1 inch Veroboard with i.c. holders on it all prepared for making quick experimental i.c. circuits. And so far as CMOS is concerned, my soldering iron has got the most reliably earthed bit in the neighbourhood!"

"All right then," conceded Smithy. "There's no need to make up a pot and weight assembly for this check circuit. Just fit a knob to the pot and we can check circuit action by turning the knob slightly."

Dick examined the circuit closely.

"That transistor is connected up in rather a weird manner," he stated. "Why have you got that 470Ω resistor between the emitter and the negative rail? And why do you have a 100μF electrolytic across the supply rails?"

"Taking your questions in reverse order," said Smithy, "the 100μF electrolytic is a supply bypass capacitor which will serve the whole circuit. It might as well go in right at the beginning. And the 470Ω resistor gives a high input im-

pedance at the transistor base. In company with the 2.7kΩ collector resistor, it also causes the voltage gain of the transistor to be a little less than 6 times. Remember that it's a changing voltage signal that we want to detect, and that is why the slider of VR1 couples to the transistor base through C2. I've given C2 a high value so that the transistor responds to a voltage which changes slowly, as would occur if the handbag in which the pot and weight are installed were handled very gently."

"Why do you want a gain of slightly less than 6 times?"

"Dear oh dear me," moaned Smithy. "You and your questions." He consulted the calculations he had made when he drew up the circuit. "We don't want the device to be too sensitive or it could be triggered by tiny tremors or even by noise on the pot track. A sensitivity which causes triggering for a pot slider movement of about 2 degrees seems to be reasonable. In the circuit there's about 6 volts across the pot track and if we assume that the total slider rotation is 300 degrees, then 2 degrees corresponds to 6 divided by 150, or 0.04 volt. This voltage multiplied by the transistor gain of slightly less than 6 times comes to a little over 0.2 volt. As you'll see in a minute, the next part of the circuit is triggered by approximately 0.2 volt, so the current you've got there gives just about the voltage gain required. Okay?"

"Blimey, yes" responded Dick, slightly taken aback by the speed with which Smithy had produced the sensitivity figures. "Well, I'll make up this bit of circuit now."

Dick unearthed an oddment of metal on which he mounted several tagstrips. He then quickly proceeded to wire up Smithy's circuit. As he did so, Smithy returned to his notepad and drew some further circuit diagrams.

FIRST CHECKS

"All finished!" called out Dick as he returned his soldering iron to its rest.

"Good show," responded Smithy, rising from his stool and walking over to his assistant's bench. "Can you connect the circuit to a 9 volt battery, please?"

Dick pulled over a PP9 battery and clipped two leads from his circuit to its terminals.

"I've done that, Smithy."

"Right," said Smithy leaning over his shoulder, "connect a testmeter switched to read volts between the negative rail and the transistor collector."

Dick switched his battered multimeter to a 0-10 volt range and applied its clips to the circuit. It indicated about 7 volts. Smithy put out his hand and slowly adjusted the potentiometer so that its slider moved a small distance towards the negative end of the track. The voltage reading increased sluggishly and then just as sluggishly returned to the 7 volt reading. A similarly sluggish reading in the other direction was given when Smithy adjusted the potentiometer slider slightly towards the positive track end.

"Very good," he commented. "The slow changes in the readings are due to C2 charging and discharging into the base circuit of the transistor. Now, here's the next bit of the overall alarm circuit."

Smithy produced one of the circuits he had prepared. (Fig. 3.)

"What bit is this?" asked Dick.

"It's the voltage detector," replied Smithy. "R5 and R6 hold the base of TR2 at about 0.4 volt above the negative rail, so that it's normally cut off and the voltage at its collector is high. The output goes low, to trigger the following part of the circuit, if a signal voltage passed via C3 takes the base up to 0.6 volt above the negative rail."

"That seems fair enough," commented Dick. "I see that this part of the circuit requires a 1N4002 diode. Have we got any of these in stock?"

"There's plenty in the spares cupboard. Actually, you'll need five of them by the time the circuit is completed, so you might as well pick up the other four as well."

Dick took the diodes from the spares cupboard after which, with Smithy watching, he soon wired up the second circuit. When it was completed he looked expectantly at the Serviceman.

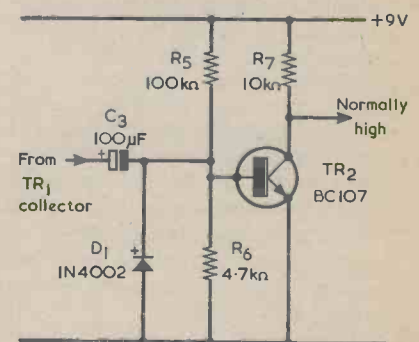

Fig. 3. A detector circuit follows the amplifier. The output at TR2 collector goes low if the potentiometer slider is moved along its track

"Put your testmeter between the collector of TR2 and the negative rail," said Smithy, "then connect up to the battery again."

Dick connected the battery. The meter needle rose slowly from its zero reading to one slightly below 9 volts.

"That slow rise in voltage," stated Smithy, "is due to C3 being initially discharged. Because of this, TR2 is turned on after switch-on until the capacitor charges."

Smithy adjusted the potentiometer slightly so that its slider moved towards the negative end of the track. The meter reading quickly dropped to zero then returned to its previous high indication.

"That's okay then," he stated. "The detector output goes low for just a small movement of VR1 spindle."

"Hey, wait a minute," put in Dick, "there's something wrong here!"

"How come?"

"This circuit detects a negative-going movement of the pot slider because TR1 changes the slider voltage to a positive-going signal before passing it on to TR2 base. But a positive movement of the pot slider won't have any effect at all, because the signal passed to TR2 base will then be negative-going and will keep TR2 cut off. So the pot and weight arrangement will only trigger the circuit when the pot is tilted in one direction."

"That's not entirely true," replied Smithy. "The circuit will also cause TR2 output to go low if the pot slider moves in a positive direction, although the sensitivity is, admittedly, a lot lower. If the pot slider movement causes the right hand plate of C3 to go negative of the negative rail by 0.6 volt, diode D1 starts to conduct and any further signal excursion discharges C3. When the signal ceases, the discharged C3 takes the base of TR2

positive again until C3 charges up once more. I'll show you."

Smithy gave the potentiometer spindle a small turn in the positive direction. The meter reading stayed at its high level for a second or so after Smithy had adjusted the potentiometer and then suddenly dipped momentarily to zero again.

LATCH CIRCUIT

"Blimey," said Dick, impressed. "You really believe in covering all eventualities, don't you, Smithy?"

"I like to keep things in order where I can," stated Smithy modestly. "Now here's the next bit of the alarm device to wire up."

He handed another circuit to Dick. (Fig. 4.)

"The two left hand gates in this circuit form a standard CMOS latch," went on Smithy, "and they couple to a third gate which, like the other two, is connected as an inverter. The latch is in its normal condition when pins 1 and 2 of the first gate are high. This causes the output at pin 10 to be low. TR2 collector connects via R8 and D2 to the input of the first gate so that, if TR2 collector goes low due to the handbag being picked up and the potentiometer setting altered, the latch is pulled to its alternative state with pins 1 and 2 low and pin 4 high. The latch stays in its new state when TR2 collector goes high again, because D2 is then reverse biased."

"Why have you put R8 in the circuit?" asked Dick.

"You'll find out in a jiffy. Just wire up that little lot, will you?"

"Okaydoke," said Dick agreeably.

Dick took up the piece of 0.1 inch Veroboard which he used for experimental i.c. circuits. It was not long before he had completed the assembly of the latch, whereupon Smithy took over from him. Smithy

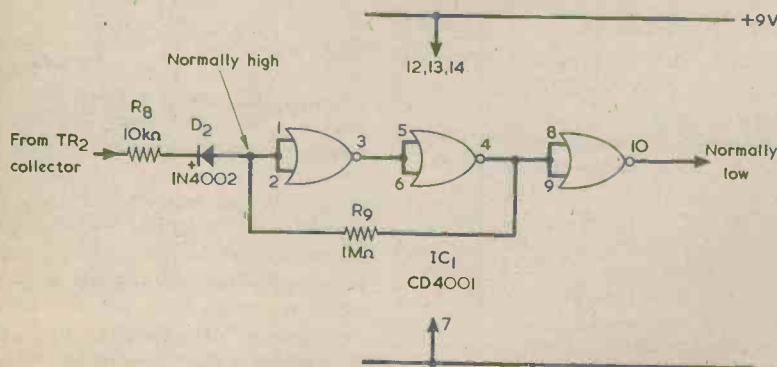

Fig. 4. The CMOS latch circuit. When the output at pin 10 goes high an output timer is enabled

PEATS for PARTS
ELECTRONIC COMPONENTS
RADIO & TELEVISION
For the convenience of Irish enthusiasts we supply:
Radio & Electronics
Constructor Data Books
Panel Signs
Transfers
Also a postal service
PEATS
the world of electronics
 25 Parnell Street, Dublin 1. Telephone 749972

MORSE IMPROVEMENT

C90 Cassettes (A) 1-12 w.p.m. with simple exercises. Suitable for R.A.E. preparation. (B) 12-24 w.p.m. computer produced professional level operator material including international symbols.

Price each: complete with instruction and exercise booklets £4.75 including postage.

Morse Key and Buzzer Unit suitable for sending practice and DIY tape preparation.

Price £4.75 including postage

Overseas Airmail £1.50 extra.

MHEL ELECTRONICS (Dept. R)
 12 Longshore Way, Milton,
 Portsmouth (UK), PO4 8LS

GAREX

V.H.F. Receivers SR-9 for 2-metres F.M., fully tunable 144-146MHz, 2-speed slow-motion dial, also 11 xtal controlled channels. Compact, sensitive, ideal for fixed or mobile listening. Built-in L.S., 12v D.C. operation £47.15 inc. VAT. Crystals, if required: £2.60 each. All popular 2m. channels in stock. Marine band version (156 162MHz) £47.15 (xtals £2.90). Mains psu for above £11.95. Pocket VHF Receiver 12 channel xtal controlled complete with nicad and charger. 4MHz bandwidth in range 140-175MHz £57.95. Amateur and Marine xtals in stock, prices as SR-9.

Amplifier module new, fully assembled 6W IC unit, 12v D.C. Low Impedance (4-8 Ω) input and output for extrn. speaker amplification, with circuit £2.75.

Neons min wire end 70p/10; £4.50/100

Slide switches min DPDT 20p ea; 5+: 16p

Resistor Kits E12 series, 22 Ω to 1M Ω

57 values, 5% carbon film, ¼W or ½W Starter pack, 5 each, value (285) £3.10

Mixed pack, 5 each ¼W + ½W (570) £5.55

Standard pack, 10 each (570) £5.55

Giant pack, 25 each (1,425) £13.60

BNC Cable mtg socket 50 Ω 25p;

5+: 20p; PL259 UHF Plug & Reducer 75p;

5+: 67p; SO239 UHF Socket panel mtd.

60p; 5+: 50p; Nicad rechargeables

physically equiv. to zinc-carbon types: AAA

(U16) £1.80; AA(U7) £1.30; C(U11) £3.35;

PP3 £5.55. Any 5+: less 10%. Any 10+ less

20%

We stock V.H.F. & U.H.F. mobile aeri-als.

s.a.s. details.

Access — Barclaycard

PRICES INCLUDE UK POST, PACKING & VAT

Mail order only. Sole Address:

GAREX ELECTRONICS

7 NORVIC ROAD, MARSWORTH.

TRING, HERTS HP23 4LS

Cheddington (STD 0296) 668684

applied the testmeter between pin 10 of the third gate and the negative rail, and connected up to the battery. The meter gave a reading of 9 volts.

"Hey," protested Dick, "that pin 10 gate output is high. According to you it should be normally low."

"It goes high at switch-on," explained Smithy, "because, as we saw just now, the collector of TR2 is low until C3 charges up."

He took up a piece of wire and momentarily short-circuited pins 1 and 2 of the first gate to the positive rail. The voltmeter reading dropped to zero and stayed there. Smithy reached over and made a slight adjustment to VR1. The testmeter returned to the 9 volt reading, which it retained steadily.

"Excellent, excellent," said Smithy happily. "The complete circuit is nearly finished now. All we need are two timing circuits. Here's the first one."

Smithy gave the circuit to his assistant. (Fig. 5.)

"Hallo," remarked Dick. "You're using an ICM7555 here. Is that the new 'CMOS 555'?"

"It is," confirmed Smithy. "I got a batch of them in recently to play around with. You'll notice also that I've now introduced an on-off switch. This is S1 (a), which is one pole of a double-pole double-throw toggle switch. The timing circuit is very simple. When the switch is in the 'Off' position C4 is discharged via R11. When S1 is put to 'On' power is applied to the circuit and C4 commences to charge via R10. The i.c. output at pin 3 is high until the voltage across C4 reaches two-thirds of the supply voltage and then it suddenly goes low and stays low. When the output is high it holds pins 1 and 2 of the CMOS latch high even when, after switch-on, the

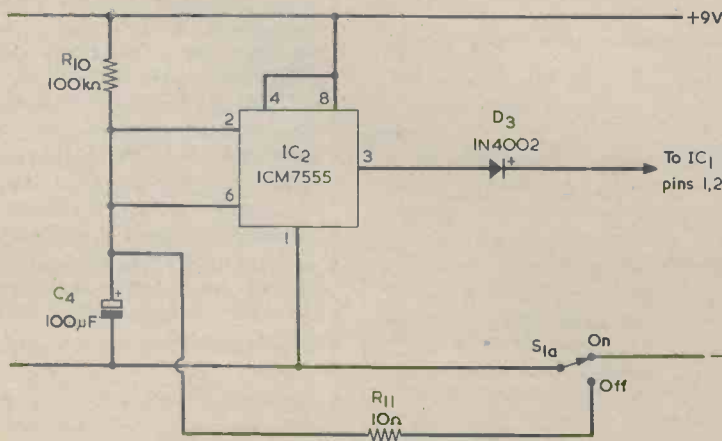

Fig. 5. This timing circuit inhibits the latch for a period after switch-on

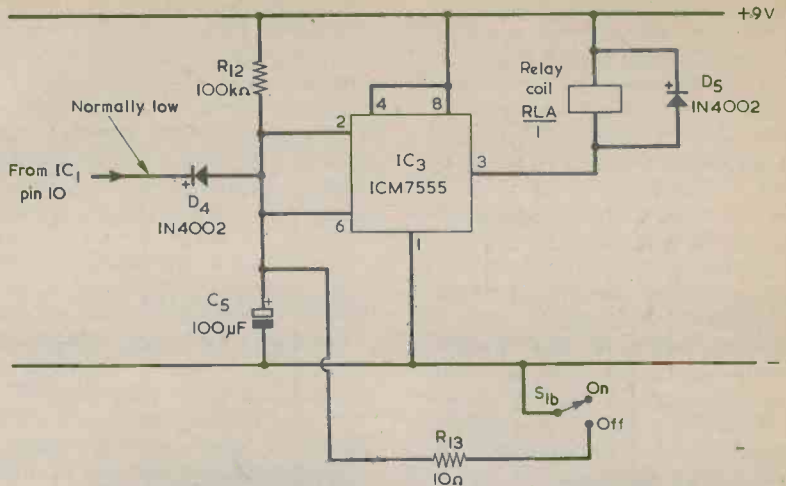

Fig. 6. The output timer. The relay causes a bell to sound a pre-determined time after the alarm circuit has been triggered

collector of TR2 goes low. TR2 collector cannot pull the latch input low because of the presence of the 10k Ω resistor, R8."

"Ah," said Dick, pleased. "That explains why you put in that resistor."

Smithy brought over from his bench a piece of polystyrene foam bearing a number of ICM7555 integrated circuits and Dick at once set to work. Again, only a short time passed before he announced the completion of the wiring. He looked a little doubtfully at what was now becoming quite a complex tangle of wires on his bench.

"This," he stated apologetically, "is beginning to look like the proverbial rat's nest, Smithy. It's not the nice and tidy sort of wiring job I normally like to turn out."

"Not to worry," said Smithy soothingly. "I can't expect you to make a neat assembly when I keep springing additional bits of circuitry

onto you, and when you're doing it in a hurry in any case. Right, we'll put the meter back on pin 10 of the gate following the CMOS latch and the negative rail and connect up to the battery again. Also, now we've got an on-off switch, we'll switch on in proper style."

Smithy carried out these actions. The testmeter reading was now low. It stayed low even when Smithy adjusted the potentiometer, VR1."

"As you can see," continued Smithy, "the output of the timer i.c. is holding the latch input high and is also inhibiting it from operating when I adjust VR1. The timer period is about 15 seconds, which will have passed shortly. Hang on a bit and then try adjusting the pot again, Dick."

After a short wait, Dick reached over and adjusted the potentiometer. The testmeter needle immediately rose to indicate 9 volts and stayed at that level.

"Gosh Smithy, this circuit really is behaving as it should."

"It is, indeed," replied Smithy, obviously pleased with the successful turn of events. "Now, let's summarise things up to now. We are making up a circuit for fitting in a handbag which includes a potentiometer actuated by a weight. When the handbag is moved, the potentiometer sends an alternating signal to an amplifier and detector which, in turn, cause a CMOS latch to change from the normal state to what we shall now call the alarm state. However, that latch is inhibited for a period after switch-on by the timer circuit you've just completed. This delay period overcomes false triggering at switch-on and, what is more important, allows the handbag to be moved around after

Fig. 7. The complete circuit of the spiked handbag alarm device. Due to the use of CMOS i.c.'s the current consumption from the 9 volt battery with the relay de-energised is of the order of 1.2mA only. A separate battery, BY2, couples to the bell via the contacts of the relay, and it should have a voltage suitable for the particular bell employed

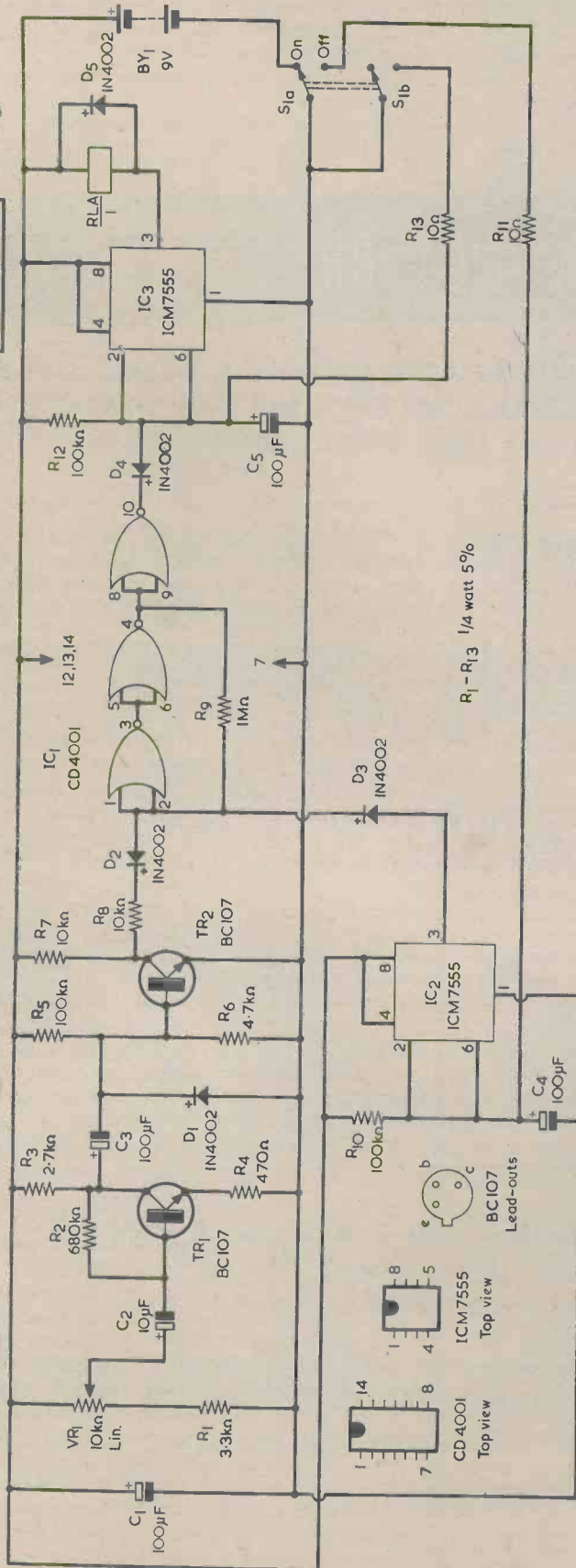

switching on before the circuit is ready to operate. This delay period can be extended by increasing the value of C4. If it is made say 1,000µF, the time delay is about 150 seconds, or two and a half minutes. A person carrying the handbag could switch on the circuit unobtrusively at some point and then carry the handbag over to a table and leave it there. That's what I call real *sneaky* spiking!"

"How long is the delay given by the timer?"

"In seconds, it's approximately equal to the value of C4 in microfarads multiplied by 0.15," replied Smithy. "C4 can have any value between 100µF and 1,000µF. I chose 100µF because we don't want to hang around for long periods whilst we're trying the circuit out."

FINAL SECTION

"All we need now," stated Dick, "is something that will ring an electric bell when the CMOS latch goes into the alarm state."

"And here's the circuit for that bit," replied Smithy. "It uses a second ICM7555 in an identical timing circuit, apart from the fact that the timer output energises a relay. Here you are."

Dick gazed at the final circuit which Smithy now passed on to him. (Fig. 6.)

"You've given the timing capacitor, C5, a value of 100µF," he remarked. "Will that give a timing delay of about 15 seconds, too?"

"It will," confirmed Smithy. "C5 can have any value between 100µF and 1,000µF and exactly the same remarks apply to it as applied to C4. After switch-on, C5 is held discharged by the normally low output of the first i.c. When the CMOS latch goes to the alarm state, because the handbag has been picked up, that normally low output goes high, allowing C5 to charge. Then, after the pre-arranged time, pin 3 of the second timer goes low, the relay energises and the electric bell in the handbag starts ringing. A suitable relay, incidentally, will be the 410Ω 'Open Relay' which is sold by Maplin."

Dick spent several evenings assembling Smithy's circuit in neat and proper form, and also drew out the complete circuit of the alarm from the scraps which Smithy had given him. (Fig. 7.)

Then, on the following Wednesday morning, a jubilant Dick burst open the Workshop door.

"It worked, Smithy!" he called out gleefully. "It worked like a charm last night. We caught the girl who was pinching the handbags just as she was leaving. She was carrying the spiked handbag and the bell in it suddenly started ringing

like an old-fashioned fire engine. Ye gods, you should have seen her face!"

"I'm glad it was successful," commented Smithy smoothly. "Perhaps you could lend me the alarm device for a few days now that you've caught your thief."

A suspicious look passed over Dick's face.

"All right then," he said reluctantly. "But what do you want it for?"

"Well," replied Smithy, "about a fortnight ago my club committee asked me to help them out with a problem they have. It appears that, at the club, there have been a few handbag thefts..."

RECENT PUBLICATIONS



TOWERS' INTERNATIONAL OP AMP LINEAR-IC SELECTOR. By T. D. Towers, M.B.E., M.A., B.Sc., C.Eng., M.I.E.R.E. and N. S. Towers, B.A. (Cantab). 192 pages, 245 x 170mm. (9 $\frac{3}{4}$ x 6 $\frac{3}{4}$ in.). Published by W. Foulsham & Co. Ltd. Price £6.95.

After "Towers' International Transistor Selector" and "Towers' International FET Selector" comes the present volume. It lists more than 5,000 American, British, European and Japanese linear i.c.'s, giving 24 specifications for each device, as well as lead functions and European and U.S.A. substitutes. The data is presented in the tabular form familiar with the two previous books, but in this case the information on each i.c. is spread over two facing pages.

A helpful introduction to operational amplifiers appears at the beginning of the book, and appendices at the end give expanded descriptions of the specifications, a glossary of terms, manufacturers and manufacturers' house numbers, application codes and lead-out diagrams. To give an idea of the range dealt with, the op-amps listed include triple comparators, triple f.e.t. input op-amps, chopper-stabilized amplifiers and parametric amplifiers.

INTEGRATED CIRCUITS — HOW TO MAKE THEM WORK. By R. H. Warring. 133 pages 215 x 130mm. (8 $\frac{1}{2}$ x 5 $\frac{1}{4}$ in.). Published by Lutterworth Press. Price £3.95.

Integrated circuits are now, of course, the active devices most commonly employed in both amateur and professional applications, and there is a wide range of i.c.'s currently available which are intended for many different uses. This book deals with many of the present types and gives no fewer than 84 practical working circuits in which they may be employed.

After an introduction to integrated circuits and a chapter on arrays (i.c.'s which comprise a number of devices not internally connected together) the book proceeds to operational amplifiers, audio amplifiers, heat sinks and complete radio circuits. Next dealt with are multivibrators, voltage regulators, electric motor speed controllers and filters. These subjects are followed by an introduction to digital circuits and a chapter on electronic organs. A final chapter is devoted to miscellaneous circuits, including hi-fi tone controls, a car thief alarm, an intercom and a digital voltmeter.

ELEMENTS OF ELECTRONICS 1. By F. A. Wilson C.G.I.A., C.Eng., F.I.E.E. F.I.E.R.E., M.B.I.M. 219 pages, 180 x 105mm. (7 x 4 $\frac{1}{4}$ in.). Published by Bernard Babani (Publishing) Ltd. Price £2.25.

This is the first of a new series, "Elements of Electronics", which is being introduced by Bernard Babani (Publishing) Ltd. The series is written in as non-technical a style as possible, and will be of particular use to the beginner, although it will also provide good text-books for the more advanced reader. Each of the "Elements of Electronics" books deals or will deal completely with its subject, but later titles will not duplicate material from earlier ones.

The present work is sub-titled "The Simple Electronic Circuit and Components", and it starts with the nature of electricity. It then proceeds to sources of electricity, simple electric circuits and resistance, electrostatics and capacitance, and electromagnetism and inductance. There are ten appendices covering such matters as mathematical basics, geometry, circuit symbols, work and power, preferred values and component marking. The last page discusses how the reader may carry on into Book 2 of the series.

SMALL ADVERTISEMENTS

Rate: 12p per word. Minimum charge £2.00

Box No. 30p extra

Advertisements must be prepaid and all copy must be received by the 4th of the month for insertion in the following month's issue. The Publishers cannot be held liable in any way for printing errors or omissions, nor can they accept responsibility for the *bona fides* of Advertisers. Where advertisements offer any equipment of a transmitting nature, readers are reminded that a licence is normally required. (Replies to Box Numbers should be addressed to: Box No. —, *Radio and Electronics Constructor*, 57 Maida Vale, London, W9 1SN.

FOR SALE: Complete and incomplete video tape recorders and closed circuit cameras. S.A.E. for details. Metal detector £10.00. 6 inch portable TV £75.00. Digital multimeter needing repair £17.50, with marks on case £20.00. Cassette tape eraser £10.00. Laser created 3 dimensional holograms £12.50. 25 mixed new zeners £1.00. Cassettes 75p. S.A.E. for list. Voice controlled ladybird toy £15.00. Radio controlled car £10.50. — J. Fulton, Derrynaseer, Dromore, Co. Tyrone, N. Ireland.

COMPLETE REPAIR INSTRUCTIONS for any requested TV, £5 (with diagrams £5.50). Any requested service sheet £1 plus s.a.e. S.a.e. brings free newsletter, details unique publications, vouchers and service sheets from 50p. AUSREC, 76 Church Street, Larkhall, Lanarkshire.

CUSTOM ENGRAVED FASCIAS for your projects in brushed aluminium, bronze, brass and a wide range of colours. Send your requirements. We do the rest. Male, 159 Victoria Road, Swindon, Wilts., SN1 3DA.

FOR SALE: Inverter, 12V d.c. to 240V a.c. Suitable running electric shaver, camping, boating, etc. £5.50. Box No. G355.

CONSTRUCT METAL DETECTORS: 1. £120 pulse discriminator (£12 construction cost). 2. £60 model (£6 con/cost). 3. £30 BFO (£3 con/cost). For all three together, written guaranteed d.i.y. plans, send £2. (Dept. RC), J. Lucas, 2 College Road, Grays, Essex. (Established 1973).

CONSTRUCTORS 200 mixed components £4. 30W soldering irons £2.60. Full refund guarantees. Lists 15p refundable. Mail only. Components bought. Sole Electronics, 37 Stanley Street, Ormskirk, Lancs.

FOR SALE: *Fundamentals of Radio Servicing* by B. W. Hicks, published by Hutchinsons Educational, £2.20 post paid. *Handbook of Satellites and Space Vehicles* by R. P. Haviland, £3.50 post paid. — Box No. G366.

FOR SALE: 50 metres connecting wire. Five 10 metre lengths assorted colours and sizes. 95p inc. P.&P. D. Hooker, Pennywood, Clarke Road, Greatstone, Kent TN28 8PB.

FOR SALE: Heathkit SB 401 Tx, 80-10 metres SSB/CW, 200 watts p.e.p. £100. Shure 444 microphone £15. BC 221 Frequency Meter with power supply and book £25. Sinclair PDM 35 Digital Multimeter in case with leads £30. CR100 with modifications £20. 500V Megger with leather case £5. All are o.n.o. Ed. Hartley, "Byways", Chapel Road, Mutford, Beccles, Suffolk, NR34 7UU.

FOR SALE: Bush cassette tape recorder, battery driven. Microphone, etc. Excellent condition. £10 plus postage. Box No. G375.

INTERESTED IN OSCAR? Then join AMSAT-UK. Newsletters, OSCAR NEWS Journal, prediction charts, etc. Details of membership from: Ron Broadbent, G3AAJ, 94 Herongate Road, Wanstead Park, London, E12 5EQ.

(Continued on page 381)



FIRST and STILL BEST

We've been producing our Electronics Components Catalogue for *over 20 years*. During that time we've learned a lot, not only in the art of catalogue production but in building a business that serves the needs of constructors. Little wonder that we have a reputation *second to none* for our catalogue — *and* for the service that backs it up. Experience both for yourself. Just send £1.30 with the coupon and a catalogue will come by return of post.

START THE NEW YEAR WELL with a Home Radio Catalogue

- About 2,500 items clearly listed and indexed.
- Profusely illustrated throughout.
- 128 A-4 size pages, bound in full-colour cover.
- Bargain list of unrepeatable offers included free.
- Catalogue contains details of simple Credit Scheme.

HOME RADIO (Components) LTD.
Dept. RC., 234-240 London Road, Mitcham, Surrey CR4 3HD
Phone: 01-648 8422

POST THIS COUPON with cheque or P.O. for £1.30

Please write your Name and Address in block capitals

NAME



ADDRESS

HOME RADIO (Components) LTD., Dept. RC
234-240 London Road, Mitcham, Surrey CR4 3HD

Regd. No. 912966, London

A CAREER IN RADIO

Start training *today* and make sure you are qualified to take advantage of the many opportunities open to the trained person. ICS can further your technical knowledge and provide the specialist training so essential to success.

ICS, the world's most experienced home study college, has helped thousands of ambitious men to move up into higher paid jobs — they can do the same for *you*.

Fill in the coupon below and find out how!

There is a wide range of courses to choose from, including:

CITY & GUILDS CERTIFICATES
Telecommunications Technicians'
Radio TV Electronics Technicians'
Electrical Installations Technicians'
Electrical Installation Work
Radio Amateurs'
MPT Radio Communications Cert
**EXAMINATION STUDENTS —
GUARANTEED COACHING
UNTIL SUCCESSFUL**

TECHNICAL TRAINING

ICS offers a wide choice of non-exam courses designed to equip you for a better job in your particular branch of electronics, including:
Electronic Engineering & Maintenance
Computer Engineering/Programming
Radio, TV & Audio Engineering
& Servicing
Electrical Engineering Installations & Contracting

COLOUR TV SERVICING

Technicians trained in TV Servicing are in constant demand. Learn all the techniques you need to service Colour and Mono TV sets through new home study course approved by leading manufacturer.

POST THIS COUPON OR TELEPHONE FOR FREE PROSPECTUS

I am interested in

Name Age

Address

Occupation

ICS

Accredited
by CACC
Member of
ABCC

To
International Correspondence Schools
Dept R278 Intertext House, LONDON
SW8 4UJ or phone 01-622 9911 (anytime)

APEL POWER SUPPLIES

STABILIZED POWER SUPPLIES WITH ELECTRONIC SHORT CIRCUIT PROTECTION

AL.212 P

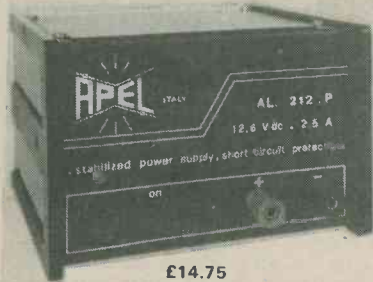

£14.75

INPUT VOLTAGE	220 V ac \pm 10% 50-60 Hz
OUTPUT VOLTAGE RANGE	12.6 V dc
OUTPUT CURRENT MAX	2.5 Amp
LOAD REGULATION	<0.3% 0-2.2 Amp
RIPPLE	<5mV 2.2 Amp
DIMENSIONS (mm)	W140 x H90 x D140
WEIGHT	1.490 Kg.

AL.315 P

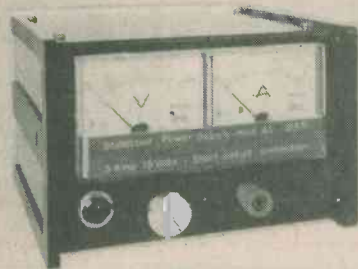

£29.50

INPUT VOLTAGE	220 V ac \pm 10% 50-60 Hz
OUTPUT VOLTAGE RANGE	1.7-15 V dc
LOAD REGULATION	<0.2% 0-2.8 Amp
DIMENSIONS (mm)	W140 x H90 x D155
RIPPLE	3mV 2.8 Amp
WEIGHT	2.330 Kg.

AL.330 P



£46.50

INPUT VOLTAGE	220 V ac \pm 10% 50-60 Hz
OUTPUT VOLTAGE RANGE	3.4-30 V dc
OUTPUT CURRENT RANGE MAX	3 Amp
LOAD REGULATION	< 5% 0-2.8 Amp
RIPPLE	10mV 2.8 Amp
DIMENSIONS (mm)	W270 x H90 x D155
WEIGHT	4.250 Kg.

Distributed in the U.K.
and Ireland by:

STOCKISTS

Alpha Sound Service,
50 Stuart Road, Waterloo, Liverpool L22 4QT,
England.

Anson Electronics,
1133 Hessele High Road, Hull, England.

Amateur Radio Shop,
13 Chapel Hill, Huddersfield, HD1 3ED,
England.

Brent Electronics,
Seaview Street, Cleethorpes,
Lincolnshire, England.

J. Birkett,
26 The Strail, Lincoln, England.

Bradford Consultants Limited,
25 Regent Parade, Harrogate,
Yorkshire, England.

F. Brown & Co. Ltd.,
44/46 George IV Bridge Street,
Edinburgh, Scotland.

N. R. Bardwell Limited,
Sellers Street, Sheffield, England.

Casey Brothers,
235 Boundary Road,
"Saint Helens",
Lancashire, England.

Electronic Services Limited,
33 City Arcade, Coventry CU11 HX, England.

A. Fanthorpe Limited,
6 Hepworth Arcade, Silver Street,
Hull, England.

G. W. M. Radio,
Portland Road, Worthing, Sussex.

Leeds Amateur Radio,
27 Cookridge Street,
Leeds LS2 3AG, England.

Target Electric Limited
16 Cherry Lane, Bristol, England.

New Cross Radio,
6 Oldham Road, Manchester,
England.

Progressive Radio,
93 Dale Street, Liverpool L2 2JD,
England.

R. E. Pitt Electrical Services Limited,
60/64 Bath Buildings, Mont Pelier,
Bristol, England.

Peats Electronics,
Parnell Street, Dublin.

R. F. Potts,
68 Bobbington Lane, Derby, England.

Brian A. Pearson Limited,
66 Moncur Street, Glasgow, Scotland.

R M E Supplies Limited,
143 Stockwell Street, Glasgow, Scotland.

Stephan James Limited,
Warrington Road, Leigh, Lancashire.

Stewarts Radio,
4 Chance Street, Blackpool, England.

The Radio Shop,
16 Cherry Lane, Bristol BS 3NG,
England.

Q. C. Trading,
1 St. Michaels Terrace, Woodgreen M22 4FT,
England.

AL.1 P5



£78.00

INPUT VOLTAGE	220 \pm 10% 50 Hz
OUTPUT VOLTAGE RANGE	1 \pm 15 V dc
OUTPUT CURRENT MAX	5 Amp
LOAD REGULATION	< 0.1% 0-45 Amp
RIPPLE	< 2mV 4.5 Amp
DIMENSIONS (mm)	W210 x H155 x D250
WEIGHT	5,100 Kg.

AL.212 PS

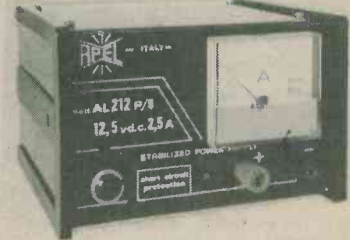

£18.00

INPUT VOLTAGE	220 V ac \pm 10% 50-60 Hz
OUTPUT VOLTAGE RANGE	12.6 V dc
OUTPUT CURRENT MAX	2.5 Amp
LOAD REGULATION	<0.3% 0-2.2 Amp
RIPPLE	<5mV 2.2 Amp
DIMENSIONS (mm)	W140 x H90 x D140
WEIGHT	1.490 Kg.
AMPEROMETER	

AL.315 P2



£54.00

INPUT VOLTAGE	220 V ac \pm 10% 50-60 Hz
OUTPUT VOLTAGE RANGE	\pm 1.7 \pm 15 V dc
OUTPUT CURRENT RANGE MAX	3 Amp
LOAD REGULATION	< 0.2% 1.8 Amp
RIPPLE	< 3mV dc
DIMENSIONS (mm)	W270 x H90 x D155
WEIGHT	4,140 Kg.

Stan Willets Limited,
37 High Street, West Bromwich.

M/S Waltons,
55a Worcester Street,
Wolverhampton WV2 4LL, England.

PEAT'S WHOLESALE LTD.

Chapel Lane, Parnell St, Dublin 1, Ireland.

PHONE 741746-740678-722845. TELEX 31787.

SMALL ADVERTISEMENTS

(Continued from page 379)

FOR SALE: Microwave Diodes 1N21B, 5 for £1.00. 1N23B, 5 for £4.00. Post 15p. — 49 Pennine Gardens, Harraby, Carlisle, Cumbria.

JOIN THE INTERNATIONAL S.W. LEAGUE. Free services to members including Q.S.L. Bureau, Amateur and Broadcast Translation, Technical and Identification Dept. — both Broadcast and Fixed Stations, DX Certificates, contests and activities for the SWL and transmitting members. Monthly magazine, *Monitor*, containing articles of general interest to Broadcast and Amateur SWLs, Transmitter Section and League affairs, etc. League supplies such as badges, headed notepaper and envelopes, QSL cards, etc., are available at reasonable cost. Send for League particulars. Membership including monthly magazines, etc., £6.00 per annum. (U.K. and British Commonwealth), overseas \$12.00. Secretary ISWL, 1 Grove Road, Lydney, Glos., GL15 5JE.

FOR SALE: "Challenge of the Stars" by Patrick Moore and David A. Hardy £2.00. "Destroyers" by Antony Preston £4.00. Box No. G376.

COLLECTORS' ITEMS. Nearly 50 copies of Radio Society of Great Britain's *Bulletins* covering period 1945 to 1949. In reasonable condition. Offers to: Box No. G377.

FOR SALE: 50 2W zeners £1.00. Switch cleaner £1.00. 1N4007 diodes 7p. Reed relay inserts 25p. Miniature relays 25p. L.E.D.'s 10p. Fuseholders 10p. Electronic shooting game £5.00. Electronic blackjack game £6.00. Radio control car £7.50. Voice controlled ladybird toy £15.00. J. Fulton, Derrynaseer, Dromore, Co. Tyrone, N. Ireland.

WANTED: Telford Communications TC10 "Multimode" 2 metre transmitter. Details and price please to Box No. G383.

THE RADIO AMATEUR INVALID & BEDFAST CLUB is a well established Society providing facilities for the physically handicapped to enjoy the hobby of Amateur Radio. Please become a supporter of this worthy cause. Details from the Hon. Secretary, Mr. H. R. Boutle, 14 Queens Drive, Bedford.

FOR SALE: Metal Detector £10. S.a.e. for lists. Box No. G384.

POSTAL ADVERTISING? This is the Holborn Service. Mailing lists, addressing, enclosing, wrapping, facsimile letters, automatic typing, copy service, campaign planning, design and artwork, printing and stationery. Please ask for price list. — The Holborn Direct Mail Company, Capacity House, 2-6 Rothsay Street, Tower Bridge Road, London, S.E.1. Telephone: 01-407 6444.

CLEARING ELECTRONICS LABORATORY. Numerous quality components available (95% new), inc: punched panels, boxes, wafer-switches, potentiometers, metal-oxide resistances, semiconductors, tools, etc. Unrepeatable — so hurry! Send £5 for a valuable selection worth at least £20. Money refund guarantee. M. J. Evans, 7 Shap Drive, Warndon, Worcester, WR4 9NY.

SHACK CLEARANCE: Large selection of good quality new components selling cheaply. S.A.E. for lists or enquiries. Box No. G386.

WANTED: FAX equipment, manuals, service sheets, etc. G2UK, 21 Romany Road, Oulton Broad, Lowestoft, Suffolk. NR32 3PJ.

CATHODE RAY TUBES. Surplus types, 09J, CV2750, 946A, CV1596, CV1391 £5 each. VCR138 £6 each. Large data display Brimar, V4167/LG/L4 £15. Tektronix T5021-P2 £15. CD1016 dual beam 5MHz scopes £90. AP1506 power supplies 200-500V, 6.3V at 10A, excellent condition £30. Solartron CD711S scope, requires e.h.t. xFr w/manual £20. 12AP7A Radar tube £10. Transformers 2 x 6.3V at 20A £8 each. Airmec crystal osc. 213 £5. Loads of other surplus equipment! Box No. G387.

(Continued on page 383)

RADIO MODELLER

ELECTRONIC BOOKS

● MODEL RADIO CONTROL

Detailing both Theory and Practice, this book, by leading authority Paul Newell, has become the standard reference work. A brief historical survey leads up to a detailed description of proportional systems, with over 100 illustrations, including theoretical circuits and p.c. layouts for an advanced digital system. 134 pages

Price £3.35

U.K. Packing & Postage 32p

ON SALE NOW
at all leading shops
or direct from:—

**RADIO MODELLER
BOOKS DIVISION,
High Street,
Sunningdale,
Berkshire SL5 0NF.**

theory and
practice of

MODEL RADIO CONTROL

Development of a system
proportional system design
digital system design
practical diagrams and
full circuit details



Wilmslow Audio

THE firm for speakers!

**SEND 30p FOR THE WORLDS BEST
CATALOGUE OF SPEAKERS, DRIVE UNITS
KITS, CROSSOVERS ETC. AND DISCOUNT
PRICE LIST**

AUDAX ● AUDIOMASTER ● BAKER ● BOWERS &
WILKINS ● CASTLE ● CELESTION ●
CHARTWELL ● COLES ● DALESFORD ●
DECCA ● EMI ● EAGLE ● ELAC ● FANE ●
GAUSS ● GOODMANS ● I.M.F.
ISOPON ● JR ● JORDAN WATTS ● KEF ●
LEAK ● LOWTHER ● MCKENZIE ● MONITOR
AUDIO ● PEERLESS ● RADFORD ● RAM ●
RICHARD ALLAN ● SEAS ● STAG ● TANNON ●
VIDEOTONE ● WHARFEDALE ● YAMAHA
SHACKMAN ● TANGENT

WILMSLOW AUDIO

DEPT REC

SWAN WORKS, BANK SQUARE, WILMSLOW
CHESHIRE SK9 1HF

Discount etc. at 5 Swan Street

Tel: 0625-529599 for Speakers, 0625-526213 for HiFi

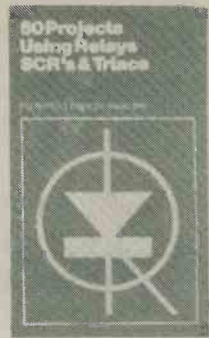
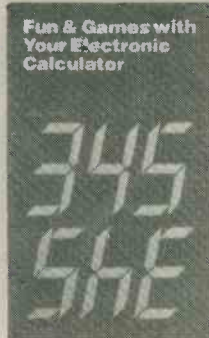
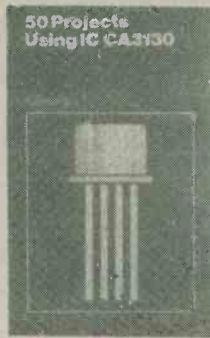
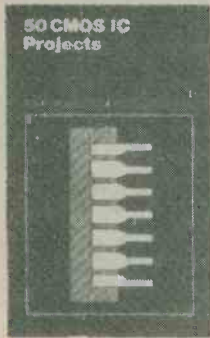

DIRECT READER SERVICE

RADIO & ELECTRONICS BOOKS

17. Solid State Power Supply Handbook	85p	35. Fun and Games with your Electronic Calculator	75p
18. 50 Projects Using IC CA3130	£1.25	36. 50 (FET) Field Effect Transistor Projects	£1.25
19. 50 CMOS IC Projects	£1.25	37. 50 Simple L.E.D. Circuits	75p
20. A Practical Introduction to Digital IC's	95p	38. How to Make Walkie-Talkies	£1.25
21. How to Build Advanced Short Wave Receivers	£1.20	39. IC 555 Projects	£1.75
22. Beginners Guide to Building Electronic Projects	£1.25	40. Projects in Opto-Electronics	£1.25
23. Essential Theory for the Electronics Hobbyist	£1.25	41. Radio Circuits Using IC's	£1.35
25. 79 Electronic Novelty Circuits	£1.00	42. Mobile Discotheque Handbook	£1.35
26. 52 Projects Using IC741	95p	43. Electronic Projects for Beginners	£1.35
27. How to Build Your Own Electronic and Quartz Controlled Watches & Clocks	85p	44. Popular Electronic Projects	£1.45
28. Two Transistor Electronic Projects	85p	45. IC LM3900 Projects	£1.35
29. How to Build Your Own Metal and Treasure Locators	£1.00	46. Electronic Music and Creative Tape Recording	£1.25
30. Electronic Calculator Users Handbook	95p	47. Practical Electronic Calculations and Formulae	£2.25
31. Practical Repair and Renovation of Colour TVs (Reprinting)	£1.25	48. Radio Stations Guide	£1.45
32. Handbook of IC Audio Preamplifier and Power Amplifier Construction	£1.25	49. Electronic Security Devices	£1.45
33. 50 Circuits Using Germanium, Silicon and Zener Diodes	75p	50. How to Build Your Own Solid State Oscilloscope	£1.50
34. 50 Projects Using Relays, SCR's and TRIACS	£1.25	51. 50 Circuits Using 7400 Series IC's	£1.45
		52. Second Book of CMOS IC Projects	£1.50
		53. Practical Construction of Pre-Amps, Tone Controls, Fitters & Attenuators	£1.45
		54. Beginners Guide to Digital Techniques	95p

POSTAGE: 20p PER BOOK. IF MORE THAN 3 BOOKS ORDERED: 10p PER BOOK

To: Data Publications Ltd., 57 Maida Vale, London W9 1SN

Please send me within 21 days copy/copies

Book Nos:

.....

I enclose Postal Order/Cheque for £

Name

Address

.....

(Block Letters Please)

(We regret this offer is only available to readers in the U.K.)

SMALL ADVERTISEMENTS

(Continued from page 381)

FOR SALE: C15 10MHz SCOPE. Complete with probes and accessories, plus spare parts. Excellent condition, hardly ever used. £50.00. Telephone: 051-334 4574.

SOLAR CELLS: Bits, books and bargains. Send 95p for Solar Cell booklet and Data Sheets or stamp for list. — Edencombe Ltd., 34 Nathans Road, North Wembley, Middlesex HA0 3RX.

RADIO, ELECTRONICS, TELEVISION BOOKS. Largest variety. Lowest prices. Write for list. Business Promotion Bureau, 376 Lajpat Rai Market, Delhi 110006, India.

PERSONAL

JANE SCOTT FOR GENUINE FRIENDS. Introductions to opposite sex with sincerity and thoughtfulness. Details free. Stamp to: Jane Scott, 3/Con North St. Quadrant, Brighton, Sussex, BN1 3GJ.

SPONSORS required for exciting scientific project Norwich Astronomical Society are building a 30" telescope to be housed in a 20" dome of novel design. All labour being given by volunteers. Already supported by Industry and Commerce in Norfolk. Recreational. Educational. You can be involved. Write to: NAS Secretary, 195 White Woman Lane, Old Catton, Norwich, Norfolk.

FOR HELP with (elementary) Computer, statistical or technical mathematics, send query, s.a.e., paper, P.O for 50p to: Box No. G380.

BROADLANDS RESIDENTIAL CLUB for elderly people. Are you recently retired and looking for a home? We have a delightful top floor room overlooking Oulton Broad, facing south. Write to: The Warden, Broadlands Residential Club, Borrow Road, Oulton Broad, Lowestoft, Suffolk.

IF YOU HAVE ENJOYED A HOLIDAY on the Norfolk Broads, why not help to preserve these beautiful waterways. Join the Broads Society and play your part in determining Broadlands future. Further details from: — The Hon. Membership Secretary, The Broads Society, "Icknield," Hilly Plantation, Thorpe St. Andrew, Norwich, NOR 85S.

CHI-KUNG for mental/physical health. Discover "Chi" — the life-force/bio-electricity in your body. Send stamp for your Free Literature. The Chi-Kung Society (REC39), 64 Cecil Road, London E13 0LR.

BUILD YOUR OWN P.A. GROUP & DISCO SPEAKERS by R. F. C. Stephens

Save money with this practical guide. Plans for 17 different designs. Line source, I.B., Horn and Reflex types, for 8"-18" drive units. £3.95 post free (\$8 overseas).

THE INFRA-BASS LOUDSPEAKER by G. Hollimar

(full constructional details for versions using 15", 12" and 10" drive units.) £2.95 post free (\$6 overseas).

THE DALESFORD SPEAKER BOOK by R. F. C. Stephens

This book is a must for the keen home constructor. Latest technology DIY designs. Plans for I.B., and Reflex designs for 10-100 watts. Also unusual centre-bass system. £2.20 post free (\$5 overseas).

VAN KAREN PUBLISHING
5 Swan Street, Wilmslow, Cheshire

T&J ELECTRONIC COMPONENTS

Quality Components —

Express Service

Semiconductors: BC107/8/9 10p, BC182/3/4 10p, 2N3702/3/4/5 8p, BSX20 17p, BF197 12p, OA90/1 7p, 1N4002 6p, BZY88 2V7 to 30V 10p, NE555 25p, 7400 10p, 741 8 pin 21p, ZN414 100p.

Resistors: ½ and ¼W 5% E12 from 4.7Ω to 1M. 2p each, 15p/10.

Potentiometers: 4.7k, 10k, 22k, 100k, 470k, 1M Log or Lin 29p.

Miniature presets: 100Ω to 1M, Horiz or vert 7p.

Opto: 0.125" & 0.2" l.e.d.'s. red 11p, yellow 19p, green 19p, clips either type 2p extra.

Switches: Standard toggle s.p.s.t. 33p, d.p.d.t. 43p, rotary 1p, 12W, 2p, 6W 3p, 4W 4p, 3W 40p, rotary mains d.p.s.t. 40p.

P.C.B. KIT: Comprehensive kit includes the following: etching dish, ferric chloride, Dalo etch resist pen, drill, 100 sq ins of copper clad board, set of p.c.b. transfers, instructions. £5.25 + 65p p&p. The transfers are available separately at £2.50.

BIB Hi Fi Accessories. Ref 61 Cassette index cards, for library containers 40p. Ref 69 anti static cleaner (20cc bottle) 40p.

Plugs and sockets. Din plugs 2 pin 7p, 3 pin 11p, 5 pin 13p, phono plugs red or black 10p, 2.5mm jack 11p, Din sockets 2 pin 7p, 3 pin 9p, 5 pin 10p, 2.5mm socket 10p.

AC-DC adapter. Provides outputs of 3, 6, 9, 12 volts at up to 300mA. Small size. Suitable for radios, cassettes etc. £3.85.

Telephone pick-up coil, suction type with 3.5mm plug 70p.

Crocodile clips. Standard 7p, small insulated, red or black 7p.

Our most popular component pack: PT3, Five ¼W resistor of each value from 10Ω to 1M. £3.25. All other packs previously advertised still available.

We also stock Veroboard, capacitors, all boxes, wire, cable, coil formers, heat-sinks. In fact too much to list here. Send a S.A.E. for our full lists.

Mail order only. All prices include VAT.

Please add 20p for postage. Same day service on all orders.

98 Burrow Road, Chigwell, Essex, 1G7 4HB

REVOR OPTICAL & TECHNICAL

6 SICILIAN AVENUE
LONDON W.C.1
Tel. 01-836 4536

£14.91

4" dia. lens

POST
FREE

FLEXIBLE
MAGNIFIER

WITH CAST IRON BASE,
PRECISION GROUND AND
POLISHED LENS, CHROME PLATED
FRAME AND FLEXIBLE TUBE.
IDEAL FOR HOBBIES, AND
DETAILED WORK WHICH REQUIRES
BOTH HANDS FREE.

CALLERS WELCOME

(Subject to price ruling at the time of issue)

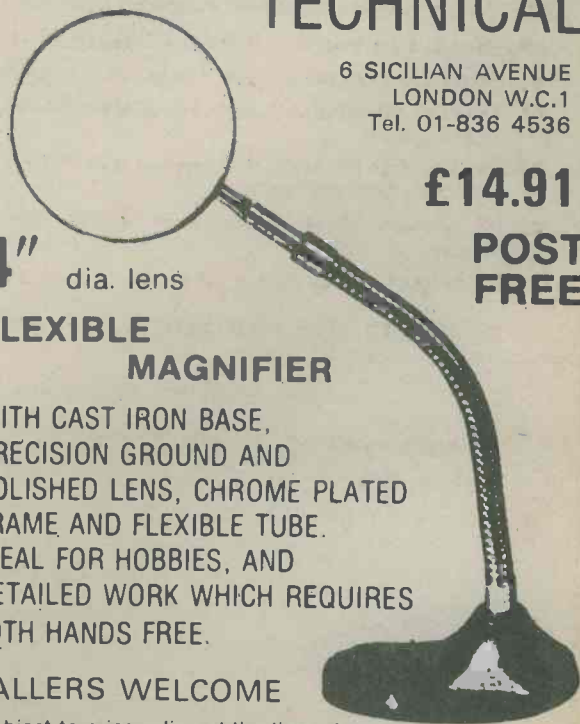

RADIO & ELECTRONICS CONSTRUCTOR

Single Copies

Price 55p each, p&p 15p

Issue(s) required

Annual Subscription

Price £8.00 inland, £9.00 overseas (including Eire)

post free, commence with issue

Bound Volumes:

Vol. 27. August	1973 to July	1974	Price £3.00, post & pkg £1.05
Vol. 28. August	1974 to July	1975	Price £3.20, post & pkg £1.05
Vol. 29. August	1975 to July	1976	Price £3.50, post & pkg £1.05
Vol. 30. August	1976 to July	1977	Price £3.70, post & pkg £1.05
Vol. 31. August	1977 to August	1978	Price £5.20, post & pkg £1.05
Vol. 32. September	1978 to August	1979	Price £5.50, post & pkg £1.05

(Available Mid-January)

CORDEX SELF-BINDERS

With title, 'RADIO & ELECTRONICS CONSTRUCTOR' on spine,
maroon only

Price £1.95, post & pkg 45p

With no title on spine, maroon

Price £1.95, post & pkg 45p

With no title on spine, green

Price £1.95, post & pkg 45p

Prices include V.A.T.

DATA BOOK SERIES

DB5 TV Fault Finding, 132 pages Price £1.20, P. & P. 22p

DB6 Radio Amateur Operator's Handbook,
New edition in course of preparation

DB17 Understanding Television, 504 pages Price £3.95, P. & P. 80p

DB19 Simple Short Wave Receivers
140 pages Price 80p, P. & P. 22p

STRIP-FIX PLASTIC PANEL SIGNS

Set 3: Wording — White — 6 sheets Price £1.00, P. & P. 9p

Set 4: Wording — Black — 6 sheets Price £1.00, P. & P. 9p

Set 5: Dials — 6 sheets Price £1.50, P. & P. 9p

Prices include V.A.T.

I enclose Postal Order/Cheque for in payment for

NAME

ADDRESS

(BLOCK LETTERS PLEASE)

Postal Orders should be crossed and made payable to Data Publications Ltd.

*Overseas customers please pay by International Money Order.
All publications are obtainable through your local bookseller*

Data Publications Ltd., 57 Maids Vale, London W9 1SN

PLEASE MENTION THIS MAGAZINE WHEN WRITING TO ADVERTISERS