

RADIO & ELECTRONICS CONSTRUCTOR

MARCH 1974

20p



AUDIO FREQUENCY METER

**ALSO
FEATURED**

TR3 REFLEX RADIO

There is a variety of **AMTRON** Electronic Test Equipment

Included in the vast range of over 200 AMTRON ELECTRONIC KITS are a number of various TEST EQUIPMENT units. In common with all AMTRON KITS they come complete

with comprehensive assembly instructions and even the solder required inside an attractive blister pack. Shown here are a few examples.



AUDIO FREQUENCY GENERATOR
Frequency ranges:
15 to 200 Hz; 200 to 2000 Hz; 2 to 22 KHz.
Rec. Retail Price £31.26.

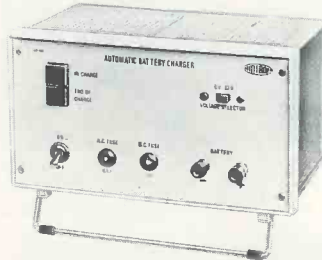

AUTOMATIC BATTERY CHARGER
Voltage 12 or 6 V (commutable on the panel). Max. charging current 2A.
Rec. Retail Price £21.26.

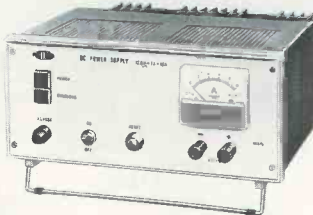

REGULATED POWER SUPPLY
Professional power supply for use with telecommunications apparatus. Supply voltage (mains) 117/125-222/240 V (AC).
Rec. Retail Price £56.82.



TRANSISTOR ANALYSER
For accurate measuring of static parameters of transistors.
Rec. Retail Price £29.70.

THE BIG NAME IN ELECTRONIC KITS



AMTRON UK, 4 & 7 CASTLE STREET, HASTINGS, SUSSEX TN34 3DY TEL: HASTINGS 2875

DENCO (CLACTION) LIMITED

355-7-9 OLD ROAD, CLACTON-ON-SEA, ESSEX

Our components are chosen by Technical Authors and Constructors throughout the World for their performance and reliability, every coil being inspected twice plus a final test and near spot-on alignment as a final check.

Our General Catalogue showing full product range .. 24p
 DTB4 Transistor & Valve circuitry for D.P. Coils .. 24p
 DTB9 Valve Type Coil Pack Application circuitry .. 24p
 MD 1 Decoder Circuitry for Stereo Reception .. 24p

All post paid, but please enclose S.A.E. with all other requests in the interests of retaining lowest possible prices to actual consumers

CF GIRO NO. 331 7056
 C.W.O. only. P. & P. 10p on orders below £5
 Discount: £10-10%, £20-15% (except net items)
 Export Order enquiries welcome (VAT free)

Official Orders accepted from
 Educational & Government Departments
ALL PRICES INCLUDE VAT

SPECIAL RESISTOR KITS
 10E12 1W KIT: 10 of each E12 value, 22 ohms—1M, a total of 570 (CARBON FILM 5%), £3.10 net
 10E12 1/2W KIT: 10 of each E12 value, 22 ohms—1M, a total of 1425 (CARBON FILM 5%), £7.20 net
 25E12 1/2W KIT: 25 of each E12 value, 22 ohms—1M, a total of 1425 (CARBON FILM 5%), £7.35 net
 20E12 1/2W KIT: 20 of each E12 value, 10 ohms—1M, a total of 1220 (METAL FILM 5%), £7.50 net
 15E12 1W KIT: 15 of each E12 value, 10 ohms—1M, a total of 915 (METAL FILM 5%), £8.15 net
 10E12 2W KIT: 10 of each E12 value, 10 ohms—1M, a total of 610 (METAL FILM 5%), £12.65 net

RESISTORS
 CF—High Stab Carbon Film, 5% MF—High Stab Metal Film, 5%
 W Type Range 1-9 10-49 50-99 100-249 250-499 500-999 1000 - Size mm
 † CF 22-1M 1 0.8 0.65 0.62 0.55 0.5 0.45 2.4-7.5
 † CF 22-2M2 1 0.8 0.65 0.62 0.55 0.5 0.45 3.9x10.5
 † CF 22-1M 1 0.8 0.65 0.62 0.55 0.5 0.45 5.5x16
 † MF 10-2M7 1 0.9 0.8 0.7 0.65 0.65 0.6 3x7
 † MF 10-2M2 1 0.9 0.8 0.7 0.65 0.65 0.6 4.2x10.8
 † MF 10-10M 1.5 1.25 1.25 1.1 1 0.95 0.88 6.6x13
 † MF 10-10M 3 2.5 2.5 2 1.75 1.75 1.6 8x17.5

For value mixing prices, please refer to our catalogue. (Price in pence each)
 VALUES AVAILABLE—E12 Series only. "NET PRICES ABOVE 100"

MULLARD POLYESTER CAPACITORS C280 SERIES
 250V P.C. Mounting: 0.01µF, 0.015µF, 0.022µF, 0.033µF, 0.047µF, 3½p, 0.068µF, 0.1µF, 4½p, 0.15µF, 4½p, 0.22µF, 5½p, 0.33µF, 8p, 0.47µF, 9p, 0.68µF, 11p, 1µF, 15p, 1.5µF, 22p, 2.2µF, 25p.

MULLARD POLYESTER CAPACITORS C296 SERIES
 400V: 0.001µF, 0.0015µF, 0.0022µF, 0.0033µF, 0.0047µF, 2½p, 0.0068µF, 0.01µF, 0.015µF, 0.022µF, 0.033µF, 3½p, 0.047µF, 0.068µF, 0.1µF, 4½p, 0.15µF, 4½p, 0.22µF, 5½p, 0.33µF, 8p, 0.47µF, 9p, 0.68µF, 11p, 1µF, 12½p, 160V: 0.01µF, 0.015µF, 0.022µF, 2½p, 0.047µF, 0.068µF, 3½p, 0.1µF, 0.15µF, 4½p, 0.22µF, 5½p, 0.33µF, 8p, 0.47µF, 9p, 0.68µF, 11p, 1µF, 12½p.

MINIATURE CERAMIC PLATE CAPACITORS
 50V: (pF) 22, 27, 33, 39, 47, 56, 68, 82, 100, 120, 150, 180, 220, 270, 330, 390, 470, 560, 680, 820, 1K, 1K5, 2K2, 3K3, 4K7, 6K8, (µF) 0.01, 0.015, 0.022, 0.033, 0.047, 2½p, each, 0.1, 30V, 4½p: 0.1, 100V, 5½p.

POLYSTYRENE CAPACITORS 160V 5%
 (pF) 10, 15, 22, 33, 47, 68, 100, 150, 220, 330, 470, 680, 1000, 1500, 2200, 3300, 4700, 4p, 6800, 10,000, 4½p.

B. H. COMPONENT FACTORS LTD.

(R.C.) 61 CHEDDINGTON ROAD, PITSTONE, NR. LEIGHTON BUZZARD, BEDS, LU7 9AQ
 Tel.: Cheddington 668446 (Std. Code 0296)
 PLEASE WRITE FOR FREE CATALOGUE

<p>Miniature Mullard Electrolytics</p> <table border="0"> <tr><td>1.0µF 63V 6p</td><td>68µF 16V 6p</td></tr> <tr><td>1.5µF 63V 6p</td><td>68µF 63V 12p</td></tr> <tr><td>2.2µF 63V 6p</td><td>100µF 10V 6p</td></tr> <tr><td>3.3µF 63V 6p</td><td>100µF 25V 6p</td></tr> <tr><td>4.0µF 40V 6p</td><td>100µF 63V 14p</td></tr> <tr><td>4.7µF 63V 6p</td><td>150µF 16V 6p</td></tr> <tr><td>6.8µF 63V 6p</td><td>150µF 63V 15p</td></tr> <tr><td>8.0µF 40V 6p</td><td>220µF 6.4V 6p</td></tr> <tr><td>10µF 16V 6p</td><td>220µF 10V 6p</td></tr> <tr><td>10µF 25V 6p</td><td>220µF 16V 8p</td></tr> <tr><td>10µF 63V 6p</td><td>220µF 63V 21p</td></tr> <tr><td>15µF 16V 6p</td><td>330µF 16V 12p</td></tr> <tr><td>15µF 63V 6p</td><td>330µF 63V 25p</td></tr> <tr><td>16µF 40V 6p</td><td>470µF 6.4V 9p</td></tr> <tr><td>22µF 25V 6p</td><td>470µF 40V 20p</td></tr> <tr><td>22µF 63V 6p</td><td>680µF 16V 15p</td></tr> <tr><td>32µF 10V 6p</td><td>680µF 40V 25p</td></tr> <tr><td>33µF 16V 6p</td><td>1000µF 16V 20p</td></tr> <tr><td>33µF 40V 6p</td><td>1000µF 25V 25p</td></tr> <tr><td>32µF 63V 6p</td><td>1500µF 6.4V 15p</td></tr> <tr><td>47µF 10V 6p</td><td>1500µF 16V 25p</td></tr> <tr><td>47µF 25V 6p</td><td>2200µF 10V 25p</td></tr> <tr><td>47µF 63V 8p</td><td>3300µF 6.4V 26p</td></tr> </table>	1.0µF 63V 6p	68µF 16V 6p	1.5µF 63V 6p	68µF 63V 12p	2.2µF 63V 6p	100µF 10V 6p	3.3µF 63V 6p	100µF 25V 6p	4.0µF 40V 6p	100µF 63V 14p	4.7µF 63V 6p	150µF 16V 6p	6.8µF 63V 6p	150µF 63V 15p	8.0µF 40V 6p	220µF 6.4V 6p	10µF 16V 6p	220µF 10V 6p	10µF 25V 6p	220µF 16V 8p	10µF 63V 6p	220µF 63V 21p	15µF 16V 6p	330µF 16V 12p	15µF 63V 6p	330µF 63V 25p	16µF 40V 6p	470µF 6.4V 9p	22µF 25V 6p	470µF 40V 20p	22µF 63V 6p	680µF 16V 15p	32µF 10V 6p	680µF 40V 25p	33µF 16V 6p	1000µF 16V 20p	33µF 40V 6p	1000µF 25V 25p	32µF 63V 6p	1500µF 6.4V 15p	47µF 10V 6p	1500µF 16V 25p	47µF 25V 6p	2200µF 10V 25p	47µF 63V 8p	3300µF 6.4V 26p	<p>VEROBOARD 0.1-0.15</p> <table border="0"> <tr><td>2½ x 5"</td><td>28p 28p</td></tr> <tr><td>2½ x 3½"</td><td>26p 19p</td></tr> <tr><td>3½ x 5"</td><td>32p 33p</td></tr> <tr><td>2½ x 1"</td><td>7p 7p</td></tr> <tr><td>2½ x 5" (Plain)</td><td>— 14p</td></tr> <tr><td>2½ x 3½" (Plain)</td><td>— 12p</td></tr> <tr><td>5 x 3½" (Plain)</td><td>— 22p</td></tr> <tr><td>Insertion tool</td><td>59p 59p</td></tr> <tr><td>Track Cutter</td><td>44p 44p</td></tr> <tr><td>Fins, Pkt. 25</td><td>10p 10p</td></tr> </table> <p>TRANSISTORS</p> <table border="0"> <tr><td>AC127 16½p</td><td>BC212L 12p</td></tr> <tr><td>AC128 22p</td><td>BC213L 12p</td></tr> <tr><td>BC107 11p</td><td>BC214L 17p</td></tr> <tr><td>BC108 12p</td><td>OC44 18p</td></tr> <tr><td>BC109 13p</td><td>OC71 13p</td></tr> <tr><td>BC148 12p</td><td>OC81 16p</td></tr> <tr><td>BC149 12p</td><td>OC170 23p</td></tr> <tr><td>BC182L 12p</td><td>T1543 33p</td></tr> <tr><td>BC183L 12p</td><td>2N2926 11p</td></tr> <tr><td>BC184L 13p</td><td>2N3702 11p</td></tr> </table>	2½ x 5"	28p 28p	2½ x 3½"	26p 19p	3½ x 5"	32p 33p	2½ x 1"	7p 7p	2½ x 5" (Plain)	— 14p	2½ x 3½" (Plain)	— 12p	5 x 3½" (Plain)	— 22p	Insertion tool	59p 59p	Track Cutter	44p 44p	Fins, Pkt. 25	10p 10p	AC127 16½p	BC212L 12p	AC128 22p	BC213L 12p	BC107 11p	BC214L 17p	BC108 12p	OC44 18p	BC109 13p	OC71 13p	BC148 12p	OC81 16p	BC149 12p	OC170 23p	BC182L 12p	T1543 33p	BC183L 12p	2N2926 11p	BC184L 13p	2N3702 11p	<p>POTENTIOMETERS Carbon Track 5K Ω to 2M Ω, log or lin. Single, 16½p Dual Gang 46p. Log Single with switch 26p Slider Pots. 10K, 100K, 500K, 30mm, 34p, 45mm, 47p, 60mm, 55p.</p> <p>DIODES</p> <table border="0"> <tr><td>IN4001 6½p</td><td>DIN 2 Pin 12p</td></tr> <tr><td>IN4002 7½p</td><td>3 Pin 13p</td></tr> <tr><td>IN4003 9p</td><td>5 Pin 180° 15p</td></tr> <tr><td>IN4004 9½p</td><td>Std. Jack 14½p</td></tr> <tr><td>IN4005 12p</td><td>2.5mm Jack 11p</td></tr> <tr><td>IN4006 14p</td><td>Phono 5½p</td></tr> <tr><td>IN914 7p</td><td></td></tr> <tr><td>IN916 7p</td><td></td></tr> <tr><td>BA100 10p</td><td></td></tr> <tr><td>OA5 42p</td><td></td></tr> <tr><td>OA47 9p</td><td></td></tr> <tr><td>OA81 11p</td><td></td></tr> <tr><td>OA200 8p</td><td></td></tr> </table> <p>SOCKETS</p> <table border="0"> <tr><td>DIN 2 Pin 10p</td></tr> <tr><td>3 Pin 10p</td></tr> <tr><td>5 Pin 180° 12p</td></tr> <tr><td>Std. Jack 14½p</td></tr> <tr><td>2.5mm Jack 11p</td></tr> <tr><td>Phono 5½p</td></tr> </table> <p>ELECTROLYTIC CAPACITORS. Tubular & Large Cans (µF V): 2.2, 25, 2.2, 63, 4.7, 10, 4.7, 25, 4.7, 63, 22, 10, 22, 25, 22, 63, 5p, 2.10, 10, 10, 50, 10, 100, 10, 10, 25, 50, 25, 10, 50, 5½p, 200, 10, 100, 25, 50, 50, 6½p, 500, 10, 200, 25, 100, 50, 9p, 1000, 10, 39p, 1000, 100, 66p, 2000, 25, 27p, 2500, 12, 17p, 2500, 25, 33p, 2500, 50, 62p, 3000, 50, 72p, 5000, 25, 66p, 5000, 50, 94p, 7000, 50, 60p, 25,000, 25, 74p. HI-VOLT: 8, 350, 14p, 16, 350, 19p, 32, 350, 25p, 50, 250, 18p, 100, 500, 33p.</p> <p>METALLISED PAPER CAPACITORS 250V: 0.05µF, 0.1µF 4½p, 0.25µF, 5½p, 0.5µF, 6½p, 1µF, 9p, 500V: 0.025µF, 0.05µF, 4½p, 0.1µF, 5½p, 0.25µF, 6½p, 0.5µF, 9p, 1000V: 0.01µF, 10p, 0.022µF, 12p, 0.047µF, 0.1µF, 16p, 0.22µF, 31p, 0.47µF, 39p.</p>	IN4001 6½p	DIN 2 Pin 12p	IN4002 7½p	3 Pin 13p	IN4003 9p	5 Pin 180° 15p	IN4004 9½p	Std. Jack 14½p	IN4005 12p	2.5mm Jack 11p	IN4006 14p	Phono 5½p	IN914 7p		IN916 7p		BA100 10p		OA5 42p		OA47 9p		OA81 11p		OA200 8p		DIN 2 Pin 10p	3 Pin 10p	5 Pin 180° 12p	Std. Jack 14½p	2.5mm Jack 11p	Phono 5½p	<p>QUANTITY DISCOUNT SPECIAL BULK BUY PRICES ARE AVAILABLE BY QUOTATION FOR LARGE PROJECTS AND TRADE</p>
1.0µF 63V 6p	68µF 16V 6p																																																																																																																								
1.5µF 63V 6p	68µF 63V 12p																																																																																																																								
2.2µF 63V 6p	100µF 10V 6p																																																																																																																								
3.3µF 63V 6p	100µF 25V 6p																																																																																																																								
4.0µF 40V 6p	100µF 63V 14p																																																																																																																								
4.7µF 63V 6p	150µF 16V 6p																																																																																																																								
6.8µF 63V 6p	150µF 63V 15p																																																																																																																								
8.0µF 40V 6p	220µF 6.4V 6p																																																																																																																								
10µF 16V 6p	220µF 10V 6p																																																																																																																								
10µF 25V 6p	220µF 16V 8p																																																																																																																								
10µF 63V 6p	220µF 63V 21p																																																																																																																								
15µF 16V 6p	330µF 16V 12p																																																																																																																								
15µF 63V 6p	330µF 63V 25p																																																																																																																								
16µF 40V 6p	470µF 6.4V 9p																																																																																																																								
22µF 25V 6p	470µF 40V 20p																																																																																																																								
22µF 63V 6p	680µF 16V 15p																																																																																																																								
32µF 10V 6p	680µF 40V 25p																																																																																																																								
33µF 16V 6p	1000µF 16V 20p																																																																																																																								
33µF 40V 6p	1000µF 25V 25p																																																																																																																								
32µF 63V 6p	1500µF 6.4V 15p																																																																																																																								
47µF 10V 6p	1500µF 16V 25p																																																																																																																								
47µF 25V 6p	2200µF 10V 25p																																																																																																																								
47µF 63V 8p	3300µF 6.4V 26p																																																																																																																								
2½ x 5"	28p 28p																																																																																																																								
2½ x 3½"	26p 19p																																																																																																																								
3½ x 5"	32p 33p																																																																																																																								
2½ x 1"	7p 7p																																																																																																																								
2½ x 5" (Plain)	— 14p																																																																																																																								
2½ x 3½" (Plain)	— 12p																																																																																																																								
5 x 3½" (Plain)	— 22p																																																																																																																								
Insertion tool	59p 59p																																																																																																																								
Track Cutter	44p 44p																																																																																																																								
Fins, Pkt. 25	10p 10p																																																																																																																								
AC127 16½p	BC212L 12p																																																																																																																								
AC128 22p	BC213L 12p																																																																																																																								
BC107 11p	BC214L 17p																																																																																																																								
BC108 12p	OC44 18p																																																																																																																								
BC109 13p	OC71 13p																																																																																																																								
BC148 12p	OC81 16p																																																																																																																								
BC149 12p	OC170 23p																																																																																																																								
BC182L 12p	T1543 33p																																																																																																																								
BC183L 12p	2N2926 11p																																																																																																																								
BC184L 13p	2N3702 11p																																																																																																																								
IN4001 6½p	DIN 2 Pin 12p																																																																																																																								
IN4002 7½p	3 Pin 13p																																																																																																																								
IN4003 9p	5 Pin 180° 15p																																																																																																																								
IN4004 9½p	Std. Jack 14½p																																																																																																																								
IN4005 12p	2.5mm Jack 11p																																																																																																																								
IN4006 14p	Phono 5½p																																																																																																																								
IN914 7p																																																																																																																									
IN916 7p																																																																																																																									
BA100 10p																																																																																																																									
OA5 42p																																																																																																																									
OA47 9p																																																																																																																									
OA81 11p																																																																																																																									
OA200 8p																																																																																																																									
DIN 2 Pin 10p																																																																																																																									
3 Pin 10p																																																																																																																									
5 Pin 180° 12p																																																																																																																									
Std. Jack 14½p																																																																																																																									
2.5mm Jack 11p																																																																																																																									
Phono 5½p																																																																																																																									

COMPONENTS

HOBBYIST - AMATEUR - DOMESTIC SURPLUS - INDUSTRIAL - BULK OFFERS

JUST A FEW OF OUR BARGAINS ARE LISTED BELOW - PAY US A VISIT OR SEND STAMPED ADDRESSED ENVELOPE FOR A QUOTE ON YOUR REQUIREMENTS

MAINS POWER SUPPLY UNIT. 400m/A, 6-7.5-9-12 VOLT MADE TO SELL AT £5.25 OUR PRICE £3.50

VALVE BASES		T03 Mica Washer 2p		ELECTROLYTICS Mullard C426, TCC, CRL, CCL, Cullins, Hunts, STC Subminiature, etc	
Printed circuit B9A - B7G	3p	3" Standard Tape - Boxed	15p	MFD/VOLT 2p	2.5/64, 12/50, 12/20, 10/20, 16/50, 16/40, 25/25, 50/25, 150/12, 150/25, 260/12, 4/60, 15/35, 6p 250/18, 400/16, 250/30, 550/12, 150/40.
Chassis UX7 - UX5 - B9G - B7G	3p	GP91-1 Cartridge, turnover stylus	65p	3p 25/6.4, 500/6, 250/6.	50p 8/800, 12,000/12, 2000/50: 32-32-50/350.
Shrouded chassis B7G - B9A	4p	GC10/4B Cold Cathode	£5.00	4p 20/12, 100/25, 100/12, 25/12, 100/15, 64/10, 125/10, 50/50, 50/10, 100/18, 6/25, 2/350.	20p 100-100/150, 100-100/275, 32-32/275.
B8A-B9A chassis	5p	Brand New Boxed 6K7G	25p	9p 8/500, 100/200, 400/40, 100/250-275, 4/16 reversible.	
TAG STRIP		WRIST COMPASS		INDICATORS	
6 way 2p Single 1p		20p with Needle Lock		Arcolelectric green, takes M.E.S. bulb	10p
1 1/4 glass fuses— 250 m/a or 3 amp (box of 12)				Bulgin D676 red, takes M.E.S. bulb	15p
3" tape spools				12 volt red, small pushfit	15p
FX2236 FerroX Cores				Mains neon, amber, pushfit	15p
PVC or metal clip on M.E.S. bulb holder				CAPACITORS	
All metal equipment Phono plug				Mixed type PFDS, 2p. 3.3, 4.7, 10, 16, 18, 22, 24, 25, 27, 30, 33, 37, 39, 47, 50, 56, 68, 88, 100, 110, 150, 200, 220, 250, 270, 300, 350, 470, 500, 600, 680, 800, 1000, 2200, 3000, 3300, 5000.	
Bulgin, 5mm Jack plug and switched socket (pair)				Poly. met., film, paper, etc. MFD/Volt. 3p. .001/1250, .005/250, .03/350, .022/70, .03/12, .03/200 .033/100, .0068/70, .056/350, .061/350, .069/350, .075/350, .08/350, .1/350, .1/500, .13/350, .25/150.	
12 volt solenoid and plunger				4p. 1500, 1800, 2200, 3000, 3300, 6800, 8200 PFD. .01/350, .013/350, .02/250, .05/125, .05/250, .25/350.	
250 RPM 50 c/s locked frequency miniature mains motor				5p. .033/100, .1/250, .25/500, .5/350.	
200 OHM coil, 2 1/4" long, hollow centre				6p. .1/600, .1/1500, .22/250, .5/250	
Relay, P.O. 3000 type, 1,000 OHM coil, 4 pole c/o				10p. .01/1000, 1/350, 2/150, 2/200, 2/250, .1/900, .22/900.	
R.S. 12 way standard plug and shell				40p. 5/150, 9/275AC, 10/150, 15/150, 40/150	

SWITCHES			
Pole	Way	Type	
4	2	Sub. Min. Slide	10p
6	2	Slide	15p
4	2	Lever Slide	10p
6	4	Wafer Rotary	15p each
4	3		
3	7		
2	5		
1	3	+ off Sub. min. edge	10p
1	3	13 amp small rotary	12p
2	2	Locking with 2 to 3 keys	£1.50
2	1	2 Amp 250V A.C. rotary	20p
1	2	Toggle	10p

RESISTORS	
1/4 watt	1p
1 watt	2p
Up to 10 watt wire	10p
15 watt wire wound	12p

SKELETON PRESETS	
5K or 500K	4p
K wirewound	5p

SAFETY PINS	
Standard size, 10 for 4p	

WIREWOUND POTS	
250, 300 OHM, 1K, 4 watt, 5K, 10K, 11K, 20K, 50K, all at 12p each	

5K switched volume control	
control	15p
5K Log Pot	15p
1meg Tandem Pot	15p

THERMISTORS	
VA1040	10p each
VA1055	
VA1066	
VA1100	
VA1077	13p

STEEL BOX WITH LID	
10 x 5 1/2 x 3" grey hammer finish	£1

RELAYS	
6 volt, 2 pole c/o heavy duty contacts	50p
Mains 3 pole c/o heavy duty contacts ex equipment	35p

TRIMMERS, 15p each	
100PF Ceramic, 30PF Beehive, 12PF PTFE, 2500PF 750 volt, 33PF MIN. AIR SPACED, 5PF, MIN. AIR SPACED, 50PF CERAMIC.	

CONNECTOR STRIP	
Belling Lee L1469, 4 way polythene.	3p each
CAN CLIPS	
1" or 1 1/8" or 1 1/4"	2p
LABGEAR MAINS DROPPER	
36 ohm 25 watt + 79 ohm 9 watt	15p

TUNING CONDENSERS 33 or 50PF, 25p	
2 Amp Suppression Choke	5p

PAXOLINE	
3 x 2 1/2 x 1 1/2"	2p
4 3/8 x 1 1/2 x 1 1/2"	2 for 1p
220K 3 watt resistors	2p
VALVE RETAINER CLIP, adjustable	2p

OUTPUT TRANSFORMERS	
Sub-miniature Transistor Type	20p
Valve type, centre tapped or straight	40p

COMPUTER AND AUDIO BOARDS
 HOST OF QUALITY, REASONABLE LEAD TRANSISTORS, SOME POWER. SILICON, GERMANIUM, ZENER DIODES, POT CORES HI-STAB RESISTORS, SOME WIREWOUND, CONDENSERS, CHOKES, TRIMPOTS, ELECTROLYTICS, ETC.
 3lb. for 75p + 25p post and packing
 7lb. for £1.50 + 40p post and packing

SUBMIN VERTICAL SKELETON PRESET
 100, 220, 470, 680 OHM 1, 2.2, 4.7, 6.8, 10, 15, 22, 47, 68, 100, 220 K OHM.
 ONLY 3p EACH

KNOBS
 SILVER METAL PUSH ON WITH POINTER, OR WHITE PLASTIC, GRUB SCREW, WITH POINTER AND SILVER CENTRE 5p EACH.

ZM1162A INDICATOR TUBE
 0-9 Inline End View. Rectangular Envelope 170V 2.5M/A £1.70

RESETTABLE COUNTER
 English Numbering Machines LTD.
 MODEL 4436-159-989
 6-14 volt, 6 digit, illuminated, fully enclosed. £2.50

THE RADIO SHACK

161 ST. JOHNS HILL, BATTERSEA, LONDON S.W.11
 Open 10 a.m. till 7 p.m. Monday to Saturday Phone 01-223 5016
 If payment by cheque allow time for clearance, otherwise by return.

3 pin din to open end, 1 1/2yd twin screened lead 35p
 10 mtrs loudspeaker extension lead fitted 2 pin din plug and socket 40p (retail 80p)

SEMICONDUCTORS

Full spec. marked by Mullard, etc. Many other types in stock

AC127 .. 12p	BC159C .. 13p	BF178 .. 25p
AC187/8 .. 12p	BC178 .. 14p	BF179 .. 30p
AD149 .. 35p	BC186/7 .. 22p	BF180 .. 20p
AD161/2 .. 26p	BCY40 .. 25p	BF181/2 .. 32p
AF116/7 .. 12p	BCY70 .. 13p	BF183 .. 28p
AF124/7 .. 20p	BCY71 .. 12p	BF184/5 .. 17p
AF139 .. 31p	BCY72 .. 8p	BF194/5/6/7 .. 12p
AF178 .. 32p	BD115 .. 62p	BF200 .. 32p
AF180 .. 40p	BD131 .. 40p	BF262/3 .. 22p
AF239 .. 37p	BD132 .. 50p	BF336 .. 28p
BC107A or B .. 10p	BD135 .. 33p	BFX29/30 .. 26p
BC107/8/9 .. 7p	BD203 .. £1.00	BFX84 .. 24p
BC108A/B .. 10p	BD232 .. 65p	BFX88 .. 24p
BC147/8/9 .. 8p	BD234/5 .. 48p	BFY50/1/2 .. 13p
BC148B/9B .. 10p	BF115 .. 20p	BSV64 .. 40p
BC157/8/9 .. 11p	BF167 .. 20p	BSX21 .. 20p
BC158A .. 13p	BF173 .. 20p	BU105/01 .. £1.30

OC35 .. 34½p	2N2904 .. 18p
TAA570 .. 1-50p	2N2905 .. 22p
TAD100 .. 1-25	2N2906 .. 15p
2N706 .. 10p	2N2907 .. 20p
2N2219 .. 20p	2N3053 .. 16p
2N2401 (ASY26-27) 25p	

BRIDGE RECTIFIERS

Amp	Volt RMS		Amp	Volt RMS	
½	1,600	BYX10 .. 30p	2	30	LT120 .. 30p
1	140	OSH01-200 .. 25p	0.6	6-110	EC433
1.4	42	BY164 .. 35p	Encapsulated with built-in heat sink .. 15p		

1 AMP RECTIFIERS

IN4002	100 volt	4p
IN4003	200 volt	5p
IN4004	400 volt	6p
IN4005	600 volt	7p
IN4006	800 volt	8p
IN4007	1,000 volt	8p

HIGH POWER RECTIFIERS

	Amp	Volt	
SR100	1.5	100	7p
SR400	1.5	400	8p
LT102	2	30	10p
BYX38-600	2.5	600	25p
BYX38-300	2.5	300	20p
BYX38-900	2.5	900	28p
BYX38-1200	2.5	1,200	30p
BYX49-600	2.5	600	25p
BYX49-300	2.5	300	20p
BYX49-900	2.5	900	28p
BYX48-300	6	300	27p
BYX48-600	6	600	32p
BYX48-900	6	900	40p
BYX48-1200	6	1,200	60p
BYX72-150R	10	150	24p
BYX72-300R	10	300	35p
BYX72-500R	10	500	43p
BYX42-300	10	300	40p
BYX42-600	10	600	45p
BYX42-900	10	900	55p
BYX42-1200	10	1,200	75p
BYX46-300*	15	300	£2.50
BYX46-400*	15	400	£2.90
BYX46-500*	15	500	£3.20
BYX46-600*	15	600	£3.80
BYX20-200	25	200	35p
BYX52-300	40	300	£1.75
BYX52-1200	40	1,200	£2.25

*Avalanche type

N50 ohm free plug (UG21D/U)	50p
N50 ohm square socket (UG58A/U)	50p
1" Terryclips black plastic coated, or chrome finish	4p
Cinch 10-way terminal block	15p
Pair of LA2407 Ferroxcor cores with adjuster	25p
Chrome Car Radio fascia	15p
Rubber Car Radio gasket	10p
DLI Pal Delayline	£2.00
Relay socket	12p
Take miniature 2PCO relay	
B9A valve can	2p
0-30 in .5 segments, black pvc, 360° dial, silver digits, self adhesive, 4½" dia.	15p

OPTO ELECTRONICS

ORP12	48p	Photo transistor	
BPX40	25p	BPX29	80p
BPX42	£1	OCF71	£1
BPY10	£1.50		
BPY68	75p	RED L.E.D.	
BPY69	£1	2v 50m/A max.	
BPY77	75p	4½ mm diam.	
	Diodes		25p

PNP PROGRAMMABLE UNIJUNCTION

BRY39	30p
F.E.T.'s	
BFW10	25p
BSV79	90p
BSV80	80p

N. Channel

BSV81 M.O.S.T.	£1
BFS28 Dual M.O.S.T.	90p
Plastic, Transistor or Diode Holder .. 1p	
Transistor or Diode Pad 1p	
Holders or pads .. 50p per 100	

Phillips Iron Thermostat	15p
Bulgin 2-pin flat plug and socket	10p
McMurdo PP108 8 way edge plug	15p
300 ohm moving coil insert 4103D 1½" diameter. Make ideal mike or speaker for communication work	25p

Tested unmarked or marked ample lead ex new equipment

AC128	6p	OC200-5	6p
ACY17-20	8p	2G302	6p
AS28/9	8p	2N2926	5p
ASZ21	8p	2N598/9	6p
BCY70/1/2	8p	2N1091	8p
BCY30-34	10p	2N1302	8p
BY127	8p	Germ. diode	3p
BZY88 series	6p	GET111	20p
OA5/7/10	10p	GET120	
OA47/81	4p	(AC128 In 1"sq. heat sink)	20p
OA200-5	5p	100v 1 amp diode	3p
OC23	20p		
OC44	6p		
OC71/2	6p		

OTHER DIODES

Centercel	5p	5lb New Mixed Components	£2 plus 40p p & p
IN916	4p		
BA145	15p		
BA182	24p		

TRIACS

Amp	Volt	
25	900	BTX94-900 .. £6.50
25	1200	BTX94-1200 .. £9

CQ11B

Infra red transmitter £4

WESTINGHOUSE 28T10 30 AMP 1000VOLT THYRISTER WITHOUT NUT .. £5

PHOTO SILICON CONTROLLED SWITCH

BPX66 PNP 10 amp .. £1

DIAC BRI00 30p

PAPER BLOCK CONDENSER

0.25MFD	800 volt	30p
1MFD	400 volt	15p
2MFD	250 volt	20p
2MFD	1.5 kv	50p
4MFD	350 volt	20p
15MFD	150 volt	25p

METAL CHASSIS SOCKETS

Car Aerial	5p
Coax	6p
5 or 6 pin 240° din	6p

ALL ORDERS OVER £3 POST FREE OVER £8 V.A.T. FREE

TAA300 T0-74 1 Watt A.F. AMPLIFIER I.C. 4-5 to 9v .. £1.62½

WIREWOUND SLIDER

150 Ohm, 250 Ohm 5K 4p each

HANDLES

Rigid light blue nylon 6½" with secret fitting screws .. 5p

Rotor with neon indicator, as used in Seafarer, Pacific, Fairway depth finders .. 20p each

Miniature Axial Lead, Ferrite Choke formers .. 2p

DEE PLUG

McMurdo DA15P 15 way chassis plug .. 20p

Fairway 18009 Coax. socket .. 5p

TIE CLIPS

Nylon self locking 7" .. 2p

CINCH 150

12 way edge socket .. 10p

1lb Mixed nuts, bolts, washers etc. .. 25p

SMALL ORDERS, ENCLOSE SUITABLE STAMPED ADDRESSED ENVELOPE
LARGE ORDERS, ADD SUFFICIENT FOR POSTAGE, INSURANCE, ETC.
TOTAL GOODS PLUS CARRIAGE, ADD 10% V.A.T.

THE RADIO SHACK

161 ST. JOHNS HILL, BATTERSEA, LONDON S.W.11
 Open 10 a.m. till 7 p.m. Monday to Saturday Phone 01-223 5016

THE MODERN BOOK CO

HIGH FIDELITY AUDIO AMPLIFIER CIRCUITS

A Texas Instruments Applications Manual Price £1.10

SIMPLE SINGLE CHANNEL RADIO CONTROL by R. H. Warring	PRICE £1.60	PICTORIAL GUIDE TO TAPE RECORDER REPAIRS by F. H. Belt	PRICE £1.50
T.V. ENGINEERS' POCKET BOOK by P. J. McGoldrick	PRICE £2.65	RAPID SERVICING OF TRANSISTOR EQUIPMENT by G. J. King	PRICE £2.00
T.V. TECHNICIAN'S BRANCH MANUAL by G. R. Wilding	PRICE £2.65	SIMPLE TRANSISTOR PROJECTS FOR HOBBYISTS & STUDENTS by L. Steckler	PRICE £1.35
T.V. SERVICING HANDBOOK 3rd Ed. by Gordon J. King	PRICE £4.00	STEREO/QUAD HI-FI by Sessions	PRICE £1.45
IMPROVING YOUR HI-FI by John Earl	PRICE £3.15	HOW TO LISTEN TO THE WORLD by B.B.C.	PRICE £2.00
ELECTRONICS POCKET BOOK by J. P. Hawker	PRICE £1.70	TRANSISTOR AUDIO & RADIO CIRCUITS by Mullard	PRICE £1.90
HOW TO GET THE BEST OUT OF YOUR TAPE RECORDER by P. Guy	PRICE £1.60	COLOUR T.V. PICTURE FAULTS by K. J. Bohlman	PRICE £2.60
110 SEMICONDUCTOR PROJECTS FOR THE HOME CONSTRUCTOR by R. M. Marston	PRICE £1.30	PRINCIPLES & CALCULATIONS FOR RADIO MECHANICS PT I by R. A. Bravery	PRICE £1.60
UNDERSTANDING SOLID-STATE ELECTRONICS by Texas Instruments	PRICE £1.40	T.V. RECEIVER THEORY I by G. H. Hutson	PRICE £2.40

ALL PRICES INCLUDE POSTAGE

We have the Finest Selection of English and American Radio Books in the Country

19-21 PRAED STREET (Dept RC) LONDON W2 1NP

Telephone 01-723 4185

NOW AVAILABLE...

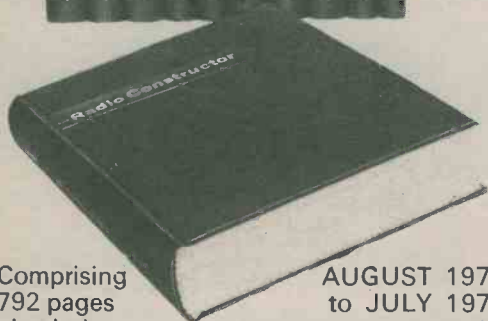

Comprising
792 pages
plus index

AUGUST 1972
to JULY 1973

**LATEST
BOUND VOLUME**

No. 26

of
**"Radio & Electronics
Constructor"**

FOR YOUR LIBRARY

PRICE £2.10 P&P 30p

BOUND VOLUME No. 24 (August 1970 to July 1971)
BOUND VOLUME No. 25 (August 1971 to July 1972)

Limited number of these
volumes still available.

PRICES £2.00 per Volume P & P 30p.

We regret all earlier volumes are now completely sold out.
Available only from

DATA PUBLICATIONS LTD., 57 MAIDA VALE, LONDON, W9 1SN

BI-PRE-PAK AUDIO BARGAINS



**8 TRACK
ONLY £11**

incl. P. & P. and VAT.

The latest B.S.R. 8 Track Cartridge Replay Deck. Ready to install in your Hi-Fi Stereo System. This unit comes complete with Hi Gain Stereo Pre-Amplifier, 4-Programme Indicator Lamps, Track Selector Switch, all leads and plugs, etc. for 230 volt A.C. mains operation.

3 W.R.M.S. I.C. AMP

only £1.65

Incl. P. & P. and V.A.T.
Order Code I.C.A. 1.

On P.C. Board with all components or 2 on one board for £2.86. Order Code I.C.A. 1/S. These amps are supplied with a free booklet on connecting up, specifications and easy to build projects using the I.C.A. 1.

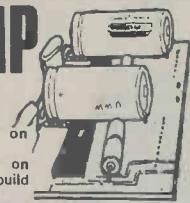

5W & 10W AMPS

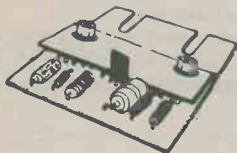

5W ONLY £1.98
10W ONLY £2.49

incl. P. & P. and VAT.

These matchbox size amplifiers have an exceptionally good tone and quality for the price. They are only 2 1/4" x 1 1/2". The 5W amp will run from a 12V car battery making it very suitable for portable voice reinforcement such as public functions. Two amplifiers are ideal for stereo. Complete connection details and treble, bass, volume and balance control circuit diagrams are supplied with each unit. Discounts are available for quantity orders. More details on request. Cheapest in the U.K. Built and tested.

Now available for 5 & 10W AMPS

Pre-assembled printed circuit boards 2" x 3" available in stereo only, will fit .15 edge connector.

Stereo Pre-Amp 1 (Pre 1). This unit is for use with low gain crystal or ceramic pick up cartridges. **£1.21**

Stereo Pre-Amp 2 (Pre 2) This unit is for use with magnetic pick-up cartridges. **£1.69**

Stereo Tone Control (STC). This unit is an active tone control board and when used with the right potentiometers will give bass and treble boost and cut. **£1.21**

Instruction leaflet supplied with all units. Post and Packing and VAT included in prices.

I enclose £..... for..... 8 Tracks/..... 3W

Amps/..... 5W Amps/..... 10W Amps/.....

Stereo Pre-Amps 1..... Stereo Pre-Amps 2.....

Stereo Tone Controls (Please insert quantities and delete those not applicable).

Name.....

Address.....

BI-PRE-PAK
Ca. Regn. No. 820919

Dept. C, 222/224, West Road,
Westcliff-on-Sea, Essex SS0 9DF
Tel: Southend (0702) 46344

Now! A FAST EASY WAY TO LEARN BASIC RADIO & ELECTRONICS



Build as you learn with the exciting new **TECHNATRON** Outfit! No mathematics. No soldering—you learn the *practical way.*

Learn basic Radio and Electronics at home - the fast, modern way. Give yourself essential technical 'know-how' - like reading circuits, assembling standard components, experimenting, building - quickly and without effort, and enjoy every moment. B.I.E.T.'s simplified study method and the remarkable **TECHNATRON** Self-Build Outfit take the mystery out of the subject, making learning easy and interesting.

Even if you don't know the first thing about Radio now, you'll build your own Radio set within a month or so!

... and what's more, you will understand exactly what you are doing. The **TECHNATRON** Outfit contains everything you need, from tools to transistors - even a versatile Multimeter which we teach you to use. All you need give is a little of your spare time and the surprisingly low fee, payable monthly if you wish. And the equipment remains yours, so you can use it again and again.

You LEARN - but it's as fascinating as a hobby.

Among many other interesting experiments, the Radio set you build - and it's a good one - is really a bonus. This is first and last a teaching course, but the training is as fascinating as any hobby and it could be the springboard for a career in Radio and Electronics.

A 14-year-old could understand and benefit from this course - but it teaches the real thing. The easy to understand, practical projects - from a burglar-alarm to a sophisticated Radio set - help you master basic Radio and Electronics - even if you are a 'non-technical' type. And, if you want to make it a career, B.I.E.T. has a fine range of courses up to City and Guilds standards.

Specialist Booklet

If you wish to make a career in Electronics, send for your **FREE** copy of "NEW OPPORTUNITIES". This brand new booklet - just out - tells you 'all about **TECHNATRON** and B.I.E.T.'s' full range of courses.

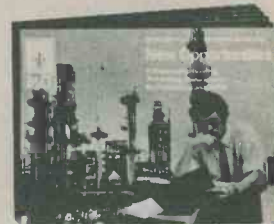

FREE

BRITISH INSTITUTE OF ENGINEERING TECHNOLOGY

Dept. BRE 23 ALDERMASTON COURT, READING

RG7 4PF

Accredited by C.A.C.C.

Member of A.B.C.C.

POST THIS COUPON FOR FREE BOOK

CL BRE 23

NAME..... AGE.....
(BLOCK CAPITALS)

ADDRESS.....

SUBJECT OF INTEREST.....

The Sinclair Cambridge... no other calculator is so powerful and so compact.

Complete kit-£24.95! (PLUS VAT)

The Cambridge – new from Sinclair

The Cambridge is a new electronic calculator from Sinclair, Europe's largest calculator manufacturer. It offers the power to handle the most complex calculations, in a compact, reliable package. No other calculator can approach the specification below at anything like the price – and by building it yourself you can save a further £5.50!

Truly pocket-sized

With all its calculating capability, the Cambridge still measures just $4\frac{1}{2}'' \times 2'' \times \frac{11}{16}''$. That means you can carry the Cambridge wherever you go without inconvenience – it fits in your pocket with barely a bulge. It runs on ordinary U16-type batteries which give weeks of life before replacement.

Easy to assemble

All parts are supplied – all you need provide is a soldering iron and a pair of cutters. Complete step-by-step instructions are provided, and our service department will back you throughout if you've any queries or problems.

The cost? Just £27.45!

The Sinclair Cambridge kit is supplied to you direct from the manufacturer. Ready assembled, it costs £32.95 – so you're saving £5.50! Of course we'll be happy to supply you with one ready-assembled if you prefer – it's still far and away the best calculator value on the market.



Features of the Sinclair Cambridge

- * Uniquely handy package. $4\frac{1}{2}'' \times 2'' \times \frac{11}{16}''$, weight $3\frac{1}{2}$ oz.
- * Standard keyboard. All you need for complex calculations.
- * Clear-last-entry feature.
- * Fully-floating decimal point.
- * Algebraic logic.
- * Four operators (+, -, x, ÷), with constant on all four.
- * Constant acts as last entry in a calculation.
- * Constant and algebraic logic combine to act as a limited memory, allowing complex calculations on a calculator costing less than £30.
- * Calculates to 8 significant digits, with exponent range from 10^{-20} to 10^{79} .
- * Clear, bright 8-digit display.
- * Operates for weeks on four U16-type batteries. (MN 2400 recommended.)

A complete kit!

The kit comes to you packaged in a heavy-duty polystyrene container. It contains all you need to assemble your Sinclair Cambridge. Assembly time is about 3 hours.

Contents:

1. Coil.
2. Large-scale integrated circuit.
3. Interface chip.
4. Thick-film resistor pack.
5. Case mouldings, with buttons, window and light-up display in position.
6. Printed circuit board.
7. Keyboard panel.
8. Electronic components pack (diodes, resistors, capacitors, transistor).
9. Battery clips and on/off switch.
10. Soft wallet.

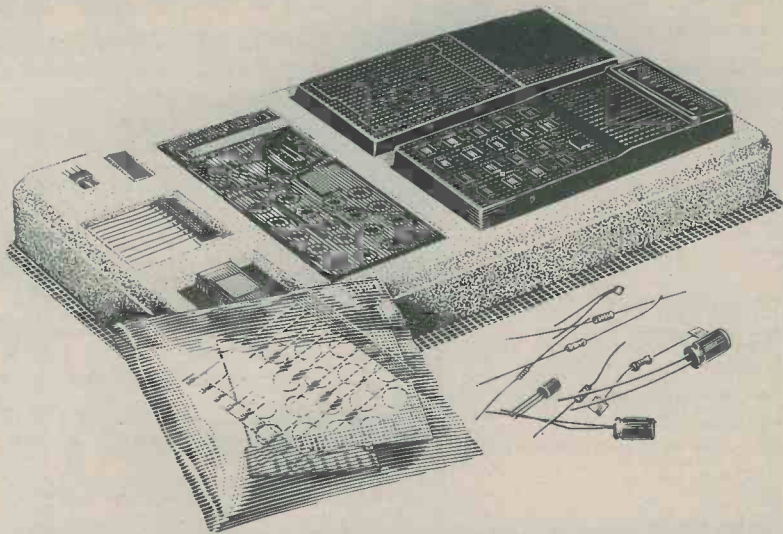

This valuable book – free!

If you just use your Sinclair Cambridge for routine arithmetic – for shopping, conversions, percentages, accounting, tallying, and so on – then you'll get more than your money's worth.

But if you want to get even more out of it, you can go one step further and learn how to unlock the full potential of this piece of electronic technology.

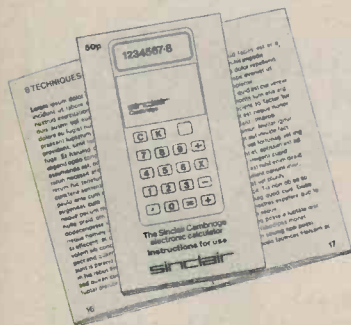

How? It's all explained in this unique booklet, written by a leading calculator design consultant. In its fact-packed 32 pages it explains, step by step, how you can use the Sinclair Cambridge to carry out complex calculations!

Why only Sinclair can make you this offer

The reason's simple: only Sinclair – Europe's largest electronic calculator manufacturer – have the necessary combination of skills and scale.

Sinclair Radionics are the makers of the Executive – the smallest electronic calculator in the world. In spite of being one of the more expensive of the small calculators, it was a runaway best-seller. The experience gained on the Executive has enabled us to design and produce the Cambridge at this remarkably low price.

But that in itself wouldn't be enough. Sinclair also have a very long experience of producing and marketing electronic kits. You may have used one, and you've almost certainly heard of them – the Sinclair Project 60 stereo modules.

It seemed only logical to combine the knowledge of do-it-yourself kits with the knowledge of small calculator technology.

And you benefit!

Take advantage of this money-back, no-risks offer today

The Sinclair Cambridge is fully guaranteed. Return your kit within 10 days, and we'll refund your money without question. All parts are tested and checked before despatch – and we guarantee a correctly-assembled calculator for one year.

Simply fill in the preferential order form below and slip it in the post today.

Price in kit form: £24.95 + £2.50 VAT. (Total: £27.45)
Price fully built: £29.95 + £3.00 VAT. (Total: £32.95)

To: Sinclair Radionics Ltd, London Road,
St Ives, Huntingdonshire, PE17 4HJ

REC/3774

Please send me

a Sinclair Cambridge calculator kit at
£24.95 + £2.50 VAT (Total: £27.45)

a Sinclair Cambridge calculator ready
built at £29.95 + £3.00 VAT
(Total: £32.95)

*I enclose cheque for £ _____, made
out to Sinclair Radionics Ltd, and
crossed.

*Please debit my *Barclaycard/Access
account. Account number _____

*Delete as required.

Name _____

Address _____

PLEASE PRINT

sinclair

Sinclair Radionics Ltd, London Road,
St Ives, Huntingdonshire
Reg. no: 699483 England
VAT Reg. no: 213 8170 88
MARCH 1974



WILMSLOW AUDIO

THE Firm for speakers!

SPEAKERS

Baker Group 25, 3, 8 or 15 ohm	£6.60
Baker Group 35, 3, 8 or 15 ohm	£7.50
Baker Group 50/12, 8 or 15 ohm	£12.50
Baker Deluxe	£9.75
Baker Major	£7.50
Baker Superb	£12.00
Baker Regent	£7.00
Celestion PST8 (for Unilex)	£2.55
Celestion MF1000 8 or 15 ohm	£10.45
Celestion HF 1300 Mk II	£6.16
Celestion G12M 8 or 15 ohm	£12.00
Celestion G12H 8 or 15 ohm	£15.00
Celestion G15C 8 or 15 ohm	£24.00
Celestion G18C 8 or 15 ohm	£33.00
EMI 13 x 8, 3, 8 or 15 ohm	£2.15
EMI 13 x 8 d/c 3, 8 or 15 ohm	£2.35
EMI 13 x 8 t/w 3, 8 or 15 ohm	£3.60
EMI 13 x 8 type 350 8 ohm	£8.25
EMI 8 x 5, cer. mag. 8 ohm	£1.65
EMI 8 x 5, 10 watt d/c roll surr. 8 ohm	£2.50
EMI 5 1/2" 93850 4 or 8 ohm	£2.80
EMI 5 1/2" 98132CP 8 ohm	£2.30
Elac 9 x 5, 59RM109 15 ohm, 59RM114 8 ohm	£2.65
Elac 6 1/2" d/c roll surr. 8 ohm	£3.35
Elac 6 1/2" d/cone 8 ohm	£2.65
Elac Tweeter TW4 4"	£1.21
Elac 10" 8 ohm	£2.65
Fane Pop 100 watt 18"	£22.50
Fane Pop 60 watt 15"	£13.00
Fane Pop 50 watt 12"	£11.00
Fane Pop 25/2 12"	£6.40
Fane Pop 15 watt 12"	£4.40
Fane Crescendo 12A or 12B	£29.00
Fane Crescendo 15	£36.00
Fane Crescendo 18	£47.50
Fane 807T 8" d/c roll surr. 8 or 15 ohm	£3.85
Fane 808T 8" d/c 8 or 15 ohm	£2.75
Goodmans 8P 8 or 15 ohm	£4.49
Goodmans 10P 8 or 15 ohm	£4.70
Goodmans 12P 8 or 15 ohm	£11.65
Goodmans 15P 8 or 15 ohm	£18.00
Goodmans 18P 8 or 15 ohm	£31.00
Goodmans 12P-D 8 or 15 ohm	£15.25
Goodmans 12P-G 8 or 15 ohm	£14.50
Goodmans 12AX Audiomax 8 or 15 ohm	£39.65

Goodmans Audiom 100	£9.50
Goodmans Axent 100	£6.60
Goodmans Axiom 401	£15.10
Goodmans Twinaxiom 8, 8 or 15 ohm	£6.79
Goodmans Twinaxiom 10, 8 or 15 ohm	£7.61
Kef T27	£4.75
Kef T15	£5.75
Kef B110	£6.75
Kef B200	£7.50
Kef B139	£11.75
Kef DN8	£1.92
Kef DN12	£4.12
Kef DN13	£2.75
Richard Allan 12" d/c 3 or 15 ohm	£2.50
Richard Allan CG8T 8" d/c 8 ohm	£6.35
WMTI speaker match, trans. 3-15 ohm	£1.10
Wharfedale Super 10 RS/DD	£9.80
2 1/2" 64 ohm, 70mm 8 ohm, 70mm 80 ohm	.65
7" x 4" 3, 8 or 15 ohm	£1.38
8" x 5" 3, 8 or 15 ohm	£1.38
10" x 6", 3, 8 or 15 ohm	£1.92
STC4001G Super Tweeter	£6.19

Peerless 20-2 (each)	£10.44
*Kefkit 2 (each)	£23.50
Kefkit 3 (each)	£34.00
Helme XLK 25 (pair)	£18.17
Helme XLK 50 (pair)	£37.18
Baker Major Module	£9.50
P.A. and HiFi speaker cabinets, Send for Free booklet "Choosing a Speaker".	
Car. and Insurance 75p per kit (£1.50 pair).	

PA/DISCO AMPLIFIERS

Carriage and Insurance £1.00	
Baker Major 100 watt	£46.00
Linear 30/40	£25.00
Linear 40/60	£30.00
Linear 80/100	£55.00

RADIOS/CASSETTES

Grundig Solo Boy	£16.00
Grundig Top Boy	£17.75
Grundig Party Boy 500	£22.75
Grundig Melody Boy 500	£26.75
Grundig Elite Boy 500	£26.75
Grundig Signal 500	£26.50
Grundig Yacht Boy 210	£34.00
Grundig Melody Boy 1000	£38.75
Grundig Satellit 2000	£121.00
Grundig C410 Cassette	£28.50
Grundig RF430 mains radio	£26.75
Grundig RF310 mains radio	£22.00
Tandberg TP41	£43.00
ITT Weekend Auto	£18.00
ITT Golf Preset	£24.50
ITT Colt	£11.50
ITT Europa	£20.50
ITT SL53 cassette	£25.75
ITT Studio 60M cassette	£32.75
ITT Studio 73 cassette	£48.00
Bush VTR178 5 band (inc. air)	£29.00
Koyo KTR1770 11 band	£58.95
Koyo KTR1663 or 1664 8 band	£42.00
Koyo KTR1883 5 band	£22.00
Murphy BA209 radio/cassette	£32.75

Carriage and Insurance 75p.
FREE with each radio - World radio stations book.

FREE With speaker orders over £7 "Hi-Fi Loudspeaker Enclosures" book.
All units guaranteed new and perfect. Prompt despatch.
Carriage and insurance 35p per speaker (tweeters and crossovers 20p)
ALL PRICES QUOTED INCLUDE V.A.T.

WILMSLOW AUDIO Department P.E.

LOUDSPEAKERS: SWAN WORKS, BANK SQUARE,
WILMSLOW, CHESHIRE. SK9 1HF

RADIOS ETC: 10 SWAN ST. WILMSLOW, CHESHIRE. SK9 1HF
TELEPHONE WILMSLOW 29599



AUDIO AMPLIFIERS

Edited by J. R. Davies

16 Transistor and Valve Designs for the Home
Constructor

124 pages

Amplifiers for Tuner Units, Record Players, Tape
Recorders, Public Address, etc., etc.

Includes contributions by such well-known authors as

A. S. Carpenter, A. Kinloch, E. Govier,
G. A. French, F. G. Rayer,
P. F. Bretherick, K. Jones, D. Aldous,
R. Murray-Shelley, C. Swires,
G. A. Stevens and V. E. Holley.

PRICE
53p

Postage 6p



BI-PRE-PAK

SUPPLIERS OF SEMI-CONDUCTORS TO THE WORLD



Telephone Corner

COMPLETE TELEPHONES
EX. G.P.O. NORMAL
HOUSEHOLD TYPE

Only **£1-05_p**

POST & PACKING 45p EACH
TELEPHONE DIALS

Standard Post Office type. Guaranteed in working order.

Only **27 1/2_p** POST & PACKING 16_p

Tested and Guaranteed Paks



TESTED AND GUARANTEED PAKS

B79	4	IN4007 Sil. Rec. diodes. 1,000 PIV lamp plastic	55p
B81	10	Reed Switches, 1" long, 3/8" dia. High speed P.O. type	55p
B99	200	Mixed Capacitors. Approx. quantity, counted by weight P & P 15p	55p
H4	250	Mixed Resistors. Approx. quantity counted by weight P & P 15p	55p
H35	100	Mixed Diodes, Germ. Gold bonded, etc. Marked and Unmarked.	55p
H38	30	Short lead Transistors, NPN Silicon Planar types.	55p
H39	6	Integrated Circuits, 4 Gates BMC 962, 2 Flip Flops BMC 945	55p
H41	2	Sil Power transistors comp pair BD131/132	55p



Unmarked Untested Paks

UNMARKED UNTESTED PAKS

B1	50	Germanium Transistors PNP, AF and RF	55p
B66	150	Germanium Diodes Min. glass type	55p
B84	100	Silicon Diodes DO-7 glass equiv. to OA200, OA202	55p
B86	100	Sil. Diodes sub. min. IN914 and IN916 types	55p
H16	15	Experimenters' Pak of Integrated Circuits. Data supplied	55p
H20	20	BY126/7 Type Silicon Rectifiers 1 amp plastic. Mixed volts.	55p
H34	15	Power Transistors, PNP, Germ. NPN Silicon TO-3 Can.	55p

Make a rev counter for your car

The 'TACHO BLOCK'. This encapsulated block will turn any 0-1mA meter into a linear and accurate rev. counter for any car with normal coil ignition system.

£1-10_p each

Ex GPO Push Button Intercom Telephones

Exactly as internal telephone systems still in everyday use where automatic internal exchanges have not yet taken over. Available in 5, 10 or 15 ways. Complete with circuits and instructions. Necessary 24 pair cable 22p per yard. Price of each instrument is independent of the number of ways.

£2.75 p.p. **38 1/2_p**

Per instrument

Cable can be sent by Parcel Post. Post and Packing per 50 yds: 73p.

Extension Telephones 71 1/2_p each p.p. 27 1/2_p £1.37 1/2 for 2 p.p. 55p.

These phones are extensions and do not contain bells.

A Cross Hatch Generator £3-85 paid

YES, a complete kit of parts including Printed Circuit Board. A four position switch gives X-hatch, Dots, Vertical or Horizontal lines. Integrated Circuit design for easy construction and reliability. This was a project in the September 1972 edition of Television.

New Paks

Tested & Guaranteed

H63	4	2N3055 Type NPN Sil. power transistors. Below spec. devices	55p
H64	4	3819 N Channel F.E.T.'s ZN3819 in plastic case	55p
H65	4	40361 Type NPN Sil. transistors TO-5 can comp. to H66	55p
H66	4	40362 Type PNP Sil. transistors TO-5 can comp. to H65	55p

Untested, Unmarked

H67	10	3819 N Channel F.E.T.'s plastic case type	55p
-----	----	-------------------------------------------	-----

Over 1,000,000 Transistors in stock

We hold a very large range of fully marked, tested and guaranteed transistors, power transistors, diodes and rectifiers at very competitive prices. Please send for free catalogue.

Our very popular 4p Transistors

TYPE "A" PNP Silicon alloy, TO-5 can.
TYPE "B" PNP Silicon, plastic encapsulation.
TYPE "E" PNP Germanium AF or RF.
TYPE "F" NPN Silicon plastic encapsulation.
TYPE "G" NPN Silicon similar ZTX 300 range
TYPE "H" PNP Silicon similar ZTX 500 range

8 RELAYS FOR £1-10_p p. & p. 27 1/2_p.

High Speed Magnetic Counter



4 digit (non reset) 24v or 48v (state which) 4 x 1 x 1 in. 33p p.p. 5p.

Plastic Power Transistors

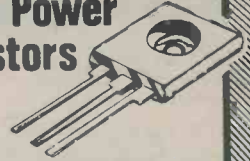

NOW IN TWO RANGES

There are 40W and 90W Silicon Plastic Power Transistors of the very latest design, available in NPN or PNP at the most shatteringly low prices of all time. We have been selling these successfully in quantity to all parts of the world and we are proud to offer them under our Tested and Guaranteed terms.

Range 1. VCE. Min. 15.		HFE Min 15.		
40 Watt	1-12	13-25	26-50	
90 Watt	22p	20p	18p	
	24p	24p	22p	
Range 2. VCE. Min 40.		HFE Min 40.		
40 Watt	1-12	13-25	26-50	
90 Watt	31p	31p	29p	
	38p	36p	33p	

Complementary pairs matched for gain at 3 amps. 11p extra per pair. Please state NPN or PNP on order.

LM 380 AUDIO I.C. as featured in Practical Wireless Dec. issue. Complete with application data £1.10.

INTEGRATED CIRCUITS

We stock a large range of I.C.s at very competitive prices (from 11p each). These are all listed in our FREE Catalogue, see coupon below.

METRICATION CHARTS now available

This fantastically detailed conversion calculator carries thousands of classified references between metric and British (and U.S.A.) measurements of length, area, volume, liquid measure, weights etc. Pocket Size 15p. Wall Chart 18p.

LOW COST DUAL IN LINE I.C. SOCKETS

14 pin type at 16p each } Now new low profile type
16 pin type at 18p each }

BOOKS

We have a large selection of Reference and Technical Books in stock.

Our famous P1 Pak is still leading in value

Full of Short Lead Semiconductors and Electronic Components, approx. 170. We guarantee at least 30 really high quality factory marked Transistors PNP & NPN, and a host of Diodes & Rectifiers mounted on Printed Circuit Panels. Identification Chart supplied to give some information on the Transistors.

Please ask for Pak P.1. only **55p**

Please send me the FREE Bi-Pre-Pak Catalogue

NAME _____

ADDRESS _____

All prices include 10% V.A.T.

MINIMUM ORDER 55p. CASH WITH ORDER PLEASE. Add 11p post and packing per order. OVERSEAS ADD EXTRA FOR POSTAGE

BUY THESE GOODS WITH ACCESS

BI-PRE-PAK LTD

Co Reg No B20919

Dept C, 222-224 WEST ROAD, WESTCLIFF-ON-SEA, ESSEX.
TELEPHONE: SOUTHEND (0702) 46344.

A SELECTION of the more unusual items from the famous HOME RADIO (Components) CATALOGUE...

LIGHT SENSITIVE DEVICES **SILICON PHOTO-VOLTAIC CELL**

Maker: FERRANTI

These cells were developed for the space programme. They may be used to power transistorised radios, small electric motors or operate light meters. For example, they will generate enough current to operate our SD104, SD105 and SD106 motors when exposed to 100 watt lamp. Although we give an output current and voltage these are nominal and taken in strong sunlight. The voltage will vary with the amount of current being consumed.

Cat. No.	Maker's No.	Maker	Volts	mA	Size
SD103	FRB150	Ferranti	1.1v	100	$\frac{1}{2} \times \frac{1}{2} \times .012$ in. (19 x 19 x .3 mm.)



SD103

PRICE (Including VAT and Postage) **£1.89**

SMALL ELECTRIC MOTORS

Cat. No.	Maker's No.	Size Dia. Length	Voltage
SD106	M5	33 x 28 mm.	6 V

Note: The SD106 will run off 2 of our SD103 Photo Voltaic silicon cells connected in series if illuminated by sunshine or 100-watt lamp at 1 ft.



SD106

PRICE (Including VAT and Postage) **£2.84**

SILICON GLASS TUBING

This tubing will withstand temperatures up to 250° C.

Cat. No.	Maker's No.	Length	Outside Dia.
8Z274	LTG54	6 in. (152 mm.)	2 in. (51 mm.)

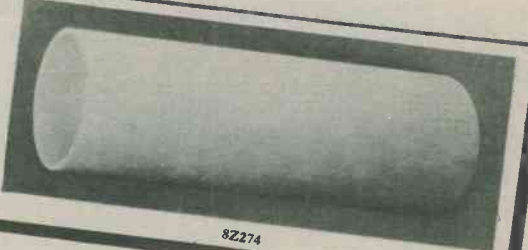

8Z274

PRICE (Including VAT and Postage) **£2.54**

When purchasing any of the above items, please state "As per your advertisement".

It goes without saying that our catalogue lists in profusion run-of-the-mill goods like Resistors, Capacitors, Pots and Coils, so we would like to bring to your notice one or two of the more exotic items. Take the first one... the SD103 cell. Apart from its rarity, it's very useful. Recently we built a little 3-transistor radio with loudspeakers, and we found that three of these cells would operate it. Regarding the mini motor and the silicon glass tubing, your ingenuity will immediately suggest ways

in which you can make good use of them. These are but 3 of *millions* (all right then - *thousands*) of exciting components in our catalogue. By now you are reaching for your pen and cheque book, but don't just buy the items shown here; get the catalogue and feast your eyes on all 240 pages. At 77 pence it's almost a gift - especially as by using the vouchers as directed you can reclaim 50p.

* Send now for catalogue

POST THIS COUPON
with cheque or P.O. for 77p.

The price of 77p applies only to catalogues purchased by customers in the U.K. and to BFPO addresses.

Please write your Name and Address in block capitals

NAME

ADDRESS



HOME RADIO (Components) LTD.
Dept. RC, 234-240 London Road, Mitcham CR4 3HD

Regd. No.
912966
London

RADIO & ELECTRONICS CONSTRUCTOR

MARCH 1974

Vol. 27 No. 8

Published Monthly (1st of Month)
First Published 1947

Incorporating The Radio Amateur

Editorial and Advertising Offices
57 MAIDA VALE LONDON W9 1SN

Telephone 01-286 6141 Telegrams
Databux, London

© Data Publications Ltd., 1974. Contents may only be reproduced after obtaining prior permission from the Editor. Short abstracts or references are allowable provided acknowledgement of source is given.

Annual Subscription: £2.70 (U.S.A. and Canada \$7.00) including postage. Remittances should be made payable to "Data Publications Ltd". Overseas readers please pay by cheque or International Money Order.

Technical Queries. We regret that we are unable to answer queries other than those arising from articles appearing in this magazine nor can we advise on modifications to equipment described. We regret that such queries cannot be answered over the telephone; they must be submitted in writing and accompanied by a stamped addressed envelope for reply.

Correspondence should be addressed to the Editor, Advertising Manager, Subscription Manager or the Publishers as appropriate.

Opinions expressed by contributors are not necessarily those of the Editor or proprietors.

Production.—Web Offset.

CONTENTS

CRYSTAL CALIBRATOR by K. J. Dorrell	466
TRADE NEWS	471
NEWS AND COMMENT	472
DUAL-TONE OSCILLATOR (Suggested Circuit 280) by G. A. French	474
TR3 REFLEX RADIO by A. Sapciyan	476
THE 'WYVERN' LOW VOLTAGE POWER SUPPLY by John R. Green	479
AUDIO FREQUENCY METER by A. P. Roberts	484
RECENT PUBLICATIONS	489
LISTENING TO OSCAR by Arthur C. Gee	490
SWITCH-OFF REMINDER by S. Jeffrey	492
SHORT WAVE NEWS – For Dx Listeners by Frank A. Baldwin	494
ELECTRONIC CANDLE by K. H. Fordham	496
IN YOUR WORKSHOP Monochrome TV Receivers	498
THE FETRON by J. B. Dance	505
NEW PRODUCT	506
RADIO TOPICS by Recorder	507
CONSTRUCTOR'S DATA SHEET No. 84 (Audio Output Powers)	iii

Published in Great Britain by the Proprietors and Publishers, Data Publications Ltd, 57 Maida Vale, London, W9 1SN

The Radio & Electronics Constructor is printed by Carlisle Web Offset.

APRIL ISSUE WILL BE
PUBLISHED ON 1st APRIL

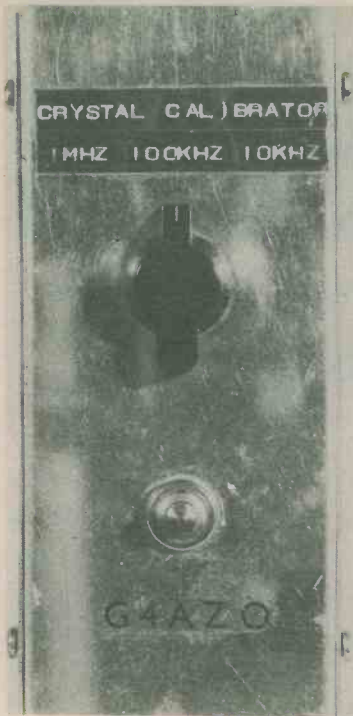

CRYSTAL CALIBRATOR

by

K. J. Dorrell, G4 AZO

This neat unit employs a single 1MHz crystal and can be switched to produce frequency markers at intervals of 1MHz, 100kHz or 10kHz.

ONE OF THE PIECES OF EQUIPMENT WHICH IS REGARDED as essential for any amateur radio station, and which can also be a very useful addition to any short wave listener's 'shack', is a crystal marker with which to check the calibration of a communications receiver.

CRYSTAL CONTROLLED OSCILLATOR

The block diagram of a simple crystal calibrator is shown in Fig. 1. This comprises a crystal controlled oscillator, running typically at 1MHz, followed by a waveform clipper which gives an output at the fundamental frequency of 1MHz together with its harmonics. When the output of the unit is connected to the aerial socket of a receiver, the signal can be used to mark the positions on the tuning scale which correspond to 1MHz, 2MHz, 3MHz and so on. If the b.f.o. of the receiver is switched on and set to zero beat with incoming signals, the receiver can be tuned to the crystal calibrator output, and thus be accurately set to any multiple of 1MHz.

A calibrator of the type shown in Fig. 1 can be very useful, but it does have its limitations. For example, the 80 metre amateur band extends from 3.5 to 3.8MHz, with the result that neither edge of the band can be marked by the calibrator. Amateur transmitting licensing conditions state that the operator must be able to prove that any signals radiated are within the band in use. It is possible, of course, to use a 100kHz crystal instead of the 1MHz unit, and this would give signals at 100kHz, 200kHz, 300kHz, and so on up to 3.5MHz, 3.6MHz, 3.7MHz and 3.8MHz, etc. It has, however, been the writer's experience that 100kHz crystals tend to



Fig. 1. A simple crystal calibrator offering an output at 1MHz and its harmonics

be less stable in terms of frequency than 1MHz crystals, and are rather more difficult to bring reliably into oscillation. Also, many receivers do not have accurately calibrated bandspread on the higher frequencies, and difficulty could be experienced in deciding to which harmonic of 100kHz the receiver is tuned. Clearly it would be advantageous to have markers available at 1MHz, 100kHz and, for accurate 'spotting', 10kHz intervals. However, crystals tend to be expensive, and 10kHz crystals are not generally available. For some time the author used a surplus twin crystal (1MHz and 100kHz) in a calibrator offering outputs at 1MHz and 100kHz and their harmonics, but the arrangement was never very satisfactory due to the fact that the crystal was quite a few cycles off frequency and no trimming would persuade it to oscillate at the correct frequency.

The unit described in this article uses a single and reliable HC6U 1MHz crystal and by use of frequency dividers, gives marker points at 100kHz and 10kHz intervals in addition to the 1MHz intervals. It is accurate to a sufficiently close tolerance for most amateur work. The crystal is readily available, and may, for instance, be obtained from Henry's Radio, Ltd.

RADIO & ELECTRONICS CONSTRUCTOR

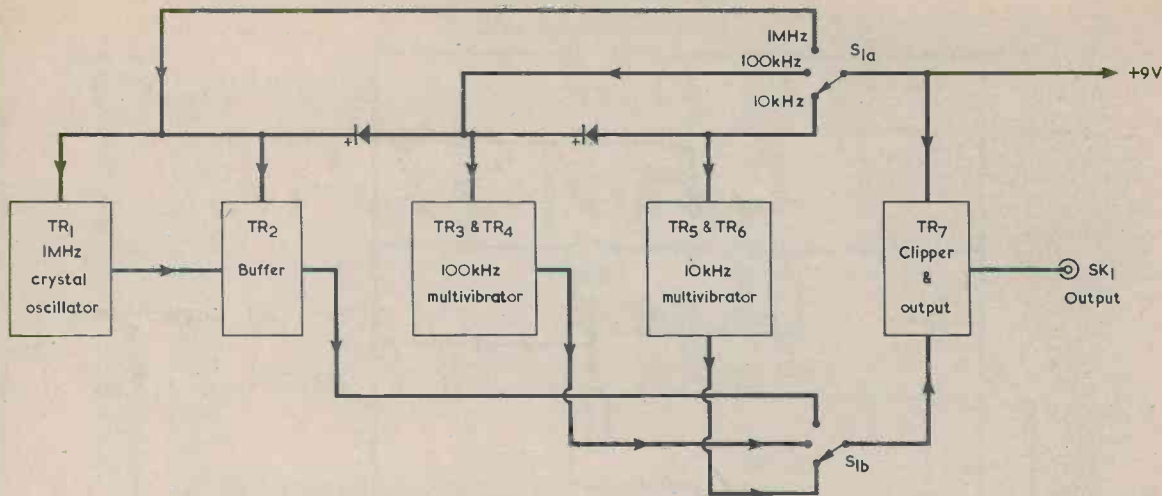

Fig. 2. Block diagram of the calibrator described in this article

THE CIRCUIT

The block diagram of the calibrator is shown in Fig. 2. When marker points at 1MHz are required, an output is taken, via the buffer stage, from the crystal oscillator. A 100kHz multivibrator, synchronised with the 1MHz crystal oscillator, is used to give 100kHz marker points. To achieve this synchronisation, the

multivibrator is set up to approximately 100kHz and a small amount of 1MHz signal is fed to the collector of one of the multivibrator transistors.

The 10kHz signal is obtained from a 10kHz multivibrator, this being locked onto the signal from the 100kHz multivibrator which, in turn, is locked onto the highly stable 1MHz oscillator. Whichever signal is selected is passed to the clipper and output stage and thence to the output socket. The two diodes in the positive supply line ensure that only the 1MHz oscillator and buffer stage are operating when the 1MHz output is selected, that the 100kHz multivibrator is brought into use when the 100kHz output is required, and that both multivibrations are running for the 10kHz output. In the practical circuit the two diodes are silicon types, with the result that the supply voltage to the crystal oscillator drops slightly when switching from 1MHz to 100kHz, and drops again when switching from 100kHz to 10kHz. These supply voltage changes cause no measurable change in crystal oscillator frequency.

The complete circuit diagram of the calibrator unit is shown in Fig. 3. C2 allows the frequency of the crystal oscillator to be 'trimmed' over a few cycles so that it can be brought 'dead on'. The crystal controlled oscillator, TR1, is the heart of the calibrator, and it is connected in a Colpitts circuit with feedback given by C4 and C5. TR1 is followed by the buffer stage incorporating TR2. TR3 and TR4 form the 100kHz multivibrator, the frequency of which is adjustable over a small range by means of VR1. The 10kHz multivibrator is given by the circuit incorporating TR5 and TR6, with VR2 providing frequency control. The 10kHz multivibrator is a little asymmetric, since R11 and R12 have slightly different values. It was found that if both these resistors were made 39k Ω VR2 slider had to be set near one end of its track, and if they were both made 47k Ω VR2 slider had to be set near the other end of its track. Thus, to allow the final setting in VR2 to be approximately central, and to avoid delving into the E24 range of resistor values, it was decided to make R11 39k Ω and R12 47k Ω . All the multivibrator frequency-determining component values are those which have been found to give the correct frequencies in practice.

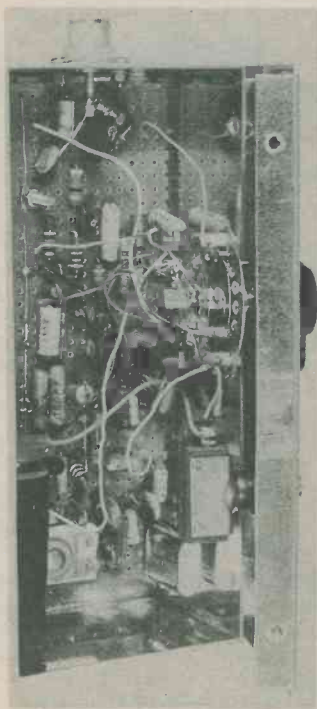

A view inside the unit with the front panel removed. The battery, covered with black insulating tape, is partly visible alongside the trimmer

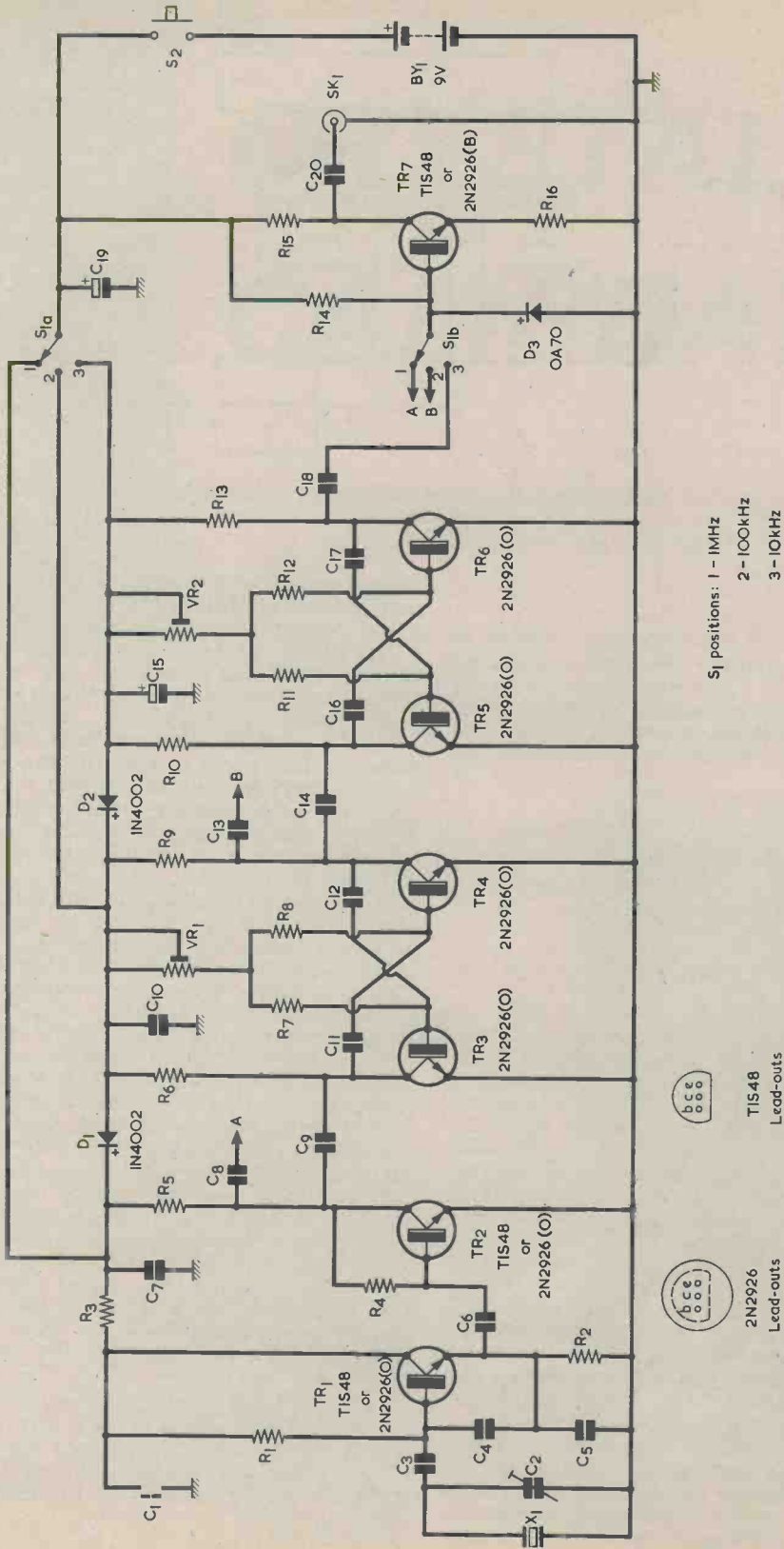

S1 positions: 1 - 1MHz
 2 - 100kHz
 3 - 10kHz

 2N2926
 Lead-outs

 TIS48
 Lead-outs

Fig. 3. Complete circuit of the calibrator unit. This offers outputs at 1 MHz, 100kHz and 10kHz

COMPONENTS

Resistors

(All fixed values $\frac{1}{4}$ watt 10%)

R1	220k Ω
R2	1k Ω
R3	1k Ω
R4	330k Ω
R5	4.7k Ω
R6	5.6k Ω
R7	82k Ω
R8	82k Ω
R9	5.6k Ω
R10	4.7k Ω
R11	39k Ω
R12	47k Ω
R13	4.7k Ω
R14	330k Ω
R15	5.6k Ω
R16	47 Ω
VR1	25k Ω miniature skeleton, vertical mounting
VR2	25k Ω miniature skeleton, vertical mounting

Capacitors

C1	0.01 μ F plastic foil
C2	30pF mica trimmer (see text)
C3	30pF silvered mica (see text)
C4	100pF silvered mica
C5	1,000pF silvered mica
C6	33pF silvered mica or ceramic
C7	0.022 μ F plastic foil
C8	10pF silvered mica or ceramic
C9	100pF silvered mica or ceramic
C10	0.1 μ F plastic foil
C11	100pF silvered mica
C12	100pF silvered mica
C13	15pF silvered mica or ceramic
C14	120pF silvered mica or ceramic

C15	10 μ F electrolytic, 12 V.Wkg.
C16	1,000pF silvered mica
C17	1,000pF silvered mica
C18	470pF silvered mica or ceramic
C19	12 μ F electrolytic, 12 V.Wkg.
C20	100pF silvered mica or ceramic

Semiconductors

TR1	TIS48 or 2N2926(0)
TR2	TIS48 or 2N2926(0)
TR3	2N2926(0)
TR4	2N2926(0)
TR5	2N2926(0)
TR6	2N2926(0)
TR7	TIS48 or 2N2926(B)

D1	1N4002
D2	1N4002
D3	OA70

Crystal

X1	1MHz crystal type HC6U
----	------------------------

Switches

S1(a)(b)	2-pole 3-way rotary
S2	Press-button

Socket

SK1	Coaxial socket
-----	----------------

Battery

BY1	9-volt battery type PP3 (Ever Ready)
-----	--------------------------------------

Miscellaneous

Chassis, with base,	6 $\frac{1}{4}$ \times 2 $\frac{3}{4}$ \times 2 in. (see text)
Veroboard panel,	0.15 in. matrix (see text)
Battery connectors	
Pointer knob	

The power switching diodes, D1 and D2, have already been mentioned. When S1(a) is switched to the 1MHz position, power from the battery is supplied to TR1 and TR2, the supply to the multivibrators being blocked by D1. When S1(a) is in the 100kHz position, power is supplied to TR1, TR2, TR3 and TR4, the supply to TR5 and TR6 being blocked by D2. Switching S1(a) to the 10kHz position causes power to be fed to all the transistors TR1 to TR6. The battery is switched on by push-button S2, and the clipper and output transistor, TR7, is powered for all positions of S1(a)(b). S1(b) selects the output of the crystal oscillator after the buffer stage, the 100kHz multivibrator or the 10kHz multivibrator as appropriate.

CONSTRUCTION

All the components apart from the switches and output socket are mounted on a piece of 0.15 in. Veroboard having 37 holes by 12 holes and with the copper strips running along the short direction. The strips are cut at the points indicated in Fig. 4, which also shows the component layout. The view is from the component side. The board is mounted, with two countersunk 6BA bolts and using insulated spacing pillars, in a chassis measuring 6 $\frac{1}{4}$ by 2 $\frac{3}{4}$ by 2 in. The chassis is a 'K' type, available from H. L. Smith & Co. Ltd., 287/289 Edg-

ware Road, London, W.2, and is provided with a detachable base having flanges on its long sides which pass inside the chassis. The base is secured by four self-tapping screws. In the present application, the chassis is turned upside-down so that the base becomes the front panel. The switches are mounted on this front panel, and flexible leads connect them up to the circuit board, the leads being just sufficiently long to enable the panel to be removed and set alongside the chassis. Holes for the coaxial output socket are required at the end of the chassis which is adjacent to TR7.

It is best to drill the mounting holes in the Veroboard first, these being used as guides for the drilling of the corresponding holes in the chassis. If the Veroboard is positioned such that the lower long end in Fig. 4 is against the side of the chassis, there should be sufficient room for the battery between the other long side of the Veroboard and the opposite chassis side. The two mounting holes for the screws which secure the Veroboard are countersunk on the outside.

The crystal is soldered to the circuit board along with the associated trimmer capacitor, the latter being a mica compression type in the prototype. However, these tend to be a little unstable over wide temperature ranges, causing typical errors in the oscillator frequency of about 2 parts per million (i.e. 2Hz at 1MHz). The author finds this sort of error tolerable, but it is

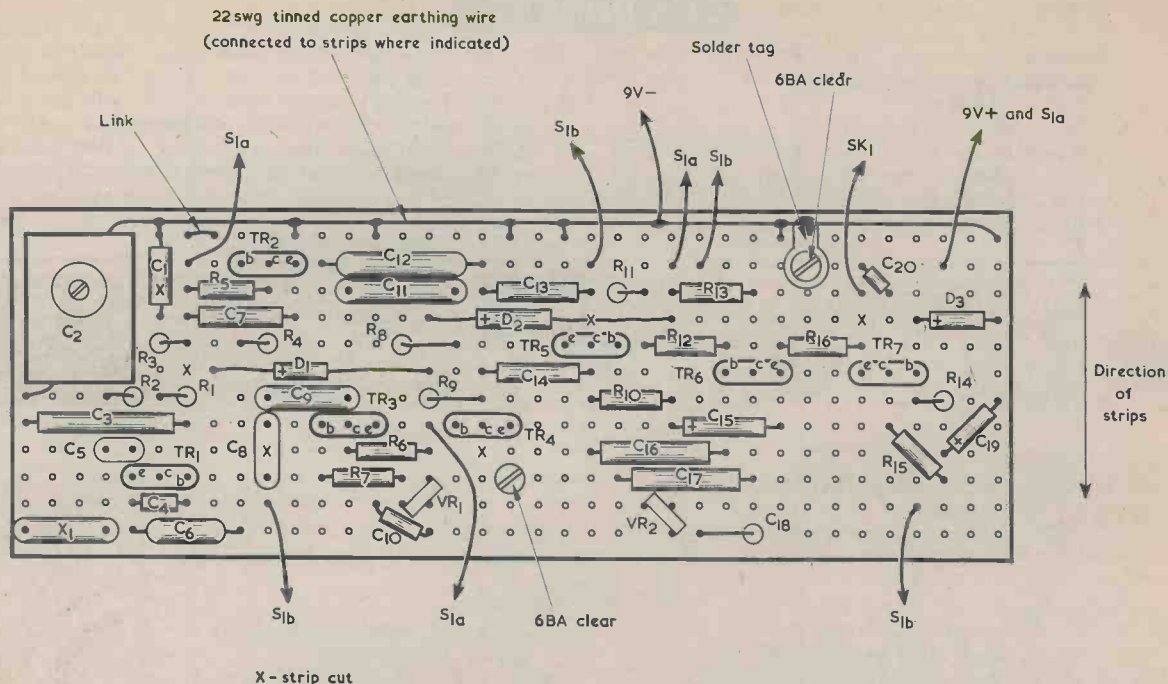

Fig. 4. Layout of components on the Veroboard. This view is from the component side of the board.

probable that an improvement would result if a Mullard concentric trimmer were employed instead.

Most of the capacitors are not critical with regard to type. The main exceptions are C3, C4 and C5, which should be silvered mica. Also C11, C12, C16 and C17 should have a reasonably close tolerance and it would be preferable to use silvered mica components here as well. The preset variable resistors, VR1 and VR2, are miniature skeleton, vertical mounting.

A 22 s.w.g. tinned copper wire runs the length of the board and provides earthing at the strips indicated in Fig. 4. It connects to the chassis by way of the adjacent mounting bolt between R13 and C20.

If the Veroboard is mounted in the manner just described, the battery should fit tightly between the Veroboard and the side of the case. It is best to leave clearance for it and to increase its size by winding insulating tape round it until it is a tight fit. The insulation tape also prevents accidental short-circuits between the metal case of the battery and other components if, for any reason, it should become dislodged. Despite its small size the battery should last a long time as the unit will not be running continually. At the time of writing the prototype has been in use for six months and has not yet required a new battery.

SETTING UP

The setting up of the calibrator should not be complicated if the following procedure is used. All that is needed is the communications receiver with which the calibrator is to be used, the receiver being coupled to a reasonable aerial. The b.f.o. of the receiver is switched on and S1 of the calibrator is set to the 1MHz position. The output of the calibrator is connected to the input

of the receiver and is turned on by pressing S2. On tuning the receiver, marker points should be heard at 1MHz intervals. These markers will be very strong, so it is advisable to set the receiver r.f. gain at minimum.

The receiver is next tuned to zero beat with the marker point at 5MHz and the calibrator is turned off and disconnected from the receiver. The aerial is now connected to the receiver and the r.f. gain turned up. The 5MHz transmissions of the National Physical Laboratory station MSF, at Rugby, should be heard anywhere in the U.K., but some patience may be necessary as the station only transmits during alternate periods of approximately 5 minutes each. For the first 5 minutes of each hour, MSF transmits carrier and seconds pulses, after which there is no transmission until 9½ minutes after the hour. Between 9½ minutes and 10 minutes after the hour, the station transmits its call-sign and frequency offset (which can be neglected as it is so small) three times in slow Morse, then sends carrier and seconds pulses from 10 to 15 minutes after the hour. The cycle then repeats throughout the hour.

The MSF carrier should be tuned in and, if possible, the b.f.o. switched off. The calibrator is next loosely coupled to the aerial by placing a short wire from the centre connector of the output coaxial socket close to the aerial input terminals of the receiver. When S2 is pressed, the signal from the calibrator should be heard simultaneously with the signal from MSF. Trimmer C2 is then adjusted until the two signals are at zero beat. As this point is approached the beat note becomes subsonic but can be detected as a fading and strengthening of the background hiss. C2 is adjusted to make the length of the fading and strengthening cycle as long as is possible. If the correct adjustment cannot be found it may be necessary to reduce the value of C3 slightly, for

example to 27pF.

The oscillator has now been accurately set to 1MHz. The multivibrators have next to be adjusted to their correct operating frequencies. The calibrator is coupled to the receiver and two consecutive 1MHz marker points, such as 4MHz and 5MHz, are tuned in and their positions noted on the tuning scale. S1 on the calibrator is then switched to the 100kHz position. More marker points should be heard now. VR1 should be adjusted until there are nine of these new marker points between the 1MHz markers, i.e. between and not including the

tuning scale positions noted. The new marker points should be very stable.

A similar procedure is used to adjust the 10kHz multivibrator, except that nine new markers are required between a pair of 100 kHz points. It is as well to check that the 100kHz multivibrator is still on frequency when S1 is in the 10kHz position. This is done by ensuring that there are ninety-nine of the 10kHz markers between any pair of 1MHz markers. If there are not, the 100kHz multivibrator should be checked and readjusted. ■

Trade News . . .

CONTACTLESS CAR IGNITION SYSTEM

Jermyn Distribution of Vestry Estate, Sevenoaks, Kent, are putting on to the market, a new contactless car ignition system which provides greatly increased performance when fitted to cars with 4, 6 or 8 cylinders.

The system totally eliminates the contact breaker, the most frequent cause of trouble in conventional ignition systems. Not only is the contact breaker likely to lead to a deterioration in performance due to build up of dirt and pitting and to gradual changes in timing as well as dwell angle but, more important, the contact breaker is incapable of giving good engine performance at high engine speeds due to such factors as contact bounce.

The new Jermyn electronic ignition system - known as System E - employs a proximity sensor in place of the contact breaker which monitors the precise position of the lobes on the distributor cam and supplies this information to the electronic control unit. At precisely the correct moment, at all engine speeds, the control unit supplies a uniform spark of 30 kV via the existing ignition coil.

As a result, it is claimed, plugs last up to approximately three times longer, fuel consumption is reduced, more power is available due to better fuel combustion and cold starting is easier. Even when on a cold morning the oil is like treacle and the battery voltage is down,

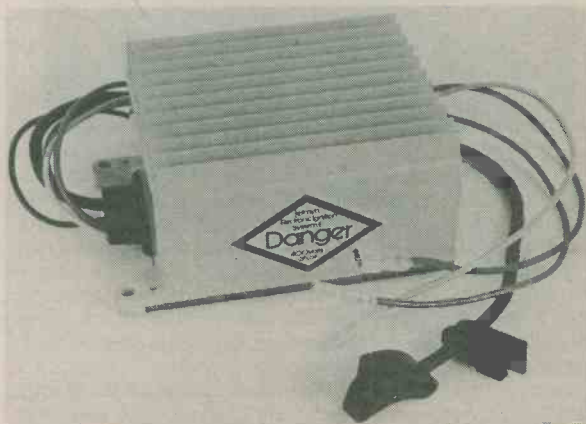

the Jermyn System E supplies a fast rise-time high voltage pulse to the sparking plugs to make cold starting child's play.

The chance of a flat battery through repeated attempts to start the engine is very much reduced.

System E is easy to fit and normally takes under an hour. It costs £22.00 including VAT, and comes complete with comprehensive instructions. Jermyn need to know the make, model and year of the car.

LIGHT INTENSITY CONTROLS

A range of One, Two and Three Gang dimmer switches have been introduced by Lab-Craft.

Designed to replace the standard pattern light switches fitted in virtually every modern house, these attractively produced and packaged units fit straight

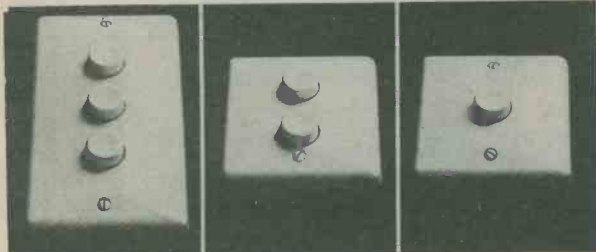

into a metal light switch box.

The design features on/off switching by depressing the control knob, and progressive intensity control by rotating the same knob. Control is from the minimum of 6 watts (a faint glimmer) at the lowest phase, through to the maximum light output of the bulbs fitted.

Radio interference suppression is built-in, and the unit is moulded in Noryl flame retarded plastic. All three work from normal 220-250 volts input. *One Gang Unit*: Rec. Retail price £5.50 inc. VAT. *Two Gang Unit*: Rec. Retail price £10.95 inc. VAT. *Three Gang Unit*: Rec. Retail price £16.45 inc. VAT. These controls are available from electrical factors and wholesalers throughout the country, or for further information contact the manufacturer: Lab-Craft Ltd., Church Road, Harold Wood, Essex.

FREQUENCY SHIFTER PREVENTS POSSIBLE FEEDBACK



In any public address system where the microphones and loudspeakers are in the same vicinity acoustic feedback occurs if the amplification exceeds a critical value. By shifting the audio spectrum fed to the speakers by a few Hertz the tendency at room resonance frequencies is destroyed and an increase in gain of 6-8dB is possible before the onset of feedback. The 5Hz shift used is imperceptible on both speech and music.

Surrey Electronics of 24 High Street, Merstham, Redhill, Surrey supply complete shifter units for both balanced and unbalanced systems having a signal overload LED, a shift-bypass switch, a PS4491 mains connector, jack or Cannon XLR audio connectors and are housed in strong weatherproof diecast boxes with an attractive durable blue acrylic finish.

A royalty is paid to the University of Manchester Institute of Science and Technology where the original development work was done.

Also available are mains-powered fibreglass shifter circuit boards at £29 for building into public address and discotheque equipment.

HEATHKIT INTRODUCE AUDIO SCOPE

The new Heathkit AD-1013 Audio Scope is a sophisticated solid-state instrument especially designed for use with any 2-channel or 4-channel stereo system to provide visual checking and monitoring of such parameters as channel separation, phasing, relative signal strengths, multipath reception, centre-tuning of receivers and tuners - all this at kit-form savings.

A built-in four-channel decoder gives independent or simultaneous visual indication of all four channels. Triggered sweep assures a stable, jitter-free signal trace. An automatic base line generator displays a straight line across the CRT screen when no signal is present. Inputs are provided on the rear panel for Left-Front, Left-Back, Right-Front, Right-Back and Multipath. Any of these inputs can be switched and observed on the screen, independently or in combination. Lighted function indicators at the edge of the CRT screen on the front panel show at a glance what function is being displayed.

A front panel input is provided for observing any external signal, permitting use of the AD-1013 as a conventional oscilloscope for checking out equipment malfunctions. A built-in independent 20 Hz to 20 kHz low distortion audio oscillator provides a convenient means of adjusting and checking any stereo system. Front panel controls are provided for frequency selection of the audio oscillator as well as controlling the amplitude of the generated signal.

The Heathkit AD-1013 Audio Scope is a valuable piece of audio gear - and a satisfying kit to build. Most of the solid-state components mount on a single circuit board in a wide-open arrangement. Point-to-point wiring is held to a minimum for easier kit assembly and self-service.

Price of the AD-1013 is £99.55, mail order, Carriage extra. For more information, contact Heath (Gloucester) Ltd., Bristol Road, Gloucester GL2 6EE.

RADIO CLYDE

One of the Spotmaster Ten/70 broadcast cartridge machines being supplied by Reslosound Ltd., of Romford Essex, for use on Radio Clyde, Scotland's first independent local radio station.



RADIO & ELECTRONICS CONSTRUCTOR

COMMENT

KA 1026 UNIT STEREO SYSTEM

Introduced by ITT at the Audio Fair, the new KA 1026 Unit Stereo System seen here represents very good value, offering as it does a 5 watts per channel Stereo Amplifier serving a BSR record deck which can be operated either 'single play' or automatically, and with cueing control, at the attractive price of £49 complete with speakers. Modern slider controls and stereo headphones facility still further heighten the value-for-money of this well-styled slimline HiFi outfit.



IRISH OPEN "OPEN BROADCASTING AREA"

Sir John Eden, Minister of Posts and Telecommunications, recently met Dr. Conor Cruise O'Brien, the Minister of Posts and Telegraphs of the Republic of Ireland, following a number of meetings between British and Irish officials after Dr. O'Brien's call last May for an Irish "Open Broadcasting Area".

Dr. O'Brien told Sir John that his Government wished to explore further the possibility of a BBC television service being transmitted in the Republic of Ireland and he asked Sir John if the BBC could estimate the cost of providing BBC 1 in its entirety to the Republic. Sir John agreed to ask the BBC to do this.

Sir John explained that if the Irish Government found

the arrangements acceptable and decided to take a BBC service for the Republic this could not be construed as binding Her Majesty's Government to any reciprocal arrangement to broadcast Radio Teilis Eireann in Northern Ireland. Sir John also explained that the Government had not yet decided whether the Fourth Television Channel should be brought into use and any decision about its use in Northern Ireland would have to take into account the Government's general broadcasting policies at the time and the views of the Northern Ireland Executive.

We noticed recently that a BBC TV weather forecaster placed a rain spot on Eire - is this an augury?

IN BRIEF

● The Radio Amateur Invalid & Bedfast Club recently issued their annual membership lists. It shows a total of 455 members, including 28 ladies, in 14 countries. 189 of the members have transmitting licences.

● Marconi Marine, at the beginning of the year, had received orders for more than 90 of their dual standard colour TVs especially designed for shipboard use. These TVs are capable of receiving programmes from nearly 100 countries when within range of their transmissions.

● This month sees the worldwide introduction by 3M of Scotch chromium dioxide cassettes. The 3M Company has announced that a licensing agreement has been signed with DuPont enabling 3M to manufacture magnetic tape utilising chromium dioxide pigment, and a range of chrome cassettes is planned for launching in the UK this spring.

● A second advanced data transmission system, designed and manufactured in Britain by AP Electronics Ltd., has been ordered by the Northern Ireland Ministry of Development to operate the roadside telephones on the new Craigavon motorway.

● Mr. Huw Wheldon, Managing Director of BBC Television, took office as a Vice-President of the Royal Television Society on 1st January, for a two-year term.

DID YOU KNOW that solder was known to the ancient Romans and is believed to be derived from the Latin word *Solidare*, meaning to join?

MARCH 1974

PRICE INCREASE

We regret that with the next issue we must increase our cover price by 2p, to 22p. The increase is the absolute minimum necessary to enable us to meet the substantial rises in costs of production already incurred.

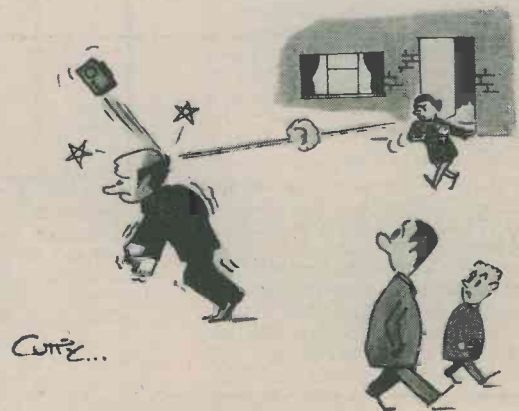

"Is that a mobile radio, Dad?"

DUAL — TONE OSCILLATOR

by G. A. FRENCH

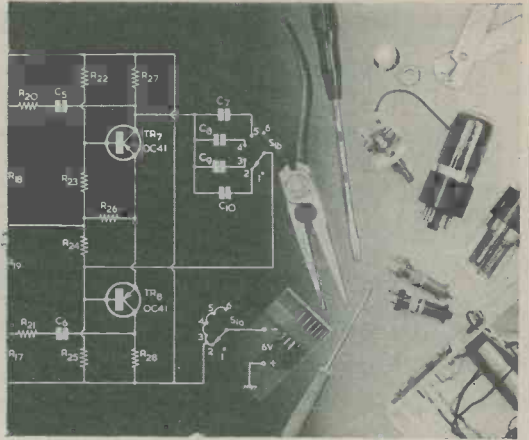

AS IS WIDELY APPRECIATED, AUDIBLE or visible signals which are intended to catch attention are much more effective when they are cyclic in character rather than steady. A typical instance in the audible field is given by the two-tone horns fitted to ambulances and fire engines. A visible example occurs in the fog-warning lights on motorways, in which two yellow lamps switch on and off alternately.

The device described in this month's "Suggested Circuit" article falls into the same category, and it consists of an oscillator unit driving a small speaker at a frequency which changes alternately from one level to another at around 1Hz. Operation is similar to that of a two-tone ambulance warning device, but the audio frequencies are somewhat lower. The unit can be used for any application where it is required to give audible warning of a fault condition, and it could also be employed as a novel door alarm in a house or flat.

CIRCUIT DIAGRAM

The circuit of the dual-tone oscillator appears in Fig. 1. In this diagram transistor TR1 is employed in a simple unijunction oscillator circuit in which C2 charges by way of R1 and R2 until the voltage across it reaches triggering level, whereupon it discharges via the emitter and base 1 of TR1 into the base 1 load. After discharge, C2 charges again, and the cycle repeats.

There are, in consequence, a series of current pulses in the base 1 circuit of the unijunction transistor, and they

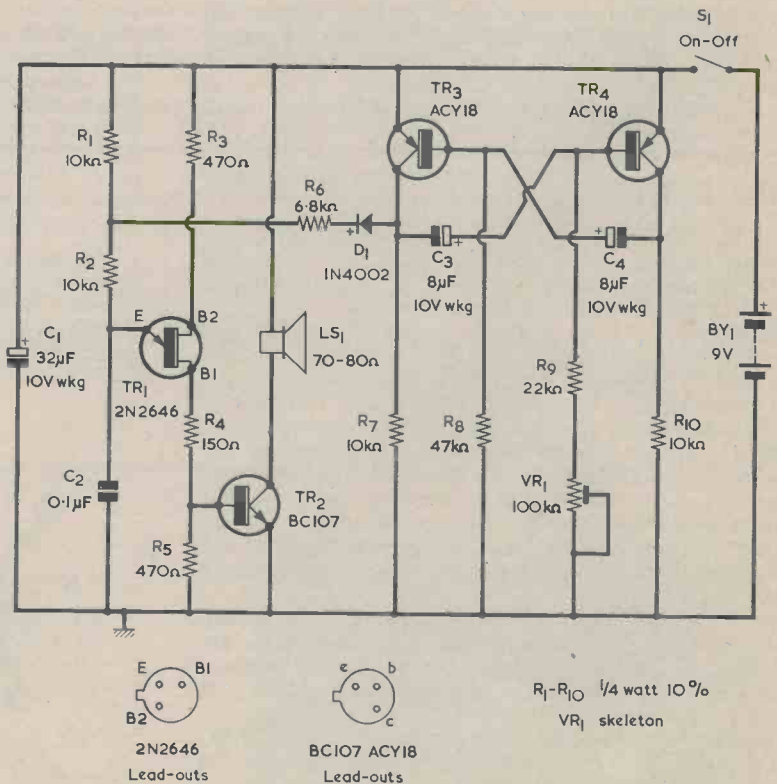

Fig. 1. Complete circuit of the dual-tone oscillator.

appear at a frequency which is governed by the rate of charge of C2. These pulses flow into the base of TR2, which turns hard on in the presence of each pulse and drives loudspeaker LS1. The circuitry around TR1 and TR2 represents a conventional unijunction transistor oscillator and following amplifier.

TR3 and TR4 appear in a conventional oscillator circuit as well, the oscillator in this case being a multivibrator. This is set up to produce a 50:50 square wave at a frequency of approximately 1Hz, with the result that each transistor is alternately turned on and off for an equal period during the successive half-cycles.

Transistor TR3 controls the frequency of the unijunction transistor oscillator. When TR3 is turned off, its collector is at the same potential as the lower negative supply rail, whereupon diode D1 is reverse-biased and the frequency at which TR1 oscillates is governed solely by the speed at which C2 charges via R1 and R2. When, on the other hand, TR3 is turned on, its collector potential is very close to that of the upper positive supply rail. Diode D1 now conducts, causing R6 to be effectively connected in parallel with R1. The rate of charge in C2 now increases as there is a lower resistance between its upper plate and the positive supply rail, and the frequency of the unijunction transistor oscillator becomes higher. Since TR3 turns on and off abruptly during the multivibrator cycle, the transition to the higher frequency as TR3 turns on and the fall to the lower frequency as TR3 turns off are both quick and sharp. With the prototype the lower frequency was approximately 600Hz and the higher frequency approximately 1kHz. There will be slight variations from these figures in units made up to the circuit due to tolerances in the charging resistor and capacitor values and to differences in triggering levels in individual unijunction transistors.

Diode D1 is essential because, without it, the junction of R1 and R2 would be drawn down to too low a potential, during the periods when TR3 is off, for the unijunction transistor to oscillate reliably.

MULTIVIBRATOR WAVEFORM

Capacitors C3 and C4 are electrolytic components and have, in consequence, a very wide tolerance on capacitance. Typical figures here can be as wide as -10 to +100% on nominal value. Because of this it is necessary to provide an adjustment for one side of the multivibrator to enable a true 50:50 square wave to be provided. When the unit is completed, it is switched on with VR1 set to a central position. VR1 is then adjusted to give equal time periods for each of the two half-cycles. If it is then felt that the frequency of change of tone is too swift, it may be reduced by

experimentally finding a suitable higher value in R8 and then re-adjusting VR1 accordingly. Alternatively, the rate of change of tone may be increased by experimentally finding the necessary lower value required in R8 and again re-adjusting VR1. In practice, however, it should be found that the value of 47kΩ specified in Fig. 1 for R8 should be satisfactory in most cases.

A considerably greater control of multivibrator frequency and waveshape can be obtained by replacing R8 with a second 22kΩ resistor and 100kΩ pre-set potentiometer, as in Fig. 2. This added potentiometer controls the period in the multivibrator cycle during which TR3 is turned off, whilst the existing VR1 controls the period over which TR3 is turned on.

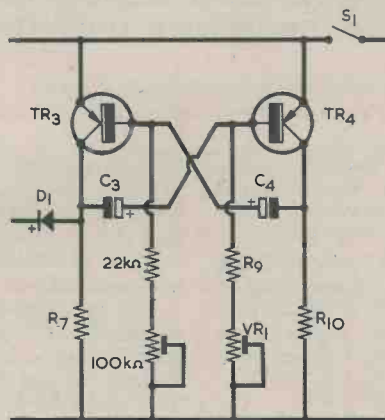

Fig. 2. A very wide control over multivibrator frequency and waveshape is given if R8 is replaced by a second 22kΩ resistor and 100kΩ pre-set potentiometer.

Bypass capacitor C1 is employed to prevent interaction between the unijunction and multivibrator oscillators when the supply has a high internal resistance or impedance, or when there are long leads to S1. The relatively low value of 32μF is quite adequate for the present circuit.

In Fig. 1 the transistor which drives the speaker is a small silicon component having a maximum collector current rating of 200mA only. It is capable of driving the loudspeaker and offering a readily audible tone, but it is important that the speaker impedance should be no lower than 70Ω or the transistor may be damaged.

It is possible to drive any speaker impedance down to 3Ω by replacing TR2 with a power transistor type BD124 and adding a series 5Ω limiting resistor, as in Fig. 3. The BD124 does not need to be mounted on a heat sink. The audible volume of the output tones increases as speaker impedance reduces, as also does the current drawn from the battery. Battery current is of the order of 8 to 10mA when the circuit of Fig. 1 is used, and it fluctuates in level with alternate half-cycles of the multivibrator. Current consumption increases to 20 to 23mA when the output circuit of Fig. 3 is used with a 3Ω speaker.

If the dual-tone oscillator is used as a door signal, S1 is replaced by the push-button at the door. The push-

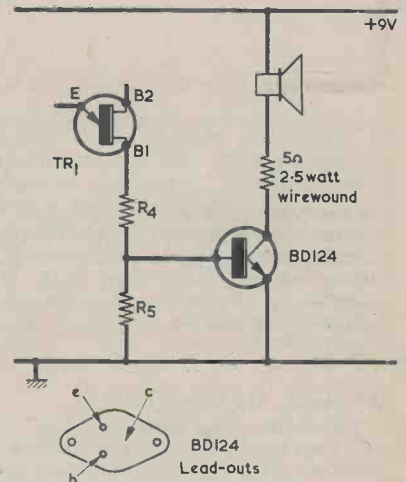

Fig. 3. Speakers with impedances lower than 70Ω may be employed if the speaker drive circuit shown here is fitted. Lower impedance speakers will provide a higher audio output level.

button can be connected to the rest of the circuit by leads of any reasonable length.

All the components are readily available, and it is possible to employ alternative transistors for TR2, TR3 and TR4 should these be already to hand. Alternatives for TR2 in Fig. 1 are BC108 and BC109. Alternatives for TR3 and TR4 are ACY17, ACY19 to ACY21 inclusive, ACY39 and ACY41. All these alternatives have the same lead-out layout as that of the BC107 and ACY18. ■

★ ★ ★ T.R. 3

REFLEX RADIO

By A. Sapciyan

A low cost medium wave local stations receiver incorporating three inexpensive transistors.

THIS SIMPLE MEDIUM WAVE REFLEX RECEIVER GIVES good results with three transistors. The output is sufficiently high for personal listening in a room where background noise is at average level. The receiver is intended for reception of local stations only, although in practice it should be possible to pick up a number of foreign transmissions after dark. With a circuit employing as few components as does this set, performance cannot of course be compared with that given by a superhet.

REFLEX OPERATION

The input stage uses an AF127, TR1, connected in the reflex mode. In common with other reflex amplifiers, TR1 provides amplification both at radio frequencies and then at audio frequencies. Initially, r.f. signals picked up on the ferrite aerial coil, L1, are applied to the base of TR1 and they next appear, in amplified form, at the collector of this transistor. The r.f. choke L2, offers a high impedance at r.f., and the r.f. signals are passed via C4 to the voltage doubling detector given by D1 and D2. The demodulated signal, which is now at a.f., is applied to the base of TR1 and this again provides amplification. Choke L2 offers only a low impedance to a.f. signals and these are in consequence built up across R3. C5 ensures that any r.f. signal still present after the choke is bypassed to chassis and does not enter the following a.f. stages.

R1, in series with R2, controls the base current of TR1 and, hence, the amplification it gives. When R1 is set to insert a low resistance into circuit the resultant high gain in TR1 produces oscillation. R1 can therefore be employed as a reaction control, it being adjusted to the point which is just below that at which oscillation occurs. Under this condition the receiver exhibits optimum selectivity and sensitivity.

The tendency towards oscillation is increased by C1. This is a home-made trimmer and the manner in which it is assembled and set up is described later. The value for R2 given in the Components List should be satis-

factory with most transistors and diodes in the TR1, D1 and D2 positions. In some occasional instances, however, it may be necessary to alter the value of R2 and this point is also discussed later. No connection is made to the shield of TR1, and this factor improves regeneration.

The a.f. signal at the junction of L2 and R3 is passed via C7 to the base of transistor TR2. This functions as an audio amplifier, its collector connecting directly to the base of the output transistor, TR3. The collector of TR3 feeds the primary of output transformer T1, whilst R7 and C8 provide emitter bias.

TR2 and TR3 appear in a d.c. negative feedback loop. If, for any reason, the emitter of TR3 were made to go more negative this would cause TR2 to be biased harder on. The collector voltage of TR2 would then go positive as also would the base of TR3, thereby counteracting the original change in voltage at TR3 emitter. There is no corresponding feedback at audio frequencies due to the presence of C8.

Output transformer T1 should present a primary impedance of around 600Ω and, to drive a 3Ω speaker, it requires a step-down ratio of 14:1. The Eagle LT700 output transformer, which has a centre-tapped primary and a ratio of slightly higher than 15:1, may be used here. No connection is made to the primary centre tap. It is desirable to use a fairly large and sensitive speaker.

The total current drawn by the receiver from the 6 volt battery is approximately 10mA.

The AF127 and AC128 specified for TR1 and TR3 are readily available. The transistor type AC151 needed for TR2 can be obtained from a number of suppliers, including Electrovalue, Ltd.

HOME-MADE COMPONENTS

The ferrite aerial coil, L1, consists of 70 turns of 30 s.w.g. enamelled wire wound side-by-side on a ferrite slab measuring 6 by $\frac{1}{2}$ by 5/32in., as illustrated in Fig. 2. The chassis tap is made 10 turns from one end. Due

RADIO & ELECTRONICS CONSTRUCTOR

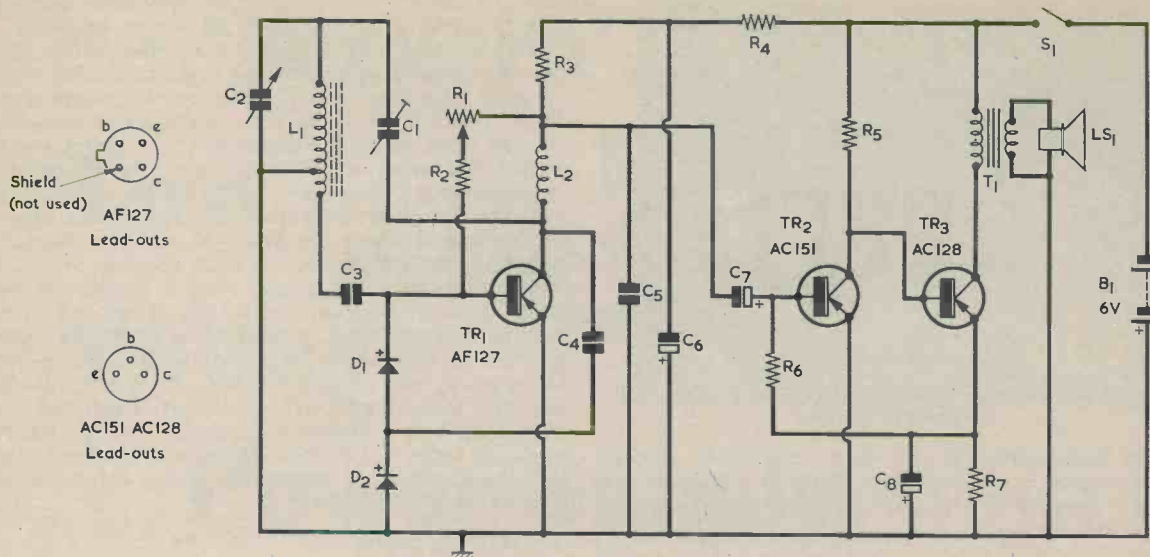

Fig. 1. The circuit of the reflex receiver.

COMPONENTS

Semiconductors

TR1	AF127
TR2	AC151
TR3	AC128
D1	0A91
D2	0A91

Switch

S1	s.p.s.t., toggle
----	------------------

Speaker

LS1	3Ω speaker
-----	------------

Battery

B1	6 volt battery
----	----------------

Miscellaneous

Ferrite slab,	6 by ½ by 5/32in. (Henry's Radio)
2 knobs	
Battery connectors	

Resistors

(All fixed values ¼ watt 10%)

R1	100kΩ potentiometer, linear
R2	330kΩ (see text)
R3	1kΩ
R4	1kΩ
R5	5.6kΩ
R6	15kΩ
R7	47Ω

Capacitors

C1	Trimmer (see text)
C2	300pF variable, solid dielectric
C3	0.001μF, plastic foil or ceramic
C4	100pF, ceramic or silvered mica
C5	0.01μF, plastic foil
C6	100μF electrolytic, 6 V.Wkg.
C7	4μF electrolytic, 6 V.Wkg.
C8	100μF electrolytic, 6 V.Wkg.

Inductors

L1	Ferrite aerial (see text)
L2	R. F. choke (see text)
T1	Output transformer (see text)

to differences in slab permeability, it is desirable to initially wind on a few too many turns at the end which connects to C1 and the fixed vanes of C2. These turns can then later be removed, as required, to give more precise coverage of the medium wave band after the set has been completed. Some control of inductance is also given by sliding the winding along the ferrite slab.

The r.f. choke, L2, is also home-made and consists of 200 turns of 36 s.w.g. enamelled wire pile-wound on a ¼in. former.



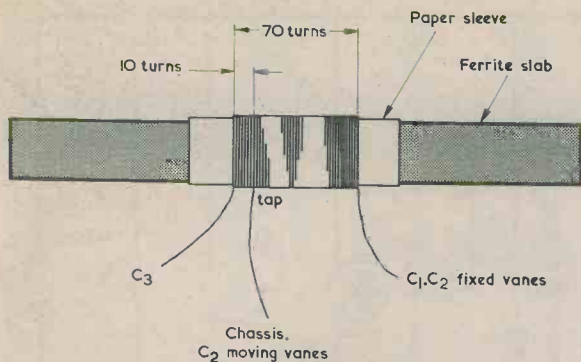

Fig. 2. The ferrite aerial winding. Further details are given in the text.

An unconventional but quite satisfactory method of assembly is employed for trimmer capacitor C1. This is shown in Fig. 3, and it consists of one enamelled wire twisted around a second. A straight piece of 16 s.w.g. enamelled wire 1in. long has one end cleaned of enamel. This end is tinned and connects to the fixed vanes of C2. It can be soldered direct to the tuning capacitor tag. One end of a length of 36 s.w.g. enamelled wire is also cleaned and tinned, and this is connected to the junction of L2 and the collector of TR1. The 36 s.w.g. wire is then close-wound over the 16 s.w.g. wire, the two ends of the wires being left open-circuit. Only the enamelled surfaces of the two wires are in contact with each other and so they do not short-

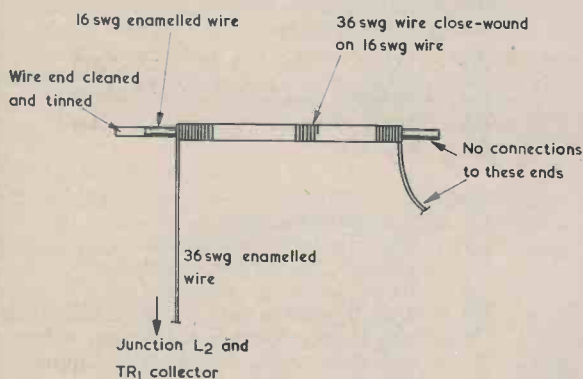

Fig. 3. This unconventional but quite practicable assembly forms the trimmer C1.

circuit together. The trimmer capacitance is adjusted later by untwisting the 36 s.w.g. wire as necessary.

Construction and layout are not particularly critical provided that lead lengths are kept reasonably short. A good plan consists of mounting the components, apart from C2, R1, S1 and the ferrite aerial, on a perforated piece of plain Veroboard (i.e. without copper strips) measuring about 4½ by 2½in., the component leads passing through the holes and being soldered into the circuit underneath. The components should be positioned along the board in roughly the same order as they appear in the circuit diagram of Fig. 1. This ensures that the output stage is positioned well away from TR1 input circuit. C2, R1 and S1 may then be mounted on a small front panel at right angles to the board. However, any other method of assembly favoured by the constructor may be used provided that the general approach to layout which has just been described is observed. L2 and T1 should not be mounted close to L1. Also, R1 should be wired such that the resistance it inserts into circuit reduces as its spindle is turned clockwise.

ADJUSTMENTS

When the receiver has been completed, a new 6 volt battery should be connected and the set switched on by means of S1. There should be a noticeable hiss from the speaker, this increasing in intensity as R1 spindle is turned clockwise. It should be possible to take the set into oscillation by means of R1 over all the tuning range offered by C2. The setting of R1 at which oscillation occurs varies with the capacitance given by C2.

If oscillation is too fierce and cannot be reliably controlled by R1 the capacitance inserted by C1 should be reduced by removing some of the turns of 36 s.w.g. wire. It is in order for oscillation to occur when R1 is only partly advanced, because this allows the receiver to continue operating after battery voltage falls with use, in which case R1 can be advanced further to provide regeneration. Initial setting up should be carried out, nevertheless, with a new battery.

In some instances it may be found that C1 does not provide sufficient control. If regeneration is weak and can only be obtained when R1 is at, or very near, its maximum position, the value of R2 should be reduced. Values of 220kΩ and 150kΩ, etc., should be tried until the desired operation is obtained. If, on the other hand, regeneration is too fierce, the value of R2 may be increased, and performance checked with values here of 470kΩ and 560kΩ, etc.

As was stated at the start of this article, the receiver is intended mainly for reception of local stations only. R1 should be adjusted for optimum sensitivity with each station tuned in. ■

BACK NUMBERS

For the benefit of new readers we would draw attention to our back number service.

We retain past issues for a period of two years and we can, occasionally, supply copies more than two year old. The cost is the cover price stated on the issue, plus 6p postage.

Before undertaking any constructional project described in a back issue, it must be borne in mind that components readily available at the time of publication may no longer be so.

We regret that we are unable to supply photo copies of articles where an issue is not available. Libraries and members of local radio clubs can often be very helpful where an issue is not available for sale.

The 'Wyvern'

Low Voltage Power Supply

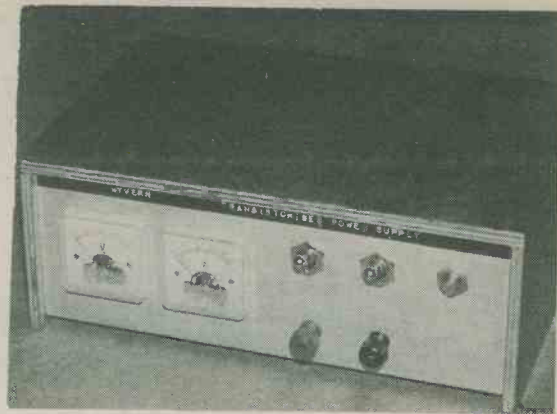

By John R. Green, B.Sc., G3WVR.

In his latest 'Wyvern' design, our contributor describes a stabilized power supply offering a continuously variable output voltage ranging from 2.5 to 20 volts. Current capability is 2 amps and the unit incorporates a current limiting circuit.

WHATEVER THE CONSTRUCTOR'S INTEREST IN RADIO and electronics may be, a versatile regulated low voltage power supply is a must in every workshop.

For many applications where power requirements exceed a couple of watts the usual string of used transistor radio batteries can give rise to poor circuit performance simply because of the internal resistance of the batteries. This leads us to the first advantage of a regulated power supply: its low output impedance.

Once the constructor accepts that semiconductors are to be used in the power supply it becomes comparatively simple to include short-circuit protection for any predetermined current limit and to make the output voltage variable over a wide and useful range.

The uses of the power supply in the test field are endless, but it is also a good money saver on transistor radio batteries and for those 'current thirsty' cassette tape recorders.

CIRCUIT OPERATION

The circuit diagram of the complete unit is shown in Fig. 1, and it will be seen that the design is quite simple and straightforward.

The mains transformer is a Douglas type MT20AT, and has a tapped 3 amp secondary offering voltages of 12, 15, 20, 24 and 30 volts. The 24 volt tapping is employed in the present design. The transformer may be obtained direct from the manufacturer, Douglas Electronic Industries, Ltd., Thames Street, Louth, Lincs., LN11 7AD. The bridge rectifier given by D1 to D4 causes reservoir capacitor C1 to charge up to approximately 33 volts off load, this falling to about 24 volts at the full secondary current rating. The diodes may be any silicon types rated at 3 amps or more and with a peak inverse voltage rating of 100 volts. A suitable type would be the PL7002, which is available from Henry's Radio, Ltd.

The zener diodes, D5 and D6, are fed via R1 and provide a 22 volt reference level. These diodes may be rated at 250mW to 400mW and could consist, for instance, of type BZY88C6V8 for D5 and BZY88C15 for D6. The emitter followers TR3, TR4 and TR5 provide current gain and a low output impedance. Since the simple form of regulator shown in Fig. 1 is employed and there is no voltage feedback to improve it, the regulation is only as good as the voltage reference level provided by the zener diodes. The overall output

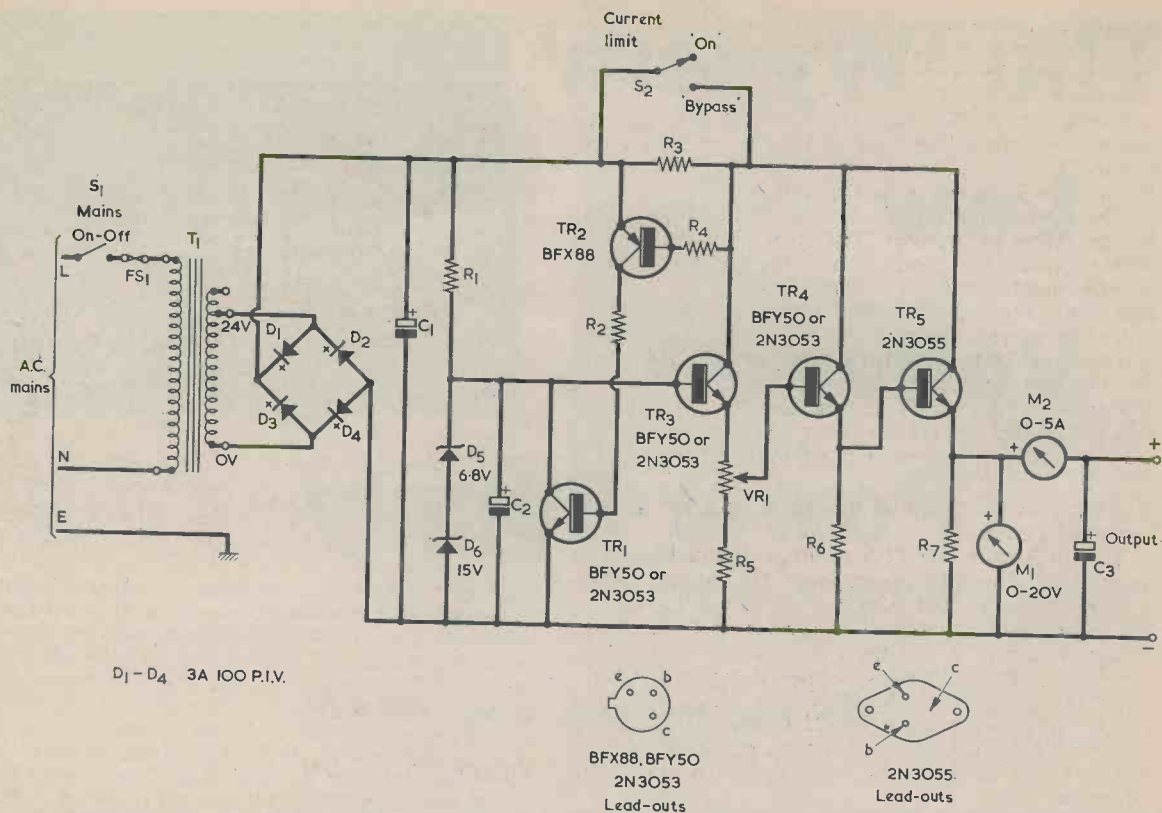

Fig. 1. The circuit of the low voltage power supply unit. Output voltage is controlled by VR1, and TR1 and TR2 provide short-circuit protection.

COMPONENTS

Resistors

(All fixed values $\frac{1}{4}$ watt 10% unless otherwise stated.)

R1	2.2k Ω
R2	10k Ω
R3	0.25 Ω 2 watts
R4	220 Ω
R5	1k Ω
R6	2.2k Ω
R7	1k Ω 1 watt
VR1	5k Ω potentiometer, linear (see text)

Capacitors

C1	2,500 μ F electrolytic, 40 V.Wkg.
C2	8 μ F electrolytic, 25 V.Wkg.
C3	100 μ F electrolytic, 25 V.Wkg.

Transformer

T1	Mains transformer, secondary 12, 15, 20, 24, 30 volts at 3 amps. Douglas type MT20AT.
----	---------------------------------------------------------------------------------------

Semiconductors

TR1	BFY50 or 2N3053
TR2	BFX88
TR3	BFY50 or 2N3053
TR4	BFY50 or 2N3053

TR5 2N3055

D1-D4 Silicon rectifiers, 3 amp, 100p.i.v.

D5 Zener diode 250-400mW, 6.8 volt 5%

D6 Zener diode 250-400mW, 15 volt 5%

Fuse

FS1 Cartridge fuse, 1 amp.

Switches

S1 s.p.s.t., toggle

S2 s.p.s.t., toggle

Meters

M1 Voltmeter, 0-20 volts (see text)

M2 Ammeter, 0-5 amps (see text)

Miscellaneous

TO-5 heat sink (for TR4)

Mica washer and insulated bushes (for TR5)

Insulated output terminal, red

Insulated output terminal, black

Fuse holder, chassis mounting

Knob, if required

Printed circuit board

Capacitor clamp (for C1)

Aluminium sheet, 16 s.w.g.

Materials for cabinet

impedance of the power supply should be in the region of 0.5Ω , which is high compared with a 'feedback' power supply, but very much better than an unregulated supply and quite adequate for amateur work.

The wiper of VR1, the output voltage control, provides a voltage at the base of TR4 of approximately 3.5 to 21 volts, and a voltage range of approximately 2.5 to 20 volts at the output terminals.

The current limiting section of the circuit functions in the following manner. The current flowing in the 0.25Ω resistor, R3, produces a voltage across the base-emitter junction of TR2. When this voltage reaches approximately 0.6 volt TR2 starts to conduct, its collector current passing through the base-emitter junction of TR1. TR1 then turns on and effectively short-circuits the zener diodes D5 and D6, lowering the output voltage such that the current flowing in R3 (which is slightly greater than the output current) cannot exceed 0.6 amps. The value of R3 used in the

R3

prototype was 0.25Ω , and this gave a current limit of just over 2 amps.

The 2N3055 in the TR5 position dissipates a large amount of unwanted power when the output voltage is low and the output current is high. For instance, a dissipation of 40 to 50 watts is typical when the output voltage is 2.5 volts and the output current is 2 amps, since some 20 to 25 volts is present across the transistor at this current. The 2N3055 is adequately rated at 115 watts dissipation (for 25°C case temperature), and whilst it does get hot under maximum power dissipation conditions, the derated dissipation is still adequate.

Constructors may be concerned over the situation which could exist when the power supply, whilst feeding a load having a large parallel capacitance, is switched off. There is then a possibility of reverse biasing the base-emitter junction of TR5 if the load voltage falls more slowly than the power supply output voltage. However, it has been checked, both in theory and in practice, that the unit will perform quite happily with an external parallel load capacitance as high as $5,000\mu\text{F}$. In the extremely unlikely event that the power supply unit is used with higher values of external parallel load capacitance, then the unit may be given additional protection by wiring a silicon rectifier rated at 3 amps or more in series with the positive output lead, i.e. between the positive output terminal and the junction of meter M2 and C3. The rectifier is wired so that it is forward biased by the normal output current. This point is mentioned mainly for the sake of completeness and it is very doubtful whether the diode will be needed in practice. Its inclusion in the circuit will cause a worsening of the regulation.

Any ripple voltage across C1 is reduced by C2 at the voltage reference point, and the output ripple is related to this reduced level. Larger values than $8\mu\text{F}$ should not be fitted in the C2 position, as such values would slow down the current limiting and might cause the power supply to fail on a total short-circuit, otherwise known as 'the screwdriver test'!

A switch, S2, is provided to bypass the current limiting circuit when current limiting is not required.

The prototype power supply was fitted with both voltage and current metering, the meters employed being Sew type MR-38P. Henelec type 38 meters (available from Henry's Radio Ltd.) have the same dimensions and could alternatively be used.

MARCH 1974

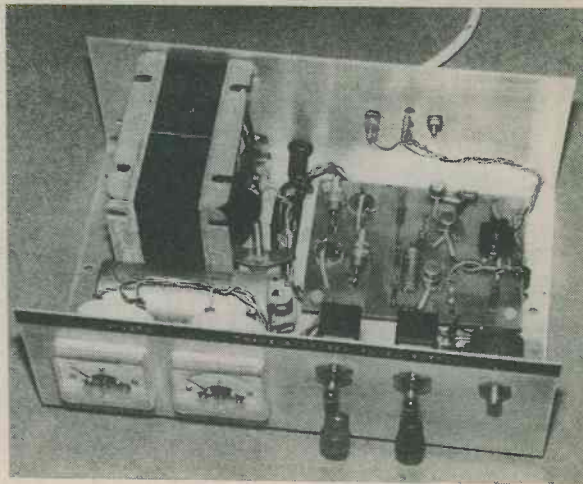

The internal layout is reasonably compact without being cluttered.

CONSTRUCTION

The simple printed circuit layout is shown in Fig. 2, this being reproduced full-size for tracing purposes. The board is viewed in this diagram from the component side. No copper areas should approach the corner mounting holes as it is required to produce a 'floating' output with both output terminals disconnected from the power supply chassis. This enables the unit to supply equipment having either a positive or a negative earth. The printed board is secured at the four mounting holes with 6BA countersunk screws, suitable spacers being fitted between the board underside and the chassis surface.

It should be noted that TR4 is provided with a small TO-5 heat sink. A suitable heat sink is the type H2 retained by Henry's Radio Ltd.

Circles are shown at the cathode ends of rectifiers D1 to D4 and these may be drilled out to take rectifier studs if D1 to D4 are of the cathode stud variety. Alternatively, small holes may be drilled for rectifier lead-outs. In the photograph showing the inside of the author's unit, there are two 'odd' rectifiers. These were used as temporary replacements for two stud rectifiers which were destroyed when the current limit circuit was mistakenly switched out under short-circuit conditions.

If any doubt exists as to rectifier polarity this may be checked by temporarily connecting each rectifier in series with a voltmeter across the 24 volt secondary of the transformer. The voltmeter will give a forward reading when its positive lead connects to the rectifier cathode. A further check of the output polarity from the bridge rectifier after it has been wired up on the board and before connecting up to C1 may also be carried out with the aid of a voltmeter. The voltage readings given in these tests will, of course, be lower than is given when the diode or diodes are coupled to a reservoir capacitor.

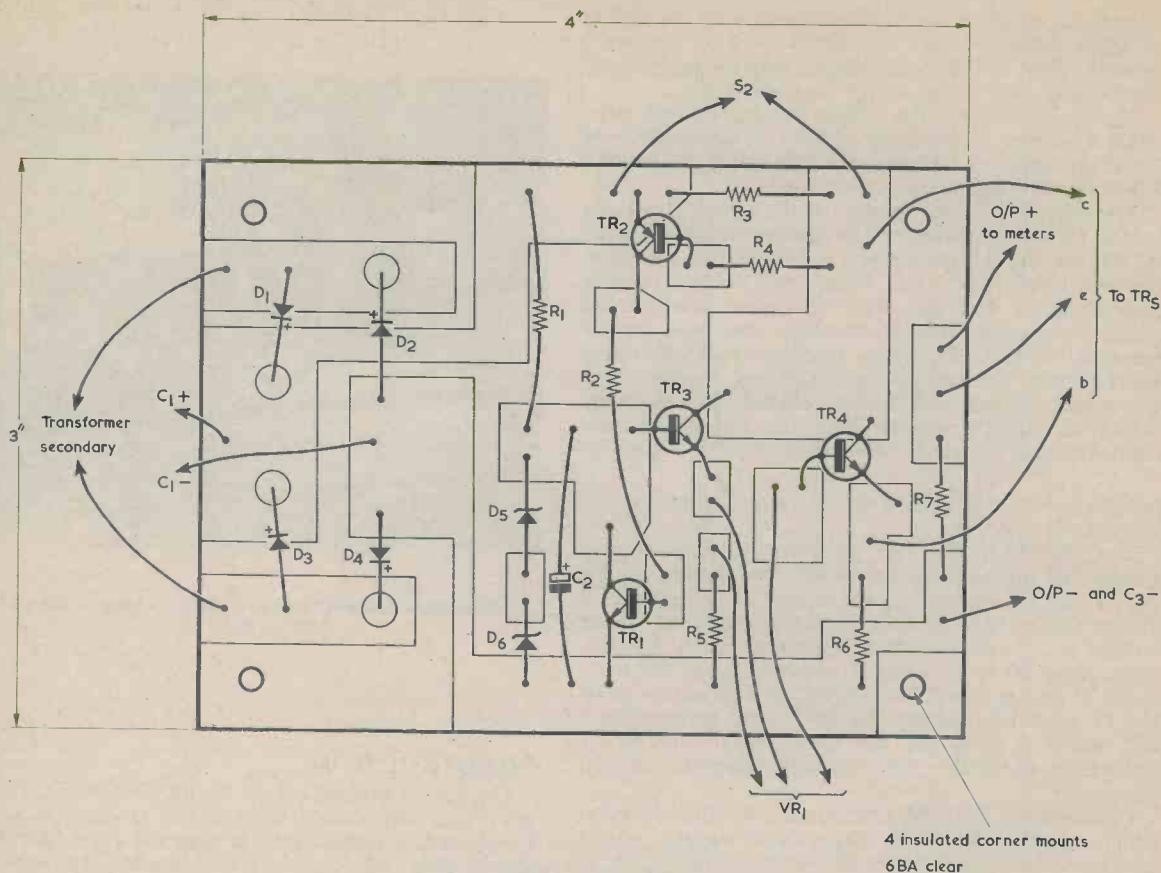
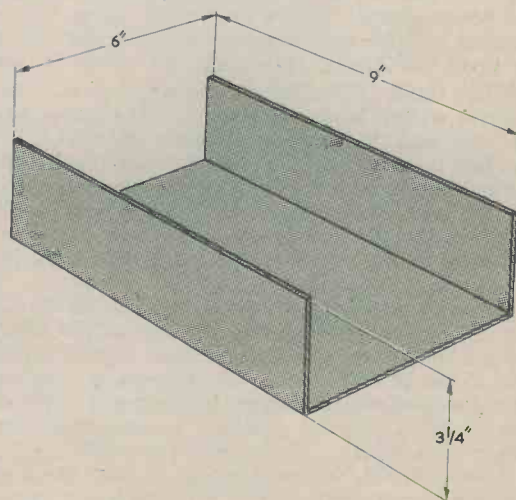

Fig. 2. The printed circuit board, which is reproduced full-size for tracing. The connections to VR1 should be made following Fig. 1, with R5 connecting to the anti-clockwise end of the track. This view is of the component side of the board.

The chassis dimensions are shown in Fig. 3, and 16 s.w.g. aluminium sheet is recommended. The chassis and cabinet follow the author's usual 'Low Boy Hi-Fi' styling, as employed in previous Wyvern designs, and they offer an attractive method of construction with good accessibility to the components.

The layout diagram of Fig. 4 shows all the major parts and their positions on the chassis. Exact dimensions are left to the constructor to decide as these may vary with different components. The output capacitor C3 (not shown in Fig. 4) is wired across the output terminals on the front panel. The can of this capacitor and that of C1 must not be allowed to come into contact with the chassis. C1 is secured by a clamp and it will be necessary to fit an insulating medium such as tape or plastic sheet between the clamp and the body of the capacitor if the latter is not already fitted with an adequate insulating sleeve.

Leads are taken from the printed circuit board to the mains transformer secondary (24 volt tap), to C1, to potentiometer VR1, to the current limit bypass switch S2, to TR5, and to the output terminals and metering circuit. TR5 is mounted on an insulating mica washer and is secured with the usual insulating bushes. It is necessary for an efficient thermal coupling to exist between TR5 and the chassis. The chassis



Material: 16 s.w.g. aluminium

Fig. 3. The chassis is very simple and requires two bends only.

surface should be flat over the area at which the transistor is mounted and the holes drilled for its lead-outs and mounting bolts should be clean and free of burrs.

In the prototype VR1 is a panel-mounting preset potentiometer with a screwdriver slot on the spindle for adjustment. Alternatively, a standard panel-mounting potentiometer may be used, this being fitted with a small knob.

The cabinet construction is shown in Fig. 5, and this employs $\frac{1}{4}$ in. plywood sheets with $\frac{1}{2}$ in. square hardwood battens as corner reinforcements. There are, also, two lower $\frac{1}{2}$ in. square battens, and the chassis is secured to these by woodscrews passed through holes at the edges of the chassis base. All the battens are screwed and glued in position.

The dimension marked 'See Text' in Fig. 5 is such that, when the chassis is screwed in position, the upper ends of the front and rear panels just meet the underside of the top plywood panel. To take up any small errors in bending, etc., it is preferable to work out this dimension from the chassis itself. The dimension will be of the order of $3\frac{1}{2}$ in.

The completed cabinet may be veneered, using a contact adhesive such as Bostik or EvoStik, and then varnished. This will give a very pleasing finish to the equipment.

TESTING

A relatively simple piece of equipment such as a power supply unit should usually work perfectly as soon as it has been completed, provided that no component or wiring errors have been made. In the event of malfunction, however, the following procedure may be adopted.

1. Remove TR1 and TR2.
2. Check the d.c. voltage across C1. This should be some 30 to 35 volts under no-load conditions.

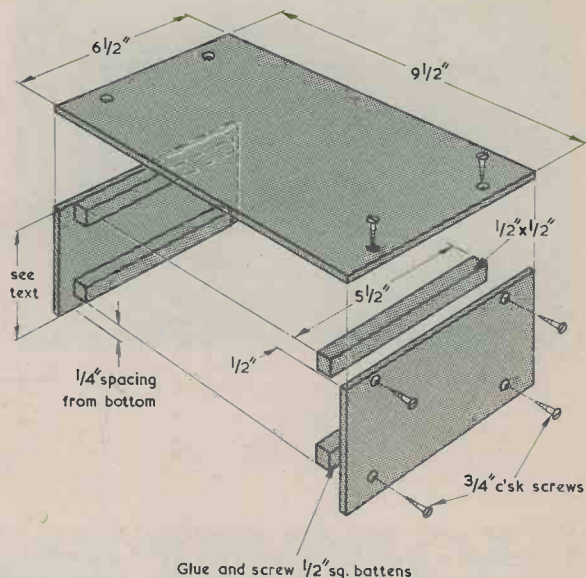

- 1 top overlaps sides
- 2 top $9\frac{1}{2} \times 6\frac{1}{2}$; sides $6\frac{1}{2} \times$ approx. $3\frac{1}{2}$; material $\frac{1}{4}$ plywood
- 3 hardwood battens $\frac{1}{2} \times \frac{1}{2} \times 5\frac{1}{2}$
- 4 secure chassis to lower battens

Fig. 5. The cabinet is made up from three pieces of plywood, with hardwood battens.

3. Check the voltage at the emitter of TR3 with respect to the negative supply rail. This should be approximately 21 volts if D5 and D6 are stabilizing correctly. It will be remembered, here, that a zener diode connected the wrong way round functions as a normal silicon diode and gives a voltage drop of about 0.6 volt only.

4. Check the voltages on the emitters of TR4 and TR5 with respect to the negative supply rail. These voltages should vary from about 3 to 20 volts as VR1 is adjusted.

5. Replace TR1 and TR2 and check the current limiting section by gradually reducing the load resistance (i.e. increasing the load current) until the output current reaches the calculated limit level. Further reduction of the load resistance should simply reduce the output voltage without significantly increasing the output current. A high wattage rheostat will be needed for this last test.

As a final point regarding the use of the power supply unit, the current limit may be bypassed by closing S2 for applications where the average output current is within the power supply unit rating but occasional peaks are somewhat higher. This set of circumstances could arise, for example, in the testing of Class B audio amplifiers.

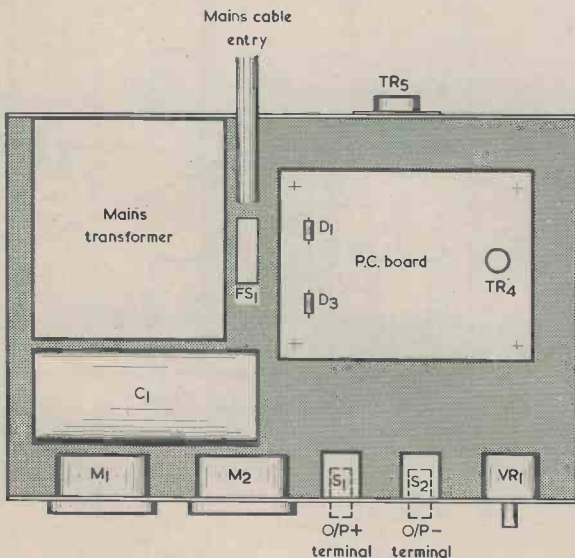
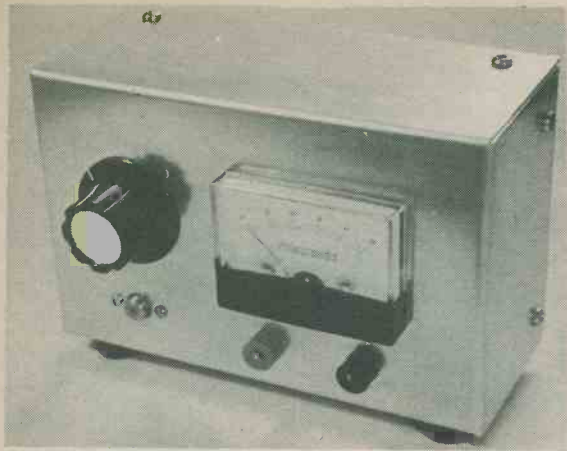

Fig. 4. The general layout of the parts fitted on the chassis.



AUDIO FREQ METER

By A. P. C.

EXCEPT FOR THOSE WHO ARE LUCKY ENOUGH TO possess a digital frequency meter, or an accurate signal generator plus an oscilloscope, most home constructors have no means of measuring audio frequency. The piece of equipment described here is relatively inexpensive when compared with the other two types of equipment, and is operated by merely feeding the signal of unknown frequency to its input. The frequency can then be read directly from the scale of a moving-coil meter.

Three ranges are covered, these being 0-500Hz, 0-5kHz and 0-50kHz. The instrument is reasonably compact, the outside dimensions of the case being 6 x 4 x 2½ in. Power is obtained from an internal 9 volt battery type PP3. This has a very long life as the unit only draws some 4 to 5mA of current.

THE CIRCUIT

A circuit diagram of the frequency meter is given in Fig. 1. The circuit consists basically of four sections. The first of these is provided by the input stages around TR1 and TR2, which ensure adequate input impedance and sensitivity, whilst the second is a Schmitt trigger squaring and emitter follower circuit incorporating TR3, TR4 and TR5. The third section is the frequency discriminator, and includes TR6 and D4. The supply voltage stabilizer employing D3 and TR7 represents the fourth section. A series stabilizing circuit is employed here in the interests of battery economy.

Dealing in more detail with these sections, the input stages may next be considered. Any piece of test equipment which is drawing current from the circuit under test should have a high input impedance, so as to have as little loading effect on the circuit as possible. In the present design, the high input impedance is given by using an f.e.t. in the TR1 position. The f.e.t. is employed in the common source mode and the input circuit has an impedance of 1.5MΩ. The f.e.t. gives a voltage gain of about 5 times.

D1 and D2 are protective diodes. Being silicon types they become fully conductive at a forward voltage of about 0.6 volt, whereupon they limit the input to the f.e.t. to approximately 1.2 volts peak-to-peak. The

An inexpensive frequency meter for a wide variety of input waveform. Frequency ranges are zero to 50 kHz.

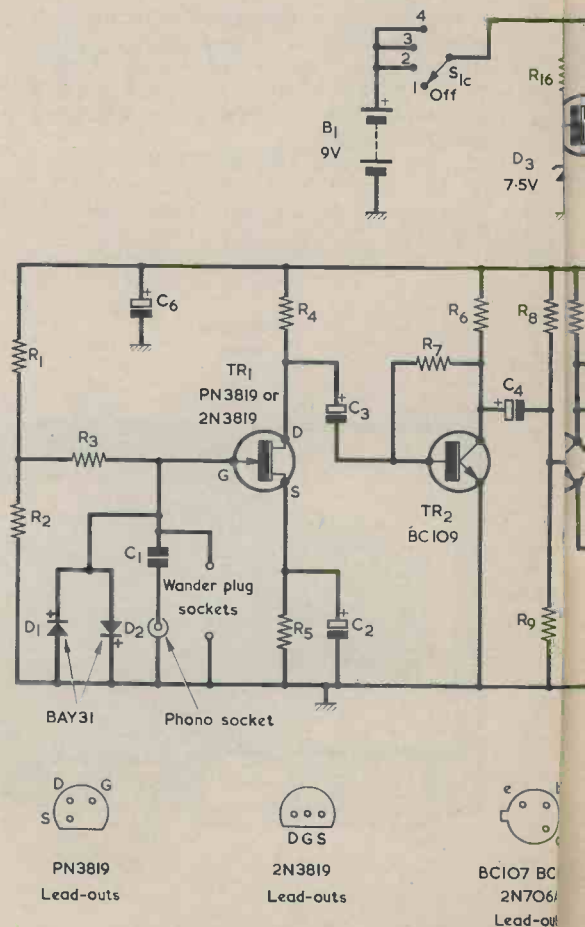

Fig. 1. The circuit of the audio frequency meter.

AUDIO FREQUENCY METER

By A. P. Roberts

An inexpensive frequency meter capable of accommodating a wide variety of input waveforms both at low and high impedance. Frequency ranges are zero to 500Hz, zero to 5kHz and zero to 50kHz.

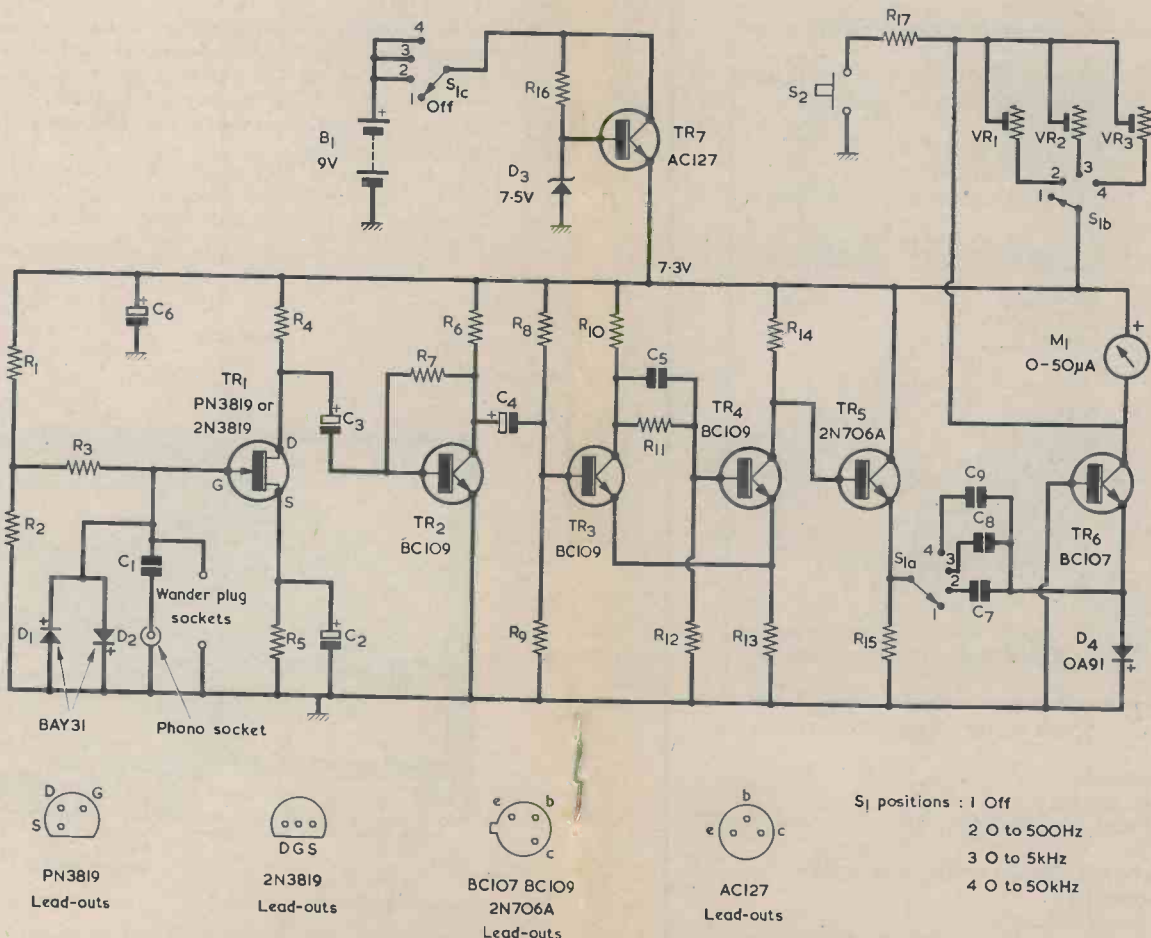

Fig. 1. The circuit of the audio frequency meter. This measures frequencies up to 50kHz.

FREQUENCY

METER

Roberts

capable of accommodating a
both at low and high impedance.
00Hz, zero to 5kHz and zero to
Hz.

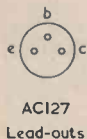
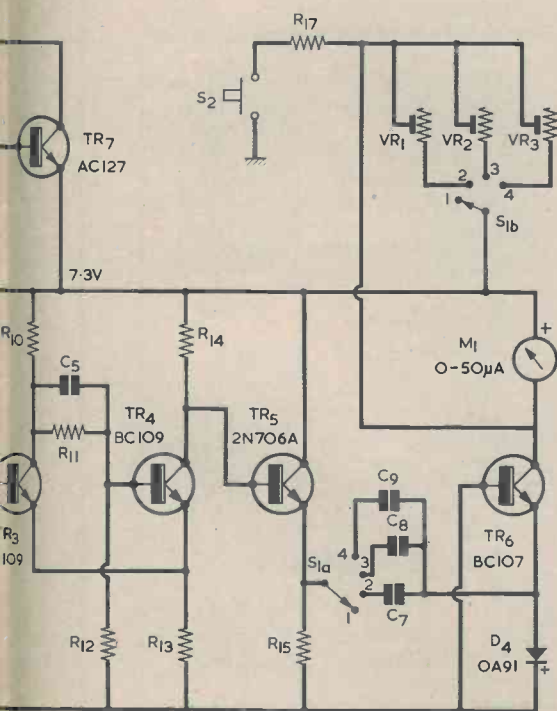

- S1 positions : 1 Off
 2 0 to 500Hz
 3 0 to 5kHz
 4 0 to 50kHz

meter. This measures frequencies up to 50kHz.

MARCH 1974



circuit can safely handle inputs of up to 20 volts peak-to-peak. TR2 is a straightforward high gain common emitter amplifier.

For the frequency discriminator stage to function correctly, it must be fed a signal of constant amplitude and waveshape. The Schmitt trigger in the second section of the overall circuit produces a square wave output regardless of whether the input waveform is sinusoidal, square or triangular, and the stabilized supply which constitutes the fourth section ensures a constant amplitude.

TR3 and TR4 form the trigger circuit. Normally, the output at TR4 collector is at a low potential. If an input signal of sufficient amplitude is applied to TR3 base, the trigger changes to the alternate state, with TR4 collector going nearly to the full positive supply potential on positive half-cycles at TR3 base. At negative half-cycles, the collector of TR4 is at its normal low potential. The changes at TR4 collector from one state to the other are very rapid, with the result that a square wave is produced having the same frequency as the input signal.

TR5 is an emitter follower. It has a voltage gain of slightly less than unity, but it allows the square wave from TR4 to be applied to the following stage at a suitably low impedance.

The purpose of the frequency discriminator is to produce a current which rises with the frequency of the applied signal, this current being indicated by a meter. There must, of course, be a linear relationship between the frequency and the resultant current. There are a number of ways in which the current can be produced, but all conventional methods are based on the charge and discharge of a capacitor. In this case the capacitor is either C7, C8 or C9, as selected by S1(a). During positive pulses from TR5 emitter diode D4 will conduct, allowing the capacitor selected by S1(a) to charge to the same voltage as that at TR5 emitter, less about 0.2 volt dropped across D4 and another 0.6 volt across the base-emitter junction of TR5. During these pulses, TR6 is turned off.

However, during the periods when TR4 collector is at a low potential the capacitor will have its left-hand

COMPONENTS

plate connected to chassis via R15. This will cause TR6 emitter to go negative and the capacitor to discharge via R15 and the base-emitter junction of TR6, resulting in a pulse of current in the collector circuit of TR6, in which the meter is connected. Provided that the discharge circuit has a short time constant, so that the capacitor can become virtually fully discharged during negative half-cycles at the highest frequency to be measured, the average current in the meter will be proportional to the frequency of the applied signal.

The point that this must obviously be the case can be demonstrated by considering input frequencies of, say, 500Hz and 1kHz. With an input frequency of 500Hz there will be 500 pulses of current passing through the meter each second; when the frequency is changed to 1kHz there will be 1,000 of these pulses each second. The pulses of current are identical in both cases, with the result that doubling the frequency has caused double the current to flow in the meter. Mechanical inertia in the meter causes it to read average current.

A pre-set variable resistor is switched to shunt the meter on each range, thereby enabling the ranges to be individually calibrated. The variable resistors concerned are VR1, VR2 and VR3.

There is one main control on the unit, this being S1 (a) (b) (c). This switch has four settings, the first being the 'Off' position whilst the other three select the desired range. The unit is very sensitive and requires only a few millivolts input. If the input signal has insufficient amplitude the Schmitt trigger will fail to operate, and the meter will read zero.

S2 can be used to connect the meter across the stabilized supply via the series resistor R17. This gives a check on battery voltage, and the facility will be discussed in more detail later.

The meter employed in the prototype is a T.T.C. type C2202 and has a full-scale deflection of 50µA. It is listed by Home Radio under Cat. No. TG75. The three pre-set potentiometers are type PN5. These fit into the Veroboard layout comfortably. Other pre-set skeleton potentiometers may be employed, of course, but it may be necessary to add wire extensions to their tags to enable connection to be made at the appropriate Veroboard holes.

THE CASE

The case used to house the prototype consists of a 6 x 4 x 2½ in. aluminium chassis with strengthening brackets at the bottom corners, as illustrated in the photographs of the rear. The deck of the chassis becomes the front panel and a 6 x 4 in. base plate serves as a rear panel. This is secured to the chassis by four self-tapping screws, which require four clearance size holes in the plate and four tapping size holes in the strengthening brackets. Four rubber feet are secured to one long side of the chassis, and the completed instrument stands on these feet.

Details of the holes which have to be drilled and cut out in the front panel are given in Fig. 2. Dimensions for the meter cut-out and mounting holes are not shown in this diagram as these are supplied with the meter, and are given on the back of the box in which it is supplied.

There are two sets of input sockets, one of which is a phono socket which accepts a plug coupled to a screened lead. This input socket is used when the input signal is derived from a high impedance source.

Resistors

(All fixed values ¼ watt 10% miniature)

R1	270kΩ	R11	22kΩ
R2	10kΩ	R12	12kΩ
R3	1.5MΩ	R13	560Ω
R4	5.6kΩ	R14	2.2kΩ
R5	4.7kΩ	R15	2.2kΩ
R6	5.6kΩ	R16	2.2kΩ
R7	1.5MΩ	R17	68kΩ
R8	18kΩ	VR1	1kΩ pre-set variable
R9	15kΩ	VR2	1kΩ pre-set variable
R10	5.6kΩ	VR3	1kΩ pre-set variable

Capacitors

C1	0.22µF plastic foil, side wires
C2	12.5µF electrolytic, 25 V.Wkg., miniature
C3	12.5µF electrolytic, 25 V.Wkg., miniature
C4	12.5µF electrolytic, 25 V.Wkg., miniature
C5	470pF polystyrene or silvered mica
C6	125µF electrolytic, 25 V.Wkg., miniature
C7	0.1µF plastic foil
C8	0.01µF plastic foil
C9	1,000pF polystyrene or silvered mica

Semiconductors

TR1	PN3819 or 2N3819
TR2	BC109
TR3	BC109
TR4	BC109
TR5	2N706A
TR6	BC107
TR7	AC127
D1	BAY31
D2	BAY31
D3	BZY88C7V5
D4	OA91

Meter

M1	0-50µA meter (see text)
----	-------------------------

Switches

S1(a)(b)(c)	3-pole 4-way, rotary miniature
S2	Push-button, push to close

Battery

B1	9 volt battery type PP3 (Ever Ready)
----	--------------------------------------

Miscellaneous

Phono socket
2 wander plug sockets
Knob
Veroboard, 0.15in. matrix (see text)
4 rubber feet
Battery connectors
Aluminium chassis, 6 x 4 x 2½ in. with baseplate
4 self-tapping screws

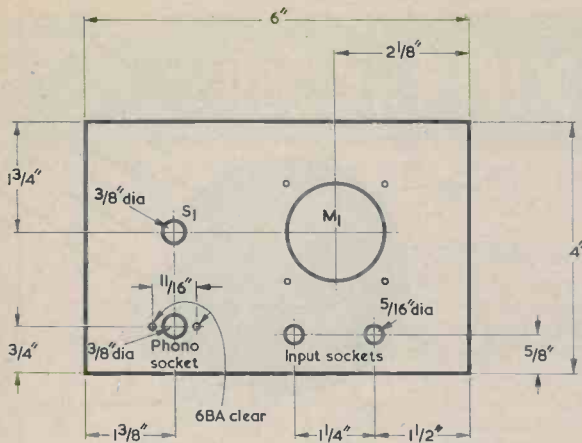
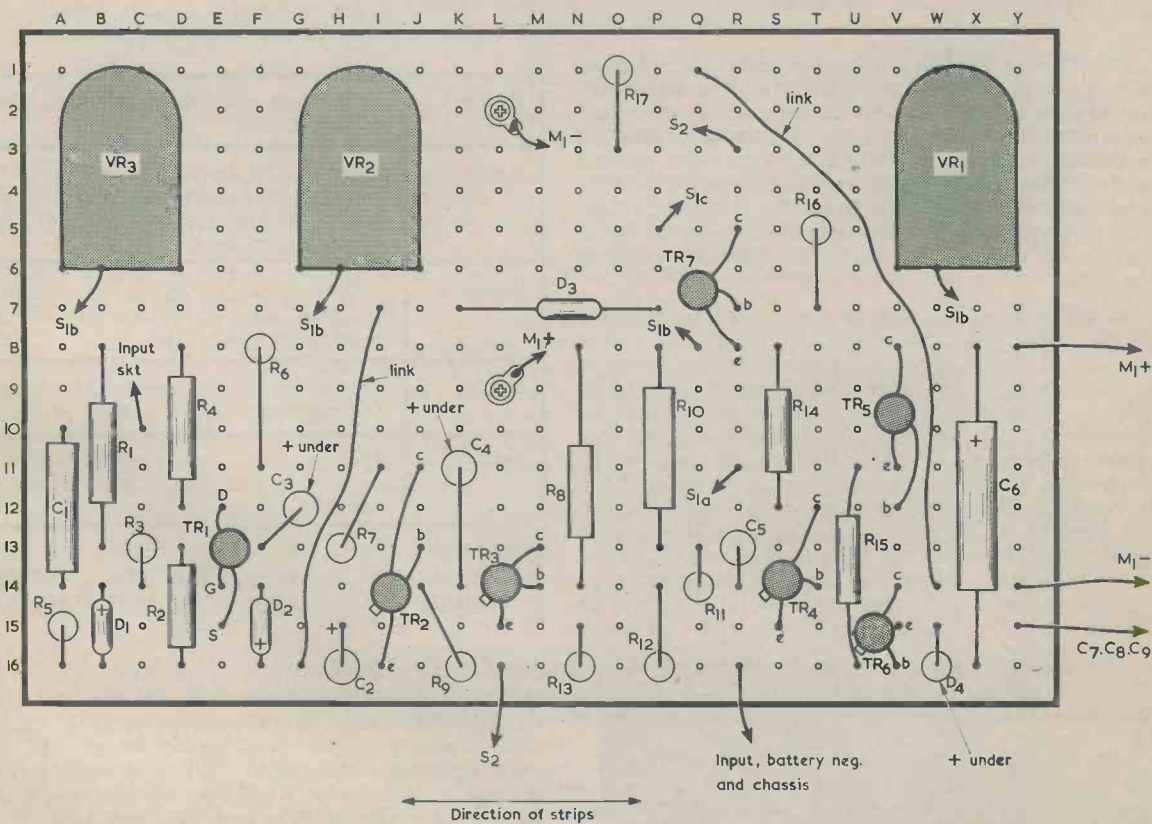

Fig. 2. Drilling dimensions for the front panel. Meter hole sizes and their positioning are given in data provided with the instrument. Switch S2 is mounted at the center of the left hand side of the case.

Connected in parallel with the phono socket are two wander plug sockets, and these may be employed for signals from low impedance circuits. The phono socket is mounted by means of two $\frac{1}{4}$ in. 6BA bolts and nuts. There is no need for the input leads to be screened inside the case, as the case itself provides overall screening. Switch S2 is fitted to the side of the case, as indicated in the photographs of the rear.

The majority of the components are mounted on a piece of 0.15 in. Veroboard having 16 strips by 25 holes and measuring approximately $3\frac{1}{2} \times 2\frac{1}{2}$ in. This is a standard size of Veroboard. A diagram illustrating this board from the component side is given in Fig. 3. Before any components are mounted the copper strips should be cut at the holes listed in the diagram. Also, the two holes at 2-L and 9-L are enlarged, using a No. 31 twist drill.

The links between holes 1-Q and 14-W, and between holes 7-I and 16-G, should be made with insulated wire. Note the connections from holes 8-Y and 14-Y to the meter tags. The wire from hole 16-Q connects to the outside connector of the phono socket, and thus completes the chassis connection. A further wire from the outside connector of the phono socket then passes to the negative battery clip. When the board is com-



Cut strips at: 6-C, 6-E, 6-I, 6-U, 6-X, 7-N, 10-D, 11-M, 12-L, 13-E,

13-K, 14-H, 14-O, 14-U, 15-J and 15-U

Fig. 3. Most of the components are fitted to a Veroboard panel. This is shown here as seen from the components side.

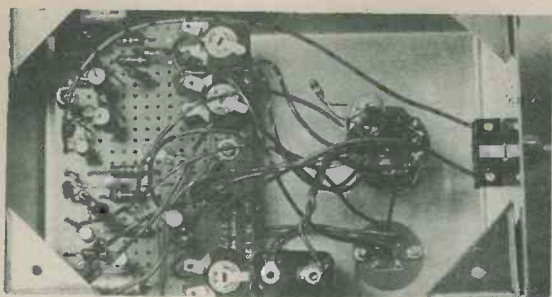

The interior of the meter. Nearly all the components are mounted on a Veroboard panel

pleted it is mounted by the two screws which make connection to the meter movement at holes 2-L and 9-L. The pre-set variable resistors are then readily accessible from the rear of the case. Wiring to switch S1 (a) (b) (c) is shown in Fig. 4.

The battery lies on the bottom of the case between the board and the phono input socket. Small pieces of foam rubber are glued to the rear of the front panel and to the back of the case to hold it tightly in position when the back is fitted.

CALIBRATION

To calibrate the unit it is merely necessary to couple it to a signal of known frequency and to adjust the appropriate pre-set variable resistor so as to obtain the correct reading in the meter. This process must be repeated on each range. VR1 controls the meter reading on the 0-500Hz range, VR2 the reading on the 0-5kHz range and VR3 the reading on the 0-50kHz range. For greatest accuracy the test signals should be at frequencies which give nearly full-scale deflection in the meter.

Suitable signals for calibration purposes are provided by the audio tones transmitted by the B.B.C. before the start of programmes, and details of these are given in the accompanying table. If an audio tone is taken from a mains-driven television receiver it must be remembered that the television chassis will be connected to one side of the mains supply and that all consequent precautions against shock must be observed. It would probably be best to couple a microphone to the input of the frequency meter and use this to pick up the sound from the television receiver's loudspeaker.

A microphone could also be used with a musical instrument and in this respect it is useful to remember that the A below Middle C is 220Hz, and that the A

The frequency meter with the Veroboard panel removed.

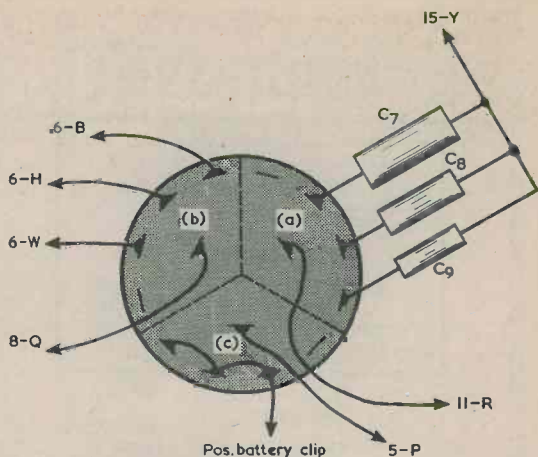
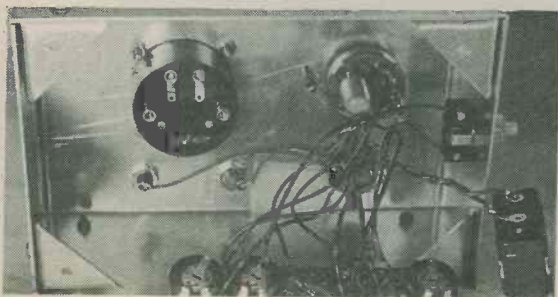

Fig. 4. Connections at switch S1 (a) (b) (c). Check with a continuity tester the four contacts which correspond to each of the three centre tags, as the latter may be positioned differently in some switches.

TABLE

B.B.C. Standard Frequency Audio Tones.
(Transmissions before start of programmes).

Radio 1 and 2	4 minutes of 440Hz prior to the signature tune
Radio 3	250Hz at 30 second intervals then 4 minutes of continuous 250Hz tone and 1 minute pulsed tone at 10 second intervals
Radio 4	900Hz tone pulsed at 15 second intervals and 4 minutes of 900Hz tone prior to the bells
BBC-1	During trade test periods 1kHz tone is transmitted for 5 minute periods
BBC-2	During trade test periods 440Hz tone is transmitted for 5 minute periods

below that is 110Hz. The A above Middle C is 440Hz, the next A is 880Hz and so on. A table giving piano scale frequencies was given in the Data Sheet in the October 1973 issue of this journal.

BATTERY TEST

With a good battery installed and the unit set to the 0-500Hz range, S2 should be pressed and the meter reading noted. This should be around half-scale deflection, the actual reading depending upon the setting given to VR1 during calibration. A note should be made of this reading. Each time in the future that the unit is used, S2 should be closed with the 0-500Hz range selected, to check that the same reading is given. If a lower indication is given then the battery voltage is excessively low and it must be replaced. If, when S2 is pressed with a good battery connected, the meter gives a reading in excess of f.s.d., the value of R17 should be increased.

RECENT PUBLICATIONS



HI-FI YEAR BOOK – 1974. Edited by Colin Sproxton.
512 pages, 140 x 215mm. (5½ x 8½ in.) Published by IPC Electrical-Electronic Press, Ltd.
Price £1.50.

The 1974 Edition of this well established book contains even more information than has appeared in previous issues. Aimed primarily at the hi-fi enthusiast and retailer it gives a directory of all currently produced high fidelity equipment and accessories available in the U.K., giving descriptions and specifications, manufacturers' addresses, recommended retail prices and, in many instances, photographs of the items listed.

The book commences with four articles covering f.m. fringe reception, developments in tuner/amplifiers, record buying for beginners and a review of the present quadrasonic scene. These are followed by a newly introduced feature: a list of magazines and books of interest to audio enthusiasts and music lovers. Then follows the directory, which forms the bulk of the volume. This is presented in 29 sections ranging from constructional kits to amplifiers, control units and hi-fi cabinets. The section in the directory on quadrasonic equipment takes up some 10 pages and lists the products of 26 manufacturers in this field. Further included in the book are directories of manufacturers and hi-fi dealers. There is also a list of v.h.f. radio transmitting stations and a table giving tape playing times.

The publishers report a sale of well over half the total print order in the first week of publication and, at the time of writing this review, are contemplating a further reprinting. This represents a practical acclaim which this comprehensive and well presented book deservedly warrants.

'Hi-Fi Year Book – 1974' should be available at leading booksellers at the cover price quoted above. In instances of difficulty it may be obtained direct, for £1.75, from the publishers at IPC Electrical-Electronic Press Ltd., Room 11, General Sales Department, Dorset House, Stamford Street, London, SE1 9LU. Cheques should be made payable to IPC Business Press, Ltd.

FET APPLICATIONS HANDBOOK. Edited by Jerome Eimbinder.
358 pages, 130 x 215mm. (5 x 8½ in.) Published by Foulsham-Tab Ltd. Price £1.85.

This book is compiled from articles appearing in the American electronics journal *EEE Magazine* over a period between 1966 and 1970. Nearly all the chapters are written by engineers employed by such firms as Union Carbide, Texas Instruments and Amelco Semiconductor, and the material is, in consequence, accurate and based on manufacturing design experience. Mathematics are employed where necessary, but may be skipped by the reader who requires a more general understanding of the devices and circuits dealt with.

The book commences with an introduction to the f.e.t. and a consideration of its characteristics, and then proceeds to f.e.t. applications, complementary f.e.t.'s, the biasing of f.e.t.'s, and the f.e.t. as a constant current source. Following chapters deal with f.e.t. noise, f.e.t. audio and v.h.f. amplifiers, source followers and phase splitters, f.e.t. chopper circuits, f.e.t. switches, f.e.t.'s in integrated circuits, f.e.t. logic circuits, photo-f.e.t.'s, an f.e.t. electrometer amplifier, the f.e.t. as a voltage controlled resistor, and oscillator design nomograms. The final four chapters discuss an improved op-amp design using f.e.t.'s, gate current, j.f.e.t. biasing and m.o.s.f.e.t. biasing. There are also two appendices devoted to mathematical derivations and design data.

This book will be of interest to the engineer and the more advanced home constructor and amateur. Of particular value are its competent authorship and exceptionally wide range.

VHF PROJECTS FOR AMATEUR AND EXPERIMENTER. Edited by Wayne Green.
230 pages, 130 x 215mm. (5 x 8½ in.) Published by Foulsham-Tab Ltd. Price £1.40.

This book consists of articles previously published in the American *73 Magazine* over a period of several years up to 1972, each being written by an American or Canadian amateur. There are 61 of these reprinted articles in all and, as may be expected, they present as wide a range in approach as is evident in the number of contributors.

All the projects are, of course, devoted to v.h.f. transmission or reception, but the English reader has to be reminded that the American amateur has a 6 metre (50MHz) band and a 220MHz band in addition to the common 2 metre (144MHz) band. As a consequence, some of the design approaches for 50 and 220MHz would need to be modified to be applicable to conditions in the U.K.

To most U.K. readers this point will be of relatively minor importance, as main interest usually lies in discovering how other amateurs tackle general design problems at these higher frequencies. The subjects dealt with cover all aspects of v.h.f. operation including transmitters, receivers, station control units and antenna design.

'V.H.F. Projects for Amateur and Experimenter' will be found particularly helpful by the amateur transmitter or listener whose hobby is based on transmission and reception at these frequencies.



LISTENING TO OSCAR

By Arthur C. Gee, G2UK.

BY THE TIME THIS APPEARS IN PRINT, OSCAR 6 may well have completed its planned life and ceased to function, though at the time of writing there is every indication that it will continue to be operative for some considerable time ahead. OSCAR 7 is scheduled for launching in March and as there will be a similar communications link in it to that in OSCAR 6 in the 'two-metre up - ten metre down' range, which will no doubt be as popular as it has been in OSCAR 6, readers who are interested in the amateur satellite field may care to hear of the steps taken at the writer's station to bring his receiving facilities for this mode up to an acceptable standard. The experience gained with OSCAR 6, will stand one in good stead with OSCAR 7 and may help guide those who have not yet attempted to receive signals from amateur satellites along lines which will lead to success.

'TURNSTILE' AERIAL

The author started listening for OSCAR 6 with a rather old, but much beloved Hammarlund HQ 110 amateur bands communication receiver, which could be considered fairly typical of the receivers used by many amateurs. The ten metre band was not a popular one with the author as propagation conditions have not been too good during recent years and much trouble has been experienced with TVI. Consequently nothing special was available in the antenna line, such for instance as a ten metre beam. The only aerial available for use on ten metres was a multiband trapped dipole, which was around 108 feet long and ran north to south. It was about 30 feet high and has 100 feet or so of coaxial feeder from its centre to the shack.

With this, reasonably good signals were received from OSCAR 6, the author in fact picking up its signals on its second orbit. However, after a visit to the shack of Pat Gowen, G3IOR, the writer realised just how far short

his receiving equipment was falling, and this was further demonstrated by G3IOR when he visited the writer and effectively proved to him what little gain was being obtained from the long wire aerial on ten metres! So the next step was to put up a ten metre aerial specifically intended for receiving OSCAR on 29.5 MHz.

Current amateur radio literature dealing with OSCAR indicated that the 'turnstile', crossed dipoles, type of antenna, gave results on ten metre OSCAR reception which were more than adequate for most purposes. Two half-wave dipoles are rigged up at right angles to one another and by means of a quarter wavelength stub connecting the two, a 90 degree phase relationship is obtained between them. The polarisation of such an arrangement becomes circular, which is ideal for the changing polarisation of signals from OSCAR caused by its 'tumbling' around in space. Erected horizontally, this antenna is also particularly useful for overhead orbits, which are the ones which give the best signals and which are often almost inaudible if a highly directional beam directed at the horizon is used. This latter type of aerial is obviously best for Dx reception, but falls down badly on signals from above. Another disadvantage of the ten metre beam antenna when used for the reception of OSCAR is that it has to be tracked on to the satellite, and there is already plenty for the single operator to do with tuning the receiver and operating the transmitter, etc., without trying to rotate the beam to keep it tracking the satellite as well. So the writer decided that the next step would be to put up a 'turnstile' antenna instead of going for a rotary ten metre beam and see what improvement resulted from its use.

Pat Gowen kindly provided the coaxial matching section and details of it are shown in the diagram and photograph. Some mechanical ingenuity is needed to sort out suitable

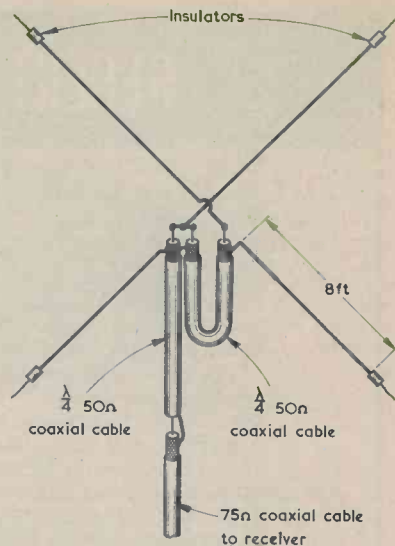
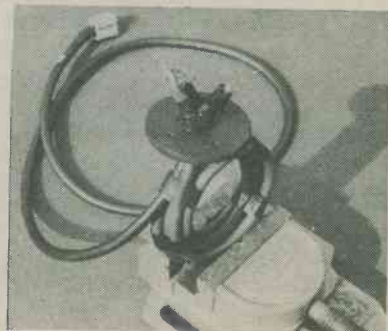

Fig. 1. Arrangement of phasing sections.

insulating arrangements at the centre, where the dipoles cross, to support the coaxial cables and anchor the inside ends of the dipole arms. The writer solved this by cutting a circle of quarter-inch thick insulating material, which can be fibreglass or Paxolin, or whatever the junk box will produce, drilling a hole large enough in the centre to accommodate the bunch of coaxial cables, then drilling four holes equally spaced around the edge of the circle to take the inside ends of the dipole arms. The connections can then be soldered and the ends of the coaxial cables protected with Araldite.

Ideally, the antenna should be rigged up from four poles eight to ten feet high or so, but this arrangement is likely to be an unobtainable ideal.



Arrangement of coaxial cable and centre insulator.

Such was the case at the writer's QTH, where the only really suitable place for locating it was above the garage roof at one side of the house. It was possible to rig one dipole from the end of the pitch of the roof of the house down to one corner of the garage roof, and to stretch the other dipole down to opposite corners of the garage roof. The coaxial feeder then hung down conveniently and could be brought into the shack in a reasonably short run. Whilst the dipoles were not truly at right angles to each other nor horizontal, which would have been the ideal, this compromise arrangement worked excellently. There was a very great improvement indeed in signal strength over the long wire antenna and furthermore, in spite of the crossed dipoles being screened to the west side of the house, little difference was noted between orbits to the west of the author's QTH from those to the east, where the dipoles are clear and unshielded.

PRE-AMPLIFIER

So this, then, advanced the reception of OSCAR very markedly indeed.

However, it was felt that there was still room for further improvement, particularly after reading an article in the *AMSAT Newsletter*, which drew attention to the advantages to be gained by putting a ten metre pre-amplifier ahead of most typical amateur bands receivers.

At this point, the writer must confess to taking a short cut and, instead of making up such a pre-amplifier from the circuit suggested in the *AMSAT Newsletter* article, he had it built for him by one of the firms who specialise in this type of equipment. (Telford Communications, 78b High Street, Bridgnorth, Shropshire, WV16 4DS.) It was a neat little unit, solid state, with its own battery contained within, an on/off switch, and coaxial cable sockets each end for the aerial input and the output to the receiver aerial socket. The pre-amplifier was simply plugged in to the aerial lead from the crossed dipoles, between the end of the aerial lead-in and the receiver. The improvement in the signal strength and the signal to noise ratio was absolutely dramatic!

OSCAR 6 reception is now as good

as can be desired at the author's QTH, it being quite commonplace to have S8 SSB and S9 CW signals on overhead passes.

CONSTRUCTIONAL DETAILS

The arms of the dipoles can be made up from any suitable aerial wire; each arm is 8ft. long. The phasing sections are of 50Ω - or thereabouts - coaxial cable and are 4ft. long. (This dimension takes in an assumed velocity factor of 0.55 in the cable). They should be coiled up and fixed with tape as shown in the photo. The general arrangement is clearly shown in the accompanying diagram and photo.

For the benefit of those readers who would like to build their own pre-amplifier, we reproduce below¹ extracts from the article by Jack Colson,

W3TMZ in the *AMSAT Newsletter* referred to above, together with the circuit given and some constructional details. This is from *AMSAT Newsletter* Volume V, Number 1, March 1973. This Newsletter is obtainable on subscription from AMSAT, P.O. Box 27, Washington, D.D. 20044. ■

Details of a 29.5 MHz pre-amplifier designed by W3TMZ and published in *AMSAT Newsletter*.

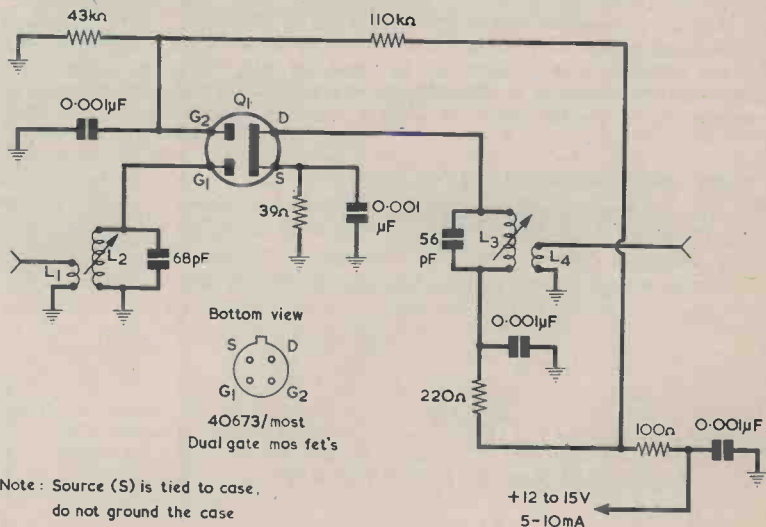

Note: Source (S) is tied to case, do not ground the case

1. A number of preamps of the following design have been built. These have had measured noise figures ranging from 2.5 to 4.5 dB and power gains ranging from 15 to 22 dB. An absolute best design has not been attempted, but what has been built performs quite well.

L1 - 2T No. 24E closewound over cold end of L2.

L2 - 10T No. 24E spaced wire diameter; 1/4 in. dia. slug tuned.

L3 - 10T No. 24 closewound; 1/4 in. dia. slug tuned.

L4 - same as L1.

The layout of the components is not critical, but a shield across the device (dual-gate MOSFET) is desirable. Almost any dual gate MOSFET will work in this circuit. The devices that have protective diodes will have slightly poorer noise figures but they do offer good transient protection and are easy to use. These devices are: 3N187, 3N200, 40673, 40819, 40820, etc.

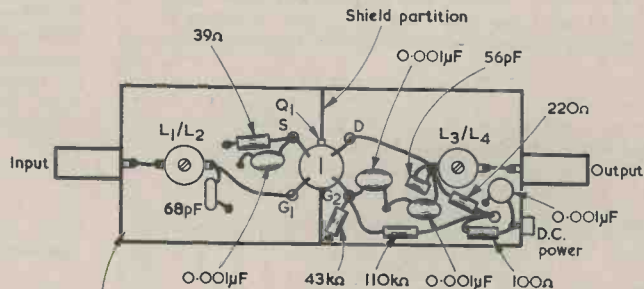

Double clad pc board (1 1/2" x 2 1/2" x 1/16")

SWITCH-OFF REMINDER

By S. Jeffrey

A sensitive circuit which indicates even the lightest of loads on an a.c. mains circuit.

THE CIRCUIT DESCRIBED IN THIS ARTICLE WAS originally designed for use in a busy repair workshop, and it indicates whether any equipment powered by the 240 volt a.c. mains is switched on. It is inserted at the supply input and causes a neon bulb to glow when any load, from as little as 15mW up to several kilowatts, is switched on. It provides a useful reminder to prevent equipment being left switched on at the end of the working day. It can also be used for any other applications where it is desirable to know if electrical equipment is turned on.

CIRCUIT OPERATION

The circuit of the reminder appears in the accompanying diagram. Transistor TR1 is a Motorola MJE340, this being a power transistor having a maximum collector rating of 300 volts. This high voltage rating,

and not the power capability, is the reason for its choice here, and the transistor does not need to be mounted on a heat sink. The MJE340 may be obtained from Henrys Radio Ltd. The neon bulb is a small wire-ended component listed by Home Radio (Components) Ltd. under Cat. No. PL32A. All the diodes are silicon rectifiers, and these are discussed in more detail later. Resistors R1 and R3 are $\frac{1}{4}$ watt whilst R2 is 1 watt. All three resistors are 10% or 5%.

The a.c. supply couples into the circuit at the right, and the two arrowed points at the left couple to the circuit which is to be monitored. The centre-tapped transformer winding, T1, causes half the supply voltage to be applied to the junction of R2 and R3. The full mains voltage cannot be applied here as the collector voltage rating of the transistor could then be exceeded.

To start an explanation of circuit operation, let us assume that a load is connected across the monitored

The switch-off reminder circuit. The neon bulb lights up when any load of 15mW or more is connected across the monitored supply points.

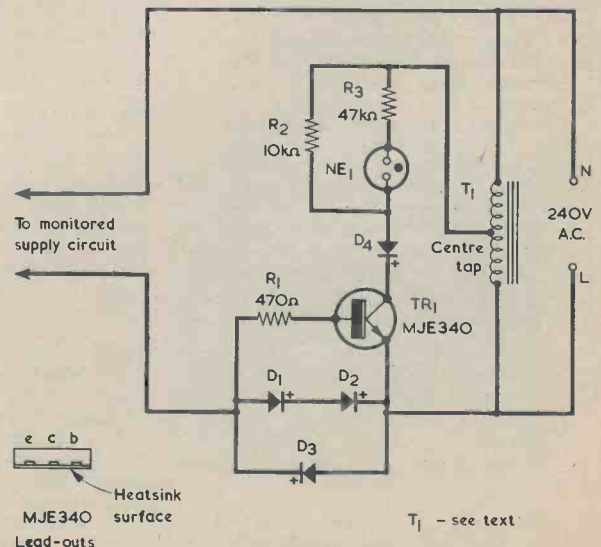

circuit. During the half-cycles when the upper line is negative, current flows to the supplied circuit via rectifier D3 and all that happens is that a forward voltage of about 0.6 volt is dropped across this rectifier.

When the half-cycles on the upper line are positive the alternating current flows through D1 and D2 in series, causing a forward voltage of about 1.2 volts to appear across the pair. This voltage is sufficiently high to allow a current to flow via R1 into the base-emitter junction of TR1, whereupon this transistor turns on. Current then flows from the transformer centre-tap through R3, the neon and D4 to the collector of the transistor, and the neon bulb lights up. If the load is removed from the monitored circuit so that no current is drawn through D1 and D2, there is no voltage drop across these rectifiers and no base current for the transistor, which remains turned off. Thus, the neon bulb only lights up when current is drawn through D1 and D2.

The purpose of D4 is to prevent the neon lighting up during the half-cycles when the upper line is negative. If this rectifier were omitted, current could then flow through R3, the neon, the collector-base junction of the transistor and R1, causing the neon to glow regardless of whether or not current was being drawn by the monitored circuit.

SENSITIVITY

Resistor R2 is included to reduce sensitivity and to keep neon operating currents well above leakage current values in the semiconductors. Assuming a neon striking voltage of 70 volts, about 7mA collector current has to be provided by the transistor to turn the neon on. With the author's circuit the sensitivity was such that the neon was just illuminated when a 4M Ω load was connected across the arrowed points at the left of the diagram. Supply wiring insulation should be much higher than 4M Ω , and so the sensitivity given with R2 at 10k Ω is a realistic figure. A sensitivity at this level also provides an automatic check on supply line leakage, since the neon glows if leakage resistance falls below 4M Ω . The sensitivity can be reduced, if desired, by selecting a smaller value for R2. If this is made considerably lower than 10k Ω , the transistor will need to be fitted with a heat sink.

The reactance of an 800pF capacitor at 50Hz is about 4M Ω , and a capacitance of around this value, if connected across the arrowed points, should also turn on the neon bulb. In practice it was found that 1,500pF was the minimum capacitance needed to do this. In consequence, if there is a long run of cable in the circuit being monitored, its self-capacitance may be high enough to turn the neon on. In this event the value of R2 should be reduced accordingly.

Diodes D1, D2 and D3 require a maximum forward current rating which is in excess of the total current which will be drawn from the 240 volt supply. Their p.i.v. figure can be very low as the inverse voltages across them are limited by the cross-connected diode or diodes. D4 is any small silicon rectifier with a p.i.v. of 200 volts, and a 1N4003 would be suitable here.

The centre-tapped mains transformer winding shown as T1 can be given by any centre-tapped transformer winding suitable for mains voltage. The author used the 250-0-250 volt h.t. secondary of a discarded valve receiver mains transformer, no connection being made to the primary or heater windings on this transformer. Similar results will be given by using 200-0-200, 300-0-300 or 350-0-350 volt h.t. secondaries. ■

RADIO & ELECTRONICS CONSTRUCTOR

APRIL ISSUE FEATURES

MEDIUM WAVE TUNER-RECEIVER

Employs 3 inexpensive transistors, this receiver can be coupled to an external amplifier or tape recorder, or used as a complete receiver in conjunction with a crystal or high impedance magnetic earphone.



TELEVISION AERIAL ATTENUATOR DESIGN

Calculates the values needed for a 75 Ω television aerial attenuator.



STEREO LOUDSPEAKER ARRAYS

Describes the use of inexpensive loudspeaker networks for improved spatial effects in stereo sound reproduction.

PLUS

MANY OTHER ARTICLES

AND

DATA SHEET No. 85

Resistance of Metals

PRICE 22p

Copies may also be obtained direct from the Publishers, 28p. including postage. Published by Data Publications Ltd. 57 Maida Vale, London W9

RADIO & ELECTRONICS CONSTRUCTOR

SHORT WAVE NEWS

FOR DX LISTENERS



By Frank A. Baldwin

Times = GMT

Frequencies = kHz

One of the compelling features of short wave listening, perhaps, is the logging of the unexpected or the unusual transmission and this can occur on almost any channel at any time. It may be a station radiating experimentally on several channels (see under Riyadh in the January issue) or a station reappearing on an old frequency (as with Saigon on 4877) or a transmission differing markedly from the published schedule and generally accepted facts, such as Singapore in parallel and in English on 5010 and 5052 (see under Singapore in the February issue). The truth is, of course, that the short waves are subject to constant changes by those operating over them and by influences from without this terrestrial sphere; combining these results in a never ending changing scene in which nothing should be taken for granted and everything subject to question.

The reappearance, after a long absence, of the Chinese station (listed Kunming) on 4759.5 at 2340 was an example of the unexpected. The frequency is subject to some slight variation, being heard at times on the listed 4760. The unusual however is represented by the logging of YVWJ Radio Cristal on the regular 4820 at 2325 when the transmission consisted of a speech in Spanish by the President of the Republic until 2351 with all the (receivable at that time) Venezuelan 60m band stations in parallel, as confirmed by tuning to 4800 YVMO Radio Lara; 4860 YVQE Radio Maracaibo; 4880 YVMS Radio Universo; 4890 YVKB Nueva R. Difusora; 4900 YVNK Radio Juventud; 4960 YVQA Radio Sucre; 4970 YVLK Radio Rumbos and 4980 YVOC Ecos del Torbes. At 2352, all stations reverted to their own programmes.

CURRENT SCHEDULES

● SOUTH AFRICA

"Radio RSA - the Voice of South Africa", Johannesburg, has the following schedule, in English, to the U.K. From 1000 to 1050 on 21490; from 1800 to 1850 on 15175 and on 17885. A Worldwide Service in English is radiated from 1030 to 1046 on 11970, 15220 and on 21535. An English Service to Canada and the U.S.A. is broadcast from 2230 to 0242 on 9585, 9695, 11900 and on 11970.

● PAKISTAN

"Radio Pakistan", Karachi, operates an External Service in English, Urdu and Sylheti to the U.K. from 1915 to 2115 on 7095 and on 9465, the newscast in English being from 2000 to 2005. A newscast at slow speed, in English to W. Europe, is radiated from 1100 to 1115 on 17910 and on 21625.

● EAST GERMANY

"Radio Berlin International - the Voice of the GDR", Berlin, schedules the following service, in English to Europe, as follows - from 1730 to 1815 on 6115; from 1830 to 1915 on 6080, 6125, 7185, 7300 and on 9730; from 2115 to 2200 on 6115.

● CHINA - 1

"Radio Peking", Peking, radiates an External Service, in English to Europe, from 2030 to 2130 on 6270, 6825, 6860, 7590 and on 9030; from 2130 to 2230 on 6270, 6825, 6860, 7590 and 9030.

Of interest to Dxers would be the following - in Mongolian from Hailar on 3900, 4815 and on 4880 from 1400 to 1500; in Mongolian from Huhehot on 4070 and on 6974 from 1400 to 1500; in Hindi from Lhasa on 4035, 5935 and on 9490 from 1600 to 1700 and a repeat of this latter programme from Lhasa, on the same channels, from 1700 to 1800.

The P.L.A. Fukien Front station has an External Service to Taiwan and offshore islands, in various Chinese dialects, signing-on at 2005 in Standard Chinese and Amoy, on 2600, 2800, 3200, 3400, 3535, 3900, 4380, 4840 (and on 4140 to 2200). The Service continues until 0530 sign-off with various additions and deletions of channels. Probably the best chance of logging this station here in the U.K. would be the transmission in Standard Chinese from 2320 to 2400 on 3200, 3400, 4380, 4840, 5170, 5240, 5900, 6400, 6765 and on 7025. Signing-on again at 1000, the transmissions, again in various Chinese dialects, continue through to 2000 sign-off.

● U.S.S.R.

"Radio Kiev", Kiev, operates a schedule in English for Europe on Mondays, Thursdays and Saturdays, from 1930 to 2000 on 5920, 6020 and on 6170.

"Radio Vilnius", Vilnius, has a Saturdays and Sundays English Service to North America and Europe from 2230 to 2300 on 7120, 7290 and on 9685.

"Radio Moscow", Moscow, offers an External Service, in English to the U.K., from 1130 to 1230 on 9450, 11705, 11745, 11830 and on 15175; from 1900 to 1930 on 5920, 5970, 6010, 6020, 6175 and on 7280; from 2000 to 2030 on 5920, 5950, 5970, 5980, 6010, 6020, 6055, 6175 and on 7280; from 2100 to 2200 on 5920, 5970, 6010, 6055, 6175, 7280 and on 9625 and from 2200 to 2230 on 5920, 5970, 6010, 6055, 6175 and on 7280.

● **ISRAEL**

"Kol Yisrael", Tel Aviv, currently operates a service in English to Europe and the U.K. from 2000 on 6205, 7095, 7170, 9495, 9785 and on 10250.

● **GREECE**

Athens has an External Service, entirely in Greek, to Europe, from 1900 to 1950 on 5960.

● **KUWAIT**

"Radio Kuwait" presents an English Service from 1430 to 0700 on 15345 and from 1630 to 1900 on 9715 and on 15415.

● **LEBANON**

"Radio Beirut" features broadcasts to Africa and Europe in English, French and Arabic from 1830 to 2030 on 11730.

● **CLANDESTINE**

The "Voice of the Middle East Nations" operates in Arabic, Kurdish and Farsi daily from 1430 to 1530 on 7200.

● **CHINA - 2**

Of interest to Dxers would be the following - in Mongolian, Huhehot on 4068 and on 6974 from 2200 to 0055, from 0330 to 0545; Hailar on 3900 and on 6080 from 2200 to 2250 and from 0430 to 0520; Urumchi on 4220 and on 5055 from 0430 to 0520 and Chifeng on 3930 from 0430 to 0520. In Uigher, Urumchi on 4500 and on 7050 from 0030 to 0115 and also from 1300 to 1345. In Kazakh, Urumchi on 5800 and on 5440 from 1400 to 1445 and from 0130 to 0215.

In Standard Chinese, Foochow on 4975 and on 5040 from 2100 to 2130 and from 0001 and 0030 for Quemoy and Matsu.

● **BULGARIA**

"Radio Sofia", Sofia, maintains an External Service in English to the U.K. from 1930 to 2000 and from 2130 to 2200 on 6070 and 9700.

● **POLAND**

"Radio Warsaw", Warsaw, radiates a service in English to Europe from 0630 to 0700 on 7285, 9540 and on 9675; from 1200 to 1230 on 7285 and 9540; from 1600 to 1630 and from 1830 to 1900 on 6095, 7125, 7285 and on 9540; from 2030 to 2100 on 6155 and 7285; from 2230 to 2300 on 5995, 6135, 6155 and on 7285.

● **ROMANIA**

"Radio Bucharest", Bucharest, projects an English programme to Europe from 1300 to 1330 on 9690, 11940 and on 15250; from 1930 to 2030 on 6150 and on 7225 and from 2100 to 2130 on 5990 and on 7195.

AROUND THE DIAL

● **NIGERIA**

Lagos can be heard, in English, from 0715 with a newscast which includes local affairs and events, on 15180. Sign-off with the National Anthem is at 0735.

● **INDIA**

All India Radio, Delhi, may be logged from 2000 on 7215 when they present a programme in English which includes the news and a talk about Indian affairs currently engaging public attention in that country.

● **PAKISTAN**

Radio Pakistan can be tuned on 21590 at 1145, when we heard a programme of local music. Identification was at 1200 after which the station closes.

● **BANGLADESH**

Dacca can be heard on 17935 at 1135, at which time a programme of local music and songs were being radiated.

● **CANADA**

Sackville is to be heard with a newscast of local events in English at 1200 on 17820.

● **AUSTRALIA**

VLQ9 Brisbane, a 10kW transmitter, is sometimes capable of being logged from 1300 on 9660 when they radiate a newscast in English, the signal however being 'wiped-out' by the BBC tuning signal at 1307.

QSX

This section being intended for the Dxer, we offer the following -

● **CHINA**

Kunming on 4759.5 on several occasions, from around 2320 onwards, with YL in Chinese. The Channel is a difficult one, CW QRM abounding.

● **CAPE VERDE ISLANDS**

Another very difficult channel is that of 3883 where, on occasions, one can hear CR4AA R.C. Cabo Verde from around 2230 onwards, being logged recently from 2250 when transmitting songs in Portuguese, guitar music etc. Sign-off was at 2302 with "A Portuguesa". Severe CW QRM just HF.

CR4AC R. Barlavento on 3930 can often be heard around 2230 and last noted here with songs in Portuguese at 2250.

● **INDONESIA**

Loggings of Indonesian stations have not been all that plentiful during the last 'season' for them here in the U.K. YDK6 Jambi was heard at 2326 on the regular 4927 channel when featuring songs in Indonesian and a local orchestral item, several chimes at 2330 and announcements by YL. RRI Palembang at 2346 on 4855 with YL in Indonesian, local 'pops' at 2355 then OM announcer at midnight; both stations being received rather late in the 'season' - but better late than never.

● **CAMEROON**

Have you ever heard Garoua sign-off? If not, it is well worth logging. Try on 5010 at 2155 when the news in Arabic is radiated, after which there is the National Anthem followed by the interval signal of flute and tam-tam repeated.

● **ANGOLA**

Another sign-off recently observed was that of CR6RS R.C. do Lobito on 4937 where, after some light music and announcements in Portuguese by OM, the National Anthem 'A Portuguesa' was heard at 2259.

ELECTRONIC CANDLE

By K. H. Fordham

A simple circuit which offers an amusing and unusual effect.

THE DEVICE TO BE DESCRIBED HERE CAN BE MADE UP in the form of a box having an m.e.s. pilot lamp on its top surface and two switches on one side. When the switches are operated in the correct manner the bulb lights up brightly.

What happens next is that if someone blows strongly on the bulb, in a manner reminiscent of blowing out a candle, the bulb dims! If the bulb is left alone, it slowly returns to full brilliance. Repeated blowing makes the bulb dimmer and dimmer until it eventually extinguishes. After some moments, however, the filament commences to glow once more and it gradually builds up to the full brightness level it had originally.

The novelty of the device can both mystify and amuse friends and acquaintances, and it can prove to be particularly popular at parties. An appreciable amount of 'puff' is required to completely extinguish the bulb, and a contest can be held to discover who can achieve this with the least number of blows.

THERMISTOR

The secret of the device is a small inconspicuous thermistor positioned alongside the bulb, and it is this which is affected by the blowing and not, of course, the bulb itself. The thermistor employed is the S.T.C. 'Brimistor' type CZ10. This component has a resistance of $11k\Omega$ at 20°C and $4k\Omega$ at 50°C . The resistance drops to approximately 150Ω at the maximum operating current of 75mA , this occurring at a body temperature in excess of 50°C .

The thermistor can be seen in Fig. 1, in which diagram it appears as TH1. Transistor TR1 functions as a constant current source, limiting the current flowing in its collector circuit to approximately 60mA . Thus, it becomes impossible to exceed the 75mA maximum rating of the thermistor. The other components in the constant current section of the circuit are R1, D1 and D2, which ensure that a stabilized voltage of about 1.2 volts relative to the upper supply line is present at the base of TR1, and resistor R2, which limits the emitter current and hence the collector current to the 60mA figure.

The current available from TR1 passes through resistor R3, the pilot lamp, which is a 6 volt 60mA type, and the thermistor. The rather unusual supply voltage of 31.5 volts is provided by three 9 volt batteries and a 4.5 volt battery in series. The supply voltage is not particularly critical, but it was found that this combination gave best results. Since a current of 60mA is drawn when the bulb is at full brightness, fairly large batteries are required.

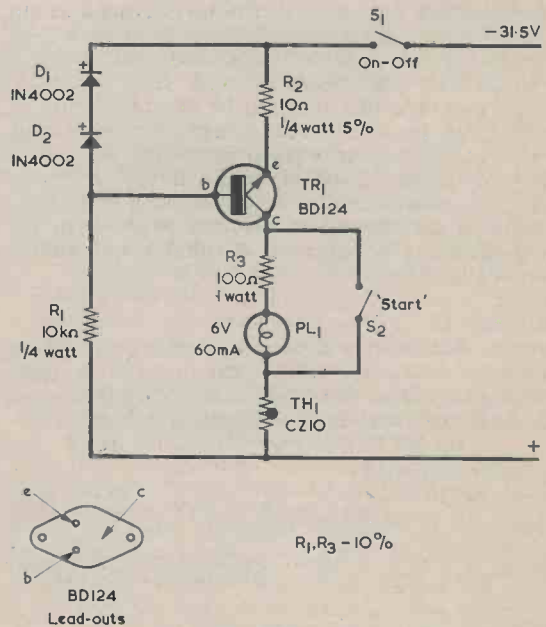
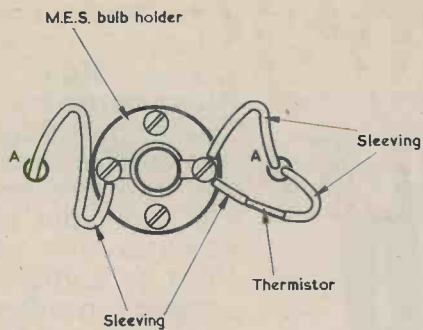

Fig. 1. The circuit of the electronic 'candle'. The bulb can be extinguished by blowing on the thermistor.



A-holes in box top

Fig. 2. The thermistor can be camouflaged in the wiring to the bulb holder. The lengths of sleeving on the thermistor leads can be black, and the other two lengths bright green and red, or similar, to detract attention from the thermistor.

THERMAL EQUILIBRIUM

The thermistor has to be in a state where it is just on the hot side of thermal equilibrium with the ambient temperature, and this necessitates an initial warm-up time. Warm-up is achieved by initially closing the 'Start' switch S2, and then opening it after a short period. If the bulb lights up when S2 is opened, the circuit is ready for use. Blowing on the thermistor then cools it and increases its resistance.

The CZ10 is a very small thermistor, having a length of around 0.3 in. and a body diameter of about 0.1 in. The body is black with metallised ends, and the latter can be painted matt black to make the component even less conspicuous. It should be mounted near the bulb and can be largely camouflaged by the wiring. The best plan is to use a panel-mounting m.e.s. bulb holder and to employ wire covered with wide diameter sleeving to connect to this. If the sleeving extends to the body of the thermistor, without covering it, the desired effect can be achieved. A suitable approach is shown in Fig. 2.

To use the device, S1 is closed to switch on the battery, after which S2 is closed to allow the thermistor to warm up. After a period S2 is opened whereupon, if the lamp lights up, the circuit is ready for use. A vigorous puff on the thermistor will cause the bulb to dim, and continual blowing will cause it to extinguish completely for a short period. The time needed for the thermistor to warm up will vary slightly for different components. In the author's circuit it is necessary to keep S2 closed for 1½ minutes after switching on.

The BD124 is a power transistor and is employed because the voltage and power requirements placed on it are a little in excess of the ratings for smaller transistors. Maximum power dissipation in the transistor is given when S2 is closed and the thermistor is fully warmed up, and is of the order of 1.3 watts. The transistor does not need to be mounted on a heat sink.

Use the NEW Strip-fix Plastic PANEL SIGNS



- ★ SET 3 - Wording - WHITE
- ★ SET 4 - Wording - BLACK

Over 1,000 words and symbols,
covering more than 300 terms, in
each set

Illustration of actual size = RADIO
SET 5 Dials. 6 sheets containing one
Large and two Medium scales, Large
Horizontal Tuning scale, Frequencies
12 Control Panels

- Easy to fix - Just cut out words
required remove backing and press down
- Stapled in booklet form
- Designed to hang above workbench
- Pocket for loose cuttings
- Professional finish

38p per set

including V.A.T.
(postage 3p)

The Perfect Transfer for
the Home Constructor

Available from
Data Publications Ltd.
57 Maida Vale, London W9 1SN

In your workshop

This month, Smithy the Serviceman indulges in a wager concerning the location of a fault in a monochrome television receiver. In the process he is also able to enlighten his assistant on some of the basic modes of operation of transistor video amplifiers and intercarrier sound channels.

"A H NOW, THIS SHOULD BE A NICE ONE TO START THE DAY WITH!"

Cheerfully, Dick picked up a single standard monochrome television receiver and carried it over to his bench. He inserted its mains plug into one of the several mains sockets at the rear of his bench and connected a coaxial lead from the Workshop u.h.f. aerial to its aerial socket. He switched on and waited patiently.

After a period the sound channel from the local transmitter became audible from the loudspeaker. Dick waited for a short further time, whereupon a faint blank raster appeared on the screen. Dick experimentally adjusted the contrast control, but this had no effect on the raster. He looked uncertainly at the screen then scratched his head.

"I would suggest," came Smithy's voice from the other side of the Workshop, "that the fault in that set lies somewhere between the video emitter follower and the sync separator."

Dick turned round irritably, to see the Serviceman surveying him calmly from his own bench.

"Dash it all, Smithy," complained Dick. "I know that you're pretty good at this servicing lark, but I'm not going to start believing that you are now able to trace faults from a distance of ten feet!"

VIDEO AMPLIFIER

"In this instance I should think I am pretty definitely able to do so," replied Smithy. "To start off with, you're getting sound, and the line and frame timebases are obviously running or you wouldn't be getting that blank raster. I would take a guess that there's no sync getting to the line and frame timebases because the raster has the characteristic appearance which you get without sync. Since the sync

separator and the picture tube modulating electrode are both driven by the video amplifier, and since there's no picture as well as no sync, everything points to a fault between the video emitter follower and the sync separator."

"You must be having me on," protested Dick defensively. "Nobody could possibly diagnose the location of a fault from those few symptoms."

"Well, I wouldn't say I'm a hundred per cent certain about the location of the fault," responded Smithy cautiously, "but that's only because it just doesn't pay to be too dogmatic about things in servicing. Nevertheless, there's a pretty good chance that what I said is true. In fact, just to show you that I'm a sporting man I'll go as far as to have a twenty pence bet with you that the fault is between the video emitter follower and the sync separator."

"Blimey, big deal," commented Dick scornfully. "O.K. Smithy, you're

on. All of twenty pence on the fact that you've diagnosed the correct position of the fault."

"Fair enough," said Smithy, walking over to Dick's bench. "I had a slight advantage here because I'm fairly familiar with the set you've got there, which is a valve and transistor hybrid job with transistors in the i.f. and video stages. However, the symptoms would point to the same fault location in most other TV's, whether they were hybrid or used transistors throughout. Now, let's check for certain that that raster really is unsynchronised."

Smithy turned the vertical and then the horizontal hold controls experimentally, returning each to its previous setting after he had finished with it. The adjustments caused no significant change in the raster.

"Well," he remarked in a satisfied tone. "There certainly is no sync getting to the timebases."

"How can you be so certain that the

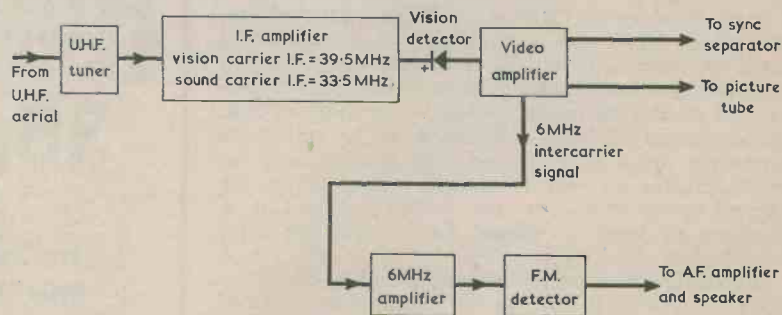

Fig. 1. Typical stage line-up in a single standard 625 line monochrome television receiver employing transistors. Some amplification of the 6MHz intercarrier signal produced at the vision detector is given by part of the video amplifier.

fault is after the video emitter follower?"

"Because," stated Smithy, "you're getting a sound signal. To start off with, this is a single standard 625 line TV with the usual intercarrier sound circuits, which means that both the vision and the sound i.f. must be getting through to the vision detector. I hardly need to tell you that the vision and sound intermediate frequencies pass through the i.f. amplifier to the vision detector, where they beat together to produce the 6MHz frequency modulated sound signal." (Fig. 1).

"I know all about that," said Dick impatiently. "Also, the vision carrier i.f. is usually 39.5MHz and the sound carrier i.f. is usually 33.5MHz."

"That's right," confirmed Smithy. "Now the output from the vision detector consists of the detected vision i.f. signal, plus the frequency modulated 6MHz sound signal, which is given by the 33.5 MHz frequency modulated sound i.f. beating in the vision detector with the 39.5MHz vision carrier i.f. The beating effect is the same as you get when you apply two different frequencies to any detector. Now, since we're obviously

getting a sound signal, it follows that the 39.5MHz vision carrier i.f. must be getting to the vision detector so that the 33.5MHz sound carrier i.f. can beat with it."

EMITTER FOLLOWER

"Well," conceded Dick, "that does at least mean that the vision signal is present after the vision detector. But you said that the fault in this set was after the video emitter follower."

"True," agreed Smithy. "And that was because the set we have here has the fairly common stage line-up in which there is an emitter follower after the vision detector, this feeding a current amplified video signal to the video output transistor and also providing partial amplification of the 6MHz sound signal. If the emitter follower is working O.K. as a sound signal amplifier, it should be equally O.K. in its capacity as video emitter follower." (Fig. 2.)

"Perhaps you're right," said Dick reluctantly. "I think the best thing I can do is get out the service manual for this set, so that I can see more closely what you're talking about."

He walked over to the filing cabinet

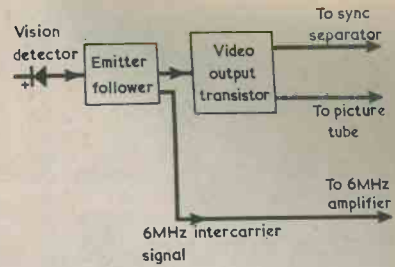

Fig. 2. It is usual to have an emitter follower between the vision detector and the video output transistor. In some instances the emitter follower stage also gives amplification of the 6MHz intercarrier sound signal.

and quickly found the requisite service manual. Returning to his bench he opened it at the circuit diagram for the receiver, whereupon Smithy pointed his finger at the vision detector and video amplifier stages. (Fig. 3.)

"Here we are," he pronounced. "As you can see, the detected signal

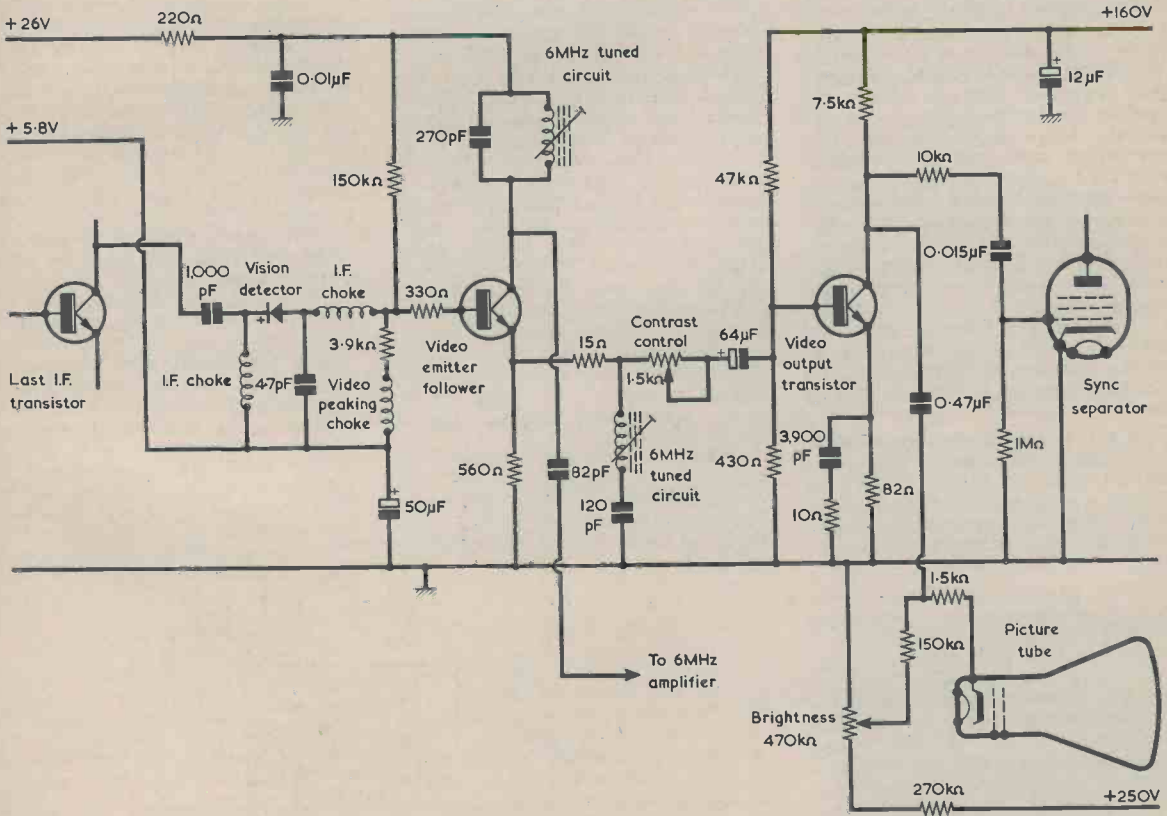

Fig. 3. Vision detector, emitter follower and video output stages of a single standard monochrome hybrid receiver. This is a simplified version of the video stages employed in the Thorn Consumer Electronics 1500 Series receivers. The provision of a number of positive supply voltages is common in receivers of this type.

from the vision detector appears across the $3.9k\Omega$ resistor and video peaking choke which form the diode load, and this detected signal is then passed to the base of the video emitter follower. This works as an emitter follower for video signals and causes these to appear across the 560Ω emitter load. In the old valve sets the detected vision signal used to go straight to a single video output valve, but with transistor sets it's pretty common to have the detected vision signal pass through an emitter follower first and then go to the video output transistor. In some transistor sets the 6MHz sound signal is taken off immediately after the vision detector but, as I said just now, in this particular receiver the emitter follower also acts as a 6MHz sound signal amplifier."

"I'm a bit puzzled here," confessed Dick. "I can visualise the need for an emitter follower to provide current amplification to drive the video output transistor, but I can't see how this can help so far as the 6MHz sound signal is concerned."

"There's a very cunning approach used in this receiver," chuckled Smithy. "If you look at that circuit you'll see that there's a 6MHz parallel tuned circuit in the collector circuit of the emitter follower transistor, and that there's also a 6MHz series tuned circuit in its emitter circuit. Now a series tuned circuit offers minimum impedance at its resonant frequency, with the result that, at 6MHz, the emitter of the transistor has a low impedance to chassis. This causes it to act in the same way as a common emitter amplifier at this frequency, whereupon an amplified 6MHz signal appears at its collector and is applied to the parallel 6MHz tuned circuit. A feed to the 6MHz sound amplifier is then taken from the collector of the transistor via the 82pF capacitor."

"Blow me, that's crafty," exclaimed Dick. "The transistor works as an emitter follower at video frequencies and as a common emitter amplifier at 6MHz."

"What is even more ingenious in the circuit," said Smithy, "is that the 6MHz series tuned circuit in the emitter circuit also functions as a 6MHz trap, and prevents the 6MHz signal getting into the video output stage."

"Well, that seems all right," said Dick. "Let's next trace the path of the video signal from the emitter follower."

"Okey-doke," replied Smithy obligingly. "We've already seen that the emitter of the emitter follower is coupled to that 6MHz series tuned circuit. This has no effect on the video signal, which passes on via the contrast control and the $64\mu F$ electrolytic capacitor to the base of the video output transistor."

"That contrast control circuit," remarked Dick, "is pretty neat, isn't it?"

"It certainly is," agreed Smithy.

"The contrast control varies the amplitude of the video signal which is eventually fed to the picture tube, of course, and in the present circuit it takes up the extremely simple form we have here. The emitter follower output and the video output transistor base circuit are both at low impedance and a series variable resistor works fine as a contrast control with no worry about loss of the higher video frequencies. Incidentally, this contrast control doesn't need a very wide range because the signal amplitude fed to the vision detector will be at a fairly constant level in any case, due to the a.g.c. circuits in the tuner and in the i.f. stages."

A.C. COUPLING

"Won't that $64\mu F$ electrolytic capacitor," remarked Dick, frowning, "give you an a.c. coupling between the emitter follower and the video output transistor?"

"It will," confirmed Smithy. "Purely a.c. video signal couplings are quite common in these single standard transistor 625 line sets. The video output transistor next amplifies the video signal, and this transistor is a device having a very high collector voltage rating which can, typically, be of the order of 115 volts. The collector couples to the cathode of the picture tube via an $0.47\mu F$ capacitor which, incidentally, gives another a.c. coupling. In this receiver there is a brightness control circuit which also couples to the cathode of the tube."

"I see that there's a capacitive coupling to the sync separator," commented Dick. "The video output collector couples to the sync separator grid via a $10k\Omega$ resistor and a $0.015\mu F$ capacitor."

"Ah yes," said Smithy carelessly. "As I mentioned earlier this set is a hybrid, and it has a valve sync separator. This clips out the positive-going sync pulses in the output of the video output transistor."

An exasperated grimace spread across Dick's face.

"That," he remarked bitterly, "is typical of the throw-away lines you come out with every now and again. For a start, how in heck do you know that the sync pulses are positive-going?"

"They're bound to be," replied Smithy. "If you like, we'll trace the video signal all the way from the vision detector. Will that satisfy you?"

"Yes, it will," stated Dick. "This I want to see."

"Right," said Smithy briskly. "Now this TV set is a single standard job for 625 lines, and the 625 line television signal uses negative modulation. This means that sync pulse tips correspond to maximum transmitted amplitude and that peak white corresponds to minimum amplitude." (Fig. 4.)

"Fair enough, Smithy. Go on!"

"Now," said Smithy, "the vision detector is connected so that its anode couples to the load. If we applied a sine wave to it we would get negative half-cycles out of it. We are, however, applying the vision i.f. to it, which means that the voltage at the vision detector cathode will go more negative as signal amplitude increases. Maximum signal amplitude corresponds to sync pulse tips, and so the signal at the detector anode will have negative-going sync pulses." (Fig. 5.)

"Humph," grunted Dick. "I must say that that seems reasonable enough. What happens next, Smithy?"

"The signal with negative-going sync pulses is fed to the emitter follower. The output of an emitter follower is in phase with its input, and so the signal at the emitter of the emitter follower also has negative-going sync pulses. This is then fed to the video output transistor, which functions in the common emitter mode. The video output transistor, inverts the signal so that, at its collector, the video waveform has positive-going sync pulses."

"Blimey, I can see it all now. It's dead easy when you trace the waveforms through like that!"

"Exactly," said Smithy. "Now, to complete the story, the waveform is passed to the sync separator which, in this receiver, means that it's passed to the grid of the sync separator valve. This method of connection causes the $0.015\mu F$ grid coupling capacitor to charge in the same way as you get with a leaky grid detector, and the positive-going sync pulse tips take the grid of the valve just slightly positive of its cathode. The picture information below the sync pulse tips falls beyond the grid cut-off voltage of the valve,

Fig. 4. The waveform of the 625 line signal, showing line sync pulses. Sync pulse tips correspond to 100% signal amplitude.

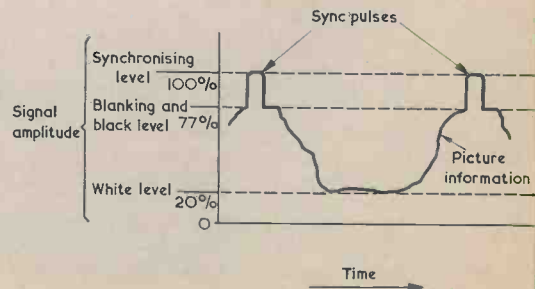

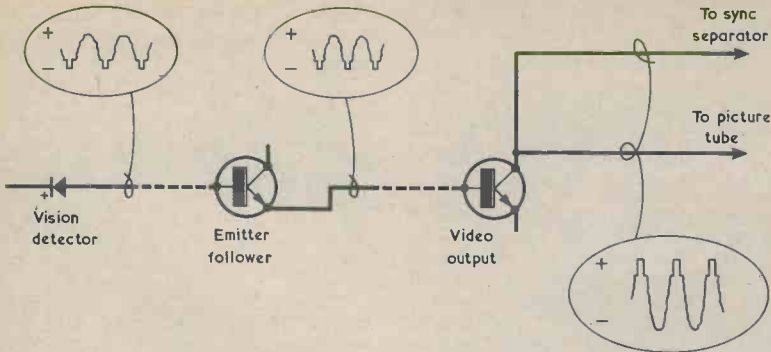

Fig. 5. The vision waveform after the vision detector and emitter follower has negative-going sync pulses. The video output transistor inverts the signal to produce a waveform with positive-going sync pulses.

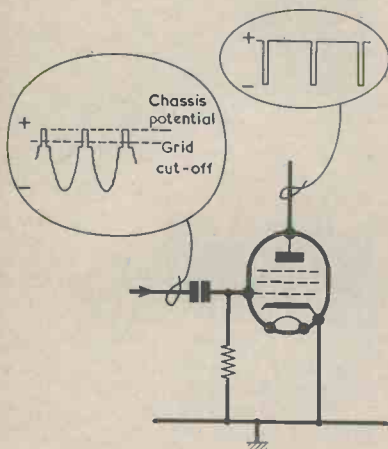

Fig. 6. The circuit conditions which exist when a vision signal with positive-going sync pulses is applied by way of a grid capacitor and resistor to a sync separator valve.

and so the valve merely amplifies the sync pulses. In other words, it separates the sync pulses from the video signal, just as it is supposed to do." (Fig. 6.)

"What happens," asked Dick, "if the sync separator is a transistor?" "Pretty well the same thing," replied Smitty. "Look, I'll show you."

Taking up a pencil, the Serviceman quickly sketched out a circuit in the margin of the manual. (Fig. 7.)

"Here's an example of a transistor sync separator," he went on. "This can be an n.p.n. transistor and we feed it with a video signal having positive-going sync pulses, just as we did with the valve. The series capacitor takes up a charge which makes the transistor base-emitter junction fully conductive on sync pulse tips, with the result that the transistor is turned hard on for sync pulse tips and is cut off for most of the waveform below these tips. Like the sync separator valve, it then works as a switch and is fully conductive only in the presence of sync pulses. Amplified negative-going sync pulses appear both at the anode of a

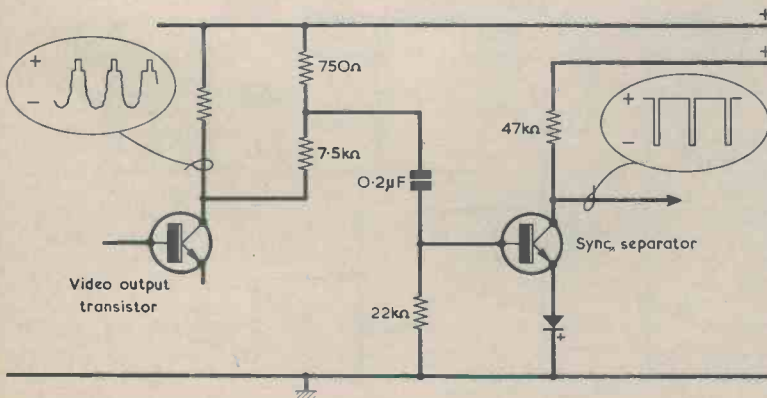

Fig. 7. Passing a signal with positive-going sync pulses to a sync separator transistor via a capacitor causes the transistor to turn hard on during sync pulse tips. The component values shown are representative.

Your Local Supplier

LONDON

THE MODERN BOOK CO.

Largest selection of English & American radio and technical books in the country.

19-21 PRAED STREET,
LONDON, W2 1NP
Tel: 01-723 4185/2926

ST. HELEN'S RADIO

Hi-Fi Equipment
Tape Recorders
Radio Receivers
Television

SPECIALISTS IN RADIO & ELECTRONIC TEXTBOOKS

ST. HELENS GARDENS
LONDON, W.10
Tel: 01-969 3657

CORNWALL

DESOLDERWICK

SOLDER-ABSORBING WICK

Approx 1cm. completely desolders a P.C.B. joint. Use with any 20-40w soldering iron.

30 cm. pack. 26p inc. p & p etc.

Multipack. Four lengths of wick in various widths. 80p inc. p & p etc.

ORIENTATION LIMITED
Coverack, Cornwall

HAMPSHIRE

BOURNEMOUTH

LARGEST HI-FI AND RADIO COMPONENT STORE IN THE SOUTH

FORRESTERS NATIONAL RADIO SUPPLIES LTD.
70-72 Holdenhurst Road
Bournemouth
Telephone 25232

Your Local Supplier

SURREY

WITWORTH TRANSFORMERS

TV Line out-put transformers

Manufacturers of the largest range in the country. All makes supplied.

Modern

BAIRD, BUSH, GEC, PHILIPS

Replacement types ex-stock.

For "By-return" service, contact London 01-948 3702

Tidman Mail Order Ltd., Dept. R.C.

236 Sandycombe Road,

Richmond, Surrey TW9 2EQ

Callers welcome.

SUSSEX

E. JEFFRIES

For your new television set
tape recorder, transistor radio
and hi-fi equipment

PHILIPS, ULTRA, INVICTA
DANSETTE, MASTERADIO, PERDIO,
MARCONI, PHILCO, FIDELITY

6A Albert Parade

Victoria Drive,

EASTBOURNE SUSSEX

WARWICKSHIRE

Norman H. Field

HI-FIDELITY

Large demonstration room, Sony, Trio, KEF, B & O,
Sanyo, BSR, Toshiba, Goldring, National etc.

TAPE RECORDERS

Sony, Revox, Tandberg, B & O
specialists. Cassette and 8-track

ELECTRONICS

All component parts, cartridges,
stills, radios, Self Build Kits, Disc-
Group and P.A. Equipment.

Norman H. Field

ALBANY HOUSE, HURST STREET,

BHAM B5 4BJ. Tel: 021 622 2323

Specialist Repair Service

FIRE

PEATS for PARTS

ELECTRONIC COMPONENTS
RADIO & TELEVISION

For the convenience of Irish

enthusiasts we supply

Radio & Electronics

Constructor

Data Books and

Panel-Signs Transfers

Also a postal service

Wm. B. PEAT & Co. Ltd.

28 PARNELL STREET

DUBLIN 1

sync separator valve and at the collector of an n.p.n. sync separator transistor."

"Well, that clears up that bit of the circuit very nicely," remarked Dick. "Wait a minute, though! You put a diode in the emitter circuit of that transistor sync separator. What's that for?"

"It's to prevent the reverse base-emitter voltage rating of the transistor being exceeded," said Smithy. "The picture information in the signal passed to the sync separator base will take it negative of chassis by quite a large amount, and this will almost certainly be greater than the reverse base-emitter voltage rating for the transistor, particularly if, as is usual, this is a silicon type. The diode prevents the flow of reverse base-emitter current under these circumstances."

"I'm a wee bit out of my depth here," said Dick, frowning. "Won't the negative signal on the transistor base have to at least go up to the base-emitter breakdown voltage of the transistor to take the diode non-conductive?"

"Quite possibly," said Smithy. "At the reverse base-emitter breakdown voltage, the base-emitter junction of the transistor acts like a zener diode. At high reverse voltages the junction and the diode will stabilize at a point where the base-emitter junction reverse current will be the same as the leakage current in the diode, and this could well be near the point where the transistor junction starts to act as a zener diode. Incidentally, the transistor won't suffer damage if its base-emitter junction is taken to the zener level provided that only a low zener current is allowed to flow."

PICTURE TUBE FEED

Smithy suddenly stopped and glared at his assistant.

"How you do it I just don't know," he stated irately.

"Do what?"

"Get me side-tracked like this. It was only a few minutes ago that I started showing you the signal polarities in the video stages of this receiver. Now you've got me nattering on about zener effect in silicon transistors!"

"Sorry, Smithy," said Dick contritely. "I think we must have got overtaken by events in some way. Where were we, anyway?"

"We were at the point where I showed you that the video signal fed to the sync separator had positive-going sync pulse tips. Or, at any rate," pronounced Smithy resolutely, "that's the point where I'm going to resume the discussion. Now, this same signal is fed, via the 0.47µF coupling capacitor, to the cathode of the picture tube. Once again the signal has correct polarity because the positive-going sync pulses cause the picture tube to cut off, whilst the negative-going video signal causes the tube beam to increase in intensity as the video amplitude level increases."

"That bit's easy," stated Dick confidently. "All you have to remember is that taking the tube cathode negative with respect to the grid is the same as taking the tube grid positive with respect to the cathode. Both cause the brightness of the spot on the tube screen to increase. What about the 6MHz sound amplifier, Smithy?"

"There's nothing very complicated in that part of the circuit," replied

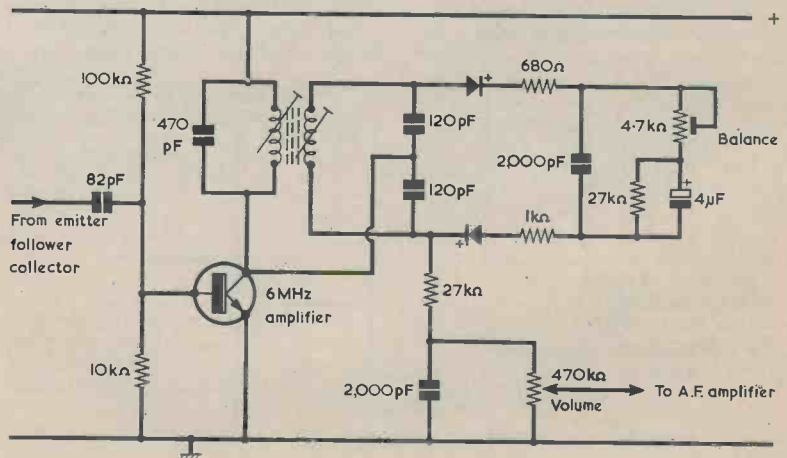

Fig. 8. Intercarrier 6MHz amplifier and ratio discriminator. This is, again, a slightly simplified version of the appropriate circuit employed in the Thorn Consumer Electronics 1500 Series.

Smithy. "I've already shown you that a 6MHz frequency modulated signal is available at the collector of the video emitter follower. This is tuned by the 6MHz parallel tuned circuit in the collector circuit of the emitter follower, and the series tuned circuit in the emitter circuit will also provide effective 6MHz tuning. In this receiver the 6MHz signal is fed via the 82pF coupling capacitor to the base of a common emitter transistor, in the collector of which is a standard ratio discriminator circuit."

Smithy indicated the circuit in the service manual. (Fig. 8.)

"That's quite a straightforward circuit," commented Dick. "I suppose you set up the 4.7kΩ potentiometer for minimum buzz."

"You do," confirmed Smithy. "The 6MHz intercarrier signal is heavily amplitude modulated by the vision signal, and if this amplitude modulation isn't removed it causes a 50Hz field buzz to be fed into the a.f. amplifier. That 4.7kΩ pot is adjusted for minimum buzz on a transmission during periods when there's no modulation on the sound signal."

Smithy stopped and proceeded to walk back to his own bench. A thought suddenly struck him and he returned to the receiver.

"Dear oh dear me," he said sheepishly. "I'd clear forgot what I came over here for in the first place! I've just remembered that I've got all of twenty pence wagered on the fact that the fault in this set is between the video emitter follower and the sync separator. With that sort of money at stake I've just got to see this repair through."

"Blow me," snorted Dick disgustedly. "You and your twenty pence! Why, that's just higher than peanuts." "Twenty pence," intoned Smithy heavily, "would have been no less than two florins in the days when money was money. Anyway, get the back off that set, Dick, and let's have a look at the works."

Dick quickly removed the back of the receiver, then reconnected the mains supply and the aerial. He unclipped the chassis and swung it out on its hinges. Smithy settled himself comfortably at the bench, pulled Dick's testmeter towards him, selected a high voltage range and clipped its negative lead to the chassis. He switched the receiver on and waited for the un-synchronised raster to appear. The sound channel became audible from the speaker.

"Right," said Smithy, as the tube screen glowed into life. "I'll do a few voltage checks now. Let's first check the h.t. supply to the video output transistor."

"H.T. supply?" queried Dick. "I thought h.t. was only for valves. Shouldn't it be Vcc with transistors?"

"It should be, rightly," conceded Smithy. "Still, tell me what the meter's reading."

"Blimey," said Dick, you've got no less than 160 volts there. Where have you got your positive meter prod?"

"At the positive end of the video output collector load," said Smithy.

"I can see what you mean by h.t. supply now," grinned Dick. "Ah, the meter reading's changed. It's showing 80 volts."

"Is it?" remarked Smithy, in a slightly disappointed tone. "Well, that's the voltage on the collector of the video output transistor."

"Isn't 80 volts high for a transistor?"

"Not for these video output types," said Smithy. "Also, 80 is the correct voltage for the video output collector in this set. Since the transistor is presumably drawing the correct collector current I don't think I'll bother to check its base and emitter voltages for the time being, as they're pretty certain to be all right. Let's have a dig at the coupling components from the emitter follower."

Smithy experimentally adjusted the contrast control, then returned it to its original setting. With the testmeter positive prod he applied gentle pressure to its tags. He next put the prod on the body of the 64μF electrolytic capacitor and gently pushed it sideways.

"Hey, do that again," called out Dick excitedly. "There was a short flash on the screen then."

Encouraged, Smithy once more exerted slight pressure on the capacitor.

"There is something there," exclaimed Dick. "There was another flash on the screen."

"I thought I saw something too," said Smithy. "Let's have a closer look at that capacitor."

He switched off the receiver and examined the capacitor.

"It looks all right," he grunted, "let's make sure it's soldered in all right."

He picked up Dick's soldering iron and carefully resoldered the capacitor lead-outs to the printed circuit pattern. He switched on again, but there was still no picture.

"This is going to be one of those annoying snags," snorted Smithy.

"It's highly improbable that the capacitor is shorted because this would then upset the biasing for the video output transistor, and the capacitor would then, in any case, let some sort of video signal get through. So there's a chance that it may be open-circuit. I don't want to go to all the trouble of removing the capacitor in case it turns out to be O.K., so I'll try the effect of bridging it with another electrolytic."

"What capacitance do you want?"

"Oh, 50μF or so will do for a quick check," replied Smithy. "And any working voltage above 8 volts or so."

Dick soon found a suitable capacitor, whereupon Smithy temporarily soldered it, on the opposite side of the board, across the existing 64μF capacitor. (Fig. 9.)

The Serviceman switched on and

**VALENCE ELECTRONICS
THE FERRANTI SPECIALISTS
TRANSISTORS-DIODES-I.C.'S-
OPTO ELECTRONICS-FLASH TUBES
ZN414 RADIO I.C. £1.30
RED L.E.D. BY HEWLETT-
PACKARD PANEL
MOUNTING**

WITH FREE CLIP		30p
BFS59	15p	ZTX504 43p
BFS60	20p	ZTX510 17p
BFS61	20p	ZTX530 21p
BFS96	15p	ZTX531 22p
BFS97	23p	ZTX550 17p
BFS98	20p	ZTX551 17p
ZTX107	9p	
ZTX108	8p	
ZTX109	11p	
ZTX212	14p	DIODES
ZTX213	14p	ZS120 8p
ZTX214	15p	ZS121 10p
ZTX300	12p	ZS122 13p
ZTX301	13p	ZS123 16p
ZTX302	17p	ZS124 18p
ZTX303	14p	ZS140 25p
ZTX304	21p	ZS141 43p
ZTX310	9p	ZS142 33p
ZTX311	10p	ZS170 10p
ZTX312	10p	ZS171 13p
ZTX313	11p	ZS172 16p
ZTX314	13p	ZS174 17p
ZTX320	31p	ZS176 23p
ZTX330	15p	ZS178 38p
ZTX331	16p	ZS270 11p
ZTX382	13p	ZS271 16p
ZTX383	15p	ZS272 18p
ZTX384	18p	ZS274 19p
ZTX450	17p	ZS276 26p
ZTX451	17p	ZS278 37p
ZTX500	12p	
ZTX501	13p	ZENERS
ZTX502	17p	KSO30A to
ZTX503	14p	KS180A
		all at 19p

ALL PRICES FULLY INCLUSIVE
P & P 10p. FREE OVER £2.
MAIL ORDER ONLY FROM:
**VALENCE ELECTRONICS, 2A CANAL
STREET, DROYLESDEN, LANCs.**

RADIO & ELECTRONICS CONSTRUCTOR

**ANNUAL
SUBSCRIPTIONS
to this magazine
may be obtained
through your
newsagent
or direct from the
publishers
ONLY £2.70
per year, post free**

Please send remittance with name and address and commencing issue required to:

**DATA PUBLICATIONS LTD
57 Malda Vale London W9 1SN**

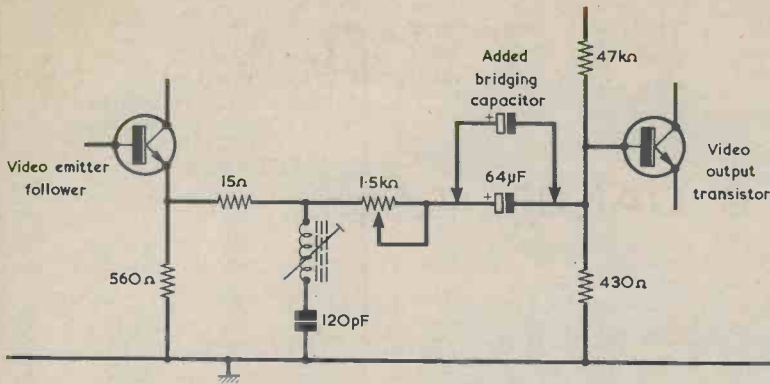

Fig. 9. Adding a bridging capacitor across an existing capacitor to check whether the latter is open-circuit.

waited expectantly. First, the loud-speaker came to life then, after a further period, the tube screen lit up. But this time there was not an un-synchronised raster, but a well-defined, clear and excellently contrasted picture.

MATTERS OF FINANCE

"That's it," said Dick exultantly.

"You've cleared the snag!"

"Thank goodness for that," replied Smithy. "That darned capacitor was beginning to niggle me. Anyway, I'll leave you to clear up this set now. Whip out the temporary capacitor I added and the duffy 64μF one that's in the set. It's definitely open-circuit and this has probably occurred at the connection point between its alu-

minium foil and one of its lead-out wires. This connection must have momentarily become good again when I applied physical pressure on the capacitor body. Then fit a new capacitor of the correct value, and give the set a final checkover. But before you do all that, pay me twenty pence!"

"Twenty pence? Blimey, Smithy, I thought you were joking about that bet."

"Of course I wasn't. I would have paid you twenty pence if that fault hadn't been where I said it was."

"Then," replied Dick airily, "I wouldn't have accepted it. I don't think that the payment of money from one person to another is conducive to the working harmony of an establishment such as this."

"It's a darned sight more conducive to working harmony than the non-payment of money," retorted Smithy heatedly. "Now come on, hand over!" "Oh, all right then."

And thus it was that Smithy, after indignantly rejecting a half pfennig, an Irish twopence piece and a 12-sided threepenny bit, became richer by a ten pence piece, a five pence piece, a single penny and no fewer than eight tiny half-penny pieces. ■

"Can I rent a T.V.
Engineer, please?"

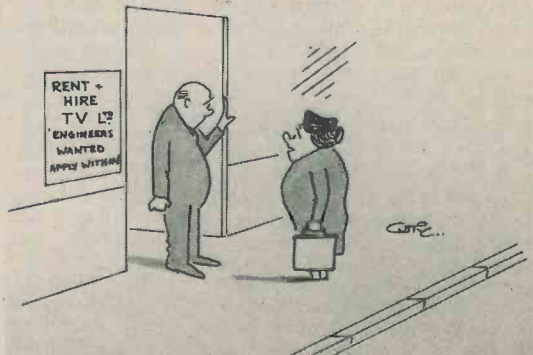

CATALOGUE RECEIVED

The latest edition of their catalogue has now been issued by Home Radio (Components) Ltd., Dept. RC, 234-240 London Road, Mitcham, Surrey, CR4 3HD. With 240 large pages, this has the same format as the last Home Radio catalogue, and it also has the same effective illustration on the front cover which depicts 'Theme on Electronics' by Barbara Hepworth.

This up-dated edition reflects the careful attention to detail which has always been a feature of Home Radio catalogues. All items are given a Cat. No., a factor which assists in ordering and avoids ambiguities. There is a helpful section at the beginning of the catalogue which advises on the various methods of ordering and making payment, this including an application form for the opening of a Credit Account.

The catalogue lists 6,785 items, all of which are clearly described and, in many cases, illustrated. The items available cover virtually every aspect of home-constructor electronics, and there is also useful advice on the choice and employment of components for particular applications. Dimensions have been changed to metric, with the Imperial sizes being retained in cases where there may be difficulty. A metric-Imperial conversion chart is printed on the bookmark.

The catalogue may be obtained direct from Home Radio (Components) Ltd., at 55p plus 22p post, and it contains ten vouchers, each worth 5p each when used as directed.

THE FETRON

by J. B. DANCE, M.Sc.

Some notes on a comparative newcomer to the electronic scene

FETRONS ARE SOLID STATE DEVICES MANUFACTURED BY Teledyne Semiconductor Ltd. which are direct replacements for certain types of thermionic valves. A Fetron is an integrated circuit mounted in such a way that it can be plugged directly into the socket of the valve it replaces. Junction field effect transistors are employed in Fetrons.

TYPES

The first Fetron to become available was the TS12AT7, which was designed to replace the 12AT7, ECC81 and similar double-triode valves in amplifier circuits. The TS12AT7 consists of two separate high voltage junction field effect transistors, one of which replaces each of the triodes in a 12AT7 valve.

The TS6AK5 was developed shortly after the TS12AT7; it is used to replace the 6AK5, the EF95 and similar low noise, high frequency pentodes. The device is employed mainly in radio frequency amplifiers at frequencies up to 500MHz, but is also an excellent low noise audio amplifier.

The TS6AK5 consists of two junction field effect transistors connected in the cascode circuit of Fig. 1(a). A similar valve circuit is shown in Fig. 1(b). It is

impossible to manufacture a single junction field effect device which will withstand high voltages and which also has a high mutual conductance. However, the TS6AK5 employs a small-signal device with a high mutual conductance at the input and a high voltage device in the output stage. The cascode arrangement brings various advantages, such as an output impedance which is much higher than that of a thermionic valve.

Fetrons will soon be available which can replace valves such as the 6AM6 (EF91) and the E180F. Other types with the very high mutual conductance of 25mA/V and 'anode' currents of about 40mA have been developed to replace valves of similarly high mutual conductance.

Work is being carried out to develop types suitable for power output stages to replace valves such as the 6V6, 6BW6 and 6AQ5. Other types will eventually be available to replace remote cut off ('variable- μ ') pentodes such as the 6BA6.

Almost any type of general purpose triode and pentode (and also many special types of valve) can be simulated with two suitable field effect transistors.

CHARACTERISTICS

Although the characteristics of the TS6AK5 shown in Fig. 2(a) are very similar to those of the 6AK5 valve shown in Fig. 2(b), they follow the square law more closely and give a much cleaner on-off action owing to the sharp cut-off.

ADVANTAGES

When compared with valves, Fetrons have the advantages of zero warm-up time, no microphony and built-in shielding. Their dissipation is considerably less than that of valves, since they contain no heater.

A further advantage is the extremely long life of the Fetron. This has been estimated as over 30 million hours (or over three thousands years of continuous operation), whereas the thermionic valve tends to change its characteristics after about 10,000 hours of operation (rather over a year). Unlike valve characteristics, the characteristics of Fetrons do not change throughout the useful life of the devices and periodic replacement is quite unnecessary.

Fetrons are strong and rugged devices, being mounted in a welded steel case which is filled with dry nitrogen. They satisfy military specifications and are being used as valve replacements in U.S. telephone systems. In this

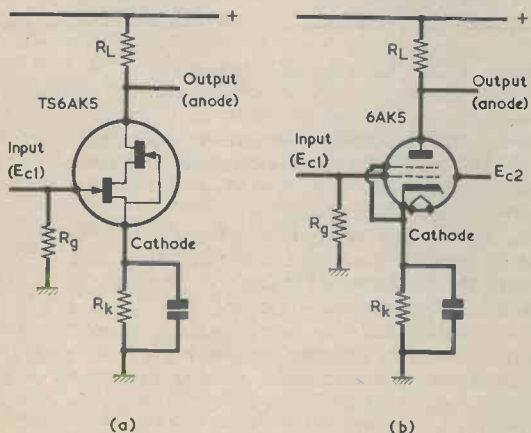
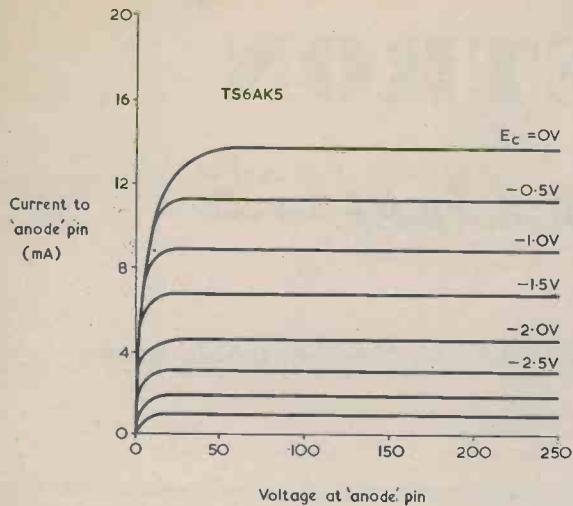
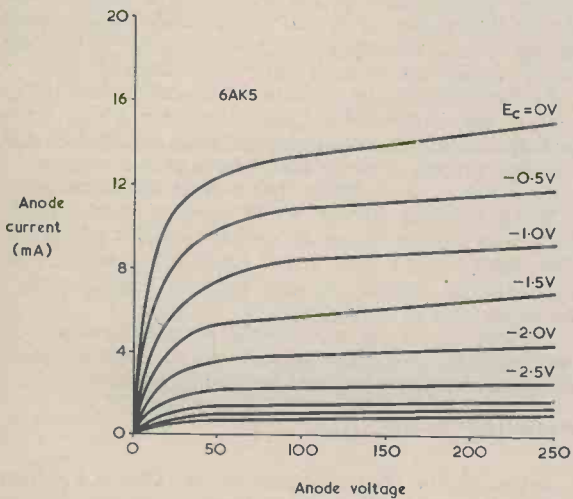

Fig. 1. The Fetron type TS6AK5 (a) and the valve type 6AK5 (b) in similar circuits



(a)



(b)

Fig. 2 (a). The characteristics of the TS6AK5 Fetron
 (b). The Fetron characteristics are similar to those of the 6AK5 valve, shown here

application they offer the considerable advantage of 'converting' existing valve equipment to solid state operation at very low capital expenditure.

Fetrons often provide a lower noise performance than similar thermionic valves and the resulting absence of noise may lead to the erroneous conclusion that the circuit is not functioning. This effect is enhanced by the absence of hum from the heater.

The inter-electrode capacitances of a Fetron are normally lower than those of the corresponding valve; the device can therefore operate at higher frequencies.

Fetrons are handled by G.D.S. Sales Ltd., Michaelmas House, Salt Hill, Bath Road, Slough, Buckinghamshire. Orders for small quantities may be sent to Best Electronics (Slough) Ltd., at the same address. ■

NEW PRODUCT SPEAKER SYSTEM

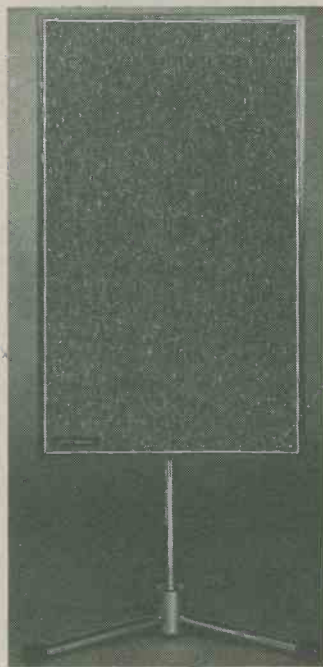

Developing a new speaker system is a long process as Eagle International discovered while researching the new AA.42. The listing of objectives is the first step and Eagle had several in mind. Flat response, good stereo image, power handling and good looks to name just a few.

The AA.42 is a 3-way speaker system utilising two tweeters, two midrange and two 8" bass drivers. The placement of these units proved critical in gaining the desired stereo image. Due to the mirror placement of the drive units the AA.42's are sold in matched pairs.

Many months in and out of anechoic chambers have resulted in a speaker with exceptional characteristics.

As appearance was also high on Eagle's list of priorities, speaker grilles were researched for both good looks and audio transparency. The AA.42 dispels the theory that a speaker has to be a black box hidden in the corner. The photograph also shows the matching speaker stand, AA.44. A heavy chrome plated unit developed to further improve both performance and appearance. However, the AA.44 is suitable for use with any other floor standing speaker system.

Specification

Type: Sealed infinite baffle
 Frequency range: 25-20,000 Hz
 Dimensions: 660 × 394 × 295 mm
 Power rating: 30 watts RMS
 Impedance: 8 ohms
 Finish: Oiled teak
 Drive units: 2 × 204 mm cone (Bass)
 Voice coil diameter: 25 mm
 Midrange: 2 × 86 mm cone
 Tweeter: 2 × 86 mm cone
 Crossover network: L & C
 Price (excluding VAT) £54.00 each
 AA.44 Speaker stands: £14.00 per pair

Radio Topics

By Recorder



IT'S NICE TO HAVE A LITTLE GOOD fortune every now and again.

Quite a sizable bit of luck came my way a week or two ago when there was an urgent call for help from a relative whose television receiver had fallen into the habit of blowing the fuse in the mains socket every time it was switched on. My usual answer to calls of this nature is to say that I'll have a look at the set but that I cannot promise I will be able to fix it, particularly if it is necessary to obtain spare parts which are normally only available to retailers.

This is, I feel, a reasonable approach. When you're servicing for a livelihood you tend to get a 'feel' for the job, acquiring what is almost an instinct for tracing down faulty components and connections. When you only do the occasional service job you cannot approach it with the same speed and experience as does the professional engineer.

Those, at any rate, are my own views on this perennial problem.

DEAD SHORT-CIRCUIT

The television receiver in question didn't, however, look at all difficult. Nor was it.

On applying my testmeter to the mains input leads I found that these exhibited a dead short-circuit whenever the receiver on-off switch was closed. A dead short could hardly be classed as an obscure fault and so I removed the back of the set, swung down its hinged printed circuit board and had a quick look at the mains wiring following the on-off switch. There were no signs of leads chafing against the chassis or any obvious things like that.

Connected across the on-off switch tags was a fat little capacitor. I decided to take a risk and I snipped one of its leads. And that was it — one TV temporarily repaired!

The capacitor in question was an 0.1 μ F component which connected directly across the mains input immediately after the on-off switch. This had broken down and was exhibiting a steady resistance of zero ohms. With the capacitor out of circuit the set ceased its fuse-blowing proclivities and worked exactly as it had done previously.

I told my relative that I had only effected a temporary repair and that a new capacitor would have to be fitted when I was able to obtain one, or if the set had to undergo any major servicing.

MAINS MODULATION

I was lucky there, on two counts. To begin with, I had been able to locate the faulty component first go. And, secondly, the set still functioned satisfactorily with the 0.1 μ F capacitor out of circuit.

You will find these capacitors in many mains-driven TV receivers, and they nearly always have a value of 0.1 μ F or thereabouts. One of their jobs is to act as an r.f. bypass and attenuate any r.f. interference which might be present on the mains supply. Another of their functions is to ensure that the mains input has a low r.f. impedance, thereby overcoming the possibility of what we used to refer to as 'mains modulation'.

In earlier mains-driven a.m. sound radios, in which the chassis was common with one side of the mains, a similar capacitor used to be connected across the mains supply after the on-off switch in order to overcome this mains modulation. Without the capacitor it was quite possible for input signals to be modulated at 50Hz if the receiver was connected to the mains such that its chassis coupled to the live side. The modulation produced a curious gurgling effect, as though people who were singing or speaking

needed to clear their throats. Normally, it would reduce in level or clear altogether if the mains connections were changed over so that the receiver chassis connected to the neutral line. With a mains modulation capacitor fitted, the receiver could be connected to the mains either way round without the trouble appearing.

Sound receivers at that time used external aerials, relying on the mains supply to provide an effective earth or counterpoise. When the receiver chassis was coupled to the live side of the mains, that 'earth' was swinging on either side of true earth by the mains voltage at 50Hz, and so it was not surprising that, in some instances, the input signal became modulated at mains frequency.

A modern TV receiver is a far cry from those older a.m. sound radios, but under some conditions it can still suffer mains modulation effects, and these could affect either the sound, the picture or both. And so it was fortunate for me that I was able to clip out the 0.1 μ F capacitor in that particular set without any of these shortcomings in performance showing up.

THE GADFLY

Changing the subject and coming over all literary, a recent release in the paperback market is a book entitled 'The Gadfly' which is written by E. L. Voynich. This paperback edition is published by Mayflower Books Ltd. and retails at 40p.

'The Gadfly' originally appeared in 1897 and has been a periodic best-seller ever since. Five million copies are reputed to have been sold and it has been translated into more than thirty languages. Its story was dramatised by George Bernard Shaw and it has been made into an award-winning colour film with a score by Shostakovich.

The book caused a great stir at the time of its publication because of its

attack on the Church of that time, and its deep-moving plot renders it very readable even in our present more cynical days. It is a book with a spectacular history.

Why do I mention it? Because its author, E. L. Voynich, was born Ethel Lilian Boole. She was the daughter of George Boole whose logical Algebra has provided the foundation for all our current computer logic operations. A talented father and daughter, indeed.

THICK FILM RESISTORS

Recent reports from EMI Electronics give details of new items resulting from their experience in high ohmic value, high voltage, low drift, thick film technology.

The range of thick film circuits produced by EMI has been expanded to include resistor networks up to 1,000M Ω . These meet the requirements of e.h.t. power supply voltage dividers, high voltage probes, photo-multiplier tube dynode chains and high power radar systems.

Also available is the new thick film focus control module shown in the accompanying photograph. The module is specifically intended for colour TV receiver applications, is suitable for operation at potentials up to 10kV, and has been tested and approved by the British Standards Institution.

Research and development for these thick film devices has been carried out by Microelectronics Division, EMI Electronics Ltd., Blyth Road, Hayes, Middlesex.

CURRENT LIMITING

Some years ago, whilst playing around with a commercially made valve communications receiver, I encountered what appeared to be an unexplained 150 Ω resistor in the a.g.c. circuit. The a.g.c. circuit was, otherwise, quite a standard one: a negative

a.g.c. voltage was developed by the detector diode and, after a 2M Ω series resistor, appeared across a 0.05 μ F capacitor, one terminal of which connected to chassis. A rotary switch, which also controlled the b.f.o., then switched the a.g.c. in or out as desired. When a.g.c. was switched out, two contacts of the switch short-circuited the 0.05 μ F a.g.c. capacitor by way of this mysterious 150 Ω resistor. In other words, one of the switch contacts was connected to chassis and the other was connected to the non-earthly side of the 0.05 μ F capacitor via the 150 Ω resistor.

After a while the penny dropped, and I suddenly realised that the 150 Ω resistor was a current limiting component. Quite high voltages, up to 25 volts or more, can appear on the a.g.c. lines of valve communications receivers, and a voltage at this level could be present across the a.g.c. capacitor at the instant when the rotary switch contacts closed. The instantaneous short-circuit current without a series resistor would be virtually limited by the internal impedance of the capacitor only, and could be of the order of several amps. Such a current would inevitably cause a tiny, but significant, spark to occur at the moment of contact closure, with the result that, after a large number of operations, the contact surfaces in the switch would become oxidised and the life of the switch would be reduced. The far-seeing design engineer who fitted the 150 Ω resistor ensured that instantaneous short-circuit current could not exceed some 170mA or so, which is well within the capabilities of a standard rotary switch.

It is, in most instances, a wise precaution to fit a series current limiting resistor in any circuit which requires a capacitor of around 0.02 μ F or more to be short-circuited by a pair of contacts, particularly if the latter are of the low current variety or are

given by a relay contact set. We are most of us familiar with the firework display which occurs when a high voltage electrolytic capacitor is accidentally short-circuited. A miniature version of such a display is still given at lower capacitances and voltages.

The same applies if a capacitor is directly short-circuited by the sudden turning on of a transistor. Again, instantaneous currents of an amp or more are feasible, and these can be completely eradicated by a suitable series resistor. Assume, for instance, that a circuit calls for an electrolytic capacitor of any value which is charged up to 10 volts to be discharged by the sudden turn-on of a transistor having a maximum collector current rating of 500mA. That maximum collector current rating is almost certain to be exceeded at the instant of turn-on unless a series resistor is fitted. In this case a series current limiting resistor of 27 Ω or more would do the trick and would keep the circuit within safe bounds.

LAMP RESISTANCE

Whilst on the subject of current flow, an item which is frequently ignored is the instantaneous initial current drawn by the humble filament lamp when it is switched on. We all know that the cold resistance of a filament electric lamp is lower than its hot resistance but I think that quite a few of us would be surprised if we realised the actual ratio which exists between the cold and hot resistances.

A 100 watt mains bulb consumes about 0.4 amp at 240 volts and has a hot resistance of 600 Ω . Its cold resistance can be, typically, no more than 40 Ω . This means that, at the instant of switching the lamp on, the current drawn from the 240 volt mains supply is 6 amps!

Small flash lamp bulbs aren't much better. An m.e.s. bulb with a nominal rating of 0.3 amp at 2.5 volts may have a cold resistance of less than 1 Ω . So the initial switch-on current at 2.5 volts is at least 2.5 amps. Small bulbs in the lower current category are rather better in this respect. I've just checked the cold resistance of a 6 volt 60mA bulb, and found it to be 30 Ω . In consequence, the current it draws at the instant of switch-on is 200mA.

These cold resistances should always be borne in mind when making up circuits in which filament bulbs are turned on and off by transistors. Fortunately, the situation is not so bad if the bulbs are controlled by thyristors or triacs, as these devices normally have surge current ratings which are well in excess of their average current ratings.

Still, it makes one pause when one thinks that the instantaneous current drawn from the mains at the instant of switching on a 100 watt lamp is greater than that consumed by a 1 kilowatt electric fire!

RADIO & ELECTRONICS CONSTRUCTOR



A thick film focus control module introduced by EMI Electronics Ltd. for use in colour television receivers. The unit is highly stable and compact, and is suitable for operation at potentials up to 10kV



1 Household contents and personal possessions up to £600.



2 All Risks cover on personal belongings up to £60.



3 Personal accident insurance (road, rail and sea risks) - £3 per week



4 Loss of cash up to £20.



5 Household removal cover up to £600.



6 All Risks cover on sports equipment up to £30.



7 Personal liability cover for the family up to £20,000.



8 Cover on Radio, Television etc., for damage in the home up to £60.



9 Holiday deposits cover up to £20.



Each £3 unit of Home Unit Insurance gives you protection up to the limit shown

This is the simplified insurance you have been waiting for. Not just cover on the contents of your home but a package of personal protection you and your family need. And it's how we save you so much money: just ONE policy to issue instead of nine! You can build up to the cover you need by additional units

(or $\frac{1}{2}$ units after the first) up to a maximum of five. So simple. So easy. Apply to your Broker, Agent or local office of a General Accident company. The Home Unit Policy can replace your existing insurances. And remember - as you buy more possessions just add more Home Units at any time. *Quote Ref. 20/9468*

THE GENERAL ACCIDENT FIRE & LIFE ASSURANCE CORPORATION LTD

Metropolitan House, 35 Victoria Avenue,
Southend-on-Sea, Essex, SS2 6BT

Please send me further particulars of the Home Unit Insurance.

Name.....

Address.....

.....
.....

20/9468

It pays to be protected by a **General Accident** company

A JOB IN COMPUTERS



A JOB FOR LIFE

IN 6 WEEKS FROM NOW YOU COULD BE IN

In these uncertain times one thing is certain: Wherever else redundancy strikes, your future in the computer industry is secure. With pay prospects of over £70 a week as a computer operator. Unlike computer programming no special educational qualifications are needed. Just a 6 week course with L.C.O.T.C. Impossible? No. We are the only commercial computer school offering a revolutionary new course in computer operating. Direct from the U.S.A. A sensational new teaching technique that uses the latest audio-visual aids plus actual "hands on" experience to familiarise you with the world's leading computers. In the next five years alone, 144,000 new data preparation personnel will be needed. You could be one of them—because the vast majority of people can become successful computer operators—trained the new L.C.O.T.C. way.

Telephone: (01) 734 2874 NOW! Or post the coupon today for full details FREE and without obligation.

London Computer Operators Training Centre, T74, Oxford House, 9/15 Oxford Street, London, W.1. Telephone: (01) 734 2874

Please send me your free illustrated brochure on exclusive Eduputer "hands on" training for computer operating.

Name

Address

Tel.:

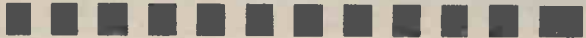



MULTIMETER Model 200H
20,000 ohm/volt **£6-60**



4½" x 3½" Meter
30uA, 50uA
or 100uA
£3-30



MULTIMETER Model C-7081GN Range Doubler
50,000 ohm/volt High Sensitivity Meter **£14-46**



CARDIOID DYNAMIC MICROPHONE Model UD-130 Frequency response 50-15,000 cps. Dual Impedance 50K & 600 ohms **£6-60**



Small **DYNAMIC MICROPHONE** as pictured or similar with remote on/off switch **£1.27**

Large S.A.E. for List No. 6. Special Prices for quantity quoted on request. Add 10p for P&P on orders under £5.
M. DZIUBAS
158 Bradshawgate, Bolton, BL2 1BA, Lancs.
All above prices include 10% V.A.T.
All items advertised in previous numbers of this magazine still available.

TWO NEW SOLDER SIPPERS MAKE DE-SOLDERING QUICK & EASY

A SUPER PRESENT ANYTIME!

Longs

Longs Ltd.
Hanworth Lane
Trading Estate
Chertsey Surrey
KT16 9LZ.



Maxi-Super HT 1810 and Maxi-Mini HT 1800 Solder Sippers

Designed for use when working or re-working P.C. Boards. Permits removal of molten solder from Multi-leg components, enabling easy extraction. The solder is 'sipped' through the nozzle, and automatically ejected when the instrument is next used. A Swiss precision instrument manufactured to a high degree of accuracy.

The anti-corrosive outside casing has a knurled finish for more positive grip, and encases plated internal parts.

The Maxi-Super has been designed with a 3.5 kg. spring action recoilless plunger, whilst the Maxi-Mini with its conveniently shaped operating button, has a 2.5 kg. spring action plunger, protected by a channel guard. Both models have been designed with an easy-to-replace 'dupont' teflon screw-in nozzle.

PLEASE FORWARD without obligation further details.	PLEASE SUPPLY Maxi-Super HT 1810 at £6.60	PLEASE SUPPLY Maxi-Mini HT 1800 at £4.95
<input type="checkbox"/>	<input type="checkbox"/>	<input type="checkbox"/>
I enclose cheque value £ _____		
NAME _____		POSITION _____
COMPANY _____		
ADDRESS _____		
SIGNED _____		
Prices include VAT		Reg. England 68496

SMALL ADVERTISEMENTS

Rate: 4p. (9d) per word. Minimum charge 60p (12/-).
Box No. 10p (2/-) extra.

Advertisements must be prepaid and all copy must be received by the 4th of the month for insertion in the following month's issue. The Publishers cannot be held liable in any way for printing errors or omissions, nor can they accept responsibility for the *bona fides* of advertisers. (Replies to Box Numbers should be addressed to: Box No. —, *Radio and Electronics Constructor*, 57 Maida Vale, London, W9 1SN

SERVICE SHEETS for Televisions, Radios, Transistors, Tape Recorders, Record Players, etc., from 5p. with free Fault Finding Guide. Catalogue 15p. Please send S.A.E. with all orders/enquiries. **Hamilton Radio** 47 Bohemia Road, St. Leonards-on-Sea, Sussex. Telephone: Hastings 29066.

BUILD THE MULLARD C.C. TV CAMERA. Complete kits now available from Crofton Electronics. Send large s.a.e. for details to: 15-17 Cambridge Road, Kingston-Upon-Thames, Surrey. Reply by post. No callers please.

BURGLAR AND FIRE ALARMS. Professional Control, Detection, and Warning equipment supplied - or advice. 1974 Catalogue 25p. **CASTLE ALARMS, P.O. Box WO6, Windsor, Berks.**

CHROMASONIC ELECTRONICS. New list 10p. post free. Data Dept., 56 Fortis Green Road, London, N10 3HN.

"FROM SEMAPHORE TO SATELLITE", 300-page hard-covered history with 1,000 illustrations, is sent to readers who send £1.99 from their Post Office to David McGarva (Giro account 17 412 0001).

CATALOGUE NO. 18, containing credit vouchers value 50p, now available. Manufacturers new and surplus electronic and mechanical components, price 23p post free. **Arthur Sallis Radio Control Ltd., 28 Gardner Street, Brighton, Sussex.**

NEW PRODUCTS. Panel mounting holder for ORP12 l.d.r.'s in polished aluminium 25p. Colour coded aluminium control knobs, 1 1/8 in. dia. 18p each. State colour. Any turned part supplied. 7p for list. Post 10p. **Electro-Mech Products, 7 Chantry Avenue, Bideford, Devon.**

BUILD IT in a DEWBOX robust quality plastic cabinet 2 in. x 2 1/4 in. x any length. S.A.E. for details. **D.E.W. Ltd., 254 Ringwood Road, Ferndown, Dorset.** Write now - right now.

UNIQUE VHF KITS, 80 - 180 MHz. Receiver, tuner, converter. World wide sales. £4.50p. S.W. Kits also available. S.A.E. for literature. **Johnsons (Radio C), Worcester, WR1 3QQ.**

MINI MAINS TRANSFORMERS. 30 x 30 x 37mm. Cool, quiet, British. Pri: 220/250V. Type MT3, 3-0-3V rms, 300mA, £1. MT7, 7-0-7V, 120mA, £1. VAT included. Use MT3 for 3V or 6V rectified d.c., MT7 for 9V or 18V. Circuits supplied. Mail order only. U.K. post 5p per order. **Amatronic Ltd., 396 Selsdon Road, South Croydon Surrey, CR2 0DE.**

DIRECT FROM MANUFACTURER - a comprehensive catalogue of UHF & VHF/FM aeriels, fixing brackets, chimney lashings, clamps, masts, amplifiers, cable, etc., for the D.I.Y. enthusiast. Complete with useful installation hints. Send 3p stamp to **Clayden Enterprises (REC), 261 Hardness Street, London S.E.24.**

(Continued on page 513)

BENTLEY ACOUSTIC CORPORATION LTD.

All prices inclusive of V.A.T.

The Old Police Station, Gloucester Road, LITTLEHAMPTON Sussex. PHONE 6743

OA2 .40	12AC6 .65	EABC80	EL86 .38	PCL86 47	UL41 .65
OB2 .40	12AD6 .65	EAF42 .50	EL91 .38	PD500 1.44	UL84 .38
5U4G .30	12AE6 .65	EAF80 .55	EL95 .39	PN45 80	UM80 .44
5V4G .54	12AF6 .35	EBF101 .55	EL80 1.00	PEN45DD	UY41 .49
5Y3GT .38	12AU6 .45	EB91 .15	EM80 .40	U Y85 .38	X1 1.00
SZ4G .35	12AV6 .40	EBC41 .55	EM81 .40	PL36 .55	X66 .65
6/30L2 .60	12BA6 .30	EBC81 .35	EM83 .55	PL81 .44	X6165 .28
6AH6 .50	12BE6 .38	EBF80 .39	EM84 .40	PL83 .39	AD140 .40
6AQ5 .40	12BH7 .27	EBF83 .43	EM87 .68	PL83 .39	AD149 .55
6AS7 .100	12K5 .95	EBF89 .30	EY51 .40	PL84 .33	AD149 .55
6AT6 .33	14S7 .75	EC92 .45	EY83 .54	PL304 .67	AD161 .50
6AU6 .30	19AQ5 .42	ECC31 .50	EY87/6 .33	PL508 .90	AD162 .50
6AV6 .33	20P4 .88	ECC35 .95	EY88 .40	PL509 1.15	AF14 .28
6BA6 .28	30C15 .75	ECC81 .27	EZ40 .55	PL802 .95	AF115 .17
6BE6 .28	30C17 .90	ECC82 .28	EZ41 .50	PY33/2 50	AF121 .33
6BH6 .70	30F5 .85	ECC83 .28	EZ80 .24	PY81 .31	AF126 .20
6BJ6 .50	30FL1 1.75	ECC84 .30	EZ81 .25	PY82 .25	BC107 .14
6BQ7A .50	30FL2 .75	ECC85 .36	EZ81 .25	PY83 .33	BC108 .14
6BR7 .95	30FL14 .85	ECC88 .44	GZ32 .54	PY88 .33	BC109 .11
6BR8 .85	30L15 .75	ECF80 .34	GZ34 .57	PY300 .80	BC113 .28
6BW6 .85	30L17 .70	ECF82 .34	HVR2 .53	PY300A	BC118 .25
6BW7 .66	30P12 .80	ECF86 .75	KTW61 .100	PY800 .80	BC211 .42
6BZ6 .49	30P19 .75	ECH35 .65	KTW62 .50	PY801 .31	BC211 .42
6C4 .28	30P21 .66	ECH42 .70	KTW63 .100	QYV03/1	BF130 .33
6C6 .22	30P31 1.75	ECH81 .30	KTW63 .100	R19 .38	BY100 .20
6C8 .66	30PL14 .80	ECH83 .44	KT66 2.40	U25 .65	BY127 .20
6C9S .75	30PL15 .95	ECH84 .44	PABC80 .38	U26 .60	OA91 .10
6E5 1.00	35L6GT .55	ECL80 .40	PC86 .60	U801 .76	OC23 .42
6F1 1.00	35W4 .33	ECL84 .60	PC86 .60	UACB90	OC24 .42
6F6G .50	35Z4GT .42	ECL85 .60	PC87 .95	UA42 .35	OC25 .42
6F18 .55	35Z5GT .42	ECL86 .40	PC90 .45	UB41 .33	OC4 .11
6F28 .70	50B5 .85	ECL86 .40	PC90 .45	UBC41 .33	OC4 .11
6H6GT .18	50C5 .45	EF22 1.50	PC90 .45	UBC81 .45	OC45 .12
6J5GT .25	ATP4 .40	EF41 .70	PCC84 .40	UBC81 .45	OC45 .12
6K7G .19	DAF91 .30	EF80 .26	PCC85 .44	UBC81 .45	OC45 .12
6K8G .35	AZ31 .60	EF83 .60	PCC88 .60	UBC81 .45	OC70 .14
6L6GC .58	DAF96 .44	EF86 .30	PCC89 .50	UBF89 .35	OC71 .12
6L7G .85	DP91 .30	EF89 .27	PCC89 .50	UC92 .45	OC72 .12
6Q7G .50	DF96 .44	EF91 .30	PCF80 .28	UC884 .75	OC74 .25
6V6G .17	DK91 .38	EF92 .30	PCF81 .48	UC884 .75	OC74 .25
6V6GT .38	DK92 .70	EF183 .29	PCF82 .33	UC885 .38	OC75 .12
6V8G .30	DK96 .25	EF184 .32	PCF82 .33	UC885 .38	OC75 .12
6X5G .28	DL92 .33	EH90 .45	PCF84 .59	UC886 .65	OC78 .17
7B6 .75	DL96 .44	EL32 .50	PCF86 .53	UC886 .65	OC78 .17
7Y4 .65	DY86 .30	EL34 .54	PCF86 .53	UC886 .65	OC78 .17
9D7 .65	DY802 .33	EL37 1.00	PCF86 .70	UC886 .65	OC78 .17
10F1 .50	E88CC .80	EL41 .60	PCF86 .70	UC886 .65	OC78 .17
10F18 .55	E180F 1.00	EL84 .23	PCL82 .32	UF41 .70	OC82D .12
12A6 1.00	EA50 .27	EL85 .40	PCL83 .34	UF40 .35	OC83 .22
			PCL84 .38	UF85 .44	OC84 .26
			PCL85 .55	UF86 1.00	OC202 .47
				UF89 .38	OC205 .47

All goods are unused and boxed, and subject to the standard 90-day guarantee. Terms of business: Cash or cheque with order only. Despatch charges:- Orders below £5, add 10p per order up to three items, each additional item 3p extra. Orders between £5 and £10 add 25p total. Orders over £10 post free. Same day despatch by first class mail. Terms of business available on request. Any parcel insured against damage in transit for only 3p extra per order. Please enclose S.A.E. with all correspondence.

Learn to understand electronics for your hobbies

1. Lerna-Kit course

Step by step, we take you through all the fundamentals of electronics and show you how easily the subject can be mastered.

- (1) BUILD AN OSCILLOSCOPE.
- (2) READ, DRAW AND UNDERSTAND CIRCUIT DIAGRAMS.
- (3) CARRY OUT OVER 40 EXPERIMENTS ON BASIC ELECTRONIC CIRCUITS AND SEE HOW THEY WORK.

2. Become a Radio-Amateur

Learn how to become a radio-amateur in contact with the wide world. We give skilled preparation for the G.P.O. licence.

Brochure, without obligation to:

BRITISH NATIONAL RADIO & ELECTRONICS SCHOOL

P.O. BOX 156, JERSEY, CHANNEL ISLANDS.

NAME _____

ADDRESS _____

BLOCK CAPS PLEASE

VERSATILE POWER UNIT

Contains double-insulated mains transformer, 2 amp thermal cut-out and bridge rectifier. Will give 1.7V-10.5V output with two extra capacitors. Ideal for Nickel Cadmium battery charger, 5V TTL stabilized supply, cassette or radio etc. These are brand new units, British made to BS4435, complete with informative instruction sheet. ONLY 83p (20p).

3 WATT TAPE AMPLIFIERS

2xECC83, EL84, EZ80 valves on 12 x 5 x 3" chassis with tone and volume controls, giving 3 watts output to the 7 x 4" 3 ohm speaker. All contained in 14 x 13 x 9" polished wooden cabinet with non-standard tape deck. Tested, in good used condition, standard mains operation. ONLY £3.30 (£1).

71b BARGAIN PARCELS

Contain hundreds of resistors, capacitors, pots & switches (all new) plus crystals, transistor panels and loads of odds and ends. Hundreds already sold at the bargain price of £1.82 (40p).

COMPUTER PANELS

Pack of boards containing at least 500 components, including at least 50 transistors. 66p (20p). 12 top quality panels containing power transistors, trimpots, IC's etc. £2.20 (30p).

500 assorted resistors £1.10 (20p), 150 poly, mica, ceramic capacitors 66p (10p), 741C 35p, 400mW zeners, 3.9V-13V 8p; OC171 16p; OC71 9p. Ferric Chloride 11b 55p (20p).

Carr. in brackets, small parts 5p. VAT included. SAE list.

GREENWELD (R1), 21 Deptford Broadway, London SE8. Callers welcome. Tel. 01-692 2009. Also 38 Lower Addiscombe Rd., Croydon.

Why go hunting for components when there's CATALOGUE 7

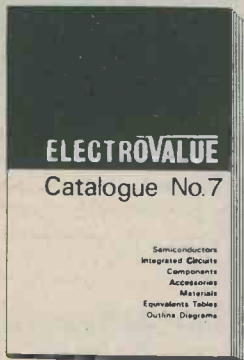

- 112 pages
- Transistors, I.C.s, Thyristors, etc.
- Rs and Cs of all kinds
- Pots

GENUINE DISCOUNTS
COMPUTERISED
HIGH-SPEED SERVICE

Look it up in Catalogue 7 first. Packed with components, attractively priced, brand new and guaranteed to spec. You are more likely to get the things you want from ELECTROVALUE and there are excellent discounts too.

Anything over £2 (except Baxandall speaker) send carriage paid—in U.K. And with Catalogue 7 you get a 25p Refund Voucher usable on orders for £5 or more list value. Catalogue 7 also includes useful diagrams and data.

25p
Post free including 25p refund voucher

ELECTROVALUE LTD.

(Dept. RC.3) 28 St. Judes Road, Englefield Green, Egham, Surrey TW20 0HB (Telephone: Egham 3603)
Northern Branch, (Personal callers) 680 Burnage Lane, Manchester (Telephone: 061-432 4945)

NEW STYLE SELF-BINDER

for "The Radio Constructor"

The "CORDEX" Patent Self-Binding Case will keep your issues in mint condition. Copies can be inserted or removed with the greatest of ease. Rich maroon finish, gold lettering on spine.

Specially constructed Binding Cords are made from Super Linen of great strength, very hard twisted and twice doubled. They are attached to strong RUSTLESS Springs under tension, and the method adopted ensures PERMANENT RESILIENCE of the Cords. Any slack that may develop is immediately compensated for and the Cords will always remain taut and strong. It is impossible to overstretch the springs, as a safety check device is fitted to each.



PRICE **90p** P. & P. 14p
including V.A.T.

Available only from:—

Data Publications Ltd.
57 Maida Vale London W9 ISN

SMALL ADVERTISEMENTS

(Continued from page 511)

FIBRE OPTICS OPTIKIT 103 contains 2 m. Crofon 1610, 64 strand light conduit plus 5 metres each FP20, FP40, FP60 Plastic Monofibre (diameter 0.5, 1.0, 1.5 mm), price £4.84 inc. booklet and VAT. Fibre Optic Suppliers. 2N5777 SILICON PHOTODARLINGTON AMPLIFIER sensitive light detector, supersedes CdS cells. Price 1 off 55p, 5 off £2.53 inc. data, VAT. Fibre Optic Suppliers. **RED LIGHT EMITTING DIODES MLED500** in TO92 case, MV54 miniature (2 mm). Price (both types) £1.10 for 5. Fibre Optic Suppliers. 40kHz **ULTRASONIC TRANSDUCERS** £3.85 per T/R pair from Fibre Optic Suppliers. **FIBRE OPTIC SUPPLIERS** are to be found at Dept. RC, P.O. Box 702, London W10 6SL.

WORLD RADIO TV HANDBOOK 1974 £3.15. HOW TO LISTEN TO THE WORLD £2.00. Postage and VAT included. David McGarva, PO Box, 114, Edinburgh, EH1 1HP.

WIDESCREEN CINE OUTFIT, comprising Zenoscope anamorphic lens; reconditioned Prince 9.5mm cine camera, with fitting for lens; widescreen viewfinder, rectangular lens hood; 5 cassettes of Kodachrome II unexposed film; widescreen lens holder for projector and 60 x 30 inch widescreen projection screen. 9.5mm cine camera, reconditioned in leather case. Four super-8, 100 ft. cine film reels in plastic case. For sale or exchange. W.H.Y? Box No. G223.

JOIN THE INTERNATIONAL S.W. LEAGUE. Free services to members including Q.S.L. Bureau, Amateur and Broadcast Translation, Technical and Identification Dept. - both Broadcast and Fixed Stations, DX Certificates, contests and activities for the SWL and transmitting members. Monthly magazine, *Monitor*, containing articles of general interest to Broadcast and Amateur SWLs, Transmitter Section and League affairs, etc. League supplies such as badges, headed notepaper and envelopes, QSL cards, etc., are available at reasonable cost. Send for League particulars. Membership including monthly magazines, etc., £2.00 per annum. (U.K. and British Commonwealth), overseas 6 Dollars or £2.50. Secretary ISWL, 1 Grove Road, Lydney, Glos., GL15 5JE.

LOUD 6V SIRENS for Burglar alarms, etc. (New and boxed). £1.25p. P.P. 10p. Counters, reeds, relays, motors, transistors, etc. 1974 list 5½p. Grimsby Electronics, 64 Tennyson Road, Cleethorpes, Lincs.

OPENSRAW TECHNICAL COLLEGE, Whitworth Street, Manchester, M11 2WH. Evening courses for radio experimenters, including radio, electronics and model control. All facilities available including professional instruction. For further details telephone 061-223-8282.

DRAUGHTING AIDS for producing 1:1 masters. Trial kits 92p. S.A.E. for price list. Adelta, (RC1), 54 Dickens Avenue, Hillingdon, Middlesex, UB8 3DL.

POSTAL ADVERTISING? This is the Holborn Service. Mailing lists, addressing, enclosing, wrapping, facsimile letters, automatic typing, copy service, campaign planning, design and artwork, printing and stationery. Please ask for price list. - The Holborn Direct Mail Company, Capacity House, 2-6 Rothsay Street, Tower Bridge Road, London, S.E.1. Telephone: 01-407 1495.

GOOD PRICE PAID for partly built panels and components of Television colour receiver, also non-working battery portable television, also 'Crofton' television camera, parts or uncompleted. Give good description and state price required. Box No. G224.

ANTIQUÉ WIRELESS MARK III crystal tuner (World War I vintage) wanted. Have for trade U.S. Army World War I BC-14A crystal set, National SW-3 and other equipment. L.W. Elias, W4DBT, 3919 Pieddexter Drive, RFD8, Winston-Salem, N.C. 27106. U.S.A.

(Continued on page 515)

PRECISION

POLYCARBONATE CAPACITORS

Close tolerance. High stability. Extremely low leakage. All 63v D.C. Plus or minus 1% tolerance:

0.47µF - 56p; 1.0µF - 66p; 2.2µF - 80p; 4.7µF - £1.30; 6.8µF - £1.64; 10.0µF - £2.00; 15µF - £2.75.

Also available plus or minus 2% and plus or minus 5%. ex. Stock.

TANTALUM BEAD CAPACITORS

Values available: 0.1, 0.22, 0.47, 1.0, 2.2, 4.7, 6.8µF at 15v/25v or 35v; 10.0µF at 16/20v or 25v; 22.0µF at 6/10v or 16v; 33.0µF at 6v or 10v; 47.0µF at 3v or 6v; 100µF at 3v. All at 10p each; 10 for 95p; 50 for £4.00

TRANSISTORS: BC107, BC108, BC109; all at 9p each; 6 for 51p; 12 for 96p. May be mixed for quantity price. BC182 and BC212 at 10p each; AF178 at 30p each. All brand new and marked. Full spec. devices.

POPULAR DIODES: IN914 - 7p each; 8 for 50p; 18 for £1.00. IN916 - 9p each; 6 for 50p; 14 for £1.00. IS44 - 5p each; 11 for 50p; 24 for £1.00. All brand new and marked.

400mW ZENER DIODES: Values available 4.7, 5.6, 6.8, 7.5, 8.2, 9.1, 10, 11, 12, 13.5, 15 volts. All new and marked. All at 9p each; 6 for 50p; 14 for £1.00. SPECIAL 6 off each voltage (66 zeners) £4.25

RESISTORS: Carbon film 5% ½w at 40°C, ¼w at 70°C. Range 2.2Ω-2.2MΩ. E12 series i.e. 10, 12, 15, 18, 22, 27, 33, 39, 47, 56, 68, 82, and their decades. All at 1p each 8p for 10; 70p for 100 of any one value. Special pack 10 off each value 2.2Ω to 2.2MΩ (730 resistors) for £5.00.

440v A.C. CAPACITORS: 01.µF, size 1½ in x ½ in - 40p; 0.25µF (1¾" x ¾") - 55p; 0.47 and 0.5µF (1¾" x ¾") - 66p; 1.0µF (2" x ¾") - 85p; 2.0µF (2" x 1") - £1.15.

SILICON PLASTIC RECTIFIERS 1.5 amp. Brand new wire-ended DO27. 100 P.I.V. at 7p each; 4 for 26p. 400 PIV at 8p each; 4 for 30p; 800 PIV at 11p each; 4 for 42p.

7p Post and Packing on all orders below £5.00.

Export orders - please add cost of air/sea mail.

PLEASE ADD 10% V.A.T. TO ALL ORDERS

Send S.A.E. for lists of other ex-stock items, L.E.D's, disc capacitors, electrolytics etc. Wholesale price lists available to bona fide companies.

MARCO TRADING

Dept. C3, The Maltings, Station Road, WEM, Salop.
Tel: Nantwich (Cheshire) 63291

ENGINEERS

FREE

YOURSELF FOR A

BETTER JOB WITH MORE PAY!

Do you want promotion, a better job, higher pay? 'New Opportunities' shows you how to get them through a low-cost B.I.E.T. homestudy course. There are no books to buy and you can pay-as-you-learn.

The B.I.E.T. guide to success should be read by every ambitious engineer. Send for this helpful 76 page FREE book now. No obligation and nobody will call on you. It could be the best thing you ever did.



POST NOW

CHOOSE A BRAND NEW FUTURE HERE!

Tick or state subject of interest. Post to the address below.

Practical Radio & Electronics (Technatron)
Electronic Engineering
Television Maintenance & Servicing
General Radio & TV Engineering
Radio Servicing, Maintenance and Repairs
City & Guilds Radio, TV Electronics Mechanics
Radio Amateurs
Practical TV
Colour Television
C. & G. LI Radio TV Servicing Cert.

Computer Electronics
Post Master General 1st & 2nd class Certs.
C. & G. Electrical Engineering Practice
C. & G. LI Installations and Wiring
General Electrical Engineering Society of Engineers (Electrical Eng.)
Electrical Installations and Wiring
C. & G. Electrical Technicians (Primary)
C. & G. Telecommunications

To B.I.E.T. BREOI Aldermaston Court, Reading RG7 4PF QK BREOI

NAME (Block Capitals Please)

ADDRESS

Other subjects

Age

Accredited by the Council for the Accreditation of Correspondence Colleges.

BRITISH INSTITUTE OF ENGINEERING TECHNOLOGY

NOW! A FAST EASY WAY TO LEARN BASIC RADIO & ELECTRONICS

Free book shows you how to learn basic Radio and Electronics at home—the fast, modern way. Give yourself essential technical “know-how”—like reading circuits, assembling standard components, experimenting, building—quickly and without effort, and enjoy every moment. B.I.E.T.'s simplified home study method and the remarkable TECHNATRON Self-Build Outfit take the mystery out of the subject, making learning easy and interesting.

General Radio and T.V. Engineering	Television Maintenance & Servicing	Radio servicing, maintenance & repairs	<input type="checkbox"/>
Colour T.V.	Practical T.V.	Electronic engineering	<input type="checkbox"/>
Radar Technology	Applied Electronics	Radio Amateurs	<input type="checkbox"/>
Practical Radio and Electronics (Technatron)	Elementary Electronics Course for Radio	Elementary Physics Course for Radio	<input type="checkbox"/>
City and Guilds Radio and T.V. Electrical Mech.			

BRITISH INSTITUTE OF ENGINEERING TECHNOLOGY
Dept. BRE 01, Aldermaston Court, Reading RG7 4PF

POST THIS COUPON FOR FREE BOOK

Accredited by C.A.C.C

Member of A.B.C.C

BRE01

NAME AGE

ADDRESS

SUBJECT OF INTEREST

BRITISH INSTITUTE OF ENGINEERING TECHNOLOGY

MASSIVE CLEARANCE BARGAINS

Bargain component parcels contain Resistors, Capacitors, Potentiometers, Knobs, Rotary, Slide, Key Switches, IF's, Tag Strips, Drive Drums, Springs, Handles, Coil Formers, Wire, Grommets, Relays, Pulley Wheels, Magnets, Transistor Panels etc., etc. Save yourself £s on these well selected parcels 6lbs net weight £1.00, p. p. 40p. Brand new Wire-wound Resistors. 1-7 Watts. Good Selection. 100 for £1 p. p. 15p.

Assorted Computer Panels. These panels are exceptionally good value and contain a minimum of 75 transistors, stacks of diodes plus Trim Pots, Polyester Capacitors, and include a few I.C.s. 10 panels for £1.00, p. p. 27p.

Mullard Ferrite Cores. LA3 50p. LA4 75p. LA2100 50p.

Assorted Electrolytic Capacitors. 6lbs net weight £1.00, p. p. 40p. Assorted Capacitors, Silver Mica, Tubular and Disc Ceramics, Polystyrene. Tremendously good selection. 300 for £1. p. p. 20p.

Please include 10% V.A.T. to total cost of goods.

MAIL ORDER ONLY
XEROZA RADIO
1, EAST STREET,
BISHOPS TAWTON,
DEVON

RING BOARD with I.C. Add-On

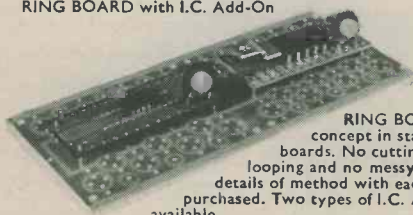

RING BOARD a new concept in standard P.C. boards. No cutting very little looping and no messy chemicals. Full details of method with each board purchased. Two types of I.C. Add-On available.

S.A.E. with enquiries please

FULL BOARD 55p

HALF BOARD 33p

QUARTER BOARD 22p

I.C. Add-On 25p

all POST FREE

RING BOARD (REC 3)
259 Chesterfield Road,
Sheffield S8 0RT. Tel. 0742 52178
ENGLAND

PLAIN-BACKED NEW STYLE SELF-BINDERS

for your other magazines

(max. format 7½' x 9½')

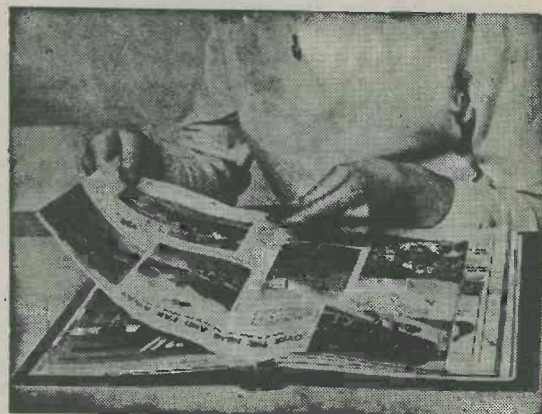

The "CORDEX" Patent Self-Binding Case will keep your copies in mint condition. Issues can be inserted or removed with the greatest of ease. Specially constructed Binding cords are made from Super Linen of great strength, very hard twisted and twice doubled. They are attached to strong RUSTLESS Springs under tension, and the method adopted ensures PERMANENT RESILIENCE of the Cords. Any slack that may develop is immediately compensated for, and the Cords will always remain taut and strong. It is impossible to overstretch the springs, as a safety check device is fitted to each.

COLOURS: MAROON OR GREEN

(If choice not stated, colour available will be sent)

PRICE **85p** P. & P. 14p

including V.A.T.

Available only from:—

Data Publications Ltd.
57 Maida Vale London W9 1SN

SMALL ADVERTISEMENTS

(Continued from page 513)

50 UNMARKED 2W ZENERS 50p. 25 unmarked tested 2W zeners 50p. 100 feet insulated copper aerial wire 50p, 100 yards £1.40. Selenium solar cells 12p. 4-digit magnetic counters 25p. 100 unmarked BZY88 zeners 50p, 1,000 £2.00. LED'S 20p. IN4007 diodes 7p. Keyring lights 25p. A.C. adaptors, 6-7½-9V £2.50. J. Fulton, Derrynaseer, Dromore, Co. Tyrone, N. Ireland.

"RADIO CONSTRUCTOR"; Unbound volumes Nos. 15 to 24. Offers invited. S.A.E. to: 3 Laxton Road, Taunton, Somerset.

WORLD DX CLUB covers all aspects of SWLing on Amateur and Broadcast Bands through its monthly bulletin "Contact". Membership costs £1.60 a year. Enquiries to John Rush, 12 Northfield Road, Thatcham, Berks.

RECITALS OF RECORDED MUSIC. The second Saturday evening of each winter month. Next recital: March 9th, 1974, 8 p.m. at Woodford Green United Free Church, Woodford Green, Essex. Bus routes 20, 20A, 179 and 275 - alight at "The Castle" stop. Programme includes Symphony No. 9 in D Minor ("Choral") by Beethoven.

FREQUENCY LIST TRANSFERS. We have a limited supply of sheets of Dial Frequency Transfers in black. Short Wave frequencies 1.8Mc/s to 32Mc/s and 144Mc/s and 146Mc/s. Includes amateur band marker frequencies at 100kc/s points and other short wave frequencies from 2 to 32Mc/s at every 500kc/s points. Each frequency is repeated. Two sheets for 5p. five sheets for 10p. postage 3p. Data Publications Ltd., 57, Maida Vale, London W9 1SN.

WANTED DEAD OR ALIVE! Cheap SW receiver. Contact: Electronics Club, Monks Dyke High School, Louth, Lincs.

6" DIA 0-8A A.C./D.C. METER £1.25. Rechargeable cells 2V 400mA 45p. 50 unmarked AC128 60p. IN4007 diodes 7p. 10 unmarked 2N3055 50p. 5 unmarked tested 2N3055 70p. 10 unmarked 2N3819 50p. 5 unmarked tested 2N3819 70p. Astrad solar radio £23.00. Milford electronic lighter £3.00. J. Fulton, Derrynaseer, Dromore, Co. Tyrone, N. Ireland.

PERSONAL

JANE SCOTT FOR GENUINE FRIENDS. Introductions to opposite sex with sincerity and thoughtfulness. Details free. 3p stamp to: Jane Scott, 50/CON Maddox Street, London W1R 0LY.

SPONSORS required for exciting scientific project. Norwich Astronomical Society are building a 30" telescope to be housed in a 20' dome of novel design. All labour being given by volunteers. Already supported by Industry and Commerce in Norfolk. Recreational. Educational. You can be involved. Write to: NAS Secretary, The Manse, Back Lane, Wymondham, Norfolk.

IF YOU HAVE ENJOYED A HOLIDAY on the Norfolk Broads, why not help to preserve these beautiful waterways. Join the Broads Society and play your part in determining Broadslands future. Further details from:- The Hon. Membership Secretary, The Broads Society, "Icknield", Hilly Plantation, Thorpe St. Andrew, Norwich, NOR 85S.

ESSEX GARDENERS. Buy your bedding and rock plants, shrubs, etc., also cacti from May's Nurseries, 608 Rayleigh Road, Hutton, Brentwood, Essex. Callers only. Monday to Saturday.

ESSENTIAL BOOKS

HANDBOOK OF INTEGRATED CIRCUITS (ICs), EQUIVALENTS AND SUBSTITUTES. This new book includes all available types of ICs made throughout the world at the present time which have some possible equivalent, substitute or alternative. Published Jan. 1974. 75p. post free.

GETTING THE BEST FROM YOUR COLOUR TV. Advice for colour TV owners and those about to acquire a set. Just published. 50p. p.p. 10p.

HOW TO MAKE WALKIE-TALKIES FOR LICENSED OPERATION. 40p. p.p. 10p.

HOW TO MAKE 2 & 4 METRE CONVERTERS FOR AMATEUR USE. 80p. p.p. 15p.

MOBILE RADIO-TELEPHONE EQUIPMENT HANDBOOK. Gives circuits, data and illustrations plus some valuable modifications for commercial radio-telephone equipment including PYE and other popular makes. Includes modifications for amateur use. £4 including postage.

BEAT THE FUEL CRISIS. (Driving and Preparing your car for Maximum Fuel Economy. 30p. p.p. 10p.

COIL DESIGN AND CONSTRUCTIONAL MANUAL. How to make your own RF and AF coils, chokes and transformers. 30p. p.p. 5p.

HI-FI P.A. GUITAR AND DISCOTHEQUE AMPLIFIER DESIGN HANDBOOK. Includes circuits up to 1100 watts output, tremolo, vibrato, fuzz box etc. 75p. p.p. 10p.

THE GOVERNMENT SURPLUS WIRELESS EQUIPMENT HANDBOOK. Gives circuits, data and illustrations plus valuable information for British/USA receivers, transmitters, trans/receivers. With modifications to sets and test equipment. Latest impression £3.25 including postage.

DIRECTORY OF GOVERNMENT SURPLUS WIRELESS EQUIPMENT DEALERS. Gives details of surplus wireless equipment stores and dealers including addresses, plus equipment and spares that they are likely to have available. A valuable book only 40p. p.p. 10p.

CONSTRUCTORS MANUAL OF ELECTRONIC CIRCUITS FOR THE HOME. Full data and instructions. 50p. post 10p.

PRACTICAL TRANSISTORISED NOVELTIES FOR HI-FI ENTHUSIASTS. 35p. p.p. 10p.

THE THEORY OF GUIDED ELECTROMAGNETIC WAVES. The most comprehensive book yet written about: waveguides, transmission lines, cavity resonators. Over 500 pages. Ideal for anyone interested in Radar & UHF. Published at £11.50. Knock down price £4. p.p. 50p.

THE SCATTERING AND DIFFRACTION OF WAVES. A goldmine of information for the experimenter, amateur and scientist. Profusely illustrated. Published by Oxford University Press at £1.60. Knock down price 80p. p.p. 20p.

COSMIC RADIO WAVES. Start a new hobby - RADIO ASTRONOMY. This big book of 444 pages is an ideal handbook both for the beginner and the established enthusiast. Numerous photographs and illustrations. Published by Oxford University Press. Price £2.50 p.p. 30p.

HOW TO RECEIVE FOREIGN TV PROGRAMMES ON YOUR TV SET BY SIMPLE MODIFICATIONS. 40p including postage.

ALL MAIL ORDER & CALLERS TO:
DEPT. R.C. GERALD MYERS (Bookseller & Publisher)
136 CARDIGAN RD., LEEDS LS6 1LU, Yorkshire, England.

SYNTHESISER MODULES

Voltage-controlled modules for synthesiser construction and other musical MIRACLES! Catalogue 15p. D.E.W. Ltd., 254 Ringwood Road, Ferndown, Dorset.

TECHNICAL TRAINING

Get the qualifications you need to succeed. Home study courses in Electronics and Electrical Engineering, Maintenance, Radio, TV, Audio, Computer Engineering & Programming. Also self build radio kits. Free details from:- International Correspondence Schools, Dept. 733E, Intertext House, London. SW8 4UJ. Tel:- 01-622 9911

MORSE MADE EASY!!!

FACT NOT FICTION. If you start RIGHT you will be reading amateur and commercial Morse within a month. (Normal progress to be expected.) Using scientifically prepared 3-speed records you automatically learn to recognise the code RHYTHM without translating. You can't help it, it's as easy as learning a tune. 28-W.P.M., in 4 weeks guaranteed. Complete course, 3 Records and Books, £4.50. P.P.I. etc. plus 40% (Overseas £1 extra). Or details only, 4p stamp. Or phone S. Bennett, G3HSC. 01-660 2896.

Box 38, 45 GREEN LANE, PURLEY, SURREY.

SMALL ADVERTISEMENTS

Use this form for your small advertisement

To: The Advertisement Manager, Data Publications Ltd., 57 Maida Vale, London W9 1SN

Please insert the following advertisement in theissue of RADIO & ELECTRONICS CONSTRUCTOR

➔			

15 words at 4p
= 60p.

ALL WORDING
IN
BLOCK LETTERS
PLEASE

I enclose remittance of.....being payment at 4p a word. MINIMUM 60p.
Box Number, if required, 10p extra.

NAME.....

ADDRESS.....

Copy to be received four weeks prior to publication. Published on the 1st of every month.

DATA BOOK SERIES

- DB5 TV FAULT FINDING**
New edition in course of preparation.
- DB6 RADIO AMATEUR OPERATOR'S HANDBOOK**
80 pages. Price 45p, postage 6p.
- DB16 RADIO CONTROL FOR MODELS**
192 pages. Price 75p, postage 10p.
- DB17 UNDERSTANDING TELEVISION**
512 pages. Price £2.10, postage 25p.
- DB18 AUDIO AMPLIFIERS**
128 pages. Price 53p, postage 6p.
- DB19 SIMPLE SHORT WAVE RECEIVERS**
140 pages. Price 80p, postage 6p.

I enclose Postal Order/Cheque for.....in payment for.....

NAME.....

ADDRESS.....

(BLOCK LETTERS PLEASE)

Postal Orders should be crossed and made payable to Data Publications Ltd.

Overseas customers please pay by International Money Order.

All publications are obtainable from your local bookseller.

Data Publications Ltd., 57 Maida Vale, London W9 1SN

PLEASE MENTION THIS MAGAZINE WHEN WRITING TO ADVERTISERS

AUDIO OUTPUT POWERS

The Table lists r.m.s. output powers in speakers of 3Ω to 75Ω for transformerless transistor Class B output stages. $V(Pk)$ is the maximum output voltage swing negative or positive, whichever is the lower. If negative and positive swings are equal then $V(Pk-Pk)$ will normally be the supply voltage less voltage drop in the output transistors. As an example, an output stage offering a $V(Pk)$ of 7 volts into an 8Ω speaker can produce an r.m.s. output power of 3.1 watts.

V(Pk-Pk)	V(Pk)	V(r.m.s.)	Watts Output					
			3Ω	8Ω	15Ω	25Ω	35Ω	75Ω
6	3	2.12	1.5	0.56	0.30	0.18	0.13	0.060
7	3.5	2.47	2.0	0.76	0.41	0.24	0.17	0.081
8	4	2.83	2.7	1.0	0.53	0.32	0.23	0.11
9	4.5	3.18	3.4	1.3	0.67	0.40	0.29	0.13
10	5	3.54	4.2	1.6	0.84	0.50	0.36	0.17
11	5.5	3.89	5.0	1.9	1.0	0.61	0.43	0.21
12	6	4.24	6.0	2.2	1.2	0.72	0.51	0.24
13	6.5	4.60	7.1	2.6	1.4	0.84	0.60	0.28
14	7	4.95	8.2	3.1	1.6	0.98	0.70	0.33
15	7.5	5.30	9.4	3.5	1.9	1.1	0.80	0.37
18	9	6.36	13	5.1	2.7	1.6	1.2	0.54
21	10.5	7.42	18	6.9	3.7	2.2	1.6	0.73
24	12	8.48	24	9.0	4.8	2.9	2.1	0.96
27	13.5	9.54	30	11	6.1	3.6	2.6	1.2
30	15	10.6	37	14	7.5	4.5	3.2	1.5
33	16.5	11.7	46	17	9.1	5.5	3.9	1.8

Henry's

**DON'T RELY ON YOUR MEMORY
BUY NOW AT BARGAIN PRICES**
Hi Fi and Transistors - Up to date
Brochures on request

**HENRY'S
CATALOGUE**
Due to rapid price changes,
shortages of paper and raw
materials, all prices in the
existing catalogues no longer
apply. Call or phone for latest
prices. A new catalogue will
be available for Aug/Sept. 1974.

You pay less
VAT with Henry's
Low Prices

BUILD THE TEXAN

**20 + 20 WATT IC
STEREO AMPLIFIER**

As featured by
Practical Wireless
1972

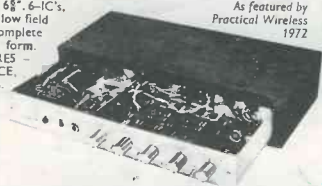

Now built and used by thousands of satisfied customers. Features slim design overall size in cabinet 15 1/2" x 22 1/2" x 6 1/2". 6-IC's, 10 transistors, stabilisers, Gardners low field transformer. Fibre Glass PC panel, complete chassis work. Now available built and tested as well as in kit form.
HIGH QUALITY & STABILITY ARE PREDOMINATE FEATURES - DEVELOPED BY TEXAS ENGINEERS FOR PERFORMANCE, RELIABILITY AND EASE OF CONSTRUCTION FACILITIES.
On/off switch indicator, headphones socket, separate treble, bass, volume and balance controls, scratch and rumble filters, mono/stereo switch, input selector: Mag, P.U. Radio Tuner, Aux. Can be altered for Mic, Tape, Tape-head etc. Constructional details Ref. No. 21 30p. Distributed by Henry's throughout UK. **FREE** - Teak cabinet with complete kit.

BUILD THE HENELEC STEREO FM TUNER

A completely new high stability stereo FM tuner. Features variable capacity diode tuning, stabiliser power supply, IC Decoder, high gain low noise. IF stages, LED indicators. Tuning meter, AFC, easy to construct and use. Mains operated. Slim modern design with fibre glass PC, Teak cabinet, etc. Available as a kit to build or ready built. Overall size 8" x 22" x 6 1/2". Produced to give high performance with a realistic price. (Parts list and constructional details Ref. No. 5 30p.) Henry's are sole distributors UK and Europe



or built and tested
KIT PRICE **£21.00 (+ VAT)** **£24.95 (+ VAT)**

KIT PRICE £28.50 (+ VAT 50p corr. packing) or built and tested **£35.00 (+ VAT 50p corr. packing)** as illustrated

EARN YOURSELF EASY MONEY, WITH PORTABLE DISCO EQUIPMENT

- DISCO MINI A complete portable disco, fitted mixer/preamp, 2 decks all facilities. **£98.50**
- As above but with Slider Controls **£118.50**
- 100 watt amplifier for above **£49.50**
- SDLS 100 watt mixer/amplifier with slider controls **£69.00**
- R50 50 watt mixer/amplifier **£49.50**
- R100 100 watt mixer/amplifier **£57.50**
- DISCO AMP 100 watt mixer/amplifier **£73.00**
- Northcour
- 400 400 watt mixer amp **£37.50**
- 800 80 watt mixer amp **£45.00**
- DISCO MIXER/PREAMPLIFIERS (OP for up to 6-100 watt amplifiers)
- SDLI (rotary controls) **£49.50**
- SDLI (slider controls) **£58.50**
- DISCO VOX (slider controls) the complete disco pre amp **£72.00**
- DJ100 100 watt power amplifier for above **£49.50**
- DJ30L MKII 3 channel 3kw sound to light **£41.25**
- DJ30L MKII Slider Controls **£45.50**
- DJ DISCLITE As 30L/II + variable speed flashes DIMAMATIC 1 kW adjustable speed auto dimmer **£25.00**
- Carlsbro Reverberation Unit **£44.00**
- Disco anti-feedback microphone **£11.95**
- Colt 150 watt liquid wheel projector **£23.50**
- 150 watt Q1 liquid wheel projector **£50.00**
- 150 watt Q1 and Liquid cassette wheel projector **£50.00**
- Spare Effects cassettes large range of patterns **£6.00**
- 6" Liquid wheels **£5.00** Various cassettes **£6.00**
- Mini spot bank fitted 3 lamps **£12.95**
- Auto Triller (mini with flashers) **£17.00**
- Bubblemaker with lighting **£22.50**
- Mixer/Mics/Speakers/Liquid UK's largest range U.K.'s largest range of Disco lighting **FREE** stock list ref. No. 18 on request.

EXCLUSIVE DECCA KELLY SPEAKERS

12 watt speaker Tweeter systems. 8" Bass Midbore and Melinex Domed HF radiator plus crossover **£12.50** per pair of systems (corr./packg. 40p) or built into veneered cabinets, size 18 x 12 x 6 1/2" **£19.50** pair (corr. £1).



HI FI TAPE EQUIPMENT

U.K.'s largest range with discounts and demonstrations for callers. Latest stock lists on request (Ref. No. 17). Phone 01-402-4736 for Barclay/Access Card. Direct orders and latest prices.

TRANSISTORS/SEMI-CONDUCTORS

U.K.'s largest range for every application. Small quantity discounts. Also Trade, Export and Industrial enquiries invited. Latest stock list (Ref. No. 36) including valves on request.

ELECTRONICS SUPPLIES

Specialists in electronics for more than 30 years. Trade and industry supplies—every type of component and equipment.

Barclaycard/Access, call, write or phone, your order 01-402 4736 EASY TERMS FOR CALLERS

LIVING SOUND LOW NOISE TOP QUALITY CASSETTES MADE BY EMI TAPES LTD. TO INTERNATIONAL STANDARDS ESPECIALLY FOR HENRY'S. ALL POST PAID LESS THAN 1/2 REC. PRICES. COMPLETE WITH LIBRARY CASES.

	3 for	6 for	10 for	25 for
C 60	£1.10	£1.98	£3.00	£7.40
C 90	£1.46	£2.80	£4.60	£11.25
C 190	£1.80	£3.45	£5.50	£13.45

Quantity and trade enquiries, invited.
LEARN A LANGUAGE — complete with phrase book. German — French — Spanish — Italian **£1.36** per course. **£5** for any 4.



LOW COST HI-FI SPEAKERS

SPECIAL OFFERS
EM1 13" x 8" — full range speakers (post 20p each or 30p pair)
*150TC — 8 ohms Twin Cone 10 watt **£2.20** each or **£4.00** pair.
*450 10 watt C/o Twin Tweeters 3, 8 or 15 ohms **£3.85** each.
EW 15 watt 8 ohms C/o Tweeter **£5.25** each.
350 20 watt C/o Tweeters, 8 or 15 ohms **£7.80** each.
* Polished wood cabinet **£4.80** post 35p.



SPEAKER KITS (corr. etc. 35p)

20-2	30 watt	£24.50 pair
20-3	40 watt	£35.95 pair
LINTON 2	20 watt	£18.30 pair
GLENDALE 3	30 watt	£32.95 pair
DOVEDALE 3	30 watt	£51.50 pair
KEF KK2	50 watt	£55.00 pair
KEF KK3	50 watt	£78.00 pair

BUILD YOURSELF A POCKET CALCULATOR

A complete kit, packaged in a polystyrene container and taking about 3 hours to assemble — that's the Sinclair Cambridge pocket calculator from Henry's. Some of the many features include: interface chip, thick-film resistor pack, printed circuit board, electronic components pack. Size 4 1/2" long x 2" wide x 1 1/2" deep. Free of charge with the kit for the more advanced technologist is a 32-page booklet explaining how to calculate Logs, Tangents, Sines etc.



PRICE **£24.95 + VAT**
Also available assembled ready for use **£27.20 + VAT**

SUPER TESTER 680R— The complete testing system

Volts AC 11 ranges from 2V to 2500V
Volts DC 13 ranges from 100mV to 2KV
Amp DC 12 ranges from 500A to 10A
Amp AC 10 ranges from 2000A to 5A
Ohms 6 ranges from one tenth of Ohm to 100MQ
Reactance 1 range from 0 to 10MQ
Capacity 6 ranges from 0 to 500pF and from 0 to 0.5uF and from 0 to 50,000pF
Frequency 2 ranges from 0 to 500Hz and from 0 to 5000Hz
Output Voltage 9 ranges 10V to 2500V
Decibels 10 ranges from —24 to +70dB

price **£18.50**

Accessories

Transistor tester	£11.00
Electronic Voltmeter	£18.00
Amplamp	£11.95
Temperature probe	£11.95
Gauss meter	£11.95
Signal Injector	£5.95
Phase Sequence	£5.95
EHT Probe	£5.95
Shunts 25/50/100A	£4.50 each

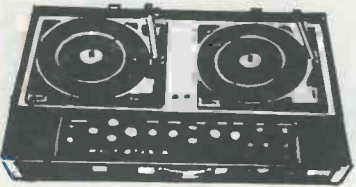

All prices corr. paid (UK) (VAT EXTRA)
Barclaycard/Access, call, write or phone your order 01-723 6963 — easy terms for callers.

FREE LISTS
36 TRANSISTORS IC'S
14 100 KITS TO BUILD
17 HI FI TAPE GEAR
2 TRANSISTOR RADIO TO BUILD

10% VAT to be added to all orders. Export supplied. Prices and descriptions correct at time of proof. E & O E.

Henry's RADIO LIMITED
EDGWARE ROAD, W2

404-406 Electronic Components and Equipment 01-402 8381
354-356 High Fidelity and Tape Equipment 01-402 5854/4736
309 PA-Disco-Lighting High Power Sound 01-723 6963
303 Special offers and bargains store
All mail to 303 Edgware Road, London W2 1BW

Open: 9 am-6 pm
6 days a week
(309 closed
Thursday)
All stores open
all day Saturday