

PRACTICAL WIRELESS

31 heo

APRIL
1968

216

**FREE
INSIDE**

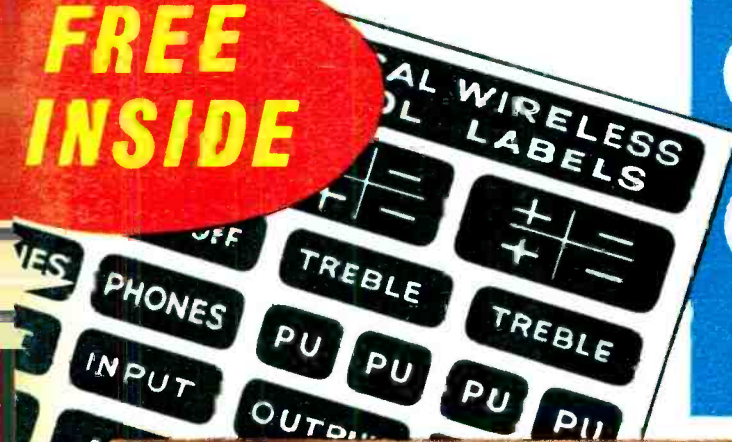

- 1 COMPLETE SET OF PANEL LABELS
- 2 FAULT FINDING CHART No.1 FOR TRANSISTOR RADIOS

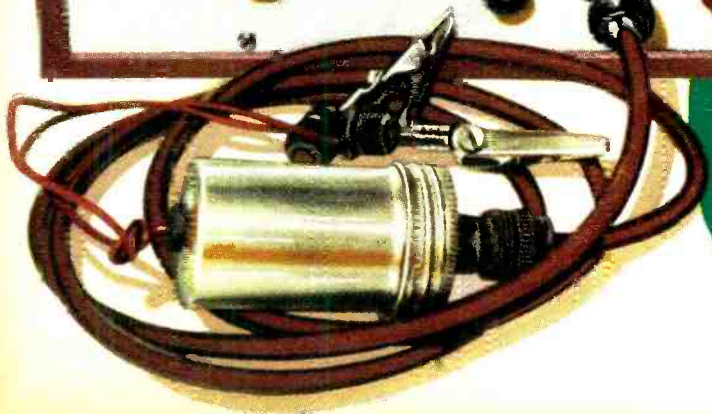

F. E. T.
VOLT OHM METER

ADCOLA
EST. 1946 (INCORPORATED)
 (Royal Trade Mark)

**SOLDERING INSTRUMENTS
 AND EQUIPMENT**

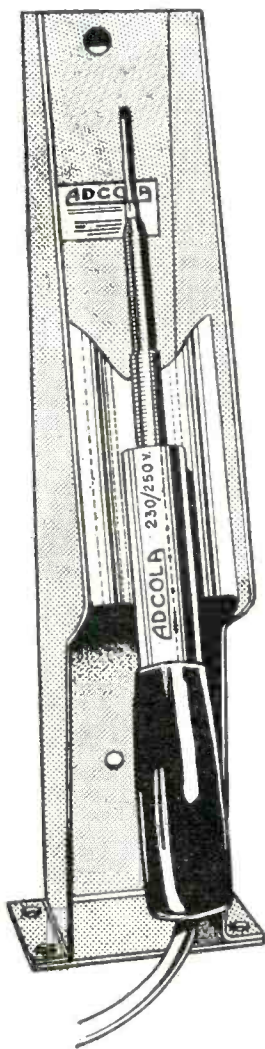

DESIGNED FOR
 THE AMATEUR'S
 RADIO STATION

ILLUSTRATED
 List No. 70 $\frac{1}{8}$ " BIT
 IN
 PROTECTIVE
 SHIELD
 List No. 68

for catalogue apply direct to:—
 Sales and Service Dept.
 ADCOLA PRODUCTS LTD.,
 ADCOLA HOUSE,
 GAUDEN ROAD,
 LONDON, S.W.4

Telephone
 01 622 0291

Telegrams
 SOLJOINT LONDON SW4

JACKSON

the big name in PRECISION components
 MINIATURE TUNING CAPACITORS

The Jackson 'O' range contains six basic types of different air-dielectric tuning capacitors with a wide variation of capacities available in each type. In addition, there are optional extras such as concentric-spindle slow-motion drives, built-in trimmers and plastic covers. The maximum capacitance per section ranges from 12, 18 or 24 pF for FM types to 420 pF for AM types.

TYPE "OO"

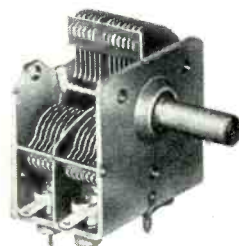

- ★ Type OO miniature twin capacitor at 12/6 each
- ★ Type OFM two-gang for FM at 12/9 each
- ★ Type O two-gang for AM at 12/9 each

Write for literature

JACKSON BROS. (LONDON) LTD. (Dept. P.W.)
 KINGSWAY-WADDON, CROYDON, CR9 4DG
 Phone Croydon 2754-5 (01-688) Grams: Walfilco, Croydon

Solder with the NEW & IMPROVED
PRIMAX OR PRIMAXA
SPOTLIGHT SOLDERING GUN

INSTANT HEAT 6 Seconds!

Twin Spotlight

SEE WHERE YOU SOLDER!

PRIMAX
 60 W W SPOTLIGHTS
 99/8d EACH 5/- P.P.P.

PRIMAXA
 100 W W SPOTLIGHTS
 129/8d EACH
 5/- P.P.P.

Distributors:

S. KEMPNER LIMITED
 384A Finchley Road · LONDON · N.W.2.
 Tel: 01-794 2371—01-435 6365

NEW MART

Dept PW15
30/32, SHUDEHILL MANCHESTER 4.
Telephone (061) 832 7710

FREE GIFT OFFER

OF A BRAND NEW WORLD FAMOUS E.M.I. FISK SOLARISCOPE VALUE £22.0 WITH EVERY ORDER VALUE £5 AND OVER. THIS UNIQUE INSTRUMENT WHICH IS A BOON TO SHORT WAVE LISTENERS CLEARLY SHOWS THE AREAS OF DAYLIGHT AND DARKNESS ALL OVER THE EARTH AT ANY GIVEN HOUR.

MINI-MOTORS 3V to 4.5V operation. Ideal for mini-racing cars, etc. "Large" (1 1/2 x 7/16 x 1 1/2 in.) 3/11. Medium (1 x 1/2 x 1 1/2 in.) 3/9. P. & P. 9d.

GENUINE DIAMOND STYLUS at 7/11 plus 6d. P.P. Available as replacements for the following popular types only at present: BSR TC8LP—BSR TC8 STEREO—BSR TC8 LP/STEREO—COLLARO STUDIO 40" LP/ROSETTE—GARRARD GC8 LP—ACOS GP65/67 LP—ROSETTE EF40LP—GARRARD GC2 LP.

SPEAKERS. 12in. round high quality British fitted tweeter cone, 6 watts, in 3Ω or 15Ω, 35/-, P. & P. 2/6. ROUND 12in. R. & A. 3Ω, 25/6, P.P. 3/6. Many other speakers from 2in. to 18in. available.

TWEETER. 2 1/2in. Black plastic cone, Square Frame, E.M.I. 3Ω, 12/6, plus 1/6 P. & P.

MICROPHONES. LAPEL/HAND MIKE—1 1/2in. dia. Lapel Clip, ideal for tape recording. With lead. Very sensitive, 7/6. P. & P. 1/-.

CRYSTAL HAND MIKE. Robust and sensitive. Cream plastic case. Just the thing for tape recorders, 8/6. P. & P. 1/6.

STUDIO CRYSTAL MIKE. Professional, Omni-directional, providing features usually only available at many times the price. Sensitivity—50dB. Response—50-12,000 c.p.s. Black Plastic with punched chromium case, swivels, stand-holder and shielded cable. Only 48/-, P. & P. 2/-.

ACOS MIC 40—World famous Desk Mike, 16/6 plus P. & P. 1/3.

ACOS MIC 45—Splendid Curved Hand Grip Crystal Mike, 18/3 plus P. & P. 1/6.

ACOS MIC 60—"Stick" Type Crystal Mike, 21/3 plus P. & P. 1/6.

ACOS ROUND Crystal Mike insert, 1 1/2in. dia., 7/6. P. & P. 6d.

TELESCOPIC FLOOR STAND. HEAVY BASE. Standard thread, ext. to 4ft. 7in. 46/6. Carriage and Packing 4/6.

TELEPHONE PICK-UP COIL. For recording or amplifying both sides of telephone conversation. Suction cup fitting to telephone, with lead, 7/6. P. & P. 1/-.

INTER-COMM. DE-LUXE 2-WAY. Highly efficient, safe BABY ALARM. Works off PP3 battery. Buzzer call system, complete with lead, plugs, battery, 55/-, P. & P. 2/6.

INTER-COMMS—DE-LUXE MODEL 2-WAY. Highly efficient 2-way, safe. Ideal BABY ALARM. Transistorised—no warm-up time required. Remote station can call master with latter switched off. Very easily fitted. Complete with battery, cable and plugs 77/6. P. & P. 2/6.

We can also offer a limited supply of a model made by Philips to retail at 6 gu.—Loud and Clear—Our Price 59/11, P. & P. 2/-. Complete with cable and plug. Standard battery 3/6 extra. This is a high quality product.

AMPLIFIER. Compact for use in mains portable grams 6 1/2 x 2 1/2 x 5 1/2in., printed circuit, vol. and tone controls attached by fly leads, over 2 watts output, 55/-, P. & P. 4/6.

4 TRANSISTOR 3W AMPLIFIER. Size 2 1/2 x 2 1/2 x 1 1/2in., 3, 8 or 15Ω output, 9 volt battery operated. Highly sensitive. Price (less battery) 52/6. P. & P. 1/6.

GARRARD RECORD PLAYER DECKS			
A780 Mk. II	£12	15 0
A790 Mk. II Laboratory Series	£15	15 0
SP25 Mk. II (Heavy turntable)	£12	15 0
Cartridges for the above: Mono dual	12	6
..... Stereo	19	6
Garrard Plinths	£3	17 0
Perspex Covers	£3	17 0
Carriage and Packing 7/6 extra.			

CAR RADIOS. Pushbutton, all transistor, two wave, fits most cars, absolutely complete. Positive or negative earth. 12 1/2 gns. Manual operated, two wave, otherwise as above 9 gns. P. & P. on each of the above 9/- extra.

MAGNAVOX "363" TAPE DECKS. LATEST MODELS. WORLD FAMOUS. 1 1/2 x 1 1/2 x 5 1/2in. below board. For 200/250V 50 cycles A.C. 3 speed, digit counter, piano key controls, 7in. reels. Every modern feature. Speeds 1 1/2, 3 1/2 and 7 1/2 i.p.s. With 1 track Marriotti heads, £13.9.6. P. & P. 10/-. Price includes Free Gift.

TAPE RECORDER. Magnificent portable solid state, battery tape recorder. The best yet. 2 speeds, capstan drive, as good for music as speech, 3in. reels. Absolutely complete with remote control, mike, tape, batteries, etc. £10.19.6. P. & P. 5/-.

PICK-UP CARTRIDGE REPLACEMENTS (Standard Fitting for all Record Players). ACOS GP/67-2 MONO 15/-, ACOS GP/73-2 STEREO 30/-, ACOS GP/91-1 MONO-DE-LUXE 21/-, Postage and Packing 3d.

Finest Quality British made MYLAR Recording Tape. Fully Guaranteed. In Cartons. 3in. 240ft. Message..... 5/- 5 1/2in. 1200ft. Long Play..... 12/6

5in. 600ft. Standard Play..... 8/6 7in. 1800ft. Long Play..... 19/6

5 1/2in. 850ft. Standard Play..... 11/6 5in. 1200ft. Double Play..... 15/-

7in. 1200ft. Standard Play..... 12/6 5 1/2in. 1800ft. Double Play..... 22/6

5in. 900ft. Long Play..... 10/- 7in. 2400ft. Double Play..... 24/-

P. & P. 1/- per reel. Four reels and over post paid.

POCKET MULTI-TEST METER. 1000Ω per volt. Volts 0.10/50/250/500/1000 A.C. and D.C. Current: 0-1-100-500mA. Resistance: 0-100kΩ. Complete with test leads, instructions, 37/6. P. & P. 1/6.

MULTITESTER—Pocket size: with built in meter protection. Wide angle, jewelled meter movement, 20,000Ω per volt D.C. 10,000Ω per volt A.C. 19 ranges—0.5, 25, 60, 250, 500 volts D.C. 0.10-50, 100, 1000 volts A.C. 0-50mA, 2.5mA-250mA D.C. ● 0-6000Ω-6 megohms. 10μA I.F.-0-001 mFd-1mFd. ● -20 to +23dB. Mirror Scale. Complete in cloth-lined leather case with carry strap and test leads. Exceptional value at £4.11.0 (P. & P. 3/6).

TRANSISTORS: Some popular types from our range: OC44 and OC45 3/6 each. OC71 2/6. OC72 3/6. OC81 and OC81D 3/- each. OC169 3/6. OC170 3/6. AF117 4/-, OC26 7/6. GETS 5/6. General purpose (Approx. OC71) 1/- each. ● NEW HIGH FREQUENCY TRANSISTORS. Sinclair ST140 4/-, ST141 6/-, both capable of operating up to 700 Mc/s. ALSO MAT100 7/6. MAT101 8/6. MAT120 7/6. MAT121 8/6. ADT140 15/-.

All Transistors postage 6d. up to 3. Over 12 sent P. & P. paid.

R.F. FIELD INDICATOR. For use with radio controlled models. Checks radiation from existing antenna. Times 1 to 250Mc in 5 bands. Sensitive 200mA meter movement. 5 section plug-in aerial. Phone jack and crystal carpiece for monitoring. No battery required. Powerful magnet for attaching to metal surfaces. Complete with instructions, 47/6. P. & P. 2/6.

TERMS. Cash with order. No C.O.D. Orders total £6 and over sent carriage paid (excepting record player decks where carriage is despatch). Guaranteed money refunded if goods returned perfect within 7 days of dispatch.

ERSIN

Multicore

5 CORE SOLDER

for quick,
easy, reliable
soldering

Contains 5 cores of non-corrosive flux, instantly cleaning heavily oxidised surfaces. No extra flux required. Ersin Multicore Savbit Alloy also reduces wear of copper soldering iron bits.



**SIZE 5
HANDY SOLDER
DISPENSER**

Contains 10 ft. coil of 18 s.w.g. Ersin Multicore Savbit Alloy. 2/6 each.



**SIZE 15
SOLDER
DISPENSER**

Contains 21 ft. coil of 60/40 Alloy, 22 s.w.g. Ideal for small components, transistors, diodes, etc. 3/- each.



SIZE 12

Ideal for home constructors. Contains 90 ft. of 18 s.w.g. Ersin Multicore Savbit Alloy on a plastic reel. 15/- each.



**BIB MODEL 8
WIRE STRIPPER
AND CUTTER**

Strips insulation cleanly and quickly, fitted with unique 8 gauge wire selector. Plastic handles. 9/6 each.

From Electrical and Hardware shops. If unobtainable, write to:
Multicore Solders Ltd., Hemel Hempstead, Herts.

GOODMANS HIGH FIDELITY MANUAL

A Guide to full listening enjoyment

The Manual is much more than a catalogue of Goodmans High Fidelity Loudspeakers—it contains informative articles, including advice on stereo, special beginners page, and full cabinet drawings. You'll find it interesting as well as informative.

The Perfect Combination MAXAMP 30

TRANSISTORISED STEREPHONIC HIGH FIDELITY AMPLIFIER 15 + 15 watts · Silicon solid state · Integrated pre-amplifier · Negligible distortion · £49.10.0.

STEREOMAX MATCHING AM/FM STEREPHONIC FM TUNER

Transistorised · Outstanding specification · Stereo de-coder (optional) £60.0.0. + £11.18.3. P.T. inc. Surcharge.

Both MAXAMP 30 and STEREOMAX have polished wood cases (10 1/2" x 5 1/2" x 7 1/2" deep) in Teak or Walnut to order.

Full specifications of the Maxamp 30 and Stereomax are given in the High Fidelity Manual — send the coupon for your FREE copy — or pay an early visit to your Goodmans dealer.

FREE Please send Hi-Fi Manual together with name and address of my nearest Goodmans dealer.

Name.....

Address.....

PW4

GOODMANS LOUDSPEAKERS LTD

AXIOM WORKS · WEMBLEY · MIDDLESEX. Tel: 01-902 1200

VALUABLE NEW HANDBOOK FREE TO AMBITIOUS ENGINEERS

Have you had your copy of "Engineering Opportunities"?

The new edition of "ENGINEERING OPPORTUNITIES" is now available—without charge—to all who are anxious for a worthwhile post in Engineering. Frank, informative and completely up to date, the new "ENGINEERING OPPORTUNITIES" should be in the hands of every person engaged in any branch of the Engineering industry, irrespective of age, experience or training.

On 'SATISFACTION or REFUND of FEE' terms

This remarkable book gives details of examinations and courses in every branch of Engineering, Building, etc., outlines the openings available and describes our Special Appointments Department.

WHICH OF THESE IS YOUR PET SUBJECT?

RADIO ENGINEERING
Advanced Radio — Gen.
Radio — Radio & TV
Servicing — TV Eng. —
Telecommunications—Sound
Recording — Automation —
Practical Radio — Radio
Amateurs' Exam.

ELECTRICAL ENG.
Advanced Electrical Eng. —
Gen. Electrical Eng. —
Installations — Draughts-
manship — Illuminating Eng.
—Refrigeration — Elem.
Electrical Science — Elec-
trical Supply — Mining Elec.
Engineering.

CIVIL ENGINEERING
Advanced Civil Eng. — Gen.
Civil Eng. — Municipal
Eng. — Structural Eng. —
Sanitary Eng. — Road Eng.
—Hydraulics — Mining
Water Supply — Petrol Tech.

ELECTRONIC ENG.
Advanced Electronic Eng. —
Gen. Electronic Eng. —
Applied Electronics — Prac.
Electronics — Radar Tech. —
Frequency Modulation —
Transistors.

MECHANICAL ENG.
Advanced Mechanical Eng. —
Gen. Mechanical Eng. —
Maintenance Eng. — Diesel
Eng. — Press Tool Design —
Sheet Metal Work — Welding
— Eng. Pattern Making —
Inspection — Draughtsman-
ship — Metallurgy — Pro-
duction Eng.

AUTOMOBILE ENG.
Advanced Automobile Eng. —
Gen. Automobile Eng. —
Automobile Maintenance
— Repair — Automobile Diesel
Maintenance — Automobile
Elec. Equipment — Garage
Management.

WE HAVE A WIDE RANGE OF COURSES IN OTHER SUBJECTS INCLUDING CHEMICAL ENG., AERO ENG., MANAGEMENT, INSTRUMENT TECHNOLOGY, WORKS STUDY, MATHEMATICS, ETC.

Which qualification would increase your earning power?
B.Sc. (Eng.), A.M.S.E., C.Eng., A.M.I.E.R.E., R.T.E.B.,
A.M.I.P.E., A.M.I.M.I., A.R.I.B.A., A.I.O.B., P.M.G., A.R.I.C.S.,
M.R.S.H., A.M.I.E.D., A.M.I.Mun.E., CITY & GUILDS, GEN. CERT. OF
EDUCATION, ETC.

British Institute of Engineering Technology

453A ALDERMASTON COURT, ALDERMASTON, BERKSHIRE

THIS BOOK TELLS YOU

- ★ HOW to get a better paid, more interesting job.
- ★ HOW to qualify for rapid promotion.
- ★ HOW to put some letters after your name and become a key man . . . quickly and easily.
- ★ HOW to benefit from our free Advisory and Appointments Depts.
- ★ HOW you can take advantage of the chances you are now missing.
- ★ HOW, irrespective of your age, education or experience, YOU can succeed in any branch of Engineering.

132 PAGES OF EXPERT CAREER - GUIDANCE

PRACTICAL INCLUDING EQUIPMENT TOOLS

Basic Practical and Theoretic Courses for beginners in Radio, T.V., Electronics, Etc. A.M.I.E.R.E. City & Guilds Radio Amateurs' Exam. R.T.E.B. Certificate P.M.G. Certificate Practical Radio Radio & Television Servicing Practical Electronics Electronics Engineering Automation

The specialist Electronics Division of B.I.E.T. NOW offers you a real laboratory training at home with practical equipment. Ask for details.

B.I.E.T.

You are bound to benefit from reading "ENGINEERING OPPORTUNITIES", and if you are earning less than £30 a week you should send for your copy now—FREE and without obligation.



POST NOW!

TO B.I.E.T., 453A, ALDERMASTON COURT, ALDERMASTON, BERKSHIRE. 3d. stamp if posted in an unsealed envelope.

Please send me a FREE copy of "ENGINEERING OPPORTUNITIES." I am interested in (state subject, exam., or career).

NAME _____

ADDRESS _____

WRITE IF YOU PREFER NOT TO CUT THIS PAGE

THE B.I.E.T. IS THE LEADING INSTITUTE OF ITS KIND IN THE WORLD

SENSATIONAL VALUE IN HIGH FIDELITY STEREO SYSTEMS



Consisting of (1) Garrard Mk II SP25 4-speed Turntable with Pick-up Heavy 12in. turntable, hydraulic lowering device and many other features inc. Plug in P.U. head. Fitted CS90 P.U. Cartridge ready wired on plinth (baseboard). Fitted plugs for Instant use. (2) Super 30 Amplifier fully wired and fitted in cabinet above. (3) Pair of Stanton III Loudspeakers. Extremely attractive cabinets finished Satin Teak Veneer, tinted Perspex 'hinged' lid. Performance comparable with equipment at twice the cost and saving approx. £18 on above units. Special inclusive price **69 1/2 Gns.**



Inc. Garrard SP25 MkII Player Unit (with heavy cast turntable) on plinth, ready wired, with plugs and fitted Goldring CS90 high compliance ceramic cartridge with diamond stylus. Assembled TA12 Stereo Amp in cabinet and Pair of Dorset Speaker Units. Total for above saving £12. Terms available. Carr. 25/- Special Price **46 Gns.** Perspex cover 59/9 extra with above.

AUDIOTRINE HIGH FIDELITY LOUDSPEAKERS



Heavy cast construction. Latest high efficiency ceramic magnets. Treated cone surround giving low fundamental resonance. "D" Indicates Tweeter Cone providing extended frequency range. Impedance 3 or 15 ohms. Response 40-18,000 c.p.s. Exceptional performance at low cost.

HF510	5"	8W	59/9	HF12	12"	15W	69/9
HF80ID	8"	8W	5/8	HF120D	12"	15W	79/9
HF81ID	8"	10W	£4.19.9	HF126	12"	15W	89/9
HF101D	10"	15W	£5.19.9	HF126D	12"	15W	5 Gns.

HIGH FIDELITY LOUDSPEAKER UNITS

Cabinets of latest styling Satin Teak or Walnut acoustically lined (and ported where appropriate). Credit terms available on all units.

DORSET Size 16 x 11 x 9in. Response 45-18,000 c.p.s. Rating 8-10 watts. Fitted Audiotrine HF10D speaker. **£8.19.9**
Impedance 3 or 15 ohms.

STANTON III Size 18 x 11 x 10in. Rating 10 watts. Incorporating Audiotrine HF 815 speaker with roll rubber surround and 15000 line magnet. High flux tweeter. Handsome Scandinavian design cabinet. Response 30-20,000 c.p.s. Impedance 3 or 15 ohms. Gives smooth realistic sound output. **16 Gns.**

DORCHESTER Size 24 x 15 x 10in. Fitted Audiotrine HF10ID speaker. Rating 15 watts. Impedance 3 or 15 ohms. Response 30-20,000 c.p.s. Provides really pleasing sound quality. **12 1/2 Gns.**

GLOUCESTER Size 25 x 16 x 10in. High flux 12,000 line speaker. Cross-over unit and Tweeter. Rating 10 watts. Smooth response **12 1/2 Gns.**
40-20,000 c.p.s. Impedance 15 ohms.

LINEAR TAPE PRE-AMPLIFIER Type LP/1 Switched Equalisation. Positions for Recording at 1in., 3in., 7in. per sec., and Playback. FM84 Recording Level Indicator. Designed primarily as the link between a Magnavox Tape Deck and Hi-Fi amplifier suitable most **10 1/2 Gns.**
Tape Decks. Terms available.

R.S.C. TA6 6 Watt HIGH FIDELITY SOLID STATE AMPLIFIER



200-250v. A.C. mains operated Frequency Response 30-20,000 c.p.s. -2dB. Harmonic Distortion 0.3% at 1,000 c.p.s. Separate Bass and Treble controls. 3 input sockets for Mike, Gram, Radio or Tape. Input selector switch. Output for 3-15 ohm speakers. Max. sensitivity 5mV. Fully enclosed enamelled case. 91 x 21 x 9in. Attractive brushed silver finish fascia plate. 104 x 3in. and matching knobs. Complete kit of parts with full wiring diagrams and instructions. Carr. 7/6
Or factory built with 12 months warranty. Post Paid **8 Gns.**

R.S.C. SUPER 15 HI-FI AMPLIFIER

FULLY TRANSISTORISED 200/250v. A.C. Mains. OUTPUT 10 WATTS R.M.S. cont. into 15 ohms. 15 WATT R.M.S. cont. into 3-4 ohms.

LATEST MULLARD TRANSISTORS. AD149, AD149, OC127Z, OC81Z, OC44, OC44, OC81Z, OC44, AC107.

5 POSITION INPUT SELECTOR SWITCH EQUALISATION to Standard R.I.A.A. and C.C.I.R. Characteristics for Gram and Tape Heads.

FULL TAPE MONITORING FACILITIES.

SENSITIVITIES: Magnetic P.U. 4 mV. Crystal or Ceramic P.U. 400 mV. Microphone 4.5 mV. Tape Head 2.5 mV. Radio/Aux or Ceramic P.U. 110 mV.

FREQUENCY RESPONSE: ±2dB 20-20,000 c.p.s.

TREBLE CONTROL: +15dB to -14dB at 10Kc/s. **NEG FEEDBACK:** 52dB.

BASS CONTROL: +12dB to -15dB at 50 c/s. **HUM LEVEL:** -75dB.

HARMONIC DISTORTION at 10 Watts 1,000 c.p.s. 0.25%.

Complete Kit of parts with full constructional details and point to point wiring diagrams. Carr. 12/6
Supplied factory built **15 Gns.** Carr. 12/6. Terms: Deposit 4 Gns. and 9 monthly payments 31/1 (Total £18.9.9). Or fitted in beautiful walnut or Teak veneered cabinet as illustrated. 31 Gns. extra.

ALL COMPONENTS ETC. ARE OF A HIGH STANDARD AND SUPPLIED BY LEADING BRITISH MANUFACTURERS.

Terms: Dep. £19 and 12 mthly of £5. Total £79. Send S.A.E. Supplied less Stanton Loudspeakers at 49 1/2 Gns. or Deposit £7.17.6 and 9 monthly payments **£5.10.10 (total 55 Gns.)**

RECORD PLAYING UNITS

All types available on Credit Terms. Ready to plug into Amplifier or Tape Recorder.

RP2 Consisting of Garrard SP25 Mk II (with heavy turntable) fitted Goldring CS90 high compliance ceramic Stereo/Mono cartridge with diamond stylus. Plinth and cover. Nor. **22 Gns.** mainly export. 226. Carr. 15/-

RP3 As above but with Goldring Lenco GL68 Transcription unit and CS90 Cartridge. Normally approx. 32 Gns. Carr. 15/- **27 1/2 Gns.**

AUDIOTRINE PLINTHS for Record Playing units. Teak finish cut for Garrard 1000-2000.



3000, AT6, AT60, SP25 or Goldring GL68. Available with clear Perspex cover **£5.19.11** or deeper type cut for TA12. Super 15 or 30 86/6 or with cover **£6.19.11**. Perspex cover sold separately at 3 Gns. Limited number slightly damaged but repaired by Manufacturer. 39/9 to clear.

R.S.C. TFM1 TRANSISTORISED VHF/FM RADIO TUNER

Total cost of parts with detailed wiring diagrams & instructions. Carr. 12 1/2 Gns.
Or factory built **16 1/2 Gns.**
Or in Teak finished cabinet as illustrated **19 Gns.**
Terms: Deposit £5 and 9 monthly payments £2. Total £23.

★High-sensitivity ★200-250v. A.C. Mains Operation. ★Sharp A.M. Rejection
★Drift-free reception. ★Output ample for any amplifier (approx. 500 m.v.).
★Simple alignment instructions. ★Output available for feeding Stereo Multiplexer.
★Tuner head giving stereo Phono Tuning for standard 80 ohm or axial input. Made to visually match our Super 15 and 30 amplifiers and of the same high standard of performance and reliability. The pre-wired tuning head facilitates speed and simplicity of construction. Printed circuitry. Only first grade transistors and components used. A quality product at half the cost of comparable units. Stereo version, all parts 191 Gns. Assembled 251 Gns. Carr. 10/-

R.S.C. SUPER 30 STEREO AMPLIFIER

BRADFORD 10 North Parade. (Half-day Wed.) Tel. 25349

Bristol 14 Lower Castle St. (Half-day Wed.) Tel. 22904

BIRMINGHAM 30/31 Gt. Western Arcade opp. Snow Hill Station 021-236-1279 No half-day

DERBY 26 Osaston Rd. The Spot (Half-day Wed.) Tel. 41361

DARLINGTON 13 Post House Wynd (Half-day Wed.) Tel: 68043

EDINBURGH 133 Leith St. (Half-day Wed.) Tel. Waverley 5766

GLASGOW 326 Argyle St. (No half-day) Tel. City 4158
403 Sauchiehall St. (Opp. Locarno) Tel. 332-1572

HULL 91 Paragon Street. (Half-day Thursday) Tel. 20505

FULLY TRANSISTORISED 200/250v. A.C. Mains. A DUAL CHANNEL VERSION OF THE SUPER 15. Employing Twin Printed Circuits. Close tolerance Ganged Pots. Matched Components. **CROSS TALK:** -52dB at 1,000 c.p.s.

CONTROL: 5 position Input Selector. Bass Control. Treble Control. Volume Control. Balance Control. Stereo/Mono Switch. Tape Monitor Switch. Mains Switch. **INPUT SOCKETS** (Matched Pairs). (1) Magnetic P.U. (2) Ceramic or Crystal P.U. (3) Radio/Aux. (4) Tape Head/Microphone. Operation of the Input Selector Switch assures appropriate equalisation. Rigid 18 s.w.g. Chassis. Size approx. 12in. wide, 3in. high and 8in. deep. Neon Panel indicator. Attractive Fascia Plate and Spun Silver Matching Knobs. Above facilities, etc., except for Ganging and Balance Control, apply also to Super 15.

THESE UNITS ARE EMINENTLY SUITABLE FOR USE WITH ANY MAKE OF PICK-UP OR MICROPHONE (Crystal, Ceramic, Magnetic, Moving Coil, Ribbon). **CURRENTLY AVAILABLE SUPERB SOUND OUTPUT QUALITY CAN BE OBTAINED BY USING WITH FIRST RATE ANCILLARY EQUIPMENT.** All required parts, point to point wiring diagrams and detailed instructions. Carr. 15/-
Unit factory built **27 Gns.** or deposit £6.2.0 and 9 monthly payments 56/3. (Total £31.8.3). Fitted cabinet as Super 15 30 Gns. Carr. 15/- or Deposit £6.2.6 and 9 monthly payments 64/- (Total £34.18.6). Send S.A.E. for leaflet



11 1/2 Gns.

32 High Street. (Half-day Thurs.) Tel. 56420 LEICESTER

5-7 County (Mecca) Arcade, Briggate (No half-day) Tel. 28252 LEEDS

73 Dale St. (No half-day) Tel. CENTRAL 3573 LIVERPOOL

238 Edgware Road, W2 (Half-day Thurs.) Tel. PAD 1629 LONDON

96 High Holborn, WC1. Tel. HOL 9874 (Half-day Sat.)

60A-60B Oldham Street (No half-day) Tel. CENTRAL 2778 MANCHESTER

106 Newport Rd (Half-day Wed) Tel. 47096 MIDDLESBROUGH

41 Blackett Street (Opp Fenwick's Store) (Half-day Wed) Tel. 21469 NEWCASTLE UPON TYNE

13 Exchange Street (Castle Market Bldgs.) (Half-day Thursday) Tel. 20716 SHEFFIELD



MAIL ORDERS TO: 102 Hencotton Lane, Bramley, Leeds 13. No C.O.D. under £1. Terms C.W.O. or C.O.D. Postage 4/6 extra under £2. 5/9 extra under £5. Trade supplied. S.A.E. with enquiries please. Hi-Fi Catalogue 4/6. Open all day Sats. except High Holborn

BUILD YOURSELF A QUALITY TRANSISTOR RADIO-GUARANTEED RESULTS BACKED BY OUR SUPER AFTER SALES SERVICE!

THE MAGNIFICENT ROAMER 7 MKIV

SEVEN WAVEBAND PORTABLE AND CAR RADIO WITH A SUPER SPECIFICATION GIVING OUTSTANDING PERFORMANCE !

● 7 FULLY TUNABLE WAVEBANDS—MW1, MW2, LW, SW1, SW2, SW3 AND TRAWLER BAND.

- Extra tuning of Luxembourg, etc.
- Built in ferrite rod aerial for Medium and Long Waves.
- 5 Section 22 inch chrome plated telescopic aerial for Short Waves—can be angled and rotated for peak S.W. listening.
- Socket for Car Aerial.
- Powerful push pull output.
- 7 transistors and two diodes including Philco Micro-Alloy R.F. Transistors.
- Famous make 7in. x 4in. P.M. speaker for rich-tone volume.
- Air spaced ganged tuning condenser.
- Separate on/off switch, volume control, wave change switches and tuning control.
- Attractive case with hand and shoulder straps. Size 9in. x 7in. x 4in. approx
- First grade components.
- Easy to follow instructions and diagrams make the Roamer 7 a pleasure to build with guaranteed results.

Total building costs
£5.19.6

P. & P.
6/6

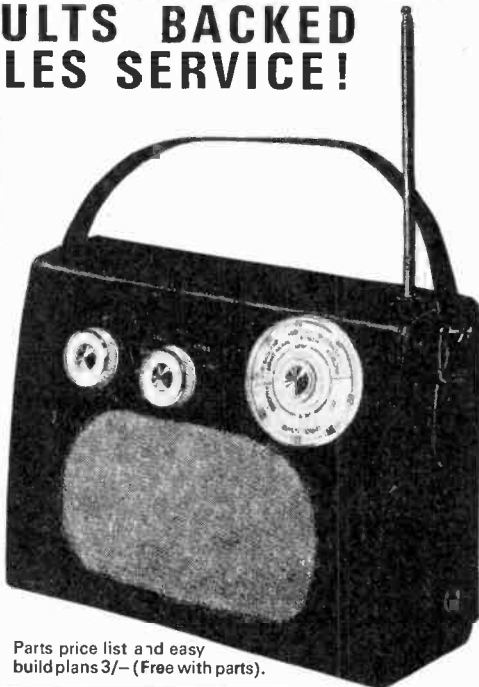

Parts price list and easy build plans 3/- (Free with parts).

TRANSONA FIVE

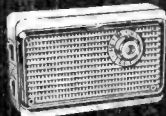

MEDIUM WAVE, LONG WAVE AND TRAWLER BAND PORTABLE

Attractive case with red speaker grille. Size 6½ x 4½ x 1½in. Fully tunable. 7 stages—5 transistors and 2 diodes, ferrite rod aerial, tuning condenser, volume control, fine tone super dynamic 3in. speaker, all first grade components. Easy build plans and parts price list 1/6. (FREE with parts).

Total building costs
42'6 P. & P.
3/6

POCKET FIVE



MEDIUM WAVE, LONG WAVE AND TRAWLER BAND PORTABLE

Attractive black and gold case. Size 5½ x 1½ x 3½in. Fully tunable over both Medium and Long Waves with extended M.W. band for easier tuning of Luxembourg, etc. All first grade components—7 stages—5 transistors and 2 diodes, supersensitive ferrite rod aerial, fine tone 3in. moving coil speaker etc. Easy build plans and parts price list. 1/6 (FREE with parts).

Total building costs
39'6 P. & P.
3/6

MELODY SIX



TWO WAVEBAND PORTABLE WITH 3in. SPEAKER

Handsome leather-look case size 6½ x 3½ x 1½in. with gilt trim and hand and shoulder straps. Fully tunable over both Medium and Long Waves. Incorporates pre-tagged circuit board, 8 stages—6 transistors and 2 diodes, ferrite rod aerial, push-pull output, wave change slide switch, tuning condenser, volume control, 3in. moving coil speaker etc. Easy build plans and parts price list 2/-. (FREE with parts).

Total building costs
59'6 P. & P.
3/6

MELODY MAKER 6



THREE WAVEBAND PORTABLE WITH 3in. SPEAKER

Smart pocket size case, 6½ x 3½ x 1½in. with gilt fittings. Fully tunable over both Medium and Long Waves with extra M.W. band for easier tuning of Luxembourg, etc. 8 stages—6 transistors and 2 diodes, top grade 3in. speaker, 2 R.F. stages for extra boost, high "Q" ferrite rod aerial. Easy build plan and parts price list 2/-. (FREE with parts).

Total building costs
69'6 P. & P.
3/6

ROAMER SIX



SIX WAVEBAND PORTABLE WITH 3in. SPEAKER

Attractive case with gilt fittings, size 7½ x 5½ x 1½in. World wide reception. Tunable on Medium and Long waves, two short waves, Trawler Band Plus an extra M.W. band for easier tuning of Luxembourg, etc. Sensitive ferrite rod aerial and telescopic aerial for Short waves. All top grade components, 8 stages—6 transistors and 2 diodes including Philco Micro-Alloy R.F. Transistors etc. (Carrying strap 1/6 extra.) Easy build plans and parts price list 2/- (FREE with parts).

Total building costs
79'6 P. & P.
3/6

SUPER SEVEN

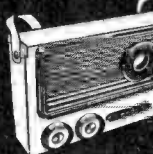

THREE WAVEBAND PORTABLE WITH 3in. SPEAKER

Attractive case size 7½ x 5½ x 1½in. with gilt fittings. The ideal radio for home, car or outdoors. Covers Medium and Long Waves and Trawler Band. Special circuit incorporating 2 R.F. Stages, push pull output, ferrite rod aerial, 7 transistors and 2 diodes, 3in. speaker (will drive larger speaker) and all first grade components. Easy build plans and parts. Price list 2/- (FREE with parts).

Total building costs
69'6 P. & P.
3/6

RADIO EXCHANGE CO.

Callers side entrance Barratts Shoe Shop ● Open 9-5 p.m.
Saturday 9-12.30 p.m.

61 HIGH STREET, BEDFORD

Telephone: Bedford 52367

VIKING AMPLIFIER

50 WATT AMPLIFIER

An extremely reliable general purpose valve amplifier. Its rugged construction yet space age styling and design makes it by far the best value for money.

TECHNICAL SPECIFICATIONS

4 electronically mixed channels, with 2 inputs per channel, enables the use of 8 separate instruments at the same time. The volume controls for each channel are located directly above the corresponding input sockets.

SENSITIVITIES AND INPUT IMPEDANCES

Channel 1 4mV at 470K } These 2 channels (4 inputs) are suitable for
 Channel 2 4mV at 470K } microphone or guitars.
 Channel 3 200mV at 1m } Suitable for most high output instruments
 Channel 4 200mV at 1m } (gram, tuner, organ etc.).
 Input sensitivity relative to 10w output.

TONE CONTROLS ARE COMMON TO ALL INPUTS

Bass Boost +12dB at 60 Hz/s. Bass Cut -13dB at 60 Hz/s.
 Treble Boost +11dB at 15 KHz/s. Treble Cut -12dB at 15 KHz/s.
 With bass and treble controls central -3dB points are 30 Hz/s and 20 KHz/s.

POWER OUTPUT

For speech and music 50 watts rms. 100 watts peak.
 For sustained music 45 watts rms. 90 watts peak.
 For sine wave 38.5 watts rms. Nearly 80 watts peak.
 Total distortion at rated output 3-3% at 1KHz/s
 Output to match into 8 or 15 ohms speaker system.

NEGATIVE FEED BACK 20dB at 1KHz/s.

SIGNAL TO NOISE RATIO 60dB.

MAINS VOLTAGES

Adjustable from 200-250v A.C. 50-60 Hz/s.

A protective fuse is located at the rear of unit.

VALVE LINE UP

Double purpose ECC83 x 3, EL34 x 2 and GZ34.

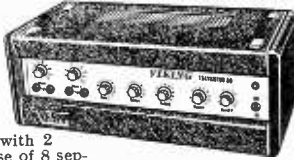

Price
27 gns
 P & P 20/-

FOUR PLUS FOUR Stereo Amplifier

A superb high quality, yet inexpensive stereo amplifier. Due to the great demand we are now able to offer this precision made instrument at a fantastically low price. The high quality, reliability and styling has been maintained in spite of its low price.

SPECIFICATIONS

Elegant styled cabinet (sizes 16" wide 5" high 8 1/2" deep) in black rexine and woodgrained sides. Brushed aluminium front panel with contrasting black/silver knobs.

CONTROLS

Stereo/Mono switch. Gram/Aux switch. Volume left. Volume right. Treble (cut and lift). Bass (cut and lift). Separate on/off switch. Neon pilot indicator.

INPUTS AND OUTPUTS

(per channel)
 Gram, aux, tape out and speaker out. A switched mains socket is

also provided at the rear of unit. Employs Mullard valves throughout. ECC83 and 2 x ECL 86 with a metal bridge rectification.

TECHNICAL SPECIFICATIONS

Gram sensitivity 40mV at 1 KHz. Aux sensitivity 50mV at 1 KHz. (Sensitivities are given for rated output).

4 watts r.m.s. (8 watts r.m.s. in monorial position). Output matches into standard 3 ohms speaker system. Suitable 10" x 6" speakers are available at 29/6 each, plus 5/- p. & p.

Bass control at 100 Hz lift + 9dB cut - 10dB. Treble control at 10 KHz lift + 8dB cut - 13dB. Total harmonic distortion 0.35% at 3 watts and 2% for rated output at 1 KHz. Negative feedback 13dB at 1 KHz. Mains supply 220-250V A.C. 50-60 Hz.

Price
13 gns
 P & P 15/-

8-watt 4-valve PUSH-PULL AMPLIFIER & METAL RECTIFIER

Size: 9" x 6" x 1 1/2". A.C. Mains, 200-250V, 4 valves. For use with Std. or L.P. records, musical instruments, all makes of pick-ups and mikes. Output 8 watts at 5 per cent of total distortion. Separate bass and treble lift control. Two inputs with controls for gram. and mike. Output transformer tapped for 8 and 15 ohm speech coils. Built and tested. £4.4.0. P. & P. 11/-, 8" x 5" speaker to suit price 14/6 plus 1/6 P. & P. Crystal mike to suit 12/6 plus 1/6 P. & P.



GEC KETTLE ELEMENT

3,000W WITH AUTOMATIC EJECTION
 200/240v. Size of hole required 1 1/8"
 List Price 32/-, Our PRICE
 15/-, P. & P. 1/6.



RADIO & TV COMPONENTS (Acton) LTD

21c High Street, Acton, London, W3

Shop Hours 9 a.m.—6 p.m. Early Closing Wednesday

Goods not despatched outside U.K. Terms C.W.O.

All enquiries Stamped Addressed Envelope

Also at 323 EDGWARE ROAD, LONDON, W.2. Personal shoppers only. Early Closing Thursday. All orders by post to our Acton address.

STAR SR 150 COMMUNICATION RECEIVER

Frequency range 535 Kc/s—30 Mc/s four wave bands, four valve plus metal rectifier superhet circuit incorporates B.F.O. band spread tuning, "S" meter external telescopic aerial — ferrite aerial, built-in 4" speaker, easy to read dial. For 240V A.C. operation complete brand new with full instructional manual. 17 gns. plus 10/- P. & P.



POCKET MULTI-METER

Size 3 1/2 x 2 1/2 x 1 1/2 in. Meter size 2 1/2 x 1 1/2 in. Sensitivity 1000 O.P.V. on both A.C. and D.C. volts. 0-15, 0-150, 0-1000 D.C. current 0-150mA. Resistance 0-100kΩ. Complete with test prods, battery and full instructions, 42/6. P. & P. 3/6. FREE GIFT for limited period only. 30 watt Electric Soldering Iron value 15/- to every purchaser of the Pocket Multi-Meter.



ANTI-THIEF CAR BURGLAR ALARM

The Melguard Safermatic consists of an electrical device housed in small metal box 4" x 2" x 1 1/2", which has been designed and developed to provide protection required by the average motorist at an economic cost. Using this system, an alarm and the immobilised condition is set automatically as soon as you park the car. Should you leave the key in the ignition, no one but you can drive the car away. Upon entering the vehicle the method of starting the car is by switching on the ignition, depressing two hidden switches, and simultaneously operating the starter. Location of the switches is known only to you. Should the alarm be set off it can be stopped by following the normal starting procedure. For 12V operation. List price 79/6, our price 29/6 plus 2/6 P. & P. Full easy-to-follow instructions supplied.

3 to 4 Watt AMPLIFIER

3-4 watt Amplifier built and tested. Chassis size 7 x 3 1/2 x 1 1/2 in. Separate bass, treble and volume control. Double wound mains transformer, metal rectifier and output transformer for 8 ohms speaker. Valves ECC81 and 6V6. £2.5.0 plus 5/6 p. & p.



600 mW FOUR TRANSISTOR AMPLIFIER

Features N.P.N. and P.N.P. complementary symmetrical output stage, 2 1/2" x 3/4" x 3/4" Speaker. Output impedance 12 ohms frequency response 3dB points 90 c/s and 12 Kc/s. Price 15/- plus 1/- P. & P. 7 x 4" Speaker to suit, 13/6 plus 2/- P. & P.

2 1/2 watt ALL TRANSISTOR AMPLIFIER

AC mains 240V. Size 7" x 4 1/2" x 1 1/2". Frequency response 100 c/s—10 Kc/s Semi conductors, two OC 75's two AC 128's and two stabilizers AA129. Tone and volume controls on flying leads. £2.10.0 plus P. & P. 3/6. Suitable 8" x 5" 10,000 line high flux speaker, 18/6 plus 2/- P. & P.

NEW TRANSISTORISED SIGNAL GENERATOR

Size 5 1/2 x 3 1/2 x 1 1/2 in. For IF and RF alignment and AF output 700 c/s frequency coverage 450 kc/s to 2 mc/s in switched frequencies. Ideal for alignment to our Elegant Seven and Musette. Built and tested. 39/6 P. & P. 3/6.



BSR TAPE DECKS 200/250V A.C. mains

Type TD2 Tape speed 3 1/2 twin track, £6.19.6.
 Type TD10 2-track, 3 speed, plus rev. counter—£7.19.6.
 Type TD10 4-track, 3 speed, plus rev. counter—£9.5.0. P. & P. on each 7/6.



FIRST QUALITY P.V.C. TAPE

5 1/2"	Std.	850ft. 9/-	5"	L.P.	850ft. . .10/6
7"	Std.	1200ft. 11/6	3"	T.P.	600ft. . .10/6
3"	L.P.	240ft. 4/-	5"	T.P.	1800ft. . .25/6
5 1/2"	L.P.	1200ft. 11/6	5 1/2"	T.P.	2400ft. . .32/6
7"	L.P.	1800ft. 18/6	7"	T.P.	3600ft. . .42/6
5 1/2"	D.P.	1800ft. 18/6	4"	T.P.	900ft. . .15/-

P. & P. on each 1/6, 4 or more post free.

EXTRACTOR FAN



AC Mains 230/250 v. complete with pull switch. Size 6" x 6" x 4". Price 27/6 plus 5/- P. & P.

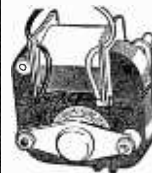

AC MAINS MOTOR

1400 R.P.M.
 230/250v

PRICE
9/6

P. & P. 3/-

NEW! The Dorset Transistor Portable Radio

with BABY ALARM facilities

600 milliwatt solid state 7 transistor plus diode and thermistor. Completely modularised high quality portable radio featuring complementary NPN and PNP output stage. The comprehensive easy-to-follow drawings supplied make this the easiest-ever transistor radio set of parts, with the following features:

- Simple connections to only 6 tags on the R.F./I.F. module, 3 I.F. stages, osc. coil and 3 transistors which with their associated components are completely wired.
- Only 4 connections on the A.F. module to complete the 4 transistor 600 milliwatt solid state amplifier.
- Pre-aligned R.F./I.F. module built and tested.
- A.F. module built and tested.
- Fully tunable over M.W. and L.W. bands. M.W. 540-1640 Kc/s (557-183 metres). L.W. 150-275 Kc/s (2000-1100 metres).
- Intermediate Frequency 470 Kc/s.
- Sensitivity: M.W. at 1 Mc/s 10 microvolts plus or minus 3dB. L.W. at 200 Kc/s 40 microvolt plus or minus 4dB.
- High Q internal ferrite rod aerial on both wavebands.
- Class 'B' modularised output stage with thermistor controlled heat stabilisation. Class 'B' output stage ensures long battery life. Current drain is proportional to the output level. Total current drain of the receiver under no signal conditions is 10-12 mA. At reasonable listening level 20-30 mA.
- Extension sockets for car aerial input, tape recorder output (Independent of volume control) and External Speaker.
- All components (except speaker) mount on the printed circuit board. Easy-to-follow instructions. Size of cabinet 12in. long, 8in. high and 3in. deep. ● Finger-tip controls.

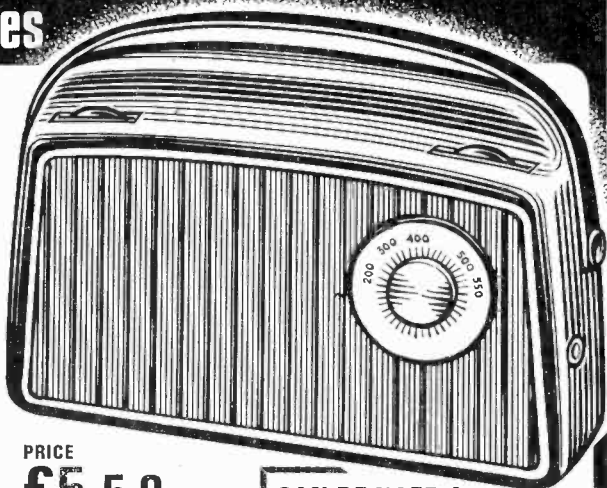

PRICE

£5.50

plus 7/6 postage & packing

**CAN BE USED AS
BABY ALARM**

Circuit and parts list 2/6 free with parts.

SPECIAL OFFER

Special Offer—Power Supply Kit to purchasers of Dorset Portable Radio parts incorporating mains transformer, rectifier and smoothing condenser, AC mains 200/250V output 9V 100mA, 9/6 extra.

Elegant Seven Mk III COMBINED

PORTABLE and CAR RADIO

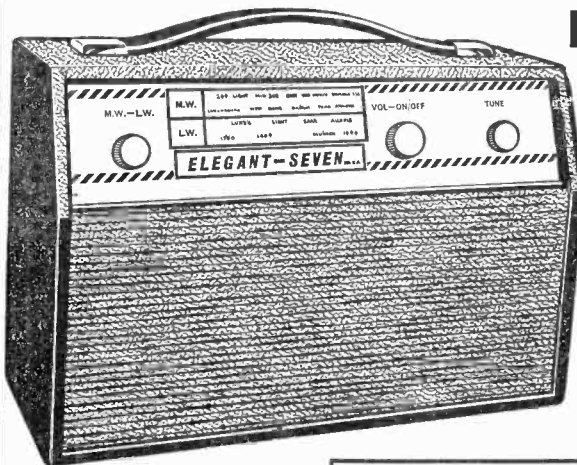

POWER SUPPLY KIT

To purchasers of 'Elegant Seven' parts, incorporating mains transformer, rectifier and smoothing condenser. A.C. mains 200/250 volts. Output 9v 100mA. 9/6 extra.

ONLY **£4.9.6**

Plus 7/6 P. & P. Parts List and circuit diagram 2/6 FREE with parts.

SPECIAL OFFER

Buy yourself an easy to build 7 transistor radio and save at least £10.0.0. Now you can build this superb transistor superhet radio for under £4.10.0. No one else can offer such a fantastic radio with so many de luxe star features.

- ★ De luxe wooden cabinet size 12½" x 8½" x 3½".
- ★ Horizontal easy to read tuning scale printed grey with black letters, size 11½" x 2".
- ★ High 'Q' ferrite rod aerial.
- ★ I.F. neutralization on each separate stage.
- ★ D.C. coupled push pull output stage with separate A.C. negative feedback.
- ★ Room filling output 300mW.
- ★ Ready etched and drilled printed circuit board back printed for foolproof construction.
- ★ Fully comprehensive instructions and point-to-point wiring diagrams.
- ★ Car aerial socket.
- ★ Fully tunable over medium and long wave. 168-535 metres and 1250-2000 metres.
- ★ All components ferrite rod and tuning assembly mount on printed board.
- ★ 5" P.M. speaker.
- ★ Parts list and circuit diagram 2/6, free with parts.

RADIO & TV COMPONENTS (ACTON) LTD.

21C HIGH STREET · ACTON · LONDON · W3
OPEN 9 a.m.—6 p.m. INCLUDING SATS. EARLY CLOSING WED. GOODS NOT DESPATCHED
OUTSIDE U.K. TERMS C.W.O. All enquiries stamped addressed envelope

All orders by post to be sent to our Acton address
323 EDGWARE ROAD, LONDON W2
Personal shoppers only. Early closing Thursday.

LINEAR

NEW RANGE OF SOLID STATE A.C. MAINS AMPLIFIERS

Employing only high grade components and transistors

If required an attractive wood cabinet with Satin Teak veneer finish can be supplied for any model. Prices from 70s.

LT55 6 WATT AMPLIFIER

A High Fidelity unit providing excellent results at modest output levels.

Frequency Response 30-20,000 cps—2dB
Sensitivity 5 mv (max)

Harmonic Distortion 0.5% at 1,000 cps.
Output for 3-8-15 ohm Loudspeakers.
Input Sockets for "Mike," Gram and Radio Tuner/Tape Recorder.

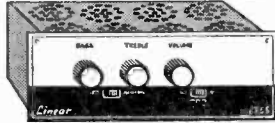

Recommended Retail price 8 gns
Size 9½ × 2½ × 5½ in.
Controls (5) Volume, Bass, Treble, Mains Switch, Input Selector Switch.

LTA15 15 WATT AMPLIFIER

High Fidelity Output switched inputs for Gram, "Mike," Tape, and Radio.

Frequency Response 10-40,000 cps—3dB

Bass Control +18dB to -16dB at 40 cps
Treble Control +17dB to -14dB at 14 Kc/s
Hum and Noise -80dB
Harmonic Distortion 0.2% at rated output.



Recommended Retail price 16 gns
Size 9½ × 3½ × 5½ in.
Output for 3-8-15 ohm Loudspeakers.

Please send a stamped addressed envelope for full descriptive details of above units, also TUNER/AMPLIFIERS STEREO and MONO

AVAILABLE FROM YOUR LOCAL HI-FI DEALER

Wholesale and Retail enquiries to:

LINEAR PRODUCTS LTD, ELECTRON WORKS, ARMLEY, LEEDS

LT66 12 WATT STEREO AMPLIFIER

A twin channel version of the LT55 providing up to 6 watts High Fidelity output on each channel.

Switched Input Facilities Socket (1) Tape or crystal PU (2) Radio Tuner (3) Ceramic PU Microphone

Controls (6) Volume, Bass, Treble, Balance, Mains Switch, Input Selector Switch, Stereo/Mono Switch.

Facia Plate Rigid Perspex with black/silver background and matching black edged knobs with spun silver centres.

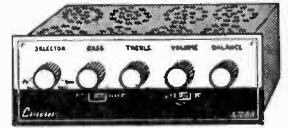

Recommended Retail price 15 gns
Size 12 × 3½ × 6 in.

PTA30 HI-FI PUBLIC ADDRESS AMPLIFIER

A successor to our popular Conchord 30 watt unit.

Input Sensitivity 2 mv (max)

- ★ Output 30 watts.
- ★ Output Terminals or Loudspeaker or combination of Speakers with total impedance between 3 ohms and 30 ohms.
- ★ Three individually controlled Jack Inputs for mixing purposes.

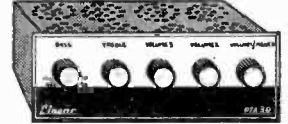

Recommended Retail price 20 gns
Size 12 × 3½ × 6 in.

Housed in fully enclosed stove enamelled steel case.

Controls Vol (1) Vol (2) Vol (3) with mains switch, Treble "lift" and "cut", Bass "lift" and "cut"

AN IDEAL UNIT FOR VOCAL AND INSTRUMENTAL GROUPS SUITABLE FOR ANY KIND OF "MIKE" AND INSTRUMENT PICK-UP, ALSO FOR RADIO, TAPE OR GRAM.

THE *Adamin* DE-SOLDERING TOOL



- Self-contained—does NOT require the use of air-lines or pumps.
- Simple, light and inexpensive.
- PERMABIT nozzle will not wear or become eroded by the solder.
- Standard nozzle $\frac{5}{64}$ in. bore. Alternative $\frac{3}{64}$ in. bore.
- Mains or low voltages.

Please ask for colour catalogue A10

LIGHT SOLDERING DEVELOPMENTS LTD. 28 Sydenham Road, Croydon CR9 2LL

Telephone 01-688 8589 & 4559

Nearly 1,700 Circuits and Diagrams plus full repair data for 800 POPULAR MODELS

1968 RIGHT BACK TO 1965

Radio & TV Servicing

Big time-saving repair library to step up your earnings

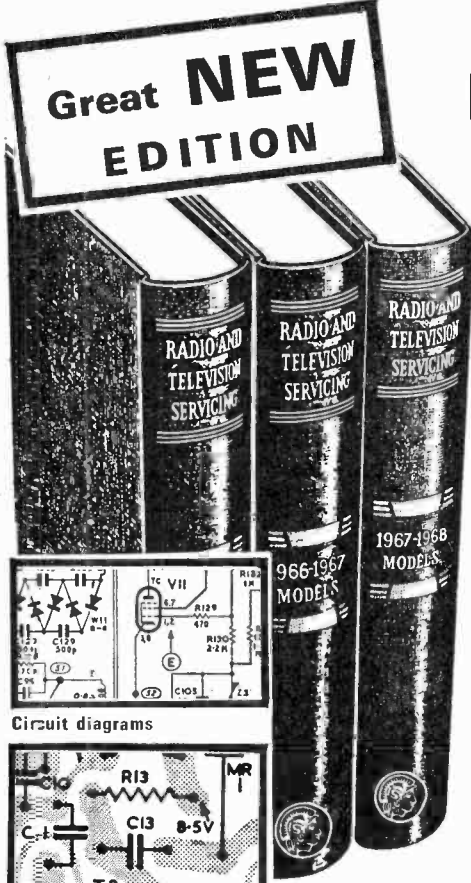

Now off the Printing Presses—a great new edition of RADIO & TV SERVICING, to save your time, to boost your earning-power. Packed with CIRCUITS, REPAIR DATA and vital information, it covers all the popular 1965-1968 TVs, Radios, Grams, Record Players and Tape Recorders—including latest data on COLOUR TV. Thousands of sets of previous editions sold. Now you can examine this big NEW edition free for a week. 3 handsome volumes—over 1,550 pages written by a team of research engineers—there's no other publication like it. Speeds up repair work for year after year. Hurry—send no money—simply post this coupon below . . . There can be no reprint once stocks are sold and there's absolutely no obligation to buy under this free trial offer.

FULL DATA AND CIRCUITS FOR REPAIR OF

- TELEVISIONS including
- COLOUR TV**
- RADIOS, RADIOGRAMS
- CAR RADIOS
- RECORD PLAYERS
- TAPE RECORDERS

SERVICING DATA FOR ALL THESE MAKES

Aiwa, Alba, Baird (including colour TV), Beogram, Beolit, Bush, Carousel, Corsor, Dansette, Decca, Defiant, Dynaport, Dynatron, Eddystone, Ekco, Elizabethan, Ever Ready, Ferguson, Ferranti, Fidelity, G.E.C. (including colour TV), Grundig, H.M.V., Kolster-Brandes, Hitachi, Invicta, McMichael, Marconiphone, Masteradio, Motorola, Murphy, National, Newmatic, Pam, Perdio, Peto-Scott, Philips (including colour TV), Portadyne, Pye, Radiomobile, R.G.D., Regentone, Roberts' Radio, Sanyo, Sharp, Smith's Radiomobile, Sobell (including colour TV), S.T.C., Sony, Standard, Stella, Stereosound, Teletron, Thorn, Trans Arena, Ultra, Van Der Molen, World Radio.

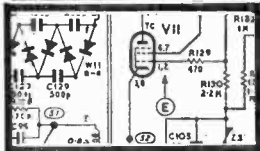

Circuit diagrams

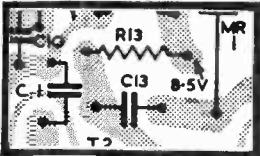

Printed panel diagrams

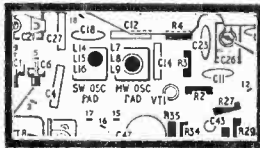

Component layout diagrams

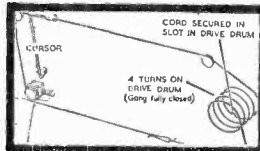

Drive-cord diagrams

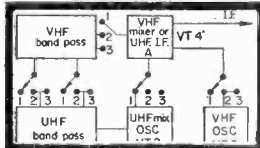

Block diagrams

PLUS LATEST DEVELOPMENTS IN RADIO AND TELEVISION

Including—Integrated Tuners, Stereo Multiplex Broadcasting—The Zenith-G.E. System: Receiver, Decoder and adjustments, Aerial, etc. Colour TV Receivers, Colour TV Test Card F, Servicing Transistor Equipment, Chemical Aids to Servicing, Batteries and Rechargeable Cells, Sound-on-Sync., Double Line Sync., Silicon Transistors, etc.

OVER 1,500 PAGES, PACKED WITH CIRCUITS, COMPONENT LAYOUT DIAGRAMS, PRINTED PANEL DIAGRAMS, TABLES AND WAVEFORM GRAPHS

Handsomely bound in rich maroon and gold.

IT'S YOURS BY POST ON 7 DAYS'

FREE TRIAL

Absolutely no obligation to buy

To: Buckingham Press Ltd., 4 Fitzroy Square, London, W.1.

Please send Radio and TV Servicing, 3 volumes, without obligation to buy if you accept my application. I will return the books in 8 days or post:

Tick (✓) Full cash price of £12, or here 15/- dep. and 16 monthly payments of 15/-.
If you are under 21 your father must fill up coupon.

Full Name (Block letters)

Address

County

Occupation

Signature

Please tick (✓) here

The address on left is

My/our property

Rented unfurnished

Furnished accom

Temporary address

If none of the above please answer here

Mr.

Mrs.

Miss

Credit price £12 15s. For Eire & N.I. send £12 with coupon. Elsewhere overseas add 10/- p. & p.

RV3/3572

Lasky's Radio

DON'T MISS THIS

HAVE YOU GOT YOUR COPY OF OUR GREAT "35th BIRTHDAY" CATALOGUE? — FREE

Printed in large 16x11in. modern magazine format—the "Birthday Catalogue" contains thousands of different items from our vast stocks of Radio, Hi-Fi, TV, Test Gear, Components, Communications and other equipment.

PLUS many bargain offers and prices exclusive to Lasky's
AND in addition every copy of the "Birthday Pictorial" is numbered and automatically enters you in our great "Birthday Draw" with over £100 in Gift Vouchers to be won.

All goods shown in the "Birthday Pictorial" are available over the counter from any of our branches—or by post to any address in the U.K. or overseas—bringing the benefits of shopping at Lasky's to you in your home.

2nd great reprint issue now ready.

Just send your name, address and a 6d. stamp for postage.

A MUST FOR EVERY ELECTRONICS HOBBYIST AND HI-FI ENTHUSIAST!



HUGE PURCHASE OFFER

CROWN MODEL TRF-6
SUPER COMPACT AM/FM 9 TRANSISTOR
POCKET RADIO

Unbelievably small for an AM/FM receiver—the Crown is only 4½in. x 2½in. x 1½in. Super sensitive 9 transistor superhet circuit with directionless stabilised reception. AM cover; MW 335-1605 Kc/s. FM cover; 85-108 Mc/s. Superb tone reproduction 2½in. PM speaker. Precision tuning. 6 section (14½in.) telescopic aerial—clips into side when not in use. Output 280 mW max. Beautifully styled and finished cabinet in black plastic with silver metal trim. Operates on one 9V battery. Complete with leather purse, ear-piece and battery. List Price 13½ Gns.



SCOOP Price £7.19.6 Post 2/6

IDEAL FOR USE WITH THE "TOMMY" WIRELESS MICROPHONE — SEE BELOW

RECORD PLAYERS

GARRARD AUTOCHANGERS

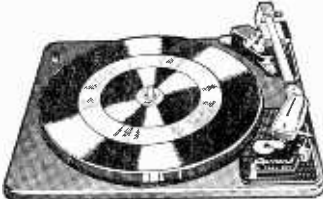

AP75	£22.11.6
AT760 Mk. II	£12.19.6
3000LH with stereo cart.	£23.19.6
A70	£13.19.6
Lab. A Mono/Stereo.	£14.19.6
Lab. A on plinth	£15.19.6
A50	£7.7.0
A1000	£6.8.0
A2000	£6.18.6

SINGLE PLAYERS

Auto. start and stop. Complete with pick-up and crystal cartridge.
GARRARD SP25 Light 4/table. £9.19.6
GARRARD SP25 Heavy 4/table. £10.19.6
(Garrard SP25's are ex-castrol)
GARRARD SRP12

TRANSCRIPTION MOTORS

GARRARD 401	£27.19.0
GARRARD Lab. 80 Mk. II	£25.0.0
GARRARD BASES	
WB1	£3.16.3
WB2	£5.5.0
CLEARVIEW PERSPEX COVERS	
WB1	£3.17.0
WB2	£5.7.11

Postage on all above 5/- extra.

SPECIAL INTEREST ITEMS!

WALKIE TALKIES

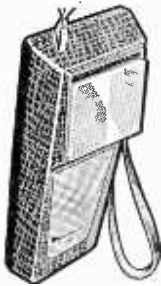

Export transceivers at a bargain price. 3 transistors. Each unit operates on one 9V miniature battery (PP3 type). 8 section telescopic aerial. Strong plastic case with wrist strap—size 5½ x 2½ x 1½in. Ideal for short range indoor and outdoor communication and for use abroad. Built in speaker/microphone. Complete with batteries. Appearance may alter slightly.

LASKY'S PRICE 99/6
per pair Post free
Not for use in U.K. owing to G.P.O. regulations.

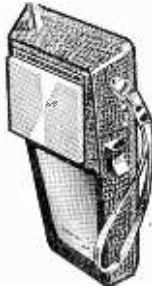

NEW INTERNATIONAL TAPE

FAMOUS AMERICAN MADE BRAND TAPE AT RECORD LOW PRICES

3in. Message tape, 150ft.	2 6	5½in. Long play, 1200ft. Acetate.	12 6
3in. Message tape, 225ft.	3 9	5½in. Standard play, 850ft. PVC.	11 6
3in. Message tape, 300ft.	7 6	5½in. Long play, 1200ft. Mylar.	15 0
3½in. Triple play, 600ft. Mylar.	10 0	5½in. Triple play, 2400ft. Mylar.	45 0
4in. Triple play, 900ft. Mylar.	17 6	7in. Standard play, 1200ft. Acetate.	12 6
5in. Double play, 1200ft. Mylar.	15 0	7in. Standard play, 1200ft. Mylar.	12 6
5in. Long play, 900ft. Acetate.	10 0	7in. Long play, 1800ft. Mylar.	19 6
5in. Standard play, 600ft. PVC.	8 6	7in. Double play, 2400ft. Mylar.	28 0
5in. Triple play, 1800ft. Mylar.	35 0	7in. Long play, 1800ft. Acetate.	15 0
5½in. Double play, 1800ft. Mylar.	22 6	7in. Triple play, 3600ft. Mylar.	60 0

P. & P. 1/- extra per reel. 4 reels and over Post Free.

THE LATEST MARVELS IN TRANSISTOR MINIATURISATION

The TOMMY MODEL WO-11 WIRELESS MICROPHONE



This brand new wireless mic. combines sensitivity with miraculous miniature size. Only 0.72 x 0.62 x 2.24in. Easily concealed with many uses—ideal for parties, games or as a baby alarm, etc. Ideal for use with the Crown AM/FM radio and model A1004 FM Tuner. Brief Spec.: Short Range transmitting; frequency 9-107 Mc/s. FM. External Antenna. Battery; Mercury 1.3V (Mallory 675 R). Weight 0.65 oz. Complete with battery and trimmer for tuning and instruction booklet

Lasky's Price £5.19.6 Post Free

SPECIAL PACKAGE PRICE if bought with the **£12.19.6** Post Free
Crown TRF 6 AM/FM RADIO. See above

TCC B4002 EXPORT FM WIRELESS MICROPHONE



Highly sensitive—for static or mobile use. Signal can be picked up by any FM radio or tuner which receives frequencies between 96-104 Mc/s over several hundred yards. Size only 3in. x 2½in. x 1in. (in leather case). Operates on one PP3 type battery. Complete with clip-on dynamic ext. mike (½in. x 2½in. x 5/16in. l) and battery. List Price 16 Gns.

Lasky's Price £6.19.6 Post Free anywhere in world.

TTC MODEL 13/500. More powerful version of above—size 7½ x 1½ x 2½in. Operates on one PP3 type battery.

Lasky's Price 12 Gns. Post free anywhere in the world.

These cannot be operated in the U.K. owing to G.P.O. regulations.

TRANSISTOR FM TUNER CHASSIS

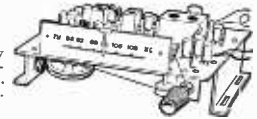

Fully tunable—range 88 to 108 Mc/s. Completely wired on printed circuit. 10.3 Mc/s. I.F. 6 transistors and 3 diodes. Slow motion tuning drive. Size 6½ x 4 x 2½in. Operates from any 9v. D.C. source. Full data and circuit supplied.

LASKY'S PRICE £6.10.0 Post 5/- extra.

MULTIPLEX ADAPTOR MODEL

Now you can enjoy stereo sound with the model FM Tuner above. Brief spec.: MPX input sensitivity 100mV. Output 150mV. Self powered by a 9v. battery. 4 transistor and 6 diode circuit. Size 5½ x 2 x 2½in. Also suitable for use with other FM tuners with MPX input. LASKY'S PRICE 99/6 Post 5/-

PACKAGE PRICE IF BOUGHT TOGETHER £11 Post 5/-

SPECIAL PURCHASE—VALVE UHF TV TUNERS

Well-known British makers surplus stocks. Now available for the first time to the Home Constructors. Add 2/6 Post and Packing on each. In metal case size 4 x 6 x 1½in. Fully tunable—complete with PC86 and PC88 valves.

LASKY'S PRICE 29/6 Without valves 7/6

LASKY'S FOR SPEEDY MAIL ORDER SERVICE

Lasky's Radio

PRESENT A NEW SENSATIONAL HI-FI UNIT TRIO Model TK-60BE TRANSISTORISED AM/FM MULTIPLEX STEREO TUNER AMPLIFIER

AT A PRICE YOU CAN AFFORD!

The 36 Transistor TR10 TK-60BE incorporates superb modern styling with many features normally found in models costing £££'s more. This great value for money Hi-Fi unit offers the following superb features: Tuner AM/FM 4-gang tuning condenser all transistor front end provides FM 2.5mV sensitivity. *Automatic FM/Stereo Mono mode silent switching circuit with Stereo signal beacon. *Illuminated pinpoint AM/FM tuning meter. *4 diode time division multiplexer de-coder giving 35dB channel separation. Amplifier * All silicon transistor amplifier provides wide 20-50,000 Hz frequency response. *Exclusive blow-out free automatic circuit breaker for power transistor protection. *Speaker output terminals and power for 2 sets of stereo speakers—switch selected (A speakers, B speakers, A+B speakers, head phones). *Centre channel output. *Full range of controls. *Front panel stereo phone jack. *Direct tape monitor switch for tape monitoring without changing cable connection. *DIN connector for tape recorder. Brief spec.: Amplifier—Music Power 60 watts (1HF standard 4 ohms). Continuous power—20 watts per channel. Signal to noise ratio—Phono 60dB, Tape HD-60dB. Input sensitivity—Phono 2mV, Tape HD-2.5mV, AUX 150mV. Speaker Impedance—4/16 ohms. Controls: Input selector, Mode, HF and LF filters, separate treble and bass controls for each channel, balance, loudness, tape monitor, output selector. Tuner: FM cover 88-108 Mc/s, AM cover 540-1600 Kc/s. FM Harmonic Distortion—0.6%. FM Signal to Noise Ratio—60dB. FM Selectivity—40dB. General: For 110/250V mains. Finish—brushed aluminium with hammer enamel case. Size 17½ x 5¼ x 14in.



LASKY'S GREAT VALUE PRICE 69 Gns. Carriage FREE

COMMUNICATION RECEIVERS

TRIO RECEIVERS

MODEL JR-500SE

This high performance receiver is made especially to cover the amateur bands and utilises a crystal controlled double heterodyne circuit for extra sensitivity and stability. Brief spec: Covers all the amateur bands in 7 separate ranges between 3.5 and 29.7 Mc/s. Circuit uses 7 valves, 2 transistors and 5 diodes plus 8 crystals; output 8 and 500 ohm and 500 ohm phone jack. Special features: Crystal controlled oscillator • Variable BFO • VFO • AVC • ANL • 8 meter • SSB-CW • Stand-by switch • Special double gear dial drive with direct reading down to 1 kHz • Remote control socket for connection to a transmitter. Audio output 1 watt. For use on 115/250 V A.C. Mains. Superb modern styling and control layout—finished in dark grey. Cabinet size 7 x 13 x 10in. Weight 18 lbs. Fully guaranteed, complete with instruction manual and service data.

LASKY'S PRICE £61.19/0 Carriage and Packing 12/6

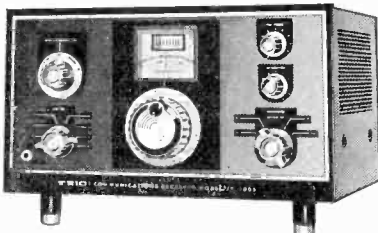

MODEL 9R-59DE

Brief spec.: 4 band receiver covering 550 Kc/s to 30 Mc/s continuous and electrical band spread on 10, 15, 20, 40 and 80 metres. 8 valve plus 7 diode circuit. 4/8 ohm output and phone jack. Special features: SSB-CW • ANL • Variable BFO • 8 meter • Sep. band spread dial • 1F frequency 456 Kc/s • Audio output 1.5 W • Variable RF and AF gain controls. For use on 115/250 V A.C. Mains. Beautifully designed control layout finished in light grey with dark grey case, size 7 x 15 x 10in. Weight 19 lbs. Fully guaranteed, complete with instruction manual and service data.

LASKY'S PRICE £36.15/0 Carriage and Packing 12/6.

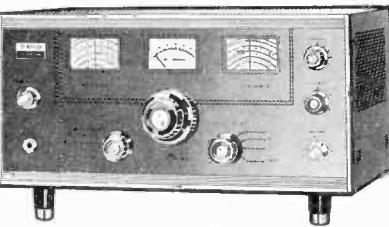

JOYSTICK VARIABLE FREQUENCY ANTENNA

Revolutionary variable frequency antenna for transmission and reception. With a variable matching unit these antennae perform as a high 'Q' device at any selected Medium or Short waveband. Send for S.A.E. for descriptive leaflet.

AERIALS (7ft. 6in. Long)	Matching units		
VFA Standard	£4 15 0	A.T.V. 3A	£3 12 6
VFA De Luxe	£5 19 6	A.T.V. 4	£4 4 0
		A.T.V. 4/RF	£6 6 0

CONSTRUCTORS BARGAINS

THE SKYROVER De Luxe

7 transistor plus 2 diode superhet, 6 waveband portable receiver covering the full Medium Waveband and Short Waveband 31-94M and also 4 separate switched band-spread ranges, 13M., 16M., 19M. and 25M., with Band Spread Tuning for accurate Station Selection. The coil pack and tuning heart is completely factory assembled, wired and tested. Superhet, 470 Kcs. All Mullard Transistors and Diodes. Uses 4 U2 batteries. 5in. Ceramic Magnet P.M. Speaker. 500mW Output. Telescopic and Ferrite Rod Aerial. Tone Control. Volume Control. Tuning Control and Waveband Selector. In wood cabinet, size 11½ x 6½ x 3in. covered with washable material, plastic trim and carrying handle. Car aerial socket fitted.

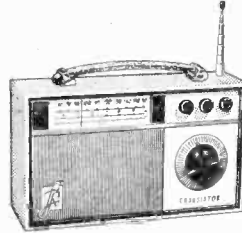

LONG WAVEBAND COVER FOR THE SKYROVER

A simple additional circuit provides coverage of the 1100/1950M. bands (including 1500M. Light programme). This is in addition to all existing Medium and Short wavebands. All necessary components with construction data.

Only 10/- extra Post Free. This Conversion is suitable for receivers that have already been constructed.

Can now be built for **£8. 19. 6** Post 5/- extra

H.P. Terms: 60/- deposit and 11 monthly payments of 12/9. Total H.P.P. £10.0.3.

Four U2 batteries 3/4 extra.

Data 2/6 extra: refunded if you purchase the parcel. All components available separately.

LASKY'S CLEAR PLASTIC PANEL METERS

Precision made in Japan by HIOKI. Each meter boxed and fully guaranteed with all fixing nuts and washers. Sizes are of front panel. Add 1/6 Post on each.

Type KR-52 3x2in. (illustrated)			
1mA DC	47/6	100µA	47/6
5mA DC	32/6	500µA	37/6
30V DC	32/6	1mA 8 Meter	39/6
50µA	58/-		
Type MK-88A 1 1/2in. square			
1mA DC	29/6	Type KR-65 3 1/2 x 3in.	
5mA DC	22/6	1mA DC	36/-
300V DC	22/6	5mA DC	35/-
50µA	36/-	300V DC	35/-
100µA	29/6	50µA	59/6
500µA	27/6	100µA	49/6
5mA 8 meter	29/6	500µA	42/6
Type MK-45A 2in. square		1mA 8 meter	39/6
5mA DC	25/-	Type MK-65A 3in. square	
3mA DC	25/-	1mA DC	36/-
300V DC	25/-	5mA DC	35/-
500µA	25/-	300V DC	35/-
1mA 8 meter	35/-	500µA	39/6
		1mA 8 meter	39/6



Branches

207 EDGWARE ROAD, LONDON, W.2 Tel.: 01-723 3271
Open all day Saturday, early closing 1 p.m. Thursday

33 TOTTENHAM CT. RD., LONDON, W.1 Tel.: 01-636 2605

Open all day, 9 a.m.—6 p.m. Monday to Saturday

152/3 FLEET STREET, LONDON, E.C.4 Tel.: FLEet St. 2833

Open all day Thursday, early closing 1 p.m. Saturday

High Fidelity Audio Centres

42 TOTTENHAM CT. RD., LONDON, W.1 Tel.: 01-580 2573

Open all day Thursday, early closing 1 p.m. Saturday

118 EDGWARE ROAD, LONDON, W.2 Tel.: 01-723 9789

Open all day Saturday, early closing 1 p.m. Thursday

ALL MAIL ORDERS AND CORRESPONDENCE TO: 3-15 CAVELL ST., TOWER HAMLETS, LONDON, E.1 Tel.: 01-790 4821

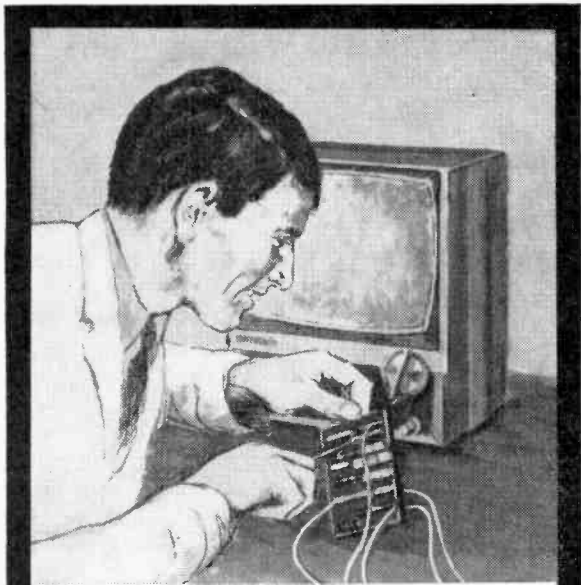

Train for tomorrow's world in Radio and Television at The Pembridge College of Electronics.

The next full time 16 month College Diploma Course which gives a thorough fundamental training for radio and television engineers, starts on 24th April 1968.

The Course includes theoretical and practical instruction on Colour Television receivers and is recognised by the Radio Trades Examination Board for the Radio and Television Servicing Certificate examinations. College Diplomas are awarded to successful students.

The way to get ahead in this fast growing industry—an industry that gives you many far-reaching opportunities—is to enrol now with the world famous Pembridge College. Minimum entrance requirements: 'O' Level. Senior Cambridge or equivalent in Mathematics and English.

To: The Pembridge College of Electronics
(Dept. PW2), 34a Hereford Road, London, W.2

Please send, without obligation, details of the Full-time Course in Radio and Television.

NAME

ADDRESS



Eddystone

SLOW MOTION DIALS

Catalogue No. 598 epicyclic dial

This full vision dial incorporates an epicyclic, ball-bearing drive mechanism of improved design and giving a reduction

ratio of approximately 10 to 1. The movement is smooth and free from backlash. Dial escutcheon measures 6" long by 4 1/4" wide, finished ripple black. Four lines are provided on the semi-circular scale for individual calibrations, the outer line being marked from 0 to 100 over 180°. Supplied complete with black instrument knob 2 1/4" diameter.



Catalogue No. 898 gear driven dial

A high grade assembly for precision instrument applications. Gear driven, flywheel-loaded mechanism, with a reduction ratio of 110 to 1, giving smooth, positive control.

Pointer travel is 7". A circular vernier scale, marked 0 to 100, is read in conjunction with the lowest line on the main scale, which has five lines for individual calibration. Overall dimensions 9 1/4" by 5 1/2". Diecast escutcheon finished glossy

black to match 2 1/4" diameter instrument knob. Complete with fixing screws and mounting template.



Eddystone Radio Limited

Eddystone Works, Alvechurch Road, Birmingham 31

Telephone: Priory 2231. Cables: Eddystone Birmingham. Telex: 33708
A MARCONI COMPANY LTD/ED8

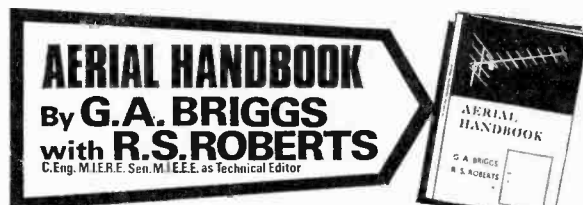

Second Edition PUBLICATION DATE 26th JAN. 1968

176 Pages Fine Art Paper. 144 illustrations (including 50 new to this Edition and 14 cartoons).

Price 15/- (16/- post free) Semi-Stiff cover.

22/6 (24/- post free) Cloth Bound Library Edition.

The first edition of *Aerial Handbook* was published in Oct. 1964 and the 5,000 copies were sold out in just over a year.

This second edition has been delayed until the plans for Colour Television and Multiplex Stereo had matured and could be dealt with from the angles of Transmission and Reception.

The activities of the B.B.C. and I.T.A. are well covered, Relay Systems, Eurovision, World Satellites and Colour Conversion, Post Office Tower, etc., also receive attention in non-technical terms.

CONTENTS

Chapter	No. of Pages	Chapter	No. of Pages
1. General Principles	16	8. Diplexers, Multiplexers and Splitters	6
2. Medium and Long Waves	7	9. Boosters and Attenuators	10
3. Short Waves	3	10. Transmitters (including Colour TV and Stereo)	44
4. VHF and Band II (FM and Stereophonic Sound)	15	11. Relay and Communal Systems	20
5. Television, Bands I and III (VHF)	14	12. Questions and Answers	7
6. Television Bands IV and V (UHF)	14	<i>Sold by Radio Dealers and Book Shops or in case of difficulty direct from the Publishers:</i>	
7. Indoor Aerials	9		



W RANK WHARFEDALE LIMITED,
IDLE, BRADFORD, YORKSHIRE

WHARFEDALE Tel.: Bradford 612552



Every year we acquire a number of exceptional bargains which we offer first of all to the purchasers of our Catalogue, in the form of a special bargain list. To give you a taste of these tempting bargains we reproduce a part of the list here.

The rest of the list consists of many other most interesting bargain items—Diodes, Neon Lamps, Switches, Transformers, Valves, etc. We can supply the complete list for a shilling, but better still, why not buy our 1968 Catalogue and get the list free. The Home Radio Catalogue is acknowledged as one of the finest electronic components catalogues available today—its 256 pages list over 7,000 items, more than 1,300 of them illustrated. And with the catalogue, in addition to the bargain list, you get 5 vouchers, each worth a shilling when used as directed, a voucher worth another five shillings if used to purchase a Weller Soldering Iron, an order form and an addressed envelope. All this for 9/6! (7/6 plus 2/- p & p). Why wait? Send your cheque or P.O. with the coupon today!

CAPACITORS, Electrolytic

List No.	Capacity	Voltage	Price
1BG1	1500 mfd.	50V	6/-
1BG2	500 mfd.	25V	4/-
1BG3	500 mfd.	12V	3/-
1BG4	100 mfd.	50V	2/6
1BG5	32 mfd.	450V	4/6
1BG6	32 mfd.	350V	3/-
1BG7	8 mfd.	500V	2/6

CAPACITORS, Non Electrolytic

List No.	Capacity	Voltage	Price
1BG11	4 mfd.	600V	6/-
1BG12	2 mfd.	800V	4/-
1BG13	2 mfd.	600V	4/-
1BG14	2 mfd.	500V	3/6
1BG15	1 mfd.	600V	3/-

Capacitor Pack 1BG17

Capacitor Pack containing Silver Mica and paper condensers. Silver Mica values 15, 25, 65, 71, 80, 160, 200, 240, 330, 470, 1000, 1500, 1670, 4000 (the 470 pf. are 750V.). 12 out of the above 14 are included in this pack. Moulded Mica values 68, 820, 1000, .002, .005, .01. (The .002 are 2250 Volts Test). 5 out of the above six are included in this pack. plus one .02 paper 750V. and 0.1 mfd. Plastiseal 750V. **Price 3/6**

CAPACITORS, TUNING

List No.	Capacity	Gangs	Notes	Price
1BG18	10pF	1	Air Tune Jackson type single hole fixing	3/6
1BG19	10+10pF	2	1 1/4 x 1 1/4 x 1 1/4 (Ideal P.M.)	4/6
1BG20	176+176pF	2	With screen and trimmers 1 1/4 x 1 1/4 x 1	8/-
1BG21	208+176pF	2	With screen and trimmers 1 1/4 x 1 x 1	3/6

CAPACITORS, TRIMMING

List No.	Capacity	Notes	Price
1BG22	1000+300pF	Compression	2/-
1BG23	50+50+50+ 50+50pF	Compression	2/-
1BG24	2—10pF	Small round ceramic 1/2 x 1/2	2/-

CAR SUPPRESSORS

1BG26A	Car Plug Suppressors	4 for 4/6
--------	----------------------	-----------

Please write your name and address in block capitals

NAME

ADDRESS

HOME RADIO LTD., Dept. PW, 187 LONDON ROAD, MITCHAM
CR4 2YQ

LOOKING FOR SOMETHING DIFFERENT?

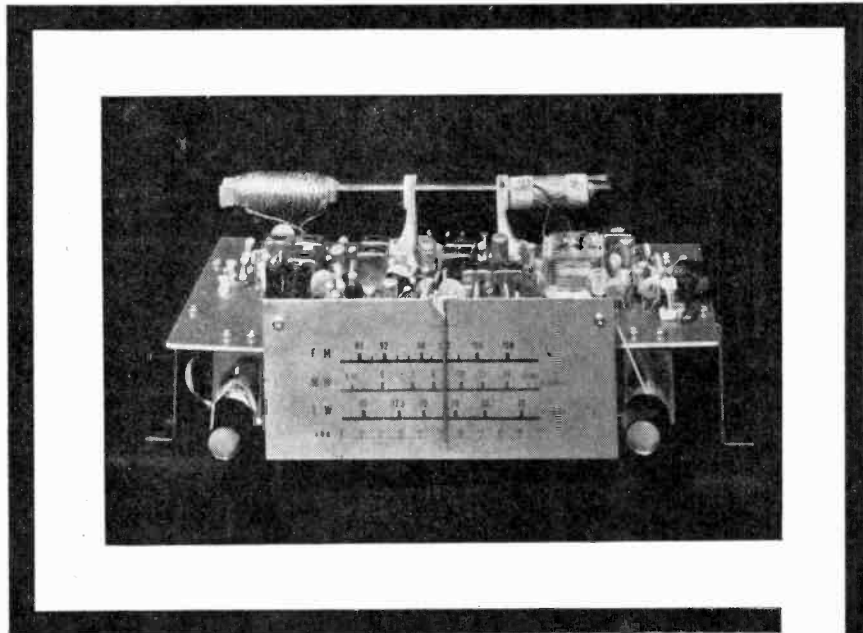

**FMT.51 Miniature
3-Band Tuner**

Micro-miniature circuit offering exceptional sensitivity and selectivity on LW, MW and FM. All transistor circuit operates from single 9 volt battery with provisions for connection to an Audio Amplifier and also to a Multiplex adaptor for FM Stereo Reception.

Call in at your "Eagle" dealer to see this exciting tuner priced at only 15 gns. inc. P.T.

For versatility, reliability and sound value insist on



Distributed by

**B. ADLER & SONS
(Radio) LTD.,** Coptic
Street, London, W.C.1.

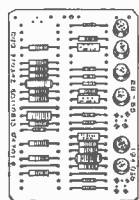

PRINTED CIRCUITS
Five assorted printed circuit boards with transistors, diodes, resistors, condensers, etc. Guaranteed minimum 20 transistors. Ideal for experimenters. 5 boards for 10/- P. & P. 2/-.



F.M. WIRELESS MICROPHONES
94-104Mc/s. Transistorised. Operates from 9V battery. Complete with additional secret tie-clip microphone. List £12.10.0 ONLY £6.15.0. P. & P. 2/6. These cannot be operated in U.K.

MODEL TE.80. 20,000 O.P.V. MULTIMETER
0/10/50/100/500/1,000V A.C. 0/5/25/50/250/500/1,000V D.C. 0-50μA. 5/50/500mA. 0/6k/60k/600k/6 meg. £4.17.6. P.P. 3/-



NEW MODEL 500 30,000 o.p.v. With overload protection, mirror scale 0-5/1/2-5/10/25/100/250/500/1,000V D.C. 0/2.5/10/25/100/250/500/1,000V A.C. 0/50μA/5/50/500mA 12A D.C. 0/60hΩ/6/60MΩ. £8.17.6. Post Paid.

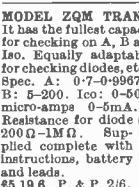

MODEL ZQM TRANSISTOR CHECKER
It has the fullest capacity for checking on A, B and Iso. Equally adaptable for checking diodes, etc. Spec. A: 0-7-0-9967. B: 5-200. Icc: 0-50 micro-amps 0-50mA. Resistance for diode 200Ω-1MΩ. Supplied complete with instructions, battery and leads. £5.19.6. P. & P. 2/6.



VARIABLE VOLTAGE TRANSFORMERS
Brand New—fully Shrouded. Input 230V 50/60c/s. Output 0-280 Volts.
1A £5.10.0
2-5A £6.15.0
5A £9.15.0
8A £14.10.0
10A £18.10.0
12A £21.0.0
20A £27.0.0
Post extra.

SILICON RECTIFIERS

200V P.I.V. 200mA	2/-
200V P.I.V. 6A	5/6
400V P.I.V. 3A	7/6
1,000V P.I.V. 5A	7/6
400V P.I.V. 6A	5/6
400V P.I.V. 8A	7/6
1,000V P.I.V. 60mA	9/6
800V P.I.V. 500mA	5/6
800V P.I.V. 5A	7/6
400V P.I.V. 500mA	3/6
70V P.I.V. 1A	3/6
150V P.I.V. 1.65mA	1/-
150V P.I.V. 25A	19/6
700V P.I.V. 100A	49/6
400V P.I.V. 3A (S.C.R.)	7/6
100V P.I.V. 5A (S.C.R.)	13/6
200V P.I.V. 5A (S.C.R.)	15/6
400V P.I.V. 5A (S.C.R.)	17/6

Discounts for quantities. Post extra.

★ TRANSISTORISED FM TUNER ★
6 TRANSISTOR HIGH QUALITY TUNER, 8 IZ ONLY 6x4x2 1/2in. 3 I.F. stages. Double tuned discriminator. Ample output to feed most amplifiers. Operates on 9V battery. Coverage 88-108Mc/s. Ready built ready for use. Fantastic value for money. £6.7.6. P. & P. 2/6. Stereo multiflex adaptors 5 gns.



AVOMETERS
Supplied in excellent condition, fully tested and checked. Complete with prods, leads and instructions.
Model 47A £9.19.6.
Model 7 £13.10.0.
Model 8 £13.
Model 9 £20.
P. & P. 7/6 each.

TE22 SINE SQUARE WAVE AUDIO GENERATORS
Sine: 20c/s to 200 Kc/s on 4 bands. Square: 20c/s to 30Kc/s. Output impedance 5,000 ohms, 200/250V A.C. Supplied brand new and guaranteed with instruction manual and leads, £15. Carr. 7/6.

TE-20RF SIGNAL GENERATOR
Accurate wide range signal generator covering 120Kc/s-250 Mc/s on 6 bands. Directly calibrated Variable RF attenuator. Operation 200/240V A.C. Brand new with instructions £12.10.0. P. & P. 7/6. S.A.E. for details.

LAFAYETTE TE46 RESISTANCE CAPACITY ANALYSER
2 p.F.-2,000 mfd 2 ohms 250 meg-ohms. Also checks impedance, turns ratio, insulation, 200/250V A.C.
Brand New £16. Carr. 7/6.

ARF-100 COMBINED AF-RF SIGNAL GENERATOR
AF. SINE WAVE 20-200,000 c/s. Square wave 20-30,000 c/s. O/P HIGH IMP. 21V P/P 600Ω 3-8V P/P. TF 100Kc/s-30 Mc/s. Variable R.F. attenuation int/ext. modulation. Incorporates dual purpose meter to monitor AF output and % mod. on R.F. 220/240V A.C. £27.10.0. Carr. 7/6.

TE-65 VALVE VOLTMETER
High quality instrument with 25 range. D.C. volts 1-5-1,500V A.C. volts 1-5-1,500V Resistance up to 1,000 MΩ. 220/240V A.C. operation. Complete with probes and instructions £15. P. & P. 0/-. Additional probes available: R.F. 35/-, H.V. 42/6.



CATALOGUE
★ ELECTRONIC COMPONENTS
★ TEST EQUIPMENT
★ COMMUNICATIONS EQUIPMENT
★ HI-FI EQUIPMENT
We are proud to introduce our first comprehensive catalogue of Electronic Components and equipment. Over 150 pages fully illustrated, listing thousands of items, many at bargain prices. Free discount coupons with every catalogue. Everyone in electronics should have a copy.

CLEAR PLASTIC PANEL METERS
First grade quality Moving Coil panel meters available ex-stock. S.A.E. for illustrated leaflet. Discounts for quantity. Available as follows: Type MR 35P, 1 1/2" square fronts.
100-0-100μA 37/6
500-0-500μA 25/-
1-0-1mA 25/-
1mA 25/-
2mA 25/-
5mA 25/-
10mA 25/-
20mA 25/-
100μA 37/6
100μA 35/-
200μA 32/6
500μA 27/6
500-0-50μA 35/-

200mA 25/-
300mA 25/-
500mA 25/-
750mA 25/-
1A D.C. 25/-
2A D.C. 25/-
5A D.C. 25/-
10V D.C. 25/-
3V D.C. 25/-
10V D.C. 25/-
20V D.C. 25/-
50V D.C. 25/-
100V D.C. 25/-
150V D.C. 25/-
300V D.C. 25/-
500V D.C. 25/-
750V D.C. 25/-
15V A.C. 25/-
50V A.C. 25/-
150V A.C. 25/-
300V A.C. 25/-
500V A.C. 25/-
750V A.C. 25/-
1mA 29/6
POST EXTRA. Larger sizes available—send for lists.

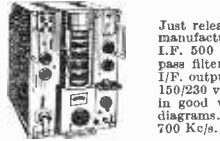

ADMIRALTY B.40 RECEIVERS
Just released by the Ministry. High quality 10 valve receiver manufactured by Murphy. Coverage in 5 bands 650 Kc/s-30 Mc/s. I.F. 500 Kc/s. Incorporates 2 R.F. and 3 I.F. stages, band-pass filter, noise limiter, crystal controlled B.F.O., calibrator, I.F. output, etc. Built-in speaker, output for phones. Operation 150/230 volt A.C. Size 19 1/2 x 13 1/2 x 16in. Weight 114 lbs. Offered in good working condition. £22.10.0. Carr. 30/-. With circuit diagrams. Also available B.41 L.F. version of above. 15 Kc/s-700 Kc/s., £17.10.0. Carr. 30/-.

UNR-30. 4-BAND COMMUNICATION RECEIVER
Covering 550 Kc/s-30 Mc/s. Incorporates variable BFO for CW/SSB reception. Built-in speaker and phone jack. Metal cabinet. Operation 220/240V. A.C. Supplied brand new, guaranteed with in-structions. Carr. 7/6. £12.10.0



NEW LAFAYETTE MODEL HA-700 AM/CW/SSB AMATEUR COMMUNICATION RECEIVER
8 Valves, 5 bands incorporating 2 MECHANICAL FILTERS for exceptional selectivity and sensitivity. Frequency coverage on 5 bands 150-400 Kc/s, 550/1,600 Kc/s, 1-6-4-0 Mc/s, 4-8-14-5 Mc/s, 10-5-30 Mc/s. Circuit incorporates R.F. stage, aerial trimmer, noise limiter, B.F.O. product detector, electrical bandspread, 8 meter, slide rule dial. Output for phones, low to 2kΩ or speaker 4 or 8 Ω. Operation 220/240V A.C. Size 7 1/2 x 15 x 10in. Supplied brand new and guaranteed with handbook 6 GNS. Carr. 10/-, S.A.E. for leaflet.

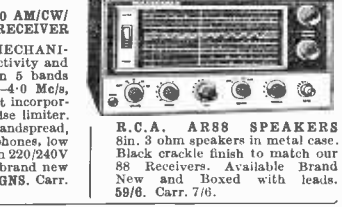

LAFAYETTE LA-224T TRANSISTOR STEREO AMPLIFIER
19 transistors, 8 diodes, 11HF music power, 30W at 8Ω. Response 30-20,000±2dB at 1W. Distortion 1% or less. Inputs 3mV and 250mV. Output 3-16Ω. Separate L. and R. volume controls. Treble and bass control. Stereo phone jack. Brushed aluminium, gold anodised extruded front panel with complimentary metal case. Size 10 1/2 x 3 1/2 x 7 1/2in. Operation 115/230V A.C. £25. Carr. 7/6.



SINCLAIR EQUIPMENT
Z12 12 watt amplifier, 89/6, PZ4 Power Supply Unit 99/6. Stereo 25 Preamp., £9.19.6. Q14 Speakers, £6.19.6. Micro-matic Radio Kit, 49/6, Built 59/6. Micro FM Radio Kit £5.19.6. All Post Paid.

SPECIAL OFFER
2 Z12 Amps, PZ4 Power Supply, Stereo 25 Preamplifier, £22

GW SMITH & CO (RADIO) LIMITED
Phone: GERRARD 8204/9155
Cables: SMITHEX LESQUARE
3-34 LISLE STREET, LONDON, W.C.2

PRACTICAL WIRELESS

VOL 43 No 12

issue 734

APRIL 1968

TOPIC OF THE MONTH

Top of the Pops

READERS with good memories may recollect that it was exactly one year ago that we began a series of articles destined to head the P.W. Top Ten. It ran for six issues and now returns for a second run, still using the title "Repairing Radio Sets".

The new series, while continuing the successful formula of alternating articles on theory and practice, leaves aside valves and gets down to the servicing of transistor equipment.

From time to time, as our budget allows, we like to present readers with the occasional bonus. Last April, the servicing series was launched with a fault-finding record; this time we have devised some very novel fault-finding charts, one of which is contained in this issue and the other next month. The charts can be used independently or in conjunction with the complete series of articles to be published.

While it is obviously impossible to tabulate every possible fault which can occur in a transistor radio set or amplifier it will be clear from the Symptoms Chart issued this month that we have at least tried! From the nine main symptoms "blocks", the user is guided to more specific symptoms which total almost one hundred.

The key reference numbers relate to 21 lines of approach to trace the offending component(s). This part of the process—diagnosis in detail—is covered in the chart presented next month, which will show recommended checking procedures for each group of faults, amounting to well over one hundred different possibilities to try.

Apart from their practical value in actual fault-finding, the charts can be used as a source of training for the lesser experienced, since by following the flow lines of checking procedures a good deal can be gleaned on the correct approach to tackling faulty equipment. For it is just as important, if not more so, to know *why* a fault produces certain symptoms than to actually locate the source of trouble.

And just in case there are readers whose sets never go wrong we have also included a set of panel labels this month! Just peel off the ones you want and press into position—no additional adhesive is necessary. If you have a lot of gear that needs smartening up we have a limited supply of extra sheets available at 2s. 6d. each.

W. N. STEVENS—*Editor*.

NEWS AND COMMENT

Leader	897
News and Comment	898
On the Short Waves <i>by Christopher Danpure and David Gibson, G3JDG</i>	911
Satellite Earth Terminals	915
Letters to the Editor	930
The MW Column <i>by Alistair Woodland</i>	938
Practically Wireless <i>by Henry</i>	941

CONSTRUCTIONAL

FET VOM <i>by J. B. Horsley</i>	900
The "Rhodian" Tape Recorder, Part 2 <i>by Julian Anderson</i>	906
The Simple Six <i>by R. F. Graham</i>	916
Combined Audio Oscillator and Frequency Meter, Part 3 <i>by H. T. Kitchen</i>	928
The "Clubman", Part 4 <i>by J. Thornton-Lawrence, GW3JGA</i>	933
Experimental Microphone Preamp <i>by A. J. Garratt-Reed</i>	942

OTHER FEATURES

Improving the CR100 <i>by C. Molloy</i>	903
Repairing Radio Sets <i>by Gordon J. King</i>	920

MAY ISSUE WILL BE PUBLISHED ON APRIL 5th

All correspondence intended for the Editor should be addressed to: The Editor, "Practical Wireless", George Newnes Ltd., Tower House, Southampton Street, London, W.C.2. Phone: TEMple Bar 4363. Telegrams: Newnes Rand London. Subscription rates, including postage: 36s. per year to any part of the world. © George Newnes Ltd., 1968. Copyright in all drawings, photographs and articles published in "Practical Wireless" is specifically reserved throughout the countries signatory to the Berne Convention and the U.S.A. Reproductions or imitations of any of these are therefore expressly forbidden.

NEWS AND COMMENT...

STEREO TRANSISTOR TAPE RECORDER



Daystrom Ltd., Gloucester, have now developed their STR-1 portable transistor stereo tape recorder. It has an 18 transistor circuit and records $\frac{1}{2}$ track stereo or mono at $1\frac{7}{8}$, $3\frac{3}{4}$ and $7\frac{1}{2}$ i.p.s. A moving coil record level meter is used and a digital counter with zero reset is standard fitting. Two 8 x 5in. speakers are employed and the amplifiers give 4W r.m.s. output per channel. Supply voltage is 230V a.c.

In kit form the STR-1 costs £45 18s. and if a ready-to-use model is required, the cost is £59 15s. Delivery in the UK is free.

NEW EQUIPMENT FOR THE R.A.F.

The Royal Air Force has accepted delivery of new radar equipment having a high immunity to any confusion caused by electronic attack and designed to scan the skies of the United Kingdom and the adjacent airspace. It is located at R.A.F. Station Staxton Wold, Yorks.

This radar, the largest ever delivered to the R.A.F., has been designed, developed, manufactured, installed and commissioned by Associated Electrical Industries (Electronics Group) under the direction of the Ministry of Technology. The Royal Radar Establishment at Malvern have co-operated throughout the development with A.E.I. who have been continuously involved in the design and production of defence radar systems for the Government since, as Metropolitan Vickers, they designed and built the world's first operational radar transmitters. It was these that helped win the Battle of Britain.

£50,000 FOR A RADIO STATION

It is reported that Manx Radio, frequently described as the only legal radio station in the British Isles, has been acquired at a cost of £50,000 by the Isle of Man Government.

The Manx Government is planning to increase coverage of the station to the UK mainland. The original licence, negotiated with the GPO restricted coverage substantially to the Isle of Man.

This station was formerly owned jointly by Pye and Mr. Richard Meyer and is said to have made a profit of £4,400 in the half-year to the end of September.

ROYAL NAVAL AMATEUR RADIO SOCIETY

Membership of the R.N.A.R.S. is open to serving and past members of the Royal Navy, Commonwealth Navies and their associates (R.F.A. service, Sea Cadets etc.).

The headquarters station, G3BZU is on 7.071kc/s \pm 5kc/s between 1200 and 1300 weekdays and 3,520kc/s at 2000 on the first Tuesday of each month.

The Society conducts Morse code proficiency transmissions at 3,520kc/s at 2000 on the first Tuesday of each month at speeds of 20, 25, 30, 35 and 40 w.p.m. and a proficiency certificate is issued for 100% copy of a particular speed.

The Society also runs an award scheme—the "Mercury" award—and its members are invited to join in on the C.H.C. Nets on 40m each Sunday.

Further details of the Society can be obtained from G3JFF, Hon. Secretary, R.N.A.R.S., H.M.S. Mercury, Leydene, Petersfield, Hampshire.

STEREO SOUND LINKS

The Post Office and the BBC have apparently agreed to arrangements under which the BBC will distribute to its stations, stereo sound programmes.

It is believed that present plans call for such links as far north as Holme Moss. Additionally, some localised arrangements include BBC microwave links for colour TV.

The stereo sound links will allow the extension to the North and Midlands of the stereo sound service. These should have been ready at the end of March but have been delayed for some weeks because of the severe January weather which delayed work on the buildings intended to house the microwave equipment.

SEMICONDUCTOR LITERATURE

Westinghouse Brake and Signal Company Ltd., 82 York Way, King's Cross, London, N.1 announce three new publications describing Westinghouse semiconductors. They are 26-127, 26-128 and 26-138 which describe additions to the extensive range of Westinghouse medium power thyristors with current ratings of 25A, 30A and 65A respectively and voltages from 100 to 1200V.

Engineering Publication 25-20 provides revised data on the well established 200A silicon diode type SxBN200, and 25-42 describes a new low power miniature silicon diode, encapsulated in an epoxy resin case, rated at 500mA with voltages of 100 to 1000V.

SWITCHES THAT RESPOND TO FREQUENCY

The Industrial Instrument Division of Smiths Industries Ltd., Kelvin House, Wembley Park Drive, Wembley Park, Middx. have designed a range of frequency-sensitive switches, responding to a signal of varying frequency.

Switches are available for over and under-speed protection and to give a signal when the frequency falls below a predetermined value.

The basic switch unit has been designed to operate with a suitable follow-up relay and will continue to give a 24V d.c. output signal until the predetermined frequency is reached. At the required level, the output voltage ceases, de-energises the relay and indicating alarm or shut-down action.

NEWS AND COMMENT

NEW REFERENCES AVAILABLE

A series of seven selection guides and cross reference charts covering a wide range of semiconductor devices is now available from Motorola Semiconductors Limited.

The series covers Zener diodes and temperature compensated reference diodes; silicon power transistors; thyristor products; germanium p-n-p power transistors; unibloc plastic silicon annular transistors; silicon power rectifier assemblies; unibloc plastic small-signal transistors.

The guides feature characteristics, performance and case configurations of the most popular devices.

All but two of the guides (silicon power rectifier assemblies and thyristor products) contain cross reference charts which give EIA type numbers against Motorola replacements, with one column listing industry preferred types recommended for new designs and another giving available types not recommended for new designs.

The publications are available on application to: The Technical Information Centre, Motorola Semiconductors Limited, York House, Empire Way, Wembley, Middlesex.

SOUND AND SCIENCE CATALOGUE

A new 90-page catalogue costing 3s. 6d. has just been published by Sound & Science Limited, 3-5 Eden Grove, London, N.7, pioneers in the Science-Hobby field in the U.K.

It is the biggest catalogue yet from Sound & Science, containing more than 20 separate sections listing over 500 items of hobby and do-it-yourself equipment, much of which is available in varying degrees of sophistication to satisfy all age-groups: microscopes, for example, are priced from 42s. for a small but effective hand-held model to £98 for an advanced, industrial-standard instrument.

COMARK RESISTANCE METER

The Resistance Meter Type 220 just released by Comark Electronics Limited will measure resistance on a linear scale from $1\text{m}\Omega$ f.s.d. to $300\text{k}\Omega$ in 18 ranges. By using a stable external current supply, the range of the instrument may be extended to give sensitivities of $300\mu\Omega$, $100\mu\Omega$ and $30\mu\Omega$ f.s.d. A very low test voltage is employed, eliminating self-heating effects and permitting measurements on very low dissipation components.

The instrument is in production and available with delivery of 8 weeks from receipt of order at a cost of £47 from Comark Electronics Ltd., Gloucester Road, Littlehampton, Sussex.

MORE F.M. FROM H. O. THOMAS

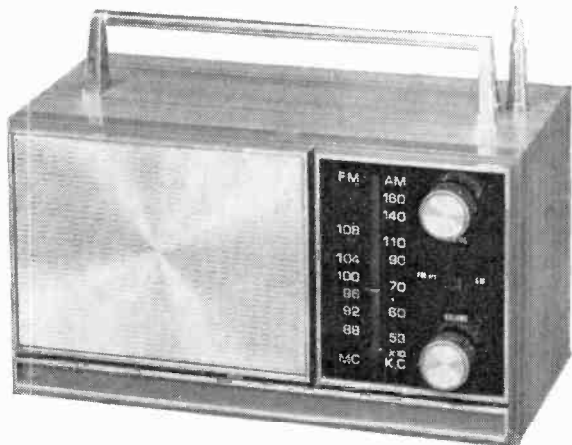

H. O. Thomas Electronics Ltd., 26/27 Avenue Chambers, Vernon Place, London, W.C.1 have introduced the Wein 9, a battery/mains receiver housed in a wood case and covering v.h.f. and medium waves.

The circuit comprises 10 transistors, 4 diodes and 1 selenium rectifier. Tuning range is 88-108Mc/s v.h.f. and 535-1605kc/s m.w. Output power is 400mW maximum. A built-in swivel telescopic aerial is provided for f.m. reception. Dimensions are $7\frac{1}{16} \times 3\frac{1}{8} \times 3\frac{3}{8}$ in. and power requirements are $6 \times 1.5\text{V}$ Ever Ready HP5 or equivalent or 220-240V a.c. mains (an adaptor is built-in).

Retail price is $13\frac{1}{2}$ guineas complete with batteries and earpiece.

COUNTING AND COUNTING CIRCUITS BOOK FROM MULLARD

A new Mullard publication—*Electronic Counting: circuits, technique, devices*—reflects the revolution that has taken place in the fundamental industrial operation of electronic counting. The book deals with all aspects of electronic counting, giving emphasis to the use of integrated circuits, transistors and semiconductor diodes.

Copies can be obtained for 27s. 6d. plus 1s. 6d. for packing and postage from Distributor Sales Division, Mullard Limited, Mullard House, Torrington Place, London, W.C.1, or from any Mullard Industrial Distributor.

"PRACTICAL WIRELESS"

and

"PRACTICAL TELEVISION"
FILM SHOW

(In collaboration with Mullard Ltd.)

Caxton Hall, Caxton Street, London, S.W.1.
(Great Hall Site)

Friday, 29th March, 1968

7.15 p.m. Sharp

In the Chair: W. N. Stevens

Editor: "Practical Wireless" and "Practical Television"

GET YOUR FREE TICKET

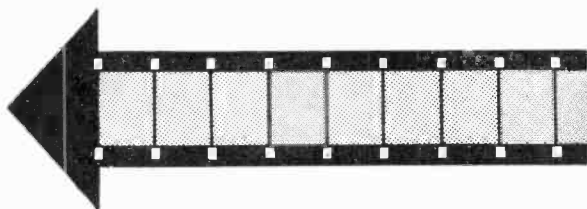

Send large s.a.e., minimum $5 \times 3\frac{1}{2}$ in., to:
Practical Wireless, Film Show, Tower House,
Southampton Street, London, W.C.2.

FET VOM

J.B.HORSLEY

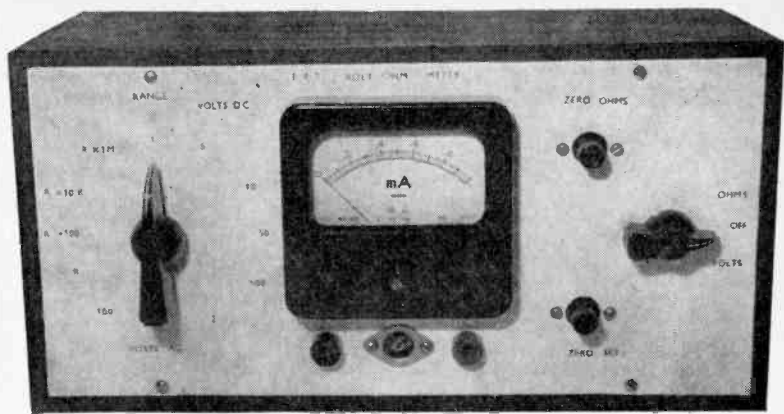

A VALVE voltmeter with its high input resistance has many advantages over the ordinary test meter which has a comparatively low resistance and can give many misleading readings. However a valve voltmeter has certain disadvantages, its much greater initial cost, and the need for a mains supply, or in the case of a battery model the running costs of h.t. and l.t. batteries. Attempts at making a transistor high resistance voltmeter were not very successful due to the much lower input resistance of transistors and also the necessity of zero adjustments when changing from one voltage range to another.

With the advent of the field effect transistor (F.E.T.) with its very high input resistance and lower power requirements, a fresh attempt was made. A few 2N3819 F.E.T.'s were purchased, the circuit of Fig. 1 constructed and the following facts established:

1. Less than 0.5 volt was required to give an f.s.d. with all the F.E.T.'s tested.
2. The scale was linear using the basic 0-1mA meter.
3. No perceptible movement could be observed on the meter when the 10MΩ gate resistor was shorted to earth.
4. Lowering the power supply from 9.5 volts to 7.5 volts made little or no difference to the gate input sensitivity, and only a small adjustment of the zero control was needed. Thus there was no need for the extra expense of a zener diode stabilisation network.

The finalised circuit is shown in Fig. 2. Five ranges of d.c. volts, three of a.c. volts, and four ranges of

resistance are provided. The instrument being required only for work on transistor circuitry the highest range covered is 0—100 volts. The resistance coverage is very comprehensive from 1Ω to 1,000MΩ. Two types of output correction are provided, a coax one mainly used for voltage checks and a plug and socket type for resistor checks. The current drain is approx. 7—9mA.

The front panel is a piece of white plastic 10 x 5 x ½ in. This is drilled as shown in Fig. 3. The meter, two switches, two pots and the three sockets are screwed on to the panel. A small stand-off bracket (Fig. 4) on which to mount the tagboard is made and drilled, and this is screwed on to the back of the meter using the meter connection terminals, two 4BA solder tags being fitted under the screws. The tagboard can now be wired up as shown in Fig. 7. At this stage it is advisable to wire up SW1 using 9in. lengths of plastic covered single strand wire and using as many different colours as possible. This makes for easier identification when connecting to the tagboard. The tagboard is now fixed on to the stand-off bracket using two 4BA 1½ in. long bolts as shown in the photograph.

A battery housing for the 1½V cell is made using a small piece of plastic and three Terry clips (Fig. 6), one clip being used to hold the battery and the other two cut down to form spring battery connections. The housing is then glued to the panel above SW1A/SW1B with impact adhesive. The battery holder is wired up to the tagboard and the

Fig. 1: Circuit used to establish basic design.

Fig. 2: Complete circuit of the Field Effect Transistor Volt—Ohm Meter.

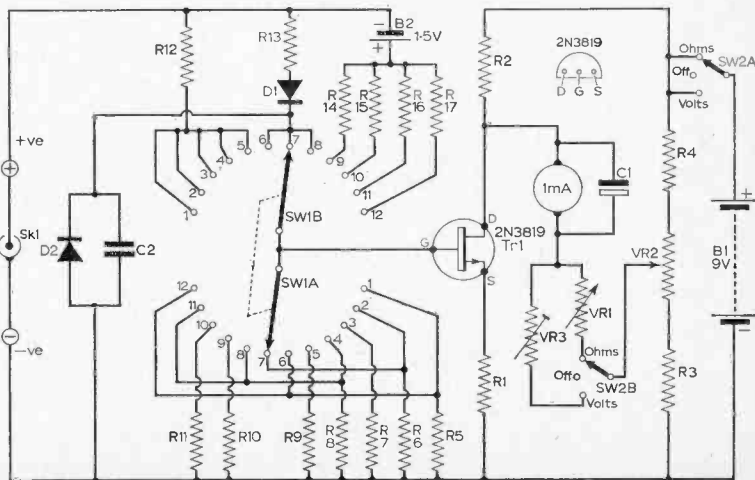
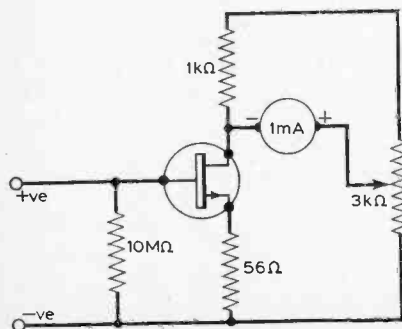

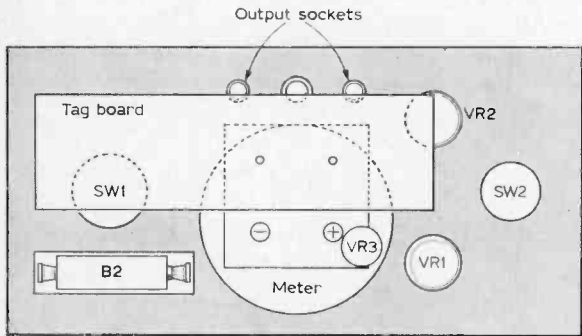
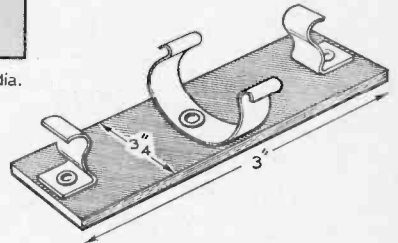
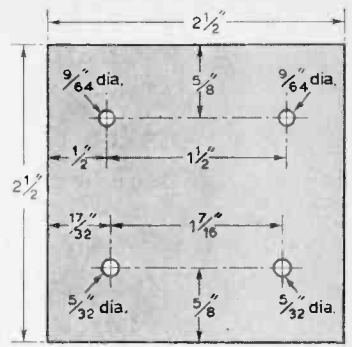
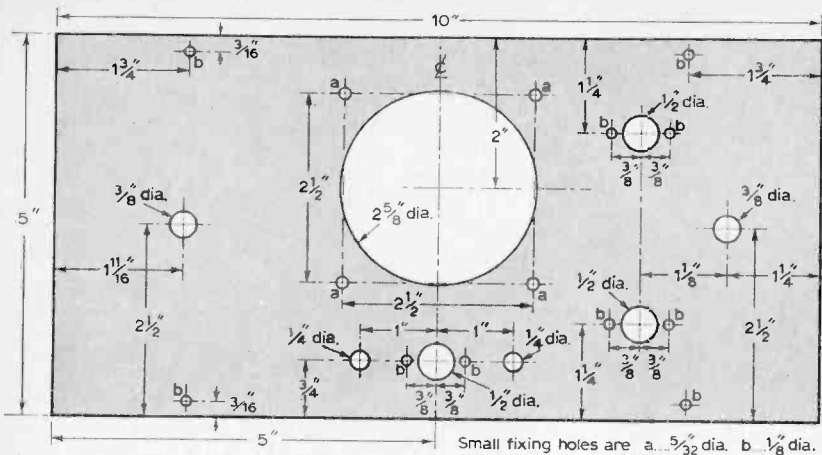

Fig. 3: Front panel drilling details.

Fig. 4: Details of the plastic stand-off bracket.

Fig. 5: Layout of main components viewed from rear.

Fig. 6: Battery housing for the 1.5 volt cell.

Fig. 7: Wiring diagram of the tagstrip.

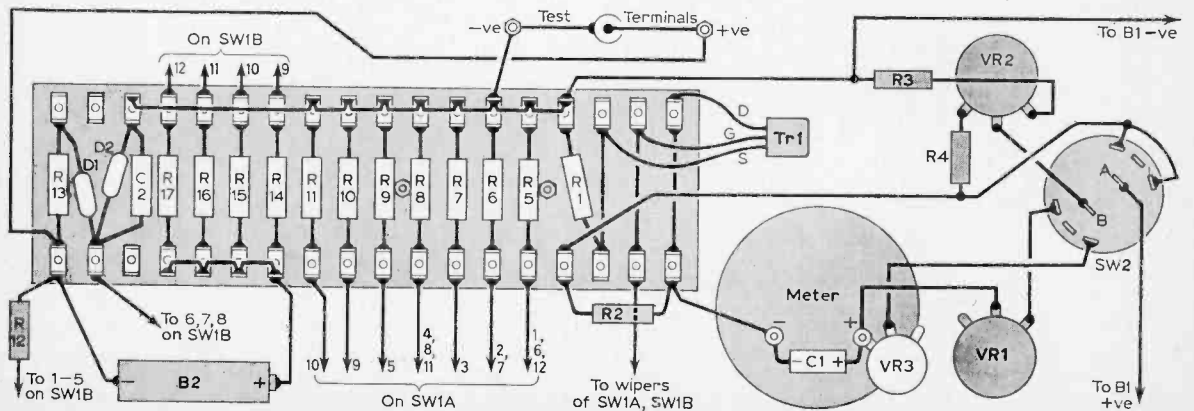
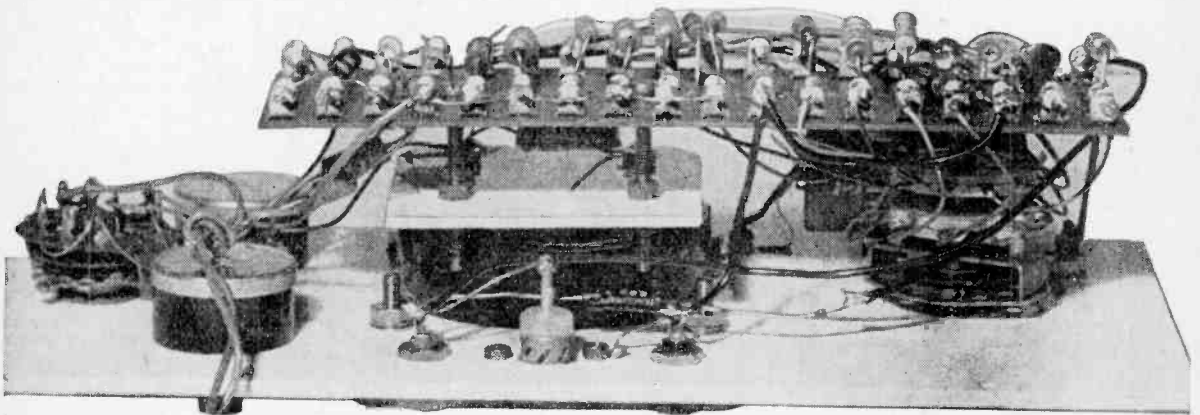

unit is now ready for testing and calibrating.

Place the battery B2 in its holder and connect up B1. Turn the switch (SW2) to volts and adjust the ZERO SET control to zero the meter. This should happen near the centre position of the track. If the zero position can be found only with the control near either end of its track, the value of R1 should be altered. Values between 22 and 100Ω should be tried.

A known d.c. voltage between 0 and 100 volts should be applied to the test terminals, with the range switch set to the appropriate position. Pre-

leads are inserted and the leads shorted together. The panel ZERO OHMS control VR1 is adjusted to read zero (f.s.d. on the meter). The other OHMS ranges are tested in the same way.

The cabinet can now be constructed using simple butted joints, panel pinned and glued with contact adhesive. Two pieces of 3/8 in. square wood 2 3/4 in. long may be glued into the cabinet to hold the battery B1 in position. Square wood (3/8 in.) can also be fixed around the inside of the cabinet and set 1/8 in. in, this being the mounting for the front panel. With the cabinet painted dull black, and transfer-type signs

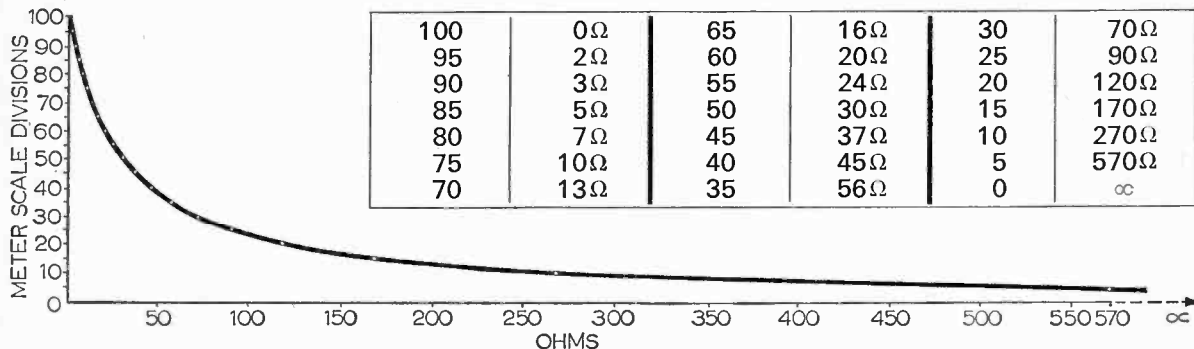

Fig. 8: Graph and chart for calibrating the meter on the Ohms range.

ferably the voltage should be one that would give f.s.d. or near f.s.d. on the range selected, i.e. on the 10 volt range a test voltage of between 8 and 10V would be suitable. The internal preset VR3 can now be adjusted to show the correct reading on the meter. The instrument is now calibrated on all of its voltage ranges. SW2 is now turned to the OHMS position and the range switch SW1 to R x 1MΩ. The test

being used on the front panel the instrument will have a professional look.

Terminating a coax lead with crocodile clips is a tricky business and a neat and serviceable job very difficult to achieve. My way round this is to terminate both ends of the coax cable with coax plugs. A small ali can (the type Denco miniature coils are supplied in) is used. A coax socket being fixed to the lid. Two wires from the bottom of the can and are terminated with crocodile clips.

★ components list

Resistors: (1/2 watt)

R1 56Ω 10%	R11 1kΩ 2%
R2 1kΩ 10%	R12 10MΩ 2%
R3 470Ω 10%	R13 10MΩ 2%
R4 470Ω 10%	R14 20Ω 2%
R5 10MΩ 2%	R15 2kΩ 2%
R6 1.1MΩ 2%	R16 200kΩ 2%
(1MΩ+100kΩ)	R17 20MΩ 2%
R7 526kΩ 2%	VR1 1kΩ w/w. TV preset
(470kΩ+56kΩ)	VR2 1kΩ w/w. TV preset
R8 100kΩ 2%	VR3 1kΩ carbon skeleton preset
R9 50kΩ 2%	
R10 10Ω 2%	

Semiconductors:

D1 EC401	} Electrovalve
D2 EC401	
Tr1 2N3819	

Capacitors:

C1 100μF 6V electrolytic
C2 0.04μF

Miscellaneous:

Tagboard 7 x 2in. 36 tags; flush-mounting coax socket; one pair plugs and sockets (red and black); two knobs; batteries—PP9 and U11; meter, 0-1mA MR65; 2P 12W switch ("Makaswitch"); 2P 2W switch; wire; solder, etc.

Intermediate values of either meter reading or resistance can be found by using the formula: $\frac{3,000}{30 + R_x} =$

Deflection (0-100), or $\frac{3,000}{\text{Defl. (0-100)}} = 30 + R_x$. No

attempt was made to re-figure the meter scale as it was considered that the meter readings could easily be calculated with a little practice.

The range switch, as supplied, has a stop after the twelfth position. In use, this can be inconvenient, therefore, the lug on the switch assembly which prevents movement of the rotor from the twelfth to the first position should be punched flat to the switch plate.

Ranges	
Input resistance 10MΩ a.c. and d.c.	
0-1V d.c.	0-10V a.c.
0-5V d.c.	0-100V a.c.
0-10V d.c.	RΩ
0-50V d.c.	R x 10 ² Ω
0-100V d.c.	R x 10 ⁴ Ω
0-2V a.c.	R x 10 ⁶ Ω

The ranges of the completed instrument are quoted above for interested constructors to peruse at their leisure.

IMPROVING THE CR 100

C. MOLLOY

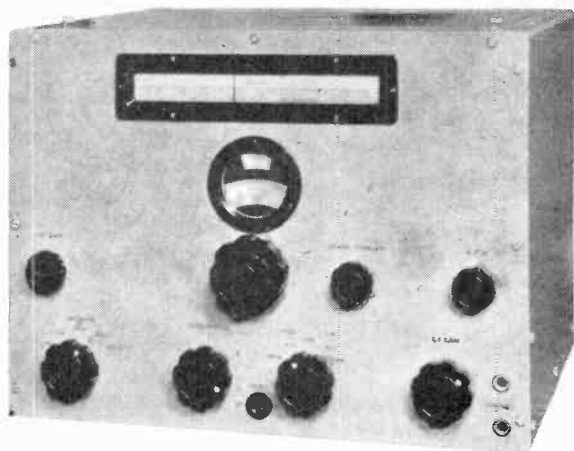

THE Marconi CR100 communications receiver, often met under its Naval designation B28, was supplied in large numbers to the Services during the last war. It is currently available on the surplus market and often changes hands in amateur circles for as little as £15—a good buy for a coverage of 60kc/s to 30Mc/s with 2 r.f. stages, 3 i.f.s, a crystal filter, b.f.o., 200 to 250 volt internal mains power pack and an output capable of driving a loudspeaker. Numerous “mark” numbers of the receiver exist, the difference in the main being confined to the aerial sockets and the output stage. Mark 2 has a muting circuit with a “U” link for switching this facility in and out as required, otherwise the basic receiver is the same for all models.

Octal valves are used throughout, the receiver giving excellent results on low and medium frequencies though above 20Mc/s the performance falls off somewhat. It can be “hotted-up” considerably by fitting modern miniature valves in place of the octal types used in the r.f. stages. Further improvements include the provision of a tuning mV-meter, a front panel control for the noise limiter and modifications to the output wiring to allow a tape recorder

and an external loudspeaker to be driven simultaneously.

Not only do modern miniature valves provide higher gain than their octal counterparts, their equivalent noise resistance and hence the internal noise generated is much lower. Valve noise becomes important at higher frequencies where signal noise is low. The noise generated within the first r.f. valve, being subject to the full amplification of the receiver, becomes a significant part of the total noise.

The 6BA6 chosen as a replacement for the KTW62 in the r.f. stages offers a good compromise between gain, noise and crossmodulation. Figure 1 is the circuit of the “front end” before modification, one set of coils only being drawn for the sake of clarity. The general layout of V1 and V2 below the chassis after modification is shown in Fig. 2. The bottom plate of the receiver is easily removed allowing access to the chassis without dismantling the cabinet. Adaptor plates (Fig. 3) are cut and drilled from sheet metal, being used to cover the space vacated by the octal holders thus helping to make a neat job as well as discouraging the flow of circulating air currents.

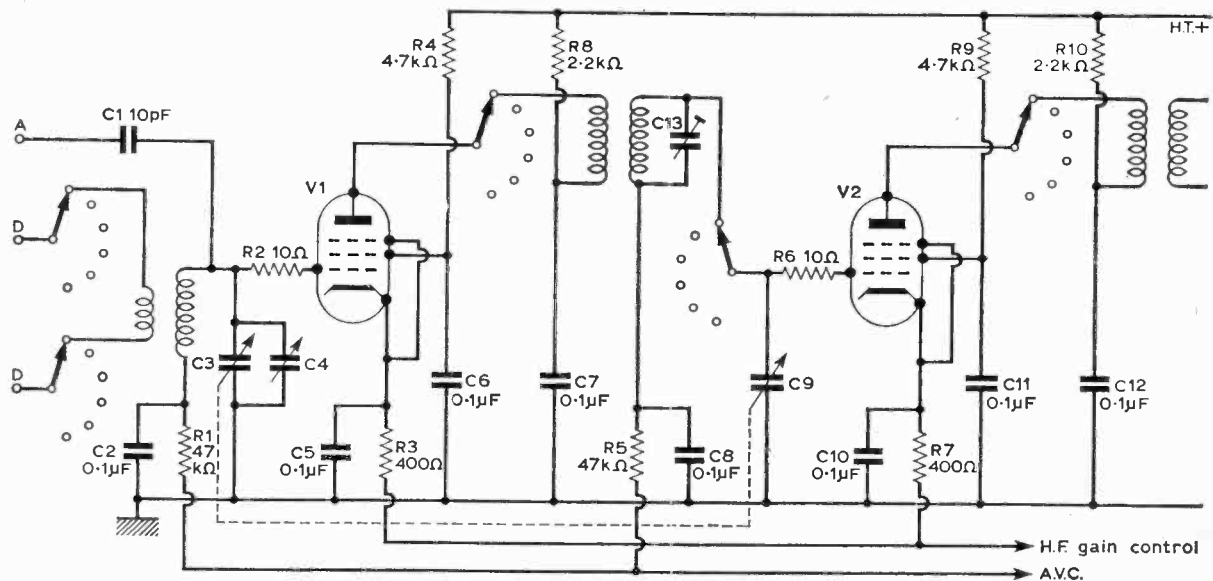

Fig. 1: R.F. stages before modification.

The only component changes required are R3 and R7 which are changed from 400Ω to 68Ω respectively. These resistors are mounted on a tag-strip adjacent to the valve holders (Fig. 2). Stand-off insulators are employed to terminate the free ends of the 10Ω grid stoppers R2 and R6, a small hole being drilled in the chassis beside each, enabling a screened lead to be run from the resistor to the appropriate section of the main tuning capacitor. Small tinplate screens are placed across the underside of the B7G valveholders in the position indicated in Fig. 2, and soldered to the chassis. Their purpose is to screen anode from grid to prevent instability.

In order to improve the signal to noise ratio, the first r.f. valve is disconnected from both the a.v.c. line and the h.f. gain control and is run at maximum gain. To remove V1 from the a.v.c. line, cut the black lead from R1 and solder it to the chassis. This lead runs from the screened coil compartment at the rear of the receiver to the end of R1 nearest to the chassis. When the a.v.c. is removed it may be necessary, occasionally, to reduce the gain of V1 to prevent overloading. Unfortunately, the h.f. gain control adjusts the bias of both i.f. and r.f. valves and in effect is a combined r.f./i.f. gain control. Therefore, in order to prevent overloading at the r.f. and mixer stages one has to reduce i.f. gain as well as r.f. gain! To remedy this situation a separate gain control is provided for V1 by fitting a 2 to 5kΩ potentiometer between the cathode resistor of V1 and chassis. Remove the red lead from the outer end of R3 and run a wire from this tag to the new gain control connecting the other two tags of the potentiometer to chassis. The new r.f. gain control is situated on the front panel between the main tuning control and the h.f. gain control giving a more balanced appearance to the front panel layout. The front panel can be removed easily for drilling by taking off the control knobs and taking out the PK screws. On some models of the CR100 a hole is already drilled in this position with an unused bracket suitable for mounting a potentiometer, fixed to the chassis behind it. The circuit of the modified r.f. stages together with component values is given in Fig. 5. The writer carried out these modifications in stages, replacing V1 to start with, trying it out before proceeding.

Finally, the mixer and r.f. stages are re-aligned. Figure 6 gives the position of the cores and where fitted, the trimmers. During alignment, the operational switch is set to MOD MAN, the passband control to 3,000 cycles, and all 3 gain controls are set to maximum. The alignment frequencies are:

- Band 1 60kc/s and 160kc/s
- Band 2 160kc/s and 400kc/s
- Band 3 400kc/s and 1400kc/s
- Band 4 1.4Mc/s and 4Mc/s
- Band 5 4Mc/s and 11M/cs
- Band 6 11Mc/s and 30Mc/s

Alignment is carried out in the usual way, adjusting the cores at the l.f. end and the trimmers and the h.f. end of each band in turn.

Some mark numbers of the CR100 are provided with a noise limiter comprising an EB34 double diode valve, a 1MΩ resistor and a toggle on/off switch, all mounted on a small sub-chassis fixed to the top of the main chassis near the tuning capacitor. The switch is rather inconveniently situated as one has to open the hinged lid of the receiver

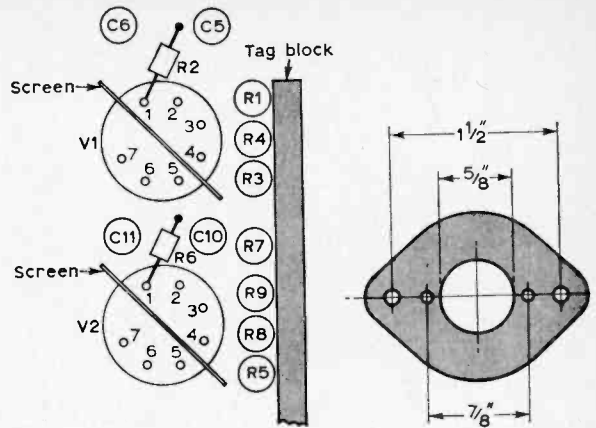

Fig. 2 (left): Below chassis layout of V1 and V2. Fig. 3: (right) Octal to B7G adaptor plate.

to obtain access to it with the consequent risk of shock. A simple but useful modification is to move the switch to the front panel (extending the wiring of course), a suitable location being above the b.f.o. control. The writer fitted a rotary type toggle switch here, wiring it in parallel with the existing switch which was left *in situ*. If this method is adopted be sure to leave the existing switch in the on position, otherwise the new panel control will be ineffective.

Only one diode of the EB34 is used by the noise limiter and a germanium diode can be substituted without loss of performance. An OA81 (CV448) is specified as this type is readily obtainable on the surplus market. It is wired across pins 3 and 4 of the octal valveholder (positive end to pin 3); the EB34 should be removed. The circuit of the noise limiter and its connections to the receiver are shown in Fig. 7.

As there is neither an S meter nor a magic eye on the CR100 the addition of a simple tuning indicator

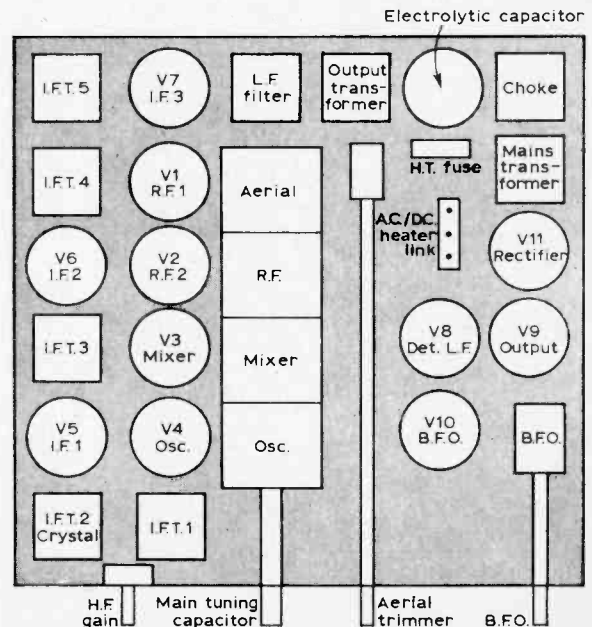

Fig. 4: Plan view of chassis.

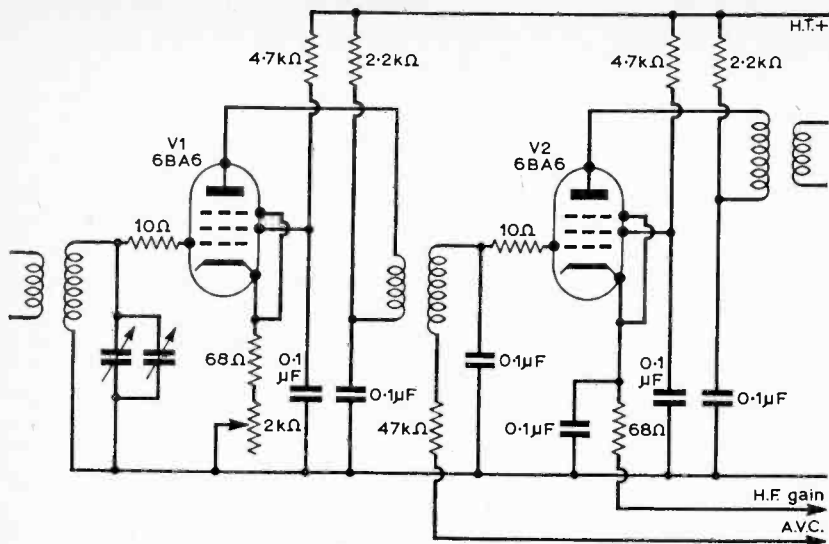

Fig. 5: R.F. stages after modification (switches omitted).

is worth while. No attempt was made to install an S meter since, in the opinion of the writer, the markings on such a meter would be largely meaningless unless some accurate method of calibration were available. A 5mA meter is used, shunted by a variable resistor, the two being placed in series with the anode of the second i.f. valve V6 (Fig. 8). The anode current is proportional to the a.v.c. voltage which in turn is proportional to the signal strength. The anode circuit of V6 is broken at the h.t. end of the 2.2kΩ resistor mounted on the tag block underneath the chassis beside the valve-holder, and leads are run from here to the tuning meter.

The meter is fitted to the front panel above the r.f. gain control space being left between them for the variable resistor which is the SET ZERO control. The meter is adjusted to full-scale deflection (5mA) in the absence of a signal, with the a.v.c. on and the r.f. and h.f. gain controls set to maximum. When a signal is tuned-in, the meter reading will decrease in value giving an indication of signal strength. A left-to-right indication is obtained by mounting the meter upside down, i.e. with the meter needle pointing downwards.

The two telephone-type sockets situated at the bottom right-hand corner of the front panel are connected in parallel and are suitable for high

impedance headphones. One of them can be used for phones and the other, to drive a tape recorder. However, there are break-jacks associated with these sockets which, in some models, are wired to disconnect the loudspeaker output (situated at the rear of the receiver) whenever a plug is inserted. This means that a tape recorder and a loudspeaker cannot be used simultaneously. It is a simple matter to solder a short piece of wire as a strap across the break-jack tags associated with the lower socket. The upper socket is now the phones output, insertion of a plug disconnecting the loudspeaker as before while the lower socket is reserved for tape output. Figure 9 shows

the wiring arrangement, the location of the two isolating capacitors and the wire strap.

An alternative arrangement is to remove the leads from the break-jack tags and extend them to a toggle switch mounted on the front panel this becoming the loudspeaker on/off switch.

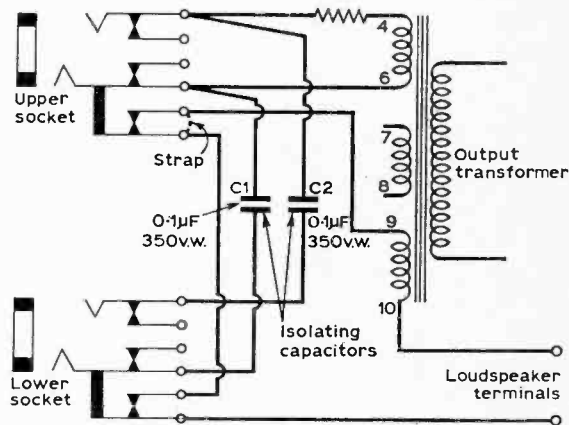

Fig. 9: Wiring of the phone sockets.

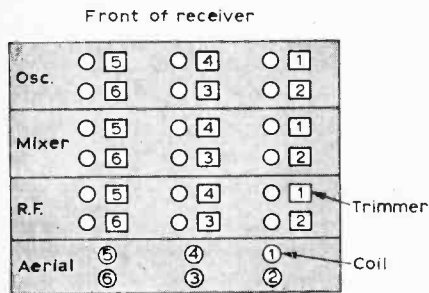

Fig. 6: Coil-pack layout.

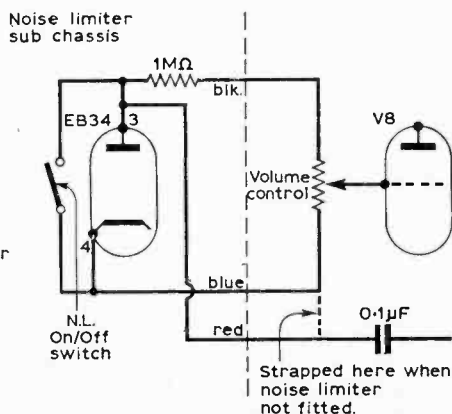

Fig. 7: Noise limiter.

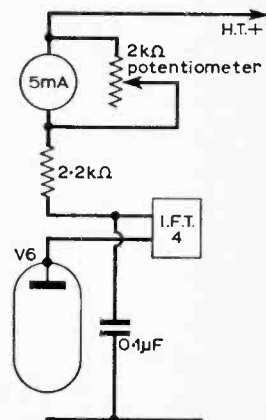
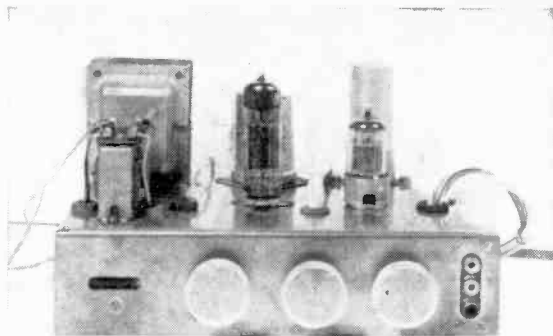

Fig. 8: Tuning meter.

THE RHODIAN TAPE RECORDER

PART 2

JULIAN ANDERSON



As mentioned last month, component layout is important in a tape recorder. Tagboard construction was chosen as it is the easiest way to keep a neat layout. The final arrangement for the major components and the control panel are shown in Figs. 5 and 6.

Using the chassis in this way the mains transformer is well away from the head, the leads to the function switch are kept short, and the high- and low-signal areas are separated.

Chassis details

The chassis is a standard size 8 x 5 x 2 in., and although constructed in the standard way is mounted in the recorder on its side, presenting one long side as the control panel. When fitted into the cabinet the underside of the chassis is exposed by removing a side panel of the cabinet. There was no intention to make the amplifier compact since this greatly complicates wiring, but the final layout is, even so, not spread out. Since the layout is designed to make working on it easy there are no interconnecting plugs and the wires to the deck switch are permanent.

Before construction begins the chassis must be drilled. The common sizes used in construction are used and only a B9A chassis punch is needed. The oblong holes to expose the magic-eye and for the input/output sockets can be drilled out and filed quite easily. The hole to take the wires to the switch needs to be fairly large since through it are carried four screened wires and three others. The hole to

take the mains to the on/off switch and back to the motor also needs to be fairly large. All holes in the chassis should be protected by grommets. The drilling details are shown in Fig 9. H.T. smoothing capacitors are often a nuisance to mount, but paxolin adaptors to mount these in the same way as a valve base are readily available. All holes should be countersunk, especially on the control panel side.

Construction

Once the chassis has been drilled the major components may be mounted leaving the mains transformer until last; to put it on first makes the chassis rather heavy and thus harder to handle. Note that the valve base for V1 should be the type to take a screening can. The h.t. rectifier is the only component mounted on the side of the chassis and this, being contact cooled, should be securely bolted using countersunk screws to keep the outside of the chassis flush. The audio sockets are mounted from underneath. Care should be taken to ensure that a plug will fit on to these since a clearance is necessary around the socket for the plug earth contact. Solder tags should be fitted at the same time as the main components to save effort later on.

The valve bases should be orientated as shown since the combination of this and the tagboard is designed for the shortest possible leads.

The volume and tone controls and the deck motor on/off switch may be mounted with the contacts facing the open side. A piece of wire should be soldered connecting their cases to earth to ensure they are properly at earth potential. The motor on/off switch used in the prototype is of the rotary kind and makes the final appearance more attractive,

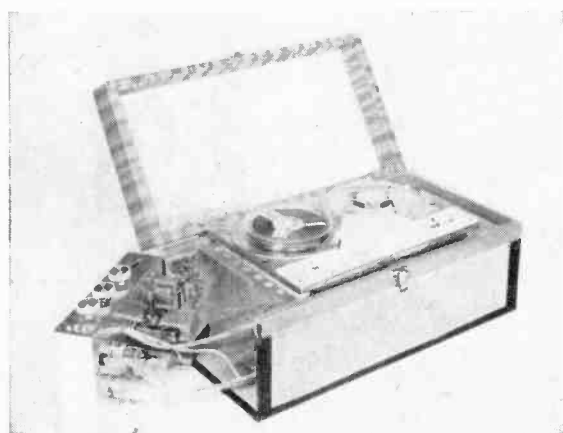

The amplifier chassis is mounted beside the deck.

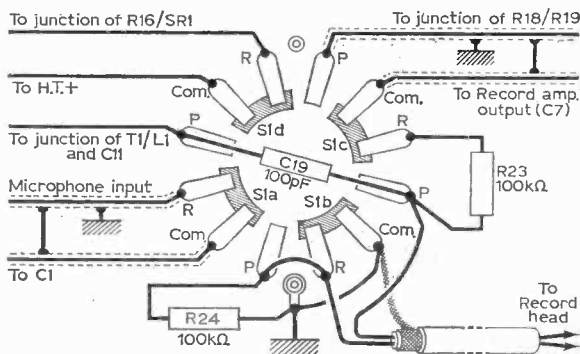
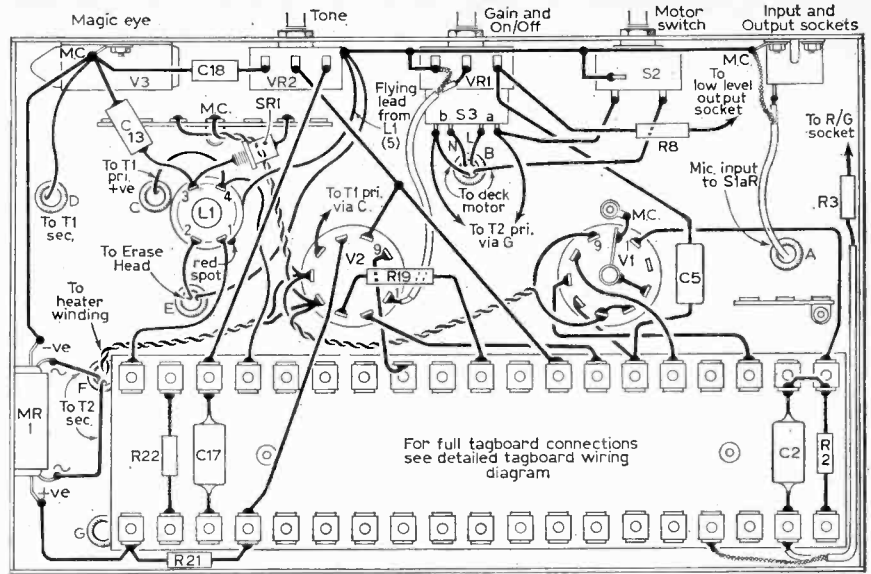

Fig. 4: Wiring to the record/playback switch S1.

but there is no reason why an on/off toggle switch need not be used.

The magic-eye should next be fitted. The DM70 has no valve base and is supplied with long leads. To mount this valve a small aluminium bracket, shown in Fig. 8, is needed. This curls around the back of the valve and pushes it on to the control panel where the cutout will stop it from sliding. The leads from the valve should be covered and soldered to the small 7-way tagstrip as shown in Fig. 8. Once this is completed the magic-eye and the tagstrip can be fitted.

Wiring can now begin. The mains lead is soldered to the double-pole on/off switch on the volume control, the other section



Note :- tags marked 'MC' are earthing connections to chassis

Fig. 5: Under view of amplifier chassis, showing wiring to main components. R19 should be mounted as closely to V2 pin 3 as possible.

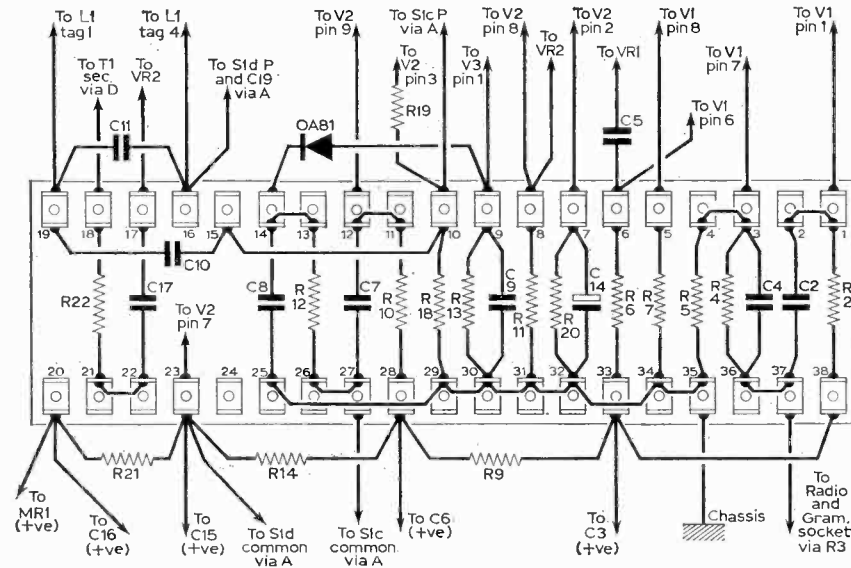

Fig. 6: Wiring of the main tagboard.

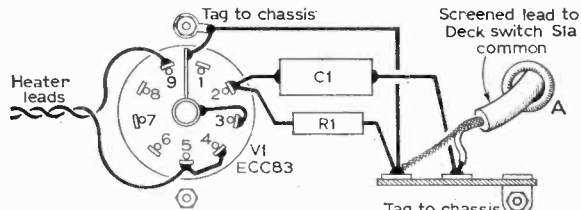

Fig. 7: Wiring to V1a grid tagstrip.

of the switch going to the primary of the mains transformer and to one contact of the motor switch. The mains lead to the motor is taken from the other contact of the motor switch and the double-pole

switch out through the same hole. The secondary of the mains transformer is taken to the rectifier contacts marked either a.c. or ~. The heater supply is connected to pins 4 and 5 of V2, and from here a parallel connection should be taken to the magic-eye tagboard already fitted and another parallel connection to pins 5 and 9 of V1, pin 4 also being connected to pin 5. One side of the heater line is earthed on to the magic-eye tagboard. Heater wires should be twisted together and laid close to the chassis to avoid hum. Only one other thing need now be done before the main tagboard is fitted. This is the small 3-way tagstrip

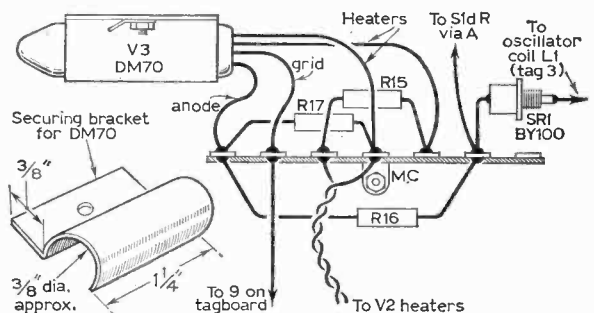

Fig. 8: Magic-eye tagstrip wiring and securing bracket details.

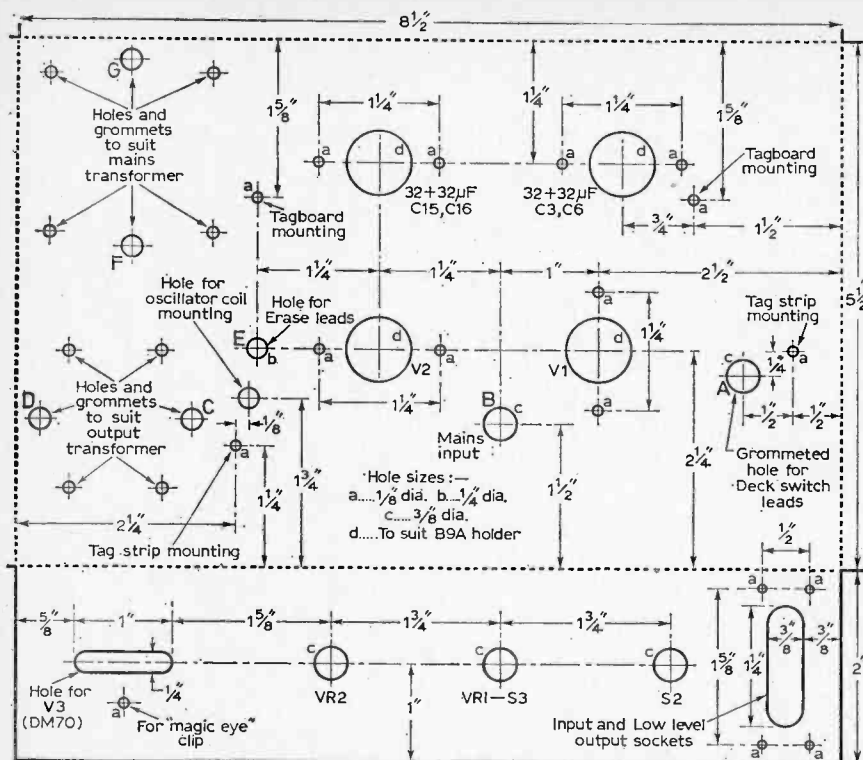

Fig. 9: Chassis dimensions and drilling details, viewed from above.

for the grid of V1A. This part of the circuit is very liable to hum pickup and the wires must be kept as short as possible, with C1 and R1 soldered right on to pin 2 of V1.

The tagboard may now be made. This is a 19-way strip and is available as standard. It will fit on to two 1 1/2 in. 4BA screws, which should be sited as shown. The screws must be locked by a nut with a further nut about 1/2 in. from the top for the tagboard to rest upon.

The wiring of the tagboard needs no explanation except that it will save considerable time later on if the wires which will be used for interconnection are fitted on at the same time as the components. Their lengths need only be approximate. The tagboard is shown in Fig. 6.

This completed, the first wires to fix are those for the smoothing capacitors. This must be done before the tagboard is bolted down since they become concealed under it. The longer wires from the tagboard can be fed through the appropriate grommet holes. The oscillator coil should now be mounted. The type suggested is easily mounted having its own plastic nut! The adjustable core in the oscillator coil should be set approximately in the centre of the windings.

The interconnecting wiring should then be started. This is perfectly straightforward. The only wires which should not be connected at this stage are those to the output transformer secondary.

The amplifier is now nearly complete. The only component not covered above is the 0.001 μF capacitor across the primary connections of the output transformer.

The switch wafer should now be wired. Three components are mounted on this for convenience.

There should be four screened wires and three others to this. The earth contact should only be made through one of the screens to avoid earth loops. Wiring for this is shown in Fig. 4.

Testing

The amplifier is now ready for testing once the loudspeaker has been connected to the secondary of the output transformer. The switch wafer should be put in the record position and a microphone plugged in. In this position the magic-eye should glow, the speaker should be quiet, the wires to the erase head should read approximately 50V a.c., and on speaking into the mic. and turning the volume control up the green line on the magic-eye should shorten.

When the wafer is switched to the playback position the speaker will be on. The magic-eye should not glow. In practice

the magic-eye may glow but will be very much dimmer: this is because of the extremely low h.t. that is needed for this valve so that even the reverse current through the rectifier is enough to produce slight glow—how much depends on the actual rectifier used.

The microphone is inoperative in this position so for testing purposes a signal must be inserted into the high-level input. In this way the recorder acts as an ordinary amplifier. The tone control may be tested after the wires to the secondary of the output transformer are connected. If the amplifier howls the leads should be reversed.

Before the recorder heads are connected it is wise to ensure that there is no voltage on the wires to the record/playback head. Testing should then go ahead in the normal way.

The record/playback head could well be not truly vertical. If this is the case the recorder will play back perfectly tapes recorded on it but other tapes will seriously lack top. It is as well to adjust this before the recorder is used seriously. The easiest

—continued on page 925

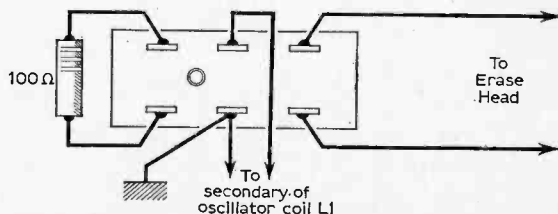

Fig. 10: A superimpose facility can be simply added by incorporating a double-pole changeover switch wired as shown.

Build your own Heathkit Electronics

A kit for every interest — Home Workshop — Hi-fi — Radio — Test — Amateur

Latest STEREO TAPE RECORDER, STR-1



Fully portable—own speakers

Kit £45.18.0

Ready-to-Use £59.15.0

FOR THIS SPECIFICATION

$\frac{1}{2}$ track stereo or mono record and playback at 7 $\frac{1}{2}$, 3 $\frac{3}{4}$ and 1 $\frac{7}{8}$ ips. Sound-on-sound and sound-with-sound capabilities. Stereo record, stereo playback, mono record and playback on

either channel. 18 transistor circuit for cool, instant and dependable operation. Moving coil record level indicator. Digital counter with thumb-wheel zero reset. Stereo microphone and auxiliary inputs and controls, speaker/headphone and external amplifier outputs . . . front panel mounted for easy access. Push-button controls for operational modes. Built-in stereo power amplifier giving 4 watts rms per channel. Two high efficiency 8" x 5" speakers. Operates on 230V a.c. supply.

Versatile recording facilities. So easy to build—so easy to use.

Latest STEREO AMPLIFIER, TSA-12

12 x 12 watts output.

Kit £30.10.0 less cabinet

Ready-to-Use £42.10.0

Cabinet £2.5.0 extra



FOR THIS SPECIFICATION

17 transistors, 6 diode circuit. ± 1 dB, 16 to 50,000 c/s at 12 watts per channel into 8 ohms. Output suitable for 8 or 15 ohm loudspeakers. 3 stereo inputs for Gram, Radio and Aux. Modern low silhouette styling. Attractive aluminium, golden anodised front panel. Handsome assembled and finished walnut veneered cabinet available. Matches Heathkit models TFM-1 and AFM-2 transistor tuners.

Full range power . . . over extremely wide frequency range. Special transformerless output circuitry. Adequately heat-sinked power transistors for cool operation—long life, 6 position source switch.

High-performance CAR RADIO, CR-1



Superb long and medium wave entertainment wherever you drive. Complete your motoring pleasure with this compact outstanding unit.

8 Latest semi-conductors (6 transistors, 2 diodes). For 12 volt positive or 12 volt negative earth systems. Powerful output (4 watts). Pre-assembled and aligned tuning unit. Push-button tone and wave change controls. Positive manual tuning. Easy circuit board assembly. Instant operation, no warm-up time. Tastefully styled to harmonise with any car colour scheme. High quality output stage will operate two loudspeakers if desired. Can be built for a total price.

KIT (less speaker) £12.17.0 incl. P.T.

8" x 5" Loudspeaker £1.10.0 extra.

Latest Portable Stereo Record Player, SRP-1

Automatic playing of 16, 33, 45 and 78 rpm records. All transistor—cool instant operation. Dual LP/78 stylus. Plays mono or stereo records. Suitcase portability. Detachable speaker enclosure for best stereo effect. Two 8in. x 5in. special loudspeakers. For 220-250V ac mains operation. Overall cabinet size 15 $\frac{3}{8}$ x 3 $\frac{3}{8}$ x 10 $\frac{1}{2}$ in.



Compact, economical stereo and mono record playing for the whole Family—plays anything from the Beatles to Bartok. All solid-state circuitry gives room filling volume.

KIT £27.15.0 incl. P.T. Ready-to-Use price on request.

A wide range of SPEAKER SYSTEMS



SSU-1

HI-FI SPEAKER SYSTEM. Model SSU-1. Ducted-port bass reflex cabinet "in the white". Two speakers. Vertical horizontal models with legs, Kit £12.12.0 without legs, Kit £11.17.6 incl. P.T.



Berkeley

The BERKELEY SLIM-LINE SPEAKER SYSTEM, fully finished walnut veneered cabinet for faster construction. Special 12" bass unit and 4" mid/high frequency unit. Range 30-17,000 c/s. Size 26" x 17" only 7 $\frac{3}{8}$ " deep. Modern attractive styling. Excellent value. Kit £19.10.0. Ready-to-Use £24.0.0.

"Mohican" General Coverage Receiver, GC-1U

Powerful 10 transistor, 5 diode circuit. Tunes 580 to 1550 kc/s and 1.69 to 30 Mc/s in five bands. Bandspread on all bands. Fixed-aligned ceramic JF transistors for best selectivity. Pre-assembled and aligned 'front-end' for fast, easy assembly. Built-in 6 x 4in. speaker. Tuning meter for pin-point tuning. Completely self-contained for portability—can be operated on 230 volt AC with Model UBE-1. Kit £2.17.6 extra.

Kit £37.17.6. Ready-to-Use £45.17.6.



Send for Latest FREE Catalogue

36 pages, many models in colour.

HEATHKIT

Please address all enquiries to:

DAYSTROM LTD., Dept. PW-4, GLOUCESTER

Please send me FREE CATALOGUE

Full details of model(s)

NAME

ADDRESS

SEE THE HEATHKIT EXHIBITION AND

HI-FI DEMONSTRATIONS
(concurrent with Audio Fair)

GRAND HOTEL
SOUTHAMPTON ROW, LONDON, W.C.1

April 18—21, 1968

Deferred terms available over £10 (UK only).
Prices quoted are Mail Order prices.

E.S.V. THE DISCOUNT STORE

Stereo amplifier

BARGAIN—A fully transistorised Hi-Fi Stereo Amplifier as illustrated. Fully built in superb black leather padded cabinet with brushed silver fascia. Uses 14 transistors giving 5 watts per channel (r.m.s.), 10 watts mono. Integrated pre-amp with bass, treble and volume controls. Suitable for use with crystal or ceramic cartridges. Output stage for any speakers from 8 to 15 ohms. **Brief specification:** Free response +3dB 20-20,000 c/s. Bass Boost approx. 10+12dB. Treble out approx. 2-16dB negative feedback—18dB over main amp. Power requirements 25V at 6 amp. **LIST PRICE 26 GNS. DUE TO HEAVY DEMAND (over 200 sold last month) PHENOMENAL PRICE REDUCTION. Amplifier 12 gns. only. P.P. 8/6. Padded leather case 2 gns. only. P.P. 4/6. If purchased together P.P. free. Maker's FULL guarantee.**

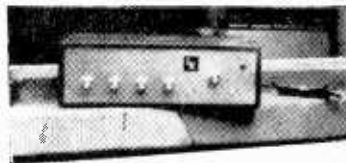

● **SCOOP—First again, with the NEW GARRARD range—Check our prices.**

Model 1025 (supersedes 1000) ..	OUR PRICE	£8 10	0 P.P. 8/6
Model 2025 (supersedes 2000) ..	OUR PRICE	£8 19	6 P.P. 8/6
Model 3500 (latest 3000) ..	OUR PRICE	£10 5	0 P.P. 9/6
Model 60 Mk. II ..	OUR PRICE	£14 11	0 P.P. 9/6
Model SL55 ..	OUR PRICE	£11 12	6 P.P. 9/6
Model SL65 ..	OUR PRICE	£15 18	6 P.P. 10/6
Model SL75 ..	OUR PRICE	£29 5	0 P.P. 10/6
Model SL95 ..	OUR PRICE	£36 10	0 P.P. 10/6
Model SP25 (Mk. II) Single Player ..	OUR PRICE	£12 19	6 P.P. 7/6
Model AP75 (auto single player) ..	OUR PRICE	£18 5	6 P.P. 9/6
Model 401 transcription unit ..	OUR PRICE	£25 4	0 P.P. 10/6
Model SRP22 Single Player ..	OUR PRICE	£5 7	7 P.P. 7/6

WB1 wood base ..	OUR PRICE	£2 19	6
WB2 wood base ..	OUR PRICE	£4 0	0
WB4 wood base ..	OUR PRICE	£3 17	9

SPC1 plastic cover ..	OUR PRICE	£2 19	6
SPC2 plastic cover ..	OUR PRICE	£4 0	0
SPC4 plastic cover ..	OUR PRICE	£3 17	9

Turntable prices are quoted less cartridge.
P.P. on bases and covers 6/6.

● **SCOOP—The SCHAUB TUNER** for Long and Medium Wavebands. Fully built in attractive cabinet with Silver Fascia. Supplied complete with leads for instant connection to Amplifier. OUR PRICE while stocks last **ONLY £3.10.0.** P.P. 4/6.

● **SCOOP—TRANSISTORISED FM TUNER CHASSIS.** Beautifully built and compact with S.M. Horizontal Dial. Low noise—battery or mains operation. Six transistor—smooth two-gang Tuning—3 I.F. Stages—coupled double tuned Discriminator terminating in an I.F. stage. Ample output for all good quality Amplifiers. Interference free. OUR PRICE while stocks last **ONLY £5.19.6.** P.P. 4/6.

● **SCOOP—THE ELPICO STEREO AMPLIFIER.** Brand new, fully built and guaranteed. 4 watts per channel—beautifully styled—fully integrated—Black and Silver Fascia with matching Knobs. Full tone and Volume controls—will instantly fit any cabinet or can be used "free standing". Original price 16 gns. OUR PRICE **£4.19.6.** P.P. 5/6.

● **SCOOP—E.S.V. 3 WATT RECORD PLAYER AMPLIFIER 62/-.** OUR PRICE 50/-. P.P. 3/5. A.C. 220-240V (non live chassis). Fully built. Tested. Complete with valves (EL84 output). 2 controls. Flying panel.

● **SCOOP—E.S.V. 3 WATT RECORD PLAYER AMPLIFIER UNIT 75/-.** OUR PRICE 57/6. P.P. 4/6. Complete with valves (UCL82 output). Fully built. Tested. Mounted on board—complete with speaker (5in. round). Knobs supplied—all leads attached—ready for instant connection to your turntable. Fully guaranteed.

● **SCOOP—E.S.V. RECORD PLAYER CABINET 75/-.** OUR PRICE 55/-. P.P. 5/6. Strongly built wooden cabinet. Two-tone. Complete with either B.S.R. or Garrard cut-out board. Gilt fittings. Strong carrying handle. Will suit any Gramophone Amplifier. Ample space for Speaker.

● **SCOOP—A TAPE AMPLIFIER** suitable for Magnavox or Collaro Decks. This beautiful Amplifier was originally priced at 20gns. Controls P/B—Trick—S/Impose. Roller—Treble—Bass. Ext. L/S (Jack) O/P (Jack). Mic—Gram. Valve line-up (supplied) EL84, EL84, ECC87, EF86, EM87. Black polished fascia fully engraved. Separate power pack supplied with Heavy Duty Mains Transformer. OUR PRICE **£9.19.6 ONLY.** P.P. 5/6.

● **SCOOP—SUPERB CABINETS** for the above. Size approx. 18in. x 15in. x 9in. Two-tone with sloping fascia for control panel. Gold finish Fittings with Keyed Locks. Original price **£7.10.0.** OUR PRICE **£3.15.0.** P.P. 5/6.

● **SCOOP—A connoisseur's PICK-UP ARM** by world famous manufacturer. Absolutely brand new with mag. cartridge (less stylus)—detachable shell—needle mounted oil damped—weighted balanced arm. Has been used by BBC. Original list price **£16.16.0.** OUR PRICE **£4.10.0 ONLY.** P.P. 5/6.

● **SCOOP—SPEAKERS—3 or 15 ohms—8 x 5in. elliptical—12,000 lines gauss—5 watts guaranteed rating—Alcomax magnet.** Absolutely brand new and guaranteed—sold elsewhere at 45/-. OUR PRICE **25/- ONLY.** P.P. 3/6.

● **SCOOP—SPEAKERS—13 x 8in.—15 ohms 10 watts guaranteed rating.** Alcomax magnet—A product of E.M.I. Absolutely brand new and guaranteed—sold elsewhere at 75/-. OUR PRICE **45/- ONLY.** P.P. 4/6.

● **SCOOP—SPEAKERS—W.B. 8in. in attractive vynair cabinet.** Speaker has die-cast chassis (gold finish), very heavy magnet and is rated at 8 watts. Ideal for hi-fi stereo equipment. Worth double. OUR PRICE while stocks last—3 or 15 ohms—4 gns. ONLY. P.P. 8/6.

● **SCOOP—The "BAKER SELHURST" custom built "GOLDEN" with inbuilt Tweeter system.** Brief specification: 12in. dia "Syma" cone—20 watts (r.m.s.)—Flux 16,000 gauss—impedance 15 ohms—response 28-17,000 c.p.s.—net weight 10 lbs. Recommended retail price **12 gns. DISCOUNT PRICE £6.19.6.** P.P. 6/6. **ONE OF THE GREATEST SPEAKERS IN THE WORLD!**

● **SCOOP—CARTRIDGES—NOT the lowest prices but all are brand new and guaranteed.**

Sonotone 9TA/HC sapphire—stereo ..	44/6
Sonotone 9TA/HC diamond—stereo ..	56/3
T.C.8.H—mono ..	27/6
T.C.8.M—mono ..	27/6
T.C.8.S—stereo ..	45/0
C.I.—stereo ..	49/6

All cartridges are supplied with fixing brackets and screws at no extra charge. P.P. on all above 2/6.

● **SCOOP—INTERCOM SYSTEM** by "Philips". This equipment is ideal for baby alarm—office—or home usage. Absolutely brand new in presentation case. Supplied complete with all leads, etc. and carries makers' guarantee. Recommended retail price **£6.6.0.** DISCOUNT PRICE **£3.3.0 ONLY.** P.P. 3/6.

● **SCOOP—RECORD PLAYERS** by famous manufacturer **19 gns.** OUR PRICE 12 gns. P.P. 15/-. Brand new in original carton with guarantee. Garrard Deck—GP91 cartridge—3 watts output. 3 control amplifier. Beautiful Two-tone cabinet. Hi-Fi tonal quality. One of the nicest Record Players available today. Limited stocks.

● **SCOOP—CAR RADIO 12 gns.** OUR PRICE 8 gns. P.P. 8/6. Well known brand name. Fully tested before despatch in makers' own carton with makers' guarantee. L.W.. M.W.—Fully transistorised—speaker and fitting kit supplied at no extra cost, also instructions for fitting. 12 volt. Please state negative or positive earth. Limited stocks. only available.

● **SCOOP—BARGAIN—SLIMLINE TV RECEIVERS.** 19in. in mint condition. Complete, tested, working but less I.F. strips. Make ideal monitors. Various famous makes. OUR PRICE **£10 ONLY.** I.F. strips if required 45/- only. P.P. 25/- (TV and Strip). Personal collection advised otherwise despatched at customer's risk.

● **SCOOP—TRANSISTOR RADIO—S.W.B.** OUR PRICE 4 gns. P.P. 3/6. A fully built and tested S.W.B. Radio. Complete in every way. Operates equally well in home or car. The performance of this Radio has to be heard to be believed. Limited stocks.

● **SCOOP—SPOTLIGHT.** Manufactured by Butlers for the Air Ministry. Universal bracket. Dozens of uses—bench—car—photography Mirrored reflector supplied. Less bulb, in carton at fraction of price. OUR PRICE 15/- EACH. P.P. 6/6.

● **SCOOP—Diodes—over 1,000,000 in stock—ideal substitute OA81 vision detector.** NOTE OUR PRICE **£1 per 500.** P.P. 2/6. (In 500 lots only).

ELECTRONIC SALES (Victoria) LTD
17 GILLINGHAM ROW · WILTON ROAD
LONDON S.W.1.

Telephone Victoria 5091

ON THE SHORT WAVES

MONTHLY NEWS FOR DX LISTENERS

Times GMT
Frequencies in kc/s

THE BROADCAST BANDS by CHRISTOPHER DANPURE

ONCE again spring is upon us, and with it come the best conditions of the year in my opinion for DX-ing. During March '67 I received *Radio New Zealand*, *Radio Free Korea*, and *Voice of Free China*, plus *Radio Australia* on the 19m.b. at 0100 GMT. During March '68 you should be able to hear those small and hard to hear stations which during other seasons are practically impossible to receive. At the same time as the general high frequency bands are giving good DX, so should the Tropical Bands of 60, 75, 90 and 125m.b.'s. through the night for the stations in the South and South-West from Europe.

South Africa: During daylight hours listen on 25 and 21Mc/s bands and for evening listening 17, 15, 11 and 9Mc/s, which should last through the night together with 7 and 6Mc/s.

West Africa: Again the same as South Africa, daylight hours on 25 and 21Mc/s, then 17, 15, 11Mc/s and night hours on 9, 7, 6 and 5Mc/s.

East Africa: From 0600-2000 listen on 25, 21 and 17Mc/s, early evening add 15Mc/s, for night hours 11, 9, 7, 6Mc/s, but between 0400-0600 GMT there will only be 15 and 17Mc/s.

South Asia: From 0600-1600 GMT 25, 21, 17 and 15Mc/s will give best results, 1600-2000 17, 15, 11 and 9Mc/s; 2000-0200 11, 9, 7, 6 and 4Mc/s; 0200-0400 GMT 9 and 11Mc/s.

South East Asia: The bands will open at 0600 on 21 and 25Mc/s, 1000 onwards add 17, then through the afternoon up until 1800 GMT the 15, 11 and 9Mc/s bands will give best results, for evening listening 11, 9, 7 and 6Mc/s, the bands will be closed for this area between 0000-0600 GMT.

Pacific Area: The bands will be closed during the period 1000-2000 GMT then 17 and 15Mc/s, 0400 onwards add 11Mc/s then after 0800 GMT add 9Mc/s.

Australia via Asia: After 0600 GMT on 21Mc/s, after 1000 add 17Mc/s, 21Mc/s closes at 1400 GMT, during the afternoon add 15, 11 and 9Mc/s, 17Mc/s closes at 1600 GMT, the bands will be closed to this area between 2200-0600 GMT.

North and South America: Bands are all open, after 1000 GMT generally 25, 21 and 17Mc/s, afternoons add 15Mc/s, evenings on 21, 17 and 15Mc/s, night hours on 11, 9, 7 and 6Mc/s.

Those were the propagation forecasts for March 1968. Now on to this month's DX-tips, the deadline for the June issue is March 20th, so all your loggings for inclusion in that issue must be in by March 20th.

ATLANTIC

BBC relay station on Ascension Island evening transmissions are now as follows:

English, French and Haussa to Africa 1645-1815 15,105, 9,600; 1815-1830 15,105; 1830-2000 15,105, 9,580; 2000-2015, 9580; 2015-2145 9,580, 7,240.

A World Service to Africa 1645-2145 15,400, 11,820. Spanish and Portuguese to Latin America 2200-0415 15,180, 11,820.

World Service to Latin America 2200-0415 15,140, 11,865.

ASIA

Israel: *Kol Israel* is now on the following schedule 1600-1630 Yiddish, 1630-1700 Persian, 1700-1735 Russian, 1735-1745 Hungarian, 1745-1800 Hungarian, 1800-1815 Ladino, 1815-1830 Mugrabit, 1830-1900 Yiddish, 1900-1930 Hebrew, 1930-2000 Russian, 2015-2030 English, 2045-2115 French, 2115-2130 English, 2145-2200 Russian, all on 9,725, 9,625, 9,009.

Japan: *Radio Japan* has the following transmissions to Europe 0700-0830 in German, French, Italian, English and Swedish on 17,825, 15,135; 1930-2100 languages as at 0700, on 11,965 and 9,700; 0100-1130 general service in English and Japanese on 15,300, 1200-2130 general service in English and Japanese on 9,560; 2200-0030 general service in English and Japanese on 9,700.

AFRICA

Ghana: The External Service of *Radio Ghana* transmits in English to Europe from 2045-2215 on 9,545.

South Africa: The All Night Service of *Radio South Africa* has been heard with strong signals here in Europe from 2200-0300 on 6,150 and 4,945.

NORTH AMERICA

Canada: *Radio Canada* will have the following alterations for March-May 1968 transmissions. From 1832-1958 to Africa in English and French on 21,595, 17,820 and 15,320; 2001-2150 to Europe in French and English on 17,820, 15,320 and 11,720 to the Americas from 2300-0045 in English, Portuguese and Spanish on 15,190, 11,945 and 9,625.

SOUTH AMERICA

Venezuela: *Radio Yaracuy* has been heard with good signals on 4,940 after 0200.

EUROPE

Switzerland: Mr. Andrew Givens informs me that the tests from committee of Red Cross in Geneva for March are on the 18th, 20th and 22nd at 0600-0700, 1130-1230, 1700-1800 and 2300-2400 on 7,210.

Until next month Good DX-ing and 73's.

FIRST my thanks to all those who sent in a log this month. My "in" tray sagged under the weight and it has been very difficult to select the ones to print. There seems to be the usual controversy of which bands are dead and which aren't. Some claimed that twenty was literally hibernating while others promptly supplied logs of juicy DX-type callsigns heard on this very same band. Conditions are rather patchy at present, so if the band seems a bit quiet one week, have a listen throughout the month, you'd be surprised what's about.

Congratulations to **Dale Harvey** on getting his ticket, call to listen for is G3XBY. **R. King** (Yorks), informs of a source of DX information given out on 80 metres by ON4UN and LA5KG. Regular bulletins given out on Mondays and Thursdays at 2100 GMT on 3.785Mc/s. Richard says that ON4UN also runs a European DX net on 80 which now has around 80-90 members.

Want to log some real exotic callsigns easily? Good, follow these instructions carefully and rich harvests of goodies shall verily be thine. Tune the receiver to 28Mc/s and peak everything up. Now tune down to 27.27.3Mc/s and tune round very carefully. Yes, it's the dreaded Citizens' Band again. Callsigns like Batman and Robin; Rattlesnake (heard him last year); Red Fox and Old Brown Hog are quite common. Now that Ten metres is climbing back to the top, the signals from 27Mc/s will be easier to receive.

Topband fans will remember GM3SVK recently heard working as G3SVK/A from Rutland on s.s.b. At the time of writing, rumours inform that a DX-pedition to the Orkneys is on. Anyone hear the station?

TWENTY METRES

Pleasing to report that the famed "Henbry Ears" were at it again last month. A huge pile of logs for this band and all showing some very fb DX come.

David Henbry (Sussex), HA500, 7ft. vertical at 30ft., claims rough approximations of sine waves emanating from the following—CE3NL, CR4BC, CX2CR, CX9AAF, EL2EL, FG7XT, FR7ZN, HL9KR, HZ7KO, KG6IF (Marcus Island), KV4CF, PZ1BF, PZ1BW, TI2XL, UL7LA, VE8MD, VK9OM (New Guinea Territory), VP2LA (St. Lucia), VP2SAB (St. Vincent), VP5AA, VP6AO, VP6GN, VP8HZ, VP8IU, YJ8BW, ZD7DI, ZD7KH, ZE6JN, ZP3AL, 3V8BZ, 4U1TU, 5H3JL, 6W8BM, 7Q7PBD, 8P6AH (New prefix for Barbados), 8R1S, 9L1DW, 9Y4LP. Think I'll flog my receiver and run a long phone lead down to Sussex.

R. Walters (Derbyshire), Eddystone 358, 120ft. long wire rescued these from 20—AP2SM, CE3ZN, CR6CE, CX2WY, DU1FF, EA6OJ, FP8DM, FR7ZD, HI2JP, JA1CIB, KR6NA, KZ5DA, LU3BU, MP4DNG, OA2EH, OY2YA, PY7GV, TA9DJ, TG7WH, TZ1BW, VE2MI, VE6BL, VE7AON, VE8JY, VK1QM, VK2CV, VK3CP, VK4GI, VK5FO, VK6EI, VK7QP, VK9MV, VP1BY, VP8JD, VQ8AU, VR2EK, W1-Ø, XE1CW, YV5ANE, ZB2A, ZD7DI, ZL1AF, ZL4DMA, ZM7AE (Tokelau Is.), ZS6DM, 5A1KA, 5U1JL, 9K2MO, 9V1OR, 9Y4AR. Another phone lead to Derbyshire too!

Martin Pasek (Notts), HRO, 180ft. long wire, is 13 years old. Persistence on 20 s.s.b. brought rewards from

—CT1AV, PZ1AC, VK2AHT, VK3BK, VK4NP, VK5MS, VK7DK, VP2AA, VP7MS, ZL4BC.

D. Higgins (Lanarkshire), KT340, 40ft. end fed indoors, all 20 s.s.b.—CR4BC, CR6CN, EA9EG, GC2LV, HR1KA, HS2AK, HV3SJ, HZ4PY, K5EIH, LX1WR, PY2PE, PZ1AC, SV1BV, TF2WKW, TI2JIC, VE8ML, VO1FU, VK3HW, VK5HV, VK6FC, VQ9DH, VU2VKZ, W5TTY, W7UMJ, YV5LA, ZB2A, ZS2MI (Marion Is.), ZS6BFP, 3A2CP, 5Z4AA, 7X2ED, 9L1BW, 9Y4VT. Daniel queries QQ7A claiming to be on Ganzo Island. He's not on my list—neither is the island.

TEN METRES

C. Bradshaw (Lincs), HRO, dipole at 25ft. logged—JA3CWM, K1BHK, UA3KHD, VE1ANJ, VE2LXZ, W1LMW, W4BG, WØELC, ZE2KL, 9H1AG, 9H1AY all on a.m.

R. Dinning (Ayrshire), HA350, PR3OX preselector, 20 metre dipole, all s.s.b.—CE3TB, CR6DX, CR7DS, CX9PP, ET3REL, HC2OA, HR1DX, K4HF/P/KV4, KZ5MB, OD5BZ, PJ4AC, TI2CAP, VK6CF, VK6LF, VP6RD, VU2JM, XE1PY, YO9CN, ZC4RB, ZD7DE, ZE7JZ, ZS1JU, 3A2CB, 5N2AAF, 5Z4KN, 9H1AC, 9J2DT, 9L1GQ, 9Y4LR, W1-Ø.

WHERE AND WHEN

Many listeners write in with queries based on where and when can I hear it, the "it" varying from letter to letter. The following snippets of gossip, picked up from varying but reliable sources, are offered because they answer the most commonly received queries.

A Countries List can be obtained from the R.S.G.B. Also, the R.S.G.B. Bulletin published monthly, contains propagation predictions for the h.f. bands—where and when the bands will be open etc. Slow morse transmissions are on most nights on 160 metres (top-band) and sent out by G stations in various parts of Britain.

The Dutch station PAØAA transmits on Friday evenings with news in English at 1915-1930 and 2115-2130. This station also sends slow morse on the same evening at 1930-2000, and for the more advanced c.w. enthusiasts from 2000 to 2030. Why not listen for him this Friday on 3.60Mc/s? All things considered, perhaps the best "standard" to check your crystal calibrators and frequency meters against is the BBC station at Droitwich. It radiates on 200kc/s and is accurate within 5 parts in 10¹⁰ of absolute which is pretty accurate by any reckoning. G3JDG is on mainly on topband at present. I will QSL with pleasure providing the report is useful and not just the usual "heard you 5 and 7 etc., please QSL".

NEWS AND CONTESTS

Three contests this month all very different from each other. March 2-3, BARTG contest for the teleprinter types; March 2-3, 2 Metre Open Contest; March 9-10, BERU Contest, this is a 3.5-28Mc/s c.w. contest in which contestants try to contact as many British Empire stations as possible.

Multi Purpose Neon Test Unit

Robust, useful and instructive—tests insulation—capacity—continuity—resistor—volume controls—also acts as signal injector and I.T. fault finder—kit complete neon indicator—4-way water switch—ebonite tubes—resistors—condensers—terminals, etc. with diagram only 9/6, plus 2/- post and insurance.

KETTLE ELEMENT

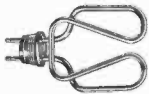

Made by famous "Best" company, suitable for most kettles. 1/2 in. dia. hole. 1500 watts. 230/250v. Normally 30/- each. Our Price 15/- each, plus 2/6 P. & P.

NO SOLDERING POCKET 3

Lots of fun to build and good results when finished—complete kit with detailed instructions and crystal earpiece (batteries 1 1/2 extra) 25 value only 19/6 plus 3/- post and insurance.



ARMCHAIR CONTROL UNIT



Remote Controller for Philips, Stella and Cosor TV sets but adaptable to most others, and to model control. Comes with three rock switches, two variable resistances and component including Mullard OA81—Knoxs—10 way plug—11ft. 7 way cable, etc. List price £8.30, yours for only 12/6, plus 2/- post and insurance.

SILICON RECTIFIERS

Tested and guaranteed.

750mA 100v. 1/3	1 Amp. 100v. 3/-
200v. 1/6	200v. 4/-
400v. 3/6	400v. 6/-
100v. 3/6	
200v. 5/-	10 Amp. 100v. 9/6
400v. 7/6	200v. 12/6
600v. 9/6	400v. 14/6

Sub-miniature glass encased—only approx. 1/2 in. long wire ended.

400mA, 50v. 1/6	100v. 2/8	200v 4/6.
-----------------	-----------	-----------



GARRARD AUTO RECORD PLAYER Model 2000

This is one of the latest products of the World's most experienced maker of fine record reproducers. Its superior features include—automatic playing of up to 8 mixed size records—stopping and starting without rejecting—manual playing—pick-up pivots to give low stylus pressure—large diameter turn-table for max. stability adjustments include pick-up height—pick-up dropping position and stylus pressure. Size is 13 1/2 x 11 1/2 in. clearance 4 1/2 in. above, 2 1/2 in. below. Supplied complete with mounting template and service sheet. Offered this month at the Special Snip price of £8.19.6 plus 7/6 carriage and insurance.

SOLID STATE IGNITION

Big things are claimed of Electronic ignition systems and if you would like to try for yourself a circuit was described in *Practical Electronics* (Sept., 1966). This requires a silicon controlled rectifier, four transistors and other components available as a kit. Price £8.15.0, post free.

INTERCOM BARGAIN



Will save time and improve efficiency. Ideal in home—office—shop—surgery, etc. Complete outfit comprises Master unit and three substations each of which can call the master and have full two-way working. No wiring problems as subs fitted with 60ft. twin flex and they plug into sockets. Also included is packet of staples—and battery. Nothing else to buy—£4.19.6, plus 4/6 post and insurance.

HURSEAL AUTOMATIC TIME SWITCH

12 hour. 15 A to control heating, lighting, radio, immersion heaters etc. Regular price 24/4/-. Limited quantity 39/6. P. & P. 3/-.

GANGED POTS

Standard type and size with good length of spindle—made by Morganite. List price is 10/- each but if you act quickly you can have them at 12/- doz. (or 1/6 each if less than doz.). Following values in stock all "lin"—10K + 10K—100K + 100K—500K + 500K all new and unused. Post 2/0 on 1st doz. then 1/- per doz. 6 doz. or more post free.



SIMMERSTAT

TYX-FL and TYX-F. Both popular types fitted to many cookers. Suitable for 230/240v. up to 16 amps. Handy device to have around the workshop. 12/6 each.

SUPPRESSOR CONDENSER

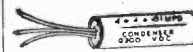

Stop your drill or other appliances interfering with you or your neighbours' radio or television. Simple instructions given, 1/6 each, 12/- doz. PP3 Eliminator. Play your pocket radio from the mains! Save 2s. Complete component kit comprises 4 rectifiers—mains dropper resistances, smoothing condenser and instructions. Only 6/6 plus 1/- post.

Be first this year

SEED AND PLANT RAISING



Soil heating wire and transformer. Suitable for standard size garden frame. 19/6 plus 3/6 post and ins.

Where postage is not definitely stated as an extra then orders over £3 are post free. Below £3 add 2/6. Semi-conductors add 1/- post. Over £1 post free. B.A.E. with enquiries please.

ELECTRONICS (CROYDON) LIMITED

(Dept. P.W.) 102/3 TAMWORTH RD., CROYDON, SURREY (Opp. W. Croydon Stn.) also at 266 LONDON ROAD, CROYDON, SURREY S.A.E. with enquiries please

FABULOUS VALUE

TRANSCRIBED HI-FI RECORD PLAYER
Build your own Hi-Fi Record Player with the Serenade fully transistorised amplifier which comes complete with the latest BSR 4 Speed Stereo/Mono Record Changer.
Advanced solid state amplifier only 4 1/2" deep, 14 transistors plus 4 diodes, separate Bass and Treble—10 watts total power. Frequency response 50-15,000 c/s.
EASY TO INSTALL NO TECHNICAL KNOWLEDGE REQUIRED
ONLY 26 + P&P 17/6
H.P. terms available. Deposit £6.16.6d and 12 monthly payments of 38/5d (Total H.P. £29.17.6d). Send £7.14.0d today.

FANTASTIC BARGAIN OFFER!

"TRANSCONTINENTAL"
FULLY TRANSCRIBED STEREO PHONIC RADIOGRAM CHASSIS
Complete with 2-10" x 6" speakers and the latest BSR Mono/Stereo Record Changer—a complete radiogram at half normal price ONLY
10 Watts Total output 34 1/2 GNS. P&P
17 Transistors & 10 diodes 2 GNS. 17/6
EASILY FITTED NO TECHNICAL KNOWLEDGE NECESSARY
H.P. available £9.2.6d deposit plus 18 monthly payments of £1.15.9d (Total H.P. £41.6.0).
Send £10 today

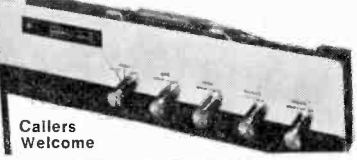

Callers Welcome

PLEASE SEND ME FREE DETAILS OF YOUR RANGE

Name _____

Address _____

LEWIS radio 100 CHASE SIDE, SOUTHGATE, Dep. P48 LONDON, N.14. TELEPHONE PAL 3733/9666

POST THIS COUPON NOW!

BI-PAK SEMICONDUCTORS

8 RADNOR HOUSE, 93-97 REGENT STREET, LONDON, W.1

AC107	3/6	KING OF THE PAKS	all at
AC126-7-8	2/6	"TOP TWENTY"	
AF118-117	3/6	Unequalled Value and Quality	10/-
AF139	10/-	BRAND NEW—UNTESTED SEMICONDUCTORS	per pak
AI492	15/-	Satisfaction GUARANTEED in Every Pak, or money back	
BC107-8-9	5/-	120 Glass Sub-min G. Purpose GERM. DIODES	
BFY50-61-61	7/6	60 Mixed GERM. TRANS. AF/RF	
BSY26-7	3/6	75 Germ. Diodes GOLD BONDED	
BSY28-9	4/6	40 TRANSISTORS Like OC81, AC128	
BSY95-96A	4/6	60 200mA Sub-min SIL. DIODES	
OC26-35	5/-	40 SIL. PLANAR TRANS. NPN BSY95A, 2N706	
OC28-29	7/6	16 SIL. RECTS. Top Hat 750mA	
OC44-45	1/9	50 SIL. PLANAR DIODES 250mA OA200/202	
OC71-81	1/6	20 Mixed Volts 1 Watt ZENER DIODES	
OC72-75	2/6	30 PNP-NPN SIL. TRANS. OC200/2S104	
OC81D-82D	2/3	150 Mixed SIL. and GERM. DIODES	
OC82	2/6	10 3 Amp SIL. RECTS. Stud Type	
OC140	5/-	30 SIL. NPN TRANS. Like BC108	
OC170	2/6	12 1.5 Amp SIL. RECTS. Top Hat	
OC171	3/6	30 AF. GERM. ALLOY TRANS. 2G300 Series	
OC201	7/6	10 1 Amp Glass min. SIL. RECTS. High Volts	
ORP12-60	8/6	80 MADT's Like MAT Series TRANS. PNP	
OCP71	8/6	20 GERM. 1 Amp RECTS. GJN Series	
OA5-10	1/9	25 300 M/c's NPN SIL. TRANS. 2N708, BSY27	
OA47	2/-	80 FAST SWITCHING SIL. DIODES IN14 Micro	
OA70	1/6	Code No's mentioned above are given as a guide to the type of device in the Pak. The devices themselves are normally unmarked.	
OA79	1/9		
OA81-85	1/6		
OA91	1/3		
OA95	1/8		
OA200	3/-		
OA202	3/6		
2N696-7	5/-		
2N706	3/6		
2N708	5/-		
2N2160	15/-		
2N2646	15/-		
2N2712	6/6		
2N2929	3/8		

THE first two satellite earth stations for public service to be owned and operated by Cable and Wireless Ltd., will, it is claimed, be operational in May 1969. The contracts are being placed with the Marconi Company Ltd., for the supply and construction of these two stations which are to be sited at Bahrain and Hong Kong. The value of the basic contracts is £2,115,000.

Each station will have facilities for transmitting up to four carrier signals and the reception of up to 32. Each of these carriers may have a capacity of 24, 60 or 132 separate communication channels.

The dish aerials are 90ft. in diameter in the form of a parabolic reflector constructed from a mild

SATELLITE EARTH TERMINALS

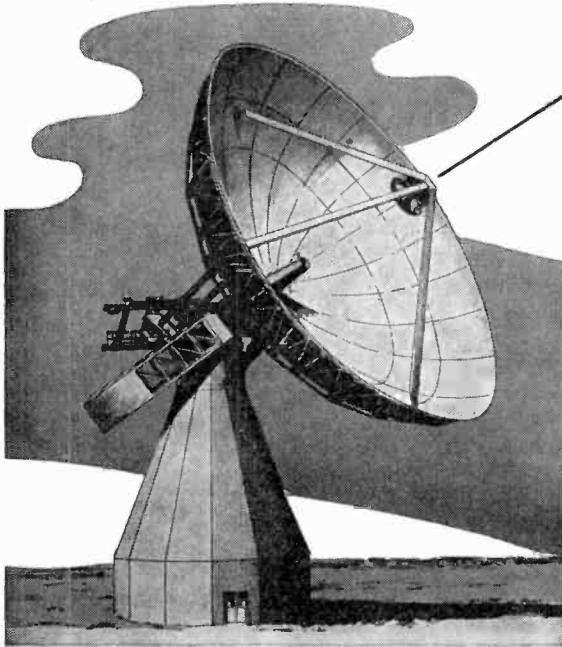

steel backing structure and covered with an aluminium alloy skin, 0.080in. thick and adjusted to a surface accuracy of better than ± 0.040 in. The Hong Kong terminal will be able to withstand typhoon conditions and will be capable of operating in gales up to 70 miles per hour, and when parked, with the dish pointing vertically upwards, it will withstand 210-mile-per-hour winds.

The signals received from space arrive at the aerial at a power of a tenth of one million millionth of a watt. Initial amplification takes place in receiver components contained in helium vapour at a temperature of the order of 250deg. below zero. In this environment, signals are amplified with the minimum of interference from the background electrical noise inherent in any conducting material, and which is temperature dependent. The transmitting valve is designed to provide peak saturation at 12kW level, although operationally a figure lower than this will normally be employed. Two travelling wave tubes are used, Marconi believe that the travelling wave tube is more reliable than klystrons in this application and it has the advantage of requiring no mechanical tuning.

The t.w.t.s. are connected in series, each stage having a gain of approximately 30dB throughout the entire civil satellite transmission band of

5,925 Mc/s to 6,425Mc/s. These are capable of multiple carrier transmission.

Cross modulation problems arising due to multi-carrier work, have been completely eliminated by maintaining the linearity of the power amplification system. Simple, but effective, auto-level control units are employed by which each radiated carrier is maintained within $\frac{1}{4}$ dB. This is achieved using variable ferrite attenuators in the waveguide feeds.

Radio energy is fed to the dish from the feed point (in the feed once), by the well-known Cassegrain principle, the secondary reflector for which is a 7ft. hyperboloid at approximately 30ft. from the apex of the dish. Radio energy from the satellite follows a reciprocal path to the feed point where a diplexer separates the transmitted and received signals.

Signals from the ground are transferred to one or two carriers which are then multiplied up to their final frequencies in the 6,000 Mc/s frequency band when they are finally amplified through a wideband (500Mc/s) travelling wave tube to approximately 3kW and then fed to the aerial.

Signals for the Hong Kong station from the satellite may be comprised initially of up to eight carriers within a 500Mc/s bandwidth in the 4,000Mc/s frequency band. These signals have a very low power of about -180 dBW or 10 watts and are amplified by high sensitivity, low-noise, cooled parametric amplifiers. Each carrier is then separated and converted down to its original frequency band and those channels destined for the earth station are extracted. They are then recombined in a form suitable for use on the SHF radio link.

The tower is approximately 40ft. high and the overall maximum height of the structure is 82ft. in the zenith position. The aerial has full steerability which means it can follow satellites in any orbit. The axes on which the dish is mounted are in an azimuth/elevation configuration, being driven about each axis by two 5h.p. d.c. electric motors. These are controlled by the servo-system which may in turn be controlled either manually from the station console or automatically by error signals which are a measure of the amount by which the aerial is pointing off target. This is sensed by the rotating tracking system and a special tracking receiver which operates at the beacon frequency originated in the satellite especially for tracking. A facility which can be added later is for the aerial to follow a pre-arranged track derived from a computer. ■

THE simple six

THIS unit is basically a slightly simplified but fully efficient receiver for medium waves only, to which various additions can be made. This allows the receiver to be finished and checked in working order as quickly as possible, and it may be retained or modified later. There are also easy circuit checks which can be made as wiring proceeds.

Figure 1 is the circuit, and since aerial/oscillator-coil alignment is frequently a source of lost sensitivity, a fixed oscillator "trimmer" C4 is employed in conjunction with a variable aerial trimmer VC1. It is only necessary to peak VC1 somewhere throughout its swing for maximum volume. This proves quite useful, since with pre-set trimming exact alignment throughout the whole tuning range is not easily achieved. By having medium-wave coverage only, the difficulties sometimes encountered by the inexperienced, in wiring and aligning a 2-band aerial/oscillator circuit, are avoided.

A single intermediate frequency stage, with double-tuned i.f.t., and followed by a transistor emitter detector, provides enough selectivity and sensitivity for all normal purposes. As this type of detector is not often seen, it should be mentioned that although the OC71 is an audio type transistor its emitter-base junction is satisfactory for detection. Resistor R4 from the positive line, and R5/R7 in series from the detector stage collector, supply the AF117 base, and increase positive bias with strong signals for automatic volume control.

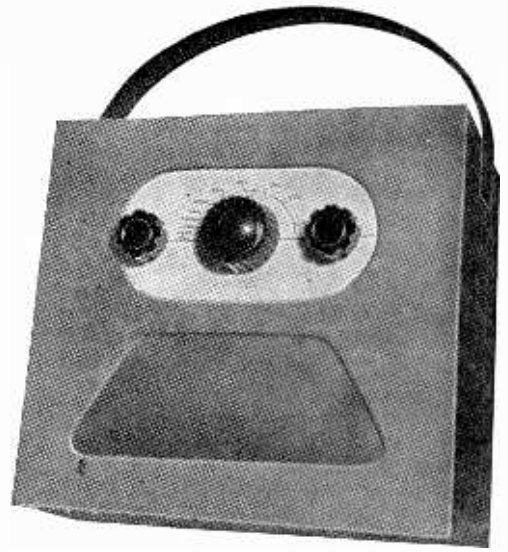

R.F. GRAHAM

The audio amplifier/driver and push-pull output circuit is very straightforward and other audio and output transistors should be satisfactory, if to hand (OC71—2xOC72; OC81D—2xOC81, etc). The values of R14 and R15 may then have to be changed, as explained later.

PANEL CONSTRUCTION

The complete receiver (including speaker) is built on a paxolin panel 5½ in. high and 6 in. wide, with components on the back and wiring on the front. A support allows this panel to stand upright, enabling the receiver to be checked and tested with all connections and components accessible. After-

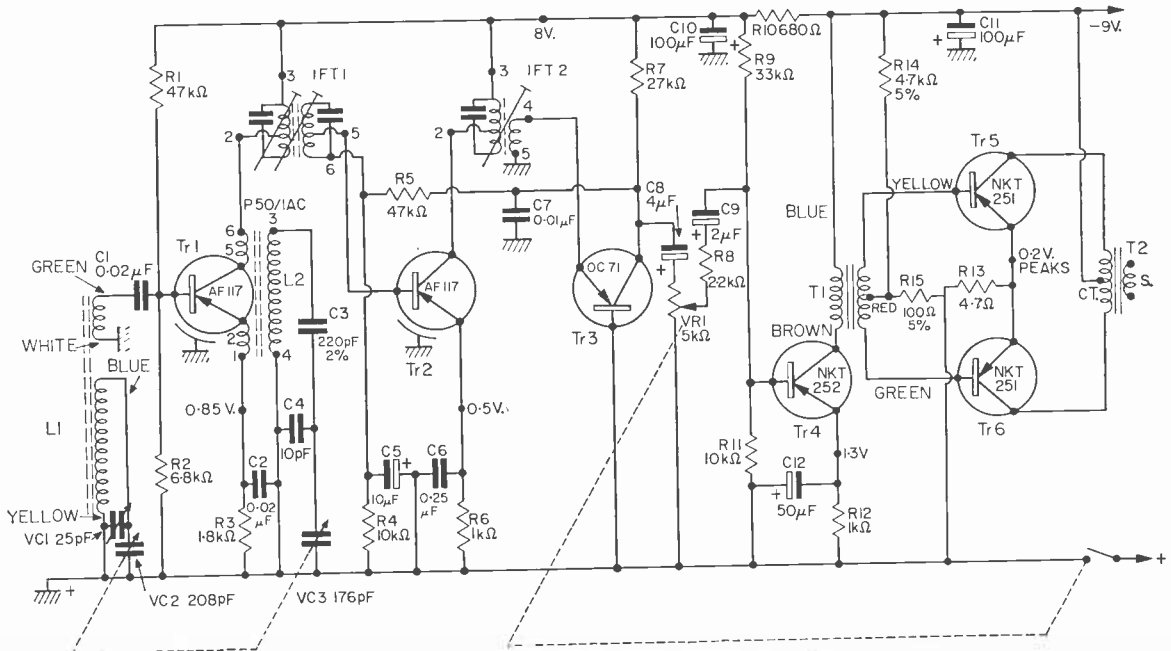

Fig. 1: Basic circuit of the Simple Six m.w. receiver.

wards, it is inserted as a single unit into a cabinet. If a suitable case is to hand, it should be possible to change dimensions to fit. A different speaker would be satisfactory but would probably influence the size of cabinet practical.

Figure 2 is the panel and components seen from behind. The best method is to cut the speaker opening and other large holes first. A number of lines lightly scribed on the paxolin will act as guides for the numerous small holes, which can be made with a $\frac{1}{16}$ in. or slightly larger drill. If one or two of these are missed, they can be made later. Components are put on the panel as wiring proceeds, and after drilling. As resistor values are important, the colour coding can be checked against the components list. Do not bend the wires sharply against the body of a resistor or capacitor.

Drilling positions for the oscillator coil and i.f.t. pins can be located by pushing a small piece of paper against the pins, holding the paper on the paxolin, and marking through with a pointed tool. Afterwards, drill so that these components fit easily.

PREPARING THE TRANSISTORS

Care should be taken that emitter, base and collector leads are correctly connected. The AF117 transistors also have shield leads. It is not easy to see all transistor leads once the transistors are in place. To simplify identification, it is useful to put short pieces of coloured sleeving on some leads enabling each transistor wire to be readily identified. Half-inch lengths of 1mm. red sleeving were put on AF117 and OC71 collector leads, with black sleeving for bases, and yellow for emitters. The audio amplifier transistors have sleeving on base and collector leads only.

FRONT PANEL WIRING

In many places the wire ends of resistors or other parts will reach. Elsewhere, thin tinned-copper or copper wire (about 26s.w.g.) can be used, with insulated sleeving where needed. It is helpful to put red sleeving on the positive or "earth" line connections, and black sleeving on the battery negative circuit wires. If each lead and joint is marked with a coloured pencil as completed, there is little chance of overlooking any connections.

The oscillator coil has a spot between pins 1 and 6, and must be placed as shown. The i.f.t. pins are identified by their positions and spacing. Tags through small holes hold the screening cans, and these tags are connected to the positive or earth line. Pins 1 and 4 of the 1st i.f.t. are not used neither is pin 1 of the 2nd i.f.t.

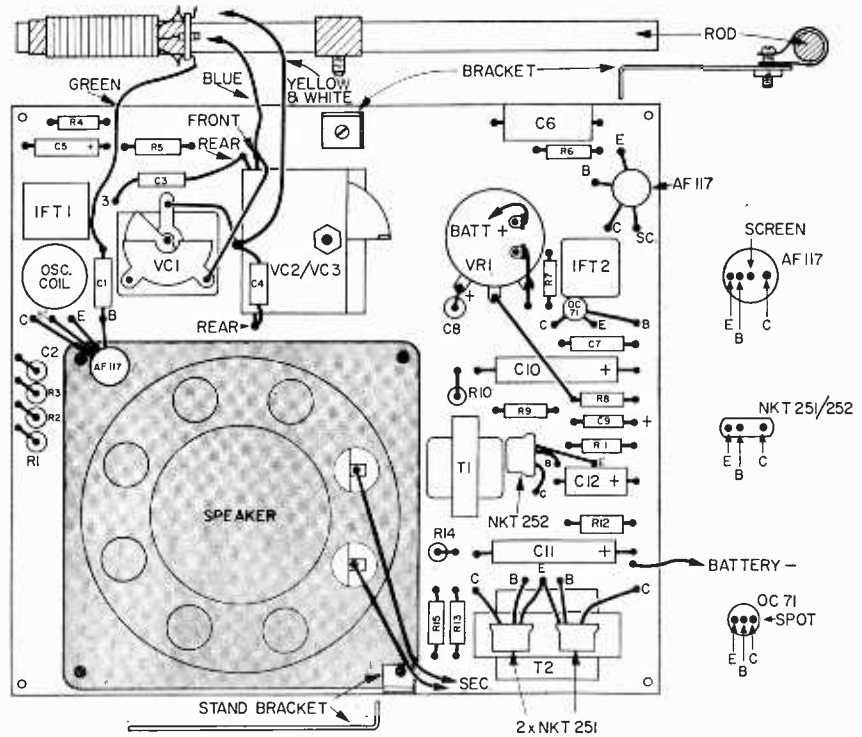

Fig. 2: Layout of components on top of the chassis.

A tag under one 4BA screw earths the frame of the ganged capacitor. A small ball drive could be fixed to a short-spindle capacitor without drive. A 208/176pF capacitor without integral reduction drive gives similar results, but the drive simplifies tuning.

All connections should be soldered rapidly, with a hot, clean iron. Prolonged heating may damage components, especially transistors. Lengths of thin flex are soldered on for battery connections, red for positive and black for negative. The correct type of battery clips should be added. The battery must never exceed 9V and must always be connected with correct polarity.

FERRITE AERIAL

The ferrite aerial is mounted by cutting a piece of aluminium about $\frac{1}{2}$ in. x 2 in. long and bending a $\frac{1}{4}$ in. flange on one end. Drill this and bolt it to the paxolin above the ganged capacitor. The other end is drilled for a bolt which passes also through a loop of insulated material round the ferrite rod. The ferrite winding has coloured markings near its tags, and connections are short pieces of thin flex.

Other medium wave ferrite aerials for 208pF capacitor, should be satisfactory. Some, as made for OC44 and similar transistors, may have slightly too many turns on the base coupling winding. If so, this section is easily modified by removing turns. With the AF117, four or five turns should be satisfactory. The oscillator coil and i.f.t.'s should be as for the transistors shown, components for OC45 and similar transistors being unsuitable.

A quick check of direct current working conditions will usually show that no serious defect is present, such as wrongly connected transistors. A meter placed in series with one battery connection should indicate a current of about 10-12mA with

no signal, or with low volume. With average good volume, current peaks rise to 25mA or more. Using a 10,000 ohms per volt meter, emitter supply point voltages were as in Fig. 1. These can vary slightly without a fault being present, due to individual variation in resistors and transistors but a large difference in voltages indicates a fault. A high voltage shows the transistor concerned is passing excess current, so its base supply circuit and connections need checking. A very low emitter voltage, or absence of voltage, shows little or no emitter current, probably due to a fault in collector or base circuit. Voltages are measured from the "earth" or battery positive line. The i.f. amplifier emitter voltage should fall slightly as a fairly strong signal is tuned in.

ALIGNMENT

Accurately tune in a weak signal, and if necessary adjust the two cores of i.f.t.1, and the single core of i.f.t.2, for best volume. With a stronger signal this corresponds to minimum voltage reading across R6.

In the original model, aerial alignment and coverage was correct with the aerial winding former flush with the end of the ferrite rod. Provided VC1 peaks for maximum volume somewhere throughout its swing (not fully open or fully closed) maximum sensitivity is obtained. Should VC1 need to be progressively closed when tuning to lower frequencies by closing VC2/VC3, push the winding slightly further along the rod, or unscrew the oscillator coil core slightly. Should VC1 need opening slightly for best results when VC2/VC3 is closed, move the winding towards the end of the rod, or screw the oscillator coil core in a little. In this way the need to adjust VC1 throughout the tuning range is reduced.

CABINET DETAILS

The cabinet was made from $\frac{3}{8}$ in. plywood. Edges are sanded, adhesive placed on meeting surfaces and parts held with small panel pins. Afterwards, edges are sanded as needed, dust cleaned off, and the exterior covered with one of the plastic or similar materials used for such purposes. Speaker gauze is glued behind the speaker opening, and the control spindles either project through holes, or have a small sub-panel which comes behind an aperture, as preferred.

A PP9 or other non-midget battery is most suitable. If this goes behind the receiver, as in the original, the cabinet needs to be at least 3½ in. deep inside. Should a cabinet be to hand in which the battery can stand besides the receiver, a depth of 2½ in. is sufficient.

The NKT252 driver transistor normally furnishes

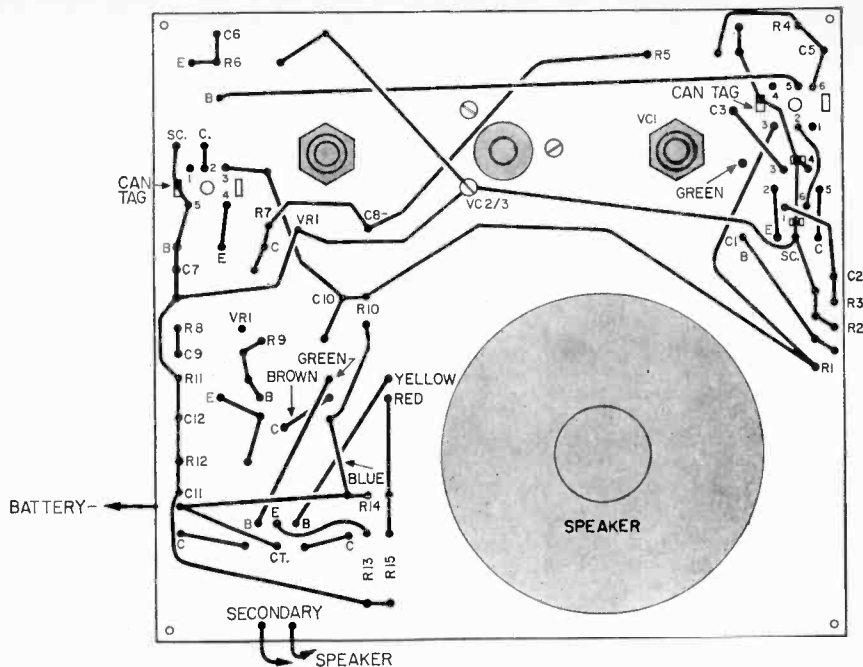

Fig. 3: Wiring beneath chassis of major components.

adequate power for driving headphones. Figure 4 introduces the phones between collector and transformer. This gives excellent results with a medium or high impedance personal phone, or complete headset (the latter is more comfortable for long periods).

If a 50Ω or other quite low impedance personal phone is to hand, this is better in parallel with the transformer primary (brown to blue). The jack should then be of the type which does not short when the plug is removed.

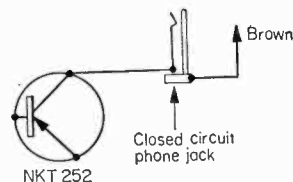

Fig. 4: Adding a phone jack.

If the speaker is to be silenced completely, opening contacts on the jack are needed to interrupt the speaker circuit. Should greater volume be required, it is in order to work phones from the output stage.

An external aerial may be needed when screening and rotation (as in a vehicle) makes the ferrite aerial unsatisfactory, or for longer distance reception. The actual external aerial may be a self-supporting telescopic type screwed to the cabinet, a vehicle aerial or a short wire. Figure 5 shows a satisfactory method of coupling. About 40 turns of

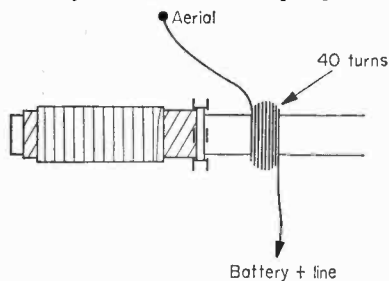

Fig. 5: Adding an extra winding on the ferrite rod aerial enabling an external aerial to be used.

32s.w.g. or other thin insulated wire are wound near the medium-wave coil. One end of this new winding is connected to a socket, terminal, or the telescopic aerial, the other end being connected to the receiver "earth" line.

Coverage around 1,500 metres can be obtained, with good results, by capacitor loading of the aerial and oscillator windings, Fig. 7. This requires a 3-point switch, open for medium waves, and closed for 1,500 metres. A midget switch can be accommodated near the ganged tuning capacitor. With the switch closed, 1,500 metres should be found at about half capacity of VC2/VC3. The 500pF trimmer is then adjusted for best volume. Should full long-wave tuning be required, a dual-wave ferrite aerial is necessary, with switching and capacitor values as shown by its maker.

TONE CONTROL

Small transistor receivers sometimes have a simple two-position tone control with "high" or normal reproduction, and a top-cut optional setting. The latter is sometimes useful also in reducing high-pitched heterodynes. A satisfactory circuit, requiring 0.05µF capacitor, and on/off or two-way switch, is shown in Fig. 6. The capacitor value may be modified to give the "tone" required.

The automatic volume control circuit is quite effective, but cannot reduce overloading in the presence of very strong signals. To overcome this, a

★ components list

Resistors: (all 10% except where marked)

R1 47kΩ	R9 33kΩ
R2 6.8kΩ	R10 680Ω
R3 1.8kΩ	R11 10kΩ
R4 10kΩ	R12 1kΩ
R5 47kΩ	R13 4.7Ω
R6 1kΩ	R14 4.7Ω 5%
R7 27kΩ	R15 100Ω 5%
R8 2.2kΩ	VR1 5kΩ log. pot with switch

Capacitors:

C1 0.02µF	C8 4µF 6V
C2 0.02µF	C9 2µF 6V
C3 220pF 2%	C10 100µF 12V
C4 10pF	C11 100µF 12V
C5 10µF 6V	C12 50µF 6V
C6 0.25µF	VC1 25pF air spaced variable
C7 0.01µF	VC2/3 Jackson 208/176pF

Semiconductors:

Tr1 AF117	} Mullard
Tr2 AF117	
Tr3 OC71	
Tr4 NKT252	} Newmarket
Tr5 NKT251	
Tr6 NKT251	

Inductances:

L1 RA2W	} Weyrad
L2 P50/1AC	
I FT1 IFT18/465	} Denco
I FT2 IFT14/465	
T1 QXD1	} Osmor
T2 QXO2	

Miscellaneous:

Loudspeaker—2/3Ω; paxolin sheet; knobs; wire;
Solder; 9V battery; battery clips, etc.

damping diode is added in some receivers, and can be included as in Fig. 8.

Diode D1 is an OA79 or similar type, and is arranged so that it only conducts with very strong signals, damping the circuit so that gain is reduced. The performance of the circuit is readily checked by disconnecting one end of D1. Results should be as before. When D1 is connected, reception of weak and moderate signals should be as before, but the volume of a strong local station should be much less than originally.

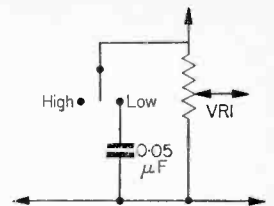

Fig. 6: A suitable tone control switch.

BIAS RESISTORS

Most small audio transistors are suitable in the NKT252 driver position with resistor values shown, but correct push-pull operation of the output stage depends on R14 and R15. A meter placed between the output transformer centre-tap and negative line

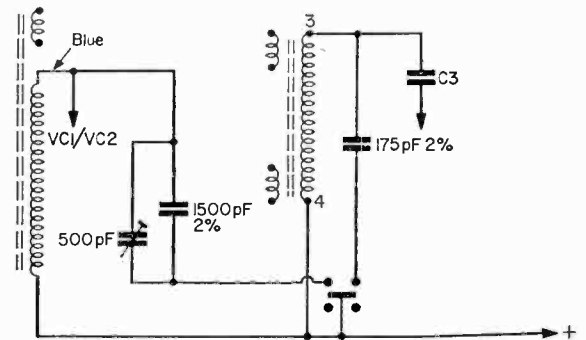
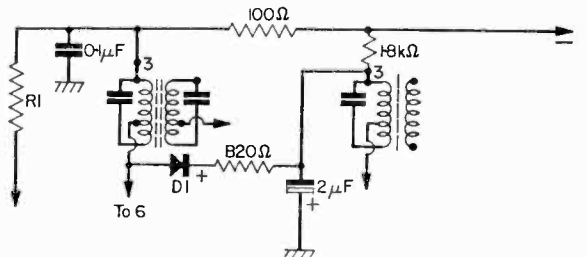

Fig. 7 (above): Modifications for long wave reception.

Fig. 8 (below): Fitting a damping diode to improve a.g.c. action.



should show about 4mA, with no signal. If the output pair bases are too negative, current will be much higher. But if the bases are too positive, current is low and distortion likely, therefore R14 or R15 may be modified, if necessary. Reducing R15 (or increasing R14) reduces collector current. Slightly raising the value of R15 increases current. So in this way most output transistors of somewhat similar type to those listed can be arranged to give satisfactory results.

The above receiver offers an uncomplicated approach to a superhet receiver. It can be constructed in its simplest form, as per Fig. 1, or the various modifications added. Needless to reiterate the necessity of checking all wiring, particularly transistors, diodes and battery polarity before switching on.

repairing radio

★ The first series ran from April–September 1967 and dealt with valve circuits. We now begin the second series, concentrating on transistor equipment. As before, the writing, will be handled by Gordon J. King (basic fault finding) and H. W. Hellyer (servicing procedures, workshop practice, etc). G. J. King sets the ball rolling . . .

WHILE millions of valve radio sets are still in use, almost all domestic electronic equipment now being made contains transistors. Although transistors operate quite differently from valves, their circuits closely resemble those of valve equipment and it is not difficult to identify the various transistor stages if one is conversant with the stages in valve sets.

The major difference between valve and transistor circuits lies in the value of the components connected to the transistor electrodes and conveying the signals to and from the various stages. For example, a coupling capacitor in a valve a.f. amplifier may be about $0.1\mu\text{F}$, while in a comparable transistor stage it would be about $5\mu\text{F}$ —sometimes greater. The main reason for this is that while valves run at relatively high voltage and low current, transistors run at low voltage and relatively high current. To take an example, a valve audio amplifier (output stage) may operate with 300V on its anode and pass, say, 80mA while a similar stage using a large transistor may have about 24V on its collector and pass up to 500mA.

This does not apply on the same scale to small-signal transistors of the kind used as r.f. and i.f. amplifiers and a.f. voltage amplifiers, for on these the collector may run at less than 9V and sometimes in the order of microamperes. Nevertheless, ordinary transistors are generally referred to as *current-operated* devices (the term *device* is common in semiconductor parlance) and valves as *voltage-operated*. To some extent this relates to the input signal, for valves require virtually no input signal current, just a signal voltage from a high impedance circuit, and transistors require the reverse in general. That is, a signal current from a low impedance circuit and little *voltage*.

It is sometimes useful to compare transistors with valves in terms of the device proper. Take a triode valve for instance. We all know that this has an anode, a grid and cathode and that the cathode temperature is raised by a heater. When the cathode is heated electrons are so to speak "boiled off" its surface and, being negative, are attracted to the positive anode, via the grid. The anode, of course, is connected to h.t. positive and the cathode to h.t. negative.

These electrodes operate in the vacuum of the valve envelope and the electrons travel from cathode to anode, through the grid, with very little hindrance from gas molecules. Since a flow of electrons represents a flow of electric current—the conventional flow of current being opposite to electron flow—anode current flows from anode to cathode. The amount of current is governed by the quantity of electrons available at the hot cathode and by the anode voltage. The current rises as the anode voltage is increased up to a point called "saturation", where all the cathode electrons are being absorbed by the anode and where further increases in voltage fail to produce corresponding current increases.

The grid is a mesh through which the electrons can pass, but by making this negative some of the cathode electrons fail to get through it (from the law that negative repels negative) and the anode current is thus reduced. The anode current can, therefore, be varied by adjusting the amount of negative potential on the grid. Most of us know these things anyway, but it is just as well to have them in mind when we look at the transistor, for then we may not be amazed to find only a few volts on the collector of a transistor each time we test in transistor sets!

Figure 1 compares the transistor with the triode valve. The transistor also has three electrodes as shown by its symbol and these are the collector, emitter and base, roughly equivalent to the valve's anode, cathode and grid. This comparison, however, cannot be taken too far, and it is sometimes desirable to look upon the transistor without basing its action on the valve at all. In this series of articles, however, we are graduating as it were from valve circuits to transistor circuits, and will thus adopt the valve/transistor analogy as far as possible.

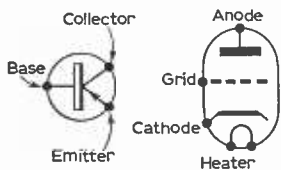
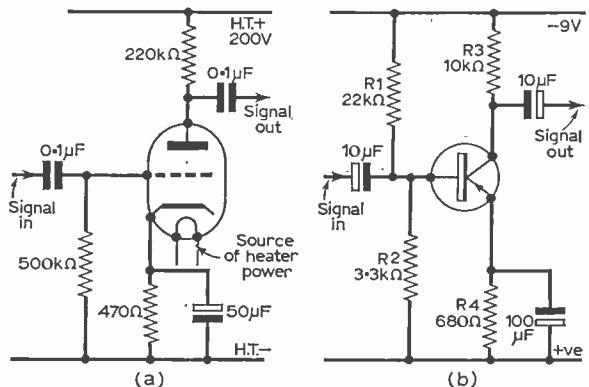
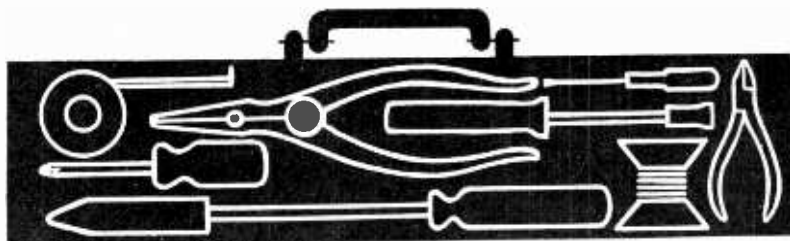

Fig. 1 (left): P-n-p transistor symbol compared with a triode valve.

Fig. 2 (right): P-n-p transistor amplifier (b) compared with triode valve amplifier (a).



sets



EQUIVALENT CIRCUITS

Figure 2 shows at (a) the elementary feeds in circuit to the electrodes of a valve with component values and at (b) the equivalent transistor circuit. These are both a.f. amplifiers, and the difference in component values is highlighted. There are pretty well the same number of components used in both circuits, but the base of the transistor circuit is fed from a potential-divider, R1, R2, from across the power supply. Some transistor stages may have only a single, higher value resistor to the supply line from the base, depending on the nature of the circuit and the type of transistor used. Note that the signal is applied to the transistor base and taken from the collector and that electrolytic coupling capacitors are used instead of the ordinary, non-electrolytic, far lower value couplers in the valve circuit.

While a valve works in a vacuum, a transistor works within a germanium or silicon crystal. The crystal is made "pure" to start with and then controlled impurities are added to give it semiconductor characteristics: it is then neither a pure conductor nor a pure insulator. The transistor is formed of two junctions, called the emitter junction and the collector junction, with the base element being common to both junctions. Various techniques are employed during the manufacture of transistors to diffuse the two junctions into the common base electrode or, in some transistors, to diffuse base and emitter regions into a crystal forming the collector, and the semiconductor characteristics of the three "electrodes" are different. It is not intended in this basically "servicing" series to investigate the deeper principles of transistors. Indeed, this would demand a series of its own. Nevertheless, something must be known about how transistors work to enable us to develop a logical approach to servicing.

CURRENT CARRIERS

Transistors, like valves, use electrons as current carriers, and the number of carriers available depends on the nature and amount of impurity diffused into the pure crystal. In other words, the pure crystal of a transistor can be looked upon as the vacuum of a thermionic valve and the impurities present as the potential source of carriers. Of course, electrical energy must be fed into the device to cause the available carriers to move and constitute a flow of electricity, but energy is not required to create the carriers as it is in a valve where it is used to heat the cathode. This is a major saving in transistor equipment as can well be imagined.

All conductors of electricity contain so-called free or mobile electrons, so there is no point in making

transistors just to get ordinary current conduction. Instead, the design is such that the current carriers can be moved between junctions in a very controlled manner.

At this stage, however, it must be mentioned that transistors are said to have *positive* current carriers in addition to the *negative* ones of the electrons themselves. These positive carriers are called *holes*. They are created in the basic crystal by including an impurity which gives the electrode a *deficiency* of electrons. This makes spaces or holes in the basic structure for electrons to fill. And this is, in fact, what happens. Electrons from another part of the transistor move in and fill the holes in an orderly manner, and the effect is that the holes move in the opposite direction to the movement of the electrons which jump from one hole to the next. It should be noted, however, that there are always fewer electrons than holes in this particular type of semiconductor, called p-type (p standing for *positive* holes).

We shall not be surprised to learn that there is also an n-type semiconductor. This is created by the addition of an impurity to the pure crystal that gives *electrons* for conduction. The number of electrons produced depends on the nature and quantity of the impurity. The n in n-type, of course, stands for *negative*—negative electrons.

P-N AND N-P JUNCTIONS

The transistor drawn in Fig. 2(b) has p-type semiconductor for its collector and emitter and n-type for its base, and for this reason is called a p-n-p transistor. It is symbolised by the arrow on its emitter pointing towards the base. Its complement is the n-p-n transistor having n-type semiconductor for its collector and emitter and p-type for its base. This type is symbolised by the arrow on the emitter pointing *away* from the base, as shown in Fig. 3.

The transistor junctions are thus either p-n or n-p. Now, when two types of semiconductor are brought together as a junction there occurs an initial balance of internal charge, as it were, and a potential barrier forms at the junction which may be broken down by a voltage applied in one polarity across the junction or reinforced when the polarity of the applied voltage is reversed. Thus, one way round current flows easily and the other way it is considerably restricted. This gives the well-known junction rectifier effect.

In practice, the emitter junction is biased for ease

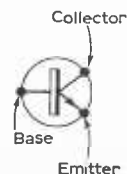

Fig 3:
Symbol of
n-p-n
transistor.

of current flow, called the forward direction, while the collector junction is biased the other way round, called the reverse direction where there is very little or no current flow. Looking at Fig. 2(b), therefore, we see that the base is set by R1, R2 to a potential well below $-9V$, that the collector is connected to the $-9V$ line through the collector load R3 and that the emitter is connected to zero volts (i.e., the positive side of the supply). This means that the collector is negative with respect to base and that the emitter is positive with respect to base. This puts a little forward current in the emitter junction and biases the collector junction the reverse way.

BASE BIAS

The current flowing into the base circuit due to forward current flow in the emitter junction is called the base current, and this current is fundamental to the transistor effect proper. At this stage, however, it must not be assumed that the base current is equal to the emitter current. This is certainly not the case because the emitter current comprises not only the base current but also the collector current when the transistor effect occurs, as we shall see.

We can say, therefore, that the base of a p-n-p transistor is biased negatively with respect to the emitter, and since the emitter is roughly the equivalent of the valve's cathode and has holes (being p-type) to provide conduction it can be considered as injecting holes into the base. Remember, though, that this happens only when the base is biased negatively with respect to the emitter.

The holes diffuse through the base and are then accepted by the collector which, as we have seen, is connected to a negative supply (positive holes being attracted by a negative charge). Thus in spite of the collector junction being connected for reverse conduction to the supply, collector current flows when base current is flowing due to the holes from the emitter. This collector current flows through the collector load R3 in Fig. 2(b) and also through the emitter resistor R4 which, as we have just seen, also passes the base current. The current in R4, then, is equal to the collector current due to the transistor effect plus the base current due to forward current in the emitter junction. It is important that these aspects are perfectly clear.

An n-p-n transistor works in a similar manner, but this time the emitter is n-type and electrons flow from it into the base and are attracted by the collector which, for n-p-n transistors, is connected to supply positive. The base of this kind of transistor is also biased positively (with respect to the emitter) for forward current in the emitter junction to get the transistor effect.

Normal collector current thus flows only when there is base current. When there is no base current there is no ordinary collector current. However, a very sensitive current meter connected in the collector circuit would record a small current which is the reverse current in the collector junction. As the base current is increased, so the collector current rises to a saturation value, as with a valve, and the value of this is determined by the collector voltage and the type of transistor. There is also a limit to the base current that the transistor will handle, above which the emitter junction dissipation is exceeded, eventually destroying the junction and ruining the transistor.

LEAKAGE CURRENT

While the reverse collector junction current is normally very small (a matter of microamperes), as just mentioned, this current can rise and add substantially to the transistor effect collector current with increase in temperature of the junction. This is called *leakage current*, and large transistors limit this current by various counteracting circuit measures and by the use of a transistor *heatsink*, the purpose of which is to drain away the heat developed in the junction by normal electrical power dissipation. By these means leakage current rise is effectively inhibited. Without them, however, the transistor could quickly run into damaging overload because junction heat causes greater power dissipation and more heat and greater than ever power dissipation, more heat and so on . . . Soon the junction power dissipation is seriously exceeded and the junction fuses. This effect is called thermal runaway.

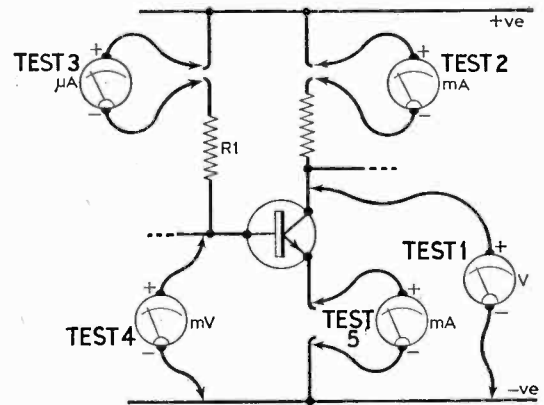

Fig. 4: Tests in a transistor stage. These are fully explained in the text.

We now know sufficient to look at the voltages and currents in a basic transistor circuit. Such is shown in Fig. 4, using an n-p-n transistor for a change. It will be seen that the current measurements are taken by breaking the feeds to the electrodes, and it must be assumed that if these current meters are not connected (when voltages are measured, for instance), the breaks in the circuits where they are introduced are joined across. This is necessary to keep the stage working correctly when the current meters are disconnected, since it is unlikely that the experimenter (or technician, for that matter) would have enough instruments at his disposal to meter the various sections of the circuit simultaneously as in Fig. 4.

BASIC TESTS

Test 1 represents a basic measurement—collector voltage. If the transistor is passing no collector current for some reason or other, then this test would indicate almost the full positive supply voltage. The actual reading is governed by the sensitivity of the voltmeter used for the test and by the value of the collector load resistor, and to avoid bad error due to the meter one with a sensitivity of at least 10,000 ohms/volt should be used, preferably 20,000Ω/V.

When the transistor is taking current a low resistance occurs between the collector and emitter and

★ FAULT FINDING CHART No 1

The fault finding chart presented with this issue is in the form of a family tree diagram of symptoms. Starting at the "root", select the appropriate main fault box then proceed along the "branches" to find the more detailed symptom. At each relevant point will be found one or more Key Numbers.

★ *A second chart will be given away free with the next issue and from this the Key Numbers will be related to particular receiver sections and components likely to have caused the fault.* ★

The two charts together will form a comprehensive guide to logical fault diagnosis and tracing and will be found useful either on their own or used in conjunction with the new series of Repairing Radio Sets.

the collector voltage could be almost zero. The effect is that almost all the supply voltage is developed across the collector load resistor, and the meter is reading effectively across an almost short-circuit. When transistors are used as switches this represents the transistor "on" position, instigated by a fairly large "switch-on" bias applied to the base. Conversely, the "switch-off" condition occurs when there is no base bias or when the base is reverse biased. Collector current, as we have just seen, is then zero and collector voltage maximum.

Test 2 represents the basic measurement of collector current. With the base bias removed there is no ordinary transistor effect and any current read on Test 2 is collector leakage current. Base current in Fig. 4 is applied through the single resistor R1, and the value of this resistor governs the amount of current flowing. A very much lower resistance than R1 is seen looking into the base due to forward conduction of the emitter junction, which means that the base current is closely equal to the current in R1 given by Ohm's law. That is, the voltage at the top of the resistor divided by its value. The current is in μA when the resistance is in megohms. Thus if the voltage is say 10V and the resistance 0.1M Ω the base current is close to 100 μA .

A meter connected as for Test 3 reads base current, but here a very sensitive current meter is needed which will indicate microamperes over a fair deflection of the pointer. Test 2, of course, is in mA (except for leakage current which, we hope, would be in microamperes) and most testmeters will read this sort of current magnitude. Technicians do not generally attempt to read base current direct, but if necessary calculate it by using Ohm's law in conjunction with the base resistor value and the supply voltage, as just explained, but this can be complicated when a base potential-divider as in Fig. 2(b) is adopted.

Test 4, for base voltage, also demands a very sensitive voltmeter, with 100mV full-scale deflection or thereabouts. It is a waste of time to connect a meter with, say, a full-scale deflection of 5V to measure base voltage, since when the correct base current is flowing the base voltage (relative to emitter) is often little more than 50mV, sometimes less than this.

Test 5, giving emitter current, is one of the most popular tests since any ordinary milliammeter can be used and because the emitter is often in the "earthy" side of the circuit so far as signal is con-

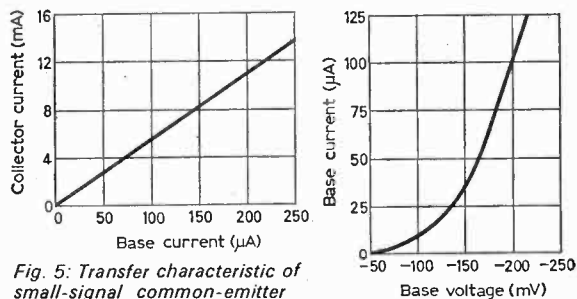

Fig. 5: Transfer characteristic of small-signal common-emitter stage.

Fig. 6: Input characteristic in common-emitter stage (in at base).

cerned. In the circuit of Fig. 4 the emitter current is equal to the collector current plus the base current.

The curve in Fig. 5 is called the *transfer characteristic* when the transistor is connected so that its emitter, as in the circuits so far given (Figs. 2 and 4), is common to both the input and output signals. This is called the *common-emitter* configuration. This shows clearly how the collector current (in mA) rises when the base current (in μA) is increased. The curve in Fig. 6 is called the *input characteristic* with the transistor connected in the same way and shows how the base current rises as the base voltage is increased. Input characteristics are essentially non-linear due to the rectifier action of the emitter junction. In practical circuits the design has to "swamp" this non-linearity to avoid input distortion.

Both of these curves are for small-signal transistors; larger transistors have correspondingly larger currents and voltages.

TRANSISTOR CIRCUIT MODES

As with valves, transistors can be connected differently, giving the common-base and common-collector connections, akin respectively to the valve earthed-grid and cathode-follower circuits. These stages, found in all kinds of transistor equipment, are shown in Fig. 7, (a) the common-base circuit with input to emitter and output from collector, and (b) the common-collector, or emitter-follower circuit as it is sometimes called, with input to base and output from the emitter.

For the sake of variety, circuit (a) is arranged with an n-p-n transistor, requiring a positive collector and base and negative emitter, and circuit (b) with a p-n-p transistor requiring a negative collector and base and positive emitter. Whatever the configuration, the electrode potentials must always suit the type of transistor used in this way.

Now a word or two about these three basic circuits. There are five main characteristics to be considered in each case. These are (i) input impedance, (ii) output impedance, (iii) current gain, (iv) voltage gain and (v) phase shift. In each case there is also a power gain which is the product of the voltage and current gains. The common-emitter has medium input and output impedances, high voltage and current gains (giving a very high power gain) and reverses the phase of the signal between input and output. The common-base has low input impedance, high output impedance, less than unity current gain, high voltage gain (giving a fair power gain) and zero phase reversal. The common-collector has high input impedance, low output impedance, high current gain, less than unity voltage gain (giving a fair power gain) and zero phase reversal.

The configurations are often mixed in commercial circuits to facilitate matching one stage to another with the least reduction in overall gain. Also p-n-p transistors are often mixed with n-p-n types in so-called complementary circuits, especially in audio amplifiers, and to allow direct-coupling (without a capacitor) from one stage to another, having in mind the required supply polarities.

GAIN FACTORS

However, before we look at this kind of coupling, let us see how a transistor provides gain. Since a transistor is basically a current amplifier its basic gain parameter is *current gain*. In the common-emitter configuration this is given by the collector current divided by the base current. From Fig. 5 we see that a collector current of 8mA is achieved when the base current is about 150 μ A. Thus, by dividing 8,000 μ A by 150 μ A we get a current gain factor of a little over 53 times. Here we have considered direct-current, and the gain factor is modified when the base and collector currents are superimposed with a.c. signal, due to impedance and reactive effects coming into play when a.c. signal voltages and currents are applied to the transistor. The signal feed circuits and components to and from the transistor can also influence the a.c. gain. Current gain in the common-emitter mode is often symbolised by alpha dash (α^1) or beta (β).

Current gain in the common-base mode is the

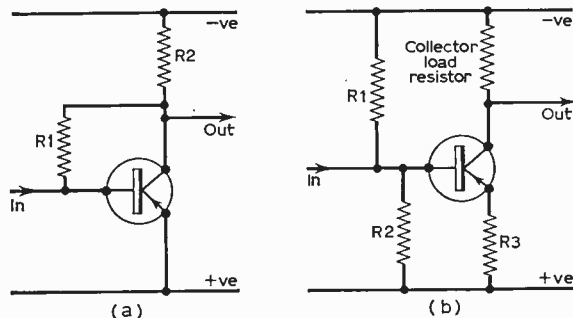

Fig. 8: Two types of d.c. stabilisation.

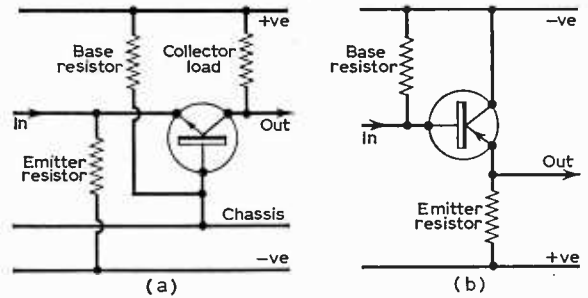

Fig. 7: Common-base stage (a) and common-collector stage (b).

collector current divided by the emitter current. We have seen that the emitter current is greater than the collector current, since it is equal to the collector current *plus* the base current. The common-base current gain, therefore, is less than unity, and is symbolised by plain alpha (α).

Voltage gain is given because the voltage drop across the collector load resistor due to the signal current in the collector is greater than the signal voltage applied to the input of the transistor to obtain the required change in emitter junction current. The collector junction has a relatively high impedance because it is biased for reverse conduction, while the emitter junction has a low impedance because it is biased for forward conduction. This means that the collector load resistor can be much higher than the transistor input impedance, and since the voltage at the collector junction is also higher than that at the emitter junction substantial voltage gains can be yielded by transistor amplifiers. The common-collector circuit, owing to its low output impedance, is the only configuration that has less than unity voltage gain, as we have seen. The power gain is a product of the current and voltage gains, and as one is high even when the other is less than unity, a transistor circuit always yields a power gain. The common-emitter circuit has high voltage and current gains, and thus has the highest power gain of all configurations.

D.C. STABILISATION

Figure 8 shows two techniques used for combating thermal runaway and for bias stabilisation. In (a) an increase in collector current due to leakage current resulting from temperature rise produces an increased voltage drop across the collector load R2. This reduces the voltage at the collector, and since it is from this point that the base bias resistor R1 picks up its potential, the base bias is also reduced, thereby pulling back the collector current. There is a limit to this simple kind of stabilisation, for if the total collector current is pulled down too far by the base current being reduced when collector leakage current rises the transistor would cut off.

Circuit (b) is more efficient and will be found in the majority of receiver stages. Here the base current is set by the potential-divider R1, R2 and to some extent by the collector current flowing through the emitter resistor R3. Should the collector current rise due to leakage current increase the voltage across R3 will also rise and this is reflected at the base as a *fall* in negative bias (remember this is a p-n-p transistor), thereby pulling back the collector current due to the ordinary transistor effect. The same arrangements are also used with n-p-n transistors.

Figure 9 shows how a p-n-p transistor can be directly coupled to an n-p-n transistor. Here the base bias for Tr1 is set by the potential-divider R1, R2, as in the circuit of Fig. 8(b), and the collector of this transistor is loaded, not by a resistor, but by the emitter-base junction of Tr2. Thus Tr2 base current constitutes Tr1 collector current. The output signal is then taken from the collector of Tr2. Both stages are in the common-emitter mode. Complementary stages of this kind are now commonly used in the audio circuits of radio sets and amplifiers.

We have now sufficient information to get to grips with most transistor servicing problems, but first one or two hints and tips.

CURRENT CHECKS WITHOUT TEARS

It is often extremely difficult in miniature transistor equipment to disconnect a resistor or transistor electrode, especially on a flimsy printed circuit board, to connect a current meter. The best plan is to measure the voltage across a resistor in the circuit carrying the current, and then work out the current by Ohm's law, using the value of the resistor in the calculation.

As an illustration, take the set-up in Fig. 10. Here the emitter current can be computed by connecting a voltmeter across the emitter resistor and then dividing the voltage measured by the value of the resistor. To get the answer in milliamperes, the value of the resistor in kilohms (thousands of ohms) should be divided by the voltage. For example, 3V measured across 1.5k would indicate a current of 2mA. Easy! Current in any part of the circuit can be likewise assessed without breaking any wires.

Now a word or two about the testmeter. This, as we have already noted, should have as high a sensitivity as possible—not less than 10,000 ohms/volt if possible. If current is measured by breaking a circuit, then the current meter should not have too great a resistance, for this will be put in circuit and upset the normal operation. A multirange testmeter is ideal, but this should have the lowest possible reading ranges (i.e., full-scale current and voltage); but this, of course, will be related to the meter's sensitivity.

Although transistors are very reliable devices when properly used, they will quickly go faulty if wrongly

THE RHODIAN TAPE RECORDER

—continued from page 908

method is to borrow a tape recorded on a high-quality machine or a pre-recorded tape. The two screws holding the record/playback head should then be adjusted to give an output with the most treble.

For those wishing to have superimpose facilities all that is necessary is a small slide switch which cuts off the erase current and shunts a 100-ohm resistor across the secondary of the oscillator coil. There is just room to mount this on the control panel between the magic-eye and the end of the panel. The wiring for this is shown in Fig. 10.

Cabinet

The cabinet used is very easy to build and provides storage for the mains lead, the microphone, a radio connecting lead and a couple of boxes of tape. In the prototype the long sides have the strength and are made from 12 mm. ($\frac{1}{2}$ in.) plywood, the short

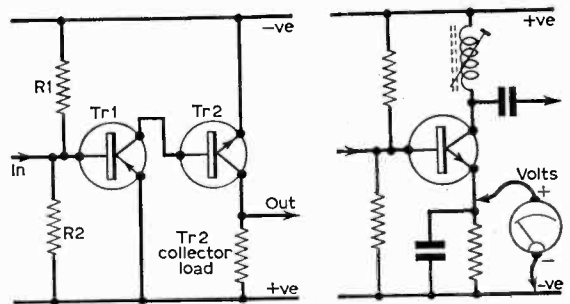

Fig. 9 (left): Direct-coupling between two complementary transistors.

Fig. 10 (right): The current can be assessed by measuring the voltage across a resistor and then dividing this by the value of the resistor (see text).

connected or subjected to voltage and current surges or excessive heat from the soldering iron.

SOME DON'TS

The following "don'ts" given by Mullard are well worth keeping in mind. Don't short-circuit the lead-outs—easy to do accidentally with a screwdriver. Don't solder when the set is switched on: short-circuits and surges can easily occur. Don't use an unearthed soldering iron as the insulation between the element and the bit may break down and the bit become "live". Don't change components when the set is switched on, as surges large enough to destroy transistors can be created. Don't use a soldering iron without a heat-shunt: transistors and associated miniature components can be damaged by excessive heating. Don't connect the battery of a set incorrectly as reverse polarity can permanently affect the characteristics of transistors. Don't make resistance measurements and continuity tests with an ohmmeter giving an output voltage of more than 1.5V. Don't connect transistors the wrong way round in circuit as the characteristics may be permanently altered. Don't bend the lead-outs nearer than 1.5mm. from the seal, otherwise the seal may be damaged. Don't damage the light-proofing, as light can affect the currents inside a transistor.

TO BE CONTINUED

sides and base being made from 6mm. ($\frac{1}{4}$ in.) plywood. The deck rests on two battens which are sunk into the long sides, one of which is drilled out to provide ventilation for the amplifier. With modern resin wood glues only glueing and pinning is necessary for a strong cabinet.

Covering the cabinet is a matter of personal choice—the author used rexine but the contact adhesive plastic sheets are easy to use and give a pleasant appearance. One final touch is to use attractive control knobs and, using a bronze aerosol spray, to cover over the inevitable scratches etc. on the control panel. To discourage tamperers the author never labels controls, but this can be done very neatly by using the press-on sticky letters available from many stationers.

In operation the TD2 deck tends to vibrate a bit and to overcome this noise the author mounted the deck on two strips of expanded rubber between the deck and mounting battens. This reduced considerably the noise of the motor. ■

NEXT MONTH

FREE!

Fault-Finding Chart (PART TWO) for TRANSISTOR RADIOS



Shows you in step-by-step detail how to remedy the faults diagnosed in this month's/Free Chart. You must have both charts for complete how-to-do-it coverage.

Other Outstanding Features

COMPREHENSIVE CHECKER

An economical instrument designed to test both p-n-p and n-p-n transistors for relative beta (current gain) and leakage. Also tests diodes and gives useful voltage, current and resistance measurements.

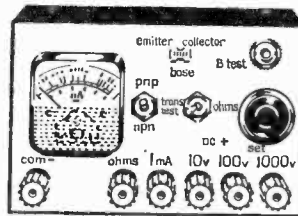

MIDGET I.C. AMPLIFIER

A midget power house for the audio enthusiast. Contains just one integrated circuit capable of giving over 1/2 watt output and gain of around 58dB.

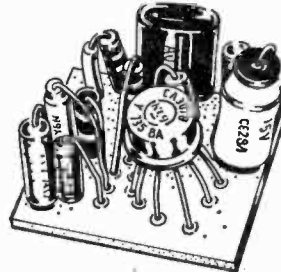

REPAIRING RADIO SETS

A further instalment of the new series of servicing articles.

PRACTICAL WIRELESS

May issue
ON SALE APRIL 5th

MAKE SURE OF YOUR COPY! ORDER NOW!

BARGAIN OPPORTUNITIES FROM



Amplifiers KITS AND READY BUILT

MULLARD STEREO 10-10 BY TRS

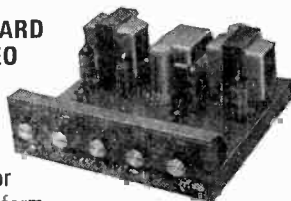

Built or in kit form

Valve amplifier to exact Mullard spec. With pre-amp tapped o/p transformer, 3 and 15Ω, all controls, H.T. and L.T. outlets, mono stereo and speaker phase switching. Complete with escutcheon, knobs, plugs, etc. Ready built (p. & p. 12/6) £20.00
Kit for building above, with instructions. £17.10.0 (p. & p. 12/6)

MULLARD 5-10 MONO

5 valve 10W basic amplifier kit complete. £9.19.6
With passive control network and panel £11.19.6.
2 valve pre-amp kit £8.12.6.

MULLARD 3-3 MONO

3 valve 3W amplifier with controls, absolutely complete kit including panel knobs, etc (p. & p. 7/6). £7.12.6

MULLARD MONO PRE-AMP

Complete kit with 2 valves, front panel, controls, etc. for use with 5-10 or other good power amp. Built and tested. Carriage on either, 5/6. £8.10.0

STEREO 2+2 PRE-AMP

Double 2 valve integrated pre-amp (4 valves in all) for use with TRS MULLARD 10-10. In kit form, with valve, front panel etc. Ready built 13 gns. (P.P. either 10s. 6d.). S.A.E. brings details.

7 VALVE AM/FM RG CHASSIS

A superbly powerful high performance instrument for the keenest enthusiasts. Provides tuning on long, medium and F.M. wavebands. Excellent sensitivity. Permeability tuning on F.M. Large clear dial, A.V.C., good neg. feedback. Magic eye. 3W output. A.C., 200/250V. Circuit diagrams available. Aligned, tested and ready for use. (Carr. and ins. £13.19.6 7/6). S.A.E. brings full details.

SINCLAIR Z.12 SYSTEM

Z.12 Amplifier, ready built and tested. Ideal for battery operation, for guitars, hi-fi, etc. etc. 89/6
As advertised.

STEREO 25 PRE-AMP/CONTROL UNIT

Input selector, tone and volume controls. Ready built with elegant front panel as advertised. £9.19.6 79/6

Z.12's and Stereo 25.

P.Z.4 Stabilised mains power unit. 99/6

ALL SINCLAIR ITEMS AS ADVERTISED

TAPE RECORDER BARGAIN

Fantastic bargain. BSR deck, modern cabinet, mike, spare reel, built-in speaker, wired amp, 4 valves, Record/Playback Controls. Superimpose. Monitoring. Extension Speaker. Conversion to 4 track facilities. Two-tone portable type cabinet 14 x 13½ x 7½ in. Builds into a 24 gn. type recorder. This complete guaranteed TRS kit with absolutely nothing else to buy costs only 15 Gns. (p. & p. 12s. 6d.)

SAVE ON THIS 'PEAK SOUND' 16-WATT STEREO AMPLIFIER

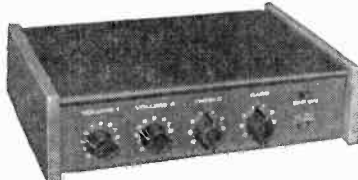

PEAK SOUND SA 8-8

14 Transistor Kit builds into superb hi-fi amp. 8W per channel (16W mono) with integrated pre-amp to take high quality ceramic p.u. Unusually easy to build by following the instructions (1/6d. purchased separately and refunded when kit is bought). This makes one of the best and most economical stereo transistor amps we have ever offered. All purchases backed by T.R.S. service facilities. When built and fitted in its special cabinet, the SA 88 equals the best in modern styling.

AMPLIFIER £9.10.0 POWER PACK £2.10.0
KIT (p.p. 4/-) KIT (p.p. 4/-)
MODERN SLIMLINE £2.10.0 (p.p. 5/-)
WOOD CABINET

COMPLETE ASSEMBLY post free if ordered at same time. £14.10.0

6 VALVE AM/FM TUNER



Med. and V.H.F. 190m-550m., 85 Mc/s.-103 Mc/s. 6 valves and metal rectifier. Self-contained power unit A.C. Magic eye, 3 push-button controls. Diode and high output Sockets. Illuminated 2-colour Persepex dial 1½ in. x 4 in. Recommended for use with the T.R.S. Mullard "3-3" or "5-10" Amplifiers featured here.

Bargain Price. Complete kit of parts, inc. Power Pack as illustrated, 11 Gns. Carr. 7/6. Ditto less Power pack 10 Gns. Carr. 7/6. Circuit and Const. details, 4/6. Free with kit.

TRS DECODER

Kit based on Mullard design. 6 Transistors. Beacon Indicator. All coils pre-checked and aligned. (Carr. & Packing 5 Gns. 2/6)

MICROMATIC AT NEW PRICES

The world's smallest radio now includes magnetic ear-piece and costs less. Kit formerly built formerly 59/6 now 49/6

SINCLAIR MICRO FM

7 Transistor pocket size combined FM Tuner/Receiver. With earpiece and telescopic aerial. Kit £5.19.6

MISCELLANEOUS

VOLUME CONTROLS. LOG and LINEAR We carry very large stocks in the widest possible range of values, single and ganged. 5K-2MΩ. 3in. spindles, Morganite Midget Type ¼ in. diam. 5mar. 1 year LOG or LIN ratios less Sw. 3/6 D.P. Sw. 5/- Twin Stereo less Sw. 7/6. D.P. Sw. 9/6 (100K to 2 Meg. only).

STEREO BALANCE CONTROLS. Log/Anti-Log 5KΩ, ¼, 1, 2 Meg. 9/- each. TYGAN FRET spkr. fabric, 12 x 12 in. 2/-; 12 x 18 in. 3/-; 12 x 24 in. 4/-. etc. BONDACOUST Speaker Cabinet Acoustic Wadding, approx. ¼ in. thick, 18 in. wide, any length cut, 2/3 ft. 6/- yd.

VEROBOARD—All standard sizes including 2½ in. x 5 in. 3/8; 2½ in. x 3½ in. 3/-; 3½ x 5 in. 5/2; 3½ x 3½ in. 3/8; 2½ x 1 7/16. 12/6. All accessories and tools in stock.

RESISTORS—Modern ratings, full range 10 ohms to 10 megohms, 10% ¼ w. 4d. ea. 5% Hi-Stab., ¼ w. 6d. ea. (below 100 ohms and over 1 meg. 9d. ea.). 1% Hi-Stab., ¼ w. 1/8 ea. (below 100 ohms 2/- ea.)

WIREWOUND RESISTORS. 2s. ohms to 10 K. 5 w. 1/8; 10 w. 1/6;

15 w. 2/- CONDENSERS Silver Mica. All values 2pF to 1,000pF. 6d. ea. Ditto ceramics 9d. Tub. 450 v. T.C.C. etc. 401 mFd to 0.1 mFd/350 v. 10d. 0.02mF to 0.1 mFd 500 v. 1/-, 0.25 T.C.C. 1/9. 5 T.C.C. 2/- CLOSE TOL. S/MICAS. 10% 5pF-500pF 8d. 600-5,000pF 1/-, 2pF-100pF 9d. 100pF 9d. 100pF-500 pF 11d. 375pF. 5,000pF. 1/6.
ALUM. CHASSIS. 18 g. Plain un-drilled, folded 4 sides, 2 in. deep. 6 x 4 in. 4/6; 8 x 6 in. 5/9; 10 x 7 in. 8/9; 12 x 6 in. 7/8; 12 x 8 in. 8/- etc.
ALWAYS IN STOCK AT KENNET PRICES. Transistors, Gals. 3 switches Valves, Speakers, Materials. See latest T.R.S. lists. Please send S.A.E. with inquiries.

TRS FM DECODER. Based on Mullard design and produced by T.R.S. Built-in indicator, 6 transistor model, readily adaptable for use with valve as well as transistor tuners for 9-15v. operation. Complete kit with Mullard specified inductors already aligned. £5.5.0 (p. & p. 2/6).

SAVE MORE ON SPEAKERS

To meet demand quicker and enable you to save even more, our task enclosure, as advertised at £4.15.6 is now offered in "Pack Flat" Kit for easy and perfect assembly in your own home. All parts accurately machined with internal mounting board cut to take 8 in. or 10 in. speaker (state which) and Tweeter. Size 21 x 15 x 7½ in. 72/6 (p. & p. 5/-).

Choose your units for the TRS enclosure from this list (all 15Ω):
Goodman's 8 in. Axlette 26. 0.0
Goodman's Twin 8 in. Axlette 26.10.0
Goodman's Axiom 10 27. 5.0
W.B. H.F. 812 24.12.6
W.B. H.F. 1012 25.15.0
At above prices whilst stocks last.
E.M.I. 3 in. Tweeter, 3 or 15Ω 17/6
X-overs from 16/9

GARRARD UNITS & PLINTHS

Brand New, Guaranteed and very attractively priced

Full details in latest TRS List

LM 3000 Record Player with 9T.A. Stereo Cartridge. Brand new as from factory. AT.60 Mk. II De-luxe Auto-changer, die-cast turntable. Less cartridge.

SP.25 De-luxe single record player, die-cast turntable. Less cartridge.

Packing and carriage on any one of the above 7/6 extra.

Garrard Plinth. Ideal mounting for the Garrard Units offered here. Will readily suit any hi-fi set-up. In fine Teak. Complete with useful soft plastic dust cover. Packing and carriage 5/- 75/-

Garrard clear-view rigid Perspex cover (carriage 3/6). 57/6

CARTRIDGE OFFERS

to purchasers of any of the above units or plinths

MONO
TC8/M Crystal 25/-
Acos GP 91-1 19/6

STEREO
Sonotone 9TA/HC with diamond 47/6
DECCA DERAM with diamond stylus 79/6

FREE TAPE WALLET

With each reel of this fine tape we give you a strongly made wallet in simulated leather with space for 2 reels of tape. This is professional quality full frequency tape with metallised leader/stop folds. These wallets ensure proper storage of your tapes.
5 in. reel, 900ft. with wallet 12/6
7 in. reel, 1200ft., with wallet 17/6
P. & p. 1/1 per reel.

TRS MAKE TRANSFORMERS

and choices of all types available singly or in prototype short runs at very competitive prices. Enquiries invited. S.A.E. with private enquiries please.

LATEST TRS LIST

Sending 6d. to TRS brings latest list by return. Packed with bargains and hard to find items to save you money and trouble. 8 large well-printed pages.

WHEN ORDERING

Cash, cheque, postal or money order with order please. Unless stated otherwise add p/p as follows—1 lb. 1/-; 1 lb. 1/8; 2 lbs., 3/8; 6 lbs., 5/2; 10 lbs., 8/8; 14 lbs., 8/-; Over 10/6.

TRS RADIO COMPONENT SPECIALISTS

Established 1946

70 BRIGSTOCK ROAD, THORNTON HEATH, SURREY

Tel.: 01-684 2188. Hours 9 a.m.—6 p.m. 1 p.m. Wednesdays
A few doors from Thornton Heath Stn. (S.R. Victoria section)

Combined AUDIO OSCILLATOR & FREQUENCY METER

PART 3

H.T. KITCHEN

ONCE the two units have been checked for correct operation individually they can be assembled on to the front panel and the rest of the wiring completed when this has been checked, the unit can be considered for alignment.

For this purpose the use of another audio oscillator that is known to be accurate will simplify and speed up the process of calibration, but it is not absolutely essential. The use of an oscilloscope is essential and it must be equipped with a timebase that will not drift over the period of time it will take to calibrate the equipment under discussion. Also required are an a.c. voltmeter capable of reading 1V r.m.s. accurately, and a d.c. voltmeter (20k Ω /volt minimum) capable of reading up to 10V. Preparations for calibration are simple, for the oscillator does not require any warming-up period. It should however be switched on for a few minutes prior to calibration, whilst a generous warming-up period say half an hour, should be allowed for the oscilloscope. VR8 should be set fully anti-clockwise to insert its maximum resistance into circuit whilst VR3 should also be fully anti-clockwise so that C13 is out of circuit. Both output controls should be set for maximum with S3 in the INT position. S4 can then be switched to Monitor Battery and the supply voltage monitored by the d.c. voltmeter set to its 10V range. VR8 should now be rotated until this meter reads 9V and the scale reading on the equipments meter noted.

S4 is then rotated to Monitor Output and the a.c. voltmeter and oscilloscope are connected to the output. VR3 is then slowly increased until the a.c. voltmeter reads 1V precisely, at which point the reading on the equipments meter should be noted. On the prototype R18 was selected so that the meter read mid scale, which of course corresponded to half the full scale reading. It would no doubt be possible to calibrate the meter specially so that it indicated a wide range of output voltages and in some cases this might prove useful.

FREQUENCY CALIBRATION

Having calibrated the supply and output voltages, attention can now be turned to frequency calibrations. The oscilloscope must of course possess means of connecting the 50c/s mains, at a suitable amplitude, to the timebase amplifier or X plates in order to make use of Lissajous' figures for comparing the mains frequency against the unknown frequency from the oscillator which is set to range 1 (20c/s to 200c/s) and fed into the oscilloscope's vertical or Y input.

VR1 is then rotated until the oscilloscope displays a full circle which means that the oscillator frequency

is equal to the mains frequency of 50c/s. Rotating anti-clockwise should display Lissajous' figures corresponding to 25c/s but it is doubtful if the next "full" figure corresponding to 16 $\frac{2}{3}$ c/s will be obtained. VR1 should now be rotated clockwise and Lissajous' figures obtained at 100c/s, 150c/s and 200c/s. When the 200c/s point is found VR4 should be rotated until the meter reads full scale. The scale linearity can now be checked by reducing the frequency and checking if the meter and oscilloscope agree at the 150c/s, 100c/s, 50c/s and 25c/s points.

It is possible that due to component tolerances the 200c/s point may not be reached at the clockwise position of VR1 or the 25c/s position at the anti-clockwise position. If 200c/s cannot be reached it indicates that the two 1 μ F capacitors C1 C5 are high in value and alternative components will have to be tried until 200c/s can be obtained. The effect of reducing R3 in value or removing it from circuit altogether could be tried but as this will affect all four ranges, it should be left until the remaining ranges have been checked for bandwidth. Should the clockwise position of VR1 cause the oscillator frequency to exceed 200c/s by any great extent it will be found that the low frequency end will not tune as low as 20c/s. This is due to C1 C5 being low in capacity and the effect of bridging them with other capacitors could be tried until it is possible to tune the desired bandwidth.

Range 2, 200c/s to 2kc/s, is next to be calibrated and in order to do so the 200c/s point should be located on range 1. The 50c/s feed to the oscilloscope's horizontal section should now be removed the oscilloscope restored to normal working order. Using the very minimum of sync or no sync at all, the coarse and fine timebase controls are adjusted to display exactly one full cycle on the c.r.t. at which point both the timebase oscillator and the audio oscillator are working at the same frequency. Without altering the oscilloscope's controls, the

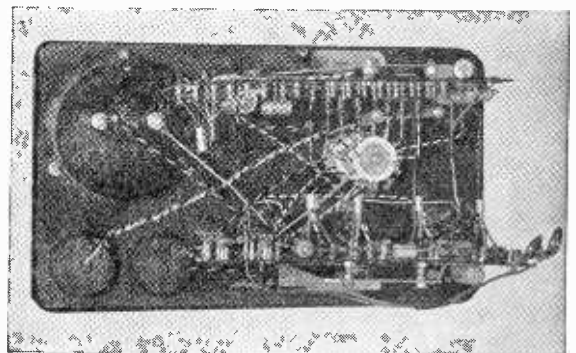

Internal view of the completed instrument.

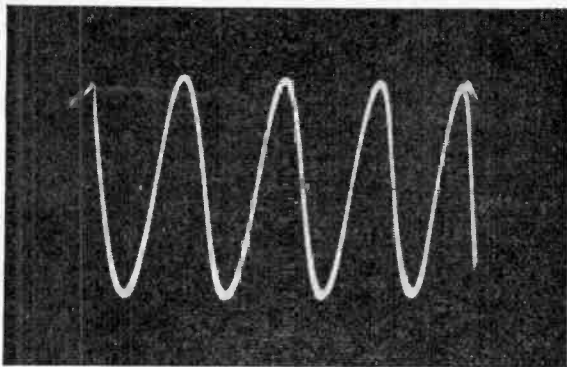

Input waveform of 1V r.m.s. 10 kc/s to Tr5 base.

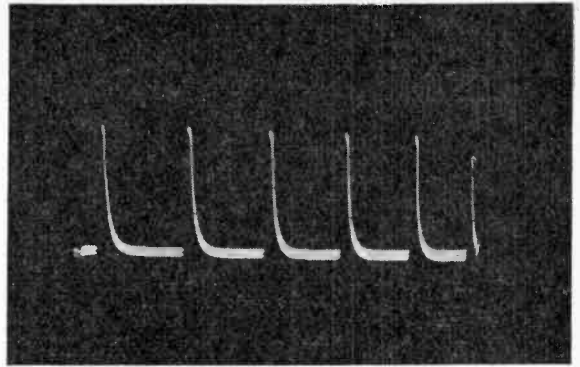

Across the meter (M1) terminals (oscilloscope y-attenuator was adjusted to equalise amplitude of all waveforms displayed).

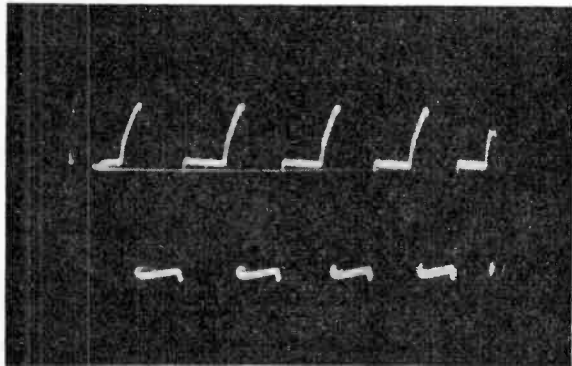

Signal as it appears at Tr7 base.

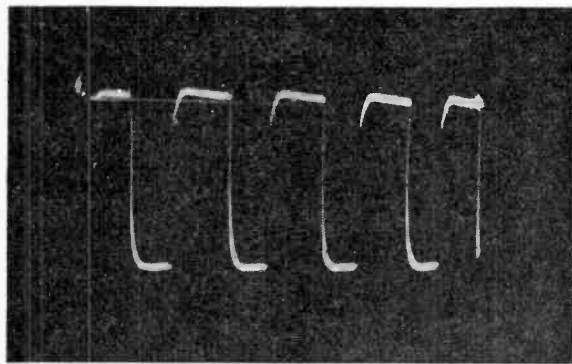

At the collector of Tr8.

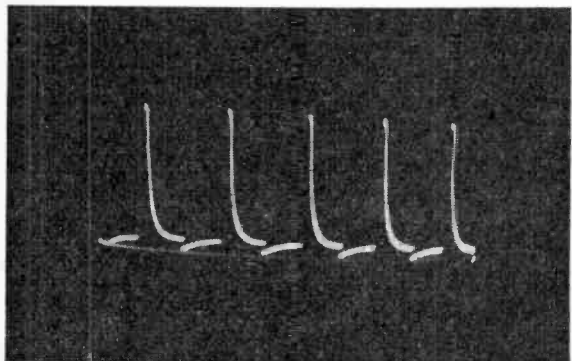

The same signal at the junction of D5/D6.

oscillator is now switched to range 2 and VR1 is rotated anti-clockwise until the oscilloscope again displays one full cycle, showing that the 200c/s point of range 2 (this should be towards the extreme anti-clockwise travel of VR1) has been reached. VR1 is now rotated clockwise again until the oscilloscope displays full cycles, 3, 4, 5 and up to a maximum of 10 full cycles. The oscillator frequency is equal to the timebase frequency of 200c/s multiplied by the number of cycles displayed. Thus 3 cycles corresponds to an oscillator frequency of 600c/s, and so on, up to the 10 cycles displayed which correspond to an oscillator frequency of 2kc/s, at which point VR5 is adjusted to make the meter read full scale.

Range 3 is calibrated in the same fashion by making the oscilloscope display one full cycle at the top (2kc/s) end of range 2, switching to range 3 and locating the bottom end frequency of 2kc/s. VR1 is then rotated to display 2, 3, 4—10 cycles to find the top limit of 20kc/s at which point VR6 is adjusted to make the meter read full scale.

Range 4 is calibrated in exactly the same manner and VR7 is adjusted to make the meter read full scale.

Although this method of calibrating an audio oscillator does not appear to be well known, it does possess the merit of simplicity and requires nothing more elaborate than an oscilloscope and the 50c/s mains. It is also capable, given an oscilloscope with a stable timebase and of course methodical working, of surprisingly accurate results.

During frequency calibration, minimum sync should be used to prevent the timebase being "pulled" into step with the signal from the audio oscillator. Whilst errors so caused might cancel out if the frequency "pulled" the timebase a different way each time it is also quite possible that it would be pulled the same way every time. Such errors would be additive, resulting in an unacceptably large error by the time the 200kc/s point was calibrated.

Should the frequency coverage of any range fall outside the desired bandwidth corrective measures will prove necessary. If the bandwidth is above the required limits it will be necessary to increase the capacity of whichever pair of capacitors out of C1 to C8 is concerned. Should the bandwidth fall below the desired limits the capacity of the affected pair is too high and will require reducing until the desired limits are reached. ■

LETTERS...

They're certainly not incompetent

With reference to Mr. M. Fisher's letter (P.W. January) in which, as a part-time commercial operator, he objects, maybe correctly, to the term "button pusher". But he then goes on to cast doubt upon the competency of Amateurs to work a net. I wonder if he has ever listened to the Radio Amateurs' Emergency Network when holding an exercise or during a real emergency. If any mistakes are made there then a life may be at stake. He might also try listening to the nets on 80m. sometime, most of which are conducted in a very orderly fashion. The fact that he complains of the poor amateurs in his district suggests that he should buy a more sensitive receiver and listen to those in other districts.

O.K. then Mr. Fisher, maybe we shouldn't call you "button pushers" but please don't call Amateurs incompetent, many of whom may hold technical qualifications far above you or me.—**P. R. Bennett, ORS29462 (R.A.F. Gatow, BFPO45).**

Quick P.C.'s

May I offer the suggestion that constructors can produce a circuit board quickly from copper laminate board by cutting through the copper with a sharp knife and peeling away the unrequired copper. This method is very quick and changes can easily be made during construction. An alternative method which I also use is to saw the copper only into a series of small squares and then join these together as required. — **H. R. Vaughan-Williams, B.Sc. (Cardiff).**

5W Amplifier mods

By inserting a 390Ω resistor in series with the 100Ω preset pot., the bias between the bases of Tr2 and Tr3 is increased, giving correct currents and no crossover distortion. The best answer would probably be to use a preset of about 1kΩ, which would better accommodate different supply voltages.—**W. Wright (East Lothian, Scotland).**

They're all E.A.R.S.

On behalf of the Exeter Amateur Radio Society I am writing to request a small space in your most excellent journal to show that Exeter still has a thriving club, and there must be many of your readers who would like to know of our existence.

The A.G.M. was recently held and new officers were elected to the committee. New ideas will be developed, interesting talks and demonstrations are being arranged, and a new drive for increased membership is being made.

Meetings are held on the first Tuesday in each month at the George and Dragon (hall at rear), Blackboy Road, Exeter, commencing at 1930 hrs (7.30 p.m.) and a hearty welcome is extended to Transmitting and Short Wave Listeners, Junior and Senior, in fact to all interested in Amateur Radio.—**Gordon Wheatcroft, G3HMY, Hon. Sec. (27 Lower Wear Road, Countess Wear, Exeter, Devon).**

Comment on "Questions Answered"

Could I be allowed to comment on the item "Tape Recorder Whistle" in "Your Questions Answered" column? (February P.W.).

Having built a recorder a few years ago everything went well until the double-triode oscillator valve went low. A new valve was obtained and plugged in and Hey presto! The finest whistle you ever did hear!

A bias trap was the answer; an 800pF preset in parallel with a coil wound on a ferrite pot core. This combination was connected in series with the lead from feed resistor to the recording head.

It took many hours to find the correct number of turns to tune the circuit to the oscillator frequency as even a few turns makes all the difference. However it certainly stopped the bias getting into the amplifier and cured the whistle.

The preset was adjusted to give nil voltage at the junction of the feed resistor and bias trap to earth on the a.c. range of a normal multimeter. — **K. A. Le Lievre (Southampton).**

Word of praise

I greatly appreciate the F.M. Switched Tuner, by Mr. W. Groome, with its cheap and easily obtained parts.

However, I now find, to be on the ball, that it is necessary to tune to a.m. on the long wave.

May I beg of you to get Mr. Groome to arrange for his tuner to switch the four programmes, for, to be perfectly honest, I have no desire to improvise on the work of such a competent man.

As a reader of all your electronic publications for over 40 years, I am delighted to note the more professional background of articles. I would, however, love to see more technical data included with circuits, also voltages for servicing at a later date.—**Ivor Dee (London, S.E.12).**

A winner

"World Radio Club", the programme for radio amateurs and DXers in the BBC World Service for overseas listeners offered an annual subscription from a selection of British magazines on radio communication, as prizes in their latest competition. The competition called for geographical information on the beam from London to Melbourne. Two of the prizewinners selected PRACTICAL WIRELESS as their choice of prize; one from South Australia, and one from Germany.—**John G. Pitman, Producer "World Radio Club". (B.B.C., London, W.C.2).**

Local club offers help

We like the sentiments expressed by D. J. Tivey in his letter to you published in your December issue. Our commiserations are due to a keen enthusiast who has struggled with the Morse code for nine years. May his local Society offer him some help? In addition to our R.S.G.B. Slow Morse transmissions, five periods per week, we can put morse on tape to suit the individual and also give him personal tuition.

One of the many benefits of membership of our Society is the receipt of our monthly newsletter.—**M. Clift, G3UNV (Ashford, Middlesex).**

THE 'CLUBMAN'

J. THORNTON-LAWRENCE GW3JGA

continued from the March issue

THE Clubman Mk III is a further development of the Mk II version, previously described, and includes an r.f. amplifier stage employing Field Effect Transistors. The circuit is shown in Fig. 26. The r.f. amplifier stage has several important functions to perform, these may be summarised as follows:

- 1—Increase sensitivity.
- 2—Increase signal to noise ratio.
- 3—Increase second channel rejection.
- 4—Reduce cross-modulation.
- 5—Provide variable gain.
- 6—Be suitable for operation with a direction finding aerial.

The addition of a conventional transistor r.f. amplifier stage will provide 1, 2 and 3, but is unsuitable when used as a variable gain amplifier, due to the large amount of cross-modulation caused by the transistor in the presence of adjacent strong signals. The use of a d.f. aerial would be complicated by the necessity of providing a base coupling winding.

An r.f. amplifier stage which satisfies all the above requirements is formed by using two F.E.T.'s in a cascode circuit. The F.E.T. provides adequate gain

and has a lower noise figure than a conventional transistor, it has excellent cross-modulation characteristics with variable gain, and the circuit has the high input impedance required to suit a d.f. aerial.

To those who are familiar with television receiver tuners, the circuit has many similarities with the conventional valve cascode circuit using a double triode, where one section is used in an earthed cathode configuration and the other in earthed grid. The source, gate and drain of the F.E.T. may be considered to be equivalent to the cathode, grid and anode of the valve.

The prices of F.E.T.'s have fallen dramatically in the last year and the types chosen for the r.f. stage are Motorola type MPF102.

The MPF102 is an N-channel type and is operated with the drain positive with respect to the source and the gate biased negatively.

Circuit Description

The circuit has been drawn the correct way up to convey the method of circuit operation as an r.f. amplifier, but it will be noted that it is upside down for the d.c. conditions, in that Tr7 drain goes to chassis through L7 and that Tr8 gate is returned to -9 volts via R25, and Tr8 source to -9 volts via the r.f. gain control, VR1. R.F. signals are passed through the aerial coupling coil L1 to the input tuned circuit, L2 and VC4. L3 is not used.

Signals appearing across L2 are passed to Tr8 gate via C22. Tr8 source is earthed to r.f. by C24. Resultant signal currents in Tr8 drain are passed directly to Tr7 source. Tr7 gate is earthed to r.f. by C23. Signal currents appearing in Tr7 drain are passed through the coupling coil L7 to the tuned winding L8 and to the frequency changer base coupling winding, L9.

D.C. biasing for Tr8 is provided by the voltage drop across R28 in the source. Tr8 gate is taken to -9 volts by R25 and the gate bias is varied by VR1, the r.f. gain control. An increase of gate bias voltage causes the current through Tr8 and Tr7 to decrease, and as the mutual conductance of the F.E.T. is dependent on source current, a reduction of the gain of the

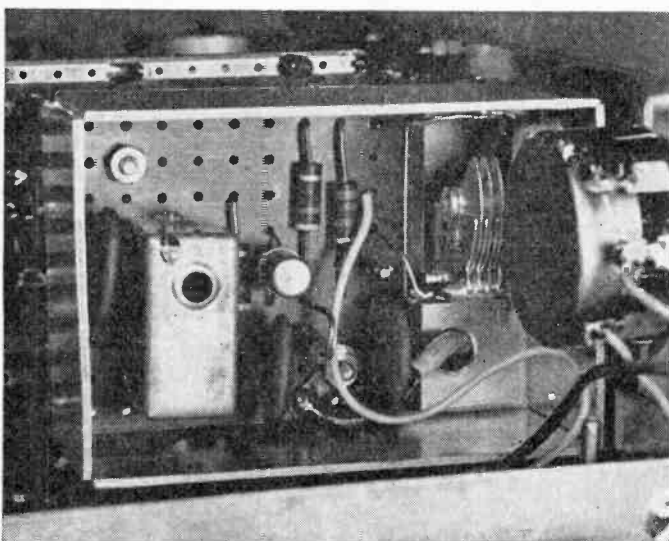

View of the b.f.o. section, described last month.

stage is effected.

Due to the wide variation in the characteristics of F.E.T.'s of the same make and type, a pre-set control, VR3, is included in series with VR1 to enable the bias voltage produced by the r.f. gain control to be set so as to cut off Tr8 completely at the minimum position. Biasing for Tr7 gate is provided by the potential divider R26 and R27.

Construction

The aerial coil L1, 2 and 3, is installed in the position shown in Fig. 29, using a B9A valveholder and the screening can is fitted by the method suggested by Denco in their coil leaflet.

The tuning capacitor VC4 is mounted on bracket B and installed in the position shown. A spindle coupler enables an extension spindle to pass through the front panel to form the "Peak AE" Control. The wiring of the r.f. amplifier stage, as shown in Fig. 27, is accomplished by using two 4-way tagstrips cut from Radiospares mounting (tag) strips (28-way) and by using three unused tags (2, 3 and 4) on the aerial coil "valveholder". The r.f. coil L7, 8 and 9, is plugged into the holder previously occupied by the aerial coil.

It is recommended that the interconnecting wiring be done first, including the connections to VR1, as shown in Fig. 28. The capacitors and resistors may be fitted next and finally the F.E.T.'s. F.E.T.'s are easily damaged by the capacitive voltage existing on some soldering irons and so it is important that the soldering iron is earthed and that a heat shunt is used when soldering. The receiver chassis should not be connected to any other equipment when soldering in the F.E.T.'s.

Testing and Alignment

To repeat the usual warning, double check all connections before switching on, particularly to the F.E.T.'s.

With the aerial coil moved to its new position and the new r.f. coil inserted in its place, it is now necessary to realign the frequency changer stage in the manner described for the Mk II receiver, but substituting L8 for L3 in the alignment instructions. The signal generator should be connected across L7 for this operation.

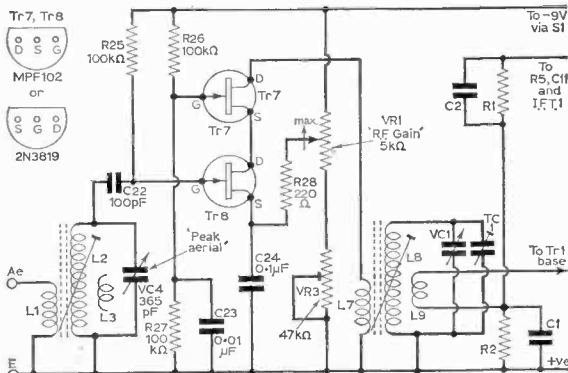

Fig. 26: Circuit of the F.E.T. r.f. stage, Mk III Clubman.

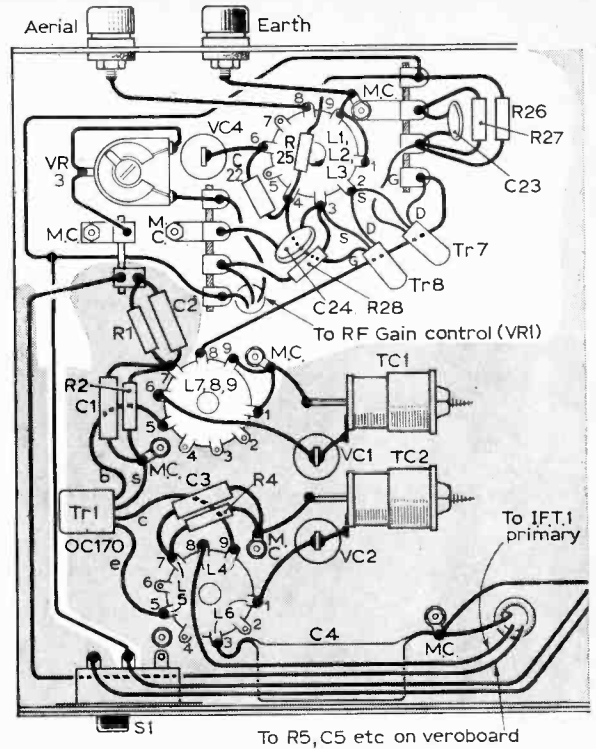

Fig. 27: Wiring diagram of the r.f. stage. The additional wiring and components are shown unshaded.

★ components list

Note: All components listed for the Mk II receiver are required for the Mk III receiver, the additional items required are listed below.

Resistors:

(Carbon $\frac{1}{4}$ watt, 10%)

R25	100k Ω	R27	100k Ω
R26	100k Ω	R28	220 Ω

Potentiometers:

VR3 47k Ω miniature pre-set

Capacitors:

C22	100pF ceramic
C23	0.01 μ F 20V
C24	0.1 μ F 20V

} disc ceramic

Variable Capacitors:

VC4 365pF single gang, type 01. Jackson Bros.

Semiconductors:

Tr7 MPF102* Tr8 MPF102*

Coil:

L7, 8 and 9 r.f. coil. 3T Yellow. Denco

Miscellaneous:

B9A valveholder, tagstrip, spindle coupler, spindle, knob, etc.

* Alternative type for the Motorola MPF102, is the Texas, 2N3819.

PEAK-SOUND 8+8W. TRANSISTOR STEREO AMPLIFIER IN KIT FORM

Build this for £9.10.0 (4/6 post). Power Pack Kit £2.10.0 (4/- post). Cabinet (see illustration) 50/- post paid or £14.10.0 the three items post paid. Parts List Booklet and full details 1/6 (free with kit). A.E.I. Circuit of 14 Transistors; 8W per Channel into 8 to 15 ohm Speaker. 50mV input. Ceramic. Crystal Cartridge. Radio Tuner or Output from Tape Recorder may be used. 20 to 20,000 Hz \pm 3dB. Neg. Feed Back 13dB. 12in. \times 3in. high \times 3in. Cabinet. Cir-Kit Board Construction Bass, Treble and Vol. Controls, for A.C. mains of 200-250V. Bass Cut and Lift; Treble Cut and Lift. Fully built £3 extra. Delivery by return post.

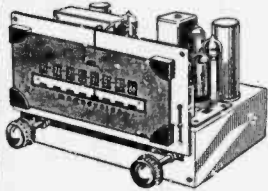
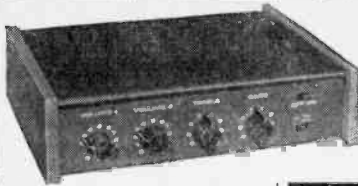

VHF/FM TUNER. 88-102MHz. Self-powered. Valves ECC85, EF89, 6BW7, ECC82, two diodes and metal rect. 8 \times 6 \times 5 1/2 in. high. Full instruction book, circuit diagrams, etc. 2/6; free with chassis. With front panel and brackets £7.19.8 tax paid and carr. paid. Can be supplied built for £8.17.6.

2 \times 4 WATT STEREO AMPLIFIER. Printed circuit. Separate power pack. Metal rectifier. ECC83 and 2-EL84. Negative feedback. Vol., base, treble each channel. Muting switch and on/off. £5.10.0 (7/6 P. & P.).

STEREO AMPLIFIER 2 \times 3 watt
200-250v. A.C. Mains. EZ80 and 2 \times ECL86. Vol., Tone, Balance controls. With o.p. Trans for 3 ohms. 9 \times 3 1/2 in. (plus trans. 2in. extra) \times 3 1/2 in. high. £6.17.6 (P. & P. 7/6 extra).
Three tone grey record player cabinet (by well known manufacturer) taking above amplifier, complete with two 6 1/2 in. speakers (one speaker in removable lid). Size 17 1/2 \times 15 1/2 \times 7 1/2 in. high. Takes Garrard 1000, 2000, 3000 autochangers. £4.17.6 (plus 7/6 carr.).
Complete Stereo Record Player using above equipment 18gms. carriage paid.



8 WATT, PUSH-PULL OUTPUT AMPLIFIER. 200-250 Volts A.C. EZ80, ECC83, 2-EL84. Bass, treble, vol/on/off. £5.15.0 (7/6 P. & P.). Size 12 \times 3 1/2 \times 5 1/2 in. high.

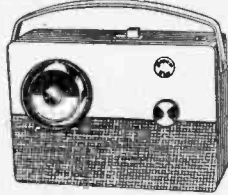

6 TRANSISTOR "SUPER SIX". M.W. and L.W. kit, £4 (5/- P. & P.). Wooden cabinet 11 \times 7 1/2 \times 3 1/2 in. All parts may be purchased separately.
3 1/2 in. 10,000 line speaker, or 7 \times 4 in. 6000 line.

TAPE AMPLIFIER FOR MAGNAVOX TAPE DECKS — 2 or 4 TRACK

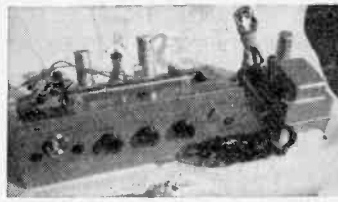

Chassis 12 1/2 \times 5 1/2 \times 4 1/2 in. high. Plastic front panel "gold" finish—12 1/2 \times 4 1/2 in. 200-250 A.C. Record/Playback amp. switch: On/On-Tone; Vol./Mc.; Vol./Gram.; Mic. Input; Gram. Input; Monitor; Speaker Socket. Valves 6BR7; 12AX7; EM84; EL84; 6X4. Separate power pack. Complete amp. and power pack, £8.17.6. (6/- P. & P.). Resine covered cabinet (tan) 15 1/2 \times 17 \times 9 1/2 in. high with sloping front for amp., complete with two tweeter speakers, and special adapting brackets for Magnavox Deck 85/- (6/- carr.) 3 speed Magnavox 2-track tape deck £10.17.6; 4-track £12.15.0. Complete Recorders (with speed compensation) 2-track £29; 4-track £32 (carr. 25/-). Worth £10 more on normal retail prices.

6 PUSH-BUTTON STEREOGRAM CHASSIS

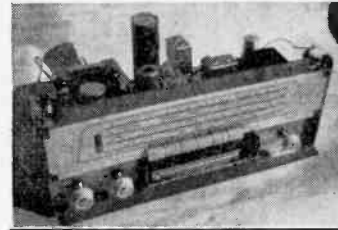

M.W.; S.W.1; S.W.2; V.H.F.; Gram; Stereo Gram. Two separate channels for Stereogram with balance control. Also operates with two speakers on Radio. Chassis size: 13 \times 7 \times 6 1/2 in. high. Dial silver and black 15 \times 3 in. 190-550M; 18-51M; 60-187M; VHF 86-100 Mc/a. Valves: ECC85, ECH81, EF89, 2 \times ECL86, EM84 and Rect. Price £19.19.0, carr. paid or £8.13.0 deposit and 5 monthly payments of 56/6. Total H.P. price £20.15.6. Cream moulded escutcheon included.

GLADSTONE RADIO

66 ELMS ROAD, ALDERSHOT, Hants.
(2 mins. from Station and Buses). FULL GUARANTEE Aldershot 22240
CLOSED WEDNESDAY AFTERNOON CATALOGUE 6d.



Now available 1968 Data Book

136 pages of data, including for the first time, colour-coded sections for quick reference—covering comparables and equivalents and all current Mullard semiconductors, valves, tubes and components for Radio, TV, Audio and HiFi applications.

PRICE 3/6 from your local TV retailer OR direct from Mullard—cash with order, plus 9d for p. and p.

Mullard Mullard Limited, Distributor Sales Division,
Mullard House, Torrington Place, London, W.C.1.

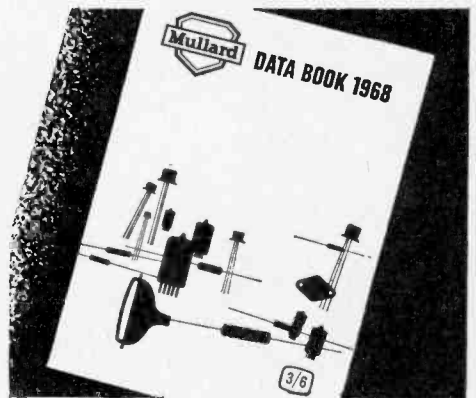

CED 53

SHORT WAVE ONE VALVE RECEIVER KIT 39/6 + 2/6 P.P.
PEAC ANALOGUE COMPUTER KIT IN STOCK
CLUBMAN Mk. I KIT COMPLETE £6.17.6 + 5/- P.P.
Without metal work £4.12.6 + 2/6 P.P.
CLUBMAN Mk. II KIT COMPLETE £10.17.6 + 5/- P.P.
Without metal work £8.12.6 + 4/6 P.P.
EXPLORER KIT COMPLETE £4. 2.6 + 2/6 P.P.
STABILIZED POWER SUPPLY KIT 0-20V.
500mA COMPLETE £4.17.6 + 5/- P.P.
RHODIAN TAPE RECORDER KIT
PORTABLE TEST UNIT KIT
AUDIO OSCILLATOR FREQUENCY METER KIT IN STOCK,
S.A.E. FOR DETAILS

S.A.E. FOR TRANSISTORS, SEMI-CONDUCTORS, FULL LIST, 700 TYPES
3 SILICON RECTIFIERS, BY100 TYPE 10/-
10 MIXED MARKED TESTED TRANSISTORS 10/-
40 UNMARKED UNTESTED TRANSISTORS NEW 10/-
1 LIGHT SENSITIVE CELL ORP12 8/6
25 MIXED UNMARKED TESTED TRANSISTORS 10/-
2 TRANSISTOR COMP. PAIR AD161/162 16/-
P.P. 1/-

OUR COMPONENTS CATALOGUE 5/- Post Paid with 10/- worth of discount vouchers.

OLRUS ELECTRONICS LTD.
748 HIGH ROAD, LEYTONSTONE
(NEXT TO GREEN MAN)

LONDON, E.11. Tel. 01-989 2751
CALLERS WELCOME—CLOSED ALL DAY FRIDAY

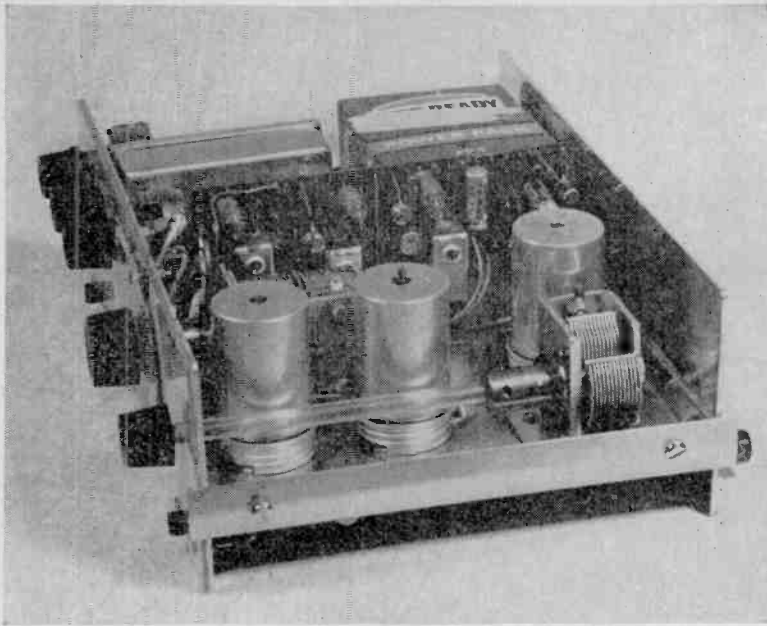

View of Mk. III Clubman. The "peak aerial" capacitor VC4 can be seen in the foreground.

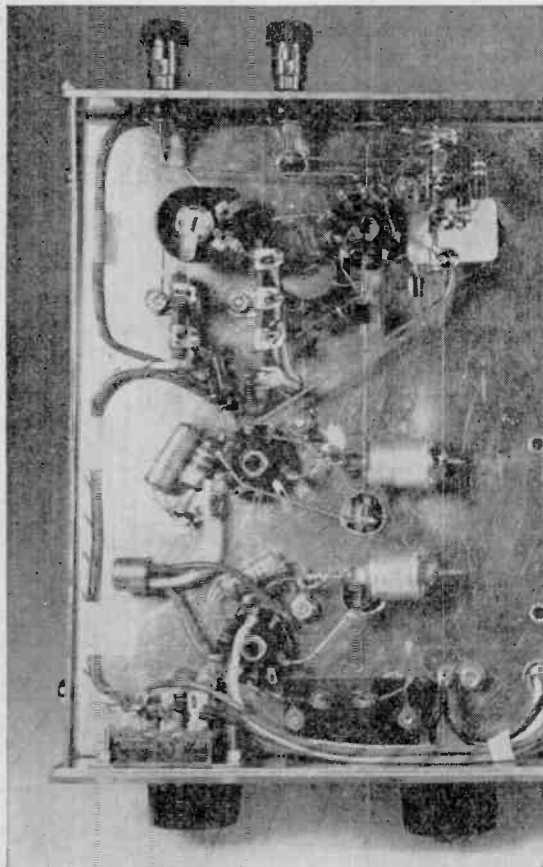

Underside chassis view of the r.f., mixer/oscillator section.

Having completed the alignment of the frequency changer stage, alignment of the r.f. amplifier should be carried out as follows:

- 1—Set VC4 to maximum capacity (fully meshed).
- 2—Set r.f. gain control, VR1, to maximum gain (clockwise).
- 3—Connect the signal generator to the earth and aerial terminal via a dummy aerial or a 470Ω resistor.
- 4—Set the signal generator to 1.6Mc/s and tune in the signal.
- 5—Adjust the aerial coil core L2, for maximum output, reducing the signal generator output as necessary to avoid overloading.

The receiver has an exceptionally high sensitivity and even with the output controls of the signal generator at zero, it may not be possible to reduce the signal sufficiently. In this case the signal generator may be loosely coupled to the receiver by laying the output lead near, but not connected to, the receiver aerial terminal. This completes the alignment of

the r.f. amplifier stage.

Tune in a signal of medium strength of 1.8Mc/s and adjust VC4 to peak up the signal to a maximum.

Set the r.f. gain control VR1 to minimum and adjust VR3 so that the received signal just disappears. This setting should allow the r.f. gain control to operate smoothly from zero to maximum.

With an aerial and earth connected to the receiver, tuning should be carried out in the normal way and the "Peak AE" control adjusted for best results when the desired signal is tuned in.

The performance of the receiver when fully aligned is given below.

Sensitivity.	1.8Mc/s	less than $1\mu\text{V}$
	5.0Mc/s	less than $1\mu\text{V}$

(For $5\mu\text{W}$ output, 6dB s/n ratio, input signal modulated 30%.)

Selectivity.	3dB down	6kc/s
	20dB down	25kc/s

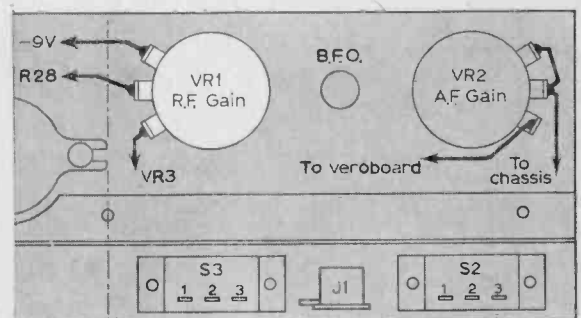

Fig. 28: Alterations to VR1, the r.f. gain control.

THE MW COLUMN

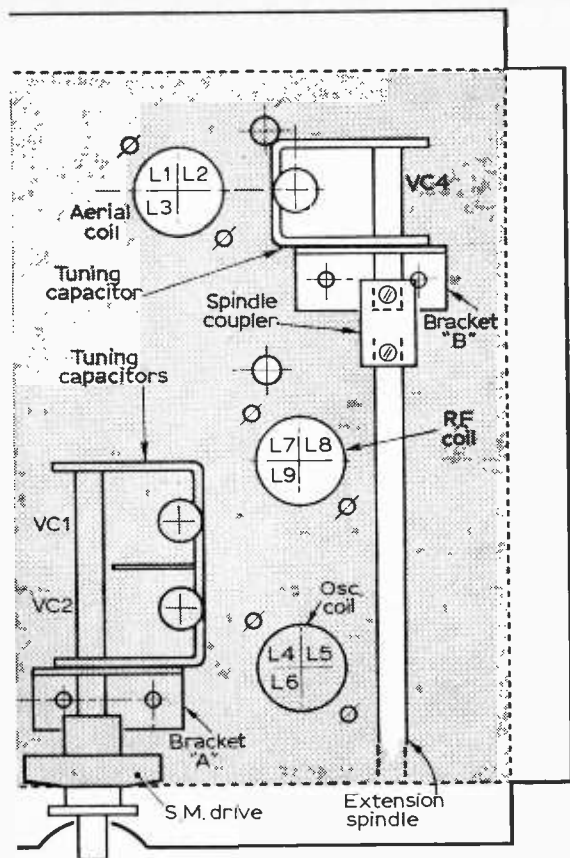

Fig. 29: Diagram showing position of r.f. and aerial coils also mounting of VC4.

Voltage Table

VR1 at maximum gain (clockwise)
20,000 ohms/V meter, 10 volt range.

	Tr7	Tr8
Source	-4.3V	-8.5V
Gate	-3.5V*	-7.5V**
Drain	0	-4.3V

* -4.5V using valve voltmeter.

** -8.9V using valve voltmeter.

Author's note :

The author has drawn our attention to a small number of errors, that have appeared in the CLUBMAN series.

- Page 673. Components list. Resistors are all $\frac{1}{2}$ watt rating.
- Page 675. Fig. 6. Left hand side of chassis dimension given as 7in. should be 6in.
- Page 735. Fig. 16. Tr1 (OC170) screen and base connections transposed.
- Page 826. To avoid confusion with the wiring of S1 in other diagrams, ignore the numbering of S1 (1-2) in Fig. 18.

CONDITIONS have not been very good of late, although there have been one or two very good days. Asia has been extremely poor and there have been many completely dead days. Despite the general depression, some good things have been heard.

Glyn Morgan reports Cairo and Canary Islands (both on 620, separated by loop); ELBC Liberia very good on 630; Godhaven, Greenland good on 650; Hofn, Iceland good after midnight on 655; an unidentified Arabic station on 1057 at 2300 (could be Tetuan on new frequency); Conakry, Guinea on 1403 at 2320.

M. Stephenson is a newcomer to MW DX and his log will interest others just starting up. It includes the following USA and Canadian stations—CBA 1070, CJON St. John's (930), CHER Sydney (950), CBH Halifax (860), CBN St. John's (640), CKBW Bridgewater (1000), CBD St. John's (1110), WOR New York (710), WINS NY (1010), WINZ Miami (940), WITC Hartford (1080), WNEW (1130), WHDH Boston (850). He also heard PJB Bonaire on 800 and *Radio Demerara*, Guyana on 760.

Some of those picked up by myself recently include VOXM St. John's (590), CKCM Grand Falls (620), CJOX Grand Bank (710), São Tomé (good signal on 759), WGY Schenectady (810), HJED *La Voz de Rio Cauca* (820), HJKC *Nuevo Mundo* (very good on 850), WHOA San Juan P.R. (870), XEW Mexico City (900), YVRQ *Radio Aeropuerto* (910), WTRY Troy (980), WCFL Chicago (1000, mixed with *XEOY Radio Mil*), KDKA Pittsburg (1020), WBZ Boston (1030), KMOX St. Louis (poor on 1120), HJCT *La Voz de la Costa* (1190), YVOZ *Radio Tiempo* (1200), WEZE Boston (1260), CKEC New Glasgow (1320), WAVY Portsmouth (1350). The three most outstanding signals heard here recently have been Godhaven (Greenland) on 650 around 0100, Hofn (Iceland) after midnight on 665 and CR6RZ heard most nights after BBC close-down on 1088. At odd times these stations were all heard at extremely high strength.

India/Pakistan, for the last few years heard on frequent occasions from 0030 onwards, has been poorly received this season. Reports have come in of reception of Indore (650), Hyderabad (1060) and Lahore (620), together with Lucknow on 910 (a new frequency), and Rajkot (now on 1070 from 910) but the almost nightly appearances of the last few years seems to be literally a thing of the past.

The Madeira station on 1331, mentioned last month, has now moved to 1421. The station at Riyadh, Saudi Arabia, on 647 is said to be 1200kW. ELBC Monrovia is said to have moved from 650 to 630. More high power in the Middle East—Beirut is to operate a 3000kW station any time now; Kuwait is due on 539 with 750kW. And talking of high power, the West Chinese station at Urumchi on 1525 is said to have a power of 2000kW, but its beam into USSR pushes this up to an e.r.p. of 8000kW!

With CR6RZ in Angola being so well heard, and other Southern African stations being logged this year, keep an ear open for *Radio Pax*, Mozambique, which has a new station operating on 1295 with 20/50kW.

TO BE CONTINUED

ALISTAIR WOODLAND

WEYRAD

COILS & TRANSFORMERS FOR CONSTRUCTORS

Special versions of our P50 Series are now available for AF117 or OC45 Transistors. They can be used in the standard superhet circuit with slight changes in component values, details of which are given in the latest edition of the Constructors' Booklet priced at 2/-.

Oscillator Coil	P50/1AC (For OC45)	P50/1AC (For AF117)	5/4
1st I.F. Transformer	P50/2CC (For OC45)	P51/1 (For AF117)	5/7
2nd I.F. Transformer	P50/2CC (For OC45)	P51/2 (For AF117)	5/7
3rd I.F. Transformer	P50/3CC (For OC45)	P50/3V (For AF117)	6/-
Rod Aerial	RA2W		12/6
Driver Transformer	LFDT4/1		9/6
Output Transformer	OPT1		10/6
Printed Circuit	PCA1		9/6

I.F. TRANSFORMERS & COILS FOR VALVE CIRCUITS

Production of Tuning Coils (Type "H") and I.F. Transformers is being continued and details of these and our other components are given in an illustrated folder which will be forwarded on request with 4d. postage please

WEYRAD (ELECTRONICS) LIMITED

SCHOOL STREET, WEYMOUTH, DORSET

NO SOLDERING
AMAZING
CIGARETTE RADIO
ONLY 25/-

Yes a perfectly ordinary packet of cigarettes! But watch your friends' astonishment on hearing it fetch in station after station, loud and clear! Still holds 10 cigarettes yet cleverly conceals highly sensitive, fully transistorised circuit (including battery). Even a young boy can assemble it under 2 hours. No soldering. No experience necessary. Only 18 connections to make. Ideal for taking to work with you. From our bulging testimonial file Mr. D. B. of Huddersfield, writes: "... I have fitted the parts in it and it is working wonderfully..." ALL PARTS including Semi-Conductors, ABC Plans, etc. ONLY 25/- plus 2/6 post etc. Parts available separately.

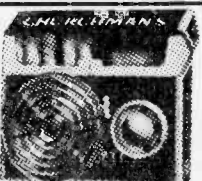

MAKE 5 DIFFERENT
TRANSISTOR
RADIOS FOR 39/6

No experience necessary. No soldering. Only 8 connections for first radio to work. Just look, you get Easy ABC Plans, Cabinet, Loudspeaker (alone 17/6), Earphone, 4 Semi-conductors, Coils, Condensers, Resistors, Tuner, Switch, Screws, etc.

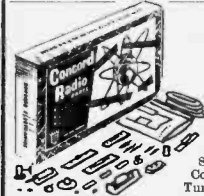

YES—EVERYTHING! Loud clear English and Foreign reception. As supplied to Educational Authorities, H.M. Forces, etc. TESTIMONIALS GALORE. Complete course—originally £6. Now only 39/6 plus 4/6 post etc.

NEW FULLY TRANSISTORISED
PORTABLE RADIOS
with Full Variable Waveband. NOW
A FRACTION OF THE 34/6
NORMAL PRICE ONLY

WHY PAY MORE? All the latest refinements are packed into this new MULTI-STATION ALL Transistor radio—the internal aerial picks up even the remote stations and the powerful built-in speaker gives room filling volume. Individual tuning, first-class reception. Purchase with confidence—packed in original manufacturers' cartons.



(Personal earpiece and battery 4/6.) Send 34/6 plus 4/6
CONCORD ELECTRONICS LTD. (PW45)
D. & P. 8 Westbourne Grove, London, W.2.

H.A.C. SHORT-WAVE
KITS

WORLD-WIDE RECEPTION

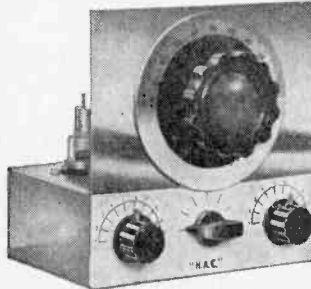

Famous for over 30 years for Short-Wave Equipment of quality, "H.A.C." were the original suppliers of Short-Wave Receiver Kits for the amateur constructor. Over 10,000 satisfied customers—including Technical Colleges, Hospitals, Public Schools, R.A.F., Army, Hams, etc.

IMPROVED 1968 RANGE

One-valve model "DX", complete kit—price 56/6 (Postage and packing 3/6).

Customer writes:—"Definitely the best one-valve S.W. Kit available at any price. America and Australia received clearly at good volume." This kit contains all genuine short-wave components, drilled chassis, valve, accessories and full instructions. Ready to assemble, and of course, as all our products—fully guaranteed. Full range of other S.W. kits still available, including the famous model "K" (recommended by radio clubs). All orders despatched by return. (Mail order only.) Send now for a descriptive catalogue, order form.

"H.A.C." SHORT-WAVE PRODUCTS
29 Old Bond Street, London W.1

Computer grade resistors

1/2w 5% cracked carbon film, Hi stability, low noise resistors. Current manufacture and not seconds or rejects. Packed in tens, any preferred value 10—10M. 1/8 for ten mixed.

Transistors

2N3708 } Silicon NPN high gain
4103 }
4285 } Silicon PNP high voltage
4289 }

Brand new, not rejects or seconds. Data sheets supplied. 3/11 each.

Capacitors

10μF 60V D.C. miniature reversible electrolytic, suitable for filters, amplifiers, crossovers etc. Brand new, not surplus. 2/10 each.

Building your own speaker cabinet?

Rexine, beige, tough wearing 2/-.
Vynair, dark green or grey 2/10.
Aluminium expanded fret, gold only 8/9.
BAF wadding, thick grade 1/3.
All prices per square foot plus 1/- P. & P.
Fabrics available up to 4ft. x any length
Aluminium up to 2ft. x 4ft.



Dept. PW
35c Pinfold Gate,
Loughborough,
Leicestershire.

practically wireless

commentary by **HENRY**

IN the columns of the *Sunday Times* I came across the statement "The answer lies somewhere between the two figures . . . the 75 per cent claimed by Steinbeck . . . the 2.6 per thousand troops admitted by the US State Department."

The subject does not really matter. What *does* interest this observer is the generous margin of tolerance allowed by the writer of the article. 2.6 per thousand, according to my reckoning, and even without the aid of Mr. Kampel's slide rule, comes to 0.26 per cent.

This is the sort of tolerance factor that Mrs. Henry employs. "Do you like my hat? Only two pounds" may be taken to mean it cost something like £2 18s. 11d. On the other hand, she will gaily tell her friends that it set her back three pounds—"Well, so it was—nearly." It is that "nearly" that contains the crux of the matter.

This has been brought home to me rather forcibly in recent weeks. Our firm has been buying new instruments, including a quite costly wow and flutter meter. Henry had fun, running the proverbial rule over a wide range of gramophone decks and tape recorder mechanisms. The results would have surprised anyone except a hardened service mechanic. Divergences such as the *Sunday Times* tolerance limits were chicken feed to the happy gentlemen who write those beautiful sales brochures.



"Do you like my new hat?"

The better mechanics were very good, and the cheaper ones were horrid. But in most cases, when the measured figures were beyond the tolerance of even the modest commercial standards, one's ears had *already* informed us that something was amiss. The wow attributable to a tape recorder capstan lies in the region of 2-10c/s and this is precisely the region in which those deceitful flappers that hold our hats up are most sensitive to speed fluctuations. Which explains why we squirm when someone replays a piano piece on some tape recorders yet tolerate worse technical variations from a gramophone record.

An eccentric disc at 33½ r.p.m. will produce a wow once in three seconds (roughly—don't argue, be tolerant!). Similarly, motor flutter, allowing the motor to be the usual kind that revolves at 3,000 r.p.m., can give a varying drive at about 50c/s. The point is that the measurements can be similar on all three sources of annoyance, but the subjective effect is very different. Because of our non-linear hearing, there is as much as a 12dB difference in the amount of variation above and below that sensitive range needed to produce the same distress. Hence the "weighting factor" that we so often see quoted.

We learn to be tolerant, applying our own physical correction factors as we go along. But it seems funny to the boffin when one of us at the bench sweats over a simple calculation to determine what value component to replace when he, the long-headed one, has used an approximation of quite daring breadth in the original design.

In a recent article by Rex Baldock in *Hi-Fi News*, entitled "Approximations", he gives some fascinating figures, for example on that hardy constant "pi". Remember how our old mentors insisted on four decimal places?



A piano piece on some tape recorders.

(3.1416 please, none of your old twenty-two upon seven.) But as Mr. B says, the use of 22/7 is only 1 part in 3,000 larger than a true value of π to five decimal places. Even the use of 10 for π^2 is only a 1 per cent error.

Also, note that pi-cubed, which bothers so many trigonometry students, is only 1 part in nearly 5,000 too low if we use 31 instead of 31.006. How much closer do you want to get?

Remember those comfortable words next time you are ferreting through the spares box for exactly the right component to complete that PW project.

It is obvious that some so-called designers have eschewed all calculations and proceeded along what might euphemistically be called "empirical" lines. One imagines them tangling up a brainstormed circuit and muttering: "Let's try a diode there and see what happens." or "Bung another resistor in—we've got plenty." And then when some production wallah stalks into the development den and rebuilds the horror to suit the factory system, and mischievously hides all the vital parts under screens and wiring harnesses, the poor mechanic is going to need more than tolerance to sort out subsequent faults.

Then is the time for a bit of the old "give and take".

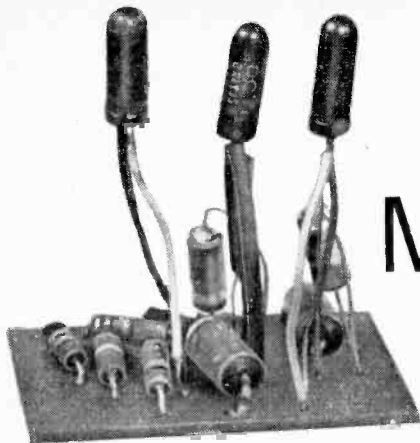

EXPERIMENTAL

Microphone Preamp

A.J. Garratt-Reed

THIS unit was originally built to feed the main amplifier enabling a Collins T.C.S. transmitter to be modulated by a cheap Japanese crystal insert microphone. However, it has proved equally suitable for use as a pre-amp with a main power amplifier as a public address system, and the prototype has been used on a number of occasions (with a good quality mike) at dances at a local club.

CIRCUITRY

The circuit is shown in Fig. 1, but it is worthwhile looking at the design considerations. A crystal microphone behaves like a voltage source in series with a capacitor of about 5,000pF. If such a source is fed into a resistive load low frequencies are attenuated and the output falls to half its maximum when the frequency f is of such a value that the load R is numerically equal to $\frac{1}{2\pi fC}$, C being the series

capacity. Now amateurs normally find it unnecessary to transmit audio frequencies below 300c/s, so putting this number into the formula we find R is

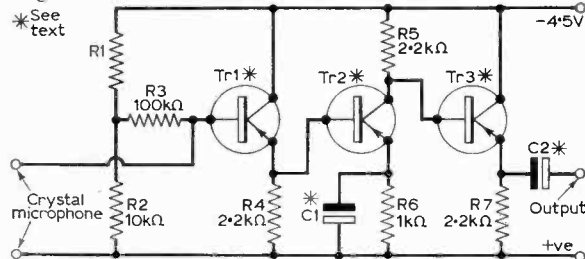

Fig. 1: Circuit of the preamp.

110kΩ. This cut-off, while making the pre-amp of little value to a singer, makes no difference to an announcer as no significant amount of information is carried by the low frequencies in speech. Evidence suggests that speech is *more* audible over interference when these low notes are removed!

INPUT IMPEDANCE

The input impedance of a transistor amplifier consists of two parts, the impedance of the transistor itself and the resistance of the bias chain. As the effects of the bias network can be almost completely eliminated we will discuss the transistor first, and assume that it contributes all the input impe-

dance, which is entirely resistive. If R_e is the emitter resistor of an emitter follower, then the input impedance is approximately $R_e \times \beta$ where β is the current gain of the transistor in the common emitter mode. This is usually about 50 with normal transistors. Hence to make the input impedance 110kΩ, R_e must be 2.2kΩ. This is R_4 in Fig. 1.

BIAS

The bias chain shown has an impedance of about 100kΩ, which, together with the 110kΩ of the transistor, gives a total input impedance of the amplifier of 55kΩ. As mentioned above, the impedance of the bias chain can be eliminated, but in trials, it was found to make little difference. However, as only one component is involved, readers may like to experiment. This process, called bootstrapping, consists of connecting a capacitor (try 25μF 6V) with its positive end to the emitter of Tr_1 and its negative end to the junction of R_1 , R_2 and R_3 . We will see later that a value of 2.2kΩ or R_4 is suitable from the d.c. bias point of view.

The output voltage from an emitter follower is very nearly equal to the input voltage, hence in our case, about 10mV. This feeds the base to Tr_2 , which has an input impedance of about 2kΩ. Hence the a.c. base current is about 0.005mA. If this transistor also has a β of 50, the alternating collector current will be 0.25mA. Across a load of 2.2kΩ this gives an output voltage of about half a volt. (This is so because the collector impedance of the transistor Tr_2 and the input impedance of Tr_3 are both much higher than 2kΩ). This output is ample to drive most audio power amplifiers, and the third stage, another emitter follower, is not strictly necessary for this purpose. However, the output impedance of about 2kΩ was too high to drive the transmitter, so the third stage was added. It is useful in that it makes the pre-amp more versatile and helps to reduce hum. The output impedance is about 40Ω.

D.C. ASPECT

The pre-amp now works for a.c. but we must still consider the d.c. aspect. Direct coupling was chosen to minimise the number of components, so the d.c. conditions of the amplifier as a whole must be considered. The amplifier transistor Tr_2 is the most critical, and this dictates the operating conditions of the other two. A collector current of 1mA was chosen for Tr_2 as a compromise between low noise and high gain. The voltage drop across R_5 is thus 2.2 volts. If the supply is 4.5 volts, and we allow 1.3 volts across the transistor (this is not a lot but is enough) then the emitter must be 1 volt

Open the pages of
The RADIO CONSTRUCTOR
 this month for . . .
**A CRYSTAL CONTROLLED
 F.M. RECEIVER**

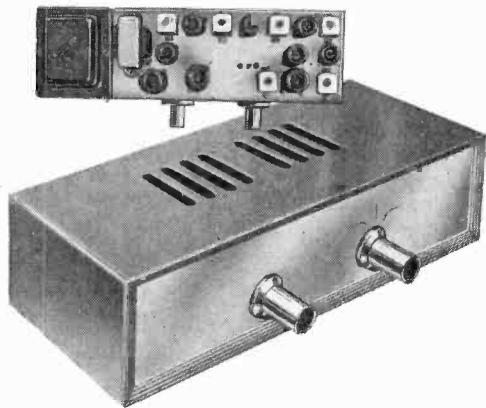

An Outstanding Constructional Project
 By J. B. Dance, M.Sc.

This two-part article describes a crystal controlled f.m. receiver incorporating the S.T.C. triple-crystal unit.

Other constructional features

**VERSATILE SIGNAL GENERATOR
 CAR AERIAL BOOSTER
 ROWING STROKE RATING METER**



-----Also in this issue-----

**FREE 2 DETACHABLE
 DATA SHEETS**

RADIO CONSTRUCTOR

MARCH ISSUE NOW ON SALE 3/-

TECHNICAL TRAINING

*in radio television
 and electronics*

Whether you are a newcomer to radio and electronics, or are engaged in the industry and wish to prepare for a recognized examination, ICS can further your technical knowledge and provide the specialized training so essential to success. ICS have helped thousands of ambitious men to move up into higher paid jobs—they can help you too! Why not fill in the coupon below and find out how?

Many diploma and examination courses available, including expert coaching for:

- Institution of Electronics & Radio Engineers
- C. & G. Telecommunication Techns' Certs.
- C. & G. Electronic Servicing
- R.T.E.B. Radio/T.V. Servicing Certificate
- Radio Amateurs' Examination
- P.M.G. Certs in Radiotelegraphy
- General Certificate of Education, etc.

Examination Students coached until successful

NEW SELF-BUILD RADIO COURSES

Learn as you build. You can learn both the theory and practice of valve and transistor circuits, and servicing work while building your own 5-valve receiver, transistor portable, and high-grade test instruments, incl. professional-type valve volt meter—all under expert tuition. Transistor Portable available as separate course.

POST THIS COUPON TODAY

for full details of ICS courses in Radio, T.V. and Electronics.

INTERNATIONAL CORRESPONDENCE SCHOOLS

Dept. 171, Intertext House, Parkgate Road, London, S.W.11

Please send me the ICS prospectus—free and without obligation.

(state Subject or Exam.)

NAME

ADDRESS

4/68

INTERNATIONAL CORRESPONDENCE SCHOOLS

JOHN'S RADIO

OLD CO-OP, WHITEHALL ROAD, DRIGHLINGTON, BRADFORD

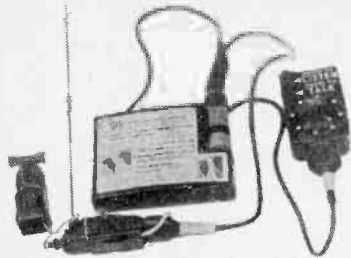

LARGE QUANTITY OF SARAH V.H.F. TRANS RECEIVERS

AVAILABLE FOR IMMEDIATE EXPORT

General Information. This set is normally carried in the life jacket of Airman. It is a complete miniature lightweight radio Trans/Receiver, which is used to give a Beacon plus two way speech communication in the event of finding themselves in the sea. It comprises a Transmitter-Receiver, a speech unit, a coding unit and a power supply either Battery or Transistor. These three items are permanently interconnected and all units are completely sealed and water tight using a combined speaker/mike. Press to talk or listen buttons, fold up aerial, a total of three valves are used, power required 6.3 volts LT 90 volts and 435 volts D.C. HT. Frequency 243Mc/s. Transmitter output pulse power. Beacon 15 watts, Talk 3 watts. SUPPLIED IN MAKER'S BOXES in Grade 1 condition singly at 45/-, post 5/- with circuit. New batteries if available 7/6 each.

B44MKIII TRANSRECEIVERS

We have a few of these V.H.F. 12 valve transreceivers operating on 3 switched channels between 80Mc/s-95Mc/s complete with all 6 crystals, headphones, mike, mobile aerial and dipole aerial, all connectors plus alloy tripod for mounting the set on. Power input 12V D.C., TX output 3 watts, internal speaker (all valves BG7). All air tested O.K. Supplied in good grade 2 condition at £10.0.0. each, carr. 30/-. Also available in matched pairs £25 per pair, carr. 30/- tested.

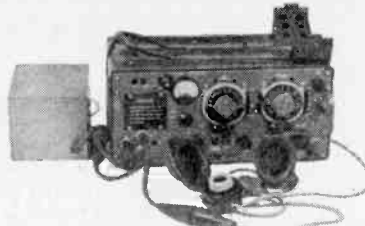

TRANS/RECEIVER TWO TWO

This is one of the latest releases by the govt. of an extremely recent R/T set covering 2-8Mc/s in two switched bands, containing 13 valves (3 EL32s in TX output) which can be used for Morse CW or R/T. Also has netting trimmer, BFO, RF and AF controls, switched meter for checking all parts of set, size 17 x 8 x 12in. Power required 12V D.C. HT 325V D.C. Supplied brand new and boxed with headphones and mike also two spare valves and circuit of set. Few only at £5.10.0., carr. 30/-. New plug in power supply made by us for either 12V D.C. input £3.10.0 or 200/250V A.C. £3.17.6.



SHORT-WAVE TRANSRECEIVER MK.III

This set is made up of 3 separate units: (1) a two valve amplifier using a 6V6 output valve; (2) (some only, not built in the very latest models) a V.H.F. transceiver covering 229-241 Mc/s using 4 valves; (3) the main short wave transmitter/receiver covering in two switched bands, just below 2 Mc/s-41 Mc/s, and 41 Mc/s-8 Mc/s (approx. 160-375 metres) using 9 valves. For R.T., C.W. and M.C.W. The receiver is superhetrodyne having 1 R.F.

stage, frequency changer, two I.F. (465 Kc/s) signal detector, A.V.C. and output stage. A B.F.O. included for C.W. or single side-band reception. T.X. output valve 807, other valves octal bases. Many extras, e.g. netting switch, quick flick dial settings, squeel etc. Power requirements LT 12 volts, HT receiver 275 volts D.C. HT transmitter 500 volts D.C., size approx. 17 1/2 x 7 1/2 x 11ins. Every set supplied in new or as new condition in carton with book including circuits, only £4.10.0, or Grade 2 slightly used 50/-. Grade 3, used but complete, 35/-. Carr. ALL 15/-. WE MAKE A MAINS 200/250 VOLT POWER UNIT in louvered metal case to plug direct into set power socket to run (1) receiver, 70/-, post 5/-, (2) TX and RX, £6.10.0, post 7/6. (3) 12 volt D.C. P.U. (original). FAIR CONDITION, 40/-, Carr. 5/-. A charge of 10/- to unpack and test the receiver of these sets is made only if requested. Headphones and Mike 15/-, new and boxed.



V.H.F. TRANSRECEIVER MK. III

This is a modern self contained tunable V.H.F. low powered frequency modulated transceiver for R.T. communication up to 8-10 miles. Made for the Ministry of Supply at an extremely high cost by well known British makers, using 15 midget B.O. 7 valves, receiver incorporating R.F. amplifier. Double superhet and A.F.C. Slow motion tuning with the dial calibrated in 41 channels each 200 Kc/s apart. The frequency covered is 39 Mc/s-48 Mc/s. Also has built-in Crystal calibrator which gives pipes to coincide with marks on the tuning dial. Power required LT 41 volts, HT 150 volts, tapped at 90 volts for receiver. Every set supplied complete with valves and crystals. New in carton, complete with adjustable whip aerial, and circuit. Price £4.10.0., carriage 10/-.

MARTIN IS HIGH-FIDELITY

PREFERRED FOR RELIABILITY, QUALITY, ADD-ON-ABILITY AND ECONOMY

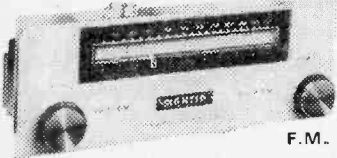

F.M. TUNER



STEREO CONTROL ASSEMBLY

You can do so much with MARTIN kits. The system of using pre-fabricated transistorised units which can be interlinked in a variety of ways enables you to assemble the combination of your choice and then extend it unit by unit until you possess a full stereo gramophone and radio assembly. When new units are produced, they can be added to existing equipment very easily with the advantage that you can continue to use equipment you already have,

so that your installation is always up to date. Most important of all is the power and quality which MARTIN Audiokits give you. Their sturdy construction assures compactness without sacrifice to quality or efficiency. They offer excellent value, are very easily installed and will give years of unflinching service. That is why people prefer MARTIN — it's simple to instal, good to listen to, and looks completely professional.

AMPLIFIER SYSTEMS • TUNERS • RECORDERS

ONLY FROM MARTIN
MARTIN AUDIOKITS are available for Mono, and can be doubled up for stereo, or as complete stereo units. 3 ohm and 15 ohm systems are available. There is a special pre-amp for low output pick-ups and escutcheon panels to suit the arrangement you choose. The tuner is styled to match.

Start by sending for leaflet at once

MARTIN ELECTRONICS LTD. 154/5 HIGH STREET, BRENTFORD, MIDDLESEX. ISLeworth 1161/2

UNITS INCLUDE:

- 5-stage input selector
- Pre-amp/tone controls
- 10 watt amp. (3 ohms)
- 10 watt amp. (15 ohms)
- Mains power supply
- F.M. Tuner

Trade enquiries invited

MARTIN ELECTRONICS

154 High Street, Brentford, Middlesex
Please send Recordakit/F.M. Tuner/Audiokit
Hi-Fi Leaflets. (Strike out items not wanted)

Name

Address

P.W. 4/68

above earth. This means that the emitter resistor is $1k\Omega$. Its by-pass capacitor need only be 6 volt working, and at least $25\mu F$. In a germanium transistor, there is a voltage of about 0.2V between the emitter and base, so the base of Tr2 is 1.2 volts to earth. This is also the potential at the emitter of Tr1, so the current in R4 is about 0.5mA, which is perfectly suitable. The base of Tr1 is 1.4 volts above the earth line. Very little current flows in R3, but as R3 is so large, in order to keep up the input impedance, there is still an appreciable voltage drop of the order of 1 volt. Thus R1 and R2 must be approximately equal. As we said before, the collector of Tr2 is 2.3 volts above earth, so the emitter of Tr3 is about 2 volts above earth. Allowing 1mA to flow in this emitter circuit dictates a value of $2.2k\Omega$ for R7. To set the bias, R2 is set at $10k\Omega$, and R1 is altered until the voltage as measured on a high resistance voltmeter across R7 is within $\frac{1}{2}$ V either way of 2V. If germanium transistors are used, start off with R1 at $15k\Omega$, but if silicon devices, which have a larger emitter-base voltage, are used, R1 will be smaller, and $10k\Omega$ could be tried as a start.

Almost any small-signal amplifier transistors should work, silicon or germanium but silicon ones tend to be quieter. The prototype has run perfectly with OC71's and with 2N2926's. The OC71's tend to hiss, and it was a little more critical adjusting the bias on the 2N2926's (Silicon n-p-n transistors). OC44's or 45's should work, as should almost any tran-

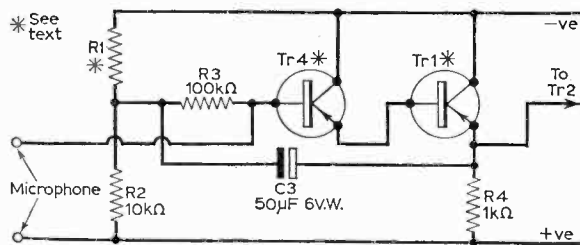

Fig. 2: Adding another transistor to improve response.

sistor which is used in circuits published in this magazine. The three transistors need not be the same type, but must all be either p-n-p or n-p-n. Figure 1 shows the circuit for p-n-p's, but the only difference for n-p-n's is that the capacitors are connected the opposite way round, and the battery polarity is reversed.

The value of C2 depends on several things. If the main amplifier is transistorised, then C2 must be at least $25\mu F$, but if a valve amplifier is being fed, things are different. If only a short screened lead connects the pre-amp to the main amplifier, $0.1\mu F$ will suffice for C2, but for good hum elimination $10\mu F$ or more is recommended. In these conditions, if a short lead connects the pre-amp to the main

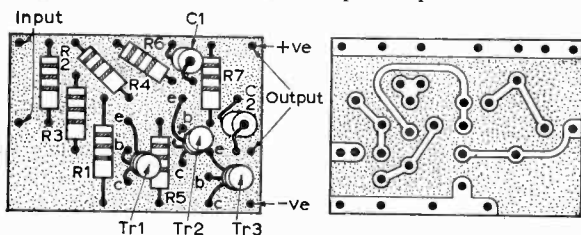

Fig. 3: Suggested layout on an etched circuit board.

★ components list

Resistors:

R1	See text
R2	$10k\Omega$
R3	$100k\Omega$
R4	$2.2k\Omega$
R5	$2.2k\Omega$
R6	$1k\Omega$
R7	$2.2k\Omega$

Capacitors:

See text

Semiconductors:

See text.

Components for Figure 2:

Resistors:

R1	See text
R2	$10k\Omega$
R3	$100k\Omega$
R4	$1k\Omega$

Capacitors:

C3 $50\mu F$ 6V

Semiconductors:

Tr1 } See text
Tr4 }

amp, then it need not be screened at all, but twin lighting flex will suffice! The lead connecting the microphone to the pre-amp must be screened, and should be as short as practicable, not more than a few yards. If a long lead must be used, for instance with a "roving mike" then the person with the microphone can carry the pre-amp in his pocket, as the lead from the pre-amp to the main amplifier can be many dozens of yards.

CONSTRUCTION

The construction is left to the reader, as it is very simple and in no way critical. The final version of the prototype was built on a printed circuit etched by ferric chloride from an off-cut of copper laminated board about $1\frac{1}{2}$ by 2in. Nail varnish was used for masking, and cellulose paint thinner to remove the varnish. The holes were drilled with a $\frac{3}{64}$ in. drill.

In order to increase the low frequency capabilities of the circuit, thus making it suitable for singing, it is necessary to modify the first stage, incorporating a fourth transistor, Tr4, as shown in Fig. 2. This circuit is known as the super-alpha pair, which should work, but has not been tried. Resistor R4 should be about $1k\Omega$, and Tr4 must be a low noise type. If several transistors are to hand it would be worthwhile experimenting to find the quietest combination. R1 should be adjusted as for the three transistor circuit. ■

BINDERS

A first class magazine deserves first class treatment. Store your copies of *Practical Wireless* with a new Easi-binder, specially designed to hold 12 copies of the new large size. It has a special pocket for storing those blueprints and data sheets too. Yours for 14/6d. from: Binding Dept., George Newnes Ltd., Tower House, Southampton Street, London, W.C.2. **Note:** Please state the volume number required otherwise a blank cover will be sent.

INDEX

No more frantic searching for that particular article which appeared in that past issue. For 1/6d. you can be the proud possessor of a *Practical Wireless* index to volume 42. This price includes postage, and the index is available from our Post Sales Department, George Newnes Limited, Tower House, Southampton Street, London, W.C.2.

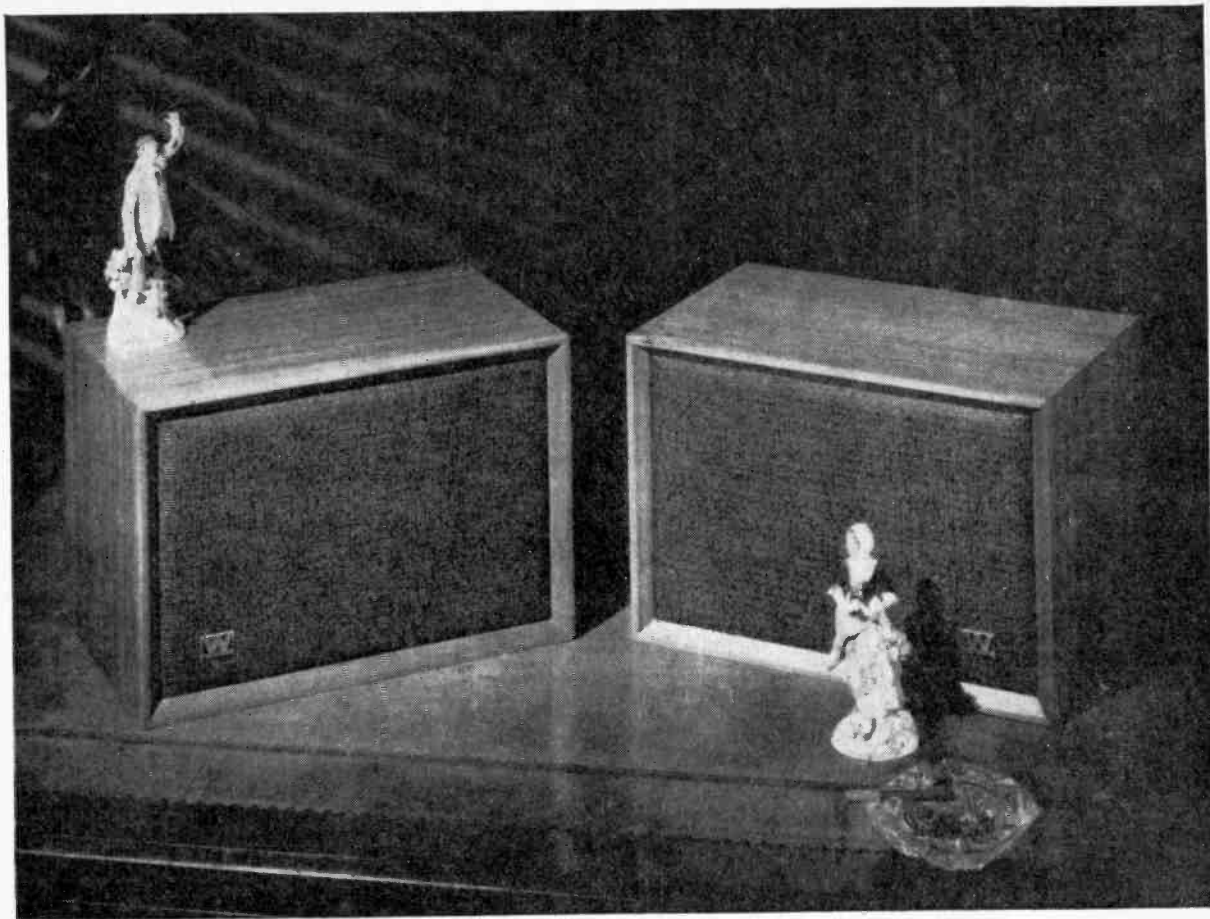

High fidelity stereo starts with Wharfedale **DENTONS** at 30gns. per pair.

The new Denton speaker system brings stereo sound within the reach of everyone. Dentons are excellent operating at less than 10 watts from the existing amplifier in your record player or tape recorder. They are *superb* when driven by a high fidelity amplifier. Each Denton contains 2 Wharfedale speakers in a beautiful cabinet that is small enough to stand on a bookshelf or mantelpiece. Ask your dealer for a demonstration and prove its superior quality.

- The Dentons are sold in matched pairs for stereo.
- The cabinets are hand veneered and rubbed; each pair made from the same tree—perfect matching of both sound and appearance.
- Each cabinet has two speaker units with a carefully designed cross-over network.
- The dimensions are perfect for mounting on a shelf—so the Denton takes up virtually none of your precious room space.
- Size 9 $\frac{3}{4}$ " high x 14" wide x 8 $\frac{3}{4}$ " deep.
- Response: 65 Hz to 17,000 Hz.
- Finish: Oiled Teak or Polished Walnut.

Please send me details of Wharfedale DENTON speakers:

NAME

ADDRESS

PW4



**RANK WHARFEDALE LTD.,
IDLE, BRADFORD, YORKS.**



OUTSTANDING SINCLAIR DESIGNS FOR THE ECONOMY MINDED

The
world's
smallest
radio

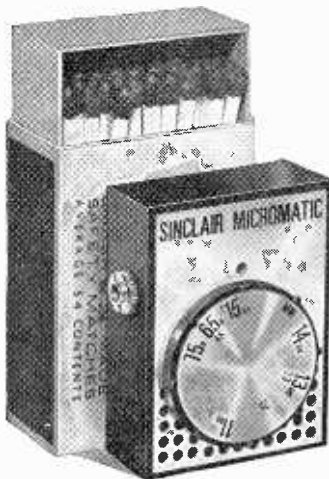

SINCLAIR MICROMATIC

The ultimate in personal listening, the Micromatic is as easy to have with you as your wristwatch. It has enormous power and range, and the magnetic earpiece now supplied assures marvellous quality. Hear how Radio 1 and other stations simply pour in. Build it yourself or buy your Micromatic ready built. This is the set you will never be without once you hear it for yourself.

- $1\frac{1}{8}'' \times 1\frac{1}{10}'' \times \frac{1}{2}''$
- Tunes over medium waveband
- Slow motion tuning control
- Aluminium front panel and dial
- Magnetic earpiece

Complete kit including magnetic earpiece and instructions

49/6

Ready built with magnetic earpiece

59/6

Mallory Mercury Cell RM.675 (2 needed) ea. 2/9

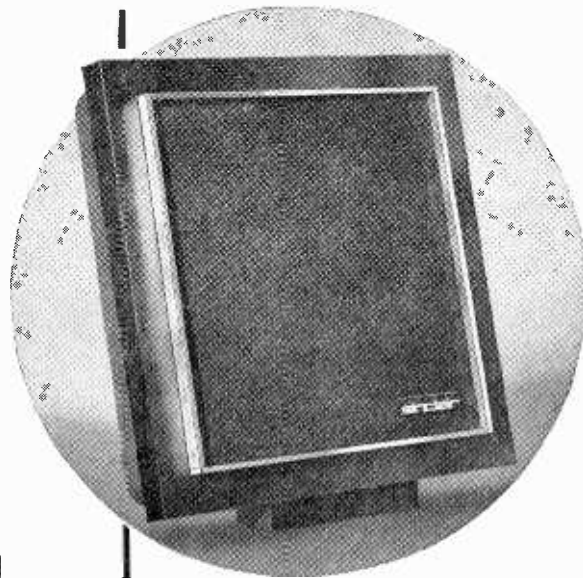

SINCLAIR Q.14 LOUDSPEAKER

BRILLIANTLY EFFICIENT ... especially in stereo

When Sinclair Radionics decided to design and manufacture a new loudspeaker, it was required from the start that its performance should be worthy of today's best high fidelity standards and be so reasonably priced that the greatest numbers could afford it. By using ultra-low resonant materials to form its acoustically contoured housing, outstandingly brilliant performance resulted. Furthermore, the unusual form of the Q.14 meant it could be used as a free-standing shelf speaker, as a wall-corner sound radiator or flush mounted singly or in multiple units on a flat surface such as a wall. The correctness of the design of the Q.14 has amply proven itself since within a few months of its introduction, it is already amongst the four most demanded loudspeakers irrespective of price. Independent laboratory tests have already shown that the Q.14 has amazingly good performance characteristics. As a judge of good sound yourself, your ear will confirm this instantly. At its price, there is nothing to stop you changing to Sinclair at once.

- Size $9\frac{1}{2}''$ in. x $9\frac{1}{2}''$ in. x $4\frac{1}{2}''$ in. deep plus detachable base
- 15 ohms impedance
- Up to 14 watts loading
- Smooth response between 60 and 16,000 Hz
- British manufacture

The Q.14 is finished in matt black with solid aluminium bar embellishment on the front. Supplied in strong fitted carton and sent post free under money back guarantee if you are not satisfied.

£6.19.6

IDEAL WITH Z.12 HI-FI SYSTEMS

The Sinclair logo, featuring the word 'sinclair' in a stylized, lowercase, sans-serif font. The letters are white and set against a black background.

SINCLAIR RADIONICS LTD, 22 Newmarket Road,
Cambridge
Phone OCA-3 52996

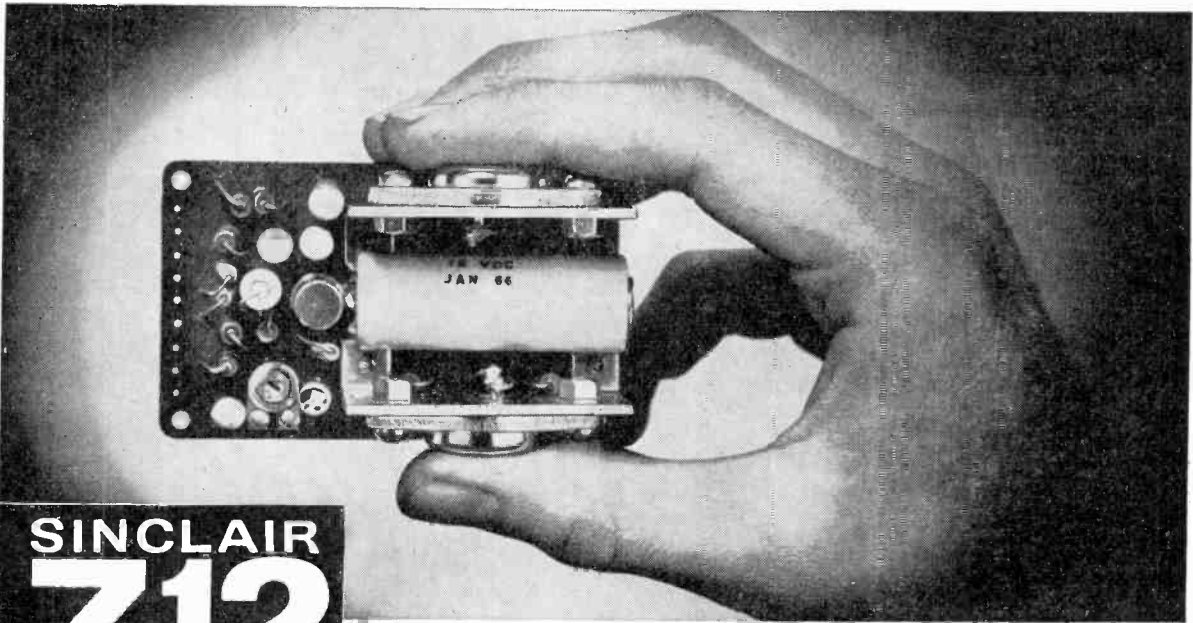

SINCLAIR Z.12

COMBINED 12 WATT HI-FI AMP AND PRE-AMP

UNCHALLENGED LEADER IN ITS FIELD

No constructor's transistor amplifier has ever achieved such successes as the Sinclair Z.12. It favours the user in so many ways—with fantastic power-to-size ratio, with far greater adaptability, with freedom to operate it from batteries or mains power supply unit (the new PZ.4 is ideal for this) with the opportunity to obtain superb stereo reproduction for very little outlay. Countless thousands of Z.12s are in use throughout the world—in hi-fi installations, electronic guitars and organs, P.A. installations, intercom systems etc. This true 12 watt amplifier is supplied ready built, tested and guaranteed together with the Z.12 manual which details control circuits enabling you to match the Z.12 to your precise requirements. For complete listening satisfaction, use your Z.12 system with Q.14 loudspeakers. It assures superb quality with substantial saving in outlay.

- 3" x 1 3/4" x 1 1/2"
- Class B Ultralinear output
- 15-50,000 Hz \pm 1dB
- Suitable for 3, 5, 8 or 15 Ω speakers. Two 3-ohm speakers may be used in parallel.
- Input—2mV into 2k Ω
- Output—12 watt, R.M.S. continuous sine wave (24 w peak)

"I made this (Z.12) stereo record player for my work as hospital chaplain and it has been a great success."
K.S.B., Basingstoke.

"The Z.12 and Q.14 live up to your high standard. I could spend pages praising these products."
I.A.W., Hereford.

Ready built, tested and guaranteed.

89/6



SINCLAIR STEREO 25

BUILT TESTED AND GUARANTEED £9.19.6

For use with two Z.12's or any good hi-fi stereo system. Frequency response 25 Hz to 30 KHz \pm 1dB connected to two Z.12's. Sensitivity Mic. 2mV into 50k Ω ; P.U. —3mV into 50k Ω ; Radio —20mV into 4-7 Ω . Equalisation correct to within \pm 1dB on RIAA curve from 50 to 20,000 Hz. With brushed and polished aluminium front panel with solid aluminium knobs to match. Size 6 1/2 in. X 2 1/2 in. X 2 1/2 in. plus knobs.

SINCLAIR PZ. 4 STABILISED POWER SUPPLY UNIT

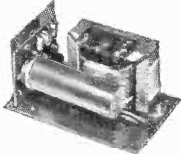

A heavy duty A.C. mains power supply unit delivering 18V D.C. at 1.5A. Designed specially for Z.12 assemblies. Ready built and tested. **99/6**

YOUR SINCLAIR GUARANTEE

Should you not be completely satisfied with your purchase when you receive it from us, your money will be refunded in full at once and without question. FULL SERVICE FACILITIES AVAILABLE TO ALL PURCHASERS.

WE PAY POSTAGE ON EVERYTHING YOU ORDER

To: SINCLAIR RADIONICS LTD., 12 NEWMARKET ROAD, CAMBRIDGE

Please send post free items detailed below:

.....

.....

.....

For which I enclose cash/cheque/money order

NAME

ADDRESS

.....

PW.4

R.S.T. VALVE MAIL ORDER CO.

144-146 WELLFIELD ROAD, STREATHAM, S.W.16

Mon.—Sat. 9 a.m.—5.45 p.m.
Closed Sat. 1.30—2.30 p.m.
Open Daily to Callers
Tel. 769-0199/1649

All valves brand new and boxed		Closed Sat. 1.30—2.30 p.m.		Open Daily to Callers	
OA2 6/8	6BH6 7/8	6K6GT 5/7	787 20/-	90L1 18/9	75 7/-
OC2 5/6	6BT6 9/7	6K7M 5/9	7Y4 8/6	20P4 19/-	78 5/-
LA7 7/9	6BQ7A 7/7	6K7G 2/7	9BW6 7/7	20P5 19/6	80 5/-
1D5 7/7	6BR7 8/6	6K7GT 4/6	10C1 12/6	25A6 5/9	85A2 7/8
1H5 7/7	6BR8 5/6	6K8M 8/6	10C2 12/6	25L6GT 5/6	150B2 9/6
1LD5 5/7	6BR7 16/9	6K8G 3/7	10F1 9/7	25Y5 8/7	150C4 7/8
1N6GT 8/7	6BW6 14/7	6K9GT 7/7	10F3 8/7	25Z4 6/8	801 6/7
1R5 5/6	6BW7 14/7	6K25 20/7	10F9 9/9	25Z5 5/7	807 6/7
1S4 5/7	6C4 2/9	6L1 9/6	10F18 9/7	25Z6 8/6	811 30/-
1S5 4/7	6CSG 4/7	6LAG 7/6	10L1 8/7	25D7 5/7	813 75/-
1T4 3/7	6C6 3/9	6L18 5/7	10LD11 15/7	30C1 6/8	866A 13/6
3A4 3/6	6C8G 6/9	6Q7G 6/7	10P13 16/8	30C15 13/6	954 4/6
3Q4 6/6	6CD6G 22/7	6Q7GT 8/6	11E3 42/7	30C17 15/6	1925 5/6
3Q5 6/6	6CH6 5/9	6SA7M 7/7	12A76 4/8	30C18 13/6	4022AR 50/-
3B4 4/9	6CW4 12/7	6SC7 7/7	12A77 3/9	30F5 15/6	5763 10/7
3R4G 8/9	6E5 7/6	6SG7 5/7	12A7 3/9	30FL1 16/7	7193 2/7
5U4G 4/7	6F1 9/7	6SH7 3/8	12A7 3/9	30FL12 16/6	7475 4/7
5V4 8/7	6F5G 8/7	6S7 5/7	12A7 3/9	30FL14 16/6	7475 4/7
5Y3GT 5/6	6F6G 4/7	6SK7GT 4/9	12A7 3/9	30FL15 15/3	7475 4/7
5Z4G 6/9	6F6G 4/8	6SL7GT 4/9	12A7 3/9	30L17 14/8	7475 4/7
6/30L2 13/7	6F11 6/7	6SN7GT 4/8	12A7 3/9	30P12 13/6	7475 4/7
6A7 15/7	6F13 5/6	6S7 5/7	12A7 3/9	30P13 13/6	7475 4/7
6A8G 12/6	6F14 12/6	6S7 5/7	12A7 3/9	30P14 13/6	7475 4/7
6AC7 3/7	6F23 13/6	6V6M 8/7	12A7 3/9	30P15 13/6	7475 4/7
6AK5 4/8	6F24 13/7	6V6G 4/8	12A7 3/9	30P16 13/6	7475 4/7
6AL5 3/7	6F25 12/7	6V6GT 6/8	12A7 3/9	30P17 13/6	7475 4/7
6AM5 2/6	6F28 11/6	6X4 3/6	12A7 3/9	30P18 13/6	7475 4/7
6AM5 3/6	6G6 2/6	6X6 3/6	12A7 3/9	30P19 13/6	7475 4/7
6AQ5 3/7	6G6 2/6	6X6 3/6	12A7 3/9	30P20 13/6	7475 4/7
6AS7G 15/7	6G8M 6/6	6Y6 11/6	12A7 3/9	30P21 13/6	7475 4/7
6AT6 4/6	6J5GT 2/6	7B7 7/7	12A7 3/9	30P22 13/6	7475 4/7
6AU6 6/7	6J6GT 4/6	7C5 15/7	12A7 3/9	30P23 13/6	7475 4/7
6B8G 2/7	6J6 3/7	7D5 6/8	12A7 3/9	30P24 13/6	7475 4/7
6B4G 15/7	6J7M 7/8	7D5 6/8	12A7 3/9	30P25 13/6	7475 4/7
6B6 8/7	6J7G 4/9	7H7 8/8	12A7 3/9	30P26 13/6	7475 4/7
6B6 6/7	6J7GT 6/8	7R7 17/8	12A7 3/9	30P27 13/6	7475 4/7

SPECIAL 24 HOUR SERVICE
OBSOLETE TYPES A SPECIALITY
QUOTATIONS FOR ANY VALVE NOT LISTED
Postage 6d. per valve. C.W.O. No C.O.D.
Manufacturers and Export Inquiries Welcome

Special 24 Hour Express Mail Order Service

SETS OF VALVES
DAF91, DF91, DK91, DL92 or DL94 ... 19/- the set
DAF96, DF96, DK96, DL96 ... 27/6 the set

BRAND NEW TRANSISTORS
AC127 7/6 OC25 11/- OC71 4/6 OC81 4/- OC82D 6/-
AF114 7/- OC28 16/- OC72 6/- OC81m/7/- OC83 7/-
AF115 7/- OC35 11/6 OC75 6/- OC81 7/- OC84 7/-
AF116 7/- OC44 4/6 OC76 6/- OC81D 4/- OC171 8/-
AF117 5/- OC45 4/- OC77 8/- OC82 6/- OC200 7/6

SEND S.A.E. FOR LIST OF 2,000 TYPES

E.S.V.—T.V. Receivers

IN STOCK NOW 19—21—23in. Slimline Receivers. All in excellent condition. Some Manufacturer's Cabinet Rejects (slight marks on Cabinet)—some rental—very slightly used but perfect. Price—one price only £18.0.0. Limited stock all orders in strict rotation. Post and packing 40/-.
Personal Collection advised—otherwise immediate despatch at customer's risk.

E.S.V. Tape Recorders

LIQUIDATION STOCK—over 150 semi-professional Tape Recorders by famous manufacturer. Capstan drive, Battery or Mains operation. Push-button Control—Brand new and complete with Mic, Spools, Tape, etc. in manufacturers carton. Our Price £14 14s. 0d. Post & packing 8/6.
Also assortment of other models at much reduced prices.
Worth 4 times this amount.

ELECTRONIC SALES (Victoria) LTD
17 GILLINGHAM ROW
VICTORIA, LONDON, S.W.1
VIC 5091

SERVICE VALVE and SEMICONDUCTOR EQUIVALENTS (RSGB)

5/6 post paid
A recently up-dated list of all types of Service valves likely to be found and used by amateurs and experimenters.
WORLD AT THEIR FINGERTIPS (RSGB)
By J. Clarricoats, OBE, G6CL
A very interesting and enlightening story of the development of Amateur Radio.
De-Luxe 47/-
Paperback 14/- post paid

AMATEUR RADIO CALL BOOK 1968 (RSGB)
6/9 post paid
An up-to-date list of UK call-signs and addresses.

A GUIDE TO AMATEUR RADIO (RSGB)
6/9 post paid
This is a new edition, containing much additional material to introduce newcomers to this fascinating hobby. We always recommend this book as an ideal way to learn about Amateur Radio.

RADIO DATA REFERENCE BOOK (RSGB)
The second edition was published last September and now carries comprehensive lists of UK and overseas TV frequencies, coaxial cables, insulating materials, rectification circuits, etc. in addition to the useful data on most aspects of transmitter and receiver design.
14/- post paid

We can supply a complete list of our stocks of publications on request.
Details of membership of the RSGB are also available on request:
RADIO SOCIETY OF GREAT BRITAIN, Dept. PW
28 LITTLE RUSSELL STREET, LONDON, W.C.1

LOOK!

PRACTICAL!

VISUAL!

EXCITING!

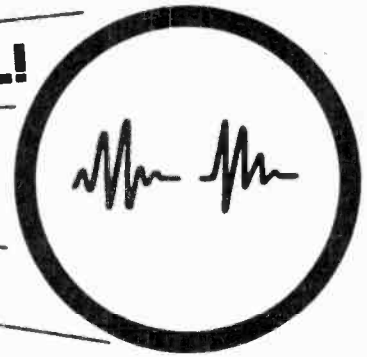

a new 4-way method of mastering
ELECTRONICS
by doing — and — seeing ...

1 ▶ **OWN and HANDLE** a complete range of present-day **ELECTRONIC PARTS** and **COMPONENTS**

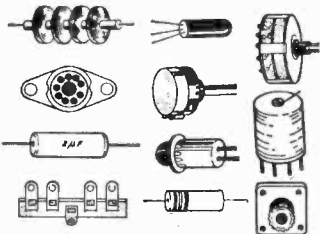

2 ▶ **BUILD and USE** a modern and professional **CATHODE RAY OSCILLOSCOPE**

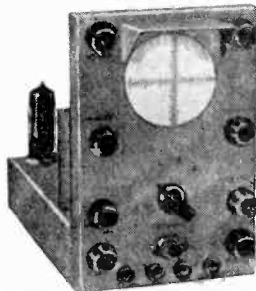

3 ▶ **READ and DRAW and UNDERSTAND** **CIRCUIT DIAGRAMS**

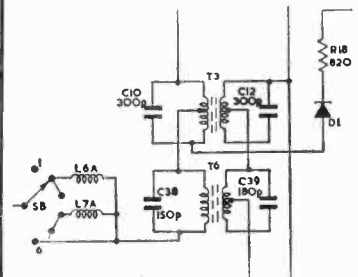

4 ▶ **CARRY OUT OVER 40 EXPERIMENTS ON BASIC ELECTRONIC CIRCUITS AND SEE HOW THEY WORK ... INCLUDING ...**

- VALVE EXPERIMENTS
- TRANSISTOR EXPERIMENTS
- AMPLIFIERS
- OSCILLATORS
- SIGNAL TRACER
- PHOTO ELECTRIC CIRCUIT
- COMPUTER CIRCUIT
- BASIC RADIO RECEIVER
- ELECTRONIC SWITCH
- SIMPLE TRANSMITTER
- A.C. EXPERIMENTS
- D.C. EXPERIMENTS
- SIMPLE COUNTER
- TIME DELAY CIRCUIT
- SERVICING PROCEDURES

This new style course will enable anyone to really understand electronics by a modern, practical and visual method—no maths, and a minimum of theory—no previous knowledge required. It will also enable anyone to understand how to test, service and maintain all types of Electronic equipment, Radio and TV receivers, etc.

FREE POST NOW
for
BROCHURE

or write if you prefer not to cut page

To: **BRITISH NATIONAL RADIO SCHOOL, READING, BERKS.** Please send your free Brochure, without obligation, to: *we do not employ representatives*

NAME BLOCK CAPS

ADDRESS PLEASE PW4

Practical Wireless Classified Advertisements

HOLIDAYS

HOLIDAY FOR BOYS 14/16 years August 1968 specialising in engineering, electronics, photography. Tuition and practical work. 11 days—£14.10.0. Write for free brochure: **INTER-SCHOOL CHRISTIAN FELLOW-SHIP**, 47 Marylebone Lane, London W.1.

BOOKS & PUBLICATIONS

ANNOUNCEMENT

A Guide to Surplus Communication Receivers

A few copies of the first edition (recently serialised in *Practical Wireless*) are still available. Price 7/6 p.p. 1/-.

ADKINS, 72 Courtenay Ave, Harrow, Middlx. Mail order only

SURPLUS HANDBOOKS

19 set Circuit and Notes .. 5/6 p/p 6d.
1155 set Circuit and Notes .. 5/6 p/p 6d.
H.R.O. Technical Instructions .. 4/6 p/p 6d.
38 set Technical Instructions .. 4/6 p/p 6d.
46 set Working Instructions .. 4/6 p/p 6d.
38 set Technical Instructions .. 6/- p/p 6d.
BC.221 Circuit and Notes .. 4/6 p/p 6d.
Wavemeter Class D Tech. Instr. .. 4/6 p/p 6d.
18 set Circuit and Notes .. 4/6 p/p 6d.
BC.1000 (31 set) Circuit and Notes .. 4/6 p/p 6d.
CR.100/B.28 Circuit and Notes .. 9/6 p/p 9d.
R.107 Circuit and Notes .. 6/- p/p 6d.
AR.88D Instruction Manual .. 16/- p/p 1/6
62 set Circuit and Notes .. 5/6 p/p 6d.
Circuit Diagram 4/- each post free, R.1116/A, R.1224/A, R.1355, R.F. 24, 25 and 26, A.1134, T.1154, CR.300, BC.312, BC.342, BC.348J, BC.348 (E.M.P.), BC.624, 22 set.

52 set Sender and Receiver circuits 7/6 post free

Resistor colour code indicator, 2/- p/p 6d.

S.A.E. with all Inquiries please. Postage rates apply to U.K. only.

Mail order only to:

INSTRUCTIONAL HANDBOOK SUPPLIES

DEPT. PW, TALBOT HOUSE, 28 TALBOT GARDENS, LEEDS 8

MISCELLANEOUS

BY100 RECS 4/- each

OC81 3/- OC71 2/6 RED SPOT 2/6

POST PAID IN BRITISH ISLES
S.A.E. FOR BARGAIN LISTS

SALOP ELECTRONICS

9A GREYFRIARS RD., COLEHAM
SHREWSBURY, SHROPSHIRE

ELECTRONIC sound and musical devices required for exploitation. Adequate finance available. Projects developed to pre-production stage required. Royalty payments guaranteed. Details only Box No. 74.

ELECTRONIC MUSIC?

Then how about making yourself an electric organ? Constructional data available—full circuits, drawings and notes! It has 5 octaves, 2 manuals and pedals with 24 stops—uses 41 valves. With its variable attack you can play Classics and Swing.

Write NOW for free leaflet and further details to **C. & S.**, 20 Maude Street, Darlington, Durham. Send 3d. stamp.

RATES: 1/6 per word (minimum 12 words). Box No. 1/6 extra. Advertisements must be prepaid and addressed to Advertisement Manager, "Practical Wireless", George Newnes Ltd., 15/17 Long Acre St., London, WC.2

TAPE RECORDERS, TAPES, Etc.

GEE'S Recording Tape and Audio Accessories cost less! Send 1/- for illustrated catalogue. **Gee Bros. Radio**, 15 Little Newport Street, London, W.C.2. Gerrard 6794.

TAPES TO DISC—using finest professional equipment 45 rpm—18/-, S.A.E. leaflet. **DEROY**, High Bank, Hawk Street, Carnforth, Lancs.

SERVICE SHEETS

SERVICE SHEETS (75,000) 4/- each: please add loose 4d. stamp: callers welcome; always open. **THOMAS BOWER**, 5 South Street, Oakenshaw, Bradford.

RADIO, TELEVISION over 3,000 models. **JOHN GILBERT TELEVISION**, 1b Shepherds Bush Rd., London W.6. SHE 8441.

SERVICE SHEETS, RADIO, TELEVISION, TAPE RECORDERS, 1925-1968 by return post, from 1/- with free fault-finding guide. Catalogue 6,000 models 2/6. Please send stamped addressed envelope with all orders/enquiries. **HAMILTON RADIO**, 54w London Road, Bexhill, Sussex.

C. & A. SUPPLIERS SERVICE SHEETS

3/6d. plus S.A.E.

71 BEAUFORT PARK
LONDON, N.W.11

We have the largest supplies of TV, Radio and Tape Recorder Service Sheets, by return of post. Please state make and number.

Mail order only.

Name and address..... PW3

.....

.....

Make

Model No.

SERVICE SHEETS (continued)

SERVICE SHEETS, RADIO, TV, 5,000 Models, List 1/6. S.A.E. Enquiries. **TELRAY**, 11 Maudland Bank, Preston, Lancs.

SERVICE SHEETS

4/- each, plus postage

We have the largest display of Service Sheets for all makes and types of Radios and Televisions, etc., in the country. Speedy service.

To obtain the Service Sheet you require please complete the attached coupon

Name:

Address:

.....

.....

To: **S.P. DISTRIBUTORS**

**30 Baker Street,
London, W.1**

Please supply Service Sheets for the following

Make:

Model No..... Radio/TV

Make:

Model No..... Radio/TV

Make:

Model No..... Radio/TV

I require the new 1968 List of Service Sheets at 1/6 each plus postage.

(please delete items not applicable)

Enclose remittance of..... (which includes postage)

MAIL ORDERS ONLY (Apr.) PW

FOR SALE

SEE MY CAT. for this and that. Tools, materials, mechanical and electrical gear—lots of unusual stuff. This Cat. is free for the asking. **K. R. WHISTON** (Dept. PWC), New Mills, Stockport.

★ HAMMERITE HAMMER PATTERN ENAMEL ★

AIR DRYING • JUST BRUSH ON

TRIAL TIN
(covers 5 sq. ft.)

3/9

+ 9d. post.

1pt. 8/-, 1pt. 16/-, Carr: orders up to 5/-, 9d; up to 10/-, 1/9d; over 10/-, 3/-. Colours: blue, silver, black, bronze. Others available. No primer needed. Panel transfers, fireproof spray thinners etc. **LIST FREE.**

INDUSTRIALISTS
SAVE TIME AND \$\$\$'s
(2 pints will do a Mini).

AMAZING RESULTS. JUST TRY IT!

FINNIGAN SPECIALITY PAINTS (PW)

Mickley Square, Stocksfield, Northumberland
Tel. Stocksfield 2280

MORSE MADE EASY !!

FACT NOT FICTION. If you start **RIGHT** you will be reading amateur and commercial Morse within a month. (Normal progress to be expected.)

Using scientifically prepared 3-speed records you automatically learn to recognise the code **RHYTHM** without translating. You can't help it, it's easy as learning a tune. 18 W.P.M. in 4 weeks guaranteed.

For details and course C.O.D. ring, s.t.d. 01-660 2896 send 8d. stamp for explanatory booklet to:

G3CHS/P. 45 GREEN LANE, PURLEY, SURREY

FOR SALE
(continued)

YUKAN SELF-SPRAY SO PROFESSIONAL THE YUKAN AEROSOL WAY—

Get these **GREY HAMMER** OR **BLACK WRINKLE (CRACKLE)** finishes

Yukan Aerosol spraykit contains 16 ozs. fine quality durable easy instant spray. No stove baking required. Hammers available in grey, blue, gold, bronze. Modern Eggshell Black Wrinkle (Crackle) all at 14/11 at our counter or 15/11 carriage paid, per push-button self-spray can. Also Durable, heat and water resistant Black Matt finish (12 ozs. self-spray cans only) 13/11 carriage paid.

SPECIAL OFFER: 1 can plus optional transferable snap-on trigger handle (value 5/-) for 18/11 carriage paid. Choice of 13 self-spray plain colours and primer (for car quality) also available.

Please enclose cheque or crossed P.O. for total amount to:
YUKAN, Dept. 307, EDGWARE ROAD, PW/D LONDON, W.2.

We supply many Government Departments, Municipal Authorities, Institutes and leading Industrial Organisations—we can supply you too.

Open all day Saturday. Closed Thursday afternoons.

MINIFLUX 4-Track stereophonic/monophonic record/playback heads. List Price 6 gns.—Special Offer 55/- each.

MINIFLUX 4-Track stereophonic/monophonic Ferrite Erase Heads. List Price £3.10.0.—Special Offer 32/6 each, or supplied together (one of each) at £3.17.6.

SKN4 4-track stereophonic record/play heads for Transistor Circuits at 55/- each. Also available 4-track and full-track monophonic Ferrite Erase Heads. All heads complete with technical specifications. Send S.A.E. for details.

LEE ELECTRONICS, 400 Edgware Rd., Paddington 5521.

CURSONS TRANSISTORS

ALL GUARANTEED

1/- each. BAY31, BAY50, DK10, OA70, OA81, OA10, OA200, OA90, OA91, OA259.

2/- each. XA101, XA102, OC71, OC72, OC81, OC81D, OC44, OC45, GET16, FST3/1, ACY22.

3/- each. OC139, OC140, 2N706, 2N708, 2N2894, BY100, RAS310AF, 2N914, 2N916, BSY25, BSY26, BSY27, BSY95A, AFZ12, BFY18, BFY19, BFY26, BFY36.

7/6 each. RAS508AF, CRS3/40, BLY10, BLY11, BUY10, BUY11, ADY22, ADY23, ADY24, 2N2234, 2N2235, OC22, OC26, OC28, OC35.

ZENER DIODES

3-9v to 26v, 1/2w 3/- each, 1-5w 4/-, 7w 5/- each.

SAE, full new list:—

B. W. CURSONS
78 BROAD STREET
CANTERBURY, KENT

FOR SALE
(continued)

8 VOLUMES Radio and Television Servicing 1959-1967. Bound "Contact". Guaranteed as new £25. RAWLINGS, 13 Field Road, Stainforth, Doncaster.

MORSE PRACTICE OSCILLATOR 25/-. B. JOLLEY, 69 Primrose Drive, Huyton, Liverpool.

WANTED

WE BUY New Valves and Transistors. State price. A.D.A. MANUFACTURING CO., 116 Alfreton Road, Nottingham.

WANTED. Newnes Radio/Television volumes, 1959 onwards. Also Avo test meter. Box No. 75.

WANTED: Popular Brand New Valves. R.H.S., Stamford House, 538 Great Horton Road, Bradford 7.

WANTED NEW VALVES ONLY

Must be new and boxed
Payment by return

WILLIAM CARVIS LTD
103 North Street, Leeds 7

VALVES WANTED, brand new popular types boxed. **DURHAM SUPPLIES (C),** 175 Durham Road, Bradford 8, Yorkshire.

WANTED: New valves, transistors etc.; state price. E.A.V. Factors 202 Mansfield Road, Nottingham.

WE BUY New Valves, Transistors and clean new components, large or small quantities, all details, quotation by return. **WALTON'S WIRELESS STORES,** 55 Worcester Street, Wolverhampton.

DAMAGED Avo Meters, Models 7 and 8, Damaged Meggers, any quantity. Send for packing instructions. **HUGGETT'S LTD.,** 2/4 Pawson's Road, West Croydon.

SITUATIONS VACANT

RADIO and tape recorder testers and trouble shooters required. Canteen, excellent rates of pay, 8.00 a.m. to 5.00 p.m. 5-day week. Elizabethan Electronics Limited, Crow Lane, Romford, Essex. Phone: Romford 64101.

SITUATIONS VACANT

A Vacancy exists for a young man aged 18 years or over, who possesses some knowledge of Transistor Circuitry and Fault-Finding. Further "on the job" training will be given in the field of Telecommunications.

Please apply to Personnel Manager,
Cambridge Works Ltd., Haig Road, Cambridge.
Tel. Cambridge 51351 Extn 327

SITUATIONS VACANT
(continued)

IF YOU ARE a Radio enthusiast and would like a position with a future, apply to **BERRY'S RADIO,** 25, High Holborn, London, W.C.1.

TV and Radio, A.M.I.E.R.E., City & Guilds, R.T.E.B. Certs., etc. on 'Satisfaction or Refund of Fee' terms. Thousands of passes. For full details of exams and home training Courses (including practical equipment) in all branches of Radio, TV, Electronics, etc. write for 132-page Handbook—FREE. Please state subject. **BRITISH INSTITUTE OF ENGINEERING TECHNOLOGY (Dept. 137K), Aldermaston Court, Aldermaston, Berks.**

FREE TO AMBITIOUS ENGINEERS! 132 page Guide to B.Sc. (Eng.), A.M.I.E.R.E., A.M.S.E., A.M.I.M.I., CITY & GUILDS, A.I.O.B., A.R.I.C.S., G.C.E., etc. on 'Satisfaction or Refund' terms. Thousands of passes—over 600 Home Study Courses in all branches of Engineering, Building, Radio, Electronics, etc. Write: B.I.E.T. (Dept. 169K), Aldermaston Court, Aldermaston, Berks.

RADIO TECHNICIANS

A number of suitably qualified candidates are required for unestablished posts, leading to permanent and pensionable employment (in Cheltenham and other parts of the UK, including London). There are also opportunities for service abroad.

Applicants must be 19 or over and be familiar with the use of Test Gear, and have had practical Radio/Electronic workshop experience. Preference will be given to such candidates who can also offer "O" Level GCE Passes in English Language, Maths and/or Physics, or hold the City and Guilds Telecommunications Technician Intermediate Certificate or equivalent technical qualifications. A knowledge of electromechanical equipment will be an advantage.

Pay according to age, e.g. at 19—£828, at 25—£1,076.

Prospects of promotion to grades in salary range £1,159—£1,941. There are a few posts carrying higher salaries.

Annual Leave allowance of 3 weeks 3 days rising to 4 weeks 2 days. Normal Civil Service sick leave regulations apply.

Application forms available from:

Recruitment Officer (RT/37),
Government Communications
Headquarters,
Oakley, Priors Road,
CHELTENHAM, Glos.

EDUCATIONAL

RADIO OFFICER training courses. Write: Principal, Newport and Monmouthshire College of Technology, Newport, Mon.

CITY & GUILDS (electrical, etc.) on "Satisfaction or Refund of Fee" terms. Thousands of passes. For details of modern courses in all branches of electrical engineering, electronics, radio, TV., automation, etc., send for 132-page Handbook—FREE. B.I.E.T. (Dept. 168K), Aldermaston Court, Aldermaston, Berks.

BECOME "Technically qualified" in your spare time, guaranteed diploma and exam. home-study courses in radio, TV servicing and maintenance. T.T.E.B., City and Guilds, etc.: highly informative 120-page Guide—free. **CHAMBERS COLLEGE** (Dept. 857K), 148 Holborn, London, E.C.1.

TRAIN FOR SUCCESS WITH ICS

Study at home for a progressive post in Radio, TV and Electronics. Expert tuition for I.E.R.E., City & Guilds (Telecoms and Radio Amateurs) R.T.E.B., etc. Many unique diploma courses incl. Colour TV, Electronics, Telemetry & Computers. Also self-build kit courses—valve and transistor.

Write for **FREE prospectus** and find out how **ICS** can help you in your career.

**ICS, DEPT. 541 INTERTECH HOUSE,
LONDON, SW11.**

ELECTRICAL



**240 volt
ELECTRICITY
ANYWHERE**



With Most Brilliant Performance Ever from 12 Volt Car Battery. **BRILLIANT HEAVY DUTY 240 volt AMERICAN DYNAMOTOR** with **BIG 220 WATT OUTPUT**. Marvellous for TELEVISION, ELECTRIC DRILLS, MAINS LIGHTING and ALL UNIVERSAL AC/DC MAINS EQUIPMENT. Marvellous for fluorescent lighting. Thousands of uses. Tremendous purchase makes fantastically low price possible. **ONLY £7.0.0** each plus 10/- delivery. C.O.D. with pleasure. **MONEY BACK** if not DELIGHTED.

STANFORD ELECTRONICS Dept. P.W.
Generator Specialist
No. 4 Rear Derby Road,
North Promenade, Blackpool
Please send S.A.E. for illustrated details.

ELECTRICAL

(continued)



LATEST ELECTRONIC BREAKTHROUGH. CUT YOUR ELECTRICITY BILLS BY HALF. FINGERTIP CONTROL OF ALL ELECTRICAL APPLIANCES UP TO 3,000 WATTS. HEAT. Vary the heat of your ELECTRIC FIRES, and save electricity. Ideal for ELECTRIC BLANKETS, household IRONS, simmer your ELECTRIC KETTLE. Excellent for SUN-RAY LAMPS. **LIGHT.** Control the brightness of all household LAMPS, from a glimmer to full brightness. Ideal for SPOT LAMPS, ARC LAMPS, etc. Useful for FLOOD-LIGHTS. **SPEED.** Controls the speed of ANY ELECTRIC DRILL, for any application. Super for LATHES, GRINDERS, FOOD MIXERS, VACUUM CLEANERS, WASHING MACHINES, SPIN DRIERS, HEDGE CUTTERS, WILL CONTROL ALL A.C./D.C. MOTORS UP TO 2 H.P. These units must not be confused with ordinary resistances and thermostats that waste power. Contained in a strong metal case. In black or grey. size now 6 x 5 1/2 x 2 1/2 inches. **SIMPLE TO USE.** No specialised knowledge required. A unique electronic achievement, contains 7 transistors and thyristors and many micro miniature electronic components. **COMPLETELY SAFE AND APPROVED.** Brand new and ready to use Improved de-luxe model. Price £12.10.0 carriage and insurance 10/-. C.O.D. 3/6. extra. 10% Trade Discount given to Schools, Universities, Colleges and Educational & Research Establishments.

COLLAPSIBLE AERIAL A fully adjustable highly efficient whip aerial. Made to exacting specifications. Copper plated sections. Brass base. An ideal aerial for TX/RX use. Easily adaptable for cars, scooters, walkie talkies etc. Brand new in maker's boxes. Only £1 each, post and packing 2/6. Two aerials for 32/-. post 2/6d.

RUN TELEVISION-LIGHTING DRILLS ETC-ETC from a 12 Volt CAR BATTERY

A superbly designed **POWER CONVERTER** (de luxe model). A 12 volt INPUT gives a 200/240 volt OUTPUT. Enables you to run up to 300 watt AC/DC TELEVISION lighting and equipment. Not to be confused with Heavy Duty Dynamotors of poor efficiency. These units are of famous British manufacture. Thousands of uses. Indispensable to caravanners, workshops and garages. The unit is contained in a compact louvered steel case. Complete with connecting leads, battery clips and full instructions. Ready to connect up and use.

Our price while stocks last, only **£6.19.6.**
Carriage 12/6. C.W.O., C.O.D. 3/6 extra.

All orders to: Dept. P.W.9.

GLOBE SCIENTIFIC LTD
24 CAWOODS YARD, MILL STREET,
MARSH LANE, LEEDS 9 Tel. Leeds 35900

METAL WORK

METAL WORK: All types cabinets, chassis racks, etc., to your specifications. **PHILPOTTS METAL WORKS LTD.**, Chapman Street, Loughborough.

ALL TYPES of metal work to your specifications. **WALTON**, 48 Green Lane, Oldham, Lancs.

RECEIVERS & COMPONENTS

150 NEW ASSORTED Capacitors, Resistors, Silvered Mica, Ceramic, etc. Carbon, Hystab, Vitreous, 1-20 watt, 12/6 Post Free. **WHIT-SAM ELECTRICAL**, 18 Woodrow Close, Perivale, Middlesex.

N.P.N. SILICON PLANAR V.H.F. Epitaxial transistors. High power version of P346A. T05 case by S.G.S. Fairchild. PT, 3-0 watts; FT, 550 Mc/s; VCBO, 25 volts. 1-9 at 5/- each. 10-24, 4/6 each, 25-99 at 4/- each, 100 up 3/6 each. **STONEMAN & TURPIN, LTD.** 2 The Rye, Eaton Bray, Dunstable, Bedford.

FET's MPF105 suitable for 2N3819 applications. 10/-. Resistors 1/2 and 1/4 W 5% 4.7Ω-4.7MΩ 2d. each. Capacitors, rectifiers, etc. S.a.e. price list.—**STUDENT ELECTRONIC SERVICES**, 194 Regent Road, Salford 5.

BRAND NEW TELEVISION TUBES 2 YEAR GUARANTEE. HUGE RANGE

12" £3; 14" £4.15.0; 17" £5.15.6
19" £6.17.6, etc., etc. Carriage, etc. 12/-

Also British and Telefunken valve lists!

PHILIP H. BEARMAN, 6 Potters Road, New Barnet, Hertfordshire. Tel. 449/1934

COMPUTER PANELS

Eight assorted printed circuit panels with transistors, diodes, resistors, capacitors etc. Guaranteed minimum 30 transistors. Ideal for Experimenters. 8 boards 10/- POST FREE.

Trade and Bulk enquiries welcome.

1500+2000 MFD Electrolytics 25 volt DC wkg, 3/- each. 9d. P. & P.

KEYTRONICS, 52 Earls Court Road, London W.8. Mail order only.

DUXFORD ELECTRONICS (PW)

Duxford, Cambs.

C.W.O. P. & P. 1/-. Minimum order value 5/-.

POTENTIOMETERS (Carbon): Long life, low noise. 1W at 70°C. ±20% ≤1M, ±30% >1M. Body dia. 1/4 in. Spindle, 1 in. x 1/4 in. 2/- each. Linear: 100, 250, 500 ohms etc., per decade to 10M. Logarithmic: 5k, 10k, 25k, etc., per decade to 5M.

SKELETON PRE-SET POTENTIOMETERS (Carbon): Linear: 100, 250, 500 ohms etc., per decade to 5M.

Miniature: 0.3W at 70°C. ±20% ≤1M, ±30% >1M. Horizontal (0.7 in. x 0.4 in. P.C.M.) or Vertical (0.4 in. x 0.2 in. P.C.M.) mounting, 1/- each.

Submini. 0.1W at 70°C. ±20% ≤1M, ±30% >1M. Horizontal (0.4 in. x 0.2 in. P.C.M.) or Vertical (0.2 in. x 0.1 in. P.C.M.) mounting, 10d. each.

RESISTORS (Carbon film): High stability, very low noise. 1W at 70°C. Body 1/4 in. x 1/4 in. Values in each decade: 10, 11, 12, 13, 15, 16, 18, 20, 22, 24, 27, 30, 33, 36, 39, 43, 47, 51, 56, 62, 68, 75, 82, 91 from 4.7Ω to 1M. ±5% 2d. each. 1.2M, 1.5M, 1.8M, 2.2M, 2.7M, 3.3M, 3.9M, 4.7M, 5.6M, 6.8M, 8.2M, 10M. ±10%, 2d. each.

SILICON RECTIFIERS: 0.5A at 70°C 400 P.I.V., 3/-, 800 P.I.V., 3/3, 1.250 P.I.V., 3/9, 1.500 P.I.V., 4/- **SEMI-CONDUCTORS:** (all new) OA5, OA81, 1/6. OC44, OC45, 1/9. OC71, OC72, OC73, OC81, OC81D, OC82D, OC170, OC171, 2/3. OC140, AF115, AF116, AF117, 3/-.

SEND S.A.E. FOR FULL CATALOGUE.



YOURS FREE FOR 7 DAYS

The New 'Picture - Book' way of learning

BASIC

- ELECTRICITY (5 Vols)
- ELECTRONICS (6 Vols)
- ELECTRONIC CIRCUITS (2 Vols)
- INDUSTRIAL ELECTRICITY (2 Vols)
- SYNCHROS & SERVOMECHANISMS (2 Vols)

You'll find it easy to learn with this outstandingly successful new pictorial method—the essential facts are explained in the simplest language, one at a time; and each is illustrated by an accurate cartoon-type drawing.

The books are based on the latest research into simplified learning techniques. This has proved that the Pictorial Approach to learning is the quickest and soundest way of gaining mastery over these subjects.

NEW!

Amazing examination technique now programmed for the Basic Electricity and Basic Electronics Manuals...

If your answer is correct — the Tester will tell you so.
If your answer is wrong — the Tester will refer you to text for you to study again!

AVAILABLE ON 7 DAYS FREE TRIAL — SEE COUPON

POST NOW FOR THIS OFFER!

TO SELRAY BOOK CO.
60 HAYES HILL, HAYES, BROMLEY, KENT

Please send me Without Obligation to Purchase, one of the above sets on 7 Days Free Trial. I will either return set, carriage paid, in good condition within 7 days or send the following amounts. Basic Electricity 70/- Cash Price or Down Payment of 15/- followed by 4 fortnightly payments of 15/- each. Basic Electronics 82/- Cash Price or Down Payment of 15/- followed by 5 fortnightly payments of 15/- each. This offer applies to UNITED KINGDOM ONLY. Overseas customers cash with order.

Tick set required (only ONE set allowed on free trial).

- | | | | |
|---------------------------------------|--------------------------|------------------------------|--------------------------|
| BASIC ELECTRICITY 70/- | <input type="checkbox"/> | BASIC ELECTRONICS 82/- | <input type="checkbox"/> |
| TRAINER TESTERS 26/- per set | <input type="checkbox"/> | TRAINER TESTERS 31/- per set | <input type="checkbox"/> |
| BASIC ELECTRONIC CIRCUITS 38/- | <input type="checkbox"/> | | |
| BASIC INDUSTRIAL ELECTRICITY 38/- | <input type="checkbox"/> | | |
| BASIC SYNCHROS & SERVOMECHANISMS 38/- | <input type="checkbox"/> | | |
| BASIC TELEVISION PART 1 22/- | <input type="checkbox"/> | | |

All prices include postage

NAME
BLOCK LETTERS BELOW
FULL POSTAL ADDRESS

BI-PRE-PAK LTD

222-224 WEST ROAD, WESTCLIFF-ON-SEA, ESSEX
PHONE: SOUTHEND (0502) 46344

LOOK—TRANSISTORS 1/- EACH

SILICON ★ PLANAR ★ P.N.P. ★ P.N.P.
All these types available

2N929	2S131	2N696	28731
28501	28512	2N697	28732
2N726	28102	2N1607	28733
2N706	28103	2N1613	
2N706a	28104	2N1711	
2N3011	2N2220		

Transistors	Price
AF114	4/-
AF115	3/-
AF116	3/-
AF117	4/-
AF118	3/6
AF119	3/6
AF178	10/-
BSY95A	5/-
OC22	7/6
OC23	10/-
OC25	8/-
OC26	5/-
OC28	7/6
OC35	5/-
OC36	7/6
OC41	2/6
OC42	2/6
OC44	1/11
OC45	1/9
OC71	2/6
OC72	2/6
OC73	5/-
OC81	2/6
OC81D	2/6
OC83	4/-
OC139	2/6
OC140	5/-
OC170	3/-
OC171	4/-
OC200	5/-
OC201	8/-
2N1302 or 3	4/-
2N1304 or 5	5/-
2N1306 or 7	8/-
2N1308 or 9	8/-

ALL TESTED AND GUARANTEED TRANSISTORS—UNMARKED. Manufacturers over-runs for the new PRE-PAK range.

No.	PRE-PAKS	PRICE
A1.	6—Silicon rectifiers BY100 type	20/-
A3.	20—Mixed marked and tested trans.	20/-
A9.	1—2N 174 real power trans. 80V 150W	20/-
A15.	2—Power Comp. Pair. AD161/2	20/-
B1.	50—Unmarked, untested, trans., new	10/-
B2.	4—Solar cells, inc. Book of Instructions	10/-
B3.	4—OAB gold bonded, diodes, Mullard	10/-
B5.	7—Matched set. OC44, 45/81D/81 + diode	10/-
B6.	15—Red spot A.F. trans. or white spot RF	10/-
B8.	2—Power trans. OC26 and OC35 type	10/-
B9.	1—Light sensitive cell. ORP12 type	9/-
B10.	10—50V trans. germ. PNP latest type	10/-
B21.	2—Sil. recs. 10 amp. 50-100 PIV	10/-
B42.	5—Switching trans. TK220 STC	10/-
B66.	150—Germanium diodes, untested	10/-
C2.	1—Uni junction, 2N2160 or 2N2646	15/-
C4.	2—RF power trans., OC22 and BUY11	15/-
C81.	4—Sil. recs. 800 PIV 1 amp. top hat	15/-
C82.	2—Power trans. TK400A/NKT404 VCB64 IC 8 amp.	15/-
	70 amp. 400 PIV. SCR's SPECIAL OFFER	70/-

★ ALL OUR SEMICONDUCTORS HAVE A WRITTEN GUARANTEE ★

Send for our FREE lists and catalogue of all our products. Check your own equivalents with our free substitution chart

FIRST EVER LOGIC KITS. Learn for yourself how computers work, even make one for yourself. Full instructions for a nights and crosses machine, binary counters, timers, etc. L.1 5 gns. L.2 10 gns. No need to purchase both kits, you can start with L.2, which incorporates L.1. DETAILS FREE.

NO CONNECTION WITH ANY OTHER FIRM. MINIMUM ORDER 10/- CASH WITH ORDER PLEASE, add 1/- post and packing. OVERSEAS ADD EXTRA FOR AIRMAIL.

17in.—£11.10.0
19in. SLIMLINE
FERGUSON—24 Gns.

TWO-YEAR GUARANTEE
EX-RENTAL TELEVISIONS

FREE ILLUSTRATED LIST OF TELEVISIONS
17"—19"—21"—23"
WIDE RANGE OF MODELS
SIZES AND PRICES
DEMONSTRATIONS DAILY

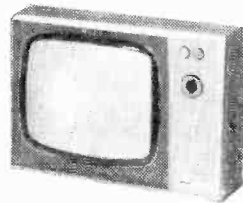

TWO-YEAR GUARANTEED TUBES 100% REGUNNED
14in.—69/6 17in.—89/6
21in. and ALL SLIMLINE TUBES 99/6
EXCHANGE BOWLS. Carr. 10/6
EX MAINTENANCE TESTED TUBES
17in.—35/- Carr. 5/- (not slimline)

COCKTAIL/STEREOGRAM CABINET £25

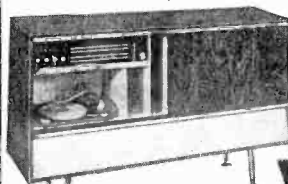

Polished walnut veneer with elegant glass fronted cocktail compartment, padded. Position for two 10in. elliptical speakers. Record storage space. Height 35½in., width 52½in., depth 14½in. Legs 1 gn. extra.

STEREO RADIO-GRAM CABINETS £15

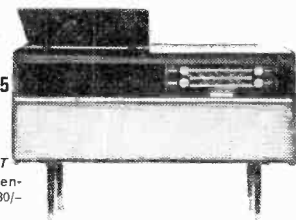

Superbly made and styled in Veneered English Walnut
LIFT UP LID TO CHANGER AND RECORD STORAGE COMPARTMENT

Position 8" x 5" Twin Speaker. Dimensions: 45 x 15½ x 15½. Legs 1 gn. Carr. 30/-
Other Models—Send for List

DUKE & CO. (LONDON) LTD.

621/3 Romford Road, London, E12 Tel. 01-478-6001/2/3

The following blueprints are available from stock. Descriptive text is not available but the date of issue is shown for each blueprint. Send, preferably, a postal order to cover cost of the blueprint (stamps over 6d. unacceptable) to Blueprint Department, Practical Wireless, George Newnes Ltd., Tower House, Southampton Street, London, W.C.2.

The Strand Amplifier }	(Oct. 1962)	5/-	The Celeste 7-transistor Portable Radio }	(June 1963)	5/-
The PW Signal Generator }			The Spinette Record Player }		
The Berkeley Loudspeaker Enclosure }	(Dec. 1962)	5/-	Transistor Radio Mains Unit }	(June 1964)	5/-
The Luxembourg Tuner }			7 Mc/s Transceiver }		
The PW Troubadour }	(June 1962)	7/6	The Citizen (December 1961) }		5/-
The PW Everest Tuner }			The Mini-amp (November 1961) }		5/-
The PW Britannic Two }	(May 1962)	6/-	The Beginner's Short Wave Superhet (Dec. 1964) }		5/-
The PW Mercury Six }			The Empire 7 Three-band Receiver (May 1965) }		5/-
Beginner's Short Wave Two }	(Nov. 1963)	5/-	Electronic Hawaiian Guitar (June 1965) }		5/-
S.W. Listener's Guide }			Progressive SW Superhet (February 1966) }		5/-
PW "Sixteen" Multirange Meter }	(Jan. 1964)	5/-	Beginner's 5-Band Receiver }	(Dec. 1966)	5/-
Test Meter Applications Chart }			Home Intercom Unit }		

★ PLEASE NOTE THAT WE CAN SUPPLY NO BLUEPRINTS OTHER THAN THOSE SHOWN IN THE ABOVE LIST. NOR ARE WE ABLE TO SUPPLY SERVICE SHEETS FOR COMMERCIAL RADIO, TV OR AUDIO EQUIPMENT. ★

Before using the query service it is important to read the following notes:

The PW Query Service is designed primarily to answer queries on articles published in the magazine and to deal with problems which cannot easily be solved by reference to standard text books. In order to prevent unnecessary disappointment, prospective users of the service should note that:

(a) We cannot undertake to design equipment or to supply wiring diagrams or circuits, to individual requirements.

(b) We cannot undertake to supply detailed information for converting war surplus equipment, or to supply circuitry.

(c) It is usually impossible to supply information on imported domestic equipment owing to the lack of details available.

(d) We regret we are unable to answer technical queries over the telephone.

(e) It helps us if queries are clear and concise.

(f) We cannot guarantee to answer any query not accompanied by the current query coupon and a stamped addressed envelope.

QUERY COUPON

This coupon is available until 5th April, 1968 and must accompany all queries in accordance with the rules of our Query Service.

PRACTICAL WIRELESS, APRIL 1968

NEW! SOLID STATE HIGH FIDELITY EQUIPMENT BRITISH MADE

POWER AMPLIFIERS — PRE-AMPLIFIERS — POWER SUPPLIES

We proudly present this new range of Audio Equipment developed from Dinsdale Mk. II—each unit or system will compare favourably with other professional equipment selling at much higher prices. Brief details are below:—

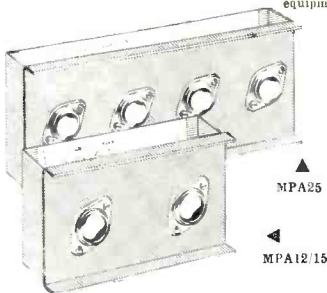
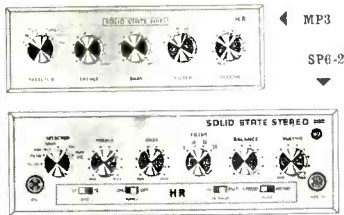

System	Comprising	Price
★ A	5 watt mono for 3/5 ohm speakers	£10.3.0
★ 1	12 watt mono for 3 to 5 ohm speakers	£13.17.6
★ 2	12 watt mono for 12 to 16 ohm speakers	£14.12.6
★ 4	24 watt mono two channel for 12 to 16 ohm speakers	£20.15.0
★ 8	20 watt mono/stereo for 12 to 16 ohm speakers	£24.0.0
★ 9	24 watt mono-stereo for 3 to 5 ohm speakers	£26.15.0
★ 14	40 watt mono/stereo for 7 to 16 ohm speakers	£29.10.0

COMPLETE FULLY ILLUSTRATED BROCHURE No.21 FREE ON REQUEST

MANY OTHER SYSTEMS AVAILABLE Send for full details

THE FINEST VALUE IN HIGH FIDELITY — CHOOSE A SYSTEM TO SUIT YOUR NEEDS AND SAVE POUNDS



VHF FM TUNER
87/105 Mc/s Transistor Superhet. Geared tuning. Terrific quality and sensitivity. For valve or transistor amplifiers. 4 - 31.2 Mc. Complete with dial plate. 2 Mullard Transistors, plus 4 Diodes. Ask for Brochure 3.
TOTAL COST TO BUILD £6.19.6 P.P. 2/6



FM STEREO DECODER Brochure 4
7 Mullard Transistors. Printed Circuit Design with Stereo Indicator. For use with any valve or transistor FM. Uses not cores to Mullard design and ger. and silicon transistors. As used by B.B.C. and G.P.O. Complete Kit Price **£5.19.6 P.P. 2/6**

TRANSISTOR CAR RADIO
Send for Brochure 15



British Made 6-Transistor MW/LW. 12 Volt 3 watt output. Push-button wave-change. Bored, ready to use with Speaker and Battery Car fixing kit and manufacturers' guarantee. Special Bargain Offer. Positive or Negative Earth.
£9.19.6 P.P. 4/6
£11.19.6. Positive or Negative Earth.



Ask for Brochure 5

MW/LW QUALITY TRANSISTOR RADIO TUNER
Fully tunable superhet with excellent sensitivity and selectivity. Output up to 1 volt peak. Complete with front panel, etc. 9 volt operated. For use with any amplifier or tape recorder.
TOTAL COST TO BUILD £3.19.6 P.P. 2/6

TRANSISTORS - SEMICONDUCTORS

COMPLETELY NEW 1968 LIST OF 1000 types available from stock. Send for your **FREE COPY TODAY.** (List No. 36)

- ★ S.C.R's from 5/-
 - ★ FIELD EFFECT TRANSISTORS from 9/6
 - ★ POWER TRANSISTORS from 5/-
 - ★ DIODES AND RECTIFIERS from 2/-
- 24 page Illustrated Brochure as above including Valves and Quartz Crystals. 1/- post paid.

GARRARD DECKS

all the LATEST MODELS



COMPLETE RANGE IN FROM £5.19.6 STOCK
Send for illustrated Brochure 16 & 17

MAYFAIR PORTABLE

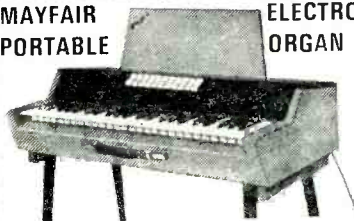

TOTAL COST TO BUILD 99 GNS.

ELECTRONIC ORGAN

Also **READY BUILT AND TESTED 128 gns.**

Deferred terms available. **DEPOSIT £36.8.0** and 12 monthly payments of **£9.** Total **£144.8.0.**
KIT OF PARTS Deferred terms: **DEPOSIT £29.19.0** 12 monthly payments of **£7.** **TOTAL COST £113.19.0.**
ORGAN COMPONENTS We carry a comprehensive stock of organ components for TRANSISTOR AND VALVE **FREE PHASE** design. Brochure 10

EXPORT PRICES ON APPLICATION

★ Build this instrument stage by stage in your own home.
★ A truly portable instrument for all enthusiasts.
★ Fully TRANSISTORISED POLYPHONIC. British design.
★ Call in for a DEMONSTRATION and see for yourself.
Full details on advertised products FREE on request

HENRY'S RADIO LTD.



303 EDGWARE ROAD LONDON W.2 PHONE: 01-723 1008/9

Open Mon. to Sat. 9 a.m.-6 p.m. Thurs. 9 a.m.-1 p.m.

WE CAN SUPPLY FROM STOCK MOST OF THE PARTS SPECIFIED ON CIRCUITS IN THIS MAGAZINE. SEND LIST FOR QUOTATION.

BUILD THESE PRACTICAL WIRELESS DESIGNS

CLUBMAN Mk I
AS PER JAN/FEB 1968 EDITION
89/6 Post 2/6 LESS CLASSIS & METALWORK
Send for Parts List 41

CLUBMAN Mk II
AS PER MARCH 1968 EDITION
72/6 Post 2/6
Send for Parts List 41

BUILD A QUALITY TAPE RECORDER with MARTIN RECORDAKITS



Ask for Brochure 6

363 DECK
★ TWO-TRACK Deck £10.10.0. Amplifier. £11.9.6. Cabinet and speaker 7 gns. Complete kits with MICROPHONE and 7in. 1,200ft. tape, spare spool.
Today's Value **£45. 29 gns.** P.P. 18/6

★ FOUR-TRACK Deck £18.10.0. Amplifier. £16.19.6. Cabinet and speaker 7 gns. Complete kits with MICROPHONE and 7in. 1,200ft. tape, spare spool.
Today's Value **£50. 32 gns.** P.P. 18/6



7-TRANSISTOR MW-LW SUPERHET PORTABLE NEW!

New printed circuit design with full power output. Fully tunable on both mw/lw bands. 7 transistors plus diode, push-pull circuit. Fitted 5 inch speaker large ferrite aerial and Mullard transistors. Easy to build with terrific results. All local and Continental stations. Size 10 x 7 x 3 1/2 in.
TOTAL COST TO BUILD £6.19.6 P.P. 4/6
Send for Brochure 1

SINCLAIR EQUIPMENT

Z12 12 watt amplifier. 89/6. P24 Power Supply Unit. 99/6. Stereo 25 Preamp. £9.19.6. Q14 Speakers. £8.19.6. Micro-matic Radio Kit 49/6. Built 59/6. £5.19.6. ALL POST PAID.



BUILD THE PRACTICAL WIRELESS I.C. F.M. TUNER

AS PER DECEMBER, 1967 ISSUE
Total cost **99 6** Post 2/6
Including R.C.A. CA3104 Circuit and Layout Diagrams. Parts List No. 40A

BUILD THE PRACTICAL WIRELESS SWITCHED F.M. TUNER
AS PER AUGUST, 1967 ISSUE
Total cost **77 6** Post 2/6 Parts List No. 39
With Circuit and Layout Diagrams

EXPLORER V.H.F. RECEIVER
AS PER JANUARY, 1967 ISSUE
Total cost **62 6** With Circuit CABINETS and Diagrams 22/6 List No. 28

CATALOGUE

LATEST EDITION
240 pages, 6,000 items
1,000 illustrations

- ★ 20 pages of transistors and semiconductor devices, valves and crystals.
- ★ 150 pages of components and equipment.
- ★ 50 pages of microphones, decks and Hi-Fi equipment.

The most comprehensive—Concise—Clear components Catalogue in Gt. Britain. Complete with 10/- worth Discount Vouchers Free with every copy.

Send today 8/6 Post paid

