

PRACTICAL

NOVEMBER 1990 • £1.50

ELECTRONICS

SCIENCE AND TECHNOLOGY

BIKE COMPUTER

Get on the road to
new horizons with
our micro-cyclo

NICAD CHARGING ADAPTOR

Plugging you into
non-stop listening

LASERS

Telling tales of
technology riding on a
light-beam

BASIC ELECTRONICS

Understanding
opamps, the
universal tools of the
analogue world



Anyone can win with our
READER LOYALTY
BONUS
See page 39



REALISTIC®

Walkie talkies

49 MHz FM
Fully Approved To
DTI Specs MPT-1336

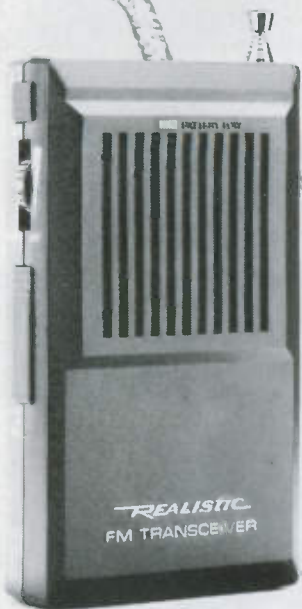

21-401

EACH
£24⁹⁵

• Licence Not Required

Realistic TRC-501. Only 25.4mm thick and five ounces light! Call button transmits a tone signal. Low-battery indicator, push-to-talk button, telescopic aerial. Includes belt clip. Requires one 9v battery.

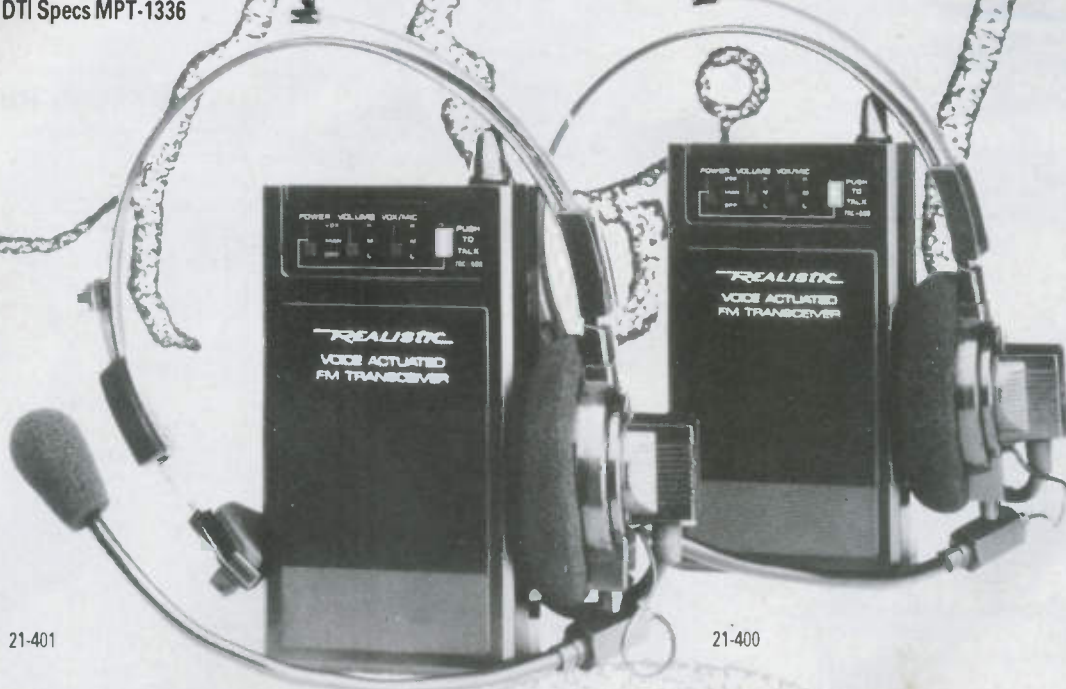

21-400

PAIR
£59⁹⁵

• Licence Not Required

Realistic TRC-500. Voice-actuation gives you hands free communication. Dual-conversion superhets for high sensitivity and clear 2-way communication. Volume switch. With belt clips. Each headset requires 9v battery.

Tandy®

Over 400 Tandy Stores And
Dealerships Nationwide. See
Yellow Pages For Address Of
Store Nearest You.

InterTAN U.K. Ltd., Tandy Centre, Leamore Lane, Walsall, West Midlands. WS2 7PS
Tel: 0922 710000



Page 12 ▲ Page 19 ▼

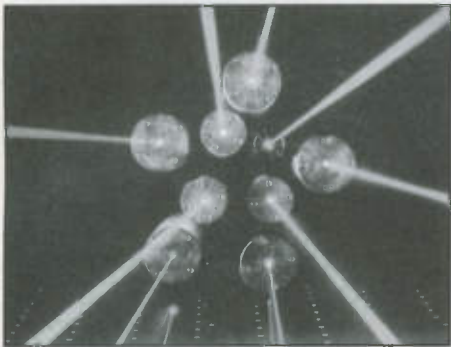

NEXT MONTH

BY POPULAR REQUEST!

"Set it free", was the cry after we showed you how to control a robot car tethered to a computer. And, "Set us free", was another cry after we presented you with some embedded microcontroller projects : "show us how to program our own 8748s!" Well, we're slaves to your command and two of our designers have lately been chained firmly to their irons. The pains of their toil will be brought before you next month, satisfying both calls for freedom. A masterful stroke! And there's more freedom for pedallers: part two of the Bike Computer with construction and alternative microcontroller use details. We've the usual liberal selection of unfettered features too, and the 1990 Annual Index.

PLUS

**A BUMPER BONUS:
GREENWELD'S
132 PAGE
CATALOGUE!**

★ UNSHACKLE YOUR DESIRES
WITH OUR DECEMBER 1990
ISSUE

★ ON RELEASE FROM FRIDAY
NOVEMBER 2ND

PE LIBERATES TECHNOLOGY
FURTHER - BE PART OF IT!



PRACTICAL ELECTRONICS

VOL 26 NO 11

NOVEMBER 1990

CONTENTS

READER LOYALTY BONUS!

GET YOUR GOODS FREE from our advertisers.....39

CONSTRUCTIONAL PROJECTS

BIKE COMPUTER by John Becker12

Make your cycling measure up to micro technology with our multi-mode miles and metric motion monitor. Or you can gear it down for use as a general-purpose 6502 microcontroller board complete with rom, ram and i/o interface.

IN-SITU NICAD CHARGER by Dave May41

Why bother to switch off your personal stereo to change the batteries? Build this adaptor and keep your listening chargeably uninterrupted!

CHIPTESTER - PART TWO by Dave Raynor48

It's no major operation to put this professional quality monitor into private health care practice for the welfare state of your chips.

SPECIAL FEATURES

LASERS - PART ONE by Mike Sanders19

Once merely science fiction concepts, lasers have become common-place realities. We examine their properties, functions and varieties.

BASIC ELECTRONICS - PART ELEVEN by Owen Bishop .25

Opamps are the theme this month, and a good understanding of what they are and how they can be used is vital for anyone with analogue intentions.

HISTORY OF TECHNOLOGY - FARADAY by Ian Poole31

The discoverer of electromagnetic induction, and the man after whom the unit of capacitance was named, Faraday was one of the greatest scientists of all time.

HOME-BASE by Ian Burley32

Heralded four years ago, the first Keyline terminals are helping people to shop without venturing outside. Our correspondent's going on-line. Will you?

WHY DIGITAL PHONES? by Tom Ivall.....35

Great benefits are to be gained from the incoming digital public mobile phone systems, some unseen, some more tangible. We examine the principles.

REGULAR FEATURES

EDITORIAL by John Becker - On your micro-bike!.....9

LEADING EDGE by Barry Fox - Electronic Yellow Pages8

SPACEWATCH by Dr Patrick Moore - Over the Sun46

INDUSTRY NOTEBOOK by Tom Ivall - St Cecilia Electronica.....57

TRACK FEEDBACK - Readers' letters, and a few answers.....47

PRODUCT FEATURES

NEWS AND MARKETPLACE - what's new in electronics.....4

SPECIAL SUBS OFFER - FREE binders for PE subscribers.....10

BOOKMARK - the Editor's browse through some new books.....45

ARMCHAIR BOOKSHOP - haven for practical bookworms58

PCB SERVICE - professional PCBs for PE Projects60

HOW TO DO IT - the route to better board building61

ADVERTISERS' INDEX - locating favourite stockists 62



EASIER VCR

Recent research by Ferguson has indicated that as many as 28% of users either never set the video to record or find it difficult to do so. Ferguson recognise that ease of use and ease of programming are critically important factors for new users and replacement purchasers alike and has introduced a couple of video recorders which should help to overcome the problems experienced by so many people.

The new Videostar FV41R and the FV42L feature Instant Help Programming (IHP), a full on-screen programming function with 'Instant Help' pages.

IHP is unique to Ferguson and makes life easy by guiding users step by step through the

programming process. Whatever stage the user is at, a simple press of a button will give instant access to one of several instant help pages, providing a comprehensive on-screen facility.

A useful facility is the 8-event over one year timer. Events can be recorded in any order, and a daily/weekly repeat facility allows the allocation of events to regular times. A particularly unusual extra feature is the ability to switch on the television set a pre-determined time. Another useful feature is the Go To function enabling the tape to be automatically wound to a specific counter number.

And, very relevant to the increasing availability of channels, is the 40 programme frequency

synthesis tuner, enabling the channel number to be directly keyed in quickly and easily.

The information received about these VCRs does not specifically mention the number of events that can be pre-programmed for non-repeat recording. The remote control handset can handle four events, so it is likely that the VCR handles the same number. This is another area to which Ferguson should possibly give attention: four events are not enough when people go on two weeks holiday and perhaps want to record many more short events which are within the limits of the tape length. Perhaps an automatic tape changing facility would be useful too.

These two new machines should now be in your local high street shops, at around £329 for the standard play FV41R, and £349 for the 8-hour long play FV42L.

SUPER BRIGHT LEDS

Panasonic's new low cost ultra-bright Gallium-Arsenide leds have become available through Trident Microsystems. The leds have been designed for bright ambient light applications and use high efficiency chips, providing two candellas at a forward current of 20mA. They feature a 5mm diameter lens made from a water-clear material, which focuses the light forward into a very narrow viewing cone.

Applications include outdoor display or information boards, or emergency signalling in any equipment where bright red graphics are required. The forward voltage drop is typically 1.8V.

For further information contact John Turney, Trident Microsystems Ltd, Trident House, 55 Ormside Way, Redhill, Surrey, RH12 2LS. Tel 0737 765900.

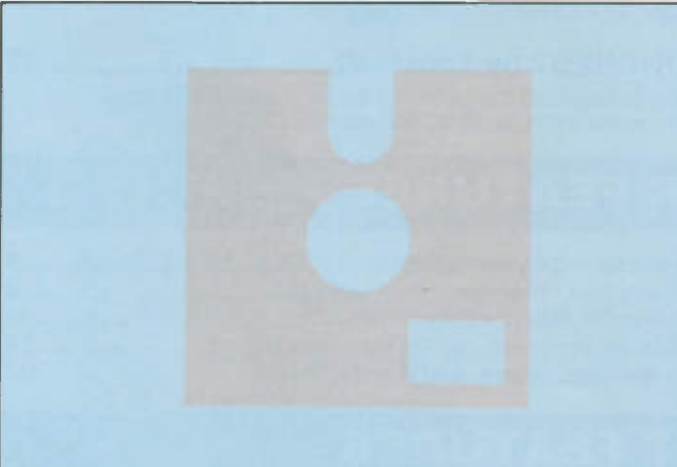

Our browse through recently received literature

Multi Sources have introduced themselves to us sending through data on some of their products. For over two years they have been marketing DC Metrology products manufactured by Measurements International Ltd, utilising National Research Council of Canada's innovative technology. In addition Multi

Sources are manufacturers of pulse sources and generators. The data received covers some of those products, including low cost high performance pulse generators, an automated potentiometer system, a four terminal scanner, and an automated dc voltage calibration system. These products are unlikely to be of interest to the average hobbyist, but PE readers in the test and development sectors of the trade should find benefit from asking for more information from Multi Sources, Unit 2, Stable Yard, Downs Barn, Milton Keynes, Bucks, MK14 7RZ. Tel: 0908 666042.

Harrison Electronics has sent through a 6-page list of surplus components for sale. Since it is dated July 1990 it is reasonable to suppose that the company specialise in surplus components and issue lists on a regular basis. This particular issue is devoted mainly to integrated circuits, from cmos 4000 to all varieties of 74ttl. Also included are linear ics, microprocessors, diodes, transistors, triacs, regulators and crystals. If you are looking for a quantity source of surplus parts at reasonable prices, give Harrisons a call, note though that there is a minimum order charge of £25 plus vat. Harrison Electronics, Century Way, March, Cambs, PE15 8QW. Tel: 0345 51289.

Gem-Tech have sent in their interesting new catalogue. It is aimed at anyone who loves electronics and wants to build simple and useful projects, and to learn from doing so. To back up the kits are a range of other items, including a good selection of books to teach you more about electronics. There is also a cross-section of the essential tools which any enthusiast is likely to need, from screwdrivers and soldering irons, to meters and other important test gear. To round off nicely, printed circuit board making materials are available too, plus an excellent CAD pcb design software package. There are some valuable discounts on offer this month. Gem-Tech, Unit J, 8 Finucane Drive, Orpington, Kent, BR5 4ED.

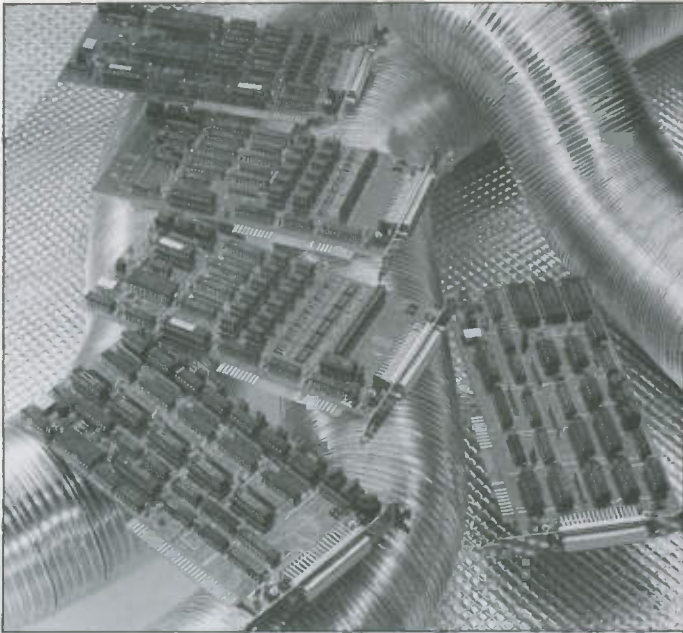

PC-BUS EXPANSION BOARDS

Arcom has developed a new range of control and monitoring I/O expansion boards for IBM-compatible PCs. The range offers unprecedented levels of system integrity and ease-of-use, say Arcom.

The fundamental limitations of existing PCbus devices has been addressed by Arcom's range, which use an evolution of the PC I/O scheme. The limitations addressed include the difficulty of finding free PC I/O address space for

expansion boards, inadequate specifications for industrial tasks, and the lack of a coherent and well-defined signal conditioning scheme to make connection to the real world.

The new I/O boards can be fitted and proven operational in minutes, tested and maintained with ease.

For more information contact **Anthony Winter, Arcom Control Systems Ltd, Units 8-10 Clifton Road, Cambridge, CB1 4WH. Tel 0223 411200.**



DYNAMIC DUO

Two new low cost analogue multimeters from Alpha are ideal for a host of general purpose applications. Both measure ac and dc voltage, direct current, resistance, dBs, and have a diode and battery test function. Pivot and jewel screw mechanism with a mirror scale are features of the analogue displays, which have both fuse and diode input protection.

Model AM1001 is the smaller of the two, measuring just 100 x 65 x 32mm and weighing only 110gms. Both ac and dc voltage can be measured to 500V and direct current to 250mA. AM2001 measures 1000V on both ac

and dc plus direct current to 10A. One drawback of the AM1001 for some hobbyist experimenters is that its dc sensitivity is only 10k ohms per volt, placing more load on some circuits than may be desirable. The other meter, though, the AM2001, has a better sensitivity of 20k ohms per volts.

Both models are fully guaranteed and supplied ready for use with test leads, battery, spare fuse and instruction manual. The prices are £9.95 and £19.95 respectively, plus vat.

For more information contact **Alpha Electronics Ltd, Unit 5, Linstock Trading Estate, Wigan Road, Atherton, Manchester, M29 0QA. Tel: 0942 873434.**



If you are organising any event to do with electronics, big or small, drop us a line,

Please note : Some events listed here may be trade or restricted category only. Also, we cannot guarantee information accuracy, so check details with the organisers before setting out.

Oct 18-19. Direct to Home Broadcast by Satellite. IEEE conference – registration £105 per day. IBA Conference Hall, Brompton Road, London SW3. 071-836 3357.

Nov 6-8. Total Solutions. NEC Birmingham. 0799 26699.

Nov 27. Installation and Maintenance of Security Equipment. IEEE symposium. National Motorcycle Museum, Solihull. 071-836 3357.

1991

Mar 19-21. Nepcon Europe and Electronics International (formerly British Electronics Week). NEC, Birmingham. 0799 26699.

April 17-18. Laboratory Manchester. Windsor Hall, G-Mex Centre, Manchester. 0799 26699.

May 15-16. Laboratory Scotland. Scottish Exhibition Centre, Glasgow. 0799 26699.

IEE FARADAY LECTURES 1990-91

Presented by the Universities of Bath and Sussex.

1990: Oct 17 Brighton. Oct 30 Edinburgh. Nov 7 Liverpool. Nov 13 Middlesborough. Nov 21 Manchester. Nov 27 Reading. Dec 4 Coventry. Dec 12 Ipswich.

1991: Jan 15 Exeter. Jan 22 Swansea. Jan 29 Southampton. Feb 5-7 London. Feb 12 Hanley, Stoke-on-Trent. Feb 27 Nottingham. Mar 6 Sheffield. Mar 13-14 Bath.

For free tickets and further information contact (enclosing SAE) The Faraday Officer, IEE, Michael Faraday House, Six Hills Way, Stevenage, Herts, SG1 2AY.

MICROPROCESSOR TRAINING COURSES

In conjunction with Colchester Institute, Flight Electronics is offering a range of intensive four-day microprocessor courses. Contact: Suzanne Kittow, Flight Electronics Ltd, Flight House, Ascupart Street, Southampton SO1 1LU. Tel: 0703 22721.

KOMPACT PAGING

Tele-Nova tell us that when they launched their first start-up radio paging system, Kompact, they were overwhelmed by the sheer number of small to medium sized companies who had now recognised that on-site radio paging systems were affordable.

The original Kompact comprises a central decoder and four receivers that simply plug into a mains socket. Now a new model, the Kompact Plus, has been launched. It is an updated system incorporating lightweight pagers as

small as credit cards with a simple to use keyboard control that enables operators to contact key members of staff anywhere on site. Four receivers and a console can be installed and ready for use at £70 per quarter. The system can be expanded to support up to 100 pagers. It can be linked to monitor machinery and interfaced to most telephone systems.

For further information contact Paul Lester, Tele-Nova, 111 Endwell Road, London SE4 2LY. Tel: 081 692 9816.

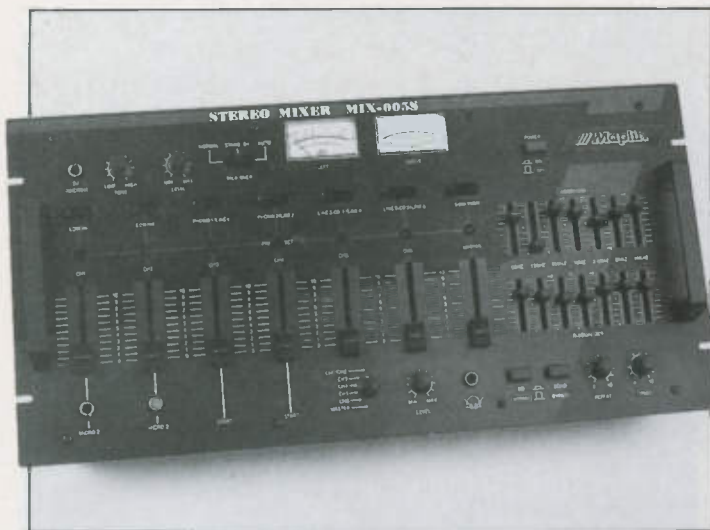

MIXING WITH THE BEST

Primarily intended for use in disco applications, Maplin's professional audio mixing desk should surely raise the roof and the amp levels! The boldly coloured (red and black) stereo mixer has six main input channels, each with preset level and slide fader controls.

Channels one and two are mic inputs with switches to select low or high levels. Chans three and four, and turntable/line level inputs are switch selectable. A special feature on these channels is the provision of auto (turntable) start outputs. Channels five and six are cd/line level inputs, which are also switch selectable.

Additional to the six main input channels is a DJ mic input with tone, level and talkover. A headphone

monitor output with level control is provided and a rotary switch allows selection of the input channel to be monitored. Alternatively the master output may be monitored.

Two seven band (left and right) equalisers are provided to enable the master output to be equalised to suit room acoustics. The mixer also has a bucket brigade (BBD) echo circuit that can produce effects ranging from rapid 'slapbacks' to reverb and discrete echoes.

Obviously this is just the job to get that disco swinging!

For further information contact any of Maplin's nationwide shops, or their head office at PO Box 3, Rayleigh, Essex, SS6 8LR. Tel 0702 554161.



FOUR IN ONE

A single instrument with four separate test and measuring systems is another new unit from Alpha. Their DOS 141 combines a DMM, function generator, frequency counter and power supply into an easy to use compact instrument.

As you will see from the photo, the instrument is full of functions - too many to list here. Judging from Alpha's data it is obviously a high

accuracy unit offering many applications in R&D, production and education. It is also ideal for the serious hobbyist who is prepared to spend the necessary £395 plus vat.

For further information contact Alpha Electronics Ltd, Unit 5, Linstock Trading Estate, Wigan Road, Atherton, Manchester, M29 0QA. Tel: 0942 873434.

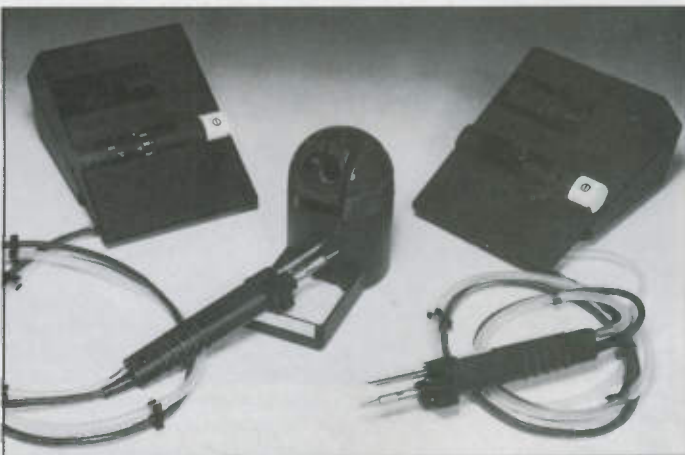

DEFUMIGATING IRON

The fumes from soldering irons really grime up your Editor's glasses after a hard day's work. If yours are too, or you're fed up with the aroma, how about asking Greenwood/Oryx for details of their new iron? The Skylab is a soldering iron that has been designed to also extract fumes directly from the area of the tip itself, reducing the possibility of gasses escaping into the atmosphere. Featuring a lightweight ergonomic

design, the iron incorporates the heating element within the tip. The extraction pipe is unobtrusively integrated into the tool itself and can be adjusted or replaced in seconds if required. However, you do also need a standard fume extraction system to which to connect the pipe.

For further information contact Greenwood/Oryx, Portman Road, Reading, Berks, RG3 1NE. Tel: 0734 595843.

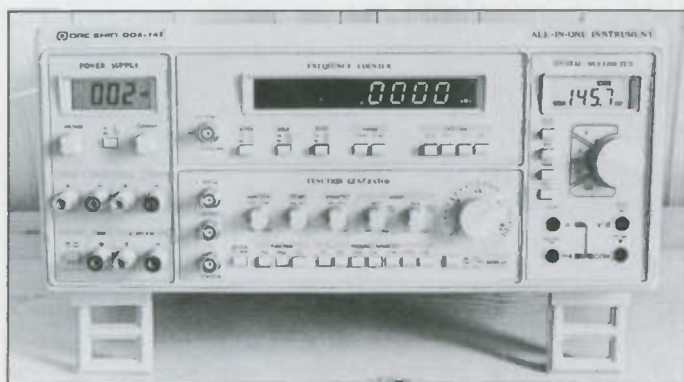

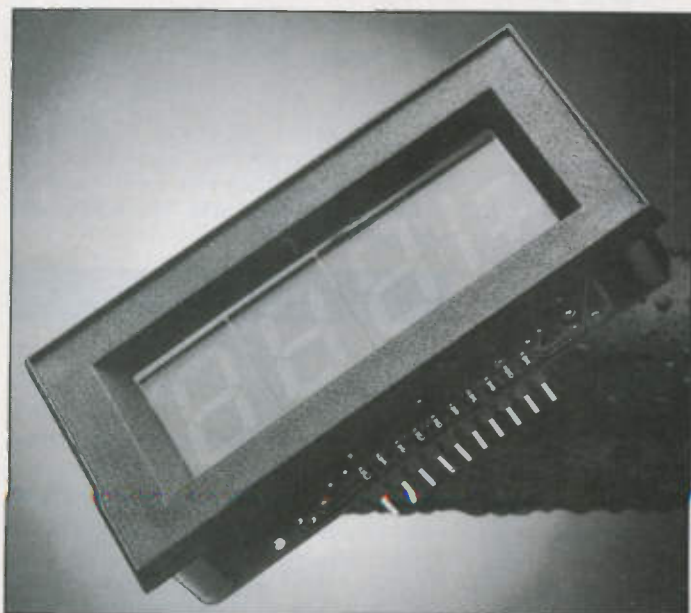

MULTI-TURN LEDS

There is a new high efficiency three and half digit led digital panel meter module which features optional scaling for its 199.99mV range.

The MDM350 has auto-zero, auto-polarity and over-range indication, and the assembly has single-ended, differential or floating measurements, together with a digital display hold and high stability bandgap reference. A multi-turn scale feature is provided for readouts in engineering units.

The bezel, which fits a 68 x 33mm cut out, is supplied with an antiglare filter and mounting hardware. Supply voltage is 5Vdc at 120mA and the operating temperature is rated at 0°C to 50°C. Temperature coefficient is 50ppm/°C and the error specification is quoted at 0.05%rdg x 32.5mm

For more information contact John Leather, Martel Instruments Ltd, Tanfield Lea Industrial Estate, Stanley, Co Durham, DH9 9QX. Tel 0207 290266.

CONTROLS UNDER CONTROL

Here's a neat idea to get rid of that jumble of remote controls cluttering up your home:

The One For All remote control has just carried off a prestigious Product of Year Award from the Television and Radio Industries Club. It apparently can replace all the remote controls you currently have - and even the ones you don't have!

It is unique from other types of universal remote control because it does not have to 'learn' from the originals, so even if the originals are missing or broken, this control can

still be used as a replacement. It is pre-programmed with all the information it needs for every type of home entertainment product you can think of, say the manufacturers, Celstel. You simply select the appropriate 3-digit code from the memory for each of your products. All the features of the original remotes are then instantly at your fingertips.

One For All will control up to 15 different products at any one time and offers many unique features and benefits to the user. At £79.95 the price compares favourably with the other alternatives on the market.

For more information contact Ruth Repton, Celstel Ltd, PO Box 135, Basingstoke, Hants, RG25 2HZ. Tel 0256 64324.

Newsorthy news of your new product could be on these pages - send us details and preferably a photograph

CHIP COUNT

74F1766 DRAM CONTROLLER

The new Burst Mode DRAM Controller (BMDC) type 74F1766 from Philips is a high performance memory timing generator designed to support Page, Nibble or Static Column modes of operation in addition to the normal DRAM access cycles. It performs memory access/refresh arbitration, refresh and memory access timing, RAS interleaving, CAS byte decoding and controls up to four banks of DRAM.

The device generates DRAM timing and so requires a companion address multiplexer like, for example, the 74F1762 Memory Address Multiplexer (already available from Philips) for row and column generation. This provides the flexibility of using the controller with any size of DRAM array by simply choosing an appropriate address multiplexer.

Output drives are designed for incident wave switching for maximum speed of operation so maximising the data rate in and out of the DRAM.

EMBEDDED MICROCONTROLLER 87C552

Philips' new 87C552 microcontroller is the most highly integrated 8-bit type to become available. It is 80C51 based and intended for real time embedded control applications. It incorporates a 10-bit analog to digital converter plus 8K bytes of eeprom.

The 87C552 is fully software compatible with the 80C51 and thus provides the user with a migration path across the entire family. In addition to the above features, the microcontroller provides two PWM outputs, two standard counter/timers of the 80C51, an additional timer with four capture registers and three 16-bit compare registers, a watchdog timer, a full-duplex UART and a series IIC interface. The on-chip 8-channel successive approximation a/d converter has a conversion time of 50µs and a resolution of 10 bits.

TLC3204X ANALOGUE FAMILY

Texas Instruments' TLC3204X family of analogue interface circuits (AIC) is designed to provide an interface between a digital signal processor (DSP), such as the TMS320C25, and real world analogue signals. Since it was first released, the family has expanded to provide new options.

The AIC consists of two basic parts, a transmit and a receive section for two-way communication between analogue and digital. All devices in the family have a series of common features: switched capacitor filter (SCF), input anti-aliasing filter and output reconstruction filter; 14-bit dynamic range ADC and DAC with sampling rate variable up to 19.2 kHz; standard modem samplings can be easily programmed; input stage featuring programmable gain to maximise signal to noise ratio; serial port for direct interface to DSP with just six lines.

The TLC32040/42 were the original designs and have a bandpass anti-aliasing filter and a passband of 300Hz-3.4kHz. The difference is in the TLC32042 whose bandpass filter has a less sharp cut off at low frequencies. At 170Hz it is only 2dB down compared to 25dB for the TLC32040. These lower frequencies are important to preserve the quality of speech in some applications. The TLC32044/45 are designed for voice band applications with a passband of 150Hz-3.65kHz.

The AIC family is built upon a flexible internal structure, developed mainly for voiceband applications. In high-speed modems for example, as data rates get into the range of 2400 to 9600 baud the cost of a dedicated custom chip solution tends to rise rapidly. A more flexible solution is to use a DSP and an analogue interface.

SOURCE DATA

Philips Components Ltd, Mullard House, Torrington Place, London WC1E 7HD. Tel 071-636 0394.

Texas Instruments Ltd, Manton Lane, Bedford, MK41 7PA. Tel 0234 270111.



It hardly seems possible but, after spending nearly three years back to the drawing board, British Telecom's new version of its Electronic Yellow Pages system is bad as the first version.

In theory EYP lets anyone with a home or business computer search through a database of two million businesses in the UK. For someone in John O'Groats hunting for a business in Land's End, the effort of penetrating EYP might perhaps be worthwhile. But for most people it will still be far easier, and cheaper, to browse through BT's printed Yellow Pages books.

The clear picture I get is of BT's computer boffins dictating "They'll use it our way or not at all".

I first ran across EYP in January 1987 when BT's Yellow Pages division in Reading connected modems to its Vax computers so that anyone with a personal computer or viewdata terminal could program it to access database by telephone. Up to 64 callers could connect at the same time.

BT's publicity made the idea sound attractive; all the user had to do is enter a

LEADING

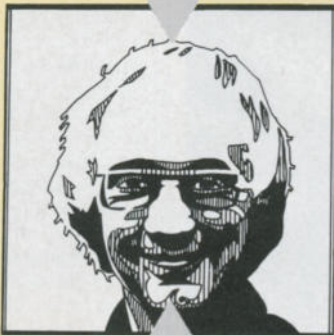

EDGE

estimated number of computer owners in the catchment area. But after a year BT admitted that there was a hard core of only 2,000 regulars left. The others had given up. BT then paid market researchers to phone the drop-outs. The researchers admitted that they heard again and again how users found the system incomprehensible, unfriendly and unusable.

CRITICAL TRIALS

When I phoned, Paul Fry business development manager for EYP, he put on a brave face.

"It was only a trial. We wanted to find out what people wanted by offering them something and then asking what they thought of it. We now know that what people want is wider scope and a more powerful search - although I don't think they realise that this will entail more effort learning how to set up the search parameters".

The EYP system invited callers to leave a message on the computer saying what they

ELECTRONIC YELLOW PAGES

keyword for a trade or service and let the computer search through its memory and display a selected list of names and addresses.

The first EYP database was a test which covered only the London area plus Reading, Guildford and Watford. Even this restricted database was absurdly incomplete. Only firms which paid for display advertisements in the Yellow Pages book were entitled to a free entry in EYP. After a year only 40% of those entitled to a free entry had filled in the form to claim it. The first time round, only 29% of display advertisers bothered. Firms which had only simple text entries in the Yellow Pages book could not go on the electronic database even if they wanted to.

OBSTACLE COURSE

Although people accessing EYP did not pay a search charge, they had to pay British Telecom for the phone call, to Reading. At the rates of the day, anyone in London using EYP during peak business hours had to pay 4.4 pence per 22.5 seconds on line, equivalent to 12p per minute (plus vat).

To connect with EYP, the caller had to understand enough about computers to load and configure communications software for teletype or videotex transmission mode, match the transmission speed or baud rate with the EYP modem telephone number and then choose the right data, stop and parity bit parameters. Although computer buffs would find this easy, everyday users need to beg or buy advice.

Once connected, the caller faced an obstacle course through the incomplete database. Strings of numbers appeared on

BY BARRY FOX
Winner of the UK
Technology Press Award

Despite BT's market research and EYP upgrading it still seems easier to thumb the printed book than the keyboard.

screen, from which the caller had to select options and then enter key words. Often these were rejected. Because the EYP system was based on viewdata software which uses 24 line pages, anyone attempting to print out the results of the EYP search onto paper got a string of blank or only partly used sheets.

As a test, I tried using EYP to search for a London dealer who sold pumps for a pond. Not counting the time spent setting up the computer parameters, it took 10 minutes and 20 sheets of paper to achieve nothing. For example, I could not stop EYP offering me the London region Ponders End.

By comparison, it took exactly one minute to take the printed Yellow Pages book off a shelf, look up "pond", follow one cross reference go straight to a firm advertising pumps for ponds.

BT's £0.5m campaign of full page newspaper advertisements, posters and radio commercials for EYP attracted nearly 40,000 potential users, which was around 25% of the

thought of the system. Fry told me that he was encouraged by the fact that out of 3,000 messages left, fan mail outnumbered hate mail by 3:1. But as leaving a message was as awkward as searching, it seems likely that many people gave up on EYP before learning how to leave a critical message.

Soon after, EYP's computer mailed me a personalised circular letter.

"I am pleased to say that there has been a great deal of interest shown in EYP" wrote Mike Rowley, Head of EYP "and the response has generally been very favourable".

"We don't see the current system as long term EYP", said Fry when I asked him what on earth was happening. "We are already designing EYP II, a second generation system to take criticism into account". His plan was to launch a revamped system late in 1988.

ENHANCED SERVICE

Now, two years later, EYP II is finally ready and BT is sending a circular letter to those who tried EYP I, urging them now to try the new "enhanced national service". This, says BT, provides a database of 2 million businesses, available at any time.

The new service is cheaper to use, because it uses one national dial up number (0345 444 444) which is charged at local call rate from anywhere in the UK. Connection is easier, because the EYP modems now automatically intelligently set themselves to match any data speed (up to 240 baud) and all the length and parity settings used for electronic mail communication.

Continued on page 43. ➔

At the beginning of this year's promising Spring while continuing my cyclic exploration of the Thames Estuary, I chanced upon another cyclist of like-mindedness. We exchanged pleasantries about the technology of our respective machines, the prime cause of my interest being the computer he had on his handlebars.

It measured about two-by-two inches and was less than an inch thick. Its top surface was almost entirely taken up with a liquid crystal display, plus a couple of touch keys. He said it had been a present from a relative in France, and although not knowing the exact cost, thought it was around £35-£40. One key controlled the display of three journey factors: speed, distance, and elapsed time. The second key simply switched the unit on and off, which caused all the trip data to be lost: its memory was volatile.

My imagination was set into high gear by this unit and I began considering the best way of making one. To achieve such miniaturisation the manufacturers would have incorporated everything on to one chip: software, lcd, microprocessor, the lot. This, regrettably, is where the hobbyist constructor is unable to compete. There's no way in which the size of his unit could be achieved without having the backing of industrial facilities. I thus gave thought to what techniques could be used by the readers for

PRACTICAL ELECTRONICS



ON YOUR MICRO-BIKE

whom I would also be designing my micro-cyclo.

Obviously, it had to be microprocessor controlled, the lcd had to be readily available, and the unit had to have appeal to a readership with a wide range of capabilities. For a while, I was severely tempted to make the unit as small as I could. This would have required the use of an embedded microcontroller, a device which embodies the microprocessor itself, plus eeprom, memory and interface circuitry. The problem here is that such devices, like the 8748 for example, need special programmers - a factor which deterred some readers

from building two recent PE projects. I also decided to give readers the opportunity to build a general purpose controller as well. Consequently, I opted to design the unit around a well established microprocessor, the 6502, plus standard peripheral chips.

The big advantage of the 6502 is that it is a device that has been around for a number of years and many readers have computers which use it, or variations on it, and so are more likely to be familiar with its coding language, and to have the facilities for programming it. The 6502 is very much still part of the mainstream scene, despite the proliferation of more sophisticated processors. It has also been upgraded by the manufacturers. The cmos version which I use here, the 65C02, has a lot more command calls available on it than the original device, but is essentially pin and code compatible. Another advantage of the 65C02 is that it consumes less power, making it better suited to battery use. And, unlike the original, it doesn't need external pull-up resistors.

To use the main control board on its own as a microcontroller for other applications, all you really need to do is change the eeprom contents! But as a bike computer, the complete unit does far more than the one that inspired me.

THE EDITOR

Editor:

John Becker

Sub-Editor:

Helen Armstrong

Technical Illustrator:

Derek Gooding

Group Advertisement Manager:

Jacqueline Barlow

Advertisement Executive:

David Bonner

Production Editor:

Richard Milner

Office Manager:

Wendy Cooper

Office Secretary:

Wendy Rhodes

Publisher:

Angelo Zgorelec

Readers' Enquiries

All editorial correspondence should be addressed to the editor and any letters requiring a reply should be accompanied by a stamped addressed envelope, or equivalent payment.

We regret that lengthy technical enquiries cannot be answered over the phone.

Advertisements

The Publishers of PE take reasonable precautions to ensure that advertisements published in the magazine are genuine, but we cannot take any responsibility in respect of statements or claims made by advertisers. The Publishers also cannot accept any liability in respect of goods not being delivered or not working properly.

© Intra Press 1990. Copyright in all drawings, photographs and articles published in PRACTICAL ELECTRONICS is fully protected, and reproduction or imitations in whole or in part are expressly forbidden. All reasonable precautions are taken by PRACTICAL ELECTRONICS to ensure that the advice and data given to readers is reliable. We cannot, however, guarantee it, and we cannot accept legal responsibility for it. Prices quoted are those current as we go to press. All material is accepted for publication on the express understanding that the contributor has the authority to permit us to do so. ISSN 0032-6372

PE Services

SUBSCRIPTIONS - Annual subscription rates are £18.00 for the U.K. or £21.00 overseas (Air mail overseas is £39.00). Please send your cheques (payable to Intra Press), payment by Visa or Access also accepted, to: Practical Electronics, Subscription Dept., P.O. Box 500, Leicester LE99 0AA. Telephone: 0858 410510 (ask for Practical Electronics Subscriptions).

BACK ISSUES - We still have a limited number of the back issues from the last three years available (Certain issues from earlier years are also available, but check before ordering). Price £1.75 - overseas £2.25 (inclusive of postage). Orders should be sent to our editorial address.

BINDERS - to hold 12 issues of PE are also available from our editorial address. Price £5.95 (overseas £6.95 - surface mail). Post included.

BOOK SERVICE - see the Book Service advertisement in the magazine.

PCB SERVICE - details inside.

Cover Photo:
Ed Davis

Practical Electronics,
Intra House, 193 Uxbridge Road,
London W12 9RA
Tel: 081-743 8888
Telecom Gold: 87: SQQ567
Fax: 081-743 3062

SPECIAL SUBS OFFER!

SUBSCRIBE AND BE GIFTED!

TAKE OUT 12 MONTHS' SUBSCRIPTION TO PE AND CHOOSE A GIFT:

★ A FREE BINDER TO HOLD 12 COPIES OF PE WORTH £5.95

OR

★ A FREE 300 PAGE BOOK "INTERNATIONAL TRANSISTOR EQUIVALENTS GUIDE" WORTH £3.95

EXTRA SPECIAL OFFER TO STUDENTS, TEACHERS AND BAEC* MEMBERS SAVE 10% AND RECEIVE THE GIFT OF YOUR CHOICE!

(*British Amateur Electronics Club)



If you already subscribe to PE you can take advantage of this special offer by extending your existing subscription - please advise your current subscription number or say from which month you want your subs to run.

Yes please PE, put me on course to a hi-tech future: Enrol me on your priority subscription list and send me 12 issues and my free gift for the following special price:

UK readers

£18

£16.20 (student/teacher/BAEC)

Overseas Readers

£22

£19.80 (student/teacher/BAEC)

Proof of my student/teacher/BAEC status is attached (e.g. headed notepaper etc.)

I wish my subs to start from the earliest possible issue

I wish to extend my existing subscription for a further 12 months commencing with the issue dated

As my free gift I would like to receive:

The Binder

The Transistor Equivalents Guide

Please send my monthly copy of PE to:

Name and address

.....

.....

Post Code

I enclose a cheque / postal order

Please charge to my Access / Visa card number

Send this form (or a photocopy of it) to:
Practical Electronics Subscriptions, 193
Uxbridge Road, London W12 9RA

COMPUTER ICs

| | |
|--|--------------|
| 80C31 MICRO | £2 |
| P8749H MICRO | £5 |
| BBC MICRO PARTS | |
| SN76489AN | £3 |
| VIDEO ULA 201647 | £10ea 10+ £8 |
| 6845 CRT | £5 |
| 6522 PIA | £3 |
| DM88LS120 | £4.50 |
| AY3-1015D UART | £2.50 |
| 8086 processor ex-equipment | £2 |
| USED 41256-15 | £1.50 |
| USED 4164-15 ex-equipment | £1 |
| 9 x 41256-15 SIMM MODULE NEW | £10 |
| 8 x 4164 SIP MODULE NEW | £9 |
| HD 146818 CLOCK IC | £2 |
| 2864 EEPROM | £3 |
| 27128A 250ns EPROM USED £1.50 NEW £2 100+ £1.50 | |
| FLOPPY DISC CONTROLLER CHIPS 1771 | £16ea |
| 68000-6 PROCESSOR NEW | £5 |
| HD63484-8 | £5 |
| ALL USED EPROMS ERASED AND BLANK CHECKED CAN BE PROGRAMMED IF DESIRED. | |
| 2716-45 USED | £2 100/£1 |
| 2732-45 USED | £2 100/£1 |
| 2764-30 USED | £2 100/£1.50 |
| 27C256-30 USED | £2 |
| 27C512 USED (ALSO 27512) | £3.00 |
| 1702 EPROM EX EOPT | £5 |
| 2114 EX EOPT 60p 4116 EX EOPT | 70p |
| 6264-128k static ram | £3.00 |
| 62256-12 32K static Ram | £7.00 |
| 2532 EPROM USED | £2 |
| 4416 RAM | £3.00 |
| USED 4416-15 RAM | £2 |
| USED 41464-15 | £5 |

REGULATORS

| | |
|-------------------------------|------------------------|
| LM317T PLASTIC TO220 variable | £1 |
| LM317T METAL | £2.20 |
| 7812 METAL 12V 1A | £1 |
| 7805/12/15/24V plastic | 38p 100+ 20p 1000+ 18p |
| 7905/12/15/24 plastic | 38p 100+ 20p 1000+ 18p |
| CA3085 TO99 variable reg | 2/£1 |
| LM338 5A VARIABLE | £5 |

CRYSTAL OSCILLATOR

| | |
|-------------------------------------|------------|
| 1.8342 £1 each 1M, 1.8432M, 4M, 16M | £1.50 each |
|-------------------------------------|------------|

CRYSTALS

| | |
|--|---------|
| 2.77 MHz/24.000 MHz/4.9152MHz/20MHz/49.504MHz, 8M, 16.568M | £1 each |
|--|---------|

TRANSISTORS

| | |
|--|--------------------|
| BC107, BCY70 PREFORMED LEADS full spec | £1 £4/100 £30/1000 |
| BC557, BC548B, BC238C, BC308B | 30/£1 £3.50/100 |
| POWER TRANSISTORS | |
| N POWER FET IRF531 | 3/£1 |
| P POWER FET IRF531 | 2/£1 |
| 2SC1520 sim BF259 | 3/£1 100/£22 |
| TIP141/2 £1 ea TIP112/125/42B | 2/£1 |
| TIP35B TIP35C | £1.50 |
| SE9301 100V 10A DARL. SIM TIP121 | 2/£1 |
| 2N3055 EX EOPT TESTED | 4/£1 |
| PLASTIC 3055 OR 2955 equiv 50p | 100/£38 |
| 2N3773 NPN 25A 160V £1.80 | 10/£18 |

QUARTZ HALOGEN LAMPS

| | |
|--|-------|
| A1/216 24V 150 WATTS | £2.25 |
| H1 12V 50W (CAR SPOT) | £1.50 |
| 14 WAY ZIF 9KT | £1 |
| TEXTTOOL single in line 32 way. Can be ganged (coupling supplied) for use with any dual in line devices. | 2/£2 |
| 28 WAY TEXTTOOL ZIF SOCKET EX NEW EQUIPMENT | £2.50 |

CAPACITORS COMPUTER GRADE

| | |
|-----------------------------------|-----------|
| 3300uF 350V SIC SAFCO FELSIC 037 | £6(£1.50) |
| 2200uF 160V SIC SAFCO FELSIC CO38 | £4(£1.20) |
| 24,000uF 50V | £3 (1.30) |

TURNS COUNTING DIALS

| | |
|--|-------|
| 10 turn dial 21 mm dia. fits 3mm spindle | £2 |
| 10 turn digital dial (3 digits) for 3mm or 6mm shaft | £3.50 |
| 10 turn clock face dial for 6mm spindle | £4 |

MISCELLANEOUS

| | |
|--|-------|
| LM335Z TO92 TEMPERATURE SENSOR 10mv/DEGREE C | £1 ea |
|--|-------|

SLOPING FRONT PLASTIC CASE 228 x 218 x 76mm

| | |
|---------------------------------------|-------|
| 76mm WITH ALL FRONT PANEL 200 x 130mm | £3.30 |
| HUMIDITY SWITCH ADJUSTABLE | £2 |
| WIRE ENDED FUSES 0.25A | 30/£1 |

NEW ULTRASONIC TRANSDUCERS 40kHz

| | |
|--------------------------------------|-----------|
| 12 CORE CABLE 7.0 2mm OVERALL SCREEN | 70p/METRE |
|--------------------------------------|-----------|

OP AMP LM10CLN

| | |
|------------------------------------|------|
| BNC 50 OHM SCREENED CHASSIS SOCKET | 3/£1 |
| BNC TO CROC CLIPS LEAD 1 metre | £1 |

LEMAG EARTH LEAKAGE TRIP 35A 30mA trip

| | |
|------------------------------------|-----------|
| AMERICAN CHASSIS 2/3 pin SOCKET | 2/£1 |
| USED 3 1/2" FLOPPY DISCS D/S 720K | 50p/10/£4 |
| TO-220 HEAT SINK sim RS 403-182 | 10/£2.50 |
| SMALL MICROWAVE DIODES AEI DC1028A | 2/£1 |

D.I.L SWITCHES 10 WAY £1 8 WAY 80p 4/5/6 WAY ... 80p

| | |
|--|------------------|
| 180 volt 1 watt ZENERS also 12v & 75v | 20/£1 |
| VN10LM 60V 1/2A 50hm TO-92 mosfet | 4/£1 100/£20 |
| MIN GLASS NEONS | 10/£1 |
| MINIATURE CO-AX FREE PLUG RS 456-071 | 2/£1 |
| MINIATURE CO-AX FREE SKT. RS 456-273 | 2/£1.50 |
| DIL REED RELAY 2 POLE n/o CONTACTS | £1 |
| PCB WITH 2N2646 UNIUNJUNCTION with 12v 4 POLE RELAY | £1 |
| 400m 0.5w thick film resistors (yes four hundred megohms) | 4/£1 |
| STRAIN GAUGES 40 ohm Foil type polyester backed balco grid alloy | £1.50 ea 10+ £1 |
| ELECTRET MICROPHONE INSERT | £0.90 |
| Linear Hall effect IC Micro Switch no 613 SS4 sim RS 304-267 | £2.50 100+ £1.50 |
| HALL EFFECT IC UGS3040 + MAGNET | £1 |
| OSCILLOSCOPE PROBE SWITCHED X1 X10 | £10 |
| CHEAP PHONO PLUGS | 100/£2 1000/£18 |
| 1 pole 12 way rotary switch | 4/£1 |
| AUDIO ICS LM380 LM386 | £1 ea LM324 |
| 555 TIMER 5/£1 741 OP AMP | 5/£1 |
| ZN414 AM RADIO CHIP | 80p |
| COAX PLUGS nice ones | 4/£1 |
| COAX BACK TO BACK JOINERS | 3/£1 |
| 4 x 4 MEMBRANE KEYBOARD | £1.50 |
| 15.000uF 40V | £2.50 (£1.25) |

1.25" PANEL FUSEHOLDERS

| | |
|---|---------------|
| CHROMED STEEL HINGES 14.5 x 1" OPEN | £1 each |
| 12v 1.2w small wire ended lamps fit AUDI VW TR7 SAAB | |
| VOLVO | 10/£1 |
| 12V MES LAMPS | 10/£1 |
| STEREO CASSETTE HEAD | £2 |
| MONO CASS.HEAD £1 ERASE HEAD | 50p |
| THERMAL CUT OUTS 50 77 85 120°C | £1 ea |
| THERMAL FUSE 121°C 240V 15A 220°C | 5/£1 |
| TRANSISTOR MOUNTING PADS TO-5/TO-18 | £3/1000 |
| TO-3 TRANSISTOR COVERS | 10/£1 |
| STICK ON CABINET FEET | 30/£1 |
| PCB PINS FIT 0.1" VERO | 200/£1 |
| TO-220 micas + bushes | 10/50p 100/£2 |
| TO-3 micas + bushes | 15/£1 |
| PTFE min screened cable | 10m/£1 |
| Large heat shrink sleeving pack | £2 |
| CERAMIC FILTERS 6M/9M/10.7M | 50p 100/£20 |
| 1eC chassis plug rif filter 10A | £3 |
| Potentiometers short spindles values 2k5 10k 25k 1m | |
| 2M5 lin | 5/£1 |
| 500k lin 500k log | 4/£1 |
| 40kHz ULTRASONIC TRANSDUCERS EX-EOPT NO DATA | |
| OMRON 12V GZV DIL RELAY 2 POLE CHANGEOVER | 2/£1 |
| SCART CONNECTOR | £1 |
| BZV48C12 WIRE ENDED 12V 7WATT ZENER 17K STOCK | 5/£1 |
| 3M/SCOTCHFLEX 50 WAY ROUND JACKETED FLAT CABLE 3659/50 (50 WAY IDC RIBBON WITH FOIL AND BRAID SCREENS, ROUND SECTION WITH BLACK PVC OUTER) £1.00/METRE. 100' REEL | £65 |
| FANS 240V 120mm | £6 (1.50) |
| (OTHER VOLTAGE/SIZES USUALLY AVAILABLE) | |
| MOULDED INDUCTOR 470UH SIZE OF 1W RES | 8/£1 |

DIODES AND RECTIFIERS

| | |
|------------------------------|-----------|
| 1N4148 | 100/£1.50 |
| 1N4004/SD4 1A 300V | 100/£3 |
| 1N5401 3A 100V | 10/£1 |
| BA158 1A 400V fast recovery | 100/£3 |
| BA159 1A 1000V fast recovery | 100/£4 |
| 120V 35A STUD | 68p |
| BY127 1200V 1.2A | 10/£1 |
| BY254 800V 3A | 8/£1 |
| BY255 1300V 3A | 6/£1 |
| 6A 100V SIMILAR MR751 | 4/£1 |
| 1A 800V BRIDGE RECTIFIER | 4/£1 |
| 4A 100V BRIDGE | 3/£1 |
| 6A 100V BRIDGE | 2/£1 |
| 8A 200V BRIDGE | 2/£1.35 |
| 10A 200V BRIDGE | £1.50 |
| 25A 200V BRIDGE £2 | 10/£18 |
| 25A 400V BRIDGE £2.50 | 10/£22 |

SCRs

| | |
|----------------------------|--------------|
| PULSE TRANSFORMERS 1 1 + 1 | £1.25 |
| 2P4M EQUIV C106D | 3/£1 |
| MCR72-6 10A 600V SCR | £1 |
| 35A 600V STUD SCR | £2 |
| TICV106D 800mA 400V SCR | 3/£1 100/£15 |
| MEU21 PROG. UNIJUNCTION | 3/£1 |

TRIACS

| | |
|-------------------------------------|--------------|
| BT 137-600 8A TO-220 | 2/£1 |
| BT138-600 12A TO-220 | 70p |
| MEU21 PROG. UNIJUNCTION | 3/£1 |
| NEC TRIAC AC08F 8A 600V TO220 | 5/£2 100/£30 |
| TXAL225 8A 400V 5mA GATE 2/ | £1 100/£35 |
| 3TA08-400 8A 400V 5mA GATE ISOL TAB | £1 |
| CA3059 0 VOLTAGE SWITCH | £1 each |

DIACS 4/£1

| | |
|-------------------------------------|--------------|
| BT 137-600 8A TO-220 | 2/£1 |
| BT138-600 12A TO-220 | 70p |
| MEU21 PROG. UNIJUNCTION | 3/£1 |
| NEC TRIAC AC08F 8A 600V TO220 | 5/£2 100/£30 |
| TXAL225 8A 400V 5mA GATE 2/ | £1 100/£35 |
| 3TA08-400 8A 400V 5mA GATE ISOL TAB | £1 |
| CA3059 0 VOLTAGE SWITCH | £1 each |

MAIL ORDER ONLY

MIN CASH ORDER £3.00 OFFICIAL ORDERS WELCOME
UNIVERSITIES COLLEGES SCHOOLS GOVT. DEPARTMENTS

MIN. ACCOUNT ORDER £10.00
P&P AS SHOWN IN BRACKETS (HEAVY) ITEMS
65p OTHERWISE (LIGHT) ITEMS

ADD 15% VAT TO TOTAL
ELECTRONIC COMPONENTS
BOUGHT FOR CASH

CONNECTORS

| | |
|--|-------|
| D25 IDC SOCKET FUJITSU | £2 |
| 34 way card edge IDC CONNECTOR (disk drive type) | £1.25 |
| CENTRONICS 36 WAY IDC PLUG | £2.50 |
| CENTRONICS 36 WAY IDC SKT | £4.00 |
| BBC TO CENTRONICS PRINTER LEAD 1.5M | £3.00 |
| CENTRONICS 36 WAY PLUG SOLDER TYPE | £4 |
| USED CENTRONICS 36W PLUG + SKT | £3 |

USED CONNECTORS price per pair

| | |
|---|--|
| D9 80p, D15 £1.50, D25 £2, D37 £2, D50 £3.50 covers 50p ea. | |
|---|--|

WIRE WOUND RESISTORS

| | |
|---|----|
| W21 or sim 2.5W 10 of one value | £1 |
| R10 OR15 OR22 2R0 4R7 5R6 8R2 10R 12R 15R 18R 20R | |
| 2R2 27R 33R 47R 56R 62R 91R 120R 180R 390R 430R 470R | |
| 680R 820R 910R 1K15 1K2 1K5 1K8 2K4 2K7 3K3 3K0 5K0 | |
| 4 FOR £1 | |
| W22 or sim 6W 7 OF ONE VALUE | £1 |
| R47 R62 1R0 1R5 1R8 3R3 6R8 9R1 12R 20R 24R 27R 33R 51R | |
| 56R 62R 68R 100R 120R 180R 220R 390R 560R 620R 910R 1K0 | |
| 1K2 1K5 1K8 2K2 2K7 3K3 3K9 4K7 8K2 10k 15K 16K 20K | |

| | |
|---|-------|
| CRYSTAL OSCILLATORS | |
| 1.8342 £1 each 1M, 1.8432M, 4M, 16M | £1.50 |
| 1.000M 4M000 6M000 10M000 12M000 15M000 16M000 | |
| 18M000 20M000 24M000 25M000 32M000 40M000 £1.50 | |
| 0.512M 1M8432 2M4576 4M096 5M396 8M064 12M288 | |
| 16M384 16M485 17M280 17M408 29M4912 44M44 £1.25 | |

PHOTO DEVICES

| | |
|-------------------------------------|-----------|
| SLOTTED OPTO-SWITCH OPCOA OPB815 | £1.30 |
| 2N5777 | 50p |
| TIL81 PHOTO TRANSISTOR | £1 |
| TIL38 INFRA RED LED | 5/£1 |
| 4N25. OP12252 OPTO ISOLATOR | 80p |
| PHOTO DIODE 50P | 6/£2 |
| MEL12 (PHOTO DARLINGTON BASE n/c) | 50p |
| 4 DIGIT LED 7 SEG. DL4770 | £1 |
| LEDs RED 3 or 5mm 12/£1 | 100/£6 |
| LEDs GREEN OR YELLOW 10/£1 | 100/£6.50 |
| LEDs ASSORTED RED/GN/YW + INFRA/RED | 200/£8 |
| FLASHING RED LED 5mm 50p | 100/£40 |
| HI BRIGHTNESS LEDS CQX24 RED | 5/£1 |

STC NTC BEAD THERMISTORS

| | |
|---|----------|
| G22 220R, G13 1K, G23 2K, G24 20K, G54 50K, G25 200K, RES @ 20°C DIRECTLY HEATED TYPE | £1 ea |
| FS225W NTC BEAD INSIDE END OF 1" GLASS PROBE @ 20°C 200R | £1 ea |
| A13 DIRECTLY HEATED BEAD THERMISTOR 1k res. Ideal for audio Wien Bridge Oscillator | £2 ea |
| CERMET MULTI TURN PRESETS 3/4" | |
| 10R 20R 100R 200R 250R 500R 2K 2K2 2K5 5K 10K 47K | |
| 50K 100K 200K 500K 2M2 | 50p each |

IC SOCKETS

| | |
|--|--|
| 6 pin 15/£1 8 pin 12/£1 14/16 pin 10/£1 18/20 pin 7/£1, 22/24/28 pin 4/£1 40 pin 30p | |
|--|--|

SOLID STATE RELAYS

| | |
|--------------------------------|-----|
| 40A 250V AC SOLID STATE RELAYS | £18 |
|--------------------------------|-----|

POLYESTER/POLYCARB CAPS

| | |
|--------------------------------------|--------------|
| 100n, 220n, 63v 5mm | 20/£1 100/£3 |
| 1n/3n/5n/6n/21/10n 1% 63v 10mm | 100/£6 |
| 10n/15n/22n/33n/47n/68n 10mm rad | 100/£3.50 |
| 100n 250v radial 10mm | 100/£3 |
| 100n 600v sprague axial 10/£1 | 100/£6 (£1) |
| 2u2 160v RAD 22mm, 2u2 100v RAD 15mm | 100/£10 |
| 10n/33n/47n 250v ac x rated 15mm | 10/£1 |
| 470n 250v ac x rated rad | 4/£1 |
| 1U 600V MIXED DIELECTRIC | 50p ea. |
| 1u0 100v RAD 15mm, 1u0 22mm RAD | £8/100 |
| 2U2 250V PMT CAPS. STOCK 6K | £20/100 |

RF BITS

| | |
|---|----------|
| MINIATURE CO-AX 50uM URM95 | 100m/£12 |
| TRIMMER CAPS ALL | 4/50p |
| SMALL 5pF 2 pin mounting 5mm centres | |
| SMALL MULLARD 2 to 22pF | 4/50p |
| SMALL MULLARD 5 to 50pF | 4/50p |
| larger type grey 2 to 25pF black 15 to 90pF | |
| TRANSISTORS 2N4427 | 50p |
| FEED THRU CERAMIC CAPS 1000pF | 10/£1 |
| MICROWAVE X BAND GUNN OSCILLATOR 9 TO 11GHz EX-EQUIPMENT (DOPPLER SHIFT MICROWAVE MODULE) | £9.50 |

MINIATURE RELAYS Suitable for RF

| | |
|--------------------------------|----|
| 5 volt coil 1 pole changeover | £1 |
| 5 volt coil 2 pole changeover | £1 |
| 12 volt coil 1 pole changeover | £1 |

MONOLITHIC CERAMIC CAPICITORS

| | |
|-------------------------------|-----------|
| 10n 50v 2.5mm | 100/£4.50 |
| 100n 50v 2.5mm or 5mm | 100/£6 |
| 100n ax short leads | 100/£3 |
| 100n ax long leads | 100/£6 |
| 100n 50v oil package 0.3" rad | £10/100 |

STEPPER MOTORS

| | |
|---|----|
| 7.5 DEGREES PER STEP 2 12 volt windings | £4 |
|---|----|

KEYTRONICS

TEL. 0279-505543

FAX. 0279-757656

P O BOX 634

BISHOPS STORTFORD

HERTFORDSHIRE CM23 2RX





The aim of this exciting computing and leisure project is three-fold:

* To enable you to build a micro-controlled unit that will tell you all the essential details about your journey on a push-bike or other wheeled vehicle.

* To use the main circuit board as an independent microcontroller under command from eeprom data of your own choosing.

* To show those of you who have had no experience of microprocessors that at their simpler levels they are easy to use and that you need have no fear of experimenting with them.

In its complete form, the project consists of the cmos versions of a 6502 microprocessor and 6522 VIA interface input-output controller, an eeprom or eeprom containing the instruction codes for the microprocessor, a 2K non-volatile memory chip, a power-saving circuit, a push-button function selector, and a 16-digit alpha-numeric lcd display. The block diagram is shown in Fig.1.

The bike computer keeps track of eight parameters during the course of your journeys:

- * current speed
- * distance travelled since start of trip
- * peak speed reached during trip
- * average speed during trip
- * elapsed time since start of trip in hours, minutes and seconds
- * elapsed time since start of trip expressed as decimal hours
- * total revolutions of the wheel since start of trip
- * total distance travelled since computer was first installed.

All distances and speeds are shown in miles and kilometres according to the switch function selected. You may instantly switch between the two measurement systems.

All functions may be reset to zero at any time, except for the total distance travelled since the computer was first installed. The latter parameter is reset to zero when the eeprom is programmed.



BIKE COMPUTER

Monitor your pedal power with John Becker's micro-cyclo - and gain a general-purpose 6502 micro-controller as well.

The computer may be used with any wheeled vehicle and with wheels of any diameter. The data for a given diameter is set into the eeprom during initial programming.

A ninth option is also provided :

* to use the bike computer as a security alarm controller triggered by unauthorised use of the bike. Resetting of the alarm requires a code number to be correctly entered on the keypad.

PROGRAMMED EPROMS

In order to complete the project you will need a fully programmed eeprom or eeprom. To program it yourself you will need an eeprom or eeprom programmer capable of handling 2Kbyte devices (16384 bits arranged as 2048 words x 8 bits) having the pin configuration shown in Fig.2. Alternatively, you may care to take advantage of a friend of mine who has kindly agreed to supply pre-programmed chips. Details later.

Fig. 1. Block diagram for the Bike Computer.

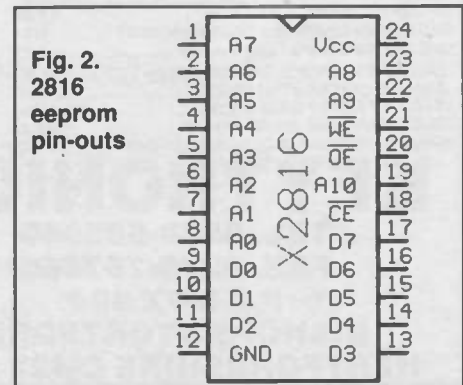
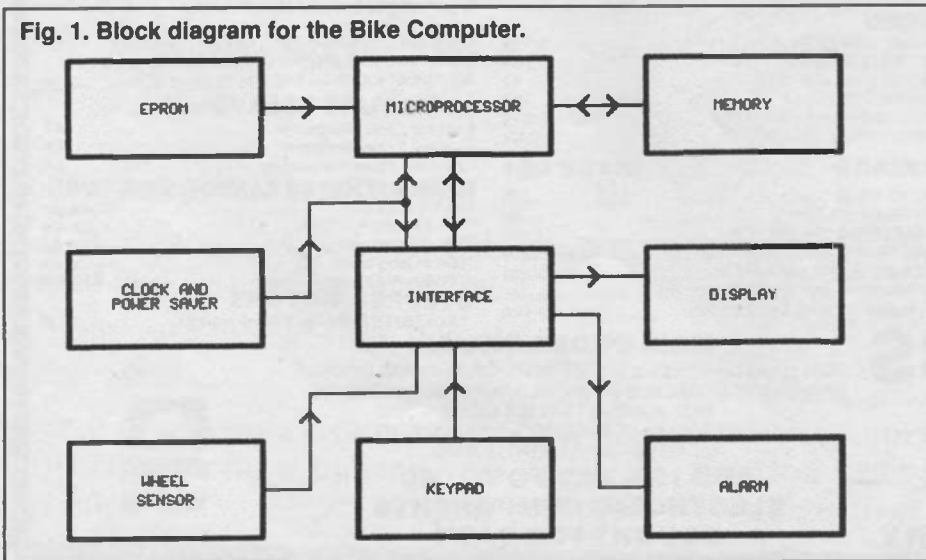

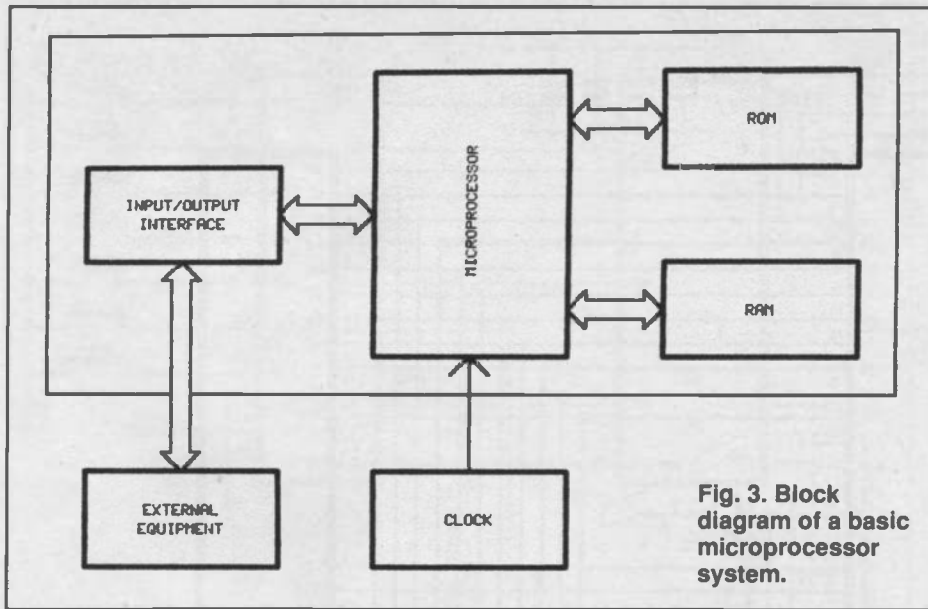

Fig. 3. Block diagram of a basic microprocessor system.

MICROCONTROLLER

There is a minimum of four hardware sections required for any microprocessor controlled system, as shown in Fig.3. The microprocessor is the heart of the system and it has been designed and manufactured to perform a number of arithmetic or logical functions in response to specific binary code instructions.

The instructions are stored in a non-volatile memory which usually takes the form of an eeprom (electronically programmable read only memory) or an eeprom (electrically erasable read only memory). It is also possible to use a battery-backed rom to store the data, though not with the same degree of data security. In use, eeproms and eeproms are identical in purpose; the main difference between them is that the former can only be reprogrammed following erasure by exposing it to ultra-violet light, whereas the latter can be erased or reprogrammed simply by changing the logic level on one pin. At least one random access

memory (ram) is required with the system. This allows for the temporary storage of data by the microprocessor during its processing operations, and for storing data which may have been derived as the result of calculations or from external sources. More than one ram can be used to increase the memory capacity. The ram is usually of the volatile type, that is, it loses its data when the power is switched off. Alternatively, a lithium battery-backed ram may be used which can retain its data for at least ten years without external power.

An eeprom may be used for secondary ram storage providing the number of changes to its data are likely to be few - an eeprom typically has a life time of 100,000 data changes. Since the internal requirements of a microprocessor may produce this number of changes in less than a second, an eeprom cannot be used as the primary ram.

The fourth hardware block required is the input-output block, allowing data to be exchanged between the system and the outside world.

BLOCK EXPANSION

The block diagram of Fig.3 is expanded in Fig.4 to show the typical interconnections between a microprocessor of the 6502 type and its three associated hardware blocks.

The 6502 has eight data lines which have the joint function of inputting and outputting data to and from rom, ram and the interface device. There are 16 address lines originating from the 6502 which are responsible for selecting which rom, ram or interface device is to be accessed and at which address within it. The devices are arranged so that each address can be treated as unique, ensuring that data conflict between the devices is avoided. Whether the devices are to be written to or read from is controlled by the R/W line. Other lines allow for the microprocessor to be interrupted during processing, or reset.

A separate clock generator sends the necessary timing pulses to the microprocessor triggering it to perform each instruction and internal operation. The clock pulses are usually produced at a crystal controlled frequency of at least 1MHz to ensure consistent high speed timing. However, they do not need to be so fast or so accurate and less precise and slower clocking rates can sometimes be used (although not in the Bike Computer).

MICROCONTROLLER CIRCUIT

Fig. 5 shows the actual interconnection details of the four parts of the microcontroller as required for the Bike Computer. For this application you will see that not all of the address lines are used, and that four inverters, IC5a-d, have appeared.

IC5b and its associated circuitry form the clock pulse generator running at 1MHz, as determined by the crystal's natural frequency. This clock frequency is routed direct to VIA chip IC3, and indirectly to IC1, for reasons we shall see presently.

Between them, IC5c, IC5d plus R1 and C1 control the initial resetting of the system when it is first switched on. At switch on, C1 will be completely empty of charge, consequently the outputs of IC5c and IC5d will respectively be high and low, so holding at reset the microprocessor IC1 via its pin 40 and the VIA (versatile interface adaptor) chip via its pin 34.

C1 begins to charge up via R1. As soon as the charge has risen sufficiently, IC5c and IC5d invert their output states, removing the reset level from IC1 and IC3. This condition will remain for as long as the power is switched on.

INITIALISATION

As soon as its reset pin has gone high, the microprocessor becomes active. The first thing it does is to look at the eeprom, IC2, to get its first instruction. That instruction is always located at the very last two addresses within the eeprom, and it takes the form of another address to which the processor must then jump.

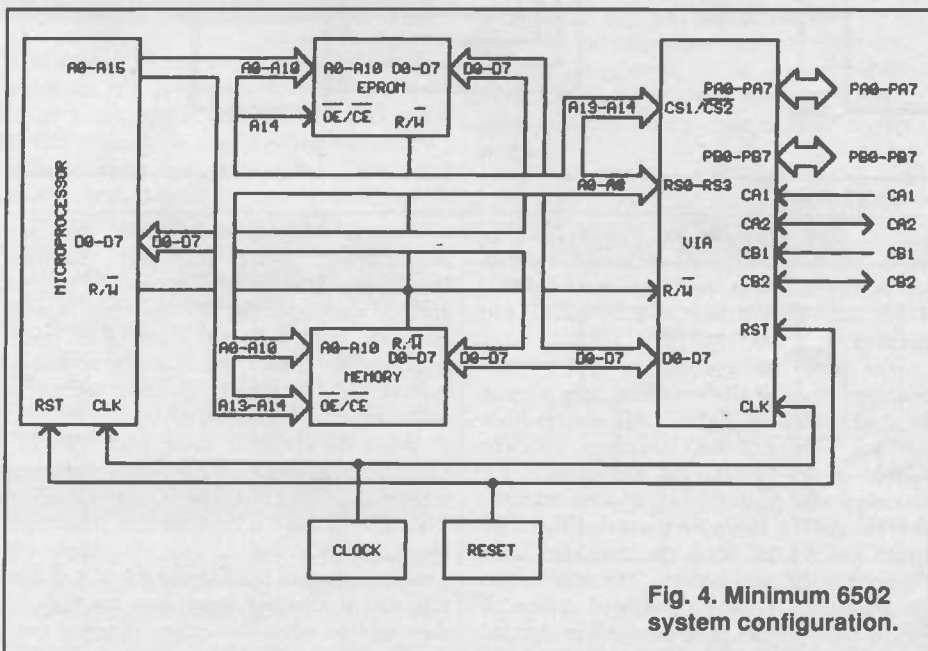

Fig. 4. Minimum 6502 system configuration.

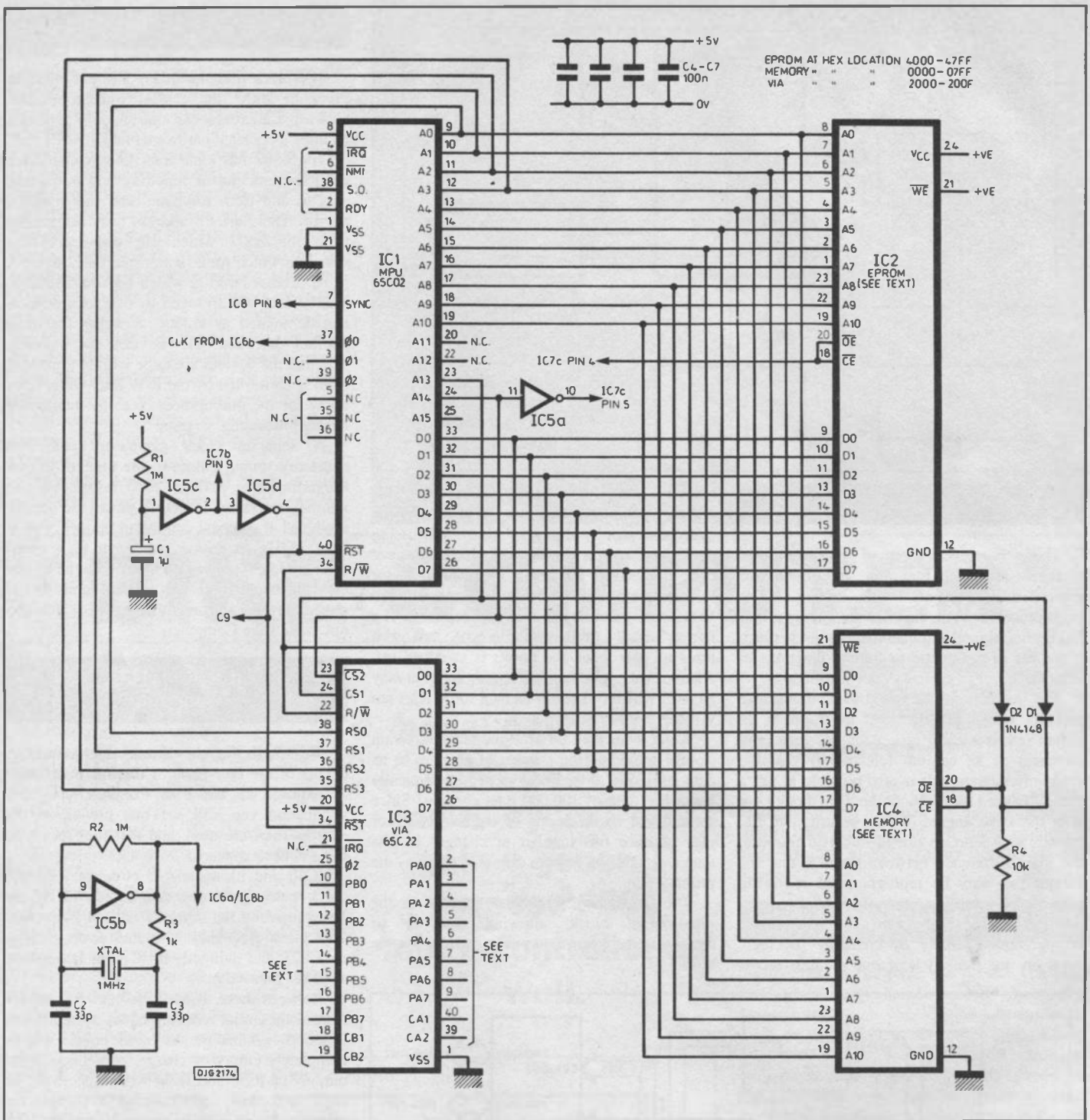

Fig. 5. Main circuit diagram for the bike microcontroller.

When designing a microprocessor-based system, the designer must always consider how the microprocessor is going to know where the eeprom is located in order to get its first instruction byte. What the microprocessor does is to send all its 16 address lines high. It then reads the data on its data lines at that moment and takes that information as the next address to which it should jump. Obviously, we can't have all the various additional chips of any circuit all responding to all the address lines being high; only the eeprom must respond. It is necessary to put the eeprom at what the system will regard as the top-most address block and to inhibit any other devices lower down the

address table while the top address block is being called. In the system presented here I've placed the eeprom at the block (hex) &4000-47FF, the VIA interface at &2000-27FF and the memory at &0000-07FF.

The first address looked at by the microprocessor, if all the address lines were to be used, would be &FFFF. All address lines are not used and the maximum effective address is &47FF. Having read &47FF, the processor then reads the next address below it, &47FE. &47FE holds the most significant bit (msb) and &47FE holds the least significant bit (lsb) of the next address. The address can be anywhere in the programmed system at which the designer/programmer has decided

to start his program. Purely for my programming convenience my software instructions start in the eeprom at address &4560. Consequently, the top two eeprom addresses hold &60 (lsb) and &45 (msb) respectively. (Had I, for example, wished to start directly at &4000, the two top codes would have been &00 and &40.)

While the eeprom is being read, VIA IC3 and Memory IC4 are inhibited by processor address lines A13 and A14: IC4 is only active while its OE and CE lines are low. Therefore, by routing A14 and A15 via the simple OR gate consisting of D1, D2 and R4, IC4 will be inhibited if either of these lines are high, as they will be when the eeprom is being read.

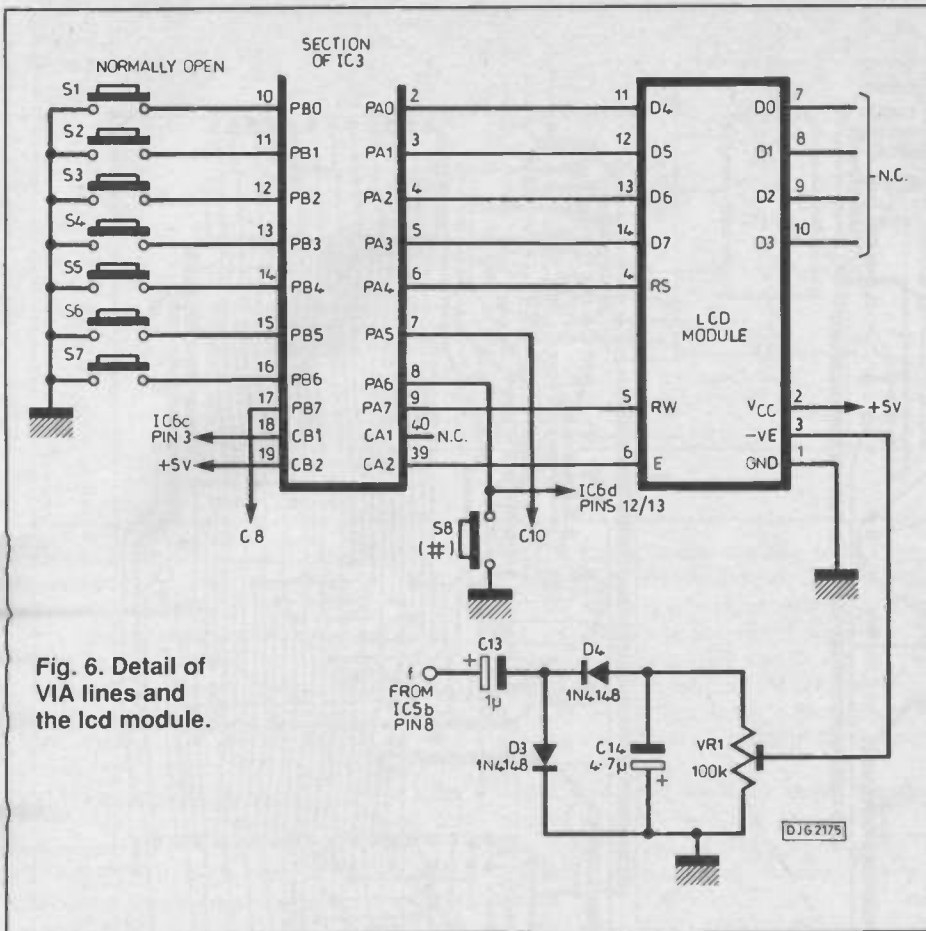

Fig. 6. Detail of VIA lines and the lcd module.

IC3 is only active if its CS1 input is high and at the same that its CS2 pin is low.

While either IC3 or IC4 are being accessed, the eeprom needs to be inhibited. This is achieved by taking its \overline{OE} and \overline{CE} lines high when address line A14 is low, using inverter IC5a to invert the logic. Although in Fig. 5 you will see that IC5a and the eeprom lines \overline{OE} and \overline{CE} apparently connect to IC7, that routing can be ignored for the moment. Just imagine that the two points in question in Fig. 5 are joined.

VIA CHIP IC3

The routing of data to and from the outside world is via IC3. It has two input-output ports, each of 8 lines (bits), labelled PA0-PA7 and PB0-PB7 respectively, any of which can at any time be set as an input or an output. There are four other lines that can be used for real-world communicating, CA1-2 and CBI-2. The functions of all 20 lines, and other internal functions of the VIA, are controlled by the status of the internal registers, which in turn are accessed via lines RS0-RS3.

It is the microprocessor which controls the reading and writing functions of all these lines and registers, in accordance with the instructions present at each address within the eeprom.

BIKE MONITORING

As a bike computer, the microcontroller circuit here needs to do five principal things: monitor a wheel rotation detector; keep track of

time; perform calculations based on rotation and time; monitor several switches; send data to the lcd display.

Fig. 6 shows detail of the VIA lines which carry the data from the wheel detector and function selector switch, and send display data to the lcd.

The figure also shows the simple negative-voltage generator around C13, C14, D3, D4 and VR3 which feeds to the lcd module. The clock source is taken directly from the output of the clock generator IC5b.

Lines PB0-PB6 and PA6 are internally held high within IC3. When any of switches S1-S8 are pressed, the corresponding line is taken low, the event is registered by the system and the program causes the necessary action to be taken, usually resulting in a change of data display function.

PA0-PA4, PA7 and CA2 send data to and control the actions of the lcd module. PA5 and

PB7 are associated with the power-saving circuit described later.

Monitoring of the bike's wheel rotation is performed by line CBI which is connected to the circuit in Fig.7.

ROTATION DETECTOR

A Hall effect sensor is used to monitor the wheel's rotation. The sensor is a device which produces an output voltage which varies in level depending on the magnetic field close to it. In this instance the sensor is mounted on the one of the bike's front forks, facing the spokes. A magnet is fixed to a plate spanning between two spokes. Each time the wheel revolves and the magnet passes the sensor, IC10, the output voltage at its pin 2 fluctuates. (IC10 is incorrectly labelled as IC7 in Fig. 7 and 10.) Opamp IC9 amplifies the voltage change by an amount governed by R10 and R11. The amplified output feeds to the Schmitt trigger circuit around IC6c which changes its output logic state when a sufficiently strong voltage change is detected. The resulting output pulse is sent direct to the VIA on its CBI line.

VR2 presets the sensitivity of the sensor by varying the threshold at which IC6c responds. C12 governs the attack and decay rates of the triggering, thus restricting the effects of minor voltage changes, and setting a minimum pulse length.

An internal shift register within VIA IC3 is triggered by each pulse. The register is read by the system at regular intervals, and then reset.

CLOCKED SAMPLING

The system has to be able to not only register pulses from the wheel sensor, but also to relate them against a precise timing factor. A combination of software programming and VIA internal timing have been used so that the wheel register count, subsequent calculations, and sending of data to update the lcd screen are performed once a second.

The VIA has an internal timer which can be set, under software control, to produce output pulses at a rate related to the crystal clock frequency. At a 1MHz clock speed, the minimum VIA pulse rate is eight pulses per second. This is divided by eight under eeprom program control resulting in a pulse rate of 1Hz, which is a nice easy figure to work with

Fig. 7. Hall sensor and Schmitt trigger circuit.

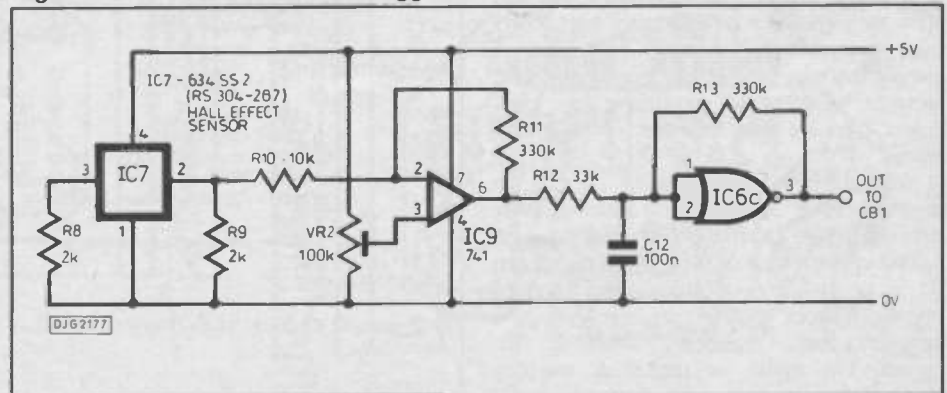

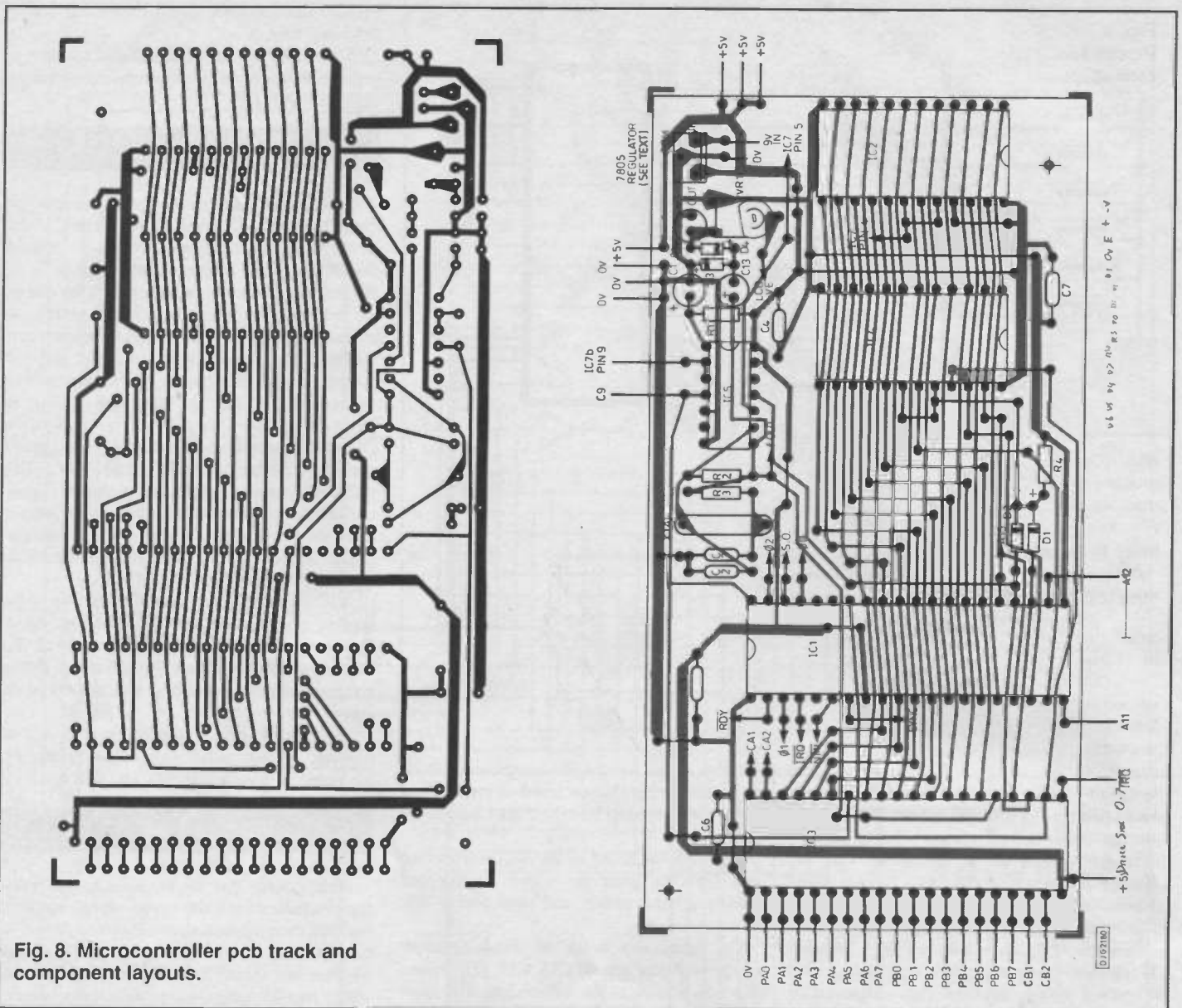

Fig. 8. Microcontroller pcb track and component layouts.

for subsequent calculations.

Under many circumstances I would feed such pulses directly to the microprocessor on one of the data lines. However, I use the pulses here to control the power saving circuit.

POWER SAVING

The memory and eeprom chips can, in effect, be almost completely turned off when their use is not immediately needed. In this state they consume considerably less power than when active. Since we only need to sample the bike data at one second intervals, there is no point in consuming any more power than we need between the sampling points.

Ideally, we don't really need the microprocessor to be active during these periods either. The 6502 processor, though, cannot be turned off as such. But what we can do is to stop its controlling clock, and so prevent it from endlessly cycling through a program loop, repeatedly accessing the eeprom. The timing of the clock stopping

COMPONENTS

MAIN UNIT

RESISTORS

R1, R2 1M (2 off)
 R3 1k
 R4 10k
 All 0.25W 5% carbon film

CAPACITORS

C1 1µ 16V elect
 C2, C3 33p polyester (2 off)
 C4-C7 100n polyester (4 off)

SEMICONDUCTORS

D1, D2 1N4148 (2 off)
 IC1 65C02 cmos microprocessor
 IC2 2816 eeprom or 27C16 cmos eeprom
 IC3 65C22 VIA
 IC4 MK48T02 lithium battery-backed cmos ram
 IC5 4584 cmos Schmitt hex-inverter

MISCELLANEOUS

DIL sockets: 40-pin (2 off), 24-pin (2 off), 14-pin. Printed circuit board.

SENSOR, POWER SAVER AND DISPLAY

RESISTORS

R5-R7 100k (3 off)
 R8, R9 2k (2 off)
 R10, R14 10k (2 off)
 R11, R13 330k (2 off)
 R12 33k
 All 0.25W 5% carbon film

POTENTIOMETER

VR1 100k skeleton preset

CAPACITORS

C8, C9 1n polystyrene (2 off)
 C10, C11, C12 100n polyester (3 off)
 C13 1µ 16V elect
 C14 4.7µ 16V elect

SEMICONDUCTORS

D3, D4 1N4148 (2 off)
 IC6 4011 cmos quad-NAND
 IC7 4071 cmos quad-OR
 IC8 4013 cmos dual flip-flop
 IC9 741 opamp
 IC10 634SS2 Hall effect sensor

MISCELLANEOUS

DIL sockets: 8-pin, 14-pin (4 off), LCD module LCM570 or similar, 12-switch telephone keypad, bar magnet, printed circuit board, plastic box 120 x 65 x 40mm.



Fig. 9.
Power saver
circuit.

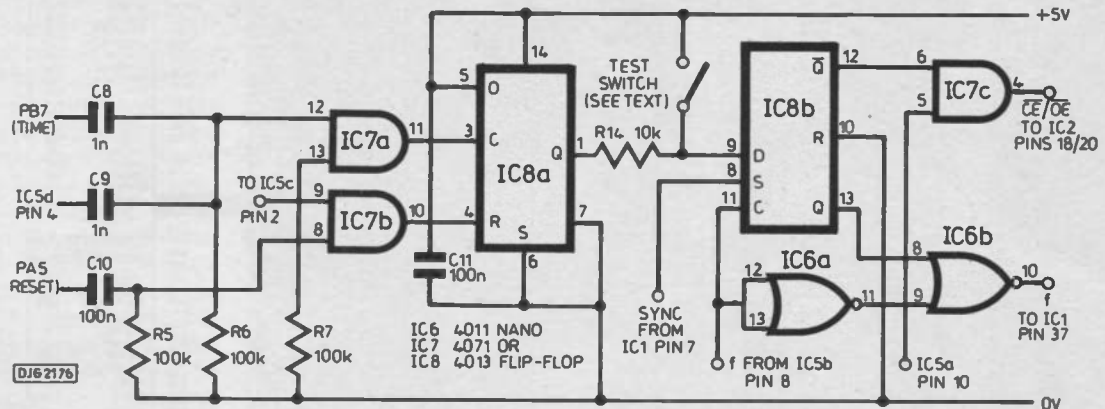

needs to be accurately synchronised with the processor's internal activities to avoid erroneous functioning. This requires the use of a moderately complicated sync control circuit, as shown in Fig. 9.

Each 8Hz timing pulse from IC3 goes through the OR gate IC7a to trigger the flip-flop IC8b. This in turn sets the Data input of a second flip-flop IC8b under trigger control on pin 11, direct from the clock oscillator IC5b. IC8b's Set input is under control from the microprocessor's Sync output, pin 7. Consequently, IC8b can only be triggered under the correct combination of sync, clock and data settings. When triggered, IC8b's Q output goes high allowing the AND gate IC6b to pass the clock pulses (coming through IC6a) to the microprocessor's clock input.

In this condition, IC8b's \bar{Q} output has no affect on the OR gate IC7c, which can continue to pass the A14 address line logic levels from IC5a to the \bar{OE} and \bar{CE} pins of the eeprom.

With clock signals available, the microprocessor reads and actions as much of the software program as fast as it can - until the software tells it to send a Stop pulse back to IC8 etc. The Stop command comes along to the VIA IC3, and out along its PA5 line to C10 in Fig. 9.

Via OR gate IC7b, the resulting pulse triggers IC8a, which inverts the Data signal on IC8b, so allowing the next correct combination of clock and sync signals to trigger the flip-flop to its opposite logic state. IC6b then closes, stopping clock pulses from reaching the microprocessor. IC8's \bar{Q} output then forces a high level, via IC7c, on the \bar{OE} and \bar{CE} inputs of the eeprom, so turning it off.

Since the processor is no longer operating, memory chip IC4 will also remain in an off condition. This state of affairs remains until the next 8Hz pulse is received, whereupon the cycle restarts.

We cannot totally turn off the VIA in this circuit (though we could in other circumstances) because we need it to continue performing two activities: using its internal timer to generate the 8Hz clock, and to continue monitoring the bike wheel rotation sensor.

The power saving circuit has also had to allow for the circuit initialisation process at power switch-on, hence the OR gates IC7a/b. IC8a is held reset by IC5c until C1 has charged up, at which point a pulse is generated across C9 providing the first clock pulse to trigger IC8a and so start the system.

MAIN CHIPS

Only the cmos versions of the microprocessor and VIA chips should be used. These are coded 65C02 and 65C22 respectively and are made by several manufacturers with various prefix and suffix codes. Either an eeprom or a normal eeprom may be used for IC2 but a cmos eeprom may be preferable because of its lower power consumption. The memory chip is a lithium battery-backed device allowing for data retention even after power switch-off. A normal volatile ram of the same pin configuration may be used if you don't mind losing the total-miles-covered storage facility. The lcd module used in the original is an LCM570 16-character alphanumeric display arranged as two rows each of eight characters. There are other types available, including low cost ones on the surplus market. Fuller details of the LCM570 were covered in PE May-Jun 90.

Friend Malcolm Harvey has kindly agreed to supply pre-programmed eeproms for a limited period at £18.00 including post and vat. Send a cheque or postal order made payable to him, c/o Unit P, 8 Finucane Drive, Orpington, Kent, BR5 4ED. Ensure you state the diameter of the wheel with which the unit will be used. Either he or I will be pleased to advise you of component sources if you have difficulty finding a supplier for any of them.

Continued on page 38.

Fig. 10. Power saver and turns sensor pcb track and component layouts.

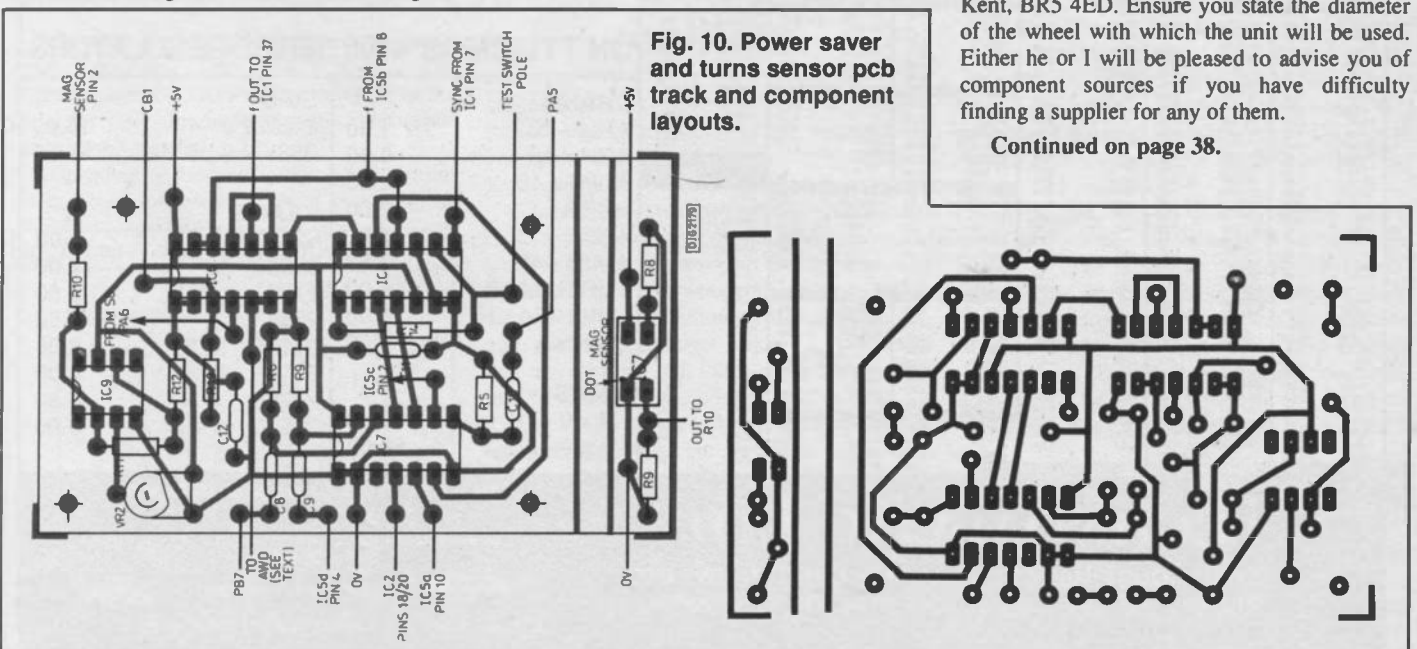

| TTL'S | | 74LS SERIES | | LINEAR ICs | | CPU's | | RAMs | | CRYSTALS | | INTERFACES/ICS | |
|-----------|-------------|-------------|-------------|------------|----------------|-------------|--------------|----------------|-------------------|------------------------|------------------|----------------|--|
| 74 SERIES | 74LS00 0.10 | 74LS01 0.10 | 74LS02 1.78 | 4555 0.28 | ADC0808 11.80 | LM393 2.50 | TD8004 2.40 | 68B09 16.00 | 2018-150 4.00 | 32 768Hz 1.00 | AD561J 20.00 | | |
| 7400 0.16 | 74LS03 0.10 | 74LS04 0.10 | 74LS05 2.50 | 4556 0.33 | AM7910DC 15.00 | LM1871 3.00 | TD8006 3.20 | 68B09E 12.00 | 2018 4.00 | 1.00 MHz 2.70 | AD5701 15.00 | | |
| 7401 0.30 | 74LS06 0.10 | 74LS07 0.10 | 74LS08 0.93 | 4557 1.06 | AN103 2.00 | LM1872 3.00 | TD8020 3.20 | 8035 3.50 | 2107B 5.00 | 1.00 MHz 2.25 | ADC0808 11.90 | | |
| 7402 0.16 | 74LS09 0.10 | 74LS10 0.10 | 74LS11 0.76 | 4560 1.38 | AY8910 4.50 | LM1886 6.00 | TD2030 2.50 | 8039 3.50 | 2111A-35 4.00 | 2.00 MHz 2.25 | AM25LS10 6.00 | | |
| 7403 0.14 | 74LS12 0.10 | 74LS13 0.10 | 74LS14 0.56 | 4561 1.58 | CA3019A 1.00 | LM1889 4.50 | TD3010 7.50 | 80C39 4.50 | 2114 1.50 | 2.45760 MHz (5j2) 2.00 | AM25LS25 3.50 | | |
| 7404 0.28 | 74LS15 0.10 | 74LS16 0.10 | 74LS17 2.16 | 4562 1.43 | CA3028A 1.10 | LM2917 3.00 | TD4700 3.50 | 80B8A 9.00 | 2114-3 4.00 | 3.12 MHz 1.75 | AM25LS28 3.50 | | |
| 7405 0.18 | 74LS18 0.10 | 74LS19 0.10 | 74LS20 2.56 | 4563 1.70 | CA3034 1.10 | LM3002 0.90 | TEA1002 7.00 | 80B8A 9.00 | 2116 1.50 | 3.12 MHz 1.75 | AM25LS31 1.20 | | |
| 7406 0.30 | 74LS21 0.12 | 74LS22 0.12 | 74LS23 2.16 | 4564 2.00 | CA3059 2.22 | LM3090 1.00 | TLO62 0.60 | 8086 9.00 | 2116-15 (Ti) 2.00 | 3.00 MHz 1.50 | AM7910DC 25.00 | | |
| 7407 0.30 | 74LS24 0.12 | 74LS25 0.12 | 74LS26 2.16 | 4565 2.50 | CA3060 3.50 | LM3911 1.80 | TLO62 0.60 | 8086 9.00 | 2116-15 (Ti) 2.00 | 3.00 MHz 1.50 | D7002 6.00 | | |
| 7408 0.23 | 74LS27 0.18 | 74LS28 0.18 | 74LS29 2.16 | 4566 2.50 | CA3060E 0.95 | LM3914 3.50 | TLD71 0.30 | 8087-5 63.00 | 2116-15 (Ti) 2.00 | 4.14 MHz 1.50 | DC80 CB1 V 28.00 | | |
| 7409 0.10 | 74LS29 0.18 | 74LS30 0.18 | 74LS31 2.16 | 4567 1.70 | CA3090 1.10 | LM3915 3.50 | TLD74 0.85 | 80287-8 63.00 | 2116-15 (Ti) 2.00 | 4.14 MHz 1.50 | DMC3446 2.50 | | |
| 7410 0.13 | 74LS31 0.18 | 74LS32 0.18 | 74LS33 2.16 | 4568 2.50 | CA3090A 0.76 | LM3916 3.50 | TLD74 0.85 | 80287-10 63.00 | 2116-15 (Ti) 2.00 | 4.14 MHz 1.50 | DMC3446 2.50 | | |
| 7411 0.30 | 74LS33 0.12 | 74LS34 0.12 | 74LS35 2.16 | 4569 2.50 | CA3100 1.00 | LM3916 3.50 | TLD74 0.85 | 80287-10 63.00 | 2116-15 (Ti) 2.00 | 4.14 MHz 1.50 | DMC3446 2.50 | | |
| 7412 0.27 | 74LS34 0.12 | 74LS35 0.12 | 74LS36 2.16 | 4570 2.50 | CA3100E 0.45 | LM3916 3.50 | TLD74 0.85 | 80287-10 63.00 | 2116-15 (Ti) 2.00 | 4.14 MHz 1.50 | DMC3446 2.50 | | |
| 7413 0.27 | 74LS35 0.12 | 74LS36 0.12 | 74LS37 2.16 | 4571 2.50 | CA3130 1.00 | LM3916 3.50 | TLD74 0.85 | 80287-10 63.00 | 2116-15 (Ti) 2.00 | 4.14 MHz 1.50 | DMC3446 2.50 | | |
| 7414 0.27 | 74LS36 0.12 | 74LS37 0.12 | 74LS38 2.16 | 4572 2.50 | CA3160 1.50 | LM3916 3.50 | TLD74 0.85 | 80287-10 63.00 | 2116-15 (Ti) 2.00 | 4.14 MHz 1.50 | DMC3446 2.50 | | |
| 7415 0.27 | 74LS37 0.12 | 74LS38 0.12 | 74LS39 2.16 | 4573 2.50 | CA3161E 2.00 | LM3916 3.50 | TLD74 0.85 | 80287-10 63.00 | 2116-15 (Ti) 2.00 | 4.14 MHz 1.50 | DMC3446 2.50 | | |
| 7416 0.27 | 74LS38 0.12 | 74LS39 0.12 | 74LS40 2.16 | 4574 2.50 | CA3162E 2.00 | LM3916 3.50 | TLD74 0.85 | 80287-10 63.00 | 2116-15 (Ti) 2.00 | 4.14 MHz 1.50 | DMC3446 2.50 | | |
| 7417 0.27 | 74LS39 0.12 | 74LS40 0.12 | 74LS41 2.16 | 4575 2.50 | CA3190E 2.70 | LM3916 3.50 | TLD74 0.85 | 80287-10 63.00 | 2116-15 (Ti) 2.00 | 4.14 MHz 1.50 | DMC3446 2.50 | | |
| 7418 0.27 | 74LS40 0.12 | 74LS41 0.12 | 74LS42 2.16 | 4576 2.50 | CA3240E 2.70 | LM3916 3.50 | TLD74 0.85 | 80287-10 63.00 | 2116-15 (Ti) 2.00 | 4.14 MHz 1.50 | DMC3446 2.50 | | |
| 7419 0.27 | 74LS41 0.12 | 74LS42 0.12 | 74LS43 2.16 | 4577 2.50 | D7002 6.00 | LM3916 3.50 | TLD74 0.85 | 80287-10 63.00 | 2116-15 (Ti) 2.00 | 4.14 MHz 1.50 | DMC3446 2.50 | | |
| 7420 0.27 | 74LS42 0.12 | 74LS43 0.12 | 74LS44 2.16 | 4578 2.50 | DAC1408 8 3.00 | LM3916 3.50 | TLD74 0.85 | 80287-10 63.00 | 2116-15 (Ti) 2.00 | 4.14 MHz 1.50 | DMC3446 2.50 | | |
| 7421 0.27 | 74LS43 0.12 | 74LS44 0.12 | 74LS45 2.16 | 4579 2.50 | DAC1408 8 3.00 | LM3916 3.50 | TLD74 0.85 | 80287-10 63.00 | 2116-15 (Ti) 2.00 | 4.14 MHz 1.50 | DMC3446 2.50 | | |
| 7422 0.27 | 74LS44 0.12 | 74LS45 0.12 | 74LS46 2.16 | 4580 2.50 | DAC1408 8 3.00 | LM3916 3.50 | TLD74 0.85 | 80287-10 63.00 | 2116-15 (Ti) 2.00 | 4.14 MHz 1.50 | DMC3446 2.50 | | |
| 7423 0.27 | 74LS45 0.12 | 74LS46 0.12 | 74LS47 2.16 | 4581 2.50 | DAC1408 8 3.00 | LM3916 3.50 | TLD74 0.85 | 80287-10 63.00 | 2116-15 (Ti) 2.00 | 4.14 MHz 1.50 | DMC3446 2.50 | | |
| 7424 0.27 | 74LS46 0.12 | 74LS47 0.12 | 74LS48 2.16 | 4582 2.50 | DAC1408 8 3.00 | LM3916 3.50 | TLD74 0.85 | 80287-10 63.00 | 2116-15 (Ti) 2.00 | 4.14 MHz 1.50 | DMC3446 2.50 | | |
| 7425 0.27 | 74LS47 0.12 | 74LS48 0.12 | 74LS49 2.16 | 4583 2.50 | DAC1408 8 3.00 | LM3916 3.50 | TLD74 0.85 | 80287-10 63.00 | 2116-15 (Ti) 2.00 | 4.14 MHz 1.50 | DMC3446 2.50 | | |
| 7426 0.27 | 74LS48 0.12 | 74LS49 0.12 | 74LS50 2.16 | 4584 2.50 | DAC1408 8 3.00 | LM3916 3.50 | TLD74 0.85 | 80287-10 63.00 | 2116-15 (Ti) 2.00 | 4.14 MHz 1.50 | DMC3446 2.50 | | |
| 7427 0.27 | 74LS49 0.12 | 74LS50 0.12 | 74LS51 2.16 | 4585 2.50 | DAC1408 8 3.00 | LM3916 3.50 | TLD74 0.85 | 80287-10 63.00 | 2116-15 (Ti) 2.00 | 4.14 MHz 1.50 | DMC3446 2.50 | | |
| 7428 0.27 | 74LS50 0.12 | 74LS51 0.12 | 74LS52 2.16 | 4586 2.50 | DAC1408 8 3.00 | LM3916 3.50 | TLD74 0.85 | 80287-10 63.00 | 2116-15 (Ti) 2.00 | 4.14 MHz 1.50 | DMC3446 2.50 | | |
| 7429 0.27 | 74LS51 0.12 | 74LS52 0.12 | 74LS53 2.16 | 4587 2.50 | DAC1408 8 3.00 | LM3916 3.50 | TLD74 0.85 | 80287-10 63.00 | 2116-15 (Ti) 2.00 | 4.14 MHz 1.50 | DMC3446 2.50 | | |
| 7430 0.27 | 74LS52 0.12 | 74LS53 0.12 | 74LS54 2.16 | 4588 2.50 | DAC1408 8 3.00 | LM3916 3.50 | TLD74 0.85 | 80287-10 63.00 | 2116-15 (Ti) 2.00 | 4.14 MHz 1.50 | DMC3446 2.50 | | |
| 7431 0.27 | 74LS53 0.12 | 74LS54 0.12 | 74LS55 2.16 | 4589 2.50 | DAC1408 8 3.00 | LM3916 3.50 | TLD74 0.85 | 80287-10 63.00 | 2116-15 (Ti) 2.00 | 4.14 MHz 1.50 | DMC3446 2.50 | | |
| 7432 0.27 | 74LS54 0.12 | 74LS55 0.12 | 74LS56 2.16 | 4590 2.50 | DAC1408 8 3.00 | LM3916 3.50 | TLD74 0.85 | 80287-10 63.00 | 2116-15 (Ti) 2.00 | 4.14 MHz 1.50 | DMC3446 2.50 | | |
| 7433 0.27 | 74LS55 0.12 | 74LS56 0.12 | 74LS57 2.16 | 4591 2.50 | DAC1408 8 3.00 | LM3916 3.50 | TLD74 0.85 | 80287-10 63.00 | 2116-15 (Ti) 2.00 | 4.14 MHz 1.50 | DMC3446 2.50 | | |
| 7434 0.27 | 74LS56 0.12 | 74LS57 0.12 | 74LS58 2.16 | 4592 2.50 | DAC1408 8 3.00 | LM3916 3.50 | TLD74 0.85 | 80287-10 63.00 | 2116-15 (Ti) 2.00 | 4.14 MHz 1.50 | DMC3446 2.50 | | |
| 7435 0.27 | 74LS57 0.12 | 74LS58 0.12 | 74LS59 2.16 | 4593 2.50 | DAC1408 8 3.00 | LM3916 3.50 | TLD74 0.85 | 80287-10 63.00 | 2116-15 (Ti) 2.00 | 4.14 MHz 1.50 | DMC3446 2.50 | | |
| 7436 0.27 | 74LS58 0.12 | 74LS59 0.12 | 74LS60 2.16 | 4594 2.50 | DAC1408 8 3.00 | LM3916 3.50 | TLD74 0.85 | 80287-10 63.00 | 2116-15 (Ti) 2.00 | 4.14 MHz 1.50 | DMC3446 2.50 | | |
| 7437 0.27 | 74LS59 0.12 | 74LS60 0.12 | 74LS61 2.16 | 4595 2.50 | DAC1408 8 3.00 | LM3916 3.50 | TLD74 0.85 | 80287-10 63.00 | 2116-15 (Ti) 2.00 | 4.14 MHz 1.50 | DMC3446 2.50 | | |
| 7438 0.27 | 74LS60 0.12 | 74LS61 0.12 | 74LS62 2.16 | 4596 2.50 | DAC1408 8 3.00 | LM3916 3.50 | TLD74 0.85 | 80287-10 63.00 | 2116-15 (Ti) 2.00 | 4.14 MHz 1.50 | DMC3446 2.50 | | |
| 7439 0.27 | 74LS61 0.12 | 74LS62 0.12 | 74LS63 2.16 | 4597 2.50 | DAC1408 8 3.00 | LM3916 3.50 | TLD74 0.85 | 80287-10 63.00 | 2116-15 (Ti) 2.00 | 4.14 MHz 1.50 | DMC3446 2.50 | | |
| 7440 0.27 | 74LS62 0.12 | 74LS63 0.12 | 74LS64 2.16 | 4598 2.50 | DAC1408 8 3.00 | LM3916 3.50 | TLD74 0.85 | 80287-10 63.00 | 2116-15 (Ti) 2.00 | 4.14 MHz 1.50 | DMC3446 2.50 | | |
| 7441 0.27 | 74LS63 0.12 | 74LS64 0.12 | 74LS65 2.16 | 4599 2.50 | DAC1408 8 3.00 | LM3916 3.50 | TLD74 0.85 | 80287-10 63.00 | 2116-15 (Ti) 2.00 | 4.14 MHz 1.50 | DMC3446 2.50 | | |
| 7442 0.27 | 74LS64 0.12 | 74LS65 0.12 | 74LS66 2.16 | 4600 2.50 | DAC1408 8 3.00 | LM3916 3.50 | TLD74 0.85 | 80287-10 63.00 | 2116-15 (Ti) 2.00 | 4.14 MHz 1.50 | DMC3446 2.50 | | |
| 7443 0.27 | 74LS65 0.12 | 74LS66 0.12 | 74LS67 2.16 | 4601 2.50 | DAC1408 8 3.00 | LM3916 3.50 | TLD74 0.85 | 80287-10 63.00 | 2116-15 (Ti) 2.00 | 4.14 MHz 1.50 | DMC3446 2.50 | | |
| 7444 0.27 | 74LS66 0.12 | 74LS67 0.12 | 74LS68 2.16 | 4602 2.50 | DAC1408 8 3.00 | LM3916 3.50 | TLD74 0.85 | 80287-10 63.00 | 2116-15 (Ti) 2.00 | 4.14 MHz 1.50 | DMC3446 2.50 | | |
| 7445 0.27 | 74LS67 0.12 | 74LS68 0.12 | 74LS69 2.16 | 4603 2.50 | DAC1408 8 3.00 | LM3916 3.50 | TLD74 0.85 | 80287-10 63.00 | 2116-15 (Ti) 2.00 | 4.14 MHz 1.50 | DMC3446 2.50 | | |
| 7446 0.27 | 74LS68 0.12 | 74LS69 0.12 | 74LS70 2.16 | 4604 2.50 | DAC1408 8 3.00 | LM3916 3.50 | TLD74 0.85 | 80287-10 63.00 | 2116-15 (Ti) 2.00 | 4.14 MHz 1.50 | DMC3446 2.50 | | |
| 7447 0.27 | 74LS69 0.12 | 74LS70 0.12 | 74LS71 2.16 | 4605 2.50 | DAC1408 8 3.00 | LM3916 3.50 | TLD74 0.85 | 80287-10 63.00 | 2116-15 (Ti) 2.00 | 4.14 MHz 1.50 | DMC3446 2.50 | | |
| 7448 0.27 | 74LS70 0.12 | 74LS71 0.12 | 74LS72 2.16 | 4606 2.50 | DAC1408 8 3.00 | LM3916 3.50 | TLD74 0.85 | 80287-10 63.00 | 2116-15 (Ti) 2.00 | 4.14 MHz 1.50 | DMC3446 2.50 | | |
| 7449 0.27 | 74LS71 0.12 | 74LS72 0.12 | 74LS73 2.16 | 4607 2.50 | DAC1408 8 3.00 | LM3916 3.50 | TLD74 0.85 | 80287-10 63.00 | 2116-15 (Ti) 2.00 | 4.14 MHz 1.50 | DMC3446 2.50 | | |
| 7450 0.27 | 74LS72 0.12 | 74LS73 0.12 | 74LS74 2.16 | 4608 2.50 | DAC1408 8 3.00 | LM3916 3.50 | TLD74 0.85 | 80287-10 63.00 | 2116-15 (Ti) 2.00 | 4.14 MHz 1.50 | DMC3446 2.50 | | |
| 7451 0.27 | 74LS73 0.12 | 74LS74 0.12 | 74LS75 2.16 | 4609 2.50 | DAC1408 8 3.00 | LM3916 3.50 | TLD74 0.85 | 80287-10 63.00 | 2116-15 (Ti) 2.00 | 4.14 MHz 1.50 | DMC3446 2.50 | | |
| 7452 0.27 | 74LS74 0.12 | 74LS75 0.12 | 74LS76 2.16 | 4610 2.50 | DAC1408 8 3.00 | LM3916 3.50 | TLD74 0.85 | 80287-10 63.00 | 2116-15 (Ti) 2.00 | 4.14 MHz 1.50 | DMC3446 2.50 | | |
| 7453 0.27 | 74LS75 0.12 | 74LS76 0.12 | 74LS77 2.16 | 4611 2.50 | DAC1408 8 3.00 | LM3916 3.50 | TLD74 0.85 | 80287-10 63.00 | 2116-15 (Ti) 2.00 | 4.14 MHz 1.50 | DMC3446 2.50 | | |
| 7454 0.27 | 74LS76 0.12 | 74LS77 0.12 | 74LS78 2.16 | 4612 2.50 | DAC1408 8 3.00 | LM3916 3.50 | TLD74 0.85 | 80287-10 63.00 | 2116-15 (Ti) 2.00 | 4.14 MHz 1.50 | DMC3446 2.50 | | |
| 7455 0.27 | 74LS77 0.12 | 74LS78 0.12 | 74LS79 2.16 | 4613 2.50 | DAC1408 8 3.00 | LM3916 3.50 | TLD74 0.85 | 80287-10 63.00 | 2116-15 (Ti) 2.00 | 4.14 MHz 1 | | | |



Lasers which once existed only in the minds of science fiction writers, are now so commonplace around us, in holograms, eye surgery, printing, etc. that people have ceased to wonder what the letters stand for.

Laser stands for *Light Amplification by Stimulated Emission of Radiation* and since one is dealing with light what better way to amplify the signals than with mirrors. So with the semiconductor laser at least, one need not be ashamed to admit that it is all done with mirrors.

Lasers operate in the spectrum between the ultraviolet and infrared ($0.1\mu\text{m}$ to $1000\mu\text{m}$) as shown in Fig.1. The advantage of operating higher in the frequency spectrum is that a higher transmission bandwidth is obtained and in the optical range the signals are also immune to electrical noise.

A feel for the attainable bandwidths can be obtained by comparing a radio signal transmitting at 10^8Hz with a laser operating at 10^{14}Hz . The maximum bandwidths obtainable from each are 10^8 and 10^{14} respectively showing that the bandwidth of the laser is six times greater than the radio in this example. With the larger bandwidth it is possible to transmit at a

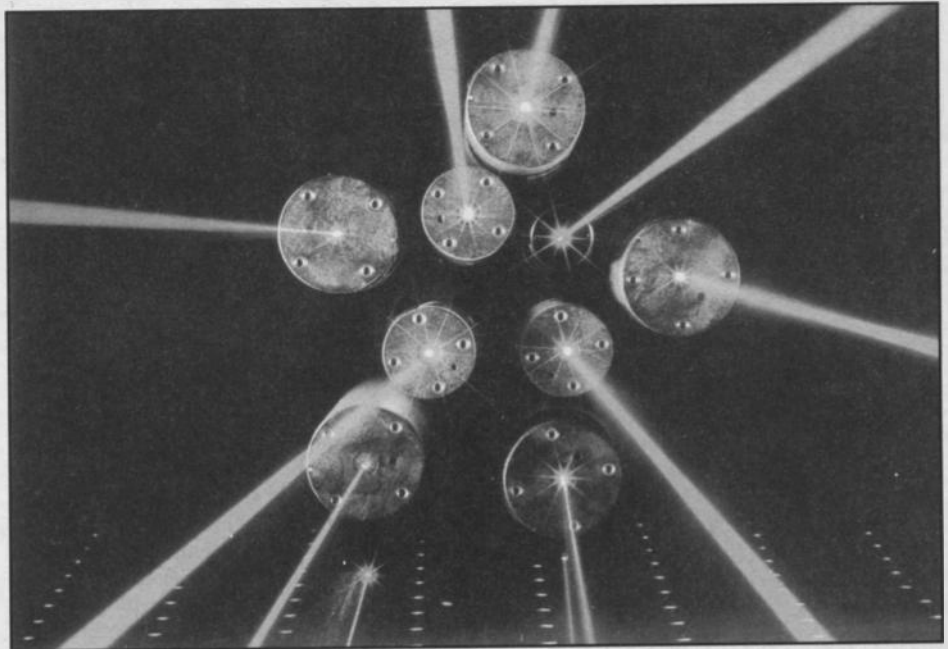

Photograph kindly supplied by laser manufacturers Spindler and Hoyer.

LASERS

higher speed and so it is possible to transmit about thirty volumes of the *Encyclopaedia Britannica* in one second. The biggest application of lasers is in communications using optical fibres and the bandwidth is a compromise between distance and number of repeaters. This aspect will be dealt with under optical fibres.

The main features of lasers are the stimulated emission and the amplification. In order to sustain the lasing, optical feedback is employed using mirrors. This is similar to using feedback in electronic amplifiers.

PROPERTIES OF LASERS

Lasers have a high brightness since the beam diverges very little. They can also be focused to a small size of the order of a wavelength of the particular laser, for making small holes, cuts, marks, etc in materials.

Depending on the type of laser, low power in the range of microwatts to high power in the

Fig. 1. Laser operating range.

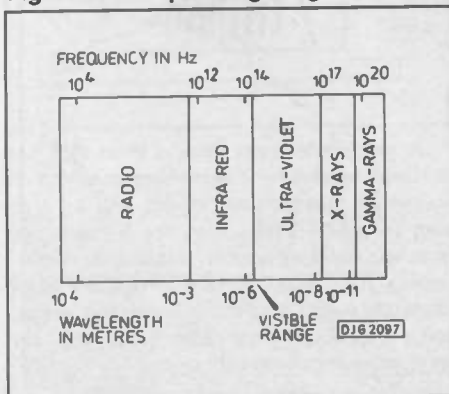

Part One. Mike Sanders coherently shines light on the science fiction devices that have become common-place realities.

range of kilowatts can be obtained. In addition, pulsed lasers can provide high instantaneous energy in the region of terawatts or hundreds of joules per pulse.

Lasers display a high degree of chromaticity (pure colour) because of the small spread in wavelength and some of the lasers that will be discussed are helium-neon, ruby, carbon dioxide, dye, neodymium-YAG, neodymium-glass and semiconductor lasers. The ruby laser was invented in 1960, followed by the gas laser in 1961 and the semiconductor laser in 1962.

Lasers also have good coherence. Coherence is a complex subject but the simple explanation is to say that if the emission is all of the same frequency and travelling in parallel, in the same direction, and in phase, the radiation is coherent.

As an example of non-coherent radiation, the sun's rays may be considered. Random frequencies at random intervals are produced. Similarly with a spotlight whose beam spreads

by about two degrees of arc. By contrast a laser diverges only a few seconds of arc and therefore the concentrated energy can be used for space communications.

There are two aspects of coherence, spatial and temporal coherence. Temporal coherence means that all the emission from the same source has a fixed phase relationship at a point in space at different times. Spatial coherence is when all the emissions have a fixed phase relationship at the same time but at different points in space. Two pure sinusoidal waveforms of the same frequency would be perfectly coherent.

One method of obtaining coherence using ordinary sources of light is to place a pinhole in front of the light. The hole acts as a diffraction grating and since only a small part of the emission is allowed through the hole, good spatial coherence is obtained. Another method is to place a diffraction grating (slits) far enough from the emitting source so that the slits are illuminated uniformly.

In comparison with ordinary sources, lasers have nearly perfect coherence but this can be improved even further as we shall see later, by altering the geometry of semiconductors, using injection locking etc. Researches are pursuing these and other avenues with almost manical commitment since, the purer the wavelength and the more coherent the emission, the wider the bandwidth that can be transmitted.

THEORY OF OPERATION

The theory of light states that light energy travels in discrete bundles called photons. Stimulating a photosensitive material with light will release electrons and the converse is

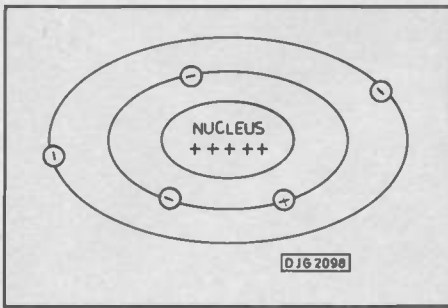

Fig. 2. Electron orbits.

also true, that is, stimulating the electrons in a laser will release light.

Three types of transitions involving photons are of interest in laser operations:

- a) absorption
- b) spontaneous emission
- c) stimulated emission

When light of the correct wavelength falls on a photosensitive material, it is absorbed. The other two terms *spontaneous emission* and *stimulated emission* will become clear in the explanation below.

But to begin at the beginning, all material is composed of atoms consisting of a nucleus with a positive charge, and one or more electrons with a negative charge, in one or more orbits around the nucleus, as in Fig.2.

TWO LEVEL SYSTEM

When energy is supplied to a material, say by heating it, the electrons revolve in larger orbits from the nucleus until they escape from the material, if sufficient energy has been applied. This is illustrated in the energy level diagram of Fig.3.

In solids, atoms are packed tightly together and therefore energy levels exist more in the shape of energy bands (Fig.4). The number of electrons in the valence band would depend on the group of the periodic table to which the element belongs.

Figs. 3 and 4. Energy levels and bands.

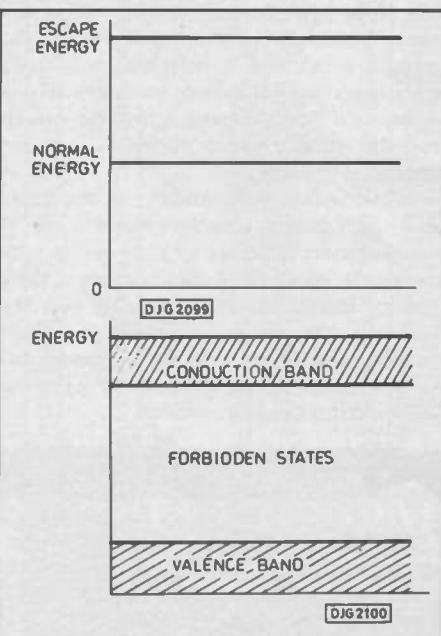

At a temperature of absolute zero, all the electrons would be in the valence band and in order for the material to conduct heat or electricity some of the electrons must be raised into the conduction band.

In between the valence and conduction bands, there are forbidden states where the electrons are not allowed to reside. The gap between the valence and conduction bands depends on the construction of the material and can be altered by chemically doping the material since this alters the physical bonds.

When an electron drops across the energy gap, light is emitted with a wavelength equal to the distance between the valence and conduction bands. For optical fibre communications wavelengths around 0.85µm, 1.3µm and 1.55µm are of interest because of certain features in glass fibre which we shall examine under Optical Fibres.

The emission from light emitting diodes is spontaneous, ie the electrons are excited and light is emitted whereas the emission from lasers is stimulated. This means that in lasers the electrons are pumped to a higher level and then allowed to engage in an avalanche effect. Rather like carrying a rock to the top of a hill. Not only is the potential energy of the rock raised but it will also dislodge other rocks on the way down.

There are more electrons in orbits closer to the nucleus than there are in orbits further away from the nucleus. This can be compared to the earth's atmosphere which is rarer the further one gets away from the earth.

The stable distribution of electrons is often displayed by the exponential graph of Fig.5, which shows more electrons at a lower energy levels. The number of electrons in the energy levels is related by the following equation:

$$\frac{N1}{N2} = \exp - \frac{(E2 - E1)}{KT}$$

where

K is Boltzmann's constant

T is the absolute temperature

N1 is the number of electrons at energy level E1

N2 is the number of electrons at energy level E2

This is the position at thermal equilibrium.

In order to provide lasing, the electrons need to be supplied with energy so that more electrons are raised to the higher energy level in the outer orbit. This process is called

Fig. 5. Electron distribution.

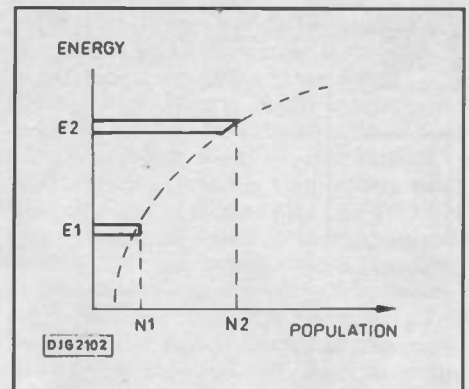
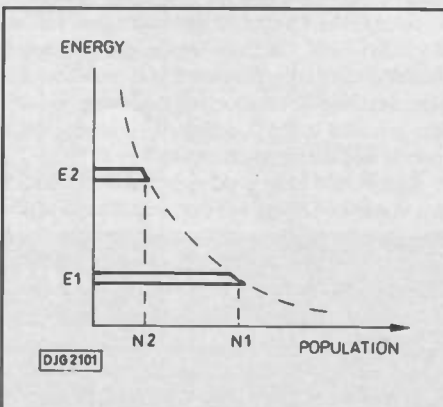

Fig. 6. Inverting the population.

population inversion and the exponential graph now looks like that of Fig.6 with more electrons at the higher level.

A system with two energy levels is called a two level system and the transition from one energy level to the other takes place at the edges of the band. The ammonia maser and the laser diode are examples of two level systems.

Two level systems are pulsed systems since they go through a continuous pump-emit, pump-emit cycle, (Fig.7). The power output from a ruby laser is like that shown in Fig.8. The build up and depletion of the population leads to the spikes and the gradual decline in height of the spikes is because the output power of the flash lamps decline. The spikes are unevenly spaced.

Figs. 7 and 8. Pulsed system, and ruby laser output pulse.

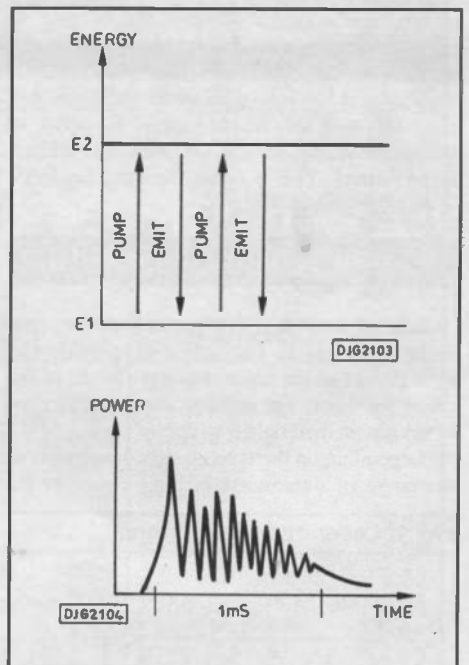

In multimode lasers there is more than one mode of operation, ie wavefront peaks as in microwave transmission. Modes will be dealt with later. Multimodes allow the lasing to hop from one mode to another, resulting in random pulsing. If the mode can be restricted to a single mode, the output is as in Fig.9 with less spiking and a gradual dying out of the oscillations. The oscillations are also evenly spaced.

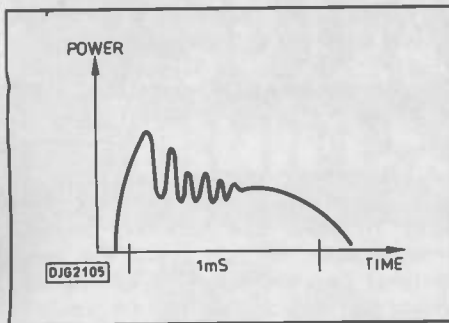

Fig. 9. Single mode pulsed output.

THREE AND FOUR LEVEL SYSTEMS

The ruby laser can also operate as a three level system, as can a dye laser. In a three level system electrons are pumped to a much higher level E2, Fig.10. If electrons will stay at level E2 for a few milliseconds, it is called a metastable state.

If they do not stay there, then spontaneous emission takes place. But assuming they do stay there for a little while, continuous pumping can take place between levels E1 and E2. The electrons then drop to an intermediate level E3 without emitting light. Lasing then follows as they drop back to E1.

Just as pumping is continuous, lasing is also continuous as the electrons drop back to E1. The frequency that is emitted is proportionate to the distance between E2 and E1:

$$f = \frac{E_2 - E_1}{h}$$

where h is Planck's constant.

The pumping energy for such lasers is

Figs. 10 and 11. Three and four level systems.

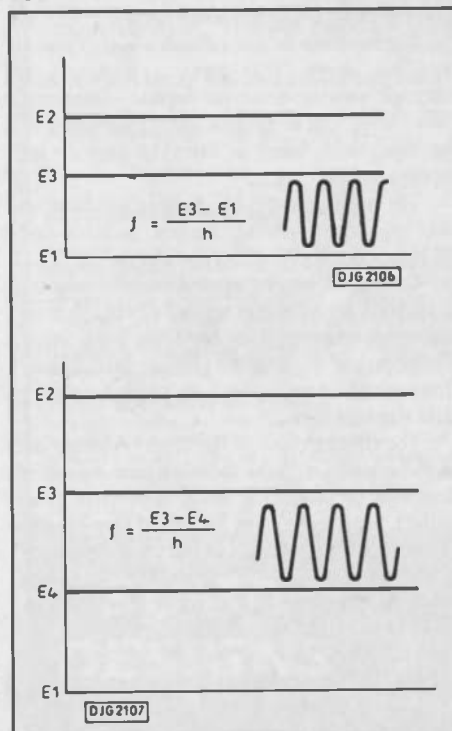

quite high since the whole population of the lasant needs to be inverted.

In a four level system, the electrons are pumped to level E2 as before where they stay for a while before dropping to level E3 in Fig.11. This is followed by lasing between levels E3 and E4 and then a transition back to E1 without radiation.

The advantage of a four level system is that less pump energy is required compared to a three level system since the whole lasant population does not have to be inverted and therefore continuous wave operation is simpler. The frequency of radiation is given by:

$$f = \frac{E_3 - E_4}{h}$$

Typical lasers employing four level systems are neodymium-YAG, helium-neon, ion and carbon dioxide. The excitation in gas lasers is by electric discharge, and by optical methods in solid lasers.

Energy transfer by collision with other ions, atoms and molecules is one of the main methods of achieving population inversion in metal vapour, carbon-dioxide and helium-neon lasers.

TYPES OF LASERS

Lasers come in all shapes and sizes from low power to high power, continuous wave and pulsed. A variety of materials can be used in liquid, solid and gas form. The excitation of these ranges from electric discharge to physical collision. Some of the commonly used materials and their methods of excitation, power outputs and frequency range will be dealt with briefly.

Fig. 12. Helium-Neon lasers.

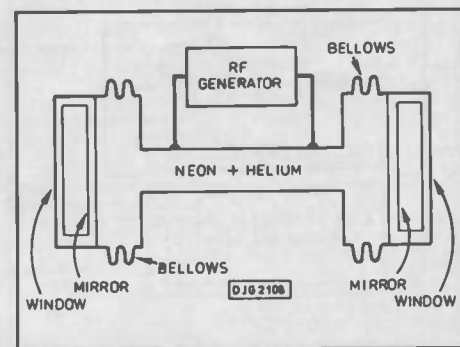

HELIUM-NEON LASERS

The most common of all the visible lasers is the helium-neon which emits at two wavelengths in the red part of the spectrum. The popular wavelength is 0.6328μm with power outputs from 0.5mW to 50mW continuous wave.

Most helium-neon (He-Ne) lasers are constructed as narrow tubes with only about 2mm diameter. The original helium-neon laser tube was 1.5cm in internal diameter and 1 metre long (Fig.12). An electrical glow discharge of about 50mW is produced by means of a voltage of about 2kV. But several

kilovolts are required to get the discharge started. Alternatively, excitation is by RF methods.

This is a low gain laser and therefore about 99% feedback is required to keep it lasing. Mirrors are mounted at each end to amplify the light by bouncing it back and forth. The mirrors are adjustable so that they can be moved both towards each other as well as parallel to each other.

One mirror is also made less opaque so that it can transmit. The original device used internal mirrors which were difficult to adjust in the low pressure gas. Today external spherical mirrors are used which are several layers of dielectric substrate.

Helium and neon are chosen because they have similar energy levels so population inversion can be achieved by transferring energy from helium to neon, neon being the lasant. The atoms that engage in the lasing are not ionised and therefore this is a neutral gas laser.

The helium-neon laser is a fairly reliable, low cost laser and is used for image and pattern recognition and in reading bar codes. It is also used in the construction industry for tunnelling and constructing sewers.

A major application of this laser is in recording and playing back holograms. It is used to measure displacement using interference fringes and to locate the edges of materials in industrial processes. In factories, the helium-neon laser is used to detect flaws on a surface and measure the roughness; this is called non-destructive testing. It is also used in alignment, ranging and flow measurements. The helium-neon laser is used to guide high power lasers to work areas and align them onto the material.

CARBON DIOXIDE LASERS

In general gas lasers can provide continuous wave operation at room temperature without the cooling required for other lasers. Also, because gases do not have the physical deformities that solids do, their emissions are closer to a single frequencies, ie, they are said to be monochromatic.

Pure carbon dioxide lases quite weakly, therefore it is common to introduce nitrogen and helium or helium and neon in small quantities. The wavelength is 10.6μm and the power output is from a few watts to several kilowatts, continuous or pulsed.

Molecular vibrations provide the lasing action rather than electronic transitions. Hydrogen fluoride and carbon monoxide also use molecular vibrations in order to supply the lasing action. Carbon monoxide lasers can supply from a few watts to several kilowatts, continuous or pulsed.

Molecular vibrations provide the lasing action rather than electronic transitions. Hydrogen fluoride and carbon monoxide also use molecular vibrations in order to supply the lasing action. Carbon monoxide lasers can supply from a few watts to about 15kW but they are only about 10% efficient.

Carbon monoxide lasers are much more

efficient, about 40% efficient but they are not only toxic but corrosive as well and therefore not employed in high power applications.

Industrial processes employing carbon dioxide lasers include cutting, welding, heat treating, scribing, marking and hole piercing. Materials that can be worked by carbon dioxide lasers are wood, paper, glass, most metals, ceramics, cloth and plastic.

| Laser | Wavelength (μm) | Power(W) |
|---------|------------------------------|--------------|
| Argon | 0.5145 to 0.488 | 0.005 to 20 |
| Krypton | 0.6471 | 0.005 to 6 |
| Xenon | 0.995 to 0.5395 | 200 (pulsed) |

Fig. 13. Comparison of ion lasers.

ION LASERS

Ionised gas is the lasant and these are usually four level systems. An electrical discharge is started in a plasma of the gas and the output is from a few milliwatts to several watts. Gases that are commonly used are argon, krypton and xenon. Typical power outputs and wavelengths emitted are shown in Fig.13.

The lasers can be tuned to wavelengths other than those shown in Fig.13 but those shown are the most common operating ranges. In addition the xenon laser can provide a higher output than the other two by operating it in a pulsed mode.

The argon laser was used by astronauts to measure the distance from the moon to the earth, and it is also used in eye surgery. The xenon laser is used for processing materials particularly is removing thin sheets of metal. Both argon and krypton lasers are used in spectroscopy, particularly Raman spectroscopy.

DYE LASERS

An organic dye is used as the lasant. A typical dye such as xanthene (rhodamine 6G) which is an organic dye could be used and pumped by nitrogen or argon lasers. An output of about 10mW could be obtained with a hundred pulses per second.

A wide bandwidth is obtained, typically 10^{13} Hz, encompassing hundreds of lines in the spectrum. Therefore it is possible to scan the visible spectrum merely by changing the dye, which can be made automatic. With this automatic facility, it is not surprising that it can be used to detect pollution and in photochemistry.

METAL VAPOUR LASERS

A process called cataphoresis is used where, for instance, cadmium is evaporated at an anode and condensed at the cathode. In this process about one gram of cadmium is used up in a thousand hours. The power is only in the range 50mW to 100mW and the current is also low so that air cooling is sufficient.

Such lasers are used in photochemistry, spectroscopy and laser light shows.

AMMONIA MASER

The ammonia maser (*Microwave Amplification by Stimulated Emission of Radiation*) was invented in 1954. The researchers were attempting to construct an amplifier but instead the device oscillated. Unable to stabilise it, the scientists accepted it as an oscillator and attempted to check its oscillating frequency range. To their amazement it could not be tuned to any other frequency apart from its frequency of oscillation.

It was then decided to use the ammonia maser as a clock since it is accurate to one second in 10,000 years. By comparison, the best clocks of the day were accurate to only one second in ten years. For time keeping the ammonia maser has been replaced by rubidium and caesium which are even more accurate.

The other use for the maser was in reception of satellite signals. Although these have now been replaced by parametric amplifiers the maser was the best available technology in those first exciting days of satellite experiments.

In order to reduce the noise in the detectors and front end amplifiers the maser was operated at -271.5°C (1.5K) which is not far off absolute zero (-273°C). This is achieved by immersing the devices in helium and at absolute zero all molecular vibration stops.

All this may seem excessive effort but when one is trying to detect a signal as low as 10^{-13} watts, in the presence of noise, extreme measures are required. Masers cannot handle powers above 10^{-5} , therefore they are ideal for these low level applications. Masers also have an edge over travelling wave tubes and klystrons since they have very little inherent noise.

Fig. 14. Ruby laser.

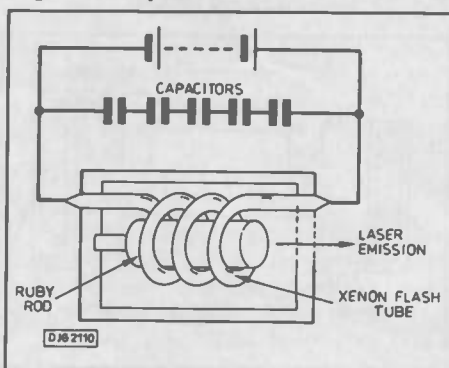

RUBY LASER

In 1960 Maiman constructed and operated the first laser made from a crystal of ruby. The ruby laser uses sapphire (Al_2O_3) as the host and triply ionised chromium ions (Cr^{3+}) as the lasant. The chromium replaces about 0.05% of the aluminium atoms.

The wavelength is $0.6943\mu\text{m}$ in the red part of the spectrum and because of the poor thermal properties of sapphire the output has to be pulsed. Nevertheless several joules of energy can be provided for piercing holes, drilling diamonds, spot welding, space probes and pulsed holograms.

Ruby is easy to cut into the required shape, usually a rod 1cm in diameter and 10cm long, (Fig.14). The ends are silvered in order to amplify the light with one end partially transmitting to provide an output path for the pulses.

A number of capacitors of about $100\mu\text{F}$ with a potential of a few kV is discharged into a flash tube. The flash tube containing xenon is wrapped around the ruby crystal. The energy absorbed from the flash tube into the ruby crystal provides enough energy for population inversion.

NEODYMIUM-GLASS LASERS

Glass is used as the host substance and triply ionised neodymium, Nd^{3+} , as the lasant. The output wavelength is $1.06\mu\text{m}$ but the bandwidth is much wider than the output from the neodymium-YAG laser. This results in several modes of oscillation and when these are locked together, a bandwidth as wide as 10^{12}Hz can be obtained with a pulse as narrow as 10^{-12} sec. Pumping is by gas discharge lamps.

But glass has a low thermal conductivity, therefore the duty cycle must be kept low, around one pulse per second. However, reasonably high energies can be obtained, around 100 joules per pulse. This makes the laser practical for hole piercing and welding.

NEODYMIUM-YAG LASERS

Once again triply ionised neodymium Nd^{3+} is used as the lasant. The host is yttrium-aluminium-garnet (YAG) which is also used as synthetic diamonds. The chemical formula of YAG is $\text{Y}_3\text{Al}_5\text{O}_{12}$. From 1% to 2% of the metal ions are replaced by neodymium.

The output is $1.06\mu\text{m}$ and can be operated pulsed or continuously from a few watts continuous up to 1kW pulsed. It is a four level system therefore population inversion is obtained with a low threshold energy.

The laser can be pulsed with a high repetition rate but above 2000 pulses per second, the average power starts to decline. Continuous wave lasers can be Q switched (Q switching will be dealt with later) in order to provide high energy pulses.

The neodymium-YAG laser is used for spot welding, seam welding, cutting, piercing holes in gemstones and exciting dye lasers.

One of the biggest application of lasers is in communications using optical fibres, therefore the semiconductor laser has been under intense development in order to provide higher power from small chips as well as purer frequencies and single modes.

The development of the semiconductor laser will be dealt with in the next part as well as methods of producing short, high peak power pulses. Such techniques for pulsed lasers include mode locking, Q switching and cavity dumping.

Next month we shall look at semi-conductor lasers.

SURVEILLANCE PROFESSIONAL QUALITY KITS

No. 1 For Kits

Whether your requirement for surveillance equipment is amateur, professional or you are just fascinated by this unique area of electronics SUMA DESIGNS has a kit to fit the bill. We have been designing electronic surveillance equipment for over 12 years and you can be sure that all of our kits are very well tried, tested and proven and come complete with full instructions, circuit diagrams, assembly details and all high quality components including fibreglass PCB. Unless otherwise stated all transmitters are tuneable and can be received on an ordinary VHF FM radio.

UTX Ultra-miniature Room Transmitter.

Smallest room transmitter kit in the world! Incredible 10mm x 20mm including mic. 3-12V operation. 500m range.....**£15.95**

MTX Micro-miniature Room Transmitter.

Best-selling micro-miniature room transmitter. Just 17mm x 17mm including mic. 3-12V operation. 1000m range.....**£12.95**

STX High-Performance Room Transmitter.

Hi performance transmitter with a buffered output stage for greater stability and range. Measures 22mm x 22mm including mic. 6-12V operation, 1500m range.....**£14.95**

VT500 High-Power Room Transmitter.

Powerful 250mW output providing excellent range and performance. Size 20mm x 4-12V operation. 3000m range.....**£15.95**

VXT Voice Activated Room Transmitter.

Triggers only when sounds are detected. Very low standby current. Variable sensitivity and delay with LED indicator. Size 20mm x 67mm. 9V operation. 1000m range.....**£18.95**

HVX400 Mains Powered Room Transmitter.

Connects directly to 240V AC supply for long term monitoring. Size 30mm x 35mm. 500m range.....**£18.95**

SCRX Subcarrier Scrambled Room Transmitter.

Scrambled output from this transmitter cannot be monitored without the SCDM decoder connected to receiver. Size 20mm x 67mm. 9V operation. 1000m range.....**£21.95**

SCLX Subcarrier Telephone Transmitter.

Connects to telephone line anywhere, requires no batteries. Output scrambled so requires SCDM connected to receiver. Size 32mm x 37mm. 1000m range.....**£22.95**

SCDM Subcarrier Decoder Unit for SCRX.

Connects to receiver earphone socket and provides decoded audio output to headphones. Size 32mm x 70mm. 9-12V operation.....**£21.95**

ATR2 Micro Size Telephone Recording Interface.

Connects between telephone line (anywhere) and cassette recorder. Switches tape automatically as phone is used. All conversations recorded. Size 16mm x 32mm. Powered from line.....**£12.95**

★★★ Specials ★★★

DLTX/DLRX Radio Control Switch

Remote control anything around your home or garden, outside lights, alarms, paging system etc. System consists of a small VHF transmitter with digital encoder and receiver unit with decoder and relay output, momentary or alternate, 8-way dill switches on both boards set your unique security code. TX size 45mm x 45mm, RX size 35mm x 90mm. Both 9V operation. Range up to 200m. Complete System (2 kits).....**£49.95**
Individual Transmitter DLTX.....**£18.95**
Individual Receiver DLRX.....**£36.95**

MBX-1 Hi-Fi Micro Broadcaster.

Not technically a surveillance device but a great ideal Connects to the headphone output of your Hi-Fi, tape or CD and transmits Hi-Fi quality to a nearby radio. Listen to your favourite music anywhere around the house, garden, in the bath or in the garage and you don't have to put up with the DJ's choice and boring waffle. Size 27mm x 60mm. 9V operation. 250m range.....**£19.95**

UTLX Ultra-Miniature Telephone Transmitter.

Smallest telephone transmitter kit available. Incredible size of 10mm x 20mm! Connects to line (anywhere) and switches on and off with phone use. All conversation transmitted. Powered from line. 500m range.....**£14.95**

TLX700 Micro-Miniature Telephone Transmitter.

Best-selling telephone transmitter. Being 20mm x 20mm it is easier to assemble than UTLX. Connects to line (anywhere) and switches on and off with phone use. All conversations transmitted. Powered from line. 1000m range.....**£12.95**

STLX High-Performance Telephone Transmitter.

High power transmitter with buffered output stage providing excellent stability and performance. Connects to line (anywhere) and switches on and off with phone use. All conversations transmitted. Powered from line. Size 22mm x 22mm. 1500m range.....**£15.95**

TKX900 Signalling/Tracking Transmitter.

Transmits a continuous stream of audio pulses with variable tone and rate. Ideal for signalling or tracking purposes. High power output giving range up to 3000m. Size 25mm x 63mm. 9V operation.....**£21.95**

CD400 Pocket Bug Detector/Locator.

LED and piezo bleeper pulse slowly, rate of pulse and pitch of tone increase as you approach signal. Gain control allows pinpointing of source. Size 45mm x 54mm. 9V operation.....**£29.95**

CD600 Professional Bug Detector/Locator.

Multicolour readout of signal strength with variable rate bleeper and variable sensitivity used to detect and locate hidden transmitters. Switch to AUDIO CONFIRM mode to distinguish between localised bug transmission and normal legitimate signals such as pagers, cellular, taxis etc. Size 70mm x 100mm. 9V operation.....**£49.95**

QTX180 Crystal Controlled Room Transmitter.

Narrow band FM transmitter for the ultimate in privacy. Operates on 180 MHz and requires the use of a scanner receiver or our GRX180 kit (see catalogue). Size 20mm x 67mm. 9V operation. 1000m range.....**£39.95**

QLX180 Crystal Controlled Telephone Transmitter.

As per QTX180 but connects to telephone line to monitor both sides of conversations. 20mm x 67mm. 9V operation. 1000m range.....**£39.95**

QSX180 Line Powered Crystal Controlled Phone Transmitter.

As per QLX180 but draws power requirements from line. No batteries required. Size 32mm x 37mm. Range 500m.....**£34.95**

GRX180 Crystal Controlled FM receiver.

For monitoring any of the 'Q' range transmitters. High sensitivity unit. All RF section supplied as a pre-built and aligned module ready to connect on board so no difficulty setting up. Output to headphones. 60mm x 75mm. 9V operation.....**£59.95**

A build-up service is available on all our kits if required.

UK customers please send cheques, POs or registered cash. Please add £1.50 per order for P&P. Goods despatched ASAP allowing for cheque clearance. Overseas customers send sterling bank draft and add £5.00 per order for shipment. Credit card orders welcomed on 0827 714476.

OUR LATEST CATALOGUE CONTAINING MANY MORE NEW SURVEILLANCE KITS NOW AVAILABLE. SEND TWO FIRST CLASS STAMPS OR OVERSEAS SEND TWO IRC'S.

**SUMA
DESIGNS**

THE WORKSHOPS, 95 MAIN ROAD,
BAXTERLEY. NEAR ATHERSTONE,
WARWICKSHIRE CV9 2LE



0827 714476
Fax: 0827 712706

ONE POUND PACKS

All packs are £1 each Note the figure on the extreme left of the pack ref number and the next figure is the quantity of items in the pack, finally a short description.

- BD2 5 13A spurs provide a fused outlet to a ring main where devices such as a clock must not be switched off.
- BD9 2 6V 1A mains transformers upright mounting with fixing clamps.
- BD13 12 30 watt reed switches, it's surprising what you can make with these - burglar alarms, secret switches, relay, etc., etc.
- BD22 2 25 watt loudspeaker two unit crossovers.
- BD30 2 Nicad constant current chargers adapt to charge almost any nicad battery.
- BD32 2 Humidity switches, as the air becomes damper the membrane stretches and operates a microswitch.
- BD42 5 13A rocker switch three tags so on/off, or change over with centre off.
- BD45 1 24hr time switch, ex-Electricity Board, automatically adjust for lengthening and shortening day, original cost £40 each.
- BD49 5 Neon valves, with series resistor, these make good night lights.
- BD56 1 Mini unselector, one use is for an electric jigsaw puzzle, we give circuit diagram for this. One pulse into motor, moves switch through one pole.
- BD67 1 Suck or blow operated pressure switch, or it can be operated by any low pressure variation such as water level in water tanks.
- BD103A 1 6V 750mA power supply, nicely cased with mains input and 6V output leads.
- BD120 2 Stripper boards, each contains a 400V 2A bridge rectifier and 14 other diodes and rectifiers as well as dozens of condensers, etc.
- BD128 10 Very fine drills for pcb boards etc. Normal cost about 80p each.
- BD132 2 Plastic boxes approx 3in cube with square hole through top so ideal for interrupted beam switch.
- BD134 10 Motors for model aeroplanes, spin to start so needs no switch.
- BD137 6.5" 4 Ohm speaker, 10 Watt rating
- BD139 6 Microphone inserts - magnetic 400 ohm also act as speakers.
- BD148 4 Reed relay kits, you get 16 reed switches and 4 coil sets with notes on making c/o relays and other gadgets.
- BD149 6 Safety cover for 13A sockets - prevent those inquisitive little fingers getting nasty shocks.
- BD180 6 Neon indicators in panel mounting holders with lens.
- BD193 6 5 amp 3 pin flush mounting sockets make a low cost disco panel.
- BD199 1 Mains solenoid, very powerful, has 1in pull or could push if modified.
- BD201 8 Keyboard switches - made for computers but have many other applications.
- BD211 1 Electric clock, mains operated, put this in a box and you need never be late.
- BD221 5 12V alarms, make a noise about as loud as a car horn. Slightly soiled but OK.
- BD252 1 Panostat, controls output of boiling ring from simmer up boil.
- BD259 50 Leads with push-on 1/4in tags - a must for hook-ups - mains connections etc.
- BD263 2 Oblong push switches for bell or chimes, these can mains up to 5 amps so could be foot switch if fitted into pattress.
- BD268 1 Mini 1 watt amp for record player. Will also change speed of record player motor.
- BD305 1 Tubular dynamic mic with optional table rest.
- BD653 2 Miniature driver transformers. Ref. LT44, 20k to 1k centre tapped.
- BD548 2 3.5V relays each with 2 pairs changeover contacts.
- BD667 2 4.7 uF non-polarised block capacitors, pcb mounting.

There are over 1,000 items in our One Pound Pack List. If you want a complete copy please request this when ordering.

GEIGER COUNTER KIT Includes tube, PCB and all components to make a 9V counter £34. Ref 39P1

PERSONAL STEREO Again customer returns but complete and with stereo head phones a bargain at only £3.00 each. Our ref 3P83.

MAINS OPERATED MICROWAVE CONTROL PANEL with Touch switches. This unit has a 4 digit display with a built in clock and 2 relay outputs - one for power and 1 for pulsed power level. Could be used for all sorts of timer control applications. Only £5.00. Our ref 6P18.

EQUIPMENT WALL MOUNT Multiangle for speakers etc. £3 each ref 3P72.

SUB-MIN TOGGLE SWITCH Body size 8mm x 4mm x 7mm SBDT with chrome dolly fixing nuts. 3 for £1. Order ref BD649.

COPPER CLAD PANEL for making PCB. Size approx 12in long x 8.5in wide. Double-sided on fibreglass middle which is quite thick (about 1/16in) so this would support quite heavy components and could even form a chassis to hold a mains transformer, etc. Price £1 each. Our ref BD683.

MAINS FANS Brand new, snail type. Approx. 6" x 4" approx. 70W only £5.00. Ref. 5P166.

REAL POWER AMPLIFIER for your car, it has 150 watts output. Frequency response 20hz to 20Khz and signal to noise ratio better than 60dB. Has built in short circuit protection and adjustable input level to suit your existing car stereo, so needs no pre-amp. Works into speakers ref. 30P7 described below. A real bargain at only £57.50. Order ref: 57P1.

POWERFUL IONISER

Generates approx. 10 times more IONS than the ET1 and similar circuits. Will refresh your home, office, workshop etc. Makes you feel better and work harder - a complete mains operated kit, case included £18.00 + £2 p&p. Our ref 18P2.

REAL POWER CAR SPEAKERS. Stereo pair output 100W each. 4-Ohm impedance and consisting of 6.5in woofer, 2in mid range and 1in tweeter. Ideal to work with the amplifier described above. Price per pair £30.00. Order ref: 30P7.

VIDEO TAPES These are three hour tapes of superior quality, made under licence from the famous JVC Company. Offered at only £3 each. Our ref 3P63. Or 5 for £11. Our ref 11P3. Or for the really big user 10 for £20. Our ref 20P20.

ELECTRONIC SPACESHIP. Sound and impact controlled, responds to claps and shouts and reverses when it hits anything. Kits with really detailed instructions. Ideal present for budding young electrician. A youngster should be able to assemble but you may have to help with the soldering of the components on the pcb. Complete kit £10. Our ref. 10P81.

COMPOSITE VIDEO KITS. These convert composite video into separate H sync, V sync and video. Price £8.00. Our ref 8P39.

12" HIGH RESOLUTION MONITOR Amber screen, beautifully cased for free standing, needs only a 12v 1.5 amp supply. Technical data is on its way but we understand these are TTL input. Brand new in makers' cartons. Price: £22.00. Order ref: 22P2.

BUSH RADIO MIDI SPEAKERS Stereo pair. BASS reflex system, using a full range 4in driver of 4 ohms impedance. Mounted in very nicely made black fronted wall unit finish cabinets. Cabinet size approx 8.5in wide, 14in high and 3.5in deep. Fitted with a good length of speaker flex and terminating with a normal audio plug. Price £5 the pair plus £1 post. Our ref 5P141.

3.5in FLOPPY DRIVES We still have two models in stock: Single sided, 80 track, by Chicon. This is in the manufacturers metal case with leads and IDC connectors. Price £40, reference 40P1. Also a double sided, 80 track, by NEC. This is uncased. Price £60, reference 60P2. Both are brand new. Insured delivery £3 on each or both.

YUASHA LEAD ACID BATTERIES 6V 10A. Superb Value at only £9.00 REF 9PRH or 2 for £15.00 ref 15P37. Also some 12V 1.9AH £7.00 REF 7P19.

VERY POWERFUL 12 VOLT MOTORS. 1/3rd Horsepower. Made to drive the Sinclair C5 electric car but adaptable to power a go-kart, a mower, a rail car, model railway, etc. Brand new. Price £20 + £2 postage. Our ref. 20P22.

SINCLAIR C5 WHEELS. Set of 4 wheels with inner tubes and tyres. 2 13" dia. front wheels and 2 16" dia. rear wheels. Brand new, £6 each, 13" Ref 6P10, 16" Ref 16P11.

C5 GEARED MOTOR, 800 RPM. £40.00.

ELECTRONIC SPEED CONTROL KIT Suitable for controlling our powerful 12v motors. Price £17.00. Ref. 17P3 (heatsink required).

ORGAN MASTER is a three octave musical keyboard. It is beautifully made, has full size (piano size) keys, has gold plated contacts and is complete with ribbon cable and edge connector. Can be used with many computers, request information sheet. Brand new, only £15 plus £3 postage. Our ref 15P15.

PHILIPS LASER

This is helium-neon and has a power rating of 2mW. Completely safe as long as you do not look directly into the beam when eye damage could result. Brand new, full spec. £35 plus £3 insured delivery. Mains operated power supply for this tube gives 8kv striking and 1.25kv at 5mA running. Complete kit with case £15.

SOLDER

22-lwg 60/40 resin cored solder 1/2 kg reel. Top quality. £4.00. Ref 4P70.

HIGH RESOLUTION MONITOR. 9in black and white, used Philips tube M24/306W. Made up in a lacquered frame and has open sides. Made for use with OPD computer but suitable for most others. Brand new. £20 plus £5 post. Our ref 20P26.

12 VOLT BRUSHLESS FAN. Japanese made. The popular square shape (4.5in x 4.5in x 1.75in). The electronically run fans not only consume very little current but also they do not cause interference as the brush type motors do. Ideal for cooling computers, etc., or for a caravan. £8 each. Our ref 8P26.

MINI MONO AMP on p.c.b. size 4in x 2in (app.)

Fitted Volume control and a hole for a tone control should you require it. The amplifier has three transistors and we estimate the output to be 3W rms. More technical data will be included with amp. Brand new, perfect condition, offered at the very low price of £1.15 each, or 13 for £12.00.

JOYSTICKS for BBC, Atari, Dragon Commodore, etc. All £5.00 each. All brand new, state which required.

SUB-MIN PUSH SWITCHES Not much bigger than a plastic transistor but double pole PCB mounting. 3 for £1.00. Our ref BD688.

AA CELLS Probably the most popular of the rechargeable NICAD types. 4 for £4.00. Our ref. 4P44.

20 WATT 4 OHM SPEAKER With built in tweeter. Really well made unit which has the power and the quality for hi fi 6.5in dia. Price £5.00. Our ref; 5P155 or 10 for £40.00 ref. 40P7.

MINI RADIO MODULE Only 2in square with ferrite aerial and solid dia. tuner with own knob. It is superhet and operates from a PP3 battery and would drive a crystal headphones. Price £1.00. Our ref. BD716.

BULGIN MAINS PLUG AND SOCKET The old and faithful 3 pin with screw terminals. The plug is panel mounted and the socket is cable mounted. 2 pairs for £1.00 or 4 plugs or 4 sockets for £1.00. Our ref.

POPULAR ITEMS - MANY NEW THIS MONTH BD715, BD715P, or BD715S.

POPULAR ITEMS - MANY NEW THIS MONTH
MICROPHONE Low cost hand held dynamic microphone with on/off switch in handle. Lead terminates in 1.35mm and 1.25mm plug. Only £1.00. Ref. BD711.

MOSFETS FOR POWER AMPLIFIERS AND HIGH CURRENT DEVICES 140v 100watt pair made by Hitachi. Also available in H pack ref 2S199 and 2SK343 £4.00 a pair. Ref 4P51.

TIME AND TEMPERATURE LCD MODULE A 12 hour clock a Celsius and Fahrenheit thermometer a too hot alarm and a too cold alarm. Approx 50x20mm with 12.7mm digits. Requires 1AA battery and a few switches. Comes with full data and diagram. Price £9.00. Our ref. 9P5.

REMOTE TEMPERATURE PROBE FOR ABOVE. £3.00. Our ref. 3P60.
25 WATT STEREO AMPLIFIER IC STK043. With the addition of a handful of components you can build a 25 watt stereo amplifier. Supplied with a circuit diagram. £4.00 REF 4P69.

600 WATT AIR OR LIQUID MAINS HEATER Small coil heater made for heating air or liquids. Will not corrode, lasts for years. Coil size 3in x 2in mounted on a metal plate for easy fixing. 4in dia. Price £3.00. Ref. 3P78 or 4 for £10.0. Our ref. 10P76.

EX-EQUIPMENT SWITCHED MODE POWER SUPPLIES Various makes and specs but generally +-5, +-12V ideal bench supply. Only £8.00. Our ref 8P36.

ACORN DATA RECORDER Made for the Electron or BBC computer but suitable for others. Includes mains adaptor, leads and book. £12.00. Ref. 12P15.

PTFE COATED SILVER PLATED CABLE 19 strands of .45mm copper will carry up to 30A and is virtually indestructible. Available in red or black. Regular price is over £120 per reel. Our price only £20.00 for 100m reel. Ref. 20P21 or 1 of each for £35.00. Ref. 35P2. Makes absolutely superb speaker cable!

NEW PIR SENSORS Infra red movement sensors will switch up to 1000w mains, UK made, 12 month manufacturers warranty, 15-20m range with a 0-10min timer, adjustable wall bracket. Only £25.00. Ref 25P16.

MAINS FANS 80mm square silent mains fans ideal for equipment cooling where space is at a premium. They give quite a good draught and use about 12 watts. £9.00 ref 9P10.

10 MEMORY PUSHBUTTON TELEPHONES These are customer returns and sold as seen. They are complete and may need slight attention. Price £6.00 Ref 6P16 or 2 for £10.00 Ref 10P77 BT approved.

MINIATURE DOT MATRIX PRINTERS. These are 24 column 5v and similar to the one sold by Radio Spares for £46.00. You can have one for £10 ref 10P92.

MYLAR CONE SPEAKERS. These 85mm square 35ohm 2 watt speakers are ideal for outside use as they are virtually waterproof. £1.00 each ref BD903.

BBC JOYSTICK INTERFACE Converts a BBC joystick port to an Atari type port. Price £2.00. Our ref. 2P261.

TELEPHONE EXTENSION LEAD 5M phone extension lead with plug on one end, socket on the other. White. Price £3.00. Our ref. 3P70 or 10 leads for only £19.00! Ref. 19P2.

LCD DISPLAY 4.5in digits supplied with connection data £3.00. Ref. 3P77 or 5 for £10. Ref. 10P78.

CROSS OVER NETWORK 8 Ohm 3 way for tweeter midrange and woofer nicely cased with connections marked. Only £2.00. Our ref. 2P255 or 10 for £15.00. Ref. 15P32.

BASE STATION MICROPHONE Top quality uni-directional electret condenser mic 600 impedance sensitivity 16-18KHz - 68dB built in chime complete with mic stand bracket. £15.00. Ref. 15P28.

MICROPHONE STAND Very heavy chromed mic stand, magnetic base 4in high. £3.00 if ordered with above mic. Our ref. 3P80.

SOLAR POWERED NICAD CHARGER 4 Nicad AA battery charger. Charges 4 batteries in 8 hours. Price £6.00. Our ref. 6P3.

MAINS SOLDERING IRON Price £3.00. Our ref. 3P65.

SOLDERING IRON STAND Price £3.00. Our ref. 3P66.

CAR IONIZER KIT Improve the air in your car, clears smoke and helps prevent fatigue. Case req. Price £12.00. Our ref. 12P8.

NEW FM BUG KIT New design with PCB embedded coil 9v operation. Priced at £5.00. Our ref. 5P158.

NEW PANEL METERS 50uA movement with three different scales that are brought into view with a lever. Price only £3.00. Ref. 3P81.

STROBE LIGHTS Fit a standard Edison screw light fitting 240V 40/min. flash rate available in yellow, green. Complete with socket. Price £10 each. Ref. 10P80 (state colour required).

WHITE EXTENSION CABLE WITH A DIFFERENCE It is flat on one side making it easy to fix and look tidy. 4 core, suitable for alarms, phones etc. Our price only £5.00 for 50m reel. Ref. 5P153.

METAL PROJECT BOX Ideal for battery charger, power supply etc. Sprayed grey size 8in x 4in x 4.5in. Louvered for ventilation. Price £3.00. Ref. 3P75.

TV SOUND DECODER Nicely cased, mains powered with 8 channels. Will drive a small speaker directly or could be fed into HiFi system etc. £12.00 each. Ref 12P22.

2KV 500 WATT MAINS TRANSFORMER Suitable for high voltage experiments or as a spare for a microwave oven etc. £10.00 Ref 10P93.

STC SWITCHED MODE POWER SUPPLY 220V or 110V operation giving 5V at 2A+24 at 0.25A +12 at 0.15A and +90V at 0.4A. £12.00 each. Ref. 12P27.

PC STYLE CASES 18" x 18" x 6" Complete with fan and grill illuminated power switch and IEC filtered power input plug. Priced at only £15.00. Ref 15P38.

PC POWER SUPPLIES Brand new with in-built fan and power switch on the back +5 -5 +12 -12 150 Watt made by Aztec £25.00 each, Ref 25P18.

BOSCHERT SWITCHED MODE POWER SUPPLIES +5 at 15A, +12 at 2A +24 at 2A 220V or 110V input. Brand new and guaranteed. Retail price is £180! Ours £20. Ref 20P30.

BULL ELECTRICAL

Dept. PE 250 PORTLAND ROAD, HOVE, BRIGHTON, SUSSEX BN3 5QT.

MAIL ORDER TERMS: Cash, PO or cheque with order. Please add £2.50 service charge. Monthly account orders accepted from schools and public companies. Access and B/Card orders accepted - minimum £5. Phone (0273) 203500. Fax: (0273) 20377.

1990 CATALOGUE NOW AVAILABLE. PLEASE SEND 6" X 9" SAE FOR FREE COPY!



Operational amplifiers were originally developed for use in computers. These were not digital computers - the sort we are all familiar with nowadays - but analogue computers. The main difference between the two types of computer is that they have different ways of representing numbers while they are processing them. In a digital computer, a numerical value is represented by a set of high and low logic levels, each corresponding to one digit of the number, expressed in binary. The high and low levels are represented by voltages; usually 0V (or close to 0V) represents logic low, while +5V (or close to it) represents logic high. The essential feature is that there are only two voltage levels recognised in the computer circuits.

In an analogue computer too, a numerical value is represented by a *voltage*. Here the voltage can take not just one of two values but *any value* within a given range. The number is represented on a suitable *voltage* scale. For example if the scale is 1V to 100, the number 135 is represented by 1.35V and 341 is represented by 3.41V. The scale would be different for much larger or much smaller numbers. In the computer, these voltages are added, subtracted, multiplied or divided, according to mathematical operations that have to be performed. It is easy to see that

Part 11: Owen Bishop examines the most vital of all active building blocks in the analogue world - the opamp.

one or more opamps. They take the voltage from the transducer, perform a few simple mathematical operations on it - perhaps correcting for errors inherent in the transducer - and then present the result to the digital circuit for further processing. Opamps are so simple to use that they have found applications in many other fields too, including audio circuits.

FEATURES

Fig.1 shows the symbol used for an opamp in a circuit diagram, and illustrates its essential features. The opamp has two input terminals, known as the inverting input and non-inverting input. The save space, we shall refer to these as (-) and (+), respectively, from now on. The opamp has one output terminal.

An opamp normally operates on a dual power supply. This has three power rails:

An important characteristic of the opamp is that the input terminals have very high input impedance. In the case of the popular 741 opamp, which has bipolar junction transistors at its inputs, the impedance is about 2MΩ. Some other types of opamp have field effect transistors at their inputs, and the impedance is often as high as 10¹²Ω (1 Teraohm). With such a high input impedance, the amplifier draws virtually no current from the circuit to which it is connected. In particular, this means that voltages in the circuit are unaffected by having the amplifier connected there. Conversely, the output of the amplifier is only a few tens of ohms. In other words, it can supply a relatively large current without any significant fall in its output voltage. The twin characteristics of high input impedance and low output impedance are ideal for an amplifier and are of course essential in amplifiers that are to perform mathematical operations precisely.

The output voltage depends on the *difference* between the input voltages at (+) and (-). The bigger the difference, the bigger the output (except that it can not exceed the power rail voltages). As might be expected, the (+) and (-) inputs work in the opposite sense. Output swings positive if (+) is positive of (-); it swings negative if (-) is positive of (+).

BASIC ELECTRONICS

amplifiers must play an important part in such a computer. To multiply a number by 25, for example, we use an amplifier with a gain of 25. We feed the voltage representing the number into the amplifier; the output voltage represents the number multiplied by 25. Division is performed by an amplifier with a gain of less than unity. As we shall show later, amplifiers can also be used for addition and subtraction. Since these amplifiers are used to perform mathematical operations, they are called operational amplifiers.

FUNCTIONS

The original operational amplifiers were made from discrete components but, nowadays, they are available very cheaply as integrated circuits. Although analogue computers are still used for specialist purposes, on the whole they have given way to digital computers. In spite of the decline of analogue computers, operational amplifiers or 'opamps', as they have come to be called, remain with us as one of the more important elements of electronic circuitry. Often their function is to perform some kind of mathematical operation, even though the circuit that they form part of would hardly be dignified by the name of 'computer'. A common use for opamps is in measuring devices, such as testmeters, electronic thermometers, and electronic kitchen scales. Even though the display and much of the operation of the device may be digital, the early stages of the circuit often uses

- Positive rail
- Ground rail, taken to be 0V
- Negative rail

The positive and negative rails are equally positive of and negative of the ground rail. For example, in Investigation 1 (below) the voltages of the three rails are +3V, 0V and -3V respectively. The power supply terminals of an opamp are connected to the positive and negative rail. There is no power connection to the 0V rail, though in some circuits we may wire one of the input terminals to 0V to obtain a 0V input level. The voltages of the power rails represent the maximum voltages positive and negative, that can be applied to the input terminals. Similarly the output voltage always lies between these two extremes. In many types of opamp, the output voltage is restricted to a narrower range and never rises as high as the positive rail or as low as the negative rail. (*Regrettably! Ed.*)

To say that (+) is positive of (-) does not necessarily mean that the (+) input is at a positive voltage. For example, if the (+) input is -1.5V and the (-) input is -2.5V, the (+) input is positive compared with the (-) input, so the output swings positive.

Opamps are able to respond rapidly to changes of input voltage. Most can amplify oscillating signals with a frequency of several megahertz. Yet they also respond to dc signals, ie to steady input voltages.

Another feature of the opamp is its very high gain. The gain of the 741 opamp, for example, is 200 000. Other types have gains as high as a million. However, we very rarely make use of this high gain. Instead, we use external components to set the gain of the amplifier circuit to the required level, which is seldom more than a few thousand.

PRACTICAL OPAMPS

Opamp ics may be packaged in metal cans similar to those used for certain transistors, but most often they are in the familiar dil (dual-in-line) package as shown in Fig.2. Although there are dozens of different opamps available, most of them follow the standard pin-out shown in this drawing. Pins 1, 5 and 8 are used for connecting external components used to compensate for various amplifier errors, though this is required only in the most critical applications. The types of compensation provided and the method of

Fig. 1. Main features of an opamp.

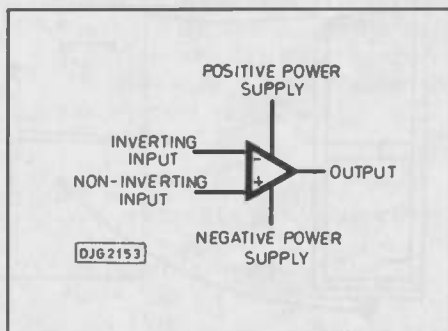

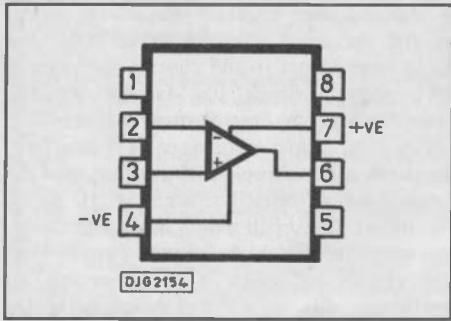

Fig. 2. Typical opamp ic.

achieving it varies with the type of amplifier. Compensation is required only in the most critical applications and, with most opamps, these terminals may be left unconnected.

Opamps are also available in larger packages, often two, three or four separate amplifiers to a package, sharing common power supply terminals.

There are several families of opamps, mostly distinguished by the type of transistor used. The most successful opamp was the 741, based on bipolar junction transistors. Although this was the industry standard as a general-purpose amplifier and is still in use, it has the disadvantage that its output voltage range is limited. It can not swing freely in either direction as far as the supply voltages. It requires a minimum supply voltage of +5V and -5V, which restricts its use in certain areas. There are many other opamps in the same family offering (at suitable prices) various refinements on the 741. They may have greater precision, faster action, higher gain, lower noise, higher slew rate (the ability of the output to swing very rapidly), or greater output current (power opamps).

Another major family of opamps is based on mosfet technology, of which the CA3130 and CA3140 are popular examples. These have the advantage that the inputs have exceedingly high input impedance. They require less power than the bipolar opamps and their output voltage is usually able to swing very close to that of the supply rails in both directions. Many of them are able to operate with low supply voltages. The ICL7611, for example, operates on voltages as low as +1V and requires an operating current of only 10µA.

Fig. 3. Opamp wired as an inverting amplifier.

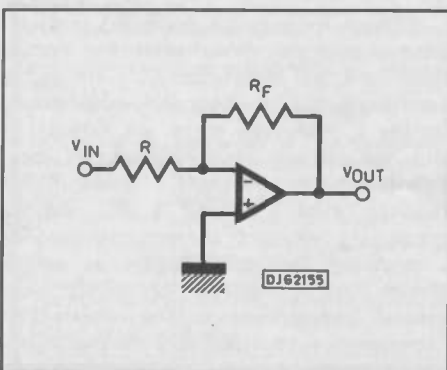

USING OPAMPS

As a first example, we investigate the use of an opamp as an inverting amplifier. Fig.3 shows the essential connections. The function of the circuit is to take an input voltage, V_{in} and produce a corresponding output voltage V_{out} . V_{out} is to be greater (ie, amplified) than V_{in} but the opposite polarity (ie, inverted). The circuit requires two resistors, the input resistor R and the feedback resistor R_f . As this is an inverting amplifier, V_{in} goes to (-) via resistor R . The other input, (+), is held at 0V by a wired connection to the 0V rail. The feedback resistor connects the output terminal to the (-); it feeds back the output voltage to the inverting input. We will see how this circuit behaves by trying it out on the breadboard.

Investigation 1 - Inverting amplifier

The circuit of Fig.4 is powered by a 6V battery, which is tapped between cell B and cell C. The voltages at the tap is taken to be 0V, and the rails are at +3V and -3V respectively. In Fig.4 we have given actual values to the resistors of Fig.3. Note that the feedback resistor has a higher resistance than

the input resistor.

V_{in} is to be a low voltage, since we are to attempt to amplify it. We obtain this by using a potential divider consisting of R_3 and R_4 . We studied potential dividers in Part 2 (Feb 90). Can you calculate what the voltage at V_{in} will be when the flying lead at the top of the divider is connected to +3V?

V_{out} is measured by a voltmeter and, as this is an inverting amplifier, we expect V_{out} to be negative. Unless you are using a meter with automatic polarity, connect the positive terminal of the meter to the 0V rail and the negative terminal to the output of the amplifier.

Set up the circuit (Fig.5); connect the power; connect the flying lead to +3V. Measure and record V_{out} . Calculate the gain of the circuit.

Repeat with the flying lead connected to +1.5V (between cell A and cell B). What is the gain?

Repeat with a negative voltage input, connecting the flying lead to -3V and then -1.5V (between cell C and cell D).

Replace R_2 with a 180k resistor and repeat the above. What is the gain of the circuit now?

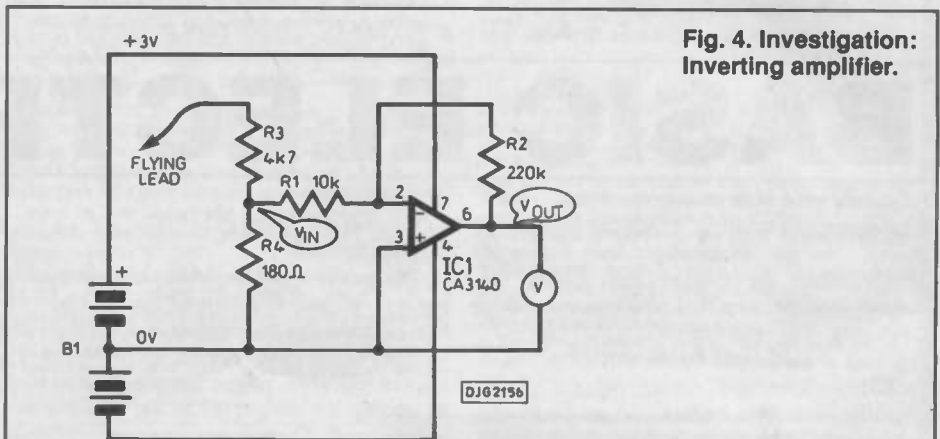

Fig. 4. Investigation: Inverting amplifier.

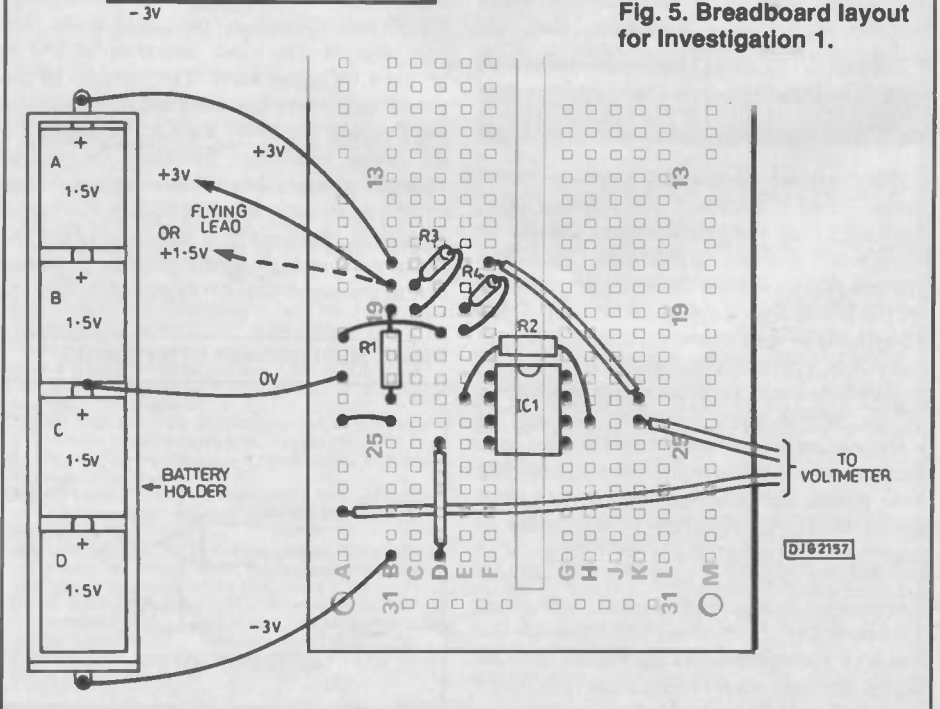

Fig. 5. Breadboard layout for Investigation 1.

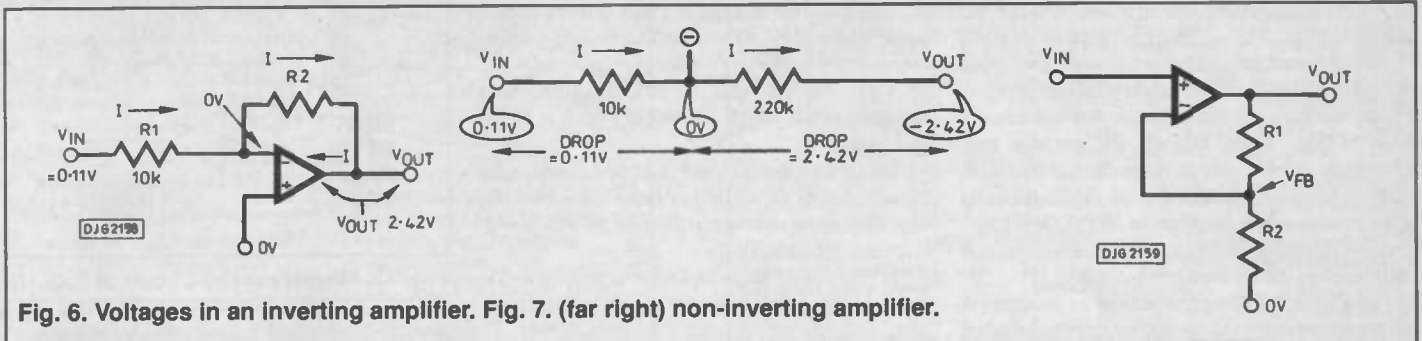

Fig. 6. Voltages in an inverting amplifier. Fig. 7. (far right) non-inverting amplifier.

FEEDBACK AND GAIN

In the inverting amplifier of Investigation 1, we feed back the output voltage to the *inverting* input (-). A positive-going input results in negative going output, which is fed back to the input and opposes the positive-going input. We call this *negative feedback*. Under such circumstances there will be a point at which the tendency for output to increase is balanced by the effect of negative feedback. In this condition the circuit is stable. The exact point at which this occurs can be found if we remember this rule, which applies to all opamp circuits with negative feedback:

Output changes until (+) and (-) are at the same voltage.

Let us see how this works in an example taken from the investigation. This rule and Ohm's Law (volt/amps=ohms) are all that we need to discover what happens. Suppose that V_{in} is 0.11V. (+) is at 0V and, if the rule above is true, (-) is also at 0V. This means that there is a voltage drop of 0.11V across R_1 . Ohm's Law tells us that the current through R_1 is $0.11/10000 = 0.000011A = 11\mu A$. We have said earlier that the input terminals draw virtually no current as this current (or almost all of it) must flow on through R_2 . If the current through R_2 is $11\mu A$, the voltage drop across R_2 must be $0.000011 \times 220000 = 2.42V$. The (-) end of R_2 is at 0V, so the other end (the end wired to the output terminal) must be at -2.42V. If the output voltage falls to -2.42V (which is what happens in the investigation) the current flowing along R_1 continues along R_2 and enters the output terminal of the opamp. The circuit is stable under these conditions.

Exercise: Work out what should happen if (a) V_{in} is 0.04V, R_1 is 10k and R_2 is 220k; (b) V_{in} is 0.15V, R_1 is 20k and R_2 is 180k.

Now we will look at the more general case. If the input voltage is V_{in} , the current I through R_1 is given by:

$$I = \frac{V_{in}}{R_1}$$

If the output voltage is $-V_{out}$, the current I through R_2 is:

$$I = \frac{-V_{out}}{R_2}$$

Since the current is the same through both resistors, we have:

$$\frac{V_{in}}{R_1} = \frac{-V_{out}}{R_2}$$

From this equation we can calculate the gain of the circuit:

$$\text{Gain} = \frac{V_{out}}{V_{in}} = \frac{-R_2}{R_1}$$

Thus the gain of the circuit is determined

simply by the ratio of the input and feedback resistors. It does not depend on the gain of the opamp itself. If we use high precision resistors, the gain of the circuit can be determined very precisely.

INPUT IMPEDANCE

There is one problem with the inverting amplifier. Although the input impedance of the opamp is very high, and we have considered this to be a big advantage, the input impedance of the *circuit* is far less. Since the (-) end of R_1 is always held at 0V, the input impedance of the circuit is the resistance of R_1 - only 10k. We have thrown away one of the opamp's useful features. Whether this matter or not depends upon the application, but it is a point to be kept in mind.

VIRTUAL EARTH

A useful concept arises from the study of the inverting amplifier. Since (+) is held at 0V (ground or earth voltage), and since the amplifier always operates to keep (-) at the same voltage as (+), (-) is always at 0V too. It acts as a *virtual earth*. Whatever current flows through R_1 , it always seems to 'disappear' into the amplifier, just as if R_1 had been connected directly to the 0V line. Actually, it does not disappear, but flows on through R_2 , but the effect is the same. We shall return to this concept later.

NON-INVERTING AMPLIFIER

As Fig.7 shows, the input to this circuit goes directly to the (+) input. The input impedance of the circuit is as high as that of the opamp input. Once again, we have negative feedback to (-) but, in this circuit, the feedback voltage is taken from a potential divider, R_1/R_2 . This is negative feedback, so the rule quoted above applies. As V_{in} varies, the output varies so as to keep both (+) and (-) at the same voltage. The feedback voltage, V_{fb} (see Fig.7), is always equal to V_{in} .

The usual equation for a potential divider applies, so we can say that:

$$V_{fb} = V_{out} \times \frac{R_2}{R_1 + R_2}$$

So:

$$V_{out} = V_{fb} \times \frac{R_1 + R_2}{R_2} = V_{in} \left(1 + \frac{R_2}{R_1}\right)$$

The gain of the circuit is:

$$\text{Gain} = \frac{V_{out}}{V_{in}} = 1 + \frac{R_2}{R_1}$$

You may remember from Part 2 that, if appreciable current is drawn from the divider, the voltage is less than that calculated by using the values of the resistors. In this case the amount of current flowing to (-) is negligible, so the gain of the amplifier is precisely determined by the resistor values.

Investigation 2 - Non-inverting amplifier

Try breadboarding the amplifier of Fig.7, and check that the gain is as quoted above.

VOLTAGE FOLLOWER

A variant on the non-inverting amplifier is shown in Fig.8. Here V_{out} is fed directly back to (-). Applying the rule, we find that V_{out} is equal to V_{in} . An amplifier that does not amplify may seem to be of little use, but it has an important application - impedance-matching. For example, if we have a photodiode in series with a resistor as in Fig.9, the voltage at A depends on the size

Fig. 8. Voltage follower and (Fig. 9a/b) using it for impedance matching.

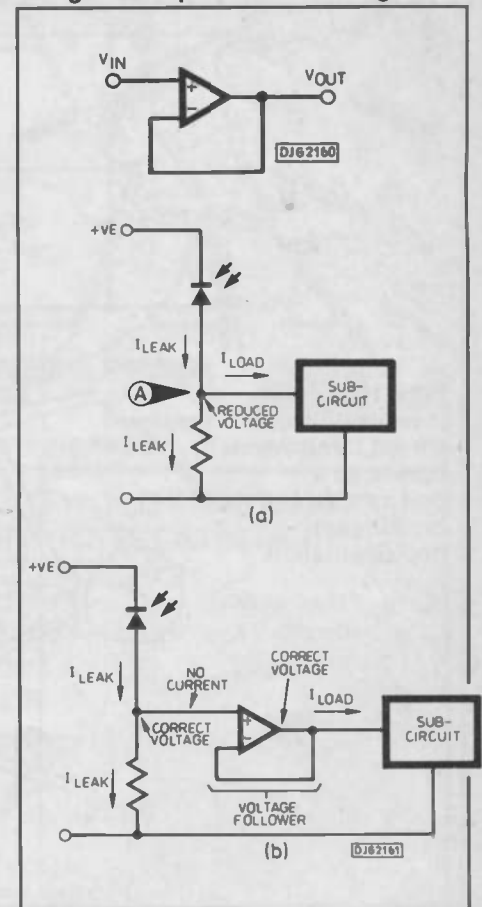

of the leakage current and is proportional to the amount of light falling on the photodiode. If point A is connected to a sub-circuit with low input impedance (Fig. 9a), a relatively high proportion of the leakage current goes to the sub-circuit. Less current flows through the resistor and, consequently, the voltage across it is reduced. A voltage follower connected as in Fig. 9b takes no appreciable current, so there is no fall in voltage. Yet the amplifier can supply a current of several milliamps to the following sub-circuit.

The voltage follower is similar in function to the common-collector circuit, or emitter-follower, described in Part 7, July 90. The V_{in} whereas, with the emitter-follower, there is a constant voltage difference of about 0.6V due to the forward voltage drop of the base-emitter junction.

COMPARATOR

The opamp is essentially a difference amplifier, with very high gain. Without feedback, even a small difference in voltage at its inputs causes the output to swing as far positive or negative as it can. This is no use for measuring a voltage; feedback is essential to limit the gain to a known level. But if we want simply to compare two voltages, to know which is the greater, all we need to do is to apply these voltages to the two inputs, without feedback, and watch which way the output swings.

Investigation 3 - A comparator

Fig. 10 shows the opamp wired to compare two voltages. One voltage comes from a potential divider consisting of a thermistor R1 (see Part 3, March 90) in series with a fixed

resistor R2. The voltage at point A rises as the temperature of R1 increases. The second voltage comes from another potential divider, consisting of VR1. We set VR1 to produce a standard voltage against which the voltage at A is to be compared.

Set up the circuit as in Fig. 11 and connect the battery. Although we do not make use of the 0V line in comparator, we still refer to the power lines as +3V and -3V.

1. Turn VR1 anti-clockwise to supply a -3V input to (1). What happens to the led? Explain this.

2. Turn VR1 clockwise to give a +3V input to (1). What happens to the led?

3. Turn VR1 so that the led comes on, then turn VR1 so that it just goes out. Now grip R1 between finger and thumb; what happens? Remove your finger and thumb; what happens?

4. Add an input resistor R4 and feedback resistor R5, as in Fig. 12. What do you notice about the feedback in this circuit? Repeat step 3. If the led does not go out when R1 cools, try cooling it further by touching a cube of ice against it. Does the behaviour of the circuit remind you of a circuit that we have described in an earlier issue?

ADDER

The circuit for performing addition makes use of the concept of virtual earth, discussed above. In Fig. 13 there are three input voltages, representing values that are to be added together. A current flows along each resistor, toward the virtual earth at the (-) input. The currents are $I_1 = V_1/R$, $I_2 = V_2/R$ and $I_3 = V_3/R$. These three currents flow on

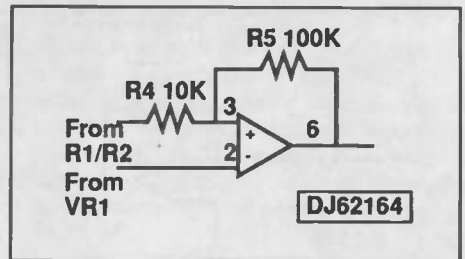

Fig. 12. Modifying the circuit of Fig. 10.

through the feedback resistor, which has the same value as the input resistors. The voltage drop across R is:

$$\begin{aligned} V_{out} &= -(I_1 + I_2 + I_3) \times R \\ &= -\left(\frac{V_1}{R} + \frac{V_2}{R} + \frac{V_3}{R}\right) \times R \\ &= -(V_1 + V_2 + V_3) \end{aligned}$$

In other words, the output voltage is the inverse of the sum of the input voltages. The circuit has added the input voltages.

We shall investigate this further next month. In the meantime, a brief discussion of the investigations so far.

DISCUSSION

Investigation 1:

$V_{in} = 3 \times R_4 / (R_3 + R_4) = 3 \times 180 / 4880 = 0.11V$.
With the flying lead at +3V, V_{out} is -2.42V. (The result varies slightly, depending on the values of your resistors). Gain = $-2.42 / 0.11 = -22$.

With the lead at +1.5V, $V_{in} = 1.5 \times 180 / 4880 = 0.055V$. V_{out} is -1.21V. Gain = $-1.21 / 0.055 = -22$.

With lead at -1.5V, $V_{in} = -0.055V$, $V_{out} = 1.21V$, gain = -22.

With the lead at -3V, $V_{in} = -0.11V$, $V_{out} = 2.42V$, gain = -22.

Using a feedback resistor of 180k, gives a gain of -18.

Exercise: (a) current is $0.04 / 10000 = 0.000004A = 4\mu A$; $V_{out} = 0.000004 \times 220000 = 0.88V$; gain is $0.88 / 0.04 = 22$

(b) current is $0.15 / 20000 = 0.0000075A = 7.5\mu A$; $V_{out} = 0.0000075 \times 180 = 1.35V$; gain is $1.35 / 0.15 = 9$.

Investigation 3:

1. The led comes on, so V_{out} must be high (almost +3V); this is because (-) is negative of (+).

2. The led goes out, so V_{out} must be low (close to -3V); this is because (-) is positive of (+).

3. The led is just off because (-) is slightly positive of (+). Warming R1 reduces its resistance, causing the voltage at A to rise; this makes (+) slightly positive of (-), making V_{out} high and turning on the led. Allowing R1 to cool reverses the above and turns the led off.

4. When R1 is warmed and V_{out} goes high, the increased output voltage is fed back; this is positive feedback, pulling up the voltage at A even further. Allowing R1 to cool does not bring the voltage at A down far enough to be made (+) negative of (-). We must increase the resistance of R1 considerably (ie, by using ice to cool it) before the voltage at A falls below (-) and the led is turned off. The action of this circuit is the same as the Schmitt trigger circuit described in Part 7, July 90.

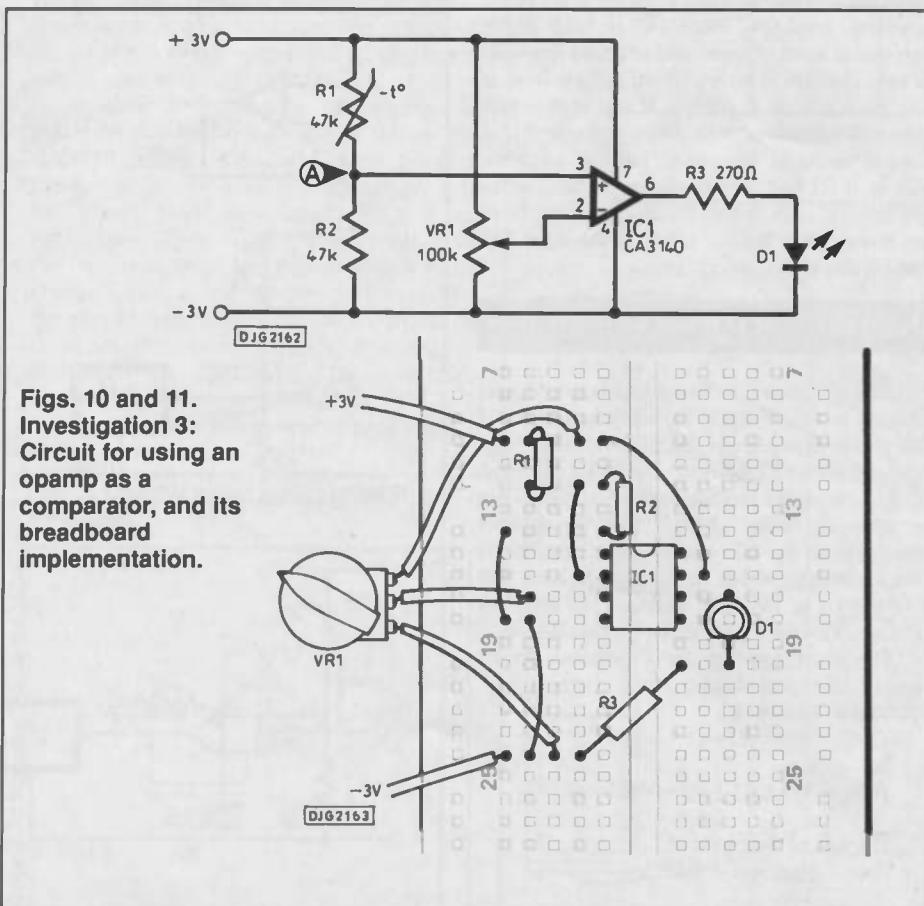

Figs. 10 and 11. Investigation 3: Circuit for using an opamp as a comparator, and its breadboard implementation.

JOIN UP WITH LITESOLD

Professional Soldering Equipment at Special Mail-Order Prices.

SK18 Soldering Kit. £19.75

Build or repair any electronic project. LC18 240v 18w iron with 3.2, 2.4, and 1.6mm bits. Pack of 18 swg flux-cored 60/40 solder. Tweezers. 3 soldering aids. Reel of De-Solder braid. In PVC presentation wallet.



ADAMIN Miniature Iron £8.60

Possibly smallest mains iron in the world. Ideal for fine work. Slim

nylon handle with finger grip. Interchangeable bits available 1.2, 1.6, 2.4, 3.4 and 4.7mm. Fitted with 2.4mm. 240v 12w (12v available). Presentation wallet.

'L' Series Lightweight Irons. 12w £9.20

High efficiency irons for all electronic hobby work. Non-roll handles with finger guards. Stainless steel element shafts. Screw-connected elements. Slip-on bits available from 1.6 to 4.7mm. LA12



Soldering Iron Stands 3&4 £7.33

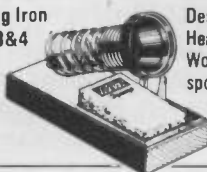

Designed specially for LITESOLD irons. Heavy, solid-plastic base with non-slip pads. Won't tip over, holds iron safely. With wiping sponge and location for spare (hot) bits. No 5 stand for EC50 iron No 4 stand for ADAMIN miniature iron No 3 stand for LA12 and LC18 irons.

De-Solder Pumps £8.65

High Quality version of increasingly popular type of tool. Precision made anodised aluminium body, plunger guard and high-seal piston. Easy

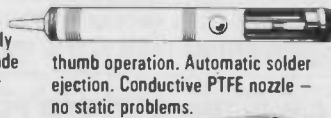

thumb operation. Automatic solder ejection. Conductive PTFE nozzle - no static problems.

Prices include p&p and VAT. Send order with Cheque/PO. Ring for Access/Visa sales



LIGHT SOLDERING DEVELOPMENTS LTD. DEPT. PE
97-99 GLOUCESTER ROAD, CROYDON CR0 2DN. 01 689 0574

TRANSFORMERS

| 12/24V or 12-0-12V | 2 x 12V Secs | 2 x 25V Tapped Secs to give 5,7,8,10,13,17, 20,25,33,40, 50V | 25V | £ | P&P |
|--------------------|--------------|--|-------|------|-----|
| 24V | 12V | £ | P&P | | |
| 0.15 | 0.05 | 3.44 | 1.87 | | |
| 0.25 | 0.5 | 3.64 | 1.87 | | |
| 0.5 | 1 | 4.36 | 1.87 | | |
| 1 | 2 | 6.08 | 2.09 | | |
| 2 | A | 7.01 | 2.20 | | |
| 3 | M | 6 | 12.08 | 2.36 | |
| 4 | P | 8 | 12.87 | 2.42 | |
| 6 | S | 12 | 15.62 | 2.64 | |
| 8 | | 16 | 18.59 | 3.08 | |
| 10 | | 20 | 25.02 | 3.52 | |
| 15 | | 30 | 31.10 | 3.63 | |
| 20 | | 40 | 44.40 | 4.12 | |
| 30 | | 60 | 63.75 | 4.89 | |
| 41 | | 83 | 73.41 | 6.32 | |

MAINS ISOLATORS

| Pri 120V x 2 or 220/240V or 415/440V Sec 440V or 240V or 110V Centre Tapped | 20VA | £ | P&P |
|---|--------|--------|-----|
| 20VA | £8.33 | 2.50 | |
| 60 | 13.60 | p 2.69 | |
| 100 | 15.87 | & 2.91 | |
| 200 | 22.49 | p 3.52 | |
| 250 | 27.20 | 3.63 | |
| 500 | 41.91 | 4.23 | |
| 1000 | 76.01 | 5.33 | |
| 1500 | 98.04 | 6.54 | |
| 2000 | 117.96 | 6.54 | |
| 3000 | 165.41 | O/A | |
| 6000VA | 353.43 | O/A | |

AUTOS

| 105,115,220,230,240V For step-up or down | 80VA | 150 | 250 | 350 | 500 | 1000 | 1500 | 2000 | 3000 | 4000 | 5000 | 7500 | 10kVA | 50/25V or 25-0-25V |
|--|--------|--------|-----|-----|-----|------|------|------|------|------|------|------|-------|--------------------|
| 80VA | 1.92 | £6.91 | | | | | | | | | | | | |
| 150 | 10.03 | p 2.09 | | | | | | | | | | | | |
| 250 | 12.25 | & 2.31 | | | | | | | | | | | | |
| 350 | 14.05 | p 2.75 | | | | | | | | | | | | |
| 500 | 19.05 | 3.08 | | | | | | | | | | | | |
| 1000 | 34.03 | 3.68 | | | | | | | | | | | | |
| 1500 | 40.40 | 4.18 | | | | | | | | | | | | |
| 2000 | 60.41 | 5.11 | | | | | | | | | | | | |
| 3000 | 102.72 | 6.32 | | | | | | | | | | | | |
| 4000 | 133.35 | O/A | | | | | | | | | | | | |
| 5000 | 155.28 | O/A | | | | | | | | | | | | |
| 7500 | 239.70 | O/A | | | | | | | | | | | | |
| 10kVA | 283.23 | O/A | | | | | | | | | | | | |
| 50/25V or 25-0-25V | | | | | | | | | | | | | | |

PO BOX 70, ILFORD ESSEX, IG5 0AP

EX STOCK

| 60/30V or 30-0-30V | 2 x 30V Tapped Secs | 60V or 24-0-24V or 30-0-30V | 30V | £ | P&P |
|--------------------|---------------------|-----------------------------|-------|------|-----|
| 60V | 30V | £ | P&P | | |
| 0.5 | 1 | 6.72 | 2.09 | | |
| 1 | A | 2 | 10.25 | 2.20 | |
| 2 | M | 4 | 13.17 | 2.53 | |
| 3 | P | 6 | 19.05 | 2.64 | |
| 4 | S | 8 | 21.72 | 2.75 | |
| 5 | | 10 | 27.46 | 3.19 | |
| 6 | | 12 | 31.32 | 3.41 | |
| 8 | | 16 | 44.04 | 4.12 | |
| 10 | | 20 | 51.28 | 4.40 | |
| 12 | | 24 | 59.09 | 4.89 | |

| 96/48V or 36-0-36V | 2 x 36-48V Secs to give 60, 72, 84, 96V or 36-0-36V or 48-0-48V | 36V | 36/48V | £ | P&P |
|--------------------|---|------|--------|------|-----|
| 96V | 36/48V | £ | P&P | | |
| 0.5 | 1 | 7.16 | 1.78 | | |
| 1 | A | 2 | 12.80 | 2.31 | |
| 2 | M | 4 | 21.05 | 2.91 | |
| 3 | P | 6 | 25.49 | 3.02 | |
| 4 | S | 8 | 32.54 | 3.32 | |
| 5 | | 10 | 46.21 | 4.18 | |
| 6 | | 12 | 57.87 | 4.40 | |
| 8 | | 16 | 63.12 | 5.28 | |

INVERTERS

12/24V DC to 240V AC
Sinewave or Square Wave
TOOL TRANSFORMERS
240-110VCT
2.2KVA £90+£5.33 p&p

Also Valve Mains Output & Matching Transformers

TRANSFORMERS WOUND TO SPEC
Batch Winding 3VA to 15KVA

TOROIDALS
Batches Wound to Order
30VA to 15KVA

AVO's & MEGGERS
Full range
Send SAE for lists

BARRIE ELECTRONICS LTD
TELEPHONE: 081-551 8454

Component Catalogue still valid into 1991

CRICKLEWOOD ELECTRONICS

90'S DECADE COMPONENT CATALOGUE

- ONE OF THE LARGEST RANGES OF COMPONENTS IN THE UK
- FAST AND EFFICIENT SAME DAY PERSONAL SERVICE
- VERY COMPETITIVE PRICE; QUANTITY DISCOUNTS AVAILABLE
- DISCOUNT VOUCHERS INCLUDED
- NO MINIMUM ORDER

CRICKLEWOOD SUPPLY MOST OF THE COMPONENTS FOR P.E. PROJECTS. 13,000 STOCKLINES (MANY UNOBTAINABLE ELSEWHERE) PLEASE PHONE US FOR YOUR SPECIFIC NEEDS.

FILL IN THE COUPON AND POST IT WITH YOUR CHEQUE, PO ETC FOR £1.50 TO RECEIVE YOUR CRICKLEWOOD ELECTRONICS CATALOGUE AND VOUCHERS WHICH YOU CAN USE AGAINST YOUR NEXT PURCHASE

Cricklewood Electronics Ltd
40 CRICKLEWOOD BROADWAY, LONDON, NW2 3ET
Tel: 081-450 0995/452 0161
Fax: 081-208 1441 Telex: 914977

VISA

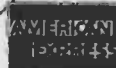

TELEPHONE ORDERS OUR SPECIALITY

CRICKLEWOOD ELECTRONICS COMPONENTS CATALOGUES

PLEASE SEND COPIES OF THE CRICKLEWOOD ELECTRONICS CATALOGUE AT £1.50 TO:

NAME
ADDRESS

Remittance enclosed £

COMPONENT SOLUTIONS LTD.

UNIT 84, ENTERPRISE CENTRE,
BEDFORD ROAD, STOKE-ON-TRENT,
STAFFS. ST1 4PZ

MICROPROCESSOR + MEMORY SPECIALIST

| | | | |
|----------|--------|----------------|-------|
| Z80A CPU | £0.95 | 2716F1 | £2.35 |
| Z80A S10 | £0.45 | 2732/2764 | £1.60 |
| Z80A P10 | £0.75 | 27128 | £2.35 |
| Z80A CTC | £0.75 | 27C256 | £2.40 |
| 8039 | £1.25 | 27512 | £5.00 |
| 8031 | £1.50 | 6116 | £1.30 |
| 80C39 | £1.70 | 6264 LP | £2.50 |
| 80C31 | £3.00 | 62256 LP | £6.00 |
| 80C85 | £1.60 | 4164 | £2.00 |
| 81C55 | £1.60 | 41256 | £2.25 |
| 82C55 | £2.10 | SIMMS 1Mx9.80 | 49.00 |
| 8251 | £1.50 | SIPS 1Mx9.80 | 49.00 |
| 8253 | £1.50 | SIPS 256Kx9.80 | 40.00 |
| N80186 | £10.00 | SIMMS 256Kx9 | 30.00 |
| 8211 | £0.90 | 78M15 | £0.20 |

MANY OTHER LINES AVAILABLE - PLEASE CALL FOR DETAILS.
ALL ABOVE ITEMS FROM STOCK, ORDERS BY RETURN POST

C.W.O. TRANSACTIONS PLEASE ADD 75P
P+P THEN 15% TO TOTAL



0782 287038



GEM TECH

Ideal
Learning
Projects
for All

Putting you on the
Diamond Road
to Electronics

Kits for
all
abilities
—
Step-by-
Step
Instructions

Projects
for
**Motoring
Audio
Lighting
Metering
Effects**
etc.

plus
**Tutorials
Books
and
Features**

plus
**Assembly
Tools**

Learn
at your
own
pace!

plus
**PCB
Making
Materials
and
equipment**

Catalogue

Free
This
Month!

plus Test Gear

plus this month's
**New Special
Offers!**

GEM-TECH

Dept PE11, Unit J,
8 Finucane Drive,
Orpington,
Kent, BR5 4ED

MAIL ORDER

Q. What can be better than buying the new 1991 132-page GREENWELD electronic components catalogue for just £1.50?

A. Getting it **FREE** with

PRACTICAL ELECTRONICS next month!!

132 pages of electronic components and equipment with 1-off prices for the hobbyist and quantity prices (R's 1/4p, C's 1/2p) for the bulk buyer.

P.S. If you can't wait until next month, send £1.50 now to:

GREENWELD

ELECTRONIC
COMPONENTS

27 PARK ROAD, SOUTHAMPTON, SO1 3TB
TEL: (0703) 236363 FAX (0703) 236307



One of the greatest scientists of all time. This statement has been used about Faraday on a number of occasions. He laid the foundations of much of today's electrical and electronic science as well as making some major discoveries in chemistry and other areas of science. He discovered electromagnetic induction, formulated the basic relationships between electricity and magnetism upon which people like Maxwell and Hertz were to build. In turn their discoveries lead on to the first wireless transmissions in the late nineteenth century.

YOUNG FARADAY

Michael Faraday was born on 22nd September 1791 in the south of London. He was the son of a blacksmith who had moved down to the south from Yorkshire some years before in search of work. He had a very rudimentary education and this meant that his research in later years was more practical in nature than theoretical. In fact he very much admired people like Maxwell who were able to look at theories mathematically.

In 1805 the family moved to North London and at about the same time when Faraday was just 14 years old he started work



Michael Faraday as portrayed in 1852. By courtesy of the Institute of Electrical Engineers.

FURTHER WORK

In spite all of these successes the idea of electromagnetic induction was never far from his mind. He kept working at it intermittently over a number of years. Then in 1831 he undertook a new series of experiments and on 29th August he succeeded. He set up his famous experiment which consisted of two coils wound on a soft iron toroidal core. The first coil was connected to a battery while the second one was connected to a very makeshift galvanometer. He noted in his experiment log book that the meter needle deflected when the battery was connected or disconnected, but that when a steady current was flowing then nothing happened.

Faraday announced his momentous discovery to The Royal Society later that year. However, very soon Faraday heard that Joseph Henry in America had performed some very similar experiments and might actually have made the discovery first. The news had actually taken some months to reach him because of the slow speed of communications in those days.

Faraday was still pursuing his work into other topics as well. He put forward the idea of magnetic lines of force. In keeping with his method of working this was very much a practical visualisation from the lines made by

FARADAY

with a bookseller. Here he learned the arts of book binding, but far more important he had access to a very wide range of books which he would not have been able to see anywhere else. The young Faraday read them avidly and soon he began to develop a keen interest in science and the latest developments which were taking place.

As the years passed Faraday's interest in science grew and when he was 21 he decided to give up his job in the book trade in preference for a new career in science. Having heard of Humphrey Davy of the Royal Institution, he applied for a job there and was accepted. Here he took on a wide variety of duties and even accompanied Davy on his lecturing tours around Europe. Faraday made the most of this experience and learned a great amount from Davy's lectures. This kindled his interest still further.

FIRST DISCOVERIES

Faraday was not content to let his opportunities pass him by. He soon started on some of his own research at the Royal Institution. Initially, he spent a lot of his time developing a form of stainless steel, and then in 1820 he discovered a new compound involving carbon, iodine and hydrogen.

However, at this time discoveries were being made in the new science associated with electricity. The magnetic field around a wire carrying current had just been detected and news of this greatly interested Faraday. He set about investigating this discovery

Faraday contributed much to electromagnetic research in the 19th century, making the momentous discovery that current could be induced into a wire.

repeating many of the experiments himself. He also proved that a wire carrying a current in a magnetic field was deflected. However, he wanted to find out whether a current could be induced in a wire in any way. He tried many experiments but they were all unsuccessful, possibly in some instances because his measuring equipment was not sensitive enough.

Although Faraday pursued his work on the idea of electromagnetic induction from time to time he also worked on several ideas related to chemistry. In fact he managed to become the first person to isolate benzene.

Faraday was achieving a great deal of success. With this came recognition, and in 1824 he was elected to the Royal Society. Then a year later he was made director of a laboratory at the Royal Institute where he worked. He also started to lecture and he was able to captivate his audiences with up-to-the-minute science and intriguing demonstrations as well as by his engaging style of lecturing.

iron filings when placed near a magnet. He was also working on some ideas of electrolysis. The names he used are still those we have today: cathode, anode, ion, cation and anion.

HEALTH

The rate at which Faraday worked took its toll. After his discovery of electromagnetic induction he fell ill and only slowly recovered. It was not until after 1840 that he started work again. This time he set about investigating the polarisation of light. Using some "heavy glass" he had discovered some years before, he managed to rotate the polarisation of light when a magnetic field was present. This effect was named after him as the Faraday Effect. He also tried to find an equivalent effect using an electric field, but to no avail. It took another 30 years before this effect was discovered by Kerr.

RETIREMENT

Faraday continued to work for a while but the effect of his illness was still apparent at times. His powers of reasoning were not as good as they had been and he suffered from loss of memory. Realising that he could not keep up his original pace of work he began to retire from his many commitments from about 1860. He was granted a place to live at Hampton Court where he spent his last years with his wife. Faraday still spent some time on his researches but he made no more major discoveries and he died on 25th August 1867 at the age of 75.



HOME-BASE

Gadget-mad Ian Burley is automating his shopping; could probably keep watchful record of his CT2 rabbiting; though he can't see a future for back-seat viewers.

SHOPPING ON-LINE

It's taken the best part of four years to be realised, but by the time this is published, the first of an initial batch of 5,000 Keyline teleshopping terminals should be in the hands of eager new owners.

We last covered news on the progress of Keyline back in June. For those of you who still aren't sure what I'm on about, briefly, Keyline is a new concept in armchair or teleshopping. You're virtually given a terminal, though there is a monthly standing charge. The device itself uses sophisticated artificial intelligence techniques to decipher plain English command phrases the user types in and convert them into legitimate shopping orders. Connection is via the phone and all purchases are done by credit card transactions. Participating companies offering goods or services will have special order processing computers to handle Keyline traffic. Keyline hopes to make the bulk of its money through taking a cut of the purchase transaction value from the service provider.

Originally, all Keyline terminals were to have unique user identity information embedded in them. However, along came the smart card and now Keyline has announced that it has adopted a smart card type manufactured by Gemplus Card International, part of the SGS-Thomson group. The card in question includes a microprocessor, 2K bytes of eeprom and the MCOS (Multi-application Chip Operating System). Incidentally, Gemplus makes the smart cards required for use with Sky TV satellite receivers, for which over 1,500,000 smart cards have already been produced from the Gemplus factory in Livingstone, Scotland. Every registered Keyline user will have their own unique smart card containing their name and address, credit card details and Keyline ID. It will be possible for Keyline users to use each others' terminals simply by using their own cards. There are also plans for public access Keyline terminals, so while the personal Keyline terminal is eminently portable you won't necessarily have to take it everywhere with you.

Eventually, it's planned that Keyline accounts will be linked to their owner's bank

accounts so that credits can be downloaded into the smart card for later use. This could be the first definitive example of electronic cash in the UK.

The current Keyline status is that STC is building an initial 5,000 terminals, though sadly these will not have the smart card facility as implementation of this technology would have forced the project to miss its end of 1990 targets. By way of recompense, Keyline is offering any users signed up for the initial batch of terminals six months usage without a standing charge. After six months users will have the option of returning their terminals and getting their deposit money back or continuing but with the standing charge from then on.

At this year's Ideal Homes Exhibition alone, 2,500 requests for priority order forms were taken on the Keyline stand. At the same exhibition, the *Daily Mail* awarded Keyline its Blue Riband Award for technical innovation. The signs so far are good, but what will you be able to do with your Keyline terminal in the early days? Seven companies are expected to be ready to do business with Keyline users by the end of this year; the National & Provincial Building Society, National Westminster Bank, Littlewoods mail order catalogue, Kays of Worcester mail order, Sun Alliance insurance, Ladbrokes betting and the associated Hilton Hotel group. The first thing which is apparent from the list is that Keyline is by no means restricted to tele-"shopping" specifically. Betting, insurance quotations and claims, hotel booking, building society and bank account management are just some of the extra uses. Online games, electronic mail and access to public information services are just a few more mooted applications. Addenbrookes Hospital in Cambridge has even been experimenting with Keyline terminals as a way of keeping in touch with mothers in their post-natal clinic.

Putting my money where my mouth is I've already ordered my Keyline Terminal. Success is not guaranteed for Keyline supremo Chris Curry, co-founder of Acorn Computers of BBC Micro fame. It will be interesting to see what news I will have to report on Keyline in a year's time - by that time it will have hopefully signed up hundreds of thousands of users, or probably failed.

TALK TO YOUR WATCH!

Last month we featured a picture from the Summer Consumer Electronics Show in Chicago of a futuristic wrist watch called a ChatterBox. From the picture, sectionally reproduced below, you may have deduced that this is a watch you can talk to - and it will play back a digitised recording of what you've said. The rather imposing black watch, which would dwarf even my chunky wrist, has a built in microphone and dual function selector switch/miniature speaker. Up to 15 seconds of sound can be digitised to an internal chip memory though the play back can be speeded up or slowed down in order to introduce fun sound effects. Although not shown at CES this time, the company behind the watch, Santa Clara California based Chatter Box Inc., is promising optional clip-on modules like an fm radio, voice pitch changer and a sound effects generator. The basic watch, which should be ready in time for the American Christmas market will sell for between \$30 and \$40, or about £16-£21 before taxes, which sounds like a bargain to me, especially after seeing the incredible chip integration inside first hand. Oh yes, a five function lcd quartz watch can be found right in the middle of the thing if you look hard enough!





CORNERING THE RADIO

Respected hifi manufacturer, Bose, has introduced a new multi-zone audio system designed to serve several rooms around your house simultaneously. This is nothing new - Bang & Olufsen, for example, has offered such a system for several years, but that relied on infra-red remote controller technology which isn't very good at reaching control receptors hidden away around corners. High frequency sonic controllers popular in the seventies can reach around corners but have a limited range and they annoy the pets! Remarkably, Bose has turned to any obvious solution which hardly anybody else uses - radio remote control. Bose UK claims it is the first company to be officially licensed by the Department of Trade and Industry to sell a radio frequency remote controller for hifi use according to the 1984 Telecommunications Act. For radio buffs, the frequency used is 27.465 MHz. The system, lavishly called the Lifestyle Music System, is a slimline cd player and am/fm tuner with thirty presets.

Designed to work with Bose Acoustimass active speakers (power amplifiers are contained in the speaker units rather than the music centre), up to two simultaneous programmes can be played - one for the tuner and another for the cd. On top of that you can have several sets of speakers in different rooms, each set to different volumes, as required, using additional remote controls. As the main remote control uses radio transmissions there's no need to point the device and you can be up to 20 metres from the music centre - in the garden, the bath, garage, wherever! Not being a hifi expert, I can only rely on reliable reports that the system is very impressive, both to use and listen to. A starter system costs a few pence shy of £2,000, which I'm told is reasonably good value, especially compared to the competition like B&O. Bose has never been exactly conventional with its characteristically recognisable speaker systems, but perhaps this time the company is on the verge of setting trend to be followed by others?



HAVE VIDEO - WILL TRAVEL

Hitachi has been showing how it has applied its television and video technology to that most hostile of viewing and listening environments; the inside of a car. A while ago the company installed a state of the art VHS-C hifi video player and tuner complete with Dolby Surround multi-speaker audio into a Lotus Esprit Turbo for the benefit of entertaining journalists (I missed out, unfortunately). The two-seater Lotus isn't really a very good place to install all this hi-tech, and lately the system has been demonstrated in a much larger Renault Espace people mover. The driver or passengers view tv or videos on the move via a high quality 5 inch tft (thin film transistor) active matrix colour monitor. In fact British law only permits passengers to watch tv in-car. A remote control is provided for video/tv selection and speaker balancing. 240 watts of power amp complements the Pro Logic Dolby Surround processor. The stereo tv tuner uses a four aerial "diversity" system for optimal signal strength. The video player unit is

removable for use out of the car. I can't see much of a future for bored back-seat passengers if the Hitachi system catches on.

TELEPOINT SIX MONTHS ON

The first Telepoint CT-2 cordless telephone networks went live over six months ago. On my travels around the country, I have seen plenty of evidence that the public base stations which users require to use their tiny phones away from home are now becoming commonplace. Next time you're at a motorway service station for example, look out for up to four one-metre long vertical antennas strategically positioned near the car park. Little Chef restaurants seem to bristle with them these days. Zone Phone sponsors the ITV London weather bulletin, Call Point and Phonepoint logos have been spotted at various sporting events and BYPS, with its catchy Rabbit logo is beginning to catch the eye even after its late arrival on the scene.

I haven't seen much sign of any users yet, however. Potential users I have spoken to have all been put off by either the lack of an incoming call facility away from home or, incredibly, by the price. At usually just less than £200, the phones are initially very attractive - being incredibly small and light and around half the price of their cellular counterparts. Unfortunately the home base station which you need to use the phone as a conventional cordless unit at home still costs another £200. Call costs are attractive in London where there is a premium rate on cellular calls within the M25 boundary, but elsewhere in the country cellular costs are reasonably close to telepoint tariffs.

None of the telepoint dealers I spoke to six months ago have seen much business from the new phones, although one dealer claimed to have discovered a niche market where office workers were using the phones with a base station as a high quality mobile phone around the office.

I suppose the biggest indictment of the poor start the telepoint services have achieved so far is that I haven't been tempted to buy one yet - and I'm gadget mad! I will buy one though - as soon as the combined phone and personal base station price breaks below the £200 barrier.

PE

Ian Burley is the Deputy Editor of BT Micronet, an on-line computer and technology magazine published on Prestel by British Telecom.



WE HAVE THE WIDEST CHOICE OF USED OSCILLOSCOPES IN THE COUNTRY

| | |
|---|-------|
| TEKTRONIX 2445 Four Trace 150MHz Dual TB | E1200 |
| TEKTRONIX 2245A Four Trace 100MHz Dual TB | E1000 |
| TEKTRONIX 2235 Dual Trace 100MHz Delay Sweep | E850 |
| TEKTRONIX 2215 Dual Trace 60MHz Delay Sweep | E450 |
| TEKTRONIX 475 Dual Trace 200MHz Delay Sweep | E550 |
| TEKTRONIX 465 Dual Trace 100MHz Delay Sweep | E450 |
| H.P. 17226 Dual Trace 27MHz Delay Sweep, 5 Function LED Display for Real Time Measurement | E750 |
| H.P. 1740A Dual Trace 100MHz Delay Sweep Trng | E350 |
| PHILIPS PM3217 Dual Trace 50MHz Delay Sweep | E400 |
| TELEQUIPMENT D775 Dual Trace 50MHz Delay Sweep | E250 |
| GOULD OS3000 Dual Trace 40MHz Delay Sweep TV Trng | E250 |
| GOULD OS1100 Dual Trace 30MHz TV Trng | E180 |
| GOULD OS300 Dual Trace 20MHz | E250 |
| GOULD OS250B Dual Trace 15MHz TV Trng | E180 |
| COSSOR CDU150 Dual Trace 35MHz Delay Sweep from E100 | E150 |
| S.E. LABS SM111 Dual Trace 18MHz | E130 |
| TEKTRONIX 2210 Digital Storage Dual Trace 50MHz (20MS/s Sampling Rate) As New | E1150 |
| GOULD 4035 Digital Storage Dual Trace 20MHz | E450 |
| GOULD OS4020 Digital Storage Dual Trace 10MHz | E450 |
| GOULD OS4000 Digital Storage Dual Trace 10MHz | E300 |
| THIS IS JUST A SAMPLE - MANY OTHERS AVAILABLE | |
| H.P. 8112A Programmable Pulse Generator 50MHz E1500 | |
| BRADLEY Oscilloscope Calibrator 192 with Cal Cert. | E800 |
| DATRON 1061 Auto Cal DMM True RMS etc | E950 |
| SOLARTRON 7075 DVM up to 7+1/2 digit AC/RMS/DC/OHM | E700 |
| R&S SW904 (Sweep Gen with display) 0.1-1000MHz | E750 |
| MARCONI TF2008 AM/FM 10KHz-510MHz Sig Gen | E450 |
| MARCONI TF2015 AM/FM 10-520MHz Sig Gen with TF2171 | E450 |
| MARCONI TF2015 with Synchroniser TF2171 | E250 |
| V TF2016 AM/FM 10KHz-120MHz Sig Gen with TF2173 | E350 |
| MARCONI TF2016 without Synchroniser TF2173 | E175 |
| H.P. 8620C Sweeper Main Frame (Plug-ins available) | E1000 |
| LEADER LV55851A Vectorscope | E600 |
| TEKTRONIX 491 SPEC ANALYSER 1.5-12.4GHz from E1000-E1400 | |
| SYSTRON DOWNER 1702 Sig Gen 10KHz-1GHz | E950 |
| POLARAD Sig Gen 11058 0.8-2.4GHz | E500 |
| POLARAD Sig Gen 11068 1.8-4GHz | E500 |
| POLARAD Sig Gen 1207A 3.7-8.4GHz | E500 |
| POLARAD Sig Gen 1207A with 1509 Freq Doubler | E750 |
| POLARAD Sig Gen 1208A 6.95-11GHz | E500 |
| POLARAD Sig Gen 1280A with 1510 Freq Doubler | E750 |
| TEKTRONIX TM504 with PG50E/SG503/7G501 E2250 | |
| RACAL STORE 14DS 14 Channel Magnetic Tape Recorder | E2000 |
| RACAL 9081 Synthesised Sig Gen 5-520MHz | E650 |
| RACAL 9089 Mod Meter 10MHz-1.5GHz | E350 |
| RACAL 9301 RMS Voltmeter 10KHz-1.5GHz | E250 |
| TIME 2004 DC Voltage Standard 0.005% | E450 |
| SOLARTRON 7150 Digital Multimeter 6-1/2 digit | E300 |
| AVO Valve Characteristic Meter VCM163 from E250-E350 | |
| FERROGRAPH RTS2 Recorder Test Set | E200 |
| THURLEY PL320MD Twice 30V 2A Quasi Mod Digital | E200 |

| | |
|--|------|
| TELEQUIPMENT GT71 Curve Tracer | E250 |
| MARCONI TF2700 Universal LCR Bridge Battery from | E125 |
| MARCONI TF237A Automatic Distortion Meter 400Hz/1KHz | E100 |
| MARCONI MOD Meters TF2300, TF2300B, TF2303 from | E100 |
| MARCONI TF2603 RF Millivoltmeter 500KHz-1.5GHz | E75 |
| MARCONI TF2430 Digital Freq Counter 10Hz-80MHz | E60 |
| MARCONI TF11521 RF Power Meter 500MHz-1025W 50ohm | E25 |
| MARCONI TF1803A RF Power Meter 20KHz-350KHz 20mW-10W | E20 |
| RACAL 9915 Freq Counter 10-520MHz Crystal Oven | E150 |
| FARNELL PSU H30/100 0-30V 0-100A | E750 |
| UNINTERRUPTED Power Supply type RBS-AC 500VA | E150 |

AVO & MULTIMETERS
GOOD WORKING ORDER - PHYSICALLY NOT BRILLIANT
SUPPLIED WITH BATTERIES & LEADS ONLY £30
ALL OTHER MODELS AVAILABLE

| | |
|---|------|
| LEADER LHV186A Two Ch Mv Meter 5Hz-500KHz; 1mV-300V | E100 |
| KRUSLI AVM23 AC Voltmeter Dual Ch 10Hz-500KHz | E75 |
| 300uV-100V | |
| Solartron 7045 Multimeter 4+1/2 digit 30 ranges Auto/Mean | E95 |
| FARNELL Pulse Gen System 1Hz-10MHz Single/Double | E40 |
| GALIC PROBE type 3300A TTL/CMOS (P&P £3) | E10 |
| Large range of BENCH POWER SUPPLIES available from | E40 |
| X-Y PLOTTERS Various Models from E25-E400 | |

SOME BRUEL & KJOER EQUIPMENT ALWAYS AVAILABLE. PLEASE ENQUIRE.

| | |
|--|----------|
| LEVELL TM38 AC Millivoltmeter 1Hz-3MHz; 5uV-500V | E50 |
| LEVELL TM3A AC Millivoltmeter 1Hz-3MHz; 5uV-500V | E40 |
| LEVELL Oscillator TG182 3Hz-300KHz; Sine/Sq | from E50 |
| LEVELL Oscillator TG150M 1.5Hz-150KHz; Sine Wave | E20 |
| LEVELL Decade Osc TF66A 0.2Hz-1.22MHz; Low dist. | from E35 |

NEW EQUIPMENT

| | |
|--|----------|
| HAMEG OSCILLOSCOPE HM1005 Triple Face 100MHz | |
| Delay Timebase | E792 |
| HAMEG OSCILLOSCOPE HM604 Dual Trace 60MHz | |
| Delay Sweep | E610 |
| HAMEG OSCILLOSCOPE HM203 7 Dual Trace 20MHz | |
| Component Tester | E338 |
| HAMEG OSCILLOSCOPE HM205 3 Dual Trace 20MHz | |
| Digital Storage | E610 |
| All other models available - all oscilloscopes supplied with 2 probes | |
| BLACK STAR EQUIPMENT (P&P all units £3) | |
| APOLLO 10 100MHz/2 Ratio Period Time interval etc | E222 |
| APOLLO 100 100MHz (As above with more functions) | E295 |
| METEOR 100 FREQUENCY COUNTER 100MHz | E109 |
| METEOR 600 FREQUENCY COUNTER 600MHz | E135 |
| METEOR 1000 FREQUENCY COUNTER 1GHz | E178 |
| JUPITOR 500 FUNCTION GEN 0.1Hz-500KHz Sine Sq In | E110 |
| CRONK COLOUR BAR GENERATOR Pal TV Video | E209 |
| All other Black Star Equipment available | |
| HUNG CHANG DMM 7030 3 digit Hand held 28 ranges including 10 amp AC/DC 1% ACC (P&P) £4 | E39 50 |
| As above DMM60100 25% | E33 50 |
| Carrying cases for above | E3 00 ea |
| OSCILLOSCOPE PROBES Switched X1X10 (P&P £3) | E11 |

This is a very small sample of stock. SAE or telephone for LIST of OVER 700 ITEMS. Please check availability before ordering.

CARRIAGE all units £16. VAT to be added to total of goods and carriage.

STEWART OF READING
110 WYKHAM ROAD, READING, BERKS RG6 1PL
Tel: 0734 68041 Fax: 0734 351696
Callers welcome 9am to 5.30pm MON-FRI (UNTIL 8pm THURS)

VARIABLE VOLTAGE TRANSFORMERS

| | |
|--|-------------------------------|
| INPUT 220/240V AC 50/60 OUTPUT 0-280V | |
| Price P&P | |
| 0.5KVA 2.5 amp max | £29.00 £3.75 (£37.65 inc VAT) |
| 1KVA 5 amp max | £37.40 £4.25 (£47.90 inc VAT) |
| 2KVA 10 amp max | £54.00 £5.48 (£68.40 inc VAT) |
| 3KVA 15 amp max | £71.60 £8.24 (£89.40 inc VAT) |
| 5KVA 25 amp max | £126.50 (Carriage on request) |

VOLTAGE CHANGING TRANSFORMER
1250 Watt auto. Tapped 0-90V, 100, 110, 115, 120, twice to obtain voltages between 90 and 240V. Fitted in heavy duty louvered metal case. Fused input. Price incl VAT & p&p £39.50.

COMPREHENSIVE RANGE OF TRANSFORMERS-LT ISOLATION & AUTO (110-240V Auto transfer either cased with American socket and mains lead or open frame type. Available for immediate delivery.

ULTRA VIOLET BLACK LIGHT FLUORESCENT TUBES
4ft 40 watt £10.44 (£12.00 inc VAT) Cellar only
2ft 20 watt £7.44 + £1.25 p&p (£8.99 inc VAT)
13in 10 watt £5.80 + 75p p&p (£6.33 inc VAT)
12in 8 watt £4.80 + 75p p&p (£5.38 inc VAT)
9in 6 watt £3.96 + 50p p&p (£4.32 inc VAT)
6in 4 watt £3.96 + 50p p&p (£4.32 inc VAT)
230V AC BALLAST KIT for either 8in, 9in or 12in tubes £5.50 + 55p p&p (£6.95 inc VAT)
For 13in tubes £6.00 + 75p p&p (£7.75 inc VAT)

400 WATT UV LAMP
Only £38.00 + £2.50 p&p (£41.98 inc VAT)
175 WATT BELFLAESTED BLACK LIGHT MERCURY BULBS Available with BC or ES fitting. Price incl VAT & p&p £19.84.

12 VOLT BILGE PUMPS
Buy direct from the importers
500 GPH 15ft head 3 amp £18.00 inc.
1750 GPH 15ft head 9 amp £20.18 + £2.60 p&p (£26.20 inc VAT)
EPROM ERASURE KIT
Build your own EPROM ERASURE for a fraction of the price of a made-up unit kit of parts less case includes 12in 8 watt 2537 Angat Tube Ballast unit pair of bi-pin leads neon indicator on/off switch safety microswitch and circuit £14.00 + £2.00 p&p (£18.40 inc VAT)

SUPER HY-LIGHT STROBE KIT
Designed for Disco, Theatrical users etc.
Approx 16 joules. Adjustable speed £48.00 + £2.00 p&p (£57.50 inc VAT)
Case and reflector £22.00 + £2.00 p&p (£27.80 inc VAT)
SAE for further details including Hy-Light and industrial Strobe Kits.

SERVICE TRADING CO
57 BRIDGMAN ROAD, CHISWICK, LONDON W4 5BB
081-995 1560
ACCOUNT CUSTOMERS MIN. ORDER £10

WIDE RANGE OF XENON FLASH TUBES

Write/Phone your enquiries
EXTENSIVE RANGE OF DIFFERENT TYPES OF GEARED MOTORS AVAILABLE FROM STOCK
WASHING MACHINE WATER PUMP
Brand new 240V AC fan cooled can be used for a variety of purposes. Inlets 1 1/2 inch. Outlet 1 inch. Price including p&p and VAT - £10.95 or 2 for £20 including p&p and VAT.

12V DC 20 RPM REVERSIBLE MOTOR

Swiss precision built. Ideal for robotics. Size: length inc. shaft 90mm. Diameter front fixing 35mm square. Currently advertised by well known supplier at £27.00 plus p&p & VAT. Our Price £14.85 inc. p&p & VAT

GIANT BLOWER EXTRACTOR UNIT

Twin output centrifugal blower 1 HP 240V AC motor, output approx. 3600 c.f.m. Size: Length 100cm; Height 27cm; Depth 25cm; Flange plate 106 x 33cm. Price £125 + VAT. Ex warehouse.

TORIN CENTRIFUGAL BLOWER

230V ac 2.800 RPM 0.8amp 130mm diameter impeller outlet 63 x 37mm overall size 195 x 160 x 150mm long. Price £175.00 + £2.50 p&p (£23 inc VAT)

SHADED POLE GEAR MOTORS

In the following sizes:
9 RPM 12 RPM 80 RPM 160 RPM 110V AC or 240V AC with capacitors (supplied). Price incl VAT & p&p £12.85

GEARED MOTORS

71 RPM 20lb inch torque reversible 115V AC input including capacitor and transformer for 240V AC operation. Price incl VAT & p&p £23.00.

SOLID STATE EHT UNIT

Input 230/240V AC. Output approx 15KV. Producing 10mm spark. Built-in 10 sec timer. Easily modified for 20 sec. 30 sec to continuous. Designed for boiler ignition. Dozens of uses in the field of physics and electronics, eg supplying neon or argon tubes etc. Price less case £8.50 + £1.00 p&p (£10.93 inc VAT) NMS

HEAVY DUTY MOTOR

Crouzet 115V/230V A.C. heavy duty 1RPM motor. Anticlockwise type 82/015. Size 68mm diameter x 55mm long. Shaft 6mm diameter x 20mm long. Price inc. VAT & p&p £19.40.

RHEOSTAT

50W 2ohm 5amp ceramic power rheostat. Price inc. VAT & p&p £10.35.

MICROSWITCH

Pye 15 amp changeover lever microswitch, type S171 Brand new. Price £5 for £8.90 inc. VAT & p&p.
NMS - NEW MANUF SURPLUS
R&T - RECONDITIONED AND TESTED

Practical Electronics Binders

As you save your monthly copies Practical Electronics quickly builds up a valuable reference library of projects and special articles, especially when every December we publish an index to the whole year. The best way to store your copies of PE for long-term reference is in our special binders. Vinyl-covered for durability, they take a whole year's issues each and are available for a mere £5.95 including postage. To order, use the coupon below, or order by phone using your credit card on 081 743 8888.

Send to: Intra Press, Intra House, 193 Uxbridge Road, London W12 9RA.
Make cheques/postal orders payable to Intra Press. Allow 28 days for delivery.

Please rush me PE binders at £5.95 each. I enclose a cheque/postal order for £.....

Name.....
Address.....
Town.....
County.....
Post Code.....



All the new public mobile telephone systems are to be digital in operation. The radio signals transmitted and received by the hand-portables or carphones are carrier frequencies modulated by digital codes. The speech signal to be transmitted is analogue-to-digital converted, then encoded into a stream of binary digits. Typically these '1' and '0' bits modulate the carrier frequency by a form of frequency shift keying (fsk). Logic 1 shifts the carrier frequency a predetermined amount in one direction; logic 0 shifts it equally in the opposite direction.

CT2

One of these new digital systems, called CT-2 (cordless telephone 2), was pioneered in Britain. In hand-portable form it's intended for three kinds of use: as a cordless phone for the home; as a business/workplace cordless phone; and as an outdoor mobile phone restricted to working near base stations set up in public places. The last-mentioned is of course the telepoint service already running in



Digital Telepoint CT-2 handset made by Siemens and due to enter full service in 1991.

engineering is an output : input ratio. Here, it's the ratio:

$$\frac{\text{communications achieved}}{\text{spectrum space used}}$$

The 'communications' is measured in erlangs (units of telephone traffic intensity, where one erlang is one permanently engaged circuit). 'Spectrum space' is measured not just in frequency bandwidth but in geographical space and time as well. This is because efficient usage of the radio spectrum depends on re-using the same radio frequencies at different places or at different times. Fig.1 illustrates this concept that spectrum space has the three dimensions of frequency bandwidth, space and time. So the above efficiency ratio in more precise form becomes:

$$\frac{\text{traffic intensity}}{\text{bandwidth x space x time}}$$

In practical units this boils down to a widely used formula in the telecoms field: erlangs per MHz per sq km. (This includes the

WHY DIGITAL PHONES?

the UK (see Ian Burley's Home Base reports in the June and July 1990 issues).

In their mode of operation the digital systems can be divided into two groups: cordless and cellular. Quite possibly hybrids could be formed from these.

Not yet in operation but due to arrive some time in the 1990s are a pan-European cellular digital system called GSM (Groupe Special Mobile); a harmonised cordless phone standard for all Europe known as DECT (Digital European Cordless Telecommunications); a low-priced, mass-market cellular digital service for Britain called PCN (Personal Communications Network); and a pan-European PCN scheme named DCS 1800 (Digital Cellular System on 1800 MHz).

Public digital systems are also on the way in Canada, the USA and Japan. The ultimate in digital technology, little more than a dream at the moment, is a global scheme known as UMTS (Universal Mobile Telecommunications System). This would probably evolve from the PCN mass-market idea and would integrate all pre-existing technologies - cellular, cordless, paging and so on. It would enable anyone owning a suitable handset or carphone to travel with it and use it throughout the world.

DIGITAL BENEFITS

All the cellular public phone services now in operation are analogue systems. The carrier frequency in each channel is frequency modulated (see Mike Sanders' article in PE August 90 for fuller details). These analogue systems are well established and well tried, so why change them? It seems almost perverse

Tom Ival examines the benefits to be gained from the incoming digital public mobile telephone systems.

to abandon analogue baseband signals when the digitised version of a speech waveform needs so much more bandwidth to transmit.

A major problem with the existing analogue cellular systems (AMPS, TACS, NMT etc) is their limited capacity. Congestion is already occurring and customers are complaining about difficulties in making calls. In the UK, the extended TACS system operated by Cellnet and Vodafone will probably reach saturation at about two million subscribers.

The limited capacity is a result of these systems' relatively low efficiency in the use of spectrum space. Efficiency in all

'time' dimension because an erlang is a circuit engaged over unit time.)

In the analogue cellular systems the spectrum space efficiency is low basically because of co-channel interference between cells. The overall frequency allocation for the system is fixed by international regulations, and as each channel within it must have a certain minimum bandwidth there is a limited, fixed number of channels. So to cope with thousands of simultaneous calls, all these available channels have to be re-used many times over.

The capacity of a system can be increased by making the cells smaller in coverage area and packing them closer together. But the closer they are, the worse the co-channel interference becomes. Then, this co-channel interference can only be kept reasonably low by reducing the transmitter powers.

Of course there is a practical limit to this process. If you took it to the extreme you would end up with the very low power and few metres range typical of the cordless phone in the home. So it's co-channel interference which fundamentally sets a limit on the spectrum space efficiency of cellular systems - a low value of erlangs/MHz/km² in the analogue case.

Fig. 1. Spectrum space available to radio systems has three dimensions: bandwidth, space and time.

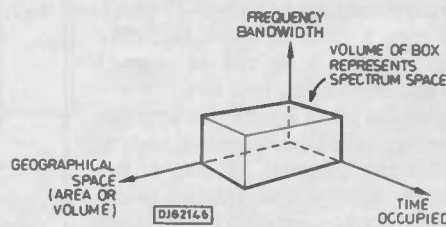

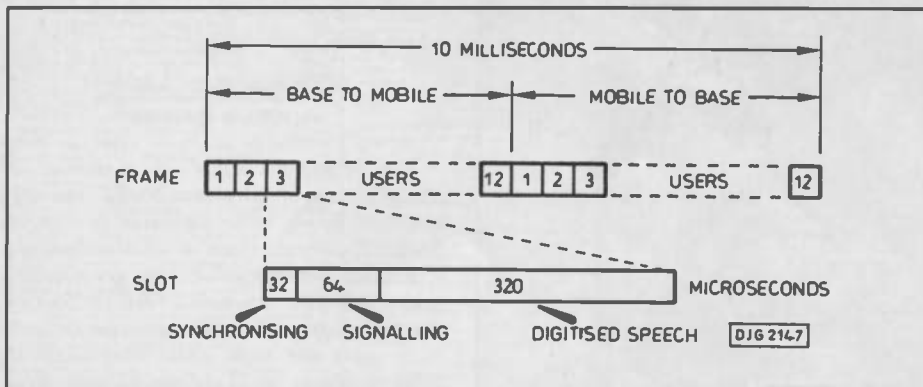

Fig. 2. Time division multiple access arrangement in the Digital European Cordless Telecommunications system. Each carrier frequency is shared on a time-division basis by 12 speech channels.

HIGHER NETWORK DENSITY

Digital signals provide better efficiency because, for a given quality of telephony, they allow much higher levels of co-channel interference. Thus, for a given transmitter power, more cells can be packed into a given area, thereby increasing the communications achieved for the same spectrum spaced used. So the value of the erlangs/MHz/km² measure of efficiency increases.

Engineers working on the GSM digital system, for example, reckon that it will give up to a three-fold improvement in spectrum space efficiency over the NMT system taken as a reference analogue system.

The reason for this superiority of digital transmission is inherent in the nature of digital signals generally. With analogue telephony the quality of the speech communication depends on how accurately the speech waveforms are maintained throughout the system. Co-channel interference disturbs or blots out these waveforms at the receiver.

With digital telephony this does not occur, at least in the same direct manner. The co-channel interference can certainly disturb the digital fsk waveform transmitted. But because this waveform is a binary coded version of the speech the disturbance doesn't affect the speech quality so much. In binary coded speech it is the mere presence or absence of 1 or 0 bits in a sequence that affects the accuracy, not the condition of the waveforms delineating these bits.

However, the bit streams sent over the air in the new digital systems are not simple codes like pcm. As Mike Sanders pointed out, straight pcm with its 64-kbit/s bit rate, would require an excessive bandwidth for each speech channel. So the speech coders adopted are designed to reduce this. Both CT-2 and DECT use adaptive differential pulse code modulation, reducing the bit rate to 32 kbit/s. And GSM uses a form of linear predictive coding that produces a bit rate of only 13 kbit/s (and possibly 8 kbit/s later on).

In addition the GSM system has a further layer of coding, called convolutional coding, for error reduction purposes. Of course, this also makes the system more tolerant to co-channel interference by reducing the bit errors

caused by this interference.

Apart from the capacity problem in cellular telephony, there are three other influences behind the decision to go digital in cellular and cordless systems generally. First, the whole of telecommunications is moving towards digital technology, in both transmission and signalling. The climax of this process will be the integrated services digital network (ISDN) which is now building up. Since public mobile telephones are connected into the fixed network, there will be engineering, operational and economic advantages in using its new technology.

Secondly, the size, cost and power consumption of vlsi digital signal processing electronics are falling rapidly. This makes the digital technology extremely attractive for producing much smaller, lighter and cheaper handsets than the analogue equivalents. Finally, because the digital methods of signal processing and signalling are programmed by software, a digital mobile system is easier and less costly to change if it has to be modified or enhanced in the future.

TIME DIVISION PRINCIPLE

All the new digital mobile systems use time division as the basic principle for multiplexing the digitised speech signals. As Mike Sanders explained, this takes the form of time-division multiple access (tdma) in the GSM cellular system. The DECT scheme, which is micro-cellular and operates within buildings, also uses tdma but in a different way.

Its carrier frequencies are in a band - not yet fully decided - in the region of 1700 MHz.

Fig. 3. The 'ping-pong' time division duplex principle used in CT2 cordless telephony. A single radio frequency carries both transmit and receive digital signals in alternate short bursts of bits.

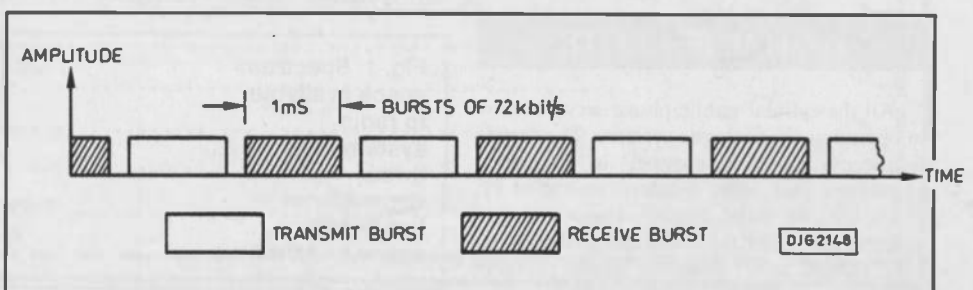

Each carrier is shared by 12 speech channels on the time division principle shown in Fig.2. Time is divided into 10ms frames, and each of these is subdivided into 417µs slots for the 12 users as shown. Each slot contains a burst of data consisting of digitised speech together with synchronising and signalling data.

In both DECT and CT-2 the handset transmits and receives speech signals on the same, single carrier frequency. To achieve this the radio channel transmits and receives alternatively in very short bursts of bits. Appropriately this is called 'ping-pong' - or, more formally, time division duplex - transmission. As shown in Fig.3, the CT-2 bursts are each 1 ms long and contain data at a rate of 72 kbit/s. This data rate has to be just over twice the basic speech coding rate of 32 kbit/s to allow speaking and listening to be virtually simultaneous.

The GSM system works in the 900MHz mobile radio band. Carrier frequencies are 200 kHz apart and each carrier takes eight speech channels. As in CT-2, the carriers are modulated by a form of fsk called Gaussian minimum shift keying which occupies less frequency spectrum than ordinary fsk. Here the transmit and receive signals are separated not in time but in frequency, by a spacing of 45 MHz.

Fig.4 shows the time division in the tdma system. Time is divided into blocks of 26 frames. Each frame of 4.62 ms is then subdivided into eight slots. Each slot, lasting for 577 µs, contains 156 bits of data made up of digitised speech, a guard period, control and tail bits and a sequence of 26 bits which the receiver uses to overcome multipath transmission effects.

In the predictive and convolutional speech order, every 20 ms of speech produces 456 bits and this number is conveyed by four of the slots shown in Fig.4. Overall the data rate transmitted by radio is 271 kbit/s.

The digital system to be used for the PCNs is still being worked out in detail but broadly it will follow the well-established GSM technology, as an outcome of international agreement. In Europe all such international agreements are now made through an organisation called ETSI (European Telecommunication Standards Institute). In 1988 this body replaced the old CEPT (Conference Europeenne des Administrations des Postes et des Telecommunications) originally set up by the telecoms authorities of 26 countries. GSM began as a CEPT group

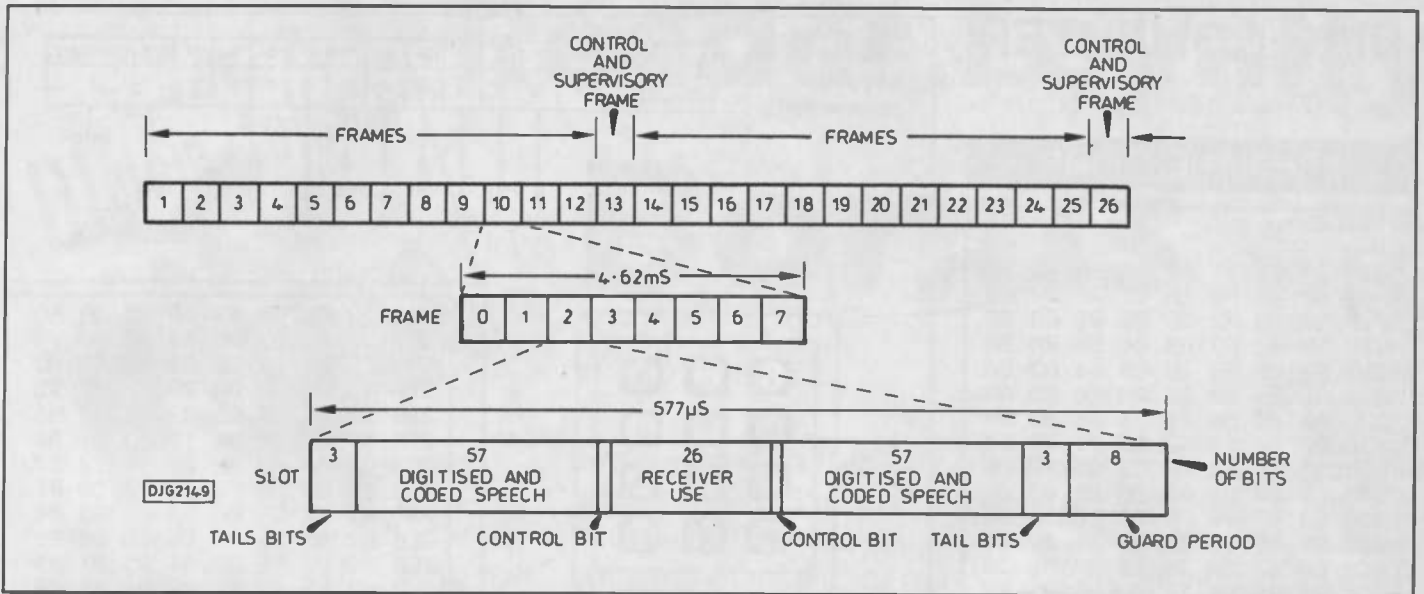

Fig. 4. Timing arrangements in the GSM digital mobile phone system. Each radio frequency carries eight speech channels. Duplex working is by frequency division rather than the time division of CT2 and DECT.

and is now within ETSI. New frequency allocations for these digital services have to be made by world-wide agreements through the International Telecommunication Union.

PING-PONG SYNTHESISER

An example of the novel circuitry needed for time division techniques is shown in Fig.5. In the 'ping-pong' duplex transmission system (Fig.3) the handset contains a frequency synthesiser which has to switch repeatedly between two frequencies: the transmitter frequency, at about 800 MHz, and the heterodyne receiver's local oscillator, which differs by about 10 MHz (to give a 10MHz IF). The problem is to maintain a frequency accuracy of 1-2 kHz at these abrupt transitions. It means that phase errors at the transitions must be kept extremely small.

Fig.5 is actually the outline of a frequency synthesiser used in the Ferranti telepoint handset. Much of the circuitry is integrated in a cmos gate-array chip. Basically it is a

conventional phase-locked synthesiser, with a flip-flop phase comparator working on pulses from the reference oscillator and programmable frequency divider. The error signal from the comparator adjusts the radio frequency generated by the voltage-controlled oscillator (vco). But the circuit also includes a technique for making an extremely fine, individual phase correction at every frequency transition.

This technique uses the two capacitors, which are alternately switched across the opamp in synchronism with the frequency transitions. The different voltages on these shift the vco frequency. Also, the phase comparator is enabled by a switched voltage level. Broadly, the phase correction works by making tiny changes to the division ratio of the programmable divider. These give slight time shifts, as small as 16 picoseconds, to the divider's output pulses. In principle the correction method is analogous to that of a vernier on a mechanical measuring instrument, by which readings can be made to a small fraction of a main scale division. PI



One of the prototype digital phones from Microtel, a consortium led by British Aerospace.

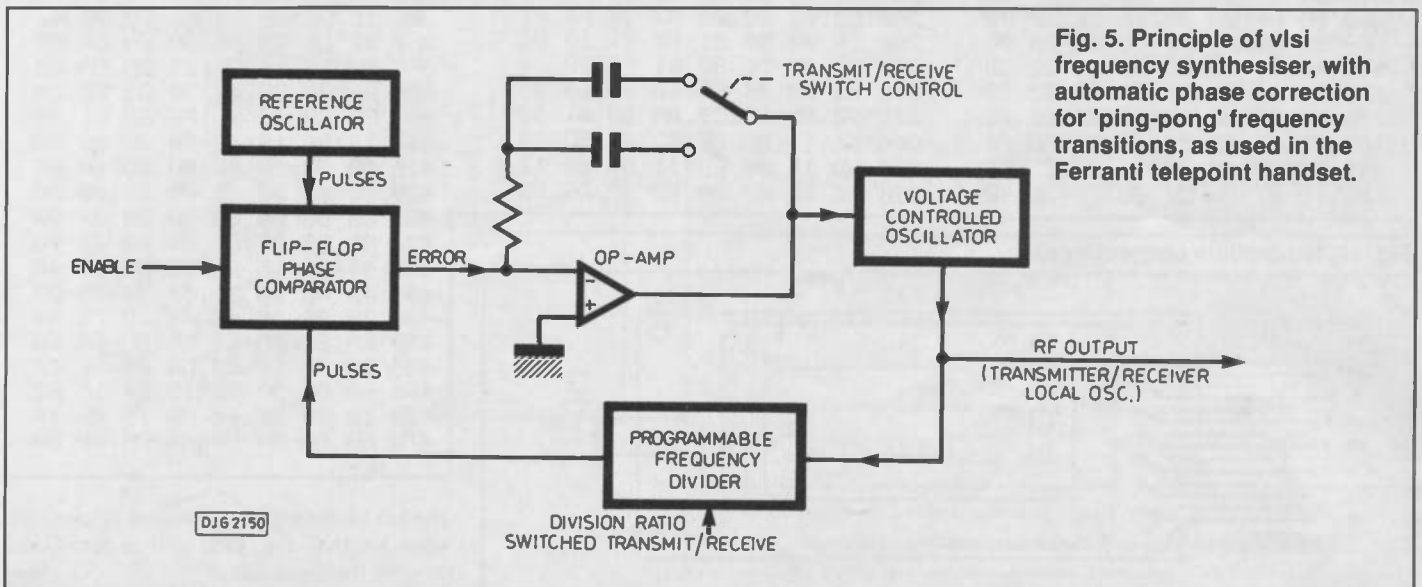

Fig. 5. Principle of vlsi frequency synthesiser, with automatic phase correction for 'ping-pong' frequency transitions, as used in the Ferranti telepoint handset.



BIKE COMPUTER

Continued from Page 17

EPROM HEX DUMP

```

000 20 88 41 AD 00 20 29 7F
008 C9 7F F0 1A C9 3E D0 0D
010 A9 00 A2 03 95 00 E8 E0
018 F0 90 F9 A9 04 EA EA EA
020 EA EA EA 20 00 44 A2 00
028 AD 0A 20 8E 0A 20 85 00
030 A2 08 86 01 18 46 00 90
038 07 20 58 40 C6 01 D0 F4
040 A5 FF F0 08 C9 03 F0 04
048 C9 07 D0 03 20 A0 43 4C
050 80 40 00 00 00 00 00 00
058 A9 09 85 1A A5 1A A8 B9
060 00 47 AA B9 20 47 A8 20
068 00 42 C6 1A D0 EE A5 69
070 29 0F AA F8 18 B5 30 69
078 01 95 30 D8 60 00 00 00
080 EE FF 06 AD FF 06 C9 08
088 B0 03 4C 70 41 A9 00 8D
090 FF 06 A9 03 85 1A A4 1A
098 B9 10 47 AA B9 30 47 A8
0A0 20 00 42 C6 1A D0 EF F8
0A8 38 A9 00 65 69 85 69 C9
0B0 60 90 14 A9 00 85 69 65
0B8 68 85 68 C9 60 90 80 A9
0C0 00 85 68 65 67 85 67 D8
0C8 A9 00 AA 85 03 95 50 95
0D0 A0 E8 E0 0A 90 F7 AA B5
0D8 30 A8 A2 A9 20 00 42 E6
0E0 03 A6 03 E0 0A 90 F0 A5
0E8 A8 C5 17 90 16 F0 02 B0
0F0 06 A5 A9 C5 18 90 0C A5
0F8 A8 85 17 A5 A9 85 18 A9
100 01 85 19 A5 69 29 0F AA
108 A9 00 95 30 A5 FF D0 09
110 20 70 46 20 E8 44 4C 4F
118 41 C9 01 D0 12 A5 19 F0
120 06 20 79 46 20 E8 44 A0
128 29 20 90 43 4C 4F 41 C9
130 03 D0 09 20 70 46 20 F4
138 44 4C 4F 41 C9 04 D0 0F
140 A5 19 90 0B 20 79 46 20
148 F4 44 A0 B9 20 90 43 20
150 40 46 20 A0 43 4C 70 41
158 00 00 00 00 00 00 00 00
160 00 00 00 00 00 00 00 00
168 00 00 00 00 00 00 00 00
170 AD 01 20 85 03 09 20 8D
178 01 20 EA EA EA A5 03 8D
180 01 20 4C 00 40 00 00 00
188 AD 00 20 29 7F A8 AD 01
190 20 29 40 D0 16 A9 01 8D
198 10 07 A2 07 86 FF A5 49

```

Fig. 11. Keypad connections.

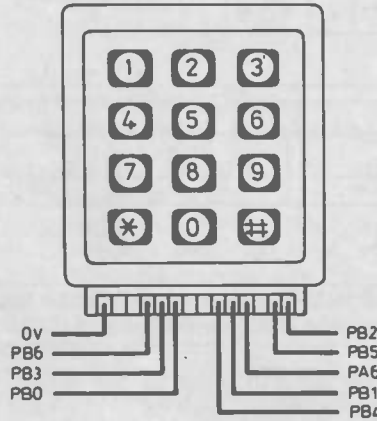
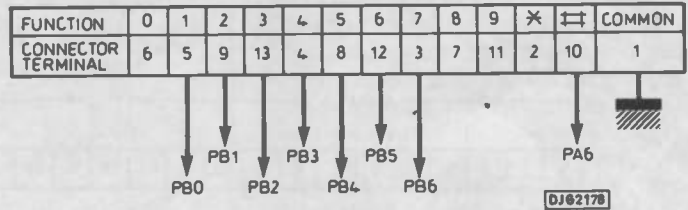

```

1A0 8D 11 07 A9 00 8D 12 07
1A8 4C D0 41 AD 10 07 D0 01
1B0 60 C0 7F EA D0 0B A5 49
1B8 F8 38 ED 11 07 C9 03 90
1C0 0D A2 00 8E 01 20 CA EA
1C8 8E 03 20 20 90 46 D8 60
1D0 A2 01 86 1B EA 20 40 46
1D8 A0 00 8C 16 07 B9 E8 47
1E0 A2 10 20 98 44 EE 16 07
1E8 AC 16 07 C0 08 D0 0A A9
1F0 C0 A2 00 20 98 44 AC 16
1F8 07 C0 10 90 E0 60 00 00
200 F8 84 05 A0 09 18 B5 00
208 65 05 95 00 90 08 CA B5
210 00 69 00 88 D0 F4 D8 60
218 00 00 00 00 00 00 00 00
220 F8 84 05 A0 09 38 B5 00
228 E5 05 95 00 CA B5 00 E9
230 00 88 D0 F6 D8 60 00 00
238 00 00 00 00 00 00 00 A9
240 00 AA 95 90 95 E0 E8 E0
248 0A 9A F7 85 C6 85 D6 A0
250 03 A2 00 BD 05 06 D0 08
258 E8 88 88 E0 03 90 F4 60
260 C9 0A B0 01 88 8C 10 06
268 8E 00 06 A0 01 A2 00 B5
270 75 D0 08 E8 88 88 E0 03
278 90 F5 60 C9 0A B0 01 88
280 8C 11 06 8E 02 06 D8 38
288 AD 10 06 ED 11 06 8D 12
290 06 38 A9 04 ED 12 06 8D

```

```

298 13 06 18 69 E0 85 0A AC
2A0 00 06 A2 00 B9 05 06 95
2A8 C7 E8 C8 E0 03 90 F5 AC
2B0 02 06 A2 00 B9 75 00 95
2B8 D7 E8 C8 E0 03 90 F5 A5
2C0 D7 C9 0A 90 13 A0 04 84
2C8 03 A0 03 A2 00 18 76 D7
2D0 E8 88 D0 FA C6 03 D0 F1
2D8 A5 C7 C9 0A B0 0D A0 04
2E0 A2 03 18 36 C6 CA D0 FB
2E8 88 D0 F5 A9 04 85 07 A9
2F0 99 8D 05 06 A9 04 85 09
2F8 A5 09 18 69 C5 0A A4 09
300 B9 D5 00 85 05 FA 20 25
308 42 C6 09 D0 EB A6 0A A0
310 01 20 00 42 CE 05 06 A5
318 C6 F0 D9 A9 05 85 09 18
320 A5 09 69 C4 AA A4 09 B9
328 D4 00 A8 20 00 42 C6 09
330 D0 ED A6 0A A9 01 85 05
338 F8 20 25 42 E6 0A A0 04
340 18 A2 03 36 C6 CA D0 FB
348 88 D0 F5 C6 07 D0 A0 A2
350 0A A0 09 B5 E0 C9 0A B0
358 05 CA D0 F7 F0 10 29 F0
360 4A 4A 4A 4A CA 95 E0 E8
368 B5 E0 29 0F 95 E0 A0 00
370 A2 00 B9 E0 00 0A 0A 0A
378 0A 18 C8 79 E0 00 95 95
380 E8 C8 C0 0A 90 EC 60 00
388 00 00 00 00 00 00 00 00
390 A2 09 B9 00 00 9D 00 06
398 88 CA D0 F6 4C 3F 42 00
3A0 A6 FF 8A 0A 85 1C AA BD
3A8 70 47 85 15 BD 80 47 85
3B0 0B BD 90 47 20 30 44 A2
3B8 10 A4 1C B9 A0 47 20 98
3C0 44 A4 1C B9 B0 47 20 98
3C8 44 A6 1C E8 BD 70 47 85
3D0 15 BD 80 47 85 0B BD 90
3D8 47 20 30 44 A2 10 A4 1C
3E0 C8 B9 A0 47 20 98 44 A4
3E8 1C C8 B9 B0 47 20 98 44
3F0 60 EA EA EA EA EA EA EA
3F8 EA EA EA EA EA EA EA EA
400 A2 00 38 4A 90 03 E8 D0
408 FA C9 00 86 FF A2 01 86
410 1B 86 19 60 00 00 00 00
418 00 00 00 00 00 00 00 00
420 00 00 00 00 00 00 00 00
428 00 00 00 00 00 00 00 00
430 A2 00 85 0C 09 80 20 98
438 44 A6 15 A0 00 B5 00 4A
440 4A 4A 4A 20 61 44 B5 00
448 29 0F 20 61 44 20 78 44
450 EA EA EA EA EA EA EA EA
458 EA EA E8 C8 C0 03 90 DD
460 60 09 30 86 15 84 16 A2
468 10 20 98 44 A6 15 A4 16
470 60 00 00 00 00 00 00 00

```

Fig. 12. lcd module connections.

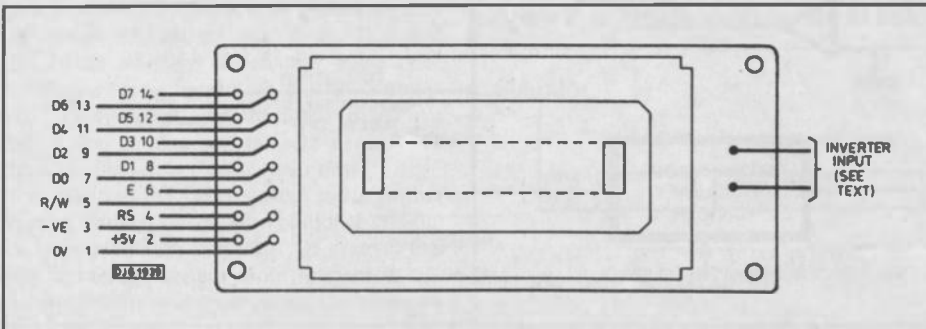

The hex dump will be continued next month, when we shall also look at it in detail, and describe the construction.

USE PC COMPILERS FOR AN SBC

For really fast development of stand alone systems, use a Lancer or Hunter target board with Hexatron's PromDOS. This emulates DOS and BIOS calls, gives you silicon discs and even allows you to run non-ROMable compiled code in a ROM environment. Too good to be true? - Call us now for a free demonstration.

THE SDS LANCER

An 8088/V20 target board with two serial ports, four parallel ports, six counter-timers, four 32 pin memory sockets, battery backup, RTC, watchdog timer, optional 8087, optional mains psu & case.

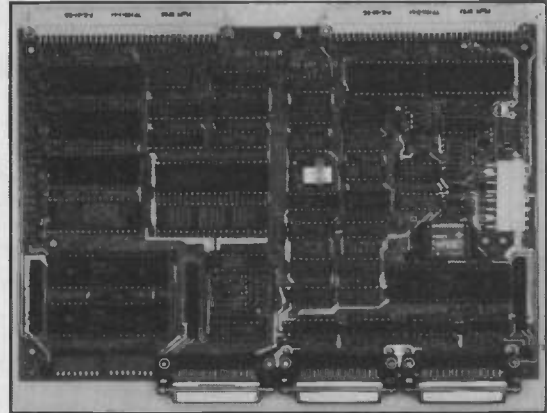

THE SDS HUNTER

An 80188 target board with 256k bytes EPROM, 256k bytes battery backed RAM, 256k bytes D-RAM, two serial ports, three counter-timers, RTC, watchdog timer, optional mains power supply and case.

Sherwood Data Systems Ltd

Unit 6, York Way, Cressex Estate, High Wycombe. Tel. 0494-464264

AGE & G ELECTRONICS

ELECTRONIC COMPONENTS MAIL ORDER COMPANY.

1990 COMPONENTS CATALOGUE IS AVAILABLE NOW.

FREE entry to win an ultraviolet exposure Unit Value £ 200.

Have you send for your copy yet?

Electronic Components at the right prices.

- FAST SERVICE
- LOW PRICES
- LARGE DISCOUNTS

Competition ends
31 Dec 1990.

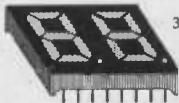

0.5" ORANGE DUAL LED DISPLAY

Value £ 2.00 absolutely free !!!

Simply complete and return the order form below and we will send your free gift.

PLEASE SEND A COPY OF THE A & G ELECTRONICS CATALOGUE AT £1.00 (REFUNDABLE WITH MY FIRST ORDER) AND MY FREE GIFT TO:

NAME

ADDRESS

I HAVE ENCLOSED £ Tick box to enter the competition.

A & G ELECTRONICS LTD.

Free Post ,100 Park Avenue ,

London E 6 2BR. (No Stamp Required)

TEL : 081-552 2386 Fax : 081 - 519 3419.

HENRY'S

ELECTRONICS

DISTRIBUTORS

ELECTRONICS DISTRIBUTORS FOR TRADE, INDUSTRY, EXPORT, EDUCATION AND HOBBYISTS

BIG DISCOUNTS
FOR EDUCATION
AND QUANTITY

- Tools/Service Aids
- Test Instruments (UK's largest in-stock Range)
- Communications
- Public Address/Disco Equipment
- Security/CCTV/Doorphones/Alarm Systems
- TV, Video Distribution
- Speakers for Hi-Fi, in car, PA and Disco
- Components, Audio, TV, Video, Telephone and Computer Accessories

SPECIAL OFFERS

Dmm was (£18.95) **£13.95**
(30 models stocked)

1 kw outdoor PIR Lights controller was (£32.95) **£19.95**
VHF/UHF TV/FM Amplifier was (£11.95) **£9.95**

Analogue MM 27 Ranges CAP/Hfe/Temp/10A AC/DC etc. was (£39.95) **£29.95**

ALL PRICES INCLUDE VAT

FREE CAR PARKING

Two Car Parks (Bell and Church Streets). Present your ticket when purchasing and get one hour as discount.

OPEN 6 DAYS A WEEK FOR CALLERS AND TELEPHONED ORDERS



HENRY'S AUDIO ELECTRONICS

404 Edgware Road, London W2 1ED

Instruments/Audio 071-724 3564

Security/Communications/CCTV 071-724 0323

Components 071-723 1008 Fax: 071-724 0322

Trade/Education/Export 071-258 1831

Account facilities available.

CATALOGUES IN COLOUR

- Instruments
 - Security
 - Supplements
 - Components
- Ask Henry's first
£1 for callers: large SAE £2 stamp UK by post. (Export £5.00) Free to Education with Trade Prices

Using nicad rechargeable nickel-cadmium secondary cells can save a lot of money, compared to using throw-away primary cells or batteries, whether of the zinc-carbon variety or the more expensive but longer lasting alkaline types. So much so, that as a result "trannies", Walkman type personal stereos, radio-cassettes etc, probably get a good deal more use. Normally one has to remove the cells when exhausted and transfer them to a charger unit for the recommended recharging period, and then replace them in the battery compartment. The unit described here enables you to recharge your nicads "in-situ".

Why should you want to recharge them without taking them out of the trannie, or whatever? Here are just a few reasons:

- 1) To save time and trouble
- 2) To save wear and tear on the battery cover and contacts
- 3) To ensure that all the cells receive the same amount of charge
- 4) So that you can use the set whilst recharging the batteries.

Dave May's adaptor lets you recharge your nicads without interrupting your listening!

priced nicad chargers are in fact just not suitable for some recharging applications. For instance, my Sanyo personal stereo uses three AA cells, whilst a charger for up to four AA cells I was given can only charge cells in pairs. All of these and the other problems as well are swept away by the handy little unit described below.

HOW IT WORKS

Fig.1 shows the circuit of the unit. It is powered from a 3V to 12V 300mA unregulated power supply of the sort

Switch S1 provides a choice of three different values of series resistance to set the charging current, and also enables the output plug polarity to be set to centre contact positive, or negative, as needed. The charging current is indicated on the meter, which monitors the voltage drop across the 4.7ohm resistor. The npn darlington transistor is normally saturated by the base current through the 8k2 resistor, so that the available values of series limiting resistor are 4R7, 4R7 + 33R, and 4R7 + 33R + 120R. In the event of excessive demand current, for example a short circuit at the output plug, the voltage drop across the 3k9 resistor turns on the BC184, reducing the base current to the darlington and limiting the current to a safe value.

CONSTRUCTION

Fig.2 shows the layout and the all important breaks in the track. Take my advice and use a proper track cutting tool. A twist drill bit can be used but the twist of the

IN-SITU NICAD RECHARGER

Of these, reason three is particularly important. With many of the nicad rechargers available, you cannot be sure that all cells will receive the same amount of charge. Unless you mark the cells and religiously rotate them around the charging positions, this can lead in time to one cell being repeatedly charged less than the others and finishing up at the end of the charge period with a lower and lower useful life than the rest. Thus recharging is needed more and more often. Some attractively

manufactured for a silly price in the Far East and sold at a modestly reasonable price from many UK outlets. This simply plugs into the in-situ charger, with reverse polarity protection provided by the 1N4001 power diode. At the other end, a lead terminated in a "spider" plug with 2.1 and 2.5mm power plugs and 2.5 and 3.5mm jack plugs will plug into the external power socket of just about any battery operated whastit. It's the bit in between that makes it useful.

flutes puts a front rake on the cutting edge and this tends to tear the copper back as it cuts: it can also leave an almost invisible whisker of copper shorting to the adjacent track. The proper tool has straight flutes and no front rake, so it does a neater job. It is not expensive and should last a lifetime. I find it pays to check with an eyeglass that each cut is complete, a moment or two spent doing this can save much longer in fault-finding when the completed circuit doesn't work.

The circuit board can most conveniently be connected to the switch and the meter with a short length of colour coded ribbon cable. The meter used is one of the very cheap indicators mass produced in the Far East and used as vu meters, power meters, vswr meters etc. Full scale deflection differs somewhat from make to make but is in the range of 120 to 250 μ A. The scale is designed to provide extra resolution at low current, becoming more cramped at the top end. This type of indicator is widely available on the surplus market and good value at a pound or two. Fig.3 shows the meter scale used on the prototype: it can be photocopied if you don't want to cut up your copy of PE (*none of our readers are vandals! Ed.*) and used to rescale your meter. An alternative version may be used, with the intermediate scale calibration marks being filled in to suit the particular meter being used, while setting up as described below.

Fig. 1. Circuit Diagram of the in-situ nicad recharger

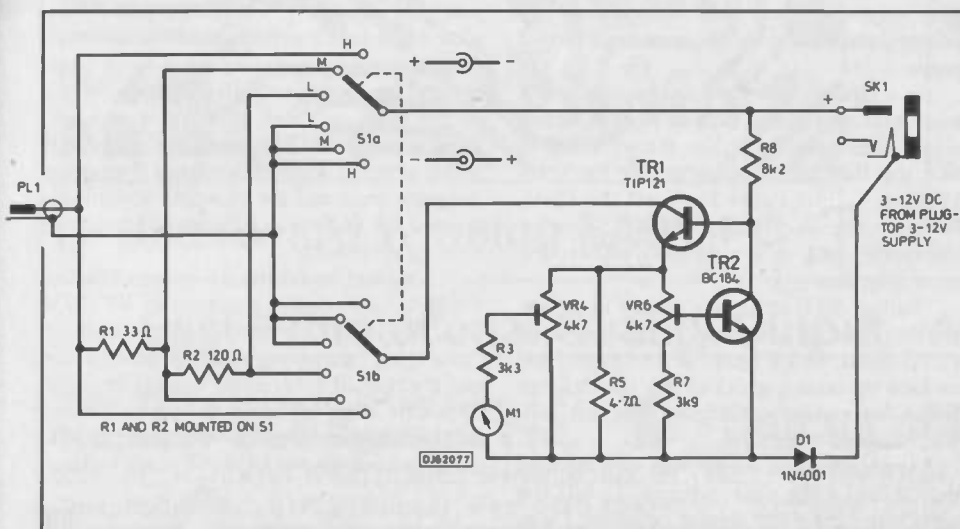
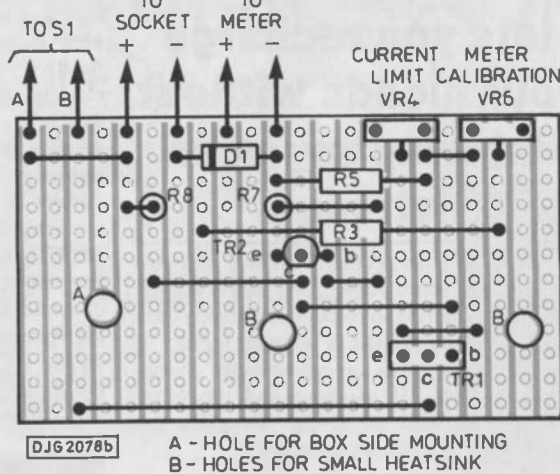
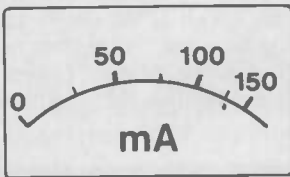

Fig. 2. Component layout for the circuit.

Fig. 3. This meter scale can be photocopy reduced/enlarged to suit your meter.



COMPONENTS

RESISTORS

| | |
|-------|----------------------------------|
| R1 | 33R |
| R2 | 120R |
| R3 | 3k3 |
| R4 R6 | 4k7 min skel vert preset (2 off) |
| R5 | 4R7 |
| R7 | 3k9 |
| R8 | 8k2 |

All 0.25W 25% carbon

SEMICONDUCTORS

| | |
|-----|--|
| D1 | 1N4001 |
| TR1 | TIP121 (with pcb vertical mounting heatsink) |
| TR2 | BC184 |

MISCELLANEOUS

| | |
|-----|---|
| S1 | 2 pole 6 way rotary switch, with pointer knob to suit |
| Sk1 | 2.1mm power socket (input) |
| P11 | Universal plug (e.g. FK08J Maplin) |
| M1 | Meter (see text) |
| Box | Small plastic (to suit) |

SETTING UP

Set the wiper of the BC 184's 4k7 pot to of the TIP121 darlington. Connect the power supply, set to 6V, to the adaptor's input. Short circuit the adaptor's output spider plug via an ammeter - digital or analogue - set to, say, the 1 amp range. Adjust the 4k7 pot for a short circuit current of 180mA. Now adjust S1 and the output voltage of the power supply so that the ammeter reads 150mA or less. Adjust the other 4k7 pot so that the reading on the adaptor's meter agrees with that on the external ammeter. The adaptor is now set up.

SETTING UP

If you only intend to use the adaptor with a single piece of equipment, omit the wiring on one side of S1, so that the adaptor can only produce the required polarity output. Only the very simplest modification to the equipment to be recharged is necessary: simply connect a shorting link or suitable resistor across the outer break contacts of the equipment's external dc power socket. Set S1 to L (low),

the power supply output voltage to 3V and plug in. Now wind up the power supply volts and/or adjust S1 to set the desired charging current - 50mA to AA cells, 150mA for commercial C and D cells - or as directed by the manufacturer.

If you intend to use the adaptor with several different items of equipment, some having centre positive and others centre negative power sockets, then S1 should be fully wired as shown. In principle, the same simple link across the power socket outer is all that is necessary in each equipment, but the inclusion of a reverse polarity connection diode as in Fig.4 is most strongly recommended: remember that off load the unregulated power supply will provide an output of 18V or more - you wouldn't want to accidentally connect that back to front to the equipment, especially if it had inadvertently been left switched on! True, this involves cutting a track as shown, but better safe than sorry.

If you measure and note the current normally taken by the radio set or whatever, say 20mA, then by setting the current indicated by the meter to 20mA more than the required charging current, you can use the radio at the same time as charging the batteries. Alternatively, the charging period can be extended instead. **PE**

Fig. 4. Modification to typical portable radio.

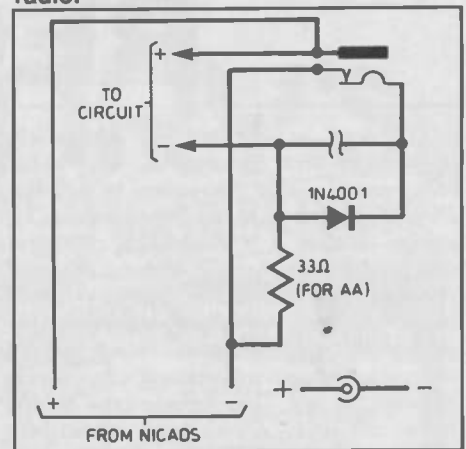

LEADING EDGE

➔ Continued from page 8.

But the search procedures are still unfriendly, muddled and time consuming. Callers first get a message on screen asking them to type a code word to identify the type of computer they are using, referred to as either Prestel or VT100 microcomputer. Illogically the caller must key VTI to signify VT100. Absurdly, the system rejects the very similar and logical instruction VT1, wasting valuable call time by transmitting the full display page of text again before each rejection.

After that, the system wastes more valuable call time on painting pretty viewdata designs on screen before asking further questions. For no apparent reason, control

key strokes must be preceded by an unseen question mark. While this is happening, any printer connected to the PC spews out wasted pages.

As a random and genuine practical test, I tried hunting for any firm in North London which sells security grilles for windows. It took less than half a minute to take the North London Yellow Pages book off the shelf, look up the section labelled "Security Services" and spot a display advert for security grilles.

Dialling EYP and trying to key in similar words, produced screenfulls of options but no useful result. I tried again, several times, and on each occasion got locked into search loops which led nowhere. Escaping was difficult, which wasted more time.

I couldn't work out how to step through the fields of the search menu, to tell the wretched thing what service or goods I was

looking for and in what area of the country. It just kept eating my mistakes, repeating the same futile search patterns based on incorrect instructions (eg searching for a town name entered as goods) and laboriously throwing up the same questions over and over again. Even at the fastest line speed available (2400 baud, which is eight times faster than many domestic modems) the viewdata screenloads wasted far too much expensive telephone time for no reward.

To try and be fair on the system I dialled the Help Line number given out by BT (0734 506506) to ask for advice. I got only an "intelligent" answering machine which asked me a string of infuriating market research questions. I left my name and phone number urging someone from EYP to phone me back. By the end of the week I'd still heard nothing. **PE**

EASY-PC

PCB and SCHEMATIC CAD

For Super Schematics....

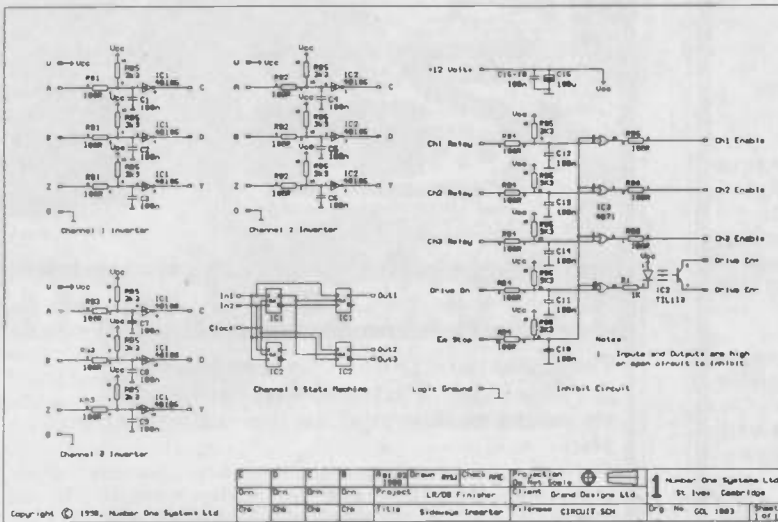

Still Only £98!!

BRITISH DESIGN AWARD 1989

- Runs on:- PC/XT/AT/386 CGA EGA VGA.
- Design:- Single sided, Double sided and Multilayer boards.
- Provides Surface Mount support.
- Standard output includes Dot Matrix printer, Pen Plotter, Photo-plotter and N.C. Drill.

.....and Perfect PCB's

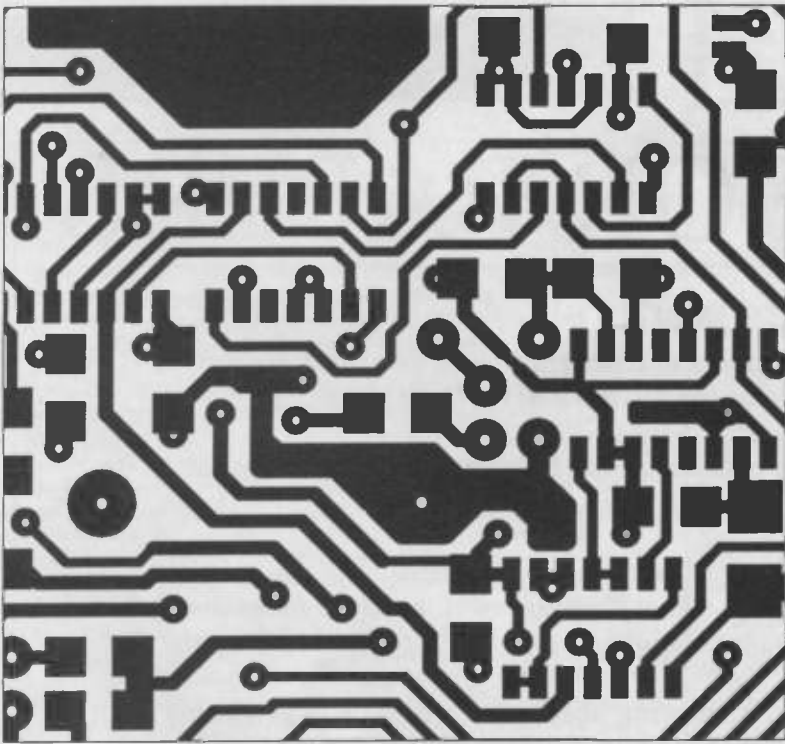

- Over 4000 installations in over 50 countries worldwide.
- Over 500 installations in Universities, Colleges etc. (Aug '90)

Use Award Winning EASY-PC

Fast Professional Quality Output - Affordable Price

Write, 'Phone or Fax for full details:- **Number One Systems Ltd.** **1** See us at DES'90 Stand 1216
 REF: PE, HARDING WAY, SOMERSHAM ROAD, ST.IVES, HUNTINGDON, CAMBS, PE17 4WR, ENGLAND.
 Telephone: 0480 61778 (6 lines) Fax: 0480 494042 ACCESS, AMEX, MASTERCARD, VISA Welcome.



NATIONAL
COLLEGE OF
TECHNOLOGY

Packaged Short Courses

The National College of Technology (NCT Ltd) offers a range of packaged short courses in analogue electronics, digital electronics & fibres, optoelectronics & programmable logic controllers for study at home or at work. The advantages are that you may,

- commence at any time
- work at your own pace
- have a tutor (optional)

and there is no travelling involved. BTEC certificates are available subject to the conditions of the award. These highly popular packed courses contain workbooks, a cassette tape, circuit board and components necessary to provide both theoretical and practical training.

Whether you are a newcomer to electronics or have some experience and simply need updating, there is probably a packaged short course ready for you. Write or telephone for details, quoting Practical Electronics, to:

NCT Ltd, Bicester Hall
5 London Road, Bicester
Oxon OX6 7BU

or telephone (0296) 613067 Ext. 202

TWO GREAT HOBBIES

ONLY
£129.00
INC VAT



...IN ONE GREAT KIT!

The K5000 Metal Detector Kit combines the challenge of DIY Electronics assembly with the reward and excitement of discovering Britain's buried past.

THE KIT - simplified assembly techniques require little technical knowledge and no complex electronic test equipment. All stages of assembly covered in a detailed 36 page manual.

THE DETECTOR - features Analytical Discrimination & Ground Exclusion, backed by the proven pedigree of C-Scope, Europe's leading detector manufacturer.

Ask at your local Hobby/Electronics shop or contact:-

CSCOPE

C-Scope International Ltd., Dept. PE
Wotton Road, Ashford, Kent TN23 2LN.
Telephone: 0233 629181.

PROGRAM NOW
SOFTWARE APPLICATIONS AND DEVELOPMENT

CALL FOR PAPERS

Program Now wants writers!

We're looking for software developers and programmers to write for what is the UK's *only* newsstand magazine for software developers.

We are looking for well-written articles on the following subjects to appear in future issues.

- *Managing interrupts in C*
- *C++ linked lists*
- *Developing a C library*
- *Concurrency in Pascal*
- *Fast floating point routines in Assembler*
- *Programming in Protected Mode on the 286*

Alternatively, we are interested in viewing abstracts, articles and programs in C, Pascal, Fortran or Assembler. We especially welcome TSRs, Vanilla C or Pascal programming routines, and articles on programming and design methodology.

Send your abstracts and outlines to:
Clive Grace,
The Editor,
Program Now,
193 Uxbridge Road,
London. W12 9RA.

If you are interested in writing for Program Now, but the above articles are not within your field of expertise, please contact us with your ideas anyway. We always consider new scripts and welcome quality writing and good programming!



Your Ed looks at some of the new books recently received.

Simple Short Wave Receiver Construction. R.A.Penfold. Babani BP275. £3.95. ISBN 0-85934-220-4.

One of life's pleasures, however experienced you are at electronics, is putting together a few components and finding that you can listen to transmissions from far off distant places. In this book Robert Penfold shares his enthusiasm for radio construction with you, showing how easy it can be to build your own receiver. He takes a look at the basics of short wave radio and then describes several practical projects to enthral you. His crystal set uses principles which date back into history but which with the aid of modern components shows how simply a receiver can be built. Moving a stage up from crystal sets, he then looks at tuned radio frequency receivers (TRFs), and describes two circuits illustrating their theory. Finally, an amateur bands receiver is presented which uses the direct conversion techniques. I am sure that anyone with an interest in the mysteries of radio will gain pleasure and knowledge from this book. How about following it up, Robert, with a book covering long wave receivers capable of picking up transmissions below the 'normal' broadcast wavelengths? That's a subject which seems to be much under-covered.

Digital Electronics Projects for Beginners. Owen Bishop. PC Publishing. £5.95. ISBN 1-870775-08-2.

With a background encompassing education as well as electronics, Owen Bishop is in an ideal position to show newcomers how to understand the exciting world of electronics and to have fun while doing so. In this book he presents 12 digital circuits that are ideal material for any beginner or early starter to cut his or her teeth on, exploring and implementing basic logic. The projects include: logic probes, movie show, progressive timer, intruder detector, capacitance meter, combination door sentry, digital die, Christmas decoration, weekly reminder, remote-control switch, metronome, and an anemometer. Each project has a circuit diagram and a drawing of the layout on stripboard making it very easy to follow the construction. Written assembly and testing details are thoroughly given, and there is an appendix giving you additional important constructional information of a more general nature. I am also pleased to see that in addition to the regularly used digital chips, some of the newer HC devices have been used as well. This is certainly a very useful and interesting book.

Getting the Most from Your PC's Hard Disk. J.W.Penfold. Babani BP280. £3.95. ISBN 0-85934-225-5.

To the uninitiated, the use of a hard disk drive on a computer might seem to be no different to using a floppy disc. Up to a point this is true, though in order to make full and better use of the hard disk, there are various procedural changes one should make. One most important aspect that should be considered is that of backing-up your files against the possibility of data loss. This book gives advice on security matters such as this, and on ways in which your files can be arranged in sub-directories, making your applications much easier to configure. A further benefit to be gained from this book is through the advice on installing your own hard disk drive on computers which do not already have the facility. You are given basic information on how a disk is fitted, and how to format and prepare it for use. Those who already have a hard disk will probably find the information on interleave factors and installing DOS to be of good use.

Fault Diagnosis of Digital Circuits. V.N.Yarmolik. Wiley. £29.95. ISBN 0-471-92680-9.

This book is a comprehensive and up-to-date treatise which emphasises the use of on-line testing techniques for digital devices used in computers. It is divided into two parts, one dealing with topics of general interest including reliability, fault modelling and testing schemes; the other highlights recent developments and focuses on various methods of compact testing. This is very much a book for the specialist electronics engineer who also has a thorough grasp of mathematics. Regrettably it will not be of use to the average hobbyist who wishes to automate the debugging of general project assemblies.

Power Control Circuits Manual. R.M.Marston. Heinemann Newnes. £12.95. ISBN 0-434-91216-6.

This book is specifically aimed at the practical design engineer and technician as well as the amateur experimenter and electronics student. It deals with its subject in an easy-to-read, down to earth and non-mathematical but very comprehensive manner. Split into eight distinct chapters, it explains the basic principles of electrical-electronic power control, shows a variety of practical control techniques. It includes switch and relay circuits, cmos switches and selectors; ac power control and dc motor control circuits; audio power control and dc power supply circuits. In nearly 200 pages the book appears to be a mine of information on virtually any aspect of power control about which you need to know more. It is full of graphs and circuits, and mostly uses solid state devices which are reasonably priced and readily available. This is undoubtedly a highly useful reference book to have in the workshop.

Electronic Engineering Semiconductors and Devices (Second Edition). John Allison. McGraw-Hill. £12.95. ISBN 0-07-084194-2.

Aimed at the serious electronics enthusiast upwards, this book describes the operation and characteristics of modern active electronic components in a precise manner which will be easily understood even though a modicum of mathematical knowledge is required as well. In this second edition, the author describes the electronic conduction processes in semiconductors, insulators, metals and respective junctions, relating them to the operating characteristics of a wide variety of electronic engineering devices. The text is based in the main on a series of lecture courses given to university electronic and electrical engineering undergraduates.

Analog Electronics. Ian Hickman. Heinemann Newnes. £30.00. ISBN 0-434-90723-5.

There is a neat quotation at the start of this book: "*Digital is easy. Analog... that's professional*". Yes, indeed, once you've grasped the fundamentals of Boolean logic, what more is there to digital electronics?! Analog electronics, on the other hand, needs the application of far more theory and mathematics in order to persuade it to function as required. In this book, Ian Hickman sets out to present readers with a wide variety of practical information about concepts and techniques which should enable them to feel at home with analog design without fear about its deeper mysteries. The book includes many examples from his large collection of circuits (built up over thirty years in commercial, professional and defence electronics) selected for their usefulness in a wide range of applications. They are practical analog circuits, complete with component values in many instances, culled from dozens of magazines (including PE), books and journals. The book includes the latest developments and techniques as well. Its aim is to take readers 'inside' electronic circuits so that they can see what makes them tick, showing how and why exactly they do what they do. The wealth of information can be applied to readers' own design problems, offering viable solutions which might not normally be self-evident. One useful chapter is that called Tricks of the Trade, offering numerous routes to alternative solutions. This book is an excellent key to a greater understanding of what analog electronics can do, and how you can make it do it.

PUBLISHERS' ADDRESSES

McGraw-Hill Book Company (UK) Ltd
Shoppenhangers Road, Maidenhead, Berks, SL6 2QL. Tel 0628 23432.

PC Publishing
4 Brook Street, Tonbridge, Kent, TN9 2PJ. Tel 0732 770893.

John Wiley and Sons Ltd
Baffins Lane, Chichester, West Sussex, PO19 1UD. Tel 0243 779777.

Bernard Babani (Publishing) Ltd
The Grampians, Shepherds Bush Road, London W6 7NF. Tel 081-603 2581.

Heinemann Professional Publishing
Halley Court, Jordan Hill, Oxford, OX2 8EJ. Tel : 0865 311366.

SPACE

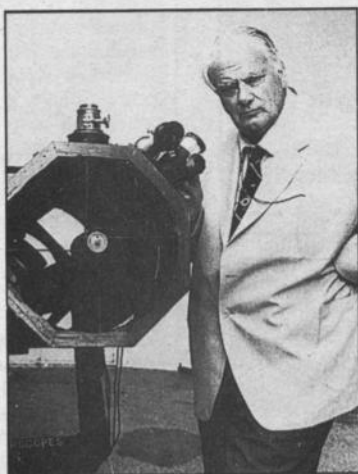

WATCH

BY DR PATRICK MOORE CBE

Amateur astronomers can explore the mysteries of the universe as valuably as NASA, ESA and Ulysses.

was held on the 24th of that month, in London, under the presidency of Captain W. Noble. Ever since then it has had an observational record second to none, and its members include professional as well as amateur astronomers.

Modern technology is so sophisticated that one may well ask "What is the use of amateur

astronomy?" The answer is that amateurs can carry out work which professionals do not want to do, have no time to do, or frankly cannot do - there are many professionals who could not distinguish between the Great Bear and Orion, so that they would be very likely to miss the sudden appearance of, say, a bright nova. Amateurs have a great record for discoveries of novae and comets; they monitor the planets and some kinds of variable stars; they make important observations of phenomena ranging from aurorae to meteors - in fact, they are kept very busy, and it may be fair to say that astronomy is still the one science in which amateurs can make valuable contributions. Certainly their work is warmly welcomed by professionals.

The BAA has monthly meetings in London as well as functions in other parts of Britain. Its main Centenary Meeting this year will be exactly one hundred years after that first gathering; a Coat of Arms will be presented, and there will be special stamps issued by the Post Office. Let us hope that the next hundred years of the Association will be as fruitful as the first.



Patrick Moore shows the original artwork of one of the new stamps highlighting the pioneering role played by British astronomers.

At the time when these notes are being written, the launch of the Ulysses probe is scheduled for October 5 (I hope to be at Cape Canaveral to see it go). Ulysses is a new kind of space-craft, designed to study the pole of the Sun. For obvious reasons, the solar poles are inaccessible to Earth-based instruments, and any space-craft to study them must be sent well out of the ecliptic plane. With Ulysses, this will be done by a pass of Jupiter, so that the initial path will take it outward. The solar poles are of immense interest, and we hope that Ulysses will provide us with our first real information about conditions there.

There is news of other probes, too. Magellan has begun its survey of the surface of Venus, while Galileo is still on its tortuous path to Jupiter. Unfortunately, there are problems with the whole space programme. Hipparcos, the astrometric satellite, has cost much more than expected, because it was put into the wrong orbit and this has added to the difficulties of the ground stations, while, of course, the trouble with the Hubble Space Telescope has led to a great financial burden as well as the scientific problems. Things are not helped by the money used in dealing with the political crisis in the Gulf. The end result is that NASA may have to cancel some of its projects, and ESA, the European Space Agency, could also be affected; missions in danger are SOHO, CLUSTER, and (sadly) the Huygens probe, to be carried to Saturn's satellite Titan by the Cassini space-craft. Let us hope that none of these cancellations actually have to be made.

THE BRITISH ASTRONOMICAL ASSOCIATION

This month is the centenary of one of the most famous astronomical societies in the world - the British Astronomical Association. It was founded in October 1890, and its first meeting

THE OCTOBER SKY

Autumn is upon us, and Summer Time in Britain ends on October 28. Of the planets, Mercury is more or less out of view, though it may just be glimpsed in the east before dawn during the first week of the month; Venus is now almost gone, though it too can be seen very low in the east just before sunrise. Saturn, very low in Sagittarius, sets early. This leaves us with the brilliant Mars and Jupiter both of which are well on view. Jupiter, in Gemini (the Twins) rises before midnight, and is then excellently placed for the rest of the night; a small telescope will show its main belt and also the four main satellites. Mars, in Taurus (the Bull) is rather north of the red star Aldebaran, and is much the brighter of the two; it is in fact brighter than any star in the sky apart from Sirius, though at the moment it cannot rival Jupiter. By the end of October Mars has an apparent diameter of 17 seconds of arc, and the main dark markings on its surface can be seen with a modest telescope - unless they are veiled by a Martian dust-storm, which is always a possibility.

The Moon is full on October 4, at Last Quarter (half) on the 11th, new on the 18th, and at First Quarter (half) on the 26th. There are no solar or lunar eclipses this month.

The Orionid meteors, associated with Halley's Comet, are active from about October 16 to 27, with a maximum on the 22nd; the

Moon will not be obtrusive, so that this is a good chance to see one of the year's richest showers. Levy's Comet has now moved into the far south, but it is interesting to note that Encke's Comet, which has a period of only 3.3 years, comes to perihelion this month. It will be in the region of Leo, so that it does not rise long before the Sun, and it is faint - but observers with larger telescopes will be looking out for it. It has a long history; the first observation of it was made by the French astronomer Pierre Mechain as long ago as 1786.

The 'Summer Triangle' (Vega, Deneb and Altair) is now dropping in the west; the Square of Pegasus dominates the southern aspect, while Orion rises by midnight, preceded by some members of his retinue - notably Aldebaran and the Pleiades cluster. However, perhaps the principal interest among the stars this month is provided by Mira, the variable star in Cetus (the Whale), which lies well below the line of stars marking Andromeda. Mira reaches its maximum on October 1 or thereabouts; the exact date cannot be given, because, like all stars of its type, Mira is not perfectly regular. The mean period is 331 days. At some maxima Mira may not exceed magnitude 3, but at others it has been known to become brighter than the Pole Star - so if you look in the south and see a bright, red, unfamiliar star, you may be sure that it is Mira. It is a vast red giant, swelling and shrinking as it changes its output of energy.



LENGTHY CALLING

Dear Sirs,

I am looking for someone to make (one-off, initially) a micro voice recorder similar to those featured by some of your advertisers, except that it must be small enough to go into a 1 x 0.5 inch (cross-section) picture frame. It must be powered by small solar/light cells around the 16 x 12 inch frame and be capable of running spoken verse for one to two minutes with a speaker approximately thimble-sized. Only a very low level output is required. Should the device prove successful, many more would be wanted.

D.H. Adams, Jesmond,
Newcastle upon Tyne.

Would any enterprising reader care to take up the challenge?
Ed.

SCOPE UPGRADING

Dear Mr Becker,

I have been given a Cossor 339A oscilloscope in working order but very dirty looking. I am cleaning it up and will service it.

At the same time I propose replacing most of the components with modern ones where possible. For example, using 0.6W metal film resistors to replace the old 0.25W and 0.5W carbon types. I also propose to change a number of capacitors, where

TRACK FEEDBACK

necessary using them in series, ie, two 450V types in place of the existing 750V rated ones. Is there any contradiction in doing this?

Incidentally, I recently took out a subscription to PE -best wishes!

Albert C. Hemes, Bromsgrove,
Worcs.

*I can't think of any reason why what you propose should be problematic, other than the possibility that the leads of some modern components may not be long enough to span across the tag boards (if the scope predates the use of pcbs). If this is the case, extra lengths of stout wire can be soldered to the components to make up for the shortage. You may find that you can still buy electrolytics having a working voltage at the rating you need without having to resort to series coupling. This would avoid you having to double the capacitance of the two capacitors in order to maintain the same value. Remember that the total capacitance of several capacitors in series is calculated as :
$$1/CT = (1/C1) + (1/C2) + (1/C3)$$

... etc*

One company who stock high voltage capacitors is Electromail, tel 0536 204555.

I am pleased to welcome you as a subscription member -you're part of an ever-increasing group of fans, which is swelling even more since started running our special subscriptions offers (see page 10 of this and other recent issues).
Ed.

UFO DETECTING

Dear Sir,

I have been trying to find a circuit diagram for a Magnetic Field Distortion Meter, but as yet I have not been able to find one or anyone who can supply a kit.

The purpose for which the meter will be used is to detect UFOs on our sky watch.

Has any such meter or circuit ever been published in PE? I would be very grateful for any help you could give me.

J.W. Moore, Worksop, Notts.

I can't see anything suitable listed

in the PE Master Index going back as far as 1975. Your best chance is to go down to your local library and find out which is nearest reference library that holds books on UFOs as well as those on electronics, and then to do some browsing.

You could also ask your library if they know of the addresses for any organisations involved in UFO hunting. There must be many around country.

In order to detect for the presence of magnetic fields you need a device such as a Hall effect sensor, or perhaps a variation on the metal detector principle. As to whether such things can be modified to perform the task you want done, I can't advise. Perhaps other readers might know?
Ed.

AERIAL PLOT

Dear Ed,

I would like to suggest that one of your authors should produce some features regarding antennas and aerials for radio, tv and cb. It would also be interesting to read an article that would allow me to build a plotter for an IBM PC.

A.D. Mathison, West Germany.

Mr Mathison gave many examples of the type of function he would like covered on aerials and related devices. We shall certainly give active thought to implementing his suggestions. Ed.

PE

Astronomy Now

Britain's leading astronomical magazine

Astronomy Now



In the November issue:

- National Astronomy Week ○
- The Astronomer Royal ○
- 'A' is for Astrophysics ○
- Beneath a Silver Dome... ○
- Royal Greenwich Observatory ○
- ○ ○ ○
- plus: News Update - The Night Sky -
Picture Gallery and more...

**November issue on sale now - price
£1.50!**

From the circuit description details of last month we now give you information on using this versatile chiptester.

1. LOAD DEVICE FROM DISC

Usually, this is the first operation of a test. Press 1 on the keyboard and the program will ask for the device type to be entered.

Normally, the devices are stored under the "root" number, ie SN74LS00 will be stored as 7400. The logical function of all the variations, eg SN7400, 74S100, 74S00, 74ALMS00, etc is the same in each case and thus valuable disc space is saved by only having one entry, 7400, for all similar types.

Note: There are one or two exceptions to this rule and they are usually where the pin configuration is different between the devices with the same root number, 74H01 is one example. It does not matter what you call devices yourself and you can construct files with alphanumeric labels up to 10 characters long.

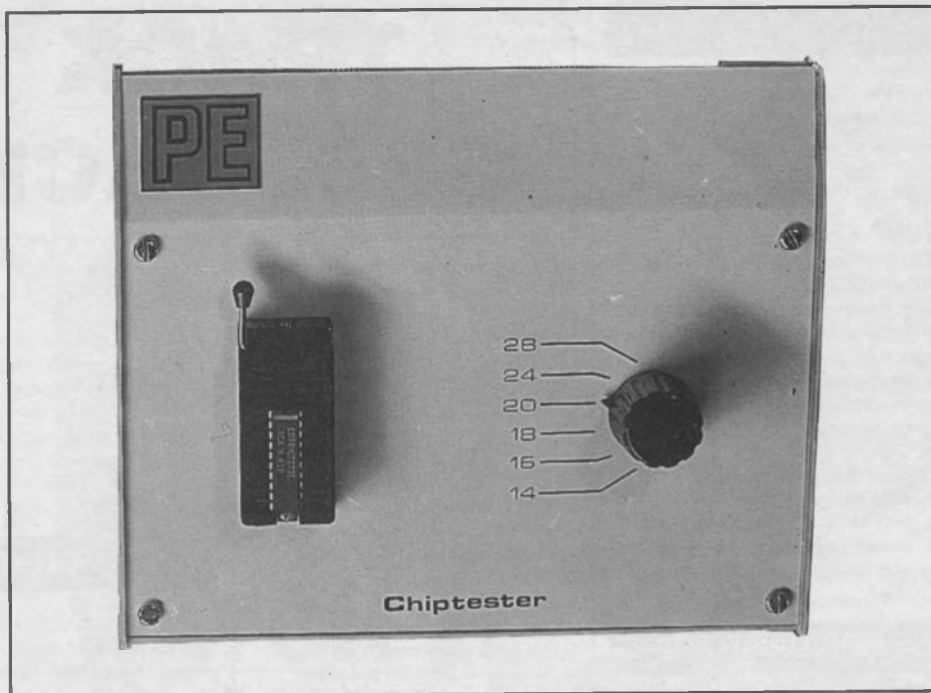

PE CHIPTESTER

One would normally, therefore, enter 7400 at this point. However, in order to demonstrate another facility, type in 74LS00 <RETURN>. The program will search the whole disc looking for the 74LS00 and of course not find it!

The message 'Type number not found' will be given and the program will ask if you wish to search for a similar number. Answer Y for this, now enter part of the core number, 740 <RETURN>.

Notice that the disc library is now in memory and the program has selected a number of devices with similar type numbers to choose from, among them will be 7400, the device required. Enter 7400 <RETURN> and the program will load in the complete device specification file and return to the main menu.

2. EDIT TEST PARAMETERS

At this stage one could go directly to 3. (Test Device) and a rapid test will be performed. However, the test parameters may be modified to display the test voltages as pin colours or as waveforms or to enable loop tests to be conducted. So press 2 to discover how the Edit Test Parameters program works.

The green words on the right show the current state of the type of tests to be carried out. At the moment everything is turned off. Notice the red help prompt at the bottom of the screen, this is a common feature in many parts of the program - always look here if you are not sure what to enter.

Let's decide to display some waveforms: answer Y to the first question.

Part Two.
This excellent test unit has extensive check and compare facilities, and you can add more to its chip library, as Dave Raynor explains.

Now we have the option of entering the pin numbers of which we wish to display the waveforms. Notice from the prompt that we could enter 0 (zero), meaning "don't display traces, but show me the voltage levels on the pins of the chip socket display". (There are two types of voltage display. One is by blue or red colours on each chip pin, the other is by waveform traces. This will become clearer after testing a chip).

For each pin number to be displayed, one must enter the number followed by a <RETURN>. Two consecutive <RETURN>s with no number in between will complete the entry line.

Alternatively, we can enter A <RETURN> for a display of all the pins of the device selected (except supply pins).

Let's select A this time.

Now we have the option of selecting a conditional loop test. This is useful if you have an intermittent fault and you wish to continue looping through the test until the device either goes on fault, or performs correctly.

Press Y to accept this test.

Answer No to "Loop until pass".

Your green codes should now read:

YES

ALL

YES

loop until fail... YES

If not, you may answer N to the prompt "is this OK" and go through the menu again. When it's right, answer Y to get back to the main menu.

3. TEST DEVICE

Now you will need a working 74LS00 chip.

Press 3 from the keyboard and the Test Device Program will be run.

On the far right of the screen is a representation of the chip socket with the ic shown in the correct position and orientation. Beneath the socket display is a panel showing the chip type and it's size. There is also a space for special messages and the cursor position which is not activated at the present point. Please note that the chip socket operating lever may in fact be found on the opposite side to that shown on the screen.

If you are concerned about inserting and removing sensitive chips with the power on, note that at this stage all pins of the socket,



except the selected supply pin, are powered down. They will not be powered down again until the main menu is re-entered.

Follow the instructions given on the main screen.

Note: The zero insertion force socket will accept chips when the operating lever is in a raised position. When the lever is lowered the spring contacts squeeze onto the chip pins, holding the chip in position.

CURSOR OPERATION

After a few cycles have been traced out, press the spacebar as suggested by the prompt at the bottom of the screen. Testing will be suspended while you inspect the display. If you now use the left and/or right cursor keys the cursor will appear and you will be able to position it wherever you desire. When there are more than 14 or 15

COMPONENTS

CAPACITORS

- C1 100 µF 6.3V radial electrolytic 0.2 inch lead pitch
- C2, C3 10n disc ceramic 25V 0.2 inch lead pitch. (2 off)

SEMICONDUCTORS

- IC1 6522 versatile interface adaptor
- IC2 SN74LS02 quad 2-input NOR

SWITCH

- S1 pcb mounted rotary 2p 6w

CONNECTORS

- J1 40-pin ic socket
- J2 28-pin low profile ic socket (3 off, see text)
- J3 28-pin universal zif socket
- J4 2-row ribbon transition connector 20-way (mini IDC dil)
- J5 2-row ribbon transition connector 34-way
- J6 ribbon cable socket (IDC) 20-way (with strain relief clip)
- J7 ribbon cable socket (IDC) 34-way (with strain relief clip)

MISCELLANEOUS

- Printed circuit board
- 1 metre 20-way ribbon cable
- 1 metre 34-way ribbon cable
- 500mA anti-surge fuse 20mm
- 20mm pcb mounting fuse clips (2 off)
- Case 170mm x 143mm x 55.5mm
- Collet knob, pointer type. 21mm for 6mm spindle
- Adhesive ribbon cable clip 20-way
- Adhesive ribbon cable 34-way
- ICs 7400 and 7414 to be used as demonstration devices in the testing.

traces on the screen, this becomes very useful as it allows the eye to follow down from one trace to another.

At the bottom right of the screen there is shown the present cursor position. If, as with the present test of the 7400, there is no clock cycle being used, the display will show the true test number, ie the test under the cursor corresponds with the test number called for in the device specification file. However, if clock cycles are in use then some of the tests in the device specification can generate from 1 to 1024 clock cycles. In this case the cursor will show the number of cycles and tests carried out to the point where the cursor is positioned.

While the trace is frozen let's have a look at what else is displayed.

SOCKET DISPLAY

On the socket display the colours represent the logic levels on the individual pins, red for +5V, blue for 0V. These colours will change as the device is being tested. The direction of the arrows indicates whether the pin is an input or output pin. If the test parameters have specified waveforms to be displayed, but no pin numbers are specified, then only this socket display will be used.

WAVEFORM TRACE DISPLAY

On the trace display the waveforms themselves indicate the logic levels and the colours are used to show whether a pin is an input or output pin. The white traces are from the output pins. These are the pins being measured and compared against the specification in the device file. If the logic level on a particular pin does not match the

device file the trace will turn blue, while still showing the logic level measured. This allows the precise fault on a chip to be located if desired. Note, however, that a fault on an input pin waveforms displayed (red) are the intended stimulus waveforms - not the measured waveforms, and thus may be used as a known reference when investigating a faulty ic.

PRINT-OUT OF WAVEFORM DISPLAY

Don't do it now, but note that if you press P on the keyboard whilst the display is frozen, then a print-out of the screen will be sent to the printer port. The program "DUMP" on the disc is used for this and if you don't have an Epson compatible printer you may swap this program for your own routine.

Press <RETURN> to recommence the tests again and notice that after the eighth cycle the display at the top of the screen will change so as to display the looping count value.

The test parameters we set up at step 2 required the device to be continually tested until it failed - since we have a working 7400 in the socket the test will continue looping forever. After several looping cycles have been traced, press the spacebar to freeze the display again.

Notice how the four sections of the ic are being tested simultaneously. On careful inspection you will see that although the first four tests cover all the possibilities of input conditions, there are four further tests that change the output state of each section of the ic individually, thus checking for internally shorted sections. When constructing your own device files keep this possibility in mind.

Now to make our device fail!

Fig. 9. Typical screen display created by Chiptester.

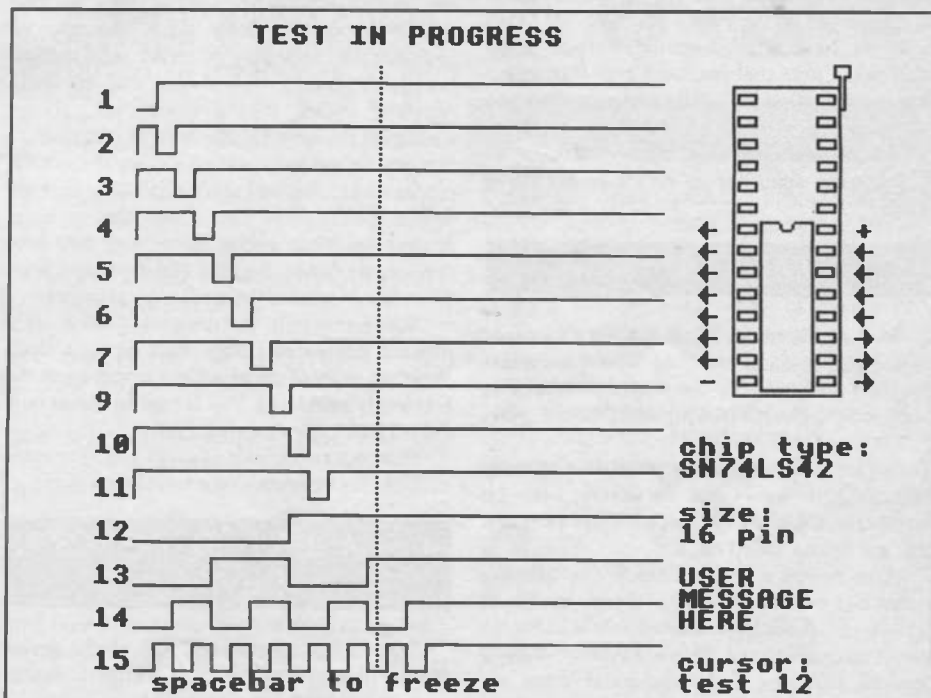

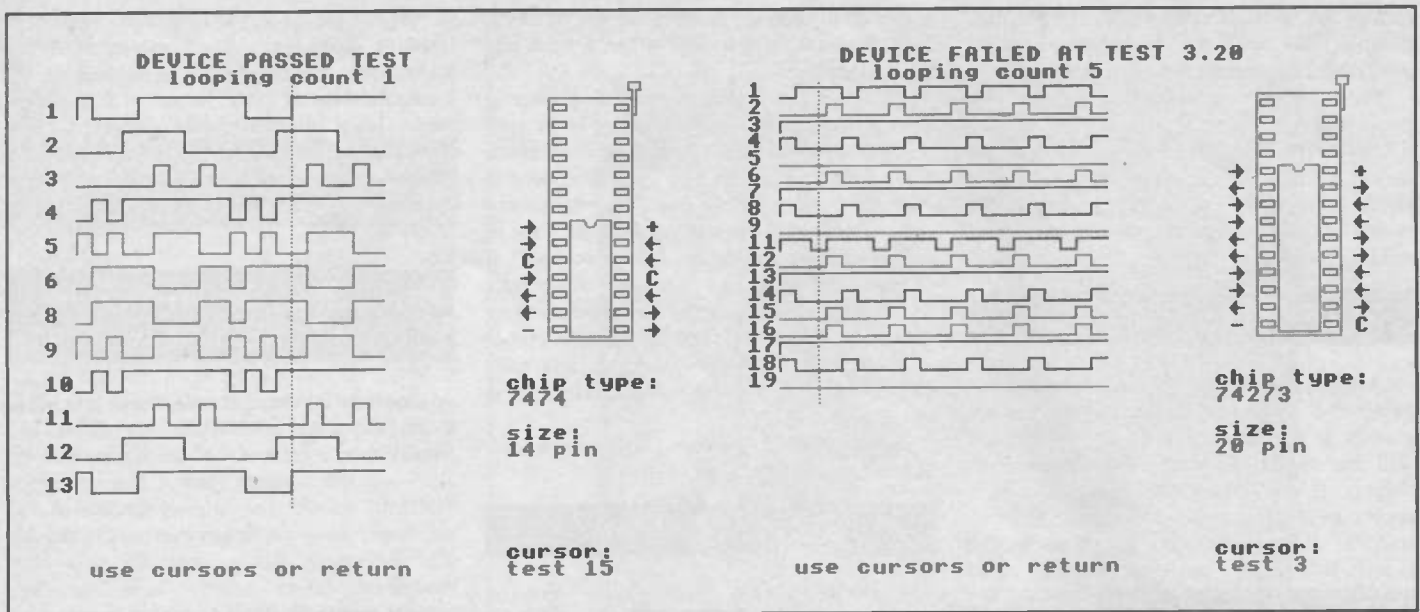

Fig. 10. Further typical Chiptester screen displays.

DEVICE FAILED MESSAGE

Press <RETURN> to recommence testing and take a small screwdriver and short together pins 8 & 9 of the ic. The ic will now fail at test 1 or 7.

The display at the top of the screen will show a message similar to:

DEVICE FAILED AT TEST 7.23
looping count 3

This means that 23 cycles had been performed before the failure occurred. Test 7 was the test number being carried out at the time (test 7 of eight tests per loop in the case of 7400) and that three loops had been performed. Note that the test number given here is the true test number relating to the device specification file. This is not the same as that shown on the cursor display.

If you have a failed device and you "loop until pass", note that the loops will start again from Test 1 after each fail. The complete test of the device will not be performed until the device actually works.

Press the spacebar to return to the main menu.

FAST TESTS

To see how much faster the testing can be performed, re-enter the Edit Test Parameters program and turn off the waveform display, but keep the device looping until failure. Now action TEST DEVICE.

Notice that the display panel is now only recording the loops and on failure, (use the screwdriver again!) the display shows the test that the device failed on.

Also notice that the Chip Socket display panel has not displayed the signal directions and levels. If we have wanted to see these we could have selected YES for waveforms, but 0 for pin numbers to be displayed when we

were in the Edit Test Parameters program.

CLOCK CYCLE DISPLAY

You will need a 7474 ic for this demonstration.

Select 7474 from the disc library (option 1) and edit the test parameters (option 2) to loop continuously, showing all waveforms. Test the device following option 3 and after one complete loop test stop the test by pressing the spacebar.

On the socket display on the right hand side of the screen you will see that pins 3 and 11 are designated as CLOCK pins by the use of the letter C.

On the waveform trace you will see that pins 3 and 11 change colour from red to blue occasionally. This is the part of the test when these pins are being used as clock pins. Notice that the "clock cycle" actually lasts for two Chiptester cycles. With some devices, eg counters, the clock may go on for many cycles, but the waveform will always end up doing complete cycles, thus a clock cycle always finishes at the same voltage level as it started.

Only on the last cycle of a clock test are the output states measured and compared against the device specification. This means that on some devices the white output traces may turn blue temporarily during the time that the output level is not as expected in the device specification.

Notice that only the designated clock input pins are allowed to change state during a clock cycle, all other input pins have to remain at the previously held level. This is true no matter how many clock cycles are specified.

Short out two ic pins again (8 and 9) or press <ESCAPE> to return to the main menu.

4. SEARCH FOR UNKNOWN DEVICE

This feature allows you to match the device library files against the measured performance

of the unknown ic. The whole library is searched, and any device with a similar pin size is matched, so the test takes considerably longer than selecting from disc and testing directly.

It's a useful test if somebody has scratched the marking off the ic or if it's a "house" coded device.

Insert the 7400 in the test socket and select option 4. Notice that the program asks for the number of pins on the chip. This automatically rules out some of the devices and shortens the testing time. Be sure to set the Chiptester switch to the same number of pins as the device.

When the test is run the program will list any device number that corresponds logically to the chip in the socket. For the 7400 there are quite a number of them since Chiptester does not distinguish between the different open collector types and devices with varying current source/sink ability.

The search feature will not test chips which require an offset in the socket.

5. ENTER/EDIT TEST DATA

Part 1 - entering data:

This is the part of the package that allows you to construct test files for yourself (or edit existing ones). You can skip this section and also section 6 if you only want to test devices already on the disc file.

Note: It is assumed that the user of this section will be fully conversant with both the logical and electrical operation of ics. For many types of device you will need the manufacturer's data sheet to help you construct valid tests.

Select option 5 from the main menu.

If you have already loaded a file from the disc as described previously then you will receive this message.

ENTER NEW DATA (Y/N)



This option allows you to use the same program to EDIT the existing device file by answering N. On this occasion though, answer Y in order to enter new data.

PRIME INFORMATION ENTRY

This is the data entry page for capturing fundamental information about the device. If you pressed Y in answer to the "enter new data" question, then the chip socket display will be empty and the bottom right-hand display panel will be blank. If it's not then you are in the EDIT mode and the following description will not make proper sense so press escape and re-answer the question with Y.

The cursor will be flashing on the entry panel for the chip type number. The yellow dot marks the 10th character which is the maximum length for a type number. Note the prompt at the bottom of the screen.

We are going to use our 74LS00 again, so enter 7400 and <RETURN>.

The next line is asking for the offset in the socket, enter 0 or just press <RETURN>. (An offset is only used for ics with unusual supply pins, see earlier in the article for details).

Now enter the number of pins on the chip: 14 <RETURN>.

For the user message you could enter any message of your own, such as:

MY FIRST TRY <RETURN>

Note from the prompt that you may enter up to 30 characters, these will be split up into three lines of 10 characters each. The yellow dots indicate the 10th character of each line.

For the clock pin numbers, Enter 0 or just <RETURN> as the 7400 does not need clock cycle testing. If the device needed clock cycle testing we would have entered the number(s) of those pin(s) designated as clock input pins.

For the 7400 we have four output pins, 3,6,8, & 11, enter these using a <RETURN> between each number and an extra <RETURN> to finish ie:

3 <RETURN> 6 <RETURN> 8 <RETURN> 11 <RETURN><RETURN>

The right hand side of the display will now show you all the parameters you have just set up, including the chip position and the input/output relationship of the device pins.

If everything is correct then answer Y to the prompt, else go back and re-enter anything you would like to change. Note that you only need to press <RETURN> to keep items previously entered.

LOGICAL DATA ENTRY

This is the section that allows entry of the actual tests to be carried out on the device. Up to 28 tests are possible and if you have specified clock pins then some of these tests may be clocked for up to 1024 cycles. Each test will be entered as a new 'page' of this display.

The first page, "Test 1 of 1", only allows definition of input and output pin levels. Other pages will allow the exit of the test or the facility to skip back to edit, or view previous tests. Note that <ESCAPE> is inactive in this part of the program as you may only return to the main menu by completing the test file tidily. This is achieved by entering 28 in the skip line. (see under last Test below).

When entering logical events, enter the pin numbers that are at a high, or logic 1 level. All others are assumed to be low. Do not enter the supply pin number. Note that pin numbers may be entered in any order, but it is usually easier to enter them in numerical order, or in the order of a pre-written logical table.

This is a truth table for one section of our 7400:

| Pin | 1 | 2 | 3 |
|----------|----|----|-----------------|
| Function | IN | IN | OUT |
| | H | H | L |
| | H | L | H=NAND Function |
| | L | H | H |
| | L | L | H |

This is the same for all the other sections of the ic and as all the pins of the socket can be measured simultaneously we can test all the sections with just four tests. However, since we have 28 tests available we will add four more tests to check that the output pins will toggle independently.

This is what our eight tests will look like:

TEST FUNCTION TABLE

| Pin | Function | Tests | | | | | | | |
|-----|----------|-------|---|---|---|---|---|---|---|
| | | 1 | 2 | 3 | 4 | 5 | 6 | 7 | 8 |
| 1 | IN | H | H | L | L | H | L | L | L |
| 2 | IN | H | L | H | L | H | L | L | L |
| 3 | OUT | L | H | H | H | L | H | H | H |
| 4 | IN | H | H | L | L | L | H | L | L |
| 5 | IN | H | L | H | L | L | H | L | L |
| 6 | OUT | L | H | H | H | H | L | H | H |
| 7 | GROUND | | | | | | | | |
| 8 | OUT | L | H | H | H | H | H | L | H |
| 9 | IN | H | L | H | L | L | L | H | L |
| 10 | IN | H | H | L | L | L | L | H | L |
| 11 | OUT | L | H | H | H | H | H | H | L |
| 12 | IN | H | L | H | L | L | L | L | H |
| 13 | IN | H | H | L | L | L | L | L | H |
| 14 | SUPPLY | | | | | | | | |

So to enter "test 1" we enter "logic high input pins" with:

1 <RETURN> 2 <RETURN> 4 <RETURN> 5 <RETURN>

9 <RETURN> 10 <RETURN> 12 <RETURN> 13 <RETURN> <RETURN>

and "logic high output pins" with:

0 <RETURN>

since no output pins are high for this test.

Notice that our yellow pins have now turned blue to indicate that the display is now in a valid state for the test number displayed (test 1).

Look at the chip socket display: if this corresponds with our first column in the test function table then press Y to answer the prompt. Notice that the display page now changes to: "Test 2 of 2" and the display now has an extra line to allow exit from the tests by entering 28. We will see this used in test 8 (see Last Test below).

Also notice that the blue has turned yellow again. This is because the display is now not valid for test 2. However, the display is useful since it shows the previous test conditions and this allows you to check previous values easily as a comparison and memory jogger.

CLOCK CYCLE ENTRY

(Skip this section when practising with the 7400).

If we had specified a clock pin(s) in the prime information section, this second test would also have displayed another line asking for the clock count value. Note for reference that once a clock count has been entered for the current test page, then the input pin logic levels may not be changed and the values assumed for the input pin levels are those of the previous test. Only the defined clock pin(s) will change logic levels during a clock cycle(s). Note also that the value entered for the output pin levels will be tested only at the end of all the clock cycles called for, although the display will show the measured output waveforms during each of the clock cycles.

So now enter the second test from our function table:

Input Pins 1 <RETURN> 4 <RETURN> 10 <RETURN> 13 <RETURN><RETURN>

Output Pins 3 <RETURN> 6 <RETURN> 8 <RETURN> 11 <RETURN><RETURN>

Skip etc. <RETURN>

Check the display against our function table and if all is well, answer Y to the prompt.

ERROR CHECKING

You may have noticed by now that the program has a certain amount of error checking built into the entry routines. Some of these allow re-entry of individual numbers and some require the re-entry of the whole line. If you make too many mistakes in one line the the program may give up and pass on to the next line anyway, so always check the display before passing on to the next test.

Now enter more of the tests in our function table, up to and including test 7.

Last Test, Exit From Data Entry

Enter test 8 like this:

Input Pins 12 <RETURN> 13 <RETURN><RETURN>

Output Pins 3 <RETURN> 6 <RETURN> 8
<RETURN><RETURN>

Skip etc.: 28 <RETURN>

After checking the display, press Y in answer to the prompt and you will return to the main menu. This is because 28 was entered in the 'skip' line.

The test files are all held in memory so you can now use options 2 and 3 to test the device and check that your specification works. If it needs editing then you may use option 5 again to re-enter the editor.

CHECKING DEVICE FILES

It is of course necessary to have a device to test and we will assume that it is also a working one!

Plug in the ic and use option 2 to set the display to show all the waveforms. Now use option 3 to test the device and when the test is complete, check the waveforms against the Test Function Table.

If you have made a mistake in entering the tests or interpreting the device data sheet then Chiptester will fail the device at the first place a fault is discovered. Check the displayed waveforms looking for the blue marked section(s) of the output traces. At this point the trace will show the measured value of the output pin in question and the value in the file is thus the inverse of this and should therefore be changed. One should study the display and discover the cause of error before making a note of the test number and using option 5 to edit the test files.

Note that there may be further errors, but Chiptester will not warn you of this until the first error is corrected.

When you are satisfied that the test files are correct you will want to save them to disc. See option 6 below for this.

5. ENTER/EDIT DATA

PART 2 EDITING DATA:

In order to edit the test data answer N to "ENTER NEW DATA".

If the Prime information is correct then answer Y to the prompt to gain entry to the Logical Data pages.

Notice that the display now shows "test 1 of 8" and the blue colour indicates that the information is valid for this test. By answering the prompt with Y each test may be quickly flipped through and checked if desired.

Note that for longer tests you may get to any particular entry quickly by answering N to the prompt then <RETURN> for each entry and using the skip function to skip directly to the particular test that you are interested in. This is possible because <RETURN> without any entry value will leave the previous values for that line intact.

Note also that one must be careful to avoid accidentally editing past the end of the file (test 8 in our example), as the effect is to create a longer file. Naturally, any accidental extension

may be converted into a valid test by repeating the last test or any valid data, but it is not possible to shorten a file by using the edit facility.

When the required test is arrived at, answer N to the prompt to enter the edit facility for that test. Notice that the display colour changes to yellow to indicate non-valid data, but this time the display shows the data for the current test rather than the previous test. Having changed the data for the test in question, one may either enter 28 for the skip number (thus leaving the edit session) or press <RETURN> to move on to the next test page.

When editing, always enter values into the line requiring change, as just pressing <RETURN> will leave the previous entry intact. If there are no pins at a logical high value then enter 0 <RETURN> to clear out the previous values.

Values that need to stay the same need not be re-entered as a <RETURN> will leave the previous entries intact.

EDITING CLOCK CYCLES

Be very careful when editing data files that contain clock cycles. Every clock cycle test must be immediately preceded by a non-clock test in order to set the state of the input pins for the clock cycle. In normal entry this is ensured by the software, but during editing it is possible to defeat the conditional entry and thereby set up a clock cycle that has another clock cycle test immediately preceding it. The input conditions are not guaranteed under these circumstances and so the test will be invalid.

6. SAVE DATA TO DISC

Once the test data has been verified option 6 may be used to save the file to disc.

The program will offer the type number currently assigned (7400 in our case) and if this is to be changed, one may do so by answering the prompt with N.

In our example we'll leave it set to 7400 and answer Y to the prompt. The disc will now be searched and in our case it is found that a 7400 already exists on file and we will be given the option of overwriting the existing file with the new data in memory. It is left to your discretion as to whether it is desirable to overwrite the existing file! Note that if we answer N, then the way to leave this section is to use <ESCAPE>.

Altering the contents of a type on disc file:

Use option 1, 5 and 6 as above to overwrite the existing file.

Altering the type number of a disc file:

It is sometimes useful to keep the data on disc file intact, but to change the type number that is assigned to it. It is not possible to do this within the main program, but there is a utility file on the disc which will do this for you.

From Basic, CHAIN"U.ALTRDEV" and follow the instructions. After use, program

control will be passed back to Chiptester.

This is most useful for discarding a rubbish file accidentally saved to disc - usually done while demonstrating Chiptester! Use a type number that you will want to use next and then after entering the correct data for this type, use option 6 to overwrite the rubbish file.

Since every device record is 349 bytes long it is possible to edit the files using DISC DOCTOR or a similar product, should the need ever arise. See the appendix for details of the record structure.

Starting a brand new set of files:

In order to comply with all versions of DFS it is necessary to start with one entry in a file already on disc. So if you wish to start a new disc, say with a new range of ics, the following procedure should be adopted:

1. Backup the master disc to your new freshly formatted disc.
2. Put away your master disc!
3. Delete the old DATA file on your backup.
4. Use option 5 to enter the data for the first new device and from the main menu press BREAK to enter Basic.
5. CHAIN the utility U. STRTFLE and follow the instructions given.

A new DATA file will now be created containing just the one entry.

Note that it is possible to start a file without using instruction 4 above, but your new file will contain a dummy entry which may be overwritten at a later date as described using U. ALTRDEV as above.

Options 7 and 8 do not require our demonstration device in order to be described.

7. LIST DEVICES ON DISC

This facility allows you to list by type number all the devices on the disc in drive 0.

The following options are selectable.

- a) list to screen
- b) list to printer and screen
- c) list in the order found in the DATA file
- d) sort the file into alphanumeric order before listing
- e) if sorted, the file may be dumped to other disc surfaces. This can only be done with systems addressing more than one drive.

When listing files longer than 60 ics to the screen, the computer will pause between batches. Press <SHIFT> to display subsequent pages.

8: BATCH TEST

This facility is very similar to option 3 except that no waveform display is provided and that the test procedure may be repeated without returning to the main menu.

The facility is provided in order to give a very speedy operation when testing batches of the same chip. Once set up, all that is required is

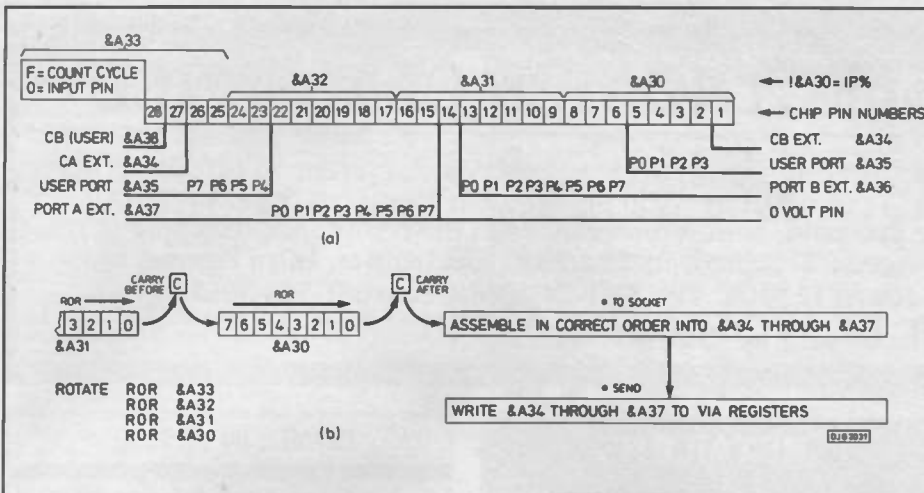

Fig. 10. (a) Socket pin to computer variable assignments. (b) Changing the word !&A30 into bytes to be sent to the socket pins.

the exchange of the chip in the socket and the press of one key on the computer.

Except for the selected power supply pin (which, if desired, may be altered by turning the front panel switch between tests), the chip socket is powered down whilst the instructions are displayed.

Exit to the main menu by pressing <ESCAPE>.

SOFTWARE WRITING

The following section discusses some software details for those who might like to experiment with writing their own programs.

In the computer, the word location !&A30 is used to store the value taken from the universal zif socket or to set the VIAs to the required output levels. As can be seen from the upper part of Fig.10a the four bytes of the word are arranged logically with the least significant bit representing pin one of the socket.

The lower part of Fig. 10a illustrates the actual socket pin connections with the ports of the VIAs. Because it's not practical to have all the VIA ports line up logically with the socket pins some conversion has to be done when writing to or reading from the socket, and this is done while the word !&A30 is converted into bytes.

Fig. 10b shows the method used to slide the word !&A30 into the various bytes waiting to be sent to the socket pins. The Rotate Right (ROR) command is used on each of the four bytes of the word in turn with the result that all the bits are moved down by one and the least significant bit (corresponding to pin 1) ends up in the Carry

bit where it can be tested and assembled into the correct position of the byte waiting to be sent to the VIA register concerned with that pin. On successive cycles of ROR instructions the remaining pins of the socket are appropriately handled.

The following example program is used to send the five pre-assembled bytes to the VIA registers and serves to illustrate all the variables and commands needed. Naturally, similar subroutines will be needed to set the directions of the VIA pins and to read in the values from the chip under test, and these may be found on the software disc using the same variable names as used below.

ADDRESSES AND VARIABLES:

Variables

| | | |
|-------------|--------|--------|
| USER PCR CB | cbuser | = &A38 |
| EXT CA & CB | cabext | = &A34 |
| USER VIA | portu | = &A35 |
| EXT VIA PA | portu | = &A37 |
| EXT VIA PB | portb | = &A36 |

Operating System call addresses

| | | |
|---------------|-----------|---------|
| O.S. call | osbyte | = &FFF4 |
| Internal page | rdsheila | = &96 |
| | wrtsheila | = &97 |
| External page | rdfred | = &92 |
| | wrtfred | = &93 |

VIA Registers

| | | |
|---------------|---------|-------|
| PCR external | PCRext | = &0C |
| PCR internal | PCRuser | = &6C |
| User (base) | Uadd | = &60 |
| Ext. A (base) | Aadd | = &01 |
| Ext. B (base) | Badd | = &00 |

Main machine code subroutines on disc.

| | |
|------------|--------------------------|
| .direction | Sets skt. pin directions |
| .toskt | Disassembles !&A30 |
| .fromskt | Assembles !&A30 |
| .send | Send disassembled word |
| .read | Read back VIA registers |

Code for sending data to socket

```
.send      LDY      cbuser
           LDX      #PCRuser
           LDA      #wrtsheila
           JSR      osbyte
           LDY      cabext
           LDX      #PCRext
           LDA      #wrtfred
           JSR      osbyte
           LDY      portu
           LDX      #Uadd+0
           LDA      #wrtsheila
           JSR      osbyte
           LDY      porta
           LDX      #Aadd+0
           LDA      #wrtfred
           JSR      osbyte
           LDY      portb
           LDX      #Badd+0
           LDA      #wrtfred
           JSR      osbyte
           RTS
```

SOFTWARE

The author, David Rayner, has kindly offered to supply readers with a copy of his software disc for the nominal price of £6. This includes postage in the UK, but overseas readers should add an extra £1 to cover the additional postage. Please write to him at 10 Hardys Field, Kingsclere, Newbury, Berks. RG15 8EU. A listing of the software is available from the PE Editorial Office. Please enclose a large stamped addressed envelope.

DEVICE PASSED TEST

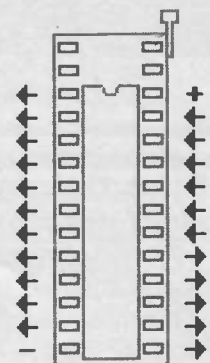
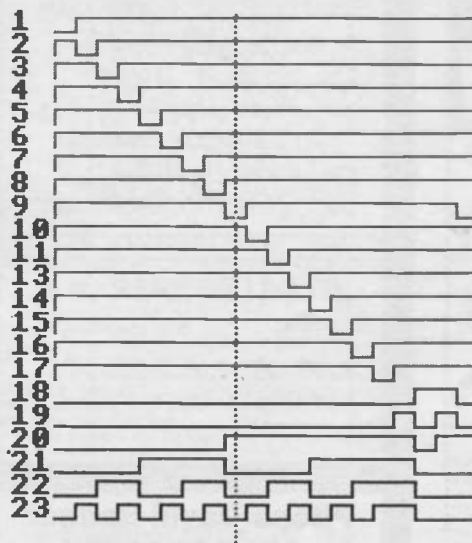

chip type:
74154

size:
24 pin

PE

PRACTICAL ELECTRONICS CLASSIFIED

Reach thousands of serious electronic and computer enthusiasts. Advertise in PE Classified pages: Rates 20p (plus 3p VAT) per word or £8.50 per single column cm (plus VAT). All classified advertisements must be pre-paid. Send your copy with the remittance (payable to Intra Press or payment by Visa or Access accepted) to: Practical Electronics, Intra House, 193 Uxbridge Road, London W12 9RA. Tel: 081-743-8888. Fax: 081-743-3062
LET PE WORK FOR YOU!

EDUCATION

FULL-TIME TRAINING COURSES

2 YEAR
BTEC NATIONAL DIPLOMA
 Electronics and Communications Engineering
 (TV, Computers, Programming, IT)

1 YEAR
BTEC NATIONAL CERTIFICATE
 1. Electronic Equipment Servicing (TV, Video, CCTV)
 2. Computing Technology (Microprocessors, DataComms, Interfacing)
 3. Information Technology (Telecomms, Satellite TV, Networks)
 4. Software Engineering (Assembler, BASIC, Pascal, CAD/CAM)

★ Those eligible can apply for E.T. grant support★
 ★ An equal opportunities programme ★
COURSES COMMENCE
 Monday 7th January 1991

LONDON ELECTRONICS COLLEGE

Dept: AA, 20 Penywern Road, London SW5 9SU. Tel: 071-373 8721

Start training now for the following courses.

- Telecomms Tech C&G 271
- Radio Amateur Licence C&G
- Microprocessor
- Introduction to Television

Send for our brochure - without obligation or telephone us on 06267 79398 (Ref: PE11/90)
 Name.....

Radio & Telecommunications Correspondence School, 12 Moor View Drive, Teignmouth, Devon TQ14 9UN

RETAILERS

EDINBURGH

OMNI ELECTRONICS

stock a wide range of electronic components at
174 Dalkeith Road
Edinburgh EH16 5DX
Tel: 031 667 2611
 Open Mon-Fri 9am-6pm
 Sat. 9am-5am
NEW CATALOGUE OUT SOON
 Price is just £1.50
 Contact Omni Electronics now for details

Practical Electronics Classified Works!

Dear Mr. Bonner,

Just a line to say that I was delighted with the response from my advert in the June Practical Electronics; the number and quality of replies exceeded my best expectations.

Yours sincerely,

M. H. C. Lewis
 Newcastle-upon-Tyne

Phone David Bonner on 081-743-8888 for details!

LONDON WEST

TECHNOMATIC LTD

Please see our display advertisement in this issue for more details!

MANCHESTER

THE ELECTRONICS SHOP

We stock a large range of electronic components, test equipment, telephone accessories, computer accessories, microphones, speakers, discolorighting, mixers, meters, stylus, so call in and have a look around.
 29 Hanging Ditch, Manchester M4 3ES
 Telephone: 061-834-1185
 Fax: 061-833-2969

SOUTHSEA

ELECTRONIC COMPONENTS

EVERYTHING FOR YOUR NEXT PROJECT
 THE BIGGEST DISPLAY IN THE SOUTH IS AT
FRASER ELECTRONICS
 42 ELM GROVE ★ SOUTHSEA ★ HANTS
 Telephone: 0705-815584

Barclaycard

Access

STAFFORDSHIRE

COMPONENT SOLUTIONS Ltd.

"answering your component problems"

Unit 62, Enterprise Centre, Bedford Road, Stoke-on-Trent, Staffs.,
 Tel: 0782 287038

COMPONENTS

CAMBRIDGE COMPUTER SCIENCE LTD

10MByte Winchester, used, 3 months Wty, £42.00 each
 5.25" Disk Drives, 80 Track DSDD £34.00 each
 5.25" drive cases, room for drive, PSU and fan £10.00 each
 5.25" Disk Drives, 80 Tk DSDD Used No Wty £15.00 each
 (The £15.00 drives are sold on a strictly "as is" basis)
 5.25" Disks, DSDD, 48tpi boxes of 10 £3.00 box
 40W PSU 5V 3.75A, 12V 1.5A-12V 0.4A cased with on/off switch £10.00 each
 Bare switch mode PSU 5V 2.5A, 12V 2A-12V 0.1A £7.00 each
 Gould PSU 0-30V @5A Limited quantity only £45.00 each
 Single Data lead (BBC Micro to Disk Drive) £2.00 each
 Dual Data lead (BBC Micro to 2 Disk Drives) £4.00 each
 Power lead (BBC Micro to Disk Drive) £2.00 each
 Dual power lead (BBC Micro to 2 Disk Drives) £4.00 each
 68000 CPUs (The first orders get 10MHz chips) £3.50 each
 8086 CPU chips £2.00 each
 Z80A CPU, CTC, P10 £1.20 each; DMA £2.00 £0.12 each
 74LS TTL, pick and mix, buy 10 or more for £0.12 each
 Types available: '00 '02 '04 '08 '11 '13 '15 '20 '21 '26 '27 '30 '32
 '33 '37 '38 '42 '74 '83 '86 '96 '107 '109 '122 '132 '136 '139 '145
 '151 '153 '157 '158 '162 '163 '164 '165 '174 '191 '193 '253 '257
 '298 '353 '365 '390 '393 '670
 2764 EPROMS (Ex-equipment) £1.00 each
 27128 EPROMS (Ex equipment) £1.20 each or £5.00/5
 27128 EPROMS £2.50 each
 27C256-25 EPROMS £3.50 each
 256K Byte DRAM Modules, removed from equipment £6.00 each
 6116 2K Byte SRAM £1.10 each
 6264 8K Byte SRAM -15 £3.00 each -12 £3.80 each
 62256-10 32KByte SRAM £5.00 each
 65256 32K Byte rams £4.00 each
 8K Byte NV ram chips £3.00 each £10.00 four
 20 pin dit low profile IC sockets £0.50 (ten) - £ 4.00 (100)
 40 pin dit low profile IC sockets £0.60 (ten) - £ 5.00 (100)
 DEC LSI11/23 CPU cards used but working £50.00 each
 CPU cards (Newbrain) Z80 CPU, 3 EPROMS & 60+ mostly 74LS ICs £2.00 each
 LCD graphics module 240 by 64 pixel with driver chips £13.00 each
 Circuit tester, finds faults in TTL & CMOS logic circuits, inc leads £8.00 each
 Keyboard, 100 keys on board LCD & micro if £8.00 each
 Metal project boxes drilled & painted but unused 28x32.5x5cm £5.00 each
 Toroidal mains transformer 12V 4A & 0.4A, 12-0-12 0.1A & 2A, 9-0-9 0.2A £4.00 each - £6.00 for 2 - £8.00 for 3
 Video Tapes, E180 VHS £2.50 each
 Smoke detectors, small size £7.00 each
 Smoke detectors, large with escape light and pause feature £13.00 each
 Prices include postage. Add 50p to orders below £5.00.
 All items new unless stated. Add 15% VAT to all prices.
 Send an SAE for our latest list or for more info.
Dept PE, 374 Milton Road, Cambridge, CB4 1SU
Tel: 0223 424602 or 0831 430496 or 0831 430552
(Mail order only, no facilities for callers)

Resistors 1/4 W 5% carbon (E12) 1p metal film 1%3p
 Resistor Pack 85 different E12 values + zero ohm link total count
 1000 resistors£8.95
 LEDs red/green 3/5mm6p each. Yellow 11p
 Cable ties 75mm1p each £5.95/1,000 £49.50 per 10,000
 Stepping motor 4 phase 12v 7.5' step 50 ohms£8.95
 SAA 1027 stepping motor driver chip£3.95
 FM transmitter Kit good quality sound£7.94
 High quality photo resist copper clad epoxy glass boards
 Dimensions single sided double sided
 3x4 inches£0.95
 4x8 inches£2.40
 6x12 inches£5.37
 12x12 inches£10.66
Special Offers
 Computer Grade Capacitors with screw terminals 3800uf 20v £2.50
 8700uf 10v £1.95, 6800uf 15v £2.95, 1000uf 16v £1.50
 7 segment Common anode led display 12mm£0.45
 LM2931A.T5.0 Low drop out 5V regulator T0220 package£0.85
 BS250 P channel MOSFET £0.45, BC559 transistor£3.95 per 100
 SAA1027 hex inverter £10.00 per 100, used 8748 Microcontroller£3.50
 Stereo LW/MW/FM Tuner pre-amp assembly complete with volume/tone controls and tuning scale Brand new in makers carton£5.95, faulty £2.50
 Circuit diagram description and setting up procedure for tuner assembly described above £0.50. 5 digit 6v electromagnetic counter£1.95
 Hour counter (used) 7 digit mains 240V AC 50Hz£0.95
 LCD display 16 digit 7x3 dots dot matrix£2.50
 Query keyboard 58 key good quality switches£5.00
 95p for P&P per order (VAT inc.)
 wide range of CMOS TTL 74HC 74F Linear transistors kits capacitors, resistors tools etc always in stock
JPG Electronics 276 Chatsworth Road Chesterfield S40 2BH
 Access orders (0246) 211202. Callers welcome

COMPONENTS

Carbon Film Resistors 1/4W E24 series 0-51R to 10MΩ - 1p
 100 ohm per value - 75p 1000 off in even hundreds per value - £7
 Metal Film 1/4W 10R0 to 1MΩ 5% E12 series - 2p 1% E24 series - 3p
 1/4W metal/carbon film E24 series 1R0 to 10MΩ - 11p
 1 Watt metal/carbon film E12 series 4R7 to 10MΩ - 1p
 BC107/8/9 - 12p BC547/8/9 - 8p BC182L 184L - 10p
 BFY50/S1/2 - 20p 2N3055 - 50p TIP31A,32A - 25p TIP41,42, - 40p
 Tantulum bead subminiature electrolytics (Mkds/Volts)
 0-1/35, 0-2/35, 0-4/35, 3-3/16, 4-7/16 - 14p 4-7/35 - 15p
 2-2/35, 4-7/25, 10-5 - 16p 4-7/35, 6-8/16 - 16p 10-16, 22/6 - 20p
 22/16 - 30p 33/10 - 30p 47/10 - 35p 100/6 - 40p
 Aluminium Electrolytics (Mkds/Volts)
 1/50, 2-2/50, 4-7/25, 4-7/50, 10/16, 10/25, 10/50 - 5p 22/16, 22/25 - 8p
 22/50, 47/16, 47/25, 47/50 - 8p 100/16, 100/25 - 7p 100/50 - 12p
 100/100 - 14p 220/16 - 8p 220/25, 220/50 - 10p 470/16, 470/25 - 11p
 1000/25 - 18p 1000/35, 220/25 - 22p 4700/25 - 70p
 Miniature Polyester Capacitors 250V Wdg. Vertical Mounting
 .01-.015, .022, .033, .047, .068 - 4p 0.1 - 8p 0.15, .22 - 4p 0.47 - 8p
 Mylar Capacitors 100V Wdg. Vertical Mounting E12 Series
 1000p to 8200p - 2p .01 to .068 - 4p 0.1 - 5p 0.15, 0.22 - 8p
 Subminiature Ceramic Plate 100V Wdg. E12 Series Vertical Mounting
 2% 1P8 to 47P - 2p 50P to 330P - 4p 10% 300P to 4700P - 4p
 Ceramic plate/disc E6 Series 50V 22P to .047 - 2p
 Polystyrene Capacitors 63V Wdg. E12 Series Axial Mounting
 10P to 820P - 2p 1000P to 10,000 - 4p 12,000P - 8p
 1N4148 - 2p 1N4002 - 4p 1N5404 - 14p W01 bridge - 25p
 OA91 - 8p AA143 - 8p W005 - 20p 1N4006 - 8p
 Zener diodes E4 series 3V3 to 33V 400mW - 8p 1 watt - 12p
 L.E.D's Red, Green & Yellow 3mm & 5mm - 10p 8mm - 20p
 20mm fuse 0-1A to 5A quick blow - 8p Anti Surge - 8p
 High Speed diodes 0.8mm, 1.0mm, 1.3mm, 1.5mm, 2mm - 30p
 Expo Reliant drilling machines 12Vdc. with improved 3-jaw chuck £7.00
 Nicada AA - 80p HP11 - £2 PP3 - £4.20 Universal Chargers - £8.80
 Glass reed switches single pole make contacts - 8p Magnets - 12p
 VAT Inclusive. Return postage 30p (free over £5). Lists free
THE C.R. SUPPLY CO.,
127 Chesterfield Road,
Sheffield S8 0RN. Tel. 567771.

Manufacturers Original Spares
 Available for many makes of TV, Video & audio Equipment. Also Sinclair, Amstrad, Commodore & Atari Computers. Write (Encl. SAE please) or Phone for a 'Price and Availability' on your requirements.
 6510 CPU (C64C) £ 8.87
 Commodore 6526 CIA (C64C/C128)£10.86
 8580 R5 (C64 C)£13.98
 Custom 8701 CLK. GEN. (C64/C128)£ 7.56
 906114 PLA (C64C)£ 5.73
 Chips 901225 CHA. ROM (C64C)£ 6.37
 901226 BAS. ROM (C64C)£ 9.21
 6C001E ULA (Spec. 48K+)£15.99
 7C001 ULA (Spec. 128K+)£16.99
 & UM1233 MODULATOR (Spec. & QL)£ 4.75
 Amstrad Original Service Manual (CPC484 + Monitors)£ 8.49
 Spares Original Service Manual (PCW/8256/8512)£13.59
 PEG1A (84pin) @£42.72 TEA2000 @£ 4.04 MA8049 (QL) @£ 5.96
 MAIL ORDER ONLY. For catalogue/Lists please send 44p stamps/cheq. etc. please add 95p (UK) P&P to above orders TEL: 0452 26883
 MARAPET (PEL) @ £11 Hornbeam Mews, Gloucester GL2 0UE

IS YOUR ADVERTISEMENT
 A TIGHT SQUEEZE?
**STRETCH OUT
 IN THE DISPLAY
 PAGES OF PE!**
 PHONE DAVID BONNER FOR
 DETAILS ON 081-743-8888

N.R. BARDWELL LTD
 200-Signal diodes 1N4148 £1.00
 100-Rectifier diodes 1N4001 £1.00
 100-Zener diodes 5V8 400mW £1.00
 30-Assorted DiI sockets up to 40 pin £1.00
 30-Assorted Sockets/Cons. Dil. Edge, I.D.C., Header etc £1.00
 30-Transistors BC478 £1.00
 20-Minature SP/CO Slide switches £1.00
 20-Magnetic ear pins + lead and Plug £1.00
 75-Electrolytics 4.7uf 63V £1.00
 1-10 Watt stereo amplifier - 4 controls and data £2.95
 Prices include VAT, postage 60p. All items new.
 Many other lines in stock.
 Shop open Mon/Sat 9.30-5.30. Lists S.A.E.
288 Abbeydale Road, SHEFFIELD S7 1FL
TEL: (0742) 552886 FAX: (0742) 500689

COMPONENTS

Winter Bargains From SARM Digital
 LEDs 3 and 5mm Red, Yellow and Green Pkt of 5 40p
 Diodes 1N4148 Pkt of 10 20p 1N914 Pkt of 10 30p
 Zener Diodes 8Zx55C 2.7V to 30.0V 5p each
 BZX85C 4.7V to 75.0V 7p each
 Veroboard 2939 £0.96, 2958 £1.05, 3939 £1.00
 Right angle D-Plugs 9-way £0.59, 15-way £0.80, 25-way £0.98, 37-way £1.37, D-Sockets 9-way £0.73, 15-way £0.89, 25-way £1.06, 37-way £1.90
 Metal Film Resistors 0.5W 1% All values 2p each
 Presets 0.15W Horiz or Vert All values 10p each
 Add 15% VAT to all prices. Post /Packaging £1.00
1991 CATALOGUE NOW CONTAINS 000's OF COMPONENTS INCLUDING SMD £1.80 (NO VAT)
 Cheques or PO's made payable to: SARM DIGITAL,
 13 PEARLE STREET, MACCLESFIELD, CHESHIRE, SK10 2AL
 MAIL ORDER ONLY, PROP N. FARRAR

COMPONENT PACKS • COMPUTER PARTS
 Processor Chips, CMOS devices, logic chips, transistors, caps, switches, (all packs £1) memory expansion boards (At com)/display adaptors (at comp) + SAE for lists
LANGHAM SOFTWARE
 Shaftesbury Centre
 Percy Street
 Swindon SN2 2AZ
 TEL (0793) 514055 (day)
 (0793) 491048 (night)
 FAX (0793) 512477

ENCLOSURES

DOES YOUR ELECTRONIC EQUIPMENT LOOK NON-PROFESSIONAL? DO YOU LACK A QUALITY FINISH?
 Achieve that professional look by using printed front panels, sub-frames, outer cases, etc. from a company that has its own metalwork division and offers a wide range of metal work at affordable prices.
 For full details large SAE to:
A C PARTRIDGE LTD,
 Metalwork Division,
 Unit D, 318 High Road,
 Benfleet, Essex SS7 5HB

RACK CHASSIS FOR THE CONSTRUCTOR
 UNITS ARE CONSTRUCTED OF ALL ALUMINIUM PARTS FRONT & REAR PANELS ARE CLEAR BRUSHED ANODIZED THE BALANCE OF PARTS ARE BLACK BRUSHED ANODIZED
 UNITS SHIPPED FLAT
 SEND FOR FREE CATALOG OF SHEET METAL BOXES, RACK CHASSIS, RACK PANELS, SHEET METAL PUNCHES, PRESS-ON LETTERING, HAND PUNCH TOOL AND PUNCH RTTS, AND OUR LINE OF OVER 300 PROFESSIONAL AND SEMI-PROFESSIONAL AUDIO PRODUCTS.
 ACCESS, VISA ACCEPTED. SHIPPED AIR PARCEL POST AT NO CHARGE.
BESCOM, INC.
 2100 WARD DR.
 HENDERSON, NV, 89015 U.S.A.
 (702)-565-3400 FAX (702)-565-4828

I recently heard a group of pop musicians enthusing on the radio about their discovery of "acoustic" music and musical instruments. Apparently this was a mind-blowing experience for them. It was some kind of revelation, a cleansing of the doors of perception. In my ignorance I had thought that all music was acoustic, in the original Greek sense of that word. But obviously I was behind the times. They were concerned with different ways of generating the sound waves, rather than with hearing.

Of course, their discussion was perfectly understandable against the background of most people's experience of music - pop, classical or whatever - which is predominantly electro-acoustic. Apart from recording, reproduction and broadcasting, even at live pop concerts the audience hears the voices and instruments mainly through the colouring of transducers, filters and loudspeakers. Sound synthesisers and musique concrete processors can only be made audible by electro-acoustics.

INDUSTRY



NOTEBOOK

conventional concert hall. We all sat like idiots gazing at an ugly heap of racks, boxes and cables for several hours. One attempt to mitigate this kind of uneasy experience is 'space music'. Four loudspeakers are placed in the corners of the hall and play back four different parts arranged by the composer in a contrapuntal relationship, or perhaps a contra-locational relationship. I haven't heard this, but it's reported to be a pleasant musical experience, possibly a bit like having several orchestras in different positions around a hall, as was popular in the baroque music period.

SUBJECTIVE

Electronic engineers working on the recording, reproduction and broadcasting of music have always been dogged by the problem of subjectivity. Even after the application of the most precise, thorough and foolproof engineering their products are still finally submitted to the vagaries of subjective

ST CECILIA ELECTRONICA

Some very good loudspeakers have been designed but as far as I know the ideal piston has not yet been produced. You are always listening to a diaphragm or cone of some thin material being vibrated into its own natural resonances by a form of electric motor - not to mention the effects of the enclosure.

PURE ENJOYMENT

Attending a live concert, opera or recital is a very special experience. There's a sense of occasion and excitement. Although the same performers may be doing the same programme tomorrow, this particular evening is unique. As an interaction between the musicians and this particular audience, it will never happen again. The excitement is increased by our anticipation of the unexpected or risky. It could be an evanescent moment of great beauty and emotion, or it could be a painfully embarrassing wrong note.

Much of this is ironed out by the technical perfection of recording. Accuracy is achieved at the expense of artistic spontaneity and interpretation.

Musical purists of a certain kind tend to sneer at the trappings of the live performance, which they see as a distraction. They say the sound itself is all that matters. A good recording, which you can listen to at home, is all you need. This attitude is one example of the polarisation that the very existence of recording seems to have created.

There are musicians who absolutely refuse to do live performances, only recordings. Others go to exactly the opposite extreme. In his BBC Reith Lecture on the symphony, the composer Alexander Goehr mentioned that certain conductors have the habit of attempting live imitation of their records in

By Tom Ivall

Subjectivity governs our appreciation of music, live or recorded - we hear what we want to hear.

the concert hall. And that orchestra managers will only appoint conductors who already have good connections with major recording companies.

ILLUSORY

Of course, we all know that a recording is not what an audience hears in a concert hall. It's a highly artificial concoction resulting from multiple microphone placings, balancing, revisions, patching to replace wrong notes and so on. Some musicians, according to Goehr, see in this "a vain pursuit of the definitive version." It is a trap which "leads to concentration on tiny details at the expense of the overall line of a performance. It is a kind of surrender to the possibilities of the medium itself, which allows for almost infinite division of the music into fragments which are then glued together by the editor."

Nevertheless, says Goehr, even though we know that recorded music is synthetic and constitutes an illusion, our experience of it influences our taste.

You get even more synthetic with electronically generated or processed music. Here I don't think there's much point in having live performances. I well remember going to an evening of electronic music in a

assessment. They would really like to have an objective measure of sound quality - perhaps a figure of merit obtained from measurements of electrical and acoustical variables - which would be independent of personal preferences but at the same time correlated with subjective experience.

A big problem with subjective assessment of sound quality - apart from variations between listeners depending on circadian rhythm, degree of tiredness etc - is that hearing is not just a passive registering of impressions. It's an active process of attention and even *intention*. To some extent you hear what you want to hear.

An engineer may listen for a particular type of distortion and suppress the emotional or intellectual effect of the artistic material. A musician may listen for features of musical performance and not be aware of quite obtrusive distortion. Whereas an engineer carries in his head a distinct a priori concept of frequency, which he may regard as the primary characteristic of sound, it's possible for a musician to say: "I cannot accept the distinction between tone colour and pitch as it is generally stated. I find that tone makes itself noticed through colour, one dimension of which is pitch." This was the composer Arnold Schoenberg writing in his *Harmonielehre*.

Although many audio engineers have great musical sensitivity I doubt whether the aesthetics and the technology can ever be merged in a synergetic way. Perhaps it's better that they remain separate. But the permanent tension between them, like that between morality and expediency, will always be interesting to watch - and hear.

(The festival day of St Cecilia, Patroness of Music, is November 22nd).



PRACTICAL ELECTRONICS BOOK SERVICE

Here is your Editor's choice of books he thinks will be of interest to electronics and computer enthusiasts

BEGINNERS AND EARLY STARTERS

Mini-Matrix Board Projects.
R.A.Penfold. 112 pages. £2.50. Order Code BP99

Shows a selection of 20 useful and interesting circuits that can be built on a mini-matrix board of 24 holes by 10 copper strips in size - an ideal book for early experimenters.

From Atoms to Amperes.
F.A.Wilson. 160 pages. £3.50. Order Code BP254.

For the absolute beginner, clearly explaining the fundamentals behind the whole subject of electricity and electronics.

Electronic Projects for Beginners.
F.G.Rayer. 128 pages. £1.95. Order Code BP48

Specially for the newcomer to electronics who is looking for a book containing a wide range of easily made projects. Some circuits need no soldering and many others show actual component and wiring layouts.

Electronics Build and Learn
R.A.Penfold. 128 Pages. £5.95. Order Code PC 101

Combining theory and practice, the book describes a circuit demonstrator unit that is used in subsequent chapters to introduce common electronic components and circuit concepts, complete with practical experiments.

Practical Electronic Building Blocks
R.A.Penfold. There are two books -
Book 1 : 128 pages. £1.95. Order Code BP117
Book 2 : 112 pages. £1.95. Order Code BP118

Book 1 is about oscillators and gives circuits for a wide range, including sine, triangle, square, sawtooth and pulse waveforms and numerous others from voltage controlled to customised ie types.

Book 2 looks at amplifiers, ranging from low level discrete and opamp types to ie power amps. A selection of mixers, filters and regulators is included.

30 Solderless Breadboard Projects
R.A.Penfold. Two books each of 160 pages. Book 1 : £2.95. Order Code BP107. Book 2 : £2.25. Order Code BP113.

Each project is designed for building on a Verobloc breadboard and is accompanied by a description, circuit and layout diagrams and relevant constructional notes. Many of the components are common to several projects. Book 1 covers linear devices, and Book 2 covers cmos logic chips.

Beginners Guide to Building Electronic Projects
R.A.Penfold. 112 pages. £1.95. Order Code BP 227

Shows the complete beginner how to tackle the practical side of electronics and includes simple constructional projects.

SATELLITE TV

Satellite TV Installation Guide - 2nd edition John Breeds. £11.95. Order Code STV1

Full of vital information for any competent diyer who wishes to install a satellite tv antenna and obtain optimum reception quality.

An Introduction to Satellite Television
F.A.Wilson. 112 pages. £5.95. Order Code BP195

Informative answers to many of the questions about this communications revolution. The information is presented on two levels, one aimed at the complete beginner, the other at professional engineers and serious amateur enthusiasts.

TEST AND MEASUREMENT

Getting the Most from Your Multimeter
R.A.Penfold. 112 pages. £2.95. Order Code BP239

There's more to what you can do with a meter than meets the casual eye. The book covers the basics of what you can do with analogue and digital meters and discusses component and circuit testing.

Test Equipment Construction
R.A. Penfold £2.95. Order Code BP248

Describes in detail how to construct some simple and inexpensive, but extremely useful, pieces of test equipment.

Oscilloscopes 2nd Edition
I.Hickman. £12.95. Order Code NT3

Subtitled 'How to Use Them, How They Work' the book is illustrated with diagrams and photographs and is essential reading for any one who wants to know about scopes, from first principles to practical applications.

How to Get Your Electronic Projects Working.
R.A.Penfold. 96 pages. £2.50. Order Code BP110.

Essential reading for anyone who wants first-time success in project assembly. Covers tracing mechanical faults as well as testing for failures of active and passive components of most types.

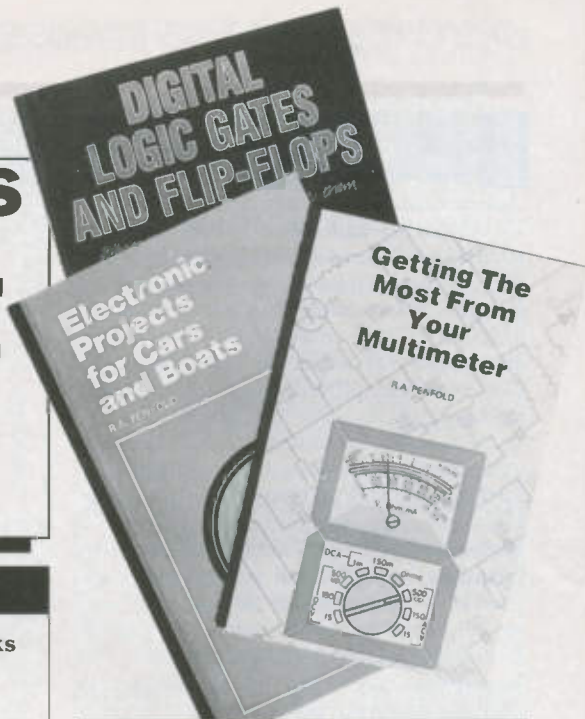

AUDIO AND MUSIC

Introducing Digital Audio
I.Sinclair. 112 pages. £5.95. Order Code PC102

A non-mathematical introduction to the new digital technology, discussing the principles and methods involved in devices such as cd, dat and sampling.

Electronic Music Projects
R.A.Penfold. 112 pages. £2.50. Order Code BP74

24 practical constructional projects covering fuzz, wah, sustain, reverb, phasing, tremolo etc. The text is split into four sections covering guitar, general, sound generation and accessory projects.

More Advanced Electronic Music Projects

R.A.Penfold. 96 pages. £2.95. Order Code BP174

Complementing BP74 by covering more advanced and complex projects including flanging, chorus, ring modulation, plus a selection of drum, cymbal and gong circuits.

Computer Music Projects
R.A.Penfold. 112 pages. £2.95. Order Code BP173

Shows how home computers can produce electronic music and covers sequencing, analogue and Midi interfacing, digital delay lines and sound generators.

Practical Midi Handbook
R.A.Penfold. 160 pages. £5.95. Order Code PC103

A practical how-to-do-it book for musicians and enthusiasts who want to exploit the capabilities of Midi. Covers keyboards, drums, sequencers, effects, mixers, guitars, and computer music software.

Midi Projects
R.A.Penfold. 112 pages. £2.95. Order Code BP182

Practical details of interfacing many popular home computers with Midi systems, and also covering Midi interfacing to analogue and percussion synths.

Electronic Synthesiser Construction.
R.A.Penfold. 112 pages. £2.95. Order Code BP185.

Even relative beginners should find the monophonic synthesiser described here within their capabilities if the book is thoroughly read. Individual aspects of the synth are dealt with separately and pcb designs are shown for the main modules.

DIGITAL AND COMPUTING

A Concise Introduction to MS-DOS. N. Kantaris. 64 pages. £2.95. Order Code BP232

A ready-reference guide for those who need a quick insight into the essential command functions of this operating system, but who don't have the time to learn it fully.

An Introduction to Computer Peripherals R.A. and J.W. Penfold. 80 pages. £2.50. Order Code BP170

Covers such items as monitors, printers, disc drives, cassettes, modems, etc. explaining what they are and how to use them with your computer and with each other.

Digital Logic Gates and Flip-Flops. Ian R. Sinclair. 192 pages. £8.95. Order Code PC 105

Intelligently looks at the basic building blocks of all digital circuits and is intended for enthusiasts, students and technicians who seek to establish a firm grasp of fundamental principles.

Introduction to 6800/6802 Microprocessor Systems R.J. Simpson and T.J. Terrell. 238 pages. £10.95. Order Code NT9

The book covers systems hardware, programming concepts and practical experimental work that will assist in understanding the 6800/6802 microprocessor, with additional information on the 6802D5E evaluation system.

An Introduction to 68000 Assembly Language. R.A. and J.W. Penfold. 112 pages. £2.95. Order Code BP184

Covers the fundamentals of writing programs that will vastly increase the speed of 68000 based machines such as the Commodore Amiga, Atari ST range, Apple Macintosh, etc.

Getting the Most from Your Printer J.W. Penfold. 96 pages. £2.95. Order Code BP181

How to use the features found on most dot-matrix printers from programs and popular wordprocessors, showing examples of what must be typed to achieve a given effect.

Micro Interfacing Circuits R.A. Penfold. Two books, each of 112 pages.

Book 1 : £2.25. Order Code BP130.
Book 2 : £2.75. Order Code BP131

Both books include practical circuits and useful background information though pcb layouts are not included. Book 1 mainly covers computer input-output techniques. Book 2 deals primarily with practical application circuits.

An Introduction to 6502 Machine Code.

R.A. and J.W. Penfold. 112 pages.
£2.95. Order Code BP147

Covers the main principles of machine code programming on 6502-based machines such as the Vic-20, Oric-1/Atmos, Electron, BBC and Commodore 64. It assumes no previous knowledge of microprocessors or machine code and gives illustrative programming examples.

A Z-80 Workshop Manual. E.A. Parr. 192 pages. £3.95. Order Code BP112

A book for those who already know Basic but wish to explore machine code and assembly language programming on Z80 based computers.

Practical Digital Electronics Handbook

M. Tooley. 208 pages. £6.95.
Order Code PC 104

Nine constructional projects introduce digital circuits, logic gates, timers, microprocessors, memory and interface circuits - an essential book for anyone interested in digital devices.

DATA AND INFORMATION BOOKS

NEW! Radio and Electronics Engineer's Pocket Book - 18th Edition. Keith Brindley. 325 pages. £9.95. Order Code NT 11

An invaluable compendium of facts, figures and formulae and is indispensable to the designer, student, service engineer and all others interested in radio and electronics.

NEW! Microprocessor Pocket Book. Steve Money. 252 pages. £9.95. Order Code NT 12

Provides a wide selection of information which will be of general use to anyone involved in developing, designing or servicing, or who just wants to learn more about microprocessor systems.

NEW! Computer Engineer's Pocket Book - 2nd Edition. Michael Tooley. 224 pages. £9.95. Order Code NT 13

An invaluable compendium of facts, figures, circuits and data indispensable to designers, students, service engineers and all others interested in computer and microcomputer systems.

Op Amps B. Dance. £7.95. Order Code NT2

Subtitled 'Their Principles and Applications' this interesting book is written in a simple non-mathematical style and provides a source of practical circuits that use both commonplace and more sophisticated opamps.

Electronic Hobbyists Handbook R.A. Penfold. 96 pages. £4.95. Order Code BP233

Provides a source of useful information that the amateur enthusiast is likely to need for day-to-day pursuance of hobby electronics.

Newnes Electronics Pocket Book I.E. Parr. £9.95. Order Code NT10

Presents all aspects of modern electronics in a readable and largely non-mathematical style, and is a good source of valuable information for enthusiasts and professional engineers alike.

Key Techniques for Circuit Design G.C. Loveday. £6.95. Order Code BM 101

Tackles the problems of designing circuits from scratch. Introducing the concept of target specifications, the design sequence, device selection, rules of thumb, and useful equivalent circuits.

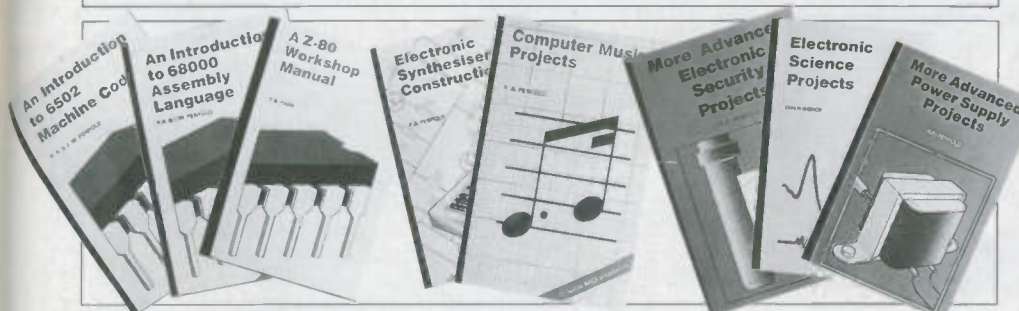

GENERAL CONSTRUCTIONAL

Electronic Science Projects. Owen Bishop. 144 pages. £2.95. Order Code BP104

A bumper bundle of experimental projects ranging in complexity and including a colour temperature meter, electronic clock, a solid state (led display) scope, an Infra-red laser, a fascinating circuit for measuring the earth's electrical field strength, and many more.

Electronic Security Devices R.A. Penfold. 112 pages. £2.50. BP56

Full of ideas for keeping your valuables safe. The circuits include designs for light, infra-red, ultrasonic, gas, smoke, flood, door and baby sensors.

More Advanced Electronic Security Projects. R.A. Penfold. 112 pages. £2.95. Order Code BP190

Follows on from where BP56 leaves off and describes a number of more up-to-date and sophisticated projects, such as pyro-sensors, infra-red and doppler-shift detection, fibre-optic loops, and many others.

Electronic Projects for Cars and Boats. R.A. Penfold. 96 pages. £1.95.

Order Code BP94
15 fairly simple projects that can be used with a car and/or boat. Stripboard constructional details are included, as are explanations of the circuit theory.

Power Supply Projects R.A. Penfold. 96 pages. £2.50. Order Code BP76

A selection of power supply designs, including simple unregulated, fixed voltage regulated and variable voltage stabilised, ni-cad charger, voltage step up, and inverter.

More Advanced Power Supply Projects R.A. Penfold. 96 pages. £2.95. Order Code BP192

Covers more advanced topics than BP76 and includes precision supplies, switch mode and computer controlled supplies, plus a selection of miscellaneous circuits.

Popular Electronic Circuits. R.A. Penfold. 160 pages. £2.95. Order Code BP80

Containing a wide range of circuit designs for experienced constructors who are capable of producing working projects direct from a circuit diagram without specific constructional details.

HOW TO ORDER

State your order code and your name and address clearly. Enclose a cheque, PO or international money order (add 50p postage per book - £1.00 for overseas surface mail), and send to:

PE Book Service
Intra House
193 Uxbridge Road
London W12 9RA

Books are normally delivered within 10 days but please allow 28 days for delivery.

PE PCB SERVICE

IT IS EASY TO BUILD PRACTICAL ELECTRONICS PROJECTS!

Simplify your project assembly - use a ready-made printed circuit board. All are fully drilled and roller tinned. Just slot in the components as shown in the project texts, and solder them. PCBs are the professional route to project perfection.

MAIL ORDERING

Select the boards you want, and send your order to: PE PCB SERVICE, PRACTICAL ELECTRONICS, 193 UXBRIDGE ROAD, LONDON W12 9RA.

Prices include VAT and postage and packing. Add £2 per board for overseas airmail. Cheques should be made payable to Intra Press (Payments by Access and Visa also accepted). Quote the project name and PCB Code Number, and print your name and address in Block Capitals. Do not send any other correspondence with your order.

TELEPHONE ORDERS

Use your Access or Visa card and phone your order to 081-743-8888 clearly stating your name and address, card number and order details. All orders receive priority attention. Many PCBs are held in stock, so they are dispatched within a few days, but please still allow 28 days for delivery in case a PCB is temporarily out of stock.

We can only supply the PCBs listed here! Please always check the latest issue of PE before ordering.

We can also supply the photocopies of the text at £1.50 for each project part inclusive of postage and packing (overseas £2.00).

Please note that we do not supply components - they can be ordered from our advertisers!

| | | |
|-------------------------------|--------|--------|
| DEC 87 | | |
| RS 232C TO MIDI | 160 | £6.43 |
| FEB 88 | | |
| DC MOTOR SERVO | 165 | £7.53 |
| MAR 88 | | |
| APPLIANCE TIMER | 166A/B | £9.38 |
| LOGIC ANALYSER - Double-sided | 168 | £20.65 |
| APR 88 | | |
| LIGHT METAL EFFECTS | 169 | £7.10 |
| JUNE 88 | | |
| AMSTRAD ROM EXPANSION | 173 | £12.60 |
| MAINS MODEM | 174 | £4.90 |
| AUG 88 | | |
| SPEAKING CLOCK | 176 | £16.75 |
| SEPT 88 | | |
| BBC MULTIPLEXER | 177 | £4.50 |
| OCT 88 | | |
| METAL DETECTOR | 178 | £6.50 |
| DEC 88 | | |
| PANNING MIXER | 181 | £7.80 |
| MAR 89 | | |
| CAMERA SHUTTER TIMER | 187 | £9.95 |
| APR 89 | | |
| PC MULTIPORT | 188A/B | £20.55 |
| MAY 89 | | |
| KIRLIAN CAMERA | 189A/C | £10.50 |
| JUNE 89 | | |
| DELUXE METRONOME | 198 | £10.95 |
| JULY 89 | | |
| PROJECTOR SYNCHRONISER | 190A | £9.50 |
| SEP 89 | | |
| FREQUENCY COUNTER-GENERATOR | 194A/B | £12.50 |

| | | |
|------------------------------------|--------|--------|
| OCT 89 | | |
| HOME SECURITY CONTROLLER | 196A/C | £19.50 |
| DEC 89 | | |
| VIDEO AGC STABILISER | 199 | £6.50 |
| ECHO STATION | 200A/B | £11.50 |
| MINI METRONOME | 201 | £5.90 |
| JAN 90 | | |
| BARGRAPH TACHOMETER | 202 | £5.90 |
| EEPROM PROGRAMMER (KEYBOARD VER) | 203 | £14.50 |
| FEB 90 | | |
| EEPROM PROGRAMMER (SWITCH VERSION) | 204 | £4.90 |
| MODEM | 205 | £11.50 |
| MOCK STEREO | 206 | £4.90 |
| MAR 90 | | |
| RADIO CLOCK (TUNER AND PULSE) | 207 | £6.50 |
| APR 90 | | |
| RADIO CLOCK (DISPLAY DECODER) | 208 | £13.50 |
| PC/INTERFACE | 209 | £5.90 |
| MAY 90 | | |
| EPROM POLY-PROG (MAIN PCB) | 210 | £8.50 |
| JUNE 90 | | |
| EPROM POLY-PROG (TOP PCB) | 211 | £7.50 |
| MESSAGE MAKER | 212 | £9.50 |
| BAUD RATE CONVERTER | 213 | £4.90 |
| INTERMITTENT WIPER | 214 | £3.90 |
| CIRCUIT BREAKER | 215 | £4.90 |
| JULY 90 | | |
| MORSE DECODER | 216 | £9.50 |
| AUG 90 | | |
| SCOPE EXPANDER | 217 | £9.50 |
| VOLTAGE PROBE | 218 | £5.80 |
| AF OCTAVE MEASURER: | | |
| FILTER DRIVE | 219 | £6.60 |
| ANALOGUE FILTER | 220 | £7.35 |
| SEP 90 | | |
| AF OCTAVE MEASURER | | |
| AMPLIFIER | 221 | £7.35 |
| SWITCHED FILTER | 222 | £7.35 |
| SWITCHED FILTER DRIVE | 223 | £7.35 |
| TELE-SCOPE - MAIN PCB | 224 | £11.50 |
| OCT 90 | | |
| TELE-SCOPE - SIGNAL PCB | 225 | £4.90 |
| TV INTERFACE | 226 | £4.90 |
| CHIPTESTER | 227 | £11.50 |
| NOV 90 | | |
| BIKE COMPUTER - MAIN PCB | 228 | £9.50 |
| - POWER SAVER | 229 | £4.90 |

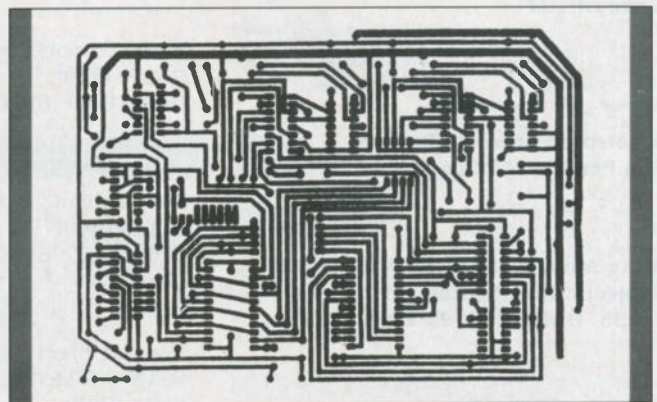

**PE PCBs are the professional route
to project perfection!**

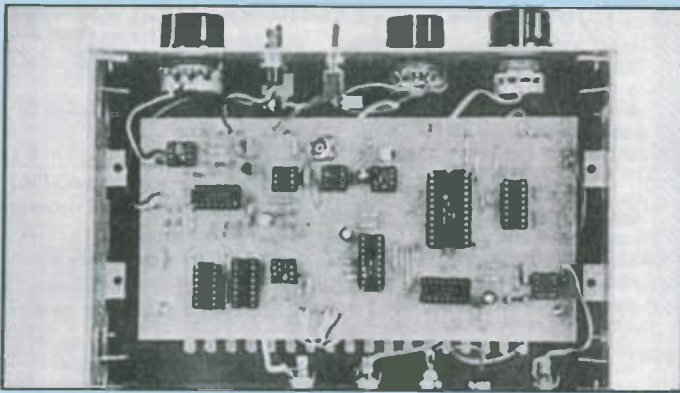

NICE AND EASY DOES IT

Building the projects published in PE is a lot easier than some of you perhaps might think. Especially when you use one of our professionally made printed circuit boards.

It's almost like painting by numbers. All the pcbs are fully drilled, and basically all you need to do is slot in the components and carefully solder them to the pcb track pads. Their places are shown in the drawings published with the project.

IDENTITIES

Component identities are usually clearly marked on them. Even if they are colour coded, like some resistors and capacitors, their values are easily worked out from component colour code charts. From time to time we publish these charts, but if you don't already have one, send a 9in x 4in stamped and self-addressed envelope to the Editorial office asking for one.

TOOLS

For many projects you only need a few simple tools - Soldering iron between 15W and 25W, with a bevelled tip. Damp sponge for keeping the tip clean. Good multicore solder of 18swg or 22swg grade. Fine nose pliers for wire shaping. Adjustable spanner or heavy pliers for tightening nuts. Miniature screwdriver for adjusting preset controls. Small wire cutters for trimming component leads. Drill and selection of bits for drilling holes in boxes. Strong magnifying glass for checking joins in close up. It's also preferable to have a multimeter for setting and checking voltages. There are some very good low cost ones available through many of our advertisers, but get one that is rated at a minimum of 20,000 ohms per volt. Many projects do not require you to have a meter, but if you are serious about electronics, you really should have one.

ASSEMBLING THE PCB

Authors will sometimes offer their own advice on the order of assembly, but as a general guide, it is usually easier to assemble parts in order of size. Start though with the integrated circuit sockets. Please use them where possible, they make life much easier than if you solder the ics themselves - with sockets you can just lift out an ic if you want.

Then insert and solder in order of resistors, diodes, presets, small capacitors, other capacitors, and finally transistors. Clip off the excess component wires before soldering, then make sure the solder covers the pads and the wires. Now use a magnifying glass, ideally one that you can hold to your eye, and take a good look at the joints, checking that they are satisfactorily soldered, and that no solder has spread between the pcb tracks and other joints. Be really thorough with visual checking since errors like this are the most likely reason for a circuit not working first time.

SOLDERING

Bring the tip of the iron into contact with the component lead and the pcb solder pad, then bring the end of the solder into contact with all three, feeding it in as it melts. Once sufficient solder has melted to fully surround the pad and the lead, remove the solder, and then the iron. Now allow the join to cool before touching it, otherwise the solder may set unsatisfactorily. If it does move, just reheat the join once more.

WIRING

Connecting the pcb to the various panel controls is the final assembly stage. Do this just as methodically, following the published wiring diagram. You can connect the wires to the pcb in one of three ways. The best is to insert terminal pins into the connecting holes on the pcb, and then solder wires direct to them. Or, pass the end of the wire through the pcb hole, soldering it on the other side. Alternatively, the wire can be carefully soldered direct to the pcb tracking. In all cases first strip the plastic covering off the wire, twist the strands together, and apply solder to them to keep them secure.

TESTING

Now you are ready to test and use the project as described by the author. Components can occasionally fail, but these days it is extremely uncommon, and if you have followed the instructions, been careful with your joins, and bought the parts from a good supplier, you will have the enormous satisfaction of having built an interesting and working unit. It really can be easy if you do it with care.

CHOOSE ONE NOW!

The PE PCB Service list shows all the pcbs available through PE. Look down the list and see which title takes your fancy - there must be at least one that will interest you! You will probably already have the relevant issue of PE, but even if you don't we can still help you.

BACK ISSUES

We can usually supply copies of back issues of PE up to three years old. These are £1.75 each including postage (£2.25 for overseas readers). If we no longer have the issue needed, we will be pleased to send a photocopy of the article for the project that you want to build. These are £1.00 each per issue, including postage (£1.50 to overseas readers).

OBTAINING PARTS

Some projects are available from advertising suppliers as complete kits. Otherwise, all the components listed in the text will be available from suppliers who specialise in individual components.

Occasionally a specific part may only be available from a particular supplier, if so the source will be given in the parts list. Otherwise there should be no difficulty in buying the parts. We have many good suppliers advertising in PE so have a look through their adverts - that's why they're here! Even though a part may not be listed in the adverts, a phone call or two should find a supplier who will be pleased to help. Like us, they too are in the business of encouraging you to enjoy electronics!

PE

Interak 1

SINGLE BOARD COMPUTER

"SBC-1"

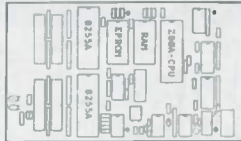

A computer doesn't have to look like you'd expect a computer to look. It doesn't have to have a keyboard and a screen and floppy disks and so on.

The SBC-1 has the bare minimum of chips a Z80 computer can have and still be a computer: A 4 MHz Z80-CPU chip, an EPROM chip (up to 32K), a static RAM chip (up to 32K) and a pair of 8255A I/O (input/output) chips giving 48 individual lines to wobble up and down. There are one or two additional "glue" chips included, but these are simple "74LS" or "HC" parts.

A star feature is that no special or custom chips (ie PALs, ULAs, ASICs etc) are used — and thus there are no secrets. The Z80A is the fastest and best established of all the 8-bit microprocessors — possibly the cheapest too!

Although no serial interface is included, it is easy for a Z80A to wobble one bit up or down at the appropriate rate — the cost is a few pence worth of code in the program: why buy hardware when software will do?

Applications already identified include: Magnetic Card reader, mini printer interface, printer buffer, push button keypad, LCD alphanumeric panel interface, 40-zone security interface for auto sending of security alarms, code converter (eg IBM PC keyboard codes to regular ASCII), real time clock (with plug in module), automatic horticultural irrigation controller.

By disabling the on-board Z80A-CPU this card will plug into our Interak 1 CP/M Plus disk-based development system, so if you don't fancy hand-assembling Z80 machine code you don't have to!

The idea is (if you are a manufacturer) you buy just one development system and then turn out the cheap SBC-1 systems by the hundred. If you are really lazy we can write the program for you and assemble the SBC-1 cards so you can get on with manufacturing your product, leaving all your control problems to us.

Greenbank

For more details write or phone us:

Greenbank Electronics, Dept PE11, 460 New Chester Road, Rock Ferry, Birkenhead, Merseyside. L42 2AE. Tel: 051-645 3391.

INDEX TO ADVERTISERS

| | | | |
|-------------------------------|----|--------------------------------|-----|
| A & G Electronics | 40 | Keytronics | 11 |
| Astronomy Now | 47 | Light Soldering | 29 |
| N.R. Bardwell | 55 | London Electronics College54 | |
| Barrie Electronics | 29 | Maplin Electronics | 0BC |
| BK Electronics | 63 | Multisources | 54 |
| J&N Bull Electrical | 24 | National College of Tech | 44 |
| C-Scope | 44 | Number One Systems | 43 |
| C.E.S. NW | 55 | Omni Electronics | 54 |
| Cricklewood Electronics | 29 | Program Now | 44 |
| C.R. Supply | 55 | Radio & Telecom School | 54 |
| Component Solutions | 30 | Sarm Digital | 55 |
| Cooke International | 55 | Service Trading | 55 |
| JPG Electronics | 55 | Sherwood Data | 40 |
| Fraser Electronics | 54 | Stewart of Reading | 34 |
| Gem-Tech | 30 | Suma Designs | 43 |
| Greenbank Electronics | 62 | Tandy | IFC |
| Greenweld | 30 | The Electronics Shop | 54 |
| Henry's | 40 | Technomatic Ltd. | 18 |
| High Q Electronics | 54 | TK Electronics | 39 |
| Hills Components | 56 | A. Wood | 55 |

**PLEASE MENTION
PRACTICAL ELECTRONICS
WHEN REPLYING TO ADVERTS**

PROGRAMMABLE ELECTRONIC LOCK KIT

NEW

Keys could be a thing of the past with this new high security lock. Secure doors to sheds, garages, even your home or prevent the unauthorised use of computers, burglar alarms or cars. One 4-digit sequence will open the lock while incorrect entries will sound an alarm. The number of incorrect entries allowed before the alarm is triggered is selected by you. Further entries will be ignored for a time also set by you. Only the correct sequence will open the lock and switch off the alarm. The sequence may easily be changed by entering a special number and code on the supplied keyboard. Kit includes: keyboard, alarm buzzer, high quality PCB and all electronic components. Supply: 5 – 15V d.c. Will drive our Latch Mechanism (701 150 @ £16.50) or relay directly.

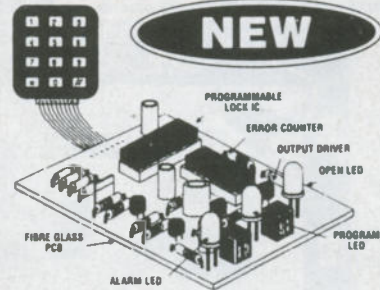

XK131 £19.95

DISCO LIGHTING KITS



DL8000K 8-way sequencer kit with built-in opto-isolated sound to light input. Only requires a box and control knob to complete. **£39.95**

DL1000K 4-way chaser features bi-directional sequence and dimming 1kW per channel. **£23.95**

XK139 Uni-directional version of the above. Zero switching to reduce interference. **£12.95**

DLA/1 (for DL & DLZ1000K) Optional opto input allowing audio 'beat'/light response. **95p**

DL3000K 3-channel sound to light kit, zero voltage switching, automatic level control and built-in mic. 1kW per channel. **£19.55**

POWER STROBE KIT

Produces an intense light pulse at a variable frequency of 1 to 15Hz includes high quality PCB, components, connectors, SWs strobe tube and assembly instructions. Supply 240V ac Size 80 x 50 x 45. **£17.25**



REMOTE CONTROL DIMMER KIT



Imagine controlling the brightness of your lights or switching them on or off from the comfort of your armchair! This kit contains all the components from front panel to the last screw to enable you to do just that and fit the shallowest wall boxes. Max power 300W (not fluorescent). **£19.95**

XK132 £19.95

IR TRANSMITTER KIT

Designed for use with the XK132 and comes complete with a pre drilled box. A PP3 9 volt battery is required. **£4.95**



XK138 TOUCH DIMMER KIT £12.95

VERSATILE REMOTE CONTROL SYSTEM

These kits can switch up to 16 pieces of equipment on and off or control 16 functions depending on the keyboard selected for the MK18 transmitter. MK12 receiver has 16 logic outputs and operates from 12 to 24V dc, or 240V ac via the transformer supplied. The MK18 requires a 9V battery and keyboard. Great for controlling lights, TVs, garage doors etc. **£19.95**

MK12 IR Receiver £19.95

MK18 Transmitter £8.95

MK9 4-Way Keyboard £2.75

MK10 16-Way Keyboard £7.95

601 133 Box for transmitter £2.95

VOICE RECORD/PLAYBACK KIT

This simple to construct and even simpler to operate kit will record and playback short messages or tunes. It has many uses – seatbelt or lights reminder in the car, welcome messages to visitors at home or at work, warning messages in factories and public places, in fact anywhere where a spoken message is announced and which needs to be changed from time to time. Also suitable for toys – why not convert your daughter's £8 doll to an £80 talking doll!

Size 76 x 60 x 15mm
Message time 1 – 5 secs normal speed, 2 – 10 secs slow speed
XK129 £25.95

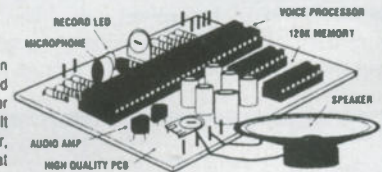

TH ELECTRONICS

13 BOSTON RD. LONDON W7 3SJ

TEL: 01-567 8910.

FAX: 01-566 1916



ORDERING INFORMATION:

All prices include VAT. Free P & P on orders over £60 (UK only), otherwise add £1.15. Overseas P & P: Europe £3.50, Elsewhere £10. Send cheque/PO/Visa/Access No. with order. Giro No. 529314002
LOCAL AUTHORITY AND EXPORT ORDERS WELCOME
GOODS BY RETURN SUBJECT TO AVAILABILITY

OMP POWER AMPLIFIER MODULES-TURNABLES-DIMMERS-LOUDSPEAKERS-19 INCH STEREO RACK AMPLIFIERS

OMP POWER AMPLIFIER MODULES

Supplied ready built and tested.

OMP POWER AMPLIFIER MODULES Now enjoy a world-wide reputation for quality reliability and performance at a realistic price. Four models available to suit the needs of the professional and hobby market i.e. Industry Leisure. Instrumental and Hi-Fi etc. When comparing prices NOTE all models include Toroidal power supply. Integral heat sink Glass fibre PCB and Drive circuits to power compatible Vu meter. Open and short circuit proof.

THOUSANDS OF MODULES PURCHASED BY PROFESSIONAL USERS



OMP100 Mk 11 Bi-Polar Output power 110 watts R M S into 4 ohms. Frequency Response 15Hz - 30KHz - 3dB. T.H.D 0.01%. S.N.R. - 118dB. Sens for Max. output 500mV at 10K. Size 355 x 115x65mm. **PRICE £33.99 + £3.00 P&P.**

NEW SERIES II MOS-FET MODULES

OMP/MF 100 Mos-Fet Output power 110 watts R.M.S. into 4 ohms. Frequency Response 1Hz - 100KHz - 3dB. Damping Factor. >300. Slew Rate 45V uS. T.H.D. Typical 0.002%. Input Sensitivity 500mV. S.N.R. - 125dB. Size 300 x 123 x 60mm. **PRICE £39.99 + £3.00 P&P.**

OMP/MF200 Mos-Fet Output power 200 watts R.M.S. into 4 ohms. Frequency Response 1Hz - 100KHz - 3dB. Damping Factor >300. Slew Rate 50V uS. T.H.D. Typical 0.0008%. Input Sensitivity 500mV. S.N.R. - 130dB. Size 300 x 155 x 100mm. **PRICE £62.99 + £3.50 P&P.**

OMP/MF300 Mos-Fet Output power 300 watts R.M.S. into 4 ohms. Frequency Response 1Hz - 100KHz - 3dB. Damping Factor >300. Slew Rate 60V uS. T.H.D. Typical 0.0008%. Input Sensitivity 500mV. S.N.R. - 130dB. Size 330 x 175 x 100mm. **PRICE £79.99 + £4.50 P&P.**

NOTE - MOS FET MODULES ARE AVAILABLE IN TWO VERSIONS STANDARD INPUT SENS 500mV BAND WIDTH 100KHZ. REC/PROFESSIONAL EQUIPMENT COMPATIBLE. INPUT SENS 775mV BAND WIDTH 50KHZ. ORDER STANDARD OR REC.

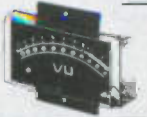

Vu METER Compatible with our 4 amplifiers detailed above. Very accurate visual display employing 11 LED diodes (7 green, 4 red) plus an additional on off indicator. Sophisticated logic control circuits for very fast rise and decay times. Tough moulded plastic case with tinted acrylic front. Size 84 x 27 x 45mm. **PRICE £8.50 + 50p P&P.**

LOUDSPEAKERS



LARGE SELECTION OF SPECIALIST LOUDSPEAKERS AVAILABLE, INCLUDING CABINET FITTINGS, SPEAKER GRILLES, CROSS-OVERS AND HIGH POWER, HIGH FREQUENCY BULLETS AND HORNS, LARGE S.A.E. (30p STAMPED) FOR COMPLETE LIST.

McKENZIE:- INSTRUMENTS, P.A., DISCO, ETC.

ALL MCKENZIE UNITS 8 OHMS IMPEDENCE

- 8" 100 WATT C8100GPM GEN PURPOSE LEAD GUITAR. EXCELLENT MID DISCO. RES. FREQ. 80Hz FREQ. RESP TO 14KHz SENS. 99dB. PRICE £28.59 + £2.00 P&P.
- 10" 100 WATT C10100GP GUITAR VOICE ORGAN KEYBOARD DISCO EXCELLENT MID RES. FREQ. 70Hz FREQ. RESP TO 16KHz SENS. 100dB. PRICE £34.70 + £2.50 P&P.
- 10" 200 WATT C10200GP GUITAR KEYBOARD DISCO EXCELLENT HIGH POWER MID RES. FREQ. 45Hz FREQ. RESP TO 7KHz SENS. 103dB. PRICE £47.48 + £2.50 P&P.
- 12" 100 WATT C12100GP HIGH POWER GEN PURPOSE LEAD GUITAR DISCO. RES. FREQ. 45Hz FREQ. RESP TO 7KHz SENS. 98dB. PRICE £36.66 + £3.50 P&P.
- 12" 100 WATT C12100TC TWIN CONE HIGH POWER WIDE RESPONSE P.A. VOICE DISCO. RES. FREQ. 45Hz FREQ. RESP TO 14KHz SENS. 100dB. PRICE £37.63 + £3.50 P&P.
- 12" 200 WATT C12200B HIGH POWER BASS KEYBOARDS DISCO. P.A. RES. FREQ. 40Hz FREQ. RESP TO 7KHz SENS. 100dB. PRICE £64.17 + £3.50 P&P.
- 12" 300 WATT C12300GP HIGH POWER BASS LEAD GUITAR KEYBOARDS DISCO ETC. RES. FREQ. 45Hz FREQ. RESP TO 5KHz SENS. 100dB. PRICE £85.79 + £3.50 P&P.
- 15" 100 WATT C15100BS BASS GUITAR LOW FREQUENCY P.A. DISCO. RES. FREQ. 40Hz FREQ. RESP TO 5KHz SENS. 99dB. PRICE £53.70 + £4.00 P&P.
- 15" 200 WATT C15200BS VERY HIGH POWER BASS RES. FREQ. 40Hz FREQ. RESP TO 4KHz SENS. 99dB. PRICE £73.26 + £4.00 P&P.
- 15" 250 WATT C15250BS VERY HIGH POWER BASS RES. FREQ. 40Hz FREQ. RESP TO 4KHz SENS. 99dB. PRICE £80.53 + £4.50 P&P.
- 15" 400 WATT C15400BS VERY HIGH POWER LOW FREQUENCY BASS RES. FREQ. 40Hz FREQ. RESP TO 4KHz SENS. 102dB. PRICE £94.12 + £4.50 P&P.
- 18" 400 WATT C18404BS EXTREMELY HIGH POWER LOW FREQUENCY BASS RES. FREQ. 27Hz FREQ. RESP TO 3KHz SENS. 99dB. PRICE £167.85 + £5.00 P&P.

EARBENDERS:- HI-FI, STUDIO, IN-CAR, ETC.

- ALL EARBENDER UNITS 8 OHMS EXCEPT EB8-50 AND EB10-50 DUAL 4 AND 8 OHM. BASS, SINGLE CONE, HIGH COMPLIANCE, ROLLED FOAM SURROUND
- 8" 50 WATT EB8-50 DUAL IMPEDENCE TAPPED 4 8 OHM BASS HI-FI, IN-CAR. RES. FREQ. 40Hz FREQ. RESP TO 7KHz SENS. 97dB. PRICE £8.90 + £2.00 P&P.
- 10" 50 WATT EB10-50 DUAL IMPEDENCE TAPPED 4 8 OHM BASS HI-FI, IN-CAR. RES. FREQ. 40Hz FREQ. RESP TO 5KHz SENS. 99dB. PRICE £12.00 + £2.50 P&P.
- 10" 100 WATT EB10-100 BASS HI-FI STUDIO. RES. FREQ. 35Hz FREQ. RESP TO 3KHz SENS. 96dB. PRICE £27.50 + £3.50 P&P.
- 12" 60 WATT EB12-60 BASS HI-FI STUDIO. RES. FREQ. 28Hz FREQ. RESP TO 3KHz SENS. 92dB. PRICE £21.00 + £3.00 P&P.
- 12" 100 WATT EB12-100 BASS STUDIO HI-FI EXCELLENT DISCO. RES. FREQ. 28Hz FREQ. RESP TO 3KHz SENS. 93dB. PRICE £32.00 + £3.50 P&P.
- FULL RANGE TWIN CONE, HIGH COMPLIANCE, ROLLED SURROUND**
- 5 1/2" 60 WATT EBS-60TC (TWIN CONE) HI-FI MULTI-ARRAY DISCO ETC. RES. FREQ. 63Hz FREQ. RESP TO 20KHz SENS. 92dB. PRICE £9.99 + £1.50 P&P.
- 6 1/2" 60 WATT EB6-60TC (TWIN CONE) HI-FI MULTI-ARRAY DISCO ETC. RES. FREQ. 38Hz FREQ. RESP TO 20KHz SENS. 94dB. PRICE £10.99 + £1.50 P&P.
- 8" 60 WATT EB8-60TC (TWIN CONE) HI-FI MULTI-ARRAY DISCO ETC. RES. FREQ. 40Hz FREQ. RESP TO 18KHz SENS. 89dB. PRICE £12.99 + £1.50 P&P.
- 10" 60 WATT EB10-60TC (TWIN CONE) HI-FI MULTI-ARRAY DISCO ETC. RES. FREQ. 35Hz FREQ. RESP TO 12KHz SENS. 86dB. PRICE £16.49 + £2.00 P&P.

TRANSMITTER HOBBY KITS

PROVEN TRANSMITTER DESIGNS INCLUDING GLASS FIBRE PRINTED CIRCUIT BOARD AND HIGH QUALITY COMPONENTS COMPLETE WITH CIRCUIT AND INSTRUCTIONS

3W FM TRANSMITTER 80-108MHz VARICAP CONTROLLED PROFESSIONAL PERFORMANCE RANGE UP TO 3 MILES. SIZE 38 x 123mm SUPPLY 12V @ 0.5AMP. **PRICE £14.49 + £1.00 P&P**

FM MICRO TRANSMITTER (BUG) 100-108MHz VARICAP TUNED COMPLETE WITH VERY SENS FET MIC. RANGE 100-300m. SIZE 56 x 46mm SUPPLY 9V BATT PRICE £8.62 + £1.00 P&P



3 watt FM Transmitter



POSTAL CHARGES PER ORDER £1.00 MINIMUM. OFFICIAL ORDERS WELCOME FROM SCHOOLS COLLEGES GOVT. BODIES ETC. PRICES INCLUSIVE OF V.A.T. SALES COUNTER. VISA ACCESS ACCEPTED BY POST. PHONE OR FAX.



PRICES INCLUDE V.A.T. * PROMPT DELIVERIES * FRIENDLY SERVICE * LARGE S.A.E., 30p STAMPED FOR CURRENT LIST.

OMP VARISPEED TURNTABLE CHASSIS



* MANUAL ARM * STEEL CHASSIS * ELECTRONIC SPEED CONTROL 33 & 45 * VARI PITCH CONTROL * HIGH TORQUE SERVO DRIVEN DC MOTOR * TRANSIT SCREWS * 12 DIE CAST PLATTER * NEON STROBE * CALIBRATED BALANCE * REMOVABLE HEAD SHELL * CARTRIDGE FIXINGS * CUE LEVER * POWER 220 240V 50 60Hz * 390 x 305mm * SUPPLIED WITH MOUNTING CUT-OUT TEMPLATE

PRICE £59.99 + £3.50 P&P.

OPTIONAL MAGNETIC CARTRIDGES

STANTON AL500
PRICE £16.99 + 50p P&P

GOLDRING G850
PRICE £6.99 + 50p P&P

OMP MOS-FET POWER AMPLIFIERS, HIGH POWER, TWO CHANNEL 19 INCH RACK

THOUSANDS PURCHASED BY PROFESSIONAL USERS



NEW MXF SERIES OF POWER AMPLIFIERS

THREE MODELS:- MXF200 (100w + 100w)
MXF400 (200w + 200w) MXF600 (300w + 300w)

All power ratings R.M.S. into 4 ohms

FEATURES: * Independent power supplies with two Toroidal Transformers * Twin LED Vu meters * Rotary indexed level controls * Illuminated on off switch * XLR connectors * Standard 775mV inputs * Open and short circuit proof * Latest Mos-Fets for stress free power delivery into virtually any load * High speed rate * Very low distortion * Aluminium cases * MXF600 Fan Cooled with D.C. Loudspeaker and Thermal Protection

USED THE WORLD OVER IN CLUBS, PUBS, CINEMAS, DISCOS ETC.

SIZES:- MXF 200 W19 - H3 1/2 (2U) - D11
MXF 400 W19 - H5 1/2 (3U) - D12
MXF 600 W19 - H5 1/2 (3U) - D13

MXF200 £171.35
MXF400 £228.85
MXF600 £322.00

SECURICOR DELIVERY £12.00 EACH



OMP LINNET LOUDSPEAKERS

THE VERY BEST IN QUALITY AND VALUE

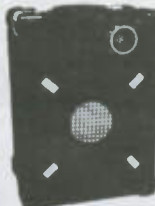

MADE ESPECIALLY TO SUIT TODAY'S NEED FOR COMPACTNESS WITH HIGH OUTPUT SOUND LEVELS FINISHED IN HARDWEARING BLACK VINYL WITH PROTECTIVE CORNERS GRILLE AND CARRYING HANDLE INCORPORATES 17 DRIVER PLUS HIGH FREQ. HORN FOR FULL FREQ. RANGE 45Hz 20KHz BOTH MODELS 8 OHM SIZE H18 - W15 - D12

CHOICE OF TWO MODELS

POWER RATINGS QUOTED IN WATTS RMS FOR EACH CABINET

OMP 12-100 (100W 100dB) PRICE £159.99 PER PAIR

OMP 12-200 (200W 102dB) PRICE £209.99 PER PAIR

SECURICOR DEL. - £12.00 PER PAIR

OMP SLIDE DIMMER 1K WATT & 2.5K WATT

CONTROL SLIDES UP TO 1KW & 2.5KW SUITABLE FOR RESISTIVE AND INDUCTIVE LOADS BLACK ANODISED CASE READILY FLUSH MOUNTED THROUGH PANEL CABINET CUT OUTS. ADVANCED FEATURES INCLUDE -

- * Full Wave Bridge Rectifier
- * Neon
- * Monitor Indicator
- * Flash Over Protection
- * High & Low Frequency Presets
- * Full Wave Suppressor to Reduce R.F.I.

SIZES:
1KW H18 - W14 - D15mm
2.5KW H28 - W16 - D19mm
PRICES - 1K WATT £15.99
2.5K WATT £24.99 + 60p P&P

PIEZO ELECTRIC TWEETERS-MOTOROLA

PIEZO ELECTRIC TWEETERS - MOTOROLA

Join the Piezo revolution! The low dynamic mass (no voice coil) of a Piezo tweeter produces an improved transient response with a lower distortion level than ordinary dynamic tweeters. As a crossover is not required these units can be added to existing speaker systems of up to 100 watts (more if 2 put in series). **FREE EXPLANATORY LEAFLETS SUPPLIED WITH EACH TWEETER.**

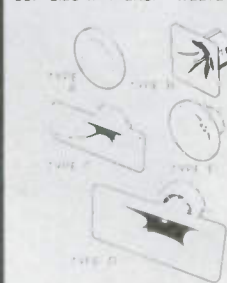

'TYPE A' (KSN2036A) 3" round with protective wire mesh ideal for bookshelf and medium sized Hi-Fi speakers. Price £4.90 each + 50p P&P

'TYPE B' (KSN1005a) 3 1/2" super horn. For general purpose speakers, disco and P.A. systems etc. Price £5.00 each + 50p P&P

'TYPE C' (KSN6016A) 2 x 5" wide dispersion horn. For quality Hi-Fi systems and quality discos etc. Price £6.99 each + 50p P&P

'TYPE D' (KSN1025A) 2 x 6" wide dispersion horn. Upper frequency response retained extending down to mid range (2KHz). Suitable for high quality Hi-Fi systems and quality discos. Price £9.99 each + 50p P&P

'TYPE E' (KSN1038A) 3 1/2" horn tweeter with attractive silver finish trim. Suitable for Hi-Fi monitor systems etc. Price £5.99 each + 50p P&P

LEVEL CONTROL Combines on a recessed mounting plate, level control and cabinet input jack socket. 85 x 85mm. Price £3.99 + 50p P&P

STEREO DISCO MIXER

STEREO DISCO MIXER with 2 x 5 band L & R graphic equalisers and twin 10 segment L E D Vu Meters. Many outstanding features 5 inputs with individual faders providing a useful combination of the following - 3 Turntables (Mag) 3 Mics 4 Line including CD plus Mic with talk over switch Headphone Monitor Pan Pot L & R Master Output controls Output 775mV Size 360 x 280 - 90mm Supply 220-240V. **Price £134.99 - £4.00 P&P**

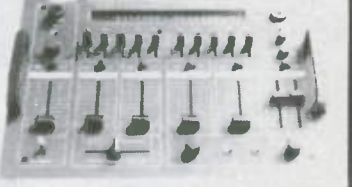

B. K. ELECTRONICS Dept PE
UNIT 5, COMET WAY, SOUTHDON-ON-SEA, ESSEX. SS2 6TR
TEL: 0702-527572 FAX: 0702-420243

1991 BUYER'S GUIDE TO ELECTRONIC COMPONENTS

Maplin

FEATURING:
AN ELECTRONICS
CAST OF
THOUSANDS!

POWER-PACKED
WITH OVER
600 PAGES!!

STARRING
HUNDREDS OF
NEW PRODUCTS
AT SUPER
LOW PRICES!

SHOWING NOW!
at your local
WHSMITH



ROD BROWN

Order you copy of the New MAPLIN Catalogue on sale NOW
Pick up a copy from any WHSMITH for just £2.45 + 50p p&p. If you live outside the UK, send £4.85 or
copy for just £2.45 + 50p p&p. If you live outside the UK, send £4.85 or
20 International Reply Coupons. I enclose £2.95.

Name _____
Address _____
Post Code _____
Send to Maplin Electronics
P.O. Box 3, Rayleigh,
Essex S56 8LR.

PERFORMANCES DAILY
At your local branch
of WHSMITH
ONLY £2.45