

76 AVE

PRACTICAL

# ELECTRONICS

MAY 1973

60¢

## PUSHBUTTON VARICAP STEREO TUNER

**FREE** INSIDE...  
**DISPLAY DEVICE IDENTICHART**



# DISPLAY DEVICE ID

PRESENTED FREE WITH PRACTICAL EL

FORMATS

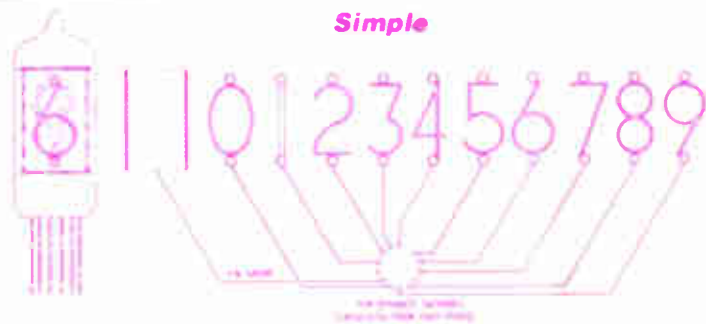

*This format consists of discrete display characters. The character set takes the form of shaped wire cathodes.*

*Seven Segment*



*Simplest bar matrix display based on a stylised figure of eight made from seven individually illuminated bars.*

SINGLE LAMP



Neon	
Manufacturer	Various
Voltage	>70V
Current	1mA
Brightness	Low
Colour	Orange



Manufacturer	Monsanto	
Type	MV1	MV2
Voltage	2V	4V
Current	50mA	50mA
Brightness	500ft-L	300ft-L
Colour	Amber	Green



Manufacturer	Monsanto
Type	MV5080
Voltage	1-6V
Current	20mA
Brightness	300ft-L
Colour	Red



Manufacturer	Texas
Type	TIL 209
Voltage	1-6V
Current	20mA
Brightness	High
Colour	Red

E-DIGIT



Neon

Filament Indicator



Type	Minitron 3015F
Voltage	10V (max), 5V (typ)

Luminescent Phosphor Indicator



Type	Ise Itron DG12H
------	-----------------

Incandescent Digital Indicator



Type	Atron DA-133
------	--------------

Liquid C

Type

# DEVICE IDENTIFICATION CHART

WITH PRACTICAL ELECTRONICS MAY, 1973

PE

ment



based on a stylised  
seven individually

Hexadecimal

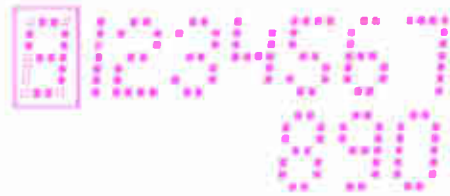

This represents the hexadecimal characters for the decimal numbers 0 through to 15 on a 4 x 7 dot matrix. This kind of format can also be achieved using a bar matrix.

Complete Alpha-numeric Matrixes

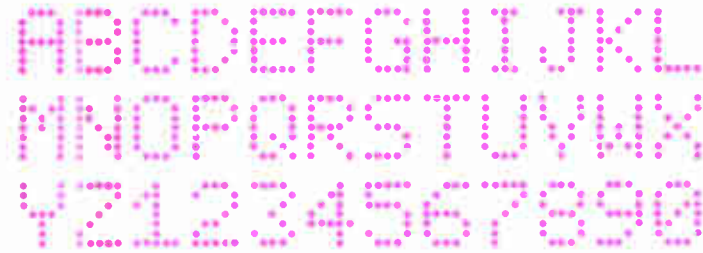

36 alpha-numeric characters available in the A.S.C.I.I. (American Standard Code for Information Interface) code are shown. The characters are made up from a 7 x 5 dot matrix.

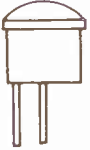

Manufacturer: Texas Instruments  
Type: TIL 209  
Voltage: 1.6V  
Current: 20mA  
Brightness: High  
Colour: Red



Manufacturer: Texas Instruments  
Type: TIL 207  
Voltage: 1.65V  
Current: 20mA  
Brightness: 750ft-L  
Colour: Red



Manufacturer: Hewlett Packard  
Type: 5082-4480  
Voltage: 1.6V  
Current: 20mA  
Brightness: High  
Colour: Red

## APPLICATIONS DATA

Using an L.E.D. to monitor the output of a TTL integrated circuit

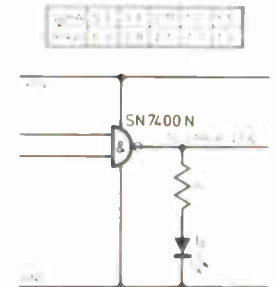

Incandescent Digital Indicator



Type: Atron DA-133

Liquid Crystal Digital Indicator

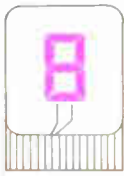

Type: RCA TA8032

Incandescent Bulb Display



Type: Spektra-Tek Series 2500

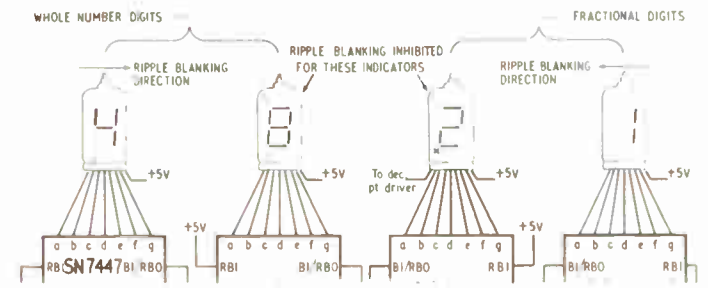

SINGLE DIGIT

Type Mullard ZM1164, ZM1020  
 Voltage 170V  
 Current 2.5mA  
 Character height 15.5mm  
 Package Tube  
 Format Simple

Type Minitron 3015F  
 Voltage 10V (max), 5V (typ)  
 Current 13mA/bar (max)  
 Character height 9mm  
 Brightness 200ft-L  
 Colour Orange  
 Package Suit 16 pin D.I.L. socket  
 Format 7-segment

Type Ise Itron DG12H  
 Voltage/segment 20V  
 Filament power 0.68W  
 Character height 12.2mm  
 Brightness 80ft-L  
 Colour Green  
 Format 7-segment

Type Atron DA-133  
 Voltage 3-5.5V  
 Power 0.1-0.12W/segment  
 Character height 12mm  
 Brightness 500ft-L  
 Colour Coloured filters available  
 Format 7-segment

Type  
 Voltage  
 Current  
 Character  
 Format  
 Application

SINGLE DIGIT L.E.D.

L.E.D. Display

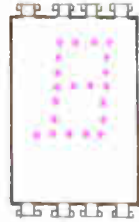

Type Hewlett Packard 5082-7300  
 Voltage 5V  
 Current 94mA  
 Colour Red  
 Character height 7.3mm  
 Format 4 x 7 dot matrix

Digital Display with logic



Type Texas TIL 306  
 Voltage 5V  
 Current (total) 170mA  
 Colour Red  
 Brightness High  
 Character height 6.8mm  
 Format 7-segment  
 Package 16 pin D.I.L.

Alpha-Numeric Display



Type Monsanto MAN 1  
 Voltage/segment 3.4V  
 Current/segment 20mA  
 Brightness 350ft-L  
 Character height 6.8mm  
 Format 7-segment

Alpha-Numeric L.E.D. Display

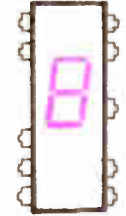

Type Monsanto MAN 4  
 Voltage/segment 1.7V  
 Current/segment 10mA  
 Brightness 400ft-L  
 Character height 4.8mm  
 Format 7-segment  
 Colour Red

Alpha Nu

Type  
 Voltage/se  
 Current/se  
 Brightness  
 Character  
 Format  
 Colour

MULTI DIGIT



Horizontal L.E.D. Display

Type Litronix DL34  
 Voltage 1.7V  
 Current/segment 5mA  
 Colour Red  
 Brightness 200ft-L  
 Character height 3.17mm  
 Format 7-segment



Multidigit L.E.D. Display

Type Texas TIL 360  
 Voltage segment 1.65V  
 Current 10mA  
 Colour Red  
 Brightness High  
 Character height 2.54mm  
 Format 7-segment



Horizontal Neon Display

Type Sperry Rand SP-730  
 Current/segment 200µA  
 Voltage 200V  
 Colour Orange  
 Brightness 225ft-L  
 Character height 8.4mm  
 Format 7-segment



Dot Matrix Tube Assembly

Type Mullard ZM1250  
 Voltage 140V  
 Current/each cathode 0.3mA  
 Colour Orange  
 Character height 9.8mm  
 Format 7 x 5 dot matrix



4 D

Type  
 Voltage  
 Current  
 Character  
 Format

Model	Atron DA-133
Voltage	3.5-5V
Power	0.1-0.12W/segment
Character height	12mm
Brightness	5000ft-L
Colour	Coloured filters available
Format	7-segment

Type	RCA TA8032
Voltage	12V pulsed
Current	35µA
Character height	19mm
Format	7-segment
Application	Transmissive type for back or edge lit readout

Type	Spektra-Tek Series 2500
Bulb voltage	12V
Bulb current	36mA
Character height	25mm
Brightness	Variable
Colour	Coloured filters available
Format	7-segment

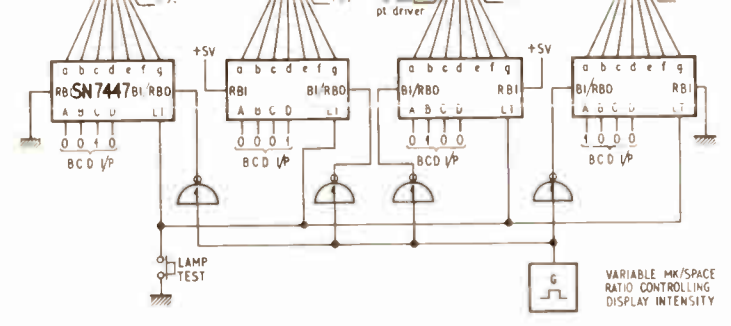

Using single digit filament indicators to give a decimal output

Type	Alpha-Numeric L.E.D. Display
Image	
Model	Monsanto MAN 4
Voltage/segment	1.7V
Current/segment	10mA
Brightness	400ft-L
Character height	4.8mm
Format	7-segment
Colour	Red

Type	Alpha Numeric L.E.D. Display
Image	
Model	Monsanto MAN 3
Voltage/segment	1.7V
Current/segment	10mA
Brightness	400ft-L
Character height	2.9mm
Format	7-segment
Colour	Red

Type	Alpha-Numeric L.E.D. Display
Image	
Model	Monsanto MAN 2
Voltage/diode	1.7V
Total current	400mA
Brightness	300ft-L
Character height	8.9mm
Format	5 x 7 dot matrix
Colour	Red

L.E.D. displays with integral logic greatly simplify digital circuits as shown in this circuit where three Texas devices are used to make a self-contained counter

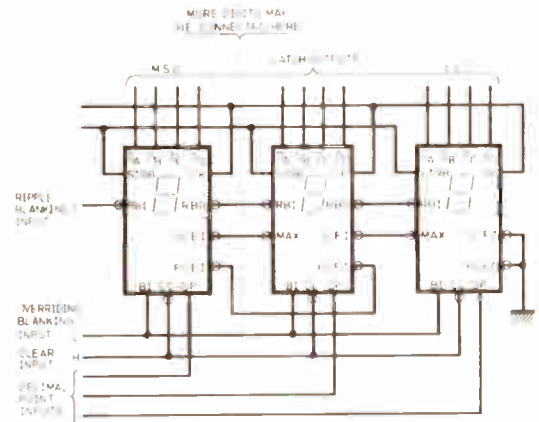

Type	Dot Matrix Tube Assembly
Image	
Model	Mullard ZM1250
Voltage	140V
Current/each cathode	0.3mA
Colour	Orange
Character height	9.8mm
Format	7 x 5 dot matrix

Type	4 Digit Liquid Crystal Cells
Image	
Model	R.C.A. TA8040
Voltage	8-50V
Current	100µA
Character height	15.2mm
Format	7-segment

Type	Pandicon 14 Digit Indicator Tube
Image	
Model	Mullard ZM1200
Voltage	200V
Current	8mA
Colour	Orange
Character height	10mm
Format	Simple

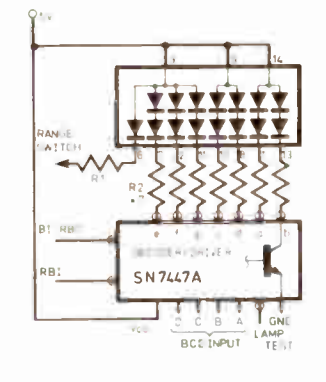

Using single digit L.E.D. indicators to convert a binary coded decimal number into decimal

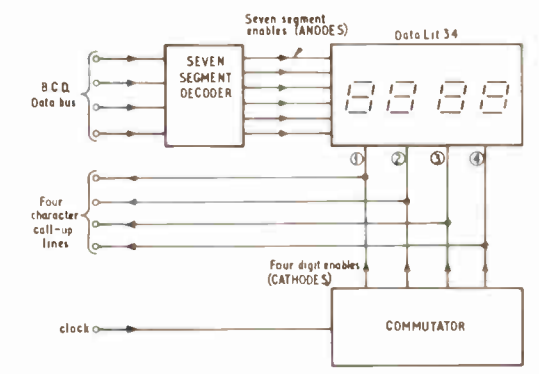

Multidigit L.E.D. displays must be used in a time sharing or multiplex mode where only one digit at a time is activated.

NOTE: The publishers of this chart (IPC Magazines Ltd) cannot accept responsibility for any errors that may have occurred. Company registered in England Reg No 53626 Registered Office Tower House 8-14 Southampton Street London WC2E 90X

# Why take the risk?

of damage to expensive transistors and integrated circuits, when soldering?

## Use Antex low-leakage soldering irons



220-240 Volts or 100-120 Volts **Model X25**

The leakage current of the NEW X25 is only a few microamps and cannot harm the most delicate equipment even when soldered "live". Tested at 1500v. A.C. This 25 watt iron with it's truly remarkable heat-capacity will easily "out-solder" any conventionally made 40 and 60 watt soldering irons, due to its unique construction advantages. Fitted long-life iron-coated bit 1/8".

2 other bits available 3/32" and 3/16".

Totally enclosed element in ceramic and steel shaft Bits do not "freeze" and can easily be removed

PRICE: £1.75 (rec. retail) Suitable for production work and as a general purpose iron

**Model CCN** 220 volts or 240 volts

The 15 watt miniature model CCN, also has negligible leakage. Test voltage 4000v. A.C. Totally enclosed element in ceramic shaft. Fitted long-life iron-coated bit 3/32"

4 other bits available 1/8", 3/16" 1/4" and 1/16"

PRICE: £1.80 (rec. retail)

OR Fitted with triple-coated, (iron, nickel and Chromium) bit 1/8"

PRICE: £1.95 (rec. retail)

### A SELECTION OF OTHER SOLDERING EQUIPMENT.



#### MODEL CN

Miniature 15 watt soldering iron fitted 3/32" iron-coated bit. Many other bits available from 3/64" to 3/16". Voltages 240, 220, 110, 50 or 24  
PRICE: £1.70 (rec. retail)

#### MODEL CN2

Miniature 15 watt soldering iron fitted with nickel plated bit 3/32". Voltages 240 or 220.  
PRICE: £1.70 (rec. retail)



#### MODEL G

18 Watt miniature iron, fitted with long life iron-coated bit 3/32". Voltages 240, 220 or 110.  
PRICE: £1.83 (rec. retail)

#### MODEL SK.1 KIT



contains 15 Watt miniature iron fitted with 3/16" bit, 2 spare bits 5/32" and 3/32", heat sink, solder, stand and "How to Solder" booklet.

PRICE £2.75 (Rec. retail)

#### MODEL SK.2 KIT

contains 15 Watt miniature iron fitted with 3/16" bit, 2 spare bits 5/32" and 3/32", heat sink, solder and booklet "How to Solder"



PRICE £2.40 (Rec. retail)

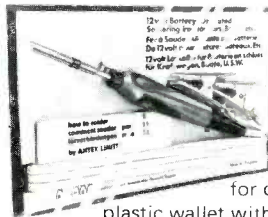

#### MODEL MES.KIT

Battery-operated 12v. 25 watt iron fitted with 15' lead and 2 heavy clips for connection to car battery. Packed in strong plastic wallet with booklet "How to Solder."

PRICE £1.95 (Rec. retail)



From radio or electrical dealers, car accessory shops or, in case of difficulty direct from:—  
**ANTEX LTD. FREEPOST**  
(no stamp required) **Plymouth**  
**PL1 1BR** Tel: 0752 67377  
Reg. No. 393594

ALL PRICES MENTIONED EXCLUSIVE OF V.A.T.

- Please send the ANTEX colour catalogue.  
 Please send the following:

I enclose cheque/P.O./Cash (Giro No. 2581000)

NAME \_\_\_\_\_

ADDRESS \_\_\_\_\_

PE5

# PRACTICAL ELECTRONICS

VOLUME 9 No. 5 MAY 1973

---

## CONSTRUCTIONAL PROJECTS

- PUSHBUTTON VARICAP STEREO TUNER** *by S. R. Beeching* 400  
Easily constructed stereo tuner using varicap tuning modules
- P.E. DIGI-CAL—11** *by R. W. Coles* 406  
Concluding article
- P.E. SOUND SYNTHESISER—4** *by G. D. Shaw* 420  
Ramp generators and input amplifiers
- LOGIC TUTOR** *by G. D. Bishop and M. Hughes* 430  
An educational aid on which a wide range of logic experiments can be performed

## GENERAL FEATURES

- BRAIN X-RAY** *by K. R. Hill* 413  
The EMI-Scanner—A computerised system for diagnosing brain diseases
- LOGIC TUTOR EXPERIMENTS—1** *by M. Hughes* 438  
The first article in this new series deals with basic gates

## NEWS AND COMMENTS

- EDITORIAL—Stereo Radio Without Tears** 399
- BOOK REVIEWS** 427, 446  
Selected new books we have received
- KIT REVIEW** 428  
The SUPACAL pocket calculator
- SPACEWATCH** *by Frank W. Hyde* 429  
Skylab experiments
- POINTS ARISING** 438  
Hi Fi Tape Link—P.E. Triffid I.C. Radio—A.F. Signal Generator
- ON THE FRINGE** *by Gerry Brown* 441  
The more unusual aspects of electronics
- NEWS BRIEFS** 441  
Design Council awards '73—Electronics Course
- INDUSTRY NOTEBOOK** *by Nexus* 442  
What's happening inside industry
- PATENTS REVIEW** 445  
Thought provoking ideas on file at the British Patents Office

## SPECIAL DATA SHEET

- DISPLAY DEVICE IDENTICHART**  
At-a-glance information on many types of readout devices

**Our June issue will be published on Friday, May 11, 1973**

---

© IPC Magazines Limited 1973. Copyright in all drawings, photographs and articles published in PRACTICAL ELECTRONICS is fully protected, and reproduction or imitations in whole or part are expressly forbidden. All reasonable precautions are taken by PRACTICAL ELECTRONICS to ensure that the advice and data given to readers are reliable. We cannot, however, guarantee it, and we cannot accept legal responsibility for it. Prices quoted are those current as we go to press. Subscription Rates including postage for one year, to any part of the world, £2.65.

TERMS Retail mail order subject to £1.00 minimum order. Cash with order only. Trade and educational establishments M/AC on application (minimum £5.00). Postage 10p inland, 25p. Europe.

GUARANTEE: All goods carry full manufacturer's warranty. Get in touch today for a complete run-down of devices available from SCS (include SAE).

S.C.S. Components Ltd., P.O. Box No. 26, Wembley, Middlesex HA0 1YY  
Registered in London No. 888454



## device of the month D.V.M. chip

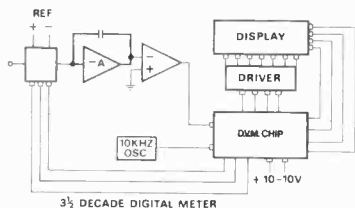

Now you can construct your own D.V.M. with this new G.I. Microelectronics chip—a single MOS LSI chip containing all the logic necessary for a

3 1/2 Decade Digital Voltmeter utilising Dual Ramp integration. Just look at some of these features:

- \* 3 1/2 Decade Display ( $\pm 1999$  max. reading)
- \* Automatic Polarity Detection
- \* Overrange Indication
- \* Chopper Output Provided
- \* Up to 50 readings per second
- \* 16 lead DIL package
- \* Full G.I. Microelectronics warranty

**complete D.V.M. logic for just**

including application notes

£7.90  
+  
VAT

## Compatible device M3 7 segment LED display

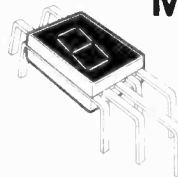

Also from Monsanto this display is ideal for use with D.V.M. chip. \* 0.125" characters

- \* Displays all numbers plus nine letters
- \* Full specification included
- \* Application notes for this unit are included in the specification on the D.V.M. chip—they are available separately, however, price: 25p.

### \*\*\* SPECIAL OFFER \*\*\*

For six weeks only; a D.V.M. chip plus 4 digits for just £14.50 + V.A.T. Offer closes 31st May, 1973.

**a superb 7 segment LED display for just**

£2.70  
+  
VAT



## KONTAKT 60

FOR INACCESSIBLE CONTACTS—More than just a cleaner. KONTAKT 60 guarantees perfect cleaning of contacts chemically in accordance with today's technology.

KONTAKT offers the following advantages:—

1. Dissolves oxides and sulphides the safe way without attacking contact substances.
2. Contains carefully selected solvents which do not attack plastics whereas they do dissolve resinified contact greases and dirt.
3. Contains *no silicone*.
4. Contains a light lubricant in order to avoid the contact paths being corroded.
5. Prevents further oxidation setting in.
6. Prevents "creep" currents.

Because of these outstanding properties KONTAKT 60 is one of the best and most popular contact cleansing agents in the world.

Users include: Rolls-Royce Ltd., C.E.G.B., South of Scotland Electricity Board, Trinity House Workshops, Kolster Brandes, Mullard, Plessey Cos., etc.

### OTHER KONTAKT PRODUCTS ARE:

70 Protective Lacquer                      80 Special Siliconized Polish  
72 Insulating Spray                        100 Antistatic Agent for Plastics  
75 Cold Spray for Fault Location       101 Dehydration Fluid

Write for full details of above complete range of Kontakt products to:—

**SPECIAL PRODUCTS DISTRIBUTORS LIMITED**

81 Piccadilly, London, W.1                      01-629 9556

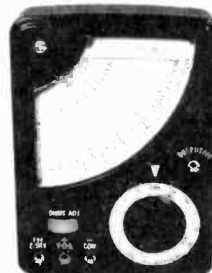

MULTIMETER Model 200H, 20,000 ohm/volt, £4.80. 30 $\mu$ A, 50 $\mu$ A or 100 $\mu$ A METERS, £2.50. POTENTIOMETERS Lin or Log, 12p; with DP Switch, 24p; Dual Ganged, 36p; special offer 5K with DP switch, 16p. JB3 Junction Box, £1.20; JB11, £1.95. 500 $\mu$ A TUNING METERS, 50p. CARTRIDGES: Compatible ACOS GP91-3, 90p; Stereo GP93-1, £1.15. CAPACITORS 100mF 25V, 5p; 220mF 25V, 5p; 400-200-50-16mF 300V, 30p; 0.1 500V d.c., 300V a.c., 4p. MINIATURE INDICATOR LAMPS (5 colours), 11p; 6 or 12V Bulbs for above, 4p. MAINS NEONS panel mounting (red, green, clear), 15p. HEADPHONES: High Impedance (2,000 ohm), 90p; Stereo (8 ohm), £1.95; Stereo/Mono 8/16 ohm £2.10. RECORDING TAPE, 5in LP 900ft, 45p; 5 1/2in LP 1,200ft, 60p; 7in LP 1,800ft, 81p.

Large S.A.E. for List No. 5. Special prices for quantity quoted on request. Add 10p for P. & P. on orders under £5.

## M. DZIUBAS

158 Bradshawgate, Bolton, Lancs. BL2 1BA



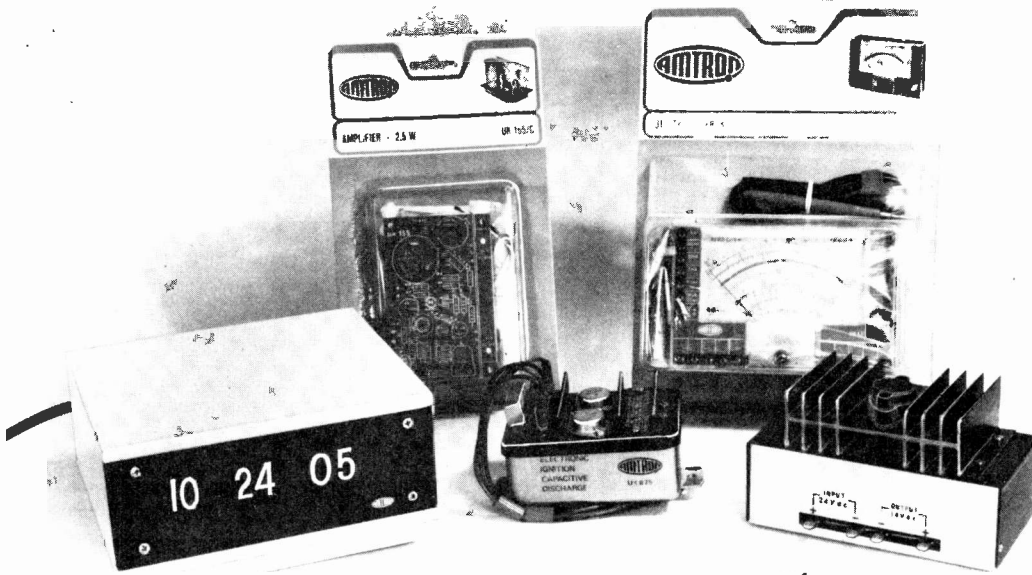

## There are 195 other good reasons for buying AMTRON electronic kits

Apart from the five items shown above, there are another 195 kits to choose from in the vast AMTRON range of electronic kits.

A few examples of equipment you can construct from AMTRON kits are:

Power supplies, preamplifiers, amplifiers, L.F. instruments, accessories for musical instruments, amateur and radio control transmitters and receivers, battery chargers, electronic car accessories, psychedelic lighting equipment, measuring instruments, tuners, receivers, I.C. digital equipment.

Only 1st class fully guaranteed components are used—solder is included with every kit.

Prices range from £1.10 to £80 and each kit is sold in protective blister pack containing complete instructions.

*Should you experience any difficulty in obtaining  
AMTRON Kits please contact us direct.*

PLEASE SEND FOR BROCHURE



TRADE & EDUCATION ENQUIRIES WELCOME

AMTRON U.K. 4 & 7 CASTLE STREET HASTINGS SUSSEX TELEPHONE HASTINGS 2875



# gspk (sales)

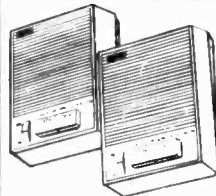

## D1075 Wireless Intercom

The great merit of wireless intercoms is that separate connecting wires are not necessary providing the stations are on the same electrical mains circuit. Communication can be up to a distance of 2 of a mile providing the power lines used are on the same side of the distribution transformer, and several stations can even be operated on the same circuit. Solid state model D1075 is fully transistorised and each unit incorporates a talk-listen button with locking bar; ON/OFF volume control and a pilot light. The lawn moulded cabinets can be desk located or wall mounted and are supplied already fitted with 1.25 metres of heavy duty lead. Operating Frequency: 160kHz. Speaker: 130mm. Dynamic 55mm. Power Output: 120mW. Size: 98 x 40 x 130mm. Printed Circuit: 3 transistors, 1 diode.

£11.60

## SOLID STATE TACHOMETER

Functionally styled for under or over dashboard installation, this electronic tachometer fits all 4-cycle, 4-cylinder, or 2-cycle, 2-cylinder 12V vehicles. Negative or positive earth. Calibrated white on black 0-8,000 r.p.m. in 100 r.p.m. divisions together with settable "danger" line, simple installation 2 screws, 4 wires. 80mm (3in) dia. dial, 50mm deep. On adjustable angle bracket. Sealed black crackle finish.

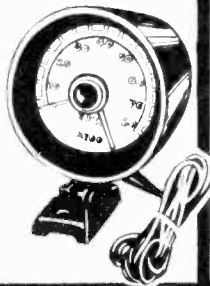

£6.86

## SPECIAL OFFER !

### AUTO BURGLAR ALARM PLUS "POP-OUT" CIGARETTE LIGHTER

Designed for easy installation on any car (whether 6 or 12V) this device activates the horn when a theft is attempted of equipment or personal belongings. This neat unit reacts when the vehicle is disturbed or rocked and continues its warning for 15 sec. after tampering. The sensitivity of the device is adjustable and controlled by a separate ON/OFF panel which can be located wherever convenient. Supplied with connecting wires and screws in attractive bubble pack, containing installation instructions and diagrams. 150 65 20mm plus panel 65 x 45 x 20mm.

£2.10 FOR BOTH

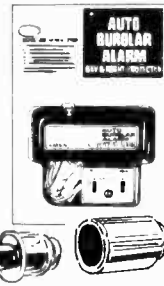

## FANTAVOX STEREO LOUDSPEAKER SYSTEM

These high quality speaker enclosures are made of tough black moulded plastic and have been designed for fitting on to almost any vehicle surface. The smart louvred fronts are silver trimmed and house heavy duty 5in (125mm) ceramic loudspeakers rated at 3/5 watts, 8 ohms impedance. Already wired with generous length connecting leads and supplied in packs of speaker pairs complete with fixing screws. Each cabinet measures 190 x 105 x 165mm.

### 1052 FADER CONTROL

Weight: 0.55 kg.

Neat, custom-made appearance slide fader control for balance of front and rear speaker volume. Simulated wood finish panel which can be quickly fitted below car dash. Supplied with generous connecting cable and fitting screws. Will suit 4, 8, 16 ohm installations. 100 x 38 x 30mm (including knob but excluding fitting bracket).

All for £4.70

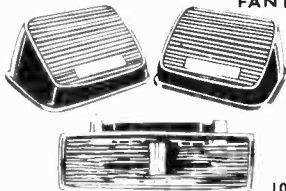

## 420ES MICROSCOPE

An extremely modestly priced yet efficient microscope capable of magnification up to 750 times with clear sharp images. This model is of the self-illuminating type and incorporates an easily rotatable four-position turret magnifying lens with rack and pinion focusing. The crackle black metal body houses the batteries for adjustable illumination. Packed in carton with built-in carrying handle and full notes for user. A sample slide also provided. 105mm at base; 180mm high. Weight: 0.40 kg.

£4.95



## G5555 PROFESSIONAL STEREO HEADPHONE

Lightweight materials are skilfully used in the construction of this model in black crackle moulding and kid-soft leathercloth with contrasting bright metal. Each ear pad houses a highly efficient 60mm reproducer unit and features ear muffs removable for cleaning. 10-self-coiled lead plug fitted. Frequency Response: 20-20,000Hz. Impedance: 4-16 ohms. Sensitivity: 110dB. Power: 0.5W. Weight: 0.39kg.

£9.25



## "SPRITE" LIGHTWEIGHT STEREO HEADPHONE

An outstanding achievement following lengthy development by one of the world's leading audio manufacturers, the T.T.C. "Sprite" offers the following specification: Extreme lightness (only 150 grammes) (5oz); Instant wearing adjustment with sliding earpieces and flexible headband; Highly efficient Mylar reproducer units; Removable, washable foam padded ear muffs; 3-metre lightweight lead with stereo plug fitted. Frequency Response: 30-13,000Hz. Sensitivity: 105dB. Power: 0.2W. Impedance: 4-16 ohms. Weight: 0.15kg.

£2.25



## D1019 "Doorphone" with Metal Unit

Three transistor solid state two-way intercom system with specially engineered weatherproof slave unit in heavy gauge metal. Sensible design features include rain protective speaker louvres, simple push-pull button, internal socket connecting lead and removable back plate for wall and door panel mounting. Master unit in high impact white moulding has complementary silver "pinhole" grille and silver black panels with ON/OFF volume control and push-to-talk switch. 60mm dynamic speaker/microphones are used for both units. 120mW output. 9V internal battery operation. Master unit: 7.7 x 40 x 105mm. Slave unit: 70 x 32 x 90mm. Supplied with battery, lead and staples. £3.90

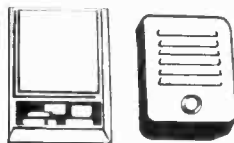

## DF100 MICROPHONE

Bijou sized model in matt silver finish with machined capping to insert housing and supplied with unique pocket/lapel clip which also doubles as a desk support. Supplied with lavalier cord, 2 metre lead fitted 3.5mm moulded plug and packed in the latest style click-fast case manufactured from smart durable padded plastic.

Impedance: 200 ohms. Sensitivity: 82dB. Frequency: 100-9,000Hz. Size: 13mm dia. x 92mm.

£3.50



## TI-C1000 MINI-METER

£2.70

This is the most compact and reliable multimeter on the market and features easy switch selection, 1,000 ohm/volt 2-jewel meter movement with zero and needle adjustment. Easy to read scale in two colours. Ranges: A.C. Voltage: 0-10V, 50V, 250V, 1,000V. D.C. Voltage: 0-10V, 50V, 250V, 1,000V. D.C. Current: 0-1-100mA. Resistance: 0-150K ohms.



Please fill in the coupon and send with 10p (refundable on ordering) for catalogue. ALL CALLERS WELCOME

To G.S.P.K. (Sales) Limited, Dept. P.E.,  
Head Office, Hookstone Park, Harrogate, Yorkshire HG2 7BU.  
Mon. to Fri. 9 a.m. - 5 p.m.

Name .....

Address .....

P.E.





### KAMODEN 72.200

#### MULTI-TESTER

High sensitivity tester. 200,000 o.p.v. Overload protection. Mirror scale. Ranges: 0/0.0/0.3/3/30/120/600/1,200V d.c., 0/3/12/60/300/1,500V a.c. 0/60A/120mA/120mA/600mA/12A d.c. 0/12A a.c. — to +63dB. 0/2KΩ/200KΩ/2MΩ/200MΩ. £18-95. Post 30p.



### KAMODEN HM-350 TRANSISTOR TESTER

High quality instrument to test Reverse Leak current and D.C. current. Amplification factor of PNP, PNP, transistors, diodes, SCR's, etc. 4" x 4 1/2" clear scale meter. Operates from internal batteries. Complete with instructions, leads and carrying handle. £12 50. Post 30p.



### KAMODEN HMG-500 INSULATION RESISTANCE TESTER

Range 10 to 100 Megohms, 500 Volt. Battery operated. Wide range clear meter 4 1/2" x 4". Complete with deluxe carrying case, batteries, instructions. £19-95. Post 30p.



### ARF-300 AF/RF SIGNAL GENERATOR

All transistorised, compact, fully portable. AF sine wave 18 Hz to 220 KHz. AF square wave 18 Hz to 100 KHz. Output sine/square 10V. P-P. RF 100 KHz to 200 MHz. Output Iv. maximum. Operation 220/240V. A.C. Complete with instructions and leads. £29-95. Post 50p.

### HAND HELD 2-WAY WALKIE TALKIES

Industrial quality in robust metal cases. Battery operation. Volume and squelch controls. Call button and press to talk button. Telescopic aerial. Complete carrying cases.

2 channel £52-50 Pair. Post 50p.  
3 channel £79-50 Pair. Post 50p.  
2 watt.

(Note: Licence required for operation in U.K.)

### HOMER INTERCOMS

Ideal for home, office, stores, factories, etc. Supplied complete with batteries, cable and free instructions.

2 Station, £2-97. 3 Station £5-25. Post 15p.  
4 Station £6-92. Post 17p.



### EMI LOUSPEAKERS

Model 350. 13in x 8in with single tweeter/crossover. 20-20,000Hz. 15W RMS. Available 8 or 15 ohms. £7-25 each. Post 37p.  
Model 450. 13in x 8in with twin tweeter/crossover. 55-13,000Hz. 8W RMS. Available 8 or 15 ohms. £3-82 each. Post 25p.

### SPECIAL OFFER! STEREO SPEAKERS

Matched pair of stereo bookshelf speakers. Deluxe teak veneered finish. Size: 14 1/2in x 9in x 7 1/2in. 8 ohms. 8W RMS. 16W peak. Complete with DIN lead. £12-95. Carr. 50p.

### EA.41 REVERBERATION AMPLIFIER

Self contained, transistorised, battery operated. Simply plug in microphone, guitar, etc., and output into your amplifier. Volume control, depth of reverberation control. Beautiful walnut cabinet. 7in x 3in x 4 1/2in. £5-97. Post 15p.



### UNR-80 RECEIVER



4 Bands covering 550kHz-30MHz. BFO. Built-in Speaker 220/240V a.c. Brand new with instructions. £16-75. Carr. 37p.



### UR-1A SOLID STATE COMMUNICATION RECEIVER

4 Bands covering 550kHz-30MHz. FET. S Meter. Variable BFO for SSB. Built-in Speaker. Bandspread, Sensitivity Control. 220/240V a.c. or 12V d.c. 12 1/2in x 4 1/2in x 7in. Brand new with instructions. £25. Carr. 37p.

### SKYWOOD CX203 COMMUNICATION RECEIVER

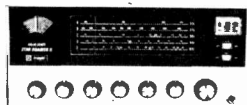

Solid state. Coverage on 5 bands 200-420 kHz and 0-55 to 30MHz. Illuminated slide rule dial. Bandspread. Aerial tuning. BFO, AVC, ANL, "S" meter. AM/CW/SSB. Integrated speaker and phone socket. Operation 220/240V a.c. or 12V d.c. Size 325 x 266 x 150 mm. Complete with instructions and circuit. £32-50. Carr. 30p.

### LAFAYETTE HA-800 SOLID STATE RECEIVER

General coverage 150-400kHz, 650 kHz-30MHz. FET front end. 2 mech. filters, product detector, variable BFO, noise limiter. S Meter. Bandspread. RF Gain. 15in x 9 1/2in x 8 1/2in. 18lbs. 220/240V a.c. or 12V d.c. Brand new with instructions. £50. Carr. 50p.



### TRIO 9R59DS COMMUNICATION RECEIVER

4 band covering 550kHz-30MHz continuous and electrical bandsread on 20, 15, 20, 40 and 80 metres. S valve plus 7 diode circuit. 4/8 ohm output and phone jack. SSB-CW. ANL. Variable BFO. S meter. Sep. bandsread dial. 1F frequency. 455kHz. Audio output 1.5W. Variable RF and AF gain controls 115/250V a.c. Size 7in x 13in x 10in with instruction manual. £49 50. Carr. paid.



### HA-10 STEREO HEADPHONE AMPLIFIER

All silicon transistor amplifier operates from magnetic, ceramic or tuner inputs with twin stereo headphone outputs and separate volume controls for each channel. Operates from 9V battery. Inputs 5MΩ/100MΩ. Output 50mW. £5-97. Post 15p.



### 1021 STEREO LISTENING STATION

For balancing and gain selection of loudspeakers with additional facility for stereo headphone switching. 2 gain controls, speaker on-off slide switch, stereo headphone sockets. 6in x 4in x 2 1/2in. £2-25. Post 15p.



### MP7 MIXER PREAMPLIFIER

3 microphone inputs each with individual gain controls enabling complete mixing facilities. Battery operated. 9 1/2in x 5 1/2in x 3in. Inputs Mic: 3 x 3mV 50K. 2 x 2mV 600 ohm. Phono meg. 4mV 50K. Phono ceramic 100mV 1 meg. Output 250mV 100K. £8-97. Post 20p.

# HI-FI EQUIPMENT

## SAVE UP TO 33 1/2% OR MORE

SEND S.A.E. FOR FULL DISCOUNT PRICE LISTS AND PACKAGE OFFERS!



## FANTASTIC OFFER! NIKKO TRM50 STEREO AMPLIFIER



17+17W r.n.s. stereo amplifier with inputs for Magnetic and Crystal phono, Tuner, Tape, Aux and Tape Monitor. Outputs for two pairs of stereo speakers and tape. Stereo headphone socket. Full range of controls including loudness control, scratch filter, etc. Size 13in x 9 1/2in x 3 1/2in. Unrepeatable offer—limited stocks!

List price £59-50  
OUR PRICE  
**£39-95**  
Carriage 50p

### NIKKO TRM 50 SYSTEM



NIKKO TRM50 17+17W rms stereo amplifier, Garrard AP76 plinth and cover, Goldring G800E cartridge, pair of Linton 2 speakers and all leads.

OUR PRICE **£93-95** Carr. and Ins. £1-50

### LEAK DELTA 30 SYSTEM



Leak Delta 30 stereo amplifier, Goldring GL75, plinth, cover and G800 cartridge. Pair of Leak L50 speakers and all leads.

OUR PRICE **£109-95** Carr. and Ins. £1-50

### TELETON SAQ206B SYSTEM



Teleton SAQ206B 8+8W amplifier BSR MP60, plinth and cover, Goldring G800 cartridge, pair of Apollo speakers and all leads.

OUR PRICE **£51-50** Carr. and Ins. £1-50

### AUDIOTRONIC ACP-8 8-TRACK CAR PLAYER



Attractive black and silver finish. 12V neg. earth. Slider controls for volume, tone and balance. Channel selector button with red pilot lamp. Complete with speakers, mounting brackets and instructions.

ONLY **£12-50** P. & P. 40p.

### AUDIOTRONIC ACR3500 CAR RADIO



Manual tuning of Medium and Long waves. 12V pos. or neg. earth. Complete with speaker, mounting brackets and instructions.

OUR PRICE **£6-50** P. & P. 50p

### AUDIOTRONIC ACR. 1 PUSH BUTTON CAR RADIO

Push button tuning of one LW and five MW stations of your choice. 12V Pos. or Neg. earth. Complete with speaker, mounting brackets and instructions.

OUR PRICE **£8-95** P & P. 50p.

### MONOTONE 6750 SYSTEM



Monotone AM/FM 4+4W stereo tuner amplifier, Garrard 2025 T/C, plinth and cover, stereo cartridge, pair of matching speakers and all leads.

OUR PRICE **£30-50** Carr. and Ins. £1

### WHARFEDALE LINTON SYSTEM



Wharfedale Linton Amplifier, Turntable, pair of Linton 2 speakers and all leads.

OUR PRICE **£95-95** Carr. and Ins. £1-25  
LINTON RECEIVER SYSTEM £125. Carr. and Ins. £1-50.

### AMSTRAD 8000 II SYSTEM



Amstrad 8000 II 7+7W amplifier. BSR MP60, plinth and cover, Goldring G800 cartridge, pair of Apollo speakers and all leads.

OUR PRICE **£45-50** Carr. and Ins. £1



### B.S.R. TD8 8-TRACK STEREO TAPE DECK

Integrated preamps (output 126mV) to feed into any stereo amplifier. Automatic and manual programme selector. 4 pole synchronous motor. 210/240V a.c.

OUR PRICE **£12-75** Carr. 50p.

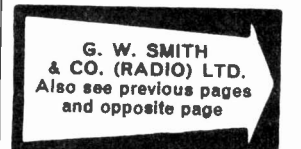



# ELECTROKIT

Now available from one company are kits for many of the articles published in the Electronics, Radio and TV Journals. Examples of our range are:

**SCORPIO IGNITION SYSTEMS** (P.E. Nov. 1971), £9.50. This kit includes all the parts for the assembly of this popular and reliable system. The hardware and the construction data are included.

**DRILL SPEED CONTROLLER** (E.E. Aug. 1972). Kit consists of resistors, rectifiers, thyristor and tag board as specified in the article, price £1.15. Kit with M.K. box, switch and plate included. £2.30.

**ELECTRONIC PIANO** (P.E. Sept. 1972). We can supply the various sections for this article in kit form:

**Power Supply**, £6.60, including all semiconductors, resistors, capacitors, transformer, heat sink and hardware less P.C.B.

**Preamp and Tremelo**, £3.20, complete with switches, hardware and electronic components, less P.C.B.

**Main Amp.**, £4.20, complete with IC-12, electronic components and P.C.B.

**13 Pitch Boards**, £39.50. Kit contains all the resistors, capacitors and semiconductors as published, but not the P.C.B.'s or the inductor.

**LIGHT DIMMER.** Kit contains all parts including circuit and construction data, 480 watts, fully suppressed. Price £2.10.

**MUSIC MAKER ELECTRONIC ORGAN** (P.W. Nov. 1972). Complete kit £4.40 or kit less resistors, P.C.B. and plastic box, £2.80. Stylus not supplied.

**MIGHTY MIDGET** (P.W. Jan. 1973). Kit contains all parts, less the battery, box and knob, £2.25.

**TRIFFID RADIO** (P.E. Feb. 1973). Kit includes all parts listed, less "tuning coil" and "miscellaneous components", £4.95. Ferrite rod and wire optional extra at 50p. P.C.B. optional extra at 65p.

We shall be offering kits for most articles published in the popular electronics magazines and will be pleased to quote prices.



Send for details of kits available (please enclose S.A.E.). All kits sent POST FREE within the limits of the U.K.

Please note. We reserve the right to withdraw kits without prior notification.

Please note, prices shown do not allow for V.A.T. Please add 10% to your order.

## ELECTROKIT

12 Lauderdale Road, London, W.9

Telephone 01-286 0011

Mon.-Fri. 9.30-5.30

Thurs. 9.30-6.30

ERSIN

**Multicore**  
5 CORE SOLDER

### for fast, easy reliable soldering

Ersin Multicore Solder contains 5 cores of non-corrosive flux, instantly cleaning heavily oxidised surfaces. No extra flux is required.

### EASY-TO-USE DISPENSERS



**Size 5**  
Savbit alloy  
18 swg, 18p  
(illustrated).  
**Size 19A**  
60/40 alloy  
18 swg, 18p  
**Size 15**  
60/40 alloy  
22 swg, 22p

### IDEAL FOR HOME CONSTRUCTORS

Size 1 cartons in 40/60, 60/40 and Savbit alloys in 7 gauges 25p



**Size 12**  
for Service Engineers and Electricians.  
75ft of 18 swg Savbit alloy. 75p



### NEW! BIB WIRE STRIPPER AND CUTTER

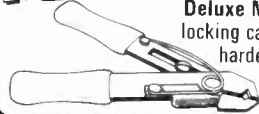

**Deluxe Model 9** Automatic opening spring, locking catch, plastic-covered handles. Case hardened and precision ground. Adjusts to most wire sizes. Cuts and strips flex, splits plastic twin flex. 75p

Prices shown are recommended retail, excluding V.A.T. From Electrical and Hardware Shops. If unobtainable, send 10p p&p direct to: **Multicore Solders Ltd.**, Hemel Hempstead, Hertfordshire HP2 7EP



## AMAZING MINI-DRILL



FOR PRECISION MODEL WORK

ABRASIVE  
SPEAR DRILL  
BURR  
NIP  
BRUSH

+ 6 TOOLS

ONLY £2.20  
P & P. 10p

Indispensable for precision drilling, grinding, polishing, etching, gouging, shaping. Precision power for the enthusiast. Shockproof. Completely portable power from 4½ volt external battery. So much more scope with MINI-DRILL. Super Kit (extra power, interchangeable chuck) £5.44 p.p. 13p. De Luxe Professional Kit with 17 tools £8.41 p.p. 23p. Money Ref. Guarantee.

**MERLIN SUPPLY CO.**

Dept. PE5D, Nailsea, Bristol BS19 2LP

## STEREO IC DECODER

HIGH PERFORMANCE PHASE LOCKED LOOP (as in 'W.W.' July '72)  
MOTOROLA MC1310P

EX STOCK DELIVERY

Specn. Separation: 40dB 50Hz-15kHz. Distortion: 0.3%, I/P level: 560mV rms. O/P level: 485mV rms per channel. Input impedance: 50k. Power requirements: 8-12V @ 16mA. Will drive up to 75mA stereo 'on' lamp or LED.

**KIT COMPRISES FIBREGLASS PCB**

(Printed and tinned), Resistors, I.C., Capacitors, Preset Potm. and Instructions. Only £3.50 post free.

**LIGHT EMITTING DIODE (Red)**

Suitable as stereo 'on' indicator. For above with panel mounting clip and instructions. Only 35p + p.p.

MC1310P only £2.77 + p.p. 6p

14 PIN DIL SOCKETS. 16p each.

SPECIAL OFFER

IN4002 100V 1A RECT. DIODES. Full Specification Devices. ONLY 6p each V.A.T. at 10% from April 1st must be added to all prices.

**Fi-Comp Electronics**

BURTON ROAD, EGGINGTON, DERBY DE6 6GY



(\*All prices include V.A.T.)  
**YES, "YOU'VE GOT THE WHOLE WORLD IN YOUR HANDS"! ALMOST UNBELIEVABLE!** Think of the year 1984 and what might be produced. Then—now—get the fantastic **ASTRAD 17** and see for yourself that the incredible Russians have done it all NOW! It's the radio perfectionist's dream come true! **THIS ONE SUPERSEDES ALL EARLIER MODELS!** It will probably make your present radio seem like a "crystal set"! Complete with optional battery eliminator for both battery and mains use! We're almost giving them away at only £19.47—a mere fraction of even today's Russian miracle price! We challenge you to compare performance and value with £80 radios! Done it all quickly, after receiving goods test 7 days, refund if not delighted. Or call. Elegant black & chrome finish face, set in fabulous Cabinet built case—constructed of fine Russian hardwood in beautiful Teak Veneer finish—prevents vibration, ensures purer & sweeter tone than ever! Volume controlled from a whisper to a roar that would fill a hall! Much wider band spread, for absolute "pin-point" station selection! Plus "MAGIC EYE" tuning level indicator for ultra perfect tuning sensitivity! Yes, the Russians have surpassed themselves, proving again their fantastic ability in the field of electronics and brilliantly reflecting their advanced micro-circuitry techniques in the field of spacehip and satellite communications. **YES, EVERY WAVEBAND** instantly at your fingertips including Standard Long, Medium, Short and Ultra Short Waves to cover the four corners of earth during 24 hours a day including all normal transmissions. VHF, FM, USW, AM: LW, MW, SW, gets, locally, local & new stations not yet operational, and messages from all over the world! Expensive **TURRET TUNER** side control waveband selection unit (as used on expensive T.V.'s!). Every waveband clicks into position giving incredible ease of station tuning! Genuine push-pull output! ON/OFF volume and separate Treble and Bass tone controls for utter perfection of reproduction and tone! Press-button dial illumination! Take it anywhere—runs economically on standard batteries (obtainable everywhere) or direct through battery eliminator from 220/240V AC mains supply. Internal ferrite rod aerial plus built-in "rotatable" telescopic aerial extending to 39in approx. It's also a fabulous **CAR RADIO**. Can also be used through extension amplifier, tape recorder or public address system. **SIZE 14in x 10in x 4 1/2in** over—Magnificently designed, made to give years of perfect service. (U.K. service facilities & spares available for years & years to come, if ever necessary!). With **WRITTEN GUARANTEE**, manual with simple operating instructions & circuit diagram. **ONLY £19.47** (with mains/battery eliminator £1.62 extra). **BOX, POST, ETC. 55p.** **BUT WAIT!** for only 50p extra you get the sensational **"COMPUTERISED" WORLD TUNING GUIDE** (it enables you to time, pinpoint & get transmissions the whole world over—even a child can do it in a flash—it even lets you know when to tune into the U.K. when abroad, NO GUESSING! NO MESSING!) **PLUS** Standard "longlife" batteries **PLUS** ultra sensitive earphone for personal listening. (Sorry—We cannot change these new radios for any earlier model purchased.) Send quickly to Uxbridge Road address, or call at either Store. **But: HURRY! SHOPERTUNITIES SAVE YOU £££.**

**THOUSANDS OF MILES REDUCED TO INCHES?  
 1973 RUSSIAN RADIO TECHNOLOGY  
 SHRINKS THE WORLD! \*COMPUTERISED?**

**THIS FANTASTIC  
 EARTH SHRINKER**



**YES, 24,901 miles  
 SHRUNK TO ONLY 14 x 10 1/2 x 4 1/2  
 inches approx?**

**BRAND NEW  
 FABULOUS ASTRAD 17**  
**PORTABLE RADIO & COMMUNICATIONS  
 RECEIVER**



**28 TRANSISTORS  
 AND DIODES!  
 WAVEBANDS:  
 STANDARD LONG and MEDIUM  
 Plus 5 SHORT WAVEBANDS  
 Plus ULTRA SHORT WAVES  
 (V.H.F. AM, FM, MW,  
 LW, USW.)**

**BATTERY  
 MODEL**

**£19.47**

**BOX  
 POST  
 ETC.  
 55p**

**MAINS/BATTERY  
 ELIMINATOR £1.62 extra**

**FIRST TIME EVER!**  
 \*NOW AVAILABLE WITH  
 fabulous "COMPUTERISED"  
**WORLD TUNING GUIDE!**  
 \*RE GUESSWORK—  
 INSTANT DATA at your fingertips—  
 enables you to **TUNE IN A FLASH** to  
 transmissions the world over!

**THIS  
 OFFER  
 ONLY  
 FROM  
 US!**

**BUY ONE FROM US!** **SAVE £21.60 NOW!**

**Fabulous BRAND NEW SOLID STATE**

**BATTERY/MAINS AC  
 Combined  
 V.H.F. AM/FM  
 RADIO and  
 CASSETTE  
 TAPE RECORDER  
 & PLAYER**



This equipment's got EVERYTHING!

**RECOMMENDED RETAIL PRICE £44**

**OUR PRICE £22.40** **CARR. ETC. 39p**

**WITH REMOTE CONTROL MICROPHONE**

(\*All prices include V.A.T.)  
 Shopertunities "thunder" ahead with an offer that's FANTASTIC (even by our standards!). We've snapped up 500 magnificent machines. Latest sensation in the world of sound! First-class makers! Fabulous VHF, AM, FM Radio AND Cassette Tape Recorder & Player combined & it also runs off standard batteries or mains. (Simply plug in the 220/240V AC line cord.) Record and play back anything, anywhere! **RECOMMENDED RETAIL PRICE GENUINELY £44! WE OFFER AT ALMOST HALF PRICE!** Wonderful features: ★ Press-button Keyboard Control Panel or latest MASTER SWITCH CONTROL! ★ "MAGIC EYE" Visual Battery check/recording level indicator or built-in automatic Leveller! ★ Separate ON/OFF and HI-LO volume controls! ★ Heavy duty built-in speaker! ★ Earphone (for personal listening or "monitoring") and extension speaker sockets! ★ Remote control microphone! ★ Built-in swivel telescopic extension aerial (24in approx.). Magnificently made case with carry handle. (DESIGNS VARY SLIGHTLY.) Takes standard 30, 60, 90 or 120-minute Cassette Tapes, obtainable everywhere. AND the amazing built-in full circuit VHF, AM/FM Radio gives you superb clarity of tone, incredible station selection. Unique rotating Station Selector Dial—gets, locally, city and region stations in every part of the country, plus B.B.C. National, VHF. Picks up dozens of foreign stations. Fabulous in your car! You could pay £££'s more for a Car Radio or Car Cassette player ALONE! £22.40, carr. etc., 39p. Complete with simple instructions, remote control microphone with on/off switch and microphone stand, **WITH WRITTEN GUARANTEE**. Send quickly, after receiving goods, test 7 days, refund if not delighted. Or call. **BONUS OFFER:** Batteries and Cassette Tape 28p extra if required.

**FIRST TIME EVER! \*SAVE £15.21!**

**BRAND NEW AC/DC BATTERY/MAINS**

**Cassette  
 TAPE  
 RECORDER  
 & PLAYER**



**FIRST CLASS MAKERS**

With remote control microphone.

**WE COULD CHARGE UP TO £26.97!**

**OUR PRICE £11.76** **POST ETC. 34p**

(\*All prices include V.A.T.)  
 THE ONE STEP FORWARD EVERYONE HAS WAITED FOR! NOW a superb deluxe portable **BATTERY/MAINS** tape recorder and player—and incredible Shopertunities bring it to you for **ONLY £12.49!** Due to our cut price we cannot name first-class makers—but rest assured you're getting one of the **BEST!** Expensive "PIANO KEYBOARD" CONTROL PANEL (or latest MASTER SWITCH control) AND AUTOMATIC LEVEL CONTROL. No fiddling with awkward tape and reels, just "slap-in" a cassette and off you go! (Takes 30, 60, or 90 minute standard cassette tapes, obtainable everywhere). Amazing performance ensures perfect tapings and superb reproduction! Remote control microphone. Rapid Rewind! Fast forward! Beautiful tone from a whisper to a roar! Completely self contained—record anywhere, indoors or out! Runs on standard batteries AND 220/240V AC mains. Separate jacks for remote control microphone, etc. Size 9 1/2in x 5in x 2 1/2in approx. Design can vary slightly. With carry handle. **WRITTEN GUARANTEE** and full instructions. (Recommended selling price £26.97!) **OUR PRICE ONLY £11.76**, post, etc. 34p. \*Send quickly, after receiving goods test 7 days—refund if not delighted.

Order by post to Uxbridge Road address or call at either store.  
 Bargains galore at both stores—(COMMERCIAL TRAVELLERS PLEASE!  
 NOTE: Merchandising office at Holborn Store.)

Dept. PE/28, 164 UXBRIDGE RD. (facing Shepherds Bush Green), LONDON W12 8AQ. (Thurs. 1, Fri. 7). Also at 37/39 HIGH HOLBORN (opposite Chancery Lane), LONDON, W.C.1. (Thurs. 7 p.m.) BOTH OPEN MON. TO SAT. 9 A.M. TILL 6 P.M.

**SHOPERTUNITIES LTD.**



# SAXON ENTERTAINMENTS

STANDARD and CUSTOM-BUILT AUDIO and ELECTRONIC EQUIPMENT  
NEW and SECONDHAND MUSICAL INSTRUMENTS. MAIN DISTRIBUTORS  
FOR A.K.G. HIGH QUALITY MICROPHONES

## SA25-SA35-SA100

LOW-PRICED AUDIO MODULES FOR  
DOMESTIC and COMMERCIAL USE

New versions  
using 3A  
"Plastic Power"  
Driver Transistors  
now available

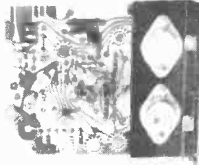

THESE THREE MODULES HAVE ENJOYED UNPARALLELED SUCCESS DURING THE FIRST FEW MONTHS OF THEIR BEING MADE AVAILABLE TO THE GENERAL PUBLIC. WE ARE PLEASED TO ANNOUNCE THAT WE CAN NOW OFFER FAST DISPATCH ON MOST OF OUR ADVERTISED ITEMS, INCLUDING THESE THREE MODULES.

**SA25** £2-95 carr. free

25 WATTS R.M.S. 7 transistors, 7 diodes

**SA35** £4-45 carr. free

35 WATTS R.M.S. 7 transistors, 7 diodes

**SA100** £10-90 carr. free

100 WATTS R.M.S. 11 transistors, 6 diodes

ALL THREE MODULES HAVE OPEN AND SHORT CIRCUIT PROTECTION, AND THE SA100 IS PROOF AGAINST OVER-DISSIPATION AND FAULTY INDUCTIVE LOADS.

ONLY ADVANCED DESIGN TECHNIQUES MAKE THESE EXTRAORDINARILY LOW PRICES POSSIBLE.

### BRIEF SPEC. FOR ALL THREE MODULES

Freq. response	20 40,000Hz 1dB
Distortion	0.2% at 1kHz
Loads	4 to 16 ohms
Quiescent current	15mA
Noise	Better than -75dB
Supply voltage	25 45V, SA25/35 40 70V, SA100
Size	4 1/2in 4in 1in (SA100) 4in 3in 1in (SA25, SA35)

Circuits, connecting instructions and application data are supplied free with all modules.

### POWER SUPPLIES FOR THE SA25/35 and SA100 AUDIO MODULES

<b>PU45</b>	Unstabilised supply for 2 SA25/35's, £4-90.
<b>PU70</b>	Unstabilised supply for one or two SA100's, £7-75, carr. 40p
<b>PS45</b>	Stabilised module for 2 SA25's or two SA35's, £3-50, carr. free
<b>MT45</b>	Transformer for above, heavy duty, £2-85, carr. 20p
<b>MT30</b>	Transformer for unstabilised supply complete with rectifier diodes mounted £3-50, carr. 20p
<b>PS70</b>	Stabilised supply module for one or two SA100's, £4-90, carr. free
<b>MT70</b>	Transformer for PS70, £4-90, carr. 40p

ALL MODULES ARE BUILT ON GLASS FIBRE P.C. BOARD AND ARE SUPPLIED FULLY TESTED

CALLERS AND MAIL  
ORDER:  
327-331 Whitehorse Road  
W. Croydon, Surrey CRO 2HS  
Tel. 01-684 6385

CALLERS ONLY:  
OUR NEW DISTRIBUTORS  
**CIRCLE SOUND**  
328-330 The Banks  
Rochester.  
Medway 404199

BUSINESS  
HOURS:  
9.30 a.m. to  
5.30 p.m.

TERMS OF BUSINESS: **C.W.O.** or **C.O.D.** (35p extra). All cash in regd. envelopes please! Telephone orders to our CROYDON BRANCH. TRADE AND EXPORT ENQUIRIES INVITED

## OTHER SAXON PRODUCTS . . .

### 120 WATT HEAVY DUTY MODULE

Featuring a rugged class A driver stage, this module will run from all our mixers etc., and most other makes of mixer. It delivers 120W into an eight ohm load and employs 4 TO3 can (115V) output transistors.

#### SPECIFICATION

Power output	120W into 8 ohms
Freq. response	20-20,000Hz ± 2dB
Input sensitivity	200mV into 10K
Construction	Fibreglass board
Size	8in x 4in x 4in (5in with supply)
Low distortion parallel push-pull output stage.	

£13-90 + 20p carr. or with supply £18-95 + 40p carr.



NEW: 160 Watt version & supply £27-90

### SINGLE CHANNEL SOUND/LIGHT CONVERTER

This compact and reliable unit operates from amplifiers with outputs from 5-100W. Does not impose a heavy load on the amplifier, or, if connected in the wrong polarity, cause any damage, as with some units.

Operation is simplicity itself and the unit is fully fused. The unit is supplied to function from bass notes but may easily be converted to respond only to treble or mid-range notes by the addition of components costing less than 5p.



£8-90 carr. free



### THREE CHANNEL SOUND TO LIGHT UNIT

Handling the total of 3,000W (3kW) this unit is unique for its price in that not only bass middle and treble but also master controls are provided. Two amplifier sockets eliminate the need for split leads, etc. Supplied in tough steel case for free-mounting or panel fixing. Fully guaranteed.

£19-75 carr. 30p

MONO VERSION £6-50, carr. 20p  
(As illustrated below, S.A.E. details. 9V operation)  
OUTPUTS UP TO 1V RMS



£15-80 carr. 30p  
**SAXON STEREO CONTROL UNIT**

Two decks, and full headphone monitoring. The unit is mains operated and measures 17 1/2in x 3in x 4in deep and is finished with a smart white on black fascia. The controls are: Left/Right deck fader, volume, bass, treble, headphone selector and volume, microphone volume, bass, treble, mains on/off. THIS IS A MUST FOR THE HOME BUILT HIGH QUALITY DISCO-THEQUE AND IS COMPARABLE TO UNITS AT OVER TWICE THE PRICE. (N.B.—Stereo only has mic. input.)

### COMPLETE AMPLIFIERS

THE CSE 100. £34-90 carr. free

This versatile unit is now available in a black vynidie case and so represents even better value than ever, delivering speech and music powers of up to 100W R.M.S. and continuous signal outputs of 70W.

Two individually controlled inputs with wide range bass and treble controls. Ideal for small groups, D.J.'s, etc.



The SAXON 100. £48-50, carr. free.

With an R.M.S. output of 120W speech and music, 100W continuous power, four individually controlled F.E.T. input stages and wide range bass and treble controls, this amplifier has established itself as a unit offering quality and reliability at low cost.

### LOUDSPEAKERS British made bargains!!!

12in 25W 8/15 ohms £5-95, carr. 30p. 15in 50W 8/15 ohm. £14-50, carr. 50p. 12in 40W 15,000 gauss magnet system 8/15 ohm, £11-50, carr. 40p.

A.K.G. MICROPHONES suitable for disco, group or general P.A. use D11DHL ideal disco mike, only £9-45 (r.r.p. £11)

ALL PRICES SUBJECT TO VAT AT STANDARD RATE

600W 3 colour light boxes, smart rexine finish.  
£15 carr. free

SEND S.A.E. FOR OUR A.K.G. PRICE LIST. DISCOUNTS ON ALL MICS.

# CRESCENT RADIO LTD

11 & 40 MAYES ROAD, LONDON N22 6TL 888 3206

MAIL ORDER  
DEPT.  
No. 11  
MAYES RD.  
LONDON  
N22  
6TL

## COMPONENTS AND HI FI FOR THE HOME CONSTRUCTOR

OUR SHOPS ARE OPEN ALL DAY  
FROM 9 A.M. TO 6 P.M. 6.30 P.M. ON FRIDAY  
(WE CLOSE ALL DAY THURSDAY)

13 SOUTH MALL, EDMONTON, N.9 803 1685

### LOW VOLTAGE AMPLIFIER

5 transistor amplifier complete with volume control, is suitable for 9V d.c. and a.c. supplies. Will give about 1W at 8 ohm output. With high I.M.P. input this amplifier will work as a record player, baby alarm, etc., amplifier.



£1-75

plus 13p P. & P.

### TRI-VOLT BATTERY ELIMINATOR

Enables you to work your Transistor Radio, Amplifier or Cassette, etc., from the a.c. mains through this compact Eliminator. Just by moving a plug you can select the voltage you require, 6, 7½ or 9 volt. This means all your transistor power pack applications can be handled by this one unit. Approx. size 2½in 2½in 3½in. Our Price £2-75 plus 10p P. & P. Same model suitably wired for the Philips Cassette £3 plus 10p P. & P.



### DIGITAL CLOCK KIT

24-hr. Nixie dig. clock kit. We supply: a complete set of components; a complete set of easy to follow instructions; printed circuits made to make construction as simple as possible; a cabinet and front panel to give a professional finish. All for the price of the components. £22-50 + 50p P. & P. Please send S.A.E. if you require more information.



### AL20 5 WATT AUDIO AMPLIFIER

A low cost high quality 5 watt audio amplifier designed for use in stereo systems, record players and other audio equipment. Supply Voltage = 9 to 30 volts. Frequency = 50 to 25 kHz. Overall Size = 3in x 2½in x 1½in approx. Full technical data and diagrams with each module. All guaranteed and a bargain at £2-63 plus 5p P. & P.



V.A.T.  
From 1st April, 1973, will you please include on your Total (Goods plus Postage and Packing) Value Added Tax at the Standard Stated Rate.

### MINIATURE RELAY

6 volt 70 ohm. Single Pole Changeover = 40p plus 5p P. & P. Approx. size = 1½in x 1½in x ½in.

### MAINS TRANSFORMER

Fused Primary 240V. Secondary 220V @ 50mA. 6.3V @ 1A. This transformer is made to a very high standard and is a small size: 2½in x 2½in x 2½in. £68p plus 15p P. & P.



### S.G. BROWN "DIPLOMAT" MONO-STEREO HEADSET

British made lightweight Headphones. Incorporate ceramic piezo electric transducers. Specific-ation:—Frequency 20-17,500 CPS. Impedance Predominantly capacitive, at 400MFD per earpiece can be regarded as 150K at 1KHz. Weight: 3.5oz. (98 grams). Please include 10p per set P.P. A Bargain at £1-50 each set.



### TRI-VOLT CAR SUPPLY

Enables you to work your Transistor Radio, Amplifier or Cassette, etc. from the 12 volt car supply. Positive or negative earth. Approx. size = 2in. x 3½in. x 1½in. This converter supplies 6, 7½ or 9 volts and is transistor regulated. A real money saving device for £2-50 plus 10p P. & P.

### MINI LOUSPEAKERS

2½in 8 ohm, 50p; 2½in 80 ohm, 50p; 2½in 40 ohm, 50p. Please include 5p P. & P. on each L.S.



### ADD LUXURY TO YOUR CAR

#### WITH A MOTOR DRIVEN CAR AERIAL

Spec.: 5 Section Extended Length 100cm Length under Fender 40cm Cable Length 120cm Supplied complete with Fixing Bracket and Control Switch. £6-75 plus 25p P. & P.

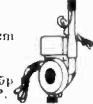

EMI LOUSPEAKER 450 10W 13in x 8in ± two 2-24in tweeters and cross-over. All wired and ready for use. This ever-popular 450 in 3-8-15 ohm imp. £3-75 plus 38p P. & P. each.

### 7in x 4in LOUSPEAKER

A top quality speaker ideal where small size is important. Manufactured by E.M.I. for a well-known hi-fi set maker. Size: 7in x 4in. Impedance: 8 ohms. Flux: 38,000. Max. Free range: 90Hz to 12kHz. Power handling: 5W. Unbeatable. Price: £1-80. Free postage on this item.



### CRESCENT CASSETTES

Top quality cassettes at unbeatable prices (complete with standard storage case): C60 28p, C90 38p, C120 48p plus 5p P. & P.



### PSYCHEDELIC LIGHT CONTROL UNIT

Three Channel Bass Middle-Treble. Each channel has its own sensitivity control. Just connect the input of this unit to the loudspeaker terminals of an amplifier, and connect three 250V up to 500V lamps to the output terminals of the unit, and you produce a fascinating sound-light display. (All guaranteed) £18-50 plus 38p P. & P.



### "CRESCENT" 100 WATT R.M.S. ALL PURPOSE AMPLIFIER U.BUILD.IT

We supply the three modules for you to build this Disco-Group-P.A. amplifier into the cabinet of your choice.  
★ THE POWER AMP MODULE TP100W 170W r.m.s. sp. wave 300W instantaneous peak into 8 ohm (60W into 16 ohm). £14-28 carr. 45p  
★ THE PRE-AMP MODULE Four control pre-amp, Vol. Bass, Treble, Middle controls. Designed to drive most amplifiers using F.E.T. first stage. £3-96 carr. 25p  
★ THE POWER SUPPLY MODULE PS100 Is supplied complete with the mains transformer. £9-86 carr. 50p Complete fixing instructions are supplied and no technical knowledge is required to connect the three ready wired modules. A fantastic bargain. If you purchase all three modules. £25 carr. 75p Send S.A.E. for further details on this or our ready built amplifiers.

## INTER-LOCKING PLASTIC STORAGE DRAWERS

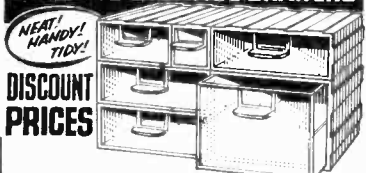

Newest, nearest system ever devised for storing small parts and components: resistors, capacitors, diodes, transistors, etc. Rigid plastic units interlock together in vertical and horizontal combinations. Transparent plastic drawers have label slots/removable space dividers. Build up any size cabinet for wall, bench or table top.

BUY AT TRADE PRICES!  
SINGLE UNITS (1D) (5ins 2½ins 2½ins). £1-25 DOZEN.  
DOUBLE UNITS (2D) (5ins 4½ins 2½ins). £2-10 DOZEN.  
TREBLE (3D) £2-20 for 8.  
DOUBLE TREBLE 2 drawers, in one outer case (6D2), £3-25 for 8, EXTRA LARGE SIZE (6D1) £3-10 for 8.

PLUS QUANTITY DISCOUNTS!  
Orders £6 and over DEDUCT 5% in the £  
Orders £10 and over DEDUCT 7½% in the £  
Orders £20 and over DEDUCT 10% in the £  
PACKING/POSTAGE/CARRIAGE: Add 35p to all orders under £5. Orders £10 and over, packing/postage/carriage free.  
QUOTATIONS FOR LARGER QUANTITIES  
Please add V.A.T. to total remittance

IVORYET LIMITED  
(Dept. PE5) 124 Cricklewood Broadway, London, N.W.2  
Tel. 01-450 4844

## WORLD RADIO TV HANDBOOK 1973

A complete Directory of International Radio and TV £3 14

- SOLID STATE PROJECTS FOR THE EXPERIMENTER by W. Green. £1-30.
- ADVANCED RADIO CONTROL by E. L. Safford Jr. £1-10.
- TEN-MINUTE TEST TECHNIQUE FOR ELECTRONICS SERVICING by E. C. Carlson £1-10.
- BEGINNER'S GUIDE TO RADIO CONTROL by R. H. Warring. £1-70.
- SERVICING WITH THE OSCILLOSCOPE by Gordon J. King. £1-92.
- TRANSISTOR AUDIO AND RADIO CIRCUITS by Mullard. £1-92.
- 110 INTEGRATED CIRCUIT PROJECTS FOR THE HOME CONSTRUCTOR by R. M. Marston. £1-30.
- ELECTRONICS POCKET BOOK by J. P. Hawker. £1-70.
- COLOUR TV WITH PARTICULAR REFERENCE TO THE PAL SYSTEM by G. N. Patchett. £3-10.
- RADIO DATA REFERENCE BOOK by G. R. Jessop. £1-12.
- DIGITAL LOGIC BASIC THEORY AND PRACTICE by J. H. Smith. £1-60.

\*ALL PRICES INCLUDE POSTAGE\*

## THE MODERN BOOK CO.

BRITAIN'S LARGEST STOCKIST of British and American Technical Books  
19-21 PRAED STREET LONDON W2 1NP  
Phone 01-723 4185  
Closed Saturday 1 p.m.

## Vary the strength of your lighting with a DIMMASWITCH

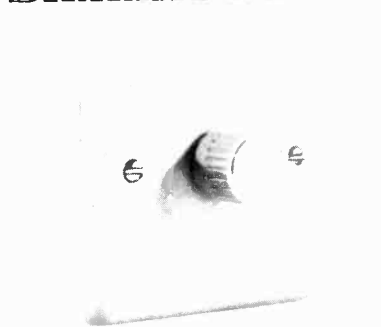

The DIMMASWITCH is an attractive and efficient dimmer unit which fits in place of the normal light switch and is connected up in exactly the same way. The white mounting plate of the DIMMASWITCH matches modern electric fittings. Two models are available, with the bright chrome knob controlling up to 300w or 600w of all lights except fluorescents at mains voltages from 200-250v, 50Hz. The DIMMASWITCH has built-in radio interference suppression:

600 Watt—£3-52. Kit Form £2-97  
300 Watt—£2-97. Kit Form £2-42

All plus 10p post and packing  
Prices include V.A.T.  
Please send C.W.O. to:  
**DEXTER & COMPANY**  
1 ULVER HOUSE, 19 KING STREET  
CHESTER CH1 2AH Tel. 0244-25883  
As supplied to H.M. Government Departments, hospitals, local authorities, etc.



# Now! A FAST EASY WAY TO LEARN BASIC RADIO & ELECTRONICS



Build as you learn with the exciting new **TECHNATRON** Outfit! No mathematics. No soldering—you learn the practical way.

Learn basic Radio and Electronics at home—the fast, modern way. Give yourself essential technical “know-how”—like reading circuits, assembling standard components, experimenting, building—quickly and without effort, and enjoy every moment. B.I.E.T.'s simplified study method and the remarkable **TECHNATRON** Self-Build Outfit take the mystery out of the subject, making learning easy and interesting.

Even if you don't know the first thing about Radio now, you'll build your own Radio set within a month or so!

... and what's more, you will understand exactly what you are doing. The **TECHNATRON** Outfit contains everything you need, from tools to transistors—even a versatile Multimeter which we teach you to use. All you need give is a little of your spare time and the surprisingly low fee, payable monthly if you wish. And the equipment remains yours, so you can use it again and again.

**You LEARN—but it's as fascinating as a hobby.**

Among many other interesting experiments, the Radio set you build—and it's a good one—is really a bonus. This is first and last a teaching course, but the training is as fascinating as any hobby and it could be the springboard for a career in Radio and Electronics.

A 14-year-old could understand and benefit from this course—but it teaches the real thing. The easy to understand, practical projects—from a burglar-alarm to a sophisticated Radio set—help you master basic Radio and Electronics—even if you are a “non-technical” type. And, if you want to make it a career, B.I.E.T. has a fine range of courses up to City and Guilds standards.

### Specialist Booklet

If you wish to make a career in Electronics, send for your **FREE** copy of “**NEW OPPORTUNITIES**”. This brand new booklet—just out—tells you all about **TECHNATRON** and B.I.E.T.'s full range of courses.

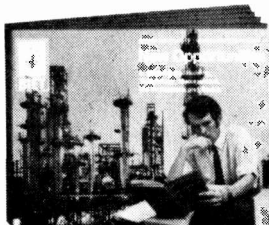

## FREE

**BRITISH INSTITUTE OF ENGINEERING TECHNOLOGY**

Dept. BPE15, ALDERMASTON COURT, READING RG7 4PF

*Accredited by the Council for the Accreditation of Correspondence Colleges.*

**POST THIS COUPON FOR FREE BOOK**

CL BPE15

NAME (BLOCK CAPITALS)

AGE .....

ADDRESS

SUBJECT OF INTEREST

## FM TUNER THOUSANDS NOW IN USE

NELSON-JONES

Reduced prices

Approved parts of this outstanding design (W.W. April 1971). Featuring 0.75µV sensitivity. Mosfet front end. Ceramic I.F. strip. Triple gang tuning, 4V r.m.s. output level, suitable for phase locked decoder, as below. Designer's own P.C.B. Tuner parts with box. Less than £11.50. S.A.E. please for lists. **NEW** Solid State Tuning Indicator and Dial-Chassis Kit. **High Performance Decoder** also available. **NEW** IC Stabilised PSU. SC, overload protected, low ripple. £3.55 p.p. 19p.

## LIGHT EMITTING DIODES (Red)

Improved Type panel or PCB mounting with free mounting clip—clear or black. Order LED1A. Please add postage. **Monsanto** miniature PCB mounting with radial leads. Order LED2. Please add postage. **NOW ONLY 35p each with connection data.**

## 7 SEGMENT LED DISPLAY

0.325in Characters 0-9 and nine letters. TTL, DTL compatible. ONLY £2.46 each, p.p. 10P. BCD-7Seg Dec Driver, £1.30.

## ELECTRONIC CALCULATOR

MODEL BC806

Pocket Size

Full 4 Function—will perform Addition, Subtraction, Multiplication and Division including Chain or Mixed Multiplication or Division as well as true credit balance. **Constant Key:** Fixed or Floating decimal point. Batteries and leather case supplied.

**PRICE ONLY £46.25**

(POST FREE)

(Mains adaptor £4.50)

V.A.T. at 10% from April 1st must be added to all prices.

**INTEGREX LIMITED, DEPT. P.E.**

P.O. BOX 45, DERBY DE1 1TW

Tel.: Repton (0283 89) 3580

New VAT EDITION



## Lasky's Audio-Tronics Catalogue 1973

The new 1973 VAT edition of Lasky's famous Audio-Tronics Catalogue will be available in early April—FREE on request. The 48 tabloid size pages—many in full colour—have been reprinted with VAT price changes for your convenience, together with many new items. Over half the pages are devoted exclusively to every aspect of Hi-Fi (including Lasky's budget Stereo Systems and Package Deals), Tape Recording and Audio Accessories. Send for your copy now and see for yourself that VAT can mean a saving on many of the 1000's of items we offer.

## FREE

Send this coupon with 15p for post and inclusion on our regular mailing list.

NAME .....

ADDRESS .....

PE11

LASKY'S RADIO LIMITED, 3-15 CAVELL STREET, LONDON E.1.









# DISCOUNTS UP TO

# 60%

## Global's GOLDEN Guarantee

WE GUARANTEE THAT WITHIN 7 DAYS OF PURCHASE IF ANY ITEM OF GOODS IS FOUND TO BE GENUINELY DEFECTIVE WE WILL REPLACE THE SAID GOODS WITHOUT QUESTION. AFTER 7 DAYS GOODS ARE COVERED BY MANUFACTURERS 12 MONTHS GUARANTEE

**GARRARD SP25 Mk. III Special Purchase.** £17.45  
Limited number available  
Garrard SP25 Mk. III  
Goldring G800  
Teak plinth and tinted cover  
All leads supplied.  
Please add £1.25 P. & P. & Ins.

### TURNTABLES

Please add 75p P. & P. & Ins.  
Connoisseur BDI Chassis £12.75  
Garrard SP25 Mk. III £9.90  
Garrard AP76 £17.20  
Garrard SL65B £13.95  
Garrard 401 £28.75  
Garrard Zero 100 (Auto) £36.90  
Garrard Zero 100 (Single) £35.80  
BSR MP60 £9.40  
Goldring GL72 £20.90  
Goldring GL72 P £27.45  
Goldring GL75 £26.85  
Goldring GL75 P £34.95  
Goldring 101 P.C. £20.00  
Wharfedale Linton + cart. £25.90  
Thorens TD125AB Mk. II £27.95  
Thorens TD160 AB & C £53.95

### TUNERS

Please add 85p P. & P. & Ins.  
Amstrad Multiplex 3000 £28.75  
Armstrong 523 £39.50  
Armstrong 524 £31.45  
Rogers R/brook FET4 (Chassis) £37.25  
Rogers R/brook FET4 (Cased) £43.50  
Rogers R/bourne FET4 (Chassis) £45.00  
Rogers R/bourne FET4 (Cased) £49.50  
Sinclair PR060 (Module) £17.45  
Sinclair 2000/3000 Tuner £29.90  
Leak Delta FM (Cased) £53.60  
Leak Delta AM/FM (Cased) £63.75  
Alpha Highgate FT150 £37.95  
Metrosound FMS 20 £38.70  
Philips RH 690 £33.00

### TUNER/AMPLIFIERS

Please add £1 P. & P. & Ins.  
Alpha Highgate 150 £48.95  
Armstrong 525 (Teak cased) £69.45  
Armstrong 526 AM/FM £77.25  
(Teak cased) £119.00  
Leak Delta 75 £32.50  
Teletron 2100 £98.90  
Goodmans One Ten £87.95  
Goodmans Mod 90 £49.50  
Rotel 150 £75.50  
Rogers Ravensbrook (Teak cased) £77.00  
Rogers R/brook (Chassis) £72.00  
Alpha FR 3000, New product £72.00

All prices correct at time of press E. & O.E. and are subject to alterations.

# GLOBAL AUDIO DISCOUNT WAREHOUSES

Dept. (PE5), 174 Pentonville Road, London, N.1. Tel. 01-278 1769  
Or: 4 High View Parade, Redbridge Lane East, Woodford Avenue Ilford, Essex. Tel. 01-550 1086

Open Monday to Saturday 9.30 a.m. to 6 p.m. LATE NIGHT FRIDAY 7 p.m.

**MAIL ORDERS:** Order with confidence. Send Postal Order. Cheque, Money Order, Bank Draft, Giro or Cash by Registered Mail. **CALLERS:** Please note that cheques can only be accepted together with cheque cards (not Barclay Card).

### AMPLIFIERS

Please add 85p P. & P. & Ins.  
Amstrad 8000 Mk. II £14.95  
Amstrad IC2000 £27.50  
Amstrad Integra 4000 £21.45  
Armstrong 521 (Teak cased) £43.90  
Alpha Highgate 212 £24.85  
Alpha Highgate FA300 £32.25  
Alpha Highgate FA400 £35.65  
Leak Delta 30 £44.85  
Leak Delta 70 £54.90  
Metrosound ST20E £24.20  
Metrosound ST60 £45.95  
Pioneer SA600 & 610 £57.25  
Pioneer SA5000A £71.95  
Pioneer SA1000 £96.95  
Rogers R/brook (Chassis) £37.95  
Rogers R/brook (Cased) £41.50  
Rogers R/bourne (Chassis) £49.95  
Rogers R/bourne (Cased) £52.75  
Sinclair PR060 2 / Z 30 PZ5 £14.70  
Sinclair PR060 2 / Z 30 PZ6 £16.70  
Sinclair PR060 2 / Z50 PZ8 £22.95  
7 Trans £4.20  
Sinclair AFU (Filter Unit) £18.25  
Sinclair 605 £21.50  
Sinclair 2000 Mk. II £28.00  
Sinclair 3000 Mk. II £42.95  
Wharfedale Linton £22.95  
Teletron SAQ 307 £52.95  
Rotel RA310 £52.95  
Rotel RA610

### SPEAKERS

Please add £1.50 per pair P. & P. & Ins.  
Amstrad 138 £13.90  
Wharfedale Denton 2 £29.50  
Wharfedale Linton 2 £35.85  
Wharfedale Melton 2 £45.90  
Wharfedale Dovedale 3 £59.80  
Celestion Ditton 120 £38.40  
Celestion Ditton 15 £50.90  
Celestion Ditton 25 £84.95  
Celestion County (new prod) £34.50  
Goodmans Double Maxim £47.40  
Goodmans Mezzo 3 £45.90  
Goodmans Magister £82.95

Special bulk purchase £2.90\* 

Plus 65p P. & P. & Ins.  
Finished in teak veneer with tinted dust cover. (Fully assembled). For Garrard SP25: 2025TC: 3000; A160: 2000; 2500; 3500; 5100; 1025; SL65B. Also for BSR, McDonald MP60 and others. For AP76, AP75, SL72B; SL75; SL95B\*. £4.20 + 65p. P. & P. & Ins. Also finished in walnut to match Japanese equipment - at no extra.

### CARTRIDGES

Please add 10p P. & P. & Ins.  
Goldring G850 £3.35  
Goldring G800 £4.70  
Goldring G800E £7.50  
Goldring G800 Super E £14.15  
Shure M3D £3.70  
Shure M44E £4.75  
Shure M55E £5.55  
Ortofon SL15 £15.85  
Sonotone 9TAHC £1.35



### ELECTRONIC ORGAN KITS

★ Portable—4 octave keyboard with 10 voices, 3 pitches—vibrato, £145.29. ★ Console—5 octave keyboard with 10 voices, 3 pitches. Keyboard can be split into solo and accompaniment. Vibrato, built in amplifier and speaker £250.93. ★ Console—2 × 4 octave keyboards and 13 note pedal board, 29 voices, Vibrato, Delay Vibrato, Sustain, Reverberation, Precussion, Wah Wah, £406.00. ★ Console—2 × 5 octave keyboards and 32 note pedal board, 32 voices. Vibrato, Delay Vibrato, Sustain Reverberation, Precussion, 3 Couplers, etc., at £572.55.

ALL COMPONENTS CAN BE BOUGHT SEPARATELY. SEND 50p FOR LATEST CATALOGUE, WHICH INCLUDES SPECIALIZED COMPONENTS, HI-FI EQUIPMENT AND ELECTRICAL HOUSEHOLD APPLIANCES.

### ELVINS ELECTRONIC MUSICAL INSTRUMENTS

8 PUTNEY BRIDGE ROAD, LONDON, S.W.18  
TEL. 01-870 4949

## P.E. SOUND SYNTHESISER

Get away to a flying start with this exciting Space Age project. Precision cut metal parts to form modular units as described in the March issue are available NOW.  
A. Power supply subframe with tab drillings only £1.35 (P. & P. 25p).  
B. Circuit board support plates fully drilled, 94p.  
Panels drilled with locating holes only: C. 20mm, 18p; D. 38mm, 21p; E. 60.5mm, 28p; F. 64mm, 31p; G. Module locking rods complete, £1.20 ea. SAVE MONEY by obtaining a complete kit of hardware which comprises 1 off each A, C, D, F, 5 off E, and 7 off B, G £17.42, Post Free. REGULATED POWER SUPPLY fully assembled and GUARANTEED by "SCOPE" Designs & Mfg. Ltd. Voltage rails adjustable from 8-17V. Nom. 15-0-15V at 500mA per rail. Stab. ratio 250 : 1; Ripple and Noise 500µV at full load. Load regulation < 1% zero to full load, line regulation < 1% for 10% change in mains voltage. Size 4in × 2½in × 7in fits easily into power supply subframe. Terrific value at £19.50 Post Free. (Include 15p for insurance if required.)  
High Quality components for oscillator/inverter and ramp generator/input amp. modules. SAE for free lists.

## EATON AUDIO

P.O. Box No. 3  
ST. NEOTS  
HUNTINGDON  
PE19 3JB

TERMS: MAIL ORDER ONLY. C.W.O. Cheques or crossed P.O. payable to Eaton Audio. Minimum order £2. Where P. & P. charges are not shown please add 10p in the £1 to orders under £5. Orders over £5 will be sent free of P. & P. All prices subject to V.A.T. increases from 1st April.

**LARGE STOCKS,  
ATTRACTIVE DISCOUNTS  
DEPENDABLE SERVICE**

# ELECTROVALUE

Electronic Component Specialists

## TRANSISTORS BY SIEMENS AND NEWMARKET

2N3055 npn silicon power	60p
AC153K pnp germanium low power	25p
AC176K npn germanium low power	23p
AD161 npn germanium medium power	42p
AD162 pnp germanium medium power	40p
AF139 pnp germanium UHF	33p
NPN: BC107 13p, BC108 12p, BC109 13p, BC167 10p, BC168 9p, BC169 10p.	
PNP: BC177 15p, BC178 14p, BC179 15p, BC257 9p, BC258 8p, BC259 9p.	

Standard groupings available.

BD135 npn medium power	26p
BD136 pnp medium power	27p

## DIODES

OA90, OA91, OA95, 6p each; OA200, 9p; OA202, 10p.

Other semiconductors: AC128, 17p; AF117, 35p; BFY51, 19p. Full lists and technical data will be found in Catalogue No. 6.

## SIEMENS' THYRISTORS

0-8A 400V 56p, 600V 70p, 3A 400V 60p, 600V 88p.

**ZENER DIODES** full range E24 values: 400mW: 2.7V to 36V, 14p each; 1W: 6.8V to 82V, 21p each; 1.5W: 4.7V to 75V, 48p each. Clip to increase 1.5W rating to 3 watts (type 266F) 4p.

## DIN PLUGS AND SOCKETS

by Hirshmann, 4A rating

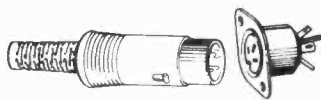

2 way LS —socket 10p, plug 12p  
3 way scr.—socket 10p, plug 12p  
5 way scr.—socket 11p, plug 15p

## TRANSISTOR ACCESSORIES

TO3 cover, 7p; Heat sinks 1°C/W, type 6W1, undrilled, 60p.

## SWITCHES

1011 SPST toggle, 20p; 409 DPDT toggle, 29p (these are chrome plated, 2.5A rating); 7201 sub-miniature DPDT 250V a.c./2A, 48p.

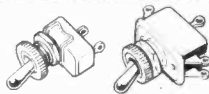

## ROTARY SWITCHES

Radiospares Miniature Maki-switch (in assembly kit form). Shaft, 48p. Wafers, MBB-2P5W, IP11W; BBM1P12W, 2P6W, 3P4W, 4P3W, 6P2W, 6p each.

## WAVECHANGE SWITCHES

IP12W, 2P6W, 3P4W, 413W, 32p each.

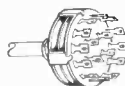

## ELECTROLYTIC CAPACITORS

Rated voltage:	3V	6.3V	10V	16V	25V	40V	63V	100V
Capacity $\mu$ F	0.47	—	—	—	—	—	7p	7p
	1.0	—	—	—	—	7p	—	7p
	2.2	—	—	—	7p	7p	7p	7p
	4.7	—	—	7p	—	7p	7p	7p
	10	—	—	7p	7p	7p	7p	7p
	22	—	—	7p	7p	7p	7p	8p
	47	7p	—	7p	7p	7p	7p	8p 12p
	100	7p	7p	7p	7p	8p	12p	18p
	220	7p	7p	7p	8p	9p	10p	26p
	470	7p	8p	9p	9p	12p	17p	24p 41p
	1,000	9p	12p	12p	17p	20p	23p	40p
	2,200	14p	16p	22p	25p	36p	40p	—
	4,700	23p	26p	37p	40p	—	—	—
	10,000	37p	40p	—	—	—	—	—

## RESISTORS — 10%, 5%, 2%

Code	Power	Tolerance	Range	Values available	1 to 9	10 to 99	100 up
C	1/20W	5%	82 $\Omega$ —220K $\Omega$	E12	9	8	7.5
C	1/8W	5%	4.7 $\Omega$ —470K $\Omega$	E24	1	0.9	0.75 nett
C	1/4W	10%	4.7 $\Omega$ —10M $\Omega$	E12	1	0.9	0.75 nett
C	1/2W	5%	4.7 $\Omega$ —10M $\Omega$	E24	1.2	1	0.8 nett
C	1W	10%	4.7 $\Omega$ —10M $\Omega$	E12	2.5	2	1.6 nett
MO	1/2W	2%	10 $\Omega$ —1M $\Omega$	E24	4	3	3 nett
WW	1W	10% $\pm$ 120 $\Omega$	0.22 $\Omega$ —3.9 $\Omega$	E12	7	7	6
WW	3W	5%	1 $\Omega$ —10K $\Omega$	E12	7	7	6
WW	7W	5%	1 $\Omega$ —10K $\Omega$	E12	9	9	8

Codes: C = carbon film, high stability, low noise. MO = metal oxide, Electrofil TR5, ultra low noise. WW = wire wound, Plensley.

Values: E12 denotes series: 10, 12, 15, 18, 22, 27, 33, 39, 47, 56, 68, 82 and their decades. E24 denotes series: as E12 plus 11, 13, 16, 20, 24, 30, 36, 43, 51, 62, 75, 91 and their decades.

Prices are in pence each for quantities of the same ohmic value and power rating. NOT mixed values. (Ignore fractions on total value of resistor order.)

## EVERYTHING BRAND NEW, GUARANTEED TO MAKERS' SPEC. NO SECONDS OR REJECTS

### KNOB

All grub screw fitting for pin shafts. Black. For other types —see Catalogue No. 6, p. 54.

F.14 (20mm) pack of 2, 32p; F.13 (26mm) pack of 2, 38p; F.12 (33mm) pack of 2, 40p; F.19 (20mm) pack of 2, 32p; F.18 (26mm) pack of 2, 38p; F.17 (33mm) pack of 2, 40p; KB.4 (20mm) pack of 4, 40p; K30/3 (17mm) aluminium, 24p each.

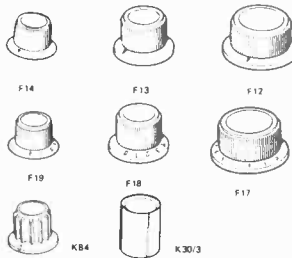

### POTENTIOMETERS

Rotary, carbon track, double wipe

SINGLE P20 lin. 100  $\Omega$  to 2.2M  $\Omega$ , 12p; JP20 Log. 4.7K  $\Omega$  to 2.2M  $\Omega$ , 12p; Dual gang lin. 4.7K  $\Omega$  to 2.2M  $\Omega$ , 42p; Dual log. 4.7K  $\Omega$  to 2.2M  $\Omega$ , 42p; Log/antilog, 10K, 22K, 47K, 1M  $\Omega$  only, 42p; Dual antilog, 10K only, 42p. Any type with 2A D.P. mains switch, 12p extra.

Only decades of 10, 22 and 47 available in ranges quoted.

DUAL CONCENTRIC DP20 in any combination of P20 values, 60p; with switch, 72p.

SLIDER

Lin. or log. 10K to 1 meg. in all popular values, each 26p.

Control knobs blk/white/red/yel/gr/blue/dk. grey/lt. grey, 5p each.

CARBON SKELETON PRE-SETS

Small high quality, PR lin. 100  $\Omega$ , 220  $\Omega$ , 470  $\Omega$ , 1K, 2K2, 4K7, 10K, 22K, 47K, 100K, 220K, 470K, 1M, 2M, 5M, 10M  $\Omega$ . Vertical or horizontal mounting, 5p each.

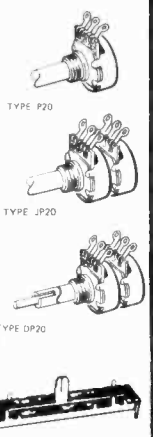

### TRANSFORMERS—MAINS

MT3 30V/2A plus 4 taps	£2.85
MT103 50V/1A plus 4 taps	£2.55
MT104 50V/2A plus 4 taps	£3.50
MT127 60V/2A plus 4 taps	£3.80
13TOS 13V/3A, CT	£1.25
2BTOS 12+12V, 2-0-2V.	£1.65

## IT'S ALL IN THE LATEST ELECTROVALUE CATALOGUE

No. 6 (4th printing) contains details of 100's of semiconductors; ICs with circuit diagrams, R's and C's of practically every kind, accessories, components, tools, materials, etc., information and equivalent tables, etc. Well illustrated (96 pages, 5 1/2" x 8 1/2") 25p post free with refund voucher for 25p allowable on orders over £5 or more.

with 25p refund voucher

## DISCOUNTS

All items offered for sale in accordance with our stated terms of business, copy of which available on request.

Not allowed on net price items. 10% on orders for £5 or more. 15% on orders of £15 or more. Prices subject to alteration without prior notice. Prices quoted DO NOT include V.A.T. Orders received after 31st March must be accompanied by an additional 10% of the net value of the order.

POSTAGE AND PACKING FREE

SURCHARGE 10p on small mail orders under £2. Overseas orders carriage and insurance charged at cost.

# ELECTROVALUE

(Dept. PE5), 28 ST. JUDE'S ROAD, ENGLEFIELD GREEN, EGHAM, SURREY TW20 0HB  
Hours: 9—5.30, Sat. 1 p.m. Tel.: Egham 3603 Telex 264475  
Eng. Reg. No. 1047769 Registered Office: 28 St. Jude's Rd., Englefield Green, Egham, Surrey TW20 0BB



**A FIRST FOR HOME CONSTRUCTORS  
A POCKET CALCULATOR KIT FROM S.C.S  
A £4 DISCOUNT TO READERS OF P.E**



- Just look at some of these features:
- \* 8 digit, fully floating decimal point.
  - \* 4 function with a constant on all functions.
  - \* Does not limit on over or underflow.
  - \* Provides 8 significant figures plus decimal point position over 99 decades.
  - \* Rechargeable batteries.
  - \* Carrying case.
  - \* Charger.
  - \* Touch key board.
  - \* Weighs just 8 oz.
  - \* Measures 5½" x 3" x 1½".
  - \* Full after-sales service.
  - \* 1 year guarantee.

A unique, three-way link up between S.C.S., a major calculator manufacturer and Practical Electronics allows us to offer you a fully guaranteed pocket calculator. Powered by a second generation MOS LSI chip from General Instrument Microelectronics, this offer brings home-constructors full manufacturers service facilities.

Available fully assembled for £47.50 + V.A.T. (tested and guaranteed). List price in kit form: £39 + V.A.T. **LESS SPECIAL £4 DISCOUNT TO ALL P.E. READERS.**

Offer closes 31st July 1973, so don't delay... send in for your pocket calculator kit today... and don't forget to use your discount voucher.

**£4 DISCOUNT VOUCHER**

I enclose a cheque to the value of £35 + V.A.T. to cover the cost of the S.C.S. Pocket Calculator Kit. (All cheques should be made payable to S.C.S. Components Ltd.)

NAME \_\_\_\_\_

ADDRESS \_\_\_\_\_

S.C.S. Components Ltd., P.O. Box No. 26, Wembley, Middlesex HA0 1YY  
Registered in London No. 888454



## STEREO RADIO WITHOUT TEARS

**T**HE stereo tuner described this month has a number of interesting features which reflect some of the current approaches to domestic receiver design, as practised by set manufacturers.

In the field of domestic radio receivers, the integrated circuit has yet to make its full contribution. Various subsections of the conventional superheterodyne circuit have been designed and produced in monolithic form, but all these devices require additional discrete components in order to function. Thus the apparent labour- and material-saving advantages of i.c.s are largely nullified. The chief problem is one of inductances and capacitances. This real difficulty associated with monolithic circuits has encouraged further investigation into less conventional receiver designs where there is no dependence on LC tuned circuits. For example, the phase-locked-loop or synchronous detector receiver has been much discussed of late, as a likely future substitute for the classic superhet.

The i.c. has however made a noteworthy contribution to stereo receiver design. Single chip phase-locked decoders have been around for some time, and they represent perhaps the most highly developed integrated circuitry, with the highest component density, found at present in a sound receiver. A less exciting but important function performed by the i.c. is as a power supply regulator—a vital role in v.h.f. receivers incorporating varicapacitance diode (truly electronic) tuning.

The completely integrated high quality receiver will emerge eventually; whether as a single chip, or as a set of two or three i.c.s each covering a major portion of the system, only the i.c. and set designers and manufacturers will have a clue at this moment in time. While awaiting the inevitable, the ultimate in integration, set makers have in recent years been employing several methods. One popular approach is a different form of integration—using pre-adjusted circuit modules, containing conventional discrettes. Mass production of complex receivers is thus greatly simplified and the need for critical alignment operations on the assembly line eliminated.

This approach has obvious attractions for the home constructor, especially where a complicated and highly sensitive piece of equipment such as a stereo tuner is concerned. This month's design illustrates the use of modules, i.c.s, and discrete components. Thus as a system it is interesting and instructive. It demonstrates how available circuit devices can be judiciously co-ordinated to produce a "state of the art design" for the modestly equipped home constructor.—F.E.B.

**Editor**  
F. E. BENNETT

**Editorial**  
D. BARRINGTON  
G. GODBOLD  
S. R. LEWIS B.Sc.

**Art Dept.**  
J. D. POUNTNEY *Art Editor*  
J. A. HADLEY  
R. J. GOODMAN  
S. W. R. LLOYD

**Advertisement Manager**  
D. W. B. TILLEARD  
Phone: 01-634 4202

P. J. MEW  
Phone: 01-634 4210

C. R. BROWN, *Classified*  
Phone: 01-634 4301

*Editorial & Advertising Offices:*  
Fleetway House, Farringdon St.,  
London EC4A 4AD  
Phone: *Editorial* 01-634 4452  
*Advertisements* 01-634 4202

# PUSHBUTTON

# VARICAP

# STEREO TUNER

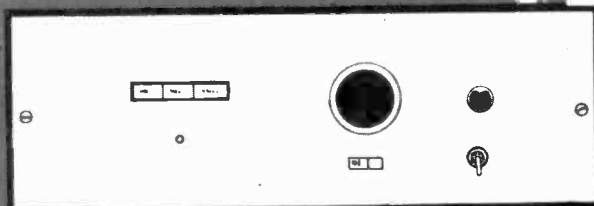

By S.R.BEECHING

UP TO recent times the only methods of tuning radios were either the variable capacitor or the variable inductor. Using either system the result was the same, mechanics in the form of pulleys and pointers were needed to physically move either the vanes of the capacitor or the core of the inductor. Any constructor who attempted to build such a radio faced not only these mechanical problems but also the problem of alignment, particularly difficult in v.h.f. radios.

Two new tuner modules recently produced by Mullard go a long way to overcoming all these difficulties; they are pre-aligned and the tuning is electronic, not mechanical, i.e. there are no moving parts.

## VARICAP TUNING

The tuner module uses a "varicap" diode for varying the tuning frequency. A varicap diode is one which takes advantage of the fact that the width of the depletion layer in a reverse biased diode varies with the reverse voltage. Thus one is effectively changing the gap between two plates of a

capacitor. The capacitances involved are small and thus at the moment varicap tuning is restricted to v.h.f. tuners.

In the Mullard LP1186 module the tuning is carried out by applying a voltage between 2 and 17 volts to its input. Because the tuning is electronic this opens up a whole field of possibilities, in particular that of remote tuning.

## THE MODULES

The tuner module type LP1186 has three stages, a tuned aerial and r.f. stage, giving good image and i.f. rejection, a separate oscillator stage for good signal handling, and a mixer stage with a double-tuned i.f. output circuit. The main characteristics of this module are shown in Table 1.

The LP1185 is an f.m.-i.f. amplifier module whose main characteristics are summarised in Table 2. Both modules require a supply voltage of 9V and this is also adequate to cover the broadcast band when applied to the varicap diode.

Cover photo by courtesy of London Electricity

Only a few components are needed around the modules for decoupling and de-emphasis. Automatic frequency control (a.f.c.) is available though this may be removed by shorting to ground when tuning weak stations.

## STEREO DECODER

An MC1310P integrated circuit stereo decoder is used to split the output of the LP1185 into right and left channel signals. The integrated circuit has the advantage over some of the earlier types in that it needs no coils. It has automatic stereo switching and an indicator driver capable of driving a 60mA bulb. A light emitting diode (l.e.d.) is shown in the circuit together with a resistor necessary to drop the voltage to the 1.5V needed for an l.e.d.

Table 3 gives some of the data on the i.c. stereo decoder.

## CIRCUIT DIAGRAM

The full circuit diagram excluding the tuning unit and the power supply are shown in Fig. 1. The input from the aerial is fed into pin B of the tuner module. The tuning voltage is applied to pin C. Capacitor C1 is only really necessary if there is a large separation between the tuning unit and the tuner and may be omitted. A.F.C. is taken from pin F of the output module and fed back to pin D of the tuner. Switch S1 removes this a.f.c. by shorting to earth.

The signal is then fed into pin 2 of the stereo decoder. D1 is the stereo indicator lamp. VR1 is used to adjust the frequency of voltage controlled oscillator which forms part of the stereo decoder.

Components C9, R4, C10, R5 are de-emphasis components needed to compensate for the pre-emphasis of the high frequency signals which is introduced at the transmission end.

Output is taken to the DIN output socket via C11 and C12.

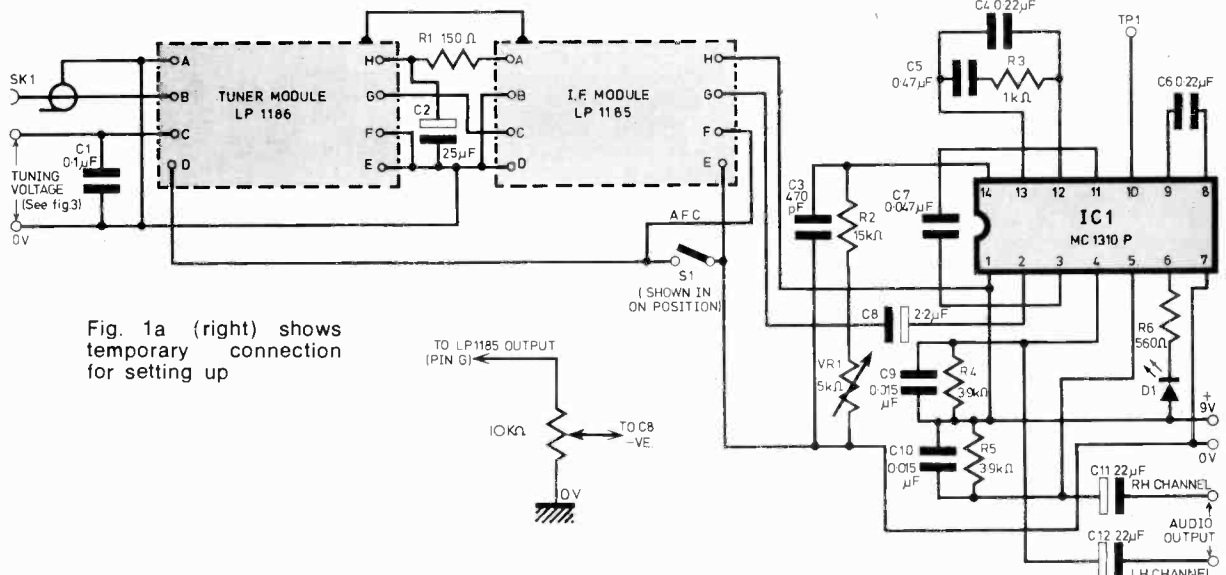

Fig. 1a (right) shows temporary connection for setting up

Fig. 1. Circuit diagram of the stereo tuner. The shaded boxes indicate ready built pre-aligned units. The tuning voltage unit is shown in Fig. 3

Table 1:  
SUMMARY OF THE CHARACTERISTICS  
OF THE LP1186 F.M. TUNER MODULE

Tuning range	87.4 to 104.5MHz
Tuning voltage	2 to 12V
Bandwidth at -3dB points	300kHz
Aerial impedance	75Ω
Power gain ( $f_{in} = 95\text{MHz}$ )	30dB
Noise factor ( $f_{in} = 95\text{MHz}$ )	6.5dB

Table 2:  
SUMMARY OF THE CHARACTERISTICS  
OF THE LP1185 F.M.-I.F. AMPLIFIER  
MODULE

Centre frequency	10.7MHz $\pm$ 50kHz
I.F. bandwidth at -3dB points	250kHz
Sensitivity for 40mV output	300μV (min) 60μV (max)
F.M. output at limiting (1mV input)	180mV
Signal-to-noise level with 150μV input	60dB
A.M. rejection	40dB

Table 3:  
SUMMARY OF THE CHARACTERISTICS  
OF THE MC1310P STEREO DECODER I.C.

Maximum input signal	500mV r.m.s.
Pilot capture range	$\pm 3\%$
Distortion	<0.3%
Maximum stereo indicator current	70mA

## POWER SUPPLY

In a varicap tuner the power supply is very important as the tuning voltage must be very stable and ripple free. The power supply circuit is shown in Fig. 2.



Photograph of the complete tuner showing the front panel layout

The low voltage from the transformer is rectified by the diode bridge D2-5, smoothed by the large capacitor C13 and applied to the input of the integrated circuit regulator IC2. VR2 is used to tap off a fraction of the output voltage to feed back into the input of the i.c. Here it is compared with a reference voltage generated within the i.c. and the output is adjusted to make the two equal. Thus VR2 can be used to accurately set the output voltage.

The i.c. used will keep the output voltage to within 0.2 per cent of the nominal voltage for loads up to 100mA and within 0.03 per cent of nominal for power supply variations, provided that there is more than three volts between input and output. Because this i.c. also supplies the stereo decoder and hence the stereo indicator lamp it is best to keep the lamp current as low as possible hence the use of an l.e.d.

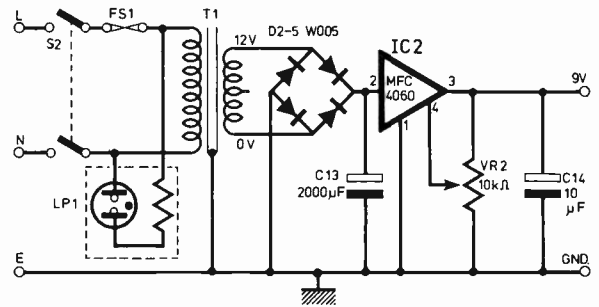

Fig. 2. Circuit diagram of the power supply unit. This not only supplies power to the modules but also provides the stabilised voltage necessary for tuning

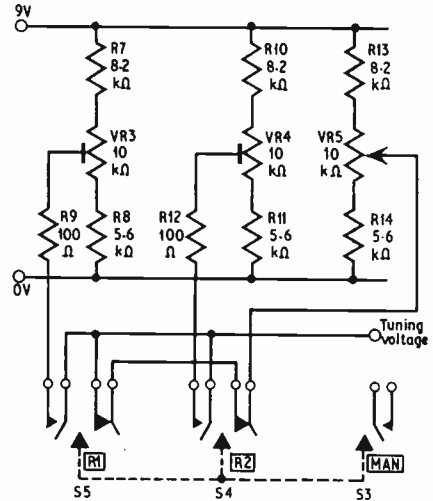

Fig. 3. A suggested tuning unit. This provides two preset voltages with a third manually variable voltage. The number of preset voltages really only depends on the size of the push button unit. There is also no reason why this tuning unit should not be mounted remote from the tuner itself. S3 is simply used to cancel the other two switches

### TUNING UNIT

As mentioned earlier, a tuning voltage of between two and nine volts will adequately cover the normal broadcast band. A suggested switching system is shown in Fig. 3. This system gives two preset stations and one manually variable setting. The number of preset stations may be extended *ad infinitum* depending only on the number of push buttons in the unit.

The circuit board shown will accommodate six preset potentiometers. Thus a six-button unit or a six-way rotary switch can be used.

Padding resistors are added at either end of the potentiometers so that fine tuning is easier, although this somewhat restricts the tuning range. Fig. 4 shows the relationship between tuning voltage and frequency and this allows calculations to be carried out on the best settings for each station. The padding resistors are mounted with the potentiometers forming small pillars.

### CONSTRUCTION

Construction is simple if the printed circuit board (Fig. 5) or the layout recommended are followed. Note that the orientation of the i.c.s is critical, a small spot indicates pin 1. Assemble the power supply components first (Fig. 6). Set VR2 to midway then switch on and test the output with a voltmeter, adjusting VR2 to give a 9V output.

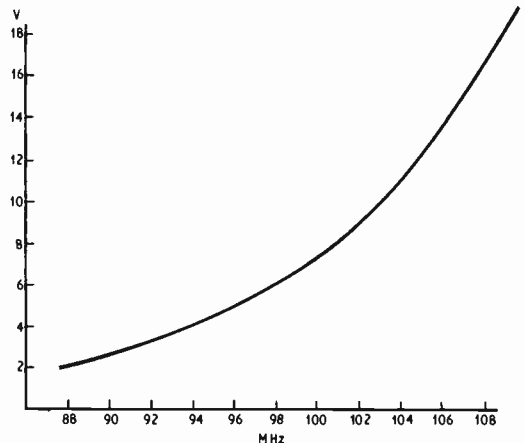

Fig. 4. Relationship between the tuning voltage and the frequency as measured in the prototype



# CIRCUIT BOARD

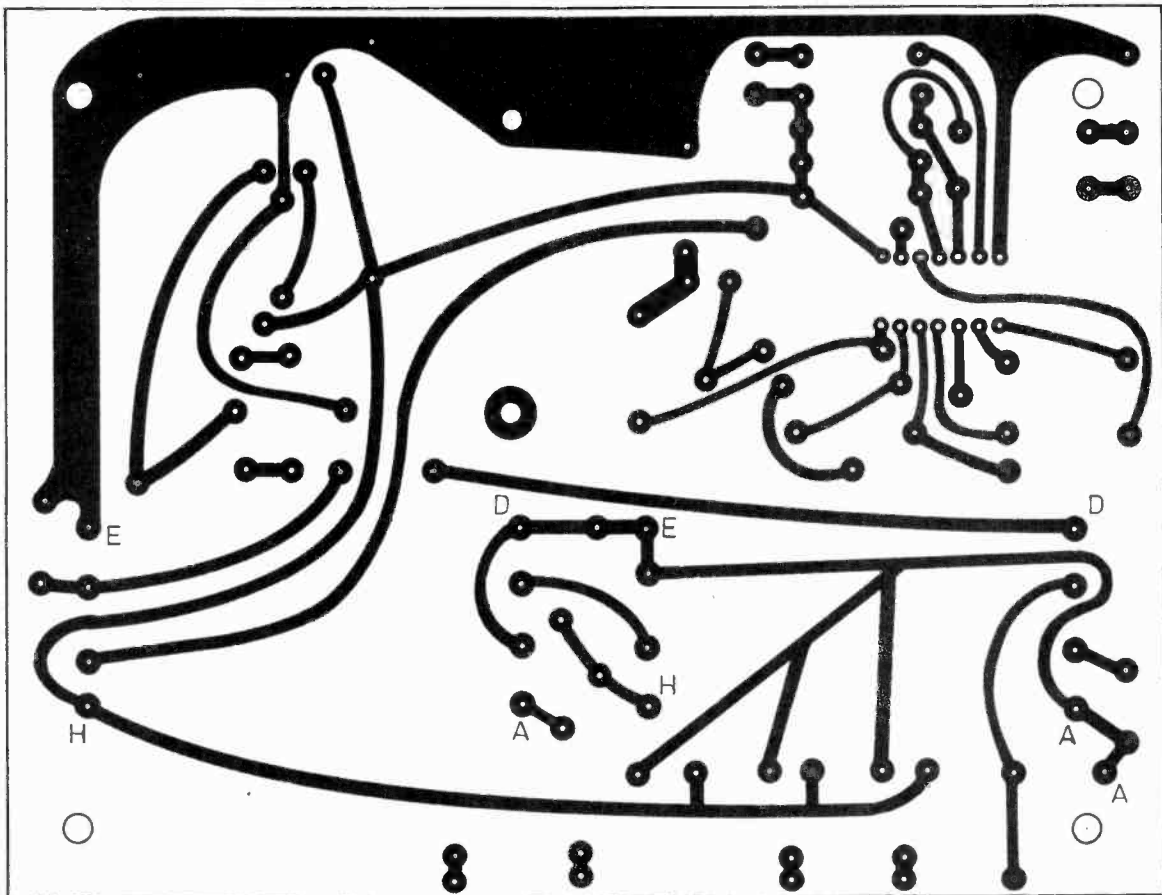

Fig. 5. The underside of the printed circuit board. The black areas indicate copper, the white areas being etched away

## COMPONENTS . . .

### Resistors

R1	150Ω	R4	3.9kΩ	R7	8.2kΩ	R10, R13	8.2kΩ
R2	15kΩ	R5	3.9kΩ	R8	5.6kΩ	R11, R14	5.6kΩ
R3	1kΩ	R6	560Ω	R9	100Ω	R12	100Ω

All  $\frac{1}{4}W \pm 10\%$  carbon except R2 5%

### Potentiometers

VR1	5kΩ skeleton preset
VR2	10kΩ skeleton preset
VR3, VR4	10kΩ skeleton preset (2 off)
VR5	10kΩ carbon linear

### Capacitors

C1	0.1μF	C8	2.2μF 64V elect.
C2	25μF 12V elect.	C9	0.015μF
C3	470pF 2%	C10	0.015μF
C4	0.22μF	C11	22μF 25V elect.
C5	0.47μF	C12	22μF 25V elect.
C6	0.22μF	C13	2,000μF 25V elect.
C7	0.047μF	C14	10μF 16V elect.

### Diodes

D1	Light emitting diode 1.5V 20mA (WestHyde)
D2-5	W005 or any 50 p.i.v. $\frac{1}{2}A$ bridge rectifier

### Integrated Circuits

IC1	Motorola MC1310P
IC2	Motorola MFC4060

### Transformer

T1 Mains primary, 12V 100mA secondary

### Modules

Tuner Module Mullard Type LP1186  
I.F. Module Mullard Type LP1185

### Switches

S1 Miniature rocker or slide on/off switch  
S2 Miniature d.p.d.t. toggle switch  
S3-5 3 way pushbutton unit, each switch cancelling the other two

### Miscellaneous

FS1 100mA fuse and fuseholder  
SK1 Coaxial socket  
SK2 5 pin 180° DIN socket, panel mounting  
LP1 Mains neon indicator with integral resistor  
PL1 Mains panel mounting plug Bulgin type P360  
3-way tag strip, printed circuit board, case, 6BA and 8BA nuts and bolts

Printed circuit board and modules can be obtained from B & B Electronics, 64 Manners Road, Balderton, Newark, Notts.

After checking the power supply attach the other components. Note the link between the cases of the two modules. Do not attach C8 at this stage. Push button units vary as to the type of contact arrangement. If you are not sure use a continuity tester, e.g. a battery and bell or lamp to find two contacts which make when the appropriate button is pressed.

As mentioned before there is no reason why the push button units should not be mounted remote from the tuner.

### SETTING UP AND TESTING

Prior to testing and final setting up, ensure that a good aerial is available and also an amplifier for monitoring. A v.h.f. aerial will be needed for low noise stereo although a v.h.f. television aerial or a length of wire will suffice for initial checks.

Before setting up is explained, some description of the stereo decoder is useful to understand what is going on. Fig. 7 shows a block diagram of the stereo decoder i.e.

The audio input is buffered and separated from the 19kHz pilot tone which is fed to two modulators which act as phase discriminators; modulator 1 is the input to the phase locking loop and modulator 2 is used as the stereo detector and indicator. Each provide an output which is proportional to the phase difference between the pilot input and the regenerated 19kHz signal (TP1). The output from modulator 1 controls the frequency of a 76kHz oscillator which is then divided by two to give a 38kHz signal necessary for decoding. The regenerated 38kHz is divided by two to give 19kHz which is fed back to the modulators, forming part of the phase locked loop.

If this regenerated 19kHz differs in phase from the 19kHz pilot then the modulator will correct the 76kHz oscillator thus locking it to the pilot tone. The resultant output from modulator 2 triggers a Schmitt trigger which switches on the stereo indicator and feeds the regenerated 38kHz to the decoder. With mono transmissions the audio comes out of the decoder outputs simultaneously, no pilot tone being present.

## INTERWIRING

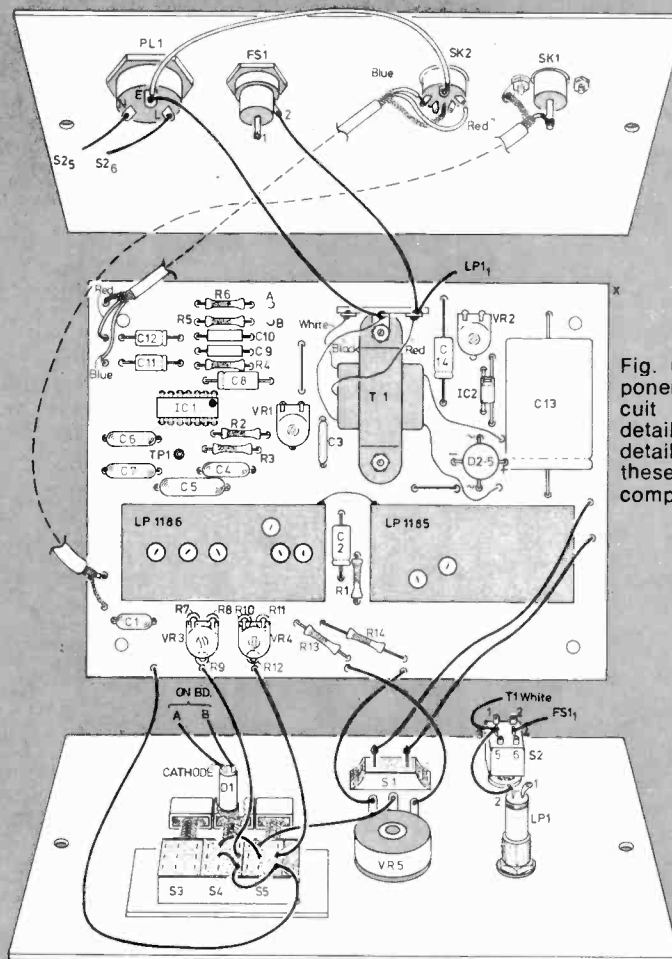

Fig. 6. Layout of the components on the printed circuit board and interwiring details. Front panel drilling details are not given as these will depend on the components used

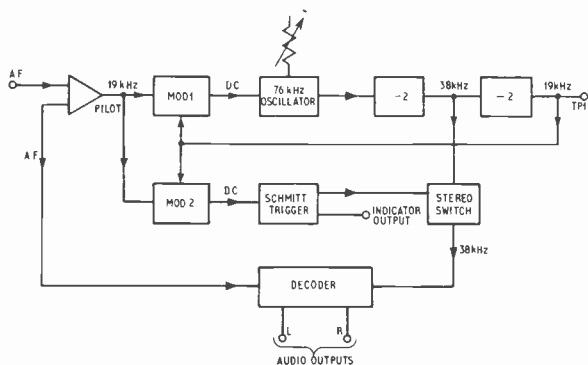

Fig. 7. Block diagram of the MC1310P stereo decoder i.c.

### OSCILLATOR ADJUSTMENT

There are two ways to set VR1, the object being to set the oscillator to 76kHz with no pilot or input signal.

Connect the tuner to an aerial and an amplifier with C8 in position on the board, then switch on. It should be possible to tune into a station at least in mono (ignore the indicator lamp if it should come on). Switch off the a.f.c. and tune slightly away from the station, then switch back to a.f.c.; the station should pull in, if the signal is strong. Leave the a.f.c. on and tune to a known stereo broadcast. Rotate VR1 until the stereo indicator just lights and a stereo output is heard. There will probably be a good deal of background noise especially with a poor aerial.

If an oscilloscope is available monitor TPI with the tuner locked onto a station. Remove the input signal and reset the frequency to this measured value.

An alternative method of setting up is to reduce the signal level to the decoder thus reducing the range of VR1. Connect the positive end of C8 to the board but connect a 10 kilohm potentiometer between its negative end and the LP1185 output (see Fig. 1a). Switch on and tune to a stereo broadcast then adjust this potentiometer to give maximum audio output. Adjust VR1 until the stereo indicator lights then alternately reduce the output with the potentiometer and adjust VR1 until the setting of VR1 is very sharp or critical, this being the correct setting. ★

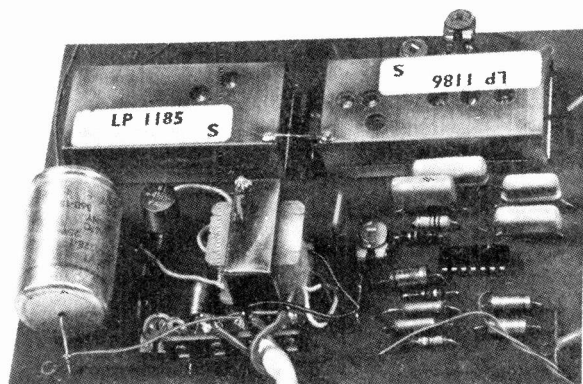

Photograph of the internal layout of the tuner

# NEXT MONTH

## General Purpose Timer

A new Integrated Circuit, the 555, provides the main circuit elements of a timing unit suited to application in the home, darkroom, workshop or factory. Covering delay times from milliseconds to hours, the 555 may in addition be used for pulse modulation or as an oscillator or in other applications. The device in its various guises is discussed in detail so that the constructor may design his own circuits. In addition, this issue includes a constructional feature on a timer using the 555.

## Wide Range Pulse Generator

A simple circuit using only two ICs, some odd components and a suitable supply, creates a pulse box capable of covering 1Hz to 1 MHz in switched ranges.

## Autotone

A novel single tone melody instrument based on a digital system. With the Autotone simple tunes can be composed and the results memorised for instant replay at the desired tempo.

The June Issue is on sale May 12 1973

PRACTICAL  
**ELECTRONICS**

# CONCLUDING ARTICLE

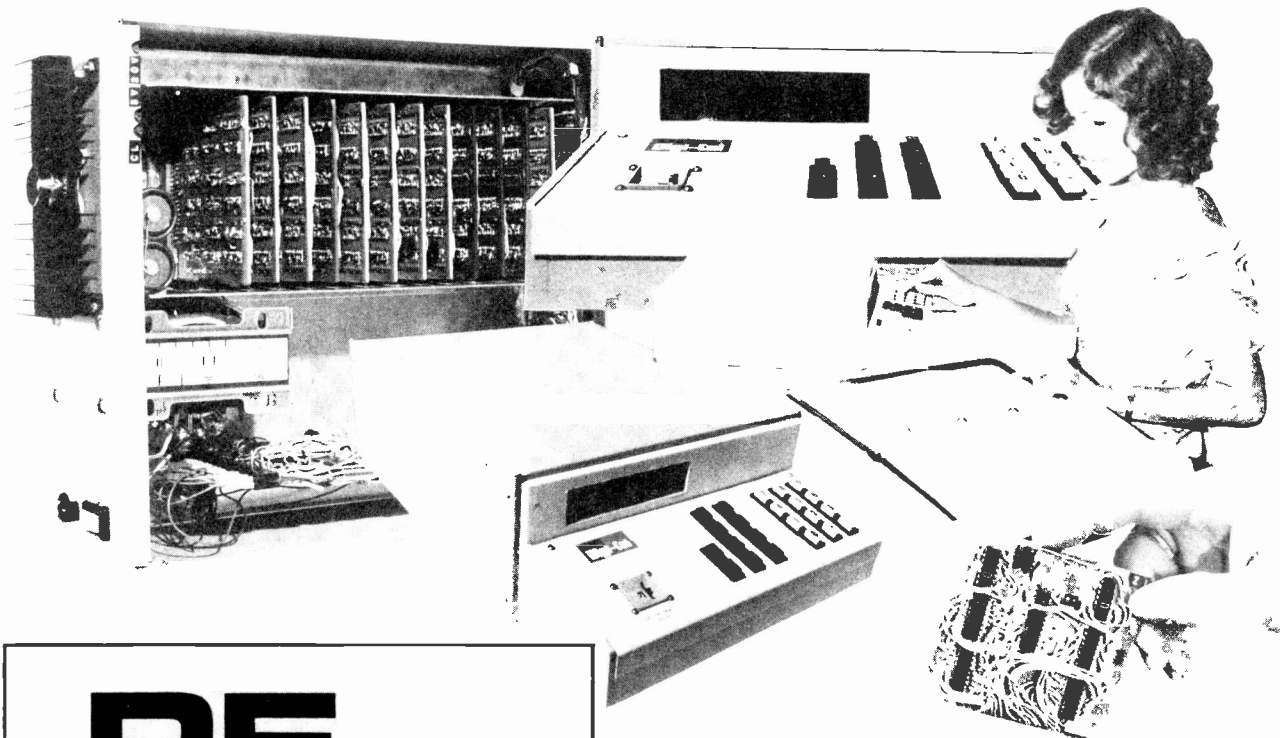

# PE

By R.W. COLES

PART 11

OVERFLOW LOGIC AND OVF BOARD

**T**HIS final part of the Digi-Cal series describes the remaining logic housed on the under-chassis overflow (OVF) board, and attempts to knit together the loose ends which have been left dangling in earlier articles. Testing and troubleshooting information is also given.

## OVERFLOW (OVF) BOARD

The existence of the OVERFLOW board was established in Part 2, when it was mentioned that this board is mounted copper side uppermost under the chassis, spaced from it by two 6BA nuts on each of the supporting bolts.

The OVF identity was not given to this board in Part 2 but is used here for ease of reference, the majority of the logic housed on this board being concerned with the OVERFLOW circuitry.

The Veroboard panel itself is mounted in the copper up fashion to facilitate the use of this board as an interconnection and power bus medium in

addition to its job of housing logic. This mounting method also permits the easy addition of circuitry without access to the underside of the board, the only compromise necessary being that of neatness, since the solder is "on display" together with the components.

## INTERCONNECTIONS

The OVF board carries the +5V and ground line power buses, from which the other logic cards are supplied. Any other logic lines which are employed, e.g. the FUNCTION CODE A and B are also allocated a copper strip for bus use to permit a tapping to be made where required.

Programme functions are distributed from the OVF board by means of a series of terminal pins which act as distribution points, the decision as to which functions require this treatment being left to the individual constructor as layouts will undoubtedly vary.

## OVERFLOW LOGIC

The OVERFLOW logic is required to detect and indicate any errors resulting from the incorrect operation of the calculator, indication being provided via the red OVF lamp on the keyboard. If this lamp comes on at all during a calculation then an improper operation has been attempted and the only course open is to depress the CLEAR key which also resets the OVF circuits.

There are several ways in which an error condition can occur, an error being a state which would result in an incorrect answer being given. Detection of these states requires a combination of three separate logic groups whose areas of responsibility are as follows:

(a) ENTRY OVERFLOW. If too many digits are entered into the E REGISTER, the most significant data can be destroyed by being shifted out of the end of the register. This condition must be detected.

(b) A REGISTER OVERFLOW. If during a multiplication sequence, the product exceeds the capacity of the A REGISTER then the CARRY STORE will stay set at the end of an addition which is an indication of OVERFLOW.

(c) ANSWER OVERFLOW. The Digi-Cal A REGISTER has a ten digit capacity although only eight digits are displayed, the other two positions in the register being for transient use during programme execution. Should either of these two positions contain other than zeros at the end of a programme sequence then an OVERFLOW has occurred.

This type of OVERFLOW can occur during ADDITION, MULTIPLICATION and when a negative answer is produced in complement form.

## OVF CIRCUITS

The active circuitry of the OVF board is shown in Fig. 11.1, where it can be seen that in addition to the OVF logic proper, IC141 and IC146 perform the functions of constant store buffering and E<sup>2</sup> gating respectively.

Bistable BS2 of IC144 acts as the common OVF latch, which is set by an output from any of the three separate OVERFLOW detection circuits, and which controls the OVF lamp driver on the KEYBOARD logic board. The OVF latch is cleared when the CLEAR key is depressed in response to an OVF indication.

The NOR section of IC145 which is a four-wide two-input AND-OR-INVERT gate combines the inputs from three detection circuits to drive the BS2 PRESET input, an output from any of the three resulting in a SET LATCH signal.

## ENTRY OVERFLOW LOGIC

IC142 and G1 of IC143 are used to detect E REGISTER overflows. The system used here to monitor the B.C.D. outputs of the most significant digit position of the register with IC142, which, in this application, can be considered as a four-input positive NOR gate with a common disable input.

The output of IC142 is gated with the E CLOCK to generate the OVF output when necessary.

Gate IC142 is in fact waiting for one or more of its inputs to go to a logic 1, indicating that the most significant digit of the E REGISTER contains other than decimal zero.

On the arrival of a further clock pulse an error output is generated to set the latch.

A problem arises here since by using the straightforward E CLOCK an error output would be produced one step too early. What is really needed is an E CLOCK "pre-pulse" which comes and goes before the register itself is clocked. At first sight this is an impossible requirement to meet; however, by using the inherent propagation delays of the gates involved, such an arrangement can be achieved.

What happens is that when a B.C.D. output other than zero appears in the most significant position of the register a 1 input to pin 9 of IC145 results.

Much later, when another number key is pressed the rising E CLOCK on IC145, pin 10 will result in an error output to pin 8, setting the latch. Even before the clock rises on pin 10, the unbuffered E CLOCK operates the common disable input connected to pins 1, 3, 5 and 9 of IC142 removing the 1 input to IC145, pin 9.

The result at the output of IC145 is an extremely narrow pulse which in practice could be too narrow to set the latch BS2. The way to stretch this pulse is to increase the propagation delay through IC142 and G1 of IC143, and this can be conveniently achieved by increasing the capacitive load on the output of IC142.

A capacitor C<sub>x</sub> is shown on the diagram and can be added if the error output is found to be too short on test; the value used should be between 200pF and 1,000pF.

No such capacitor was necessary on the prototype.

## A REGISTER OVERFLOW LOGIC

The operation of the A REGISTER detection logic is quite straightforward; in this case the task is simply to detect the presence of a stored carry at the end of ten clock pulses during a multiplication or addition.

The rising edge of the END OF TEN output from board CB triggers a monostable made up of BS1 of IC144 and G2 of IC143. The indication that the clock sequence is at an end is gated with the CARRY SENSE output from board AD, in G3.

The output of G3 is gated with an inverted FUNCTION CODE A (which is an indication of the arithmetic operation being performed) in the AND section of IC145 to produce the ERROR output at pin 8.

## ANSWER OVERFLOW LOGIC

Detecting an integer in the two most significant A REGISTER positions seems on the face of it to be quite straightforward, but in practice such considerations as lack of space on the A boards to install i.c. gates, and lack of edge contacts on the A boards to allow external i.c. gates pose some problems.

The only practical solution is to construct a special gate using discrete components which operates as a positive logic NOR. This design requires only the installation of four diodes, and the utilisation of only one edge contact on each A board.

The problem of the low logic 1 levels associated with TTL outputs is overcome by clamping the emitter of TR22 of the gate to about  $\frac{1}{2}V_{cc}$ , and using TR23 to regenerate suitable logic levels to interface with IC145 pin 13.

Pin 1 of IC145 gates the ERROR output from the discrete component gate with what is effectively an END OF PROGRAMME signal (DISPLAY A) so that valid transient outputs from TR23 during programme execution have no effect on the OVF LATCH.

# OVF BOARD

## DESTINATION OF OVF TERMINATIONS

- a ENTER K (from keyboard)
- b RECALL K (from keyboard)
- c E<sup>2</sup> (from programme)
- d TRANSFER A to Z (from programme)
- e A1/25, A2/25
- f DISPLAY A (from programme)
- g AD/36
- h CB/35
- i FUNCTION CODE A (from keyboard)
- j ED/3
- k E3/32
- l E3/31
- m E3/30
- n E3/29
- o ED/4
- p CLEAR (from keyboard)
- q E1/28, E2/28, E3/28
- r E1/27, E2/27, E3/27
- s Z1/25
- t Z2/24
- u OVF (to keyboard)

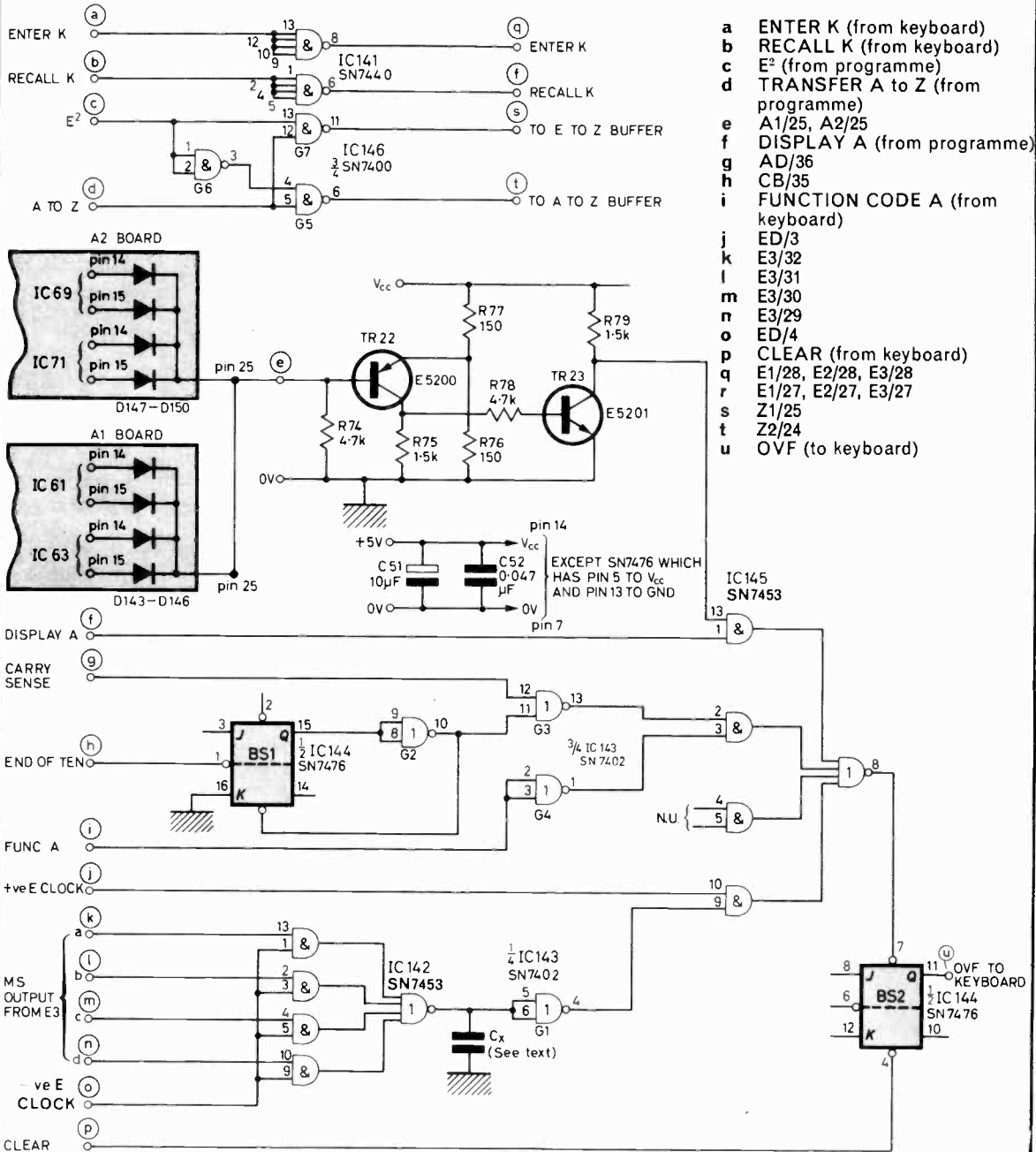

Fig. 11.1. Circuit diagram of the various units contained on the OVF board

## DIVIDE OVERFLOW

No logic has been included to show that an OVERFLOW during a DIVISION operation has occurred.

Logic to fulfil this function would be simple to design and could use pins 4 and 5 of IC145 as an access to the OVF LATCH, but this was not carried out on the prototype because a divide overflow is very obvious to the operator by virtue of the fact that no answer is produced on the display.

## E SQUARED GATING

It was only after the component location stage of Digi-Cal design that it was realised that the addition of a very few gates could produce an automatic E<sup>2</sup> facility to complement the basic arithmetic functions.

The gating required is so simple that the incorporation on the OVF board is quite straightforward.

The object of the three gates shown in Fig. 11.1 as part of IC146 is to divert the A to Z transfer command from the PROGRAMME to the E to Z buffer gate when the E<sup>2</sup> latch on the PROGRAMME board is set.

This simple operation causes the MULTIPLY programme to multiply the number in the E REGISTER by itself. The normal command to transfer the A REGISTER contents to the Z REGISTER is blocked and the E to Z transfer substituted, resulting in the number E being both multiplier and multiplicand.

## CONSTANT STORE BUFFERS

IC141 is an SN7440 buffer gate which is interposed between the KEYBOARD outputs and the constant store to provide the drive and inversion

## OVF LOGIC CONSTRUCTION

Although the E<sup>2</sup> logic and the constant store buffers will have to be wired up before the testing stage, it is best to leave the OVF detection logic until the calculator is operating correctly. Connecting up these circuits before proper operation is realised could lead to confusion.

Having both the i.c.s and the wiring on the copper side of the board takes a little getting used to when soldering, but there are no special problems to look out for, and circuit tracing is really much easier. The board layout is shown in Fig. 11.2, and mounting position in Fig. 11.3.

## OVERALL TESTING

It would be a very optimistic constructor indeed who wired up the whole Digi-Cal, switched on, and expected it to work perfectly first time.

There will no doubt be wiring errors, perhaps a faulty i.c. (there were three in the prototype), and a dry joint or two.

The policy of piecemeal testing suggested in previous parts will undoubtedly have eliminated most

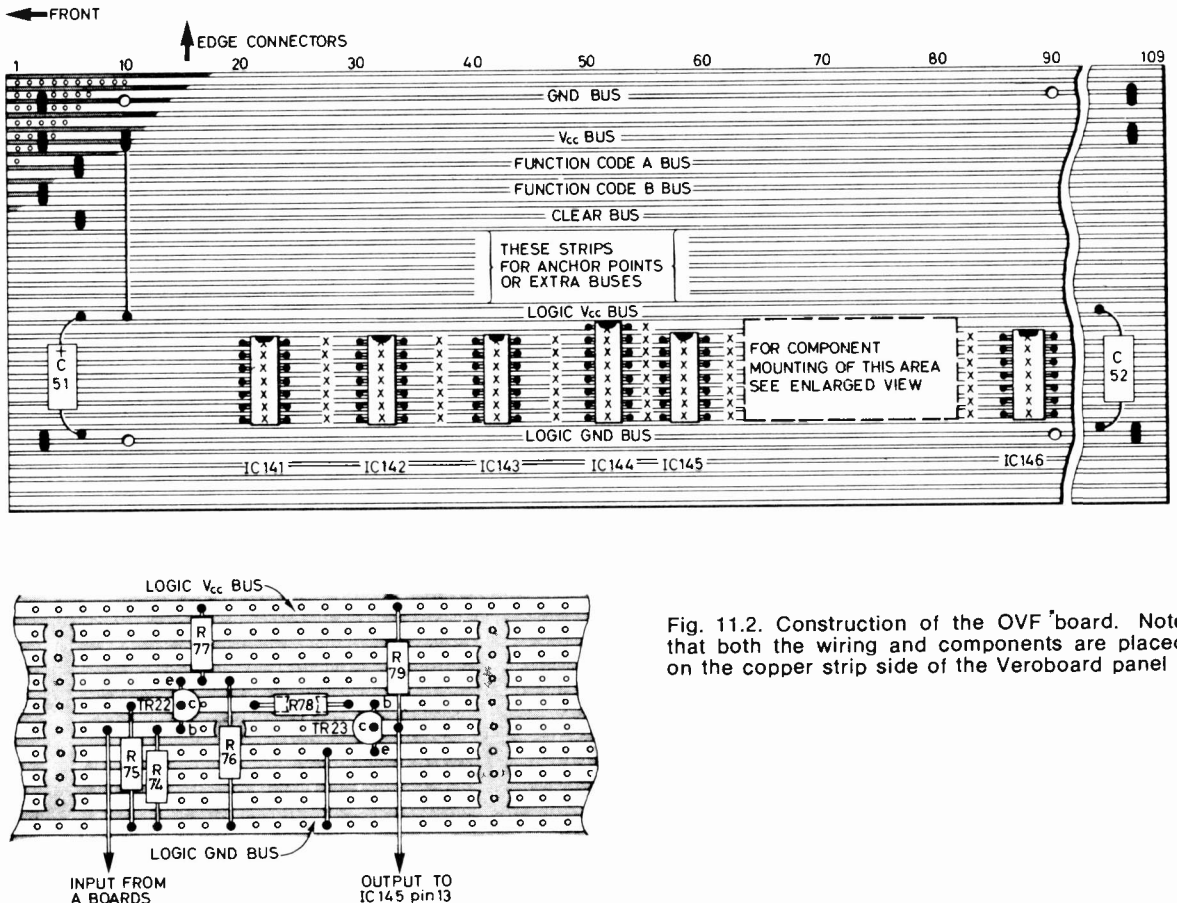

Fig. 11.2. Construction of the OVF board. Note that both the wiring and components are placed on the copper strip side of the Veroboard panel

# COMPONENTS . . .

## OVF BOARD

### Resistors

R74	4.7k $\Omega$
R75	1.5k $\Omega$
R76	150 $\Omega$
R77	150 $\Omega$
R78	4.7k $\Omega$
R79	1.5k $\Omega$

### Capacitors

C51	10 $\mu$ F 15V elect.
C52	0.047 $\mu$ F
C <sub>x</sub>	(see text)

### Diodes

D143-150 West Hyde type "red" or any small silicon diode (8 off)

### Transistors

TR22	E5200	(West Hyde)
TR23	E5201	

### Integrated Circuits

IC141	SN7440
IC142	SN7453
IC143	SN7402
IC144	SN7476
IC145	SN7453
IC146	SN7400

### Miscellaneous

11in  $\times$  3.6in  $\times$  0.1in matrix Veroboard panel

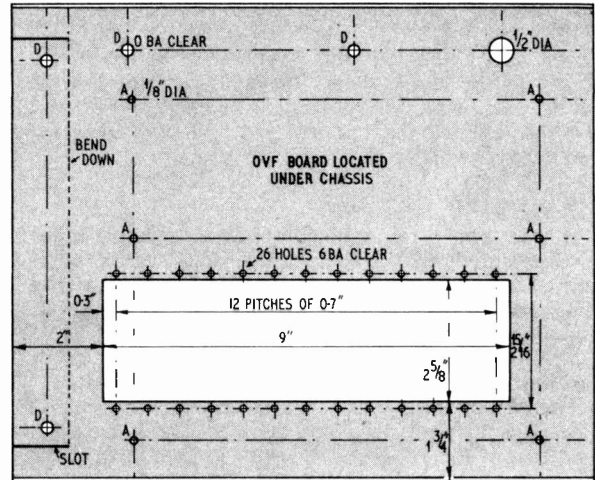

Fig. 11.3. The OVF board is mounted on the underside of the chassis in the four holes marked "A" in the main chassis plate

faults, and certainly the constructor who has reached the final testing stage, which basically involves making the programmes work as required, will be sure that all the boards are fundamentally serviceable.

The first hurdle to be cleared is the correct operation of the ADD/SUBTRACT programme and when this has been achieved (with a slow clock speed if desired) the bulk of the arithmetic section can be given a clean bill of health.

The MULTIPLY and DIVIDE programmes can then be tackled in turn and if any problems are encountered a thorough understanding of the way the calculator should be operating will soon sort these out.

It cannot be stressed enough that after gathering evidence via a multimeter and display, the best strategy in solving a problem is to sit down with a paper and pencil and ponder the possible causes: aimless probing will get you nowhere.

## CLOCK SPEED

The ultimate objective of the testing phase is to increase the clock speed to as high a rate as possible while maintaining correct operation.

In the prototype a speed of over 1MHz was obtained despite the far from ideal underchassis "bird's nest" wiring resulting from prototype modifications.

Constructors should be able to do better than this easily since all improvements have been incorporated in the published designs and any advance achieved in this respect will be rewarded by a shorter maximum multiplication time, important when operating near to the maximum capacity of the machine. ★

**Corrections.** We apologise for these errors which occurred during the course of Digi-Cal articles.

Part 3, Fig. 3.2. Capacitors C3, C4, C5 and C6 should be connected between +5V and GND, not as shown. The strobe outputs from IC7 are reversed, i.e. pin 12 should be strobe 8 and pin 4 should be strobe 1.

Part 4, Fig. 4.2. Switch S19 is shown twice, the K switch should be S5. S13 is shown twice, the **Decimal Point** switch should be S3. Both are shown correctly on Fig. 4.5. The diode labelled D103 on IC26 should be D101.

Part 5, Fig. 5.8. The K switch should be labelled **Recall K** output.

Part 6, Fig. 6.10. Connection from the Z1 and Z2 sockets to the E1, E2 and E3 boards show the pin numbers incorrectly. Correct destinations can be found by adding 22 to each of the pin numbers associated with the E boards, e.g. Z1/1 should go to E3/31. Also Z1/19 should go to AD/41, and Z1/20 to AD/42. Z2/19 goes to AD/39; Z2/20 to AD/40, not as shown. Z2/44 should go to Z1/42 and Z2/42.

A1/1 should go to AD/27; A1/10 to AD/31; A1/11 to AD/32.

A2/1 should go to AD/25; A2/10 to AD/29; A2/11 to AD/30.

Fig. 6.7. CP in IC77 and 78 should go to pin 3 not 2.







THE EMI SCANNER

# BRAIN X RAY

A NEW COMPUTERISED SYSTEM FOR DIAGNOSING BRAIN DISEASE

by K. R. HILL

**T**HE EMI-Scanner is a computerised X-ray transverse axial tomography system using new techniques invented in the Central Research Laboratories of EMI Ltd. It has been developed by EMI in conjunction with Department of Health and Social Security after a four year research and development programme.

The equipment is able to produce pictures of cross sectional slices of the human brain. The basic system consists of a number of units:

1. The Scanning Unit which scans the patient with X-rays to produce a series of intensity output readings.
2. The X-ray Control Unit which controls the X-rays and the operation of the Scanning Unit.
3. The Computer Unit which stores and processes the data.
4. The Viewing Unit which displays the results on a cathode ray tube screen.
5. The X-ray generating system.

## THE BASIC PROBLEM

The conventional X-ray photograph taken of the human body suffers from a serious drawback in that it is attempting to portray a three-dimensional object on a two-dimensional photographic plate. The X-ray picture indicates the X-ray intensity after it has passed through the object being examined. Typically the X-rays will have passed through bone, tissue, fat, blood, etc. and the resulting picture produced will be confused due to the superimposition of the various materials. Frequently the diagnostician is attempting to detect a small variation in the X-ray absorption of tissue (which may indicate some abnormality such as a tumour) when the area of interest is masked by a nearby bone. This situation is shown in Fig. 1.

The human brain poses a considerable problem for radiologists because it is totally enclosed in the protective bone of the skull. In an attempt to overcome some of the limitations of the conventional skull X-ray, several more sophisticated techniques have been developed such as angiography, ventriculography, and radioactive isotope brain scanning. These techniques, while giving some improvement in diagnoses, can cause considerable discomfort to the patient as well as in some cases requiring a team of highly trained staff to perform them. In addition to this the patient may need to be hospitalised after examination.



**THE MACROBERT AWARD**

For the invention of a new X-ray technique, Mr Godfrey Hounsfield and EMI Limited won the 1972 MacRobert Award.

This Award, often described as the Nobel Prize for engineering, consists of a Gold Medal and £25,000 prize money. It is presented annually, in recognition of the technological innovation contributing most significantly to the prestige and prosperity of the United Kingdom.

It was instituted by the MacRobert Trusts in 1968 and is administered by the council of Engineering Institutes, which is the federal body for 15 chartered engineering institutes.

This is the first time the award has been made in the field of electronics. In his citation for the Award, the Chairman of the MacRobert Award Evaluation Committee said, "One of the medical referees consulted during the evaluation stated that no comparable discovery has been made in this field since Röntgen discovered X-rays in 1895, and we agree with him."

"The EMI-Scanner system developed by Mr Hounsfield within the Central Research Laboratories of EMI is epoch-making, because it breaks away from the photographic techniques for recording X-ray pictures which in principle have remained unchanged since Röntgen's day . . ."

"There is another aspect of EMI-Scanner which is remarkable. In these modern days it is rarely that one finds great developments which are the work of one man. The EMI-Scanner is different: the submission for the MacRobert Award was prepared not by the inventor, but by EMI, who stated, 'Mr Hounsfield has been the guiding expert throughout all aspects of the work. The EMI-Scanner was as much a one-man invention as anything can be these days' . . ."

## THE NEW TECHNIQUE

The EMI-Scanner offers considerable advantages to both the diagnostician and the patient.

This new system uses X-rays to produce pictures of slices of the head as shown in Fig. 2. The head of the patient rests in a rubber head cap, and a gantry, on which is mounted the X-ray tube and detectors, is able to rotate around the head to perform the scanning sequence shown in Fig. 3. With the gantry in the 0° start position, the X-ray tube and detectors move so as to make a linear pass of the head. The whole gantry then rotates 1° and the X-ray tube and detectors move back to make a further linear pass.

The gantry then rotates a further 1° and this sequence of linear passes and 1° rotations is repeated until a total rotation of 180° has been achieved. Each complete scan does in fact yield results for two contiguous slices of the head as shown in Fig. 4. The thickness of each slice can be adjusted to either 0.8cm or 1.3cm by means of collimators in the X-ray beam. The two pictures from a single patient scan are achieved by using two detectors each with its own associated data processing channel.

The X-ray detectors used are photomultipliers with sodium iodide scintillating crystals. During each linear pass of the head, 160 readings of X-ray intensity are made by each detector so that for each complete scan of 180° a total of  $180 \times 160 = 28,800$  readings are taken. The 160 readings are controlled by means of a glass grating consisting of alternately transparent and opaque sections. This grating moves with the X-ray tube and detectors, and passes between a lamp and photodiode. The output from this photodiode controls the operation of electronic circuits which measure the output of each detector.

For each complete scan the scanning system yields a set of 28,800 readings from each of the two detectors plus an additional set of 28,800 reference readings of the X-ray intensity before passing through the patient's head. These three sets of readings are put into digital form by an analogue to digital converter and stored in the buffer section of a magnetic disc pack. This is illustrated in the block diagram of the system Fig. 5.

## DATA PROCESSING

These readings of X-ray intensity now have to be used to solve many thousands of simultaneous equations so that the X-ray absorption value at each point in the slice can be calculated. This operation is performed by a mini-computer, which, by means of a specially written computer program, is able to call-up these readings from the disc store and process them. The computation, which takes about five minutes for each picture, results in 6,400 output values in digital form which are stored in the main storage section of the magnetic disc pack.

## PICTURE DISPLAY

The 6,400 digital values can be called-up on command and converted into analogue form where they may be used to build up a picture on the cathode ray tube screen of the Viewing Unit. This picture consists of a matrix of  $80 \times 80$  picture points, the brightness of each point representing the X-ray absorption of the tissue.

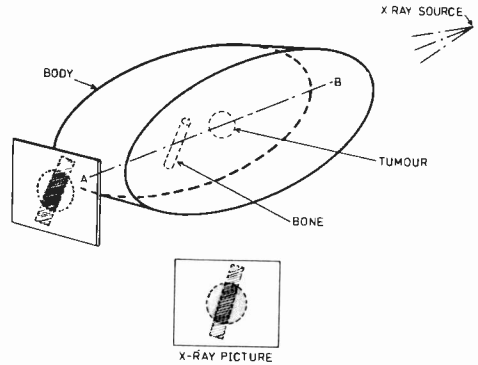

Fig. 1. Conventional X-ray technique

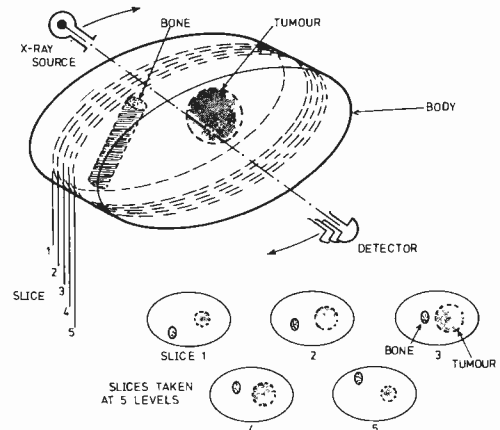

Fig. 2. Computerised transverse axial technique

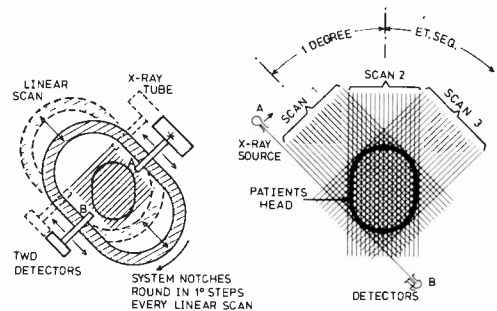

Fig. 3. Motion of scanning frame and detectors for producing two contiguous slices

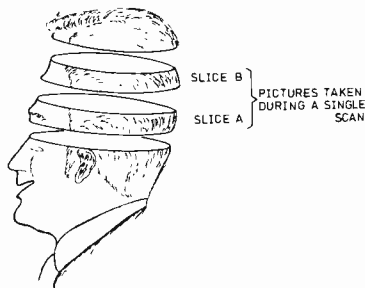

Fig. 4. Two slice planes taken during a single scan

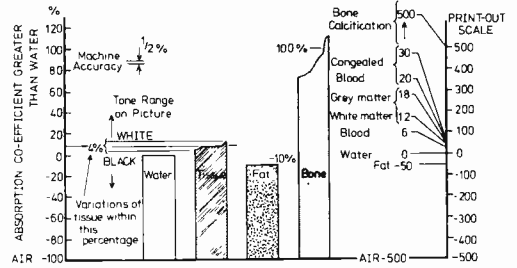

Fig. 6. X-ray absorption chart

An alternative method of displaying the results is to use a line printer which will print out the numerical values of the X-ray absorption coefficient at each point of the  $80 \times 80$  matrix.

The chart shown in Fig. 6 illustrates the range of measurement of the system. The left-hand scale shows the percentage X-ray absorption coefficient greater or less than that of water and the vertical blocks show the coefficients for materials commonly encountered in clinical radiology, i.e. blood, tissue, bone, etc. The right-hand scale on the chart shows the scale actually used on the equipment, with dense bone at +500, water at 0 and air at -500. The system is accurate to within  $2\frac{1}{2}$  units on a range 0 to 500.

In order that the diagnostician can select the information which is displayed on the Viewing Unit there are two very important controls—window width and window level.

The window width control selects the range of X-ray absorption values which yields black to peak white on the cathode ray tube screen.

The window level control enables this selected band to be moved up or down the scale of absorption values. As an example with the window level

control set at +15 (centre of the band) and the window width set at 20 all tissue with X-ray absorption values less than +5 would appear black and all values greater than +25 would appear white. Values between +5 and +25 would appear of different brightness values between black and peak white.

An illustration showing the effect of the window level control is shown in Fig. 8. The top left-hand picture shows the control set at -50; all values less than -60 appear black, all values greater than -40 appear white. The dark ring represents air trapped in the hair of the patient. The top centre picture shows the control set at 0 with the saline fluid-filled ventricles just beginning to show. The top right- and lower left-hand pictures show intermediate settings of the control to show detail of brain tissue at +10 to +20. The lower right-hand picture shows the control set at +50 with the white ring representing the bone of the skull. These pictures clearly show that the diagnostician can select the displayed picture to suit the material under examination.

By switching the window width control to a "measure" position, which yields 1 digit black to peak white on the display, it is possible to measure the X-ray absorption at any chosen point in the picture.

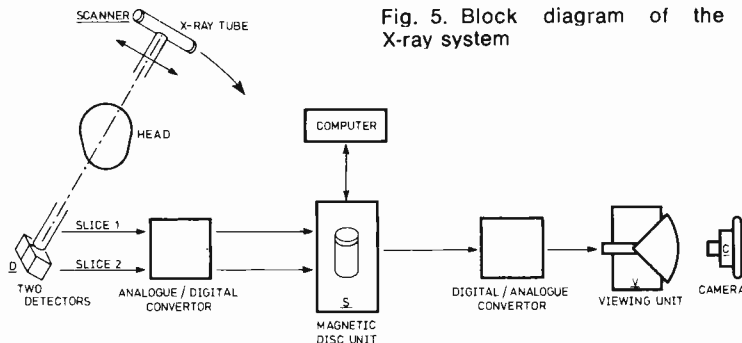

Fig. 5. Block diagram of the computerised X-ray system

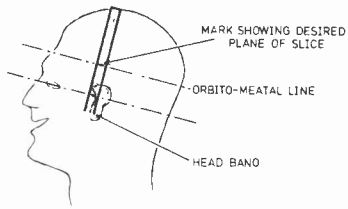

Fig. 7. Marking the slice planes on a headband

The window level control is adjusted until the point under examination is just changing from black to white. The absorption value can then be read off directly from the window level scale.

### PATIENT PREPARATION

As each complete scan of the patient yields results on only two 1.3cm thick slices of the head it may be necessary to perform three or four such scans to cover the major part of the brain. If, however, it is desired to locate the examination at a certain point this is done very easily. Firstly an adhesive white tape is fixed over the head of the patient to form a head-band. This is then marked to show the orbito-meatal line, which is an imaginary line drawn between the corner of the eye and the meatus of the ear, used as a reference point. If for example the diagnostician requires to examine a slice 5cm above this position on the head-band. This is illustrated in Fig. 7.

At this point the patient's head is inserted in the machine and the rubber head cap is collapsed onto the skull by means of water pressure to expel the air. The patient's head within the head cap is located

in a plastic cone on which is printed a scale, and the mark denoting the chosen plane of slice is then read off against this scale. This reading is noted and the patient is then moved either into or out of the machine by means of a hand-wheel beneath the diagnostic table until a pointer and scale indicate the same value as the head cone reading. The patient has then been set in the machine such that a slice either side of the marked plane is examined.

A range of different plastic head cones is available in order to accommodate heads of various sizes and also to allow the head to be tilted for certain special examinations.

Each patient is normally allocated an identifying number which the radiographer can enter into the machine store before each scan by means of thumb-wheel switches on the X-ray Control Unit. This number appears on the pictures and print-outs for that scan and so gives a positive link between the patient and the result.

The computer normally processes each set of readings in serial order from the buffer store. However, should the diagnostician require the results from a certain patient quickly, then the computer can be instructed to give priority processing to a selected picture.

### APPLICATIONS

As with any X-ray technique the EMI-Scanner system relies on the fact that the various structures found in the brain must have different X-ray absorption values in order that they can be differentiated. Even though the system is extremely sensitive there may be cases where the use of a contrast medium can be an advantage. Typically a small quantity of an X-ray opaque substance such as iodine can be injected intravenously into the patient.

If for instance there is a lesion which takes up the contrast medium more than the surrounding normal tissue then the diseased area will show up clearly on the picture, and, using the EMI-Scanner system, will continue to do so for several hours. The use of contrast media in this way should be compared with the technique used in angiography where the fluid is injected into the arterial system of the body and the effect lasts for only a few seconds.

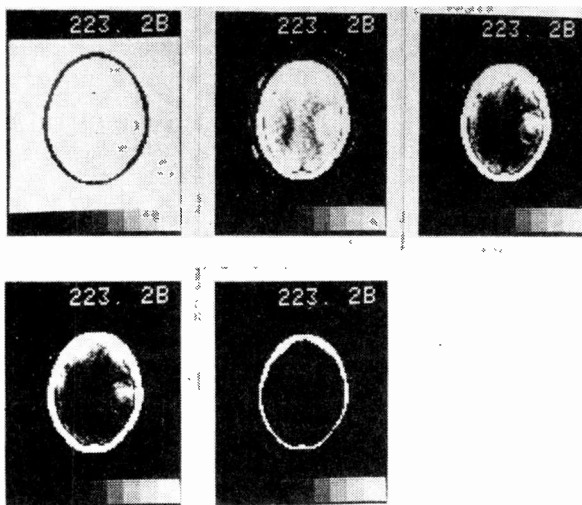
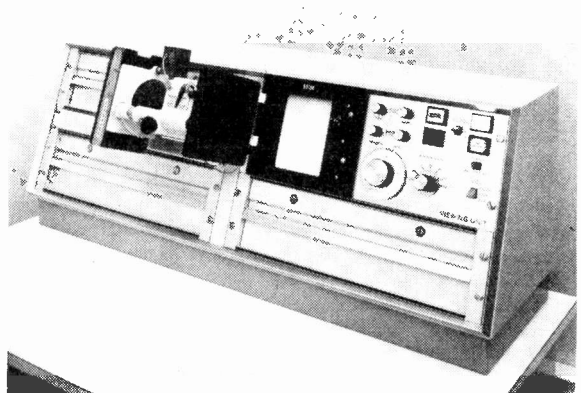

Fig. 8 (left). Effect of the "window level" control  
The Viewing Unit



# look! electronics really mastered

... practical  
... visual  
... exciting!

no previous knowledge  
no unnecessary theory  
no "maths"

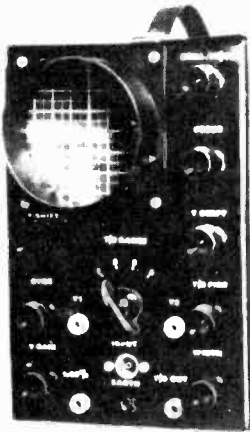
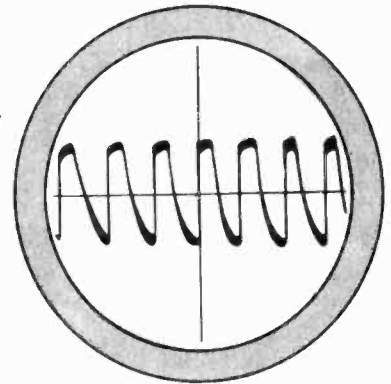
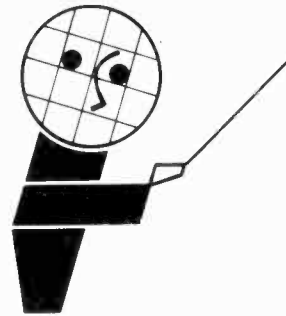

RAPY

**BUILD, SEE AND LEARN**  
step by step, we take you through all the fundamentals of electronics and show how easily the subject can be mastered. Write for the free brochure now which explains our system.

## 1/ BUILD AN OSCILLOSCOPE

You learn how to build an oscilloscope which remains your property. With it, you will become familiar with all the components used in electronics.

## 2/ READ, DRAW AND UNDERSTAND CIRCUIT DIAGRAMS

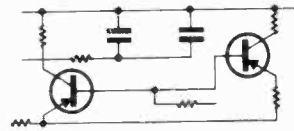

as used currently in the various fields of electronics.

## 3/ CARRY OUT OVER 40 EXPERIMENTS ON BASIC ELECTRONIC CIRCUITS & SEE HOW THEY WORK, including :

valve experiments, transistor experiments amplifiers, oscillators, signal tracer, photo electric circuit, computer circuit, basic radio receiver, electronic switch, simple transmitter, a.c. experiments, d.c. experiments, simple counter, time delay circuit, servicing procedures.

This new style course will enable anyone to really understand electronics by a modern, practical and visual method—no maths, and a minimum of theory—no previous knowledge required. It will also enable anyone to understand how to test, service and maintain all types of electronic equipment, radio and TV receivers, etc.

**FREE** POST NOW for BROCHURE

or write if you prefer not to cut page

To BRITISH NATIONAL RADIO & ELECTRONICS SCHOOL, P.O. BOX 156, JERSEY. Please send your free brochure, without obligation, to: we do not employ representatives

NAME

BLOCK CAPS

ADDRESS

PLEASE EL53

**special free gift also to all our students**

# PCB'S FROM PHONOSONICS



VERSATILE LIGHT EFFECTS PCB (Mk. 2)

All PCB's Fibreglass, Drilled, Roller Tinned. Circuit and Layout Diagrams. Free with each PCB. Rotary Pots supplied as standard except where stated. PCB's designed by Phonosonics except where stated otherwise.

## DESIGNS PUBLISHED IN P.E.

**AURORA (Apr./Aug. 71)** Multichannel Sound Controlled Light S/c's (excl. SCR's), Rs, Cs, Cores, Pots, 8 ch., £17.75; 4 ch., £10.15. Power Supply (supplies 8 chans.), unstab., £2.85; stab., £3.65. PCB (4 1/2in x 11in) for P/A and 4 chans. incl. pots, £2.35. PCB (4 1/2in x 5in) for PSU, Sync. Gen, 8 cores, 8 SCR's, £1.35.

**A.F. SIGNAL GENERATOR (Nov. 72)** S/c's, Rs, Cs, Pots, Sw's. PCB (2 1/2in x 4in) also holds Sw's, £3.15.

**AUDIO MIXER (Jan. 72)** Rs, Cs, Pots (i.c. excl.), PCB (1 1/2in x 2in), £1.55.

**BIOLOGICAL AMPLIFIER (Jan./Feb. 73)**—Pre-amp Set S/c's, Rs, Cs, Pots (i.c.'s excl.), PCB (1 1/2in x 3 1/2in), £2.90.

**DOOR BELL YODELLER (Apr. 71)**—S/c's, Rs, Cs, Pots, Transformer, Loudspeaker, PCB (3in x 3 1/2in), £7.70.

**ELECTRONIC PIANO (Sept. 72/Jan. 73)** Lower Prices! PA/Trem—Rs, Cs, Pots (excl. 2K), £1.70. PCB as publ., £1.50. Power Supply—Rs, Cs, £1.10. PCB as publ., 90p. Pitch 1-12—Rs, Cs, £1.90 each set. Pitch 13—Rs, Cs, £1.30. Pitch PCB as publ., £1.80 each. Combined sets for PA/Trem, PSU, all 13 Pitch—Rs, Cs, Pots (excl. 2K), £23.70. PCBs, £23.20.

**GEMINI STEREO AMP (Nov. 70/Mar. 71)** Stereo Sets and PCBs Pre-Amp—S/c's, £1.85. Cs, Pots, Maka-Sw's—with 1W 2% M.O. Rs, £11.60—with 1/2W 5% C.F. Rs, £9.35—with 1/4W 5% C.F. Rs, £8.90. PCB (3 1/2in x 10 1/2in) for kits with M.O. or 1/4W C.F. Rs. Holds pots and Maka-Sw's, £2.10. Main Amp—Rs, Cs, Pots, £5.40. PCB (3 1/2in x 5in), £1.40. PSU—Rs, Cs, Pot, £3.70. PCB (2in x 4in), 75p.

**GEMINI STEREO TUNER (Apr./Jun. 72)** Rs, Cs, Pot, £3.80. PCB as published, £1.80.

**HI-FI TAPE LINK (Mar./Apr. 73)**—PCB, etc., in preparation.

**LOGICAL RADIO CONTROL (Dec. 71/Jan. 72)**—Sets incl. PCB as publ., Rs, Cs, S/c's and Pots (where req.) but excl. I.C.'s. Coder 1 and Clock Pulse Gen., £3.75. Coder 2A, £3.60. Coder 2B, £3.85. Decoder, £1.45.

**MODEL SERVO CONTROL (Feb./Mar. 72)**—Sets incl. PCB as publ., Rs, Cs, S/c's and Pots (where req.) but excl. I.C.'s. Servo Amps: "A", £2.15; "B", £3.70; "C", £2.20. Fail-Safe, £1.30.

**MICROPHONE MIXER (Apr. 69)**—S/c's, Rs, Cs, Pots, PCB (3 1/2in x 4 1/2in)—also holds pots, £4.10.

**PHOTOPRINT PROCESS CONTROL (Jan./Feb. 72)** Finds exposure, controls timing, stabilises mains voltage. S/c's, SCR, LDR, Rs, Cs, Pots, Relay, Keyswitch, T/former. PCB (3 1/2in x 5 1/2in) also holds pots, relay, keyswitch, £8.80.

**SOUND SYNTHESISER (Current Series)**—Details on request.

**TAPE NOISE LIMITER (Feb. 72)**—Mono Circuit S/c's, Rs, Cs, Pot, PCB (1 1/2in x 3in), £2.20. Regulated Power Supply (will feed 2 units) and PCB (1 1/2in x 2 1/2in), £3.20.

**TRIFFID (Feb. 73)**—PCB As Published, 60p.

**ULTRASONIC TRANSMITTER-RECEIVER (May 72)** Rs, Cs, Pot, S/c's, Relay, Dual PCB (2in x 5 1/2in), £3.90.

**VERSATILE LIGHT EFFECTS UNIT (Jun. 72)**—Single Channel Sound Controlled Light—also has built-in variable strobe. S/c's (excl. SCR), Rs, Cs, Pots, T/formers, Keyswitch, £8.85. PCB (3 1/2in x 7 1/2in) also holds Pots, Sw, T/former (T/77), £1.50.

## SOME OTHER DESIGNS AVAILABLE

**VIBRASONIC GUITAR PRE-AMP. (Practical Wireless Sept. 70)**—Incl. Mic P/A, 2 Guitar P/A, Tremulant and Tone Controls, Master Volume. S/c's, Rs, Cs, Rotary Pots, LDR, Lamp, Coupling T/former, £7.75. PSU, £2.80. PCB (4in x 1 1/2in) also holds rotary or slider pots, £2.30.

**REVERBERATION UNIT (Practical Wireless Nov.-Dec. 72)** S/c's, Rs, Cs, Slider Pots T/former, £6.80. PCB (2in x 1 1/2in) also holds sliders (compatible with publ. panel) £1.20.

**8 WATT AMPLIFIER (Practical Wireless Nov. 72)** Main Amplifier—S/c's, Rs, Cs, Pot (Mono Set), £3.90. PCB (2 1/2in x 3in) (Mono). 60p. Pre-amp—S/c's, Rs, Cs, Pots, Maka-Sw., Mono, £2.50; Stereo, £5.20. PCB (3 1/2in x 7 1/2in) (Stereo)—also holds all pots and Maka-Sw., £1.50.

**AURORA AUXILIARY CONTROL UNIT (2 variable freq. strobe gens. and 4 variable amplitude freq. gens.),** Rs, Cs, Pots, S/c's, £3.25. PCB (3 1/2in x 5 1/2in), also holds all pots, £1.35.

**THYRISTORS (400V P.I.V.),** 1A 50. 3A 55. 7A 70p. 16A 95p.

**SLIDER POTS (PCB Mounting),** Mono, 40p; Dual, 60p; Knobs, 13p.

S.A.E. for Free List of these and other designs.

Orders: U.K. 10p P. & P. Overseas P. & P. at cost.

V.A.T.—All Prices V.A.T. Exclusive.

**PHONOSONICS, Dept. P.E.5, 25 Kentish Road, Belvedere, Kent DA17 5BW. Mail Order only**

# Just hold this while I switch on.



Sorry about that, Roger.

BAND-AID\* Washproof Plasters.

© Johnson & Johnson LTD

\* TRADE MARK

## AUTOMATIC EMERGENCY SUPPLY

250v 50 Hz—150 watt Inverter. Full kit of parts excluding meter. Circuit as appeared in December P.W. Complete kit—£16.95 + 80p. P. & P.

## OTHER INVERTERS AVAILABLE IN KIT FORM

150 Watt—£13.50 + 60p P. & P. 75 Watt—£7.80 + 60p P. & P.  
300 Watt—£17.90 + 85p P. & P. 40 Watt—£5.20 + 40p P. & P.  
25 Watt—£2.60 + 20p P. & P.

All above operate from 12v. battery and give 250v.-50Hz. Output. 24 volt types are also available, alternative outputs or taps can be supplied. Transformers and/or Transistors can be supplied separately.

## SPECIAL OFFER

12v. Fluorescent lights, suitable for tents, caravans, houses or secondary lighting for factories, hotels, etc. 12 inch—8 watt—£3.40 post paid. 21 inch—13 watt—£4.20 post paid. Large discounts available for quantities.

## TEXAN AMPLIFIER

Fibre glass P.C. board—£2.00 + 10p P. & P.  
Transformer—£4.00 + 30p P. & P.  
Other components including Teak Cabinet—£24.00 + Postage.

## ASTRO ELECTRONICS

6 BARNES ROAD, CHESTERFIELD, DERBYSHIRE

<b>LED's</b>			
TIL302 4 for	£10	<b>I.C.'s</b>	
6 for	£14	MM531 I Clock	£12.50
DL34 4 digits	£15	ZN414 Radio	£1.10
TIL360 6 digits	£18	Sig555 Mono/astab.	£0.90
TIL209 4 for	£1	CA3082 7-seg. driv.	£2.10
50 for	£10		
<b>CALCULATORS</b>		<b>KITS (incl. I.C. sockets)</b>	
Advance Mini	£45	Calculator	£41
Advance Exec. 8	£45	Digitronic (6)	£36
Advance Exec. 16-1	£95	Digitronic (4)	£32
Advance Exec. 16-2	£110	Bywood clock kit	£34
Post & Packing I.C.'s, LED's, 10p.		<b>P.E. Calculator Kit</b>	<b>£34.50</b>
<b>KITS, CALC's, METERS 50p.</b>		<b>ADD 10% VAT TO ALL ORDERS</b>	



You may telephone your order and pay by ACCESS.  
ANSAFONE — 24-hour service.

**LATEST! New Digital Clock**  
I.C.'s available with alarms.  
S.A.E. for details:

# BYWOOD

**ELECTRONICS**  
181 EBBERS ROAD, HEMEL  
HEMPSTEAD, HERTS. 0442 62757





View of a patient in position on the scanning unit

## TECHNICAL DETAILS

The circuit techniques used are in general of a conventional nature incorporating both discrete components and integrated circuits mounted on printed circuit boards. Both the Scanning Unit control electronics and the viewing Unit contain a large amount of logic circuitry.

The X-ray Control Unit

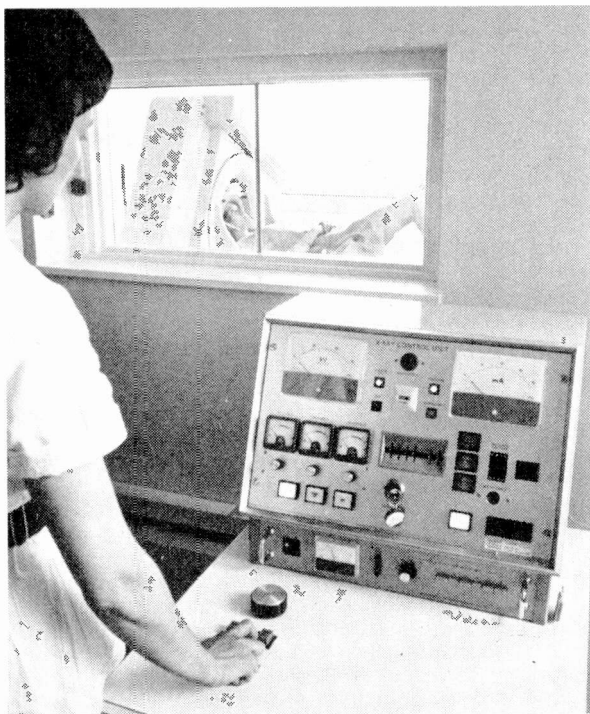

A feature of the system is the high degree to which the various controls are interlocked to ensure safe and correct operation by non-technical operators. As an example of this, the scanning sequence cannot be started until four conditions are satisfied:

1. That the scanning gantry is in the start position.
2. That the operator has set the patient's identifying code on the thumbwheel switches.
3. That the computer is ready to receive data into the disc buffer.
4. That the operator has removed the safety key from the Scanning Unit control panel and has inserted it in the X-ray Control Unit.

The status of these interlocks is clearly shown by means of indicating lamps so that the operator can check visually before starting the sequence.

The system for generating the X-rays is designed to give good stability and incorporates regulators for both voltage and current to the X-ray tube. Three-phase a.c. mains is converted to 100V 150Hz by a power conversion unit, which is then fed to the e.h.t. transformer. The output voltage is full wave rectified and smoothed to give an output of up to  $\pm 70\text{kV}$  w.r.t. earth for the X-ray tube.

The X-ray tube is a fixed anode type, the cathode being aligned to give a line rather than a spot focus.

## CONCLUSION

This system is being confidently predicted by many radiologists as one which will revolutionise the use of X-rays. The significance of this new technique has already been noted in Great Britain where its inventor, Mr G. N. Hounsfield, of the Central Research Laboratories of EMI Ltd., has recently received the MacRobert Award for outstanding innovation in engineering.

## ACKNOWLEDGEMENT

The writer wishes to thank the Directors of EMI Ltd. for permission to publish this article. ★

# PE Sound Synthesiser

## 4

# RAMP GENERATORS & INPUT AMPLIFIERS

By G.D. Shaw



**T**HIS month, the operation and construction of the ramp generators and input amplifiers will be described together with guidelines on using the various modules, so far described, in combination.

### RAMP GENERATOR

The ramp generator to be described is effectively a sawtooth oscillator capable of working down to very low frequencies. At the low end of its working range the output of the device may be considered to be slowly changing d.c. and, unlike the v.c.o. which produces an output waveform swinging about zero, the output of the ramp generator is single-ended, that is, swinging from zero to about  $-3.5V$ .

The reason for this arrangement is that the ramp generator is considered essentially as a device for programming other voltage controlled modules all of which require control voltages of one polarity only. This requirement, incidentally, does not mean that alternating voltages cannot be used for programming and, as will be shown, many interesting effects can be obtained when the control voltages vary about zero.

As with the v.c.o. the principle of operation is that of the linear integrator although the circuit shown in Fig. 4.1 is very much simpler.

IC1 is the integrator which receives its positive control voltage either from VR1, an external source, or from both in combination. IC2 is a comparator which, since single ended operation is required, utilises a reference voltage set by R7-R8 and transistor TR1 to discharge the integrating capacitor C1. The reference voltage also determines the peak ramp output voltage of the circuit.

### CIRCUIT OPERATION

The operation of the circuit is as follows. The divider R7/R8 provides  $-3.5V$  at the non-inverting input of IC2 and effectively biases TR1 off. Assuming that the R1 input to IC1 is open circuit, a positive voltage derived from VR1 is applied to the inverting input of IC1 via R2 and the integrator begins to ramp negatively at a rate determined essentially by R2/C1.

When the ramp output voltage applied to the inverting input of IC2 is equal to or greater than

the reference voltage the comparator switches to its positive saturation state, turns on TR1, and discharges C1 via R6 and R7.

The sawtooth output waveform is taken from the junction of R4 and R5 via VR4 while a pulse output is available from the emitter of TR1. Note that this requires to be a.c. coupled if it is to be used effectively.

### CONSTRUCTING THE RAMP GENERATORS

Construction of the ramp generators is perfectly straightforward, the recommended circuit board layout being shown in Fig. 4.2. Note that both ramp generators (RG1/RG2) are built on one circuit board and that power supply decoupling is not required.

The method of construction should generally follow that employed for the v.c.o. module. Components should be mounted to the front panel and prewired before the panel is secured to the circuit board support plate. Note, however, that in this case the main wiring harness from the ramp generators should leave the front panel at the top and pass over the top edge of the circuit boards while the wiring to the input amplifiers should be as short as possible and routed direct to the appropriate circuit board.

A detail of the panel component wiring and board layout is shown in Fig. 4.3. The McMurdo plug should now be prewired and mounted into the support plate.

### TESTING

When assembly of one of the ramp generators has been completed make temporary connections to power supply leads and front panel controls and connect a resistor of at least 10 megohms across the integrating capacitor C1. Set VR2 and VR1 to their minimum values, VR3 to its mid-position, and switch on the power supply. Observe the integrator output on the oscilloscope and adjust VR3 for zero offset. Switch off and remove the 10 megohm resistor.

Set VR2 to its mid-position and switch on again. A sawtooth waveform of about 7Hz should now be observed. Gradually reduce the setting of VR2 until the slope of the ramp begins to show slight rippling.

# RAMP GENERATORS

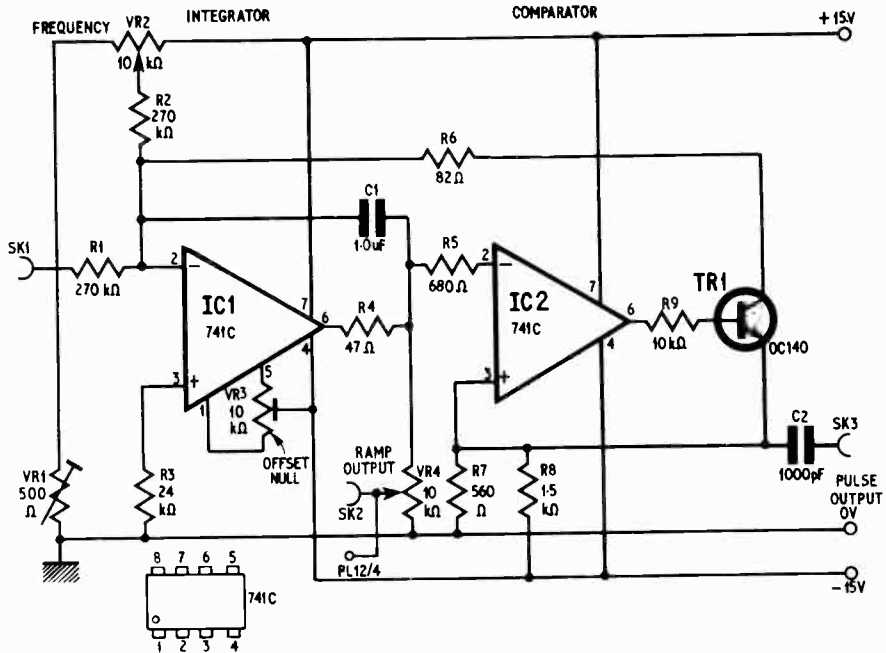

Fig. 4.1. Circuit of a ramp generator

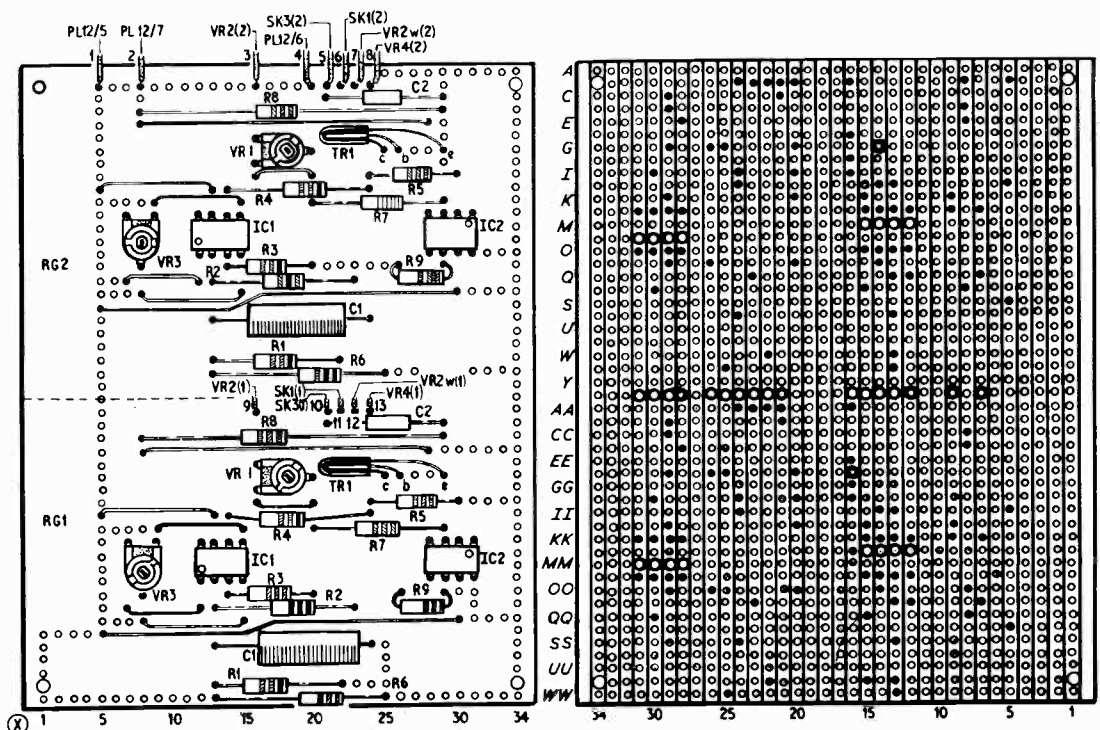

Fig. 4.2. Component layout and wiring of ramp generators

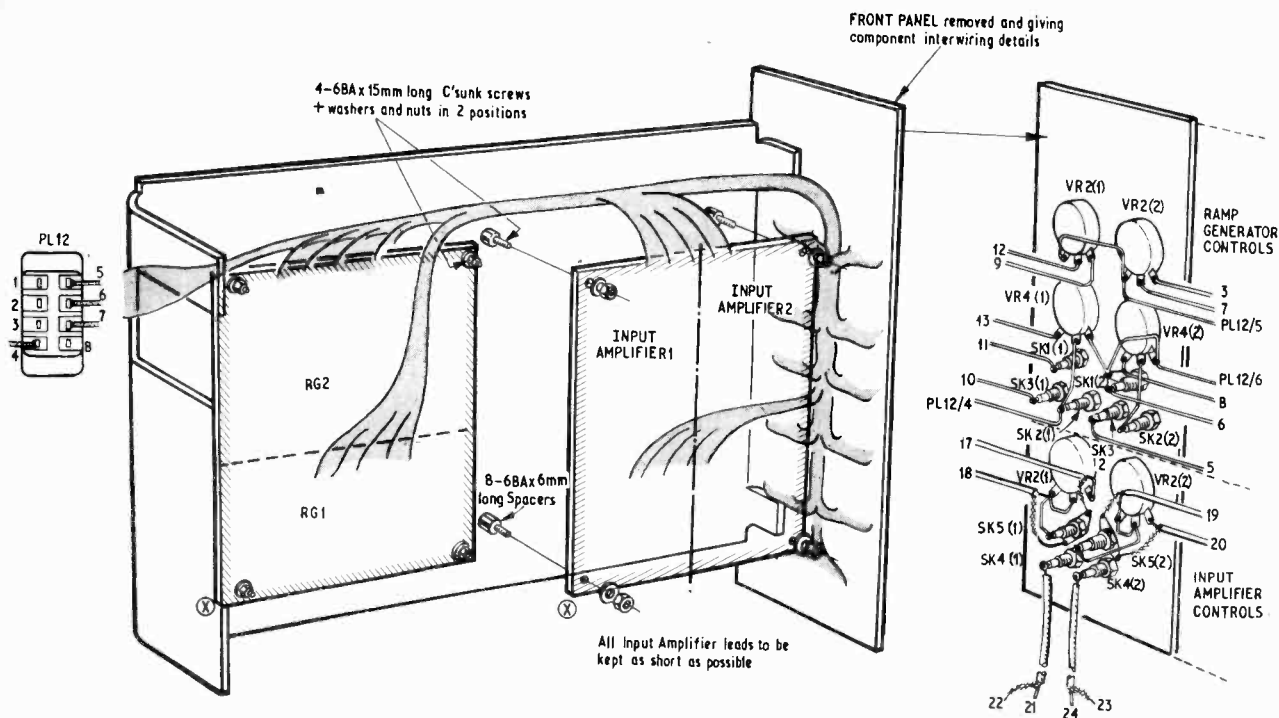

Fig. 4.3. Control panel wiring and board layout of ramp generator module, A lead should be taken from SK2(2) to PL12/8

## COMPONENTS . . .

### RAMP GENERATOR (2 OFF)

#### Resistors

R1, R2	270k $\Omega$ (2 off)
R3	24k $\Omega$
R4	47 $\Omega$
R5	680 $\Omega$
R6	82 $\Omega$
R7	560 $\Omega$
R8	1.5k $\Omega$
R9	10k $\Omega$

All 2%  $\frac{1}{2}$  watt metal oxide

#### Capacitors

C1	1 $\mu$ F polyester 25V
C2	1,000pF polystyrene

#### Integrated Circuits

IC1, IC2	741C 8 pin D.I.L. (2 off)
----------	---------------------------

#### Transistor

TR1	OC140
-----	-------

#### Potentiometers

VR1	500 $\Omega$ horizontal carbon preset
VR2	10k $\Omega$ miniature moulded carbon linear potentiometer
VR3	10k $\Omega$ horizontal carbon preset
VR4	10k $\Omega$ miniature moulded carbon linear potentiometer

#### Miscellaneous

SK1-SK3 2mm miniature sockets (3 off), 2 Elma knobs, 34  $\times$  17 way 0.1in matrix Veroboard

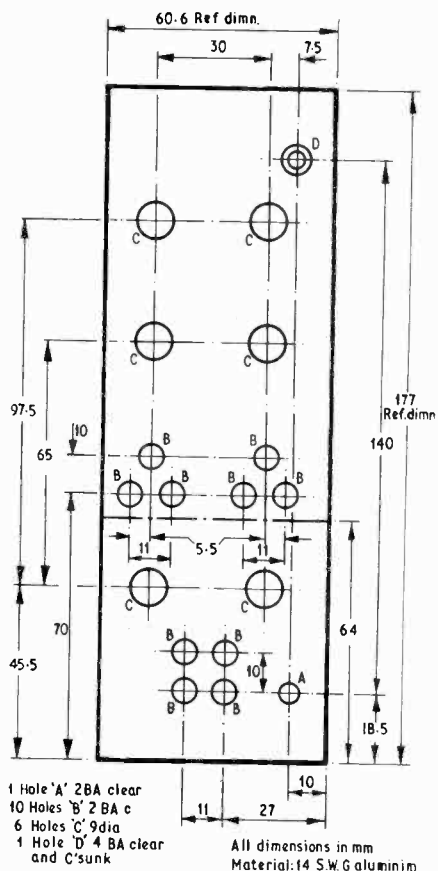

# INPUT AMPLIFIER

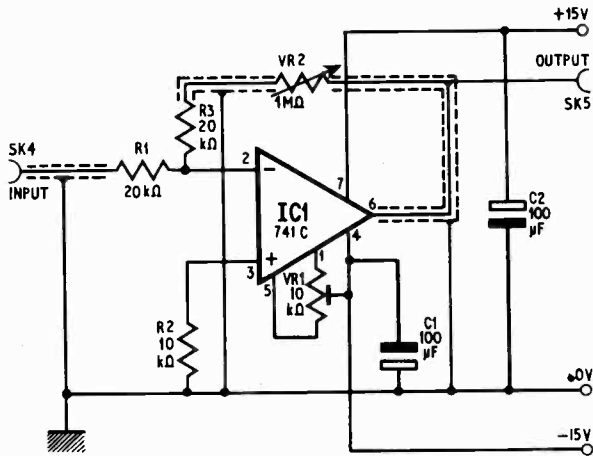

Fig. 4.4. Circuit of an input amplifier

## COMPONENTS . . .

### INPUT AMPLIFIERS (2 OFF)

#### Resistors

- R1 20k  $\Omega$
- R2 10k  $\Omega$
- R3 20k  $\Omega$
- All 2%  $\frac{1}{2}$  watt metal oxide

#### Capacitors

- C1, C2 100 $\mu$ F elect. 25V (2 off)

#### Potentiometers

- VR1 10k  $\Omega$  horizontal linear preset
- VR2 1M  $\Omega$  linear miniature moulded carbon

#### Integrated Circuit

- IC1 741C 8 pin D.I.L.

#### Miscellaneous

- SK4, SK5 2mm miniature sockets (2 off), 34  $\times$  17 way 0.1in matrix Veroboard, 1 Elma type knob

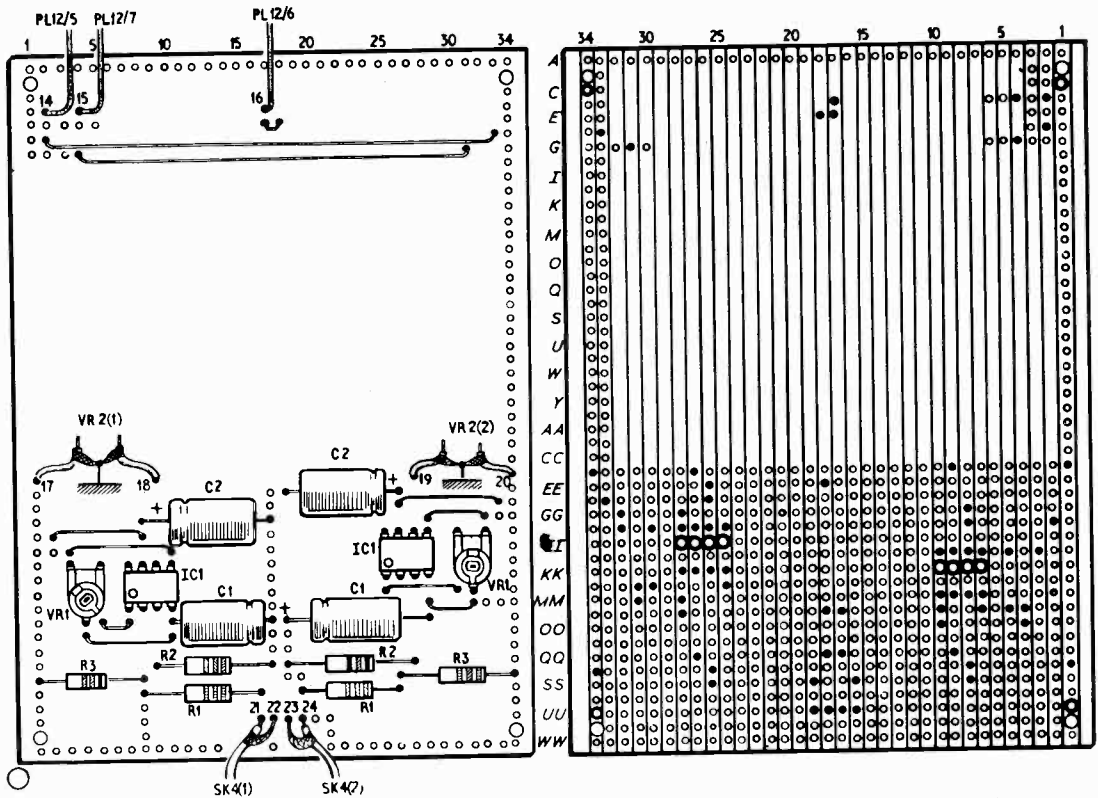

Fig. 4.5. Circuit board layout of input amplifiers

Increase the setting of VR1 until the rippling disappears and make further reductions in the setting of VR2, adjusting VR1 as necessary to keep the slope ripple free. Note that at the minimum setting of VR2 the ripple effect is at very low frequency and shows itself more as a hesitancy in the motion of the oscilloscope trace.

With careful adjustment, and the component values shown, it is possible to achieve a low frequency of 0.01Hz but it is almost impossible to remove ripple entirely at this frequency and generally it is best to set the low end of the range to 0.05Hz to ensure stability. The upper frequency limit with the 1.0 $\mu$ F integrating capacitor is about 15Hz.

In the prototype instrument one ramp generator was built as described and the second was built with an integrating capacitor of 0.47 $\mu$ F thus giving an upper frequency limit of about 30Hz with very little sacrifice to the v.l.f. end of the range. Such a procedure is recommended since the higher frequency is very useful in the production of rapidly changing, complex sound patterns.

When both ramp generators have been built and tested, mount the circuit board on the support plate in the position remote from the front panel (Fig. 4.3).

## INPUT AMPLIFIERS

The input amplifier theoretical circuit is shown in Fig. 4.4 and the circuit board layout in Fig. 4.5.

Although very simple in design rather more care is required in the component layout if hum pick-up is to be avoided, this latter problem tending to occur more when the gain control VR1 is at its maximum setting. Note that screened wire is used to connect the input sockets and gain controls to the circuit board. These wires should be trimmed as closely as possible to the required length and led directly to the circuit board without being formed into a harness.

The only setting up required is the adjustment of the offsets. VR2 should be set to maximum, the input grounded and, with the power supply on, adjusted to give an output level of precisely zero.

Reference to block diagram in Part One will show that Oscillator 1 is programmed directly by Ramp Generator 1 through the medium of a prewired interconnection. Accordingly tag 4 on the ramp generator McMurdo socket (SK12) should be connected to tag 1 on the v.c.o. socket (SK8). This direct connection may be over-ridden by inserting either an open circuit or grounded jack plug into the external programming socket of the v.c.o. Alternatively a jack plug coupled to a patch cord may be used to provide programming from another source.

It is recommended that grounded jack plugs are used if precise manual control of v.c.o. frequency is required.

## PROGRAMME DATA SHEET

The completion of this module provides the constructor with greater facilities for the production of programming waveforms and some quite complex sound structures. With the addition of the v.c.o. module there are now seven separate circuits and 12 controls to manipulate. There is thus a need for a method of logging control settings and interconnections so that any given sound structure may be repeated at a later date.

Details of a data sheet which will prove ideal for the purpose are given in Fig. 4.6. Control settings

would normally be recorded in the circles on the front panel representation while module interconnections would be indicated by a dot in the appropriate square on the grid matrix. Data recorded in the figure relates to the production of a type of bird song which will be described in detail in a later article.

## USING THE CONSTRUCTED MODULES

The provision of the input amplifiers allows waveforms from the oscillators and/or ramp generators to be mixed either additively or subtractively when used in combination with the voltage inverter. The permutation of all the possible settings of amplitude and frequency controls implies that an enormous range of sound structures may be produced and, whereas it is beyond the scope of this article to cover all the possibilities, a number of simple experiments are suggested for guidance.

Starting with the ramp generators, Fig. 4.7a shows the type of relationship which may be observed on the oscilloscope when one ramp generator is running at ten times the frequency of the other. With the output of a v.c.o. coupled to a suitable power amplifier and its frequency control at zero, application of either of the waveforms shown will cause the v.c.o. frequency to be swung from the lowest end of the range to an upper frequency determined by the amplitude of the ramp generator waveform.

Since the upper frequency limit of the v.c.o. is dictated by the saturation level of the differential stage and since the gain of this stage is 10 then a programming waveform amplitude of about 1.4V will drive the v.c.o. to its maximum frequency.

Fig. 4.7b shows the effect of mixing the waveforms shown in Fig. 4.7a additively. To achieve this, route the outputs of the ramp generators to separate input amplifiers which have their gain controls set to zero, i.e. unity gain, and then to the inputs of the voltage inverter. Observation of the output of this latter device reveals the composite waveform.

With the ramp generator output levels adjusted so that the maximum combined level is about 1.4V route the voltage inverter to the input of the v.c.o. The result is an undulating sound the lowest frequency of which is continuously rising at a rate set by the frequency of the slowest running ramp generator.

## SUBTRACTIVE MIXING

Fig. 4.7c shows the effect of subtractive mixing of the ramp generator waveforms. Achievement of the staircase form is as follows.

Set the amplitude of the slowest ramp generator output to 1.4V and route this to the voltage inverter via an input amplifier set to unity gain. Route the second ramp generator to the voltage inverter direct. Since this now sees the inputs from the ramp generators at opposite polarities the result is subtractive mixing which, when the amplitudes are at the correct levels, produces a staircase as shown.

Application of this waveform to the v.c.o. produces a rising, arpeggio-like sound. A falling arpeggio may be produced by reversing the routing of the ramp generators with the slowest direct to the voltage inverter, and fastest to the voltage inverter via the input amplifier. In this latter case the frequency control of the v.c.o. has to be set to its maximum level since the waveform from the voltage inverter is now positive going.

# SYNTHESISER PROGRAMME SHEET

 METER RANGE REVERBERATION 10 I/P LEVEL    7.3 MIX O/P LEVEL    10 O/P LEVEL RING MODULATOR	OUTPUT AMPS L    R I/P LEVEL PAN O/P LEVEL DIFF. AMP		TONE T. BOOST T. CUT B. BOOST B. CUT	SAMPLE & HOLD 0 RATE 0 D.C. 5-8 BIAS 8-3 LEVEL COLOUR	RAMP GENERATORS 1    2 0.6    1.3 10    3.0 O/P 1.5    0.8 LEVEL INPUT AMPS	ENV SHAPER C    4 MODE    RATIO 0    6 ATTACK    DECAY SUSTAIN    O/P 1.5 O/P	OSCILLATORS 1    2 7.1    f 0 O/P 10 O/P INVERTER
--	---	--	--	--	--	--	--

	Signals Inputs				Sig or Con		Control Inputs												Control Changes																		
	I/P Amp 1	I/P Amp 2	O/P Amp L1	O/P Amp L2	O/P Amp R1	O/P Amp R2	Tone C	Ring Mod	Ring Mod	Reverb	Diff I 1	Diff I 2	Diff N 1	Diff N 2	Inverter	Meter	S&H DC	S&H N		Env Sh C1	Env Sh C2	Env Sh E	Reverb	O/P Amp L	O/P Amp R	R G 1	R G 2	Osc 1a	Osc 1b	Osc 2a	Osc 2b						
R.G. 1	●																																				
R.G. 2																																					
Osc 1 MM																																					
Osc 1																																					
Osc 2 MM																																					
Osc 2																																					
Noise																																					
I/P Amp 1																																					
I/P Amp 2																																					
O/P Amp L																																					
O/P Amp R																																					
Tone C																																					
Ring Mod																																					
Reverb																																					
Env Shaper																																					
S&H	●																																				
Diff Amp																																					
Inverter																																					
KBD Signal																																					
KBD Sync																																					

DESCRIPTION OF SOUND
EXTERNAL EQUIPMENT
RECORDING DETAILS Stereo/Mono 1/2 Track / 1/4 Track 15 ips / 7 1/2 ips / 3 3/4 ips Special Effects

Fig. 4.6. Example of a programme data sheet

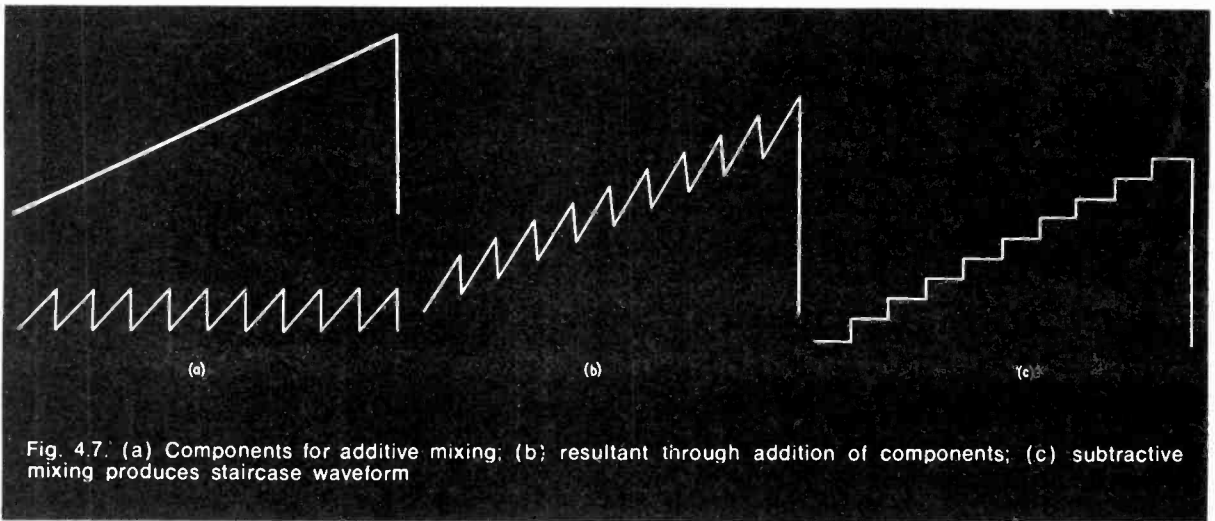

Fig. 4.7. (a) Components for additive mixing; (b) resultant through addition of components; (c) subtractive mixing produces staircase waveform

### FIXING THE V.C.O. LIMITS

In these examples the v.c.o. has been programmed through its maximum working range but it is, of course, possible to achieve the same effect within very precise frequency limits. For example, suppose it is wished to provide an arpeggio rising from 130Hz

to 520Hz, the frequency control of the v.c.o. is set to give the voltage required to produce 130Hz. The fact that the ramp output will, at times, be zero volts will not affect the l.f. performance limit since the v.c.o.s were originally set up with a link simulating a zero-volt programming input. Thus from Fig. 3.4 in last month's article it will be seen that the initial setting of the v.c.o. will require an input of about 24mV. Also it will be seen that a frequency of 520Hz requires an input of about 42mV and thus the output amplitude of the combined ramp generator signal will have to be (42-24)mV. In a similar manner the manipulation and adjustment of the manual and automatic voltage sources can set the programmed sequence almost anywhere in the working range of the v.c.o.

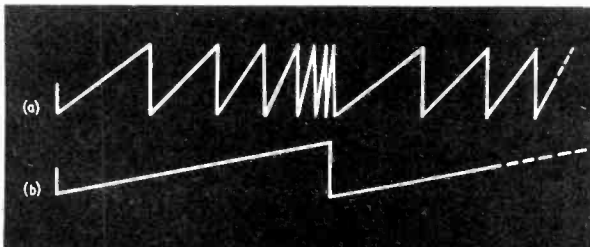

Fig. 4.8(a). Programmed ramp generator output (b) programming waveform

### PROGRAMMING THE RAMP GENERATORS

The monotonous repetition of the ramp generator output can be considerably varied by application of programming voltages to its own external control input. Fig. 4.8 illustrates the effect of applying a steadily rising voltage to the control input.

The voltage has been derived from the output of the other ramp generator running at a fairly low frequency and routed via one of the input amplifiers set to provide a peak ramp output of positive 14V. The resultant output of the programmed ramp generator consists of a series of ramps gradually increasing in frequency as the programming voltage rises to its peak, the aural effect when used to programme a v.c.o. being a kind of bounce.

For the best effect the programmed ramp generator should be running at about twenty times the frequency of the other.

An extension of the above system is shown in the block diagram Fig. 4.9. In this case one of the v.c.o.s is also providing a programming waveform which is first amplified to provide an output swing of  $\pm 7V$ . This is then combined, in the voltage inverter, with the output of the programming ramp generator set to its maximum output level. The voltage inverter is then routed to the programmed generator which has

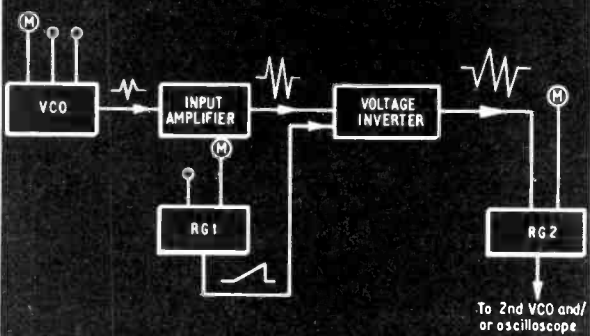

Fig. 4.9. Block diagram for ramp generator programming



been set to run at about 7Hz, the overall result being a bounce which is changing its rate in a pattern depending on the relative frequencies of the programming sources.

### EXPERIMENTAL COMBINATION

There are many other combinations of the programming devices all of which result in the production of characteristic sounds. The constructor is encouraged to investigate these as widely as possible noting the control settings and interconnections which produce sounds of particular interest.

It should be noted that even quite small adjustments to amplitude and frequency of programming waveforms can cause relatively great changes in the sound structure. This is particularly the case when amplitudes are adjusted in complex programming waveforms such that the waveform changes potential, i.e. crosses zero. In these cases the v.c.o. will cease to oscillate for as long as the programming waveform remains positive and thus, for a fairly rapidly changing waveform, the long term output of the v.c.o. will resemble a series of tone bursts of varying frequency.

The use of positive going programming waveforms to the v.c.o. should be investigated with care, particularly when the manual frequency control is at or near zero. The sudden application of a large positive input will cause an unpleasant click due to the increase in v.c.o. output voltage as it goes into saturation. Similarly a low potential positive input applied for a prolonged period will, on its removal, give rise to a click when the v.c.o. comes out of saturation.

### USING A RECORDER

It is perhaps prudent, at this stage, to mention that a tape recorder is a most necessary adjunct to the Synthesiser if the full potential of the instrument is to be realised. This is essential because, although live performance is possible, it is somewhat limited due to the design of the keyboard which is monophonic. In order to produce complex realisations, it is necessary to employ a recorder in order that multitracking of one form or another may be used to blend or superimpose consecutive series of sound structures into a comprehensive whole.

In a similar manner many sound effects may be enhanced by the addition or superimposition of secondary sounds. This procedure can be particularly useful when complex effects such as storms, battles or woodland birdsong are being synthesised.

Quite apart from the creative aspects of using the tape recorder another important reason for its application with the Synthesiser lies in the establishment of a taped library of sounds.

Many excellent books and articles have been written on this subject but, in the field of creative recording, T. Dwyer's "Composing with Tape Recorders" (Oxford University Press 1971) contains much useful information.

#### NOTE:

The power supply transformer in Part 2 has 0-30, 0-30V separate secondaries. R1 and R6 should be 5.6k $\Omega$  2%  $\frac{1}{2}$  watt metal oxide resistor. IC2 should be insulated from chassis with a mica washer. In Part 3, VR2 is 100k $\Omega$ .

Next month: Sample Hold and Noise Generator.



# BOOK REVIEWS

### ELECTRONIC MUSIC PRODUCTION

By Alan Douglas

Published by Sir Isaac Pitman & Sons Ltd

148 pages 5 $\frac{1}{2}$ in  $\times$  8 $\frac{1}{2}$ in. Price £2.75

**E**LECTRONIC MUSIC PRODUCTION presents a very much "up to the minute" look at the use of electronics in the production of music with special reference to the synthesiser and the applications of voltage control. The book is divided into four main sections. 1—Properties of conventional musical instruments. 2—Musical scales, temperament and tuning; concord and discord. 3—Electronic music generators. 4—Electronic music and the composer. Additionally there are two appendices which provide, in the first, a detailed specification of the Synthi 100, a highly advanced synthesiser designed for interfacing with a computer and, in the second, details of MUSYS documentation standards together with an example drawn from part of a composition programmed on the Synthi 100. Finally there is a comprehensive bibliography and index.

*Electronic Music Production* is a lucidly written book packed with data much of which will be new to the reader. There are plenty of clear line illustrations and circuit diagrams and there is little doubt that this book will be "required" reading for all students of electronic music—amateur and professional alike.

G.D.S.

### LOGIC AND LOGIC DESIGN

By B. Girling and H. G. Moring

Published by International Textbook Company

328 pages, 9in  $\times$  6in. Price £5.80

**A**BASIC understanding of logic is essential for anyone interested in the design of computers and associated logic systems. This book, based on a course of lectures given at The City University, provides an excellent introduction to logic, starting from basic number and set theory. It covers the Computer Science requirements for a B.Sc. degree and each chapter concludes with a bibliography and a set of questions with solutions.

This book is very well written and concepts are explained with the aid of copious clearly drawn diagrams. The book does not deal at all with engineering considerations in logic circuit design, concentrating rather on the logical concepts involved. As well as all the standard aids to logic design many up to date references are quoted so that modern concepts can be understood.

With the increasing interest in Computer Science this book will no doubt find its way into many degree courses as the standard reference work. It is well bound and excellently printed and though the price is rather high it is good value for money.

S.R.L.

# POCKET CALCULATOR KIT REVIEW



## Supacal Calculator

Obtainable from S.C.S. Components Ltd., P.O. Box 26, Wembley, Middx HA0 1YY.  
Price £39 (+ V.A.T.) with special £4 discount to P.E. readers.

**I**MEDIATELY upon opening the box containing the SUPACAL calculator kit the decision should be made as to whether one is sufficiently equipped in terms of both tools and experience to undertake the construction of the calculator. *Should there be any doubt in this respect, it is strongly recommended that the services of a more experienced friend or colleague be recruited for this work.* The minimum tools required for building the kit are a good soldering iron of 10 to 25 watts with a bit preferably no more than a sixteenth of an inch diameter, also a pair of side cutters, a pair of long nosed pliers, and a good light.

Many solder joints have to be made in a small area and a certain degree of skill is needed to avoid short circuits and dry joints. Fine solder is provided with the kit and this greatly simplifies the construction.

## COMPONENT PACKING

All components come in plastic bags marked with the value of the components contained, but it is as well to check these values against those required as it is always better to be safe than sorry. Because the printed circuit board has tracks both sides many solder joints have to be made on both sides of the board; this is tedious but it is essential to make good connections.

The display board and the inverter board for the 25V i.c. supply come as ready made units and this eases the constructor's task enormously. The keyboard is already fitted into the top half of the case and wiring to the main circuit board is simple, though here again solder joints have to be made top and bottom of the board.

## HANDLING PRECAUTIONS

The calculator i.c. comes in a piece of protective conductive foam and the handling precautions in the instructions should be carefully followed. A socket is provided for the i.c. so the usual problems of soldering to an m.o.s. integrated circuit are overcome.

Instructions for the insertion of all components are given and these are easy to follow. A circuit diagram

and point-to-point wiring diagram are also supplied. Total construction time for the SUPACAL was three and a half hours in this reviewer's case. Any difficulties will probably be caused by poor soldering and a good light is useful for checking.

The kit suppliers offer a back-up service in the form of a fixed price repair facility and this ensures a fully working calculator no matter how much of a mess you made of the construction. Once the calculator is working then all parts are guaranteed for one year.

## CALCULATOR CONSTRUCTION

Now something about the calculator itself. It is housed in a strong plastics case and uses two rechargeable batteries for its power source. A ready built charger is provided with the kit; fully charged batteries give about eight hours working. There is an automatic fade-out facility which switches off the display (which consumes about half the total power) approximately ten seconds after a key has been pressed.

The keyboard uses conductive rubber contacts which give the machine an extremely light touch; in fact the switches are almost too sensitive, some care being needed not to enter a digit unintentionally.

## CAPABILITY

The calculator can handle all four arithmetic operations with all calculations being in floating point, with eight digits being displayed. There is a stored constant facility which, unlike most other calculators, can be used with *all* four functions. Another advantage of this calculator is that it will not overflow. Other calculators will ignore any entries over eight digits long; the SUPACAL stores not only the eight digits entered but also stores an exponent up to  $10^{79}$ ; the true decimal point position is found by dividing by powers of ten until the point appears on the display. This enables more accurate answers to be found.

## INSIDE THE POCKET CALCULATOR

How does the pocket calculator work? The "heart" is the second generation single chip MOS LSI circuit type C500 manufactured by General Instruments Microelectronics. It contains within its 4,000 active devices all the logic necessary for performing eight digit, four function plus constant and floating decimal point, calculations.

The chip contains a read-only-memory (ROM) of 2,000 bits, a random-access-memory (RAM) of 100 bits and associated control logic, dividers and timing circuits for clocking and multiplexing. The chip simply requires a 25V supply and a clock input of 50kHz to 100kHz, a keyboard, display, and circuits to drive the display and it becomes a fully operational calculator.

The display interface is by means of discrete buffer/driver transistors for segment and digit driving. The display is multiplexed, i.e. each digit is only driven for one-ninth of the time, there being nine i.e.d. digits with seven segment format.

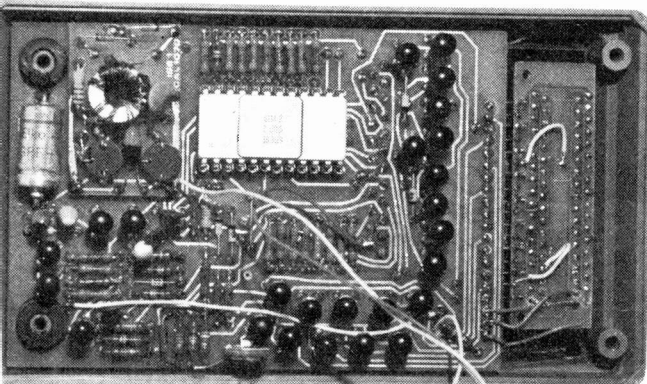

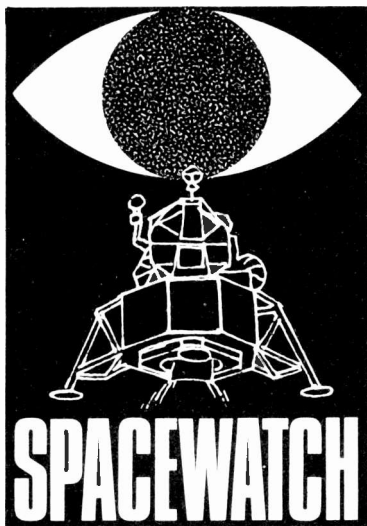

BY FRANK W. HYDE

### SKYLAB EXPERIMENTS

The number of activities that have been planned for the *Skylab* project are extensive. The work periods are 28 days for the first crew and up to 56 days for the next two crews.

In some experiments the astronauts will be used to study the effect of prolonged weightlessness. So far the longest time in the weightless state has been 18 days. This was by three Russian astronauts during the *Soyuz 9* flight.

One of the after effects that became noticeable after the *Soyuz* flight was a curious random stumbling which each astronaut suffered but for varying times. All had returned to normal within three weeks.

As the Russians always operate the "shirt sleeve" mode as it were, the *Skylab* experiments will be comparable though, of course, the available area for movement will be greater.

There will be specific exercises which each member of *Skylab* crew will do. These, together with studies of the changes induced in muscles, bones and the blood chemistry will enable a better assessment to be made of the space-induced effects.

Each man will have a special standardised diet to follow. With a special spring balance designed for zero gravity use, the astronauts will measure and record the mass of food they eat.

The spring balance is a coil spring to which is attached the item to be measured. The oscillation of the spring is measured electronically. The period of the oscillation depends upon the mass and on the known properties of the spring. In a similar way the astronauts will check their body weight using a spring chair.

Other experiments to be carried out are the study of crystal growth

of metals and alloys together with solidification properties by using an electric furnace. One special study will be that of the possibility of producing doped semiconductors of high chemical uniformity. It is thought that in zero gravity the effects of thermal convection in a gravity field will be avoided.

The changes in flammability which have been noticed in short periods of weightlessness in aircraft will also be studied. On many occasions it has been noted that flames tend to go out when the weightless condition has been reached.

### EARTH RESOURCES STUDY

Because the orbit of the space station will be inclined by 50° to the equator something like 75 per cent of the earth's surface will be covered and the station will return every five days over a given area. This provides a unique opportunity to study earth resources. Some 132 experiments originating from about 24 countries will be undertaken.

Observations will be made with cameras both in the visible and the infra-red part of the spectrum, together with the microwave sweeps. The moisture in the soil, the vegetation type and its condition will be determined by comparing the photographs from different spectral areas.

The experiments are varied and the chart below gives some details.

These are but a few of the experiments agreed by NASA and there are many more suggestions involving, in some cases, on-board equipment and in others the use of data collected. NASA accepted 19 experiments from the total of 3,400 proposals sifted by the Science Teachers Association.

The results of the first period will undoubtedly influence the later programmes particularly on the effects of weightlessness.

### SOLAR OBSERVATION

The experiments involving solar observation are designed to both add to existing data and check the present thinking. Several of the station's telescopes are under automatic control from Earth. This has many advantages since there will be intervals between the change of crews when the station will be unmanned; continuous operation of the selected instruments is important.

The white light coronagraph will measure the brightness of the corona and the polarisation. This will be done at distances varying between 1.5 and 6.0 solar radii from the Sun. The instrument has a number of sizes of occulting discs which are controllable and prevent the direct light from the Sun from reaching the objective lens. The scattered light is reduced to 10<sup>-10</sup> of the mean solar radiance.

CHART 1

<i>Experiment</i>	<i>Originator</i>	<i>Observation</i>
Ecological	Joseph Otterman	Identification of land in Israel suitable for wheat and date palms.
Ecological	US Department of Agriculture	Seek infestation areas by pine beetles in South Dakota.
Environment	Japan	Effect of human activities on the environment.
Astronomical	High School Students	Skylab telescopes to look for "cloud moons" thought to be 60° ahead and 60° behind the moon in its orbit.
		Inspection of solar photos for planet between Sun and Mercury.
Biological	High School Students	Radishes grown in weightless conditions to show effect of light and gravity on direction of root and shoot growth.
		Observe spider making web to detect any differences due to gravity.

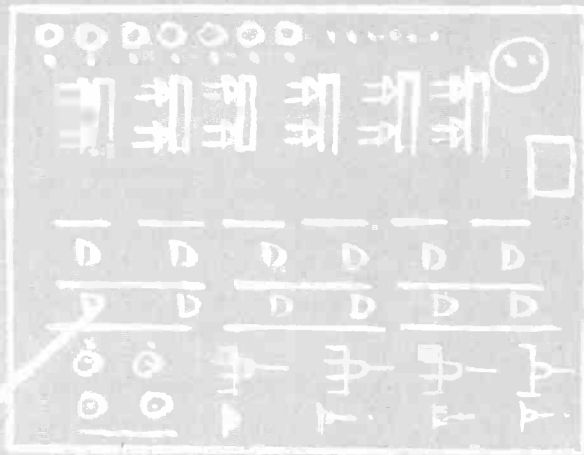

# LOGIC TUTOR

By G. D. Bishop and M. Hughes

To many, the fundamental principles involved in computing are a foreign language. In this article the construction of a comprehensive Logic Tutor is described. Elsewhere in this issue is the first article on using the Tutor providing an introduction to digital logic theory with practical exercises so that at the end of the series a full understanding of computing should be gained.

## TUTOR FUNCTIONS

The Logic Tutor is designed to demonstrate the AND, NAND, NOR and OR gates in NAND logic form. Other circuit functions demonstrated are flip-flops, counters and shift registers.

To demonstrate logic theory it is necessary to construct a basic bread board on which exercises can be carried out. This panel can be seen in the photograph with the various symbolic functions marked upon it.

The complete tutor can be made, using entirely bought parts, for about £9. This can, of course, be reduced by judicious shopping.

## LOGIC BOARD

In the prototype a 13in × 10in × 4in wooden box was used for housing the Tutor electronics, the logic board forming the lid.

The latter is drilled as in Fig. 1 using a 1.2mm drill for the terminal pin holes. Other holes should be shaped to suit the switches, lamps and digital indicator purchased but at this stage none of these components should be mounted. The logic symbols

## COMPONENTS . . .

### DISPLAY CIRCUITS

#### Resistors

R1-R11 100Ω (see text) (11 off)  
 R12-R17 1kΩ (6 off)  
 R18 47kΩ  
 R19-R28 470Ω (10 off)  
 All 10% ¼ watt carbon

#### Transistors

TR1-TR32 BC108 or any 300mW n.p.n. silicon planar switching transistor (32 off)

#### Lamps

LP1-LP10 Round M.E.S. bulbs 1.5V, 0.2A

#### Cold cathode tube

V1 Hivac GF2M or Mullard ZM1026

### LOGIC CIRCUITS Integrated Circuits

IC1-IC6 945 D.I.L. (6 off)  
 IC7-IC10 946 D.I.L. (4 off)  
 IC11-IC12 930 D.I.L. (2 off)  
 IC13 962 D.I.L.  
 IC14 933 D.I.L.  
 IC15 945 D.I.L.

#### Diodes

D1-D2 OA91 (2 off)

#### Capacitors

C1-C2 100µF elect. 6V (2 off)

#### Switches

S1 Mains on/off toggle  
 S2-S5 Single pole, changeover toggle (4 off)  
 S6-S7 Miniature push button switches  
 LP11 Round M.E.S. bulb 1.5V, 0.2A  
 D.I.P. Veroboard 6in × 3½in

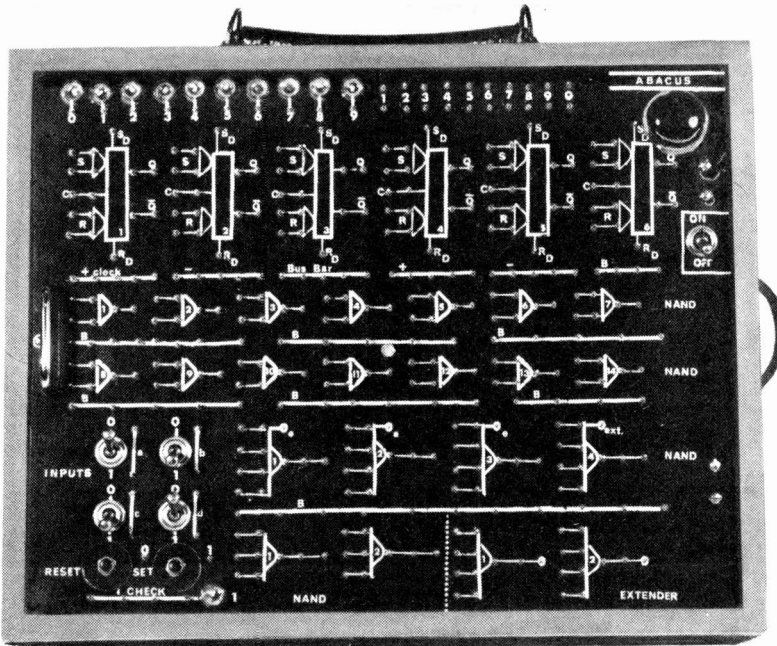

The completed Logic Tutor showing the front panel layout

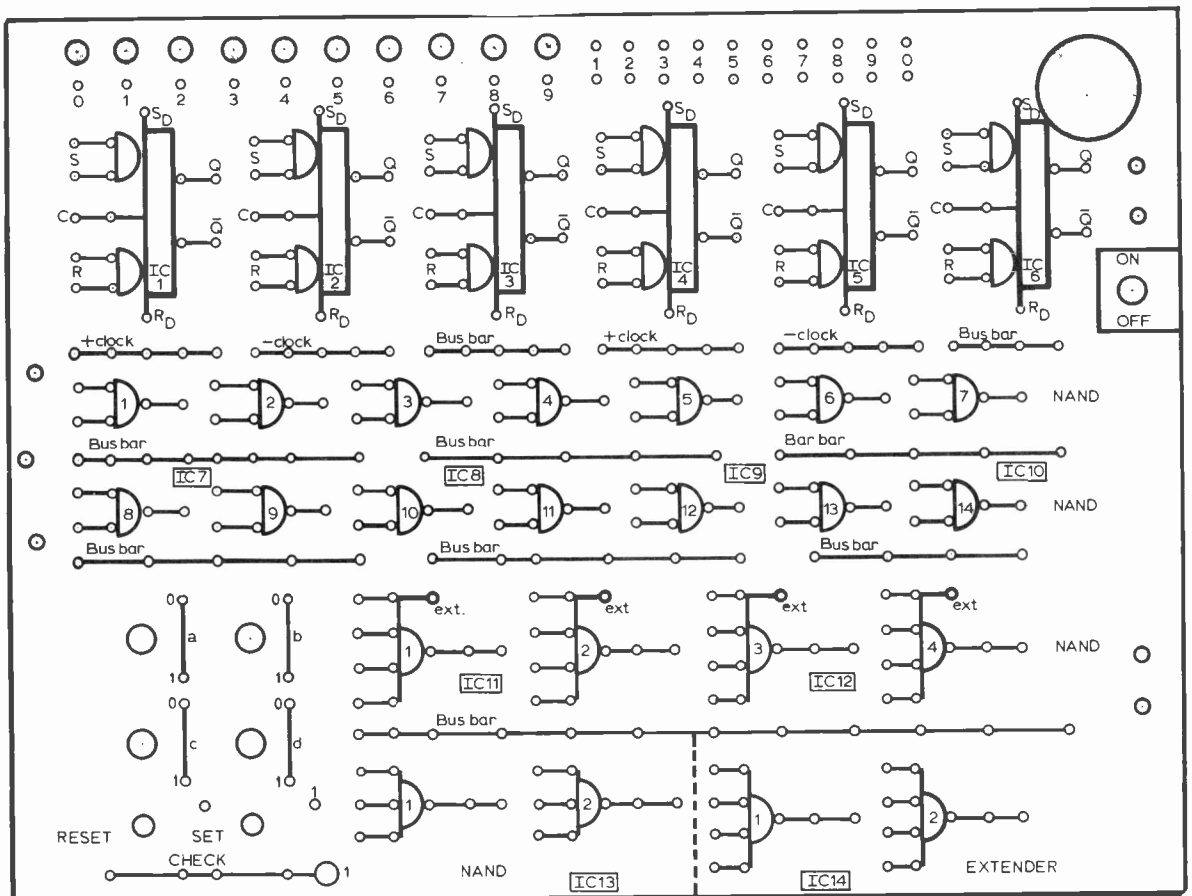

All holes shown thus  are to be made to suit components available

Veripins to be interwired under the board as indicated by heavy solid lines

Fig. 1. Layout of logic board showing drillings and symbols

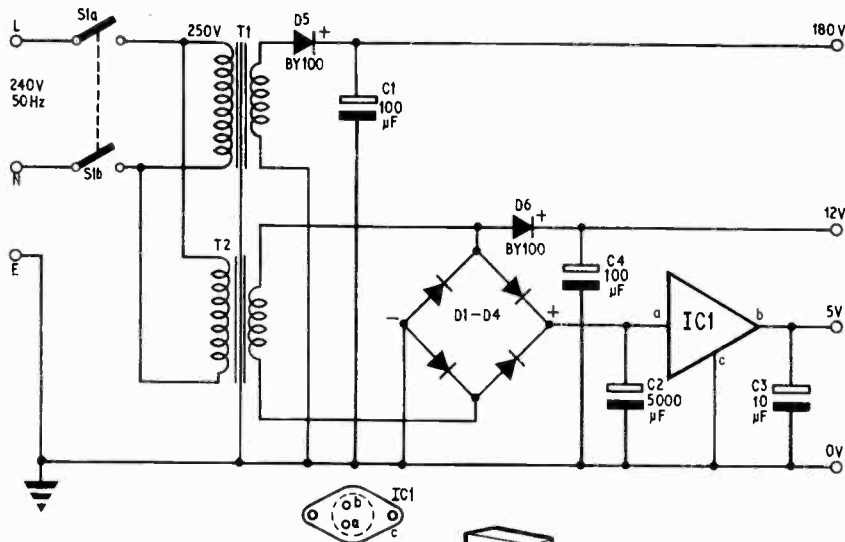

Fig. 2. Circuit diagram of power supply

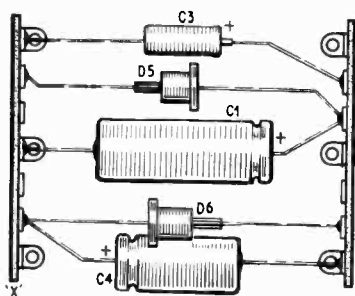
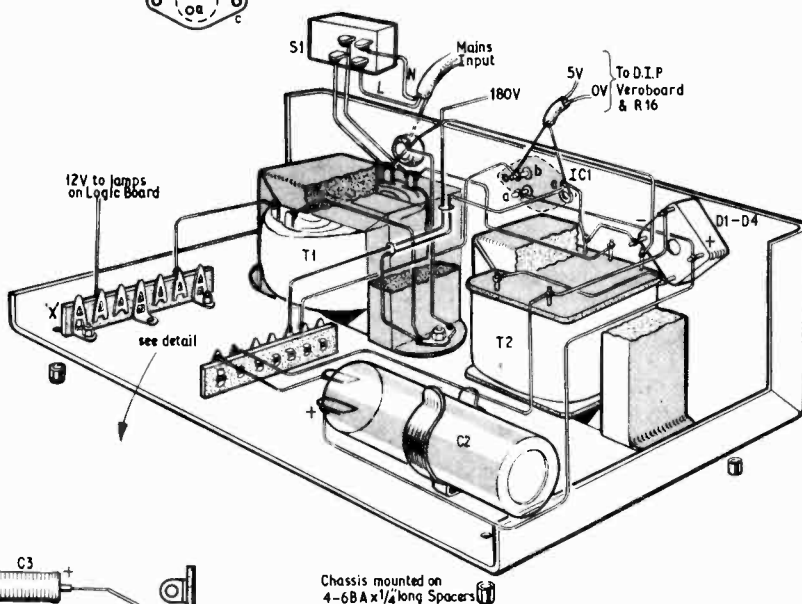

Fig. 3. Component layout and wiring for the power supply unit

## COMPONENTS . . .

### POWER SUPPLY UNIT

#### Capacitors

C1 100µF elect. 350V	C3 10µF elect. 15V
C2 5,000µF elect. 15V	C4 100µF elect. 15V

#### Rectifiers

D1-D4 REC41A Silicon Bridge Rectifier
D5-D6 BY100 (2 off)

#### Regulator

IC1 5V-600mA monolithic voltage regulator (R.S. type MVR-5V or similar)
---

#### Transformers

T1 240V primary; 150V, 10mA secondary
T2 240V primary; 9V, 1A secondary

#### Miscellaneous

18 s.w.g. aluminium as required, 12 way tag strip, double-sided terminal pins and pick-up tags 1.2mm diameter (R.S. types)

on the board indicate six RS/JK flip-flops, fourteen two-input NAND gates, four four-input NAND gates, two three-input NAND gates and two four-input extenders (AND). Most logic functions can be demonstrated with these.

The logic symbols are marked on the drilled board with paint or Letraset. These should be lacquered for permanent fixing after the double-sided terminal pins are pressed into the 1.2mm holes. These pins have a shoulder to facilitate insertion without risk of pushing the pin right through the board.

## POWER SUPPLY

The next item to be tackled is the power supply which feeds the integrated circuits with a stabilised 5 volt, and the output displays.

To observe the logic outputs two alternative displays can be used; lamps to indicate outputs singly or a cold cathode numerical indicator. Although included this item can be dispensed with if costs are to be kept down.

The display supply requirements are 12V for the lamps and 180V for the neon indicator. The circuit diagram in Fig. 2 show how these outputs are derived.

The power supply unit is mounted on an 18 s.w.g. aluminium sub-frame as in Fig. 3, which also gives the interwiring details.

When the wiring is complete the output voltages should be checked with a meter before any loads are connected. If everything is functioning satisfactorily the sub-frame can be screwed to the base of the box.

## D.I.P. MOUNTING AND WIRING

The fifteen D.I.P. integrated circuits are mounted on a D.I.P. Veroboard (Fig. 4) in the orientation shown. Pin numberings for the i.c.s are identical as indicated on the key. When the i.c.s are soldered the wire links are added.

The next job is to connect the i.c.s to the logic board. In Fig. 5 the board symbol input and output pins are related directly to the numbered i.c. pins on the Veroboard so that point-to-point wiring can be made. To illustrate this; to wire IC1 to its corresponding logic board symbol, IC1 pins are connected to the underside of the logic board at the corresponding pin numbers (Fig. 5(a)).

Next the two-input NAND gates are wired (IC7-IC10), the four-input (IC11-IC12), the three-input

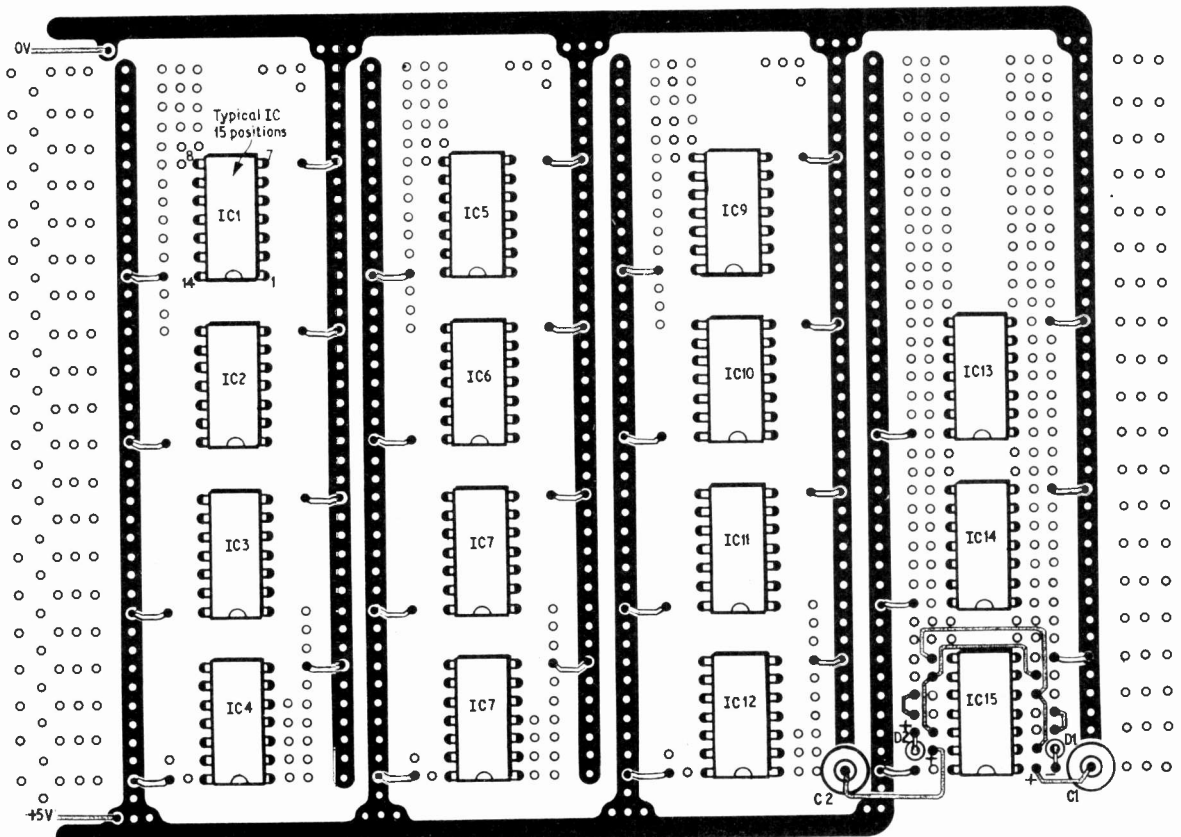

Fig. 4. Wiring and layout of the fifteen D.I.P. integrated circuits on the D.I.P. Veroboard

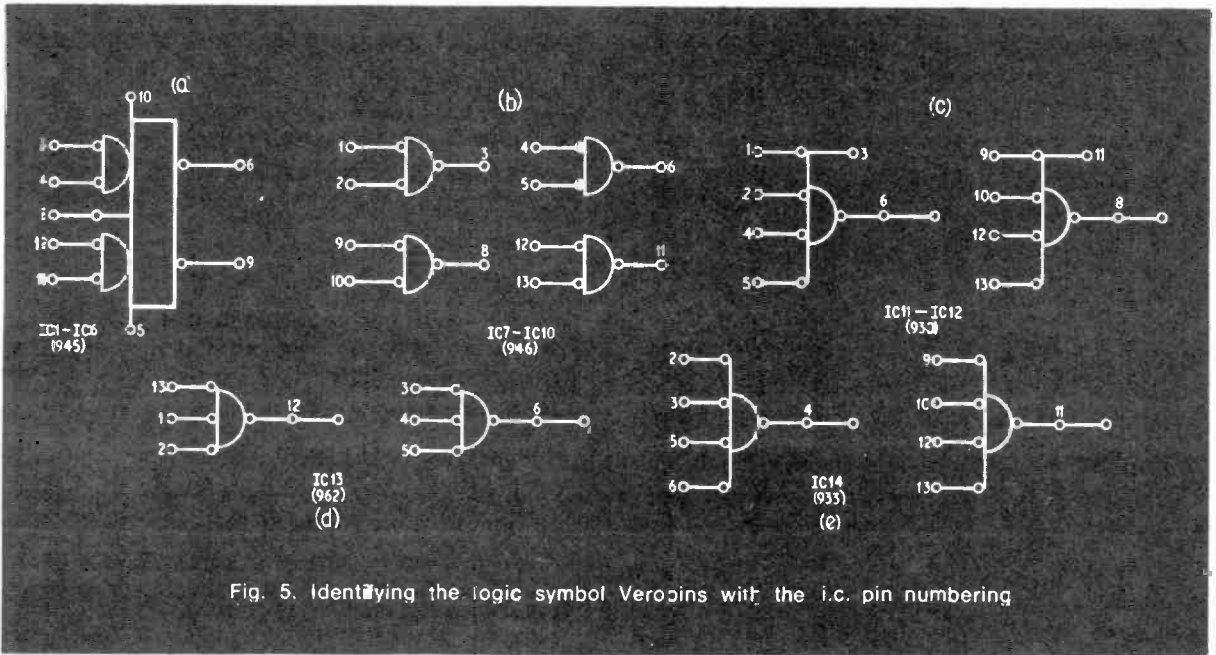

Fig. 5. Identifying the logic symbol Verocpins with the i.c. pin numbering

(IC13), and finally the four-input gates (IC14) all being wired according to the relevant gate symbol of Fig. 5. The Veroboard can be fixed finally to the underside of the front panel with nuts, screws and stand off bushes.

**LOGIC SWITCHES**

Four switches are provided (S2-S5) for logic 0 or 1 inputs to the gates. Here, 0 corresponds to 0 volts and 1 to 5 volts as indicated in Fig. 6. A switch output is taken from either of two Verocpins at the switch pole. Wiring for all four switches is given later in Fig. 10.

**CLOCK GENERATOR**

Most counting circuits can best be demonstrated by applying a clock input of about 2 to 4Hz. This function is provided on the logic board by a 946 i.c. connected as a free running multivibrator (Fig. 7). The timing elements include two 100µF capacitors.

Two outputs are available from this circuit, positive and negative square wave clock pulses. The pins for these are adjacent to the JK flip-flops (Fig. 1). It should be noted that the adjacent "bus-bars" alternatively marked "B" are earth returns to complete signal paths when patching leads. Wiring for the clock generator IC15 is included in Fig. 4.

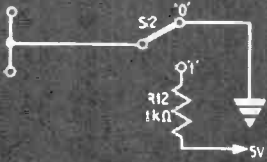

Fig. 6. Input switch circuit

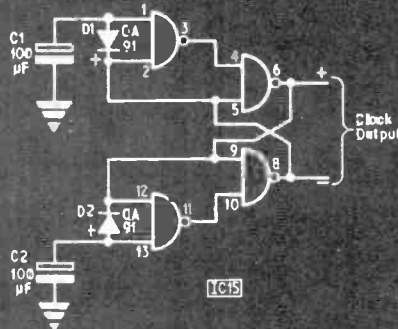

Fig. 7. Circuit diagram of the clock generator

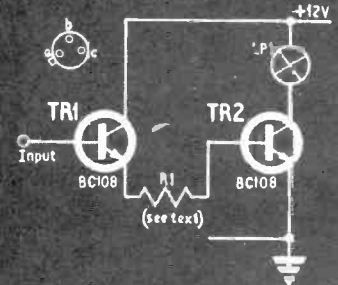
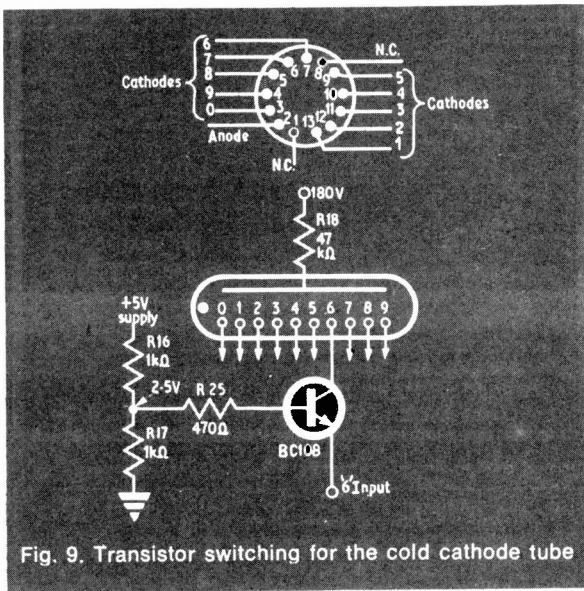

Fig. 8. Lamp driver circuit:









Each cathode of the indicator tube is switched by a transistor (Fig. 9) the emitter of each being connected to board Veropins numbered 1-0. A wiring detail of the transistor drive circuits indicators and switches is given in Fig. 10.

### DISPLAY CHECKS

Connections to the indicator tube can be made with the same tags as used for terminating the patching leads, this saves the cost of a special valve base. For a rigid transistor assembly the supply lines and earth returns should be of stiff copper wire.

The first test is with the indicator which should glow as soon as its 180V supply is connected. All the numbers will glow until a particular cathode is grounded when all the current passes via one number which cancels off the others.

If this test is satisfactory connect the 5V supply to the panel and check that the indicator lamps light when the logic inputs are applied to their terminals, remembering that "off" corresponds to 0 and "on" corresponds to 1.

### WIRING THE INDICATORS

If the lamp bulbs are screw types these can be screwed into the holes provided. The cold cathode tube should be a press fit and glued finally into position.

The lamp driving circuits consist of two transistors and a resistor (Fig. 8) with the inputs connected to adjacent Veropins (0-9). The value of the series resistor may have to be tailored so that the appropriate lamp gives the required light output. The limits to be expected here are 27 ohms to 220 ohms. All drive circuitry is mounted close to each lamp base.

### PATCHING LEADS

Some leads can now be terminated with tags for patching exercises. These should be of 12in, 8in, 4in and 2in lengths. More short leads will be required than long leads and it facilitates easy location of a particular length if the lengths are of one given colour.

The Logic Tutor should now be functioning and simple exercises can be performed to get the feel of the instrument. See page 438. ★

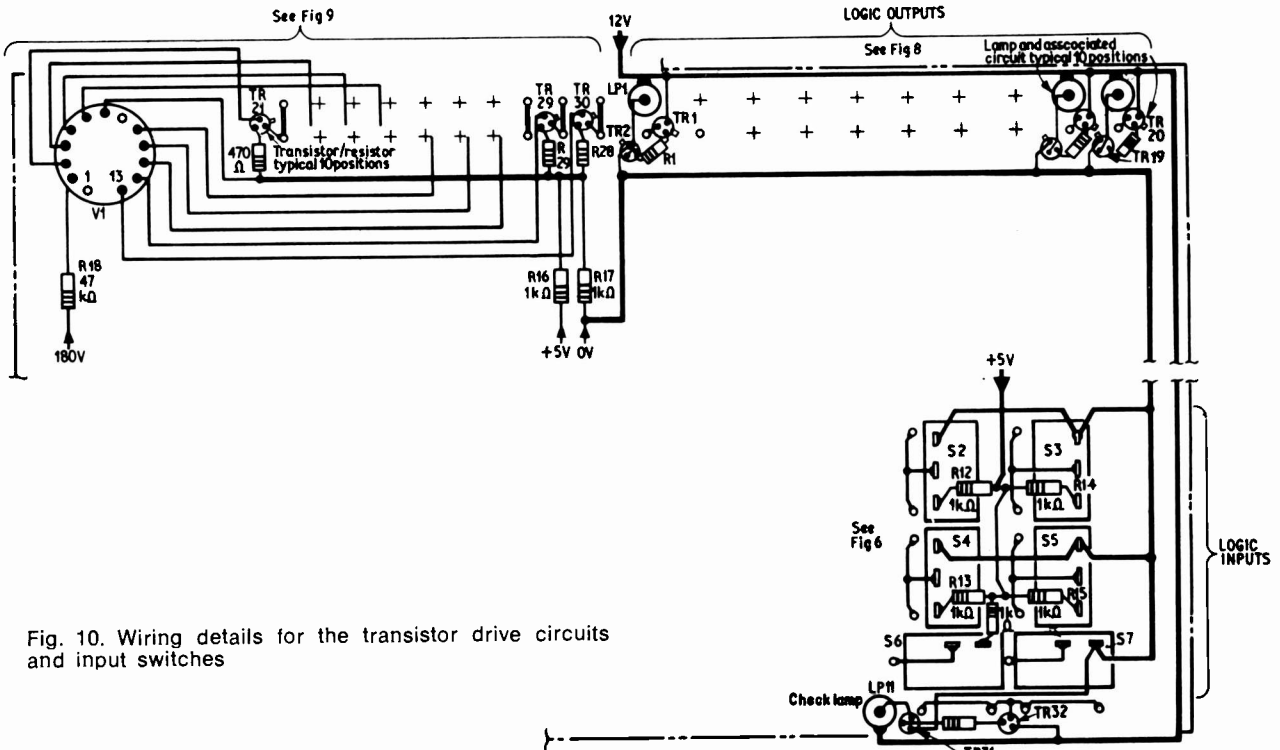
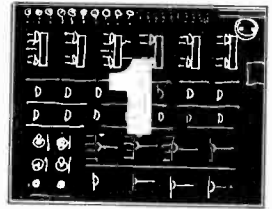

Fig. 10. Wiring details for the transistor drive circuits and input switches

# LOGIC TUTOR EXPERIMENTS..



## AND and OR GATES

IN DIGITAL LOGIC there are two states, these are low and high or off and on states. In positive logic, which is the type used in the Logic Tutor, the off or low state is 0V and the on or high state 5V. These two conditions we also know as logical 0 and logical 1 respectively.

The simplest gate which allows or stops a 0 or 1 input is the AND gate formed by an arrangement of diodes as in Fig. 1.1.

### TRUTH TABLES

If there is no connection to either input the output will rise to 5V since no current flows through the resistor but if either input is grounded current flows to ground thereby reducing the output to zero volts.

This is logically expressed in logic truth tables and the output sequence is expressed as A.B which is the Boolean Algebra way of representing A AND B. So in the circuit both A AND B must be 1 in order that the output is 1.

### PROVING IT

To electrically check the truth table connect the four logic input switches to the inputs of EXTENDER 1 and the output

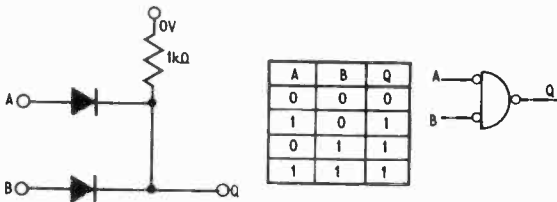

Fig. 1.1. AND gate and truth table

of this to the CHECK lamp. Operating the switches will show that the lamp lights only when all inputs are logical 1.

### OR GATE

If the diodes of the AND gate are reversed and the supply is changed to 0V an OR gate is formed as in Fig. 1.2. In this gate the output is always 1 if any input is 1, that is, the diodes will conduct if the input goes to 5V but the output return to zero if no input is connected or the inputs are grounded.

It is not possible to demonstrate an OR gate on the tutor since it is seldom used on its own.

The OR function is normally expressed as a combination of NAND functions known as a wired OR functions which will be demonstrated in a later exercise. The OR function is written as A OR B; symbolically this is  $A + B$ .

by M. Hughes

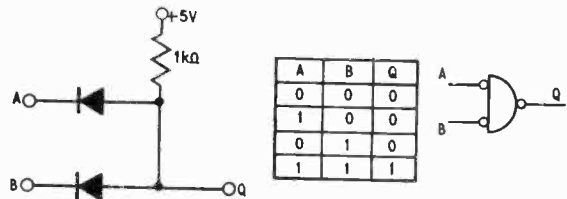

Fig. 1.2. OR gate and truth table

## POINTS ARISING

### HI FI TAPE LINK (March, April 1973)

In Components List, Page 213, R121, 220Ω was omitted. In Fig. 6 page 328, R13 adjacent to C12 should be R12. TR9 and TR109 base diagram, drain and gate connections reversed. On underside wiring collector of TR103 should go directly to R102 not via point marked TO SK2 PIN. In Table 3 TR10 collector voltage is dependent on VR5. First paragraph page 332 should read "collectors of TR10 and TR110 is 12 volts".

### P.E. SYNTHESISER

See note on page 427

### P.E. TRIFFID I.C. RADIO (February 1973)

R7 should be 4.7kΩ not 10kΩ as specified. R17 should be 10Ω not 10kΩ as in the components list. High gain transistors *must* be used for TR2 and TR3. Fig. 7. Transistor TR4 should read c.b.e. not as shown.

### A.F. SIGNAL GENERATOR (November 1972)

VR2 should be 10kΩ not 1kΩ as shown in Fig. 1 and components list. In Fig. 3 C5 and C7 to S1 have been reversed, i.e. C5 should be where C7 is shown.

# 10 Action Packed Instrument kits from Heath

MANY MORE IN THE LATEST CATALOGUE

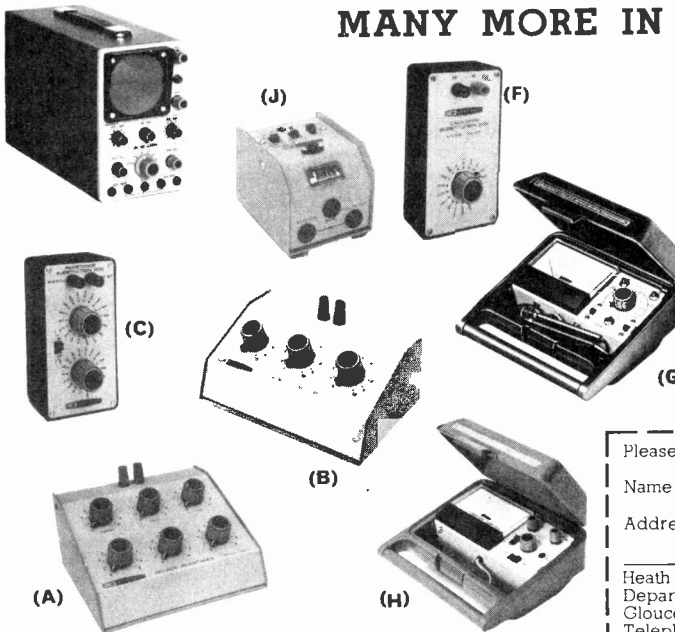

- (A) Decade Resistance Box, K/IN-17.
- (B) Decade Capacitor Box, K/IN-27.
- (C) Resistance Sub Box, K/IN-37.
- (D) Service Scope, K/OS-2.
- (E) Popular VVM, K/IM-18D (Not illustrated).
- (F) Capacitor Sub Box, K/IN-47.
- (G) Solid-state VVM, K/IM-17U.
- (H) Transistor Tester, K/IT-18.
- (I) RF Signal Generator, K/RF-1U (Not illustrated).
- (J) Transistor/Diode Checker, K/IT-27.

Many other instruments/Hi-Fi kits in wide range.

Please send me the FREE Heathkit catalogue

Name

Address

Heath (Gloucester) Limited  
 Department PE/5/73  
 Gloucester GL2 6EE  
 Telephone 0452 29451



Continuous Credit and No-Deposit Terms available

## Ever had Component Problems?

1. Problems of choosing your components?
2. Problems of getting them quickly?
3. Problems of locating a supplier?



**HOME RADIO (COMPONENTS) LTD** have created a catalogue and an organisation that between them solve your problems simply & economically

### PUT US TO THE TEST

FIRST YOU'LL NEED THE CATALOGUE.  
 SEND COUPON with 75p CHEQUE or P.O.  
 YOU'LL NEVER SPEND 15 BOB BETTER!

The price of 75p applies only to catalogues purchased by customers in the UK and to BFPO addresses.

Please write your Name and Address in block capitals

Name

Address



HOME RADIO (Components) LTD. Regd. No. 912966 London  
 Dept. PE, 234-240 London Road, Mitcham CR4 3HD



# Gerry Brown . . . ON THE FRINGE

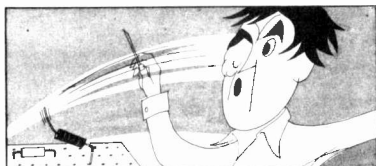

## SHEER CUSSINESS

The number of times I have heard people justifiably complain about having put a screwdriver down on the floor while adjusting some piece of equipment, only to find, on going to pick it up, that the darned thing had surreptitiously "hopped it". If that didn't happen, one could lay even odds that the four screws, previously lying on your left-hand side, had somehow learned to interpret the structure of the DNA molecule enabling them to grow legs of their own.

Screwdrivers are not, however, exclusive in possessing a mind of their own, oh no. Indeed, the effect is not entirely foreign to the wrong side of hot buttered crumpets, marmalade toast, and (on occasion) the resistor that you've just soldered into position (and for which you are enduring agonies in order to prove that you just don't make dry joints) flying off at one end and treating both you and your starboard eye to a good "dollup" of molten solder! Soad's Law, for that is the nice way of putting what this effect has come to be known as, is almost certainly

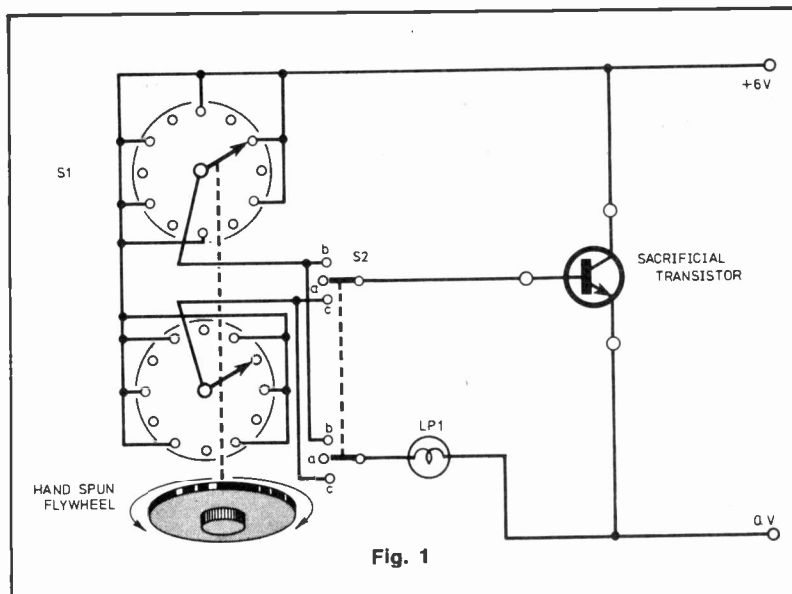

Fig. 1

the one which equates with the belief that "If something can go wrong, then it will".

My old friend Denis has an interesting theory about the effect (also, in ancient literature, referred to as the 4th Law) and has recently put it to the test. He believes, you see, that Soad still exists somewhere, and further that he controls his meddling from either the Moon, or that other satellite which the earth is supposed to have.

The test, which you may have already proved unwittingly, is accomplished by employing a "sacrificial" circuit like the one I've shown in Fig. 1. With such an arrangement one can easily establish how far away this bloody-minded individual is.

First set switch S1 to position "a", then select the most expensive transistor you have, and connect it into circuit. Spin the flywheel-driven

rotary switch (the normal wafer type, but with mechanical "click" and "end stops" removed). When it has come to a standstill, decide quite deliberately to yourself whether to operate switch S2 to "b" or "c". This done, now operate the switch quickly to the *opposite* position of your choice; but do it within 2-68 seconds, I implore you.

Provided the decision is made within this time, I'm told it has never been known to "do-in" a transistor. This being so, it looks certain that this ubiquitous enemy of mankind must inhabit a world about a quarter of a million miles from here, composed, for the most part, of dud transistors, brand-new screwdrivers, and fluff-covered "jam-butties".

Judging from his discussion a couple of months back, I have a shrewd suspicion that Frank Hyde knows something of the fella's co-ordinates but is not letting-on!

# NEWS BRIEFS

## 1973 Design Council Awards

Two electronics companies feature prominently among this year's Design Council Awards for consumer goods. Sinclair Radionics win an award for the Sinclair Executive calculator and Rank Radio International win an award for the Wharfedale "Isodynamic" headphones.

The Sinclair Executive pocket calculator was launched in June 1972 and now, nine months later, sales are running at nearly £100,000 per month and profits of £300,000 are forecast for the financial year ending in April this year.

The Wharfedale Isodynamic headphones also introduce some technological advances to achieve a quality of sound previously only reached in headphones costing well over twice as much.

The Wharfedale system combines the best of the

electrostatic method with the simplicity and price advantage of the electromagnetic method by using a lightweight diaphragm driven evenly all over its surface by magnetic means.

Launched in London last year, sales for the first year are expected to reach 100,000 units and in fact Wharfedale are having difficulty meeting the demand.

## New Electronics Course at Keele University

AMONG nine new courses announced by Keele University is a new degree course in Electronics. There is great demand for honours Electronics, it being one of the major growth areas in scientific studies. There is particular interest in Electronics where it overlaps with such areas as cybernetics, information theory and "bioelectronics".

Three and four year courses will be on offer, and amongst the permissible combinations of courses over three years will be Electronics and Music.

For further information please contact the Director of Information Services or Professor D. J. E. Ingram, Department of Physics, University of Keele, Keele, Staffordshire ST5 5BG.

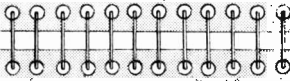

# INDUSTRY NOTEBOOK

By Nexus

## PRICE WAR CONTINUES

A phenomenon of the electronics industry is that while everything else seems to be shooting up in price, many electronic products persist in going down. This is mainly due to the nature of the beast. High technology demands big investment in R and D and, more often than not, a further major investment in production equipment. So new products tend to start their life as high cost items capitalising on improved performance. Then, as production increases, there is the so-called "learning curve" which, when mastered, gives fewer rejects and higher production rates. By this time, other firms are getting into the same market and any monopoly position that may have been attained is soon eroded. Add these factors together and you can see the reason why prices tumble.

No less an authority than Dr Ian Mackintosh, 20 years in the semiconductor business and now a leading consultant, goes as far as to suggest in a recent press interview that aggressive pricing is the key to success. Essentially, he maintains, semiconductors is a volume industry and nobody gets volume without competitive prices. He cites the 1971 price war in TTL devices as nothing new and forecasts a similar war in MOS devices.

Certainly, ready availability of devices and lowered prices are working their way through into products. Look at digital multimeters. The Solartron 4440 is billed in the advertisements as low-cost at £115. Along comes Sinclair with the DM1 at £49. Not to be left out of the act, Advance Electronics introduce the Alpha DMM8 at £55.

It wasn't all that long ago that a digital panel meter was listed at

£99. Today you can get one for well under £50. Of course, the products I have mentioned are not all to the same specifications and therefore not directly comparable but the trend is there—downwards in price.

The trend is most obvious in consumer products—in radio, TV, tape recorders, pocket calculators. Look around and shop around—you can see it happening. I find it intriguing that some of my friends in manufacturing industry claim it is often cheaper to buy their employers' products through cut-price retail outlets than through their own staff shops.

The biggest shock, however, comes not through price competition between existing technologies and derivatives thereof, but when a completely new technology threatens to displace the old. Semiconductor memory manufacturers may well spend restless nights following the disclosures that IBM researchers have developed amorphous film bubble memories and got them into experimental use. Moreover, IBM say the new process cuts bubble memory costs ten-fold as well as conferring advantages such as extremely high density packaging.

## EUROCONTROL

It was quite an experience attending the signing of Eurocontrol's latest commercial contracts for the new KARLDAP air traffic control centre at Karlsruhe. The signing was between Plessey Radar, Thomson-CSF and AEG-Telefunken on the one hand, and Eurocontrol officials on the other, and covered the supply of electronic equipment to the value of over £5 million. We had full simultaneous translations of the proceedings which took place in the Eurocontrol Brussels HQ beneath the flags of the member nations.

Plessey Radar's share was worth £1.25 million. Good for Britain, of course, but what was most pleasing was to be in at a ceremony where nations and companies were working amiably together towards a common good.

## ERNIE Mk. II

Having never won a penny on Premium Bonds it was interesting to visit the newly installed ERNIE Mk II at Lytham St Annes and see for myself that everything was fair and above board and that my lack of success was nothing more than bad luck.

The original ERNIE, now honourably retired, was built by the Post Office and did a marvellous job. The success of Premium Bonds has been so staggering that Old ERNIE was too sluggish to cope

with the draw. It was taking ten working days to generate the prize list. New ERNIE picks out the winners of over 90,000 prizes each month in just three hours. This is remarkable when you remember that each random number generated has to be checked against a master file to see if it has been sold or not.

New ERNIE was designed by Dr Roger Harding of Plessey Telecommunications under a contract worth £250,000. Plessey has also supplied a smaller system to New Zealand who run a similar Bonds scheme. Plessey now have ERNIE on offer world-wide and could secure more orders from governments who wish to run similar savings schemes.

To-date, ERNIE has paid out 10 million winners with nearly £350 million of prizes. Average odds of winning are 10,350 to 1. Don't despair—there will be even more prizes in future.

## GROWTH

Several sectors of electronics are now showing good growth. VAT has helped Pitney-Bowes in selling electronic cash registers which have calculating power and produce cash receipts showing the amount of VAT paid. Sales are well up on the forecasts. NCR is another company gearing up to get in on the electronic point-of-sale business.

Over £3.5 million is said to have been invested in getting a production line going at Dundee for the NCR 280 retail terminal and first orders have been taken in the UK. In the United States the order book is reported as being 20,000 units of which 4,500 have been installed. Dundee output is planned to match a sales forecast of over 1,000 units this year rising to over 4,000 units by 1975.

Finally, MDS Data Processing Ltd. report big European sales for the 2400 Key Display System, a key-to-disc data entry system for computers. In 14 months more than 500 systems have been ordered which, together, use 6,000 key-stations.

## AEROSPACE EXPORT DRIVE

More than 100 British aerospace companies will be in Paris for this year's air show in June. Electronics companies will be well represented during what promises to be a boom exhibition despite setbacks on the Concorde programme. Last year's exports were in the region of £400 million for the industry as a whole with electronic nav aids and guided missiles accounting for a big chunk.



# Build yourself a TRANSISTOR RADIO

WITH AFTER SALES SERVICE

## ROAMER 10 WITH VHF INCLUDING AIRCRAFT

10 TRANSISTORS. 9 TUNABLE WAVEBANDS, MW1, MW2, LW, SW1, SW2, SW3, TRAWLER BAND, VHF AND LOCAL STATIONS ALSO AIRCRAFT BAND.

Built-in ferrite rod aerial for MW/LW. Retractable, chrome plated 7 section telescopic aerial, can be angled and rotated for peak short wave and VHF listening. Push-pull output using 600mW transistors. Car Aerial and tape record sockets. 10 transistors plus 3 diodes. Fine tone moving coil speaker. Ganged tuning condenser with VHF section. Separate coil for Aircraft Band. Volume/on/off, wave change and tone controls. Attractive case in black with silver blocking. Size 9in x 7in x 4in.

Easy to follow instructions and diagrams. Parts price list and easy build plans 30p (FREE with parts). Earpiece with plug and switched socket for private listening 33p extra.

TOTAL BUILDING COSTS

**£9.35**

P.P. & INS. 52p  
(OVERSEAS P. & P. £1.05)



## ROAMER EIGHT

Mk. I

NOW WITH VARIABLE TONE CONTROL

7 TUNABLE WAVEBANDS: MW1, MW2, LW, SW1, SW2, SW3 AND TRAWLER BAND. Built-in ferrite rod aerial for MW and LW. Retractable chrome plated telescopic aerial for short waves. Push-pull output using 600mW transistors. Car aerial and tape record sockets. Selectivity switch. 8 transistors plus 3 diodes. Fine tone moving coil speaker. Air spaced ganged tuning condenser. Volume/on/off, tuning, wave change and tone controls. Attractive case in rich chestnut shade with gold blocking. Size 9in x 7in x 4in approx. Easy to follow instructions and diagrams. Parts price list and easy build plans 25p (FREE with parts). Earpiece with plug and switched socket for private listening 33p extra.

TOTAL BUILDING COSTS **£7.68** P.P. & INS. 47p  
(OVERSEAS P. & P. £1.05)

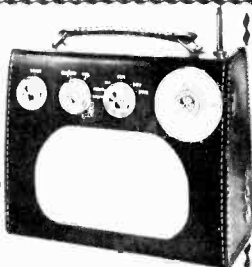

## ROAMER SEVEN

Mk. IV

7 TUNABLE WAVEBANDS: MW1, MW2, LW, SW1, SW2, SW3 AND TRAWLER BAND. Extra

medium waveband provides easier tuning of Radio Luxembourg, etc. Built-in ferrite rod aerial for MW and LW. Retractable 4 section 34in chrome plated telescopic aerial for SW. Socket for car aerial. Powerful push-pull output. 7 transistors and 2 diodes, including micro-alloy R.F. transistors. Fine tone moving coil speaker. Air spaced ganged tuning condenser. Volume/on/off, tuning and wave change controls. Attractive case with curving handle. Size 9in x 7in x 4in approx. Easy to follow instructions and diagrams. Parts price list and easy build plans 25p (FREE with parts). Earpiece with plug and switched socket for private listening 33p extra.

TOTAL BUILDING COSTS **£6.58** P.P. & INS. 47p  
(OVERSEAS P. & P. £1.05)

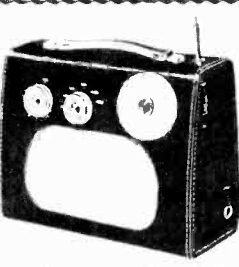

## ROAMER SIX

6 TUNABLE WAVEBANDS: MW, LW, SW1, SW2, TRAWLER BAND PLUS AN EXTRA MW BAND FOR EASIER TUNING OF LUXEMBOURG, ETC. Sensitive ferrite rod aerial and telescopic aerial for short waves. 3in speaker. 8 stages. 6 transistors and 2 diodes including micro-alloy R.F. transistors, etc. Attractive black case with red grille, dial and black knobs with polished metal inserts. Size 9in x 5 1/2in x 2 1/2in approx. Easy build plans and parts price list 25p (FREE with parts).

TOTAL BUILDING COSTS **£4.38** P.P. & INS. 31p  
(OVERSEAS P. & P. £1.05)

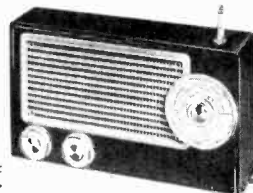

## POCKET FIVE

3 TUNABLE WAVEBANDS: MW, LW, TRAWLER BAND WITH EXTENDED MW BAND FOR EASIER TUNING OF LUXEMBOURG, ETC. 7 stages. 5 transistors and 2 diodes, supersensitive ferrite rod aerial, fine tone moving coil speaker. Attractive black and gold case. Size 5 1/2in x 1 1/2in x 3 1/2in. Easy build plans and parts price list 10p (FREE with parts).

TOTAL BUILDING COSTS **£2.50** P.P. & INS. 24p  
(OVERSEAS P. & P. 65p)

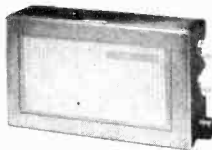

## TRANSONA FIVE

5 TRANSISTORS AND 2 DIODES

3 TUNABLE WAVEBANDS: MW, LW AND TRAWLER BAND. 7 stages. 5 transistors and 2 diodes, ferrite rod aerial, tuning condenser, volume control, fine tone moving coil speaker. Attractive case with red speaker grille. Size 6 1/2in x 4 1/2in x 1 1/2in. Easy build plans and parts price list 10p (FREE with parts).

TOTAL BUILDING COSTS **£2.75** P.P. & INS. 25p  
(OVERSEAS P. & P. 65p)

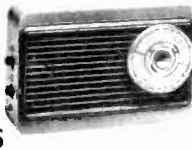

## TRANS EIGHT

8 TRANSISTORS AND 3 DIODES

6 TUNABLE WAVEBANDS: MW, LW, SW1, SW2, SW3 AND TRAWLER BAND. Sensitive ferrite rod aerial for MW and LW. Telescopic aerial for short waves. 4in speaker. 8 improved 15p transistors plus 3 diodes. Attractive case in black with red grille, dial and black knobs with polished metal inserts. Size 9in x 5 1/2in x 2 1/2in approx. Push-pull output. Battery economiser switch for extended battery life. Ample power to drive a larger speaker. Parts price list and easy build plans 25p (FREE with parts).

TOTAL BUILDING COSTS **£4.95** P.P. & INS. 33p  
(OVERSEAS P. & P. £1.05)

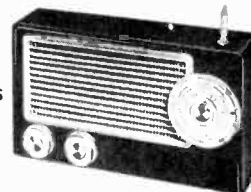

## NEW! "EDU-KIT"

BUILD RADIOS, AMPLIFIERS, ETC. FROM EASY STAGE DIAGRAMS. FIVE UNITS INCLUDING MASTER UNIT TO CONSTRUCT. Components include: Tuning Condenser; 2 Volume Controls; 2 Slider Switches; Fine tone moving coil speaker; Terminal Strip; Ferrite Rod Aerial; 2 Plugs and Sockets; Battery Clips; 4 Tag Boards; Balanced Armature Unit; 10 Transistors; 4 Diodes; Resistors; Capacitors; Three 3in Knobs. Units once constructed are detachable from Master Unit, enabling them to be stored for future use. Ideal for Schools, Educational Authorities and all those interested in radio construction. Parts price list and easy build plans 25p (FREE with parts).

ALL PARTS INCLUDING CASE AND PLANS **£6.05** P.P. & INS. 33p  
(OVERSEAS P. & P. £1.05)

## RADIO EXCHANGE LTD

61a HIGH ST., BEDFORD MK40 1SA. Tel. 0234 52367  
Reg. no. 788372

I enclose £ \_\_\_\_\_ please send items marked

ROAMER TEN	<input type="checkbox"/>	ROAMER SEVEN	<input type="checkbox"/>
ROAMER EIGHT	<input type="checkbox"/>	TRANS EIGHT	<input type="checkbox"/>
TRANSONA FIVE	<input type="checkbox"/>	ROAMER SIX	<input type="checkbox"/>
POCKET FIVE	<input type="checkbox"/>	EDU-KIT	<input type="checkbox"/>

Parts price list and plans for

Name \_\_\_\_\_

Address \_\_\_\_\_

P. E. 53

FULL AFTER SALES SERVICE

★ Callers side entrance "Lavell" Shop  
★ Open 10-1, 2.30-4.30 Monday-Friday, 9-12 Saturday  
★ PLEASE NOTE: ALL PRICES NOW INCLUDE V.A.T.



# PATENTS REVIEW...

## CAR WARNING CIRCUIT

A Company which is very active in the field of patents for car safety devices is Joseph Lucas (Industries). Their latest device, BP 1 297 385, triggers an alarm if a driver attempts to leave his vehicle without removing the ignition key.

In the patent circuit, Fig. 1, the car battery has its negative terminal earthed to chassis and its positive terminal connected to one side of a car internal rooflight LP1.

The other side of the light is earthed to chassis via three separate parallel paths. One of these paths contains switch S1 which is operated by the passenger door of the vehicle and closes when the door is open. The second path contains a switch S2 which is manually controlled from within the vehicle.

The third parallel path contains a diode D1 and switch S3 in series. Switch S3 is operated by the driver's door and closes when the door is opened. Closure of any one of the switches S1, S2, S3 energises LP1.

The "live" side of switch S3 is connected to the positive battery terminal via an alarm buzzer or bell in series with a resistor R1.

An *npn* transistor TR1 has its collector-emitter path connected across the alarm and its base connected to the positive battery terminal through resistor R2 and to earth via switch S4. The switch S4 is ganged to the ignition switch and closes when the ignition key is in position.

When the car is being driven, S4 is closed and current flows through R2; no current flows through the alarm or the transistor. When the driver stops the vehicle and removes the ignition key, S4

### BP 1 297 385

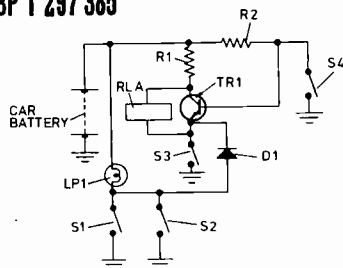

Fig. 1

opens. As the driver gets out of the car the act of opening his door closes S3 and TR1 is turned on by current flow through resistor R1. This short circuits the alarm, which thus cannot sound.

In the event that the driver forgets to remove his ignition key, S4 stays closed and no base current reaches the transistor when S3 closes (as the driver opens his door). In this case the alarm receives current via R1 and sounds the alarm.

The presence of the diode D1 ensures that the alarm cannot be operated when one or both of the switches S1 and S2 are operated.

## BUTLER-TYPE OSCILLATOR CIRCUIT

### BP 1 282 853

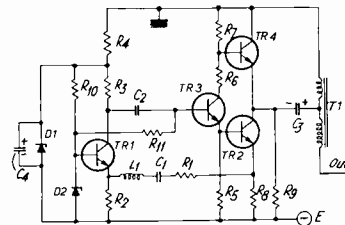

Fig. 1

International Standard Electric Corporation in BP 1 282 853 discloses a Butler-type oscillator circuit of the generally known type in which a first and second transistor have their emitters coupled by a series resonant circuit.

The first transistor has its base biased to a fixed potential and its collector coupled to the base of the second transistor to limit feedback amplitude. The output signal is in the form of a clipped sine wave so in some uses, e.g. in telephony where distortion may cause the faulty operation of receiving equipment, the clipped signal must be corrected by filtering. The filterers necessary can, however, be bulky and costly in comparison with other miniaturised components.

What ISEC suggest is a modified Butler-oscillator with three *npn* transistors TR1, TR2 and TR3 and a buffer output stage formed from an *npn* transistor TR4 mounted in emitter follower configuration.

## CIRCUIT PROTECTION

Connecting a car battery into circuit the wrong way round can cause damage, e.g., in the generating and regulating circuits of the vehicle. A diode can be used to block wrong polarity currents but where the circuit carries heavy surges, the diode is at risk.

In BP 1 293 046 Pal-Magnetron Narodni Podnik of Czechoslovakia describe three closely related simple ways of connecting circuits which must carry heavy currents and are sensitive to polarity.

The circuit, Fig. 1, shows a relay with its contacts RLA1 in series with a battery and the coil in series with diode D1 and switch S1. The coil, D1 and S1 are connected in parallel with the battery.

The contacts RLA1 are normally open and the diode D1 ensures that current will flow through the relay coil (when S1 is closed) only if the battery is connected with the correct polarity. Incorrect polarity will cause the diode to block current flow through the coil with the result that the contacts stay open and the polarity sensitive load is safeguarded.

The circuit in Fig. 2 shows RLA1 contacts connected as in Fig. 1 but diode D1 is used in parallel with the coil. A resistor R1 is connected in series with the coil and S1.

Again, current flows through the relay coil only if the battery is correctly connected, but in this case if the polarity is wrong the diode D1 will conduct and, in effect, put a short across the relay coil stopping it operating. The resistor R1 prevents the full short circuit current from passing through the diode when the battery is connected incorrectly.

### BP 1 293 046

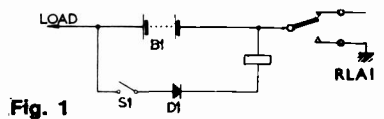

Fig. 1

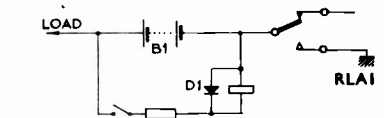
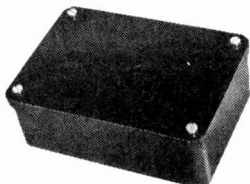

Fig. 2

# 'YOUR CASE' NOW SOLVED

BLACK P.V.C. BOXES AVAILABLE



IDEAL FOR ELECTRONIC APPARATUS  
AND SPECIAL RIG ENCLOSURES

- ★ ROBUST MOULDING
- ★ ALL INSULATED
- ★ EASY TO CUT AND DRILL
- ★ SELF FINISH
- ★ WILL NOT CORRODE
- ★ WILL NOT BURN

Length	Width	Depth	Price each	P. & P. each
4 in.	4 in.	1½ in.	38p	13p
4 in.	4 in.	2 in.	41p	14p
6 in.	3 in.	1½ in.	38p	14p
6 in.	4 in.	2 in.	52p	14p

ALLOW 21 DAYS FOR DELIVERY

**ADAPTABOX, DEPT. PE  
26 WELBY GARDENS  
GRANTHAM, LINCS.**



# BOOK REVIEWS

## THE RADIO AND ELECTRONIC ENGINEER

(The Journal of the Institution of Electronic and Radio Engineers)

VOL. 43 No. 1/2 January/February 1973.

It is unusual to review a Journal, but this particular publication is of especial and topical interest to all who are involved in any way with semiconductors. The January/February issue of the *Radio and Electronic Engineer* is almost entirely devoted to special contributions from leading British scientists and engineers who have been associated with semiconductor developments during the past 25 years. Collected together are 18 papers, each written with authority based upon intimate involvement and covering some particular aspect of the design, development, manufacture or application of discrete active devices and integrated circuits.

As a technical record of the first twenty-five years of semiconductors, including their impact and influence upon different specialised fields of application, this issue of the *Radio and Electronic Engineer* warrants a place on the bookshelf of any electronics enthusiast.

Copies may be obtained from the IERE Publications Sales Department, 9 Bedford Square, London, WC1B, price £2.00 per copy, post free.

## HANDBOOK OF BASIC ELECTRONIC EQUIPMENT

By W. Oliver

Published by Foulsham Technical

102 pages, 5½ in × 9 in. Price £1.75

THE AUTHOR of this book will be known to all readers of Foulsham-Sams books as the man who translates American into English. The main idea behind this book seems to be that of giving readers some technical background on basic equipment but mainly information on suppliers.

However, if one is going to give technical information it is essential not to give wrong information. The note inside the front cover states that "mathematics . . . have been minimised so that the book will be easily understood by even beginners". After reading the book it makes me wonder whether Mr Oliver knows any maths! For instance, on capacitors: "the total effective capacity of capacitors in series is the sum of the individual capacitors"; or on resistors: "2K and 4K in parallel, then in series with the 3K, gives you roughly 1,333 ohms" (yes, very roughly, in actual fact 4,333 ohms); the term EMF is used where potential drop is meant; a varactor is described as a "very special kind of diode" whereas all diodes exhibit varactor action.

If one is going to present technical information, especially for beginners then one has got to be a little more accurate than this. No, I am afraid I would not recommend this book to any beginner; the suppliers addresses may be useful but as a technical work it leaves very much to be desired.

S.R.L.



## become a RADIO-AMATEUR!

learn how to become a radio-amateur  
in contact with the whole world. We give  
skilled preparation for the G.P.O. licence

**free!**

Brochure, without obligation to:

**BRITISH NATIONAL RADIO & ELECTRONICS SCHOOL**  
P.O. BOX 156, JERSEY

NAME: \_\_\_\_\_

ADDRESS: \_\_\_\_\_ E .53

BLOCK CAPS please



# Sinclair Project 60

## Now—the Z.50 Mk.2

with built-in automatic transient overload protection

When originally introduced, the Sinclair Z.50 proved how it was possible to design and produce a popularly priced modular power amplifier having characteristics to challenge the world's costliest amplifiers. Many thousands of Z.50's are now giving excellent service day in, day out. But we have also learned that constructors do not always use their Z.50's ideally. That is why we have introduced modifications whereby risk of damage through mis-use, is greatly reduced and performance further enhanced. The Z.50 Mk.2 has improved thermal stability, more accurately regulated D.C. limiting to ensure more symmetrical output voltage swing and clipping and still less distortion at lower power. Z.50 Mk.2 is compatible with all other Project 60 modules, and may be incorporated to advantage in existing systems. Eleven silicon epitaxial planar transistors are now used, two more than in the original Z.50. Circuitry has been re-designed, making this versatile high performance amplifier better than ever.

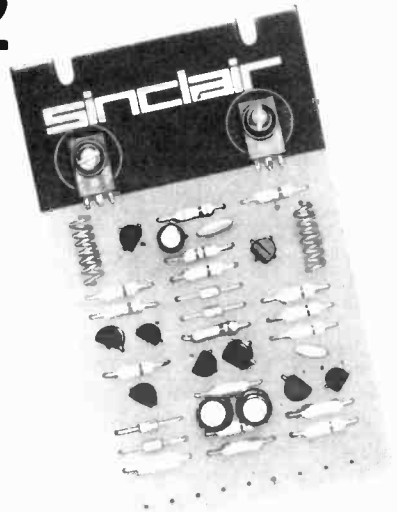

with free manual  
£5.48

**Z.30** the power amplifier for quality and economy

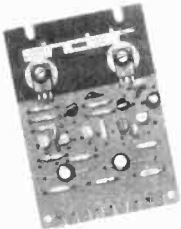

with free manual  
£4.48

The Z.30 provides excellent facilities for the constructor requiring a high fidelity audio system of less power than that available from Z.50's. Using a power supply of 35 volts, Z.30 will deliver 15 watts RMS into 8 ohms, or 20 watts RMS into 3 ohms using 30 volts. Total harmonic distortion is a fantastically low 0.02% at 15 watts into 8 ohms with signal to noise ratio better than 70 dB unweighted. Input sensitivity 250mV into 100K ohms. Size 80 x 57 x 13 mm (3 1/4 x 2 1/2 x 1/2). Z.30, Z.50 and Z.50 MK.2 modules are compatible and interchangeable.

**Brilliant new technical specifications**

Input impedance 100 K $\Omega$   
Input (for 30w into 8 $\Omega$ ) 400mV  
Signal to noise ratio, referred to full o/p at 30v HT 80dB or better  
Distortion 0.02% up to 20W at 8 $\Omega$ . See curve  
Frequency response 10Hz to more than 200 KHz  $\pm$  1dB  
Max. supply voltage 45v (4 $\Omega$  to 8 $\Omega$  speakers) (50v 15 $\Omega$  speakers only)  
Min. supply voltage 9v  
Load impedance – minimum : 4 $\Omega$  at 45v HT  
Load impedance – maximum : safe on open circuit

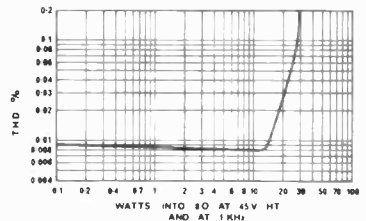

## Typical Project 60 applications

System	The Units to use	together with	Units cost
Simple battery record player	<b>Z.30</b>	Crystal P.U., 12V battery volume control, etc.	<b>£4.48</b>
Mains powered record player	<b>Z.30, PZ.5</b>	Crystal or ceramic P.U. volume control, etc.	<b>£9.45</b>
12W RMS continuous sine wave stereo amp. for average needs	<b>2 x Z.30s, Stereo 60; PZ.5</b>	Crystal, ceramic or mag. P.U., F.M. Tuner, etc.	<b>£23.90</b>
25W RMS continuous sine wave stereo amp. using low efficiency (high performance) speakers	<b>2 x Z.30s, Stereo 60; PZ.6</b>	High quality ceramic or magnetic P.U., F.M. Tuner, Tape Deck, etc.	<b>£26.90</b>
80W (3 ohms) RMS continuous sine wave deluxe stereo amplifier. (60W RMS into 8 ohms)	<b>2 x Z.50s, Stereo 60; PZ.8, mains transformer</b>	As above	<b>£34.88</b>
Indoor P.A.	<b>Z.50, PZ.8, mains transformer</b>	Mic., guitar, speakers, etc., controls	<b>£19.43</b>

F.M. Stereo Tuner (£25) & A.F.U. (£5.98) may be added as required.

### Guarantee

If, within 3 months of purchasing any product direct from Sinclair Radionics Ltd., you are dissatisfied with it, your money will be refunded at once. Many Sinclair appointed Stockists also offer this same guarantee in co-operation with Sinclair Radionics Ltd.

Each Project 60 module is tested before leaving our factory and is guaranteed to work perfectly. Should any defect arise in normal use, we will service it at once and without any charge to you, if it is returned within two years from the date of purchase. Outside this period of guarantee a small charge (typically £1.00) will be made. No charge is made for postage by surface mail. Air Mail is charged at cost.

# sinclair

Sinclair Radionics Ltd., R.O. London Rd., St. Ives, Huntingdonshire PE17 4HJ (Phone: St. Ives 64311). Regd. Bus. No. England 699483.

# the world's most advanced high fidelity modules

## Stereo 60 Pre-amp/control unit

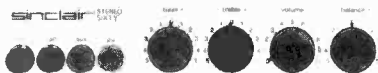

Designed specifically for use on Project 60 systems, the Stereo 60 is equally suitable for use with any high quality power amplifier. Since silicon epitaxial planar transistors are used throughout, a really high signal-to-noise ratio and excellent tracking between channels is achieved. Input selection is by means of press buttons, with accurate equalisation on all input channels. The Stereo 60 is particularly easy to mount.

**SPECIFICATIONS**—Input sensitivities: Radio — up to 3mV, Mag. p.u. 3mV correct to R.I.A.A. curve  $\pm 1$ dB  $\cdot 20$  to 25,000 Hz. Ceramic p.u. — up to 3mV. Aux — up to 3mV. Output: 250mV. Signal to noise ratio: better than 70dB. Channel matching: within 1dB. Tone controls: TREBLE  $+12$  to  $-12$ dB at 10KHz. BASS  $+12$  to  $-12$ dB at 100Hz. Front panel: brushed aluminium with black knobs and controls. Size: 66 x 40 x 207mm.

Built, tested and guaranteed. **£9.98**

## Project 60 Stereo F.M. Tuner



The phase lock loop principle was used for receiving signals from space craft because of its vastly improved signal to noise ratio. Now, Sinclair have applied the principle to an F.M. tuner with fantastically good results. Other advanced features include varicap diode tuning, printed circuit coils, an I.C. in the specially designed stereo decoder and switchable squelch circuit for silent tuning between stations. In terms of high fidelity this tuner has a lower level of distortion than any other tuner we know. Stereo broadcasts are received automatically, a panel indicator lighting up as the stereo signal is tuned in. This tuner can also be used to advantage with most other high fidelity systems.

**SPECIFICATIONS**—Number of transistors: 16 plus 20 in I.C. Tuning range: 87.5 to 108MHz. Sensitivity:  $7\mu$ V for lock-in over full deviation. Squelch level: Typically  $20\mu$ V. Signal to noise ratio:  $>65$ dB. Audio frequency response: 10Hz — 15KHz ( $\pm 1$ dB). Total harmonic distortion: 0.15% for 30% modulation. Stereo decoder operating level:  $2\mu$ V. Cross talk: 40dB. Output voltage: 2 x 150mV R.M.S. maximum. Operating voltage: 25–30VDC. Indicators: Stereo on, tuning. Size: 93 x 40 x 207mm.

Built and tested. Post free. **£25**

## Super IC.12 Integrated circuit high fidelity amplifier

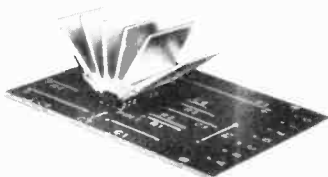

Having introduced Integrated Circuits to hi-fi constructors with the IC.10, the first time an IC had ever been made available for such purposes, we have followed it with an even more efficient version, the Super IC.12, a most exciting advance over our original unit. This needs very few external resistors and capacitors to make an astonishingly good high fidelity amplifier for use with pick-up, F.M. radio or small P.A. set up, etc. The free 40 page manual supplied, details many other applications which this remarkable IC. make possible. It is the equivalent of a 22 tran-

sistor circuit contained within a 16 lead DIL package, and the finned heat sink is sufficient for all requirements. The Super IC.12 is compatible with Project 60 modules which would be used with the Z.50 and Z.30 amplifiers. Complete with free manual and printed circuit board.

### SPECIFICATIONS

Output power: 6 watts RMS continuous (12 watts peak). 6–8 $\Omega$ . Frequency Response: 5Hz to 100KHz  $\pm 1$ dB. Total Harmonic Distortion: Less than 1%. (Typical 0.1%) at all output powers and frequencies in the audio band (20V). Load Impedance: 3 to 15 ohms. Input Impedance: 250 Kohms nominal. Power Gain: 90dB (1,000,000,000 times) after feedback. Supply Voltage: 6 to 28V. Quiescent current: 8mA at 28V. Size: 22 x 45 x 28mm including pins and heat sink.

Manual available separately 15p post free.

With FREE printed circuit board and 40 page manual.

**£2.98** Post free

## Power Supply Units The new PZ.8 Mk.3

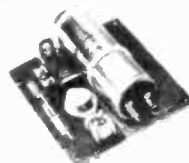

The most reliable power supply unit ever made available to constructors. Brilliant circuitry makes failure from over load and even direct shorting of the output impossible. This is due to an ingenious re-entrant current limiting principle which, as far as we know has never before been available in any comparable unit outside the most expensive laboratory equipment. Ripple and residual noise have been reduced to the point of almost total elimination. This is, of course, the perfect unit for Project 60 assemblies, particularly where the new Z.50 MK.2 amplifiers are used. Nominal working voltage — 45.

PZ.8 Mk.3—£7.98

(Mains transformer, if required) £5.98

PZ.5 30v. un stabilised

(not suitable for Project 60 tuner) £4.98

PZ.6 35v. stabilised

(not suitable for IC.12) £7.98

## Project 605



the easy way to  
buy and build  
Project 60  
without  
soldering

Project 605 in one pack contains one PZ.5, two Z.30's, one Stereo 60 and one Masterlink, which has input sockets and output components grouped on a single module and all necessary leads cut to length and fitted with clips to plug straight on to the modules thus eliminating all soldering.

Complete with comprehensive manual, post free  
All you need for a superb 30 watt high fidelity stereo amplifier

**£29.95**

## Order form

Please send

I enclose cash/cheque/money order.

Name \_\_\_\_\_

Address \_\_\_\_\_

PE/5/73

SINCLAIR RADIONICS LTD., LONDON ROAD  
ST. IVES, HUNTINGDONSHIRE PE17 4J

**sinclair**











# GUNTON ELECTRONIC IGNITION KIT

£9.35 INC. VAT

READY BUILT UNIT  
GUARANTEED 5 YEARS £11.55 INC. VAT

Patents Pending. 12 volt only—state pos. or neg. earth. Capacitive discharge ignition is recognised as being the most efficient system and will give you:

- ★ Continuous Peak-Tuned Performance
- ★ Up to 30% reduced fuel consumption
- ★ Easier All-weather Starting
- ★ Increased Acceleration and Top Speed
- ★ Longer Spark Plug Life
- ★ Increased Battery Life
- ★ Elimination of Contact Breaker Burn
- ★ Purer Exhaust Gas Emission

Kit includes absolutely everything for assembly: Ready drilled Case and Hardware Printed Circuit Board, Cables, Coil Connectors, Silicon Grease Nuts and Bolts, etc. 8 page illustrated instructions cover fitting of all types of tachometers. Call in for a workshop demonstration. S.A.E. all enquiries please, or Phone 33652. (Many letters from satisfied customers.)

SCORPIO: Transformer £2.42. Printed Circuit Board 83p  
All prices include carriage and V.A.T.



# ALUMINIUM BOXES

Complete with baseplate and screws

## AT DIRECT FROM MANUFACTURERS' PRICES WITH RETURN OF POST SERVICE

Type No	L	W	D	Price
7*	5½	2½	1½	44p
8*	4	4	1½	44p
9*	4	2½	1½	44p
10*	5½	4	1½	53p
11	4	2½	2	44p
12	3	2	1	39p
13	6	4	2	59p
14	7	5	2½	68p
15	8	6	3	88p
16	10	7	3	96p

\* These sizes accept standard veroboard range.  
All prices include carriage and V.A.T. 20% discount on 10 or more boxes. 30% discount on orders over £10.

Dept. PE5, ELECTRONICS DESIGN ASSOCIATES  
82 BATH STREET, WALSALL WS1 3DE

# COMPARE OUR PRICES

Speaker Bargains	£p	ACOS GP91/28C or GP91/38C stereo compatible	1-05
E.M.I. 13in x 8in 3, 8 & 15 ohms	2-00	ACOS GP94 stereo ceramic	1-75
plain	2-25	ACOS GP95 stereo crystal	1-35
with tweeter	3-50	ACOS GP96 stereo ceramic	1-75
twinned tweeter		9THAC Sonotone stereo ceramic (diamond)	1-95
Type 350-20 watt with	7-25	9THAC Sonotone stereo ceramic (diamond) slimline	1-95
tweeter 8 ohms, P.P. 37p.	1-30	ACOS GP67/2C mono crystal	65
8in x 6in 3, 8 & 15 ohms	1-05	ACOS GP101 compatible crystal	75
7in x 4in 3 & 8 ohms	2-30	19-TI Sonotone stereo crystal	90
FANE 8in 8 ohm, dual cone	1-50	Postage 5p per cartridge	
CELESTION 8in 15 ohm			
BAKER GROUP 25 12in 25W			
8 or 15 ohm	5-75		
Postage 25p per speaker			
2 1/2in 8 or 16 ohm P.P. 10p	50		

Kit-form cabinets, teak	£7.75	Battery Eliminators	
(17in x 10in x 6in)		240v input 6 or 9v d.c. output at 150 mA	1-99
with a 13in x 8in or 8in cut out		240v input 6, 7½ or 9v output at 300 mA	2-99
(12in x 12in x 6in) with a 8in x 5in or 8in cut out.	2-25	12v d.c. input (for cars) 6, 7½ or 9v d.c. output at 300 mA	2-99
(please specify cut out)		P. & P. 10p	
Add 35p per Cabinet for post & packing			

Microphone Bargains	£p	Tapes—"MYLAR" base finest quality British made.	
MIC45 "ACOS" metal case, crystal hand	95	5in 600ft 36p	5 1/2in 1800ft 85p
CM 20 Crystal Hand	45	5in 900ft 45p	7in 1200ft 55p
DX143 Dynamic, cassette-type stick	1-00	5 1/2in 1200ft 55p	7in 1800ft 80p
DM160 PLANET stick metal, switch crystal	1-45	5 1/2in 2400ft 95p	
DM160 Dynamic uni-dir, ball metal	3-75	Postage 5p each	
UD130 50K/600 ohm uni-dir, ball metal	4-50		
TW209 Lesson dual imp ball metal uni-dir	5-75		
Condenser Mike uni-dir 600 ohm	7-95		
Guitar mike	45		
Lapel type, crystal	40		
Postage 17p each			

Cartridges—with standard fittings & stylus	£p	Plastic Library Cases for 5in Reels 16p	
GOLDRING G850	3-25	5 1/2in Reels 19p	
GOLDRING G800	4-95	7in Reels 21p	
		P. & P. 5p each	

**THIS MONTH'S SPECIAL OFFER**  
**Amstrad Stereo Headphones**  
Model HP55A with v. controls. Recommended retail price £6.95. Our price £3.95. P. & P. 25p  
Slight price alterations due to V.A.T. will effect certain of our items after April 1st.

**RIVERSDALE ELECTRONICS**  
ALL OUR MERCHANDISE IS FULLY GUARANTEED

Mail Order Dept. E5/73,  
P.O. Box 470,  
Manchester M60 4BU  
SEND 25p FOR  
COMPLETE CATALOGUE

# ZIGGY'S 2001 ELECTRONICS Co. Ltd. RARE BARGAINS



**SPECS. MULTIMETER U4324.** Sensitivity 20,000 OPV DC. Usually high current ranges. 3 amp. a.c./d.c. Voltages AC3 to 900V d.c. 0.6 to 1200V. Resistance 500 ohms-20-200-2,000kΩ. Transmission level -10 to +12dB. This high quality instrument has diode protection. Complete with test leads, batteries, etc. PRICE £8 plus 25p post, etc.

**MULTIMETER 4312.** Similar to above but special features include 6 amp current range and instrument is housed in metal case with carrying handle. (Illustrated leaflet sent on request.) ONLY £8.50 plus 25p P. & P.  
**EAGLE LT700 TRANS., LT44 TRANS.** Our price 32p each, postage 6p.

**ARE YOU HUMBLED ABOUT YOUR RUMBLE?** SP25 drive wheels, 65p plus 5p P. & P. MP60 drive wheels, 55p plus 5p P. & P.  
**SUBMINIATURE TOGGLE SWITCHES**—very useful, very small. S/P, 25p, DP/ST, 33p; DP/DT, 45p. Postage 5p each, over 10, postfree.  
**SUBMINIATURE MAINS TRANSFORMERS.** Eagle MT6, 6-0-6, 100 M/A, 80p, postage 10p. MT 12, 12-0-12, 50 M/A, 80p, postage 10p.  
**MINIATURE TYPE MAINS TRANSFORMERS.** Eagle Type MT280, 6-0-6 280 M/A, £1.20. MT150, 12-0-12, 150M/A, £1.20, MT100, 24-0-24, 100 M/A, £1.20. R/S types, 13V, 0.5 amp. C. Tapped, £1.06, 16 3V. 0.3 amp. C.T., £1.06. Postage 15p on miniature size.

**DIAMOND STYLUS FOR SONOTONE 9THAC, LP178,** 65p plus 5p P. & P. LP/LP, 95p plus 5p P. & P.  
**FOR SPEEDY DELIVERY OF THESE MINT CONDITION COMPONENTS PLEASE SEND C.W.O. TO ZIGGY'S 2001 ELECTRONICS CO. LTD., DEPT. P.E.3, 34 MABLEY STREET, LONDON, E.9.**  
N.B.—After 1st April please add 10% for VAT—Sorry.

# ELECTRONIC BARGAINS

**COMPAKS**  
Manufacturers' fall-outs which include functional and part-functional units. Ideal for learning and experimenting.  
PAK 1 13 mixed 7400 series 66p  
PAK 2 10 unijunction T1543 55p  
PAK 3 6 S.C.R.'s 55p  
PAK 4 50 silicon and germanium NPN and PNP transistors 55p

Valve Equivalent Book 40p  
Transistor Equivalent Book 40p  
List over 3,000 equivalents

## ACOUSTIC WADDING

Bonded Acrylic Fibre lin thick. Per square yard 50p  
**VYNNIA SPEAKER CLOTH**  
Black—Black and Silver—Black and Gold  
Sizes:  
18in x 25in 60p  
36in x 25in £1.10  
36in x 50in £2.20  
Send S.A.E. for samples

## SOLDERING IRONS

	Retail Price	Our Price
Antex CN240	£1.98	£1.56
Antex CN240	£1.87	£1.49
Antex X25	£1.92	£1.54

## FERRANTI RADIO CHIP

ZN414 £1.23

## AMPLIFIER MODULE

5 watt, 9 volt supply, 4, 8 or 16Ω speaker, £3.30  
Fully Guaranteed. Mail order only. P. & P. 13p. Cheque or P/O to:

**T. F. J. ELECTRONICS**  
25 EASTBURY COURT  
LEMSFORD ROAD  
ST. ALBANS, HERTS.

# 4-STATION INTERCOM



**Solve your communication problems with this 4-Station Transistor Intercom system (1 master and 3 Subs), in de-luxe plastic cabinets for desk or wall mounting. Call/talk/listen from Master to Subs and Subs to Master. Ideally suitable for Business, Surgery, Schools, Hospital, Office and Home. Operates on one 9V battery. On/off switch. Volume control. Complete with 3 connecting wires each 98ft and other accessories. P. & P. 40p.**  
**MAINS INTERCOM (new model)**  
No batteries—no wires. Just plug in the mains for instant two-way, loud and clear communication. On/off switch and volume control with lock system. Price £14.40. P. & P. 35p extra.

# INTERCOM/BABY ALARM



Same as 4-Station Intercom for two-way instant communication. Ideal as Baby Alarm and Door Phone. Complete with 6ft connecting wire. Battery 14p. P. & P. 25p.

# Transistor TELEPHONE AMPLIFIER

Why not boost business efficiency with this incredible De-Luxe Telephone Amplifier. Take down long telephone messages or converse without holding the handset. A useful office aid. On/off switch. Volume control. Battery 14p extra. P. & P. 22p. Full price refunded if not satisfied in 7 days.

**WEST LONDON DIRECT SUPPLIES (PE/5)**  
189 KENSINGTON HIGH STREET, LONDON, W.8



# UNISOUND FOR THE NEW SOUND



AT  
**£26.12**

INC.  
VAT

It's the RT-VC system that screws together to save you pounds! Unisound comprises two superb speakers and an amplifier/record deck plinth—all beautifully finished in simulated teak. The stereo amplifier (4 watts per channel into 8 ohms) is based on the famous Mullard Unix system brought up-to-date by RTVC using integrated circuits. Turntable is the proven Garrard 2025TC complete with stereo cartridge and tinted acrylic cover. Speakers are big EMI Twin-cone units all ready for mounting in their elegant cabinets, which simply need screwing and gluing together. Easy step-by-step instructions. **£26.12 complete plus £1.40 packing + £1.40 post.** Diamond Stylus £1.25 extra. Stereo headphones with adaptor £4 extra. Send for leaflet.

**AN RTVC EXCLUSIVE DESIGN**

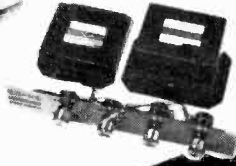

**UNISOUND MODULES ONLY £6.95 + 50p. p. & p.**

For the man who wants to design his own stereo—here's your chance to start, with Unisound—pre-amp, power amplifier and control panel. No soldering—just simply screw together. 4 watts per channel into 8 ohms. Inputs: 120mV (for ceramic cartridge). The heart of Unisound is high efficiency L.C. monolithic power chips which ensure very low distortion at all power levels over the audio spectrum.

**RTVC No price in**

If you can solder on printed circuit board you can build this push-button car radio kit. It's simple—just follow the step-by-step instructions

**THE TOURIST  
PB CAR RADIO KIT  
AN INCREDIBLE BUY  
ONLY FROM RTVC**



\* Circuit diagram and comprehensive instructions 50p free with parts.

\* Fully retractable lockable car aerial £1.25 post paid.

**PRICE ONLY £7.70 p. and p. 55p**  
Speaker with baffle and fixing strips £1.50. 25 p. & p., post free if bought with the kit. Send for leaflet.

The Tourist PB is suitable for 12 volt working on both negative and positive earth vehicles. It covers the full medium and long wave bands. It is permeability tuned and sturdily constructed. Output is a full 2.5 watts into an 8ohms speaker. But the Tourist PB will operate into any loudspeaker from 8 to 15 ohms.

Apart from the output stage, which is an integrated circuit, the only other electronic components that need soldering are some capacitors, resistors, etc. The kit includes a pre-built RF tuner unit, and fully modulated IF stages which are pre-aligned before despatch. As well as electronic components this kit also contains 2 diamond-spun aluminium knobs, elegant matching front panel, dial, washers, screws and wire. The Tourist PB can be mounted in any standard size dash panel and it has an illuminated tuning scale. Chassis size is: 7" wide, 2" high and 4 $\frac{1}{8}$ " deep.

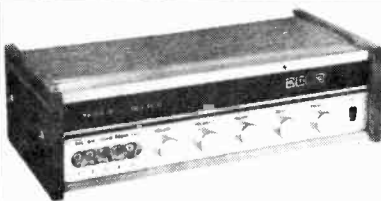

## RELIANT Mk IV

**A GOOD QUALITY AMPLIFIER—12 Watts £10.50 (inc. VAT). 20 Watts £13.50 (inc. VAT)**

\*5 Electrically Mixed inputs. \*3 Individual Mixing controls. \*Separate bass and treble controls common to all 5 inputs. \*Mixer employing F.E.T. (Field Effect Transistors). \*Solid State Circuitry. \*Attractive Styling INPUTS 1. Crystal Mic or Guitar 9mV. 2. Moving coil Mic. or Guitar 8mV Inputs. 3, 4 & 5 are suitable for a wide range of medium output equipment (Gram. Tuner, Monitor, Organ, etc.) All 250mV sensitivity. Power output: 12/20 watts into 8 ohms. Size approx. 12 $\frac{1}{2}$  x 6 x 3 $\frac{1}{2}$  ins.

12W  
3 ohms only  
version

**£10.50** plus  
60p  
**£13.50** p & p

20W  
8-15 ohms  
version

## SOUND 50

**50 WATT AMPLIFIER.** Output Power: 45 watts R.M.S. (Sine Wave) Frequency Response 3dB points 30Hz and 18KHz. Total Distortion: less than 2% at rated output. Signal to noise ratio: better than 60dB. Bass Control Range: 13dB at 60Hz. Treble Control Range: 12dB at 10KHz. Inputs: 4 inputs at 5mV into 470K. Each pair of inputs controlled by separate volume control. 2 inputs at 200mV into 470K. Size: 19 $\frac{1}{2}$  x 10 $\frac{1}{2}$  x 8ins. Amplifier £31.35 plus £1.50 p. and p. **£31.35 (inc. VAT)**

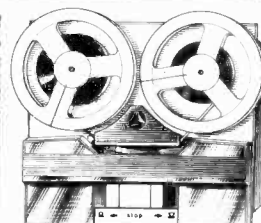

## PE TAPE LINK CONSTRUCTORS

Suitable 3 speed tape deck, less heads. Caters up to 7ins. spools. Unused but store soiled hence no warranty. **£8** plus **£1 p & p**

\* Denotes VAT has been absorbed in the price without increase on VISCOUNT audio systems.

**Increase with VAT!**

# VISCOUNT III AUDIO STILL ONLY £52\* COMPLETE

14 + 14w. r.m.s. 40Hz to 40kHz ± 3dB. Total distortion at 10w. at 1kHz - 0.1%. This is real value for money! We have designed 2 systems and the heart of them both is the Viscount III amplifier. A unit of great eye appeal with teak finished cabinet. FET's (Field effect transistors) are incorporated on the input stages, just like top priced units. FET's give you more of the signal you want and almost none of the hiss you don't. Both units have output sockets for headphones and tape recorder.

For both systems we have chosen the famous Garrard SP25 Mk. III deck, with fitted magnetic cartridge, which comes complete with simulated teak plinth and tinted acrylic cover.

The exclusive Duo loudspeaker systems are incomparable for quality within their price range. Large speakers in extremely substantial cabinets. There's a choice of the Duo II's for the smaller room or the big Duo III's for real bass response.

**PRICES: SYSTEM 1**

Viscount III R 101 amplifier	£24.20 + £1 p & p
2 Duo Type II speakers	£15.40 + £2.20 p & p
Garrard SP25 Mk. III with MAG. cartridge plinth & cover	£25.00 + £1.75 p & p
total	£64.60

Available complete for only **£52\*** + £3.50 p & p

**PRICES: SYSTEM 2**

Vicount R 101 amplifier	£24.20 + £1 p & p
2 Duo Type III speakers	£35.20 + £3.30 p & p
Garrard SP25 Mk. III with MAG. cartridge plinth & cover	£25.00 + £1.75 p & p
total	£84.40

Available complete for **£69\*** + £4 p & p

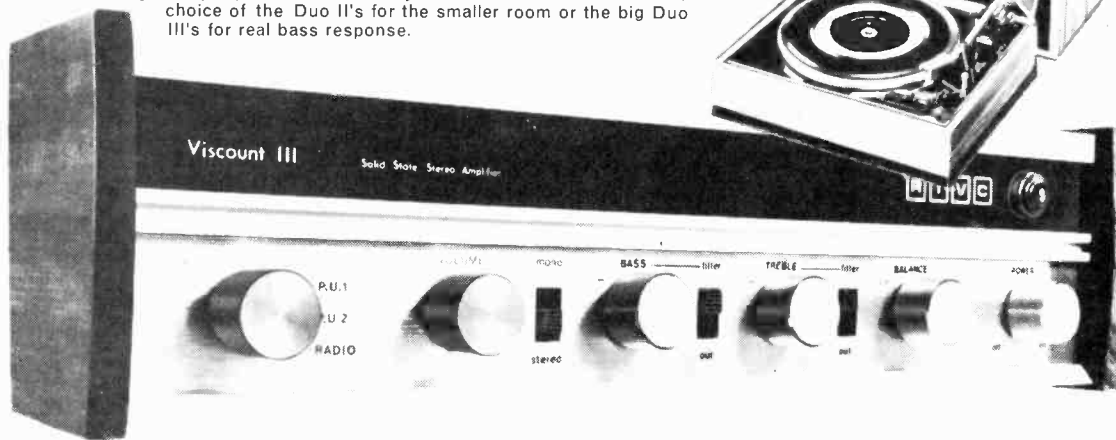
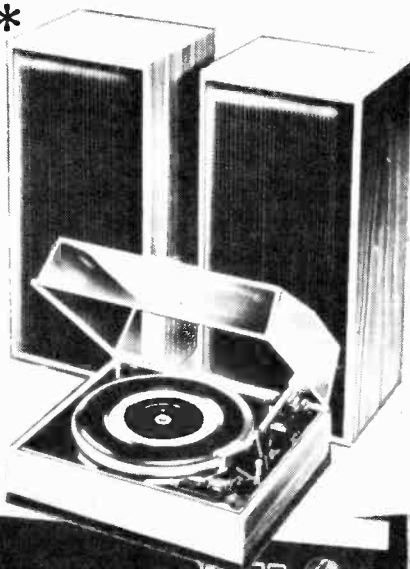

**SPEAKERS:** Duo Type II Size approx. 17in. x 10½in. x 6½in. Drive unit 13in. x 8in. with parasitic tweeter. Max. power 10 watts ohms. Simulated Teak cabinet. £15.40 a pair (inc. VAT), £3.30 p. and p. Duo Type III Size approx. 23½in. x 11½in. x 9½in. Drive unit 13½in. 8½in. with H.F. speaker. Max. power 20 watts. 8 ohms. Freq. range 20Hz to 20KHz. Teak veneer cabinet.

**SPECIFICATION R101:** 14 watts per channel into 3 to 4 ohms (suitable 3-15 ohms.) Total distortion @ 10W 1kHz @ 0.1%. P.U.1 (for ceramic cartridges) 150mV into 3 Meg. P.U.2 (for magnetic cartridges) 4mV @ 1kHz into 47K equalised within idB R.I.A.A. Radio 150mV into 220K. (Sensitivities given at full power). Tape out facilities: headphone socket, power out 250mW per channel. Signal-to-noise ratio. (all controls at max.)—P.U.1. and radio — 65dB, P.U.2 — 58dB. Cross talk better than — 35dB on all inputs. Size approx. 13½in. x 9in. x 3½in. Send S.A.E. for fully illustrated brochure. 12 month's written guarantee.

**ONLY FROM US**

**TIMES OF OPENING:** Acton—Mon.—Sat. 9.30-5.  
Closed all day Wed.  
Edgware Rd.—Mon.—Sat. 9.30-5. Closed all day Thurs

**VISIT OUR SHOWROOMS** **RTVC**  
Radio and TV Components (Acton) Ltd.  
21d High Street, Acton, London W3 6NG  
323 Edgware Road, London W2  
Mail orders to Acton. Terms C.W.O.  
Goods not despatched outside U.K.  
All enquiries S.A.E.

# Would you spend an hour a day to earn more money in Electronics- Television-Radio?

If you're willing to give up one hour or more a day we can help you get into the lucrative growth industries of electronics, television, radio.

And if you're already *in*, we can help you get on!

With our know-how and wide experience in teaching, plus your determination to study, we can turn your interest into the technical knowledge you need for success. Once you've got the qualifications you need, you'll be in a good position to take full advantage of the opportunities which exist today in all fields of electronics—in television (colour and black/white) and in radio. (We teach you the theory and practice of valve and transistor portable circuits while you build your own 5 valve receiver, transistor portable and high grade test instruments.)

With ICS you study at home—at your own pace, when you choose, in the time you've got available. Your ICS tutors will give you all the help and encouragement you need to pass any exams you want to take.

Don't waste another day. Take your first step now towards a better paid, more assured future. Send for your FREE Careers Guide today.

**ICS** your key to the door of opportunity

Tick or state subject of interest and post to:  
International Correspondence Schools  
Dept. 230H, Intertext House, Stewarts Road  
London SW8 4UJ

Subject of interest .....

- Society of Engineers Graduateship (Electrical Engineering)
- C & G Telecommunications Technicians Certificates
- C & G Electrical Installation Work
- C & G Certificate in Technical Communication Techniques
- MPT General Certificate in Radio Telegraphy
- Audio, Radio & TV Engineering & Servicing
- Electronic Engineering, Maintenance, Engineering systems, Instrumentation & Control systems
- Computer Engineering and Technology
- Electrical Engineering, Installations, Contracting, Appliances
- Self-build radio courses

Name .....

Address .....

Occupation ..... Age .....

Accredited by the Council for the Accreditation of Correspondence Colleges

**BELLING LEE INSULATED TERMINALS.** Red or Black, 5 amp max. 10p pair, p.p. 31p

**BERCOSTAT WIREWOUND RHEOSTAT.** 50 volt, 800  $\Omega$ , 25 watts, 2in dia. 25p, p.p. 71p.

**FINNED ALUMINIUM HEATSINK.** 9in x 11in. Ready drilled. 20p, p.p. 61p.

**SUB-MIN. CROC. CLIPS.** Red or Black, insulated 4p. Min. quantity, 6, p.p. 31p.

**GARRARD MAG. TAPE DECKS:** 11 p.p.s., 50V, solenoid operated brakes, etc. Main voltage motors £7-40 each, p.p. £1-23.

**4in PLAINAIR FANS.** Complete, capacitor, ex equip. 2,500 r.p.m. £3-50, p.p. 40p.

**ELECTRIC MOTORS. HOOVER OR CROMPTON PARKINSON.** 250V. Single phase a.c.  
1 h.p., 1,440 r.p.m., £3-75, p.p. £1.  
1 h.p., 1,425 r.p.m. or 2,800 r.p.m., £6-75, p.p. £1-25.  
1 h.p., 1,440 r.p.m., £2-25, p.p. 75p.

**AUDIO CONNECTORS**  
3 pin Din Plug ..... 13p each.  
5 pin Din Plug A type, B type ..... 13p ..  
2 pin Din Speaker Plug/Socket ..... 10p ..  
3 pin Din Line Socket ..... 13p ..  
3.5mm Jack Plug Screened ..... 10p ..  
Standard Jack Plug ..... 10p ..  
Screened Standard Jack Plugs ..... 15p ..  
Stereo Jack Plug ..... 18p ..  
Screened Stereo Jack Plug ..... 18p ..

**Phono Plugs:** Red or Black 3p each. P.p. on above items 31p.

**MAINS NEONS**  
Red or Green. Size: 1in x 3in x 11in. 15p, p.p. 31p.

**LEVER ACTION P.O.1000 TYPE SWITCHES**  
Lock 4-pole changeover, 15p, p.p. 31p. Ex equip.  
Lock 2-pole changeover, 10p, p.p. 31p. Ex equip.

**AUDIO LEADS**  
Screened Phono Leads 46in long, 15p.  
3.5mm JACK/3.5mm JACK 7ft 6in long, 40p.  
3-Pin Din A Type, 3-PIN A TYPE. Approx. 5ft long, 70p.  
P.p. on above items 31p.

**MULLARD & MALLORY SCREW TERMINAL CAPACITORS** 4,500pF 64V, 7,100pF 40V, 50p each. 20,000 30V, 25,000 25V, 35,000 15V, 30p each, p.p. 16p.

**MULLARD FULLWAVE RECTIFIERS**  
6-48V, 15 amp, 75p, D.P. 10p.

**BELLING LEE** 1.5 amp in-line rubber covered interference suppressor, 25p, p.p. 8p.

**RUBBER 3 PIN 5 AMP NON-REVERSIBLE CABLE CONNECTORS,** 20p, p.p. 31p.

**SOLENOIDS 12 VOLT PULL ACTION**  
2in x 1in x 1in, 40p, p.p. 8p.

**40 REED SWITCHES WITH MAGNETS.** Operated by 10 push buttons 10in x 6in x 1in, 50p, p.p. 23p.

**SIEMENS [MINIATURE] RELAY.** Four pole changeover dust cover/base 48V, 2500, 50p, p.p. 5p new.

**OMRON MK2 MIDGET POWER RELAY.** 12V d.c. Double pole changeover. New, 70p, p.p. 5p.

**STC MINIATURE RELAY** 290  $\Omega$ , perspex cover, Two pole changeover 6-15V new, 35p, p.p. 3p.

**GARDNER'S POTTED TRANSFORMER,** 0-250V. Input: 18V 500mA, 50V 150mA, 6V 250mA output. Size: 3in x 2 1/2in x 2 1/2in, £1, p.p. 20p. Ex equip. tested.

**TELESCOPIC AERIALS**  
Chromed 7in closed, 28in extended, 6 section ball jointed base, 23p, p.p. 8p new.

**MULLARD 4 DM 180 INDICATORS** in plastic holder/cover, ex equip., size approx. 1 1/2in x 1 1/2in x 1in, 36p, p.p. 8p.

**PRINTED CIRCUIT BOARD/19 ACY 19's 10 OA200**  
Diodes: 1 reel relay: 1 AZ 229 zener ass. capacitor/resistors. Power supply 22V, 250 mA d.c. Output 240V a.c. £1, p.p. 20p. Ex equip.

**WIRING CABLE**  
Size: 1-020. Various colours. 350yd, 80p, p.p. 26p.

**TOGGLE SWITCHES.** Double throw. Double pole. Ex equip. new condition, 75p doz., p.p. 13p.

**TOGGLE SWITCHES.** Single pole, double throw. Ex equip., new condition, 50p doz., p.p. 13p.

**PAINTON PLUG SOCKETS.** Type 159 series. Working voltage 350V a.c./d.c. current, max. 3 amp a.c./d.c. 7 pin plug and socket, 50p, p.p. 6p. 15 pin plug and socket, £1, p.p. 6p. 31 WAY PLUG AND SOCKET, £1-50, p.p. 6p.

CASH WITH ORDER PLEASE

**FIELD ELECTRIC LIMITED**  
3 Shenley Road  
Borehamwood, Herts.  
Adjacent Elstree Mainline Station  
Tel.: 01-953 6009

## LOUDSPEAKER BARGAINS

- Fane Pop 100W, 18", 8/15 ohm £21-45
- Fane Pop 60W, 15", 8/15 ohm £12-26
- Fane Pop 50W, 12", 8/15 ohm £10-17
- Fane Pop 25/2 25W, 8/15 ohm £3-94
- Fane Pop 15 12" 15W, 8/15 ohm £4-40
- Fane 122/104 or 122/12 £9-90
- Fane Crescendo 15", 8 or 15 ohm £37-50
- Fane Crescendo 12", 8 or 15 ohm £24-20
- Fane 8" d/cone 808T, 8 or 15 ohm £2-64
- Fane 8" d/cone, roll surr. 807T, 8 or 15 ohm £3-16
- Baker Group 25, 3, 8 or 15 ohm £6-00
- Baker Group 35, 3, 8 or 15 ohm £7-50
- Baker De Luxe 12" d/cone £9-62
- Baker Major £7-50
- EMI 13" x 8", 3, 8 or 15 ohm £2-25
- EMI 13" x 8" type 150 d/cone, 3, 8 or 15 ohm £2-58
- EMI 13" x 8" type t/w, 3, 8 or 15 ohm £3-85
- EMI 13" x 8" type 350, 8 ohm £2-25
- EMI 6 1/2" 93850, 4 or 8 ohm £2-80
- Elac 9" x 5" 59RML09, 15 ohm £2-53
- Elac 9" x 5" 59RMLL4, 8 ohm £2-53
- Elac 6 1/2" d/cone 6RM220, 8 ohm £2-59
- Elac 6 1/2" d/cone, roll surr. 6RM171, 8 ohm £3-22
- Elac 4" tweeter TW4, 8 or 15 ohm £1-21
- Celestion P58 for Unitek £2-16
- Celestion MFL000 25W horn, 8 or 15 ohm £10-45
- Elac 5" 3 ohm £1-75
- Elac 7" x 4", 3 or 8 ohm £1-52
- Elac 8" x 5", 3, 8 or 15 ohm £1-93
- Wharfedale Bronze 8 RS/DD £3-11
- Wharfedale Super 8 RS/DD £5-50
- Wharfedale Super 10 RS/DD £9-80
- Goodmans 8P, 8 or 15 ohm £3-80
- Goodmans 10P, 8 or 15 ohm £4-49
- Goodmans 12P, 8 or 15 ohm £11-55
- Goodmans 15P, 8 or 15 ohm £17-05
- Goodmans 18P, 8 or 15 ohm £19-70
- Goodmans Twinaxiom 8 £6-79
- Goodmans Twinaxiom 10 £7-61
- Goodmans Axent 100 £6-60
- Eagle DT33 dome tweeter, 8 ohm £4-95
- Eagle HT15 tweeter, 8 ohm £3-46
- Eagle CT5 tweeter, 8 ohm £1-21
- Eagle MT10 tweeter £3-30
- Eagle CT10 tweeter £1-92
- Eagle Xovers CN23, 28, 216 £1-10
- Kef T27 £4-67
- Kef T15 £5-50
- Kef B110 £6-16
- Kef B200 £7-42
- Kef BL39 £10-72
- Kefik 2 £12-75
- Richard Allan 12" d/cone, 3 or 15 ohm £2-20
- Richard Allan 8", 3, 8 or 15 ohm £2-27
- 10" x 6", 3, 8 or 15 ohm £1-92
- 8" x 5", 3 or 8 ohm £1-38
- 7" x 4", 3 or 8 ohm £1-38
- 3", 8 ohm or 80 ohm £5p
- 2 1/2", 64 ohm £5p
- Speaker matching transformer, 3/8/15 ohm £1-10
- Adastra Hiten 10", 10W, 8 or 15 ohm £2-80
- Adastra Top 20 12", 25W, 8 or 15 ohm £6-32

Stephen speaker kits and cabinets—send for illustrated brochure and list of recommended speakers.

Car stereo speakers—ask for leaflet.

PA/Disco amplifiers (carr. and ins. £1):

- Baker 100W £46-00
- Linear 30/40 £25-00
- Linear 40/60 £30-00
- Linear 80/100 £50-00

FREE with speaker orders over £7—"Hi-Fi Loudspeaker Enclosures" book.

All units guaranteed new and perfect. Prompt despatch.

Carriage and insurance 25p per speaker. (Tweeters and Crossovers 15p each.)

All prices quoted inclusive of V.A.T.

**WILMSLOW AUDIO, Dept. PE**  
**SWAN WORKS, BANK SQUARE, WILMSLOW CHESHIRE SK9 1HF**



# BI-PRE-PAK

SUPPLIERS OF SEMI-CONDUCTORS TO THE WORLD

## COMPLETE TELEPHONES



EX. G.P.O. NORMAL HOUSEHOLD TYPE

**ONLY 95p**

POST & PACKING 35p EACH



## TELEPHONE DIALS

Standard Post Office type Guaranteed in working order.

**ONLY 25p**

POST & PACKING 15p

## TESTED AND GUARANTEED PAKS

B79	4	IN4007 Sil. Rec. diodes, 1,000 PIV 1 amp. plastic	50p
B81	10	Reed Switches, mixed types large and small	50p
B99	200	Mixed Capacitors. Approx. quantity, counted by weight	50p
H4	250	Mixed Resistors. Approx. quantity counted by weight	50p
H7	40	Wirewound Resistors. Mixed types and values	50p
H9	2	OCPT1 Light Sensitive Photo Transistor	50p
H28	20	OC2001/2/3 PNP Silicon uncod'd TO-5 can	50p
H30	20	1 Watt Zener Diodes, Mixed Voltages 6.8-43V	50p
H35	100	Mixed Diodes, Germ. Gold bonded, etc. Marked and Unmarked	50p
H38	30	Short lead Transistors, NPN Silicon Planar types	50p
H39	10	Integrated circuits 6 gates BMC 962, 4 flip flops BMC 945	50p
H40	20	BFY 50.2, 2N696, 2N1613, NPN Silicon uncod'd TO-5	50p
H41	2	BD131, BD132, Complementary Plastic Transistors	50p
<b>UNMARKED UNTESTED PAKS</b>			
B1	50	Germanium Transistors PNP, AF and RF	50p
B66	150	Germanium Diodes Min. glass type	50p
B83	200	Trans. manufacturers' rejects all types NPN, PNP, Sil. and Germ.	50p
B84	100	Silicon Diodes DO-7 glass equiv. to OA200, OA202	50p
B86	100	Sil. Diodes sub. min. IN914 and IN916 types	50p
B88	50	Sil. Trans. NPN, PNP equiv. to OC200/1 2N706A, BSY95A, etc.	50p
H6	40	250mW. Zener Diodes DO-7 Min. Glass Type	50p
H15	30	Top Hat Silicon Rectifiers, 750mA. Mixed volts	50p
H16	15	Experimenters' Pak of Integrated Circuits. Data supplied	50p
H17	20	3 amp. Silicon Stud Rectifiers, mixed volts	50p
H20	20	BY126/7 Type Silicon Rectifiers 1 amp. plastic. Mixed volts	50p
H34	15	Power Transistors, PNP, Germ. NPN Silicon TO-3 Can	50p

## MAKE A REV COUNTER FOR YOUR CAR

The 'TACHO BLOCK'. This encapsulated block will turn any 0-1mA meter into a linear and accurate rev. counter for any car with normal coil ignition system.

**£1 each**



OVER TRANSISTORS IN STOCK **1,000,000**

We hold a very large range of fully marked, tested and guaranteed transistors, power transistors, diodes and rectifiers at very competitive prices. Please send for free catalogue.

**600,000** Silicon planar plastic transistors. Unmarked, untested, factory clearance. A random sampling showed these to be of remarkably high quality.

Audio PNP, similar to ZTX500, 2N3702/3, BCY70, etc.

Audio NPN, similar to ZTX300, 2N3708/9, BC107/8/9, BC168/9, etc.

R.F. NPN and switching NPN Types also. Please state type of transistor required when ordering.

ALL AT 500 for £3, 1,000 for £5, 10,000 for £40

## OUR VERY POPULAR 3p TRANSISTORS

TYPE "A" PNP Silicon Alloy, TO-5 can.

TYPE "B" PNP Silicon, plastic encapsulation.

TYPE "E" PNP Germanium AF or RF.

TYPE "F" NPN Silicon plastic encapsulation.

TYPE "G" NPN Silicon, similar ZTX300 range.

TYPE "H" PNP Silicon, similar ZTX500 range.

**8 RELAYS FOR VARIOUS TYPES P & P 25p £1**

**VALUE ADDED TO YOU** On orders of £4 or over. See below:

Please read very carefully:

We will give a discount to customers who send in an order for £4 or over. This discount will be equal to the V.A.T. rate current at this time. If your order does amount to £4 or over, all you need to send is the total cost of goods and postage as stated in this advertisement. No addition for V.A.T. is needed.

V.A.T. for orders under £4: If the total cost of goods plus postage and packing is less than £4, kindly add 10% (10p in the £) to your remittance. Incorrect amounts will delay your order.



## A CROSS HATCH GENERATOR FOR £3.50 !!!

YES, a complete kit of parts including Printed Circuit Board. A four position switch gives X-hatch, Dots, Vertical or Horizontal lines. Integrated Circuit design for easy construction and reliability. This is a project in the September edition of Practical Television.

**This complete kit of parts costs £3.50, post paid.**

A MUST for Colour T.V. Alignment.

## Our famous PI Pak is still leading in value for money.

Full of Short Lead Semiconductors & Electronic Components, approx. 170. We guarantee at least 30 really high quality factory marked Transistors PNP & NPN, and a host of Diodes & Rectifiers mounted on Printed Circuit Panels. Identification Chart supplied to give some information on the Transistors.

Please ask for Pak P.I. Only 50p. 10p P & P on this Pak.

## FREE CATALOGUE

FOR TRANSISTORS, RECTIFIERS, DIODES, INTEGRATED CIRCUITS, FULL PRE-PAK LISTS



**100,000** Plastic Power Transistors

in stock, more on way!

## NOW IN TWO RANGES

These are 40W and 90W Silicon Plastic Power Transistors of the very latest design, available in NPN or PNP at the most shattering low prices of all time. We have been selling these successfully in quantity to all parts of the world and we are proud to offer them under our Tested and Guaranteed terms.

Range 1	VCE Min. 15	HFE Min. 15	
40 watt	1-12	13-25	26-50
90 watt	20p	18p	16p
Range 2	24p	22p	20p

Range 2	VCE Min. 40	HFE Min. 40	
40 watt	1-12	13-25	26-50
90 watt	30p	28p	26p
	35p	33p	30p

Complementary pairs matched for gain at 3 amps. 10p extra per pair. Please state NPN or PNP on order.

**INTEGRATED CIRCUITS.** We stock a large range of I.C.s at very competitive prices (from 10p each). These are all listed in our FREE Catalogue, see coupon below.

**METRICATION CHARTS** now available. This fantastically detailed conversion calculator carries thousands of classified references between metric and British (and U.S.A.) measurements of length, area, volume, liquid measure, weights, etc. Pocket Size, 15p, Wall Chart, 18p.

## LOW COST DUAL IN LINE I.C. SOCKETS

14 pin type at 15p each | Now new low 16 pin type at 16p each | profile type.

## BOOKS

We have a large selection of Reference and Technical Books in stock.

These are just two of our popular lines: **B.P.I. Transistor Equivalents and Substitutes** 40p

This includes many thousands of British, U.S.A., European and C.V. equivalents. **The Iliffe Radio Valve & Transistor Data Book 9th Edition** 75p

Characteristics of 3,000 valves and tubes. 4,500 Transistors, Diodes, Rectifiers and Integrated Circuits. Post and Packing 21p. Send for lists of these English publications.

N.B.—Books are void of V.A.T.

Please send me the FREE Bi-Pre-Pak Catalogue.

NAME .....

ADDRESS .....

MINIMUM ORDER 50p. CASH WITH ORDER PLEASE. Add 10p post and packing per order. OVERSEAS ADD EXTRA FOR POSTAGE.

# BI-PRE-PAK LTD

DEPT. A. 222-224 WEST ROAD, WESTCLIFF-ON-SEA, ESSEX

TELEPHONE: SOUTHEM (0702) 46344

# Practical Electronics Classified Advertisements

RATES: 9p per word (minimum 12 words). Box No. 20p extra. Semi-Display £7 per single column inch. Advertisements must be prepaid and addressed to Classified Advertisement Manager, "Practical Electronics" IPC MAGAZINES LTD., Fleetway House, Farringdon Street, London EC4H 4AD

## COURSES

### NEWCASTLE UPON TYNE POLYTECHNIC

#### B.Sc. Physical Electronics

You could use and extend your existing knowledge of electronics by enrolling for the above four-year sandwich course and open up exciting career prospects in industrial electronics, semiconductor and computer research and development, automation, nuclear energy, and medical physics.

For further details and application forms, contact: Dr. J. L. Clark, Head of Department, Department of Physics and Physical Electronics, Ellison Building, Ellison Place, Newcastle upon Tyne NE1 8ST.

London Borough of Enfield  
Trent Park College of Education  
Cockfosters, Barnet, Herts.

#### TECHNOLOGY TEACHING 3-YEAR COURSE FOR MEN AND WOMEN

VACANCIES exist on the Course starting in September, 1973 for Mature Students (over 24 years) wishing to become teachers of Technology, for whom there is an increasing demand in Schools. Learning through problem solving situations forms an essential part of the Certificate Main subject "TECHNOLOGICAL STUDIES", involving techniques and methods of craft, Science and Mathematics, and offering a wide range of practical experience.

Applications will be considered from students with various qualifications and types of experience, together with an interest in the development of practical solutions to a wide range of problems.

Grants are available. Prospectus, information and application forms from:

The Academic Registrar, Trent Park College of Education, Cockfosters, Barnet, Herts.

D. B. Denny, Chief Education Officer.

**FULL TIME COURSES** in Electronics and Television. These are nine-month courses, starting September 1973, leading to City and Guilds Certificates. Extensive laboratory work is included, and there are, in most cases, no fees for those under 18 enrolment. Full details from: SECTION 272, Electrical and Electronic Engineering Department, Southall College of Technology, Beaconsfield Road, Southall, Middx.

## LADDERS

**LADDERS**, 241ft £9-80, cnrr. 80p. Leaflet (Dept. PEE), HOME SALES LADDER CENTRE, Baldwin Road, Stourport, Wores. Tel. 029-93 2574.

## SITUATIONS VACANT

**MEN!  
£50 p.w.  
can be yours**

Jobs galore! 144,000 new computer personnel needed by 1977. With our revolutionary, direct-from-America, course, you train as a Computer Operator in only 4 weeks! Pay prospects? £2500+p.a. After training, our exclusive appointments bureau—one of the world's leaders of its kind—introduces you FREE to world-wide opportunities. Write or 'phone TODAY, without obligation.

London Computer Operators  
Training Centre  
M85, Oxford House  
9-15 Oxford Street, W.1  
Telephone 01-734 2874

127 The Piazza, Dept. M85  
Piccadilly Plaza, Manchester 1  
Telephone 061-236 2935

### ULSTER: THE NEW UNIVERSITY MAGEE UNIVERSITY COLLEGE, LONDONDERRY INSTITUTE OF CONTINUING EDUCATION

Applications are invited for the following technical posts:—

Ref: 73/129/148/30 TECHNICIAN: Duties: Language Laboratories, recording studio and ancillary audio services.

Ref: 73/130/149/31 TECHNICIAN: Duties: Operation and maintenance of CCTV services and preparation of programme material.

Qualifications: HNC or equivalent, plus at least seven years' previous experience.

Salary scale: £1,881-£2,241 per annum.

Application forms and further particulars should be obtained from The Registrar, The New University of Ulster, Coleraine, Co. Londonderry, N. Ireland (quoting appropriate ref. no.) to whom completed applications, including the names and addresses of three referees, should be returned not later than 31st May, 1973.

## TEKTRONIX U.K. LIMITED

have vacancies for

### PRODUCT SERVICE TECHNICIANS

to repair and recalibrate our range of oscilloscopes and other products at our Harpenden office.

A good knowledge of basic electronics is necessary and a flair for fault-finding would be an advantage.

We offer good working conditions, profit sharing, non-contributory life assurance and pension schemes.

Please write or telephone: R. M. Garrett, Tektronix U.K. Limited, 36/38 Coldharbour Lane, Harpenden, Herts. Telephone: Harpenden 61251, Ext. 25.

## BOOKS AND PUBLICATIONS

### ★ KILRIMONT BOOKS ★

Understanding Electronic Components, £3.50;  
Transistor Circuit Design Tables, £2.80;  
Digital Logic, £1.50\*; Audio Technicians Bench Manual, £3; Using an Oscilloscope, 70p\*;  
TV Technicians Bench Manual, £2.50; Computer Science, £2; Introduction to Semiconductor Devices, £1.90.  
Many others, please send for lists. Please add 5p postage where starred.  
KILRIMONT BOOKS (D), Kilrिमont House, London Road, Braintree, Essex CM7 8QL.

**THOSE 1,000 BANBURY UFO's!** Details of our Prediction (and list) S.A.E. Numerous Charts, Map, Detectors. R. & E. PUBLICATIONS, Highlands, Needham Market, Suffolk.

**DIGITAL COMPUTER** Logic and Electronics. A four volume Self-Instructional course, £2.99 post free. Money back assurance. CAMBRIDGE LEARNING, 8a Rose Crescent, Cambridge.

## FOR SALE

**SEEN MY CAT?** 5,000 items. Mechanical and Electrical Gear, and materials. S.A.E. K. R. WHISTON, Dept. PE, New Mills, Stockport.

### TV LINE OUT-PUT TRANSFORMERS

Tidman Mail Order Ltd., 236 Sandycroft Road, Richmond, Surrey TW9 2EQ  
01-948 3702

**COMPLETE SET P.E.** With Blueprints for sale, offers please. H. KNIGHT, Retford House, Robin Lane, High Bentham, Lancaster.





## PSYCHEDELIC MINI-STROBE

A very POWERFUL, POCKET-SIZED STROBE-LIGHT that is SELF-CONTAINED and you can take anywhere. Go to parties and really BRAIN-FREEZE them with DAZZLING PSYCHEDELIC EFFECTS and STOP-MOTION FLASHES. Boffin's new MINI-STROBE kit constitutes a fully solid-state electronic device which is COMPLETE with FUTURISTIC case/reflector unit, printed-circuit board, electronics, and source-lamp—the only extra is a battery which you can buy locally. The whole thing can be easily built in a few hours.

A veritable FLICKERING FASCINATOR! Adjustable flash-rate.

GET ONE (or two) NOW and BEGIN STEALING THE THUNDER at DISCOS and PARTIES with your own POCKET-LIGHTNING!

SEND £2.10 (inc. VAT) for YOUR MINI-STROBE. MAIL ORDER ONLY

To: **Boffin Projects**  
4 Cunliffe Rd., Stoneleigh, Ewell, Surrey

## ONE CHIP CALCULATOR

MOS INTEGRATED CIRCUIT

- Add, subtract, multiply, divide
- 12-digit display
- Fixed decimal point at 0, 2, 3 or 4
- Automatic lockout of "unsafe" p & p incl. repeat operation
- True credit balance sign display
- Automatic overflow indication
- Leading zero suppression
- Data Sheet 50p (refund on purchase)

£12.50

O'DRISCOLL

68 Hammer Hill, Haslemere, Surrey GU27 3QZ  
Tel. 0428-2058

## FIBRE OPTIC SUPPLIERS

P.O. BOX 702 · LONDON W10 6SL

FLEXIBLE LIGHT CONDUIT is used almost like wire to convey light to inaccessible positions for inspection, panel indicators, photo-electric and other applications.

FIBROFLEX SIZE 1 glass fibre flexible light conduit, 1-14 mm active dia. bundle sheathed in P.V.C. Supplied complete with epoxy resin + 10 ferrules. Prices: 5 metres, £2.97; 10 m, £4.40; 25 m, £6.60; 50 m, £11; 100 m, £17.60.

CROFON 1610 1-80 mm active dia., 64 filament plastic light conduit. Prices: 1 metre, £1.43; 2m, £2.86; 5 m, £6.60; 10 m, £11; 25 m, £22; 50 m, £42.35.

PLASTIC OPTICAL MONOFILAMENT. Type FP 20, 0.5 mm dia. unsheathed. 100 m, £3.85; 200 m, £6.60; 500 m, £13.75. Type FP 40, 1.0 mm dia. unsheathed. 10 m, £2.20; 25 m, £4.40; 50 m, £8.25; 100 m, £14.30.

MARE'S TAILS: Spray of several thousand glass fibres, ready to use as part of decorative displays. £11 each.

HN 32 LINEAR POLARIZER 0.030" thick. 32% luminous transmittance, 0.005% extinction. Applications leaflet, inc. light intensity control, stress analysis, glare reduction, etc., supplied with orders. 2" x 2" square, £1.43 per pair; 3" sq., £2.75 per pair; 4" sq., £4.40 per pair. Prices shown above include V.A.T., postage and packing. Send S.A.E. for full range of products, price list and samples.

## DIMMIT

range of light dimmers

- ★ attractive standard wall mounting models for home and office, etc.
- ★ commercial modules for studio, stage, disco and clubs, etc.
- ★ professional modules for industrial use on heaters, lamps, motors, etc.

Rotary and slider control versions. Ratings available: 400W, 1KW, 2KW.

Send 10p for complete catalogue and price list. Discount for quantities.

DEPT. 11  
YOUNG ELECTRONICS

54 Lawford Road, London NW5 2LN  
Tel. 01-267 0201

## OWN BUSINESS OPPORTUNITY

exists in Scottish Highlands. Rural community needs: (1) R, TV and electrical repairs—constant demand; (2) Cottage manufacture of electronic gadgets for sale by post. Good train link Glasgow and London. Cottage available from early September. Local and national support for right men and women. Initiative, and own car or van, essential. Some own capital an advantage. Write, in confidence, Box 49.

Versatile

10 in ONE



MINI-LAB

Comprising:

- AC and DC Voltmeter • Audio Generator • Ohm Meter • Resistance Substitution • Capacitance Substitution • DC Ammeter • Battery Supply • RF Signal Generator • RF Field Strength Indicator.

This new, unique instrument combines all you need for testing. Money back if not satisfied.

£11.25

plus 25pp.&p.

Cash with order or send S.A.E. for illustrated data sheet to:

J. H. ASSOCIATES LTD. (Dept. PE)  
Cricketfield Lane, Bishop's Stortford, Herts

**HARDWARE**—Screws, nuts, washers and other useful items in small quantities. Sheet aluminium to individual requirements, punched/drilled. Send 6p for list. RAMAR CONSTRUCTOR SERVICES, 29 Shelbourne Road, Stratford-on-Avon, Warwickshire.

**GLASS FIBRE P.C. BOARD**—large supplies available. ¼ in single sided one ounce copper, 2p per 3 sq in (under 1ft); 75p per sq ft (over 1ft). ¼ in double sided one ounce copper, 1p per sq in (under 1ft); £1 per sq ft (over 1ft). Please add 10p per sq ft postage and packing. We can cut to your size at 1p per cut. SOLID STATE LIGHTING, The Firs, Smallworth Lane, Garboldisham, Diss, Norfolk.

## ELECTRONICS FANATICS

whether beginner or advanced — we offer a range of over 35 SUPER projects.

Have you ever wanted to build A MACHINE THAT LEARNS? Or perhaps make a TEACHING DEVICE? Maybe you fancy the idea of an ELECTRONIC FANTASY MACHINE? How about a "Thing" capable of REPRODUCING ITSELF? Whatever your electronic turn-of-mind, there's just GOT TO BE LOADS TO INTEREST YOU in the science-fiction-world of BOFFIN.

GET YOUR CATALOGUE — SEND JUST 15p NOW!

MAIL ORDER ONLY

TO: **BOFFIN PROJECTS**

4 CUNLIFFE ROAD  
STONELEIGH, EWELL  
SURREY

Designs by GERRY BROWN and JOHN SALMON and presented on TV.

**NEW WATTMETERS.** Portable, multirange wattmeters. From: METER REPAIRS, 39 Chesholm Road, London, N16 0DS.

**EXPERIMENTERS!** Hundreds of unusual items cheap. 1973 catalogue 5p. (Mail Order Only.) GRIMSBY ELECTRONICS, 64 Tenney Road, Cleethorpes, Lincs.

**ALUMINIUM SHEET** to individual sizes or in standard packs, 3p stamp for details. RAMAR CONSTRUCTOR SERVICES, 29 Shelbourne Road, Stratford-on-Avon, Warwks.

**CLEARING LABORATORY,** scopes, V.T.V.M.'s, V.O.M.'s, H.S. recorders, transcription turntables, electronic testmeters, calibration units, P.S.U.'s, pulse generators, D.C. null-potentiometers, bridges, spectrum analysers, voltage regulators, sig-gens, MC relays, components, etc. Lower Beeding 236.

# RAYMER MICROCHIP

# RE500

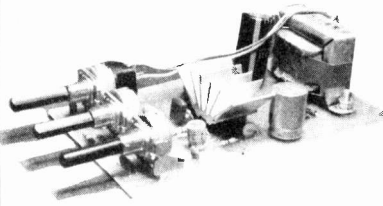

SPECIFICATIONS

OUTPUT 5W RMS (10W peak)  
FREQUENCY RESPONSE 10Hz to 50kHz ± 3dB  
TOTAL HARMONIC DISTORTION less than 1%

LOAD IMPEDANCE 4 to 16 ohms  
INPUT IMPEDANCE 100kΩ nominal  
POWER GAIN 40dB typical  
SIZE 140mm x 80mm x 45mm  
With free instruction sheet  
PRICE £6.93 (inc. VAT) + 25p P. & P.

Guaranteed 12 months against failure in normal use. This advanced high-fidelity integrated amplifier is completely self-contained and only requires connecting to mains, speaker and input.

Ideally suited for:  
MONO RECORD PLAYERS  
MONO CONVERSION TO STEREO  
STEREO CONVERSION TO QUADRAPHONIC  
(× 2 Microchip + Decoder)  
TV AMPLIFIER  
TAPE AMPLIFIER

PA INSTALLATIONS  
AUDIO ALARM, ETC.

TRADE ENQUIRIES WELCOMED

NAME.....

ADDRESS.....

PLEASE SEND.....

I enclose P.O./Cheque/Money Order

**RAYMER ELECTRONICS LTD., STANLEY ROAD  
CAMBRIDGE CB5 8LB**

Reg. Bus. 1031205

# BUILD A PROFESSIONAL SYNTHESISER



You too can build a professional synthesiser like the one illustrated using the professionally-proven range of Dewtron modules. **NEW MODUMATRIX** modular matrix system replaces clumsy patching. 3 and 4 octave keyboards and contacts.

**VCO-2 STABLE, PRECISION V/C OSCILLATOR** gives SINE, TRIANGULAR AND SQUAREWAVE outputs, 1 volt/octave voltage control. £22 each or £25 each 2 or more matched. **SHE-1 SAMPLE, HOLD AND ENVELOPE MODULE** gives variable attack, sustain, touch-sensitive playing when used with VCO-2 signals. £15.

Modules (except VCO-1) guaranteed two years.

With over 7 years' unblemished reputation in these pages, Dewtron continues to lead in new technical developments in electronic sound effects! Ask any of our customers. See our products in the music stores, too. Suppliers of special equipment to a leading group. Our modules are used in professional equipment by other manufacturers and in our own built synthesisers, e.g. "Gipsy" G.I. Approved by the Association of Musical Instrument Industries. Send 15p for full catalogue of our famous musical effects.

**D.E.W. LTD.** 254 Ringwood Road, FERNDOWN, Dorset BH22 9AR

using **Dewtron** (Regd. Trademark)

PROFESSIONAL MODULES  
**CASH SAVINGS**

by buying modules and parts in bulk!  
All modules are available separately:  
Ring Modulator RM2, £8. Voltage-controlled Oscillator VCO1, £10.50, giving sawtooth and square-wave outputs. Envelope shapers, ES1, self-triggered or ES2 keyboard-triggered, either type £13. White noise type WN1, £7. Voltage-controlled amplifier VCA1, £10. Voltage-controlled selective amplifier (filter for waa-waa, etc.) SA1, £12. Voltage-controlled Phase PH1, £17. Automatic Announcement Fader module for fading of music by microphone announcement, AF1, £9. etc., etc. ALL MODULES ARE BUILT, TESTED AND SEALED FOR LONG LIFE. Simply connect coloured wire connections as per easy instructions, build cabinet and wire in controls and patchboard connections! Joystick controls £4.50. REVERB Module and spring unit £15.

## PRINTED CIRCUIT KIT

BUILD 60 INTERESTING PROJECTS ON A PRINTED CIRCUIT CHASSIS WITH PARTS and TRANSISTORS from your SPARES BOX

CONTENTS: (1) 2 Copper Laminate Boards 4 1/2in x 2 1/2in. (2) 1 Board for Matchbox Radio. (3) 1 Board for Wristwatch Radio, etc. (4) Resist. (5) Resist Solvent. (6) Etchant. (7) Cleanser/Degreaser. (8) 16-page Booklet *Printed Circuits for Amateurs*. (9) 2 Miniature Radio Dials SW/MW/LW. Also free with each kit: (10) Essential Design Data. Circuits, Chassis Plans, etc. for 60 TRANSISTOR-BASED PROJECTS. A very comprehensive selection of circuits to suit everyone's requirements.

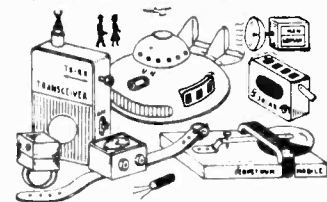

EXPERIMENTER'S  
PRINTED CIRCUIT KIT

70p

Postage & Pack. 10p (UK)

Commonwealth:

SURFACE MAIL 15p

AIR MAIL 60p

Australia, New Zealand,  
South Africa, Canada

(1) Crystal Set with biased Detector. (2) Crystal Set with voltage-quadrupler detector. (3) Crystal Set with Dynamic Loudspeaker. (4) Crystal Tuner with Audio Amplifier. (5) Carrier Power Conversion Receiver. (6) Split-Load Neutralised Double Reflex. (7) Matchbox or PhotoCell Radio. (8) "TRI-FLEXON" Triple Reflex with self-adjusting regeneration (Patent Pending). (9) Solar Battery Loudspeaker Radio. The smallest 3 designs yet offered to the Home Constructor anywhere in the World. 3 Subminiature Radio Receivers based on the "Triflexion" circuit. Let us know if you know of a smaller design published anywhere. (10) Postage Stamp Radio. Size only 1 1/2in x 0 7/8in x 0 7/8in. (11) Wristwatch Radio 1 1/2in x 0 7/8in x 0 7/8in. (12) Ring Radio 0 7/8in x 0 7/8in x 0 5/8in. (13) Bacteria-powered Radio. Runs on sugar or bread. (14) Radio Control Tone Receiver. (15) Transistor P/P Amplifier. (16) Intercom. (17) 1-valve Amplifier. (18) Reliable Burglar Alarm. (19) Light-Seeking Animal. Guided Missile. (20) Perpetual Motion Machine. (21) Metal Detector. (22) Transistor Tester. (23) Human Body Radiation Detector. (24) Man/Woman Discriminator. (25) Signal Injector. (26) Pocket Transceiver (Licence required). (27) Constant Volume Intensity Control of Matchbox by Induction. (28) Inductive-Loop Transmitter. (29) Pocket Triple Reflex Radio. (31) Wristwatch Transmitter/Wire-less Microphone. (32) Rain Alarm. (33) Ultrasonic Switch/Alarm. (34) Stereo Pre-amplifier. (35) Quality Stereo Push-Pull Amplifier. (36) Light-Beam Telephone "Photophone". (37) Light-Beam Transmitter. (38) Silent TV Sound Adaptor. (39) Ultrasonic Transmitter. (40) Thyristor Drill Speed Controller. (41) Light Dimmer. (42) I.C. Pre-amplifier. (43) I.C. Amplifier. (44) I.C. Intercom. (45) I.C. Radio. (46) Raudive Voices Receiver. (47) Biofeedback Amplifier. (48) Brainwave Detector. (49) Proximity Switch. (50) Laser Projector. (51) Plus 10 Photoelectric Circuits, Simple Alarms, Long Range Alarm, Projector, etc.

**YORK ELECTRICS, Mail Order Dept.**  
335 BATTERSEA PARK ROAD, LONDON, S.W.11

Send a S.A.E. for full details and a brief description of all kits and Projects.

## A.M.C. ELECTRONICS LTD.

### SCORPIO ELECTRONIC IGNITION UNIT

COMPLETE KIT WITH  
ALL PARTS AND  
COMPREHENSIVE CONSTRUCTION  
AND FAULT FINDING DATA

COMPLETE KIT £11.00 + V.A.T. post paid.  
DATA 10p + V.A.T. S.A.E. (Foolscap please).  
TRANSFORMER £2.30 + V.A.T. post paid.  
P.C.B. GLASS FIBRE 65p + V.A.T. post paid.  
LATEST NEWS — P.E. TRIFFID. P.C.B. 65p post free.  
Please add 15p to orders under £1.50. Send S.A.E. for other itemised prices.

**AMCEL, MAIL ORDER** 160 DRAKE STREET, ROCHDALE  
LANCASHIRE OL16 1PY

### BAKER 12in. MAJOR £9

30-14,500 cps. Double cone woofer and tweeter combination. Baker ceramic magnet assembly, flux density 145,000 gauss. BASS RESONANCE 40 c.p.s. 20 watt RMS.

MAJOR MODULE KIT **£11.50**  
30-17,000 cps. with tweeter, crossover and baffle.

BAKER LOUDSPEAKERS

V.A.T.— ADD 10%

Regent 12 in. 15W	£8	Superb 12 in. 20W	£15	Group 25 12 in. 25W	£8
Major 12 in. 20W	£9	Auditorium 12 in. 25W	£14	Group 35 12 in. 35W	£9
Deluxe 12 in. 15W	£10	Auditorium 15 in. 35W	£20	Group 50 15 in. 50W	£20

**BAKER LOUDSPEAKER CO., BENSHAM MANOR PASSAGE**  
THORNTON HEATH, SURREY Tel. 01-684 1665

# FREE!

## Over 150 ways to engineer a better future

HIGHER PAY

A BETTER JOB

SECURITY

### find out how in just 2 minutes

That's how long it will take you to fill in the coupon. Mail it to B.I.E.T. and we'll send you full details and a free book. B.I.E.T. has successfully trained *thousands* of men at home - equipped them for higher pay and better, more interesting jobs. We can do as much for YOU. A low-cost B.I.E.T. home study course gets results fast - makes learning easier and something to look forward to. There are no books to buy and you can pay-as-you-learn.

Why not do the thing that really interests you? Without losing a day's pay, you could quietly turn yourself into something of an expert. Complete the coupon (or write if you prefer not to cut the page). No obligation and nobody will call on you... but it could be the best thing you ever did.

#### Others have done it, so can you

"Yesterday I received a letter from the Institution informing that my application for Associate Membership had been approved. I can honestly say that this has been the best value for money I have ever obtained - a view echoed by two colleagues who recently commenced the course".—Student D.I.B., Yorks.

"Completing your course, meant going from a job I detested to a job that I love, with unlimited prospects".—Student J.A.O. Dublin.

"My training with B.I.E.T. quickly changed my earning capacity and, in the next few years, my earnings increased fourfold".—Student C.C.P., Bucks.

#### FIND OUT FOR YOURSELF

These letters—and there are many more on file at Aldermaston Court—speak of the rewards that come to the man who has given himself the specialised know-how employers seek. There's no surer way of getting ahead or of opening up new opportunities for yourself. It will cost you a stamp to find out how we can help you. Write to **B.I.E.T. Dept. BPE04 Aldermaston Court, Reading RG7 4PF.**

Practical Radio & Electronics Certificate course includes a learn while you build **3 transistor radio kit.**

Everything you need to know about **Radio & Electronics** maintenance and repairs for a **spare time income** and a **career** for a better future.

This FREE 76 page book can put you on the road to success through a B.I.E.T. Home Study Course. Choose your subject now!



CUT OUT THIS COUPON

Tick or state subject of interest. Post to address below.

<input type="checkbox"/> MECHANICAL	<input type="checkbox"/> Man. Prod.—cont.	<input type="checkbox"/> Constructional-cont.
<input type="checkbox"/> A.M.S.E. (Mech.)	<input type="checkbox"/> Quality Control	<input type="checkbox"/> Building
<input type="checkbox"/> Boiler Inspect.	<input type="checkbox"/> Salesmanship	<input type="checkbox"/> Building Drawing
<input type="checkbox"/> & Operation	<input type="checkbox"/> Storekeeping	<input type="checkbox"/> Build. Foreman
<input type="checkbox"/> C & G Eng. Crafts	<input type="checkbox"/> Work Study	<input type="checkbox"/> Carpentry & Join.
<input type="checkbox"/> C & G Fabricat.	<input type="checkbox"/> Works	<input type="checkbox"/> Civil & Municipal
<input type="checkbox"/> Diesel Eng.	<input type="checkbox"/> Management	<input type="checkbox"/> Engineering
<input type="checkbox"/> Eng. Inspection	<input type="checkbox"/> DRAUGHTSMANSHIP	<input type="checkbox"/> Constructional
<input type="checkbox"/> Eng. Metallurgy	<input type="checkbox"/> A.M.I.E.D.	<input type="checkbox"/> Engineering
<input type="checkbox"/> Inst. Eng. & Tech.	<input type="checkbox"/> Design of Elec.	<input type="checkbox"/> Construction
<input type="checkbox"/> Inst. Motor Ind.	<input type="checkbox"/> Machines	<input type="checkbox"/> Surveyors
<input type="checkbox"/> Mainten. Eng.	<input type="checkbox"/> Die & Press Tool	<input type="checkbox"/> Institute
<input type="checkbox"/> Mechanical Eng.	<input type="checkbox"/> Design	<input type="checkbox"/> Clerk of Works
<input type="checkbox"/> Sheet Metal Work	<input type="checkbox"/> Electrical	<input type="checkbox"/> Council Eng.
<input type="checkbox"/> Welding	<input type="checkbox"/> Draughtsman-	<input type="checkbox"/> Geology
	<input type="checkbox"/> ship	<input type="checkbox"/> Health Eng.
	<input type="checkbox"/> Gen. Draughts-	<input type="checkbox"/> Heat & Vent.
	<input type="checkbox"/> manship	<input type="checkbox"/> Hydraulics
	<input type="checkbox"/> Jig & Tool Des.	<input type="checkbox"/> Inst. of Builders
	<input type="checkbox"/> Tech. Drawing	<input type="checkbox"/> Inst. Works &
	<input type="checkbox"/> RADIO & TELE-	<input type="checkbox"/> Highway Sup.
	<input type="checkbox"/> COMMUNICATIONS	<input type="checkbox"/> Painting & Dec.
	<input type="checkbox"/> Colour TV	<input type="checkbox"/> Public Hygiene
	<input type="checkbox"/> C & G Radio/TV/	<input type="checkbox"/> Road Engineer.
	<input type="checkbox"/> Electronics	<input type="checkbox"/> Structural Eng.
	<input type="checkbox"/> C & G Telecomm.	<input type="checkbox"/> Surveying
	<input type="checkbox"/> Tech.	<input type="checkbox"/> GENERAL
	<input type="checkbox"/> Prac. Rad. Elec.	<input type="checkbox"/> Agricultural Eng.
	<input type="checkbox"/> (with kit)	<input type="checkbox"/> Council of Eng.
	<input type="checkbox"/> Radio Amateurs	<input type="checkbox"/> Inst.
	<input type="checkbox"/> Exam.	<input type="checkbox"/> Farm Science
	<input type="checkbox"/> Radio & TV Eng.	<input type="checkbox"/> General Educat.
	<input type="checkbox"/> Trans. Course	<input type="checkbox"/> Gen. Plastics
	<input type="checkbox"/> TV Maint. & Serv.	<input type="checkbox"/> Pract. Maths
	<input type="checkbox"/> AUTO & AERO	<input type="checkbox"/> Pract. Slide Rule
	<input type="checkbox"/> Aero Eng.	<input type="checkbox"/> Pure & Applied
	<input type="checkbox"/> A.M.I.M.I.	<input type="checkbox"/> Maths
	<input type="checkbox"/> A.E.C. Cert.	<input type="checkbox"/> Refrigeration
	<input type="checkbox"/> Auto Engineer.	<input type="checkbox"/> Rubber Tech.
	<input type="checkbox"/> Auto Repair	<input type="checkbox"/> Sales Engineers
	<input type="checkbox"/> C & G Auto. Eng.	<input type="checkbox"/> Tech. Report
	<input type="checkbox"/> Garage	<input type="checkbox"/> Writing
	<input type="checkbox"/> Management	<input type="checkbox"/> Timber Trade
	<input type="checkbox"/> MAA/IMI/Dipl.	<input type="checkbox"/> University Ent.
	<input type="checkbox"/> Motor Vehicle	
	<input type="checkbox"/> Mechanics	
	<input type="checkbox"/> CONSTRUCTIONAL	
	<input type="checkbox"/> A.M.S.E. (Civil)	
	<input type="checkbox"/> Architecture	

Coaching for many major exams including ONC, C & G, etc.

G.C.E.

58 'O' & 'A' LEVELS SUBJECTS Over 10,000 group passes

## POST TODAY FOR A BETTER TOMORROW

To B.I.E.T., Dept. BPE04, Aldermaston Court, Reading RG7 4PF BPE04

NAME \_\_\_\_\_  
Block Capitals Please  
ADDRESS \_\_\_\_\_

OTHER SUBJECTS \_\_\_\_\_ AGE \_\_\_\_\_

Accredited by C.A.C.C.

**BRITISH INSTITUTE OF ENGINEERING TECHNOLOGY**

Published approximately on the 15th of each month by IPC Magazines Ltd., Fleetway House, Farringdon Street, London, E.C.4. Printed in England by Chapel River Press, Andover, Hants. Sole Agents for Australia and New Zealand: Gordon & Gotch (A/asia) Ltd., South Africa: Central News Agency Ltd., Rhodesia and Zambia: Kingstons Ltd., East Africa: Stationery and Office Supplies Ltd. Subscription Rate (including postage): For one year to any part of the world £2.65 (£2.15.0).

Practical Electronics is sold subject to the following conditions, namely, that it shall not, without the written consent of the Publishers first given, be lent, resold, hired out or otherwise disposed of by way of Trade at more than the recommended selling price shown on the cover, and that it shall not be lent, resold or hired out or otherwise disposed of in a mutilated condition or in any unauthorised cover by way of Trade, or attached to or as part of any publication or advertising, literary or pictorial matter whatsoever.

# Henry's

## BUILD THE TEXAN

# YOUR COMPLETE AUDIO-ELECTRONIC STORES

More of everything at the right price. All your electronic requirements within 200 yards - call and see for yourself.

BUILD THE

# TEXAN

### ★ FREE TEAK CASE with complete kits!

**FEATURES:** New slim design with 6 ICs, IC sockets, 10 silicon transistors, 4 rectifiers, 2 zeners. Special Gardners low field slim line transformer. Fibreglass PC panel. Complete chassis work.

**HIGH QUALITY & STABILITY ARE PREDOMINATE FEATURES** —DEVELOPED BY TEXAS ENGINEERS FOR PERFORMANCE, RELIABILITY AND EASE OF CONSTRUCTION.

**FACILITIES:** On/off switch indicator, headphone socket, separate treble, bass, volume and balance controls, scratch and rumble filters, mono/stereo switch, Input selector: Mag. P.U., Radio Tuner, Aux. Can be altered for Mic, Tape, Tape head etc. (Parts list Ref. 20 on request). Constructional Details Ref. No. 21. 30p.

**SPECIAL KIT PRICE** **£28.50** P. & P. 45p COMPLETE WITH FREE TEAK CABINET

## 20 + 20 WATT INTEGRATED I.C. STEREO AMPLIFIER

(As featured in "Practical Wireless" May to August 1972)

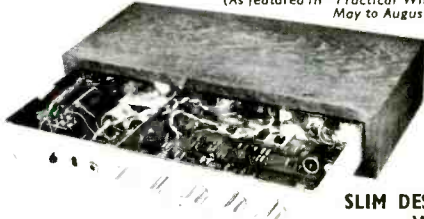

**SLIM DESIGN WITH SILVER TRIM**

Overall chassis size 14 1/2 in. x 6 in. x 2 in. high

Designer approved kits distributed by Henry's!

**ELECTRONIC KITS**  
Henry's introduce new huge range of audio and electronic kits now in stock, everything supplied, tremendous value. Detailed list Ref. No. 14 on request.

**IC RECEIVER**  
ZN414 Radio integrated circuit as featured in Practical Wireless, January, 1973; Practical Electronics, February, 1973. Price £1-20.

**BATTERY TAPE DECK**  
Garrard 9V tape deck with heads, etc. As previously advertised. Limited quantity. £9.50. Post 30p.

**LEARN A LANGUAGE**  
Recorded Cassettes with step by step phrase books. French, German, Spanish, Italian. £1.36 per course. £5.00 per set of four.

**DISCO SPOTBANK**  
As illustrated on the front cover of Practical Wireless, April, 1973. £12.75. P. & P. 35p.

**HI-FI EQUIPMENT**  
Warehouse prices with BIG DISCO UNITS plus demonstrations (for callers) and GUARANTEES.

**FREE** 24-page detailed brochure (Ref. No. 17).  
★ You can see the savings ★

**HIGH QUALITY CASSETTES**  
The best U.K. low noise tapes but at a special price. "Living Sound" cassettes meet the highest international standard (IEC 60). Fantastic price savings.

	C60	C90	C120
3 for	£1.00	£1.33	£1.62
6 for	£1.80	£2.57	£3.15
10 for	£2.80	£4.20	£5.00

RRP 70p 97p £1.47  
Full guarantee. Post paid. Made by EMI especially for Henry's.  
See earlier page of this magazine for transistors and semiconductor devices.

**ULTRASONIC TRANSDUCERS**  
Operate at 40kc/s up to 100 yds. Ideal remote switching and signalling. Complete with data and new I.C. circuits.  
PRICE PER PAIR £5.90. Post 10p.

**MARRIOTT TAPE HEADS**

4 TRACK MONO or 2 TRACK STEREO	£2.00
"17" High Impedance	£2.00
"18" Med. Impedance	£2.00
"36" Med.-Low Imp.	£3.50
Erase Heads for above	75p
"63" 2 track mono — High Impedance	£1.75
"43" Erase Head for above	75p

**7 SEG & NIXIE TUBES**  
(Post 15p per 1 to 6)  
XN3, XN13, GNG 0-9 side view with data, 85p.  
GNP-7, GNP-8 0-9 side view with decimal points and data, 95p.  
3015F 7 seg. £2 each, £7 per 4 with data.  
12 and 24 hour clock circuits. Ref. No. 31 15p.

**MINIATURE AMPLIFIER**  
5 transistor. 300mW o/p. Fitted volume and sensitivity control 9 volt operated. £1.75 each, p.p. 15p.

**QUALITY SLIDER CONTROLS**  
60mm stroke singles and ganged. Complete with knobs. 5kΩ, 10kΩ, 25kΩ, 100kΩ, 250kΩ, 500kΩ. 1 meg. Log and Lin. 40p each, 10kΩ, 25kΩ, 50kΩ, 100kΩ, 250kΩ, Log and Lin. ganged. 60p each.

### LOW COST HI-FI SPEAKERS



E.M.I. Size 1 3/4 in x 8 1/2 in and Ceramic Magnet

**TYPE 150** 6 watt, 3, 8 or 15 ohms £2.20. Post 22p.

**TYPE 150TC** Twin cone version £2.75. Post 22p.

**TYPE 450** 10 watt with twin tweeters and crossover, 3, 8 or 15 ohms. £3.85. Post 25p.

**TYPE 350** 20 watt with tweeter and crossover, 8 and 15 ohms. £7.70. Post 28p.



**POLISHED CABINETS** 150, 150TC, 450 £4.60. Post 30p.  
**ASSEMBLED IN POLISHED CABINETS (8 OHM)**  
**SERIES 6 (Assembled 150TC)** per pair £16.50. Post 70p.  
**SERIES 8 (Assembled 450)** per pair £18.95. Post 70p.

### TEST EQUIPMENT

Just a selection

- SE250B Pocket Pencil Signal Injector, £1.90
  - SE500 Pocket Pencil Signal Tracer, £1.50
  - TH133D Robust 2 K/Volt, £8.55; with case £4.95
  - TE15 Grid Dip Meter 440 KHz—280 MHz, £13.45
  - 500 30 K/Volt Multimeter, £9.25; with leather case, £10.50
  - 200H/20K/Volt Multimeter, £4.20; with case £4.95
  - AF105 50K/Volt Multimeter, £8.50; with case, £9.50
  - A4341 A/C/DC Multimeter with transistor tester with steel case, £10.50
  - TE20D RF Generator 120KHz—500MHz, £15.95. Carr. 35p
  - TE22D Audio Generator 20Hz—200KHz, £17.50. Carr. 35p
  - CI-5 3in Pulse Scope 10Hz—10MHz, £39.00. Carr. 50p
  - TE65 Valve Voltmeter 28 ranges, £17.50. Carr. 40p
- ALL NOMBEX MODELS IN STOCK



### BUILD THIS VHF FM TUNER

5 TRANSISTORS 300kc/s BANDWIDTH PRINTED CIRCUIT. HIGH FIDELITY REPRODUCTION. MONO AND STEREO. A popular VHF FM Tuner for quality and reception of mono and stereo. There is no doubt about it—VHF FM gives the REAL sound. All parts sold separately. Free Leaflet No. 3 & 7. TOTAL £6.97, p.p. 20p. Decoder Kit £5.97. Tuning meter unit £1.75. Mains unit (optional) Model PS900 £2.47. Post 20p. Mains unit for Tuner and/or Decoder PS6/12 £3.25. Post 20p.



### ML3 MW/LW TUNER TO BUILD



Uses Mullard Module. Slow motion tuning. Built-in battery. Ferrite aerial. Overall size 7in x 2 1/2 in x 3 1/2 in. TOTAL COST TO BUILD £4.85. Post 15p. All parts sold separately—Leaflet No. 6.

### "BANDSPREAD" PORTABLE TO BUILD



Printed circuit all transistor design using Mullard RF/IF Module. Medium and Long Wave bands plus Medium Wave Bandspread for extra selectivity. Wave Bandspread, fibre glass 600mW push-pull output, fibre glass PVC covered cabinet, car aerial. Attractive appearance and performance. TOTAL COST TO BUILD £7.98, p.p. 32p (Batt. 22p). All parts sold separately—Leaflet No. 2.

### PA-DISCO-LIGHTING

UK's Largest Range—Write phone or call in. Details and demonstrations on request.  
DJ30L 3 Channel sound to light unit, 3kW, £29.50  
DJ40L 3 Channel Mic (Built-in) to light, 3kW, £38.75  
DJ70S 70 watt Disco amp/mixer, £49.75  
DISCOMP 100 watt Disco amp/mixer, £65.85  
DJ105S 30 watt Disco amp/mixer, £32.25  
Ampl. Feedback Quality Mics, £11.50  
DJ500 50 watt PA amplifier, £43.95  
DJ700 70 watt £52.75  
Group 300 150 watt rms Group Valve amplifier, £86.00  
● Portable discos—details on request  
● Credit terms for callers



FIBRE OPTICS · LIGHTING · MICS · EFFECTS · PROJECTORS · SPOTS · DIMMERS · STANDS · MIXERS · SPEAKERS  
Everything for PA — Disco — Lighting. FREE Stock List Ref. No. 18.

### CATALOGUE

Fully detailed and illustrated covering every aspect of Electronics—plus data, circuits and information. 10,000 Stock lines at Special Low Prices and Fully Guaranteed.

**PRICE 55p** (40p FOR CALLERS) **PLUS! FIVE 10p VOUCHERS**

Send to this address—Henry's Radio Ltd. (Dept. PE), 3 Albemarle Way, London, E.C.1—for catalogue by post only. All other mail and callers to "303", see above.

### SINCLAIR PROJECT 60 MODULES

—SAVE POUNDS

Z30 £3.57 Z50 £4.37  
STEREO 60 £7.97 PZ5 £3.97  
PZ6 £6.37 PZ8 £4.77.  
Transformer for PZ8 £2.95.  
Active Filter Unit £4.45.  
Stereo FM Tuner £16.95.  
IC12 £1.80 Q16's £15 pair.  
Post, etc. 20p per item.



**PACKAGE DEALS** Post 25p  
2 x Z30, Stereo 60, PZ5 £15.95  
2 x Z30, Stereo 60, PZ6 £18.00  
2 x Z50, Stereo 60, PZ8 £20.25  
Transformer for PZ8 £2.95  
PROJECT 60S KIT £19.95

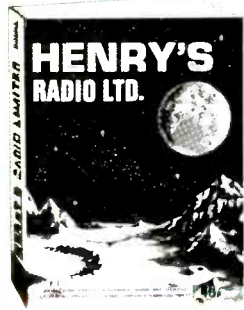

**VAT** Prices DO NOT include Value Added Tax. From 1st April, 1973, 10% must be added and shown separately to your total order (inc. of carriage and packing). Help us to help you receive your order without delay. E & OE

**Henry's RADIO LIMITED**  
EDGWARE ROAD, W2

404-406 Electronic Components and Equipment 01-402 8381  
354-356 High Fidelity and Tape Equipment 01-402 5854/4736  
309 PA-Disco-Lighting High Power Sound 01-723 6963  
303 Special offers and bargains store  
All mail to 303 Edgware Road, London W2 1BW

Open—9 am-6 pm  
6 days a week  
(309 closed Thursday)  
All stores open all day Saturday