

Personal Computer

A transputer for your PC

US\$2.95/SFr4.8/£1.76/BFr127
Lire4,500/Dkr31.00

World November 1987 £1.20

BRITAIN'S BIGGEST MICROCOMPUTER MAGAZINE

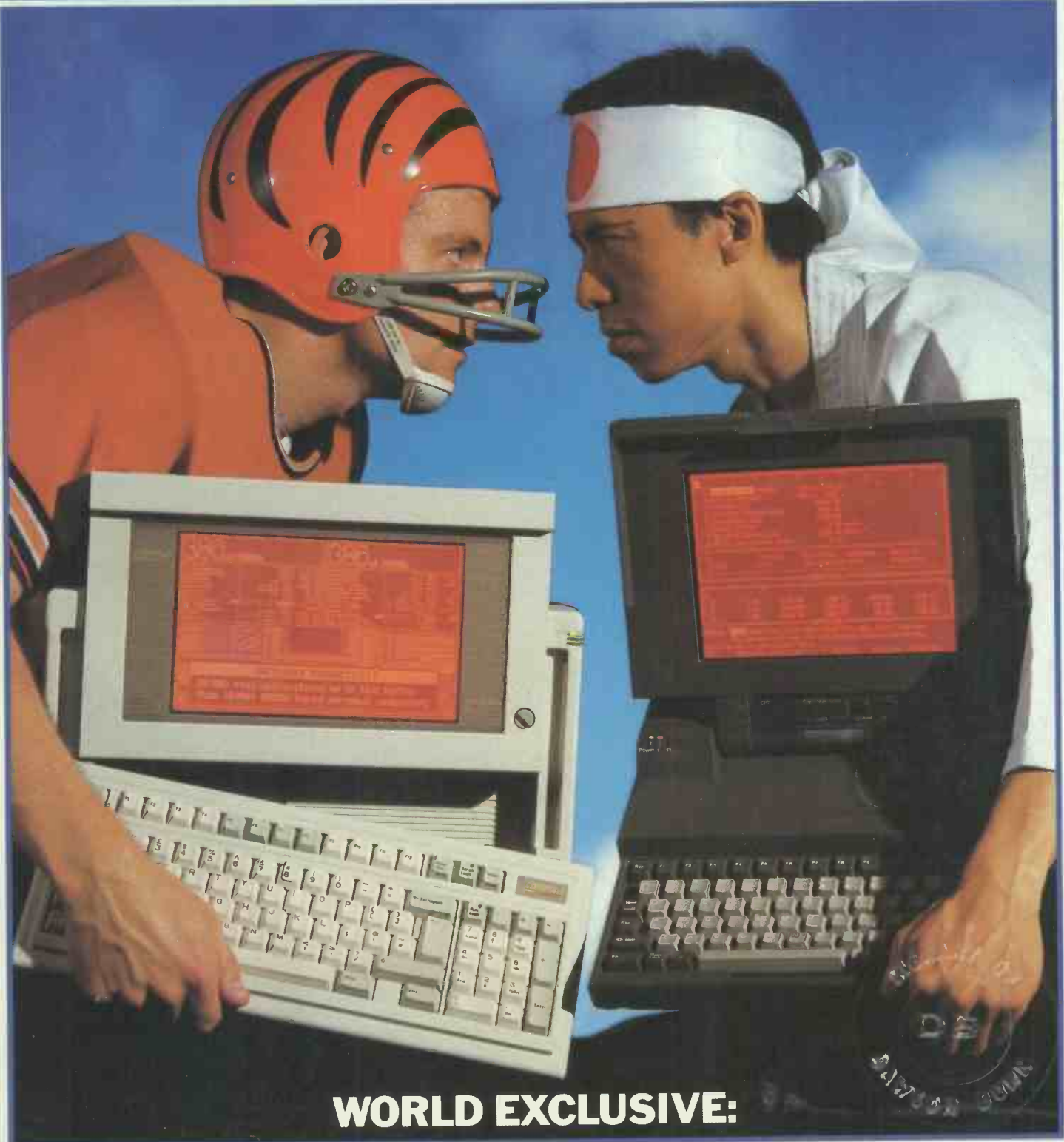

WORLD EXCLUSIVE:

COMPAQ PORTABLE 386 vs TOSHIBA 5100

The 386 war hots up

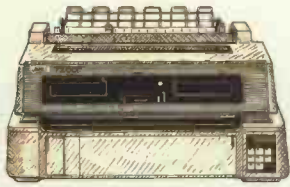

7200 NLQ MATRIX

The world's first multi-function, multi-wire, flat-bed printer. It allows you to print virtually any kind of business form. It gives quality print as well as colour and plotting facilities.
Speed: 324cps (Draft). 108cps (LQ).
Columns: 136. **Compatibility:** IBM, Epson, or Diablo 630.
Price: £1625.



5510/5520 NLQ MATRIX

High speed, NLQ with full graphics mode and 3K memory. 5520 is the colour version.
Speed: 180cps (Draft). 30cps (NLQ).
Columns: 80. **Compatibility:** IBM & Epson.
Price: 5510 £329. 5520 £449.



6500 DAISYWHEEL

This new daisywheel is designed for heavy duty office use. It's very fast and includes parallel and serial interfaces.
Speed: 60cps. **Columns:** 132.
Compatibility: IBM & Diablo 630.
Price: £1299.



6300 DAISYWHEEL

Our best selling general purpose daisywheel printer. It's fast speed and low noise level make it ideal for the office.
Speed: 40cps. **Columns:** 132.
Compatibility: IBM & Diablo 630.
Price: £899.



6200 DAISYWHEEL

A popular wide bodied letter quality printer, perfect for the smaller office. Parallel or serial interface.
Speed: 30cps. **Columns:** 132.
Compatibility: IBM & Diablo 630.
Price: £579.



6100 DAISYWHEEL

The U.K.'s best selling daisywheel printer. 100 character wheel. 2K memory expandable to 8K.
Speed: 20cps. **Columns:** 110.
Compatibility: IBM & Diablo 630.
Price: £399.

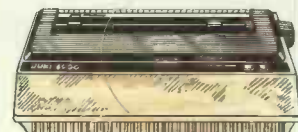

6000 DAISYWHEEL

A letter quality printer designed for home use. 100 character wheel and either parallel or serial interface.
Speed: 10cps. **Columns:** 90.
Compatibility: IBM graphics printer.
Price: £199.



The Juki 7200. The first printer in the world that can print anything.

Well, when we say anything we mean virtually any kind of business document. Everything from the usual cut sheets, labels and continuous paper to multi-part sets, envelopes, business cards, airline tickets, freight bills, cheques, statements and ledger leaves.

This is due to its revolutionary flat bed design and three way feed system. Combine this with print quality to rival a laser and the option of colour, you have something no other machine can match.

On top of that we offer a full 2 year warranty* on all Juki printers. So, for more detailed information on any model call us now for free on 0800 521111.

Sole Distributor:

JUKI
The Master Printers

Micro Peripherals Ltd

Intec 2, Unit 3, Wade Road, Basingstoke, Hampshire RG24 0NE.

Telephone: 0256 473232. Telex: 859669 MICRO P G. Facsimile: 0256 461570.

Unit 5/6, Newhallhey Works, Newhallhey Road, Rawtenstall, Rossendale, Lancashire, BB4 6HL.

Telephone: 0706 211526. Facsimile: 0706 228166.

*Does not include printheads, ribbons and daisywheels.

All prices are RRP Ex VAT.

All trade marks are recognised.

C LIBRARIES

DATABASE			
Btrieve v4.10	MS-DOS	£180	
Btrieve/Multi user	MS-DOS	£430	
Btrieve/Network	MS-DOS	£430	
XQL	PC-DOS	£430	
CBTREE (source any C)		£ 80	
C-Index/Plus (source any C)		£175	
C-ISAM (L,MS)	MS-DOS	£225	
C-to-dBase (source CI)	MS-DOS	£120	
C-tree (source any C)		£230	
R-tree	MS-DOS	£175	
db-VISTA (most C's)	MS-DOS	£160	
db-VISTA (with source)	MS-DOS	£405	
db-VISTA multi-user	MS-DOS	£405	
db-QUERY single-user	MS-DOS	£160	
db-QUERY single (w.sce)	MS-DOS	£405	
Lattice dBCII (L)	MS-DOS	£160	
Lattice dBCIII (L,MS)	MS-DOS	£160	
SoftFocus Btree (source any C)		£ 55	
SoftFocus ISAM (source any C)		£ 30	
Virtual Memory File Man.	PC-DOS	£150	

GRAPHICS			
Enhanced Graphics Tlkt	PC-DOS	£170	
Essential Graphics	PC-DOS	£145	
GFX Graphics	PC-DOS	£ 50	
Graphic (CI, L, DS, MS)	PC-DOS	£255	
GSS Kernel	PC-DOS	£350	
GSS Lattice Binding	PC-DOS	£110	
GSS Graph.Tlkt (L,MS,+)	PC-DOS	£335	
GEM Prog.Toolkit (L)	PC-DOS	£405	
GSX Prog.Toolkit (DR)	PC-DOS	£270	
HALO (CI, L, MS)	PC-DOS	£175	
MetaWINDOWS (CI, L, MS)	PC-DOS	£110	
MetaWINDOWS Plus	PC-DOS	£155	
Turbo WINDOWS/C (Turbo)	PC-DOS	£ 55	

SCREEN & WINDOWS			
Blaise View Mngr. (s'ce)	PC-DOS	£245	
Curses Screen Mngr. (L)	PC-DOS	£120	
Entelekon Windows (s'ce)	PC-DOS	£ 99	
Multi-windows (MS, L)	PC-DOS	£220	
Panel Plus (source)	PC-DOS	£295	
Vitamin C (source)	PC-DOS	£145	
Windows for Data (most)	PC-DOS	£270	
Windows for C (most C)	PC-DOS	£170	
Greenleaf Datawindows	MS-DOS	£110	

GENERAL FUNCTIONS			
Greenleaf (source)	PC-DOS	£ 95	
Smorgasbord (source)	PC-DOS	£150	
Blaise Tools Plus (sce)	PC-DOS	£110	
ESI Utility Lib (source)	PC-DOS	£105	
Entelekon Funct (source)	PC-DOS	£ 95	
Phoenix Pforce (source)	PC-DOS	£235	
Phoenix Pforce C++ (sce)	PC-DOS	£235	
Pro-C (most C)	PC-DOS	£720	
Security Library object	MS-DOS	£ 95	

ADA COMPILERS

AdaVantage V2.00 is now validated by the US Department of Defence.

AdaVantage v1.5	PC-DOS	£ 380
AdaVantage v2	PC-DOS	£ 700
Artek Ada v1.25	MS-DOS	£ 350
JANUS/Ada C-Pack	MS-DOS	£ 75
JANUS/Ada ED-Pack	MS-DOS	£ 285
JANUS/Ada D-Pack	MS-DOS	£ 825
JANUS/Ada S-Pack	MS-DOS	£2890
Augusta (with source)	CP/M-80	£ 75
JANUS/Ada C-Pack	CP/M-80	£ 80
JANUS/Ada D-Pack	CP/M-80	£ 260
Supersoft Ada	CP/M-80	£ 250

PRICES & DELIVERY

Prices do not include VAT or other local taxes but do include delivery in UK and Europe.

Please check prices at time of order, ads are prepared some weeks before publication.

This page lists some of our products. Call us for a complete pricelist.

Order by phone with your credit card.

COMMS LIBRARIES

Blaise Asynch (source)	PC-DOS	£120
Essential Comms (L,MS)	PC-DOS	£110
Greenleaf Comms (source)	PC-DOS	£ 95
Multi Comms (L,MS)	PC-DOS	£120
Novum Comms. (source)	PC-DOS	£140

SCIENTIFIC LIBRARIES

Wiley Scientific Lib.	ANY C	£120
Mathpak 87 (L,MS)	MS-DOS	£ 80

PROGRAMMERS UTILITIES

PC-Lint v2.0	MS-DOS	£ 80
Pre-C (Phoenix Lint)	MS-DOS	£175
Figureflow C-DOC	MS-DOS	£165
C-BROWSER	PC-DOS	£190
C Toolset	MS-DOS	£ 90
Lattice Cross Ref.	MS-DOS	£ 40
Lattice Text Utilities	MS-DOS	£ 85

REAL TIME & MULTI-TASKING TOOLS

Csharp (CI, L2, MS3) s'ce	MS-DOS	£445
Concurrent C (PC/MPX) s'ce	MS-DOS	£ 60
Multi C (L,MS,CI)	PC-DOS	£110
Multiforms (L,MS)	PC-DOS	£125
Op.Sys.T'box (MS) s'ce	PC-DOS	£ 60
Timeslicer v3.01 (L)	PC-DOS	£ 90
Timeslicer v4.01M (MS)	PC-DOS	£165

THE C LANGUAGE

New Aztec V4.1 is ANSI compatible and new MW Lets C now has large model.

C COMPILERS			
Alcor C	Z80 + CP/M-80	£ 85	
Aztec C Personal 1.06D	CP/M-80	£120	
Aztec Commercial 1.06D	CP/M-80	£200	
BDS C 1.60	Z80 + CP/M-80	£ 70	
Eco-C v3.48	Z80 + CP/M-80	£ 50	
Hi-Tech C	Z80 + CP/M-80	£ 99	
Mix C	Z80 + CP/M-80	£ 35	
Toolworks C/80 v3.2	CP/M-80	£ 45	
Advantage C++	MS-DOS	£440	
Aztec C86 Professional	MS-DOS	£120	
Aztec C86 Developer	MS-DOS	£185	
Aztec C86 Commercial	MS-DOS	£285	
CI C86 Plus	MS-DOS	£290	
CI C86 Optimizing	MS-DOS	£230	
De Smet C88 Starter	MS-DOS	£ 85	
De Smet C88 Programmer	MS-DOS	£125	
De Smet C88 Enhanced	MS-DOS	£165	
De Smet C88 Prof.	MS-DOS	£200	
ECO-C88 V3.22	MS-DOS	£ 50	
HIGH C (Metaware) v1.4	MS-DOS	£415	
HIGH C 386 v1.3	MS-DOS	£610	
Hi-Tech C	MS-DOS	£ 99	
Lattice C v3.20	MS-DOS	£235	
Mark Williams LETS C	MS-DOS	£ 60	
Microsoft C v4.0	MS-DOS	£245	
MIX C	MS-DOS	£ 29	
Turbo C v1.0	PC-DOS	£ 65	
Toolworks C v3.2	MS-DOS	£ 45	
Zorland C v2.05	PC-DOS	£ 29	
Zorland C Power Pack	PC-DOS	£ 59	
Zorland C Optimiser	PC-DOS	£ 29	
Aztec C86 Developer	CP/M-86	£250	
Aztec C86 Personal	CP/M-86	£150	
CI Optimizing C86	CP/M-86	£270	
De Smet C Starter	CP/M-86	£ 85	
De Smet C Programmer	CP/M-86	£125	
De Smet C Enhanced	CP/M-86	£165	
Hi-Tech C	CP/M-86	£ 99	

Lattice C v1.04	CP/M-86	£260
HIGH C (Metaware)	C-DOS 286	£415
Aztec C65 v1.05	Apple DOS	£195
Aztec C65 V3.20	Apple PRO-DOS	£250
Aztec C65 Prime	Apple DOS	£ 75
Aztec C68 Commercial	MACINTOSH	£285
Aztec C68 Developer	MACINTOSH	£185
Hi-Tech C	ATARI	£ 99
Lattice C	ATARI	£ 75
Mark Williams C	ATARI	£140

C CROSS COMPILERS

We supply Aztec, Lattice, IAR and Hi-Tech Cross Compilers hosted on MS-DOS and targeted on Z80, 8085, 6502, 6801, 68HC11, 6301, 8051 and 68000. Please call for information or advice.

C INTERPRETERS

C-terp	PC-DOS	£180
Interactive C	PC-DOS	£195
Introducing C	PC-DOS	£ 85
Living C-personal	PC-DOS	£ 60
Living C Plus	PC-DOS	£135
Instant-C v2.0	MS-DOS	£380
RUN/C	MS-DOS	£ 60
RUN/C Professional	MS-DOS	£120
Instant-C v1.27	CP/M-86	£380

PROLOG LANGUAGE

Arity Standard	PC-DOS	£ 85
Arity Prolog v4.0	PC-DOS	£260
Arity Interpreter+Compil.	PC-DOS	£585
Chalcedony Prolog /I	MS-DOS	£ 90
PROLOG Prof. Int. v1.5	MS-DOS	£265
Micro-PROLOG v3.1	MS-DOS	£ 75
Prolog-86 v2.01	MS-DOS	£115
Prolog-1 v2.2	MS-DOS	£299
Prolog-2 Personal	PC-DOS	£145
Prolog-2 Programmer	PC-DOS	£495
Prolog-2 Professional	PC-DOS	£995
Turbo-Prolog v1.1	PC-DOS	£ 60
ADA Educ. Prolog	MS-DOS	£ 45
ADA FS Prolog	MS-DOS	£ 55
ADA VMI Prolog	MS-DOS	£ 85
ADA VML Prolog	MS-DOS	£165
Prolog-1 v2.2	CP/M-86	£299
Micro-Prolog v3.1	CP/M-86	£ 75
Micro-prolog v3.1	CP/M-80	£ 60
Prolog-1 v2.2	CP/M-80	£225

DISK COPYING SERVICE

We can copy files to and from 400 disk formats including CP/M, CP/M-86, MS-DOS, PC-DOS, ISIS, APPLE, SIRIUS, BBC, TORCH, APRICOT, HP150, TRSDOS, DEC RT-11, IBM BEF, ATARI520, AMSTRAD.

Our charge is £10.00 + disk + VAT with discounts on small quantities and disks are normally despatched within 24hrs of receipt.

For more information call us.

GREY MATTER

4 Prigg Meadow, Ashburton, Devon TQ13 7DF.
TEL. (0364) 53499

GREY MATTER

4 Prigg Meadow, Ashburton, Devon TQ13 7DF.
TEL. (0364) 53499

GREY MATTER

4 Prigg Meadow, Ashburton, Devon TQ13 7DF.
TEL. (0364) 53499

PROGRAMMING TOOLS

Ada Compilers	Algo Compilers
Assemblers	Assembler Libs.
Basic Compilers	Basic Interpreters
Basic Utilities	Basic Libraries
BCPL Compilers	C Compilers
C Interpreters	C Libraries
C Utilities	Cobol Compilers
Comms.Libraries	Cross Assemblers
Database Libs.	Debuggers
Dis-assemblers	Editors
Engineers Libs.	Expert Systems
Forth	Fortran Compilers
Fortran Libraries	Graphics Libraries
Icon	Linkers
Lisp	Modula-2
Nial Interpreters	OPS 5
Pascal Compilers	Pascal Libraries
Prolog	Rexx
Screen Libraries	Smalltalk
Snobol	

We stock many items for which there is no space in these advertisements.

LINKERS

Plink-86 Plus v2.23	MS-DOS	£285
Link & Locate	MS-DOS	£265
Plink-II	CP/M-80	£315
SLRKN (Z80)	CP/M-80	£ 45
SLRKN-PLUS (Z80)	CP/M-80	£150

CONTENTS

Vol 10 No 11 November 1987



Cover photography by Tony Hutchings
Cover story begins on page 98

BENCHTESTS & REVIEWS

COMPAQ PORTABLE 386 vs TOSHIBA 5100 98

The battle of the portable/laptop PCs goes another round as arch rivals Compaq and Toshiba enter new contestants in the form of 80386-based machines. Peter Jackson places his bets on the likely winner.

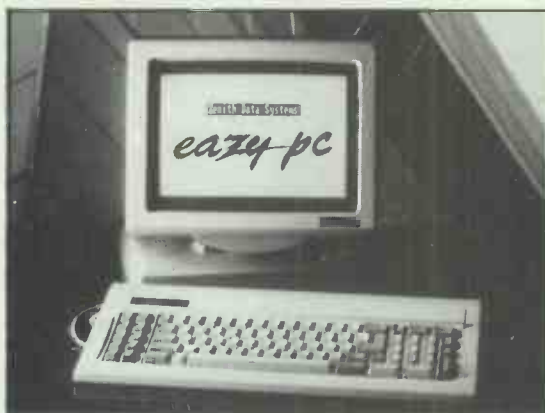

ZENITH EAZY PC 104

Martin Wren-Hilton looks at the performance of this entry-level PC that is the first to include Microsoft's text-based windowing front-end, MS-DOS Manager, and wonders whether the 3½in disk drives will help or harm the machine's appeal.

MONOPUTER 114

Harnessing the power of a transputer within a conventional PC is now possible. Howard Oakley looks at one solution, and describes the software hoops users need to go through to make the two technologies work together.

PC WORKS 128

Many packages have tried to emulate Ability's success as a low-end integrated PC software package. Owen Linderholm assesses the worth of Microsoft's offering which is derived from the company's Macintosh-based product.

HYPERCARD 132

A cross between an operating system front-end, a card index system and an applications generator is the easiest way to describe Apple's most innovative software product to date. Robin Webster put its power to the test.

SPELLMASTER 148

What works with View, InterWord and WordWise and can spell all three names correctly? Spellmaster from Computer Concepts should do — in theory. Ian Waugh tested the ROM-based BBC Micro utility in practice.

VIP PROFESSIONAL 154

A Lotus 1-2-3 compatible spreadsheet for the Amiga, Atari ST and Apple IIGS *must* be good news. Geof Wheelwright looks at how well it performs and what extras users of these machines can expect.

CROSSTALK MK 4 vs SMARTCOM III 158

Comms addict Robert Schifreen compares these two heavyweight communications products for the PC, and questions whether the multitude of powerful facilities helps or hinders the online process.

Founder Angelo Zgorelec Editor Derek Cohen Deputy Editor Nick Walker Production Editor Ginny Conran Acting Production Editor Lauraine Danker Technical Editor Owen Linderholm Staff Writer Robert Schifreen Editorial Assistant Chris Cain Consultant Editors David Tebbutt, Dick Pountain Art Director Martyn J Rowbotham Art Assistant Stephen Holmes Publishing Director Mike Agate Publisher David Mankin Production Controller Judith Middleton Production Manager Rachel Wynne Production Assistant Mark Levy Group Advertisement Manager Jan Pitt Advertisement Manager Moira Thomson Deputy Advertisement Manager Nick Ascough Sales Executives Stephen Babb, Sally McLester, Anthony Lavelle, Helen O'Driscoll, Alan Gonsalves, Mary de Sausmarez, Claire Wheaton

FEATURES

- 386 OPERATING SYSTEMS** 108
So you finally have the ultimate status symbol — an 80386-based PC. If you are not to use it merely as a faster PC, you need alternatives to plain 640k-bound MS-DOS. Nick Walker looks at two 386-specific operating systems and two windowing front-ends, all of which make full use of the new chip's memory-addressing capabilities.
- FROM CHAOS TO BEAUTY** 118
Creativity in nature is driven by random chaotic events producing new species. Barry Martin and Mike Mudge describe how to combine randomness and mathematical models to produce startling colour graphics on a well-programmed Beeb.
- FIRST IMPRESSIONS** 124
Photographer Tony Sleep captures some of the early highlights of this year's PCW Show.
- TIME TRIALS** 138
Battling his way through the hundreds of reader contributions, Nick Walker reports on responses to PCW's Benchmark listings and produces league tables of the most interesting timings around.
- MACHINE VISION** 142
We take for granted the ability to distinguish a friend's face in a football crowd, or the baked beans from the spaghetti hoops; but teaching computers to do the same is a difficult task, as Nick Hampshire explains.

REGULARS

- NEWSPRINT** 70
Eggy faces all round as the target for OS/2 looks to be lower than was hoped for. Guy Kewney reveals all about this and more.
- WEST COAST CONNECTION** 86
Tim Bjarin questions the wisdom of Atari and Amstrad buying up their distributors, and reveals new plans for Postscript.
- LETTERS** 92
Compaq reveals why it *knows* that OS/2 will run on its machines. Plus other much-valued reader feedback.
- SCREENPLAY** 168
Infocom's most punnishing (sic) game so far is among Steve Applebaum's discoveries for the fun-loving computer user.
- BIBLIOFILE** 172
Our experts assess which books will help you most in your attempts to understand the complex world of databases.
- MAILBOX** 178
An international network enables you to send messages to the States through your local bulletin board. Peter Tootill unravels FidoNet.
- SUBSET** 180
The fastest and shortest methods of clearing your computer's memory of anything remotely useful.
- PROGRAM FILE** 182
A Donkey-Kong type game for the Amstrad PCW leads off this month's collection of useful and amusing programs submitted to Owen Linderholm.
- END ZONE** 208
If you're buying or selling, joining a club or wanting to make music, our regular columns have the info you need.
- ADVERTISERS' INDEX**
- CHIPCHAT**
Our editor's opportunity to reveal the funnier side of looking after your favourite monthly magazine.



- BANKS' STATEMENT** 94
Martin Banks questions whether computer games can damage more than you or your children's trigger fingers.
- COMPUTER ANSWERS** 166
Steve Gold helps those in search of ways of improving their computing without shedding too many tears.

STATIONERY



Prices are per 1000, minimum order total 1000. FREE delivery U.K.

2 PART STATEMENTS	26
3 PART STATEMENTS	27
2 PART INVOICES	29
3 PART INVOICES	33
4 PART INVOICES	45
SECURITY PAYSLEIPS	48
PAYSLEIPS	21
REMITTANCE ADVICE	18
BANK GIRO	15
P14/P60	34
P35	34
STATEMENT ENVELOPES	21
PAYSLEIP ENVELOPES	21

CALL FOR FREE SAMPLE SETS

NETWORKING



ISC offer the industry standard NOVELL networking system – with professional installation service and qualified support staff.

Example Configurations contain the following –

Three Network cards (for server & two terminals)
Novell Netware 286 v2.0a
Six metre cables
12 month guarantee

G/NET (MAX 8 TERMINALS)	2150
ARCNET (MAX 15 TO 20 TERMINALS)	2295
ETHERNET (MAX 20 TO 30 TERMINALS)	2395
ADDITIONAL NETWORK CARD & CABLE	295
INSTALLATION	350
PER METRE CABLING	1

(Installation includes site survey, quotation for extensive wiring if required, installation of cards in systems, network configuration and full testing)

MAINTENANCE



ISC now offer ON SITE 24 HOUR response support on all the products we supply using our own qualified staff.

As with all our services we GUARANTEE the LOWEST prices and the HIGHEST level of support.

We also will contract equipment not originally supplied by ourselves – example pricing below.

PRODUCT	CONTRACT PRICE	RESPONSE
TANDON PCA 20	180 PER ANNUM	24 HOURS
EPSON FX1000	53 PER ANNUM	24 HOURS
PEGASUS ACCOUNTS	0 BI ANNUAL	HOTLINE

As a guide, allow 10% of the RRP for contracts



U.K.'s BEST SERVICE



Head Office:

**FORRESTER HOUSE
BRAMLEY ROAD,
ST IVES
CAMBRIDGESHIRE
PE17 4WS.**



**HOT LINE (16 lines)
0480 300530**

SCOTTISH OFFICE:

19 CARDEN PLACE, ABERDEEN AB1 1UQ
TEL: (0224) 639944 (8 LINES)



TRAINING



We offer Introductory or Advanced level training at your premises on a wide range of products some of which are listed below

Pegasus Wordstar Wordperfect Word DBase2/3/ Delta 4 R:Base Dataease Lotus 1-2-3 MSODS Supercalc Symphony Smart Novell Xenix Framework & Hardware Training

Prices are 175 pounds per day for upto 6 people on most courses, call today to discuss your requirements with our training manager

PEGASUS ACCOUNTING



PEGASUS ACCOUNTING (2YRS FREE SUPPORT INCLUDED)

We are the largest independent Pegasus dealer in the U.K. with over 2000 modules installed to date

PEGASUS SINGLE USER 160
MULTI COMPANY WITH 8 MODULE INTEGRATION – THE STANDARD FOR MORE THAN 50% OF COMPUTERISED BUSINESSES IN THE U.K.

PEGASUS SENIOR V3 POA
THE ENHANCED VERSION OF SINGLE USER WITH MULTI CURRENCY, NOMINAL CONSOLIDATION, AND HUNDREDS OF OTHER FEATURES

PEGASUS MULTI USER V3 POA
THE MULTI TERMINAL VERSION OF SENIOR, RUNS ON A VARIETY OF NETWORKS INCLUDING NOVELLE & TOKEN RING

ELITE/ELITE SENIOR 295
COMPREHENSIVE DATABASE WITH THE ABILITY TO READ AND WRITE PEGASUS DATA FILES FOR SPECIAL USES

WORK INVOICING 295
INTEGRATES WITH SINGLE USER FOR COMPLEX INVOICING AND REPEAT BILLING

SUPPORT CONTRACT (PER MODULE) 50
ISC WILL SUPPORT YOUR PEGASUS FOR 2 YEARS EVEN IF IT WAS PURCHASED ELSEWHERE

Also available: Data transfer/Upgrades/
Bespoke Training/Installation

THE  C

IF YOU PROVIDE A CURRENTLY ADVERTISED LOWER PRICE

COMPUTERS



All computers are inclusive of:

DOS keyboard mono screen Hercules graphics serial & parallel ports & full test prior to delivery

TANDON (Pcx=4.77mhz, PCA=6/8mhz switchable & 640K Ram)

PCX10	10MB 360K FLOPPY (No Serial)	695
PCX20	20MB 360K FLOPPY (No Serial)	895
PCA20	20MB 1.2MB FLOPPY	1395
PCA30	30MB 1.2MB FLOPPY	1595
PCA40	40MB 1.2MB FLOPPY	1795
PCA70	70MB 1.2MB FLOPPY	2295

TO REPLACE MONO WITH E.G.A. COLOUR ADD	295
INTERNAL 20mb TAPE STREAMER ADD	595

APRICOT (XEN Xi=8mhz, XD=10mhz, 386=16mhz)

Choice of 1.2mb 5.25 inch or 1.44mb 3.5inch floppy
all Xen computers have WINDOWS as standard

XEN XI20	20MB 512K RAM 80286 GEM	1695
XEN XD20	20MB 1MB RAM 80286 GEM	1995
XEN XD45	45MB 1MB RAM 80286 GEM	2495
XEN 386	30MB 1MB RAM 80386 VP PLANNER	2695
XEN 386	45MB 2MB RAM 80386 VP PLANNER	3495

TO REPLACE MONO WITH PAPER WHITE ADD	145
TO REPLACE MONO WITH E.G.A. COLOUR ADD	750

AMSTRAD (8mhz, 512k Ram standard)
all Amstrad computers have GEM as standard

PC1512DD	TWIN 360K	495
PC1512HD	20MB 360K FLOPPY	845
PC1640SD	360K FLOPPY EGA STANDARD	695
PC1640DD	TWIN FLOPPY EGA STANDARD	795
PC1640HD	20MB 360K FLOPPY EGA STANDARD	995

TO REPLACE MONO WITH C.G.A. COLOUR ADD	165
--	-----

I.B.M. (call for different configurations)

SDD	TWIN 360K 640K RAM	1295
SFD	20MB 360K FLOPPY 640K RAM	1595
ATX	30MB 1.2MB FLOPPY 512K RAM	2995
M30-021	20MB 720K FLOPPY 10MHZ 640K RAM	1695

TOSHIBA (Powerful Portables)

T1100	SINGLE FLOPPY (CLEARANCE SALE)	795
T1200	20MB 80286 PROCESSOR 640K RAM	1945
T3100/10	10MB 80286 PROCESSOR 640K RAM	2395
T3100/20	20MB 80286 PROCESSOR 6400K RAM	2695

L I M I T E D

U.K.s LOWEST PRICE

COMPUTER SYSTEMS

Head Office:

**FORRESTER HOUSE
BRAMLEY ROAD,
ST IVES
CAMBRIDGESHIRE
PE17 4WS.**



HOT LINE (16 lines)
0480 300530

SCOTTISH OFFICE:

19 CARDEN PLACE, ABERDEEN AB1 1UQ
TEL: (0224) 639944 (8 LINES)

We also supply COMPAQ (Deskpro & Portables)
AST (10Mhz EGA systems)
Olivetti & Zenith ranges
Tulip AT Compatibles

PRINTERS

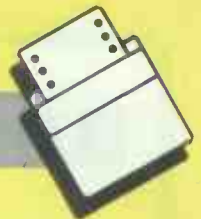

EPSON

80 COLUMN (A4 SIZE)		
LX800	150 CPS 25NLQ TRACTOR	205
FX800	200CPS 50NLQ TRACTOR	305
EX800	300CPS 50NLQ TRACTOR	395
LQ800	180CPS 60NLQ 24PIN HEAD	435

L32 (WIDE LISTING)

FX1000	200CPS 50NLQ TRACTOR	395
EX1000	300CPS 50NLQ TRACTOR	515
LQ1000	180CPS 60NLQ 24PIN HEAD	575
LQ2500	270CPS 90NLQ 24PIN HEAD	795

LASER

CANON LBP SERIES 2 LASER 8 PAGE PER MINUTE	1595
HEWLETT PACKARD SERIES 2 8 PAGE PER MINUTE	1995
EPSON GQ3500 6 PAGE PER MINUTE (HP COMPAT)	1595

OTHER

CANON A55	180CPS 45NLQ 132COL TRACTOR	375
FUJITSU DX2100	220CPS 55MLQ 80 COL TRACTOR	295
FUJITSU DX2200	220CPS 55NLQ 132 COL TRACTOR	395
JUKI 6100	15CPS DAISYWHEEL	275
JUKI 6200	30CPS DAISYWHEEL	425
JUKI 6300	35CPS DAISYWHEEL	635

SPECIALS

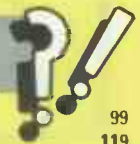

APRICOT 256K RAM	99
APRICOT 512K RAM	119
IBM 256K RAM	119
IBM 512K RAM	139
3.5 INCH 720K DISKS	27
20MB UPGRADE FOR IBM EGA CARD & MONITOR	345
	595

SOFTWARE



PEGASUS SINGLE USER	160
PEGASUS SENIOR V3	POA
PEGASUS MULTIUSER V3	POA
SAGE ACCOUNTANT	120
SAGE ACCOUNTANT PLUS	150
SAGE PAYROLL	85
DBASE3+	415
DBASE2	255
DELTA 4 PROFESSIONAL	335
WORDSTAR PROFESSIONAL V4	205
WORDSTAR V4	190
WORDSTAR 2000 REL 2	259
WORD (MICROSOFT)	270
WORDPERFECT	295
WORDCRAFT	345
LOTUS 1-2-3 V2	249
LOTUS SYMPHONY	359
SMART INTEGRATED V3	395
SUPERCALC 4	225
GRAPHOX LOGISTIX	195
OPEN ACCESS	335
ABILITY	99
ABILITY PLUS	129
VENTURA DESKTOP PUBLISHING	645

5000 other titles available, please call for prices.

WARRANTY

IF WITHIN 7 DAYS, THE DIFFERENCE WILL BE REFUNDED

BACKUP your troubles **£29.95** in your old **CLIP** bag!

CLIP — THE BACKUP PROGRAM STANDARD

The PROBLEM —

Your free backup utility is slow, difficult to use, and can only restore files into ready-made directories.

It does not record its progress — so you backup everything to be safe.

Or nothing because it's such a bore.

CLIP has the longest track record of all backup programs and an enviable reputation for reliable service. Purchasers of 1000+ copies of CLIP include British Telecom, Philips and Ashton-Tate.

Only the best will do for backup.

The SOLUTION —

CLIP keeps a log of its backups, so you can afford to be selective.

It maintains a menu of your customised commands, so you do not have to stop and think. It is fast, and it compresses data.

Result — fewer disks, less time, less effort, no worry, greater security.

- ★ High-speed data compression
- ★ Execute by highly visual Menu or by command line entry
- ★ On-line help at every point
- ★ Can select new files only
- ★ Multiple wildcard select, include or exclude basis.
- ★ Save to any media-floppy, hardcard Bernoulli etc
- ★ Save to remote/network drive
- ★ Restores directories + files
- ★ Recovery after media errors
- ★ Log of all backup operations

For an experimental period, CLIP 4.0L is offered at £29.95, (The previous advertised price was £67.85). Order now and prove that the trial price is the right one for you and us.

Available for PC/XT/AT and compatibles, PCDOS/MSDOS
Price includes VAT and UK postage. c.w.o. or Access



KEELE CODES LTD

University of Keele, Keele, Staffordshire, UK Tel: (0782) 629221 Telex: 36113

Almo Computer Systems

New Number
More Lines
0730 68877

THIS MONTHS SPECIAL : DICONIX - £339

TOSHIBA 24 Pin Head Printers

P321	(216/72cps)	£415
P341E	(216/72cps)	£489
P351	(288/100cps)	£736
P351C	(288/100cps) Col	£988

EPSON Dot Matrix Printers

LX800	(150/25cps)	£201
FX800	(240/40cps)	£307
FX1000	(240/40cps)	£393
LO800	(180/60cps)	£447
LQ1000	(180/60cps)	£597
LQ2500	(270/90cps)	£747
SQ2500	(270/90cps) P/S	£962
EX800	(300/50cps)	£397
EX1000	(300/50cps)	£533

JUKI Daisywheel Printers

6100	(20cps)P	£261
6200	(30cps)P	£388
6300	(40cps)P/S/IBM	£602
6500	(60cps)P	£738

OTC High speed Dot Matrix Printers

850XL	(850cps)P&S	£1515
-------	-------------	-------

DICONIX PORTABLE INK JET

Portable Ink Jet Batt/Main	£339
----------------------------	------

BROTHER D/wheel Printers

HR20	(20cps)P/S	£343
HR25XL	(25cps)P/S	£535
HR40	(40cps) P/S	£766
TwinWriter Daisy/D.Mat		£997

BROTHER Dot Matrix Printers

2024L	(160/96cps) P/S	£612
M1409	(180cps)	£296
M1509	(180/45cps) P&S	£381
M1709	(240/50cps) P&S	£458
M4018	(480/67cps) P&S	£1151

OKI Microline Dot Matrix Printers

182	(120/60cps)P/I	£203
182S	(120/60cps)S	£228
182HS	(H/Speed Ser)	£245
192	(160cps)P/I	£287
192	(160cps)S	£328
193	(160cps)P/I	£372
193	(160cps)S	£417
292	(200/100cps)Col	£446
293	(200/100cps)Col	£595
294	(400/100cps)Col	£816

MICRO P D/wheel Printers

MP26	(26cps) P&S	£197
MP40	(40cps) P&S	£264

CANON Dot Matrix Printers

PW1080A+(160/27cps)	£199	
A55	(180/34cps)	£380
A60	(200/100cps)P	£370
A65	(200/100cps)P	£434

LASER PRINTERS

Canon LBP-8A1 (8pm)P/S*	£1404
Canon LBP-8A2 (8pm-Gr)*	£2612
Canon Series II *	£1580
HP Laserjet	£1456
HP Laserjet 500 Plus (P&S)	£2916
HP Series II	£1910
Epson GQ3500 Laser	£1310
QMS PS800 (Postscript)	£2979
QMS PS800+ (Postscript)	£3528
Citizen Overture 110 P&S	£1260
Brother Laser	£1745
*Excl Toner	

MICRO P Dot Matrix Printers

MP135	(135/27cps) P	£130
MP165	(165/35cps) P	£161
MP200	(200/40cps) P	£245
MP201	(200/40cps) P	£254
MP480	(480/74cps) P	£269

P=parallel, S=serial, I=IBM, col=colour

CITIZEN Dot Matrix Printers

120D	(120/25)P	£133
120D	(120/25)S	£143
LSP10	(120/25)P	£167
LSP10	(120/25)S	£203
MSP10E	(160/40)P	£200
MSP10E	(160/40)S	£220
MSP15E	(160/40)P 136	£234
MSP15E	(160/40)S 136	£254

CITIZEN 24 Pin Head Printers

HPQ45	(200/66)P&S	£533
-------	-------------	------

CITIZEN Daisywheel Printers

Premier 35 (35)P 136	£401
----------------------	------

NEC 24 Pin Head Printers

P660	(216/72)P/I	£379
P665	(216/72)S	£413
CP660	(216/72)P/I Col	£438
CP665	(216/72)S Col	£480
P760	(216/72)P/I 136	£448
P765	(216/72)S 136	£482
CP760	(216/72)P/I 136 Col	£517
CP765	(216/72)S 136 Col	£551
P565XL	(264/88)P&S 136	£736
P960XL	(384/128)136	£963
8800	(55)P/I/S/Diablo 136	£825

Amstrad PC1512 & PC1640 available + Dictaphone 12 months on-site maintenance

Access/Visa/Applec card accepted. All prices are exclusive of VAT. Telephone for prices for other printers and accessories.

Prices correct at time of going to press. Cables from £15 extra. Carriage Printers £8, Laserprinters £15.

Terms cash with order - Mail order only

Phone (0730) 68877 16a College Street, Petersfield, Hampshire. GU31 4AD

CHECK OUR PRICES FIRST



1. Bespoke Software in: 'C', Basic, Database Languages including Dbase II/III, TAS+, DataEase, Psion Archive
2. Professional advice given
3. Competitive Prices
4. Suppliers to PLC's and Government Departments
5. Access and Barclay Cards accepted
6. Open Saturdays 10am-4pm

AMSTRAD PC

NEW MODELS	HERCULES (CGA) (EGA)		
	Mono	Colour	Colour
PC 1640 Single disk	£455	£579	£709
PC 1640 Twin disk	£535	£659	£789
PC 1640 20MB Amstrad Hard Disk	£799	£925	£1059

SPECIAL OFFERS

ON PC 1512's	Mono	Colour
PC 1512 Single disk	£389	£495
PC 1512 Twin disk	£459	£585

*All PC 1512's include Migent Ability and four U.S. Gold Games

AMSTRAD PCW—NEW MODEL
PCW 9512-512K 1x3" Single 720K disk, Daisy Wheel printer, Locoscript II, Mail Merge & Spell Checker **£439**

*Whole range of PCW Software at massive discounts. Please call for details.

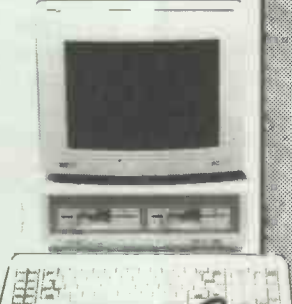

A.S.T.

- * Manufactured in USA * High Quality *
- * 10 MHz Clock Speed * AT Compatible *
- * Complete Desk Top Publishing Systems *

PREMIUM 286	RRP	RTM
Premium 286—Model 120—1MB RAM, 20MB Hard Disk, Mono	£2525	£1750
Premium 286—Model 140—1MB RAM, 40MB Hard Disk, Mono	£2925	£2050
Premium 286—Model 170—1MB RAM, 70MB Hard Disk, Mono	£3325	£2350
Publisher I—Model 140, Turbo Laser, Turbo Scanner, Mouse, Mono	£7495	£5250
Publisher II—Model 140, Turbo Laser, Mouse, Mono	£5995	£4150
Premium EGA Screen extra cost	£400	£279



CARRIAGE

All prices include delivery.
Orders over £79—free next day delivery
Orders below £79—free 1st class post next day £2.50

SOFTWARE

INTEGRATED	RRP	RTM	WORD PROCESSORS	RRP	RTM
ABC (all in one)	£149	£99	Sage PC-Write	£99	69
Ability	£99	£65	DAC Word II	£43	£31
Ability+	£159	£105	Gem Write	£87	£65
Integrated 7	£99	£65	GST First Word	£69	£49
First Framework	£87	£65	Volkwriter 3	£199	£135
Logistix	£99	£69	Volkwriter D/L	£39	£29
Psion PC4	£69	£49	Microsoft Word Jnr	£61	£45
Psion Xchange	£495	£295	SSI Word Perfect Jnr	£86	£65
			SSI Word Perfect Personal	£173	£125
ACCOUNTS			SPREAD SHEETS		
Migent Account Ability	£99	£65	Lotus 123	£395	£229
Sage Accountant	£149	£105	Microsoft Multiplan 3	£175	£114
Sage Accountant+	£199	£135	Microsoft Multiplan Jnr	£61	£45
Sage Bookkeeper	£99	£69	Paperback Vp-Planner	£79	£57
Comsoft Bookworker	£173	£95	SSI Mathplan	£375	£269
Sage Financial Controller	£299	£205	Sage PC Planner	£99	£69
Sage Payroll	£99	£69			
MAP Integrated Accounts	£175	£115	DTP/GRAPHICS		
MAP Complete Accounts	£299	£199	Mirrorsoft Fleet St. Editor	£109	£75
MAP Payroll	£99	£69	Xerox Ventura VII	£795	£465
TAS Accounts	£499	£359	Autosketch	£79	£56
TAS Accounts—Advanced	£799	£575	TurboCad (Full Version)	£325	£229
DATABASE			TurboCad Jnr	£86	£59
Space Retrieve	£99	£69	Delta Graph	£61	£39
TAS+ Latest Version	£99	£69	Sage DTP	£300	£145
TAS+ Developer	£199	£139	Fantasy	£69	£49
TAS+ Developer Multi-User	£349	£249			
Rbase 5000	£295	£205	NEW		
First Software dbase II	£99	£65	SSI Word Library	£147	£105
Coxton Card Box	£52	£35	Sage Desk Set	£69	£49
Comsoft Delta 4.3R	£87	£59	Sage PC Chart	£99	£69
Sapphire DataEase	£545	Call	Network Microsoft		
TSI DAC-Base	£49	£35	Word	£795	£569
SSI Data	£195	£139	Multiplan 3	£395	£289
Paperback Vp-Info—Multi-User	£79	£57	Rbase V	£545	£379
			Project	£595	£429
COMMUNICATIONS			No license unlimited users/server.		
Sage Chit Chat	£99	£69			
Datsoft Datatalk	£150	£109			
Gem Camm	£62	£45			

PERIPHERALS

PRINTERS	RRP	RTM	MODEMS	RRP	RTM
AMSTRAD			PACE		
Work on PC Compatibles Parallel Interface *Best value*			*British Built* High Quality* Superb Value*		
DMP 2000 80 Column 105 CPS, Tractor Feed	£138	£129	Nightingale V21, V23, Manual	£86	£79
DMP 3000 80 Column 105 CPS, 26 NLQ, IBM/Epson Compatible	£169	£139	Linet V21, V23, Autodial/Answer	£142	£115
DMP 4000 136 Column 200 CPS, 50 CPS NLQ, IBM/Epson Compatible	£349	£285	Series 4 21235 V21, V23, Multispeed	£265	£210
			Series 4 12005, V21, V23, V22 1200	£399	£319
			Series 4, 24005, V22, 815	£499	£389
PANASONIC			Pace/Amstrad Modem Card & Datatalk Software—works on PC & Compatibles	£149	£129
British Built					
PI081 80 Column 120 CPS, 28 CPS NLQ, Tractor	£245	£195	**Special Offer Sage Chit Chat & Linnet Modem £179**		
PI595 136 Column 240 CPS, 51 CPS NLQ, Tractor	£695	£459	CITIZEN		
PI592 136 Column 180 CPS, 38 CPS NLQ, Tractor	£495	£395	*2 Year Warranty* Superbly Engineered*		
			1200 & Parallel Interface 120 CPS, 40 CPS NLQ	£229	£135
LASERS			MSP-10E 160 CPS, 40 CPS NLQ, Tractor Feed	£349	£225
Citizen Overture 110 Laser 10ppm IBM/Diablo	£1995	£1329	MSP-15E 160 CPS, 40 CPS NLQ, Tractor Feed—Wide Carriage	£449	£259
A.S.T. Laser 8ppm & 12 months on site warranty	£3250	£2279	DWP 35 35 CPS Daisy Wheel, RK Buffer	£680	£449
IBM/Diablo	£2195	£1679	HQP45 200 CPS, 66 CPS NLQ, 24 Wire Print	£795	£599
Canon LP8 II 8ppm	£1495	£1079	Head S&P Interface		
AST Turbo Scanner					
TEAC EXTERNAL TAPESTREAMER 22MB, backs up 20MB in 4 minutes	£499	£429			

R.T.M. SYSTEMS

Tel: 0772 58099 (24 hours)
Telex: 265871 Monref G Quote
"Ref Mag 31520" as first line of text.

27 Bold Street,
Preston PR1 7NX

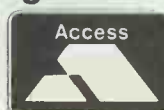

Please add VAT—All prices subject to change without notice and goods subject to availability.

ATT peripherals

CORPORATION

SPECIALISTS IN EXPORT

PRINTERS

EPSON LX 800	£205	NEC P5	£799
EPSON FX 800+	£305	NEC P6	£425
EPSON FX 1000			£395
EPSON EX 1000			£515
EPSON LQ 1000			£575
EPSON LQ 2500			£765
BROTHER HR20			£355
BROTHER HR25 XL			£532
BROTHER M1509			£385
BROTHER M1409			£299
BROTHER TWINWRITER			£975
FULL RANGE OF SIEMANS PRINTERS AVAILABLE			

MODEMS

HAYES SMART MODEM	£360
DOWTY QUATRO	£612
DOWTY MINIMO + 2	£209
DACOM DSL 2123	£172
MIRACLE WS2000	£105
PC COMMS QUATROCARD	POA
RACAL MILGO	POA
THORN DATATECH	POA
PACE SERIES IV	POA

MONITORS + ADD-ON BOARDS

NEC MULTISYNC	£544
SONY 10" COLOUR	£495
TAXAN EGA	£418
INTEL INBOARD 386	£1260
ORCHID JET 386	£740
AST PREMIUM/RAMPAGE	POA
HERCULES MONO	£199
HERCULES COLOUR	£105

DRIVES + TAPE BACK UP

SEAGATE 20Mb ST225 Inc WD Cont	£372
SEAGATE 30 Mb ST238 + Cont	£504
SEAGATE 40Mb ST251	POA
RODINE	POA
EVEREX INT 20 Mb T/S	£665
EVEREX INT 60 Mb T/S	£890
EVEREX EXT 20 Mb T/S	£746
EVEREX EXT 60Mb T/S	£970

MOUSE DEVICES + SOFTWARE

MS MOUSE	£142
PC MOUSE	£130
LOGIMOUSE	£76
SUMMA MOUSE	£89
MS WORD	£245
DB3+	POA
LOTUS 123	POA
SUPERCALC	POA
MULTIMATE ADV	POA
SMART	POA

LAP TOP COMPUTERS AND ACCESSORIES

NEC MULTISPEED	POA
KAYPRO 200	POA
DRAMS 64K	£1.50
DRAMS 256K	£5.00
DRAMS 128K	£9.00
MATHSCO-PRO 80287 - 6MHz	£175
MATHSCO-PRO 8087 - 5MHz	£105
MATHSCO-PRO 8087 - 8MHz	£140

SPECIAL OFFERS

PARALLEL PRINTER CABLES	£12.50
EP TONER CART	£74.95

RING NOW: 01-739 4596

ATT peripherals

Corporation Ltd

(T1) INDUSTRIAL UNITS STANWAY STREET LONDON N1 6RY
TEL: 01-739 4596 Telex 895 1182 GECOMSG

CALLERS BY APPOINTMENT ONLY



ATT Corporation Ltd

PRICE GUARANTEE

PROVIDE A WRITTEN LOWER QUOTATION FROM AN AUTHORISED DEALER WITHIN 7 DAYS OF PURCHASE AND THE DIFFERENCE WILL BE REFUNDED!

CALLERS BY APPOINTMENT ONLY "PRICES SUBJECT TO FLUCTUATION. VAT NOT INCLUDED"

SPECIALISTS IN EXPORT

APPLE

MACINTOSH II	POA
MACINTOSH SE 2x800	£1875
MACINTOSH SE 1x800/20MB	£2450
Keyboard for the above	£75
MACINTOSH PLUS	£1550
IMAGEWRITER II	£365
MAC DRIVE 800K	£240
HARD DISK 20Mb	£850
APPLE LASERWRITER	£3400
LASERWRITER PLUS	£3900

PROFESSIONAL DESKTOP PUBLISHING

Apple Mac SE 1 x 800 HD20
Laser/Writer Plus
Two Appletalk Cables
Aldus Pagemaker
Adobe Illustrator
Mac Draw
Mac Paint
Cricket Draw
Microsoft Word

★ **£6995** ★

LASER PRINTER — HEWLETT- PACKARD (SERIES II)

8 Pages per minute
300 DPI
512k RAM to 4 Parallel or Serial Ports
Including Cable Toner

SOFTWARE

Ventura Publishing
Microsoft Word V3

APRICOT

★ SPECIAL ★

XEN XI/512k/20Mb/1.2Mb	£1950
XEN I/1Mb RAM/20Mb/1.2Mb	£2095
XEN XD/1Mb RAM/40Mb/1.2Mb	£2695
XEN 80386/1Mb RAM/30Mb/1.2Mb	£2350
XEN 80386/2Mb RAM/45Mb/1.2Mb	£3150
P/WHITE MONITOR	£280
GREEN MONITOR	£140
MONO CARD	£160
EGA CARD	£299
EGA COLOUR MONITOR	£625

LASER PRINTERS

★ SPECIAL PRICES ★

EPSON GQ LASER 3500	£1195
T.I. OMNILASER MODEL 2015	£4500
CANON LBP SERIES II P&S PORTS	£1575
HP LASER JET	£1450
HP LASER JET II P + S PORTS	£1795
HP LASER PLUS	£2100

products carry a 12 months Full
Guarantee with HOTLINE Phone Support

FINANCE

LEASE RENTAL
CASH
LEASE PURCHASE
HIRE PURCHASE
INSTANT CREDIT (Subject to Status)

RING NOW: 01-729 7033

ATT Corporation Ltd



(TI) INDUSTRIAL UNITS STANWAY STREET LONDON N1 6RY

TEL: 01-729 7033

Telex: 895 1182 GECOMS G

RSC Ltd



(0923) 243301
(24 hrs)
(0923) 241921



Export, Government & Educational Orders Welcome
All enquiries & payments to
RSC Ltd, 75 Queens Road, Watford WD1 2QN
TLX: 265871 MON REF G, REF CJJ128
Tel: Watford (0923) 243301 - 241921
Callers Welcome



All prices subject to change without notice - all goods subject to availability

ALL PRICES EXCLUDE VAT - CARRIAGE FREE

AMSTRAD HARDWARE

Amstrad PCW 8256	£285.00
Amstrad PCW 8512	£379.00
Amstrad PCW 9512	£474.00
Amstrad PC 1512 SD Mono	£375.00
Amstrad PC 1512 DD Mono	£469.00
Amstrad PC 1512 CD Colour	£515.00
Amstrad PC 1512 DD Colour	£610.00
[PC 1512 RANGE INCLUDES - Ability and four U.S. Gold games]	
Amstrad PC 1640 SD/MD Mono	£469.00
Amstrad PC 1640 DD MD	£565.00
Amstrad PC 1640 HD 20/MD Mono	£845.00
Amstrad PC 1640 SD/CD Colour	£610.00
Amstrad PC 1640 DD/CD Colour	£705.00
Amstrad PC 1640 HD 20/CD Colour	£989.00
Amstrad PC 1640 SD/ECD Enhanced	£749.00
Amstrad PC 1640 DD/ECD Enhanced	£845.00
Amstrad PC 1640 HD 20/ECD Enhanced	£1125.00

RSC's OWN COMBINATION

PC 1512 Single Drive Mono with 32MB Card	£645.00
PC 1512 S/D Colour + 32MB Card	£785.00
PC 1512 D/D MONO + 32MB Card	£739.00
PC 1512 D/D Colour + 32MB Card	£880.00
PC 1640 S/D M/D Mono + 32MB card	£739.00
PC 1640 D/D M/D Mono + 32MB card	£835.00
PC 1640 S/D/CD Colour + 32MB card	£880.00
PC 1640 DD/CD Colour + 32MB card	£975.00
PC 1640 SD ECD + 32MB card	£1019.00
PC 1640 DD ECD + 32MB card	£1115.00

HARD DISK & CARDS

Tandon 20Mb Hard Card	£245.00
Tandon 20Mb Hard Disk (with fitting)	£265.00
Miniscribe 32MB Hard Card	£285.00
Miniscribe 32MB Hard Disk (with fitting)	£275.00
Miniscribe 40MB Hard Disk (with fitting)	£375.00

BLANK DISKS



	Per Box	5 or more
TDK M2D D/S/D/D (For PC1512/1640)	£12.00	£11.50
TDK M2 DD DS/D/D (96tpi)	£15.00	£14.00
TDK M2 HD/DS H/D (1.6M H. Density)	£23.00	£22.00
RSK MF 2HD D/S/D/D (3.5 Inch 135tpi)	£24.00	£23.00
TDK MD 2HD D/S/D/D (3.5 Inch H. Density)	£35.00	£34.50

RSC's OWN BRAND

Fully Guaranteed
(With free plastic box as drawing above)

	Per Box	5 or more
RSC RM20 D/S/D/D (For PC1512/1640)	£9.00	£8.00
RSC RM0D (96 tpi)	£11	£10
RSC RM40 (H density)	£18	£16
RSC 3 1/2" D/5 (135tpi)	£18	£16

COMPUTER ADD-ONS

128K Upgrade PC to 640K	£19.50
Maths Co-Processor 8087-2	£135.00
NEV 30 - Replacement 8086	£28.00
Tape streamer - cipher 1525	£375.00
Storage boxes - nibbons - printer tractors sheet feeders - printer stands and free advice PLEASE RING	

DOT-MATRIX PRINTERS

Epson LX86 100 cps/20 NLQ/80 col	£189.00
Epson LX800 (NEW - LATEST)	£194.00
Epson LQ800 180 cps/60 NLQ/80 col	£435.00
Epson LQ1000 180 cps/60 NLQ/132 col	£570.00
Epson EX800 300 cps/50 NLQ/80 col	£384.00
Epson EX1000 300 cps/50 NLQ/136 col	£515.00
Epson FX800 200 cps/50 NLQ/80 col	£305.00
Epson FX1000 200 cps/50 NLQ/80 col	£399.00
Epson LQ2500 270 cps/90 NLQ/136 col	£699.00
Epson SQ2500 Ink Jet	£985.00

UMP4000 136col - 200cps F/T 50 NLQ	£275.00
DMP3160 80col - 160cps F/T NLQ	£156.00
Canon PW1080AI 160 cps/27 NLQ/80 col	£234.00
Canon A55 180 cps/45 NLQ/132 col	£399.00
Canon A60 200 cps/100 NLQ/80 col	£399.00
Canon A65 200 cps/100 NLQ/132 col	£491.00
Star NL10 120CPS/30nlq/80col	£189.00
Star NX15 120CPS/30nlq/136col	£288.00
Star NB24-10 24pin/216cps/72nlq/80col	£415.00
Star NB24-15 24pin/216cps/72nlq/136col	£525.00
Star NB15 Same as above but 300cps	£595.00
Panasonic KX-P1081 120 cps/24 NLQ/80 col	£149.00
Panasonic KX-P1592 180 cps/38 NLQ/136 col	£343.00
Panasonic KX-P1595 240 cps/51 NLQ/136 col	£450.00
Panasonic KX-P1082 160cps/160 NLQ col	£199.00
MP 135 135 cps/27 NLQ/80 col	£147.00
MP 165 165 cps/35 NLQ/80 col	£173.00
MP 200 200 cps/40 NLQ/80 col	£235.00
MP 201 200 cps/40 NLQ/132 col	£275.00
MP 480 480 cps/74 NLQ/80 col	£369.00
NEC P6	£389.00
NEC P7	£447.00
JUKI 5520 COLOUR	£335.00

DAISYWHEEL PRINTERS

Panasonic KX-P3131U 17cps (recommended)	£240.00
Micro-P 26 26cps	£225.00
Micro-P 40 40cps	£330.00
Juki 6100 20 cps	£257.00
Juki 6200 30 cps	£417.00

LASERS

Epson GQ3500 (latest)	£1345.00
Canon LBP 8 Mark II	£1795.00
HP Laser Jet II	£1945.00

PLOTTERS

Epson Hi80	£350.00
Roland DX7 880A	£649.00
Roland 980A	£950.00

DATA SWITCHES

A range of High quality data switches in Centronics or RS232 Interface Rotary type with steel cases for durability

RSC DSC1 - (Parallel) (2 Device T switch - 3 female connections)	£34.00
RSC DSC2 - (Parallel) (4 Device T switch - 5 female connections)	£52.00
RSC DSR1 - (Serial) (2 Device T switch - 3 female connections)	£30.00
RSC DSR2 - (Serial) (2 Device T switch - 5 female connections)	£44.00

COMMUNICATIONS FOR ALL PC'S

Amstrad Pace Card Modem for PC & Compatible

Datataik (software included)	£138.00
GemComm (Software)	£58.00
Miracle WS4000 V21/V23	£156.00
Sage Chit Chat Software	£69.00
Sage Chit Chat Pack (with Pace modem)	£182.00
Sage Chit Chat Pack 2 (including V22 AA/AD modem)	£475.00
Sage Chit Chat Pack 3 (including V22 Big AA/AD modem)	£585.00
Linnet V21/V23 auto	£129.00

SPECIAL OFFERS

Brother Twinwriter	£875.00
Cherry Digitiser (NEW ONE)	£399.00

RSC'S OFFER

- ★ PC 1640 ECD 20 MB ★
- ★ EPSON GQ 3500 ★
- ★ Ventura Publisher ★
- ★ All for £2999 ★

CLASSIC RANGE

Lotus 1-2-3 Ver 2.1	£230.00
Lotus Symphony	£330.00
dBase III Plus	£399.00
Supercalc 4	£199.00
Wordstar 2000 Ver 2	£228.00
Framework II	£330.00
Javelin	£395.00
Wordstar Professional V4	£235.00
Word Perfect V4.2	£249.00
Microsoft Word	£249.00

PC & COMPATIBLE SOFTWARE

Lotus 1-2-3 Ver 2.1	£230.00
Lotus Symphony	£330.00
dBase III Plus	£399.00
Supercalc 4	£199.00
Wordstar Professional	£235.00
Framework II	£330.00
Javelin	£395.00
Wordstar Professional 4	£235.00

PROGRAM DEVELOPMENT

Turbo Pascal	£55.00
Turbo Tutor	£25.00
Turbo Editor Toolbox	£41.00
Turbo Graphix Toolbox	£41.00
Turbo Prolog	£55.00
Turbo Basic	£55.00
Turbo Lightning	£55.00
Turbo Word Wizard	£41.00
Reflex (the analyst)	£78.00
Sidekick (Barland)	£55.00
Travelling Sidekick	£450.00
Quick Basic Compiler (Microsoft)	£69.00
Learning DOS (Microsoft)	£26.00
MS-DOS Users Guide	No VAT £60.00
MS-DOS Prog Ref	No VAT £60.00
Zorland C-Verstion 2	£26.00
Zorland Powerpack	£52.00
Zorland Linker	£18.00
Turbo C	£63.00
Turbo Eureka	£55.00

INTEGRATED

Able One	£67.00
Ability	£67.00
Ability Plus	£120.00
Pision-Four	£54.00
Logistix	£87.00
First Framework	£69.00
First Choice	£130.00
ABC	£115.00

ACCOUNTS

Sage Bookkeeper	£72.00
Sage Accountant	£110.00
Sage Accountant Plus	£150.00
Sage Payroll	£70.00
Sage Fin. Controller	£240.00
DAC - Easy Accounting	£60.00
Ability Accounts	£79.00

DATABASES

Sage Retrieve	£72.00
Tas +	£60.00
VP Info	£67.00
PC Promise (Full Version)	£45.00
Cardbox	£38.00

WORD PROCESSING

Sage PC Write	£69.00
Wordsstar 1512 (Amstrad)	£46.00
Word Perfect Junior	£73.00
Word Perfect Personal	£155.00
Volkswriter 3	£160.00
Gem 1st word	£55.00

SPREADSHEETS

Supercalc 3 (Amstrad)	£46.00
Multiplan Jnr	£30.00
VP PLANNER	£67.00
Words & Figures	£78.00
Microsoft Multiplan	£130.00
Sage PC Planner	£72.00

DESKTOP PUBLISHING

Fontosy	£59.00
Fleet Street Editor	£39.00
Printshop	£26.00
Ventura Pub.	£595.00
Turbo Cad	£75.00
Autosketch	£59

GENERAL & GRAPHICS

Gem Draw	£69.00
Gem Graph	£69.00
Delta Graph	£52.00
Norton Utilities 4.0	£55.00
Gem WordChart	£69.00
Gem Font Editor	£73.00
Flying Start	£52.00
Portex	£82.00
Microsoft Windows	£59.00
VP Expert	£67.00
Copy II PC	£29.00
Microsoft Mouse (sem)	£139.00
Sharemaster	£99.00
Sideways	£42.00

COMPUMART

WATFORD (0923) 55633



Our prices are so consistently competitive that we've usually undercut them by the time they appear in print. Phone us direct and we'll give you the best prices on the day.

We offer:

- ★ Competitive prices
- ★ Wide range of Hardware & Software
- ★ All Equipment fully tested
- ★ Huge stocks
- ★ Rapid delivery

★ **A Number One Service from the Number One Company**

New and ex-rental equipment available

★ Phone for details ★

EX DEMO

COMPAQ PORTABLES

Portable Plus (128K RAM, 360K + 10Mb Disks)	£1595.60
Portable II Model 1 (256K RAM, 360K Disk)	£1595.60
Portable II Model 3 (640K RAM, 360K + 10Mb Disks)	£2203.30

TOSHIBA

T3100 (640K RAM, 720K + 10Mb Disks)	£2196.70
T1100 (256K RAM, 720K Disk)	£986.70

IBM ATE (512K RAM, 1.2Mb + 20Mb Disks) With Keyboard	£1958.60
IBM PCXTDD (256K RAM, 2x360K Disks) With Keyboard	£1064.00
IBM PCXTFD (256K RAM, 360K + 10Mb Disks) With Keyboard	£1198.00
IBM Mono Monitor with controller	£228.00
Phillips Green Monitor with Hercules Card	£210.00
Compaq Deskpro 286 Model 2 (640K RAM, 1.2Mb + 20Mb Disks) with Dual-mode Monitor and Keyboard	£2294.80
Olivetti M19 (256k RAM, 2 x 360k Disks)	£831.45

PRINTERS

HP Laserjet (8ppm)	£1397.00
IBM Quietwriter Model 1 (60cps)	£752.00
Olivetti DM580 (192cps/40cps)	£974.20
Brother M1409 (180cps/45cps)	£285.30
Epson FX80 (80 col/160cps/32cps)	£315.20
Epson JX80 (Colour/160cps)	£390.00
Epson FX105 (160cps/32cps)	£398.00
NEC P560 (264cps/88cps NLQ)	£685.00
NEC P560 Serial (264cps/88cps NLQ)	£765.00

All prices include Printer Cable

We hold stocks on all the following:-

COMPUTERS

IBM
Olivetti
Compaq
Toshiba

PRINTERS

NEC
Epson
Toshiba
HP

SOFTWARE

Database
Spreadsheet
Word Processing
Graphics

Modems, Tape Backup, Monitors, Hardcards & Consumables

Details given in this advertisement may be subject to change without notice

Service just a telephone call away!

Please ring now for an immediate response and today's prices

Prices exclude VAT & Delivery. All orders are subject to C.W.O.



In today's hi-tech world, most hardware and software houses are talking about computer speed. But in reality most run at a pace very similar to that of our dear friend illustrated.

Terrific.

As you're powering your way through a Lotus, I, II, III programme you may be wanting to interrupt and move to Sidekick. Press the keys, sit back and wait.

And wait.

And wait. (You could have made a cuppa by the time it flashes up.)

At Dackombe and Company we believe you shouldn't have to do any waiting at all. Ever. That's why we've integrated DSC into all of our top-of-the-line computers.

So what's DSC?

It actually stands for Dynamic Speed Control (the name of our subsidiary company) and it works in a similar way to the automatic transmission in your car. You want power, you put your foot down. The car changes gear and bingo! Maximum speed and engine performance.

Running at full speed

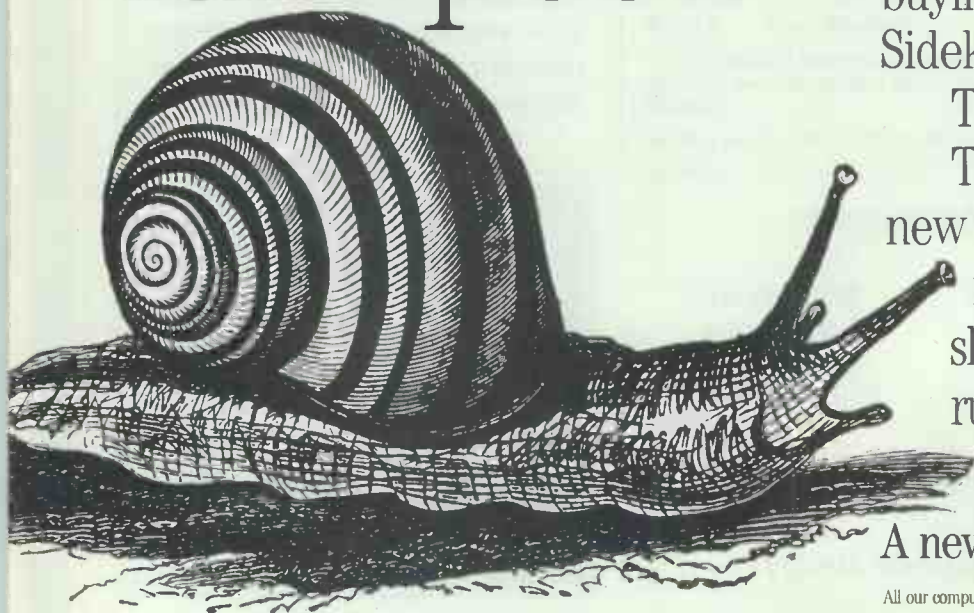

DSC technology offers the same automatic speed switching while the computer is running.

So when you're in Lotus 1, 2, 3 and you want to find out who's buying you a pint after work on Sidekick. Easy! Press the keys.

There you are. Bob's buying. Take a closer look at our new range of computers at your nearest dealer. And he'll show you what we mean by running at full speed.

DSC
DYNAMIC SPEED CONTROL

A new breed of computer technology

All our computers are guaranteed for one year if purchased through an authorised dealer.

Dealer Enquires Invited DSC PO Box 5305, GPO Hong Kong

Dynamic Speed Control (DSC) is a wholly owned subsidiary of J. A. Dackombe & Co. Ltd., A British owned and managed company.
Dynamic Speed Control Business Reg. No. 10160927-001-12-86-8 J. A. Dackombe & Co. Ltd. Business Reg. No. 10160927-000-12-8

OPTIMUM TECHNOLOGY

MORE THAN JUST LOWER PRICES

LISTED BELOW IS JUST A SELECTION FROM OUR WIDE RANGE OF PRODUCTS — AVAILABLE IN A WIDE RANGE OF FORMATS — PLEASE CONTACT US WITH YOUR REQUIREMENTS

OPTIMUM



NOVEMBER'S OPTIMUM CHOICE

- **MICROSOFT MOUSE**
SPECIAL OFFER — £129
— the best? The hi-resolution 200 dots per inch original. Includes FREE Show Partner with complete set of tools for royalty-free presentations, Microsoft Paintbrush, Expert Menu, computer-based-training etc.
- **SPARK — THE LAPTOP!**
Ask for full details on this low cost yet high quality Japanese portable from Interquadram — from only £750!!!
- **LOTUS METRO £65**
— the essential 'sidekick' for all 1-2-3 users — memory resident — includes appointment book, calculator, DOS Manager, Macros, Notepad, Editor, Clipboard etc. etc.
- **FASTBACK V5**
— not the cheapest but certainly the best and fastest hard disk backup facility — uses standard floppies — no hardware required. Backs up hard disks in minutes.
- **FREE SHORTFORM CATALOGUE** on request.
- **FREE DATAPAKS** on items of interest.
- **FREE 'OPTIMUM SPREAD' GAME WITH EACH ORDER**
(5 1/4" IBM Format — while stocks last — other gifts may be substituted at our discretion.)

WORD PROCESSORS

Lotus Manuscript	£259
Multimate Adv. II (NEW!)	£295
Samna Word IV	£395
Volkswriter Deluxe	£39
MS Word - Microsoft	£245
Word Perfect 4.2	£239
Word Perfect Library V1.1	£124
Wordstar Prof. V4 (NEW!)	£199
Wordstar 2000 PLUS Rel 2	£249

DATABASES

Cardbox Plus V3.5	£245
Delta Professional V4.3	£345
dBase-III Plus V1.1 (unprot.)	£395
Clipper (new version)	£369
Foxbase Plus	£369
Geniffer V1.01 app. gen.	£229
Paradox V1.11 - new low price	£275
Paradox V2.0 (NEW!)	£369
O & A V2 (inc. spell. chk.)	£225
Rbase-5000	£245
Rbase SYSTEM-V	£445

SPREADSHEETS

Javelin - new low price	£95
Logistix V1.18 - new low price!	£95
Lotus 1-2-3 V2.01	£235
Lotus HAL/Metro	£98/£65
Lotus Report Writer	£69
Plan Perfect	£295
Multipan V3.02 (NEW!)	£139
Supercalc-4 V1.1	£219

INTEGRATED PACKAGES

ABC	£139
Ability/Ability Plus	£79/£154
Account-Ability	£96
PFS: First Choice Inc. Spell Chk	£119
Framework-2 V1.1 (unprot.)	£325
Smart-3.1	£395
Smart Spell Checker	£89
Symphony V1.2	£329
Pision Xchange	£245
Pision PC-Four	£65

SPARK LAPTOP

Hi-Value IBM Compatible Portable from Interquadram

SPARK options include single or dual 720K 3.5" disc drives, 384K or 640K Memory, LCD or EL-Backlit LCD Display.

SPK-3841 1 x 720K/384K/LCD	£747
SPK-3842 2 x 720K/384K/LCD	£896
SPK-6401 1 x 720K/640K/LCD	£843
SPK-6402 2 x 720K/640K/LCD	£994
SPK-3841EL 1 x 720K/384K/EL-LCD	£843
SPK-3842EL 2 x 720K/384K/EL-LCD	£994
SPK-6401EL 1 x 720K/640K/EL-LCD	£937
SPK-6402EL 2 x 720K/640K/EL-LCD	£1088

Options:
5 1/4" external disc drive £168
Rechargeable Standard Battery £35
Rechargeable Hi-Capacity Battery £57
Carry Case £39
NOTE: Please add £10 & VAT for above.

MISCELLANEOUS

CAD/Graphics/Utils/Lang. etc

Autosketch (Autodesk)	£69
COPY II PC	£47
COPY II PC Option Board	£89
FastBack V5.14	£159
Gem Collection	£89
GEM Draw Plus — (NEW!)	£163
GEM Graph	£145
Hard Disc Optimiser	£39
Harvard Graphics	£289
Intelligent Backup V2.1 (NEW!)	£79
LOTUS FREELANCE PLUS	£279
Logitech Modula-2	£74/£165
MS C Compiler	£249
MS Flight Simulator V2.13	£39
MS Macro-Assembler	£115
MS Project	£225
MS QUICKBASIC V3 (NEW!)	£75
MS WINDOWS	£69
The Newsroom	£49
Norton Utilities V4 (NEW!)	£69
Norton Advanced Utils (NEW!)	£99
Norton Commander	£55
Norton Editor	£87
ProDesign-2 V2.5	£238
Sideways V3.1	£43
SOZ1 Lotus Compressor V1.53	£55
WordPerfect Library V1.1	£124
Xtree V2	£47

DTP

Aldus Pagemaker V1.0A	£525
Gem Desktop Publisher	£275
PageAbility - Migent (NEW!)	£189
Ventura Publisher V1.1	£595

BORLAND

EUREKA: The Solver	£65
REFLEX-UK (NEW)	£129
Reflex Workshop	£59
Sidekick (unprotected)	£59
Travelling Sidekick	£59
Sidekick & T/Sidekick	£79
Superkey	£59
Turbo Basic (NEW!)	£65
Turbo C (NEW!)	£79
Turbo Prolog V1.1	£54
Prolog Toolbox (NEW!)	£59
TURBO PASCAL (inc. 8087)	£55
Turbo Database Toolbox	£44
Turbo Editor Toolbox	£42
Turbo Gameworks	£42
Turbo Graphix Toolbox	£39
Turbo Numerical Toolbox	£67
Turbo Tutor V2	£28
Turbo Holiday Jumbo Pk	£175
Turbo Lightning	£59
Word Wizard	£42

COMMUNICATIONS

Our Free communications consultancy means that you can simply telephone or write for free datapaks and/or advice on modems and software.

Modems: All modems are Auto-Dial/Auto-Answer and BABT approved. Baud rates are V21=300/300 V23=1200/75 V22=1200/1200 V22bis=2400/2400.

We also supply modems from Dowty/Racal/Tandata/Steebek/Dacom/PC at best prices.

IBM PC Modem Cables	£15
Modem Cables for other computers	£23
DACOM SYSTEMS (internal cards - all include Datatalk software)	
Unity V21/23	£299
Unity Gold V21/V22/V23	£389
Unity Quad V22bis/V22/V21/V23	£589
DATAFLEX DESIGNS	
Stradcom V22/V21 internal & software	£189
MIRACLE TECHNOLOGY	
WS SERIES — EXTERNAL	
WS4000 V21/V23 (Economy)	£149
WS3000 V21/V23 Professional Series	£259
WS3000 V22 (& V21/V23)	£395
WS3000 V22BIS (& V22/V21/V23)	£545
Datatalk with WS Modems	£80
PACE SERIES-4/LINNET — EXTERNAL	
Pace Linnet V21/23 (Economy)	£139
Series-4 2123S (V21/V23)	£229
Series-4 1200S (V22/V21/V23)	£359
Series-4 2400S (V22bis/V22/V21/V23)	£449
HAYES 1200 V22/V21/V23 (NEW!)	£395
HAYES 1200B V22/V21/V23 (internal NEW!)	£375
HAYES 2400 V22bis/V22	£595
TD400 Teletext Card (NEW!)	£269

Comms Software:	
Carbon Copy Plus (each)	£137
Crosstalk-4 (NEW!)	£149
Crosstalk XVI	£99
Datatalk	£133
Sage Chit-Chat - special offer	£69
Smartcom-III V1.0A - NEW!	£139
Vicom with GEM Desktop	£139

SAGE

All Sage products available at best pricing

Financial Controller	£225
Bookkeeper	£84
Accountant	£118
Accountant Plus	£159
Payroll	£82
Retrieve	£82
Chit-Chat - Special Offer	£69

HARDWARE

Hercules Graphics Cards	CALL
Logimouse C7+ (PC or AT)	£94
Logimouse - Bus (NEW!)	£109
MS Mouse - Bus, Serial or PS2	£129
Orchid Tiny-Turbo 286	£385
EGA Wonder Card (NEW!)	£249
Vega Deluxe Auto EGA	£239

YES!

PLEASE RUSH ME
 The following good(s):

A FREE Datapak on:

A FREE shortform Catalogue.

I enclose £ _____ inc. carriage/VAT

My credit card number is



Signature _____

UK Carriage: Most items add £5 + VAT
Express/dBase/Smart/Spark/Modems please add £10 + VAT

Name _____

Address _____

Phone No. _____

OPTIMUM TECHNOLOGY LTD

Rowlandson House, 289-293 Ballards Lane, Finchley, London N12 8NP

Sales Desk: 01-446 2223

Telex: 923729 (Roland G) Fax: 01-446 1963

PLEASE ADD CARRIAGE, THEN VAT TO ALL PRICES

The above is a sample of the goods we supply — please ask for latest shortform catalogue. We welcome official PLC/Govt./Educational/Local Authority and Export orders. Pro-Forma invoices available on request. Above software is in IBM 5 1/4" format — please enquire for other formats. Prices/specifications subject to change without notice. Please phone to arrange demonstrations or to collect goods.

QUOTE: "KIRKLANDS ARE SELLING PRINTERS FOR LESS" THAN DEALERS CAN BUY THEM: PC DEALER 10 JUNE 1987. YES, WE ARE BACK, WITH A LARGER RANGE OF PRINTERS AT BETTER THAN EVER PRICES, LOOK AT THESE:

STAR

Product No.	
XS1 NL-10 (including Interface)	£175
XS2 NL-10 (including serial I/f)	£205
XS3 NX-15 (parallel)	£275
XS4 ND-15 (parallel)	£335
XS5 NR-15 (parallel)	£410
XS6 NB-24/10	£405
XS7 NB-24/15	£515



120cps (30cps NLC)
Bi-directional logic seeking
9pin print head. 5Kb standard buffer, full front panel control, push tractor, single sheet feed.

To order either: Ring 0782.744700, ask for Paul and quote your Access: Visa number or fill in the order form below.

EPSON

Product No.	
XE8 LX800	£193
XE9 FX800	£295
XE10 FX1000	£380
XE11 EX800	£380
XE12 EX1000	£510
XE13 LQ800	£420
XE14 LQ1000	£570

AND EVEN CHEAP LASERS

Product No.	
XL15 Epson GQ 3500	£1320
XL16 Canon LBP 8 Series 2	£1575
XL17 QMS K8 (inc. toner)	£1380
XL18 QMS PS800 (postscript)	£2895

POSTSCRIPT UPGRADE

XL119 (for any Canon engine)	£1810
------------------------------	-------

Also available, Oki, Brother, Qume, Kyocera etc., We also have a large range of cables available. Call us on **0782 744700** to discuss your requirements.

All prices quoted are exclusive of carriage and VAT. These prices only apply to mail order custom.

NOW YOU'VE SEEN THE PRINTERS, JUST LOOK WHAT'S ON OFFER IN THE PC MARKET

THE KBM CANARY SERIES III

Product No.

- K1 PC XFD Comprising:
 1 x 4.7/10MHz Mother board (Baby case)
 1 x 512k RAM
 1 x Mono/Graphic/Printer Card
 1 x Serial Card
 1 x 360k Floppy drive
 1 x TTL Monitor
 1 x Mouse
 1 x User Guide
 1 x Keyboard

Price: £495

K2 as above but with STD case and 2 x 360k Disk drives

Price: £575

K3 as K1 but with 1 x 360k Floppy disk,
 1 x 20Mb Hard disk
 Clock Calendar and battery back-up

Price: £775



As used by Tamworth College, F.E. Halton College, Keele University, South Cheshire College, N.S. Polytechnic, TNT, Staffordshire C. Council, and many, many more satisfied users.

OTHER PRODUCTS

- Product No.
 K4 AT Comprising:
 1 x 6/8/10 MHz Mother Board
 1024k RAM
 1 x 1.2Mb Floppy
 1 x 20Mb hard disc
 1 x Mono/Graphic/Print Card
 1 x TTL Monitor
 1 x User guide
 1 x Keyboard
 1 x Serial-Parallel card

Price: £1195

Product No.	
K5 MS DOS & Basic	£55
K6 Second 360k Disk drive	£80
K7 Mouse	£49
K8 EGA card	£125
K9 20Mb Hard card	£270

Other options available. Please ring. All products carry 1 year warranty and on site maintenance available at £50 per unit.

To: Kirklands Business Systems Ltd
 Kirkland House, Lytton Street, Stoke on Trent ST4 1DH
 Tel: 0782 744700
 (Education/Dealer enquiries welcome). Telex: 36393 KBSLTD G.
 Fax: 0782 744566

ORDER FORM

Name
 Address.....
 Tel:.....

ORDER DETAILS	
Product Number	Description
<input type="checkbox"/>
<input type="checkbox"/>
<input type="checkbox"/>
<input type="checkbox"/>
<input type="checkbox"/>
<input type="checkbox"/>

Postage (insured next day) £12 per product. UK mainland only

Acceptable methods of payment: Please tick Cheque
 Access/Visa Number..... Official order (enclosed)
 Cash Other (please specify)
 ALL PRICES EXCLUDE VAT.

COMPUTER PRECISION

TOSHIBA PORTABLE COMPUTERS	
T5100:	80386 16MHz, 2MB RAM, 40MB Hard Disk (29ms) 1.44Mb Floppy, Plasma Display (640x400, EGA,CGA), 80387 Socket, Ser/Par, MS DOS 3.2, 15Lbs.
T3200:	80286 12MHz, 1Mb RAM, 40MB Hard Disk, 720K Floppy, Plasma Display (720x400, EGA,CGA), 2 IBM Expansion Slots, 80287 Socket, Ser/Par, MS DOS 3.2, 18.7Lbs
T3100/20:	80286 8MHz, 640K RAM, 20MB Hard Disk, 720K Floppy, Plasma Display (640x400), Ser/Par, MS DOS 3.2, 15Lbs.
T1200:	8086 9.54MHz, 1MB RAM, 20MB Hard Disk, 720K Floppy, Supertwist LCD, Ser/Par, 8 Hour Battery MS DOS 3.2, 10Lbs
T1100+:	8086 8Mhz, 640K RAM, 2 x 720K Floppy Supertwist LCD Ser/Par, 8 Hour Battery, MS DOS 3.2, 10Lbs
T1000:	8088 4.77Mhz, 512K RAM Exp to 1.2MB, 720K Floppy, Supertwist LCD, Ser/Par MS DOS 2.11 in ROM, 6.5 Lbs
PLEASE CALL FOR THE LATEST TOSHIBA PRICES	

NEC COMPUTER SYSTEMS	
Multispeed	NEC V30 9.54Mhz, 640K RAM, 2 x 720K Floppy, Ser/Par, 6 Hour Battery, Software in Rom MS DOS 3.2, 11Lbs £1295
APC IV40:	80286 8Mhz, 40MB Hard Disk 1.2MB Floppy 640K RAM, Ser/Par, MultiSync Monitor & EGA Card, MS DOS 3.2 £2495
APC IV20:	20MB Hard Disk, rest same as above £2195
TANDON COMPUTER SYSTEMS	
PCA70:	70MB Hard Disk, 1MB RAM 1.2MB Floppy Ser/Par, 14" Mono Monitor, MS Windows MS DOS 3.2, GW Basic £2250
PCA40:	40MB Hard Disk, rest same as above £1795
PCA30:	30MB Hard Disk, rest same as above £1575
PCA20:	20MB Hard Disk, rest same as above £1350
	Tandon Enhanced Monitor & EGA Adapter £310
Zenith	Z181 Laptop 2 x 720 Floppy 640k RAM £1350

MONITORS AND ADAPTERS	
NEC Multisync Monitor	£499
Sony Multiscan Monitor	£625
Taxan Multiscan Monitor	£550
Vega Deluxe Card	£249
ATI EGA Wonder Card	£249
Hercules Mono Graphics Plus.....	£189
Hercules Incolour.....	£290
Wyse WY-700 Monitor.....	£695

DOT MATRIX PRINTERS	
Epson LQ2500 270cps 90nlq.....	£730
Epson LQ1000 180cps 60nlq.....	£575
Epson LQ800 180cps 60nlq.....	£425
Epson EX1000 250cps 50nlq.....	£525
Epson EX800 250cps 50nlq.....	£390
Epson FX1000 200cps 40nlq.....	£385
Epson FX800 200cps 40nlq.....	£305
Epson LX800 150cps 25nlq.....	£195
NEC Pinwriter P6 216cps 72nlq.....	£395
NEC Pinwriter P7 216cps 72nlq.....	£465
Diconix 150 Portable 150cps.....	£335

SOFTWARE	
AbilityPlus.....	£135
Advanced Nortons Utilities.....	£90
dBase 3 Plus v1.1.....	£415
Framework II v1.1.....	£335
Lotus 1-2-3 r2.01.....	£239
MS Multiplan 3.....	£120
MS Word 4.....	£260
Norton Utilities v4.....	£55
SuperCalc 4.....	£205
Ventura Publisher v1.1.....	£595
VP Info.....	£65
VP Planner.....	£65
Word Perfect 4.2.....	£260
Wordstar Professional.....	£235

MOUSE DEVICES	
Microsoft Mouse v6	£135
Mouse Systems PC Mouse.....	£135
Logimouse C7.....	£76
Summouse.....	£89

LASER PRINTERS	
*HP LaserJet 11, 8ppm.....	£1950
Epson GQ-3500 6ppm.....	£1350
Mannesman Tally MT 910.....	£2695
Canon LBP8 MK 11.....	£1695
*AST Turbo Laser 8ppm.....	£2495

BORLAND SOFTWARE	
Turbo C.....	£59
Turbo Basic.....	£49
Basic Telecom Toolbox.....	£55
Basic Editor Toolbox.....	£55
Basic Database Toolbox.....	£55
Turbo Pascal 8087/BCD.....	£47
Pascal Database/Editor.....	£35
Turbo Pascal Tutor.....	£20
Pascal Graphics Toolbox.....	£35
Pascal Gamesworks.....	£30
Turbo JUMBO Pack.....	£155
Turbo Numeric Methods Toolbox.....	£49
Turbo Prolog.....	£47
Turbo Prolog Toolbox.....	£49
Eureka the Solver.....	£49
Reflex.....	£90
Superkey.....	£49
Sidekick.....	£49
Turbo Lightning.....	£49

MATHS CO-PROCESSORS	
8087 5MHz.....	£115
8087 8MHz.....	£145
80287 6MHz.....	£165
80287 8MHz.....	£199
80287 10MHz.....	£275
80287 16MHz.....	£475

(* Inc 1 Year on site Maintenance)

MEMORY BOARDS	
AST Rampage XT 2MB RAM.....	£395
AST Rampage 286 2MB RAM.....	£595
AST Advantage 1.5MB RAM.....	£525
AST RAMvantage 2MB RAM.....	£525
Intel AboveBoard 286 2MB RAM.....	£575
Intel AboveBoard PS/286 2MB RAM.....	£625

COMMUNICATIONS	
WS4000 V21,23 AA AD.....	£145
WS4000 V21,22,23,AA,AD.....	£339
WS3000 V21,22,23 AA,AD.....	£399
WS3000 V21,22,23,22BIS.....	£520
Pace Series 4 V21,22,23.....	£320
Pace Series 4 V21,22,23,22BIS.....	£399
Pace Linnet V21,23.....	£119
Quattro V21,22,23,22BIS.....	£625
Lion Systems ORATOR.....	£695
Procomm 20 Telex Card.....	£695
Stradcom V21,V22 Internal Modem.....	£175

This Page Was Produced Using Ventura Publisher And HP LaserJet II

Official orders are accepted from GOVERNMENT & EDUCATIONAL AUTHORITIES & PLCs. Prices exclude VAT. EXPORT enquiries welcome

AUTHORISED TOSHIBA NEC TANDON DEALER

Comprehensive services include: Consultancy, Demonstrations & Hotline support

 **01-226 3043** 

TELEX 268048 EXTLDN FAX 01-226 7948

COMPUTER PRECISION LTD, 271 UPPER STREET, ISLINGTON, LONDON N1 2UQ

Computers by Post

LOWEST U.K. PRICES GUARANTEED



PRINTER RIBBONS



		2+	5+	12+
ACORN	AP80	£2.70	£2.20	£2.00
	API00	£2.70	£2.20	£2.00
AMSTRAD	DMP1	£3.90	£3.30	£3.10
	DMP2000/3000	£4.40	£4.10	£4.00
	PCWB256/8512	£4.30	£4.00	£3.80
BROTHER	HR5	£3.00	£2.80	£2.60
	HR15 Corr	£2.90	£2.50	£2.30
	HR15 FAB	£3.30	£2.90	£2.60
	HR15 MS	£3.20	£2.80	£2.50
	HR15 also for HR25/HR35			
CANON	EP44	£2.90	£2.50	£2.30
	M1009	£3.40	£2.90	£2.70
	PW1080A Black	£3.10	£2.60	£2.40
	PW1080A Red or Blue	£4.50	£4.10	£3.80
	PJ1080 Ink Jet Colour. One Off			£10.90
	PJ1080 Ink Jet Black. One Off			£8.90
	1515	£2.70	£2.20	£2.00
	1525	£2.70	£2.20	£2.00
	MPS801	£3.60	£3.00	£2.80
	802/1526	£3.70	£2.90	£2.70
CENTRONICS	803	£3.40	£2.90	£2.70
	MPS1000	£2.70	£2.30	£2.10
	4022	£2.70	£2.30	£2.10
	MSC801 Colour. One Off			£18.50
	DPS1101 SS	£2.40	£1.90	£1.75
	DPS1101 MS	£2.90	£2.50	£2.30
	DPS1101 Corr	£1.80	£1.50	£1.40
	GLP 1/2	£3.40	£2.90	£2.70
	120D	£5.00	£4.60	£4.30
	2000 MS	£3.10	£2.60	£2.40
DAISYSYEP	2000 FAB	£4.90	£4.20	£4.00
	MX/FX/RX80 Black	£2.70	£2.30	£2.10
	MX/FX/RX80 Red or Blue	£3.90	£3.20	£3.00
EPSON	100 Series	£3.70	£3.30	£3.00
	LX80/LX86	£2.70	£2.30	£2.10
	LX80 Colour. One Off			£18.50
	LQ800	£3.70	£3.30	£3.10
JUKI	LQ1000	£4.50	£3.90	£3.60
	6000/2200 Corr	£3.10	£2.70	£2.50
	6100 MS	£2.90	£2.50	£2.30
	6100 SS	£2.40	£1.90	£1.75
KAGA	6100 Corr	£1.80	£1.50	£1.40
	KP810 Black	£3.10	£2.60	£2.40
	KP810 Red or Blue	£4.50	£4.10	£3.80
M/TALLY	MT80	£3.70	£2.90	£2.70
	80/82	£1.40	£1.10	£1.00
OKI	84	£3.90	£3.40	£3.20
	Mate 20 Colour	£7.00	£6.50	£6.20
	Mate 20 Black	£6.60	£6.20	£6.00
PANASONIC	Dot Matrix	£5.00	£4.60	£4.30

QUENDATA	DWP1120 MS	£3.10	£2.60	£2.40
	DWP1120 FAB	£4.90	£4.20	£4.00
QUME	Sprint 7/9 MS	£2.80	£2.30	£2.10
	Sprint 7/9 FAB	£4.00	£3.70	£3.40
SEIKOSHA	GP50	£6.00	£5.50	£5.20
	GP80	£2.70	£2.20	£2.00
	GP100/250	£2.60	£2.20	£2.00
	GP500/550	£3.90	£3.30	£3.10
	GP700 Colour. One Off			£18.50
	SP1000	£6.00	£5.50	£5.20
	CP80	£3.70	£2.90	£2.70
SHINWA	Fastext 80 (Twinpack)	£11.70	£11.20	£10.90
	TPI M/S	£12.50	£10.70	£9.95
SMITH	TPI Fabric	£5.70	£5.25	£4.95
	TPI Corr	£5.00	£4.70	£4.50
CORONA	D100/200	£4.80	£4.40	£3.90
	D300	£6.00	£5.50	£5.30
STAR	DP/GEMINI/SG	£1.40	£1.10	£1.00
	SR15	£4.90	£4.50	£4.30
	NL10	£5.00	£4.40	£3.70

DISK STORAGE



MODEL	SIZE	CAPACITY	PRICE
DD40L	3 3/4"	40	£8.50
GS100	3.5"	100	£13.90
DD50	5 1/4"	50	£8.90
DD100	5 1/4"	100	£11.70
LIBRARY CASE	5 1/4"	10	£1.50
NON-LOCKABLE DISK BOXES			
MD12/30	3 3/4"	24	£7.20
MF50	5 1/4"	50	£8.00

COMPUTER STATIONERY



PLAIN WHITE WITH MICRO-PERF EDGES	PRICE			
SIZE	GSM	QUANTITY	1 BOX	2 BOXES
11 x 9 1/2	60	2000	£12.50	£12.00
11 x 9 1/2	70	2000	£15.50	£14.50
EXACT A4	70	2000	£20.90	£18.75
11 1/2 x 9 1/2	90	1000	£13.20	£11.25

LASER PRINTER CONSUMABLES

TONER CARTRIDGES	PRICE
Epson GQ3500	£18.50
Okilaserline 6	£18.50
HP Laserjets	£74.95
HP Laserjet Mk II	£84.95
Canon A1/A2	£74.95
Canon A8 Mk II	£84.95
QMS K8	£74.95
Citizen Overture	£22.95

FLOPPY DISKS



5 1/4"		BOXES OF 10 DISKS		
JVC Inc Plastic Case		1-2	3-9	10+
MD-1D	S/side D/dens 40TR	£9.99	£9.50	£9.25
MD-2D	D/side D/dens 40TR	£11.99	£11.50	£11.25
MD-2DD	D/side Q/dens 80TR	£15.99	£15.50	£15.25
MD-2HD	D/side H/dens 1.6MB	£26.99	£25.99	£25.49
MEMOREX				
MD-2D	D/side D/dens 40TR	£11.99	£11.50	£11.25
MD-2DD	D/side Q/dens 80TR	£15.99	£15.50	£15.25
MD-2HD	D/side H/dens 1.6MB	£26.99	£25.99	£25.49
VERBATIM - DATALIFE				
MD525	S/side D/dens 40TR	£11.60	£11.00	£10.60
MD550	D/side D/dens 40TR	£14.80	£14.00	£13.60
MD577	S/side Q/dens 80TR	£14.99	£14.75	£14.49
MD557	D/side Q/dens 80TR	£19.50	£19.00	£18.60
FUJI				
*S/side D/dens 40TR		£10.99	£10.50	£10.25
*D/side D/dens 40TR		£13.49	£12.99	£12.75
*Coloured Disks - red, green, blue, beige, grey £1.00 per box extra.				
D/side D/dens 80TR		£17.99	£17.50	£17.25
3 1/2"				
JVC	S/side D/dens	£17.99	£17.25	£16.99
SONY/FUJI	S/side D/dens	£18.99	£18.25	£17.99
FUJI/MEMOREX	D/side D/dens	£26.99	£26.50	£25.99
SONY	D/side D/dens	£27.99	£27.50	£26.99
3" DISKS				
CF2 5 Disks		£2.89 each		£14.45 pack
CF2 10 Disks		£2.49 each		£24.90 pack

SPECIAL OFFERS ON DISKS

	PRICES PER 10 DISKS		
	20 disks	50 disks	100 disks
TDK 5 1/4" SS/DD	£8.50	£8.00	£7.50
MAXELL 5 1/4" SS/DD	£8.75	£8.25	£7.75
BASF 5 1/4" SS/DD 40TR	£8.75	£8.25	£7.75
3M 5 1/4" DS/DD	£11.90	£11.50	£11.25
DYSAN 5 1/4" HD/1.6MB	£20.95	£19.95	£17.95
Bulk Disks			
5 1/4" SS/DD 40TR	£6.40	£5.90	£4.80
5 1/4" SS/DD 40TR	£7.40	£6.90	£5.80
5 1/4" DS/DD 80TR	£8.40	£7.90	£6.80
Life time guarantee. Disks include envelopes, labels, hub-rings and write protect.			
3 1/2" DS/DD	£18.80	£17.80	£16.80
Life time guarantee.			

PRINTER CABLES



Amstrad CPC	Parallel	£8.90
BBC	Parallel	£6.50
IBM/Amstrad PC/Atari ST	Parallel	£14.50

PRINTERS

Epson LX800	£186.95
Epson FX800	£294.95
Epson FX1000	£379.95
Epson EX800	£384.95
Epson EX1000	£509.95
Epson LQ800	£399.95
Epson LQ1000	£525.95
Epson LQ2500	£678.95
Epson GQ3500 Laser	£1259.95
Amstrad DMP3160	£174.95
Amstrad DMP4000	£299.95
Amstrad LQ3500	£299.95
Citizen LQ20D	£139.95
Citizen LSP10	£159.95
Juki 6100	£269.95
Panasonic KXP1081	£139.95
Star NL10 inc I/F	£179.95
Star NX15	£272.95

LASER

Star ND15	£342.95
Star ND15	£342.95
Star NR15	£412.95
Star NR24-10	£419.95
Star NR24-15	£531.95
Star NR15	£619.95
Epson GQ3500 Laser	£1259.95
HP Laserjet Mk II Laser	£1989.95
Canon LBP8 Mk II Laser	£1599.95
Okilaserline 6 Laser	£1495.95
QMS K8 Laser	£1549.95
Citizen Overture Laser	£1495.95

AMSTRAD 1512

SDMM	£379.95
DDMM	£479.95
Colour Extra	£139.95
20Meg Hard Card Extra	£249.95

AMSTRAD 1640

SD Mono	£479.95
DD Mono	£579.95
20Mb Mono	£869.95
CGA Colour Extra	£139.95
EGA Colour Extra	£279.95

DELIVERY

All consumables and software post free Hardware £5 + VAT 4 Day. £9 + VAT 24 Hour. Laser Printers £15 + VAT 24 Hour.

FAMOUS SOFTWARE BIG DISCOUNTS

MS Word 3	£239.95	Smart	£379.95
Word Perfect 4.2	£239.95	Symphony	£329.95
Word Star	£339.95	Ventura Publisher 1.1	£599.95
Professional V.4	£199.95	Open Access II	£379.95
D Base 3 Plus	£339.95	PFS-1st Choice	£109.95
Lotus 123	£235.95	VP Planner	£59.95
Supercalc 4	£195.95	VP Info	£59.95

EPSON PC'S

PCe 20Meg	£989.95	PC AX2 20Meg	£1379.95
-----------	---------	--------------	----------

COMPUTERS BY POST GUARANTEE If after buying any of the hardware or software in this advertisement, you find the same item offered at a lower price locally within one week, we will refund the difference.

All prices exclude VAT

CREDIT CARD HOT-LINE



01-760 0014

Computers by Post (PCW), 14 Emmabrook Court, Sea Road, Rustington, West Sussex.

Export Enquiries Welcome

To: Computers by Post, 14 Emmabrook Court, Sea Road, Rustington, West Sussex. I wish to order _____

My computer is _____
I enclose cheque/PO for £ _____ inc VAT
or charge my Access/Visa No: _____

Name _____

Signature _____

Address _____

Postcode _____ Tel No: _____



NOW AT
Queens House, 2 Holly Road,
Twickenham, Middlesex TW1 4EG

OLIVETTI M19
256k, 20Mb HD, Monitor, Kbd, DOS £895

01-891 6433

All orders subject to carriage and VAT at 15%

SYSTEMS SPECIALS

FREE PRINTER and CHOICE OF SOFTWARE!*

with all TANDON PCA SYSTEMS.
Includes FREE EPSON FX800 (220cps)
and ANY SOFTWARE PACKAGE WITH
RSP UP TO £400

* As specified

TANDON PCA20 1Mb, RAM, 20Mb HD, Mono Screen, Graphics, P/S Ports, Keyboard Dos 3.1	£1899
TANDON PCA30, 1MB, 30Mb HD	£2099
TANDON PCA40, 1MB, 40Mb HD	£2399
TANDON PCA70, 1MB, 70Mb HD MONO SYSTEMS	£2999
For colour systems	add £220
For EGA systems	add £495

We are NET- WORKING SPECIALISTS

Full consultation, Installation,
Software and System Support,
Hotline and Maintenance Contracts
on **NOVELL NETWORK, G-NET,
TOKEN RING, ARCNET,
ETHERNET.**

Call for consultation.

FREE LASER PRINTER AND CHOICE OF SOFTWARE!*

with all COMPAQ DESKPRO 386
SYSTEMS. Includes FREE HEWLETT-
PACKARD 2686AU LASER-JET
PRINTER, 8 PAGES/MINUTE, and
ANY SOFTWARE PACKAGE WITH
RSP UP TO £400.

* As specified

COMPAQ 386 M40 (16MHz), 1Mb RAM 40Mb HD, Mono Screen, Kbd, P/S Ports, DOS 3.2	£5875
COMPAQ 386 M70 1Mb, 70Mb HD	£6475
COMPAQ 386 M130 1Mb, 130Mb HD	£7969
For colour systems	add £220
For EGA systems	add £395

SOFTWARE TOP 10

LOTUS 1-2-3	£240
WORDSTAR 2000	£220
DBASE III+	£410
SUPERCALC 4	£210
SMART 3	£405
SYMPHONY	£335
MULTIMATE ADVANTAE	£295
MSWORD	£245
DATAEASE	£415
PEGASUS MODULES (SU)	£175
WORDCRAFT	£315

MEMORY

AST Rampage (XT), 2Mb	£395
AST Ramvantage (AT), 2Mb	£495
AST Rampage (AT), 2Mb	£595
Everex Minimagic 128k (AT)	£110

COMMUNICATIONS

IRMA 3270 CARD	£875
IRMA 3279 GRAPHICS	£1475
AST 3270 CARD	£695
SMART ALEX 5250 Emulation	£695
AST 5251 (Local) CARD	£575
QUATTRO CARD V21, 22, 22Bis, 23	£595
PACE SERIES 4, V21, 23, AA, AD, Hayes	£220
HAYES SMART MODEM 1200B	£345

PRINTERS

BROTHER 1109, 120cps, 80 col	£175
BROTHER 1509, 180cps, 132 col	£375
BROTHER 4018, 480cps, 100 NLQ	£1195
NEC P6, 180cps, 80 col	£410
NEC P7, 180cps, 132 col	£495
NEC P5XL 220cps, 132 col	£799

LASERS/PLOTTERS

CANON LBP8 A1 LASER	£1595
EPSON LASER PRINTER, 6PPM	£1395
QUME LASER 10 PLUS, 10PPM	£2095
HP7440 PLOTTER, A3	£775
HP7475 PLOTTER, A3/A4	£1395
ROLAND DXY 880A, A3	£675

SYSTEMS **

OLIVETTI M24, 640k, 20Mb HD	£1195
OLIVETTI M24SP, 640k, 20Mb, (10MHz)	£1595
OLIVETTI M28, 512k, 20Mb, 1.2Mb	£2095
APRICOT XEN Xi, 20Mb, 512k RAM, 1.2Mb	£1795
APRICOT XEN I XD, 45Mb, 2Mb (10MHz)	£2545
APRICOT XEN I 386, 45Mb, 2Mb RAM	£3095
TOSHIBA 1100 Plus, 2x720k FD, 640k	£1495
TOSHIBA 3100 Laptop, 10Mb, 640k	£2595
All TANDON/AMSTRAD Systems	£POA
COMPAQ PORTABLE 3 available now	£POA

**All systems include keyboard, monitor and DOS

ENHANCED GRAPHICS

Paradise Switchable EGA Adaptor	£210
Everex EGA + Card, 256k, Parallel Port	£245
Taxan EGA Compatible Colour Monitor	£399
NEC Multisynch Hi-Res Colour Monitor	£530

HARD DISKS

SEAGATE 20Mb HD with Controller Card	£275
Tandon 20Mb Business Card	£295
Miniscribe 30Mb Hard Card	£395
Tandon 40Mb hard disk (half height)	£495
Tandon 40Mb HD with Controller Card	£575



MIGHTY MICRO

Sherwood Centre
268 Wilmslow Road, Fallowfield
Manchester, M14 6WL



MIGHTY MICRO 061-224 8117

MIGHTY MICRO 061-224 8117

MIGHTY MICRO 061-224 8117

MIGHTY MICRO 061-224 8117

Commodore Amiga

Amiga 500	£ POA
Amiga 500 + colour	£ POA
Amiga 1000	£ 726.00
Amiga 1000 + colour	£ 956.00
Amiga 2000	£1040.00
Amiga 2000 + colour	£1825.00

Atari ST series

Atari 520 STFM	£ 260.00
Atari 520 mono	£ 390.00
Atari 520 colour	£ POA
Atari 1040 STF	£ 521.70
Atari 1040 mono	£ POA
Atari 1040 colour	£ POA
Atari Mega ST2	£ 869.50
Atari ST2 mono	£ 956.95
Atari ST2 colour	£1303.00
Atari Mega ST4	£1330.40
Atari ST4 mono	£1389.95
Atari ST4 colour	£1677.00

Plus lots of Amiga
+ Atari software & books

COMING SOON
ATARI PCS
ATARI LASER PRINTER

Amstrad

PC1512 SD Mono	£ 399.00
PC1512 SD Colour	£ 549.00
PC1512 DD Mono	£ 499.00
PC1512 DD Colour	£ 649.00
PC1640 SD Mono	£ 499.00
PC1640 SD Colour	£ 649.00
PC1640 SD ECD	£ 799.00
PC1640 DD Mono	£ 599.00
PC1640 DD Colour	£ 749.00
PC1640 DD EGA	£ 899.00
PC1640 HD20 Mono	£ 899.00
PC1640 HD20 Colour	£1049.00
PC1640 HD20 EGA	£1199.00

Tandon

PCX + EGA	£1064.00
PCX10 + Mono	£ 625.00
PCX10 + EGA	£ 985.00
PCX20 + mono	£ 999.00
PCX20 + EGA	£1315.00
PCA20 + mono	£1499.00
PCA20 + EGA	£1820.00
PCA30 + mono	£1750.00
PCA30 + EGA	£2055.00

Please call for other models

Amstrad W/P

PCW8256	£ 299.00
PCW8512	£ 399.00
PCW9512	£ 499.00

Opus

Opus System 1	£ 499.00
Opus System 2	£ 599.00
Opus System 3	£ 699.00
Opus System 4	£ 995.00

Zenith

Zenith Z — 181	£1499.00
Zenith Z — 148	£ 637.00
Zenith Z — 148 mono	£ 778.00

Word Processing

WordStar 1512	£ 60.82
WordStar 2000	£ 347.83
WordStar Release 4	£ 295.65
Volkswriter Deluxe	£ 39.12
Word Perfect Jr	£ 66.91

Database Systems

Reflex 1512	£ 60.82
VP Info	£ 86.08
dBASE II (1512)	£ 103.47
dBASE III plus	£ 418.75
Tas Plus	£ 99.00

Financial Software

Supercalc (1512)	£ 60.82
Supercalc 4	£ 250.00
VP planner	£ 86.08
Javelin	£ 410.00

Integrated Packages

Ability Plus	£ 172.50
ABC	£ 172.50
Symphony	£ 490.00
First Choice	£ 149.00
Integrated 7	£ 86.00

Graphic Based

MS-Windows	£ 89.95
GEM Presentation	£ 295.00
GEM Desktop Pub	£ 295.00
Ventura Publisher	£ 795.00
GEM Write	£ 86.91
All GEM products are supported, please call for more info.	
Auto Sketch	£ 69.52
Fleet St Editor	£ 130.34
News Room	£ 34.73

Printers

Epson GQ — 3500 Laser	£1435.00
Juki 6000	£ 174.00
Juki 6100	£ 286.95
Juki 6200	£ 542.50
Amstrad DMP2000	£ 156.48
Amstrad DMP3160	£ 173.87
Citizen 120D	£ 173.04
Citizen MP — 20	£ 286.85
Epson LX-86	£ 199.00
Epson LQ-800	£ 475.00
MP480	£ 320.00
Star NL — 10	£ 216.52
Star NX — 15	£ 325.78
Star NB — 24 10	£ 499.00
Brth Twinwriter	£ 799.00

Printers

Panasonic KX1081	£ 173.00
Panasonic KX1082	£ 216.00
Panasonic KX1083	£ POA
NEC P6	£ 420.00
NEC P7	£ 499.00
NEC P5XL	£ 799.00
NEC P9XL	£1050.00

Modems

WS2000	£ 108.00
WS3000 V21/22b/23	£ 650.00
WS4000 V21/23	£ 149.95
Dacom Unity Int.	£ 349.00
Nightingale	£ 99.00
Linnnet V21/23	£ 135.00
Amstrad PC int.	£ 150.00
GEM Comm	£ 94.95
PMS Dialup	£ 78.21

Monitors

Phillips 7502	£ 78.25
Phillips 7513	£ 104.30
Taxan K12R2	£ 285.00
Phillips 8533	£ 273.85
NEC MultiSync	£ 599.00
Ferguson TV/mon	£ 182.55

IBM add ons

Orchid EGA	£ 191.00
2Mb board empty	£ 147.00
2Mb board full	£ 375.00
256K board full	£ 120.00
Logimouse serial	£ 86.00
Logimouse Parallel	£ 133.00
2XRS232C	£ 45.00

TAPE Streamers

★★ Various ★★
Internal
&
External

PSION
organisers
all models
in stock
PLUS PLUS PLUS
Large range of
Specialist
Calculators

IBM Hard Disks

20 Mbyte + Controller	£ 299.00
30 Mbyte + Controller	£ 322.00
20 Mbyte Hardcard	£ 300.00
30 Mbyte Hardcard	£ 320.00

Now on full demonstration with most of available software.

Desktop Special

Amstrad PC1640 EGA DOUBLE DRIVE

Plus 30 Mbyte Card

Plus EPSON GQ3500 Laser Printer, Gem Desktop Publisher

£2999

Others

We also stock disks, computer books, ROMS, calculators, RAMS and other chips, cables, tape streamers, many printers, a massive range of software and computer consumables.

All prices EXCLUDE VAT.



EXPORT SPECIALISTS

Exported to over 60 countries in 1986

EASY ACCESS

Close to M56, M6, M63 and M602.

BULLETIN BOARD SYSTEM (FIDO and OPUS)

Ring (061) 224 8117 out of shop hours. Use for prices, requests, general messages. P.D. software and so on. Runs at V21 300/300 and V23 1200/75.

MIGHTY MICRO 061-224 8117 MIGHTY MICRO 061-224 8117

Safe Recovery from Disk Crashes

Your hard disk contains vital business files. You need to make a backup copy of your data **frequently** so that if your disk fails today, you are still in business tomorrow.

With **HoldFast** you can back up your data **FAST**, at low cost and great convenience, using the diskette drives you already have. A daily backup typically takes about a minute and can be run with a one-word command. **HoldFast**

- ★ runs **fast**, up to 1+ megabytes per minute.
- ★ runs on **any MS/PC-DOS** since version 2.0.
- ★ backups are indexed for **direct access to files**.
- ★ can use **any diskette**: 3.5", 5.25", 8" or other.
- ★ uses **error correction** to survive diskette faults.
- ★ backups use less space than on your DOS hard disk.
- ★ can backup **just the recently changed files**, for typical daily backup time under one minute.
- ★ includes utilities to search the directories on both your hard disk and your backups.
- ★ uses path and name patterns to select or ignore files and/or directories, with any number of path or name patterns.

Holdfast is priced at **£20.00** + VAT including delivery. It does its job simply, quickly, securely, and with unchallenged value for money.

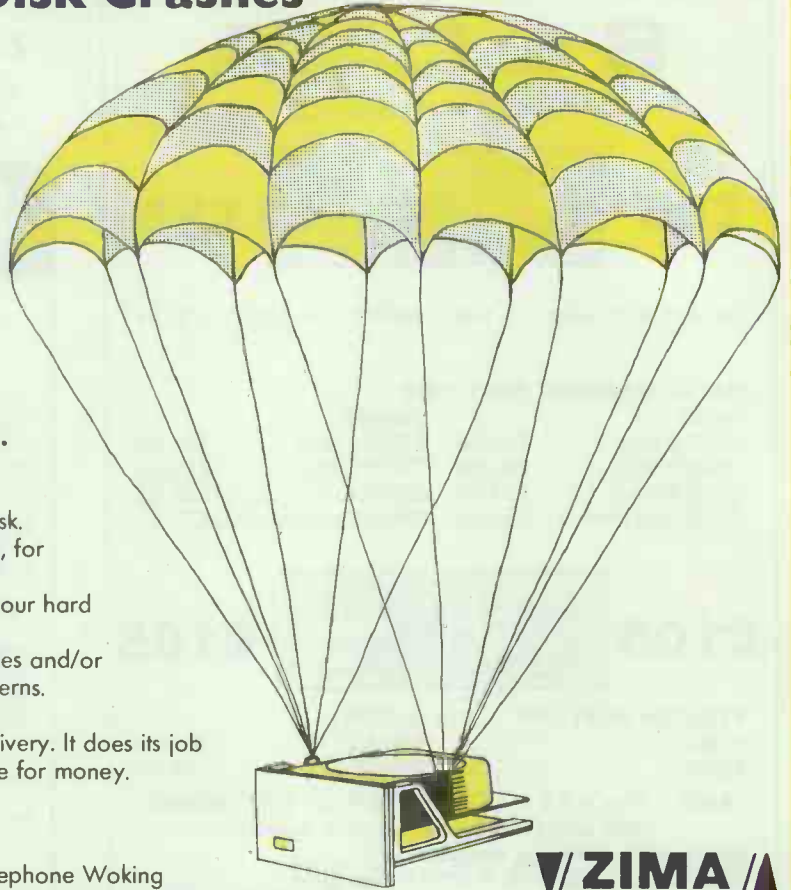

Order **HoldFast** from Zima Computing Ltd., telephone Woking (04862) 72431, or write to us at P.O. Box 167, Woking, Surrey, England GU21 4YU. Modem users can meet us on CIX at Guildford (0483) 573337/8, "join HoldFast" at the ':' prompt.

ZIMA
Computing Ltd

COMPISTAND!LTD!

WE DEDICATE THIS SPACE

TO

OLIVETTI AND TANDON

BUT DON'T FORGET OUR INCREDIBLE PRICES ON SOFTWARE AND PERIPHERALS

OLIVETTI M240 (8086 PROCESSOR)

Options too numerous to mention but here are some examples.

- M240 Dual 360Kb 5¼" Drives
- M240 1 x 360Kb 5¼" Drive, 1 x 720Kb 3½" Drive
- M240 20Mb Hard Disk, 1 x 360Kb 5¼" Drive
- M240 20Mb Hard Disk, 1 x 360Kb 5¼" Drive, 1 x 720Kb 3½" Drive
- M240 30Mb Hard Disk, 1 x 360Kb 5¼" Drive
- M240 30Mb Hard Disk, 1 x 360Kb 5¼" Drive, 1 x 720Kb 3½" Drive

All of the above come with 640K RAM, Parallel and Serial Ports and 102-key keyboard. A wide range of displays and controllers are available. Internal Tape Streamer Systems are also in stock. ALL PRICES ON APPLICATION.

OLIVETTI M28 (80286 PROCESSOR)

Full 20Mb system including keyboard, mono monitor, MS-DOS 3.2 £1995
As above, 40Mb system £2335
As above, 68Mb system £2622
Many other configurations available - prices on application

OLIVETTI M380 (80386 PROCESSOR)

M380 COMPACT 1.2Mb Floppy Drive
40Mb Hard Disk, 1Mb RAM
M380 1.2Mb Floppy Drive
68Mb Hard Disk, 4Mb RAM
M380 TOWER 1.2Mb Floppy Drive
135Mb Hard Disk, 4Mb RAM

TOP JOB included in all configurations of M380. Call for details on these amazing machines. Prices on application

TANDON

PCX Dual Drive	£645
PCX20	£860
PCA20	£1290
PCA30	£1505
PCA40	£1725
PCA70	£2155
TARGET 20	£1435
TARGET 40	£1650

The above prices include monochrome monitor (green or amber), keyboard and MS-DOS. For EGA colour monitor and car, add £285

SPECIAL OFFERS

EPSON LQ800	£425
EPSON LQ1000	£545
ZENITH Z181 Portable	£1255
D-BASE 3+	£375

Full range of Dot Matrix, Daisy Wheel and Laser printers - Call for best prices. Prices for Add on Boards, Hard Disks, Modems and other software available on request.

CALL US NOW ON CHICHESTER (0243) 771786.

COMPISTAND!LTD!

Quarry Lane, Chichester, West Sussex, PO19 2NY

All prices include full 12 months warranty but are exclusive of VAT and delivery.

PC-88 Turbo
8 MHz
20 Bytes
GEM Collection

£795

- NEC V-20 Processor, 4.77/8 MHz switchable
- 640 K RAM, Clock/Calendar + Battery Backup
- 20 Mbyte Hard Disk, 360 Kbyte Floppy
- Parallel + RS232 Serial card
- 130 W Power Supply, 8 Expansion Slots
- Full Set of Manuals

- Full GEM Collection from Digital Research
- Professional Keyboard + MOUSE
- Hi-Res 12" Monitor
- Hercules compatible mono card
- MSDOS 3.21 + E BASIC
- 12 Months unconditional Warranty

PC-286 Turbo
10 MHz - 0 wait states
40 Mbytes 40 mS
GEM Collection

£1295

- 286 Processor, 6/8/10 MHz switchable
- 640 K RAM, Clock/Calendar + Battery Backup
- 40 Mb 40 mS Hard Disk, 1.2 Mb Floppy
- Parallel + RS232 Serial card
- 200 W Power Supply, 8 Expansion Slots
- Full Set of Manuals

- Full GEM Collection from Digital Research
- Professional Keyboard + Mouse
- Hi-Res 14" Monitor
- Hercules compatible mono card
- MSDOS 3.21 + E BASIC
- 12 Months unconditional Warranty

PC-386 S
16 MHz
44 Mbytes 28 mS
GEM Collection

£2495

- 36 16 MHz Processor
- 2 Mbyte RAM, Clock/Calendar + Battery Backup
- 44 Mb 28 mS Hard Disk, 1.2 Mb Floppy
- 1 Parallel + 2 RS232 Serial ports
- 200 W Power Supply, 8 Expansion Slots
- Full Set of Manuals

- Full GEM Collection from Digital Research
- Enhanced Keyboard + MOUSE
- Hi-Res 14" Monitor
- Hercules compatible mono card
- MSdos 3.21 + E BASIC
- 12 Months unconditional Warranty

Full Compatibility with DOS, XENIX, AUTOCAD, NOVELL, etc.

Prices exclusive of VAT.

OPTIONS

- range of CGA/EGA and Disk Upgrades
- wide variety of peripherals

- networking cards
- Nationwide on-site maintenance

PLEASE FEEL FREE TO VISIT OUR SHOWROOM

01 965 3225



ELONEX (UK) Ltd.

WAYS HOUSE, NORTH CIRCULAR RD, LONDON NW10 7XB

FAX: 01 965 3246

TELEX: 946240 CWEASY/REF 19020170

GILTRON ELECTRONIC SERVICES

PC AT COMPATIBLES

Tatung: 7000E/640K/1.2Mb/20Mb Mono	£1690.00
Tatung: 7000G/640K/1.2Mb/40Mb Mono	£2225.00
Tatung: (EGA in lieu of Mono add £499).	
Opus PCV: 1Mb/1.2Mb/30Mb/Mono	£1250.00

PC XT COMPATIBLES

Amstrad PC1640/HD20/MD	£849.00
Amstrad PC1640/HD20/ECD	£1139.00
Amstrad PC1640/DD/ECD	£849.00
Opus PCIII/TF/768K/2x360K/Mono	£669.00
Opus PCIII/HD/1024K/360K/30Mb Mono	£949.00
(Opus EGA in lieu of mono add £299)	
Commodore PC10/512K/2x360K/Mono	£679.00
Commodore PC20/512K/20Mb/Mono	£979.00
(Commodore PC's include 1 year on-site maintenance)	
GES PC/640k/2x360k	£499.00
GES PC/640K/360K/20Mb	£839.00

OTHER COMPUTERS

Atari 520 STFM Computer	£245.00
Atari SH 125 Mono Monitor	£125.00
Atari SC1224 Colour Monitor	£325.00
Atari 1040 STF Computer	£409.00
Atari 1040 STF Computer with SH125	£489.00
Commodore Amiga A500 Computer	£409.00
Commodore 1081 Monitor	£262.00
Commodore 64 Computer Super Pack	£139.95

PRINTERS

Star NL-10 120 cps/30 nlq/80 col	£189.00
Star NX-15 120 cps/30 nlq/136 col	£295.00
Star ND-15 180 cps/45 nlq/136 col	£375.00
Star NR-15 240 cps/60 nlq/136 col	£449.00
Star NB24-10 24-pin/216 cps/72 lq/80 col	£459.00
Star NB24-15 24-pin/216 cps/72 lq/136 col	£579.00
Star NB-15 24-pin/300 cps/100 lq/136 col	£649.00
Amstrad DMP-2000 105 cps/27 nlq/80 col	£129.00
Amstrad DMP-3160 160 cps/40 nlq/80 col	£186.00
Amstrad DMP-4000 200 cps/50 nlq/136 col	£325.00
Amstrad LQ-3500 160 cps/60 lq/80 col	£325.00
Epson LX-800 180 cps/25 nlq/80 col	£239.00
Epson FX-800 240 cps/40 nlq/80 col	£375.00
Epson FX-1000 240 cps/40 nlq/136 col	£480.00
Epson LQ-800 24-pin/180 cps/60 lq/80 col	£549.00
Epson LQ-1000 24-pin/180 cps/60 lq/136 col	£730.00
Juki 5520 Colour/180 cps/30 nlq/80 col	£349.00
Juki 6100 Daisy-wheel/18 cps/132 col	£269.00
Juki 6200 Daisy-wheel/30 cps/132 col	£415.00
Juki 6300 Daisy-wheel/40 cps/132 col	£625.00
Juki 6500 Daisy-wheel/60 cps/132 col	£749.00
Micro-P MP135 135 cps/27 nlq/80 col	£139.00
Micro-P MP165 165 cps/35 nlq/80 col	£169.00
Micro-P MP201 200 cps/40 nlq/80 col	£275.00
Micro-P MP480 480 cps/80 nlq/80 col	£299.00
Micro-P Daisy Junior DVV/80 col/12 cps	£149.00
Micro-P MP26 Daisy-wheel/80 col/26 cps	£229.00
Micro-P MP40 Daisy-wheel/80 col/40 cps	£320.00

SOFTWARE

Lotus 123
Ability Plus
Smart Integrated System
Lotus Symphony
Account-Ability
Comsoft Bookworker
Sage Financial Controller
Page-Ability
Fleet Street Editor
Wordstar 1512
DBase III

THESE PRICES DO NOT INCLUDE VAT OR DELIVERY CHARGES
ALL PRICES ARE CORRECT AT TIME OF GOING TO PRESS
ALL PRODUCTS ARE OFFERED SUBJECT TO AVAILABILITY

USE ACCESS/VISA CARD



FOR FAST DISPATCH PHONE:

061-865 8819

**GILTRON ELECTRONIC
SERVICES
FREEPOST
(NO STAMP NEEDED)
MANCHESTER
M32 8FJ**

PHONE NOW FOR CURRENT
OFFERS ON THESE AND
OTHER SOFTWARE.

P.C. CLUB

1000's of programmes from **30p** each

for the IBM-PC and compatibles on 5¼" diskettes.
Here's just a small selection from the PC CLUB library.

All disks just £5.99. TICK BOX's required.

Programmers send us
your shareware for international distribution.

- GAMES 1** ABM, Brick, Bugs, Qubert, Spacewar + 15 other Games/programmes.
- GAMES 2** Original Adventure.
- GAMES 3** Bandit, Pocker, Rockets, Roulette, Blackjack, Stock and Submarine Chase.
- GAMES 4** Kong, Golf, Monopoly & Striker
- GAMES 5** 3 Demon, Castle, Baby and Jumpjoe.
- GAMES 6** Hopper, Kalscope, Polymaze, Space Commanders2 and Thatsall.
- PC WRITE V2.4** Multi-function Word Processor.
- FREWORD** The easy to use Word Processor.
- BEGINNERS WORD PROCESSOR** — An Excellent way of learning about the WP.
- PROCOMM V2.42** of this excellent modem program with terminal emulation.
- Q-MODEM V2.3** of this popular program.
- KERMIT PC/Mainframe Host Comm** by Columbia Univ, V2.29.
- E-Z FORMS** — Business form generation, Completion and generating programs.
- FINANCE MANAGER** — Menu driven many options, Personal Date Book.
- DESKMATE** — Calculator, Clock, Calendar, Notepad, Phone+ PARTNER all on one disk.
- PORTFOLIO MANAGEMENT** — Analyse your stocks and Shares.
- FREECALC** — Easy to use menu-driven spreadsheet. 50 col x 250 row.
- PC-CALC** — Well-Known spreadsheet. 123.64 col x 250 row.
- PC GRAPHICS** — Create your own PC graphics.
- DISKCAT** — Super capacity disk file catalog.
- PC-DBMS** — V1.0 Menu driven database management system.
- FILE EXPRESS** — Menu driven general purpose database manager. 2 Disks (£11.98).
- PIANOMAN** — Turn your PC into piano. Good for learning about music.
- TIP NOTES + TECHNIQUES** for the IBM PC.
- PC CLUB CATALOG** with Pacman and disk full of other games/ utilities.

Please make cheque/postal order payable to:

**PC CLUB LTD
CENTURY HOUSE, LEWES ROAD,
SCAYNES HILL, HAYWARDS HEATH,
WEST SUSSEX, RH17 7NG
Telephone: 0444 86232**

Subtotal for Diskettes _____

Postage and Packing £2.00 (Overseas £3.00)

VAT 15% of above

Total enclosed _____

We cannot guarantee the suitability of programs for
users needs or equipment

THOUGHTS & CROSSES

(COMPUTERS) LTD.

33 MARKET STREET, HECKMONDWIKE, WEST YORKS

COMPUTERS

Acorn Archimedes 305/310 (phone for availability)	Call
Amstrad CPC464 with Colour Monitor + £100 FREE software	£299
Amstrad CPC6128 colour system with FREE software	£399
Amstrad PC1512 CM DD (on site maintenance contract)	£746
Amstrad PC1512 CM SD	£377
Amstrad PC1512 (on site maintenance contract)	£331
Amstrad PC1512 MM DD	£573
Amstrad PC1512 MM DD (on site maintenance contract)	£228
Amstrad PC1512 MS DD	£458
Amstrad PC1512 MS DD (on site maintenance contract)	£22
Amstrad PC1640 20H-D CM	£1206
Amstrad PC1640 20H-D MM	£1033
Amstrad PC1640 DD CM	£361
Amstrad PC1640 DD MM	£368
Amstrad PC1640 ECD 20H-D	£1378
Amstrad PC1640 ECD 20H-D (on site maintenance agreement)	£52
Amstrad PC1640 ECD DD	£1033
Amstrad PC1640 ECD DD (on site maintenance agreement)	£48
Amstrad PC1640 ECD SD	£918
Amstrad PC1640 ECD SD (on site maintenance agreement)	£43
Amstrad PC1640 SD CM	£746
Amstrad PC1640 SD MM	£573
Amstrad PCW8256	£343
Amstrad PCW8512	£458
Amstrad PCW9512	£573
Amstrad 1040 STF	£499
Atari 1040 STF with Monochrome Monitor	£599
Atari 520 STF	£299
Atari 520STX + Mouse (while stocks last)	£219
Atari Mega ST4 inc. Mono Monitor	£949
Atari Mega ST4 inc. Mono Monitor	£1249
BBC Master 128	£425
BBC Master Compact + Philips Green Screen Monitor	£458
BBC Master Compact + Philips Medium Res Colour Monitor	£531
BBC Master Compact + TV Modulator	£417
Commodore Amiga A500	£138
Spectrum Plus 2	£139
Spectrum Plus 3	£199

On Site Maintenance Contracts are only available at the prices stated - When buying a system from us.

PRINTERS

Canon PW1080A	£285
Canon A55 (141/2 Carriage)	£425
Citizen 1200 NLO	£175
Citizen MSP10E	£275
Citizen MSP 25E (141/2 Carriage)	£525
Epson LX85	£275
Citizen MSP15E (wide carriage)	£325
Parasonic KOP10E1	£185
Amstrad DMP 3160	£195
Amstrad DMP 2000	£159
Epson LQ800	£564

DAISY PRINTERS

Juki 6200	£549
Citizen Premier 35	£649

PRINTER ACCESSORIES

Epson LX80/86 Tractor Unit	£25
Epson LX80/86 Sheet Feeder	£85
Juki 6100/6200 Tractor Feeder	£159
Juki 6100/6200 Sheet Feeder	£220

EXTERNAL CENTRONICS TYPE

Kempston interface-E Rom based for Spectrum	£39.95
QL Centronics interface	£20
Triper 20/64 for CB VIC20/64	£50

PRINTER RIBBONS

Amstrad PCW8256	£5.50
Brother EPA4	£2.99
Brother HRS	£2.99
Brother M1009 Centronics GLP	£3.80
Canon Kaga Takah	£5
CSM MPS801	£6.50
Citizen 1200	£5
DMP 2000/3000	£5
Epson LX80	£4.50
Epson MXFM/RX80	£4
Juki 6100 Single strike	£2
Juki 6100 Multistrike	£5
Mannesman Tely MT80/MT80 Plus	£5
OKI Microline 80	£2.30
Qume Multistrike	£4.30
Sekosha GP80	£4.50
Sekosha GP100	£4.50
Shimwa CP80CPA80 SP80	£5
Star NL 10	£8

10 or more ribbons deducted 10%
Others available, please ask.
Also PRINT WHEELS available please ask.

LEADS

Amstrad Centronics Printer Lead	£10
Amstrad Centronics Lead	£10
Atari 520ST printer	£10
BBC Centronics Printer Lead	£10
BBC Microtec RGB	£5.95
BBC Serial RS232 Printer Lead	£10

Commodore Serial Lead	£5.95
Dragon Centronics Printer Lead	£10
Einstein Centronics Printer Lead	£10
IBM Printer Lead (Cable)	£399
Memotech Centronics Printer Lead	£10
MSX Centronics Printer	£15
Onus Discovery Centronics Lead	£15
Onus Centronics Printer Lead	£10
OL to RS232 Lead	£14.95
Walbridge to Centronics Lead	£15
ZX Interface 1 to RS232 'D'	£14.95
RS232 'D' to RS232 'D'	£15

MONITORS

Microvitec 1431 MS (Standard res)	£215
Microvitec 1451 MS (Medium res)	£269
Microvitec 1451 DO (Standard OL)	£275
Philips 7522 anti-glare screen monitor (20MHz)	£82
Philips 7522 anti-glare amber screen monitor	£95
Philips 7542 anti-glare paper white monitor (20MHz)	£95
Philips CM8833 TTL Audio Med Res	£290

DISK DRIVES

Amstrad PCW 512K Upgrade + 720K Second Drive	£189
Atari SF354 3H/6 Drive	£180
Atari SF314 1H/6 Drive	£190
Cumana (Atari) 1H/6 Drive	£199
QL 720K Drive + Interface	£199
QL Twin 720K Drive + Interface	£299
Amstrad FD-1 (Second Drive)	£99
Comuna CSX 400	£135
Commodore 1541C	£195
Cumana CB8005	£319

DISKETTES

5 1/4" SS DD 48+pi	10 for £9
5 1/4" DS DD 48+pi	10 for £9
5 1/4" DS DD 96+pi	10 for £9
3" CP	10 for £9
3 1/2" Single Sided	10 for £18
3 1/2" Double Sided	10 for £18

AMSTRAD PC PRODUCTS

10 MByte Hardcard + Controller Card (Dysan)	£349.00
300MByte Hardcard + Controller Card	£499.00
FD-3 Second Disk Drive	£169.95
Hard Disk Backup Unit (including Cartridge)	£530.00

PSION ORGANISER PRODUCTS

Organiser 11 CM (8K Ram 32K Rom)	£99
Organiser 11 XP (16K Ram 32K Rom)	£139
16K Datapak	£19
32K Datapak	£34
64K Datapak	£79
128K Datapak	£99
9K Datapak	£39
Datapak Formatter	£44
Finance Pak	£29
Link Up Adaptor Cables	£12.95
Mains Adaptor	£12.95
Maths Pak	£29
RS232 Link	£47
Spelling Checker Pak	£29

ATARI ST SOFTWARE

GFL Football	£22.50
Music Studio	£26.95
CAD 3D	£45.00
Anik	£26.95
Androsoft	£26.95
Alar	£45.00
Pirates of Barbary Coast	£11.65
Back Pack	£45.00
Fast! Basic	£81.00
Artic Fox	£18.00
GFA Basic	£54.00
GFA Basic Compiler	£54.00
1st Word Plus	£72.00
Devpac	£44.95
Saved	£33.50
Beaurocracy	£31.50
Enchanter	£26.95
Hitch Hikers Guide to Galaxy	£26.95
Hollywood Hero	£26.95
Leather Goddesses of Phobos	£26.95
Sorcerer	£26.95
Spellbreaker	£26.95
Tinny	£31.50
Wishbringer	£26.95
Prohibition	£26.95
Intergames	£18.00
Kunsa	£72.00
Megamar	£140.00
Assembler	£45.00
BCPL	£90.00
Cambridge Lisp	£135.00
Lattice C	£90.00
Make	£45.00
MCC Pascal	£81.00
Jupiter Probe	£22.50
Balance of Power	£26.95
Art Director	£45.00
Fleet Street Editor	£103.00
Mercenary Compendium	£22.50
Chess	£22.50
Barbanan	£22.50
Psychosis	£22.50
Silicon Dreams	£18.00
Starblazer	£18.00
The Pawn	£18.00
Guid of Thieves	£18.00
Accountant	£152.00
Accountant Plus	£206.00
Book Keeper	£102.50
Roadwar 2000	£22.50
Flight Sim 2	£45.00
Flight Sim 2	£81.00
Trimbase	£199.50
VIP Professional Gem	£15

AMSTRAD PC 1512/IBM COMPATIBLE SOFTWARE

ACCOUNTING SOFTWARE	
Money Manager Plus	Connect £33.00
Easy Accounting	DAC £90.00
Easy Mate	DAC £47.00
Easy Tutor	DAC £28.00
Integrated Accounts	MAP £122.00
Sales Ledger & Invoicing	MAP £41.00
Sales & Marketing	MAP £81.00
Magic	MAP £81.00
Nominal Ledger	MAP £41.00
Purchase Ledger	MAP £41.00
Stock Control	MAP £41.00
Payroll	MAP £41.00
Maspac (SSP System)	MAP £41.00
Sales Order Entry	MAP £57.00
Purchase Order Entry	MAP £57.00
Job Costing	MAP £81.00
Book Keeper	Sage £93.00
Accountant	Sage £139.00
Accountant Plus	Sage £186.00
Financial Controller	Sage £279.00
Payroll	Sage £93.00
Accountability	Migent £95.00

BUSINESS PRODUCTIVITY

ABC (Complete Business)	ABC £140.00
Reflex (PC 1512 only)	Amsoft £95.00
Sidewalk (PC1512 only)	Amsoft £27.00
Reflex PC	Borland £93.00
One Up	Comsoft £41.00
Able One	Conceptdata £81.00
Hal	Lotus £399.00
Ability	Migent £95.00
Ability Plus	Migent £189.00
Moneypower	Monewise £81.00
PC Four	Pison £65.00
Desktop	Sage £49.00
Portex System	Showings £93.00
Open Access II Entry	SPI £122.00

COMMUNICATIONS

Chitchat	Sage £95.00
----------	-------------

DATABASES

Cambase	£41.00
Delta 4.3	£81.00
Dac-Base	£41.00
Plying Start	£95.00
Superbase Personal (Gem)	£95.00
Retrieve	£183.00
SSI Data	£71.50
Tas Plus	£71.50

ENTERTAINMENT SOFTWARE

ADVENTURE GAMES	
Portal	Activision £22.50
Dragonworld	Autogenic £18.00
Fahrenheit 451	Autogenic £18.00
Nine Princes in Amber	Autogenic £18.00
Baloo	Infocom £27.00
Deadline	Infocom £21.00
Enchanter	Infocom £21.00
Leather Goddesses of Phobos	Infocom £27.00
Moonmist	Infocom £27.00
Planetfall	Infocom £27.00
Seastalker	Infocom £21.00
Rental Package	Infocom £21.00
Sorcerer	Infocom £26.00
Spellbreaker	Infocom £31.00
Tinny	Infocom £26.00
Wishbringer	Infocom £26.00
Zork 1	Infocom £21.00
Zork 2	Infocom £21.00
Zork 3	Infocom £21.00
Passengers in the Wind	Intergames £18.00
Lord of the Rings	Mebourne £18.00
Jewels Of Darkness	Rainbird £18.00
Silicon Dreams	Rainbird £18.00
Ultima III	US Gold £18.00
ARCADE GAMES	
GBA Championship Basketball	Activision £22.50
Alex Higgins Snooker	Amsoft £18.00
Mean 18 Golf	Amsoft £18.00
Pinball Construction	Amsoft £18.00
Pitstop II	Amsoft £18.00
Summer Games II	Amsoft £18.00
Winter Games	Amsoft £18.00
World Games	Epyx £22.50
Rock and Wrestle	Mebourne £18.00
Super Sunday	Nexus £21.00
Great Escape	Ocean £18.00

Top Gun	£18.00
AMFM Trivia 1	£22.50
AMFM Trivia 2	£22.50
Rainbird	£18.00
Initiator	£152.00
Simp Poker	£206.00
STRATEGY/SIMULATION	
GFL Championship Football	Activision £22.50
Cynus II Chess	Amsoft £18.00
Destroyer	Epyx £22.50
Conflict in Vietnam	Microprose £22.50
Crusade in Europe	Microprose £22.50
Decision in the Desert	Microprose £22.50
F15 Strike Eagle	Microprose £20.00
Helical Ace	Microprose £16.00
Silent Service	Microprose £22.50
Solo Flight	Microprose £18.00
Splitfire Ace	Microprose £18.00
FLIGHT Simulator Jet Scenery Disk Et	Microsoft £16.00
FLIGHT Simulator Jet Scenery Disks 1-6	Microsoft £83.00
Balance of Power	Mindscape £27.00
Chess	Paion £22.50
Chemtate	Robotek £13.50
Jet	Sublogic £43.00
Geitnsburg	SSI £27.00
Bridge Player 2000	CP Software £17.95

OTHERS

Mind Probe	Human Edge £31.00
Fortune Teller	Status £13.50

GEM SOFTWARE

Gem Draw	Digital Research £81.00
Gem Draw Business Library	Digital Research £31.00
Gem Font Editor	Digital Research £81.00
Gem Fonts & Drivers	Digital Research £31.00
Gem Graph	Digital Research £69.00
Gem Programmers Toolkit	Digital Research £145.00
Gem Word Chart	Digital Research £81.00

SPREADSHEETS

Lotus 123	£310.00
Supercalc 3	Amsoft £63.00
Lotus 123	Grafal £93.00
Gem Utilities	Grafal £93.00
Book Mark	Intelliso £64.00
K Spread 2	Migent £189.00
Words & Figures	Litretre £93.00
Word Junior	Microsoft £36.00
VP Planner	Paperback £81.50
PC Planner	Sage £93.00

UTILITY SOFTWARE

Superkey	Borland £57.00
Turbo Basic	Borland £66.00
Turbo Gamesworks	Borland £41.00
Turbo Lighting	Borland £66.00
Turbo Pascal	Borland £66.00
Turbo Pascal Graphic Toolbox	Borland £146.00
Turbo Prolog	Borland £56.00
Dac Easy Port	Dac £39.00
PI Module 2	Hsolt £45.00
The Knite-86	Hsolt £25.00
Learning DOS	Microsoft £25.00
Quick Basic	Microsoft £70.00

WORD PROCESSORS

Mindreader Executive	Advance £41.00
Wordstar 1512	Amsoft £63.00
First Word Plus	GST £58.00
PC Write	Sage £79.00
Tasword PC	Tasman £22.50
Tasprint PC	Tasman £27.00

MISCELLANEOUS

Basic 2 Manual	Amsoft £11.50
Autosketch drawing tool	Autodesk Inc. £73.00
Motor Trade Package	Blyth Craftware £90.00
Professionals Package	Blyth Craftware £90.00
Touch n Go Typing Tutor	Carton £22.50
Delta Graph graphics analysis	Comsoft £39.00
Fleet ST Editor electronic publishing	Microsoft £122.00
Complete Introduction audio & Happy	Realtime £27.50
PC Tilt	Retail Solutions £65.00
Summamouse	Summa £115.00

WE ALSO STOCK SOFTWARE FOR

Spectrum	500 titles
Commodore 64	400 titles
Amstrad 464	200 titles
Amstrad 6128	200 titles
Amstrad PCW8256/8512	100 titles
BBC	200 titles
QL	80 titles
Commodore Amiga	

EXPORT ORDERS WELCOME
ASK OR SEND FOR PRICE LIST

Tel: (0924) 409753 for



EXPORT ORDERS WELCOME ASK OR SEND FOR PRICE LIST

Tel: (0924) 402337 for General Enquiries.

TELEX 556577 CROSSG

Shop open 9-5pm Mon-Sat; Mail Order 9-8pm Mon-Fri.

ALL PRICES INCLUDE VAT AND CARRIAGE



Slough Computers



AMSTRAD PC1640
FLOPPY AND HARD DISK
SYSTEMS
FROM **£499**
RANGE OF BUDGET PRICED
SOFTWARE IN STOCK

BONDWELL PC PORTABLES

MODEL 8 LAPTOP **£799**
512K 3 1/2" DRIVE.
SUPERTWIST LCD S/P VIDEO
MODEL 18 PORTABLE **£699**
640K, 2 x 5 1/4" DRIVES. CRT
ALL WITH DOS/BASIC 2.11



FREE!
1 YEARS ON-SITE
SERVICE



THE OPUS PC II RANGE
1024K, 2 DRIVES + RAM DISK.
HERCULES COMPATIBLE GRAPHICS.
4.77-8MHz TURBO V20
AT STYLE KEYBOARD.
TILT & SWIVEL MONITOR **£679**

SYSTEMS FROM £499-20MB £969
EGA SYSTEMS FROM ONLY £799
VARIOUS OPTIONS AVAILABLE INCLUDING
1.2MB & 3 1/2" FLOPPIES AND 8087

PC USER "THIS IS THE ONE I'D BUY"

NEW FROM OPUS — PC VYAT

New low cost AT has just been released by Opus. It's a small footprint machine with a 1.2Mb floppy, 30Mb Winchester, 10MHz zero wait 80286, mono/colour graphics card, 14" amber flat screen, display and 102 enhanced keyboard at a cost of only £1295



245 HIGH STREET, SLOUGH, BERKS SL1 1BN Tel: SLOUGH (0753) 21594/32753
VAT & CARRIAGE MUST BE ADDED TO ALL PRICES. TELEPHONE/MAIL ORDERS WELCOMED
ALL PRICES SUBJECT TO CHANGE WITHOUT NOTICE

CALL FOR PROGRAMS
NOT LISTED

« **BB** »

★ ★ SPECIAL ★ ★
20Mb CARD — 215.00



Business Supplies
021-745 7442



PACKARD BELL XT 20Mb TURBO 785.00

5.8MHz, 640k RAM, Mono Graphics Card & Monitor, UK Keyboard, GWBasic, MSDOS 3.2, Ser/Par, Clk Cal.

PACKARD BELL AT 20Mb 6/8/10 1285.00

AT Compatible 640k RAM (to 15Mb), 6.8MHz 0 Wait State, 10MHz 1 Wait State, Mono Monitor, UK Keyboard
GWBasic MSDOS 3.2, Clk Cal, 8 Slots, 210 Watt power supply.

MINISCRIBE 30Mb HARDCARD 286.00

HARDWARE	SOFTWARE
AST 120 PREMIUM 2861895.00	PARADOX V 2.0i385.00
AST 140 PREMIUM 2862195.00	Q&A (512K) V 1.1158.00
AST 170 PREMIUM 2862595.00	R:BASE 5000206.00
EGA DISPLAY — ADD285.00	RAPIDFILE197.00
	LOTUS MANUSCRIPT232.00
	LOTUS FREELANCE252.00
	SAGE FIN/CONTROLLER215.00
	HARVARD P/GRAPHICS215.00
	TURBO BASIC45.00
	WORDSTAR 151246.00
	CARDBOX38.00
	TURBO BASIC DATABASE/ EDITORT/BOX34.00
	BOARDS
WS4000 V21/23135.00	PARADISE EGA AUTO/S195.00
HAYES 1200 V21/22/23299.00	AST RAMVANTAGE(OK)340.00

CAR PHONES FITTED WITH HANDS-FREE FROM 3.99 per WEEK

★ Based on 5 year lease and subject to status

ALL PRICES EXCLUDE VAT & DELIVERY — SOFTWARE 2.50 —
HARDWARE 7.50. ACCESS/VISA OR CASH WITH ORDER — OFFICIAL
ORDERS FROM Pic's. LOW DEPOSIT FINANCE AVAILABLE OR LEASE
FROM 4.99 PER WEEK

021-745 7442

BB BUSINESS SUPPLIES — 21 HILTON AVENUE — BIRMINGHAM B28 0PE

USED COMPUTER.®

magazine.

The source for all types of used business computers.

Get your free copy from:

COMPUTER EXCHANGE

5A THE BALCONY, QUEENS ARCADE,
LEEDS, LS1 6LF. TEL: (0532) 435583.

PC SHARE

The smarter alternative
to the confusing world
of networks.

PC
SHARE



PLUS
YOUR PC



GIVES YOU
A TWO-USER PC



AND LETS YOU SHARE ALL THIS!

You can add the expense and complexity of LAN and a second PC to your system, or you can simply plug-in PC Share and grow.

PC Share gives you all the advantages of a Network complete with Password Protection, File Security, Electronic Mail and Sharing of files, data and peripherals.

However, with PC Share you don't get the disadvantages of a Network such as high cost, difficult installation, the need to learn a new system or expensive and on-going support.

PC Share is easy to install and easy to use. It works with the most popular applications and allows the users to run the same or different programs. Users see exactly the same familiar applications and DOS. AT £350* IT'S A BARGAIN.

For more information call us at (0252) 725507. Dealer Enquiries Welcome.

*PC SHARE/G supports Two Graphics Workstations (other video configurations available)

Options Available: AT Style Keyboard — £90. High Resolution TTL Monitor Amber or Green — £150.

UK DISTRIBUTOR:

SAVTEC COMPUTER TECHNOLOGY

LOYSTAR

the Power without the price

Do you have an IBM or a true compatible?

We've done it again with a professional word processing package at unbelievable price of **£39.95** including VAT & postage. No more installation problems, it is ready for you to use, enter LOY from your keyboard and start the editing session.

FEATURES:

- ★ Drop down menus containing all the commands, accessed by a function key.
- ★ Most of the menu commands are accessed from the keyboard (interactive word star look alike commands).
- ★ Two windows, to edit two files simultaneously.
- ★ On-line help facility.
- ★ On-line justification, word wrap and pagination.
- ★ Advanced dot commands and embedded printer control commands.
- ★ Ultra fast search and search/replace facility.
- ★ Recovery of the deleted lines of text.
- ★ Built in DOS commands, Copy, Del, Ren.
- ★ Compatible with Turbo Lighting spell checker.
- ★ No overlay business, one Exe. file, load and run.
- ★ The file size is limited by your memory size.
- ★ Support wide range of printers through the PDG utility, which allows you to implement a custom driver to drive about any printer in the market place.

Above all the price is only **£39.95** inc VAT and postage
Cheques or postal orders should be made payable to

LOYVIEW LIMITED

2nd Floor, 155 Oxford Street, London W1
Tel: 01-734 2408/9

MANAGEMENT PRODUCTIVITY TOOLS

For IBM PC, Amstrad and Compatibles

OUR EXCLUSIVE RANGE OF CREATIVE AND INNOVATIVE SOFTWARE FOR YOUR MANAGEMENT NEEDS

PROJECT PLANNING – INSTAPLAN –

The Project Planning System that works the way you think. "Top Down" approach helps you define activities, assign resources, produce Gantt charts, PERT charts for analysis and presentation. **£149.95 (exc. VAT)**

FLOW CHARTS – EASYFLOW –

Screen Graphics programme dedicated to draw flow charts and organisation charts, ideal for systems analysts. Supports most popular matrix or laser printers. **£149.95 (exc. VAT)**

SALES MANAGEMENT – ACT –

Maintain efficient control over sales and professional contacts. Be in Control!! **£349.95 (exc. VAT)**

Send **£5** for full feature memo-disk and documentation for each software. Full refund when you purchase.

**Computer Assisted Solutions
Wentways House, West End
Marden, Kent TN12 9JA
Telephone: (0622) 831 765**

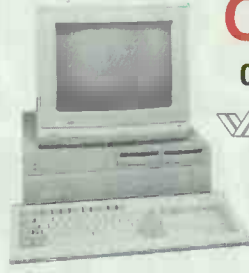

Slough Computers



COMMODORE
AMIGA

A500 &
A2000

Come and see the superb Commodore Amiga 2000 starting at only **£1095** including one year's on site service
New Amiga 500 now available
Call for latest special offers

Tandon

PCA20 1024K. 6/8MHz. 80286. MSDOS 3.1
1.2Mb FLOPPY. 20MB WINCHESTER

£1695
AT NO EXTRA COST WE WILL SUPPLY
THE ABOVE SYSTEM WITH
EGA CARD AND MONITOR SAVING **£500**
NEW 70MB PCA 70 NOW AVAILABLE
FROM **£2295**



The new target range and other models available

STOP PRESS – NEW OPUS PC III RANGE

Just launched at the PCW Show – a world beating new range of PC's from Opus. These are small footprint machines styled as the PC/AT. Features include a 10MHz clock speed with no waits, mono/colour graphics card, 14" amber flat screen display and 102 key enhanced keyboard. This system with a 30MB Winchester will cost only **£995**

OPUS PC EGA UPGRADE BARGAIN

14" Enhanced colour monitor with multiple choice colour switch PLUS EGA/CGA/HGC Graphics card, all to suit PC's and compatibles at at previously unheard of price of only **£399**

DISK DRIVE BARGAIN

Miniscribe 30Mb 68MS card-mounted Winchester	£299
Miniscribe 40Mb 1/2 height drive and controller	£399
Archive 40Mb internal tape streamer only	£349

245 HIGH STREET, SLOUGH, BERKS SL1 1BN Tel: SLOUGH (0753) 21594/32753
VAT & CARRIAGE MUST BE ADDED TO ALL PRICES. TELEPHONE/MAIL ORDERS WELCOMED
ALL PRICES SUBJECT TO CHANGE WITHOUT NOTICE

FORTTRANSOFT LTD

PROFESSIONAL SOFTWARE FOR THE IBM PC/XT/AT AND COMPATIBLES, eg. OLIVETTI, COMPAQ, AMSTRAD, OPUS ...

BASIC is fine for short programs and when speed and portability are not important. Besides, you can draw pretty pictures on the screen with BASIC. However, if you are writing large programs and wish to protect all the hours (in some cases years) you spent in writing your software then Fortran comes into its own. Whilst most languages are 'here today – gone tomorrow', Fortran, designed in the late fifties, still remain the dominant language for scientific and general purpose programming today. This means that programs you write today will work tomorrow on future generation of machines with little or no change.

Fortransoft now brings you an affordable ANSI 77 Fortran Compiler. And you can still draw pretty pictures on the screen because the GRAPHKIT library comes with the compiler and is included in the price.

FS-Fortran 77 is now at level 3.15 and current users may obtain a copy of the compiler for **£2** all incl.

FS-Fortran 77 with CGA graphics routines.....	£34.95
FS-Fortran 77 with CGA and Hercules mono graphics routines.....	£39.95
FS-FORTRAN 77 with CGA and Olivetti 640x400 graphic routines.....	£44.95
FS-FORTRAN 77 with CGA and EGA colour graphics routines.....	£44.95

FS-BASICON is a translator program for converting your IBM BASIC and GW BASIC programs, including some of the graphics calls, into Fortran 77. A virtually complete translation may be obtained, thus enabling you to have your converted BASIC programs up and running within hours instead of weeks..... **£49.95**

FS-Graphkit is a comprehensive suite of graphics and sound routines, including routines for drawing lines, circles, ellipses, painting, read/write to port, get time and data, reading a single key from the keyboard, screen dump, etc.

FS-GRAPHKIT is available for use with Microsoft Fortran, Ryan McFarland Fortran, IBM Professional Fortran, Lattice C, and Zorland C, Prospero Fortran77, and Microsoft Optimising Compiler. (Please specify which compiler when ordering).

CGA colour graphics.....	£19.95
CGA and Hercules mono graphics.....	£24.95
CGA and Olivetti 640x400 graphics.....	£29.95
CGA and EGA colour graphics.....	£29.95

FS-Sortmerge is a suite of Fortran-callable routines for sorting/merging an unlimited number of records on multiple keys. Any combination of alphabetic and numeric keys may be specified.

FS-Sortmerge for FS-Fortran 77 Compiler.....	£19.95
FS-Sortmerge for Microsoft Fortran Compiler.....	£19.95
FS-Sortmerge for Ryan McFarland/IBM Professional Fortran.....	£24.95

Fortransoft acknowledges all trademarks and registered names in this advert. Please indicate Compiler and Computer type when ordering. All prices include packing, postage and VAT. Please add **£3** for delivery outside Europe. All software comes on 5.25" 360k/1.2M (please specify). COD's and purchase orders are NOT accepted. Overseas dealer enquiries welcome. Send cheque with order to: (or write for further details)

FORTTRANSOFT LTD

60 HARNESS WAY, ST. ALBANS HERTS AL4 9HB.

(Tel: (0727) 32409)

ADVICE-LINE

07357-4466 for PRINTERS GALORE!

LOW, LOW PRICES but with FULL BACK-UP SERVICE

Call our Engineers for advice on printer selection.

OKI MICROLINE PRINTER SPECIALISTS

Superb range of dual mode printers, speeds of 100 cps NLO and 400 cps draft. Competitive performance and features with unique Print Menu giving user friendly operation. PC Compatibility. Call for engineering advice. Competitive prices to match any competition. DEALER ENQUIRIES WELCOME.



CALL FOR PRINT SAMPLES

OKI Microline 393
24 pin matrix - now available

MICROLINE
OFFICIAL APPOINTED DISTRIBUTOR

LOW PRICE LASER TONER CARTRIDGES

- £1850
 - £3150
 - £86
 - om £179
 - 8 £1995
 - £1995
 - £3750
 - £1595
 - £1550
- TERS**
- 3 cps £255
 - 3 Plotter £725
 - £235
 - £350
 - actor £145
 - r A3 Size £535
 - £1995

- CANON LBP8 £74.75
- CANON LBP8 Mk II £74.75
- CITIZEN £22.95
- EPSON GC3500 £18.50
- HP LASER JET £74.75
- HP SERIES II £74.75
- KYOCERA £28.50
- OKI LASERLINE 6 £18.50
- TECHNITRON TLP-12 £17.50



OKI LASERLINE 6

NOW LASER JET PLUS COMPATIBLE at £1895 + VAT
An ultra quiet compact H.P. compatible laser printer. Low noise, long life and a wide range of emulations. Large capacity input and output stackers. Face down output stacking. High reliability. TRADE ENQUIRIES WELCOME

OTHER LEADING PRINTERS



● CENTRONICS ● NEC
● STAR ● TOSHIBA
DEALER ENQUIRIES WELCOME.

MOBILE/CAR POWER SUPPLIES

INPUT 12v, 24v, 48v. OUTPUT 240v 50HZ
IDEAL FOR MICROS, PRINTERS ETC
FROM £249 + VAT

UNINTERRUPTABLE POWER SUPPLY (UPS) 250 VA 20 min back up £750

OTHER POWER RATINGS AVAILABLE

AMSTRAD

Appointed Dealer

- AMSTRAD 1512 Sgls Disc Mono £399
- AMSTRAD 1512 Dual Disc Mono £499
- AMSTRAD 1512 Sgls Disc Col. £549
- AMSTRAD 1512 Dual Disc Col. £649
- AMSTRAD 8256 Sgls Disc + Ptr £299
- AMSTRAD 8512 Dual Disc + Ptr £399
- 10m, 20m etc.
- AMSTRAD 9512 single disc £499
- + daisy wheel printer
- AMSTRAD 1640 ECO 640K COLOUR
- 1640 Single Disc - £799
- 1640 Dual Disc - £899
- 1640 20mB Hard Disc - £1199
- TANDON 20mB plug in business card - £275.
- P.C. 1640 OTHER DISPLAYS EPOA

SOFTWARE

- WORDSTAR 1512 £59
- SUPERCALC 3 £59
- VOLKSWRITER deluxe £39
- ABILITY PLUS £169
- SAGE SOFTWARE EPOA



AMSTRAD 1640 NOW AVAILABLE!

Amstrad printer cable £12.00

THIS MONTH'S DISCOUNT OFFERS

EPSON PRINTERS

- LX 800 £205
- FX 800 £325
- FX 1000 £395
- LQ800 £450
- LQ1000 £595
- EX800 £395
- EX1000 £525
- LQ2500 £799

JUKI PRINTERS

- 6100 £259
- 6200 £435
- 6300 £675
- 6500 £999
- PANASONIC KX - P3131P 17cps £259
- IBM parallel £12
- BBC £10

LASER PRINTERS

- Canon Laser LBP-8 MK II £1850
- Canon Laser LBP-8 DA I £3150
- Canon Font Cartridge from £179
- Centronics Line Printer 8 £1995
- H.P. Laser Jet series II £2099
- H.P. Laser Jet 500 plus £3750
- Centronics PP 8 £1595
- Epson GQ 3500 £1550

DAISYWHEEL SPECIALS

- 1/2 PRICE DYSNEER NOW ONLY
DAISYWHEEL DW20 20cps RRP £569 £199
SPECIAL OFFER
- Dyneer DW-40 40cps £749
 - Dyneer 20 Tractor Feed £115
 - Quendata Tractor Feed £75

OTHER PRINTERS & PLOTTERS

- Canon PW1080A 160 cps £255
- Roland DXY880A A3 Plotter £725
- Star NL - 10 £215
- Epson FX 105 + £350
- Centronics GLP & Tractor £185
- Hitachi 672 Plotter A3 Size £535
- OTC 700 700cps £1995

Micro GENERAL

COMPLETE RANGE OF PRINTER BUFFERS, INTERFACES, CABLES AND RIBBONS AVAILABLE. PLEASE CALL FOR ADVICE 07357 4466.
Specialists in MICRO and PRINTER technology
Dept PCW 11 Unit 25, Horseshoe Park, Pangbourne, Reading, RG8 7JW



TELEPHONE ORDERS taken 9-5.30 Mon to Fri. & 9-12.00 Sats.
Delivery Charge of £9 + VAT on all printers and computers.
ALL PRICES EXCLUDE VAT & CARRIAGE.
Prices subject to change without notice.



Goto Computers



10 Old Crown, Windsor Road, Slough, Berks SL1 2DL

Sales Hotlines:
Telex 847698 GOTOC G



Slough (0753) 34191
Slough (0753) 824767

★ 150 MILE FREE DELIVERY — ★ ASK ABOUT OUR 3 CHEQUES OVER 3 MONTHS SCHEME
(£5 OVER 140 MILES OR GOODS UNDER £100)

COMPUTERS

	£
ALL INCLUDE KEYBOARD MONITOR % DOS	
AST Premium 286 6/8/10MHz 20Mg Mod 120	1825
Amstrad PC1640 20Mb HD EGA Mon KB etc	1075
Amstrad PC1640 Mono Display	899
Atari PC512k 1FD Mouse Mono Monitor	499
EFI 80386 20meg 1meg RAM 10MHz	2785
EFI PC AT 1FD 1mg RAM KB Mon 20meg HD	1100
Epson PCAX 40mg 640k 10MHz Mono Mon	2175
Epson PCAX2 20meg EGA 8 or 10MHz 1.2mFD	1599
Flyer A286 20mb HD Laptop	3425
GOTO Xtra PC 8088-2 8MHz 1FD KB Monitor	385
NEC APC 1V20meg Multisync/EGA 640k	2095
NEC APC 1V40meg Multisync/EGA 640k	2395
NEC Multispeed Laphed PC 2x720k Dr	1200
Olivetti M240 20meg HD 10Mz Mon/KB/DOS	1495
Olivetti M380 40Mg 16MHz Tape Back Up	Call
Opus PCV Turbo 6/10MHz 1meg 30mg HD	1275
Opus PC11 System 4 20meg Mono	875
Opus PC11 Turbo 4.77/8MHz 1FD 256k	475
Packard Bell VT286 AT 20mg-65ms 1FD	1240
Sharp PC-7221 AT Port 20megHD 1FD	2200
Sharp PC7100 20Meg Superwist Mon Etc	1375
Suntech PC XT Turbo 8MHz 20mg 640k k/m	750
Tandon EGA Monitor and Adaptor	420
Tandon PAC 286 Removable Winchester	1575
Tandon PCA20 20mg 1mgRAM Mono	1295
Tandon PCA20 EGA 20m 1mRAM	1525
Tandon PCA30 30mg 1mgRAM Mono	1500
Tandon PCA40 40mg 1mgRAM Mono	1715
Tandon PCA70 70mg 1mgRAM Mono	2025
Tandon PCX20 20mg 256k Mono	875
Tandon Target 20mg 1mgRAM Mono	1350
Zenith Easy PC 20mg HD 720k 3.5FD	899
Zenith Z-181 Laphed PC 2x720k Dr	1225

Seagate ST4038 1/2Ht 30mg Kit AT/XT	385
Sysgen 60Mb Smart Image Streamer Int	720
Tandon 20Mb Business Card	245

DOT MATRIX PRINTERS

	£
Amstrad LQ3500 60LQ/160cps	345
Brother 1709 50/240cps 136cl NEW	410
Brother 2024L NLQ/190cps	570
Brother M4018 100NLQ/480cps 18pin	1075
Canon A65 34WPQ/100NLQ/200cps 132c	445
Citizen 120D 25NLQ/120cps 80 col	142
Citizen HQP-45 66NLQ/200cps 136c	495
Doconix 150(cps) Ink Jet Portable	280
Epson EX 800 50NLQ/300cps 80 col	375
Epson EX1000 50NLQ/300cps 136 col	499
Epson FX1000 40NLQ/200 132 col NEW	380
Epson FX800 40NLQ/200 80 col NEW	295
Epson LQ 1000 80LQ/160cps 156c24pi	535
Epson LQ 2500 Colour Option	54
Epson LQ 800 60LQ/160cps 80c 24 pin	390
Epson LQ2500 90LQ/270cps 24pin	690
Epson LX800 25NLQ/180cps 80 col	195
Juki 7200 24 wire flatbed AMF NEW	1250
NEC P565XL Colour	740
NEC Pinwriter P5XL 88NLQ/264 136c	705
NEC Pinwriter P6 72/216 24P 80col	376
NEC Pinwriter P7 72/216 24P 136c	438
NEC Pinwriter P9 120/380 24P 80col	975
OTC 850XL Printnet 850cps 240 1pm	1399
Olivetti 285/1 Colour 35NLQ/160 JX 80	405
Panasonic 1083 48NLQ/205c/240D 15"	375
Panasonic KX-P1081 24NLQ/120 80col	145
Panasonic KX-P 1082 32NLQ/160cps 80col	195
Panasonic KX-P1592 51NLQ/240 136col	330
Star NB 24-15 72NLQ/216cps 136Cl 24pin	525
Star ND15 45NLQ/180cps 136 col + Par I/F	365
Star NL10 30NLQ/120 80cl + Parallel I/Fc	192
Star NX15 30NLQ/120 136cl + Parallel I/F	282

SOFTWARE

	£
Ability Plus NEW EGA Vers	189
Autocad 2.6 Basic	265
Autosketch	65
Boeing Calc 3D Power Spreadsheet	240
Borland SuperKey/Reflex/Skick Pro Ea	56
Borland Reflex The Analyst V 1.1	64
Borland Turbo Basic NEW	58
Borland Turbo C NEW	79
Borland Turbo Pascal 4.0 NEW	55
Clipper dBase III Compiler NEW	315
Comsoft DELTA 4 Professional	270
DS BACKUP + Hard Disk Backup NEW	85
Dbase III + V 1.1 Unprotected	375
Eureka: The Solver Borland	65
Fantasy Ver 2 On-Screen Fonts/Draw	69
Formula FDP Form Design	385
Framework II Ver 1.1	305
GEM Desktop Publisher + Desktop NEW	275
Harvard Graphics Log Charts 3D Graph	335
Harvard Professional Publisher	525
Lotus 123 Rel 2.01	232
Lotus Freelance Plus	265
Lotus Manuscript Word Processor	230
Lotus Measure (Scientific) NEW	320
Lotus Metro NEW	55
Lotus Symphony 1.2	320
MACE + Unformat etc	69
Mastergraphics Ashton Tate Presentation	380
MathCad 2.0 Maths Scratchpad	185
Microsoft C 4.0	255
Microsoft Flight Simulator V 2.13	37
Microsoft QuickBasic ver 3.0	68
Microsoft Word 4.0 NEW	399
Multimate Advantage 11 NEW	278
Norton Advanced Utils NEW	95
Open Access II V2 NEW	355
Paradox Rel 2.0 Rel DBase NEW	560
Paradox Stand alone Ver	285
Pro-Design 11 ver 2.5 CAD	245
Protel PCB Designer	775
SAGE Accountant Plus	140
SAGE Financial Controller NEW	215
SAGE Payroll V7 NEW	70
Smart System 3.1 LAN Ready v 3.10	375
Statgraphics Ver 2.1 NEW	435
SuperProject Expert NEW	call
Supercalc 4.1	215
Ventura Desk Top Publishing V 1.1	499
What's Best! Linear Programming System	Call
Wordperfect 4.2 NEW	245
XTREE File & Directory Man't V2.0	42

MONITORS/ADAPTORS

	£
Genius 402 bit mapped A4 + card DkTpPub	£1325
Hercules InColor Card 720x348 RAM Font	258
NECJC 1401 P3E Multisync EGA PGA 800	480
Paradise EGA Card EGA CGA Herc AutoSwc	210
Philips 7713 P39 Green Flatsquare 14"	128
Tandon 480 EGA Card New	240
Taxan 565 PGA card 640 x 480 132col	235
Taxan 660 12" EGA 640x350	378
Taxan 760 14" EGA 640x350	399
Taxan 770 + Multivision 15/35KHz	480
Taxan 840 320x200 Olivetti etc	599
Taxan 860 16" EGA 0.39mm dot 640x350	599
Taxan 980 + Card 20" EGA Autocad	1365
Taxan KX 123 Green NEW + Cable	110
Taxan Supervision 1V + card Hi-res Color	390
Taxan Viking 1 19" 1280x960 DeskTopPub	1656
VEGA Delux Video7 EGA card 640x480	230
Wyse 700 Graphics Subsystem 1280x800	695

DAISYWHEEL PRINTERS

	£
Brother HR25XL 25cps dual 132Col	500
Brother HR40 FJT 30sheet Sheetfeed	705
Citizen Premier 35cps Fric/Frac	428
Juki 6200 30cps 132 col	365
Panasonic KX-P3131 17cps 110col Diab	235
Panasonic KX-P3151 22cps 132 col	365
Ricoh RP 3200Q 30cps 7k Bfr Diablo 630	350
Ricoh RP3400Q 50cps 7k Bfr Diablo 630	795

PLOTTERS/DIGITISERS/LASER

	£
Brother B12 Laser 15 Res Fonts 300dpi	1925
Centronics PP-8 Laser 8ppm 300 dpi	1325
Cherry A3 Graphics Tablet Mk II NEW	460
Citizen Overture 110 10ppm NEW	1350
Epson GO-3500 6ppm 640k	1295
Hewlett-Packard 7475A A3 6 Pen Plotter	1325
Hewlett-Packard LaserJet Series 2	1850
Hewlett-Packard ScanJet Imager	1500
Kyocera F-1000 Laser NEW	1925
OKI Laserline 66ppm	1325
Ricoh LP4081-RI	2795
Ricoh Lasermaster RX	3400
Roland DPX-3300 A1 8 Pen 15kb EPH+Stand	2995
Roland DPX2200 A2 8pen 45cms Free OSM	2410
Roland DXY 880A A3 8pen FB 20cms	605
Roland DXY 885 A3 8pen 30cms 415/276cm	795
Roland DXY 980A A3 as 880A + EPH DigD 23cms	865
Roland DXY 990 as 885 + EPH DigD AdjSpee	980
Summasketch Plus 1000 lpl NEW	525

COMMUNICATIONS

	£
Amstrad Comms Pack Card + Datatalk	135
Datatalk Software V3.27	99
Hayes 2400 V22bis External	565
Hayes Smart/Md 21/22/23 Keycd + Smartcm3	450
Hayes SmartModern V21 V23 + Smartcomm3	375
Miracle Keycard 3000 V21 V23	245
Miracle Keycard 3000 V22	305
Miracle Keycard 3000 V22/BIS	435
Miracle WS3000 V21 V23 Auto	205
Panafax UF-600AT Facsimile Machine	2699
SAGE Comms Pack Modem+Chit Chat	210
Smartcom 111 Software	145
Trend Opal Telex Slimline Display	1350

ADD-ONS & UPGRADES

	£
AST Mini 11 I/O Serial/Parallel Game/C1	105
AST PC/Short Memory Board 384k	105
Brother 3.5" Floppy Drive 1Mb Capacity	93
Cypher 1525 CT 20meg 1meg/min Amstrad	380
Cypher 5210 XT/AT Streamer	525
Fastdata Barcode Reader PC + software	310
High Fidelity Mem-Plus PC to 640k	125
IOS Card Parallel + 2 Serial Games/Clock	67
Indentica 60meg External Streamer	560
Intel Above Board 286 512k XT or AT	385
Intel Inboard AT to 386 cables/1megRAM	1350
Kodak Datashow PC to Overhead Proj	925
Logimouse C7 PC or AT	76
Microsoft Mouse Bus/Ser + Paint etc	130
MiniScribe 30Mg HardCard only 9.5w	299
Miniscribe 3425+ 20mb-53ms Hard Drive	199
Miniscribe 6985 85Mb Hard Drive 28ms	Call
NEC 20Mg H/Drive D5126 80ms + WD + kit	270
NEC 40meg H/Drive D5146H 40ms + WD + Kit	380
Orchid JET 386 16MHz 3x AT Speed	675
Orchid Tiny Turbo	325
Orchid Turbo 286 12MHz	855
Seagate ST225 1/2Ht 20mg Kit AT/XT 65m	250

PROCESSORS/RAM CHIPS

	£
Intel 80287 8Mz	192
Intel 80287-6 5Mz	148
Intel 80287 5Mz	95
Intel 8087-2 8Mz (Amstrad/Comp/M24)	134
NEC DRAMS 64k 150ns 9 chips	8
NEC Drams 256k 150ns 9 chips	21
NEC V20 replaces 8088	13
NEC V30 replaces 8086	14

NETWORK SYSTEMS

	£
ASTorus AST-RSN Hware + TapesIny Sware	1375
Novelle Advanced Network 286/V2.0 + Keycard	1950
Novelle Adv Nware 286 + G-Net Keycard	1950
Novelle Adv Nware + Disk Co-ProcessorBd	2390
Novelle Advanced Network/86	1295
Novelle Advanced Network/286	1850
Novelle Network 286 3 cards G/Net Cble	2100
Orchid PC-NET + Software	675
SageNet 2Boards Software Cables Plugs	299
Walters Novel Comp 80mg Fileserver	3360

ORDERS TAKEN FROM UK GOVERNMENT BODIES — EDUCATIONAL ESTABLISHMENTS — ESTABLISHED COMPANIES
EXPORT ORDERS UNDERTAKEN-LEASING AND H.P. ARRANGEMENTS. PRICES SUBJECT TO CHANGE WITHOUT NOTICE



OPEN 9.00AM TO 5.30PM MON THRU FRIDAY AND 9.30AM TO 12.15PM SATURDAY

WE MOVE SERVICE NOT BOXES — Please add VAT to all prices



ANNEX

0494 81 6683

★ COMPETITIVE PRICES
★ EX-STOCK DELIVERY
★ PROFESSIONAL ADVICE

TANDON

PCX20 XT 20MB Winchester, 360KB floppy, parallel port	£925
PCA20 AT 20MB Winchester, 1.2MB floppy, 1MB, P/S port	£1375
PCA30 AT 30MB Winchester, 1.2MB floppy, 1MB, P/S port	£1645
PCA40 AT 40MB Winchester, 1.2MB floppy, 1MB, P/S port	£1775
PCA70 AT 70MB Winchester, 1.2MB floppy, 1MB, P/S port	£2225
TARGET20 AT Small footprint; as PCA20	£1495
TARGET40 AT Small footprint; as PCA40	£1695
EGA SYSTEMS ADD	£260

AMSTRAD

PC 1640 SD ECD Single 360K floppy drive, enhanced colour	£745
PC1640 DD ECD Dual 360K floppy drive, enhanced colour	£845
PC 1640 HD ECD 20MB hard disk, 360K floppy drive, enhanced colour	£1125
PC 1640 SD CD Single 360K floppy drive, colour	£625
PC 1640 DD CD Dual 360K floppy drive, colour	£695
PC 1640 HD CD 20MB hard disk, 360K floppy drive, colour	£945
PC 1640 SD MD Single 360K floppy drive, mono	£485
PC 1640 DD MD Dual 360K floppy drive, mono	£575
PC 1640 HD MD 20MB hard disk, 360K floppy drive, mono	£845
PC 1512 SDM Single 360K floppy drive, mono	£399
PC 1512 SDC Single 360K floppy drive, colour	£549
PC 1512 DDM Dual 360K floppy drive, mono	£499
PC 1512 DDC Dual 360K floppy drive, colour	£499

OPUS

SYSTEM 1 Mono, 1x360K floppy, 256K RAM	£495
Colour, 1x360K floppy, 256K RAM	£695
EGA, 1x360K floppy, 256K RAM	£795
SYSTEM 2 Mono, 1x360K floppy, 1024K RAM	£595
Colour, 1x360K floppy, 1024K RAM	£795
EGA, 1x360K floppy, 1024K RAM	£895
SYSTEM 3 Mono, 2x360K floppy, 1024K RAM	£695
Colour, 1x360K floppy, 1024K RAM	£895
EGA, 1x360K floppy, 1024K RAM	£995
SYSTEM 4 Mono, 1x360K floppy, 1024K RAM, 20MB hard disk, and controller card	£985
Colour, 1x360K floppy, 1024K RAM, 20MB hard disk, and controller card	£1185
EGA, 1x360K floppy, 1024K RAM, 20MB hard disk, and controller card	£1285

MONO MONITORS

TAXAN	
KX123 12" green, PC compatible	£95
KX124, 12" amber, PC compatible	£95
KX125 12" b/w, PC compatible	£95
VIKING-1 19" b/w display system, software included	£1725

COLOUR MONITORS

TAXAN	
K14P 14" Vision Standard Resolution	£195
K12SV620 12" Supervision 620 RGB High Res	£275
K12SV625 12" Supervision 625 RGB High Res	£315
K12SV4M 12" Supervision IVM RGB Ultra High Res	£315
K12SV4 12" Supervision IV RGB Ultra High Res	£420
K12SV660 12" Supervision 660 EGA Ultra High Res	£395
K14SV760 14" Supervision 760 EGA Ultra High Res	£415
K14SV765 14" Supervision 765 EGA Ultra High Res	£395
K14SV760/VDE 14" Supervision 760 IBM EGA Ultra High Res	£475
K14MV770+ 14" Multivision 770+ Ultra High Res	£525
K16SV840 16" Supervision 840 RGB High Res	£665
K16SV860 16" Supervision 860 EGA High Res	£665

Prices Exclude only
VAT and Delivery

K20SV980 20" Supervision 980 Ultra High Res	£1875
K20SV990 20" Supervision 990 Ultra High Res	£1945
NEC	
MULTISYNC MONITOR	£585

SOFTWARE

LOTUS 1-2-3	£285
SYMPHONY	£395
WORDSTAR PROFESSIONAL	£240
D BASE III+	£385
SMART	£465
FRAMEWORK	£355

MATHS CO-PROCESSORS

D8087 5MHz	£89
D8087-1 10MHz	£159
D8087-2 8MHz	£129
D80287-6 6MHz	£129
D80287-8 8MHz	£175
D80287-10 10MHz	£195
D80387-16 16MHz	£379

32 BIT ADD IN BOARDS

TRANSPUTER	
Monoputer-4 IMST414-20 transputer, 2MB	£1395
Monoputer-8 IMST800-20 transputer, 2MB	£1795
ACORN SPRINGBOARD	
1MB PC Arm Card 32 bit RISC	£995
4MB PC Arm Card 32 bit RISC	£1950
ACORN SOFTWARE	
"C"	£250
LISP	£250
Fortran	£250
Prolog	£250
BBC BASIC	50
INTEL INBOARD	
Intel Inboard 386 0K	£1250
Intel Inboard 386 2MB	£1595
Intel Inboard Piggyback 1MB	£355
Intel Inboard cable	£140
ORCHID	
JET 386 16MHz	£785

ADD IN BOARDS

HERCULES IN COLOUR HI RES 720x348	£299
HERCULES MONO GRAPHICS CARD PLUS	£189
INTEL ABOVE BOARD AT WITH 512K	£459
INTEL ABOVE BOARD AT WITH 2MB	£779
287 TURBO-10	£395
287 TURBO-10	£545
NUMBER SMASHER 640K	£485
NUMBER SMASHER 640K+8087	£685
FASTCACHE286 9MHz	£345
FASTCACHE286 12MHz	£495
FASTCACHE286 9MHz+287	£625
FASTCACHE286 12MHz+287	£895
BOCARAM AT 0K	£156
BOCARAM AT 1MB	£273
BOCARAM AT 2MB	£390
BOCARAM AT 4MB	£702
BOCARAM AT Daughter Board 0K	£78
BOCARAM XT 0K	£124
BOCARAM XT Daughter Board 0K	£189

**MANY MORE ITEMS
AVAILABLE PLEASE
PHONE FOR DETAILS**

Annex Components Ltd
Unit 3A
St Johns Estate
Penn, Bucks
HP10 8HR

PLOTTERS

7440-OP1 COLOUR PRO, 8 PEN A4	£875
7475-OP1 6 PEN GRAPHIC PLOTTER A4/A3	£1521
7550A 8 PEN AUTO SHEET FEED A4/A3	£3315
7570A DRAFT PRO PLOTTER A1/A2	£4055
7595A DRAFTMASTER I A4-40 SINGLE SHEET	£7715
7596A DRAFTMASTER II A4-A0 ROLL FEED	£7860

LASER PRINTERS

EPSON	
GQ3500 6 PAGE/SINGLE BIN	£1395
CANON	
LBP8A1 8 PAGE/A4	£1675
LBP8A2 8 PAGE/A4/GRAPHICS	£2425
LBP8 MARK II	£1745
KYOCERA	
F1010 10 PAGE/SINGLE BIN	£2285
F2010 10 PAGE/DUAL BIN	£3785
HEWLETT PACKARD	
2686A LASER JET	£1495
33440A LASER JET SERIES II	£1945
2686D LASER 500	£2995

DAISYWHEEL PRINTERS

JUKI	
6100 20 CPS	£257
6200 30 CPS	£409
6300 40 CPS	£629
6400 60 CPS	£759
MICRO-P	
26 26 CPS	£232
40 40 CPS	£318
PANASONIC	
KX-P3131U 17 CPS	£295

DOT MATRIX PRINTERS

EPSON	
LX 800 180 C PS/25 NLQ/80 COL	£216
LQ 800 180 CPS/60 NLQ/80 COL	£489
LQ 1000 180 CPS/60 NLQ/132 COL	£654
EX 800 300 CPS/50 NLQ/80 COL	£435
EX 1000 300 CPS/50 NLQ/136 COL	£585
FX 800 200 CPS/50 NLQ/80 COL	£339
FX 1000 200 CPS/50 NLQ/80 COL	£432
LQ 2500 270 CPS/90 NLQ/136 COL	£819
SQ 2500 INK JET	£1059
AMSTRAD	
DMP 3160 80 COL	£179
DM P 4000 200 CPS/50 NLQ/WIDE	£299
PANASONIC	
KX-P-1081 120 CPS/20 NLQ/80 COL	£180
P1592 180 CPS/38 NLQ/136 COL	£435
CANON	
PW 1080 AT 160 CPS/27 NLQ/80 COL	£293
A55 180 CPS/45 NLQ/132 COL	£445
A60 200 CPS/100 NLQ/80 COL	£445
A65 200 CPS/100 NLQ/132 COL	£565
MICRO-P	
135 135 CPS/27 NLQ/80 COL	£169
165 165 CPS/35 NLQ/80 COL	£229
200 200 CPS/40 NLQ/80 COL	£329
201 200 CPS/40 NLQ/132 COL	£349
480 480 CPS/74 NLQ/80 COL	£369
FUJITSU	
DX2100 220 CPS/44 NLQ/80 COL	£339
DX2200 220 CPS/44 NLQ/136 COL	£441
DX2300 270 CPS/54 NLQ/80 COL	£489
DX2400 270 CPS/54 NLQ/80 COL	£593
DL2400 180 CPS/60 LQ/136 COL	£789
DL2600 288 CPS/96 LQ/136 COL	£1053
DL3300 240 CPS/60 LQ/80 COL	£555
DL3400 240 CPS/60 LQ/136 COL	£644
DL8800 240 CPS/80 LQ/136 COL	£2992

Tel: 0494 81 6683
0494 81 6684
0494 81 66895
Telex: 838844 TRANST G

IGNORE THE REST – WE ARE THE VERY BEST



olivetti M28

40Mb Hard Disk
8MHz Clock Speed
512 RAM MSDOS
Olivetti Monitor
Olivetti Keyboard

£2500.00

olivetti M28

20Mb Hard Disk
8 MHz Clock Speed
512K RAM MSDOS
Olivetti Monitor
Olivetti Keyboard

£2195.00

NEW olivetti M240 NEW

20Mb Hard Disk
10 MHz Clock Speed
640K RAM MSDOS
Olivetti Monitor
Standard Keyboard

£1495.00

olivetti M24

20Mb Hard Disk
Olivetti Monitor
Olivetti Keyboard
640K RAM MSDOS

£1295.00

COMPLETE AMSTRAD SYSTEMS

PC1640 DD Colour EGA **£899.00**
PC1640 20Mb Colour EGA **£1199.00**
PC1512 DD Mono **£559.00**
PC1512 20Mb Mono **£899.00**
PCW9512 **£499.00**

***Call for Special Prices.
Large Discounts for quantity.**

Tandon Complete Systems

PCX 256K, 10Mb, Screen,
Keyboard, MSDOS **£695.00**
PCX 256k, 20Mb, Screen,
Keyboard, MSDOS **£950.00**
PCA 20, 1MB 20Mb, Screen,
Keyboard, MSDOS **£1395.00**
PCA 30, 1MB 30Mb, Screen,
Keyboard, MSDOS **£1695.00**

LASER PRINTERS

**CANON
HEWLETT PACKARD
EPSON
KYOCERA
ALL AT LARGE DISCOUNTS**

WE SUPPLY EVERYONE FROM LEADING UK COMPANIES,
GOVERNMENT DEPARTMENTS, EDUCATIONAL
ESTABLISHMENTS, LOCAL AUTHORITIES, THE COMPUTER
TRADE TO SMALL BUSINESSES AND THE PRIVATE
INDIVIDUAL – ANYWHERE IN THE WORLD!

CALL US NOW – IN YOUR AREA!

EDINBURGH
031 556 9903

NEWCASTLE
091 276 6887

MANCHESTER
061 228 7965

NOTTINGHAM
0602 583716

BIRMINGHAM
021 643 5072

LONDON
01 481 3929

BRISTOL
0272 273665

PRINTERS

Epson LX800 180/25 CPS **£205.00**
Epson FX800 240/40 CPS **£325.00**
Epson LQ1000 180/60 CPS **£625.00**
Brother M1109 100 CPS **£179.00**
Brother HR20 Daisywheel **£335.00**
Olivetti DY200 Daisywheel **£349.00**
NEC P6 216/72 CPS **£395.00**
NEC P7 216/72 CPS **£460.00**
Amstrad DMP 4000 **£299.00**

SOFTWARE

DBase III Plus **£425.00**
Framework II **£330.00**
GEM Collection **£75.00**
Lotus 123 **£249.00**
MS Word 3 **£280.00**
Multimate II **£299.00**
Multiplan II **£125.00**
SMART Software **£425.00**
Wordstar Professional **£215.00**
Sidekick for Amstrad **£17.00**
Reflex for Amstrad **£40.00**

Multisoft Accounting System

BinderHamlyn

training and implementation throughout
the United Kingdom from
Binder Hamlyn.



ZENITH DATA SYSTEMS

Z-248

20Mb Hard Disk
80286 Processor
512K RAM MSDOS
Hi-res Monitor
Keyboard

£2345.00

Z-386

40Mb Hard Disk
80386 Processor, 16 MHz
1Mb RAM MSDOS
Hi-res Monitor
Keyboard

£3995.00

Z-181 LAPTOP

640K RAM
TWIN 720K drives
Supertwist Screen
Keyboard
MSDOS

£1345.00

Z-183 LAPTOP

10Mb Hard Disk
8 MHz Clock Speed
640K RAM MSDOS
Single 720K drive
Supertwist Screen
Keyboard

£1949.00

Opus PC II COMPATIBLES

SYSTEM 3

Twin 360k Disk Drives
1Mb RAM 4.77/8 MHz
Mono display, keyboard, MSDOS

£699.00

SYSTEM 4

20Mb Hard Disk
1Mb RAM MSDOS
Mono Monitor, Keyboard

£995.00

SYSTEM 5

20Mb Hard Disk
80286 Processor, 1Mb RAM
Mono Monitor, Keyboard

£1295.00

Discount on all Systems **POA**
CGA Option inc. 14" Monitor—add **£200.00**
EGA Option inc. 14" Monitor—add **£300.00**

Piccadilly Micros, 9 Grosvenor Terrace, Broad Street, Birmingham B15 1AU. Telephone: 021 643 5072. Telefax: 021 643 9379

- ★ 12 months warranty ★ 7 day money back guarantee ★ Next day del. available
- ★ On site maintenance contracts available ★ Finance plans available

All prices exclude VAT and delivery and are correct at going to press. Piccadilly Micros reserve the right to vary prices without prior notice.
Trade enquiries welcome. Additional discounts for bulk orders.

RING ROUND 062

SELTEC

LOW-LOW-LOW-COST PROGRAMS

Out of the thousands of programs we have collected, for a small service charge from £6 we bring you a SELECTION OF THE BEST that have been carefully tested and documented. Suit IBM-PC and compatibles. 5 1/4" and 3 1/2", DOS 2 or greater.

Please note that in those instances where Basic is required, users should have Basic, GWBasic, or our shareware compatible version on disk M9001. Basic2 is not suitable.

Our games have a CGA emulator so those with Hercules boards can play.

MS-DOS GAMES

M1014: CREATE YOUR OWN ADVENTURES. Express your own ideas and fantasies. Generates games of your design. Needs Basic.

M1044: MARTIAL ARTS. Match your skills against all sorts of villains and dangers.

M1050: SUPER COMPILED GAMES (7). With Polymaze, Landmine, Drain, Elevator, Eliza, Starwars. Ready to run.

M1051: 50 BASIC GAMES. Includes a Star-trek, Swarm, Baseball, Hobbit, Blackfri, Antonyms, many more.

M1052: GAMES OF STRATEGY (3). Be challenged with Air Traffic Controller, Inter-bridge Construction, and Global War.

M1053: GAMES FOR B'S AND UNDER. Special selection for the young 'uns. 13 games including a design your own secret adventure. Some games require Basic.

M1055: PINBALL GAMES (2). Good graphics and absorbing arcade game. Has Centre Fielder, Cyclops, Flume, Magic, Pin.

M1066: CHINESE CHECKERS. A well designed board game with good graphics.

M1068: MUSIC COMPOSER. Use your computer to write songs and melodies. Shows real notes.

M1059: EGA LIFE. Generates patterns of bacteria based on your input. Brilliant in hi-res colour.

M1060: CHAMPIONSHIP GOLF COURSE. You play on a course based on a real one used on professional circuit.

M1061: ADULT GAMES. Including Strip Poker, Adult Trivia, etc.

M1063: SPACE RESCUE ADVENTURE. A comprehensive, and sophisticated game to challenge you.

M1064: ADULT JOKES. A collection of witty, funny and often blue jokes.

M1065: TEST YOUR ESP. Could be used seriously or in fun. Computer shuffles and displays one of 25 cards with special symbols.

M1066: CROSSWORD SOLVER. Helps you find those elusive words in crosswords.

M1067: BRIOGE. A comprehensive and well-designed game to sharpen your play.

UTILITIES

M2041: BAYLEY UTILITIES. Has mail facility for those who share the computer with others, wish to log computer time, more.

M2042: EGA UTILITIES. Help you to make better use of screen - change colours, borders, lines, etc.

M2043: SPECIAL COLLECTION UTILITIES. With Nsweep (genuine), PC-Sweep, add line ends to ASCII file, hard disk directory, adjust margins on Epson printer, etc.

M2045+: LIKE-SIDEKICK RESIDENT UTILITIES. Calculator, note pad, data base, appointments calendar, cut & paste, term. communications. 2 disks. Easy, powerful. £18.

M2046: HOT UTILITIES. Superior directory, system stats, diskcheck, file find, etc. For colour screen.

M2047: MACINTOSH EMULATOR. Doesn't run Mac programs, but provides a Dos shell like the Mac's. Great to watch, use.

WORD PROCESSING/PRINTING

M3007: SPELLING CHECKER. Works with most word processors. We've added thousands of new words incl. business/computer terms.

M3020: EXCELLENT WORD PROCESSOR. Compatible with Wordstar, has clear, easily followed commands on screen.

M3021: QUALITY MULTI-FONT PRINTING on dot matrix, Incl. Courier, Greek, Helvetica, Palatino, Roman, Italics, etc.

TOP QUALITY PUBLIC DOMAIN & USER SUPPORTED SOFTWARE

M3024: WORD PROCESSING FOR KIDS. Special features, large lettering, easy to use. A gem.

M3025: TOUCH TYPING - PRACTICE AND EVALUATION. Lets you read script from screen, reports speed/accuracy.

M3026: EGA/CGA WORDPROCESSING. A many featured program that makes extensive use of colour screens. Delight to use.

M3028: FANCY PRINTING FOR WORDSTAR. Access many special characters, change line spacing, do sub/superscript, etc.

M3029: PC-WRITE ENHANCEMENTS. Uses macros to enhance the key command structure for easier and faster use.

M4017: ONE-PAGE DESKTOP PUBLISHING. Suits preparation of flyers, notices.

GRAPHICS

M4014+: COMPUTER-AIDED DESIGN. Dancad3d will do complex drawing, 2 or 3 dimensions, print sharp lines for mechanical drawing, illustrations, animate parts. We've squeezed 4 disks on to 2. Needs CGA. £18.

M4026: SCREEN CAPTURE UTILITIES. Grabs colour, b/w, graphics, etc. A professional printing aid.

M4022: EGA GRAPHICS. 3 dimensional wire-frame modelling. Move, tip, scale, rotate.

M4023: BUSINESS GRAPHICS. For pie/bar charts, graphs, comparisons. Easy to use.

M4024: PAINT GRAPHICS FOR MONO/HERCULES. Good facilities and you don't need colour. Patterned shading, backgrounds, etc.

LANGUAGES

M9001: BASIC/GWBASIC COMPATIBLE INTERPRETER with tutorial. Runs programs written in industry standard Basic. Suits PC compatibles.

M5023: Z80 CROSS ASSEMBLER. New version that lets you write & compile CP/M programs on PC.

M5034: MINI-ADA. Substantial sub-set of major new language. Pascal & Basic source code + disassembler. Requires Turbo Pascal.

M5035: ZBASIC COMPILER. Fast, easy to use version, with editor & examples on disk.

M5036: TURBO PASCAL CROSS-REFERENCER. Lists, beautifies, cross-references source code.

M5038: EXPERT SYSTEM SHELL. Contains utilities to develop, test and run new expert systems. Menu driven. Turbo Prolog source provided. Book available.

COMMUNICATION

M6011: COMMUNICATION UTILITIES - new version with compression/decompression tools, RS232 tutorial.

M6014: SUPER NEW COMMUNICATIONS - Telex. Powerful, yet easy to use, menu driven. Contact bulletin boards.

M6016: PRESTEL/VIATEL COMPATIBLE communications program for contacting these bulletin boards. Handles split baud rate (1200/75).

CALCULATION/BUSINESS

M7001: GENERAL LEDGER ACCOUNTING. Has GLedger, Cash Book, Profit/Loss, Balance Sheet. Prints cheques. Data can be read by Lotus 123. Easy to use.

M7004: STOCK MARKET ANALYSIS. Special aids to help "think and grow rich". For managing and evaluating portfolios and prospects. Needs Basic.

M7024+: PAYROLL SYSTEM. Flexible, easy to use, adjustable rates. 2 disks. Good doc. £18.

M7040: 123 COMPATIBLE SPREADSHEET. Also does graphs, pie charts. 5 x 200 cells.

M7041: MEMORY-RESIDENT SPREADSHEET. Full-featured. At hand when you want it. Insert calcs into text, etc.

M7042+: BILLINGS FOR SERVICES (Professions/trades, etc). Costs, mailing list, invoices, controls drs, file merge. Quality program, easy to use. Powerful reporting. 2 disks. £18.

M7043: INTEGRATED SPREADSHEET/EDITOR. On one disk. Effective combination.

M7044+: CONTRACT BID ESTIMATING. 5 disk set of powerful programs for calculating costs, margins, progress and final estimates. Flexible to use. Needs hard disk. £36.

M7045: ACCOUNTS RECEIVABLE AND INVENTORY. Integrated system for small business that has up to 200 debtors. Prints invoices, cost of sales reports, etc.

M7046: GOAL SEEKING FOR SPREADSHEETS. Works backwards with your spreadsheet from a specified target and lets you examine options.

M7047: POINT OF SALE INVOICING. Suits retailer with different products/depts, reads bar codes, controls inventories, etc.

M7048: PURCHASE ORDER SYSTEM. Keeps track of orders, goods received, quantities, prices, suppliers.

M7049: PERSONAL FINANCIAL ANALYST. Examines your monetary/assets situation and makes projections for planning.

DATABASE

M8009: SUPER DATABASE MANAGER. New version. 120 fields, 16 million records, fast sorting, fields anywhere on screen. Calculations. Two disks on one!

M8018+: DBASEIII COMPATIBLE DATABASE MANAGER. Same functions and runs same files as DB3. Major or small tasks, good reporting, labels. Extensive docs. Highly rec. 2 disks. £18.

M8019: DBASEIII UTILITIES (1). Add colour, printer control codes, compress/decompress, menu front end, show data flow, read file structure.

M8020: DBASEIII UTILITIES (2). Weighted Retrieval. New view of data based on your selection criteria. Attach relative importance to factors.

M8021: DBASEIII UTILITIES (3). Add ons and utilities. Compiled, with C source. Display header info, port addresses, date entry, count comments, encryption, view files, strip characters, more.

M8022: HOME INVENTORY. Keep a record of your possessions re theft, fire, insurance, etc.

EDUCATION

M9019: CHEMISTRY GAME that teaches chemical valences, atomic bonding and structure.

M9020: IQ WORKOUT. Gives practice on synonyms, antonyms, analogies, numbers. Evaluates. Needs Basic.

M9021: COMPUTER-AIDED TESTING. Shows questions, checks answers, re-presents questions until correctly answered, evaluates.

M9022+: MODULAR2 TUTORIAL. 2 disks that teach you how to program in this important new language. £18.

M9023+: TURBO C TUTORIAL. If already familiar with another language, this will give you a good grounding in Turbo C. Sample source included. 2 disks. £18.

M9024: SPANISH LANGUAGE TUTORIAL. Includes vocabulary and conjugation of verbs. Extensive.

M9025: JAPANESE TUTORIAL FOR BUSINESS AND TRAVEL. The words, pronunciation, grammar, most useful to the casual speaker.

M9026: FRENCH TUTORIAL. Emphasis is on conjugation of verbs.

M9027: SECONDARY MATHS (2). Compiled with Pascal source. Equations, lines, triangles, Ohms Law, Parallel Circuits.

GENERAL

M9504+: RECIPE MANAGEMENT. Contains hundreds of recipes and excellent searching. Add your own. 2 disks. £18.

M9511: PERPETUAL DIARY. Plan ahead for appointments, events, birthdays. Print reports. Needs Basic.

M9512: GOURMET PIE RECIPES. Some of the most delicious you've ever tasted. Menu-driven.

M9513: LIFESTYLE & HEALTH ANALYSIS. Has personality assess, biorhythms, heart disease risk, alcohol screening, life expectancy. Needs Basic.

M9514: CHURCH MANAGEMENT (1) PROSPECTS. Keeps track of those interested in joining, personal data, etc.

M9515: CHURCH MANAGEMENT (2) MEMBERSHIP. Details of new members, anniversaries, birthdays, Sunday school membership, etc.

PHONE NOW WITH YOUR ORDER

0344 863020

SHAREWARE REQUIRED FOR INTERNATIONAL DISTRIBUTION
We have extensive marketing and distribution facilities locally and overseas and require quality software for international distribution. Adequate documentation should be on the disk.
Please forward submissions to our Chief Executive at the address below.

CP/M AND MACINTOSH
Call or write for free catalogue.

PUBLIC DOMAIN NEWSLETTER
For news, reviews, views and how to use public domain and user-supported software subscribe to our bi-monthly newsletter and keep informed on the free programs that help your computer to serve you. INCLUDES UPDATES TO CATALOGUE. Only £12. (VAT not applicable.)

ORDERS:
For individual disks the first disk costs £10, the second £8, and each disk thereafter is £6. Sets are as specified.
Add £2 post/pack (£3 foreign). UK residents add 15% VAT to total.

ORDERS MUST BE PREPAID.

PAYMENT BY MAIL TO:
SELTEC COMPUTER PRODUCTS LTD,
"Farley Hall", Wokingham Rd, Bracknell,
Berkshire, RG12 5EU UK.

TELEPHONE ORDERS: (0344) 86 3020
Pay by Access/Mastercard or Barclay/Visa.

We cannot guarantee the suitability of public domain/user-supported software for users' needs or equipment. AK1002

PC GAMES FOR ONLY £2!

Out of the hundreds of games we have collected from the public domain and user-supported software, we bring you a special selection of some of the best games available - and you may choose them in any combination that you wish.

Choose any number for only £2 each (service charge), with a minimum of six programs, and we transfer them on to one, or more, of our disks for you.

We include source coding where possible. The programs are documented or the instructions are built in to the program. Disks are formatted for MS-DOS ver 2 or greater. 360K 5¼" and 3½" disks.

Programs are intended for IBM-PC or close compatibles (such as Amstrad 1512). If Basic is specified then Basic or GWBasic (or our shareware compatible version on M9001) is required, not Basic2. Basic is required if an asterisk is shown alongside the name.

We have added a CGA emulator to our disks so that those with Hercules boards can also play.

GAMES

G1: ACQB. Arm Chair Quarterback is a football strategy game. Rules are explained. You provide wits, the computer action.

G2: AFGHANISTAN. War Game with choice of weapons and roles.

G3: ANTONYMS.* Word game that challenges you to find the opposite of nominated words. Source provided.

G4: ASTRO. Dodging enemy ships and meteors. Well animated. Suit all ages.

G5: BABY. Gruesome but popular Kong-type game. Climb levels whilst avoiding the falling babies.

G6: BACKGAMMON. A good version of this popular board game.

G7: BASEBALL.* Match play with strategic choices of play for pitching, hitting.

G8: BEAST. Marauding beasts chase you through a hi-res maze.

G9: BIORHYTHM.* Prints chart of emotional, mental, physical biorhythms.

G10: BLACKFR13.* Investment simulation. Try to increase value of portfolio without going broke.

G11: BLACKJACK. Good version of this popular card game.

G12: BLUESBOX.* Easy to use song composer.

G13: BRICKS. Quick moving game where you hit a ball against a wall to demolish it. Like playing squash against the computer.

G14: BUGSI Centipede creature hunts you through the forest. When you fire and hit it, the creature multiplies! Fast game.

G15: CATCH 88.* Sky is raining letters and numbers. Catch them by correctly matching.

G16: CHASE. You're in a high voltage maze, chased by robots. Compiled with Pascal source code.

G17: CHESS.* Well designed, good board on screen.

G18: CIA.* Adventure with spies and other sinister doings.

G19: CIVILWAR.* Tactical simulation based on actual battles in Civil War.

G20: CRISIS. You're our last hope to save the world from alien invaders.

G20A: DIGGER. Fun to play. Good graphics as digger digs tunnels for gold/emeralds while hungry creatures hunt for digger.

G21: DILEMMA. You have to outguess your opponent. Cooperate or oppose?

G22: DOTS.* Board strategy game against the computer, joining dots with lines.

G23: DSK. Disk Crash. As a floppy disk you have to avoid the falling magnets.

G24: DRAIN. Joke program which causes computer to pretend it's awash and needs to drain.

G27: ELECTION.* Simulates candidate campaigning, raising funds, giving speeches. Good choices win points.

G28: ELEVATOR. You're at the bottom of a series of elevator shafts. Try to reach top without getting clobbered by elevator.

G29: ELI.* Animated cartoon depicting the adventures of Eli.

G30: ELIZA. Classic Psychiatrist game where the computer counsels you. Compiled version.

G31: ENCOUNTE.* Space encounter of the unfriendly kind. Good battle.

G32: ENTRAP. Othello board-type game, cleverly designed, good graphics.

G33: FIRE. Forest fire is raging and you have limited resources to combat. Will you lose the forest? What is your strategy?

G34: FLIGHTMARE. You are a pilot for Omegans against marauding vandals.

G35: FOOTBALL.* Tactical play in a footy simulation.

G36: FORTUNE. Wheel of fortune. Spin the wheel and win prizes or be penalised. More than one can play.

G37: FROG. Frog tries to cross road to safety and avoid being splattered by traffic.

G38: FUN.* Fun with numbers. It helps to understand a little algebra to solve the problems.

G39: GEOGRAPHY. Educational game that tests you on cities, capitals, countries, etc.

G40: PC-GOLF. Very well presented. Takes into account handicaps, clubs, swing, choice of three courses.

G41: GRIME. Hi-res fight against those nasty grimes that threaten to attack and overwhelm.

G42: HANGMAN.* Correctly spell the mystery word before the computer hangs your image.

G43: HANOI.* Transfer disks from one pile to another. Requires thought.

G44: HOBBIT.* Adventure. Hobbit thief tries to steal from the wizard's castle.

G45: HORNADETTE. Adventure. Invading the Castle and find the secret formula.

G46: IBMADV. Adventure. Government agent infiltrates IBM headquarters.

G47: IQUEEN.* Board game based on chess and using only queens.

G48: JUMPJOE. Mad robots chase Joe through rooms and past obstacles on space station.

G49: KONG. Climb the structures against falling objects and other dangers.

G50: LANDER.* Try to land a spacecraft against gravity, adjusting rocket thrust. Good sound and graphics.

G51: LANDMINE. The enemy has buried mines and you have to reach headquarters - preferably intact.

G52: LIFE2. Enter details of bacteria colonies and they breed, generating patterns on the screen.

G53: LOCUST. Spreadsheet setting. Kill the numbers, zero a column to win. They keep growing!

G54: MARS ESCAPE.* Adventure. Your mission is to escape from Mars.

G55: MAZE1. Mazes with different degrees of difficulty. Good graphics.

G56: METEOR.* Erase solid blocks before the constantly falling meteors hit you.

G57: MEMBRANE.* Chemistry game. You are a cell membrane. Learn about cell behaviour.

G58: MUSICIAN. Compose songs, music. Helps you to compose on the screen and play back.

G59: OIL. Offshore Drilling Simulation. Organise resources to strike oil or go broke.

G59A: PACMAN. Classic where you are in a maze hunting treasure while the monsters hunt you. Different levels of play.

G60: PANGO. Attempts to clear bees in a field by stunning-or squashing with blocks.

G61: PARATROOPER. Fight off the paratroopers who keep landing until they can overwhelm.

G62: PINBALL. Good screen effects let you play this arcade type game with the cursor keys.

G63: PIRATE.* Adventure set on a pirate ship.

G64: PITFALL. Fast moving flight through valley or pit. Good screen effects. Needs fast reflexes to avoid walls and other dangers.

G65: POKER. Card game. Several can play or just you against the computer.

G66: POKER MACHINE. (ONE ARMED BANDIT). Try to line up the reels for your win.

G67: POLYMAZE. Computer generates hexagonal mazes and will demonstrate how to solve them.

G68: PRESCH.* Spelling and number games for small children.

PROVOCATIVE PINUPS: These are intended for printing. Hang alongside last month's sales figures (or whatever).

G69: CALENDAR GIRL.

G70: JEZABEL.

G71: DAWN.

G72: DELILAH.

PROVOCATIVE SCREEN PICS: These are animated screen pictures.

G73: RECLINING NUDE.

G74: STRIP.

G75: PYRAMID. Fast moving game where you step onto cubes to avoid bouncing rocks and creatures.

G76: QBERT. Bert & the Snake. Jump from one tile to another pursued by the snake and falling fruit.

G77: RACECAR.* You race the computer on racetrack controlling speed, braking, etc.

G78: RAIN. Challenging pinball game that has very good graphics and cursor control.

G79: ROCKETS. Fascinating, fast, hi-res game of space battle.

G80: ROULETTE. Gambling simulation using screen version of a roulette wheel. Cheaper than going to a real casino.

G81: SCATTER. Logic puzzle. Fire a laser to determine whereabouts of 10 atoms in a box.

G82: SEAWOLF.* Valiant submarine commander attempts to sink the invasion fleet with his torpedoes.

G83: SECRET ADVENTURE.* Create your own adventure. For small children. Answer questions about rooms and monsters and it generates a game for you.

G84: SKYTREK. Comprehensive strategy game of the Startrek type.

G85: SLOTMACHINE.* Poker Machine game that can be played by all ages. Animated.

G86: SOLITARE. Card game that shows you the draw and you work out where to place each card.

G87: SPACEWARS. Nicely presented Starwars type of game with many factors to consider.

G88: SPACEVADERS. Race across the screen shooting them down. Good graphics.

G89: STARLANE.* Interstellar Trading. Space Monopoly where you try to build an empire.

G90: STOCKMARKET. Simulation game where you try to amass your fortune in stocks and shares.

G91: SQUARE.* Like Tic Tac Toe but more combinations with dots on larger board.

G92: SUBCHASE. You're in a destroyer on patrol trying to destroy subs swarming below.

G93: SWARMS.* Attack of the killer bees! BeeWars?

G94: TANK.* Two tank commanders slug it out.

G95: TRADE.* Star trading by intergalactic merchant. The ultimate travelling salesman.

G96: WIZARD.* Adventure in the Wizard's castle against monsters, elves, hobbits, dwarf, etc.

G97: WOMBAT.* Generates questions for mental arithmetic. Suits primary children.

G98: WEATHER.* Answer questions about conditions of last two days and it will attempt to forecast tomorrow's weather.

G99: XWING. Very good version of starwars-type game where you are pitted against Darth Vader and the Death Star space station.

ORDERS:

The service charge for each program is £2. There is a minimum charge of £12 (six programs) plus £2 for postage and packaging (£3 foreign). UK purchasers add 15% VAT to total.

ORDERS MUST BE PREPAID.

PAYMENT BY MAIL TO:

SELTEC COMPUTER PRODUCTS LTD,
Farley Hall, Wokingham Rd, Bracknell,
Berkshire RG12 5EU UK.

TELEPHONE ORDERS:

Pay by Access/Mastercard or Barclay/Visa.
Tele: (0344) 86 3020

FAX: (0344) 863999

We cannot guarantee the suitability of programs for users needs or equipment.

CIRCLE NUMBERS BELOW AND SEND TO US WITH PAYMENT AND YOUR NAME AND ADDRESS. OR TELEPHONE US WITH THE PARTICULARS. SEE ABOVE.

G1	G2	G3	G4	G5	G6	G7	G8
9	10	11	12	13	14	15	16
17	18	19	20	20A	21	22	23
24	25	26	27	28	29	30	31
32	33	34	35	36	37	38	39
40	41	42	43	44	45	46	47
48	49	50	51	52	53	54	55
56	57	58	59	59A	60	61	62
63	64	65	66	67	68	69	70
71	72	73	74	75	76	77	78
79	80	81	82	83	84	85	86
87	88	89	90	91	92	93	94
95	96	97	98	99			

1002A

PACKARD BELL

THE HIGH LEVEL AT COMPUTER FOR LOW LEVEL PRICES



VX 88 small footprint
very fast XT compatible
with 20 MB only £725!
with 30 MB only £795!
with 40 MB only £995!

Since its founding in 1929, Packard Bell has established itself as a leader in electronic innovation and quality. Today, that innovation and quality is found throughout the complete range of new Packard Bell Business System Products. State-of-the-art technology, reliability, durability and value, hallmark each of these new products. To meet expanding business application requirements, the VT286 provides:

- Significantly faster Processing and Throughput.
- 640KB RAM standard; expandable to 15MB.
- High capacity Disk Drives and 1.2 MB Floppy Disk.
- Parallel and Serial Interface.
- 220W Power Supply.
- Professional Keyboard.
- MSDOS 3.2, GW Basic 3.2
- 7 Channel DMA.
- 16 Level Interrupts, 3 Program Timers.
- 4 Level Memory Protection

For further information please call on 01-842 0071

CAL-ABCO

Over 50 offices worldwide

CAL CIRCUITS-ABCO (U.K.) LIMITED
SPENDALE HOUSE, THE RUNWAY, SOUTH RUISLIP, MIDDX.
HA4 6SE; Tel: 01-842 0071 Fax: 01 841 3891, Telex: 295441

Cal-Abco acknowledges all trade marks in this advertisement

ADMICRA

An **AAA** Company

Tandon

ATARI

Roland

AUTOCAD

AUTHORISED DEALER

MANNESMANN TALLY

TAXAN

PC1512 from £449 inc. FREE 640K Upgrade

Opus. PCII from £499

Tandon PCX & PCA SUPPLIED WITH 12 MONTHS FREE ON-SITE MAINTENANCE

BASIC AUTOCAD SYSTEM

Opus System 4 (20Mb, 1MB RAM) 720 x 348 resolution mono parallel & serial ports. Basic Autocad Mouse Hitachi A3 plotter

£1799

ADVANCED AUTOCAD SYSTEM

Tandon PCA20 (20MB, 1MB RAM) 720 x 348 resolution on 14" screen. 1 parallel & 2 serial ports Autocad plus ADE 2 & 3. Cherry A3 digitiser. Hewlett Packard 7570AA1

£7999

We can tailor Autocad systems to your requirements due to our extremely wide range of support peripherals (see below) **Installation and training.** Please call for details

VIKING ULTRA HIGH RESOLUTION 19" DISPLAY. Ideal for Desk Top Publishing & CAD PLEASE CALL

ALLOY MULTI-USER Turn your XT/AT into a Novell compatible multi-user system from **£1199 per station**

ATARI 1040 ST Mono £559

Multitech 910 Small footprint 80286, 10MHz 20Mb Monographics 1P & 25 — Superb value **£1395**

HARD DISK UPGRADES IBM/compatibles

20/30Mb Hard disk controller.....	£249/£299
20/30Mb Hard card.....	£269/£319
Sanyo Memory upgrade to 256K + RAM disk + 25% extra disk capacity.....	£65
Amstrad PC 1512 upgrade to 640k.....	£29

APRICOT ADDONS

512k Memory Board.....	£115
20Mb Hard Disk Upgrade.....	£695
Hi Res Mono Monitor for Portable.....	£109

PRINTER PROMOTIONS

PANASONIC 1081	£169
MP 165	£189
STAR NL 10	£199
EPSON LX800	£199
EPSON FX800/1000	£319/£399
M. TALLY MT85/86	£299/£399
EPSON EX800/1000	£399/£539
NEC P6/P7	£409/£499
EPSON LQ800/1000	£459/£619
JUKI 6100	£259
QUENDATA 1120	£169
HP LASERJET 2	£2195

SHEETFEEDERS Please Call

ACCOUSTIC HOODS Please Call

PRINTER BUFFERS

Serial/parallel in/out 8K-2MB from **£79**

★ New ★ All Purpose X-buffer — Please call

FANFOLD PAPER All sizes available eg

11" x 9 1/2" 60gm	£9.75	(2000 sheets)
12" x 9 1/2" 60gm	£12.99	(2000 sheets)
A4 Clean Edge 70gm	£15.95	(2000 sheets)*
85gm	£9.30	(1000 sheets)
11" x 14 1/2" 60gm	£13.50	(2000 sheets)*

Delivery £2.65 (fixed) + £1 per box. Extra £1 per order for items marked *

LABELS 89mm x 36mm from **£3.25/1000**. 70mm x 36mm from **£2.95/1000**. Please call for other sizes.

RIBBONS for all printers eg

EPSON FX MX RX 80/100	£2.49/£3.75
EPSON LX 80	£2.95
JUKI 6100 single strike	£1.15
SHINWA/M TALLY MT80	£3.79
KAGA/CANON	£3.99
QUME MS4	£2.65
APPLE IMAGEWRITER	£3.35

PRINTWHEELS from **£3.95**

Delivery 95p any Quantity ribbons/printwheels

Official Government/Educational Authority orders welcomed.

Please add 15% VAT to all prices (inc. carriage) Limited space precludes listing of our full range of products. Please telephone if you do not see the item you require

SOFTWARE SPECIALS

VENTURA DTP	£595
Supercalc 4.....	£212
VP Planner.....	£65
VP Info.....	£65
Wordcraft 3.0 (IBM).....	£349
WORDSTAR 2000 Plus	£239
Wordstar Prof 4.....	£239
Word Perfect 4.2.....	£265
Turbo Pascal (8087+BCD).....	£55
Turbo Reflex.....	£79
Turbocad *New release.....	£99
CADD inc. mouse.....	£169
Autosketch.....	£69
Ability-Integrated Package.....	£79
Sage Financial Controller.....	£239

MICRO FACTS: Please call for details

PLOTTERS — DIGITISERS etc.

Hitachi 672 A3.....	£459
Roland 880A A3.....	* £659
Roland 885 A3.....	£779
Hewlett Packard 7570AA1.....	£3995
Roland DPX2000 A2.....	** £2895
Graphtec GP9001 A0.....	£6,195
Summasketch 12" x 12" digitiser.....	£395
Cherry A3 digitiser.....	£495
Logimouse Plus.....	£85
MOUSE SYSTEMS PC Mouse.....	£99

* inc FREE 11k buffer ** inc stand

DISKS — POST FREE Packed in tens No quibble guarantee

Prices for ONE box. All extra boxes — **10% EXTRA DISCOUNT**

5 1/4"	DYSAN	SONY	PRECISION
SSDD	£11.90	£10.90	£8.90
DSDD	£15.90*	£13.90	£10.90
DSQD	£17.90	£15.90	£13.90
HD1.6MB	£19.90	£19.90	—

*** DYSAN DSDD — 1 EXTRA DISK PLUS LIBRARY CASE**

SONY 3.5" SS £16.90 DS £19.90

SONY PLAIN LABEL UNBOXED — PLEASE DEDUCT £2

AMSOFT 3" £28.90

LOCKABLE DISK BOXES

40 3 1/2" DISKS **£7.95**
70 5 1/4" DISKS **£9.95**

ADVANCED MICROCOMPUTER APPLICATIONS LTD 1ST/2ND FLOORS 40, HIGH ROAD, BEESTON NOTTINGHAM NG9 2JP Tel: 0602 252627

ADMICRA An AAA Company

EVERY WORD IS PERFECT.



THE NEW AMSTRAD 9512 WORDPROCESSOR WITH

The letters you send speak volumes for your company's image. Scrappy typing, untidy layouts and poor spelling announce that you're a less than professional outfit.

Whereas beautifully presented correspondence shows quite clearly that you're a company to be reckoned with.

Now Amstrad's new wordprocessor with daisywheel printer and spellcheck facility means that any company can produce superb quality letters, reports and documents.

With the minimum of effort, and for a minimal outlay.

THE PERFECT WORDPROCESSOR.

The Amstrad PCW 9512 is a very stylish looking piece of machinery. But its good design isn't merely cosmetic.

The keyboard has been constructed to enable the user to make the most of the 9512's facilities with the least amount of hassle.



And the monitor is paper white, which makes it much easier to follow what you're doing.

The inclusive word processing software features 'pull down' menus, giving you different options to choose from so that you can layout your text (and cut or change it) quickly and easily.

What's more the software also offers you another invaluable and unusual feature. It will check your spelling for you, using its built-in dictionary of 78,000 words.

Never again will your letters let you down.

And if you want to combine mailing lists and letters to mail out to prospective clients or customers the mailmerge facility will even take care of that for you.

THE PERFECT PRINTER.

Unlike a dot matrix, the daisywheel printer that comes with the PCW 9512 prints 'solid' characters.

And what that means is superb letter quality

SCREENS SCREENS SCREENS

BEST EQUIPMENT! BEST DEALS! BEST CHOICE!

Forget the rest – check the best – SCREENS



FROM £299.00!

ST100 BEGINNER PC

An exceptional 16Bit Beginner PC at an incredible price. Add to the basic kit the peripherals of your choice!

- 8088-2 CPU (4.77/8MHz) ● 512K Ram ● 360K Floppy Disk Drive ● Mono Graphic Card ● Parallel Printer Port ● 150W Power Supply ● 84 key keyboard ● 6 Free full sized Expansion slots.

ST100 ENHANCED, AS ABOVE PLUS MS-DOS 12" MONITOR & RS232 PORT **£399.00!**
 ST100 20 MB XT, AS ENHANCED PLUS 20 MBYTE HARD DISK & CONTROLLER **£769.00!**
 ST100 COLOUR SYSTEMS ADD **£199.00!**



PROFESSIONAL PERFORMANCE

£945.00!

CL-20 TURBO XT

Desktop Turbo XT Computing at an affordable price and NO HIDDEN EXTRAS. Another SCREENS Exclusive!

- 8088-2 CPU (4.77/8MHz) Hardware Selectable ● 640K Ram ● 360K Floppy Disk Drive ● 20MByte Winchester Hard Disk ● 2 Free Floppy Disk Cavities ● Serial Port ● 2 x Printer Ports ● Real-time clock with battery backup ● Slim AT Type keyboard ● 12" High Resolution Amber/Green Screen Monitor included ● 5 Free Expansion slots ● Games Port ● Turbo Indicator ● MS-DOS/GW BASIC v3.2 ● ONE YEAR ON-SITE MAINTENANCE



PROFESSIONAL PERFORMANCE

£499.00!

CL-1D TURBO DESKTOP

An incredible value for money package exclusively from SCREENS

- 8088-2 CPU (4.77/8MHz) Hardware Switchable ● 640K Ram ● 360K Floppy Disk Drive ● 3 Spare Floppy Drive cavities ● Serial Port ● 2 x Parallel Ports ● 1 x Games Port ● Real-time clock & battery backup ● Slim AT type keyboard ● Turbo indicator ● Power on LED ● Maintenance option ● 12" High Resolution Amber Monitor on swivel/tilt stand ● MS-DOS v3.2 ● GW BASIC v3.2 included in price ● 5/6 Full sized IBM Expansion slots.



£1199.00!

ST420 BABY 12MHz TRANSPORTABLE AT

One of the best offers on the market today, at any price! Brought to you exclusively from SCREENS a simply amazing price.

- 80286-10 CPU (6/10/12 MHz clock) ● 512K User Ram installed ● 5" High Res Paper White Monitor ● 165W Power Supply ● FDD/HDD Controller Cards ● 1.2MByte Floppy Disk Drive ● 20MByte Winchester Hard Disk ● Parallel Printer Port ● Serial Port ● Full Sized Expansion slots ● MS-DOS v3.2 ● ONE YEAR ON-SITE MAINTENANCE INCLUDED IN PRICE.



PROFESSIONAL PERFORMANCE

£599.00!

CL-2D TURBO DESKTOP

Everything a small office could want plus more. Compare our specification to price and buy with confidence today!

- All specifications as CL-1D plus ● Dual 360K Floppy Disk Drive ● One year On-Site Maintenance

Who else but SCREENS could bring you the BEST EQUIPMENT! BEST DEALS! BEST CHOICE!



£1499.00!

ST320 ENHANCED BABY 12MHz AT

UNBEATABLE! UNBELIEVABLE! UNSTOPPABLE!

- Small Footprint AT ● 80286-10 CPU (6/10/12 MHz) ● 1 MByte Ram ● 101 Key AT Professional Keyboard ● 200W Power Supply ● 1.2MByte Floppy Disk Drive ● 30MByte Winchester Hard Disk ● Serial Port ● Parallel Port ● Hercules compatible mono graphic card ● 14" High Resolution Amber Monitor on swivel/tilt stand ● MS-DOS v3.2 ● ONE YEAR ON-SITE MAINTENANCE ● 40M Byte Hard Disk Version also available CGA/EGA VERSIONS AVAILABLE **£1699.00!**



£699.00!

CL-2P TRANSPORTABLE PC

The power of a Desktop Turbo in a transportable case, ideal for the businessman on the move. At an unbelievable price!

- 8088-2 CPU (4.77/8MHz) Hardware Selectable ● 640K Ram ● Built in 9" Amber Monitor ● Dual 360K Floppy Disk Drives ● Real-time clock with battery backup ● 2 x Parallel Ports ● Dual RS232 Ports ● Four free full sized expansion slots ● Provision for external monitor ● Low profile keyboard ● Reset button ● Security lock ● MS DOS/GW BASIC v3.2 ● ONE YEAR ON-SITE MAINTENANCE INCLUDED IN PRICE ● XT 20MB VERSION ALSO AVAILABLE



£2995.00!

ST386 16MHz DESKTOP

Who else but SCREENS could bring you the latest specifications 386 at a price to leave the competition standing!

- Small Footprint ● 80386 (16MHz) ● 2 MByte Ram ● 2xRS232 ● Parallel Printer Port ● 101 Key Keyboard ● Real-time clock with battery backup ● 1.2MByte Floppy Disk Drive ● 40MByte 28ms Winchester Hard Disk ● 200W Power Supply ● 14" High Resolution Amber Monitor on swivel/tilt base ● Socket for Maths CoProcessor ● MS-DOS v3.2 included.

FREE! A PUSH BUTTON 14" PORTABLE COLOUR T.V. WITH ANY HARD DISK XT/AT SYSTEM. OFFER MUST END WHEN T.V. STOCKS ALLOCATED. HURRY NOW!

CHECK OUR ROCK BOTTOM PRICES ON EXTENSIVE RANGE OF ADD-ONS, PRINTERS, MONITORS, CONSUMABLES & SOFTWARE. SEND LARGE S.A.E. FOR OUR PRICE LISTS TODAY.

SCREENS MICROCOMPUTERS & ELECTRONICS LTD

TRUST SCREENS TO DELIVER

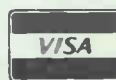

MAIN AVENUE · MOOR PARK · NORTHWOOD · MIDDLESEX · ENGLAND

TEL: SALES 09274 20527 TEL: EXPORT 09274 20664 TLX: 929224 SCREEN G FAX: 0923 240402

CORPORATE - EDUCATIONAL - EXPORT ENQUIRIES WELCOME · PRICES QUOTED EXCLUDE VAT & DELIVERY · 24 HOUR DELIVERY SERVICE AVAILABLE · ALL PRODUCTS CARRY ONE YEAR WARRANTY

PRODUCTS SUBJECT TO AVAILABILITY · ON-SITE MAINTENANCE - INSTALLATION - TRAINING & CREDIT FACILITIES AVAILABLE · IBM IS REGISTERED TRADE MARK OF INTERNATIONAL BUSINESS MACHINES INC

MS-DOS/GW BASIC ARE TRADE MARKS OF MICROSOFT INC · SCREENS ARE LICENSED CREDIT BROKERS · DELIVERY CHARGES: SOFTWARE = £2. HARDWARE UNDER £200 = £6. OVER £200 = £10. OVER £2000 F.O.C.

SCREENS



TRUST SCREENS TO DELIVER



SCREENS

■ THE ONLY

WITH



T The new Citizen LSP-100 may bear more than a passing resemblance to the Epson LX800. But two crucial differences set these 9-pin dot matrix printers apart.

H Firstly, there is the LSP-100's unrivalled versatility. The built-in font produces over 400 different print styles, including reverse printing, proportional spacing, double height, double width, double strike and italic. While working in Epson mode it will accommodate an amazing 239 downloadable characters and 93 in IBM mode.

E Secondly, the LSP-100 is very competitively priced and unlike any other printer has a two year warranty.

■ It is the only one to choose.

N For more information call Citizen, free of charge, on 0800 282692.

E ■ L S P - 1 0 0

	LSP-100	LX 800
Speed		
NLQ mode	30 cps	25 cps
Draft Pico (10cpil)	150 cps	150 cps
Draft Elite (12cpil)	175 cps	180 cps
Buffer	4k	3k
Downloadable Characters		
	239 (Epson mode)	6
	93 (IBM mode)	
Built-in fonts	1	2 (NLQ only)
Paper Feed		
Standard tractor feed	Yes	Yes
Bottom feed	Yes	No
Warranty	2 years	1 year
Price	£249	£275

CITIZEN
COMPUTER PRINTERS

RE: CSD IN RECEIVERSHIP

£1½ MILLION OF LIQUIDATED PC SOFTWARE AT FRACTION OF COST

SAVE 66%



DESKTOP PUBLISHING

Wordcraft Elite DTP c/w Imagemaster, full function, spell checker, calculator & comms, NEW **£295**

- *Career Planning £25
- *Management By Exception .. £25
- *Sell Training £55
- *Sell Application £55
- *Management Advantage £75
- *Thoughtware Lightyear £75
- *Evaluating Effects £35
- *Understanding Styles £35
- *Leading Effectively £35
- *Motivate to Achieve £35
- *Defining Goals £35
- *Improving Performance £35
- *Performance Appraisal £35

LOTUS RIVAL



DAYBREAK TECHNOLOGIES

Silk, 1-2-3 style spreadsheet, saves as you type, innovative help, not protected, list £295, NEW **£95**

ASHTON-TATE



ASHTON-TATE
dBASE III PLUS LATEST VER
Industry standard database approx 1 billion records per file, 128 fields per record. **£295**

A M S T R A D



SIDEKICK

Best known pop-up utility, Inc notepad (uses Wordstar commands), calculator, NEW **£15**

- *My Accountant £25
- *Swift £35
- *Perfect Writer II £35
- *Perfect Calc II £10
- *Perfect Filer II £15
- *Perfect Link £5
- *PC Promise £45
- *PC Promise (full) £75
- *Sage Deskset £35
- *Datamaster £95
- *Conducting Meetings £10
- *Assessing Management £35
- *Managing Stress £25

MAC SOFT

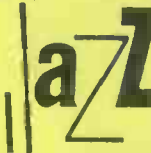

MACINTOSH JAZZ PACKAGE

Software from Lotus, Inc word processing, spreadsheet, database, comms, (NEW) **£100**

M E M R E S



QUOD ERAT

QED+

Memory resident for IBM & Apricot. Spec inc WP, calculator, form design. NEW, manuals **£75**

C O M P A Q



COMPAQ PORTABLE

IBM compatible, minimum spec 512k, twin floppies, printer card, diags, manuals, (DEMO) **£695**

VOLKSWRITER



DE LUXE VERSION

Cut price version of well known heavyweight word processing software. NEW **£30**

LOTUS PLUS WP

h3d6hh1d1f8h
3HE437jb5j

WORDS & FIGURES

Lotus 1-2-3 version 1 clone includes spreadsheet & full word processing, NEW **£50**

- *K-Chat £50
- *K-Comm £50
- *K-Graph £50
- *K-Report £50
- *K-Text £50
- *K-Paint £50
- *K-Mouse £50
- *Zorland Compiler £20
- *Zorland Windows £20
- *Zorland Optimiser £20
- *Main Street Filer £20
- *Graphlink £20
- *Money Manager Plus £15

I N T E G R A T E D



MIGENT ABILITY

Inc word processor, spreadsheet, flat file database, graphics, & communications NEW **£50**

TOP DATABASE



KNOWLEDGE MAN 2

One billion records per file, 255 fields per record, compares with £500+ databases **£150**

LAPTOP & ACCS



KAYPRO 2000 SYSTEM

Rechargeable portable computer. Inc Wordstar, Calcstar, MS-DOS, MITE. Demo **£695**

A P R I C O T

- *dBase III £195
- *Wordstar 2000 £195
- *Wordperfect £195
- *Dataease £95
- *Perfect Calc II £30
- *Perfect Filer II £30
- *Data Master £50
- *Sales Edge £15
- *Expert Ease £15
- *Management Edge £15
- *QED Plus £75

C O M P A Q



COMPAQ PORTABLE III

IBM compat, 640k, 1x1.2mb floppy, 20mb hard, 80286 plasma display DEMO **£2500**

COMPSOFT



compsoft plc

(“BUDGET” DELTA 4)

Transactional database management system. 2 sec retrieve. No programming required. NEW **£50**

5mb HARD DISK

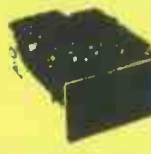

FLOPPY DISK PRICE

5mb full height internal hard disk for IBM PC & BBC model B. Controller extra, (DEMO) **£50**

S A M N A



PLUS IV

SAMNA PLUS 4

Corporate class word processing, spreadsheet. 75 plus printers supported. NEW **£295**

- *Gem Comm £75
- HP150 Programmers tool kit £95
- *Amstrad Reflex £50
- *dBase III C tools £30
- *Wordstar 1512 £50
- *Sage PC-Planner £75
- *Sage PC-Write £50
- *Microsoft Flight Simulator .. £30
- *Fleet St Editor for BBC £25
- *Moneypower £95
- *dBase II 1512 £75
- *Framework II latest version .. £275
- *Wordstar 2000 version II ... £225

A/C PACKAGE



PC LEARNING SOFTWARE

SAGE BOOK KEEPER

Inc sales ledger, purchase ledger, nominal ledger. Up to 1000 accounts & suppliers. NEW **£50**

Part exchanges accepted.

* indicates brand new goods

ACCESS AND VISA ACCEPTED
PRICES SUBJECT TO 15% VAT
MAIL ORDER (CARRIAGE EXTRA)

Morgan Computer Co.

OPEN MONDAY TO SATURDAY
PRICES SUBJECT TO CHANGE
GOODS SUBJ. TO AVAILABILITY

64-72 NEW OXFORD STREET, LONDON WC1. 01-255 2115 & 179 TOTTENHAM COURT ROAD LONDON W1. 01-636 1138



"FIENDISHLY LOW PRICES"

SEIKOSHA SP1200



A high quality, feature packed printer, ideal for home or light office use. 120cps in Draft, 22cps in NLQ. 80 column carriage. Automatic single sheet feed. Tractor feed. NLQ front control. 12 months warranty. Parallel interface.
£189.00

SEIKOSHA MP5300

Wide carriage dot matrix printer. Fast, quiet and a bargain at the price. Ideal for printing spreadsheets and all continuous stationary. 300cps Draft, 60cps in NLQ. Automatic single sheet feed. Complete control from front panel. Both Parallel and Serial interface. Optional cut-sheet bin feed available. 12 months warranty.
£389.00

SEIKOSHA SP180

The quality home printer at an affordable price. 80 column. 100cps Draft and 16cps NLQ. Friction feed and drop-on tractor feed. Choice of Serial or Parallel interface. Long ribbon life. 12 months parts and labour warranty.
£149.00

EIZO 3010 MONO MONITOR

Green, amber and white reverse. Compatible with IBM composite PAL output. Will also run on BBC, Acorn, Apple II c/e, Epson. 12" matt black screen for low reflection. Complete with phono-phono cable. 12 months warranty.
£55.00

MODEMS - FROM RACAL

Top quality modems at low low prices.
2BM external modem V21/V23 with software.....£299.00
2BM internal modem V21/V23 with software.....£299.00
External modem V22.....£399.00
Internal modem V22.....£360.00
External modem V22 with autodial..£450.00
Internal modem V22 with autodial...£425.00
High spec, multispeed external modem with error correction.....£580.00

AMSTRAD 1512 FAN

Is your Amstrad PC1512 running a little hot? Are you planning to upgrade it with a hard disk? Then you need an Adfan. Designed for the 1512. Full fitting instructions included.
£27.00

All goods guaranteed. Official Purchase orders accepted from Government, Local Authorities, Universities and PLC's. All prices exclusive of VAT and subject to change without notice. Delivery charges extra. No returns or repairs accepted without Returns Authorisation Number (obtainable from our Technical Support Department).

Defective dead-on-arrival merchandise repaired or replaced immediately at our carriage expense. Carriage on warranty repairs is paid by the customer. Non-defective credit returns subject to a 10% restocking fee. Technical support available Monday to Friday. Export and trade enquiries welcome.

FOR FULL PRICE LIST PLEASE CALL
 TELEPHONE ORDERS WELCOME



0727-37451 / 72790



SINGLE AND MULTI-USER
 MICRO-COMPUTER
 SOFTWARE SALES AND SUPPORT

SHOWROOM • 99 PARK STREET LANE • BRICKETWOOD • HERTFORDSHIRE • AL2 2JA • ST ALBANS (0727) 72790

TELEX: 8950511 ONE ONE G (Quote Ref: 15412001)

HEAD OFFICE • UNIT A • CAXTON CENTRE • PORTERS WOOD • ST ALBANS • HERTFORDSHIRE • AL3 6XT • (0727) 37451

COMPUTER EXPRESS HOLLAND • NIJVERHEIDSWEG • N60 • 3812 PM • AMERSFOORT • NETHERLANDS • (33) 630544
 COMPUTER EXPRESS AMERICA • 1713 S.E. ELLIS STREET • PORTLAND • OR • 97202 USA • TELEPHONE (503) 235 0277

CLEAN-UP YOUR POWER SUPPLY

A rugged high performance filtered and conditioned power supply block. 3 x 13 Amp sockets each capable of delivering 5 Amps of clean power. Will protect your PC's from unwanted noise on your power supply. Designed for both wall or floor mounting. A real 'Rolls-Royce' job.
£110.00

EIZO EGA MONITOR

Eizo 8042 EGA monitor. Full EGA compatibility, switchable mono. Looks good and performs like a dream. 0.39mm dot pitch for high resolution. Supplied with a cable to suit IBM. Ask about the special deals we can do on AST and Dataflex EGA cards.
£336.00

EIZO 12" COLOUR MONITOR 7030M

Works with all IBM and compatible PC's. Switchable colour or mono. Low glare screen. Complete with cable.
£179.00

LOCK-UP YOUR PC

Security lock for IBM PC/XT/AT. Screws on to back of PC case and locks over on/off switch. 3 keys supplied.
£25.00

IRWIN TAPE BACK-UP



Save your data securely before you lose it! Irwin are the world's most popular tape back-up systems. Automatic back-up so you can save data when you are away from your machine. Full-error correction to ensure that you can recover data even from a damaged tape. Suitable for most MS DOS machines. Fire, theft, clumsy fingers, spilled coffee - Irwin can protect you from consequences of these disasters.

INTERNAL

10 MB PC & XT/Compatible.....£285
Extra Formatted Cartridges.....£34
20 MB PC/XT/Compatible.....£360
20 MB 286/AT/Compatible.....£360

EXTERNAL

10 MB PC & XT/Compatible.....£349
10 MB AT/Compatible.....£349
Extra Formatted Cartridges.....£34
20 MB PC/XT/Compatible.....£430
20 MB 286/AT/Compatible.....£430

UPGRADE YOUR AMSTRAD

30 MB Hard Disk on a card purpose designed by X-Tech for the PC1512. Low power requirement, low heat generation. Average access time of 65 m.sec - that's fast. Includes free cooling fan and full fitting instructions. It's a real quality hard disk.
£563.00

SEIKOSHA PERFECT LETTER QUALITY



Why bother with a noisy daisy wheel printer when you can have a fabulous 24 pin printer at this price. The Seikoshia SL-80 has 50 characters per second in perfect letter quality and 150cps in draft, parallel interface, and 80 column carriage. Fully compatible with IBM and Epson codes.
£349.00

AST MEGAPLUS II

If you have an older PC that you are loathed to part with but want something extra out of it then Megaplus is for you. 64K of RAM, one serial port, clock/calendar and a range of utility software.
£90.00

BOOKWORKER ACCOUNTING S/W

The friendliest accounts system ever. Includes sales, purchase, stock control and nominal ledgers, and even invoicing. Works a treat with the Amstrad 1512 or 1640. Usual price £173.80 plus VAT.
£145.00

EPSON LX-86

High on performance and low on price with a host of built in features. 120cps draft speed and 16cps in NLQ, 80 column carriage and parallel interface. Epson quality at a gift price.
£165.00

SOFTWARE CORNER

GEM Write (Amstrad).....£39.00
GEM Diary (Amstrad).....£19.00
GEM Draw (Amstrad).....£35.00
GEM Graph (Amstrad).....£35.00
GEM Wordchart (Amstrad).....£45.00
GEM Draw Business Library.....£16.00
GEM Fonts + Driver + Editor.....£65.00
Supercalc 3 (IBM).....£99.00
Superproject Plus (IBM).....£99.00
Amstrad PC1512 Sidekick.....£15.00
Microsoft Chart (IBM).....£140.00



"HORDES OF MONSTER BARGAINS"

PANASONIC 1081

This 120cps draft/30cps NLQ little beast is a surprising winner. It continues to sell very well, no doubt helped by the fact that everybody discounts it so massively! But it has excellent 9-pin quality, is Epson and IBM compatible, comes with a tractor feed, is 80 columns wide and amazingly cheap!
£149.00

STAR NL10

For value for money nothing can match our new low price. One of the most popular printers ever with a speed of 120cps draft and 35 NLQ. Built-in back mounted tractor feed, friction and auto single sheet feed. Comes with choice of interfaces. Recommended by Which? Very strong NLQ, 80 column wide.
£179.00

EPSON LX800

Although previous LX series printers were considered under-specified compared to the NL10 and others, the range continues to be the best seller - ever. This latest offering zips along at 150cps draft and 25cps NLQ and comes with Parallel Esc-P or IBM Parallel interfaces as standard, plus a top-mounted tractor feed. Good, clear typeface, 80 column wide.
£192.00

NEC P7 PINWRITER

Heavy duty 24-pin dot-matrix prints draft at 180cps and Letter Quality (LQ) at 72cps. A very successful product in the corporate sector. 132 column.
£441.00

EPSON LQ2500



Although very expensive, this fast (270cps, 72cps LQ) printer continues to sell in impressive numbers even in the face of strong competition in a fiercely contested market segment. Probably the best printer Epson ever made. 132 column.
£689.00

MIGENT ABILITY

A knock-down integrated system. We recommend it because it does spreadsheet, WP, Database and Comms professionally. For the budget user there is nothing to match it at this price. Great if you are learning.
£40.00

MIRACLE WS4000 V21/V23 Modem

This is the most popular Modem in the country today. Why? Mainly because it is cheap, reliable, looks good and does the job, which is really quite a simple one, after all. You can use it to access Telecom Gold, One-to-One, EasyLink, Prestel and all the bulletin boards that keep sprouting up. You also need a serial cable (£15.00) and software. We recommend Sagesoft ChitChat (£71.00) because that package also allows you to access Prestel. Most others don't.
£139.00

All goods guaranteed. Official Purchase orders accepted from Government, Local Authorities, Universities and PLC's. All prices exclusive of VAT and subject to change without notice. Delivery charges extra. No returns or repairs accepted without Returns Authorisation Number (obtainable from our Technical Support Department). Defective dead-on-arrival merchandise repaired or replaced immediately at our carriage expense. Carriage on warranty repairs is paid by the customer. Non-defective credit returns subject to a 10% restocking fee. Technical support available Monday to Friday. Export and trade enquiries welcome.

FOR FULL PRICE LIST PLEASE CALL
TELEPHONE ORDERS WELCOME



0727-37451 / 72790



SINGLE AND MULTI-USER
MICRO-COMPUTER
SOFTWARE SALES AND SUPPORT

SHOWROOM • 99 PARK STREET LANE • BRICKETWOOD • HERTFORDSHIRE • AL2 2JA • ST ALBANS (0727) 72790

TELEX: 8950511 ONE ONE G (Quote Ref: 15412001)

HEAD OFFICE • UNIT A • CAXTON CENTRE • PORTERS WOOD • ST ALBANS • HERTFORDSHIRE • AL3 6XT • (0727) 37451

COMPUTER EXPRESS HOLLAND • NIJVERHEIDSWEG • N60 • 3812 PM • AMERSFOORT • NETHERLANDS • (33) 630544

COMPUTER EXPRESS AMERICA • 1713 S.E. ELLIS STREET • PORTLAND • OR • 97202 USA • TELEPHONE (503) 235 0277

EPSON FX800/1000

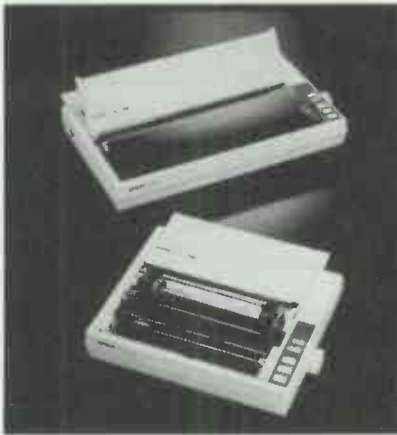

No printer propaganda would be complete without listing the FX series. It was on the back of this range and its ancestors that Epson came to dominate the market. The 800 is the descendent of the 80 and 85, prints draft at 200cps and NLQ at 40cps and is 80 columns wide. The 1000's parents were the famous 100 and 105. It goes at the same speed and is 132 columns wide. Both include tractor feeds and Epson/IBM compatibility. Worthy pedigrees and a safe 9-pin choice.

FX800 £293.00
FX1000 £384.00

LOTUS 1-2-3 (VERSION 2.01)

Although imitated by half a dozen lookalikes, the original business spreadsheet continues to out-sell all of its rivals and is the Number One selling software package - ever. Very popular with corporates and government. Our huge volumes enable us to offer it at an exceptionally low price.
£220.00

XEROX VENTURA DESK TOP PUBLISHER (VERSION 1.1)

Rightly or wrongly, Desk Top Publishing (DTP) is the latest industry buzzword. There are a lot of packages about, but the general consensus is that this is the best. It's in fashion.
£527.00

WORD PERFECT (VERSION 4.2)



Statistics show that more Word Processing software is sold than any other kind. Word Perfect is the best selling WP package in the world today - full stop. It is also, in the view of most trade people, the best. Strongly recommended. In software terms, only Lotus outsells it.
£219.00

SUPERCALC 4

If you want an alternative to Lotus 1-2-3 and its clones, this is the only one worth considering. They say it is everything Lotus should have been. Easy to use and quick, good graphics, it may be number two, but it tries harder!
£192.00

AMSTRAD 1640

No listing would be complete without mention of this machine. Some of the shortcomings of the 1512 have been rectified, mainly the display. The 1640 is excellent value for money, coming as it does with an 8086 8MHz chip, 640k RAM, mouse, Gem, MS-DOS and full colour EGA screen. The old 1512 was selling 7000 to 9000 units per month in this country, and we expect the successor 1640 to have similar success. For real value buy the single drive version and add a 32mb Scribecard! Available in colour only.

Single Floppy £730.00
Double Floppy £825.00
20mb Hard Disk £1095.00

TANDON TARGET



This small-footprint mini-AT is about the most stylish around. Fast 20 or 40mb hard disk, 1.2mb floppy, 1mb RAM, serial and parallel ports, 14in mono monitor, keyboard, MS-DOS 3.2. Good price for a pedigree AT.

Target 20 £1599.00
Target 40 £1814.00

EPSON PC-AX

This 10MHz AT is robust and sets the standard for big-box design and style. Comes with keyboard and MS-DOS, you need to pay extra for the monitor and graphics adaptor board. This is a popular item for power users on a budget, such as local authorities!

AX20 £1299.00
AX40 £1649.00
AX60 £2399.00

MINISCRIBE 32MB HARD DISK CARD

This Scribecard is revolutionizing hard disk upgrades in the U.S. and U.K. Why? Because it's cheap! It is also easy to install, reasonably fast (65ms) and readily available. Takes up one and a half slots and works great in the Amstrad, IBM, Olivetti. You name it.
£295.00

SMART SYSTEM

The trouble with integrated packages is that they tend to do one thing at most very well, and all the others not so well as a dedicated package. Smart is the only integrated system in which all of its components (WP, Spreadsheet, Database, Graphics, Communications, Diary) are competent to stand on their own against the competition. The best-selling integrated package.
£349.00



COMPUTER

EXPRESS

"COME AND MEET OUR TRAINED SHOWROOM STAFF"

NARROW DOT MATRIX PRINTERS

Epson LX800 - The Brand New Best Seller!	£192
Star NL10 - The Number Two Seller-Best Spec	£179
Panasonic 1081 120cps & 80 col - Brand New!	£149
Panasonic 1091 - Byte Magazine Says It's No 1	£227
Epson FX800 - Brand New! 240cps! Wow!	£293
Epson EX800 - 300cps & 80 column-Super Fast!	£373
Seikosa MP1300A1 - 300cps!	£299
MP 165 - Cheap Fast And Good Quality 180cps	£169
Oki Microline 182 - The Number 2 Brand	£187
Oki Microline 192 - Perennial Favourite	£282

WIDE DOT MATRIX PRINTERS

Star NX15 - The New Wide-body NL10!	£287
Star NR15 - Replaces the SR15-A Great Mover	£397
Panasonic 1595 - The Panasonic Favorite	£519
Epson FX1000 - Brand New! Replaces FX105	£384
Epson FX1000 - 300cps & 136 column-Super Fast!	£498
Seikosa MP5300A1 - 132col Version of MP1300	£439
MP 200 - 200cps! 132 column!	£259
MP 201 - 132 column 200cps	£294
Oki Microline 193 - Worth A Look	£359
Oki Microline 293 - Worth A Long Look	£608

24-PIN DOT MATRIX PRINTERS

Epson LQ800 - Letter Quality-24 Pin Printhead	£420
Epson LQ1000 - Letter Quality-24 Pins-132 Col	£570
Epson LQ2500 - This one is really good!	£689
Star NB15 - The big, up-market Star 24-pin 300cps	£598
Star NB24-15 - Similar to above, but 216cps	£517
Star NB24-10 - 80 column 24-pin winner	£413
NEC P6 - Good Buy	£379
NEC P7 - One of the Best Sellers Ever - 24 pin	£441

DAISY WHEEL PRINTERS

Star Power Type 18cps - The Current Cheap One!	£179
Juki 6100 - 20cps - Very Popular, still no. 1	£253
Juki 6200 - 30cps - Still Popular	£393
Juki 6300 - 40cps - Very Up-Market	£639

COLOUR PRINTERS

Okimate 20 Thermal Printer	£159
Juki 5520 - The Market Leader - Fast!	£335
Epson EX-Series Colour Option	£55
NEC P565XL - Heavy-Duty Office Favorite!	£740
Epson LQ2500 Colour Option/Makes LQ2500 Colour	£55
Seikosa MP1300 Colour Kit/Makes MP1300 Colour	£87

INK JET PRINTERS

Epson SQ2500 - Ink jet printer with this one!	£970
---	------

PLOTTERS, DIGITIZERS & LASERS

HP LaserJet II - Newer, Better, Cheaper!	£1945
Cherry A3 Digitizer	£475
Roland DXY-880A Plotter - Best Value A3 Plotter	£600
Roland DXY-990A Plotter	£922
Epson GQ3500 - Brand new with HP Emulation!	£1222

RIBBONS

Epson FX80/85/800/LX800 (also MP165, Juki 5510)	£4.75 each
Longbow FX80/85/800/LX800 compatible ribbon	£2.80 each
Epson EX-series cartridge ribbon	£7.51 each
Longbow Oki 182/192/193 compatible ribbon	£4.61 each
Longbow NEC P3-P7 black compatible ribbon	£4.85 each
NEC P-6 black ribbon	£7.88 each
Longbow Panasonic 1080-1081 compatible ribbon	£3.18 each
Star NL16 cartridge ribbon	£4.66 each
Longbow LQ800 compatible ribbon	£2.99 each

NOTE: The minimum quantity for ribbon orders is three (3) units.

CABLES AND THINGS

IBM-Compatible Centronics Parallel Cable (Round)	£12
BBC Centronics Parallel Cable (Ribbon)	£8
Two-Way Printer T-Switch	£45
80 Col Printer Stands	£21
SpaceBase Adjustable Floor-Standing Printer Stand	£85

AMSTRAD PC

Amstrad 1512 Single Floppy/Mono Monitor	£375
Amstrad 1512 Double Floppy/Mono Monitor	£475
Amstrad 1512 Single Floppy/Colour Monitor	£500
Amstrad 1512 Double Floppy/Colour Monitor	£600
Amstrad 1640 Single Floppy (EGA Colour 640k)	£730
Amstrad 1640 Double Floppy (EGA Colour 640k)	£825
Amstrad 1640 20mb Hard Disk (EGA Colour 640k)	£1095

EPSON PC's

Epson PC AX-20 Mark II (640k RAM, 20mb HD & EGA)	£1299
Epson PC AX-40 AT (640k RAM, 1.2mb Floppy, 40mb HD)	£1649
Epson PC AX-60 AT (640k RAM, 1.2mb Floppy, 60mb HD)	£2399
Epson PCc (20mb XT with keyboard, DOS & mono monitor)	£950

All goods guaranteed. Official Purchase orders accepted from Government, Local Authorities, Universities and PLC's. All prices exclusive of VAT and subject to change without notice. Delivery charges extra. No returns or repairs accepted without Returns Authorisation Number (obtainable from our Technical Support Department). Defective dead-on-arrival merchandise repaired or replaced immediately at our carriage expense. Carriage on warranty repairs is paid by the customer. Non-defective credit returns subject to a 10% restocking fee. Technical support available Monday to Friday. Export and trade enquiries welcome.

FOR FULL PRICE LIST PLEASE CALL TELEPHONE ORDERS WELCOME

MACDOUGALL PC's

MacDougall 286 AT 512k 10mb/20mb HD/mono monitor ...	£999
--	------

TANDON

PCA 20mb Hard Disk AT (1mb RAM Keyboard DOS Monitor)	£1345
PCA 30mb Hard Disk AT (1mb RAM Keyboard DOS Monitor)	£1569
PCA 40mb Hard Disk AT (1mb RAM Keyboard DOS Monitor)	£1789
PCA 70mb Hard Disk AT (1mb RAM Keyboard DOS Monitor)	£2145
Target 20mb Mini AT (Complete mono system)	£1599
Target 40mb Mini AT (Complete mono system)	£1814
PAC-286 (complete EGA AT with removable 32mb hard disk)	£1996

OLIVETTI PC's

Olivetti M28 AT Compatible - 20mb Hard Disk	£1831
Olivetti M240 Double Floppy	£759
Olivetti M240 20mb hard disk	£1092
Olivetti Mono Monitor for M240	£167
Olivetti 102-key Keyboard for M240	£120
Olivetti M380 40mb hard disk Compact System	£3307

SHARP PORTABLES

Sharp PC7100 20mb Hard Disk SuperTwist Screen	£1399
Sharp PC7200 (20mb 80286 AT Super Twist & Super Fast!)	£2099

TOSHIBA

Toshiba T3100 20mb 80286 Portable	£2790
Toshiba T1100 Plus	£1271
Toshiba T1000	£810
Toshiba T1200	£1946

MONITORS

Eizo ER8042S 14in Ultra-High Res EGA Colour Monitor	£445
ADI 14in Mono Monitor with Tilt/Swivel Stand	£120
NEC Multi-sync EGA monitor	£489

ATARI

Atari Expandable PC Twin Drive Mono (8088/2)	£579
Atari Expandable PC 20mb Hard Disk Mono (8088/2)	£799
Atari 520STFM 512k RAM, disk drive, mouse	£250
Atari 1040STF 1mb RAM, disk drive, mouse, no monitor	£380
Atari 1040STF with Mono Monitor, 1mb RAM, disk drive	£469
Atari 1040STF with Atari SC1224 Colour Monitor	£670
Atari SH204 20mb Hard Disk Drive	£478

ATARI TOP SELLING SOFTWARE

Cyber Studio Cad 3D ver 2.0 - It's here at last!	£64
Flight Simulator II - Very Realistic Best Seller	£36
VIP Professional (Lotus Clone Gem Version)	£149
Metacomco Lattice C Compiler	£71
First Word Plus - Word Processor with Graphics	£62

CATS 'N' MICE

Mouse Systems Mouse with Pop-Up Menus & PC Paint	£140
Mouse Systems Mouse with Pop-Up Menus Only	£125
Microsoft Bus or Serial Mouse - Don't forget the cat!	£132
Logitech Logimouse C7	£77
Logitech Logimouse Plus Package	£89

DISKETTES

Computer Express 5.25in DS/DD 48tpi disks	£1.00 each
Computer Express 5.25in DS/DD 96tpi Hi-Density	£1.65 each
Computer Express Branded 3.5in DS/DD diskettes	£1.99 each
Un-branded Verbatim 3.5in SS/DD diskettes	£1.15 each

COMMUNICATIONS

Miracle WS4000 V21-V23 Modem	£139
Miracle WS3000 V22 Professional Modem	£385
Sage Chitchat Comms Pack (Modem/Software/Cable)	£199
Crosstalk IV Comms Software	£93
Sage Chitchat Comms Software	£71
One-To-One Electronic Mail Subscription	£20
RS232 serial modem cable	£15

HARD DISKS

Dysan/Western Digital 20mb File Card	£279
Miniscribe 32mb ScribeCard Hard Disk Card	£295
Western Digital 32mb FileCard (with X-Tree software)	£299
Seagate 20mb Hard Disk with WD controller and cables	£225
Plus HardCard 20mb	£525
Plus HardCard 40mb (the quality leader)	£850

SPECIAL OFFERS

LX-86 Auto Sheet Feed	£39
Olivetti M24 20mb Hard Disk complete mono system	£1199
M24SP Complete System (Monitor/Keyboard/DOS)	£1399

ADD-ON BOARDS

AST SixPack Plus 64k memory Multifunction Card	£165
Qubie SixShooter Multifunction Card 64k memory	£125
Intel AboveBoard with 0k installed	£199
Everex Mini Magic Ram Expansion Card (384k)	£117
Hercules Graphics/Graphics Plus Card	£179
Everex EverGraphics Plus (Clone Hercules Card)	£95
Eizo Auto-Switch EGA Card	£199
Paradise Auto-Switch EGA Card	£219
AST Rampage	£200
AST 3720 Terminal Emulation Card	£649
AST 5251 Model 12 Remote Emulation Card	£525
AST SixPack Premium 256k Clock Parallel & Serial	£330
AST SixPack Premium 1mb EMS daughter board	£150

CHIPS, CO-PROCESSOR AND DRAM

64k dRAM chips (nine to make 64k)	£1.15 each
256k dRAM chips (nine to make 256k) 150 N.S.	£3.00 each
Intel 8087 5mb Maths Co-Processor	£95
Intel 8087-2 8mb Maths Co-Processor	£135
Intel 80287-8 Maths Co-Processor	£185

IBM-COMPATIBLE SOFTWARE

WordStar 2000 Plus release 2	£229
WordStar 3.4	£149
WordStar Professional Version 4	£193
WordStar 2000 Plus	£269
Word Perfect ver 4.2 - The Number 1 WP Package	£219
Microsoft Word ver 3 - Number 2 WP Package	£249
Multimate ver 3.31	£189
Multimate Advantage II	£275
Lotus Manuscript - Latest Blockbuster WP Package!	£235
PFS: First Choice	£108
PFS: Professional Write	£120
Framework II Version 1.1	£311
Symphony version 1.2 (Latest Version)	£318
Symphony Spelling Checker	£89
Symphony Text Outline	£50
Lotus 1-2-3 ver 2.1 Top Selling Package In The World	£222
Lotus Spotlight - The desktop manager!	£39
Lotus Metro - Lotus front-end manager	£53
Lotus Report Writer - A must for Lotus fans!	£75
Supercalc ver 4 - The Celebrated Lotus-Beater!	£192
Graflox Logistix	£79
Javelin	£89
Smart System - The Best Integrated Package	£349
Executive Systems X-Tree (Super Friendly HD Organizer)	£40
Executive Systems Hot - Make own menus and hot keys!	£36
Roseoft Prokey - Customise your keyboard	£55
Pegasus Accounts (per Module)	£199
Pison Chess - You too can play like Gary Kasparov	£19
Quid Software Copywrite (Backup Protected Software)	£35
Microsoft Flight Simulator - Don't crash!	£39
Microsoft Quick Basic version 3 - The Ultimate Basic	£55
Funk Software Sideways	£40
Living Videotext Ready!	£50
Borland Turbo Lightening	£47
Microsoft Windows	£59
Norton Utilities 4 - Every user need this one!	£52
Norton Commander - Control program for power users!	£35
Ventura Desk Top Publisher	£527
Freelance Plus	£266
Delta Professional	£19
Ansa Paradox II - Multi-User Database!	£289
Cardbox Plus	£225
Ashton-Tate Rapid File	£199
dBase III Plus - Best Selling Professional Database	£349
FoxBase Plus	£269

LOW-COST SOFTWARE

VP Planner by Paperback Software - Best Seller!	£61
VP Info (dBASE II Clone)	£62
VP Expert	£75
Borland Sidekick - The Original Co-Resident Process!	£49
Borland Turbo C - C How You Like This!	£65
Borland Turbo Pascal - The Classic Borland Product	£47
Borland Turbo Basic	£55
Sage Bookkeeper	£75
Sage Retrieve Database	£71
Sage PC Planner Spreadsheet (Lotus Clone)	£71
Sage Desk-Set	£49
Sage PC-Write Word Processor	£71
Sage Accountant	£19
Sage Accountant Plus - Top Selling Cheap Accounts	£155
Sage Payroll	£85
Sage Financial Controller - Just reduced from 995!	£240
Personal Word Perfect	£139
Word Perfect Junior	£75
Microsoft Word Junior	£59
WordStar 1512	£60
Amstrad Multiplan Junior	£59
Amstrad Supercalc 3	£60
Amstrad Amstrad Reflex	£60
Precision Software Superbase Personal	£75
Migent Ability - Top Integrated Package	£40
Migent Ability II - Spend a Little More, Mate!	£119
Words & Figures - Lotus 123 v1 Clone with WP	£80

0727-37451 / 72790

SINGLE AND MULTI-USER MICRO-COMPUTER SOFTWARE SALES AND SUPPORT

SHOWROOM•99 PARK STREET LANE•BRICKETWOOD•HERTFORDSHIRE•AL2 2JA•ST ALBANS (0727) 72790

TELEX: 8950511 ONE ONE G (Quote Ref: 15412001)

HEAD OFFICE•UNIT A•CAXTON CENTRE•PORTERS WOOD•ST ALBANS•HERTFORDSHIRE•AL3 6XT•(0727) 37451

COMPUTER EXPRESS HOLLAND•NIJVERHEIDSWEG•N60•3812 PM•AMERSFOORT•NETHERLANDS•(33) 630544

COMPUTER EXPRESS AMERICA•1713 S.E. ELLIS STREET•PORTLAND•OR•97202 USA•TELEPHONE (503) 235 0277

£149.95

+ VAT

System

Solver

Put your PC in its place

FREE
CHAIR



If you're losing ground to your computer, put it smartly in its place with the new System-Solver desk from Opus. It'll accommodate your system beautifully and still leave lots of room for you.

What's more the System-Solver is every bit as generous on price as it is on space. At just **£149.95+VAT** Opus have thought of everything including a free matching chair.

The System-Solver is a desk for the new PC age, attractively styled and sensibly constructed, as good to work at as it is to look at. A top shelf accommodates both monitor and printer and below, the main desktop is equipped with two smooth-flow paper feed channels.

With an ingenious system to remove all that troublesome keyboard cable and shelves to house both your computer and manuals, there's a remarkable amount of usable desktop space available.

Open the System-Solver's drawer and you'll find a few more surprises, like the built-in lockable diskette box to safeguard your software and tidy-tray for all those odds and ends.

This British-built Opus desk also features scratch resistant surfaces, sturdy steel underframes, heavy duty castors and simple assembly. It's designed for all leading PC systems including those from Opus, *Amstrad, IBM, Olivetti and Compaq etc.

So if your PC system needs putting in its place call Opus today on **0737-765080** or simply post the coupon below. Delivery in mainland Britain is free and generous education and government discounts are available. We also welcome dealer and export enquiries. (*Extension lead required).

Desk Measurements: Height 27"; Width 47"; Depth 32".

To: Department SP, Opus Supplies Ltd., 53 Ormside Way, Holmesthorpe Industrial Estate, Redhill, Surrey.

Please send me the following:

_____ System-Solver Desk(s) at £172.44 each (Incl. VAT).

I enclose a cheque for £ _____ or please debit my

credit card account with the amount of £ _____

My Access Barclaycard _____
no. is: (please tick) _____

Name _____ **PCW**

Address _____

Telephone _____

THE RENAISSANCE GAINS MOMENTUM

SINCE THE "GENIUS OF LEONARDO" WAS UNVEILED OVER 150 COMPANIES
HAVE DISCOVERED THE WORLD OF BUILDING EXPERT SYSTEMS



When Creative Logic launched Leonardo, our aim was to not only establish a new benchmark for Expert Systems software, but to make the benefits of Expert Systems available and accessible to every organisation. Have we achieved these aims?

The facts speak for themselves.

ALVEY CLUB GETS AID FROM LEONARDO

Leonardo was selected by Aries. This successful Alvey Club used Leonardo to port its equity selection expert system onto a personal computer.

150 LEONARDOS INSTALLED

In just 3 months Leonardo has been used by over 150 organisations. Leonardo is unique in offering users a range of expert systems products to cater for different levels of knowledge bases. Whether you're a first-time user or professional knowledge engineer, small company or multi-national, Leonardo can and is delivering the benefits of expert systems in all spheres.

NEW PRODUCTS

With Leonardo, Creative Logic has already set the standard by which other products will be judged. However we haven't stopped there. There are new interface packages available with Leonardo 2 and 3 and Creative Logic has just announced the DEC VAX version of the system. Creative Logic continues to develop new products for the future.

SEEING IS BELIEVING

We think the facts speak for themselves, but what better way to judge for yourself than getting started with Leonardo 1 and attending one of our free half day seminars at Brunel Science Park. See the genius of Leonardo in action and assess the potential benefits for your organisation.

If you'd like to purchase a copy of Leonardo 1 send a cheque to Creative Logic Limited with your order. If you'd like to attend a seminar or like further information on the Leonardo range of products, just return the coupon or call Des Cassidy direct on 0895 74468 or 0895 70091.

Leonardo

Please return this coupon (no stamp required) to: Creative Logic Limited, FREEPOST, Brunel Science Park, Kingston Lane, Uxbridge, Middlesex UB8 3BR. Tel: 0895 74468/9

NAME _____ TITLE _____

COMPANY _____

ADDRESS _____

POSTCODE _____ TEL. NO. _____

Please send me _____ copies of Leonardo 1 at £149 + £4.95 P&P + VAT.

Cheque/PO enclosed Please invoice my company Please send me further information

PCW 11/87

**OVER 10,000 sq. ft. OF SHOWROOM,
DEMONSTRATION
AREAS, SERVICE
AND STORAGE**

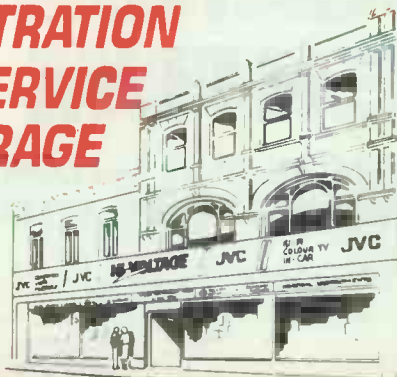

HI VO

London's Largest

**LONDON'S LARGEST SPECIALIST
AMSTRAD DEALER**

We are an official Amstrad Service Centre

NEW AMSTRAD PC1640 MODELS

HI-RES MONO MONITOR MODELS

SD Single Drive	£499	} Extra for CGA Colour Monitor £149 Extra for EGA Hi-Res Colour Monitor £299
DD Double Drive	£599	
20Mb Hard Drive	£899	
SD 20Mb Single Drive plus 20Mb Hard Card	£749	
SD 30Mb Single Drive plus 30Mb Hard Card	£799	

**NEW PC
CATALOGUE
PHONE NOW**

STOP PRESS
**JUST RELEASED
LOW COST PC'S**
Commodore PC1 from **£433**
Zenith Eazy PC from **£499**
Atari PC from **£521**

NEW MISSION 386 PC's

Comes complete with
2 year warranty

386/16MHz

Prices from **£1995**

386/20MHz

Prices from **£3295**

286/8MHz

Prices from **£1290**

286/12MHz

Prices from **£1690**

AMSTRAD PC 1512

MONO MONITOR MODELS

SD Single Drive	£399
DD Double Drive	£499
SD 20Mb Single Drive + 20Mb Hard Card	£649
SD 30Mb Single Drive + 30Mb Hard Card	£699

Extra for CGA
Colour Monitor **£149**

EPSON PC'S

PCe High Performance
10 MHz inc 20 Meg
hard disk
and
monitor **£999**

PC-AX2 10 MHz
AT with 20 Meg
hard
disk **£1399**

HARD DISKS ON A CARD

Including formatting and
configuring
21 Megabyte **£249.95**
30 Megabyte **£299.95**

PART EXCHANGE— WE ARE THE SPECIALISTS

TOP PRICES ALLOWED
ON YOUR
PCW 8256/8512 or
PC 1512
**FOR A NEW
PC 1512 OR PC 1640**

**ALTERNATIVELY
EXCHANGE AGAINST
ANY OF THE
FOLLOWING MODELS**

OPUS PCII (XT) OR PC5 (AT)
SBC PC (XT) OR MISTRAL (AT)
TANDON PCX (XT) OR PCA (AT)
MISSION 286 (XT) OR 386 (386)
COMMODORE PC20 (XT)
OR PC40 (AT)

AMSTRAD PCW WORDPROCESSORS

NEW

PCW 9512

inc Daisy Wheel Printer

• 512K Ram
• Paper white high
resolution monitor
• Spellchecker **£499**

PCW 8512 inc Printer **£399**

PCW 8256 inc Printer **£299**

**SECOND HAND MODELS
FROM £199**

OPUS PC's

We carry all models of this popular
range of PC clones. Prices from **£399**

20 meg Hard disc
models. Prices
from **£799**

Mono Monitor **£99**

EGA
Monitor **£399**

NEW OPUS PC5
AT Model inc
Mono Monitor
£1295



SBC PC COMPATIBLES

SBC PC-Turbo

8 MHz Turbo. NEC V40 CPU. MS DOS
3.2 +GW Basic. 640K Ram. 12 months
on site service free.

SBCFD **£599**
2 x 360K disc drive mono monitor

SBC HD 20 **£999**
20 Mb hard disc mono monitor
CGA colour **£199** extra
EGA colour **£399** extra

SBC Mistral 286 AT

12 MHz AT80286
30 Meg hard disc, 1 Meg Ram.
British designed and built. 12
months on site service free.

SBC 286 AT with
mono monitor
£1799

SBC 286 ATC with
colour monitor **£1999**



SBC 286 ATE with EGA
colour monitor **£2199**

HI VOLTAGE

Computer Shop

**DON'T TAKE A CHANCE
— COMPARE BEFORE YOU BUY**



**OVER 40
PRINTERS ON
DISPLAY. MOST
ON DEMONSTRATION**

DOT MATRIX PRINTERS

Amstrad DMP3160 NLQ IBM	£189.95
Amstrad DMP4000 NLQ 132 col 200cps	£339.95
Amstrad LQ3500 24 pin	£339.95
Citizen 120D	£156.47
Citizen LSP10 NLQ IBM	£173.89
Epson LX800 NLQ (150cps)	£195.95
Epson FX800 NLQ 200cps	£299.95
Epson FX1000 NLQ 132 col 200cps	£385.95
Epson EX800 NLQ 300cps	£389.95
Epson EX1000 NLQ 132 col 300cps	£519.95
Epson LQ800 NLQ	£437.95
Epson LQ1000 NLQ 132 col 180cps	£584.95
Epson LQ2500	£759.95
Oki-Mate 20 Colour + software	£173.87
Panasonic KXP1081	£156.47
Star NL10 NLQ inc I/F	£199.95
Star NX15 NLQ 132 col	£313.95
Star NR15 NLQ 132 col 240cps	£486.95

Star NB24-10 NLQ 80 col 24 pin	£478.95
Star NB24-15 NLQ 132 Col. 24 Pin	£609.95
Star NB15 NLQ 132 Col. 24 Pin	£759.95

DAISYWHEEL PRINTERS

SILVER REED EXP500
Full specification Daisy Wheel
Printer. From the famous typewriter
manufacturer. Special Offer Price. **£165**

Juki 6100	£286.95
Juki 2200 Typewriter Serial	£217.95

All popular interfaces, cables, etc. available from stock. Custom cables made to order.

Let our experts match your computer to the printer of your choice. Printers - All models parallel-centronics interface Serial RS232C available at same or slightly higher prices.

LASER PRINTERS

Prices from only **£1349**

THE UK'S LARGEST RANGE OF LASER PRINTERS ON DEMONSTRATION

Are you confused by the variety of lasers available? No problem! Visit our showroom and compare before you buy. Off the shelf delivery on most models.



Canon
LBP-8 II

Epson
GQ-3500

Oki
Laserline 6

QMS-
KIS K8

Hewlett Packard
Laserjet
Series 2

Citizen
Overture 110

**Plus full ranges from
Canon and Hewlett Packard**

LONDON'S AMIGA CENTRE

Hi-Voltage are the Amiga experts. As Commodore's largest computer store we are proud to give the world's most advanced computer pride of place in our showroom. We stock the most comprehensive range of peripherals and software including colour printers, as they become available. New items are arriving every day so contact us now!

NEW AMIGA A500
INCLUDING
PRICES FROM **£399** FREE
SOFTWARE

NOW IN STOCK

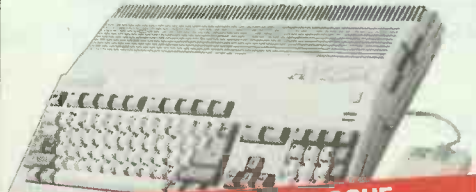

**NEW AMIGA CATALOGUE
JUST PRINTED -
PHONE FOR YOUR FREE COPY.**

**NEW AMIGA
A2000
NOW IN STOCK**

Including on site maintenance

Standard
versions from **£1095**
IBM Compatible
version from **£1595**

LARGE RANGE OF DISCOUNTED
AMIGA SOFTWARE.

FULL RANGE OF CBM 64C/128D
COMPUTERS AND PERIPHERALS IN STOCK

**ACORN
ARCHIMEDES
NOW ON
DEMONSTRATION**

**ATARI
ST RANGE**

including
520, 1040 and
Mega ST

**IN STOCK AT
LOW PRICES**

**EXPORT CUSTOMERS SUPPLIED
TAX FREE - ASK FOR EXPORT LIST**

Official orders welcomed from PLC's
government and education establishments

**ALL PRICES EXCLUDE VAT
OPEN MON-SAT 9AM-6PM**

HI VOLTAGE

**Largest range of floppy disks and printer ribbons
available in London over the counter.**

**London's largest range of games and software.
Thousands of titles in stock.**

Mail Order + Export Hot Line Phone 01-686 6362



Delivery by Securicor (4 day) please add £5.75 per item.
Delivery by Securicor 24 hour please add £9.95 per item.
(Laser Printers £15 - 24 hour delivery)



Send off or order by 'phone quoting your Access, Visa No. Phone 01-686 6362.
Immediate despatch on receipt of order or cheque clearance. Or Telex your order on:
946240 Attn 19001335. **EXPORT CUSTOMERS SUPPLIED TAX FREE.**

Dept. PCW, 53-59 High Street, Croydon, Surrey CR0 1QD. Fax: 01-681 8939. Tel: 01-681 3022

Prices correct at copy date. Subject to change without notice due to currency fluctuations etc. E. & O. E.

**WILDING'S PRESENT
THE COMPLETE RANGE
OF PROFESSIONAL**

BROTHER

New

Brother Laser Printer

SAVE £200

on Manufacturer's recommended price

FREE

1 Years Maintenance



For a demonstration
phone your local Wilding
branch or 01-514 1525

Brother HL-8 The Brother HL-8 is a second generation letter quality and graphics laser printer designed to be fast, quiet and easy to use. The HL-8 can print on a wide variety of media, from single sheets up to legal size, to envelopes and transparencies. There are five

resident typestyles plus many options available. The HL-8 plugs into any computer and is totally compatible with all popular software.

£1995

Here's why it must be Wilding's

PRICE GUARANTEE

It goes without saying that Wilding customers can be certain of outstanding value for money. If you purchase any product in this advertisement from Wilding's and find that you can buy it cheaper from another retailer locally within seven days, we will refund the difference.

DEMONSTRATION AND ADVICE

Wilding's skilled, attentive staff will offer expert advice on the printer most suited to your needs and offer full comparative demonstrations.



AFTER SALES SERVICE

Service at Wilding's carries on long after the equipment is purchased. Our skilled maintenance team comprising in excess of 150 engineers offer high-speed, efficient after sales service.

50 BRANCHES NATIONWIDE

Wilding's stores can be found in major towns around Britain, where you have the confidence and benefits of dealing with a major public company.

WILDING'S ARE BROTHERS LARGEST UK DISTRIBUTOR

PRINTERS

with
Wilding's Unique
3 Year Parts
Guarantee

Brother combined Daisy Wheel and Dot Matrix Printer

Brother Twinriter 5

The first printer to combine both daisy wheel and dot matrix printing systems into a single unit. Now you can have 40cps letter quality printouts for word processing requirements and 160cps dot matrix speed for data processing or first drafts.

£995



All prices exclude VAT

Brother Daisy Wheel Printers



Brother HR-20
Fast 22cps printing, 8K buffer memory. Centronics and RS232C interfaces.

£345

Brother HR-40
Amazing 40cps printing yet very quiet, full range of typestyles and pitches plus 2-colour printing.

£845

Brother Dot Matrix Printers

Brother M-1109
The M-1109 offers 100cps draft print and 25cps NLQ print. Fitted with both Centronics and RS232C interfaces.

£174

Brother M-1409
The M-1409 provides superfast 180cps printing plus prestige NLQ font. There's a 3K buffer memory and tractor feed.

£345

Brother M-1509
136 column width with 180cps draft print and 45cps NLQ print. 3K buffer memory and tractor feed.

£435

Brother M-1709
Amazing 240cps draft print and 50cps NLQ. 136 column width 24K buffer, paper parking and function mode.

£495



Brother M-1724
Excellent quality 24 pin head, 216cps draft print and 72cps NLQ, dual Centronics and RS232C interfaces.

£595

Brother M-2024
NLQ print at an amazing 96cps, draft at 160cps. Quality 24 pin head and wide 136 column width.

£695

Brother M-2518
Unique new paper express feature ideal for multi-part forms. 360cps draft, 75cps NLQ plus letter quality (LQ) at 50cps. (Available Nov.)

Brother M-4018
Remarkable range of features including 480cps draft, 100cps NLQ and 67cps LQ. Bottom Feed, single sheet friction feed and tractor feed standard.

£1295

WILDING'S OFFER PROFESSIONAL ADVICE AND TECHNICAL BACK UP

CENTRAL LONDON
261 Grays Inn Road (London Sales Office)
54 Baker Street
278 High Holborn
157 Moorgate
275 Regent Street
8 New College Parade, Swiss Cottage
BATH Strahan House, Avon Street
BOLTON 36 Great Moor Street
BRIGHTON 133 Western Road
BRISTOL
Eidon Way, Brislington (Regional Sales Office)
14 Union Street
10-11 Denmark Street
BROMLEY 33 Widmore Road
CAMBRIDGE 2 Sussex Street
CHESTER 84 Northgate Street
COLCHESTER 103 High Street
CROYDON 7-9 St. Georges Walk
FINCHLEY 134 Ballards Lane
GLOUCESTER 4 Grosvenor House, Station Road
GRAVESEND 199 Parrock Street

Tel: 01-278 4333
Tel: 01-486 0798
Tel: 01-430 0333
Tel: 01-628 0501
Tel: 01-499 2836
Tel: 01-586 7593
Tel: 0225 339933
Tel: 0204 386937
Tel: 0273 29079
Tel: 0272 721681
Tel: 0272 293199
Tel: 0272 277396
Tel: 01-290 6466
Tel: 0223 65714
Tel: 0244 351915
Tel: 0206 46768
Tel: 01-686 4957
Tel: 01-346 7195
Tel: 0452 23111
Tel: 0474 61635

GUILDFORD 9 Tunsigate
HADLEIGH (Essex)
241-243 London Road (Regional Sales Office)
HIGH WYCOMBE 12 Church Street
HORNCHURCH 196 High Street
ILFORD
531-535 High Road (Regional Sales Office)
IPSWICH 16 Carr Precinct, Carr Street
KINGSTON 26 Castle Street
LEEDS 22 King Edward Street
LUTON 25 Wellington Street
MAIDSTONE 88 King Street
MANCHESTER 125 Oldham Street
NORTHAMPTON 30 Gold Street
NORWICH 10 Queens Road
OXFORD 21 High Street
PETERBOROUGH 19 Cowgate
PUTNEY 339 Putney Bridge Road
READING 16 West Street
ROMFORD 17 High Street
RUISLIP
69 High Street (Regional Sales Office)

Tel: 0483 579489
Tel: 0702 551066
Tel: 0494 36378
Tel: 04024 48629
Tel: 01-514 1525
Tel: 0473 57469
Tel: 01-549 9461
Tel: 0532 468118
Tel: 0582 425771
Tel: 0622 685422
Tel: 061-834 5682
Tel: 0604 22713
Tel: 0603 666011
Tel: 0865 250256
Tel: 0733 311040
Tel: 01-788 3452
Tel: 0734 503465
Tel: 0708 765896
Tel: 08956 38700

SLOUGH 261 High Street
SOUTHEND 26 Alexandra Street
SWINDON 47-48 Havelock Street
WALTHAM CROSS 91 High Street
WALTHAMSTOW 7 The Arcade, Hoe Street
WATFORD 166 High Street
WIMBLEDON 120 The Broadway
WOOLWICH 21 Thomas Street
HEAD OFFICE: 531-535 High Road,
Ilford, Essex. Tel: 01-514 1525
Telex: 264371 Fax: 01-478 0436

Tel: 0753 39356
Tel: 0702 331876
Tel: 0793 33111
Tel: 0992 764200
Tel: 01-520 7668
Tel: 0923 32121
Tel: 01-540 7822
Tel: 01-855 0631

WILDING
OFFICE EQUIPMENT PLC

TRANSFER YOUR DATA THE EASY WAY

CARD DEVICES LTD. PRODUCE A UNIQUE RANGE OF ADD ON DRIVES
AVAILABLE FOR POPULAR PC'S INCLUDING

★ APRICOT ★ IBM ★ SIRIUS/VICTOR 9000 ★ OLIVETTI ★ AND MANY OTHERS

As there are now many different computer systems available on the market it has become more difficult to transfer data between these machines. CARD DEVICES LTD. have a simple solution to the problem with their AF RANGE OF DISC DRIVE UNITS. Now it is possible to overcome the different disc sizes and formats to enable the user to transfer data simply and effectively.



IBM PC/XT/AT 3.5" ADD ON DRIVE

TO PROVIDE DATA FILE COMPATIBILITY WITH THE APRICOT RANGE OF COMPUTERS AND ALSO THE IBM PERSONAL SYSTEM 2

AF 300 PC . . . £295.00
AF 300 AT . . . £295.00

ALSO AVAILABLE FOR IBM CLONES

IBM WINCHESTER UPGRADES

20MB internal £367.00 external £439.00
40MB internal £683.00 external £754.00

IBM WINCHESTER WITH TAPE BACK-UP

20MB Winchester with tape back-up external £781.00
40MB Winchester with tape back-up external £1097.00

IBM TAPE BACK-UP . . . £499.00

UP TO 52MB EXTERNAL OR INTERNAL
ALL UNITS INCLUDE CONTROLLER AND CABLES

XENOCOPY-PC™ is a program to copy files, i.e., Format/Duplicate/Read/Write disks from over 300 other micros. All you need is a PC or clone with capability to read 360k disks, and a copy of XENOCOPY-PC™ For Only £95.00

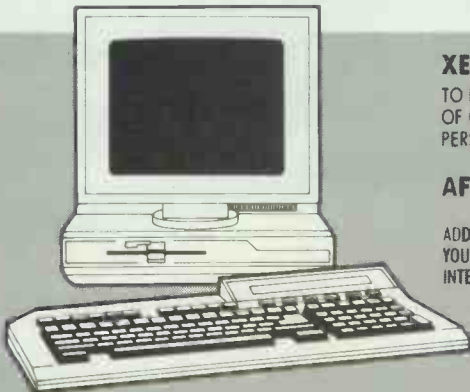

XENi 3.5" ADD ON DRIVE

TO PROVIDE DATA FILE COMPATIBILITY WITH THE APRICOT RANGE OF COMPUTERS THAT HAVE A 3.5 INCH DISC DRIVES ALSO THE IBM PERSONAL SYSTEM 2

AF 300 XENi . . . £295.00

ADD 20MB OF WINCHESTER TO YOUR APRICOT PC FOR ONLY
INTERNAL £495.00 EXTERNAL £595.00

**MORE RAM
ON YOUR XEN
OR XENi
512k
£175.00**

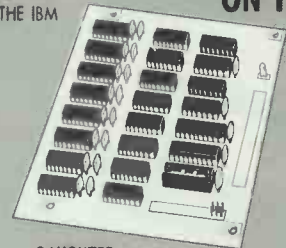

DAUGHTER BOARD RAM

APRICOT 5.25 ADD ON DRIVE FOR PC/Xi/F SERIES

TO PROVIDE DATA FILE COMPATIBILITY WITH THE IBM PC/XT AND CLONES

AF500A . . . INSTALLED ON THE APRICOT PC/Xi/ F SERIES . . . £395.00

AF300F2 . . . INSTALLED AS A SECOND DRIVE ON THE F1 SERIES . . . £295.00

ALL ABOVE UNITS ARE SUPPLIED WITH A SEPARATE CONTROLLER CARD WHICH IS FITTED INSIDE THE APRICOT COMPUTER IN ONE OF THE SPARE EXPANSION SLOTS

APRICOT 512K RAM CARD PC/Xi/F SERIES £120.00

SIRIUS/VICTOR 9000 5.25" ADD ON DRIVE

TO PROVIDE DATA FILE COMPATIBILITY WITH THE IBM PC/XT AND CLONES

AF500S . . . £395.00

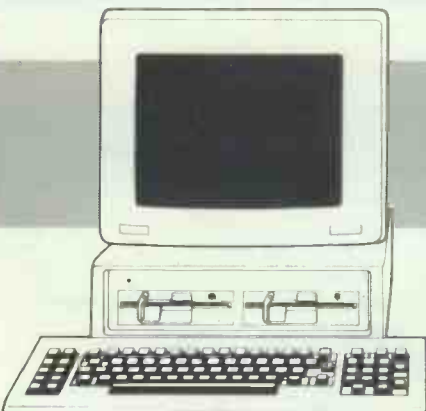

AMSTRAD 3.5" ADD ON DRIVE AF 300 AMSTRAD . . . £295.00

TO PROVIDE DATA FILE COMPATIBILITY WITH THE APRICOT RANGE OF COMPUTERS AND ALSO THE IBM PERSONAL SYSTEM 2

AMSTRAD WINCHESTER UPGRADES:

20MB internal £350.00
20MB external £395.00
AMSTRAD TAPE BACK-UP external £450.00



CARD DEVICES

ALL PRICES DO NOT INCLUDE VAT AND DELIVERY

Card Devices Ltd., Unit 9, Padmores Yard,
St. Johns, Woking, Surrey GU21 1SE

Tel: 04862 76996/65634 Telex: 858541 ALPHD D

The new version of Book Worker has taken even a little criticism into account.

As you can probably guess *Book Worker* is well recommended, but it does have a couple of drawbacks. For instance the Sales Receipts routine only pays off aged balances, and not individual invoices – a bit annoying that. Also the package comes on two disks, although

PC PLUS
February 1987

And that's just the beginning. ■ In addition to an open item accounting facility (so now you can pay off individual invoices as well as aged balances), the new version of Book Worker has several other new features. ■ These include the integrated handling of cash sales, spooling of invoices or statements for batch printing, the choice of printing statements weekly or monthly and a direct link not only to Delta, but to Lotus 1-2-3 as well. ■ Naturally, the new version of Book Worker is every bit as easy to use as the original. ■ Most operations are carried out at the touch of a single key and on screen it looks and performs just like the manual book-keeping system you're used to. ■ If operating the new version of Book Worker is simplicity itself, then finding out more about it is even easier still - call Freefone Compsoft. ■

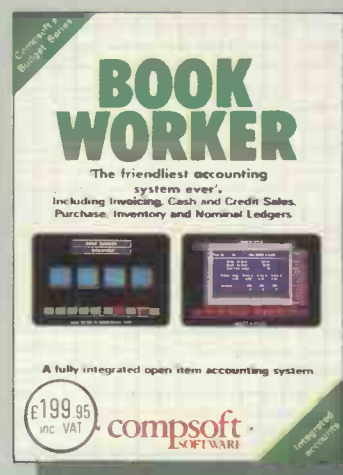

THE NEW BOOK WORKER
IT TAKES EVERYTHING
INTO ACCOUNT

· **compsoft** ·
SOFTWARE

Available from Alders, Laskys, Office International, Rymans, Tandy, Wildings and all good computer dealers.

WHAT MORE DO YOU NEED TO KNOW ABOUT ZORLAND C?

The C specialists!

Zorland sells more C compilers than anyone else in Europe. We started shipping in September 1986 and we haven't looked back since. Now we are considered to be the C specialists!

Our aim is to provide a 'one-stop' service for the C programmer whether novice or professional.

What about the others?

Independent sources say Zorland C is the top selling C compiler in Europe. The Independent 1512 User Group confirmed that 65% of their customers bought Zorland C as against only 9% for Turbo C!

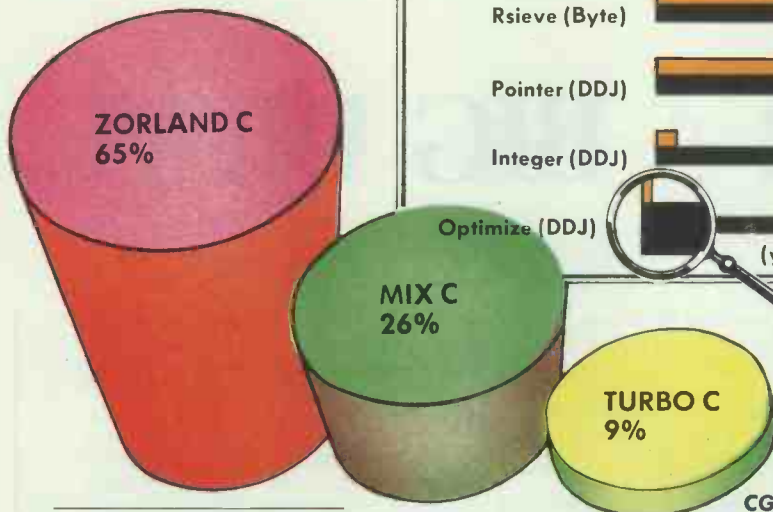

Six good reasons!

Here are six good reasons why you should consider Zorland C as your first choice in C compilers:

1. Zorland C has a low-cost entry point of only £29.95
2. Zorland offers the full source code to the library for only £19.95! This is invaluable for professional programmers and students wishing to study the inner workings of the library.
3. Zorland's new Optimizer will accelerate your programs to execute by up to 30% faster than Turbo C!

Zorland's Optimized C beats any compiler — period.

4. Zorland's range of add-on libraries can save you weeks or even months in the production of serious application programs.

5. Zorland's Technical Hotline has earned itself the reputation of being one of the best in the business! FREE!

6. Zorland produce ZCNEWS — the only monthly magazine of it's kind in Europe. Full of

The family grows!

Here are just a few of the new add-on libraries that will be available shortly. No other C compiler offers such a wide range of support products.

Graphics TOOLKIT £29.95 An excellent collection of functions for drawing boxes, circles, ellipses, lines, graphic fonts, fills, patterns, etc. The program you write is 'device independent'

GRAPHICS
ZORLAND GRAPHICS TOOLKIT

ZASM — Zorland's Assembler Fully MASM compatible with

BIG manual/beginners guide.

DATA ENTRY — You draw screens and this prog generates the source code!

BTREE MULTI-USER Make your database applications Multi-User with this BTREE add-on.

GAMES
ZORLAND GAMES TOOLKIT

TSR/MACROS — Make your program Memory Resident with our TSR functions. Includes Keyboard Macros!

COMMS TOOLKIT — Save hours with this ready made comms toolkit. Supports up to eight serial ports!

ZORLAND'S UTILITIES — £19.95 Comprehensive set of utilities. Examine disk sectors, command line editor, etc. etc.

DISK OPTIMIZER — £19.95 Reduce the time taken to access files on your hard disk, easily.

SUPERTEXT TOOLKIT
£29.95

More than 90 text processing functions together with full source code for a full-blown wordprocessor! Includes 'Wordstar' compatible keys, customizing, 'dot' commands, etc. Now you can include a Wordprocessor into your applications!

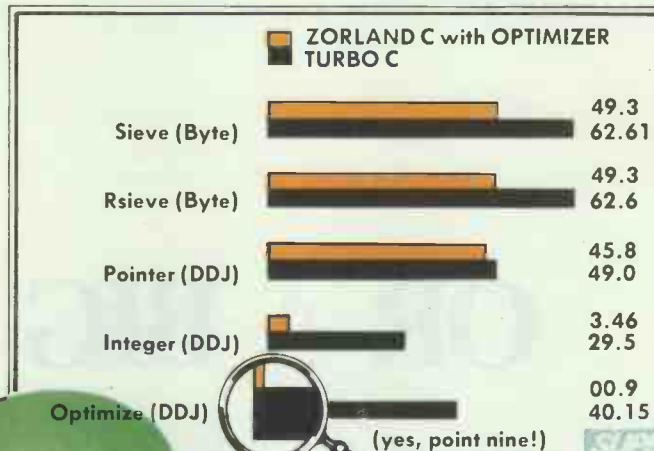

(yes, point nine!)

thus allowing you to use external drivers for screens, plotters, lasers etc. Includes 70 page manual and drivers for CGA, EGA, Hercules, etc.

GAMES TOOLKIT £29.95 Chess, Backgammon and Wari 150 page manual explains how to write your own games of skill and strategy. Comes with three ready to play games and the full source code.

SUPERTEXT
ZORLAND SUPERTEXT TOOLKIT

Reviewer's rave!

"High quality . . . impressive performance at a knock-down price!"
Personal Computer World

"Actually an improvement on some of the more expensive packages from America!"
Amstrad Professional Computing

"There is nothing to touch Zorland C . . . even at a much higher price!"
PC PLUS

SPECIAL OFFER

Until 31st December 1987
Get the Linker and Librarian software (worth £19.95) FREE when you buy Zorland C at £29.95!

BUYING A POWERFUL PERSONAL COMPUTER IS NO LONGER A BIG ISSUE.

OR A BIG DEAL.

'It's very, very good.' (Simon Rockman, *Popular Computing Weekly*.)

'More than adequate for most businessmen's needs... I propose to buy one out of taxed income.' (Michael Bywater, *Punch*.)

'... the basic machine is marvellous, good value and will sell in the thousands.' (Robert Schiffreen, *Personal Computer World*.)

The machine they're talking about is the Z88, from Clive Sinclair – the first truly portable, truly full-facility computer ever marketed.

It's less than an inch thick, and the size of an A4 pad. It weighs under 2lb. And it costs just £249.99, plus VAT.

Until now, a portable computer has been a computer you *can* carry with you. The Z88 is a computer you'll *want* to carry with you.

Wherever you are... at home, on the move, in meetings, in hotels... with the Z88 you can compute or word-process instantly.

The Z88 comes with 32K of RAM built in, of which around 20K is available – enough for about 2,000 words of text. This is easily expandable to 416K by simply slotting in solid-state RAM packs. And with the coming introduction of 1 Mbyte packs, total RAM of 3 Mbytes will be available – enough to hold the complete works of Shakespeare.

The resident software includes a highly powerful integrated word-processing and spreadsheet package.

Word-processing includes multi-column layout, global search and replace, and embedded calculations. Spreadsheet includes text-handling and sorting. The display shows bold, italics, underlining, and page-breaks.

But to make a portable computer a genuine tool for personal productivity, it should provide more than word-processing and spreadsheet applications. If you're getting rid of paper, get rid of *all* your paper.

So the Z88 includes a database, calculator, free-form diary, calendar, and real-time clock and alarm. (When you put the Z88 in your briefcase, you can take just about everything else out.)

The operating software allows you to switch instantly between any of the built-in applications – such as word-processing and spreadsheet – without the delay of loading separate software into the computer's memory. With the Z88, it's just a matter of pressing a couple of keys.

New dimensions to computing, from Clive Sinclair.

Despite its compact size, the Z88 has a full QWERTY keyboard with virtually silent, short-travel keys. It includes special function keys, such as \diamond , \square , INDEX and MENU, which





Z88. £249⁹⁹_{+VAT}

make it exceptionally easy for novice users to find their way quickly around the sophisticated built-in software.

The screen is a state-of-the-art supertwist LCD, which provides a massive improvement on normal displays in both contrast ratio and viewing angle – providing a clear, sharp read-out. The screen provides a large working area of 8 lines x 94 characters.

The remainder of the screen consists of sections which hold menu details (including all the Z88's commands); a unique page map (which shows you where you are on a complete page); diary date; filing and directory details; and operating system details which give you information on the Z88's status (such as battery strength).

From the start, the Z88 was designed to incorporate every reliable idea that contributes to genuine portability. These include:

ASCII files import/export facility between the Z88 and IBM-compatible PCs (version for BBC PCs coming soon)...

Connection to any popular printer via a built-in printer editor and RS232 cable...

A serial-to-parallel converter cable for connection to non-serial printers...

Permanent storage on slot-in EPROM packs – up to 416K now, 3 Mbytes soon – means no moving parts, no vulnerable disks...

Power-saving technology to provide 20 hours active use from four AA batteries (and one year on standby)...

Built-in capacitor to preserve data when batteries need to be changed (mains adaptor also available)...

BABT-approved modem, coming soon...

Programming language is BBC BASIC, and the Z88 screen provides extensive graphics capability.

All this, with a comprehensive manual and carrying case. And all for a basic price of just £249.99 plus VAT!

See, try, buy the Z88 now... at Dixons or Comet.

The Z88 is available now. Mail-order customers have been using it for months. Now it's in the High Street – at Dixons and Comet, everywhere.

Look in, and try it for yourself. And see why, at £249.99, so potent a personal computer is no big deal.

Available from
DIXONS AND COMET,
NOW.

CAMBRIDGE
COMPUTER

OVER
100000 SALES
A YEAR IN THE USA ALONE

Beltron[®] computer

AT COMPATIBLE

WAS ~~£1245~~

NOW

£1195

- * 80286 CPU switchable 8/10 MHz
- * Legal 32K Phoenix Bios
- * 640K RAM
- * 8 Expansion slots
- * 20 MB Seagate hard disk
- * Western digital controller card
- * TEAC 1.2 MB floppy
- * 2 RS232, 2 parrel & 1 games port
- * Clock/Calendar - battery back-up
- * Monochrome graphic card
- * Hi res 14" green or amber monitor with tilt and swivel.
- * 200W power supply
- * 102 key professional keyboard
- * MS-DOS 3.1
- * Full set of manuals
- * **12 month warranty**

XT COMPATIBLE

£495

- * 8088-2 CPU switchable 4.77/8.00 MHz
- * Legal Bios
- * 512K RAM
- * 8 Expansion slots
- * Floppy disk controller
- * 2 x 360K floppy
- * 1 Parrallel printer port
- * Clock/calendar
- * Monochrome graphic card
- * Hi res 12" green or amber monitor with tilt and swivel.
- * 135W power supply
- * 84 key professional keyboard
- * MS-DOS 3.1
- * Full set of manuals

10 MHz
XT

BELTRON 386

- * **12 month warranty**

Includes:

- * 1MB RAM
- * 40 MB 28 MS miniscribe hard disk

£2835

Options

ST-225 20MB HDD £219.00
Miniscribe 40MB
28MS HDD £525.00
ST-225 + WD-X2 XT
CONTL + CBLs £275.00
Fujitsu 360K FDD £69.00
WD-X2 XT HDD
CONTL £59.00
Genius Mouse MS & MSM Compatible £69.00

WD AT 2FDD/2HDD
CONTL £135.00
MATHS CO-PROCESSORS
8087-2 £135.00
80287-6 MHz £145.00
80287-10 MHz £269.00
H-EGA card £145.00
Mono/graphic/PRN card £49.00

Colour/Mono/PRN card £95.00
MONITORS
12" HI-RES Mono w/tilt + swivel £85.00
14" HI-RES Mono w/tilt + swivel £99.00
14" RGB £239.00
14" EGA £339.00

I/O Plus II 2 RS232, 1 PRN & Games Port Clock/calendar with battery back-up £79.00
I/O Plus 2 RS232, 1 PRN & Games Port. £59.00
RS232 Card + optional 2nd RS232 £29.00
Modem Autoans/ Autodail + software £145.00

2MB Multifunction CD with 2 RS232, 1 PRN & Games Port (OK) £99.00
Clock/calendar with bat/backup £30.00
102 Key XT/AT Keyboard £79.00
84 Key XT/AT Keyboard £59.00
TEAC 1.2 MB FDD £89.00

Options

All prices quoted are exclusive of VAT

- Service contracts available at competitive prices!
- Please phone or write for further details, colour brochure and full price list.

Beltron Computers System Inc.
have outlets in USA, West Germany, Spain, UK, and the Far East.
IBM XT/AT are registered trade marks of International Business Machines Inc.

Sole Agents in United Kingdom **Continental Limited**

15 Cheltenham Trade Park, Cheltenham,
GL51 8LZ Telephone: (0242) 221590/91
Telex: 265871 MONREF G Ref: WJJ032

DIMENSION computers l.t.d.

27/29 High Street
Leicester LE1 4FP
Tel: (0533)
517479/21874

THE MIDLAND'S LARGEST COMPUTER STORE

AMSTRAD PC RANGE

Including the new 1640 Models

PC1512 Single Drive Mono 640K	£379.00
PC1512 Dual Drive Mono 640K	£474.00
PC1512 Single Drive Colour 640K	£519.00
PC1512 Dual Drive Colour 640K	£616.00
PC1640 Single Drive Mono	£474.00
PC1640 Dual Drive Mono	£569.00
PC1640 Single Drive Colour	£616.00
PC1640 Dual Drive Colour	£699.00
PC1640 Single Drive ECD	£759.00
PC1640 Dual Drive ECD	£854.00

AMSTRAD 20Mb SYSTEM PLUS DMP3000 PRINTER OFFERS

PC1512 Single Drive Mono 640K with 20Mb Hard Disc	£799.00
PC1512 Single Drive Colour 640K with 20Mb Hard Disc	£949.00
PC1640 Single Drive Mono with 20Mb Hard Disc	£854.00
PC1640 Single Drive Colour with 20Mb Hard Disc	£995.00
PC1640 Single Drive ECD with 20Mb Hard Disc	£1149.00

The above prices include FREE DMP3000 PRINTER plus Spreadsheet, Wordprocessor and 3D CAD software. PC1512 offers also include Upgrade to 640K plus Ability Software Suite and 4 US GOLD games.

32Mb HARD CARD

32Mb hard card upgrade for single or dual drive Amstrad PC's giving Amstrad users a high quality internal 30Mb hard disc system. Fast, quiet operation, takes just ten minutes to install £299.00

PRINTER OFFERS

ALL PRINTERS INCLUDE FREE PC PRINTER LEAD

STAR NL10

Dot Matrix Printer — Print Speed 120 cps in Draft Mode and 30 cps in Near Letter Quality Mode; Friction and Tractor Feed; 5K Buffer; Automatic Single Sheet Paper Set; Front Mode Select Panel £199.00
Optional Cut Sheet Feeder £55.00

STAR NX15

As STAR NL10 but with 15" wide carriage £299.00

THE NEW EPSON LX800

Print Speed 150 cps in Draft Mode and 25 cps in Near Letter Quality Mode; Friction and Tractor Feed plus 3K Buffer £208.00

EPSON GQ3500

Laser Printer — Print Speed 6 pages per minute; Multiple Font; IBM Character set; 512K Memory; 150 Sheet Standard Paper Feed; Landscape and Portrait Format £1346.00

STAR NB24-10

24 pin Dot Matrix Printer with Print Speed of 216 cps; Draft and Immaculate 72 cps Letter Quality £434.00

THE NEW AMSTRAD DMP3160

Dot Matrix Printer
Print Speed 160 cps in Draft Mode and 40 cps in Near Letter Quality Mode. Friction and Tractor Feed £159.00

AMSTRAD DMP3000

10" Carriage Dot Matrix Printer £129.00

AMSTRAD DMP4000

15" Carriage Dot Matrix Printer £285.00

THE NEW AMSTRAD 3500

24 Pin Dot Matrix Printer £349.00

256K PRINTER BUFFER

Compatible with any Centronics Printer £114.95

ASHTON TATE'S JAVELIN

What must be the most powerful business analysis/calculation software has come down to just £89.95. Javelin, voted software product of the year by Infoworld, gives you 10 different ways to look at your data, and cannot be beaten for analysing data of time. Also has presentation quality graphics. £89.95

AUTHORISED AMSTRAD DEALER

AMSTRAD OFFICE PROMOTION

PC1512 Dual Drive Mono 640K with WORDSTAR 1512 Wordprocessor, SUPERCALC 3 Spreadsheet, plus the new AMSTRAD 3160 PRINTER	£649.00
As above, but with Colour Monitor	£819.00

AMSTRAD 32Mb SYSTEMS

PC1512 Single Drive Mono 640K with 32Mb Hard Card	£689.00
PC1512 Dual Drive Mono 640K with 32Mb Hard Card	£779.00
PC1512 Single Drive Colour 640K with 32Mb Hard Card	£829.00
PC1512 Dual Drive Colour with 32Mb Hard Card	£929.00
PC1640 Single Drive Mono with 32Mb Hard Card	£739.00
PC1640 Dual Drive Mono with 32Mb Hard Card	£839.00
PC1640 Single Drive Colour with 32Mb Hard Card	£887.00
PC1640 Dual Drive Colour with 32Mb Hard Card	£979.00
PC1640 Single Drive ECD with 32Mb Hard Card	£1029.00
PC1640 Dual Drive ECD with 32Mb Hard Card	£1129.00

The above prices include Spreadsheet, Wordprocessor and 3D CAD software. PC1512 offers also include Upgrade to 640K plus Ability Software Suite and 4 US GOLD games.

OLIVETTI DM105 COLOUR DOT MATRIX PRINTER

Unbeatable on price/performance, the Olivetti DM105 offers the following features:

* IBM/Epson Colour Emulation	
* 120 cps Draft, 25 cps Near Letter Quality Mode	
* Prints NLQ, Draft and Graphics in Full Colour	
* Up to 240 Dots Per Inch Graphic Resolution	
* Normal or Colour Draft/NLQ Text Output	
* Full IBM Compatibility	£173.00
Optional Tractor Feed Unit	£30.00

SBC MISTRAL 286 AT RANGE

30Mb Mono	£1799.00
30Mb Colour CGA	£1999.00
30Mb Colour EGA	£2199.00
40Mb Mono	£1999.00
40Mb Colour CGA	£2199.00
40Mb Colour EGA	£2399.00

SBC PC RANGE

Dual Drive Mono	£599.00
Dual Drive Colour	£799.00
20Mb Mono	£999.00
20Mb Colour	£1199.00

Prices include free 1 year on site maintenance contract.

SBC MONITORS

12" Green including swivel and tilt	£79.95
14" Green or Amber including swivel and tilt	£99.95
14" Medium Res. Colour	£269.95
14" EGA Compatible Colour	£359.00

COMMODORE AMIGA A2000 with 1081 HIGH RES. COLOUR MONITOR

..... £1099.00
including 1 year on site maintenance contract.

PERSONAL CALLERS AND EXPORT ENQUIRIES WELCOME

ALL ITEMS SUBJECT TO AVAILABILITY

ALL PRICES EXCLUDE VAT AND ARE CARRIAGE FREE

DIMENSION COMPUTERS LTD.

27/29 High Street, Leicester

Tel: (0533) 517479/21874

Fax: (0533) 511638

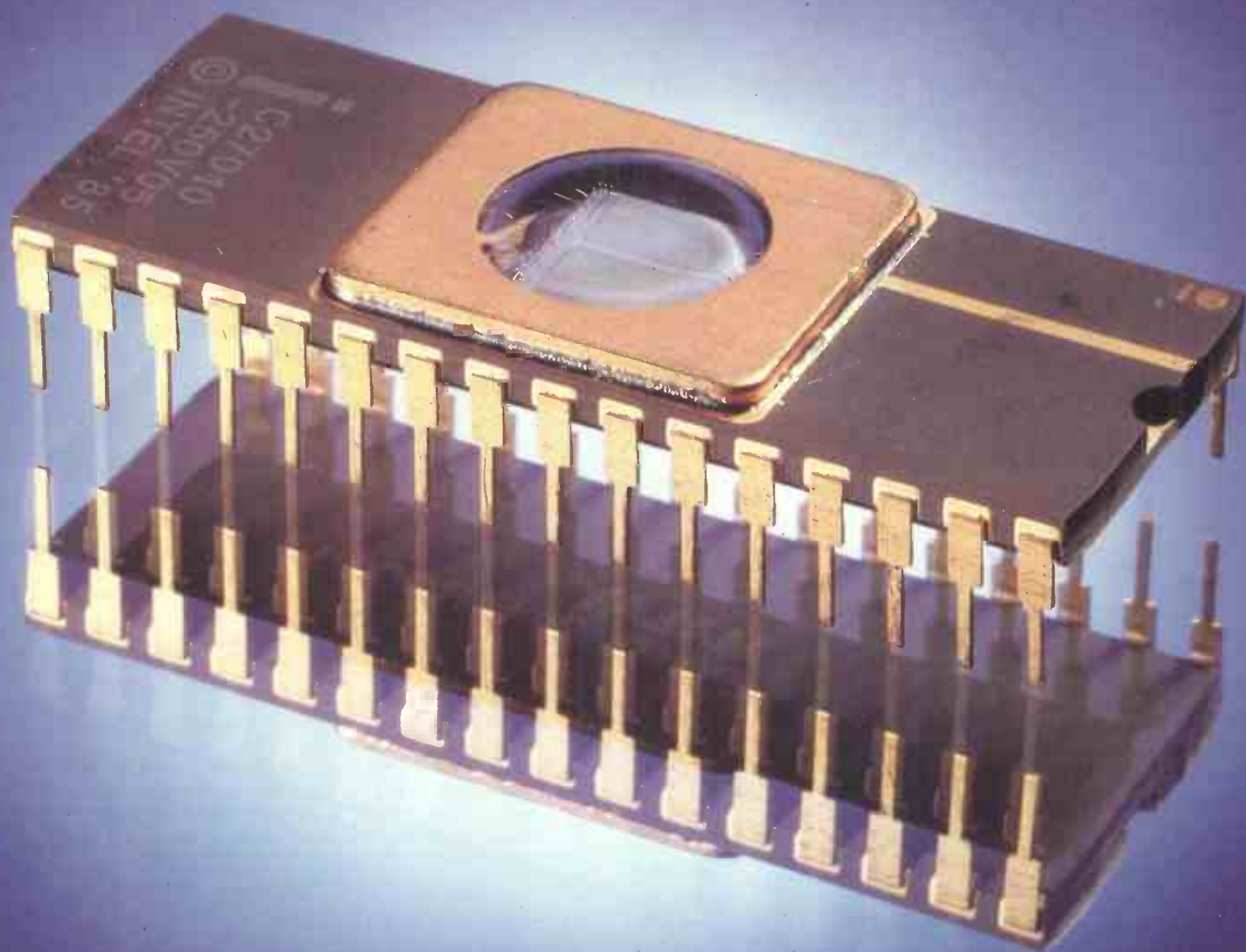

SPELL *Master* ✓

Spellmaster contains 59,536 separate English words
stored in 131,072 bytes in one chip

- Compatible with all BBC models
- Works with INTER-WORD, WORDWISE PLUS and VIEW
- Checks spelling at up to 10,000 words per minute.
- Checks text as it is entered



Computer Concepts



ONLY ONE OTHER PERSONAL COMPUTER LOOKS THIS GOOD..



SUBSTANTIAL SAVINGS
ON ALL EDUCATION,
BUSINESS
AND PUBLIC SECTOR ORDERS

£1,295

Introducing the PC V Turbo from Opus Technology, a remarkable new high performance low-cost AT compatible created by popular demand.

With a price tag of just £1,295, the PC V Turbo offers you everything you demand from an AT compatible and more – more performance, more quality, more features:

- Turbo 80286 microprocessor
- 6/10 MHz (zero wait state) switchable clock speeds
- 1 Mb motherboard memory
- 30 Mb Winchester
- 1.2 Mb ½-height floppy
- Enhanced, extended 102-key keyboard
- 80287 maths co-processor option
- Parallel/serial printer ports
- Mouse port
- 14" super high resolution flat-screen amber monitor
- Dual mode mono/colour graphics card
- Keyboard lock
- 8 expansion slots
- Phoenix BIOS
- Space for additional drive
- EGA option
- Super small footprint
- Comprehensive user manual
- 12-month guarantee

PCV TURBO
A small price to pay for quality.

Opus Technology.

For details call Sales today on **0737 765080** or Fax 0737 769873. Price quoted exclusive of VAT and carriage.
Opus Technology Ltd, 53 Ormside Way, Holmethorpe Industrial Estate, Redhill, SURREY RH1 2LW

AVAILABLE FOR AMSTRAD PC1512

AVAILABLE FOR IBM COMPATIBLES**



12 Programmable Function Keys

Extra-size Keys where you need them

Separate Numeric Pad

Made in the UK

2 Alt and Control Keys

Dedicated Cursor and Function Pad



Just about everybody agrees that using an "enhanced" keyboard is a great improvement. But it can also be a great expense - and if your investment has gone into AMSTRAD PC1512* machines it will also prove a great difficulty.

At ELECTRONE we decided to do something about all this and set out to produce the DASHBOARD. It is reasonably priced, comes in two versions - one to fit the AMSTRAD port and one to fit the IBM† standard port (which means it will work with most industry standard machines available).

But there's more. Like all our keyboards, the DASHBOARD is "soft," which means that if you buy our easy-to-use DASHBOARD UTILITIES Software you can dedicate keys to perform selected tasks whenever you want.

Consider the possibilities. Whole macros at the touch of a button (even if your software doesn't have a facility for macros), regularly used sentences, paragraphs or whatever, again at the touch of a button - then there's all

those hard to remember printer control codes, you can store those on whichever keys you want, if you're writing software you can even store mini programs on a button.

The potential is virtually limitless, because you can use each key in *all* its modes and you can change the whole keyboard configuration according to what you are doing.

So, if you want to enhance your machine with something a bit more meaningful we suggest that you fit a new DASHBOARD and for extra acceleration, install our DASHBOARD UTILITIES and really start motoring.

Electrone

†Copyright IBM Corp. *Trademark of Amstrad Consumer Electronics Plc **IBM Compatible must have standard keyboard port

OUR NEW DASHBOARD MAKES YOUR MACHINE EVEN FASTER

Electrone Ltd. Haywood House, High Street, Pinner, Middlesex HA5 5QA Telephone: 01-429 2433

.. FORTUNATELY WE MAKE THAT TOO



**SUBSTANTIAL SAVINGS
ON ALL EDUCATION,
BUSINESS
AND PUBLIC SECTOR ORDERS**

From
£499

30 Mb XT model
only
£995

Announcing the PC III Turbo from Opus Technology – Britain's first range of 10 Mhz Super Turbo PC/XT compatibles. Enhanced performance, stunning specifications, compact design and prices which stop where many others start.

Now you can choose from a quality range of stylish PC-compatibles with mono, colour and EGA versions, or select a pace-setting new XT computer for as little as £995.

PC III TURBO 30 Mb XT

- 8088 super turbo processor 4.77/10 MHz
- 14" flat screen amber monitor
- Extended 102-key keyboard
- Advanced multi-function card – Mono/Colour graphics adaptor, Parallel and Serial ports, floppy disk controller and mouse port
- Six free expansion slots
- 360 K floppy disk drive
- 1 Mb motherboard memory
- 30 Mb Winchester
- Super small footprint case
- Lockable keyboard
- Phoenix BIOS
- Space for second disk drive
- Battery-backed clock/calendar
- 180 watt UL-approved power supply
- Comprehensive UK user manual
- 12-month guarantee – on-site maintenance option

PC III TURBO
A small price to pay for quality.

Opus Technology.

For details call Sales today on **0737 765080** or Fax 0737 769873. Price quoted exclusive of VAT and carriage.
Opus Technology Ltd, 53 Ormside Way, Holmethorpe Industrial Estate, Redhill, SURREY RH1 2LW

TECHNOMATIC

17 Burnley Road, London NW10 1ED Tel: 01-208 1177
305 Edgware Road, London W2 Tel: 01-723 0233

BUSINESS SOFTWARE

INTEGRATED PACKAGES

Smart V 3.10	£415(a)
Framework II V 1.1	£325(a)
Symphony V 1.2	£329(a)
Open Access II V 2.0	£355(a)
Lotus 1.2.3	£231(a)

WORD PROCESSORS

Wordstar Professional V 4.0	£199(a)
Microsoft Word V 3.10	£275(a)
Microsoft Word Junior	£49(b)
Multimate Advantage	£269(a)
Word Perfect Personal	£159(a)
Word Perfect Junior	£79(b)

DATABASE

dBase III Plus V 1.1 unpr.	£375(a)
dBXL (dBase III + clone)	£115(a)
Quicksilver - Compiler dBase III	£365(a)

SPREADSHEET

Supercalc 4	£219(b)
Javelin	£99(a)
Logistix	£95(c)

LOTUS SERIES

Manuscript	£269(b)
Hal	£95(b)
Freelance Plus	£275(b)
Quickcode	£49(c)

META i

Assembler/Disassembler/Emulator handles the following CPU's.
6500 family, Z8X family
6800 family, 808X family
Emulator for all single rail eproms up to 27512 Full details on request. £695(a)

BUDGET SOFTWARE

Ability Plus	£149(c)
Psion PC-Four	£65(c)
VP Planner	£65(c)
VP Info	£65(c)
WordStar 1512	£59(b)

DESKTOP PUBLISHING

Ventura Publisher	£749(a)
Pagemaker	£595(a)
GEM DTP	£275(b)
Page Ability	£199(b)

UTILITIES

Norton Utilities V 4.0	£55(c)
Norton Advanced Utilities	£89(c)
Copy II PC	£35(c)
Fastback	£165(c)
Xtree V 2.0	£49(c)

BORLAND SOFTWARE

Reflex Ver 1.1	£70(b)
Reflex Workshop	£52(b)
Turbo C	£55(b)
Turbo Basic	£50(b)
Turbo Pascal BCD/8087	£49(b)
Turbo Prolog	£50(b)
Turbo Prolog Toolbox	£52(b)
Turbo Lightning	£52(b)
Eureka The Solver	£55(b)
Sidekick	£52(b)
Superkey	£52(b)
Turbo Holiday Jumbo Pack	£149(b)

Full Borland Range in stock.

LANGUAGES & O.S.

Microsoft Basic Interpreter	£210(b)
MicroSoft Quick Basic V 3.0	£60(c)
Microsoft C Compiler V 4.0	£235(a)
Microsoft Cobol Compiler V 4.0	£235(a)
Microsoft Macro Assembler	£90(b)
Microsoft Windows V 1.03	£72(c)
Zorland C	£29(d)
Zorland C - Power Pack	£59(c)
Learning DOS	£24(c)

PROFESSIONAL CAD

Autosketch	£69(d)
AutoCad Basic V 2.6	£300(a)
AutoCad ADE1,2&3 V 2.6	£2500(a)
Pro-Design II V 2.5	£245(b)

ACCOUNTING SOFTWARE

Accountability	£89(b)
Sage Book Keeper	£85(b)
Sage Accountant	£115(b)
Sage Account Plus	£160(b)
Sage Financial Controller	£225(b)
Sage Payroll	£70(b)

MISCELLANEOUS

MS Flight Simulator	£39(c)
Psion Chess	£25(c)

The above is just a sample of our Business Software range. Please send for our complete listing.

ARCHIMEDES

Please send for details on Acorn's latest 32 bit Super Fast RISC Computer.

AMSTRAD PCs

PC1640DD/ECD	£875
PC1640HD/ECD	£1175
PC1512DDCM	£499
PC1512HDCM	£629

Other models of Amstrad available from stock.

CO Processors

8087-5MHz	£120(c)	8087-8MHz	£160(b)
8087-10MHz	£199(b)	80287-6MHz	£160(b)
80287-8MHz	£220(b)	80287-10MHz	£260(b)
V-20 5MHz	£10(b)	V-30 5MHz	£10(b)
V-20 8MHz	£12(b)	V-30 8MHz	£12(b)

AT Interface Cards

EMS Card 4Mb OK	£169(b)
(incl Ser/Par Ports) 2Mb	£349(b)
Dual I/O Card - 1 Par/1 Ser Port	£69(c)

INTERFACE CARDS

for IBM PC/XT & Compatibles

Auto Switch 560 Card	£239 (b)
----------------------	----------

EGA Board

* Multimode card including all the capabilities of IBM, EGA, Hercules mono card, IBM colour and mono card.	£179(b)
--	---------

Monochrome Graphics Card	£65(b)
--------------------------	--------

Colour Graphics Card	£59(b)
----------------------	--------

Multi I/O Card

* Parallel/Serial Ports	£79 (b)
* Battery backed calendar/clock.	

RAM Card with 384K (Expandable to 512K).	£86 (b)
--	---------

RS232 Serial Card

Short slot card with option for 2nd port	£35(c)
Extra for 2nd port	£22

Parallel Interface Port

Short slot card, Epson/Centronics compatible	£19(c)
--	--------

POINTING DEVICES

Microsoft Mouse Ver. 6.02 (please specify Bus or Ser version)	£129(b)
---	---------

Logimouse (Serial)	£76(b)
--------------------	--------

PC Compatible Witty Mouse

Plugs into serial port, adaptor for parallel conn. to k/bd. MS software compatible.	£39(b)
---	--------

RB2/Cad 5 Tracker Ball	£175(b)
------------------------	---------

TRANSNET LAN

for ATs, XTs, PCs & Compatible

- * Economical to purchase
- * Easy to install
- * Simple to use

Starter kit links two stations. incl. adaptors, cabling and easy to use menu driven software

	£409(a)
--	---------

Adaptor for additional system	£189(b)
-------------------------------	---------

Ask for full details

MAIL ORDER
& RETAIL
17 Burnley Road
London NW10 1ED
Telex 922800
WEST END BRANCH
305 Edgware Road
London W2

Visit our
Edgware Road shop
for demonstrations.

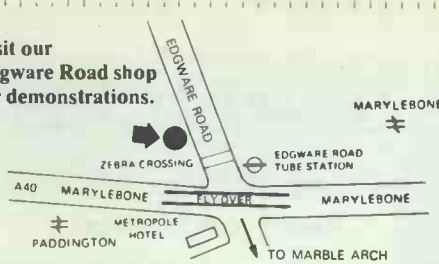

For fast delivery telephone
your order on 01-208 1177
using VISA/Access Card



Orders welcome from
government depts &
educational establishments

All prices ex VAT.
All prices subject
to change without
notice. E & O accepted.
Please add carriage
(a) £8.00 (Datapost)
(b) £2.50 (c) £1.50
(d) £1.00

SYCLON AT TURBO

Fastest AT with 80286-12 CPU

The first AT with Dynamic Speed
Control for full time 12.5MHz operations
on CPU and memory.
Auto Speed switching allows use
of conventional add-on cards.

System Spec:

80286-12 CPU, 12.5/8 MHz modes, 1Mb Ram.
80287 Socket 8 Expansion Sockets
Mono or Colour Graphics Adaptor
1 x 20 Mb Winchester, 1 x 1.2 Mb floppy,
Real Time clock with battery back up,
200W Power Supply, 1 Parallel/1 Serial Port,
AT Style Keyboard

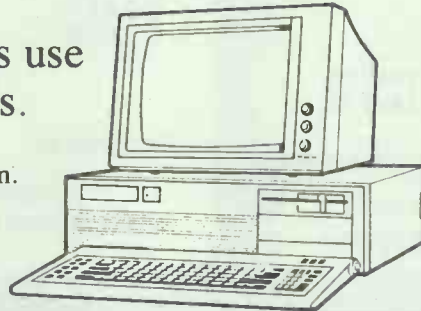

SYCLON SAT01 £1195(a)

SYCLON PC/XT TURBO

8088-8 cpu, 8/4.77 MHz Modes, 640K Ram
8087 Socket, 8 Expansion Slots,
Mono or Colour Graphics Adaptor,
2 x 360K floppies for PC,
1 x 360K floppy + 1 x 20 Mb
Winchester for XT
Real Time Clock + battery back up
1 Parallel/1 Serial/1 Games Port
150W PSU/AT Style Keyboard



£469(a)
£649(a)
£55(b)

SYCLON PC TWO TURBO SYCLON XT TWO TURBO

12" Hi Res TTL mono monitor £65 if purchased with Syclon

PRINTERS

DOT MATRIX PRINTERS:

EPSON PRINTERS:

LX800	£189(a)		
FX800	£299 (a)	FX 1000	£405 (a)
EX800	£409 (a)	EX1000	£549 (a)
LQ800	£399 (a)	LQ1000	£529 (a)
GQ 3500 Laser Printer			£1350 (a)
Taxan KP815			£269 (a)
Taxan KP915			£369 (a)
National Panasonic KX P1081			£149 (a)
Star NL 10 with IBM Interface			£192 (a)
Amstrad DMP3000 Printer			£159 (a)

DAISY WHEEL PRINTERS

Juki 6100			£279 (a)
Brother HR20 (Parallel & Serial Interface)			£349 (a)
National Panasonic KX P3131 with 38K buffer			£249 (a)
Integrex Inkjet Colour Printer			£549 (a)
IBM EGA/CGA dump 64 colour screen dump for Integrex.			£45 (b)

PLOTTERS

Hitachi 672 A3 4 colour High speed, high precision plotter Serial & Parallel Interface.			£465 (a)
Roland DXY 880A A3 8 pen			£645 (a)
IBM Type Parallel Printer Lead (2m)			£12 (d)

SHARERS & BUFFERS PB 128K Buffer

Internal buffer suitable for most
EPSON printers. Easy to instal.
Instructions supplied. **£89 (b)**

Printer Sharers:

(All lines are switched).			
2 computers to one printer	Parallel	Serial	£25 (c) £25 (c)
3 computers to one printer			£39 (c) £39 (c)
4 computers to one printer			£45 (c) £45 (c)
2 computers to 1 or 2 printers.			£49 (c) £49 (c)

Cable sets for all popular computers available.

External Serial/Parallel	£37.50(c)
Parallel/Serial converter	£37.50(c)

A wide range of printer interfaces, sheetfeeders,
tractor units, acoustic hoods, ribbons available
from stock.

WINCHESTER DRIVES

Seagate ST225 20Mb with kit	£265(b)
MiniScribe 20Mb with kit	£259(b)
Seagate ST238 30Mb with kit	£299(b)
MiniScribe 30Mb with kit	£279(b)
MiniScribe 40Mb half ht 25mSec Access	£549(b)
Seagate ST4038 30Mb full ht.	£560(a)
Seagate ST 4051 40Mb full ht.	£670(a)
Mini Scribe 30 Mbyte File Card	£329(a)

MONITORS

Mono 12" Composite

Philips 7502 Green	£69(a)
Philips 7522 Amber	£75(a)
Philips 7542 White	£79(a)
Taxan KX 117 Green P31	£85(a)
Taxan KX 118 Green P39	£90(a)
Taxan KX 119 Amber	£90(a)

Mono 12" TTL

Philips 7513 Green	£85(a)
Taxan 123 Green P31	£99(a)
Taxan 124 Amber	£109(a)

RGB

Philips 14"	£195(a)
Taxan 620 12"	£269(a)
Taxan 625 12"	£319(a)

RGB EGA

Taxan 760 14"	£474(a)
Taxan 770 Multi Scan 14"	£599(a)
Mitsubishi 1440 14"	£479(a)
NEC 14" Multi Sync	£549(a)

3M DISC & CARTRIDGES

Winter Olympics Competition

Thousands of prizes to be won plus entry in a
raffle for a trip for two to the Canadian Olympics

Discs in packs of 10

5.25" 745 48 TPI DSDD	£10.50(d)
5.25" 747 96 TPI DSDD	£13.25(d)
5.25" HD 1.6 Mb for AT	£25(d)
3.5" 96 TPI DSDD	£18(d)

Cartridges

DC1000	£12.00(d) each
DC300 XLP	£16.50(d) each
DC600A	£18.50(d) each
DC2000	£27(d) each

We can only show a small range of the products
stocked by Technomatic in this advertisement. If
you would like further information, please
indicate your interest by ticking the appropriate
box and we will send you a brochure.

- Syclon Software Modems
 Printers Monitors BBC Systems

NAME _____

ADDRESS _____

POST CODE _____

Return to Technomatic Ltd 17 Burnley Road,
London NW10 1ED PCW 11/87

QUALITY SERVICE + UNMATCHED PRICES

Computers £

Tandon PCX 20	899.00
PCA 20	1325.00
PCA 40	1745.00
PCA 70	2175.00

For EGA Systems add £300.00

AST Premium 20	1575.00
Premium 40	1850.00

Victor VPCIII 30Mb	1749.00
VPCIIe 30Mb	1299.00
Tandy Laptop	999.00

New

Tandon Target 20Mb	1445.00
Tandon PAC 286 2x30Mb	2490.00

Now Available

Also Authorised Dealers for
Amstrad, Apricot and Kaypro

Desk Top Publishing £

Software	Ventura	695.00
	Pagemaker	525.00
	Gem Publisher	295.00
Laser Printers	Epson GQ 3500	1395.00
	HP Laserjet II	1995.00
	AST Turbolaser	2225.00
	Ricoh Postscript	4250.00
	Kyocera F1010	2000.00

PACKAGE
DEAL
£ 4625

Tandon PCA 20
Wyse 700 Monitor
HP Laserjet II
Ventura, Mouse
PC Paintbrush

Networking

Authorised Novell Netware Dealers
Call for expert guidance, installation and training

All prices are CWO and exclusive of VAT

MICRO
MINDER CONSULTANTS LTD

01-870 4650/ 7431
68 Upper Richmond Road, London SW15 2RP

MIR MICRO-RENT

When you choose to rent - Micro-Rent

Excellent service • Full technical support • Immediate delivery • Wide choice of computers, printers and other peripherals • Ex-rental machines available for purchase.

And the most competitive rates for rental by the day, week or month.

BREAKDOWNS? Ask about Micro-Rent Sprint service that guarantees delivery within two hours: Call Micro-Rent **Sprint** on 01-700 4621.

• APPLE • APRICOT •
• IBM PC. XT. AT. PS/2 •
OLIVETTI • MACINTOSH
• TANDON • COMPAQ •
SIRIUS • LASER PRINTERS
• DESK-TOP PUBLISHING •
• FAX MACHINES •

01-700 4848

MIR

MICRO-RENT
St. Marks Studios,
Chillingworth Road,
London N7 8QJ.

MAC-PLUS



TANDON



IBM PC AT

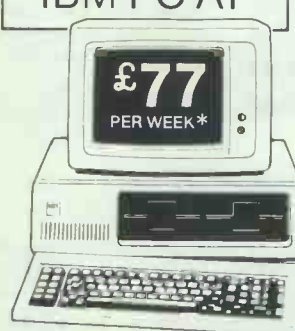

H-P LASERJET

£58 PER WEEK*

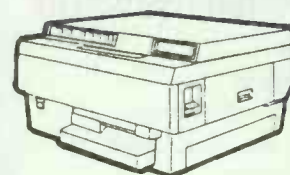

*Prices quoted are based on 3-month rental, excluding VAT.

SPECIAL



LeadLine is a new desktop publishing aid for laser printer users who wish to create effects similar to those seen on video or record covers or even as on TV. The program allows full page graphics at 300 dpi and interactively automates any two or three dimensional transformation in postscript-like fashion with a few key strokes.

All *LeadLine* fonts come as stroke tables making full use of B-spline curves when you arrange headlines in some circular, bent, dented or otherwise massaged shape. Because fonts, patterns and free hand drawings you create are stored as mathematical equations rather than bitmaps, perfectly smooth lines and curves at any size and angle are guaranteed.

LeadLine includes drivers for HP LaserJet+ and Epson compatible printers. Output files compatible with most desktop publishing programs can also be generated.



HOW TO MAKE YOUR LASER HEADLINES

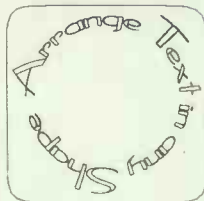

LeadLine comes with 8 fonts and 32 different patterns. All fonts and patterns can be modified in 3D space, they can be drawn in black or white, as lines or with an airbrush, and both with a thickness adjustable between 1 and 127 pixels, thus allowing an endless number of designs.

LeadLine is available now for Unix (III & V) on Torch hardware, PC-AT compatibles running Microport UNIX V, and for PC DOS on IBM compatibles (CGA, EGA or Herc., min. 512 Kb memory, min 1 Mb disk).

LeadLine comes with a 135 page manual and is not copy protected. Introductory price: £148.75 incl. 15% VAT and P&P until 31.10.1987 (normal price £168.75).

Order from: Designer Pixels, 8 Polwithen Rd., Penzance, Cornwall, TR18 4JS, (0736) 61210.



Please rush:

copies of *LeadLine* at £148.75 (£168.75 after 31.10.87) ea. Incl. VAT + P&P. Working demo showing its power on screen and in print, £5.00 only. Our system: Torch Unix III, Torch Unix V, Microport Unix V, PC DOS. Payment by cheque only.

Sender: _____

Order from: Designer Pixels, 8 Polwithen Rd., Penzance, Cornwall, TR18 4JS, (0736) 61210. PCW



RAGLEY DATA SYSTEMS LTD, Pendennis House, Keevil, Trowbridge, Wiltshire BA14 6NA.

Telephone: 0380 870867.

Telex: 449148 RDS

TEL: 0789 765295
0380 870867

COMPUTERS

We supply and install:

- ★ — AMSTRAD — APRICOT — ★
- ★ — TANDON — TANDY — TATUNG — ★
- ★ — PACKARD-BELL — ZENITH — ★

CALL for prices

Portable SPECIALISTS — SPECIAL OFFERS INCLUDE —

Toshiba T3100-20.....	2999	Zenith Z181.....	1379
Toshiba T1100+.....	1377	Zenith Z183.....	1999
Toshiba T1200.....	2110	Datavue Spark.....	747
Toshiba T5100 New!.....	Call	Datavue Snap.....	2147

DESKTOP PUBLISHING SYSTEMS

Systems supplied to meet your requirements:

CANNON SCANNER SYSTEM.....	1316	EPSON GQ3500.....	1427
VENTURA.....	Call	CANON Ser2.....	1806
PAGEMAKER.....	Call	H-P LASERJET.....	2081
MICROSOFT MOUSE.....	127	CENTRONICS PP8.....	1600
WYSE WY700 MONITOR.....	765	WORDPERFECT.....	298
APRICOT LASER PRINTER.....			1750

PRINTERS

Examples from our wide range:

EPSON LX800.....	205	BROTHER 1409.....	335
EPSON FX800.....	306	BROTHER 1509.....	378
EPSON FX1000.....	391	BROTHER 4018.....	1187
EPSON LQ800.....	435	BROTHER HR40.....	833
EPSON LQ1000.....	575	PANASONIC P1081.....	180
EPSON LQ2500.....	799	PANASONIC P1595.....	539
H-P ThinkJet.....	435	STAR NB24/15.....	665

CALL for prices of other models & alternative brands

PC SYSTEM ENHANCEMENTS

- ★ — INTERQUADRAM SPECIALIST DEALER — ★

Full support on this exciting range!
Current SPECIAL OFFERS include

Pro-Sync card.....	225	Quadboard AT 1MB.....	430
Princeton HX12E Monitor.....	381	Quad 386XT.....	1206
XTRAM card 384k.....	180	QuadSprint 8086.....	242

- ★★ NEW ★★ QUADSTAR LOCAL AREA NETWORK ★★ NEW ★★

- ★ — PLUS THE PORTABLES — SPARK AND SNAP — SEE ABOVE — ★

Irwin 20Mb Int. tape.....	475	20Mb Hardcard.....	305
30Mb Hardcard XT type.....	389	Microsoft Mouse.....	127
Hercules comp. card.....	75	Vega EGA card.....	256
Taxan EGA & Monitor.....	665	Serial/parallel.....	75
Lifesaver 2e Ext. tape.....			550

C A D SYSTEMS

Complete systems configured to suit your budget & requirements.

Preferred products from major manufacturers include:

- AUTOCAD — PRO-DESIGN — TDS —
- HEWLETT PACKARD — ROLAND — CHERRY

SOFTWARE

Special offers this month:

Lotus 1-2-3.....	250	Symphony.....	375
Supercalc IV.....	235	Sage Accountant+.....	165
Wordstar 1512.....	60	Wordstar 2000.....	250
Multimate Advantage.....	299	Cardbox Plus.....	256
dBase III plus.....	350	Flight Simulator.....	39

TERMINALS

Wyse 50.....	380	Opus II.....	307
Wyse 60.....	420	Ampex 220.....	365
Wyse 85.....	390	Esprit 6515.....	417
Wyse 99GT.....	685	Esprit 6310.....	417
Wyse 60 PC.....	420	Esprit 6110+.....	307

DEDICATED TO SERVICE

CALL US FOR:

- SYSTEMS DESIGN — MAINTENANCE — RENTAL —
- LEASING — SECOND-USER & EX-DEMO EQUIPMENT

- ★★ ALL PRICES EXCLUDE DELIVERY & VAT ★★

TELEPHONE 0380 870867/0789 765295

- ★ 24hr Ansaphone ★

RANGE OF SECOND USER & EX-DEMO EQUIPMENT AVAILABLE

AFTER A FEW YEARS SOME COMPUTERS ARE ONLY COMPATIBLE WITH ONE THING.



Unlike some of our competitors, the Samsung PC range doesn't come with built-in obsolescence.

Whatever developments there are in computers, ours will almost certainly be able to keep up with them.

We've made both our XT and AT computers IBM compatible.

So they'll be able to grow as fast as your business needs.

Each of our computers is also made to industry standard specification.

And because we've been working with the world's leading computer manufacturers for years, we know how to build reliability into our computers as well as technology.

(We're so confident, in fact, that we offer a 1 year on-site warranty with every Samsung PC.)

As one of the world's largest companies we're also able to guarantee one other thing.

That we're in the computer market to stay.

So if you're looking for your first PC, choose carefully.

Or you could be throwing your money in the bin.

For a full information pack on Samsung PC's and Data Monitors, send this coupon to: Samsung Electronics (UK) Ltd. Unit 1, Hook Rise Business & Industrial Centre, 225 Hook Rise South, Surbiton, Surrey KT6 7LD, Tel: 01-391 0168. Or call any of the distributors below.

Name

Company

Address

PCW1



You can't go wrong with
SAMSUNG

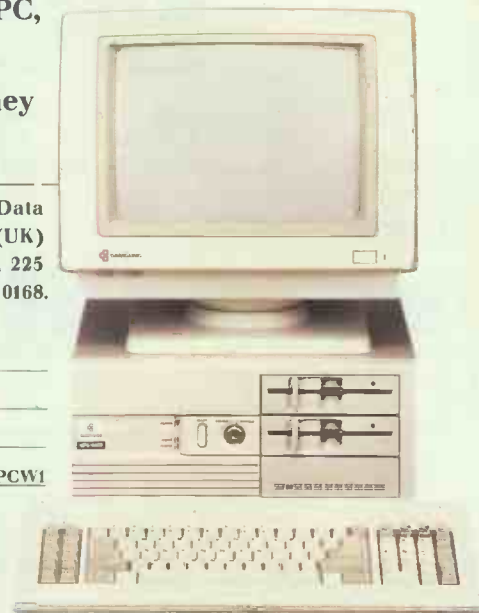

SAMSUNG DISTRIBUTORS: HUGH SYMONS DISTRIBUTION SERVICES LTD (0202-745744).
IDEAL HARDWARE (01-408 1331) · EIRE & N. IRELAND: REYNOLDS ELECTRONICS LTD (01-500144).

MAYFAIR NEWS

AST PREMIUM 286 £

MODEL 120 1MB + 20 MB MONO	1895
MODEL 140 1MB + 40 MB MONO	2195
MODEL 170 1MB + 70 MB MONO	2595
EGA Colour Display (Extra)	295
40 MB Tape Streamer	450

OLIVETTI

M24 640K 1 x 360K	1035
M24 640K + 40 MB	1695
M24 5P 640K/20MB	1570
M28 512K 20MB	2195
M28 512K 40MB	2695
Colour Display Extra	220
M28 40MB Tape Backup	480

SPERRY

MICRO IT 512K 20MB	2295
PC/IT 512K 44MB	2990
PC/IT 1MB 69MB	4295
PC/IT 1MB 117MB	6195
EGA Colour Display Extra	450
XENIX for PC/IT	650
4 Port Terminal Adaptor	245

TANDON

PCX 10 256K 10MB	799
PCX 20 256K 20MB	949
PCA 20 1MB 20MB	1495
PCA 30 1MB 30MB	1745
PCA 40 1MB 40MB	1945
PCA 70 1MB 70MB	2395
EGA Colour Display Extra	450

PORTABLE MICROS

NEC	
Multispeed 640K 2 x 720K LCD	1295
OLIVETTI	
M15 512K 2 x 720K LCD	995
TOSHIBA	
T3100 640K 10MB Plasma	2495
T3100 640K 20MB Plasma	2895
T1100 PLUS 640K 2 x 720K LCD	1395
ZENITH	
Z181 640K 2 x 720K LCD	1495
Z183 640K 10MB LCD	1999

HARD DISKS

Seagate 20MB + Controller	295
Seagate 40MB + Controller	745
Quantum IQ Kit - 80MB + Controller + Software	895
Tandon 20MB Disk Card	295

MODEMS

Dataflex Strodcom V21, 22 (INTL)	165
Steebek Quattro V21, 22, 23 (INTL)	695
Pace Series 4 V21, 22, 23 (EXTL)	399



NEC APC IV

Superb new high spec AT with EGA and brilliant Multisync display; 80286; 640K RAM; Fast Disk (40 MS); EGA Adaptor and Multisync Monitor; Enhanced Keyboard; MS DOS 3.2. £2,195 (20MB) £2,495 (40MB)



OLIVETTI M24

Superior performance and excellent display from Europe's no.1 PC compatible. 640K RAM; 20MB compatible hard disk; serial/parallel; 7 slot bus; keyboard; mono display; MS DOS £1,295

BOARDS £

Persyst 2MB EMS	349
AST Rampage AT 2MB EMS	575
AST Advantage 1.5MB S + P	425
AST Six Pak Premium 2MB EMS	449
Orchid Turbo 286 (12MHZ)	895
Orchid Jet 386	765
Intel Inboard 386	1295
Intel Inboard Cable	145
Hercules Mono Plus	180
Hercules InColour	299
AST 3G+ 256K EGA	230
Vega Deluxe EGA	235
AST 3780	595
AST 5251/11	595
AST 5251/12	525
AST 3270 COAX	745

MONITORS

NEC Multisync	495
PRINCETON HX12E EGA	450
WYSE WY700 1280 x 800 B/W	695

NETWORKING SYSTEMS

PC NET; ARC NET; Novell Netware
Please Call For Full Details.

STOP PRESS

NEW OLIVETTI M24
AVAILABLE FROM STOCK.
CALL FOR FULL DETAILS.

MATRIX PRINTERS £

BROTHER	
M1509 180CPS/45CPS NLQ	375
M1709 240CPS/50CPS NLQ	435
4018 480CPS/100CPS NLQ	1145
EPSON	
LX 800 150CPS/25CPS NLQ	199
FX 800 240CPS/35CPS NLQ	320
FX1000 As Above 130 COL	399
LQ 800 180CPS + LQ	445
LQ 1000 As Above 130 COL	595
LQ 2500 270CPS + LQ	745
EX 1000 300CPS/50CPS NLQ	525
SQ 2500 INK JET 450CPS	995
NEC	
P6 180CPS + LQ	395
P7 180CPS + LQ	465
P9 380CPS/120CPS LQ	995
OLIVETTI	
DM 100 120CPS + NLQ	209
DM 290 160CPS + NLQ	365
DM 296 220CPS + NLQ	595
DM 600 200CPS 70CPS LQ	795
PCPR 3 400/100CPS NLQ	1250

DAISYWHEEL PRINTERS

Brather HR40 SSF/Tractor	795
Juki 6100 18cps	249
Juki 6200 30cps	475
Juki 6300 40cps	699
Olivetti DY 200 25cps	345
Olivetti DY 300 30cps	495
Olivetti DY 450 45cps	849
Olivetti DY 800 80cps	999

LASER PRINTERS

AST Turbolaser*	8PPM.....	2995
AST Turbolaser Plus*	15PPM.....	3995
Canon LBP-8 Mk 11	8PPM.....	1695
Epson GQ3500	6PPM.....	1345
H-P Laserjet*	8PPM.....	1490
H-P Laserjet Series 11*	8PPM.....	1995
H-P Laserjet Plus*	8PPM.....	2170
Oki Laserline 6	6PPM.....	1395
Qume Laser 10 Plus*	10PPM.....	2095

(* = Incl. On-Site Maintenance)

SOFTWARE

Microsoft Crosstalk	95
Ashton Tate dBase 3Plus	375
Ashton Tate Rapid File	195
Symontex Q+A	199
Sapphire Dataease	375
Compsort Pro Delta	375
GEM Collection	80
Lotus 123	235
Lotus Symphony	335
Lotus Freelance Plus	275
Microsoft Windows	59
Migent Ability	89
Microsoft Multiplan 3	120
Innovative Smart System	425
Multimote Advantage	265
Micropro Wordstar 4	225
Micropro Wordstar 2000/2	265
Microsoft Word 3	265
Wordperfect 4.2	245
Xerax Ventura DTP	695

Blenheim House,
Podmore Road,
London SW18 1AJ
01-871 2555/Telex 936066

**MAYFAIR
MICROS**

How to make sure your Printer doesn't slow your PC down.



Without a Megabuffer your Printer can slow-down the rate your PC outputs to the rate your Printer prints. Turning a 5 minute print file into half-an-hour. Which means that the PC can be out of action for long periods. Merely outputting. With a Megabuffer the PC outputs at its top speed into the Megabuffer memory, the PC is then released for further work, and the Printer prints at its own rate from the Megabuffer memory.

- Allows you to use your PC more
- Can emulate special plotter handshake protocols
- Compatible with most computers, printers and plotters: IBM & compatibles, AMSTRAD, HP, ACT, SHARP, EPSON, CALCOMP and many more • Can cut PC output time to one sixth or less.
- Software-independent
- Data Buffer and interface converter
- Pause, 'reprint page' and multiple copy facilities

Full range of memory sizes for every application: 64K **£160**, 128K **£216**, 256K **£278**, 512K **£388**, 1MB **£556**.

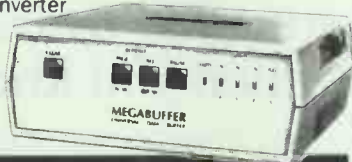

Flexible Interfacing that keeps them all talking

Eliminate miles of spaghetti and all those 'T' and 'X' switches with a simple Megaswitch which allows your PC to instantly connect to a selection of printers and plotters.

MEGASWITCH AS - Serial Data Selector

- Single unit multiplexer and demultiplexer • 2K data buffer
 - RS-232 and RS-422 versions • Can operate as RS-232/RS-422 converter • Diagnostic output • Megabuffer compatible
 - Multiplexer - Ideal for printer sharing. 4 inputs and 2 outputs. Can automatically select any channel supplying data
 - Demultiplexer - Ideal for driving several different printers from a PC. 2 inputs and 4 outputs
- Software and manual selection. Downloadable code translation tables. Hardware and XON/XOFF handshakes (RS-232) **£189**



INPUT UP TO 5 PCs



MEGASWITCH S - RS232 Serial Selector

- Connects any of 5 inputs to either of 2 outputs
- Universally compatible - works with all baud rates and handshake arrangements
- LED indication of data flow
- Use it with a Megabuffer for additional time saving **£99**

OUTPUT UP TO 2 PRINTERS UP TO 2 PLOTTERS

RINGDALE PERIPHERALS

11 Decoy Road, Worthing, West Sussex BN14 8ND
Telephone (0903) 213131
Telex 265871 REF: JBC2021

MEGASWITCH AP - Parallel Data Selector

- Connects any of 4 inputs to either/both of 2 outputs
- Can automatically switch to any channel supplying data
- Ideal for laser printer sharing
- Universally compatible - works with all standard centronics computer and printer interfaces
- Use it with a Megabuffer for additional time saving **£169**

UK delivery £3/UNIT, cables from £15. VAT extra Dealer and Export Enquiries welcome

System Science

C COMPILERS

AZTEC	
AZTEC C86/PROF (MS-DOS) large mem. asm, link	£149.00
AZTEC C86/DEV (MOS-DOS) adds source debug editor	£225.00
AZTEC C68/COMM (MOS-DOS) adds ROM support, lib source	£325.00
AZTEC C68/COMM-MAC, AMIGA	£325.00
AZTEC C for PC/M-80, Apple Dos, Prodos	£ call

LATTICE	
LATTICE C Compiler ver 3-	£295.00
8087, all mem. models	£95.00
LATTICE Screen Editor	£129.00
LATTICE C SPRITE Debugger	£175.00
LATTICE dBC-II or III Dbase library	£175.00

MICROSOFT C 5.0 with Code View, Quick C large mem. source debugger, 8087	£325.00
TURBO C from Borland NEW Editor, Linker, Large mem options	£69.00

LIVING C PLUS (NEW) Interpreter and Comp.	£145.00
RUNC-C PROFESSIONAL Interp.	£125.00
RUNC-C - Interpreter excellent tutorial	£60.00
C CROSS Compilers 6809, 68070, 8051, 6301, 80386	£ call

C LIBRARIES

GRAPHICS	
Metawindows - many languages	£115.00
Essential Graphics Library	£175.00
Graphic C - source, colour, EGA	£245.00
Halo - specify compiler	£195.00

COMMUNICATIONS	
GREENLEAF COMMUNICATIONS Ints, Ring Buff., Status & Control	£125.00
BLAISE ASYNCH MANAGER Port control, XMODEM protocol	£125.00

SCREEN and DATA ENTRY	
PANEL entry screens - most languages	£215.00
Vitamin C - Screen, print layout code	£145.00
Windows for Data, Windows for C	£215.00

GENERAL	
GREENLEAF GENERAL FUNCTIONS Dos, Disk, Video Strings, Date, Keybd.	£125.00
PortCe - source lib, comms, dbase, screen etc	£245.00
The C programmers toolkit	£95.00

ISAM & DATAFILE	
CTREE - Faircom (source) B tree lib.	£245.00
RTREE - Reports generator for CTREE	£195.00
Bitrive - database library, many lang.	£195.00
Bitrive N - Novell, PC-NET networks	£425.00

BLAISE C TOOLS PLUS - source	£125.00
DOS, Dos, screen, windows, keyboard etc	£125.00
C Scientific Subroutines - source Matrix, polynomial, diff. eqn. etc	£125.00

PHOENIX	
PLINK-86 Plus - overlay caching	£325.00
PMATE-86 programmers editor	£120.00
PRE-C Link utility	£195.00
PRX-86 Plus debugger	£225.00
PDISK - backup, disk cache & utils	£95.00

BRIEF multi-file editor	£145.00
dBRIEF addition for DBASE programmers	£75.00
EPSILON - Emacs style editor	£145.00
PC/Vi screen editor	£125.00
MKS Toolkit (lots of Unix goodies, inc. VI)	£95.00
QUILT Software Revision Management	£99.00
PC-LINT by Gimpel	£99.00
CLIPPER - DBase III Compiler	£545.00

ASSEMBLERS and CROSS-ASM

Microsoft 8086 macro Asm (SYMDEBUG & LINK)	£115.00
Cross Assemblers 68xx, 68000, Z80, 8080, 6502, 8048, 8051 etc.	£ call
Simulators - Z80, 8048, 8051 etc	£ call
Quelo 6800 and 68020 cross assemblers	£ call

LMI Forth-83

PC-FORTH, asm, Editor, DOS access	£125.00
PC/FORTH Programmers package with 8087 graphics	£195.00
UR-FORTH high perf., 8087, graphics	£245.00
METACOMPILERS 8080, Z80, 8096, 6303 etc etc	£ call

BORLAND	
TURBO C (NEW)	£69.00
TURBO PASCAL	£69.00
TURBO PASCAL JUMBO PACK	£225.00
Turbo Tutor	£29.00
TURBO PROLOG new	£69.00
TURBO LIGHTNING	£69.00
Superkey or Sidekick	£69.00

TURBO DATABASE TOOLBOX	£49.00
TURBO GRAPHICS TOOLBOX - PC-DOS	£49.00
TURBO EDITOR TOOLBOX - PC-DOS	£49.00
BLAISE POWER TOOL PLUS	£75.00
BLAISE ASYNCH PLUS	£75.00
TURBO POWER UTILITIES	£75.00
TURBO POWER EXTENDER	£75.00
T-DEBUG PLUS	£49.00

FORTRAN/PASCAL/BASIC

Fortran Graphics, Scientific Libraries	£ call
Microsoft FORTRAN-77 with Codeview	£275.00
PRO-FORTRAN-77	£395.00
RM-FORTRAN-77 with RM-FORTE toolset	£595.00
PRO-PASCAL MS-DOS	£295.00
Microsoft Pascal	£185.00
QUICK BASIC - Microsoft (PC-DOS only)	£75.00
PASCAL 2 full features, Turbo compatible	£325.00

LISP and PROLOG

TURBO PROLOG (PC Only)	£69.00
micro-PROLOG PROF (full mem., wind.)	£245.00
micro-PROLOG entry level version	£95.00
MuLISP/MuSTAR (Common LISP)	£195.00
Golden Common LISP (PC-DOS only)	£495.00
MuMATH/MuSIMP Symbolic maths	£275.00
TransLIP Common	£75.00
PC Scheme from Texas	£95.00

TEXT WINDOWS, COMMUNICATION, DISK

VENTURA Desktop Publishing System	£795.00
FINAL WORD 2 - author's WP	£275.00
MicroTEX - scientific typesetting	from £395.00
MICROSTAT - comprehensive statistics	£315.00
STATGRAPHICS statistics and graphics	£545.00
WINDOWS by Microsoft	£85.00
WINDOWS Software Dev. kit	£395.00
ZAP Communications - VT100, 4010 emulation	£85.00
PC/Intercomm - VT100, 102 Kermit etc	£95.00
UNIFORM - PC r/w, format CP/M disks	£65.00
CONVERT - PC add formats	£85.00
UNIDOS run CP/M software on PC	£275.00
NORTON UTILITIES advanced	£99.00
Dan Bricklin's DEMO program	£65.00

MODULA-2	
Pecan Modula-2 Powersystem	£95.00
Pecan Modula-2 Advanced Pak	£195.00
Logitech Modula-2/86 Apprentice	£69.00
Logitech Modula-2/86 Wizards package	£159.00

PECAN ucSD PRODUCTS	
POWER SYSTEM p system with a compiler	£95.00
Pascal, Fortran-77, Basic or Modula-2	£95.00
PDQ Pascal starter pak	£69.00
JACK-2 Integrated WP, database, spreadsheet	£95.00

All prices are exclusive of VAT. Please add £3.00 p&p, plus VAT to your order

38 Charterhouse St,
London EC1M 6JJ

Tel: 01-251 0043

01-248 0962

BTGOLD 76: CJJ028



"PLEASE NOTE"
NEW ADDRESS

The TWIN Classic



No wonder Tweedledee is looking pleased with himself, he's found out the 7 reasons why you should get the TWIN. A program so similar to 1-2-3™ that if you know how to use 1-2-3™ then you know how to use the TWIN.

1. A spreadsheet amazingly similar to 1-2-3
2. Fantastic presentation level graphics
3. 1-2-3 Macro compatible
4. No copy protection
5. Reads and writes 1-2-3 files directly
6. Site licensing plans available
7. It only costs **£69.95**
(inc. VAT & postage)

The TWIN Classic is part of the Integrated 7 family of programs. For more information about this — and other MOSAIC products — contact 0604 830496.

PC MANAGEMENT

"Clones Challenge LOTUS"

The first clone for LOTUS 1.2.3. is out, and is being sold under the claims of "amazingly similar to 1.2.3. which it is. Software clones of this kind could have a major effect on the market for all PC software. The TWIN was developed by MOSAIC SOFTWARE"

PC MAGAZINE

"Companies currently using 1.2.3. could safely introduce TWIN into the same environment. In spreadsheet and database functions it is a true 1.2.3. clone. Represents excellent value for the money. A powerful spreadsheet with very good graphics"

WHAT'S NEW IN COMPUTING

"The TWIN offers the chance to buy a program which has a spreadsheet compatible with 1.2.3. and a number of improvements as well"



30-DAY MONEY BACK GUARANTEE

YES, you may try the TWIN on your IBM PC/XT, Amstrad PC1512 or compatible (min 512k RAM is needed) for 30 days. If you find that TWIN does not perform in accordance with our claims and provided that all goods are returned to us (in a good condition) within 30 days of purchase, we will refund your purchase price.

Mosaic Software Inc. PO Box 97, Northampton NN4 0YY, England.
MOSAIC and the TWIN are Trademarks of MOSAIC SOFTWARE INC.
Other brand and product names are Trademarks of their respective holders.

The TWIN offers so much more for so much less

Send this coupon with your cheque for £69.95 (inc. VAT & postage) made payable to: MOSAIC SOFTWARE INC. and we will send you your TWIN Classic. (Allow up to 14 days for delivery.)

NAME _____ TITLE _____

COMPANY _____

ADDRESS _____

POST CODE _____

TELEPHONE _____

PCW11

Post to: MOSAIC SOFTWARE INC. PO Box 97, NORTHAMPTON NN4 7YY, ENGLAND Tel: 0604 830496

ORDER TODAY
AND SAVE £5.00

PC YEAR BOOK 1988

Paper Back Up.



Demand the best backup for your PC. Demand the PC Yearbook 1988

Following hot on the heels of the successful PC Yearbook for 1987, here's the completely updated 1988 edition, the brand-new guide for all IBM and compatible PC users. With over 500 pages crammed with essential information, the PC Yearbook 1988 is just what you need to get the best from your PC.

It's all inside

This resource-full book contains all you need to know about PC hardware, software, services, supplies.

Discover the secrets of networking, the best maintenance deals, the most suitable printers, the new IBM PS/2, and much more. Be briefed on the implications of Desk Top Publishing, and on business graphics, and on micro/mainframe links.

Turn to the PC Yearbook
Inside you'll find listings — all carefully cross-referenced — of IBM dealers, of training organisations, of peripherals suppliers, of consultants. There are full details on over 3,500 software packages available for your PC, as well as invaluable reviews and articles on the concerns of all PC users.

The PC Yearbook costs just £40 — around 10p a day for a comprehensive reference book that's always to hand, and always useful. Order now using the form below, and claim a special £5 discount for prepayment.

The PC Yearbook 1988.
The essential backup for you and your PC.

PC YEARBOOK DISCOUNT ORDER FORM

Please send me _____ copy/ies of **The PC Yearbook 1988.**

I enclose cheque for £35 plus £2.50 UK p&p, SAVING £5 on the published price.

Please invoice me/my company for £40 plus £2.50 UK p&p.

Signed _____

Name _____

Company _____

Address _____

Send to VNU Business Publications, Directories Booksales Dept.,
FREEPOST 25, London W1E 6EZ. Telephone: 01-439 4242.

Out Now!

VNU Business Publications
32-34 Broadwick St
London W1A 2HG
Telephone: 01-439 4242



Rumours of an '80388' chip being available by early 1988 lend foundation to doubts about the success of OS/2 and the 80286. Guy Kewney substantiates these doubts, and lends weight to other industry happenings, in this month's news and views.

Jumping the gun

Doubts about Microsoft's OS/2 operating system have been boosted by the discovery of a chip that makes it look obsolete before it is available.

The chip comes from Intel itself. Rumour in Silicon Valley points to a half-size 80386 chip for early next year. It would probably be called 80388, after the 8088 (which was the 8-bit version of the 8086).

Microsoft is the company most likely to be affected by this news, and IBM could end up with egg on its face, too; the problem of the 80286 chip (the one used in the AT) is now becoming one you don't need to solve.

The problem is simple but virtually impossible to explain in less than three closely-typed pages. So, I'll summarise. The 80286 chip turned out to be

incapable of running PC programs in protected segments, because: (a) IBM used illegal interrupts on the 8088 which trip up the 80286 in protected mode; and (b) Intel didn't get the protection system working properly.

But, unfortunately, the latest whizz-bang operating system from IBM and Microsoft is OS/2, and that has to work on 80286 machines. Therefore, it can't take advantage of the really nice software protection that is built into the 80386.

The 80286 does have one thing going for it. The advantage of using it is simple: it runs 8088 code fast, and can run at 12MHz — much quicker than any 8086 (standard PC-style family chip) ever could.

It operates at 12 times faster than a standard 8088-based system, which is four times the speed of a good 'turbo-pc'.

It has, therefore, an assured future for the next year or so as the engine in the standard MS-DOS 3.X machine.

But an 80388 would be a 16-bit chip, like the 80286, and should plug into a simpler board than the AT-type boards. It would be cheaper to make, much faster (capable of running at 25MHz, eventually) and, best of all, be able to run a more advanced operating system than OS/2.

Microsoft has already announced Windows 386 for Compaq and Zenith, and, I expect, Olivetti and Tandon, plus one or two Far East clone makers, to follow soon — if it hasn't already by the time this issue of PCW is printed.

Hats should not be hung on the OS/2 hook. I think reports of its success are premature.

Games in C

When Zorland says that you can 'write your own games' using its C language compiler, it isn't thinking of arcade blasters in multiple colours. It's thinking of computing games — chess, backgammon, and the like.

The Games Toolkit costs £23 and includes three programs which will play games: chess and backgammon are two, and the third is 'the strategy game, War!' which I know nothing at all about.

I'm taking all this on trust; also, the news that Zorland has announced a graphics toolkit which draws all sorts of shapes. I know I should have contacted Zorland for corroborative details, but I was giggling too hard at the news that 'the availability of the two new toolkits coincides with the launch of the Zorland C compiler a year ago.'

You ring the company, a year ago if you like, on (01) 854 1194.



Hitachi becomes at least the fifth monitor maker to claim that it has 'the first multi-scan colour monitor which has full IBM PS/2 VGA compatibility', with the announcement of its £675 Multi 560. It's nice enough, despite the hype, with 800 by 560 dots and up to 80Hz vertical scan. The company also sells a £350 controller card which will handle software that imagines it is talking to a standard mono, Hercules, CGA or EGA screen, as well as VGA output.

Innovation reaps awards

On the face of it, the idea of an 'Innovation Challenge' is silly, even if it is to be organised by *The Guardian* computer page.

You might ask yourself: 'If bright young inventors won't produce a new idea for the money, why would they come up with one just to get an award from a newspaper?'

However, after a little gloomy thought, I have to admit that I know lots of people who would regard the commercial challenge as too daunting, but who are quite capable, intellectually, of coming up with new technology for the trivial award of being told they are bright.

Should you know any shy but innovative people, phone (0895) 52131 and ask Rena Brimelow for details of the Challenge.

You can also mention to your innovative friend (though I doubt this will really impress them) that the winner will have the project backed, commercially, by Akhter Group.

A slight technical hitch

You'll read no announcements in *this* column about new Amstrad micros, printers, or whatever... well, you *nearly* won't.

I can't resist informing you that a fortnight before the new monochrome PC1640s were released at the PCW Show, a dealer (and a big one) found that an order of PC1512s had arrived and were all 1640s — including the mono ones.

'Oh, heck,' said the distribution manager. 'Can you just put them in the back of the shop and keep quiet about it?'

It was too late. Trade paper *PC Dealer* had already blown the slip-up — the same publication in which Amstrad itself had already goofed by printing the wrong ads three weeks before the launch, giving price details of the new machines.

It made a dull summer bearable, I suppose.

FOR AS LITTLE AS £159 YOU CAN BE THE HOME SECRETARY.

There's more to home computers than fun and games. Just add a printer (and the necessary software) and your computer becomes a word processor. And you become a very efficient secretary.

If the printer you add is the Amstrad DMP 2000 your efficiency will even extend to saving quite a lot of money.

Because the DMP 2000 costs just £159 (incl. VAT).

Yet it will print draft quality text at up to 105 characters per second. And Near Letter Quality at up to 26 characters per second.

As you would expect it is compatible with all Amstrad home computers. But it is also compatible with Epson and any other make that has the same Centronics Parallel Interface.



NEW

If you've already graduated to a PC there's the new Amstrad DMP 3160 printer.

It's compatible with all Amstrad PC's as well as Epson and all other IBM compatible PC's. It costs just £199 (plus VAT):

Both printers have easy front loading and both will take ordinary A4 paper. One of them is bound to be right for your particular home office.



Please send me further information on the DMP 2000 and the DMP 3160

PCW/11

NAME _____

COMPANY _____

TELEPHONE _____

ADDRESS _____

AVAILABLE AT: ALLDERS · COMET · CURRYS · DIXONS · LASKYS · JOHN LEWIS · AND GOOD INDEPENDENT COMPUTER STORES
*Recommended retail price including VAT, £228.85. Prices correct at 1-9-87 but may change without notice.

AMSTRAD

Amstrad plc., PO Box 462,
Brentwood, Essex CM14 4EF.
Telephone: (0277) 262326.

The secret of Borland's success is "Quality, Speed, Power, & Price"

We're one of the biggest software companies in the world—and we got that way by making "Quality, Speed, Power, & Price" essential characteristics of every Borland software program. Look for Borland software—then look no further.



Turbo Prolog™

Our new Turbo Prolog has drawn rave reviews—which we think are well deserved—because Turbo Prolog brings 5th-generation language and super-computer power to your IBM PC and compatibles. Turbo Prolog is a high-speed compiler for the artificial intelligence language, Prolog, which is probably one of the most powerful programming languages ever conceived. We made a worldwide impact with Turbo Pascal, and you can expect the same results and revolution from Turbo Prolog, the natural language of Artificial Intelligence. Minimum memory: 384K.

Reflex® and Reflex Workshop™

No matter what business you're in, if you use Lotus 1-2-3® or dBASE® you need Reflex and the new Reflex Workshop to give you all the tools and views to see what your numbers mean. The new Reflex 1.1 with expanded memory support allows you to manage huge databases of up to 8 megabytes of RAM, 32,000 records, and 250 fields per record with "Reflex Lightning Speed." The Reflex Workshop gives you a wide range of analytical tools written for specific applications like Finance/Accounting, Administration, Sales and Marketing, and Production and Operations. You can use the tools "as is" or modify them to suit your business needs. Minimum memory: 384K.

SuperKey® Turns 1000 Keystrokes into 1!

If you use SideKick, you need SuperKey. They're designed to work together—and work for you. SuperKey's an amazing keyboard enhancer for your IBM PC and compatibles. With easy-to-write macros, you and SuperKey can turn 1000 keystrokes into 1. Minimum memory: 128K.

SideKick® Instant Desktop Management!

Powerful desktop management program and the #1 best seller for the IBM PC. SideKick includes notepad, calendar, calculator, appointment scheduler, telephone directory, autodialer, and ASCII table. It's RAM-resident—which means SideKick is always there ready to react when you need to do something, call someone, or find out something in a hurry. And it does all this while you run other programs. Minimum memory: 128K.

Travelling SideKick®

It's the electronic organizer for this electronic age. Neither you nor your secretary need to face 1987 with old-fashioned 1887 diaries. Traveling SideKick has everything they have—and a lot more. (Unlike dusty old diaries, Traveling SideKick doesn't "expire" at the end of '87, because it's electronic and good for '88, '89, '90 and on and on and on.) It's a professional binder, a software program, and a report generator—a modern business tool that prints your ever-changing appointments in daily/weekly/monthly/yearly form. (If your schedule changes hourly Traveling SideKick handles the changes instantly.) Whether you use your own personal computer or have someone's help with that, Traveling SideKick is the smart new way to take your computer with you—without taking your computer with you. Minimum memory: 256K.

Turbo Lightning® Solves All Your Spelling Problems!

While you use SideKick, Reflex, Lotus 1-2-3®, and most popular programs, Turbo Lightning proofreads as you write! If you misspell a word, Turbo Lightning will beep at you instantly, and suggest a correction for the word you just misspelled. Press one key, and the misspelled word is immediately replaced by the correct word. And if you're ever stuck for a word, Turbo Lightning's thesaurus is there with instant alternatives. Minimum memory: 256K.

Lightning Word Wizard™ Technical Reference Manual For Turbo Lightning!

An important addition to Turbo Lightning, Lightning Word Wizard includes fascinating and challenging word games like "Akerue" (try reading that backwards), "That's Rite," "CodeCracker," "CrossSolver," "MixUp," and "FixUp," to name some of them. Lightning Word Wizard introduces you to the "nuts and bolts" of Turbo Lightning technology, and gives you more than 20 different calls to the Lightning engine. Minimum memory: 256K.



Turbo Pascal, the worldwide standard in high-speed compilers, and Family.

Turbo Database Toolbox®

A perfect complement to Turbo Pascal, because it contains a complete library of Pascal procedures that allows you to search and sort data and build powerful database applications. It comes with source code for a free sample database—right on disk. Minimum memory: 128K.

Turbo Editor Toolbox®

Recently released, we call our new Turbo Editor Toolbox a "construction set to write your own word processor." Source code is included, and we also include MicroStar, a full-blown text editor with pull-down menus and windowing. It interfaces directly with Turbo Lightning to let you spell-check your MicroStar files. Minimum memory: 192K.

Turbo GameWorks®

Turbo GameWorks is what you think it is: "Games" and "Works." Games you can play right away (like Chess, Bridge and Go-Moku), plus the Works—which is how computer games work. All the secrets and strategies of game theory are there for you to learn. You can play the games "as is" or modify them any which way you want. Source code is included to let you do that. Minimum memory: 192K.

Turbo Tutor® 2.0

The new Turbo Tutor can take you from "What's a computer?" through complex data structures, assembly languages, trees, tips on writing long programs in Turbo Pascal, and a high level of expertise. Source code for everything is included. New split screens allow you to put source text in the bottom half of the screen and run the examples in the top half. There are quizzes that ask you, show you, tell you, teach you. Minimum memory: 192K.

Turbo Graphix Toolbox®

Includes a library of graphics routines for Turbo Pascal programs. Lets even beginning programmers create high-resolution graphics with an IBM®, Hercules®, or compatible graphics adapter. Our Turbo Graphix Toolbox includes all the tools you'll ever need for complex business graphics, easy windowing, and storing screen images to memory. It comes complete with source code, ready to compile. Minimum memory: 192K.

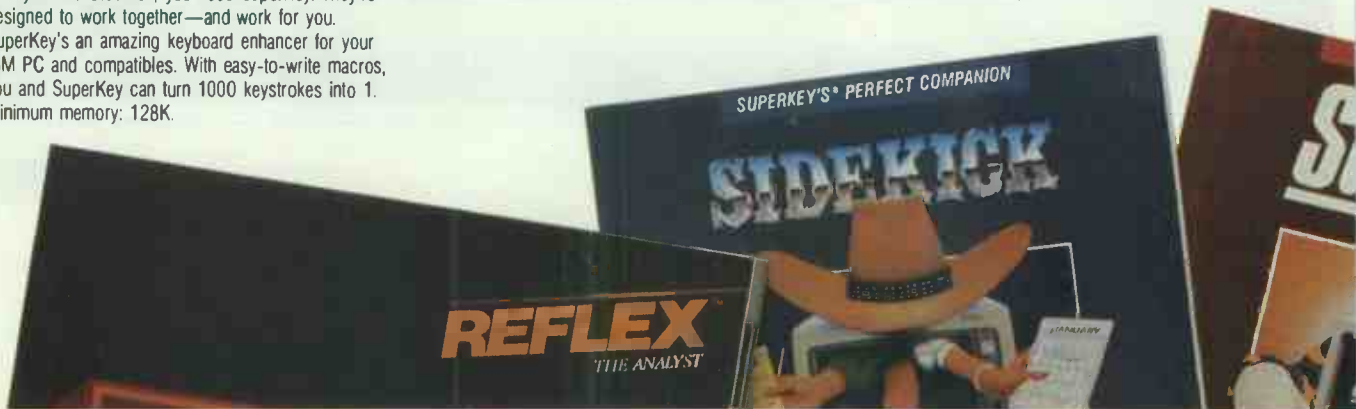

Turbo C: The fastest, most efficient and easy-to-use C compiler at any price

Turbo C : The fastest, most efficient and easy-to-use C compiler at any price.



Compilation speed is more than 7 000 lines a minute, which makes anything less than Turbo C an exercise in slow motion. Expect what only Borland delivers : Quality, Speed, Power and Price.

Turbo C : The C compiler for amateurs and professionals

If you're just beginning and you've "always wanted to learn C" now's your chance to do it the easy way. Like Turbo Pascal, Turbo C's got everything to get you going. If you're already programming in C, switching to Turbo C will considerably increase your productivity and help make your programs both smaller and faster. Actually, writing in Turbo C is a highly productive and effective method - and we speak from experience. Eureka : The Solver* and our new generation of software have been developed using Turbo C.



£89.95

Free MicroCalc spreadsheet with source code

Turbo C : a complete interactive development environment

Like Turbo Pascal® and Turbo Prolog™, Turbo C comes with an interactive editor that will show you syntax errors right in your source code. Developing, debugging, and running a Turbo C program is a snap.

Turbo C : The C compiler everybody's been waiting for. Everybody but the competition

Borland's "Quality, Speed, Power and Price" commitment isn't idle corporate chatter. The price tag on Turbo C isn't a "typo", it's real. So if you'd like to learn C in a hurry, pick up the phone. If you're already using C, switch to Turbo C and see the difference for yourself.

Sieve benchmark (25 iterations)

	Turbo C	Microsoft®C	Lattice C
Compile time	3.89	16.37	13.90
Compile and link time	9.94	29.06	27.79
Execution time	5.77	9.51	13.79
Object code size	274	297	301

Benchmark run on a 6 Mhz IBM AT using Turbo C version 1.0 and the Turbo Linker version 1.0 ; Microsoft C version 4.0 and the MS overlay linker version 3.51 ; Lattice C version 3.1 and the MS object linker version 3.05.

Technical Specifications

- Compiler** : One-pass compiler generating linkable object modules and inline assembler support. Included is Borland's high performance "Turbo Linker". The object module is compatible with the PC-DOS linker. Supports tiny, small, compact, medium, large, and huge memory model libraries. Can mix models with near and far pointers. Includes floating point emulator (utilises 8087/80287 if installed).
- Interactive Editor** : The system includes a powerful, interactive fullscreen text editor. If the compiler detects an error, the editor automatically positions the cursor appropriately in the source code.
- Development Environment** : A powerful "Make" is included so that managing Turbo C program development is highly efficient. Also includes pull-down menus and windows.
- Links with relocatable object modules** created using Borland's Turbo Prolog into a single program.
- ANSI C compatible.**
- Start-up routine source code included.**
- Both command line and integrated environment versions included.**

YES ! I want the best !

Copies	Product	Price	Totals
___	Turbo C	£ 89.95	£ ___
___	**Turbo Pascal (Ver 4.0 w/8087 & BCD)	69.95	£ ___
___	Turbo Prolog	69.95	£ ___
___	Turbo Prolog Toolbox	69.95	£ ___
___	Turbo Basic	69.95	£ ___
___	Reflex : The Database Manager	129.95	£ ___
___	Reflex Workshop	69.95	£ ___
___	Reflex & Reflex Workshop	149.95	£ ___
___	Turbo Database Toolbox	69.95	£ ___
___	Turbo Graphix Toolbox	69.95	£ ___
___	Turbo Tutor	49.95	£ ___
___	Turbo Editor Toolbox	69.95	£ ___
___	Turbo GameWorks	69.95	£ ___
___	Eureka: The Solver	69.95	£ ___
___	Turbo Lightning	69.95	£ ___
___	Lightning Word Wizard	49.95	£ ___
___	SideKick	69.95	£ ___
___	Superkey International Version	69.95	£ ___
___	Turbo Jumbo Pack (Pascal family Ver 3-0)	125.00	£ ___
___	*The Developers Library (Pascal Toolboxes Ver 4-0)	245.00	£ ___
___	Outside UK add £10 shipping per copy	£ ___	£ ___
___	Add 15% VAT	£ ___	£ ___
___	Amount enclosed	£ ___	£ ___

Prices include shipping to all UK cities
Carefully describe your computer system :
Mine is : 8 bit 16 bit
I use PC-DOS CP/M 80 MS-DOS CP/M 86
My computer's name and model is _____

The disc size I use is 5 1/4" 3 1/2" 3"
Payment : Access Visa Money order Cheque
Credit card expiration date _____
Card No. _____

Signature _____
Name : _____
Shipping Address : _____

Postal Code : _____
Telephone : _____

CODs and purchase orders WILL NOT BE accepted by Borland. Outside UK make payment by credit card or International Postal Money Order.
*Time limited promotional offer if purchased before 30th November 1987 £99.95
** Turbo Pascal and Family of Toolboxes are still available in Ver 3-0

**NOT COPY PROTECTED
60 DAY MONEY-BACK GUARANTEE**

If within 60 days of purchase you find that this product does not perform in accordance with our claims call our customer service department and we will gladly arrange a refund.

All prices are suggested list prices and are subject to change without notice.

BORLAND INTERNATIONAL DEPARTMENT E11
ONE CUMBERLAND PLACE
LONDON W1H 7AL
(01) 258-3797

Vive la difference

BE 1012

System requirements
PC, XT, AT and true compatibles, PC-DOS (MS-DOS) 2.0 or later.
Floppy drive, 320 k.

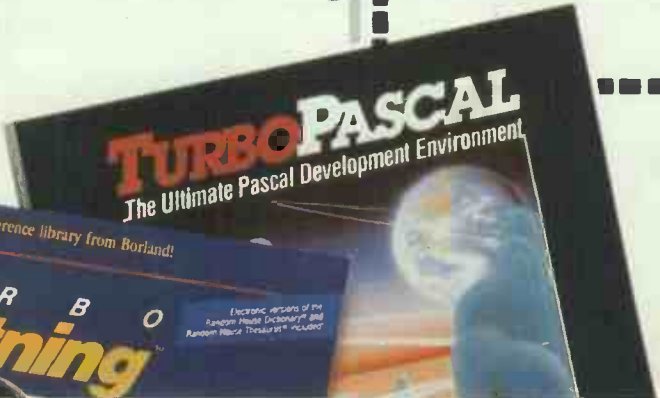
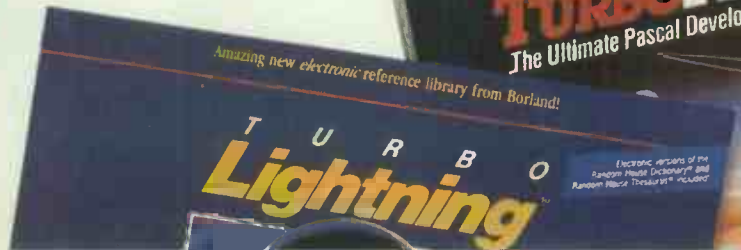

Publish and be praised.

THE COMPANY
BUSINESS
Report May 1987
Volume 1, No. 1



GEM Desktop Publisher Sets Price/Performance Benchmark for Software Industry

Digital Research announces its high performance easy to use, full function page composition software application - GEM Desktop Publisher. Introducing the true price/performance, available at the end of May, at a suggested retail price of £295.

"We're excited to provide an integrated team of products for personal publishing with the addition of GEM Desktop Publisher to our family of GEM applications," said Dick Williams, Chief Executive Officer of Digital Research. "Users now have a more complete and easier to use solution for combining text and graphics than ever before. But more important for the user is the outstanding price/performance offered by our product," continued Williams.

Flexibility is a key feature of this GEM-based software product. The user can define a location anywhere in a document and automatically place text or graphics at that location.

Continued on page 5

Desktop Publishing Increases Its Share of the Market
Employees Interested in Receiving Their Own Desktop Publishing Software

Projected Market Shares



Desktop publishing expert John W. Seybold, establishes some shopping criteria for the "godsend" desktop publishing software, from the May issue of Byte. He feels the system should "let you compose text in a manner that comes close to the requirements of typesetting." Including well-designed and proportionally spaced characters, multiple fonts, sizes, etc.

Seybold also believes that the system should allow you to perform the composition tasks "in a manner that is considerably less code-intensive than that which characterizes trade computer typesetting." This includes the "feature of WYSIWYG which lets you point to the effects desired rather than requiring that you describe them by some sort of command language". He feels that software programs that were "code-intensive" and required "considerable user experience" should not be included in the desktop publishing category.

"As a product offering, it's the best thing that ever happened to personal computers," says desktop publishing expert, John W. Seybold, about desktop publishing, in the May issue of Byte.

Desktop publishing, the latest development in microcomputers, offers the user the ability to combine text and graphics to create professional quality brochures, newsletters, fliers, sales reports, marketing briefs, books, manuals, forms, and other publications on their own computer. And, as Stewart Alsop says in the February edition of PC Magazine, "Ever since Gutenberg, publishers have been looking for a better, cheaper, faster way to get words and pictures on paper."

Growth for PC Software Market
Software Revenues for U.S. Suppliers

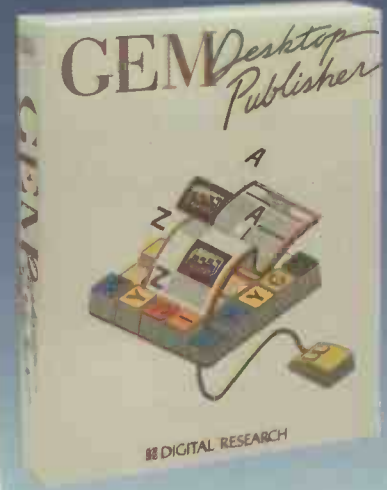
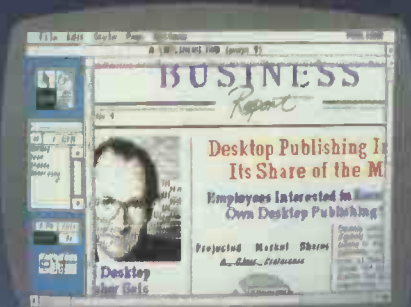
GEM® Desktop Publisher™ makes it easy.

With GEM Desktop Publisher you can create eye catching, professional-quality reports, brochures, newsletters, mailers, marketing briefs, manuals, and many other documents on your own personal computer.

GEM Desktop Publisher is so easy to learn and use. Its icon-based, 'drop-down' menus eliminate the need to memorise complicated commands and help you become productive immediately. GEM Desktop Publisher features the fastest turn around time from concept to high quality finished output.

It is big on performance and features yet small on price, setting a new price/performance benchmark at £295 (ex. VAT).

GEM Desktop Publisher is compatible with your existing word processor software. You can easily incorporate images that you create with the GEM family of applications from GEM Draw Plus to GEM Graph.

GEM Desktop Publisher is so flexible that you can use word processor files or keyboard commands from many popular word processors, such as WordStar™ and MultiMate™.

It support the full IBM PC™ family, 100% compatibles, and the new IBM Personal System/2™ family of computers, plus a wide range of printers.

WHAT YOU SEE IS WHAT YOU GET

- Total flexibility in inserting, deleting and rearranging pages, text and graphics.
- Style sheets for easy page formatting and layout consistency.
- Merging of text and graphics.
- Automatic text flow around graphics.
- Fonts in multiple sizes, many colours and many styles.
- Automatic reformatting of documents.
- Automatic scaling of graphics.
- Rule measure in inches, picas and centimetres.
- Mapping of menus and mouse functions to keyboard.

Praiseworthy results . . . easily achieved.
That's GEM Desktop Publisher.

Phone (0635) 35354 for the name of your local distributor.

 **GEM** Desktop
Publisher

ANOTHER GEM® FROM
DIGITAL RESEARCH®

Mission wins



All the people who were laughing at Mission at the PC User Show in June can now wipe the smile off their faces: the company has regained the 'exclusive' badge for its imports of Wearnes-built ALR machines in the UK.

At the show, Euromicro was able to offer a 386 system for £1600 — a good £400 below Mission's price. And both systems were built by Singapore-based Wearnes, which owns the American firm, Advanced Logic Research

The Mission 386: £1990 worth of 'comprehensively configured' Wearnes-built micro

(which designed its hardware).

The original plan was for Wearnes to establish itself, slowly and carefully, in the UK, using Euromicro as the stock onto which it would graft itself.

But Mission boss, Farad Azima, is not a man to deal in half measures, and he stepped into the market with a big splash. Not only did he hold a

banquet in a large (and expensive) London hotel to celebrate winning the ALR franchise, but he flew all the ALR people over to London to witness the launch.

Presumably, the message reached home — that Mission was the company which was prepared to spend a lot of money establishing the ALR range in the public eye; and Euromicro, which had a 'gentlemen's agreement' to buy hundreds of 80386 machines from the factory direct, suddenly found itself out in the cold.

'We have had our distribution agreement terminated,' said Jim Wood at Euromicro. 'And there is no possibility of Wearnes taking us over to start their European headquarters — they have now set up in Italy.'

With some satisfaction, Farad Azima confirmed that he was now sole importer of ALR hardware, and attributed this achievement to his plans for 1988.

'We will be working towards building the ALR machines here in the UK, but, more than that, we will actually be designing parts of the system here, contributing to the range,' he said.

manager had installed.FT (File Transfer).

You can only use this if you dial into the system through packet-switching networks because Telecom Gold's own PADs are strictly 7-bit outfits. As a result of this, you can't transfer files from one Gold computer to another without a few interesting kludges.

I took a nice, simple file, 2k or so in length, which happens to be a program called TFind from Kiwisoft (a public domain source). I uploaded it to my own system, system 81:, using an error-correcting protocol called Xmodem. I have seen slower versions of Xmodem, but not often.

On my system, I was given the option of storing this file as an ASCII file (no use, obviously), a binary file, or an 'expanded hex' file. So I did it twice: once as binary; and once as 'expanded hex' because it warned me that binary files couldn't be sent as electronic mail to other users on different systems.

The expanded hex looked just like an old 'DUMP' under CP/M and it did, indeed, prove possible to send to another user on another system. Magically, although it had an introduction saying 'To You from Him (and so on)' at the top, it was perfectly transparent to the expanded hex downloader at the other end, and the recipient was able to run the program. Success!

But at what price?

Sending via this version of Xmodem took an incredibly long time and, although time charges are somewhat lower than they used to be, it would be silly to try transmitting a file of anything like the length of this Newsprint column.

Worse, you are charged something close to 30p to transmit, and another 30p to receive a simple 2k file. This column — which is an outline format file — would cost *pounds* at each end.

The still-embryonic Mercury Link 7500 rival service reckons that Telecom Gold can only manage 400 users per computer, where Mercury can accommodate 1000. Mercury encourages users to log on, transmit data fast using fast modems, and log off; leaving the lines free. Gold, by contrast, complains that it can't make money now that its users have worked out this cost-saving trick.

A commercial outfit, given this problem, would restructure its billing system and its costs in order to continue to attract users.



An Apricot AT-compatible with a built-in network has appeared, just in time to prevent people from wondering whether the company's products were starting to look rather ordinary.

This trick of being one jump ahead of the dull mob is what characterised Apricot when it was the leading UK micro maker, and it's nice to see it again.

On the other hand, £2000 for an AT clone (with a green screen) these days isn't very special, even with a 30Mbyte hard disk. So, if Apricot does make a success of this new range, it will be proof that its name still carries some weight in the market.

The network is provided on the main board of the computer, in a single chip 'which will make it possible to build full-function 286-based networks at approximately 50 per cent of the cost of systems currently available'.

Apricot does specialise in corporate networks and multi-user systems, these days; and that sort of touch should appeal to people who don't necessarily buy the cheapest network system around.

But the writing is on the wall. At press time, I was eagerly looking forward to seeing a Mitac system, based on the far superior 80386 chip, for well under £2000 — a price level which Mission has already reached.

Tarnished Gold

It's hard for me to talk to my friends inside Telecom Gold these days because they live by a different set of assumptions from mine. They seem to regard themselves as an essential utility which has to cover its costs. I regard them as a commercial venture which has to *manage* its costs.

I'll have another moan about money in a moment. But first, consider: unlike Prestel, you can't play Shades and mail isn't free. Unlike BIX, there aren't lots and lots of fascinating other users in various online conferences. Unlike The Source, you can't download interesting shareware programs. And, unlike CompuServe, you can't send messages to most American computer users through CServe Mail or MCI Mail.

And, Gold has pitifully few users because it only sells well in the UK (where it is said to be the market leader).

The discovery that you can send and receive proper computer files rather than plain text (ASCII files) was made by accident — I discovered that my system

SURPLUS COMPUTER STOCKS

SAVE £1330

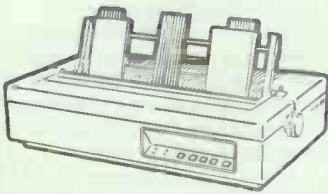

EPSON SQ 2000 PRINTER

Special purchase of industrial quality inkjet printers, 175 CPS draft, 105 CPS letter quality mode, parallel interface, 2k buffer. This full-size, heavy duty (weight 39.6lb) printer has a 24 jet print head. Proportional spacing, bit image graphics. Boxed, with full one year warranty, includes manuals and mains lead. Limited supply. Original price £1825. Optional sheet feeder £100. Optional tractor feed £75.

£495

BRAND NEW

100 CPS

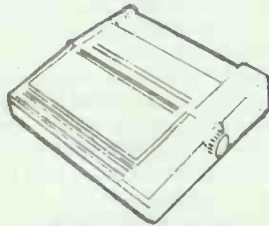

COPAL SC1000

Copal SC1000 standard parallel interface dot matrix printer. Uses Epson escape codes. Specification: friction and tractor feed 100 CPS, subscript and superscript, condensed and dual density, takes fanfold, roll, cut-sheet and copy paper, eight international character sets selectable by dip switch settings. Compatible with most popular PC programs. (Also available Copal SC 1200, 120 CPS £110). Brand new boxed including manuals & ribbon.

£99

UNDER DEALER



IBM PC CONVERTIBLE

Convertible spec includes twin 3 1/2" floppies 360k LCD 80 column by 25, 256k RAM expandable to 640k by RAM cartridges. Full size "QWERTY" keyboard, utilities can be ported over. Powered by 240/110 volt A/C mains adaptor (included) or optional battery pack. Limited supply of these innovative "clamshell" style machines have had nominal demonstration use. Complete with manuals & covered by 3 months parts and labour warranty

£995

NEC SYSTEM



ALL PARTS AVAILABLE

NEC PC-8201A battery powered portable. 40 column by 10 lines display, 16k RAM, 10 programmable function keys, includes free personal applications tape, built-in word processing, communications package, Microsoft BASIC, takes 4xAA size batteries, continuous clock/calender, £150. PC-8281A data recorder £35. NiCad battery pack £10. PC-8200 parallel printer cable £10. PC-8221 thermal printer £50. All goods demo. Computer

£150

DP 20 £195

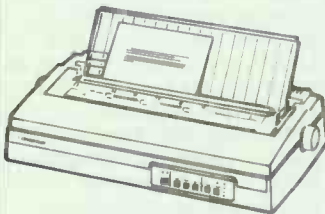

DATAPRODUCTS DP 20

£499 list price. Daisywheel spec includes 22 CPS serial interface, full width 136 column, heavy duty. Choice of 10, 12, 15 CPI and P.S. daisywheels. Complete with mains lead, ribbons & Courier 10 daisywheel. Works on COM 1 with IBM or compatible, emulates Diablo 630 for easy installation. Free "Mode" command disk! Single bin sheetfeeder £100 extra, double bin sheetfeeder £150. Tractor feed £75. Brand new, boxed.

£195

PORTABLE



APRICOT PORTABLE PC

Minimum spec, 256k RAM, 720k 3 1/2" disk drive, LCD 80 x 25 display, serial & parallel printer ports, bundled software includes SuperWriter, SuperCalc, SuperPlanner, MS-DOS vers 2.11, BASIC, Apricot manager, optic fibre light pipe, carrying case. Obtained from the service department of major retailer, tested & are covered by a three months parts & labour warranty. (Also available Apricot FP slightly enhanced BIOS features £325)

£250

ONE ONLY



NORTHSTAR MULTI-USER

Northstar Dimension 50 Multi-user computer, runs MS-DOS. Specification: 15mb hard disk, 512k memory, 512k cache memory, 360k disk drive, 360k assimilated disk drive, extended vertical memory, IBM CGA colour output, two terminals, 256k on-board memory, IBM style keyboard, password security. Can be seen running at New Oxford Street. Complete with manuals & covered by a three months parts and labour warranty

£2000

HAYES COMPAT

DACOM SYSTEMS



DSL 2123 AD

DSL 2123 AD/H

BT and CCITT approved. DaCom DSL 2123 AD/H intelligent modem. AutoDial AutoAnswer. Standards of line connection and operation supported include: V21 (300bps) originate or answer, V23 (75/1200bps) originate or answer, V23 half duplex, V23 pseudo duplex and auto mode detection. Includes 9 volt AC transformer, new style modular jack plug on 2 metre cable and socket for hand set connection. Complete with manual.

£150

FLEA MARKET

PARTS ONLY, NO WARRANTY	GIVEN
ACT Sirius complete	£295
Linokey 2 inc disk drive	£450
Decwriter II	£95
IBM 5 1/4" 360k floppies	£30
No-name 132 col printer fast	£75
Osborne I brown case	£95
*OKI IBM Plug'n Play	£25
Tandy Model III 16k	£45
*DRE ICL 2348 hard disk	£195
surplus 5 1/4" foppies 10s	£6
Bit 24 for BBC	£15
*Scotch DC300 A data cart	£5
110v Nec Spinwriter	£250
Various Qume printers	£75
Ricoh 1600	£99
Pet 8032	£75
Pet 8050 double disk drive	£195
*Alphanumeric keyboards	£35
HP Thinkjet HP IB	£75
Zynar hard disk off Nestar	£50
OKI 92 dot matrix printer	£45
Quad Liberty PC board	£50
Quad Liberty AT board	£50
Pantronics PC+ colour plus	£50
Clock calender 256k cards	£35
*Assorted shredders from	£150

MISCELLANEOUS

Compaq 286 Deskpro 30mb	£1895
Apple Iic	£295
Apple Iic 5 1/4" external floppy	£125
Apple Scribe printer for Iic etc.	£125
Apple Europlus CPU	£95
Apple Iie	£225
Merlin 16 line phone system	£1000
Kaypro 2000 EXP box	£250
Televideo 1605 pc compatible	£595
Televideo 1605H ditto inc 10mb	£795
PR1 acoustic coupler	£25
Compaq Plus inc 256k 10mb	£1100
Apple Macintosh 128k	£595
*Dacom Auto answer modem	£65
Tandon PCA 20 mono AT comp	£1500
Polaroid Palette demo	£750
Compaq Deskpro 10mb	£995
Kaypro 2000 inc software	£695
*Steebek-Dowty SB1212 V22	£250
Kimtron terminal	£250
*Epsom Taxi mouse & software	£75
Olivetti M24 2 x 360k, 640k	£625
Tandon "baby" AT 30mb	£1500
Quadjet 4 colour 80 col printer	£195
Dataproducts DP55	£395
Symbiotic 40mb for Macintosh	£595
HP Vectra 40mb hard disk	£500

IBM CARDS

Orchid PCTurbot 186	£150
Orchid Blossom PcNet	£125
Misslink	£125
AST Rampage AT 1mb	£125
Irma PC 3278 card	£195
Gateway G net	£125
5250 Enhanced	£495
128k Idea Minimix	£95
128k AT Top Hat upgrade	£95
AST Flashpack	£125
AST Advantage AT 128k	£195
*AST Advantage	£250
CGA compatible	£50
CGA IBM	£75
AST Rampage	£100
Intel Above Board AT	£150
Hercules Mono	£95
AST Sixpack inc 64k	£75
Quad Silverboard	£150
AST Megaplus	£35
Quad board inc 64k	£75
Hyperam 256k	£50
EGA compatible	£95
EGA IBM	£125
PC Express	£150
AST Advantage AT 128k	£195
*AST Colourgraphplus card	£50

IBM HARDWARE

IBM PC 64k, inc monitor & kbd	£550
IBM PC 512k complete	£695
IBM XT 640k 10mb complete	£995
IBM ATX 30mb complete	£2500
IBM PS/2 model 30 complete	£1500
IBM AT co-processor 80287	£95
IBM Wheelprinter	£350
IBM Pro graphics monitor	£600
IBM Pro graphics adaptor	£200
IBM Colour printer	£250
IBM Proprietary	£200
IBM SDLC card	£50
IBM Async Comms card	£50
IBM swivel monitor stands	£25
*IBM Translator unit	£195
IBM AT tech ref manuals	£25
IBM Cluster adaptor	£150
IBM printer stand	£15
IBM Displaywrite II	£50
IBM Displaywrite upgrade	£75
IBM 10mb upgrade inc card	£150
IBM 20mb upgrade inc card	£250
Mountain 20mb internal drive	£200
*Microsoft Pascal compiler	£195
Ideadisk 10mb & 5mb backup	£250
Alloy 17.5mb tape streamer	£250
*IBM uncased 5 1/4" floppies	£65

Part exchanges accepted.

* indicates brand new goods

ACCESS AND VISA ACCEPTED
PRICES SUBJECT TO 15% VAT
MAIL ORDER (CARRIAGE EXTRA)

Morgan Computer Co.

OPEN MONDAY TO SATURDAY
PRICES SUBJECT TO CHANGE
GOODS SUBJ. TO AVAILABILITY

64-72 NEW OXFORD STREET, LONDON WC1. 01-255 2115 & 179 TOTTENHAM COURT ROAD LONDON W1. 01-636 1138

The future belongs to us

Our future is being decided now. Most readers of *PCW* are playing the role of unwitting midwives, facilitating the birth of who knows what kind of technological nightmares.

Because we're devoted to our computer technology, we tend not to think in terms of right and wrong, good and bad. We're in the computer game because we find it interesting for its own sake. We push the occasional worry about the consequences of our work to the backs of our minds.

But it's time we took stock and, with the help of BBC1's *Welcome to my World*, entered the vital debate which will decide the future for us and our descendants.

This short series (five programmes, BBC1, Sunday nights) takes us into the future we are presently creating. Each programme takes a single theme and presents it in the form of a documentary. This means that if you missed the first (broadcast on 11 October) you won't be lost if you switch on next Sunday.

To give you an idea of what the series is about, programme one looks at the future of employment (or lack of it) and the way companies leave the country to avoid the high taxes required to support those they've thrown out of work.

Another programme reveals what happens when a car company discovers that it can return better profits to its shareholders by playing the money markets. We are all caught up in the stock market as we go to the garage or the supermarket to find the prices changing by the day.

Other programmes tackle computerised warfare, the privatisation of information, and how a smoothing iron could make £10m profit on the stock market. There's much more, but you get the general idea.

There is a positive side, if you can call it that. Individuals find ways of breaking into the electronic systems. With a telephone, you could commit an electronic crime in Toronto while based in Mongolia. One chap even makes a tidy living reprogramming bank cash cards.

Today, we can still choose from a variety of different futures, but, as the ownership of real computer power becomes more and more concentrated and its

distribution more and more dispersed, we will lose the opportunity to choose. Those with power will become increasingly powerful and those without (like you and me) won't stand a chance.

The programs might frighten you because it already seems too late to stop our present drift towards a world in which dancing electrons become more important than people; a world in which a computer-aided killing on the Stock Exchange is more worthwhile than productive work performed by human beings.

Please watch the rest of the series or, better still, video them so you can watch them twice. The program brings home, in a fictional documentary style, the possible results of our present love affair with information technology. We need public debate, urgently, about the

The BBC: an investigation of IT out of control

consequences of present decisions (or lack of them). What better place to start than through the pages of *PCW*.

Don't wait for another TV series or another appeal in the magazine. Watch this series. Think about what's being said. Sleep on it, and if you feel you have a contribution (for or against), write to the editor or to me at *PCW*, VNU House, 32-34 Broadwick Street, London W1A 2HG, and we'll get the debate into the open before it's too late.

David Tebbutt

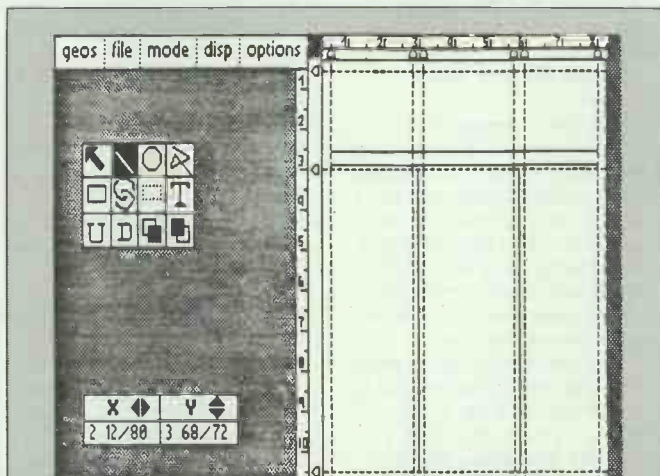

Windowing on the Commodore 64 is the province of GEOS (graphic environment operating system): this now has a desktop-publishing system attached. Geopublish is from Berkley Softworks, which wrote Geos. It will sell for \$70, and the company is (perhaps understandably) unforthcoming about exactly which versions of the Commodore 64 it will run on. Details from California on (415) 664 0883.

Driving mice away

Amstrad's decision to put a mouse on every PC was great: unfortunately, as time goes by, little problems emerge. In particular, using this system with Microsoft Windows isn't normally possible because, although Amstrad meets most of Microsoft's published mouse requirements, Microsoft itself uses 'illegal' mouse calls.

A solution has been devised by Dr George Bielstein at Mercantile and General Facilities: a piece of software

costing £22.50 which will 'drive' the mouse correctly.

Another problem that has bugged me with one or two timer-based programs on the Amstrad, is the fact that the mouse alters the clock to 18 clicks per second rather than 55 clicks.

This is easy to solve if you can sacrifice your mouse: just don't use the MOUSE program at startup and the clock will work normally. Otherwise, you could be in trouble.

Dr Bielstein is available on (01) 876 1670.

The search goes on

The quest for the ideal comms program continues, with Mirror and Transend being my two newsworthy developments of the month; and there's still no outright winner.

Transend now has the ability to do sliding-window Kermit file transfers, which every serious bulletin board hacker will want for transatlantic work. It still does Prestel well, and has a noticeably improved user interface, editor and programming language.

Mirror remains the only program that will work in the background, leaving me to run programs while it stores incoming batches of data. But it still doesn't do Prestel/viewdata, and won't do sliding window Kermit or Xmodem.

Then, in September, Softklone executives arrived in the UK and took me to a quiet corner of a hotel in Essex where they showed me work in progress on both these essentials.

The new Mirror should be out in a few months — possibly before the end of the year, definitely in time for the Which Computer? Show in February 1988. That version will probably not have a sliding window facility, but it will have Prestel — handled, cleverly, as a terminal emulation. However, it doesn't make the program any larger.

Taking the risk

You might like to risk the sum of £12 on a program called Encode for the BBC Micro, especially if you have a shared hard disk in a network.

The software encrypts any BBC file with a password, so that even somebody with a disk sector editor would not be able to read it.

The author, TK Boyd, claims that he'll give a prize (no details) to anybody who breaks his encryption system, and he'll sell you the manual for £1 (to be deducted from the cost of the software later) to read before buying the code.

It could be well worth doing, especially if you have confidential school reports, or a diary, or some other embarrassing information which you don't want casual passers-through-the-system to read.

Details from Boyd at Seaford College, Petworth GU28 0NB.

Brown Bag strikes again

Sandy Schupper wanted to know (he said) what I thought of legal proceedings against Database, publisher of various computer magazines. 'It's a disaster for us, don't you think?' he said.

This calls for some explanation. Make yourself comfortable.

Schupper is about to release an 'artificial intelligence' text editor, called Mind Reader, onto the UK market. It's an editor which studies your writing habits, learns what you are likely to type, and offers to complete the word or even the sentence for you. So, if I type a capital V, it might assume I was starting to type VNU, the publisher of PCW.

With this launch under way, Sandy is very worried about his image, and that image has just been given a big PR boost by a smallish Database publication which gave away copies of PC Outline — a software outline processor used extensively in the PCW office — to several thousand readers.

Most people would consider such publicity a boon, but Sandy reckons it is a disaster.

His company is trying to popularise the concept of free-trial software, known as 'shareware'. It's a concept which has made money for several American suppliers, and Sandy has brought it to the UK where he has added his own special touch, trying to create a new kind of 'pyramid shareware' for us.

That isn't what *he* calls it. He calls it Brown Bag Software UK, and it's a publishing/distribution outfit which owns the rights to HomeBase and PC Outline, and a few others.

All these programs have one thing in common: you can copy them freely and give them to friends. If you use them, however, you have to write to Sandy Schupper's Brown Bag Software and pay the 'registration fee'.

And Sandy's big innovation is that he offers you something back if anybody else registers a copy that you gave them to try. A pyramid-selling system, in fact; but not, I would think, in any way unethical.

The 'disaster' which had Sandy reaching for his expensive lawyers was simple — this Database magazine gave away the wrong version of PC Outline. It carried the American address for

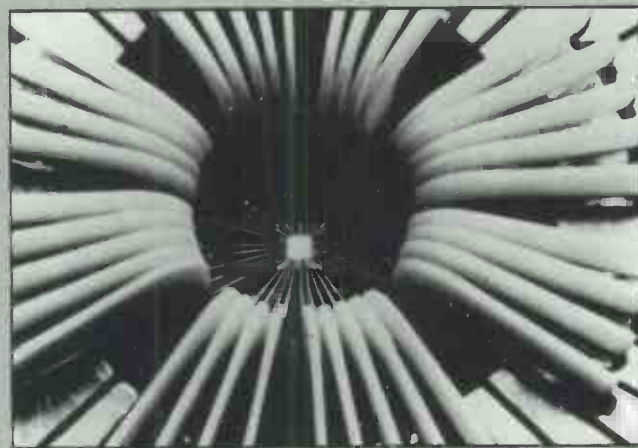

Frightening, the semiconductor builders of the world. IBM has released pictures of transistors, made with parts 'one thousand times thinner than a human hair' — something which theorists had doubted was possible. Just to remind you (if you had forgotten) that IBM is the world's largest and most advanced builder of silicon devices. It also builds computers, of course.

registration, suggested the wrong price, and was not the latest, relatively bug-free version.

Sandy went wild (say his colleagues) and raised hell. 'Well, what do you think?' he asked.

This put me in a tricky situation.

For a start, I reckon the situation could only be seen as a disaster if he got nothing out of it. Knowing Sandy as I do, I find this hard to imagine. He appears to have the magazine over a barrel on a technicality (the sign-on does specifically prohibit using the software in a promotional campaign without the written permission of the copyright holder) and so he is certain to beat it into offering a pretty nice deal in exchange for calling off his lawyers. Well, calling it a disaster is probably going to increase the magazine's sense of his rage, so why not?

After that, before agreeing that disaster has struck, you have to ask what would have happened if the magazine had given away the correct copy.

The answer is that one, I'm afraid, is that if it had proved popular, Brown Bag UK would have been placed under extreme strain.

And it is my considered opinion that it wouldn't have stood it.

The organisation currently (at press time) consists of a contract outfit (two people) receiving requests for software and money for registration. It's a complex system because they receive requests from two sources and have to keep accurate records.

One of the sources is Brown

Bag's own bulletin board — which, by the by, you are welcome to call on (0279) 74885 — which has the advantage of being a *great* way of leaving a message for Sandy Schupper himself — he reads it.

I offer a final Sandy Schupper anecdote: I put the phone down on his voice, resoundingly pointing out that the giveaway disks 'had the wrong version of PC Outline, and had the price in dollars, and had the American address, for God's sake. Nobody's going to send registration to an American address! It's done us incalculable harm in the market...'

And, I download PC Outline from Brown Bag's UK bulletin board. Not only was it the same version, with the same American address and with the price in dollars, but it had the same bug in 'version 3.24' which I reported in version 1.6 when I first met Sandy, a year ago.

I don't know what would have happened if many of the 35,000-odd recipients of the disks had tired to register with the UK office, but the American address might be seen by some as not so much a disaster but more of a lucky escape.

Despite all these misgivings, it has to be added that Sandy is taking this shareware idea seriously. He's even commissioned some serious market research showing, for example, that 95 per cent of corporate users of shareware do pay for it, but that less than 10 per cent of home users do.

I hope he can have the bugs ironed out and make a go of it.

Monitor madness

A very worried Microvitek has sent out a message warning anybody who has its Cub monitor that they shouldn't open the thing up and try adapting it for the Acorn Archimedes.

Normally, nobody would dream of doing this, but it seems that somebody — 'I'm afraid we don't know who' said the publicity manager at Microvitek — has published an article showing how.

'The article apparently advises that reconnecting some of the circuitry inside the monitor will enable it to work with the Archimedes,' said this executive. 'I've only seen a copy of the article, and I haven't tried doing the operation, but it seems that it could be very dangerous.'

The voltages inside colour monitors are very high — not just dangerous, but *lethally high*. Could a skilled person make the changes safely, I asked?

'We're seriously looking into that, but the point is that even if you did have the skill to make the alteration, you probably wouldn't, because the Cub doesn't have the performance needed. It would produce a very poor-quality picture with this modification,' said the Microvitek source.

Sharing the cost

An alternative to the shareware concept, and one being tried by MathSoft to publicise its MathCAD package (reviewed in PCW last month) is to offer a cut-down version of the program, free.

MathCAD itself understands equations. 'The user can enter equations, and see them displayed with all of the special symbols and notations, as if written on a notepad,' promises MathSoft International.

The company has a 'mini-MathCAD' available free, on a disk, and will send this — 'free of charge' it says — to any PCW readers who request it by phoning (0827) 86239, or writing to MathSoft, Freeport, Tamworth, Sussex B79 7BR.

This mini-version comprises a demo program to run through some of the features; a tutorial to teach the basics; and a Mathcad system, restricted only in being unable to do serious printing, store documents or work on large documents.

A LOT MORE THAN JUST A CLONE!

LATEST GATE ARRAY TECHNOLOGY
SECURITY LOCK
UP TO 10MHz CPU SPEED
ONE YEAR WARRANTY
REPUTABLE MANUFACTURER

TURBO XT

- 4.7-10MHz CPU
- 640 KB RAM
- Sockets for Expansion RAM
- Multi I/O Card
Parallel & Serial Ports,
Game Port, Real Time
Clock, FDD Controller
- Legal Bios
- GW Basic + Manual
- MS DOS + Manual
- Mono/Color Graphics
Video Card
- 102 Keys enhanced
Keyboard
- 150 Watt PSU
- 1 x 360k Floppy

TURBO AT

- 6-10 MHz CPU
- 512 KB RAM Expandable
to 1Mb
- Parallel and Serial
Ports, Game Port
- FDD and HD Controller
- 32k Legal Bios
- GW Basic + Manual
- MS DOS + Manual
- Mono/Color Graphics
Video Adaptor
- 102 Keys Enhanced
Keyboard
- 200 Watt PSU
- 1 x 1.2Mb FDD

£549

+ VAT

£975

+ VAT

ALL OPTIONS AVAILABLE
incl. 20Mb Removable
Hard Disk Drive

ALL OPTIONS AVAILABLE



DEALER ENQUIRIES
WELCOME
PLEASE PHONE 01-7497421



LASER™

286

MICRO COMPUTERS AIDED TECHNOLOGY LTD

THE OLD MILL,
MILLERS WAY,
SHEPHERDS BUSH ROAD
LONDON W6 7NA
PHONE: 749 6061 TELEX: 946765 MCAT G FAX: 749 1053

LASER IS A TRADE MARK OF VIDEOTECHNOLOGY INFO-TECH LTD

THE ADVANTAGE PC 1640 IS VERY

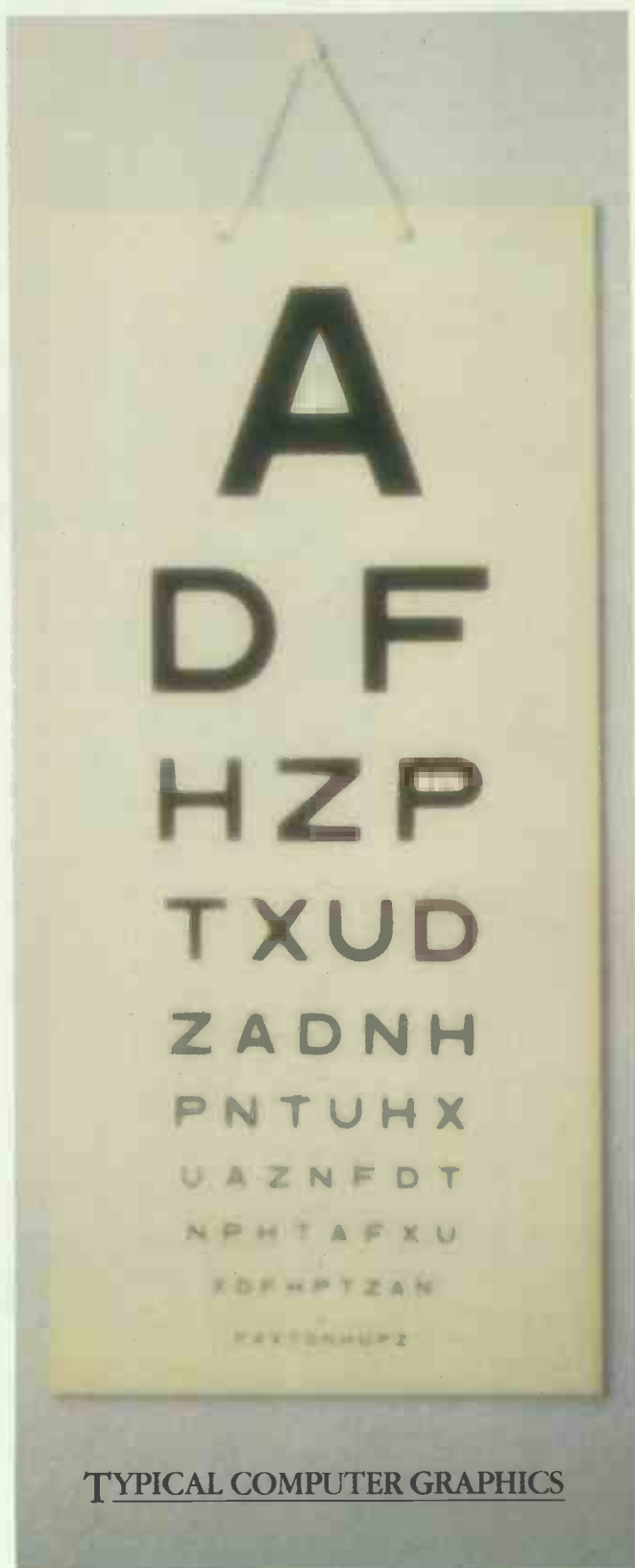

TYPICAL COMPUTER GRAPHICS



ENHANCED COMPUTER GRAPHICS

E OF THE NEW Y EASY TO SEE.

In 1986, Amstrad took the computer world by storm with their first PC.

Its combination of compatibility and exceptional value for money meant that in under 6 months it became brand leader in the U.K. personal computer market†

But rather than resting on our laurels, we've gone one better.

The new PC 1640 range of personal computers offers the same industry standard compatibility and value for money, plus graphics capabilities that have to be seen to be believed.

A SIGHT FOR SORE EYES

If you use a computer a great deal you'll soon see the advantage of better graphic display.

It's less of a strain on your eyes to scan the monitor and spot the information you require. So you get less fatigue and consequently your time is used far more efficiently.

The enhanced colour display monitor on the PC 1640 ECD models offers graphics of stunning clarity, and the use of 16 colours on screen at any one time. (There are, in all, 64 colours to choose from.)

Of even greater interest to serious computer users is the in-built graphics expansion board on all models. This enables you to use practically all the industry standard enhanced graphics programs.

For the experts, this means EGA and CGA with colour ECD monitors. And MDA, monochrome EGA and

Hercules with monochrome monitors. For the ordinary user it just means clearer information, and the chance to get into high quality desktop publishing as well as exciting areas such as Computer Aided Design.

BIGGER AS WELL AS BETTER

The standard memory is now even bigger at 640K RAM. And all 1640's are powered by the 8 Mhz 8086 processor, still up to twice the speed of some of our competitors.

There are 3 full size expansion slots allowing you to use your 1640 for networking, modems and other applications.

And you get an RS 232 C serial port as well as a parallel interface port for printers and lots of other add-ons. (There's even a joystick port, so you can play ultra high resolution games.)

There are 9 models in the range, with a choice of enhanced colour, colour or monochrome.

From 360K byte floppy disk to 20 megabyte hard disk and all including a mouse and free software. So whatever your needs, there's an Amstrad PC 1640 that is exactly right for you.

With prices that start at £499 plus VAT* rising to £1199 plus VAT* the tremendous competitive advantage



THE NEW AMSTRAD PC 1640. NOW WITH ENHANCED GRAPHICS OPTION‡ AND 640K MEMORY

of the new Amstrad PC 1640 is also very easy to see. If you're in business, you should make it your business to take a closer look.



All Amstrad PC 1640s come complete with monitor, disc drive system unit, keyboard, mouse and 640K RAM. Hard disc versions feature 20 megabyte hard disc. The 9 model variants in the range are:

Single drive	Mono display (MD)	£499 + VAT
Double drive	Mono display (MD)	£599 + VAT
Hard disc drive	Mono display (MD)	£899 + VAT
Single drive	Colour display (CD)	£649 + VAT
Double drive	Colour display (CD)	£749 + VAT
Hard disc drive	Colour display (CD)	£1049 + VAT
Single drive	Enhanced colour display (ECD)	£799 + VAT
Double drive	Enhanced colour display (ECD)	£899 + VAT
Hard disc drive	Enhanced colour display (ECD)	£1199 + VAT

Please send me more information about the Amstrad PC 1640.

NAME _____

COMPANY _____

ADDRESS _____

POST CODE _____

TEL _____



THE AMSTRAD PC 1640

Amstrad plc., PO Box. 462, Brentwood, Essex CMI4 4EF.
Telephone: (0277) 262326.

PCW/11

*Recommended retail prices including VAT range from £573.85 to £1378.85. Prices correct at 1.9.87 but may change without notice. †Source: Romtec. ‡Except CD model.
AVAILABLE THROUGH: ADL · ADT · ALLDERS · COMET · COMPUTER MARKETING · DIXONS · ELTEC · FIRST SOFTWARE · HILL INTERNATIONAL · LASKYS · JOHN LEWIS
LIGHTNING · MBS · METYCLEAN · MICRO PERIPHERALS · NORBAIN · NORTHAMBER · OFFICE INTERNATIONAL · P & P · SANDHURST · HUGH SYMONS · VISTEC · WILDINGS

See us on
Stand 2116 at the
PCW Show

WordPerfect
now available for
VAX/VMS



WordPerfect Library. Speaks volumes for software integration.

WordPerfect Library brings new meaning to the subject of software integration by linking three of today's most advanced software packages – WordPerfect, PlanPerfect and SSIData.

Programs are immediately accessed from the Shell menu by a single key stroke as are the 6 powerful utilities which provide a full function Calculator, Calendar, Notebook, File Manager, Macro and Program Editor.

The movement of text, figures, graphs and records

is simplicity itself within WordPerfect Library, which gives an impressive degree of flexibility, in operation and is simplified by the use of function keys and a colour coded template dispensing with the need for complex control codes. Create your own menu structure, from which you can run DOS commands and batch files.

To improve your knowledge and to find out details of how you too can join the WordPerfect Library, telephone or write to Sentinel Software.



SENTINEL
SOFTWARE

Wellington House, New Zealand Avenue,
Walton on Thames, Surrey KT12 1PY.
Telephone: (0932) 231164
Telex: 916005. FERGUS G.

WordPerfect

PlanPerfect

Library

Executive

A little dodgy, maybe . . .

You certainly won't be patronising PC-XS (get it? Excess?) for used micros. But, nonetheless, you might soon find yourself buying from somebody who does.

This new outfit charges a hefty £100-£400 to anybody with a micro to sell (depending on the number of items) and keeps a database of used equipment. It then offers the database to potential buyers at £250 per year — and, on top of that, it takes a commission charge.

The idea is to 'encourage the second-hand market for computer equipment' and, at first sight, it sounds absurd. Who would pay that sort of money?

Well, possibly, dealers and distributors, and corporate buyers.

Despite the new company's proud words, there already is a market in used micros (used mainframes, of course, have sold briskly for years). It is generated by repair firms.

In the last few months, several people have written to PCW offering ultra-cheap PCs — someone had 300 for prices as low as £250, built out of spare parts left over from dead machines.

One big maintenance firm sells used IBM PCs, refurbished, for just over £1000 complete — and there are a lot of people who are quite delighted to have the Real Thing at the price of a clone.

The question does arise, however, as to whether these prices would make it worthwhile selling.

Car distributors and dealers have a well-organised system of auctions and trades, so that any dealer who wants to can buy your used car as a part-exchange on a new one. But computers are much cheaper than cars.

Consider: someone is taken by a new AT clone, cost around £1500. They offer the dealer their old CP/M machine in part-exchange — it possibly cost £1500 itself when new, six years ago.

The dealer will have to pay £100 to this broker. The machine, after £200 (at least) has been spent repairing it, will have to go out and compete with the new Amstrad 9512 at £500 — including printer! At best, it might fetch £300 retail. The broker takes a percentage, the buyer has to pay a fee, and at

HEADLINE NEWS Summer '87

LaserMaker

a brief introduction...

by TOM O'CONNOR, Managing Director

LaserMaker PC Composition Software has been developed over a four year period from our initial composition system for the Linotype 302 phototypesetter back in 1982. In those early days our main consideration was to produce a cost-effective system with high quality output and justification. The current version of the software is now open to use particularly with our latest product offering, which is a direct PC line ElectroErosion printer.

to the IBM 4250 direct-to-negative ElectroErosion printer. Some of the stories on this page are about certain uses of our software in specific markets. Others relate to the IBM 4250, which we believe is innovative in its quality and capability. As you, the reader, will now be aware, this whole page was composed using LaserMaker on a PC AT and output to the IBM 4250 ElectroErosion printer.

Satellite Keyboards

"the image setters"

© Satellite Keyboard, Newcastle Upon Tyne

IBM 4250/II ElectroCompositor and the IBM 4250

The IBM 4250/II ElectroCompositor prints high quality negatives of 2500 x 2500 dots and is now offered with a direct connection to the IBM PC or PS/2 range of computers. Its simplicity, versatility, adaptability and price quality make the 4250/II ideal for the publishing environment. The space required for the 4250 is minimal and, with the low noise level, the 4250 can be incorporated into a workstation environment.

LaserMaker Professional Composition Software, which operates on the IBM PC and PS/2 range of computers, has launched a new output program for the IBM 4250, recently on display at the IFAA conference, when Bill Leach and the ElectroErosion team were in London. Interest is very high and the market is ideal for a high quality composition package for the PC in combination with the well-known high quality output of the 4250.

Electroerosion printing creates text and graphics on a special medium by depositing a slurry containing dark conductive particles on a light conductive surface. The particles are then fired to create a permanent image.

I was quite impressed with the specification of IBM's latest 'High Resolution Printer, model 4250' — until somebody sent me some printout.

The printer is one which LaserMaker now supports with its pretty pricey Composition Software; and, to prove it, the company sent me a page which could be used as a master for making a print plate. It's an *electro-sensitive sheet of silvered paper!*

For making plates, of course, this is no drawback; the contrast between the aluminised surface and the carbon sub-layer is very high. And the 600 dots per inch resolution is quite good enough for newspaper production, frankly.

But, somehow, when you have spent £20,000 on a printer and £1595 on publishing software, you don't expect to get a sheet of paper that looks as if a giant Sinclair Spectrum printer shoved it out!

LaserMaker is on (0602) 731803.

the end of all that, what is left for the dealer?

'I could maybe give you a fiver for it,' he will say, sincerely.

And, if the trade-in is a genuine XT, which costs £3000 at birth, it has to slug it out with brand-new clones at £500.

Dataflex has come up with the idea of a replacement 80386 motherboard, costing £1750, for the original IBM PC or XT. You keep the case and plug in the new board: it takes just 20 minutes (Dataflex says!) and you have a supermicro.

Even that deal doesn't sound all that wonderful to me. I know where I can get a complete 80386 system, with a high-density 1.2Mbyte drive and a proper big-system power supply, for roughly that price — talk to my friend, Robin Bradbeer, about a Mitac system. And I'd be able to keep my old PC as a spare, or a means of educating my children, or for writing 360k diskettes . . .

I think people will just keep their old machines — unless, of course, PC-XS can cut overheads. Now, where did I hear about somebody with an old mule and a cart?

PC-XS can be contacted on (0734) 591551.

Dataflex sells the Hauppauge 386 motherboard, on (01) 543 6417.

Clouding the view

Let's play a game. Imagine for one moment that you are a whacking-big software house. You have spent a few million dollars developing a nice, easy-to-use, graphical front-end for MS-DOS. You have publicly said that the future lies not with the boring A> prompt, but with windows and icons. You even scold other software houses when they write directly to the hardware, ignoring the pretty (slow) user interface. Finally, you decide to launch an upgrade to your word processor.

Q Do you upgrade your word processor so that it runs under your amazing graphical environment?

A Of course you do.

Unless you're Microsoft. For a company that considers Windows to be the answer to life, the universe and everything, you may think that Microsoft is displaying much *chutzpah* in releasing Word 4.0 — *not running under Windows.*

I think it was a good decision for users, but bad for the company. Good for the users because Word 4.0 has lots of nice, new features and is faster than Word 3.1. Bad for the company because Microsoft is going head over heels to persuade other

software houses to revise their applications to run under Windows.

Interestingly, Windows comes complete with its own word processor, Windows Write. I use Windows Write and Word 4.0 for different purposes. Windows Write is great for short letters (incorporating graphics), while Word 4.0 is useful for longer documents.

For Word 4.0, not running under Windows means two big things: firstly, it doesn't display *true* WYSIWYG; and, secondly, it is *very* fast.

Having used Word 4.0 for over a month now, I love it. With added functions like revision marking, redefinable keys, document retrieval and macros, it gives Word Perfect a run for its money.

Word 4.0 sells for £425 and Microsoft can be contacted on (0734) 500741.

Martin Wren-Hilton

Anything to declare?

I have to admit that I've never needed a customs form for a portable computer when lugging one around the world, but should you be worried about the possibility, you'll be reassured to hear that the London Chamber of Commerce has researched the problem.

Kindly, that body has passed on its own phone number as a point of reference for people wanting a 'carnet' or machine passport.

The Chamber says: 'Many business travellers have a rude awakening at the Customs desk when they cannot carry their PC along with their camera and calculator, and an admissions carnet and export licence can avoid long delays at Customs.'

I suspect the advice is more important if you are crossing borders into and out of Comecom countries, where certain hi-tech stuff is prohibited for export from the West. Although I have to add that I've never even seen a Customs official on my way out of a country, it's always imports they're looking for — and I gather they're more likely to be interested in bags of white powder than silicon chips.

Details can be obtained on (01) 248 4444 from Brian Burke at the London Chamber of Commerce.

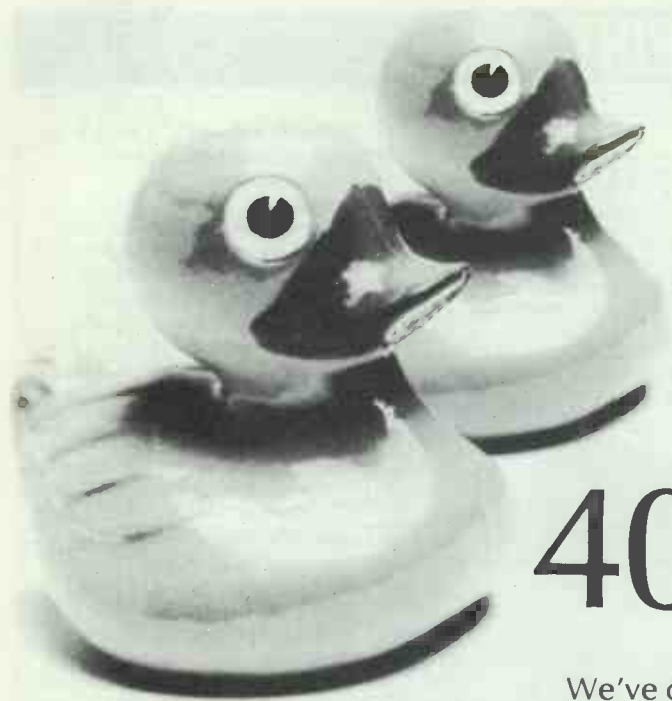

Two Little Ducks

20MB-£199

ex. VAT

40MB-£299

ex. VAT

We've done it again!

Kudos Systems were the first to bring you a complete 20MB hard disk system for less than £300. And now the Kudos HarDisk 20 is back – for an amazing £199 (ex. VAT). We've also hatched the Kudos HarDisk 40 – a complete 40MB hard disk system for only £299 (ex. VAT).

If you canardly believe it then give us a wing on 01-200 6511 or clip the coupon below.

Kudos HarDisk 20 – £199 ex. VAT

Includes: Miniscribe 5¼", 20MB hard disk drive, Western Digital controller card, cables, manual and utility disk.

20MB Amstrad fixing kit

– £11.95 ex. VAT

Fixing kit and modified front bezel for installing the HarDisk 20 in an Amstrad PC.



The Kudos Systems Price Guarantee
 If you buy from Kudos Systems then discover that you could have bought the same products at an advertised UK price lower than ours, then we will refund the difference.



Kudos HarDisk 40 – £299 ex. VAT

Includes: Miniscribe 5¼", 40MB, hard disk drive, Western Digital controller card, cables, manual and software.

AMSTRADS – Lowest prices guaranteed – phone for details

All Kudos Systems' products come with a 12 month no-quibble guarantee

To Kudos Systems Ltd, Capitol House, Capitol Way, Edgware Road, London NW9 0ED

Please rush me the following products:

(Qty)	Kudos HarDisk 20	£241.50
(Qty)	HarDisk 20 fixing kit for Amstrads	£13.74
(Qty)	Kudos HarDisk 40	£356.50

★ Prices include VAT and courier delivery to your door

Please send me your latest information pack

I enclose a cheque for £ _____

or debit my Visa Card Number _____

Name _____

Company _____

Address _____

Postcode _____ Telephone _____

Approx No. of PC's in Company _____

TOTAL _____

If you're a government department, education authority or PLC, just send us an official order and your goods will be despatched on the same day. If you're a dealer and would like a copy of our dealer datafile call Gary Munz on 01-200 6511. For details of our personal export scheme call Karen Bond Sax on 01-200 6511.

Kudos Systems Ltd
 Capitol House
 Capitol Way
 Edgware Road
 London NW9 0ED
Tel: 01-200 6511
 Tlx: 8813241
 Fax: 01-205 3911

Personal callers welcome – Call in and save on delivery charges.



All tradenames and product names are the property of their respective manufacturers/owners.

Noise reduction level

Normally, boxes to quieten printers cost more than the printers themselves. At a startling price of £40 (£36 if you assemble it yourself from parts) Kador has combined the tasks of an acoustic box with the requirement for a printer stand, with a kit called Peace'n'quiet.

Kador also makes a data switch box for the Amstrad PCW (old version) at £278. This marvel can be used for both serial and parallel connections, the company says, though the details supplied are scanty. The idea is that you keep your old PCW printer when you buy a new daisywheel, and can switch easily between the two. Or you can switch between printer and modem without constant unplugging.

I do like clever little accessories like this, so (under protest) I'll even mention Kador's £14.50 screen filter (even though I can't stand the things).

Details of all these products can be obtained from Kador on (0784) 2522662.

Connect four more

For people who have often wondered just how to win at 'Connect Four', a plastic-based game where you have to create rows of four counters, vertical, horizontal or diagonal, 4-Sight will give you a better insight into just how it can be done.

It's one of four releases from Gamma Games, on a disk worth £14.95 and including a pretty good chess game, a backgammon game, and a lot of frustration for the poor, unfortunate human playing the PC.

As you probably suspected, or know from playing a brother or sister who wasn't any good, the trick to winning seems to involve counting spaces as well as watching potential patterns develop. 4-Sight is supposed to be 'hard to beat' at level five, and the default level is level two. At level two, it took me half an hour to get near it. And my sister had better watch out next time!

It's very good value, and details can be obtained from (0279) 412441.

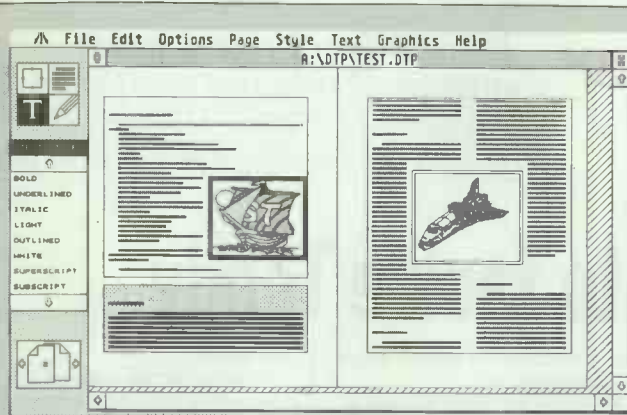

GST was kind enough to invite me to its secret headquarters somewhere in Cambridge just before the grand unveiling of its new baby at the PCW Show. The baby, baptised 'Timeworks Desktop Publisher', is the latest addition to the already crowded DTP software family.

Originally developed for the American software house that generously lent its name to the product, Timeworks will be available in November for the Atari ST and Amstrad PC or compatible running GEM. The Atari version will retail for £99, making it one of the cheapest DTP packages for the ST; and, although no price has been fixed for the PC version, it is not expected to be significantly higher.

During my introductory session with Timeworks, I noticed that GST has broken with its tradition and provided keyboard shortcuts in addition to the GEM menus. On further investigation I discovered that the company is considering adding this feature to future updates of its existing range; this may come as good news to people using GEM on the slower PCs, where moving the mouse can be more like walking your tortoise on a lead.

The program will feature an elaborate graphics editor similar to Easy Draw, and GST is developing a sophisticated algorithm to re-size pictures imported from other drawing programs without adversely affecting the clarity. At present, the company plans to support GEM-standard object files as well as Degas, Neochrome and PC Paintbrush.

GST is the company which brought you First Word, the word processor that was once bundled with the ST, and as such you would expect good text handling. You won't be disappointed, with basic word-processing functions being built into Timeworks as well as the ability to load in files from Wordstar, First Word, Wordwriter and, of course, ASCII. Commands can be embedded within these files so that much of the initial formatting, such as typeface and point size, can be set within the word processor, and automatic onscreen 'greek' makes the full-page views pleasantly tidy.

The version that I saw running was unfinished but still impressive; its only serious omission being the lack of automatic kerning. Printer support is provided via standard GEM drivers, meaning that virtually all 9 and 24-pin printers are already supported, as are Postscript and HP laser printers. Currently, the only clear thing about Atari's laser printer is that it will require a lot of memory, so as yet there is no driver for it. It shouldn't be too before one becomes available, however.

The ability to send Postscript files to disk means that expensive printing hardware becomes unnecessary, as it will be relatively cheap to send disks or mail directly to professional typesetters.

Timeworks will be published in England by Electric Software, which can be contacted on (0954) 61258.

Grapevine

● Borland has released version 4.0 of Turbo Pascal, which breaks out of the 64k segment barrier of the IBM PC. No news, however, of CP/M versions as yet. Watch for a thorough review in PCW in the near future.

● Facsimile for computer users

has taken a step closer with the launch of Akhterfax 'which will cost only a quarter of the price of a traditional fax' — an add-in board for PCs which will send or receive documents in the ordinary way. However, to send an image of a piece of paper, you do need one more device — a paper scanner. Details from Akhter's publicity agent on

(0895) 52131.

● Virgin has moved into business software. It calls its Virgin Software label 'Useful Programs for the PC'. First off was Collectors Catalogue for recording your stamps, records, comics, postcards, or whatever else you hoard. Six other titles are under development. No reports as yet on quality. Details on (01) 727 8070.

● Logotron has decided that it doesn't have to live in the education ghetto for ever. With a price of £13 per program it has jumped into business programs — but not just for the PC. Its 1295 label (the number of pennies per package) includes a 'writer' and a 'filer' as well as a 'planner', and runs on Commodore machines as well as PCs. Details on (0223) 323656.

● Sir Clive is about to hit the American market: his Cambridge Computer Z88 finally has a ROMable operating system, a big factory, and an American backer in SCI. SCI is very big, but computer enthusiasts will remember it from the long-ago Sprinter rotary printer and, more recently, from the fact that it built the Zenith 171 and thus allowed the company to win a big order from the American tax authorities. Now, SCI has someone on the board of Sinclair's company — and has put in some money, too. The machine remains nice but is still at least £100 over-priced. At that, I still expect to see Cambridge Computer sell over 20,000 by the end of 1987.

● Greek characters with a BBC Micro and an Epson-compatible matrix printer can be produced by Sciways, a package which can actually produce 350 newly-defined characters both onscreen and on the printer. It's a 'sideways' ROM that you buy, and it gives chemistry symbols, maths characters and strange languages for a total of £38.52. Details on (0202) 747695.

● DAT — digital audio tape — turns out to be a better way of storing computer data on tape than any computer tape drive. Sony and Hewlett-Packard have jointly announced that they will develop this audio technology for computer users, offering a disk backup device that can store 1.2Gbytes, and a fast-search capability with a 20-second average access time.

● Digitask has saved me hours of hard work in writing about its new machines, by observing three times in two paragraphs that it advertises in PCW. I can take a hint, you chaps: you don't want me to say anything that might contradict your claims, right?

It's fine by me. . .

END

THE WEST COAST CONNECTION



Tandy is firmly placed as the world's number one distributor of personal computers, but Atari is keen to change that. PCW's US correspondent Tim Bajarin reports on Tramiel's obsession with the microchip.

Tramiel set to tackle Tandy

With over 600 computer centres and over 4000 electronic retail outlets, Tandy is one of the largest distributors of personal computers in the world. Only IBM and Apple, with their dealer networks, move more boxes. But for Tandy, it has taken a long time to get to this point.

While the TRS models became a standard for computer hobbyists, Tandy's initial attempt to get into the business market was very poor, partly because the company took a long time to realise that the IBM PC operating system was the *real* standard.

But, when Tandy grasped the direction of the market, it really began to move. The model 3000 and 1000 series are quickly becoming bestsellers in the US and the company-owned stores give Tandy the best distribution network anyone could have. The company has come a long way from the days when it was peddling its leather products.

This success story has caused many a personal computer vendor to envy Tandy and consider emulating its distribution operation.

Now Atari's ever-resourceful head, Jack Tramiel, has decided to take on Tandy with his version of a company-owned distribution strategy. In August, Atari bought the Federated Electronics chain of 70 stores.

These stores, most in the western US, carry everything from car stereos to television cameras.

Although Atari is not necessarily into the traditional consumer electronics market, Tramiel says that he is interested in making *anything* that uses a micro chip.

In fact, company insiders say that his next major purchase will be a semiconductor company. Some think he may buy into the National Semiconductor consortium, but others believe he is more interested in Inmos, the Thorn EMI subsidiary that produced

the Transputer, a chip Tramiel is interested in.

Most US analysts looked at the Federated deal as an important way for Atari to gain US distribution. Up to now, Atari has struggled to persuade 'serious' computer shops to carry his ST line.

With the Federated distribution channel, he can push more products out of the door and continue on his profitable road.

However, the big question is whether, in the end, this risky venture will pay off.

Federated has been losing about \$5 million a quarter, and it will take a lot of money and new marketing directions for it to recover.

Stewart Alsop, editor of a US PC industry insider newsletter, believes this is the 'first serious mistake Tramiel

has made.'

Alsop cites the failures of companies who made similar moves, and thinks that buying Federated could be detrimental to Atari.

But never count Tramiel out — he has a way of making things work. With his new manufacturing plants in Asia, you can expect him to do *exactly* what he says he will do and produce *any* product that uses a microcomputer chip. So, expect to see Atari TVs, phones and CD players, and perhaps even high-tech toasters.

While a lot of attention has centred on Atari's Federated acquisition, Amstrad has also taken some similar steps to gain better control of its US distribution.

Amstrad's purchase of its Texas-based distributor, VidCo,



Atari chief Jack Tramiel: diverse interests

is seen by analysts and vendors as simply a way for Amstrad to have more say in the US market.

In the US, Amstrad products have met with only mild acceptance, and, like Atari, have not penetrated the computer speciality stores.

Jobs plots his NeXT move

When Steve Jobs left Apple Computer in the summer of 1985 and started his own company, NeXT, his aim was to develop a high-end computer for the education market.

During his two-year moratorium with Apple — during which time he could not compete with it — he acquired Pixar, the graphics computer manufacturer. This added credence to his high-end workstation plans and had many believing that he really was going after the education market.

There was only one problem with that direction. Universities and colleges are very mean with money, and, although Stanford and some other universities put funds into Jobs' company, most analysts could not see the university market as making NeXT any money.

Sources close to Jobs are now explaining that he is, in fact, looking at giving the world the next major computer for both education *and* business.

In California recently, Jobs talked about the three waves of personal computer technology. According to him, the first was the Apple II, second was the IBM PC, and third was the Mac, with each wave lasting about ten years.

Jobs implied that 1989/90 will see the next wave of technology and, although not actually naming himself as the one who would initiate it, it was clear to the audience that NeXT is his guess as the next technology leader.

Jobs believes that the user interface is vital to a machine's success, and he clarified his plans to add a new user windowing interface to Unix — the operating system he has chosen.

Those close to the company claim that Jobs has taken his two years of non-competition with Apple and made the most of it. As a result, it is becoming clear that Steve Jobs, the man who gave us the Apple II and Mac standard today, is aggressively trying to give us the technology that will lead the market for another decade.



Steve Jobs: aggressive approach

Company insiders say that the NeXT PC will use the new 68030 Motorola chips with 32-bit colour depth.

The only flaw in his plan, according to informed sources, is his choice of Unix as his operating system. Its success has been small when compared to the Apple II or MS-DOS.

Many agree that all PCs will eventually run under multi-user/multi-tasking windowing environments, but OS/2 with the Presentation Manager will probably provide the best way of implementing this approach in personal computing.

THE WEST COAST CONNECTION

Postscript clones compete in PDL market

Steve Jobs declared Hewlett-Packard (HP) 'brain dead' for choosing a page description language (PDL) other than Adobe's Postscript for its printers. HP has now changed its mind and, with the help of QMS, now offers Postscript on its LaserJet printers.

The industry is watching the announcement of the new Postscript clones very carefully as they move into a market dominated by Adobe for three years.

There are other alternatives to Postscript, such as Imagen's DDL or Xerox's Interpress, but Postscript is clearly the industry standard of today — particularly after IBM announced its support. HP's HPGL, the limited page description language on the LaserJet, is actually the market leader since HP claims 80 per cent of the market for laser printers.

Apple's own QuickDraw routines will soon be a part of its PDL offerings. But, even in their best form, they cannot compete with Postscript for high-quality output, font rotation and true font smoothing.

New lasers are coming onto the market monthly, and the continuing demand for high-quality typography raises the issue of Postscript clones' potential for adding user cost to Postscript printers, making these clones items to watch as we approach 1988.

The two leaders in this field — Phoenix Technologies and Conographic Corporation. Phoenix, and Bitstream, an electronic-font supplier from Cambridge, Mass — recently

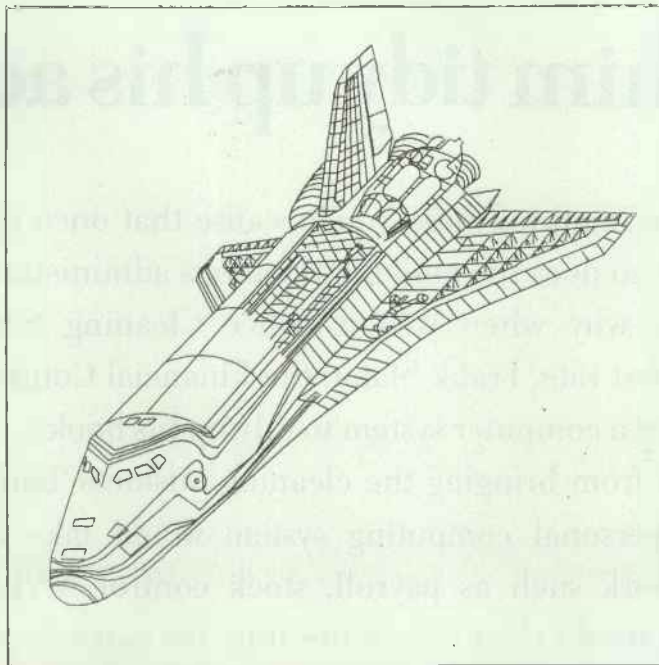

Conographic's RIP board speeds up the printing of the Postscript file of the Space Shuttle Columbia from 3 minutes to 2.69 seconds

announced a high-performance PDL interpreter for laser printers with Postscript compatibility.

It provides high-speed printing of text and graphics, and features an open architecture design to accommodate other page description language and device standards.

Now printer manufacturers who want Postscript compatibility and HPGL compatibility can go to Phoenix, obtain its board and have a printer that emulates Apple's LaserWriter and HP's LaserJet all in one.

Phoenix describes its 100 per

cent compatible architecture as 'light table-compatible', which means that the output precisely matches. And its pre-processed outline technology allows for high-speed printing of Postscript fonts.

Phoenix claims that the Bitstream fonts are a key component to the technology and gives true Postscript compatibility.

The other major player, Conographic, also has a Postscript-compatible solution through its ConoScript software running on a Conodesk 6000 RIP board.

Conographic actually licenses the same fonts as

Adobe, and so also claims 100 per cent Postscript compatibility.

The RIP board is the fastest output enhancer I have seen, giving a standard Canon laser printer anywhere from 10 to 50 times faster performance than the Apple LaserWriter.

As an example, the Postscript file of the Space Shuttle takes around three minutes to process on the Apple LaserWriter. If you use the Conographic system, that same file takes 2.69 seconds to process.

Another key example comes from a complicated font-sheet Postscript file. A very basic 8pt full sheet on the LaserWriter takes 44.5 seconds to process; on the Conographic system it takes just 1.43 seconds.

The key issue for the new Postscript clones is not just compatibility but also new levels of processing speed and flexibility.

Although Adobe is working on a new generation of Postscript technology, as well as adding colour and its new Postscript Display product, it will have to do much more to the processing power if it wants to maintain its marketplace lead.

Many major Japanese manufacturers, and perhaps even some European and domestic vendors, will produce Postscript clones in 1988. This competition may bring the price of these printers down, but the main advantage will be the performance boost given to existing laser printing engines.

Phoenix Technologies is on (617) 769 7020. Conographic Corporation is on (714) 474 1188. Bitstream is on (617) 497 6222.

More punch for hard disk back-up

Utility software lacks the glamour and appeal of packages such as Excel or Pagemaker, and so tends to get lost in all of the application hype. This is especially true when it comes to disk back-up products. They're generally very bland, but if you have ever crashed your hard disk, you know how important these products are.

One company, United Software Security of Vienna, Virginia, has decided to give its disk back-up product, TakeTWO, more punch.

TakeTWO Manager is one of the most powerful tools for hard disk management I have

seen, combining disk back-up with file management, file annotation and report generation features.

A fast OOPS feature allows you to undelete files and completely restore lost files; and, if you accidentally format your hard disk instead of a floppy, just type A:TT and you resurrect all your files.

Individual products offer some of these features, but this type of integrated solution on one disk is a utility that hard-disk users will find very useful.

The price is \$139.

United Software is on (703) 556 0007.

New technology for Christmas

Last Christmas saw low-cost PCs entering the US market for the first time. Many thousands of professionals who were familiar with PCs through their work decided that, at under \$1000, they could afford to buy one to use at home.

But, this was old technology. The low-cost PCs were 8088-based machines running at 4.77MHz. Ironically, these 'old technology' products were similar to machines that were bought in great numbers for \$4000 a few years ago.

Since last Christmas, 8088-based boxes have further reduced in price. You can buy

an 8088 PC with 640k memory, dual disks and a monochrome monitor for as little as \$599.

While this Christmas will see many new users attracted to these machines, the real trend will be for the professional workers and computer literate set to buy 80286-based AT machines.

A quick check of retail stores shows 80286 PCs running at 8MHz, with 640k memory, a single 1.2Mbyte floppy, a 20Mbyte hard disk and a monochrome monitor, retailing for as little as \$1295. Some colour systems with a 40Mbyte hard disk are selling for \$1895.

The coming months should see the 80286 XT/AT class machines become the computer of preference for the home professionals. **END**

Frank Slater knew all about cleaning, but it took IBM to help him tidy up his accounts.

If you've got a small business, you'll realise that once your company starts to grow, so does the amount of tedious administrative work.

That's why when Wetton Office Cleaning Services began growing at a fast rate, Frank Slater, the Financial Controller decided that he needed a computer system to tidy up his books.

Apart from bringing the cleaning business 'bang up to date', installing a personal computing system would take care of time consuming work such as payroll, stock control, VAT returns and invoicing. He would then have more time for more important things like financial forecasting.

With this in mind, Frank spoke to his local IBM Dealer. They sat down together, discussed the company's particular needs and developed the most suitable solution.

Frank was pleased because his dealer 'got down to the nitty gritty' of what he wanted and worked out a system that was simple to use. As a result, business has become more efficient; Frank instantly knows how profitable any one contract is at any time.

What's more, he feels that he can rely on the back-up and support of a company like IBM who will be here 'into the next century'.

Write to us for our two free booklets. They explain, in plain English, how IBM and its dealers can not only tidy up your accounts but also sort out your word processing needs.

Please send me the IBM accounting and word processing booklets.

Name _____

TPCW II

Position _____

Company _____

Type of Business _____

Address _____

SEE IT ALL AT IBM'87 EXHIBITION,
LONDON, OCT 27TH - NOV 6TH.

FOR DETAILS PHONE

01 995 7700.

Postcode _____

Telephone (Work) _____

Send this coupon to Dorothy Moore, IBM United Kingdom Limited, Freeport,
London W4 5BR, or telephone 01-995 7700 during working hours.

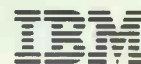

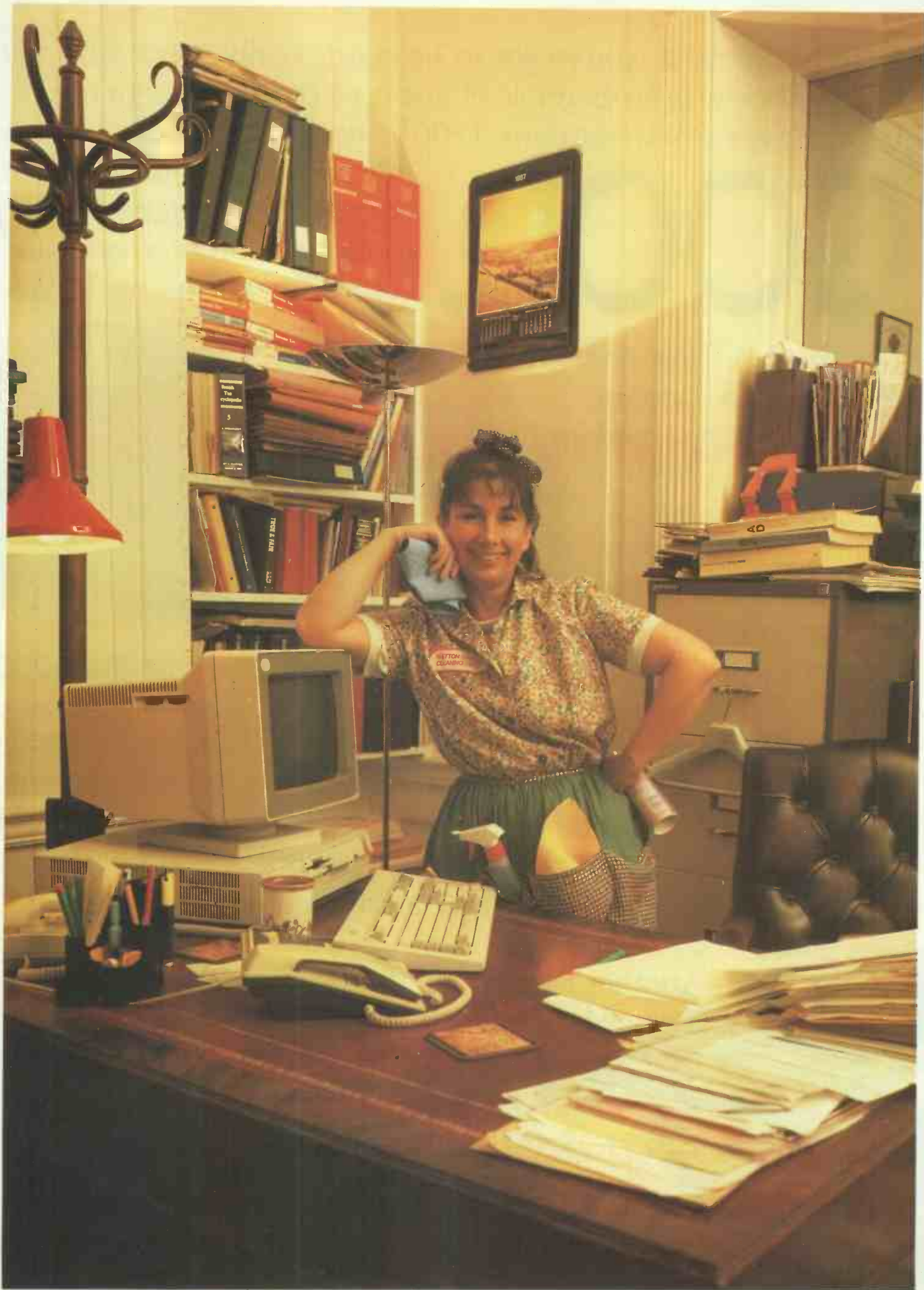

To be the best, you've got to be good. Really good. And the modem below is an example of just how good a modem can be. It's a Hayes Smartmodem 1200™ with V.21, V.22, V.23. A

GOOD,

"purpose built" modem that is specially designed and configured for international communications by Hayes,

the world's foremost PC modem manufacturer.

This 1200 bps modem is available in both a stand-alone version (Smartmodem 1200) and an internal version (Smartmodem 1200B™).



Along with all the requisite features, the Smartmodem 1200 is endowed with many ➔ automatic features—such as automatic speed selection, auto-answer and auto-dial, and an automatic speed buffer (flow control), a feature new to 1200 bps modems that compensates for different data rates between modems and computers. The Smartmodem 1200 also offers you full-duplex asynchronous, synchronous and autosynchronous (AutoSync*) modes.

Another requirement for being the best is that you be better than everyone else. And that is exactly what Smartcom III™ is. As the most ➔ powerful communications software available, it has all the standard features you'd expect and more. Such as terminal emulators,

APPROVED
for connection to telecommunication
systems specified in the instructions for
use, subject to the conditions
of use therein.

© 1987 Hayes Microcomputer Products Limited, 1 Roundwood Ave., Stockley Park, Uxbridge Middlesex UB11 1AE. Telex 263048 HAYESK G.



BETTER.

unattended operations, error-free file transfer protocols, a peruse buffer, a full-featured editor, and full-featured videotex (Prestel) emulator. ←

So whether you're a power user or a complete novice, with Smartcom III you can take full advantage of Hayes' advanced modem technology.

Once you're so good that you're better than everyone else, you're the best. And the best is what you have when you use Smartcom III with our Smartmodem 1200. Together they represent not only the most advanced communications package in the UK today, but also the ability to be fully compatible with the world's largest and fastest growing international PC modem base.



BEST.

The Hayes Smartmodem 1200, Smartmodem 1200B and Smartcom III are now ready for your perusal. They're worth a look. So take a look. These products are available through **Hayes Authorised Dealers** only. For one near you, call 01-848-1858. **Hayes™**

*Requires software incorporating the Hayes Synchronous Driver (HSD).



Compaq replies to OS/2 story

I must correct some of the mistaken assertions about Compaq's views on OS/2 contained in your September issue ('Cake eaten, and kept', Newsprint, page 70). While they may have made for a more colourful report, they are factually inaccurate.

Compaq has never described the new Microsoft operating system as 'useless', as your report states, nor refused to support it. Indeed, Compaq president Rod Canion committed the company to making it available to users in a speech delivered on 28 April — barely three weeks after the announcement.

While warning that the market should not expect an automatic and rapid mass migration to OS/2 — because of its cost and heavy memory requirements as well as its late availability — Canion noted that, once large corporations are able to develop special applications around it, 'then we'll see some important problems being solved'.

In the short term, and for some time after OS/2 begins shipping, Canion suggests that DOS 3 and its further extensions will continue to meet the needs of a very large body of personal computer users.

Canion also said on April 28, and repeated on July 6, that Compaq believes its existing products, using a non-Micro Channel bus, will provide better performance under OS/2 than IBM's new PCs. As beta test versions of OS/2 have largely been written on Compaq Deskpro 386s, Compaq could be considered to have a reasonable level of fact on which to base its belief.

In other words, the benefits of OS/2, which have been

recognised from the outset, will be available to users of a wide range of industry-standard systems — including the high-performance systems developed by Compaq. Users can, therefore, consider the costs vs benefits of moving to OS/2 quite independently of the costs vs benefits of moving to IBM's new PS/2 architecture.

Peter Bayley,
marketing director, Compaq,
Richmond, Surrey

Service with a smile

Bouquets! Over the last seven years of buying computer equipment and peripherals, I have had atrocious service (mostly from the bigger names in the industry), generally adequate service, and good service from PCW advertisers. It is with great pleasure that I write about recent exceptional service from two advertisers.

With some trepidation I bought a daisywheel printer by mail order last year from Computer Express — at a price some 30 per cent below other advertisers in the same issue. As the Express premises are 200 miles away, I shut my eyes to problems of service.

After a year of sterling service the printer went wrong, probably due to switching between computers and printers with everything 'on'! I contacted Express, and after a little difficulty, David Raine talked me through the diagnostics to check that the fault was with the printer and not elsewhere. It was. I was fortunate to be able to drop the printer in on a Monday.

Express rang at the end of the week with a cost, and the following Tuesday the printer was returned to me. An eight day turn-around on repairs, and the best prices advertised! Express deserves to succeed!

My second happy story concerns RSD Connections of Ware. I ordered a printer switch box with cables by phone. When it arrived it had

the wrong cables — an easy misunderstanding when trying to communicate over the phone. I rang at 3.30 pm, to which the reply was 'Please return the cables we sent, and we'll get the new ones off to you.'

The cables arrived by post at 9.30 am the following morning — I hadn't even been able to get to our post office to send off the others. For once, even the GPO got it right!

Michael Davis,
Rochdale, Lancs

Mandelbrot algorithms

The opening shot of your review of the Acorn Archimedes (PCW, August) showed the machine displaying a Mandelbrot set. Where can I find the formula to produce this type of graphic myself?

Also, I want to produce some vector graphics on my BBC Micro that have been drawn in perspective, but the formulae I use are very long-winded. Can anyone help?

J Smith,
Longtown, Herts

Jack Weber's article 'Fractal sets' (PCW, December 1986) contained some innovative and fast algorithms for drawing parts of the Mandelbrot set. Though written for the Apple Macintosh, they were produced in Basic and you might find it an interesting task to convert them to BBC Basic.

Transputer goes to the wall

I was very pleased to read your article on transputers (PCW, August). I'd rather read about advances in technology than about the same old boring PCs that have been around for five years.

I particularly liked the picture

at the top of the third page and wonder if it is available as a wall poster?

George McKinlay,
Chorley, Lancs

Inmos has a number of posters of its products and the company can be contacted on (0454) 616616.

Author hits back

Reviewers, and particular book reviewers, are often in a position of commercial power when their reviews appear in print. Not only do their views have a potential effect on the sale of the book in question, but it also invariably looks like sour grapes if the author writes to refute the statements made in the review.

Nonetheless, I'll have to take that risk in commenting on Graham Wood's review of my book, *Mastering DOS Plus*, in the September issue.

Wood claims that it is misleading to represent the book as relevant to the Acorn Master as this machine needs 'an expensive hardware upgrade' to run DOS Plus. This will be news to all Master 512 owners, as their machines are supplied as standard with this operating system. Philips will also be surprised to learn that it has sold no 'Yes micros in the UK.

If anything is misleading, it must surely be Wood's comments on the sample 'Expert System' included in the book. Rather than recommending Amstrad machines in 9 out of 10 cases, they are actually mentioned as 11 out of 33 possible options.

Having devoted four months to writing the book, it would indeed be encouraging 'to gain a few bucks', but this is hardly likely to be achieved when potential buyers read such ill-informed and destructive reviews as this within your pages.

Simon Williams,
Beaworthy, Devon

To
Personal Computer World
32-34 Broadwick St.
London W1A 2JG
England

Sir,

Item my reply to your article of July by
Nick Walter and Owen Tunderholm about the
Atari Dtp.

You may think it's a bit late to comment
your article about Atari Dtp. I needed time to
make, with the help of Publishing Partner, a
"Gothic" font in order to show the results of
what an individual can get with that program.
It is completely untrue that you can't have an
automatic kerning adjustment. You won't find
how to obtain this in the manual, but it is
possible with Ced.Prg., added in the font
program of Publishing Partner. You will see
the results of a different automatic kerning in
the added pages.

Please note that the "Gothic" font is printed
with an ordinary 9 pin dot matrix printer
Epson-800.

I think we only discover progressively
what a powerful computer the PC really is.
For instance look at the drawing I can get with
Publishing Partner.

We are now in an era of this century where
each individual can make his own fonts of
which the computer can make in his turn a lot
of alternatives. This all at the price of a
sophisticated typewriter.

I join to this letter a copy in "Gothic" font,
which for each paragraph, one of the
thousands possibilities.

Yours sincerely,

E. Marcens

Publishing

**Personal
Computer**



Better never than late

I have just finished reading the
'Chip Chat' section of
September's PCW in which
you told how you were
unwilling to pass on
information on setting up
bulletin boards to a reader
who wanted to start a
computer dealership.

Many people set up in
business purely for the money
and to hell with the customers
afterwards, but I have
generally found people in the
computer trade to be friendly
and helpful. I would have
thought that PCW would have
been pleased to help, as it
would have benefited your
readers. After all, not everyone
is in it purely to make money.

We should be striving to
make computing better for
everyone.

Trevor Monahan,
Skegness, Lincs

*There is a difference between
asking for information for your
own use, and getting help in
order to set up a business.
Anyone who's knowledge of
the computer industry is
gained mainly through writing
letters to magazines is hardly
in a position to offer sound
advice to others.*

*We consider it a service to
our readers to protect them
from people who think that the
business of selling computers
can be learned as easily as
selling ice cream.*

Poor program production

Your magazine's excellent
clarity and print quality is often
let down by the poor
reproduction of the listings in
Program File, with some of
them being atrocious to say
the least.

I appreciate that you are
dependent on the actual
printer, but surely many
readers are sufficiently
experienced computer users to
know how to obtain good-
quality output.
Karaoli & Dimitriou,
Athens, Greece

*In order to avoid introducing
errors into the programs we
receive, we use the printed
listings supplied by the
program authors. But it does
sometimes seem that, however
able they are to write complex
and fascinating programs,
fitting a new printer ribbon is
beyond them.*

However, with our wonderful

*Kyocera laser printer, we are
often able to reprint the
listings, particularly when
supplied on PC or ST disks.
Sadly, though, doing
something with listings printed
on silver Sinclair paper is
beyond us.*

*In addition, the reproduction
process means that, between
an original 80-column sheet
and our page-size
requirements, some
degradation in quality is
inevitable. However, last
month's PCW showed how
good we can be. And there's
always the PCW Disk Library to
remove the need to type the
listing in at all.*

Computer of note



Leafing through the February
issue of PCW, I was interested
to read the article by David
Levy about the 'musical dice'
method of composing minuets
which was published in 1792
and attributed to Mozart. He
also mentions a similar system
devised by Bach's pupil,
Johann Philipp Kirkenberger.

There is a growing body of
opinion among music
historians that JS Bach himself
could not have found time to
achieve his vast output of
musical compositions — and
also to have fathered
approximately 20 children —
without the help of some form
of primitive music computer.

Some device providing a
readout from a clavichord-style
keyboard has been suggested.

The fact that Bach's third
son, the most gifted of all at
the keyboard*, should have
been christened CP/M Manual
(or CP Emanuel) can be no
accident, and is obviously a
thinly-veiled reference to the
user guide for his machine's
operating system.

There is a growing body of
opinion among music
EJ Chance, St Albans

END



BANKS' STATEMENT

Unreal time

A lethal combination of graphics and games is loosening some people's grip on reality and on their own humanity. Martin Banks wonders if the situation is terminal.

You will probably realise that this is not an easy thing for me to admit, but I am very much like everyone else in the world. I eat, drink, hate working and have, at the very least, dual standards.

Even my dual standards are boringly similar to everyone else's. I know that when I want to do something it is OK, but that when someone else wants to do something that sounds reasonably similar, I will often pronounce that it isn't similar at all, is positively harmful and should not be allowed. Everyone, especially everyone who has ever been a parent, will be guilty of such dual standards at least once in their lives.

That is why I have decided to jump in, bite the bullet, run something up the flag pole and see who salutes it. I am going to have a go at something that I feel is bad, even though it is closely related to something else which I feel is perfectly OK.

The overall subject can be covered by two words: graphics and games. Now, I am not the world's greatest fan of computer games, except for one particular sub-species, the flight simulation programs. Whether it comes from growing up in an aircraft-industry family (just as coal miners claim to have mining in their blood) or reading too many *Biggles* books as a child, but I love having a go at them. It is one of the great sadnesses of my life that there are so few simulators available for the MS-DOS environment.

Couple good graphics to a good flight simulator and the effect can be terrific, to the point where a new reality can be created that is good enough to train pilots.

Yet so many computer games now available have, for me at least, an overpowering tendency towards violence. I use the word 'overpowering' specifically, for some recent news from the US is now tending to support a pet theory of mine that was put forward in these pages several years ago. This theory states that young minds can be trained by violent computer games into thinking that this is the way the world works.

I seem to remember that the last time I voiced this opinion, which also touched on the appallingly sexist nature of many of the games as well, it got treated with boredom and mild contempt. Fair enough, I thought, let time see who is right.

Well, I think I might be (which makes a change from most of my predictions). I was listening to the radio some time ago with, I have to admit, only half my brain in gear. I therefore missed some specific details of the news report in question. However, the basic details were unquestioned: psychologists in the US were pinpointing direct relationships between violent computer games — in particular adventure games with a high graphics content — and an increase in both murders and suicides committed by young men. (Young women, for various reasons, rarely play computer games.)

Adventure games, it would appear, have this strange effect on the young mind, the close interaction between the game and the player distorting their conceptions of what is, and isn't, reality. To get whatever prize sits at the end of the particular game's 'rainbow', the player invariably has to perform a variety of anti-social acts. These include entering other people's houses, stealing, carrying offensive weapons with intent and, of course, using those weapons to kill off opponents.

Yes, yes, I know it's only a game, and I know many people as ancient as myself who enjoy them as a genuine intellectual challenge. Such ancients do not, however, have young impressionable minds, and the evidence would seem to be growing that such minds do take the games as the role-model for their approach to life: 'If you want it, steal and fight for it. If someone dies then it is all in the game.'

Adventure games are also brutal with failures. Make a mistake and you can find yourself terminated in a single line message. (You can also get asked if you want another game.) Such a question is not asked of the growing number of young men in the US who, on considering them-

selves a failure of suitable dimensions, apply the 'game solution' to themselves. Suicides connected to computer games are said to be on the increase.

The unavoidable problem is, the games *are* educational. In another radio report I heard, a Dr Patricia Greenfield, of the University of California at Los Angeles, pointed out their educational qualities. She suggested that they were particularly good for training people to infer a three-dimensional reality from a two-dimensional, screen-based image. This, she suggested, would be good for training people to work in the screen-based environments of the future, where operators of equipment from micro-surgery systems to megawatt machines will be distanced from the reality of their actions.

And once they are trained in this capability, the screen could become their only reality, and the screens themselves are vulnerable, open to (and here comes an emotive word) manipulation. Think about it for a second. The way in which high-resolution graphics are going means you can't tell the difference between a computer-generated picture and a television shot. Couple that hardware capability to the graphics manipulation software now becoming available — applications which let the skilful add, subtract and modify an image at will — and the prospect is positively Orwellian.

Most people already get most of their information from the 2D TV screen. If they can't tell the difference between camera shots and computer-generated images, then the information they receive will open to manipulation, at the mercy of those controlling the generation process. There are armies of people who think *Coronation Street* is real.

To get people really in the swing of things, why not use the educational properties of adventure games, coupled with the best in graphics manipulation, to train everyone into getting used to seeing things in a certain 'way'. That way, we won't know what is reality, and probably won't care until it's too late.

END

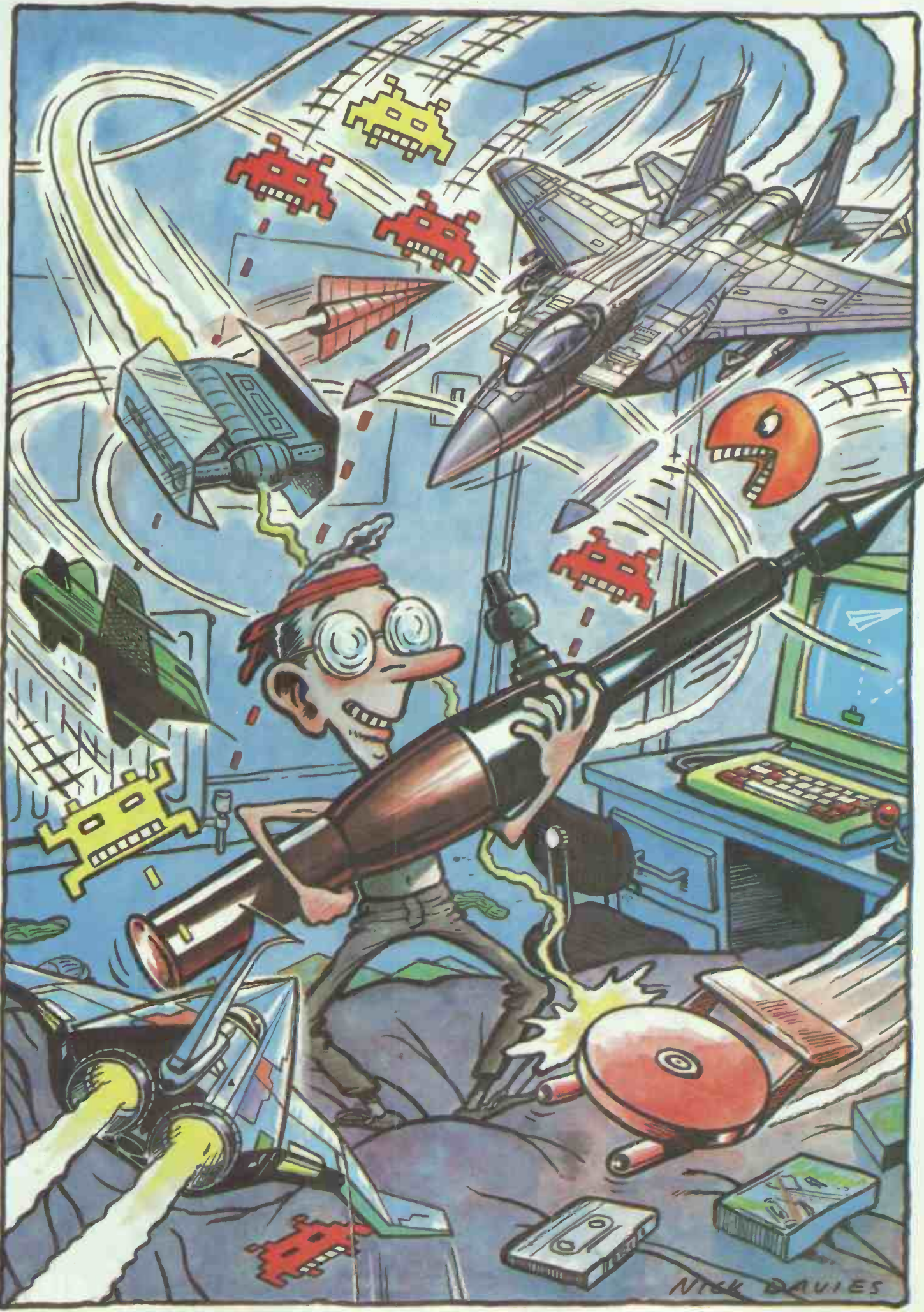

Illustration by Nick Davies

NICK DAVIES



CHUCK YEAGER'S ADVANCED FLIGHT TRAINER

The instinct to survive. Out of control, screaming towards Earth at Mach 3, just 8 seconds and 20,000 ft left! Fly aileron rolls, Cuban 8's, even hammerhead stalls. Simulation so realistic you may just blackout. Remember - test pilots are only wrong once.

CLIMB INTO THE COCKPIT WITH THE GREATEST TEST PILOT EVER - CHUCK YEAGER. FLY 14 DIFFERENT AIRCRAFT INCLUDING EXPERIMENTAL JETS, COMPETE AGAINST 6 ADVERSARIES.

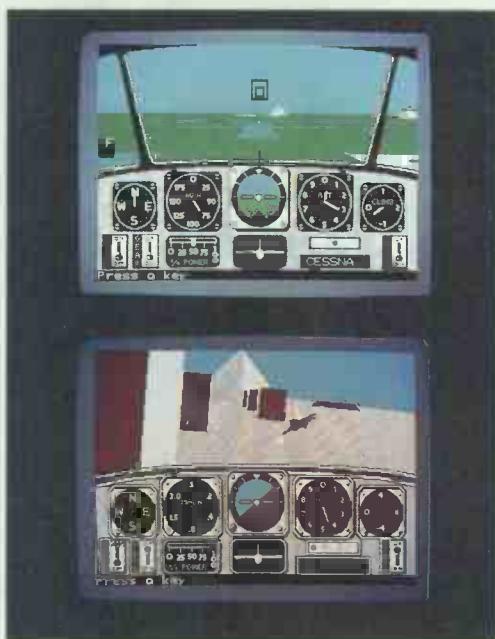

DYNAMIC INSTRUMENTATION, BLACK BOX RECORDERS AND 10 VIEWPOINTS WITH ZOOM UP TO 256X.



UNLEASH THE POWER OF YOUR IMAGINATION

Electronic Arts software is available on a wide range of home computers including Commodore C64, Commodore Amiga, Atari ST, IBM PC and compatibles, Spectrum and Amstrad. Electronic Arts products are available from good software stockists and especially where you see this sign.



For a full broadsheet describing the complete range or information on your nearest stockist write to: Electronic Arts, 11-49 Station Road, Langley, Berkshire SL3 8YN, England. Or call our Customer Services Dept on 0753 46465.

ELECTRONIC ARTS

Compaq Portable 386 vs Toshiba T5100

Compaq and Toshiba, arch-rivals in the 286 portables market, now do battle in the 386 field with the launch of their respective Portable 386 and T5100 laptops. Peter Jackson dons his referee's cap to decide the winner.



As the PC-compatible world becomes more and more accustomed to seeing 80386-based machines appearing on their desktops, it is no surprise to find Compaq, which invented PC portability, and Toshiba, which dominates the power PC laptop market, offering 32-bit portables.

It is equally unsurprising to find that they have approached the 32-bit market from different directions, based on what they have done before.

The Compaq Portable 386 is similar to the earlier AT-compatible Portable III, with a 'lunchbox' look and a tendency to go for standards such as 5¼in floppy disks rather than pushing for smaller and lighter systems. And the Toshiba T5100 looks like the earlier AT-compatible T3100, with a laptop-style fold-up display and fixed keyboard, the use of space-saving technologies like 3½in floppy drives, and the use of external, non-portable expansion boxes.

In the new portable 80386 market, it is the form factor that seems to count with Toshiba. The company says that the T5100 can still go into a briefcase; that it has the slim, dark good looks that power-user executives prefer; and that it doesn't bang your knees when you try to carry it with its built-in handle. Compaq points to the no-compromise approach to industry standards; the portable expansion board options; a tape back-up option; and the way that the machine protects software investment with its 5¼in drive.

Compaq Portable 386

Hardware

Outwardly, the Portable 386 looks exactly like Compaq's lunchbox-style Portable III, or the earlier Sharp PC-7000. The single floppy disk drive and the 40Mbyte hard disk are mounted vertically at the right-hand end, while the keyboard clips on to form the front face of the enclosure. Unclipping the keyboard reveals a plasma display screen, once again identical to the Portable III's.

Opening up the case by removing six Torx star-slot screws reveals a layout also familiar from the Portable III, but with unfamiliar components.

In the Portable III, Compaq had decided to make the system easy to maintain by mounting the main board at the back of the case with its component side facing outwards; this was a trade-off between accessibility and the risk of damage, since the board components are only protected by a single thickness of case plastic. The solution was to make the case from an immensely strong material described by Compaq as 'bullet-proof plastic', and the same design holds with the Portable 386.

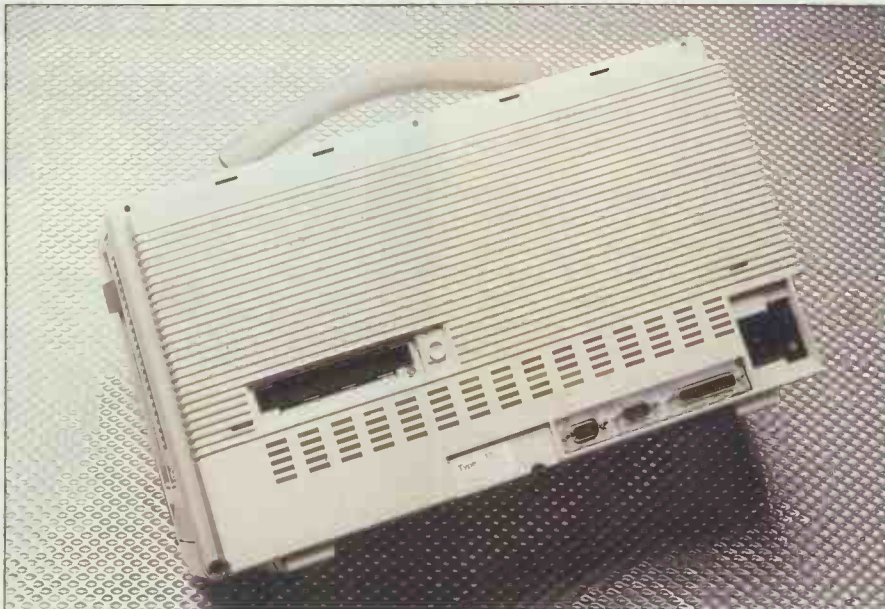

The centrally-mounted expansion slot takes snap-on boxes: one of which holds a 40Mbyte tape streamer; the other takes expansion cards

At first, the board was obscured by impressive amounts of electromagnetic shielding, comprising pierced aluminium cages and sheets over the high-frequency components. This is necessary if the machine is to pass the Federal Communications Commission's interference tests in the US, and although a label on the review machine stated that certification had not been achieved, it also stated that production machines definitely would be FCC Class B approved.

The first impression of the revealed circuit board was how small it is for what it does. At the top right-hand corner, the unmistakable square block of the 20MHz 80386 and a socket for the optional 20MHz 80387 maths co-processor are to be found. Hens' teeth are easier to come by than reliable 80387 chips, let alone 20MHz ones, so it was a considerable surprise to find a 20MHz chip fitted in the review machine. The 80387 socket is, oddly, too big, leaving a spare row of socket holes around the chip, but this had no effect on performance. The oversized socket is designed to take a Weitek maths co-processor board as well as a standard 80387. This board provides a 10-fold performance improvement.

The main system RAM is at the centre of the board, using single-in-line memory modules (SIMMs) to provide 1Mbyte as standard; there are four SIMM sockets in all, so each SIMM in the base machine holds 256k. The chip configuration of the 2Mbytes of RAM in the review machine was a little strange, with four surface-mount 256kbit chips and two unfamiliar chips on each SIMM; but it is reasonable to deduce that each of the two extras — labelled

2801J-08 — is an unusual 1.5Mbit chip rather than a now-standard 1Mbit chip. There is room on each SIMM for eight of these, which would take the main RAM to 6Mbytes on the main board; and with a Compaq expansion board, the maximum 32-bit RAM capacity of the machine is 10Mbytes.

All the RAM chips are very fast and very expensive 80ns types rather than the cheaper 120ns and 150ns ones used in most PCs, enabling the RAM to keep up with the speed of the 20MHz processor.

The interfaces around the edge of the board include ribbon cables connecting the on-board floppy and hard disk controller to the internal drives, various power connectors, 9-pin and 25-pin D-type connectors connected directly to the RS232 and Centronics interfaces on the board, and a ribbon cable leading to the display daughter-board. This board fits at right-angles to the main board at the bottom of the case, and provides the control circuitry for both the internal plasma display and the external RGB monitor socket. Using this daughterboard design, as in the Portable III, means that Compaq can offer upgrades either for the internal display or the external monitor driver without changing the main board design. At present, the only option is an EGA card that will drive any external EGA monitor — Compaq offers one of its own — as well as the plasma screen.

There are actually two expansion sockets on the main board, impressive for a portable machine but not meeting anybody else's standards. The first, near the centre, is a 96-pin connector designed either for Compaq's 40Mbyte tape back-up unit or for its PC-compatible expansion box, both of which clip onto the back of

BENCHTEST

the machine. The latter provides sockets for two full-length AT-standard expansion boards at the expense of portability.

The second, smaller, expansion socket provides 32-bit and 8-bit buses for Compaq's own expansion boards. There is space for two of these postcard-sized boards in the Portable 386, fitting at right-angles to the main board in a compartment at the base of the enclosure.

The keyboard interface is also new, and allows any standard PC or AT keyboard to plug directly into the socket if required. Plugging in an XT-compatible keyboard from a Taiwanese XT clone proved that this worked; although the plug was tricky to insert and seemed loose, the keyboard worked fine.

The keyboard itself is new, and intended to be compatible with IBM's now-standard Enhanced keyboard layout. However, width limitations mean that the separate cursor keypad on the Enhanced keyboard has been dropped, and the cursor keys share the numeric keypad — as they do on the old PC and AT keyboard designs. Apart from that, the Compaq board has all the advantages and disadvantages of the Enhanced keyboard in general.

As with all other Compaq keyboards, this one seemed squashy and unresponsive compared with the official IBM model, or even Taiwanese clone boards. But that, of course, is a matter of taste and Compaq has certainly sold a lot of keyboards in its time.

The hard disk is a shock-mounted 3½in unit with a capacity of either 40Mbytes with access time below 30ms, or 100Mbytes with access time below 25ms. As with the original 16MHz DeskPro 386, these drives use the SCSI and ESDI controller standards, respectively.

The floppy disk drive is a standard 1.2Mbyte 5¼in unit that can read 360k disks but, like every other such drive, fails to write them reliably. A 360k floppy drive is offered as an option for those who do want to write

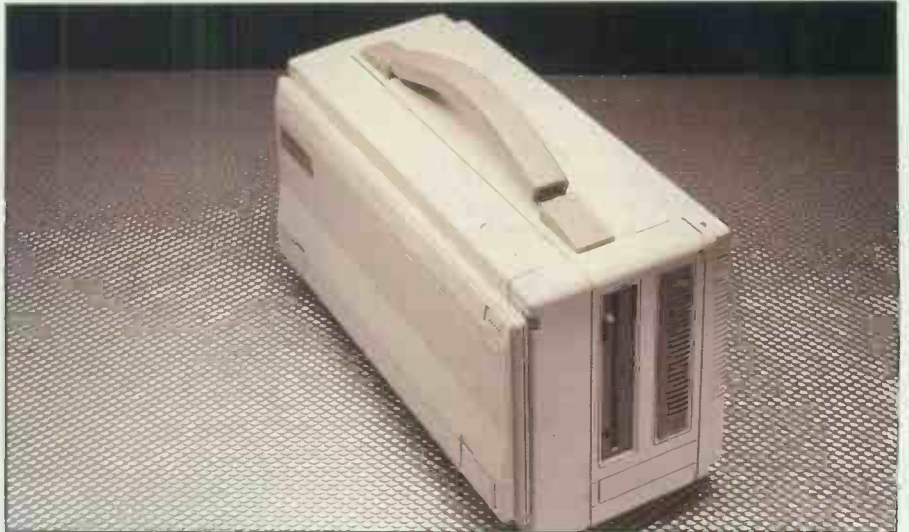

Compaq maintains that 5¼in floppy drives are the industry standard and so has not been tempted by 3½in ones. The 1.2Mbyte drive can be replaced with a 360k unit

360k disks properly.

The cantilever mounting of the display, as with the earlier machine, allows the screen to be lifted from the case on a kind of Anglepoise principle, and can be tilted to suit different types of lighting or to fit the user's preferences.

The display itself uses DC plasma technology, and has the usual Compaq display modes: 640×200 and 320×200 for CGA compatibility in monochrome, and Compaq's own 640×400 mixed text-and-graphics standard. The external RGB monitor interface, of course, provides the same modes with colour added.

The advantages of plasma technology are speed, inherent luminescence rather than the reflective operation of LCDs, and the ease of producing high-resolution panels with the same aspect ratio (height to width proportions) as CRT monitors. The disadvantage is the high power consumption, higher than a hard disk drive, which limits any plasma-screen portable to mains operation.

The overall impression of the machine, as with other Compaq products, is that it is a high-quality piece of engineering and industrial design, given the constraints of the system specification. The circuit boards are clear of jumper wires and late additions, and are obviously ready for full-scale manufacturing. The casing is in its final form and material — not surprising, since it is essentially the same as the Portable III's. And Compaq is so confident about the shock-proof mountings of the hard disk that company staff are happy to drop the machine from waist height and demonstrate that it still works.

And as with other Compaq products, the price of this build quality is the high cost of the system com-

pared with comparable hardware from other manufacturers.

System software

The operating system supplied with the machine is MS-DOS 3.2, with all that entails. Compaq also supplies some extra utilities to handle the special features of the machine.

As with the DeskPro 386, the Portable 386 comes with the Compaq Expanded Memory Manager (CEMM), which is installed as an MS-DOS device driver at boot time. This can be set up to mimic the Lotus-Intel-Microsoft expanded memory specification in 32-bit main RAM, use the memory above 640k as extended memory for Xenix, and set up RAM disks to make full use of the RAM capacity of the machine. And naturally, since the Portable 386 RAM is contiguous, it should run OS/2 straight out of the box once the CEMM driver has been discarded.

A new feature is a RAM cache for the hard disk, which sets aside an area of RAM to buffer data retrieved from the disk and hold copies of the most recently-used disk sectors. When the processor wants disk data it tries the cache first, and if the information is there it is retrieved from the fast 80ns RAM without any mechanical disk delays. The effectiveness of this depends on the amount of RAM allocated to the cache, and on how often the application software needs to go to disk. For big programs like AutoCAD, or for badly-organised programs like WordStar 3.3, overlay files are kept on disk and constantly referred to. Cache RAM, like RAMdisk, can speed these up wonderfully, but without the risk of data loss inherent in RAMdisks.

More RAM is taken up by Compaq software for the BIOS ROMs, which

Benchmarks

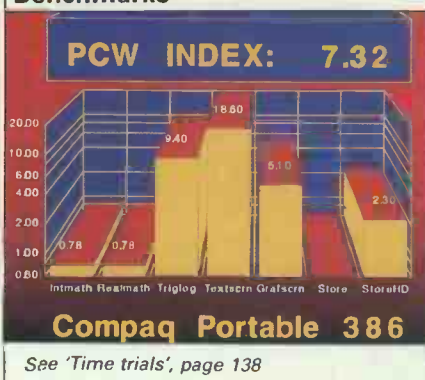

are copied into fast RAM to speed up all BIOS calls made by operating system or applications software. Once again, this technique was introduced in the DeskPro 386.

The other two main extras concern the plasma display. The Advanced Display Attribute Programming Tool (ADAPT) allows the plasma display attributes to be changed, often necessary when running CGA applications in monochrome. Some colour combinations in CGA programs — in menu bars and pop-up windows, for instance — just do not show up in monochrome without some alteration in the way the plasma screen displays its text. ADAPT allows the display to be altered so that all the information is visible. And, the ScreenSave utility blanks the screen after a user-selectable time period without any keyboard or computer activity.

Otherwise, Compaq's version of MS-DOS is no different from anyone else's, and there is no point in going into more detail.

In use

The surprising thing in using the Portable 386 is that there is no impression of blinding speed, at least when it is compared with, say, a 12MHz AT clone like Compaq's own. The figures show that this is illusory, since the performance is there. But the difference between a fast AT and a 20MHz 80386 machine is by no means as great as the difference between an old 4.77MHz PC and the fast AT, and it would be necessary to run the Portable III and Portable 386 machines side by side to spot the differences in daily use.

But the Portable 386 is certainly a fast and responsive machine, although it is psychologically difficult to believe that the small plasma-screened brick on the desk is one of the most powerful PCs on the market, and could be sold, if Compaq wished, as a 20-user system. That is a marketing problem for Compaq, and one which the company addresses in its promotional videos.

The PCW Benchmark figures show that the Portable 386 is a fast machine indeed, but the performance in real-life applications is just as interesting.

For these tests, AutoCAD and Lotus 1-2-3 were set up on the machine, with test data files. The AutoCAD files were the now-standard Nozzle and Columbia drawings, while the Lotus file was a big 500x500 worksheet with a macro to drive it. The base level for the comparisons was an old 4.77MHz PC clone with no 8087 maths processor to help it out; with this machine the Nozzle drawing took 260 seconds, the Columbia drawing took 111 seconds, and the 1-2-3 macro took



The greater height of the 5100 accommodates the extra memory and video cards. External keyboard and RGB ports allow it to be used purely as a system unit

182 seconds to complete.

On the Portable 386, with both AutoCAD and 1-2-3 taking advantage of the 80387, the times were 7.4 seconds for the Nozzle, 4.4 seconds for the Columbia, and 11.9 seconds for the 1-2-3 macro.

There was one interesting wrinkle on the tests, when the machine was set up without LIM expanded memory. With the expanded memory driver installed, the 1-2-3 macro slowed down from 11.9 seconds to 17.9 seconds, showing that expanded memory management really does impose a performance penalty on 1-2-3, even with LIM emulation in fast 32-bit RAM.

Those figures are a bit misleading, since the 80387 is an expensive option rather than a standard fitting, and it would have been better to remove it. However, that did not seem wise given the rarity of the machine and Compaq's protective attitude towards it.

Another speed test, this one ignoring the 80387, was provided by Landmark Software's useful SPEED.COM program, which runs continually with a variety of tests and gives average performance figures in terms of megahertz and performance multiples of a 4.77MHz PC. For example, if SPEED.COM shows a figure of 16MHz, that means that the machine is running as fast as a 16MHz 80286 machine with one memory wait state. The wait state gives a comparison with the IBM AT, which runs at 8MHz with one wait state.

SPEED.COM for the Portable 386 gave results of 24.5MHz — or roughly that, since it was right at the top of the scale — and a performance multiple of 11 compared with a 4.77MHz PC. The extra 4.5MHz over the rated clock speed of the machine's 80386

is a result of the fast 32-bit memory access compared with the 16-bit, one wait state memory access of the 80286. This once again emphasises the importance of processor-memory bandwidth in 80386 systems.

Toshiba T5100

Hardware

At first sight, the T5100 looks exactly like the 80286-based T3100, which is not too surprising since they are, externally, almost identical. Internally, though, the changes are substantial.

Opening up the case — a tricky procedure, until it is realised that the five screws are only there to back up some tough plastic clips like those on the IBM PC Convertible — demonstrates the simplicity of the internal design. Once again custom chips are used heavily, although this time Toshiba has the advantage of its own massive chip-making facilities, and all the custom circuits feature a Toshiba logo.

The main RAM fits underneath the keyboard, and uses vertically-mounted 1Mbit chips rather than SIMMs to save board space and reduce the vertical space required. The T5100 comes with 2Mbytes of RAM as standard, expandable to a maximum 4Mbytes by plugging in a small expansion card in the space provided next to the main RAM, still underneath the keyboard. The 80386 and its associated 80387 socket are half visible under the disk drive casings, while the back of the box is filled with the line-sensing 110V/240V power supply, running across the full width of the rear. The 80386 runs at 16MHz rather than the Portable 386's 20MHz, which reduces the RAM speed requirements.

BENCHTEST

As with the Compaq Portable 386, the 2Mbytes of RAM can be treated as LIM expanded memory, as extended memory for Xenix, or for RAMdisks, using a Toshiba driver provided.

The disk drives provided as standard are a 3½in floppy drive holding the same 1.44Mbytes as the double-sided, high-density IBM PS/2 drives, and also capable of reading and writing 720k disks; and a 40Mbyte, 29ms access time hard disk in a surprisingly small casing. The floppy disk and hard disk controllers are actually attached to the drives rather than provided on the motherboard, meaning that different drives can be installed if standards or user needs demand it.

There is one Toshiba-standard expansion slot, designed to take a BAPT-approved Hayes-compatible 1200 baud modem, a bi-synchronous communications board for mainframe links, or an interface board for the Toshiba expansion box that can hold up to five standard IBM expansion boards.

The standard interfaces on the back panel include an external RGB monitor port, a bi-directional Centronics parallel port that doubles as an external floppy disk drive connector, and a 9-pin RS232 serial port compatible with that on the IBM AT. Another connector on the side of the machine, near the front, is hidden behind a break-out cover and is intended for any IBM-compatible keyboard to be plugged in. This makes it possible to use the machine as the heart of a desktop system; a colour monitor and a full-size detachable keyboard can be kept at the office with an expansion box and external floppy drive if desired, and the T5100 can be used with its lid down as though it were just another very small PC system unit.

The display is almost identical to that in the Compaq Portable III and Portable 386, but Toshiba has stolen a march by including hardware and drivers for EGA displays on the plasma panel, as well as the usual 80×25

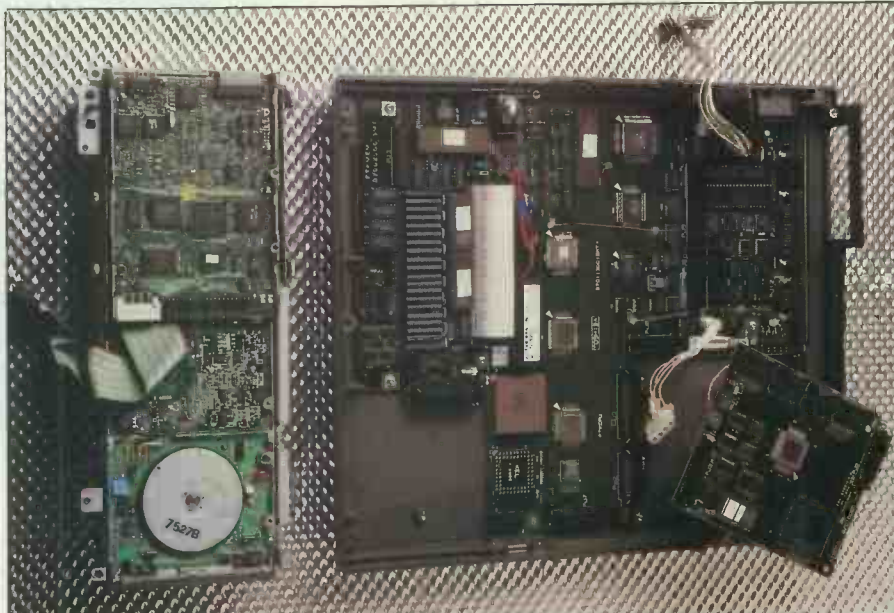

The modular internal elements comprise power supply, disk drive unit, EGA video board and main motherboards. Surface mounting contributes to the machine's low profile

text, CGA graphics, and Toshiba-specific 640×400 display modes found on previous Toshiba portables. The display is also taller than Compaq's, making the aspect ratio even more compatible with that of conventional CRT screens.

In EGA mode, the display can show 640×350 dots in four 'shadings', which are really different intensities; those intensities comprise black, full on, and two intermediate levels. As we shall see later, this makes it possible to juggle with the screen settings and produce a readable display even with EGA software using the full 16 colours of that mode.

The keyboard is the same as the T3100's, with a couple of exceptions, and has 10 function keys across the top and a full cursor key set at the bottom right. A new function key, Fn, is provided to give compatibility with the IBM Enhanced keyboard layout. Holding down Fn and pressing the '1' or '2' keys on the top numeric row gives the extra two function keys that may be required by software which recognises the full 12 keys of the Enhanced layout.

Attaching an external 5¼in floppy disk — 360k or 1.2Mbyte drives are available — is simply a matter of plugging its cable into the Centronics port, moving a switch on the side of the machine to A or B depending on the drive letter required, and rebooting to give the system a chance to figure out that the drive is attached. All the test software was transferred to the T5100 hard disk using an external drive, and it worked quickly and reliably. Of course, it is impossible to have an external drive and a

parallel printer connected at the same time, but the big hard disk capacity means that the floppy will only be needed to transfer software provided by companies which do not yet support the PS/2 3½in floppy standard.

According to Toshiba, its entire range of laptops was designed from the case inwards rather than from the electronics outwards, so that the case size and shape was fixed first and the engineers were forced to design the hardware to fit it. So, the inside of the T5100 is crowded, and maintenance will certainly be tougher than with the Compaq Portable 386; but within the constraints, the use of custom chips makes the electronics board design simple and spacious. The problems of dismantling and servicing will be mechanical ones rather than electronic ones caused by too many hot-running components in too small a space.

The T5100 is another neat piece of engineering, and again the feeling is one of surprise that so much power can be built into so small a package.

System software

The operating system provided is again MS-DOS 3.2, with some extra utilities to take advantage of the new hardware it is running on. The memory manager driver is installed in a CONFIG.SYS file, with parameters specifying how much RAM is to be used for LIM expanded memory, extended memory, or RAMdisk. Alternatively, the memory configuration can be changed at any time by running a SETUP program and rebooting.

The speed of the processor can be

Benchmarks

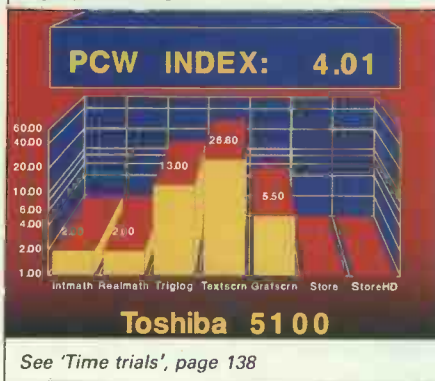

changed from the keyboard using a resident program. Holding the Fn key down and pressing the PgDn key takes the speed down to 8MHz for those few programs — such as communications packages — that may have trouble with the 16MHz clock rate. This command can be issued at any time, and the effects are immediately visible in things like a directory listing on the screen, which is noticeably more sluggish at the lower rate.

Another resident utility, this time one loaded from disk, allows configuration of the EGA mode of the plasma display to fit the software that is running. This utility, XCHAD, is like the CHAD software supplied with the T3100, but altered to handle the extra attributes of the EGA mode. XCHAD can also be called up at any time, and simply puts up a list of the 16 colours of the EGA standard with their current plasma intensities next to them. These settings can be changed from the keyboard using the cursor keys, and the changes are immediately reflected in whatever software is currently on the screen. This interactivity means that different settings can be tried to find the best combination.

For example, in Microsoft Windows the menu highlights were invisible thanks to the colour combination, and in Lotus' Freelance Plus graphics package the currently-selected menu item was also invisible. XCHAD allowed that to be fixed by eliminating the colour clashes.

Once again, the rest of MS-DOS

3.2 does not require much coverage.

In use

The T5100 ran everything thrown at it, in EGA and CGA modes, including things like Rix's EGAPaint, Freelance Plus, Windows, GEM, Word Perfect, RapidFile, AutoCAD, 1-2-3, and the rest. No hitches apart from the EGA colour problem, and fast performance as expected.

The fixed keyboard and screen of the machine, necessary because of its laptop design, seemed limiting compared with Compaq's detachable keyboard and more flexible tilt and swivel display. But overall, there is nothing to stop the T5100 becoming a user's only system as long as the plasma display is satisfactory. And the display, even in EGA mode, is fast enough and clear enough to satisfy most users.

The same tests were performed on the T5100 as on the Portable 386, although it is worth emphasising that the Toshiba machine was without an 80387 and that all the T5100 tests were in EGA mode. So, direct comparisons are a little risky to make.

The T5100 took 42.6 seconds to draw the Nozzle in AutoCAD, and 18.9 seconds for the Columbia; while the 1-2-3 worksheet macro took 33.9 seconds without LIM expanded memory, and, oddly, 33.3 seconds with the LIM driver omitted. Toshiba claims that its expanded memory is superior to Compaq's, and these figures seem to back that up.

As with the Portable 386, Landmark's SPEED.COM came up with a

1MHz rate higher than the clock rate of the 80386 chip; this time the machine was shown performing as fast as an AT running at 18.5MHz with one memory wait state. The fast 32-bit RAM access was again responsible. And the SPEED program also showed the machine performing 9.9 times faster than a 4.77MHz PC.

Conclusion

It would be wrong to think that no user will ever need portable machines at this level of performance. In the future, this standard will be the minimum that users require for any job.

What's more, either of these machines combined with an external monitor and a full-size IBM-compatible keyboard would make a fine desktop system with portability thrown in, at the cost of limited expansion options that can only be put right by spending more money.

In terms of performance, these systems are right at the top of any league. In terms of marketing, it was inevitable that Toshiba — which has carved out a market in high-power laptops without having any desktop systems worthy of note — would take this route. It was less likely that Compaq would produce a 32-bit portable, since the company's desktop systems, including the 16MHz DeskPro 386 and the new 20MHz 80386 desktop originally codenamed X-15, are making the company most of its revenue these days.

But with both these machines on the desktop, the Compaq Portable 386 seems too bulky for a true portable, and does not have EGA as standard; while the Toshiba is smaller, easier to carry, has EGA, a better display aspect ratio, and, trivially, a better keyboard feel as far as *this* observer is concerned.

Against that, the missing 4MHz in the T5100 clock speed should not deter those who *must* have an 80386 with portability. If portability is the real concern, then the T5100 is undoubtedly the superior machine.



Compaq is on (01) 940 8860.
Toshiba is on (0276) 62222.

END

Technical specifications

Compaq Portable 386

Processor: Intel 80386, 20MHz
Co-processor: Optional Intel 80387 or Weitek 1167 floating-point chips
RAM: 1Mbyte expandable to 10Mbytes with LIM support
Mass storage: Single 1.2Mbyte 5¼in floppy drive, 40Mbyte hard disk
Storage options: 360k 5¼in floppy drive, 100Mbyte hard disk, clip-on 40Mbyte tape back-up unit
Keyboard: IBM Enhanced keyboard compatible
Display: Plasma, 80×25 text, 640×400 graphics, CGA-compatible
Standard interfaces: RGB monitor port, parallel printer port, RS232C, IBM-compatible keyboard socket
Expansion: One 8-bit and one 32-bit Compaq-specific slots, 96-pin expansion port for clip-on IBM-compatible expansion box
Size: 9.8ins×7.8ins×16ins
Weight: 20lbs
Bundled software: MS-DOS 3.2, expanded memory manager, cache manager

Toshiba T5100

Processor: Intel 80386, 16MHz
Co-processor: Optional Intel 80387
RAM: 2Mbytes, expandable to 4Mbytes with LIM support
Mass storage: Single 1.44Mbyte 3½in floppy drive, 40Mbyte hard disk
Storage options: External 360k or 1.2Mbyte 5¼in floppy drive
Keyboard: 82 keys
Display: Four-intensity plasma panel; EGA-compatible
Standard interfaces: RGB monitor port, bi-directional parallel printer or external disk drive port, RS232C, IBM keyboard socket
Expansion: Single internal Toshiba-specific slot, or external IBM-compatible expansion box
Size: 12.2ins×3.6ins×14.2ins
Weight: 15lbs
Bundled software: MS-DOS 3.2, expanded memory manager, EGA colour editor

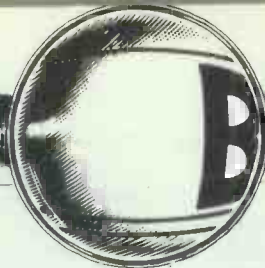

eaZy pc

Zenith Data Systems has produced a neat little desktop unit called the eaZy PC. But the machine's non-standard disk size and its lack of growth potential give some cause for concern. Martin Wren-Hilton examines its place in the home market.

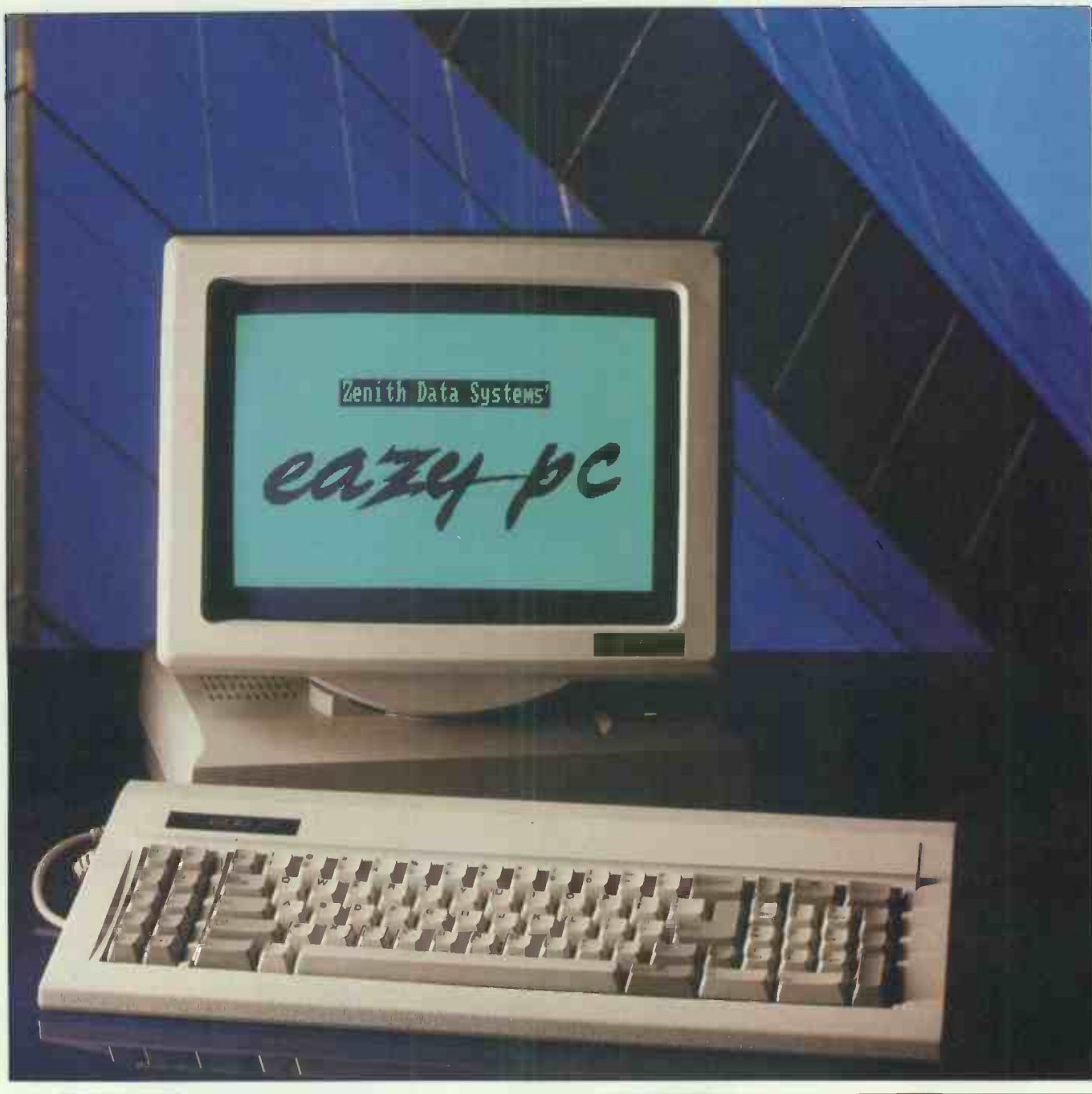

Zenith Data Systems is perhaps best known for its range of PC-compatible laptops including the Z-183 and the Z-181. To date, however, the company has not shown much impact in the desktop market despite a broad range of offerings from the Intel 8088-based Z-159 to the recently announced Z-386. With the eaZy pc (sic), Zenith is aiming to attack the Amstrad market and that of the soon-to-be-announced IBM Personal System/2 Model 25.

Four things distinguish the eaZy pc from other machines: its diminutive size, its sharp display, its quiet operation and its lack of standard PC expansion slots. The machine comes in three models, each one with different storage capacities.

Hardware

The eaZy pc looks neat. A crisp paper-white monochrome monitor is permanently attached to the processor box by its swivelling base. You can't separate the two, and it would be unwise to attempt to do so as the monitor contains the power supply for the system. On the left-hand side of the monitor are two small knobs for altering the contrast and brilliance of the display, while the 3½in disk drives are on the right-hand side. This unusual arrangement is normally found only on laptops; and it makes the insertion of disks awkward — as you can't easily see what is going into where — and has the only advantage of allowing the keyboard to be pushed up against the front of the machine on cramped desks.

On the back of the eaZy pc are three ports: one for a Zenith mouse, one for a parallel printer and one for expansion. The expansion port is interesting as it is the only means of adding extras to the machine. There are no internal expansion slots, and the only internal option is a real-time clock which must be fitted by the dealer. Lack of expansion is the single biggest drawback to the eaZy pc.

Opening up the box — a procedure that is not recommended, as there are no user-serviceable parts inside — is a bit tricky. Because the monitor and processor box are inseparable, getting inside requires some manual dexterity. Lying the machine 'face down', with the glass screen on a work surface, proved to be the easier way. Four screws hold the base of the processor box to the upper half.

Inside, two large metal shields reduce any electromagnetic emissions. The one on the left covers the disk drives while the one on the right conceals the motherboard. Taking this off (having removed the loudspeaker) reveals the processor, memory and support chips.

The eaZy pc is driven by an Intel 8088-compatible processor — the

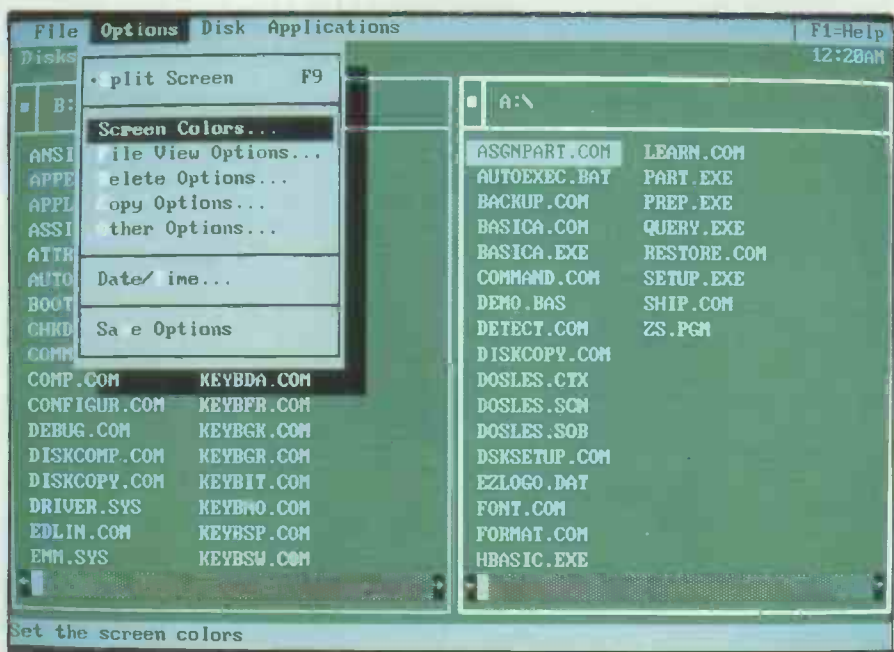

MS-DOS Manager, though text-based, emulates a number of functions of MS-Windows including a 'point and shoot' approach to launching applications and file management

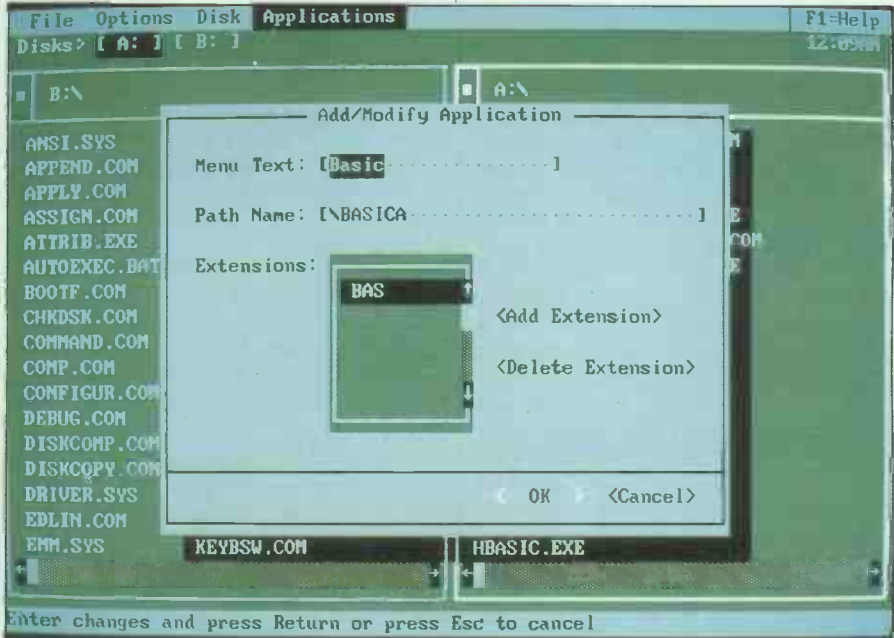

Applications can be installed on a menu and filename extensions can be linked to them. In this way, clicking on a document can automatically open a word processor

NEC V4u running at 7.14MHz. That makes it faster than the original IBM PC, and on a par with most low-cost PC clones. There is no option for running the machine at 4.77MHz (the speed of the original IBM PC). This feature is found on many PC-compatibles for the purpose of running certain copy-protected software, although it is no longer such an important issue as this method of copy-protection is seldom used.

For reasons that I cannot fathom, Zenith chose not to include a socket for an 8087 co-processor. This expensive mathematics chip (£150 or so) is a great boon when using programs such as Lotus 1-2-3 which have been designed to take advantage of it.

On the motherboard are the CGA

(Colour Graphics Adaptor) compatible chips and the disk controller, as well as 512k of RAM. The overall standard of construction is high and the eaZy PC seems well-built — unlike some cheap PC clones.

One thing that makes the eaZy pc very pleasant to use is the complete lack of noise (due to the absence of a cooling fan). Despite the Amstrad fan fiasco, I am sure that the eaZy pc doesn't need one. It uses cool running CMOS chips and has ventilation slits all over the top of the processor box.

As mentioned above the eaZy pc comes in three models — the EZ-1, the EZ-2 and (you guessed it) the EZ-3 — with the only difference being storage capacity. EZ-1 has a single

BENCHTEST

720k 3½in disk drive, while EZ-2 has two. For applications where greater capacity and increased speed are required, the EZ-3 has a single 720k 3½in disk drive and a 20Mbyte hard disk. For the purposes of this Benchtest, I examined the EZ-2.

In theory 3½in disks have several advantages over other types of disks. With twice the capacity of the industry standard 360k 5¼in disks, and occupying less space, 3½in disks will doubtless become a standard of the future; and there's the crunch. In practice, 3½in disks are a bit of an anomaly: the software sitting on most dealers' shelves is in 5¼in only and Zenith doesn't offer an external 5¼in to make life any easier.

Of course, you could always buy the combined 128k RAM/modem/serial port and use a serial cable with software such as PCXFER — but it is rather like cracking walnuts with a sledgehammer.

If you're considering purchasing the eaZy pc, think carefully whether you could exist in a 3½in world while most people live in a 5¼in world. If you, or a friend, already have a PC-compatible with the larger drives, how will you exchange files?

On paper, the eaZy pc's disk drives should be as fast or faster than their 5¼in counterparts. In transferring data, they probably are, but starting up they seem to take forever. This is common to all 3½in drives, and is not just peculiar to Zenith's.

Zenith has indicated that kits will be made available to upgrade from EZ-1 and EZ-2 to EZ-3, although no prices were available at the time of going to press.

The power switch for the eaZy pc is located on the back of the display. Spending hours behind many computer screens can be an eye-watering experience. Not so with the eaZy pc. Its crisp white-on-black display is among the nicest around. With a 25KHz scan rate, this 14in monitor is very pleasant to use. The glass surface has been treated to reduce eye-strain caused by unwanted reflections of light sources and contrast, and brilliance controls allow the display to be altered according to either conditions or your preferences.

The graphics adaptor built into the eaZy pc is CGA-compatible (as far as



Twin 3½in floppy drives, mouse and parallel ports are the minimal external access points available. The expansion port allows for the addition of a serial port and/or modem

software is concerned), representing different colours with grey shades. In text mode, characters are formed in 8×16 graphics cells which makes the screen much easier to read than conventional CGA display systems (such as the Amstrad PC1512) where text characters are formed in 8×8 graphics cells.

Similarly, the graphics mode is also an improvement over conventional CGAs. Like the IBM Personal System/2, each line of graphics is scanned twice, giving the clarity of a 640×400 resolution from 640×200 pixels.

Coming back to my previous concerns about expandability, the biggest drawback of the eaZy pc's display and graphics is the lack of growth potential. There is no way of changing to a colour monitor or increasing the resolution beyond 640×200 at a later date. (The same complaint has been levelled at the Amstrad PC1512.)

The review machine was an American model, so it came with an American 84-key keyboard (that is, no pound sign and other keys changed around). Otherwise, the layout was standard with 10 function keys on the left and an integrated numeric/cursor control keypad on the right. I found the eaZy pc keyboard acceptably good with the key 'click' being produced by the machine's internal loudspeaker. For comfort, the typing angle can be altered to one of two positions and LEDs are provided to show the status of NumLock and CapsLock keys.

When using a word processor or navigating through a spreadsheet, the speed of the cursor can be a hindrance on most PC-compatibles. A neat program called Cruise Control

from Revolution Software in the States (distributed in the UK by Ctrl Alt Deli) gets round this problem by accelerating the cursor up to a decent speed (see October Newsprint for more details).

However, the eaZy pc gets bonus points by including just such a feature in the firmware. Even at the MS-DOS command prompt A>, the cursor accelerates the longer you hold a key down. In most application programs this should prove a real boon, but I hope that the code in the BIOS firmware doesn't conflict with any software that intercepts the keyboard directly. It didn't on any software I tested.

It is worth remembering that a new 101-key keyboard, as provided with the IBM Personal System/2, is now becoming the new industry standard, although most low-end machines such as the eaZy pc have the smaller keyboard.

Zenith is offering four options for the eaZy pc — a mouse, a real-time clock, a 128k RAM module and a combined 128k RAM module with a modem and serial port. The real-time clock must be fitted by a dealer, while the other two modules plug into the expansion connector on the back of the processor box. According to Zenith, the modem is Hayes-compatible.

The 128k RAM module boosts memory to 640k and the combined 128k/modem/serial port module gives you a 9-pin serial port. Here are three things to bear in mind:

- If you want a serial port, you have to buy the modem and extra RAM.
- The serial port uses the AT-style 9-pin D connector.
- If you buy the 128k RAM module,

Benchmarks

Intmath	5.22
Realthat	5.11
Triglog	38.72
Textscrn	80.30
Grafscrn	28.86
Store	24.06

All timings in seconds. For a full explanation of the PCW Benchmarks, see the December 1986 issue, page 164.

Technical specifications

Processor:	NEC V40 (Intel 8088-compatible) running at 7.14MHz
RAM:	512k
ROM:	32k containing BIOS
Mass storage:	EZ-1: one 720k 3 1/2in disk drive EZ-2: two 720k 3 1/2in disk drives EZ-3: one 720k 3 1/2in disk drive and one 20Mbyte hard disk drive
Keyboard:	84 keys: 10 function keys, 57 alphanumeric keys, 17 keypad keys
Monitor:	14in monochrome, white on black, 25KHz horizontal scan rate
Display modes:	Text mode (8x16 pixels giving 400 scan lines, 16 grey shades). CGA-compatible graphics mode (640x200 double scanned to 400 scan lines, two grey shades)
Standard interfaces:	Parallel printer port, Zenith mouse port
External expansion:	Zenith proprietary expansion port for either a 128k RAM module or a 128k RAM module with a modem and a serial port
Internal expansion:	Real-time clock (fitted by dealer)
Size:	14insx13insx13ins
Weight:	EZ-1: 28lbs, EZ-2: 29lbs, EZ-3: 30lbs
Bundled software:	Tutorial, MS-DOS Manager
Operating system:	MS-DOS 3.20

In perspective

Zenith's eaZy pc is very much a low-end machine, aimed at the home market. It is very competitively priced when compared with many of the cost-cutting, corner-cutting clones. Comparisons will doubtless be made with the monochrome Amstrad PC1512; the screen on the eaZy pc is much clearer, however. In both text and graphics modes, it shows 400 scan lines — a great relief for the eyes.

The question of disk sizes is a difficult one. In VCR terminology the 5 1/4in disks can be thought of as the VHS of the computer world, with 3 1/2in being like Betamax (smaller, more technically advanced and not as popular). Ironically, both 3 1/2in disks and Betamax were invented by the same people, the Japanese giant, Sony.

Both the Amstrad and the Zenith have 512k RAM as standard, expandable to 640k. The Zenith is smaller and quieter, but lacks the expansion slots, and that is its biggest weakness. It also lacks a socket for an 8087 mathematics co-processor that boosts the speed of applications such as Lotus 1-2-3.

The fact that the eaZy pc crashed when attempting to run WordPerfect Executive gave some cause for concern, although all other software seemed to work just fine.

Microsoft's MS-DOS Manager, as bundled with the eaZy pc, is a nice way to get acquainted with the machine. All-in-all, the eaZy pc is a well-polished, if a little unusual, PC-compatible.

you can't add a serial port or modem later.

Clearly, leaving out the industry-standard PC expansion slots from inside the box has made it smaller, but it's quite a price to pay. It means that the eaZy pc can never be hooked up to a network, can't use LIM expanded memory adaptors, can't be used as a 3278 or 5251 terminal and can't take any third-party expansion devices. For many applications, particularly those within companies where comms is an important issue, the eaZy pc is a no-hoper.

For domestic use, the eaZy pc could be a winner. It is low-priced, small, quiet and self-contained — all important attributes in the home.

Software

For the first time, Microsoft's MS-DOS Manager comes bundled with this machine. Two 3 1/2in disks are shipped with the eaZy pc — one contains MS-DOS 3.20 and the MS-DOS Manager, while the other has set-up programs, a tutorial and GW-Basic.

MS-DOS Manager is a friendly front end, much like Microsoft Windows. Unlike Windows, it is character-based only, so does not

support the more advanced graphics features of Windows. Also, it does not support multi-tasking or 'cutting and pasting' between applications. What it does is simply show the current directory on the screen, and makes mundane file shunting and deleting a little easier. It looks pretty and is easy to use.

At the top of the screen are the four pull-down menu headings, as well as the current time. Pressing the 'Alt' key activates the menus that can be selected by either pressing the highlighted letter (like Microsoft Windows 2) or by using the cursor keys. The main window shows the current drive and directory. Changing drives is as simple as pressing Ctrl-A or Ctrl-B, and running an application involves moving the cursor to the desired program and pressing Enter. Messages of guidance are shown at the bottom of the screen to help you select the appropriate choices.

I have one minor niggle about MS-DOS Manager. When going through the directory, the screen is completely redrawn for each line scrolled and creates a noticeable and irritating flicker.

The setup programs make backups

of the two disks, as well as perform other things such as parking the head of the hard disk on model EZ-3. Also on the second disk is a simple tutorial and GW-Basic for writing your own programs.

For compatibility, I ran Microsoft Works, WordStar 4.0 and WordPerfect Executive. Surprisingly, WordPerfect Executive did not run. After loading, it printed a short, garbled message before crashing the machine. The moral? Test all software on your own machine before buying the program; but if this is not possible, get assurances from your dealer that the software will run correctly — tell them at the time of purchase that you intend to run the software on a Zenith eaZy pc.

I would have run more exhaustive software-compatibility tests, but for the fact that I ran up against the 'disk' problem — all my software is on 5 1/4in disks and Zenith provides no tools to aid the transition.

Documentation

Zenith's eaZy pc comes with three slim but comprehensive guides and a thicker MS-DOS manual. The three slim guides are: the *Owner's Manual*, which leads you through setting the machine up; the *MS-DOS Quick Reference*; and the *MS-DOS Manager*. The thicker MS-DOS manual gives a detailed breakdown of each command, and all four publications are well laid out.

Prices

Starting at £499 (excluding VAT), the eaZy pc is competitively priced: the EZ-1 costs £573.85, the EZ-2 costs £688.85 and the EZ-3 costs £1033.85 including VAT (£499, £599 and £899 excluding VAT).

Prices for optional extras were not available at the time of going to press.

Conclusion

With a built-in monochrome display and very limited expansion potential, the eaZy pc resembles a laptop PC-compatible — except that it is not portable. For lightweight applications such as dedicated word processing, the eaZy pc is ideal. For heavyweight processing, especially with disk-intensive programs such as databases, the eaZy pc begins to slow down. Graphics are very clear, but too low a resolution for serious graphics work.

Is it easy-peasy as the name would imply? Well, setting up the hardware was very straightforward. It is, quite literally, a matter of 'plug in and go'. For first-time PC users and for businessmen and women who want a PC at home, the eaZy pc is worthy of serious consideration.

Zenith is on (0494) 459266.

END

386 operating systems

Next year sees Microsoft's OS/2 enter the market, and this is being heralded as the best thing to happen in the world of 386 system software. Some people can't wait, however, so Nick Walker presents a review of four products that utilise some of the 386's more advanced features.

So you have a shiny new 80386-based IBM compatible on your desk. What are you going to do with it? In 90 per cent of cases the answer seems to be run existing MS-DOS applications. True, they'll run lightning fast, but doesn't it seem a waste to use this wonderful 32-bit multi-tasking processor running single 16-bit applications in a restricted 640k of memory? According to the sales literature, the 80386 is capable of multi-tasking while addressing 4 Gigabytes (4000Mbytes) of memory and yet still retains compatibility with existing MS-DOS software.

The problem is lack of software. There are no applications that use the 386 to its full advantage, and until some 286 and 386 operating system standards are set, there won't be any. The operating system we are supposedly all waiting for is OS/2 — the 80286-based operating system from Microsoft. With luck, initial shipments of OS/2 will begin early next year but I doubt it will become truly useful until 1989.

For those who can't wait or have doubts about OS/2, there is some system software that lets you exploit the power of this processor and it's available now.

In this review, I'll examine four products that make use of the 386's more advanced features. Two of the products are full-blown operating systems: PC-MOS from The Software Link (TSL) and Concurrent DOS 386 from Digital Research.

The other two products co-exist with MS-DOS 2.11 and enhance its functions — Windows 386 from Microsoft and DESQview from Quarterdeck.

Concurrent DOS 386

Digital Research has offered an alternative to MS-DOS for the IBM PC and its compatibles ever since the PC was launched. The 386 is the latest addition to the Concurrent DOS family — a collection of operating systems that offers a high degree of compatibility with MS-DOS applications and also true multi-user and multi-tasking facilities. To be compatible with Digital Research's previous operating systems, Concurrent DOS 386 also offers data file compatibility with CP/M 86. Concurrent DOS 386 uses the advanced facilities of the 80386 to provide a more secure and more powerful variant of standard Concurrent DOS.

Overview

Concurrent DOS 386 is one of the true operating systems of the products reviewed. It does not totally replace MS-DOS but sits alongside it to be called upon when required. Unlike Windows 386 and DESQview, which use the existing MS-DOS to their advantage, Concurrent DOS 386 makes no use of the MS-DOS system or system files once running. What separates Concurrent DOS 386 from previous versions is the way in which it uses the 386 processor — the processor is constantly switched into virtual 8086 mode. In this mode, it behaves like lots of separate 8086 processors running simultaneously, each in its own memory area.

Concurrent DOS 386 is both a multi-tasking and multi-user system capable of supporting up to ten users from a single machine. Each user on

the system is assigned to one of the virtual 8086 processors and can run up to four multi-tasking applications, provided they can generate the right command from their terminals. Using hardware rather than software partitions of the users and tasks ensures that all the users are secure from each other and in theory, any user could have a system crash and recover without disturbing anyone else.

As the majority of MS-DOS applications are not written to be used in the multi-user sense, a number of Concurrent DOS specific applications have been developed (multi-user, multi-access databases, for example). Although Concurrent DOS 386 uses one of the features of the 80386 chip, it sets no standards for running 32-bit native mode software. Using this operating system is, therefore, strictly for running the various varieties of 16-bit software.

Installation

Concurrent DOS 386 has the easiest installation procedure of any operating system I have installed. Booting the system with disk one of the five floppy disks supplied takes you through a menu-driven installation program that copies all the files and determines which facilities are available on the system. Once installed you can choose which operating system, MS-DOS or Concurrent DOS 386, you would like the system to boot up with. If you want the system to start up in Concurrent, an extra command is added to your existing 'AUTOEXEC.BAT' start-up file.

You need a minimum of 512k of RAM and two floppy disk drives,

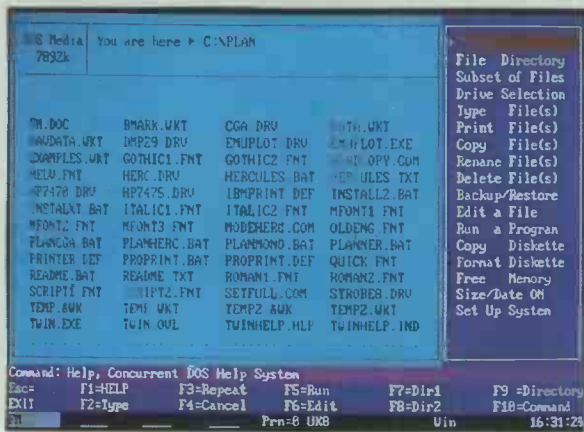

The file manager included with Concurrent DOS 386 offers features similar to Xtree. New applications can be configured, disks formatted, directories searched and programs launched

A simple windowing system is provided with Concurrent DOS 386. The windows are limited to text-based applications and cannot be re-sized when an application is running

although a hard disk is obviously preferable. If the system has more than 640k of RAM, the virtual 8086 mode of the processor means the extra memory is automatically used when required — there is no need for a page memory scheme such as LIM (Lotus, Intel, Microsoft standard). The 386 uses the entire memory space in an ordinary linear fashion. The speed benefit of any extra RAM is highlighted when using the system multi-user or multi-tasking.

The fact that Concurrent DOS 386 doesn't interfere with MS-DOS means that you can quit Concurrent at any time and return to MS-DOS. After installation the first thing to do is run the 'SETUP' program and configure the system. From here you can inform the system of up to five printers connected to both parallel and serial ports and two other users using terminals connected to serial ports.

In use

Concurrent DOS 386's command structure is very similar to MS-DOS. Commands can be executed directly from the Concurrent DOS A> prompt in the MS-DOS fashion; however, a lot of the commands can also be issued from a number of menu programs. The majority of standard MS-DOS commands are supported.

An Xtree-like program can be invoked by pressing the F2 function key or typing FM at the command line. The screen is divided into three: a main panel listing files, a command panel of commonly used operating system commands, and a prompt panel at the bottom which also lists the current function key designations. From this program, you can perform most of the operations normally issued at the MS-DOS prompt. All the usual features of a file manager program are there including launching programs, specifying wild-

cards, tagging files and directory management. Its more unusual features include the manipulation of CP/M media and an integral back-up routine.

The control key in combination with the 1 to 4 numeric keys allows you to switch between multi-tasking applications. The first time the command is issued, a new version of the operating system is launched for that task.

Initially, the four multi-tasking applications take over the whole screen when they are invoked. Concurrent DOS 386 has a system of windows which, in theory, allows you to run applications within windows. However, when I attempted this, I ran into many problems. The first problem was the failure of any program that attempted to use EGA graphics. Digital Research assures me that Concurrent DOS 386 should be able to multi-task one EGA application and have others suspended. A window command or window menu program allows you to display all four tasks on the screen simultaneously. Manipulating the window while the applications are running causes screen conflicts, so Digital Research suggests that you first set up the windows you require before running the application within them.

Windows are only capable of handling well-behaved text applications — CGA or EGA graphics need full screen. All this is extremely limiting and seems to defeat the object of windows. My recommendation is to stay with the default of each task occupying its own screen.

Multi-tasking and multi-user systems have to solve the problems of conflicts over access of a device. For example, two tasks and two users may start to print at the same time and it's up to the operating system to sort it all out. Concurrent DOS will support up to five printers and happi-

ly have all five printing concurrently. All printing runs via a printer spooler file containing all the text awaiting printing, even if two users want to access the printer at the same time. A printer manager program allows the user of the main screen to control this queue of files to be printed.

There are a number of other features which improve upon the facilities of MS-DOS. These include the three commands EDITMENU, RUNMENU and COPYMENU which allow you to create your own menus to control the system. A macro definition facility allows you to change the commands assigned to the ten function keys and numeric keypad keys. In combination with Ctrl, Alt and Shift, 50 macros of up to 20 characters each can be assigned. Six batch files called STARTUP1.BAT to STARTUP6.BAT replace the single AUTOEXEC.BAT of MS-DOS and are run upon start-up. The first four correspond to the four tasks of the main system user and the last two set up the serial terminals.

I was pleasantly surprised by how compatible Concurrent DOS 386 was with existing MS-DOS applications. The two main exceptions are memory resident and badly-behaved programs that insist on using an EGA screen. Digital Research claims that version 2.0 of Concurrent DOS will be able to support both these and will even run the extremely badly-behaved SideKick from Borland.

In the main, however, Concurrent DOS 386 ran 95 per cent of the software I tried on it, including PC Write, PC Outline, GEM, Lotus 1-2-3, WordStar Release 4.0 and Microsoft Flight Simulator version 2.0. Microsoft Word ran smoothly until it came to the spelling checker which loads memory-resident. CP/M compatibility is limited to data file compatibility — the hard disk utility creates a parti-

OPERATING SYSTEMS

tion that conforms to the CP/M standards but this does involve reformatting the hard disk and starting from scratch. Memory schemes such as EMS run perfectly under Concurrent DOS, even when two multi-tasking applications are using it at the same time. I felt sure it would crash.

Very few applications can be made to run on terminals attached to the system, as these have to be strictly text based and use no screen addressing. Even applications requiring the ANSI.SYS screen addressing system will fail when used from a terminal. Release 2 of Concurrent DOS 386 is claimed to support IBM emulation terminals which means that additional users will be able to run straight MS-DOS applications and use multi-tasking.

Concurrent DOS uses the simplest kind of multi-tasking, with each task given 1/60th of a second. The processor just cycles between them in a round-robin fashion: there are no priorities to assign to tasks and the only possible control is to suspend a task. The system seemed quite secure — on a number of occasions, a single task crashed in a way that would normally bring the whole system down but, switching to another task, suspending the crashed one and then relaunching it, rescued the situation.

I didn't have the facilities to set-up a true multi-user system so I was unable to test the system in that sense. The version I used was a three-user version which, with extra cost, can be upgraded to accommodate ten users. Looking at the manual gives the impression that there is very little security in the usual multi-user sense. There is no log-in procedure and no user privilege levels — only a password which can be assigned to files or directories.

Two 'applications' are included with Concurrent DOS 386: a text editor to replace and surpass MS-DOS's EDLIN (not difficult) and a simple card file solely for storing names, addresses and phone numbers. Both are adequate for their purpose but are nothing spectacular.

Documentation & prices

The manual included with Concurrent DOS 386 consists of two separate volumes: the *User's Guide* and the *Reference Guide*. Both are bad but the *User's Guide* is truly awful, leaving me more confused than I was before I consulted it. Digital Research should watch a new user installing and using the system and then re-order and re-index the entire manual. My advice is throw the *User's Guide* away and use the on-line

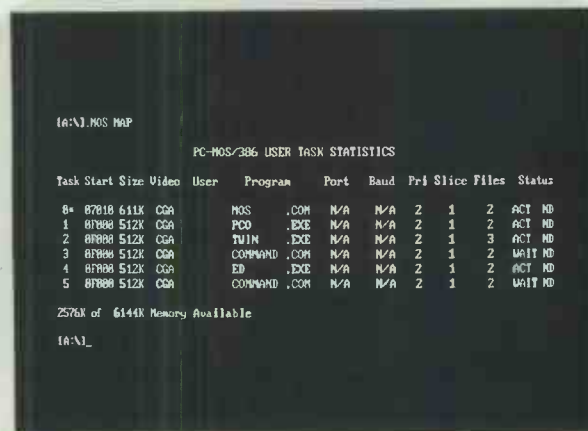

```
PC-MOS/386 USER TASK STATISTICS
Task Start Size Video User Program Port Baud Pri Slice Files Status
0+ 07010 611K CGA MOS .COM N/A N/A 2 1 2 ACT MD
1 07000 512K CGA PCD .EXE N/A N/A 2 1 2 ACT MD
2 07000 512K CGA TWIN .EXE N/A N/A 2 1 3 ACT MD
3 07000 512K CGA COMMAND .COM N/A N/A 2 1 2 WAIT MD
4 07000 512K CGA ED .EXE N/A N/A 2 1 2 ACT MD
5 07000 512K CGA COMMAND .COM N/A N/A 2 1 2 WAIT MD

2576K of 6144K Memory Available
PC-MOS
```

PC-MOS offers a high degree of control over its multi-user and multi-tasking features. The MOS MAP command, shown here, gives a list of all tasks active, which users they belong to, priorities, and memory allocation

help facility and *Reference Guide*.

Concurrent DOS 386 costs £395 for the three-user version, which can be upgraded to a ten-user system for an extra £100.

PC-MOS/386

PC-MOS/386 is The Software Link's (TSL) first attempt at a complete operating system and it is compatible with a large number of existing MS-DOS applications. In addition, PC-MOS offers a multi-tasking, multi-user environment and, most surprisingly of all, a standard of its own for the development of native 32-bit 80386 software. It is the most ambitious of the products reviewed here.

Overview

PC-MOS can totally replace MS-DOS. I believe there is no way both operating systems can exist on the same machine, as PC-MOS actually replaces the system files of MS-DOS with its own of the same name. It uses the 80386 processor in a very ingenious way because it not only uses the virtual 8086 mode, but also switches into native 386 mode to run 32-bit software.

PC-MOS is capable of supporting up to 25 users from a single machine. It distinguishes no difference between a task and a user. The main system user must, however, create a task that activates a user's terminal on a serial port. A total of 99 tasks are available providing you have the memory to run them. TSL applied the limit of 25 users just to maintain a reasonable performance.

No multi-user applications have, to date, been written for PC-MOS. It is strictly a case of one task, one program — two users trying to run the same MS-DOS program or edit the same MS-DOS data file would soon encounter file corruption and system crashes.

Installation

Some warning of the difficulties you can experience installing PC-MOS is given when the manual suggests that you should appoint a technically competent system administrator. In theory, on a hard, disk MS-DOS machine, PC-MOS can just be installed 'over' the current operating system.

According to the manual, installing PC-MOS is as simple as booting it from floppy disk and transferring the system using the .MSYS command in a similar way to the MS-DOS SYS command. I've tried this twice on two different machines and both times ended up with a non-booting machine that can't even be returned to MS-DOS. My suggestion for installing PC-MOS is back-up all your important files, do a low-level format on the hard disk and install it from scratch.

PC-MOS needs a minimum 386 configuration of 512k RAM and two floppy disks. However, there is very little you can do with that — in order to start getting the most out of it, you need at least 2Mbytes of RAM and a 20Mbyte hard disk.

Once installed, the first thing you need to do with PC-MOS is create a CONFIG.SYS file to inform it of your computer's configuration. The format of CONFIG.SYS will be familiar to MS-DOS users with such commands as BUFFERS, COUNTRY and DEVICE. Commands that won't be familiar include: SLICE, to define how much time is allocated to each task; SMPsize, to change the task supervisor's memory size; and FREEMEM, to inform the system of free memory ranges.

In use

One of the big selling points of PC-MOS is that it uses practically the same commands as MS-DOS — fair enough if you like an operating en-

DESQview 2

DESQview is an application integrator, which means that it is a single-user, multi-tasking environment for existing MS-DOS applications. DESQview works on any ordinary PC-compatible but benefits from running under an 80386-based machine. Before covering the advantages of using DESQview on an 80386 machine, I will briefly address the features of DESQview that all users can access (for a complete review of DESQview, see PCW September issue).

DESQview divides processor time between all the applications running on a variable time-slice basis. A basic windowing system means that it is possible for the user to watch all the applications running and act accordingly. One feature unique to DESQview is its use of virtual memory, which means that you can have more programs running than will fit in your computer's memory. When there is no more RAM available of a program, DESQview swaps a program you are not using to the PC's hard disk.

When using an 80386 processor, DESQview automatically invokes the virtual 8086 mode of this processor. This has a number of benefits. Firstly, all the available memory is used before DESQview starts to use the hard disk for program swapping. However, the best aspect of using DESQview with a 386 machine is the autonomy it gives to each multi-tasking program. The separate video memory assigned to each program means that practically everything will run in a

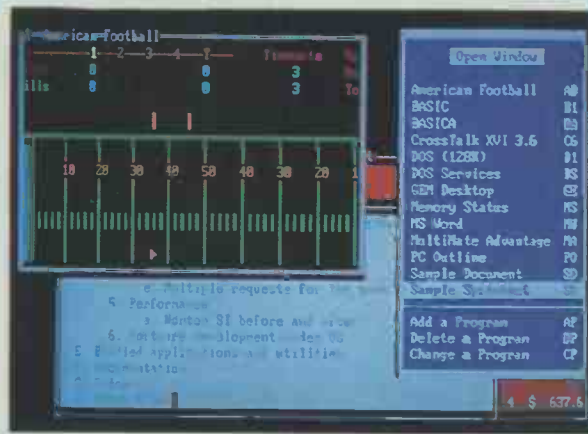

window without affecting any other windows — including CGA graphics programs which are normally suspended; the only exception to this being EGA graphics programs which will multi-task but require the whole screen whenever they are accessed. DESQview 2 costs approximately £125.

environment that dates back to the early 1970s and is probably the single most intimidating aspect to a new computer user. Frankly, I was hoping for something a bit more friendly.

All the old-favourite commands such as DIR, COPY, CD and RENAMED are here, the only difference being that in PC-MOS they should be preceded by a dot (.). There are, however, a few fundamental differences. If you really want to feel at home you can switch off the need for a dot, but this increases the time spent on executing each command.

PC-MOS improves upon the standard MS-DOS commands in a number of areas. One of the useful and yet simple extensions is the ability to scroll through previous commands by using the 'up cursor' key. This allows you to edit and re-issue commands as required. PC-MOS also increases the wildcard function available using the two commands .EXCEPT and .ONLY. For example, to delete all the files except .DOC file, you issue the command '.EXCEPT *.DOC DO .ERASE'.

The PC-MOS multi-tasking facilities are activated via a series of memory partitions set up by users. The command .ADDTASK creates a partition and has parameters to: specify the memory required; give the task a number (defaults to 1 plus the highest task currently running); give a security level to the task; specify a batch file for the task to run upon creation; specify the type of terminal a new user running under the task is using; specify the serial port of a user's terminal; and set the baud rate of a terminal. The Alt key and the numbers on the numeric keypad allow a user to access any task from the main console or from suitably configured workstations. Most parameters are optional — for example,

'ADDTASK 128' is enough to specify a single task of 128k. With each new task, a new version of PC-MOS is launched from which you can run any applications.

PC-MOS offers no windowing system for the display of multi-tasking application, and each task takes over the entire screen when viewed. Once a task is launched, it is possible to adjust the size of memory allocated to it using the MOS SIZE command. From the DOS (PC-MOS) prompt it is possible to remove the task and get a complete map of all the tasks and what they are running.

PC-MOS offers more control over the multi-tasking environment than any other system I have used. For example, it is possible to adjust the amount of time that each task is assigned. The default value of each time-slice is 1/18th of a second; this can be increased by the command MOSADM to around 14 seconds.

To further confuse things, it is also possible to change the priorities of tasks. The task with the highest priority will always get processing time before any task with a lower priority — of course, when waiting for input or writing to disk, there is plenty of time for the other tasks to run. It is imperative to restrict the access to these task commands, otherwise you will have users locking everybody else out of the system.

As far as MS-DOS applications are concerned, PC-MOS is not as compatible as might be desired. About half of the MS-DOS applications I tried worked satisfactorily, although this does include some notoriously badly-behaved programs. Among the programs that *did* work were Lotus 1-2-3, WordStar Release 4, dBase III, Harvard Graphics and PFS: Write. PC Outline, PC Write, the Microsoft Flight simulator, GEM and Windows

proved too much for PC-MOS to handle. There is no support for programs that use the EGA graphics standard, so any EGA cards you have will spend the rest of their lives emulating the lesser CGA graphics standard.

To be fair to both TSL and Digital Research, the problems with EGA cards are not easily solved. Certain registers on the EGA graphics card are write-only (yes, write-only!) so there is no way of returning to a previous state of the card. In the majority of cases, a task could crash and not affect any other task; but even in this case it is hard to get the memory back to relaunch the task without rebooting the entire system.

The most worrying problem, however, is the number of times a single-task crash brought down the entire system (14 times over a period of three weeks). With a possible 25 users, that could be a lot of data lost.

PC-MOS can support a wide range of terminals. By far the most flexible terminal to use is the new Wyse 60 (or similar) which simulates IBM PC monochrome or CGA screens. Using one of these terminals, additional users should be able to run practically all applications. Using straight serial terminals restricts you to strictly text-based applications and then without fancy screen addressing.

As far as printing is concerned, PC-MOS maintains a printer spooler file — a list of everything awaiting printing which it feeds to the printer at a manageable rate. Two programs are used in this operation; a spooler and a print processor. The spooler is invoked in all tasks where spooled output is required; the print processor needs a task of its own dedicated to the spooling operation, and controls printing of spooled files.

PC-MOS has considerable facilities

Windows 386

Microsoft's first offering to the 386 software scene is Windows 386, a version of its graphics environment. Windows is a single-user multi-tasking environment that is capable of running existing MS-DOS applications but is really designed to run specially-written Windows applications. Windows applications make use of the WIMP (windows, icons, menus and pull-down menus). A variant of Windows will eventually be used as the standard front-end to Microsoft's OS/2 operating system, so if you are considering using OS/2, getting acquainted with Windows will probably ease the transition.

Windows 386 'feels' exactly the same as its lesser sibling, the soon to be announced Windows version 2.0. Release 2 of Windows introduces cosmetic changes to the system in that the 'tiling' system of window management has been replaced by overlapping windows. Under the tiling system, the entire desktop area is always covered by the open window. With Windows 2 and Windows 386, each window is individually resizable and movable in a similar way to the Apple Macintosh. It's surprising just how much easier Windows is to use because of this change.

Windows 386 uses the virtual 8086 mode of the 80386 processor for each task. Not only does this ensure that the full addressable memory space is used without the need for an extended memory scheme, but it should also mean that the failure of a single task is less likely to crash the entire system. Fortunately, I had a beta copy of a Windows application with

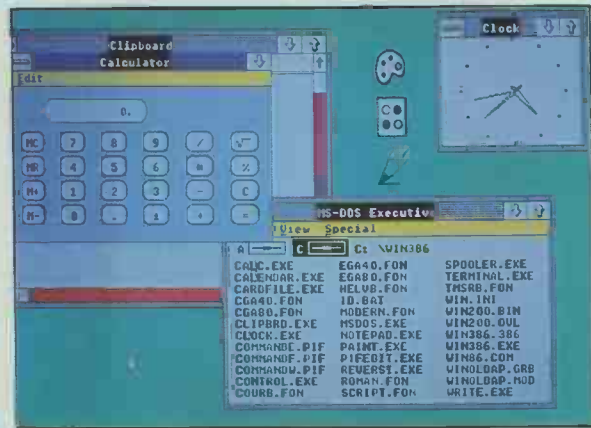

which I could generate a situation that caused the whole system to crash. Sure enough, with Windows 386, everything else kept going and the application died within its own resizable window — very impressive. I couldn't find any way to close down the crashed window from here, but at least you can save all your other data files before re-booting.

No price had been decided for Windows 386 at the time of writing.

for the setting up of security if needed. You may secure files or entire directories from unauthorised use, and assign your own password and user ID codes. PC-MOS security lets you selectively determine levels of access for users to individual files, directories and multi-tasking partitions. If you are really concerned about the security of your system, however, you can encrypt files using a built-in encryption facility.

PC-MOS includes a text editor and debugger as standard with the system; both are considerable improvements over MS-DOS equivalents DEBUG and EDLIN.

Documentation & prices

One 300-page manual is included with PC-MOS/386 and, considering its size (small by operating system standards), it does a very good job. I was particularly impressed to find a number of occasions where TSL admits the limitations of PC-MOS and offers advice on how to overcome them.

PC-MOS costs £195 for a single-user volume, £595 for a five-user system and £995 for 25 users.

Conclusion

The first question you need to answer when deciding on 386 system software is: Do you want to go the whole hog and use the system as a multi-tasking, multi-user environment? If the answer is yes, then only Concurrent DOS and PC-MOS/386 will be able to provide this. If all you

Multi-user, multi-tasking and concurrency

One of the most confusing aspects of computing is the definitions of multi-user, multi-tasking and concurrency. This is mainly due to manufacturers' over-optimistic claims, particularly those claiming that multi-tasking programs are, in fact, concurrent.

A multi-user system is one where a single processor looks after the activities of two or more users working via terminals. The terminals have little or no processing power of their own and are connected to the main system by a serial link. It is up to the main system to share its processor between all the users — obviously, the more users there are on a system, the more powerful the main system has to be. Multi-user systems are commonly confused with networks; however, a network consists of a number of systems — all with their own processing power — sharing common resources such as a large-capacity hard disk, laser printers and modems.

A system is said to be multi-tasking when it gives the impression of running more than one application simultaneously. In fact, the processor is dividing its time between all the applications which are running, with each application waiting its turn to gain a few moments of the processor's time. The simplest form of multi-tasking is *time-slicing*, where each task is given the same amount of time. An alternative system uses priorities, and applications which require a lot of processing power can be given more time than, for example, an application that is busy printing.

With concurrency, a number of applications are actually running simultaneously. In order to do this the computer system needs multiple processors, at least one for each application running concurrently. True concurrency is still rare among microcomputers.

want to do is enhance the machine capabilities as a single-user environment, then both these products represent considerable overkill.

For a single user, the choice is between DESQview 2 and Windows 386. If you already have a collection of MS-DOS software, DESQview offers the best solution for getting the most out of it. Windows 386 is more likely to appeal to a new user who wants to be right up to date with current standards in applications software. When OS/2 finally becomes available, the number of Windows applications will boom.

As for the choice between Concurrent DOS 386 and PC-MOS/386, I

reached the following conclusion. PC-MOS/386 is by far the most capable of the two systems. It offers up to 25 users, with each user capable of multi-tasking applications; it also offers a standard for the development of 32-bit software. The problem with PC-MOS/386 is that it's a bit flakey and I certainly wouldn't want to trust 25 users' data to it.

Concurrent DOS 386 is altogether less ambitious but, after years of development, it is a far more robust product. At the moment, my choice is Concurrent DOS 386 because of its reliability, but given another year's development, PC-MOS/386 will probably prove superior. **END**

LOGITECH MOUSE

From the World's leading Mouse Experts

At LOGITECH, we have spent years developing the most advanced mouse hardware and software and we have earned the reputation of the world's leading mouse experts. As proof of our unsurpassed engineering, the LOGITECH Mouse has been chosen by many of the world's largest computer manufacturers - Apollo, AT & T, DEC, Epson, HP, Nixdorf, Norsk Data, Olivetti, Zenith.

Our mouse and bus mouse are high quality products, offering you the latest mouse technology at the lowest available price.



Purchase our best selling LOGITECH Serial Mouse or Bus Mouse and Plus Package (including Mouse Driver, Click, Logi-

menu, Point & Click Shell for Lotus 1-2-3, Point, Text Editor) with CADD, Paint and Publisher software at very affordable prices. Each package is a complete solution that gets you the results you need right now.

Advantages and main features

- High resolution (200 dpi) - a must for all CAD / CAM applications
- Opto-mechanical technology offering the best of both worlds - optical precision and the rugged durability of mechanical technology
- Reliability
- Ergonomic design, no need for grid or pad
- Compatibility with all the major hardware and software
- Easy to install, easy to use
- Best mouse software

 LOGITECH

LOGITECH U.K.
Linford Forum, Rockingham Drive
GB-Milton Keynes, Bucks, MK 146 LY
Tel. 908 67 99 76

SILICON EXPRESS LTD.
Silicon House, Fowke Street, Rothley
GB-Leicestershire, LE77 9PJ
Tel. 533-37 49 17

SOFTSEL COMPUTER PRODUCTS LTD
Softsel House, Syon Gate Way
Great West Road, Brentford, GB-Middlesex TWB 9DD
Tel. 1-568 88 66

SOFTWARE LIMITED
2 Alice Owen Tech. Cent., 251 Goswell Road
GB-London EC1V 7JQ
Tel. 1-278-23 77

*Get your hands
on more
solutions*



LOGITECH has selected for you some of the highest performance graphic applications to be bundled with the Mouse or the Bus Mouse.

CADD Solution

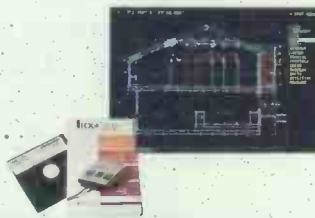

The LOGITECH Mouse, Plus Software and LOGICADD (Generic Cadd 3.0 plus DotPlot). Everything to turn your PC into a full featured CADD workstation. It is the complete solution for dimensioned line drawing and CADD.

PAINT Solution

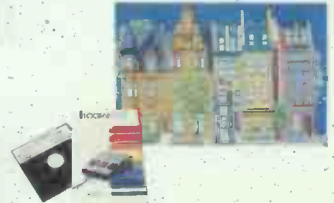

The LOGITECH Mouse, Plus Software and LOGIPAIN (PC Paintbrush). With 11 types fonts and a 16 colour palette, it's the paint set that's used by professionals and beginners alike.

DESKTOP PUBLISHING Solution

The LOGITECH Mouse, Plus Software and PUBLISHER Software (PFS: First Publisher). It's the complete package that makes it easy to produce high-impact, professional-looking documents.





Monoputer

The much-heralded Transputer is at last available on a reasonably-priced PC add-in board from MicroWay. Howard Oakley has become hooked on its speed and power, and describes the hardware and software now available for the more adventurous user.

There can hardly be any computer enthusiasts who have not heard of Inmos' Transputers, and most of us have dreamed hard and waited long to get our hands on one. The original Inmos evaluation board, designated the B004, was relatively expensive — especially when bought with the development system software (TDS) — and can still only support the T414 Transputer rather than its faster and more powerful big brother, the T800.

Earlier this year, the British-based European subsidiary of MicroWay Inc (well-known for its specialist knowledge and support of the 8087 and other co-processors and accelerators) started to market what is essentially a cheaper and improved version of the B004, which can take either the T414 or T800 chips, and bundles an Inmos-written Occam-2 compiler with it. The board fits into any IBM PC, AT or compatible, so offering itself to the widest possible market.

I received my Monoputer board at the end of June, and it has now had over two months of intensive evaluation. Although the hardware — and much of the software — described here has been used in final-release form, they are but the start of a new wave of Transputer-based add-ons. The recent announcement that Atari is to design a whole machine based on the Transputer came as little surprise, and I expect several other manufacturers to follow suit over the next few months. However, this board is available now, at relatively low cost, and could give a taste to developers and others of what this next wave of machines will be like.

Hardware

The Monoputer board is, like most Transputer-based products, a fairly simple piece of hardware. It occupies one long slot in a conventional PC

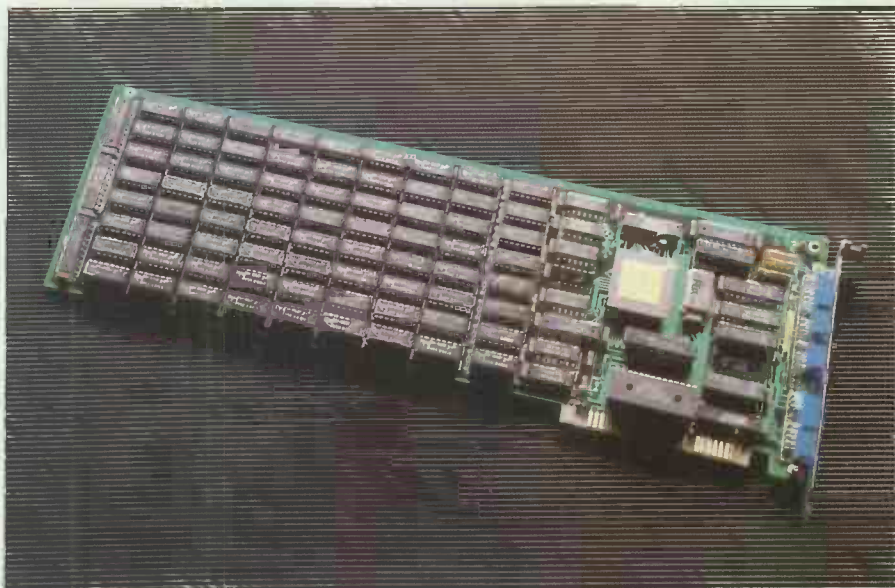

clone, and consists of one Transputer (which can be a T414 or a T800 — they are pin-compatible), 2Mbytes of RAM, and the supporting chips to enable I/O with the host.

The board is designed to act as a prototype card, in that it is normally seen to be at addresses hex 300 to 31F as far as the host PC is concerned. However, the external interface consists of three D connectors, two of which sport jumpers which must be correctly configured to support use of the correct I/O links. In the near future it may be possible to use these to link to other devices (such as Transputers), but this will be of little use unless you buy a special-purpose board (such as MicroWay's graphics board). In its current configuration, the host occupies one of the board's Transputer links.

Installing the hardware is simple, as no hardware or DIP-switch reconfiguration is necessary. The job is made a little more complicated,

though, because it is easier to remove the external jumpers before putting the board in, so you should make note of their exact location for replacement purposes.

When the jumpers have been replaced and the machine reassembled, you can power-up and run the Transputer. The only problem that you might experience is at which addresses the file server functions on the PC will look for the I/O links for the Transputer: on IBM PCs, the base is hex 300; on Amstrads, hex 150; and other machines may vary again. If the base address differs from the default, it can be set when you call the host file server (to load and run any Transputer program), and should then be embedded in all batch files which call the server.

The optional upgrade to a T800 is a very important one. The T414, while running at 20MHz clock speed and thus offering the full 10 MIPS (million instructions per second) of

'real' Transputers, was designed as something of a stop-gap. It carries out all floating-point arithmetic routines in software, and has only 2k of fast 'on-chip' memory. The Benchmark timings on page 116 may look impressive, but they are only for a T414 running at 20MHz. When you upgrade to a T800 (another £250 or so on top of the cost of the T414, but all prices are likely to keep falling), you have a hardware floating-point unit which accelerates all the maths routines, and 4k of fast memory which can be filled with commonly-used variables and code subroutines. The net effect is to halve most Benchmark times, except for those which involve floating-point maths, which are reduced even more dramatically.

It is puzzling that MicroWay's board appears to be the only cheap board of its kind which supports both the T414 and the T800. Apparently, the design modification to allow this is not major or costly, but the benefit to the user is great: at present, T800s are in short supply and considerably more expensive, so you can start off with a Monoputer board and the T414, upgrading later. However, suppliers are going to be very reluctant to take back T414 chips when there are good supplies of the T800, so do not plan on getting any allowance on your old chip. It would also be worth your while being very careful when pulling Transputer chips to do a swap — they break easily!

Software

Operating system

The Monoputer board runs using a file-server program under PC- or MS-DOS. In the case of the bundled Occam-2 compiler, programs run in parallel with a pair of Occam processes which pass messages to and from the links with the host PC. A simple MS-DOS program, AFSERVER.EXE, runs on the host PC to convert these messages into calls to the host operating system. Your Occam-2 program thus calls various file-server functions to read the keyboard, write to the screen, access host files, and so on, by passing messages through Occam software channels to the Occam file server, which then passes the message to the PC, which carries out the action required and returns a result which goes back over the link to the Occam file server, and so to your program.

This means that every program written and compiled for the Monoputer must be linked with two parallel processes and then run under the host file-server program. Unfortunately, this does not make the best use of the Transputer's speed, and the Benchmarks reflect this. Inmos has Benchmarked the T414 using a separate chip to handle the host interface, and reports times

roughly half those which I have given here; so, if the server overhead can be reduced, your programs will run much more quickly still. Some users — myself included — are currently examining ways in which this can be achieved (including sequential and asynchronous host access).

However, for someone used to fairly low-level access to the PC's facilities, the file server is almost complete in the support it provides. It allows you to write to and read from host memory blocks, call BIOS and DOS interrupts, and do most tasks short of pushing and popping the stack (required for TopView, for instance). The host server is also 'well-behaved' in that it does not modify interrupt vectors or (necessarily) directly manipulate hardware. Therefore, it will run under TopView, Windows, or other host operating environments, even if it will not actually make the most of their added facilities. Provided that your Occam program does not make too many demands on the host, such host-based multi-tasking can be very useful as it does not slow the Transputer at all.

The greatest problems with the file server become apparent when using an Enhanced Graphics Adaptor (EGA). As you can only write pixels on the EGA by means of interrupts and not (as with the CGA) by writing direct to memory, a program which is graphics-intensive becomes bound by the slowness of the file server. A classic example of this is in displaying the Mandelbrot set, which can be calculated amazingly quickly (typically, times of a couple of minutes for an EGA screen) but then requires, say, four minutes for the pixels to be written to the screen. The answer must lie in using a graphics adaptor in which the screen is mapped into accessible memory, or even a Transputer-based graphics board which bypasses the host altogether.

Accessing the file-server functions from parallel processes is no easy matter. One software channel is provided in each direction to communicate with the Occam server, so only one process at a time can access host facilities. If you allow two or more processes to try access in parallel, disaster soon strikes when messages become confused or deadlocked. On the other hand, it makes a lot of sense to run processes such as reading the keyboard and writing to the screen at the same time, and code for this runs very efficiently on the board.

One answer lies in creating a third process to coordinate server access, as shown in the example program above (reproduced with permission from the compiler manual). This kind of tool could easily be provided with in a more sophisticated file server,

```

PROC tester.program(CHAN OF ANY from filer, to filer)
#USE "C:\OCCAM2\FLIBST4.OBJ" -- those are the two file server channels
#USE "C:\OCCAM2\IDCDW32.OBJ" -- and these are library files
VAL CloseOption IS 0: -- constant definitions
VAL f.ok IS 0:
VAL ReadKey IS 29:
VAL ready IS TRUE: -- BOOLS for use in channels
VAL go IS TRUE:
VAL stop IS FALSE:
VAL done IS FALSE:
VAL err1 IS 1:
VAL err2 IS 2:
VAL err3 IS 3:
INT len, screen.id, keybd.id, result1, result2:
[1]BYTE outchar: -- write.block only works on arrays
BDGL more, running:
CHAN OF BDGL scwrre, scwrck, kbrere, kbrack,
clckre, clckoc: -- one CHAN in each direction for each
CHAN OF INT kbtosc, antoer: -- PAR process with controller
SEQ
more := TRUE -- more keys to read
running := TRUE -- program still running
outchar := ""
open.output.stream(from filer, to filer, 0, screen.id, result1)
open.input.stream(from filer, to filer, 0, keybd.id, result2)
IF -- these open file server streams
(result1 = f.ok) AND (result2 = f.ok)
PAR -- these are the parallel processes:
INT keyint: -- (local variables)
BDGL fine: -- 1. KEYBOARD READ
SEQ
WHILE more
SEQ
kbrere 1 ready -- to controller, ready to access
kbrack 7 fine -- wait for go ahead from controller
IF -- (chan 1 var outputs var to chan,
fine -- chan 7 var inputs from chan to var)
SEQ
write.integer(to filer, ReadKey) -- read 1 key
read.integer(from filer, keyint) -- stroke
read.integer(from filer, result1)
kbrere 1 done -- tell controller we've finished
TRUE
result1 := 1
IF
result1 = 0 -- we have a keystroke, so
kbtosc 1 keyint -- send integer value to screen
TRUE
SKIP
INT keyint: -- (next local variables)
BDGL fine: -- 2. SCREEN WRITE
SEQ
WHILE more
SEQ
kbtosc 7 keyint -- get integer from keyboard read
outchar[0] := BYTE(keyint) -- convert into byte array
scwrre 1 ready -- do AFserver controller protocol
scwrck 7 fine
IF
fine
SEQ
write.block(from filer, to filer, screen.id,
outchar, len, result2)
scwrre 1 done -- char written to screen
IF
keyint = 13 -- if return pressed, quit
SEQ
more := FALSE
clckre 1 ready
clckoc 7 fine
IF
fine
SEQ
-- close down
close.stream(from filer, to filer,
screen.id, CloseOption, result1)
close.stream(from filer, to filer,
keybd.id, CloseOption, result2)
terminate(filer from filer, to filer,
result1) -- close streams & quit
running := FALSE
clckre 1 done
TRUE
antoer 1 err1 -- error message
TRUE
SKIP
TRUE
antoer 1 err2
BDGL req: -- 3. AFSERVER ACCESS CONTROLLER
SEQ
WHILE running -- this is a series of alternative processes
PRI ALT -- note priorities in ALT are highest = first
clckre 7 req -- wanting to do close & terminate
IF
SEQ
clckoc 1 go -- give go ahead
clckre 7 req -- and wait until complete
TRUE
antoer 1 err3
scwrre 7 req -- wanting to do screen write
IF
req
SEQ
scwrck 1 go
scwrre 7 req
TRUE
antoer 1 err3
kbrere 7 req -- wanting to do keyboard read
IF
req
SEQ
kbrack 1 go
kbrere 7 req
TRUE
antoer 1 err3
INT err (1, 3):
[2]BYTE answer: -- 3. DEMO ERROR HANDLER
SEQ
WHILE running
SEQ
antoer 7 err
IF
err = 0
SEQ
-- Insert your error handler code here!
write.block(from filer, to filer, screen.id,
"i've fallen over", len, result1)
answer := ""
INITOSTRING(len, answer, err)
write.block(from filer, to filer, screen.id,
answer, len, result1)
-- then do close or debug as desired
TRUE -- i.e. if err = 0
SKIP -- do nothing and then get on with program
TRUE
SKIP

```

which could also provide libraries of operating system functions at a higher level and so form a primitive operating system for the board itself — an enhancement which many users would value.

Occam-2 standalone compiler

If you wish to access all the facilities of a Transputer, Inmos claims that you should write your programs in Occam. The compiler bundled with the MicroWay board was produced by Inmos and is compatible in almost all respects with the far more expensive TDS. The two main omis-

CHECKOUT

sions are an editor, something most users will be quite happy with as it enables them to use their own favourite with a clear conscience; and the configurator program which sets up linked code to run on different hardware configurations, and which is irrelevant for programs to run on this board alone.

Occam is a sparse language, not dissimilar from the Pascal family, and has unique features for parallel processing (a cursory glance at the example program in this article will reveal some of its differences). This implementation has some restrictions from the standard language definition, but none that should cause much concern as they can either be circumvented easily (for example, the lack of ports, which can be simulated by channels placed at fixed locations in memory) or prove irrelevant (such as the omission of CASE as a process, as IF can have multiple condition-choices). There are a few rough corners still, such as the fact that segments of arrays must be of a size given by a variable or a constant but not an expression, and problems with word alignment when you re-type BYTE variables.

However, when you start to compile an Occam program, you realise that the compiler was not designed for the faint-hearted. In the first instance, every Occam program must run under a 'harness', a short, prefatory section of Occam code which must be re-edited for every new program. You then run a change control utility on that harness source so that library and program files which must be linked together can be identified. Next, you compile your own source, then that of the harness, using different compilation options. Finally, you link all the object files — either using the output from the change control utility (the easy option) or a long and error-prone command line. If this sounds long-winded and unnecessarily unfriendly, it is. Most users resort to a batch file, but this causes problems if errors occur during the initial compilation.

With reference to errors, the compiler unfortunately halts and aborts when it finds your first error. If you are prone to making a few little typographical errors in your source code, or when you are first learning Occam, you might wish that it had the courtesy to inform you about a few more each time. As Occam is very sensitive to little things such as the number of spaces by which each line is indented, and is a heavily type-orientated language, frustration is common during the early learning phase. As you generate less errors, you start to appreciate the fact that in- and out-dentation dictate program

structure. You do not have to insert a host of semicolons and dreary ENDS, and the richness of some of the language's unique features will become apparent to you. For myself, it is a relationship which began with hate, but is now approaching something like love.

The machine code generated by the Occam compiler is closely related to its source — indeed, there is a facility for inline assembly (using a subset of the Transputer opcodes) which may prove useful to those prepared to flout the Inmos' ethic that writing assembler is playing with fire.

The documentation for the compiler was initially very poor, but a new version of the manual is now supplied and this should provide almost all the information which you might require in an accessible way.

In summary, although this compiler is rather unfriendly in operation, it is otherwise an ideal bundled compiler if you wish to run parallel processes. If you are reluctant to learn Occam and see no practical use for its features, then this compiler is unlikely to tempt you towards the Inmos camp.

Lattice Logic's C Compiler V1.3

Although originally commissioned by Inmos, Lattice Logic of Edinburgh is now selling a range of other language compilers through MicroWay. This implementation of C has just gone to full release, and supports a full *Kernigham and Ritchie* standard with additional features almost to the level of an established PC standard like Microsoft C Version 4.0. In operation it is very much simpler than the Occam-2 compiler, as in most instances you merely compile your source and link it with the libraries provided, using two simple command-line entries. However, if you are trying more sophisticated things, such as linking your own libraries and using your own harness, or linking object files from other languages, all the complex hooks and options are provided.

'Include' files provided are: ASCII, ASSERT, CHANIO (supporting low-level access to links), CTYPE, DOS

(providing compatibility with Microsoft C), ERRNO, MATH, SETJUMP, STDIO, STRING, and TIME (to the ANSI standard). No allowance is currently made for Occam-style use of channels to communicate between processes, or parallel processes themselves, except by linking C programs within an Occam harness.

There are a few puzzling omissions from the implementation — for example, the 'rand' and 'srand' functions are still not provided. In general, though, this is a complete and professional version of C. It is remarkable in surpassing Occam in its performance, under certain conditions. Lattice Logic has taken a good deal of time and trouble to optimise use of the fast on-chip memory, and this becomes particularly worthwhile when using the T800. For example, the 'triglog' Benchmark has been reported to run twice as fast under C than under Occam, when using a T800. I suspect that, as there are no such differences on the T414, it shows a deficiency in the Occam compiler for T800 targets too.

Pascal and other languages

Lattice Logic is also supplying a very pleasant implementation of Pascal which is now becoming available in its full release version (1.2) and is conforming to BS 6192:1982, level 1 (which is functionally equivalent to the ISO 7185 standard). For those who wish for a more Modula-like version, it comes with extensions to allow modules, inline assembly, relaxation of type-checking, short (32-bit) reals, and so on. The purist will be pleased that these only operate if you deliberately invoke a compiler option.

I have been particularly impressed with the friendliness of this compiler, as its error messages come close to telling you just what you should correct and are thoroughly documented. The major omission, which I suppose is inevitable in a Pascal centred on the ISO standard, is a complete lack of graphics facilities. I understand that Lattice Logic is addressing this, and graphics modules will probably be placed in the public domain soon.

The Benchmarks for Pascal seem

Benchmarks

	Occam-2	Lattice Logic C	Pascal
Intmath	< 0.01	< 0.01	< 0.01
Realmath	0.09	0.32 *	0.4 *
Triglog	0.53	2.8 *	5.0 *
Textscrn	150	232	232
Grafscrnt	103	150	—
Store	7.6	3.2	—

Notes: * Using 64-bit IEEE floating-point reals

† IBM screen mode 4 (medium-resolution CGA)

For a full explanation of the PCW Benchmarks, see the December 1986 issue, page 164. All programs are compiled.

perfectly respectable when you consider the additional run-time overhead that the language demands.

Lattice Logic is also marketing what is claimed to be a full-featured Fortran 77, now on full release too, although I have not had the opportunity to examine that yet.

There are a couple of other C compilers shortly to become available, one from Norway and one from the US. I have looked at a very fast Prolog interpreter, from Coherent Research Inc (US), which offers a good Clocksin and Mellish-style Edinburgh syntax implementation which is the fastest AI language I have ever seen. The machine hardly seems to take any time in backtracking, and always generates output very quickly. Version 0.4 offers 56 predicates, and comes with a lovely display of logic programming in setting a monkey a goal as a task. The result is a blow-by-blow account of the actions required to achieve that goal, generated at lightning speed.

I hope that MicroWay intends to market this interpreter, and that Coherent is going to expand the number of predicates to take it up to a full-blown and user-friendly Prolog implementation, as it alone could be a good reason for filling a lot of PCs with Monoputer boards.

Applications

The only current application which appears to be available for the Monoputer board is Predict, a numerical forecasting package which is claimed to be so number-intensive that it really needs a maths co-processor, an 80386 or a Transputer before it is a practical proposition.

There are a number of demonstration programs available from the Transputer Users' Group or written by MicroWay. These include the inevitable Mandelbrot graphics, Conway's Game of Life (a classical example of parallel programming) and a shareware disassembler.

Benchmarks

Benchmark times are given for three of the compilers reviewed here. They were carried out on a T414 Monoputer board running in a standard IBM PC/XT (4.77MHz) with an IBM Colour Graphics Adaptor, a standard IBM 10Mbyte hard disk, and PC-DOS 3.0. I have not run the other host-bound Benchmarks for Pascal as they are little different from C, using almost identical file-server code.

You may, for interest, like to compare these timings with those for 80386 machines (without a maths co-processor) and the Acorn Archimedes (allowing for its use of interpreted Basic — see PCW August). The T414 Monoputer board certainly matches the best, and all indications are that a single T800 will outperform any other microcomputer when compared for 'onboard' Benchmarks. The slowness of the host file server is all too apparent, though.

Documentation

At present the Monoputer board does not come with a hardware manual, but this should be available shortly. The manual for the Occam-2 Standalone Compiler has been rewritten and should now prove thorough and clear, but does not include a tutorial in Occam; I would recommend Dick Pountain and David May's *Tutorial Introduction to Occam Programming*, published by Collins, which may even convert those who see little point to the language. I find the Inmos documentation on Transputers rather opaque, and would like to see a text which covers the chips and their instruction sets in detail but in a lucid way.

Future hardware

MicroWay and other suppliers of Transputer boards are developing more new and potentially revolutionary products than any other sector of the industry. Over the next few months, expect to see a broadcast-

quality graphics board, multiputer boards and more, as well as add-ins and add-ons for other machines (Kuma, for instance, is already selling a peripheral for Atari STs). Surprisingly — and thanks to Inmos — British firms lead the world for once.

Conclusion

It's available, it's reasonably cheap, and it's now quite well-supported by a range of languages. But is it useful? As the Monoputer board stands now, it could serve as a specialist accelerator for those who have computation-intensive tasks of any type. It could well have a significant impact on the City, for instance, in providing much faster analysis and forecasting. This board is really the tip of an iceberg, though. When you can push output to a Transputer-run graphics engine, more markets open up — and they should prove market leaders for really fast high-quality graphics.

The two major drawbacks seem to be the host, and the lack of an operating system which can cope with varying hardware configurations. Frankly, PC clones may be the most popular boxes around, but they are too slow and crude to do justice to the Transputer. It is essential that some form of operating system be available soon to cope with the problem of running programs on multiputer boards: at present, any program can only be configured for a specific hardware setup. If I write and compile an application for the T414 Monoputer board, it will not make use of a brace of T800s on someone else's board, say.

If you do decide to go for Transputers, I would recommend that you join the Transputer Users' Group. Topics which I have touched upon in this review are the subject of whole articles in its newsletter, and the group can always put you in touch with someone who can help.

Would I recommend the Monoputer board? If you are a hardware or software developer, and you want to be at the leading edge in a couple of years time, you have to buy one and start learning soon. If you have a vertical-market application which still runs slowly, or could benefit from a lot of processor power, then you will be delighted with one, when your software runs on it. If you are into high-quality graphics, it will be the cheapest professional system. If you're a hacker or techno-yuppie, you should have one already.

Prices

MicroWay Monoputer board T414-20, 2Mbytes RAM, Occam-2 compiler	£1495
MicroWay Monoputer board T800-20, 2Mbytes RAM, Occam-2 compiler	£1750
MicroWay Quadputer board 4xT414, 1Mbyte RAM each	£3690
MicroWay Quadputer board 4xT414, 4Mbytes RAM each	£7440
MicroWay Quadputer board 4xT800, 4Mbytes RAM each	£8700
Lattice Logic C; Pascal, Fortran compilers, each	£475
MicroWay/Inmos Occam-2 standalone compiler, separate	£475
Inmos Transputer Development System	£1500
Coherent Prolog Interpreter	Price to come

All prices are exclusive of VAT.

Technical specifications

Processor:	Inmos T414-20 Transputer
RAM:	2Mbytes, plus 2k on-chip
ROM:	None
Host:	IBM PC, AT or compatible, requires one full-length expansion slot
Host operating system:	PC-DOS or MS-DOS version 2.10 or later
Bundled software:	Occam-2 standalone compiler, file server

MicroWay is on (01) 541 5466.

The Transputer Users' Group can be contacted by sending a reply-paid addressed envelope to: TUG, Brooklands Lodge, Park View Close, Wroxall, Ventnor, Isle of Wight PO38 3EQ.

Howard Oakley is a naval medical officer involved in physiological research, and is a computer addict both at home and at work. **END**

From chaos to beauty

From the depths of scientific mystery and a basic knowledge of mathematics, weird and wonderful designs can be produced, from a computer with graphical output. Barry Martin and Mike Mudge present a kaleidoscope of patterns and figures.

'Chaos' is a respectable scientific discipline emerging in many areas, ranging from turbulent flow through population dynamics, heart cell dynamics and neurological patterns to the study of lasers. Any readers interested in the underlying theory can refer to the publication, *The Universality of Chaos*, a collection of papers edited by Predrag Cvitanovic and published by Adam Hilger (1984). However, with no knowledge of the theory and only a minimal knowledge of basic mathematics, patterns and designs of breathtaking beauty and intricacy can be produced — all that is required is a microcomputer with graphical output. Colour graphics, although not essential, can be used to produce subtle effects

and attractive designs.

The procedure is based on iterations of ordinary real numbers. A starting point (x_0, y_0) is chosen and then successive points (x_1, y_1) , (x_2, y_2) , and so on, are generated using some mathematical function. A digital computer plots the points so quickly that it appears as if electronic raindrops are falling onto the graphics screen. Eventually, after a thousand or so points have been plotted, a pattern begins to emerge. Patterns can be varied by changing the starting point or by changing numerical parameters in the mathematical function, thus giving infinite variety from any one point generator.

Do not, however, get the impression that the formulae have to be

complicated in order to produce exotic patterns. Very simple formulae using, for example, functions such as $SGN(x)$ and $SQR(ABS(x))$, which are available on all micros, can yield exquisite designs as can be seen from the detailed examples which appear in this article.

Some patterns seem to build up in one area of the screen for thousands of iterations and then, suddenly, the whole process jumps to another region and a further segment of the pattern develops. Obviously, some experimentation with scaling is usually necessary to reveal the full content of a given point generator. Increasing the magnification of an area surrounding a particular point of a pattern will reveal more of the

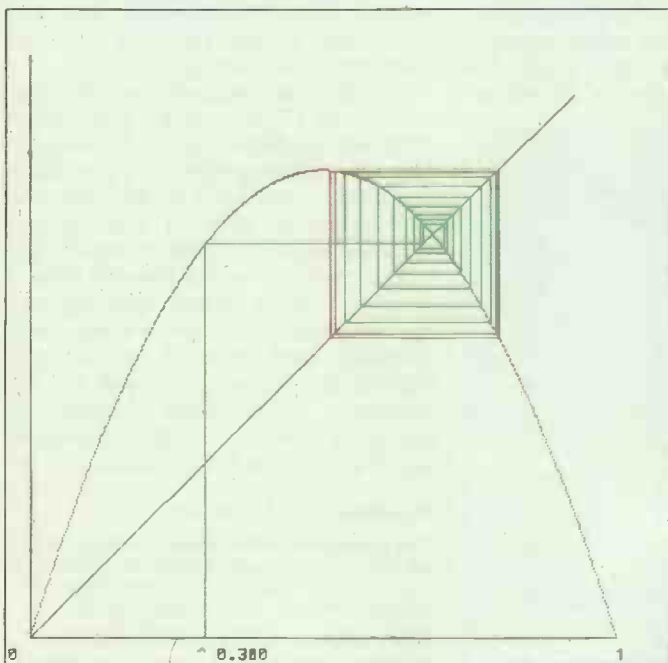

Fig 1

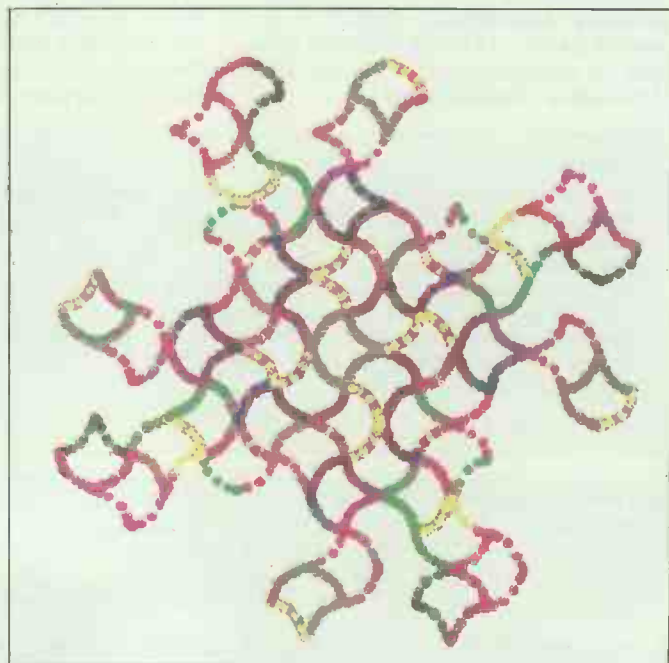

Fig 2

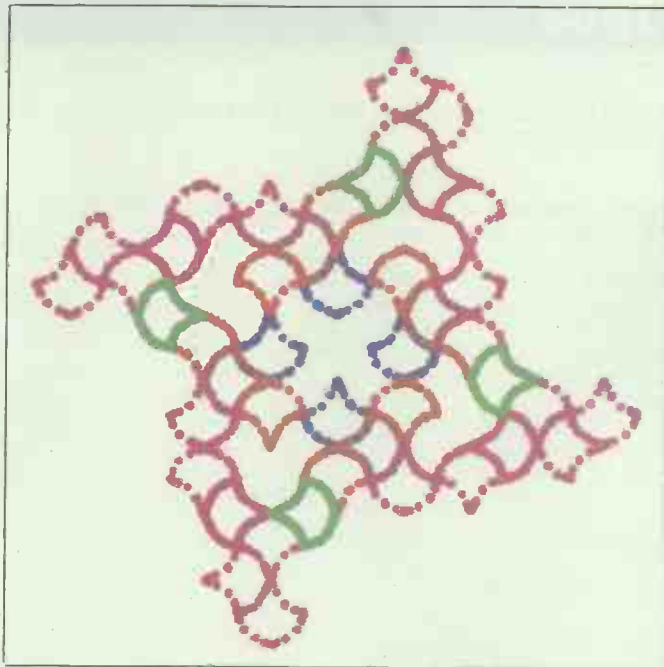

Fig 3

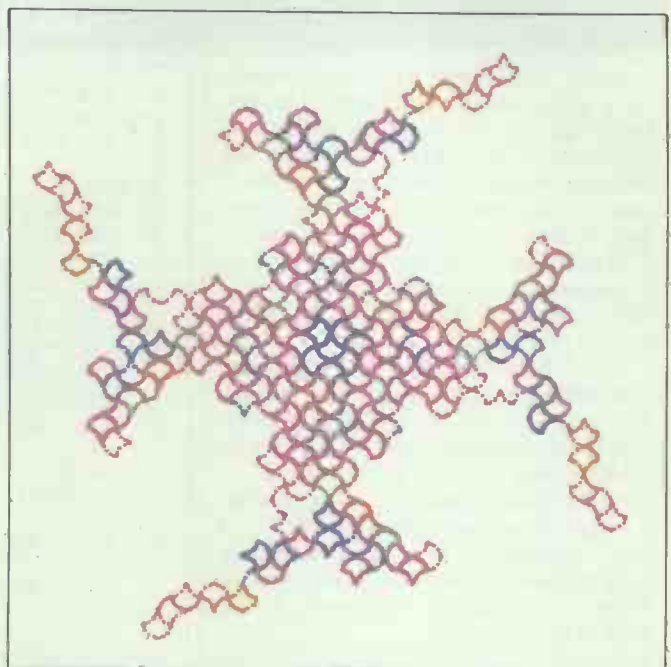

Fig 4

microstructure of the pattern and will probably produce a thing of beauty in itself.

Colours may be used to enhance the artistic appeal of the patterns, for example, by assigning colour according to how far the point being plotted is from the origin of coordinates. Alternatively, you can change colour according to the number of iterations required to compute the position of the point — for example, vary the colour every 100 iterations.

The techniques for developing the patterns described in this article were inspired by the Mandelbrot sets presented by Dr MM Novak and Jack Weber in the article 'Fractal Sets', *PCW*, December 1986. Mandelbrot's patterns emerge from complex numbers (not easy things for many people to manipulate on their computers) and the seeds for the iterative process are the points, infinite in number, found in a region of the plane. For every point on the screen a complicated calculation needs to be done many times over, and the computer generation of a complete pattern may take hours or even days, although Weber does describe ways to reduce this computation time.

Furthermore, to obtain detailed resolution of the final picture, high-powered graphics facilities are required. The process described here, on the other hand, uses only real numbers and the pattern grows from only a single seed, the starting point (x_0, y_0) . The pattern begins to appear after a minute or so of computation, and exciting pictures can be produced using nothing more elaborate than the screen of a portable TV set.

Using such pattern-generating techniques, it is possible to design your own personalised wallpaper or

textiles so that no-one else in the world would be likely to have the same pattern. Imagine going into a shop, keying a couple of your own secret numbers into a computer terminal, and a computer-based automatic 'pattern designer' then produces rolls of unique personalised wallpaper or even a unique dress fabric.

However, to return to the 'chaos' of reality upon which all of this is based, before you all branch out into computerised wallpaper design, we will look at a one-dimensional case (no pretty pictures) which will illus-

trate how chaotic phenomena rise from an ordered situation.

One-dimensional chaos

As an example we will look at the equation (known to mathematicians as the logistic equation) (1) $\dots x_{r+1} = 4Cx_r(1-x_r)$, where $r = 0, 1, 2 \dots$ successively. We take a starting value x_0 anywhere between 0 and 1 and then compute $x_1, x_2, x_3 \dots$ using equation (1).

A procedure such as this is called an 'iterative scheme' and the computation of each successive x — value is called an iteration. Before

```

10 REM PROGRAM "HOPALONG".
20 REM THIS GENERATES PATTERNS BY ITERATION FROM "HOPALONG".
40
50 MODE 1
60 REM READ IN DATA: CONSTANTS P,Q,R, INITIAL POINT, 'CENTRE' POSITION,
70 REM SCALE AND NUMBER OF ITERATIONS.
80 INPUT "CONSTANT P ",P
90 INPUT "CONSTANT Q ",Q
100 INPUT "CONSTANT R ",R
110 INPUT "X COORDINATE OF STARTING POINT ",X
120 INPUT "Y COORDINATE OF STARTING POINT ",Y
130 INPUT "X COORDINATES OF CENTRE POINT ",XC
140 INPUT "Y COORDINATES OF CENTRE POINT ",YC
150 INPUT "HORIZONTAL SCALE ",XS
160 INPUT "VERTICAL SCALE ",YS
170 INPUT "NUMBER OF ITERATIONS REQUIRED ",N
180 CLS
190 ICOUNT=0
200 T=1/SQR(2)
210
220 REM START ITERATION.
230 FOR I=1 TO N
240 X1=Y-SGN(X)*SQR(ABS(Q*X-R))
250 Y=P-X
260 X=X1
270 ICOUNT=ICOUNT+1
280 PRINT TAB(0,0);ICOUNT
290 REM ROTATE PLOT THROUGH -45 DEGREES.
300 U=T*X+T*Y
310 V=-T*X+T*Y
320 PLOT 69,XC+XS*U,YC+YS*V
330 NEXT I
340 STOP

```

GRAPHICS

starting, however, we must decide on a value for the constant C , as the behaviour of the iterative scheme is dependent on the constant we choose. Firstly, C must lie between 0 and 1; this keeps the successive iterates within the range zero to one. If C is less than 0.25, the values of x_r as r becomes large approach zero. If C lies between 0.25 and 0.75, the values of x_r approach $1 - \frac{1}{4C}$.

For C between 0.75 and 0.9, more interesting features begin to emerge. For example, when $C=0.76$, x_r alternately approaches the two values of 0.589356083 ... and 0.730591286 ... and, as larger values of C less than 0.9 (or, more accurately, 0.8925 ...) are chosen, x_r simultaneously approaches an increasing number of these 'limit' values, as shown in the box below.

C	Number of 'limit' values
0.2	1
0.24	1
0.76	2
0.87	4
0.89	8
0.892	16

Limit values

The algebraic significance of this phenomenon is well-understood by the mathematical pundits and is, indeed, quite predictable and orderly. However, as C gets closer to the special value 0.8925 ..., order ceases and chaos takes over. The values of x_r become distributed between 0 and 1 in a thoroughly haphazard way, but order can return as C is further increased towards unity. For example, if you try $X_0=0.96$, you should find that just three points are visited.

```

10 REM PROGRAM "AXHEADS".
20 REM THIS GENERATES ITERATES WHICH "TILE" THE PLANE
30 REM WITH AXEHEAD LIKE FORMS.
50
60 MODE1
70 REM READ IN DATA: CONSTANT A, INITIAL POINT, 'CENTRE' POSITION,
80 REM SCALE AND NUMBER OF ITERATIONS.
90 INPUT "CONSTANT A ",A
100 INPUT "X COORDINATE OF STARTING POINT ",X
110 INPUT "Y COORDINATE OF STARTING POINT ",Y
120 INPUT "X COORDINATES OF CENTRE POINT ",XC
130 INPUT "Y COORDINATES OF CENTRE POINT ",YC
140 INPUT "HORIZONTAL SCALE ",XS
150 INPUT "VERTICAL SCALE ",YS
160 INPUT "NUMBER OF ITERATIONS REQUIRED ",N
170 CLS
180 ICOUNT=0
190 T=1/SQR(2)
200
210 REM START ITERATION.
220 FOR I=1 TO N
230 X1=Y-SIN(X)
240 Y=A-X
250 X=X1
260 ICOUNT=ICOUNT+1
270 PRINT TAB(0,0);ICOUNT
280 REM ROTATE PLOT THROUGH -45 DEGREES.
290 U=T*X+T*Y
300 V=-T*X+T*Y
310 PLOT 69,XC+XS*U,YC+YS*V
320 NEXT I
330 STOP
    
```

All the various features described above can be displayed using the program 'CHAOSMW' on page 122, which is written in BBC Basic. This first draws the parabola having equation (2) $y=4Cx(1-x)$, together with the straight line having equation (3) $y=x$. It then carries out the iterative process which is illustrated in Fig 1 where, in this case, $C=0.8$ and $x_0=0.3$.

CHAOSMW originated from Matthew Wells, who produced it as part of an undergraduate project at the University of Aston, Birmingham

in 1986. However, he is making no claims to be the first to write such a program: many mathematicians during the last few years have constructed similar routines.

To help you centre and scale the plots on your own monitor, it will be useful to know that on a screen of 1280 X 1024 pixels, $x_0 = 200$, $y_0 = 100$, $x_s = 900$ and $y_s = 900$ gives a good picture.

Two-dimensional chaos

The two-dimensional mappings which we will consider are of the

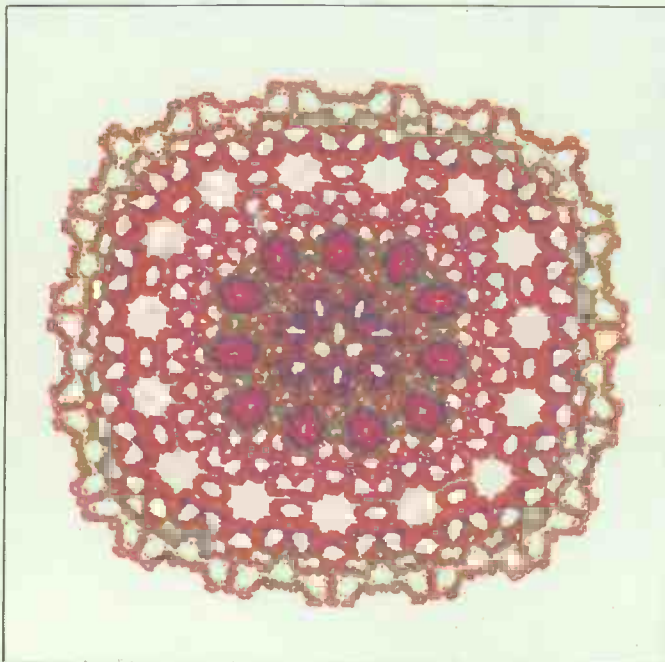

Fig 5

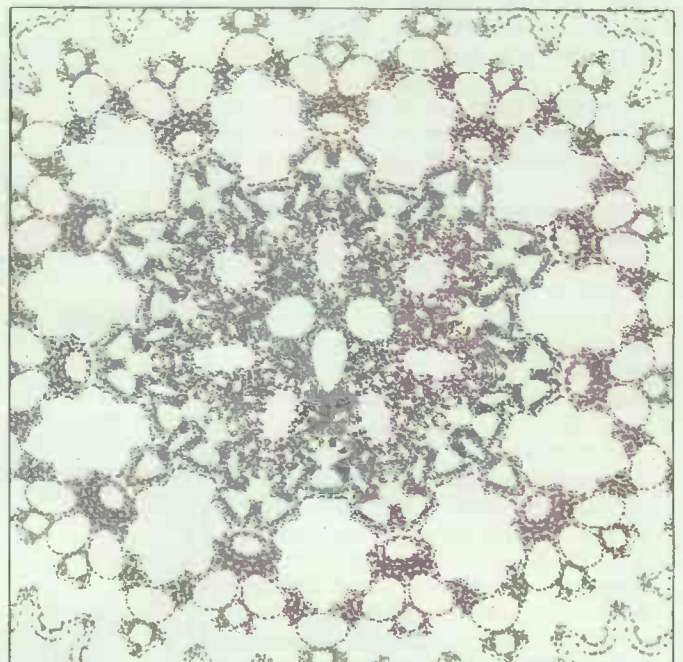

Fig 6

COTSWOLD PRESS LIMITED

Desktop Publishing Bureau

- From Macintosh or IBM disks
- All major programmes supported
- 24 hour turnaround
- Full range of Adobe Fonts
- High quality output on Linotype 300
- Modem service available
- IBM to Macintosh disk conversions
- Full training and advisory service.

VENTURA BUREAU

Typesetting

- Cotswold Press are a conventional typesetting house, using Linotype equipment with a full page-make-up system.
- Most major word processing programmes are being supported.

Hardware

- We can supply full IBM AT Compatible Systems with full training on software and hardware.

For further information contact: Kaye Morrison or Pierre Macke.
Cotswold Press Limited,
Stanton Harcourt Road, Eynsham, Oxford.
Telephone: Oxford (0865) 880608.

☆ MEMOTECH MTX 512 ☆



£39.95

Plus £3.05 postage (total £43)

- ☆ 64K User Ram ☆
- ☆ Z80 Processor ☆
- ☆ 3 Channel Sound ☆
- ☆ 16 Colours ☆
- ☆ Extensive Software ☆
- ☆ CP/M 2.2 Adaptable ☆
- ☆ Fully Guaranteed ☆

☆☆☆☆☆☆☆☆☆☆☆☆☆☆☆☆

Further details/orders to:

UK HOME COMPUTERS
82 Churchward Avenue, Swindon, Wilts SN2 1NH
Tel: 0793 695034

THE GENIUS OF LEONARDO

When Creative Logic launched Leonardo, our aim was to not only establish a new benchmark for Expert Systems software, but to make the benefits of Expert Systems available and accessible to every organisation. Have we achieved these aims?

The facts speak for themselves.

250 LEONARDOS INSTALLED

Already Leonardo is in use at over 250 organisations. Leonardo is unique in offering users a range of expert systems products to cater for different levels of knowledge bases. Whether you're a first time user or professional knowledge engineer, small company or multinational, Leonardo can and is delivering the benefits of expert systems in all spheres.

NEW PRODUCTS

With Leonardo, Creative Logic has already set the standard by which other products will be judged. However we haven't stopped there. There are new interface packages available with Leonardo 2 and 3 and Creative Logic has announced the DEC VAX version of the system.

SEEING IS BELIEVING

We think the facts speak for themselves, but what better way to judge for yourself than getting started with Leonardo 1 or attending one of our free half day seminars at Brunel Science Park.

If you'd like to attend a seminar or like further information on the Leonardo range of products, just return the coupon or call us on **0895 74468**



Please return this coupon (no stamp required) to: Creative Logic Limited, FREEPOST, Brunel Science Park, Kingston Lane, Uxbridge, Middlesex, UB8 3BR. Tel: 0895 74468/9.

NAME _____
TITLE _____
COMPANY _____
ADDRESS _____
POSTCODE _____ TEL. NO. _____

PCW6

Leonardo

GRAPHICS

form (4) $x_{r+1}=f(x_r, y_r)$, $y_{r+1}=A-x_r$, where A is a numerical constant, $r=0,1,2 \dots$ successively and starting values (x_0, y_0) are to be specified, and $f(x,y)$ is a non-linear function of the ordered pair (x,y) . Readers have the opportunity to investigate the consequences of replacing $y_{r+1}=A-x_r$ by $y_{r+1}=g(x_r, y_r)$, a second non-linear function. Brief experimentation within this area, however, suggests that the resulting patterns may be over-elaborate with a consequent loss of aesthetic appeal.

The first family of mappings to be considered is (5) $x_{r+1}=y_r - \sin(x_r)$,

$y_{r+1}=A-x_r$, where $r=0,1,2 \dots$ successively with starting values of $(0,0)$. The necessary program 'AXHEADS', is listed on page 120.

It seems that if $A=\pi=3.1415026 \dots$, this program displays a repetition of the four points $(0,0)$, $(0,\pi)$, (π,π) and $(\pi,0)$. This phenomenon is somewhat analogous to the predictable and orderly behaviour previously described for the one-dimensional mapping equation (1) when the constant C is less than $0.87 \dots$. We are not, therefore, surprised by the approximation to four-fold symmetry that results from choosing a value for A which is sufficiently close to π

(see Fig 2 referring to $A=3.1421$).

20,000+ points have been plotted and the colour changed every 50 iterations. However, the results associated with the value $A=3.15$ and using different numbers of iterations are displayed in Figs 3 and 4. These pictures display some of the infinite variety associated with the point-generator equation (5), as discussed in the introduction.

Scaling with $A=3.12$, and initial point $(0,0)$ on the screen mentioned above, is reasonable with $x_c=600$, $y_c=550$, $x_s=10$ and $y_s=10$.

A second family of mappings to be considered is (6) $x_{r+1}=y_r - \text{sign}(x_r) \times |Qx_r - R|$, $y_{r+1}=P-x_r$, where P, Q and R are numerical constants, $r=0,1,2 \dots$ successively and starting values (x_0, y_0) are to be specified.

The case when $x_0=0$, $y_0=0$, $R=0$ and $Q=1$ has been discussed by Martin, *The Mathematical Gazette*, volume 70, number 452, June 1986, pages 140-142, for a range of values of P .

The general investigation of the point generator, equation (6), may be carried out using the program 'HOPALONG' on page 119 of this article (the name was coined by AK Dewdney who writes on Computer Recreations in *Scientific American* magazine) for which specimen output is provided in the form of Figs 5 and 6.

History

This approach to pattern generation has been inspired by the analysis of the so-called Hénon Attractor defined by (7) $x_{r+1}=1+y_r - ax_r^2$, $y_{r+1}=bx_r$, where a and b are numerical constants, $r=0,1,2 \dots$ successively and starting values (x_0, y_0) are to be specified (see, for example, M Hénon, *Communications in Mathematical Physics*, volume 50, pages 69-77, 1976). The chaotic situation resulting when $a=1.4$ and $b=0.3$ is displayed through four stages of magnification using up to 5×10^6 points with starting values $(0,0)$. The black-on-white pictures presented have no artistic merit, but did prompt considerable mathematical investigations resulting in part from their apparent 'ultimate' simplicity.

Such advantages seem unlikely in relation to the point generators (5) and (6) featured here, although some mathematicians are optimistic. Readers are encouraged to experiment with alternative forms of (4) — that is, to develop new designs rather than to seek underlying advances in the rather difficult mathematical theory.

Barry Martin is a lecturer in mathematics at Aston University, Birmingham. Mike Mudge is the author of PCW's regular maths column, Numbers Count (page 211).

END

```

10 REM PROGRAM "CHAOSMW".
20 REM THIS PROGRAM DISPLAYS SUCCESSIVE ITERATES OF THE LOGISTIC EQUATION
30 REM X(N+1)=4*C*X(N)*(1-X(N)).
40 REM TO START IT ASKS FOR A VALUE OF C BETWEEN 0 AND 1
50 REM AND FOR AN INITIAL VALUE OF X BETWEEN 0 AND 1.
60 REM THIS PROGRAM WAS WRITTEN BY MATTHEW WELLS. 1986.
70 MODE1
80
90 INPUT "CONSTANT 0<C<1 ",C
100 INPUT "STARTING VALUE 0<STARTX<1 ",STARTX
110 INPUT "MAXIMUM NUMBER OF ITERATIONS ",MAXIT
120 INPUT "X COORDINATE OF ORIGIN ",XO
130 INPUT "Y COORDINATE OF ORIGIN ",YO
140 INPUT "LENGTH IN PIXELS OF X-AXIS ",XS
150 INPUT "LENGTH IN PIXELS OF Y-AXIS ",YS
160
170 REM DRAW AXES AND THE PARABOLA 4*C*X*(1-X).
180 CLS
190 PRINT TAB(0,0)
200 PRINT TAB(4,31) "0"
210 PRINT TAB(0,0)
220 PRINT TAB(34,31) "1"
230 PRINT TAB(0,0)
240 PRINT "C=";C
250 PRINT "X(0)=";STARTX
260 PLOT 4,XO,YO
270 PLOT 5,XO+XS,YO
280 PLOT 4,XO,YO
290 PLOT 5,XO,YS
300 PLOT 4,XO,YO
310 PLOT 5,XO+XS,YO+YS
320 X=0.0
330 SCALE=1/YS
340 FOR I=1 TO YS
350 X=I*SCALE
360 PLOT 69,XO+X*XS,YO+YS*4*X*C*(1-X)
370 NEXT I
380
390 M=0
400 X=STARTX
410 PLOT 4,XO+STARTX*XS,YO
420 GCOL 0,1
430 REM START ITERATION.
440 Y=4*X*C*(1-X)
450
460 REM PAUSE TO SEE DEVELOPMENT OF PLOT.
470 FOR N=0 TO 400
480 NEXT
490 PLOT 5,XO+X*XS,YO+YS*Y
500 PLOT 5,XO+Y*XS,YO+Y*YS
510 X=Y
520 M=M+1
530 REM INTRODUCE COLOUR CHANGE AFTER 50 ITERATIONS.
540 IF M<50 THEN GOTO 560
550 GCOL 0,2
560 IF M=MAXIT THEN STOP
570 GOTO 440

```

Half a dozen steps to the right decision.

When you've seen one printer you really haven't seen them all. That's why, when you're trying to choose your first or your next, you really need all the help you can get. Here are a few steps to get you started.

1 **Compatibility.** You needn't worry about matching any of our six 9-pin printers with your present system.

A simple slot-in interface means that any



Star printer can be used with virtually any terminal or PC set up. And, equally important, the software command sets are switchable.

2 **Value.** Getting more doesn't mean you have to pay more. All our printers are proof of that. Whatever your budget, the Star 9-pin printers start from just £248 for the NL-10 going up to £589 for the NR-15.

3 **Simplicity.** The Front Control Panel on all Star business printers gives you total control at the touch of a button. Selecting draft or Near Letter Quality printing, print pitch, margins and paperfeed control are sheer simplicity. No mess, no fuss and no more fiddly DIP



switches for all your usual daily needs. All our machines have semi-automatic single sheet feeding too. Simply drop your page into the top, press a lever,



and the printer advances it to the correct position ready for printing.

4 **Performance.** Star's 9-pin range has a choice of two paper widths, either 10" or 15" (80 col or 136 col) and three performance levels 120, 180 and 240 cps for draft quality listings, state-

ments and spread sheets. They also have very respectable Near Letter Quality speeds of 30, 45 and 60 cps for correspondence and more important documents. In either mode, Star's print clarity is envied by our competition.

5 **Support.** When you buy a Star printer you buy superb back up too. We've a National three-level support system which operates through all our registered Star dealers backed by the

finest distributors in the country, so you're in good hands. Should you need any help at any time, our dealers will give you all the friendly, knowledgeable assistance you need.

6 *If you still can't quite make up your mind, fill out this coupon. We'll send you our brochure so you can discover even more about the remarkable Star range of printers for business. We'll also tell you about our range of 24-Pin printers too. Or just call Belinda on 01-840 1829.*

Name _____

Company _____

Address _____

Postcode _____

Telephone _____

THE
Star
PRINTERS FOR BUSINESS

Star Micronics U.K. Ltd. Craven House,
40 Uxbridge Road, Ealing, London W5 2BS.
Telephone: 01-840 1800.

A division of Star Micronics Co., Ltd., Japan.

PCW 911

First impressions

Over 75,000 people attended this year's PCW Show at Olympia from 23-27 September. There were 420 exhibitors and no-one could count far enough to calculate the number of products on show. Even if you were there, it's likely you missed some of the highlights. Our show coverage this month, courtesy of editor Derek Cohen and photographer Tony Sleep, is necessarily brief due to publishing deadlines, but next month will see a fuller report on the very wide range of products and activities that makes the PCW Show the only one worth visiting.



Acorn

For most visitors, the PCW Show was their first chance to lay fingers on Acorn's award-winning Archimedes (it was nominated Home/Small Business Micro of the Year in the British Micro Awards).

The teeming crowds on the Acorn stand were reminiscent of the response that Amstrad usually gets. An auditorium at the front of the stand was used to demonstrate various applications on a bank of monitors. And, to counter the blasts of gunfire cannoning over from the adjacent US Gold stand, Acorn had wisely seeded the whole area with extra loudspeakers to demonstrate the machine's sound capabilities.

One of the more spectacular demonstrations was of the spinning globe used as the BBC TV logo. This image is manipulated in real time, and the globe spinning not just at high speed, but in reverse, demonstrates not just the fast processing speed of the Archimedes, but also Acorn's cockiness at having a machine so good that it might just not need the Beeb's sponsorship.

Also on show was the PC emulator for the Archimedes running an authentic, if a little slow, copy of Lotus 1-2-3.



Atari's CD-ROM

Atari is gaining a reputation for surpassing even the most speculative gossip. Star attraction was this CD-ROM unit which will take compact discs holding 550Mbytes each and interface to Atari STs using the ordinary hard-disk drive port.

What was not expected was that the unit will also function as an ordinary audio CD player, as well as playing the new CD video disks.

And for those with PC-compatibles, Atari will include an interface board which will also function as a standard hard-disk controller.

The price? A ridiculously reasonable £399. Deliveries promised before Christmas.



Commodore Village

Eating facilities at Olympia were rather sparse because Commodore bought up the restaurant. Commodore booked the restaurant and filled it with its dealers and software developers.

Past shows have seen Commodore stands packed with people eager to glimpse the Amiga being put through its paces. It could be that everyone's seen one now, but the crowds were noticeably absent. Interesting new products included a CAD package from UK software house Taurus, and a video-mixing console that looked like it needed three university degrees just to read the screen.

Commodore's own exhibit included a 'Hall of Fame' type display of its long history in computing. Among the market-leading products that there seemed not to be room for in among the products shown, were the C16 and the Plus/4. Perhaps the company just plain sold them all.



British Micro Awards

Few people have ever seen *PCW*'s editor in a dinner jacket. So, if that has been one of your ambitions, cut this picture out and pin it up immediately.

The occasion was the British Micro Awards, and the recipient of this particular award was Anita Sinclair of Magnetic Scrolls whose *Guild of Thieves* was voted Game of the Year.

Other award winners included Tandon for its PAC286, which was reviewed in the June issue of *PCW*; Adobe Illustrator; and the Acorn Archimedes.

The ceremony was compered by Willie Rushton, whose jokes were far too rude for a family magazine like this. However, worth telling are his stories about Apricot — 'who made their machines IBM compatible just before IBM made its machines IBM compatible' and Clive Sinclair, whose C5 came off the worse for a road accident — it drove into a pigeon.



Mac surprise

No, it's not an Apple Macintosh. It's not even a Macintosh clone. This is the KS-1000 Transfer computer from KS Brotherbox of Kien Kwo Road, Taipei. Inside you'll find an 8088 CPU running at 4.77 or 10MHz, 768k of RAM, a 132-column Hercules-compatible display, and two 3½in drives plus a hard disk.

The display is 9in paper white, but I kept expecting to see the 'Happy Mac' smiling back at me. Instead, there was a very dinky AutoCAD demo.

The KS-1000's big brother, the KS-1050 Transfer Computer, is the AT-compatible equivalent. Strangely, RAM starts at 512k expandable to a meagre 1Mbyte, which means that this won't be the smallest OS/2 machine to date.

In case you were wondering, each machine contains four expansion slots, although the AT version has an extra bulge on the back to accommodate longer cards.

Brotherbox was at the show looking for dealers and distributors, so its prices are quoted for importers rather than end users. And \$750 for the 1000 and \$1300 for the 1050 seemed rather high when that might translate to £1000 as a street price.

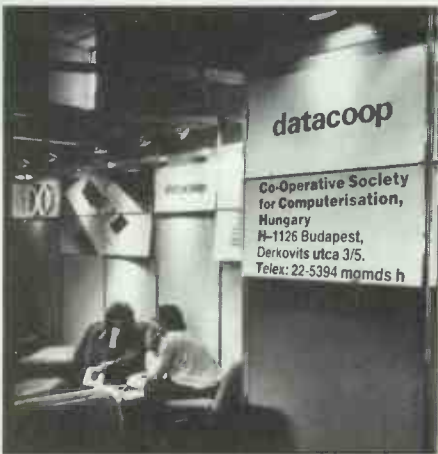

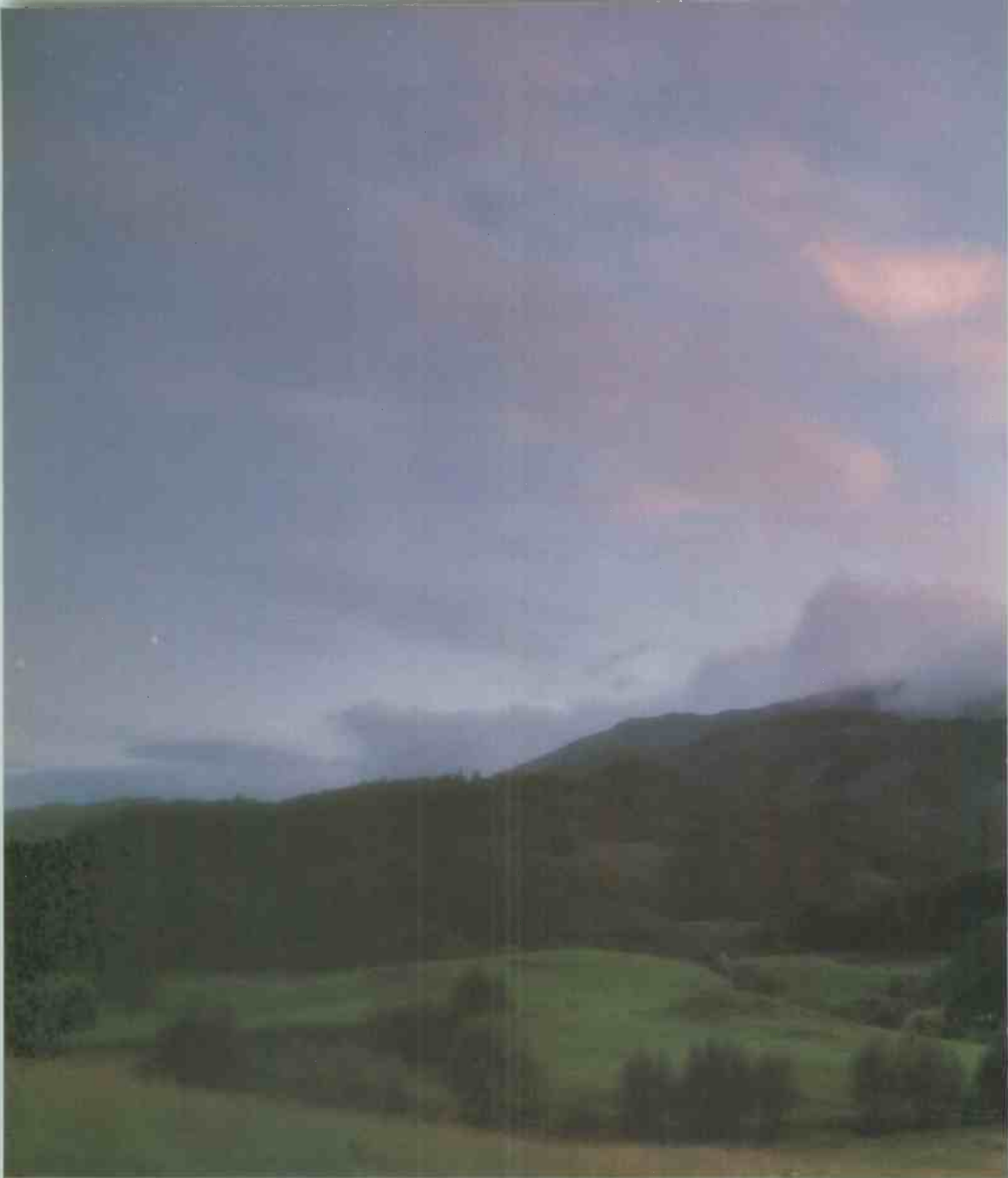

We've built a unique feature into our MBC 16 computer. Automatic membership of the SMUA - the Sanyo Micro Users Association.

This provides one years on-site maintenance with the unrivalled guarantee that if your computer develops a fault, we'll ensure that an engineer reaches you within eight working hours of receiving your call - anywhere on mainland Britain.

SMUA also gives you immediate access to our Technical Support



**Stick a pin anywhere in the British Isles
and we'll get there in 8 hours.**

Hotline which offers expert advice on software problems.

And why is such an extraordinary service free of charge?

Let us just say it's a measure of our confidence in Sanyo's reputation for reliability.

If you'd like to know more about our full range of computers including details of the exciting new models available in 1988 please send your business card to Mr Roger Hunt, Sanyo Business Systems, Sanyo House, Otterspool Way, Watford, Herts WD2 8JX. Or call us on 0923 57233/57235.



SANYO
BUSINESS SYSTEMS

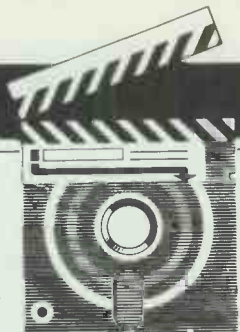

SCREENTEST

PC Works

Going down but not quite out, the line of MS-DOS applications is sustained by Microsoft's PC Works, a basic integrated package for the PC and compatibles. But is it too little, too late?

Owen Linderholm finds out.

Although Microsoft is trying to lead the PC market into a new age with the OS/2, Windows and Presentation Manager programs, it still has a commitment to the old world of MS-DOS. I am sure, however, that we will be seeing fewer and fewer of the old-style text-based programs from Microsoft. PC Works could thus be described as the first of the last MS-DOS programs: the process will take years but is beginning now just the same, a decline equivalent in style but not scale to that of the Roman Empire.

PC Works is a fairly simple text-based integrated package consisting of word processor, spreadsheet, database and communications programs. It is aimed at the cheap compatible market and those users who don't want to move on to Windows.

In keeping with the new Microsoft style of a standard user interface across its range of products, PC Works uses a common menu interface with a single splittable window, very similar to Microsoft's programming products. The window takes up most of the screen and has horizontal and vertical scroll bars, making it a virtual window onto a much larger area.

There are two ways to do almost everything in the program. One is to select commands and move the cursor around using the mouse. This works speedily and seems to be the way the program was intended to be used. You can also move around and select items with the keyboard and, although this is often as fast, it is much slower in some cases (scrolling through a document, for example).

Menus are drop-down and show

an unusual level of design. They have 'shadows' — the latest fashion trend in WIMP design — but the shadows are 'real'. You can see through them to the underlying text. This holds true for every sort of display the program can use except LCD on portable machines, where the shadows are dappled but do obscure the underlying text. It's a shame that the design of PC Works features and power isn't quite on the same level as the design of the program's interface and functionality.

Installation

Installing PC Works is an intelligent, semi-automatic process. The program will install itself automatically onto a working disk — an extremely sensible practice because this makes using and, therefore, damaging your master disks difficult. The installation program automatically recognises the configuration of your machine and then pops up a menu of additional information for you to alter. This involves display types and monitor types you want to use, printers for text and graphics, file organisation, whether to use Help or not, whether to include graphics printer fonts, which country defaults to use, which mouse driver to use, and whether or not to delete unwanted printer drivers, and so on.

When an application is open, two of the menus that appear are common to all of the applications. These are the File and Window menus. The File menu is used to launch new applications in new windows, to save the current file, to exit PC Works or to switch to a DOS shell to temporarily run other applications. The Win-

dow menu allows you to call Help or consult the tutorial (two features I was unable to test at the time of the review), to change the settings or to switch to a different open window (you can have up to eight of these).

Word processor

This is a fairly basic-level word processor, as you would expect in an introductory integrated package. It is essentially a straightforward WYSIWYG program, but not on the same level as the Macintosh-based Microsoft Works program which provides the usual onscreen Macintosh fonts and bit-mapped display.

At the top of the applications window is a ruler bar showing character positions and left and right margins. You can scroll through the document using the scroll bars at the bottom and right of the screen window, or cursor keys. Text is entered as usual by typing it in, with all the standard editing keys (delete, backspace, insert, and so on) operational. Editing also works on selected pieces of text which can be marked using the F8 key and the cursor keys or by using the mouse.

I found the word processor pleasant to use for entering and editing text. The response to typing is very good and mouse-based editing is a pleasure after the rigours of WordStar. It can be hard to force your fingers not to push Control-K, but once you get used to the mouse, what a relief!

The menu options available in the word processor, apart from File and Window, are: Edit, Print, Select, Format and Options.

Edit is used for standard editing

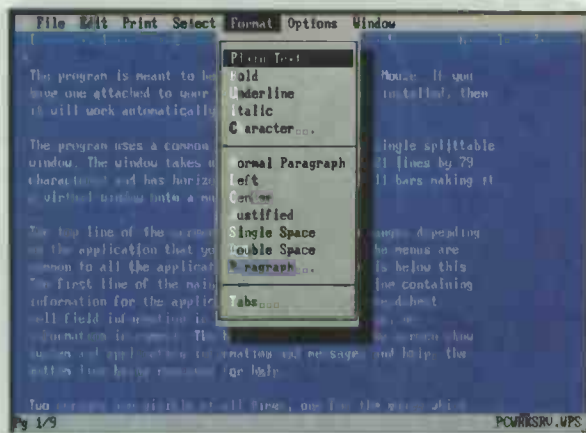

The PC Works word processor. This is a typical PC Works screen with the standard menu interface; notice the shadows 'underneath' the menu. Formatting options are shown

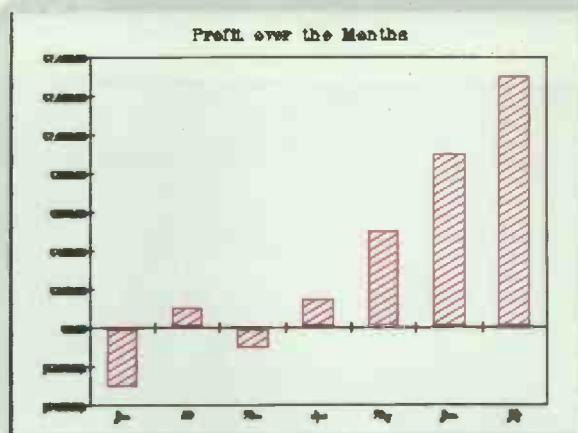

A screen view of the chart shown in the diagram on page 131. You can see that although the lettering is almost illegible on a CGA, it matches the printout in terms of style

functions like Undo, Move, Copy and Delete, with the last three referring to marked blocks of text and the first to the last editing command performed. Other editing options allow character or paragraph formats, special characters, dates and times, insertion of fields from a database file or charts from a spreadsheet file.

The Print menu allows you to select the text printer you want to use, although the default will be assumed if you don't want to choose one. You can also use a database file for mailmerge printing and for label printing. The other options are to set up the page layout for printing and to print and select which pages should be printed.

The Select menu is used for search and replace and for going directly to a specified page in a document.

The Format menu allows you to specify text formats like bold, italics, and so on. You can also specify paragraph formatting, including spacing and justification. This menu is also used for setting tabs and for setting the global paragraph style (indenting, alignment, spacing and paragraph gaps).

The final menu is for miscellaneous options. This lets you split the document window into two for separate views of a single document (and more convenient cutting and pasting), display or hide the ruler, special characters (hard carriage returns, soft spaces, and so on) and the complex headers and footers, alter pagination and perform a spell check.

The spelling checker is a fairly typical American phonetic spelling checker. I used it to spot my mistakes and then often had to enter the replacement myself. As an example (which many other spelling checkers also get wrong), I mistyped database as 'daabase'. The spelling checker suggested the following alternatives: debase, debaser and Tabasco. More

thought to people who make typing mistakes as well as spelling mistakes and less concentration on pepper sauce, please!

The rest of the word processor operated as expected — I had a little trouble getting printer drivers to work correctly, but nothing like I've had with printer drivers on some programs.

Spreadsheet

The basic form of the spreadsheet is

'PC Works . . . is aimed at the cheap compatible market and those users who don't want to move on to Windows.'

similar to that of the word processor — a window surrounded by scroll bars and data lines of information — but there are the expected differences in organisation. At the top is an editing line which displays spreadsheet cell contents and allows values or formulae to be edited. The rest of the window holds the usual spreadsheet cells, with the top line and left most four columns used to show cell labels.

A cell-sized cursor is used rather than the usual character-sized cursor, and the contents of the cell over which the cursor is resting are displayed in the editing line above the spreadsheet window. To enter data, simply move the cursor to the desired cell and start typing. The data will appear on the editing line and, when you press Return, the correct value will be transferred to the cell.

Superficially, the menus are almost

the same in the spreadsheet as in the word processor; the only difference is that there is a menu called Chart. However, the items selectable under each menu are different.

The Edit menu has the standard options: 'move', 'copy', 'clear' (the value), 'delete', 'insert' and 'copy special'. This last option lets you copy values only, add values to destination or subtract values from destination.

Some new items are also on the Edit menu: Fill Right, Fill Down and Name. The Fill options let you copy a cell into a range of cells that have been marked below it or to its right. If these have formulae, then the cell references will be adjusted accordingly. Name is used to provide a specific name for a cell.

The Print and Select menus operate as expected, with modifications for their use within a spreadsheet program.

The Format menu is essentially used for formatting cells. The available display/data formats are: general, fixed, dollar, comma, %, exponential, logical and time/date. Other entries in the menu are for style (bold, italic and justification) and cell width.

The Options menu, as with all the options menus in PC Works, is a mish-mash of miscellaneous features. You can freeze or unfreeze titles, split a display into two, show formulae rather than results, protect cells from being changed inadvertently, and switch between manual and automatic recalculation.

The final menu is the new one, Chart. This is a gateway to the second dimension of PC Works' spreadsheet, the Chart Window. The menu lets you define a set of cells for a chart, create a new chart, view a chart, or select any one of the currently-defined charts (if any). The first two take you into the Chart Window, while the third will display the chart if one is currently defined. This

SCREENTEST



The PC Works spreadsheet is data format compatible with Lotus 1-2-3. As you can see, the basic layout of the screen is the same as that for the word processor

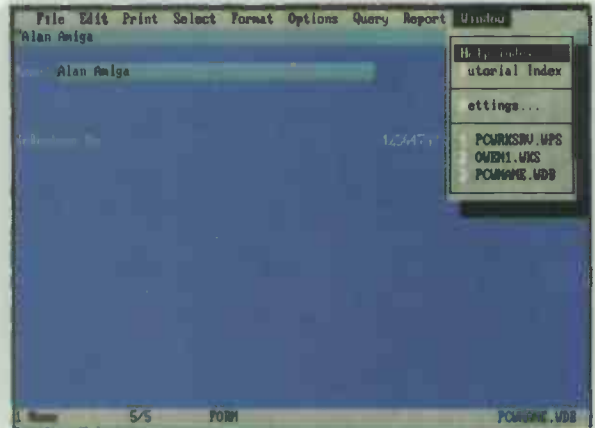

The PC Works database in form view mode with a record consisting of two fields visible. The menu on the right is the Window menu which lets you switch between applications

is done in the best colour-graphics mode available and is displayed full-screen.

The onscreen charts are generally as good as they can be and PC Works knows enough to make full use of any graphics mode it is in. I tried it on screens ranging from LCDs on portables through to a VGA display using one of the new VGA-compatible display cards with a new high scan-rate monitor. It worked fine on every single one, although the pie-chart labelling could have been done considerably more intelligently: overlapping text is hard to read.

I found the spreadsheet very functional and easy to use. The formats and commands available are similar to those in other Microsoft spreadsheets such as the Mac version of Works and Excel, although they are much less powerful than in the latter program. I used it for various businesslike things such as graphing Benchmark results and averages, and checking the disastrously low figure at the end of my payslip. I'm quite sure it would be up to checking the comparative yields of the various share portfolios that I don't own!

Database

The database is the most complex-looking part of PC Works but is in fact the simplest, especially since it is a flat-file database rather than a relational one. It is obviously a database that was designed to integrate with a word processor — the report and export facilities are very good. These features are all, however, carry-overs from the Macintosh Microsoft Works program. PC Works tries to cover much the same ground.

For new files, the database opens up in the 'forms designer' where you

set up the way you want the input form for a single record in the database to look. The forms designer is simple and only has two menus for editing and field formats. You simply move the cursor to where you want the fields to be, and enter the field name, and format and size. Once this is done, you leave the forms designer and enter the main viewing window of the database.

The database has three further modes; 'form view', 'list view' and

'PC Works may seem to have more disintegration than integration, but its cut-and-paste facilities are very powerful.'

'report designer'. The form view presents records in the format designed in the forms designer and lets you step through records with Ctrl-PgUp and Ctrl-PgDn. The forms view window looks like a word processor window except that the cursor highlights a whole field and you can't do anything with the blank areas where no field is defined.

At this point you are ready to enter information into the database or edit information. This is straightforward. Simply move the cursor (which in form view highlights the data part of a field) to the correct field using the mouse or the cursor keys, and then type in the information.

The database forms view has the widest range of menus available of any of the parts of PC Works. Be-

sides the usual ones, there are menus for formatting fields in the same manner as the spreadsheet, setting up queries using the Query Define window, and obtaining getting reports using the Report Define window. The Options menu switches from form view to list view, lets you redesign forms and protect fields from modification.

All the other menus and options are the usual ones that crop up throughout PC Works for printing, editing, selecting, and so on.

The list view window is essentially the same as the spreadsheet view in the spreadsheet module of the program except that each column corresponds to a field of the database and each database record appears on a row below this. The field names are displayed at the top of columns and lets you see a great deal of information from the database at once and for tabular data can be an easier way to enter or analyse data.

The Query menu lets you define a query by entering search criteria into fields in a Query Design window that is almost exactly the same as the Forms Design window. Other options on the menu then let you apply the query to your data, show and hide records, and also sort the database on any combination of the various fields.

The Report Menu is simpler, but its main function is to take you into the Report Design window which is almost as complicated as the rest of the database program. The options available let you look at and edit old reports you have set up, create new reports, view the text output from the report generator, save the output as a text file, and load in and switch reports around.

The Report Design window displays the database in list view.

However, in the Report Design window, no values are displayed, nor are the field names given at the top. Instead, you are able to design a report format that consists of any of the fields from the database displayed in any format you like, with any of the query criteria already applied. In addition, you can enter new titles and fields containing additional information to make a more comprehensive report.

The database is a fairly simple one, with nothing like the programming power or functions of standalone database programs. Nevertheless, it is useful in conjunction with the spreadsheet and word processor, especially for presenting reports. A finished report can be exported to the word processor for embellishment with explanations, sample data and charts.

Communications

This is *always* the weak link in integrated software. Comms is a specialised field, and it often isn't worthwhile for an integrated package to devote too much of its available room and functionality to comms since it is probably the least-used of the main applications.

Even to look at, the communications window is the simplest of all the applications. The communications program is the only PC Works window without scroll bars. All it has is the menu bar across the top and the two program information lines along the bottom. There is no option to load standard settings from disk: you will have to keep a separate PC Works communication file for each communications service you access.

Firstly, you go to the Options menu to set up terminal information like baud rate and emulation type, communications information such as port settings, phone information such as the number to call, and the type of dialling (tone or pulse) to use. The range of options available in each of these sections is very small and is evidence of the application's limitations.

The communications program can manage all the usual baud, parity and data settings, and can connect via all the usual ports. However, you can only emulate an ANSI or a VT52 terminal with limited settings and you can only use one modem initialisation string. This leads to questions about hanging up the modem, and access to other modem functions. The answer is that they aren't available unless you have a Hayes-compatible modem and, even then, only limited access is possible. Of course, you *could* enter the complex and weird modem commands manually...

The only two menus available apart from File and Window are Con-

nect and Transfer. Connect lets you dial, redial, hang up, pause or break. You can also record or replay one — and only one — sign-on sequence.

The Transfer menu lets you capture or send text (ASCII) files and also transmit or receive files in Xmodem format.

And that is *all* PC Works' communications program does. The acid test for comms is what happens when you try to access online services. The good news is that I had no problem with Telecom Gold and, in fact, PC Works would be perfectly capable if that was all you wanted comms for. I was also able to access various UK bulletin boards with reasonable success except that I wasn't able to use the best transfer protocol for files, Kermit.

However, when I tried to access the Source via PSS and IPSS, I had a rude shock. I couldn't even log on to PSS. Almost immediately, I received pop-up messages saying 'parity error' even though I was at the correct parity. Not surprisingly, the messages stayed when I tried again at a different parity setting. I was also given the more mysterious message of 'frame error'. I gave up.

Integration

The integration between the different programs within PC Works is mostly done on a cut-and-paste basis with marked data from window to window. This always works, and allows you to extract data from the various programs and send it to any other program within PC Works. The exception to this is the communications program which can only export information as text files and cannot accept any input information.

In addition to the cut-and-paste functions, some of the menus include items for transferring information. Specifically, graphs can be included in text files, as can database fields for mailmerge facilities. These are the only 'live' data-transfer facilities, where data values change in the copy when they are changed in the

In perspective

The major competitors to PC Works are Ability, Ability Plus, PFS: First Choice and Open Access II. PC Works falls somewhere near the top of this list in terms of power and functionality, and also in terms of price.

In the end, however, since PC Works is neither outstandingly better nor considerably worse than any other programs, you are going to have to make a choice based on personal preference. As Microsoft is slowly rationalising its user interface and the presentation of its programs, you will be fairly happy with PC Works if you like other Microsoft applications programs.

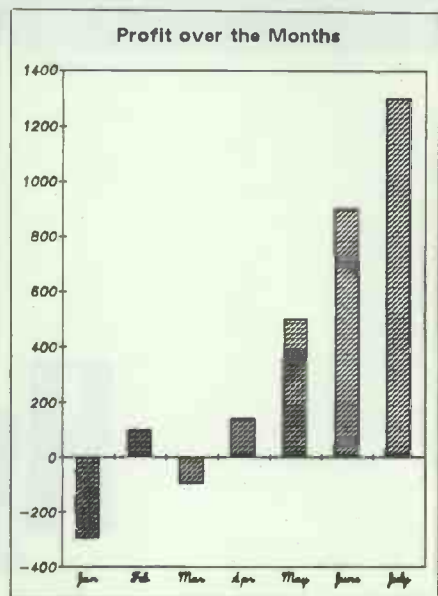

A piece of sample output from the Chart area of PC Works' spreadsheet

original. Otherwise the cut-and-paste facilities are 'dead', in that once data has been transferred, it is immutable. This is a shame since programs like Ability, which have been around a long time, have fully live integration.

PC Works may seem to have more disintegration than integration, but its cut-and-paste facilities are very powerful. It is easy to take a paragraph from the word processor and drop it into the spreadsheet, or take a set of fields from the list view of the database and put them into the word processor.

Conclusion

PC Works is a reasonably well put together program. It has arrived rather late on the integrated software scene, coming very much after programs like Framework, Symphony and even Ability or Open Access II. If the company producing it had been smaller or less well established, I would say that this program stands little chance in an increasingly powerful and sophisticated market — regardless of how good the program is. However, Microsoft has the clout and power to push PC Works very hard and is likely to make a reasonable success of it.

The word processor is fairly good and integrates well with the other parts of the program. The spreadsheet is also good and is easy to use. The database is a bit simpler and is acting purely as the database part of an integrated program; it wouldn't stand up on its own. The communications program is barely adequate — it's just OK if you only want basic email facilities.

PC Works certainly isn't my favourite integrated program, but neither is it anything like my most hated.

PC Works costs £145 from Microsoft on (0734) 500741.

END

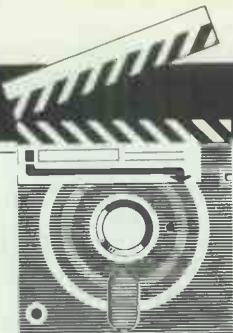

SCREENTEST

HyperCard

Apple's latest trump card is HyperCard — a toolkit of many talents which allows Mac users to write their own programs. It also turns information storage and retrieval from a chore into a challenge, as Robin Webster found to his delight.

When Apple launched the Macintosh back in 1984 the system came with two bundled software packages — MacWrite and MacPaint. Although there's no denying that MacWrite played its part in selling machines, there is also little doubt that Bill Atkinson's MacPaint application was the one that convinced most early users to open their wallets.

MacPaint came with unique features such as onscreen palettes that let you select different painting tools and patterns with the click of a mouse. And, while it didn't necessarily turn ham-fisted klutzes into creative artists, it did allow the average person to produce professional-looking graphics in a fraction of the time taken before. After MacPaint's success, however, Bill Atkinson seemed to disappear into the woodwork. The only sign that he was still active came with a trivial database application called Rolodex that could be found on Macintosh-orientated bulletin boards in the US.

Although MacPaint and the tiny Rolodex seem to have no logical connection, Atkinson has spent the last three years or so developing a hybrid of the two: an extraordinary Macintosh application called HyperCard.

What exactly is HyperCard? Apple calls it a 'personal toolkit for information', which may seem to be deliberately vague, but is understandably so. The problem is that HyperCard defies easy classification. You can view it as an extremely flexible database system that can store and organise written information and graphic images, or you can look at it as an elegantly simple Macintosh programming environment. In reality, it's

both these things and more. It can store and retrieve information, perform mathematical tasks, play sounds, and even produce animated effects.

Capabilities

HyperCard is a real colossus, requiring a minimum of about 700k of RAM to work properly. The minimum configuration required is 1Mbyte of memory and two 800k floppy disk drives, but you'll need more memory and a hard disk to really put the system through its paces. This review was carried out mainly on a Mac Plus with 1Mbyte of memory and an attached Apple HD20 SCSI hard disk, although I was able to spend some time working with HyperCard on a Macintosh II.

Here's the bare bones of HyperCard's structure. Information is stored on what are called 'cards': at the simplest level, you browse through these cards as you might through the records of any conventional database system. At the highest level, you can search any card, anywhere, for any value. There is support for CD-ROM, videodisc and network access as well as standard Macintosh disk media. One card may contain up to 30,000 characters, although it's unlikely that this amount of elbow room will be required.

A collection of cards is known as a 'stack'. A single HyperCard stack may be a staggering 0.5Gbytes in size and contain up to 16 million objects — for example, text fields and buttons. Text fields are used when you wish to enter information or have HyperCard display the result of some calculation. Buttons, as in dialogue box

buttons, can also be placed on cards, and programs known as 'HyperTalk scripts' can make them do rather amazing things at the click of the mouse. A button might jump you from one card to the next; it might take you to another stack; it might play a melody; it might produce a pie chart based on a group of entered values... the list is endless.

HyperTalk was created by Bill Atkinson and Apple software developer, Dan Winkler. The syntax is so simple, it's virtually guaranteed that within the first few days of using HyperCard you'll be writing useful scripts. Indeed, Apple is praying that those Mac users who never dreamed they could write their own program for the machine will use HyperCard to develop 'StackWare' (the Apple-trademarked term for HyperCard-developed applications).

HyperCard is like any other Macintosh application in that it has an icon which may be double-clicked or, alternatively, can be chosen as the startup application for automatic launching. Since Apple provides two application disks — HyperCard & Stacks (which appears as any other disk on the desktop) and HyperCard Startup (which automatically launches the application when used as the Macintosh startup disk) — users can choose which they prefer.

There are a couple of interesting points about the startup disks. Firstly, although you require a System file, a Finder file isn't necessary. If there is no Finder present, there will be no 'About the Finder' option contained in the Apple menu; when you quit HyperCard, the Macintosh 'Shutdown' dialogue box will be displayed instead of the desktop.

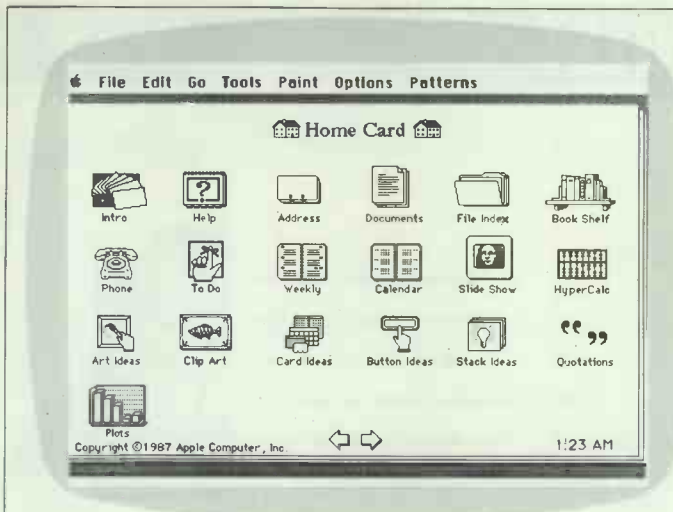

The Home Card is like the opening menu of a HyperCard application. It is not a replacement for the Mac's Finder but offers many similar features

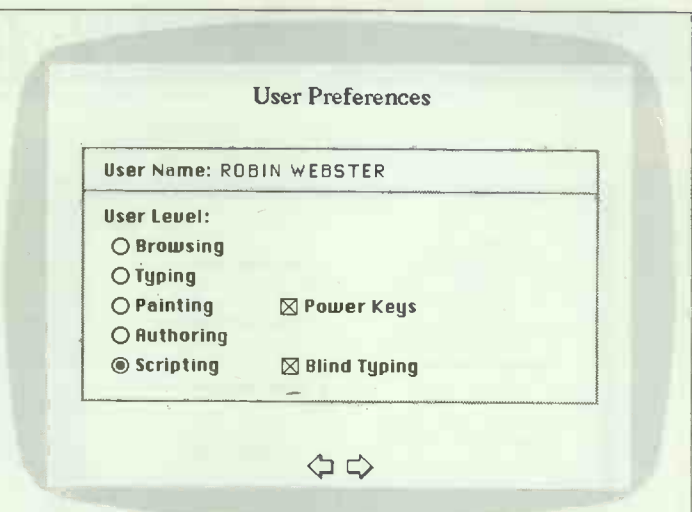

Among the User Preferences available is 'Blind Typing' which allows a sequence of commands to be typed from the keyboard without the actual text appearing on the screen

Secondly, you can launch other Macintosh applications on the disk — such as MacWrite or MacPaint — from within HyperCard, even if no Finder file is available. When this is the case, quitting a standalone application will automatically return you to HyperCard.

Mac memories

Having booted HyperCard, the first thing you will see is the 'Home Card'. This will remind many Macintosh users of the standard Finder environment, as it displays what appears to be a variety of named icons which are obviously meant to be clicked on. While you can launch other Macintosh applications with Hypercard, the Home Card should not be thought of as a replacement Finder — it's only one of a number of special cards that make up what is called the 'Home Stack'. The Home Stack's cards (excluding the Home Card) allow you to set up such things as user access levels and folder pathnames that should be followed when loading specific stacks.

There are a number of ways in which you can access the 'User Preferences' card in the Home Stack; one of the simplest is to click on the left arrow along the bottom of the Home Card. On the User Preferences card there is a place to enter the user name — HyperCard uses this to communicate with you on a personal basis via a dialogue box or a card field at some point. Below the user name lines there are five user-level options:

- **Browsing** A limited range of menus are displayed. Users can search for and display information in stacks but are not allowed to enter or edit that information. This setting will be used primarily when a HyperCard developer doesn't want any alterations made to his stack application.

- **Typing** Using this option, users can enter new information and edit

existing information.

- **Painting** Users can take HyperCard's palette of MacPaint-style tools to create and edit graphics images on cards.

- **Authoring** Users can create new buttons and fields and edit existing ones. At this level you can also choose whether or not to activate the so-called 'Power Key' commands (commands issued using the Command key in combination with some other key).

- **Scripting** This is the highest user level. All menus and menu options are available, and users can create HyperTalk scripts or edit existing ones. You can also choose whether or not to activate the 'Blind Typing' option, which allows you to enter short commands without any visual feedback on what you've typed.

As mentioned earlier, Hypercard comes with a basic set of stacks all ready to go — these are provided on two additional floppy disks. The user selects and views a stack of cards by clicking once on the relevant icon. For example, if you need to summon help information, you click once on the question-mark icon named 'Help'. In reality, the icon has a HyperTalk script 'behind' it.

The Help icon script is:

```
onMouseUp
  visual effect zoom open
  go to stack'Help'
end Mouseup
```

As you can see, HyperTalk's syntax is quite straightforward. In English, you would interpret this script as saying: 'When the user clicks on this icon, go load the stack named "Help" and show the first card in that stack.'

The only line in the script that may seem a little unusual is 'visual effect zoom open'.

Commands starting with 'visual effect' or 'visual' are used to produce a special effect on the Macintosh

screen as you move between cards and stacks. In the Help script example, 'visual effect zoom open' suggests that the first card of the Help stack zooms open instead of just being suddenly dumped into view. This may seem trivial, but I found that the special effects lessened the tedium of navigating around card stacks.

Traditionally, people who want to store information on a computer system have found it extremely difficult to find the appropriate database. The quick-and-dirty approach to storing data as a collection of flat-file records may seem fine until you come to sophisticated data analysis or preparing detailed reports. And, while relational databases may seem to offer all the sophisticated searching capabilities anyone could want, they are often difficult to use: you may have to acquire some heavy-duty programming skills before they provide any discernible benefits.

Also, information often has to be restructured to meet the requirements of the relational data model. If your information doesn't fit, you're out of luck.

Atkinson's law

Bill Atkinson designed HyperCard around a much more informal notion: why not let users store information on the computer equivalent of filecards and let them link a card to any other by means of script-driven buttons. HyperCard provides ways of linking cards and, therefore, by association, the information they hold. There is no rigid data model to grapple with, no formal rules for linking this card with that. You either:

- Use HyperCard's guided 'LinkTo' option to automatically link cards and stacks; or

- Write your own script to do the linking.

One word of caution — if you change the name of any card in-

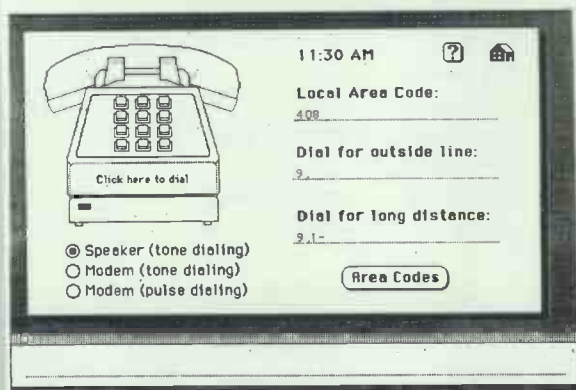

The user has a choice of methods for auto-dialling a telephone. The message box at the bottom is where further HyperCard commands could be issued one at a time

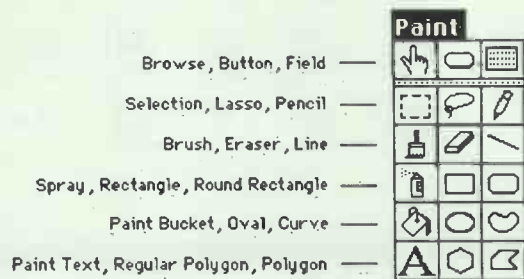

The Paint toolbox, like many of the pull-down menus, can be 'torn off' and positioned where the user wants on the screen. The familiar tools add borders and other enhancements

involved in a link, you will be responsible for updating the linking script. HyperCard won't do this for you. There isn't much to this procedure, however: just re-use the LinkTo option or type the new card name into the old button script.

When you've entered a stack, pretty much anything is possible. The first card can be an index, a map, or any other type of guide to the rest of the stack contents. Alternatively, the first card may be some kind of main 'function' card which is then backed up by other types of reference cards (for instance, a telephone dialler backed up by an area code list). Each card occupies all of the standard 9in Mac screen. On Macs equipped with larger screens, cards are not scaled up in size: users just see more space around each card. The rationale behind this was to keep the HyperCard environment consistent from machine to machine.

A card, technically speaking, is really only an empty screen. You must add the graphic images, text fields and buttons that make the card work for you in storing or manipulating information. To do this, you have to understand how to use the card's 'layers'. Normally, database records have only a single layer that contains a number of fields for data entry. A card, however, can have a 'Background' layer and a 'Card' layer.

The Background layer is where you normally put graphics, buttons, and fields when you want every card in a stack to share them. If you place a picture of a standard 3x5in index card in the Background layer of a name and address stack, each card created in that stack will look like a 3x5in card. If you place 'Next Card' and 'Previous Card' buttons in the background later, each card will have

those buttons. And if you put a text field in the Background layer, each card will have an equivalent field. To create one or more unique cards in a stack, however, you have to place any of the above into the Card layer.

A good example of how to use the Card layer is HyperCard's Clip Art stack. Although each card has the same Background layer design (a border with a group of buttons), the Card layer contents are quite diverse. Some cards have a picture only, while others have both a picture and a button. New users should look carefully at how all the stacks provided are put together — especially the Introduction to the HyperCard

'HyperCard can store and retrieve information, perform mathematical tasks, play sounds and produce animated effects.'

stack — before designing their own. There are many readily available building blocks that can be copied and used in your own applications.

When you start to create StackWare applications, you'll need to familiarise yourself with the items from the 'Tools' menu. This menu is unusual in two ways. First, instead of a list of commands, it contains tool icons. The top three are the 'Browse' tool, the 'Button' tool, and the 'Field' tool.

You select Browse when you want to navigate from place to place within HyperCard stacks. It's chiefly for clicking on buttons and selecting/

editing text in text fields. Choose Button when you want to create or edit a button. HyperCard will automatically highlight all buttons on the current card with a black outline so that they are clearly visible. A selected button is surrounded by a moving dotted line.

The Field tool is used when you want to create or fit a text field on a card. Fields may be resized by dragging on the bottom right-hand corner and they can display any installed Macintosh font. Remaining icons are readily recognisable as MacPaint-style drawing, editing and selection tools, but these are enhanced versions of the originals.

The other unusual feature of the Tools menu is that you can 'tear' it off from the menu bar across the top of the screen. To tear, all you have to do is click on the menu and then drag past the bottom edge or beyond either side while holding the mouse button down. Once torn from the menu bar, the Tools menu takes the form of a window and will remain in view until you click on the close box in the top left corner. This feature is a good combination of the pull-down and pop-up menu concepts and I used it frequently.

The only other tear-off menu is the 'Patterns' menu, which contains fill patterns for use with the painting tools. Otherwise, all the other HyperCard menus are of a conventional design.

Communication

There are two ways of communicating with HyperCard; via the menus across the top of the screen, or via a special window called the Message box. If you only have browsing access, all you'll see will be the 'File', 'Edit' and 'Go' menus and you won't

be able to modify cards or stacks. If you have authoring or scripting access, though, you'll see every available menu and you can make whatever changes you feel are necessary.

The menus may be too slow, but you can always use the Message box — just select the 'Message' option from the Go menu (or use the Command-M key combination). The Message box is used to issue one-line commands which are then carried out immediately by HyperCard (as opposed to HyperTalk scripts which are activated only by specific events occurring within HyperCard). The one-line constraints on commands naturally limits the extent of their power, but they are definitely an excellent way to move around quickly within HyperCard or test portions of HyperTalk scripts.

Here's how you would retrieve a card from the address stack using the Message box. First, click on the address stack icon on the Home Card. The first card of that stack will be displayed. Choose Find from the Go menu and you'll notice that when the Message box appears, it already contains a 'find' command template. All you have to do is enter the text string HyperCard should look for. After entering the text, you press Return and HyperCard then locates the first relevant card. While it is looking for a match, the cursor takes on the shape of a beachball that spins while the search progresses.

When a target card has been found, HyperCard displays it and places an outline around the text you are looking for. If more than one card meets the specification, all you have to do is hit Return to view them in turn. The data retrieval algorithm is quite fast — I never really felt I had to wait too long for a search to be completed. In addition, the Message box can be used as a calculator. You type in the values you wish to have evaluated and press Return — the answer will appear immediately in the Message box.

If you find that the Message box gets in the way of some activity, select the 'Blind Typing' option on the User Preferences card. This arrangement traps keyboard commands even when the Message box is not displayed. And, when you get used to the idea of not seeing on the screen what you're typing, it's not really that hard to do — the only problem is when you make typing mistakes. If this happens it's not a catastrophe — just show the Message box and edit the command in the normal manner. I didn't encounter any real problems here and was quite happy keeping the blind typing option turned on all the time.

HyperCard's printing capabilities are not only quite sophisticated, but are also surprisingly easy to use. If

HyperTalk let loose

HyperTalk allows the average Macintosh user to develop his own applications in an elegant way. Its syntax is quite easy to follow and there are few major rules that must be observed. If you try to do something you're not allowed to, HyperCard's error dialogues are usually very helpful in pinpointing the problem.

There are two places in which you can enter HyperTalk commands: one is in the Message box; the other is in the scripts that make card buttons come alive. Be aware that short commands entered in the Message box are acted upon as soon as you hit Return, while commands stored in the form of scripts can be much longer and will only be activated when a particular event takes place (for example, a button being clicked). Also, scripts can do some pretty sophisticated things like automatically selecting any HyperCard menu command, or selecting all or part of a card graphic and moving it around on the screen.

Animation

As an example, let's take the Clip Art stack provided by Apple. One card has a picture of a car and a button marked 'Drive the car'. If you click on the button, the car image will be dragged backwards and forwards across the screen. Here's the script behind the button:

```
onMouseup
  put the userLevel into saveLevel
  if the userLevel < 3 then set userLevel to 3 — 'Painting'
  if the userLevel < 3 then exit mouseUp
  choose select tool
  doMenu 'Select All'
  doMenu 'Select'
  set dragSpeed to 100
  drag from 256,171 to 150,171
  drag from 150,171 to 350,171
  drag from 350,171 to 256,171
  doMenu 'Select All'
  doMenu 'Revert'
  choose browse tool
  set userLevel to saveLevel
end mouseUp
```

All pretty-self explanatory, as you can see.

Sound generation

Commands are provided for producing sounds. The simplest sound that can be made is the system 'beep'. Beeps are of a fixed pitch and the only variable is the number that can be made. The command 'beep 10', therefore, would produce ten system beeps. If, on the other hand, you want to compose some reasonable-sounding music, you would use the 'Play' command instead. A sound script using Play might look like this:

```
play 'Boing' 120 e c d g3h gq d4 e cw
```

The word between quotes is the musical voice of the sound to be made — in this case, a 'boing' type of sound. The '120' is the tempo. The letters and numbers are the list of notes to be played. To play sounds other than 'boing', it's up to you to make the data for the new sound available. The actual data for sounds are stored as resources and you can use an application such as ResEdit to move sounds (resource type 'snd') among stacks.

Visual effects

HyperCard's visual effect commands have been based on the kind of special effects used in film and television. The commands — all must be preceded with the words 'visual effect' or just 'visual' — are:

zoom out/zoom in	iris open/iris close
dissolve	wipe left/wipe right/wipe up/wipe down
checkerboard	barn door open/barn door close
venetian blinds	scroll left/scroll right/scroll up/scroll down

The speed at which these effects occur when moving between cards and stacks can be set by using them in conjunction with the adverbs fast, slow, slowly, very fast, very slow, or very slowly. Be warned, though — it can be addictive fooling around with these particular commands.

HyperTalk command list

A full list of HyperTalk commands is given below:

add	divide	multiply	set
answer	do	open	show
ask	doMenu	printing	sort
beep	drag	play	subtract
choose	edit script	pop	type
click	find	print	visual effect
close	get	push	wait
convert	global	put	write
delete	go	read	
dial	hide	reset Paint	

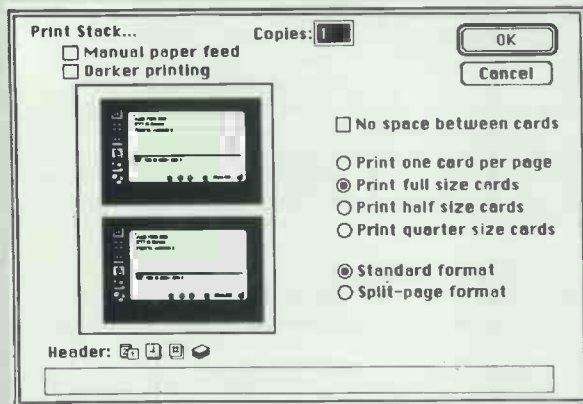

Print options allow for the selection of a number of ways of arranging the cards on the printed page. The usual header icons for date, time and page number are included

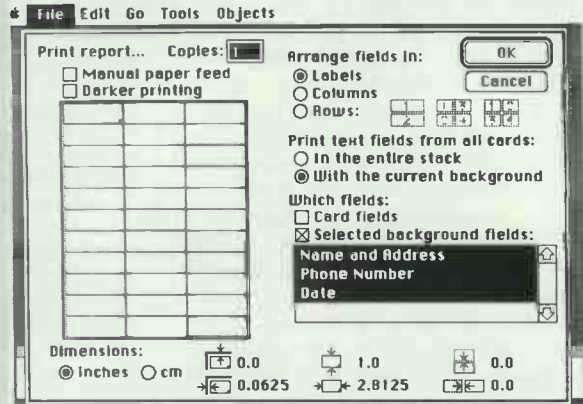

Fine control is provided over how each card is printed, with the possibility of specifying certain fields and selecting cards with a common background

you want a hard-copy of a single card, all you need do is choose the 'Print Card' option from the File menu while that card is displayed. This works more or less like a snapshot capability. When it comes to printing whole stacks, though, there are quite a few options for page arrangement, card sizes, and header text.

Undoubtedly the slickest HyperCard print dialogue is the one devoted to printing reports and labels. 'Print Report' essentially lifts all the text from user-specified fields on cards in a single stack (you cannot merge fields from different stacks) and prints that text out according to the layout you specify in the Print Report dialogue box. Fields may be printed on labels, or on full sheets of paper in column or row format.

As far as labels are concerned, you can change the number of labels per page, their size, and the spacing in between by dragging on the images in the 'minipage'. Any changes you make update the measurements displayed along the bottom of the dialogue box. The minipage can also give visual feedback on the space taken up by each selected card field on a full-page report. If you wish to alter the default space taken up by a field, drag the relevant column guide to one side or the other.

HyperCard supports both the Apple Imagewriter and LaserWriter printers, but there are some limitations to the latter. When you select the 'Landscape Printing' option on the LaserWriter Page Setup dialogue, printing can take longer than you might expect. Make sure you select the 'Faster Bitmap Printing?' option to avoid the frustration of hearing the laser printer chugging away but not receiving any hard-copy for what the HyperCard manual itself describes as an 'extremely long time'.

Documentation

The 200-plus page manual is of the usual Apple style and quality in that it covers all the basics and offer hints for further exploration. If you use it

'Traditionally, people who want to store information on a computer system have found it extremely difficult to find the appropriate database.'

in conjunction with the online Help system, you shouldn't have any trouble finding your way around the application. If you're looking for good coverage of the HyperTalk language, however, you'll be disappointed.

At the time of writing the only source for HyperTalk info were the Help stack that comes with HyperCard (only a basic overview of commands and functions), and *The Complete Hypercard Handbook* by US computer journalist, Danny Goodman, the first major book on the application. In production is a more technical document called the *HyperCard Script Language Guide* which will be made available in the US via the Apple Program Developers' Association. The release of this document should give would-be StackWare developers everything they need.

Price

HyperCard will be shipped free with all new Macintosh systems. If you already have a Mac, it will cost \$50 for a shrink-wrapped copy including four disks and a manual.

Conclusion

There is so much that is open-ended about HyperCard that it can be a real problem trying to focus on its major features. Certainly, it is an unique environment which makes the task of information storage and retrieval less of a chore and more of an adventure. It is also the first tool that non-technical Macintosh users can use to develop practical applications.

Already, commercial StackWare products are surfacing. While writing his book, Danny Goodman also found time to develop two StackWare applications called Focal Point and Business Class. The former is a time and information management system that includes a daily appointment calendar, address cards, phone conversation logs, a spreadsheet, and an invoice and graph generator. The latter is a travel planning tool that provides information on international currency exchange rates, transportation schedules, local customs, time differences, and so on. They are priced at about \$100 and \$70 respectively and will be distributed in the UK by Activision.

Dialog Information Services is said to be working on ways to use HyperCard as a front-end to its online database offerings. And many libraries are considering converting their tired, old card file systems to HyperCard format.

Apple, meanwhile, intends to cultivate the education sector. It's already offering financial incentives to educational establishments and students to upgrade their old 512k Macs to Mac Plus status so that they can use HyperCard. Also, a number of important educational organisations have been chosen as early test sites for the application.

HyperCard will be available in the UK from Apple Computers on (0442) 60244. **END**

Psion PC-Four. Very serious software. Very silly price. £69.

(exc VAT)

Psion PC-Four. A word processor, spreadsheet, database and graphics designer. All well tried and trusted. All four £69 (exc VAT).

If you've ever dreamed of owning a suite of key programs for your PC without having to dig deep into the pocket, here's the eye-opener.

PC-Four gives you four powerful, feature-packed programs (plus a tutor for each, for good measure), all for the price you'd expect to pay for just one of them.

They're not 'pruned down' versions of other programs, either. They're all well-proven and highly rated. What's more, you can exchange data between the four programs (or with other programs, for that matter) so you can integrate your work. And they're all extremely easy to use, with help screens sensibly related to the current operation available at all times.

You might think, at such a low price, that the programs don't have all the features that you'd expect or want. You'd be wrong.

Take PC-Quill. 'Which Computer' called it "...the best general purpose word processor on the market". With good reason. It has full editing, text and page formatting facilities, automatic page numbering and word count, headers, footers, glossaries and so on. It incorporates mail merge from the keyboard or saved files. And the display reflects the print-out - with type emphases. So you can see what you're getting.



The spreadsheet, PC-Abacus, can handle 999 rows and 255 columns, and uses memory efficiently. Its numerous features include identification of columns, rows and cells by textual content (so formula can be entered in English, not computerese), split window displays, automatic replication of formulae, format control, merging from different spreadsheets simultaneously, and a full range of functions and conversions - with string handling and condition testing. PC User called it "extremely versatile."

Then there's PC-Archive. This powerful database can handle a number of huge files (up to 64k records each) at a time. It can be used direct from the keyboard, or through its comprehensive interactive programming language - which is structured so that it can be extended. And it has a built in 'forms' designer to format the screen display and print-out. "Its degree of usefulness is extraordinary" said PC User. We're not surprised.

It's the same story with the graphics creator, PC-Easel. This gives a wide choice of 3D, line and pie chart displays with interactive entry and design. Data can be entered direct or from a saved file and manipulated by formulae, or it can be created by manipulation of existing data. It provides user positioned vertical and horizontal annotations, keys and labels, and automatic scaling of the axes. And it allows multiple representations on one display. Micro Decision referred to it as "an extremely flexible graphics package".

On top of all this, remember, there is a tutorial disk, to show you how to use the more important elements of each program. And of course, there is a comprehensive manual.

PC-Four is designed for all IBM* PC compatibles, including the new low priced clones. Now you know what it does and what it runs on, take another look at the price. Twice.

For the name of your nearest stockist or a colour brochure, contact Psion on 01-723 9408.



Psion Limited, Psion House, Harcourt Street,
London W1H 1DT Tel: 01-723 9408
Telex: 296489 PSIONC G. Fax: 01-724 6646

* IBM is a registered trade mark of International Business Machines Corporation.

Time trials

It is now one year since we launched our new PCW Benchmarks and thanks to input from readers, they have proved most successful. More developments are planned and Nick Walker looks at some of the new innovations in our rating system.

The PCW Benchmarks are one year old and to celebrate, we have included a poster with this issue listing around 150 machines tested so far. In the past year, I have received over 1000 letters about these Benchmarks: of these, approximately 95 per cent were in favour and 5 per cent were against.

Thank you for your response so far, but there is still a number of gaps to be filled. If your machine isn't on the poster then please test it and send in the results; even results for machines we've already covered will help to confirm their accuracy. Another area in which your help would be much appreciated is in the production of Benchmark listings for languages such as Cobol, Lisp, Smalltalk, Prolog and BCPL.

Introducing the Index

Two new features have been added to the PCW Benchmarks — the PCW Index and a new graphic way of displaying the Benchmarks in the magazine. One major gripe that came through in your letters is that you miss the average figure that used to accompany the old Benchmarks. In response to this we have introduced the PCW Index.

A straight average is even more meaningless with the new Benchmarks than with the old ones because the actual timings for one machine can easily span a range of between 0.03 and 150 seconds for the various tests.

Instead we have used a geometric mean which gives each result equal weight in the final value. Rather than give this value straight, we thought it more useful to express a machine's performance in relation to the ubiquitous IBM PC.

In order to do this, we very carefully produced a set of timings for an IBM PC/XT with 20Mbyte hard disk, IBM colour monitor, PC-DOS 2.11 and an IBM CGA graphics card. Using these timings as a standard, a PCW Index of 8 means that the

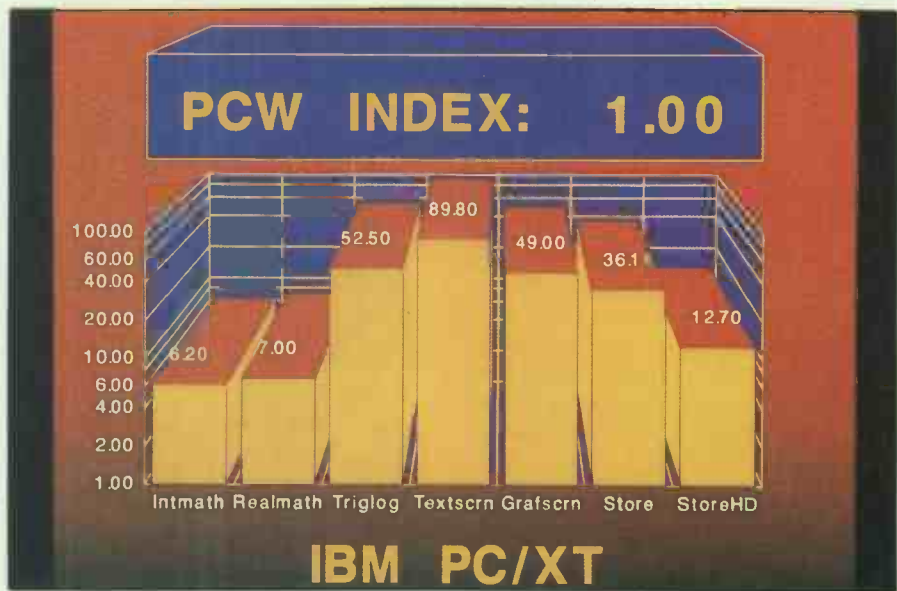

The new Benchmark graphic shown here was created with Davrelle from Soft Image Systems, and then exported to a 35mm slide camera

Charting the Benchmarks

We had a number of criteria when looking for a presentation graphics package to display the PCW Benchmark timings.

Firstly, it had to interact with a Lotus-compatible spreadsheet. PCW's Benchmark timings are stored in Sagesoft's PC Planner (alias The Twin). Secondly, it had to be capable of producing high-quality full-colour graphics that could be output to a camera or printer. And finally, once we had established a standard style for the chart, we wanted to be able to run off old or create new charts simply and quickly without having to start from scratch each time.

Davrelle from Soft Image Systems met all these criteria, though we had some problems finding our way through the program. Despite running under GEM, some of Davrelle's methods are far from intuitive; but, once some of the omissions and anomalies are ironed out, it will be a first class product.

One of Davrelle's most endearing features is that it draws its data directly from an original spreadsheet file. A nifty set of sliders allows the user to specify exactly which rows and columns in the spreadsheet hold the data. Once the 'data windows' have been set, a couple of keystrokes produces a chart in the default style and colours. In addition, if the spreadsheet should later change, a process called 'Davrellating' allows you to automatically update all the charts.

Finally, Davrelle allows us to define a standard chart format through which different sets of data can be passed.

Once the charts have been created, they are 'printed to disk'. We take our disk to a London company called Neville Computer Graphics, which runs the GEM output files through a 4000-line resolution Honeywell camera to produce the final 35mm slides. All future PCW Benchmark timings along with the PCW index will be presented in this graphic form.

machine is eight times faster than an IBM PC. Similarly, a PCW rating of 0.2 signifies a machine that is a fifth

of the speed of the IBM PC.

If any statisticians out there can think of a better scheme, please let

IBM PC or compatible Turbo Pascal Benchmarks.

```

program intmath;
var i,x,y : integer;
begin
  x := 0;
  y := 9;
  writeln ('Start');
  for i := 1 to 1000 do
  begin
    x := x + (y * y - y) div y
  end;
  writeln ('Finish',x); end.

program realmath;
var i : integer;
    x,y : real;
begin
  x := 0.0;
  y := 9.9;
  writeln ('Start',x);
  for i := 1 to 1000 do
  begin
    x := x + (y * y - y) / y;
  end;
  writeln ('Finish',x); end.

program triglog;
var i : integer;
    x,y : real; begin
  x := 0.0;
  y := 9.9;
  writeln ('Start');
  for i := 1 to 1000 do
  begin
    x := x + sin( arctan( cos( log (y)))));
  end;
  writeln ('Finish',x); end.

```

```

program textscrn;
var i : integer;
begin
  writeln ('Start');
  for i := 1 to 1000 do
    writeln ('1234567890qwertyuiop',i);
  writeln ('Finish'); end.

program grafscrn;
var x,y : integer;
begin
  writeln ('Start');
  GraphMode;
  for x := 1 to 100 do
    for y := 1 to 100 do
      plot (x,y);
    TextMode;
  writeln ('Finish'); end.

program store;
var i : integer;
    testfile : text;
begin
  writeln ('Start');
  Assign (testfile,'test.***');
  Rewrite (testfile);
  for i := 1 to 1000 do
    write (testfile,'1234567890qwertyuiop');
  Close (testfile);
  writeln ('Finish'); end.

```

me know. However, please don't complain to me that a single rating figure is meaningless — I already know.

The other new feature of the Benchmarks is a new graphical form of displaying them. The graph is produced using a presentation graphics package from Soft Image Systems called Davrelle.

Benchmark design

One of the reasons for the success of the old Benchmarks was that they were short and easily understood. Users of any machine, even if it hadn't been Benchtested in PCW, could type in the Benchmarks and get a measure of how fast the machine was compared with its rivals. To make it easy for the Benchmark listings to be used, we have kept them as short as possible. Only a few of the letters objecting to the new Benchmarks suggested an alternative and those that did almost all fell down on this score.

Another problem the new PCW Benchmarks had to overcome was that of different machine architectures. We believe there is

more to microcomputing than the IBM PC and its many clones, so it was imperative that the new Benchmarks would run on as many machines as possible. While considering the different machines the Benchmarks were going to run on, it became apparent that all machines had a Basic language available. As languages other than Basic often run the Benchmark programs considerably faster, we have compiled our Top Ten list on the basis of the Basic timings only.

In order to be totally fair, we also insist that the Basic supplied with the machine is used. If no Basic is supplied as standard, the most popular interpreted Basic for the machine is run. However, we did want to include comparisons in performance between different languages running on the same machine. To help the writing of Benchmark programs in different languages, the actual Benchmark tasks are specified in language-independent form.

Having decided that the Benchmarks should be short and independent, the most difficult decision was determining which features to test.

After much consideration, the following were chosen:

- Two separate Benchmarks (Intmath and Realmath) to test integer and real arithmetic. Integer arithmetic gives a good indication of the general processor speed, whereas real arithmetic speed depends on the quality of the algorithms in the software, unless a numeric co-processor is used.

- A separate Benchmark to test logarithmic and trigonometric functions, as these are primarily of interest to scientific users and certain heavy number-crunching business applications.

- Two separate Benchmarks (Textscrn and Grafscrn) to test the speed of text and graphics screen I/O. The graphics screen I/O test uses nothing more complex than Plot (i,j) to enable it to run on as many machines and languages as possible.

- A Benchmark that measures the disk drive speed; this is by far the most controversial of the six Benchmarks as disk speed is affected by so many factors. For example, an old hard disk will perform more slowly than a new one, due to file frag-

BENCHMARKS

Microsoft Basic benchmarks for the IBM PC and compatible. Should also work unaltered with GWBasic, Turbo Basic, Quickbasic and any other Microsoft compatible Basic for the PC.

```
100 REM intmath
110 PRINT "Start"
120 X% = 0
130 Y% = 9
140 FOR I% = 1 TO 1000
150 X% = x% + (Y% * Y% - Y%) \ Y%
160 NEXT I%
170 PRINT "Finish",X%
180 END
```

```
100 REM realmath
110 PRINT "Start"
120 XI = 0
130 YI = 9.9
140 FOR I% = 1 TO 1000
150 XI = XI + (YI * YI - YI) / YI
160 NEXT I%
170 PRINT "Finish",XI
180 END
```

```
100 REM triglog
110 PRINT "Start"
120 XI = 0
130 YI = 9.9
140 FOR I% = 1 TO 1000
150 XI = XI + SIN(ARCTAN(COS(LOG(YI))))
160 NEXT I%
170 PRINT "Finish",XI
180 END
```

```
100 REM textscrn
110 PRINT "Start"
120 FOR I% = 1 TO 1000
130 PRINT "1234567890qwertyuiop",I%
140 NEXT I%
150 PRINT "Finish"
160 END
```

```
100 REM grafscrn
110 PRINT "Start"
120 SCREEN 2
130 FOR X=1 TO 100
140 FOR Y=1 TO 100
150 PSET (X,Y)
160 NEXT Y
170 NEXT X
180 SCREEN 0
180 PRINT "Finish"
190 END
```

```
100 REM store
110 PRINT "Start"
120 OPEN "test.***" FOR OUTPUT AS #1
130 FOR I%=1 TO 1000
140 PRINT #1,"1234567890qwertyuiop"
150 NEXT I%
160 CLOSE #1
170 PRINT "Finish"
```

The slowest machines

MACHINE	PCW INDEX
Casio PB-700 pocket computer	0.1
Texas Instruments TI99/4A	0.16
Sharp PC1600	0.27
HP 71B pocket computer	0.29
Memotech MTX512	0.35
Sinclair Spectrum	0.36
Atari 800/130XE	0.47
Commodore Plus/4	0.47
Apple II/IIB	0.69
Coleco Adam.	0.72

All timings were run in interpreted Basic supplied with the machine.

Fastest in any language

MACHINE/LANGUAGE	PCW INDEX
PD11-44/Fortran 77	71.58
Prime 550/Prime Fortran	36.45
RM Nimbus PC1+8087/ Zorland C	14.29
RM Nimbus PC1/Pro Pascal	14.15
Acorn Archimedes/Basic V	13.82
Atari 520ST/Fig Forth	12.60
Inter-Orient AT/ Turbo Pascal	11.72
Apricot Xi/DeSmet C	9.99
Apple Macintosh II/MBasic	9.14
Apricot PC/Pro Pascal	8.93

mentation. The Benchmark doesn't attempt to overcome these problems, but it is simple and our subsequent experiments have proved it to be a reasonable index when compared against far more complex disk test procedures. Most users don't start

The fastest IBM compatibles

MACHINE	PCW INDEX
Mission 386	7.27
Compaq Portable III	6.21
RM VX386	6.19
Dell 286 ¹²	4.54
IBM PS/2 Model 50	4.22
ITT Xtra XL	3.77
Wyse PC286	3.76
IBM PC/XT286	3.71
Citadel PC/AT	3.67
Apricot Xenii	3.52

All timings were run in interpreted Basic supplied with the machine.

The fastest 68000-based machines

MACHINE	PCW INDEX
Apple Macintosh II	9.14
Apple Macintosh SE	5.00
Commodore Amiga 1000	2.16
Atari 520ST	1.74
Sinclair QL	1.10

All timings were run in interpreted Basic supplied with the machine.

with a fresh disk every morning, and the aim of this Benchmark is to reflect the real world, albeit at the cost of strict scientific comparability.

We realise that not all machines and/or languages are able to run all the Benchmark programs. Some

machines do not have graphics, some languages do not support floating-point arithmetic. To be fair, in compiling the various Top Ten tables printed here and on the accompanying poster, we have excluded from consideration those machine/software combinations not capable of running at least five of the seven programs; and, unless stated, all timings were conducted using the Basic supplied as standard with the machine.

The future

There are two areas where we'd like help in further developing the PCW Benchmarks. Firstly, we'd like to receive listings of the Benchmark programs in other languages — Prolog and Lisp are two that immediately spring to mind.

Secondly, we'd like to extend the Benchmark programs to test performance on other tasks. The advent of graphic co-processors, blitter chips and other hardware enhancements means we need some way of testing specifically the contributions these features make to machine performance. Any English language algorithms will be most welcome, though to maintain compatibility, it must be possible to write the programs in a standard interpreted Basic.

Finally, we'd like to thank you for your contributions.

END

THE LATEST THING IN AMSTRAD PRINTERS.



Now when your Amstrad printers' ribbon runs out, you can run out and buy the latest thing in Amstrad printers: Amstrad printer ribbons.

They're available from ADL, Alders, Comet, Currys, Dixons, Eltec, Farnell, First Software, Laskys, John Lewis, Lightning, Norbain, Office International, O.S.T.A., Rymans, Northamber, P&P, Sandhurst, Wildings and Hugh Symons.

<u>CODE NO.</u>	<u>SUITABLE FOR</u>	<u>RETAIL PRICE</u>
Soft 06409	DMP 2000/3000/3160	£5.99
Soft 06441	PCW 8256/8512	£6.99
Soft 50015	DMP 4000	£8.04

Prices correct at 1.9.87 but may change without notice.



Amstrad plc., PO Box 462,
Brentwood, Essex CM14 4EF.
Telephone: (0277) 262326.

Machine vision

The human visual system is a complex and sophisticated one but there are severe limitations on what the eyes and brain can take in. Nick Hampshire examines the development of computer vision systems which could enable us to see things never before seen.

The human eyes and their associated areas of brain form a visual system of amazing complexity and sophistication. Let's take a fairly simple scene such as a pile of books on a wooden desktop; on top of the books is an orange and a tennis ball, and beside the pile of books is an old-fashioned alarm clock. The eye and brain are unable to analyse and understand such a scene in an instant. We recognise the books as being books, we do not think that perhaps they may be blocks of wood or plastic. We do not confuse the orange and the tennis ball, and attempt to eat the ball and play tennis with the orange. We know the position of everything in the scene, and can reach out and pick up the orange or select a book from the pile.

The visual system formed by the brain and the eye is capable of performing this visual analysis in just a fraction of a second. If we look at the scene for a slightly longer period, perhaps as little as one second, we are able to gain more information. We can analyse the position of the hands on the clock and from that information determine the time. We can analyse the writing along the spines of the books and from that information determine the contents of the books.

In as little as one second, the human eye and brain have gained enough information to be able to answer such questions as 'What time is it?' or 'Is the blue book on top of the pile a dictionary?' or even 'Is the orange ripe?' In a very short space of time, the human visual system has acquired a lot of knowledge about a scene.

The visual process is thus concerned with the conversion of an optical image into knowledge about the world as it is perceived in that image. It is a process which we all take for granted — we do not have to *think* about seeing, we just *see*. Yet the process is so complex that it is

unlikely that computers will be endowed with any but the most rudimentary visual capabilities until well into the next century.

Blind spot

The human visual system, despite its enormous sophistication, does, however, have severe limitations. Foremost of these is its very limited spectral response. The unaided human eye can not see images in the far ultraviolet, or infra-red areas, neither can the human eye perceive X-rays or microwave radiation. It is also very difficult for the human eye to differentiate between subtle variations in light intensity. With 200 different shades of the same colour, ranging from full intensity to totally colourless, the human eye will fail to distinguish between adjacent shades.

It is these limitations in human visual capabilities which have been the primary target for development by researchers into machine vision. The result of this work has allowed computer vision systems to see things which mankind has never seen before, from the moons of Jupiter to the metabolism of chemicals deep within a living human body. These developments have considerably augmented the human visual capability, and are proving to be of enormous scientific and economic value.

Given the current state of development, the subject of machine vision can thus be divided into three areas of development. The first of these is the technology of visual input, and involves the sensing of an image and its conversion into digital form. This data can then be utilised by the second area of development which is image manipulation. This involves performing mathematical operations upon the image to change it or extract more information from it. The third and last area of development is image analysis and recognition — in other words, the extraction of knowledge about the world from visual in-

formation. The first two of these areas of development are now well understood; the third area is still a long way from being even remotely solved and, if you excuse the pun, is the subject of much academic groping in the dark.

Image input

The most obvious means of placing a visual image into a computer's memory is to use a conventional TV camera. The camera can be colour or monochrome, even infra-red, and equipped with lenses to allow it to view microscopic objects or objects at great distances. To make it sensitive to selected wavelengths of light, it can be fitted with filters, and it is even possible to use filters to input a colour image with a monochrome camera. The TV camera can be connected directly to the computer or located at the far ends of our universe and linked by radio communications.

A TV camera's output contains information about the image as a measurement of the light intensity at every point in the image. This image can be considered as being divided into a grid which, on a standard TV camera, is scanned line by line in about forty milliseconds. During this period, 625 lines are scanned with each line containing the equivalent of over 1000 image points. This stream of data is in analogue form and has to be converted to digital format by a very high speed analogue to digital converter before it can be put into a computer.

Each picture element, or pixel, can have a varying intensity value which depends on the amount of light hitting that point on the image detector. In digitised form, each pixel thus requires between 4 and 8 bits to represent the intensity value, and a standard black and white TV image is represented by between two and four million bits of data — this translates into a data rate of 50 to 100 million bits per second. If the image

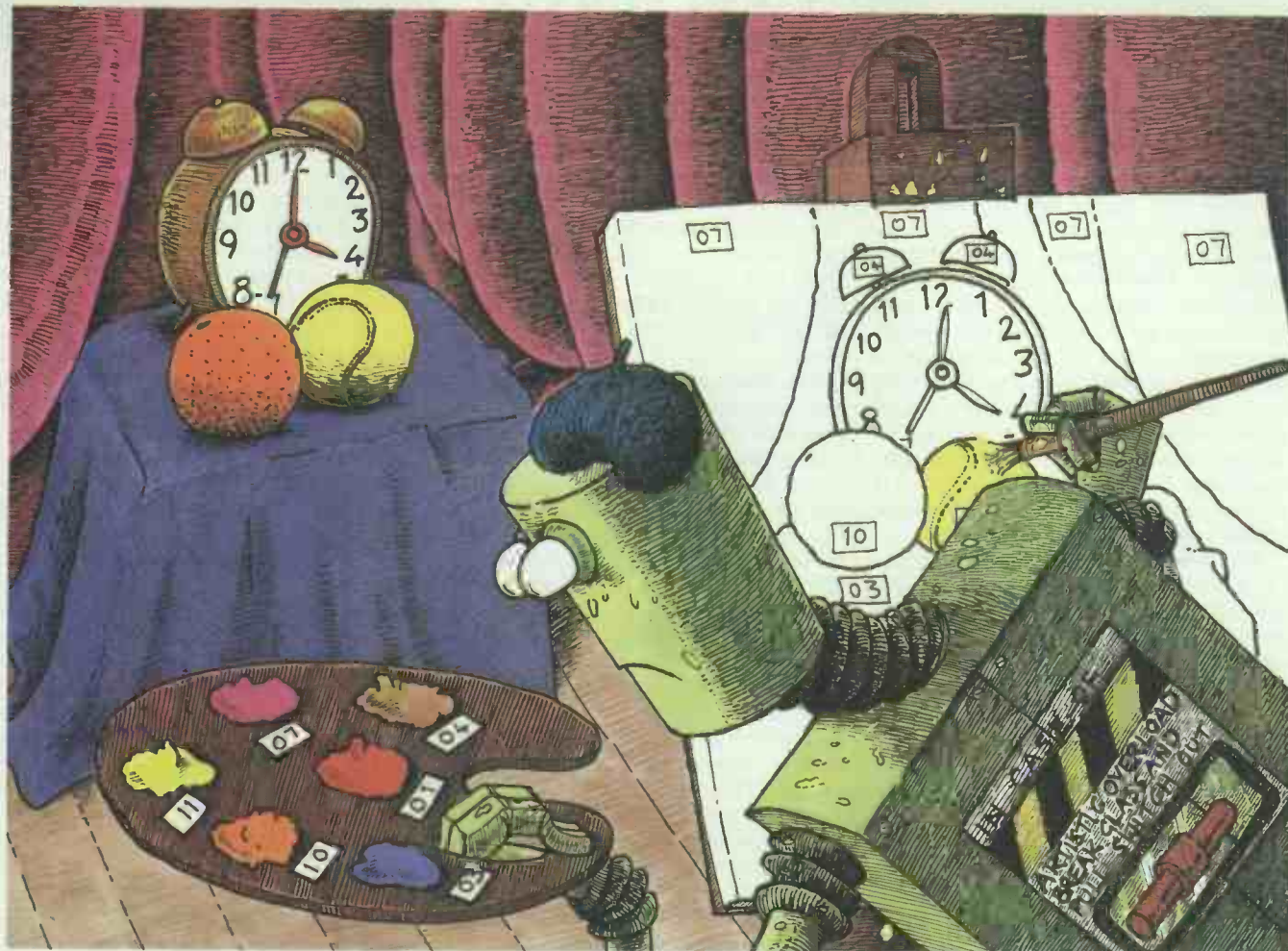

is derived from a colour TV camera then the data rate is even higher.

In practical computer image processing systems, the high data rate is overcome by analysing just a single image rather than a flow of images. The high data input rate can be slowed down to a manageable level by a special piece of hardware called a frame grabber. As its name suggests, this device takes a single frame from the TV camera, digitises it and then stores it in memory. The data output does not necessarily have to be an array of 625x1000 pixels: the frame grabber hardware can produce a scaling of this image by sampling every other line and every fourth pixel as well as omitting the top and bottom 30 lines — this would produce a digitised image of 256x256 pixels square. When the image data has been acquired by the frame grabber, it can be accessed by the computer at a much slower rate.

The data provided by a frame grabber is simply an array of values stored in memory. If the frame grabber digitises an image into a 256x256 array of pixels with 64 levels of intensity, or 'grey scales' as they are usually referred to, then the image will occupy just under 50k of memory. This is quite a modest image digitisation and is typical of some of the frame grabber systems which can be purchased for use with

desktop computer systems. Professional high-resolution systems, such as those used on spacecraft, will digitise images with a resolution several thousand pixels square and perhaps a thousand grey scale levels. Whatever the resolution of the digitised image, the data store in memory can then be analysed and manipulated by the computer.

Medicinal purposes

Image data need not necessarily be derived from a TV camera — indeed, some of the most exciting work on machine vision has used totally non-visual imaging systems. Perhaps the best known of these is the medical CAT scanner. The term CAT stands for Computerised Axial Tomography; this refers to the mathematical techniques which are used to construct an image of a slice through a living body and which, unlike conventional X-ray pictures, shows all the soft tissue locations as well as the location of the bones.

The data required to construct the image is obtained by taking a series of about 300 measurements at regular intervals all around the patient. Each of these measurements produces a series of values indicating reflections, refractions or intensities, typically giving a total of over 100k of data. This data is then used by the computer to construct an image of

the slice through the patient defined by the plane of rotation of the detector. The mathematics used are quite complex and involve extensive use of Fourier analysis.

Space-based remote sensing and medicine have both been the major driving forces behind the development of computerised imaging and machine vision systems. They have made enormous advances since 1964, when many of the foundations for this work were laid down by Dr Robert Nathan at the Jet Propulsion Laboratory in California for the Ranger 7 moon probe. There are now a whole range of imaging techniques which rely on computers to build images which would be impossible to obtain by any other means.

Image manipulation

When it has been digitised and stored within the computer's memory, an image can be manipulated to improve and extract more information from it. The image will be stored as an array of pixels, with each pixel having an intensity value. Thus, each pixel might be stored as a single byte which would allow it to have up to 2⁸ or 256 grey scale levels of brightness. With colour images this would be repeated three times — once for red, once for green and once for the blue component of the image. The number of grey scales

IMAGE PROCESSING

and the resolution of the digitised image would depend on the frame grabber or image capture hardware.

One of the first things which can be done with such an image is to remove any 'noise' which may have been introduced into the image by the imaging hardware or in its transmission. These are things like the 'snow' or regular interference patterns often seen on TV screens when reception is bad or the antennae is faulty. The 'snow' in an image can be easily removed by locating individual pixels whose brightness shows an abnormal variation from those surrounding it. It can then be reset to a brightness level equal to the average of the surrounding pixels.

The image can also be corrected for faults or inadequacies in the image capture system. Many TV cameras have a tendency to have a non-uniform response to light across the tube's surface, so an object may appear brighter in the centre of the tube than at the edge. This effect can be measured with the camera aimed at a uniformly-lit plain surface. This measured variation in intensity can then be used to correct the intensity of any image by adding a correction factor to every pixel's intensity.

Another correction which can easily be performed is to rectify distortions created by the lenses of a camera. Many low-price TV cameras use cheap lenses which often give rise to geometric distortions at the edge of the image. By measuring these distortions against a reference grid, it is possible to use a 'rubber banding' technique to remove this distortion from the received image.

The computer can also be used to alter the brightness in an image which is either too dark or too light. This is done by first drawing a histogram of the intensities of all pixels in

the image. In a properly exposed image, this histogram should form a standard bell-shaped distribution curve centred in the middle of the intensity range. If the histogram shows that the intensity is weighted too heavily towards either the light or dark ends of the intensity scale, then it is a simple matter to adjust this by adding or subtracting a correction value to the intensity of each pixel.

The contrast within an image can also be altered using the histogram analysis of pixel intensities. If the histogram shows a very narrow bell curve with the majority of pixels having very similar intensity values, then the computer can be used to adjust these values in order to improve the contrast, so broadening the spread of values in the histogram. This can be done by multiplying each pixel's intensity value by a constant in order to produce the required contrast, and then adjusting the position of the histogram in order to ensure its location in the centre of the intensity range. The manipulation of image contrast and brightness should be compared to the controls on a TV set which allow the same type of manipulation.

Since the human eye is not very good at discriminating between very slight variations in light intensity, it is possible to use contrast manipulation to show detail in an image which would not otherwise be visible. It is this ability to manipulate an image in order to extract the maximum information from that image which is one of the most powerful features of computerised image processing.

One form of such manipulation is the process of 'pseudo-colouring'. This technique can be used to identify certain light intensities by displaying them in colour. For example,

a user might be interested in examining all pixels with the intensity range 30 to 35. By assigning these with the colour red on a colour monitor, they can then be immediately identified from pixels with other intensities. This form of pseudo-colouring has been used with great effect in the display of many satellite images or in CAT scan images. It has also been used recently to add colour to old black and white movies — thanks to computerised image manipulation, you can now see Laurel and Hardy in full colour.

Computerised image manipulation also allows portions of an image to be extracted, masked out, rotated, magnified or even be replaced by portions of other images. It is these techniques which are currently revolutionising sections of the printing and advertising industry. It is now possible to electronically retouch and amend photographs or film with such precision that it is impossible to detect where any changes have been made — a technology which means that photographs can now lie very convincingly.

Another form of image manipulation which is finding considerable use in industry is image comparison. This technique compares a reference image with the image which is being input, and checks to see if they match.

This process is done by comparing each pixel and calculating the absolute value of the difference between the two intensity values. This process can be used to automatically check that complex products such as printed circuit boards are complete. Any difference between the reference and test image will stand out on the resulting comparison image as bright areas, whereas all the rest will be a very dark image.



These examples show a set of full-colour photographs input to the computer by means of a video camera. As well as the main picture, up to 15 windows can be displayed holding, among other things, user-generated graphics, images being



digitised in real time, text or, as here, a set of freeze frames. These frames can be moved around independently.

Image processing is performed using a co-processor board based around the Intel 82786 chip. First, the main picture is

Image recognition

As can be seen from the example at the beginning of this article, the process of image analysis and recognition is an exceedingly complex one. It is a process which involves the analysis of a visual scene and the extraction of information from that analysis in order to build a knowledge base about the environment within the image. This visual process not only creates new knowledge but also utilises existing knowledge in order to carry out the visual analysis. This places image recognition firmly into the domain of artificial intelligence — indeed, some researchers consider that it is one of the main foundations upon which AI will develop.

Image recognition techniques have been developed from early work on recognition of printed text, work which has now resulted in a range of commercial products such as the Kurzweil Discover which was reviewed in the September issue of *PCW*. Compared with the analysis of real world images, character recognition is relatively easy. Characters are fixed, 2D and black and white, whereas the image of a machined metal part will have many levels of light intensity which will vary according to the attitude of the part in space and the distribution of light sources. Many of the problems encountered in machine vision are the result of trying to reduce such complex images to the simplicity of a black and white character. Machine vision thus draws together the three related fields of image processing, pattern recognition and scene analysis.

A typical example of the capabilities of current image recognition systems is a robot which visually selects the correct component from a box of assorted components, and then

orientates the component correctly so that it will fit into the object being assembled. For a human this is a very simple task; for a computer using the latest machine vision techniques, it is a task of enormous complexity.

The first problem is one of inputting the image and converting it to a form in which it is possible to perform object recognition on the various components in the image. A TV camera is normally used and the resulting image is then processed to identify the edges of the various components in the image. However, the simple detection of the edges is insufficient for any pattern recognition process to be performed, as objects may be touching or on top of each other. Similarly, variations in light intensity, object surface reflectivity and shadows cast by one object over another, all complicate the problem.

The only way to overcome these problems is to give the vision system some degree of knowledge about the objects which it is trying to recognise — knowledge about the various shapes which make up the images of the various components, plus knowledge about the lighting and the surface reflectivity of the various objects. With this level of knowledge, the system can be designed to refine the raw edge image and give each of the components in the image a more solid shape and definition.

Simple components can be recognised at this stage from an outline since there are probably a limited number of ways in which they can be orientated. Thus a bolt has just two orientations, lying on its edge and standing up on its head, and both have easily identifiable outlines. Components with complex shapes are, however, much harder to recognise and usually require an analysis

of their component shapes and surfaces — a task made much harder by the 2D nature of the input image. Again, the system must utilise a knowledge of shapes in order to deduce information about the depth and spatial positioning of objects in the image. Programs which perform this task usually have as their output a line drawing of all the objects in the image.

This type of image analysis is usually sufficient to ensure recognition of components by a robot. The line drawing will be compared to images of known objects stored in a database, with the computer making full allowance for size normalisation and object orientation. This will usually ensure successful recognition in most cases, although difficulty will be encountered where different objects are identical at certain angles of viewing.

In order to progress beyond the recognition of an object from a small universe of different objects, and for the computer to analyse unknown objects and acquire knowledge about the relationship between objects, it is necessary to apply artificial intelligence techniques to the problem. It is at this stage that the image recognition process splits into two separate areas — on the one hand there is pattern classification, and on the other there is scene analysis.

Pattern classification is concerned with the mapping of feature vectors containing measurements of the objects, and grouping them into classes. This is important because it defines the physical shape and size of an object. In the example at the beginning of this article, pattern classification would be concerned with the spherical nature of the ball and orange, the rectangular surfaces of the books, the circular face of the clock and the angular association of



pseudo-coloured and displayed on a standard EGA screen before being modified with standard paint-type software. Individual areas of the image can be selected and enhanced

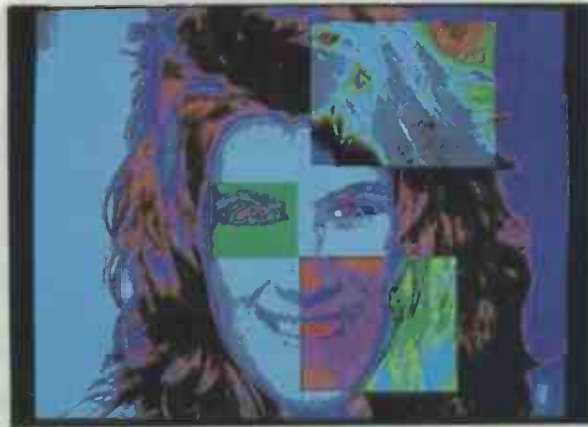

using edge-detection techniques. When the area around the eye has been enlarged, it can be used to analyse and classify certain features

"THE SYSTEM" from I.Q.

Buy the package - Buy the components. Either way YOU WIN!

WORLD EXCLUSIVE

IQ 121 WORKSTATION ONLY £208
(Side tables ONLY £25 each)
Other Workstations from ONLY £118
Brochure on request

PC 1640
21 Megabyte Seagate Hard Drive ONLY £998
32 Megabyte Seagate Hard Drive ONLY £1,098

Table tops Black Ash
Other models: Grey Ash,
Teak, Oak.

Keyboard table
slides in/out and
locks

Side table
right or left
mounting

Purpose designed steel
frame, heavy duty
castors.

MP26
Daisywheel Printer ONLY £225

Printer table 80 column or Wide
Printer. Designed for efficient
paper flow. Slides in/out.

PLUS

Optional Personalised Delivery,
Installation, Initiation (MS.DOS)
& 4 Weeks Telephone support

ONLY £59

On-Site servicing, training, etc., by
one of our helpful Agents
now available most parts
of mainland UK!

SAVE 5%
On all orders for the
complete package
Applies to any combination
IQ-Workstation, Computer
& Printer
(Limited Offer)

IQ 110 CHAIR
Pneumatic action with
heavy duty base ONLY £98

IQ 121 WORKSTATION (GREY)
ONLY £188

I.Q. COMPONENTS AND PRICES

COMPUTERS

AMSTRAD PC 1512, 640K mono, 21 Megabyte Seagate Hard Disc
ONLY £649 Includes "ABILITY"

AMSTRAD PC 1512, 640K mono, 32 Megabyte Seagate Hard Disc
ONLY £748 For Colour Monitors add just £100

PRINTERS

AMSTRAD DMP 3160, 160 CPS Dot Matrix Printer ONLY £199

STAR NL10 with interface ONLY £199

DMP 4000 200 CPS Dot Matrix ONLY £228 All others on request

SOFTWARE

Pro Packs Plus - Request our comprehensive list of professional
business packages with specialist software and support i.e. Pro Pack
Lawyer ONLY £1998 (includes everything needed to computerise a
Law Practice).

EXTRAS ALL AT I.Q. PRICES!!

Networks, Tape Back-ups, Modems, Surge Protectors, Turbo Cards,
Maths Processors, Plotters, Printers, Furniture, Acoustic Cabinets.

AND NOW: The World's finest VDU Safety/Anti Glare Screen worth £79
IQ-Price £57 (Limited Offer)

FIRST TIME IQ'S OWN SOFTWARE:

FAST DISC BACKUP/MS.DOS MADE EASY

Simple, friendly menus to backup your data and MS.DOS tutorial - save
many frustrating hours ONLY £24.98 (Launch price)!

ORDER NOW

FREE Surge Protector and Mouse Pad if we receive your order within one month
of publication date.

IQ-FRANCHISES NOW AVAILABLE FOR MOST REGIONS

All prices plus carriage and VAT

PLEASE CONTACT YOUR NEAREST OFFICE

IQ-SHOWROOMS & OFFICES:

LONDON (CITY): Argyll House, 6-13 Chamber Street,
London E1 8BW. ☎ 01-480 5516/0860-357148
Fax: 01-480 5830 Telex: 915183 WICKS'G

MIDLANDS: 8 Holdom Avenue, Saxon Park Industrial Estate,
Bletchley, Milton Keynes MK1 1QU ☎ 0908-641 444

NORTH: Ascot Court, 71-73 Middlewich Road, Northwich,
Cheshire CW9 7BP. ☎ 0606-2777 (Head Office)

SCOTLAND: Unit 7b St. James's Business Centre,
Junction 29, Linwood Road, Paisley PA3 3AT
☎ 041-887 1308 Fax: 041-889 0954



IMAGE PROCESSING

the hour and minute hand; it would also be concerned with the 'orange-ness' of the orange and the 'blue-ness' of the book. Scene analysis is concerned with building up a description of the objects in an image in terms of 3D solids and how they relate spatially. Thus scene analysis would be concerned with how the orange and the ball were placed upon the book, their relative positions and sizes.

With these two analyses of the image, it is then possible to build up a knowledge base about the visual scene. The knowledge base can then be interrogated about relationships between objects, object sizes and positions, and even about the nature of objects. Only when the computer has built up such a knowledge base does it become possible to successfully interact with the objects which have been perceived. A full knowledge of the scene with the orange, the ball, the books and the clock is essential before any attempt can be made to remove the orange from the books and place it upon the table. Armed with this type of visually derived knowledge, a computer can use a robot arm to not only select the required object, but also calculate the required set of movements in order to orientate the object correctly and put it in the required place.

The future

Machine vision covers a range of different subjects, most now quite well developed — the exception being the area of true machine vision with its recognition of objects and scene analysis. So far such systems have been limited to very simple worlds containing toy blocks or a small number of different components. This is a long way from a practical, general-purpose machine vision system.

Part of the problem lies in our lack of understanding about the way in which biological vision systems work, particularly the way that information is extracted from an image. The other problem is that standard general-purpose computers are not necessarily the best devices for performing the computation required by machine vision. Indeed, the computational power required for machine vision has been estimated at between 1 and 100 billion instructions per second. To put this into perspective, a supercomputer like the Cray 2 is only capable of working at a maximum speed of half a billion instructions per second. Even the extraction of fairly low-level features from an image requires in excess of 10,000 operations per pixel.

Improvements in our understand-

ing of biological vision systems and the need to reduce the computational overload in image analysis are leading scientists towards the development of new architectures for vision systems. It is these new architectures which offer the best chances of overcoming many of the problems currently facing researchers.

Most of these new architectures are based around special-purpose parallel systems. This is a logical choice since a visual image is a truly parallel set of data. For fast preliminary feature extraction, each pixel should, in theory, have its own processor. This is not really practical, but the development of special-purpose visual signal processors has shown considerable improvement in operational speed, particularly when used in parallel or in pipelined structures. The purpose of these processing chips is to perform all the low-level feature extraction and, in the process, reduce the quantity of image data to manageable quantities.

Some success is also being shown in the application of array processing systems. An example of this is the Wisard adaptive image classifier developed by Professor Igor Aleksander of Imperial College, London. This is a deceptively simple system which uses RAM chips to emulate a neural network. The system has shown itself to be very good at performing image recognition, particularly on such complex images as the human face. It has proved very tolerant to wide variations in the image's orientation compared to the training images, and will even successfully recognise a partial image. There has been considerable interest in this system for security applications as well as the more conventional machine vision applications.

Conclusion

The ability to be able to put an image into a computer opens up the possibility of a whole range of fascinating applications. General-purpose machine vision may require special, very powerful computers, highly complex programming techniques and may take another 50 years to develop, but most image processing can be performed with a desktop computer. Frame grabbers are available for machines like the Amiga or the IBM PC for as little as £400, including a black and white TV camera.

One such system is the NewTec Digi-View for the Amiga, which will give a 320×200 resolution image with 16 grey scale levels. (It should be noted that the Amiga is a very good machine for image processing since it combines an excellent display with a fast processor and does

not suffer from the 640k maximum memory size of the IBM PC.) Another system which is available for the PC is the more expensive but more sophisticated Microsight II from Digithurst which costs just over £1000 but produces a 512×512 image with 63 grey scale levels.

With image input devices such as these, it is possible to do a whole range of image manipulations — even image analysis and recognition with a standard PC.

Images courtesy of Digithurst, (0763) 42955.

The mathematics of image manipulation

Most of the simpler image manipulation techniques, such as contrast or intensity enhancement, can be performed by simple calculations on individual pixels. However, the more complex operations such as edge detection or convolution are area processes which use comparisons between the pixel whose intensity value is being calculated and its neighbouring pixel's intensity values. These calculations are usually performed using blocks of nine pixels, thus:

A	B	C
D	X	E
F	G	H

where X is the pixel being calculated and A to H are its surrounding pixels. Every pixel in the image will need to be calculated in this manner, with the result being stored as a new image in another part of memory.

The convolution and edge detection algorithms are virtually the same and are 2D adaptations of linear processes which were developed for signal processing. The basic calculation is as follows. Where p is the named pixel's intensity value and K is the value of a kernel for that pixel; the kernel is a 3×3 grid of values which determines the nature of the filtering operation:

$$p(X) = p(A) * k(A) + p(B) * k(B) + p(C) * k(C) + p(D) * k(D) + p(E) * k(E) + p(F) * k(F) + p(G) * k(G) + p(H) * k(H)$$

A typical kernel to detect edges would have the following values:

-1	-1	-1
-1	8	-1
-1	-1	-1

This is known as a Laplacian area filter. To convolve an image and make it 'sharper', use a similar kernel but with the centre value increased to 9. Particular features can be detected by using a matched filter kernel. The following kernel will enhance only the vertical edges of the image:

-1	0	1
-1	0	1
-1	0	1

All these techniques are computationally very intensive — it takes over half a million calculations to detect the edges in a 256×256 resolution image using the above technique, which is one of the simplest and least computationally intensive.

END



SCREENTEST

Spellmaster

The BBC Micro's software base now includes Spellmaster from Computer Concepts, an easy to use but impressive spelling checker designed for much more than BBC word processors.

Ian Waugh has words with it.

There can be few professional writers who have not yet succumbed to the charms of a word processor. Even the occasional letter writer, the budding novelist and the scribbler can benefit in many ways from using a computer to produce their writings.

Of course there is no point in using a computer for its own sake, and word processors need to offer significant advantages for it to be worthwhile the writer learning the new skills required. Spell checking is one of the most common advantages to computer-based writing. Whether you are a bad speller or a bad typist, a spelling checker can take the tedium out of producing clean copy.

It simply checks the words in your text against a master dictionary. If it finds the word it moves on; if it doesn't find it, it lets you know.

A spelling checker cannot tell if a word is used correctly in a particular context. For instance, it would pass this rather laboured example: 'Eye sore write threw there evil planes'. It is excellent, however, for spotting typing errors and letter transpositions 'Ikie thsi'.

The two major problems with spelling checkers are their slowness and often inconvenient method of operation. It is essential, too, to be able to add your own words to the dictionary. Computer Concepts' Spellmaster for the BBC Micro sets out to rectify these problems.

The most popular word processors for the BBC are View, Interword, Wordwise and Wordwise Plus which account for around 95 per cent of those in regular use. Spellmaster was designed specifically to work with these programs but it can check spooled ASCII text from other word

processors and large files on disk — such as those created with a second processor.

Setting up

Spellmaster is now supplied on one 128k EPROM. Because of a shortage of chips, early versions were supplied on two chips. Both versions are functionally the same, however, although you can trade in your two chips for one for £25.

The EPROM is mounted on a piggy-back board which allows switching to take place between the eight 16k banks. The Spellmaster program occupies one bank and the other seven hold the master dictionary — over 59,000 words.

The EPROM will plug comfortably into any ROM socket in any BBC Micro (B, B+ and Master) although it is slightly longer than the more usual 16k EPROM. It won't fit into a normal Master cartridge because of its height and you will need a tall cartridge such as the Care Master which holds the EPROMs above the computer's casing.

In use

Spellmaster has four methods of operation. Its most powerful and convenient is that of immediately checking each word as it is typed in without noticeably slowing down the typing rate.

From View, Interword and Wordwise(+), Spellmaster can check the text currently in memory. It also has its own editor into which text can be loaded, checked and saved and it can check large files on disk.

*SPELL takes you into the Spellmaster language. The main menu is similar in design to that of Wordwise

and Interword. The first two options let you save and load a file. They give you a Y/N prompt if you are about to save and overwrite an existing file or if you are going to load a file and one already exists in memory. Option three lets you load text to the cursor position.

Most checking will be done directly from a word processor but some facilities are only available from Spellmaster itself. It's a straight ASCII editor and can be used to build *EXEC and !BOOT files. Movement around the editor uses keys similar to those used by Wordwise and, to some extent, Interword. You can move, copy and delete sections of text and change screen mode.

If a file contains control codes, these are shown as full stops. After checking, you should be able to save the text and load it back into the word processor it came from.

Option four is used to check files too large to fit into memory. You will only need this option if you have created a very long file on a second processor or if you are using a word processor other than View, Interword or Wordwise(+). It checks the file word by word and outputs a new file, marking any words it cannot find in its dictionary.

Two file names are requested. If the second one is omitted, the new file overwrites the old one and the first letter of any unrecognised word is replaced with a backslash (\). This ensures the new file is no longer than the original one, as some word processors (such as Scribe) do not like their file lengths changed. If a second file name is given, then unrecognised words are prefaced with '#!'. All unrecognised words are

stored in Spellmaster's own editor.

Option five is Search and Replace which prompts for a Global or Selective replacement. Wildcards are not supported.

Option six simply prints out the text held in the editor in 80-column format.

Options seven and eight are concerned with creating and editing user dictionaries. This is a vital aspect of any spelling checker, as no matter how large the master dictionary, you will always want to add words and proper nouns.

Option eight produces a list of any currently resident user dictionaries and lists those ROM sockets which contain sideways RAM. The list includes sockets which may already contain data, and installing a dictionary there will completely overwrite the contents.

You can install as many dictionaries as you have RAM banks. Each could probably hold around 3000 words but unless you are writing a medical text book or a scientific thesaurus, you will probably only build up a dictionary of a few hundred words.

Option seven reads a user dictionary into Spellmaster's editor. If there is more than one it will list them and ask you for the appropriate ROM socket number. You can add, delete and edit dictionary words in the editor using the normal editing functions. New words need not be inserted in alphabetical order as the program will sort them when installing the dictionary with option eight.

*DSAVE and *DLOAD are used to save and load user dictionaries. If no filename is given, the dictionary will be saved with the name USERDIC.

When in View or Wordwise(+), the Spellmaster menu is activated by pressing CTRL/J. Interword has a special menu option devoted to Spellmaster which is activated with

CTRL/f8. The menu is the same in all cases — a window appears at the top of the screen and lists five options:

- 1: Check entire text
- 2: Check marked section
- 3: Browse
- 4: Check from cursor
- 5: Turn immediate check on/off

Options one, two and four (CTRL/V also activates a Check from cursor) move through their designated area of text and highlight each word not found in a dictionary.

Option five toggles the immediate check option on and off. This checks each word as it is typed and beeps if it is not found in any of the dictionaries. If you don't want to stop typing — you'll probably not want to ruin a good train of thought — you can go back to the word when you've finished the sentence or section of text. If it is noticeably wrong, you can correct it and Spellmaster will check it again after editing as you move off it.

You can check the word at the cursor by pressing CTRL/C. You will hear a beep if the word has been recognised, otherwise the window appears at the top of the text, displaying the word in question. This also happens with options one, two and four when a word is not recognised. The window offers the following choices:

- 1: Ignore
 - 2: Add to dictionary
 - 3: Correct word
- ESC end check

Option one ignores the word but only on that one occurrence, and it will flag the same word if it meets it again in the text.

Option two adds the word to the user dictionary. It's wise to check that the word is spelled correctly, otherwise you could continue your writing career with a particular misspelling as your trademark.

If a user dictionary has not been

installed or if the RAM bank has been write-protected, you will receive a 'Can't add word' error.

Option three lets you correct the word. The lower part of the window displays the suspect word on the top line. A number of words closest alphabetically to the suspect word appear beneath, and you can scroll through them forwards and backwards with the cursor keys to find the correct spelling. If you find it, pressing RETURN will correct that word along with every subsequent occurrence of the word in the text from that position onwards. Spellmaster makes no pretence at any artificial intelligence for making correct guesses at words.

Occasionally when checking a section of text, the program may flag a word it does not recognise and when you try to correct it, you realise that it is indeed misspelled but the correct spelling is not in the dictionary. When you exit the check routine, you may either be at the top of the text (when checking the entire text or marked text) or where you left the cursor (when checking from cursor). Escaping from the routine, unfortunately, does not leave you at the suspect word. You must find the incorrect word manually or with search and replace, correct it and add it to the dictionary.

You can jump through the dictionary using SHIFT, CTRL and the up and down cursor keys. SHIFT moves you by the first letter, CTRL moves you by the third letter. Alternatively you can type in the first letter or letters of the word. As you do so, you move through the dictionary towards the word. In fact, rather than type '3' for option three, you can simply start to enter the word. If you want to look for a different word, you must scroll by at least one word or press the space bar. ESCAPE will take you to the previous three-choice menu.



The Spellmaster main menu gives access to a simple text editor, allows modification of user dictionaries, loading and saving of text from the editor, and access to all the 'star' commands



Pressing Ctrl-C in any application that uses standard ASCII files activates the spelling checker, from where you can add words to the dictionary and activate the 'guess correct spelling' feature

Correct context

To know that a word is correct it must seen in context. In Interword, the entire screen is displayed with the word highlighted. In View and Wordwise(+), the word is shown surrounded by three lines of text and, although the formatting may not be the same as that in the editor, it is more than enough to identify the word in context.

Spellmaster ignores all one and two-letter words which prevents it beeping at post codes and simple abbreviations, although it means it doesn't pick up things like 'ot' and 'lm'. It's generally the longer words which have 'hidden' errors.

Option three (and CTRL/B) lets you browse through the dictionary using the same keys you use when looking for a correct spelling. When a word has been located, pressing RETURN will place it in the text at the cursor position.

Interword is unique in having a built-in menu devoted to Spellmaster. In order for Spellmaster to work with Wordwise(+) and View, it needs to claim 256 bytes of workspace. In a model B, PAGE is set 256 bytes higher; but in the Master computers, the workspace is claimed elsewhere and will not affect PAGE or any application ROMs. You can prevent the workspace being claimed with *WORKOFF and let Spellmaster reclaim it with *WORKON.

Spellmaster has several additional * commands. *BROWSE duplicates the Browse option from the Spellmaster menu. *CHECK must be followed by a string of at least two characters. It can accept a trailing wildcard (*) to represent a group of characters and a single character wildcard (#) which cannot be placed within the first two characters. The routine will list any group of words which conform to the string pattern: for example, *CHECK PERSON* would list all words which begin with 'PERSON', and *CHECK COM#U* would list all words beginning with COM which had 'U' as their fifth letter. You can use this to check the spelling of a word — for example, *CHECK SEP#RATE would reveal that it's 'separate' and not 'seperate'.

*CROSSWORD is similar to *CHECK but it can only use the single wildcard character (#) and not the asterisk (*). To help solve a crossword, you would replace each unknown letter with a #.

*ANAGRAM expects a string of letters and will list all words in the dictionary which contain only those letters. This, too, can be used to help solve crosswords.

Finally, one of the most interesting commands is *FUZZY which lists all



*Spellmaster has a number of additional functions. Here you can see the *ANAGRAM command finding all the anagrams of AETL. Other commands include *BROWSE; which enables you to use Spellmaster like a dictionary; and *CHECK, which can help solve crossword puzzles*

words which are approximately similar to the string parameter. It has a crude 'sound-alike' check but words like THREW and THROUGH don't turn up in each other's lists. In most cases, however, the word you require will show in the list.

'Whether you are a bad speller or a bad typist, a spelling checker can take the tedium out of producing clean copy.'

Don't use *CHECK or *FUZZY without a string parameter from a word processor (not even Spellmaster itself) or you may lose your text.

For technical reasons of speed, it apparently was not practical to make *ANAGRAM, *CROSSWORD and *CHECK search through the user dictionaries and, consequently, they are restricted to words in the master ROM. This isn't much of a loss with *CHECK as the Browse and Check word options let you sort out most queries from within a word processor. As crosswords are often full of unusual words, it's a pity that the *CROSSWORD command cannot search the user dictionaries, too.

Conclusion

In practice, Spellmaster is unbelievably easy to use. No other spelling checker for the BBC can check text from within a word processor (other than ROMspell in check on entry mode) and, as the dictionaries are in ROM and RAM, checking is amazingly fast. It checked 4000 words in Wordwise Plus in 25 seconds — a

speed of 9600 words per minute. It is generally at least ten times faster than existing spelling checkers and often much faster than that. It even outperforms spelling checkers for the Apple Mac, the IBM PC and the Atari ST by at least a third.

Spellmaster's dictionary size of over 59,000 words is second only to Viewspell which has around 77,000 words. Spellmaster, however, allows the use of several user dictionaries automatically, whereas Viewspell needs prompts for any more than one user dictionary and is considerably more clumsy in operation.

Spellmaster is also the only BBC spelling checker which can check text on entry, check text held in RAM and check files on disk.

Spellmaster is a pretty impressive piece of software. You really do need at least one bank of sideways RAM to make full use of its potential but whatever activity you're involved in, you should acquire the tools of the trade.

It's rather amazing to see a program for the BBC outperform those for the bigger machines — and by such a large amount. Spellmaster is a credit to Computer Concepts' programming ability and any writer will soon find it an indispensable and invaluable aid to their writing. If you're looking for a spelling checker, there simply is no other choice.

STOP PRESS

Computer Concepts is developing a version of Spellmaster for use with the Acorn Archimedes, which will be combined (hopefully) with a thesaurus and CC's new WYSIWYG word processor. This should be available towards the end of the year.

Spellmaster costs £59 (incl VAT) from Computer Concepts, Gaddesden Place, Hemel Hempstead, Herts HP2 6EX. Tel: (0442) 63933.

END

THE PROTECTOR

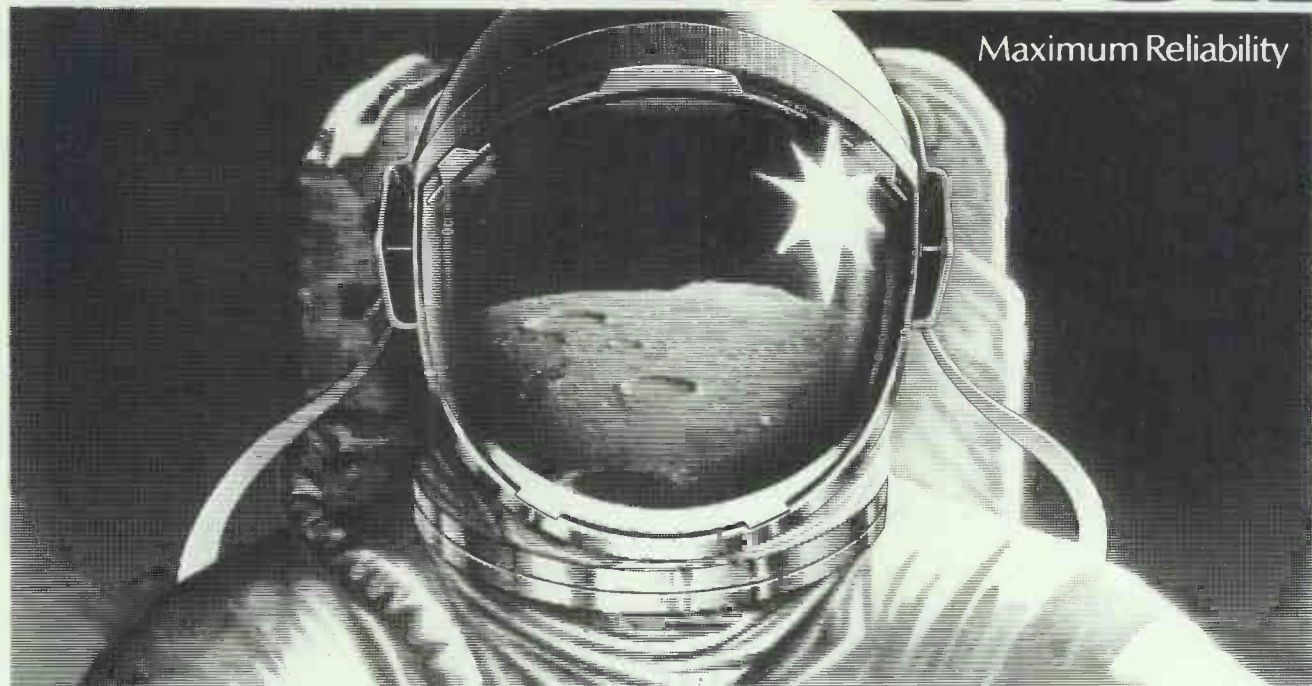

Protects your data against dust and drop-outs

Maxell's High Density (HD) floppies fight dust and drop-outs three ways. Maxell has reduced the conventional one-billionth-of-a-bit error rate to one-hundredth-billionth of a bit!

This dramatic improvement results from a proprietary disk surface cleaning process. Second, the new Tight Grip (TG) jacket assures constant, closer contact of disk and jacket liner, and the liner gently cleans your disk as it spins. And third, the jacket is anti-static treated, preventing dust-attraction.



Even the outside is special: hold a Maxell between greasy fingers and you'll see that the jacket's embossed surface will leave no record of the crime. Clean, debris-free disks are the *sine qua non* for reliability.

The powerful benefits of Maxell protection are a clean disk, a clean signal, high resolution and error-free performance unequalled for reliability.

For the protection you deserve, Maxell floppies are it! Maxell floppies come in 8", 5 1/4", 3 1/2" and 3" sizes.

maxell[®]

When every bit counts, it's Maxell.

**NOW! 10 MAXELL FLOPPY DISKS
FOR THE PRICE OF 8**

'PHONE THE HOTLINE 0923 777 171

OFFER SUBJECT TO AVAILABILITY. PROMOTIONAL PACK ONLY.

Who would you expect to design the
ultimate power PC?

IBM[®]

Honeywell[®]

Apollo[®]

Hewlett-Packard

ICL

Sun

Digital

Who would you prefer?

Over the years the Apple™ name has become synonymous with intuitive, easy to use computers.

So, when it's Apple that introduce the ultimate



power PC, it has to be the perfect combination.

The Macintosh™ II has both the power and flexibility to suit even the most voracious user, while still retaining Apple's famed point-and-click simplicity.

At its core is the new 32-bit Motorola 68020 microprocessor.

The beauty of selecting the 68000 series for Macintosh really pays off in the Macintosh II. The upward compatibility of this series means that over 2000 current Macintosh applications can already take advantage of the Macintosh II's power.

The Motorola 68020 allows you to run virtually every Macintosh program at four times the speed of a Macintosh Plus, while a new co-processor enables you to perform mathematical calculations at a staggering 200 times the speed.

But speed is only part of the story.

The Macintosh II also offers incredible flexibility.

Like all Macintosh products it has a built in LAN which allows information exchange and resource sharing.

With its open architecture and 6 expansion slots you can customise it to serve virtually any purpose you can imagine. Both now and in the future

Because it's not constrained by today's technology, your investment in a Macintosh II is an investment in the future.

You don't even have to limit yourself to one operating system as the Macintosh II can run all three industry standard microcomputer operating systems; Macintosh, MS-DOS™ and UNIX™ off one workstation.

There is also a choice of memory options — up to 16 megabytes of RAM. And, although our 40 megabyte hard disk drive is probably sufficient storage for most users you can employ an internal drive of up to 80 megabytes.

Add to all that its superb colour graphics, its high resolution bit-mapped screen and its vast palette of over 16 million colours and you have the ultimate PC.

You may be surprised that Apple make a computer this powerful but try it and you'll be glad they do. Experience the Macintosh II at the MacUser Show, from 10-12 November at the Business Design Centre, London.

- Please send me a ticket for the MacUser Show.
- Please send me more information about the Macintosh II.

The MacUser Show

Post to: Apple Computer (UK) Limited. FREEPOST.
Information Centre, Eastman Way, Hemel Hempstead,
Hertfordshire HP2 4BR or dial 100 and ask for Freefone Apple.

NAME _____
TITLE _____ TELEPHONE _____
COMPANY _____
ADDRESS _____



Apple™ The power to succeed.

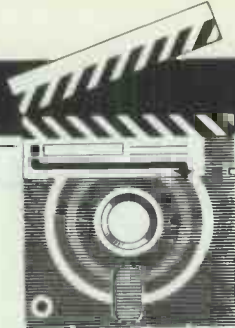

SCREENTEST

VIP Professional

For those people who don't own a bona-fide PC-compatible, VIP Professional is a versatile, advanced spreadsheet which serves admirably as a Lotus 1-2-3 clone for the Atari ST, the Commodore Amiga and the Apple IIGS. Geof Wheelwright tests an ST GEM version.

Serious software support for small-business computing is once again stepping out from under the wing of the IBM PC and Macintosh hardware designs. New business applications for the likes of the Atari ST, the Commodore Amiga and even the little-seen (at least in the UK) Apple IIGS have started to timidly make their way forward onto the software shelves of the nation's retailers.

One of the most popular applications among all manner of business microcomputer users has always been the spreadsheet — the classic financial 'what-if?' tool that allows users to conduct complex extrapolations with electronic versions of their ledgers. It should, therefore, be heartening to users of those machines to see the recent releases of Logistix (a spreadsheet-based integrated package for the Amiga), K-Spread (a spreadsheet from Kuma for the ST) and AppleWorks 2.0 (the latest version of an integrated package for the Apple IIGS that includes a spreadsheet).

Unfortunately, all of those applications still shut these users off from the main body of work written about this subject, as most books about spreadsheet design use the PC-based Lotus 1-2-3 spreadsheet as their starting point. Such applications also generally cut off Amiga, ST and Apple IIGS users from sharing spreadsheet files with PC users operating under Lotus 1-2-3.

There is, however, a solution at hand. It is called VIP Professional, from VIP Technologies, and comprises a fully Lotus-compatible spreadsheet which is available in versions for the Atari ST, the Commodore Amiga and the Apple IIGS.

Overview

The most popular current version of VIP Professional is for the Atari ST. This is sold in the UK by longtime Atari boosters Silica Shop, and will cost you just a shade under £200 for the version that provides full support to the ST's Macintosh-like GEM interface (although you may be able to buy early text-only versions a little cheaper). VIP Professional is also one of the few full-range spreadsheets available for any of these machines (with the possible exception of the IIGS, which can run the full range of Apple II software — including the original VisiCalc software which started the popularity of spreadsheets in the first place).

In my view, it is the latter point which is of more immediate concern. Despite the dominance of Lotus 1-2-3 in the PC world, a spreadsheet for the ST, Amiga or IIGS will have to stand or fall on its own merits for the users of those machines. After all, each of the buyers of those systems had the choice to buy a PC-compatible system and did not; therefore, any software they use for it has to be judged on how well it exploits that machine, as opposed to how well it helps to turn their micro into a PC clone.

Indeed, impressive hardware and software emulators now exist for all three of these machines which permit them to run full-blown PC software. And, in most cases, these emulators cost little more than VIP Professional.

So, if someone is looking at VIP Professional, they should judge it entirely on its own merits — although comparisons with Lotus 1-2-3 may be

useful in context-setting.

The first question we must thus address is just how useful VIP Professional is for the first-time spreadsheet user on the Amiga, ST or IIGS. I'll deal with this question mainly in terms of the ST, as that is the machine I primarily used to review the software. Not surprisingly, I would say that, overall, VIP Professional is no easier or harder for the novice ST user to learn than it would be for that person to start with Lotus 1-2-3 on a PC.

Setting up

VIP Professional comes with two floppy disks: one containing the software itself; and the other being used for context-sensitive 'help' files, and some sample spreadsheets and macros. These are configured such that you can run the system off a single drive if necessary; the entire application loads into memory from disk one (after double-clicking the mouse on the filename 'PROFESS.PRG'), then you can stick disk two into the drive to gain access to help and example files.

I found that by placing the help disk in drive A after loading up the software and using the 'Directory' command to set the directory to C (as in MS-DOS), I was able to save and load files from the hard disk while obtaining help files from the A drive.

In use

There are several important innovations within VIP Professional that make the package somewhat simpler to use than the software it is trying to copy. First and foremost, the version I tested uses the Atari's GEM

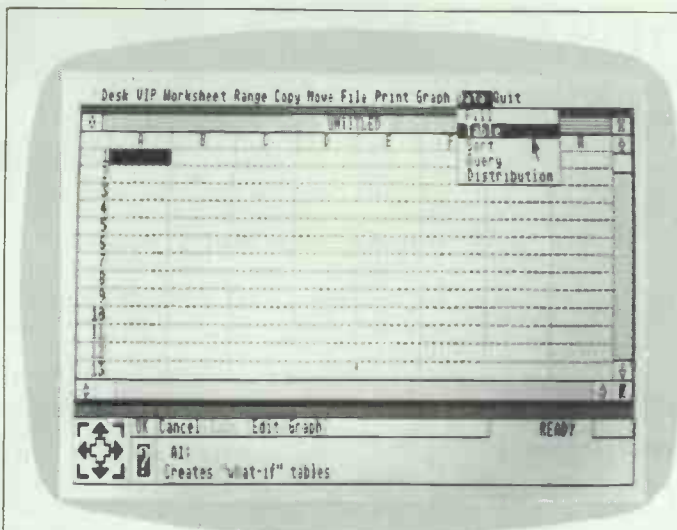

The VIP Professional blank screen looks much as you would expect from a Lotus-compatible spreadsheet, but with pull-down menu titles and a graphic-enhanced command line

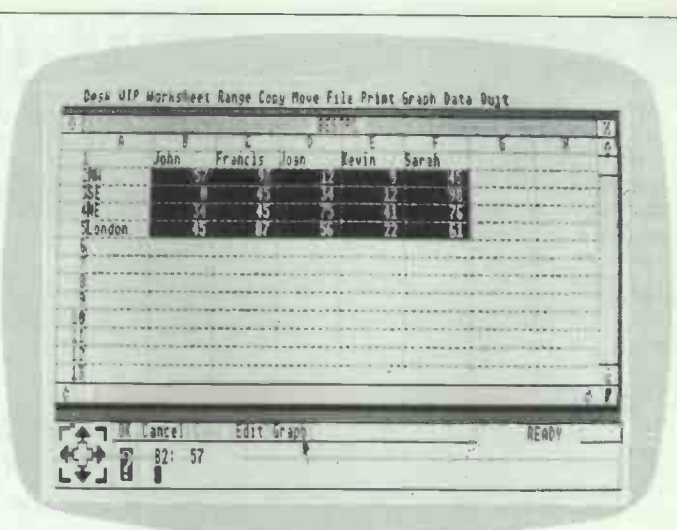

VIP Professional uses the GEM interface properly. The mouse is used to highlight figures that are to be cut, pasted or used for a graph

interface to the full. This means that when you start up the application, it provides you with the same kind of consistent look and feel that you will have become used to in other Atari applications.

The main spreadsheet grid dominates the middle two-thirds of the screen, with pull-down menus running across the top, a pointer (which changes shape from a thick cell indicator to a regular pointer icon, depending on where it sits on the screen) somewhere in the middle of the screen, and a large graphics-driven 'status box' runs along the bottom.

The graphics-driven status box along the bottom of the screen allows you to enter data in the form of commands to move about the spreadsheet using the mouse. There is a large cursor cluster at the far bottom left-hand side of the screen which can be used to 'page up' and 'page down' quickly around the spreadsheet (all controlled by the pointer), and a question-mark icon which brings up the help menu as opposed to obtaining it by pressing the F1 key.

There is also a series of action boxes above and to the right of the question mark which allow you to confirm or cancel a command using the pointer, as well as give recalculation, editing and graph commands. The rest of this box is dedicated to telling you which cell you are editing and allowing you to enter data into it.

I would suggest that for a user new to spreadsheets and only recently acquainted with GEM, these commands are by no means intuitive. In addition, the documentation I was sent for the GEM version refers almost exclusively to the text version of the software, with mention in the first few pages only of any pull-down menus and icons. There was, however, a brief introductory booklet which

did address this version and seemed to provide all the help I needed — although that may be small comfort to a novice.

At any rate, the main data entry section of the VIP Professional spreadsheet looks exactly as you would expect it to, with the names A through H running across the top to show initial names of columns (the vertical portions of the electronic ledger) and the numbers 1 through 12 providing the same for the rows (horizontal references for the spreadsheet).

Along the top is a set of pull-down menus that should be familiar to all ST users. The left-most of these is the 'DESK' menu, containing any desk accessories you may have installed in the machine; while immediately next to it is a menu entitled 'VIP'. This menu offers the choice to GOTO a named cell immediately, get context-sensitive help, construct a database query, build a table, or switch the background grid of the spreadsheet on and off.

All the other menus are exact replicas of the menus contained in the Lotus 1-2-3 spreadsheet. For non-Lotus users, these are:

- **Worksheet** The menu title for a series of options which govern large-scale changes of a spreadsheet model you have loaded in from disk or created in memory from the keyboard. This is where you would insert and delete cells, change the size of cells, and change the 'format' of the data contained within the cells.

- **Range** The commands under this menu title are designed to allow control over a specific group of cells or 'range'. Using the options under this range, you can carry out operations such as erasing specific cells, change the way in which some are displayed, and 'name' a range for later operations on that 'named range'.

- **Copy** Allows you to duplicate the contents of a cell or range of cells to

another cell or range of cells. This is a particularly useful function when dealing with formulae that you might wish to repeat throughout a spreadsheet model.

- **Move** This performs the same function as copy, but moves the cell or cells rather than simply making a duplicate of them and placing this in another area of the spreadsheet.

- **File** You use this menu to carry out all file operations, such as saving files and retrieving them. This menu is also used to change the name of the directory from which VIP Professional will draw data files, and to allow parts of files to be imported and exported to disk.

- **Print** This menu does what you would expect — it allows you to print a VIP Professional spreadsheet to paper or to disk. It also allows you to control the way in which information is sent to the printer, particularly with regard to headers, footers, margins and page length.

- **Graph** This menu allows you to use the data you have already entered into VIP Professional to create and add to graphic representations of that data. The system supports bar, pie, stacked bar, line or XY graphs and, when used with an Atari colour monitor, also provides a choice of colours for the graphs.

- **Data** You use this menu command to carry out VIP Professional's limited database operations. These allow database tables to be queried, sorted and redrawn in accordance with any changes that may have been made to the information contained in them.

- **Quit** Leaves the program when you reply with a 'yes' to the 'Yes/No' question that this command generates. If you haven't saved your file, VIP Professional will give you a chance to say whether or not you wish to do so when you use the Quit command.

Those are the basic menus and their functions, and you can access

these menus in one of two ways. You can either use the mouse and pointer to point to the pull-down menu in question and then use the mouse button to select your choices; or you can use the traditional Lotus 1-2-3 '/' command key to invoke the 'Command' mode, and then use the cursor keys to access the menu of your choice.

Some confusion does arise, however, which is inherent in the way that VIP Technologies has implemented this laudatory choice of command keys. The command choice is structured in such a way that if you start by selecting menus using the '/' key and the first letter of each command (that is, '/' and the 'F' key would select the File menu), you cannot easily switch over to issuing commands with the mouse again. You need to press the Esc key a couple of times to get the system back to having a mouse 'pointer', and then you will be able to issue commands from the mouse.

In that sense, VIP's attempts to be more user-friendly than Lotus do not work so well, as you can either use the spreadsheet like a Lotus user or an ST user, but not like a mixture of both.

It is, however, praiseworthy that VIP has tried to ensure that every command you could issue via the keyboard using normal Lotus commands in VIP Professional, can also be issued via the mouse for those ST users who may know nothing about Lotus 1-2-3 and who have just bought VIP Professional as a high-powered spreadsheet.

Suitability

In terms of how well VIP Professional satisfies the needs of the first time user, I have to admit that it is no easier to use for the novice than Lotus 1-2-3. While VIP Technologies

has made every attempt to make use of the ST interface and make the system more friendly, you can see that the company has always been held back (in terms of how far it can go with this approach, that is) by the fact that it is committed to the program being fully 1-2-3 compatible.

'... a spreadsheet for the ST, Amiga or IIGS will have to stand or fall on its own merits for the users of those machines.'

This gives VIP Professional some disadvantages when compared with other 1-2-3 spreadsheets such as Kuma's K-Spread, which is dedicated solely to providing spreadsheet power under GEM (on both the PC and the ST) and makes none of the compromises in the interface that are necessary to keep VIP compatible.

This leads me to the next question — whether or not VIP Professional is an acceptable Atari substitute for Lotus 1-2-3 among experienced Lotus 1-2-3 users who perhaps have a PC at the office and an ST at home.

The major advantage of the ST version of VIP Professional for this job — and the reason why the ST implementation currently scores over that of the Amiga and the IIGS — is that the ST's disk drives can read from and write to file formats from most compatible computers which use 3½in disks. Such machines include the entire Toshiba range of desktop portable computers and the

new IBM Personal System/2 range.

In theory, this also means that anyone running Lotus 1-2-3 on a PS/2 or Toshiba portable can take their 3½in disk with Lotus data files on it, stick that disk in an Atari ST running VIP Professional, and expect VIP to read all the data and formulae without any problems. At least, that's the theory...

I discovered something slightly different. Yes, the ST could easily read data files from both DOS 3.3 and Toshiba DOS 2.11 without any problems, and could even import Lotus .PRN files as ASCII. But, I did have problems with spreadsheet files.

The problem may well have been with my software, but it is not likely to have been unique. I tried taking a file saved under Lotus 1-2-3 version 2.01 for the Toshiba 1100 series, and reading that file into VIP Professional. I encountered two problems. The first revolved around the fact that my version 2.01 of Lotus 1-2-3 saves files with the extension .WK1, while VIP Professional expects the older .WKS extension on its Lotus 1-2-3 files. Thus, the first thing I had to do when trying to read my Lotus files into VIP Professional was change the file extension on my file from .WK1 to .WKS. This was carried out without any problems. But, when I tried to then load the file into VIP Professional, I was still faced with the dreaded 'Not a valid worksheet file' message.

Undaunted, I tried to create an 'exported' version of my Lotus 1-2-3 file on the Toshiba and found that it would read into VIP Professional without any problems as an ASCII file — stripped of formulae and proper cell placement.

To try and see where the problem was, I then created a new spreadsheet file under VIP Professional, and tried saving that to my Toshiba disk and loading it up under Lotus 1-2-3. To my joy, the file created under VIP Professional worked without any trouble under Lotus 1-2-3 — formulae and all.

Whatever the reasons for this, it seems that, at least in my test version of the software, VIP Professional has still not quite got the business of bringing data in from Lotus 1-2-3 down pat, although it does seem that it can get information back out to Lotus 1-2-3 without troubles.

Comparison

It would be interesting to conduct a little comparison between Lotus 1-2-3 and VIP Professional — and I think even the most hardened Lotus enthusiast will find it hard to fault the ST software.

To start with, VIP is huge. It operates in an 8192-rowx256-column mat-

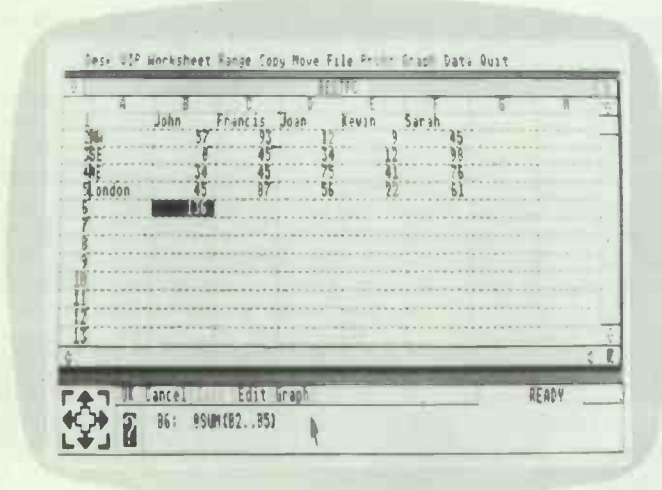

You can see from the entry format of this formula that it is identical to what you would use in Lotus 1-2-3 and, therefore, that everyone familiar with 1-2-3 should have few problems with VIP Professional

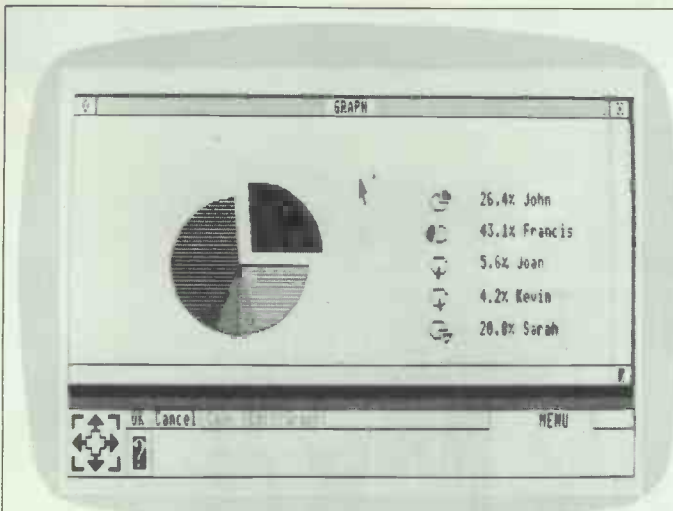

VIP Professional offers essentially the same graph types as 1-2-3, including the fairly standard pie chart. Unfortunately, it also requires the same degree of complexity

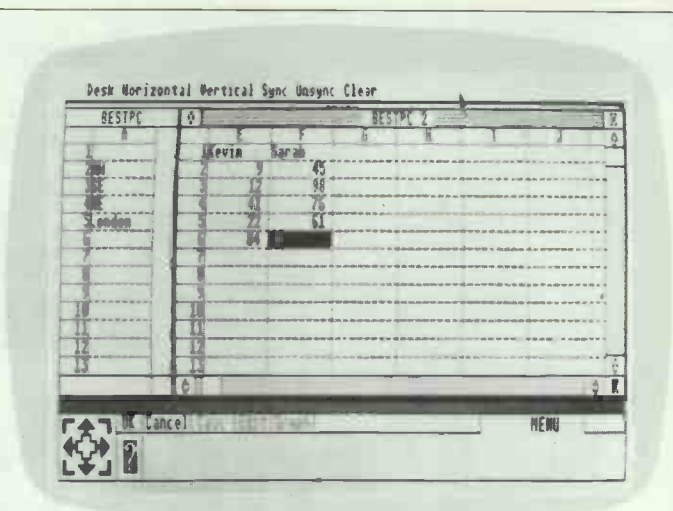

The Split Windows function of 1-2-3 is mimicked to great success within VIP Professional, and uses GEM to make the most of resizing and scrolling around windows

rix, using sparse memory management. This latter point is important as it means that VIP will only ever map the data that's in its cells, rather than having to keep track of the empty cells. On some spreadsheets, for example, placing a single number in the last cell of the spreadsheet (commonly somewhere like IZ8192) will cause the whole spreadsheet to be filled up, as it has been designed to fill all the cells upwards and to the left of IZ8192 with zero values.

But, sparse matrix spreadsheets such as VIP Professional and Microsoft Excel merely remember the cells that have data in them, and where those cells are located in the spreadsheet. All the remaining cells are assumed to be blank and, therefore, VIP Professional doesn't have to bother remembering them.

Another feature offered by VIP Professional that you won't find in Lotus 1-2-3 is the use of multiple windows. You can, for example, have a spreadsheet in one window, a database in another and a graph in a third, with the graph updated each time you change the data linked to it and then click on the graph window to redraw it. In this respect, VIP Professional is more like Symphony than 1-2-3.

Movement around the spreadsheet is also a lot easier than it is in 1-2-3. In a large spreadsheet, where you might well have a vast amount of data spread out on a large worksheet, you can use the 'express' icon to move around quickly. This is the cursor key icon I mentioned earlier which sits at the bottom left-hand corner of the screen. By pointing to any one of the four corners of this icon and clicking on the mouse, you can control movement to the four corners of your current worksheet. You will note here that I use the word 'current' — the express icon will only move as far out in the spreadsheet as you have placed data, and no further. Consequently, there

is no chance of 'over-shooting' the end of the spreadsheet.

You will also find that the arrows in this iconic key cluster provide you with much finer control than the horizontal and vertical slider bars at the bottom and side of the main data entry screen — these move around the spreadsheet a little too quickly for my liking.

With regard to spreadsheet functionality itself, you'll find nothing missing from what you would expect in a Lotus 1-2-3 clone. There are keyboard macros (although with no facility yet for including mouse movements in the macros), a vast range of '@' functions (including PMT, IF, TRUE, SUM, DATE and others) and, in the version I looked at, even local currency support for the pound sterling symbol (£).

Unfortunately, that attention to detail extended to neither the documentation nor the example files that come with VIP Professional. Although pound sterling is supported in the software, the manuals refer to dollar signs (\$) as the currency format. And, in an example on disk of how to use VIP Professional to fill in your tax return, it is a 1984 US Internal Revenue Service form that you find yourself staring at.

These quibbles aside, however, the examples are generally quite helpful and should provide both novice and intermediate users with a good idea of how to go about developing macros for specific jobs.

Documentation

Getting VIP Professional up and running is a fairly simple task, although I could not give VIP Technologies high marks for the installation section of the documentation. The information on how to install VIP Professional to run on my ST hard disk was buried obscurely in an introductory update booklet, so that I ended up conducting part of my test from floppy disks.

Frankly, VIP Professional's documentation lets the package down. While it is excellent as a minimalist reminder for existing 1-2-3 users, it is definitely not aimed at first-time spreadsheet users. These users may obtain some help from the onboard example files, but I suggest that any novice who seriously wants to get to grips with VIP Professional will have to buy a book on 1-2-3 and learn the rudiments from that.

Conclusion

For the first-time spreadsheet buyer, whether you're using an Amiga, an ST or an Apple IIGS, there are easier spreadsheets that you could buy than VIP Professional. There are, however, few that would be more powerful or as well-supported in third-party documentation (via the vast library of training books which are available for 1-2-3 users).

For experienced PC users who run STs, Apples or Commodores as their home systems and want to have a Lotus 1-2-3 clone for those machines, give VIP Professional a careful look before considering full-blown PC emulation and a real copy of Lotus 1-2-3 (or one of its many PC clones).

While ST users should look carefully at any disk compatibility problems they might have in reading PC files directly, users of all the machines should be able to get Lotus 1-2-3 files onto VIP Professional and back using a modem and communications software, so this is not an insurmountable problem.

If you don't own a PC clone and want to run Lotus 1-2-3, this is probably as close as you'll ever get. And, given the better user interface on the GEM edition I tested — along with the large worksheet and easy navigation — some may even find it better.

VIP Professional (GEM) costs £199 and is available from Silica Shop, 1-4 The Mews, Hatherley Road, Sidcup, Kent DA14 4DX. Tel: (01) 309 1111.

END

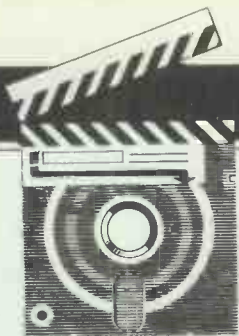

SCREENTEST

Crosstalk Mk4 vs Smartcom3

Commercial communications packages are being used more and more by businesses wanting to streamline their telephone operations. Crosstalk Mk 4 and Smartcom III are two such packages on the market and Robert Schifreen has been using both to see which he prefers.

I've been using a wonderful communications package for 18 months now, on my PC at home and at work. It's called Procomm, and you get it free by asking a friend for a copy. If you like it, you send the American author \$25 to ease your conscience. If you don't, you reformat the disk.

Procomm is written and marketed not by highly paid programmers and business people, but by comms hobbyists who add to the software the features that *they* want. It shows.

Crosstalk and Smartcom aren't written for a hobby. They are commercial products, aimed at businesses which want to connect to Telecom Gold, Prestel, the company's mainframe and more. They offer full built-in programming languages that allow a company's DP department to set up customised front-end systems so that operators can log in and use the system without having to know how it works. It's understandable that few large companies will trust their communications software to a spotty American bedroom-ridden teenager, but I feel, after using Crosstalk and Smartcom, that these packages could learn a thing or two from their users.

Crosstalk Mk. 4

Crosstalk Mk. 4 is supplied on two 360k 5¼in floppies. Installing the

software is just a matter of copying these disks to an XTALK directory on the hard disk (you can run it from floppies if you must).

Having copied the software, the next step is to configure it for your particular needs and preferences.

The hard way to do this is to issue a series of commands from the Crosstalk command line, to tell the system about your RS232 ports, modem, phone numbers and so on. The easy way is to type DO CONFIG and let something called a 'script' guide you through the procedure. The menu script is a program written in CASL — Crosstalk's built-in programming language of which more later. I opted for the easy route.

Having typed XTALK and received the quote of the day (pearls of wisdom from the likes of Einstein, displayed while the rest of the program loads) and started the menu, the first piece of information you are asked for is whether you are using a colour monitor. You can also specify whether you are using a graphics adaptor that flickers and, if you are, Crosstalk will stop it flickering by slowing down screen output. Problem: it slows it down so much that you'll soon want the flickering back.

The CONFIG menu allows you to specify the name of a script that will automatically run as soon as you load Crosstalk. This can be the MENU (which guides you through

the dialling and connecting process) or CONFIG script, none at all, or one that you write yourself to provide a unique front-end for you or your company.

You are also asked to specify two numbers known as the Outnumber and the LDnumber. The Outnumber is what you have to dial to get an outside line from your switchboard (usually 9, if anything at all) while the LDnumber is the code to get you into your favourite long distance telephone company. This is designed for American users, though Mercury subscribers in the UK may find it useful. (Don't put your Mercury ID in there, though.)

The program then scans your PC's hardware looking for valid COM ports and presents you with a list of them, from which you choose the one that your modem will be connected to. My PC at work had an internal Hayes 1200 baud modem which was recognised, correctly, as being COM2. At home, I have a WS4000 plugged into COM1. The port you specify will be the default for all communication sessions with Crosstalk.

Crosstalk comes installed for 16 modems, all of which are American. However, the list lacks popular UK models like those from Pace, Miracle Technology, Dacom and Dowty. This is not as serious as it seems, though, as you can select the 'none of these'

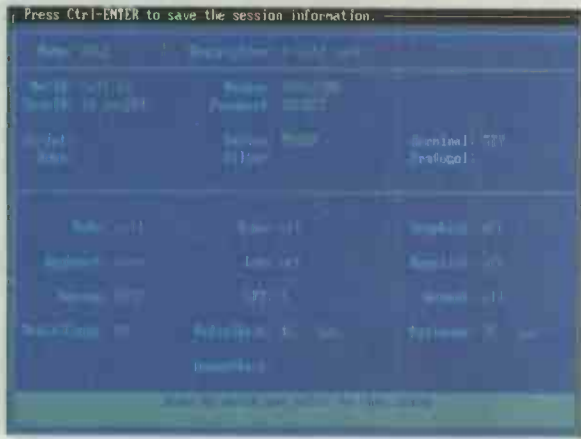

CROSSTALK MK 4

Crosstalk's 'phone book' entry system for Telecom Gold. The ID and password can be automatically transmitted if commands to do this are inserted in a script file

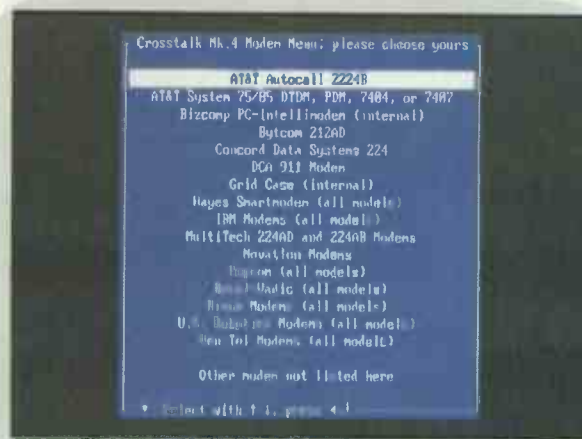

CROSSTALK MK 4

Crosstalk supports 16 types of modem, compared with Smartcom which works properly only with Hayes kit. The list is mainly American, but you can create your own definition

option from the list of modems and enter details by hand. The information required is the dialling prefix (ATDP on Hayes-ish modems), the dialling suffix (normally just a carriage return), the commands string to put the modem into speed-seeking host mode and the string to initialise the modem before each call.

With these details recorded, you can start using Crosstalk to connect to remote systems. If you've still not learned the commands (I had, but still preferred the menu system), you can type DO MENU and another script springs into action.

Calling up

The philosophy that Crosstalk uses to make calls is similar to the way that you normally use the phone to call people. The program creates and lets you maintain a file on disk called the phone book.

Like most of Crosstalk's functions, the phone book can be edited and accessed using menus, commands or Alt keys. The menu lets you create, edit and use entries, though there's nothing to stop you enhancing the menu as its source code is included. To create a new card, you have to supply a number of pieces of information about the service. To save time, you can select from a number of American database systems (The Source, OAG, CompuServe, MCI Mail, and so on) and a number of characteristics are then extracted and put into the card for you. You still have to specify the phone number and other personal details. Some people will, I'm convinced, still insist on supplying the software with IDs, passwords and so on. If you ask me, software should not even ask for such details, but should make you enter them by hand.

Each card has its own local definition of the terminal type and modem to be used with that service. These details are copied from the initial settings you specified when installing the software, so if you started off by saying that your modem was a Hayes connected to port COM2, then all your cards will contain the same details by default. Unfortunately, if you re-run the configuration menu, the new settings are not copied to existing cards. This proved inconvenient for me, as my PC at work has the modem on COM2 while at home I use COM1. Having suffered for a week, and being forced to maintain separate phone books, I came across a script called FIXBOOK that would do just what I wanted.

Crosstalk will support up to 115,200 baud (sorry, bits per second), but few RS232 ports will operate at much above 19,200. Unlike Procomm, you can't change the PC's baud rate or other settings while online.

The card is also the place where you specify the default file transfer protocol and instructions about dialling, redialling and waiting. Incidentally, Crosstalk does nothing to stop you getting the system to keep redialling an engaged number up to 99 times automatically, despite British Telecom's regulation of four, spread over a couple of hours.

Crosstalk will also act as a host system, allowing you (or anyone else) to dial up your computer and issue most Crosstalk commands remotely. This is set up by creating a special card called ANSWER that tells the system how to greet the caller, what he or she is allowed to do, what password (if any) is required and, optionally, which script to run.

Crosstalk is a modular system. The

main program consists of a 155k file, and drivers for specific modems, terminals are separate files that are loaded according to the configuration details that you supply. The advantage of this method is that support for new modems and so on can be added by distributing new driver files and not whole new versions of Crosstalk. As well as modem device drivers, the terminal drivers support straight TTY, ANSI, DEC, Televideo, Esprit II and IBM3101 emulation.

Other modules provide filters for converting, removing or analysing incoming characters and support for file transfer protocols.

Making the connection

Having set up the phone book, you can use one of the cards to make a call. For a number that you only dial occasionally or on impulse, there's no need to add it to the phone book if you don't want to — you can just dial manually by entering terminal mode and issuing AT commands to the modem from the keyboard.

Assuming that you have set up everything properly, you should be able to select the 'dial a number from the phone book' option on the menu and get straight through to your chosen service. However, talking to something through an RS232 connection has never been one of the most error-free areas of computer science and, as someone's law probably says, if something *can* go wrong, it probably *will*.

In my case, I had been too clever with the modem initialisation string. Normally when I talk directly to a modem, I type AT to get an OK message, followed by ATZ to reset everything. I had entered this into Crosstalk's modem 'init' string, using the vertical bar character as a carriage

NEW AM NOW OTHER HOME COM

Amiga 500 is here.

With a mind-blowing array of features and capabilities.

And a £499[‡] price ticket (inc.VAT), hundreds of pounds less than anyone could have predicted.

"...a miracle of compression..." writes *Popular Computing Weekly** "...it all adds up to a formidable system which is clearly better than anything else at the price."

This elegant little machine takes family computing into new dimensions of creativity, excitement and productivity.

It outruns and outguns office PCs as a business multi-tasker, performing a deskful of different jobs simultaneously, at over 7 million steps per second in realtime.

So other home computers may not be the only machines it consigns to the toy cupboard.

AMAZING SCIENCE FACT!

Amiga is used by Disney, Universal and other Hollywood studios for its dazzling 3D graphics manipulation and animation powers.

A sophisticated high-speed graphics processor called a blitter chip transforms images in realtime.

You can paint the screen with more than 4,000 colours. Create and modify designs and effects as you like, with pin-sharp resolution.

You command an almost limitless workshopful of stunning professional graphics capabilities.

With an optional Genlock interface, you can capture images off videotape. Manipulate and mix



them with graphics. Then re-transfer them to videotape!

This means you can produce spectacular special effects like those created by Amiga computers for Channel 4's *Chart Show* and the American TV science fiction series *Amazing Stories*.

YOU AIN'T HEARD NOTHING YET!

Concealed within the sleek Amiga shape, there is also a pro-quality sound synthesiser and four-track stereo sound system.

Driven by another powerful and unique custom chip, it can synthesise musical instruments and

[‡]Includes DeluxePaint from Electronic Arts worth £79 + VAT! *Excludes monitor or TV modulator.

GA 500. PUTERS ARE JUST TOYS.

Your Amiga can also synthesise the human voice.

It can speak back anything you care to write on the keyboard.

So this is one computer that can not only word process with faultless professionalism, and incorporate superlative graphics into the text, it can also read the text back to you aloud.

GAMESMANSHIP AND WORKMANSHIP!

The new Amiga 500, in fact, dumbfounds its competitors in every way.

Graphics, stereo sound, multi windowing, multi screens, 512K to 1Mb RAM (expandable by an incredible 8 further megabytes externally**), 3½" internal disk drive with 880K of mass memory, 4 unique dedicated chips plus the 16/32-bit power and 7.14MHz speed of its central processor, communications and vast expansion potential all add up to a computer of immense professional capability.

Yet the same technology allows the Amiga 500 to play games so mind bending that only full-scale arcade machines

have been able to play them until now.

AND AMIGA MEANS 'FRIEND'!

However many of the Amiga's extraordinary talents you find yourself using, they will all be beautifully simple and natural.

You will be totally at home in the friendly and effortless Amiga

environment, where everything happens by windows, icons, mouse and pulldown menus.

And the Amiga 500 simplifies life in another way too.

There is now no comparable home computer. At any price.

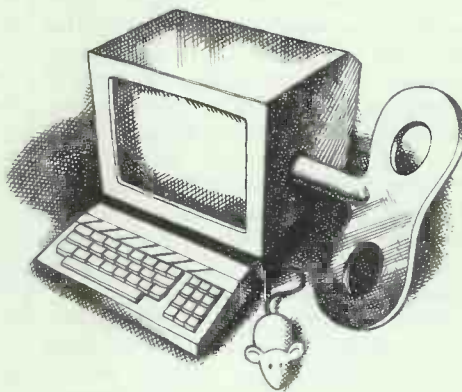

Try the astonishing new Amiga 500 at your nearest Commodore Amiga dealer.

And discover why *Personal Computer World*†, having tested the graphics performance of Amiga's latest and most powerful rival, concluded "...Amiga still reigns supreme..."

AMIGA



Commodore

INCREDIBLY
ONLY **£499***
INCLUDING VAT

und effects.

An optional digitiser allows you to take onboard real sounds. Mix and modify the two. Translate your compositions from keyboard sheet music. Play them back through the monitor's speaker or your hi-fi.

Popular Computing Weekly, 22-28 May 1987 *Personal Computer World*, February 1987 **Subject to availability.

AMIGA IS A TRADEMARK OF COMMODORE - AMIGA INC. © 1987 COMMODORE BUSINESS MACHINES (UK) LTD. ALL RIGHTS RESERVED.

SCREENTEST

return as the manual told me. I discovered, after much tearing of hair, that Crosstalk was stopping at the first carriage return and assuming it had found the end of the string.

The moral here is that you won't get very far unless your modem has a built-in speaker so that you can hear what's going on, if anything.

File transfer

Modules are currently provided for Xmodem, Ymodem, Kermit (not sliding window), Dart, Xtalk and CompuServe B file transfers. Uploading or downloading a file is a matter of pressing Alt-F10 while online to obtain a menu, and making the correct selections from one or more menus to specify the name of the file and the required protocol.

I had no problem in transferring files to PCW's own bulletin board system, and was impressed with the way the program gave an often-updated characters-per-second throughput. At 1200 baud, using Ymodem, this hovered between 112 and 114 throughout; it acted firstly as a reassurance that everything was working, and also allowed me to experiment to find which of the transfer methods was best for certain jobs and from certain systems.

Another option on the file transfer menu allows you to turn on Capture mode, which simply spools all incoming text to a file or to the printer, or both. You can also press Alt-G to grab the current screen image and put it in the spool file.

Macros

Crosstalk contains a macro facility that lets you create your own Crosstalk commands. A macro has to be a word, of up to 16 characters, and

```
assume device "MODEM"
assume terminal "DEC"

repeat
  if speed = 2400 then reply p2400; else reply p1200;
  wait 2 ticks
  reply
  print #w, ". ";
  wait 1 second
until timeout = 0
track clear

while online

  watch for
    case "NAL" : wait 5 ticks : reply "D1"
    "@" : wait 5 ticks : reply "C " + NetID
    case "CONNECT" : END
    "illegal" : wait 5 ticks : bye
    "rejecting" : wait 5 ticks : bye
    space "not re" : wait 5 ticks : bye
  endwatch

wend

end
```

This extract from the Telenet log-in script illustrates the look and feel of Crosstalk's language

that word then becomes a Crosstalk command that can be used from the command line or within a script until you delete its definition with the Forget command.

There are good and bad points about the way macros work. First, the bad news. You can't set up shorthand macros that can be called by pressing just, say, an Alt key combination. You can't embed function keys in there either, though you can use the equivalent command instead. The good news is that you can create a macro with the same name as an existing Crosstalk command and your macro will be given priority. Although this can be potentially dangerous (like if you create a macro called MACRO, thus removing the macro command) it does mean you can disable some of the more powerful of Crosstalk's commands or rename them to something that others won't know.

To execute a macro, you either type its name from the command line, or you can produce a menu of them with the LIST MACROS command. You can then select the one you want and execute it by pressing Return.

Scripts

MS-DOS contains a wonderful facility called 'batch files'. This allows you to create a text file containing a number of MS-DOS commands and then, by typing the name of the batch file from the command prompt, MS-DOS will execute the list of commands one by one as though you were actually typing them.

Crosstalk takes this a number of steps further. It allows you to create an ASCII text file containing not just commands that can be typed at Crosstalk's command line (like those to access the phone book and make calls), but a number of other Basic-



SMARTCOM III

Smartcom has 14 predefined activity settings which can be used as they are or customised by the user. A script associated with a particular activity can be exported

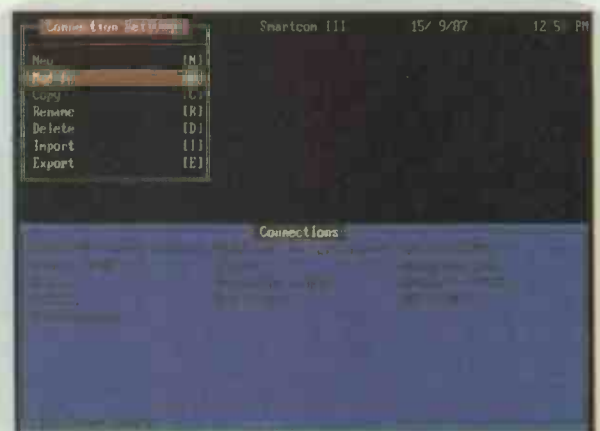

SMARTCOM III

There are 13 connections as standard in Smartcom. These allow you to connect to a service via PSS, the normal telephone network or via direct connection without a modem

Orator's unique
power leaves even the most
sophisticated modems
speechless.

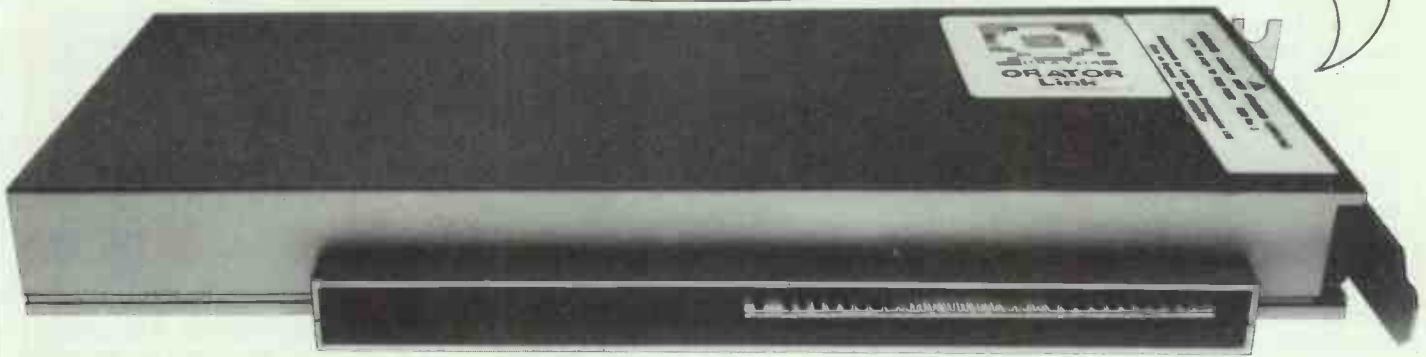

Orator is much more than a sophisticated multi-speed modem.

Like all good multi-speed modems, it offers your PC access to mainframes, minis and a whole range of on-line services. At speeds from 300 bps to 2400 bps full duplex – completely automatically.

The most powerful.

But quite unlike *any* modem, it has a powerful data communications package as standard, complete with built-in voice facilities.

This means Orator can offer a unique, immensely powerful hardware and software package to any IBM-compatible PC.

The most versatile.

Orator offers terminal emulations, including Viewdata and VT100, and a full voice and data call telephone directory.

It also provides unattended and timed opera-

tion, automatic log-on and file transfer, voice storage and retrieval, and answerphone operation with selectable user-recorded messages.

The most competitive.

What is even more remarkable about Orator is that it costs no more than an ordinary modem! For only £795, Orator gives you what no multi-speed modem can offer.

And Orator simply slots inside your PC.

The most accessible.

If you're impressed by what the industry is calling "the single most important addition to the PC", go straight to your high street dealer and demand a demonstration. Or contact one of our distributors: Northamber plc 01-391 5211.

P&P Micro Distributors plc
0706 217744. You'll discover
that Orator speaks for itself.

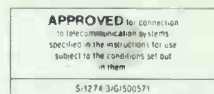

I would like more information on Orator.

NAME _____
POSITION _____
COMPANY _____
ADDRESS _____
POST CODE _____
TEL. No. _____

Atlantic Office Communications, Oxford Road, Stokenchurch, High Wycombe, Bucks HP14 3SX.

Orator is a trademark of Atlantic Office Communications IBM is a registered trademark of International Business Machines Corp. Price correct at time of going to press.

like commands that deal with windows, graphics, sound and maths.

The manual states that in-house programmers have even written database systems and arcade games in CASL. In addition to being able to define its own variables, a script has access to a number of predefined system ones. These include the data from the phone book card so that the script can transmit the user's ID and/or password when the remote system is asking for it.

CASL even allows inline machine code subroutines, like Turbo Pascal.

Documentation

Such a complex piece of software takes time to get used to, and the longer this takes, the more hostile you will feel towards it. The Crosstalk manual starts with a good tutorial about setting up and accessing a phone book entry, which allowed me to make my first call within half an hour or so. Over half the manual is taken up with a detailed reference section about the CASL commands, though there is no tutorial here and unless you've used a high-level language like Basic or C before, you will be lost. There is a whole disk of sample scripts supplied, though, which acts as a good starting point. All the examples are comms-related but I'd love to have seen the arcade game.

Incidentally, if you're just discovering comms in a big way, bear in mind that Crosstalk's manual has a pocket at the front with discount vouchers for all sorts of American databases, including CompuServe.

Smartcom III

Opening the Smartcom III box reveals three 5¼in disks and, thoughtfully, a couple of 3½in ones as well, none copy protected. The 30 per cent increase in disk space might prompt you to think that Smartcom's program code is slightly larger than Crosstalk's. That's an understatement. It's massive, weighing in at some 700k, split into one EXE file and two overlay programs.

As if being forced to have a 640k machine to use the program was not enough, there is also a distinct lack of sample script files on the disk. You can't beat learning by example, especially with the manual's lack of a tutorial, which makes Crosstalk start to emerge as the better package with the contest hardly into the opening round.

Those Hayes people obviously realized that the large manual looks fairly daunting to the new user, and helpfully included a 'get you started' card at the front of the manual. Following this, I managed to dial into Telecom Gold within a couple of mi-

minutes by calling up the menus and hitting the keys that I was told.

Pleased with my initial speedy progress, I took the package home for the weekend to introduce it to my WS4000. As soon as I started Smartcom, I was informed that the modem 'was not responding' and the software refused to go any further. I knew full well that the modem was responding perfectly as its lights flickered when Smartcom started, and also because Procomm still worked perfectly.

By Sunday afternoon, having kicked everything in sight and even having resorted to reading the manual, I was no better off so I called Hayes the next day. I realised that the fault lay in one or more of the AT commands that Smartcom was sending to the modem to initialise it, but a search through the program's code with my best debugging tools failed to find the commands (they are encrypted, for security and speed).

According to Hayes, the actual command that is sent to initialise the modem (and which you can't change) is as follows:

```
AT E0 V1 Q0 S0=0 S3=30 S4=31
S5=255 S12=10 T (return)
ATH114 (return)
ATX3 TMI L1 &Q N2 B &K S7=60
S8=4 S9=6 S10=14 S11=90 (return)
ATS6=4 D; S6=2 (return)
```

This explains why the software sits around for six seconds saying 'initializing modem' before every call. Like the proverbial watched pot, it probably wouldn't take so long if I didn't stare and make faces at it.

The interesting command here is ATH114. This is an undocumented Hayes command that returns a three-digit number. This tells the software what type of Hayes modem it is talking to and — very handy this — being undocumented, it's only Hayes who knows about it. And who wrote Smartcom? Right.

The upshot of this is that, unless your modem is *really* made by Hayes, it's possible that it won't work properly, or at all, with Smartcom III. My WS4000 didn't, but the office Pace Series 4 and Quattro card did, though they must have been returning slightly non-standard codes to Smartcom as the software refused to hang up the modem after a call. This indicated that the modem was not the modem that the software thought it was.

There is no easy way out of this situation. The software doesn't have a list of modems for you to choose from — though considering the software is made by Hayes, it's not surprising. The only way I could use Smartcom on my WS4000 was to use the software's direct connect

method, which links you straight to the computer's COM port without interrogating the modem. I had no further problems using this method. However, I have a feeling that Hayes's support desk may not pull out as many stops to help the Dowty user as they would a Hayes user.

Getting involved

Having followed the getting started card a few times and managing to call Telecom Gold, I decided it was time to stop entering the phone numbers manually and, instead, set up a database of services and numbers that the software would dial automatically.

Treating the electronic dialling directory in the same way as you treat your address book may seem like a great idea to Crosstalk's designers, but Hayes takes a different view. It sees its average user wanting to call a large number of different services, and probably having more than one way of calling each service. For example, they may call Telecom Gold via direct dial, or through PSS.

Smartcom works on the principle of the activity and the connection. To make a call, you then select one of each. Personally, I found this rather hard to grasp at first, as Hayes seems to have gone out of its way to confuse people. An example will probably clarify things — the default list of activities include Kermit Host, Prestel, Gold, Direct Connect and so on. Defined in the activity setting for Prestel is the type of emulation required, the size of the receive buffer, the screen colours and keyboard definitions. In the connection part goes which COM port you want, whether the modem is in answer or originate mode, the phone number, baud rate, parity settings, whether to pulse or tone dial, whether the modem's speaker should be on or not, and so on.

With everything set up properly, you then call a service by selecting from a menu the desired activity and connection. I can see only one major use for having separate activity and connection settings. If you use networks like PSS, you can have one connection to define the logging in to PSS, and then separate activity settings to decide what service to call once connected to the network.

One interesting thing that you notice, though, when setting up all this data is the facility for key redefinition. You can redefine just about any key on the keyboard for use when connected to that particular service. To achieve such a level of customisability, the program takes over not just the keyboard but most of the rest of the machine, too. Not only does it take over KEYBUK and

force your quotation marks to be over the '2' key whether you want them there or not, but it takes over the memory of the machine and will work with very few resident programs, SideKick thankfully being one exception.

Redefining a key doesn't just mean replacing it with another character. Actually, you can replace it with a string of up to 32, so you could make Alt-Y become Yours Sincerely to aid in finishing letters.

The other point of note is that Prestel appears on the list of settings at all. Smartcom's biggest selling point over and above Crosstalk is that it supports Prestel graphics (in all eight colours, though yellow shows as brown) on a CGA or EGA monitor. This is not as easy as it sounds, as neither of these two graphics adaptors should be able to do it. On the EGA, Hayes admits that it manages to do the emulation by totally reprogramming the card's registers and character set. How it gets eight colour block graphics in text mode on a CGA isn't documented, though I'm sure that certain other software companies are studying Hayes' code as you read this.

Admirable as all this sounds, there are problems with the Prestel emulation. All the text (on a CGA or EGA) is spread over all 80 columns, so every character has a space next to it and slows reading by half. You also have to wait for a full frame to be displayed on the screen — you can't interrupt it by pressing a route number before the display has finished.

File transfers

Like Crosstalk, Smartcom has a number of ways of sending a file automatically. One is autotyping, which sends an ASCII file to the modem character by character, as though you were typing it yourself. The benefit of not actually typing the text is that autotyping is faster, but no error checking takes place so keep an eye on the screen to ensure that line noise doesn't reduce the text to garbage.

In case the remote system can't accept autotyped characters as fast as Smartcom can send them, you can put in delays between every line, character or both. The Smartcom manual recommends changing the delay between characters from 0.00 to 0.01 seconds. There's accuracy for you.

For error-checked and/or 8-bit files, Smartcom supports Xmodem, Ymodem and Kermit protocols. To download or upload a file, you call up the session menu by pressing F3 while online, and prompts appear to gather the file name to be sent or received. My only criticism about the file transfer system, apart from the lack of sliding window Kermit, is that

```
CALL check_drives[ arg1 , 1 ] ;
IF 1 THEN GOTO main ;
START DIRECTORY arg1 . count ;
IF ERROR_NUMBER <> 0 THEN GOTO got_err ;
i = 0 ;
eol = 0 ;
do_dir0:IF ( i >= count ) THEN GOTO do_dir1 ;
IF ( rx_break ) THEN GOTO do_dir3 ;
NEXT DIRECTORY ENTRY name ;
fn = name ;
IF VALID_NAME( name ) = NAME_IS_PATH THEN
name = concat( "[", name, "]" ) ;
IF detail THEN GOTO do_dir2 ;
eol = ( i MOD 5 ) = 4 ;
IF ( NOT eol ) THEN
name = MID( CONCAT( name , " " ) , 1 , 16 ) ;
IF eol THEN TYPE LINE name ;
IF ( NOT eol ) THEN TYPE TEXT name ;
i = i + 1 ;
GOTO do_dir0 ;
do_dir2:j = CREATED( fn ) ;
```

This example is taken from the Smartcom program that provides you or others with remote access to your PC

the only protocol appearing in the session menu is the one you specified as the one to be used when the connection was defined. It's possible to change this but it takes time. I'd rather be presented with the list of available protocols, like Procomm does for me, and be able to choose one.

Scripts

Like Crosstalk, Smartcom has a programming language. The snazzy acronym this time is SCOPE, which is Simple Communication Programming Environment. What the word 'Simple' applies to, I have no idea. Certainly not the learning process, as you don't get an example script disk (with Crosstalk you do) and you don't get any documentation apart from a reference guide that lists all the commands in alphabetical order.

Multiple sessions

It's a sad fact that computers are so unsuited to doing the one thing that we all expect of them — making light work of performing more than one task at a time. Both Crosstalk and Smartcom allow you to have a number of active sessions running, but you need a separate communications port (and modem) for each one.

Assuming you have these, both programs will perform a sort of multi-tasking, in that characters coming down a line will be recognised and stored even if that port is not the one being displayed on the screen. This means you can be downloading your mail from Gold and downloading some data from the company mainframe at the same time.

Conclusion

I don't really like either of these two packages. From the start, I felt that they were far too complex for the basically simple job they were trying to do, that of sending characters to, and reading characters from, the RS-232 port. My opinion didn't change that much over the couple of weeks I used them.

Even now, when I know the packages well enough to use them without referring to manuals, I still find myself reverting to Procomm to check my Gold mailbox before returning to Smartcom or Crosstalk to finish researching this review.

I suppose there are a couple of advantages that these programs have over Procomm. The programming languages are wonderful, though I don't think I could learn either of them to a reasonable standard in less than two months. And if I did want to learn one of them, I'd go for Crosstalk because of the example script disk. To be fair to Hayes, apparently there is a similar disk for Smartcom on the way but I have yet to see it.

Smartcom has two plus points. Firstly, its learn mode which lets you use a service and, as you do, it creates a script file to recreate in the future what you are doing now. For example, if you log on to Gold, read and download your mail, then log off, the program will create a script for you which will do the same thing for you again at a later date. It also scores on the Prestel emulation. It's hard to read and very slow, but at least it's there. Its only real competitor is Datatalk but this only gives four colours on a CGA. ChitChat, from Sage, gives no graphics at all.

Personally speaking, I'm sticking with Procomm, though I may brush the dust off Smartcom occasionally if Prestel ever gives me back my account. If I had to set up a custom front-end to a remote system, I'd rather stick with a language I know well, as opposed to learning a new one. Therefore, I'd stay with Turbo Basic and Borland's almost-ready-now Turbo Basic Telecom Toolbox.

Smartcom III costs £149 and Crosstalk Mk 4 is £155, both excluding VAT. These packages should be available from dealers. If you don't have a friend who owns Procomm, look in PCW's Bulletin Board listing for a local IBM PC bulletin board — most have a copy for downloading. The latest version is 2.4.2. **END**

COMPUTER ANSWERS

*Steve Gold takes his toolkit to your problems.
The address to write to is: Computer Answers, PCW,
32-34 Broadwick Street, London W1A 2HG.*

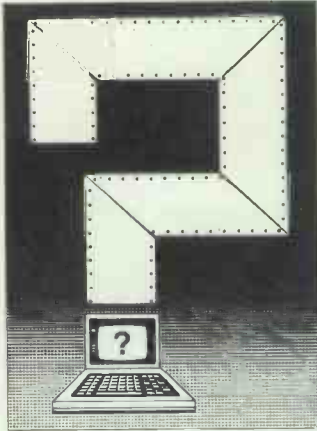

Computer Answers is PCW's help column. We offer advice about all kinds of specific hardware and software problems through the pages of the magazine. We also welcome further information in response to published queries.

Received wisdom

I recently received a summons to attend the local magistrates court for not having a valid TV licence.

During the period involved I used the colour TV only for use with my computer and not, as alleged, as an 'apparatus for wireless telegraphy'.

I am a self-employed computer programmer — can I get off the charge?
(Name and address supplied)

In an ideal world, yes, you could — and should — be found 'not guilty'.

Unfortunately, the excuse of 'computer use only' has been tried before and many hopeful computer users' hopes have been dashed by busy magistrates.

Contesting the case will cost you a lot of money (for legal representation). Defending yourself in court is admirable, but in practice often backfires, leaving the magistrate to pick up the pieces.

My experience of cases such as this leads me to believe that the only way to avoid paying a TV licence fee is to (a) totally disable the tuner in your TV — namely, convert it wholly into a computer monitor, and (b) remove any outward sign of TV usage, TV aerials, for instance.

Such is the level of

penetration of TVs into households (98 per cent), that the authorities take the view that the onus of proving that you don't watch TV in your own home rests on the defendant. It's not fair, but that's life, I'm afraid.

Memory lapse

I own a Tandy 1000 with a third-party RAM expansion card to take it to 640k. My problem is that I think I have 16k of RAM unaccounted for on my machine. When I execute CHKDSK, the computer returns a total of 638,976 bytes in RAM. Shouldn't I have 655,368 bytes total memory?

My Tandy dealer says that a Tandy-supplied RAM board will solve the problem, but the official Tandy product costs a lot of money. Do I have a bad RAM chip?

Adrian Freeman,
New Southgate, London

Your Tandy salesman is wrong. The official Tandy RAM expansion on the Tandy 1000 will give the same results with CHKDSK as your existing board does.

Unlike the vast majority of PC compatibles on the market today, the Tandy 1000 uses 16k of RAM, normally used as system memory, as video memory. Therefore, no matter how much you expand your machine, you will always be 16k short, so to speak.

A touch of typing

I am considering buying one of the Amstrad PCW range with a view to teaching myself touch-typing. Are there any programs available for this?
Jane Carter, Nottingham

There most certainly are! The PCW is one of the most popular machines for DIY touch-typing courses, perhaps due to its amazing price/performance ratio.

Most touch-typing courses for computers we've seen have been excellent, but are not necessarily as interactive as they might be. This is a shame, so you may be as well to go ahead and buy your PCW, but consider investing in a book on the subject. Most of the books are considerably cheaper than the touch-typing

tutors found on the PCW and also include many more tutorials.

There is, however, no substitute for the real thing, so consider typing your correspondence, for example, on the machine as often as possible. Regular practice with real applications is often a better way to learn than by typing examples from a book.

Having learned touch-typing 'the hard way' myself, my main problem was looking at the keyboard when typing — try not to do this. Look at the screen, and you'll learn a lot faster.

On the tilt

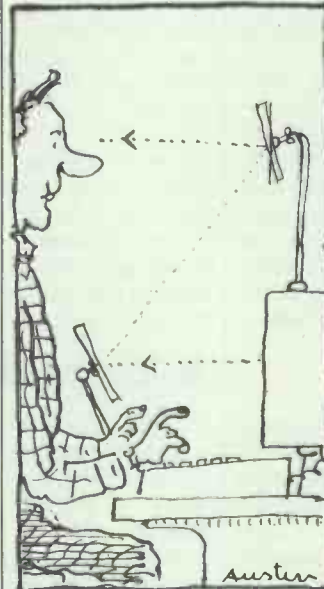

Having seen a tilting screen available for my brother's BBC Micro monitor (a Kaga Taxan) I wonder if there is anything similar available for my Amstrad PCW8512 monitor? If there isn't, are there any other options? Being fairly tall (6 feet 3 inches) I find myself having to crick my neck looking down at the monitor.
S Davies, Tarporley, Cheshire

You have my sympathy. Unfortunately, as far as I am aware, there is no screen tilt unit available for the PCW series. But there are simpler — and equally inexpensive — solutions to your problem.

Firstly, your problem seems to be limited to the PCW screen unit itself. Your height means that you are probably looking down, instead of

horizontally across, at the PCW monitor. On an average desk I calculate that this will involve raising the PCW screen unit about four inches at least.

You may try one of the open frame printer stands currently available for Epson-style printers. Instead of raising the printer, however, use it to raise the PCW monitor unit. As well as raising the monitor several inches — albeit not as elegantly as a swivel stand — the open space under the monitor could be used for parking your PCW keyboard when not in use.

The second solution is far from elegant, but very cheap. Try placing a book under the monitor to tilt the screen upwards — not too far, or it will slip.

The third solution is a little more unusual. There are a number of special seats available which allow you to kneel with your legs tucked — but fully supported — under the chair. This arrangement — an alternative to sitting upright — is considered by many to be a much more relaxing and a healthy alternative to conventional chairs.

Such chairs don't come cheaply, however — £50 is a typical price. Some Health Authorities will supply orthopaedic chairs of this nature free of charge if you are unusually small/tall and/or physically handicapped.

A colleague of mine obtained just such a chair (costing over £130) from the NHS because of her small size (5 feet). If you use your computer at work, this will add considerable weight to your case for obtaining a special chair free of charge.

Sharetime

Is it possible to extract share prices from the Prestel Citiservice and use them in a spreadsheet such as Lotus 1-2-3? Also, is it possible to automate this process?
M Wilson, Aberdeen

With a little careful planning, yes, it's perfectly possible. The package you need is called Datatalk from Datasoft. Available for the IBM PC and close compatibles, Datatalk is capable of automated logon and frame saving.

Once offline, Datatalk has a specific utility which will

convert the viewdata frames of Prestel into normal text (7-bit ASCII). The resultant files can then easily be loaded into 1-2-3 or almost any other database/word-processing program.

Greek translation

I have bought an Amstrad CPC6128 for use here in Greece. Would it be possible to use the machine properly in the US?

George Gerontzis, Athens, Greece

Greek televisions are much the same as those here in the UK in that they work to a derivative of the PAL colour standard. The difference between Greece and the UK is in the frequency used by the sound carrier on TV signals.

While there should be no problem when using your Greek CPC6128 with a UK colour TV, you cannot do so with a US set. This is because the US television network works to 525 lines on the NTSC standard — totally different to the 625 lines PAL standard used in Europe. You will also experience problems in that the US mains work to 110 volts, while Europe and Greece work to 240 volts at a different frequency.

Your best solution — assuming you wish to use the machine in the US — would be to take your own monitor to the US and use a voltage transformer (costing about £30) to feed power to your CPC computer. The monitor may not be so easy to use with a US power supply, but your local TV stockist in the US will be able to advise on a power supply unit once you get there.

Hot and bothered

I bought a VIC 20 in a local sale to use as a second machine to my C64. When I power-up the VIC 20, it becomes very hot indeed during the first 15 minutes, but then cools off. Is there something wrong?

J Easterbrook, Bridgwater, Somerset

The temperature rise is normal and is no cause for concern. The VIC 20 contains several large-scale integrated (LSI) circuits that become quite warm in use. Like other Commodore machines, it uses a convection design to dissipate the heat. In the VIC 20's case, however, it can take up to 20 minutes for the air to begin circulating effectively.

NEC portable has the killer touch

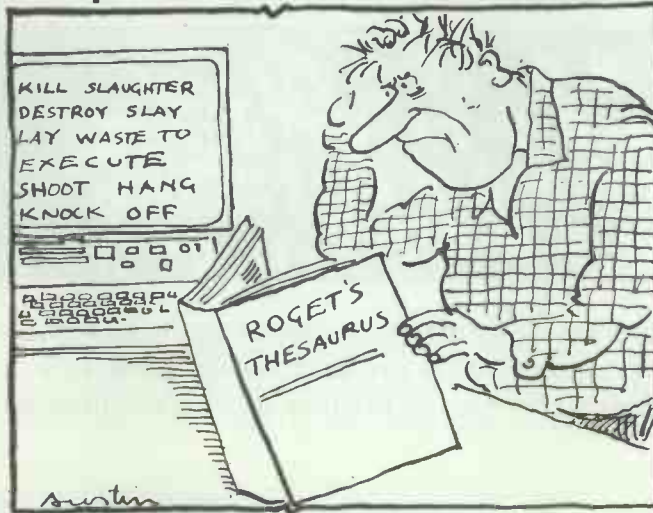

I inadvertently named a file KILL" T when prompted for a file name on my NEC laptop. The file was placed in the menu as KILL" T.DO and I can't seem to remove it, no matter what I type. I've tried KILL" KILL" T.DO", but the machine refuses to accept nested quotation marks. Help!

P Madden, Leicester

The solution to your problem — which is often encountered on similar machines such as the Tandy Model 100/200 series and the Olivetti laptop — is simple. Type KILL "KILL" + CHR\$(34)+ "T.DO" and the file will be removed from the menu. Basic's KILL command is more flexible than the MS-DOS DEL command.

Glaring error

I work with a computer for several hours a day and find the colour display on an Amstrad PC1512 gives me a headache. I wear glasses, but VDU shields don't seem to help. Is there another solution?

Peter Redfern, Manchester

Spectacle wearers have particular problems with colour computer monitors. The image of the screen is reflected across the lens in such a way that the eye has difficulty focusing on the main image. While your brain interprets the image, your eyes are becoming strained when looking at the screen — hence the headache.

You have two options to alleviate your problem.

First, consider switching to contact lenses — the multiple image and/or glare effect is considerably diminished with contact lenses — particularly with the softer lenses now coming on the market.

Second, spectacle lens coatings have improved dramatically over the past year or so. The latest spectacle lens coatings include a quartz derivative which diffuses reflections on the surface of the lens, while allowing incident (direct) light straight through.

The effect of this quartz

coating is dramatic — my own optician quotes a 90 per cent reduction in glare and internal lens reflections. Consult your optician — the cost is about £20 above that of normal spectacles. The coating is not, sadly, available under the NHS free or reduced rate scheme.

No entry

I recently upgraded my PC/XT compatible to an AT compatible, retaining the 20Mbyte hard disk for use with the AT. Despite my following the hard disk manufacturer's installation procedure, the AT does not seem to recognise that the hard disk is present. Is this a DOS problem?

I Hoffman, London

One reason for your difficulty is that the XT looks for a hard disk at address 0, while the AT looks at address 1. You will need to move the jumper block (located on the back of, or underneath, the drive) from position 0 to 1.

You will also have to reformat your hard disk using both high and low-level format procedures. This will allow the AT disk controller to read and write to the disk. For information on this, you should refer to the instructions which came with your hard disk controller — not the XT's hard disk.

Double deadlock

I'm having problems with my 64k Atari 600XL. When I enter a line of Basic, the machine locks up. Short of powering down the machine, the only way out is to use the system reset key. But, even when I press reset, the computer locks up again on the next line. What's wrong?

Dave Green, Sheffield

This is not a hardware fault — it's a known bug in Atari Basic. The bug affects two versions of Atari Basic — Revision A, as found in the cartridge for the old 400, 800 and 1200XL machines; and Revision B, built into the 600 and 800XL computers.

The problem usually occurs when corrections are made to a line before a carriage return is entered on the machine. As I understand it, the bug locks the machine up when an exact multiple of 256 bytes of data is entered on a single line of Basic which has been edited before the Return key has been pressed.

The bug has been fixed in Revision C of the Basic ROM which is fitted to the 65XE and 130XE machines. Your local Atari dealer should be able to order Revision C for you for about £10.

Side issues

Now that the BBC Model B is getting a little long in the tooth, I've noticed several firms advertising sideways RAM units for the machine very cheaply. Leaving aside 16k units which I can use for images of ROMs, what use is a 32k or above capacity SWR?

Phil Rose, London

Some BBC Model B ROMs come as part of a set — for instance, the AMX ROM set — and require each other to interact. This is why 32k and 64k SWR units were first marketed for the Model B. However, when cheaper RAM chips arrived, some manufacturers started producing 128k and even 256k SWR units with software to use the sideways RAM as a disk drive.

Most driving software I've seen for SWR units takes up at least 14k of the sideways RAM — on a 128k unit that leaves you with 114k for data, which is a 40-track disk drive's capacity.

128k SWR units cost as little as £50 at the moment. If you use software that requires a lot of disk accesses, an SWR unit as a RAM disk is probably a useful investment.

END

SCREENPLAY

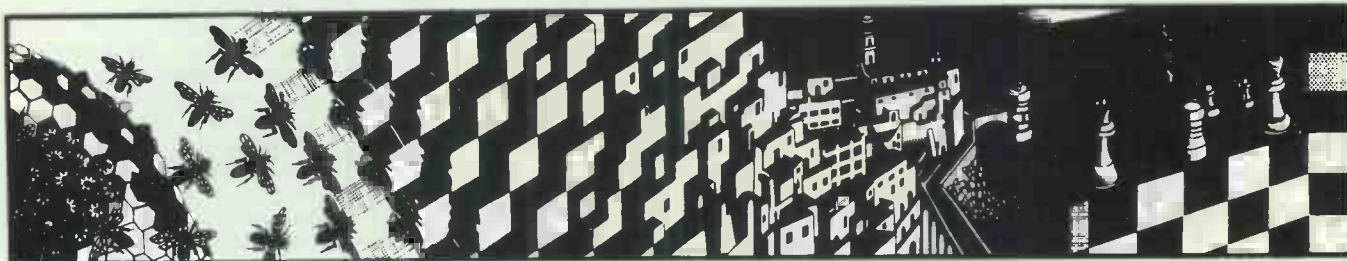

Confusion rains on Stephen Applebaum as he grapples with figures of speech, walks like an orc and serves time as a sorcerer's apprentice in the search for this month's rippingest yarns.

Language barriers

Title: Nord and Bert Couldn't Make Head or Tail of It
Computer: IBM PC; Apple II series; Apple IIGS; Atari ST; Amiga; Macintosh; Commodore 64/128
Supplier: Activision
Format: Disk
Price: all versions £24.99, except C64/128 £29.99

Although unmistakably an Infocom product, Nord and Bert is quite different from any of the company's previous adventures. Although it retains nearly all the Infocom characteristics, it diverges from the norm with a subtly different mode of gameplay.

Nord and Bert Couldn't Make Head or Tail of It is a collection of eight, tenuously linked, mini text adventures involving various forms of verbal trickery. To play, you should be *au fait* with the homonym, oxymoron, spoonerism, cliché, idiom and pun. Prior knowledge of these forms of linguistic gymnastics is helpful, though not essential, as the program's manual explains most of their meanings.

As in Knight Orc (reviewed alongside) there is no need to make a map. Because, unlike previous Infocom adventures, Nord and Bert displays the locations you can move to in a status line along the top of the screen. To move, all you do is type the name of your desired destination. This takes the emphasis away from having to learn the adventure's topography and leaves you free to think through the many puzzles that have to be solved in order to complete all eight episodes.

Another new and welcome feature is a hint facility. When you get stuck, you just type 'HINT' for a list of items about which information is available. Selecting the item pertinent to your current predicament produces a number of useful tips on how to get out of it.

The game's action begins in Puns-

ter, a small town whose community has been riven by a strange and inexplicable phenomenon: people, objects and animals are mutating into completely different forms; and furthermore, actions that were once simple to perform now require the use of old, time-worn phrases. It would appear that Punster has been hit by a plague which attacks language itself.

Your objective is to reverse the changes that have occurred in Punster, so that the town can return to its 'happily mundane condition'. How you go about it is entirely up to you. The eight stories comprising the adventure can be assayed in any order, though the eighth can be played only after completion of the first seven, since they each reveal part of a password necessary to enter the concluding scenario in which you meet the Mayor of Punster.

There are just too many stories to mention them all here, so I will just pick out my favourites.

The first tale, called Go to the

Shopping Bizarre, is based around homonyms. These are words which are pronounced the same but are spelt differently and have totally unconnected meanings. In this weird episode, you have to reverse the strange changes that have come over some of the people and goods in Punster's main shopping mall, in the hope that your handiwork will rebuild the store's damaged customer confidence.

Nothing in the story is quite what it seems. Take, for instance, a young girl wearing a ribbon with the words 'Worst Brat' embroidered on it, who jumps from a shelf in the meat aisle. The idea is to transmute her back into her true form. In this case you type 'Examine Bratwurst', at which she 'tumbles head over heels to the floor in a blur' and then turns into a sausage.

Buy the Farm is a bucolic tale of simple, if slightly odd, country folk. Ever since the plague hit Punster, farm owners have been too ill to go about their daily chores. Consequent-

Location: Field Farm score: 2 out of 19

You can go: Road, Barn, Barnyard, Stable, Market
sandy dirt across the plain. A scant sign of life here is a freshly burrowed molehill on the ground.

Marking the corner of the property is a large stack of hay, whose musty odor sticks in your nostrils.

The old dog follows behind you.

>make a mountain out of the mole hill
There is a tremendous rumbling in the distance, getting louder and louder, until it is deafening. The ground shakes with violence from the mammoth pressures of the earth's crust. The dirt around the molehill crumbles away as mighty, jagged granite peaks begin to emerge from deep underneath it, and you are knocked back as the mountain continues to rise majestically.

The surrounding landscape, once bleak, now undergoes transformation into a fertile valley before your very eyes. Crops sprout and grow tall with the crisp snapping sound of fresh corn being husked.

Yet with the abundance comes new dangers, as two birds can be seen circling above, surveying the lush crops.

ly, once highly productive land has become barren waste, echoing the early dust bowls. So, much as in the previous tale, your objective is to return one of Punster's run-down farms to its former glory.

Idioms are the main verbal device in *Buy the Farm*. These are quirky expressions peculiar to a particular language, in this case English, and include such sayings as 'you can't teach an old dog new tricks' and 'a rolling stone gathers no moss.'

Although only normally meant metaphorically, idioms such as those just given are acted out literally in *Nord and Bert*. Making a 'mountain out of a mole hill' actually causes 'jagged granite peaks to emerge from underground' and the barren

farmland to become a 'fertile valley'. And what is more, the only way to get to a nearby market is to visit the farm's stable, find a cart and put it before the horse.

Personally, my favourite story is *Act the Part*, where you get to play a character called Sammy in a 1950s sitcom. In the episode featured, you are all set for a peaceful evening when a knock at the door heralds the arrival of Bob, your obnoxious brother-in-law. Bob would not be so bad if it were not for his practical jokes, the ones that you always seem to be the butt of. Since the script says you cannot just throw him out, you play him at his own game.

There are some wonderful touches in *Act the Part*. When you move to

one of the locations in your flat, the screen displays the message: 'You move across the stage'. And when you don a pair of rubber washing-up gloves to pick up a live electrical cord, the audience 'sucks in its collective breath' in anticipation. Touching Bob with the live end sets the audience alight and gains you a point to boot. As the game progresses, the tricks you play on Bob become more outrageous.

Nord and Bert couldn't Make Head or Tail of It is unlike any other adventure you have played. It is not as difficult as most other Infocom products and could be completed within a day, quite easily. Nevertheless, if you enjoy wordplay, then *Nord and Bert* is an entertaining challenge.

Orc talk

Title: Knight Orc
Computer: Atari ST; Commodore Amiga
Supplier: Rainbird
Format: Disk
Price: £19.95

Orcs are notorious for their bad manners, evil smell and penchant for attacking humans. Unlikely though it is, however, orcs may just possibly be the victims of bad PR. It is difficult to tell, when every programmer depicts them as a *bête noir*. But all that is set to change. Because, after years of suffering at the mercy of sword-swinging machismos, the orc's day has finally come. Level 9 has buried the hatchet (and this time not between an orc's ears) and produced *Knight Orc*, an outstanding graphical adventure which casts the player in the role of an orc.

Knight Orc is the best graphic/text adventure to come out of Level 9 so far. The company's other attempts at putting pictures into its programs have, on the whole, been extremely poor.

The graphics on the disk version of *Knight Orc* are a far cry from the crude line drawings of the *Silicon Dreams* trilogy. Instead of using a computer to draw the program's pictures, Level 9 employed an artist to paint some original designs, which it then digitised. This process has a mellowing effect on the 'paintings', so that they look as if they have been photographed with a soft focus lens. Although not as arresting as the graphics in 'The Pawn' and 'The Guild Of Thieves', they make an interesting *divertissement* from the game's mammoth chunks of text.

Ironically, *Knight Orc* is distributed by Rainbird, which also handles *Magnetic Scrolls*, the company responsible for *The Pawn* and *Guild Of Thieves*. This could be auspicious for Level 9, because I think people will

be judging adventures produced in the next few months against *Knight Orc*, and not its two highly-rated and much vaunted stable-mates.

The game follows the trials and tribulations of a particularly — even by orc standards — ugly character called Grindleguts. At the Orc's Head Inn Grindleguts is volunteered as the orc's champion by his friends, whereupon he is tied to a horse in readiness to joust a human knight. The adventure begins the following morning when you, Grindleguts, awake from your drunken stupor and discover the not so jolly prank you have been dupe to.

Grindleguts' adventures are told in three episodes. In *Loosed Orc*, the first chapter, you must collect pieces of rope and tie them together to make a single rope long enough to enable you to cross a broken viaduct and return home to your friends.

The second and third parts, *A Kind of Magic* and *Hordes of the Mountain King* respectively, are linked and can be passed between at will. Your objective in these two phases is to learn 21 magic spells, recruit other characters and solve the secret of your true persona. The game's *dénouement* is truly unique, and makes for one of the weirdest and most imaginative final twists I have seen in a computer game to date.

In *Knight Orc*, Level 9 has departed dramatically from the conventional style of adventure gameplay. Mapping, for instance, is normally a beneficial, if tedious, exercise. In *Knight*

Orc, you are actually advised not to make a map, because, unlike the majority of adventures on the market, *Knight Orc* features a system whereby it is possible to move to a location, object or character simply by typing GOTO <place>. And if an object has been moved by another character, then you need only type FIND <object> to locate it. Similarly, you can follow characters about, wait for them and even ambush them, just by using a few simple built-in commands.

If all this sounds too simple, I can assure you that it is not. Such commands are necessary because of the way the game's 70 characters operate. While you are moving about the world of *Knight Orc*, performing deeds of violence and cowardice, so too, are they. Treasure secreted about the game is not there simply for your benefit: the inhabitants, too, want a cut of the profits and they are not above killing an orc, particularly one as gruesome as Grindleguts, to get it.

In *Loosed Orc* you have a helper named Denzyl. He is a bit dim-witted but on the whole does what you ask. Denzyl, like the other characters, can be spoken to using multi-clause sentences. You can ask him to go and perform a task, such as finding and bringing back a specific object. While he is off doing your bidding, you can continue on your way, since he will usually find you wherever you are.

Denzyl and everyone else in *Knight Orc* has their own personality and

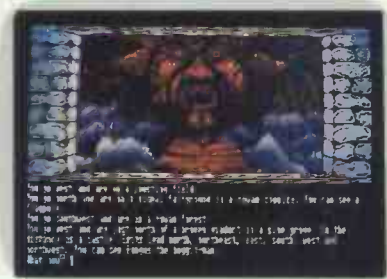
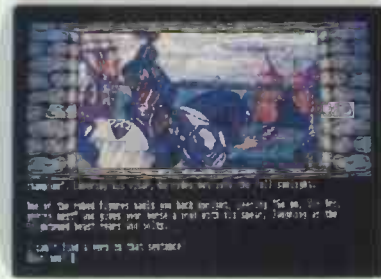

SCREENPLAY

purpose in life. It is not rare to come across someone drunk from having spent too long at the local tavern. There is even the possibility that Denzyl might bungle a task set him because he decides to pop in for a few jars on the way back to you. Nothing is certain in Knight Orc.

Death in Knight Orc is more

embarrassing than tragic. When you croak, a Valkyrie descends and carries you into the clouds where you are sneered at for your ugliness and sent directly back to earth, dispossessed of everything you accumulated before passing over. All is not lost, though, because you need only return to the spot where you died to

reclaim your belongings.

Level 9 has lived in the shadow of Magnetic Scrolls for the past year or so, but has finally emerged, looking much better for the experience. Never mind the challenge from Infocom — there's now a stronger, home-grown rival nipping at Magnetic Scrolls' heels.

Wizard wheeze

Title: King's Quest III: To Heir Is Human

Computer: Apple II series; Apple IIGS; Macintosh; Atari ST; Amiga; IBM PC

Supplier: Activision

Format: Disk

Price: all versions £24.99, except for IBM PC £19.99

Sierra On-Line's latest 3-D adventure, King's Quest III, follows hot on the heels of parts I and II, both of which were extremely popular. If you read the small print on the game's packaging, though, you will find the sentence 'Completion of King's Quest I and/or II not required'.

If you take it on its own merits, and ignore the fact that it is little more than a variation on 'parts' I and II, King's Quest III is, actually one of the most technically accomplished and challenging arcade adventures to surface in a long time.

King's Quest III differs considerably from conventional graphic/text adventures such as The Pawn since it is played by moving an animated character about the game's locations using a joystick rather than typed movement commands.

Only when you want to interact with people or objects do you have to type anything. Actions such as examining an object, communicating with other characters and buying and selling all require the keyboard.

Although billed as '3-D', King's Quest III is really nothing of the sort, because scant attention was paid to perspective. When the hero walks into the distance, he does not appear to get smaller, as in the real world. Instead he remains the same size.

In the adventure you play an enslaved youth named Gwydion. For 18 years he has been in the thrall of Manannan, an evil wizard who presides malevolently over Llewddor, a small fishing community.

Early in the adventure, Manannan announces that he intends to take a trip. This provides you as Gwydion with your chance to learn Manannan's spells, escape from the house which has been your prison for the past 18 years and lift the evil spell hanging over Llewddor.

The game begins in Manannan's

mountain-top retreat. The evil wizard has not yet departed and so you are expected to perform some menial chore such as clean his study or dust the kitchen.

The inside of the house, like all the game's many locations, is portrayed in stunning detail: candles flicker in sconces attached to the walls and a mirror on a dressing table actually reflects whatever is placed before it. There is a great deal to see, although most things remain tantalisingly out of reach until after Manannan has started his journey. Before he goes you must play at being his abject servant.

Attempting to learn the secret of Manannan's magic or simply just neglecting your duties can result in humorous, if often tragic, consequences. If you are caught trying to learn spells, Manannan 'zaps' you with a well-aimed bolt of lightning from his finger, reducing you to a pile of dust.

The punishment for the second offence is a session of exercises. Gwydion is forced to perform a series of sit-ups, press-ups, star jumps and twists with greater alacrity than Jane Fonda.

Boredom is the arcade adventure's greatest enemy. Where text adventures allow the player to move quickly on from locations where nothing much happens, King's Quest III requires the player to guide Gwydion across the full width of the screen before the program will load the next scene, a process which takes several seconds and seems increasingly long as the game progresses. A facility for speeding up Gwydion's movement is included in the program, but even so, some scenes are tortuously long in comparison with their text-based counterparts.

As well as a great deal of patience,



King's Quest III also demands a degree of proficiency with a joystick. When Gwydion leaves Manannan's house, if possible having collected several of the ingredients necessary for some of the wizard's spells, he must be guided along a winding path flanked on either side by a steep drop. One wrong move sends Gwydion to a painful death.

Mastering Manannan's magic is of prime importance if you are to defeat the evil wizard and liberate Llewddor. There are seven spells to be learned, including ones for causing deep sleep, making Gwydion fly like an eagle or a fly, and for brewing a storm. Each spell is cast using a potion made up from ingredients scattered throughout the wizened wizard's house and Llewddor. To make a potion, you simply mix the correct ingredients following instructions outlined in a small booklet packaged with the program.

If you are willing to put up with the breaks between scenes, King's Quest III provides a fresh and distinctly different kind of adventure. Most of the locations are beautifully drawn and well worth the wait. My favourite scene is one with a small cottage complete with smoke billowing from its chimney. If you tell Gwydion to open the front door and enter the house, he is quickly kicked out again by an irate bear. Some of the other locations include a small waterfall, skittering squirrels, flying seagulls and a nasty-looking Medusa.

King's Quest III is a refreshing break from normal run-of-the-mill text adventures. Despite its rather simple appearance, it is actually quite challenging and will baffle even experienced adventurers. If you are looking for something new, make sure King's Quest III is near the top of your list.

END

INDUSTRY STANDARD SOFTWARE.

AMSTRAD STANDARD PRICES.

There are two factors that have made the Amstrad name pre-eminent in the world of computers.

Outstanding quality. And prices that are a mere fraction of any of the alternatives.

Now Amstrad have brought both of these qualities to software for Industry Standard PC's.

Amstrad Infomaster for example is a fast, accurate and powerful database that is exceptionally easy to use.

It has a long list of features that put it in the forefront of database software.

It is designed for Amstrad PC's or any other IBM compatible PC, and it can be used with hard disc drive or twin floppy discs systems.

And it is available only from Amstrad.

..... **£69.00**

—PLUS VAT*

Then there is Amstrad Wordstar Express.

Wordstar Express is the market leader in word processing software with an amazing spellcheck system that covers 85,000 words. It also offers excellent editing and formatting facilities.

..... **£69.00**

—PLUS VAT*

And for businesses that need advanced financial data processing there is now Amstrad Supercalc 3.21.

It not only performs highly complex forecasting and financial modelling but presents the results in brilliant high resolution graphics using up to 16 colours.

..... **£69.00**

—PLUS VAT*

Any of these Amstrad programs would cost hundreds of pounds from another manufacturer.

From Amstrad they are just £69.00 plus VAT* each.

So it looks as if there is now a new industry standard for software too.

The Amstrad Standard.

*Recommended retail price including VAT, £79.35. Price correct at 1.9.87 but may change without notice.

Please send me information on Amstrad software packages.

NAME _____

COMPANY _____

ADDRESS _____

POST CODE _____ TELEPHONE _____

PCW. 11



Amstrad plc., Box 462.
Brentwood, Essex CM14 4EF.
Telephone: (0277) 262326.

AVAILABLE THROUGH: ADL · ALLDERS · COMET · CURRYS · DIXONS · ELTEC · FARNELL · FIRST SOFTWARE · LASKYS · JOHN LEWIS · LIGHTNING
NORBAIN · NORTHAMBER · OFFICE INTERNATIONAL · O.S.T.A. · P&P · RYMAN · SANDHURST · HUGH SYMONS · WILDINGS



BIBLIOFILE

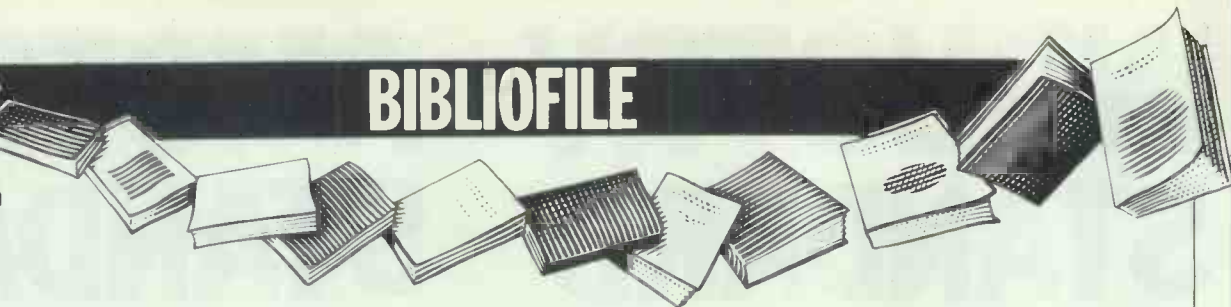

For readers with storage and retrieval problems, our specialist subject this month is database management; while those of you seeking a lighter load may be interested in our stories of computer crime and nocturnal programming.

Introduction to dBase III Plus Programming



Publisher: Ashton-Tate
Authors: Ashton-Tate Training Department
Price: £31.30 (includes disk)

There are two good ways to learn programming: one is by experience and the other is by having an experienced person

to guide you. This teach-yourself workbook, prepared by Ashton-Tate's own training department, appears to offer the best of both worlds.

It's written and published by the company that wrote dBase III Plus — so the authors should know what they're talking about — and provides a gentle introduction to one of the more complex areas of any database system — its inbuilt programming language.

Right from the start, the book makes it clear just at whom it is aimed. It will teach you to write programs to access and maintain a database 'in such a way that an employee who knows nothing about dBase III Plus can enter and locate data and produce reports by following simple onscreen instructions and pressing the appropriate keys'.

This book is a follow-up to

an earlier one about using dBase III Plus. This first book covers the creation and maintenance of a database, indexing, sorting and creating a command file. Although it's not essential to have completed, or even seen, the earlier course, you are advised that, unless you know these subjects, you will find it difficult to jump in at the deep end and start programming.

Having started by explaining the benefits of using programs at all, the first pages guide you through entering (and editing, if you get it wrong) a simple program to print out the records in a database. By the end of the book, you will have designed a complete inventory system for a fictitious company, debugged it, created custom input and output screens, and included error trapping in case the operator

makes a mistake when using the program.

This book, along with the example programs on the bundled disk, provides a good introduction to dBase III Plus programming. It is aimed at someone in a company's computing department who is setting up systems to be used by other employees. As such, it assumes that the reader is not totally new to programming in some high-level language, even if not specifically a dBase command language.

There's a lot of waffle and non-essential information in here, but someone who perseveres and works through the complete course, including the exercises, should find the effort amply rewarded. You can even send off to Ashton-Tate for a certificate after you've completed the course.

Roger Dalton

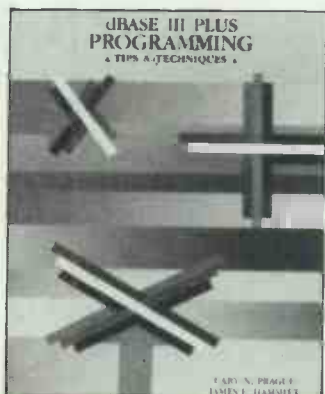

dBase III Plus Programming: Tips & Techniques

Authors: Cary N Prague & James E Hammitt
Publisher: Ashton-Tate
Price: £19.95

dBase III is not the most friendly database generator to use and the manuals included with the product are even less friendly. Probably the most difficult aspect of using dBase III is adding the finishing touches to make the database easy and enjoyable to use.

This book attempts to help in that area. The authors, Cary Prague and James Hammitt, are experienced dBase programmers and *dBase III Plus Programming* offers some of their work for use in your dBase programs; the detailed descriptions that accompany every dBase listing make it easy to modify the routines for your own system.

The book begins with a lengthy chapter on the differences between dBase III and dBase III Plus, most of which is devoted to the Ashton-Tate 'easy to use' dBase front-end — Assist.

Although the authors do their best to cover the features of Assist, it is obvious that they *don't* use it. The overriding message of chapter one is that 'Real programmers don't use Assist' and you will never get the most out of dBase until you starting using the programming language.

From here onwards, *dBase III Plus Programming* really starts to prove interesting. Despite being aimed at existing users of dBase III, the authors devote a lot of space to consideration before creating a database under it. This includes descriptions of normalisation, structured database design, data dictionaries and the user interface. I was particularly pleased to see that the authors acknowledged a situation in which dBase III *wouldn't* be the perfect product to use, considering that

this book is published by Ashton-Tate!

The rest of the book sums up the collected discoveries of the authors after many months of dBase III programming. Among the most interesting were: a routine for creating graphs under dBase III; a search program that will work off phonetics if no perfect match is found; how to create a system tutorial for new users of your system; and an algorithm for generating large letters on the screen up to full-screen size.

Overall, then, this book is a must for all dBase III programmers. My only questions are: Why doesn't Ashton-Tate bundle this book with dBase III? And why wasn't it available a year ago when I was wading through the convoluted dBase programming manual?

Barbara Gaskell

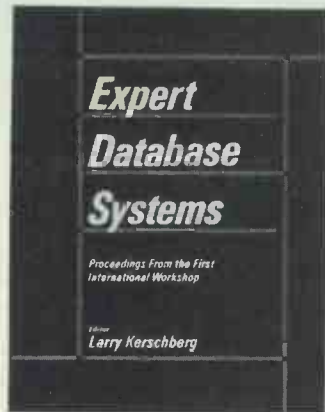

Expert Database Systems

Editor: Larry Kerschberg
Publisher: The Benjamin Cummings Publishing Company Ltd
Price: £42.95

'An Expert Database System (EDS) involves a combination of Expert System (ES) and Database Management System (DBMS) technology. EDSs will be used for developing applications requiring knowledge-directed processing of shared information.'

Seems quite a good idea, doesn't it? However, unless you have an uncontrollable urge for reading conference papers or, conversely, are genuinely researching the subject, then *Expert Database Systems: Proceedings from the First International Workshop* is really a bit too highbrow for us ordinary mortals.

These published papers are the result of 110 researchers and practitioners from 13 countries congregating at the University of South Carolina 'to present their research work and to discuss the issues related to Expert Database Systems'.

Of the 96 papers submitted to the workshop this volume contains: the keynote address, given by Dr John Miles Smith of the Computer Corporation of America, and entitled 'Expert Database Systems: A Database Perspective'; three working group reports (some working group meetings ran well past midnight, we are told); and 37 full-length papers.

It's all serious stuff, and if you think that you can manage 'Semantic Retrieval and Levels of Abstraction' or 'Interactive Classification of Conceptual Knowledge', you're a better (wo)man than I.

I'm all for conference papers being published as long as it is appreciated that they do reach out to only a very small section of the public, notably

those with strong arms and a healthy bank balance.

Think about it if you're on friendly terms with the purchasing power of your local library, otherwise spend your money elsewhere.

Lorna Kyle

Data Base Management Packages

Kathy Lang

Software Factfiles

Data Base Management Packages

Author: Kathy Lang
Publisher: Ashford Press Publishing

Price: £85 including quarterly update bulletin for one year

The question for many would-be system managers must be: 'How do I know that this package is the best/most suitable for me?' To purchase a reference book of reviewed software products, therefore, can only be thought of as helpful.

Former PCW database reviewer Dr Kathy Lang has collected together her reviews and articles (some old, some new) of database management packages and published them in this 'factfile' to that end. She intends that this file should provide 'a survey of the more popular data management systems on the market'.

It's a ring-bound manual, very similar to the documentation of some of the software products that it describes. The author states that the manual will be updated twice yearly (only to those who subscribe, of course) and that in between the major updates, a bulletin will also be issued covering all relevant changes since the previous edition.

We're not told, however, how much this subscription will cost. It's quite a money-oriented enterprise if you also consider that suppliers were invited to contribute a synopsis on their own products, 'for a modest fee'. Five suppliers took up the gauntlet.

The book is split into five sections dealing respectively

with 'Starter/Powerful/System Development Packages', 'Overall Comparisons' of products reviewed and 'Comparisons' with other packages. The number of products reviewed in each of sections 1-3 ranges from which is a good enough sample, and each review is split into subsections such as 'Screen Display', 'Selection and Sorting', and 'Calculations', although these subsections are not always strictly adhered to.

I was absolutely horrified by the amount of spelling mistakes present; the odd one or two can always be blamed on the typesetter, but misspelling a product name really cannot be excused: File became Filer; dBase II became Base II; poor File also lost its screen displays on page 35 — one nice blank empty page! These mistakes really should have been spotted; they do give the impression that the book was rushed together with no thorough re-reading or checking.

There also seemed to be an awful lot of 'very easy to learn and use' and 'powerful and flexible' statements floating about but that could be me nit-picking too much.

In general I liked it, and any book that aims to sort out the wheat from the chaff, at least has its priorities — if not its orthography — right.

Lorna Kyle

General

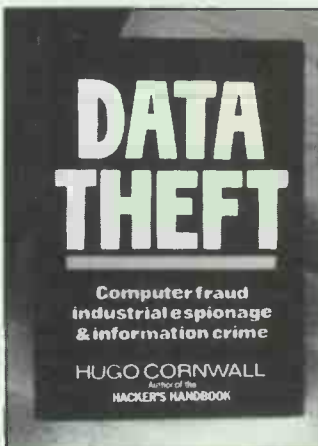

Data Theft

Author: Hugo Cornwall
Publisher: Heinemann
Price: £12.95

Everyone knows that this decade's huge increase in the use of computers has produced a massive growth in computer crime.

What has not increased is the awareness and acceptance by most companies that their own system is potentially vulnerable. Although a number

of official reports on the subject have been available for some time now, these have usually been very specialised, very expensive, and rather hard to obtain.

Now, though, Hugo Cornwall, author of *The Hacker's Handbook*, seems to have changed sides. Drawing on the best examples from reports already published, and from his quite substantial experience that made his first book a best-seller, he has put some good advice into this guide. It should fast become required reading in every computer department in every company the country.

The title of the book says it all. These days, information is not only easier to steal than physical equipment, but its loss is also often infinitely more damaging and much harder to spot, let alone detect.

Data Theft doesn't concentrate solely on huge mainframe computers, nor does it concentrate just on telephone lines as the weakest links in a system. One example Hugo Cornwall gives reinforces the fact that it's the people who run computers that are always the weakest link.

He tells how he arrived outside the computer department of a company, carrying a large piece of British Telecom equipment. He said he'd come to repair the company's data lines, and the doorman summoned a computer operator who immediately led him to the computer room and left him to it. His identity was not checked out at all.

Cornwall (it's a pseudonym) was now in a position to bug any terminal he wanted, or to borrow some floppy disks from nearby PCs and copy them overnight before returning to the building with parts he had to 'return to the depot' for.

In reality, he did nothing more than cover some of the cable junction boxes with stickers advertising the security consultancy that had hired him.

This book is packed with useful tips for everyone who works with computers that handle potentially sensitive or confidential data. It mentions dozens of real incidents, not least the 'complete mishandling and extreme carelessness' on the part of Prestel's security staff that led to the Prince Philip hack a couple of years ago and the recent acquittal of the two hackers concerned.

A good read. This book is highly recommended.

Roger Dalton

Turn the page for more reviews of database management books.



Programmers at Work

Author: Susan Lammers
 Publisher: Microsoft Press
 Price: £12.95

When you slave away in front of the monitor at midnight, compiling and recompiling with the occasional break for more coffee, have you ever felt yourself to be part of a mystical network of hacker programmers united by insomnia and coding brilliance? If you have, then this book is not for you. Normal human beings, however, can get a fascinating glimpse into this nocturnal world from its pages.

Susan Lammers sets out to interview a wide cross-section of programmers who worked on many of the major PC software packages. Almost all the interviewees are American and all but one are based in the US. This, unfortunately, gives the book a bit of an exclusive American Silicon Valley 'yuppie' feel. The interviews are basically question-and-answer sessions and have been extensively edited to produce a coherent piece which allows the programmer's personality to show through.

Also included are a short biographical note on each programmer, a sample of their work in design or coding and a glossary for the non-technical reader.

I found the whole book a fascinating insight into the attitudes and personalities of a wide range of brilliant programmers. Anyone interested in the creative process and the psychology of creating programs would love it (yes, that is how they talk!).

Finally, I'll let the programmers speak for themselves. Gary Kildall (author of CP/M): 'It's fun sitting at a terminal and letting the code flow.'

C Wayne Ratcliff (author of dBase II): 'My job title was computer. Other people have programmed computers, but I

have been one.' Bob Carr (designer of Framework): 'We all know sensual pleasures taken to excess are a curse ... it's the same with menus.'

Michael Hawley (programmer for SoundDroid): 'There's a dark side to every powerful technology.'

Alan Douglas

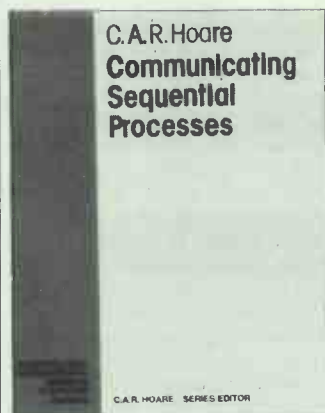

Communicating Sequential Processes

Author: C A R Hoare
 Publisher: Prentice-Hall
 Price: £29.95 (hardback) £14.95 (paperback)

Are you fed up with the usual programming fare of Basic, C and Pascal? Do you want to find out how to unleash the power of parallel computers? If so, this may be the book for you. The language of *Communicating Sequential Processes* (CSP) was designed for specifying and implementing parallel systems and leads directly to Occam, the programming language for the Transputer.

Tony Hoare is Professor of Computation at Oxford University and one of Britain's foremost computer scientists. He is the inventor of the quicksort sorting routine. Much of his work has been devoted to specification of parallel systems and to proving, mathematically, that programs are correct.

The fundamentals of CSP are: sequential processes (which perform a sequence of actions, one at a time); composition of these to form parallel processes (which may perform many actions simultaneously); communication between processes (sending data back and forth); and, non-determinism (in which the behaviour of a process is not completely predictable).

The book introduces each of these concepts informally, with excellent running examples. It

then goes on to give mathematical laws describing their properties and, for the adventurous, a Lisp implementation of CSP. In keeping with the author's interest in correctness, he gives methods for specifying the behaviour of a system and then proving that a program meets that specification.

Professor Hoare has a well thought-out, lucid style which has been honed through use in many courses and seminars on CSP. Readers with little mathematical knowledge will find that side of the book heavy-going, but it repays study, since it shows CSP to have many beautiful properties not found in other languages.

This book won't make your computer of today any faster but if you want a glimpse into the computers of tomorrow, the state of the art in understanding parallelism and the workings of one of the finest minds in computing, read it.

Nicolas North

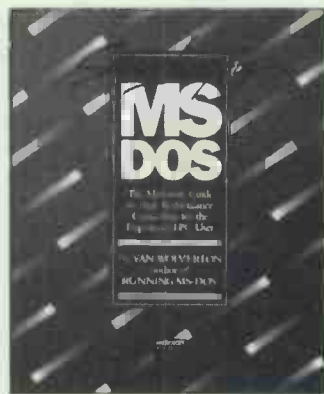

Supercharging MS/DOS

Author: Van Wolvert
 Publisher: Microsoft Press
 Price: £17.95

Introductory books on either operating systems or actual computers have always seemed to me to represent pretty easy money for an author. All you have to do is take the original documentation and re-write it so that it can be understood by human beings, add a few examples (usually variations on the original manual again) then retire to a tax haven! Well, not quite, but the average text entitled 'Understanding/Using/Running CP-M/MS-DOS (select appropriate parameters) doesn't look as if it represents a lifetime's devotion to the task in question.

Mind you, at least you get what you pay for — unless, that is, you're expecting a lot

more. This is what usually happens when you buy a book beginning with the word 'Advanced'. What you want is a guide to the more powerful features of the system and also lots of tips on getting it to perform clever tricks which might even turn out to be useful. What you often get is a book which devotes a lot of time and space to describing the basic system commands all over again.

Supercharging MS-DOS does, in fact, live up to its title. Although written as continuous narrative (actually, quite a good read) and not in reference-book style, it is really what used to be called in computing a 'cook book'. That is, it provides lots of short examples of commands and command files to, for example, make complex system-prompt definitions or time and date stamp files, or use 'Debug' as an editor. But much of the book is devoted to learning the advanced batch-file techniques necessary to design a complete interactive menu system using DOS commands. Now, you may not actually want a complete menu system but it's certainly true that, if you learn how to create one, you'll learn a lot about MS-DOS in the process. Thus you learn all about ANSISYS and extended key codes, about CONFIG.SYS and using a RAM disk, about controlling the display and printer so that they do what you want them to do rather than what the system in its default state does. Wolverton takes the reader through the use of IF, GOTO and FOR and all of his batch files lay heavy emphasis on the importance of error trapping.

It is a tribute to the book that you're left at the end feeling that there can't be much more left to say about MS-DOS — at the command level at least. If you want anything further, and the brief flirtation with Debug may well whet the appetite of more than one reader, then you need a text on 8086 Assembler and a Programmer's Guide to MS-DOS — and then you're in a different league.

Jeff Wells

Roger Dalton and Barbara Gaskell are freelance computer journalists. Lorna Kyle is a systems analyst/programmer. Alan Douglas is a non-nocturnal programmer hacking away during the day on a PC. Nicolas North is a computer science researcher at the National Physical Laboratory. Jeff Wells is a teacher of Computing at Haringey College, London.

Next month: Desktop Publishing

Pick the one that stands out from the rest



In recent years the microcomputer market has been flooded by countless different products, many of which have disappeared as quickly as they came. There is, however, one exception: Tulip Computers. This is an idea which germinated in Holland and is the result of years of intensive research. Tulip Computers puts performance and value first, quality not quantity is their motto, and that is the way they have established the firm root they now have in the European market. They are the largest producing computer supplier in the Netherlands and their success is now flourishing all over Europe.

By thorough research and learning from faults of others, Tulip have developed all the options available and have created PC, XT, AT, and 386, the most up-to-date and sophisticated compatibles.

It is this success story which is attributed to research, quality and service that makes Tulip Computers the experts in their field.



Tulip computers uk plc

Unit 6, The Satellite Business Village, Fleming Way,
Crawley, West Sussex RH10 2NE. Telephone: 0293 562322 (10 lines)
Facsimile: 0293 553307. Telex: 878678. Callback TULIP.

We're the experts in our field

THE NEW SINCLAIR HAS ONE BIG DISK



THE SINCLAIR ZX SPECTRUM+3 WITH 6 FREE GAMES AND A JOYSTICK

ADVANTAGE.

ZX SPECTRUM +3. £199



The new Sinclair ZX Spectrum +3 is a real hero – because it helps you to be one.

While you're a daring motorbike rider or the all-conquering intergalactic warrior, you're gaining priceless experience in handling computers.

Loading games is quick and easy with the built-in disk-drive. You'll be in the thick of the action in seconds. And the fantastic 128K memory gives you the power to outsmart the most sophisticated enemy.

Get to grips with the latest high-tec graphics on the vast universe of games available (six of which come free). And there's a free joystick to give you ultimate control.

But the real hero is the person who buys it. For the ZX Spectrum +3 is only £199, so they've really saved the earth.

ZX SPECTRUM +2. £139



The amazing ZX Spectrum +2 has a built-in datacorder – to save you the bother of tape recorders and leads. The advanced 128K memory helps you get the most from the vast universe of games available.

Every model comes complete with six free games to start you off, and a free joystick to make you super agile.

With the advanced Sinclair technology you can afford to let your imagination go wild. Because at £139, only your enemies pay heavily.

BE WHO YOU WANT TO BE.

Available at: Alders, Boots, Clydesdale, Comet, Connect, Currys, Dixons, John Lewis, John Menzies, Lasky's, Tandy,* W.H. Smith, Visionhire, Wigfalls, and all good independent stores.

*ZX Spectrum +2 only.
Recommended retail price Sinclair ZX Spectrum +2 £139 including VAT, Sinclair Spectrum +3 £199 including VAT at 1,10.87. Prices subject to change without prior notice.

Please tell me more about the SINCLAIR ZX Spectrum +2 ZX Spectrum +3

Name _____

Address _____

Amstrad plc, Brentwood House, 169 Kings Road, Brentwood, Essex CM14 4EF. Tel: (0277) 262326

sinclair



Message for Fido

*Fido Net started as the plaything of two comms enthusiasts.
Today it's a worldwide electronic mail system linked to 2000 users.
Peter Tootill charts the rise of this professional network still run by 'amateurs'.*

Most bulletin board users know that there is some sort of link-up between Fido bulletin boards — but many don't realise that Fido Net (as it's called) is now a fully-fledged electronic mail system.

These days, too, Fido Net covers a lot more than just Fidos: other bulletin board systems (BBSs) such as Opus, TBBS and Wildcat can join in too and there are even some stand-alone electronic mail systems that use Fido Net protocols and can link into the system.

Worldwide network

Technically, Fido Net is a non real-time packet switching message system — in simple terms it is a sophisticated international electronic mail system.

However, instead of using a small number of mainframe computers like the commercial systems do, it runs on a large number of microcomputers which are all independently operated. There are currently about 2000 nodes on the world list — and I do mean *world list*. There are participating networks in North America (of course), most Western European countries, Australia, Singapore, Malaysia, Indonesia and the Southern and Western Pacific ocean area.

You can send a message to anyone using any of these systems simply by entering it on your nearest participating bulletin board system. The cost is very reasonable as well. A message can be sent to the US for not much more than the cost of an airmail letter (the actual costs vary because they are set by the sysops of the individual BBSs themselves).

Fido was the brainchild of an American called Tom Jennings. He and a friend, John Madill, lived on opposite sides of the United States

and wanted a straightforward way of communicating with each other. This was in June 1984 and the first Fido Net messages were soon bouncing across the country.

Other bulletin board operators became interested and joined in. By August 1984 there were 30 nodes and in the Spring of 1985 nearly 200. The network has spread widely since then. Today there are over 2000 nodes of which about 1600 are publicly accessible. The rest are private systems that are members of the net for some particular reason.

The basic concept of Fido Net is very simple. Each participating BBS closes down at a set time (usually 3.30 am local time) and assembles any outgoing messages into packets. It then dials other nodes and sends the packets, waiting between calls for incoming messages from other systems.

This process continues for about an hour, with systems alternately dialling and listening, after which they turn back into ordinary BBSs. The receiving system unpacks the messages and stores them in the bulletin board's message area ready for the addressee(s) to call in and read them.

In the early days, each node simply dialled other nodes direct and sent the messages. This soon became unworkable because of the number of systems trying to call each other and more complex structures were devised as a result.

The world was divided into three zones. Each zone is divided into regions and these are divided into nets. Nets usually consist of a dozen or so systems within the local call area of their host system. Messages are all routed via these hosts. This has several advantages: it cuts down

on congestion and makes for more economical operation — the only long distance calls are between hosts and this mail is usually compressed and sent using high speed modems. The whole system is designed to keep the actual online time, and hence running costs, to an absolute minimum.

Fido Net is operated entirely by amateurs. The node list is maintained by a group in St Louis and there are a series of levels of coordinator: one international coordinator, then three zone coordinators, about 30 regional coordinators and probably over 100 net coordinators. The whole set-up is overseen by the International Fido Net Association (IFNA). Despite the amateur nature of the system, it all appears to be run in a very professional and businesslike manner. Indeed it has to be, with 2000 participating systems there is no room for sloppiness!

Echomail

A recent enhancement to Fido Net is called Echomail. This adds conferencing to Fido Net's electronic mail capabilities. Until the introduction of Echomail, Fido Net was just a point-to-point system, in which a message was addressed to a node and then sent to that node.

With Echomail, several BBSs join together to carry a conference on a particular topic and all messages that are entered in the relevant section of each BBS are echoed to all the participating BBSs. This means that an individual can take part in an electronic conference that spans a number of systems simply by calling his or her local BBS. Echomail also has the ability to work on an international level.

Costs

Who pays for running the net and all the telephone calls involved in transferring messages? The cost of sending a message is usually borne by the sender. Fido Net has simple cost tables built in and these indicate the approximate cost of sending a message to any other node on the list.

The accounting system is relatively unsophisticated, making no allowance for the length of message or any attached files. If you want to use net mail, you send the sysop of your chosen BBS a few pounds which are then credited to your account. The cost of any message you send is then deducted from your remaining credit. Echomail costs are borne by the sysops of the participating BBS, but they may charge a small subscription to use the feature.

How to join

The main problem if you want to join the net (assuming that you are running a suitable BBS) is that there is a huge array of new concepts to learn. Also, some of the documentation is not very good. This is compounded by the fact that much of the software is public domain or shareware and there seems to be no single source of supply. You are dependent on another more experienced sysop to tell you what software you need and to help you get started.

Another thing you need, at least if you are going to use the world nodes list, is plenty of disk space. The list is about 150k in length and it is updated every week. This is done by means of a clever routine which uses a file containing the differences

between last week's node-list and this week's.

If you're careful and keep backups before updating, and ask for too many sets of reports, the process can really gobble up disk space. I had over a megabyte free on a hard disk recently and ran out during the update. I was, however, applying two weeks' worth of updates and asked for a complete list of all nodes with their locations, phone numbers, sysops' names, and so on. The list when printed currently runs to 54 pages.

If you want to join the net, you need to be running a BBS that uses one of the software packages that can support net mail. Fido and the newer versions of Opus have net mail options built in. TBBS requires the addition of a package called Seadog. This is a standalone electronic mail system but it has no BBS features of its own — messages can be entered at the keyboard or received over the net but no-one can dial in and leave a message to be forwarded as they can with a Fido system.

As well as Seadog, TBBS needs a set of programs that extract messages from the net mail area and pass them to Seadog, and vice versa. Seadog can also be used with Fido and Opus as it gives extra features such as the ability to receive mail at any time (crash mail), not just during pre-defined mail slots.

If you are going to use the world node list you need a program that processes it and turns it from the format issued by the St Louis group into a form that can be used by Fido, and the others. A popular one is cal-

led XLATLIST, which also updates the list using the current NODELIST file and the latest difference file (called NODEDIFF).

Incidentally, XLATLIST has the most sweeping disclaimer I have ever seen: 'We accept no responsibility for anything at all! After it has been processed, Fido 'compiles' the list. In effect this means constructing an index and a list of nets to speed up access. Some systems (Seadog included) have problems with large nodelists and another shareware package called NLBUG has to be used.

Seadog is a commercial program but there is a public domain equivalent called Dutchie, which was written by Henk Wevers, a Dutchman, who is also the European Fido Net co-ordinator.

Dutchie is strictly shareware but, for the benefit of the ordinary amateur user, has the most generous level of user contribution I have come across — the author just asks you to send him a postcard.

The main problem with Fido Net is that all the relevant software runs on MS-DOS systems. There are implementations for DEC Rainbow, Sirius and Sanyo as well as the PC but, as far as I know, none for any British BBS systems.

There is no reason why they shouldn't be developed, though, as the protocols are in the public domain and should be available from many participating systems — see 'Further reading', below.

Perhaps some enterprising BBC programmer will produce a Fido Net compatible system for the BBC-based bulletin boards — there are quite a few around.

Further reading

Further background information is contained in the following items which should be available from a number of Fido Net systems and will be on this month's PCW disk. (Files are given in brackets, but these vary, so you may have to do a bit of detective work if you are trying to track them down on a BBS.)

Specification of Fido packet protocols (20 October 1984) (FIDOMAIL.DOC)

Fido Net protocols in OSI format (1987) (FCS001.PRN)

Early history of Fido Net (8 February 1985) (FIDOHIST.DOC)

IFNA policy (24 October 1986) (POLICY3.DOC)

Useful background article by Steve Townsley (Log On the Tyne) (1987) (ROUTING.TXT)

Fido's complete operating manual — Fidonet section (undated). (FIDONET.DOC)

You can contact Peter Tootill electronically on: Telecom Gold 83: VNU202, Prestel 219991119, or CompuServe 72746,3202.

END

Telecom Gold introduces Xmodem protocols — at a price

At long last Telecom Gold supports Xmodem file transfer protocols. In fact, it has gone one better and added Ymodem and Ymodem batch as well. This means that you can now send messages without the fear of line noise making unwanted changes to your text.

Various types of file can be sent, including 8-bit binary files. However, if you want to send them to other people, binary files must be converted to a format that can be handled by a mailer which can only cope with 7-bit data. This is done automatically for you by the system.

The new feature (called FT — for file transfer) supplements RAP which has been available on Gold for some time.

The introduction of FT couldn't have come at a better time for Gold, and you can't help wondering if its timing wasn't a total coincidence. Gold has recently been losing revenue because of its pricing policy of charging by the minute. With its new pricing structure that charges you for every character sent or received, offering file transfer makes real commercial sense for Gold but can be crippling on the user.

As of October, it costs 6.5p per minute during the day to be online to Gold, and 2.5p after 7pm. In addition, it costs 4p for every 512 characters sent or received during the day, and 1p in the evening. So, think carefully before you use Gold to transfer huge files, and remember that your average Fido bulletin board often offers more transfer protocols (including Kermit) and is free. Xmodem has the advantage of being an almost universal standard and is built in to most programs that provide file transfer facilities.

I'm surprised that Kermit has not been included, because it is designed to be used over packet networks such as PSS that use 7 data bits. Indeed, Kermit has been available on some Gold computers for a while, but it has been kept very low key. The new system has to do clever things to the network to make it accept the full 8 bits used by Xmodem to transfer binary data (technically, it switches the PAD to transparent mode).

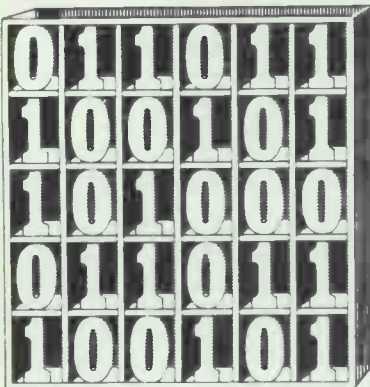

David Barrow presents more machine code routines and information for assembly language programmers. All helpful programming hints and short, useful new routines are welcome, as are improvements to or conversions of those already printed. Submissions must be printed or typed clearly and be documented to the SubSet standard, although documentation may be amended for publication. Send your contributions to SubSet, PCW, 32-34 Broadwick Street, London W1A 2HG.

Wipeout challenge results

There was a good response to the memory-clearing challenge I set in July. Except for a lone 8080 routine, all the attempts received so far are in Z80 code. I am still waiting for solutions in 6502, 68000, 8086 and any other codes.

The problem was to write a short code sequence that would clear any programs or

data from user memory and return control to the operating system. There were four conditions:

- 1 The program must overwrite all user memory and terminate with a warm boot, or reset.
- 2 After overwrite, entry at any point in user memory must cause only a warm

boot or reset.

3 Either the start or end address of user memory (or both) must be read from system parameters.

4 The program must originally reside in user memory but not necessarily at any specific address.

Most contributors appear to have invested a major part of their programming effort in a semantic quest to find as

liberal an interpretation of the rules as English will allow. This accords well with the old programmer's maxim: if you don't like the solution, change the problem!

Nevertheless, I have managed to select three Z80 routines that do more or less what was asked and which typify the varied approaches to the problem. But it is the 8080 routine which deserves the laurels for sheer ingenuity.

Pushing restarts

WIPOTA (Fig 1) is from Kim Bastin of Stockholm whose difficulty in removing encyphered files from memory prompted the challenge. WIPOTA assumes user memory to extend from 100H to one byte lower than the address held in locations 0006 and 0007.

Kim's routine set the Stack Pointer at the top of memory

and loads DE with two 'RST 0' instruction codes. It then writes a two-byte subroutine at locations 100H and 101H, points HL at the subroutine and jumps to it.

The subroutine iterates, using a 'JP (HL)' instruction, and uses a 'PUSH DE' instruction to push a pair of 'RST 0' instructions repeatedly down through memory until the subroutine is overwritten. After the subroutine is overwritten the next

instruction fetched is a 'RST 0' — causing a warm boot.

Kim has included a check for user memory being an odd byte length. In this case the routine writes a 'RST 0'

instruction in the highest location and adjusts the SP.

For an even TPA size, the six instructions between asterisks may be replaced by the single instruction 'LD SP,(6)'.

FIGURE 1

```

=====
WIPOTA: Fill user memory with "RST 0" instructions.
Length: 22 bytes
Timing: 92 + bytes cleared * 7.5 c.cycles.
RST0 EQU 0C7H ;Code for "RST 0".
PUSHDE EQU 0D5H ;Code for "PUSH DE".
JPHL EQU 0E9H ;Code for "JP (HL)".
WIPOTA LD DE,RST0*256+RST0 ;D & E <-- "RST 0" code. 11 C7 C7
;
*****
LD HL,(6) ;HL <-- TPA top + 1 from 2A 06 00
BIT 0,L ;BDOS. If TPA has even CB 45
JR Z,EVEN ;number of bytes then skip 28 02
;
DEC HL ;else even up HL & write 2B
LD (HL),E ;"RST 0" to top byte. 73
;
EVEN LD SP,HL ;SP <-- (adjusted) TPA top.F9
*****
LD HL,101H ;Now write instructions 21 01 01
LD (HL),JPHL ;"PUSH DE" & "JP (HL)" 36 E9
DEC HL ;to locations 100H & 101H 2B
LD (HL),PUSHDE ;leaving H1 = 100H. 36 D5
;
JP (HL) ;Exit WIPOTA code by jump E9
to location 100H.
;
... 2-byte sequence "PUSH DE: JP (HL)" at 100H, with HL = 100H,
... causes pairs of "RST 0" code bytes to be pushed repeatedly
... from the TPA top to all user memory, including locations
... 100H,101H. When 100H,101H is overwritten by code 0C7C7H the
... loop terminates in a warm boot (restart 0).
=====

```





FIGURE 2

```

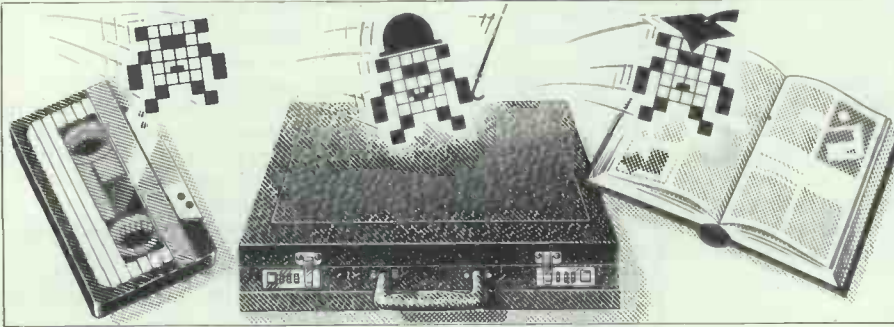
=====
WIPOTB: Fill user memory with "RST 0" instructions.
Length: 25 bytes.
Timing: 152 + bytes cleared * 21 c.cycles.
BASE EQU 8 ;User memory start - change to suit
; your requirements.
WIPOTB LD HL,(6) ;HL <-- TPA + 1. 2A 06 00
; (This address also marks the start
; of BDOS. If the instruction here
; is executed with register C = 0
; then a warm start is effected.)
;
DEC HL ;Lower HL to leave space 2B
DEC HL ;for an LDIR instruction. 2B
LD SP,HL ;Set SP = location where F9
PUSH HL ;LDIR will be & push that E5
; address as return address
; after exit from WIPOTB.
;
LD (HL),0EDH ;Store 2-byte LDIR instr. 36 ED
INC HL ;to top of user memory. 23
LD (HL),0B0H ; 36 B0
;
LD DE,BASE ;DE <-- address of lowest 11 08 00
; byte to be wiped.
;
SBC HL,DE ;BC <-- (HL <-- ) number of ED 52
LD C,L ;bytes to overwrite. 4D
LD B,H ;Note that the unknown 44
; state of Carry flag in
; "SBC HL,DE" will result
; in one or both of LDIR
; code bytes being finally
; overwritten.
;
LD L,E ;HL <-- lowest byte of 6B
LD H,D ;memory to overwrite, 62
INC DE ;DE <-- lowest + 1. 13
LD (HL),0C7H ;Write "RST 0" to lowest 36 C7
RET ;and exit to "LDIR" instr. C9
;
... RET from WIPOTB transfers control to the LDIR instruction
... at the top of user memory, with HL = lowest address = 0C7H,
... DE = lowest address + 1 and BC = bytes to transfer. This
... causes "RST 0" instructions (code 0C7H) to be written from
... BASE up to the 1st or second bytes of the LDIR instruction
... when a warm boot (restart 0) occurs.
=====

```

-  Games
-  Scientific/mathematic
-  Business
-  Toolkit/utilities
-  Educational/Computer Aided Learning

Borrowing time

Feel like sharing your software with other readers? Programs which have been published in the magazine will form the basis of the PCW Disk Library. Owen Linderholm outlines how it will work.

The box on this page gives details of the PCW Disk Library. This new service provides disk copies of selected programs from Program File and also disks to accompany some of the articles featured in this issue of the magazine.

At present we can provide only disks of programs for the IBM PC or compatibles, the BBC Micro, the Atari ST, the Apple Macintosh, the Commodore Amiga and the Amstrad CPC and PCW ranges. Because considerable effort is involved in producing the disks, we cannot put every prog-

ram published in the magazine on to disk. We will endeavour to put all the long programs that are difficult to type on to disk, but shorter programs will be left out. This shouldn't be too much of a problem since these are the ones that are easiest to type in.

All disks will cost £5, the price of which will include return postage and packing and a royalty to the original author of the program. It is important to realise that these disks are copyright. They are *not* public domain and may not be copied at will. If you order one and a friend wants a

copy, they will have to order their own.

Disks with the programs for a current issue will not always be available immediately. There may be a delay of a month or two until we are able to provide disk versions of some programs. However, if a program is going to go into the disk library at some point, the PCW Disk Library logo will appear by it. This will let those who would want a disk version save their fingers until the program is available. As soon as a program is available, it will appear in the catalogue list in the magazine.

No documentation is provided on the disks, so don't order one unless you have the corresponding issue of PCW. Of course, if you have committed the sacrilege of throwing away an issue of PCW, you can always order a copy from our Back Issues department. Either write to the Back Issues department at our Broadwick Street address or telephone (01) 439 4242 and ask for the Back Issues department. Please have ready the issue date(s) you want.

The list of programs currently available is shown in the box on the opposite page.

The cryptic number before each disk is the order number which you will need to quote to order a disk. If you haven't got an order number, you won't be able to order a disk! So please don't ring with enquiries about whether or not a particular program is on disk: if it's not in the catalogue which will be in PCW each month, then it's not available on disk. If a program you want is not in the catalogue, then please write

Guidelines for program listings

PCW is interested in publishing quality programs written in any of the major programming languages for all popular home and business micros. When submitting your programs, include a disk or cassette version of your program, comprehensive documentation and a clear, dark listing on white paper.

The listing should be no more than 80 characters wide and, if possible, sample output from that program should be included. Ensure that you have marked the software, listing and documentation with your name and address, program title, machine (along with any minimum requirements) and a daytime telephone number.

We will be including some of the programs published in Program File in the PCW Disk Library. If you have any objections to your program being included, please indicate them, otherwise it will be assumed that the program can be included in the Disk Library. A total royalty of 50p is paid per disk sold from the disk library. The sum is shared among the authors of the programs on the disk.

Here are some guidelines for submitting programs. Check through previous Program Files to see the sort of programs we prefer. Original ideas are always welcome, as are good implementations of utilities and applications. Obviously the programs should be well-written, easy to understand and preferably not too long. All programs should be fully debugged and must be your own, original, unpublished work.

We will try to return submissions if they are accompanied by an appropriate stamped, addressed envelope, but please keep a copy of everything. Programs are paid for at the rate of £50 per page of published listing, plus a £50 bonus for Program of the Month.

Send your contributions to Owen Linderholm, Program File, PCW, 32-34 Broadwick Street, London W1A 2HG.

IBM PC 5.25 inch 360K

IBM5-OCT87-0001 Oct 87 MBasic Molecular Models
Create and display correct 3D molecular models
Sept 87 MBasic MSDOS File Manager
Access files via a menu system with password protection

IBM5-APR87-0002 Apr 87 Turbo Pascal Circuit Validation
Create and analyse logic circuits on screen in graphics

Apr 87 PC/AT CMOS RAM Editor
Examine and modify the AT's CMOS RAM

IBM5-SEP86-0003 Sept 86 Turbo Pascal Logiprolog
Interpreter for simple version of Prolog

Aug 86 Turbo Pascal Sideways Printer
Print things out sideways on the printer

IBM5-JUL86-0004 Jul 86 Turbo Pascal 6502 Emulator
Run 6502 code on your PC. Can run the BBC Micro OS!

Feb 86 MBasic Expert System
Powerful expert system shell

IBM5-NOV87-0005 Nov 87 Turbo Pascal Menus
Front end menus for programs and DOS in Turbo

Sep 87 Graphics Algorithms
Very fast graphics routines in assembler and Turbo

IBM5-FEB87-0012 Feb87-Apr 87 Teach Yourself Prolog
Programs from the teach yourself Prolog series

BBC Micro (single sided/single density 100K disks)

BBC1-JUL87-0006 Jul 87 Artwork
Fully featured painting program, icon based

Mar 87 1d Cellular Automata
Investigate a fascinating mathematical world

BBC1-NOV87-0013 Nov 87 *USE
Text file display and search utility for help files

Nov87 Empty Drive
Checks if a drive is empty, works with most DFS's.

Apple Macintosh single sided disks

MAC--JUL87-0007 Jul 87 worm Plotter
Unusual mathematics based patterns

Jun 87 Excel Macros
Derive rules from tables of data using Excel

MAC--DEC86-0008 Dec 86 Mac Mandelbrot
Mandelbrot program with a new, fast plotting algorithm

Mar 86 Mac Fractal
Create realistic 3D landscapes using pseudo fractals

Atari ST single sided disks

ST---JAN87-0009 Jan 87 Darwin's Lens
Investigate natural selection (black and white)

Sept 86 Super Breakout
The old favourite in black and white

Amstrad PCW single sided disks

PCW--JUN87-0010 Jun 87 Mailout
Mailmerge program for LocoScript

Jun 86 Touch Typing Tutor
How to untangle your fingers..

Amstrad CPC single sided disks

CPC--AUG87-0011 Aug 87 Adventure Creator
Superb text adventure creation system

Nov 85 Amsquill
Powerful and fully featured word-processor

MICROMART

The fastest Modula-2 software development system for

the IBM PC range & compatibles £ 75

With M2SDS you develop your Modula-2 programs in a powerful window environment, where all the tools are integrated for speed and efficiency:

- syntax directed editor
- incremental compiler - much faster than a conventional compiler
- fast linker - produces stand-alone executable programs
- library manager - modules are compact and ergonomically managed
- clock, ASCII table, calculator
- all modules are provided in source form

M2SDS supports the 8087 maths co-processor, REAL arithmetic calculates to 15 digits accuracy and easy access to the MS-DOS/PC-DOS/Concurrent-DOS operating environment. Programs and data may use up to the full 640K DOS memory. No other software development system has as many tools and toolboxes as M2SDS.

SDS-XP	£ 185
Debugger	£ 70
M2SDS demonstration disks	£ 5
Turbo-Pascal to Modula-2 source code translator	£ 35

AMIGA £ 115

Extremely fast single-pass compiler, integrated into the Amiga Workbench, full support for documented functions (Intuition, Exec, Graphics, etc.), double-precision numeric types, including FFP, produces optimised machine code, links in just a few seconds! The comprehensive development system contains an editor, compiler, linker, library modules (Standard & Amiga libraries), manual and introductory Modula-2 book.
Minimum configuration: 512K, 1 drive.
Demonstration disk £ 5

IBM/370 Mainframes £ 6500

One of the fastest compilers in the world (single-pass, 36000 lines/minute), full 32 bit arithmetic, separate compilation of modules with all the benefits of Modula-2 (version control, type checking between modules, etc.), interface to Assembler and Fortran, support of project libraries, produces high efficient native code (including arithmetic checks) for linker and loader.
Annual contract for support £ 1100

All these products with full support are available from

RTA REAL TIME ASSOCIATES LTD
Conning House, 59 Conning Road,
Croydon, Surrey, CR0 6DF
Telephone 01-656 7333/4/5

Dealer inquiries welcome

A + L. Meier-Vogt
Im Späten 23
CH-8906 Bonstetten/ZH
Tel. (41) (1) 700 30 37

E-Mail: APLUSL@komsys.ifi.ethz.ch (UUCP)

(don't call) to us with a request for it to be put on. If I get enough requests, a program may be added to the library.

Disks can be ordered *only* from S&S Enterprises, PCW Disk Library, 31 Holloway Lane, Amersham, Bucks HP6 6DJ. Payment can be made by credit card, cheque, banker's draft, postal order or cash. Telephone

orders by credit card can also be made on (0243) 4201 or (0243) 28095. Please do *not* call or write to PCW with orders. We *cannot* help: The £5 price covers return post and packing and includes VAT.

Enough of disks. I have finally started to get some responses to my algorithms/programs for multi-precision arithmetic. Firstly, LV



Five powerful programs for the IBM PC and compatibles. Use the coupon below and send today for our free comprehensive brochure. Quality, performance and great value for money.

TAS-SPell PC

THE SPELLING CHECKER

Spelling mistakes and typing errors spoil any document. TAS-SPell PC can check the spelling of TASWORD PC text at over 4000 words per minute.

TAS-SPell PC includes a comprehensive dictionary of over 70,000 words provided under license from the Longman Group UK Ltd. You can add your own specialised words to the dictionary. The dictionary contents can even be displayed giving on-screen reference at the touch of a key!

£39.95

TAS-SIGN PC

THE SIGN MAKER

Produce and print your own signs, posters, banners and large notices to get your message across with maximum impact.

Print across the paper in the usual direction OR along the length of the paper to produce large eye-catching banners and notices. Four distinctive lettering styles, in addition to italics, underlining, constant or proportional letter spacing. Characters can be printed at any height from less than one inch to the full width of the paper.

£39.95

TASWORD PC

THE WORD PROCESSOR

Power and versatility combined with a remarkable ease of use. Whatever your needs, from a simple letter to a best selling novel, TASWORD PC can meet your requirements. Simply and efficiently.

Tasword PC combines a remarkable ease of use with a host of useful features: detailed on-screen help at the touch of a key, comprehensive print options, on-screen formatting, an indispensable range of text editing commands and even a built-in mail merge. Power, flexibility and ease of use combined into one program.

£29.95

TASPRINT PC

THE STYLE WRITER

Give your dot matrix printer a new dimension of exciting capabilities. Print output from TASWORD or almost any other program in one of the distinctive TASPRINT typestyles. Ideal for notices, headings within documents, and for that special letter that must command attention.

TASPRINT PC drives all dot matrix printers with full bit image graphics capabilities to form, with a double pass of the print head, output in any of 25 distinctive fonts. The program also includes a font editor which you can use to create your own lettering styles.

£29.95

TASCOPY PC

THE GRAPHICS PROCESSOR

A complete graphics package for dot matrix printer owners. Edit and enhance screen copies and create your own diagrams and pictures. Capture copies of the screen while running almost any other program. Print diagrams and pictures from within Tasword and most other programs. Create your own lettering styles, formulae, symbols and logos to annotate your TASCOPY diagrams. The applications of this suite of programs are enormous — letter headings, logos, formulae, chemical structures, bar charts and graphs.

£39.95

Available from good stockists and direct from:
DEPT. PCW, TASMAn SOFTWARE LTD., SPRINGFIELD HOUSE, HYDE TERRACE, LEEDS LS2 9LN. TEL: (0532) 438301.
If you do not want to cut this magazine simply write out your order or brochure request and post to the above address.

All prices include VAT and post and packing.

Please send me your comprehensive brochures on your PC products.

I enclose a cheque/P.O. made payable to TASMAn SOFTWARE LTD or charge my ACCESS/VISA number for the items marked below (tick box):

Expires



TAS-SPell PC
£39.95

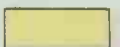

TAS-SIGN PC
£39.95

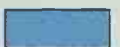

TASWORD PC
£29.95

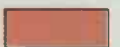

TASPRINT PC
£29.95

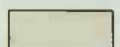

TASCOPY PC
£39.95



Telephone ACCESS/VISA orders:
LEEDS (0532) 438301.



Name:

Address:

Overseas: The following distributors of Tasman products may be contacted for the address of local suppliers. Many products are supplied in translated form. FRANCE & SWITZERLAND Semaphore Logiciel La Plaine CH 1283 Geneva. NORWAY Kelydata Postboks 192, 1371 Asker. PORTUGAL Informova Campo Grande 28 4 A 1700 Lndvnr. NEW ZEALAND Software Supplies P.O. Box 865 Christchurch. GERMANY Profitech Southampton St. 50 52 D 4500 Orsnabruck. RSA Spectra Rentals P.O. Box 2733 Johannesburg. BENELUX Filisoft P.O. Box 1353 9701 B Groningen. DENMARK Quicksoft Bakkegaards Alle 9-11 DK-1804 Fredensberg. C Copenhagen. AUSTRALIA Dolphin Computers Unit 2, 7 Waltham Street Artarmon NSW 2064.

PROGRAM FILE

Angus wrote in with a method for increasing the speed of the multiplication routine. This essentially involves finding the degree of precision to which your computer's Basic calculates. You can then use several at a time instead of using single digits.

For example, if your computer can calculate up to nine digits of precision, you can use four-digit chunks for the multiplication. Multiplying two 8-digit numbers in this way would take $8/4$ times $8/4 = 4$ multiplication operations, whereas my published method would take 8 times $8 = 64$ multiplications. There is of course an overhead in organisation, but LV Angus's method is obviously faster.

I also received a modification to one of the binary tree algorithms given in June 1987's Program File. NC Duncan spotted a way to improve the unloading routine when finding data in the tree in alphabetical order. Essentially, the improvement is that the upward pointer for each element in the tree is signed according to its direction — positive from the left, negative from the right. This information has to be included when constructing the tree.

The unloading routine then works as follows. If you go up from the left, you reach the next entry to be printed, so print it and look to its right. If you go up from the right, you reach an entry that has already been printed, so go up again. An indicator is used to control the direc-

tion of movement down the tree.

This method takes very slightly longer for entering data into the tree but is 25 per cent quicker at accessing the data. It also saves memory space in that the array GOT% is no longer needed.

Finally, I received from C Semmens a program to perform indefinite precision division properly. The program takes division back to its basics. Multiply the denominator (divisor) by what you guess is the first digit of the answer (quotient). Align this result (trial product) under the numerator (dividend) and see if the trial product is the largest that can be subtracted from the dividend without giving a negative result.

Adjust the guess up or down as necessary to get the correct trial product. When you have the right digit, subtract the product from the dividend, bring down the next digit of the dividend (zero if necessary) and repeat the process with whatever is left of the dividend after subtracting the product.

There are only 10 products of one digit with any given denominator, two of them trivial. In multi-precision arithmetic where any given digit is likely to occur many times in the result, it makes sense to calculate all 10 products once and keep them rather than recalculating them all the time. (Note: this technique could be used successfully with multiplication as well.)

The first part of the program standardises the format of the number,

```

10REM ***** LONGDIV *****
20REM ***** (C) 1987 Clive Semmens *****
30
40REM DIVISION ROUTINE - PRECISION LIMITED BY PERMISSIBLE STRING LENGTH -
50REM 255 IN THE CASE OF THE BBC MICRO USED
60
70REM ALTHOUGH THIS IS WRITTEN AND DEBUGGED IN BBC BASIC, LONG MEANINGFUL
80REM VARIABLE NAMES HAVE BEEN AVOIDED, AS HAVE VARIOUS USEFUL
90REM FACILITIES OF BBC BASIC'S, SUCH AS PROCEDURES AND
100REM MULTI-INSTRUCTION LINES, TO ALLOW FAIRLY EASY CONVERSION TO
110REM OTHER DIALECTS.
120
130REM VARIABLES USED:
140REM N$ IS THE NUMERATOR
150REM D$ IS THE DENOMINATOR
160REM R$ IS THE REMAINDER
170REM S$ IS THE SIGN, IF ANY
180REM X$ IS LOCAL ONLY - USED FOR BUILDING NEW REMAINDER AFTER SUBTRACTIO
N
190REM OF PRODUCT OF CURRENT ANSWER DIGIT AND DENOMINATOR
200REM A$ IS THE ANSWER
210REM T$( ) ARE THE TRIAL PRODUCTS
220REM A IS A DIGIT OF THE ANSWER
230REM B,C,G,H,I ARE LOCAL ONLY
240REM D IS THE NUMBER OF DECIMAL PLACES REQUIRED
250REM F IS A FLAG INDICATING WHETHER WE HAVE YET REACHED THE DECIMAL POIN
T
260REM L IS THE NUMBER OF SIGNIFICANT FIGURES IN THE DENOMINATOR
270REM N IS INITIALLY THE NUMBER OF PLACES BEFORE THE POINT IN THE ANSWER
280REM N LATER BECOMES THE NUMBER OF DECIMAL PLACES REQUIRED
290REM P IS THE PLACE VALUE OF THE CURRENT ANSWER DIGIT
300REM X IS THE NUMBER OF PLACES BEFORE THE POINT IN THE NUMERATOR
310REM Y IS THE NUMBER OF PLACES BEFORE THE POINT IN THE DENOMINATOR
320
330 REM ENTRY SECTION *****
*
340
350INPUT "How many places? "D
360PRINT
370INPUT "Enter the numerator: "N$
380PRINT
390INPUT "Enter the denominator: "D$
400
410 REM STANDARDIZE FORMAT *****
*
420

```

MICROMART

Farsight £99

is not only a Lotus 1-2-3 clone but an integrated system which includes a spreadsheet that is fully compatible with Lotus 1-2-3 and many extra features, such as: windowing system which allows several spreadsheets to be open simultaneously, extended search function, direct interface to the word processor, etc.

The word processor is highly efficient, fast, easy to use, comprehensive, 10 different font styles, proportional spacing, as many independently formatted blocks as you want. The word processor is ideal for writing anything from memos to books!

The window manager allows full access to DOS commands. It can drive up to 2 printers as background tasks for maximum efficiency.

Farsight utilizes all the colours/attributes available on your colour or monochrome monitor and offers high speed at low cost!

Farsight Graphics £ 29

Pie-Charts, bar charts, stacked bars, line graphs, supports all cards including Hercules and EGA.

Address Manager £ 60

Compatible with Farsight. Addresses are sorted alphabetically or by post-code. For each address you have 10 different criteria for selection + 12 lines of data. The system is quick and easy to use.

Farsight is written in

Modula-2

All these products with full support are available from

RTA REAL TIME ASSOCIATES LTD
Canning House, 59 Canning Road,
Croydon, Surrey, CR0 6QF
Telephone 01-656 7333/4/5

Dealer inquiries welcome



A. + L. Meier-Vogt
Im Späten 23
CH-8906 Bonstetten/ZH
Tel. (41) (1) 700 30 37

E-Mail: APLUSL@komsys.ifi.ethz.ch (UUCP)

MICROMART

DISCOUNT DISCS UNBEATABLE QUALITY AND VALUE

All disks are packed in a sturdy plastic library case and are guaranteed error free for life.

3 1/2" single-sided 135tpi	£14.95
3 1/2" double-sided 135tpi	£16.95
5 1/4" double-sided 40/80 track	£8.95
5 1/4" single sided 40/80 track	£6.95

All prices are for 10 and include VAT and postage and packing

SPECIAL OFFER

3 1/2" double-sided 25 for £34.95 (bulk packed)

Access, Visa and Mailorders to:

ALTRA

629 ROUNDHAY RD. OAKWOOD
LEEDS LS8 4AR

Telephone: 0532 484961
Official and Trade Orders Welcome

BRANDED DISKS (Box of 10)

3" MAXELL CF2	£23.95
3.5" SONY MFD 2DD 135 tpi	£21.95
3.5" SONY MFD-2HD 135 tpi	£49.00
5.25" MAXELL DS/DD 48 tpi	£13.95
5.25" DATALIFE DS/DD 48 tpi	£13.95
5.25" DYSAN (IBM AT) 802914-02	£26.50

C.W.O. PRICES INCLUDE CARRIAGE & VAT. (C.O.D. ON REQUEST)

☆ QUANTITY DISCOUNTS ☆

EG 10 BOXES SONY MFD-2DD	£18.50/box
EG 10 BOXES DYSAN (IBMAT)	£21.95/box
1 BOX OF 10 3M D.C.600A DATA CARTRIDGE	£229

JOHN HOLMES COMPUTERS

FULBECK, GRANTHAM,
LINCS NG32 3LD

Tel: (0400) 72818

OFFICIAL GOVERNMENT
AND EDUCATIONAL ORDERS
WELCOME

AMSTRAD, OPUS AND TANDON
AUTHORISED DEALER



PROGRAM FILE

```

430REM STRIP AND SAVE SIGNS
440
450S$=""
460IF LEFT$(N$,1)<>"-" THEN 490
470S$="-"
480N$=RIGHT$(N$,LEN(N$)-1)
490IF LEFT$(D$,1)<>"-" THEN 550
500IF S$="" THEN S$="-" ELSE S$=""
510D$=RIGHT$(D$,LEN(D$)-1)
520
530 REM STRIP LEADING ZERO(S)
540
550IF LEFT$(N$,1)<>"0" THEN 580
560N$=RIGHT$(N$,LEN(N$)-1)
570GOTO 550

580IF LEFT$(D$,1)<>"0" THEN 640
590D$=RIGHT$(D$,LEN(D$)-1)
600GOTO 580
610
620REM LOCATE AND REMOVE DECIMAL POINTS - IF ANY
630
640X=0
650IF X=LEN(N$) THEN 700
660IF MID$(N$,X+1,1)="" THEN 690
670X=X+1
680GOTO 650
690N$=LEFT$(N$,X)+RIGHT$(N$,LEN(N$)-X-1)
700Y=0
710IF Y=LEN(D$) THEN 760
720IF MID$(D$,Y+1,1)="" THEN 750
730Y=Y+1
740GOTO 710
750D$=LEFT$(D$,Y)+RIGHT$(D$,LEN(D$)-Y-1)
760N=X-Y
770
780REM COUNT AND REMOVE PLACE-VALUE ZEROES BETWEEN POINT AND FIRST SIG. FI
G.
790
800IF LEFT$(N$,1)<>"0" THEN 840
810N$=RIGHT$(N$,LEN(N$)-1)
820N=N-1
830GOTO 800
840IF LEFT$(D$,1)<>"0" THEN 910
850D$=RIGHT$(D$,LEN(D$)-1)
860N=N+1
870GOTO 840
880
890REM ALIGN FIRST SIG. FIGS. ACCORDING TO RELATIVE SIZES
900
910IF N<D$ THEN 940
920N=N+1
930N$="0"+N$
940R$=N$
950D$="0"+D$
960L=LEN(D$)
970
980REM TEST FOR OVERFLOW. LIMIT NO. OF DECIMAL PLACES IF NECESSARY
990
1000IF ABS(N)>252 THEN 2050
1010IF N+D>253 THEN D=253-N
1020
1030REM EXTEND REMAINDER OUT TO LENGTH OF DENOMINATOR, IF NECESSARY,
1040REM WITH TRAILING ZEROS
1050
1060IF LEN(R$)\L THEN 1120
1070R$=R$+"0"
1080GOTO 1060
1090
1100 REM SET UP TRIAL PRODUCTS * * * * *
*
1110
1120DIM T$(9)
1130
1140REM FIRST PRODUCT IS 1 * DENOMINATOR!
1150
1160T$(1)=D$
1170
1180REM REPEAT FOR EACH PRODUCT 2 * DENOMINATOR TO 9 * DENOMINATOR
1190
1200FOR B=2 TO 9
1210T$(B)=D$
1220T$(B)=""
1230H=0
1240
1250REM STEP BACKWARDS ALONG THE DENOMINATOR MULTIPLYING. H IS CARRY DIGIT.
1260
1270FOR C=L TO 2 STEP -1
1280G=(ASC(MID$(D$,C,1))-48)*B+H
1290H=G DIV 10
1300G=G MOD 10
1310T$(B)=CHR$(G+48)+T$(B)
1320NEXT C
1330T$(B)=CHR$(H+48)+T$(B)
1340NEXT B
1350
1360 REM GENERATE LEADING ZEROS IF ANY * * * * *
*
1370
1380F=0
1390A$=""
1400IF N>0 THEN 1550
1410A$="0."
1420IF N=0 THEN 1460
1430FOR P=1 TO -N
1440A$=A$+"0"
1450NEXT P
1460N=D+N
1470F=1
1480
1490 REM MAIN LOOP * * * * *
*
1500
1510REM HERE WE CALCULATE EACH DIGIT OF THE ANSWER BY LOOKING THROUGH THE
1520REM TRIAL PRODUCTS IN DESCENDING ORDER UNTIL WE FIND ONE WHICH IS
1530REM SMALLER THAN THE CURRENT REMAINDER

```

PROGRAM FILE

```

1540
1550FOR P=1 TO N
1560
1570REM TRY EACH TRIAL PRODUCT
1580
1590A=0
1600IF R<D$ THEN 1640
1610A=10
1620A=A-1
1630IF R<T$(A) THEN 1620
1640A$=A$+CHR$(48+A)
1650
1660REM SUBTRACT PRODUCT FROM REMAINDER
1670
1680IF A=0 THEN 1940
1690I=LEN(R$)-L
1700
1710REM IF THE CURRENT REMAINDER IS LONGER THAN THE DENOMINATOR, JUST COPY
1720REM THE EXCESS DOWN
1730
1740IF I>0 THEN X$=RIGHT$(R$,I) ELSE X$=""
1750H=0
1760
1770REM AFTER EACH STAGE THE LEFTMOST DIGIT WILL BE ZERO AND BE DROPPED
1780

1790FOR C=L TO 2 STEP -1
1800G=ASC(MID$(R$,C,1))-ASC(MID$(T$(A),C,1))-H+48
1810IF G>47 THEN 1850
1820G=G+10
1830H=1
1840GOTO1860
1850H=0
1860X$=CHR$(G)+X$
1870NEXT C
1880
1890REM ADD A ZERO ON THE END OF THE REMAINDER TO GIVE SOMETHING FOR THE
1900REM LEAST SIG. FIG. OF THE NEXT PRODUCT TO BE SUBTRACTED FROM
1910
1920R$=X$+"0"
1930GOTO1950
1940R$=RIGHT$(R$,LEN(R$)-1)+"0"
1950NEXT P
1960
1970REM INSERT DECIMAL POINT IN ANSWER AND RETURN TO MAIN LOOP, OR END.
1980
1990IF F=1 THEN 2030
2000A$=A$+"."
2010N=D
2020GOTO 1470
2030PRINT S$+A$
2040END
2050PRINT "OVERFLOW"
2060END
    
```

although it won't accept exponential form.

This month's programs

Program File in recent months has contained mostly very long programs, so this month I am concentrating on shorter programs. Program of the Month is for the Amstrad PCW range. It is a simple but well-programmed version of that favourite arcade game Kong where a

gorilla runs around dodging things. The screens are held as data statements and can be easily edited to create new ones.

Other programs this month include a directory lister for the Psion Organiser, a program to provide menu control for MS-DOS, written in Turbo Pascal, a neat disk label printer in Microsoft Basic for the PC, two very useful BBC utilities and several other high quality programs for different machines.

Program of the Month Amstrad PCW Kong by Robert Cornwell

This program is a platform-style arcade game reminiscent of Donkey Kong. You have to manoeuvre your little man around screens full of ladders and walls, dodging rolling fireballs and picking up umbrellas for points.

The program uses Basic and a machine code subroutine, and has

five playing screens. When all seven umbrellas have been collected, the man should be moved to the highest point of the screen and a new screen will appear. When screen five has been completed, the program loops back to screen one.

The control keys are: Z - left; X - right; J - jump; U - up.

The screens are stored as data statements, making it easy to edit them and allowing the user to add more screens by merging them in. The user-defined graphics are also held in data statements and can be changed.

```

10 REM KONG
20 :
30 REM by Robert Cornwell
40 :
50 REM user defined graphics
60 DATA 24,56,9,29,58,24,20,52
70 DATA 24,28,16,56,92,24,40,44
80 DATA 90,126,126,90,90,126,102,66
90 DATA 66,126,66,66,66,126,66,66
    
```

MICROMART

READ & PRINT BAR-CODES USING ANY COMPUTER

Complete identification system including microprocessor controlled scanner hardware plus software to print barcodes on Epson (or similar) dot matrix printer. Most Industrial & commercial codes can be read. Packages available for virtually any computer. Our systems are in regular use by many private & public sector organisations worldwide. Prices start from £250. More information on request

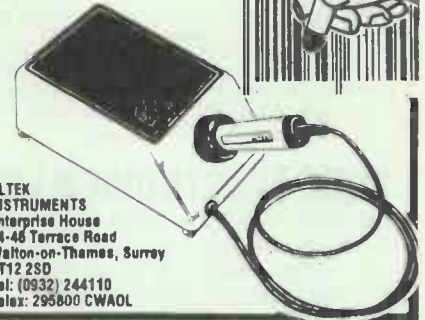

ALTEK
INSTRUMENTS
Enterprise House
44-46 Terrace Road
Walton-on-Thames, Surrey
KT12 2SD
Tel: (0932) 244110
Telex: 295800 CWAOL

MULTI-DISK READING SERVICE

45a Foregate Street, Worcester WR1 1EE

- ★ Transfers Data from Disk to Disk
- ★ Over 750 formats available
- ★ High quality typesetting

★ Typesetting
from Word
Processing
or PC
Disks

Tel:
Worcester
(0905) **25560**



MICROMART

DECA COMPUTER POWER UNBEATABLE VALUE: NEW RANGE

DECA 386 AT £2995
32-Bit 80386 Processor, 6/16MHz zero wait state, 2Mb RAM, 40Mb hard disk: 1 x 1.2Mb floppy disk, 1 parallel, 2 serial ports.

DECA BABY 286 AT £1395
A 12MHz Computer, with 80286-10 Processor, 1Mb RAM, 20Mb hard disk, 1 x 1.2Mb floppy disk, 1 parallel, 2 serial ports.

DECA TURBO-XT £595
4.77/8.00MHz, 640k RAM, 2 x 360k floppy disk drives.

All machines come with microsoft MS-DOS 3.2 + GW Basic, full documentation, 101 key keyboard, Monochrome Monitor and M/G Card
Delivery and VAT excluded

ZONE ELECTRONICS LTD

Specialists in Business and Accounting Systems

Westbury House, 18 Eldorado Road
Cheltenham, Glos GL50 2PT
Tel: (0242) 221 271 Telex: 43432

MICROMAIL

COMPUTER BOOKS BY MAIL ORDER FROM IRELAND

Over 1000 New & Best-Selling Titles
on Micros, Languages,
Operating Systems & Software
Recent titles include

Inside Xerox Ventura Publisher
Windows Programming Secrets
The Power of WordPerfect 4.2
C: The Complete Reference
IBM Personal System 2
The Amiga DOS Manual

For free mail order catalogue cut out & post to:

**MICROMAIL,
146 BANDON ROAD, CORK**

Name

Address

POSTSCRIPT
LINOTRONIC
300 OUTPUT
FILM BROMIDE
ARTWORK
OHP & 35MM
SLIDES

Wordwork

— p l c —

99 LEMAN STREET · LONDON E1 8EY
01 · 488 3840 / 3849

PROGRAM FILE

```
100 DATA 255,1,1,1,1,1,255
110 DATA 255,128,128,128,128,128,255
120 DATA 255,0,241,17,31,0,255,0
130 DATA 255,0,17,170,68,0,255,0
140 DATA 255,195,165,153,153,165,195,255
150 DATA 60,30,15,15,23,35,65,96
160 DATA 24,126,102,219,219,102,126,24
170 DATA 231,153,153,255,255,153,153,231
180 :
190 REM Set up machine code
200 MEMORY %HCF
210 RESTORE 430
220 address=%HE000
230 FOR j%=1 TO 31
240 sum=0:READ code$,check$
250 FOR j%=1 TO 21 STEP 2
260 byte = VAL("&H"+MID$(code$,j,2))
270 PDKE address,byte
280 sum=sum+byte:address=address+1
290 NEXT
300 IF sum<>VAL("&h"+check$) THEN PRINT "Error":STOP
310 NEXT
320 :
330 REM set pokes
340 screen=%HE000
350 print1=%HE003
360 udgs=%HD100
370 pen=%HD001
380 paper=%HD000
390 double=%HD006
400 GOTO 750
410 :
420 REM Machine Code
430 DATA c30e0c35be0cd29e01198,626
440 DATA 2c2100b60168013e20f5d5,395
450 DATA 3e0873237223133d20f8d1,3aa
460 DATA ab03ebf13d20ec9c1cd5a,6ca
470 DATA fce900c9661a6f2202d00a,49b
480 DATA 3210d0030a6f030a67ed4b,33a
490 DATA 10d006001113d0ed02a02,3a3
500 DATA d0cdfce02204d02113d022,595
510 DATA 11d0c9cd30e0cd29e0f32a,67a
520 DATA 11d07e232211d0cdea011,52d
530 DATA 4f81010800e3b0dd2a04d0,4b1
540 DATA 0e98fd214fa12a00d07d06,3e1
550 DATA 08fdcb0006380d07ddcb06,3d2
560 DATA 16ddcb001607c3a4e0cb04,4f1
570 DATA ddc0816ddcb0016cb04dd,530
580 DATA cb0816ddcb001610d7fd23,4ae
590 DATA 3a06d0a7cad1e0dd7e08dd,672
600 DATA 7709dd7e00dd7701dd2379,4a9
610 DATA fe05c2d1e001c802dd09af,576
620 DATA dd230dc282e02a04d00110,440
630 DATA 00092204d02110d035c262,359
640 DATA e0fbc91100b8fe20300311,4cf
650 DATA 00d16f260029292919c95c,31f
660 DATA 260054cb25010fe1094e23,2d5
670 DATA 46eb29292909c93059005c,363
680 DATA d05ea06170644067106ae0,504
690 DATA 6cb06f907250752078f07a,544
700 DATA c07d9080608330860089d0,53f
710 DATA 8ba08e709140941097e099,5ae
720 DATA b09c809f50a220a5f0a7c0,679
730 DATA aa90ad60b0000000000000,21f
740 :
750 REM initialise
760 PRINT CHR$(27)+"f"
770 score%=0:level=1:lives=3
780 DIM a$(45,31),bx$(2),by$(2),bd$(2),sp$(2)
790 PDKE paper,0
800 PDKE double,0
810 PDKE pen,255
820 s$="":sp$(1)=st$:sp$(2)=s$:st$=s$
830 bx$(1)=2:by$(1)=3:bd$(1)=1
840 bx$(2)=82:by$(2)=3:bd$(2)=2
850 :
860 REM Set up graphics
870 RESTORE 60
880 FOR i=0 TO 95:READ j:PDKE udgs+i,j:NEXT:m1$=CHR$(0)
890 m1$=CHR$(0):m2$=CHR$(1):m3$=CHR$(2):l1$=CHR$(3):b1$=CHR$(4):br$=CHR$(5):p1$=CHR$(6):p2$=CHR$(7):e1$=CHR$(8):u$=CHR$(9):b$=CHR$(10)
900 j:=2$=CHR$(11)
910 CALL screen
920 :
930 REM Set up Screen
940 IF level=1 THEN RESTORE 1920:p1$=p2$:e1$=e1$
950 IF level=2 THEN RESTORE 2260:p1$=p1$:e1$=e1$
960 IF level=3 THEN RESTORE 2600:p1$=p2$:e1$=e1$
970 IF level=4 THEN RESTORE 2940:p1$=p1$:e1$=e1$
980 IF level=5 THEN RESTORE 3280:p1$=p2$:e1$=e1$
990 PRINT CHR$(27)+"E"+CHR$(27)+"H"
990 PDKE double,1:a$="SCORE="+STR$(score%):scx%=2:scy%=29:CALL print1(scx%,scy%,a$):PDKE double,0
1000 FOR y%=0 TO 31:READ ts:FOR x%=0 TO 45:tx=VAL(MID$(ts,(y%+1),1)):ax$=ts%vs1%t%
1010 x1%=x%*2:IF tx=0 THEN GOTO 1080
1020 IF tx=1 THEN CALL print1(x1%,y%,p1$):GOTO 1080
1030 IF tx=2 THEN CALL print1(x1%,y%,b1$):GOTO 1080
1040 IF tx=3 THEN CALL print1(x1%,y%,br$):GOTO 1080
1050 IF tx=4 THEN CALL print1(x1%,y%,e1$):GOTO 1080
1060 IF tx=5 THEN CALL print1(x1%,y%,l1$):GOTO 1080
1070 CALL print1(x1%,y%,u$)
1080 NEXT:NEXT
1090 mx%=10:my%=27:d%=1:CALL print1(mx%,my%,m1$)
1100 m$=m1$:par%=0
1110 y1%=30:FOR x1%=0 TO (lives-1):x%=x1%*2+40:CALL print1(x1%,y1%,m1$):NEXT
1120 x%=35:y%=1:a$="LEVEL"+STR$(level):CALL print1(mx%,y%,a$)
1130 :
1140 REM start loop
1150 as=INKEY$:IF as="z" THEN GOSUB 1340:GOTO 1220
1160 IF as="u" AND ax((mx%/2),my%)=5 THEN CALL print1(mx%,my%,l1$):my%=my%-1:CALL print1(mx%,my%,m1$):IF ax((mx%/2),my%)=0 THEN CALL print1(mx%,my%,m1$):IF mx%=76 AND my%=1 THEN GOTO 1890
1170 IF as="j" THEN GOSUB 1610:GOTO 1180
1180 IF as="x" THEN GOSUB 1410:GOTO 1220
1190 z%=ax((mx%/2),my%):IF z%=5 THEN st$=l1$ ELSE st$=s$
1200 IF m$=m1$ THEN j%=-j%
1210 z%=ax(((mx%+j%)/2),(my%+1)):IF z%=0 OR z%=6 THEN CALL print1(mx%,my%,st$):m1$=z%:mx%=mx%+j%:CALL print1(mx%,my%,m1$)
1220 j%=0:z%=ax((mx%/2),my%):IF z%=5 THEN st$=l1$ ELSE st$=s$
1230 IF ax((mx%/2),my%)=6 THEN par%=par%+1:GOSUB 1750
1240 n%=n%+1:IF n%=3 THEN n%=1
1250 bx%=bx%(n%):by%=by%(n%):IF mx%=bx% AND my%=by% THEN GOSUB 1820
1260 IF bd%(n%)=1 THEN GOSUB 1480
1270 IF bd%(n%)=2 THEN GOSUB 1550
```

PROGRAM FILE



Psion Organiser Directory Utility

by Lawrence Blanchard

When I first bought my Psion Organiser, the one thing that really frustrated me was the fact that the manual states that there is a file called 'MAIN' on each DataPAK, but I couldn't find one. Nor could I see any subsequent files which I created.

The following is a DIR utility which will allow a user to see all the files on a specified DataPAK.

How to create DIR

- 1) Select the PROG option from the main menu.
- 2) Select NEW from the programming sub-menu.
- 3) Type the name of the procedure you are going to enter (that is, MAIN followed by <EXE>).
- 4) Type the procedure as it is listed, but without the line numbers or comments (it may all be entered in upper case if that is more convenient).
- 5) When the procedure has been entered, press the <ON> key. Select TRANS and SAVE the procedure.

6) Follow steps 1 to 5 for each of the procedures listed below.

How to install DIR

- 1) With the cursor, move to the place within the main menu where you would like to insert DIR.
- 2) Press the <MODE> key.
- 3) Type DIR and press <EXE>.

How to use DIR

- 1) Select DIR from the main menu.
- 2) It should display DIR A:. Press the <Mode> key until the correct DataPAK is selected, then press the <EXE> key.
- 3) Each time <EXE> is pressed, the next file will be displayed along with the number of records within that particular file.
- 4) When there are no more files to be displayed, the 'END OF PAK' message will be displayed; <EXE> will redisplay the files; and <ON> will terminate the listing and return to the main menu.

DIR: The Main Program segment
NDEVICE: Return the number of the next DataPAK
STRIPS: Strip all the white space from a string
GETKEY: Fetch a key, exit program if it is <ON>
WAIT4: Wait for the specified key to be pressed
ERROR: Perform required error-handling
EOP: Display the 'END OF PAK' message
NB: \$A2 stores the current DataPAK reference

```

01 DIR:
02 Local C%,D$(1),K%,P$(16),N$(1),B%,B$(5)
03 Onerr ERROR::
04 start::
05 C% = Peekb($A2)
06 N$ = ""
07 C!s
08 Cursor ON
09 Do
10 DS = Chr$(%A + C%)
11 At 1,1
12 Print "DIR ";DS;";";
13 K% = GETKEY:
14 If K = 2
15 C% = NDEVICE:(C%)
16 Pokeb $A2,C%
17 Endif
18 Until K% = 13
19 Cursor OFF
20 loop::
21 C!s
22 P$ = DIR$(D)
23 Do
24 Open P$,A,F%
25 B% = COUNT
26 Close
27 BS = STRIP$(GEN$(B%),4)
28 P$ = P$ + REPT$( " ",16-Len(P$)-Len(B$))+BS
29 Print P$
30 GETKEY:
31 P$ = DIR$(N$)
    
```

MICROMART

DUST COVERS

IN WASHABLE PROOFED NYLON
 FABRIC FINISHED WITH TONING PIPING

AMSTRAD PC 1512 & 1640 dust covers

2 Piece Cover £9.00
 Please state colour or mono screen.

IBM dust covers

IBM PC—£9.00
 IBM AT—£9.50

OLIVETTI M24 dust covers

Monoscreen £9.00
 Colourscreen £9.50

OLIVETTI M28 dust covers

APRICOT XEN dust covers

12" Monitor £9.00

Other dust covers

BBD DUST COVERS are specialist manufacturers of high quality tailored dust covers. We make a wide range of covers for other Business computers, Printers, Photocopiers etc and we match printer covers to computer covers wherever possible.
 Make cheques payable to:

BBD COMPUTER DUST COVERS
 The Standish Centre, Cross Street, Standish, Wigan WN6 0HQ.
 Tel: (0257) 422968 Ext 45 Fax 0257 423 909
 Dealer enquiries welcome.

PACE ELECTRONICS

Why not increase the speed of
 your PC by using the 8087/80287
 Numeric Data Processor

8087/2 (8MHz) prices 1-10 PCS £135
 80287/8 (8MHz) prices 1-10 PCS £198
 80387 (16MHz)..... £475

Upgrade your memory

256K D RAMS 256K x 1 £1.87

All prices excluding VAT/P&P
 If you purchase Super Calc 4/Ability/
 Smart we offer discount on 8087
 products. Competitive prices.

Pace Electronics offer the PC user
 technical support and advice on
 the above products.

PACE ELECTRONICS LTD

84 HIGH STREET, STONY STRATFORD,
 MILTON KEYNES MK11 1AH
 Tel: 0908 562664 Telex: 826679 PACE G

Bored with the keyboard?
 Accounts not adding up?
 Spreadsheets not spreading?

LUCY PARR

has the solution.

I offer you

accurate Locoscript Typing,
 also Locoscript 2

Also

Pocket Wordstar for PCW8512,
 Wordstar 1512, Wordstar Original
 and 1st Word plus Atari ST

(0243) 863130

15 Somerset Gardens,
 Bognor Regis, W Sussex
 PO71 2AA

PC-SIG LIBRARY

Over 700 disks

Finally, Software you don't have to be rich to own

We're ISD, UK's Sole Authorised Distributor for PC-SIG. We offer the world's largest library of public domain and user supported software, (whose authors request a donation from satisfied users). Only £6 per disk, you buy software that's been selected from leading authors, thoroughly analysed and professionally supported.

- 499 PROCOMM Professional communications programme written in compiled MicroSoft C and assembly code.
- 523 SIDE WRITER Perfect for spreadsheets, this application prints text files sideways.
- 528 NEW YORK WORD Powerful word processing with split-screen editing, mail merge, auto hyphen, and more.
- 574 FREECALC Word Processing and spreadsheet application for forecasting and budgeting.
- 78 PC WRITE Our most popular word processor. "I'm more at ease with PC WRITE than WordStar".
- 521 FREE FILE Easy-to-use and learn relational data base manager.
- 414 UNPROTECT Various routines to disconnect protection schemes.
- 522 INSTANT RECALL Memory-resident programme for storing and retrieving a wealth of information.
- 417 PROLOG VERSION 1.9 complete with editor and documentation.
- 405 DESKTEAM Desk organisational tool with phone dialer, notepad, calendar, and calculator.
- 478 HARD DISK UTILITIES The best and most useful utilities for the hard disk user.
- 133 ULTRA UTILITIES A must for every PC owner. For recovering lost or accidentally erased files.
- 558 PC-PROMPT A memory resident help utility that provides formatting for DOS commands online.
- 429 ELEMENTARY C Application for learning C Language.
- 424 PASCAL COMPILER Popular compiler written in Turbo Pascal.
- 423 PROJECT MANAGEMENT PC management system capable of handling 1000 tasks.
- 404 EZ-FORMS Programme for generating tailor-made forms.
- 398 ESIE EXPERT SYSTEM Artificial intelligence shell to build a custom knowledge base.
- 480 PC OUTLINE Like Thinktank, this is a great way to organise, outline, and classify ideas.
- 515 THE DRAFTSMAN Create data graphs or slide shows from Lotus 1-2-3, Symphony, or Visicalc.

STARTER SPECIAL

QUICK START EVERYTHING FOR THE NEW USER, includes

CATALOGUE LISTING OVER 600 DISKS

403 COMPUTER TUTOR	5	PC FILE III
78 PC WRITE	273	BEST UTILITIES
199 PC CALC	476	PATRICK'S BEST GAMES
405 DESKTEAM		

£70 VALUE — ONLY £40

Most Programmes have documentation on disk and request a donation from satisfied users.

ADD £2.00 Shipping & VAT Total enclosed £.....

Name

Address

Phone



ISD INTERNATIONAL
SOFTWARE DISTRIBUTORS LTD
P.O. Box 872, Sutton Coldfield,
West Midlands, B75 6UP
Telephone: 021-378 2229

MEMBERSHIP AVAILABLE

SOLE UK AUTHORISED PC-SIG DISTRIBUTOR

PROGRAM FILE

```

32      Until PS = ""
33      EOP:
34      Goto loop::
35  ERROR::
36      ERROR:
37      Return

01  EOP:
02      Cls
03      At 1,1
04      Print "*****END OF PACK****"
05      GETKEY:
06      Cls
07      Return

01  GETKEY:
02      Local K%
03      K% = GET
04      If K% = 1
05          Stop
06      Endif
07      Return(K%)

01  ERROR:
02      Cls
03      Print Chr$(16)
04      At 1,1
05      Print ERR$(ERR)
06      At 1,2
07      Print "press space key"
08      WAIT4:(" ")
09      Return

01  WAIT4:(W$)
02      Local K$(1)
03      Do
04      Until Chr$(GETKEY:) = W$
05      Return

01  NDEVICE:(C%)
02      Local B%,D$(1),M$(5)
03      M$ = ":MAIN"
04      B% = C%
05      Do
06          B% = B%+1
07          If B% > 2
08              B% = 0
09      Endif
10      D$ = Chr$(%A + B%)
11      Until Exist(D$ + M$)
12      Return(B%)

01  STRIPS:(INS)
02      Local OUT$(255),L%,C$(1),C%
03      L% = Len(INS)
04      While L% > 00
05          C$ = Mid$(INS,L%,1)
06          C% = Asc(C$)
07          If C% <> 00 And C% <> 09 And C% <> 32
08              OUT$ = C$ + OUT$
09      Endif
10      L% = L% - 1
11      Endwh
12      Return(OUT$)

```



Turbo Pascal Menus for the IBM

by Simon Maneggio

This is a menu control program for the IBM, this time written in Turbo Pascal. It is simpler than the Basic program XT Manager (Program File, PCW September) but uses graphics in a neat way for making selections. The two programs make a good contrast in programming styles and

PROGRAM FILE

approach, especially since they have been written in different languages.

When the program is run, you can set the title of the whole menu, save the current menu, delete an entry or quit. You can also insert new menu entries by selecting an entry (press one of the function keys or move to the entry using the cursor keys). The screen changes to allow you to enter a name for the menu item and the command which the menu item is to perform; this can be any one-line DOS command. In practice it would be sensible to use a batch file name, so that the batch file can then issue a series of commands.

Remember that the batch file must return to the menu directory and run the menu again before ending. The

final decision is whether or not to return to the menu on ending — *not* returning is a sensible way to terminate use of the menu.

When a menu created in this way is saved, you are asked to supply a menu name. Two files are then created, 'menuname' .mnu and 'menuname'.bat. The second of these actually runs the menu and the first holds details of the choice. To use a created menu, simply type 'menuname' then select items using the cursor keys or function keys.

To enter the program, type it in and compile it to a COM file using Turbo's options menu. The compiled file MENU.COM should be kept in the same directory as the menus and batch files.

```

program MenuGenerator;
{ By S.Maneggio 06/06/87
  Compile this file to a COM file called menu.com
  To execute a menu you have created type the name of the menu.
}

type
MenChoiceRec = Record
    Title       : string[11];
    command     : string[70];
    ReturnToMen : boolean;
    Defined     : boolean;
end; { record }
MenDetRec = Record
    MenuTitle : string[40];
    Choices   : array[1..10] of MenChoiceRec;
end;

var
MenuDetFile : file of MenDetRec;
MenuDetails : MenDetRec;
BatchFile   : text;
MenuName    : string[8];
FileName    : string[12];
MenuTitle   : string[30];
Choice      : char;
DispStat    : 0..1;
CurrentChoice, LastChoice, KeyChoice : 1..10;
QuitGenerator, QuitMenu, Generate, SelectedChoice, FileExists : boolean;

procedure InitializeChoices; { Mark all choices undefined }
var i : integer;
begin
for i := 1 to 10 do
    MenuDetails.Choices[i].Defined := FALSE;
MenuDetails.MenuTitle := '';
end;

procedure DrawBox(x, y, width, height : integer);
begin
draw(x, y, x + width, y, DispStat);
draw(x + width, y, x + width, y + height, DispStat);
draw(x + width, y + height, x, y + height, DispStat);
draw(x, y + height, x, y, DispStat);
end;

procedure DrawFrame(x, y, width, height : integer);
begin
DrawBox(x, y, width, height);
DrawBox(x + 2, y + 2, width - 4, height - 4);
end;

procedure displayMenu;
var x, y, sx, n : integer;
begin
DispStat := 1;
graphcolormode;
graphbackground(lightblue);
palette(2);
textcolor(3);
gotoxy(20 - (length(MenuDetails.MenuTitle) DIV 2), 1);
writeln(MenuDetails.MenuTitle);
sx := 2;
n := 1;
for x := 1 to 2 do begin
for y := 1 to 5 do begin
gotoxy(sx, 2 + y * 4);
textcolor(1);
writeln('F', n);
textcolor(3);
gotoxy(sx + 6, 2 + y * 4);
if MenuDetails.choices[n].Defined = TRUE then
    writeln(MenuDetails.choices[n].Title);
DrawFrame((sx * 8) - 16, ((2 + y * 4) * 8) - 12, 40, 14);
n := n + 2;
end; { for }
n := 2;
sx := 22;
end; { for }
if generate then begin
gotoxy(1, 25);
write('T(itl) R(emove) S(ave) Q(uit)')
end
end;
end;

```

MICROMART

Budget

TYPESETTING

The pioneers in high quality, budget-priced typesetting of magazines, books leaflets etc. from your disk [IBM, Amstrad, BBC, Apricot etc.] or by modem via our own Typenet system or Telecom Gold.

Send now for your free information pack, to:

BUDGET TYPESETTING

53 Rowan Walk
Bromley, Kent BR2 8QW
Telephone 0689 53546
Typenet 0689 50866
Telecom Gold 83: BTL001

EKRA for AMSTRAD

- The Full Range
- Immediate Delivery
- Lowest Mail Order prices
- Authorised Dealer
- Professional Consultancy
- Competitive Software Tailoring

BUSINESS SYSTEMS		£
Amstrad PC12DM	Dual Drive, Mono	445.00
Amstrad PC1640DC	Dual drive, Colour	640.00
Amstrad PC1640HM	20Mb H Drive, Colour	775.00
Amstrad PC1640HC	20Mb Hard Disk Colour	899.00
Amstrad PCW8512	Disk based Word Pro 2 drive	369.00
Amstrad PCW9512	Daisywheel WP	449.00
HOME MICROS		PDA
DOT MATRIX PRINTERS		
Amstrad DMP3000	80 col, 105CPS, F/T, NLQ	149.00
Amstrad DMP3160	80 col, 160CPS, F/T, NLQ	179.00
Amstrad DMP4000	136 col, 200CPS F/T, 50 NLQ	299.00
Micro Periph MP480	80 col, 480CPS, F/T, 70 NLQ	299.00
Canon PW1080A	80 col, 160CPS, F/T, 30 NLQ	279.00
Juki 5520(P)	80 col, 180CPS, F/T, 27 NLQ	369.00
Epson LX86	80 col, 120CPS, F/T, 16 NLQ	249.00
Epson FX800	80 col, 200CPS, F/T, 40 NLQ	349.00
DAISYWHEEL PRINTERS		
Micro Peripherals MP26	132 col, 26CPS	229.00
Juki 6000 (P/S)	80 col, 12CPS	179.00
Juki 6100 (P)	132 col, 20cps	229.00

- Prices exclude VAT and delivery.
- This is a small selection, please ring for prices of other items including hardware and consumables.

EKRA TECHNOLOGY

33 Barkby Road, Leicester LE4 7HN UK
Tel: 0533 668134 Tlx: 341419 spce g

POWER AND PROTECTION

Cost-effectively satisfy a computer's two most important needs — clean power and a convenient reliable source. Linebloc is an easy-fit high quality in-line filter. Stripbloc multi-socket



provides up to six IEC-320 mains outlets (five fused)

Easy-fit Linebloc — just £10.95 + £1.00 p&p. Five-outlet Stripbloc with neon and fuse — just £12.85 + £1.00 p&p
To order, telephone (0243) 825811.
Render Limited, Durban Road, Bognor Regis, West Sussex, PO22 9RL.
A WKR Group company. 

MICROMART



You never need to lose Data again

Losing Data is the easiest thing to do in computing, getting it back again is not so easy — until now! We can give you total data recovery with a new software product called

SECOND CHANCE

All it will cost you is £75 (plus VAT)!

Return the coupon below for your second chance in data recovery

NAME.....
 POSITION.....
 COMPANY.....
 ADDRESS.....
 TEL:.....
 TELEFAX:.....

TECHNICAL MEDIA SERVICES LTD
 62 KELVINGROVE STREET, GLASGOW G37SA
 TEL: 041 332 6636 TELEFAX: 041 221 5318

ROCK BOTTOM DISKS

The Lowest Quality Disk prices in the UK (with Lifetime Guarantee)

Plain Label 5.25" DISKS by Wabash

	10	25	50	100	200	500+
5 1/4" DS/DD 48tpi	5.50	11.00	20.00	38.00	75.00	Call
5 1/4" DS/DD 96tpi	6.00	11.50	21.80	39.50	77.50	Call
5 1/4" AT/1.6Mb	16.00	35.00	68.00	125.00	248.00	Call
Disk Box for 10 5 1/4"	£1.30					

Plain Label 3.5" DISKS by Wabash

	10	30	50	100	200	500+
3.5" SS/DD 135tpi	10.95	31.40	49.90	94.30	117.68	Call
3.5" DS/DD 135tpi	11.25	32.00	52.90	100.00	189.18	Call
Branded 3.5" WABASH DATATECH boxed in 10's	10	30	50	100	200	500+
3.5" SS/DD 135tpi	15.00	42.50	69.00	134.00	Call	Call
3.5" DS/DD 135tpi	16.00	45.00	71.50	140.00	Call	Call
Disk Storage Box 10 3.5"	£1.10					

ALL PRICES INCLUDE VAT & POSTAGE (UK ONLY)
 All disks supplied with Labels & 5 1/4" also with sleeves etc
No Quibble 14 Day money back guarantee plus a full Lifetime Guarantee.

Official Govt./Educational/Company/Export Orders welcome.

Cheques/P.O. To: Athene Consultants
 33 Holly Grove, Fareham, Hants PO16 7UP
 Credit Card Hotline: 0329 282083. 8.30am to 6.30pm

PROGRAM FILE

```

procedure DisplayChoiceFrame(num : integer);
var x, y: integer;
begin
    if num mod 2 = 0 then
        x := 206
    else
        x := 46;
    y := (6 + ((num - 1) div 2) * 4) * 8 - 16;
    DrawFrame(x, y, 108, 24);
end;

function DetectKey( var Key1, Key2 : char) : boolean;
begin
    Key1 := £0; Key2 := £0;
    if keypressed then begin
        DetectKey := TRUE;
        read(kbd,Key1);
        if (Key1 = £27) and keypressed then
            read(kbd,Key2);
    end
    else
        DetectKey := FALSE
    end;
end;

procedure GetChoiceDetails;
var TempRetMen : char;
begin
    clrscr;
    writeln('CHOICE F-',CurrentChoice);
    writeln;
    writeln('Title of choice (Maximum Length of 11) >>');
    writeln;
    writeln('Command (Maximum Length of 80) >>');
    writeln;
    writeln('Return to the menu after executing command (Y/N) >>');
    gotoxy(42,4);
    readln(MenuDetails.choices[CurrentChoice].Title);
    gotoxy(34,6);
    readln(MenuDetails.choices[CurrentChoice].command);
    repeat
        gotoxy(52,8);
        read(TempRetMen);
        TempRetMen := uppercase(TempRetMen);
    until TempRetMen in ['Y','N'];
    MenuDetails.choices[CurrentChoice].ReturnToMen := (TempRetMen = 'Y');
    MenuDetails.choices[CurrentChoice].Defined := TRUE;
end;

procedure GetMenuTitle;
begin
    clrscr;
    write('New Menu Title (Maximum Length 40) >>');
    readln(MenuDetails.MenuTitle)
end;

procedure CreateBatchFile;
var i : integer;
Str : string[2];
begin
    filename := menuname + '.BAT';
    writeln('Creating File ',filename);
    assign(BatchFile, filename);
    rewrite(BatchFile);
    writeln(BatchFile,'start');
    writeln(BatchFile,'echo off');
    writeln(BatchFile,'Menu ',menuname);
    for i := 10 downto 1 do begin
        if i = 10 then
            Str := '10'
        else
            Str := chr(i + 48);
        if MenuDetails.choices[i].defined = TRUE then begin
            write(BatchFile,'if not errorlevel ',str,' goto notf');
            writeln(BatchFile,str);
            writeln(BatchFile,MenuDetails.choices[i].command);
            if MenuDetails.Chchoices[i].ReturnToMen = FALSE then
                writeln(BatchFile,'goto quitmenu')
            else
                writeln(BatchFile,'goto skip');
            write(BatchFile,':notf');
            writeln(BatchFile,str);
        end; { if }
    end; { for }
    writeln(BatchFile,':skip');
    writeln(BatchFile,'goto start');
    writeln(BatchFile,':quitmenu');
    close(BatchFile);
end;

procedure GetMenuName;
begin
    clrscr;
    write('Name of menu (Maximum Length 8) >>');
    gotoxy(1,50);
    readln(MenuName);
end;

procedure SaveMenuDetails;
var i : integer;
begin
    assign(MenuDetFile,filename);
    writeln('Saving to file ',filename);
    rewrite(MenuDetFile);
    write(MenuDetFile, MenuDetails);
    close(MenuDetFile);
end;

procedure SaveController;
begin
    clrscr;
    if choice = 'C' then begin
        GetMenuName;
        FileName := MenuName + '.MNU'
    end; { if }
    SaveMenuDetails;
    CreateBatchFile;
end;
    
```

PCW & PC

MEMORY & V30 UPGRADES

MEMORY & DISK UPGRADES

PC COPY AND DISC HOLDERS
 Elegantly styled, £18.95 each, £29.95 when purchased together.

PC MEMORY UPGRADE £17.49
V30 PROCESSOR UPGRADE £21.95
DMP 2/3000 BUFFER UPGRADE £4.95

PCW PRODUCTS IN OUR RANGE ARE DESK TOP or MONITOR MOUNTING PRINTER STANDS — £9.50.

MONITOR MOUNTING TRAY £15.00
TRANSPORTATION HANDLE £19.95
TRAY AND PRINTER STAND £19.95
PCW MEMORY UPGRADE £18.95
PCW 8256 SECOND DRIVE Inc. all tools required £124.95

CONTINUOUS STATIONERY AND LABELS
 DISCS 3" CF2's, 5 1/4" DSDD 48tpi

Call for prices and be **PLEASANTLY SURPRISED**
PRICES INCLUDE VAT AND P&P — UK

MEAC DESIGNS
 Dept. PCW1, 5A Harpton Parade,
 Village Way, Yateley, Camberley,
 Surrey, GU17 7SB. 0252 879005

DESK TOP COMPANIONS

```

procedure LoadMenuDetails;
var i: integer;
begin
  assign(MenuDetFile,Filename);
  {$i-} reset(MenuDetFile){$i+};
  if IOresult = 0 then begin
    read(MenuDetFile, MenuDetails);
    close(MenuDetFile)
  end { if }
  else
    FileExists := FALSE;
end;

procedure LoadController;
begin
  GetMenuName;
  Filename := MenuName + '.MNU';
  LoadMenuDetails;
end;

procedure GetCommand;
var
  Key1, Key2: char;
  ValidCommand: boolean;
begin
  ValidCommand := FALSE;
  while not(ValidCommand) do
    if DetectKey( Key1, Key2) then begin
      ValidCommand := TRUE;
      if Key1 = £27 then begin
        if ( ord(Key2) >= 59 ) and ( ord(Key2) <= 68 ) then begin
          CurrentChoice := ( ord(Key2) - 58 ); { function key }
          SelectedChoice := TRUE
        end { if }
        else begin
          case key2 of { Check keypad cursor keys }
            £77: if CurrentChoice < 10 then { cur right }
                  CurrentChoice := ( CurrentChoice + 1 );
            £75: if CurrentChoice > 1 then { cur left }
                  CurrentChoice := ( CurrentChoice - 1 );
            £72: if CurrentChoice > 1 then { cur up }
                  if CurrentChoice = 2 then
                    CurrentChoice := 9
                  else
                    CurrentChoice := ( CurrentChoice - 2 );
            £80: if CurrentChoice < 10 then { cur down }
                  if CurrentChoice = 9 then
                    CurrentChoice := 2
                  else
                    CurrentChoice := ( CurrentChoice + 2 );
          end { case }
        end { else }
      end { if }
    else
      if upcase(Key1) = £13 then { Return pressed }
        SelectedChoice := TRUE
      else
        if generate then
          case upcase(key1) of
            'T': begin { Change Menu Title }
                  GetMenuTitle;
                  DisplayMenu;
                end;
            'S': begin { Save Menu }
                  SaveController;
                  DisplayMenu;
                end;
            'R': begin { Remove choice }
                  menudetails.choices[CurrentChoice].defined := FALSE;
                  DisplayMenu;
                end;
            'Q': QuitMenu := TRUE; { Quit Menu Generator }
          end; { case }
        end; { if }
      if SelectedChoice then
        if menudetails.choices[CurrentChoice].defined = TRUE then
          KeyChoice := CurrentChoice; { Chosen }
      end;

procedure AmendOrNewPrompt;
begin
  textmode;
  textbackground(black);
  clrscr;
  writeln('Do you wish to (C) Create a new menu');
  writeln('                (A) Amend an existing menu');
  writeln('                (Q) Quit');
  writeln;
  repeat
    read(kbd,choice);
    choice := upcase(choice);
  until choice in ['C','A','Q'];
end;

procedure OperateMenu;
begin
  DispStat := 1;
  LastChoice := CurrentChoice;
  DisplayChoiceFrame(CurrentChoice); { Display choice Frame }
  GetCommand;
  DispStat := 0;
  DisplayChoiceFrame(LastChoice); { Delete choice Frame }
end;

begin
  if paramcount = 1 then begin { Use menu }
    KeyChoice := 0;
    CurrentChoice := 1;
    Generate := FALSE;
    Filename := paramstr(1) + '.MNU';
    LoadMenuDetails;
    displayMenu;
    repeat
      SelectedChoice := FALSE;
      OperateMenu;
      if SelectedChoice then
        if menudetails.choices[CurrentChoice].defined = TRUE then
          KeyChoice := CurrentChoice; { Chosen }
    until keyChoice < 0;
  end;
end;

```

Variations on an

OPUS

The Incomparable Compatible

£ 495	Opus PCII Turbo 8MHz
£ 599	512k Twin Floppy
£ 635	512k 1.2Mb Floppy
£ 657	256k 5Mb Hard Disk
£ 675	512k 5Mb Hard Disk
£ 725	512k 10Mb Hard Disk
£ 765	512k 15Mb Hard Disk
£ 839	512k 20Mb Hard Disk
£ 883	1024k 20Mb Hard Disk
£ 930	512k 30Mb Hard Disk
£ 974	1024k 30Mb Hard Disk
£1149	512k 40Mb Hard Disk
£1193	1024k 40Mb Hard Disk

Add for colour upgrades

£ 199	CGA Card and Philips 8533 Med. Res. VDU
£ 389	EGA Card and TVM EGA VDU
£ 459	EGA Card and Taxan 660 EGA VDU
£ 515	EGA Card and NEC Multisync All Standards VDU

THE OPUS PC5

80286 CPU, 1024k RAM, 1.2Mb FDD, Parallel/Serial Ports, 30Mb hard disk, Keyboard and Hi-res mono monitor £1295

Multi-user multitasking systems
40Mb to 125Mb Hard Disk storage

3 User £3199

4 User £3799

XT Upgrading to AT. Call for quote.
Maintenance Contracts on all systems.

THE PACIFIC TRIO

PACIFIC 88 with INTEL 8088-2 CPU, 512k RAM, 360k or 720k FDD, Parallel/Serial/Games Ports, Battery backed Clock/Calendar, 84 key AT Style keyboard, Hi-res mono monitor, £449 with 1FDD, £539 with twin FDD, £599 5Mb Hard disk version. £725 16Mb Hard disk version. £795 20Mb Hard disk version. £999 with 40Mb 33 m/s hard disk.

PACIFIC 286 with INTEL 80286 CPU, 640k RAM, 1.2Mb FDD, Parallel/Serial Ports, Battery backed Clock/Calendar, 101 key AT Style keyboard, Hi-res mono monitor, £849 with no hard disk, £1095 with 20Mb HD, £1295 with 40Mb 33 m/s HD, £1395 with 40Mb 28 m/s HD, £1895 with 71Mb 28 m/s HD.

PACIFIC 386 with INTEL 80386 CPU, 1024K RAM, 1.2Mb FDD, Parallel/Serial Ports, Battery backed Clock/Calendar, 101 key AT Style keyboard, Hi-res mono monitor, £2498 with 40Mb 33 m/s HD, £2598 with 40Mb 28 m/s HD, £3098 with 71Mb 28 m/s HD.

PACIFIC COMPUTERS(UK)LTD

565-569 Chiswick High Road,
London W4 3AY
Call 01-994 1054
Telex: 291432 Bellil G

Mr Retailer

Retailers Point of Sale System
At Last!

All the benefits of point of sale enjoyed by the Multi Nationals for the smaller Retailer. Replaces old fashioned till, with an easy to use, fast, computerised system. All retailers Bookkeeping including Stock, VAT, Day Books, Salesman's Commission, Balance Sheet etc, etc, up to date at the moment you press the button to put your money in the till.

The Retailers Dream is Now a reality!
Mr Retailer Software system £495.00
Dealers required.

Complete High Quality Tandon Hard disk system with printer etc £1,700
All prices plus VAT

Access Computers
Cranbrook Road, Hawkhurst, Kent TN18 4AT
Phone: 0622 58356

AVON COMPUTER EXCHANGE LTD

Biggest independent computer distributor in the West and Wales. Specialist in home and Business computers and networking.

AMSTRAD	ATARI
6128 Mono..... £219	1050 Disc Drive..... £99
6128 Colour..... £299	520 ST FM..... £249
PCW 8256..... £299	1040 Mono..... £519
PCW 8512..... £399	COMMODORE
PCW 9512..... £499	AMIGA 500..... £412 wv
DMP 3160..... £179	AMIGA 1000..... £699
DMP 4000..... £299	AMIGA 2000..... £999
DMP 2000..... £139	ARCHIMEDES 310 c.£999

EGA MONITOR plus CARD.....	£399
EPOS SYSTEMS.....	from £599!!
NETWORK 2 COMPUTERS.....	from £399
TAPE STREAMER 40Mb.....	£449
HDISK FOR AMSTRAD 1512 inc. control card.....	£299

OPUS MACHINES.....	from £449
FAST 30Mb XT.....	£799
FAST AT 6-8-12 switchable.....	£1295

20% off all software
with this advert.

42, CANNON STREET,
BEDMINSTER, BRISTOL BS3 1BN.
Telephone: 0272 637981

126 CHURCH ROAD,
REDFIELD, BRISTOL BS5
Telephone: 0272 542116

87 CITY ROAD, CARDIFF
Telephone: 0222 483069

Opening at Swindon & Newport shortly.

PROGRAM FILE

```

clsscr;
halt(KeyChoice);      { Return choice to batchfile as an msdos errorlevel}
end { if }
else begin
Generate := TRUE;      { Generate Menu }
QuitGenerator := FALSE;
repeat
FileExists := TRUE;
InitializeChoices;
AmendOrNewPrompt;
if choice < 'Q' then begin
if choice = 'A' then
LoadControler;
if FileExists then begin
displayMenu;
CurrentChoice := 1;
QuitMenu := FALSE;
repeat
SelectedChoice := FALSE;
OperateMenu;
if SelectedChoice then begin
GetChoiceDetails;      { Change choice }
DisplayMenu;
end; { if }
until QuitMenu;
else begin
writeln('Menu File Does not exist. Press any key');
repeat until keypressed;
end { else }
end { if }
else
QuitGenerator := TRUE;
until QuitGenerator;
end; { else }
end.
    
```



MBasic Disk Labeller

by Ken Smith

Disk Labeller prints out small, label-sized lists of the files on a floppy disk for use as disk labels. It also prints the disk's volume name, and the date and information about the space left on a disk. (See the example which appears *before* the program listing.)

The program has no 'bells or whistles' but does have enough comments to enable readers to get a vague idea of how it works. It requires an Epson printer but could be altered for use with other printers. The listing as it stands will run on any set-up consisting of 256k of RAM, a hard disk and an Epson, but

the following notes should help you to convert it to run on other configurations.

The program assumes that access to COMMAND.COM is available either on the default drive or via the PATH command. It also assumes that the same is true for SORT.COM and LABEL.COM. There should be a minimum of 2k of free space on the default drive.

The disk to be labelled should *not* be placed in the default drive: if you want to use the program on a single-floppy system, load it into a RAM disk.

No 2

```

-----
MENU .EXE MENU .TXT PC-FILE .BAT PCDEF .EXE
PCDOC .EXE PCEXPOR .EXE PCFILE .EXE PCFILE .PIF
PCFILE .PRD PCFILE .XXX PCFIX .EXE PCIMPOR .EXE
PCLABEL .EXE PCOVL .EXE PCPRINT .EXE PCSETUP .EXE
PCSORT .EXE PCUTIL .EXE
-----
    
```

06-10-1987 18 files. 348239 bytes 2048 free

```

10 REM DISK LABELLER
11 REM By Ken B Smith. York, 25 April 87
12 REM 75 minutes to running and an hour to comment
13 REM Nasty BASIC - all gotos and repeats - but it is a QADLP for sure
14 REM QADLP = Quick And Dirty Labelling program
20 CLS
22 PRINT "          DISK LABELLER (A4) Labels"
24 PRINT "          ====="
26 PRINT:PRINT:PRINT:PRINT
30 PRINT:PRINT:PRINT
32 REM Here lie the printer codes used by an Epson
34 ESCs = CHRs(27): ESCAPE
35 PINITs = ESCs + "e": ' Initialise
36 PEMPHS = ESCs + "E": ' Emphasised
37 PBIGs = CHRs(14): PSMALLs = CHRs(15): ' Big and Small Characters
38 PCOMPs = ESCs + "c" + CHRs(18): ' Line Compression the 18 gives rgstrtion
39 PCBIGs = ESCs + "F"
40 PSUBs = ESCs + "s" + CHRs(1): ' Suscript on
42 WIDE = 54: ' How wide is the label print area in condensed
44 WIDEs = STRINGS(WIDE,"-"): ' Underline sequence
46 ACROSS = 4: ' How many entries across
48 DOWN = 11: ' How many lines down of entries
50 ONLABEL = ACROSS * DOWN: ' How many entries per label
52 FBYTES = 0: ' Total of File sizes
54 LCOUNT = 1: ' Line Counter
55 FCOUNT = 1: ' File Count
56 PCOUNT = 1: ' entries per line counter
58 DNUM = 1: ' label Number counter
    
```

PROGRAM FILE

```

60 TOTLABS = 0 : ' Total number of labels from a disk (Total files / onlable)
62 BLEFT = 0 : ' Remaining space on Disk
64 X = 0 : ' The dreaded X counter
97 ' Now we can start the program with a request for a drive letter
98 ' Since hard disks would use a lot of labels and they would be tricky to see
99 ' we will restrict ourselves to A and B for now
100 INPUT "Drive Letter ";DL$
101 ' Since someone is bound to put in lower case we shall convert
102 ' Take the ASCII value and see if it is over 90 (Z) is so lower case
103 ' To get an UPPER CASE equivalent take 32 from the ASCII value
105 IF ASC(DL$) > 90 THEN DL$ = CHR$(ASC(DL$)-32)
108 ' Now see if it is A or B and produce a suitable SHELL command to DIR
109 ' the disk with a PIPE (|) to SORT (must be available) to LABFILE.DAT
110 IF DL$ = "B" THEN SHELL "DIR B: | SORT > LABFILE.DAT":GOTO 130
120 IF DL$ = "A" THEN SHELL "DIR A: | SORT > LABFILE.DAT":GOTO 130
124 ' we didn't get A or B so try again
125 GOTO 100
128 ' Open up a file called "LABFILE.DAT" for Input by lines
130 OPEN "1", "LABFILE.DAT"
138 ' Gosub to get a line from the file into As
140 GOSUB 5000
148 ' If the line is Blank get the next one (Initial lines are often so)
150 IF As = "" GOTO 140
155 ' Tricky bit of MIDS to get the File Count and Remaining bytes
180 FCOUNT = VAL(As):L% = INSTR(As,"(s)"):BLEFT = VAL(MIDS(As,L%+4))
182 TOTLABS = FIX(FCOUNT/ONLABEL) + 1 : ' The FIX + 1 makes the numbers correct
164 ' get two more lines and see if we have a label by looking for "no"
165 GOSUB 5000:GOSUB 5000: IF INSTR(As,"no") > 0 THEN GOTO 190
168 ' We have a label - search for its position using the "is"
170 I% = INSTR(As,"is") + 2
178 ' but it could be blank so watch out
180 L% = LEN(As) : IF L% > I% GOTO 200
188 ' Get the disk label name. DOS 3.2 will not hack the SHELL LABEL sequence
190 INPUT "Disk Name ";DNS$:SHELL "LABEL "+DL$+";"+DNS$:GOTO 210
198 ' The name is on disk so pull it to DNS
200 DNS = RIGHT$(As,L%-I%)
208 ' Printer sequence. Watch the semi colons for spacing et al
209 ' repeated out of laziness on lines 520-560
210 LPRINT PINITS;PEMPHS;PBIGS; : ' Initialise, Emphasis and Large letters
220 LPRINT DNS; : ' Print the Label
230 LPRINT PCBIGS;PSMALLS;PCOMPS; : ' Cancel BIG get to small and Condensed
240 LPRINT PSUBS;WIDES; : ' Pull into subscript and print the line
248 ' get a disk entry
250 GOSUB 5000
258 ' Add the size to FBYTES counter
260 FBYTES = FBYTES + VAL(MIDS(As,14,8))
268 ' print the entry adding the DOT that is NOT on the DIR listing
269 ' the spaces at the end can be changed to vary width of label see WIDE
270 LPRINT MIDS(As,1,8);" ";MIDS(As,10,3);" ";
278 ' if we are upto ACROSS across then line feed and reset counters
280 PCOUNT=PCOUNT+1:IF PCOUNT>ACROSS THEN PCOUNT = 1:LCOUNT = LCOUNT + 1:LPRINT
288 ' if we are up to DOWN lines do another label
290 IF LCOUNT > DOWN THEN GOTO 500
298 ' Go back and get the next one
300 GOTO 250
396 ' Now we are at the end of the run and this label needs finishing
397 ' So line feed to DOWN lines and throw in the final message
400 FOR X = LCOUNT TO DOWN: LPRINT:NEXT X
410 LPRINT WIDES;
420 LPRINT DATES;" ";FCOUNT "files. ";FBYTES;" bytes ";BLEFT;" free"
428 ' The 3 line feeds clear the labels to the next one
430 LPRINT:LPRINT:LPRINT:CLOSE 1:GOTO 10
496 ' Here we have a continuation problem. The label is full so just at the
497 ' trailer and a slightly different message on the tail
498 ' line feed to the next label and reset counters before going back
500 LPRINT STRINGS(WIDE,"")
510 LPRINT DATES;" "; "End of Label ";DNUM;" of ";TOTLABS;" - CONTINUED ";
DNUM = DNUM + 1
520 LPRINT:LPRINT:LPRINT: LCOUNT = 1:PCOUNT = 1
530 LPRINT PINITS;PEMPHS;PBIGS; : ' Initialise, Emphasis and Large letters
540 LPRINT DNS;
550 LPRINT PCBIGS;PSMALLS;PCOMPS
560 LPRINT PSUBS;WIDES
570 GOTO 260
4000 STOP
5000 IF EOF(1) GOTO 400 ELSE INPUT £1,As
5010 RETURN

```



BBC *HELP Command

by Chris Bowerman

Users of programs often lack access to a command that will provide them with various levels of help and information. *USE provides a user-oriented information system which can be used in any application that involves searching through or displaying ASCII text information files on screen. An example of this recently was in an educational program to page through a 'textbook' held on disk. I also have a copy of *USE on all my disks to provide program LOAD and other information in moments of amnesia.

Enter the program as shown and RUN it (having saved a copy in case of bugs). Enter a pathname or directory and (by means of A or D) the

type of filing system in use (DFS or ADFS). The pathname or directory indicates the directory in which the program will look for the information text-files. The pathname should not terminate with a dot. The *SAVE line needed to save the utility to disk will also appear.

First, the facilities provided: the utility creates a new command *USE. Typing

*USE <RETURN>

displays the default text-file (called I-MAIN) on screen and typing

*USE <filename> <RETURN>

displays the named text-file on screen. The cursor keys are used to move the files (Fig 1) which are displayed a text-windowful at a time.

MICROMART

TYPESETTING

with your

IBM and AMSTRAD

from **£1.65** per 1000 characters

Enter your data onto your computer and key in the data, tables etc. in the position you would wish the final typeset version to be, no need to enter special and confusing typesetting commands, our system requires raw text only.

The text is then sent to our page make-up facility where each individual page is made up to your specifications. We have five years experience typesetting from disk.

WE SPECIALISE IN

books, magazine typesetting, reports - especially computer manuals and foreign language manuals.

For more information or if you wish to discuss a specific job please contact Kim or Milan at

KAMSET

34 Rayleigh Road, Hutton, Brentwood, Essex
Telephone (0277) 218676

EDUCATIONAL SOFTWARE

PC

PC

Christmas

PlayTime

Time

1 & 2

£9.95

£14.95

each

Advent calendar
with a new
picture & carol
each day,
Games for
ALL the year.
Letter for
Santa Claus
& crackers
with jokes.

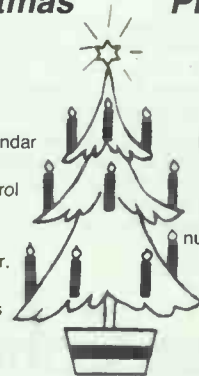

Fun with letters
& words, art
music, time
logical games,
numbers & sums
letter writing
& much more.
PT1 for 3-6
PT2 for 5-8

For AMSTRAD PC1512/1640 and other PCs

G & M Software
031-331 1460

Echline Place,
Sth Queensferry,
W. Lothian EH30 9XB

Inashua

DISKETTES

3 1/2"	50+	500+	1000+
SSDD	1.16	1.12	1.07
DSDD	1.44	1.38	1.32
5 1/4"			
SSDD	0.47	0.45	0.43
DSDD	0.59	0.56	0.54
SSQD	0.73	0.70	0.67
DSQD	0.82	0.78	0.75
DSDH	1.36	1.30	1.24

FROM

CAROUSEL TAPES

3 Park Parade, Stonehouse
Glos GL10 2DB
Tel: 045383 5500

Prices ex. VAT. Inc Delivery

PANTHER SOFTWARE

Mall Order Price List

TITLE	Supplier	RRP £	OUR PRICE
IBM (Disc)			
Company 87	PANTHER	14.95	13.49
Daily News	PANTHER	9.99	8.99
Star Glider	Rainbird	19.95	17.95
F15 Strike Eagle	Microprose	21.95	19.49
Cyprus II Chess	Microprose	119.95	117.95
Book-Keeper	Sage Soft	113.85	99.85
Accountant	Sage Soft	171.84	150.84
Protest	Amor	59.95	49.99
Fleet Street Editor	Mirrorsoft	149.95	129.95
PC Four	Pision	69.95	61.95
ATARI ST (disc)			
TNT	Infogrames	19.95	17.95
Passengers On The Wind	Infogrames	24.95	22.49
Knight Cir	Rainbird	19.95	17.95
Into The Eagles Nest	Pandora	19.99	17.95
Tracker	Rainbird	24.95	22.49
Balance Of Power	Mirrorsoft	29.95	26.49
Habswriter	Haba	59.95	52.95
Lattice C Compiler	Metacomco	99.95	87.95
Animator	Microdeal	29.95	26.49
AMIGA (disc)			
Balance Of Power	Mirrorsoft	39.95	34.95
Star Glider	Rainbird	24.95	22.49
Guik Of Thieves	Rainbird	24.95	22.49
Mr-Amiga File	Haba	99.95	87.95
Music Studio	Activision	34.99	30.95
AMSTRAD CPC (tape)			
Wizball	Ocean	8.95	7.95
High Frontier	Activision	9.99	8.95
Exolon	Hewson	8.99	7.95
AMSTRAD CPC (disc)			
Big Trouble In Little China	Activision	14.99	13.49
Trivial Pursuit	Domark	19.95	17.95
SPECTRUM (tape)			
Exolon	Hewson	7.99	6.99
Wizball	Ocean	7.95	6.99
CBM 64 (tape)			
Deathwish III	Gremlin	9.99	8.95
Ace 2	Cascade	9.95	8.95

Make cheques payable to 'PANTHER SOFTWARE', send SAE for full price list stating computer. Software also available for MSX, AMSTRAD PCW, BBC, ELECTRON CBM C16 PLUS 4

PANTHER SOFTWARE, Mall Order Dept PCW, 2 Riverway Gardens, The Meadows, Nottingham NG2 3LL Tel: (0602) 860664

RT²

gives you real time on a pc

RT² provides multitasking, timing, memory allocation, semaphore, and i/o support for real-time applications. It is fast, modular, compact and configurable, and fully documented. Using RT² you can get the following benefits:

- ★ reduced costs and improved performance
- ★ high performance interrupt-driven code
- ★ support for both Microsoft and Intel high-level languages
- ★ flexible licensing to suit small or large users

Enquire now!

Alan Cohen

Alan Cohen (Computer Consultants) Ltd
225a Finchley Road, London NW3 6LP
Tel: 01-4355493

DISKETTE TAPE CONVERSION

Tape-Diskette-Tape Diskette-Diskette

Specialised conversions for
Typesetters

Incompatibility need not be
a problem

and for an efficient and reliable
service at competitive rates call:

Ken Evison on Dorking (0306) 76694

KENNETH C. EVISON
154 South Street
Dorking, Surrey RH2 2ET

The search option automatically looks for the next occurrence of the searchword in the file. The searchword is given by hitting COPY, entering the searchword in response to the 'seek' prompt and then hitting RETURN. If no searchword has been entered, then the search option prompts for one.

To test the utility we need some text-files (untokenised files in GSREAD format) about 60 lines long. The default file is always called I-MAIN. No name restriction is placed on other file names, of which there must be at least one — let's call it TEST. Any file produced by a word-processor will do (as will those produced for *SPOOL and *BUILD).

Typing *USE <RETURN> (or hitting f0) will subsequently cause the default file (I-MAIN) to be displayed. Typing *USE TEST will produce the named file TEST on screen as explained above.

To use the utility as an information-providing facility, the default file I-MAIN should consist of general information indicating the names of files containing more detailed information (which may be accessed by typing *USE <file name>). These files in turn refer to other files, creating a hierarchy of information.

You must ensure that the appropriate mode and text window for the format of the text-file to be displayed are selected before calling USE. The line length of the screen mode must be considered when preparing text-files: the maximum line length which can be displayed in any mode is 20 characters.

As USE is loaded from disk it must be saved on all disks with which you wish to use it. Note that I have deliberately not prescribed a certain directory for the USE file so that several copies can be held on disk in different directories, each of which

can access different information files.

The program is fairly well supplied with comments so I'll just mention the basic stages of operation. First, the command line, which will hold any filename, is retrieved and the appropriate file is opened. The height of the window is then checked to ascertain the length of a screenful and the main loop, which checks for keypresses and executes the appropriate options, is entered.

Because of the program's use of memory (&884 to &AFF and &C00 to &CFF), the following facilities may become corrupted while using the utility: sound, printer, serial port, cassette, speech, user-defined characters, Econet. Should this be a problem the code can be assembled for another address by altering C% in line80 and P% in line 980. Zero page locations &70 to &7C are used as in Fig 2.

Key	Effect
↓	move down file
↑	move up file
←	move to start a file
→	search for given word
DEL	quit
COPY	enter new search word

Fig 1

Location	Description
70-73	DFS Parameter block
74	file handle
75-76	counter of lines displayed
77	value to be subtracted
78	number of lines to be decremented
79	height of window in lines
7A	top of window
7B	value of character from file
7C	store for Y in search and input

Fig 2

```

10REM >>>> *USE <<<<
20REM (c) Chris. Bowerman 1987
30CLS
40PRINT "" >>>> *USE source code <<<< <<<
50INPUT "Pathname for ADFS or directory for DFS "P$
60INPUT "A)DFS or D)FS ? "F$:P$=P$+" "
70IF F$="A" THEN length=10 ELSE length=7
80C%=884
90FORZ=0 TO 1:P%=C%:[OPTZ]*2
100.pn EQU$ P$ \ pathname
110.eop EQU$ 0:EQU$ 0 \space for filename given after *USE or defau
1t one
120:
130 setup LDAE4:LDXE1:JSR&FFF4 \setup cursor keys
140:
150LDAE160:LDXE&B:JSR&FFF4:STX&7A:LDAE160:LDXE9:JSR&FFF4:TXA:SEC:SBC&7A:ST
A&79 \ get height of text window
160.file LDAE1:LDYEO:LDXE&70:JSR&FFDA \retrieve any filename after *USE
170LDYEO:LDA(&70),Y:CMPE13:BNEYfn \if FILENA given GOT0Yfn else...
180LDAEfn MOD256:STA&70:LDAEfn DIV256:STA&71 \use default one
190.yfn LDYEO
200.11 LDA(&70),Y:STAeop,Y:INY:CMPE13:BNE11
210STAeop+length\ terminate filename 6 DFS, 8 ADFS
220:
230.start LDXEpn MOD256:LDYEPn DIV256 \open the file
240.open LDAE64:JSR&FFCE:STA&74:CMPE0:BEQnormalise:JSRscreen
250:
260.12 JSRgetKey \get a key and branch to the appropriate routine
270.j0 CMPE136:BNEj1:LDAE0:STA&70:STA&71:STA&72:STA&73:JSRwriteptr:JSRscree
en:LDAE136
280.j1 CMPE139:BNEj2:JSRupscro11:JSRscreen:LDAE139
290.j2 CMPE138:BNEj3:JSRscreen:LDAE138
300.j3 CMPE127:BNEj4:JMPClosedown:LDAE127
310.j4 CMPE137:BNEj5:JSRsearch:JSRscreen:LDAE137
320.j5 CMPE135:BNEj6:JSRinput:LDAE135
    
```

PROGRAM FILE

```

330.j6 JSRneof:BEQ12 \check for end of file
340:
350.closedown \exit cleanly
360LDAE0:LDY&74:JSR&FFCE
370.normalise LDAE4:LDX&0:JSR&FFF4
380RTS
390:
400.screen LDAE12:JSR&FFEE \display a text-window-full of the file
410.13 JSRgetchr
420CMPE13:BNEJ7:JSR&FFEE:JSRincr:LDAE10
430.j7 JSR&FFEE
440LDAE134:JSR&FFF4:CPY&79:BNEJ8:RTS
450.j8 JSRneof:BEQ13:RTS
460:
470.incr INC&75:BEQJ9:RTS \count the number of lines displayed
480.j9 INC&76:RTS
490:
500.getchr LDY&74:JSR&FFD7:RTS \get next character from file
510:
520.upscroll LDAE75:CMPE&79:BCSok2:LDAE76:BNEok2:LDAE0:STA&75:STA&76:LDAE0:
STA&70:STA&71:STA&72:STA&73:JSRwriteptr:RTS \move back through file in screen
fulls
530.ok2 JSRreadptr:LDAE79:STA&78:SEC:LDAE75:SBC&78:STA&75:LOA&76:SBC&20:STA
&78
540.14 JSRback:DEC&78:BNE14
550RTS
560:
570.back LDAE2:STA&77:JSRreduce:JSRwriteptr \used by "upscroll" to move ba
ck a line
580.back2 JSRgetchr:CMPE13:BEQJ10:JMPback
590.j10 JSRwriteptr
600RTS
610:
620.writeptr LDAE1:LDX&70:LDY&74:JSR&FFDA:RTS \write PTR
630:
640.readptr LDAE0:LDX&70:LDY&74:JSR&FFDA:RTS \read PTR
650:
660.reduce LDAE70:CMPE&77:BCSok1:LDAE0:ORA&71:ORA&72:ORA&73:BNEok1:LDAE0:S
TA&70:STA&71:STA&72:STA&73:PLA:PLA:JSRwriteptr:RTS \used to move PTR backwar
ds
670.ok1 SEC:LDAE70:SBC&77:STA&70:LDAE71:SBC&0:STA&71:LDAE72:SBC&0:STA&72:L
DAE73:SBC&0:STA&73:RTS
680:
690.getkey \get keyhit
700.15 LDAE129:LDX&255:LDY&127:JSR&FFF4
710CPY&FF:BEQ15:TXA
720RTS
730:
740.neof \check for not end of file
750LDAE127:LDX&74:JSR&FFF4
760CPX&0:RTS
770:
780.search LDAword:CMPE13:BNE16:JSRinput:JMPsearch \search for a given wor
d - if none is supplied get one
790.16 LDY&0:STY&7C
800.17 JSRgetchr:STA&7B
810JSRneof:BNEopse
820LDY&7C:LDAE7B:CMPE&7B:Y:BNE18
830LDY&7C:INY:LDAword,Y:CMPE13:BEQfound:DEY
840LDAword,Y:CMPE&7B:BEQ19
850.18 LDY&7C:CPY&1:BCS16:JMP17
860.19 LDY&7C:INY:STY&7C:JMP17
870.nope JSR&FFE7:LDAE7:JSR&FFEE:LDY&255 \not found so say so
880.110 INY:LDAmessg,Y:JSR&FFEE:CMPE13:BNE110:JSR&FFE7:JSRgetkey:PLA:PLA:L
DAE136:JMPJ0
890.found LDAE7:JSR&FFEE:JSRreadptr:LDAE1:JSRreduce:JSRwriteptr:JSRback2:R
TS \found so display
900:
910.input JSR&FFE7:LDY&255:.111 INY:LDAprompt,Y:JSR&FFEE:CPY&6:BNE111 \ind
ut searchword
920LDY&255:STY&7C
930.112 LDY&7C:INY:STY&7C:JSRgetkey
940CMPE127:BNEJ11:LDAE&8:JSR&FFEE:LDAE32:JSR&FFEE:LDAE&8:JSR&FFEE:LDY&7C:DEY
:DEY:STY&7C:JMP112
950.j11 LDY&7C:STAword,Y:JSR&FFEE
960CMPE13:BNE112:LDAE135:RTS
970:
980:PS%=&P%=&C00:[OPTZ*2
990.messg EQU$ "Not found (<RETURN>)":EQUB 13 \store prompts at &C00
1000.prompt EQU$ "Seek :-"
1010.fn EQU$ "I-MAIN":EQUB 13 \default filename if none given
1020.word EQUB13\STRING TERMINATED BY 13
1030: NEXT
1040:
1050REM Print out SAVE and other information
1060PRINT "Code ends at &";PS%
1070PRINT "Max. search word length =";&FF-(word AND&FF)
1080PRINT " *SA. USE ";&C%:" ";&P%:" ";&setup;" or :-" CALL&:";setup
1090PRINT " or :- <fo>":OSCLI("K.OCALL"+STR$(setup)+"M")

```

MICROMART

COMPUTER REPAIRS

SPECTRUM 16/48	£19.95
SPECTRUM +	£19.95
QL	£27.95
COMMODORE 64	£35.00
AMSTRAD 464/664	£24.95
AMSTRAD 6128	£27.95
AMSTRAD PCW 8256/512	P.O.A.
AMSTRAD PC 1512	P.O.A.

PLEASE PHONE FOR DETAILS

THE PRICES SHOWN ARE FULLY INCLUSIVE OF PARTS, LABOUR, POSTAGE, INSURANCE, VAT AND 3 MONTH GUARANTEE. SEND ITEM WITH CHEQUE AND DESCRIPTION OF FAULT TO:



DEPT PCW, UNIT 6,
STANLEY HOUSE, STANLEY AVENUE,
WEMBLEY, MIDDX HA0 4JB.
Telephone: 01-902 5218

SIGNWRITER

Instant display lettering by computer

- Signs printed across or down the page
- Drives most dot-matrix printers etc
- Sharp characters any size - the bigger the better
- Create logos, symbols, fonts in any language
- Extra fonts £5.75 each + disk:

ROME Shop Fair
Down Hand Olde 

LABELWRITER

- Multiple identical labels, any size & number across
- Uses all the printer's type-styles
- Serial numbers and logos too

PAPERBASE De Luxe

Personal bibliographic database

- Stores, finds, and styles references
- Flexible storage in portable sequential files

PRICES: ^aPC & Apricot ^bAmstrad PCW ^cBBC

All available from the publisher:
WIGHT SCIENTIFIC
44 Roan Street London SE10 9JT
(01) 858 2699

Also:
OXSTAT for statistics
HISTO for histograms
FREQ for word counts
INDEXER

16-bit SIGNWRITER created this advertisement, A4-size

MEDIA CONVERSIONS

DISK/DISK • TAPE/DISK • TAPE/TAPE

We can transfer your data between over 1000 different Minis, Micros and Mainframes.

Tape
1/2" - 800, 1600, 3200, 6250 BPI
3/4" - QIC-11, QIC-24, (QIC-02).
DEC'DOS', TAR, ANSI, CPIO, IBM Labelled/Unlabelled.

Floppy
8", 5 1/4", 3 1/2", 3" CPM, CPM86, MDOS, MSDOS, PCDOS, UNIX, XENIX, IDRIS, TAR, RT11, IBM, BEF, ISIS, FLEX, OS9, APPLE, ACORN, TORCH, VICTOR-SIRIUS, ATARI etc.

WP/Typesetting
Many formats including DISPLAYWRITER, OLIVETTI, WORDPLEX, LINOTYPE etc.

Overnight - Most formats returned by next day's post.

Prices from £10 per disk.
Usual terms C.W.O.
Ring or write for a full format list.

A.L. DOWNLOADING SERVICES
VOYSEY HOUSE
BARLEY MOW PASSAGE
LONDON W4 4PT
01-994 5471

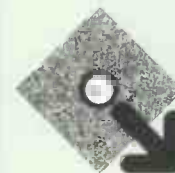

BBC Empty Drive Tester

by John Tissandier

Many packages require two disks and dual drives to operate. Normally the system disk is placed in drive 0 and the data disk in drive 1. However, even sophisticated packages do not seem able to detect when there is no data disk present. The second drive continues to spin in vain.

This utility checks to see if a drive is empty when accessed and, if so, returns control to the program. An instruction to insert the data disk in

the drive is displayed. Once you have tried the simple demonstrations you will be able to incorporate this check into your own programs.

Run 'DEMO1' without a disk in drive 1. The message 'Insert data disk and press RETURN' should appear on the screen. Now insert any disk in drive 1 and press RETURN. The disk will be catalogued.

The command *CAT 1 in line 110 could be replaced by another com-

MICROMART

LOOK !

PC/XT/Amstrad & compats 30Mb Hard drive	£295
30Mb Kit (incl cont and cables)	£355
40Mb Hard Drive	£525
40Mb Kit (as above)	£585
AT Compats 30Mb Hard Disk Kit	£385
40Mb Hard Disc Kit	£495
80Mb Kit	£899
Complete range of Hard Drive up to 168Mb	
Hard Cards 20Mb	£360
30Mb	£385
Complete AT 286 and 386 systems	
80286 Base 8MHz 512k 8 slots 1.2Mb I/O Card	£999
80386 16MHz 512k 8 slots	£1750
Ask for tech specs	
Amstrad 640k Upgrade Kit	£25.95 inc VAT

These prices are exclusive of VAT unless otherwise marked. P&P Free.

ACD COMPUTER SERVICES

Dept. PCW, Gotham Moor Farm,
Gotham, Nottingham NG11 0LH
Tel: 0602 830884; Telex: 378120

NEW AND USED EQUIPMENT BARGAINS (Used unless stated otherwise)

Dec Vax, Unibus and Que—Systems and Options	Call
Dec Printers and Terminals—VT100, LA10 etc.	Call
Dec Rainbow's, Pro's, Decmate's	Call
Tektronix 4010, 4014, 4027, 4114, 4631, 4662, 4924, 4953	Call
Emulex SDC3, SC21, FE07, UC003	Call
Data Dynamics Sig/Net 3 System 3FND	£300
Superbrain SD, JD, JR—1 & II, also Compuser	Call
Apple IIE with Symbolic 20Mb Winchester	1,000.00
Logica VFS 2200 CPU Box (No VDU or Printer)	300.00
Televideo TS806-02 Multi-user CPM System	500.00
Rathouser RS951 Twin Bin Sheet Feed	100.00
Diablo Tractor (HS31, 1940, 1950, 1940 etc)	75.00
Diablo 820, 630, 1345A, 1641, 1650 Printers	Call
Facit C7500 Serial and Parallel Printer	900.00
Datsouth DS180 Printer	500.00
Olilog DU130, DQ202, DQ202A, DU202, D215, DQ504	Call
Intel SBC 304 128k Memory expansion NEW	150.00
Intel Various Modules, System Boxes, etc	Call
Xyloces 570, 575 and Wizard Controllers	Call
KMF B8000 Se-Labs 8800 Serial Tape Interface	300.00
Kennedy 9000/800/1600 Magnetic Tape Drive	500.00
Tandberg TDC3000 Cartridge Tape Drive	250.00
Digi-Data 1735, 1749 Magnetic Tape Drives	Call
Timeplex E-Series Concentrator	200.00
Televideo VDU's Model No's 912/914/925/950/970	250.00
S.E.L. 3006 Unibus Int. (Cambridge Ring)	250.00
Microbar DBC68K Multibus 68000 Single Card	250.00
Archive 30201 Cartridge Tape Drive NEW	300.00
Matrox RGB 1000, VGM 1000 Multibus RGB Colour	300.00
3COM Multibus Ethernet Controller NEW	350.00
Claude Lyons LVC800 Line Voltage Conditioner	300.00
Farnell 66-40A Power Supply (5V) — 40A NEW	100.00
Lambda L052-5 OR L0DX-152 Power Supply NEW	60.00
Mitsubishi D319 19" Colour Monitor	250.00
Summagraphics Bit Pad One — IEEE Int. NEW	300.00
Summagraphics 20 x 20 SGPDP Controller	200.00
Intercolour 801G Colour VDU	350.00
CDC BR881A Double Sided D/D Floppy drive	100.00
Raii 3 313 980 781 314 Servo Motors NEW	50.00
Dataproducs 2230 3001PM Drum Printer	300.00



ASHLING UK
Equipment bought and sold
Call Tom Tobin on 0788 70618

ALL TYPES OF BUSINESS COMPUTERS AND PERIPHERALS

from micros to mainframes

Bought, sold and exchanged.

For fast efficient service

Call Phil Rose or Grant
Penaluna on

(0606) 783338. Telex: 946 240

Quoting 1902 5795

Fax: 0606 79367

**DELOSTAR
ELECTRONICS LTD**

Delostar House, Barnton,
Cheshire CW8 4JS

PROGRAM FILE

mand: for example, *LOAD :1.file. Any drive can be tested — no other change is required to the program. So, in the rest of the documentation where it refers to 'drive 1' read 'any other drive'.

If the utility fails to work (that is to say, drive 1 continues to spin and the message does not appear) then you must increase the values of two user parameters 'delay' and 'start_delay' at lines 200-210. Note that values are expressed in seconds.

The start_delay was introduced after testing the utility on a Master. I discovered that the 1770 DFS behaves differently from the original standard DFS. With the former it is necessary to allow drive 0 to stop before the utility tests drive 1, otherwise it does not work. The problem is apparent only if the utility is chained rather than loaded, and run.

On my standard Model B using Pace drives, this delay is unnecessary and 'start_delay' can be made equal to zero.

Similarly, I can reduce the value of the other parameter 'delay' to two seconds. This delay determines the amount of time allowed to access a disk in drive 1 before the effort is abandoned (see below for a more detailed explanation). Lowering the values of 'delay' and 'start_delay' to their minimum working values will make the utility more efficient, so be prepared to experiment.

Note that if the utility works consistently with 'start_delay' equal to zero, then lines 210, 310-450 can be deleted from DEMO1. Similarly, line 170, 270-410 can be deleted from DEMO2.

Incidentally, the third user parameter 'code' determines where the machine code is assembled and can be changed to any other convenient value.

A second version of the demonstration program is included. It is similar in every respect except that the machine code is loaded indirectly rather than being assembled. This makes the program shorter. In this case first run the source program 'SOURCE' which assembles and automatically saves the object code as 'm/c'. The code occupies 93 bytes from &0C00 to &0C5C.

Before running SOURCE do remember to change the values of 'delay' and 'start_delay' if you found this necessary using DEMO1.

To include the routine in your own programs study DEMO2 or follow the instructions below:

- use the ON ERROR command to point to the error-handling routine
- disable escape (*FX200,1)
- load the code (*LOAD m/c)
- give the start address (code=&C00)

- before accessing a drive CALL code

- immediately after the drive has been accessed disable event (*FX13,5)

- set up the error-handling routine

- the details of this, such as where the message appears on the screen, may be altered

- the last line of the error-handling routine should be a GOTO jump to the line that called the code.

Since the BBC system does not have a built-in way of coping with the problem, the solution is to use an interrupt routine. This is fairly easy as the operating system has a number of events available. If an event is enabled and it occurs, then control passes to the user's own code. The event vector (eventv) at address &220 must point to this code.

In this utility, event 5 is used. This occurs when the interval timer crosses zero. It is enabled with the command *FX14,5, or an OSBYTE call with A=14 and X=5. The initial value of the timer has to be stored in five bytes and addressed by the X and Y registers. A call to OSWORD with A=4 will write this value to the timer. After this, the value will be incremented 100 times every second.

Since the timer is incremented and the event occurs when it reaches zero, we give the timer an initial negative value. The utility converts the delay in seconds set by the user at line 200 to the appropriate value.

The value of the delay must be such that the minimum time is wasted before the user is informed that a drive is empty. But there must be enough time to allow the operating system/disk filing system to access the drive. In the demonstration program an attempt is made to catalogue a disk but, whatever the disk command, as soon as it is completed the event must be disabled with *FX13,5.

When called, the machine code does the following. There is an initial delay as determined by the value of start_delay. The event vector is given the address of the event-handling routine. The timer is set to its initial value and the event is enabled. Control returns to the Basic program.

The program then tries to access drive 1. If successful, the disk is catalogued, the event disabled and the program ends.

If, however, there is no disk in drive 1, then after four seconds the timer crosses zero, which causes a jump to the event handling routine. This is very simple. Apart from saving and restoring the registers, all it consists of is an OSBYTE call with A=&7D, which sets the Escape condition. This is partially equivalent to

PROGRAM FILE

pressing the Escape key. The disk access is interrupted and, because of the ON ERROR command, control now passes to the error routine.

This checks to see that the error is not 17 (Escape), in which case it is reported in the usual manner. Otherwise a message to insert a data disk is displayed.

It is necessary to disable the Escape key at the beginning of the program in order for this strategy to work. Otherwise pressing it would cause the message to be displayed in appropriately. Note that the *FX200,1 command used does not stop the OSBYTE call from working.

To test if the utility is compatible

with your disk filing system try *CAT with no disk in drive 0 and press Escape. If the drive fails to stop, then the utility will not work. The Watford DDFS is the only one I know of that behaves in this manner. Apart from this, the program should be compatible with most systems. It has been tested with the following:

BBC Model B

BASIC 1 & BASIC 2
Acorn DFS & Watford DFS
Pace 40k dual drives
Cumana 40k dual drives
Viglen 40/80k dual drives

Master 128

Acorn 1770 DFS
Viglen 40/80k dual drives

Explanation of DEMO1 by line number

60	If error jump to special error handling routine
100	Call empty drive check routine
110	Simple example of disk access for demonstration
120	Disable event 5
170	Disable Escape key
200	Set main delay
210	Set start_delay
220	Start address of code
250	Address of event vector
310-450	Delay start of main routine
460	Start of initialising phase
460-490	Write address of event handling routine to event vector
500-570	Set up initial value of timer in 5 byte data section
580-590	X & Y registers set to address of value
600-610	Write value to interval timer
620-640	Enable event 5
650	Return from initialising phase
660	Start of event handling routine
670-720	Save registers
730-740	Set Escape condition
750-800	Restore registers
810	Return from event handling routine
830-870	Data area for initial value of timer; also used as workspace
930	Disable event 5
950	Deal with other errors
960	Instruct user to insert disk in drive
980	Jump back to check routine until instruction carried out

```

10 REM Empty drive utility
20 REM Demo 1
30 REM John Tissandier
40 REM July 1987
50 :
60 ON ERROR GOTO 920
70 MODE 7
80 PROCinit
90 PRINT CHR$(131); "DEMO 1"
100 CALL code
110 *CAT 1
120 *FX13,5
130 END
140 :
150 DEF PROCinit
160 LOCAL d,delay,evntv,osbyte,osword
170 *FX200,1
180 :
190 REM User parameters
200 delay=4
210 start_delay=1
220 code=&C00
230 :
240 d=&10000-delay*100
250 evntv=&220
260 osword=&FFF1
270 osbyte=&FFF4
280 FOR pass=0 TO 2 STEP 2
290 PK=code
300 [OPT pass
310 LDA &start_delay*5.5
320 BEQ skip
330 STA data
340 .loop1
350 LDX &FF
360 .loop2
370 LDY &FF
380 .loop3
390 DEY
400 BNE loop3

```

MICROMART

Please call to trade in
IBM/Apricot PC's

P.B. ELECTRONICS LTD
P.O. BOX 96 WARRINGTON WA4 1LD
(0925) 415636
TEL 937400 ONEONE G. Quire Ref: 2860001

EPSON PC + 640k 20Mb 360k Floppy Disc Mono Monitor £699

EPSON FX800	£312.00	EPSON LQ800	£453.00
EPSON FX1000	£399.00	EPSON LQ1000	£599.00
EPSON EX800	£395.00	EPSON LQ2500	£749.00
EPSON GQ 3500	£1325	EPSON SQ2500	£975.00
CANON LASER PRINTER LBP-8 £1475.00			
EPSON COMPUTERS			
EPSON PC/20Mb 512k MONO mon £950.00			
BROTHER			
M1409	£302.00	M1509	£390.00
M1709	£453.00	M4018	£1049
HR20	£347.00	HR25 XL	£521
HR35	£746	HR40	£746
STAR			
NR-15	£405.00	NL-10	£178.00
NB24-15	£525.00	NL-10	£159.00
NB-15	£655.00	NX-15	£272.00
NB24-10	£444.00	ND-15	£339.00

IBM COMPATIBLE COMPUTERS

SBCFD 640k 2x 360k F/D mono monitor, keyboard, MS DOS	£599.00
SBCFD Cas above with 14" colour monitor	£799.00
SBCHD 20/40k 1x 360k F/D 20Mb, hard disk, mono mon, keyboard, MS DOS	£999.00
SBCHD 20/2 Cas above with 14" colour monitor	£1199.00
SBC 286AT 1Mb RAM 1x 1.2Mb F/D 30Mb hard disk green/amber monitor	£1799.00
SBC 286ATe as above with 14" EGA colour monitor	£1999.00

Please note all SBC computers inc 12 months on-site maintenance. Prices exclusive of VAT.

Major suppliers of a wide range of popular computers, peripherals, software etc. Call for competitive prices.

ADVANCED STATISTICAL SYSTEM for BBC Models B, B+ and Master 128 FIRST

Standard, Professional and Academic Features

Fast, robust, accurate, interactive, modular. Full data management. Transforms, dummy variables, data subsets. Scatter & Normal prob. plots. Detailed Univariate Stats., t tests.

Unrivalled regression facilities
(Weighted, through the origin, standardised). Correlation matrix, ANOVA for regression, Residuals, fitted values & confidence intervals. Contour plots from regression. Advanced regression DIAGNOSTICS, VIF's, influential points etc.

Unique ROBUST regression.
True NONLINEAR regression
Two and Three-way ANOVA. Cluster analysis. Time Series & smoothing. Nonparametric methods. Distribution generators. Histograms. Chisquared tests. Specialised Linear Calibration. "Outlier" detection. Numerous other powerful options. Full utilities (data saving, dumps, printing, formatting, etc.)

Comprehensive Manual—Full User Support

Special versions available for

32016 Co-processor ACW, & Archimedes

Price £90-£150 depending on features.

Versions for Industry Standard PC's available.

Full details from:

Serious Statistical Software

Lynwood, Bentley Heath Lane, Willaston, S. Wirral L64 1SD.

Tel 051-327 4268

ASHCOM

Atari hardware

520 STFM, keyboard/mouse/5 meg drive	£259.95
1040 STF keyboard/mouse/1 meg drive	£439.95
1040 SFT plus colour monitor	£799.95
SF 314 1 meg drive	£169.95

Commodore Amiga range

A500 4	£499.95
A1010 disc-drive	£249.95
3.5 inch discs DS/DD guaranteed (packed in 10s)	£14.95

Amazing prices on peripherals and all software. All prices include VAT at 15% and P&P on UK mainland. To order send cheques/PO or Visa/Access details to the address below or phone with credit card.

ASHCOM

10 The Green, Ashby de la Zouch,
Leicestershire LE6 5JU.

For more information call us on
(0530) 411485 for send SAE for
full price list.

MICROMART

PostGraph

A plotter program for scientists, academics and professionals. Draws high quality line graphs, scatter graphs and histograms. Designed for theses, research papers, project reports. Complete with built-in text editor for data file preparation. Imports data as ASCII text files from other programs. Previews plotter output on screen. Can copy preview screen to printer for rough drafts.

Plotters supported:
EPSON HI-80 Plotter (all modes)
HEWLETT-PACKARD Graphics Language-compatible
WATANABE (and compatibles)

Requires: IBM-PC/XT/AT or compatible computer (including AMSTRAD PC1512) running PC-DOS/MS-DOS 2.x or 3.x with at least 300K of free memory. Graphics board (CGA, EGA or Hercules) needed for on-screen preview of plotter output (otherwise program will run in text-only mode). Epson or compatible printer with graphics needed for screen dump.

Not copy-protected. You may return the program for any reason within 30 days after purchase for a full refund.

Price: £19.95

No VAT. Price includes airmail to all countries. Disk formats other than standard IBM 5.25 inch: please call. Orders, stating computer type, with cheque (all currencies acceptable) to:

Syntax Systems

6 Caberston Avenue, Walkerburn, Peeblesshire, EH43 6BA
Telephone: (089 687) 222

ALEXMAN LTD

0293 22210

Gatwick Press Buildings,
Lowfield Heath
Crawley, Sussex, RH11 0PH

Suntek PCXT Turbo 20Mb, Mono **£845**
Suntek PCXT Turbo 20Mb, Colour **£995**
Suntek PCAT 20Mb, Mono **£1795**
Suntek PCAT 20Mb, Colour **£2145**

Also

FULL AMSTRAD RANGE

Not including VAT and carriage

COMPUTECK

Some Points of Interest

A business has to make a profit to survive and you, the customer provide that profit to keep that business trading. Out of that profit comes lots of costs and usually a large one is advertising. We at Computeck keep our advertisements small and running costs to a minimum, then we can pass these savings on to you by way of discounts, as much as 20% on some items. At present we have 800 plus items on our lists of new and used hardware and software. We trade in software and hardware for new items. So send a SAE today for our up to the minute prices from an Archimedes to a Ram chip we have it all - Minerva Systems, Pace, Computer Concepts, AMS, Beebug, ACP, Taxan, Vire Micros, etc. etc. We are also registered Acorn Dealers. So if the above makes sense to you, buy from us and we will be able to pass on bigger and bigger savings to you.

Due to large stocks - 10 tape based games £12.95 + £1.50 PP

Telephone 04574 65953 ACCESS and VISA accepted

Computeck (Dept MU)

2 Werneth Road, Glossop, Derbyshire SK13 9LZ

WARNING:

Anyone sending 'pirated' software on any media will be reported to the Software House or Author for legal action by them!

PROGRAM FILE

```

410 DEX
420 BNE loop2
430 DEC data
440 BNE loop1
450 skip
460 LDA #interrupt MOD 256
470 STA evtv
480 LDA #interrupt DIV 256
490 STA evtv+1
500 LDA #(d MOD 256)
510 STA data
520 LDA #(d DIV 256)
530 STA data+1
540 LDA #&FF
550 STA data+2
560 STA data+3
570 STA data+4
580 LDX #data MOD 256
590 LDY #data DIV 256
600 LDA #4
610 JSR osword

620 LDX #5
630 LDA #14
640 JSR osbyte
650 RTS
660 .interrupt
670 PHP
680 PHA
690 TXA
700 PHA
710 TYA
720 PHA
730 LDA #&7D
740 JSR osbyte
750 PLA
760 TAY
770 PLA
780 TAX
790 PLA
800 PLP
810 RTS
820 .data
830 NOP
840 NOP
850 NOP
860 NOP
870 NOP
880 ]
890 NEXT
900 ENDPROC
910 :
920 REM Error routine
930 *FX13,5
940 VDU 7
950 IF ERR<17 REPORT:PRINT " at line ";ERL:END
960 PRINTTAB(0,2);CHR$(134);"Insert data disc and press RETURN"
970 REPEAT UNTIL GET=13
980 GOTO 100

10 REM Empty drive utility
20 REM Source code
30 REM John Tissandier
40 REM July 1987
50 :
60 MODE 7
70 PRINT" Assembling..."
80 PROCassemble
90 PROCoscl("SAVE m/c "+STR$code+" "+STR$P%)
100 PRINT "Machine code saved as";CHR$(131);"m/c"
110 END
120 :
130 DEF PROCassemble
140 :
150 REM User parameters
160 delay=4
170 start_delay=1
180 code=%C00
190 :
200 d=%10000-delay*100
210 evtv=%220
220 osword=%FFF1
230 osbyte=%FFF4
240 FOR pass=0 TO 2 STEP 2
250 P%code
260 [OPT pass
270 LDA #start_delay*5.5
280 BEQ skip
290 STA data
300 .loop1
310 LDX #&FF
320 .loop2
330 LDY #&FF
340 .loop3
350 DEY
360 BNE loop3
370 DEX
380 BNE loop2
390 DEC data
400 BNE loop1
410 .skip
420 LDA #interrupt MOD 256
430 STA evtv
440 LDA #interrupt DIV 256
450 STA evtv+1
460 LDA #(d MOD 256)
470 STA data
480 LDA #(d DIV 256)
490 STA data+1
500 LDA #&FF
510 STA data+2
520 STA data+3
530 STA data+4
540 LDX #data MOD 256
550 LDY #data DIV 256
560 LDA #4
570 JSR osword
580 LDX #5
590 LDA #14
600 JSR osbyte
610 RTS

620 .interrupt
630 PHP
640 PHA
650 TXA
660 PHA

```

PROGRAM FILE

```

670 TYA
680 PHA
690 LDA E&7D
700 JSR osbyte
710 PLA
720 TAY
730 PLA
740 TAX
750 PLA
760 PLP
770 RTS
780 .data
790 NOP
800 NOP
810 NOP
820 NOP
830 NOP
840 ]
850 NEXT
860 ENDPROC
870 :
880 DEF PROCoscli(com$)
890 oscli=&FFF7
900 $&900=com$
910 X%=0:Y%=9
920 CALL oscli
930 ENDPROC

10 REM Empty drive utility
20 REM Demo 2
30 REM John Tissandier
40 REM July 1987
50 :
60 ON ERROR GOTO 210
70 MODE 7
80 PROCinit
90 PRINT CHR$(131):"DEMO 2"
100 CALL code
110 *CAT 1
120 *FX13,5
130 END
140 :
150 DEF PROCinit
160 *FX200,1
170 *LOAD m/c
180 code=&C00
190 ENDPROC
200 :
210 REM Error routine
220 *FX13,5
230 VDU 7
240 IF ERR<>17 REPORT:PRINT " at line ";ERL:END
250 PRINTAB(0,2):CHR$(134):"Insert data disc and press RETURN"
260 REPEAT UNTIL GET=13
270 GOTO 100
    
```



MBasic Number Pursuit

by David Aitken

This program was written in BasicA on a standard IBM PC with a double-sided disk drive but should work on any machine with a version of Microsoft Basic.

Converting the program to run on other computers

All graphics are produced by printing strings to the screen locations using the LOCATE command. This is unusual in any experience in that it uses coordinates as (y,x): that is, it counts down and then counts across with position (1,1) at the top left of the screen rather than (0,0).

Other commands which may be unfamiliar to home machine users could be:

WIDTH 40/80 — which sets screen to 40 or 80 characters per line.

SCREEN — which is used in this case to turn on the colour mode.

PLAY"MB T string" — play music in background at a tempo and with the notes given as letters.

STRING\$(length,ascii code) — makes a string of characters in this case usually square to clear an area of screen.

KEY — there are a number of varia-

tions of this command in the program and their function is described there. They are all concerned with the use of the function keys and could be omitted with the sub-routines.

The game is loosely based on trivia board games, but with number calculations as the questions — a page of help instructions is included at the beginning and can be called up during the game using a function key.

The screen is divided into four windows during play. The largest window contains the game board and is at the top left of the screen. It is four-sided and four tokens must be collected before returning to the centre to win.

In a strip across the bottom of the screen are two windows. To the right-hand side is a small window containing a die to give each player their move. The rest of the strip on the left-hand side is used for input/output. Prompts are given here to tell the player what they should do next to continue. The player's answers to the calculations are also entered in this space.

In the top right-hand corner is a

MICROMART

SOVERIGN MAIL-ORDER

289 St. Saviours Road, Leicester LE5 4HG
TEL: (0533) 490043. OPEN Mon-Sat 11am to 7.30

Dealers of Atari ST's & Atari PC's
software and hardware

DISCS DISCS

100 3.5"SS/DD for £109
10 3.5"SS/DD for £14.00
10 3.5"DS/DD for £16.00
10 5.25"DISCS for £6.50

NEW NEW NEW

ST Mouse extension
leads for STFM — STFM
at **ONLY £4.99**
each

LOOK 5 FREE DISCS

Buy 20 5.25" discs at
£13.00 get 5 extra FREE

ATARI 1040 STFM
FREE MOUSE & MAT ETC.
+ free software
ONLY £459.88

MOUSE MATS at £4.50

Lots of software get our
special free ST price
list, send large SAE

ATARI 520 STFM
FREE MOUSE & MAT ETC.
+ free software
ONLY £285.88

**ALL PRICES INC. VAT & P/P
IN THE UK MAINLAND**

MS-DOS FLEX UNIFLEX OS-9 OS-9/68K CROSS ASSEMBLERS

A suite of cross assemblers supporting
the following devices:

1802 1805 6303 6502 6503 6800 6801
6802 6803 6804 6805 68HC05 146805
6808 6809 68HC11 8020 8021 8022 8031
8035 80C35 8039 80C39 8040 8048
80C48 8049 80C49 8050 8051 8080 8085
8748 8749 8751 Z8 Z80 68000

Extensive directives support modular,
conditional and structured programming.
Supplied with conversion utilities and
powerful macro preprocessor.

COMPLETE SUITE £295 + VAT
INCLUDING FULL 'C' SOURCE (not 68000)
INDIVIDUAL ASSEMBLERS £40 each

Micro Concepts Tel: 0242 510525
2 St Stephens Rd, Cheltenham, Glos

TECH SUPPLIES

Ex-stock electronic components,
over 1,000 stock lines. Computers,
peripherals, word processors, test
equipment and office equipment.

NO ORDER TOO SMALL
NO ORDER TOO LARGE

19i Winchester Avenue,
Denny, Stirlingshire FK6 6QE

Tel: 0324 825627

Open 7 days. 9am-4pm, 7.30pm-10.30pm

(426)



MICROMART

ARE YOU THROWING YOUR MONEY OUT OF THE WINDOW

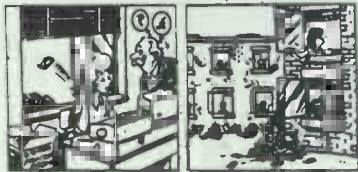

HAVE YOUR FABRIC RIBBONS RE-INKED FOR ONLY £1.50 or re-ink your own — OPM 2000 — OPM 3000 by using our kit comprising of 1 spare ribbon, 1 bottle of special ink and full instructions. EACH RIBBON WILL RE-INK ON AVERAGE 40 TIMES. ONLY £12.95

FREE SOFTWARE VOUCHER WITH EVERY COMPUTER

	RRP
PCW 8526 Disc Based Word Processor with Monitor & Printer	+ £45 Voucher £458.85
PCW 8512 Twin Disc Drive Word Processor with Monitor & Printer	+ £57 Voucher £573.85
CPC 464 Cassette Based Computer with Green Screen & Games Pack	+ £20 Voucher £199.95
CPC 464 Cassette Based Computer with Colour Screen & Games Pack	+ £30 Voucher £299.95
CPC 6128 Disc Based Computer with Green Screen	+ £30 Voucher £299.95
CPC 6128 Disc Based Computer with Colour Screen	+ £40 Voucher £399.95

Send for our Catalogue of over two thousand titles all at discount prices. All prices include post & packaging UK only. Export orders welcome.

COMSOFT

Suppliers of Hardware and Software for the Amstrad Computer
Comsoft House, 48 Duke Street, Coldstream, Warwickshire
TD12 4LF. Tel: 0890 2979. 24-hr Order Service on 0890 2854

GREAT SAVINGS! — AND GREAT SUPPORT!!

- ★ Keen prices AND helpful advice/on-site maintenance.
- ★ Big range: Amstrad, Tandon, SBC, Opus II, Commodore, Atari.
- ★ Printers by: Amstrad, Seiko-sha, Mannesmann Tally, Star, Honeywell
- ★ Software by (almost) EVERYBODY.
- ★ Hard cards, internal drives, modems, tape streamers, Bernoulli boxes.

All with big discounts (up to 20% on software), or free on-site maintenance by a national firm (for hardware). Delivery and printer cables free.

Hardware

- ★ PC1640 ECD HD20 £1100 (rrp £1199). EGA graphics, super-readable!
- ★ PCW9512 £499 (incl. daisywheel!) The WP!
- ★ PC1512 HD20, MM, £800 (was £899). Quality with capacity.
- ★ PC1512 HD20, CM, £969 (was £1069). Capacity with colour.
- ★ SBC 286AT, 30Mb MM, £1550 (was £1799). The fier!
- ★ SBC 286AT, 30Mb, CM, £1800 (was £2199). Beauty and the Beast!
- ★ Atari/Commodore machines, 10% off list. Twelve months warranty. Ampex screens at silly prices. Twelve months warranty
- ★ 20/30Mb hard, £350 Internal kit, or card.
- ★ Amstrad modem card, £130 (was £150). Log onto any Bulletin Board!
- ★ Amstrad floppy, £140 (was £159). Full instructions.

We fit for £10 within 30 miles of Sunderland, Tyne & Wear.

Software

15-20% off list price for many products.

Add VAT at 15% to all prices. Cheque with order, payable to R. B. McTernan.



PERIPHERAL
HARDWARE

Microcomputers, Software
and Peripherals

26 UNDERHILL RD
CLEADON VILLAGE
SUNDERLAND,
TYNE & WEAR SR6 7RS
Wearside (091) 536 7951

REGIPLATE PAPER FEED TRAY FOR THE PCW PRINTER

Margins and headings always in the same position. Make your own templates with repeated accuracy. You can insert text in any position by overprinting on pre-printed paper, even from another source (i.e. copier).

The low price doesn't reflect on the plates high quality manufacture, and as it offers both lateral and longitudinal accuracy. It must be the best value and use, ever. In fact if you aren't completely satisfied, you may return it within 14 days for a refund.

To order your "regiplate"

Send cheque or postal order for

£5.95 + £1.50 P/P UK
£2.80 P/P Europe

To

Elect Organs, 31, The Lawns, Hinckley, Leics.
England. LE10 1DY. Tel: 0455 612484

PROGRAM FILE

double window. The first time it is used it gives a list of the possible places to which the player can move, and the sort of calculation which they will be asked to do. This is later covered by the actual calculation required, and these two displays alternate as required.

Scoring

The introductory pages to the game ask for the number of players and their names. At this point each player is asked for a difficulty level — 1, 2, 3, 4. This difficulty level is used to increase the complexity of the calculations asked and also to decide the number of points a player earns. The number is increased for every correct answer and decreased for each error.

In addition, each token receives a bonus and the first person home to the centre with four tokens receives another bonus. Because of the weighting effect of starting at a high-

er level of difficulty, it is quite possible (though a little unlikely) for the first person back *not* to have the highest total of points. This is one of the reasons why the function key to call up a display of points was included.

Typing in the program

Apart from the function key interrupts in which the routines have to call the board drawing subroutine, only the footnote subroutine is called by other subroutines. All other routines are called from the main loop of the game — lines 900 to 1100. It is therefore possible to type and debug each routine separately if the footnote routine is entered first, or immediately after the initialisation and instructions routines.

REM statements are not called at any point and can be omitted to reduce typing. The routines to use and alter the function keys can be omitted or included last.

```

1 WIDTH 40:KEY OFF:SCREEN 0,1,0,0:GOTD 900
2 REM *****
3 REM **
4 REM ** Mathematical Pursuit (IBM)
5 REM ** by D. Aitken
6 REM **
7 REM *****
8 REM
9 REM *****
10 REM ** FUNCTION KEY 1 - SCORES
11 REM *****
12 KEY(1) STOP:KEY(2) STOP
13 COLOR 0,1:FOR J = 1 TO 20:LOCATE J,2:PRINT STRINGS(25,219):NEXT
14 COLOR 7,0:LOCATE 1,5:PRINT " POINTS SCORED.":PRINT
15 FOR L=1 TO NP:LOCATE 2*L+1,3:LP=INT(WT(L)*50+.5):LB=LEN(SCS(L))*100
16 PRINT NMS(L):" has scored":LP*LB:PRINT:NEXT
17 LOCATE 9,5:PRINT " TOKENS GAINED"
18 FOR L=1 TO NP:LOCATE 3*L+8,3:PRINT NMS(L):" has these --":S$=""
19 FOR M=1 TO LEN(SCS(L)):T$=MID$(SCS(L),M,1)
20 IF T$="1" THEN S$=S$+" blue,"
21 IF T$="2" THEN S$=S$+" green,"
22 IF T$="4" THEN S$=S$+" red,"
23 IF T$="6" THEN S$=S$+" yellow,"
24 NEXT M:IF S$<>" " THEN S$=LEFT$(S$,LEN(S$)-1):REM ** removes last comma **
25 LOCATE 3*L+9,3:PRINT S$:NEXT L
26 XX=-99:FTS="Press ENTER to continue ":GOSUB 500:GOSUB 9010:KEY ON:RETURN
27 REM *****
28 REM ** FUNCTION KEY 2 - instructions/help
29 REM *****
30 KEY(1) STOP:KEY(2) STOP:GOSUB 10200:CLS:GOSUB 9000:KEY ON:RETURN
31 RETURN
32 REM *****
33 REM ** rolls the dice for moves
34 REM *****
35 COLOR 4,1:FOR J = 20 TO 24:LOCATE J,34:PRINT " ":NEXT
36 XX=0:FTS=NMS(PL)+"'s move ":GOSUB 500:FOR J=1 TO 40:NEXT
37 SPS=CHR$(1):FOR J = 1 TO MO:REM sps is spot on dice - a face character
38 IF (J=1) THEN DIS(1) = " " :DIS(2) = " " :DIS(3) = DIS(1)
39 IF (J=2) THEN DIS(1) = " " :DIS(2) = " " :DIS(3) = DIS(1)
40 IF (J=3) THEN DIS(1) = " " :DIS(2) = DIS(1) :DIS(3) = DIS(1)
41 IF (J=4) THEN DIS(1) = SPS+" " :DIS(2) = " " :DIS(3) = DIS(1)
42 COLOR 7,1:FOR K = 21 TO 23:LOCATE K,36:PRINT DIS(K-20):NEXT K:
43 FOR I = 1 TO 90:NEXT I,J
44 FOR J = 1 TO 500:NEXT:RETURN
45 REM *****
46 REM ** offers the choice of moves
47 REM *****
48 COLOR 5,1:FOR J = 1 TO 19:LOCATE J,29:PRINT STRINGS(12,219):NEXT
49 XX=0:FTS="You may move to these places":GOSUB 500:RESTORE 12000:LM=0
50 COLOR 0,5:LOCATE 1,29:PRINT " No Subject":PRINT:J=(PO(PL)+4)+HO:
51 REM no of data items to read
52 FOR K=1 TO J:READ MO$:NEXT K
53 FOR J=1 TO 5:LJ=2-1:MV$(J)=MID$(MO$,L,2):REM separates single moves*****
54 IF MV$(J)="EE" THEN LM=LM-1:GOTO 340:REM LM counts no. possible moves
55 IF J>1 THEN COLOR 0,5:LOCATE 4*J-3,35:PRINT "or"
56 TP=VAL(MV$(J)):IF CA(TP)=BL THEN TP$ = " ADD"
57 IF CA(TP)=RE THEN TP$ = " SUBTRACT"
58 IF CA(TP)=GR THEN TP$ = " MULTIPLY"
59 IF CA(TP)=YE THEN TP$ = " DIVIDE"
60 IF CA(TP)=FR THEN TP$ = " FREE GO"
61 LOCATE VE(TP),HO(TP):COLOR 0,CA(TP):PRINT STR$(J):
62 REM **** SHOWS POSSIBLE MOVES ON BOARD ****
63 LOCATE 4*J-1,29:PRINT J:":TP$:REM *** LISTS POSSIBLE MOVES ****
64 LM=LM+1:NEXT J
65 XX=-99:FTS="Input number of move wanted ":GOSUB 500:REM footnote
66 Z=VAL(Z$):IF Z<1 OR Z>LM THEN FT$="ERROR IN INPUT":GOSUB 500:PLAY "p5":
67 GOTO 360
68 LOCATE VE(PO(PL)),HO(PO(PL)):COLOR CA(PO(PL)),0:
69 PRINT " " +CHR$(31)+CHR$(29)+CHR$(29)+" " :
70 REM *** BLANKS OLD POSITION ****
71 XX=0:PO(PL)=VAL(MV$(Z)):GOSUB 9240:REM *** new position marked ****
72 RETURN
73 REM *****
74 REM ** offer choice of question routine
75 REM *****

```

PROGRAM FILE

```

400 COLOR 7,1:FOR J = 1 TO 16:LOCATE J,30:PRINT STRINGS(10,219)::NEXT
410 COLOR 9,7:IF CA(PO(PL))=BL THEN QO=1
420 IF CA(PO(PL))=RE THEN QO=2
430 IF CA(PO(PL))=GR THEN QO=3
440 IF CA(PO(PL))=YE THEN QO=4
445 IF CA(PO(PL))=FR THEN GOSUB 6000:GOTO 490:REM *** FREE MOVE
450 ON QO GOSUB 2000, 3000, 4000, 5000:REM ADD, SUBTRACT,MULTIPLY, DIVIDE
460 XX=-99:FTS="INPUT YOUR ANSWER ":GOSUB 500
470 Z=VAL (Z$):IF Z<>RIGHT$(STR$(Z),LEN(STR$(Z))-1) THEN FTS="ERROR IN INPUT":
XX=0:GOSUB 500:PLAY "P5":GOTO 460
480 XX=0:IF Z=AN THEN AN$="TRUE":FTS=" CORRECT ":GOSUB 500:GOTO 490
482 AN$="FALSE":FTS="You are WRONG !":PLAY MF 01:GAG:GOSUB 500:PLAY "P1 GAG 04"
490 FOR J = 1 TO 16:LOCATE J,30:PRINT STRINGS(10,219)::NEXT:RETURN
497 REM *****
498 REM **          footnotes of assorted kinds          **
499 REM *****
500 COLOR 7,1:FOR J = 21 TO 24:LOCATE J,1:PRINT STRINGS(34,219)::NEXT
510 FOR J=0 TO 6:LOCATE 22,1
520 X=INT(LEN(FTS)/2):COLOR J,7:PRINT STRINGS(17-X,219):FTS:STRINGS(17-X,219):
530 FOR Y = 1 TO 60:NEXT Y,J:BEEP:COLOR 6
540 IF XX=-99 THEN LOCATE 23,4:PRINT NM$(PL)+" ":INPUT:Z$
550 RETURN
597 REM *****
598 REM **          main program starts here          **
599 REM *****
900 GOSUB 10000:REM ****  initialisation of variables  ****
910 GOSUB 10100:REM ****  get names of players  ****
920 PL=INT(RND(1)*3+1):REM PL is current player. This decides who will start.
930 IF PL=1 OR PL=NP THEN GOTO 920
997 REM *****
998 REM **          main LOOP of game          **
999 REM *****
1000 CLS:WIDTH 40
1005 CLS:GOSUB 9000:REM *****  draws board  ****
1010 GOSUB 9220:REM *****  updates game board - start of each move ****
1015 KEY(1) ON:KEY(2) ON:KEY ON:REM *****  turns on function key interrupts ****
1020 GOSUB 200:REM *****  rolls dice for moves ****
1030 KEY(2) STOP:GOSUB 300:PEM *****  offers choice of moves ****
1040 IF LEN(SC$(PL)) = 4 AND PO(PL) = HOME THEN GOTO 800:REM *** winner ***
1050 KEY(1) STOP:GOSUB 400:REM *****  QUESTION AND ANSWER ****
1055 KEY(1) ON:KEY(2) ON:REM ***  FUNCTN KEYS BACK ON ***
1060 IF AN$="TRUE" THEN WT(PL)=WT(PL)+1:REM ***  increase for right ***
1070 IF AN$="TRUE" AND (PO(PL)=13 OR PO(PL)=17 OR PO(PL)=21 OR PO(PL)=25)
THEN GOSUB 1200:REM *****  TOKEN GAINED ROUTINE *****
1080 IF AN$="FALSE" THEN WT(PL)=WT(PL)-1:REM ***  DECREASE FOR WRONG ****
1090 PL=PL+1:IF PL=NP THEN PL=1:REM ***  NEXT PLAYER ***
1100 KEY(1) STOP:KEY(2) STOP:GOTO 1010 REM ***  DISABLE FUNCTN KEYS ****
1197 REM *****
1198 REM **          TOKEN GAINED ROUTINE          **
1199 REM *****
1200 KEY(1) STOP:KEY(2) STOP
1205 Z$=RIGHT$(STR$(CA(PO(PL))),1):REM ***  single character to add to score **
1210 FOR X=1 TO LEN(SC$(PL)):IF MID$(SC$(PL),X,1)=Z$ THEN Z$="X-5"
1211 NEXT X:IF Z$="" THEN 1250:REM ***  to return if already have token ****
1220 PLAY "MB T255"+A1$:REM background music tempo fast+tune
1230 XX=0:FTS=" YOU HAVE WON A TOKEN ":GOSUB 500:PLAY A2$:SC$(PL)=SC$(PL)+Z$
1240 FTS=NM$(PL)+" you have "+STR$(LEN(SC$(PL))):GOSUB 500
1250 KEY ON:RETURN
1997 REM *****
1998 REM **          CREATES ADDITION QUESTION          **
1999 REM *****
2000 LOCATE 1,30:PRINT " ADD":A=INT(RND(1)*20+WT(PL)):B=INT(RND(1)*20+WT(PL))
2020 LOCATE 3,33:PRINT USING "EEEE":A:LOCATE 4,32:PRINT USING "+EEEE":B
2030 LOCATE 5,32:PRINT " _____":AN=A+B:RETURN
2997 REM *****
2998 REM **          CREATES SUBTRACTION QUESTION          **
2999 REM *****
3000 LOCATE 1,30:PRINT " SUBTRACT"
3010 A=INT(RND(1)*20+WT(PL)):B=INT(RND(1)*20+WT(PL)):IF B>A THEN 3010
3020 LOCATE 3,33:PRINT USING "EEEE":A:LOCATE 4,32:PRINT USING "-EEEE":B
3030 LOCATE 5,32:PRINT " _____":AN=A-B:RETURN
3997 REM *****
3998 REM **          CREATES MULTIPLICATION QUESTION          **
3999 REM *****
4000 LOCATE 1,30:PRINT " MULTIPLY"
4010 A=INT(RND(1)*20+WT(PL)):B=INT(RND(1)*10+WT(PL)):IF B>12 THEN 4010
4020 LOCATE 3,33:PRINT USING "EEEE":A:LOCATE 4,32:PRINT USING "*EEEE":B
4030 LOCATE 5,32:PRINT " _____":AN=A*B:RETURN
4997 REM *****
4998 REM **          CREATES DIVISION QUESTION          **
4999 REM *****
5000 LOCATE 1,30:PRINT " DIVIDE"
5010 A=(RND(1)*24+WT(PL)):B=(RND(1)*8+WT(PL)):IF B%12 OR B%=0 THEN 5010
5020 LOCATE 3,33:PRINT USING "EEEE":A%B:LOCATE 4,32:
PRINT " _____":LOCATE 5,33:PRINT USING "EEEE":B:AN=A%B:RETURN
5997 REM *****
5998 REM **          FREE MOVE CONDITIONS          **
5999 REM *****
6000 PL=PL-1:AN$="FREE":FOR J=1 TO 4:LOCATE 2+J,31:PRINT "FREE GO":NEXT:RETURN
7997 REM *****
7998 REM **          winner found routine/new game offered          **
7999 REM *****
8000 COLOR 6,3,14:CLS:PRINT STRINGS(40,"*")
8010 PRINT NM$(PL):" IS TOO FAST FOR YOU ALL":PRINT STRINGS(40,"*")
8020 FOR X=2 TO 6 STEP 2:PLAY A1$:FOR Y=1 TO 15:A=INT(RND(1)*15+5):
B=INT(RND(1)*26+6):LOCATE A,B
8030 COLOR 21,X:IF Y/2=INT(Y/2) THEN PRINT " FIRST " ELSE PRINT " VICTORY"
8040 NEXT Y,X:COLOR 6,3:LOCATE 2,1:PRINT STRINGS(40,"*")
8050 PRINT "EEEEEE BUT ARE YOU THE WINNER EEEEE"
8060 FOR X=1 TO 2500:NEXT X:COLOR 14,2,10:CLS
8080 PRINT SPC(12):"THE POINTS SCORED":PRINT STRINGS(40,"-")
8090 FOR X=1 TO NP:PRINT NMS(X):PRINT STRINGS(12,"*")
8100 PRINT SPC(8)"POINTS SCORED" TAB(24):INT(WT(X)*50+.5)
8110 B=LEN(SC$(X))*100:IF (B=400 AND PO(X)=0) THEN B=600
8120 PRINT SPC(8)"BONUSES SCORED" TAB(24):B
8130 NEXT:LOCATE 20,1:PRINT " The WINNER is"
8140 W=0:T=0:FOR X=1 TO NP:P=LEN(SC$(X))*100:IF P=400 THEN P=600
8150 P=INT(P+WT(X)*50+.5):IF P>T THEN T=P:W=X
8160 NEXT:PLAY A1$+"P2"+A2$:COLOR 22:LOCATE 20,23:PRINT NMS(W):PLAY A1$+A2$
8197 REM *****
8198 REM **          NEW GAME OFFERED          **
8199 REM *****
8200 COLOR 7,1:CLS:PRINT " DO YOU WANT A NEW GAME?:PRINT
8210 PRINT "To play with the same players enter ...1":PRINT
8220 PRINT "To play with new players enter .....2":PRINT
8230 PRINT "To end the game enter .....3":PRINT:PRINT
8240 COLOR 23:PRINT " PRESS THE NUMBER OF YOUR CHOICE"
8250 Z$=INKEY$:IF Z$="" THEN 8250
8260 IF Z$<"1" OR Z$>"3" THEN 8250
8270 IF Z$="2" THEN RUN
8280 IF Z$="3" THEN CLS:LOCATE 20,10:PRINT "THANK YOU FOR PLAYING":PLAY "P3":
WIDTH 80:COLOR 7,1:CLS
8290 IF Z$="3" THEN KEY 1,"list ":KEY 2,"run"+CHRS(13):KEY 3,"load ":
KEY 4,"save":KEY 5,"cont"+CHRS(13):KEY 6,"lpt1":KEY 7,"tron"+CHRS(13):
KEY 8,"TROFF"+CHRS(13):KEY 9,"key":KEY 10,"screen":END

```

MICROMART

PROTECH

Amstrad PC1512 Upgrade

Speed up your data processing

18 4164 — 15 D — RAMS +
S/W only £18.00

Upgrade your P.C. to 640k. Then make your computer process disk data faster using the disk cache program supplied FREE with our expansion kit.

The disk cache program can make tasks run up to 10% faster on mini based systems and up to 100% faster on floppy based systems.

Price includes postage, VAT, instructions and FREE S/W. (S/W available separately for only £2 to cover distribution costs) Send cheque/PO for £18 payable to Product Technologies to:

Product Technologies, Dept PCW,
151 Gloucester Place,
London NW1 6DX.

CREDIT CARD ORDERS PHONE: 01-724 0959

GEOL COMPUTERS

★ We deal in the whole range of computers from PCs to Spectrums including peripherals

★ Atari STFM Ferguson colour monitor now at new price of —
£459

Amiga 500, phone for cheapest price

PC1512 phone for cheapest price

We are main dealers for
Tuniworks range for the ST and
PC

We are now also at

1000 Uxbridge Road, Hayes
Tel: 01-573 2726

45 Boston Road, London W7
Tel: 01-579 6133 (416)

Reach the top
with...

LCL

Complete Self Tuition Courses



Amstrad (CPC, PCW, PC) (Disc/tapes)

Electron, BBC (tape/disc)

Spectrum Commodore 64

(IBM PC and Apple)

★ BEST REVIEWS ★

★ AS SEEN ON

★ TV WORLD

★ LEADERS ★

★ At all Major Stores ★ ★ Hons. Graduate/Teacher Authors ★

COMPLETE SELF-TUITION COURSES

(Each contains 24 programs) £5 off

total for 2, £10 off total for 3, £17 off

total for 4

MICRO MATHS (CPC, PCW, PC)

Course taking beginners (from age 8

yrs) to O-Level/GCSE, 24 programs on

59 topics on 2 tapes/discs + 2 books

£24

PRIMARY MATHS COURSE (CPC)

Course taking beginners (from 5 years)

to secondary school entrance in 35

programs divided into 18 lessons/tests.

All animated graphics, 2 discs/tapes

£24

MICRO ENGLISH (CPC, PCW)

Course taking beginners to English

Language GCSE. Incorporates real

speech, no extras required 2

tapes/discs £24

MEGA MATHS (CPC)

A-Level course for mature beginners.

A-Level Students or Micro Maths

users. Covers 105 topics on 2

tapes/discs + books £24.

NEW

IMMEDIATE
DESPATCH

MAJOR STORES
VISA

Phone orders or requests for free colour catalogue to:
LCL (Dept PCW), Melody House, 13 Deanfield Road,
Henley, Oxfordshire RG9 1UG

Tel: 0491 579345 (10am-10pm)

SCIENTIFIC SOFTWARE

STATIS 2 — Scientific Statistics Package.
 Parametric and nonparametric methods - ANOVA including repeated measures - Simple & Multiple linear regression - Nonlinear regression to user defined function (1)
 Power analysis - Graphical output pie & bar charts, line plots & scatter diagrams (2)
 and much more **£250**
REF — Reference database application
 Allows references to be stored and retrieved according to AUTHOR, JOURNAL, KEYWORDS etc., ready for publication **£50**
INTEG — Hard disk utility
 Define your own menu
 run your applications by a single keystroke. Similar menu for MSDOS commands **£50**

All applications run on IBM or compatible eg. AMSTRAD XEN under MSDOS.

Please send cheque or write for details to:

ClydeSoft

78 Meadows Avenue, Larkhall,
 Lanarkshire ML9 2JG

(1) MSBASIC Compiler-Microsoft (2) CSX Graphics-Digital Research

SLIP A DISC

☆ Spectrum software 25% cheaper than RRP

Commodore and Amstrad software 29% cheaper than RRP

Atari software 28% cheaper than RRP

We also stock Amiga, MSX, BBC, Electron and IBM compatible software

☆ all calculations are on average

Dept PCW, 5 St. Bernard's Rd.,
 Newcastle, Staffs ST5 6HH.
 Tel: 0782 711269

Please send a large SAE for current lists
 Cheques are made payable to Slip-a-Disc
 Post and packaging free expect overseas
 (Please add £1). Open 7 days a week

BIT ON THE SIDE!

6128, 8256/8512
 IBM PC + compatibles
 All Epson compatible printers

Spreadsheet Users.
 Don't be limited by the width of your printer. Take a turn for the better with BIT ON THE SIDE, the sideways printing program that handles the widest of spreadsheets.

£24.95 Inc. VAT + P&P

Cheques/POs to:

AWARE SOFTWARE

Dept PCW,
 157 Lonsdale Rd, Formby,
 Merseyside L37 3HF
 Tel: (07048) 31312
 Trade enquiries welcome

PROGRAM FILE

```

8300 FOR X=1 TO NP:SCS(X)="":PO(X)=0:NEXT:GOTO 930:
REM *** WT(X) HAS NOT BEEN RESET YOU MAY WISH TO DO SO ***
8997 REM *****
8998 REM ** draws game board and marks positions **
8999 REM *****
9000 COLOR 0,1:FOR J = 1 TO 20:LOCATE J,1:PRINT STRING$(28,219):NEXT
9010 COLOR 7,0:LOCATE 1,1
9020 PRINT
9030 PRINT
9040 PRINT
9050 PRINT
9060 PRINT
9070 PRINT
9080 PRINT
9090 PRINT
9100 PRINT
9110 PRINT
9120 PRINT
9130 PRINT
9140 PRINT
9150 PRINT
9160 PRINT
9170 PRINT
9180 PRINT
9190 PRINT
9200 PRINT
9210 PRINT
9220 FOR PP=0 TO 28
9230 LOCATE VE(PP),HO(PP):COLOR CA(PP),7:
PRINT "█"+CHR$(31)+CHR$(29)+CHR$(29)+"█":NEXT PP:
REM *** forms 2X2 square ***
9240 FOR PP=1 TO NP
9250 COLOR 0,CA(PO(PP)):LOCATE VE(PO(PP)),HO(PO(PP)):PRINT SYS(PP):PLAY "AC"
9260 NEXT PP:COLOR 7,1,0:RETURN
9997 REM *****
9998 REM ** Initialisation and variable list *****
9999 REM *****
10000 COLOR 0,5,4:CLS:REM BLACK ON PINK
10002 FOR X=1 TO 10:LOCATE 13,1:PRINT SPC(X):"NUMBER PURSUIT":
10004 P=X/3:IF INT(P)=P THEN PLAY "MB"+"T255ABCEB2"
10006 NEXT X:RANDOMIZE(VAL(RIGHT$(TIMES,2)))
10010 HOME=0:NP=0:PL=0:BL=1:RE=4:GR=2:VE=6:FR=7:
REM start,num. of players, current player, colours codes of catagories
10012 A1$="GABDDEDBGABBAGAGABDDEDBGABBAAG":
A2$="GAGBBCBGGGGGGGAGBCCBGGGGGGG":REM *** music strings *****
10020 DIM D$(4),M$(5):REM dice scores,possible moves each throw
10022 DIM HO(28),VE(28),CA(28):REM X,Y coordinates, catagory of question
10024 DIM N$(3),SY$(3),SC$(3),PO(3),WT(3):
REM names,symbols,scores,positions, difficulty level of players
10030 KEY 1,"SCORES":KEY 2,"HELP":REM *** REDEFINE FUNCTION KEYS ***
10032 FOR X=3 TO 10:KEY X,"":NEXT:REM *** TURNS OFF OTHER KEYS ***
10034 ON KEY(1) GOSUB 20:ON KEY(2) GOSUB 40:REM *** functn key interrupts ***
10060 FOR X=0 TO 28:READ HO(X),VE(X),CA(X)
10062 IF X=10 THEN LOCATE 21,17:PRINT "by D. Aitken"
10068 P=X/5:IF INT(P)=P THEN PLAY "T255ABCEG2"
10070 NEXT:PLAY "c255ABCEGA2"
10080 FOR X=1 TO 3:READ SYS(X),PO(X),WT(X):
YS=SYS(X)+CHR$(31)+CHR$(29)+CHR$(29)+SYS(X):SY$(X)=Y$:
REM *** FORMS A 2X2 SYMBOL *****
10090 NEXT:RESTORE:N$(0)="new":RETURN
10098 REM ** find names of players and offer rules **
10099 REM *****
10100 COLOR 7,1,1:CLS:INPUT "How many players ";J$:J=VAL(J$):
PRINT STRING$(39,"-")
10120 IF J < 1 THEN BEEP:PRINT:PRINT:COLOR 4,7:PRINT"Error in input! !":
BEEP:GOTO 10140
10130 IF J > 3 THEN BEEP:PRINT:PRINT:COLOR 4,7:PRINT"Too many players! !":
BEEP:GOTO 10140
10140 IF (J > 3) OR (J < 1) THEN FOR X = 1 TO 1000:NEXT:GOTO 10100
10150 FOR X = 1 TO J:INPUT"NAME OF PLAYER ";N$(X):PRINT:
PRINT"You are player ";CHR$(64+X):PRINT:
10152 INPUT"what difficulty level do you want - ENTER 1, 2, 3 or 4":WT$:
W=INT(VAL(WT$)):PRINT STRING$(39,"-")
10154 IF W<1 THEN W=1 ELSE IF W>4 THEN W=4
10160 WT(X)=W:IF LEN(N$(X))/2<>INT(LEN(N$(X))/2) THEN N$(X)=" "+N$(X)
10170 NEXT:NP=J
10172 PRINT STRING$(39,"="):LOCATE 23,3:COLOR 23:
REM *** color 23 white foreground letters flash ***
10174 PRINT"if you wish instructions PRESS Y or N,"
10176 Z$=INKEY$:IF Z$="" THEN 10176
10178 IF Z$="Y" OR Z$="y" THEN GOTO 10200
10180 IF Z$="N" OR Z$="n" THEN COLOR 7:RETURN
10190 GOTO 10176
10197 REM *****
10198 REM ** Instructions and rules *****
10199 REM *****
10200 COLOR 0,6,14:CLS:REM BLACK ON brown
10210 PRINT "This game is like Trivial Pursuit with"
10220 PRINT "addition, subtraction, multiplication"
10230 PRINT"and division questions.":PRINT
10240 PRINT"You win a token if you answer questions"
10250 PRINT"correctly in any of the four corners."
10260 PRINT"Collect one from each corner and return"
10270 PRINT"to the centre square to be first.":PRINT
10280 PRINT"HOWEVER, YOU MIGHT NOT BE THE WINNER.":PRINT
10290 PRINT"You gain points for each correct answer"
10300 PRINT"and bonuses, 100 points for each token"
10310 PRINT"and 200 points for being first.":PRINT
10320 PRINT"THE WINNER IS THE PERSON WITH THE MOST"
10330 PRINT"POINTS AFTER THE FIRST PLAYER REACHES"
10340 PRINT"THE CENTRE.":PRINT
10350 PRINT"Beware the more answers you get correct"
10360 PRINT"the harder the questions become!"
10370 COLOR 16:LOCATE 24,1:INPUT "press ENTER to continue":Z$
10371 REM *** color 16 makes the foreground black flash ****
10380 COLOR 0:RETURN:REM *** to switch off flashing black *****
10997 REM *****
10998 REM ** data for positions and player symbols **
10999 REM *****
11000 DATA 14,10,7,17,8,4,20,8,1,23,4,2,17,12,6,20,14,4,23,16,1:
REM 7 positions so far
11010 DATA 11,12,2,8,14,6,5,16,4,11,8,1,8,6,2,5,4,6:REM 13 so far
11020 DATA 1,1,4,8,1,1,14,1,7,20,1,2,27,1,6,27,6,4,27,10,7,27,14,1,27,19,2:
REM next is 23
11030 DATA 20,19,6,14,19,7,8,19,4,1,19,1,1,14,2,1,10,7,1,6,6
11049 REM *** data for players ****
11050 DATA "AA",0,1,"BB",0,1,"CC",0,1,"DD",0,1:
REM *** LETTERS PRINT ON BOARD TO SHOW POSITIONS OF PLAYERS
11999 REM *** data for moves offered ****
12000 DATA 01040710EE,02050811EE,03060912EE,17212513EE:REM position 0 ie HOME
12110 DATA 1210EEEEEE,1300EEEEEE,2814010407,1527020508:REM positn 11 ie GREEN
12010 DATA 0200EEEEEE,03040710EE,17050811EE,1819060912:REM position 1 ie RED
12020 DATA 0301EEEEEE,1700EEEEEE,1618050710,1519050811:REM position 2 ie BLUE
12030 DATA 0217EEEEEE,181601EEEE,151900EEEE,1519000710:REM position 3 ie GREEN
12040 DATA 0500EEEEEE,06071001EE,21081102EE,2022031209:REM positn 4 ie YELLOW
    
```

PROGRAM FILE

```

12050 DATA 0604EEEEEE,2100EEEEEE,2022011007,1923021108:REM positn 5 ie RED
12060 DATA 2105EEEEEE,202204EEEE,192300EEEE,1824011007:REM positn 6 ie BLUE
12070 DATA 0800EEEEEE,09040110EE,25110205EE,2624120603:REM positn 7 ie GREEN
12080 DATA 0907EEEEEE,2500EEEEEE,2624040110,2723110205:REM positn 8 ie YELLOW
12090 DATA 2508EEEEEE,242607EEEE,232700EEEE,2228040110:REM positn 9 ie RED
12100 DATA 1100EEEEEE,12010407EE,13020508EE,2814030609:REM position 10 ie BLUE
12110 DATA 1210EEEEEE,1300EEEEEE,2814010407,1527020508:REM positn 11 ie GREEN
12120 DATA 1311EEEEEE,281410EEEE,271500EEEE,2616010407:REM positn 12 ie YELLOW
12130 DATA 142812EEEE,152711EEEE,162610EEEE,172500EEEE:REM positn 13 ie RED
12140 DATA 1513EEEEEE,162812EEEE,172711EEEE,182610EEEE:REM positn 14 ie BLUE
12150 DATA 1416EEEEEE,1317EEEEEE,28121803EE,27111902EE:REM positn 15 ie FREE
12160 DATA 1517EEEEEE,141803EEEE,131902EEEE,28122001EE:REM positn 16 ie GREEN
12170 DATA 160318EEEE,151902EEEE,142001EEEE,132100EEEE:REM positn 17 ie YELLOW
12180 DATA 1719EEEEEE,162003EEEE,150221EEEE,14220106EE:REM positn 18 ie RED
12190 DATA 1820EEEEEE,1721EEEEEE,16032206EE,15022305EE:REM position 19 ie FREE
12200 DATA 1921EEEEEE,182206EEEE,172305EEEE,16032404EE:REM position 20 ie BLUE
12210 DATA 202205EEEE,192305EEEE,182404EEEE,172500EEEE:REM positn 21 ie GREEN
12220 DATA 2422EEEEEE,2521EEEEEE,20062609EE,27081905EE:REM positn 22 ie YELLOW
12230 DATA 2422EEEEEE,2521EEEEEE,20062609EE,27081905EE:REM positn 23 ie FREE
12240 DATA 2325EEEEEE,222609EEEE,212708EEEE,20062807EE:REM positn 24 ie RED
12250 DATA 242609EEEE,232708EEEE,222807EEEE,211300EEEE:REM positn 25 ie BLUE
12260 DATA 2527EEEEEE,280924EEEE,130823EEEE,14122207EE:REM positn 26 ie GREEN
12270 DATA 2826EEEEEE,2513EEEEEE,24091412EE,23081511EE:REM position 27 ie FREE
12280 DATA 2713EEEEEE,261412EEEE,251511EEEE,24091510EE:REM positn 28 ie YELLOW
    
```



C Batch File Input by Andy Lawrie

This program is for any MS-DOS for batch commands and so can be computer running DOS versions 2 or used with menus, and so on. 3. It provides simple single key input

```

/*
batchin.c

A program, written in C, to allow the flow of a batch file to be influenced
by keyboard input at run time.

For the IBM PC, XT, AT and compatible computers, and other MS DOS machines
running DOS version 2 or 3.

Usage
-----

Syntax : batchin <valid reply string> <prompt string>

<Prompt string> will be output to the screen, followed by a space, after
which batchin will wait for one of the characters in <valid reply string>
to be entered from the keyboard. Characters both from the keyboard and in
<valid reply string> are converted to upper case.

Batchin returns a code to the batch file which can be tested by the 'if
errorlevel x' batch command. A return code of 0 means that <valid reply
string> and/or <prompt string> was omitted from the command line,
otherwise the position within <valid reply string> of the typed character,
starting at 1, is returned.

Note that the batch file must test first for the characters at the end
of <valid reply string> as 'if errorlevel x' will regard as true any
code equal to or greater than x.

Notes
-----

The program as listed was compiled by Zorland C.

Library functions
-----
exit(code)      As K & R
getch()        In Zorland C, this function waits for a char to
               be entered from the keyboard and returns it
               immediately without an echo. Here lies a possible
               incompatibility if you use a different compiler.
printf(string,args) As K & R
strpos(string,char) Returns the position within string of the first
                   occurrence of char, or -1 if char not in string
strupr(string)    Converts string to upper case
toupper(char)     Returns upper case char

*/

#include <stdio.h>

main(argc,argv)
int argc ;
char *argv[] ;
{
    int argnum,keypress,position ;

    /* check that we have sufficient arguments */
    if(argc<3) exit(0) ;

    /* print prompt to stdout */
    for(argnum=2;argnum<argc;argnum++) printf("%s ",argv[argnum]) ;

    /* convert <valid reply string> to upper case */
    strupr(argv[1]) ;

    /* fetch characters until we get one that is in <valid reply string> */
    do {
        keypress=toupper(getch()) ;
        position=strpos(argv[1],keypress) ;
    } while(position==1) ;

    /* echo it to the screen with a cr/lf */
    printf("%c\n",keypress) ;

    /* exit with the appropriate return code */
    exit(++position) ;
}

/* end of batchin.c */
    
```

MICROMART



SONY® - the one and only!
The makers of the Macintosh disk drives only recommend one brand of disks... their own!
Single Sided (boxes of 10) - £13.00
Double Sided (boxes of 10) - £17.50
Single Sided Bulk (boxes of 50) - £60.00
Double Sided Bulk (boxes of 50) - £75.00

Peak Systems™
Hard Disks & Tape Drives
20Mb - £625 30Mb - £795
50Mb - £1150 80Mb - £1495
160Mb - £2295
20Mb Tape - £650 60Mb Tape - £850
 SCSI kit for 512(E) when ordered with a Peak drive - £99
30 Day Money Back Guarantee
 (Prices do not include VAT or Carriage)

Gloucester House
 Malvernbury, Wilt. SN16 0LH
 Tel: (0566) 224665

Profiler — Min = 4120:0000 Max = 4120:3FF0

```

4120:2A10
4120:2A20
43C3:0000
43C4:0000
430
430
430 - Memory resident pop-up program
430 for MS-DOS on the XT/AT
430 - Uses clock interrupts to make a
41 Histogram of code use.
41 - Identify heavily used code and
41 speed-up your .COM, .EXE or Turbo
430 Pascal programs.
430 - Lists resident programs and
430 interrupts: see what's in memory.
430 - Zoom and scroll the histogram.
41 - Break out to MS-DOS DEBUG.
41
41 £25+VAT. Analogue I.S. Ltd.
41 1 Warrender Park Crescent,
41 Edinburgh EH9 1DX
41 Overseas P&P £1
4120:2070
4120:2B90
4120:2BA0
4120:2B80
Int = 4120:2B43 — 64 — 128
    
```

NEW COMPUTER DESK & CHAIR FROM OPUS
£149.95

Ideal for most PC Systems including those from OPUS, AMSTRAD, IBM, OLIVETTI & COMPAQ etc

*** FEATURES**
 Swivel chair
 Lockable diskette box
 Tubular steel frame
 Metal castors
 Slots for cables

*** DIMENSIONS**
 Total Height 35"
 Desktop Height 27"
 Desk Width 47"
 Desk Depth 32"
 Shelf Depth 12"

Opus PC II Turbo (XT Compatible) from £499
 Opus PC5 (AT Compatible) from £1295

For further details please contact:
R H COMPUTER CONSULTANTS
 Abbey House, 28/29 Railway Approach, Worthing
 Sussex BN11 1UR Tel: Worthing (0903) 213551

Your chance to buy, sell or swap equipment.

ACORN

● 20Mb HARD DISC. In own case with PSU, controller and cables. Little used. BBC with ADFS compatible. Cost £800+ new. Bargain at £550 ono. Tel: Chris (0276) 65675 evenings.
 ● BBC B WITH ACORN DFS. 40/80 DS drive, ATPL rom board, Watford screen dump rom, Spread Sheet and Scribe Wordprocessor. All excellent condition £295. tel: 0491 873330 eves.
 ● BBC B. Complete with DFS, ADFS speech upgrade and printer £250. SWR board + roms also available. Chris Porter, "Blue Hedges", Ship Road, West Hanningfield, Chelmsford, Essex. Tel: Chelmsford 400419.
 ● BBC-B Watford DFS, 128k sideways ram, AMX mouse, Prism 2000 modem, Music 500, Wordwise Plus, Graphics extension rom, manuals, software and leads. Immaculate condition £460. (0753) 884981. Can also be bought individually.
 ● WATFORD 32K SHADOW RAM £40. Two DSDD drives in Technomatic Plinth £150. Wordwise Plus £25. Romspell £18. Epson MX80 printer with tractor and Vignac acrylic stand £80. Tel: (0234) 750050.

AMSTRAD

● AMSTRAD CPC 464. Col. Monitor, 3" drive, 256k RAM expansion, speech synth, Grafpad 2, Joystick, Epson LX-80 dot-matrix printer + tractor feed. Manuals, software, discs etc. £450 + computing desk if wanted. Tel: (073081) 5339.
 ● AMSTRAD CPC464. Monochrome disc drive, 256k RAM disk, 64k expansion, DMP1 printer, TV modulator, Hisoft C, Pascal, Tasword. 20 discs, games. Would be £800 new. Accept £350 or reasonable offer. Leeds 403457.
 ● AMSTRAD CPC 664. With extra 64k £99. Amstrad colour monitor, £50. Amstrad second disk drive with cable £25. Tel: Graham (042) 879 2416. All calls must be after 7pm.
 ● AMSTRAD CPC464. Colour monitor CP/M, disk drive, romboard, Protex and Prospell roms, Firmware manuals, Magazines, software speech unit, Lightpen + Multifare disks. Total value £950, accept £400 ono. Tel: (0705) 255789.
 ● 428. 464 + 6128 socketed chip, DDI, rampack, lightpen, speech, synth, books, software. Cost over £700. First £450 secures. Buyer collects. Reading 696544 after six pm. It's the best of both!
 ● 1512HD20 COLOUR. Complete GEM paint, Draw, Fonts, Diary, Graph, Supercalc 4, Wordstar 4, Sidekick, Bstram, Games. 3 mths maintenance. £1,700+. Will take £980. Tel day (0494) 711431. Eve (024029) 273.

APPLE

● MACINTOSH 128k. Single

400k disk drive. Multiplan, Macwrite, Macpaint, Carry case. Numeric keypad, Imagewriter. All manuals and packaging £750 ono. Tel (0222) 625510. Cardiff.
 ● BIG SCREEN MAC. 1Mb RAM, 5Mb hard disk, ie Lisa with Mac software; Imagewriter; cables, Macserve and more. £900 ono, or might split. Tel: (0392) 213132.
 ● APPLE II+ 64k, twin drives, Z80 card, printer card, monitor, CPM, cardbox, visicalc £300. Tel: Kessock (046373) 464. Inverness.

APRICOT

● APRICOT PC. 256k, twin disk drives, 10mb hard disk, 9" green monitor, Superwriter, Supercalc etc. Brother HR10 printer, as new, boxed, less than 1 year old, £500. Tel: (0621) 59201.
 ● APRICOT F1. 256k RAM, green screen, Superwriter, Supercalc, Wordstar, GW Basic, MS DOS pack. 720k drive + five unused discs. Very little used. Bargain price £400 ono. Tel 0760 337982 eves only.
 ● APRICOT F1 256k MSdos 2.11, Superwriter, Supercalc, Turbo Pascal, GW Basic, PD software utilities and games £200. Also Apricot 512k ram boards £75. tel: (0524) 65201 ext 4378 daytime, (0524) 824037 evenings. Lancaster.
 ● APRICOT SOFTWARE for sale or exchange. Vast library. Tel: (0222) 482613. Leave message if you get answering machine.
 ● APRICOT PC twin floppy, green monitor. Supercalc, Superwriter, Superplanner. Manager software, £500 ono. Tel: (01) 878 4891, 9.00-5.30.

ATARI

● S.T. BACKUP CARTRIDGE BY HAPPY COMPUTERS U.S.A. Also large selection of public domain games, UTI's and art £5 per disk. Large SAE for list. Mr Stock, 15 Woodbrook Road, Birmingham B30 1UE.
 ● 1040 STF. SC1224 colour and mono monitors. 1st Word Plus, Fast basic. Megamax C and more. Four months old. Worth over £1900. £1100 ono. Contact Wayne Davis (0566) 82450 for details.
 ● ATARI 520STFM. Twin disk drives, Med-res colour monitor, printer, mags and books, £200 software. Perfect condition, £750. Interested? Write to Adrian Turner, 20 Havers Lane, Bishop's Stortford, Herts CM23 3PB.
 ● ATARI 520STM. Hi-res mono monitor, 1/2Mb drive, mouse, 1st Word, 10 blank discs, manuals, only one month old, £350. Martin Smith, 8 Dougill Street, Bolton BL1 5JY.
 ● 520AT. Half Mb drive. Disk box, blank disks, books, mags, printer cable, Starglider, Pawn, Brataccas, Degas, GSTC, PD software. Monitor not included. All boxed, £350 ono. Tel: Adrian (0656) 736694.

COMMODORE

● COMMODORE 64, 1541 drive + 1701 colour monitor, £95 each. Vizastar + Vizawrite, £40 each. Commodore 128 Superscript + Superbase, £35 each. Tel: (073) 781 3644.
 ● COMMODORE PET 3032. Upgraded to 4032 (new roms) + Toolkit rom, large keyboard, fast double disk drive 4040. IEE4888 to Parallel printer converter plus books, manuals and cables, £350. Southampton (0703) 442626.
 ● COMMODORE 64 + 1541 Disk drive, tape recorder, Easy Script, Future Finance, CP/M cartridge, Logo, Maggie database, games and books. Excellent condition, £170 the lot. tel: (049) 379 601 after 6pm.
 ● COMMODORE PET 2001N 32K ram, basic IV, green screen. 80 column 2023 dot-matrix printer. Two tape decks. Plenty books, magazines and software including games, word processor, £360 ono. Wilmslow (0625) 528840.
 ● COMMODORE 8096. 8050 double disk-drive, 4022 printer. Monitor, manuals, £2,500 when new. Excellent condition, complete system £195. Tel: Paul (09363) 6618.
 ● CBM128. 1541, 1530, MPS 803, Tractor feed, Simons basic, Music Maker, Joysticks, blank discs, games, spreadsheet 128 + word processor. Worth £1100, accept £760 ono. Tel: Mr A Hart (0756) 4713.
 ● COMMODORE 64. Datasette, disk drive, printer and modem. All in good condition. Plus lots of software, £375. Tel: Coventry 419248 after 6pm.

CP/M

● OSBORNE 01 Wordstar, Mail Merge, Supercalc, Basic, Microlink, Datarstar, Supersort and monitor (11 inch). Best offer over £160 secures. Tel: (04946) 77401. Beaconsfield.
 ● Z80 DEVELOPMENT SYSTEM for Sale. Zilo C ZDS140 complete with emulator, Basic, Pascal PLZ choice of two. Best offers to Tel: (0283) 840169 (Midlands).
 ● WINDOW WORD. 4-window Word Processing package with Speller, £90. Star NL-10 printer, parallel, IBM-Graphic interfaces, one-month old, £190. Apricot infrared mouse Lightpipe, £45. Thomas Macinowski. Tel: (01) 249 7440.

IBM COMPATIBLES

● TANDON TARGET 286, 20Mb hard disk, 1.2Mb floppy, beautiful compact PC. 2 months old. Unwanted, and a gift at £1595. Tel: (01) 580 7144.
 ● COMPAQ DESKPRO 286. 30Mb hard disk, integral tape back-up, 1.2Mb floppy, 18 months old RGB card. All manuals plus DOS 3.1 and five tapes, £1995. Tel: (01) 444 4838.
 ● OLIVETTI M24, 640kb, 2 x 360k floppies. Canon PW-1156A wide body printer, framework DR-Draw, CAD,

Basic, Pascal, 'C', Smalltalk. All full documentation + lots of PD-S/W. VGC, £1300 ono. Tel: (0256) 771348.
 ● TOSHIBA T1100 PORTABLE Computer. Battery/mains powered. 512k Ram. Internal 720k disk drive. IBM compatible. Framework II software plus manuals and case. Perfect condition. Must sell, £995 ono. Tel: Brian (0923) 240662 evenings.
 ● AMSTRAD PC1512, 10mb hard disk, mouse, Wordstar, Sidekick, games + other software disks. 5 months old, guarantees + dictaphone, call out service. Reason of sale, rarely used, £875 ovno. Tel: (01) 906 2170 evenings. (NW7).
 ● TORCH GRADUATE WITH PSION EXCHANGE SOFTWARE. Perfect condition. £250 ono. Enquiries (01) 935 1956 Lewis.
 ● BONDWELLS LAPTOP PC. Backlit LCD plus green screen. 5.25" External drive, software-Lotus 123, dBase 3+, Sidekick, Crosstalk, Microsoft word. Xtree Graphics, eggs the lot. Tel (0279) 37484.
 ● DACOM PC123B1S MODEM. With all speeds and Datatalk software. For email, gold and prestel. Hayes compatible and BT approved. 6 months guarantee. Price £435. Tel (01) 834 4675.
 ● IBM PC. 20MB 640K MEMORY. Hercules Graphics, mono display. Realtime clock, serial port 2x parallel ports. DOS 3.2 some P.D. software. £800 o.n.o. Tel Harpenden (05827) 5761 eves.
 ● FERRANTI ADVANCE 86B. IBM compatible. 512K RAM, 2x360K disk drives, monitor, manuals and software. £350 o.n.o. Tel Uttoxeter (08893) 2821 eveings.
MISCELLANEOUS
 ● TYPOGRAPHIC H. DUTY PRINTER, CENTRONICS I/F. Two fonts resident, 16 max., dozens available. Full S/W control all functions. Full set manuals. Bargain at £350 ono. Tel: Chris (0276) 65675 evenings.
 ● MICROVITEC 1451 COLOUR MONITOR. £150 Centronics 739 printer, proportional and graphics, £110 ono. Also Nascom boards, AVC, memory etc. Twin disc drive, Perry. Tel: (0926) 54527 evenings. (0203) 688771 weekdays.
 ● SIRIUS 2 x 600K drives. Hi-res monitor. Robust carrying cases. Recently serviced. MSDOS, CPM, Wordstar, Spellstar, MS Basic and much more software, manuals and mags, £700. Tel: Cardigan (0239) 87548.
 ● HEWLETT PACKARD 9836C COLOUR COMPUTER. 1.9Mbytes ram, 65Mbyte disc, HP7550 sheet feed plotter. Offers please. tel: (0602) 691281.
 ● HISTORIC MAGAZINE COLLECTION. The first five years of PCW. From Vol. 1 No. 1 1978 to 1983 in five

matching PCW binders. Offers around £100 plus p&p. tel Robin on (0942) 270161.
 ● SIRIUS Twin 600k drives, 256k ram, Wordstar, Supercalc, DBase II. All manuals. Perfect condition, £500 ono. Heath (01) 430 1611 days.
 ● PACE MODEM plus Data Highway software and card, £75. Zork I, II and III, £15. Wizardry I, II and III, £15. Scrabble, £5, Z80 card and CPM, £25, Pascal II, £40. All for Apple II series. Tel: (0948) 2676.
 ● PSION ORGANISER. Plus 8K-16K ddata pack. Utility pack and Link Up communication pack. £40. Tel (01) 858 6086 evenings.
 ● FORTUNE 32:16. UNIX operating system. 10 MBYTE H/D. With Fortune Word w/p software. Offers £600? Tel Sharpthorne 810748.
 ● PCW MAGAZINES. Complete from number one. VGC. Buyer to collect. Offers? Tel Folkestone (0303) 41880.
 ● SOLARTON DIGITAL VOLTMETER. Maestro 7075 High accuracy sampling. With BCD output module. Ideal for data logging applications £1600. (under half price) or exchange for IBM-XT & Software. Fleet (0252) 623316.

PERIPHERALS

● MODEM CASE 400/213 300 and 1200/1275 Baud. Auto dial, Auto answer. Ideal for Prestel and Bulletin boards, £125. Tel: Steve on Orpington 57433 after 7pm.

PORTABLES

● IBM PORTABLE PC + cable, 256k, Asynch, comms card, DOS, one careful lady owner, £600 ono. Lamorna Lee, Tel: (0256) 56144 ext 5625 or (0962) 67476 evenings and weekends.
 ● NEC PC8201A LAPTOP PORTABLE, 24k ram, full manuals, application software. All in good condition, £150 ono. Tel: Peterborough (0733) 253331 eves.
 ● COMPAQ 2 PORTABLE. 640K, 10Mb hard disk and 1 floppy. As new with software. And Fujitsu printer, cables etc, £2127 ono. May separate. (021) 382 7389 day (021) 308 1807 eve.
 ● GRID COMPASS 1100 16 BIT PORTABLE. Bright display, bubble memory etc. Built-in modem. Cost £4750, accept £1,000. Grid 2202 disk drive double sided. New, £300. (021) 382 7389 day (021) 308 1807 eve.
 ● MICROWRITER Spellstar, Spellstar, MS Basic and much more software, manuals and mags, £700. Tel: Cardigan (0239) 87548.
 ● HEWLETT PACKARD 9836C COLOUR COMPUTER. 1.9Mbytes ram, 65Mbyte disc, HP7550 sheet feed plotter. Offers please. tel: (0602) 691281.
 ● HISTORIC MAGAZINE COLLECTION. The first five years of PCW. From Vol. 1 No. 1 1978 to 1983 in five



238 (near Glasgow).
 ● EPSON PX-8 120K, ROM Basic, Wordstar, Supercalc, Cardbox, Scheduler, all manuals, 2-chargers, 200V, 110V, P40 Epson printer, all for £450. Tel (01) 272 7538 Don or Mal.
 ● NEC PC8201A. As new complete with Wp and comms. software. Cassette recorder included, Only £180. (0293) 25067 after 7.00pm.
 ● EPSON PX-8 PORTABLE. 120K RAM, P-80X printer, usual software and manuals, original boxes and numerous tapes. £650. Tel (061) 928 0998 to ask owner

to return your call.

PRINTERS AND PLOTTERS

● MICROLINE 192T PRINTER. 80 col, tractor or friction, boxed, as new with spare ribbons, £225. Wannit? Tel: Steve on Orpington 57433 after 7pm.
 ● IBM COLOUR INKJET. Unused, £295. EGA Quad ram + 256k, £95. Mono card, £49. Original IBM software packages. BBC model B + disc drive, as new, offers invited. Tel: (01) 388 1620 after 8pm.
 ● NEC PRINTER, PC8023

BE-C. In excellent condition, boxed with manual. £78. Tel: London (01) 751 2262 after 6pm.
 ● EPSON GQ3500 LASER PRINTER, with 1.5Mb ram and HP + emulation card. Just a few weeks old, as new, £1699. Tel: (0943) 816133.
 ● SILVER REED EXP 500 PRINTER, with tractor feed, £95 ono. Opus printer stand with base unit for computer mounted on castors, £100 ono. Tel: (01) 449 9751 (Barnet).
 ● NEC SPINWRITER 5530 DAISYWHEEL. 136/163 Column, 3 font, automatic sheet feeder, manuals, heavy duty professional printer. Bargain £550. Tel Brighton (0273) 32369.
 ● SANPLE DAISY STEP 2000 FOR SALE. Plus spare daisywheel and ribbons. 18cps letter quality. Little used. Connects (parallel) to PCXT etc. £95. Tel John Coward at Parsons, (01) 352 0651.

SINCLAIR

● SPECTRUM 48K PLUS with Interface I + Microdrives + Joysticks + cartridges + games + books + instructions. Cost £890, sell £250. Total cash or will split. No time wasters. Tel: (01) 452 4076. Rohit, evenings only.
 ● QL 640K. CST disc interface, 80 track DSSD 5 1/4 drive. Microvitec monitor. Metacomco C, BCPL Pascal, Assembler, GST-ASM, CP/ Mulator, Toolkit II, books and discs. Offers around £500. Hopkins (01) 388 6561 ext 225 9-6pm.
 ● SINCLAIR QL. Ferguson green monitor. Epson RX80 with interface. Includes Pyramide software and cartridges, books and magazines £225 o.n.o. Tel: Martin on (01) 435 2468.
 ● SINCLAIR QL. With serial 8056 printer, ICE ROM, Psion software 2.3, cartridges, books,

magazines, 11 months old. Excellent condition, £85 o.n.o. Tel Graham (061) 799 0635 after 6pm.
 ● SINCLAIR QL. 640K. Colour monitor disc drive, colour printer, plus 10 books, Pascal, Q-Liberator, Graphic QL and V-2.3. Psion software. Bargain at £400. Tel (0623) 513887 after six pm Edwin.
 ● QL 512K, 2 x 720K 5 1/4" drives, parallel printer adaptor microvitec colour monitor. ICE ROM and manuals. Plus a myriad of software. Excellent condition. £450. Tel: Harlow (0279) 20789.

SOFTWARE

● FOR SALE Complete software and manuals. DBase III plus, £400 ono. Tel: London (01) 897 3679.
 ● USED IBM SOFTWARE. DBase III plus, Ventura Publisher and Autocad 2.52. Willing to exchange other IBM software. Write to Tom PO Box 80029, Cheung Sha Wan, Hong Kong.
 ● LOTUS 123 for Apricot 3.5" machines. Unused, seals still unbroken. Costs £300 new (incl VAT + delivery. Anyone wanting to buy it for £150. Tel: Des (0242) 583502 eves (0452) 711480 days.
 ● MICROSOFT PASCAL COMPILER V3.3. Unused. With all original documentations. Good reason for sale. £80. Tel (01) 794 2373 ask for Mr Nam.
 ● DATAMASTER.V2.11. Menu driven relational database for IBM PC or compatibles. Brand new and unused. Still with registration card. £100 o.n.o. (£250+ new). Tel (0679) 63258 evenings and weekends.

TANDY

● TANDY 200 PORTABLE. Fully expanded ram. Combined modem. Includes Word processor, Spreadsheet, Diary, Address

and comms. With diskdrive, manuals, cables and PSUs, £575. Interested? Tel: Steve on Orpington 57433 after 7pm.
 ● TRS-80 MOD III 48k. Green screen, 80trk disk drive. RS-232 board fitted, manuals and lots of software, £200. Tel (0732) 844633 evenings.
 ● TRS-80 MODEL 1. Comprising keyboard unit (16k), expansion interface unit (32k), two 5 1/4 inch floppy drives and monitor. Also Visicalc and profile software, manuals and all connection cables. Spare keyboard unit too. Any offers. Neil, (01) 894 4328.
 ● TANDY 1000EX COMPUTER, Colour monitor, joystick, printer, cable, basic manual, £460. J Price, 18 Garrett Close, Chartfields Estate, Kingswinford, West Midlands DY6 7FR. Tel: (0384) 279687.

WANTED

● DOES ANYONE KNOW of an independent users group for the Epson PX-8. Please contact Mr Tebb, 102 Keldregate, Bradley, Huddersfield HD2 1TB.
 ● LYNX COMPUTER 48k CIRCUIT DIAGRAM AND MEMORY MAP. Also Centronics printer interface and disc drive controller. Mr A Warren, 8 Brooklyn Road, South Norwood, London SE25 4NH.
 ● WANTED URGENTLY. Matmos PC 64K Z80A based computer made by TA alphantronics with d/drive (s) to run CP/M 2.2. Will pay upto £250. Tel (0602) 760006 after 6pm Mondays to Thursdays.

TRANSACTION FILE ADVERTISEMENT FORM

All Transaction File ads must be submitted by readers on this form or a photocopy of this form. Maximum 30 words. Print one word per box, very clearly. Name, full address and/or telephone number must be included in the 30 words. All ads must be accompanied by a flat fee of £5. Make cheques or POs payable to Personal Computer World. Ads accepted from private readers only. Ads cannot be repeated (unless sent in on another form) and we cannot guarantee to print an ad in any specific issue. Please help our typesetter to help you by writing your ad very clearly. Send your completed form to: Chris Cain, Transaction File, PCW, 32-34 Broadwick Street, London W1A 2HG.

Please find enclosed my cheque/PO for £5, together with details of my name, address and telephone number.

Please tick the appropriate category for your ad from those listed below:

Acorn Amstrad Apple Apricot Atari Commodore CP/M IBM & Compatibles Miscellaneous Monitors Peripherals Portables
 Printers & Plotters Sinclair Software Sharp Tandy Wanted

Roger Howorth is our resident keyboard wizard with his finger on the pulse of computer music. This month he looks at sampling, which is used to produce those s-s-silly noises.

Sampling is one of the basic methods of sound production using computers. It involves digitally recording a sound into RAM, perhaps editing it in some way and finally playing it back, either as a rhythmic effect, or as a musical note.

The theory of digital recording is fairly straightforward: a sound is presented as an electronic signal to an analogue to digital converter (ADC) — think of this as a camera continually taking snapshots of the voltage present at the input. These snapshots, or samples, are in fact numbers which are directly related to the input voltage.

Sampler quality is defined by three things:

- the number of snapshots that can be taken per second: the more taken, the greater the accuracy of the recording (a good analogy is the number of dots your computer display uses per line);
- the range of numbers that can be output by the ADC — again, the greater the range the better; and
- the amount of RAM available for sample storage.

Putting all this into more quantitative terms, the number of samples taken is expressed in KHz. Fig 1 shows that the highest frequency a sampler can accurately record is governed by the number of samples taken per second. That's why this figure is often referred to as 'bandwidth'.

A compact disk machine runs at 44.1KHz or 44,100 samples per second: this is pretty good, but some digital tape machines work at 48KHz, and expensive keyboards go well beyond 50KHz.

Fig 2 shows how the wave from Fig 1 is distorted as it is reconstructed by the sampler, due to the sample rate being too low.

The range of numbers a sample must fall within is measured in bits, with systems currently using either 8, 12 or 16 bits. There is talk of 24bit chips being just around the corner; that's good news, because the wider the chip, the better the sample.

Clearly, as the quality of samplers increases, so does the amount of data they produce, but home computer sampling packages are seriously limited in this respect. The computer is usually quick enough at gathering and organising this data within its RAM; but, unless you're prepared to dedicate a hard disk drive for sample

storage, you'll end up with samples that last only a few seconds sampled at more than 8bits/20KHz.

Editing tools

Software aids vary between systems, with some having no facilities for editing or indeed any permanent storage. Others only allow the front and end of your sample to be moved to make the sample shorter. More exotic systems, though, allow for amplitude changes and merging of different samples, the list of options growing with the system's cost.

One editing tool considered vital is the 'loop', which allows you to make a short sample play for a variable period, and can even make one that was sampled with a sharp cut-off fade away gently. Looping is good for both memory consumption and the playability of the sample, as the looped sound can be replayed for as short or long a time as is required (see Fig 3).

Voice counts

Most cheap add-on samplers only function monophonically: that is, they can only play one sample at a time. This is all very well for effects such as Paul Hardcastle's famous 'N-n-n-nineteen' vocal, but it's only just short of useless in musical terms where, in order to play a chord made up of five notes, the sampler would have to play five sounds at once.

Some samplers can of course do this and they are known as 'polyphonic'. They are attributed with a number of 'voices', which is the maximum number of sounds that can be played at once. They don't necessarily use more memory but they do require a more sophisticated digital to analogue converter (DAC) — sometimes one for each voice. Naturally you have to pay for these extras.

Playing time

When you've worked out how a sample is recorded, the playback technology is quite easy to grasp; the sample data being fed to a DAC which converts the computer's binary numbers into your hi-fi's volts.

The mechanisms used to tell the sampler which sample to play at what volume, pitch, and so on, are a subject unto themselves. Often, though, samplers are linked via a Musical Instrument Digital Interface (MIDI) to either a set of drum pads, keyboard or sequencer.

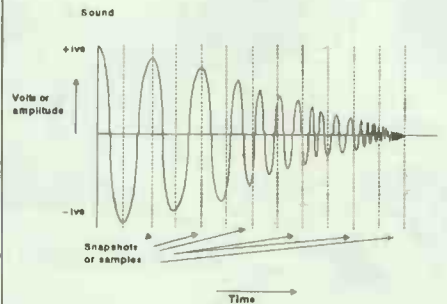

Fig 1 The frequency of the sound wave is increasing with time, yet the sample rate shown can only accurately record the first few wavelengths. The diagram also clearly shows that a sample is needed at both +ive and -ive peaks in order to record the wave's frequency correctly; therefore, the highest frequency that a sampler can record is half the sample rate.

These two factors force samplers into a vicious circle of producing more data in the quest for better sounding samples. This in turn demands massive amounts of storage, such as hard disk drives, which make the cost of such systems too expensive for most people

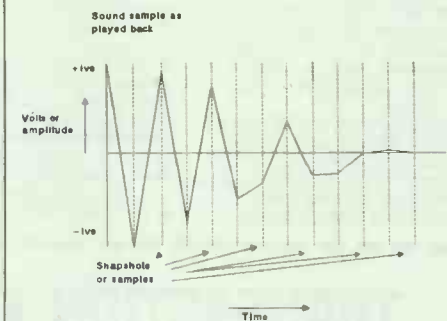

Fig 2 The lower frequencies are reproduced quite accurately, but the later higher ones are distorted beyond recognition by the low sample rate

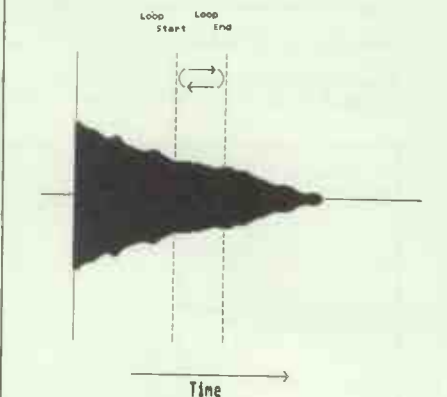

Fig 3 The 'looped' section of the sample is replayed as much as necessary in order to vary the 'length' of the sample

Controlling your sampler

Innovative Software, which makes the IS Digitiser sampling board for the Atari ST, has released a new piece of software to run alongside the Digitiser, providing control of samples via the Atari's MIDI port. Multiple keyboard splits can be set up, which means that providing you have enough RAM, you can assign a different sample to every note on your MIDI keyboard. Remember, though, that the digitiser itself is a monophonic device, so you can only play one sample at a time.

The sampler, which retails for £99.95, includes variable sample rate from 4 to 25KHz, along with effects such as echo and reverb as well as a real-time oscilloscope and reasonable editing facilities. An unusual feature is that as well as outputting sampled sounds to your hi-fi, it can also send them to the monitor or TV loudspeaker, without necessarily using either the hardware interface or the main software package. The various source files supplied by Innovative allow you to play back samples from your own Basic, C or machine code programs.

The IS Digitiser and new MIDI software, which costs £19.95, are available from Chips Data Direct on (0903) 40509.

Hybrid Arts' ADAP SoundRack represents the ultimate 'add on' sampler. Besides some sophisticated software you

get a 16-bit linear stereo sampler that runs at up to 44.1KHz, which is identical to the CD format, giving 10 seconds stereo (or 20 seconds mono) in 8-voice polyphony.

Being based around the Atari ST means that all editing, looping, and so on, is done in colour with your mouse. SoundRack is disk compatible with Akai S900, Emax, Ensoniq Mirage, Korg DDS1, Prophet 2000/2002 and the Roland Sampler.

It also boasts several real-time digital effects such as DDL, reverb, chorus, and so on, and with a 4Mbyte machine could give over a minute of sampling, dumping onto hard disk. Currently it's limited to a stereo output, but before long someone will hopefully offer a modification that routes the eight voices to separate outputs. At entry level SoundRack will set you back £19.99. Further details from Syndromic Music on (01) 444 9126.

Roger Howorth is a freelance computer journalist and sound recording engineer who owns and experiments musically with an Atari ST. If you would like to share your musical experience with Roger or you would like to pass on any interesting snippets, why not write to him care of PCW, VNU House, 32-34 Broadwick Street, London W1.

NUMBERS COUNT

Mike Mudge juggles with positive integers, is spellbound by powerful numbers and wonders, is this a case for geometric analysis?

Consider the n -digit positive integer, N , expressed in base 10 in the conventional manner: that is, $N = a_0 + a_1 \times 10 + a_2 \times 10^2 + \dots + a_{n-1} \times 10^{n-1}$ where $0 \leq a_i \leq 9$.

Given N , the idea is to construct a related positive integer, $F(N) = P_r(N)$ where $r = 2, 3, 4, 5, \dots$, defined to be the sum of the r^{th} powers of the digits of N .

Thus $P_2(123) = 1^2 + 2^2 + 3^2 = 14\text{sp}$, while $P_4(423) = 4^4 + 2^4 + 3^4 = 353$.

Now, if $P_r(N) = N$, then N is defined to be a 'powerful number' of degree r , to base N .

Some examples of powerful numbers to base 10:

Degree 3. $P_3(153) = 1^3 + 5^3 + 3^3 = 153$.

Degree 4. $P_4(1634) = 1^4 + 6^4 + 3^4 + 4^4 = 1634$.

Degree 5. $P_5(4150) = 4^5 + 1^5 + 5^5 + 0^5 = 4150$.

Degree 6. $P_6(548834) = 5^6 + 4^6 + 8^6 + 8^6 + 3^6 + 4^6 = 548834$.

Problem (i) Construct an efficient algorithm to 'dissect' a given positive integer, base 10, into its constituent digits base b .

Problem (ii) Generate all the powerful numbers of degree r to base 10 up to a given N_{max} .

Problem (iii) Provide a theoretical and/or empirical argument to define all the powerful numbers of degree r to base 10. Hint: how large can a

powerful number of degree r to base 10 be? There are only finitely many for a given r . Is there always at least one?

Problem (iv) Generalise the results of (i) and (ii) to base b not equal to 10.

Is it possible to have a positive integer which is a powerful number (albeit with different degrees) in more than one number base? Furthermore, is there a possible geometrical interpretation of the above transformation?

If the two-digit integer, to base 10, a_1a_0 , is regarded as representing (or being represented by) the point in the x,y -plane with coordinates $x = a_0$, $y = a_1$; and, similarly, in three-dimensional space for $a_2a_1a_0$ where $z = a_2$ is there a geometrical interpretation of the mapping defined by $P_r(N)$?

(1,5,3) is in some sense a 'fixed point' for the mapping defined by $P_3(N)$. The points (1,3,5), (3,5,1), (3,1,5), (5,1,3) and (5,3,1) can be regarded as joined to (1,5,3) by 'unit arrows' corresponding to one stage in the mapping: that is, geometrically $P_3(1,3,5) = (1,5,3)$.

Has this picture any physical significance?

When the numbers N involved have more than three digits, the geometry is in an n -dimensional hyperspace. Although this is difficult (if not impossible!) to visualise, the set of points associated with power-

ful numbers may be open to some interesting interpretation.

Readers are invited to suggest functions $F(N) = F([a_0, a_1, \dots, a_{n-1}])$ other than $P_r(N)$ that may generate interesting results when iterated on the set of positive integers base b . Reference to Numbers Count, PCW November 1983 ('The Persistence of an Integer') will provide one example of such an extension.

Send your attempts at this project to Mike Mudge, 'Square Acre', Stourbridge Road, Penn, Staffordshire WV4 5NF, tel: (0902) 892141, to arrive by 1 February 1988.

It would be appreciated if such submissions contained a brief summary of results obtained, in a form suitable for publication in PCW. These submissions will be judged using subjective criteria, and a prize will be awarded by PCW to the 'best' contribution received by the closing date.

Please note that submissions can only be returned if a stamped addressed envelope is provided.

Review: W-sequences, April

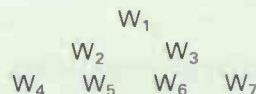

The basic binary-tree structure exhibited by the terms of a W-sequence will interest programmers:

This structure leads directly to certain generalisations concerning junction points: thus if Z is a junction point of $W(a,b,c,d_1,d_2)$ then all members of $W(a,b,z,d_1,d_2)$ are also junction points of that sequence.

Computation and counting of terms of W -sequence involves no essential difficulty, efficient sorting is merely needed at the final stage. Determination of a particular term, for example the 2157th in a particular W -sequence such as $W(2,3,1,1,1)$, can be readily carried out by repeated division of 2157 by 2 noting the presence of a non-zero remainder. (Answer, 30646.)

Junction points for $W(2,3,1,1,1)$ start with $Z_1 = w_{11} = w_{16} = 31$, $Z_2 = w_{22} = w_{32} = 63$, $Z_3 = w_{23} = w_{33} = 94 \dots w_{271} = w_{191} = 2551 \dots w_{383} = w_{543} = 7654 \dots$

Some combinations of parameters

which do not yield junction points were discovered, including (i) a & b both even, + (ii) d_1 and d_2 one odd and the other even.

An analysis of $W(2,3,1)$ and $W(2,3,2)$ shows that the terms are divided between the residue classes 3,1,2 and 0 modulo 4 in ratios 5:2:2:1 within 'very small' error.

Thus for the first 1303 terms of $W(2,3,2)$ (those less than 20000) the ratios are 49.58:21.03:20.18:9.21. If this process is repeated for sets of terms within each interval of 20000 up to 680000, the corresponding intervals are (48.77-49.80):(20.86-21.23):(20.18-20.95):(8.65-9.21).

Note that apart from $c = w_1$ itself, all terms of $W(2,3,c)$ are congruent to 1,3,4 or 5 modulo 6. Further, apart from $c = w_1$ and possibly w_2, w_3 and w_4 , every term in $W(6,9,c)$ is congruent to 7, 10, 37 or 43 modulo 54

(except when c is congruent to zero modulo 18, when W_n is congruent to 1 modulo 54).

This month prizes go to Gareth Suggett of 31 Harrow Road, Worthing, Sussex BN11 4RB for a combination of theoretical observations and computation, and also to Philip Newton Webb of 83 Sopwith Crescent, Merley, Wimborne, Dorset for considerable analysis and flow-charting relating to W -sequences.

Mike Mudge welcomes correspondence on any subject within the areas of number theory and other computational mathematics. Particularly welcome are suggestions, either general or particular, for future Numbers Count articles; all letters will be answered in due course.

Isolated readers can be put into contact with others sharing the same interests. However, greater efficiency regarding published problems should result from contacting the prizewinner directly.

USER GROUPS

Rupert Steele looks at a user group service, run on Prestel, and has news of a mini-revival among local clubs.

The sophistication of user groups is increasing. Many are sending me newsletters produced on laser printers, or distributing on disk — often with useful little utilities thrown in. Others are running bulletin boards or areas on Prestel. Perhaps the most important is ClubSpot 810, run by the Electronic Publications Committee of the Association of Computer Clubs.

This database has consistently been one of the most accessed areas on Prestel. It contains information on a variety of machines, as well as a general hobby area. You can see it on Prestel by keying *810# or using keyword search *clubspot# — although if you really want to get into the computer details, you will have to become a member of Prestel Microcomputing. This gives you access to the closed-off pages for a relatively modest fee. And while you are on Prestel, you can of course take advantage of its other facilities, such as the national electronic mail service. For more information, contact Andy Leeder, secretary of the Electronic Publishing Committee, ClubSpot 810, Church Farm, Stratton St Michael, Norwich NR15 2QB.

Directory enquiries

Recently I have received interesting letters from two directory stalwarts, the 1512 Independent Users' Group and BOOG.

The 1512 Group is taking an in-

terest in Amstrad's PC1640, and has devised a part exchange scheme for members who want to upgrade. They can do so by selling their machine at a suitably low price to somebody outside the group who can't afford a mint condition 1512. Details are available from The 1512 Independent Users' Group, PO Box 55, Sevenoaks, Kent TN13 1AQ. Tel: (0732) 63157.

BOOG meanwhile has changed its contact point — you should now address enquiries to Jeremy Browne of BOOG Ltd, 102a Aldershot Road, Fleet, Hants GU13 9NY. Tel: (0252) 621745. He adds that the group is offering assistance not only for the Osborne machines, but also for other CP/M micros. Some BOOG members are also upgrading to MS-DOS machines, and they are being supplied with relevant material.

Local clubs latest

Local clubs were the backbone of the hobby computing movement before (almost) everybody could afford their own machine, but are now generally operating on a rather smaller scale. However, there are a few groups which continue to thrive, and the Association of Computer Clubs has sent me some details. The Harrow Computer Group, for instance, meets regularly in the Harrow Arts Centre; meetings alternate between the hardware subgroup and a general get-together, which often features a lec-

ture. As with all Association of London Computer Clubs, membership of the Harrow Group entitles you to visit other ALCC groups. Contact Norman for details at 4 Tapley Court, St Johns Road, Harrow HA1 2HZ. Tel: (01) 863 5241. Harrow's activities are also available on Prestel page *81021254#.

Moving west, I have been contacted by the West Herts Micro Users Association, which meets fortnightly on Tuesday evenings at St Stephen's Parish Centre, Station Road, Bricket Wood, St Albans, Herts. Its special interest subjects are networking, hardware and computer-aided engineering. Details from Brian Larkin, 82 Church Street, Leighton Buzzard, Beds LU7 7BT, or call Terry Bradbury on (0727) 73633.

The Huntingdonshire Computer Club draws its members from the St Neots, Huntingdon and St Ives districts. It meets on the morning of the second Sunday of each month in the St Ives Centre, IVO Centre, St Ives, with an additional informal meeting on the evening of the last Thursday of the month in the lounge of the Horseshoes public house, Offord D'Arcy. John Childs is the secretary, at 57 Manor Gardens, Buckden, Huntingdon PE18 9TW.

If you would like your user group or club to have a mention in this column, or you wish to be considered for the Directory of User and Support Groups, please write to Rupert Steele, 12 Philbeach Gardens, London SW5 9DY.

DIRECTORY OF USER GROUPS



GROUP

CONTACT

NOTES

● MACHINES 68 Microgroup	J Turner, 63 Millais Road, London E11 4HB	Hardware/software for 68000/6800
Apricot File	Apricot File, TP Group, PO Box 509 London N1 1YL (01) 833 3501	Detailed technical Apricot newsletter
Atari National User Group	N Lewis, 13 Weavers Walk, Courthouse Green, Coventry CV6 7LG	Newsletter; SAE please
Atari ST-Club	Paul Glover, ST-Club, PO Box 20, Hertford	PD software available
Basug	Sheila Hurst, PO Box 177, St Albans, Herts AL2 2EG (0727) 73990	Apple systems
BOOG	Victor Nollen, 38 Rocks Lane, Barnes, London SW13 0DA (01) 833 2526	Osborne support group
Commodore Plus 4	Steve Kent, 203 Wolverhampton Road, Pelsall Walsall, West Midlands WS3 4AW	SAE please
Compucorp University Users Group	c/o Compucorp, Cunningham House, Westfield Lane, Kenton, Middx HA3 9ED	
HICUPS	Bruce Ainge, Foxberry House, 16 Foxberry Road, London SE4 2SP (01) 691 5202	Hitachi MBE 16002 PC group
IBM PC User Group	Ian Fraser, PO Box 830, London SE1 0DB (01) 620 2244	Covers IBM PCs and all compatibles
ICPUG	Jack D Cohen, ICPUG, 30 Brancaster Road, Newbury Park, Ilford IG2 7EP (01) 346 0050 (home); (01) 579 1229 (day)	Commodore machines from PET to Amiga. £10 subs + £1 entry fee
Independent Psion Organiser User Group (IPSO)	Mike O'Regan, 130 Stapleford Lane, Beeston, Nottingham NG9 6GB	SAE please. Monthly newsletter IPSO FACTO
IOUG	Gary Ramsay, 1 Kingsway Crescent, Burnage, Manchester M19 1GA	Oric users; newsletter IOU
IQLUB (renamed QUANTA)	Brian Pain, 24 Oxford Street, Stony Stratford, Milton Keynes MK11 1JU	Sinclair QL and compatibles
Jupiter Ace User Domain Resource Centre	Ian Jones, 21 Dene Street, Pallion, Sunderland SR4 6JB (091) 565 2833	Software/hardware ideas exchanged. SAE please
MacTel	David Nicholson-Cole, 15 Elm Tree Avenue, West Bridgeford, Nottingham NG2 7JU Board (0602) 817696 or (0742) 350319	Bulletin board for Mac users 300/300; 1200/75; 1200/1200
Macintosh User Group UK	John Lewis, 55 Linkside Avenue, Oxford OX2 8JE. (0865) 58027	£25 subscription: professional group
Memotech Owners Club	Phil Eyres, 23 Denmead Road, Harefield, Southampton SO2 5GS	SAE please
NATGUG (National Amstrad, Tandy and General Users Group)	Brian Pain, 24 Oxford Street, Stony Stratford, Milton Keynes MK11 1JU (0908) 564271	Tandy, Genie, MS-DOS, Amstrad
NBUG	Gerald McMullon, 36 Armitage Way, Cambridge CB4 2UE	NewBrain SAE please
OPEN#STREAM	1 Ranelagh Road, Deal, Kent CT14 7BG	NewBrain group
Research Machines National User Group	Steve Burrows, Wirral CAE Services Ltd, Gorsey Lane, Wallasey, Wirral L44 4HE (051) 639 8237	RML 380Z, 480Z, Nimbus and 80286/80386 machines
Sanyo MBC-550	Mr M H Syed, Wistaria, 53 Acacia Grove New Malden, Surrey KT3 3BP (01) 942 9009	Informal group
Sharp User Group	Andrew Fergusson, 11 Harcourt Close, Henley on Thames, Oxon RG9 1UZ (0491) 574 850	£6 Subscription. Newsletter (60 pages) & software library
SORD/PIPS	Mr B Nicholson, 5 Brunton Place, Edinburgh EH7 5EG (031) 556 2340	Informal group for UK users of SORD M- 23
Tangerine	David Cawthorne, 40 Westbourne Road, West Kirby, Wirral L48 4DH (051) 625 7311	Informal info sheet and newsletter; £2/copy
The One And Only	Neil Smith, 42 Hayes Road, Bromley BR2 9AA	ZX Spectrum software exchange. SAE please
T199/4a EXCHANGE	Clive Scally, 40 Barrhill, Patcham, Brighton BN1 8UF (0273) 503968	Subscription £6; quarterly newsletter
Transputer Users Group	Dr Howard Oakley, Brooklands Lodge, Park View Close, Wroxall, Ventnor, Isle of Wight PO38 3EQ	£5 subscription
UK Amiga Users Group	66 London Road, Leicester LE2 0QD. (0553) 550993 voice; 550893 BBS	
UKAS (UK Adam Subscribers)	Keith Marner, 33 Homer Road, Croydon CR0 7SB (01) 654 2184	Coleco Adams. Journal every 2 months; SAE please
UK Einstein User Group	Graham Bettany, UKEUG, 80 Dales Road, Ipswich IP1 4JR	£15 subscription. Monthly newsletter. SAE please
West Midlands & Oxon TI User Group (International)	Gordon Pitt/Peter Brooks, 259 Sneyd Lane Bloxwich, Walsall WS3 2LS Bloxwich 476373	National T199/4 group Subscription £12.50; monthly newsletter

An up-to-date list of UK bulletin boards, compiled by Peter Tootill.

London

Airtel - TBBS (01) 200 3439
24 hrs; 3/1275; Pilots' area
Brixton ITeC (01) 735 6153
24 hrs; 1275
Comunitel (01) 968 7402
24 hrs; 1275v
Crystal Tower (01) 886 2813
24 hrs; 3-24
Gen interest; Apple & IBM
CyberZone (01) 638 2034
24 hrs; 3
Dark Crystal Fido
(01) 207 2989; 24 Hrs; 3-12
Distel (01) 679 1888
24 hrs; 300; Display electronics- Commercial
3/1275 on 01 679 6183
Gnome at home (01) 888 8894
24 hrs; 1275v
Hackney BBS (01) 985 3322
24 hrs; 1275v
Health data (01) 986 4360
24 hrs; 1275v
Hendon Fido #1 (01) 200 7577
(01) 220 8281 24 Hrs; 3/1275
Opus system
ITCU Training (01) 960 4742
24 hrs; 1275v
Lots of ITeC training materials
Link Fido (01) 659 6992
24 hrs; 3-12
London U'gnd (01) 863 0198
24 hrs; 3-24 Wildcat BBS
Marctel (01) 346 7150
24 hrs; 3/1275 FBBS system
MBBS Mitcham (01) 648 0018
24 hrs; 3/1275
Metrotel (01) 941 4285
24 hrs; 1275v
HBBS London (01) 883 5290
24 hrs; 3/1275
MNBBS London (01) 455 6607
24 hrs; 3/1275
OSI Lives (01) 429 3047
24 Ring back; 300
Owltel (01) 927 5820
24 hrs; 1275v
PC Access (01) 853 3965
24 hrs; 3-24 For PC users
Poly Fido (01) 580 1690
24 hrs; 3-12
Taecom (01) 573 8822
MF: 7pm-8am; WE:all day Sun
300 Interak micro section
TBBS Rovoreed (01) 542 4977
24 hrs; 3-24
TBBS London (01) 348 9400
24 hrs; 3-12
Techno Line (01) 450 9764
24 hrs; 1275v; Commercial
Techno-line 2 (01) 452 1500
MF: evenings; WE:24 hrs
1275v Commercial
The Star BBS (01) 586 6882
24 hrs; 3/1275; Atari ST area
The Village (01) 464 2516
24 hrs; 3-24
Atari 520ST based
Twighl't Phone Fido
(01) 624 5338 24 hrs; 3
Typnet (01) 676 0283
24 hrs; 300; Budget Typsetting
WBBS Wimbledon (01) 542 3772
Sat 7pm - Mon 8am; 3/1275

The Midlands

CBABBS; Birmingham
(021) 430 3761 24 hrs
(not Thurs); 300 Atari based
can send mail to Canada
Digital Matrix Fido
Birmingham (021) 705 5187
24 hrs; 3/1275
Compu-store on-line
The City; Birmingham
(021) 353 5486 24 hrs; 300

Atari 8 bit & ST; Lonely Hearts
TUG II; Birmingham
(021) 444 1484; 24 hrs; 3/1275
Amstrad;Tandy;online Adventure
Wolverhampton BBS
(0902) 745 337; 24 hrs; 3/1275
MS-DOS; CP/M; Commodore areas

The North East

49'ers; Cleveland
(0287) 43 920 MF:10pm-4am
WE:10pm-4am; 3/1275
FBBS colour for BBC users
Avon Fido; Weston Super Mare
(0934) 29 570 24 hrs; 3/1275
Forum-80; Hull (0482) 859 169
MF:7pm-11pm; WE:1pm-11pm
3/1275
Midnight-8am on Bell 103 tones
LEMS Fido; Leeds
(0532) 600 749 Daily 10pm-8am
3/1275
Hamnet; Hull (0482) 465 150
MF:6pm-8am; WE:24 hrs; 3/1275
Radio Hams
Key Board; Milton Keynes
(0908) 668 398
8pm-8am exc Tues and Thurs
12h Runs on a Spectrum.
Log On Tyne Fido; Tyneside
(091) 477 3339 24 hrs; 3/1275
MacTel Sheffield
(0742) 350 319 24 hrs; 3-24
For Macintosh Users
MacTel HQ; Nottingham
(0602) 817 696 24 hrs; 3-12
Macintosh Users
MacTel Green Box; Nottingham
(0602) 811 950 24 hrs; 3-24
For Macintosh users
MBBS Leconfield (0401) 50 745
24 hrs; 3/1275
Norview; Northants
(0604) 20 441; 24 hrs; 1275v
OBBS Bradford (0274) 480 452
24 hrs; 3/1275
Colour for BBC users
On-Line Systems; Cleveland
(0429) 234 346; 24 hrs; 3-24
Viewdata/scrolling
PD-Sig Fido 1; Warwick
(08926) 61 149 24 hrs; 3/1275
PD software interest group
Stockton Fido; Teeside
(0642) 605 838 Daily 6pm-6am
300; MSX
The Sharrow BBS; Ripon
(0765) 707 887 24 hrs; 3/1275
Viewdata & scrolling BBC based

The North West

Bolton BBS (0204) 43082
MF:8pm-8am; WE:24 hrs; 3-24
8am-8pm on ring back
CNOL; Lancaster (0524) 60 399
24 hrs; 300
Clinical BBS for medics
Fido Compulink North; Liverpool
(051) 220 3761 24 24 hrs
3/1275
Fido Manchester (061) 773 7739
24 hrs; 3/1275
Mektronic Electronic
design cons
Intel-Ace; Oundle
(0832) 73 003 MF:6pm-8am
WE:24 hrs; 1275v
Liverpool Mailbox
(051) 428 8924 24 hrs; 3-24
UK TBBS HQ system
Matrix; Liverpool
(051) 737 1882; 24 hrs; 3/1275
Multi-user games; 4 lines
NBBS Cheshire (0936) 77 025
24 hrs; 3/1275
OBBS Manchester
(061) 427 1596 24 hrs; 3/1275
Portal; Wirral (051) 355 0911

MF:8pm-6am; WE:24 hrs; 3/1275
Pyramid; Leigh; Lancs
(0942) 609 611 24 hrs; 3
Stoke ITeC (0782) 265 078
24 hrs; 1275v
TeePee Link; Manchester
(061) 494 6938 24 hrs; 3-24
Telemac 15; Macclesfield
(0625) 33 703 24 hrs; 3/1275

The South East

Acorn BBS; Cambridge
(0223) 243 642 24 hrs; 1275v
ARCNET; Colchester
(0376) 518 818 24 hrs; 300
BABBS; Felixstow
(0394) 276 306 24 hrs; 3-24
Banat Board; Oxford
(0865) 882 872 24 hrs; 3-24
FidoNet UK coordinator
BBS09; Portsmouth
(0705) 736 025 MF:7pm-7am
WE:24 hrs; 300 059; Sci-Fi
Dragon; CoCo sections
BITEC; Basildon (0268) 22 177
24 hrs; 1275v
BITEC; Basildon
(0268) 25 122 24 hrs; 300
Bloxam; Banbury (0295) 720812
Daily 10pm-1am; 300
C A T S Fido; Maidenhead
(0628) 824 852 24 hrs; 3/1275
V22/bis coming
C View Rochford; Kent
(0702) 54 6373 24 hrs; .275v
CIX; Guildford (0483) 575 337
or 338 24 hrs; 3-24; multi-user
CP/M User Group; Windsor
(0753) 868 196 24 hrs; 3-24
CP/M and MS-DOS software
Datasoft Opus; Ilminster
(04605) 4615 24 hrs; 3-24
Inc Datatalk Support area
Dr Solomon's Fido; Amersham
(02403) 4946 24 hrs; 3-24
mostly for IBM programmers
Fido PD Software; E Grinstead
(0342) 315 636 24 hrs; 3-24
PD software database
Gospot Apricot BBS
(705) 524 805; 24 hrs; 300
LABBS; Surrey (0883) 844 164
24 hrs; 3/1275; The Prisoner
Lasermail Fido; Worthing
(0903) 212 552 24 hrs; 3/12
Maptel; Southend (0702) 552 941
24 hrs; 300; commercial system
NBBS Essex; Brentwood
(0277) 228 867 24 hrs; 3/1275
subscribers only
Patnet; Colchester
(0206) 844 813 Daily 8pm-8am
12h; runs on a Spectrum
PD-SIG System; Uxbridge
(0895) 420 164 24 hrs; 3-24
also on 0895 52685
Pete's Place; Colchester
(0206) 862 354 24 hrs; 3-24
good IBM SIG
RICBBS; Basildon (0268) 710 637
MF:5pm-10pm; WE:24 hrs
RSGB; London (0707) 52 242
24 hrs; 1275v
SBBS - Watford (0923) 676 644
9pm-11am plus 11pm-6am daily
3/1275
TBBS Gamlingay; Sandy; Beds
(0767) 50 511 24 hrs; 3-24
Trinity 3; Reading
(0734) 484 847 24 hrs
3/1275 TBBS system

The South West

BOOG BB; Fleet; Hants
(0252) 626 233 24 hrs; 3/1275
Osborne; MS-DOS; CP/M areas
CBBS South West; Exeter
(0392) 53 116 24 hrs; 3/1275

Jersey Fido (0534) 39 389
24 hrs; 3/1275
QMC Viewdata; Basingstoke
(0256) 471 757 24 hrs; 1275v
Queen Mary's College
TBBS Blandford; Dorset
(0258) 54 494 24 hrs; 300
Blandford Computers
Trinity 1; Exmouth
(0395) 272 611 24 hrs; 3-12
Trinity 2; Faringdon
(0367) 81 507 24 hrs; 3/1275
Sponsored by Courier Consultancy
Vampire's Coffin; Heybridge
(0932) 245 593 24 hrs; 1275v
Viewdata & scrolling

The West

Access Fido; Worcester
(0905) 52 536 24 hrs; 3-24
midi section
Octopus Bristol (0272) 421 196
MF:6pm-6.30am; WE:24 hrs; 3/1275

Scotland

Aberdeen ITeC (0224) 641 585
24 hrs; 1275v
Aberdeen Commodore
(0224) 781 919 24 hrs; 300
Commodore 64 based
Beteigeuse 5; Inverness
(0463) 231 339 24 hrs; 3/1275
Kirklees ITeC; Batley
(0924) 442598 24 hrs; 1275v
Information Technology Centre
Livingstone BBS; Livingstone
(0506) 38 526 24 hrs; 300
People's Palace; Glasgow
(041) 956 6537 Daily 6pm-8am
3/1275 Colour

Wales

Bulletin AI Fido; Swansea
(0792) 297 845 MF:6pm-9pm
WE:24 hrs; 3-12
Capital Data Line; Cardiff
(0222) 461 824 24 hrs; 300
computer repair company
Cardiff ITeC (0222) 464 725
24 hrs; 1275v
Communitree; Powys
(0874) 711 147; 24 hrs; 300
Cymrutel; Colwyn Bay
(0492) 49 194; 24 hrs; 1275
FBBS Swansea (0792) 203 953
24 hrs; 3
MGBBS Mid Glamorgan; Ferndale
(0443) 733 343 6pm-1am daily
300
Proteus Opus; Porthmadog
(0766) 4154 24 hrs; 3-24
ANSI colour graphics

Northern Ireland

Deep Thought Fido; Bangor NI
(0247) 467 863 24 24 hrs; 3-24
PC-DOS; CP/M; BBC; Tech help Sigs
PBBS 1 Portadown (0762) 333 872
Daily 10pm-1am; ring back; 300

Eire

DUBBS; Dublin (0001) 885 634
MF:8pm-8am; WE:24; 3-24
Amiga based; astronomy SIG
Dublin Fido; Dublin
(0001) 854 522; 24 hrs; 3-24
IACCBBBS; Eire
(0001) 903 341 24 24 hrs; 300
Irish ACC Runs on Commodore 64
Infomatique; Dublin
(0001) 764 942 MF:10pm-6pm
WE:10pm-6pm; 3/1275 Amiga based

Peter Tootill can be contacted electronically on the numbers which appear on page 179.

LEISURE LINES

NOVEMBER

Brainteasers courtesy of JJ Clessa.

Quickie

No prizes, no answer published, but you can easily check if you have a bible (Matthew 16:23) — you may be surprised if you do.

To whom did Jesus say 'Get thee behind me...?'

Prize puzzle

Mary, Sally and Jane share the same birthday, although their ages are different. In fact, at this year's birthday party it was realised that:

- Three times Mary's age plus Sally's age equal twice Jane's age.
- Twice the cube of Jane's age is equal to three times the cube of Mary's age plus the cube of Sally's age.

There are no common factors between any of the three ages. What are the ages?

Solutions on postcards or backs of envelopes only to reach PCW, Leisure Lines, Prize Puzzle November, VNU House, 32/34 Broadwick Street, London W1A 2HG, no later than 30 November.

August prize puzzle

Tougher than usual this month —

although we did give a clue by advising lateral thinking.

The answer is: $(4\frac{1}{6})^2$
When 20 is added, $(4\frac{9}{6})^2$ is the result;
When 20 is subtracted, $(3\frac{1}{6})$ is the result.

There's no need to resort to base

12 arithmetic or use complex numbers, as most entrants did. Anyway, of the 70 entries, only 17 had the correct solution — and the winning card came from P G Spain of Glasgow. Congratulations Mr Spain, your prize is on its way.

To all the rest, keep puzzling.

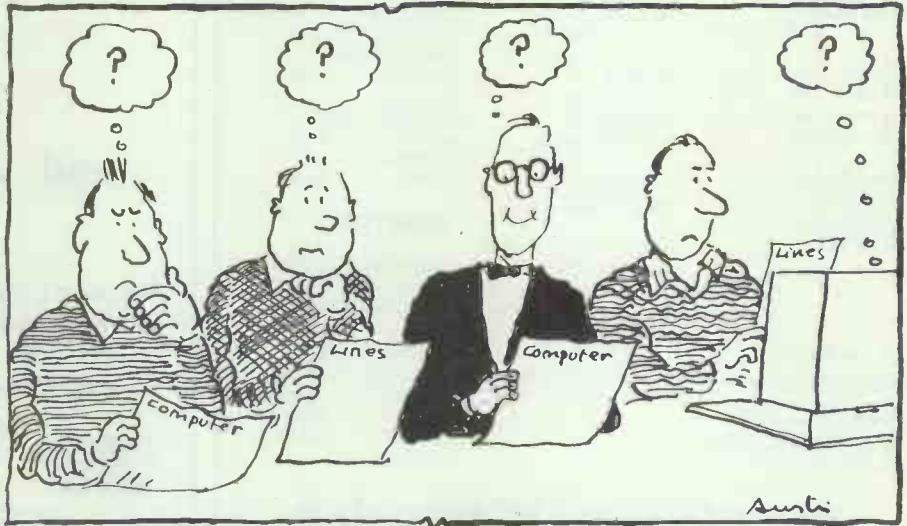

DIARY DATA

A look ahead at computer shows to April 1988. Readers are advised to check details before setting out on their journey.

AMSTRAD COMPUTER SHOW G-Mex, Manchester — Database Exhibitions (061) 456 8383	23-25 October 1987
SOFTEACH Heathrow Penta Hotel, London — Softsel (01) 568 8866	24-25 October 1987
MAC USER SHOW '87 Business Development Centre — Montbuild (01) 486 1951	10-12 November 1987
ELECTRON & BBC MICRO USER SHOW New Horticultural Hall, London — Database Exhibitions (061) 456 8383	13-15 November 1987
COMPUTERS IN THE CITY Barbican, London — Online International (01) 868 4466	17-19 November 1987
COMPEC Olympia, London — Cahners Exhibitions (01) 891 5051	17-20 November 1987
COMPUTER RECRUITMENT FAIR Novotel, London — Intro UK Ltd (0491) 681010	27-28 November 1987
OFFICE UPDATE NEC, Birmingham — Andrew Centre (01) 891 5051 Ext 285	19-22 January 1988
WHICH COMPUTER? SHOW NEC, Birmingham — Cahners, Belinda Caver (01) 891 5051	19-22 January 1988
COMPUTERS IN RETAIL AND RETAIL TECHNOLOGY NEC, Birmingham — Focus Events (01) 834 1717	15-17 March 1988
ELECTRONIC PRINTING AND PUBLISHING EXHIBITION Olympia, London — BED Exhibitions (01) 647 1001	March 22-24 1988
COMPUTERS IN TRANSPORT AND DISTRIBUTION Wembley Conference Centre, London — Computers in Transport and Distribution (0303) 45979	April 19-21 1988

RGP

59 EXETER STREET, PLYMOUTH

DISTRIBUTION

ALL DISKS CARRY A LIFETIME
FREE REPLACEMENT GUARANTEE

**** TEL (0752) 225732 ****

DISKS

5.25" - BOX OF 10
PRICE PER BOX

1-4	48 TPI	96 TPI	1-4	720K
5-9	7.55	17.75	5-9	17.75
10-24	6.75	17.75	10-24	17.00
25-49	5.75	18.05	25-49	16.05
50 plus	5.35	15.55	50 plus	15.55
	4.75	15.00	50 plus	15.00

BULK PACKED
PRICE EACH

50 DISKS	48 TPI	96 TPI	50 DISKS	720K
100 DISKS	49p	1.59	100 DISKS	1.75
500 DISKS	45p	1.52	500 DISKS	1.59
1000 DISKS	34p	1.45	1000 DISKS	1.45
	30p	1.38	1000 DISKS	1.39

FOR HIGHER QUANTITIES
CALL US FOR LOWER
PRICES PLUS OTHER
FORMATS.

DISK BOXES
PRICE PER BOX

HOLDS 40	5.25"	10.50
HOLDS 50	5.25"	11.50
HOLDS 70	5.25"	12.50
HOLDS 90	3.50"	12.95
HOLDS 100	5.25"	13.50

PRINTER STANDS AND
CABLES ALSO AVAILABLE.

10% DISC. FOR 5 - BOXES
25% DISC. FOR 10 - BOXES

**** COMPETITIVE PRICING
WITH LARGE DISCOUNTS ON
BULK PURCHASES. ****

SOFTWARE

COMPSOFT
BUDGET RANGE
BOOKWORKER 115.00
DELTA 4 57.00
DELTA GRAPH 39.00
DOMINO 57.00
1 UP 27.50

TRUST RANGE
TRUSTWRITER 28.00
TRUST DESKTOP 15.00
TRUST
DATABASE 28.00
TRUST SPELLING
CHECKER 13.00

OTHER PRODUCTS
LABELS 45.00
TURBOCAD
JUNIOR 59.00

PRINTERS

EPSON LX-800 192.50
EPSON FX-800 303.80
EPSON EX-800 388.50
STAR NL-10 173.60
STAR NX-15 272.30
STAR ND-15 342.30
STAR NR-15 412.30
JUKI 6100 299.25
JUKI 6200 434.25

ALL PRICES EXCLUDE VAT AND POSTAGE

FARNHAM COMPUTERS

We are dealers for

AMSTRAD

Acorn

and ATARI ST

For your Computer,
Software and
Peripherals
requirements

Call Us for Prices:

**1 South Street,
Farnham, Surrey
Tel: 0252 723107**



ANNOUNCEMENT OF CONVENIENCE SMALL SIZE, GREAT PERFORMANCE



Features:

- * 640 x 400 resolution, 80 characters by 25 lines back-lighted LCD display (angles adjustable)
- * Detachable 84 key keyboard
- * Can support both 3-1/2" and 5-1/4" Floppy/Hard disk Drive
- * External MDA, CGA connectors available
- * Dimension: 400mm x 255mm x 190mm
- * Weight: around 8.5 kg
- * Intel 80286 CPU (6/8/10/12 MHz), Legal BIOS
- * 80386 system available

Manufacture & Exporter

ARCH-TECH COMPUTER CORP.

4F-4., No. 391, SEC. 4, HSIN-YI ROAD.

TAIPEI, TAIWAN, R.O.C. TEL: (02)7095458

TLX: 19041 GOLDNWAY FAX: 886-2-7064439

HIGH PERFORMANCE

UNIQUE CONCEPTS ON 286 AND 386

PLASTOW 286.

31cm x 22.4cm (12.2" x 8.8")

- 6 CHIPS SET.
- 1 SERIAL/1PARALLEL ON BOARD.
- 8/10/12 MHz ONE WAIT STATE.
- MEMORY 640/384 RAM DISK OR 512/512 SELECTABLE.

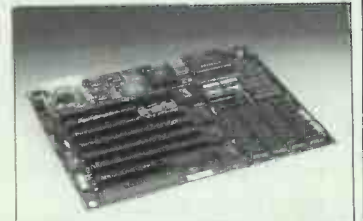

PLASTOW 386.

31cm x 35cm (12.2" x 13.75")

- 8 CHIPS SET.
- 16 MHz 0 WAIT STATE.
- 2 MRAM MODULE ON BOARD.
- 6 LAYERS BOARD.

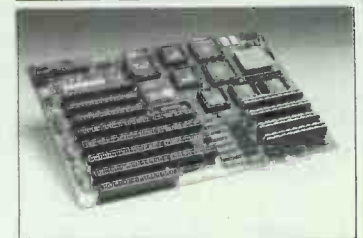

**QUALITY IS THE LIFE,
WE GUARANTEE OUR PRODUCTS.**

NEW PRODUCTS ARE
COMING SOON !



COMPLETE SYSTEM
AVAILABLE TOO.

**PLASTOW TAIWAN
ENTERPRISES CO., LTD.**

MAILING ADDRESS: P. O. Box 14-55, TAIPEI, TAIWAN, R.O.C.

TEL: 886-2-3511004(REP.) TLX: 25533 INCHIAO.

FAX: 886-2-3969765

PC/AT COMPATIBLES

BREAKING THE PRICE BARRIER!!!!!!
MANUFACTURED IN THE UNITED KINGDOM
USING HIGHEST QUALITY JAPANESE PRODUCTS
NEW LOW PRICES

PC/XT £355

**PC/XT, 20MB,
MONITOR TTL £649**

★ 8088/V20 ★ 640k
★ "NEC" FLOPPY DRIVE ★ "SERIAL/PARALLEL" PRINTER PORT
★ HERCULES GRAPHICS DISPLAY ADAPTOR ★ KEYBOARD NUMS +
CAPS LOCK ★ 8 SLOTS ★ FLAT SCREEN MONITOR.



AT/TURBO £680
WITH 20MB
MONITOR £949

★ DYNAMIC SPEED CONTROL ★
★ 80286 6/8/12 MHZ ★ 512K RAM EXPANDABLE TO 1M
★ LEGAL BIOS ★ FLOPPY DRIVE 1.2M
★ PRINTER PORT ★ GRAPHICS DISPLAY ADAPTOR ★ AT STYLE KEYBOARD
WITH SEPARATE CURSOR PAD
★ MOUSE £35 ★ 40MB NEC 5146 £399 30MS UPGRADE £250 ★

★ NEW 386 TURBO £2150 ★

40MB HARD DISK £399 (22MS) EGA MONITOR AND CARD £400.
MONITOR, 40MB 30MS HARD DISK, 640K RAM, 1.2MB FLOPPY KEYBOARD, DOS 3.2

ALL SYSTEMS ARE TOTALLY COMPATIBLE

HI REST TTL MONITOR £69 20MB HARD DISK £299
BILINGUAL SYSTEMS EXPORT ORDERS WELCOME

12 MONTHS WARRANTY AND SUPPORT INCLUDED PRICES EXCLUDING VAT
FOR ORDERS AND ENQUIRIES PLEASE CONTACT

C.A.S. COMPUTER POINT LTD

51A DARTMOUTH ROAD, LONDON SE23

01-291 5777 FAX 01-708 2734 TLX: 8952387 ANSWER G

Call for best prices on software.



COMPLEX

NEVER BEATEN ON PRICE

MULTISOFT ACCOUNTS

Single User £199 per module

Support and Multi User Software available

Comart Quad plus financial controller super price POA
Single user £275 per module

Amstrad 1512 640K (20Mb Tandem Hardcard)	£629
Amstrad 1640 Mono (20Mb Tandem Hardcard)	£679
Amstrad 1640 Colour (20Mb Tandem Hardcard)	£799
Amstrad 1640 EDC (20Mb Tandem Hardcard)	£949
(30Mb Hardcard Miniscrib) + £79 (Twin Disc drive Amstrad) + £89 (128 Memory Upgrade) + £19	

ATARI

520STFM	£235
520STFM + mono monitor	£315
520STFM + Philips 8833	£395
1040STFM	£399
1040STFM + mono monitor	£479
1040STFM + Philips 8833	£624

CUMANA DRIVES

Atari 3 1/2" Drive	£121
Atari 20Mb hard disk	£399
Atari 30Mb hard disk	£629
Atari 40Mb hard disk	£899
Atari 60Mb hard disk	£1099

COMMODORE

Amiga 500	£438
Amiga 500 modulator	£25
Amiga II	£949
Amiga II	£1049
Amiga 2000 1Mb	POA
Amiga Bridge +5 1/4	POA
PC Double Disk Drive	£799
PC One Disk Drive 20Mb	£1099
AT 20Mb 1.2 Disk Drive 20Mb	£1775

EPSON PC PLUS

Epson machines	POA
----------------	-----

VICTOR

Victor machines	POA
-----------------	-----

OLIVETTI

Divetti 240	POA
M24 1 D/D	£949
M24 2 D/D	£1025
M24 20Mb (Olivetti)	£1350
M24 20Mb (Seagate)	£1250
M24 30Mb (Seagate)	£1450
M24 SP	£1499
M28 20Mb H/D	£1999
M28 20Mb + T/S	£2499
M28 40Mb	£2549
M28 40 Mb + T/S	£2999

All machines come with keyboard
Monitor and MS-DDS. M24's 640k
colour monitor £250 extra.

SPERRY

Sperry machines	POA
-----------------	-----

AMSTRAD PC

1512 1DD Mono	£379
1512 2DD Mono	£469
1640 1DD Mono	£469
1640 2DD Mono	£569
1640 1DD Hard Disk Mono	£799
1640 1DD Colour	£599
1640 2DD Colour	£689
1640 1DD 20Mb HD Colour	£949
1640 1DD ECD	£725
1640 2DD ECD	£799
1640 1DD 20Mb HD ECD	£1099

BONDWELL PC

B8 Portable	£679
B18 Portable	£599
Other Models Available	POA
Colour Monitor add	£199

SBC

SBC Floppy	£525
SBC 20Mb	£899
SBC 35 20Mb	£899
SBC At 30Mb 1.2DD green screen	£1349
6.8.2 Mhz	£1499
SBC At 30Mb 1.2DD colour 6.8	
+ 12 Mhz	£1675
SBC At 30Mb 1.2DD ega colour 6.8	
+ 12 Mhz	£1849

Free 12 months a sight maintenance
with all Bondwells + SBC measures

TANDON

PCX	£625
PCX 10	£899
PCX 20	£775
PCA 20	£1349
PCA 30	£1599
PCA 40	£1749
Colour Upgrade	£260
Tandon Target 20Mb	£1399
Tandon Target 30Mb	£1750
Tandon Target 40Mb	£2075
Ega colour upgrade	£475
PC 70 Mb	

PS2

Irwin 20Mb internal	£375
Irwin 40Mb internal	£450
Irwin 60Mb internal	£595

IBM XT/AT

Irwin 10Mb internal XT	£299
Irwin 20Mb internal XT	£375
Irwin 20Mb internal AT	£375
Irwin 40Mb internal AT	£389
Irwin 60Mb internal AT	£499
Irwin 20Mb external XT	£399
Irwin 20Mb external AT	£399
Irwin 40Mb external AT	£450
Irwin 60Mb external AT	£599
Interface card XT/AT	£75

MULTI USER SYSTEMS

Comart Quad 20Mb	£4250
Comart Quad 40Mb	£4999
Northstar Dimension 30Mb	£3680
Northstar Terminals	£799
M24 running Xenix (as AT)	POA
Apricot Multi User Newtwork or Xenix	POA
20Mb Hard Disk Upgrades from	£325

HARD DISKS

Seagate 20Mb 65ms	£249
Seagate 30Mb 65ms	£299
Seagate 40Mb 40ms	£425
Miniscribe 20Mb	£299
Miniscribe 30Mb	£375
Miniscribe 20Mb hard card	£299
Miniscribe 30Mb hard card	£299
Tandon 20Mb + Cont.	£225
Tandon 20Mb Hard Card	£225

MONITORS

NEC Multisync	£485
Philips 7502 (green)	£89
Philips 7522 (amber)	£75
Philips (paper white)	£79
Philips 8833	£235
Philips 8852	£265
Philips 8873	£325
CAGA 1212	£95
CAGA 1213	£105
CAGA Supervision II	£275
CAGA Supervision III	£345
CAGA Supervision 660	£389
CAGA Supervision 760	£409
CAGA Supervision 860	£635

EGA cards to suit monitors.

DOTMATRIX PRINTERS

Amstrad DMP 3000	£145
Amstrad DMP 3160	£165
Amstrad DMP 4000	£289
Amstrad LQ 3500	£299
Brother 1109	£185
Brother 1409	£325
Brother 1509	£365
Brother 1709	£449
Brother 2024	£599
Canon 1080A	£215
Canon A55	£349
Citizen 120D	£139
Citizen LSP10	£199
Citizen MSP 01E	£259
Citizen MSP 15E	£349
Citizen HDP45	£579
Epson LX86	£185
Epson LX800	£199
Epson FX800	£299
Epson FX1000	£375
Epson EX800	£385
Epson EX1000	£499
Epson LQ800	£425
Epson LQ1000	£589
Epson LQ2500	£695
Epson S02500	£949
Micro P 135	£139
Micro P 165	£165
Micro P 200	£249
Micro P 201	£369
Micro P 480	£359
Micro P 700	£429
NEC Pinwriter P660 Parallel	£389
NEC Pinwriter P665 Serial	£389
NEC Pinwriter P660 Colour Parallel	£419
NEC Pinwriter P665 Colour Serial	£445
NEC Pinwriter P760 Parallel	£439
NEC Pinwriter P765 Serial	£469
NEC Pinwriter P760 Colour Parallel	£499
NEC Pinwriter P765 Colour Serial	£529
NEC Pinwriter 560XL Parallel	£889
NEC Pinwriter 560XL Serial	£899
NEC Pinwriter 960XL Parallel	£899
Panasonic 1081	£155
Panasonic 1091	£225
Panasonic 1092	£299
Panasonic 1591	£379
Panasonic 1595	£439
Star NL10	£189
Star NX15	£275
Star ND15	£349
Star FR10	£349
Star NR15	£419
Star NB24 10	£425
Star NB24 15	£535
Star NB15	£595

MODEMS

Pace Nightingale	£79
Pace Series 421235	£219
Pace Series 42005	£349
Pace Series 42005	£439
Miracle WS3000	£85
Miracle WS3000 2123	£229
Miracle WS3000 22	£379
Miracle WS3000 221315	£509
Miracle WS4000	£139

Phone for prices on Thom, Dacan, Rascal and Steebek.

SAGE SOFTWARE

Bookkeeper	£72.50
Accountant	£112.00
Accountant +	£145.00
Payroll	£72.50
Retrieve	£72.50
Chitchat	£72.50
PC Planner	£72.50
Desk set	£50.00
PC write	£72.50
Financial controller	£218.00
Financial controller multi user	£179

CAR PHONES & FAX

Clearstone CTN8000	£710
NEC 5A	£699
NEC 6A	£890
Panasonic EB118 with VSP	£919
Panasonic C10M	£999
Panasonic C30 MHF with VSP	£1049
Motorola 4500X	£749

TRANSPORTABLES

NEC BA 2AH Battery and VSP	£999
NEC BA 4AH Battery and VSP	£1349
Panasonic C50P	£1099
Motorola 4500X	£945
Mobira Talkman	£1099

TRANSMOBILES

NEC BA 2AH Battery and VSP	£1149
NEC BA 4AH Battery and VSP	£1249
Panasonic C70PM	£1199
Panasonic C80 PMHF	£1245
Motorola 4500X	£999
Mobira Talkman	£1199

HAND PORTABLES

NEC 9A	£1299
Motorola 800CS	£1299
Mobira Cityman	£1495
Mitsubishi Romar	£1299
Carphone fitting ESO and Hands free available — phone for price.	

FAX

Canon Model 220	£1760
Canon Model 520	£2499
Canon Model 610	£2895
Canon Model 710	£3995

GOVERNMENT AND EDUCATIONAL ORDERS
WELCOME. EXPORT ENQUIRIES WELCOME
STANDARD DELIVERY £5 AND NEXT DAY
£9.50 — ADD 15% TO ORDER TOTAL
Complex House, 28 Bradgate Road, Hinckley LE10 1LA
(0455) 635583
Manchester 061-976 3763

EXTRA SPEED CARD

FOR NORMAL (4.77 MHZ) COMPATIBLE PC

ONLY



(ENDUSER PRICE)

- LET YOUR NORMAL PC GET 2.8 - 3.1 TIMES SPEED
- FULL COMPATIBLE ALL SOFTWARE
- WITH HARDWARE SWITCH AND RESET KEY
- NORTON UTILITY SOFTWARE TESTING RESULTS
- NORMAL PC (4.77 MHz) 1.0
- TURBO PC (8.00 MHz) 1.8
- NORMAL PC + EXTRA SPEED CARD 2.8-3.1

WE ALSO OFFER
FULL COMPATIBLE
PC/XT/AT
386 SYSTEMS
AND INTERFACE CARD

ARCNET CARD

LOCAL AREA NETWORK CONTROLLER BOARD

- BASED ON DATAPOINT'S ARCNET MODIFIED TOKEN PASSING PROTOCOL.
- FULLY SMC ARCNET-PC100 COMPATIBLE
- FULLY NOVELL VIANET SOFTWARE COMPATIBLE
- SOFTWARE AND HARDWARE COMPATIBLE WITH IBM PC/XT/AT
- 2.5 MEGABIT DATA TRANSFER RATE
- UP TO 255 NODES PER NETWORK
- 2K DUAL PORT MEMORY BUFFER FOR HIGH SPEED INTERLEAVED MESSAGE TRANSFERS
- 4 MILE MAXIMUM NODE SEPARATION
- 508 BYTE MAXIMUM MESSAGE PACKET SIZE
- DRIVES 2.000 FT OF RG 62/U 93 ohm CABLE

OEMs, DISTRIBUTORS
WANTED



YUTIONAL
ENTERPRISE CO., LTD.

3F. No. 337, Sec. 4, Shin Yi Rd. Taipei,
Taiwan. R.O.C Tel: (02) 700-0400, 702-9270
Telex: 14233 YUTIONAL Fax: 886-2-7000490

Computer Manuals Limited



Suppliers of books
Literature
Manuals
Software
Training Programmes

30 Lincoln Road, Olton, Birmingham B27 6PA, England
Telephone: 021-706 6000
Telex: 334361 Compco G

£200 OFF AMSTRAD PC 1640's

Delivery FREE within U.K.

FREE 10 disks
containing
games, utilities
etc, with each
computer



CLASSIC INTEGRATED ACCOUNTS

CLASSIC Accounts	£1140	£199
CLASSIC Accounts + Stock	£1425	£249
CLASSIC Stock Control	£285	£69
CLASSIC Payroll	£385	£99

OCTOBER SPECIAL

AOKI TURBO XT 20MB
CLASSIC ACCOUNTS
DOT MATRIX PRINTER

ONLY £999 (+ £20 carriage)

Call us for Specialist Systems e.g.

Multi User JAROGATE 286 and 386 BROMCOM
with SMB or PEGASUS SENIOR Accounts.

Desk Top Publishing systems with Laser

AMSTRAD COMPUTERS

1640 ECD 32Mb	£1099
1640 ECD 20Mb	£999
1640 CD 32Mb	£979
1640 CD 20Mb	£879
1640 MD 32Mb	£849
1640 MD 20Mb	£749
*1512 CM 32Mb	£919
*1512 CM 20Mb	£819
*1512 MM 32Mb	£789
*1512 MM 20Mb	£689

*With Free ABILITY etc.

AMSTRAD WORD PROCESSORS

PCW 9512	£479
PCW 8512	£399
PCW 8256	£299

TANDON COMPUTERS

PCX 20	£899
PCA 20	£1399
PCA 30	£1599
PCA 40	£1799
PCA 70	£2299

EGA Systems + £325

EPSON COMPUTERS AND PRINTERS

PCHD 20Mb	£899
LQ1000	£575
LQ800	£475

SANYO MBC 16 COMPUTERS

**Twin Floppy Mono	£699
**20Mb Mono	£999
**Twin Floppy Colour	£949
**20Mb Colour	£1199

**With 12 months on site maintenance

AOKI COMPUTERS

Turbo XT 20Mb	£769
---------------	-------------

APRICOT COMPUTERS

XEN-i XD	from £2395
XEN-i 386	from £2995

AR KEL COMPUTER SERVICES LTD
7A MILL HILL ROAD, MARKET HARBOROUGH,
LEICS LE16 7DN

TELEPHONE: 0858 32495

Please add 15% VAT to all U.K. orders

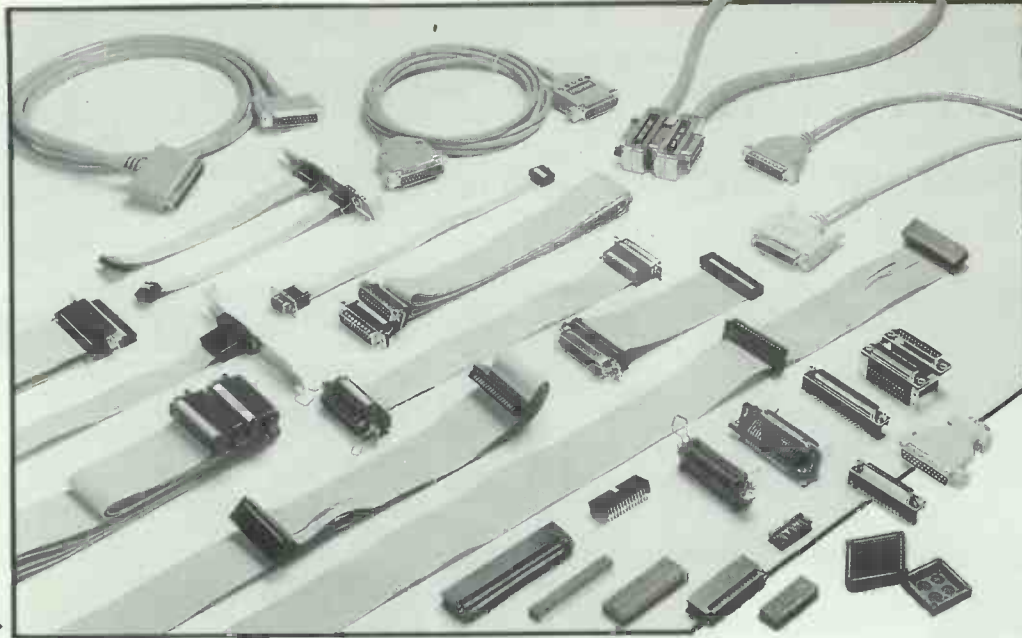

YOUR BEST CHOICE!

Cable, connector and cable with connectors assembled the way you design, you just specify the amount, the length, and we go to work for you.

If you are cable and profit minder, call us today. We'll offer at anytime, anywhere with prompt delivery and the best prices.

As a specialized supplier in Taiwan, we are your best source for high quality computer cable, connectors and cable with connectors assembled. We offer warranty in quality reliability and reasonable price.

Orders of customer redesign are welcome. For more information, please contact us now.

HUNTRIUMPH IND. CO., LTD.
 No. 28, Alley 65, Lane 285, Sec. 1, Nei-Hu Rd., Taipei, Taiwan, R.O.C.
 P.O. Box: 84 Nei-Hu Taipei, Taiwan, R.O.C.
 Telex: 15338 HUNTIME
 Fax: 886-2-7965805

HUBCOURT LIMITED — BUSINESS SYSTEMS — Established 1980

SEAGATE HARD DISKS FOR IBM AND COMPATIBLES

225	20MB	half	65MS	£245
238	30MB	half	65MS	£275
251	40MB	half	40MS	£419
277	65MB	half	40MS	£520
4096	80MB	full	28MS	£875
Filecard 20MB			65MS	£275 Miniscribe
Filecard 30MB			56MS	£295 Miniscribe

Full range of hard disks from most major manufacturers from 10MB to 800MB and over can be supplied. All can be preformatted and ready for installation.

INTERNAL TAPE BACK-UP UNITS

40MB ALLOY	£399	60MB WANGTEK	£619
------------	------	--------------	------

Call for Price on Externals.

FLOPPY DISKS

3.5" PS/2 Compatible	£189	5.25" 360K	£69	1.2MB AT	£95
----------------------	------	------------	-----	----------	-----

MONITORS

12" Mono TTL	£75	14" Mono TTL	£99
14" EGA & Card	£399	VGA SPECIAL PRICE	£530
SPECIAL PRICE PS/2 Compatible CARD			£220.

CARDS (24 MONTHS WARRANTY)

2MB EMS Card Suitable upto 12MHz	AT-£119	XT-£109
3MB EMS = I/O suitable up to 12MHz	AT-£179	XT-£169 (1.5MB)
Hercules Compatible Mono Graphics short card		£59
80286 XT Speed Card with 8K Cache RAM & 8MHz		£199
XT 640K Expansion Card + I/O		£99

ALL RAM CARDS WITH OK, Chips £80 per megabyte

PRINTERS

Full range including Lasers call for Best Price

COMPUTERS

Opus all Models — £CALL sbc full range £CALL AST AT Systems full range from £1350
 10MHz XT from £499 6/8/12MHz AT from £999
 386 Systems from £2399 full specifications available on request.

WE ARE THE PC SPECIALISTS AND CARRY ONLY THE HIGHEST QUALITY GOODS. ALL HAVE 12 MONTHS WARRANTY — MANY 24 MONTHS. WE OPERATE A SWAP POLICY FOR FAULTY GOODS.

PAYMENT BY ACCESS ACCEPTED.

ALL PRICES EXCLUDE CARRIAGE AND VAT
 PHONE FOR BEST PRICES ON ALL GOODS.

Phone: 0702 72588

LOWEST PRICES IN UK?

MICROS	Commodore 64C Compendium £160	Psion II CM £82	Letter organiser £30
Commodore 64C/cassette unit £195	Commodore 128D £395	Psion II XP £115	Finance Pack £26
Commodore Amiga package POA	Commodore 64/1541C Disk drive £310	16K Datapak £11	Maths Pack £26
Commodore 128/Cassette unit £200	Amstrad PCW 8256 £299	32K Datapak £30	Developer £43
Amstrad PCW 8512 £499	Amstrad PCW 9512 £499	64K Datapak £52	Pocket Spd Sht £34
Amstrad PC 1640 DD/ECD £876	Amstrad PC 1512 SD Mono £399	128K Datapak £86	RS232 Link £41
Amstrad PC 1512 DD Mono £549	Amstrad PC 1512 DD Colour £649	Formatter £99	Comms RS232 £52
Amstrad PC 1640 DD/MD £749	AMSTRAD PC 1512 BUSINESS PACK (PC 1512 DD Mono, DMP 3000 Printer, Best selling Wordstar & Supercalc) £680	CASIO	Data Bank
Atari 520 STM Package POA	PRINTERS	FX451 £17	SF3000 £56
Epson LX 800 - The Best Seller £199	Star NL10 - The Best Seller £199	FX580 £22	BC 300 £56
Citizen 120-D-A Hot Seller £150	Panasonic 1081 - The Hot Seller £150	FX3800P £17	PF 7000 £26
Amstrad DMP 2000 NLQ £135	Amstrad DMP 3000 NLQ £140	FX7000G £43	PF 3200 £34
Amstrad DMP 3160 NLQ £150	Amstrad DMP 4000 NLQ £299	FX4000P £26	ACCESSORIES
Citizen 120D for Commodore £160	Commodore MPS 1000 £200	Pocket Computers	RP8 £14
MP 135 £130	Juki 6100 20 cps 110C D-Wheel £265	PB1000 £120	RP16 £29
Star NX15 £300	Panasonic 1982 £195	FX850P £78	RC2 £21
Epson FX 1000 £400	Brother HR20, D-Wheel £345	FX730P £69	OR4 £26
Brother N1109 £168	Citizen 120D — Serial I/Face £160	FX750P £78	RC4 £31
PHOTOCOPIERS & FAX MACHINES	Canon PC3 £450	PB700 £103	OR40 £33
Canon PC5 £550	Canon PC14 £760	TYPEWRITERS & CALCULATORS	OR8 £60
Canon Fax 110 £1525	Sharp Fax-F0-200 £1615	Canon Typestar 7 £175	FA3 £20
DISK DRIVES & MONITORS	Commodore 1541C £164	Typestar 6 II £148	FP-12-S £44
Commodore 1571 £210	Amstrad 3" DD1/FD1/FD2 POA	Typestar 5 II £129	FA7 £60
Commodore 40 Column colour monitor £174	Commodore 80 Column colour monitor £187	Canon S200 £158	FP40 £86
ANSWERING SYSTEMS	PANASONIC 1406 £86	Canon S300S £347	FP100 £25
PANASONIC 1416 £113	PHOTOCOPIERS & FAX MACHINES	Epson FX 1000 £400	MD100 £286

Complete range of Casio, Commodore & Amstrad add-ons at discount prices. Prices/Goods subject to availability and change without notice. ALL PRICES EXCLUDE VAT. P&P £5 (within UK). Export Enquiries welcome. TELEX: 8951182 GCOMS G.



K.K. STATIONERS



187 Edgware Road
 Marble Arch
 London W2 1ET
 Tel: 01-723 1436

126 Edgware Road
 Marble Arch
 London W2 2D2
 Tel: 01-402 4592



DISCOUNT COMPUTER SOFTWARE

	List Price	Our Price
PEGASUS SINGLE-USER	£350.00	£155.00
PEGASUS SENIOR	£450.00	£285.00
PEGASUS MULTI-USER	£600.00	£345.00
SAGE ACCOUNTANT +	£199.00	£149.00
LOTUS 123 V2.1	£450.00	£299.00
SUPERCALC 4	£396.00	£260.00
SUPERCALC 3	£95.00	£59.00
WORDSTAR	£295.00	£195.00
WORDSTAR 1512	£95.00	£59.00
WORDCRAFT V3.0	£485.00	£320.00
DELTA PROFESSIONAL	£560.00	£335.00
BUDGET DELTA	£95.00	£67.00

Try us for all your software requirements
Send cheque with order to:

UK SOFTWARE

Third Floor, 42 Baldwin St.,
Bristol BS1 1PN
Tel: 0272 298998

Please add £10 carriage and VAT to all orders

4 WAY AUTO PRINTER SHARER FOR ONLY £99

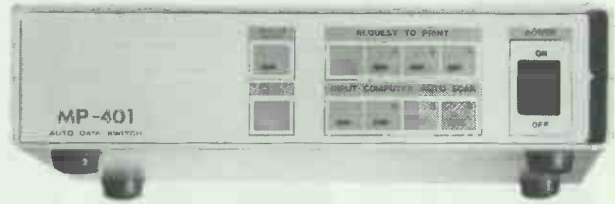

SPEC: MP401 4 way Auto-switch with 25 wayD type parallel I/O suitable for IBM & Compatible machines.

OTHER PRODUCTS AVAILABLE:

MECHANICAL			
2 WAY 25D TYPE	39.95	2 WAY CENTRONICS	£49.95
3 WAY 25D TYPE	£46.95	3 WAY CENTRONICS	£67.95
4 WAY 25D TYPE	£55.00	4 WAY CENTRONICS	£77.95
2 WAY X OVER 25D	£55.79	2 WAY X OVER 36C	£81.95

AUTO-SWITCH PARALLEL AND SERIAL		BUFFERS	
MP/MS401 4 WAY	£99	PB64 64K RAM	£122.95
MP/MS801 8 WAY	£153.95	PB256 256K RAM	£195.00

LINE CONVERTERS		PARALLEL TO SERIAL	
SERIAL TO PARALLEL	£69		£69.00

TO ORDER PLEASE SEND CHEQUES BUT ADD VAT & £3 P&P
DEALER AND EXPORT ENQUIRIES WELCOME

BRIGDEN TECHNOLOGY

0322 331984

UNIT24 ERITH BUSINESS CENTRE
ERITH HIGH ST, ERITH, KENT DA8 1QY

Paragon Provides More...

Mitac's small-footprint Paragon family provides you with a complete line of elegant office solutions. What's more, Mitac adds proven reliability backed by our years of OEM manufacturing experience.

...386 Superpower

Paragon 386 brings new speed and power to the world of small-footprint microcomputers.

...On-board Graphics

Paragon's 286's and 8088 provide on-board graphics for vivid color and high resolution on virtually any PC monitor.

...Flexibility

A host of other on-board features get your system up and running right away, leaving five expansion slots free. Storage options include 5-1/4" and 3-1/2" high-capacity disk drives.

...Reliability

Mitac insures the quality of every Paragon microcomputer by subjecting it to the same 5-phase test performed for our largest OEM's — and we quietly manufacture for some very large firms.

...Support

Mitac's international branch offices serve your local needs. Currently Mitac is seeking new distributors in many parts of the world. Contact our nearest branch office



PETITE... PRODUCTIVE... PERFECT... PARAGON

small-footprint personal computers

BRANCH OFFICES - North America ■ Distributors/Dealers: American Mitac Corp. (800)321-8443 ■ OEM/Private label: Mitac Research Corp. (408)432-1506/7 ■ Europe ■ Mitac GmbH (W.G.) 0211-41-2086 ■ Mitac Japan Corp. 03-586-1831 ■ HEADQUARTERS ■ Mitac International Corp. Taipei - 886-2-501-8231

DISTRIBUTORS: Asia/Pacific ■ Australia-Tech Pacific Pty Ltd (03)6909055 ■ New Zealand-Auckland-Pacific Computers (09)577219 ■ Singapore & W. Malaysia-ACS Computer Pte Ltd. 2741144 ■ Comprehensive Computer System Sdn. Bhd. (03)7199740-2 ■ Indonesia-Jakarta-P.T. Multipolar Corp. 5793360 ■ Thailand-Bangkok-Computer Management Limited 253-0614-9 ■ Philippines-Manila-Integrated Computer Systems, Inc. 722-4111 to 16 ■ Hong Kong-Indoprima Ltd. 5474112 ■ East Malaysia-Capital Associates (S) Sdn. Bhd. 4202345 ■ Pakistan-Karachi-Selling Business Systems 526075 ■ Europe/Middle East/Africa ■ Italy-Dylog Italia Srl 011-650-3933 ■ Lebanon-Advanced Computer Systems and Electronics 354587 ■ Oman-Avaban Trading Establishment 703048 ■ South Africa-Micronics (PTY) Ltd. 864-2150 ext223 ■ Spain-ELSI 52-338-308 ■ Sweden-Betoma Data AB 08-820280 ■ Switzerland-Rotronic AG 01-492-3211 ■ United Kingdom-Integragraphic Ltd. 0532-588659 ■ Structures and Computers 01-879-5511 ■ PC Distribution (Birmingham) 021-742-0791 ■ Holland AVT 0709-54891 ■ West Germany-Heiron Computer-technik GmbH 089-858060 ■ Compuronic Computer-Systems GmbH 02427-1037 ■ Central/South America ■ Argentina-Hakomp S.A. 54-11-35-1873 ■ Chile-Equipos Y Servicios Sincelar Chile Ltd. 56-2-251-8343 ■ Mexico-Digital Victor, S.A. 52-514-1042 ■ Panama-Calim, S.A. 507-27-5553 ■ Peru-Cosap Data, S.A. 51-14-710157 ■ North America ■ United States-Microstar Computer Technology (213)452-9110 ■ Tainn Systems & Technology (818)882-6837

mitac

When reliability is a decisive factor

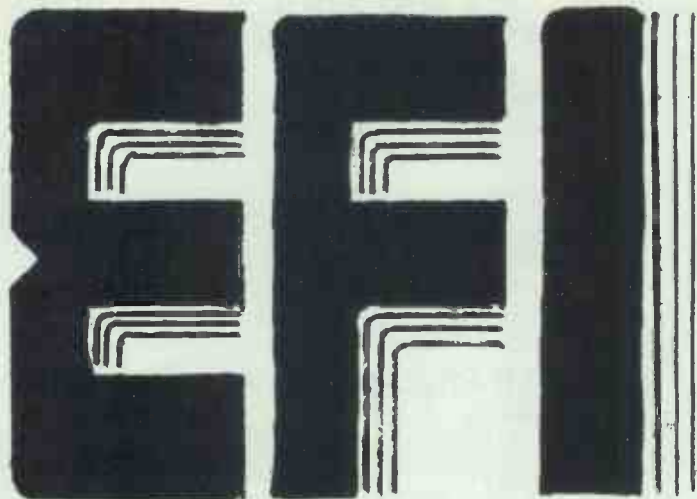

*The Newest Name
In The World Of
Personal Computers*

— 88

8008-2 CPU 4.77/8MHZ
PHOENIX BIOS
640KB RAM
360KB FLOPPY DRIVE (JAPAN)
MONO GRAPHICS DISPLAY CARD
HI-RES MONO MONITOR
2 SERIAL PORTS
2 PARALLEL PORTS
1 GAME PORT
BATTERY BACKED CLOCK CAL
84 KEY KEYBOARD
APPROVED POWER SUPPLY
TURBO AND RESET BUTTONS
LED INDICATORS
MANUAL

£459.00

— 286

80286 CPU 6/10MHZ
PHOENIX BIOS
640KB RAM
1.2MB FLOPPY DRIVE (JAPAN)
MONO GRAPHICS DISPLAY CARD
HI-RES MONO MONITOR
2 SERIAL PORTS
2 PARALLEL PORTS
BATTERY BACKED CLOCK CAL
WESTERN DIGITAL CONTROLLER
101 KEY ENHANCED KEYBOARD
APPROVED POWER SUPPLY
TURBO AND RESET BUTTONS
LED INDICATORS
MANUAL

£899.00

— 386

80386 CPU 6/816MHZ
PHOENIX BIOS
1MB RAM
1.2MB FLOPPY DRIVE (JAPAN)
MONO GRAPHICS DISPLAY CARD
HI-RES MONO MONITOR
2 SERIAL PORTS
2 PARALLEL PORTS
BATTERY BACKED CLOCK CAL
WESTERN DIGITAL CONTROLLER
40MB 40MS HARD DISK
101 KEY ENHANCED KEYBOARD
APPROVED POWER SUPPLY
DESKPRO LOOK-A-LIKE
MANUAL

£2,277.00

**CALL — [0306] 888512/76024
For your Local Dealer**

EFI COMPUTER & ELECTRONICS (UK) LTD
UNIT 10, VINCENT WORKS, VINCENT LANE,
DORKING, SURREY.

BUFFERED SMART SWITCHES

- BOTH PRINTERS PRINTING DIFFERENT DOCUMENTS SIMULTANEOUSLY •
- SOFTWARE CONTROL • OVERRIDE SWITCH • RESET & MULTIPLE COPY FUNCTION •
- EXPANDABLE • SIMULTANEOUS DATA INPUT • AUTO SELECT •
- ACS - AUTO COMPUTER SELECT • SI - SIMULTANEOUS INPUT • C - COPY • SPS - SOFTWARE PRINTER SELECT

CENTRONICS

- PB-DP (64K) £249 • 1 Centronics input and 2 output soft select with 64K buffer expandable to 256K. • C/SPS
- PB-4-2 (256K) £365 • 4 Centronics input and 2 output with 256K buffer. ACS/C/SPS
- PB-6-2 (256K) £545 • 6 Centronics input and 2 output with 256K buffer. ACS/SI
- PB-7-1 (256K) £495 • 7 Centronics input and 1 output with 256K buffer. ACS/SI

SERIAL

- SB-4-2 (256K) £445 • 4 Serial input and 2 serial output with 16K buffer at each input & a total of 256K memory. ACS/SI/C/SPS
- SB-7-1 (512K) £695 • 7 Serial input and 1 serial output with buffer at each input and a total of 512K memory expandable to 1MB. ACS/SI

UNIVERSAL BUFFER

- SERIAL & PARALLEL INPUT AND OUTPUT • X ON AND X OFF SOFT AND DTR HARD HANDSHAKE • CENTRONICS • 2 FRONT PANEL T SWITCH INPUT AND OUTPUT • COPY •
- UB (64K) £220
- RESET • EXPANDABLE TO 256K •
- UB (256K) £250

SMART AUTOMATIC SWITCHES

- AUTO COMPUTER SELECT • SERVICE • REQUEST LED INDICATION • MANUAL OVERRIDE SWITCH • UNSERVICED COMPUTER RECEIVES BUSY •

CENTRONICS

- IPS4A (25pin) £150 • 4 Parallel input and 1 parallel output
- IPS8A (25pin) £200 • 8 Parallel input and 1 parallel output

SERIAL

- V24-4A £180 • 4 Serial input and 1 serial output
- V24-8A £230 • 8 Serial input and 1 serial output

INTELLIGENT PRINTER BUFFERS

- SELF-TEST FUNCTION • BUFFER/PRINTER READY INDICATOR • BUFFER RAM STATUS INDICATOR • RESET AND MULTIPLE COPY FUNCTION • BUFFER BYPASS SWITCH •

- PB (64) £140 • 1 Centronics input and 1 Centronics output with 64K buffer
- PB-2 (64) £185 • Above with 2 way manual switch to connect 2 micros to 1 printer or vice versa
- PB (256) £190 • 1 Centronics input and 1 Centronics output
- PB-2 (256) £235 • Above with 2 way manual switch to connect 2 micros to 1 printer or vice versa

ACCESSORIES

- | | | | | | |
|---------|---|--------|--------|---|--------|
| KSM 101 | RS232 Serial to parallel converter with PSU | £65.00 | KSM105 | 36 Pin centronics gender changer (M/M - F/F) ribbon | £10.00 |
| KSM102 | RS232 25 pin D type Gender Changer (M/M - F/F) shielded | £10.00 | KSM108 | Data Flow Booster - Centronics | £40.00 |
| KSM103 | RS232 Serial - Surge Protector - M/F shielded | £20.00 | KSM109 | Data Flow Booster - Serial RS232 - V24 | £50.00 |
| KSM 104 | Parallel to serial RS232 converter with PSU | £70.00 | KSM110 | Multi-Link Switch Selectable Serial RS232 cable | £24.00 |

CUSTOM CABLE-MAKING SERVICE AVAILABLE



Add postage: Switches £3.50. Buffer £5.00 each. & cable £0.75 each - 15% VAT

KEYZONE COMPUTER PRODUCTS LTD

U14, Acton Business Centre,
School Road, London NW10 6TD
Telephone: 01-965 1684/1804. Telex: 8813271 GECOMS G



SINCLAIR PRODUCTS AND CAMBRIDGE COMPUTERS

Spectrum 128k Plus Two computer, without joystick and software pack £139(£146)£176, with joystick and software pack £149(£158)£190, Spectrum Plus 3 (New disc machine) £199(£203)£233, Blank micro-drive cartridges for the QL and the spectrum £2.50 (£3)£4, QL floppy disc interface (see Cumana disc drive section for suitable drives) £86(£94)£94, Spectrum floppy disc interface (see Cumana section for suitable disc drives) £76(£76)£86, Spectrum centronics printer interface and cable £46(£42)£47, Cambridge computers Z88 £295(£327)£343 Mains adaptor £10(£15)£20, 128k ram cartridge £50(£57) £59, 32kram cartridge. £13(£17)£19.

ATARI COMPUTERS



All ST computers come with a mouse and software. Atari 1040STF £462 (£449) £489, 520STFM £283 (£280)£320, Cumana 1000k ST disc drives: single £136(£136)£152, dual £242(£236)£260, Atan 500k ST disc drives £109(£119)£125, Atari ST monochrome monitor £139(£149)£198, Atari 12" medium resolution ST colour monitor £377(£368)£419, 14" low resolution colour monitor £276(£278)£329, Atari SMM804 printer £186(£188)£222, Centronics printer cable for the ST range £16(£16)£20, We offer good discounts on most ST software for example: Hisoft DEVPAK £43(£41)£45, Hisoft Basic Compiler £72 (£67)£71, Firstword Plus £66(£61)£65, Metacombo Lattice C. £84 (£75)£79, Computer Concepts Fast Basic £94(£75)£79, LDW Basic ST, new basic compiler £63(£58)£62, Piston Chess £22(£22)£26, Sublogic flight Simulator 2 £43(£41)£45, Starqilder £22(£22)£26, Atan 130 XE Computer + Game £95 (£99)£120.

AMSTRAD PRODUCTS

Amstrad PC1640 computers:— ECD single floppy £867(£866)£973, ECD dual floppy £964(£957) £1064, ECD 20MB HD £1289 (£1257)£1364, CD single £713(£715)£822, CD dual £808(£805)£912, CD HD £1126(£1105)£1212, MD single £560(£570)

£677, MD dual £655(£660)£767, MD HD £972(£960) £1067, Amstrad PC1512 Computers:— mono single £459(£475)£582, mono dual £567(£578)£685, colour single £607(£615)£722, colour dual £716 (£714)£825, DMP3160 printer £205(£205)£238, PCW9512 computer £544(£555)£662, PCW8512 £468(£485)£592, PCW8256 £351(£375)£482, Amstrad 612B— colour £391(£420)£500, green £291(£320)£404, Amstrad DMP2000 printer £166 (£171)£204, Extra disc drive for Amstrad 612B £99 (£105)£136, Amstrad joystick £11(£12)£16.

COMMODORE COMPUTERS

Commodore Amiga A500 Computer + modulator + software (voucher price) £462(£462)£512, Ram expansion £108(£106)£111, Amiga A500 + 1081 colour monitor + modulator + watch + software (voucher price) £719(£711)£818, Commodore 128 computer + cassette recorder + software + mouse £199(£200)£242, Commodore 128D £418(£408) £448, 1571 disc drive £276(£269)£285, Commodore 64C computer £164(£164)£189, Commodore 64C computer with mouse, cassette recorder and software £191(£193)£223, Converter to allow the use of most ordinary mono cassette recorders with the Commodore 128 and Commodore 64 £9.78(£9)£11, Commodore cassette recorder £32(£32)£36, Commodore MPS1000 printer £269(£262)£296, 1541C disk drive £194(£192)£208.

ACORN RISC COMPUTERS

A305 £918(£819)£869, A310 £1006(£895)£945, Mono monitor £97(£65)£115, Colour monitor £230 (£220)£270.

PSION ORGANISER

Organiser I/CM £93(£94)£104, Organiser II XPE £125 (£127)£137, Datapack 64K £72(£72)£77, Spell checker £28(£29)£31, Link up adaptors £12(£13) £15, RS232 link £46(£46)£52, Formatter £47(£47) £52, Maths pack £27(£27)£29, Finance pack £27 (£27)£29, Mains adaptor £12(£15)£20.

PRINTERS

Amstrad DMP2000 £156(£171)£204, Epson LX800 £276(£275)£309, Star NL10 £235(£234)£270, Interfaces for NL10 £37(£35)£37, Canon PW1080A £303(£296)£338.

CUMANA 3.5" AND 5.25" CASED DISK DRIVES WITH CABLE AND POWER SUPPLY, 40/80 track switchable double sided to suit floppy disc interfaces of the Sinclair QL, Sinclair Spectrum and BBC B 3.5" drives:— single £134(£134)£156, dual £224(£219) £251, 5.25" drives:— single £172(£169)£199, dual £310(£306)£347.

SWANLEY ELECTRONICS

The Computer Export Specialists.
Dept PCW, 32 Goldsel Rd., Swanley, Kent BR 8 8EZ, England

Tel: SWANLEY (0322) 64851. We give an additional discount of 2% to UK personal callers who pay cash. Official orders welcome. UK prices are shown first and include post and VAT. The second price in brackets is for export customers in Europe and includes insured airmail postage. The third price is for export customers outside Europe (Including Australia etc) and includes insured airmail postage.

MAIN BOARD & ADD-ON CARDS

Major Business:

- IBM compatible personal computers, including PC, PC/XT and PC/AT, also 386VAT COMPUTER.
- Monochrome monitor, color monitor, keyboard, add-on cards and computer peripherals.
- Subcontract manufacturer of OEM projects.



OEMTEK OEMTEK TAIWAN, INC. (OTI)

Head Office, Factory: 2-1, Science Rd., 1,
Science-Based Industrial Park, Hsin Chu,
Taiwan, R.O.C.
Tel: (035)772187/9. Telex: 34527 OEMTEKTN.
Fax: 886-35-776208.

BONDWELL MASTER DEALER
OFFICIAL DEALERS ★ AMIGA ★ AMSTRAD ★ ATARI

COMPUTERS

Commodore AMIGA 2000 1Mb RAM & Colour Mon	PHONE
Commodore AMIGA 500 + Deluxe Paint	PHONE FOR LATEST PRICES
Amstrad PC Series incl DN-SITE MAIN-TENANCE	FROM 399.00
MEGA ST 2Mb Mono System	764.35
MEGA ST 4Mb Mono System	999.13
Atari 1040STF Mono System	477.39
Atari 1040STF	390.43
Atari 520STFM Mono System	346.96
Atari 520STFM	233.91
Bondwell 8s Laptop 512K RAM 720K Drive	Supertwist LCD
Bondwell 18 Transportable 640K RAM Dual 5.25" Drives	599.00
Bondwell 38 Professional PC 4.77/8 MHz	599.00
Bondwell 38 with 20Mb Winchester	899.00
SBC FD Twin Floppy 640K HGA/CGA Battery Backed Clock	559.00
SBC Mistral 286 AT Mono 6/8/12MHz 1M RAM 30M Winch	1559.00
Psion Organiser XP expandable to 128 Kb RAM	109.00
Psion Hardware/Software Add-ons	PHONE

PRINTERS

Citizen 1200 Dot Matrix 120/25cps	164.35
Citizen 1200 for Commodore 64/128	169.57
Commodore DPS 1101 Daisywheel	155.65
Dkimate 20 Ribbon Transfer Colour Printer	159.00
Okimate 20 for Amiga	173.04
Star NL10 120/25cps	190.43

MONITORS

Atan High Res Mono Monitor	119.00
Atari Med Res Colour Monitor	319.00
Commodore 1901 Col 14"	260.00
Philips 8833 14" Col RGB/Comp Med Res	251.30

Philips BM7502 Green 12" Comp Video + Sound	72.00
---	-------

DISKS DRIVES

Atari 0.5Mb Disk Drive	119.00
Atari 1Mb Disk Drive	159.00
Atari 20Mb Hard Disk	559.00
Supra 20Mb Hard Disk for Atari	503.48
Cumana CSA354 1Mb Disk Drive for Atari ST	123.00
Cumana CDA358 2 x 1Mb Dual Drive for Atari ST	209.00
Cumana CAX354 Disk Drive for Amiga	117.39
Scribecard 30Mb PC Disk Drive on a card	299.00

ACCESSORIES

Amiga 500 512K RAM & Battery Backed Clock	86.91
PEP Smart Printer Buffer 256Kb	99.95
PEP Smart 2-Printer Switch	89.00
PEP Smart 4-Computer Printer Sharer	129.95
PEP Printer Networks & Cables	PHONE
PC Multifunction Card - RS232 + Clock/calendar	86.95
PC Monographics Card	86.95
Surge Protector 13amp Plug or Adapter	10.39/13.00

SOFTWARE (Examples)

Wordstar 1512/Word Jnr/SuperCalc 3.1	each 52.90
Reflex for Amstrad	52.90
PC Planner (123 Clone)	69.00
Word Perfect Jnr	69.00

DISKS (Box 10)

5.25" DS/DD Goldstar	8.69
3.5" SS/DD Goldstar	17.39
3.5" DS/DD Goldstar	20.87
3" DS (CF2) Amstrad	26.00

Please add 15% VAT to above prices
CARRIAGE £8, EXPRESS DELIVERY £12, Software & Small Items FREE.

Delta Pi Software Ltd

8 Ruswarp Lane, WHITBY, N. Yorks. YO2 1ND.
Tel: 0947 600065 (9am-7pm)



PANASONIC Model JU-363 3 1/2" Disc Drives. Shugart interface, 1/2 height, 1 megabyte double sided double-density 80 track, low component. Will interface to just about anything. (A quantity discount of at least 20% is available for 10+ off)

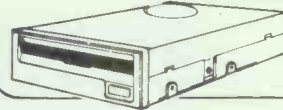

£59.50

DUPLEX Model M100 Monochrome Monitors. With 12" high resolution green screen & composite video input. Equivalent to other models such as ZENITH & PHILIPS.

£49.50

PLESSEY Model T24 V22/V22 bis 1200/2400 Baud MODEM. Compact automatic modem featuring the latest technology & the highest data rate over the ordinary phone system. Features:

- * Free software disc for IBM PC & compatibles & MATMOS PC
- * High speed PRESTEL compatibility
- * Auto call & auto answer
- * New low price & generous quantity discounts

£249.50

Please note:

We have many other items of new & secondhand equipment in stock currently including FUJITSU Winchester drives & DEC & DATA GENERAL computers. Please ask for list. VAT & carriage must be added to all items.

MATMOS Ltd., 1 Church Street, Cuckfield, W. Sussex RH17 5JZ (0444) 414484/454377

COMPUTER APPRECIATION, 111 Northgate, Canterbury, Kent CT1 1BH. (0227) 470512
TELEX 966134 COMPAP

HITCHI Model 305S/SX 3" disc drives. With SHUGART compatible interface (34 way edge connector) & suitable for BBC with DFS, AMSTRAD 664/6128, TATUNG EINSTEIN & many others. Will usually replace 5 1/4" drives directly. 250K (double density unformatted) per side reversible; 40 track; standard power connector for 12V & 5V; overall power consumption typically 3.7W. Supplied BRAND NEW with connector pin-out details etc. but uncased without PSU. Data cables are available for AMSTRAD & BBC (£7.50) and an installation pack including data & power cables with instructions is available for the TATUNG EINSTEIN (£12.00)

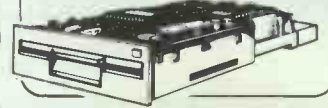

£24.95

ITT SCRIBE III WORD PROCESSING SYSTEM. Professional system originally selling at around £6000 without printer. Now offered with software included & a variety of different options available. This system is available from us ALL BRAND NEW at the cost of current budget systems, but with office-quality performance & features. Colour leaflet available.

SOFTWARE INCLUDES —
DATABASE * AUTOMATIC LETTER WRITING * HELP FILES * BASIC * PROGRAMMABLE COMMANDS * MATHS/ACCOUNTS FUNCTIONS * FULL EDITING
HARDWARE INCLUDES — 128k SCREEN/WORKSTATION * DUAL DSSD SHUGART 5 1/4" DISC DRIVES



£290.00

P & C
LT3200
LI3200
LI3200
LI3200



IBM-AT Compatible

high speed high performance Laptop

80286, 6/12 MHz clock
1.44 MB 3-1/2" Floppy Drive
20/30/40 MB Hard disk
640x400 high resolution Plasma Display



P & C SHITEN ENTERPRISE CO., LTD.

RM 7, 8 FL., NO. 100, ROOSEVELT RD., SEC. 3, TAIPEI, TAIWAN, R.O.C.
P.O. BOX: 30-291, TAIPEI, TAIWAN, R.O.C.
CABLE: PCSHITEN
TEL: (02)395-1400
TLX: 19206 PCSHITEN
FAX: 886-2-3512073

IBM PC/AT® are registered trademarks of IBM

A Selection of Products for Your Apple Macintosh

Including Colour Software for the Macintosh II

	Price Ex VAT	Inc VAT
MORE: Living Videotext *	249.00	286.35
Outlining & Presentation Software		
GRAPHICWORKS: Mindscape *	69.48	79.90
Low Cost Colour Publishing on your Mac		
CRICKET DRAW: Cricket *	295.00	339.25
Powerful Colour Graphics Package		
CRICKET GRAPH: Cricket *	175.00	201.25
Colour & 3-D Graphs on an Imagewriter //		
XPRESS: Quark *	695.00	799.25
State-of-the-Art DeskTop Publishing Software		
4TH DIMENSION: ACI *	645.00	741.75
Single or Multi-User, Relational Database		
MAC PLUS or SE CARRY CASE	39.90	45.88
Holds Macintosh, Keyboard and Hard Disk		
IMAGewriter // CARRY CASE	36.50	41.97
Matching Carry Case for Imagewriter & Cables		
C.I.TOH IMAGewriter Ribbons	15.65	18.00
Box of Six Black Ribbons for Imagewriter I or //		
SONY 400K 3.5" Disks	13.04	15.00
Box of Ten Sony Single-Sided Disks		
SONY 800K 3.5" Disks	20.00	23.00
Box of Ten Sony Double-Sided Disks		
POSTAGE per Item	1.74	2.00
Telephone Orders; Mon to Fri: 9.30-6.00 Credit Cards Welcome		

* Colour Images on Macintosh II System - Call in for a Demonstration

© Authorised Apple Dealer

STIRLING MICROSYSTEMS

The Specialist Centre for Apple Macintosh Systems

231 Baker Street, London NW1 6XE 01-935 5262

CARDCHECK LIMITED

THE MICRO CENTRE

572 Wilmslow Road, Withington
Manchester M20 9DB

COMPUTERS

IBM PS/2
Model 30 System Unit£1399
Model 50 System Unit£2399

COMPAQ

Deskpro 286 Model 20£2370
Deskpro 286 Model 40£2735
Deskpro 386 Model 40£4750
Other ranges.....

TANDON

PCX20£895
PCA20£1345
PCA30£1570
target 20 and 30Call

AMSTRAD

PC1512 SD Mono£399
PC1512 DD Mono£499
PC1640 SD ECD£799
PC1640 HD ECD£1199

DOT MATRIX PRINTERS

CITIZEN

120D£160
MSP20£335
HQP45£660

EPSON

LX800£235
LQ800£475
LQ1000£635

STAR

NL10£245
SG15£325

DAISYWHEEL PRINTERS

Juki 6000£165
Juki 6100£286
Pan. PR281£287
GPR2000£189

LASER PRINTERS

Canon LBP-8 MkII£1795
Kyocera F-1010 (10PPM)£2345
HP Laserjet£1595
Centronics PP-8£1395
Epson£1595

MONITORS

Call Philips Mono from£69
Call for full Microvitec, Eizo, Kaga
and Casper mono colour EGA
range.

VIDEO CARDS

Mono Hercules compatible£77
EGA Multi-switches£225
Vega Video 7£250

MOUSE DEVICES

Suma Mouse from£89
Manager Mouse£115
MI-KI Mouse£60
ModemsCall
Disk DrivesCall

SOFTWARE

Microsoft Word Junior£55
Microsoft Word£340
Sidekick (Borland)£59
dBASE III Plus£400
dBASE III (Amstrad PCW)£109
Wordstar 1512£55
Wordstar 2000 Plus£375
Supercalc III (Amsoft)£55
Sage Accountant Plus£169

ACCESSORIES

5.25" DSDD £10 per box of 10
3.5" DSDD £25 per box of 10
DRAMS, Expansion and I/O cards
Cables, Listing Paper and Rib-
bons in stock.

Our highly qualified Technical Staff will offer you full technical advice and support.

Export enquiries welcome. Visa and Access welcome. All prices exclusive of VAT. Nominal P&P charge. Prices subject to change without notice. CONTACT SALES DEPARTMENT (061) 448 1080

THE VITAL SOUND CHAMPION

For PC Users
who love the
Quiet Life

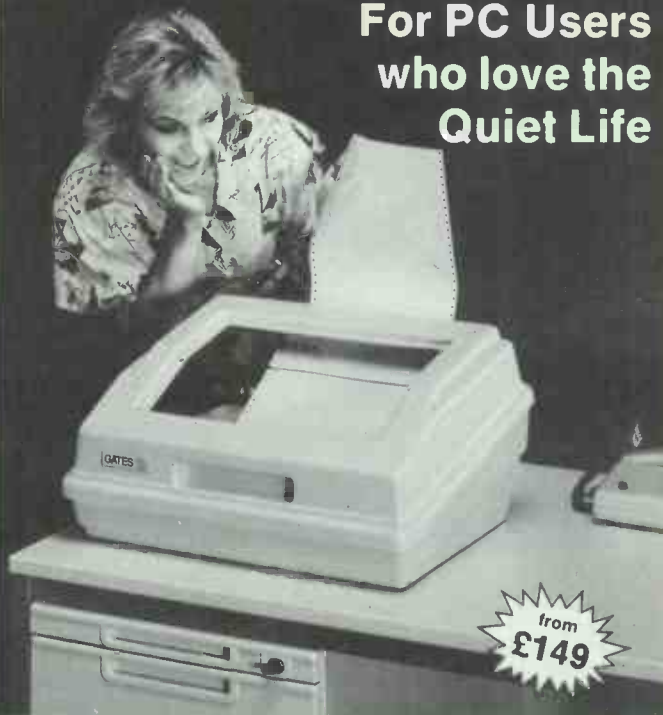

PC users know that even today's smaller desk-top printers are simply too noisy.

The problem is still with us.

Now there is an inexpensive and practical solution.

- * The SOUND CHAMPION is a lightweight, compact and stylish Sound Controller that *CUTS OUT UP TO 90% of PRINTER NOISE.*
- * Durable, easily cleaned, impact resistant, with rubber feet to prevent sliding, its small enough for a really close desk-top fit, so you won't have to shift your printer.
- * It has bottom and rear-feed slots to give smooth paper flow, with a specially developed soundseal gasket for super-quiet operation – plus a big, clear-view window mounted on memory hinges that allows access to the printer with both hands.

VITAL FOR EVERY PRINTER:

Frankly, you can't find a better product to make your printer more productive.

And if you can find a lower price EQUIVALENT MODEL Printer Sound Controller anywhere else within 30 days of purchase from VITAL – we'll refund the difference.

With three models to choose from there's a VITAL Sound Champion for every PC printer. Call us and find out the one that works for you.

01-729 0960

Phone now for a Quiet Word.



ALL VISA AND ACCESS
CARDS ACCEPTED



Vital OFFICE EQUIPMENT

52 Hoxton Square, London, N1 6PB

Telex: 298951 BILWAY G

KIRIN PRICE GUIDE



CALL NOW
FOR
RIDICULOUS
AMSTRAD
PRICES

**OLIVETTI COMPUTERS
MAIN DEALER**

M19/keyboard/Mono } PLEASE
M24/keyboard/Mono } CALL FOR
M28/keyboard/20MB/ } CLEAR OUT
Colour } PRICES
New M240-M380C
Price on application

COMPAQ PC

DeskPro 286/20 £2350.00
Portable 111 Model 20 £3160.00

IBM PC

PC/XT 286-20MB £1750.00
PC/ATX/30MB £2250.00
PC Enhanced keyboard £150.00
ProPrinter XL £425.00
EGA Hi-Res Monitor £485.00

MULTISYNC SPECIAL

NEC Monitor £485.00
TAXAN 770 £485.00
SONY MultiSync £535.00
EIZO 8060 FlexiScan £495.00

AMSTRAD COMPUTERS

PC1512SD } PLEASE
PC1512DD } CALL FOR
PC1512HD 10Mb } SPECIAL
PC1512HD 20Mb } PRICE
Colour Monitor £175.00 extra
New PC1640 in stock.
All softwares available including SAGE
Soft and others.
Please ring for quote.

HARDCARDS & DISKS

PLUSCARD 20 £595.00
PLUSCARD 40 £821.00
MiniScribe 20 £275.00
MiniScribe 30 £300.00
Seagate 20MB Kit £275.00
Seagate 40MB Kit £445.00

ADD-ON BOARDS

MultiFunaction 384K £145.00
256K Ram Card £85.00
384K Ram Card £119.00
Maths Co-Pro.8087-5Mhz £125.00
Maths Co-Pro.80287 8Mhz £225.00
AST. Orchid Tech. Intel Etc.

PRINTERS

Citizen 120D £165.00
Citizen MSP25 £405.00
Citizen Premier 35 £485.00
Epson LX800 £210.00
Epson FX1000 £410.00
Epson EX1000 (sp) £445.00
Epson LQ800 £456.00
Epson LQ2500 £750.00
Star NL-10 Parallel £185.00
Star NX-15 Parallel £325.00
Star NR-15 £485.00
Panasonic P1080 £180.00
Panasonic P1092 £284.00
Panasonic P1592 £365.00
Panasonic P1595 £477.50



LASER PRINTERS

QMS K8 £1645.00
H-P Laser Jet 500+ £2650.00
H-P Laser Jet/Ser.2 £1850.00
CANON LPB-8/Ser.2 £1646.00
KYOCERA F1010 £2096.00
KYOCERA F2010 £3446.00
Toner Cartridge/A1 £66.50

CITIZEN & HERMES also available from stock

ALL PRICES EXCLUDE VAT & DELIVERY CHARGES

SOFTWARES

LOTUS, MICROSOFT, SAGE, MICRO-PRO, BORLAND, ASHTON-TATE DIGITAL RESEARCH ETC.

MODEM CARD

Special Modem for Amstrad PC1512 £129.00
Dowty Quatro Card V22 bis £635.00
PC Com Quatro Card £635.00
MiracleTech WS4000 £150.00
Thorn EMI VX524 £380.00

TAPE BACK-UP

Maynard 20Mb Portable £766.00
Maynard 60Mb Portable £966.00
Maynard 20MN Internal £575.00
Maynard 60Mb Internal £850.00

Also stock MOUNTAIN, EVEREX, IRWIN.

TERMINALS

WYSE 30 £285.00
WYSE 50 £365.00
WYSE 60 £425.00

COMMUNICATION BOARDS

IRMA Board £785.00
ATACHMATE £998.00
PCOX/Standard £580.00
PCOX/Plus £850.00

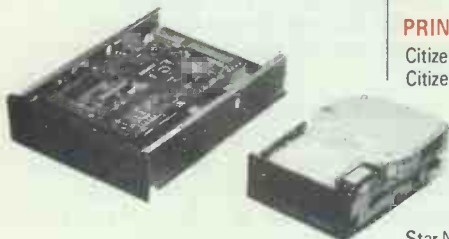

NEC 20MB Kit £255.00
NEC 40MB HardDisk £420.00
I.O. Mega 10 + 10 Box £1200.00
I.O. Mega 10MB Cartridge £52.00
I.O. Mega 20MB Cartridge £58.00

GRAPHIC CARDS

Hercules Mono Plus £155.00
Hercules Colour Plus £285.00
Hercules Compatible Mono £89.00
Paradise AutoSwitch EGA £275.00
Sigma EGA Card £210.00
Genoa Spectrum 4 Cards in 1 £185.00
Genoa Super EGA L3 £245.00
Genoa Super Hi-Res L5 £350.00



KIRIN COMPUTING SYSTEMS LTD

Unit 69, Abbey Business Centre,
Queenstown Road,
London SW8 3NS
Tel: 01-720 7722 FAX. 01-627-4667

PCOX/3720 PC £1250.00
PCOX/Standard Remote £425.00
PCOX/3720 PC Remote £950.00

KEYBOARDS

Keytronics 5150 (83 Keys) £130.00
Keytronics 5151 (99 Keys) £195.00
EECO 8600 for AT/PC/XT (94 Keys) £99.00



NEW LOW PRICE ST!



£260 +VAT=£299

SO MUCH FOR SO LITTLE!

There is nothing that can compare with the incredible value for money offered by Atari's 520ST-FM. For only £260 (+VAT=£299), you can purchase a powerful 512K RAM computer, with a 95 key keyboard (including numeric keypad), MIDI interface, GEM, a palette of 512 colours, mouse controller, and a 512K built-in disk drive. The 520ST-FM has a TV modulator built-in, and comes with a lead to allow you to plug it straight into any domestic colour television set. The mains transformer is also built-in to the keyboard, so there are no messy external boxes. You couldn't wish for a more compact, powerful and stylish unit. Atari ST computers are now firmly established in the UK, there are nearly 500 software titles already available for a wide variety of applications and the list is growing all the time. And that's not all. When you buy your new 520ST-FM (or any Atari ST computer) from Silica Shop, you will get a lot more, including a FREE Silica ST Starter Kit worth over £100. Read the ONLY FROM SILICA section on the left, to see why you should buy your new high power, low price 520ST-FM from Silica Shop, the UK's No1 Atari Specialists. For further details of the range of Atari ST computers and the FREE Silica ST Starter Kit, complete and return the reply coupon below.

ATARI 520ST-FM NOW ONLY £260 (+VAT=£299)
 520ST-FM with 512K RAM & mono monitor £399 (inc VAT) Upgrade from 512K RAM to 1024K RAM £100 (inc VAT)

ATARI 1040ST-F - NEW PRICE

We are pleased to announce a new reduced price point on the 1040ST-F which is now available for only £499 (inc VAT). The 1040 is a powerful computer with 1Mb of RAM and also includes a built-in 1Mb double sided 3 1/2" disk drive. The 1040 has been designed for use on business and professional applications most of which require a high resolution monochrome or colour monitor. It does not therefore have an RF modulator for use with a domestic TV set. Modulators can be fitted for £49 (inc VAT).
 1040ST-F Keyboard Without Monitor £499 (inc VAT)
 1040ST-F Keyboard + High Res SM125 Mono Monitor £599 (inc VAT)
 If you would like further details of the 1040ST-F, return the coupon below.

MEGA STs NOW IN STOCK

For the user who requires even more RAM than the 520 or 1040 ST's offer, the new MEGA ST computers are now available. There are two MEGA ST's, one with 2Mb of RAM and the other with a massive 4Mb. Both new computers are fully compatible with existing ST's and run currently available ST software. The MEGA ST's are styled as an expandable Central Processing Unit with open architecture and a detachable keyboard. They are supplied with GEM, a free mouse controller and all extras as with the 520 or 1040. Prices are as follows:
 MEGA ST 2Mb Keyboard + CPU £899 (inc VAT)
 MEGA ST 2Mb Keyboard + CPU + SM125 Mono Monitor £999 (inc VAT)
 MEGA ST 4Mb Keyboard + CPU £1199 (inc VAT)
 MEGA ST 4Mb Keyboard + CPU + SM125 Mono Monitor £1299 (inc VAT)
 If you would like further details of the MEGA ST's, return the coupon below.



ONLY FROM SILICA

Finally, there's a personal computer that not only solves problems like other computers, but also solves the one problem that other computers have created. Affordability. Silica Shop are pleased to present the ST range of personal/business computers from Atari. The ST was designed utilizing the most recent breakthroughs in semiconductor technology, producing a personal computer that performs tasks with fewer parts. Which means it costs less to make. And less to buy. The latest ST computers now include built in power supplies and built in disk drives. The TOS operating system and GEM window environment are now on ROM chips which are already installed in the ST keyboard. This enables automatic instant booting when you switch on. Silica Shop are pleased to offer the complete Atari ST range. Our mail order department is situated in Sidcup and we have 3 retail outlets at Sidcup, Lion House (Tottenham Court Rd) and Selfridges (Oxford Street). We have eight years experience of Atari products, longer than any other UK company, and are well established as the UK's No.1 Atari specialist. With a group turnover of over £9 million and in excess of 80 staff, we offer you unbeatable service and support. We provide several facilities which you will find invaluable during your Atari computing life and most of these facilities are available ONLY FROM SILICA. We suggest that you read through what we have to offer, before you decide where to purchase your Atari ST.

FREE STARTER KIT - Only From Silica

When you purchase any Atari ST keyboard, you will not only get the best value for money computer on the market, but you will also receive the following from Atari Corporation as part of the package:
 * BASIC Language Disk * BASIC Manual * ST Owners Manual * TOS/GEM on ROM
 If you buy your ST from Silica Shop, you will also receive:
 * NEochrome Sampler - colour graphics program * 1st Word - Word Processor
 In addition, we at Silica would like to see you get off to a flying start with your new computer, so we have put together a special ST STARTER KIT worth over £100, which we are giving away FREE OF CHARGE with every ST computer purchased at our normal retail prices. This kit is available ONLY FROM SILICA and is aimed at providing users with a valuable introduction to the world of computing. We are continually upgrading the ST Starter Kit, which contains public domain and other licensed software, as well as books, magazines and accessories all relevant to ST computing. Return the coupon below for full details.

DEDICATED SERVICING - Only From Silica

At Silica Shop, we have a dedicated service department of seven full time Atari trained technical staff. This team is totally dedicated to servicing Atari computer products. Their accumulated knowledge, skill and experience makes them second to none in their field. You can be sure that any work carried out by them is of the highest standard. A standard of servicing which we believe you will find ONLY FROM SILICA. In addition to providing full servicing facilities for Atari ST computers (both in and out of warranty), our team is also able to offer memory and modulator upgrades to ST computers.

1Mb RAM UPGRADE: Our upgrade on the standard Atari 520ST-M or 520ST-FM keyboard will increase the memory from 512K to a massive 1024K. It has a full 1 year warranty and is available from Silica at an additional retail price of only £86.96 (+VAT = £100).

TV MODULATOR UPGRADE: Silica can upgrade the 1040ST-F to include a TV modulator so that you can use it with your TV set. This is an internal upgrade and does not involve any untidy external boxes. A cable to connect your ST to any domestic TV is included in the price of the upgrade which is only £49 (inc VAT). The upgrade is also available for early 520ST computers at the same price.

THE FULL STOCK RANGE - Only From Silica

We aim to keep stocks of all Atari ST products and our warehouse carries a stock of over £25 million. We import many software titles direct from the USA and you will find that we have new releases in advance of many of our competitors. Unlike dealers who may only stock selected titles, we have the full range. In addition, we carry a complete line of all books which have been written about the Atari ST. A range as wide as ours is something you will find is available ONLY FROM SILICA.

AFTER SALES SUPPORT - Only From Silica

Rest assured that when you buy your ST from Silica Shop, you will be fully supported. Our free mailings give news of releases and developments. This will help to keep you up to date with new software releases as well as what's happening in the Atari market. And in addition, our sales staff are at the end of a telephone line to service all of your Atari requirements. If you purchase an ST from Silica and would like any technical advice, we have a full time technical support team to help you get the best from your computer. Because we have both the staff and the systems specifically dedicated to providing after sales service on Atari ST computers, we are confident that our users enjoy an exceptionally high level of support. This can be received ONLY FROM SILICA.

FREE CATALOGUES - Only From Silica

At Silica Shop, we recognise that serious users require an in-depth information service, which is why we mail free newsletters and price lists to our ST owners. These are up to 48 pages long and are crammed with technical details as well as special offers and product descriptions. If you have already purchased an ST and would like to have your name added to our mailing list, please complete the coupon & return it to us. This information service is available ONLY FROM SILICA.

FREE OVERNIGHT DELIVERY - From Silica

Most orders are processed through our computer within 24 hours of receiving them. Most hardware orders are sent by the overnight GROUP 4 courier service FREE OF CHARGE to customers within the UK. This method helps to ensure minimum delay and maximum protection.

PRICE MATCH - Only From Silica

We hope that the combination of our low prices, FREE UK delivery service, FREE Starter Kit and FREE after sales support, will be enough to make you buy your Atari equipment from Silica Shop. If however, there is something you wish to purchase, and you find one of our competitors offering it at a lower price, then please contact our sales department, providing us with our competitor's name, address and telephone number. If our competitor has the goods in stock, we will normally match the offer (on a same product - same price basis) and still provide you with our normal free delivery. We realise that we are not the only company who will match a competitor's price. However, if you come to us for a price match, you will also be entitled to our after sales service, including free newsletters and technical support. This makes our price match promise rather special, something you will receive ONLY FROM SILICA. We don't want you to go anywhere else for your Atari products. So shop at Silica, the UK's No1 Atari Specialist.

SIDCUP (& Mail Order) 01-309 1111
 1-4 The Mews, Hatherley Road, Sidcup, Kent, DA14 4DX

LONDON 01-580 4839
 Lion House (1st floor), 227 Tottenham Court Rd, London, W1P 0HX

LONDON 01-629 1234 ext 3914
 Selfridges (1st floor), Oxford Street, London, W1A 1AB

To: Silica Shop Ltd, Dept PCW 1087, 1-4 The Mews, Hatherley Road, Sidcup, Kent, DA14 4DX

PLEASE SEND ME FREE LITERATURE ON THE ATARI ST

Mr/Mrs/Ms: Initials: Surname:

Address:

Postcode:

Do you already own a computer
 If so, which one do you own?



THE SOFTWARE FACTORY®

Suite 78, Kent House, 87 Regent Street, LONDON W1R 7HF

WORD PROCESSING/DESKTOP PUBLISHING

Aldus Pagemaker	£389
Turbo Lightning	£42
Volkswriter 3	£110
Fancy Font	£106
Wordperfect 4.2	£148
Multimate	£205
Wordstar 2000+	£219
PFS: Pro Write	£96
Wordstar Pro Version 4	£189
Microsoft Word	£167
Lotus Manuscript	£273
Multimate Advantage	£212
Ventura Desktop Publishing	

DATABASES

PFS: Pro File	£109
Quickcode 3	£105
Rapidfile	£183
Paradox	£296
Reflex	£67
Q&A	£167
DBASE 3+	£299
Foxbase+	£220
Revelation	£342
R Base System V	£289
Kipper	£304

SPREADSHEET/INTEGRATED PACKAGES

Framework 2	£295
Spreadsheet Auditor	£64
Supercalc 4	£189
Lotus 1-2-3 Ver. 2	£235
Symphony	£379
Multiplan	£95
Enable 2.0	£296
VP Planner	£38
Lotus Hal	£86

GRAPHICS & DESIGN

Autosketch 8087/80287	£105
Autosketch	£84
Prodesign 2	£122
Chartmaster	£159
Freelance+	£265
Publishers Paintbrush	£166
Microsoft Chart	£144
PC Paintbrush+	£83
Diagram Master	£144
Harvard Presentation Graphics	£175
TurboCad	£199
Energraphics	£204

COMMUNICATIONS & PRODUCTIVITY TOOLS

Freeway Comms	£169
Prokey	£55
Crosstalk XVI	£75
Carbon Copy+	£90
Smartcom 2	£75

NETWORK APPLICATIONS

Wendin DOS Multiuser/Task	£199
Multilink Advanced	£595
Wordperfect Station	£57
Wordperfect Server	£235
Dbase 3 LAN PAK	£459

LANGUAGES/UTILITIES

Copywrite	£29
Turbo Pascal	£52
Quicksave	£129
Turbo Prolog	£52
Lattice C	£168
XENIX O/S 2.0	£299
XENIX SCO	£375
Microsoft Basic Compiler	£167
Zerodisk	£45
Norton Advanced	£67
PC-Globe	£89
Fastback	£68
Duet	£89
Microsoft Fortran	£212
Microsoft C Compiler	£212
Quick Basic	£53
Fast Forward	£89

DESKTOP ENVIRONMENTS

Lotus Metro	£51
MS Windows	£49
Sidekick	£45

STATISTICS

SPSS/PC+	£539
Systat	£357
Statgraphics	£324

PROJECT MANAGEMENT

Microsoft Project	£189
Timeline 2.0	£197
Harvard Total Project 2	£249
Superproject+	£243

**PLEASE CALL IF YOU DON'T SEE WHAT YOU REQUIRE.
ALL PRICES CARRIAGE PAID, BUT PLEASE ADD VAT AT 15%.
MAIL ORDER ONLY - WE WELCOME COMPANY ACCOUNTS.**

ORDER LINE: (01) 660 7970

OPEN: 9am-7pm Mon-Sat

**WHY BUY 'BUDGET' SOFTWARE WHEN YOU CAN NOW
HAVE THE REAL THING?**

PLEASE CHECK PRICES AT TIME OF ORDER - ADS ARE PREPARED SOME WEEKS BEFORE PUBLICATION

MICRO MEDIA

Freeport,
Dept. PCW, Rydal Mount, Baker Street,
Potters Bar, Herts EN6 3BR (NO STAMP REQUIRED)

Computer Supplies Ltd. **0707 52698 (5 lines)**

Head Cleaners

	1	2+	6+
5¼"	3.95	3.50	3.15
3½"	5.00	4.55	4.10

5¼ MICRO MEDIA Brand Discs

Includes Plastic Library Case

	10	30	50	100	250
SS/DD	6.55	18.55	29.05	53.10	118.00
DS/40T	7.90	22.30	34.90	64.60	144.50
DS/80T	9.40	26.50	40.20	75.15	165.90
DS/HD for PCAT	20.10	57.20	90.10	168.60	385.55

5¼ Reversible discs (Flippy's)

Have two write protect notches & index holes.

Suitable for 40 or 80 track drives.

	10.55	30.00	47.40	88.10	204.55
--	-------	-------	-------	-------	--------

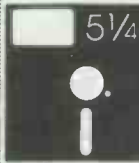

All discs supplied are with labels, 5¼" write protects, envelopes & hub rings.

Discs purchased direct from one major manufacturer. 100% certified error free - lifetime guarantee.

5¼ Rainbow Discs come in five colours

	25	50	100	250	500
SS/DD	16.50	30.75	57.10	134.50	252.45
DS/40T	17.95	33.10	60.70	141.45	262.20
DS/80T	19.00	35.20	64.85	148.75	276.00

5¼ Unbranded Discs

	9.80	19.35	36.40	86.55	163.85
SS/DD					
DS/40T	10.95	20.65	38.20	89.70	172.50
DS/80T	11.80	22.30	41.60	95.75	179.50

3½ MICRO MEDIA Brand

SS/DD	17.55	50.45	80.25	147.70	347.80
DS/DD	18.75	53.90	85.95	159.20	376.55

PRICES INCLUDE V.A.T.



3½ Unbranded Discs

	10	30	50	100	250
SS/DD	15.10	42.60	65.95	117.70	264.75
DS/DD	16.20	45.70	72.95	128.50	290.00

AUTUMN CATALOGUE OUT NOW - CALL OR WRITE FOR YOUR COPY

Monitor Swivel Bases



Pan tilt revolves around 360 degrees 12.5 degrees tiltable up and down Adjustable by front mechanism.

55x280x260mm for 12" Monitors	55x355x320mm for 14" Monitors
1 12.10	1 16.70
3+ 10.99ea	3+ 15.15ea
6+ 10.35ea	6+ 14.30ea

Adjustable Copy Holder

A4 adjustable desk clamping. Magnifying cursor line.

Paper thickness adjustment. Paper height adjustable clip.

A4 Version 25.35

Holds up to 300g

Desk Top Version 13.69

Holds up to 1000g

A3 Version 40.65

Holds up to 1400g



Printer Stand 5mm perspex

80 Column Version 400 x 310 x 100mm 21.65

132 Column Version 600 x 310 x 100mm 29.30

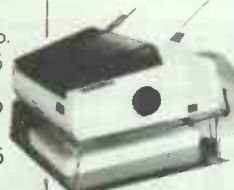

Mobile Printer Stand

Rugged steel frame. Height adjustable basket for output paper & base shelf for input paper. Self assembly - includes castors.

80 column £52.90

132 column £65.40



The Space Saver

Paper feed and refeed positioned one above the other. Dial controlled paper feed with adjustable deflectors ensures smooth flow and automatic refeeding.

80 column 414x380x460mm	132 column 530x380x460mm
1 34.85	1 42.50
3+ 32.75	3+ 40.00
6+ 31.05	6+ 38.30

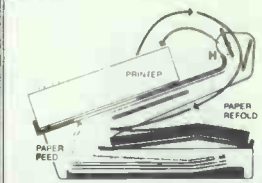

Printer Ribbons

Prices (£) per each ribbon

	3	6	12
Amstrad 8512/8256	5.65	5.35	4.90
R, G, BR, BL, Y	7.50	7.10	6.55
DMP 2000/3000	2.80	2.60	2.35
Brother HR15 MS	3.30	3.10	2.80
R, BR, BL	4.35	4.10	3.75
Centronics GLP	3.65	3.45	3.15
R, G, BR, BL, Y	4.65	4.40	4.00
Canon 1080/1156	3.30	3.10	2.80
R, G, BR, BL, Y	4.95	4.65	4.25
Citizen 120 D	4.70	4.35	4.15
Diablo Hytype II MS	2.80	2.65	2.40
R, BR, BL	3.80	3.55	3.25
Epson			
FX/MX/RX 80 FX 800	3.55	3.35	3.10
R, BR, BL, G, Y	4.95	4.65	4.25
MX 100/FX 1000/FX 105	4.65	4.35	4.20
R, BR, BL	5.85	5.55	5.10
LX 80/86 GX 80	2.80	2.65	2.40
R, G, BR, BL, Y	4.70	4.45	4.05
Juki 6100 MS	3.30	3.10	2.80
6100 SS	2.05	1.90	1.75
R, BR, BL	2.75	2.60	2.35
Kaga KP810/910	3.30	3.10	2.80
R, G, BR, BL, Y	4.95	4.65	4.25
M/Tally MT80 MS	4.10	3.85	3.55
Panasonic KP110	5.50	5.20	4.75
R, G, BR, BL, Y	7.20	6.80	6.25
Qume IV MS	3.30	3.10	2.80
Fabric	3.30	3.10	2.80
Star NL 10	5.50	5.20	4.75
Shinwa CP80 MS	4.10	3.85	3.55

One off if ordered with other product Please mix colours and types for best prices R = Red, BR = Brown, BL = Blue, G = Green, Y = Yellow

If the ribbon you require is not listed please let us quote

The above is a small selection of the 250 different ribbons we stock. We shall be pleased to find your ribbon, however old or obscure.

MD 120

1 12.55	5¼" x 120
3+ 11.90 each	
6+ 11.35 each	



Wire Printer Stand

stacks print-out in document tray automatically. Suitable for most standard printers. Made of safety coated steel wire. For 80 column £14.50 For 132 column £16.50



MD 50

5¼" x 50
1 7.80
3+ 7.40 each
6+ 7.10 each



MD 100

5¼" x 100
1 10.80
3+ 10.30 each
6+ 9.80 each

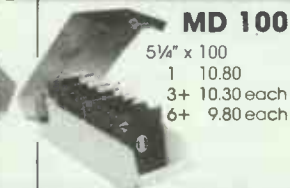

MM 40

3½" x 40
1 8.30
3+ 7.90 each
6+ 7.50 each



MM 80

3½" x 80
1 10.95
3+ 10.40 each
6+ 9.90 each



Computer Labels

Continuous fanfold, sprocket fed

	Price per 1,000	3,000
70x36	3.85	11.55
89x36	5.65	14.25
89x49	7.95	20.40
102x36	6.35	15.30

Please state no. of labels across the sheet (1, 2 or 3)

Computer paper

Plain fanfold, micro perf edges

Size	Weight 1200s gm	per box	1box	3box +
11x9½	60	2	16.90	43.80
	80	2	20.90	53.55
Exact A4				
11½x9¼	70	2	22.50	58.50
	90	1	16.90	45.15

ALL PRICES INCLUSIVE OF POSTAGE & PACKING AND V.A.T.

MICRO MEDIA

Computer Supplies

Freeport, Dept. PCW, Rydal Mount, Baker Street, Potters Bar, Herts. EN6 3BR



Access & Visa



Out of Office Hours (Answer machine)

0707 52698 (5 lines)

Orders despatched 24 hrs.

Please allow 5 days for delivery.

For next day delivery, please ring for details. Postage covers U.K. only.

A Catalogue is available with a more comprehensive range of products including - 3M & Verbatim discs - a wider choice of paper labels, ribbons and accessories.

Ring or write to obtain your copy now!

Educational and HMG orders accepted. For official orders/invoice/credit orders there is a minimum order value of £15.00 excluding V.A.T. Any order under £15.00 will be subject to £3.00 handling charge.

Personal callers welcome
Weekdays 8.30am - 5.30pm
Saturdays 9.30am - 1.00pm

SIERRA Computer Consultants Ltd.

NEW TANDON TARGET

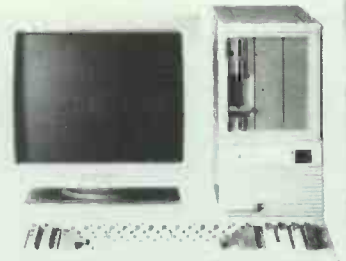
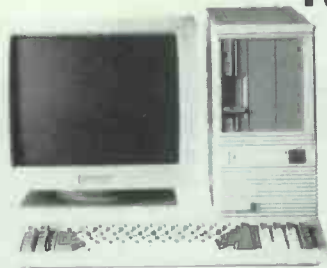

AVAILABLE NOW
1mb RAM
20mb FIXED DISC
FULL MONO SYSTEM RRP £1995
40mb VERSION RRP £2295

CALL FOR SPECIAL OFFERS

QUALITY PC COMPATIBLES		FERRANTI	PRICE	SOFTWARE	PRICE
TANDON	RRP	XT 20mb	CALL	LOTUS 123	269
PC XT 10mb	995	AT 20mb	CALL	SYMPHONY	359
PC XT 20mb	1195	AT 40mb	CALL	DBASE II +	359
PC AT 20mb	1795	AT 76mb	CALL	WORD 3	295
PC AT 30mb	2095			WORDSTAR	169
PC AT 40mb	2395			WSTAR 2000 +	325
PC AT 70mb	2995			SMART SYSTEM	395
FULL MONO SYSTEMS EGA OPTION ADD £395		OLIVETTI		PRINTERS	
		M24 20mb	CALL	EPSON LX86	239
		M28 20mb	CALL	EPSON FX800	359
		M28 40mb	CALL	EPSON FX1000	459
		ALL FULL MONO SYSTEMS		JUKI 6100	345
				JUKI 6200	535

SIERRA COMPUTER CONSULTANTS LTD. The Sanderson Centre, Lees Lane, Gosport, Hants.
Tel: 0705 504516/504874

SOFT-OPTIONS

YOUR ONE STOP COMPUTER SHOP

66 CAVENDISH PLACE

EASTBOURNE

E. SUSSEX BN21 3RL



★ 12 months full warranty

OPTION-386 £2895 ex-VAT

- ★ 6/8/16 MHz 80386
- ★ 1 meg. of High Speed RAM
- ★ 1 x 1.2mb floppy drive
- ★ HighRes mono monitor
- ★ Herc. compatible graphics card
- ★ 2 serial, 2 parallel ports
- ★ 101 key enhanced keyboard
- ★ 40 meg. 28ms hard disk
- ★ DOS 3.2 with GW Basic
- ★ Runs all major IBM software

OPTION-286 £1395 ex VAT

- ★ 8/10 Mhz 80286
- ★ Specification similar to Option-386
- Except with 30mb, 40ms Segregate hard disk

- ★ CGA Option card & monitor add £350
- ★ EGA Option card & monitor add £399
- ★ Nation wide, maintenance contracts available.
- ★ FREE caring and supportive backup for our machines for as long as you require.
- ★ All callers made most welcome.

★ FREE wordprocessing, spreadsheet, database, utilities and games software with all computers purchased

★★★ASK ABOUT OUR OPTION-88, full spec. 8088 machine from £669 (ex-VAT)

Amstrad 1512 DD/Mono	£549.00	FREE
Amstrad 1512 DD/col	£699.00	128k
Amstrad 1512 20meg Mono	£875.00	Mem
Amstrad 1512 20meg col	£1049.00	up/g
Amstrad 1640 DD EGA	£899.00	with
Amstrad 1640 20meg EGA	£1149.00	all
Amstrad DMP 3160 printer	£169.00	1512's
Amstrad DMP 4000 printer	£349.00	
Int. Modem V21/V23 + s/w	£149.95	
Amstrad 8256 SD inc s/w	£395.00	
Amstrad 8512 DD inc s/w	£495.00	

ACCESSORIES FOR AMSTRAD

30meg Hard card	£345.00
40meg stream tape kit	£399.00
20meg Seagate inc kit	£325.00
30meg Seagate inc kit	£345.00
40meg Seagate inc kit	£575.00
3" Disks, box of 10	£28.00
Ribbon for 8256/8512 range	£4.30
Ribbon for DMP 3000 series	£4.69
Ribbon for DMP 4000 series	£6.26
Full range of Books & Software ex-stock	

PRINTERS

Canon Laser LBP-8A1	£1950.00
Canon Laser LBP-811	£2195.00
Epson Laser GQ3500	£1795.00
HP Laserjet 2	£2618.00
OKI Laserline 6	£1899.00
★ 2 year warranty on most printers	
Juki 5520 180cps	£449.00
Juki 7200C 324cps	£1625.00
Micro-P MP135, 135cps	£169.00
Micro-P MP165, 165cps	£229.00
Micro-P MP480, 480cps	£369.00
Micro-P MP201, 136col, 200cps	£349.00
Cannon Ink Jet, 7 colour	£449.00
Cannon Bubble Jet	£449.00
Epson LX86, 80col, 120cps	£275.00
Epson FX80, 80col, 200cps	£430.00
Epson FX1000, 132col, 200cps	£555.00
All printer accessories available.	
Ribbons, sheet feeders etc.	
Ring for details.	
LOW, LOW PRICES	
OKI Printers, full range, LOW PRICES	

MONITORS & ACCESSORIES

14" Mitsubishi Dual CGA/EGA	£499.00
14" Mitsubishi CGA, 640x200	£349.00
14" Taxan 770 + multisync	£625.00
12" Taxan Hi-res RGB	£389.00
14" Philips Med-res RGB	£269.00
12" Taxan Mono, amber or green	£129.00
12" Philips, Mono, IBM compat	£99.00
14" NEC Multisync	£595.00
CGA Compatible Card	£45.00
EGA Compatible Card	£129.95
AT above-board mem. Ok	£110.00
256k, 120ns memory set (9 chips)	£24.75
64k, 150ns memory set, (9 chips)	£11.95
IBM compatible printer cable	£8.00
Maxell DD/DS disks, box of 10	£13.65
Verbatim DD/DS, plus box 10	£14.65
ACT DD/DS disks, box 10	£8.25
3.5" DD/DS Verbatim disks	£29.95

★★★

We also stock Paper, Labels and many other accessories, ask for FREE lists.

★★ SPECIAL ★★

OPUSEGA card AND monitor	£399.00
OPUSEGA monitor alone	£329
OPUS Spacer + FREE chair	£149.95

SOFTWARE & BOOKS

We have an ENORMOUS list of all popular software titles, far too large to do justice to here, please ask for our lists — you'll be glad you did.

Open: Mon-Sat 9.00-5.30

SALES HOTLINE (0323) 411875
FAX (0323) 4118
CARRIAGE EXTRA
ALL PRICES EX-VAT
ALL PRICES SUBJECT TO CHANGE WITHOUT NOTICE

★ ALL CALLERS MADE VERY WELCOME — COME AND TRY OUR MACHINES AND SOFTWARE BEFORE YOU BUY — NO OBLIGATION — EXTENSIVE REFERENCE LIBRARY



At Tandon we've always thought you can have the best of both worlds.

And to prove it we're cutting the price of three of our advanced range even further.

The PCA20 is down to £1,795. The PCA30 has fallen to £2,095. And the PCA40 now costs only £2,395.

But you won't simply be buying high-powered computing at low-powered prices.

You'll be buying a micro that's compatible with the reliable, familiar, established industry standard.

To find out more fill in the coupon.

It could answer all your questions on computers.

Please send me more information on Tandon's low price, high quality PCA Range. Tandon (UK) Ltd. Freepost, Redditch, B97 4BR. Telephone: (0527) 46800.

Name _____

Job Title _____

Company/Address _____

Postcode _____ Tel _____

Nature of Business _____

No. of Employees _____

No. of Installed PCs _____

Tandon
PCW11



Your One-Stop Shopping Centre

Ask for detailed catalogues.

Companies—Why not open a Credit Account for regular purchases?

Telephone Hotline 01-993 1198

Fax 01-578 2352

AMSTRAD PC1512 SOFTWARE

INTEGRATED PACKAGES		PC Promise	
Ability	£91.97	Delta 4	£55.96
PFS First Choice	£137.08	Condor Jr	£79.96
Open Access	£119.96	Cardbox	£47.96
VP Planner	£79.99	Dbase II	£95.96
Lotus 1-2-3	£321.00		
Psion PC-4	£63.96	SPREADSHEETS	
ABC	£172.00	Supercalc 3	£55.96
ACCOUNTS		VP Planner	£79.96
Sage Bookkeeper	£93.10	Multiplan Jr	£55.96
Sage Accountant	£141.55	Scratchpad Plus	£47.96
Sage Accountant Plus	£189.05		
Sage Payroll	£94.05	WORDPROCESSING	
Map Integrated Accounts	£142.45	Wordstar 1512	£55.96
Comsoft Bookworker	£159.95	GEM Write	£71.96
Sage Financial Controller	£275.00	Wordperfect Jr.	£79.20
GRAPHICS + UTILITIES		Wordperfect Personal	£159.20
GEM Draw	£79.99	New Word II	£119.96
GEM Graph	£79.99	PC Write	£108.26
GEM Wordchart	£79.99	Word Junior	£55.96
GEM Fonts and Drivers	£31.96	Turbo Lightning Spell Checker	£63.96
GEM Dairy	£31.96		
GEM Font Editor	£79.99	SPECIAL OFFER	
Sidekick	£23.96	Typing Tutors for newcomers to computers	£24.50
DATABASE		Touch 'N' Go	£24.50
Reflex	£55.96	lankey Typing	£24.50
VP Info	£79.96	lankey Two Fingers	£24.50

LISTING PAPER

2000 sheets 11" x 14.5" 1pt 60gsm	£14.76
1000 sheets 11" x 9.5" 2pt. OTC	£16.95
2000 sheets 11" x 9.5" 1pt. 60gsm	£12.96
1000 sheets 11" x 9.5" 2pt. NCR	£22.16
2000 sheets A4 Size 1pt. 70gsm Micro Perf	£14.94
1000 sheets A4 Size 1pt. 85gsm Micro Perf	£9.32

Small £22.80
Large £28.60



COMPUTER LABELS

	1 across	2 across
2000 3 1/2" x 1 7/16"	£8.05	£9.20
2000 3 1/2" x 1 15/16"	£10.65	£11.80
2000 4" x 1 7/16"	£8.65	£9.65
2000 4" x 1 15/16"	£11.80	£12.35

Other sizes of labels & Listing Paper available. Ask for details.

BOOKS

Introducing the Amstrad PC	£7.95
Amstrad Basic 2 Manual	£9.50
Using DOS Plus on Amstrad	£9.95
Business Graphics on Ams. PC	£12.95

COPY HOLDER

Adjustable
Desk Clamping
£19.50



DUST COVERS

Protect your valuable equipment from dust and accidental spillage.

PC1512 (State if colour or mono)	£8.50
DMP2000/3000 Printers	£4.50
DMP4000	£5.50

DESK TOP PUBLISHING

Fleet Street Editor	£109.00
Fontasy	£59.00
Print Shop	£34.50
Print Master	£29.95

SCREEN FILTERS

Anti Glare - Reduce eye strain, fatigue - Increase efficiency

PCW 8256/8512	£16.95
PC 1512 (state if colour or mono)	£16.95

PRINTOUT BINDERS

£4.10 each
or
£33.00 for 10

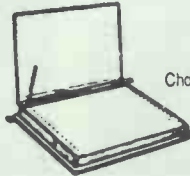

Adjustable, Hard back for 11" x 9.5" to 11" x 14.5" Choice of colours - Red, Blue, or Black

PRINTER STAND



Versatile printer stand
Sturdy steel and plastic construction with space saving design

£34.95

For 80 col. printer

DISC STORAGE



DD50L 50 X 5.25"



DD70L 70 X 5.25"

Extremely high quality lockable with dividers

DD40 - 40 capacity 3.5" Discs	£12.59
DD50 - 50 capacity 5.25" Discs	£7.90
DD70 - 70 capacity 5.25" Discs	£14.89

Low Prices!

On Ribbons & Discs

NEW

RIBBONS

Long lasting quality ribbons for your printers

	Qty 1	Qty 2	Qty 4+
Amstrad DMP2000/3000	£4.45	£3.85	£3.30
Amstrad DMP4000	£7.95	£7.50	£6.75
Brother EM200	£4.26	£4.14	£3.83
Brother HR15 M/S	£4.03	£3.91	£3.45
Brother HR15/25F	£4.26	£4.14	£3.56
Brother M1009	£3.85	£3.74	£2.58
Brother M1509	£7.47	£6.90	£6.72
Brother M1409	£8.80	£8.51	£7.92
Canon PW 1080A	£3.68	£3.45	£2.53
Canon SX 100/SX 300	£2.88	£2.53	£2.49
Citizen MSP 1020	£5.98	£5.63	£5.38
Citizen 1200/LSP 10	£4.03	£3.92	£3.63
Epson MX80/FX80/85	£3.34	£3.11	£2.30
Epson LX/CX80/86	£3.11	£2.99	£2.18
Epson MX/FX100	£3.34	£3.11	£2.82
Epson LQ 1500	£3.45	£3.22	£3.10
Epson LQ800	£3.95	£3.56	£3.22
Epson LQ1000	£4.74	£4.48	£4.26
Juki 2100/2200/6000	£2.07	£1.96	£1.86
Juki 6100 MS	£1.73	£1.61	£1.50
OKI ML 82/83	£1.38	£1.15	£1.24
OKI ML 84	£2.64	£2.30	£2.27
OKI NL 182/192/193	£6.07	£5.46	£5.36
Panasonic KXP	£4.14	£4.00	£3.45
Star NL 10	£5.63	£5.42	£5.30
Star SR 10	£6.84	£6.55	£6.15
Star NX/ND/NR/NB15	£9.14	£8.62	£8.22

FLOPPY DISCS



Detailife 5 Year Warranty

		Qty 10	Qty 20+
5.25"	SS/DD	£13.70	£13.10
	DS/DD	£16.90	£16.56
3.5"	SS/DD	£27.50	£26.00
	DS/DD	£37.50	£36.00
3M Lifetime Guarantee			
5.25"	SS/DD	£12.72	£12.26
	DS/DD	£14.72	£14.26
3.5"	SS/DD	£25.00	£24.30
	DS/DD	£28.00	£26.90
Nashua			
5.25"	SS/DD	£13.00	£12.70
	DS/DD	£14.10	£13.90
Plain label in cases			
5.25"	SS/DD	£8.70	£8.00
	DS/DD	£9.63	£8.95

COMPACT CLEANING KIT FOR YOUR PC

Spend £15.11 now and save several times over on maintenance charges

£15.11 per kit

The Kit contains:

- 1 x 5.25" Head Cleaning Disc
- 1 x 50ml R/W Head Cleaning Fluid
- 1 x 100ml Anti-Static Screen Cleaner
- 1 x 100ml Anti-Static General Purpose Cleaner
- 10 x General Purpose Wipes
- 5 x Urethane Swabs
- 2 x Spray Pump Attachment
- Instruction Leaflet

Overseas customers are supplied Tax Free



Kavin Computer Supplies
3 Market Place
Acton
London W3 6AL
Tel.: 01-993 1198

Mail Order + Export Hot Line Phone 01-993 1198

Telex 947838 GEEWS Dept KCS All prices include VAT

P&P charges—Ribbons 25p each

Listing Paper £2.50 per box

All other items 50p each. Maximum £7.50.



All Products are covered by KCS Guarantee

You order by 3 pm . We despatch by 4 pm

LINK TO TELEX

Hasler provide the missing link

Is your minicomputer the strong silent type? Unfortunately without our link to the telex network the answer is yes.

To make your computer talkative you need the **Hasler Telex Unit**, a direct connecting interface which provides the missing link between your computer and the international telex network.

With a wide range of advanced software packages to choose from, designed to integrate with your existing system software, you can extend the function of your user terminals to send and receive telexes.

Cost effective and simple to install the **Hasler Telex Unit** has broken the silence of thousands of computers worldwide.

Why not talk to Hasler — your computer can't.

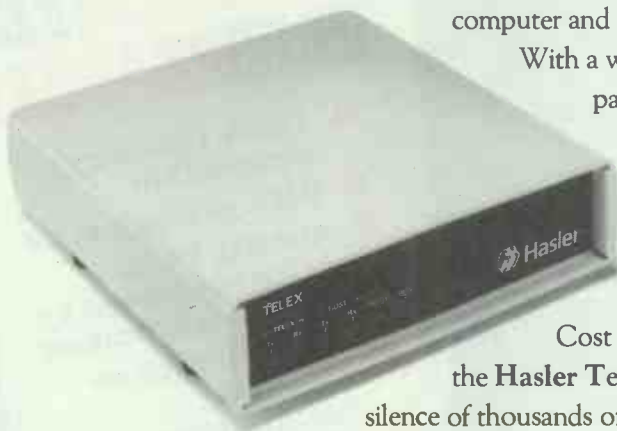

Hasler

Hasler (Great Britain) Limited
Computer Systems Division

Commerce Way, Croydon
CR0 4XA, England
Telephone 01-680 6050
Fax 01-688 4900
Telex 25628
(HASLER G)

Please send me more information on Hasler's Link to Telex
My minicomputer is: (Make) _____ (Model) _____
Name: _____
Position: _____
Company: _____
Address: _____
Postcode: _____
Tel: _____

Get the best for less at Ness

ARABIC VERSIONS
AVAILABLE
EXPORT ORDERS WELCOME

**THE
NEW PC 386**
FROM
£2995



**THE NESS SUPER XT
TURBO 20MB £695**

- NEC V20 Super processor
- switchable 4.77/8 MHz clock
- 20MB hard disk
- 1 x 360K floppy drive

**THE NESS SUPER AT
TURBO 20MB £1095**

- a true 10 MHz computer
- switchable 6/8/10 MHz
- 20MB hard disk
- 1.2MB half height floppy

**FEATURES FEAT
URES FEATUR**

- 100% industry compatible
- high performance
- quality build
- fully supported by NESS technicians
- stand-alones or systems
- installation and after-sales engineering
- wide range of upgrades available
- many peripherals in stock
- comprehensive software
- satisfaction or money back in 14 days
- ON SITE MAINTENANCE FOR 1 YEAR INCLUDED

**THE NESS
SUPER
PC-386T**
£2995

- Intel 80386 processor
- up to 2MB RAM on mother board
- fast 16 MHz clock
- 1.2K floppy drive
- full AT compatibility



★ 30MB, 40MB, 80MB AND MORE UPGRADES AVAILABLE

ALL NESS COMPUTERS COME WITH THE FOLLOWING AS STANDARD:

- | | |
|---------------------------------------|-------------------------------|
| ● professional keyboard | ● high-resolution 12" monitor |
| ● parallel and RS232 serial ports | ● full set of manuals |
| ● clock/calendar with battery back-up | ● 8 x expansion slots |
| ● monographic and printer cards | ● 12 month guarantee |

ADDITIONAL OVERSEAS AGENTS REQUIRED

NESS INDUSTRIES LIMITED

38-40 Upper Clapton Road, London E5 8BQ

Telex: 261840 NESS G Fax: 01-806 2743



FOR QUALITY

PHONE: 01-806 1072/8904

**AT
COMPATIBLE**
FROM
£995

NTSGROUP

Call 031-220 1115
or 01-373 3050



PC/XT

NTS PC-10MHz From ONLY £399

Spectacular low cost IBM compatible entry level system. Full 640K RAM, dual RS232 C and parallel printer interface. NEC V20 processor dual clock speed 4.77 10 MHz, one 360K floppy drive. Hercules compatible. 101 Key enhanced keyboard. Free PC-Write word processing software. Full 12 months parts /labour warranty - unbeatable. Call Now!

NTS XT-10 MHz from ONLY £695

Amazing Amstrad, beater, fast NEC V20 dual 4.77/10MHz processor, 20 Mb hard disc, one 360K floppy drive, dual RS232 ports, and parallel printer port, 640K RAM, AT style 101 key keyboard. Hercules compatible graphics, 12" high resolution TTL monochrome monitor with tilt-swivel base.

Free NTS mouse with hard disc version.

NTS AT286-16 Compact from ONLY £895*

We think that this is the fastest AT on the market, it boasts VLSI technology and an ultra small footprint and will run most applications at 16 MHz. One 1.2 Mb floppy drive, or fast access 20 Mb hard disc, dual RS232 ports and parallel printer port. 101 key enhanced keyboard, full 1 Mb RAM 12" high resolution TTL paper white, green or amber monitor available.

8 slot chassis.
* Zenix V version with 101 0 ports available for £2,475. Handles up to 8 concurrent users - call for further details.

New Compact!
16MHz
Norton SI 15.3

NTS AT 386-20 From ONLY £1795*

A fast 80386 based mini-computer with 20, 40 or 80 Mb hard disc, one 1.2 Mb floppy drive, dual RS232 and parallel printer ports, 12" paper white, green or amber monitors. * Unix system 5 available with up to 301/0 ports supporting up to 24 concurrent users, call for further details.

We don't know of a faster 386, ours runs at 20 MHz with 'O' wait states, and comes with 2Mb RAM as standard, expandable to 8Mb on board.

New 386!

NTS - PORTABLE/LCD From only £945*

Superb backlit LCD Display and weighs only 9kg! Smart VU system shows the LED Clock speed etc.

Available in XT, AT or 386 format with various combinations of floppy and hard discs. Call now for further details!

HOW TO ORDER: Order with confidence, 14 days money back guarantee. Full 12 months parts/labour warranty. Call 031-220 1115 or 01-373 3050 (London) for further details or mail cheque/Postal order to: 9 St. Colme Street, Edinburgh EH3 6AA. Access and Visa welcome. All prices exclude VAT at 15% and are subject to change without notification. Personal callers are welcome. Generous discounts to dealers and Education. Call for the name of your nearest dealer or distributor. On-site maintenance available nationwide.

STOP!

WE'VE GOT THE PRICES YOU NEED!

WHY PAY MORE?

CLIPPER	343 RRP 595
DBASE II	245 RRP 395
DBASE III PLUS	395 RRP 595
DELTA 4 PRO	335 RRP 545
FRAMEWORK II	325 RRP 550
FREELANCE PLUS	260 RRP 395
GEM DRAW PLUS	119 RRP 199
HERCULES PLUS	175 RRP 245
JAVELIN	90 RRP 99
LOTUS 1-2-3 2.01	225 RRP 395
LOTUS MANUSCRIPT	235 RRP 395
MS MOUSE	129 RRP 175
MS WORD 3.11	249 RRP 425
MULTIMATE	194 RRP 295
MULTIMATE ADV II	285 RRP 495
PARADOX 1.1	185 RRP 295
PARADOX 2.0	325 RRP 595
QUICKSILVER	269 RRP 460
RAPID FILE	195 RRP 275
SAMNA 4	339 RRP 550
SAMNA 4 PLUS	369 RRP 650
SMART 3.1	399 RRP 695
SUPERCALC 4	209 RRP 396
SUPERPROJECT PLUS	279 RRP 495
SYMPHONY 1.2	325 RRP 550
TURBO BASIC	49 RRP 70
WORD PERFECT 4.2	239 RRP 425
WORDCRAFT 3	299 RRP 475
WORDSTAR 2000 PLUS	245 RRP 465
WORDSTAR PRO 4.0	195 RRP 399

- This is a small selection - call for details!
- Fast delivery!
- Friendly professional service!
- Credit accounts available!
- Government/export orders welcomed!

0480 · 53044/413122

Elite Computer Systems

UNIT 2 · HALCYON COURT · ST MARGARET'S WAY
HUNTINGDON · CAMBS PE18 6DG

Prices shown are for IBM/compatibles. All prices subject to carriage and VAT and are correct at time of going to press



**A PROFESSIONAL
640 x 400
RESOLUTION
NEW SUPERTWIST
LCD FOR
PROFESSIONAL
USE.
NOT TOY AT ALL**

KESYS CORPORATION IS THE GENUINE
DESIGNER & MANUFACTURER
AND WE PROVIDE THE SALES PROGRAM
TO REINFORCE YOUR SALES
FORCE IN REALISTIC CONTACT US NOW
THE NEW EXPERIENCE

TOYS-LIKE LCD SCREEN & KEYBOARD
WON'T HELP YOU IN HANDLING
JOBS. THAT'S WHY WE COME
UP THIS PORTABLE PC FOR YOU.
80286 AT 12 MHz WITH VARIETY
HARD AND FLOPPY DRIVE. BUNDLE
WITH CONNECTOR FOR RGB &
MONO GRAPHICS MONITORS.
CIRCUIT FOR DATA TRANSFERS
BETWEEN EXTERNAL AND
INTERNAL DISK DRIVE IN 5-1/4" AND
3-1/2" FORMAT. UP TO 11
LANGUAGES MECHANICAL
84 KEYSWITCHES KEYBOARD
AVAILABLE.

KESYS

KESYS CORPORATION

2nd Floor, No. 40, SEC. 1, HSI
HAI RD. TAIPEI, TAIWAN.
R.O.C.
TLX: 15332 KESYS
FAX: +886 2 396 5829

STOP!!

Don't throw out your used
Laser Toner Cartridges

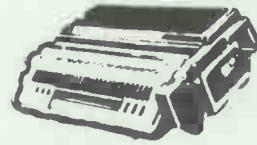

We can refill them for only £50
and save you 40-50% and More!!

International Laser Products Ltd.
9A Church Street
Cobham KT11 3E6
(0932) 66118 (3 lines)

Service applies to Canon based printers only
[Apple, Laserjet, QMS, Qume, etc.]

All cartridges unconditionally guaranteed

Ask about our FREE pickup and delivery service!

QUATROSTAR LTD

**BUSINESS / SOFTWARE DEVELOPMENT / AUTOCAD SYSTEM SPECIALISTS
PRESENT THE EFI RANGE OF QUALITY DESKTOP COMPUTER SYSTEMS
FROM £459.00 TO 24 MHz**

*** THIS MONTHS SPECIALIST SYSTEM OFFERS ***

<u>SOFTWARE DEVELOPMENT</u>	<u>AUTOCAD PROGRAMMER</u>	<u>PERFORMANCE SOLUTION</u>
:EFI 286 TURBO 6/8/10MHz	:EFI 286 TURBO 6/8/10MHz	:EFI 386 TURBO 6/8/16MHz
:LST=13.2MHz "0" WAIT &	:LST=13.2MHz "0" WAIT &	:LST=19.2MHz "2" WAIT &
:1MBYTE INTERNAL RAM	:2MBYTE SUPPORT RAM	:10MBYTE SUPPORT RAM
:5.25/1.2MB,5.25/360KB	:5.25/1.2MB DISK DRIVE	:5.25/1.2MB,3.5/720KB
3.5/720K DISK DRIVES	:10MHz CO-PROCESSOR	DISK DRIVES
:20MB HARD DISK	:40MB HARD DISK(40MS)	:80MB HARD DISK (27MS)
:EGA COLOUR MONITOR	:EGA MULTI-SYNC MONITOR	:EGA MULTI-SYNC MONITOR
£1620.20	£2427.50	£4626.50
<u>ALL SUPPLIED WITH FULL FUNCTION KEYBOARDS, WITTY MOUSE, DOS 3.2 & GW BASIC</u>		
<u>12 MONTHS PARTS AND LABOUR WARRANTY</u>		

**** COMPLETE SYSTEMS INCLUDING HIGH RES TTL MONITOR ****
 EFI 88 TURBO (FULL XT COMPATIBLE) FROM £459.00
 EFI286 TURBO (FULL AT COMPATIBLE) FROM £899.00
 EFI386 TURBO WITH 40MB HARD DISK FROM..£2399.00
 EGA SYSTEMS FROM£714.00
 HARD DISK SYSTEMS (20 MBYTES+) FROM....£720.00
 MOUSE, TAPE STREAMERS, NETWORKS +++ OPTIONS FOR CUSTOM SYSTEMS.
**** FULL ON SITE MAINTENANCE AGREEMENTS AT 5 % OF HARDWARE PRICE ****

ALL PRICES EXCLUSIVE OF VAT
 CUSTOMER HARDWARE/SOFTWARE CONSULTANCY SERVICE
FOR DETAILS CALL 01 367 4086

* LST=LANDMARK CPU SPEED TEST. COPYRIGHT 1985 LANDMARK SOFTWARE

For '386 power on your desk



... or off it!

- 16 and 20 MHz versions
- 0 wait states
- Ex stock, only from



INTER · ORIENT

01 · 441 · 9866



PC PROMISE

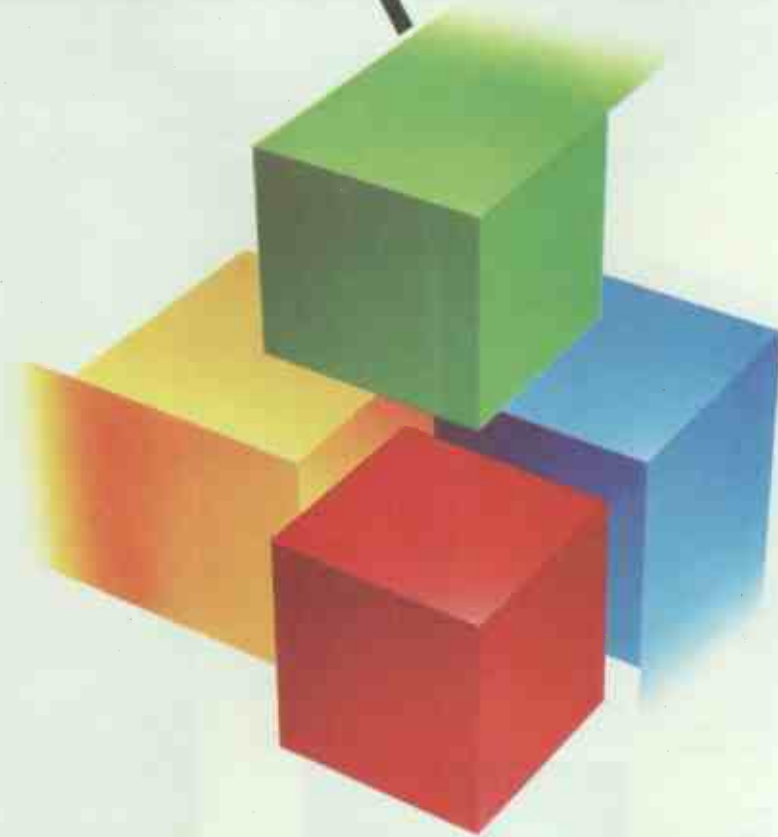

building a better database

PC Promise is a Powerful Relational Database Manager recognized for its ease of use when voted WHICH Computer Magazine's "Best Database Buy".

What is a Relational Database Manager?

A relational database simply means you can store information in a number of separate files and cross reference them for reporting and updating. With 'Flat file' database managers you can only use one file at a time. This makes it very difficult to get a complete overview of your business position.

IT'S EASY TO USE

You simply lay out your business forms on the screen as you would on a piece of paper. Within seconds you will be storing and retrieving information. You can also design menus and help screens to suit your needs, making task selection simpler for the inexperienced user.

IT'S FLEXIBLE

Changing business forms is as easy as changing your mind. PC Promise allows you to change the layout of your forms: you can add, delete or alter fields on the screen without having to reorganise files.

A few of the many business tasks PC Promise will handle:

- | | | |
|-----------------------|---------------------|---------------------|
| ★ Labels | ★ Order Processing | ★ Personnel Records |
| ★ Standard Letters | ★ Estate Agency | ★ Membership Files |
| ★ Invoicing | ★ Insurance Records | ★ Car Sales |
| ★ Job Costing | ★ Sales Ledger | ★ Patient Records |
| ★ Solicitor's Records | ★ Library Records | ★ Inventories |
| ★ Mailing Lists | | |

Specifications:

- ★ Amstrad PC, IBM PC and Compatibles
- ★ Minimum 256K bytes memory
- ★ Single disk drive
- ★ Supports mono and colour screen
- ★ 1800 characters per field
- ★ File security by Password
- ★ Variable length fields
- ★ Calculation +, -, ×, ÷ and dates.
- ★ Reports up to 240 character wide
- ★ Data can be interchanged with Word Processors, Spreadsheets and other databases.
- ★ Screens can be redefined as windows (several can be viewed simultaneously).

“ A range of features far beyond what businesses usually get for such a price

PC World

Both Menu driven and Relational, PC Promise really is an unusual product, packed full of features not found in other databases

PC Plus

A number of features make PC Promise stand out among the competition for Best Budget Database **”**

Amstrad Professional Computing

Support:

90 days FREE Hotline support is available directly from the Publishers, with extended support if required at minimal cost.

Still not sure?

Try out a demonstration diskette of PC Promise for £5.00. Send your cheque with the completed coupon, or call us on 01-942-2538.

For your local dealers call:

Lightning Distribution 01-965 5555
 Microdealer International 0908-74000
 GEM Distribution 0279-412441
 Softsel 01-568 8866
 P & P Micro Distributors 0706-217744
 Leisuresoft 0604-768711
 Vanguard Leisure 0772-617665
 Software Limited 01-278 2377

Sweden Compsort 08-7714500
 Spain ICS 071-458600
 Norway SoftTech Data 04-816773
 Holland Systel 023-339101
 Australia Amsnet 075-531734
 Germany Taurus 0617-23115

Duncan Databases acknowledge all trade names.

01-965 5555
 0908-74000
 0279-412441
 01-568 8866
 0706-217744
 0604-768711
 0772-617665
 01-278 2377

To Duncan Databases Ltd, 9 Chestnut Grove, New Malden, Surrey, KT3 3JJ, England.

Please send me a PC Promise demo diskette

Name _____

Address _____

Telephone _____

enclose cheque value £ _____

DUNCAN •

DDDB

DATA

BASES •

PC Promise (Budget Version) is £69.95 (inc. VAT).

Genius Mouse



GM-6 PLUS MOUSE

MENU MAKER SOFTWARE
DR. HALO III SOFTWARE
MOUSE PAD, CUTTING PAD
MOUSE POCKET



**MORE PRACTICAL
MORE CONVENIENT
LESS EXPENSIVE**

The Genius Mouse GM-6 Plus is the most versatile and convenient Mouse there is. It comes in its own handy casing, ready to use any time you need it. No matter what your set-up is nor what program you use, the Genius Mouse GM-6 Plus will run its mazes.

Product Function	Genius Mouse GM6	Logimouse C7
	Genius	Logi Mouse
	Microsoft PC Mouse	
Interface	Serial	Serial
Power Supply	Internal	Internal
Resolution (dot/inch)	22-200 dpi programmable	200 dpi
Button clicks	1 million	0.3 million
Menu maker	YES	NO
Driver	YES	YES
Paint software	DR. HALO III	NO
Slide show	DR. HALO III	NO
Pad	Mouse/cutting pad	NO
pocket	YES	NO

Click a button, flip a switch and your Genius Mouse GM-6 Plus is compatible with PC Mouse and Microsoft Mouse. It compares favorably with other in its category, even with Logitech Mouse.

A house for your mouse, makes it more practical, more convenient to use. When the surface is not smooth, it has its own running pad. Flip the pad, and you have a very convenient cutting board.



Genius Mouse Pocket and Pad

GENIUS MENU MAKER

With most other software is too hard to create a pop-up menu. Even with built-in software, you cannot create your own. Using the Genius Menu Maker, you may create a special pop-up menu for any applications. For example, DBASE II, DBASE III, WORDSTAR, SYMPHONY, MS WORD, GBASIC, FRAME WORK, PERSONAL EDIT, VISICALC, SUPERCALC & SMART WORK... etc.

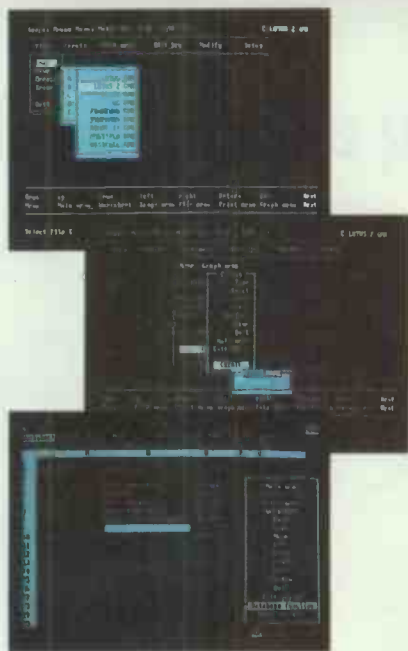

Create a Pop-up Menu and Run in Your Applications

PROFESSIONAL PAINT & SLIDE SHOW - DR. HALO III

The Professional Graphics Software:

- * Includes 256 color types
- * Create and store symbols
- * Lasso — move or cut-and-paste an irregular shape, nondestructively across the screen
- * On-screen help function

- * Can work on CGA, EGA, Hercules, PGA and VGA displays
- * Make more than 200 slide show presentation of all pictures stored in memory, one by one, automatically and timed.



Paint & Slide Show

KYE

Kun Ying Enterprise Co., Ltd.
Chung-Hsiao W. Road, Sec. 1,
No. 41, Suite 1311
Taipei, Taiwan, ROC
Telex: 11388 Kunying
Fax: 2-361-5300
Tel: 02-3813682 • 3118545

Lotus 123, Wordstar, Logitech, Microsoft, PC Mouse, Hercules, DR. Halo III are registered trade markers.

3D INTERFACE SYSTEMS PUT YOU IN CONTROL

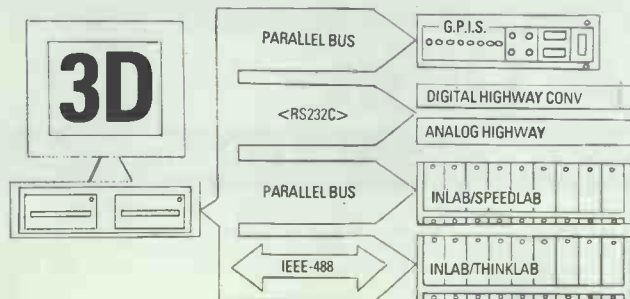

INTERFACING:

- ★ Thermocouples type K, T, E, etc
- ★ Platinum resistance (RTD's)
- ★ pH probes
- ★ Temperature controllers
- ★ Electronic balances
- ★ Weighing machines
- ★ Load cells
- ★ Pressure sensors
- ★ Accelerometers
- ★ LVDT's
- ★ DC Servo's
- ★ Analytical equipment
- ★ Input/output BCD
- ★ Shaft encoders
- ★ Frequency counting and period measurement

As from 10th July please note
our new address



*Making the most of
Micro-Computer
Technology*

3D Digital Design and Development Ltd.
Interface House
4 Chase Side Works
Chelmsford Rd, Southgate
London N14 4JN
Tel: 01-886 3668 Telex: 8953742

برامج عربية لأجهزة الكمبيوتر

Cordoba
قرطبة

► ARABIC-ENGLISH WORD PROCESSOR ◀

Andaluz

► ARABIC LANGUAGE SUPPORT SYTEM ◀

METRACO COMPUTERS LTD.

86 Chesson Road
London W14 9QU
United Kingdom

Telephone: 01-381 8823
Telex: 269722 Metrac G

metraco



STRADCOM

The Dataflex Stradcom is a powerful modem and provides a wide range of communication facilities. Small in size but big in performance, this modem fits any IBM PC/AX/AT or compatible micro computers such as the Amstrad PC 1512

- Full Duplex at 1200/1200 and 300/300 baud — with automatic sense of the incoming modem.
- Very simple to install — slide into any spare expansion port
- Full AT (Hayes compatibility) — guaranteed
- Auto dial — hold up to 100 telephone numbers.
- Auto re-dial — press one key and Stradcom re-dials automatically.
- DOS gateway — stay on line but reference other systems at the same time.
- Six error detection protocols — communication with security.
- Powerful async software included — handle asynchronous communication services such as Prestel.
- Free registration to easylink — saves you £40 registration fee.

£199 + VAT

KKS Electronics
Eastern United Trading Estate
Ruspidge
Cinderford
Gloucester
GL14 3AW
Telephone 0594 26435
Reader enquiries welcome

ASTRACOM + DIALUP

The perfect DATACOMMbination
Apart they're POWERFUL
Together they're UNBEATABLE

ASTRACOM

The Astracom 1000 is a multi-standard intelligent modem, providing auto-dial, auto-answer and centronics printer controller facilities. It has been designed to be low cost, high performance, and above all, easy to use.

DIALUP

Dialup is a SIMPLE TO USE yet extremely powerful communications software package. It is designed for the computer enthusiast and the newcomer and can be used for many applications and interests in today's computer orientated world.

It can be used to access popular services such as PRESTEL, Microlink, Micronet or Telecom Gold and electronic mail, file transfer and downloading software.

£199 + VAT

Caves
77 Wilson Road
Wyke
Bradford

Telephone 0274 604230
Reader enquiries
welcome

LOW COST PROGRAMS FOR IBM/PC COMPATIBLES

ONLY £5 A DISK

LANGUAGES

'C' TUTOR

One of the best introductions to this very popular language. Over 500k of Tutorial in 150 pages, takes you step by step, programming as you learn. Two disks — last updated 25.8.86.

A86 FAST ASSEMBLER

8086 Assembler with amazing speed. 12 page Manual. Updated 19.10.86. Two disks — over 363k of files.

PD PROLOG (see Byte Oct 86)

A very sophisticated 5th generation development tool. 34 page Manual. Updated 8.10.86.

UNIFORTH

A full Assembler, incl. Editor and Software Floating Point arithmetic. Supports the forth-83 Standard. 37 page Manual. 241k of programs.

FORTH

Full FORTH Assembler on 2 Disks. Very professional version. Uses IBM options and extensions. Built in Editor and file interface. Has Assembler and Linker. Macro support, IBM video and graphics facilities. 44 page Manual. 39 files on disk.

VISIBLE PASCAL COMPILER

Split screen operation allows you to see the code as the program runs. Marvellous for learning Pascal or debugging. Uses Macros. Includes Compiler, Editor and Debugger. 16 sample programs, 210k in all. Includes Manual.

ASSEMBLY LANGUAGE TUTORIAL

Easy to read chatty style Tutorial, 5 part Manual in 73k takes the beginner through the theory and practice of Assembler. Also has utility to disassemble COM or EXE files.

PC-PROFESSOR

The best known and best loved Tutorial in the BASIC computer language. Starts from first principles.

COMMUNICATIONS

PROCComm — THE BEST THERE IS!

Transfers at up to 19000bps, emulates 10 terminals, has windows, pop-up menus, graphics and sound effects. 100 number telephone directory, pre-defined scripts for several popular on-line services. Transfers Binary or ASCII files — full support offered. Last updated 8.1.87. Two disks full. 658k. Massive 336k Manual.

QMODEM — ROLLS ROYCE OF TELECOMMS

Makes it easy to talk to Bulletin Boards and computers worldwide. Interfaces with Topview and Deskview. Has autodial, redial, windowing, XMODEM, screen colour definition. Supports any Modem (incl. Hayes) at any speed up to 9600. Massive 66 page Manual. Updated 12.10.86. 463k of programs on 2 disks.

RBBS — REMOTE BULLETIN BOARD SYSTEM

With this it is easy to set up your own Bulletin Board System. 926k on three disks. Updated 24.1.87. This is a total rewrite of earlier versions. Huge 114k Manual.

FIDO — ELECTRONIC MAIL & BULLETIN BOARD

A Packet-Switched Electronic Mail System. Unlimited number of users, absolute security, 8 file transfer methods. A fully automatic system. 3 packed disks — 926k of program.

PC — CODE — COMPUTER SECURITY PACKAGE

A computer security system which codes and encodes text for transmission. Cannot be de-coded without the key. Output to a Comms program or a printer.

WORD PROCESSORS

PC WRITE 2.7 — THE BEST AT ANY PRICE!!!

The very latest version of PC Write with 2 documents on screen, 50,000 word auto spelling checker, proportional spacing, special fonts, support for over 300 named printers incl. Lasers. 45 Turbo-fast Help screens, includes a User's Manual and a Beginner's Tutorial. One of the most powerful Word Processors available. PC WRITE 2.7, TWO DISKS, £10 THE PAIR (Please add £1.50 P&P).

ROFF — 4 — THE SCIENTIFIC WORD PROCESSOR

Designed to print special features needed for the preparation of technical manuscripts. Special symbols or fonts can be designed by the user together with super and sub-scripts, backspace etc., even for standard printers without a back space facility. Has a preprocessor for macro definition, footnotes etc. Version 1.61. Written in 'C' Incl. Manual.

SAIL — WORD PROCESSOR FOR COLOUR MONITOR

Powerful and easy to use, more than 100 commands, multiple files, multiple buffers, cut and paste, key macros, repeat commands, multi-windowing. Incl. Manual. Updated 1.4.87. On-line help.

PRINTER UTILITIES

E-Z FORMS — SUPER FORM PRINTER

Create, store, revise and print out all sorts of business forms. Supports dot matrix or daisywheel printers. Includes 38 ready to print sample forms, including invoice, agenda, memo, order, expenses, business card, phone directory etc. Manual on disk.

LETTER & LABELS — ONE OF OUR BEST!!

Mailist Database which stores, searches and displays your clients on screen or printer. Will print selected mailing labels and also letters appended with names and addresses from the Database. Includes Manual. Updated 19.10.86.

PRINTER UTILITIES

Contains: FONTEdit — and CREATEFONTS, which allow you to make your own fonts for printing on a dot-matrix printer — some sample fonts included. Also SIDEWRITER. Updated 20.5.86. Manuals included.

UTILITIES

DESKTEAM 1.04 — SIDEKICK LOOKALIKE

Includes Alarm Clock, Calculator, Phone Book, Typewriter, Calendar, Notepad and Auto Phone Dialler. A memory resident program activated with a single keypress. 75 page Manual. Updated 4.7.86. 356k.

IMAGE — AMAZING 3-D WIRE FRAME MODELLING

Create, view and edit 3-D objects. Allows you to move, scale, rotate, and tip your image anyway you choose. Several sample images included. Two versions — (state which you require) — CGA or EGA version. Includes Manual. Written 26.3.87. (USA).

SUPER UTILITY DISK — JUST ARRIVED!!!

Contains: SIMCGA (colour prog on mono monitor); SCAVENGE; EATMEM; FMARK; MAPMEM; MARK; EGA DEMO; MULTITASK; PC BOSS, 13 SUPER UTILITIES — DISK FULL (360k).

ALL DISKS COST £5 EACH
PLEASE ADD £1.50 FOR P&P
We always send you Software
by return.

THE LANGUAGE LABORATORY
55 FELTWELL ROAD, SOUTHERY
DOWNHAM MARKET,
NORFOLK PE38 0NR
Catalogue on a Disk (Free Program) £1.50

DATABASES

pBASE — A DATABASE MANAGEMENT SYSTEM

Designed to allow programmers to develop applications programs, pBase allows you to store, sort, calculate and display data in any way you choose. 135 page Manual. 230k of program.

INSTANT RECALL

Memory resident, free-form Database with its own built-in Word Processor. Highly interactive with your other programs. 40 page Manual. Updated 26.8.86.

PC — FILE III

Menu driven Database Manager. Stores, amends, deletes, searches and prints out the chosen information. Sets up Macros, prints Mailing Labels from the stored records, exchanges data with Visicalc. 41 page Manual.

CARDEX — ELECTRONIC ROTARY CARD INDEX

Stores and prints names and addresses, will interface with SIDEKICK, prints Mailing Labels with a single keystroke. Comprehensive Manual.

BUSINESS PROGRAMS

PRESENT

A super presentation program for a colour computer which allows you to save any screen image, sort into a display file, and then runs them automatically. High or Med res. graphics, 40 or 80 columns, 6 pallets of colour, 16 background colours. Stores 100 'slides' on a 360k diskette.

PC — STOCK AND PC — GENERAL LEDGER

Graphic display of stocks and shares trends, and a complete double entry accounting package. 100 page Manual.

GENERAL LEDGER (DELUXE VERSION)

Suitable for the needs of a small to medium sized business. Prints out Balance Sheet, Profit and Loss Account, Audit trail, interfaces with LOTUS 1-2-3.

PORTWORTH AND SIDEWRITER

Portfolio monitoring with facility to monitor 25 stocks and shares. Prints bar charts and Line charts. Sidelwriter prints text sideways from any printer. Super for spreadsheets.

INVENTORY AND STOCK CONTROL

Can keep track of 8000 records, and is designed as a point of sale recording system. Prints daily, weekly or yearly summaries. Manual included.

ACCOUNTS PROGRAMS

TURBO-CALC SPREADSHEET

Includes Editor, Graphics Routines, and has a total of 20,000 cells. Incl. Manual.

ASEASY — A LOTUS-LIKE SPREADSHEET

A superb Spreadsheet written in Turbo-Pascal. Many features. Cell editing, block moves, block copies, formulas, functions, graph plotting. Stores or prints results.

FINANCE MANAGER II — GENERAL LEDGER

Menu driven double entry bookkeeping system for the small business. 2000 accounts, maintains multiple sets of books, prints financial reports, graphs etc. Huge Manual.

MISCELLANEOUS

ENHANCED CONSOLE DRIVER (see BYTE OCT 86)
 Mono or CGA compatible console driver. Allows user to define windows, set alarms, turn clock display on, etc.

NEWKEY 2.4

Superb Keyboard Definition program. Allows you to customise your system, create your own Macros etc. 22p Manual.

Evesham Micros

All Prices Include VAT & Delivery
Next Day Delivery £5.00 Extra

AMSTRAD 1512/1640

ALL PRICES VAT & DELIVERY INCLUSIVE

1640
IN STOCK
NOW!

1640ECD single floppy	£ 869.00	STANDARD
1640ECD twin floppy	£ 969.00	AMSTRAD
1640ECD HD 20MEG	£ 1299.00	MODELS
1640ECD HD 32MEG (1 floppy)	£ 1199.00	EVEHAM
1640ECD HD 32MEG (2 floppy)	£ 1299.00	32 & 42
1640ECD HD 42MEG (1 floppy)	£ 1379.00	MEG

FULL 1512 RANGE INCLUDING THE HIGHLY POPULAR
EVEHAM 32/42 MEG 640K SPECIALS

MONO		COLOUR	
SD-MM	£ 479.00	SD-CM	£ 649.00
DD-MM	£ 579.00	DD-CM	£ 759.00
HD20MEG	£ 949.00	HD 20MEG	£ 1119.00
SD 32MEG	£ 829.00	SD 32MEG	£ 999.00
DD 32MEG	£ 949.00	DD 32MEG	£ 1119.00
SD 42MEG	£ 1029.00	SD 42MEG	£ 1169.00

All 32 & 42 MEG models are upgraded to 640k (£20.00 extra on standard models). We use top quality hard disk units in our conversions (as used by you know who).

THE AMSTRAD OFFICE

Exciting promotion from
Amstrad includes 1512
twin drive mono, DMP
3160 printer, Wordstar
and Supercalc.
OUR PRICE...ONLY
£729.00 inc

THE EVEHAM OFFICE

Includes the Amstrad
office as above fitted
with a 32MEG hardcard
and 640k upgrade. A
really useful bundle for
only...
£1089.00 inc

Make the right decision
with a

Star

ALL PRINTER PRICES
INCLUDE

- VAT
- PRINTER CABLE
- INSURED DELIVERY

printer from Evesham Micros

If you would like a detailed print sample of any model please send S.A.E.

We use and recommend Star printers, they offer the best combination of features, print quality, reliability and value for money.

- Star **NL-10** New low price (inc. cartridge, state type) £ 219.00
- ...2 extra ribbons (value £ 13.90) **FREE** with NL-10 orders...
- Star **NX-15** Wide carriage version of **NL-10** £ 319.00
- Star **ND-15** Faster version of **NX-15** £ 419.00
- Star **NR-15** 240cps, 60 NLQ wide carriage £ 499.00
- Star **NB24-10** Brilliant 24 pin printer 216cps, 72cps NLQ £ 479.00
- Star **NB24-15** Wide carriage 24 pin £ 599.00
- Star **NB-15** Ultimate 24 pin, 100cps in NLQ! £ 719.00
- Star **SF10-D** Sheet feeder, all 10" models £ 59.00
- Star **SF15-D** Sheet feeder for NX, ND & NR15 £ 159.00
- Star **SF15-B** Sheet feeder for NB15 & 24-15 £ 199.00
- PANASONIC KXP-1081** Best sub £200.00 model £ 179.00
- Micro P. **MP165** Fast & popular £ 219.00
- Micro P. **MP200** Very fast printer for the money £ 299.00
- Micro P. **MP26** Excellent 26cps d'wheel great value £ 249.00
- Micro P. **MP40** Yes a 40cps d'wheel for this price £ 349.00
- Amstrad **DMP3160** New version now 160cps £ 189.00

Other models in stock at competitive prices

32 MEG HARDCARD



PRICE DESTRUCTION!

Western
Digital
Filecard

Only
£319.00
INC VAT & DELIVERY

A staggering offer on top brand equipment, due to our purchasing commitment we can offer this product at below trade price! We even supply it ready tested and configured, all you have to do is slot it in and start using it (please specify 1512, 1640 or other).

- Simple fitting
- Low power consumption
- Superb quality
- Full year warranty
- Suits SD or DD PCs

STOP PRESS
"XTREE" file management software included **FREE**. This normally retails for £50.00

21 MEG HARDCARD

Tandon Business Card
Top quality at low price

£ 269.00

MEMORY UPGRADE Upgrade 1512 memory to 640K, full instructions	£ 19.95
TAPE STREAMER Cipher 1525-CT, 25 MEG capacity for Amstrad	£ 469.00
NEC V30 Replaces 8086, Improves operating speed	£ 24.95
8087-2 MATHS CO-PROCESSOR 8MHZ, Improves calculation speeds	£ 159.00
2MEG "EMS" Fully loaded Zucker 2MEG RAM board	£ 299.00
MODEM CARD Amstrad's PC modem, inc Microlink membership	£ 158.00

COPY II Option Board

The 100% effective disk backup method. This half card fits in an expansion slot and will allow you to make backups of ANY, yes ANY disks (excluding protection by physical damage).

- Simple to fit
- Easy to use
- Success guaranteed
- Amstrad instructions
- Works with single or dual floppy systems

Only **£79.95**

DISKS & BOXES

25 bulk packed DS/DD disks with tabs & labels	£ 13.95
25 disks as above with 50 capacity storage box	£ 22.95
25 disks as above with 100 capacity storage box	£ 24.95
50 capacity lockable storage box as offered with disks	£ 10.95
100 capacity lockable storage box	£ 13.95

COPY II[®] PC

Protect your Software Investment...

For Amstrad PC and other compatibles

- Back up most protected software! (for personal use)
- Run many popular business programs from your hard disk!
- Verifies disk copies!
- Includes disk drive speed check!
- Fully automatic!

ONLY
£34.95

Central Point Software's best selling copy program. Allows many popular programs to run from hard disk without reference to floppy eg.; DBASE LOTUS 123 SYMPHONY etc.

NEW, "Version 4.01"

PC TOOLS[™]

The most complete PC utilities program...

For Amstrad PC and other compatibles

- Powerful DOS interface! (will run resident)
- Fast hard disk backup & restore!
- Compress a hard disk!
- Undelete files!
- Unformat a hard disk!
- Over 20 utilities built in!

ONLY
£34.95

Central Point Software's powerful new disk utility.

Combines the best features of Norton/Mace utilities, Fastback and Disk Optimizer into one incredibly powerful and ultra low priced package.

NEW, "Version 3.0"

PC Magazine "Editor's Choice" award

Evesham Micros

All prices INCLUDE VAT/delivery. Next day delivery £ 5.00 extra
How to order

Send cheque/P.O. or Access/Visa details
By phone with Access/Visa no.
Government, educational & PLC orders welcome
Same day despatch whenever possible
Callers welcome, open 6 days 9.30-5.30
TELEX: 333294 EMICRO

Evesham Micros
63 Bridge Street
Evesham
Worcs. WR11 4SF
TEL: (0386) 765500



Also at; 1756 Pershore Rd., Cotteridge, Birmingham B30 3BH Tel; 021 458 4564

Don't gamble on accounting software



"The program is well designed, comprehensive, simple to use and about a quarter the price it is worth"
Review by PC Plus Magazine.

unless you have a deal like this

Whenever a business changes its accounting system the risk factor involved is daunting. Forget glossy brochures. Forget what salesmen claim. The only real way to eliminate the gamble is to run an accounts package on your own system, over a period of time. Only then can you really be sure.

It would be futile in an advertisement to even try to convince you of the merits of Easifacts Accounts and Payroll programs. Would you really be persuaded by a list of comprehensive features? Would you believe us if we told you how simple they are to operate?

That's why we offer you the opportunity of a no risk deal, to prove for yourself how Easifacts Accounts and Payroll programs really will run your accounts more efficiently – and what's more, you won't be stuck with software you'll regret buying.

Easifacts Accounts and Payroll programs are designed for the Amstrad PC and other compatible PC's. Test drive one, or both today. Remember, there's no risk. You're protected for a one month trial period by a full money back guarantee.

EASIFACTS

Easifacts Limited Ketwell House, 75-79 Tavistock Street,
Bedford MK40 2RR Telephone: (0234) 218191

NO RISK TRIAL APPLICATION

Please send me the following program(s). I understand I am protected by a money back guarantee should I wish to return the software within 30 days and during this period can call upon FREE user support scheme when required.

	Amount
Easifacts Accounts Package with Sales/ Purchase/Nominal Ledger/Cash Book (@ £232*	_____
Easifacts Payroll Package @ £117*	_____
PRICE SAVER Easifacts Accounts and Payroll @ £299	_____

I enclose my cheque, for £ _____ made out to Easifacts Limited.

Name _____

Company _____

Address _____

Tel _____

*(Including carriage and VAT.)

PLANNER 1295

LOGOTRON

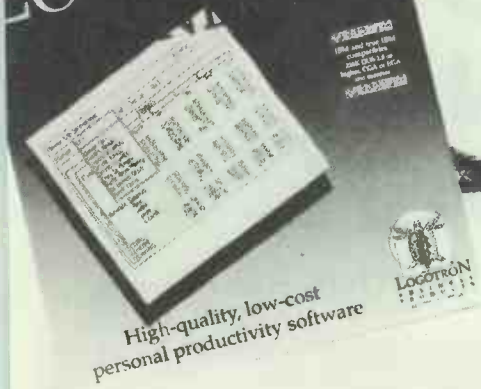

High-quality, low-cost personal productivity software



SPREADSHEET
£12.95

WRITER 1295

LOGOTRON

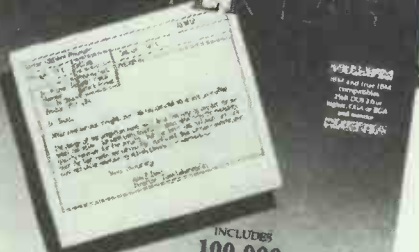

High-quality, low-cost personal productivity software



Includes 100,000 word spellchecker

WORD PROCESSOR
£12.95

FILER 1295

LOGOTRON

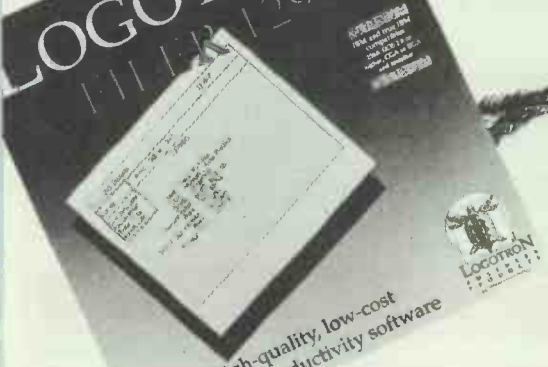

High-quality, low-cost personal productivity software



DATABASE
£12.95

1295 is all you need

LOGOTRON

1295 BUSINESS SERIES

Fully integrated software for the Commodore 64/128, IBM PC and all IBM compatibles

For all the information telephone or write to Richard Laidler at;
Logotron Business Products, Dales Brewery, Gwydir Street, Cambridge England CB1 2LJ ☎ (0223) 323656



LOW LOW PRICES

ABBOT'S AUTUMN ABERRATION!

LOW LOW PRICES

pay less for your computer requirements from Abbot

Epson Printers

The Worlds best selling range of printers

Epson RX100 136 column wide carriage printer, 100 c.p.s., parallel interface, tractor and friction feed £199

Epson FX100 136 column wide carriage printer, 200 c.p.s., parallel interface, tractor and friction feed £319

LQ 800 Letter quality, 24 pinhead, 180 c.p.s. draft 60 c.p.s. letter quality, parallel and serial interfaces, friction feed £428

LQ 800 Tractor feed £42

LQ 800 Sheet feed £139

LQ 1000 Wide carriage version of LQ 800 £565

LQ 1000 Tractor feed £52

LQ 1000 Sheet feed £155

Amstrad

PC15 Single Disk Mono £440

PC1512 Double Disk Mono £489

PC1512 Double Disk Colour £699

PC1512 20 Mb Hard Disk Colour £999

PC1640 Double Disk EGA Monitor £849

PC1640 20Nb Hard Disk EGA Monitor £1099

Brother

1109 Tractor/Dual Inter £199

1409 Dual Interface/NLQ/Tractor £389

LQ 100 LQ Font for 1409/1509/1709 £70

LQ 200 LQ Font 164 RAM for 1409/1509/1709 £80

SF 30 Sheetfeed for 1409 £99

Monitors

C9M 9" Mono £92

C14TUTX 14" Colour TV/RGB £193

C12ND High Def 12" RGB £322

RGB Amp £89

Metal Monitor Stand £46

Laser Printers

Centronics PP-8 (8 page/min) Serial or Parallel £1284

Centronics PP-8 (8 page/min) Serial, Parallel 1.5Mb RAM with full HP Laserdot plus emulation £1606

Centronics 1.5Mb Card £485

Centronics Toner Cart. £39

Centronics OPC Belt £49

Centronics Developer Kit £190

Centronics Font Card £99

Nintendo

Deluxe set including Robot, Zapper, two games, console and two controls. £159

Standard set including two hand controls, game and console £100

PCW 8256-PCW 8512 upgrade

Citadel kit with 1 Mbyte internal 3" drive and 256K of memory. Easy to follow instructions, as simple as changing a plug £129.57

Printer Stands

OFFERS!

1000's of ZX81 and VIC20 books

Tandata Modems available

Star Printers

Superb quality and reliability

NL 10 Popular low cost model 120 c.p.s. draft 30 c.p.s. N.L.Q. friction feed and tractor feed, parallel, I.B.M. Apple or Commodore interface (state which) £199

NL 10 Extra for RS232 serial interface £32

NL 10 Sheet feed £55

NX 15 Wide carriage version of NL 10 parallel interface £309

NX 15 Extra for RS 232 serial interface £80

NX 15 Sheet feed £121

ND 15 Mid price wide carriage, 180 c.p.s. draft 45 c.p.s. N.L.Q. friction and tractor feed, parallel interface £387

ND 15 Extra for RS 232 serial interface £75

ND 15 Sheet feed £119

NR 15 Faster version of ND 15 240 c.p.s. draft 60 c.p.s. N.L.Q. £467

NB 24-10 Letter quality, 24 pin head 216 c.p.s. draft 72 c.p.s. letter quality, parallel interface, friction and tractor feed £463

NB 24-10 Extra for RS 232 serial interface £75

NB 24-15 Sheet feed £50

NB 24-15 Wide carriage version of 24-10 £600

NB 24-15 Sheet feed £169

NB 24-15 Second bin for sheet feed £109

NB 15 Heavy duty letter quality, 24 pin head, 300 c.p.s. draft 100 c.p.s. letter quality, parallel interface, friction and tractor feeds £699

NB 15 Extra for RS 232 serial interface £75

NB 15 Sheet feed £169

NB 15 Second bin for sheet feed £109

Printer Lead

Parallel Printer Lead £15

20 Best Selling Books

1 Locomotive BASIC 2 Manual £9.95
Amstrad

2 Using Supercalc 4 £17.45
Que

3 Mallard BASIC book 2 £9.95
Amstrad

4 Using MSDOS on the Amstrad PC £9.95
Newtech

5 Enhancing your Amstrad 1512 £14.95
Newtech

6 Step by step guide to Locoscript £4.95
Amstrad

7 Using Wordstar 1512 £9.95
Newtech

8 Amstrad PC Technical Reference Manual £19.95
Amstrad

9 dBase III Plus handbook 2nd Edition £18.95
Que

10 Amstrad PC Owners Handbook £19.95
Newtech

11 Advanced MSDOS £19.95
Microsoft

12 Advanced disk user guide BBC Cambridge Micro £16.95

13 Running MSDOS 2nd Edition £19.95
Microsoft

14 Using Supercalc 3 £9.95
Newtech

15 Programming the 8086/8088 £16.95
Sybex

16 Programming the Pslon Organiser II £9.95
Kuma

17 Programmers Guide to IBM PC £16.95
Microsoft

18 Amstrad CP/M Plus £12.95
M.M.L. Systems

19 Word Perfect tips and traps £18.45
Que

20 View a dap hand gulde £12.95
Dabs Press

There is no V.A.T. on books

Memory

41256/15-256K DRAM 198 each

8264 DRAM 86p each



LIMITED OFFERS

Abbot Computer Products Ltd.
Foley Bank, Worcester Road,
Great Malvern, Worcs. WR14 4QW
Telephone: Malvern (06845) 62061

ASK US TO QUOTE FOR ITEMS NOT LISTED

Carriage is £6.00 per order,
excluding Leads, IC's and books
where the charge is £1.00

Add VAT at 15% to all items except books

Payment with order please

Now AVAILABLE ON 3.5" disks (please add 50%)

ButtonWare, INC. AUTHORIZED DISTRIBUTOR Post Office Box 5766 - Bellevue, WA 98006

SHAREWARE

★★★ A MARKETING REVOLUTION ★★★

Quality professional software for the Amstrad PC1512 and other compatibles. Price covers medium, VAT & postage. Documentation on disk where appropriate. "SINGLE DISKS AS SHOWN. ANY 5 for £25; 10 for £39; 20 for £65"



0732 771344

SPECIAL FEATURES - PC TYPE+ £15 (counts as 3) The Ultimate Word Processor

- 100,000+ word FAULT FINDER that catches typos and double words
- Works hand-in-hand with PC-File; allows you to pull in information from specific fields in PC-File
- Mail merge that works with PC-File databases, and comma delimited (Wordstar) formatted files. Also allows keyboard input
- Works hand-in-hand with PC-Style, ButtonWare's style checking program. You can style check the document currently in RAM memory
- PC-Label included to simplify label processing
- Work with up to 10 files simultaneously
- Block and column moves and copy, including from one file to another
- Sort up to 8 levels by column or row; accepts ascending, descending, case sensitive and case insensitive requests
- Line width expandable to 240+ characters
- Whoops key to recover up to 10 "lost" or deleted lines
- Save up to 10 Smart Keys (macros) to eliminate repetitive keystrokes. Allows pausing for keyboard input

- Three levels of help including detailed step-by-step directions
- Search and replace includes optional case sensitivity
- Date and time stamps
- Add, align and sort columns of numbers
- Use any DOS command (like DIR or COPY) without leaving PC-TYPE+
- Up to 12 printer escape code sequences to work with your printer. This allows you to have bold, underlining, italics, etc.
- Column formatting/reformatting. Now includes the ability to have two or more columns per page (newsletter style)
- Customize PC-TYPE+ to fit your individual needs
- Cross hairs that allow you to visually line up columns and rows
- Ability to create backup files and check for duplicate file names
- Character Transition Table provided
- Ability to put a temporary place marker in a file

ACCOUNTS

- 22 CashTrack 7.99 Personal finances organised
- 26 Retail Point of Sale 7.99 PC-Sell handles stock/sales ledger/invoices at the counter
- 21 Time & Money 7.99 The best of our personal finance programs. Ok for small business. Does more than just accounts.
- 1A FREEWAY UK Sales 15.00 This software is supported by registration by Free way in UK. Counts as 3
- 48 The Front Office V5.1 15.00 Prospecting, Sales Management, Sales Order Processing, Job costing & Profit Analysis. Needs Hard disk. Counts as 3
- 78 Automotive Accounts 7.99 Maintain sales ledger & inventory system for car repair (or other small) business. Produce invoices. Twin floppy ONLY!!!

COMMUNICATIONS

- 419 PC-Dial 7.99 Buttonware comms. program
- 10 Procomm V2.42 7.99 Famous COMMS program
- 19 O MODEM 7.99
- 74 PC-Board 11.99 Public Domain bulletin board system. Easier to set up than Fido or Opus.

DATABASES

- 700 U-Mind 7.99 Generates (GWBASIC) programs. A bit like The Last One
- 14 Geneology 7.99 Graphical representation on screen & printer. Program runs alone tutorial needs Basic. Counts as 2
- 701 Wampum/Wampum docs. 11.50 Menu driven dBase III clone. Counts as 2
- 703 PC-File Plus 11.50 Paint screens 5 times faster than PC-File. 175+ helps, on screen tutorial, inbed & next calculations, sophisticated report writer. Works with PC-Type Plus. Easy. Supported by us. Counts as 2
- 24 Instant Recall 7.99 Unique memory resident free-form database.
- 70 Biblical Quotations 11.50 Huge database of Biblical quotes. Min. 2 drives.

GAMES (please note that you need a CGA card. All Amstrad ok)

- 800 PC-Cheese 7.99 2 games. Graphical simulation.
- 802 PINBALL 8.99 9 Pinball machines emulated. Fast!
- 803 Bushido 7.99 As good as most other Martial Arts games
- 806 Fun Music Programme 7.99 A jukebox of medleys. Needs Basic.
- 807 Games III 8.99 Backgammon/Strategic US War Game (Maps etc.)/Big Rig
- 801 Games I 8.99 Frogger, Digger, Parotro, Willy Rogue, Spowith.
- 804 Games II 7.99 Golf, American Football, Blackjack, Archery & much more.
- 53 Adult Trivial 7.99
- 65 Games VIII 7.99 Backgammon, Hangman
- 61 Games VI 7.99 Casino Games: Bandit, Blackjack, Poker, Roulette, Sub-chase, Stock Exchange.
- 47 Sleuth 7.99 Great detective adventure with graphics.
- 64 Cavequest 7.99 Graphical adventure. Reminds me of Elite with castles
- 52 Games IV 7.99 Mahjong, Backgammon, Spacewars, Flightmare, Dragons
- 55 Games V 7.99 Monopoly, Kong, Golf, Striker.
- 60 Planoman 7.99 Play music on keyboard. "record" it on disk, play it back!
- 81 Card Games I 7.99 Bridge, Canasta, etc.

GRAPHICS

- 903 PC-Key-Draw 8.99 CAD/Animation/Graphics/Scale/Rotate/Slides/Text More facilities than ProDesign & PC-Paint. Represented by us in UK
- 900 Danced 3D 7.99 Drawing, Animation, Wire Frame, Graphs, Needs 640k.
- 901 Draftman 7.99 Produces pie, exploded pie, stacked bar, line & scatter charts
- 19 PC-Demo 7.99 Produce graphics display screens for presentations.

LANGUAGES

- 408 Fig-Forth 7.99 Very good implementation
- 409 Small "C" 7.99 With primer
- 502 P-Basic/PC-Prof 8.99 GWBasic done with hands-on Basic tutorial.
- 501 Mini Ade 7.99 (Now compiled)
- 503 Pascal Compilers 7.99 One a subset of Turbo (everything but disk I/O); One Tiny Pascal; One Viable Pascal - built in editor/debugger.
- 63 Llap/XLlap 7.99 Latest version with expert systems demo.
- 7 PD-Protog V1.85c 7.99 Probably the best 8086 assembler in the world. With debugger. We are the UK agents for this superb product. Version 3.07.
- 25 Macro Assembler (A86) 7.99 This one works well and is straightforward to set up. See also PC-Protog
- 84 "C" Tutorial 7.99
- 83 TASM 7.99 Table driven cross-assembler. Set up for 6502, 8048 8051 but configurable for Z80 etc. (who's volunteering?)
- 406 CHASM 7.99 CHisp ASemMber. Compiled version of old standby. Retained mainly for the tutorial - otherwise use disk 25. (Now compiled)

WORD PROCESSING

- 6 PC-Outline V3.15aw 7.99 Famous memory resident outline processor a la Brainstorm form Brown Bag Software.
- 16 PC-Style V1.2 7.99 Graphic reports on your writing readability, style, personal tone etc. Works hand-in-hand with PC-Type Plus even while working on a document. Supported by us.
- 3 PC-Write V2.6 7.99 Math/foreign chars. Edit two docs. Brilliant help screens. Memory residency. 300 printers supported (incl. Laser) etc. Simple graphics. This is the version prior to that marketed by Sagesoft for £99.
- 8 Galaxy V1.2 7.99 Perhaps the fastest WP in the world. Wordstar keys. Pull down menus.
- 31 Chewy Wordprocessor 7.99 Probably the best one for novices. Includes comprehensive hands-on training course.
- 17 EZ-Spell 7.99 Spell-checker. Works with PC-Write.
- 18 Foglin/Tally etc 7.99 Various programs to analyse text, word counter, index etc.
- 82 Freeword 7.99

NEW PRODUCTS (Please note these include updates).

- 86 Graycom 7.99 Prestal comms. program from Paul Fletcher. All speeds to 9600 baud. CGA/EGA cards required (OK all Amstrads). Most modems. Save from us then carousel. Download Telesoftware. Easy to use.
- 87 Help DOS 7.99 On-line help of all the DOS commands.
- 89 Newfonte 7.99 Tool for creating new screen fonts in Turbo Pascal.
- 90 ZAXXON 7.99 The famous game from SEGA, EGA (PC1640) only.

NEW PRODUCTS (Please note these include updates).

- 92 Bermuda Triangle 7.99 A sort of yacht simulator with a quest
- 93 Sem Spade 7.99 Text adventure on the steamier side of town.
- 94 Home Budget Management Sys. 7.99 Useful nominal ledger.
- 95 Stock Inventory 7.99 (Not stocks and shares).
- 96 MACREAD 7.99 Various programs for reading MAC pictures on PC's. Includes naughty pictures. Suitable EGA/CGA.
- 97 Commando 7.99 DOS Shell program.
- 98 Critical Path Management 7.99 Limited facility scheduler/Unlimited facility Gantt charts.
- 99 HI-RES 7.99 Super painting program. Works with mouse. Lots of facilities but no text on Shareware version. OK single drives. Similar to GEM paint without the hassle. CGA in colour/EGA in mono.
- 100 Computer Pranks 7.99 Lots of high jinks to play on your friend's computer!
- 101 Family Tree 7.99 Genealogy program.
- 102 Screen Write 7.99 Special wordprocessor for script-writers. Unique formatting features.
- 103 Uttila IV 7.99
- 104 Statistical Analyze 11.50 Kwikstat (counts as 2).
- 106 Mr. BILL 11.50 Billing system for professionals (i.e. accountants, solicitors etc.) (counts as 2).
- 108 DROEGE 11.50 CAD for printed circuit design (counts as 2).
- 400 Z80 Emulator 7.99 Run your CP/M software (fit on IBM format disks).
- 414 Function Key Editor 7.99

Please note that we are authorized representatives for various authors so we get the latest versions first!

EDUCATIONAL

- 39 Foreign Languages I 7.99 French, German, Spanish, Italian. Needs Basic.
- 1023 Educate I 8.99 High quality programs incl. Maths, Analogies etc. Needs Basic.
- 51 Educate II 8.99 Quality young children's games.
- 68 MS-DOS Tutor 7.99 Tutorial for learning about MS-DOS!
- 85 Fastype 7.99 At least a decent touch typing course from beginner to advanced under ShareWare.

SPREADSHEETS AND STATISTICAL

- 600 Turbo-Calc 7.99 20,000 cells, bar graphs (poor). Also features Galaxy-style text editor!
- 601 AS-EASY-AS 7.99 Amazing Lotus feel-like spreadsheet with numerous facilities, including decent graphics, macros. Has its own text-editor. No documentation but gives examples.
- 401 Sideways Graph 7.99 Menu-driven. Ok for Lotus/ASCII files.
- 4 PC-CALC V3.0 7.99 Relational spreadsheet. Take data from other spreadsheets or from PC-File Plus databases. Supported by us.
- 20 Statistical Analyze 7.99 SPC-Professional. Beautifully complex graphic output
- 72 Express Graph 7.99 Very easy to use colour business graphics. Pie, Exploded Pie, Segmented Lines, 3D bars etc. from typed data or imported.
- 80 Goal Seeker 7.99 Memory resident, works with Lotus, SuperCalc, Multiplan etc. to enable user to seek and result (goal).
- 82 Curvfit 7.99 Performs least squares curve fit on x, y data. Curves for 25 equations fitted. Equation co-efficient, Correlation co-efficient & Best fit are computed. Predictions for y can be calculated. Imports from Lotus possible.

UTILITIES

- 27 Critical Path Management 7.99 IPM Project Management
- 420 Hard Disk Utilite. 7.99 Includes disk space optimiser, diagnosis etc.
- 9 Deskmate 7.99 Memory resident clock, calendar, notepad etc.
- 415 Utilites I 7.99 Many useful utilities but including a super disc-doctor program
- 11 Critical Path Management 7.99 PC/PM. Gantt charts, 1000 tasks
- 422 PC-Tickle 7.99 Reminds you of appointment etc., has simple maths which allow it to report on expenses or hours utilised at certain activities.
- 403 Screens Creation 7.99 Set up entry screens for Basic & other programs. This saves worrying about field names & screen editing. Handles data entry. Brilliant!
- 413 Utilites II 7.99 Undelete/Unerase/sector editor/partition
- 421 XD-Extended DOS 7.99 Utility tools from Buttonware.
- 34 Multi-tasking utilte. 7.99 Dosemulc enables up to 7 programs to run together. Other programs frozen in.
- 46 PC-Stock 7.99 Graphical analysis of Stocks & Shares.
- 30 Print Enhancers 7.99 3 programs to get NLO fonts from non-NLO printers
- 28 File Encryptor 7.99 Secure your data. Prize if you can beat it!
- 423 Make Menus 7.99 Utlis. to make menus on hard disks
- 35 Micro-Cache 7.99 Working copy of a commercial program. Limited features. UK product with full support
- 57 Homebase 11.50 Brown Bag's famous competitor to Sidekick. Best with Hard-disk. Counts as 2
- 44 Astronomy 11.50 Relational statistics of planets, sun & moons. Counts as 2
- 69 DOS Shells 7.99 For those who don't like GEM, Sill River, WFU, T-Shell.
- 73 Baker's Dozen 7.99 13 useful utilities from Buttonware incl. mini-spreadsheet, calendar, sideways print (largest font), sort text files, redirect printer to disk, snapshot, undelete & more.

VERTICAL

- 418 Estbid 25.00 Estimating & Job Costing package. Counts as 5 disks.
- 33 Estate Agent 7.99 American but realistic. For residential agencies.
- 23 PDS'Quote 7.99 Quotation system
- 12 SuperSoft 7.99 Surveyors measurement and calculation program.
- 87 Surveyors 7.99 Well proven newagency software written by our associates. This version is complete but is limited to 50 customers. On registration this limit is removed.
- 76 Make My Day 7.99 Time Management + Programs suitable for financial calculations for loans, savings etc. Time management includes Appointment calendar, job scheduler, Expense Accounts plus TIME LOG for solicitors, accountants etc.
- 79 Portfolio Maintenance 7.99 PFR01 addresses the problem of "Return on investment" of shares held.

Please send cheque/postal order or Access/Visa to:

(For brief reviews and full list send 70p stamps).

Educational & Government orders welcome

SHAREWARE MARKETING, 87 HIGH STREET, TONBRIDGE, KENT. TEL.: 0732 771344

How to write your own software without the help of a programmer!



Mailing List Menu

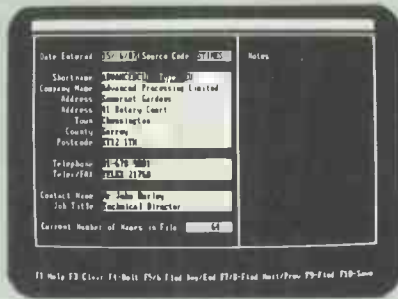

Entry Screen



Print out to Screen

Develop your first application on day 1.

With TAS you can take any type of information like names and addresses or stock records and design an entry form by simply "painting" the screen. TAS then writes the data entry program for you.

When you run this program you enter your information and store it on disk. This is a database. And you can create as many as will fit on your disk. With another function, the "database browser" you can display this information on the screen and browse through it and change it.

Reports are just as easy. You tell the report generator which file you want to report from and then simply answer the questions it asks you.

When you've finished, TAS will generate a program that produces the report you want and you can run that report time after time.

A Relational Database.

You may know that with any database application you enter, store, retrieve and manipulate data. "Relational" means that you can simultaneously "relate" more than one file to another.

For example a sales order "relates" to both stock records and a customer record. The resulting invoice "relates" to the customer record and a sales daybook record. With TAS you can simultaneously access and relate more files than any other database package and do so with ease.

"How not to do it".

One thing is certain. After you finish a database application, you usually know exactly what's wrong with it. With TAS it is easy to subsequently change and modify both your files and your applications without having to re-enter your data.

Excellent documentation and on-screen help will show you how to use the 4th generation language, add more powerful features which include extensive calculations, pull down menus, multiple windows, business graphics, 128 colour combinations and much more.

Result... your applications are more user-friendly, easier to use, look better and have more "polish" than some of the very expensive "professional" packages. And YOU have written them.

TAS Plus is fast and easy to learn. All you need is a little application and an IBM PC or compatible computer (including the AMSTRAD PC1512) with 512KB RAM and a hard disk or two floppy disks. TAS Plus Multi-User for MS-Net compatible Networks costs £349.00 plus VAT.

TAS™
Relational Database
£99

MEGATECH Quote Ref: PCW 11

111-113 Wandsworth High Street, London SW18 4HY.

Tel: 01-875 6511 (6 Lines), Telex: 21768

We use it ourselves.

Our in-house fully integrated sales order processing and financial accounting system (yes it is for sale) was developed using TAS. Running on a multi-user network we can provide instant answers to such questions as "who bought what, when and at what price". And that's only part of it.

"Excellent value for money, especially for novices wanting to learn and developers wanting economic runtime systems." **Personal Computer World Magazine**

"There is no doubt that TAS is a very capable product. It handles serious sized applications and does so with speed." **What Micro Magazine**

"TAS manages to pack plenty of power into its small price." **PC Magazine**

"On a value for money basis this must be one of the most attractive databases on the market."

Accountancy Age
"If you cannot find a commercial package to suit your organisation then most certainly this must be one of the first places to start looking in order to produce a system of your own."
Personal Computing with the Amstrad

Never run out of steam.

TAS is so fast and powerful that most of the TAS utilities are developed in TAS itself. No other database is remotely capable of doing this. And that is exactly where you benefit. It's simple enough for the first timer but powerful enough for the professional software developer. So you have little to worry about whether TAS is suitable for your particular application or not.

As PCW Magazine said in their review of TAS Plus: "Excellent value for money, especially for novices wanting to learn and developers wanting economic runtime systems."

Build a reputation for efficiency.

TAS is for people like you. You like using a computer. You know that it is vitally important to have accurate, up-to-date information instantly available. You also know of many applications that can be done easier, better and quicker with a computer. Cut down on shuffling bits of paper. Cut down repetition. Everyone performs better because the job is more interesting and more fun. That's what TAS is all about. With TAS you can make a computer do what you want it to do.

Nothing else needed.

At £99.00 TAS-Plus is complete. It consists of the Relational Database, Screen Painter, Program Generator, Report Generator, Database Browser, 4th Generation Language, "Idiot Proof" (no disrespect) drop-down menu-driven Command Editor, Runtime Compiler for fast program execution, Tutorial and Manual.

Simultaneously access up to 16 files, each with 16 indices. Each file may have 65,000 records of up to 10,000 characters each. Import and export data with other software packages including dBase-III, wordprocessing packages and spreadsheets.

Multi-User Version Available.

This version supports full file and record locking and works on all MS-Net compatible networks. Software you develop now will run without change if you upgrade to TAS Plus Multi-User later on.

30-Day Money Back Guarantee.

The parcel you receive is fully operational but limited to saving 250 records. Provided the sealed, unlimited copy remains unopened you can return the goods within 30 days (in good condition) FOR A FULL, NO QUIBBLE, REFUND. Have a go. Order your copy today with the coupon below. We also accept purchase orders from PLC's and Government.

We despatch by 1st class post on the same day we receive your order

TAS™ Send to MEGATECH, Ref: PCW 11
111-113 Wandsworth High Street,
London SW18 4HY

YES! Please send me 1 Copy of TAS Plus. I enclose a cheque for £115 (incl VAT and P&P) made payable to MEGATECH or charge my Access or VISA card

Number: Expiry Date:

Signature:

(Card) Name:

(Card) Address:

Postcode: Tel:

PRIORITY ORDERS
01-874 6511
Use Access/Visa Card
Quote Ref: PCW 11

A VAT invoice will be included in the parcel. Enclose a company letterhead if invoice name and address are different from card name and address.

Made for
TELECOM
GOLD...



CONTACT

Communications Software that will transform the way you work ...

... automatically ...

CONTACT will collect your electronic mail and store it on disk. Automatically. If all the phone lines are engaged CONTACT will keep trying - so you don't have to.

... in your office (even before you arrive) ...

CONTACT can start working before you get into your office and can even automatically print each letter on a separate page for easy filing and distribution.

... through the cra...ckle ...

And if noisy phone lines sometimes ruin your messages then CONTACT will work with Telecom Gold's new File Transfer system (FT) to ensure that they get through every time without error.

... Providing the solution to your Corporate communications needs ...

CONTACT can also be used as a VT100 terminal for your company mainframe, or to access Prestel and other Viewdata Services. There is even a version of CONTACT that can receive BBC Datacast, Ceefax and Oracle transmissions.

CONTACT Software for your IBM PC or compatible

- ▲ simple to install
- ▲ simple to use
- ▲ professionally supported
- ▲ realistically priced at £79.95 including VAT and P&P within the UK
- ▲ all the power you need to communicate now ...
... and tomorrow

To place your order or request a free information pack call

X-ON Software Ltd on 01 881 3659

or write to: X-ON Software Ltd, 65 Victoria Road, London N22 4XA

Name

Address

Access Card No.

Signature

STILL ONLY £79.95



OLYMPIC SYSTEMS LTD.

IMPORTERS · DISTRIBUTORS

COMPUTER SUPPLIES & ACCESSORIES
FREE CARRIAGE
TRADE ENQUIRIES WELCOME

TOP BRAND DISKS					
3" MAXELL CF2 £22.50					
3 1/2"					
BRAND	DSDD	DSHD PS/2	DSDD 48 TPI	DSQD 96 TPI	DSHD AT DISKS
SONY	£18.50	£45.00	—	—	—
DATALIFE	£20.50	£45.00	£14.50	£16.50	£22.50
DYSAN	£20.50	—	£12.50	£16.50	£19.50
3M	£19.50	—	£12.50	£16.50	£22.50

Prices per box of 10 disks

UNLABELLED DISKS Certified & Guaranteed			
	10	25	50
3 1/2" DSDD Supplied with labels	£11.00	£26.00	£50.00
5 1/4" DSDD, 48 TPI Supplied with Labels, Envelopes & Write Protects	£10.00	19.50	£38.00

COLOURED DISKS
Verex 5 1/4" DSDD 48 TPI Disks in Plastic Library Case
Available in: RED, BLUE, GREEN, YELLOW & WHITE.
£9.90 per box of 10

DISK STORAGE SYSTEMS					
	YUDD100L	5 1/4" x 100	£ 8.50	YA10	5 1/4" x 10 Plastic Library Case £1.75
	YUD50L	5 1/4" x 50	£ 6.50		
	YA6090L	3" x 60 or 3.5" x 90	£10.50	YA5	5 1/4" x 5 Disk Transit Case £1.25
	YA40L	3 1/2" x 40	£ 6.00		

All with Lock & 2 Keys

DISK DRIVE HEAD CLEANING KITS WITH FLUID
3 1/2" £4.50 5 1/4" £3.75

VERBATIM VCP404 ALL IN ONE KIT
1 Bottle General Surface Cleaner
1 Bottle Anti-Static Fluid
1 Bottle CRT Cleaning Solvent
3 Manual Spray Pumps
1 5 1/4" Floppy Head Cleaning Kit
50 Lint Free Cloths
SPECIAL PRICE £12.50

MOBILE PRINTER STAND
 Rugged steel frame. Height adjustable basket for output paper & base shelf for input paper. Self assembly - includes castors.
80 column £45.00
132 column £57.50

SCREEN FILTER
12" ANTI-STATIC ANTI-REFLECTION £9.00

DATA SWITCHES
AVAILABLE IN RS232 or CENTRONICS

AB SWITCH BOX £24.50
ABC SWITCH BOX £26.50
ABCD SWITCH BOX £32.50
X SWITCH BOX £45.00

3M DATA CARTRIDGES
DC 1000 £13.50
DC 2000 £24.00
DC 300XLP £19.50
DC 600A £20.50
Packed in 5's

BINDERS
REXEL BINDERS FOR: 11" x 14 1/2" PAPER BLUE WITH WHITE STRIPES
£9.50 per box of 10

EDUCATIONAL & GOVERNMENT ORDERS ACCEPTED.
COMPANY CREDIT ACCOUNTS OPENED.
PLEASE CONTACT FOR DETAILS.

PERSONAL CALLERS WELCOME
MON-FRI: 9.00am to 5.30 pm
SAT: 9.30 am to 5.00 pm

PRINTER STANDS		
	YU-S23 PRINTER STAND Securely holds any printers wide or small. Made of molded plastic. £10.50	
	YU-S24 UNIVERSAL PRINTER STAND Knock-Down type. A cantilever refold paper trays use no table space. Fits all printers, standard carriage and wide: Made of molded plastic. £19.50	
	YU-S25 K/D PRINTER STAND Made of molded plastic. Feeds and refolds paper underneath the printer, takes up hardly more space than the printer itself YU-S25A: for 80 col. printer. YU-S25B: for 132 col. printer. 80 column £28.50 132 column £32.50	

PRINTER RIBBONS		
	Price per Ribbon	
AMSTRAD	8512/8256	£3.95
	DMP 2000/3000	£2.25
BROTHER	HR15MS	£2.75
CITIZEN	120D	£3.75
COMMODORE	MPS 801	£4.00
DIABLO	HYTPYE II MS	£1.90
EPSON	FX/RX80 FX800	£2.75
	MX/100/FX1000	£3.75
	LX80/86	£2.25
JUKI	6100MS	£2.50
PANASONIC	KXP110	£3.95
QUME	IV M5	£2.50
STAR	NL-10	£4.50

MOST OTHER MAKES OF RIBBON AVAILABLE, PHONE FOR DETAILS

COPY HOLDERS		
	YU-H33 DESKTOP COPY HOLDER Size: 9 1/2" x 11 1/2" With smooth slide line guide. £10.50	
	YU-H32 COPY HOLDER WITH ADJUSTABLE ARM Size: 9 1/2" x 11 1/2" With smooth slide line guide. £15.00	
	YU-H34 COPY HOLDER WITH ADJUSTABLE ARM. Size: 19" x 12" With smooth slide line guide. £30.00	

MONITOR STANDS
 YU-MS12 MONITOR STAND For 12" CRT. Fits large CRT's with feet separation up to 10" x 11". Stable 25° tilt and 360° turn.
12" £10.50 14" £13.50

 YU-M10 MONITOR MOVER
Solid steel structure with a finish that ensures stability and longevity. Expand work space.
£75.00

DUST COVERS
Protect your computers from dust. Complete set for Monitor, CPU & Keyboard.
IBM PCXT £6.50
IBM PCAT £8.50

CABLES
IBM PC Shielded £ 8.50
IBM RS232 £10.50
IBM Keyboard extension £10.50

GENDER CHANGERS
MALE to MALE or FEMALE to FEMALE £6.00
LASER PRINTER TONER CARTRIDGE FOR CANON HP/APPLE £75.00

PLEASE NOTE PRICES ARE EXCLUSIVE OF VAT @ 15%
FREE POSTAGE & PACKING IN U.K.
TO PLACE YOUR ORDER PLEASE CONTACT:

OLYMPIC SYSTEMS LTD.

34-36 RUTLAND STREET, LEICESTER LE1 1RD
Telephone: (0533) 511212 · Fax: (0533) 513586



ANY ORDER UNDER £12.50 WILL BE SUBJECT TO £2.50 HANDLING CHARGE



OUR COLOUR CATALOGUE IS AVAILABLE WITH A COMPREHENSIVE RANGE OF PRODUCTS.
CALL FOR YOUR COPY TODAY.

S.Z.D. Business Systems

BRYNGWYN BACH, RHUALLT, ST.
ASAPH, CLWYD, LL17 0TH
Telephone 0745 582286

DON'T READ THIS if you want to pay more for your computer requirements
These are only a sample from our current Price List

PRINTERS

EPSON, LX800 150cps 80col £193.00 / EPSON FX 1000, 160cps 132col £308.00 / WEC P5, 264cps 136col £739.00 / WEC P6, 216cps 80 col £385.00 / OHI ML192 160cps 80 col £276.00 / OHI ML182 120cps 80col £188.00 / CANNON PU1080 160cps 80col £239.00 / CANNON A60 200cps 80col £395.00 / SBC TP180-9 180cps £209.00

Also stockists of

STAR/CITIZEN/BROTHER/ZUTU/AMSTRAD
ZUTU 6100 (Daisywheel) £245.00 / ZUTU 6200 30cps 132col £399.00

LASERS KYOCERA F101 £1849.00 / KYOCERA F2010 £3595.00 **COMPUTERS** Amstrad 1512 SD/MM £359.00 / Amstrad 1640 HD/CM £939.00 / Opus PCII £639.00 / PCII AT £1170.00 / Epson PC £563.00 / Epson PC + 20mgbtHD £1189.00 / SBC Floppy D/D £519.00 / SBC 20mgbt £889.00 / SBC 286 AT 30mgbt £14.50 / Bondwell 34 Twin Floppy £475.00 /

All SBC and Bondwell Units carry 12 months on site maintenance free - Call for prices on TANDON/FERRANTI/ACORN/COMMODORE/ATARI PLOTTERS Graphtec WP3100 was £895.00 now £748.00 / Graphtec 3200 was £1100.00 now £899.00 / Graphtec 3300 was £1300.00 now £1099.00 **SCANNERS** Cannon 1X -12 £641.00 / PC Paintbrush plus Scann Dvr £91.00 **DISKS** Phone now for the best prices in the U.K.

**** **STOP PRESS** ****

Amstrad 1512 DD/MM Computer
Amstrad DMP 3000 Printer
Wordstar Wordprocessor
Supercalc Spreadsheet

£539.00 plus V.A.T. while stocks last

Phone now for the best prices on
COMPUTERS/PRINTERS/SOFTWARE/ MODEMS/STREAMERS
MONITORS/CONSUMABLES

1. All items covered by full 12mth warranty 2. Next day delivery for most goods 3. Ask about on site maintenance 4. Government and educational orders welcomed 5. Trade enquiries welcomed 6. Leasing and finance facilities available 7. Ask to be put on our mailing list 8. All prices quoted are ex. V.A.T. and carriage.

FREE OVERNIGHT DELIVERY!*

01-455 9823

COMPUTERS/CALCULATORS/PLOTTERS

LASER PRINTERS			
CANON LBP8	£1495.00	HP 28C (SCI PRO CAL)	£200.00
GENICOM	£2795.00	HP7440 (A4 2 PEN PLOTTER)	£750.00
KYOCERA	£2400.00	HP745A (A3 6PEN PLOTTER)	£1360.00
EPSON GQ3500	£1395.00	HP7550 (8 PEN A4/A3)	£3220.00
AST PREMIUM PUBLISHER SYST 1	£5600.00	HP7580B (A1)	£7500.00
BDS (CANON COMPATIBLE)	£2197.00	ALL HP RANGE STOCKED	
QUME LASER TEN	£2095.00	ROLAND 980 (A3/8 PEN)	£945.00
NEC L08	£2399.00	TAXAN 710 (A3/6 PEN)	£895.00
HP LASER PLUS	EPOA	SHARP PC 1500A	£147.00
HP LASER JET	£1495.00	PC1600 (16K)	£199.50
HP THINK JET	£435.00	AMSTRAD 8512 PC/1512 1640	
AST TURBO-LASER	£2999.00	MONO/COLOUR/DISK 10/20Mb	FROM £449.00
OKI LASERLINE	£1595.00	AMSTRAD SOFTWARE, SAGE ETC IN STOCK	
OLIVETTI M240	EPOA		
EPSON PC + TRANSPUTER	EPOA		
EPSON PC AX WITH 20MB H/D	EPOA		

IBM COMPATIBLE EXPANSION PRODUCTS AST/PERSYS/EVEREX/TECMAR/GENOA/OMEGA/QUADRAM/ORCHID/PARADISE

SPECIAL AUTUMN* OFFER ON EPSON PRINTERS

MONITORS/PRINTERS

MICROLINE 182 (120 CPS)	£193.50	TAXAN - PRINTERS AND PLOTTER RANGE HELD	
MICROLINE 192 (160 CPS)	£283.00	EPSON COMPLETE RANGE IN STOCK	
MICROLINE 847/F (200 CPS)	£620.00	LX86 (120CPS)	POA*
OKI 294 (400 CPS)	£750.00	LQ1000 67K BUFFER (180CPS)	POA*
OKI COMPLETE RANGE IN STOCK		LQ800 (60 180CPS)	POA*
NEC P7	£460.00	LQ2500	POA*
NEC P5	£745.00	EX8000	POA*
NEC COMPLETE RANGE IN STOCK		EX1000	POA*
DISK DRIVES/TAPE STREAMER POA		SQ2500 (NEW)	POA*
QUME 12/20	£410.00	BROTHER HR20	£333.00
QUME 12/45 SPRINT (S/P)	£599.00	HR25 (3K BUFFER 25CPS)	£529.00
QUME 1190 (90 CPS)	£1355.00	HR40 (35CPS)	EPOA
QUME COMPLETE RANGE IN STOCK			
STAR NB15 (136COL 300CPS)	£760.00	(BUFFERS/IN-LINE 1256K/512MG)	
STAR NL10 (120CPS/80COL)	£197.00	AUTO-SWITCHES/BI-DIRECTIONAL CONVERTERS	
MODEMS			
MODULAR TECH LION SYSTEM		MONITOR/TERMINALS	
NIGHTINGALE/INTERLEKT/DACOM MASTER/EPSON STEEBEK/ANSWERCALL ETC FROM	£73.50	ZENITH	FROM £425.00
MANNESMANN TALLY (full range) STOCKED		TELEVIDEO	FROM £280.00
MT290 (IBM/EPSON COM)	£600.00	WYSE	FROM £360.00
MT90 (INKJET 220/110 CPS)	£395.00	QUME	FROM £360.00
MT85 (80 COL IBM)	£264.00	HAZELTINE/SPRIT	FROM £425.00
MT910 LASER	£2800.00	TAXAN/PHILIPS/ZENITH	FROM £65.00
		NEC MULTISYNC COLOUR	EPOA

CAN YOU FIND A LOWER PRICE
PHONE US FOR BEST DEAL

SOFTWARE

IBM COMPAQ/OLIVETTI/AMSTRAD		SMART SYSTEM	£385.00
LOTUS 1-2-3	£222.00	SMART SPREAD SHEET	£299.00
SYMPHONY	£339.00	SMART WORD PROC	£220.00
GRAPHWRITER COMBO PAK	£339.00	DATA MANAGER	£299.00
CHARTMASTER	£295.00	MICROSOFT PROJECT	£275.00
MAP MASTER	£285.00	SUPERCALC 4	£238.00
PSF PROF WRITE	£169.00	TURBO CAD	£330.00
PSF PROF PLAN	£250.00	MULTIMATE	£247.00
FREELANCE 4	£250.00	QUICKCODE III	£179.00
FRAME WORK II	£313.00	SAGE CHIT-CHAT	FROM £76.00
D/BASE III PLUS	£375.00	SAGE ACCOUNTS	FROM £85.00
D/BASE CLIPPER	£369.00	CROSSTALK	£120.00
JAVELIN	£345.00	GEM PAINT/WRITE	£125.00
EASY FILLER	£199.00	BORLAND TURBO RANGE	FROM £22.00
LOGISTIX	£95.00	JENNIFER	£275.00
HERCULES GRAPHIC CARD PLUS	£195.00	SAMNA PLUS	£498.00
FORMATTING AVAILABLE		MULTIMATE ADVANTAGE	£247.00
HARVARD PRESENTATION		ORMIS 30 BASE	£295.00
GRAPHICS	£250.00	LATTICE C COMPILER	£245.00
MS WINDOWS	£75.00	VP INFO	£32.00
COBOL COMPILER	£495.00	LOTUS MANUSCRIPT	£269.00
PASCAL COMPILER	£190.00	VENTURA DESKTOP PUBL	£590.00
FORTTRAN COMPILER	£220.00	VOLKSWRITER III	£187.00
VOLKSWRITER 3	£169.00	WORD III	£243.00
MICRO SOFT MOUSE/		WORDCRAFT	£309.00
WINDOWS	£199.00	WORD PERFECT	£249.00
LOTUS HAL	£115.00	WORD PERFECT LIBRARY	£124.00
FUNK SIDWAYS 3.1	£68.00	WORDSTAR	£144.00
HARVARD TOTAL 2	£399.00	WORDSTAR 2000 + (R4)	£279.00
R/BASE SYSTEM 5	£395.00	WORDSTAR PROFESSIONAL	£193.00
(SELECTION OF EXTENSIVE RANGE)		MULTIPLAN	£109.00
OPEN ACCESS II	£395.00	SAGE PC PLANNER	£71.00
OPEN ACCESS	£265.00	VP PLANNER	£61.00
PARADOX II	£395.00		
FOXBASE 7	£345.00		

NETWORKING 'LAN' VERSIONS AVAILABLE POA

GOODS FULLY GUARANTEED. PRICES EXCL VAT (P&P EXTRA ON GOODS UNDER £300)

Company and Government orders accepted by telephone.
Barclaycard/Access/Visa accepted by phone

Tel: 01-455 9823
MOUNTAINDENE
22 Cowper Street, London EC2

Semaphore cards

For high quality and reliability.

2Mb EMS MEMORY CARD

Memory enhancement board offering a maximum configuration of 2Mb and full compatibility with the Lotus/Intel Expanded Memory Paging Specification

- ◆ Fully socketed memory
- ◆ Configurable start address at 256K, 512K and above 640K
- ◆ Software Zero K installed
- ◆ Add £60 for each 512K memory (120ns)
- ◆ Price is for XT card
- ◆ Add £20 for AT card

£129

3Mb MULTIFUNCTION CARD

Multifunction card for the PC AT offering standard I/O functions and up to 3Mb of Extended Memory

- ◆ Fully socketed memory
- ◆ Configurable start address at 256K, 512K and above 1Mb
- ◆ 1 serial port, 2nd optional
- ◆ 1 parallel printer port
- ◆ Game port
- ◆ Zero K installed
- ◆ Add £60 for each 512K memory
- ◆ Add £15 for 2nd serial port

£175

4Mb MEMORY CARD

High performance Extended Memory card for the PC AT offering up to 2Mb on main board with a further 2Mb on piggyback board supplied

- ◆ Fully socketed memory
- ◆ Configurable start address at 256K, 512K and above 1Mb
- ◆ Extendable to max 16Mb
- ◆ Zero K installed
- ◆ Add £60 for each 512K memory (120ns)

£175

1200/1200 MODEM SHORT CARD

Remarkable high performance half-size modem card

- ◆ CCITT V22/V21 Full Duplex and Bell 212A/103 compatible
- ◆ Software compatible with Hayes Smartcom II and AT command set
- ◆ Auto dial & Auto answer
- ◆ Selective COM1 or COM2 port
- ◆ Built-in speaker
- ◆ Fail-safe line protection circuit

£125

Non Telecom approved.



EGA MULTIMODE CARD

Powerful Multimode Graphics Short Card supports all four display standards

- ◆ Fully compatible with IBM EGA, CGA, MDA & Hercules Mono Graphics
- ◆ All modes can be displayed on a single EGA monitor
- ◆ Supports 132 column text in EGA mode
- ◆ Supports 640 x 400 pixels in CGA mode with double scan capability
- ◆ 256K display memory
- ◆ Light pen interface
- ◆ Flicker free display

£165

MULTI I/O CARD

A short size card providing fully configurable standard I/O functions

- ◆ Short card 4 x 5"
- ◆ Parallel printer port
- ◆ One serial port, 2nd optional
- ◆ Real-time clock-calendar with battery backup (PC, XT only)
- ◆ Game port
- ◆ Add £15 for 2nd serial port
- ◆ Multi I/O combined with 2Mb EMS Memory Card £149

£69

ETHERNET CARD

Intelligent High Speed 10Mbps/sec Network Card with 80186 processor and 82586 LAN coprocessor on board

- ◆ Ethernet (CSMA/CD, IEEE 802.3)
- ◆ Protocol is in the firmware
- ◆ Power-on diagnostic
- ◆ NETBIOS level compatible
- ◆ Suggested Network programs NetWare, PC-NET and MS-NET

£375

MONO GRAPHICS SHORT CARD

High resolution graphics for your monochrome display monitor

- ◆ Short card 4 x 6"
- ◆ Text Mode 80 x 25
- ◆ Graphic mode 720 x 348 Pixels
- ◆ One parallel printer port
- ◆ Full compatibility with Hercules mono graphics card

£69

COLOUR GRAPHICS SHORT CARD

Colour/Graphic Adaptor, fully compatible with IBM's

- ◆ Short Card 4 x 5"
- ◆ Alphanumeric mode: 40 x 25 80 x 25
- ◆ Graphics mode: 320 x 200 4 colours 640 x 200 2 colours
- ◆ Composite video ports
- ◆ Add £10 for printer port

£59

384K MEMORY CARD

The cost effective solution for filling out the base memory on your PC, XT

- ◆ Short card 4 x 5"
- ◆ Uses 64K and 256K chips
- ◆ Configurable start address
- ◆ High reliability
- ◆ 384K installed

£89

Other Cards in range

- Hard disk controller @ £85
- Hard/Floppy controller (AT) @ £145
- Multi Serial 4 port @ £119
- Multi User 4 port Xenix @ £195
- Dual Serial Card RS422/232 @ £89

We offer a full 12 months warranty and if you have any problems or questions you can call us for Technical Support.

Access & Visa accepted. Please add VAT to all prices. Carriage is free within mainland UK.

Call us for a catalogue of complete product range and further information.



**SEMAPHORE
SYSTEMS LIMITED**

7 Moreland Ct, Finchley Rd, London NW2 2PJ
Tel: 01-435 6315/01-433 1255

THE MOST INCREDIBLE PRICES ON EPSON and TOSHIBA PRINTERS EVER!

Great Bargains on Surplus Computer stocks

EPSON LX86 £155



- ▶ Draft 120 cps
- ▶ NLQ 16cps
- ▶ Cut Sheet Feeder
- ▶ Option (for only another £35)
- ▶ Tractor Feed Option

The LX86 is an 80 column compact printer that is exceptionally easy to use. Just press the buttons on the front to switch between NLQ and draft modes, or to change the font or character size. Or attach the EPSON cut sheet feeder that holds up to 75 pages and sit down with your favourite WP package to print page after page of text with a quality that you will be proud of.

Options Available:

Epson Cut Sheet Feeder (fits the LX80 or the LX86)	£35
Epson Tractor Feed	£15
Parallel Cable	£12.50

ERSYST EMS CARD £69



- ▶ Up to 1mb Memory
- ▶ Split Memory Addressing
- ▶ Parallel, Serial & Games Ports
- ▶ Clock Calendar

Take advantage of all the latest software, such as windowing software, etc. The Persyst SBIII EMS Card allows you to add 1mb of memory on top of the 256Kb of DOS... And all at a price £100's less than normal.

TOSHIBA P321 £345



- ▶ 24 Pins giving Superb Quality
- ▶ Draft 216cps
- ▶ NLQ 72cps
- ▶ Cut Sheet and Tractor Options

The P321 is an 80 column printer, fully IBM Printer Compatible that delivers superb letter quality text. The reason? Unique 24 pin design with fine 8-mil pins that create tiny, precisely placed, overlapping dots for a quality difference that you will see immediately.

Options Available:

▶ Tractor Feed	£69
▶ Cut Sheet Feeder	£145
▶ Second Bin for Cut Sheet Feeder	£85
▶ Qume Emulation	£18
▶ Serial Interface Kit	£25
▶ Downloadable Type Font Kit	£45
▶ Parallel Cable	£12.50

RACAL CP2123 £99



- ▶ Auto Dial – Auto Answer
- ▶ V21 – 300 Baud
- ▶ V23 Prestel

The Racal CP2123 internal modem with V23 Prestel compatibility and 300/300 BPS V21. This modem is an add-on card that can be used with most IBM compatibles... The normal RRP is over £390.

There's a good deal going on at
Surplus Computer Sales Ltd
 20A Horseshoe Park, Pangbourne, Berks



07357-5455



Export orders welcome

Prices exclude only VAT and Delivery

Maintenance Available

Telephone Orders Welcome

Next day delivery on all orders

Demonstration Facilities

30 day Money Back Guarantee. 12 month Warranty on all printers

‘I LIKE THIS MACHINE... FOR THE MONEY IT’S UNBEATABLE’

Benchtest of the Dell 286¹² in Personal Computer World, July 1987.

This review, our first in the UK, concluded that the 286¹² 'has a higher specification than just about any standard machine'...

- Intel 80286 running at 6 or 12 MHz
- High resolution Monochrome Monitor
- One megabyte of RAM on the system board
- 1.2 megabyte, 5.25" floppy disk drive
- Combined floppy and hard disk controller
- 192 watt power supply
- Eight expansion slots (five available)
- System Clock/Calendar/Configuration Data in CMOS RAM with battery back-up
- Hercules compatible monochrome graphics card
- 2 Serial and 2 Parallel Ports
- Enhanced 102 key keyboard
- The unique Smart VU™ system displaying computing speed and diagnostic checks

Plus a year's on-site maintenance, 12 month warranty and Technical Hotline included in the price.

286¹² with 40 Meg, 28 MS hard drive **£1,799**
with 70 Meg, 28 MS hard drive £2,099

EGA COLOUR SYSTEMS

Exactly the same specifications as the above system but incorporating:

- High Specification EGA card
- EGA high resolution monitor
- 2 Serial and 1 Parallel Port

286¹² with 40 Meg, 28 MS hard drive £2,199
with 70 Meg, 28 MS hard drive £2,499



286⁸ MONOCHROME SYSTEMS

Exactly the same specification as the 286¹² but with:

- Intel 80286 running at 6 or 8 MHz
- 286⁸ with 20 Meg, 65 MS hard drive **£1,299**
with 40 Meg, 40 MS hard drive £1,599

EGA COLOUR SYSTEMS

Exactly the same specifications as the above system but incorporating:

- High Specification EGA card
- EGA high resolution Monitor
- 2 Serial and 1 Parallel Port

286⁸ with 20 Meg, 65 MS hard drive £1,699
with 40 Meg, 40 MS hard drive £1,999



386¹⁶ MONOCHROME SYSTEMS

- Intel 80386 running at 16 MHz
- High resolution Monochrome Monitor
- One megabyte of Static RAM on the system board
- 1.2 megabyte, 5.25" floppy disk drive
- Combined floppy and hard disk controller*
- 192 watt power supply
- Eight expansion slots (five available)*
- System Clock/Calendar/Configuration Data in CMOS RAM with battery back-up
- Hercules compatible Monochrome Graphics card
- 2 Serial and 2 Parallel Ports
- Enhanced 102 key keyboard
- The unique Smart VU™ system displaying computing speed and diagnostic checks.

*The 150 Meg system has a separate ESDI hard disk controller and four available slots.

386¹⁶ with 40 Meg, 28 MS hard drive **£3,199**
with 70 Meg, 28 MS hard drive £3,499
with 150 Meg, 18 MS hard drive £4,199

EGA COLOUR SYSTEMS

Exactly the same specifications as the above system but incorporating:

- High Specification EGA card
- EGA high resolution Monitor
- 2 Serial and 1 Parallel Port

386¹⁶ with 40 Meg, 28 MS hard drive £3,599
with 70 Meg, 28 MS hard drive £3,899
with 150 Meg, 18 MS hard drive £4,599



SEE HOW IT PAYS YOU TO DEAL DIRECT WITH DELL

Since the UK launch of the Dell Computer Corporation in June this year, our fast and powerful compatibles have been creating quite a stir. People were surprised by our low prices for high quality machines which could earn reviews like those quoted opposite and below.

Astonishingly Low Prices

And when we announced that our prices even included a year's on-site maintenance and a free Technical Hotline Service, credibility was stretched still further.

The main reason we can offer low prices is that we sell our computers direct to you, the end user. There are no Dell appointed dealers, so you pay considerably less because you don't have to pay a dealer's profit margin.

The Fastest Computers In Their Class

Our parent company designs and builds each machine in Texas, employing some of the best technical brains in the business.

Consequently our machines aren't simply clones; they have original features you don't find on expensive machines. And Dell Computers are fast. Here's what the *Europa Report 1987* has to say:

"The (Olivetti) M380/C rated 6.4 on our primes test: a reasonable result, although Compaq's Deskpro, with its own flashy RAM card, rated 7.15. IBM's PS/2 Model 80 comes in at 6.97, but the Dell 386¹⁶ blows them all away, scoring 8.25."

PC Business World puts it more succinctly:

"An 80386 pc, the fastest ever tested by PC Business World."

The 386¹⁶ high performance is achieved by the first industry use of pure static RAM and by its 32 bit proprietary memory architecture.

Besides this, all Dell Computers are compatible with programs that run on the IBM PC, XT and AT – and also run Microsoft's OS/2. Indeed, the 386¹⁶ features a user-switchable expansion bus which means it offers true compatibility with existing hardware and software standards without decreasing the power of the processor.

Major US Users Choose to Deal Direct

After just three years in the States we have more than 100,000 satisfied users, amongst them organisations of the stature of Rockwell International and NASA.

They have found that ordering a computer over the 'phone doesn't mean you are left on your own.

In fact, you get something that no dealer can give – a direct relationship with the designer and manufacturer of your machine.

That relationship works in the UK because we provide an unparalleled service to ensure that you are fully satisfied. From the start we actually guarantee your satisfaction.

30-day Money-Back Guarantee

If you are not entirely happy with your Dell Computer, you can return it within 30 days and we will refund

your money in full. When you keep your machine, parts and labour are covered by a 12-month warranty.

12 Months' Free On-Site Service

In addition, your Dell comes with that full year's on-site maintenance contract included in its price. If your hardware needs service, a fully-trained engineer will be with you before the end of the next working day.

And should you have a software problem or any questions, you can call our free Technical Hotline Service. At the end of a 'phone will be an expert who has access to a full history of your machine.

Contact Dell To Save Money Now

Your machine is delivered by courier within days of us receiving your order. It all takes just minutes to set up and if you need help, you can call our Technical Hotline.

Find out how you can save money with Dell today. Ring us on 0344 860456 or return the coupon below. If you 'phone we'll give you a price for the configuration you need. 'Phone with a purchase order number and you could have exactly the machine you want in days.

Prices do not include VAT. IBM and Microsoft are registered trademarks of their respective operating companies.

DELL COMPUTER CORPORATION *More computer, less money.*

Dell Computer Corporation, Cookham Road, Bracknell, Berkshire RG12 1RD. Tel: 0344 860456.

To: Andrew Harris, Managing Director, Dell Computer Corporation, **FREEPOST (RG 1462), Bracknell, Berkshire RG12 1BR, or phone 0344 860456.**

- Please call me on (day) _____ at (time) _____ to talk about the model(s) ticked
- Please send me details of the following Dell Computers 286⁸ 286¹² 386¹⁶
All models are supplied with mono or EGA monitors.
- Please send me a complete and unabridged copy of the PCW Review of the 286¹².

Name _____
Position _____
Company _____
Address _____
Postcode _____
Telephone _____

It would help us to send you the most useful information if you would also complete the following:
Type of business _____
No. of employees using pc's _____
No. of pc's in company _____
No. of pc's likely to be purchased in the next 12 months _____
Type of pc's currently used _____



is the name we have chosen for the smart new range of PC-compatible products for the business computer division of Spectrum Group plc. Spectrum, and its nationwide network of Master Dealers, are justifiably proud to bring to the table a range of PC computers and peripherals, the quality and value of which is simply second to none.

From our compact twin drive sbc FD at £599, through to our top-of-the-range British developed and manufactured, 286 ATE (EGA) at £2399, we can offer you a 'stand alone' system, or multi-user/network system that's more efficient than anything in its class today. To compliment your system, choose from our range of monitors, printers, network systems and uninterruptable power supplies, which pound-for-pound beat anything on the market.

Finally we are so confident about our new product that we include a 12 month On-Site Maintenance Contract with every sbc computer.

FREE ON SITE MAINTENANCE

On site maintenance for PC's can be very expensive, in some cases costing hundred's of £££'s per annum. We are that confident of the quality of SBC PC compatible products that we now include a full 12 months Fast Call Out On Site Service Contract with every SBC computer FREE OF CHARGE.

SBC PRINTERS

Sensational Value TP180-9 Dot Matrix Printer **£249.00**

SBC MONITORS

12" green T.T.L. Ex VAT £79.95
 14" green or amber including swivel and tilt Ex VAT £99.95
 14" medium resolution colour Ex VAT £269.95
 14" EGA compatible colour Ex VAT £359.00

SBC Uninterruptable Power Supplies

No need to lose valuable data due to unexpected power failures, our system allows you up to 18 minutes of back-up time - a U.P.S. is invaluable in today's business environment

PWM 200 (200W) Ex VAT £199.00
 PWM 500 (500W) Ex VAT £299.00
 UPS 1000 (1KVA) Ex VAT £799.00

The SBC FD

Priced...to beat you know who!

Now, from your sbc Master Dealer an enhanced range of superbly styled, second generation PC XT compatible computers that are faster and considerably more reliable than their predecessors.

Just check out the features listed below then add on our Free 12 month On-Site Maintenance Contract worth £54, then we think you'll agree,

We know how too!

Undoubtedly the best value PC in Europe today

The sbc FD Twin drive 360K

£599.00 ex VAT

with Free 12 month On-Site Maintenance Contract

SBC HD20



Features	1512 DMM	SBC FD	Features	1512 DMM	SBC FD
Microprocessor	8086-2	NECV-40	Basic language supplied	Lucas-motive Basic-2	Industry Std. GW Basic-3.2
8087-2 co-processor socket	✓	✓	Expansion slots	3	4
Parallel centronics port	✓	✓	EGA graphics option	No	✓
RS232 serial port	✓	✓	CGA graphics output	No	✓
Power supply rating	30W (approx)	135W	Mon/c colour changer/switch	No	✓
Power supply location	In monitor case	In Main case	Dual speed processor	No	✓
Twin 360K floppy drives	✓	✓	640K RAM as standard	No	✓
Mouse and controller	✓	No	Full 12 months on-site warranty included in purchase price	No	✓
Gem and gem paint	✓	No			
MS DOS 3.2	✓	✓			

Specifications as the FD but with one 20MB hard disk

Ex VAT **£999** with Free 12 month On-Site Maintenance Contract

SBC FDC as FD but with 14" colour monitor **£799** Ex VAT
SBC HD20C as HD20 but with 14" colour monitor **£1199** Ex VAT

SBC MASTER DEALER NETWORK · SBC MASTER DEALER NETWORK

LONDON
 ETT Computer Junction, 475/477 High Road, Harrow Green, Leytonstone Tel: 01 556 2266
 EC2 Bell Court Business Services Ltd, 4th Floor, Bell Court House, 11 Broadfield Street, Tel: 01 528 4855
 H3 Mayflower Business Systems 42 Hendon Lane, Finchley, Tel: 01 346 6300
 HW2 Kay Jay Systems, 135 Doles Green Road Tel: 01 208 0100
 HW2 Dethle Electronics Ltd, 665 Finchley Road Tel: 01 794 3307
 HW3 Business Technology Consultants Ltd, Masons House, 1 Valley Drive, Kingsbury Tel: 01 206 1665
 HW4 Micropartners, Park Royal Business Centre, 9-17 Park Royal Road, Tel: 01 361 8544
 M18 Damson Computing, 6 Rays Road, Edmonston Tel: 01 803 7074
 SE 8 Computer Facilities, 2 Kings Highway, Plumstead Tel: 01 854 5313
 S19 Alders Department Store, 145-159 High Street, Eitham Tel: 01 850 9911
 SW11 Arding & Hobbs, Clapham Junction, Tel: 01 226 8877
 W1 Micro Arvika Ltd, 270A Tottenham Court Road, Tel: 01 360 5382
 W2 Henry's Radio, 40A/4E Edgware Road, Tel: 01 402 6822
 W6 Magnetism Ltd, Thames Wharf, Ramville Road Tel: 01 365 3344
 W12E Play Data Services, 33 Southampton Street Tel: 01 240 9905

AVON
 BATH Computer News, 9 Wacoit Street, Tel: 0225 60541
 M4/USA PAI Systems UK Ltd, The Sun, Crown Glass Place Tel: 0272 856502
 WESTON SUPER MARE K. K. Computers, 32 Alfred Street Tel: 0534 495274

BEDFORDSHIRE
 LEIGHTON BUZZARD Computa-Scene Ltd, 8 Hockliffe Street Tel: 02525 377090
 LUTON Mail Computers, '8 Cardiff Street, Tel: 0582 458806

BERKSHIRE
 BRACKNELL Miller Computing, Unit 10, Longshot Lane Tel: 0344 41133
 READING Computer Care, 487 Oxford Road, Tel: 0734 508099
 SLough Slough Computers, 245 High Street, Tel: 0753 21944

BUCKINGHAMSHIRE
 CHESHAM D.L. Chittenden, 59-61 The Broadway, Tel: 0494 784441

CHESHIRE
 ALTRINGHAM Regent Computers, 14 Regent Road Tel: 061 228 0333
 CREWE Microman, 128 Nanwich Road, Tel: 0270 216014
 SALE Legh Computer Systems, 75 Cross Street Tel: 061 855 2144
 WARRINGTON Pyramid Micros, Cairn Street, Tel: 0925 35713
 WARRINGTON Simtek, 1 Tanning Court, Tel: 0925 762913

CLEVELAND
 MIDDLESBROUGH Breris Computer Services, 1 King Edwards Square, Tel: 0642 242017
 MIDDLESBROUGH Silicon Services, Room 308, Broadcasting House, Newport Road, Tel: 0642 226945

CORNWALL
 PENZANCE S.W. Microdial, 17 Market Jew Street Tel: 0229 29099
 PERRINTH Perinth Communications, 14 Castlegate Tel: 0768 67446

CUMBRIA
 BARROW IN FURNESS C.A.M.E., 48 Cavendish Street Tel: 0229 29099
 ST ALBERTS L.B. & C. Computers, 6 Lower Aymer Square Tel: 0726 67337

DERBYSHIRE
 ALFRETON Gordon Harwood, 69-71 High Street Tel: 0773 636781

DEVON
 PLYMOUTH Datalink Ltd, Datalink House, 45 Weston Park Road, Plymouth, Tel: 0752 674435
 TAVISTOCK Grand Software, 4 Down Road, Tel: 0522 2737

DORSET
 BOURNEMOUTH Edoncray Ltd, 137 Stewart Road Tel: 0202 25252
 PORTLAND Datalink Ltd, 21 Reform, Easton, Tel: 0305 826532
 WEYMOUTH MSL Micro Systems Ltd, 10 Queen Street Tel: 0305 354918

DURHAM
 CONSETT Derwentside ITC, Gate House Factory, Unit 4, Beryedge Road, Tel: 0207 390166

ESSEX
 BASILDON Alders Department Store, Eastgate Centre Tel: 0258 27858
 BASILDON Godfreys, 28/30 East Walk, Tel: 0268 289379
 CHELMSFORD Maxton Hayman, 5 Broadfield Road, Tel: 0245 354595

GREATER MANCHESTER
 MANCHESTER Executive Reprographics & Business Consultants, 214 Oxford Road, Tel: 061 228 9537
 OLDHAM Professional Computer Services, 108/110 Yorkshire Street, Tel: 061 624 4065

HAMPSHIRE
 PORTSMOUTH Linkline (Portsmouth) Ltd, 312 Victory House, Somers Road North, Tel: 0705 863738
 SOUTHAMPTON Datalink, 289 Salisbury Road, Totton Tel: 0703 624225

HERTFORDSHIRE
 BALDOCK Threshold Electronics Ltd, Icknield Way, Tel: 0462 895994
 KNEBWORTH A.P.T. International, Entech House, London Road, Welwyn Garden City, Tel: 0438 814827
 ROYSTON Shop Associates, Long Barn, North End, Meldreth Tel: 0763 61666
 WATFORD S.R.S. Microsystems, 34 The Parade, High Street Tel: 0923 226602

HUMBERSIDE
 HULL M.F. Brerman & Sons, 308 Newland Avenue, Tel: 0482 4978
 HULL B & K Cash Systems, 135 Beverley Road Tel: 0482 226396

KENT
 CANTERBURY Canterbury Computers, 56/57 Palace Street Tel: 0227 462101
 CHATHAM Alders Department Store, 220/240 High Street Tel: 0634 407377
 CHATHAM Arrow Computer Services, 42 New Road Tel: 0634 65781
 RAINHAM Microway Computer Centre, 39 High Street Tel: 0634 376702
 SITTINGBOURNE Secretstone Ltd, Central House, Centre Avenue Tel: 0795 77639
 TENTERDEN MGA Micro Systems, 140 High Street Tel: 05806 4276

LANCASHIRE
 BLACKBURN Time Computers, Time House, 36 Granville Road, Tel: 0254 63414
 BLACKPOOL Electronic Services, 176 Victoria Road, West Cadeby, Tel: 0253 822700
 BLACKPOOL Diskland Computers & Office Supplies, 139 Leyton Road, Tel: 0253 301743
 BOLTON ACE Computer Equipment, 27 Victoria Road, Horwich, Tel: 0204 698710
 BURNLEY Burnley Computer Centre, 12 Halshead House, St. James Road, Tel: 0282 34772
 LEICESTER Cavendish Office, 67 Fringale, Tel: 0772 569552
 PRESTON 4 Mat Computing, 67 Fringale, Tel: 0772 569552

LEICESTERSHIRE
 HINCKLEY Leigh Computer Systems, 28 Bridgate Road, Tel: 0455 612159
 LEICESTER Sonal Computers, 105 Belgrave Road, Tel: 0533 692040
 LEICESTER Dimension Computers, 27-29 High Street Tel: 0533 574719
 LEICESTER Cavendish Office, 66 London Road Tel: 0533 550993
 DARHAM Zebra Computer Services, Glendon Road, Uppington Tel: 0752 821234

LINCOLNSHIRE
 STAMFORD Orange Business Systems Ltd, 46A High Street, Tel: 0780 57563

MERSEYSIDE
 LIVERPOOL Bits & Bytes Computers, 18 Central Station, Ranelagh Street, Tel: 051 709 4036
 NEWTON-LE-WILLOWS Source Computers, 4 Cross Lane Tel: 09252 29045

MIDDLESEX
 HARROW ASC Systems Ltd, Brent House, 214 Kenton Road, Tel: 01 907 1867
 HARROW Burcote Computer Systems, 211 Kenton Road, Kenton Tel: 01 907 3636
 NORTHWOOD Screens Computers, 6 Man Avenue, Moor Park, Tel: 09274 20664
 TWICKENHAM Productive Computers Ltd, 72 Heath Road, Tel: 01 891 4991
 UXBRIDGE JKL Computers, 7 Windsor Street, Tel: 0895 51815

NORFOLK
 KINGS LYNN Computer Plus, 40 New Conduit Street, Tel: 0553 77450
 NORWICH Viking Computer Centre, Ardeny Rise, Off Canton Grove Road, Tel: 0603 401982
 THETFORD Thetford Micros, 21 Guildhall Street, Tel: 0842 61645

NORTHAMPTONSHIRE
 NORTHAMPTON Portasoft Ltd, 2 Polesworth Court, Lumberbush, Tel: 0604 407150
 NORTHAMPTON Consoq, 302 Wellington Road, Tel: 0604 230815

NORTHUMBERLAND
 ALNWICK Alnwick Computerware, The Market Place Tel: 0665 604816

NOTTINGHAMSHIRE
 NOTTINGHAM Dial Computer Services, 2 Birdsall Avenue, Wollaton, Tel: 0602 282200

sbc is the business computer division of Spectrum Group plc
 20 Bilton Way, Luton, Beds LU1 1UU. Tel: 0582 402545

Prices correct at time of going to press. E. & O.E.

INTRODUCING The British Designed, British Built, SBC Mistral 286 AT40 WITH POWER TO SPARE

Yes! designed in Cambridge, motherboard built in Bristol, casing and power supply assembly produced in Stourbridge plus final assembly in London. It's as British as we can make it, and the best. The heart of the Mistral is the superb 12" x 12" motherboard built at British Aerospace (BAe's) Filton plant using the latest surface mounting technology.

It has already been acclaimed as "the 286 board by which others will be judged in the future". sbc is proud to bring you the finest quality and value AT-compatible in the world, and now includes a massive 40MB hard disk.

Ex VAT
£ 1999
with Free
12 month On-Site Maintenance Contract



Main Features of Mistral 286 AT Series

1. PC AT-compatible
2. 80286 CPU
3. 1 MB RAM on board (max 4 MB)
4. 1.2 MB floppy drive
5. 40 MB hard disk
6. Maximum display resolution 1024 x 768
7. Battery back-up real time clock
8. RS232 serial and parallel port
9. 6 expansion slots
10. 80287 maths co-processor socket
11. Motherboard built in the UK by British Aerospace
12. 14" green or amber monitor including swivel and tilt stand
13. MS DOS 3.2 GW-BASIC 3.2
14. Full 12 months on-site warranty.
15. 84 key AT keyboard

SBC MISTRAL 286 ATC



Featuring the 286 but with the SBC 14" medium resolution colour monitor and CGA compatible colour card.

£2199.00 Ex VAT
inc. MS DOS 3.2, GW Base 3.2
Also available with 30MB Hard Disk

SBC MISTRAL 286 ATE



Featuring the 286 but now coupled with the SBC 14" EGA colour monitor and EGA compatible colour card.

£2399.00 Ex VAT
inc. MS DOS 3.2, GW Base 3.2

Sensational but True The SBC System M* Multi-user/Network System

Just take a Mistral 286 AT. Add 3 sbc FD's. Network with our custom designed sbc - NET, and what have you got? The most incredible value, multi-user, intelligent terminal, computer system.



from just
£4699.00

*Available only from sbc System M authorised Dealers.

SBC MASTER DEALER NETWORK

OXFORDSHIRE

BANBURY Alphacore, Little Boulton House, Southern Road
Tel: 0295 735202
BICESTER ITT Terryphone Ltd., Station Approach, London Road,
Tel: 0865 244661
CHIPPING WORTON Cotswold Computers, 6 Middle Row
Tel: 0608 41232
HEADINGTON Absolute Sound & Video, 19 Old High Street
Tel: 0865 605990
MIDLINGTON Brookwood Computers, Brookwood House,
8 Banbury Road, Tel: 08675 5408

SHROPSHIRE

TELFORD Business Computer Centre, Unit 2, Paddock Mount
Office, Dawley Centre, Dawley, Tel: 0552 400714

STAFFORDSHIRE

BURTON ON TRENT Datafield Computers Ltd.
3 Horninglow Road, Tel: 0283 44132
TAMWORTH Small Business Computer Services, 1st Floor,
81a Bolebridge Street, Tel: 0827 63349
TAMWORTH Micro-Tronics, 27a Market Street, Tel: 0827 51480

SUFFOLK

BURY ST EDMUNDS Harlam Computers, 11 Guildhall Street,
Tel: 0284 705046

SURREY

CAMBERLEY Allders Department Store, High Street
Tel: 0278 82211
CROYDON Allders Department Store, North End,
Tel: 01 581 2577
CROYDON Hi-Voltage, 53-59 High Street, Tel: 01 681 3022
SUTTON Allders Department Store, High Street, Tel: 01 842 6000
CATERHAM Mega Computers Ltd., 72a High Street
Tel: 0883 49231

SUSSEX

BRIGHTON Games, 71 East Street, Tel: 0273 728681
HORSHAM Micromax Ltd., Unit 30, Lawson Hunt Ind. Est.,
Brookbridge Heath, Tel: 0403 56276
HOVE Business Plan Ltd., 10 The Drive, Tel: 0273 72231

WORTHING Data Direct, 53 Rugby Road, Tel: 0903 40509

TYNE & WEAR

HEYTON LE MOLE Carrera Computing, Carrera House, 69 High
Street, Eastingway Lane, Tel: 091 526 7036

WARWICKSHIRE

LEAMINGTON SPW World Group Services, 39a Regent Street
Tel: 0926 30209
NUNEATON Microcity, 1a Queens Road, Tel: 0203 387049
RUGBY Rugby Micro Spares, 30 Oxford Street, Tel: 0788 75643

WEST MIDLANDS

BIRMINGHAM Allen James, 831 Stratford Road, Sparkhill,
Tel: 021 775 5737
BIRMINGHAM Astro Computers, 3 Elmton Road, Marston Green
Tel: 021 779 6771
BIRMINGHAM Mentorium Systems Ltd., 168 Corporation
Street, Tel: 021 236 3349

WILTSHIRE

SWINDON Simcon Associates Ltd., Brunswick House,
38 Dover Street, Old Town, Tel: 0793 619969
SWINDON Codepoint Systems Ltd., Dammas House, Dammas
Lane, Tel: 0793 618130

WORCESTERSHIRE

MALVERN Wordscope, Colwell House, Walkley Road
Tel: 0684 42055
WORCESTER Computer Counter Ltd., Unit 95B Blackpole
Trading Estate (West), Tel: 0905 58351

YORKSHIRE

BRADFORD Enicks, Fotocomic House, Rawson Square
Tel: 0274 309266
HARRIGATE A.M.B. Group, 23 St. Marys Walk, Tel: 0423 63464
ROTHERHAM Rotherham Computer Centre, 135 Wellgate
Tel: 0709 369912
SCARBOROUGH Paperstall-Phoneink, 181/183 Dean Road,
Tel: 0723 366066
SHEFFIELD Computer Eng. & Support Services,
Regency House, 75-77 St. Marys Road, Tel: 0742 737303
SHEFFIELD Victoria Motors, 2-4 St. Josephs Road,
Tel: 0742 340065

SHEFFIELD West Riding Graphic Supplies Ltd., WRG House
49 Wellington Street, Tel: 0742 709861
SHEFFIELD Playdata Systems & Supplies, 50 Portland Avenue,
Aston, Tel: 0742 872157

WALES

CARMARTHEN Strong Computer Systems, Bryn Cottage
Tel: 0267 232446
HAWERDREWEST Business Informal Systems, Swan Square,
Bridge Street, Tel: 0437 68228
MIDDL Mord Micro Systems, 8 Deylor Avenue, Bryn-y-Baal,
Nr. Mold, Chwyd, Tel: 0352 56162
NEWPORT Gwent Computers, 92 Chespostow Road,
Tel: 0633 841760
WREKHAM Wrexham Computers, 24 Abbot Street,
Tel: 0978 358832

NORTHERN IRELAND

BELFAST Chevon Computing, 32 Malone Park
Tel: 0232 361335
LISBURN WMA Electric, 25 Antrim Street, Tel: 04662 3184

SCOTLAND

ABERDEEN Knight TV & Computers, 108 Rosemount Place
Tel: 0224 630526
ANGUS Lud Castle Computing Ltd., 1A Hill Street, Arbroath
Tel: 0241 72827
CUMBERNAULD Megabyte Computers, 12 Etrick Square,
Town Centre, Tel: 0236 738398
DUNDEE Dave Business Computers Ltd., 173 Brook Street,
Broughly Ferry, Tel: 0382 77039
ELGIN Mobile Micros Ltd., 1 East Back Street, Bishopmill
Tel: 0343 69584
GLASGOW Rulford Kyle, 10 Royal Terrace, Tel: 041 332 2505
PEEBLES Peebles Micro Systems, 9 Eschels, Tel: 0721 21479
PERTH Vics Independent Supplies, 31-33 South Street
Tel: 0738 36704

CHANNEL ISLANDS

GUERNSEY Channel Isle Computer Dist. PO Box 299,
St. Peter's Port, Tel: 0481 47968

Bondwell

BW-8



Portable Wonder

"Very few machines costing even twice as much offer so many facilities in such a small and attractive package - a portable wonder". Which Computer Feb '87.

NOW FEATURES ADVANCED
SUPERTWIST LCD SCREEN

- True portability, approx 4.5 Kg (10lbs)
- Low-power CMOS components
- 512KB system RAM
- Built-in 3.5" disk drive, double-density 720KB formatted capacity

NEW LOW PRICE

£799.00

All prices shown are ex VAT

Not all dealers stock every advertised item, please phone before making your journey.



Master your way to a fortune and enjoy a world journey in the process.

Do you enjoy challenging puzzles and brain teasers?
Lateral thinking?

Are you a Sir Rannulph Feinnes on logistical detail with
the tenacity of Captain Cook?

If so you'll really enjoy playing the Travel Game,
a testing world trip in pursuit of a real cash sum which
certainly isn't trivial.*

You'll be stranded in the strangest places with only a
handful of small change unless you get the answers right.
You could catch malaria. Miss your plane. Run into strikes.

On top of all this to unearth the treasure you'll have to
crack a critical sequence of clues dotted around the globe –
with foresight, planning, persistence and perception.

In fact the remarkably life-like and educational Travel
Game has most of the pitfalls and a lot of the pleasures of
travel.

Anyone with access to an IBM compatible PC can play at
their own difficulty level simply by following the screen
prompts and using hard copy print-out if necessary.

At just £24.95 (plus 95p p & p) the Travel Game is
priceless in terms of enjoyment. And you could be much
richer when you return home.

Complete the
coupon to secure
your game or
telephone

051 708 8202

for credit card orders.

THE
TRAVEL
GAME

Allow 10 days for delivery. Money back guarantee if not
delighted.

*An initial £5,000 prize will be increased by £1 for every
game sold.

To: The Travel Game, FREEPOST, Liverpool L1 8AB.
Telephone 051 708 8202

Please send me _____ copy(ies) of the Travel Game at
£24.95 per game plus 95p postage and packing. Total
cost £25.90. I enclose a cheque to the value of £_____

Alternatively please debit my Access Visa credit
card number.

Please indicate your credit card address if different
from the one below.

Name _____

Address _____

_____ Post Code _____

Telephone _____

The answer to the Spectrum-users prayer the **DISCIPLE**

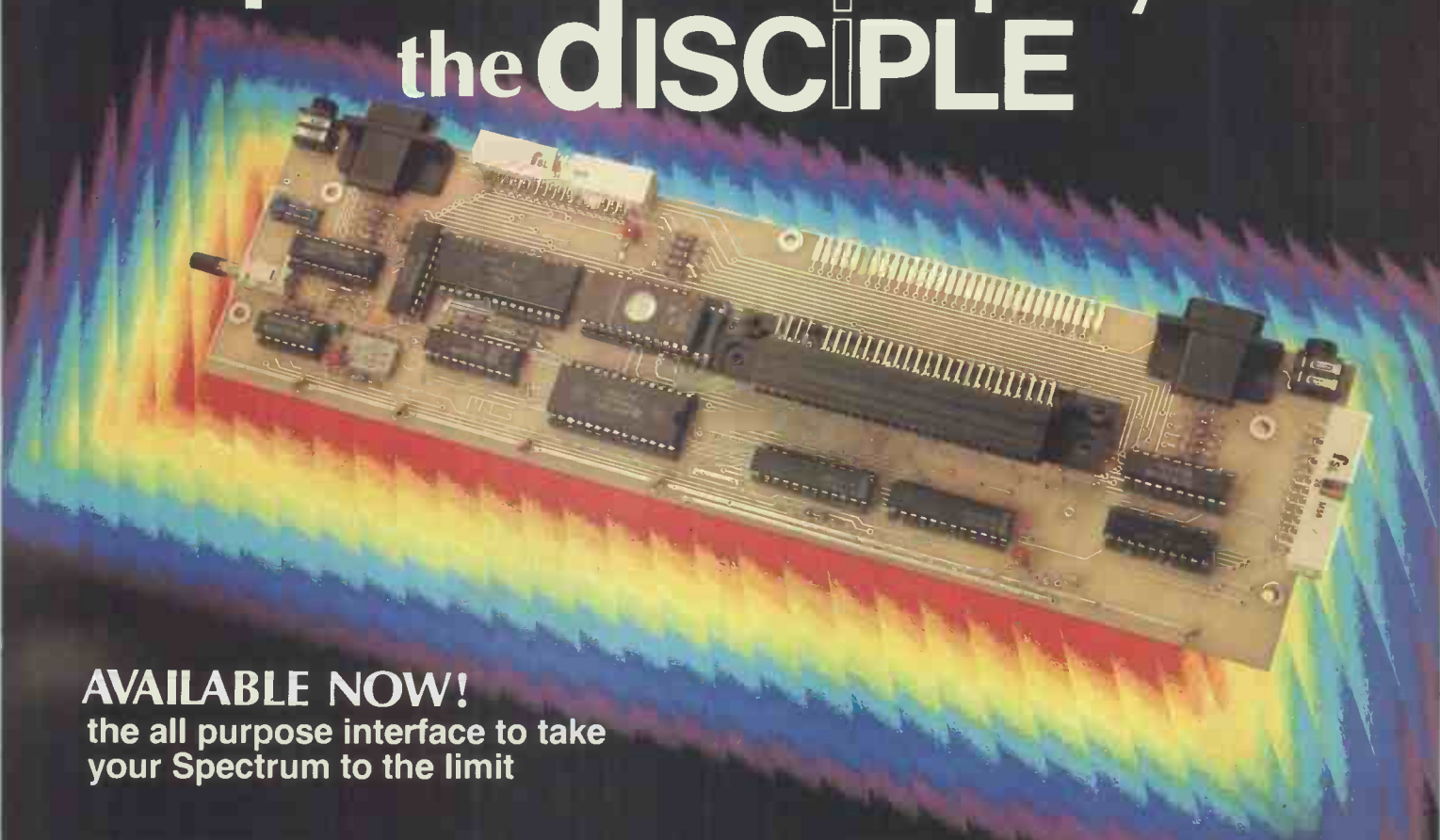

AVAILABLE NOW!
the all purpose interface to take
your Spectrum to the limit

DISK INTERFACE

- ★ Allows up to 1.6Mb of storage on 2 drives
- ★ Loads a full 48K program in 3.5 seconds, 128K programs in less than 10 seconds
- ★ Compatible with any standard drive – single or double density, single/double sided, 40/80 track, 3½" or 5¼"

SNAPSHOT BUTTON

- ★ Saves any program instantly – at any point you wish and as often as you like.

PRINTER INTERFACE

- ★ Compatible with the whole range of Centronics parallel printers
- ★ Single/double size screen dumps allow print-out of any games screen
- ★ Also normal Sinclair LPRINT LLIST commands

DUAL JOYSTICK PORTS

- ★ Sinclair and Kempston compatible.

NETWORKING

- ★ Operating system allows Disciple to act as file server; shared access to printer and disc drive for up to 64 Spectrums
- ★ Interface 1 Compatible



Use the Disciple with the 48K, the Spectrum +, the 128K or the Plus Two

the **DISCIPLE**

the ultimate disk, printer, joystick and network controller for the Spectrum **£89.95** (inc VAT)

Designed by Miles Gordon Technology for Rockfort Products (a trading division of Vignesh Ltd)

Write or call us on 01-203-0191
for details of:

- Disciple + 780K Drive at £199.95
- Disciple + Dual Drive/Printer

packages

- Special Disciple Software Titles
- User Club + Magazine – "Format"

"The Disciple means that upgrading Spectrum owners do have a choice other than selling their machines and buying a Plus Three"
(Popular Computer Weekly)

To: Rockfort Products, 81 Church Road, London NW4 4DP

Please send me POST FREE (Quantity) DISCIPLE Interfaces
@ £89.95 each, including VAT & P&P.

I enclose CHEQUE/POSTAL ORDER for £.....
OR debit by ACCESS or VISA (tick as appropriate)

CARD NO

EXPIRY DATE

SIGNATURE

NAME (Block Capitals).....

ADDRESS

Postcode.....

Overseas orders and trade enquiries welcome. Telex 933740 GANESH G.

IF YOU THINK YOU ARE FAST, TRY GET

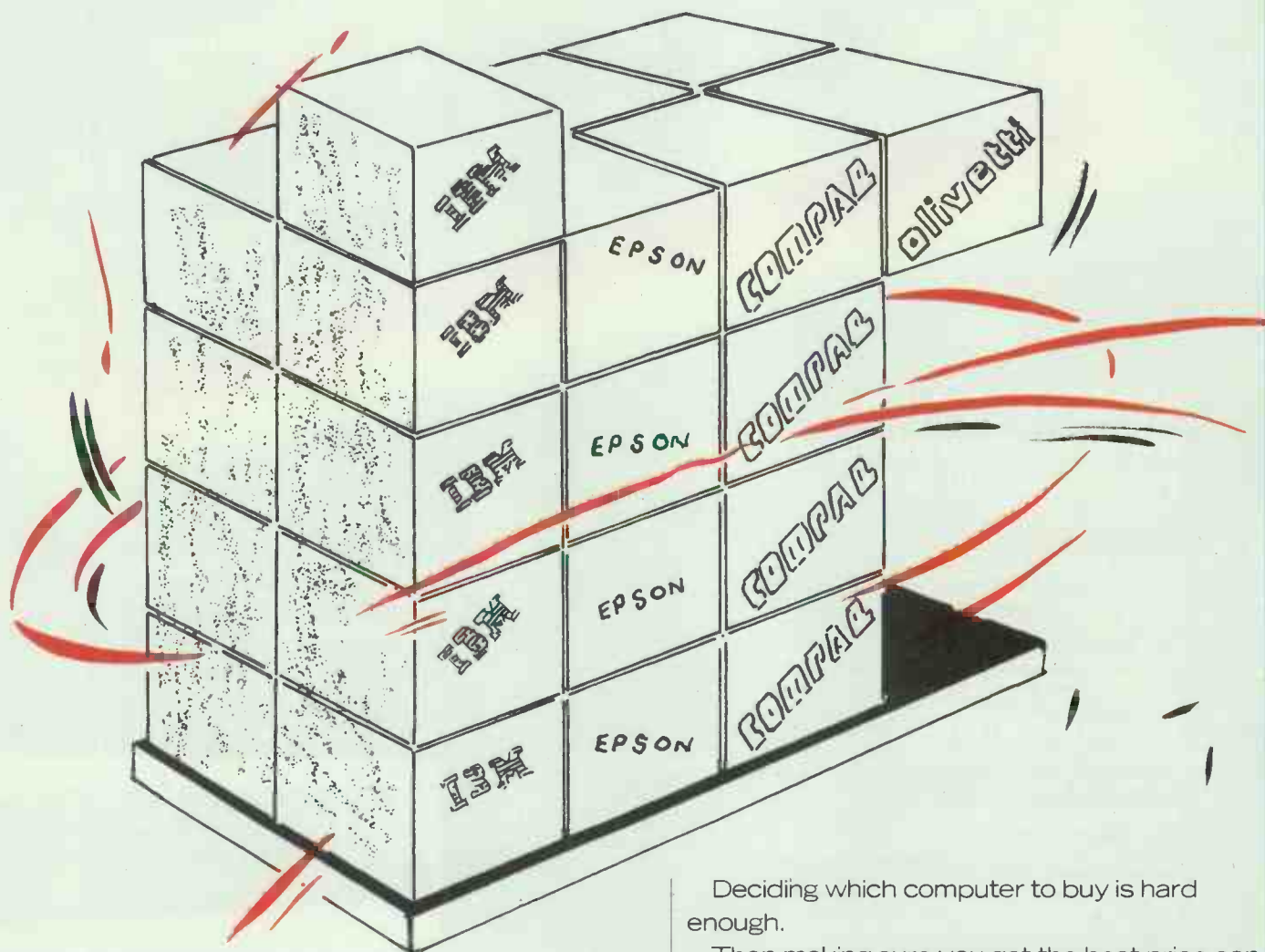

Deciding which computer to buy is hard enough.

Then making sure you get the best price can be even more of a problem.

However, the real difficulty arises when you want one delivered straightaway.

You'll hear more excuses in five minutes than a traffic warden does in a week.

Unless, of course, you come to Worldwide Computers.

We can certainly offer you the choice you

L O N D O N

0 1 5 4 3 2 2 1 1

Worldwide House, Quicks Road, Wimbledon, London SW19 1EX
Telex: 8955888 Fax: 01-543 7812

B R I

0 2 7 3

Regent House, 2 North
Telex: 8776



AY'S COMPUTERS ING ONE DELIVERED

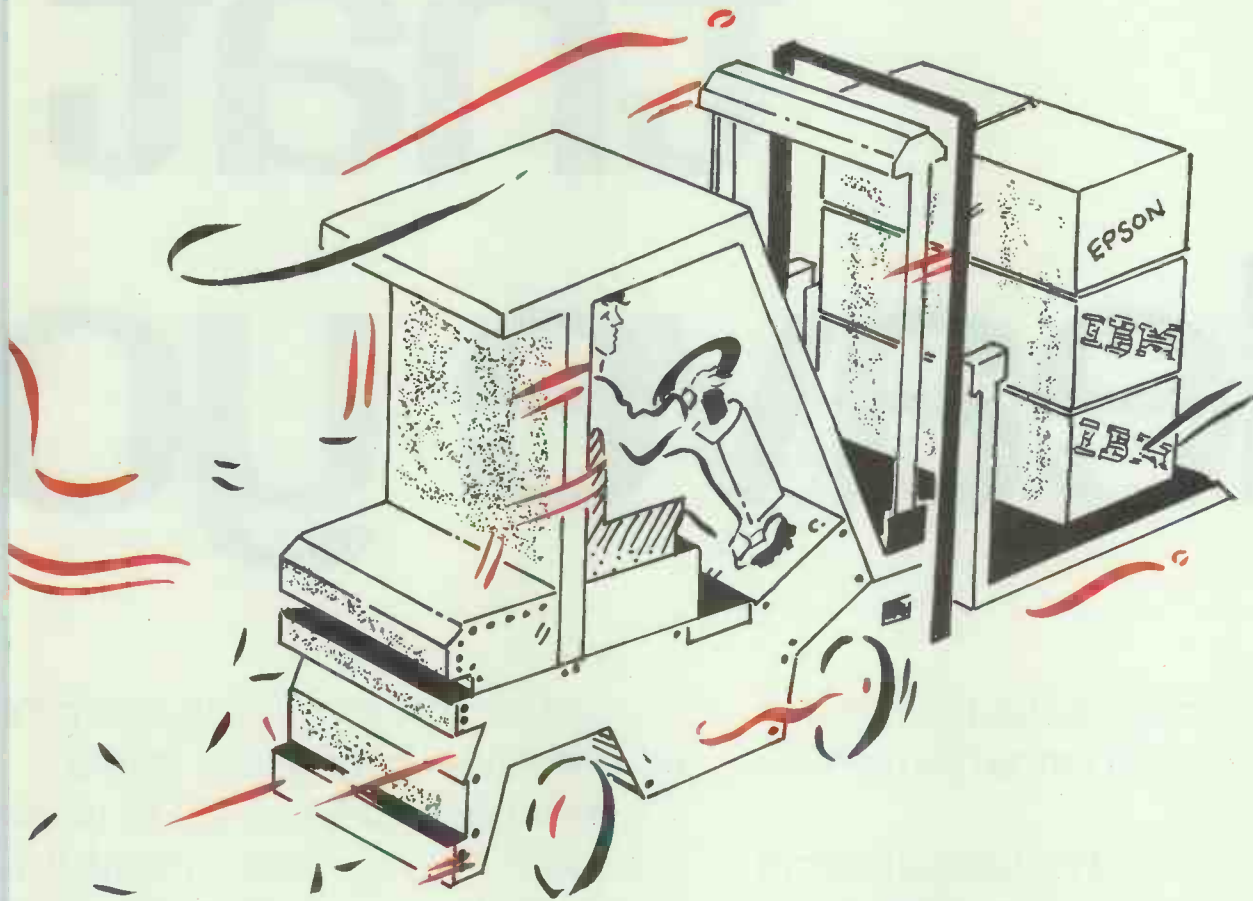

want.

And, we believe you'll find the prices pretty hard to beat.

But, equally importantly, we can supply 90% of our range within 24 hours. Not 2 weeks.

All this means, if you want a computer, you'd be better off speaking to us first.

Because when it comes to offering real value, we have a reputation for being able to deliver the goods.

T O N

9 3 3 1

S C O T L A N D

0 3 1 5 5 4 4 3 6 1

ghton, Sussex BN1 1YA
273671513

11-14 Maritime Street, Edinburgh EH6 6SB
Telex: 728298 Fax: 031-554 2581



Reliable that leave you

There's no disputing the fact that Panasonic make a range of extremely reliable printers.

We've proved it by testing them in temperatures that would make other printers grind to a halt. It's the high standard of design, manufacturing and quality control which goes into every Panasonic product that makes our printers so reliable.

But reliability isn't at the expense of performance.

The KX-P1081 Dot Matrix model, for example, zips through your documents at 120 characters per

second, or you can switch it to print excellent near letter quality results.

Alternatively, if you want to go all out for quality, the Panasonic KX-P3131 Daisy wheel prints at a busy 17 characters per second.

The results were impressive

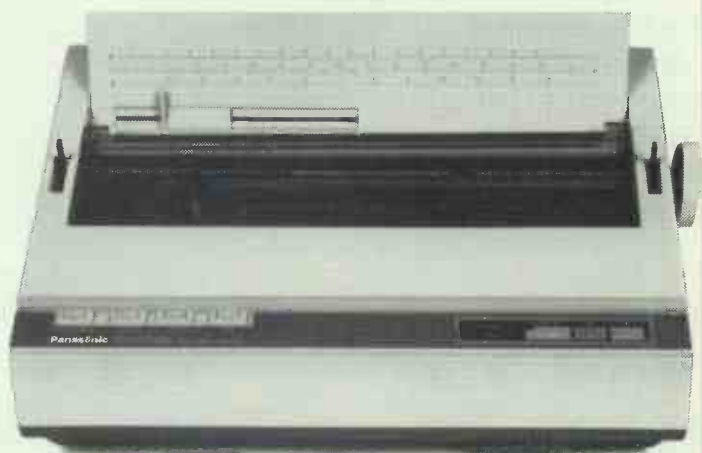

printers won't u broke.

enough to scoop a coveted "Best Buy" award from "What To Buy For Business Magazine."

Naturally all our printers are compatible with almost every computer and software package available. And there can be no

argument about the price, which leaves just one thing to be resolved. Which Panasonic do you choose?

Clip the coupon below or call Julie Everard for more information about the full range of Panasonic printers.

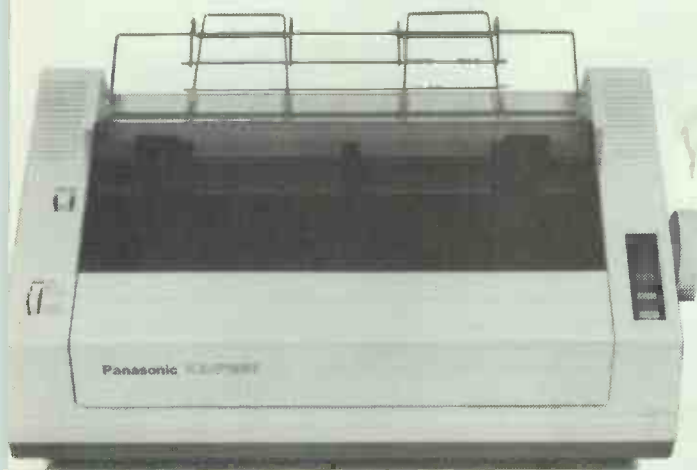

DAISYWHEEL PRINTERS: KX-P3131 (17 CPS, 120 COL.), KX-P3151 (22 CPS, 132 COL.)

To: Panasonic Industrial UK Limited, 280-290 Bath Road, Slough, Berkshire SL1 6JG. Telephone: Julie Everard on 0753 73181. Please send me details on the full range of Panasonic printers.

Name _____

Position _____

Company _____

Address _____

Post Code _____

Tel. No. _____

Panasonic
Office Automation 



AGAINST THE IBM CLONE We Create the Competitive Edge

JEC-3233 is an enhanced personal computer which is characteristic of its new design. By using ASIC and SMT technology, we represent the system in CPU card design to achieve the smallest package with the greatest performance, and offer you the best advantages:

- 1) Enhanced performance and expansion functions.
- 2) Various options supported with full compatibility.
- 3) A practical system for business networking and management.
- 4) The most competitive price in the market.
- 5) Compact footprint enhances working space and reduces delivery costs.
- 6) Easily maintained and transported.

JEPSSSEN Enterprise offers a full range of enhanced PC products including PC/XT system, PC/AT system and their add-on cards such as video display cards, multi I/O cards, disk drive controllers ... and many others

Our R & D team constantly offers new products to keep ahead of the market and accepts designs from the customers. We will meet your requirement in design, production and service. Most of all, we guarantee the strictest quality control from our production line.

JEC-3233 AT A GLANCE

Microprocessor	<ul style="list-style-type: none"> • 80286 10MHz (option 12MHz) with one wait state • Optional 80287 Math co-processor
Memory (RAM)	1MB standard
Permanent Memory (ROM)	128K standard
Storage Devices (Optional)	<ul style="list-style-type: none"> • One 5-1/4" half-high 1.2MB high density FDD • One 5-1/4" half-high 360KB FDD • One half-high 20MB HDD
System Expansion	Seven expansion slots
Standard Port	<ul style="list-style-type: none"> • Parallel printer port • RS-232C serial port • Game port • Built-in real time clock
Display	<ul style="list-style-type: none"> • Standard monochrome display • Optional color display
Software Supported	<ul style="list-style-type: none"> • Operating system: <ul style="list-style-type: none"> • MS-DOS 3.1. CP/M86 • Xenix 286 version • Programming languages: <ul style="list-style-type: none"> GW-BASIC, PSCAL C, any other IBM PC/AT compatible language • Existing standard application software base: <ul style="list-style-type: none"> Autocad, Framework... etc.
Dimensions/Weight	16cm(H) x 31cm(W) x 42cm(D); 10 Kgs (22 lbs.)

IBM PC/XT/AT are registered trademark of the International Business Machines Corporation. MS-DOS, GW-BASIC are registered trademarks of Microsoft Corporation. CP/M-86 is a registered trademark of Digital Research Inc.

JEPSSSEN ENTERPRISE CO., LTD.
Manufacturer/Exporter

ROOM 1105, NO. 415, HSIN-YI RD., SEC. 4, TAIPEI, TAIWAN, R. O. C.
P.O. BOX: 43-71 TAIPEI TEL: (02) 7069137-8, 7068694-5
TELEFAX: 886-2-7069879 TLX: 14296 JEPSSSEN



OFFER

THE ULTIMATE SUPPORT SERVICE FOR YOUR NETWORK OR STAND ALONE SYSTEM

Whether your system is based next door or half way around the world, our unique support solution will give you the most instant online help facilities available today. A simple device allows our technical support personnel instant access to your system to solve your urgent problems. You retain full visual and physical control on the system which is also secured by full password protection.

Our methods are proven and have become invaluable to all our customers who have joined our scheme. You can even use our system to communicate with your other branches or offices whatever the distance. Furthermore, this service is complimented by our own hardware maintenance division?

We are the main suppliers of the following:

IBM — Compaq — Victor — Toshiba Tokenring — Ethernet — GNET — Arcnet — Snet Netware — Open Access — Pegasus — DBase III + all major affiliated products.

For Further details of our unique support solution, contact:

Da Vinci Computers Ltd.
112 Brent Street, Hendon,
London NW4 2DT. UK

Tel: 01-202 2272

Tlx: 265871 (MONREF G)

& refer to 81:MMD102

Fax: 01-202 4982

Telecom Gold:

81:MMD102



QUICKNET UK



PC/AT P52 NETWORKING

NOVELL

CORVUS

Hardware:

ELAN, OMINET, ETHERLINK

Software:

NOVELL NETWARE, 3COM+SHARE, CORVUS PC-NOS

Services:

CONSULTANCY, INSTALLATION, CABLING, TRAINING, MAINTENANCE

All 3 COM and NOVELL products
at Best Possible Prices
New! PS/2 Ethernet Cards

Available
Call to Arrange
FREE ONSITE
QUOTATION

3Com NOVELL EPSON PRINTERS

LQ/800	£199
LQ/1000	£299
LQ/2500	£399
SQ/2500	£399
GQ/3500	£525
LX/800	£435
FX/800	£599
FX/1000	£735
EX/800	£945
EX/1000	£1299

HARD DISKS

Seagate ST-225 20Mb (65MS)	£245
Seagate ST-225 20Mb (65MS) kit for PC's	£299
Seagate ST-238 30Mb (65MS) kit for PC's	£349
Seagate ST-251 40Mb (36MS)	£399
Seagate ST-251 40Mb (36MS) kit for PC's	£449
Miniscribe 3053 45Mb (25MS)	£625
Miniscribe 6085 80Mb (25MS)	£799
Priam 130Mb (13MS) Hard Disk	£1895
Tandon 20Mb Hard Card	£289
Miniscribe 30Mb (65MS) Hard Card	£375

Kits include Controller Card, Cables, Screws and Rails



FREE Delivery on all orders over £400
Redstar same day delivery (optional)

TELEX NO: 265451 MONREF G
ATTN: MAILBOX 83: JBC2024

01-949 7161

1st FLOOR, APSLEY HOUSE, APSLEY ROAD, NEW MALDEN, SURREY KT33NJ

All prices exclude VAT & Delivery. Trade marks acknowledged.
Quicknet reserve the right to vary prices without prior notice.
Official government and company purchase orders accepted.

DIGITASK

BANISH THE

Like many others you've probably found your head swimming with facts, jargon, prices and names, some you've heard of and some you'll never hear of again! But Digitask is one name you're going to hear a lot more of.

Digitask have been producing PC compatibles and supplying compatible hardware for nearly four years, to end users, corporates and dealers. Our customers include some of the biggest names in the business and nearly every university and technical college in the land.

Our components are individually sourced throughout the world and imported to the UK. This allows us to choose the best of all the available options and then to build and test the systems in-house. So when you call, our technical staff are fully conversant with all aspects of system design and maintenance.

Our reputation for service is second to none, our clients keep coming back for more.

A 100% British owned company based in the UK, we are going to be around when others have long gone. Maybe that is why over 8000 computer users have chosen Digitask.

**XT COMPATIBLE
BUSINESS
PRO
£879**



DIGITASK PC16-X

- NEC V20 super processor operating at 4.77 MHz
- Soft/hard switchable to 8 MHz Turbo (provision for 8087-2 co-processor)
- Full 640 KB on-board memory as standard
- Single floppy drive
- 8 IBM® compatible expansion slots (7 on portable)
- 1 × parallel port, 1 × serial port (2nd serial opt.)
- 1 × clock, 1 × games port, 1 × light pen interface
- Easy access flip-top lid (slide on portable)
- 84 key, AT® style keyboard
- Colour display or mono graphics adaptor
- Composite green/amber monitor (internal 9" TTL on portable)
- Free Application/Utilities Software
- One year parts and labour warranty (on-site maintenance available)

STARTER SYSTEM (Specifications as above) **£499**

FULL FEATURE SYSTEM Dual 360KB Floppy **£695**

Drive 640K Ram

High Resolution TTL Monitor, Mono-Graphics Adaptor

BUSINESS PRO SYSTEM 20MB Hard Drive, **£879**

Single 360KB Floppy Drive

BUSINESS PRO PLUS SYSTEM **£1069**

20MB Hard Drive, 1 × 1.2MB + 1 × 360KB Floppy Drive

STOP PRESS 3 NEW XT EGA SYSTEMS

STARTER SYSTEM EGA £799
FULL FEATURE SYSTEM EGA £899
BUSINESS PRO SYSTEM EGA £1199

Identical specifications to the PC16-X range but with EGA display adaptor and monitor

PHONE 0342 24631 NOW

or Contact Digitask, Unit M, Charwoods Business Centre, Charwoods Road, East Grinstead, West Sussex RH19 2HH. Telex 957418 G

Fax 0342 26662

EXPORT ENQUIRIES WELCOME

Prices Do Not Include VAT or Carriage

DIGITASK

PC BLUES!



AT COMPATIBLE
**AXIOM
GOLD 20**
£1275

DIGITASK AXIOM 286-10

- 80286-10 processor (6/10 MHz switchable) •
- Optional 80287 co-processor • Phoenix BIOS • Full Megabyte on-board memory supplied • 1.2 MB floppy drive • 6 × 16 bit IBM® compatible expansion slots (5 usable on portable) • 2 × 8 bit expansion slots • 2 × parallel ports, 1 × serial port (2nd serial opt.) • Easy access flip-top lid (slide on portable) • Small Footprint • 84 key, AT® style keyboard • Mono/graphics adaptor • High resolution TTL monitor (internal 9" on portable) • One year parts and labour warranty (on-site maintenance available)

AXIOM SILVER (Specifications as above) **£1165**
AXIOM GOLD 20 1 × 20MB Hard Drive **£1275**
AXIOM GOLD 40 2 × 20MB Hard Drive **£1475**
AXIOM GOLD 20 EGA 1 × 20MB Hard Drive **£1799**
 with EGA card and monitor

Other configurations - please call



AT COMPATIBLE
**AXIOM
GOLD 20**
£1375

THE DIGITASK PORTABLE RANGE

- PC16-X STARTER SYSTEM PORTABLE** **£699**
- PC16-X FULL FEATURE PORTABLE** **£779**
- PC16-X BUSINESS PRO PORTABLE** **£965**
- PC16-X BUSINESS PRO PLUS PORTABLE** **£1135**
- AXIOM SILVER PORTABLE** **£1155**
- AXIOM GOLD 20 PORTABLE** **£1375**
- AXIOM GOLD 40 PORTABLE** **£1575**

Specifications as desktop systems



XT COMPATIBLE
**BUSINESS
PRO**
£965

PHONE 0342 24631 NOW

or Contact Digitask, Unit M, Charlwoods Business Centre, Charlwoods Road,
East Grinstead, West Sussex RH19 2HH. Telex 957418 G
Fax 0342 26662

EXPORT ENQUIRIES WELCOME

Prices Do Not Include VAT or Carriage

DIGITASK

ONE STOP SHOPPING AT THE BEST PRICES

DOT MATRIX PRINTERS

	RRP	Our Price
AMSTRAD		
DMP 3160 80col 160cps 25 NLQ F/T P	169	155
DMP 4000 136col 200cps 50 NLQ F/T P	349	260
BROTHER		
M1109 80col 100cps 25NLQ F/T P & S	220	162
M1409 110col 180cps 45NLQ F/T P & S	385	289
M1509 136col 180cps 45NLQ F/T P & S	495	353
M1709 136col 240cps 65NLQ F/T P & S (dual interface) IBM/FX	595	419
CITIZEN		
120D 80col 120cps 25NLQ F/T P	245	149
MSP-10 80col 160cps 40NLQ F/T P	349	259
MSP-15 136col 160cps 40NLQ F/T P	449	325
MSP-50 80col 300cps 60NLQ T P	525	387
MSP-55 132col 300cps 60NLQ T P	695	512
EPSON		
LX-800 80col 160cps 25NLQ F/T P	275	185
FX-800 80col 200cps 40NLQ F/T P	430	294
EX-800 80col 300cps 50NLQ T P	555	372
FX-1000 136col 200cps 40NLQ F/T P	550	380
LQ-800 80col 180cps 60NLQ F P 24 pin head	625	399
EX-1000 136col 300cps 50NLQ T P	745	509
LQ-1000 136col 180cps 60NLQ F P 24 p h	835	559
P-80 XS PORTABLE 80col 45cps		250
FUJITSU		
DX2100 80col 220cps 44NLQ F/T P (S OPT)	435	293
DX2200 136col 220cps 44NLQ F/T P (S OPT)	565	391
DX2300 80col 324cps T P OR S IBM/EP S comp.	625	479
DX2400 136col 324cps T P (S OPT) IBM/EP S Compatible	760	582
DL3300 80col 324cps 24 p h BI-T P IBM/EP S/D630 Compatible	710	545
DL3400 136col 324cps 24 p h BI-T P (S OPT) Compatible as 3300	825	632
MICRO-P MP201 132col 200cps 40NLQ F/T P	399	273
NEC		
P6 80col 216cps 72NLQ F P 24 p h	549	375
P7 136col 216cps 72NLQ F P 24 p h	649	437
OKI		
ML 182 80col 120cps NLQ F P	269	185
ML 192 80col 160cps NLQ F P	375	280
ML 193 132col 160cps NLQ F P	485	357
OLIVETTI		
DM100/4 80col 120cps 25NLQ F P	295	199
DM280/1 180col 160cps 35NLQ F/T P	466	307
DM290/1 136col 160cps 35NLQ F/T P	581	363
STAR		
NL-10 80col 120cps 30NLQ F/T P	278	179
ND-15 136col 180cps 45NLQ	489	340
NX-15 136col 120cps 30NLQ F/T P	389	270
NR-15 136col 240cps 60NLQ F/T P	589	395
PANASONIC		
KXP1081 80col 120cps 28NLQ	245	139
KXP1092 80col 180cps 35NLQ	395	315
KXP1592 132col 180cps 38NLQ	495	339
KXP1595 132col 240cps 51NLQ	695	449
PRECISION 4010 80col 480cps 100 NLQ F/T P+S 4 Print Heads	369	305
ACOUSTIC PRINTER HOOD (80col printers)	99	85

TOP RANGE DOT MATRIX PRINTERS

BROTHER 2024L 132col 160cps 96NLQ 24 pin head P OR S	795	575
BROTHER 4018 132col 480cps 100NLQ 67LQ IBM-EP S Compat 18 pin head	1495	1120
DAISY M6001 136col 850cps 129 NLQ F/P P+S 3 Print Heads	2195	1775
EPSON LQ2500 136col 270cps 90NLQ T P 24 p h	1045	675
EPSON SQ2500 Ink Jet	1345	983
OKI ML84 80col 200/400cps NLQ F/T P	779	618
OLIVETTI DM600 132col 200cps 70NLQ P & S	1179	929
STAR NB 24-15 136col 216cps 72NLQ F/T P 24 p h 360d.p.i.	759	517
STAR NB 24-10 80col 216cps 72NLQ F/T P 24 p h 360d.p.i.	599	410
STAR NB 15 136col 300cps 100NLQ F/T P 24 p h 260d.p.i.	949	619
NEC PINWRITER P5 136col 264cps 88NLQ F P 24 p h	1066	745
TOSHIBA P351/2 136col 300cps 100NLQ P & S	1099	884
FUJITSU DL 2400 136col 220cps P IBM/Diablo/EP S compat	1010	863

ORDERS OVER £350 CLAIM YOUR FREE IBM CENTRONICS PRINTER CABLE OR PRINTER CLEANING KIT. OVER £250 CLAIM YOUR FREE CASE/KB OR YDU CLEANING KIT.

(OFFER AVAILABLE WHILE STOCKS LAST)

LASER PRINTERS

EPSON GQ3500 6p min LJ+/Diablo630/Pageprinter	1795	1295
KYOCERA F1010 10p min LJ+/FX/Diablo/Queme NEC/IBM	2495	2095
KYOCERA F2010 10p min Dual BIN LJ+/FX/Diablo/Queme NEC/IBM	4595	3790
CENTRONICS PP8 8pm S OR P FX/Diablo/IBM	1595	1339
CENTRONICS PP8 8pm LJ+	1995	1675
CANON 1X-12 SCANNER (Without Interface)	850	702
MANNESMAN TALLY MT910 10pm Dual Bin P OR S	3290	2717
OKI LASERLINE 6 6pm LJ/FX/Diablo/Queme/NEC	1899	1370
CITIZEN OVERTURE 110 10pm FX/Diablo	1995	1460
QUEME LASER 10+10pm LJ+ FX/Queme/IBM	2683	2216
H.P.LASERJET 8pm LJ+	2618	2095
OLIVETTI PG101 8pm Diablo/Epson/LJ	3209	2499
APRICOT (KYOCERA) LASER	2499	1995

DAISY WHEEL PRINTERS

BROTHER		
HR20 117col 22cps F P & S (dual i/face)	445	327
HR25XL 132col 25 cps F P & S (dual i/face)	695	499
JUKI		
6000 80col 12cps F P	199	147
6100 132col 20cps F P	399	255
6200 132col 30cps F P	579	394
6300 132col 40cps F P	899	629
6500 132col 60cps F P	1299	935
OLIVETTI		
DY450/1 132col 45cps F P Diablo compat	1140	799
DY800/2 132col 80cps F P & S (dual i/f)	1483	1059
FUJITSU		
SP 320E 48cps P Diablo compat quiet	999	766
QUEME		
11 80col 40cps (without i/face) P OR S	1210	956
12 80col 20cps	450	355
RICOH		
3200Q 30cps 7K P D630 compat	445	367
3400Q 50cps 7K P D630 compat	995	821
DATA PRODUCTS DP20 136col 20cps S	445	200

COLOUR PRINTERS

OLIVETTI		
DM 285/1 80col 160cps 35NLQ F/T P JX compat	555	415
DM 295/1 132col 160cps 35NLQ F/T P & S (dual i/face) JX compat	707	526
DM 590/1 132col 192cps 120NLQ F P JX/Queme/Diablo compat	1137	846
TOSHIBA 351C 136col 288cps 100NLQ F P & S IBM compat	1475	1130
FUJITSU DL 2400 180cps LQ60 24 p h P & S IBM/FX80/JX80 compat	1135	870

PLOTTERS

EPSON HI-80 4 pen A4	400	345
HP 7440A 8 pen A4	1160	985
HP 7475A 6 pen A3	1796	1315
HP 7550A 8 pen A3	3813	3399
ROLAND DXY 880A 8 pen A3	775	605
ROLAND DXY 980A 8 pen A3	1100	860

MICE & DIGITISING TABLETS

LOGIMOUSE & SOFTWARE (SERIAL)	99	75
LOGIMOUSE & SOFTWARE (BUS)		83
MICROSOFT MOUSE (bus or serial)		129
MOUSE SYSTEM S MOUSE + PC PAINT		127
GENIUS MOUSE		55
SUMMASKETCH 12 x 12 W. CURSDR		425
SUMMASKETCH 12 x 12 & GEM DRAW		569
SUMMASKETCH 9 x 6 & GEM DRAW		479
CHERRY A3 GRAPHICS TABLET		455
GRAPHTECH A4 NEW		546
SUMMASKETCH BIT PAD + NEW	399	295

If you don't see what you want call for more details

We are the most consistently low priced advertiser in the UK. Our prices and products are genuine. Excellent service, totally comprehensive range and a same day delivery service* make Digitask the best choice every time.

PHONE 0342 24631 NOW

or Contact Digitask, Unit M, Charlwoods Business Centre, Charlwoods Road, East Grinstead, West Sussex RH19 2HH. Telex 957418 G. Fax 0342 26662

*Please call for details

EXPORT ENQUIRIES WELCOME

Prices Do Not Include VAT or Carriage

COMPUTERS (Inc Monitor + Keyboard)

DIGITASK PC16X STARTER SYSTEM XT compat. Single 360KB floppy drive	499
DIGITASK PC16X FULL FEATURE SYSTEM XT compat. dual 360KB floppy drive	695
DIGITASK PC16X BUSINESS PRO SYSTEM XT compat. 20 MB hard drive, 1 x 360KB floppy	879
DIGITASK PC16X BUSINESS PRD PLUS SYSTEM XT compat. 20 MB hard drive, 1 x 1.2MB, 1 x 360KB floppy drive	1069
DIGITASK AXIDM SILVER 286 AT compat. single 1.2MB floppy drive, 1 MB RAM	1165
DIGITASK AXIOM GOLD 20 AT compat. 1 x 1.2 MB floppy, 20MB hard drive	1275
DIGITASK AXIOM GOLD 20 EGA. AT compat. 1 x 1.2MB floppy, 20MB EGA Monitor + EGA Contr NEW	1799
DIGITASK AXIOM GOLO 40 2 x 20MB H/D 1 x 1.2MB floppy	1589
DIGITASK PORTABLE STARTER as per PC16X STARTER SYSTEM (9" TTL internal monitor)	699
DIGITASK PORTABLE FULL FEATURE	779
DIGITASK PORTABLE BUSINESS PRO	965
DIGITASK PORTABLE BUSINESS PRO PLUS	1135
DIGITASK PORTABLE AXIOM SILVER as AXIOM 286 above (9" TTL internal monitor)	1155
DIGITASK PORTABLE AXIOM GOLO 20	1375
DIGITASK PORTABLE AXIOM GOLD 40	1575
MULTITECH ACER 1100 386 SYSTEMS FROM	2600

TAILORED SYSTEMS OUR SPECIALITY. OTHER CONFIGURATIONS PLEASE CALL.

WINCHESTER DRIVES

20MB H.H.T SEAGATE ST225 (65ms)	195
30MB H.H.T SEAGATE ST238 + RII Contr. & Cables XT only	295
40MB H.H.T SEAGATE ST251-1 (28ms)	495
40MB H.H.T SEAGATE ST251 (40ms)	448
80MB H.H.T QUANTUM SC551 Drive & Contr. + SW (12ms)	999
44MB H.H.T SEAGATE M60553 (28ms)	576
30MB F.H.T SEAGATE ST4038 V.COIL (40ms)	435
40MB F.H.T SEAGATE ST4051 (40ms)	525
72MB F.H.T SEAGATE M6085 (28ms)	773
80MB F.H.T SEAGATE ST4096 (28ms)	999
WD/NCL XT Hard Drive Controller & Cables NCL SHORT CONTROLLER (up to 16MHz) FDO/HDD for AT	80
AT OR XT HARD DRIVE Cable set	169
WORM DRIVES	12 CALL

TAPE STREAMERS

XR4 40MB Internal streamer XT & AT	450
XR4 40MB External streamer XT & AT	560
XR4 DRIVER BOARD for External streamer	85
WANGTEK FAD5000 40Mb int.	500 419
WANGTEK 5099 EK 60Mb int.	750 639
WANGTEK 5125 125Mb int.	950 829
EVEREX STREAM-20 20MB Internal streamer	895 585
EVEREX STREAM-60 60MB Internal streamer (XT OR AT)	1295 815
QIC-125 Fast Prof 125MB b.up Novell, 3COM comp	1499 1349

T-SWITCHES & BUFFERS

T-SWITCH Parallel 1-2 (or serial 1-2)	35
INTELLICOM LONGLINK Parallel to parallel inc 50ft cable (up to 7000ft)	149 135
UPGRADE TECH BUFFER 64KB P-P	140 119
UPGRADE TECH BUFFER 256KB P-P	256 219
UPGRADE TECH BUFFER Half Megabyte Dual Channel full feature stand alone	395 335
UPGRADE TECH BUFFER One Megabyte Dual Channel full feature stand alone	495 419

EGA MONITORS

NEC MULTISYNC 14"	649 469
PHILIPS MULTISYNC 14"	603 545
SONY MULTISYNC CPD1402E 14" NEW	795 579
THOMSON MULTISCAN 14"	669 559
PACKARD BELL EGA 14"	599 349
TAXAN 760 14"	579 399
TAXAN 860 16"	899 618
TAXAN 770 MULTISYNC 14"	799 590

EGA ADAPTORS

MITAC/Paradise Manual Switch MDA/ CGA/EGA/HERC PLANTRONICS	109
MITAC/Paradise Autoswitch MDA/CGA/ EGA/HERC PLANTRONICS	129 225
VEGA DELUXE	225
EVA 480 NEW MDA/CGA/EGA/PGA/ PLANTRONICS/132 x 25/28/44 60 lines on Wordperfect/Wordstar - VEA Emulation to run Ventura 1.1 in PS.2 mode. Hardware 200M/pan/window/drivers for AUTOCAO, LOTUS, SYMPHONY, WORDPERFECT, WOROSTAR, IBM/DEC TERMINAL EMULATION	229

EGA & MONITOR COMBI

PACKARO BELL MONITOR + EGA ADAPTOR	495
NEC MULTISYNC + VEGA	678
NEC MULTISYNC + EVA 480	679
TAXAN 770 + PARAOISE AUTOSWITCH	694
SONY CPD1402E + EVA 480	799

COLOUR MONITORS

TAXAN SUPERVISION II 12" Hi Res	389 265
TAXAN SUPERVISION III 12" Ultra Res	459 309
TAXAN SUPERVISION IVm 12" Hi Res	499 349
TAXAN SUPERVISION IV 12" Ult Res	579 409
THOMSON 36512VP1R 14" Med Res	261 225
THOMSON 36382SIR 14" Hi Res	385 329

MONO MONITORS

SAMSUNG SM 125F 12" Amber, Med Pers, Hi Res TTL/IBM With T & S	139 95
TAXAN KX-1201 12" Green comp P31	109
TAXAN KX-1202 12" Green comp P39	119 95
TAXAN KX-1203 12" Amber comp PUL	119 95
TAXAN KX-1212 12" Green Hi Res P39	149 105
TAXAN KX-1213 12" Amber Hi Res PUL	149 105

DTP MONITORS

WYSE 700 (1280 x 800)	895 779
GENIUS A4 (736 x 1008)	1649 1475
VIKING I 19" (1280 x 960) + DRIVER S/W	2299 1956

MAINBOARDS

SUPER TURBO XT 4.77/8 MHz (up to 640K - with OK)	149
SMALL FOOTPRINT PC/AT comp 6/8/10 MHz (OK)	499

SPECIAL OFFERS

SEAGATE ST238 30 MB H.H.T + Controller	575 295
BROTHER 3.5" FLOPPY DISK DRIVE IN 5.25" CHASSIS	114 95
1Mb (720Kb formatted)	138 115
1.6Mb/1Mb (1.2Mb/720Kb formatted)	142 120
2Mb/1Mb (1.6/720Kb formatted)	385 355
2MB Above Function Card Fully Populated	

DIGITASK PERIPHERALS

576K Rammaster Expansion Card (OK)	59	Our Price
640K Multifunction Card (OK) 1P, 1S, 1G, 1C, SW	97	
2MB Above Function Card (OK) 1P, 1S, 1G, 1C Multi I/O Adapter 1P, 1S, 1G, 1C, 2F1, SW	179 95	
Multi I/O Adapter & Display Adaptor 1P, 1S, 1G, 1C, 2F1, CGA, MGA, LP, SW	159 89	
8255 I/O Card	89	
Async Comms Adaptor (dual port) 2S	39	
Async Comms Adaptor (1 port)	27	
4 Port Multi Async Comms Adaptor 4S	119	
Clock Adaptor	47	
Games Adaptor	24	
PSIO-XT Short Multifunction Adaptor 1P, 1S, 1C, 1SW	99	
Floppy Drive Adaptor (4 drive) 4FL	65	
Floppy Drive Adaptor (2 drive) short 2FL	54	
360/1.2 MB Floppy Adaptor (XT)	79	
Diamond (D10-500) I/O card (AT)	89	
Diamond (D10-300) I/O card (XT)	79	
Colour/Graphics Adaptor	79	
Colour/Graphic Printer Adaptor RGB. 2 comp LP	129	
Mono/Graphics (Hercules Compat) card	87	
Parallel Printer Adaptor	18	
4 Bank eprom Programmer/Analyser	259	
PCP-128 TO 128K SW	149	
Eprom Eraser	129	
EPROM/Microprocessor Programmer PCP 128+	199	
FDO/HDD Controller for PC/AT	249	
Serial/parallel card (AT)	69	
Copy Board	99	
40 Track Disk Duplicator	979	
Sine Wave Uninterrupted Power Supply for 1.8KVA	1995	
Sine Wave UPS for 1000VA	1499	
Sine Wave UPS for 750VA	1249	
Sine Wave UPS or SUPS for 500VA	495	
Sine Wave UPS or SUPS for 300VA	395	
Trans Net TR001	299	
Trans Net Utility S/W	99	

DEALER ENQUIRIES WELCOME



ALL VISA AND ACCESS CARDS ACCEPTED



BRANDED PERIPHERALS

RAM EXPANSION	
AST ADVANTAGE OK 1S, 1P (AT only) upgradeable to 3MB	349
AST ADVANTAGE PAK OK (up to 1.5MB) PC/XT	119
AST RAMPAGE (2MB) pop to 256K XT	199
AST RAMPAGE 286 (2MB) pop. to 512K AT	449
AST RAMVANTAGE with 128K (upgradeable to 3MB) for PCAT	369
AST SIXPACK PLUS 64KB, 1C, 1S, 1P (upgradeable to 384K)	205
AST SIXPACK PREMIUM 512KB, C, 1S, 1P, (EMS)	329
INTEL ABOVE BOARD XT	221
INTEL ABOVE BOARD 286 12.5MHz/PS2	395
ORCHID RAMQUEST 50/60 (2MB) EMS PS/2	749
PERSYST STRETCH (Lotus/Intel/MS) up to 2MB(OK pop)	219
EVEREX Mini Magic 60K pop up to 576K	85
EVEREX RAM 3000 AT (OK pop) up to 3MB	219
EVEREX Magic Card AT 1P, 1S, WS. (OK pop) up to 2MB	259
INTEL INBOARD 386/AT OK	1131
INTEL INBOARD 386/AT 1MB	1450
NETWORKS	
AST-PC NET II (RSN 34 PCS more with repeaters 5Mbps)	345
3-COM	CALL
IRMA Emulators & Accessories	CALL
CHASE AT-8 8MHz 32K Ram 32K Rom 50-38400 Baud 8 port serial intell controller using 80186 PC/AT-ATE-ATX Xenix 5/concurr PCDOS-5 comp with drivers	1099
GO-FASTER BOARDS	
AST FLASHPAK (NEC V30 at 9.45MHz)	289
INTERQUADRAM QUADSPRINT	329
MOUNTAIN RACECARD 80286	459
ORCHID TINY TURBO	330
ORCHID TURBO EGA	499
ORCHID JET 386 PC/AT upgrade up to 3 x faster!	695
ORCHID TURBO PGA	949
DISPLAY ADAPTERS	
AST 3-G EGA, card 256K, MDA, Herc, CGA & EGA compat	218
AST COLOURGRAPHPLUS (full spectrum) 32KB, 1P	159
EVEREX THE EDGE Mono/Colour 80/132col, Lotus/Symphony compat	319
EVEREX GRAPHIC EDGE as above with graphics	339
ORCHID EGA, (MDA, CGA & Hercules compat)	221
TAXAN KIF3810 IBM comp (640 x 400 dots)	229
TAXAN KIF 3800 IBM CGA comp supervision IV/VM 840	145
TAXAN KIF3600SP IBM CGA compat (short) 1P	119
HERCULES PLUS CARD	178
HERCULES COLOUR CARD	94
HERCULES Monochrome/GR Adaptor	145
HERCULES "In-Colour"	399 225
PARADISE AUTOSWITCH EGA	399 254
OTHER	
FASTDATA BAR CODE READER IBM + SW	352
ADDONICS SERIAL/PARALLEL CARO for AT	89
ADDONICS MULTI-ASYNC CARD for AT (4 port)	195
BROTHER 3.5" FLOPPY DRIVE for PC/XT (INTEGRAL PSU)	159
ORATOR	795 699

RAM CHIPS & PROCESSORS

INTEL 8087 (8087-3) 5MHz math co-proc chip (PC/XT)	95
INTEL 8087-2 8MHz math co-proc chip (TURBO PC/XT)	134
INTEL 80287-6 5MHz math co-proc (PC/AT Apricot)	149
INTEL 80287-8 8MHz math co-proc (PC/ATX Apricot)	220
INTEL 80287-10 10MHz math co-processor	289
NEC V-20 FAST PROCESSOR (8088 equiv.)	13
NEC V-30 FAST PROCESSOR (8086 equiv.)	13
SAMSUNG 4164 DRAM CHIP 150ns (set of 9)	9.50
SAMSUNG 41256 DRAM CHIP 150ns (set of 9)	25
SAMSUNG UPGRADE 256KB - 640KB	42.50
SAMSUNG ONE MEGABYTE CHIP SET (36 x 41256) multiples of 1MB only	99

PC/XT/AT HARDWARE

POWER SUPPLY 135/150 max Watt Switch Mode XT	89
AT Keyboard replacement (84 Key)	109
TOSHIBA FLOPPY DRIVE 360KB Half HT	69
TOSHIBA FLOPPY DRIVE 1.2MB for PC/AT	125
FLOPPY DRIVE 360KB Half HT DS/DO (Grey front) for AT	95
GREAT COMMUNICATOR 1.2 floppy drive w contr cables ROM S/W XT	179
EXTENDED KEYTRONIC XT/AT Keyboard (102)	130
EXTENDED KEYBOARD (101 keys)	99
KEYBOARD K-150M AT-Style for XT (84 Key)	89
CASE PC/XT Swingtop (Incl hardware kit)	55

DIGITASK

OUT OF THE BLUE

The ACER 1100 – the 386 from Multitech



Represented in over 60 countries Multitech's commitment to research and development has yet again peaked with the introduction of the ACER 1100 series of computers.

Based around the Intel 80386 processor driven to 16MHz the 1100 is certainly one of the fastest personal computers in its class today, exceeding most of its rivals by a factor of some ten per cent. It runs over three and a quarter billion pounds worth of existing software some 300 per cent faster than a standard AT. And as a bonus tomorrow's 32 bit programs up to 1000 per cent faster than today's AT.

With 32bit architecture, unique interleaved memory and massive expansion capabilities it is very much tomorrow's technology today.

Users will find the 1100s generous memory and lightning processing speed indispensable for financial applications, CAD-CAM, CAE, AI and even software development . . . to say nothing of multiuser and server applications.

For More Information Contact

*Digitask, Unit M, Charlwoods Business Centre, Charlwoods Road, East Grinstead, West Sussex RH19 2HH.
Telephone: 0342 24631 Telex: 957418 G*

DIGITASK

SOFTWARE Massive Discounts

DATABASE

FOXBASE + NEW	395	325
CLIPPER COMPILER	595	325
CORNERSTONE	100	61
DBASE III+	595	375
DELTA PROFESSIONAL	495	328
PARADOX II	595	349
O & A SYMANTEC	250	159
QUICKSILVER COMPILER	425	220
R-BASE 5000	295	208
RAPIDFILE	275	189
REFLEX	100	57
REFLEX WORKSHOP	70	48
SAGE RETRIEVE	99	69
VP INFO	100	52

WORD PROCESSORS

LOTUS MANUSCRIPT	395	233
MULTIMATE ADVANTAGE II	495	295
PFS WRITE	115	99
PROTEXT NEW	60	42
SAGE PC WRITE	99	65
TURBO LIGHTNING	70	45
VOLKSWRITER III	325	155
VOLKSWRITER DELUXE	40	29
WORD III	425	238
WORDCRAFT	475	309
WORD PERFECT	425	238
WORDPERFECT LIBRARY	149	120
WORDSTAR	295	144
WORDSTAR 200 + REL2	465	228
WORDSTAR PROFESSIONAL + REL 4	399	193

DTP/GRAPHICS/CAD

ALDUS PAGEMAKER	CALL	
AUTOCAD	2500	CALL
AUTOSKETCH	79	49
CHARTMASTER	295	229
EASY CAD	353	253
FASTCAD	2525	CALL
FLEET STREET EDITOR	149	75
FONTASY	80	58
FREELANCE +	320	265
HARVARD PRESENTATION GRAPHICS	295	219
PUBLISHERS PAINTBRUSH	225	162
VENTURA DESKTOP PUBLISHING	795	469
VUTRAX PCB DESIGN	CALL	
VP GRAPHICS NEW	79	65

OTHER

COPY II PC	50	38
COPY II PC OPTION BOARD	90	74
DESQVIEW	98	67
EUREKA: THE SOLVER	70	47
FLIGHT SIMULATOR II NEW	45	34
GEM COLLECTION	130	73
GEM DRAW +	130	119
GEM GRAPH	180	123
LIGHTNING (CACHE)	99	94
MS DOS 3.2		65
NORTON COMMANDER	55	37
NORTON UTILITIES	85	50
PC TOOLS	40	32
S/KICK (TRAVELLING)	70	48
S/KICK	70	43
S/KICK(TRAV) & S/KICK NCP	109	89
SAGE DESK SET	69	45
SAGE PC CHART	99	89
SIDEWAYS	50	34
SUPERKEY	70	47
V-FEATURE	95	89
V-FEATURE DELUXE	125	119
WINDOWS (MICROSOFT)	85	54
BROOKLYN BRIDGE	107	87

SPREADSHEETS

JAVELIN	100	85
LOTUS 123	395	219
LOTUS HAL	120	81
MULTIPLAN	175	107
NOTE IT	69	59
SAGE PC PLANNER	99	69
SUPERCALC IV	396	189
VP PLANNER	100	52

PERSONAL PRODUCTIVITY

ABILITY	99	49
ABILITY +	159	99
FRAMEWORK II	550	297
LOTUS SYMPHONY	550	317
PFS FIRST CHOICE	149	108
SMART	695	445
SMART SPELLCHECKER	95	87
SUPERPROJECT +	495	290

ACCOUNTS

ACCOUNTABILITY	99	68
DAC EASY ACCOUNTS	85	59
MULTISOFT ACCOUNTS (PER MODULE)	390	270
SAGE ACCOUNTANT	140	105
SAGE ACCOUNTANT +	199	138
SAGE BOOK-KEEPER	99	71
SAGE FINANCIAL CONTROLLER	299	211
SAGE PAYROLL	99	67

PROGRAM DEVELOP'M'T & LANGUAGES

MICROSOFT C	345	245
QUICK BASIC COMPILER	85	67
TURBO BASIC	70	47
TURBO C	70	53
TURBO DATABASE TOOLBOX	50	34
TURBO EDITOR TOOLBOX	50	34
TURBO GAMEWORKS	50	29
TURBO GRAFIX TOOLBOX	50	34
TURBO HOLIDAY JUMBO PACK	165	157
TURBO PASCAL	70	45
TURBO PROLOG	70	47
TURBO PROLOG TOOLBOX	70	47
TURBO TUTOR	30	23
ZORLAND C	30	27

COMMUNICATIONS

CROSSTALK XVI	169	93
SAGE CHIT-CHAT (S/WARE)	99	68
SMARTERM VT-100	135	119
DATATALK		10
SMARTERM 240	229	178
CROSSTALK MARK 4	150	107

**If you don't see
what you want call
for more details**

We are the most consistently low priced advertiser in the UK. Our prices and products are genuine. Excellent service, totally comprehensive range and a same day delivery service* make Digitask the best choice every time.

PHONE 0342 24631 NOW

or Contact Digitask, Unit M, Charlwoods Business Centre, Charlwoods Road, East Grinstead, West Sussex RH19 2HH. Telex 957418 G. Fax 0342 26662

*Please call for details

EXPORT ENQUIRIES WELCOME

Prices Do Not Include VAT or Carriage



M O D E M S E L E C T O R

MANUFACTURER	MODEL	SPECIFICATION	DESCRIPTION	AUTO AMS	NO STORE	AUTO DIAL	ERR CORR	AUTO SENSE	BUFF. I/FACE	PULSE TONE	AUTO LOG ON	RRP	OUR PRICE
AMSTRAD ANSWERCALL	INTERNAL MODEM MINIMODEM	V21 V23	Suitable for all compatibles, with free Datatek software. Simple direct connect modem	Y	Y	HAYES		Y	Y	PULSE	Y	140 (75)	129 59
DACOM	DSL 2123AD	V21 V23	Mainstay of Dacom range	Y	Y	HAYES		Y	Y	BOTH	Y	(255)	155
DACOM	DSL 2123GT	V21 V22 V23	Fully buffered to 9600 intelligent	Y	Y	HAYES	Y	Y	Y	BOTH	Y	(398)	350
DACOM	PC123	V21 V22 V23	Latest IBM multispeed internal	Y	Y	HAYES	Y & EPAD	Y	Y	BOTH		489	300
DACOM	PC123BIS	V21 V22 V22BIS V23	Latest IBM high speed internal	Y	Y	HAYES	Y & EPAD	Y	Y	BOTH		699	540
INTERLEKT INTERLEKT	PORTMAN PROSPECT	V21 V23	Reliable no frills modem	Y					OPT			123	130 50
MIRACLE	WS3000	V21 V23	Low cost manual modem			OPT		Y	Y	BOTH		108	80
MIRACLE	WS3000 2123	V21 V22 V23	Cost effective multispeed	Y	Y	HAYES		Y	Y	BOTH		295	200
MIRACLE	WS3000 Z2	V21 V22 V22BIS V23	Cost effective multispeed	Y	Y	HAYES		Y	Y	BOTH		495	365
MIRACLE	WS3000 ZBIS	V21 V23(V22V22 OPT)	Multispeed top of Miracle range	Y	Y	HAYES		Y	Y	BOTH		630	469
MIRACLE	WS4000	V21 V23(V22V22 OPT)	Budget Hayes multispeed	Y	Y	HAYES		Y	Y	PULSE		170	133
MODULAR TECHNOLOGY	INTEROVER 3021 INTEROVER 5022	V21 V22	Low cost compact stand alone	Y	Y							98	79 200
PAGE	LINNET	V21 V23	Pace best selling buffered modem	Y	Y	HAYES		Y	Y	BOTH		139	119
PAGE	NIGHTINGALE	V21 V23	Low cost manual modem	Y	Y	HAYES		Y	Y	BOTH		99	77
PAGE	SERIES 4 2123S	V21 V22 V23	Latest multispeed (Space Age)	Y	Y	HAYES		Y	Y	BOTH		265	224
PAGE	SERIES 4 1200S	V21 V22 V22BIS V23	Latest multispeed (Space Age)	Y	Y	HAYES		Y	Y	BOTH		399	315
PAGE	SERIES 4 2400S	V21 V22 V22BIS V23	Top pace range multispeed	Y	Y	HAYES		Y	Y	BOTH		499	389
MISSING LINK MISSING LINK	BREAKOUT 2123 BREAKOUT 2400 QUATTRO CARD	V21 V23 & S/W V21 V22 V22BIS V23 & S/W	IBM internal card & software pack IBM internal card & software pack Multispeed IBM internal card	Y	Y	HAYES	Y	Y	Y	BOTH	Y	525	440
RACAL	MP51222	V22	Stand alone professional modem	Y	Y	OPT		Y	Y	AUTO	Y	625	599
RACAL	V12422	V21 V22 V22BIS	High spec PSTN multispeed	Y	Y	Y		Y	Y	AUTO	Y	865	819
RACAL	MP524	V26	Synchronous leased line & PSTN	Y	Y	Y		Y	Y	AUTO	Y	530	509
RACAL	CP2123	V21 V23	Stand alone	Y	Y	Y		Y	Y	AUTO	Y	356	299
RACAL	CP2123PM & S/W	V21 V23 & SPEAKEASY	IBM internal card & software pack	Y	Y	HAYES	Y	Y	Y	AUTO	Y	450	395
RACAL	CP2123PM	V21 V23	IBM internal card	Y	Y	HAYES		Y	Y	AUTO	Y	385	295
RACAL	PM22	V22	IBM internal card latest Racal	Y	Y	HAYES		Y	Y	AUTO	Y	495	395
DOVY	QUATTRO	V21 V22 V22BIS V23	Multispeed modem top Dovyr range	Y	Y	HAYES	Y	Y	Y	BOTH	Y	795	590
DOVY	DUO	V21 V22 V23	Intelligent multispeed	Y	Y	HAYES	Y	Y	Y	BOTH	Y	595	455
DOVY	MINIMO + 2	V21 V23	Multi-stream modem plus!	Y	Y	HAYES	EPAD	Y	Y	AUTO	Y	340	280
DOVY	SB1712	V22	Auto/Manual direct connect	Y	Y	HAYES		Y	Y	PT (OPT)	Y	245	190
DOVY	TRIO CARD	V21 V22 V23	UK best selling V22 stand alone	Y	Y	OPT	Y	Y	Y	BOTH	Y	495	399
DOVY	SB2426	V26BIS	Multispeed IBM internal card		Y	HAYES		Y	Y	BOTH	Y	595	455
DOVY	SB4227	V27	PSTN or LL synchronous modem					Y	Y		Y	317	270
DOVY	SB8529	V28	High speed SyncAsync private line									795	625
TANODATA TANODATA	TM512 TM602	V21 V23 V21 V22 V23	Easy to use professional modem Cost effective reliable multispeed	Y	Y	HAYES	EPAD OPT	Y	Y	AUTO	Y	255	195
THORN THORN	VX543 VX512 VX524	V21 V23 V21 V22 V23 V22 V22BIS	Thorn's best selling low cost modem New multispeed high tech modem Top of the range multispeed	Y	Y	Y	Y	Y	Y	AUTO	Y	186	165
LIOR SYSTEMS DEV	ORATOR	Call for details	Integrated speech & data comms centre			HAYES		Y	Y	BOTH		499	459
									Speed buff			795	699

★ SPECIAL OFFER - FREE Chit-Chat S/W & IBM cable with every V22, V22BIS (RRP £M9) OR only £45 with every V21, V23. ★

* Please call for details

Claim Your FREE "One to One" Subscription (RRP £50) with every modem over £200

Prices Do Not Include VAT or Carriage

PHONE 0342 24631 NOW FAX 0342 26662

or Contact Digtask, Unit M, Charlwoods Business Centre, Charlwoods Road, East Grinstead, West Sussex RH19 2HH. Telex 957418 G

PSION XCHANGE

Xchange is a suite of programs including Database, Spreadsheet, Wordprocessor and Business Graphics. Multitasking allows you to run upto 8 applications simultaneously, data sharing allows you to transfer data from one application to another.

ARCHIVE DATABASE

Multifile relational database. Only memory restricts the number of files in use at one time. Variable length records with a maximum of 255 characters per field, 255 fields per record, 65535 records per file. Command language allows the user to define procedures using a powerful editor: Flexible multifile indices provide fast access and a form designer for screen and printer input and output.

QUILL WORDPROCESSOR

Text and page formatting, underlining, bold, italic, superscript, subscript, justification, tabs, line spacing, page size, page headers, footers and numbering. On screen editing, fast page access, cut and paste, block copy, block move, insert/ overwrite modes, search and find, search and replace, key define and mail merge. Document size only restricted by disk capacity, background printing allows the user to print documents while working on others.

£295
INC VAT
NETWORK VERSION
UP TO 10 STATIONS
£990
INC VAT

EASEL BUSINESS GRAPHICS

3D Business graphics including bar, line and pie charts, no limit to the number of values or numbers or sets of figures. Automatic rescaling, user define colours, text annotation of graphs at any pixel point. Intelligent evaluation of data formulae or manipulation of existing data. Images stored in internal format; monitor resolution is the only limit on final image quality. Accepts data from spreadsheet, database, etc.

ABACUS SPREADSHEET

Expansive spreadsheet with 999 rows, 255 columns, virtual memory system buffers to disk only when full, facilitating very large spreadsheets. Efficiency memory used only for full cells, each cell only uses 14 bytes. Variable width cells, block copy, block move, insert/ delete columns and rows, merge and consolidation of data from different spreadsheets. Accurate to 15 significant figures, full range of mathematical, scientific, date, average, ASCII and DIF conversion.

PC FOUR 79.35 INC VAT

Xchange is available from Transform Ltd, to run on the following IBM PC/XT/AT and IBM compatibles, APRICOT PC, F SERIES, XEN, ICL DRS20, DRS300, OPD, LOGICA KENNET MERLIN 4000, VICTOR SIRIUS, TORCH GRADUATE and BT TONTO. We offer onsite training and DATABASE applications to suit your requirements. Network upgrades enables Xchange to run on upto 10 workstations. Evaluation packs available for £10.00p. For further details contact Transform.



Transform LTD



24 West Oak, Beckenham, Kent BR3 2EZ 01-658 6350

NORTHWEST COMPUTER SUPPLIES (PCC LTD)

82 School Lane, Didsbury, MANCHESTER M20 0RY
Tel: 061-434 9747 MicroLink 72: MAG003

BORLAND/PC DOS SOFTWARE

Turbo Pascal NEW V4 with 8087 & BCD	49	Turbo Basic	49
Turbo Tutor V2	23	Turbo Basic Toolboxes	Call
Turbo Toolboxes		Comms/Graphic	49/37
Numeric Methods/Database (Isam)	37/37	Turbo Lighting/Word Wizard	Call
Editor/GameWorks/Graphics	39/39	Turbo REFLEX/Reflex WORKSHOP	Call
Special - TPas + Any Toolbox + Tutor	105	Prilog/Protlog Toolbox	49/49
Turbo - TPas + Tbox + Tutr + Edi + Game + Grap	169	Sidekick/Trav Sidekick/Superkey	59/49
Turbo "C"	59	IBM format only	
Eureka - The Solver	49		

Paradox 2.0 (Ansa)	385	Microsoft RBASE System V (NEW VERS)	395
Javelin	120	Lattice 'C' Compiler	219
XEROX Ventura Publisher (IBM vers)	625	Norton Utilities/Commander	67/39
Q & A (512k vers)	245	ADVANCED Norton Utilities/Editor	89/69
DOS 3.1 (most compats)/Dos 3.2	57/72	VP-Planner/VP Info	69/69
GEM Desktop/Draw plus	39/149	VP-Graphics/VP-Expert NEW	69/69
GEM Collection (Desktop + Write + Paint)	105	GW-Basic (with HERC & Col Graphics)	95
GEM Desktop Publishing	236	Wordstar (NEW vers 4)/Professional	265
Microsoft Windows/Project	66/214	Flight Simulator/Jet	35/37
Microsoft Quick Basic Compiler	66	Hitchhikers Guide to the Galaxy	23
Microsoft 'C' Comp/Macro Assem	265/99	BBC Basic for IBM Compats (SUPERB)	95
Ablint Plus/Fring Start	119/55	Other software prices - Call	

WYSE 386/286 AT COMPUTERS

WYSE 286 AT - (WY-2108-01)		WYSE 20MB hard disc drive	350
Modular design, 8MHz, 80286, 512k		WYSE 40MB hard disc drive	875
1.2MB Flop, keyboard, ser, par	1219	NCS 30/18 hard disc drive	475
WYSE 286 AT - (WY-2112-01)		WYSE EGA display system	869
Modular design, 12.5MHz, 80286, 1MB		WYSE Mono display system (Herc)	369
1.2MB Flop, keyboard, ser, par	1749	PRINCETON EGA display system	595
WYSE 386 AT - (WY-3216-01)		NCS Mono display system (Herc)	195
Modular design, 16MHz, 80386, 1MB		WYSE 700 Hi-Res system (1280x800)	799
1.2MB Flop, keyboard, ser, par	3499	WYSE 30/WYSE 60 Terminals	349/525

MODEMS etc/MEMORY/MICE/CO-PROCESSORS

Pace Linnet (V21/V23 Buff)	119	Amstrad package (Datatalk + linnet)	145
Pace Series 4 1200s (V21/22/23)	289	Crosstalk V.4	109
WS4000 V21/V23 (V21/23 Buff)	149	Mirror II	79
Steebek Quattro (Ext or Card)	695	DIALUP Comms (EPAD/Prestel/Kermit)	89

MEMORY UPGRADES (AMSTRAD IBM's etc)		512k (18 x 256 DRAMS-150ns)	59
Rampage AST (AT) with 512k	460	512k (18 x 256k DRAMS-120ns)	79
Rampage AST (XT/PC) with 512k	209	512k (18 x 256k DRAMS-100ns)	99
Mouse System Mouse	135	512k Sta. Col RAM (Compact 386 etc)	99
Microsoft Mouse (serial or Bus)	149	8087 5MHz/8MHz/10MHz	125/175/269
Microsoft Mouse with WINDOWS	187	80287 8MHz/10MHz	295/235
128k Amstrad Upgrade (18 x 64k DRAMS)	29		

XENIX/UNIX for AT's

Santa Cruz Xenix (System V)		MicroPort Unix (System V)	
Op System/Dev/Text	595/595/195	Op System/Dev/Text	166/132/132
(all of the above)	1295	Complete set as above	399
Informix SQL/CSQL/4GL	1050/1050/1500	Merge OS (DOS as a UNIX job)	132
SCO Lynx (WP system)	595	Other Unix Hardware	
SCO Professional (lotus lookalike)	795	8 Port Wyse Intelligent Serial Card	695
Microsoft Pascal	696	Cypher 60mb Tape Str. (Xenix or DOS)	1250

Postage & Packing at COST. Manufacturer's Guarantees. All prices plus VAT at 15% (except EXPORT) Payment with all orders - Please. Mail order only

THE GREAT COMMUNICATOR

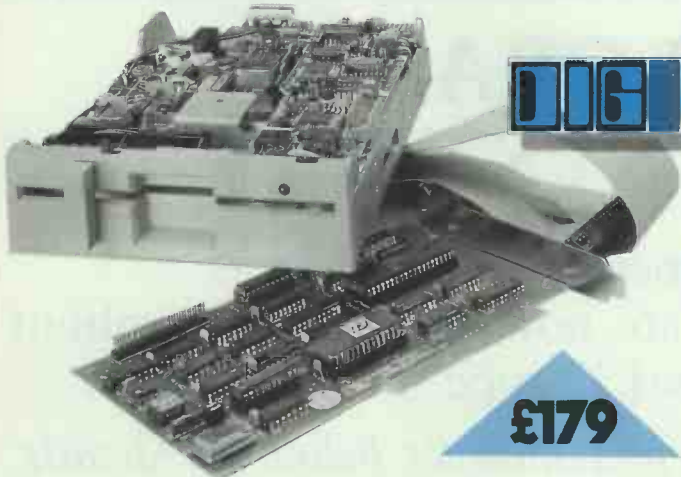

£179

- Allows free interchange between XT® and AT® computers
- Dual drive controller and Brand Name 80TR, 1.2MB formatted drive
- Achieves more than 3-times capacity of normal 360KB floppy drive
- Controller handles (intelligently with on-board ROM) combinations of 1.2MB and 360KB floppies
- FAST data transfer (500K Bits/sec) in 1.2MB format. Excellent for Winchester backup
- 1.2MB drive reads/writes and formats 360KB using normal DOS 3-X commands
- No messy DOS patch software necessary!
- Standard DIGITASK ONE YEAR parts and labour warranty



ABOVE FUNCTION CARD

£179

- Up to 2MB expansion memory (2048KB)
- First 384KB may be configured as conventional memory
- LIM, LOTUS®, INTEL®, MICROSOFT®, (EMM) specification
- Async Comms adaptor (configurable as COM1 or COM2 or disable)
- Parallel Printer Port (configurable as LPT1 or LPT2 and Hercules® compatible)
- Real time clock/calendar with battery backup
- Games adaptor
- Utility software includes expanded memory manager, clock, ramdisk and printspooler
- Includes cables
- Fully compatible with IBM® PC/XT/AT computers
- Standard DIGITASK ONE YEAR parts and labour warranty
- (Unpopulated) Ram at £99/megabyte

PHONE 0342 24631 NOW

or Contact Digitask, Unit M, Charlwoods Business Centre, Charlwoods Road, East Grinstead, West Sussex RH19 2HH. Telex 957418 G

PERIPHERALS CONNECTION LIMITED INTRODUCES . . . GOLDMINE™

The high performance SCSI
(Small Computer Systems Interface) adaptor for
IBM AT/XT/PC and compatibles. One Goldmine™
can control up to TEN storage peripherals (floppy disks,
hard disks, streamer tapes and compact disks)

FEATURES: Half-size expansion card
8/16 bit modes operation
DMA/Interrupt channel selection
11.2Mbits per second transfer rate
Concurrent operation with IBM AT Disk Controllers
Ability to control up to 512MB of hard disks

OEM and reseller enquiries most welcome, for additional details

Please contact:

**Peripherals Connection Ltd, 3 The Mall, London W5 2PJ.
Telephone: 01-840 6262. Telex: 263083 OIL G. Fax: 01-840 0462**

THE COLORADO MEMORY SYSTEMS

Range of tape streamer back-up systems
(44MB, 60MB and 125MB) are now available throughout
the UK and Europe

*Please contact the exclusive representatives below for details
of authorised distributors in respective countries*

**UK: Peripherals Connections Ltd
3 The Mall
London W5 2PJ
Telephone: 01-840 6262
Telex: 263083 OIL G
Fax: 01-840 0462**

**USA: Executive Sales Systems
Number One Duane #21
Redwood City
CA 94062
Telephone: 415 365 8987
Fax: 415 572 2385**



Available from Harrods, Selfridges (London W1), selected branches of Dixons, Rymans, Underwoods, Wildings and other leading stores and approved Psion stockists.



"The ultimate chip . . . all the powerful functions of the Letter Organiser, Data Organiser and Informed Organiser cleverly grafted onto one Superchip!"



" . . . the word processor for people on the move. The work is done by the time you return to the office . . . no tape for the audio typist to type . . . no messy handwritten notes to decipher . . . download and print for drafts or export to PC. Wordprocessor for final polishing . . ."



"Smartest address book yet . . . sorts into alphabetical order on surname or company name, selective printing and categorising and lots more . . . Toolkit for data file and data pack management. Indispensable . . ."



"A standard others will seek to emulate . . . simply fantastic. Uncomplicated and quick to use for anyone who needs facts at their fingertips.

Up to 16 prompts, 238 characters per record, any file length subject only to available storage, sorts alphabetically or numerically, comprehensive selective print features and much, much more."

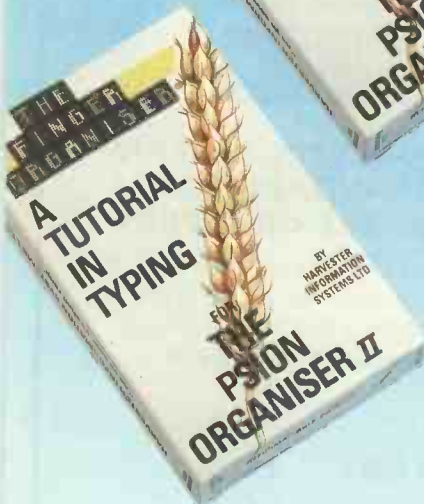

" . . . teaches you to use the Psion Organiser keyboard naturally . . . makes typing information into the Organiser II quicker and easier. It's a lot of fun too! . . ."

Helps to make typing information into the Psion Organiser II quicker and easier . . . It's a lot of fun too!



*All Harvester programs can be used on CM and XP Organiser II's.
** Fingering is that advocated by Harvester's Finger Organiser typing method.

by

HARVESTER INFORMATION SYSTEMS LTD

"as ye sow, ye shall reap"

Enquiries from Educational and Government Departments welcome. Telephone 01 207 5659

AUTUMN SALE

PLEASE READ THIS

WHOLESALE PRICES TO YOU THE USER

5.25" DISKS

Plain label by leading manufacturers ie. R.P.S. Wabash etc.

	25	50	100	200	500
SS/SD 48tpi	£10.00	£19.00	£35.00	£68.00	£164.00
SS/DD 48tpi	£10.50	£20.00	£38.00	£74.00	£174.00
DS/DD 48tpi	£11.00	£21.00	£40.00	£78.00	£190.00
DS/DD 96tpi	£11.50	£22.00	£42.00	£82.00	£200.00

All above inc. envelopes, label sets and hub rings

UK MADE Library cases bought with above only £0.95 EACH

Full 100% error free lifetime warranty

3.5" DS/DD DISKS

Plain label. Memorex etc

	10	20	50	100	200	500	1000
	£15.00	£26.00	£62.00	£110.00	£198.00	£450.00	£800.00

LOCKABLE DISK BOXES AND LIBRARY CASES

80cc printer stand (plastic)	£15.00
5.25" 50 Capacity Ref. YU-DD50L YA50L	£9.75
5.25" 100 Capacity Ref. YU-DD100L YA100L	£10.00
IBM/Amstrad printer cable (6ft)	£8.00
3.5" 40 Capacity Ref. YU-DD40L YA40L	£7.25
3.5" 80 Capacity Ref. YU-DD80L	£9.75

SPECIAL OFFERS

★ EXCEPTIONAL VALUE ★

25 5.25" DS-DD DISKS
PLUS
100 CAPACITY LOCKABLE DISK BOX
FOR
ONLY £17.60

OR
50 5.25" DS-DD DISKS
PLUS
100 CAPACITY LOCKABLE DISK BOX
FOR
ONLY £27.10

20 3.5" DS-DD DISKS
PLUS
40 CAPACITY LOCKABLE BOX
FOR
ONLY £29.50

OR
50 3.5" DS-DD DISKS
PLUS
80 CAPACITY LOCKABLE BOX
FOR
ONLY £68.20

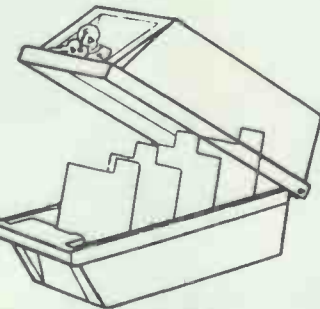
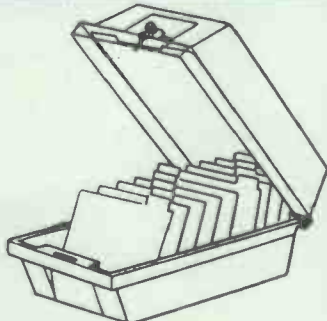

REMEMBER THE PRICE YOU SEE IS ALL YOU PAY. (UK ONLY)
THEY INCLUDE VAT AND CARRIAGE

Cheque or Postal Order to:



Manor Court Supplies Ltd

Dept JT9, Glen Celyn House, Penybont,
Llandrindod Wells, Powys LD1 5SY
Telephone: 0597 87784 or 0597 87792

Orders accepted from educational & government depts.
Dealer enquiries invited.

CLP COMPUTER SUPPLIES

PAPER	PER BOX	1 BOX	5 PLUS
11x9 5 (80)	2000	12 40	10 66
60 GSM Micro Perf	2000	11 90	9 83
60 GSM Pin or Music	2000	13 90	11 92
70 GSM Micro perf	1000	19 53	15 93
2PT NCR			
11x11 5 (132 col)	2000	17 00	12 65
60 GSM Pin or Music	2000	17 40	12 74
70 GSM Pin or Music			
TRUC A4			
90 GSM	1500	17 90	16 09
70 GSM	2000	19 50	14 40

LABELS	IMPERIAL	METRIC	500	1000	5000	10000
2 3/4 x 1 1/16	70x36	2 50	4 10	15 00	27 00	
3 1/2 x 1 5/16	89x36	2 55	4 20	16 00	28 00	
3 1/2 x 1 1/16	89x36	2 50	4 10	15 00	27 00	
3 1/2 x 1 5/16	89x49	3 90	5 50	22 00	40 55	
4 x 1 1/16	102x36	2 40	4 40	18 88	33 70	
5 x 1 1/16	127x36	2 95	5 40	20 30	37 60	
4 x 1 1/2	102x49	4 90	8 50	39 50		
2 3/4 x 1 1/16	70x36	2 90	4 60	15 50		

PLEASE STATE 1 2 OR 3 HOLE
If you require 1/10 or 1/4 vertical spacing please ask
These are for lined 9 1/2" tractor feeds. 2 and 3 wide

RIBBONS	1-5
AMSTRAD	
8512 85256	3 71
Coloured	4 82
Longlife	4 76
Coloured	6 27
BROTHER	
M1009	3 10
Coloured	4 45
HR15 25 35	3 03
Coloured	3 81
CANNON	
PW 1156 1080	2 89
EPSON	
Fx Mk II RX80 85	2 75
Coloured	3 81
LX 80	2 52
Coloured	3 50

RIBBONS	1-5
EPSON	
MK Fx RX100 105	3 15
Coloured	4 23
LO LP 1500	2 95
LC2500	4 83
Coloured	3 60
SHINWA	
CP80	3 78
Coloured	5 01
STAR	
Gemini 10 15	1 40
Coloured	1 90
NL10	4 63
Coloured	5 80
RADIX 15	2 65
Coloured	4 45



SEND FOR OUR NEW CATALOGUE
* MORE QUANTITY MORE DISCOUNT *

* ALL PRICES INC DELIVERY 8 JUST ADD VAT *



PHONE CLP ON 0258-89 400
FREE POST BLANDFORD, DORSET DT11 7BR
TELECOM GOLD 72: MAG 70253



dGE

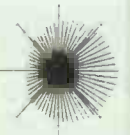

HI RES GRAPHICS ON-SCREEN SETS THE STANDARD FOR PROGRAMMABLE GRAPHICS

dGE — THE database Graphics Extension adds 28 new functions to your database, allowing you to generate hi-res graphs and charts on-screen, directly from your database programs.

Versions available for:-

dBASE II	£90
dBASE III & III+	£120
dBMAN	£120
CLIPPER Compiler	£150



Bits Per Second Ltd.
17 Guildford Road, Brighton BN1 3LU
Telephone: (0273) 727119

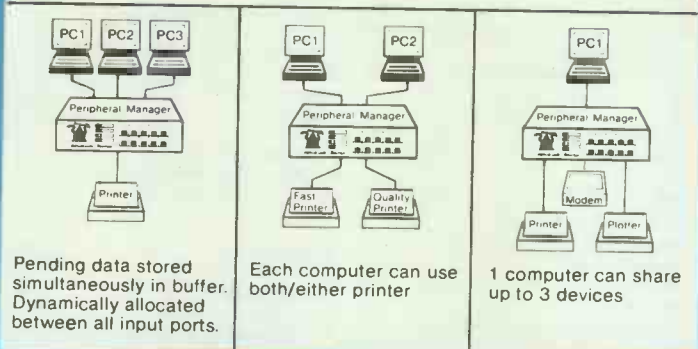
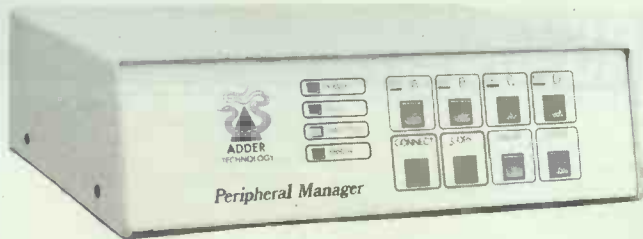

Pending data stored simultaneously in buffer. Dynamically allocated between all input ports.

Each computer can use both/either printer

1 computer can share up to 3 devices

SIMULTANEOUS Data Transfer Control Between Computers & Peripherals

The **Peripheral Manager** has a 256K Buffer, and will store data for fast transfer between all attached devices.

The unrivalled flexibility of the **Peripheral Manager** is fully programmable.

Ports inter-connect, with manual or software control.

Pause channel controls data into and out from the port.

Printer can give multi copies.

Centronic EPM1 Model
Four Ports 36 pin female

£395 + VAT
carriage paid

Serial/Centronic EPM2 Model
2 RS232 Serial Ports (25 way female)
2 Centronics Ports (36 pin female)

£395 + VAT
carriage paid

Each **Peripheral Manager** has a comprehensive manual
Ex-stock for immediate delivery

HOMESTEAD DATA PRODUCTS LTD

145 EDINBURGH AVENUE, SLOUGH. SL1 4UA
Fax (0753) 691037 Telex 846086 CABLIN-G

Tel: (0753) 691661



©1987

DR SOLOMON'S £10 SOFTWARE

DR SOLOMON'S DATA RECOVERY SERVICE

We offer a data recover service.

Phone us if you've lost data, and never assume we can't help you. We can do things you thought were impossible.

We can get data off formatted disks, corrupted disks, disks with bad directories, disks that claim to be 160k floppies and are actually 30 Mb hard disks, and disks that claim not to be there.

Deleted files and directories are our meat and drink. Its expensive, - but no fix no fee.

We can tackle anything - phone for a quote.

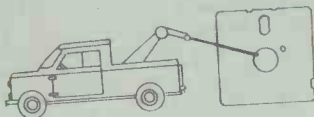

180 PROGRAMS
NOW AVAILABLE
PLEASE PHONE FOR FREE
CATALOGUE

- PC-PRESTALK*** A comms package; all speeds including 1200/75, and does Prestel graphic £20
- DOSMENU** A menu-driven front end for DOS, lets you Choose any application (e.g. 123 or WordStar) or DOS command with a single keystroke command from a menu.
- UNDELETE** Lets you recover files that you have accidentally deleted from floppy or hard disk; also works in subdirectories. Works on all versions of DOS. £15
- REDIRECT*** Lets you redirect the printer to a file.
- SIDELINE** Prints your wide spreadsheet printouts sideways. Needs IBM graphics printer or EPSON or compatible.
- BURN*** Blanks the screen after a given time to prevent burn-in.
- QPRINT*** Lets your printer run while you use your PC for other jobs.
- FASTHELP*** You can design your own help screens, which are just a keystroke away, even when running a program. Also has cut-and-paste from one program to another.

QUALIPRINT

Lets a cheap dot matrix printer do high quality printing. Works with IBM, Epson and compatible printers.

4 FONT SETS

Available for use with QUALIPRINT for business and decorative use (£10 each or all four for £30).

Slimline Font
Italic Typewriter
Bold Upright Font
Broadway Font
Subastar Font

- BUFF 128*** Increases the type-ahead buffer from 15 to 128.
- UNFORMAT/RESCUE** Recovers data from formatted hard disks and data from corrupted hard or floppy disks. £39
- SNAPSHOT*** Dumps the contents of a screen to a file.
- GRAFSHOT*** Dumps the contents of a graphic to a file.
- PRINT CONTROL** Sends any string of characters, including untypeable control characters, to a printer. Handy for form feeds, setting tabs, etc.
- SLOWER*** Makes your IBM or compatible run as slowly as you would like!
- INDEX** Gives you a master list of all the files on all subdirectories, sorted alphabetically.
- LIST** Like DIR, but gives you much more information, sorted.

PROGRAMS MARKED *

Circle No 134 ARE FOR IBM'S AND COMPATIBLES ONLY

Send your orders to:
S&S Enterprises, Utilities Division
31 Holloway Lane, Amersham
Bucks HP6 6DJ



CHOOSE ANY FIVE FOR £40!

£10 & £15 Programs only

All programs cost £10.00 except where stated +VAT
You can buy a package of any nine programs for £65 or any five for £40.
This offer only includes our £11 and £15 programs

PLEASE ADD VAT TO ALL ORDERS



S&S ENTERPRISES (AMERSHAM) LTD. (02403) 4201 & 28095

ADVERTISERS INDEX

3							
3D Digital Design & Development Ltd	241	Database Publications Ltd	237	K	Peripherals Connections	274	
A		Dell Computer Corporation	254/255	KESYS Corporation	236	Piccadilly Micros	29
ATT Corporation Ltd	8/9	Delta PI Software	224	KK Stationery Ltd	220	Pinner Wordpro	19
Abbot Computer Products Ltd	246	Designer Pixels	63	KKS Electronics Cinderford	221	Plastow Taiwan Enterprises Co Ltd	216
Advanced Memory Systems Ltd	65	Digital Research (UK) Ltd	113	Kairn Computer Supplies	232	Pision Ltd	137
Almo Computer System	6	Digital Research (UK) Ltd	74	Keele Codes Ltd	6	Q	
Amstrad Consumer Electronics plc	141	Digitask Business Systems Ltd	266/267	Keyzone Ltd	223	Quatrostar	236
Amstrad Consumer Electronics plc	171	Digitask Business Systems Ltd	268/269	Kirin Computing (Erima UK Ltd)	226	Quayle, Davison & Partners	258
Amstrad Consumer Electronics plc	176/177	Digitask Business Systems Ltd	270	Kirklands Business Systems Ltd	14	Quicknet (UK) Ltd	265
Amstrad Consumer Electronics plc	35/35	Digitask Business Systems Ltd	271	Kudos Systems Ltd	84	R	
Amstrad Consumer Electronics plc	71	Digitask Business Systems Ltd	272	Kun Ying Enterprises Co Ltd	240	RGP Microsystems	216
Annex	28	Digitask Business Systems Ltd	273	L		RSC Ltd	10
Apple Computer	152/153	Dimension Computers Ltd	55	Logotron	245	RTM Systems	7
Arch-Tech Computer Corporation	216	Duncan Databases Ltd	239	Loyview	25	Ragley Data Systems Ltd	63
Arkel Computer Services Ltd	219	Dynamic Speed Control	12	M		Ringdale Engineering Company Ltd	67
Atlantic Office Communications Ltd	163	E		Manor Court Supplies Ltd	276	Rockfort Products (Vignesh)	259
B		EFI Computers & Electronics (UK) Ltd		Matmos Ltd	224	S	
B B Business Supplies	24	Electronic	222	Maxell (UK) Ltd	151	S & S Enterprises	277
Bits Per Second Ltd	276	Electronic Arts	58	Mayfair Micros	66	SL Data Ltd	19
Borland International (UK) Ltd	72/73	Elite Computer Systems Ltd	96/97	Metraco	241	Samsung UK Ltd	64
Brigden Technology	221	Elonex	21	Micro Computer Aided Technology	79	Sanyo Marubeni (UK) Ltd	126/127
C		Evesham MicroCentre Walliton	243	Micro General	26	Savtec Computer Technology	24
CAS	217	F		Micro Media	229	Sereens Microcomputers	36
Cambridge Computers Ltd	52/53	Facts Software Ltd	244	Micro Minder	62	Seltec	30/31
Cal Abco (UK) Ltd	32	Familam Computers	216	Micro Peripherals	IBC	Semaphore Systems Ltd	252
Calend	OBC	Fortransoft	25	Micro Rent	62	Sentinel Software Ltd	82
Card Devices Ltd	48	Future Tec Ltd	19	Mighty Micro	18	Shareware	247
Cardcheck Ltd	225	G		Mitac International Corporation	221	Sierra Computer Consultants Ltd	230
Citizen	37	Giltron Electronic Services	22	Mold	251	Silica Shop Ltd	227
Commodore Business Machines (UK) Ltd	160/161	Goto Computer	27	Morgan Computer Company	38	Slough Computers	24
Complex	218	Greymatter	1	Morgan Computer Company	76	Slough Computers	25
Compsoft plc	49	Greymatter	279	Mosaic Software Inc	68	Soft Options	230
Compstand	11	H		Mountandene Ltd	251	Spectrum Group plc	256/257
Computacenter Ltd	20	Harvester Information Systems Ltd	275	N		Star Micronics (UK) Ltd	123
Computer Concepts	56	Hasler UK	233	National Laser Products	236	Stirling Microsystems	225
Computer Exchange	24	Hayes Microcomputer Products Ltd	90/91	Ness Industries Ltd	234	Surplus Computer Sales	253
Computer Express Ltd	39	Hi Voltage	44/45	Newtons Laboratories	248	Swanley Electronics	223
Computer Express Ltd	40/41	Homestead Electronics	277	North West Computer Supplies	273	System Science (Systematika)	67
Computer Manuals Ltd	218	Hubcourt Ltd	220	Northern Technology Systems Ltd	235	T	
Computer Precision Ltd	15	Huntriump Industrial Co Ltd	220	O		Tandon Computer (UK) Ltd	231
Computer assisted Solution	25	I		Ocmteck	223	Tasman Software Computers	184
Computers by Post	16	IBM (UK) Ltd	88/89	Olympic Systems Ltd	250	Technomatic Ltd	60/61
Continental Ltd	54	ISC Ltd	4/5	Optimum Technology Ltd	13	The Cotswold Press Ltd	121
Continuous Listing Paper	276	Intelligent Quotient	146	Opus	42	The Language Laboratory	242
Creative Logic Ltd	121	Inter Orient	238	Opus	57	The Software Factory	228
Creative Logic Ltd	43	J		Opus	59	Thoughts & Crosses	23
D		Jepssen Enterprise Co Ltd	264	Osiris Computers	17	Transform Ltd	273
Da Vinci Computers Ltd	265	Juki (Europe) GmbH	1FC	P		Tulip Computers	175
				P & C Shiten Enterprise Co Ltd	224	U	
				PC Club	22	UK Home Computers	121
				Panasonic Ind (UK) Ltd	262/263	UK Software Ltd	221
						V	
						Vital Office Equipment	225

MICROMART ADVERTISERS INDEX

A							
A & L	183	Compuceek	202	L	Render Ltd	193	
A & L	185	Computer Facilities	189	LCL	205	S	
ACD Computer Services	200	Comsoft	204	Lucy Parr	191	Serious Statistical Software	201
AL Downloading Services	199	D		M		Slip-A-Disc	206
Access Computers	196	Delostar	200	MDS Computer Supplies	189	Sovereign Mail Order	203
Alan Cohen Computer Consultants	198	E		MEAC Designs	194	Suredata	199
Alexman Ltd	202	Ekra Technology	193	Micro Concepts	203	Syntax Systems	202
Altek Instruments	187	Elect Organs	204	Micro Mail	188	T	
Altra	186	F		Microcom Systems	190	Tech Supplies	203
Analogue Information Systems Ltd	207	Four Party Services Ltd	187	P		Technical Media Services Ltd	194
Ashcom	201	G		PB Electronics	201	Translatum International UK Ltd	207
Ashling UK	200	G & M Software	197	Pace Electronics Ltd	191	W	
Athene Consultants	194	Goel Computer Services	205	Pacific Computers (UK) Ltd	195	Wight Scientific	199
Avon Computer Exchange Ltd	196	I		Panther Software	198	Wordwork	188
Aware Software	206	International Software Distribution	192	Peripheral Hardware	204	Wyvern Typesetting	187
B		J		Prospec Computer Systems	189	Z	
BBD Computer Dust Covers	191	John Holmes Computers Ltd	186	Protech Product Technology Ltd.	205	Zone Electronics	188
Budget Typesetting Ltd	193	K		R			
C		Kamsat	197	RH Computer Consultants	207		
Carousel Tapes	197						
City Disc Conversions Ltd	198						
Clydesoft	206						

BASIC LANGUAGE

New Quickbasic V3.0 uprates the competition with TURBO-BASIC.

BASIC INTERPRETERS

BBC Basic (86)	PC-DOS	£ 95
Professional BASIC	PC-DOS	£ 70
TrueBasic v2.0	PC-DOS	£ 95
Microsoft MS-BASIC	MS-DOS	£210
MEGABASIC v5.2	MS-DOS	£235
Dig.Res. CBASIC	CP/M-86	£290
MEGABASIC	CP/M-86	£235
MEGABASIC	MP/M-86	£365
BBC BASIC	280+CP/M-80	£ 95
Dig.Res. CBASIC	CP/M-80	£130
Microsoft MBASIC	CP/M-80	£ 60
MEGABASIC	CP/M-80	£195

BASIC COMPILERS

Microsoft QuickBASIC	PC-DOS	£ 60
Softaid MTBASIC	PC-DOS	£ 60
Turbo Basic	PC-DOS	£ 60
ZBASIC	PC-DOS	£ 75
Alcor Multi-Basic	MS-DOS	£ 75
Microsoft MS-BASIC	MS-DOS	£235
Dig.Res. CBASIC	MS-DOS	£390
Dig.Res. CBASIC	CP/M-86	£390
Dig.Res. CBASIC	CP/M-80	£435
ZBASIC	280+CP/M-80	£ 75
Softaid MTBASIC	280+CP/M-80	£ 60
Alcor Multi-Basic	280+CP/M-80	£ 85

FORTRAN COMPILERS

New V4.00 from Microsoft now mean four excellent 77's to choose from.

Lahey F77L v2.20	MS-DOS	£360
RM/FORTRAN 77 v2.11	MS-DOS	£400
MS-FORTRAN 77 v4	MS-DOS	£250
Pro Fortran 77 v1.22	MS-DOS	£220
Pro Fortran v2.144	MS-DOS	£220
Utah Fortran	MS-DOS	£ 35
FS-Fort. (GGA & Herc)	MS-DOS	£ 35
Pro Fortran v2.1	CP/M-86	£220
Pro Fortran v1.25	CP/M-80	£220
Nevada Fortran v3.3	CP/M-80	£ 35
Pro Fortran 77	ATARI 520ST	£120

We have Fortran Libraries In stock.

LIBRARIES & UTILITIES

Database

CADSAM (source code)	MS-DOS	£ 75
Btrieve	MS-BASIC + MS-DOS	£180
Btrieve/N	MS-BASIC + MS-DOS	£430
Multikey	MS-BASIC + MS-DOS	£145
CADSAM (source code)	CP/M-80	£ 75

Graphics

Halo	MS-BASIC + MS-DOS	£175
GSS Graph.Dev:Tkt	PC-DOS	£335

Sundries

Finally Quickbasic +	PC-DOS	£ 75
PANEL Screen Manager	MS-DOS	£100
Wiley Scientific Lib.	PC-DOS	£110

Tuning & Debugging

Betatools Dev.System	PC-DOS	£100
Vicar	MS-DOS	£ 35

ASSEMBLERS

Microsoft's Macro-86 V5.00 with Codeview may be here by now.

2500AD 8086 Asm.	MS-DOS	£ 95
Dig.Res. RASM-86	MS-DOS	£180
MS Macro-86 v4.0	MS-DOS	£ 95
Phoenix PASM-86	MS-DOS	£115
Phar Lap 386	MS-DOS	£415
Visible Computer 8086	PC-DOS	£ 95
2500AD 8086 Asm.	CP/M-86	£ 95
Dig.Res. RASM-86	CP/M-86	£180
2500AD 280 ASM	CP/M-80	£ 95
Dig.Res. RMAC	CP/M-80	£180
Microsoft Macro-80	CP/M-80	£ 60
SLR Z80ASM	CP/M-80	£ 45
SLR Z80ASM-PLUS	CP/M-80	£175
SLR MAC	CP/M-80	£ 45
SLR MAC-PLUS	CP/M-80	£175
SLR 180 (Hitachi)	CP/M-80	£ 45
SLR 180-PLUS (Hitachi)	CP/M-80	£175

Not all assemblers are supplied with a linker. Check before ordering.

PASCAL LIBRARIES

TURBO PASCAL LIBRARIES

Blaise Power Tools Plus	PC-DOS	£ 70
Blaise Turbo Asyn.Plus	PC-DOS	£ 70
Mathpak 87 (TP)	MS-DOS	£ 60
Paragon Supertools	PC-DOS	£ 65
RM Graph Nimbus +	MS-DOS	£ 49
Science & Eng.Tools	MS-DOS	£ 50
Report Builder	MS-DOS	£ 70
System Builder	MS-DOS	£ 90
Turbo Halo Univ.Graph.	PC-DOS	£105
T-Debug Plus v2	PC-DOS	£ 35
Turbo Database	CP/M & MS-DOS	£ 45
Turbo Editor Toolbox	PC-DOS	£ 45
Turbo Extender	PC-DOS	£ 55
Turbo Gameworks	PC-DOS	£ 35
Turbo Graphix Toolbox	PC-DOS	£ 49
Turbo Advantage (Lader)	MS-DOS	£ 60
Turbolink Plus v3.15A	PC-DOS	£ 60
Turbopower Utilities	PC-DOS	£ 60
Turbo Optimiser	PC-DOS	£ 45
Turbo Professional	PC-DOS	£ 45
Turbo Screen	CP/M, MS, PC-DOS	£ 60
Turbo Tutor	CP/M & MS-DOS	£ 29
TurboWINDOWS/Pasc. (TP)	PC-DOS	£ 55

GENERAL PASCAL LIBRARIES

Blaise Tools (s'ce) (MS)	PC-DOS	£ 85
Blaise Tools 2 (s'ce)	PC-DOS	£ 80
Blaise Asynch (s'ce) (MS)	PC-DOS	£120
Btrieve (MS)	PC-DOS	£180
MetaWINDOWS (MS)	PC-DOS	£110
Halo (MS)	PC-DOS	£175
Blaise View Mngr. (MS)	PC-DOS	£205
Shark database (Propas)	MS-DOS	£250
Prospect Graphics (Pro)	MS-DOS	£ 80
Panel (Screen) (MS)	MS-DOS	£205
Shark database (Propas)	CP/M-86	£250
Prospect Graphics (Pro)	CP/M-86	£ 80
Shark database (Propas)	CP/M-80	£150

DISK COPYING SERVICE

We can copy files to and from 400 disk formats including CP/M, CP/M-86, MS-DOS, PC-DOS, ISIS, APPLE, SIRIUS, BBC, TORCH, APRICOT, HP150, TRSDOS, DEC RT-11, IBM BEF, ATARI520, AMSTRAD.

Our charge is £10.00 + disk + VAT with discounts on small quantities and disks are normally despatched within 24hrs of receipt.

For more information call us.

MODULA-2 COMPILERS

New Farware compiler. FTL is an excellent value learning tool.

Pecan P-Sys. w.Mod-2	PC-DOS	£ 80
Farware Modula-2	MS-DOS	£ 70
FTL Modula-2 (sml.mem)	MS-DOS	£ 45
Interface M2-SDS	PC-DOS	£ 75
Interface M2-SDS-XP	PC-DOS	£185
Modula-2/86 Apprentice	PC-DOS	£ 70
Modula-2/86 Wizard	PC-DOS	£140
Modula Corp.PC Mod.2	PC-DOS	£150
Modula 2/86	CP/M-86	£410
FTL Modula-2	280/CP/M-80	£ 45
Hochstrasser Mod.2	280/CP/M-80	£100
Turbo Modula-2	280/CP/M-80	£ 55
TDI Modula-2	ATARI 520ST	£ 75
MacModula-2	MACINTOSH	£100

PRICES & DELIVERY

Prices do not include VAT or other local taxes but do include delivery in UK and Europe.

Please check prices at time of order, ads are prepared some weeks before publication.

This page lists some of our products. Call us for a complete pricelist.

Order by phone with your credit card.

PASCAL LANGUAGE

Metaware excellence now on Concurrent Dos 286 and on the 386. Better Turbo compatibility on new version Pro Pas

ALICE Pascal Intrprtr.	PC-DOS	£ 80	Mystic Pascal v1.6E	PC-DOS	£ 29
Dr Pascal Interpreter	MS-DOS	£ 39	Oregon Pascal-2	MS-DOS	£280
Marshall Pascal v2.01	MS-DOS	£150	Prospero Pascal v3.0	MS-DOS	£220
Metaware Prof.Pascal	MS-DOS	£415	Turbo-Pascal	MS-DOS & PC-DOS	£ 60
Metaware Prof.Pas/386	MS-DOS	£610	Pecan P-Sys w.UCSD Pas.	IBM-PC	£ 80
Microsoft Pascal v3.32	MS-DOS	£180	Pecan P-Sys Pascal Prof.	IBM-PC	£155
Metaware Prof.Pascal	C-DOS	£415	Pro-Pascal v2.14	CP/M-86	£220
Turbo-Pascal v3.01	CP/M-86	£ 60	Turbo-Pascal v3.01	CP/M-86	£ 60
Pascal MT+ v5.6	CP/M-80	£ 99	Pascal MT+ v5.6.1	CP/M-80	£290
Pro-Pascal v2.18	CP/M-80	£220	Turbo-Pascal v3.01	CP/M-80	£ 45
MCC Pascal	ATARI ST	£ 75	Pecan P-Sys w.UCSD Pas	ATARI ST	£ 80
Pecan P-Sys w.UCSD Pas	APPLE][£ 80			

We have many Pascal Libraries. Enquire

CROSS ASSEMBLERS

We supply cross-assemblers by Avocet, 2500AD, IAR Systems and Pecan hosted on MS-DOS, CP/M-86 and CP/M-80 with over 30 target processors. In total over 200 products with no space to list them here. We hold some stock but you should allow 10-14 days for delivery. Please call for information or advice.

PROGRAMMING TOOLS

Ada Compilers	Algol Compilers
Assemblers	Assembler Libs.
Basic Compilers	Basic Interpreters
Basic Utilities	Basic Libraries
BCPL Compilers	C Compilers
C Interpreters	C Libraries
C Utilities	Cobol Compilers
Comms.Libraries	Cross Assemblers
Database Libs.	Debuggers
Dis-assemblers	Editors
Engineers Libs.	Expert Systems
Forth	Fortran Compilers
Fortran Libraries	Graphics Libraries
Icon	Linkers
Lisp	Modula-2
Nial Interpreters	OPS 5
Pascal Compilers	Pascal Libraries
Prolog	Rexx
Screen Libraries	Smalltalk
Snobol	

We stock many items for which there is no space in these advertisements.

GREY MATTER

4 Prigg Meadow, Ashburton, Devon TQ13 7DF.
TEL. (0364) 53499

4 Prigg Meadow, Ashburton, Devon TQ13 7DF.
TEL. (0364) 53499

4 Prigg Meadow, Ashburton, Devon TQ13 7DF.
TEL. (0364) 53499



CHIP CHAT

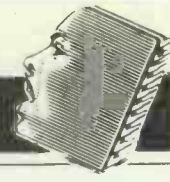

A new keyboard — the KB 102 — from Emco Electronics has been developed 'specifically to suit the demands of the UK market'. The photo accompanying the press release shows otherwise — not a 'f' sign in sight.

'Our press release about the new multifunction keyboard was unfortunately sent out with the wrong photograph,' claimed the next missive from Emco.

At last, we thought: a 'f' sign.

Nope. Just twelve function keys instead of ten. We're still trying to figure out what the UK-specific angle was . . .

You have to admire the cheek of Sentinel Software, UK distributor of WordPerfect. At the PCW Show the company was selling, for a mere £1, a \$12.95 book entitled: *A WordStar Survivor's Guide to WordPerfect*. In response to the question: 'Isn't changing over to WordPerfect hard?' the book's authors reply: 'You've

already learned one of the hardest-to-learn word processors around . . .' It is, of course, a matter of argument whether WordPerfect's Shift-F10 is any easier to remember than WordStar's Ctrl-KR for pulling text into a document. Personally, I find PC-Write's Ctrl-F3 far more logical . . .

Dire warnings have gushed forth about formatting disks in the new 1.44Mbyte 3½in disks as found on IBM's Model 80 and Apricot's VX series. As with 5¼in disks, high and low-density drives don't like swapping disks. But we can't understand what all the fuss is about. Cleverly, when the high-density 3½in disks were designed, an extra notch was added which could be detected by the drive mechanism to ensure that the disk was formatted and written on in the correct manner. No manufacturer seems to have taken this up. Must be too easy for them . . .

Talking of disks, thanks must

go to Ashey and Shane of Amersham, Bucks, who sent in the ultimate in vapourware: a perfectly manufactured floppy disk without any disk in it — just the black sleeve and paper pocket. 'Is this the new IBM DOS 3.3 system disk to accompany the abridged manuals?' they asked . . .

People in the computer industry move around pretty fast, but they don't all want to have the stories of their lives re-told every time their photo is circulated to the press.

Pity poor Helen Johanssen of Rapid Solutions, who has moved 'from invoice clerk to marketing services manager in nine years'. Helen's spare-time activities include sailing and music, it says. Next they'll be sending round pictures of new managing directors in their nappies . . .

Victor Technologies and Sentinel Software are planning to save the Korup Rain Forest in Africa by organising a cricket league. They could have saved a couple of rain forests by wasting less paper with the length of their press release . . .

PCW staff writer Robert Schifreen doesn't have the muscles of an Arnold Schwarzenegger. You may have wondered how he continually carried around the '211b' Cambridge Computer Z88 he reviewed in our September issue. He didn't — it was a typo. Sorry, Uncle Clive . . .

Walters has proudly announced that its XT and AT compatibles will run Lotus 1-2-3. That the company is announcing the fact at all does make one wonder whether in the past, 1-2-3 *didn't* run on them. Walters is, after all, one of the oldest survivors of the clone wars. If you own one of its earlier models, load 1-2-3 and WAIT now before it's too late . . .

NEC laid on a day at Goodwood for press and distributors to drive round the circuit in Formula 2 racing cars. One chap got a specially-battered cup for being the person 'most likely to have an accident on the way home'. Seems he drove round the circuit in second gear all the time . . .

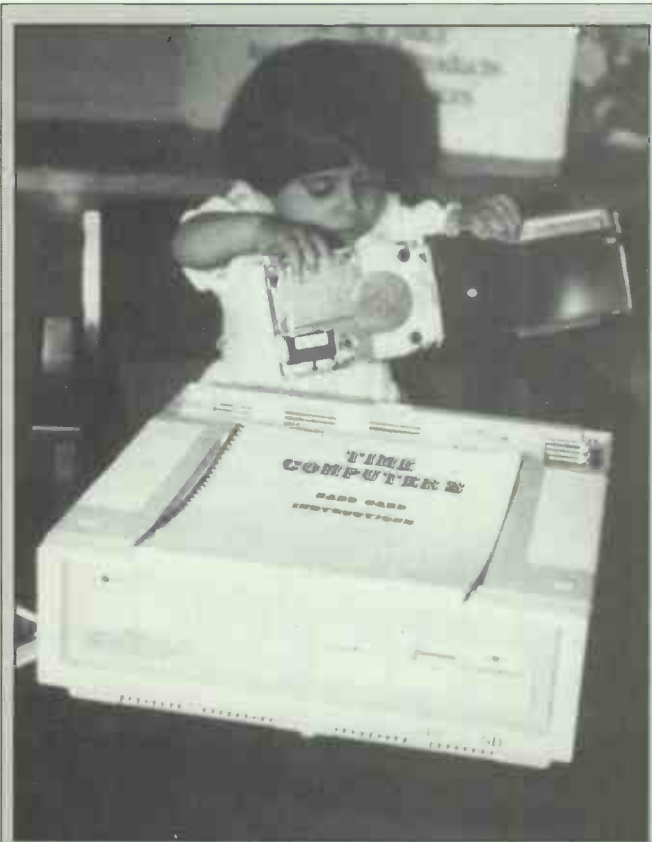

Child slavery must be rampant in the computer industry. Sales manager Tahir Mohsan of Time Computers in Blackburn sent us a photograph of his daughter Sadia being forced to work in his company's spares department fitting its £249 hard cards into single-drive Amstrads. But at least she's getting on with the job.

Alan Sugar's son Daniel spent two days pestering the life out of three busy editors at VNU. He phoned, at hourly intervals, insisting that we fax him the pages in our current issues covering Amstrad products. All the issues were on sale at his local newsagent.

Perhaps he could get a job with Time Computers fitting disk drives into his father's machines.

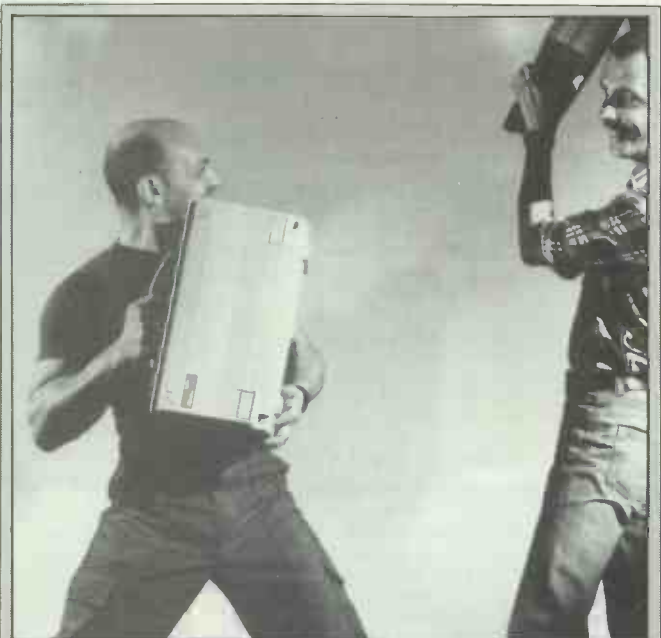

This month

We had to smile at the very close timing of the launches by Compaq and Toshiba of portable 386 machines. Already, these two companies are fighting hard for the yuppie and power corporate users' custom, and the new machines will escalate the battle. Which one is the winner? Find out on page 98.

Big companies don't always get it right, and Robert Schifreen's review on page 158

of two major communications packages reveals how little major commercial products sometimes score over low-cost shareware products.

Finally, you may notice some small changes in this issue of PCW. We're trying to make the layout and typography of the magazine more logical. Above you can see editor Derek Cohen and art director Martyn Rowbotham wielding 386 portables at five yards to settle a minor artistic disagreement.



Impeccability.



Impeccability] sic. *not liable to sin, faultless.*
 Having taken the lead in camera technology and produced the perfect image, the Canon Mark II Laser Printer now takes the lead in producing the perfect word. Whilst others may be satisfied with standard technology, a few enlightened perfectionists know that technical excellence and sophistication are the true way forward. See the light and let the faultless Canon range be your way ahead.

With true presence of mind, Canon have produced printers from small matrix to powerful lasers all possessing impeccable qualities. These true virtues have

produced the popular PW-1080A and A-55 Matrix, the sharp clarity of the 18 wire A-60 and A-65 Matrix and the colourful PJ-1080A Ink Jet Printer.

Whatever the Canon product, impeccability is the operative word.

Distributed by:

Micro Peripherals Ltd

Intec 2, Wade Road, Basingstoke,
 Hampshire RG24 0NE.
 Tel: 0256 473232 (32 Lines).

LBP-8II (Pictured above).
 Speed: 8 pages per minute. Memory: 512K, expandable to 1.5Mb. Compatibility: Diablo 630.
 Price: £2195.



Canon

Unit 5/6, Newhallhey Road, Rawtenstall,
 Rossendale, Lancashire BB4 6HL.
 Tel: 0706 217799 (16 Lines).

Whatever the Words - We've Got the Abilities.

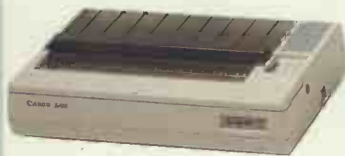

A-55
 This attractive NLQ printer offers low cost with high performance.
 Speed: 180cps draft, 34cps NLQ.
 Columns: 156. Compatibility: IBM/
 Epson. Price: £499.

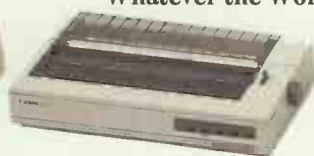

A-65
 A superb performer, fast and highly competitive offering excellent word processing quality (WPQ) output.
 Speed: 200cps draft, 100cps NLQ, 34cps WPQ. Columns: 156.
 Compatibility: IBM or Epson.
 Price: £548.



A-60
 Yet another great achiever capable of producing terrific word processing, quality output.
 Speed: 200cps draft, 100cps NLQ, 34cps WPQ.
 Columns: 80. Compatibility: IBM or Epson. Price £478.



PW-1080A
 This acclaimed NLQ printer has become an industry standard where high quality print and high speed are required.
 Speed: 160cps draft, 30cps NLQ. Columns: 80. Compatibility: Epson.
 Price: £349.



PJ-1080A
 The ideal presentation printer where colour graphics are required. It even prints on overhead projection film.
 Speed: 37cps. Columns: 80. Compatibility: Epson. Price: £499.

Why are PC users from New Zealand to Norway changing over to PCL?

PCL (Personal Computer Language) is the ideal language for beginners and experts alike. It is easy to learn and offers much greater practical programming power than either BASIC, Pascal or C.

PCL has a logical syntax and a clear structure which encourages the writing of very readable programs. Extensive debugging features and sensible error messages help you to track down errors quickly.

PCL is a major new high level language, implemented as the fastest interpreter on earth. **PCL** is not a scaled down adaptation of a mainframe language like Basic, Pascal or C – it was designed for the PC.

Calend* developed **PCL** for the practical PC user. You will find that **PCL** is more powerful and easier to learn than any language you have come across.

PCL makes you more productive and it gets more performance out of your micro. It gives you the flexibility of an interpreter with an execution speed that puts most compilers to shame.

Join the fast growing number of **PCL** programmers. Get your applications running in record time. Why waste time wrestling with the quirks of the traditional languages. **PCL** has more useful built-in functions than the others:

- Sophisticated windowing, boxes frames and menus. Save and restore window settings and contents.
- Extremely fast screen displays.
- Array arithmetic.
- Sorting.
- Extended text manipulation and scientific functions. 16 digits precision. Date arithmetic. Automatic 8087/80287 support.
- Powerful file handling, directory and disk management.
- Dynamic record structures.
- DOS command interface.
- RS232 communications up to 19200 Baud handled by built-in background tasks.
- Supports the IBM graphics characters, but not pixel graphics which are incompatible with fast text display.
- Any **PCL** application can be made RAM-resident

...and much more.

PCL has over 330 built-in functions.

Any **PCL** program can call on the interpreter itself at run time and pass source code for immediate execution. Useful for self-modifying, intelligent programs, spread-sheets, data dictionaries, AI applications etc.

Description	BASICA	MS-BASIC	C	PASCAL	PCL
Empty loop x 10000	4.6	.23	.09	.25	.04
BYTE Magazine decimal arithmetic benchmark: With 8087:	252.5	17.32	39.4	31.88 6.29	14.82 6.09
Display 24 lines of 80 characters on standard colour display: Mono or EGA display:	3.62 3.40	4.00 3.40	4.6 3.8	2.70 2.45	.15 .04
Format & display 100 decimal numbers: With 8087:	6.95	2.02	2.6	1.51 1.35	42 .25
Convert 1000 decimals to character strings: With 8087:	22.0	3.56	6.5	3.89 2.87	3.17 1.04
Convert 1000 character strings to decimals: With 8087:	50.7	3.92	13.1	8.18 3.48	2.43 1.12
Catenate two 10 byte strings x 1000:	3.2	.65	.32	.58	.32
Sequential write, 1000 x 90 byte records	18.3	9.0	11.2	7.5	2.9
Sequential read, 1000 x 90 byte records	18.2	8.6	9.2	7.4	2.5

All timings are in seconds. They were taken on a standard IBM PC with PC DOS 3.1, a real-time clock and a 10MB hard disk. BASICA is the PC-DOS interpreter, MS-BASIC is Microsoft's compiler (version 2.0), C is the Digital Research version 1.1, PASCAL is Borland's Turbo Pascal 3.0

Minimum system requirements: IBM PC/XT/AT or compatible, 256k RAM, mono or colour monitor, PC DOS or MS DOS version 2.1 or later. **PCL** comes on a 5¼ diskette (not copy protected) with 16 sample programs. It is accompanied by a 255 page manual. The manual covers all aspects of **PCL** programming, is well structured and has a sensible index. 30 days money back guarantee for single copy prepaid UK orders.

Become more productive – order **PCL 2.0** from Calend for £100 (includes VAT and UK postage).

CALEND
P.O. BOX 94
TWICKENHAM TW2 6DD
Telephone: 01 894 7409

*Calend is an independent UK software house.