

Hobby

AN ARGUS SPECIALIST PUBLICATION

Electronics

Project Electronics For Everyone

85p

POPULAR COMPUTING
Sound Effects for ZX Computers

LOW COST OSCILLOSCOPE PROJECT

Build this design for under £79

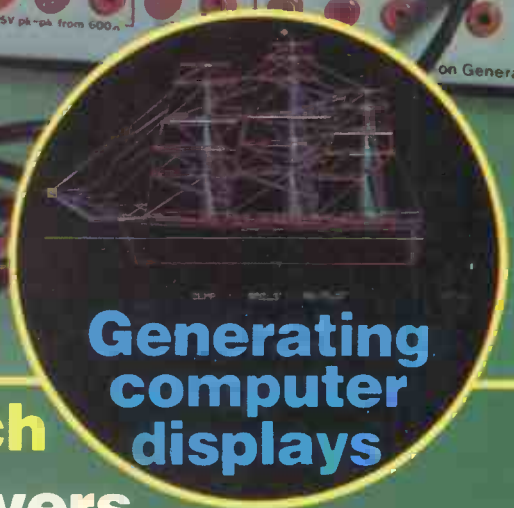
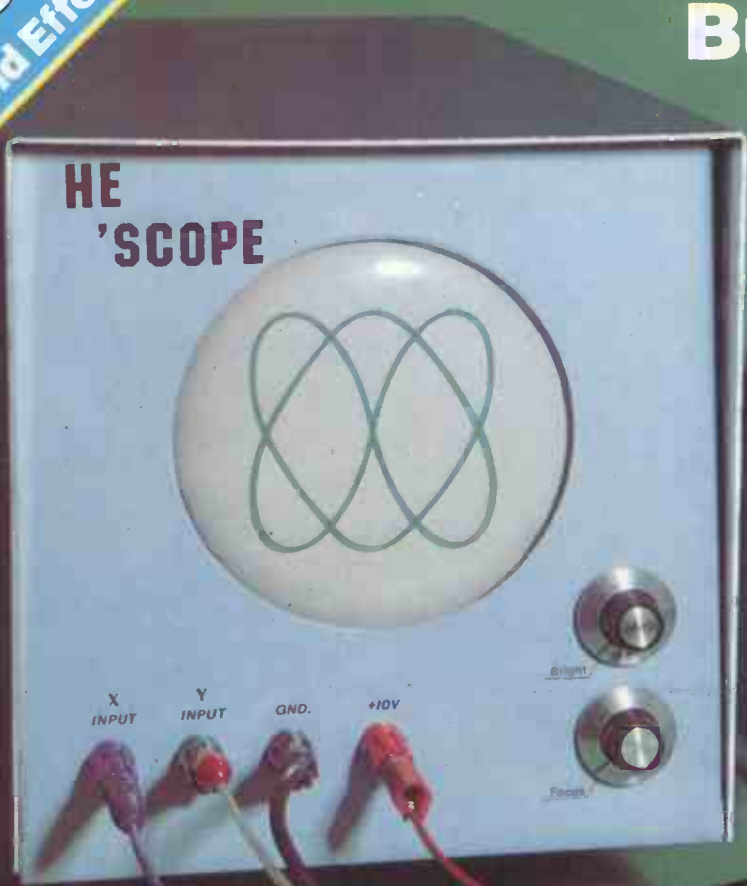

Generating computer displays

Transmitter Push-to-Talk Latch
Traffic Light Toy for Young Drivers

Hobby Electronics

JUNE 1983
Vol 5 No 6

PROJECTS

- ★THE HOBBY 'SCOPE 11
Riding out of the sunset comes the most economical 'scope in town.
- ★ZX SOUND BOARD 20
Noises for your ZX81 or Spectrum micro.
- ★CAR BATTERY WARNING DEVICE 30
Don't let your battery drive you bats.
- ★POP AMPS NO. 8 36
TTL logic tester.
- ★CB PUSH-TO-TALK SWITCHER 45
The biggest advance in radio since the human thumb.
- ★TRAFFIC LIGHT TOY 65
Keep the kids off the streets.

FEATURES

- FAMOUS NAMES 26
Sir John Turton Randall.
- COMPONENTS FOR COMPUTING 38
Looking at displays.
- ★CAREERS IN ELECTRONICS PART 2 52
Getting into technical writing.
- THE ELECTRONIC REVOLUTION 56
Bringing it all back home.
- BOOK REVIEWS 62
Alarms and investigations.

REGULARS

- Monitor 6
- Points of View 16
- What's On Next 18
- HE Bookshelf 29
- Buylines 34
- HE PCB Service 71
- HE PCB Printout 72
- Classified Advertisements 73



Hobby Scope — page 11

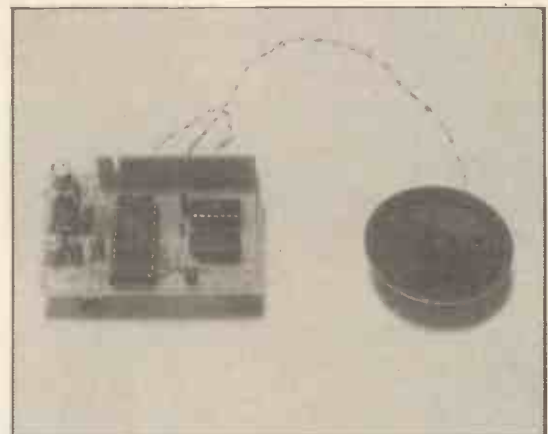

Sinclair Sound Board — page 20

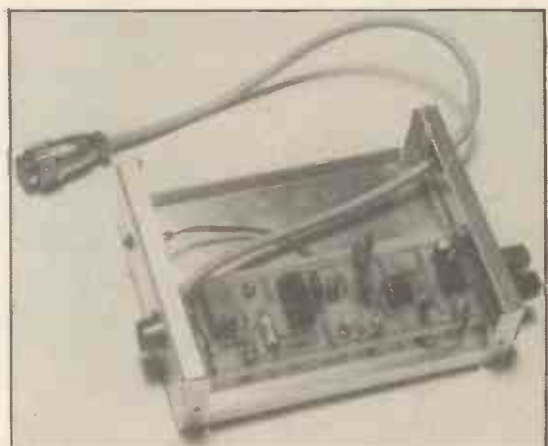

CB Rap Latch — page 45

Editor: Ron Keeley
 Editorial Assistant: Helen Armstrong BA
 Technical Illustrator: Jerry Fowler
 Advertisement Manager: Jolyn Nice
 Divisional Advertisement Manager: Gary Price
 Managing Editor: Ron Harris BSc
 Managing Director: T.J. Connell

Hobby Electronics is normally published on the second Friday of the month prior to the cover date.
 Hobby Electronics, 145 Charing Cross Road, London WC2H 0EE, 01-437 1002. Telex No 8811896. Published by Argus Specialist Publications Ltd.
 Origination by Ebony Typesetting, Trion House, 13 Dean Street, Liskeard, Cornwall PL14 4AB.
 Distributed by S. M. Distribution Ltd, 16/18 Trinity Gardens, London SW9 8DX.
 Printed by QB Ltd, Colchester. Covers printed by Alabaster Passmore.

Notice: The contents of this publication including all articles, designs, plans, drawings and programs and all copyright and other intellectual property rights therein belong to Argus Specialist Publications Limited. All rights conferred by the Law of Copyright and other intellectual property rights and by virtue of international copyright conventions are specifically reserved to Argus Specialist Publications Limited and any reproduction requires the prior written consent of the Company. All reasonable care is taken in the preparation of the magazine to ensure accuracy, but Argus Specialist Publications Ltd cannot be held responsible legally. ©Copyright 1982 Argus Specialist Publications Ltd. Member of Audit Bureau of Circulation.

COMTECH ELECTRONICS

TRANSISTORS		MJE3055		2N3708		LM747		50p		5mm red		7p		VOLTAGE REGULATORS		CAPACITORS	
BC107B	12p	BD132	48p	2N3771	8p	LM748	25p	3mm green	5p	TA T0220	40p	Electrolytic, radial	Value/Volts	Price	Value/Volts	Price	
BC108C	12p	BD136	30p	2N3772	17p	LM1458	36p	5mm yellow	10p	7805	33p	1uF/63	6p	220uF/25	15p		
BC109C	13p	BD137	30p	2N3773	17p	LM1496	70p	3mm yellow	10p	7812	33p	2.2uF/63	6p	470uF/25	23p		
BC113/4	15p	BD138	35p	MPSA12	20p	LM3900	47p	5mm yellow	10p	7815	33p	4.7uF/63	6p	1000uF/25	32p		
BC115/6	16p	BD140	35p	MPSA13	20p	2N3886	90p	rectangular	15p	78L05	30p	100uF/63	5p	100uF/63	6p		
BC117	16p	BD204	40p	MPSA14	22p	2N3903	10p	stackable	3p	78L12	30p	100uF/35	20p	22uF/16	6p		
BC119	19p	BD206	40p	MPSA42	23p	2N3904	10p	RED	70p	78L12	10p	4.7uF/25	8p	47uF/16	8p		
BC139	19p	BD222	56p	MPSA43	23p	2N3905	10p	GREEN	72p	78L15	14p	10uF/25	5p	100uF/16	9p		
BC140	26p	BD239A	40p	MPSA45/6	22p	2N4306	10p	YELLOW	15p	78H05 5V at 5A	50p	47uF/25	8p	100uF/16	9p		
BC142/3	27p	BD240A	42p	MPSA64	22p	2N4033	30p	CMOS	60p	LM309K 5V at 1A	120p	22uF/25	5p	220uF/16	12p		
BC151	32p	BD240C	48p	MPSA82	24p	2N4037	30p	LM317K Adj/1.5A	240p	LM337T Adj/1A	240p	100uF/10	9p	1000uF/10	19p		
BC169C	32p	BD241A	50p	MPSA84	24p	2N4061	10p	LM723CN Adj.	200p	7805	33p	100uF/10	9p	220uF/10	35p		
BC170	32p	BD242A	52p	MPSA93	30p	2N4062	10p	CMOS	60p	4082	12p	0.1uF/35	12p	8.8uF/25	20p		
BC172	32p	BD243A	52p	TIP29A	30p	2N4061	10p	4000	12p	4093	12p	0.22uF/35	12p	10uF/16	20p		
BC179	32p	BD244A	52p	TIP29C	30p	2N4062	10p	4002	12p	4098	12p	0.33uF/35	12p	15uF/16	28p		
BC182	32p	BF180	30p	TIP31A	33p	2N4403	14p	4006	12p	4511	15p	0.47uF/35	12p	22uF/16	35p		
BC187C	16p	BF181	30p	TIP31B	33p	2N4403	14p	4007	12p	4512	15p	0.68uF/35	12p	33uF/10	36p		
BC188	16p	BF182	30p	TIP31C	33p	2N4403	14p	4011	11p	4514	11p	1uF/35	12p	47uF/10	60p		
BC184L	8p	BF183	30p	TIP32A	33p	2N4403	14p	4014	11p	4516	11p	3.3uF/35	12p	100uF/63	80p		
BC182L	8p	BF184	30p	TIP32B	33p	2N4403	14p	4015	11p	4555	36p	4.7uF/25	20p	100uF/3	40p		
BC184	8p	BF185C	30p	TIP32C	33p	2N4403	14p	4016	11p	4556	36p	CMC ceramic, miniature plate.					
BC212	8p	BF195	12p	TIP47	65p	2N5551	20p	4017	11p	4558	36p	Ceramic disc 83V: 10N, 22N, 47N 4p each.					
BC212L	8p	BF196	12p	TIP47	65p	2N5551	20p	4022	11p	4558	36p						
BC213	8p	BF197	12p	TIP47	65p	2N5551	20p	4026	11p	4558	36p						
BC213L	8p	BF198	12p	TIP47	65p	2N5551	20p	4026	11p	4558	36p						
BC214	8p	BF199	12p	TIP47	65p	2N5551	20p	4026	11p	4558	36p						
BC214L	8p	BF244C	25p	TIP12R	60p	747C	50p	4026	11p	4558	36p						
BC237	8p	BF245	25p	TIP12R	60p	747C	50p	4026	11p	4558	36p						
BC238/9	10p	BF256C	25p	TIP2955	70p	748C	35p	4026	11p	4558	36p						
BC251	10p	BF257	30p	TIP3055	70p	CA3089	170p	4026	11p	4558	36p						
BC300	10p	BF258	30p	TIS44	20p	CA3090C	300p	4026	11p	4558	36p						
BC301/2	10p	BF259	30p	TIS80	24p	CA3140E	40p	4026	11p	4558	36p						
BC302/4	10p	BF336	30p	TIS92	20p	CA3160E	100p	4026	11p	4558	36p						
BC307	10p	BF337	30p	2N1613	30p	CA3181E	155p	4026	11p	4558	36p						
BC308/9	10p	BF338	40p	2N1711	30p	CA3189E	245p	4026	11p	4558	36p						
BC327	12p	BF457	30p	2N1893	28p	CA3240E	110p	4026	11p	4558	36p						
BC328	12p	BF458	30p	2N2218A	25p	CA3240E	110p	4026	11p	4558	36p						
BC337	12p	BF459	30p	2N2219A	25p	CA3240E	110p	4026	11p	4558	36p						
BC338	12p	BF459	30p	2N2219A	25p	CA3240E	110p	4026	11p	4558	36p						
BC413C	10p	BFX29	28p	2N2222A	18p	LF355	85p	4026	11p	4558	36p						
BC414C	10p	BFX30	28p	2N2222A	18p	LF355	85p	4026	11p	4558	36p						
BC415C	10p	BFX31	28p	2N2222A	18p	LF355	85p	4026	11p	4558	36p						
BC416C	10p	BFX86	28p	2N2369A	15p	LM301	25p	4026	11p	4558	36p						
BC477	23p	BFX87	28p	2N2484	24p	LM311N	120p	4026	11p	4558	36p						
BC478	23p	BFX88	28p	2N2904	20p	LM318M	40p	4026	11p	4558	36p						
BC479	23p	BFY50	23p	2N2904A	22p	LM324	40p	4026	11p	4558	36p						
BC546	10p	BFY51	20p	2N2905	22p	LM339	45p	4026	11p	4558	36p						
BC547B	10p	BFY52	20p	2N2905A	22p	LM348	60p	4026	11p	4558	36p						
BC548B	10p	BFY53	20p	2N2906	25p	LM358	65p	4026	11p	4558	36p						
BC549C	10p	BFY54	20p	2N2906A	25p	LM388	120p	4026	11p	4558	36p						
BC550C	10p	BU205	140p	2N2907	23p	LM388	120p	4026	11p	4558	36p						
BC556	10p	BU208	140p	2N2907A	23p	LM388	120p	4026	11p	4558	36p						
BC557B	10p	MJ2955	98p	2N3053	24p	LM384	120p	4026	11p	4558	36p						
BC558B	10p	MJE340	48p	2N3054	56p	LM386	130p	4026	11p	4558	36p						
BC559C	10p	MJE370	70p	2N3441	110p	LM387	130p	4026	11p	4558	36p						
BC560C	10p	MJE371	84p	2N3442	120p	LM387	130p	4026	11p	4558	36p						
BCY70	17p	MJE520	80p	2N3702	49p	LM393	70p	4026	11p	4558	36p						
BCY71	18p	MJE521	80p	2N3703	9p	LM393	70p	4026	11p	4558	36p						
BCY72	15p	MJE2955	80p	2N3704	9p	LM741	14p	4026	11p	4558	36p						
BD115	50p																
BD131	45p																

★ FAST RELIABLE SERVICE ★
★ VERY COMPETITIVE ★

COMTECH
ELECTRONICS

MAIL ORDERS

205 STURDEE ROAD
LEICESTER LE2 9FY
Telephone: (0533) 779578

THANDAR PORTABLE TEST BENCH

A wide range of high performance instruments, at prices that are hard to beat, puts professional test capability on your bench.

COUNTERS - TF200 10Hz to 200MHz; TF040 10Hz to 40MHz; PFM200A 20Hz to 200MHz (hand-held model); TP600 prescales to 600MHz; TP1000 Prescales to 1GHz.

MULTIMETERS - TM351 0.1% 3 1/2 digit LCD; TM353 0.25% 3 1/2 digit LCD; TM355 0.25% 3 1/2 digit LED; TM354 0.75% 3 1/2 digit LCD (hand-held model); TM451 0.03% 4 1/2 digit with autoranging and sample hold.

OSCILLOSCOPE - SC110A 10MHz, 10mV sensitivity, 40mm CRT with 6mm graticule divisions.

THERMOMETERS - TH301 -50°C to +750°C, 1° resolution; TH302 -40°C to +1100°C and -40°F to +2000°F, 0.1° and 1° resolution. Both accept any type K thermocouple.

GENERATORS - TG100 1Hz to 100kHz Function, Sine, Square, Triangle Wave; TG102 0.2Hz to 2MHz Function, Sine, Square, Triangle Wave; TG105 5Hz to 5MHz Pulse, Free Run, Gated or Triggered Modes.

LOGIC ANALYSERS - TA2080 8 channel 20MHz; TA2160 16 channel 20MHz.

ACCESSORIES - Bench rack, test leads, carrying cases, mains adaptors, probes, thermocouples etc.

Send for our latest catalogue and price list.
Thandar Electronics Ltd,
London Road, St. Ives,
Huntingdon, Cambridgeshire PE17 4HJ.
Telephone (0480) 64646. Telex 32250.



thandar
ELECTRONICS LIMITED

PUTTING THE BEST WITHIN YOUR GRASP



TH12



MULLARD SPEAKER KITS

Purposefully designed 40 watt R.M.S. and 30 watt R.M.S. 8 ohm speaker systems recently developed by MULLARD'S specialist team in Belgium. Kits comprise Mullard woofer (8" or 5") with foam surround and aluminium voice coil. Mullard 3" high power domed tweeter. B.K.E. built and tested crossover based on Mullard circuit, combining low loss components, glass fibre board and recessed loudspeaker terminals. SUPERB SOUNDS AT LOW COST. Kits supplied in polystyrene packs complete with instructions. 8" 40W system - recommended cabinet size 240 x 216 x 445mm
 Price £14.90 each + £2.00 P & P.
 5" 30W system - recommended cabinet size 160 x 175 x 295mm
 Price £13.90 each + £1.50 P & P.

Designer approved flat pack/cabinet kits, including grill fabric. Can be finished with iron on veneer or self adhesive vinyl etc.
 8" system cabinet kit £8.00 each + £2.50 P & P.
 5" system cabinet kit £7.00 each + £2.00 P & P.



STEREO CASSETTE TAPE DECK MODULE

Comprising of a top panel and tape mechanism coupled to a record/play back printed board assembly. Supplied as one complete unit for horizontal installation into cabinet or console of own choice. These units are brand new, ready built and tested.

Features: Three digit tape counter. Autostop. Six piano type keys, record, rewind, fast forward, play, stop and eject. Automatic record level control. Main inputs plus secondary inputs for stereo microphones. Input Sensitivity: 100mV to 2V. Input Impedance: 68K.
 Output level: 400mV to both left and right hand channels. Output Impedance: 10K. Signal to noise ratio: 45dB. Wow and flutter: 0.1%. Power Supply requirements: 18V DC at 300mA. Connections: The left and right hand stereo inputs and outputs are via individual screened leads, all terminated with phono plugs (phono sockets provided). Dimensions: Top panel 5 1/2" x 11 1/2". Clearance required under top panel 2 1/2". Supplied complete with circuit diagram and connecting diagram. Attractive black and silver finish.
 Price £26.70 + £2.50 postage and packing.
 Supplementary parts for 18V D.C. power supply (transformer, bridge rectifier and smoothing capacitor) £3.50



LOUDSPEAKERS

15" 100 watt R.M.S. (HI-FI, P.A., DISCO, BASS GUITAR) Die cast chassis, 2" aluminium voice coil, white cone with aluminium centre dome. 8 ohm imp., Res. Freq. 20Hz., Freq. Resp. to 2.5KHz., Sens. 97dB (As photograph). Price: £32.00 + £3 carriage.

12" 100 watt R.M.S. (HI-FI) Die cast chassis. 2" aluminium voice coil. Black cone. 8 ohm imp., Res. Freq. 20Hz., Freq. Resp. to 4.5KHz. Sens. 95dB. (As photograph). Price: £23.50 + £3 carriage.
 8" 50 watt R.M.S. (HI-FI, P.A.) 1 1/2" aluminium voice coil. White cone. 8 ohm imp. Res. Freq. 40Hz., Freq. Resp. to 6KHz. Sens. 92dB. Also available with black cone fitted with black metal protective grille. (As photograph). Price: White Cone £8.90, Black cone/grille £9.50 P&P £1.25.

12" 85 watt R.M.S. McKENZIE C1285GP (LEAD GUITAR, KEYBOARD, DISCO) 2" aluminium voice coil, aluminium centre dome, 8 ohm imp., Res. Freq. 45Hz., Freq. Resp. to 6.5KHz., Sens. 98dB. Price: £22.00 + £3 carriage.
 12" 85 watt R.M.S. McKENZIE C1285TC (P.A., DISCO) 2" aluminium voice coil. Twin cone. 8 ohm imp., Res. Freq. 45Hz., Freq. Resp. to 14KHz. Price £22 + £3 carriage.
 15" 150 watt R.M.S. McKENZIE C15 (BASS GUITAR, P.A.) 3" aluminium voice coil. Die cast chassis. 8 ohm imp., Res. Freq. 40Hz., Freq. Resp. to 4KHz. Price: £47 + £4 carriage.

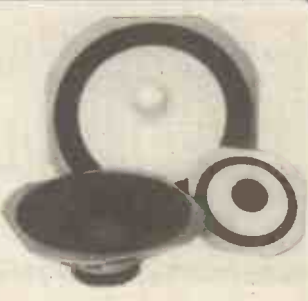

PIEZO ELECTRIC TWEETERS - MOTOROLA

Join the Piezo revolution. The low dynamic mass (no voice coil) of a Piezo tweeter produces an improved transient response with a lower distortion level than ordinary dynamic tweeters. As a crossover is not required these units can be added to existing speaker systems of up to 100 watts (more if 2 put in series). FREE EXPLANATORY LEAFLETS SUPPLIED WITH EACH TWEETER.

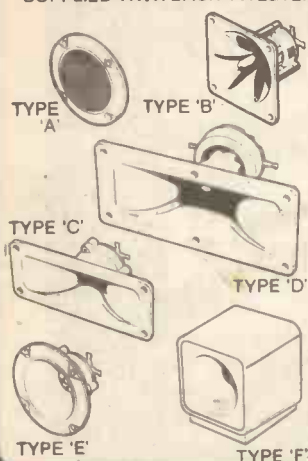

TYPE 'A' (KSN2036A) 3" round with protective wire mesh, ideal for bookshelf and medium sized Hi-fi speakers. Price £4.29 each.

TYPE 'B' (KSN1005A) 3 1/2" super horn. For general purpose speakers, disco and P.A. systems etc. Price £4.99 each.

TYPE 'C' (KSN6016A) 2" x 5" wide dispersion horn. For quality Hi-fi systems and quality discos etc. Price £5.99 each.

TYPE 'D' (KSN1025A) 2" x 6" wide dispersion horn. Upper frequency response retained extending down to mid range (2KHz). Suitable for high quality Hi-fi systems and quality discos. Price £7.99 each.

TYPE 'E' (KSN1038A) 3 3/4" horn tweeter with attractive silver finish trim. Suitable for Hi-fi monitor systems etc. Price £4.99 each.

TYPE 'F' (KSN1057A) Cased version of type 'E'. Free standing satellite tweeter. Perfect add on tweeter for conventional loudspeaker systems. Price £10.75 each
 P&P 20p ea. for SAE for Piezo leaflets).



OMP 80 LOUDSPEAKER

The very best in quality and value.

Ported tuned cabinet in hard-wearing black vinylite with protective corners and carry handle. Built and tested, employing 10in British driver and Piezo tweeter. Spec: 80 watts RMS; 8 ohms; 45Hz-20Hz; Size: 20in x 15in x 12in; Weight: 30 pounds.

Price: £49.00 each
 £90 per pair
 Carriage: £5 each £7 per pair

BK ELECTRONICS

Prompt Deliveries
 VAT inclusive
 prices
 Audio Equipment
 Test Equipment
 by
 Thandar
 and
 Leader

PANTEC

HOBBY KITS. Proven designs including glass fibre printed circuit board and high quality components complete with instructions.

FM MICROTRANSMITTER (BUG) 90/105MHz with very sensitive microphone. Range 100/300 metres. 5 x 46 x 14mm (9 volt) Price: £6.58.

DIGITAL THERMOMETER -9.9°C to +99.9°C. LED display. Complete with sensor. 70 x 70 mm (9 volt) Price: £22.94

3 WATT FM TRANSMITTER / WATT 85/115MHz varicap controlled, professional performance. Range up to 3 miles 35 x 84 x 12 mm (12 volt) Price: £10.64

SINGLE CHANNEL RADIO CONTROLLED TRANSMITTER/RECEIVER 27MHz Range up to 500 metres. Double coded modulation. Receiver output operates relay with 2amp/240 volt contacts. Ideal for many applications. Receiver 90 x 70 x 22 mm 9/12 volt) Price: £14.38. Transmitter 80 x 50 x 15 mm (9/12 volt) Price £9.15. P&P All Kits +50p. S.A.E. for complete list.



3 watt FM Transmitter

BSR P256 TURNTABLE

P256 turntable chassis ● S shaped tone arm ● Belt driven ● Aluminium platter ● Precision calibrated counter balance ● Anti-skate (bias device) ● Damped cueing lever ● 240 volt AC operation (Hz) ● Cut-out template supplied ● Completely manual arm. This deck has a completely manual arm and is designed primarily for disco and studio use where all the advantages of a manual arm are required.

Price £31.35 each. £2.50 P&P



OMP POWER AMPLIFIER MODULE



New model.
 Improved specification

NEW OMP100 Mk.II POWER AMPLIFIER MODULE Power Amplifier Module complete with integral heat sink, toroidal transformer power supply and glass fibre p.c.b. assembly. Incorporates drive circuit to power a compatible LED Vu meter. New improved specification makes this amplifier ideal for P.A., Instrumental and Hi-Fi applications.

SPECIFICATION
 Output Power: - 110 watts R.M.S.
 Loads: - Open and short circuit proof 4/16 ohms.
 Frequency Response: - 15Hz - 30KHz -3dB.
 T.H.D.: - 0.01%.
 S.N.R. (Unweighted): - 118dB ±3.5dB.
 Sensitivity for Max. Output: - 500mV @ 10K.
 Price: - £31.99 + £2.00 P&P.
 Vu Meter Price: - £7.00 +P&P.

HOME PROTECTION SYSTEM

Better to be 'Alarmed' than terrified. Thandar's famous 'Minder' Burglar Alarm System. Superior microwave principle. Supplied as three units, complete with interconnection cable. FULLY GUARANTEED.

Control Unit - Houses microwave radar unit, range up to 15 metres adjustable by sensitivity control. Three position, key operated fascia switch - off - test - armed. 30 second exit and entry delay.

Indoor alarm - Electronic swept freq. siren. 104dB output.
 Outdoor Alarm - Electronic swept freq. siren. 98dB output. Housed in a tamper-proof heavy duty metal case.

Both the control unit and outdoor alarm contain rechargeable batteries which provide full protection during mains failure. Power requirement 200/260 Volt AC 50/60Hz. Expandable with door sensors, panic buttons etc. Complete with instructions.

SAVE OVER £100 Usual price £228.85 - B.K.E.'s BARGAIN PRICE £128.00 + £5.00 P&P
 S.A.E. for colour brochure.



12" 80 watt R.M.S. loudspeaker. A superb general purpose twin cone loudspeaker. 50 oz. magnet. 2" aluminium voice coil. Rolled surround. Resonant frequency 25Hz. Frequency response to 13KHz. Sensitivity 95dB. Impedance 8ohm. Attractive blue cone with aluminium centre dome.
 Price £18.49 each + £3.00 P&P



B.K. ELECTRONICS

UNIT 5, COMET WAY, SOUTHEND-ON-SEA, ESSEX, SS2 6TR

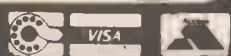

★ SAE for current lists. ★ Official orders welcome. ★ All prices include VAT ★ Mail order only ★ All items packed (where applicable) in special energy absorbing PU foam. Callers welcome by prior appointment, please phone 0702 527572

MONITOR

New Hifi Amplifier

The AX30 is a new low-cost, high performance hifi amplifier from JVC. The amp boasts 50W per channel (RMS), and uses a system which JVC call 'Super A' to give the low distortion of a Class A amplifier with the efficiency of a Class B one. Switching (related to crossover) distortion is said to have been eliminated, and TIM distortion insignificant. The power supply is direct low impedance, and the power amp and phono equaliser stages are each direct-coupled to their own power supply stages, to minimise the likelihood of interference. Triple power protection ensures that there is very little danger of damaging speakers or output transistors if you overload the system with too much volume.

The AX30 has a fluorescent peak power display, for power monitoring and as a warning against clipping; two tape deck connections; a video/aux input for audio replaying of video or other sources; independent switches for two sets of speakers, and loudness control, amongst other more usual amp features.

The specification gives output power as 50W per channel min into 8R at 1KHz (DIN); total harmonic distortion at 0.001% at 42W output, 8R; Aux to speaker output 0.007% at 40W output, 8R 20Hz to 20kHz, with switching and transient distortion zero; frequency response 10Hz to 10kHz, +0.5 - 3db at 8R; weight six kilos, and dimensions 43.5 x 11.7 x 30.3cm (17.4 x 4.68 x 12.1in). Cost is £99.90. For more information contact your local hifi dealer or JVC (UK) Ltd., Eldonwall Trading Estate, Staples Corner, 6-8 Priestley Way, London NW2 7AF. Tel: 01 450 2621.

A Knip In The Air

Advertised as specially for the hobby electronics enthusiast, Draper Tools are producing the Knipex range of West German pliers and cutters in various formats.

Knipex electronic pliers in special tool steel have 20mm jaws with a smooth gripping surface and spring-loaded PVC-covered handles. They come in three patterns. Knipex Relay Adjusting Pliers come in oil-hardened chrome vanadium electric steel and have 34mm jaws with extra-thin tips; designed for adjusting relay springs and other very fine adjustments, they come in four patterns. Knipex Electronic Super Knips, in stainless steel, have full-flush cutting faces for use on soft wire down to 0.2mm thickness. They have zero-play joints and spring-loaded soft PVC handles.

The range can be obtained from most hardware and electronics shops, or contact Draper Tools Ltd., Hursley Rd., Chandlers Ford, Eastleigh, Hants S05 5YF.

Computer Camp

Following a successful inauguration in 1982, Camp Aldenham, a Day Adventure and Computer camp for



children is this year running five one-week sessions (Monday through Friday) from 25th July to 26th August.

The camp is non-residential and aims to introduce children from five to thirteen to a choice of sports and crafts during the summer holidays when they are often at a loss for anything interesting to do. Activities range from horseriding and sailing to judo and pottery, but of interest to Hobby readers and their families in particular is the Computer Camp and Microelectronics Centre.

This is for children from nine to thirteen and offers personal tuition for two hours a day as part of attendance at the Camp, and they assure us that everybody attending will actually get ten hours 'hands on' experience in the week. The computers used are Texas Instruments TI100/4A home computers, plus five full-spec equivalents. Anyone wishing to do the Micro-electronics Centre will get an additional two hours a day in electronics at an all-in supplementary charge, but will miss out on some non-electronic options — not a terrible hardship.

The Camp makes transport available to ferry children there and home again. For more details, contact Camp Aldenham, Aldenham School, Elstree, Herts WD6 3AJ. Tel: Radlett 7553 or 6131, for brochure.

Odd Components

Ambit International (who were nominated—along with Electroplan and Manhattan Skyline—for the title of AES/Electronic Times Distributor of the Year) is sole UK stockist for Alps and TOKO switches and components and has added the new Alps dual-in-line switches, designed to prevent flux ingress when soldering, and the entire range of TOKO F-series push switches, which can be built up from basic modules to various requirements including combined mains and DC



switching capability.

Ambit's ever-increasing stock now includes a range of TOKO 20kHz low pass active filters for the digital audio market, the PAL 0900 series. These are thick-film low pass filters with a variety of terminating impedances with carefully optimised group delay and stopband attenuations up to -95dB. Ambit has its eye on the emgrance of the digital audio disk which is soon to come on the market, and the analogue to digital and digital to analogue designs required to complement it.

Requests for low cost DC-controllable cassette mechanisms have led to the launch of the AMBTN-3600 mechanism which can be supplied with a variety of heads. The standard version has a stereo record/replay, and an erase head and the motor is from 12VDC with less than 0.08% RMS wow and flutter.

Ambit, like Alps and most of the other manufacturers it supplies, is aimed primarily at the industrial market but is a source of unusual components and information.

Enquiries to Ambit International, 200 North Service Rd., Brentwood, Essex CM14 4SG. Tel: (0277) 230909.

MONITOR

Software Option

Elkan Electronics has prepared a free package of information sheets, called the Elkan File, on the publications, hardware and software they handle. This is mostly concerned with the Sharp pocket computers, the PC1251, PC1500 and OC1211 (plus the Tandy PC2 and Radio Shack TRS-80 PC), the Dragon 32, and the Apple II. They aim especially to provide information in a concise, easy-to-implement form.

This also includes a new quick-reference card designed by Nanos Systems Corp. in the USA for the Sinclair ZX80 and 81. The card comes in the form of an accordion-style fold-out with ten panels (twenty pages, in effect) and is said to "contain all the basic information necessary for programming the ZX80 and ZX81". Cards are also available for Apple, Tandy and other micros, from local computer dealers or from Elkan, at £3.50 each.

Elkan is also the UK and European agent for Rainbow, a monthly magazine for supporting the Dragon 32 and Tandy TRS-80 colour computers, with programs and information. A sample copy costs £1.95 plus a large self-addressed envelope stamped with 56p.

Send for your Elkan File and/or Rainbow to Elkan Electronics, FREE-POST, 11 Bury New Road, Prestwich, Manchester M25 8JZ. Tel: 061 798 7613 (24 hour service).

Texas For Starters

A new computer console believed to be the first 16-bit computer for around £75 has been announced by Texas Instruments. Unlike most computers in this price range, the TI-99/2 basic computer can use software on solid state cartridges as well as on cassettes. In addition, Texas Instruments is introducing new low cost peripherals and software for the TI-99/2 that will also work with the TI-99/4A family computer. The TI-99/2 is designed to allow computer novices to learn to program a computer in TI BASIC and BASIC- supported assembly language.

The combination of the £75 computer and the new low-cost peripherals, says Texas, make this the lowest cost computer system on the market. The TI-99/2 will be targeted primarily at the

technical enthusiast, engineer or student in the home. Additionally, they expect the computer to be purchased as the first computer in the home for those who are just beginning their experience with a computer system, or as a second computer in the home after the purchase of a TI-99/4A family computer.

The TI-99/2 console has an elastomeric typewriter-like keyboard with 48 raised moving keys in a staggered QWERTY arrangement similar to the TI-99/4A. The computer has 4K2 bytes of built-in random access memory (RAM), of which 4K Bytes is user accessible, and can be expanded to a total of 36K2 bytes of RAM. Most peripherals for the new system will plug into a "Hex-bus" peripheral-interface connector in the rear of the console. The Hex-bus port allows users to connect any peripheral developed for TI's Compact Computer family. Currently, these consist of the RS232 interface, HX-3000, the "Wafertape" digital tape drive unit, HX-2000, and the HX-1000 four colour printer/plotter.

Two "Solid State Software" cartridges, *Learn to Program* and *Learn to Program BASIC*, will be available initially for the unit. Other cartridges will be available later. Twenty software programs will be available on cassettes at the initial launch. Educational programs include: Picomath-80, Math I and II, Statistics I and II, Sunrise Time, Datetimer and Civil Engineering. Programs for personal management are: household formulas, chequebook manager, purchase decisions and general finance. Entertainment cassettes include: Lunar Landing Biplot, The Minotaur, TI Trek, and Mind Games I, II, III and IV. These programs, as well as user-written programs, can also be run on the TI-99/4A family computer.

The TI-99/2 features monochrome display capability and contains a built-in RF modulator to allow connection to any television. A cassette interface cable is also included to interface directly to the new TI program recorder or many ordinary cassette tape players. In addition, the TI-99/2 comes with an AC adapter, a user's manual and a demonstration cassette, and measures 24 x 26 x 35cm. Availability in Europe is planned for late summer.

For more information contact Texas Instruments Ltd., Manton Lane, Bedford MK41 7PA. Tel: (0234) 67466.

Book For Boffins

Birmingham author Laurence Shaw's latest book *The Practical Guide for People With a New Idea*, puts the complex and offputting business of patenting into a nutshell. Three or four hours spent digesting this 98 page information packed paper back will turn a good inventor into a potentially rich inventor.

The aim of the book, with a foreword by Sir Eric Weiss, President of Foseco

Minsep, is to instruct people with an original, potentially lucrative idea, how to protect an invention, product or scheme and exploit it to the full. Market research, approaching the manufacturer, telling the world about an idea, patenting an invention, secret patents, checking if the idea is original, patent costs and life span, are all covered, along with copyrights, designs, licences and how to trademark a product effectively without copying an existing one.

The book costs £5.95, post paid, from Laurence Shaw, George House, George Road, Edgbaston, Birmingham B15 1PG, and is bound to be interesting to the ingenious mind which wants to turn ideas into hard cash.

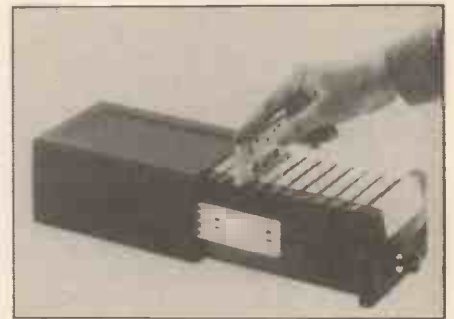

Data Store

Fed up with losing your software cassettes, or finding them under the armchair, jammed up with fluff? Arthur Fischer (UK) Ltd. have introduced their CBox Drawer Unit to the UK, designed specially to store software cassettes in a safe and accessible form.

Each cassette is stored in a 'CBox', a cassette-sized, spring-loaded frame which clicks into place in a drawer unit, and lifts out again at the touch of a button. Each drawer unit has ten CBoxes, and the labelling system is designed to be easily altered as necessary.

There are two standards of drawer unit, the standard at £17.50 and the deluxe (lockable) at £19.50, including VAT and p&p. Of course, the system could be used by audiophiles as well as computer operators. Orders and enquiries to Arthur Fischer (UK) Ltd., 25 Newton Rd., Marlow, Bucks SL7 1JY. Tel: (06284) 72882.

Hey, Stack!

For those who find the totally flat keyboards of many micros, especially the very small ones, tiring to read and easy to misread, Warp Factor Eight are marketing an extremely simple device — or devices — to alleviate (or elevate) the problem somewhat. It's a set of custom-designed self-adhesive plastic legs to raise your micro to the point (taking the Spectrum as an example) where you can actually see the top row of print over the tops of the keys without having to place yourself vertically above the machine.



MONITOR

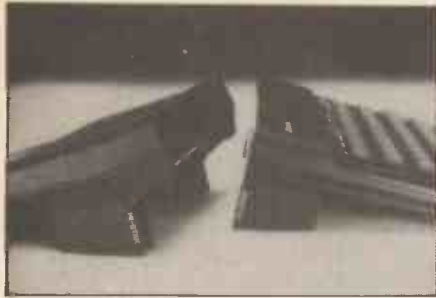

Called Hi-Stack, this set of legs seems a little bit pricy at £3.95 (including p&p and VAT, however) but in their favour they are extremely smart, solid and well-made and my sample pair has been doing a great job on my telephone and shows no sign of toppling or coming adrift.

The pack comes with a very comprehensive set of instructions. Orders and enquiries to **Warp Factor Eight, 6 Pelham Rd., Braughing, Ware, Herts SG11 2QU. Tel: (0920) 821841.**

Join The Club

The **British Amateur Electronics Club (BAEC)** has announced price rises for 1983 from 1st July, when the subscription for UK and Eire members will go up to £5.50, £8.00 for overseas airmail members and £7.00 for surface mail and all European subscriptions. That still leaves plenty of time to join or re-join at the 1982 rates of £4.00, £7.00 and £6.00 respectively. Payments in sterling only, please.

The BAEC have announced that their **18th Amateur Electronics Exhibition 1983** will be held at The Shelter, centre of the Esplanade, Penarth, South Glamorgan, Wales, from Saturday 16th July to Sunday 24th July 1983, opening from 7.30pm during the week and including the afternoons at weekends.

For those new to BAEC, it is the only national amateur electronics club in the UK and is open to everyone interested in electronics, here and abroad. It was founded in 1966 and aims to provide the means for amateur enthusiasts to give and receive help with electronics problems.

The heart of the organization is the BAEC Newsletter, which comes out quarterly (but, since the BAEC runs its year from 1st January to 1st January, members will receive all the bulletins for the year they join, regardless of when they join). As well as practical and theoretical articles on all aspects of electronics, it runs Help Wanted, Sales, Exchanges and Requirements sections.

One section of the club, with its own organiser, is devoted to beginners, with advice and equipment offers to get them started, and beginners' articles appear regularly in the newsletter.

Members also receive a library list which is updated from time to time and contains many technical books and magazines, including USA publications. This is run postally. A list of club members is circulated so that members

can contact each other locally and correspond.

A final carrot is a number of special price concessions.

To give you an idea, the January newsletter contains the first part of an article on Basic Semiconductor Theory and Putting it into Practice, thoughtful reports on the Breadboard and Electronic Hobbies Fairs, letters and book reviews, a list of thirty or so well known suppliers offering discounts to members, part one of a series on basic electronics (with a highly practical bias concentrating on resistors), and other general information, A4, card cover, 34 clearly duplicated pages. Good value.

For application forms or further information contact the **Hon. Secretary, Mr. J. G. Margetts, 113 South Road, Horndean, Hampshire PO8 0ER.**

Oric On The Horizon

The 16K version of the Oric 1 micro should be available in late May/early June, after a delay of several months. Oric say that technical problems due to the specification of a chip changing late in the day, and also the overwhelming demand for the 48K version (four times that for the 16K), have led to the 16K machine being held up. The micro will be delivered to all existing mail order customers when available, and they will be offered the option of returning the 48K machines loaned in replacement or keeping these and paying the price difference.

Oric is no longer taking orders by mail, and is instead relying on its extensive network of distributors, including W H Smith, Dixons, Greens, Laskys, Micro C and specialist outlets all over the country, so there should be no problem for anyone in finding a supplier, in fact . . . by this time you probably won't be able to move for the things, sitting in smug rows on their shelves, murmuring alluringly "touch my keys, program me, examine my software, take me home". Before you know where you are, even the budgie'll be into Froglets.

Don't say I didn't warn you! (Quick, nurse, pass the teabags, she's having one of her paranoia attacks.)

Please address enquiries, if necessary to **Judith Pattern Public Relations, 24 Easton Drive, Kingston upon Thames, KT2 7QT. Tel: 01 546 5144.** However, we advise that you speak to your local dealer first, as the PR company are being kept very busy.

Going Out For A Spin

How many of our more youthful readers recall playing 45s and long players and possibly even the odd 78 on one of those tichy little Phillips (or whoever) portable record-players? The ones with the single speaker (you couldn't call it a *loudspeaker*) built into a jolly red or blue plastic lid, which lifted off to reveal a five-inch turntable, stout little plastic arm and a foot or two of straggly wire so that you could prop the speaker up just far enough away from the 'player to get an LP on it, and every gust of wind threatened to lift your precious singles off the turntable and send them bowling into a corner . . . sweet memories.

Audio Technical's new AT-727 Soundburger is one of those. The space-age design, the obligatory connections for two sets of mini headphones, the 110mV line outputs for connection to a full stereo system, the 30 to 25,000Hz frequency response, the DC servo motor and double belt, the signal-to-noise ratio of more than 50dB, the dynamically balanced tonearm giving superb tracking on any reasonably level surface (can you use it on your knee in the back of a car?) and the optional mains adaptor, its very stereoness, undreamed-of in 1962, cannot mask the immutable truth that what we have here is one of those marvellous take-it-anywhere, won't-do-your-singles-any-harm-if-you're-careful-with-it **RECORD PLAYERS.** And about time too. It even has a carrying strap.

At £89.95, it's not rock-bottom cheap, but it's bound to catch the eye of itinerant record freaks, or those moving away from the family stereo to the



independence of a bedsit or student room.

But alas, I can't see the Soundburger bringing back the days of twisting by the pool. For one thing, there is no output to external speakers without an additional amplifier, and for another thing, there's no 78rpm. And as Tony Benyon said many years ago, Leonard Cohen is much more fun at 78, and I suspect the same goes for Culture Club and Ultravox . . . I wonder where I put my Phillips plastic portable?

For more information and specification, see your hifi dealer or contact **Audio Technica Ltd., Hunslet Trading Estate, Low Road, Leeds 10.** Tel: (0532) 771441.



Sound With Sinclair

Just three months ago, **Bi-Pak Semiconductors** published details of their first sound generator for use with the Sinclair ZX81 computer, adding much-needed sound to an otherwise silent computer. So successful has this proved with Sinclair users that Bi-Pak have now introduced a new modified version for use with all Sinclair computers, ie ZX81, Sinclair Timex 1000 and the Sinclair Spectrum.

Designated ZON X, the unit is self-contained in a black plastic case with a loudspeaker and manual volume control. No power supply or batteries are required to power the unit — it simply plugs into the rear of the Sinclair computer.

The new unit offers a wide range of sound effects. These are obtained using the three-channel-plus-noise sound chip, and is designed so that the pitches and volumes of the three channels and overall attach/decay envelope can be controlled by simple basic statements. This means that pianos, organs, bells, helicopters, lasers, explosions etc. can be simulated and added to existing program.

For use with the Spectrum there is a further plug-in adaptor which houses a crystal and other electronic devices needed to give unlimited sound facilities.

The ZON X unit is available from **Bi-Pak Semiconductors, PO Box 6, Ware, Herts.** Tel: (0920) 3442/3182. The ZON X for use with the Sinclair Timex 1000 is £25.95; with special adaptor for Sinclair Spectrum: £32.75; the Spectrum adaptor only £6.80. All the above prices include VAT and postage.



Newseum

A new gallery devoted to telecommunications has been opened by the Prince of Wales at the **Science Museum** in London.

The gallery is titled "Telecommunications — A Technology For Change" and is sponsored by Standard Telephone and Cables (STC) to mark that company's centenary. Its opening also marks World Communications Year, a prime objective of which is to bring the subject more into the public eye. The story of telecommunications over the last hundred years is told in two sections in adjoining galleries, one arranged chronologically while the other displays the technologies which make distance communication possible.

The first section concentrates on the way telecommunications have altered our lives, and include mock-ups of the telegraph office at Tonbridge Railway Station in 1895, a ship's radio cabin in 1910 and the radio operator's position in a Lancaster bomber from the Second World War. There are also taped reminiscences of life with cable companies between the 1920s and 1950s.

The second part of the exhibition is more technical, and is introduced at the entrance with a display of telephone engineers maintaining the thousands of underground telephone wires concealed beneath our feet, and the giant 'H' poles that used to follow the roads and railways and are now hardly ever to be seen. Telecommunications terminals, land, sea and space links, and switching systems are covered in separate displays, and there are working demonstrations and computer graphics displays illustrating aspects of communications systems in a memorable and easy-to-follow way. There is a built-in cinema which shows a short film by STC, called "Echoes", which assesses just where we stand at

the moment and where communications may go in the future.

Sounds like a good venue for a school or club outing, for those who don't see themselves getting to London under their own steam. Enquiries to **The Science Museum, South Kensington, London SW7 2DD.** Tel: 01 589 3456.

Everything's OK

New from **OK Industries (UK) Ltd.:** a battery-powered wire-wrapping tool, the Just Wrap BJW-3, which uses spooled wire and wire-wrapping posts, together with a wire gun, to make a continuous series of connections without wire stripping, cutting or soldering. The batteries are rechargeable.

Also new are two component-handling tools. The LB-100 lead bender and crimper is designed for all common axial components such as resistors, diodes and capacitors, and also for many radial and 'TO' packages. The LB-100 will do a variety of angles and bends (see illustration). The TP-1 cutter and crimper, is a high carbon steel tool which is designed to handle up to 20 AWG (0.8mm) soft wire leads and to trim and crimp component leads flush to the PCB prior to soldering.

More specialised are the BB1-1416 and BB1-2428 IC insertion tools, for 14 and 16 pin and 24 and 28 pin ICs respectively (I bet you're wondering how we worked that one out, aren't you?). The tools are nickel-plated steel for durability and protection from static, important for MOS and CMOS.

OK's Electroware division specialises in the supply of tools and accessories for electronics building, and produce a catalogue which features many of OK's lines most likely to be of interest to hobbyists. That, and information about new projects, can be obtained from **OK Industries UK Ltd., Dutton Lane, Eastleigh, Hants SO5 4AA.** Tel: (0703) 610944.

Rapid Electronics

MAIL ORDERS:
Unit 1, Hill Farm Industrial Estate,
Boxted, Colchester, Essex CO4 5RD.
TELEPHONE ORDERS:
Colchester (0206) 36412.

ACCESS AND
BARCLAYCARD
WELCOME

LINEAR			
555CMOS 80	ICL7106 790	LM339 45	LM3911 120
555CMOS 150	ICL7611 95	LM348 60	LM3914 175
709	ICL7622 180	LM358 50	LM3915 195
▶741 14	ICL7621 290	LM377 170	LM3916 105
748 35	ICL8038 195	▶LM380 65	MC1496 68
9400C 350	ICL8211A 200	LM381 120	MC3340 135
AY-9-1270 720	ICM2724 785	LM382 120	▶MF10CN 350
AY-9-1270 370	ICM7556 80	LM384 130	LM922 400
AY-9-1270 540	LF351 45	LM386 65	ML924 195
CA-3046 60	LF353 95	LM387 120	ML925 210
▶CA3080 65	LF356 45	LM393 100	ML926 140
CA3089 190	LM10 360	LM393 100	ML927 140
CA3090AQ 375	LM301A 25	LM393 100	ML928 140
CA3130E 85	LM311 70	LM393 100	ML929 140
CA3140E 36	LM318 120	LM393 100	ML929 140
CA3181E 100	LM324 40	LM393 100	MM5387A 465
CA3189 290	LM334Z 100	LM393 100	NE531 150
▶CA3240E 110	LM335Z 125	LM393 100	NE544 205
		LM393 100	▶NE555 16
		LM393 100	NE556 45
		LM393 100	▶NE555 110
		LM393 100	NE556 110

TRANSISTORS			
AC125 36	BC149 9	BC517 40	BF337 40
AC126 25	BC158 8	BC547 7	BF490 23
▶AC128 20	BC159 8	BC548 10	BF490 23
AC176 25	BC160 45	BC549 10	BF490 23
AC187 22	BC168C 10	BC549 10	BF490 23
AC188 22	BC169C 10	BC549 10	BF490 23
AD142 120	BC170 8	BC549 10	BF490 23
AD149 80	BC171 10	BC549 10	BF490 23
AD151 40	BC172 10	BC549 10	BF490 23
AD162 40	BC177 18	BC549 10	BF490 23
AF124 60	BC178 18	BC549 10	BF490 23
AF126 50	BC179 18	BC549 10	BF490 23
AF139 40	BC182 10	BC549 10	BF490 23
AF186 70	▶BC182L 8	BC549 10	BF490 23
AF239 75	BC183 10	BC549 10	BF490 23
BC107 10	BC213 10	BC549 10	BF490 23
BC107B 12	BC214 10	BC549 10	BF490 23
▶BC108 12	BC214L 7	BC549 10	BF490 23
BC108B 12	BC212 10	BC549 10	BF490 23
BC108C 12	BC212L 10	BC549 10	BF490 23
▶BC109 10	BC213 10	BC549 10	BF490 23
BC109C 12	BC213L 10	BC549 10	BF490 23
BC114 18	BC214 10	BC549 10	BF490 23
BC115 22	▶BC214L 8	BC549 10	BF490 23
BC117 15	BC237 8	BC549 10	BF490 23
BC119 35	BC238 14	BC549 10	BF490 23
BC137 40	BC308 12	BC549 10	BF490 23
BC139 40	BC327 14	BC549 10	BF490 23
BC140 28	BC328 14	BC549 10	BF490 23
BC141 30	BC337 14	BC549 10	BF490 23
BC142 25	BC338 14	BC549 10	BF490 23
BC143 25	BC477 30	BC549 10	BF490 23
BC147 8	BC478 30	BC549 10	BF490 23
BC148 8	BC479 30	BC549 10	BF490 23

MIN. D CONNECTORS			
9 way 15 way	25 way 37 way		
Plugs solder lugs 60p	85p 125p 170p		
Right angle 120p	180p 240p 350p		
Sockets lugs 90p	130p 195p 290p		
Right angle 160p	210p 290p 440p		
Covers 100p	90p 100p 110p		

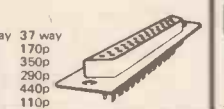

SOLDERING IRONS			
Antex CS 1.7W Soldering iron	460		
2.3 and 4.7mm bits to suit	65		
CS 1.7W Iron: 450, element: 210			
Antex XS 25W Soldering iron	210		
3.3 and 4.7mm bits to suit	65		
Solder pump desoldering tool	480		
Spare nozzle for above	70		
10 metres 22awg solder	100		

CONNECTORS			
DIN Plug Skt Jack	Plug Skt		
2 pin 9p	9p 2.5mm 10p 10p		
3 pin 12p 10p 3.5mm 9p 9p			
5 pin 13p 11p Standard 16p 20p			
Phono 10p 12p Stereo 24p 25p			
1mm 12p 13p 4mm 18p 17p			
UHF (CB) Connectors:			
PL259 Plug 40p, Reducer 14p.			
SO239 square chassis skt 35p.			
SO239S round chassis skt 40p.			
IEC 3 pin 250V/6A.			
Plug chassis mounting	38p		
Socket free hanging	60p		
Socket with 2m lead	120p		

SCRs			
▶C106D	30		
400V 8A	70		
400V 12A	95		

VERO			
VEROBLOC	350		
Size 0.1" matrix:			
2.5 x 1	22		
2.5 x 3.75	55		
2.5 x 5	85		
3.75 x 5	95		
VO board	160		
Veropins per 100:			
Single sided	60		
Double sided	60		
Spot face cutter	105		
Pin insertion tool	162		
Wiring pen and spool	310		
Spare spool 75p	Combs 6		

SWITCHES			
Submin toggle.			
SPST 55p, SPDT 60p, DPDT 65p.			
Miniature toggle:			
SPDT 80p, SPDT centre off 90p.			
DPDT 90p, DPDT centre off 100p.			
Standard toggle:			
SPST 35p, DPDT 48p			
Miniature DPDT slide 12p.			
Push to make 14p.			
Push to break 22p.			
Rotary type adjustable stop.			
1P12W, 2P6W, 3P4W all 55p each.			
DIL switches:			
4SPST 80p 6 SPST 80p, 8SPST 100p.			

VOICE SYNTHESISER!
Now your computer can talk. The GI SPO256 speech processor is able to store programmed program to synthesise speech. Allophone (extended phoneme) system gives unlimited vocabulary. Easily interfaced with any digital system; ten TTL compatible signals are used to select the allo-phones. SPO256 . 770p. Data: 50p.

MICRO			
6116P3	320	6852	240 8228 220
6502CPU	325	6875	495 8251 250
6522VIA	295	6880	100 8263 350
6532	570	81LS95	85 8255 225
6551 ACIA	650	81LS96	85 8259 390
6800 CPU	220	81LS97	85 MC1488 55
6801 CPU	250	8080A	250 MC1489 55
6809 CPU	620	8085AC	340 280A CPU 290
6810 RAM	115	8155	350 280A PIO 260
6821 PIA	110	8212	110 280A CTC 260
6840	360	8216	100 280A SIO 900
4116P20	70	8224	120 280ADMA 1150
5101L-1	220	6850	110

SOCKETS			
4 pin	5 pin	6 pin	7 pin
8 pin	9 pin	10 pin	11 pin
12 pin	14 pin	16 pin	18 pin
20 pin	24 pin	28 pin	32 pin
36 pin	40 pin	48 pin	56 pin
64 pin	80 pin	96 pin	112 pin
128 pin	144 pin	160 pin	176 pin
192 pin	208 pin	224 pin	240 pin
256 pin	272 pin	288 pin	304 pin
320 pin	336 pin	352 pin	368 pin
384 pin	400 pin	416 pin	432 pin
448 pin	464 pin	480 pin	496 pin
512 pin	528 pin	544 pin	560 pin
576 pin	592 pin	608 pin	624 pin
640 pin	656 pin	672 pin	688 pin
704 pin	720 pin	736 pin	752 pin
768 pin	784 pin	800 pin	816 pin
832 pin	848 pin	864 pin	880 pin
896 pin	912 pin	928 pin	944 pin
960 pin	976 pin	992 pin	1008 pin
1024 pin	1040 pin	1056 pin	1072 pin
1088 pin	1104 pin	1120 pin	1136 pin
1152 pin	1168 pin	1184 pin	1200 pin
1216 pin	1232 pin	1248 pin	1264 pin
1280 pin	1296 pin	1312 pin	1328 pin
1344 pin	1360 pin	1376 pin	1392 pin
1408 pin	1424 pin	1440 pin	1456 pin
1472 pin	1488 pin	1504 pin	1520 pin
1536 pin	1552 pin	1568 pin	1584 pin
1600 pin	1616 pin	1632 pin	1648 pin
1664 pin	1680 pin	1696 pin	1712 pin
1728 pin	1744 pin	1760 pin	1776 pin
1792 pin	1808 pin	1824 pin	1840 pin
1872 pin	1888 pin	1904 pin	1920 pin
1936 pin	1952 pin	1968 pin	1984 pin
2000 pin	2016 pin	2032 pin	2048 pin
2080 pin	2096 pin	2112 pin	2128 pin
2144 pin	2160 pin	2176 pin	2192 pin
2208 pin	2224 pin	2240 pin	2256 pin
2272 pin	2288 pin	2304 pin	2320 pin
2336 pin	2352 pin	2368 pin	2384 pin
2400 pin	2416 pin	2432 pin	2448 pin
2464 pin	2480 pin	2496 pin	2512 pin
2528 pin	2544 pin	2560 pin	2576 pin
2592 pin	2608 pin	2624 pin	2640 pin
2672 pin	2688 pin	2704 pin	2720 pin
2736 pin	2752 pin	2768 pin	2784 pin
2800 pin	2816 pin	2832 pin	2848 pin
2880 pin	2896 pin	2912 pin	2928 pin
2944 pin	2960 pin	2976 pin	2992 pin
3008 pin	3024 pin	3040 pin	3056 pin
3080 pin	3096 pin	3112 pin	3128 pin
3152 pin	3168 pin	3184 pin	3200 pin
3232 pin	3248 pin	3264 pin	3280 pin
3312 pin	3328 pin	3344 pin	3360 pin
3392 pin	3408 pin	3424 pin	3440 pin
3472 pin	3488 pin	3504 pin	3520 pin
3552 pin	3568 pin	3584 pin	3600 pin
3632 pin	3648 pin	3664 pin	3680 pin
3712 pin	3728 pin	3744 pin	3760 pin
3792 pin	3808 pin	3824 pin	3840 pin
3872 pin	3888 pin	3904 pin	3920 pin
3952 pin	3968 pin	3984 pin	4000 pin
4032 pin	4048 pin	4064 pin	4080 pin
4112 pin	4128 pin	4144 pin	4160 pin
4192 pin	4208 pin	4224 pin	4240 pin
4272 pin	4288 pin	4304 pin	4320 pin
4352 pin	4368 pin	4384 pin	4400 pin
4432 pin	4448 pin	4464 pin	4480 pin
4512 pin	4528 pin	4544 pin	4560 pin
4592 pin	4608 pin	4624 pin	4640 pin
4672 pin	4688 pin	4704 pin	4720 pin
4752 pin	4768 pin	4784 pin	4800 pin
4832 pin	4848 pin	4864 pin	4880 pin
4912 pin	4928 pin	4944 pin	4960 pin
4992 pin	5008 pin	5024 pin	5040 pin
5080 pin	5096 pin	5112 pin	5128 pin
5152 pin	5168 pin	5184 pin	5200 pin
5232 pin	5248 pin	5264 pin	5280 pin
5312 pin	5328 pin	5344 pin	5360 pin
5392 pin	5408 pin	5424 pin	5440 pin
5472 pin	5488 pin	5504 pin	5520 pin
5552 pin	5568 pin	5584 pin	5600 pin
5632 pin	5648 pin	5664 pin	5680 pin
5712 pin	5728 pin	5744 pin	5760 pin
5792 pin	5808 pin	5824 pin	5840 pin
5872 pin	5888 pin	5904 pin	5920 pin
5952 pin	5968 pin	5984 pin	6000 pin
6032 pin	6048 pin	6064 pin	6080 pin
6112 pin	6128 pin	6144 pin	6160 pin
6192 pin	6208 pin	6224 pin	6240 pin
6272 pin	6288 pin	6304 pin	6320 pin
6352 pin	6368 pin	6384 pin	6400 pin
6432 pin	6448 pin	6464 pin	6480 pin
6512 pin	6528 pin	6544 pin	6560 pin
6592 pin	6608 pin	6624 pin	6640 pin
6672 pin	6688 pin	6704 pin	6720 pin
6752 pin			

The Hobby 'Scope

Christopher Murphy

The first part of HE's learn-as-you-build oscilloscope, at the hobbyist's price.

MOST PEOPLE involved with electronics are aware of the enormous value of an oscilloscope in circuit testing, yet how many hobbyists are affluent enough to own one? Hobby Electronics, in co-operation with a leading London component retailer, have designed a low cost modular oscilloscope (the Hobby 'Scope) which, at under £80, is within the grasp of most hobbyists. Obviously, at this price it would be unreasonable to expect the facilities of a £200 instrument, yet this simple design should prove to be an invaluable tool to anyone who, until now, has struggled with nothing but a multimeter.

For maximum flexibility, the 'Scope has been divided into separate functional units or modules; for under £40 there is an X-Y plotter (display unit) which will operate with either the scope add-on, to provide a full single trace oscilloscope, or the curve tracer add-on, which is a useful tool for component testing and identification.

We will be presenting these projects over four issues, beginning this month with an overview and then, in the three subsequent issues, we will give the full circuit and constructional details of the three units described above.

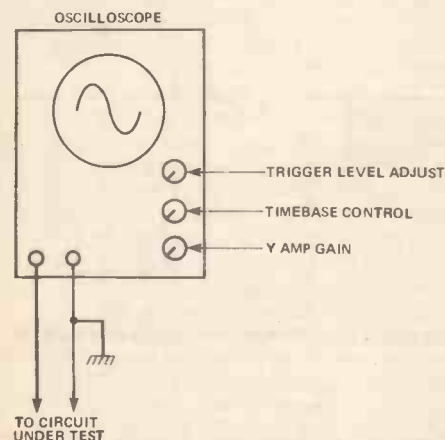

Figure 1. The basic functions of an oscilloscope (see text).

The Oscilloscope

An oscilloscope is a piece of test equipment based around the cathode ray tube (CRT), a device similar to that found in a television, which enables voltage waveforms to be displayed as they vary with time. This is illustrated in Figure 1. The oscilloscope has two terminals referred to as the 'Y Input' for connection to the circuit under test; the Y Input consists of the signal terminal and the ground or return terminal. The waveform shown, in this case a sine wave, is representative of the type of signal to which the Y input is normally connected; it has two important attributes, namely Amplitude and Frequency. The Y amplifier within the scope has a variable or switched gain (amplification factor) normally controlled by a potentiometer and/or multi-gang switch on the front panel of the instrument; the Y gain has to be adjusted by the user so that the physical height of the displayed waveform falls comfortably on the screen. Similarly there is a Timebase control which must be adjusted to suit the frequency of the incoming waveform. The timebase circuit within the scope controls the period of time over which the waveform is displayed from left to right across the screen; if

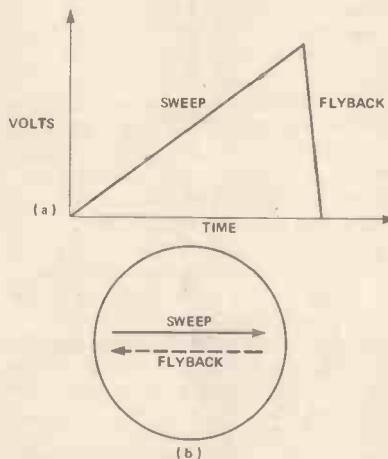
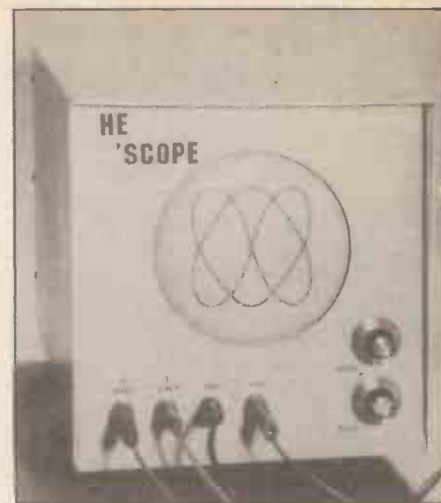

Figure 2. The sweep moves steadily across the screen, returning rapidly.



this period is too long then too much information (too many cycles) become compressed onto the screen width; if too short, only a fraction of the waveform will be seen. An oscilloscope does not, as you might expect, capture a single sample of the waveform and freeze it on the screen (storage oscilloscopes are able to do this—at much expense!), but repeatedly updates the screen with identical portions of the waveform—this is a necessity imposed by the working principles of the CRT as we shall see, and the consequences are that oscilloscopes are really only useful for displaying waveforms that are repetitive, such as sine waves or square waves. Now, in order that the waveform can be viewed as a stable display there is the additional requirement of a Trigger circuit, whose purpose is to ensure that each time the waveform is drawn on the screen, the starting point is the same 'place' on the incoming waveform. The starting Trigger point is referenced to a particular voltage level on the incoming waveform, and usually can be varied by means of a

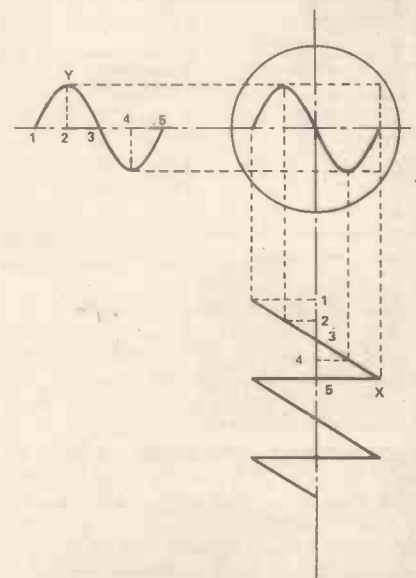

Figure 3. The electron beam sweeps an accurate replica of the Y-input.

control on the front of the instrument; the effect of varying this control is to alter the starting point of the display, which therefore appears to travel left-right across the screen.

The Cathode Ray Tube

A major part of understanding the workings of an oscilloscope lies with the cathode ray tube itself. Physically, a CRT is an evacuated glass envelope (vacuum tube), shaped with a long narrow tube at one end tapering out to form a wide flat round screen at the other end (more expensive tubes taper to a rectangular screen). At the narrow end there are a number of pins which are the electrical connections to the inner works; these lie mainly within this narrow tubular section. On the inside surface of the glass screen there is a coating of phosphor which is electro-fluorescent. The basic principle by which a display is produced is that a fine beam of electrons is produced within the far end of the tube and accelerated towards the phosphor screen, which emits light over the area that is being bombarded with electrons. By means yet to be revealed, the electron beam is brought to a focus and can be made to strike any given point of the screen, producing a small spot of light. If this electron beam is scanned about the screen, it traces out a thin line of light because the phosphor persists in its emission for some tens of milliseconds; providing that the line is retraced by the beam of electrons every few milliseconds or so, a stable display of the line will be seen, without flickering.

The actual geometry of the CRT internal electrodes is fairly complex in a modern high performance tube, however the schematic of Figure 2 is an adequate representation of the various internal components, at least for our purposes. The principle by which an electron beam is generated is called thermionic emission. A cylindrical plate of metal, the cathode, is heated indirectly by a tungsten filament inside the cathode. The cathode, like all metals, produces a cloud of electrons around the surface when it is heated, but in great quantity at a temperature that can be practically realised. The electrons thus emitted from the surface of the cathode can easily be persuaded to leave the area by the high positive potential present on the series of electrodes Anode 1 to Anode 3. These three anodes can for the moment be considered as one, held at a high positive voltage of about 2kV, and consisting of a metal plate with a small hole centered on the axis of the tube. Electrons accelerate from the cathode towards this anode and most of them fly straight through the center hole, eventually to strike the screen. However there is a further obstacle in the path of the electrons, in the form of a grid or mesh electrode, surrounding the cathode and thus between the cathode and anode. The grid is always biased negative, relative to the cathode, and acts as a

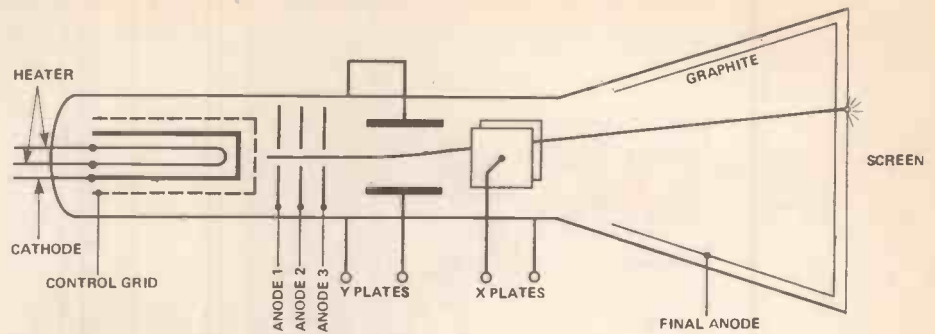

Figure 4. A simplified representation of the internal workings of the cathode ray tube.

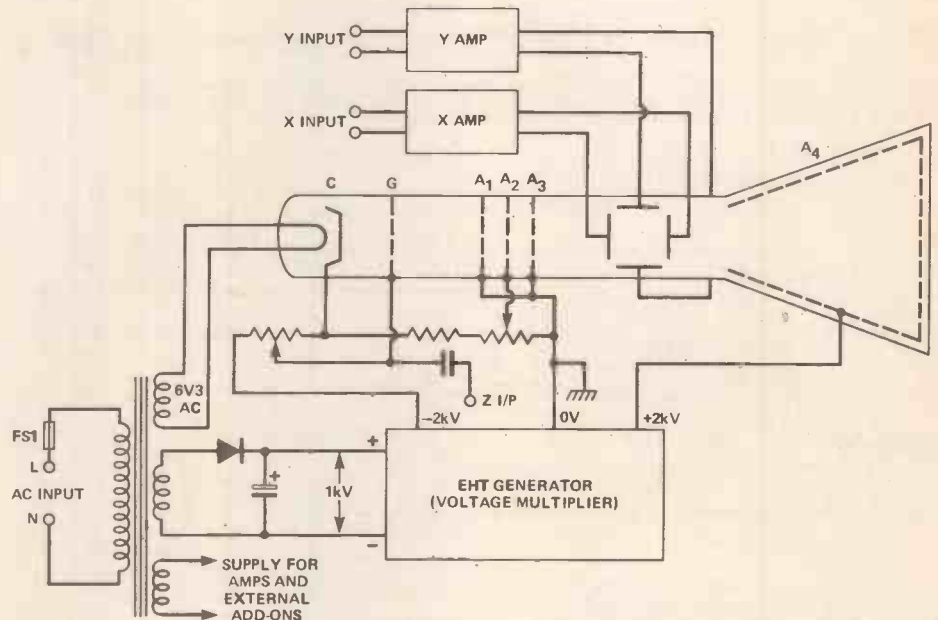

Figure 5. Block diagram of the X-Y plotter.

control over the number of electrons able to leave the cathode. By varying the negative potential applied to this grid, the brightness of the display can be indirectly varied from maximum down to complete darkness (electron beam turned off).

Shaped Fields

As can be seen in Figure 4 there are three anodes in a practical CRT, the purpose of which is to focus the electron beam. Anodes 1 and 3 are held at the same high positive potential whilst Anode 2 is a few hundred volts more negative than the other two (but still highly positive relative to the cathode). The geometry of these anodes is arranged so that electrons travelling through the system, but which are off-axis, experience a small accelerating force (electric field) which tends to move them towards the centre of the tube. The potential of Anode 2 is made variable, and on every oscilloscope there is a Focus potentiometer which the user must adjust to produce the finest possible spot size. The physics of the focussing system is too complex for a complete explanation, however a useful analogy is to consider the electrons moving in

electric fields in terms of balls rolling down a hillside (ie in a gravitational field); by shaping the profile of the hillside into a U-shaped channel, it is obvious that any ball initially launched at the side of the channel (ie off-axis) will roll towards the centre as well as down the hillside, and by choosing the exact profile of the channel all balls, no matter where released, can be made to pass through the same point on the axis. This is what, in electric terms happens as electrons pass through the anodes and 'meet' at a point on the CRT screen.

The remaining system in a CRT to be described is the electrostatic deflection plates — the means by which the illuminated spot can be moved to a given part of the screen. Beyond the three anodes are two sets of parallel plates at right angles to one another and referred to as the X-plates (vertically aligned) and the Y-plates (horizontally aligned). By applying a voltage to any pair of plates, an electric field is established at right angles to the electron beam and will deflect it in the direction of the field. The X-plates will produce a horizontal deflection and the Y-plates a vertical deflection. In practice the deflection plates are not parallel but

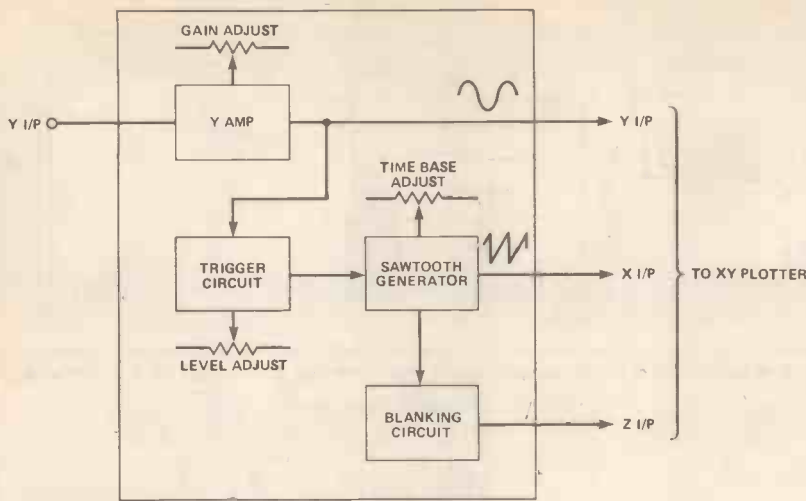

Figure 6. Block diagram of the X-Y processing unit.

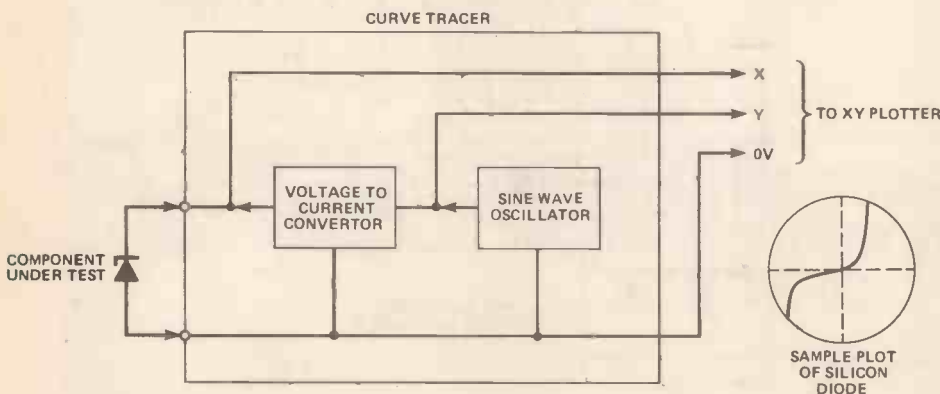

Figure 7. Block diagram of the curve tracer unit.

diverge towards the screen. This is partly to allow for the divergence of the electron beam when deflected, and partly to improve the linearity of the deflection voltage.

A final point to note is that the electrons, having struck the screen, must have some means of returning to their source — otherwise a charge would build up on the screen, repelling the electron beam. This is provided by coating the inner surface of most of the tube, beyond the deflection plates, with a thin layer of graphite and making a connection to it on the side of the tube. This coating, the 'Final anode' is sufficiently thin so that the electrons are not prevented from striking the phosphor.

X-Y Plotter

The X-Y Plotter is the most important module of the Hobby 'Scope. It contains a CRT and all the electronics required to convert the CRT into an easily used display unit, namely the power supplies for the tube and the deflection amplifiers. Physically, the X-Y Plotter is a self-contained unit with a lead at the rear to connect to the mains supply; on the front panel, the CRT screen is viewed through a circular hole and there are two rotary

controls for brightness and focus. All connections to the scope are made to terminal posts on the front panel (X-input, Y-input, Ground and external supply) with the exception of the Z input (see later), which is at the rear.

A block diagram of the X-Y Plotter, Figure 5, reveals its simplicity. A transformer isolates the unit from the mains and provides several secondary voltages for the circuit; a 6V3 AC winding supplies the CRT heater filament, another winding of 800V AC provides the supply for the EHT accelerator voltages, and the remaining winding provides for the X and Y Amplifiers. The 700V AC is rectified to produce 1kV DC, which is then stepped-up to 2kV and 4kV in a four stage multiplier circuit; this is preferred to providing 4kV direct from a transformer secondary, which would be very expensive because of the heavy insulation requirements. The EHT supply directly feeds the CRT anode voltages and, by means of a resistor potential divider chain, the voltages for the other electrodes. The potentials of the grid and second anode are made variable with potentiometers to allow the brightness and focus, respectively, to be adjusted. The X and Y Amplifiers essentially amplify convenient input

voltage levels of $\pm 2V$ (full scale deflection) to the necessary $\pm 150V$ needed to drive the deflection plates of the CRT.

A further input, called the Z-input, is AC coupled into the control grid to allow the brightness to be controlled dynamically by an external signal, as is necessary for the 'Scope Add-on.

'Scope Module

A block diagram of the unit that turns the X-Y Plotter into an oscilloscope is shown in Figure 6. An oscillator generates a 'sawtooth' waveform which must be applied to the X-input of the X-Y Plotter; this causes the electron beam to sweep smoothly across the screen from the far left to the far right, and then rapidly fly back to the starting point to repeat the sweep. In the absence of any Y input this would cause the display of a horizontal line in the centre of the screen. When a signal is applied to the X-Y Plotter Y-input, however, the beam is displayed so as to display the input waveform plotted against time. The display will also show, albeit faintly, the signal during the rapid flyback of the X deflection. This flyback is undesirable and so is suppressed by a negative going pulse applied to the Z-input of the plotter; it coincides with the flyback period and therefore blanks the beam at this time. An extra Y Amplifier, provided within the 'Scope Module, has switchable gain so allowing a wide range of input voltage amplitudes to be displayed on the scope.

As mentioned earlier, the timebase waveform has to be synchronised with the incoming signal to obtain a steady display; this is achieved with a Trigger circuit, which compares the input signal with the level control potential and forces the sawtooth oscillator to flyback when it detects a coincidence.

Curve Tracer

A curve tracer is a device that allows a plot of a component's voltage versus current characteristic, plotting current on the vertical (Y) axis and voltage on the horizontal (X) axis. This is useful for checking or identifying components such as diodes or transistors, as each device has a characteristic curve (that of a PN junction diode is shown in Figure 7). An oscillator periodically sweeps the required range of current by generating a representative voltage — this is applied to the Y input of the plotter. The voltage (which actually represents a current) is converted to a current in a proportional voltage to current convertor and is made to pass through the component being tested. The voltage which then develops across the component is fed to the X input of the plotter.

The oscillator need not be sinusoidal; in fact a symmetrical triangular wave would produce a more evenly bright trace. *The Hobby 'Scope project continues next month.*

GET BIG POWER

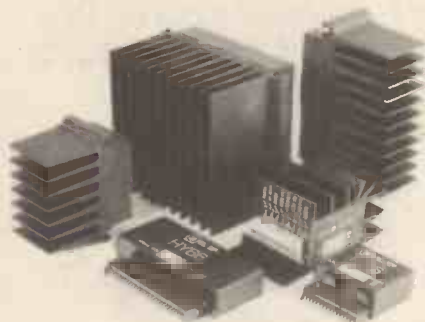

Modular Amplifiers the third generation

Due to continuous improvements in components and design ILP now launch the largest and most advanced generation of modules ever.

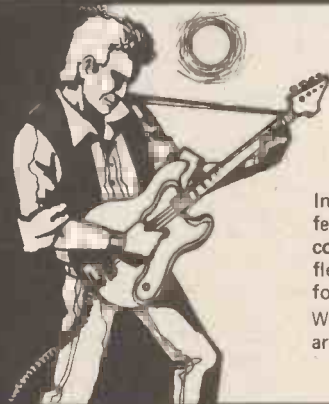

WE'RE INSTRUMENTAL IN MAKING A LOT OF POWER

In keeping with ILP's tradition of entirely self-contained modules featuring, integral heatsinks, no external components and only 5 connections required, the range has been optimized for efficiency, flexibility, reliability, easy usage, outstanding performance, value for money.

With over 10 years experience in audio amplifier technology ILP are recognised as world leaders.



BIPOLAR MODULES

Module Number	Output Power Watts rms	Load Impedance Ω	DISTORTION T.H.D. Typ at 1KHz	I.M.D. 60Hz/7KHz 4:1	Supply Voltage Typ	Size mm	WT gms	Price inc. VAT
HY30	15	4-8	0.015%	<0.006%	± 18	76 x 68 x 40	240	£8.40
HY60	30	4-8	0.015%	<0.006%	± 25	76 x 68 x 40	240	£9.55
HY6060	30 x 30	4-8	0.015%	<0.006%	± 25	120 x 78 x 40	420	£18.99
HY124	60	4	0.01%	<0.006%	± 25	120 x 78 x 40	410	£20.75
HY128	60	8	0.01%	<0.006%	± 35	120 x 78 x 40	410	£20.75
HY244	120	4	0.01%	<0.006%	± 35	120 x 78 x 50	520	£25.47
HY248	120	8	0.01%	<0.006%	± 50	120 x 78 x 50	520	£25.47
HY364	180	4	0.01%	<0.006%	± 45	120 x 78 x 100	1030	£38.41
HY368	180	8	0.01%	<0.006%	± 60	120 x 78 x 100	1030	£38.41

Protection: Full load line. Slew Rate: 15v/ μ s. Rsetime: 5 μ s. S/N ratio: 100db. Frequency response (-3dB) 15Hz - 50KHz. Input sensitivity: 500mV rms. Input Impedance: 100K Ω . Damping factor: 100Hz > 400.

PRE-AMP SYSTEMS

Module Number	Module	Functions	Current Required	Price inc. VAT
HY6	Mono pre amp	Mic/Mag. Cartridge/Tuner/Tape/Aux + Vol/Bass/Treble	10mA	£7.60
HY66	Stereo pre amp	Mic/Mag. Cartridge/Tuner/Tape/Aux + Vol/Bass/Treble/Balance	20mA	£14.32
HY73	Guitar pre amp	Two Guitar (Bass Lead) and Mic + separate Volume Bass Treble + Mix	20mA	£15.36
HY78	Stereo pre amp	As HY66 less tone controls	20mA	£14.20

Most pre-amp modules can be driven by the PSU driving the main power amp. A separate PSU 30 is available purely for pre amp modules if required for £5.47 (inc. VAT). Pre-amp and mixing modules in 18 different variations. Please send for details.

Mounting Boards

For ease of construction we recommend the B6 for modules HY6-HY13 £1.05 (inc. VAT) and the B66 for modules HY66-HY78 £1.29 (inc. VAT).

POWER SUPPLY UNITS (Incorporating our own toroidal transformers)

Model Number	For Use With	Price inc. VAT
PSU 21X	1 or 2 HY30	£11.93
PSU 41X	1 or 2 HY60, 1 x HY6060, 1 x HY124	£13.83
PSU 42X	1 x HY128	£15.90
PSU 43X	1 x MOS128	£16.70
PSU 51X	2 x HY128, 1 x HY244	£17.07

Please note: X in part no. indicates primary voltage. Please insert "0" in place of X for 110V, "1" in place of X for 220V, and "2" in place of X for 240V.

MOSFET MODULES

Module Number	Output Power Watts rms	Load Impedance Ω	DISTORTION T.H.D. Typ at 1KHz	I.M.D. 60Hz/7KHz 4:1	Supply Voltage Typ	Size mm	WT gms	Price inc. VAT
MOS 128	60	4-8	<0.005%	<0.006%	± 45	120 x 78 x 40	420	£30.41
MOS 248	120	4-8	<0.005%	<0.006%	± 55	120 x 78 x 80	850	£39.86
MOS 364	180	4	<0.005%	<0.006%	± 55	120 x 78 x 100	1025	£45.54

Protection: Able to cope with complex loads without the need for very special protection circuitry (fuses will suffice). Slew rate: 20v/ μ s. Rise time: 3 μ s. S/N ratio: 100db. Frequency response (-3dB): 15Hz - 100KHz. Input sensitivity: 500mV rms. Input impedance: 100K Ω . Damping factor: 100Hz > 400.

'NEW to ILP' In Car Entertainments

C15

Mono Power Booster Amplifier to increase the output of your existing car radio or cassette player to a nominal 15 watts rms.

Very easy to use.

£9.14 (inc. VAT)

Robust construction,

Mounts anywhere in car.

Automatic switch on.

Output power maximum 22w peak into 4 Ω .

Frequency response (-3dB) 15Hz to 30KHz, T.H.D. 0.1% at 10w 1KHz

S/N ratio (DIN AUDIO) 80dB, Load Impedance 3 Ω .

Input Sensitivity and impedance (selectable) 700mV rms into 15K Ω 3V rms into 8 Ω .

Size 95 x 48 x 50mm, Weight 256 gms.

C1515

Stereo version of C15.

£17.19 (inc. VAT)

Size 95 x 40 x 80. Weight 410 gms.

Model Number	For Use With	Price inc. VAT
PSU 52X	2 x HY124	£17.07
PSU 53X	2 x MOS128	£17.86
PSU 54X	1 x HY248	£17.86
PSU 55X	1 x MOS248	£19.52
PSU 71X	2 x HY244	£21.75

Model Number	For Use With	Price inc. VAT
PSU 72X	2 x HY248	£22.54
PSU 73X	1 x HY364	£22.54
PSU 74X	1 x HY368	£24.20
PSU 75X	2 x MOS248, 1 x MOS368	£24.20

WITH A LOT OF HELP FROM



PROFESSIONAL HI-FI THAT EVERY ENTHUSIAST CAN HANDLE...

Unicase

Over the years ILP has been aware of the need for a complete packaging system for its products, it has now developed a unique system which meets all the requirements for ease of assembly, adaptability, ruggedness, modern styling and above all price.

Each Unicase kit contains all the hardware required down to the last nut and bolt to build a complete unit without the need for any special tools.

Because of ILP's modular approach, "open plan" construction is used and final assembly of the unit parts forms a compact aesthetic unit. By this method construction can be achieved in under two hours with little experience of electronic wiring and mechanical assembly.

Hi Fi Separates

UC1 PRE AMP UNIT: Incorporates the HY7B to provide a "no frills", low distortion, (<0.01%), stereo control unit, providing inputs for magnetic cartridge, tuner, and tape/monitor facilities. This unit provides the heart of the hi fi system and can be used in conjunction with any of the UP Unicase series of power amps. For ultimate hum rejection the UC1 draws its power from the power amp unit.

POWER AMPS: The UP series feature a clean line front panel incorporating on/off switch and concealed indicator. They are designed to compliment the style of the UC1 pre-amp. Performance for each unit which includes the appropriate power supply, is as specified on the facing page.

Power Slaves

Our power slaves, which have numerous uses i.e. instrument, discotheque, sound reinforcement, feature in addition to the hi fi series, front panel input jack, level control, and a carrying handle. Providing the smallest, lowest cost, slave on the market in this format.

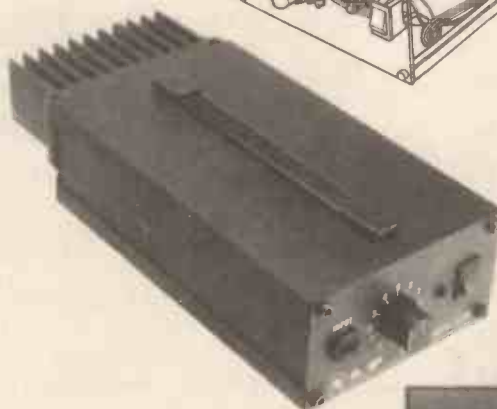
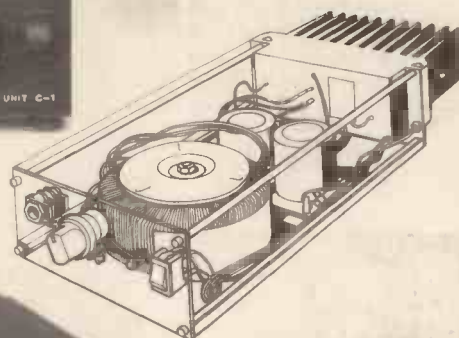

TO ORDER USING OUR FREEPOST FACILITY

Fill in the coupon as shown, or write details on a separate sheet of paper, quoting the name and date of this journal. By sending your order to our address as shown at the bottom of the page opposite, with FREEPOST clearly shown on the envelope, you need not stamp it. We pay postage for you. Cheques and money orders must be crossed and made payable to I.L.P. Electronics Ltd. If sending cash, it must be, by registered post. To pay C.O.D. please add £1 to TOTAL value of order.

PAYMENT MAY BE MADE BY ACCESS OR BARCLAYCARD IF REQUIRED

UNICASES

HIFI Separates					Price inc. VAT
UC1	Preamp				£29.95
UP1X	30 + 30W/4-8Ω	Bipolar	Stereo	HiFi	£54.95
UP2X	60W/4Ω	Bipolar	Mono	HiFi	£54.95
UP3X	60W/8Ω	Bipolar	Mono	HiFi	£54.95
UP4X	120W/4Ω	Bipolar	Mono	HiFi	£74.95
UP5X	120W/8Ω	Bipolar	Mono	HiFi	£74.95
UP6X	60W/4-8Ω	MOS	Mono	HiFi	£64.95
UP7X	120W/4-8Ω	MOS	Mono	HiFi	£84.95
Power Slaves					
US1X	60W/4 Ω	Bipolar	Power	Slave	£59.95
US2X	120W/4 Ω	Bipolar	Power	Slave	£79.95
US3X	60W/4-8Ω	MOS	Power	Slave	£69.96
US4X	120W/4-8Ω	MOS	Power	Slave	£89.95

Please note X in part number denotes mains voltage. Please insert '0' in place of X for 110V, '1' in place of X for 220V (Europe), and '2' in place of X for 240V (U.K.) All units except UC1 incorporate our own toroidal transformers.



Post to: ILP Electronics Ltd., Freepost 4, Graham Bell House, Roper Close, Canterbury CT2 7EP, Kent, England. Telephone: (0227) 64778. Technical: (0227) 64723. Telex: 965780.

Please send me the following: _____

Total purchase price _____

I enclose Cheque Postal Orders Int. Money Order

Please debit my Access/Barclaycard No. _____

Name _____

Address: _____

Signature _____

POINTS OF VIEW

Feel like sounding off?
Then write to the Editor stating your Point of View!

HEBOT Rides Again

Dear Sir,
I have just read the HEBOT II article in the November '82 issue of your magazine, where you ask for submissions on the subject of other interfaces.

I own a PET computer by Commodore and would like to know the details of how to control HEBOT II with it, therefore I would be pleased if you could work this out for me as I am not very good at electronics.

P R Brown,
Stevenage,
Herts.

Coming soon in Hobby Electronics!

You Don't Ohm Me

Dear Sir,
As an enthusiastic hobbyist in hifi, I want to build your Audio Signal Generator (HE May '82), the relatively simple design of which appeals to me. Unfortunately I cannot obtain locally the prescribed thermistor RA53 (or R53 alternatively). Stockists of electronic components always request the ohmic value of such a thermistor, which is not given in your article. Simply referring RA53 or R53 means nothing to them. To order just one piece from England (Maplin or Watford) is not very convenient.

Physically similar thermistors are available locally (Philips?) as long as I know the correct ohmic value. Another alternative available is to use the slightly cheaper glass-bead type thermistor. I shall be pleased to know if this can be used instead.

Yours faithfully,
J F Bednarik,
Pretoria,
S. Africa.

The RA53 is, in fact, a glass bead thermistor. It is rated at 3mW at 20°C with a resistance of 5k at that temperature, and has a minimum resistance of 80R. Hope that helps. PS. You forgot to put your SAE in. Actually about 5% of our enquiries forget to include their SAEs (not counting the ones who don't think of sending one in the first place) — which is why they end up here!

But then, if you have something especially pertinent or fascinating to ask or say, and send an SAE, you may have the double honour of a personal reply and a letter on the POV page as well.

Calling All Cars

Dear Sir,
I am a new reader to HE and find it very interesting reading, and will be subscribing to the magazine on a regular basis.

I would gratefully appreciate your experience and knowledge to help me to make my own small alarm paging system with the best possible range. My intention is to install a small transmitter unit in my car which would transmit a signal independently or through the car aerial, activated by vibration sensors, and door switches which would be received by a small pocket bleeper, either carried or in the home.

Being a newcomer to electronics I thought this was a very good idea of mine but like all good ideas I now see something like it is already on the market, but very expensive.

I will be happy to forward any remittance for plans, literature etc. Would you make it as straightforward as possible, me being a newcomer to electronics, and include information of my nearest electronics agent for the best stock of components?

I hope to make this alarm and lots of other items in the near future and look forward to hearing from you.

Yours sincerely,
David Knowles,
Barton,
Eccles.

After having thought about this for a bit, we have some ideas on this type of project and, subject to checking the legality of the suggestion as it stands, we hope to be producing one or more projects along these lines.

Does anyone else have any comments or suggestions?

When looking for components stockists, consult our Directory of Electronics Components and Hardware Suppliers (HE October '82) and the update which appeared last month, and also consult our advertisers — don't overlook mail order. It's an extremely reliable way of gaining access to large stocks of components.

Let There Be Lights

Sir,
I have just ordered Counter Driver and Numeral Display Projects from your Bookshelf but I urgently need assistance and direction. You see I'm an amateur and without boring you I will be grateful if you will be able to tell me how I could construct the

words JESUS SAVES to glow permanently and if need be the power supply to go with them to ensure non-interference. If I can be assisted by way of a circuit diagram and list of components I will very much appreciate it. If not, I won't be discouraged from buying HE, it's a great magazine.

Yours sincerely,
David Amakiri,
Crystal Palace,
London.

Dear Sir,
I'm trying to create a waterproof, battery operated clock with an LED display and I was wondering if you could help or put me in touch with somebody who could. The idea is to have the readout on one side of a piece of fabric with the circuit board and battery on the inside.

Yours,
J. Johns,
Kingwood,
Herts.

Firstly, sorry, chaps, but we cannot design circuits to specifications. If the Lord had intended the staff of HE to design circuits to order, He wouldn't have given us a magazine to publish. We don't have an infinite number of hands!

To get a light to glow permanently all you have to do is wire up enough light bulbs, Christmas tree lights, LEDs etc. to create the display you want. I wouldn't recommend domestic bulbs, as they get hot and burn out, but for any other kind of small light source you would need a suitable power supply circuit. That's a basic aspect of electronics, so if you want to get into that, try *Power Supply Projects*, £1.75 from the HE Bookshelf service (see page 29). As for Mr. Johns, can anybody help? I must confess, my mind boggles to know what it's for. A digital alarm umbrella? Upholstery for your goldfish bowl? Could there be a new project in this somewhere??

Low Resistance

Dear Sirs,
I will firstly say that I qualify as a devoted HE reader and that I have collected every single issue since November '78.

Since you seem to be in the know about electronics suppliers I wonder if you could give me some advice on where I can obtain some miniature resistors of power rating 0W/125 or below. These seem to be extremely

difficult to get hold of for some reason.

Yours faithfully,
N.S. Jones,
Stratford-upon-Avon,
Warks.

The resistors you want are in the RS Components catalogue. RS itself only deals with the trade, but any component in its stock can be ordered from your regular retail supplier (most of them deal with RS), although you will naturally have to pay for the service. And then there is our Components Directory in HE October '82 and April '82, and our gallant army of advertisers — a handful of phone calls can unmask wonders, if you know what you're asking for.

Teletext Kits

Dear Sir,
I am interested in Teletext/Prestel kits, could you please advise me of any manufacturers or agents other than Bradley Marshall Ltd?
Yours faithfully,
C.V. Parker,
Bildeston,
Ipswich.

Bradley Marshall Ltd. is the only Teletext/Prestel kits supplier known to us — does anyone out there know of another?

We Can't Amplify

Dear Sirs,
Project: Power Amplifier (HE June '81).
While going through some old HEs I came across this interesting project, but to my surprise the parts list which was provided with the article was incomplete. For example, values of resistors are not always given in the PCB diagram. As I am interested in making one, I would be very grateful if you could send the complete parts list since getting the kit would mean I have to pay more for the postage than the kit.
Thanking you,
V. Alexander,
Selangor,
Malaysia.

Sorry, but this circuit was provided by Capricorn Electronics, and to protect their design the Parts List was not completely described. You'll have to write to the address given to see if they're still supplying the kit or would be prepared to help you with some of the parts.

Out Of Data

Dear Hobby Electronics,
I am desperately begging for your help. I am involved in a college project where there are a few integrated circuits needed. I require data on these ICs to adapt my project to them. This is where the help comes in.
It would be very time consuming to

write to each manufacturer for their data. The datas that I require are as follows:

IC8038, IC7400, IC4093, IC555, IC4534, IC4511, IC4081, IC4011, IC4001, ICULN2803A, seven segment LED FND500, seven segment LED HP 5082-7730.

Are the seven segment displays compatible?

If there are any charges for your service, please send me the bill and I would gratefully pay for the charges.

I do hope that you can help me. I am an HE addict, I have every issue since it was launched on November 1978. A great magazine, keep it up. Yours waiting patiently,
S. Ferrol,
Dagenham,
Essex.

Every now and then somebody asks us for data on one particular device and we happen to have it at arm's length and can provide it — but if we guaranteed this service, and charged for it, well, you the reader would probably not be able to afford the service. There are electronics consultancies in every reasonable-sized town in the country, but their services don't come cheap.

Surely your college, either the library or one of your lecturers, keeps data sheets for these devices? That is their job, after all! I would try asking them, first.

Otherwise, you will have to contact the manufacturers, the same as we do when we get stuck, either by letter or by phone. It will help speed up the response you get to do three things: i) find out by phone first of all which department at which address you need to contact to get data on ICs; ii) send an SAE; iii) if you don't hear within a fortnight, phone the department you wrote to and ask if they have your letter.

If you are really stuck, I seem to recall Ilford Central Reference Library was good on science and technology, although data sheets might be stretching their resources a bit. Their number will be in your phone book.

Sorry we can't help with lists like this. Anyway, you wouldn't get much credit if we did all the research!

Games People Play

Dear Sir,
I have read your magazine with interest since its introduction and have enjoyed constructing many of the projects. I appreciate your encouragement of worthwhile community projects, for example, in the Year for the Disabled.

I would like to suggest a competition to design an original and attractive electronic game which could be used for raising money at various charity fetes, church fairs, etc. The wire loop game surely has been played out and I think there is a good opening for an alternative game which could be played by one or more players and which offered a challenge

and value for money.

I would like to see a worthwhile and practical project to enhance still further the reputation of your excellent magazine.

Yours faithfully,
J. Dakes,
Stone-on-Trent,
Staffs.

As it happens, we have several ideas for electronic games in the pipeline. We don't actually want to reveal our plans at this stage, but keep looking in HE. And thanks for the kind words.

Mail Order Maestros

Dear Sir,
On Tuesday 7th February, I sent by post orders to three of your advertisers, namely Rapid Electronics, John Bull and Bi-Pak.

I received delivery of the goods ordered, by post, on Friday, Saturday and finally today.

Congratulations to the efficiency of the firms concerned and the Post Office.

Yours faithfully,
M J Turner,
Whitstable,
Kent.

Nice to hear about the good things instead of the grolries for once! And living proof that mail order really does work, for anyone thinking of taking the plunge. Thank you, M.J.

Wah's That Again?

Dear Hobby Electronics,
I would like to enquire about a project which appeared in HE June '82, the Auto Wah. I wondered if a kit is available and how much it is including case and all the necessary bits. Please send me an answer quickly since I want to make it for a friend of mine who has an electric guitar.

Thank you.
Ali Modjdehian,
Sussex University.

The kit for the Auto Wah, with or without case, is available from Magenta Electronics — see their advertisement in this (and every) issue of HE. The produce kits for many HE projects old and new, so they are usually the first people to check.

PS Has your friend warned his neighbours?!!

While offering help and advice about projects and general electronics subjects tends to be priority number one in Points of View, not omitting to mention my colleague C. Dick across the way, we would also like to hear the odd Point of View from time to time, so if you have anything you want to praise, speculate on, comment on or sound off about in the world of electronics, let us know. Its your voice as well as ours. Of course if you don't need a reply you don't need to enclose an SAE either — it gives a wonderful sense of freedom! **HE**

COMING SOON TO . . .

Hobby Electronics

ZX81 HIGH RESOLUTION GRAPHICS BOARD

User-definable, high resolution graphics for the Sinclair ZX81 computer — without fuss! This is a simple add-on PCB that plugs into the ZX81 ROM socket; no modifications to the computer hardware are needed in this project! The ZX HRG is completely software controlled and allows you to program high resolution graphic characters for, say, a Space Invader game, graph plotting or anything else.

Software control allows the high resolution characters, once set up, to be saved on cassette then loaded and re-used at any time, and switching between either HRG user-graphics or the standard Sinclair character set is easy, under software control. Any single element of an 8x8-pixel character can be individually controlled, giving a screen resolution of 256x176, allowing finely details graphics programming.

The ZX HRG Board is the first half of a Sinclair Graphics Package. The second project is a user-programmable joystick controller — the first of its kind! Unlike all others it can be instructed to operate with any commercially available games programme, and will appear in the August issue of Hobby Electronics. A slightly different version for the Sinclair Spectrum will also be out shortly.

SATELLITE AND CABLE TELEVISION EXPLAINED

The communications revolution is nearly upon us! Find out about the technology of tomorrow's entertainment world in our July issue.

ALL ABOUT ELECTRONICS

Commencing a new series, especially written for the novice. All aspects of electronics will be covered in 12 separate parts, leading from basic theory through to descriptions of complete electronic systems.

COMPONENTS FOR COMPUTING

The second part of the article looking at computer display systems, leading up to a simple video display project in a future issue.

THE HOBBY 'SCOPE

Continuing with the circuit details of the X-Y Plotter unit of our super low-cost oscilloscope project.

Please reserve copies of the July issue of

**Hobby
Electronics**

for
Name

Address

.....

.....



**Hobby
Electronics**

**July issue on sale at
your newsagent
from 10th June.
Place your order now!**

Although these articles are being prepared for the next issue, circumstances may alter the final content.

BI-PAK

CATALOGUE

BI-PAKS NEW 1983 CATALOGUE IS OUT!

"IRRESISTABLE RESISTOR BARGAINS"

Pak No.	Qty*	Description	Price
SX10	400	Mixed "All Type" Resistors	£1
SX11	400	Pre formed 1/4 watt Carbon Resistors	£1
SX12	200	1/4 watt Carbon Resistors	£1
SX13	200	1/4 watt Carbon Resistors	£1
SX14	150	1/4 watt Resistors 22 ohm 2m2 Mixed	£1
SX15	100	1 and 2 watt Resistors 22 ohm 2m2 Mixed	£1

Paks SX12-15 contain a range of Carbon Film Resistors of assorted values from 22 ohms to 2.2 meg. Save pounds on these resistor paks and have a full range to cover your projects
*Quantities approximate, count by weight

"CAPABLE CAPACITOR PAKS"

Pak No.	Qty*	Description	Price
SX16	250	Capacitors Mixed Types	£1
SX17	200	Ceramic Capacitors Miniature Mixed	£1
SX18	100	Mixed Ceramics 1pF-56pF	£1
SX19	100	Mixed Ceramics 68pF-0.5mF	£1
SX20	100	Assorted Polyester/Polystyrene Capacitors	£1
SX21	60	Mixed C280 type capacitors metal foil	£1
SX22	100	Electrolytics, all sorts	£1
SX23	50	Quality Electrolytics 50-1000mF	£1
SX24	20	Tantalum Beads, mixed	£1

*Quantities approximate, count by weight

BARGAINS

SX42	20 small 125 Red LEDs	£1
SX43	10 Rectangular Green LEDs x 2	£1
SX46	30 Assorted Zener Diodes 250mW-2 watt mixed voltages, all coded New	£1
SX47	4 Black Instrument Knobs—winged with pointer 1/2" Standard screw. Fit size 29 x 20mm	50p
SX49	20 Assorted Slider Knobs Black/Chrome etc	£1
SX80	12 Neons and Filament Lamps. Low voltage and mains — various types and colours — some panel mounting	£1

SX52	6 Black Heatsink will fit TO-3 and TO-220 Ready drilled Half price value	£1
SX53	1 Power Finned Heatsink This heatsink gives the greatest possible heat dissipation in the smallest space owing to its unique staggered fin design pre drilled TO-3 Size 45mm square x 20mm high 40p	
SX54	10 66 size 35mm x 30mm x 12mm 35p	
SX55	1 Heat Efficiency 1. Power Finned Heatsink 90mm x 80mm x 15mm High Drilled to take up to 4 x TO-3 devices £1.50 each	

SEMICONDUCTORS FROM AROUND THE WORLD

100 A Collection of Transistors, Diodes, Rectifiers, Bridges, SCR's, Triacs, IC's both Logic and Linear plus Opto's all of which are current everyday usable devices 100

Guaranteed Value over £10 at Normal Retail Price

Yours for only **£4.00** Data etc in every pak Order No. SX56

BI-PAK'S OPTO BARGAIN OF THE YEAR!

Valued at over £10—Normal Retail—we offer you a pack of 25 Opto devices to include LED's Large and Small in Red, Green, Yellow and Clear, 7 Segment Displays both Common Cathode and Common Anode PLUS bubble type displays—like DL-33 Photo Transistors—similar to OCP71 Photo Detectors—like MEL11-12 This whole pack of 25 devices will cost you just

25 **£4.00** 25

AND we guarantee your money back! you are not completely satisfied. FULL data etc included
Order No. SX57.

TECASBOTY

The Electronic Components and Semiconductor Bargain of the Year. A host of Electronic components including potentiometers, rotary and slider presets—horizontal and vertical Resistors of mixed values 22ohms to 2M2 1/8 to 2 Watt. A comprehensive range of capacitors including electrolytic and polyester types plus disc ceramics etcetera. Audio plugs and sockets of various types plus switches, fuses, heatsinks, wire nuts, bolts, gromets, cable clips and ties, knobs and P.C. Board. Then add to that 100 Semiconductors to include transistors, diodes, SCR's, opto's, all of which are current everyday usable devices in all a Fantastic Parcel! No rubbish, all identifiable and valued in current catalogues at well over £25.00. Our Fight Against Inflation

Price —
— Beat the Budget
— Down with Depression
JUST £6.50.
O/No SX85

Send your orders to Dept EE6, BI-PAK PO BOX 6, WARE, HERTS. SHOP AT 3 BALDOCK ST. WARE, HERTS.

Use your credit card. Ring us on Ware 3182 NOW and get your order even faster. Goods normally sent 2nd Class Mail. Remember you must add VAT at 15% to your order. Total. Postage add 75p per total order.

Presented with a Professional Approach and Appeal to ALL who require Quality Electronic Components, Semiconductors and other Accessories ALL at realistic prices.

There are no wasted pages of useless information so often included in Catalogues published nowadays. Just solid facts i.e. price, description and individual features of what we have available. But remember, BI-PAK's policy has always been to sell quality components at competitive prices and THAT WE STILL DO.

We hold vast Stocks "in stock" for fast immediate delivery, all items in our Catalogue are available ex stock.

The Catalogue is designed for use with our 24 hours "ansaphone" service and the Visa/Access credit cards, which we accept over the telephone.

To receive your NEW 1983 BI-PAK Catalogue, send 75p PLUS 25p p&p to:-

BI-PAK (Catalogues) PO Box 6 WARE, Herts. SG12 9AD Access & VISA accepted Ring 0920 3182 for immediate despatch

SOUND with SINCLAIR

MAKE AMAZING SOUND EFFECTS WITH YOUR ZX 81, TIMEX Sinclair 1000 or SPECTRUM

THE ZON X 81 **£25.95** incl p&p & VAT



- The ZON SOUND UNIT is completely self-contained and especially designed for use with the ZX 81, TIMEX Sinclair 1000 and Spectrum Computers. It just plugs in — no dismantling or soldering.
- No power pack, batteries, leads or other extras.*
- Manual Volume Control on panel — ample volume from built-in loud-speaker.
- Standard Sinclair — 16K Rampack or printer can be plugged into ZON X Sound Unit without affecting normal computer operation.
- Huge range of possible sounds for Games, Music, Helicopters, Sci-Fi, Space Invaders, Explosions, Gun-shots, Drums, Planes, Lasers, Organs, Bells, Tunes, Chords, etc., or whatever you devise!
- 8 full octaves. Uses 3-Channel sound chip giving programme control of pitch, volume of tones and noise all with envelope control.
- Easily added to existing games or programmes using a few simple "BASIC" lines or machine code.
- No memory addresses used — 10 mapped.

FULL instructions with many examples of how to obtain effects and the programmes, supplied. Fully guaranteed. British Made.

*Except with Spectrum, you need the Spectrum Extension Board Order No. SE1 — PRICE £6.80 inc. VAT.

Payment may be made by Cheque, P.O. Giro No. 388 7006. Postal Order or Credit Card.

Export orders:— Bank Cheque, International Money Order, U.S. \$ or £ Sterling.

BI-PAK Dept EE, PO Box 6 63A High Street Ware, Herts. Access & VISA accepted Ring 0920 3182 for immediate despatch

Sinclair Sound Board

Original Design by Charles Baudouin
Development by Mike Lord

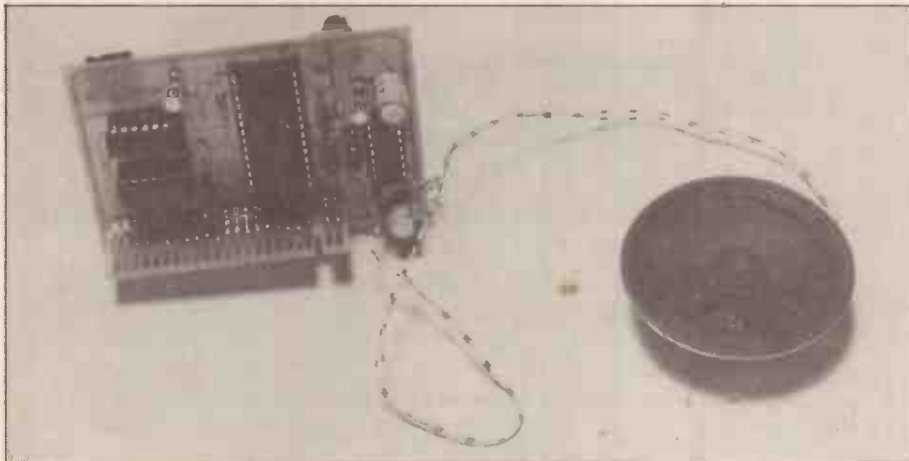

Do your ZX81 or Spectrum programs seem dull and lifeless? Do they lack that Snap, Crackle or Pop? If so then our Sound Board may be the answer!

Our ZX Sound Board is based on the General Instruments' 8912 sound generator chip, which gives you three programmable tones or noise with the option of automatic envelope control, so your computer can carry on with other things while the sound is being produced. The board has been designed to work on both the Spectrum and the ZX 81 (1K or more RAM) without modification, and features a built-in amplifier to drive an 8 or 16 ohm speaker as well as a volume control (for work in the early hours!) and a 'Reset' button for turning it off quickly when the neighbours start knocking!

The unit is designed to plug into the rear connector of the computer; a matching edge connector plug is fitted to the rear of the sound board to allow for other add-ons such as the ZX81 RAM Pack or printer.

Circuit Description

The heart of the board is the sound generator chip, IC3. The data needed to program its operation comes in from the computer's data bus, on leads D0-D7, while the IC itself is under control of the signals on the BC1 and BDIR chip inputs. These are

improved by ICs 1 and 2 whenever the computer performs an I/O operation with address line A5 or A6 low. These two address lines have been chosen because they do not conflict with any of the I/O addresses used by Sinclair add-ons such as the ZX printer. Putting the board in the computer's 'I/O Map' rather than the 'Memory Map' means that we can use the same board for both the ZX81 and the Spectrum without modification, although it does make use with the ZX81 slightly more complicated.

R2 and C3 reset the 8912 chip when power is applied to the board, or it can be reset any time by operating SW1; R3 limits the current flowing through the switch from C3 to a sensible level.

IC3 needs a clock signal of somewhere between 1 and 2MHz, and this is provided by using part of IC2, (which is a quad 2-input NAND with Schmitt Trigger inputs), R1 and C1 as an oscillator. The output of the oscillator is buffered by a spare gate from IC1.

The three sound outputs of IC3 are connected together and to the load resistor R5, then the resulting signal is fed through the low-pass filter R4/C4 to round off the edges of the square waves produced by IC3 before being amplified in IC4 to drive the loudspeaker. R6 and C7 guard against ringing and possible oscillation in IC4.

Construction

A single-sided PCB has been used to keep the cost down, so two wires have to be soldered in, as shown in Figure 2. Once this has been done, the resistors, capacitors and IC sockets can be fitted, care being taken to ensure that the electrolytic capacitors are fitted the right way round. Do not fit the ICs themselves yet.

The termination pins of the 23+23 way socket should now be fed through the board, so that they project out of the component side, the body of the socket being on the track side of the PCB. Position the connector so that it is square onto the PCB, with about half of the length of the termination pins on each side of the board. Solder two of the corner pins to the copper pads first, then check again that the connector is mounted squarely before soldering the other pins to the square pads on the board (some of the pins don't go through square pads, and so don't need to be soldered). Take great care not to create accidental short-circuits to adjacent pads or track when you are making the soldered joints!

The 23+23 way plug, which is a double-sided PCB, should now be fitted. Again, it must be mounted square onto the main PCB, the contact tails from the socket being bent down and soldered onto it on both sides.

The switch and volume control are

Parts List

RESISTORS

(All 1/4W, 5% carbon)

- R1470R
- R2, 4 33k
- R3, 5 1k
- R6 3R3

POTENTIOMETERS

- RV1 10K preset
(see Buylines)

CAPACITORS

(Disc ceramic unless noted)

- C1 1n
- C2, 5, 7 100n
- C3, 8 4u7
16V electrolytic
- C4 10n
- C6, 9 100u
16V electrolytic

SEMICONDUCTORS

- IC1 74LS02
Quad NOR gate
- IC2 74LS132
Quad NAND Schmitt trigger
- IC3 AY-3-8912
Sound generator
- IC4 LM380N
Audio amplifier

MISCELLANEOUS

- SK1 ZX edge connector
23 + 23 way 0.1in socket with
polarising pin in position 3,
wire/wrap contact terminations.
- PL123+23 way plug
- SW1 push switch
Single pole momentary
- PCB; 3 x 14-pin, 1 x 28-pin DIL IC
sockets; loudspeaker, 8 or 16 ohm;
connecting wire, solder etc.

BUYLINESpage 34

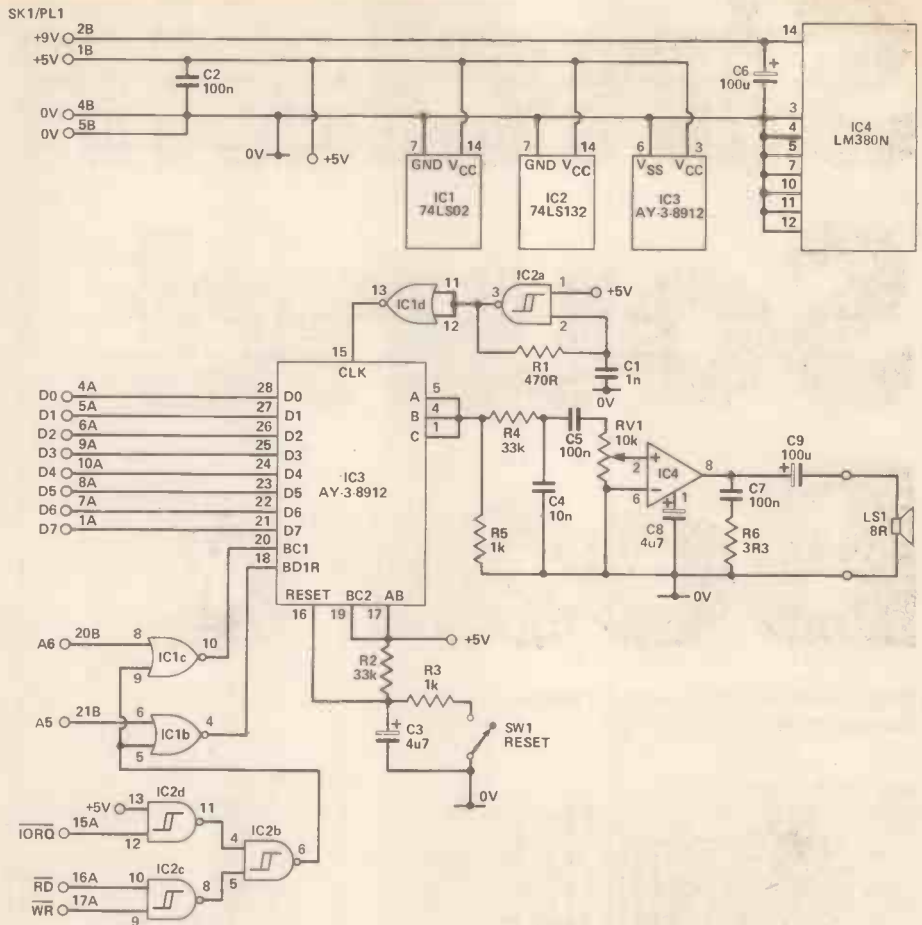

Figure 1. The circuit.

Figure 2: PCB Overlay. Note that SK1, SW1 and RV1 (dotted) are mounted on the track side of the board.

to be soldered onto the *track side* of the main PCB, which has been laid out to accommodate the types given in the parts list.

Finally, a pair of wires should be soldered into the two holes indicated in Figure 2, to connect with the loudspeaker, then the ICs plugged in.

Preliminary Tests

Before doing anything you might regret, check the board very carefully for possible short-circuits between tracks or connector pins. Then check again that the correct components have been inserted in the correct places, and the right way round. If you are very unlucky, a fault which is overlooked at this stage could damage your computer!

Now, plug the board into the back of your computer, REMEMBERING TO TURN THE POWER OFF FIRST!! Restore power to the computer, and check it works exactly as before.

Turn the volume control fully clockwise. You should be able to hear a slight buzzing sound from the loudspeaker, which will increase if

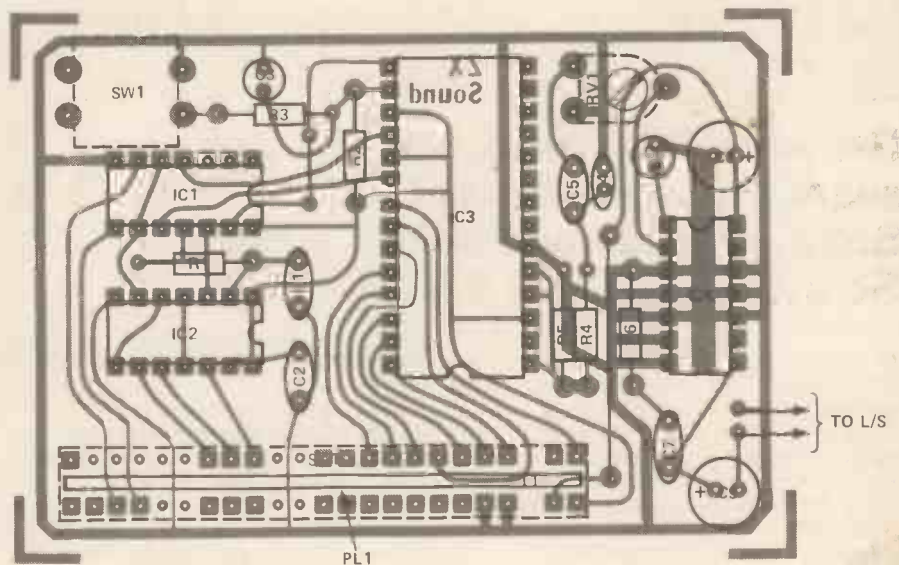

you touch the left-hand terminal of RV1 with the tip of your finger.

If you are using it with a Spectrum, then you can check that the sound generator is working by entering the line:

(OUT 159,8: OUT 223,15) which should result in a hissing noise. If you have a ZX81, you will have to load the 'Demo' program and use that to test the board as described in the next few sections.

SPECTRUM			ZX SOUND BOARD			ZX81		
PIN	A	B	PIN	A	B	PIN	A	B
1	A15	A14						
2	A13	A12						
3	D7	+5V	1	D7	+5V	1	D7	+5V
4		+9V	2		+9V	2	RAMCS	+9V
5	KEY		3	KEY		3	KEY	
6	D0	0V	4	D0	0V	4	D0	0V
7	D1	0V	5	D1	0V	5	D1	0V
8	D2	CK	6	D2	0V	6	D2	∅
9	D6	A0	7	D6		7	D6	A0
10	D5	A1	8	D5		8	D5	A1
11	D3	A2	9	D3		9	D3	A2
12	D4	A3	10	D4		10	D4	A3
13	INT	IORQGE	11			11	INT	A15
14	NMI	0V	12			12	NMI	A14
15	HALT	VIDEO	13			13	HALT	A13
16	MREQ	Y	14			14	MREQ	A12
17	IORQ	V	15	IOREQ		15	IOREQ	A11
18	RD	U	16	RD		16	RD	A10
19	WR	BUSRQ	17	WR		17	WR	A9
20	-5V	RESET	18			18	BUSAK	A8
21	WAIT	A7	19			19	WAIT	A7
22	+12V	A6	20		A6	20	BUSRQ	A6
23	-12V	A5	21		A5	21	RESET	A5
24	MI	A4	22			22	MI	A4
25	RFSH	ROMCS	23			23	RFSH	ROMCS
26	A8	BUSAK						
27	A10	A9						
28		A11						

Table 1. The three columns give the edge connector pin signals for the Spectrum, the ZX Sound Board and the ZX81, from left to right.

This table covers the same ground as the ones published with "ZX Interfaces Explained" (HE August '82, page 12), with some corrections, and can be kept as a handy reference guide to Sinclair micro connections.

Inside The 8912 Sound Chip

The 8912 is basically a 'three-channel device', although in this circuit all three outputs have been connected to the single audio amplifier.

It contains a variable frequency tone source and a programmable amplitude control for each of the three channels A, B and C. A single — common — noise generator is also included, and its output can be added to or replace the output of any of the tone sources. The programmable amplitude control for any of the channels can be controlled by the computer or by an 'Envelope Generator' in the chip itself. This generator can be programmed to provide a variety of envelope shapes,

automatically controlling the output level of the sound channel or channels. The values to be put into R7 selected.

Fourteen registers in the 8912 control the various sound generation functions. They are referred to as R0 to R13. R0 and R1 control the frequency of the tone produced for channel A. The larger the number entered into these registers, the lower the resulting note frequency. R0 is the 'Fine Tune' register, and can be programmed with any value between 0 to 255. R1 provides 'Coarse' tuning, and can take any value from 0 to 15. R2 and R3 are similar Fine and Coarse tuning registers for channel B, and R4, R5 for channel C.

The frequency of the noise

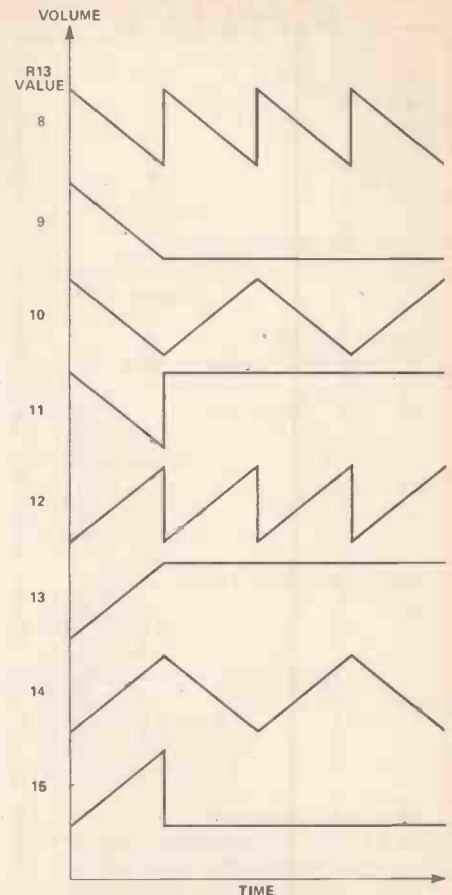

Figure 3. Envelope shapes available from the Sound Board's Envelope Generator.

generator can be controlled by entering a value from 0 to 31 into R6; the larger the value the lower the basic frequencies of the 'noise' produced.

R7 lets you select noise or tone output (or both) for each of the three channels. The values to be put into R7 should be between 0 and 63, calculated as the sum of:

- 1 to turn OFF tone from channel A
- 2 to turn OFF tone from channel B
- 4 to turn OFF tone from channel C
- 8 to turn OFF tone from channel A
- 16 to turn OFF tone from channel B
- 32 to turn OFF tone from channel C

R8, 9, and 10 control the output levels of channels A, B and C respectively. If they are loaded with a value between 0 and 15, then the output level for that channel will be determined by the value, 15 being the loudest. If, on the other hand, you enter the value 16, then the output level for the channel will be controlled by the Envelope Generator.

The Envelope Generator can vary the amplitude of any selected channel(s) to impose any of eight envelope shapes on the sound output, according to the value loaded into the register R13. Details of these envelope shapes are given in Figure 3. Note that some give a continuous (or continuously varying) output, while others give only a burst of sound every time R13 is loaded.

The duration of envelope shapes is controlled by values put into R11 and

Sounds

Dissonance	
REG	VALUE
7	56
8	8
9	8
10	8
0	200
2	133
4	103

Choo-Choo	
REG	VALUE
6	30
7	55
8	16
11	200
13	14

Chimes	
REG	VALUE
1	1
2	130
4	60
7	56
8	16
9	16
10	16
12	50
13	8

Shot	
REG	VALUE
7	55
8	16
12	5
13	9

(You'll get a 'shot' everytime you enter 9 into register 13.)

Demo Routines

```

1 REM 123456789ABCD
2 LET A$="110000019FFFED59OEDFED51C9"
3 LET A=16514
4 FOR B=1 TO 25 STEP 2
5 POKE A,16*CODE A$(B)+CODE A$(B+1)-476
6 LET A=A+1
7 NEXT B
100 PRINT "REG VAL"
110 INPUT R
120 PRINT R:"
130 INPUT V
140 PRINT V
150 GOSUB 990
160 GOTO 110
9990 POKE 16515,R
9991 POKE 16516,V
9992 LET A=USR 16514
9994 RETURN
    
```

Note: characters 'O' in line 2 are Zeroes, not the letter 'O'

SOUND BOARD DEMO PROGRAM FOR SPECTRUM

```

100 PRINT "Reg Val"
110 INPUT "Reg ";R;"Val ";V
120 PRINT R;TAB 6;V
130 OUT 159,R: OUT 223,V
140 GO TO 110
    
```

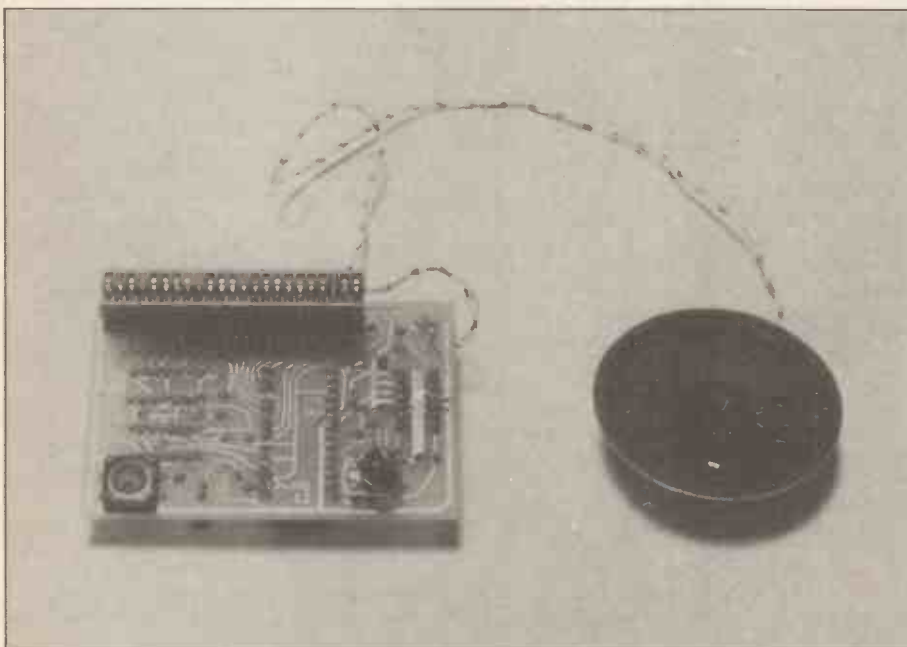

R12; larger values giving longer times. R11 is the 'Fine Tune' register, and R12 provides 'Coarse Tune'; both registers can take values from 0 to 255.

There are two further registers in the 8912, known as the 'Address Register' and the 'Data Register'. To put a value into any of the registers R0 to R13 you have to put the number of the register into the Address Register, then load the value into the Data Register. Reading the Data Register will give you the content of

the register whose number is in the Address Register.

Programming It

As the board is I/O mapped, Spectrum owners should use the IN and OUT commands, the appropriate addresses being:

159 to write to the Address Register
 223 to write to the Data Register
 191 to read from the Data Register
 So, to load the value 11 into the

envelope shape register R13, we would use the two statements:

```

OUT 159,13
OUT 223,11
    
```

The 'DEMO' program given later simplifies things a little by letting you enter just the register number and contents.

The ZX81, however, lacks the IN and OUT instructions of the Spectrum; this means that a small machine code routine has to be loaded first to access the I/O map.

Lines 2-7 of the ZX81 'DEMO' program load this M/C program into the memory space reserved by the REM statement of line 1; once you have run this once then the characters in line 1 will change, and you can delete lines 2 to 7 if you wish. Lines 9990-9994 are a subroutine which calls the M/C routine, putting the value V into the 8912 register number R. Lines 100-160 are a short routine which uses the subroutine at 9990 and lets you experiment with the board by just entering the 8912 register numbers and the values you want stored there.

Sounding Out

Some interesting sounds to try out are listed under the heading 'Sounds to Try'. Remember that all of the 8912's registers that are not mentioned should contain '0' (pressing the board Reset button puts zero into all of the registers). These examples should get you started, then you can make a splash or any other sound you fancy!

74 SERIES		74136 28p	74LS11 13p	74LS244 50p	4041 40p	CA3048 220p	MC1310P 150p	ZN426E 300p	MJ4502 50p	2N3702/3 10p	BRIDGE RECTIFIERS		TIL321/2 130p
7400 11p	74141 55p	74LS12 13p	74LS12 13p	74LS245 70p	4042 40p	CA3059 280p	MC1458 35p	ZN427E 580p	MJE340 50p	2N3704/5 12p	1A 50V 19p	TIL330 140p	7750/60 200p
7401 11p	74143 200p	74LS13 15p	74LS14 25p	74LS251 30p	4043 40p	CA3080E 70p	MC1495L 30p	ZN428E 400p	MJE2955 90p	2N3706/7 10p	1A 100V 20p	DISPLAYS	
7402 11p	74144 200p	74LS15 12p	74LS15 12p	74LS256 150p	4076 48p	CA3086 48p	MC1496 35p	ZN450E 190p	MJE3305 70p	2N3719 20p	1A 100V 25p	3101F5 200p	DL707 Red 140p
7403 12p	74145 40p	74LS20 13p	74LS20 13p	74LS257 30p	4077 18p	CA3089 200p	MC3340P 120p	ZN4550 800p	MPF103/4 30p	2N3823 30p	1A 100V 30p	DL707 140p	PN357 120p
7404 12p	74148 60p	74LS22 13p	74LS22 13p	74LS259 35p	4078 18p	CA3090AO 400p	MC3403 65p	ZN4590 200p	MPF105 30p	2N3866 90p	2A 50V 30p	FND500 90p	FND507 90p
7405 15p	74150 50p	74LS26 14p	74LS26 14p	74LS260 22p	4082 15p	CA3100E 11p	MC3405 250p	ZN4595 670p	MPSA12 50p	2N3904 15p	2A 100V 35p	FND500 90p	FND507 90p
7406 15p	74151A 36p	74LS27 13p	74LS27 13p	74LS261 50p	4086 40p	CA3140T 90p	MK50398 E7	ZNA134 30p	MPSA13 50p	2N3906 15p	2A 100V 35p	FND500 90p	FND507 90p
7407 15p	74153 36p	74LS28 14p	74LS28 14p	74LS266 20p	4089 12p	CA3160E 100p	MN57160 620p	ZNA234 850p	MPSA14 50p	2N3909 15p	2A 100V 35p	FND500 90p	FND507 90p
7408 14p	74154 50p	74LS30 13p	74LS30 13p	74LS273 55p	4093 24p	CA3161E 150p	MN6221A 600p		MPSA42 50p	2N4001 15p	2A 100V 35p	FND500 90p	FND507 90p
7409 14p	74155 36p	74LS31 13p	74LS31 13p	74LS279 30p	4095 90p	CA3162E 450p			MPSA43 50p	2N4001/3 25p	2A 100V 35p	FND500 90p	FND507 90p
7410 14p	74156 40p	74LS32 13p	74LS32 13p	74LS283 30p	4096 75p	CA3189E 11p			MPSA44 50p	2N4002 10p	2A 100V 35p	FND500 90p	FND507 90p
7411 16p	74157 30p	74LS33 14p	74LS33 14p	74LS288 90p	4095 90p	CA3200G 200p			MPSA45 50p	2N4003 10p	2A 100V 35p	FND500 90p	FND507 90p
7412 14p	74159 75p	74LS40 12p	74LS40 12p	74LS299 150p	4097 290p	D002C 48p			MPSA56 25p	2N4004 10p	2A 100V 35p	FND500 90p	FND507 90p
7413 14p	74160 40p	74LS42 30p	74LS42 30p	74LS321 150p	4099 100p	DAC1408.8 E2			MPSA70 25p	2N4005 10p	2A 100V 35p	FND500 90p	FND507 90p
7414 14p	74161 40p	74LS43 30p	74LS43 30p	74LS322 180p	4099 100p	DA C 0808 200p			MPSA83 30p	2N4006 10p	2A 100V 35p	FND500 90p	FND507 90p
7416 18p	74162 40p	74LS47 36p	74LS47 36p	74LS323 180p	4099 100p	HA1388 190p			MPSA80 50p	2N4007 10p	2A 100V 35p	FND500 90p	FND507 90p
7417 18p	74163 40p	74LS51 14p	74LS51 14p	74LS324 150p	4099 100p	HA1388 250p			MPSA82 50p	2N4008 10p	2A 100V 35p	FND500 90p	FND507 90p
7420 14p	74164 45p	74LS55 14p	74LS55 14p	74LS348 90p	4503 45p	ICL7106 700p			MPSU07 60p	2N4009 10p	2A 100V 35p	FND500 90p	FND507 90p
7421 18p	74165 45p	74LS74 18p	74LS74 18p	74LS352 60p	4505 400p	ICM7217 750p			MPSU45 78p	2N4010 10p	2A 100V 35p	FND500 90p	FND507 90p
7422 20p	74166 45p	74LS75 18p	74LS75 18p	74LS353 60p	4505 400p	ICM7555 80p			MPSU46 78p	2N4011 10p	2A 100V 35p	FND500 90p	FND507 90p
7423 18p	74168 45p	74LS76 18p	74LS76 18p	74LS363 140p	4507 35p	LC7120 300p			MPSU47 78p	2N4012 10p	2A 100V 35p	FND500 90p	FND507 90p
7425 18p	74170 120p	74LS77 18p	74LS77 18p	74LS364 140p	4508 35p	LM1010 325p			MPSU48 78p	2N4013 10p	2A 100V 35p	FND500 90p	FND507 90p
7426 18p	74172 250p	74LS78 18p	74LS78 18p	74LS365 30p	4511 45p	LM1010 325p			MPSU49 78p	2N4014 10p	2A 100V 35p	FND500 90p	FND507 90p
7427 18p	74173 50p	74LS86 16p	74LS86 16p	74LS366 30p	4512 48p	LM1010 325p			MPSU50 78p	2N4015 10p	2A 100V 35p	FND500 90p	FND507 90p
7428 18p	74174 55p	74LS90 22p	74LS90 22p	74LS367 30p	4514 110p	LM1010 325p			MPSU51 78p	2N4016 10p	2A 100V 35p	FND500 90p	FND507 90p
7429 14p	74175 50p	74LS92 30p	74LS92 30p	74LS368 30p	4515 110p	LM1010 325p			MPSU52 78p	2N4017 10p	2A 100V 35p	FND500 90p	FND507 90p
7432 18p	74176 50p	74LS93 22p	74LS93 22p	74LS373 55p	4516 110p	LM1010 325p			MPSU53 78p	2N4018 10p	2A 100V 35p	FND500 90p	FND507 90p
7433 22p	74177 45p	74LS95 40p	74LS95 40p	74LS374 55p	4516 110p	LM1010 325p			MPSU54 78p	2N4019 10p	2A 100V 35p	FND500 90p	FND507 90p
7437 22p	74178 70p	74LS96 50p	74LS96 50p	74LS375 45p	4518 40p	LM1010 325p			MPSU55 78p	2N4020 10p	2A 100V 35p	FND500 90p	FND507 90p
7438 22p	74180 40p	74LS107 20p	74LS107 20p	74LS377 70p	4520 50p	LM1010 325p			MPSU56 78p	2N4021 10p	2A 100V 35p	FND500 90p	FND507 90p
7441 55p	74181 115p	74LS109 27p	74LS109 27p	74LS378 70p	4521 90p	LM1010 325p			MPSU57 78p	2N4022 10p	2A 100V 35p	FND500 90p	FND507 90p
7442A 30p	74184A 90p	74LS112 20p	74LS112 20p	74LS379 70p	4521 90p	LM1010 325p			MPSU58 78p	2N4023 10p	2A 100V 35p	FND500 90p	FND507 90p
7443 30p	74185 90p	74LS114 20p	74LS114 20p	74LS389 160p	4527 60p	LM1010 325p			MPSU59 78p	2N4024 10p	2A 100V 35p	FND500 90p	FND507 90p
7445 50p	74186 470p	74LS122 25p	74LS122 25p	74LS393 45p	4526 60p	LM1010 325p			MPSU60 78p	2N4025 10p	2A 100V 35p	FND500 90p	FND507 90p
7446A 50p	74188 250p	74LS123 34p	74LS123 34p	74LS399 160p	4532 60p	LM1010 325p			MPSU61 78p	2N4026 10p	2A 100V 35p	FND500 90p	FND507 90p
7447A 50p	74189 250p	74LS124 30p	74LS124 30p	74LS467 E19	4537 60p	LM1010 325p			MPSU62 78p	2N4027 10p	2A 100V 35p	FND500 90p	FND507 90p
7448 45p	74190 45p	74LS124 30p	74LS124 30p	74LS540 40p	4534 400p	LM1010 325p			MPSU63 78p	2N4028 10p	2A 100V 35p	FND500 90p	FND507 90p
7451 15p	74192 45p	74LS125 25p	74LS125 25p	74LS610 E19	4536 270p	LM1010 325p			MPSU64 78p	2N4029 10p	2A 100V 35p	FND500 90p	FND507 90p
7453 15p	74193 45p	74LS126 25p	74LS126 25p	74LS628 150p	4539 90p	LM1010 325p			MPSU65 78p	2N4030 10p	2A 100V 35p	FND500 90p	FND507 90p
7454 15p	74194 45p	74LS132 34p	74LS132 34p	74LS628 150p	4539 90p	LM1010 325p			MPSU66 78p	2N4031 10p	2A 100V 35p	FND500 90p	FND507 90p
7460 15p	74195 40p	74LS133 25p	74LS133 25p	74LS628 150p	4539 90p	LM1010 325p			MPSU67 78p	2N4032 10p	2A 100V 35p	FND500 90p	FND507 90p
7470 30p	74197 40p	74LS136 25p	74LS136 25p	74LS628 150p	4539 90p	LM1010 325p			MPSU68 78p	2N4033 10p	2A 100V 35p	FND500 90p	FND507 90p
7473 25p	74198 90p	74LS138 27p	74LS138 27p	74LS628 150p	4539 90p	LM1010 325p			MPSU69 78p	2N4034 10p	2A 100V 35p	FND500 90p	FND507 90p
7474 18p	74199 80p	74LS145 70p	74LS145 70p	74LS628 150p	4539 90p	LM1010 325p			MPSU70 78p	2N4035 10p	2A 100V 35p	FND500 90p	FND507 90p
7475 22p	74221 55p	74LS147 100p	74LS147 100p	74LS628 150p	4539 90p	LM1010 325p			MPSU71 78p	2N4036 10p	2A 100V 35p	FND500 90p	FND507 90p
7476 25p	74225 65p	74LS148 75p	74LS148 75p	74LS628 150p	4539 90p	LM1010 325p			MPSU72 78p	2N4037 10p	2A 100V 35p	FND500 90p	FND507 90p
7480 25p	74251 65p	74LS151 40p	74LS151 40p	74LS628 150p	4539 90p	LM1010 325p			MPSU73 78p	2N4038 10p	2A 100V 35p	FND500 90p	FND507 90p
7481 120p	74273 120p	74LS153 40p	74LS153 40p	74LS628 150p	4539 90p	LM1010 325p			MPSU74 78p	2N4039 10p	2A 100V 35p	FND500 90p	FND507 90p
7482 65p	74279 40p	74LS154 40p	74LS154 40p	74LS628 150p	4539 90p	LM1010 325p			MPSU75 78p	2N4040 10p	2A 100V 35p	FND500 90p	FND507 90p
7483A 38p	74283 50p	74LS155 30p	74LS155 30p	74LS628 150p	4539 90p	LM1010 325p			MPSU76 78p	2N4041 10p	2A 100V 35p	FND500 90p	FND507 90p
7484 65p	74284 160p	74LS156 35p	74LS156 35p	74LS628 150p	4539 90p	LM1010 325p			MPSU77 78p	2N4042 10p	2A 100V 35p	FND500 90p	FND507 90p
7485 60p	74290 75p	74LS157 25p	74LS157 25p	74LS628 150p	4539 90p	LM1010 325p			MPSU78 78p	2N4043 10p	2A 100V 35p	FND500 90p	FND507 90p
7486 18p	74293 90p	74LS158 30p	74LS158 30p	74LS628 150p	4539 90p	LM1010 325p			MPSU79 78p	2N4044 10p	2A 100V 35p	FND500 90p	FND507 90p
7489 170p	74298 100p	74LS161 38p	74LS161 38p	74LS628 150p	4539 90p	LM1010 325p			MPSU80 78p	2N4045 10p	2A 100V 35p	FND500 90p	FND507 90p
7490A 20p	74351 150p	74LS162 38p	74LS162 38p	74LS628 150p	4539 90p	LM1010 325p			MPSU81 78p	2N4046 10p	2A 100V 35p	FND500 90p	FND507 90p
7491 35p	74365 35p	74LS163 38p	74LS163 38p	74LS628 150p	4539 90p	LM1010 325p			MPSU82 78p	2N4047 10p	2A 100V 35p	FND500 90p	FND507 90p
7492A 24p	74367 35p	74LS164 40p	74LS164 40p	74LS628 150p	4539 90p	LM1010 325p			MPSU83 78p	2N4048 10p	2A 100V 35p	FND500 90p	FND507 90p
7493A 24p	74368 30p	74LS165 50p	74LS165 50p	74LS628 150p	4539 90p	LM1010 325p			MPSU84 78p	2N4049 10p	2A 100V 35p	FND500 90p	FND507 90p
7494 35p	74376 100p	74LS166 50p	74LS166 50p	74LS628 150p	4539 90p	LM1010 325p			MPSU85 78p	2N4050 10p	2A 100V 35p	FND500 90p	FND507 90p
7495A 35p	74377 100p	74LS167 50p	74LS167 50p	74LS628 150p	4539 90p	LM1010 325p			MPSU86 78p	2N4051 10p	2A 100V 35p	FND500 90p	FND507 90p

Home Computer Show

Birmingham

THE
METROPOLE HOTEL
AT THE
NATIONAL
EXHIBITION CENTRE

VISIT THE COMPLETE SHOW FOR THE HOME USER AND SEE:

A COMPLETE cross section of all hardware and software available to the home user.

A FULL RANGE of home computers priced from £50 upwards.

A COMPUTER ADVICE CENTRE run by independent experts for the answers to all our questions.

WIN WIN WIN TWO COMPUTERS — one for you, one for a school of your choice — to be won at each show: FREE entry form with advance tickets

JUNE SATURDAY 4th (10am-6pm)
SUNDAY 5th (10am-4pm)

ADULTS: £2.00 UNDER 8s & OAPs: FREE
25% DISCOUNT for parties of
20 or more.

SPONSORED JOINTLY BY:

A&B Computing
Computing Today Personal Software
Personal Computing Today
Home Computing Weekly
ZX Computing

HE **BIRMINGHAM**
Home Computer Show
Send £1.00 Save £1.00 One person per coupon only
Please enclose SAE
Mr. Mrs. Miss
Address
ASP Exhibitions
145 Charring Cross Road
London WC2H 0EE
01-437 1002

Sir John Turton Randall

Not well known to the public, his experiments with the magnetron effect brought about a breakthrough in the generation of microwaves.

Ian Sinclair

This is no exotic mid-European name, and yet Sir John Turton Randall's fame is of a distinctly select variety. Like many distinguished academics, Sir John Randall is famous to a fairly small number of people who know of his achievements.

That is by no means to say that the achievements themselves are obscure — his work on microwaves enabled radar to play a crucial part in Britain's defences during the Second World War, quite apart from opening the way for the many roles radar has played since that time. In a very different context, it has given rise to some removes to that increasingly familiar phenomenon of our time, the microwave oven. Behind the headlines and high-street familiarity of winning wars and microwave cookery there are always the back-room boffins, rewarded perhaps but rarely renowned.

Sir John Randall was (and still is) one of these. Born in 1905, he pursued a brilliant academic career, and gained his MSc degree from the University of Manchester in 1926, at an age when most students are struggling with a lower degree. He worked in electrical research in the laboratories of GEC between 1927 and 1937, but then returned to academic life as a Warren Research Fellow of the Royal Society in the years 1937 to 1943.

Microwave Generation

This was no return to ivory towers or dreaming spires. His research in those years was very strongly connected with his work at GEC, and centred on the generation of microwaves. At that time, "microwave" was the term loosely applied to any frequency of more than

about 1GHz (1000 MHz), and there was at that time no satisfactory way of generating these frequencies at high power. The first radar experiments were, in fact, conducted using frequencies around 50MHz.

To see why such difficulties existed, we have to think of the methods that were used for constructing oscillators. A conventional high-power oscillator of the mid-30s would use a triode valve, not so very different from the type we still use for the same purpose, with the cross-section shown in Figure 1. Electrons are emitted from the hot tungsten filament which, for a large transmitting valve, would typically use 115V 200A just in heating. These electrons are then attracted by the high positive voltage of the anode, a metal cylinder which forms the outside of the valve and which is water or air cooled.

The flow of electrons between cathode and anode is controlled by a "grid", a coil of wire or a wire-mesh cylinder placed between anode and cathode, whose voltage can be varied. With a high negative voltage on the grid, electrons will be repelled back to the cathode, none reaching the anode; with a positive voltage on the grid, a few electrons land on the grid but most travel on to the anode. The voltage on the grid controlled is the anode current, just as the voltage on the gate of a FET controls the drain current.

Oscillation Limitations

Triode valves of this sort were used and still are produced for radio transmitters, and they could be used as high power oscillators by adding some positive feedback, using circuits such as the one in Figure 2. Such oscillators could

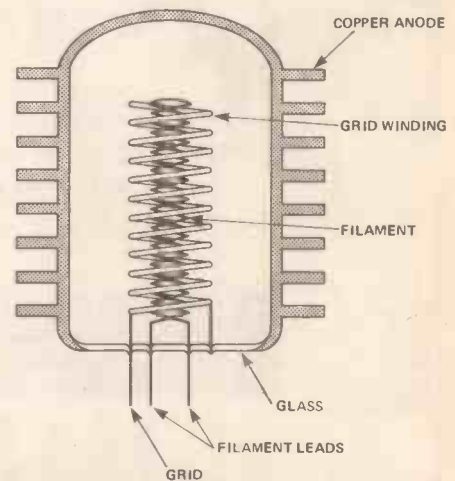

Figure 1. Cross-section of a typical triode transmitting valve.

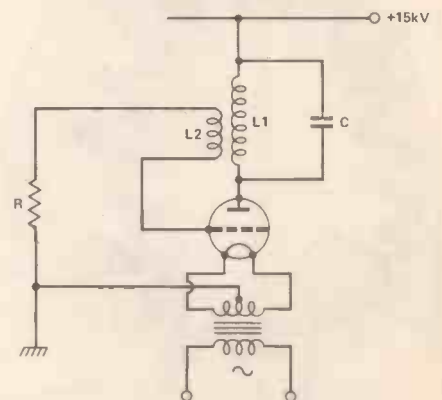

Figure 2. The type of circuit which would be used as an oscillator with a triode valve.

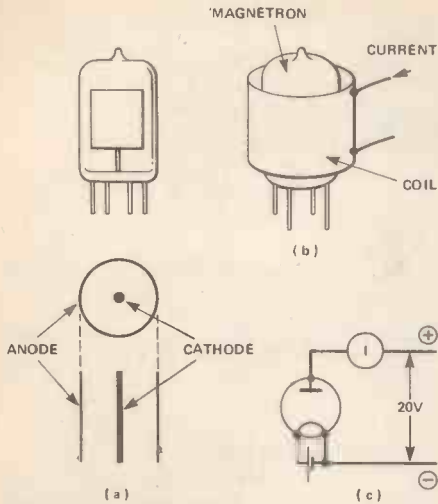

Figure 3. The magnetron. (a) Views of the structure. (b) The valve, which is a simple diode, is used inside a magnetic field provided by a large coil. (c) The circuit connection to the valve — the current drops suddenly as the magnetic field is increased.

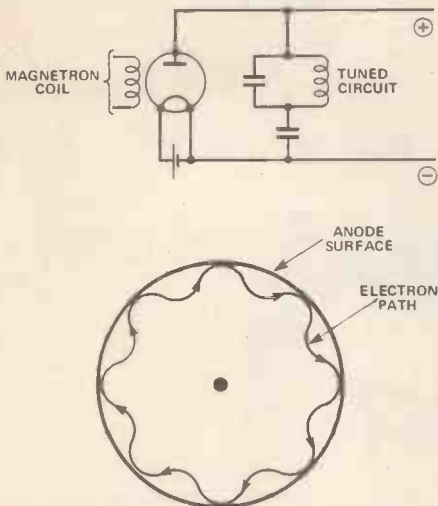

Figure 4. Using the magnetron valve with a tuned circuit. This causes the electron path inside the valve to be corrugated as the anode voltage oscillates.

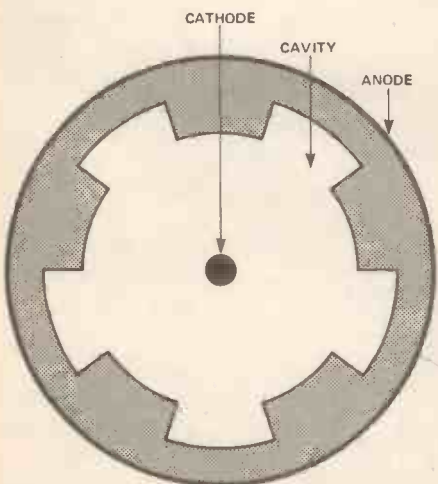

Figure 5. Cross-section of a cavity magnetron. The cavities act as tuned circuits for a microwave frequency.

produce an output whose frequency is controlled by the inductance of the tank coil and the value of capacitance connected across it, but there was a limit to the frequency that could be obtained. One limitation was simply that it's difficult to make a "coil" of less than one turn, but the more serious limitation was due to the valve itself.

The action of the oscillator depends on the positive feedback from the anode to the grid so that as the anode current increases, and its voltage decreases, the grid voltage is forced to increase. This works normally at low frequencies, but at higher frequencies it starts to suffer from the effect called "transit time".

The voltage between the grid and the filament is never very large, so that the electrons move comparatively slowly between these electrodes — slowly meeting at a few million metres per second! What we're comparing this with, however, is how quickly the voltage at the grid will change if a frequency of a 1GHz is being generated. One complete cycle of a 1GHz wave takes just one nanosecond, and the grid voltage would change from maximum to zero in a quarter of this time, 250 picoseconds. At the lower electron speeds, it would be possible for an electron to leave the filament when the grid voltage was positive, but for the grid voltage to have become zero or negative by the time the electron reached it!

An electron struggling along at a speed which is one hundredth of the speed of light, for example, will cover 3mm in one nanosecond, which is a lot less than the distance between the filament and the grid of a large transmitting valve. The snag is that if you close up the gap, you are likely to have problems of sparking across the gap, particularly as the metal expands and even more so if there is any vibration.

Enter The Magnetron

Much was done to develop the transmitting triode, but transit time remains a problem that can't be got around in valves any more than we can get around it in transistors. This was the problem that faced two men working at Manchester in the early days of World War II. One of the two was John Randall, the other Dr. Henry Boot. Together, they made the valve that won the war.

For a long time before those days, an effect called the "magnetron effect" had been known — it is used today in an 'A' Level Physics experiment to measure the ratio of charge to mass for the electron. The cross-section down a simple magnetron is shown in Figure 3; it consists of a diode valve using an electron-emitting cathode and a cylindrical anode in a glass tube, evacuated and sealed, all within a coil which provides a steady magnetic field.

Without any magnetic field, current flows between cathode and anode when the anode is at a positive voltage and the cathode is hot. When the magnetic field is switched on, the electron path becomes bent, and if

the field is strong enough, the electrons will move in circles, just missing the anode, so that the anode current drops to zero.

Now the interesting thing about this device is that the electrons can be moving very fast, so the time needed to perform each revolution inside the anode is very short. The other point is that if a tuned circuit is connected between anode and cathode, the valve will generate oscillations as the electron beam alternately touches and misses the anode (Figure 4). Randall and Boot's great step forward was to combine the valve with the oscillating circuit to form the cavity magnetron.

Perhaps they had been watching a flautist, because what occurred to both of them was that as the electrons travelled past a bottle-shaped cavity in the wall of the anode, the cavity might act as a tuned circuit for microwaves, just as the air inside a flute acts as a tuned circuit for the breath of the flautist. They suspected already that the cavity would act as a resonant circuit; the question was — would it be forced into oscillation by the electrons?

It Works!

Randall and Boot constructed a prototype to test their ideas. The prototype still exists — it would nowadays be classed as a CW magnetron, because it generated microwave radiation continuously, rather than in pulses. To their delight, the frequency of oscillation was very high, well above 1GHz, and the power, even with continuous oscillation, was also very high. A breakthrough in the generation of microwaves had been made just at a time when such a development was sorely needed.

Pulsing the cathode voltage of the magnetron produced even more dramatic effects — the generation of very large peak powers (up to 100kW even in these days) which greatly extended the range of the early radar transmitters.

This, combined with the use of high frequencies (which allowed the radar to distinguish between smaller targets, and to see more details of large ones) formed the basis of our radar early in the War, and allowed us to concentrate our pitifully small airforce, reduced to a shell by well-meaning pacifist politicians, on facing the enemy, rather than trying to patrol the whole of our shores.

John Randall, like so many distinguished academics, quietly resumed an academic career after the War, and a grateful Government presented him with a prize of £12,000 in 1949. To understand what that means, you have to realise that you could buy a semi-detached house in Essex for around £900 at that time. He had been elected as a Fellow of the Royal Society in 1946, and he held several professional appointments in physics before changing his interests to zoology. He was knighted in 1962, and is at present Professor of Zoology at Edinburgh University.



Multicore makes soldering easy fast & reliable

Ersin Multicore

Ersin Multicore, solder contains 5 cores of non-corrosive flux, instantly cleaning heavily oxidised surfaces. No extra flux is required. Comes in handy dispensers and tool box reels in two different alloys 40/60 tin/lead for general purpose electrical soldering and 60/40 tin/lead ideal for small components and fine wire soldering.

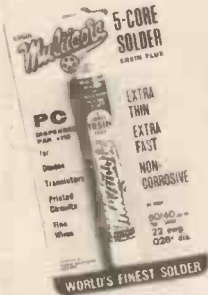

Size PC115 60/40 tin/lead
£1.38 Handy pack 0.024mm dia



Size 3 40/60 tin/lead
£4.37 Per reel 1.6mm dia



Size 10 60/40 tin/lead
£4.37 Per reel 0.71mm dia



Size 19A 60/40 tin/lead
£1.15 Handy pack 1.22mm dia

Multicore Savbit

Multicore Savbit, solder increases the life of your soldering bit by 10 times, for better soldering efficiency and economy. Comes in two handy dispensers and tool box reels.



Size 5 Savbit
£1.15 Per pack 1.2mm dia



Size 12 Savbit
£4.37 Per reel 1.2mm dia



Size SV130 Savbit
£1.73 Per pack 0.144mm dia

Multicore Alu-Sol

Multicore Alu-Sol, solder contains 4 cores of flux, suitable for most metals especially aluminium. Comes in handy dispensers on tool box reels.

Size AL150 Alu-Sol
£2.07 Per pack 1.04mm dia



Size 4 Alu-Sol
£7.82 Per reel 1.6mm dia

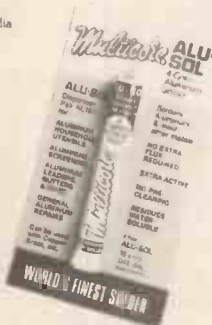

Multicore Solder Wick

Multicore Solder Wick, absorbs solder instantly from tags and printed circuits with the use of a 40 to 50 watt soldering iron. Quick and easy to use, desolders in seconds.

Size AB10 Solder Wick
£1.43 Per pack



Multicore Tip Kleen

Multicore Tip Kleen, soldering iron tip wiping pad. Replaces wet sponges.



Size 2 Tip Kleen
£0.92 Per pack

Bib Wire strippers and cutters

Wire strippers and cutters, with precision ground and hardened steel jaws. Adjustable to most wire sizes. With handle locking-catch and easy-grip plastic covered handles.



Size 9 Wire Strippers
£2.69 Per pair

All prices inclusive of VAT. Available from most electrical and DIYs stores. If you have difficulty in obtaining any of these products send direct with 50p for postage and packing. For free colour brochure send S.A.E.

Bib Audio/Video Products Limited
(Solder Division), Kelsey House,
Wood Lane End, Hemel Hempstead,
Hertfordshire, HP2 4RQ.
Telephone: (0442) 61291
Telex: 826437

You're never alone in the dark with a

Bat Light

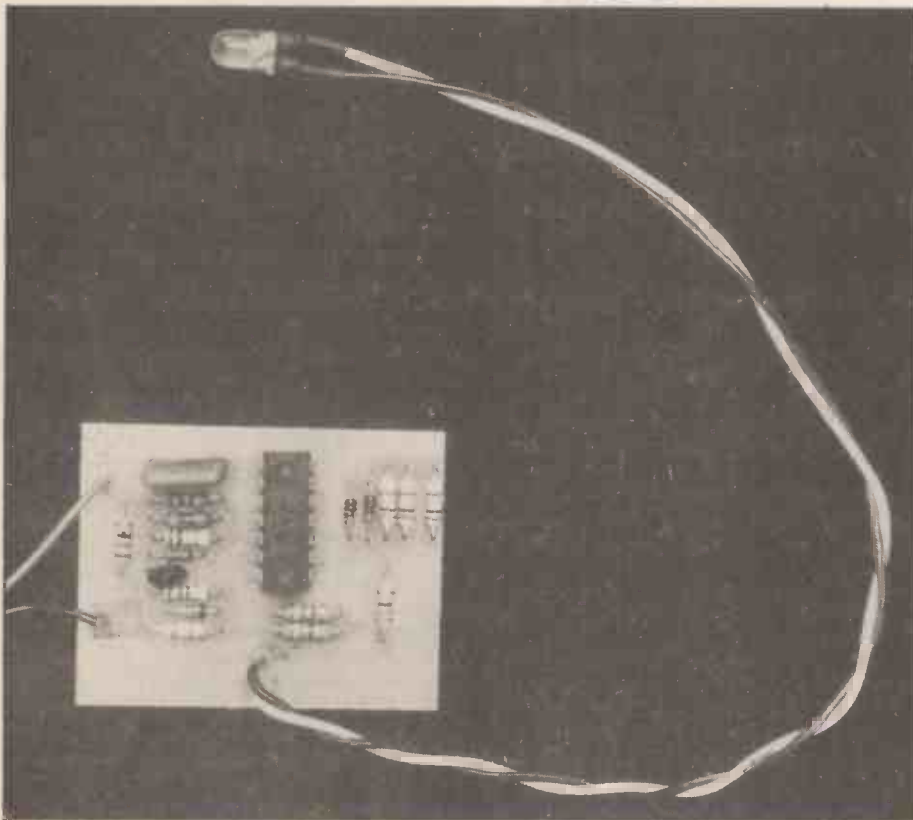

Andy Armstrong

THIS IS a simple but unusual gadget which can enable you to tell if your car battery is getting low, if the fan belt is slipping, or if you have worn brushes in the alternator or similar faults. It employs a LED indicator which can glow red, through varying shades of yellow, to green. The LED is green when the battery is at about 13V5, and red when it is at 11V5. Thus a healthy but off-charge battery at about 12V5 will light the indicator to a mid-yellow colour.

Fine, you may say, I know about the battery voltage, but how does that tell me if the alternator brushes are worn out or the fan belt is slipping? Deduction, that's how.

If you find that the LED will not turn green, no matter how fast the engine is running when the headlights are switched on, then insufficient electricity is being generated to run the headlights and charge the battery at the same time. If the colour remains constant, then the fanbelt is probably slipping but if it flickers, the brushes are likely to be wearing.

Ignore this warning at your peril! A friend of mine did for about two months of daytime driving, then one night on a country lane, the engine and lights just faded out!

Indicator Circuit

The circuit uses a quad op-amp, type LM324. An LM348 would work equally well, and is pin compatible. The circuit splits into two main functions; a triangle wave generator using three parts of the quad IC, and a comparator using the fourth part.

The triangle generator looks complicated but isn't. IC1a forms an integrator which can ramp up or down depending on whether the voltage on pin 8 of IC1c is low or high, respectively. IC1c and IC1d define the upper and lower limits of the triangle waveform, by means of a bistable action.

If pin 8 is high, then the non-inverting input, pin 12, of IC1d will be held high via D3, forcing the output at pin 14 high. Since pin 8 is at a voltage near the positive supply rail, the integrator output (IC1a pin 1) will be ramping down. This voltage reaches pin 10 of IC1c, but not pin 14 of IC1d since D4 is reverse biased. When it falls below the reference voltage (derived from the divider chain R4 and R5) on pin 9, the output on pin 8 goes low. This allows the voltage on pin 12 of IC1d to fall to the ramp output voltage (5V8), so the

output on pin 14 also goes low. This, in turn, has the effect of ensuring that the voltage on pin 8 remains low until the ramp output voltage exceeds the 6V8 reference voltage present on pin 13 of IC1d.

All this produces a triangle waveform with its limits at 5V8 and 6V8. This is fed to the inverting input of the IC16 comparator. The other input of the comparator is fed with a divided down version of the battery voltage, so that the output of the comparator switches rapidly, with a mark to space ratio determined by the battery voltage; R10 is included to ensure clean switching.

While the comparator output is high, the green part of the LED is on; when it is low the red part is on. The persistence of vision of the eye causes the colours to appear blended into various shades of yellow if the battery voltage is in a middle region. Resistors R11 and R12 are different values to equalise the red and green brightness levels. If the battery is either very good or very flat, of course, pure red or pure green will show.

The power supply is also of interest: car electrical systems sometimes have substantial voltage spikes on them. R13, D2, and C2 form a network which prevents these spikes from damaging the IC. D2 supplies an added bonus in that a reversed power supply will only heat up R13, rather than destroying the circuit; in this condition the LED will remain obstinately red, regardless of battery voltage.

One further comment on the functioning of the circuit: the more astute among you may have noticed that the function of parts c and d of the IC is that of a comparator with hysteresis, which can be carried out with a simple op-amp. True—but this circuit was designed for an economical quad op-amp and it has been used to provide a comparator whose switching levels do not depend on precisely how close to the supply rails the op-amp output can swing. For anyone handy enough to do their own layout, an alternative circuit using three op-amps is provided, without further comment (Figure 2).

Construction

In the main, construction is straightforward; having made the PCB, and made sure that there are no unetched areas causing short circuits, solder down the components, following the overlay and take care over the polarity of all the diodes and C2.

Several points need to be noted however. When the board is built and checked against the overlay, the bi-colour LED should be connected up. Do not at this stage worry which way round it goes. It is then ready for testing. If you have a variable voltage power supply and an accurate multimeter this is simplified—if not don't worry, it's just more time consuming. For those with power supply and multimeter proceed as follows: Connect the battery indicator to the power supply and, with the aid of the

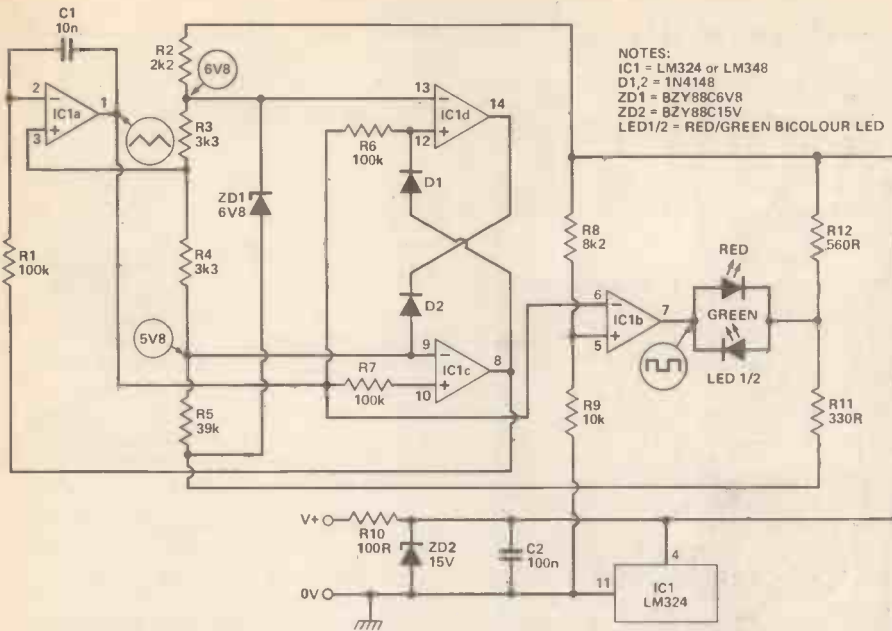

Figure 1a. The circuit. The colour of the LED varies with voltage.

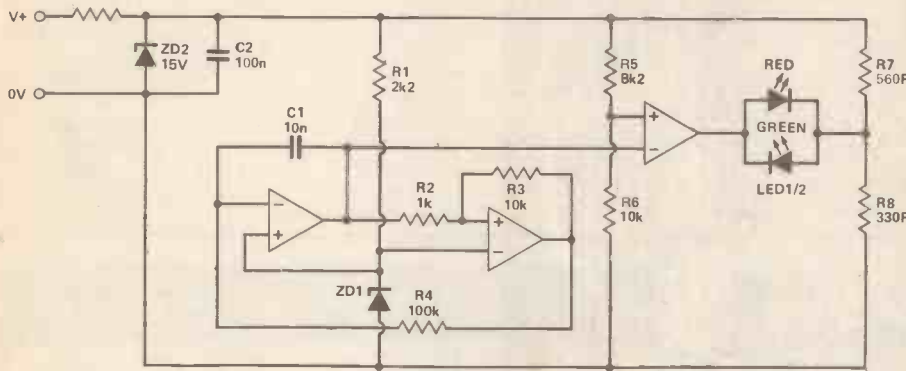

Figure 2. An alternative circuit using three op-amps.

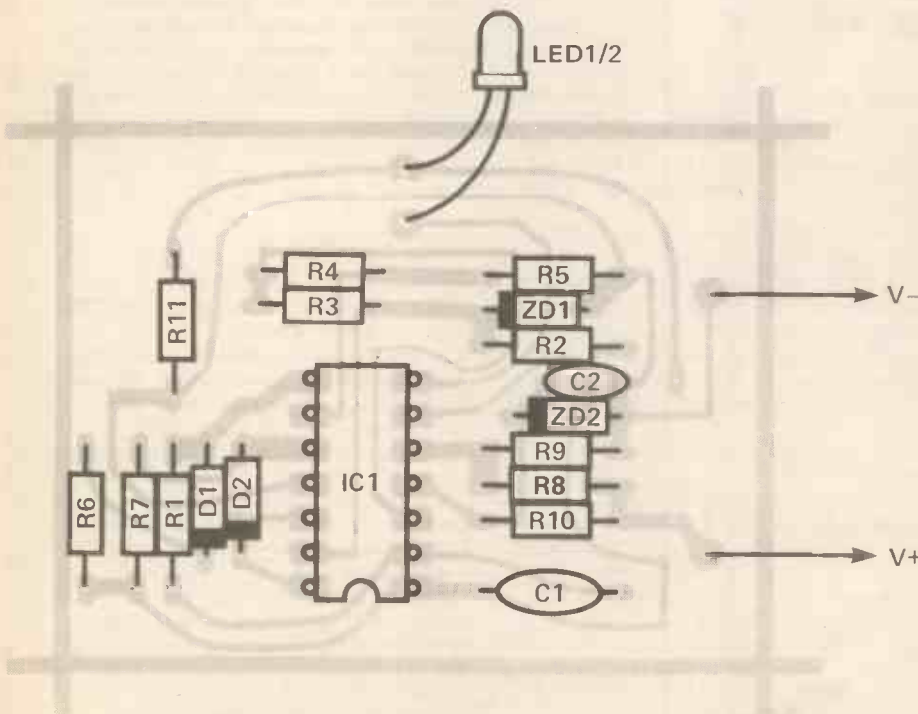

Figure 3. PCB component overlay.

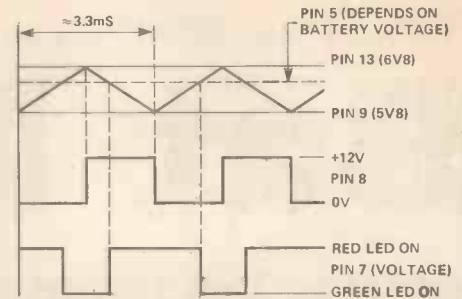

Figure 1b. Timing waveform. IC1a maintains the voltage on pin 1 at the level of pin 13. The current charging or discharging C1 cancels the current in R1. The total cycle time is 3.3mS.

meter, set the output to 12V5. The LED should glow with a shade of yellow; if only one colour shows, the power supply connections may be reversed. Assuming a yellow glow is obtained, increase the voltage to between 13V5 and 14V. Somewhere in this region a single-coloured glow should be obtained; if the voltage is outside this range, and the colour is red, then the LED connections should be reversed. Now reduce the voltage to 11V5, around which point a red glow should be seen. If the voltage is outside the range of 11V to 12V, or if the pure green glow was not obtained between 13V5 and 14V, then this can be altered: the cause is likely to be the inaccuracy of the Zener ZD1, or of R8 and R9. The cure is to add a resistor in parallel with R8 if the voltages at which pure colours were obtained were too high, or in parallel with R9 if these voltages were too low. In either case, a parallel resistance of 100k will cause a change of about 0V3 in the above voltages. Experiments based on this should soon indicate the resistor value needed. This resistor should be added in, above R8 or R9, as appropriate, simply soldered to its leads at the point where they are bent, as shown in the diagram, Figure 4.

For those lacking a bench power supply, a reasonable alternative method is to use the car itself as a means of calibration. The battery indicator should be connected to the supply, in a temporary manner, and the engine started. By choice of the appropriate add-on resistor (if needed) the indicator should be adjusted so that the LED just turns completely green when the engine is running moderately fast. Take care not to rev the engine too fast, as damage may result.

Installation

There are two methods for mounting this unit into the car. The first is to put the entire unit into a plastic box with a small hole drilled in it, with the LED mounted in the hole using the standard LED mounting bush which is normally supplied with the LED. The plastic box can then be mounted in any clearly visible position, probably under the dashboard, using double-sided adhesive pads. In order to make sure that these pads do not peel off after a few months,

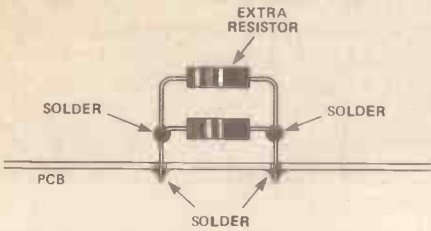

Figure 4. Mounting an extra resistor in parallel with R8 or R9. This may be necessary if the voltage is excessive or inadequate at this point.

it's necessary to thoroughly clean the surface to which they are to be stuck so that all grease and dust is thoroughly removed.

An alternative — and perhaps neater method—is to enclose the PCB in a plastic box, which need not be specially smart, and connect up the LED with a reasonable length of flexible wire. In this case it's necessary to take care to observe the LED polarity and to sleeve the connections so that they cannot short. A small hole may then be drilled in an appropriate place in the dashboard, to balance with any other indicator lights, and the LED may be mounted in the mounting bush. The PCB in its case may then be mounted on any convenient surface, the bulkhead for example, behind the dashboard, out of sight.

For either of these methods of installation, the board is best mounted

RESISTORS

(All 1/4 watt 5% carbon)

R1, 6, 7	100k
R2	2k2
R3, 4	3k3
R5	39k
R8	8k2
R9	10k
R10	100R
R11	330
R12	560R

CAPACITORS

C1	10n polyester
----	---------------

Parts List

C2	100n disc ceramic
----	-------------------

SEMICONDUCTORS

IC1	LM324 or LM348 quad op-amp
ZD1	BZY88C6V8
ZD2	BZY88C15V
D1, 2	1N4148 or equivalent
LED1/2	red/green bi-colour LED

MISCELLANEOUS

PCB, wire, solder etc; optional case.

BUYLINES page 34

into the plastic box with a double thickness of self adhesive pads, and the wiring from the PCB to the supply should be carefully insulated and clipped away from sharp edges where it may abrade. This is very important, because a short circuit of that nature in a car could be dangerous.

For the permanent installation, it is advisable to connect the power side of the unit to a source of power only energised when the ignition switch is on. If the unit is left connected and in operation while the car is stationary, the car battery may be significantly discharged over a period of two or three weeks. The ground side should simply be earthed under any convenient fixing screw in the area.

Variations

As it stands, this circuit is designed for a 12V electrical system. However, if ZD1 were changed to a 3V3, a limited degree of operation with a 6V electrical system would be possible, though the LED would be rather dim and, quite possibly, some experimentation would be needed with values of R11 and R12. For use on a 24V electrical system, ZD1 could be left at 6V8 and the value of R8 could be raised to between 15k and 20k, in order to provide suitable indication.

Should it be difficult to obtain the bi-coloured LED, two ordinary LEDs of different colours can be connected in parallel in opposite directions.

Send for my CATALOGUE ONLY 75p (plus 25p post/packing)

My all-inclusive prices quoted in the Catalogue are the lowest. All below normal trade price — some at only one tenth of manufacturers quantity trade.

See my prices on the following:

CAPACITORS . . . ELECTROLYTIC; CAN, WIRE END, TANTALUM, MULTIPLE, COMPUTER GRADE, NON POLAR, PAPER BLOCK, CAN, POLY, MICA, CERAMIC. LOW AND HIGH VOLTAGE, RESISTORS. 1/8th WATT to 100 WATT; 0.1% TO 10% CARBON, METAL AND WIRE WOUND + NETWORKS. FANS, BATTERIES, SOLENOIDS, TAPE SPOOLS, VARIABLE CAPACITORS AND RESISTORS, TRIMMERS, PRESETS, POTS . . . SINGLE, DUAL, SWITCHED, CARBON, CERMET AND WIREWOUND, SINGLE OR MULTITURN, ROTARY AND SLIDE. DIODES, RECTIFIERS, BRIDGES, CHARGERS, STYLII, SOCKETS, PLUGS, RELAYS, TRANSISTORS, IC'S, CLIPS, CRYSTALS, ZENERS, TRIACS, THYRISTORS, BOXES, PANELS, DISPLAYS, LED'S, COUPLERS, ISOLATORS, NEONS, OPTO'S, LEADS, CONNECTORS, VALVES, BOOKS, MAGAZINES, TERMINALS, CHOKES, TRANSFORMERS, TIMERS, SWITCHES, COUNTERS, LAMPS, INDICATORS, BELLS, SIRENS, HOLDERS, POWER SUPPLIES, HARDWARE, MODULES, FUSES, CARRIERS, CIRCUIT BREAKERS, KNOBS, THERMISTORS, VDR'S, INSULATORS, CASSETTES, METERS, SOLDER, HANDLES, LOCKS, INDUCTORS, WIRE, UNITS, MOTORS, COILS, CORES, CARTRIDGES, SPEAKERS, EARPHONES, SUPPRESSORS, MIKES, HEATSINKS, TAPE, BOARDS and others.

Prices you would not believe before inflation!

BRIAN J. REED TRADE COMPONENTS

ESTABLISHED 26 YEARS

161 St. Johns Hill, Battersea, London SW11 1TQ

Open 11 am till 7 pm Tues. to Sat. Telephone: 01-223 5016

Lightning ELECTRONIC COMPONENTS

THE CHOICE IS YOURS — CALL AT OUR NEW SHOWROOM OR USE OUR VERY FAST MAIL ORDER SERVICE.

EITHER WAY WE'LL KEEP YOU HAPPY *****

Furthermore we promise if any part ordered by mail fails to please just return within 7 days for a full refund.

For a vast selection of electronic components & equipment of all kinds. Here is just a selection of our stocks. Many more items listed in our catalogue available now 70p post paid.

RESISTORS

1W 5% C.F.	1R to 10M	2p each	100 for £1 00
1W 5% C.F.	10R to 1M	2p each	
1W 5% C.F.	10R to 820k	5p each	
1W 1% M.F.	10R to 680k	5p each	100 for £3 00

100 off prices one value only no mixing

CAPACITORS

Met Plate	100pF to 470pF	5p	Disc	01uF 50V	10p (100 for £5)
Ceramics	56pF to 220pF	5p	Ceramics	1uF 50V	10p (100 for £5)
	220pF to 1000pF	7p			
	1200pF to 4700pF	8p		Variable 0 to 500pF	95p

100 off any one type less 30%

Electrolytics — polys — Tanis — Full range in catalogue

V. REGULATORS (FIXED)

Ve 100mA	78L05	78L12	78L15	31p	LM317K	1.5 Amp	£3.35
Ve 100mA	78L05	78L12	78L15	53p	LM338K	5 Amp	£4.70
Ve 1 Amp	7805	7812	7815	60p	LM336K	10 Amp	£11.00
Ve 1 Amp	7905	7912	7915	60p	L723	1A OIL	£9.45
				65p	L723	T099	£9.00

FOTO COATED RESIST BOARD

High quality fibre glass laminate pre-coated with positive photo resist. For small batch production of PCB's from single sided 12" x 18" (18.30)

1.5mm Single sided	1.53	1.6mm Double sided	1.30
100 x 150mm Euro	1.83	203 x 114mm	2.10
203 x 114mm	1.83	203 x 228mm	4.10
203 x 228mm	3.50		
457 x 305mm	9.10		

Fotodensitometer concentrate £2.42
Chemical Dishes 12" x 10" £1.50
Acetate Sheet £0.20
457 x 305mm £2.00

Transfer Pack 5 assist. sheets £2.00

PANEL METERS

Until now panel meters have proved an expensive part of your project. Now available this new quick fit type. 32mm Square Meter



The following Do ranges —
50uA — 100uA — 500uA — 1mA
5mA — 10mA — 50mA — 100mA
500mA — 1A — 5A — 25V — 50V
ONLY £1.95 each

Postage & Packing 50p per order (free over £10) Please add VAT at 15%. Telephone orders welcome by Access or Barclaycard

POTENTIOMETERS

Preset 1W Horiz	5p
1W Vert	11p
Std single Pot	25p
Single & Switch	60p
Dual Gang	75p

TRANSISTORS

R2010B	2.60
TIP29A	0.39
TIP29C	0.45
TIP30A	0.39
TIP30C	0.45
TIP31A	0.39
TIP31C	0.45
TIP32A	0.39
TIP32C	0.45
TIP33C	0.85
TIP34C	0.85
TIP35C	1.95
TIP36C	1.90
TIP41A	0.45
TIP41C	0.45
TIP42A	0.45
TIP42C	0.48
TIP110	0.82
TIP115	0.82
TIP121	0.99
TIP126	0.99
TIP141	1.20
TIP142	1.20
TIP146	1.25
TIP147	1.25
TIP295B	0.89
TIP305B	0.57
TIP343	0.30
TIP590	0.28
2N1309	0.28
2N3053	0.28
2N3054	0.48
2N3055	0.48
2N3904	0.14
2N3904A	0.14
2N3773	2.25
40673	0.92
40871	1.05
40872	1.05

Lightning ELECTRONIC COMPONENTS Showroom & Mail Order Distribution Centre at: — 18 Victoria Road, TAMWORTH, Staffs B79 7HR Telephone 0827-65767.

CRICKLEWOOD ELECTRONICS LTD.

40 Cricklewood Broadway, London NW2 3ET. Tel. 01 452 0161. Tlx. 914977.

Here's a selection from our vast stocks. Well priced list free on request. Orders by phone quoting credit card no. or by mail order. Callers welcome. All products first grade franchised source. All in stock items despatched same day. Official orders welcome from Govt Dept. schools, etc. Please add 60p p.p. + 15% VAT. Overseas orders no VAT but allow £2.00 min. p.p. Quantity discounts negotiable.

TRY US NOW - WE'VE GOT WHAT YOU NEED.

RESISTORS	2.2 10 11p 2.2 30 30p 3.3 25 10p 3.3 30 12p 3.3 63 12p 4.7 16 8p 4.7 25 9p 4.7 30 12p 4.7 47 14p 4.7 63 12p 4.7 100 14p 10 15 12p 10 25 12p 10 30 12p 10 47 14p 10 63 14p 10 100 16p	Single sized 100 160 156 100 220 156 203 114 1.85 233 220 3.99 2N2907 26p 2N2924 1.65 100 220 2.15 203 114 2.21 233 220 4.56 Doubled sized 2N2924 1.65 2N2924 2.15 2N2924 4.56 2N2924 1.65 2N2924 2.15 2N2924 4.56 2N2924 1.65 2N2924 2.15 2N2924 4.56 2N2924 1.65 2N2924 2.15 2N2924 4.56	2N2905 28p 2N2906 29p 2N2907 30p 2N2908 31p 2N2909 32p 2N2910 33p 2N2911 34p 2N2912 35p 2N2913 36p 2N2914 37p 2N2915 38p 2N2916 39p 2N2917 40p 2N2918 41p 2N2919 42p 2N2920 43p 2N2921 44p 2N2922 45p 2N2923 46p 2N2924 47p 2N2925 48p 2N2926 49p 2N2927 50p 2N2928 51p 2N2929 52p 2N2930 53p 2N2931 54p 2N2932 55p 2N2933 56p 2N2934 57p 2N2935 58p 2N2936 59p 2N2937 60p 2N2938 61p 2N2939 62p 2N2940 63p 2N2941 64p 2N2942 65p 2N2943 66p 2N2944 67p 2N2945 68p 2N2946 69p 2N2947 70p 2N2948 71p 2N2949 72p 2N2950 73p 2N2951 74p 2N2952 75p 2N2953 76p 2N2954 77p 2N2955 78p 2N2956 79p 2N2957 80p 2N2958 81p 2N2959 82p 2N2960 83p 2N2961 84p 2N2962 85p 2N2963 86p 2N2964 87p 2N2965 88p 2N2966 89p 2N2967 90p 2N2968 91p 2N2969 92p 2N2970 93p 2N2971 94p 2N2972 95p 2N2973 96p 2N2974 97p 2N2975 98p 2N2976 99p 2N2977 100p 2N2978 101p 2N2979 102p 2N2980 103p 2N2981 104p 2N2982 105p 2N2983 106p 2N2984 107p 2N2985 108p 2N2986 109p 2N2987 110p 2N2988 111p 2N2989 112p 2N2990 113p 2N2991 114p 2N2992 115p 2N2993 116p 2N2994 117p 2N2995 118p 2N2996 119p 2N2997 120p 2N2998 121p 2N2999 122p 2N3000 123p 2N3001 124p 2N3002 125p 2N3003 126p 2N3004 127p 2N3005 128p 2N3006 129p 2N3007 130p 2N3008 131p 2N3009 132p 2N3010 133p 2N3011 134p 2N3012 135p 2N3013 136p 2N3014 137p 2N3015 138p 2N3016 139p 2N3017 140p 2N3018 141p 2N3019 142p 2N3020 143p 2N3021 144p 2N3022 145p 2N3023 146p 2N3024 147p 2N3025 148p 2N3026 149p 2N3027 150p 2N3028 151p 2N3029 152p 2N3030 153p 2N3031 154p 2N3032 155p 2N3033 156p 2N3034 157p 2N3035 158p 2N3036 159p 2N3037 160p 2N3038 161p 2N3039 162p 2N3040 163p 2N3041 164p 2N3042 165p 2N3043 166p 2N3044 167p 2N3045 168p 2N3046 169p 2N3047 170p 2N3048 171p 2N3049 172p 2N3050 173p 2N3051 174p 2N3052 175p 2N3053 176p 2N3054 177p 2N3055 178p 2N3056 179p 2N3057 180p 2N3058 181p 2N3059 182p 2N3060 183p 2N3061 184p 2N3062 185p 2N3063 186p 2N3064 187p 2N3065 188p 2N3066 189p 2N3067 190p 2N3068 191p 2N3069 192p 2N3070 193p 2N3071 194p 2N3072 195p 2N3073 196p 2N3074 197p 2N3075 198p 2N3076 199p 2N3077 200p 2N3078 201p 2N3079 202p 2N3080 203p 2N3081 204p 2N3082 205p 2N3083 206p 2N3084 207p 2N3085 208p 2N3086 209p 2N3087 210p 2N3088 211p 2N3089 212p 2N3090 213p 2N3091 214p 2N3092 215p 2N3093 216p 2N3094 217p 2N3095 218p 2N3096 219p 2N3097 220p 2N3098 221p 2N3099 222p 2N3100 223p 2N3101 224p 2N3102 225p 2N3103 226p 2N3104 227p 2N3105 228p 2N3106 229p 2N3107 230p 2N3108 231p 2N3109 232p 2N3110 233p 2N3111 234p 2N3112 235p 2N3113 236p 2N3114 237p 2N3115 238p 2N3116 239p 2N3117 240p 2N3118 241p 2N3119 242p 2N3120 243p 2N3121 244p 2N3122 245p 2N3123 246p 2N3124 247p 2N3125 248p 2N3126 249p 2N3127 250p 2N3128 251p 2N3129 252p 2N3130 253p 2N3131 254p 2N3132 255p 2N3133 256p 2N3134 257p 2N3135 258p 2N3136 259p 2N3137 260p 2N3138 261p 2N3139 262p 2N3140 263p 2N3141 264p 2N3142 265p 2N3143 266p 2N3144 267p 2N3145 268p 2N3146 269p 2N3147 270p 2N3148 271p 2N3149 272p 2N3150 273p 2N3151 274p 2N3152 275p 2N3153 276p 2N3154 277p 2N3155 278p 2N3156 279p 2N3157 280p 2N3158 281p 2N3159 282p 2N3160 283p 2N3161 284p 2N3162 285p 2N3163 286p 2N3164 287p 2N3165 288p 2N3166 289p 2N3167 290p 2N3168 291p 2N3169 292p 2N3170 293p 2N3171 294p 2N3172 295p 2N3173 296p 2N3174 297p 2N3175 298p 2N3176 299p 2N3177 300p 2N3178 301p 2N3179 302p 2N3180 303p 2N3181 304p 2N3182 305p 2N3183 306p 2N3184 307p 2N3185 308p 2N3186 309p 2N3187 310p 2N3188 311p 2N3189 312p 2N3190 313p 2N3191 314p 2N3192 315p 2N3193 316p 2N3194 317p 2N3195 318p 2N3196 319p 2N3197 320p 2N3198 321p 2N3199 322p 2N3200 323p 2N3201 324p 2N3202 325p 2N3203 326p 2N3204 327p 2N3205 328p 2N3206 329p 2N3207 330p 2N3208 331p 2N3209 332p 2N3210 333p 2N3211 334p 2N3212 335p 2N3213 336p 2N3214 337p 2N3215 338p 2N3216 339p 2N3217 340p 2N3218 341p 2N3219 342p 2N3220 343p 2N3221 344p 2N3222 345p 2N3223 346p 2N3224 347p 2N3225 348p 2N3226 349p 2N3227 350p 2N3228 351p 2N3229 352p 2N3230 353p 2N3231 354p 2N3232 355p 2N3233 356p 2N3234 357p 2N3235 358p 2N3236 359p 2N3237 360p 2N3238 361p 2N3239 362p 2N3240 363p 2N3241 364p 2N3242 365p 2N3243 366p 2N3244 367p 2N3245 368p 2N3246 369p 2N3247 370p 2N3248 371p 2N3249 372p 2N3250 373p 2N3251 374p 2N3252 375p 2N3253 376p 2N3254 377p 2N3255 378p 2N3256 379p 2N3257 380p 2N3258 381p 2N3259 382p 2N3260 383p 2N3261 384p 2N3262 385p 2N3263 386p 2N3264 387p 2N3265 388p 2N3266 389p 2N3267 390p 2N3268 391p 2N3269 392p 2N3270 393p 2N3271 394p 2N3272 395p 2N3273 396p 2N3274 397p 2N3275 398p 2N3276 399p 2N3277 400p 2N3278 401p 2N3279 402p 2N3280 403p 2N3281 404p 2N3282 405p 2N3283 406p 2N3284 407p 2N3285 408p 2N3286 409p 2N3287 410p 2N3288 411p 2N3289 412p 2N3290 413p 2N3291 414p 2N3292 415p 2N3293 416p 2N3294 417p 2N3295 418p 2N3296 419p 2N3297 420p 2N3298 421p 2N3299 422p 2N3300 423p 2N3301 424p 2N3302 425p 2N3303 426p 2N3304 427p 2N3305 428p 2N3306 429p 2N3307 430p 2N3308 431p 2N3309 432p 2N3310 433p 2N3311 434p 2N3312 435p 2N3313 436p 2N3314 437p 2N3315 438p 2N3316 439p 2N3317 440p 2N3318 441p 2N3319 442p 2N3320 443p 2N3321 444p 2N3322 445p 2N3323 446p 2N3324 447p 2N3325 448p 2N3326 449p 2N3327 450p 2N3328 451p 2N3329 452p 2N3330 453p 2N3331 454p 2N3332 455p 2N3333 456p 2N3334 457p 2N3335 458p 2N3336 459p 2N3337 460p 2N3338 461p 2N3339 462p 2N3340 463p 2N3341 464p 2N3342 465p 2N3343 466p 2N3344 467p 2N3345 468p 2N3346 469p 2N3347 470p 2N3348 471p 2N3349 472p 2N3350 473p 2N3351 474p 2N3352 475p 2N3353 476p 2N3354 477p 2N3355 478p 2N3356 479p 2N3357 480p 2N3358 481p 2N3359 482p 2N3360 483p 2N3361 484p 2N3362 485p 2N3363 486p 2N3364 487p 2N3365 488p 2N3366 489p 2N3367 490p 2N3368 491p 2N3369 492p 2N3370 493p 2N3371 494p 2N3372 495p 2N3373 496p 2N3374 497p 2N3375 498p 2N3376 499p 2N3377 500p 2N3378 501p 2N3379 502p 2N3380 503p 2N3381 504p 2N3382 505p 2N3383 506p 2N3384 507p 2N3385 508p 2N3386 509p 2N3387 510p 2N3388 511p 2N3389 512p 2N3390 513p 2N3391 514p 2N3392 515p 2N3393 516p 2N3394 517p 2N3395 518p 2N3396 519p 2N3397 520p 2N3398 521p 2N3399 522p 2N3400 523p 2N3401 524p 2N3402 525p 2N3403 526p 2N3404 527p 2N3405 528p 2N3406 529p 2N3407 530p 2N3408 531p 2N3409 532p 2N3410 533p 2N3411 534p 2N3412 535p 2N3413 536p 2N3414 537p 2N3415 538p 2N3416 539p 2N3417 540p 2N3418 541p 2N3419 542p 2N3420 543p 2N3421 544p 2N3422 545p 2N3423 546p 2N3424 547p 2N3425 548p 2N3426 549p 2N3427 550p 2N3428 551p 2N3429 552p 2N3430 553p 2N3431 554p 2N3432 555p 2N3433 556p 2N3434 557p 2N3435 558p 2N3436 559p 2N3437 560p 2N3438 561p 2N3439 562p 2N3440 563p 2N3441 564p 2N3442 565p 2N3443 566p 2N3444 567p 2N3445 568p 2N3446 569p 2N3447 570p 2N3448 571p 2N3449 572p 2N3450 573p 2N3451 574p 2N3452 575p 2N3453 576p 2N3454 577p 2N3455 578p 2N3456 579p 2N3457 580p 2N3458 581p 2N3459 582p 2N3460 583p 2N3461 584p 2N3462 585p 2N3463 586p 2N3464 587p 2N3465 588p 2N3466 589p 2N3467 590p 2N3468 591p 2N3469 592p 2N3470 593p 2N3471 594p 2N3472 595p 2N3473 596p 2N3474 597p 2N3475 598p 2N3476 599p 2N3477 600p 2N3478 601p 2N3479 602p 2N3480 603p 2N3481 604p 2N3482 605p 2N3483 606p 2N3484 607p 2N3485 608p 2N3486 609p 2N3487 610p 2N3488 611p 2N3489 612p 2N3490 613p 2N3491 614p 2N3492 615p 2N3493 616p 2N3494 617p 2N3495 618p 2N3496 619p 2N3497 620p 2N3498 621p 2N3499 622p 2N3500 623p 2N3501 624p 2N3502 625p 2N3503 626p 2N3504 627p 2N3505 628p 2N3506 629p 2N3507 630p 2N3508 631p 2N3509 632p 2N3510 633p 2N3511 634p 2N3512 635p 2N3513 636p 2N3514 637p 2N3515 638p 2N3516 639p 2N3517 640p 2N3518 641p 2N3519 642p 2N3520 643p 2N3521 644p 2N3522 645p 2N3523 646p 2N3524 647p 2N3525 648p 2N3526 649p 2N3527 650p 2N3528 651p 2N3529 652p 2N3530 653p 2N3531 654p 2N3532 655p 2N3533 656p 2N3534 657p 2N3535 658p 2N3536 659p 2N3537 660p 2N3538 661p 2N3539 662p 2N3540 663p 2N3541 664p 2N3542 665p 2N3543 666p 2N3544 667p 2N3545 668p 2N3546 669p 2N3547 670p 2N3548 671p 2N3549 672p 2N3550 673p 2N3551 674p 2N3552 675p 2N3553 676p 2N3554 677p 2N3555 678p 2N3556 679p 2N3557 680p 2N3558 681p 2N3559 682p 2N3560 683p 2N3561 684p 2N3562 685p 2N3563 686p 2N3564 687p 2N3565 688p 2N3566 689p 2N3567 690p 2N3568 691p 2N3569 692p 2N3570 693p 2N3571 694p 2N3572 695p 2N3573 696p 2N3574 697p 2N3575 698p 2N3576 699p 2N3577 700p 2N3578 701p 2N3579 702p 2N3580 703p 2N3581 704p 2N3582 705p 2N3583 706p 2N3584 707p 2N3585 708p 2N3586 709p 2N3587 710p 2N3588 711p 2N3589 712p 2N3590 713p 2N3591 714p 2N3592 715p 2N3593 716p 2N3594 717p 2N3595 718p 2N3596 719p 2N3597 720p 2N3598 721p 2N3599 722p 2N3600 723p 2N3601 724p 2N3602 725p 2N3603 726p 2N3604 727p 2N3605 728p 2N3606 729p 2N3607 730p 2N3608 731p 2N3609 732p 2N3610 733p 2N3611 734p 2N3612 735p 2N3613 736p 2N3614 737p 2N3615 738p 2N3616 739p 2N3617 740p 2N3618 741p 2N3619 742p 2N3620 743p 2N3621 744p 2N3622 745p 2N3623 746p 2N3624 747p 2N3625 748p 2N3626 749p 2N3627 750p 2N3628 751p 2N3629 752p 2N3630 753p 2N3631 754p 2N3632 755p 2N3633 756p 2N3634 757p 2N3635 758p 2N3636 759p 2N3637 760p 2N3638 761p 2N3639 762p 2N3640 763p 2N3641 764p 2N3642 765p 2N3643 766p 2N3644 767p 2N3645 768p 2N3646 769p 2N3647 770p 2N3648 771p 2N3649 772p 2N3650 773p 2N3651 774p 2N3652 775p 2N3653 776p 2N3654 777p 2N3655 778p 2N3656 779p 2N3657 780p 2N3658 781p 2N3659 782p 2N3660 783p 2N3661 784p 2N3662 785p 2N3663 786p 2N3664 787p 2N3665 788p 2N3666 789p 2N3667 790p 2N3668 791p 2N3669 792p 2N3670 793p 2N3671 794p 2N3672 795p 2N3673 796p 2N3674 797p 2N3675 798p 2N3676 799p 2N3677 800p 2N3678 801p 2N3679 802p 2N3680 803p 2N3681 804p 2N3682 805p 2N3683 806p 2N3684 807p 2N3685 808p 2N3686 809p 2N3687 810p 2N3688 811p 2N3689 812p 2N3690 813p 2N3691 814p 2N3692 815p 2N3693 816p 2N3694 817p 2N3695 818p 2N3696 819p 2N3697 820p 2N3698 821p 2N3699 822p 2N3700 823p 2N3701 824p 2N3702 825p 2N3703 826p 2N3704 827p 2N3705 828p 2N3706 829p 2N3707 830p 2N3708 831p 2N3709 832p 2N3710 833p 2N3711 834p 2N3712 835p 2N3713 836p 2N3714 837p 2N3715 838p 2N3716 839p 2N3717 840p 2N3718 841p 2N3719 842p 2N3720 843p 2N3721 844p 2N3722 845p 2N3723 846p 2N3724 847p 2N3725 848p 2N3726 849p 2N3727 850p 2N3728 851p 2N3729 852p 2N3730 853p 2N3731 854p 2N3732 855p 2N3733 856p 2N3734 857p 2N3735 858p 2N3736 859p 2N3737 860p 2N3738 861p 2N3739 862p 2N3740 863p 2N3741 864p 2N3742 865p 2N3743 866p 2N3744 867p 2N3745 868p 2N3746 869p 2N3747 870p 2N3748 871p 2N3749 872p 2N3750 873p 2N3751 874p 2N3752 875p 2N3753 876p 2N3754 877p 2N3755 878p 2N3756 879p 2N3757 880p 2N3758 881p 2N3759 882p 2N3760 883p 2N3761 884p 2N3762 885p 2N3763 886p 2N3764 887p 2N3765 888p 2N3766 889p 2N3767 890p 2N3768 891p 2N3769 892p 2N3770 893p 2N3771 894p 2N3772 895p 2N3773 896p 2N3774 897p 2N3775 898p 2N3776 899p 2N3777 900p 2N3778 901p 2N3779 902p 2N3780 903p 2N3781 904p 2N3782 905p 2N3783 906p 2N3784 907p 2N3785 908p 2N3786 909p 2N3787 910p 2N3788 911p 2N3789 912p 2N3790 913p 2N3791 914p 2N3792 915p 2N3793 916p 2N3794 917p 2N3795 918p 2N3796 919p 2N379
------------------	--	--	---

BUYLINES

ZX Sound Board

This project uses the AY-3-8912 Programmable Sound Generator IC, the slightly more expensive of the two General Instrument PSGs. Why the 8192, which provides a single I/O port and is a 28-pin package, should be more expensive than the 8910 (which has two I/O ports and is a much larger 40-pin chip) is something of a mystery. However, the 28-pin IC is easier to use and allows the PCB to be smaller, too.

There are a few points to note with regard to the components: the potentiometer RV1 should be a miniature Cermet preset on the 5mm (0.1") format. Similarly, the switch SW1 is a dome top, momentary contact 5mm PCB mounting type, and should be used to complete a neat job. All the electrolytics are miniature radial types.

The 23+23-way edge connectors can be difficult to find, however **Rapid Electronics** of Colchester will be stocking all the parts for the ZX Sound Board, including the edge connectors. A case is really not necessary for this project and the total cost, excluding only the PCB (see page 72) should be around £15.

CB Rap Latch

Finding a single, convenient source for the components of this project was not an easy task — but after much diligent searching, it was found that **Ambit International** stock either the required bits and pieces or suitable substitutes!

The 12V OUB type relay is listed by their stock code number 46-70030, and the four-way locking audio connectors are available as stock numbers 10-10004 (for the mic connector) and 10-11004 (for the socket).

The very common BC109 and BC 179 transistors are also supplied in plastic rather than metal cases, in

which case they are known as BC239 and BC309 respectively, so don't get worried if you are offered these devices as alternatives! There may be some difficulty, also, in obtaining a 33u tantalum capacitor (C6); if this is the case, simply use the next largest value (which should be 47u) and replace the 1MR timing resistor (R9) with the value 680k. This will produce approximately the same timing period (35 seconds, in fact) which can be confirmed by substituting the new values into the formula given in the text. All the polyester capacitors are C280 types.

The cost of this project, excluding the case and PCB, should be around £6.00. **Ambit** will supply a suitable case for about £2.36 if you quote their stock number 21-06103, and the printed circuit board is available through our own PCB Service (see page 72).

Traffic Light Toy

A simple project, this, with a simple list of parts, all of which are available from **Greenweld Electronics**. Fittingly, the cost is quite low, too; around £2.50 excluding the case and PCB. The most suitable case from **Greenweld** is their type V213, which measures 100x75x40mm and costs 84p — dearer than a tobacco tin, but neater with it.

We have put the Traffic Light Toy on a PCB because this method of construction results in a more reliable job, and provides less margin for error! The cost could be reduced to rock bottom by constructing on stripboard — however we would not then be able to offer advice or assistance should there be any problems.

Pop Amps

All of the components and parts used for these simple circuits are readily available from suppliers advertising in

HE. Dedicated experimentors will already have most of the bits and pieces in their 'junk box', but newcomers trying out these circuits for the first time should try to build up a collection of components and parts; the best buys are available from bargain-pack dealers such as **BI-PAK**, who provide low-cost selections of resistors, capacitors and so on to the electronics world at large. Their address is **BI-PAK**, PO Box 6, Ware, Herts., or phone 0920 3182.

Car Battery Indicator

None of the components for this ingenious circuit are particularly hard to find. You have a choice of ICs, but the LM324 is the cheaper of the two. Red/Green bi-colour LEDs go by several different code numbers but are generally easily obtainable; however, we know that both **TK Electronics** and **Bi-Pack** stock all the necessary, so they are the most convenient suppliers.

The PCB measures only 52 x 40mm, so only a small case is needed if you choose a concealed installation. Be sure to keep plastic cases away from heat sources, though!

Component cost, excluding case and PCB, should be around £2.00.

Update

The most difficult component to source for our **BBC Micro/HEBOT Interface** project proved to be the connector mating with the BBC's Auxiliary Power Output socket. BBC owners might like to know that **Kelan (Hobbyboard) Ltd** has a large stock of the correct plugs and will happily supply them separate from the BBC/HEBOT interface kit.

The toroid for the **Aerial Without Wings** project is being supplied by **Neosid Small Orders 1982** and is their type number 28-041-28. For reliable long wave reception, the number of turns should be increased to between 20-25. If, in any event, reception appears weak when using the Aerial, winding the additional number of turns should provide a sure cure.

BEASTIES

BY RH

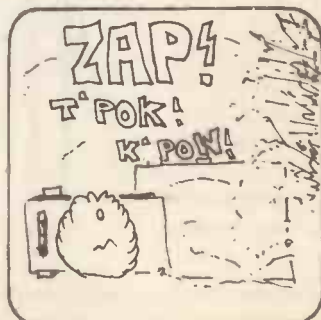
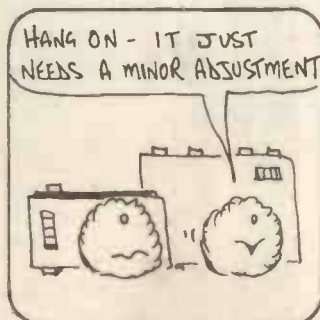

**ENCLOSURES
INDICATORS
BREADBOARDS
ANCILLARY TOOLS**

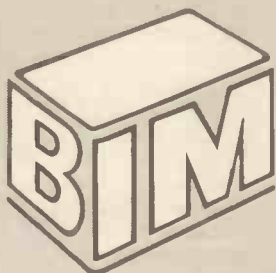
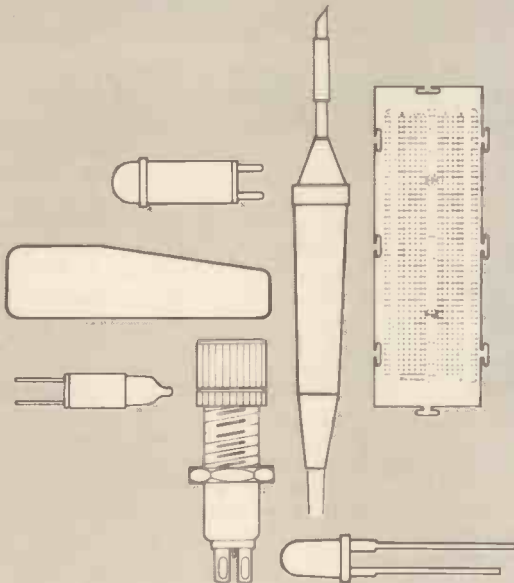

**WRITE OR PHONE FOR OUR
LATEST CATALOGUE**

BOSS INDUSTRIAL MOULDINGS LIMITED
James Carter Road, Mildenhall, Suffolk IP28 7DE
Telephone: Mildenhall (0638) 716101
Telex: 818758 Answer Back 'LITZEN G'

**MAKE YOUR
OWN P.C.B's.**

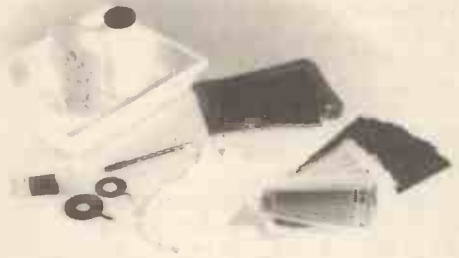

DIRECT ETCH KIT

COPY DIRECT FROM MAGAZINE or OWN DESIGN
Simple system - Complete kit containing PCB, Pattern Transfer & Etch Resist Sheets, Tray & Etchant, Copper Cleaning Block, Gloves & full instructions. **£15.60**
Produces 10 PCBs.

Price inclusive of VAT & carriage. Please allow 21 days for delivery. Cheques, PO's or signed Access orders welcomed.



a division of
KELAN ENGINEERING Ltd
Hookstone Park
Harrogate, N. Yorks

complete P.C.B. workshop

HB/PC1

LITZEN G



**MINIATURE TOOL SETS
AT MINIATURE PRICES**

Ideal for work on optical and electronic equipment, instruments and models. Japanese made, top quality metric tools in hardened and tempered steel, with fitted plastic cases. Swivel-top, chromium-plated brass handles. Not to be confused with similar cheap non-Japanese sets.

SCREWDRIVER SET 113. 6 plain screwdrivers, blades 0.9, 1.2, 1.8, 2.3, 3.0 and 3.5mm. Price **£2.70**.

SOCKET SET 227. 5 socket spanners, 3.0, 3.5, 4.0, 4.5 and 5.0mm. Price **£2.80**.

CROSSPOINT/HEXAGON SET 305. 2 Japanese crosspoint screwdrivers, sizes 0 and 1. 3 Hex. key wrenches 1.5, 2.0 and 2.5mm. Price **£2.70**.

COMBINATION SET 228. 5 open spanners 4.0, 4.5, 5.0, 5.5 and 6.0mm. 5 socket spanners 3.0, 3.5, 4.0, 4.5 and 5.0mm. 2 crosspoint screwdrivers bit sizes 0 and 1. 3 screwdriver bits 1.5, 2.5 and 3.5mm. 3 Hex. keys 1.5, 2.0 and 2.5mm. 1 scriber. 1 swivel-top driver/holder. Price **£4.83**. All prices include postage and 15% VAT.

Ring for Access/Barclaycard
Sales or send remittance to:



Light Soldering Developments Limited, 97-99 Gloucester Road, Croydon, Surrey CR0 2DN. Tel: 01-689 0574.

POP AMPS

Owen Bishop

Simple measuring circuits based on operational amplifiers

No. 8: TTL logic probe

THIS CIRCUIT is for testing logic levels in TTL (transistor-transistor logic) circuits. When we discuss these we so often think in binary terms of '1's and '0's, or 'high's and 'low's, or +5V and 0V levels, that we sometimes lose sight of the fact that TTL input and output levels need not be exclusively 0V or +5V. Voltages in between these levels are perfectly acceptable, for these circuits are designed to tolerate manufacturing variability. Nevertheless, there must be standards of some sort, with guaranteed output levels and acceptable input levels.

The INPUT voltage levels specified by the manufacturers for all members of the 7400 TTL family, including the 74LS00 series are:

- Logical '1' — minimum is +2V
- Logical '0' — maximum is +0V8

Thus any voltage between 0V and +0V8 is recognised as 'logical 0' or 'low', while any voltage between +2V and +5V is recognised as 'logical 1' or 'high'.

The OUTPUT levels are specified so as to give a margin of error (0V4 to 0V5) which puts them securely within the input ranges:

- Logical '1' — minimum is +2V4 (+2V5 for LS)
- Logical '0' — maximum is +0V3 (+0V4 for LS)

When we are testing a circuit, it is the input levels which matter most, for the question is: "What effect is this level having on the logic gates to which it is being fed? Which will they take it to be, a '0' or a '1'?"

The probe tells you instantly how the test output will look to a TTL input. It has a multicoloured LED which glows green for 'low' level, and red for 'high' levels. At intermediate levels, which could mean anything (or nothing) to a TTL input, the LED is out. Should the test output be changing rapidly between 'high' and 'low', the LED glows yellow.

How It Works

The probe is based on two op-amps, both acting as comparators. This

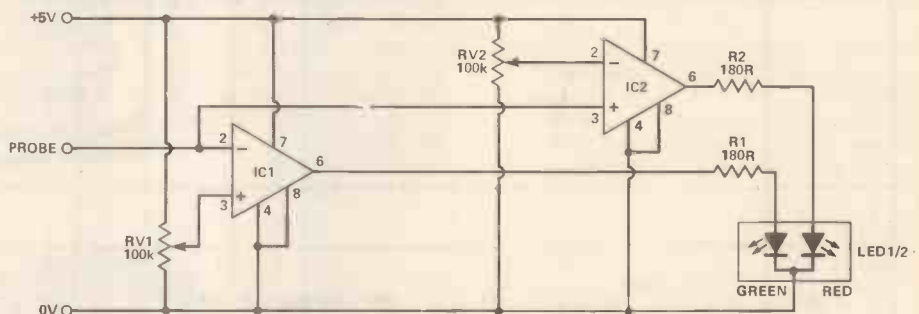
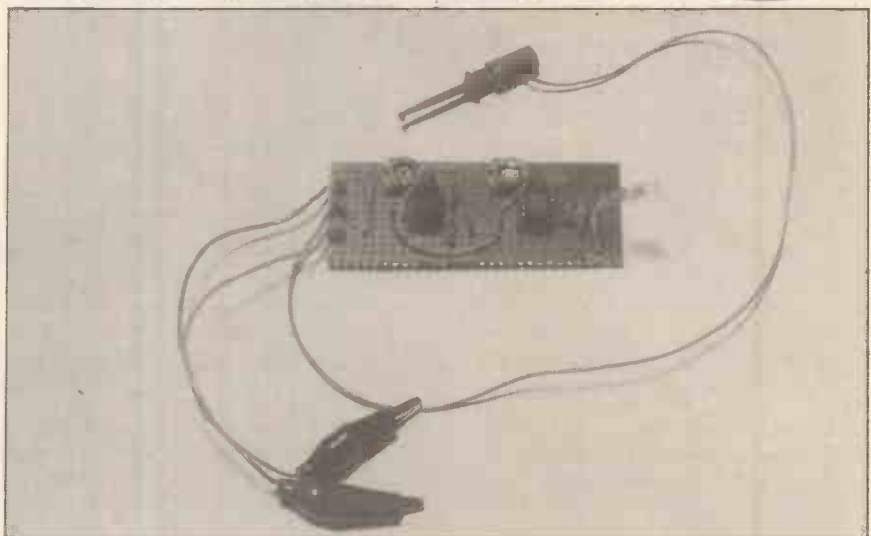

Figure 1. The circuit: watch the probe connections.

project uses the 7611 CMOS op-amp because it can operate on a + 2V5 supply (actually it works down to + 0V5) and its output swings fully to either rail. The test voltage is fed to the inverting input of the first op-amp (IC1) and, at the same time to the non-inverting input of the second op-amp (IC2). This voltage is compared with a reference voltage which is supplied to the other input of each op-amp from a potential divider (RV1, RV2). The voltage at the wiper of RV1 is set to +0V8, consequently whenever the input voltage from the test point is lower than 0V8, the output from IC1 rises sharply to +5V and current flows through the green element of the LED. The op-amp has no feedback resistor so its full gain is operative and it switches sharply at the threshold point. This means that the green element of the LED is either fully off or fully on, and a clear indication of the state of the test point is given.

IC2 works in the opposite fashion; RV2 is adjusted so that the voltage at its wiper is +2V. As a result, the output of IC2 swings high and turns on the red element of the LED whenever the test voltage exceeds 2V.

A voltage between 0V8 and 2V is too high to turn on the green element,

but too low to turn on the red element, so the LED is not lit. However if the voltage is oscillating between 'high' and 'low' levels, the red and green elements are switched on alternately; the eye merges the

Parts List

RESISTORS

(1/4 watt 5% carbon)
R1,2 180R

POTENTIOMETERS

RV1,2 100k
min preset

SEMICONDUCTORS

IC1,2 7611
CMOS op-amp
LED1/2 tri-colour LED
common cathode type

MISCELLANEOUS

Stripboard, 78 x 30mm (11 strips x 30 holes); 2 x 8-pin IC sockets; 3 x 1mm terminal pins; 1 x red, 1 x black miniature croc clips; 1 x miniature probe clip; wire, solder etc.

BUYLINES page 34

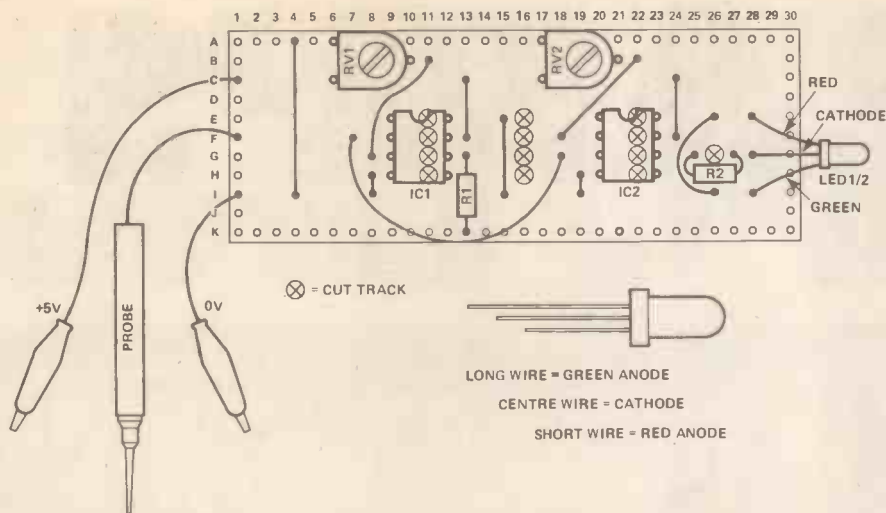

Figure 2. The veroboard layout. Keep the wire links as neat as possible.

colours and the light from the LED appears to be yellow (the exact shade depends on the mark-space ratio).

Construction

As the photograph shows, this project can easily be fitted onto a scrap of stripboard. It takes its power supply direct from the power rails of the circuit which is being tested and needs only 9mA, so it is unlikely to

cause an overload. The power leads are fitted with crocodile clips, but it is recommended that you use a miniature probe clip on the test input lead. These spring-loaded hooks, which are sold under various names (such as E-Z-Hook), are very easy to attach to almost any part of a test circuit. You can clip these to the terminal pin of a logic IC, the wire lead of a resistor or (through one of the holes) to the copper track of a circuit-board.

Wiring up the probe circuit takes very little time. Points to watch for are:

- 1). The 7611 is a CMOS IC, so you should take the usual precautions to avoid electrostatic charges while assembling the circuit. It is safer not to put the ICs in their sockets until all the wiring has been done.
- 2). The test input goes to *pin 2* of IC1, but to *pin 3* of IC2.
- 3). The terminal wires of the LED must be correctly connected. The type specified contains two LEDs in a single moulding, and they have their cathode wire in common (common cathode). For the LED used in the prototype, the connections were indicated as shown in the drawing.

When you have completed assembly, connect the power leads to 0V and +5V (regulated supply). Adjust RV1, until the voltage at pin 3 of IC1 is exactly +0V8, then adjust RV2 to bring the voltage at pin 2 of IC2 to exactly +2V. Touch the probe lead to +5V and the LED shines bright red. Touch the lead to 0V and it shines bright green. When the lead is not connected to anything you will probably see the LED glowing in various yellowing-orangy shades, due to the test lead picking up alternating electromagnetic interference from the mains. This happens because the op-amps have extremely high input impedance.

HE

The SCOPEX SG315

A new range of test capabilities

Combined Oscilloscope and Function Generator in one Precision Instrument



SCOPEX Instruments Limited
Pixmore House, Pixmore Avenue, Letchworth,
Herts. SG6 1HZ Tel: (04626) 72771 Telex: 825644

The Scope
15 MHz bandwidth
5 mV sensitivity
Timebase range
1 μ s-100 ms/cm
8x10 cm screen
vertical display
A+B. B invert
X-Y display,
X deflection
through A channel
for max.
sensitivity
Normal, TV and ext.
trigger

The Function Generator
0.2 Hz-250 KHz
Sine
Square
Triangular
DC offset variable
Duty cycle variable
Output 20v,
600 ohms
20 dB attenuator
plus variable
VCF input
TTL sync output

Function Generator can be supplied separately for you to fit to any Scopex Dual Trace scope, just state type when ordering, FG4, FG14/25.

Function Generator also available in an instrument case, FG1.

Prices:

SG315—£295+VAT. Price includes Probes and Mains Plug and carriage UK mainland.

Function Generator for mounting on Scopex Dual Trace Scopes:

FG4, FG14/25—£69+VAT

Function Generator: FG1—£79+VAT

NEW!
SG315

COMPONENTS FOR COMPUTING

This month we look into the television screen — or rather, behind it.

Paul Kelly

TODAY, with as little as £50, it is possible to go out and buy a home computer that plugs straight into a TV set to provide a text and graphics display. High level language programming and interactive graphics require a great deal of simultaneous information to be presented to the computer user and, at present, the cathode ray tube (CRT) provides the only real effective method. Virtually no computer currently on the market is without an interface to either TV or monitor, the exceptions being rather special purpose machines (machine code trainers, industrial controllers etc.) and therefore irrelevant to the mass market. It is hardly surprising, with personal computer sales running in excess of £1M per annum (in the UK) and with fierce competition between at least a dozen manufacturers, that the price barrier of £50 has been broken. Once again LSI chips (large scale integration) are responsible for the fall in the manufacturing costs of computers; in particular most of the circuitry associated with the video display can now be provided by an inexpensive device called a CRT Controller.

This month we introduce our subject with some facts and figures relating to the CRT displays (TV and monitors) and the basics of video circuitry, leading to a detailed investigation of CRT controllers next month. Also, there will be a small cheap project intended to illustrate the principles of video generating circuitry; however it will not incorporate a CRT controller but some simple low-cost discrete circuitry with plenty of scope for experimentation.

The Cathode Ray Tube

CRTs are employed in both television sets and monitors in much the same way; an electron beam is scanned across the fluorescent screen in a

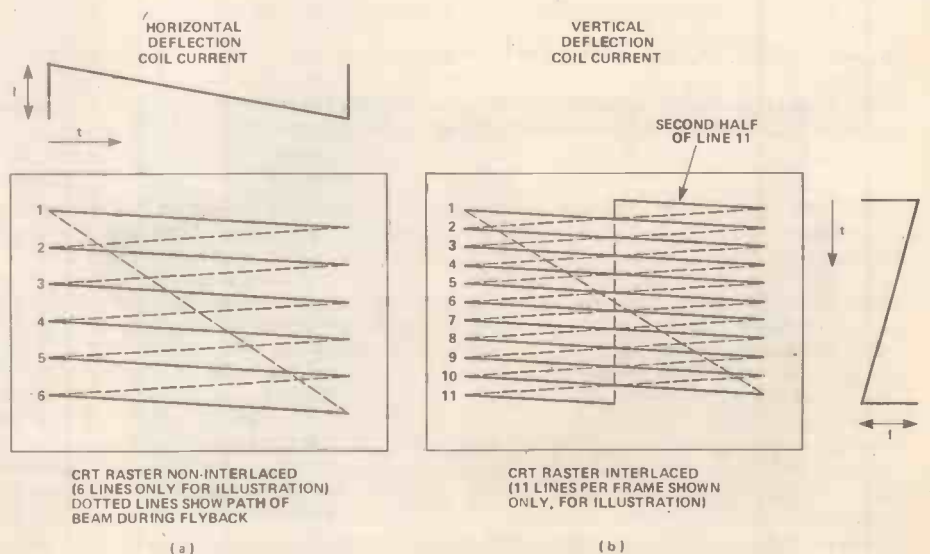
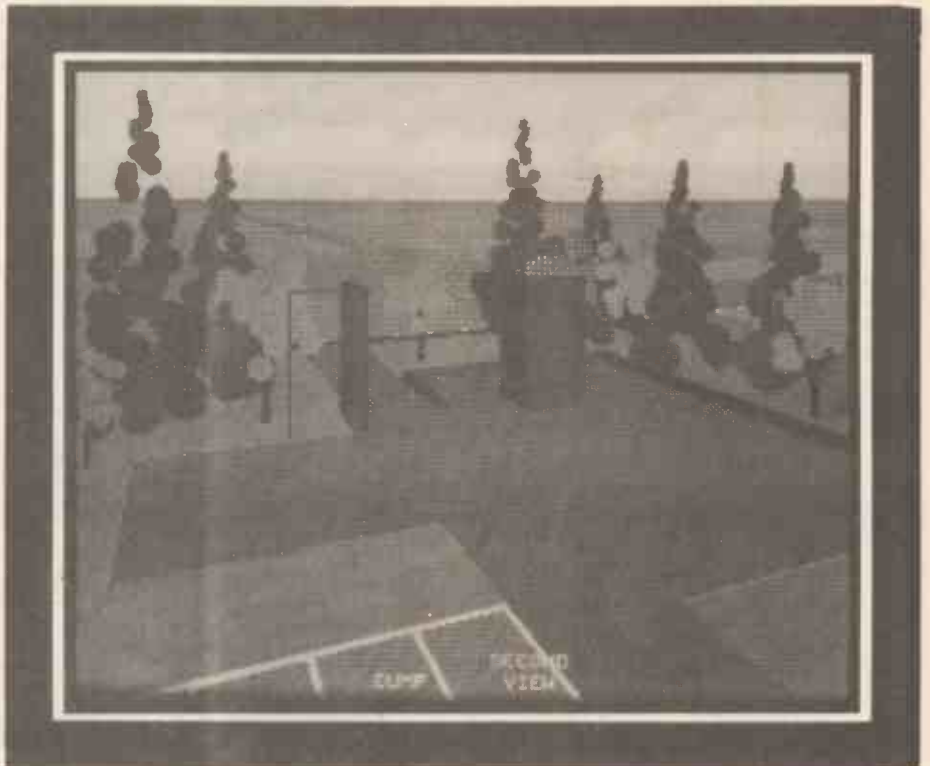

Figure 1a, b. A CRT raster is generated by scanning an electron beam from the top left hand corner of the screen, one line at a time, down to the bottom right. Figure 1a shows a non-interlaced raster of 312 lines (only six are shown for simplicity). An interlaced raster, shown in 1b, generates 625 lines (of which 11 are shown here) by scanning, first, the odd-numbered lines. The dotted lines indicate the 'retrace' or 'blanking' periods (flyback).

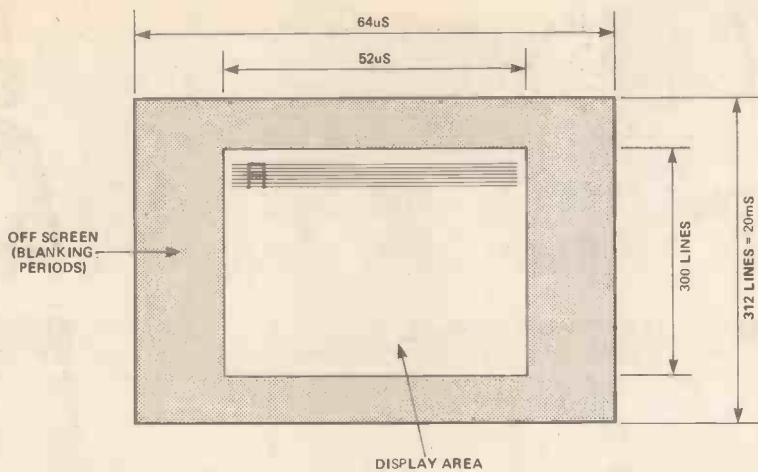

Figure 2. The time required for the flyback (blanking) periods overlaps the horizontal and vertical scanning periods. Thus the 'active line period' is 52µs instead of 64µs and the vertical picture is 300 lines deep, not 312. However in computer displays the active line period is limited to approximately 40µs wide and about 200 lines deep.

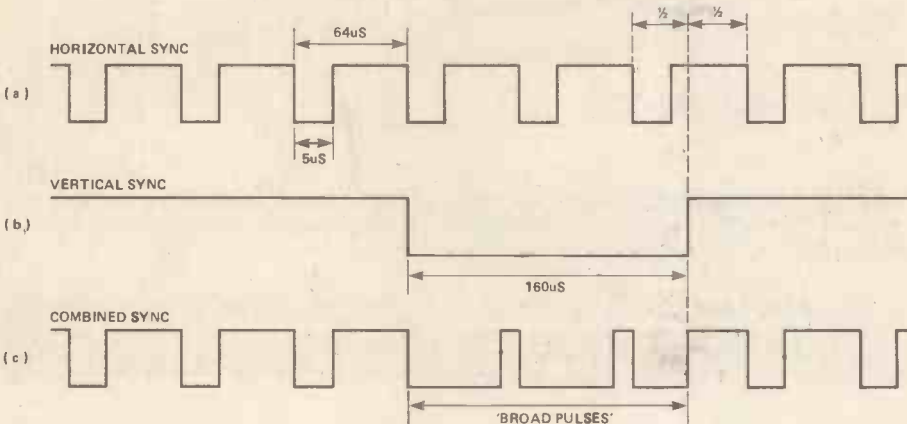

Figure 3a, b, c. The horizontal and vertical synchronization pulses are combined to produce a 'combined sync' signal; during the vertical sync period, the horizontal pulses are 'stretched' to produce the so-called 'broad pulses' to ensure that the horizontal oscillator stays locked in during these times.

mesh of horizontal lines called a 'raster', illustrated in Figure 1. A periodic sawtooth current waveform is passed through the 'horizontal' magnetic deflection coil of the tube, causing the electron beam to sweep across the screen, tracing a horizontal line across its width and then rapidly flying back to the far left before repeating the process. Simultaneously a much slower sawtooth waveform is applied to the 'vertical' deflection coils of the CRT, and this has the effect of spreading the horizontal traces into a cascade of discrete lines over the entire area of the screen. The fluorescent coating of the screen has the property of emitting light (usually white, but some monitors show green or amber) when bombarded with an electron beam and this emission persists for some tens of hundreds of milliseconds after the electron beam has passed. In Figure 2 the path of an electron beam has been traced out (6

lines only are shown) as in a CRT raster. The dotted line indicates the fast 'flyback' or retrace periods, during which the electron beam is always suppressed. During the forward traces (solid lines) the electron beam may be turned on, for all or part of its travel on each line, by means of a signal applied to the control grid of the CRT; by this means a picture can be built up. In Figure 2 it is shown how the character 'A' is displayed by the raster. The character will persist without flickering provided that the display is refreshed (ie, the character redrawn) in regular frames and at intervals shorter than the persistence time of the phosphor (fluorescent material).

In a TV set or monitor there are many more lines to a raster than has been shown in the two figures — in fact in the UK there are 625 lines/frame (a 'frame' is a complete picture) for an interfaced TV picture (we will explain

interlacing in a moment) and usually 312 lines for a non-interlaced monitor. Each line is scanned in 64µs and half a frame (called a 'field' in TV parlance) is repeated every 20ms. These figures ensure that a flicker free raster can be constructed with no visible 'gaps' between the lines.

Raster Master

Internal to a TV or monitor are all the circuits required to generate a raster. To display a picture it is also necessary to provide two external signals: a control signal that modulates the brightness of the scanning electron beam and some 'synchronisation' signals that force the monitor to generate its raster in registration with the incoming control signal. This control signal is obviously analogue (continuously varying) in the case of a TV picture so as to represent the various shades of grey, however for a computer display only black and white are normally required so that the control signal is in the form of a serial stream of 'highs' and 'lows', representing white and black respectively. For a monitor, separate inputs are generally provided for the control signal and sync signal but in a TV set they must be combined (forming a 'composite video' signal) and modulated onto a UHF carrier. Inevitably the process of modulation and subsequent demodulation within the set causes a deterioration in the display quality when compared with a monitor, but it is a small price to pay.

Synchronisation signals for UK standard CRT displays have been drawn in Figure 3: 3a shows the horizontal or 'line' synchronisation signal, which is a negative going pulse of about 5µs duration repeated every 64µs. The negative transition of this pulse triggers the start of each horizontal sweep within the TV set. Figure 3b is the vertical or 'field' synchronisation signal, which also is a negative going pulse, but of 160µs duration (two and a half lines) and a period of 20ms (ie 50Hz scanning rate). The negative transition of this signal triggers the start of the TV set's vertical timebase circuit. As shown in Figure 3c the vertical and horizontal sync pulses are mixed together to form a combined sync signal. It is essential for picture stability that the horizontal sync pulses are still present during the vertical sync pulses, as the horizontal oscillator in the TV can easily drift out of synchronisation in two and a half lines. The horizontal sync is effectively superimposed onto the vertical sync by 'stretching' the horizontal sync pulses almost to the full length of a line, all but for the last 4µs or so, during the period of each vertical sync pulse; these are the so-called 'broad pulses'. Inside the TV, the sync separator circuit can identify each horizontal sync pulse by the negative transitions of the combined sync signal, even during vertical sync period. To extract the vertical sync itself, an RC integrator circuit having a time constant longer than the short horizontal sync pulses is used. This circuit does not give a trigger output for the ordinary horizontal sync pulses

because, even during the broad pulses, it 'sees' only one long pulse of about two and a half lines width.

In a TV set it is normal to 'interlace' the rasters of alternative frames as shown in Figure 1. This means that the lines making up one-half of a complete picture (one 'field') fall exactly midway between the lines making up the other half of the picture (the previous 'field'), effectively doubling the number of lines of the raster. The purpose of this is to double the vertical picture resolution, showing 625 lines instead of 312, but without increasing the bandwidth of the picture signal. If all 625 lines were to be displayed sequentially in one frame while maintaining the same bandwidth (and hence line frequency), then the vertical scanning rate would have to be halved from 50Hz to 25Hz and the picture would flicker badly. Because of the tendency of the human eye to average the brightness of points (in this case, lines) that are close together, an interlaced scan of a frame appears to flicker much less than the same frame scanned fully sequentially. However interlacing is not often used with computer displays or, if it is, it should in any case be used with caution. The system works well with television pictures where object boundaries tend to be smooth transitions of grey — which is not the case with computer displays. The perception of flickering brightness varies from person to person and from picture tube to picture tube. Many people find CEEFAX and the BBC computer display (which can use interlacing) intolerably irritating. Monitors with long persistence phosphors are available specifically for interlaced displays, however, they had a disadvantage that fast moving objects show a significant afterglow and so are not suitable for video games.

The synchronisation requirements of an interlaced raster as shown in Figure 4 (a) and (b). In principle, interlacing is achieved by scanning 312½ lines in each field, as illustrated in Figure 1b (which shows only 11 lines/frame — 5½ lines/field — for simplicity). As you can see from the sync waveforms in Figure 4, there is another oddity included, called 'equalisation pulses'. It is difficult to describe the need for these pulses without explaining the sync separator and trigger circuits inside the TV; suffice to say that the horizontal sync pulses have some influence on the exact trigger point of the vertical oscillator (due to imperfect separation of the two types of sync pulse) and that the equalisation pulses ensure that horizontal sync events leading up to the vertical sync pulses are identical for even and odd fields. These equalisation pulses have no effect on the horizontal oscillator.

Colour It . . .

A colour cathode ray tube contains three electron guns which train on a matrix of red, green and blue phosphor dots arranged in alternating sequence (red, green, blue, red, green, blue, etc.) across each horizontal line of the

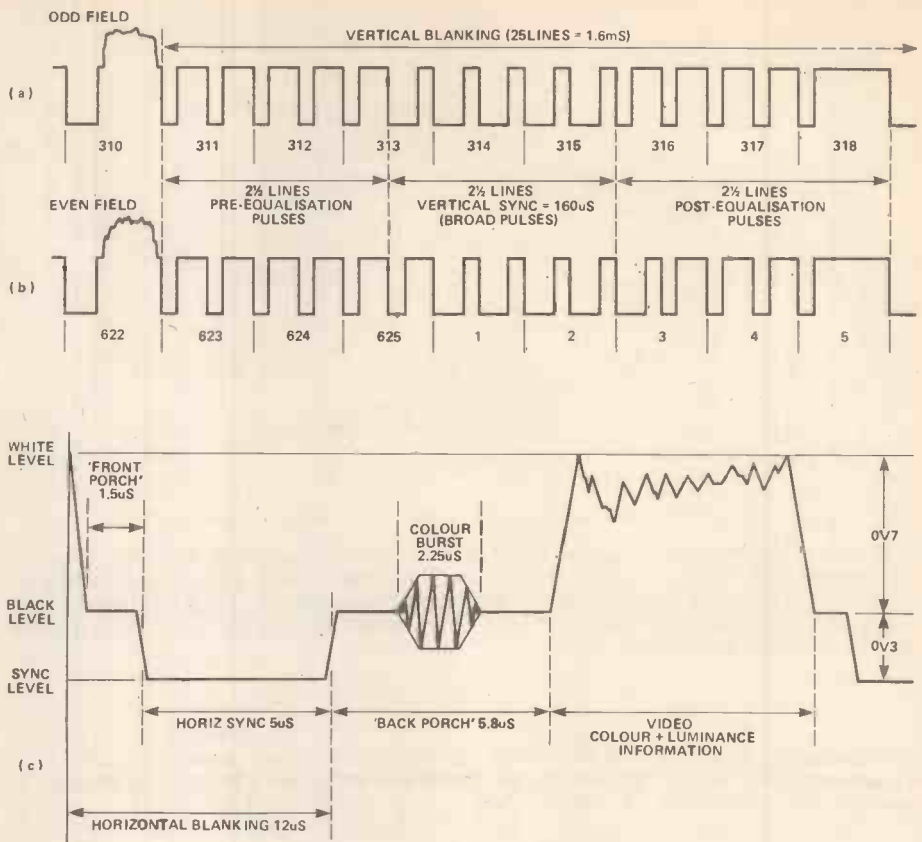

Figure 4. To maintain the stability of an interlaced scan, 'equalisation pulses' are inserted during the vertical blanking period. Diagram c shows, in simplified form, the waveform of a single line scan.

screen. A 'shadow mask' is placed immediately behind the screen, so designed that each electron beam may strike dots of one of the three colours only. A raster can be produced on a colour tube in the same way as for a monochrome (black and white) tube, ie using sawtooth current waveforms supplied to magnetic deflection coils and effecting all three beams equally. During the travel of the electron beams along the lines of the raster, signals applied to the individual control grids of the three guns will control both the colour and brightness of the picture at each point on the screen. The overall brightness of a spot is the sum of the brightness components of the three colours while the colour is determined by the relative proportion of each colour in the 'mix'.

Compared with a television receiver, colour monitors are relatively simple to drive; there are three inputs called R, G and B, which directly control the spot brightness of the picture in each colour and, of course, a sync input. In hardware terms it is a small step from providing one control signal for a monochrome monitor to provide three signals for a colour one, as we shall explain later.

When colour television was introduced it was thought desirable that black and white sets should also be able to receive the signal. This means that colour information must be added to the monochrome composite signal in such a way that a monochrome receiver will be unaffected by its presence. The method

of encoding colour or 'chrominance' signals on TV broadcast transmissions (in the UK and most of Europe) is called PAL, standing for Phase Alternating Line, and the same method of encoding must be employed by a computer providing an interface to a colour television set.

A full description of the PAL system is beyond the scope of this article, because quite complex mathematics are required, however for interest we offer a brief qualitative description — those of you who wish to experiment with video circuits will be relieved to learn that commercial PAL encoder/modulators are available that accept a standard RGB input and give an output for direct connection to a TV!

Colour information in the PAL system is modulated onto a subcarrier at 4.44MHz. This frequency has been chosen because it is mid-way between two adjacent high order harmonics (integer multiples) of the TV horizontal frequency (15625Hz). Now the added signal falls within the bandwidth of the ordinary monochrome signal (6MHz) but, because of the chosen frequency of the subcarrier, it is possible to separate the subcarrier from the monochrome brightness or 'luminance' signal within the TV set with minimal interference (in fact, the Fourier components of the luminance signal interleave in the frequency plane with the Fourier components of the subcarrier — but this is a difficult concept without the necessary mathematical background

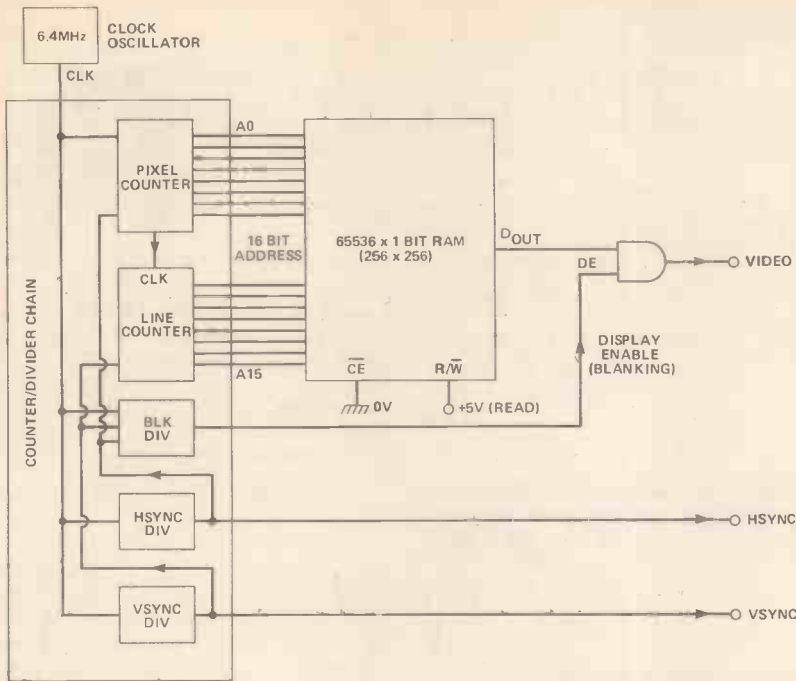

Figure 5. Block diagrams of a simple computer video display generator, which can read out 256 bits of information (each bit corresponding to a single picture element or 'pixel' per line,) for 256 lines.

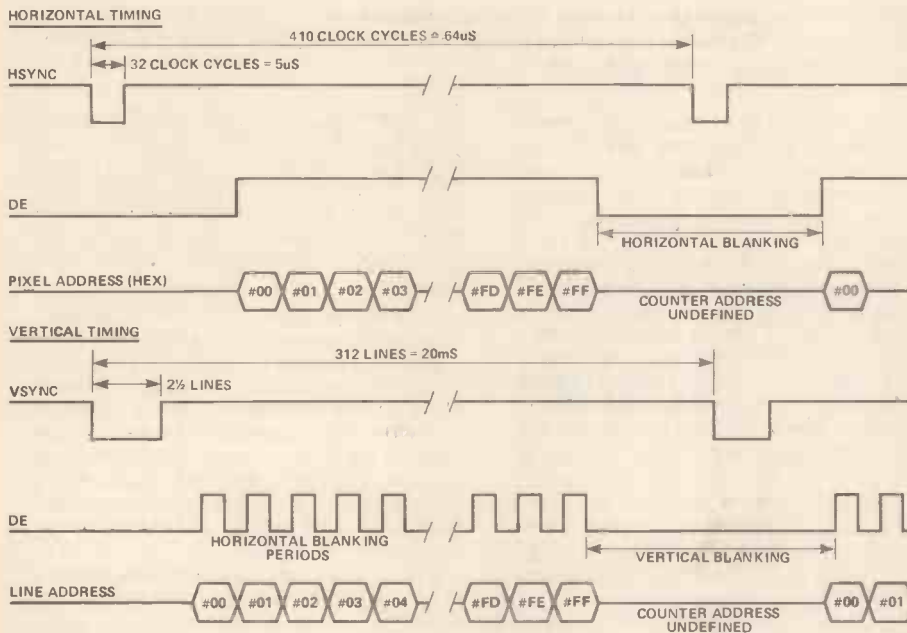

Figure 6. The waveforms which would be produced by the system shown in Figure 5.

and this the reason for a 4.43MHz subcarrier being chosen.

The colour information is 'phase-modulated' onto the subcarrier so as to allow two signals to be carried; these are 'colour difference' signals (R-Y) and (B-Y), where the Y is the luminance signal. The three signals of Y, R-Y, and B-Y are sufficient to reconstruct the R,G

and B signals inside the receiver. The television set decodes the 'colour difference' information by comparing the phase of the modulated subcarrier with an internal 4.43MHz oscillator to separate the R-Y signal, and with a phase quadrature (90°) of the oscillator to extract the B-Y information. In order to establish a common phase reference

between the transmitter and the TV receiver, a 'colour burst' signal of ten cycles of 4.43MHz is transmitted following the horizontal sync pulse, and is used by the TV receiver to lock its internal oscillator. The situation is further complicated by the fact that, every alternate line, the phase of the colour burst is inverted, together with the subcarrier phase. In so doing any errors in phase occurring during transmission through a "foggy" atmosphere, which will cause errors in the displayed colours to appear, will be in opposite senses on alternate lines; the human eye will average these colour errors and will see the correct colour. It is the lack of this refinement in the American NTSC system that has earned it the description 'Never Twice the Same Colour', for in areas of fringe reception in the US (ie, just about everywhere) colour TV pictures can be seen with the colours waxing and waning with the wind.

Compared with the price of a portable colour TV these days, a colour monitor (at £300-£400) seems poor value for money. This is misleading because the colour bandwidth of a TV (about 1-2MHz) results in a very much poorer picture, where computers are concerned, than with a colour monitor; if you look closely at the screen of a high resolution colour monitor you will see that the density of phosphor dots is generally a lot higher than on even the best colour TV set!

Generating Video

The block diagram of Figure 5 is the basis of most computer video circuits. Any picture displayed on a CRT can be considered built up of a number of pixels (picture elements) in a rectangular array; say for example, 256 pixels per line and 256 lines (of a possible 312 non-interlaced). In the case of a computer display, each pixel is either off (black) or on (white) and thus may be represented in the computer by a single logic level (or one bit of data). To represent a picture of 256 pixels by 256 lines a memory of 65536 x 1 bit capacity is required. In Figure 5 a random access memory (RAM) is used to 'store' a frame of display data. Now in order to produce a monitor video input and so generate a display, it is necessary to read, in sequence, the entire contents of the RAM for each frame at a rate of 256 pixels/40µs, for each line.

All the necessary timing signals for our video generator are produced by a chain of counters and dividers (and supporting logic) clocked by a common 6.4MHz oscillator (preferably crystal controlled) Figure 6 shows the signals that are generated, and these repeat over the period of one non-interlaced frame. The video RAM is cyclically accessed by an 8-bit pixel address counter and an 8-bit line address counter, which sequence through all 65536 addresses every frame. Obviously the counters (shown as blocks) are quite complex, in that they are required to start counting after a

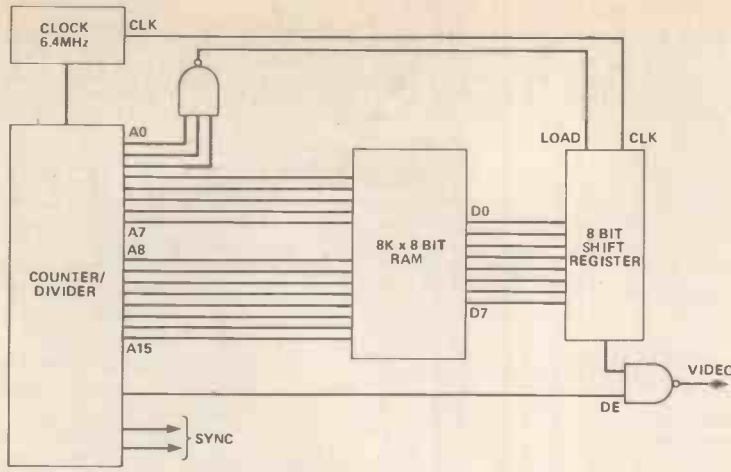

Figure 7. The system adapted for use with byte-wide (8 bits wide) RAM; the three low-order address bits A0-A2 are used to LOAD the shift register every eighth clock cycle with a byte addressed by the remaining 13 addresses bits. Because the address bits A3-A7 can address 32 bytes, the display remains 32 x 8 = 256 bits wide.

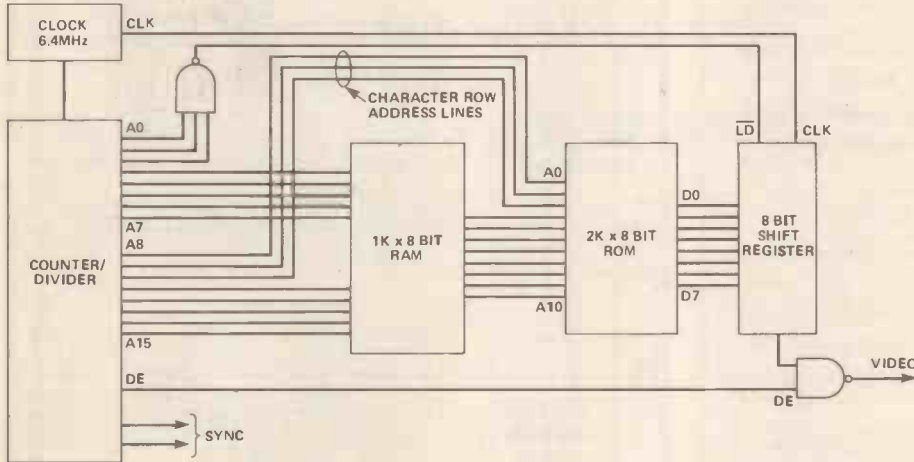

Figure 8. Using a character-generator ROM reduces the dynamic memory size, but makes the circuit more complicated. Briefly, the RAM is first loaded with 1024 (32 x 32) characters which will form a 32-character by 32-line display. The RAM sequentially decodes address lines A3-A7 and A11-A15 to select the character to be displayed; address lines A8-A10 select in turn each of the eight rows of pixel information for the characters (selected in turn by A3-A7) to be displayed on a particular line (selected in turn by A11-A15). Lines A0-A2 are again used to LOAD the shift register with pixel data once every eight clock cycles. The display is still 256 x 256 pixels!



period of blanking (flyback) and to stop at the end of the display period of each line (in the case of the pixel counter) or of each frame, (for the line counter), and are triggered by the blanking and sync signals which themselves have been divided down from the clock frequency. Nevertheless, each block in the counter chain can be made from two or three TTL chips, (as will be seen in our project). Notice that the output stream of data is gated with the DE (Display Enable) signal to ensure a black level during blanking; This gives a black border around the picture display and is also used, in some TV sets, as a black level reference.

Most memory devices are organised as 8 bits by so many words, to ease their use with 8-bit microprocessors. Figure

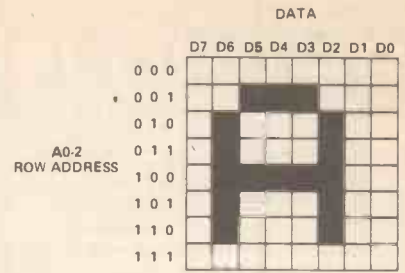

Figure 9. The pixel information in ROM representing the character 'A' (a pixel or picture element is the smallest element that can be displayed and is essentially limited by the highest frequency that the display generator or television can handle).

7 shows how our black system can be modified to accommodate these devices. This change is also beneficial when we come to describe how data is written into the video RAM by the microcomputer. Basically, the RAM is addressed, as before, by the high order 13 bits of the 16-bit pixel/line counter, while the low order three bits of the counter are used to load the output of the byte-wide RAM into an 8-bit shift register on every eighth cycle of the clock. During the other seven cycles the data in the shift register is clocked to the video output sequence. This is an alternative to the more obvious solution of multiplexing the RAM outputs onto the video output with an 8-1 line multiplexer addressed by A0-A2; the advantage of the shift register is that, once the data is latched in it does not matter if the outputs of the RAM change. This becomes important when the RAM is shared with a microprocessor (again more of this next month).

In computing displays that require only a fixed set of characters (alphanumerics) to be displayed it is possible to make a large saving on the size of the RAM required. Figure 8 contains a 2K 8-bit 'character generator' ROM which contains data describing (pixel by pixel) up to 256 characters, each of 8 pixels by 8 lines (see Figure 9 for the character 'A'). In addition there is a 1K 8-bit RAM which can store 1204 character codes for a display of 32 characters of 32 lines. The data outputs of the RAM address the character ROM, thereby selecting the appropriate character.

For each raster line, addresses A3-A7 select in sequence the character codes of the 32 character line specified by A11-A15 (32 lines). This repeats over eight lines for each character row as the address lines A8-A10 select each of the eight rows of the characters stored in the ROM. This is difficult for some people to visualise. If you imagine the addresses A0-A15 going through a straight binary sequence you should be able to work out what, in terms of character codes in the RAM and character data in the ROM, will appear on the video output stream.

HE PROJECT KITS

I.C.
TRANSISTORS
CAPACITORS

TOOLS
RESISTORS
HARDWARE

CASES
KITS

MAGENTA

Make us your No. 1 SUPPLIER OF KITS and COMPONENTS for H.E. Projects. We supply carefully selected sets of parts to enable you to construct H.E. projects. Kits include ALL the electronics and hardware needed. Printed circuit boards (fully etched, drilled and roller tinned) or Veroboard are, of course, included as specified in the original article, we even include nuts, screws and I.C. sockets. PRICES INCLUDE CASES unless otherwise stated. BATTERIES ARE NOT INCLUDED. COMPONENT SHEET INCLUDED. If you do not have the issue of H.E. which includes the project — you will need to order the instruction reprint at an extra 45p each.

Reprints available separately 45p each + p. & p. 40p.

- AUTO TESTER** May 83 £6.68
STALL THIEF May 83 (inc relay) £10.22
STEREO VOICE OVER UNIT April 83 £17.52
OPTIONAL MIC PRE AMP April 83 (no case) £4.26
AUTO POWER DOWN April 83 no case £6.05
PHASE FOUR Dec 82 £18.71
STEREO NOISE GATE Dec 82 £15.36
TAPE/SLIDE SYNCHRONIZER Dec 82 £21.73
BIG EAR Dec 82 less pipe parts £5.21
MICROAMMETER ADAPTOR Dec 82 £4.98
ODOMETER Nov. 82 £14.98
DIANA V.C.O. Nov 82 £4.89
'CB SQUELCH UNIT Oct 82 £9.19
'JUNIOR' SLOT CAR CONTROLLER Sept 82 £5.60 less case.
ZX INTERFACE BOARD Sept 82 inc edge con £11.33.
T.V.I. FILTER July 82 £5.33
AUTO WAH June 82 £18.98 inc case or £12.28 less case.
AUTO GREENHOUSE SPRINKLER June 82 £16.38 less pump and power supply (12V 2A).
TELEPHONE TIMER June 82 £33.42 less power supply (suitable type below).
POWER SUPPLY DESIGN 12V 500mA June 82 £9.98
ECHO REVERB UNIT May 82. Less case £33.98. Economy case W83 £3.76 extra.
DIGITAL THERMOMETER May 82 excluding case + bezel £16.90
AUDIO SIGNAL GENERATOR May 82 £20.98.
CABLE TRACKER May 82 £9.98
DIGITAL CAPACITANCE METER. Apr 82 £21.37
SIGNAL TRACER Apr 82 £3.86
BIKE ALARM Apr 82 £11.74
DIGITAL DICE Mar 82 £7.29
BICYCLE SIREN Mar 82 £10.89
NOISELESS FUZZBOX Feb 82 £10.45
MASTHEAD AMPLIFIER Feb 82 £14.74
DRUM SYNTHESIZER Dec 81. Full kit £21.37
GUITAR HEADPHONE AMPLIFIER Dec 81 £3.72
IN CAR CASSETTE POWER SUPPLY Dec 81 £4.77
SCRATCH FILTER Nov 81 Mono £5.82 Stereo £8.98
LED VU METER Nov 81 less case £4.87
SIMPLE STYLUS ORGAN Nov 81 less case £4.98
METRONOME Nov 81 £12.71
- TELEPHONE BELL REPEATER** Oct 81 £13.67
Med linking wire extra 14p metre
COMBINATION LOCK Oct 81 less solenoid £18.65
BABY ALARM Oct 81 £8.70. Fig 8 linking wire 7p metre
'DIANA' METAL LOCATOR Sept 81 £24.50
REACTION TESTER GAME Sept 81 £12.81
VARIABLE BENCH POWER SUPPLY Aug 81 £28.98
ULTRASOUND BURGLAR ALARM July 81 £19.98
ELECTRONIC DOOR BUZZER July 81 £5.98
ELECTRONIC METRONOME July 81 £4.99
CONTINUITY CHECKER June 81 £5.71
ENVELOPE GENERATOR June 81 £17.98
AUDIO MIXER June 81 £5.33
PUBLIC ADDRESS AMPLIFIER March 81 £19.48. Extras - horn speakers £8.83 each, PA MIC £4.40
FUZZBOX March 81 £10.98
WINDSCREEN WIPER CONTROLLER March 81 £8.20
STEAM LOCO WHISTLE March 81 £12.98
PHOTOGRAPHIC TIMER March 81 £3.50
HEARTBEAT MONITOR Feb 81 £24.98
TWO-TONE TRAIN HORN Feb 81 £5.60 less case
medium wave radió Feb 81 £8.20
BENCH AMP Jan 81 £10.80
NICAD CHARGER Jan 81 £8.20
CHUFFER Jan 81, less case £7.53
BATTERY CHARGE MONITOR Dec 82 £5.77
MEMORY BANK - MINI SYNTHESISER Nov & Dec 80 £29.98
TRANSISTOR TESTER Nov 81 £8.54 inc test leads
GUITAR PRE-AMP Nov 80 £6.65 case (diecast) extra £2.29
INTRUDER ALARM Oct 80 £20.98
TOUCH SWITCH Sept 80 £2.75 less case & contacts
GUITAR PHASER Sept 80 £16.28
SOUND OPERATED FLASH TRIGGER July 80 no skt £5.33
FOG HORN June 80 £8.64
SPEED CONTROLLER FOR HORN April 80 £17.66 (less case)
DIGITAL FREQUENCY METER April 80 £39.98
GUITAR TUNER Nov 79 £12.82
CAR ALARM Feb 79 £12.91

MORE PROJECT KITS - SIMILAR STYLE TO H.E.

- INSTRUCTIONS INCLUDED (SEPARATELY 45p EACH)
 PLEASE QUOTE REF. NO. WHEN ORDERING
- 81 PEST CONTROL** Ultrasonic cat scarer £7.65
82 COMPONENT TESTER £8.88
84 GUITAR NOTE EXPANDER £17.98
86 CAMERA OR FLASH GUN TRIGGER Infra red system £12.61
88 SIMPLE INFRA RED REMOTE CONTROL £17.20
87 0-12V POWER SUPPLY £17.98
89 SOUND TO LIGHT - single channel £8.42
810 THREE CHANNEL SOUND TO LIGHT £21.44
- 811 IN SITU TRANSISTOR TESTER** £5.98
812 WEIRD SOUND EFFECTS GENERATOR £5.98
813 AUDIBLE VISUAL METRONOME £5.98
814 ELECTRONIC DICE £5.71
816 MINI EGG TIMER £4.34
818 LED JEWELLERY - Cross brooch £2.77 Star brooch £9.91 Spiral brooch £7.98

MORE KITS AND COMPONENTS IN OUR LISTS
 FREE PRICE LIST
 Price list included with orders or send sae (9 x 4) CONTAINS LOTS MORE KITS, PCBs & COMPONENTS

1982 ELECTRONICS CATALOGUE

Illustrations, product descriptions, circuits all included. Up to date price list enclosed. All products are stock lines for fast delivery.
 Sends 80p in stamps or add 80p to order.

MORE H.E. PLUS E.E. and E.T.I. PROJECTS KITS IN THE PRICE LIST

MAGENTA gives you FAST DELIVERY OF QUALITY COMPONENTS & KITS. All products are stock lines and are new & full specification. We give personal service & quality products to all our customers—HAVE YOU TRIED US?

MAGENTA ELECTRONICS LTD

HY37, 135 HUNTER ST., BURTON-ON-TRENT, STAFFS.
 DE14 2ST. 0283 65435. MON-FRI 9-5. MAIL ORDER ONLY
 ADD 45p P&P TO ALL ORDERS. PRICES INC VAT

ACCESS AND BARCLAYCARD (VISA) ORDERS ACCEPTED BY PHONE OR POST.
 SAE ALL ENQUIRIES

Prices inc. VAT
 OFFICIAL ORDERS WELCOME
 OVERSEAS Payment must be in sterling.
 IRISH REPUBLIC and BFPO: UK PRICES
 EUROPE UK PRICES plus 10%
 ELSEWHERE write for quote.

SOLDERING / TOOLS

- ANTEX X5 SOLDERING IRON 25W** £5.48
SOLDERING IRON STAND £1.98
SPARE BITS. Small standard, large, 85p each. For X5 + X25
SOLDER. Handy size. 99p
SOLDER CARTON £1.84
DESOLDER BRAID 69p
HEAT SINK TWEEZERS 25p
DESOLDER PUMP £6.48
HOW TO SOLDER LEAFLET 12p
LOW COST CUTTERS £1.69
LOW COST LONG NOSE PLIERS £1.68
WIRE STRIPPERS & CUTTERS £2.69
- PRECISION PETITE** £11.87
12V P.C.B. DRILL £7.98
GRINDING STONE 50p
GRINDING WHEEL 50p
SAW BLADE 85p
BRASS WIRE BRUSH 50p
BURR 50p
- VERO SPOT FACE CUTTER** £1.49
PIN INSERTION TOOL £1.98
VEROPINS (pk of 100 0.1") 52p
MULTIMETER-TYPE 1 (1,000 ohm) £5.48
MULTIMETER TYPE 2 (20,000 ohm) with transistor tester. Very good £14.75
CROCODILE CLIP TEST LEAD SET: 10 leads with 20 clips 99p
- MULTIMETER TYPE 2 - YN360 TR, £14.75**

- RESISTOR COLOUR CODE** 21p
CALCULATOR 49p
CONNECTING WIRE PACK TYPE ED. 11 colours 49p
ILLUMINATED MAGNIFIERS
 Small 2" dia. (6 x mag.) £1.14
 Large 3" dia. (4 x mag.) £2.40
CAST IRON VICE £2.98
SCREWDRIVER SET £1.98
POCKET TOOL SET £3.98
DENTISTS INSPECTION MIRROR £2.85
JEWELLERS EYEGLASS £1.50
PLASTIC TWEEZERS 69p
PAIR OF PROBES WITH LEADS (icc) 77p



20,000 ohm. Includes transistor tester. AC + DC volts. DC current. 4 very useful resistance ranges. We've used it and we like it.

- SPEAKERS.** Miniature, 8 ohm 87p
 64-75 ohm 89p
CRYSTAL EARPIECE 85p
MONO HEADPHONES £2.98
TELEPHONE PICK-UP COIL 72p
- MIN. BUZZERS.** 6V. 50p. 9V. £1 10.
 12V. 85p.
MAGNETIC EARPIECE 15p
STEREO HEADPHONES £4.35
F.M. AERIAL 89p

- VEROBOARD 0.1" COPPER STRIPS**
 10 strips 24 holes £1.20 per 5
 24 strips 37 holes 70p
 24 strips 50 holes 88p
 36 strips 37 holes 89p
 36 strips 50 holes 99p
 Terminal pins 0.1" 52p/100
- PP3 CLIPS** 10p
PP9 CLIPS 11p
- PANEL METERS**
 50uA; 100uA; 1mA, 1A, 25V, 100uA-0-5 DEC BREADBOARD £3.98
 BIMBOARD 1 BREADBOARD £3.98
 VEROBLOC BREADBOARD £4.20

Q. MAX PUNCHES

- 1" - £2.88; 1.5" - £3.08
 2" - £3.17; 2.5" - £3.24

- JUNIOR HACKSAW** 85p
SPARE BLADES 25p/12
ABRAFRAME HACKSAW 87p
SPARE BLADES 36p/12
QUICKTEST (Quick connect mains block), £8.98

HELPING HANDS JIG £5.30

Heavy base. Six ball and socket joints allow infinite variation of clips through 360°. Has 2 1/2" diameter (25 x) magnifier attached, used and recommended by our staff.



30 SOLDERLESS BREADBOARD PROJECTS

Book by R. A. Penfold

Clear verobloc layouts and circuit diagrams. Includes: fuzz box, radio, metronomes, timers, transistor checker, switches, etc. Introduction gives basic information on components including resistors, capacitors, IC's, transistors, photocell etc. Ideal for beginners as well as those with some experience. Complete kit including verobloc, book, and components.

- (Less batteries) £24.74 OR (Less book) £22.50
 (or Less verobloc) £20.25 OR (BOOK ONLY) £2.25

BOOKS

- SEMICONDUCTOR DATA BOOK** Newnes £5.90
ELECTRONIC PROJECTS FOR HOME SECURITY £3.36
ELECT. PROJECTS IN PHOTOGRAPHY £3.36
110 ELECT. ALARM PROJECTS £5.35
MODEL RAILWAY PROJECTS £1.95
BASIC ELECTRONICS. Theory & practice £7.98
BEGINNERS GUIDE TO BUILDING ELECT. PROJECTS £1.50

ADVENTURES WITH MICROELECTRONICS

Similar to 'Electronics' below. Uses I.C.s. Includes dice, electronic organ, doorbell, reaction timer, radio, etc. Based on Bimboard 1 bread board.
 Adventures with Microelectronics... £2.55
 Component pack £29.64 less battery.

ADVENTURES WITH ELECTRONICS

by Tom Duncan

An easy to follow book suitable for all ages. Ideal for beginners. No soldering, uses an S-Dec breadboard. Gives clear instructions with lots of pictures. 16 projects—including three radios, siren, metronome, organ, intercom, timer, etc. Helps you learn about electronic components and how circuits work. Component pack includes an S-Dec breadboard and all the components for the projects.
 Adventures with Electronics £2.40. Component pack £18.98 less battery.

Step-by-step fully illustrated assembly and fitting instructions are included together with circuit descriptions. Highest quality components are used throughout.

Sparkrite

BRANDEADING ELECTRONICS
NOW AVAILABLE IN KIT FORM

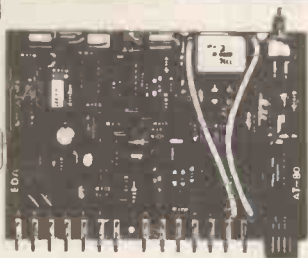
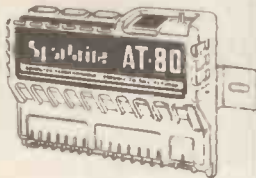

AT-80 Electronic Car Security System

- Arms doors, boot, bonnet and has security loop to protect fog/spot lamps, radio/tape, CB equipment
- Programmable personal code entry system
- Armed and disarmed from outside vehicle using a special magnetic key fob against a windscreen sensor pad adhered to the inside of the screen
- Fits all 12V neg earth vehicles
- Over 250 components to assemble

VOYAGER Car Drive Computer

- A most sophisticated accessory
 - Utilises a single chip mask programmed microprocessor incorporating a unique programme designed by EDA Sparkrite Ltd.
 - Affords 12 functions centred on Fuel, Speed, Distance and Time
 - Visual and Audible alarms warning of Excess Speed, Frost/Ice, Lights-left-on
 - Facility to operate LOG and TRIP functions independently or synchronously
 - Large 10mm high 400ft-L fluorescent display with auto intensity
 - Unique speed and fuel transducers giving a programmed accuracy of + or - 1%
 - Large LOG & TRIP memories. 2,000 miles. 180 gallons. 100 hours
 - Full Imperial and Metric calibrations
 - Over 300 components to assemble
- A real challenge for the electronics enthusiasts!



SX1000 Electronic Ignition

- Inductive Discharge
- Extended coil energy storage circuit
- Contact breaker driven
- Three position changeover switch
- Over 65 components to assemble
- Patented clip-to-coil fitting
- Fits all 12v neg. earth vehicles

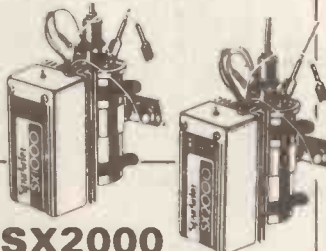

TX1002 Electronic Ignition

- Contactless or contact triggered
- Extended coil energy storage circuit
- Inductive Discharge
- Three position changeover switch
- Distributor triggerhead adaptors included
- Die cast weatherproof case
- Clip-to-coil or remote mounting facility
- Fits majority of 4 & 6 cyl. 12V. neg. earth vehicles
- Over 145 components to assemble.

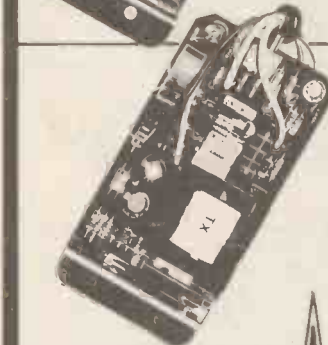

SX2000 Electronic Ignition

- The brandleading system on the market today
- Unique Reactive Discharge
- Combined Inductive and Capacitive Discharge
- Contact breaker driven
- Three position changeover switch
- Over 130 components to assemble
- Patented clip-to-coil fitting
- Fits all 12v neg. earth vehicles

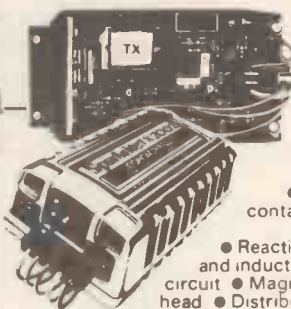

TX2002 Electronic Ignition

- The ultimate system
- Switchable contactless
- Three position switch with Auxiliary back-up inductive circuit
- Reactive Discharge. Combined capacitive and inductive
- Extended coil energy storage circuit
- Magnetic contactless distributor triggerhead
- Distributor triggerhead adaptors included
- Can also be triggered by existing contact breakers
- Die cast waterproof case with clip-to-coil fitting
- Fits majority of 4 and 6 cylinder 12v neg. earth vehicles
- Over 150 components to assemble

All SPARKRITE products and designs are fully covered by one or more World Patents

SPECIAL OFFER

"FREE" MAGIDICE KIT WITH ALL ORDERS OVER £45.00

MAGIDICE Electronic Dice

- Not an auto item but great fun for the family
- Total random selection
- Triggered by waving of hand over dice
- Bleeps and flashes during a 4 second tumble sequence
- Throw displayed for 10 seconds
- Auto display of last throw 1 second in 5
- Muting and Off switch on base
- Hours of continuous use from PP7 battery
- Over 100 components to assemble

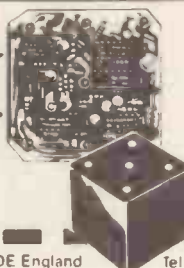

SPARKRITE 82 Bath Street, Walsall, West Midlands WS1 3DE England

Tel (0922) 614791 Allow 28 days for delivery

	SELF ASSEMBLY KIT
SX 1000	£12.95
SX 2000	£19.95
TX 1002	£22.95
TX 2002	£32.95
AT 80	£32.95
VOYAGER	£64.95
MAGIDICE	£9.95

PRICES INC VAT, POSTAGE & PACKING

NAME _____ HE6

ADDRESS _____

I ENCLOSE CHEQUE(S) POSTAL ORDERS FOR

£ _____ KIT REF _____

CHEQUE NO _____

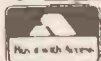

BRANDEADING BRITISH ELECTRONICS

CUT OUT THE COUPON NOW!

THIS DEVICE is primarily intended for use with a CB rig, and it provides two functions: first it gives a latching action so that once the PTT (Push-to-Talk) switch on the microphone has been pressed and released, the rig will stay in the transmit mode. In order to switch back to the receive mode the PTT switch is again operated briefly; another momentary operation of the switch sends the rig back to the transmit mode, and so on. This avoids having to hold down the PTT switch throughout transmissions, and is more convenient in use (especially during long periods of operation when repeatedly holding down the switch can become a bit tedious).

The second function is an automatic return to the receive mode after about 36 seconds. This is included as a fail-safe system to ensure that the equipment cannot be accidentally left transmitting, blocking a channel for a long period of time. If you should accidentally leave the unit in the transmit mode it will simply revert to receive after 36 seconds and prevent the channel from being blocked for any longer than that. It also discourages long uninterrupted transmissions which tend to be unpopular with other CB users! A LED indicator switches on about ten seconds or so before the unit automatically reverts to the receive mode so that the user has reasonable warning before the transmission is cut off. Of course, once the unit has automatically returned to receive it is simply necessary to push the PTT switch again in order to return to transmit.

PTT Switching

The microphone PTT switching and latching action circuits are shown in Figure 1. The PTT switch is usually a double pole changeover type, with the centre tag of one pole connected to earth. The switch is biased to the receive position by a simple spring mechanism, and this produces a short circuit from the NC (normally closed) tag to earth. This is used to provide the path to earth for the loudspeaker and, more importantly, to disconnect the loudspeaker when the switch is placed in the transmit position. This is because there is often a significant level of breakthrough from the microphone to the loudspeaker, and if the loudspeaker was to be left connected it would result in acoustic feedback and could even cause oscillation. The short circuit that is produced from the NO (normally open) tag to earth when the switch is set to transmit is used to operate the transmit/receive switching within the rig. This can be performed using a relay, but in most modern rigs purely electronic transmit/receive switching is used.

The other pole of the PTT switch is used to disconnect the microphone when set to the receive mode. While this may seem pointless it must be remembered that the transmit/receive

CB Rap Latch

R. A. Penfold

This click-in, click-out latching switch also incorporates a time-out function.

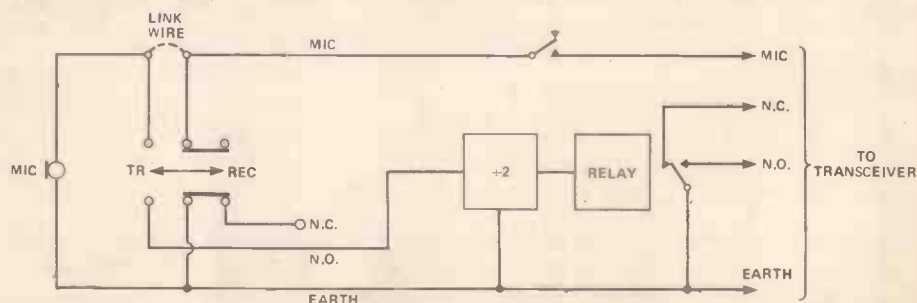
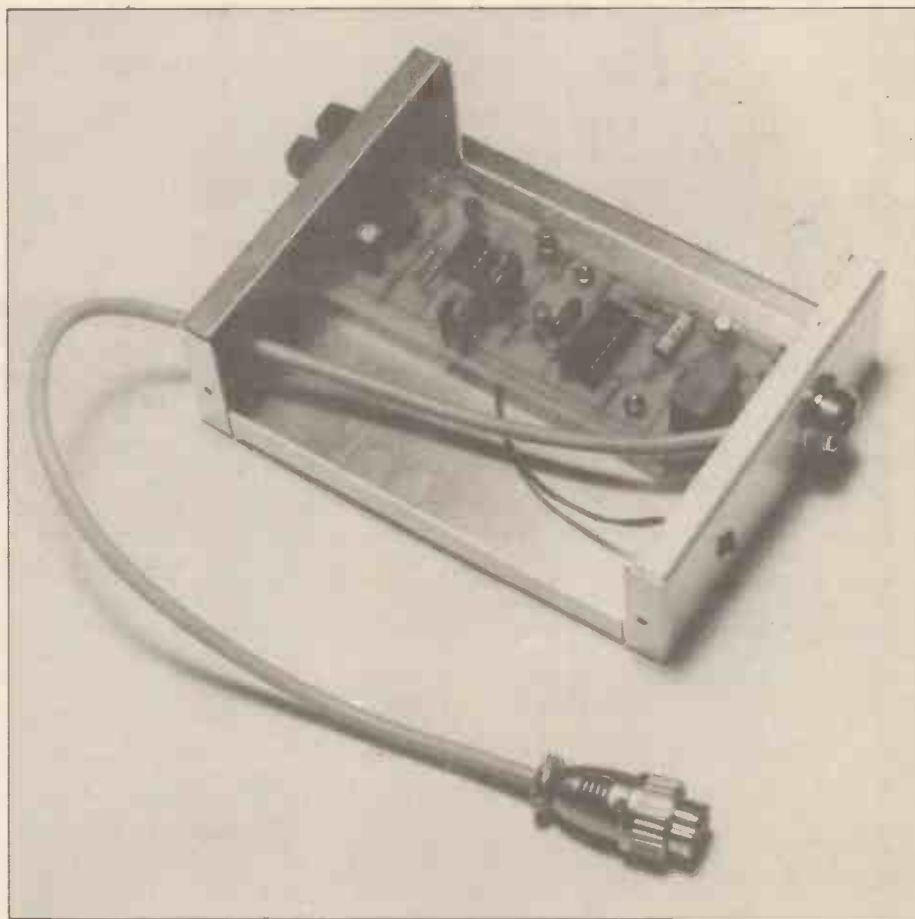

Figure 1. Switching and latching circuits: note the link wire.

How It Works

THE PTT switch is not used to directly control the transmit/receive switching, but is instead used to control a relay and the relay contacts then control the rig. A divide-by-two flip-flop circuit is used between the PTT switch and the relay driver; the output of this changes state each time the PTT switch is operated. If the output of the flip-flop is initially low (the relay is switched off), operating the PTT switch sends the output of the flip-flop high and switches on the relay. This takes the rig from the receive mode to transmit. Operating the PTT switch again sends the output of the flip-flop low, so that the relay switches off and the rig is set back to the receive mode. Another operation of the PTT switch sets the rig to the transmit mode again, and so on, so that only a brief operation of the PTT switch is needed to switch modes.

A simple timer circuit is triggered each time the relay is switched on and the rig is placed in the transmit mode. If the relay switches off before the end of the output pulse from the timer, a reset pulse is sent from the relay driver to the timer circuit. This pulse ensures that when the timer is triggered again it commences a fresh timing run and gives a full length output pulse. However, if the pulse from the timer finishes first, the flip-flop is reset and the rig is returned to the receive mode.

A voltage comparator monitors the voltage on the timing capacitor in the timer circuit, and when this reaches a certain threshold level (which occurs about ten or fifteen seconds before the pulse from the timer ceases) the comparator switches on a LED indicator.

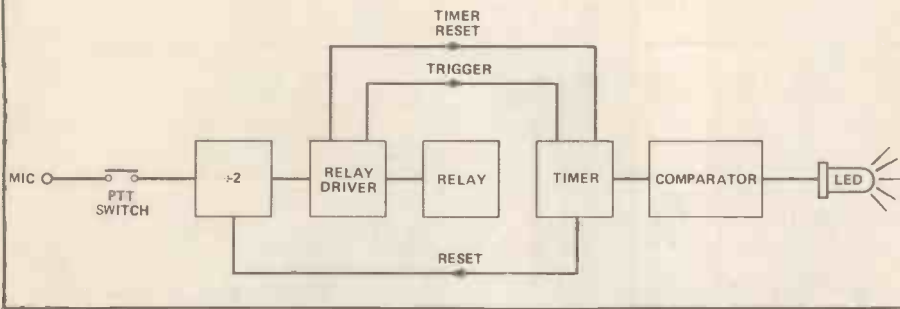

switching within the rig will operate very rapidly but not instantly. The result could be a short burst of oscillation, due to acoustic feedback, when releasing the PTT switch since the loudspeaker would be instantly reconnected while the rig would take a moment longer to go to the receive mode. In practice this would be unlikely to happen unless the microphone and the loudspeaker were in very close proximity to one another, but the PTT switch ensures that it *cannot* occur, as it will only connect the microphone or the loudspeaker to

the rig, and not both at once.

The latching action of the unit is obtained using a simple divide by two flip-flop circuit which drives a relay. The PTT switch provides a short circuit to earth each time it is operated, and this is used to clock the divide by two circuit and change the state of the relay. The latter has a pair of changeover contacts which are used in place of the PTT switch.

Note that the PTT switch must have a link wire added, as shown in Figure 1. If this is not done, the microphone would be disconnected by the PTT

switch when it was released, and the microphone signal would not be coupled through to the rig.

The Circuit

The full circuit diagram of the Rap Latch unit is shown in Figure 2.

The divide by two circuit is a CMOS 4020BE device (IC1): it is actually a 14-stage binary counter but only the first stage is used here. Although it may seem wasteful to leave more than 90% of the device unused, where a single, simple flip-flop is needed there is not much choice. The 4020BE is not an expensive device anyway, and in this application it is ideal because it has a Schmitt trigger input and, together with R1 to R3 plus C1, this eliminates problems of multiple operation due to contact bounce in the PTT switch. The 4020BE is clocked on the negative edge of the input signal and the PTT switch is therefore used to generate a negative going signal when it is operated so that IC1 is clocked immediately, rather than as the PTT switch is released. R4 and C2 provide a reset pulse for IC1 at switch-on, so that the circuit starts with the relay switched off and the CB rig in the receive mode. Common emitter transistor Q1 is used as the relay driver.

The timer circuit is a standard 555 monostable (IC2), and C4 couples a brief trigger pulse to this as the relay switches on. Pin 4 is the reset terminal of IC2 and this is taken high by R8 so that the timer operates normally. However if the relay switches off before the end of the timing period, C3 couples a positive pulse to the base of Q3, and this device momentarily pulls pin 4 of IC2 low so that the monostable is reset and will start a new timing run when it is triggered again.

If the output pulse of IC2 is allowed to reach a natural conclusion, a negative pulse is coupled to the base of Q2 by C5, and this results in Q2 briefly switching on. This gives a reset pulse to IC1 so that the relay is switched off and the rig is

NOTES:
IC1 = 4020BE
IC2 = 555
IC3 = CA3140E
Q1,3 = BC109
Q2 = BC179
D1,3 = 1N4148
LED1 = TIL209

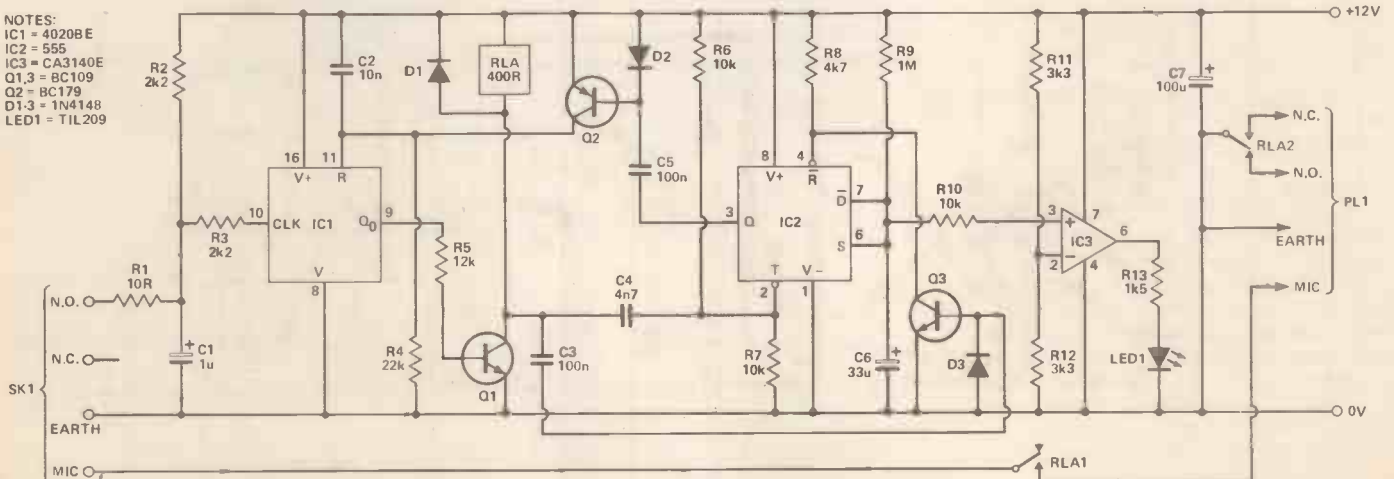

Figure 2. The entire Rap Latch circuit.

automatically returned to the receive mode.

IC1 is the voltage comparator, and this has a reference voltage of about half the supply potential set at its inverting input by R11 and R12. R10 couples the non-inverting input to C6, the timing capacitor for IC2, and the potential on this capacitor will normally be less than half the supply voltage. This gives a low output from IC3 and LED 1 is not switched on.

If the charge on C6 is allowed to go beyond 50% of the supply potential, though, the non-inverting input of IC3 is taken to a higher voltage than the inverting input, IC3's output goes high, and LED4 switches on. The output pulse from IC2 does not end until the charge potential on C6 has reached two thirds of the supply voltage, and LED1 is therefore switched on several seconds before the pulse from IC2 ends.

Note that IC3 is a MOSFET input device which draws no significant current from the timer circuit and does not have any detrimental effect on it. Due to the high value timing resistor (that must be used to give the fairly long pulse length from IC2), it is essential to use a good quality component for C6; for this reason a tantalum capacitor is specified. The switch-off time provided by IC2 can be changed if desired, and the time in seconds is nominally $1.1 \times R9 \times C6$, where R is in ohms and C is in microfarads.

Construction

Details of the printed circuit board are provided in Figure 3. IC1 is a CMOS device and IC3 has a PMOS input stage, so these both require the usual MOS handling precautions. Fit them in IC sockets (sixteen pin for IC1 and eight pin for IC3), handling them as little as possible, and do not fit them until the unit is complete in all other respects.

Provided the specified relay is used, this will fit directly onto the printed circuit board. It is possible to use any

RESISTORS		SEMICONDUCTORS	
(All 1/4 watt 5% carbon)		IC1	4020BE
R1	10R	14-stage ripple counter	
R2,3	2k2	IC2	555
R4	22k	timer	
R5	12k	IC3	CA3140E
R6,7,10	10k	MOS op-amp	
R8	4k7	Q1,3	BC109 NPN
R9	1M	Q2	BC179 PNP
R11,12	3k3	D1,2,3	1N4148
R13	1k5	silicon diode	
CAPACITORS		LED4	TIL209
C1	1u 63V	3mm red LED	
axial electrolytic		MISCELLANEOUS	
C2	10n	RLA	400R 12V relay
polyester		DPDT contacts, min. PC-mounting	
C3,5	100n	SK1/PL1	4-way locking audio
polyester		connectors	
C4	4n7	Four-way screened cable; case;	
mylar		PCB; wire, solder etc.	
C6	33u 10V	BUYLINES	
tantalum		page 34	
C7	100u 16V		
radial electrolytic			

relay having a 12 volt operating coil with a resistance of about 300 ohms or more, provided it has at least two sets of changeover contacts, but if a relay other than the specified type is used it may be necessary to extensively redesign the printed circuit layout, or mount the relay off-board.

An aluminium box measuring 102mm wide by 133mm deep by 38mm high makes an inexpensive but practical housing for this project. If an alternative case is used it is advisable to choose a metal type so that any exposed microphone lead is screened by the case. A somewhat narrower case could be used, but the depth and height dimensions given above represent just about the minimum usable figures.

A LED indicator, LED1, is mounted on the front panel in the normal plastic panel clip, and SK1 is mounted to the right of this (as shown in the

photographs). SK1 will probably need to be a four-way locking audio connector, but a few rigs use a DIN microphone connector and, if necessary, SK1 must be altered accordingly. PL1 is a matching plug for SK1, and this connects to the printed circuit board via a four-core screened cable. The earth connection is carried by the outer braiding of the cable plus one of the inner conductors. This leaves three inner conductors to take the remaining connections.

Wiring SK1 and PL1 to the unit correctly represents the only awkward aspect of construction, and the circuit diagram of the transceiver should include details of the connections between the microphone insert, PTT switch, and microphone plug. Reference to this, plus Figures 1 and 3 of this article should make the correct method of connection clear. If a circuit diagram of the transceiver is

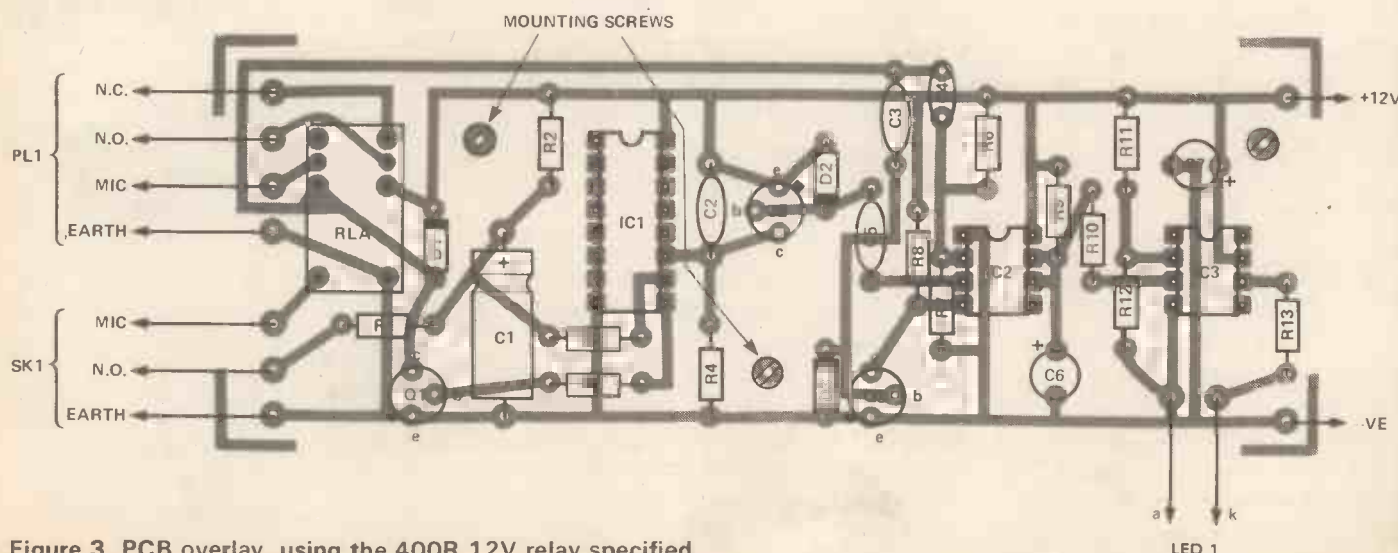

Figure 3. PCB overlay, using the 400R 12V relay specified.

Project

not available it should be possible to deduce the correct method of connection by opening the microphone and output plug and examining the wiring. It would be sensible not to attempt this project unless or until you are confident that SK1 and PL1 can be connected correctly for your rig!

An exit hole for the output lead is drilled in the rear panel of the unit and this should be fitted with a grommet. A two way terminal strip is also fitted on the rear panel, providing a convenient way of connecting the unit to a 12 volt power source (which can be either a car battery or a CB mains-powered supply).

As explained earlier, a link wire must be added to the PTT switch to prevent the microphone from being disconnected when the switch is released. With most PTT microphones, it is possible to gain access to the switch by removing three screws at the rear and then carefully removing the unit; microphones of this type are readily available, if your rig was supplied with a less accommodating type! There should only be two leads connecting to one pole of the switch — one coming from the microphone insert and the other being part of the microphone lead. The link wire is soldered across the two tags to which these leads connect, but make sure that you do not accidentally desolder one of the leads.

Testing

Connect the unit to the 12 volt DC power source, being careful to get the supply polarity right. With the microphone connected to SK1 the relay should switch on or off (as appropriate) each time the PTT switch is operated. If the relay is left switched on, after about 20 to 25 seconds LED1 should switch on, and after a further ten to fifteen seconds both LED1 and the relay should switch off. Once the unit is functioning correctly it can be connected to the rig (ie, connect PL1 to the microphone socket of the rig) for an on-air test.

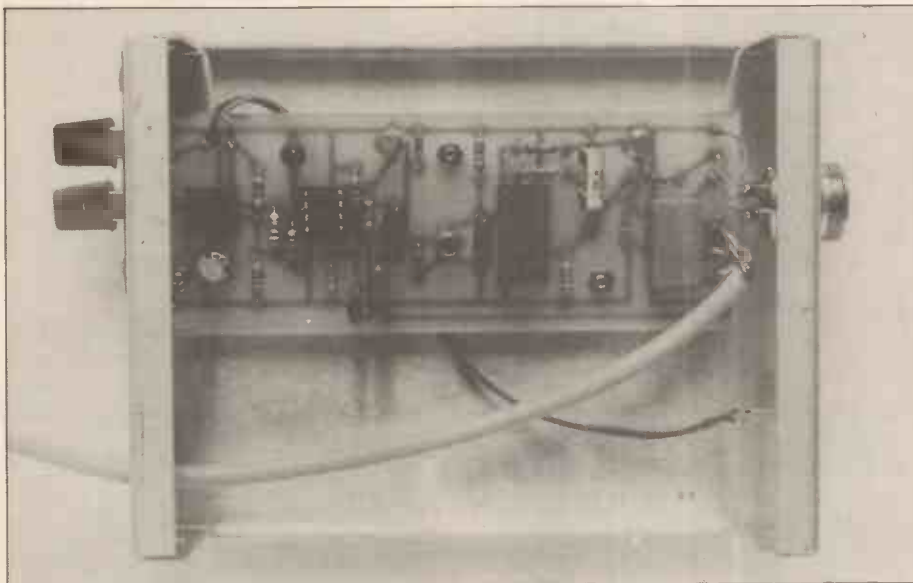

Inside the Rap Latch.

HE

Do you think that designing and understanding electronic circuits is beyond you?

The summer edition of Electronics Digest, *Gateway To Circuit Design*, provides a step-by-step introduction for the newcomer to the art of circuit design. Firstly, you'll be introduced to the commoner electronic components — but not in a passive way. Electronics is a practical subject, so *Gateway To Circuit Design* will enable you to build simple circuits for yourself, and take measurements on them (along the way learning how to use a multimeter). Once these introductions are over, *Gateway To Circuit Design* shows you what goes into the design of a wide range of electronic equipment — for audio, computing and electronic music, for instance.

Gateway To Electronics is an occasional popular series in Electronics Digest, published by Argus Specialist Publications. Previous issues in the series have concentrated on projects; now we'd like you to design your own!

At all good newsagents now or available by post from Electronics Digest, 513 London Road, Thornton Heath, Surrey.

**We'd like
to show you
that you're wrong**



£1.85

ROBOTICS FANS!!! LOOK!!



ONLY
£4.95

"BIG TRAK" MOTORIZED GEARBOX

These units are as used in the "Big Trak" computerized vehicle, and offer the experimenter in robotics the opportunity to purchase the electro-mechanical parts required in building remote controlled vehicles. The unit comprises:

- a) 2 x 3V motors, linked by a magnetic clutch, thus enabling turning of the vehicle;
- b) A gearbox contained within the black ABS housing reducing the final drive speed to approx 50rpm.

Data is supplied with the unit showing various options on driving the motors, as well as a direction controller circuit, enabling the unit to turn right, left or go straight ahead.

2N3055

Made by Texas — full spec devices, 60p each; 10 for £4; 25 for £3; 100 for £34; 250 for £75; 1000 for £285.

SCOOP!!

AA NI-CADS 10 for £9.95

Brand new nickel cadmium batteries by GE, standard 1.2V at 450mA/H. Professional quality with solder tags both ends. Special price, £1.40 ea; 10 for £9.95; Box of 80 £85. Nicad Charger: Charges up to 4AA, C or D cells + PP3. Only £7.95.

COMPUTER SOFTWARE

We now sell a range of tapes and books for DRAGON 32, SPECTRUM, ZX81, BBC and VIC20. Send a.a.e. for list stating for which computer required, or call in our shop.

SIMON GAME

Simon is back again. Another supply of ready built PCB's for this flashing light/pulsating tone computerised game is now with us. Supplied tested and working with speaker and instructions £4.95.



NOW
REDUCED
TO £3.95

ELECTRO DIAL

Electrical combination lock for maximum security-pick proof. One million combinations! Dial is turned to the right to one number, left to a second number, then right again to a third number. Only when this has been completed in the correct sequence will the electrical contacts close. These can be used to operate a relay or solenoid. Overall dia 65mm x 60mm deep. Only £3.95.

FERRIC CHLORIDE

New supplies just arrived — 250mg bags of granules, easily dissolved in 500ml of water. Only £1.15. Also abrasive polishing block 95p.

STABILIZED PSU PANEL

A199 A versatile stabilised power supply with both voltage (0-30V) and current (20mA-2A) fully variable. Many uses inc bench PSU, Ni-cad charger, gen. purpose testing. Panel ready built, tested and calibrated £7.75. Suitable transformer and pots £6.00. Full data supplied.

REED RELAYS

Manufacturers rejects — DIL and other PCB mounting types. SP, DP and 4P — make, break and c/o contacts. Not tested, so may be only partially working or o/c etc, so very low price — pack of 10 assorted £1; 25 £2.00; 100 £7.00.

TELESCOPIC AERIALS

As used in Shlclair microvision, 9 section 100-610mm. Only 95p.

IN4148 — BEST PRICE EVER

Supplied in packs of 100, by Toshiba £2 per pack; 3 packs £5.50; 10 packs £15; 25 packs £32; 100 packs £115.

COMING SOON . . .
MORE COMPUTER GAMES PCB'S
— MICROVISIONS, ALPHIE,
AVENGER, INTRUDER, AND
STARBIRD

LIE DETECTOR

Not a toy, this precision instrument was originally part of an "Open University" course, used to measure a change in emotional balance, or as a lie detector. Full details of how to use it are given, and a circuit diagram. Supplied complete with probes, leads and conductive jelly. Needs 2 4.5V batts. Overall size 155x100x100mm. Only £9.95 — worth that for the case and meter alone!

GREENWELD

443A MILLBROOK ROAD, SOUTHAMPTON SO1 0HX
All prices include VAT — just add 50p post. Tel (0703)
772501

CAMBRIDGE LEARNING SELF-INSTRUCTION COURSES

NEW MICROPROCESSORS & Microelectronics £6.50

Now you can learn all about microprocessors — their construction, design, and operation — using our programmed learning technique. Suitable for all ages, all levels of interest, this course has been designed for ease of understanding. It assumes no prior knowledge other than arithmetic; and at the end you will know what that piece of "black plastic" in your computer is actually doing.

Contents include: algorithm design, programmable logic, microcomputer architecture, a microprocessor family, semiconductor technology, number systems, arithmetic — integer and floating point, data representation and scaling, programming, microprocessor development system.

GSC SUPERKIT £19.90



Learn the wonders of digital electronics — without the problems of soldering.

This practical beginners' kit comes complete with instruction manual, components, and EXP300 breadboard to teach you all the basics of digital electronics. The only extra you need to buy is a 4½V battery.

This self-instruction course teaches gating, boolean logic, R-S and J-K flipflops, shift registers, ripple counters, and half-adders.

DIGITAL COMPUTER DESIGN £8.50

This up-to-date theory course covers the design of digital computers, both from their individual logic elements and from integrated circuits. You are first shown the way in which simple logic circuits operate and then, through a series of exercises, arrive at a design for a working machine.

Please send for our free booklist for further information on these and our other courses.

GUARANTEE No risk to you. If you are not completely satisfied, your money will be refunded upon return of the item in good condition within 28 days of receipt.

CAMBRIDGE LEARNING LIMITED, UNIT 95 RIVERMILL SITE, FREEPOST, ST IVES, CAMBS, PE17 4BR, ENGLAND. TELEPHONE: ST IVES (0480) 67446. VAT No 313026022

All prices include worldwide postage (airmail is extra — please ask for prepayment invoice). Giro A/c No 2789159. Please allow 28 days for delivery in UK.

-SUPERKIT(S) @ £19.90
-DIGITAL COMPUTER DESIGN(S) @ £8.50
-MICROPROCESSORS & MICROELECTRONICS @ £6.50

I enclose a *cheque/PO payable to Cambridge Learning Ltd for £..... (*delete where applicable)

Please charge my:

*Access / American Express / Barclaycard / Diners Club Eurocard / Visa / Mastercard / Truscard

Expiry Date..... Credit Card No

Signature.....

Telephone orders from card holders accepted on 0480 67446 Overseas customers (including Eire) should send a bank draft in sterling drawn on a London bank, or quote credit card number.

Name.....

Address.....

Cambridge Learning Limited, Unit 95 Rivermill Site, FREEPOST, St Ives, Huntingdon, Cambs. PE17 4BR, England. (Registered in England No 1328762).

BACKNUMBERS

February 1980

Passion Meter, Win Indicator, Short Circuit Special, Kit Review Special, Into Electronics Construction Part 1.

September 1980

MicroMixer, Reaction Tester, Guitar Phaser, Development Timer, Teletext Explained, Into Digital Electronics Part 1.

April 1981

Pre-Amplifier Part 1, Super Siren, Guitar Tremolo, Russian Roulette Game, Doorbell Monitor, Anatomy of a Space Shuttle.

May 1980

MiniClocks, 5080 Preamp, Model Railway Track Cleaner, 5080 Loudspeakers, Loudspeaker Crossover Design, Radio Controlled Model Survey.

October 1980

Kitchen Timer, Tug 'o' War Game, Light Dimmer, Freezer Alarm, Intruder Alarm, Temperature-Controlled Soldering Iron.

May 1981

Electronic Organ, Voice-Operated Switch, Infra-Red Controller, Pre-Amplifier Part 2, Audio Millivoltmeter.

June 1980

Microbe Radio Control System, Egg Timer, Two Watt Amplifier, Fog Horn, Short Circuits, LEDs and LED Displays.

January 1981

Car Rev-Counter, Bench Amplifier, Sound-Into-Light Converter, Chuffer, Electronic Games reviewed.

June 1981

Power Amplifier Part 1, Continuity Checker, Envelope Generator, Early Radio, Gadgets, Games and Kits Supplement.

July 1980

Sound-Operated Flash Trigger, 18 + 18 Car Stereo Booster, Hazard Flasher, Electronics in Photography, Electronic Espionage, Piezo Electricity.

February 1981

Heartbeat Monitor, High-Impedance Voltmeter, Medium Wave Radio, Two-Tone Train Horn, Audio Signal Generator.

July 1981

Burglar Alarm, Doorbuzzer, Treble Booster, Electronic Aids for the Disabled, Power Amplifier Part 2.

August 1980

EquiTone Car Equaliser, Pass-The-Loop Game, Gaztec Gas Detector, OP-Amp Checker, In-Car Entertainment Survey, Introducing Microprocessors.

March 1981

Public Address Amplifier, Windscreen Wiper Controller, Bicycle Speedometer, Photographic Timer, Microcassettes.

August 1981

Electronic Ignition, Thermometer, Electronic Organ (final part), RPM Meter, Bench Power Supply, Radio Control Survey, Into Electronic Components Part 1.

All of the 1980 issues, except January and April, are still available together with the remaining issues from 1981.

All backnumbers cost £1.25 each. For those of you who only want copies of articles, we do offer a photocopying service. Each copy costs £1.25 and information as to its title and publication date should be given. Ordering backnumbers and photocopies could hardly be easier, just fill in the coupon, cut it out and send it to:

**Hobby Electronics,
145 Charing Cross Road,
London WC2H 0EE**

Please remember to mark your envelope with the service you require, **BACKNUMBERS** or **PHOTOCOPIES**, otherwise our mailroom won't like you.

**HOBBY ELECTRONICS
BACKNUMBER ORDER FORM**

Please send me the following items:

NAME

ADDRESS

.....

.....

.....

Back issues at £1.25 each

I enclose £.....

Cheques and Postal Orders should be made payable to ASP Ltd.

**HOBBY ELECTRONICS
PHOTOCOPY ORDER FORM**

Please send me the following items:

NAME

ADDRESS

.....

.....

.....

Photocopies of in the

..... issue at £1.25 each

I enclose £.....

Cheques and Postal Orders should be made payable to ASP Ltd.

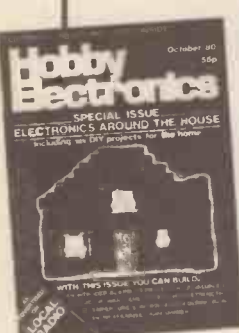
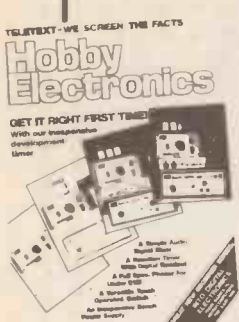
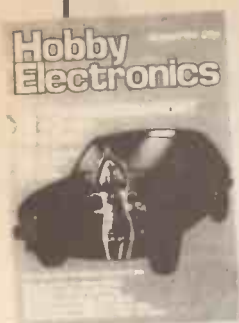
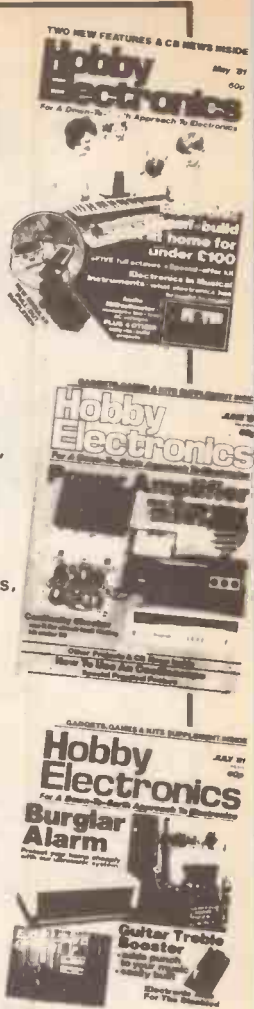

HOBBY HERALD
HAS ALL THE
LATEST NEWS
FOR THE
ELECTRONICS
HOBBYIST

When you need to update yourself with all that is available in the "Do-it-yourself" market, then you need the Hobby Herald.

Packed with product information essential to the electronics enthusiast, this new electronics catalogue lists over 60 exciting products ranging from All Purpose Cutters to Verobloc, the solderless breadboard. All products are available throughout the U.K. from over 200 stockists.

HOBBY HERALD

Alternatively ordering products through the Herald is simplicity itself, and you can pay by either cheque, Barclaycard or Access. So make sure you get your copy of Hobby Herald by ringing
(04215) 62829.



BICC-Vero Electronics Ltd.,
Industrial Estate,
Chandlers Ford, Hampshire,
SO5 3ZR.

BICC vero

CALL IN AND SEE FOR YOURSELF

AUDIO ELECTRONICS

ALL PRICES INCLUDE VAT

TEST EQUIPMENT CENTRES ALL MODELS ON DISPLAY OPEN SIX DAYS A WEEK

RETAIL • MAIL ORDER • EXPORT • INDUSTRIAL • EDUCATIONAL

DIGITAL MULTIMETERS (UK C/P Free)



ALL MODELS 3 1/2 DIGIT UNLESS STATED



HAND HELD (With free carry case)
 KD25C=13 range 0.2A DC 2 meg ohm £24.95
 KD30S=16 range 10A DC 2 meg ohm £29.95
 KD30C=26 range 1A AC/DC 20 meg ohm £34.95
 KD55C=28 range 10A AC/DC 20 meg ohm £39.95
 6010+ 22 range 10A AC/DC 20 meg ohm £34.40
 7030+ As 6010 but 0.1% basic. £41.30
 KD615=16 range 10A DC 2 meg plus Hfe tester £39.95
 189M 30 range 10A AC/DC 20 meg plus Hfe tester £69.95

HAND HELD AUTO RANGE
 DM2350=21 range 10A AC/DC 20 meg ohm (Miniature) £49.95
 HD30 16 range 0.2A AC/DC 2 meg ohm £41.95
 HD30/B As above plus cont. buzzer £44.50
 HD31 22 range 10 AC/DC 2 meg ohms plus cont. buzzer £58.95
 +Optional carry case £2.95

BENCH MODELS

TM353=27 range LCD 2A AC/DC £86.25
 TM355=29 range LED 10A AC/DC £86.25
 TM351=29 range LCD 10A AC/DC £113.85
 2001 28 range LCD 10A AC/DC plus 5 range Cap. Meter with case £108.00
 TM45 1 4 1/2 digit LCD every facility (0.02%) £171.00
 1503a 4 1/2 digit LCD every facility (0.05%) £171.00
 1503Ha 0.03% basic version of above £189.00
 *Optional carry case £6.84

ALWAYS BARGAINS IN EQUIPMENT FOR CALLERS

FREQUENCY COUNTERS



PFM200A 200 MHz hand held pocket 8 digit LED £67.50
 8110A 8 digit LED bench 2 ranges 100 MHz £77.00
 8610B 8 digit LED bench 2 ranges 600 MHz £113.85
 8000B 9 digit LED 3 ranges 1 GHz £178.00
 TF040=8 digit LCD 40 MHz £126.50
 TF200=8 digit LCD 200 MHz £166.75
 =Optional carry case £6.84
 Prescalers - Extended range of most counters
 TP600 600 MHz £43.00
 TP1000 1 GHz £74.00

SIGNAL GENERATORS (220/240v AC)

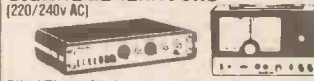

FUNCTION: All sine/square/triangle/TTL etc
 TG100 1 Hz - 100 KHz £90.00
 TG102 0.2 Hz - 2 MHz £166.75

PULSE
 TG105 Various facilities 5 Hz - 5 MHz £97.75

AUDIO: Multiband Sine/Square
 LAG27 10 Hz to 1 MHz £90.85
 AG202A 20 Hz to 200 KHz (List £94.50) £83.50

RF
 SG402 100 KHz to 30 MHz (Last few) £59.95
 LSG17 100 KHz to 150 MHz £79.35

ELECTRONIC INSULATION TESTER

YF 501 500V 0-100m with carry case £63.00

MULTIMETERS (UK C/P 65p)

C7081 50K/V 21 ranges. Range doubler 10A DC. SPECIAL PRICE £15.95
 ETC5000/5001 21 ranges. 50K/V. Range doubler. 10A DC. £16.50

TMK500 23 ranges 30K/V. 12A DC plus cont. buzzer. £23.95
 NM56R 20K/V. 22 range pocket £10.95
 EU102 14 range 2K/V pocket £5.95
 830A 26 range 30K/V. 10A AC/DC overload protection, etc. £23.95
 360TR 23 range 100K/V. Large scale 10A AC/DC plus Hfe £36.95
 AT1020 18 range 20K/V. Deluxe plus Hfe tester £17.50
 ST303TR 21 range 20K/V plus Hfe tester £16.95
 YN 360TR 19 range 20K/V plus Hfe tester £13.95

VARIABLE POWER SUPPLIES (UK C/P £1.00)

PP241 0/12/24V. 0/1A. £35.00
 PP243 3 amp version £59.95
 PS 1307S 8/15V 7 amp twin meter £24.95

DIGITAL THERMOMETER

TH301 LCD -50°C to +750° with thermocouple £68.43

AC CLAMP METER

ST300 0/300A-0/600 VAC. 0/1 Kohm 9 ranges With carry case (UK C/P 65p) £28.50

LOGIC PROBES

LP10 10 MHz £28.50
 LDPO76 50 MHz with carry case and accessories £71.30

OSCILLOSCOPES



Full specification any model on request. SAE by post.
HM Series HAMEG, **SC THANDAR**, **CS Series TRIO**, **3 Series GROTECH**

SINGLE TRACE
 3030 15 MHz 5mV. 95mm tube plus component tester C/P £3.00 £177.10
 SC 110A=Miniature 10 MHz battery variable Post free £171.00
 HM103 15 MHz 2mV. 6 x 7 display plus component tester C/P £3.00 £181.70
 =Optional carry case £6.84 AC adaptor £6.69 Nicads £12.50

DUAL TRACE (UK C/P £4.00)
 HM203/4 Dual 20 MHz plus component tester £303.60
 CS1562A Dual 10 MHz (List £321.00) £269.50
 3131 Dual 15 MHz + component tester £276.00
 CS1566A Dual 20 MHz All facilities (List £401.35) £349.50
 HM204 Dual 20 MHz plus component tester sweep delay. £419.75
 CS1820 Dual 20 MHz with extra facilities (List £508.30) £485.00

OPTIONAL PROBE KITS
 X1 £7.95 X10 £9.45
 X1 - X10 £10.50 X100 £16.95

HIGH VOLTAGE METER

Direct reading 0/40 KV. 20K/Volt. (UK C/P 65p) £23.00

DIGITAL CAPACITANCE METER

0.1 pf to 2000 mid LCD 8 ranges DM6013 £25.75 (Carry case £2.95)

TRANSISTOR TESTER

Direct reading PNP, NPN, etc. TC1 (UK C/P 65p) £21.95

AUDIO ELECTRONICS

Cubegate Limited

301 EDGWARE ROAD, LONDON W2 1BN. TEL: 01-724 3564
 ALSO AT HENRY'S RADIO,
 404/406 EDGWARE ROAD, LONDON W2. TEL: 01-723 1008

FREE CATALOGUE! SEND LARGE SAE (UK 20p)

ALL PRICES INCLUDE VAT
 Order by Post with CHEQUES/ACCESS VISA or you can telephone your orders. All orders despatched within 5 days unless advised.

CAREERS IN ELECTRONICS

'83

Brian Donaldson

If you are looking to the future with an eye towards a career in electronics, you could do worse than checking out the lot of the technical writer. Theirs is the sort of career which would interest people who care about their work, who would enjoy writing and who like plenty of variation.

ESSENTIALLY, there are two directions a technical writer can take his communicative talent — into technical journalism or technical authorship. Each direction demands a different approach, and each requires a different writing style (see later examples) but, even so, many similarities exist between the two careers, allowing the possibility of moving from one to the other. I suppose I am a good example of such an exchange. My initial background in writing was technical journalism but, after a number of years, I decided a change was a good idea and so moved to technical authorship. Now, incidentally, I do neither for a living, but it's like riding a bike — once the skills have been learned they will never be forgotten. And writing *is* a skill. Don't let anyone tell you it's an art which cannot be learned because that is just not so!

The Same But Different

Both technical author and technical journalist are concerned primarily with the reader. The author's reader will probably (though not always) be an engineer or technician: often the service engineer who repairs faulty equipment belonging to a customer. Speed of repair is the most important factor to him — the sooner the equipment is working again, the sooner the customer is happy! Readers of a journalist's work, however, will probably be members of the public, and this pin-points the main difference between the author and the journalist: the author has a captive audience — his reader will read because he *needs* to know specific information. The journalist's reader will *only* read if he is interested. So, the writing style must differ to cater for the different readers.

The author must be concise; his work must be purely factual and written in as logical and clear a manner as possible.

Getting In Touch

The two writers' professional organisations, the NUJ and ISTC, will be able to provide information about relevant training courses. Their respective addresses are:

NUJ, Acorn House, 314-320 Gray's Inn Road, London, WC1X 8DP.

ISTC, 17 Bluebridge Avenue, Brookmans Park, Hatfield, Herts. AL9 7RY.

In comparison, a journalist's work may be quite 'loose' and not so strict regarding, say, grammatical construction or formality. This is because the journalist's reader has time to re-read an article if it wasn't fully understood on first reading. Personal feelings may be displayed by the journalist but this would be frowned upon if shown by the author, because the author's reader needs to understand straight away the important points and not be bothered by trivia not directly concerning him.

Illustration is often best by example so I'm going to write two brief paragraphs now, which show the difference between the writing styles of the journalist and the author. Both paragraphs describe the same thing — a TV — and cover the same aspects, but in them the different writing styles (exaggerated for the purpose) are apparent.

How a journalist might write about the TV:

The latest offering from the Itchitoesanfeet Company of Japan is the K3026, new 26 inch colour TV with advanced microprocessor-controlled circuitry to improve picture quality. Capable of receiving up to 12 different, preselected English TV channels, the set can also be adapted for use worldwide. This TV is the first of a

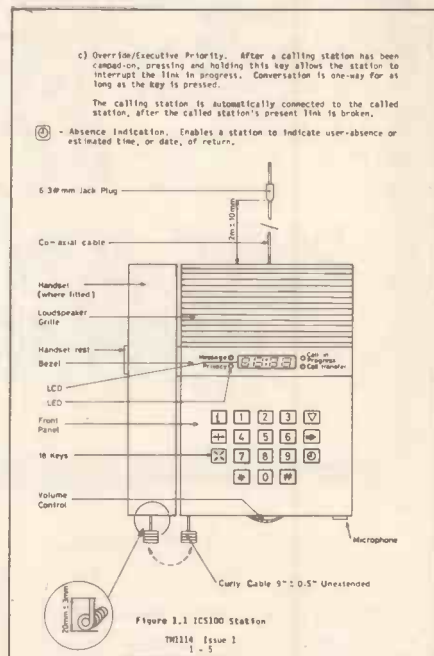

A page from the technical manual for Multitone Electronics' ICS 100 Internal Communications System. The technical author not only writes the text but also prepares the drawings.

completely new range of 5 screen sizes to be introduced by Itchitoesanfeet. The range will extend down to a 12 inch portable TV and all TVs will feature similar picture quality improvements as in the K3026.

How the author might write about the TV:

A new receiver chassis has been released: the K30. The chassis is used with a range of colour tubes of: 26 inch; 22 inch; 18 inch; 14 inch; 12 inch sizes to give identical electrical features to all television receivers in the K30 range.

Features include:

- plug-in PCB option to select picture format (PAL, SECAM, NTSC)
- preselect tuning of 12 reception frequencies in the range 40 to 860MHz.

First television to be marketed from this range is the K3026.

You'll see, I hope, that both examples say more or less the same thing but in very different ways!

Qualifications

Any kind of technical writing, combining as it must an understanding of electronics at some level with the ability to write sensibly and with clarity, is a kind of a hybrid craft for which there is very little specific formal training of



The conclusion of the technical author's labours: a service engineer slaving over a hot soldering iron, the technical manual by his elbow.



The technical journalist at work: Steve Ramsahadeo, former project development editor of ETI, makes sure the project works before writing the text.

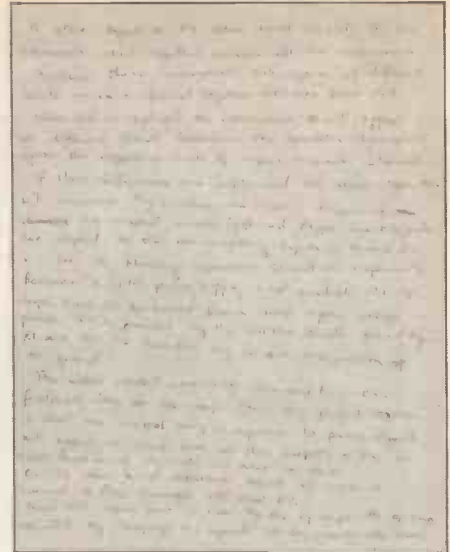

Technical journalism also requires working with other writer's text. Often this means transcribing hand-written copy, editing it into the prescribed style for the magazine as it is re-typed.

2.5 Slave Power Supply
The slave power supply is mains powered and supplies power to units connected to its output bus. Connection to the two arms of the bus are made via 2 1/4" jack sockets on the rear of the unit. A third 1/4" jack socket is used to make connection with the main power supply bus. Electronic circuitry incorporated in the slave power supply transfers information between the master power supply bus and the slave power supply bus.

2.5.1 Mains Input Voltage Selection
The power supply may be strapped to operate from any of the following voltages: ± 10% 50-60 Hz
110 VAC, 120 VAC, 220 VAC, 240 VAC
The power supply must be strapped and fused as for the appropriate mains voltage as shown in figure 3.

2.5.2 Output Connections
2 off 1/4" audio jack sockets are provided at the rear of the unit, one for each arm of the slave supply bus.
1 off 1/4" audio jack socket is provided at the rear of the unit for connection into the master supply bus.

2.6 Stations
Each station contains its own microprocessor which performs the various control and communication functions. The microprocessor and hence the station identity is selected by means of a dual in line switch which is located under a cover in the base of the unit. The station identity is independent of where it is connected in the system.

2.6.1 Station Separation
Stations should be acoustically isolated from each other to prevent the risk of acoustic oscillation.

2.7 Line Powered Bus Coupler
A line powered bus coupler enables a tee-off arm to be connected to the main cable without the use of a slave power supply.
A bus coupler will provide an arm that can support 5 stations.

Tasks for the technical author also include writing and preparing other documents such as the installation manual (above), user instruction books and even sales literature.

benefit to the prospective candidate. Yet, technical authors, who are required to be more precise, generally need a greater depth of understanding and usually come to their trade from a diploma or degree level course in electronics. For such as these, courses are sometimes provided by universities or polytechnics at post-degree level, which offer short but intensive training in the discipline of writing. Such courses force-feed the graduate with enough information to allow a jump straight into either journalism or authorship; this jump can take place at a reasonably high level.

On the other hand, recruitment advertising seeking technical journalists will rarely specify a formal electronics background — though obviously some knowledge of the subject is necessary! Of more importance in technical journalism is enthusiasm, the ability to work with other people, good humour under pressure (the corridors ring with laughter — Ed.) and the capacity to learn at all times.

At this end of the scale, 'A'-level or even 'O'-level students may be fortunate enough to be employed as a junior assistant; such vacancies often

occur and many good writers have entered journalism or authorship this way. There's nothing quite like experience and, it may reasonably be argued, three years of learning how to do the job, while actually sitting at the desk and doing it, will make a more able writer than any degree will. In the end, it all depends on the individual and making the best of an opportunity.

All good employers realise the importance of, and benefits gained by providing, an in-service training scheme of some description for their employees. Some universities, polytechnics and a number of specialist companies can help with such a scheme. All writers — graduates, non-graduates, old, young, experienced, inexperienced alike will, because of this in-service training, be able to give greater service to the employer afterwards.

Union Dos

Whatever your career, it is always a good idea to join a professional authoritative body. The main journalists' organisation is the National Union of Journalists (NUJ) which, although officially a union, also provides information, news and views of current affairs involving journalists of all kinds. No member is under pressure to take an active rôle in the life of the union but, also, no member is prevented from doing so.

The technical authors' main professional body is the Institute of Scientific and Technical Communicators (ISTC), which provides a similar service as the NUJ in that news, information, details of courses and lectures of interest are regularly circulated to members.

The Job Itself

The title 'technical writer' is slightly misleading, actually, since neither journalist nor author spends the whole day writing; putting pen to paper can only be attempted after an amount of research into the topic has been

undertaken. The writer must thoroughly understand the subject in order that his words convey the correct and full meaning to the reader because, if the writer doesn't know what he's writing about, how can the reader understand? At best the reader will not grasp the meaning, at worst he will be confused! So the first thing the writer has to do in his work is to study closely and carefully the topic he is going to write about.

The second thing is to think about is: who is the reader? How much does he already know about the subject? It is necessary to decide and define the reader at this early stage, before the writer begins an article or book.

When finally the article, manual, report, pamphlet, or whatever has been written, it must undergo a number of stages of close scrutiny in an attempt to remove all errors: in grammar, spelling, typing, accuracy etc. Often, in these stages, other people are involved, working as a team to produce the final printed work. Inevitably, errors will creep in at any or all of these stages, possibly making their way to the printed page, but a small team of, three people say, with experience, good management and just a little bit of luck, will be able to eliminate the majority.

I hope, in this limited space, I have been able to give an idea of the work of a technical writer, whether a journalist or an author. Both careers can be interesting and rewarding, and can give a high level of job-satisfaction. If you are interested in pursuing either career, your first stop is your local Careers Office; they'll be pleased to help and advise regarding suitability and be able to suggest methods of entering the profession. The rest is up to you!

Our thanks to Multitone Electronics P.L.C., 6-28 Underwood Street, London N1, who kindly supplied the technical manuals illustrating this article.

electronize

AUTO-ELECTRONIC PRODUCTS

KITS OR READY BUILT

TOTAL ENERGY DISCHARGE ELECTRONIC IGNITION

IS YOUR
CAR AS
GOOD
AS IT
COULD
BE ?

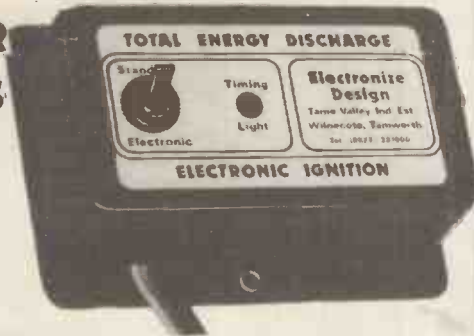

- ★ Is it **EASY TO START** in the cold and the damp? Total Energy Discharge will give the most powerful spark and maintain full output even with a near flat battery.
 - ★ Is it **ECONOMICAL** or does it "go off" between services as the ignition performance deteriorates? Total Energy Discharge gives much more output and maintains it from service to service.
 - ★ Has it **PEAK PERFORMANCE** or is it flat at high and low revs. where the ignition output is marginal? Total Energy Discharge gives a more powerful spark from idle to the engines maximum (even with 8 cylinders).
 - ★ Is the **PERFORMANCE SMOOTH**? The more powerful spark of Total Energy Discharge eliminates the "near misfires" whilst an electronic filter smooths out the effects of contact bounce etc.
 - ★ Do the **PLUGS and POINTS** always need changing to bring the engine back to its best? Total Energy Discharge eliminates contact arcing and erosion by removing the heavy electrical load. The timing stays "spot on" and the contact condition doesn't affect the performance either. Larger plug gaps can be used, even wet or badly fouled plugs can be fired with this system.
 - ★ **TOTAL ENERGY DISCHARGE** is a unique system and the most powerful on the market - 3½ times the power of inductive systems - 3½ times the energy and 3 times the duration of ordinary capacitive systems. These are the facts:
Performance at only 6 volts (max. supply 16 volts)
SPARK POWER — 140W, SPARK ENERGY — 36mJ
SPARK DURATION — 500µS, STORED ENERGY — 135mJ
LOADED OUTPUT VOLTAGE
50pF load — 38kV, 50pF + 500k — 26kV
- We challenge any manufacturer to publish better performance figures. Before you buy any other make, ask for the facts, its probably only an inductive system. But if an inductive system is what you really want, we'll still give you a good deal.
- ★ All **ELECTRONIZE** electronic ignitions feature:
EASY FITTING, STANDARD/ELECTRONIC CHANGEOVER SWITCH, STATIC TIMING LIGHT and DESIGNED IN RELIABILITY (14 years experience and a 3 year guarantee).
 - ★ **IN KIT FORM** it provides a top performance system at less than half the price of comparable ready built units. The kit includes: pre-drilled fibreglass PCB, pre-wound and varnished ferrite transformer, high quality 2µF discharge capacitor, case, easy to follow instructions, solder and everything needed to build and fit to your car. All you need is a soldering iron and a few basic tools.

Most **NEW CARS** already have electronic ignition. Update **YOUR CAR**

PROTECT YOUR CAR WITH AN ELECTRONIZE ELECTRONIC ALARM



- ★ **2000 COMBINATIONS** provided by an electronic key - a miniature jack plug containing components which must match each individual alarm system. (Not limited to a few hundred keys or a four bit code).
- ★ **60 SECOND ALARM PERIOD** flashes headlights and sounds horn, then resets ready to operate again if needed.
- ★ **10 SECOND ENTRY DELAY** allows owner to dis-arm the system, by inserting the key plug into a dashboard mounted socket, before the alarm sounds. (No holes in external bodywork, fiddly code systems or hidden switches). Re-closing the door will not cancel the alarm, before or after it sounds, the key plug must be used.
- ★ **INSTANT ALARM OPERATION** triggered by accessories or bonnet/boot opening.
- ★ **30 SECOND DELAY** when system is armed allows owner to lock doors etc.
- ★ **DISABLES IGNITION SYSTEM** when alarm is armed.
- ★ **IN KIT FORM** it provides a high level of protection at a really low cost. The kit includes everything needed, the case, fibreglass PCB, CMOS IC's, random selection resistors to set the combination, in fact everything down to the last nut and washer plus easy to follow instructions.

**FITS ALL 12 VOLT NEGATIVE EARTH VEHICLES.
SUPPLIED COMPLETE WITH ALL NECESSARY LEADS
AND CONNECTORS PLUS TWO KEY PLUGS**

Don't Wait Until Its too Late ~
Fit one **NOW!**

fill in the coupon and send to:

ELECTRONIZE DESIGN Dept E · Magnus Rd · Wilnecote · Tamworth · B77 5BY · tel 0827 281000

TOTAL ENERGY DISCHARGE (6 or 12 volt negative earth)

- Assembled ready to fit £26.70 £19.95
- D.I.Y. parts kit £15.90 £14.95

TWIN OUTPUT. for cars and motor cycles with dual ignition

- Twin, Assembled ready to fit £36.45 £29.95
- Twin, D.I.Y. parts kit £24.55 £22.95

INDUCTIVE DISCHARGE (12 volt only)

- Assembled ready to fit £15.95 £12.75

Prices Include VAT.

P+P £1.00 (UK)

CAR ALARM

- Assembled ready to fit £37.95
- D.I.Y. parts kit £24.95

I enclose cheque/postal order OR debit my Access/Visa card



Name _____

Address _____

Code _____

electronics today

INTERNATIONAL

NEXT
MONTH

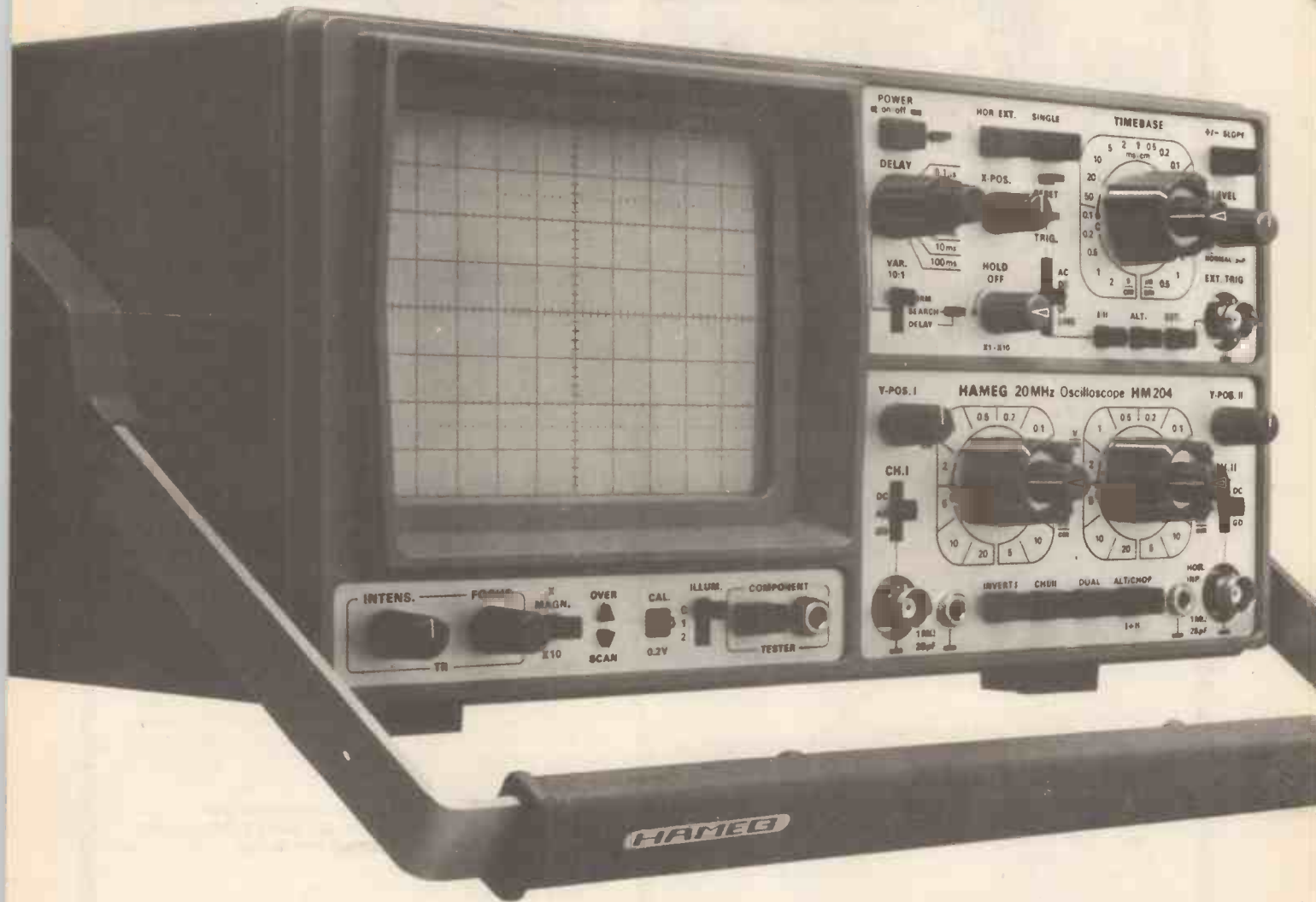

Portable Induction Loop

Following the degree of interest that our feature on Induction Loops aroused, Vivian Capel has designed a practical system. Now there's no excuse for the hard-of-hearing to be left out of things anymore.

Tech Tips Special

Eight pages of ingenious, novel, and money-saving designs from one of the country's largest design teams — yourselves.

Microcomputer Output Driver

Don't let your micro just sit there, contentedly passing information back and forth inside itself — get it busy working for *you*, with this 16-channel output driver.

TV Storage Scope

This little unit will enable you to utilise your TV screen to display oscilloscope waveforms. It's always seemed illogical

that you have to use two CRTs for different jobs, hasn't it — now you can use just the one. Not only that, but the unit will store waveforms too, all for under £100.

Oscilloscope Survey

Just in case you're too lazy to build the TV Scope, we're taking a look at the options open if you want to buy one. And if you're too poor to afford a new scope, we'll be examining the state of the second-hand market too. If you're on the look-out for test equipment, don't miss the July issue of ETI.

LOOK OUT FOR
THE JULY ISSUE
ON SALE JUNE 3rd

Articles described here are in an advanced state of preparation. However, circumstances may dictate changes to the final contents.

THE ELECTRONIC REVOLUTION: POWER IN THE HOUSE



In the last of the series, we scan the least celebrated but most ubiquitous aspect of electricity. Without household gadgets, not many people would have the time to experiment with micros or relax with the video. Nor are we just talking about the ladies — you could have been chopping the wood or salting a side of pork. What a difference a plug makes . . .

John Biggins

Over the past hundred and fifty years electricity has brought about two of the most spectacular changes in the entire course of human affairs. One was the communications revolution, which began with the electric telegraph, and gained momentum in the years between the Wars with the development of broadcasting by wireless and television. The other was the great cybernetics explosion which began with the first electronic computers in the years just after 1945 and which was accelerated in the 1950s and 1960s by the application first of the transistor and second of micro circuitry. Both these developments have had incalculable effects on the way we live and think. But what about the third and quietest of the electronic revolutions: electricity's overthrow of traditional order in the domestic world?

This might not seem much when compared with the other two. There were no Zworykins or Marconis, and it was only very rarely — with things like the hair-drier perhaps — that electricity produced a completely new service

rather than greatly improving an already existing one. Yet the changes which electricity has brought about in the kitchen and the laundry since 1900 have been quite as momentous in their way as broadcasting or computers. Throughout the developed world — even in a fitful sort of way in the Communist part of it — it has liberated half the population from the endless back-breaking tyranny of household labour, reducing domestic service as a form of employment and spawned an economic sea-change (labelled the Consumer Society) in the process. If you want to find the origins of Women's Liberation look as much to the small, mass-produced AC electric motor as to the pill.

Not bad. But how did all this happen? The answer is, very gradually. Public electricity supply had started out in the USA and Britain at the beginning of the 1880s as a street- and house-lighting service and although a couple of the early electricity generating pioneers — notably Thomas Edison — had tried to build up demand for power by marketing a range of consumer electrical gadgets, public use of electricity had been very slow indeed to get beyond illumination;



Getting back to the basics: an early electric eggbeater, c. 1920; with no handle and precious little insulation, it was definitely not intended for portable use!



A Crompton electric iron from 1891 — an advance on the old style of fire-heated flat-iron.



GEC's 1895 version of the electric cooker; notice the brass lighting-style switches mounted on one side.

all the more so since the electric light was very nearly strangled at birth by the invention of the incandescent gas mantle in 1881. Electric flat-irons began to appear in the late 1880s, some of them quite lethal like the French models which operated by means of an arc burning between two carbon electrodes inside the casing. Fitful experiments were made with electric hotplates, but it was not until 1894 that the Crompton firm in the UK began marketing an electric cooking stove, a bulky sheet-iron affair with exposed heating elements made of iron wire wrapped around fireclay bars.

Electric vs. Gas

The design of cooking ranges had advanced a great deal from the open fire days at the beginning of the 19th century. As metal-casting and production engineering had improved a whole industry had grown up supplying standard cast iron coal-burning cookers, sometimes with refinements like water-heaters and glass oven doors. These had done a great deal to make cooking less laborious by allowing the heat to be controlled with some

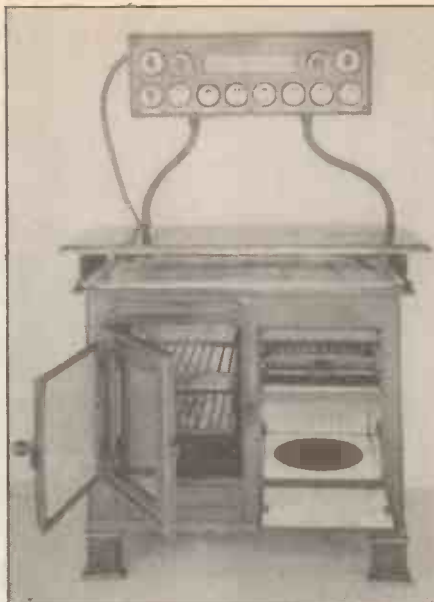

By 1912, electric cookers had come to resemble modern ones — almost!



Preparing the way for the teabag that mainstay of Western civilisation, the electric kettle, was around by 1905.

accuracy. But kitchen work was still a tedious, time-consuming, dirty business for housewives and servants, with all the early morning ritual of coal heaving and clinking and raking and firefighting to be gone through before cooking could begin. It was not until the first gas stoves appeared in the 1840s that the work got any lighter. However, gas was not without its drawbacks, as was pointed out by an 1895 publicity blurb emanating from the City of London Electricity Company, which was trying to interest the public in electric stoves:

No danger; No combustion; No chimney; No fires to light and watch; No matches to look for; No heat wasted; Perfect regulation; No more burnt meats or pastry; No explosions; Pure air; Sanitary kitchens —
NO POISONOUS GASES AROUND FOOD WHILE COOKING!

Still, poisonous gases or not, electricity for cooking took a long time to catch on with the public outside the few wealthy households who could afford a cooker and the electricity bills which

followed. This was partly a result of the fact that by 1914 only about one British home in ten was connected to the mains. But it also stemmed from the faults of the cookers themselves, and in particular their elements, which tended to corrode and burn out in a remarkably short time, as well as short circuiting freely when cooking water slopped over them.

Things took a marked turn for the better in 1906 when A.L. Marsh patented nickel-chrome electrical heating elements. Not only had nichrome a much better resistance than iron or carbon, it was also much less vulnerable to corrosion. Less frequent element changing meant that elements could be better protected inside cooking stoves and at the same time design improved considerably, with blue-grey and later white enamel panels replacing the blacked ironwork of the earlier stoves. And after 1918 electricity tariffs got cheaper as the national system was rationalised and uniform charges came in. Electric cookers began to acquire thermostatic oven regulators in the mid-1930s, which reduced the bother of cooking. After this, little improvement took place until the arrival of the microwave cooker in the late 1960s. Electric cooking never managed to knock gas out of first place as the nation's favourite means of food preparation but it still made a large contribution to the lightening of the housewife's lot.

Putting on the Heat

Ni-chrome elements also did a great deal to aid electric space heating in the later 1900s. Previous attempts at electric room heaters had centred on wall-plates with iron wires embedded in a ceramic surface, or on large incandescent bulbs warmed to red heat, rather than on wire elements around a clay core. Reliable wound-wire



This GEC cooker from 1936 is cut away to show the heating elements, and insulation, of both the oven and the hob.



An "Apollo" electric fire from 1904; the elements are encased in glass globes — like electronic valves!

elements were now possible and by about 1912 the electric fire had made its appearance in the shape loathsomely familiar to generations of dwellers in digs and bedsits, combining voracious consumption of meter shillings with a heat output barely perceptible more than a yard or so away. A good part of the problem was that until the mid-1960s, when decadent foreign notions of central heating began to make their way into the nation's domestic architecture, Britain was a country whose home heating was built around abundant supplies of cheap coal burnt in the most wasteful and inefficient way possible in an open grate.

The legendary dank chill of the British bedroom could not be dispelled by the puny glow of a two-bar electric fire, which rather served to make the arctic



By 1925, electric heater design had achieved a form which remained virtually unchallenged for the next 50 years.

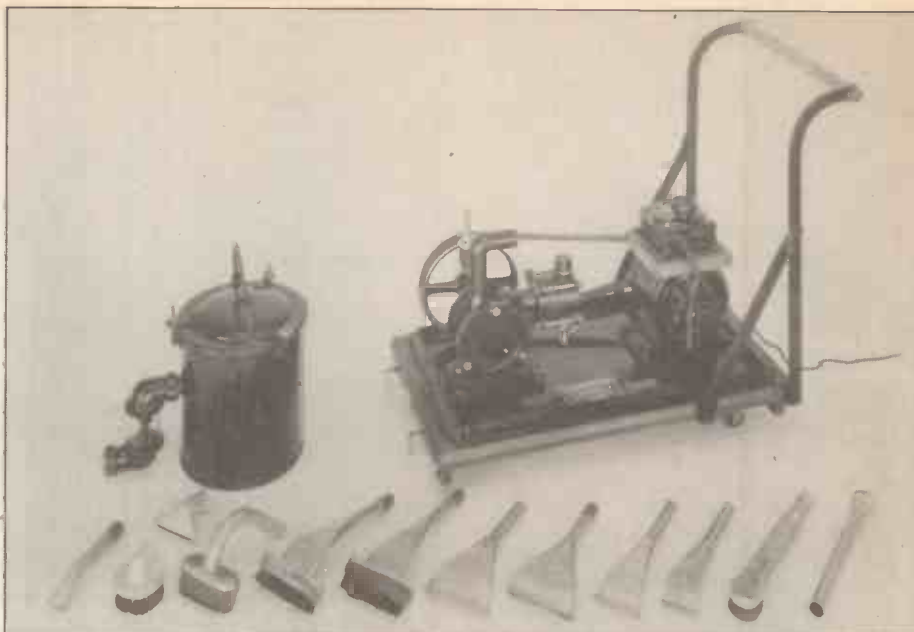

This British Vacuum Cleaner Company model, from an age when motor cars were scarce, looks as suitable for the Stables and the Garden as for the House, with an attachment for every eventuality.

gloom even more noticeable. Chilblains remained the English Disease and the Permissive Society had to wait for the advent of the gas-boiler rather than the cheap electricity which had done such interesting things for the social life of the Scandinavians. But all the same, some experiments in economical and effective space heating by electricity were made over the years. After a mere half-century of public electricity supply, in 1930, some unknown genius of the staff of the Watford electricity supply company had realised that, although the generators had to be kept running, very little power was used between 10pm and 6am. So why not sell it at cheap rates, so that people would be encouraged to invest in those new Swedish-built storage heaters carved out of a block of steatite? The result of this unexpected stroke of imagination was the first UK experiment in cut-rate electricity for home heating, or "the soapstone tariff" as it was called.

But even amongst the citizens of Watford, it seems that electric central heating never really caught on. Electric immersion heaters became moderately popular in the 1950s after the problem of making a watertight seal around the element had been solved. But as for house warming by electricity, the position is best summed up by a plaintive sticker seen a couple of years ago in the back of a decrepit Cortina parked on a London street: "I Had a Rolls Royce, But Then I Invested in Electric Central Heating".

Cleaning Up

The great electric labour-savers were the washing machine and the vacuum cleaner, and although neither of these devices was created by electricity, both owed their existence as a consumer durable to the perfection of small, mass-produced electric motors in the USA

around 1910. Between them they not only took most of the pain and drudgery out of the business of household cleaning (a far more time-consuming business then than now, thanks to coal fires and dirty city air) but also made possible a major economic revolution by allowing the disbandment of that huge army of ill-paid female servants who kept the pre-1914 civilised world going, figuring in the households of even the most lowly of office-clerks.

The idea of mechanical clothes washing and carpet cleaning had already been around for quite some time before electricity was applied to them. For most women before the First World War, washing day had been a gruelling weekly ordeal of copper boiler and passing stick (for those who have never heard of it, a length of telegraph pole fitted with two handles to allow it to be pounded up and down on the clothes in the boiler). All in all it was not far advanced from two stones on the bank of a stream, and the idea of a mechanical agitator had been tried in one form or other for over a century: either a barrel with paddles rotated by a crank, or a wooden trough on rockers with a stone roller running to and fro inside.

At the end of the 19th century some of the larger public laundries had experimented with steam engines as prime-movers for mechanical washing. But female muscle power was cheap, and it was not until the mid-1900s that electric motors were tried as motive power for washing agitators, though the water was still heated separately by a coal fire. Likewise, with the cleaning of carpets and furnishings, various ideas had been tried since the mid-19th century to get around the necessity for taking everything out of doors and thrashing it energetically with a carpet beater. Sir Joseph Whitworth had patented a carpet-sweeper with spiral revolving brushes in the 1840s. And in



Despite its clumsy appearance, the washing machine was a tremendous advance on boiling and hand-washing.

1901, H.C. Booth had developed a system for sucking up dust and decanting it into a cloth bag. The earliest vacuum cleaners were operated on contract by the Vacuum Cleaning Company Ltd. and consisted of vans the size of a small milk float driven around London by uniformed staff who sometimes gave demonstrations at specially arranged parties held for members of society, like a kind of up-market Tupperware. Domestic vacuum cleaners also appeared during the 1900s, though these were anything but labour-saving devices, requiring as they did two servants to operate them: a maid to do the sweeping and a boy to operate the bellows with a lever, rather like an old-

fashioned harmonium. The trouble was that, prior to 1914, there was really not a great deal of demand for either washing machines or vacuum cleaners. In Europe at any rate servants were cheap and plentiful, so why pay fifty pounds for a washing machine when that amount would hire you a human drudge for a whole year?

Servants' Lib.

Things were rather different in the USA however, even before the Great War. The Americans had always been fascinated by labour-saving devices (much to Europe's amusement) largely because servants had never been plentiful outside the slavery states of the old South. In fact, most Americans had come to America precisely in order to escape from a life of semi serfdom in the Old World. Electric powered vacuum cleaners began to appear in the States around 1912 as the production line techniques of Ford Motors were applied to other items, and since purchasing power was far more evenly distributed there than in Europe they soon found a mass market. Within a few years the same sort of social changes were on the way on the other side of the Atlantic as well. The munitions factories of 1914-18 had given working class girls a line of escape from the hated position of domestic slavery and in addition they had given them wages unimaginable in 1914 — much to the disgust of their betters. When the War ended they were unwilling to re-enter domestic service for the sort of pay which had been usual in peacetime and as a result the pages of *Punch* were filled with sour little jokes about "the servant problem".

The consequence of this sudden dearth of cheap labour was that interest in electric home aids blossomed almost overnight at the beginning of 1919. American-style mass production soon

appeared in Britain and by 1920 the price of a vacuum cleaner had come down to six pounds from about twenty six pounds in 1913, which put it well within the reach of a skilled working class home. By 1926 the Hoover company had captured the UK market to such an extent that "hoover" made its way into the Oxford Dictionary as noun and verb. Washing machines soon followed and by the mid-1930s the consumer durables industry was well established in Britain, making a major contribution to dragging the country out of the Depression and leaving as its monuments a series of Babylonian- and Egyptian-style factories scattered around the western suburbs of London.

Not only was the burden of housework immeasurably lightened and the working housewife becoming a possibility: the change was already under way towards a new economic world largely geared to the production of consumer goods rather than heavy capital equipment. In time this would be christened the Affluent Society, or the Consumer Society, or Mr. MacMillan's famous "You've Never Had it So Good" society. It would even make its way into the Communist world, in a dingy and semi-competent form, causing no end of trouble as people's expectations of washing machines and vacuum cleaners and electric sewing machines grew far beyond socialised production's capacity to fulfil them.

For the time being though the effects were restricted to the home as electricity finally ousted gas from its position as domestic service number one, so that today a household without electricity is almost unthinkable. The next step? Probably a situation in which all the domestic work will again be controlled by servants, but electronic servants in the form of robots and computers, and housework as such will become a part of history.

HE



This Hotpoint machine, from 1937, was probably the equivalent of the modern-day nappy boiler.



The Dalek-like crest on top of this 1932 refrigerator contains the motor and heat-sink.



The classic upright 'Hoover' from 1936. How many of these, we wonder, are still doing good service?

SAVE £4.25 by receiving a FREE magazine binder when you subscribe to

Hobby Electronics

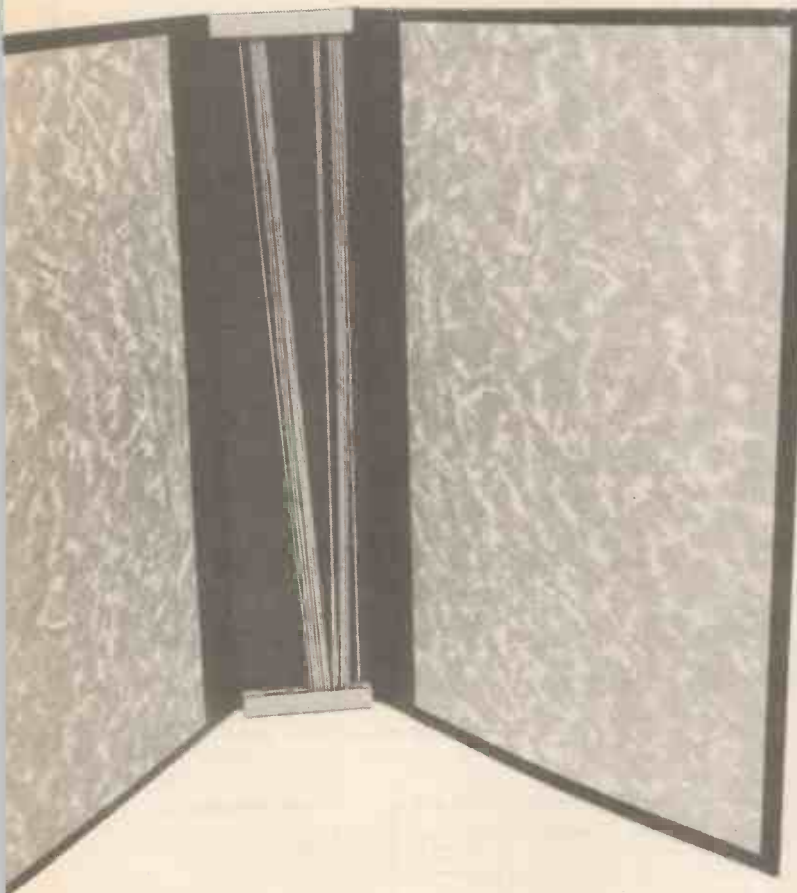

It's true, by subscribing to Hobby Electronics you will not only receive your personal copy direct to your door for a whole year but also have a superb A S P magazine binder in which to keep your copies AND IT'S FREE!

All you have to do to receive your FREE binder is book a new subscription or renew an existing subscription to Hobby Electronics.

What could be simpler? Normally priced at £4.25, these attractive binders will hold approximately 12 issues of Hobby Electronics.

Not for you any longer the chore of having to track down dogeared copies of your favourite magazine, instead you will merely go to your bookshelf and they will be waiting for you in pristine condition.

Don't miss out on this outstanding offer — subscribe today and receive your FREE binder within 14 days of your order being received.

SPECIAL OFFER

Cut out and SEND TO :

Hobby
Electronics

513, LONDON ROAD,
THORNTON HEATH,
SURREY, CR4 6AR
ENGLAND.

Please send my free binder and
commence my personal subscription to
with the Issue

**SUBSCRIPTION
RATES**
(tick as
appropriate)

£11.95 for 12 Issues
UK
£13.95 for 12 Issues
overseas surface
£26.90 for 12 Issues
Air Mail

I am enclosing my (delete as necessary)
Cheque/Postal Order/International Money

Order for £.....
(made payable to ASP Ltd)

OR

Debit my Access/Barclaycard*
(*delete as necessary)

Insert card no.

Please use **BLOCK CAPITALS** and include post codes.

Name (Mr/ Mrs/ Miss)
delete accordingly

Address

.....

.....

.....

.....

Signature

Date

BOOK REVIEW

The theory of digital systems and the practice of home security are the subjects under scrutiny this month.

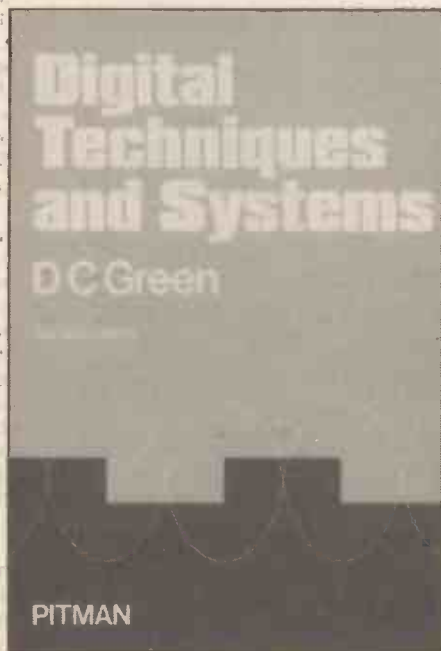

Digital Techniques and Systems (2nd Edition) by D. C. Green. Published by Pitman Books Ltd., London, October 1982. £5.95. Reviewed by Owen Bishop.

This is a course book for examinations of the Technical Education Council but, despite being a seriously intentioned 'textbook', it is attractively laid out and much of its subject matter is of interest to the hobbyist.

The book is really two books under one cover. The first part (88 pages) deals with digital logic circuits, and the second part (87 pages) deals with data transmission. There are also twenty-six pages of appendices and index.

After a brief introductory chapter, the first part looks first at logic gates, describing the logical action and functions of AND, OR, NOT, NAND, NOR exclusive-OR, and exclusive-NOR in detail. The presentation assumes no previous knowledge of the subject and introduces new concepts in clear language in an easily understood way. Textbook pages often appear to be too cluttered with text and diagrams to appeal to the general reader, but the pages of this book avoid this, even though there is plenty of information to digest on each page.

It is copiously illustrated with line diagrams. The logic diagrams conform to the BS3939 standard throughout. This is a requirement for many electronics examinations and may at first glance be unfamiliar to many of our readers. Curiously, most popular

magazines in the UK use the unofficial so-called 'British' symbols for gates, or the US symbols. The British Standards Institute has gone to great lengths to prepare a very workable standard and it seems strange that it should not have been adopted by the amateur.

The chapter on gates includes truth tables, and a summary of Boolean algebra with a useful table of Boolean logic rules. This leads on to a clear discussion of Karnaugh maps and how they may be used to design logic networks.

There are plenty of illustrative examples, and sets of questions. No answers are given, except to those numerical exercises which appear in the second half of the book. The lack of answers is no disadvantage with regard to logic circuits. When you have worked out your answer, get out a breadboard and a few logic ICs, wire up the circuit and find out in a practical way if your answer is correct. Presumably the author intends readers to do something of this kind, for the book is exclusively a theoretical one, with no practical exercises included. That is not to say it lacks a practical approach for the text is full of references to the many applications of digital electronics.

It also takes a more than usual interest in the internal details of the logic ICs. You will find the circuit diagram and a full explanation of the working of TTL gates such as NAND, NOR, AND-INVERT, and AND. Schottky and low-power Schottky gates are also explained. Those readers who have come into electronics as a hobby and who have been content to accept logic gates as 'black boxes' with inputs and outputs and goodness-knows-what inside, will be interested to find out just how these gates work. Manufacturers' data sheets provide so little information on this subject, and are full of unfamiliar jargon such as 'propagation delay', 'fan out', 'open collector outputs', and 'noise immunity' without ever explaining clearly what they mean or how they relate to the circuit on the chip. This book explains all about TTL gates, and CMOS gates, and touches briefly on ECL.

The book then deals with the stock types of medium-scale integrated logic circuit — flip-flops, counters, Schmitt (not Schmitt, the only error I have found in the book!) triggers, and shift registers. Once again, we are taken right inside the chips, with full descriptions of what they do and how to use them.

The section dealing with logic circuits concludes with a chapter on computer

memory. Here the emphasis is strongly on main-frame computer memory with a detailed description of ferrite cores, but less on PROMs and RAM than the average electronics/microcomputer enthusiast would like to know. This is no doubt the result of the slant imposed by the TEC syllabus.

The first part of the book is intended to cover the Digital Techniques IIIA and B half-units of the TEC scheme, and appears to do so thoroughly and at an appropriate level. The scheme is listed in an appendix and beside each point is a helpful page reference to the text. The second part of the book covers the Transmission Systems III half-unit.

Transmission Systems is concerned with the transmission of digital data over lines. This includes sending data from one computer to another or the transmission of digitised speech and similar signals over a telephone network. The emphasis is once again on main-frame computers. This section gives an interesting overall account of the main methods of data transmission and the problems inherent in this operation. Those of our readers who wish to expand their general knowledge of this topic would find this readable and of interest. It describes the distortions which alter the shape of a digital pulse when sent along a line and describes how the pulse may be regenerated on arrival at its destination.

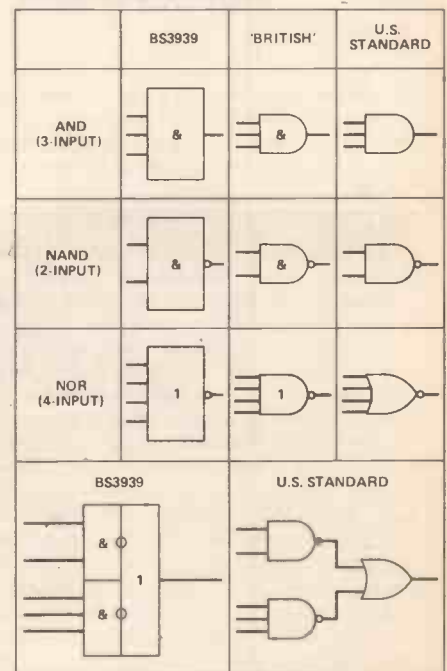

Figure 1. Gate symbol standards compared: see above.

NEWS

There are chapters on digital modulation, data links, pulse code modulation and the use of optical fibre links. There are plenty of block diagrams to illustrate the many systems of transmission described, but no circuit diagrams of the equipment employed. While this section is essential to the TEC student and covers this need fully, it is unlikely to be of interest to the more practical-minded of our readers. The description of modems, for example, would not be of much help to anyone wishing to build and use a modem to send data from one home computer to another.

The book ends with a number of appendices, listing the more frequently used TTL and CMOS logic ICs. One gives a complete explanation of binary arithmetic. Another cross-references the text pages to the TEC syllabuses. Finally there is a set of forty multiple choice questions (with answers) which cover the subject-matter of the whole book.

Conclusions: This is a well written and illustrated book which fulfils its stated purpose of providing for the TEC student of Digital Techniques III A and B and Transmission Systems III. If electronics is your hobby and you want to know more about how to handle logic circuits and what goes on inside them, it is worth while adding this book to your collection. Even if you are not particularly interested in data transmission, the book is still worth the money, just for its extensive treatment of logic circuits. If you are also interested in finding out more about the principles of data transmission, then this is a bonus and you should certainly buy it.

Building and Installing Electronic Intrusion Alarms (3rd Edition) by John E. Cunningham.

Published by Howard Sams and Co., Inc., Indianapolis, USA, August 1982. Distributed by Prentice/Hall International, Hemel Hempstead. £8.20

Reviewed by Owen Bishop.

This book shows the electronics hobbyist how to protect his home and car from the ravages of would-be intruders and thieves. As the title suggests, the emphasis is on raising a resounding alarm as soon as entry or theft is attempted, with the intention of scaring away the miscreant before he or she has had time to place even a finger upon the prospective loot.

The author makes the important point that commercially installed systems are

usually highly expensive and that a great deal of money can be saved by building it yourself. Against this must be set the fact that wiring a perimeter loop to protect all the windows and doors of your house takes a long time. It is typical of the practical approach of the book that the author discusses at some length the points in favour of and against building your own system or having one fitted by the professionals.

It appears that the hobbyist can produce something every bit as reliable and effective as the commercial system, provided that the basic electronics are understood and the constraints of operating such a system are taken into account. There is the bonus that, if you install your own system, nobody else knows how it works. A burglar may know how to by-pass the more widely-used commercial systems, but the home-brew variety may have all sorts of pitfalls for the intruder and this feature in itself is a strong deterrent.

Before buying this book, which for its modest size (16pp, 136 x 216mm) is relatively though not excessively expensive, you should consider whether you feel able to plan, build and maintain a system which will reliably protect your house or car.

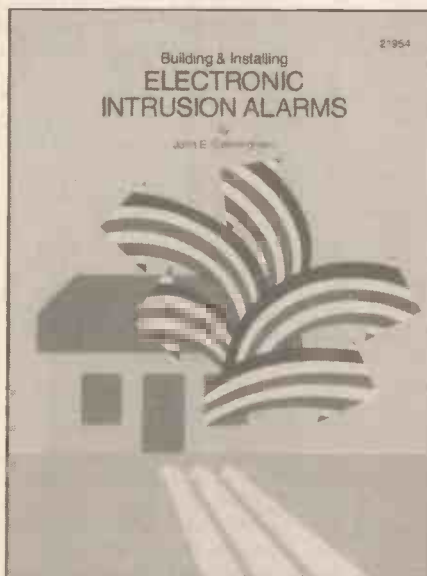

If you are a regular reader of this magazine and have built some of the projects and got them to work, the answer to this is probably 'yes', for none of the projects described in the book is complicated to build and detailed circuit diagrams are given. However, strip-board layouts or PCB designs are not given, so you need to be able to translate a circuit diagram into practical form. If you do decide to buy the book and use it, you will find that the price is reasonable for the amount of expertise and information packed into it.

A list of components is given for each circuit, in which each item is fully described. Thus, if it happens that certain types of component are not readily available in this country (as is almost inevitable when a book is of US origin), you should be able to use the descriptions in the components list to find a suitable substitute. Most of the circuits are based on discrete

components, so eliminating the problem of obtaining obscure types of integrated circuit. A few circuits use the 555 timer and the LM3909 oscillator. There are two circuits employing a combination-lock IC. The LS7225 required for one of these is not widely available from UK suppliers, but is stocked by Ambit International. I have not been able to find a supplier for the other IC, the LS7220, used in one of the car alarm circuits.

The author has a clear style and leaves very little unexplained. On the general level, he has some interesting points to make concerning the mode of operation and hints for using thyristors, unijunction transistors and the 555 IC. Some of his novel circuits are interesting too, particularly the electronic system based on two UJTs, and the voltage-sensitive system used for protecting a car.

The book describes about thirty circuits altogether, including a variety of trigger circuits, photoelectric intrusion alarms, proximity alarms, audio-triggered alarms, shock and vibration alarms, proximity alarms, audio-sounding devices, and car alarms. A few of these are not really feasible or even permissible in UK (for example a radio warning link, and various connections to the public telephone system) but these take up only a small part of the book. Apart from the circuits there is copious detail of the many kinds of switches, pressure-pads and other triggering hardware that is available, and how to incorporate these into your system most effectively. The author considers power supplies, coming down heavily in favour of battery-power, which topic is fully investigated.

The final chapter deals with the vexatious question of false alarms, the bane of so many security systems, both amateur and professional. If your system is prone to false alarms you might just as well have no system at all, for neighbours and others will simply ignore its warnings. Fortunately this aspect of alarm systems is well taken care of by the author. He has obviously had much experience in dealing with this kind of fault and explains the many causes of false triggering in great detail, with useful hints on running down the source of trouble and how to cure it.

Conclusion: This is a well-written, fully illustrated book of workable, inexpensive (mainly) and thoroughly practicable circuits for the moderately experienced home constructor. There is plenty of helpful advice and information on setting up a home security system geared to your own circumstances and requirements. The majority of the book is applicable to conditions in UK. If you intend to set up your own system and have the ability to do it, this book is good value for money. If you are thinking about having a system installed commercially, the cost of the book is small in relation to what the system will cost, and it's worth buying in order to give yourself enough background knowledge to be able to define your requirements, keep the 'experts' on their toes and generally ensure that you obtain satisfaction.

EUROPA ELECTRONICS

Mail Order to 160 High Road, Willesden, London NW10 2PB
TEL: 01-907 1659

SEND FOR A FREE LIST OF OUR LARGE RANGE OF ITEMS
ALL DEVICES ARE NEW, FULL SPEC AND GUARANTEED

Post & Packing: Add 30p to all orders under £5.

VAT: All UK orders add 15% to total cost including p. & p.

74LS SERIES		74LS148	75p	TTL	TRANSISTORS	4000 CMOS	LINEAR ICs
74LS00	11p	74LS151	40p	74 SERIES	AD161	4000	741
74LS01	11p	74LS154	80p	7400	AD162	4001	748
74LS02	11p	74LS155	30p	7401	BC107	4002	7A J019
74LS03	12p	74LS156	36p	7402	BC108	4003	1A J048
74LS05	12p	74LS157	25p	7403	BC109	4004	1A J059
74LS06	12p	74LS158	30p	7404	BC109C	4005	1A J060
74LS07	12p	74LS159	36p	7405	BC117	4006	1A J070
74LS08	12p	74LS160	36p	7406	BC118	4007	1A J080
74LS09	12p	74LS161	36p	7407	BC119	4008	1A J090
74LS10	12p	74LS162	36p	7408	BC121	4009	1A J100
74LS11	13p	74LS163	36p	7409	BC122	4010	1A J110
74LS12	12p	74LS164	40p	7410	BC123	4011	1A J120
74LS13	12p	74LS165	50p	7411	BC124	4012	1A J130
74LS14	15p	74LS166	60p	7412	BC125	4013	1A J140
74LS15	25p	74LS167	85p	7413	BC126	4014	1A J150
74LS20	12p	74LS168	85p	7414	BC127	4015	1A J160
74LS21	12p	74LS169	85p	7415	BC128	4016	1A J170
74LS22	12p	74LS170	70p	7416	BC129	4017	1A J180
74LS26	12p	74LS171	55p	7417	BC130	4018	1A J190
74LS27	13p	74LS172	55p	7418	BC131	4019	1A J200
74LS28	14p	74LS173	55p	7419	BC132	4020	1A J210
74LS30	12p	74LS174	40p	7420	BC133	4021	1A J220
74LS32	13p	74LS175	40p	7421	BC134	4022	1A J230
74LS33	14p	74LS176	40p	7422	BC135	4023	1A J240
74LS37	14p	74LS177	40p	7423	BC136	4024	1A J250
74LS38	14p	74LS178	40p	7424	BC137	4025	1A J260
74LS40	12p	74LS179	40p	7425	BC138	4026	1A J270
74LS42	12p	74LS180	40p	7426	BC139	4027	1A J280
74LS44	12p	74LS181	90p	7427	BC140	4028	1A J290
74LS47	12p	74LS182	120p	7428	BC141	4029	1A J300
74LS48	14p	74LS183	120p	7429	BC142	4030	1A J310
74LS49	14p	74LS184	120p	7430	BC143	4031	1A J320
74LS51	14p	74LS185	120p	7431	BC144	4032	1A J330
74LS54	14p	74LS186	120p	7432	BC145	4033	1A J340
74LS55	14p	74LS187	120p	7433	BC146	4034	1A J350
74LS56	120p	74LS188	120p	7434	BC147	4035	1A J360
74LS73	18p	74LS189	120p	7435	BC148	4036	1A J370
74LS74	18p	74LS190	36p	7436	BC149	4037	1A J380
74LS75	18p	74LS191	36p	7437	BC150	4038	1A J390
74LS76	17p	74LS192	36p	7438	BC151	4039	1A J400
74LS83	36p	74LS193	36p	7439	BC152	4040	1A J410
74LS85	48p	74LS194	36p	7440	BC153	4041	1A J420
74LS86	16p	74LS195	36p	7441	BC154	4042	1A J430
74LS90	22p	74LS196	45p	7442	BC155	4043	1A J440
74LS91	66p	74LS197	45p	7443	BC156	4044	1A J450
74LS92	32p	74LS198	45p	7444	BC157	4045	1A J460
74LS95	40p	74LS199	45p	7445	BC158	4046	1A J470
74LS96	50p	74LS200	45p	7446	BC159	4047	1A J480
74LS107	20p	74LS201	45p	7447	BC160	4048	1A J490
74LS109	27p	74LS202	45p	7448	BC161	4049	1A J500
74LS112	20p	74LS203	45p	7449	BC162	4050	1A J510
74LS113	20p	74LS204	45p	7450	BC163	4051	1A J520
74LS114	22p	74LS205	45p	7451	BC164	4052	1A J530
74LS122	28p	74LS206	45p	7452	BC165	4053	1A J540
74LS123	34p	74LS207	45p	7453	BC166	4054	1A J550
74LS124	30p	74LS208	45p	7454	BC167	4055	1A J560
74LS125	24p	74LS209	45p	7455	BC168	4056	1A J570
74LS126	25p	74LS210	45p	7456	BC169	4057	1A J580
74LS132	34p	74LS211	45p	7457	BC170	4058	1A J590
74LS133	30p	74LS212	45p	7458	BC171	4059	1A J600
74LS136	25p	74LS213	45p	7459	BC172	4060	1A J610
74LS138	27p	74LS214	45p	7460	BC173	4061	1A J620
74LS139	27p	74LS215	45p	7461	BC174	4062	1A J630
74LS145	70p	74LS216	45p	7462	BC175	4063	1A J640
74LS147	120p	74LS217	45p	7463	BC176	4064	1A J650
		74LS218	45p	7464	BC177	4065	1A J660
		74LS219	45p	7465	BC178	4066	1A J670
		74LS220	45p	7466	BC179	4067	1A J680
		74LS221	45p	7467	BC180	4068	1A J690
		74LS222	45p	7468	BC181	4069	1A J700
		74LS223	45p	7469	BC182	4070	1A J710
		74LS224	45p	7470	BC183	4071	1A J720
		74LS225	45p	7471	BC184	4072	1A J730
		74LS226	45p	7472	BC185	4073	1A J740
		74LS227	45p	7473	BC186	4074	1A J750
		74LS228	45p	7474	BC187	4075	1A J760
		74LS229	45p	7475	BC188	4076	1A J770
		74LS230	45p	7476	BC189	4077	1A J780
		74LS231	45p	7477	BC190	4078	1A J790
		74LS232	45p	7478	BC191	4079	1A J800
		74LS233	45p	7479	BC192	4080	1A J810
		74LS234	45p	7480	BC193	4081	1A J820
		74LS235	45p	7481	BC194	4082	1A J830
		74LS236	45p	7482	BC195	4083	1A J840
		74LS237	45p	7483	BC196	4084	1A J850
		74LS238	45p	7484	BC197	4085	1A J860
		74LS239	45p	7485	BC198	4086	1A J870
		74LS240	45p	7486	BC199	4087	1A J880
		74LS241	45p	7487	BC200	4088	1A J890
		74LS242	45p	7488	BC201	4089	1A J900
		74LS243	45p	7489	BC202	4090	1A J910
		74LS244	45p	7490	BC203	4091	1A J920
		74LS245	45p	7491	BC204	4092	1A J930
		74LS246	45p	7492	BC205	4093	1A J940
		74LS247	45p	7493	BC206	4094	1A J950
		74LS248	45p	7494	BC207	4095	1A J960
		74LS249	45p	7495	BC208	4096	1A J970
		74LS250	45p	7496	BC209	4097	1A J980
		74LS251	45p	7497	BC210	4098	1A J990
		74LS252	45p	7498	BC211	4099	1A J000
		74LS253	45p	7499	BC212	4100	1A J010
		74LS254	45p	7500	BC213	4101	1A J020
		74LS255	45p	7501	BC214	4102	1A J030
		74LS256	45p	7502	BC215	4103	1A J040
		74LS257	45p	7503	BC216	4104	1A J050
		74LS258	45p	7504	BC217	4105	1A J060
		74LS259	45p	7505	BC218	4106	1A J070
		74LS260	45p	7506	BC219	4107	1A J080
		74LS261	138p	7507	BC220	4108	1A J090
		74LS262	20p	7508	BC221	4109	1A J100
		74LS263	20p	7509	BC222	4110	1A J110
		74LS264	20p	7510	BC223	4111	1A J120
		74LS265	20p	7511	BC224	4112	1A J130
		74LS266	20p	7512	BC225	4113	1A J140
		74LS267	20p	7513	BC226	4114	1A J150
		74LS268	20p	7514	BC227	4115	1A J160
		74LS269	20p	7515	BC228	4116	1A J170
		74LS270	20p	7516	BC229	4117	1A J180
		74LS271	20p	7517	BC230	4118	1A J190
		74LS272	20p	7518	BC231	4119	1A J200
		74LS273	20p	7519	BC232	4120	1A J210
		74LS274	20p	7520	BC233	4121	1A J220
		74LS275	20p	7521	BC234	4122	1A J230
		74LS276	20p	7522	BC235	4123	1A J240
		74LS277	20p	7523	BC236	4124	1A J250
		74LS278	20p	7524	BC237	4125	1A J260
		74LS279	20p	7525	BC238	4126	1A J270
		74LS280	20p	7526	BC239	4127	1A J280
		74LS281	20p	7527	BC240	4128	1A J290
		74LS282	20p	7528	BC241	4129	1A J300
		74LS283	20p	7529	BC242	4130	1A J310
		74LS284	20p	7530	BC243	4131	1A J320
		74LS285	20p	7531	BC244	4132	1A J330
		74LS286	20p	7532	BC245	4133	1A J340
		74LS287	20p	7533	BC246	4134	1A J350
		74LS288	20p	7534	BC247	4135	1A J360
		74LS289	20p	7535	BC248	4136	1A J370
		74LS290	20p	7536	BC249	4137	1A J380
		74LS291	20p	7537	BC250	4138	1A J390
		74LS292	20p	7538	BC251	4139	1A J400
		74LS293	20p	7539	BC252	4140	1A J410
		7					

Traffic Light Toy

Andy Armstrong

A project ideal as a present for youngsters

THIS PROJECT, which makes a perfect toy for very young drivers, is a touch-operated traffic light that is stepped through the standard sequence of red, red/amber, green, amber by pressing touch sensitive contacts. There is no worry about the batteries dying quickly, either, as the circuit switches itself off after a short time unless the sequence is stepped.

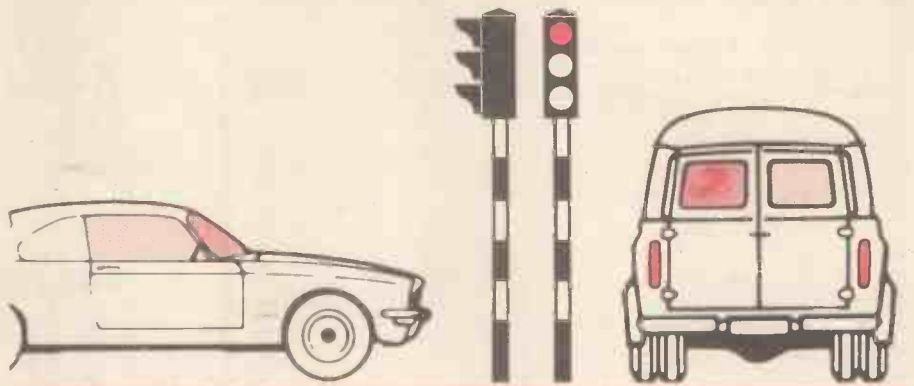

Traffic Circuits

The CMOS gate IC1a is one quarter of the 4093 device, a NAND gate with Schmitt trigger inputs, wired as an inverter. Normally the voltage on the inputs is above the switching threshold so that the output is 'low'. When the contacts are shorted by touching them, the inputs go momentarily to 0V and the output switches to 'high' for as long as the contacts are being handled.

The positive-going clock pulse is used simultaneously to drive a two-bit binary counter, formed from a dual D-type flip-flop IC2, and a second Schmitt trigger NAND gate set up as a retriggerable monostable.

The clock pulse is gated to the monostable inputs via D1 and begins to charge up C1; when the voltage on the capacitor goes above the trigger threshold level, the output of the gate will rapidly switch to a logic 'low' state; this signal is then used to enable the LED driver gates IC3a,b,d.

The monostable on-time is set, by the value of C1, to allow a reasonable length of time between operations of the touch switch. If the lights are not changed during the on-time, the output of IC1d goes high, inhibiting the driver gates. However if the switch is touched while IC1d output is still high, the monostable is re-triggered so that the timing period starts anew.

A D-type flip flop has the property that, when it is clocked (by the output of IC1a in this circuit) its 'Q' output assumed whatever logic state was present on its 'D' input at the time of the positive-going clock edge. Since the 'D' input is here connected to the corresponding 'Q' output, every time a positive clock edge occurs IC2a will flip (or flop, as the case may be). However IC2b is clocked by positive going transition of the \bar{Q}_a output, so that it receives only one positive-going edge for every two produced by operating the touch switch.

Two counter outputs, \bar{Q}_a and \bar{Q}_b , directly feed the LED gates for the Red and amber LEDs, while \bar{Q}_a and \bar{Q}_b are

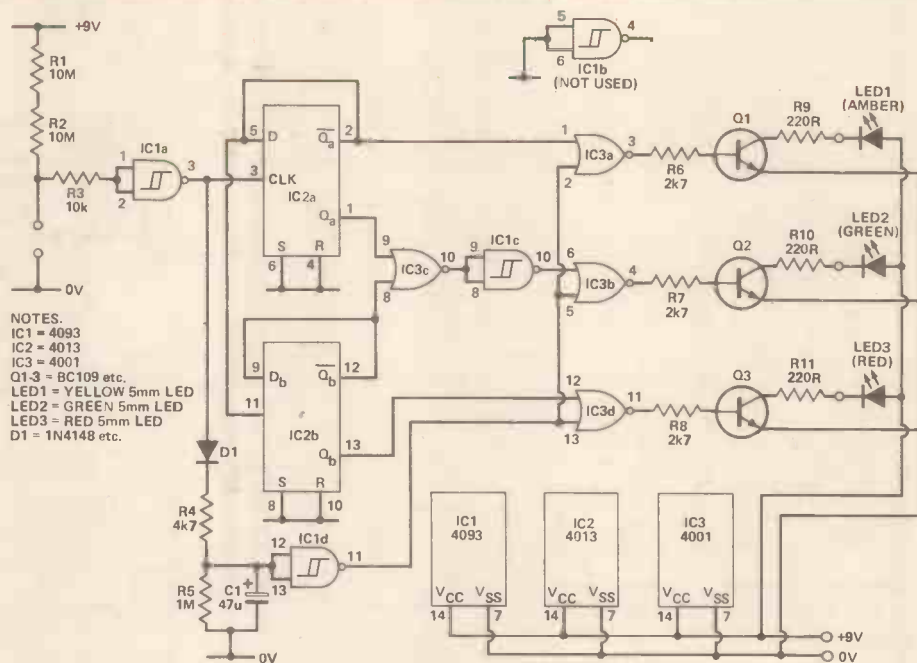

Figure 1. The circuit.

decoded by IC3c and drive the Green LED via IC1c (which is used as an inverter) and gate IC3b. As can be seen from Figure 2, which shows the timing sequence of the circuit, the Green LED is on for only one quarter of the time—which is exactly your experience of traffic lights, isn't it!

The Truth Tables in Figure 3 show that the NOR gates, IC3a,b,d, are enabled when any one input is held 'low'; then any change at the other input will appear, inverted, at the gate output. If any one input is held 'high', though, the output is held 'low', so the gate is disabled (inhibited).

One input of each gate is wired to the output of the re-triggerable monostable, IC1d, so that when its output is 'low' (touch switch operated), the NOR gates are enabled. Then, if \bar{Q}_a , \bar{Q}_b or the output of IC1c goes low, the appropriate gate output will go 'high', turning on Q1, 2 or 3 and lighting its LED. However when the monostable times out, the NOR gate outputs are held 'low' so that the transistors are biased off, and the

LEDs turn off too. The power consumption of the CMOS logic in this state is so low that the battery life is virtually its stated shelf-life!

Construction Talk

Experienced model-makers will find no difficulty in the mechanical assembly of the Traffic Light Toy, whether they use the proverbial tobacco tin that the prototype was built into, or a plastic case.

Since pipe-smoking relatives are fewer, these days, and a plastic case is in any event safer and easier to use, it might be better not to go scrounging but to buy a small standard enclosure. It must be large enough to take the PCB and a PP3 battery; the PCB measures 70 x 58mm and a PP3 is 49 x 27 x 16mm, so the case will need to be around 70 x 85mm or 91 x 58mm, depending on which way round the battery is mounted.

The construction methods has been lifted directly from the technique used to

How It Works

THE block structure of the Traffic Light Toy is shown below: briefly, the trigger senses when the touch switch is operated and produces a positive clock pulse while the fingers are still in contact with the touch plate. This positive edge steps the counter to its next stage and simultaneously triggers the monostable; the output from this holds open the LED driver circuits, allowing the decoded counter outputs to drive the appropriate signal LED. If the monostable is not re-triggered within a

short time (by once again operating the touch switch), its output goes 'high' and the drive circuits are inhibited, turning off the LEDs to conserve the battery. However, the circuit maintains the previous CMOS logic levels so that the next time the device is used, it steps to the next traffic light state immediately the touch switch is operated. In the 'standby' condition the current consumption is the very small amount drawn by the CMOS gates.

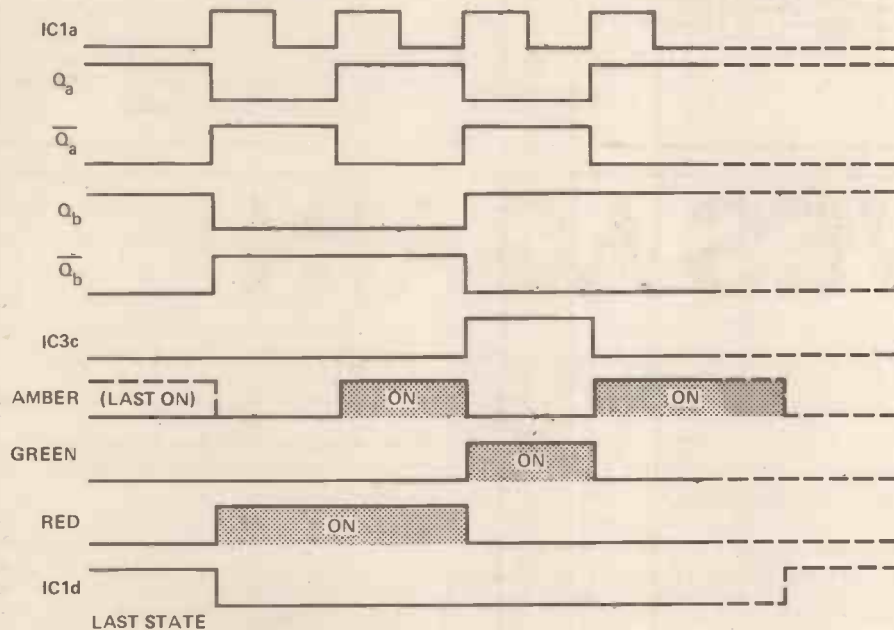
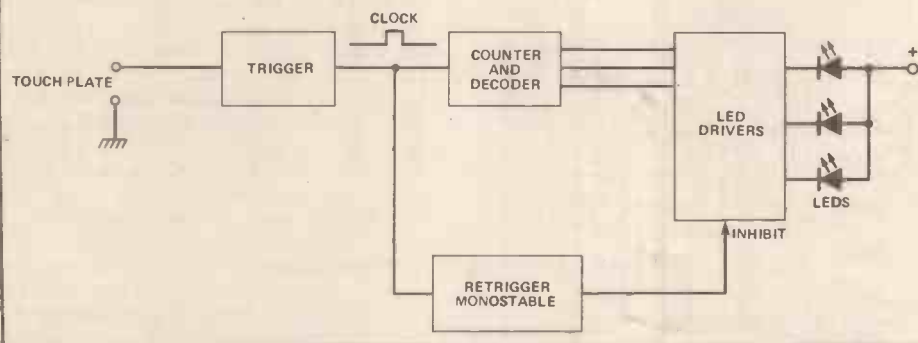

Figure 2. Timing sequence for the Traffic Light.

build the model rail signalling lights in the September 1982 issue of Hobby Electronics. The details are shown in Figure 4.

The materials are readily available from any modelling shop, or even the local ironmonger, if you have one. The bracket holding the LEDs can be cut from 18SWG copper or brass shim, drilled to take the LEDs and then attached to the post by bending the bottom flange and either soldering or gluing it in place.

The light cowlings are formed from copper tube with an inside diameter of 5mm. The post is a length of 6mm (1/4") copper tube; drill a hole in the lid of the case, insert the tube till it projects slightly below the bottom surface and fix it with epoxy glue. A rear cover for the

lights can be fashioned from another small piece of 18SWG copper or brass shim, but must not be attached to the LED bracket yet!

The printed circuit board can be easily assembled by following the layout shown in Figure 5; it is always advisable to insert the CMOS ICs last to reduce the risk of static damage; in any case treat them with care! Once the board is complete, temporarily connect up the LEDs and the battery; then, by touching or momentarily shorting the touch switch pads, you should be able to step the LEDs through their ordained sequence (not that when power is first applied the logic state of the circuit will be random, so any light or lights may be on).

Next comes the touch-plate; this is

A	B	A+B	A·B	A+B	A·B
0	0	0	0	0	0
0	1	1	0	0	1
1	0	1	0	0	1
1	1	1	0	1	0

Figure 3. Truth Tables for IC3, a 4001B quad NOR gate.

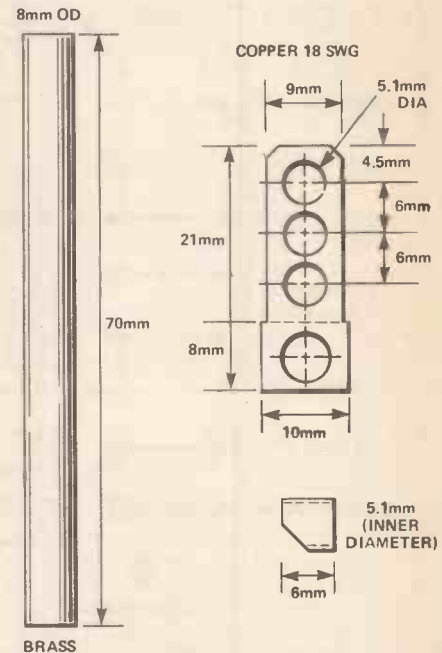

Figure 4. Construction measurements for the post and cowl.

Parts List

RESISTORS

(All 1/4 watt 5% carbon)

R1,2	10M
R3	10k
R4	4k7
R5	1M
R6,7,8	2k7
R9,10,11	220R

CAPACITORS

C1	47u
	25V radial electro

SEMICONDUCTORS

IC1	4093B
	quad Schmitt trigger NAND
IC2	4013B
	dual D-type flip-flop
IC3	4001B
	quad NOR
Q1,2,3	BC109
	or similar
D1	1N4148
	or similar
LED1	5mm yellow LED
LED2	5mm green LED
LED3	5mm red LED

MISCELLANEOUS

PCB; case (see Buylines); PP3 battery and connector; PCB pins; wire, solder etc; metalwork for stand (see text).

BUYLINESpage 34

Figure 5. PCB overlay: insert the CMOS ICs last.

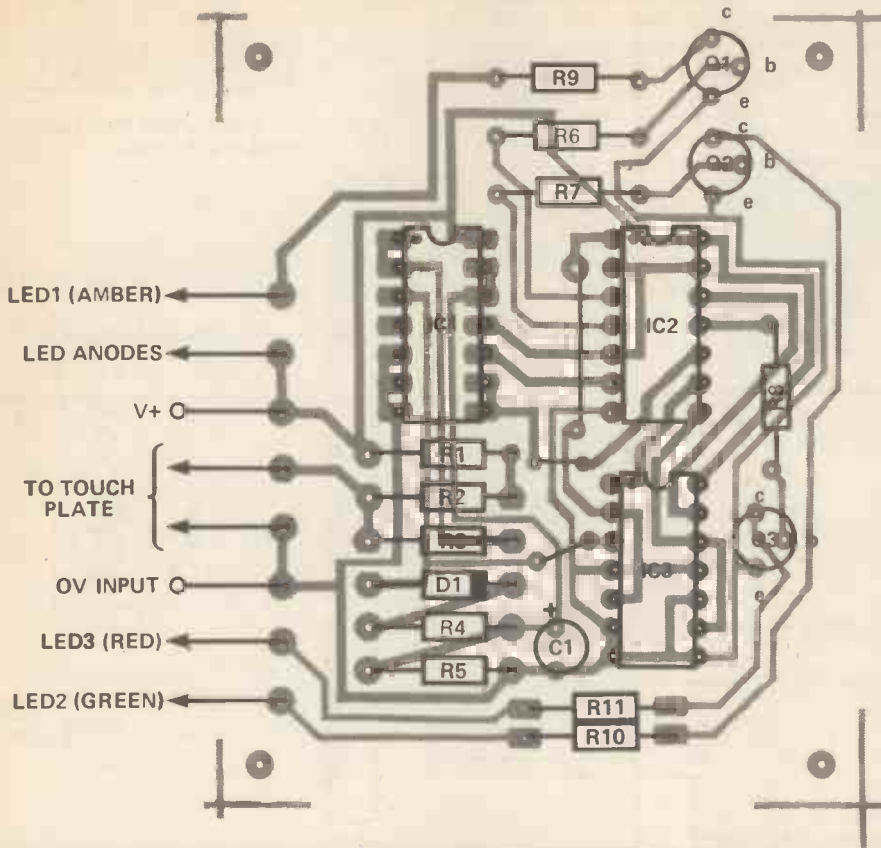

easily made from a small piece of Veroboard with alternate tracks linked. After drilling a small hole in the lid of the box and leading through the wires, the touch plate should be fixed to the lid using dabs of epoxy glue. Mount the PCB and battery in the bottom of the case (double sided sticky pads, two or three layers thick, will do here) and connect up the touch plate wires. It is worth checking at this stage that the touch switch works; it can sometimes fail if your fingers are sticky from perspiration (leaving behind a thin film of conducting fluid) or if they are bone dry. Make sure these are not the causes of failure before you write to the editor!

If you have not already constructed the signal stand, do this now. The LEDs should be connected to the PCB by lengths of colour-coded wire led down the post and through the lid of the case. Take care when soldering the LEDs as they are easily damaged. Solder the wires to the relevant PCB pads (the coloured wires are so you can tell which is which—use red wire for the red LED, yellow and green for the other two) and then screw down the lid of the case. Now attach the rear cover to the back of the LED mounting bracket.

Next paint the completed Traffic Light Toy. Various colour schemes can be used—why be boring—and then you have it. Now all you have to watch out for are the toy traffic police!

HE

IT LIVES AGAIN!

From the past it came, growing daily, striking terror into the hearts of lesser publications, and spreading its influence across the country in its quest to infiltrate every town, every home, every mind.

Not a horror story, but a success story. And if electronics theory strikes terror into you, then you need the help of **Electronics — It's Easy**. Originally a long-running series in Electronics Today International, **Electronics — It's Easy** was printed as a set of three books. They sold out. It was reprinted as a single volume. Now this phenomenally successful publication is available again, in its third reprint. **Electronics — It's Easy** is a comprehensive and simply-written guide which explains the theory (and the practice) of electronics step by step. Every aspect of the subject is covered, starting with the basic principles and working through to the how and why of today's technology.

You can obtain your copy of **Electronics — It's Easy** by mail order using the coupon below. Make cheques or postal orders payable to ASP Ltd; alternatively you may pay by Access or Barclaycard.

Send to: Sales Office (Specials),
513 London Road, Thornton Heath
Surrey CR4 6AR

Please send me..... copies of Electronics —
It's Easy. I have enclosed £..... (£4.95 each
including p&p).

NAME

ADDRESS

Please debit my account

My Access/ Barclaycard No. is

Signature





Universal NI-CAD, battery charger. All plastic case with lift up lid. Charge/Test switch. LED indicators at each of the five charging points.

Charges:- PP3 (9V), U12 (1.5V penlite), U11 (1.5V "C"), U2 (1.5V "D"), Power:- 220-240V AC, Dims:- 210 x 100 x 50mm. Knock down price only while stocks last.

Only **£6.00**
Order No. **MW 398**

Multitester & Transistor Tester
DC volts 0-1v-5v-2.5v-10v-50v-250v-1000v ±3%
AC volts 0-10v-50v-250v-1000v ±3%
DC current 0-50µA-2.5mA-25mA-0.25A ±3%
Resistance:
Minimum 0-2-2-200-200k ohms } ±3%
Midscale 20-200-20k-200k ohms }
Maximum 2k-20k-2m-20m ohms }
As a transistor tester
Leakage current 0-150µA at Z1k range } ±5%
0-15mA at X10 range }
0-150mA at X1 range }

Only **£11.95**
Order No. **HT 320**

PLEASE ADD 15% VAT & £1 P&P



ENFIELD ELECTRONICS
208 BAKER ST., ENFIELD, MIDDX. Tel: 01-366 1873

UNBEATABLE PRICES

3 1/2 Digit LCD Display: 1 colon, 3 decimal points, plus/minus sign and lo bat indicator. Complete with low power-7126 display driver

Driver set at **£8.50**
Display separate at **£3.50** each
Driver separate at **£5.50** each

BC182 70p per 10 pieces
BC212 70p per 10 pieces
BC547 60p per 10 pieces
Spectrol 3/4" Trimmer Pots at **55p** each
Special pack of LED'S 10 red, 10 yellow, 10 green c/w clips at **£2.50** per pack

REMEMBER OUR PRICES INCLUDE VAT.
Send large SAE for our list of resistors, diodes, capacitors.
TERMS: Strictly cash with order. Trade enquiries welcome.
Handling charge of 50p on all orders under **£5.**

CAMTEC CIRCUITS & SYSTEMS LTD
5 York road, Bognor Regis, West Sussex PO21 1LW
TEL: (0243) 882911

TALK TO THE WHOLE WORLD

Study now for the
RADIO AMATEUR'S EXAMINATION

We have had 40 years successful experience in training men and women for the G.P.O. Transmitting licence.



FREE R.A.E. brochure without obligation from:-
British National Radio & Electronics School
READING, BERKS. RG1 1BR

Name

Address

HE/6/817 BLOCK CAPS PLEASE

LEARN BASIC ELECTRONICS

with our PPG FUN KITS
Four LEARNING courses plus 50 KITS to prove your knowledge.

Send for catalogue to:
ELECTROMECH LTD
51a Meldreth Road, Shepreth, Royston, Herts SG8 6PS
TEL: 0763 61372

— A negative ion generator kit

This kit will saturate your home or office with millions of refreshing ions. Without fans or any moving parts it will put out a pleasant breeze. A pure flow of ions pours out like water from a fountain. The result is that the air feels pure, crisp and wonderfully refreshing. **£18.00.**

H.E. Scope ZD29. July 83. Ring for price.
Echo Reverb (less case) ZD11. May 82. **£29.50.**
R/C Speed Controller ZD3. April 80. **£13.50.**
MOSFET Hi-Fi Power Amp ZA94 (2 x 140 Watts. Less case and hardware). **£33.25.**

SPECIAL OFFERS
9 Volt Mini Buzzers **60p.**
Transducers 32KHz. Transmit/Receive. **£1.00 pair.**

All prices include post and V.A.T.

Visa/Access Welcome
Shop Hours 9am to 6pm. Mon-Sat

BYTEK
311 Edgware Road
London W2
Tel: 01-723-9246



WILMSLOW AUDIO
The firm for Speakers

Bigger and Better

the colourful Wilmslow Audio brochure
— the definitive loudspeaker catalogue!

Everything for the speaker constructor — kits, drive units, components for HiFi and PA.
50 DIY HiFi speaker designs including the exciting new dB Total Concept speaker kits, the Kef Constructor range, Wharfedale Speakercraft, etc.
Flatpack cabinet kits for Kef, Wharfedale and many others.

- ★ Lowest prices — Largest stocks ★
- ★ Expert staff — Sound advice ★
- ★ Choose your HiFi Speakers in the comfort of our ★
two listening lounges
(Customer operated demonstration facilities)
- ★ Ample parking ★

Send **£1.50** for catalogue
(cheque, M.O. or stamps — or phone with your credit card number)

- ★ Access — Visa — American Express accepted ★
also HiFi Markets Budget Card.



WILMSLOW AUDIO
The firm for Speakers

0625 529599

35/39 Church Street, Wilmslow, Cheshire SK9 1AS

Lightning service on telephoned credit card orders!

RECHARGEABLE BATTERIES AND CHARGERS

PRIVATE OR TRADE ENQUIRIES WELCOME
FULL RANGE AVAILABLE
SEND SAE FOR LISTS

- £1.45 for booklet "Nickel Cadmium Power"
- NEW ALL BRITISH MULTI CHARGER
- NEW SEALED LEAD RANGE AVAILABLE

SANDWELL PLANT LTD
2 Union Drive, Boldmere, Sutton Coldfield,
West Midlands O21-354 9764
Southern Office O462 733254

WHY WRITE TO LONDON

When you can walk to the Midlands largest selection of DIY.

Plugs, sockets, connectors, cable, flex, leads, boxes, Aerials, styli, components, elements, semi-conductors, meters.

In fact the lot!

Spares and repairs for all electronic, electrical and audio.

H. G. Electronics Co.
1350 Stratford Road, Hall Green,
Birmingham B28 9EH
Telephone: 021-777 2369



Elen Electronics DISCO

Tired of boring 3 & 4 channel lighting controllers. Then try our new 8 CHANNEL PATTERNMAKER for spotlights or lighting screens.



16 different sequential patterns including Catherine Wheel, Screen Writer, Checker & Light Train.

Kit comprises PCB & all components including 2K PROM & Monitor LEDs. Only £27.00 + VAT.

Hardware kit including case, 12 way socket & matching plug, mains lead etc. Only £9.50 + VAT.

Please add 60p P&P to order.

ELEN ELECTRONICS
Unit 1, Station Road,
Madeley, Telford, Shropshire



MARCO TRADING GOT YOUR LATEST COPY YET???

Our 72 page fully illustrated catalogue includes special offer lists, order forms, and pre-paid envelopes and lots lots more.

To obtain your copy of Marco Trading's latest catalogue send 35p plus 26p postage to:
Orders may now be placed by telephone using your Access/Barclaycard, phone us and we do the rest.
Marco Trading, Dept HB6, The Maltings, High Street, Wem, Shropshire, SY4 5EN. Tel: 0939 32763.

MASTER ELECTRONICS NOW! The PRACTICAL way!

This new style course will enable anyone to have a real understanding of electronics by a modern, practical and visual method. No previous knowledge is required, no maths, and an absolute minimum of theory.

You learn the practical way in easy steps mastering all the essentials of your hobby or to start or further a career in electronics or as a self-employed servicing engineer.

All the training can be carried out in the comfort of your own home and at your own pace. A tutor is available to whom you can write personally at any time, for advice or help during your work. A Certificate is given at the end of every course.

You will do the following:

- Build a modern oscilloscope
- Recognise and handle current electronic components
- Read, draw and understand circuit diagrams
- Carry out 40 experiments on basic electronic circuits used in modern equipment
- Build and use digital electronic circuits and current solid state 'chips'
- Learn how to test and service every type of electronic device used in industry and commerce today. Servicing of radio, T.V., Hi-Fi and microprocessor/computer equipment.

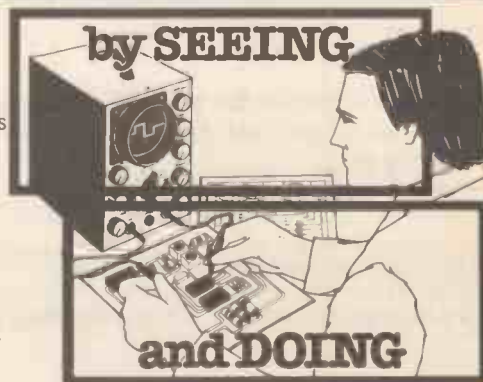

New Job? New Career? New Hobby? Get into Electronics Now!

FREE!
COLOUR BROCHURE

Please send your brochure without any obligation to

I am interested in:

HE/5/821

NAME _____

COURSE IN ELECTRONICS as described above

ADDRESS _____

RADIO AMATEUR LICENCE

OTHER SUBJECTS _____

MICROPROCESSORS

LOGIC COURSE

BLOCK CAPS PLEASE

POST NOW TO:

British National Radio & Electronics School Reading, Berks. RG1 1BR

PCB FOIL PATTERNS

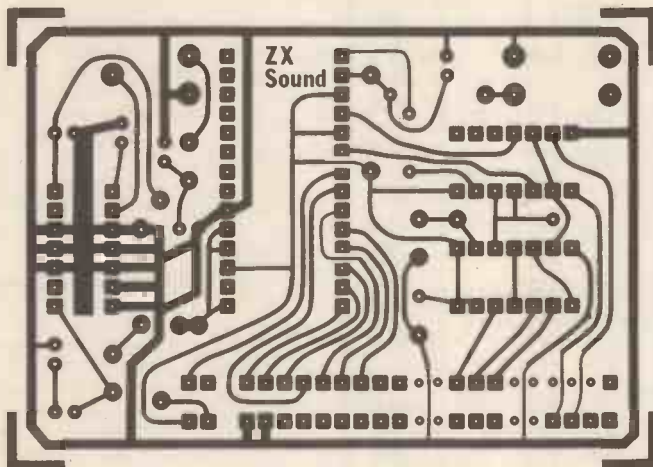

Above: The foil pattern of the Sinclair Sound Board.

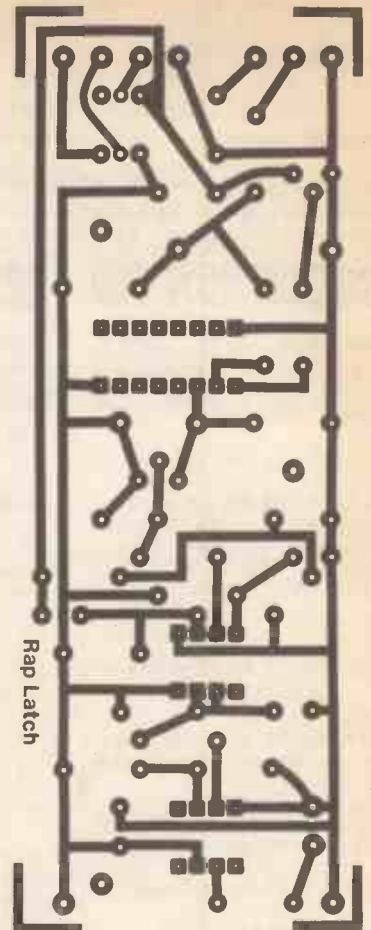

Above: Make the Rap Latch printed circuit board from this foil pattern.

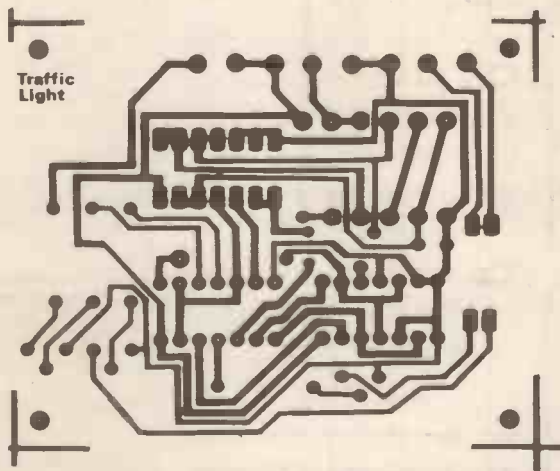

Above: Track-side view of the Traffic Light Toy printed circuit board. The design can easily be transferred to stripboard if necessary.

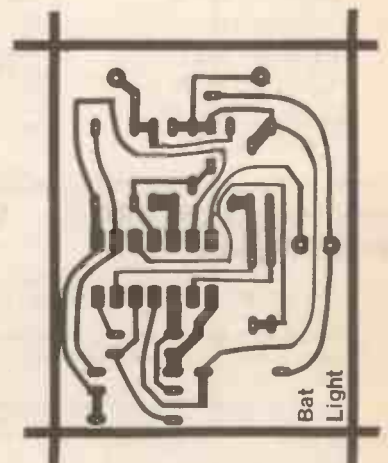

Above: The Bat Light PCB is small and compact, designed for convenient mounting under the dashboard.

Lineage:

26p per word (minimum 15 words)

Semi-display £7.5 per single column centimetre

Ring for information on series bookings/discounts

All advertisements in this section must be prepaid.

Advertisements are accepted subject to the terms and conditions printed on the advertisement rate card (available on request)

01-437 1002
EXT 204Send your requirements to:
Jo James,
ASP Ltd.,
145 Charing Cross Road,
London WC2H 0EF.**FOR SALE****POWERFUL SW Medium FM** portable radio, only £14.95 p + p £2.55. Sharland Enterprises, 7 Mountview, Mill Hill NW7 3HT.**KIG RETURN AN AD No 7...** Pre-amplifier... "Convert any amplifier to magnetic pickup capability"... £3.99 + Advert 7... 8 Cunliffe Road, Ilkley.**BRASS DIMMER SWITCHES**Now available at only **£14.99** plus 95p p&p. Overseas orders allow £1.50 p&p on each item. Send s.a.e. for our full price list on Brass Dimmers and Brass Switches.Mr P. Kanbi
36 Wendover Road
Harlesdon,
London NW10**ANYTHING TO SELL?**

Then sell it quickly and cheaply

Phone ASP
Classified
01-437 1002
ext. 204**BOOKS & PUBLICATIONS****ELECTRONICS BOOKS.** International publishers. Lowest rates. Ask list. Business promotion. 376 Lajpatrai Market Delhi India.**PARAPHYSICS JOURNAL** (Russian translations). Psychotronics, Kirlianography, heliophonics music telekinetics. Computer software. SAC 4 x 9". — Parlab, Downton Wilts.**MACHINE CODE.** If you are at all interested in learning more about this invaluable tool, then join the ZX machine code users club. Send £1.00 for trial issue of club magazine "Micro Arts" to: Toni Baker, 5 Dumergue Avenue, Queenborough, Kent ME11 5BT. Cheques payable to Micro Arts.**KITS****ELECTRONIC kits for sale:** Morse Practice £4.10, Dice £8.10. SAE for details. Bee Micro, 33 Bevendean Crescent, Brighton, E Sussex.**PRINTED CIRCUITS.** Make your own simply, cheaply and quickly! Golden Fotolac light-sensitive lacquer — now greatly improved and very much faster. Aerosol cans with full instructions, £2.25. Developer 35p. Ferric chloride 55p. Clear acetate sheet for master 14p. Copper-clad fibreglass board, approx. 1mm thick £1.75 sq. ft. Post/packing 75p. White House Electronics, Castle Drive, Praa Sands, Penzance, Cornwall.**DIGITAL WATCH** replacement parts, batteries, displays, backlights, etc. Also reports publications charts. S.A.E. for full list: Profords Copners Drive, Holmer Green, Bucks HP15 6SGE.**COMPONENTS****BUMPER BOX OF BITS**WOW!! We've got so many components in stock, we can't possibly list them all! — So buy a box, in it you'll find resistors, capacitors, displays, switches, panels with transistors, diodes, IC's, etc., coils, pots... and so on. All modern parts — guaranteed at least 1000 items. Minimum weight 10lbs. ONLY **£8.50** inc.**ELECTRONICS WORLD**
1F Dews Road Salisbury Wilts SP2 7SN
COMPONENTS**ALL NEW COMPONENTS**

C-MOS 4012-8p, 4017-25p, 4019-14p, 4022-32p, 4023-12p, 4024-20p, 4025-12p, 4049-18p, 4071-12p, 4078-28p, 4081-10p, 4518-28p, 4520-26p, 4528-34p, 4557-140p, NE567-38p, SPX6-20p, 314A223-4p. TTL 7400-6p, 7404-8p, 7412-8p, 7419-14p, 7414-20p, 7416FJ-12p, 7495-24p, 74LS92-24p.

30p P&P order under £6. No VAT
V Bansal, 14 Davlgdor Road, Hove,
Sussex BN3 1QD. Tel (0273) 732419**MAIDSTONE ELECTRONIC** components shop. Thyronics Control System, 8 Sandling Road, Maidstone, Kent. Maidstone 675354.**NOW OPEN** in Newcastle, Waterloo Street: "Marlborough Electronic Components". For the best in electronic components. Test equipment etc. Tel: 618377.**WAVEBANDS**Auto Electronics,
103 Coventry Street,
Kidderminster
Tel: (0562) 2179

Brand new components by return post or ring with Access/Barclaycard number for same day despatch.

All manufacturers guaranteed new stock. All at most competitive prices. Catalogue available only 50p. All prices inclusive of VAT.

COMPONENTS. Chassis mounting fuse holders £0.11; 20mm Fuseholder Screw-driver release 6.3A £0.93; 20mm Fuses Mains from £0.14, Anti-surge from £0.17; Aerial Splitter/Combiner from £3.33; Diodes from £0.04; Capacitors from £0.10; Light Emitting Diodes 5mm Round Lens, Red £0.09, Yellow £0.12, Green £0.11, Red/Green/Yellow £0.32; Resistors from £0.02; Transistors from £0.13. Postage & Packing £0.50. Send S.A.E. for details to: R & B Electique, 3 Shute End, Wokingham, Berks RG11 1BH. Mail order only.

Our readers search these columns for components. Make sure they find you.

Contact Jo James
ASP Classified
01-437 1002
Ext 204**PLANS 'N DESIGN****AMAZING ELECTRONIC PLANS.** Lasers, Super-powered Cutting Rifle, Pistol, Light Show, Ultrasonic Force Fields, Pocket Defence Weaponry, Giant Tesla, Satellite TV Pyrotechnics, 150 more projects. Catalogue £1 (refundable) — from Plancentre, Bromyard Road Industrial Estate, Ledbury HR8.**EQUIPMENT****CAPACITANCE METERS** 0-500nF in four ranges requires PP3 £10 to: S. Neal, Old Hayes, Ham Lane, Elstead, Godalming, Surrey GU8 6HQ.**TVDX.** VHF to UHF Converter. Receive VHF DX signals on a UHF TV set, hundreds sold £13.50. VHF 2M, 4M, Airband Convertors. 10.7MHz IF £9 Satellite TV equipment available. SAE Data, Lists H. Cocks, Cripps Corner, Robertsbridge, Sussex. Tel 058083-317.**U.V. Light exposer unit** for use in prep. of Photo-resist P.C.B's. Attractive wooden construction with exposer area of 250x150mm. Case 350x250x95mm 240V operation. Only £37.00 p&p. Send cheque to V.E.P. Ltd., 5 Hewens Road, Uxbridge, UB10 0FR.**CENTURION ALARMS**We manufacture,
you save £ £ £'s

Send s.a.e. or phone for our Free list of professional D.I.Y. Burglar Alarm Equipment and accessories. Discount up to 20% off list prices, eg. Control Equipment from £15.98, Decoy Bell Boxes from £5.95 inc.

TRADE ENQUIRIES WELCOME

☎ 0484-21000
or 0484 35527 (24 hr. ans.)
CENTURION ALARMS (ETI)
265 Wakefield Road, Huddersfield
HD5 9BE, W. Yorkshire
Access & Visa
Orders Welcomed**BURGLAR ALARM EQUIPMENT** As used in the trade. JN Security Centre, 176 Sydenham Centre, 176 Sydenham Road, London SE26 5JZ Tel 01-778 1111 Showroom open six days.**HIGH POWER MERCURY ION LASER,** emits green/red light. Easily built by the amateur constructor. Ideal school project etc. comprehensive kit of plans, including source of all materials. £5.25 + 25p p&p. Lastertech, 31 Mill Brow, Chaderton, Lancs.

Get Antex technology at your fingertips

The most sophisticated range in soldering. Irons, bits, kits, stands, stations and accessories — everyone at the force front of soldering technology.

Take the new satin chrome bits, for example specially designed to give you 50% to 300% longer working life.

It's just one more advance from Antex.

For the very latest in the science of soldering send for a catalogue now.

Please send literature and price list to:

Name _____

Address _____

Telephone _____

Excluding V.A.T. (15%) and Postage & Packing

Made in England.

Our products are widely distributed by wholesalers and retailers throughout the U.K. Please try your local dealer.

and keep up to date with the science of soldering from ANTEX H.E.6

TCSU1 Soldering Station

For safe 24 volt temperature-controlled miniature soldering iron, variable tip temperature 65-430°C, antistatic earth connection, with XSTC or CSTC iron. R.R.P. £55.00

ST4 Stand

R.R.P. £1.75

SK5-BP and SK6-BP
Soldering Kits
Fitted with safety plugs.
SK5-BP kit R.R.P. £7.80
SK6-BP kit R.R.P. £8.00

SK6 Soldering Kit
Contains model XS230 iron and the ST4 stand
R.R.P. £7.20

SK5 Soldering Kit
Contains model CS230 iron and the ST4 stand
R.R.P. £7.00

Model XS

— 25 Watts
Available for 240 and 115 volts
R.R.P. £5.40
50, 24 and 12 volts
R.R.P. £5.60

Model XS-BP

— 25 Watts
Fitted with safety plug 240 volts
R.R.P. £6.20

Model C

— 15 Watts
Stainless steel shaft only.
240 and 115 volts
R.R.P. £5.20
50 and 24 volts
R.R.P. £5.40

Model CS

— 17 Watts
Available for 240 and 115 volts
R.R.P. £5.20
50, 24 and 12 volts
R.R.P. £5.40

Model CS-BP

— 17 Watts
Fitted with safety plug 240 volts
R.R.P. £6.00



ANTEX (Electronics) Ltd.,

Mayflower House, Plymouth, Devon. Telephone: 0752 667377 Telex: 45296

100 FREE PROGRAMS

FROM SILICA SHOP — WITH EVERY PURCHASE OF AN

ATARI 400

800



ATARI PRICES REDUCED!
We at Silica Shop are pleased to announce some fantastic reductions in the prices of the Atari 400/800 personal computers. We believe that the Atari at its new price will become the U.K.'s most popular personal computer and have therefore set up the Silica Atari Users Club. This club already has a library of over 500 programs and with your purchase of a 400 or 800 computer we will give you the first 100 free of charge. There are also over 350 professionally written games and utility programs, some are listed below. Complete the reply coupon and we'll send you full details. Alternatively give us a ring on 01-301 1111 or 01-309 1111.

ATARI 400 £159
with 16K

ATARI 400 £228
with 48K

ATARI 800 £349
with 48K

400/800 SOFTWARE & PERIPHERALS

Don't buy a T.V. game! Buy an Atari 400 personal computer and a game cartridge and that's all you'll need. Later on you can buy the Basic Programming cartridge (£35) and try your hand at programming using the easy to learn BASIC language. Or if you are interested in business applications, you can buy the Atari 800 + Disk Drive + Printer together with a selection of business packages.

Silica Shop have put together a full catalogue and price list giving details of all the peripherals as well as the extensive range of software that is now available for the Atari 400/800. The Atari is now one of the best supported personal computers. Send NOW for Silica Shop's catalogue and price list as well as details on our users club.

THE FOLLOWING IS JUST A SMALL SELECTION FROM THE RANGE OF ITEMS AVAILABLE:

ACCESSORIES Cables Cassettes Diskettes Joysticks Le Stick - Joystick Misc Supplies Paddles	Mountain Shoot Rearguard Star Flite Sunday Golf	BUSINESS Calculator Database Management Decision Maker Graph-It Invoicing Librarian Mort & Loan Anal Nominal Ledger Payroll Personal Finl Mgmt Purchase Ledger Sales Ledger Statistics 1 Stock Control Teletink 1 Visicalc Weekly Planner Word Processor	DYNACOMP Alpha Fighter Chompelo Crystals Forest Fire Intruder Alert Monarch Moonprobe Moving Maze Nominus Jigsaw Rings of The Emp Space Tilt Space Trap Stud Poker Triple Blockade	Maths-Tac-Toe Metric & Prob Solv Mugwump Music Terms/Notatn Musical Computer My First Alphabet Number Blast Polycalc Presidents Of U.S. Quiz Master Starware Stereo 3D Graphics Three R Math Sys Video Math Flash Wordmaker	Soram States & Capitals Touch Typing	EMI SOFTWARE British Heritage Comedy Diskette Dice Poker Dog Daze Domination Downhill Eastern Front Galahad & Holy Gr Graphics/Sound Jax-O Jukebox Lookahead Memory Match Midastouch Minotaur Outlaw/Howitzner Pac Man Space Invaders Star Raiders Super Breakout Video Easel	Castle Centurion Checker King Chinese Puzzle Cotteracker Comedy Diskette Dice Poker Dog Daze Domination Downhill Eastern Front Galahad & Holy Gr Jax-O Jukebox Lookahead Memory Match Midastouch Minotaur Outlaw/Howitzner Pac Man Space Invaders Star Raiders Super Breakout Video Easel	Seazy Adventure Solitaire Space Chase Space Trek Sultans Palace Tact Trek Terry Wizards Gold Wizards Revenge	Jawbreaker Mission Asteroid Mouskattack Threshold Ulysses/Golden Fi Wizard & Princess	PERIPHERALS Centronics Printers Disk Drive Epsom Printers Program Recorder RS232 Interface Thermal Printer 16K Memory RAM 32K Memory RAM	PROGRAMMING AIDS from Atari Assembler Editor Microsoft Basic Pascal (APX) Pilot (Consumer) Pilot (Educator) Programming Kit	SANTA CRUZ Basics of Animation Bobs Business Display Lists Graphics Machine Kids 1 & 2 Horizontal Scrolling Master Memory Map Mini Word Processor Page Flipping Player Missile Gr Player Piano Sounds Vertical Scrolling	PERSONAL INT from APX Adv Music System Banner Generator Blackjack Tutor Going To The Dogs Keyboard Organ Morse Code Tutor Personal Fitness Prg Player Piano Sketchpad	SILICA CLUB Over 500 programs write for details
ADVENTURE INT Scott Adams Adv No 1 Adventure Ind No 2 Pirate Adv No 3 Mission Imp No 4 Woodoo Cast No 5 The Count No 6 Strange Ody No 7 Mystery Fun No 8 Pyramid of D No 9 Ghost Town No 10 Sav Island 1 No 11 Sav Island 2 No 12 Golden Voy Angle Worms Deflections Galactic Empire Galactic Trader Lunar Lander	AUTOMATED SIMULATIONS Crush Crumble Cmp Datesions of Ryn Dragons Eye Invasion Orion Rescue at Rigel Ricochet Star Warrior Temple of Aghar Upper Reaches Aps	EDUCATION from ATARI Alpicalc Atlas of Canada Cubbyholes Elementary Biology Frogmaster Hickory Dickory Inst Compng Dem Lemonade Letterman Mapware	EDUCATION from ATARI Conv French Conv German Conv Italian Conv Spanish Energy Czar Hangman Invit To Prog 1/2/3 Kingdom Music Composer	ENTERTAINMENT from APX Alien Egg Anthill Attank Avalanche Babel Blackjack Casino Block Buster Block 'Em Bumper Pool	ENTERTAINMENT from ATARI Asteroids Basketball Blackjack Centipede Chess Entertainment Kit Missile Command Pac Man Space Invaders Star Raiders Super Breakout Video Easel	ON LINE SYSTEMS Crossfire Frogger								

FOR FREE BROCHURES - TEL: 01-301 1111

For free brochure and reviews on our range of electronic products, please telephone 01-301 1111. To order by telephone just quote your name, address, credit card number and order requirements and leave the rest to us. Post and packing is FREE OF CHARGE in the UK. Express 24 hour delivery available at an additional charge.

- **SHOP DEMONSTRATION FACILITIES** - we provide facilities at our shop in Sedcup, Monday to Saturday 9am to 5.30pm (closing Thursday 10pm, Friday 8pm).
- **MAIL ORDER** - we are a specialist mail order company and are able to supply goods direct to your door.
- **MONEY BACK GUARANTEE** - if you are totally unsatisfied with your purchase, you may return it to us within 15 days. On receipt of the goods in satisfactory condition we will give you a full refund.
- **PAINT EXCHANGE SECOND HAND MACHINES** - we offer a part exchange scheme to trade in many makes of TV, games for personal computers.
- **COMPETITIVE PRICES** - our prices, offers and service are very competitive. We are new, knowledgeable and will normally match any lower price quoted by our competitors.
- **HELPFUL ADVICE** - available on the suitability of various computers.
- **AFTER SALES SERVICE** - available on all computers out of guarantee.
- **VAT** - all prices quoted above include VAT at 15%.
- **CREDIT FACILITIES** - we offer credit over 12, 24 or 36 months, please ask for details.

SILICA SHOP LIMITED
Dept HE 0683 1-4 The Mews, Hatherley Road, Sidcup,
Kent DA14 4DX Telephone 01-301 1111 or 01-309 1111

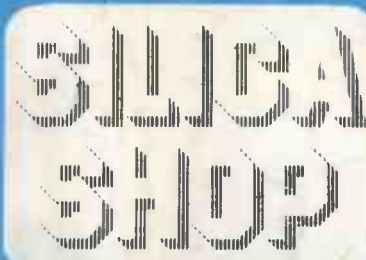

FREE LITERATURE

I am interested in purchasing an Atari 400/800 computer and would like to receive copies of your brochure and test reports as well as your price list covering all of the available Hardware and Software.

Name.....
Address.....
.....
.....
Postcode.....