

FREE GADGETS, GAMES & KITS SUPPLEMENT INSIDE

SEPTEMBER '81

ISSN. 0142-6192

Only 60p

Hobby Electronics

A Down-To-Earth Approach To Electronics

HE 'Diana' Metal Detector

Use it to find hidden treasure!
Kit under £35



**Chromascope Video
Synthesiser review**

**Detecting Illness Electronically
-medical electronics feature**

HE READER OFFER • HE READER OFFER • HE READER OFFER

High-quality tools at low price

See Inside



Ambit's new concise component catalogue is out !!

Our new style concise parts/prices catalogue is available at most newsagents for 50p - or direct from here.

CMOS 4000	4559	2.75	7476N	0.30	74265N	0.66	74LS153N	0.35	74C04	0.20	68488	5.25	
4000	0.13	4560	2.18	7480N	0.26	74273N	2.67	74LS154N	0.99	74C08	0.20		
4001	0.20	4561	0.70	7481N	0.20	74278N	2.49	74LS155N	0.50	74C10	0.20	Z80 series	
4002	0.14	4562	2.75	7482N	0.75	74279N	0.89	74LS156N	0.50	74C14	0.55	Z80A	4.99
4007	0.19	4566	1.59	7485N	0.75	74283N	1.30	74LS157N	0.36	74C20	0.20	Z80ADRT	7.50
4008	0.70	4568	2.18	7486N	0.24	74284N	3.50	74LS158N	0.40	74C30	0.20	Z80APIO	4.10
4008AE	0.80	4569	1.95	7489N	1.05	74285N	3.50	74LS160N	0.40	74C32	0.20	Z80ASIO/1	14.00
4009	0.30	4572	0.30	7490N	0.30	74290N	1.00	74LS161N	0.40	74C42	0.80	Z80ASIO/2	14.00
4010	0.30	4580	3.25	7491N	0.55	74293N	1.05	74LS162N	0.40	74C48	1.03	Z80ASIO/9	14.00
4011AE	0.24	4581	1.50	7492N	0.35	74297N	2.36	74LS163N	0.40	74C73	0.50	Z80CTC	4.00
4011	0.15	4582	0.99	7493N	0.35	74298N	1.85	74LS164N	0.50	74C74	0.50	Z80ACTC	4.50
4013	0.35	4583	0.80	7494N	0.70	74365N	0.85	74LS165N	1.20	74C76	0.48	Z8001	65.00
4015	0.70	4584	0.49	7495N	0.60	74366N	0.85	74LS166N	1.75	74C83	0.98		
4016	0.30	4585	1.00	7496N	0.45	74367N	0.85	74LS168N	0.85	74C85	0.98		
4017	0.65	4702	4.50	7497N	1.40	74368N	0.85	74LS169N	0.85	74C86	0.26	PROM	
4019	0.68	4703	4.48	74100	1.10	74390N	1.85	74LS170N	1.85	74C89	2.68	2708	2.00
4021	0.75	4704	4.24	74104	0.62	74393N	1.85	74LS173N	0.75	74C90	0.80	2716	3.55
4022	0.68	4705	4.24	74105	0.62	74490N	1.85	74LS174N	0.55	74C93	0.80	2532	8.50
4023	0.19	4706	4.50	74107	0.26			74LS175N	0.55	74C95	0.94	2732	8.50
4024	0.45	4720	4.00	74109N	0.35	74LSN series		74LS181N	1.35	74C107	0.48		
4025	0.18	4723	0.95	74110N	0.54	74LS00N	0.11	74LS183N	2.96	74C151	1.52	RAM	
4026	1.05	4724	0.95	74111N	0.68	74LS01N	0.11	74LS189N	1.28	74C154	2.26	2102	1.70
4028	0.60	4725	2.24	74112N	1.70	74LS02N	0.12	74LS190N	0.60	74C157	1.52	2112	3.40
4029	0.75	40014	0.54	74116N	1.98	74LS03N	0.12	74LS191N	0.60	74C160	0.80	2114 2	1.49
4030	0.35	40085	0.99	74118N	0.85	74LS04N	0.14	74LS192N	0.68	74C161	0.80	4027	5.78
4035	0.75	40098	0.54	74119N	1.20	74LS05N	0.14	74LS193N	0.68	74C162	0.80	4116 2	1.59
4040	0.68	40106	0.54	74120N	0.95	74LS08N	0.14	74LS194N	0.42	74C163	0.80	4116 3	1.49
4042	0.65	40160	0.69	74121N	0.34	74LS09N	0.14	74LS195N	0.42	74C164	0.80	4864P	12.50
4043	0.68	40161	0.69	74122N	0.34	74LS10N	0.13	74LS196N	0.65	74C165	0.84	6116P-3	12.50
4043AE	0.93	40162	0.69	74123N	0.40	74LS11N	0.14	74LS197N	0.65	74C173	0.72	6116P-4	11.25
4044	0.68	40163	0.69	74125N	0.40	74LS12N	0.15	74LS200N	3.45	74C174	0.72	8264	12.50
4046	0.69	40174	0.69	74126N	0.40	74LS13N	0.28	74LS202N	3.45	74C175	0.72		
4047	0.69	40175	0.69	74128N	0.65	74LS14N	0.49	74LS221N	0.60	74C192	0.80		
4049	0.30	40192	0.75	74132N	0.50	74LS15N	0.14	74LS240N	0.99	74C193	0.80	XTALS	
4050	0.30	40193	0.75	74136N	0.65	74LS20N	0.13	74LS241N	0.99	74C195	0.80	1MHz	3.00
4051	0.65	40194	0.69	74141N	0.45	74LS21N	0.15	74LS242N	1.65	74C200	4.52	3.2768MHz	2.00
4052	0.69	40195	0.69	74142N	1.85	74LS22N	0.15	74LS243N	1.65	74C221	1.06	4MHz	1.70
4053	0.69			74143N	2.50	74LS26N	0.18	74LS244N	0.83	74C901	0.38	4.194MHz	1.70
4054	1.30	TTL 'N'		74144N	2.50	74LS27N	0.14	74LS245N	1.50	74C902	0.38	4.43MHz	1.25
4055	1.30	7400N	0.10	74145N	0.75	74LS28N	0.35	74LS247N	1.35	74C903	0.38	5MHNz	2.00
4056	1.35	7401N	0.10	74147N	1.50	74LS30N	0.13	74LS248N	1.35	74C904	0.38	6.5536MHz	2.00
4059	5.75	7402N	0.10	74148N	1.09	74LS32N	0.14	74LS249N	1.35	74C905	5.64	7MHz	2.00
4060	0.95	7403N	0.11	74150N	0.79	74LS33N	0.16	74LS251N	0.46	74C906	0.38	8MHz	2.00
4063	1.15	7404N	0.12	74151N	0.55	74LS37N	0.17	74LS252N	0.46	74C907	0.38	8MHz	2.00
4066	0.38	7405N	0.12	74153N	0.55	74LS38N	0.16	74LS257N	0.55	74C908	0.84	9MHz	2.00
4067	4.30	7406N	0.22	74154N	0.55	74LS40N	0.13	74LS258N	0.39	74C909	1.52	10MHz	2.00
4068	0.18	7407N	0.22	74155N	0.55	74LS42N	0.40	74LS259N	0.39	74C910	3.62	11MHz	2.00
4069	0.18	7408N	0.15	74156N	0.55	74LS47N	0.42	74LS260N	0.70	74C914	0.86		
4070	0.25	7409N	0.15	74157N	0.55	74LS48N	0.65	74LS266N	0.24	74C918	0.98		
4071	0.22	7410N	0.12	74159N	1.90	74LS49N	0.61	74LS273N	0.90	74C925	4.32		
4072	0.22	7411N	0.18	74160N	0.55	74LS51N	0.14	74LS275N	3.20	74C926	4.32		
4073	0.22	7412N	0.19	74161N	0.55	74LS54N	0.15	74LS279N	0.35	74C927	4.32		
4075	0.18	7413N	0.27	74162N	0.55	74LS55N	0.15	74LS280N	2.05			Voltage Regulators	
4076	0.60	7414N	0.51	74163N	0.55	74LS63N	1.50	74LS283N	0.44			78XX 1A TO-220	0.58
4077	0.23	7416N	0.27	74164N	0.55	74LS73N	0.21	74LS290N	0.58	Processors 8080		78XX 1A TO-3	0.99
4078	0.25	7417N	0.27	74165N	0.55	74LS74N	0.18	74LS293N	1.30	8080 series		79XX 1A TO-220	0.60
4081	0.15	7402N	0.13	74166N	0.70	74LS75N	0.28	74LS295N	1.50	8080AFC/2	7.50	79XX 1A TO-3	1.35
4082	0.25	7421N	0.28	74167N	1.25	74LS76N	0.22	74LS298N	1.50	8212	2.30	78G 1A TO-220	1.10
4093	0.45	7422N	0.20	74170N	1.25	74LS78N	0.24	74LS365N	0.35	8214	3.50	78G 1A TO-3	3.95
4099	0.99	7423N	0.22	74173N	1.10	74LS83N	0.50	74LS366N	0.35	8216	1.95	78H 5A TO-3 5v	4.25
4175	1.15	7425N	0.22	74174N	0.75	74LS85N	0.70	74LS367N	0.35	8216	1.95	78H 5A TO-3 12v	5.45
4502	0.90	7426N	0.22	74175N	0.75	74LS86N	0.18	74LS368N	0.35	8224	3.50	78HG 5A TO-3	7.45
4503	0.55	7427N	0.22	74177N	0.75	74LS90N	0.32	74LS373N	0.78	8251	6.25	79HG 5A TO-3	7.45
4506	0.75	7428N	0.35	74178N	0.90	74LS91N	1.25	74LS374N	0.78	8255	5.40	LM317 .5A TO-202	1.30
4507	0.45	7430N	0.13	74179N	1.35	74LS92N	0.39	74LS375N	1.15			LM337 .5A TO-202	1.75
4508	1.99	7432N	0.23	74180N	0.75	74LS93N	0.38	74LS377N	1.99			78S40 1.5A	1.20
4510	0.70	7437N	0.22	74181N	1.22	74LS95N	0.48	74LS378N	1.40				
4511	0.85	7438N	0.22	74182N	0.70	74LS96N	1.20	6800P	3.75				
4512	0.70	7440N	0.14	74184N	1.20	74LS107N	0.25	68A00	4.25				
4514	2.20	7441N	0.54	74185N	1.20	74LS109N	0.25	68B00	4.75				
4515	2.50	7442N	0.42	74188N	3.00	74LS112N	0.25	6802	5.55				
4516	0.75	7443N	0.62	74190N	0.55	74LS113N	0.25	6809	15.00				
4518	0.75	7444N	0.62	74191N	0.55	74LS114N	0.25	6810	1.75				
4520	0.80	7445N	0.62	74192N	0.55	74LS122N	0.40	68A10	1.85				
4521	2.36	7446N	0.62	74193N	0.55	74LS123N	0.55	68B10	2.04				
4522	1.49	7447N	0.62	74194N	0.55	74LS124N	1.80	6820	1.95				
4527	0.95	7448N	0.56	74195N	0.55	74LS125N	0.29	6821	1.75				
4528	0.95	7450	0.14	74196N	0.55	74LS126N	0.29	68A21	2.10				
4529	1.40	7451N	0.14	74197N	0.55	74LS132N	0.45	68B21	2.34				
4539	1.10	7453N	0.14	74198N	0.85	74LS133N	0.30	6840	4.25				
4543	1.00	7454N	0.14	74199N	1.00	74LS136N	0.25	68A40	4.55				
4549	3.50	7460N	0.14										

Hobby Electronics

SEPTEMBER 1981
Vol 3 No 11

Editor: Hugh Davies
Senior Art Editor: Andrew Sawyer
Advertisement Sales Executive:
Melanie Mackenzie-Aird

PROJECTS

★ 'DIANA' METAL DETECTOR <i>Build this project...you could unearth a fortune</i>	10
LOW-POWER PILOT LIGHT <i>Reminds you to turn equipment off</i>	21
LIGHT/WATER ALARM <i>Simple audible alarm project</i>	28
CAR LIGHTS DELAY <i>Helps you see in the dark</i>	38
POWER PACK <i>An adjustable mains adaptor</i>	42
HE ELECTRONIC IGNITION <i>Additional information . . . lower kit price</i>	50
SHORT WAVE RADIO <i>Long-distance reception at low cost</i>	52
REACTION TESTER GAME <i>Easily built and has six skill levels</i>	58
PCB FOIL PATTERNS <i>Track patterns of our PCBs</i>	62

FEATURES

★ ELECTRONICS IN DIAGNOSTIC MEDICINE <i>How electronics aids doctors' diagnoses</i>	15
★ TECHNICAL TERMS — <i>New Feature</i> <i>Understanding the Hall Effect</i>	23
FAMOUS NAMES <i>Oliver Heaviside — an original genius</i>	26
GADGETS, GAMES & KITS <i>FREE supplement on the latest electronic products</i>	31
BUILDING SITE <i>Hot tips on soldering</i>	39
CLEVER DICK <i>Those technical queries answered</i>	41
INTO ELECTRONIC COMPONENTS <i>Part 2 of this new series for beginners</i>	46
YOUR LETTERS <i>The Editor gives his views</i>	55
BREAKER ONE FOUR <i>A mixture of CB topics this month</i>	62

NEWS & INFORMATION

Monitor — Electronics News	6
HE Next Month	8
Subscriptions — the easy way to buy HE	27
★ Tool Set Offer	29
★ Video Synthesiser Offer	37
★ Multimeter Offer	50
Prize Winners! — HE Schools' Competition	56
Breadboard 81 Exhibition	60
Electronics Digest — Autumn Edition	60
NEW Printed Circuit Board Service from HE	61
First National Citizens' Band Show	63
Books From HE	64
Classified Ads	65

Assistant Editor: Keith Brindley Editorial Assistant: Judith Jacobs
Drawing Office Manager: Paul Edwards Managing Editor: Ron Harris BSc
Layout Artist: Enzo Grando Managing Director: T. J. Connell

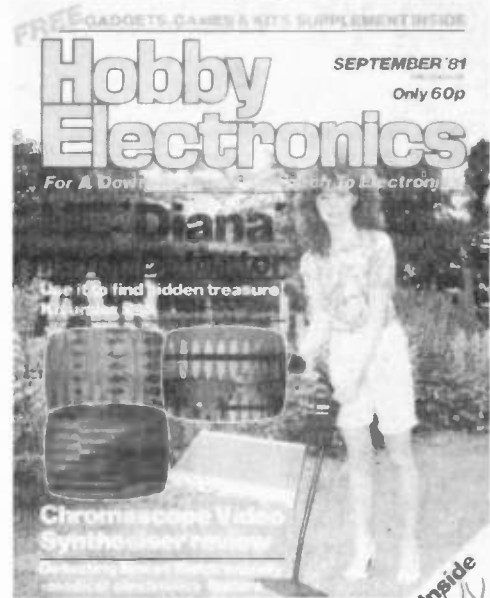

HE READER OFFER • HE READER OFFER • HE READER OFFER
High-quality tools at low price

This month's cover shows Carole Anne with a look of determination on her face as she searches for hidden treasure with the HE 'Diana' Metal Detector. Why did we call this project Diana? See page 10 for the answer



The HE Short Wave Radio is easy to build and covers 1.5 to 33 MHz in three ranges — see page 52



HE Tool Set Offer — five high-quality tools for the electronics hobbyist — details on page 29

Hobby Electronics is normally published on the second Friday of the month prior to the cover date.
Hobby Electronics, 145 Charing Cross Road, London WC2H 0EE, 01 437 1002. Telex No 8811896. Published by Modmags Ltd.
Distributed by Argus Press Sales & Distribution Ltd, 12-18 Paul St, London EC2A 4JS. Printed by QB Ltd, Colchester. Covers printed by Alabaster Passmore.
Copyright: All material in this publication is subject to world-wide copyright protection. Permission to reproduce printed circuit board patterns commercially or marketing of kits of the projects must be sought from the Publisher. All reasonable care is taken in the preparation of the magazine to ensure accuracy but Modmags cannot be held responsible for it legally. © Copyright 1981 Modmags Ltd ABC Member of Audit Bureau of Circulation.

20 POWER AMPS

19 FUNCTIONAL MODULES

DAWN

POWER UP TO 480 WATTS RMS SINGLE CHANNEL

Which amplifier?

I.L.P. Amplifiers now come in three basic types, each of which is available with or without heatsink. Having decided the system you want – home hi-fi (models HY30, 60 or 120 for example), super quality hi-fi with extra versatility (MOS120, MOS200) or Disco/PA/Guitar (HD120, HD200 or HD400) you will then decide whether amplifiers housed within their own heatsinks or plate amplifiers for bolting to a metal chassis will suit. With choice such as this and a brilliant new range of I.L.P. functional modules to choose from you now have the chance to build the finest audio system ever offered to the constructor.

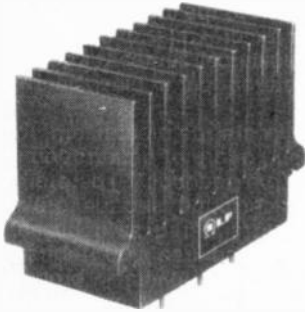

AMPLIFIER WITH HEAT SINK

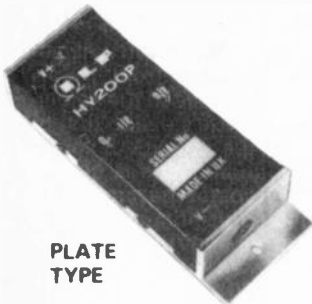

PLATE TYPE



PSU

BIPOLAR Standard, with heatsinks										Without heatsinks				
MODEL NUMBER	OUTPUT POWER Watts rms	DISTORTION		SUPPLY VOLTAGE TYP/MAX	SIZE mm	WT gms	PRICE	VAT	MODEL NUMBER	SIZE in mm	WT gms	PRICE	VAT	
		T.H.D. Typ at 1kHz	I.M.D. 60Hz/7kHz 4:1											
HY30	15w/4-8Ω	0.015%	<0.006%	±18±20	76x68x40	240	£7.29	£1.09						
HY60	30w/4-8Ω	0.015%	<0.006%	±25±30	76x68x40	240	£8.33	£1.25						
HY120	60w/4-8Ω	0.01%	<0.006%	±35±40	120x78x40	410	£17.48	£2.62	HY120P	120x26x40	215	£15.50	£2.33	
HY200	120w/4-8Ω	0.01%	<0.006%	±45±50	120x78x50	515	£21.21	£3.18	HY200P	120x26x40	215	£18.46	£2.77	
HY400	240w/4Ω	0.01%	<0.006%	±45±50	120x78x100	1025	£31.83	£4.77	HY400P	120x26x70	375	£28.33	£4.25	

Protection: Load line, momentary short circuit (typically 10 sec) Slew rate: 15V/μs Rise time: 5μs
S/N ratio: 100db Frequency response (-3dB): 15Hz - 50kHz
Input sensitivity: 500mV rms Input impedance: 100kΩ Damping factor: (8Ω/100Hz)>400

HEAVY DUTY with heatsinks										Without heatsinks			
HD120	60w/4-8Ω	0.01%	<0.006%	±35±40	120x78x50	515	£22.48	£3.37	HD120P	120x26x50	265	£19.84	£2.98
HD200	120w/4-8Ω	0.01%	<0.006%	±45±50	120x78x60	620	£27.38	£4.11	HD200P	120x26x50	265	£23.63	£3.54
HD400	240w/4Ω	0.01%	<0.006%	±45±50	120x78x100	1025	£38.63	£5.79	HD400P	120x26x70	375	£34.28	£5.14

Protection: load line, PERMANENT SHORT CIRCUIT (ideal for disco/group use should evidence of short circuit not be immediately apparent).
The Heavy Duty range can claim additional output power devices and complementary protection circuitry with performance specs. as for standard types.

MOSFET Ultra-Fi, with heatsinks										Without heatsinks			
MOS120	60w/4-8Ω	<0.005%	<0.006%	±45±50	120x78x40	420	£25.88	£3.88	MOS120P	120x26x40	215	£23.32	£3.50
MOS200	120w/4-8Ω	<0.005%	<0.006%	±55±60	120x78x80	850	£33.46	£5.02	MOS200P	120x26x80	420	£28.53	£4.28
MOS400	240w/4Ω	<0.005%	<0.006%	±55±60	120x78x100	1025	£45.39	£6.81	MOS400P	120x26x100	525	£38.91	£5.84

Protection: Able to cope with complex loads, without the need for very special protection circuitry (fuses will suffice).
Ultra-fi specifications:
Slew rate: 20V/μs Rise time: 3μs S/N ratio: 100db Frequency response (-3dB): 15Hz - 100kHz
Input sensitivity: 500mV rms Input impedance: 100kΩ Damping factor: (8Ω/100Hz)>400

POWER SUPPLY UNITS			
MOEEL NO.	FOR USE WITH	PRICE	VAT
PSU30	± 15V combinations of HY6/66 series to a maximum of 100mA The following will also drive the HY6/66 series except HY67 which requires the PSU30.	£4.50	£0.68
PSU36	1 or 2 HY30	£8.10	£1.22
PSU50	1 or 2 HY60	£10.94	£1.64
PSU60	1 x HY 120/HY 120P/HD 120/HD 120P	£13.04	£1.96
PSU65	1 x MOS 120/1 x MOS 120P	£13.32	£2.00
PSU70	1 or 2 HY 120/HY 120P/HD 120/HD 120P	£15.92	£2.39
PSU75	1 or 2 MOS 120/MOS 120P	£16.20	£2.43
PSU90	1 x HY200/HY200P/HD200/HD200P	£16.20	£2.43
PSU95	1 x MOS200/MOS200P	£16.32	£2.45
PSU180	2 x HY 200/HY 200P/HD 200/HD 200P or 1 x HY400/1 x HY400P/HD400/HD400P	£21.34	£3.20
PSU185	1 or 2 MOS200/MOS200P/1 x MOS400/1 x MOS400P	£21.46	£3.22

All models except PSU30 and PSU36 incorporate our own toroidal transformers

FP480 BRIDGING UNIT FOR DOUBLING POWER

Designed specially by I.L.P. for use with any two power amplifiers of the same type to double the power output obtained and will function with any I.L.P. power supply. In totally sealed case, size 45 x 50 x 20mm, with edge connector. It thus becomes possible to obtain 480 watts rms (single channel) into 8Ω. Contributory distortion less than 0.005%.
Price: £4.79 + 72p. V.A.T.



I.L.P. ELECTRONICS LTD.

FREEPOST, 6 Graham Bell House, Roper Close, Canterbury, Kent, CT2 7EP
Telephone (0227) 54778 (Technical (0227) 64723) : Telex 965780

Available also from MARSHALLS, TECHNOMATIC, WATFORD ELECTRONICS and certain other selected retailers.

GOODS BY MAIL ORDER DESPATCHED WITHIN 7 DAYS

OF A NEW ERA



Which modules?

In launching eighteen different units all within amazingly compact cases to help make complete audio systems using I.L.P. power amplifiers, we bring the most exciting, the most versatile modular assembly scheme ever for constructors of all ages and experience. Study the list - see how these modules will combine to almost any audio project you fancy - and remember *all I.L.P. modules are compatible with each other*, they connect easily. Modules HY6 to HY13 measure 45 x 20 x 40mm. HY66 to HY77 measure 90 x 20 x 40mm. They are so reliable that all I.L.P. modules carry a 5 year no quibble guarantee.



MODEL NO.	MODULE	DESCRIPTION/FACILITIES	CURRENT REQUIRED	PRICE	VAT
HY6	MONO PRE AMP	Mic/Mag. Cartridge/Tuner/Tape/Aux + Volume/Bass/Treble	10mA	£6.44	£0.97
HY7	MONO MIXER	To mix eight signals into one	10mA	£5.15	£0.77
HY8	STEREO MIXER	Two channels, each mixing five signals into one	10mA	£6.25	£0.94
HY9	STEREO PRE AMP	Two channels mag. Cartridge/Mic + Volume	10mA	£6.70	£1.01
HY11	MONO MIXER	To mix five signals into one + Bass/Treble controls	10mA	£7.05	£1.06
*HY12	MONO PRE AMP	To mix two signals into one + Bass/Mid-range/Treble	10mA	£6.70	£1.01
*HY13	MONO VU METER	Programmable gain/LED overload driver	10mA	£5.95	£0.89
HY66	STEREO PRE AMP	Mic/Mag. Cartridge/Tape/Tuner/Aux + Volume/Bass/Treble/Balance	20mA	£12.19	£1.83
HY67	STEREO HEADPHONE	Will drive headphones in the range of 4Ω - 2KΩ	80mA	£12.35	£1.85
HY68	STEREO MIXER	Two channels, each mixing ten signals into one	20mA	£7.95	£1.19
HY69	MONO PRE AMP	Two input channels of mag. Cartridge/Mic + Mixing/Volume/Treble/Bass	20mA	£10.45	£1.57
HY71	DUAL STEREO PRE AMP	Four channels of mag. Cartridge/Mic + Volume	20mA	£10.75	£1.61
*HY72	VOICE OPERATED STEREO FADER	Depth/Delay	20mA	£13.10	£1.97
*HY73	GUITAR PRE AMP	Two Guitar (Bass/Lead) and Mic + separate Volume/Bass/Treble + Mix	20mA	£12.25	£1.84
†HY74	STEREO MIXER	Two channels, each mixing five signals into one + Treble/Bass	20mA	£11.45	£1.72
†HY75	STEREO PRE AMP	Two channels, each mixing two signals into one + Bass/Mid-range/Treble	20mA	£10.75	£1.61
†HY76	STEREO SWITCH MATRIX	Two channels, each switching one of four signals into one	20mA	£13.10	£1.97
†HY77	STEREO VU METER DRIVER	Programmable gain/LED overload driver	20mA	£9.25	£1.39

The modules are encapsulated and include latest design high quality clip-on edge connectors.

For easy mounting we recommend
B6 Mounting board for modules HY6 - HY13
 78p + 12p. V.A.T.
B66 Mounting board for HY66 - HY77
 99p + 13p. V.A.T.

All I.L.P. modules include full connection data.

I.L.P. Products are of British Design and Manufacture.

* Ready August - may be ordered now
 † Ready September - may be ordered now

All the above modules operate from ±15V minimum to ±30V maximum - higher voltages being accommodated by use of dropper resistors. HY67 can only be used with the PSU 30 power supply unit

See our advertisement on page 65

TO ORDER USING OUR FREEPOST FACILITY

Fill in the coupon as shown, or write details on a separate sheet of paper, quoting the name and date of this journal. By sending your order to our address as shown at the bottom of the page opposite, with FREEPOST clearly shown on the envelope, you need not stamp it. We pay postage for you. Cheques and money orders must be crossed and made payable to I.L.P. Electronics Ltd. If sending cash, it must be by registered post. To pay C.O.D. please add £1 to TOTAL value of order. When ordering, U.K. customers must include the appropriate V.A.T. as shown.

PAYMENT MAY BE MADE BY ACCESS DR BARCLAYCARD IF REQUIRED.

OF RECEIVING YOUR ORDER

ALL WITH I.L.P.'S 5 YEAR NO QUIBBLE GUARANTEE

To: I.L.P. ELECTRONICS LTD. ROPER CLOSE CANTERBURY CT2 7EP

Please supply

..... Total purchase price £.....

I enclose Cheque Postal Orders International Money Order

Please debit my Access/Barclaycard Account No.

NAME

ADDRESS

Signature

HE/9/81

ALL U.K. ORDERS DESPATCHED POST FREE

MONITOR

Help The Handicapped

WE ARE PLEASED to report that the response to the HE Project Design Competition for the International Year of Disabled Persons 1981 has taken an encouraging upturn during the last month (see comment under Your Letters, page 55). As a reminder, the closing date for the competition is *1st September 1981* — contact the Editor before this date if you have any questions about project designs.

While on the subject of IYDP it is worth noting the following:

First is a series of informal workshop sessions where those attending make aids for the disabled. Paul Tippell, lecturer in electronics, has been running these sessions during term time at Richmond-upon-Thames College, Egerton Road, Twickenham TW2 7SJ (tel 01 892 6656) during the last three years. The next sessions will begin on Tuesday 22nd September 1981 between 7.00 and 9.30 PM each week. Just contact Paul at the College or call in on any Tuesday evening at 7.00 PM and ask for Workshop H3.

Fee for each term (usually 12 weeks) is £9.

Examples of items that could be made at the sessions include electronic remote controls for operating radio, TV and other electrical appliances, devices for opening garage doors

automatically when a car is driven up to them, remotely-controlled door locks and low-cost communications aids.

Paul told HE that one project completed recently by the workshop was an 'extended computer keyboard' which enabled a disabled person to program a computer — with his or her toes!

Second item for your diary is a low-cost course 'Disabled People — Living and Learning', organised by ACTIVE. It is to take place on the Isle of Wight on 25th September — full details are given in the first letter under Your Letters this month.

Third is 'IYDP And Then . . . ?' — the Autumn Conference of ACTIVE. It will take place on Saturday 17th October 1981 in the Great Hall, Imperial College, London SW7. This conference will look at the increasing importance of self-help and one-off solutions to the needs of severely disabled people, methods of approaching problems and some practical examples of equipment to make.

The conference will include a small exhibition of play, leisure and communication aids.

Fees, including refreshments and buffet lunch, are £8 for TLA/ACTIVE members, £6.95 for non-members and £15 for families (not more than four people).

Contact: Judy Denziloe, ACTIVE, Seabrook House, Darkes Lane, Potters Bar, Herts EN6 2HL (tel 0707 44571) for further details.

Handy Microcassette

JUST DELIVERED to the HE office is one of the latest devices from AIWA — the CS-M1.

You would be forgiven for thinking that the CS-M1 is just another ordinary radio/cassette recorder if it were not for the machine's size (rather, lack of it). AIWA calls the CS-M1 a micro stereo radio cassette recorder — and micro is definitely the operative word. Case dimensions are only 230 mm wide, by 80 mm high, by 36 mm deep. It weighs in at only 720 g, too.

Apart from:

- recording and playing back using a microcassette

- (not a standard cassette)
- its small size
- a metal tape facility

the CS-M1 is similar to larger more conventional machines. The radio section features FM stereo and AM medium wavebands, while the tape section has cue/review controls, a tape position counter, built-in electret condenser microphones for stereo live recordings, and auxiliary inputs to record from an external source (such as your hi-fi system).

Many other features are also included, which we hope to tell you all about in a future Gadgets, Games & Kits supplement.

The AIWA CS-M1 retails at £109.95 or under.

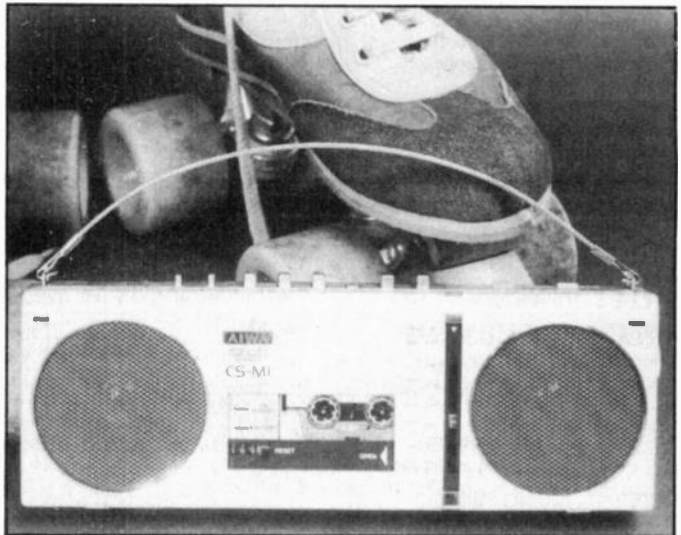

TV Games From Activision

EIGHT GAMES CARTRIDGES are planned for release in the UK in the autumn, from Californian-based Activision.

Under Monitor in the January '81 issue of HE we commented on the formation of Activision by some of the engineers who had been working for Atari and who had produced games cartridges which were compatible with Atari's Video Computer Game. We also mentioned the legal wrangle that had ensued between the two companies.

Now that the air has cleared, the cartridges are to be marketed in the UK by Computer Games

Limited, with the following titles:

Tennis	Skating
Boxing	Fishing Derby
Dragster	Kaboom
Laser Blaster	Freeway

According to Computer Games Limited, Tennis and Boxing will be the first to appear, in September, followed by Dragster and Laser Blaster in October, Fishing Derby and Skating in November and Freeway and Kaboom (whatever that is) in December. Each game will cost £16.95, and we hope to review them in our Gadgets, Games & Kits supplement.

The games will be available from Circolec, 1 Franciscan Road, Tooting, London SW17 8BR (tel 01 767 1233).

Sharpen-up Your Hi-fi Pencils

A SMALL SNIPPET from the June 1981 issue of the Antique Wireless Newsheet, Number 71:

'Did you know that the name of "Sharp", that well known Japanese manufacturer of hi-fi and car radios, came from the 1920's when they produced an "everlasting pencil" — always sharp?'

Trap Those Signals!

IF YOU PLAN to build the HE Short Wave Receiver, or have one already, then you need a good aerial to get the best results from it. Ler Modules Ltd claims that: 'About the easiest and least expensive way to be able to transmit/receive on five bands is to use a trap dipole'.

The company is offering a pair of LAR 7 MHz weatherproof traps, 500 W rating, a pair of lightweight end-insulators and in-

structions for making a five-band trap dipole for £12.50, including VAT (postage and packing £1.75 extra).

This dipole will cover the 80, 40, 20, 15 and 10 metre amateur bands.

Of course, you won't need the 500 W rating until you start transmitting, and you need an Amateur Radio Licence for that. . .

LAR Modules Limited, 60 Green Road, Leeds LS6 4JP (tel 0532 782224).

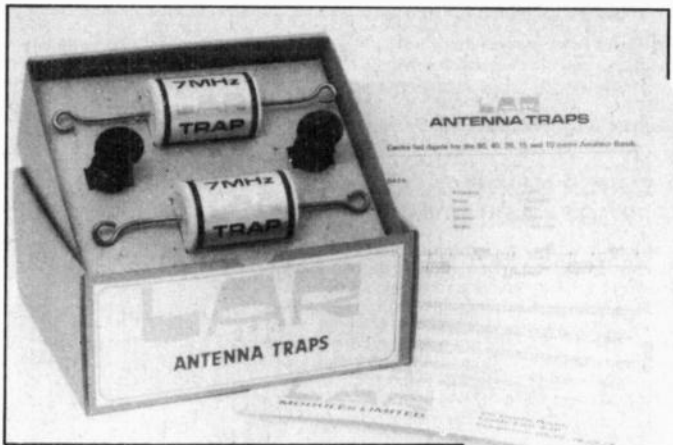

DXTV Reception Group

THE NATIONAL DXTV (long-distance television reception) group has been meeting regularly in London since February 1981.

This group, formed by George Grzebleniak (RS 41733), has acquired and made use of a large

variety of TV equipment ranging from a 5" multi-band black-and-white TV to a 27" colour model which has provision for reception of satellite transmissions.

Details can be obtained from George Grzebleniak, c/o 185 Fleet Street, London EC4A 2HS, enclosing a self-addressed stamped envelope.

Rack Those Tools With Rawplug

TWO RACKS have been introduced by the Rawplug Company to help cope with the ever-increasing number of tools that do-it-yourself enthusiasts seem to accumulate.

First is the Rawplug Handy Tool Rack which, it is claimed, will hold over 50 hand tools ranging in size from a medium-length saw to a 1/16" drill bit. The rack is made from stove-enamelled steel, measures 36" by 4" by 4" and can be fitted in a garage, shed, above a workbench or in a

cupboard. It costs £4.99 including VAT and comes complete with fixing screws and — naturally enough — Rawplugs.

The second rack is for the do-it-yourself gardener and will hold a mixture of long- and short-handled tools (we're sure that many HE readers fit in a spot of gardening between project building). This rack is about 36" long by 4", costs £4.99 including VAT and comes complete with fittings.

The Rawplug Company Limited, Rawplug House, London Road, Kingston-upon-Thames, Surrey KT2 6NR (tel 01 546 2191).



Amateur Radio Courses Taken By Fear

FRANK FEAR (G8CVR) will be running two courses in Amateur Radio from September this year.

The first will run for three 10-week terms and will cover the syllabus of the Amateur Radio Course Examination Number 765. Applicants need not have previous knowledge of the subject. The course will be held at the Broadway North Adult Centre, Queen Mary's Grammar School, Sutton Road, Walsall, on Monday and Wednesday from 7.00 to 9.00 PM, starting from 21st September 1981. Enrolment days are Monday 14th and Tuesday 15th September, between 6.30 and 8.30 PM at the Adult

Centre. Cost of the course is £5 per term, or £12.50 in advance for the three terms.

The second course will run for 10 weeks and is intended for those who have some previous knowledge of amateur radio or who have failed the May '81 examination. It will be held at Barr Beacon Comprehensive School, Old Hall Lane, Aldridge on Thursday evenings, from 24th September. Enrolment day is Thursday 17th September, between 6.30 and 8.30 PM at Barr Beacon, and the cost is £5.

Frank Fear has been running these courses for two years and, because of the unexpected response last year, was forced to run an extra evening course. The same arrangement could be made this year.

If you want details of these courses, contact Frank Fear on 0922 52706.

Leader Test Gear From Sinclair

LOOKING FOR SOME test equipment? You might find what you want in the Leader range from Sinclair Electronics.

Although Sinclair Electronics has been stocking Leader products since the middle of last year, according to Tony Starling, SE's Sales and Marketing Manager, a recent decision was made to select 'items of potential interest' for the electronics hobby market.

Examples are the LSG-16 signal generator (£63.25 including VAT) and the LAG-26

audio generator (£73.60 including VAT).

The LSG-16 covers 100 kHz to 100 MHz (up to 300 MHz in harmonics) in six ranges. It has a 1 kHz modulator and provision for external modulation. A crystal oscillator facility is also provided.

The LAG-26 covers 20 Hz to 200 kHz in four ranges and has a rated harmonic distortion of within 0.5%.

We hope to test the above instruments and report on our findings in a future Gadgets, Games & Kits supplement.

Further details from Sinclair Electronics Limited, London Road, St. Ives, Huntingdon, Cambs PE17 4HJ (tel 0480 64646).

Latest In Microcassette Recorders

PEARLCORDER S801 has been introduced by Olympus Optical Company, and is the smallest microcassette recorder that we've seen yet.

You may remember Move Towards Microcassettes, the special feature on pages 10 and 11 of the March '81 issue of HE. There we featured the D6710 microcassette recorder from Philips and the M5850FG microcassette recorder/radio from Sanyo. The S801, intended primarily for use as a dictating machine, is smaller than these two and offers some interesting features.

Instead of the conventional mechanical tape log counter, the S801 has an LCD display. This works in conjunction with a built-in memory, which enables you to stop the tape automatically at pre-programmed points indicated by the counter.

We tested a sample machine and found it comfortable to handle, although the slide controls took some getting used to after years of button-pushing. We also found that loading and unloading a cassette was not as fast or as easy as it was for the D6710 or M5850FG.

However, the S801 is a rugged looking machine built in a metal case and finished in matt black. It comes complete with a blank microcassette cartridge, pouch, wrist strap, personal earpiece and a set of batteries (two AA-size cells).

Olympus offers 12 different accessories to go with the machine, including a telephone pick-up, remote control switch, car cigarette lighter socket adaptor and an AC mains adaptor.

The cost is £106.42 (including VAT) from Offmech Services Limited, 13/19 Curtain Road, London EC2A 3LT (tel 01-247 8986).

Offmech offers full service back-up on microcassette recorders and dictating machines.



Hobby Electronics

Don't miss
the October issue —
out September 11

Five low-cost projects for the home

TOUCH LAMP

The HE Touch Lamp can be turned on and off with the lightest of touches. It's easy to build and handy to have at the bedside

COMBINATION LOCK

No keys to worry about with this project: you just need a good memory to remember the right push-button combination. A simple-to-build project with home security in mind

ENTRY PHONE

Imagine: a dark evening, it's pouring with rain and a stranger knocks at your front door. Now, instead of having to speak through the letter box you can address callers in comfort — with the HE Entry Phone

TELEPHONE BELL REPEATER

No, not an ingenious method of mass-producing telephone bells at home but a project that will relay the sound of a ringing 'phone to any other room in the house

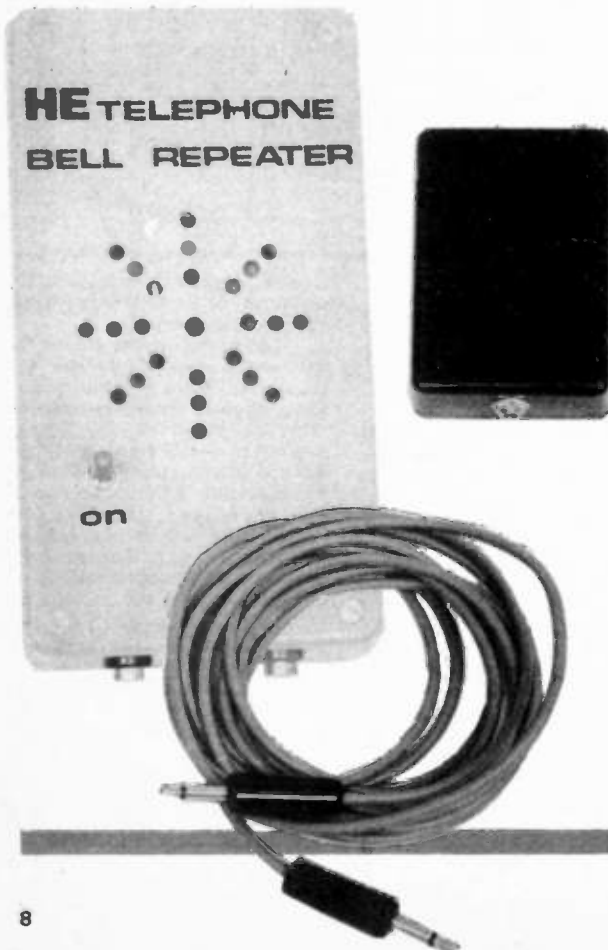

BABY ALARM

This one is bound to be a hit with baby, so we've used a rugged box for the design. The HE Baby Alarm keeps an electronic ear open for you at the cot'side

Main Feature

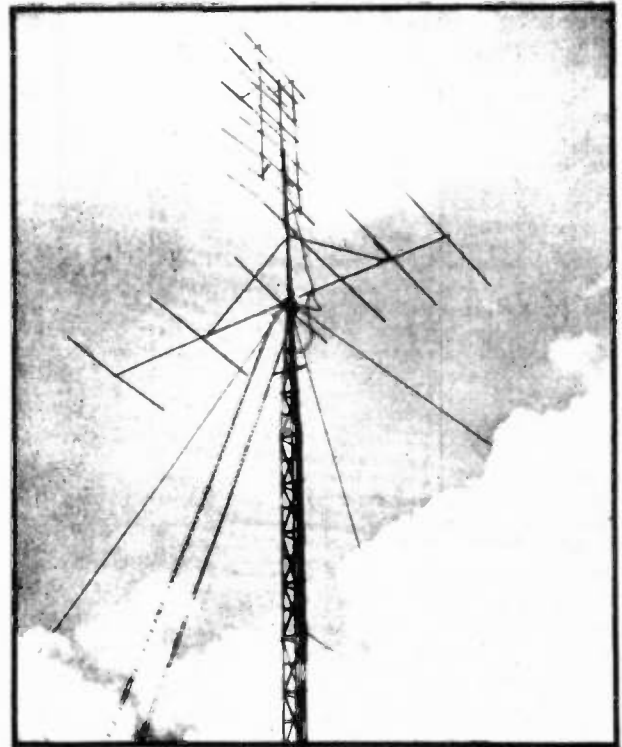

AERIALS

In the early days of radio, 'aerial' referred to a length of wire strung between a couple of convenient trees. Nowadays, aerials (antennae or antennas if you prefer) come in all shapes and sizes. This article looks at how aerials work and how they are constructed. If you are thinking of getting started on Citizen's Band when it becomes legal then this article will help you understand simple aerial design

Items mentioned here are those planned, but unforeseen circumstances may effect the actual contents

HE 'Diana' Metal Detector

Build yourself this pulse induction metal detector and perhaps you'll find yourself a fortune! It's ideal for beginners and novices to electronics *and* treasure hunting, because it is simple to construct and needs no special test equipment to set it up for use

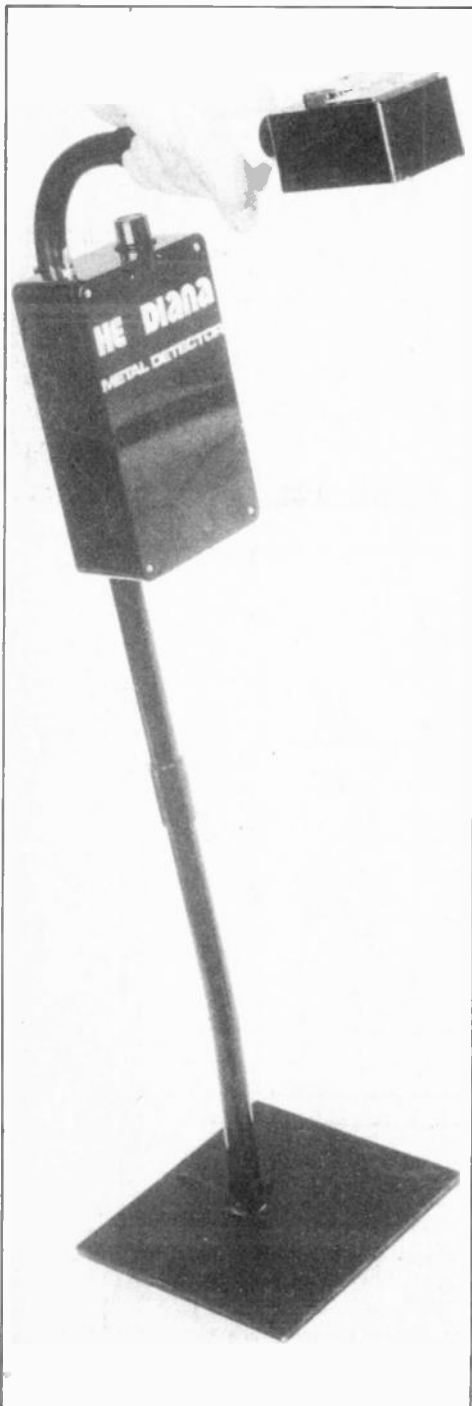

The Roman goddess Diana (pictured on the right) was, according to myth, a huntress usually depicted in Roman art with bow and quiver, and accompanied by a hound. Because this project is the ideal metal detector for would-be treasure hunters we have adopted the name 'Diana' to evoke a hunting atmosphere.

The HE 'Diana' Metal Detector is easy to build and equally easy to use. You can make it out of readily available components and hardware well below the costs of equivalent commercial detectors.

Pulse induction (see How It Works) is used in the detector to create a very sensitive circuit — our prototype is capable of detecting the presence of small metal coins at a fair depth. It cannot, however, distinguish between ferrous metals (such as iron) and non-ferrous metals (eg, gold, silver, aluminium).

Construction

Build up the printed circuit board (PCB) as shown in Fig.2: start by inserting and soldering all low-profile components first (eg, resistors, diodes, IC sockets and preset resistors), making sure the diodes are the right way round. Also insert and solder the wire links.

Next insert the remaining components — carefully checking that both the transistor and the electrolytic capacitor are the correct way round. Solder in terminal pins where connections to the PCB are to be made.

Push fit the ICs into their sockets, aligning the dot or notch on the top of each IC with the notch shown in the overlay in Fig.2.

Now, mark and drill the larger of the two cases for the PCB pillars, potentiometer, switch, mounting clips, and the coil and meter wires. Mount the PCB, switch, potentiometer, and wire as shown in Fig.3.

Next, cut out a round hole in the bottom of the smaller case for the panel meter. A suitable tool for this job is an Abraframe hacksaw. Another way to make the hole is to drill a circle of small holes and then file out the large hole.

Drill the four holes to fit the meter bolts (see Fig.4) then mount the panel meter in position.

Solder resistor R19 into position on the rear of the panel meter.

Using the hardboard rough side down, construct the search head of the metal detector as shown in Figs.5 and 6. Drill the hole for the handle connector. The four pieces of prepared beading are glued using a rapid-bond

Figure 1. Circuit of the HE 'Diana' Metal Detector

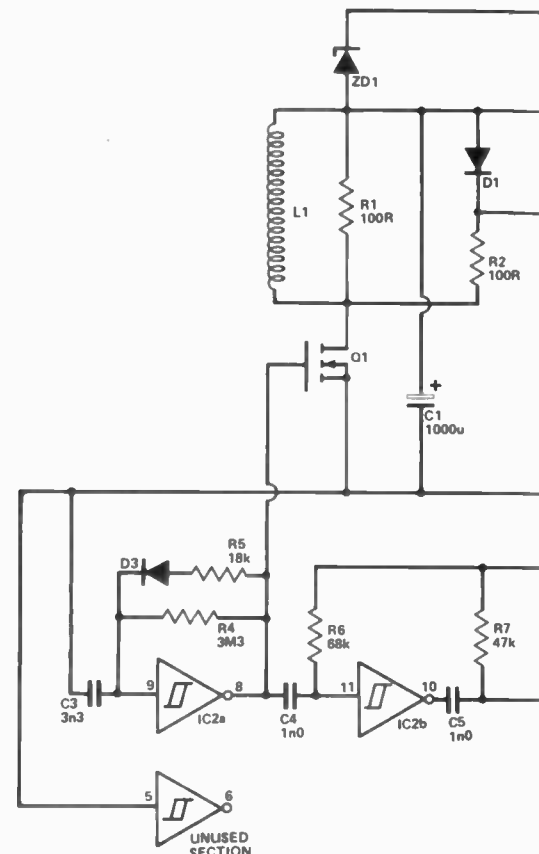

adhesive to the rough side of the hardboard, with the beading groove towards the board and facing outwards. Apply the glue to both the hardboard and the beading — also apply glue on the corners of the beading.

Hold the assembly for about five minutes till firm, then leave for at least two hours until the glue is fully cured.

Next wind the coil. Thread about one metre (1 m) of insulated copper wire through the hole from the 'beaded' side to the handle connector side, then carefully wind 22 turns of wire around the groove. Leave approximately 1 1/2 metres over, for threading through the hole. The two wire ends of the coil need to be long

Diana, mascot of our metal detector project, on her mettle as she goes to hunt

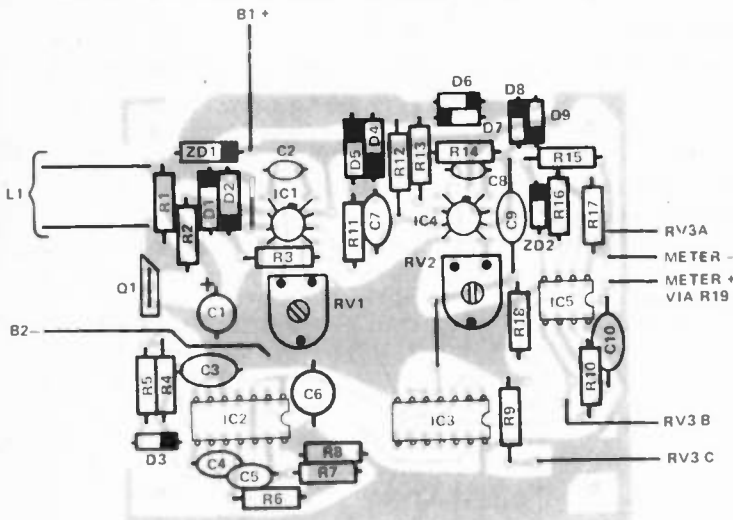
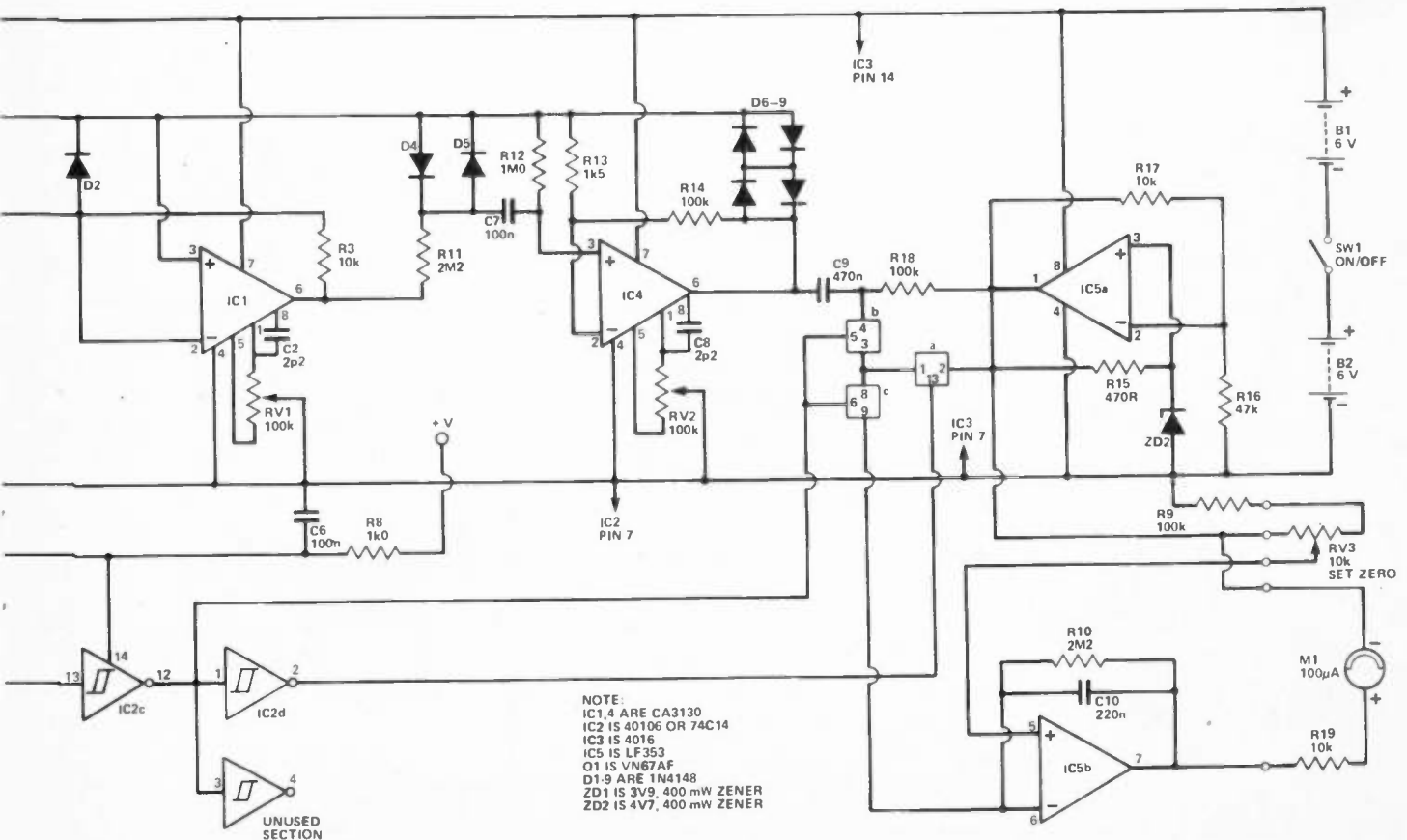

Figure 2. PCB overlay showing component locations



Project

enough to reach the electronics at the top of the handle with 200 mm to spare.

Now, assemble the handle parts as in Fig. 7. Remember to drill a hole in the handle section for the wires into, and out of, the cases.

Cut the end off the hand grip before pushing it into position — a drop of washing up liquid as a lubricant will make positioning easier.

Now, connect 1 m of two core wire to the panel meter, as shown in Fig. 4. Thread the wire through the handle and down the stem to the other case position.

Fasten the panel meter case to the handle.

Fix the larger case to the handle using two saddle clips. Thread the two ends of the search coil wire through the handle to join the PCB. Protect and cover this wire from the coil to the PCB

using 2 mm sleeving. If you find it a difficult job to thread the coil wires through the sleeving, first insert a length of stiff wire and use it to pull through the coil leads.

Before connecting the panel meter into the circuit, make the following checks, using the panel meter as a makeshift voltmeter. If you connect a 100k resistor in series with the meter it will read 10 VDC full scale deflection (100 μ A on the meter scale). Connect the lead from the negative terminal of the meter to the negative side of B2 and:

- Check that the voltage on ZD1 anode is about 9 V
- Measure the voltage at pin 6 of IC1 and adjust RV1 until this voltage equals the voltage at ZD1 anode
- Measure the voltage at pin 6 of IC4 and adjust RV2 until *this* voltage also equals the voltage at ZD1 anode

Once set no further adjustment is necessary.

Disconnect the batteries and then solder the panel meter wires to the PCB as shown on the overlay.

Move the search coil away from any metal — we suggest you hold it in mid-air to keep the search head clear of floor board nails or other metallic objects — and adjust RV3 until the meter reads zero.

The metal detector is now ready for use but you may wish to give the search head a few coats of varnish to help preserve it. All that remains is for us to wish you 'Happy Hunting'.

How It Works

- A magnetic field is built up around the search coil by passing a current through it. The current is then switched off and the magnetic field slowly decays to zero.
- The rate of decay of the field is altered by the presence of metal.
- The resulting voltage change across the coil is amplified and fed to the panel meter.
- Movement on the panel meter indicates the presence of metal.

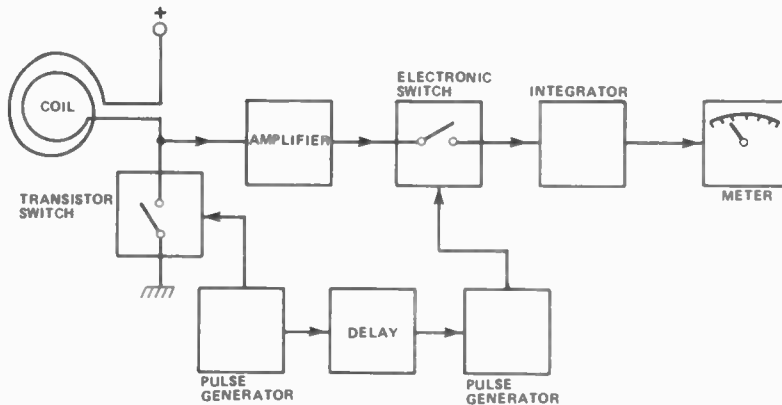

Oscillator IC2a generates a positive pulse which turns on Q1, with the result that a current builds up in search coil L1. At the end of this pulse, Q1 is turned off and the voltage waveform shown below appears across the coil, and falls to zero in time X. If metal is near the coil the voltage falls more slowly to zero (ie, time Y). Operational amplifiers IC1 and IC4 amplify the coil voltage 10 000 times. Monostable multivibrators IC2b and c generate a second pulse, accurately timed after the first pulse,

which is used to turn on an electronic switch (formed by IC3a, b and c) just as the coil voltage is reaching zero.

As metal approaches the coil the voltage across it decays more slowly. Therefore the pulses passed by the electronic switch get bigger.

Integrator IC5b amplifies and smooths the pulses from the electronic switch and drives meter ME1. The output voltage from the integrator thus increases as the coil approaches metal, and this is registered on the meter.

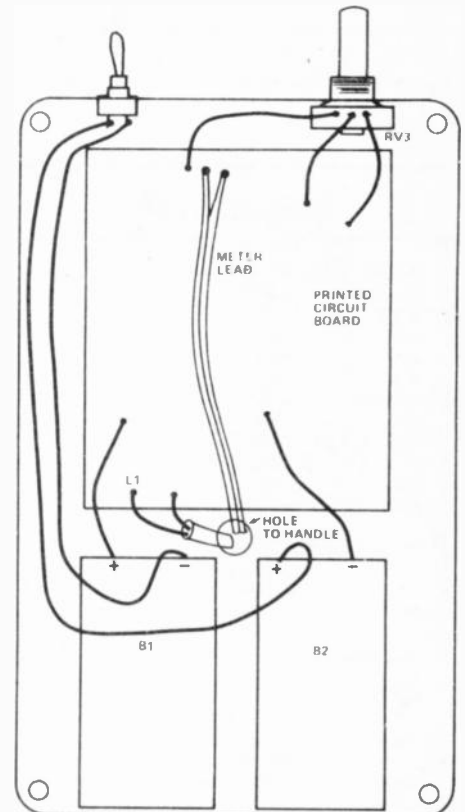
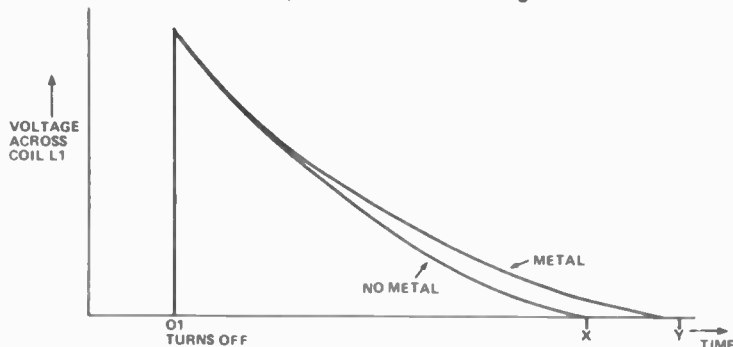

Figure 3. Layout and wiring of the main case, which holds the PCB and two batteries. Each battery consists of four AA-size cells

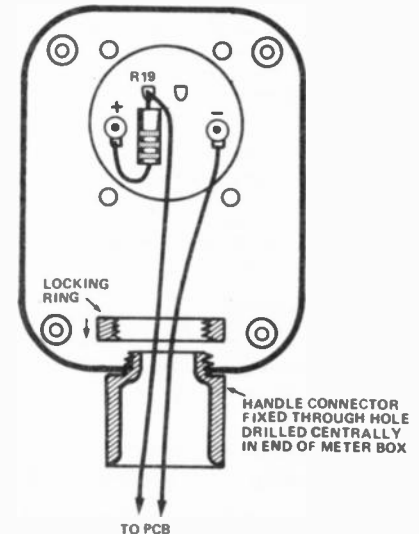

Figure 4. Inside of meter box, showing wiring and mounting of meter and handle connector

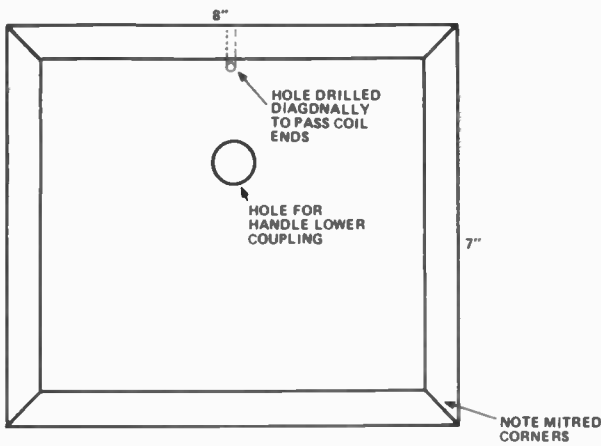

Figure 5. Underside of the search coil head

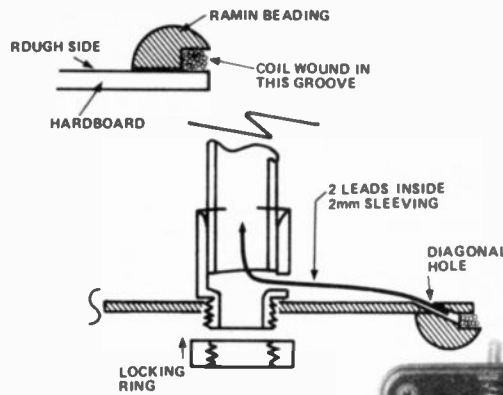
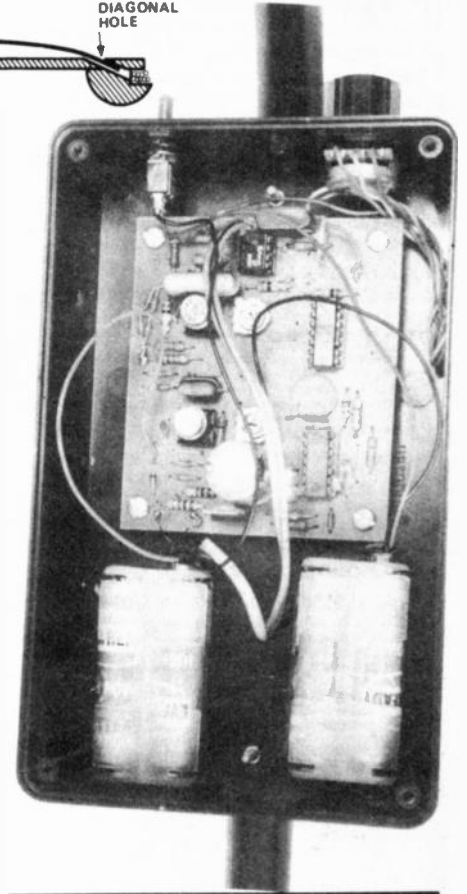

Figure 6. Sections of the search coil head showing coil leadout and route up into the handle



Parts List

RESISTORS (All 1/4 W, 5%)

R1,2	100R
R3,17,19	10k
R4	3M3
R5	18k
R6	68k
R7,16	47k
R8	1k0
R9,14,18	100k
R10,11	2M2
R13	1k5
R15	470R

POTENTIOMETERS

RV1,2	100k miniature horizontal preset
RV3	10k linear potentiometer

CAPACITORS

C1	1000u, 16 V electrolytic
C2,8	2p2 polystyrene
C3	3n3 polystyrene
C4,5	1n0 polystyrene or ceramic
C6	100n ceramic
C7	100n polyester
C9	470n polyester
C10	220n polyester

SEMICONDUCTORS

IC1,4	CA3130 operational amplifier
IC2	40106 or 74C14 hex Schmitt trigger
IC3	4016 quad bilateral switch
IC5	LF353 operational amplifier
Q1	VN67AF VFET transistor
D1-9	1N4148 diode
ZD1	3V9, 400 mW zener diode
ZD2	4V7, 400 mW zener diode

MISCELLANEOUS

- SW1 single-pole, single-throw toggle switch
- 2 x battery holders + clips
- 100 uA panel meter
- Cases to suit
- Control knob
- Wood for coil former
- Handle assembly clips, bends and hand-grip
- 28 SWG insulated copper wire
- 2 mm sleeving
- IC sockets and PCB pins

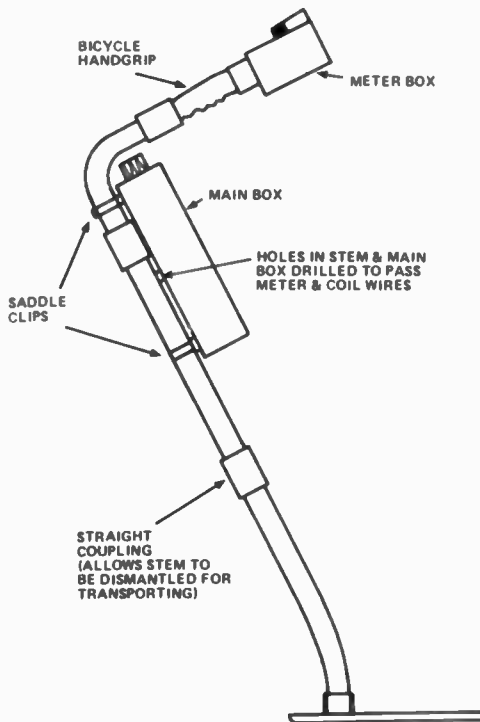
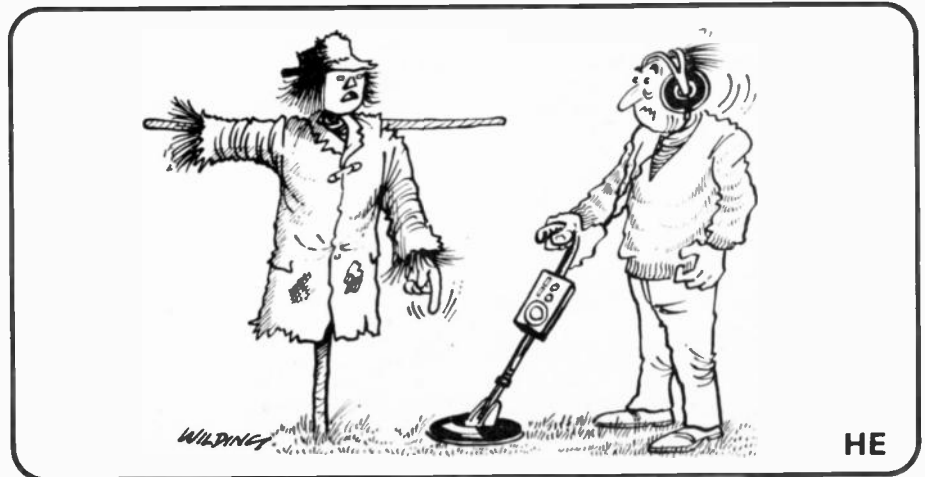

Figure 7. Details of handle and stem construction showing mounting positions of the two cases

Buylines

A full kit of parts is available from:
Magenta Electronics Ltd,
 135 Hunter Street,
 Burton-on-Trent,
 Staffs
 DE14 2ST
 for £33.85. This price includes VAT,
 PCB, cases and all hardware, but please
 add 40p to cover postage and packing.



NEW KITS THIS MONTH

115 WATT AMPLIFIER

Complete kit for making this up in module form. Unique design makes frequency response 5Hz to 25KHz, which puts this well into the hi-fi category. **£13.50.**

SUPPLY KIT, MAINS OPERATED large enough to operate two 115v watt amplifiers in stereo or parallel. **£14.50 + £3.00 post.**

3 - 30v VARIABLE VOLTAGE POWER SUPPLY UNIT

With 1 amp DC output, for use on the bench, students, inventors, service engineers, etc. Probably the most important piece of equipment you can own, (after a multirange test meter). Gives variable output from 3 - 30 volts and has an automatic short circuit and overload protection. In case with volt meter on the front panel. Price for the full kit, complete with instructions is **£13.80.**

IONISER KIT

Refresh your home, office, shop, work room, etc. with our negative ION generator. Makes you feel better and work harder — complete mains operated kit, without case **£9.95.** Case **£4.00.**

STROBE LIGHT

Intended for use at discos or in window displays etc. Gives a bright flash of white light at a speed which you can vary between approximately 1 flash per second up to 20 flashes per second. Another useful application of a strobe is for looking at rotating wheels, cogs, etc. By turning the speed adjustment you can get the light to synchronise with the wheel and cause it to appear stationary. You can thus look at a rotating device for its faults, you can see a broken cog for instance. It uses a Xenon tube and is housed in a neat wooden case with the variable control at the back. Works off normal 230/240V mains — **£12.50 + £1 post.**



SPOT LAMPS



In neat plastic case is a 60 watt reflector type screw in lamp size approximately 5" x 5" x 6" deep. Case made from heavy duty plastic and designed so that any number of these may be joined together to make a running light or other display. **£4.80 + 50p each post.**

ROPE LIGHT

4 sets of coloured lamps in translucent plastic tube arranged to give the appearance of a running or travelling light. With variable speed control box, ideal for disco or shop window display. Complete, made up, ready to plug into mains. **£36.00 + £2 post.**

COMPUTER KEY SWITCHES (make your own keyboard)

These are for making up on a p.c.b. and consist of a vertical mounting computer type reed switch, which makes circuit when a magnet passes over it. The magnet is located in the plastic plunger which in turn is depressed by a push rod, to which the legended top is fixed. These are made up in banks of 6, price **£2.30** per bank of 6 (including tops)

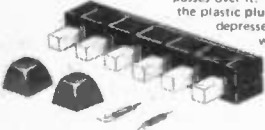

OUR CAR STARTER AND CHARGER KIT has no doubt saved many motorists from embarrassment in an emergency you can start car off mains or bring your battery up to full charge in a couple of hours. The kit comprises: 250w mains transformer, two 10 amp bridge rectifiers, start/charge switch and full instructions. You can assemble this in the evening, box it up or leave it on the shelf in the garage, whichever suits you best. Price **£11.50 + £2.50 post.**

GPO HIGH GAIN AMP/SIGNAL TRACER. In case measuring only 5 1/2" x 3 1/2" x 1 1/2" is an extremely high gain (70dB) solid state amplifier designed for use as a signal tracer on GPO cables, etc. With a radio it functions very well as a signal tracer. By connecting a simple coil to the input socket a useful mains cable tracer can be made. Runs on standard 45v battery and has input, output sockets and on-off volume control, mounted flush on the top. Many other uses include general purpose amp, curing amp, etc. An absolute bargain at only **£1.85.** Suitable 800hm earpiece **69p.**

COIN SWITCH



Mounted in sheet metal case with removable coin tray and Yale type lock. Switches on for one hour per 10p coin. **£4.60 + £1 post.**

12 V CAR IGNITION COIL

Suitable for most cars, also for where a high voltage from LT is required. **£11.50.**



SUPER HI-FI SPEAKER CABINETS

Made for an expensive Hi-Fi outfit will suit any decor. Resonance free cut-outs for 8" woofer and 4" tweeter. The front material is carved Dacron, which is thick and does not need to be stuck in and the completed unit is most pleasing. Colour black. Supplied in pairs, price **£6.90** per pair (this is probably less than the original cost of one cabinet) carriage **£3.50** the pair.

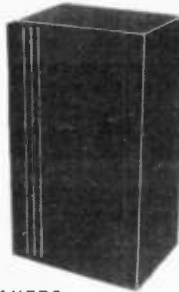

LOUDSPEAKERS

8" woofer and 4" tweeter, 4 ohms 35 watts power rating **£6.90** per pair Ditto but 8 ohms, **£11.50** per pair Post **£2.00**



MOTORISED DISCO SWITCH

With 10 amp change-over switches. Multi-adjustable switches all rated at 10 amps, this would provide a magnificent display. For mains operated 8 switch model **£8.25**, 10 switch model **£6.75**, 12 switch model **£7.25.**

3 CHANNEL SOUND TO LIGHT KIT

Complete kit of parts for a three-channel sound to light unit controlling over 2000 watts of lighting. Use this at home if you wish but it is plenty rugged enough for disco work. The unit is housed in an attractive two-tone metal case and has controls for each channel, and a master on/off. The audio input and output are by 1/4" sockets and three panel mounting fuse holders provide thyristor protection. A four-pin plug and socket facilitate ease of connecting lamps. Special snip price is **£14.95** in kit form or **£19.95** assembled and tested.



THIS MONTH'S SNIP

IN FLIGHT STEREO UNIT (for breaking down)

Ex BOAC, hand held unit contains two very well made moving coil transducers, these can be used, either as loudspeakers or microphones, 8 ohm. Other useful parts: 12 position single pole switch, special feature being that its only just over 1/2" diameter and 1/2" deep. Unique stereo pot, edgewise control twin 5K, 5 transistors and 2 x 7418 i.c.'s, 1 x 220 of 12v, and 1 x 100 of 25v, 1 rocker switch, 1 push switch, many other parts. Break up value probably over **£12**, our price **£2.30.**

STACKABLE MICROSWITCHES

Snap action changeover type with 3 amp contacts. These are so designed that they can be mounted in a long line and held together by a length of studding or they could be mounted in a cradle. Approximate size: 30 x 21 x 4mm thick. Price 28p each.



100uA PANEL METER

Japanese made (Shinohara Electrical) so very good quality, these have a full vision front, are approx 2" square and come complete with mounting studs and nuts. A thoroughly reliable instrument usually retailed at over **£4**, offered at a snip price this month of **£2.85** or 10 for **£25.00.**

12v MOTOR BY SMITHS

Made for use in cars, these are series wound and they become more powerful as load increases. Size 3 1/2" long by 3" dia. These have a good length of 1/2" spindle — price **£3.45**. Ditto, but double ended **£4.25.**

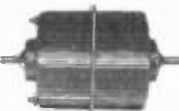

EXTRA POWERFUL 12v MOTOR

Made to work battery lawnmower, this probably develops up to 1/2 h.p., so it could be used to power a go-kart or to drive a compressor, etc. **£6.90 + £1.50 post.**

MINI-MULTI TESTER

Deluxe pocket size precision moving coil instrument, jewelled bearings - 2000 o.p.v. mirrored scale. 11 instant range measures: DC volts 10, 50, 250, 1000. AC volts 10, 50, 250, 1000. DC amps 0 - 100 mA.



Continuity and resistance 0 - 1 meg ohms in two ranges. Complete with test prods and instruction book showing how to measure capacity and inductance as well. Unbelievable value at only **£6.75 + 50p post and insurance.**

FREE Amps range kit to enable you to read DC current from 0 - 10 amps, directly on the 0 - 10 scale. It's free if you purchase quickly, but if you already own a Mini-Tester and would like one, send **£2.50.**

FREE OUR CURRENT BARGAIN LIST WILL BE ENCLOSED WITH ALL ORDERS.

TRANSMITTER SURVEILLANCE

Tiny, easily hidden but which will enable conversation to be picked up with FM radio. Can be made in a main board — all electronic parts and circuit **£2.30.**

RADIO MIKE

Ideal for discos and garden parties, allows complete freedom of movement. Play through FM radio or tuner amp. **£6.90** comp kit.

FM RECEIVER

Made up and working, complete with scale and pointer needs only a speaker, ideal for use with our surveillance transmitter or radio mike. **£5.85.**

CB RADIO

Listen in with our 40 channel monitor. Unique design ensures that you do not miss a word or syllable. Complete kit with case, speaker and instructions only **£5.99.**



VENNER TIME SWITCH

Mains operated with 20 amp switch, one on and one off per 24 hrs, repeats daily automatically correcting for the lengthening or shortening day. An expensive time switch but you can have it for only **£2.95.** These are new but without case, but we can supply plastic cases (base and cover) **£1.75** or metal case with window **£2.95.** Also available is adaptor kit to convert this into a normal 24hr. time switch but with the added advantage of up to 12 on/off's per 24hrs. This makes an ideal controller for the immersion heater. Price of adaptor kit is **£2.30.**

STEREO HEADPHONES

Japanese made so very good quality. 8 ohm impedance, padded, terminating with standard 1/4" jack-plug. **£2.99** Post 60p.



TIME SWITCH BARGAIN

Large clear mains frequency controlled clock, which will always show you the correct time + start and stop switches with the dials. Comes complete with knobs. **£2.50.**

SAFE BLDCK

Mains quick connector will save you valuable time. Features include quick spring connectors, heavy plastic case and auto on and off switch. Complete kit **£1.95.**

6 WAVEBAND SHORTWAVE RADIO KIT

Bandspread covering 13.5 to 32 metres. Based on circuit which appeared in a recent issue of Radio Constructor. Complete kit includes case materials, six transistors, and diodes, condensers, resistors, inductors, switches, etc. Nothing else to buy if you have an amplifier to connect it to or a pair of high resistance headphones. Price **£11.95.**

SHORT WAVE CRYSTAL RADIO

All the parts to make up the beginner's model. Price **£2.30.** Crystal earpiece **65p.** High resistance headphones (gives best results) **£3.75.** Kit includes chassis and front but not case.

RADIO STETHOSCOPE

Easy to fault find — start at the aerial and work towards the speaker — when signal stops you have found the fault. Complete kit **£4.95.**

INTERRUPTED BEAM

This kit enables you to make a switch that will trigger when a steady beam of infra-red or ordinary light is broken. Main components — relay, photo transistor, resistors and caps etc. Circuit diagram but no case. Price **£2.30.**

UNUSUAL MOTORISED PUMP

The motor is a normal 1/2" stack induction motor, mains operated. The spindle is fitted a nylon worm drive, this considerably reduces speed and turns a nylon cog wheel to which is coupled a link operating a small bellows pump. The outlet and inlet to and from this pump are nylon pipes to which flexible tubing can be connected. Obviously, there will not be a big flow of air from this pump but quite considerable pressures can be developed. Price **£4.60 + 50p.**

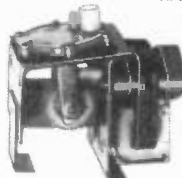

SOLENOID AIR VALVE

Made to work with the above pump. This mains operated valve will stop the flow of air or gas when mains is applied to it. 220v - 230v model — **£3.45.** 100v model — **£2.30.**



(Not licenceable in the U.K.)

J. BULL (Electrical) Ltd.

(Dept. HE), 34 - 36 AMERICA LANE,
HAYWARDS HEATH, SUSSEX RH16 3QU.

J. BULL (Electrical) Ltd — Established 30 years. MAIL ORDER: Cash, p.o. or cheque with order — please add 60p to all orders under £10, to offset packing, etc. ACCESS & BARCLAYCARD welcomed. Our shop is open to callers BULK ENQUIRIES INVITED. Telephone: Haywards Heath (0444) 54563.

Electronics In Diagnostic Medicine

Would you trust a computer to diagnose your illness? Graham Thirsk shows that although increased use is being made of electronic diagnostic techniques and data analysis, there will still be a need for the doctor and nurse

THE WORD ELECTRONICS in the title may be clear enough, but what is meant by diagnostic medicine? Put simply, it is the detective work that the doctor has to do to discover why your body is not functioning correctly when you are ill. This 'fault-finding' may be approached in many different ways, and some simple examples are: asking questions about the symptoms, using simple techniques such as taking your temperature, or looking and feeling for abnormal signs. More sophisticated techniques will often require the use of electronic equipment. The doctor collects all the facts together, derived from one or more of these techniques, and makes a logical deduction about the cause of the illness. This deduction will, of course, be guided by the doctor's experience. I used the expression 'fault-finding' because an electronics service engineer uses similar fault-finding procedures for electronic circuits.

Diagnosis From ECG

Electronic instruments have aided the detective work required in diagnosis since early amplifiers were first used to detect and display the electrical activity of muscle. Of particular interest is the electrical waveform produced by the heart muscle, and this waveform is called the electrocardiogram, or ECG. Early ECG machines were large and required a special electrically-screened room for their operation. It was also necessary for the patients to sit with their feet in water to ensure a good ground (earth return) connection. Modern ECG machines, however, can be small enough to fit into the doctor's black bag and require no screening. With the modern machines only simple electrode connections are required to the patient.

Advances in diagnostic techniques have often taken place as a direct result of advances in electronic technology and their application to medicine. Interestingly, these advances have often produced a demand for more sophisticated equipment to yield more information and hence stimulate further developments in electronics. An example of this interaction is shown by the development of ECG monitoring.

Studies of the ECG have shown that changes in the normal functioning of the heart are nearly always accompanied by changes in the ECG waveform. Consequently, the ECG is used widely to assist in diagnosis of malfunction of the heart. Such is the importance of the ECG that methods were devised for continuously displaying the ECG of certain high risk patients, such as those who had recently had a heart attack, on a cathode ray tube. As a result, much information was acquired about abnormal heart rhythms or arrhythmias and soon doctors felt that a record of the ECG during 24 hours in the normal life of these high risk patients would yield much valuable information about the condition of the heart. This could be done easily using a special portable cassette recorder, but to play back the recording would obviously require 24 hours in real time, which is impractical. The development of digital techniques, particularly in

microprocessors and solid-state memories, has enabled instruments to be constructed which can replay the tape at high speed, memorise that patient's normal heart rhythm, detect any abnormal rhythms, store them and classify them according to a pre-programmed order of priority and the number of times each occurred. This processing can be completed within minutes for a 24-hour recording, and also the sections of ECG containing the abnormal rhythm can be displayed on an oscilloscope, following a simple machine instruction.

Doppler Analysis

The interaction between the development of electronic and medical sciences continues even now. A recent innovation has been the measurement of the flow of blood within the blood vessels. This technique uses the doppler shift of a burst of high frequency sound waves, ultrasound, by the movement of blood cells within the vessels. The doppler effect is simply a change in the sound pitch that results when there is a relative motion between the sound source and the observer. If a sound wave is reflected off the moving object then movement towards the sound source produces an increase in the pitch of reflected sound and movement away from the source produces a decrease in the pitch. If a continuous beam of ultrasound is passed into the body, any movement in the same axis will produce a change in frequency of the reflected beam. This is similar to frequency modulation as used in radio transmitters.

The returning beam is demodulated to remove the original carrier frequency and this leaves just the signal produced by the movement, the doppler information.

The information obtained in this way used to be analysed by amplifying the shift frequencies (typically 1 to 3 kHz) to drive loudspeakers. The analysis was based on listening to the result. Although apparently a crude method, much information about flow could be derived in this way. However, a more quantitative method of dealing with the data was required. Initially, a zero crossing technique (that is, counting the number of times a doppler waveform crossed the zero voltage point) was used to obtain information about the frequency content of the doppler signal. Subsequent research showed this method to be hopelessly inaccurate when used on complex signals such as those produced when studying blood flow. Recently, the availability of fast and inexpensive microprocessors made it possible to analyse the doppler signal mathematically to provide true real time spectrum analysis, together with a statistical treatment of the data. Such is the impact of this latest development and the diagnostic information it provides, that doctors are currently researching methods to best apply this powerful technique to diagnostic medicine. Improvements to the technique that might be incorporated into subsequent designs of instruments have already been suggested.

These two examples, ECG and doppler analysis, serve to il-

illustrate the interaction between electronics and medicine, where advances in one discipline may stimulate developments in the other and vice versa.

Analysing Waveforms

Observations and recordings of electrical signals produced by various parts of the human body have long been important diagnostic tools. Several types of waveform can be obtained, some of the more important ones being electromyogram (EMG), produced by ordinary muscle, electroencephalogram (EEG), produced by brain cells and electrocardiogram (ECG), produced by heart muscle. All are detected by amplifying signals obtained from electrodes placed at different points on the skin surface and recorded on paper.

The ECG is the most commonly used and is probably the most useful. A typical ECG waveform is shown in Fig.1. The segments, P Q R S T represent electrical events occurring within the heart. Each occurs at a specific point in the cardiac cycle (one heart beat). The number of cardiac cycles occurring each minute is the heart rate, usually 70 beats/minute in a healthy person at rest, but as high as 160 beats/minute under stress or during exercise. The shape of the waveform and the time relationship of the segments yields important information about the state of the heart.

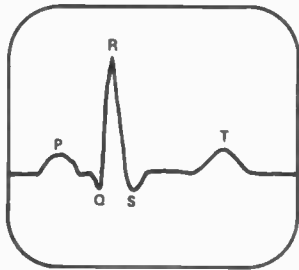

Figure 1. Typical ECG (electrocardiogram) waveform. It is divided into segments P Q R S T for analysis of electrical events in the cardiac cycle

Although this is an apparently simple technique, there is first the difficulty of detecting and selectively amplifying an electrical signal of approximately 1 millivolt (1 mV) peak-to-peak in the presence of induced AC noise such as 50 Hz mains hum of several volts peak-to-peak. Second, since the human body may be considered as being filled with a conductive fluid, an electrical signal from areas other than the ones being studied may also be present at the skin surface. For example, electrical signals produced by the movement of muscles is a common source of interference on ECG recordings. Third, it is generally recognised that a current flow of greater than 10 microamps (10 uA) across the heart can be fatal and since good electrical contact with the skin is essential, precautions must be taken to avoid leakage of current to the skin electrodes, especially when mains-powered equipment is used.

Use of modern circuit design has minimised most of these difficulties. Front-end circuitry is of the differential type offering a very high common mode rejection ratio (the noise, common to two amplified signals, tends to be cancelled out). Amplifiers with specific passband together with deep-notch filters (to limit amplification to an extremely narrow band of frequencies) further improve the selectivity and noise immunity of the instruments. Isolation of the patient from the instrument and power supplies is achieved by transformers or more recently by opto isolators (devices incorporating a light source and a light detector).

The ECG has become such an important index of heart function that all high risk patients, such as those undergoing surgery in the operating theatre or those in intensive care units, have their ECG waveform monitored continuously and displayed on a 'scope of some type. Early bedside monitors comprised a high persistence low sweep speed oscilloscope and an analogue meter giving an indication of heart rate. Modern monitors, however, can display several seconds of ECG waveform at one time, while continuously updating this display by using analogue-to-digital conversion and a digital memory. Digital display of heart rate is provided either by means of LED displays or as alphanumeric on the 'scope itself. An audible and visible alarm is also usually provided to alert the nurse immediately in the event of the heart rate exceeding preset limits.

Various other body functions may be monitored in a similar manner: temperature using thermistor probes, respiration by measuring impedance changes related to chest movements and blood pressure by means of strain gauge type pressure transducers.

Patient monitoring techniques have gradually been improved to provide further detailed information about the patient's condition. Patients recovering from a heart attack may now be allowed out of bed to walk around in the hospital and still have their ECG monitored by means of telemetry. In this, the ECG is modulated onto a radio frequency (RF) carrier wave and is transmitted by a short range transmitter to a base station where it is demodulated and displayed on a 'scope in the usual way. This provides a valuable half-way stage between intensive care monitoring in bed and the patient being allowed home.

Detection of abnormal heart rhythms or arrhythmias by observation of the ECG is an essential part of the monitoring of patients with heart disease. Some arrhythmias may be just an indication of impaired heart function, while other abnormal rhythms may be a threat to life. Arrhythmia detection initially depended upon constant observation of the ECG by the nurse and the recognition of abnormal patterns. However, it is not possible to concentrate on a display of this kind for more than 60% of the time and abnormal rhythms often went undetected. Automated detection systems are able to observe the ECG for 100% of the time, classify any arrhythmias and store them in memory for later review. Normal and abnormal ECG waveforms are differentiated by a template matching process. In this, the monitor initially stores the normal waveform for a particular patient in its memory and compares all the subsequent waveforms

Bed 1 Room BED101	Patient Information	Ward: 06/05/81 12:44
U. T. COBLEY		ID 25
Name: U. T. COBLEY	ID#: 25	SS#: - -
Sex: m	HT: 2 5	WT 80
BSA: SQM	Date of Birth: 02/03/45	Age 36
Race: EUROPEAN	Blood Type AB	RH NEG
Religion: CATHOLIC	Home Phone (063) 592-8165 EXT 22	
Next of Kin: WIFE	Phone: - - - - - EXT	
Physician: Dr ZHIUAGO	Phone: (063) 592-1138 EXT	
Admitted From: HOME	Date/Time: 21/04/81 06:21	
Transferred/Discharged to:	Date/Time: / /	
Allergies: PENICILLIN		
Major Complaints and Other Notes		
ADMITTED WITH SEVEPE CHEST PAIN WITH EXTREME BREATHLESSNESS		
Select 1 Enter Data	2 Purge Bed	3 Select Bed

Figure 2. Example of how information on individual patients can be printed out in hard copy form. The advantages of data handling equipment include immediate (automatic if required) updating of information, analysis of data and saving of time for nurses

with this template. Deviations from the template are then classified and stored for later review together with data on the number and types of abnormal rhythms detected.

Handling The Data

The volume of patient data now being produced by modern nursing methods has prompted the development of data handling equipment for medical purposes based on microprocessor technology. Features include:

- on-line assimilation of data from monitoring equipment and production of trend graphs for periods of up to 24 hours from this data
- analysis of data from arrhythmia monitors
- recording of drugs given to the patient, when they were given and in what doses
- storage of the patient's personal data such as age, weight, height, names of relatives and the name of the family doctor.

Hard copy of this information is also often provided for inclusion in the patient's medical notes, an example of which is shown in Fig. 2. Data handling of this type has become sophisticated to the point where data obtained from blood pressure measurements made in the operating theatre can be analysed and interpreted on-line, providing the doctor with a complete diagnosis in a very short time.

The monitoring techniques described are all attempts to provide continuous information about the patient's condition, to collect and provide easy access to all this data while relieving the nurses of tedious routine observations and in this way enabling them to spend more time caring for the patient.

Diagnosis From Images

An area of medical diagnosis which is currently undergoing the fastest development, as a direct result of the advances in electronics, is diagnostic imaging. Diagnostic imaging is the science of producing pictures of the internal structures of the body without damage to them. The best known imaging technique is that which uses X-rays to produce a photograph of internal structures such as bone but which does not allow X-rays to pass through these structures. The technique is limited, since only structures that are opaque to X-rays can be seen with clarity. To see other structures, such as the stomach and intestines, these must first be outlined with a contrast medium which absorbs the X-rays. The patient must swallow a contrast medium (for example, barium sulphate) and then undergo a series of X-ray photographs as the contrast medium passes through the intestines. A further disadvantage of X-ray photographs is that they are static and cannot show motion of any kind. In fact, motion during exposure of the X-ray film results in blurred images. However, the most serious disadvantage of X-ray techniques is that X-radiation is known to be harmful to healthy body tissue and therefore excessive exposure should be avoided.

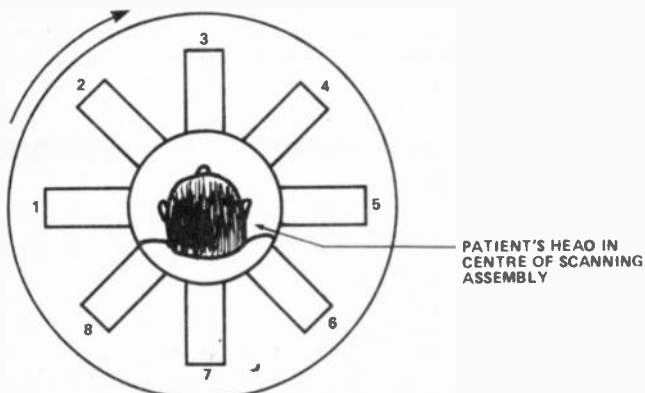

Figure 3. Scanning elements of a greatly simplified computerised tomography scanner. As shown, the patient's head is placed in the centre of the assembly. X-rays are emitted from elements 1 to 4 and are received by elements 5 to 8. The whole assembly then rotates a few degrees and the sequence is repeated

Advances in microcomputing techniques have enabled some of the shortcomings of X-ray imaging to be overcome. For example, X-ray scans of brain tissue can now be made using a computerised tomography scanner (CT Scanner). Initially developed by EMI this instrument produces pictures of suc-

cessive sections (1 mm thick) through the head using X-rays (see Fig. 3). Each element 1 to 4 in Fig. 3 sequentially emits a burst of X-rays which are received by the elements 5 to 8 and converted to an electrical signal which is stored by the computer. The scanhead revolves a few degrees after all the elements are fired and the sequence is then repeated. In this way, the computer memory stores information about the absorption of the X-rays as they pass through each tissue type and an image can then be reconstructed on a video monitor by reading the information out of the memory in the correct sequence. A complete brain scan requires 50 to 100 sections to be constructed, which is a lengthy process taking 20 minutes or more. The sections are often stored on floppy discs for later review and analysis.

Ultrasound Imaging

A technique for examining the interior of the body painlessly, without the use of X-rays, has been developed in the last 10 years. It uses high frequency sound waves, typically 1 to 10 MHz in frequency, to probe the organs of the body. From the echoes produced, pictorial images of the organs can be constructed by means of techniques first used for radar and sonar.

When pulses of ultrasound travel through a medium they are reflected and scattered in much the same way as audible sound. The diagnostic application of ultrasound depends mostly on the fact that the pulses are partially reflected at boundaries between tissues that differ in their ability to transfer the ultrasound energy (acoustic impedance). Acoustic impedance is dependent upon the density of the medium and the velocity of sound passing through it. The density of soft tissue is close to that of water and the velocity of sound through it is close to the velocity of sound through water. The velocity ranges from 1 450 metres per second in fat to 1 600 metres per second in muscle. Therefore, the difference in impedance between tissues is not very great and consequently the echoes are small.

Typically only 0.5% of the incident energy is reflected at a boundary in a manner that can be detected, and this requires a sensitive receiver. However, since much of the ultrasonic energy crosses the boundary it penetrates deeper into the body and thus is an effective probe of deeper organs. These strong reflections may limit the usefulness of ultrasonic diagnosis in some analyses.

The resolution of the system depends upon the wavelength used to form the image. Generally, resolution increases as the wavelength decreases. Since wavelength is inversely proportional to frequency, a better resolution requires high frequencies. In practice, the ultrasound is attenuated as it passes through the body by absorption and scattering, and the rate of attenuation is directly proportional to the frequency. Therefore, a compromise between resolution and depth of penetration is necessary. Frequencies of 3 to 5 MHz are the most useful for general ultrasound imaging.

The ultrasonic pulses are generated by a piezoelectric transducer, and usually the same transducer serves for detecting the pulse echoes. The piezoelectric crystal is excited by a voltage pulse at the resonant frequency of the crystal, causing it to emit a brief burst of high frequency sound. The length of the pulse is restricted to one wavelength by electrical and acoustic damping, to maximise the resolution of the system. The crystal then waits for returning echoes which cause it to vibrate and produce an electrical signal proportional to the amplitude of the echo. The distance of the reflecting boundary from the transducer can be determined by measuring the interval between the moment the pulse is transmitted and the moment the echo is received. Pulse echo information obtained in this way can be displayed on the CRT.

Image Display

A single sweep of the CRT is difficult to observe and so the process of transmit/receive is repeated at 1 000 times/second to provide a flicker-free display. Figure 4 shows a typical display obtained in this way and is known as an A mode (amplitude versus distance) display.

This type of display provides limited information about structures in the sound beam, so the echoes are usually presented in the form of a brightness modulated display (B scan). In the B scan each echo is represented by a spot of light, the brightness of which is proportional to the amplitude of the echo received. However, to form a pictorial image of a cross-section of the body, much more information is required.

Feature

In static scanners, which provide non-moving pictures, the transducer is mounted on a mechanical arm which is able to move in two directions. Data is then obtained not only on the strength of the echo and the position of the boundary, but also on the position of the probe and the direction of the ultrasound beam. Each position of the probe, together with the position and brightness of the echo, is stored by the scanner. If the probe is moved, different structures will be in the beam and different echoes will be returned. Thus by integrating all the lines of information at each probe position, a composite picture of the underlying structures can be built up. This picture has several different brightness levels equivalent to what is called a grey scale.

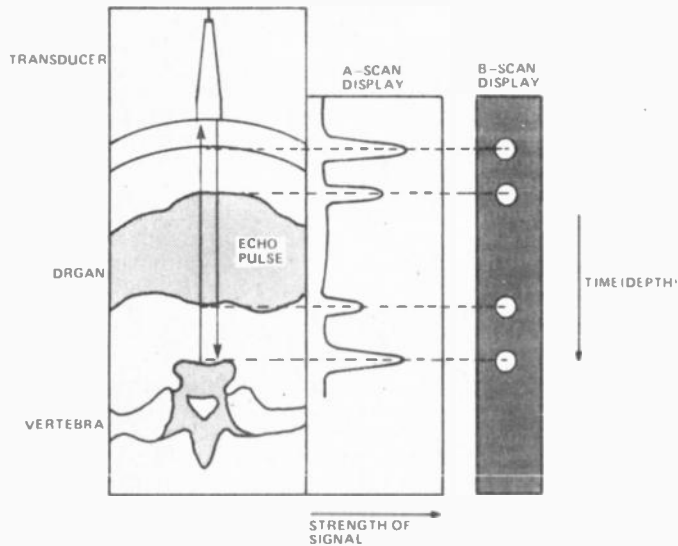

Figure 4. Example of display obtained from an ultrasonic scanner. The piezoelectric transducer transmits a pulse of sound and then 'listens' for the echo, in this example from the organs and bones in the abdomen

Intermediate lines of the image are stored by a scan converter. Early scan converters were analogue devices, but more recently digital scan converters have been developed. The analogue scan converter is a vacuum device resembling a CRT but the phosphorescent screen is replaced by a silicon target. The surface of the target consists of a mosaic of tiny silicon oxide elements, each of which stores a charge corresponding to the brightness of the image at that position. Once the image is formed, it is scanned by sweeping an electron beam of low intensity over the target in rapid horizontal motion, like the raster scan on a TV screen. The raster scan is repeated in the CRT and the current from the scan converter controls the current in the electron gun of the CRT. The result is a display of the image stored in the scan converter target. Satisfactory operation of the analogue scan converter requires careful adjustment.

To avoid some of these problems, digital scan converters were developed. In the digital scan converter the image information is split up into a regular, two-dimensional matrix of picture elements. A typical picture consists of 512 x 512 elements, and the position of each element corresponds to the location of a word in random access memory. The brightness of each picture element corresponds to the value of the word, and the composite picture stored in the memory can be read out and displayed on the CRT in the usual way.

The ultrasound pulse is attenuated as it travels through tissue and consequently for a given interface between tissues, the echoes become weaker as the distance from the transducer increases. To produce a display with uniform brightness, for similar echoes, compensation for attenuation is required. This is known as time gain compensation or TGC and it increases the gain of the receiving amplifier logarithmically, as the time from the transmission of the pulse increases. Figure 5 shows a typical static B scanner in block form.

Real Time Scanning

Static B scans of this type take up to 15 seconds to build up an image of one full cross-section through the body and so cannot depict fast-moving objects such as the heart. So, a real time scanning system was needed that could rapidly produce a

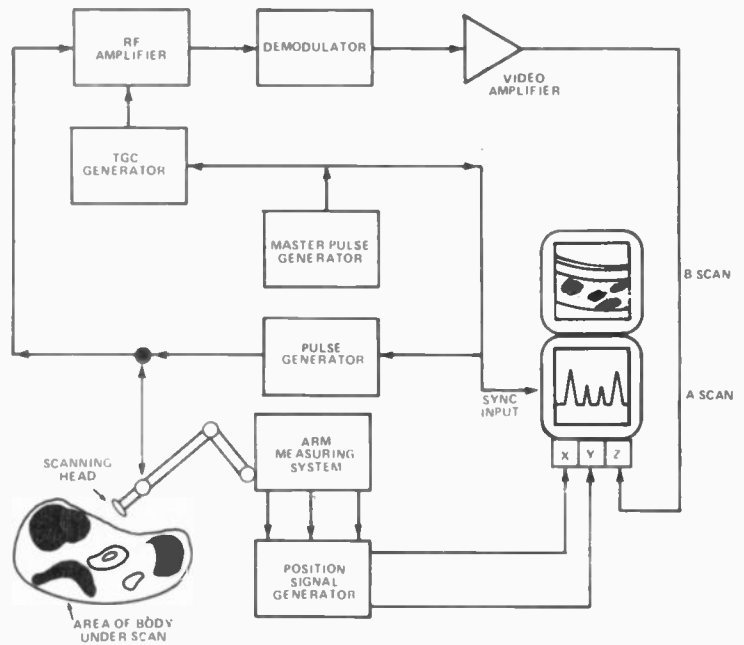
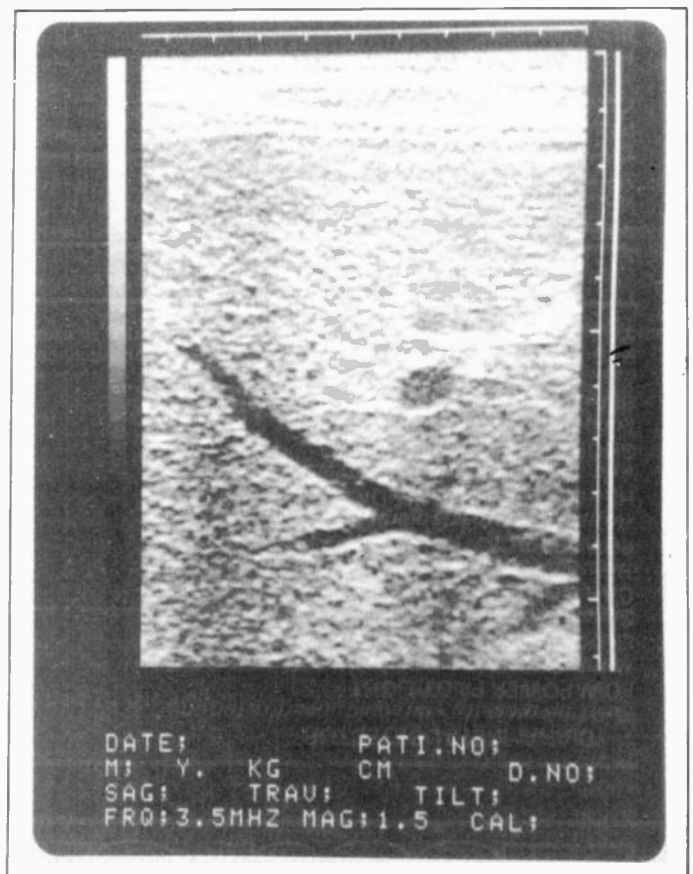

Figure 5. Main parts of a typical static B scanner

series of stop-frame images. Two advantages of such a system are the ability to freeze motion and to greatly reduce the time needed for an examination. Real time moving images are also easier to interpret than static ones. There are two main types of real time scanner: sector or linear array. In the first type of scanner the sound beam from the transducer is either mechanically or electronically swept across the patient at high speed. It produces a series of stop-frame images, like cine film. Linear array scanners have a probe consisting of up to 400 transducer crystals in line which are fired in rapid sequence to produce repeated scans. These transducers are very small so that several elements are usually fired together to increase the sound intensity. By introducing a delay in the signal path of each element, it is possible to focus the sound beam at selected distances, thus improving the resolution of the system. An image produced by a sector scanner is shown in Fig. 6.

Figure 6. Ultrasound image of human liver, showing one of the blood vessels within it



Real time imaging is developing rapidly as a result of the application of new electronic technology. Memories with faster access times coupled with microprocessor control have enabled faster image formation with subsequently higher frame rates. This effectively allows even the fast motion of the heart valves to be frozen easily. Early instruments used 3-bit digital memories and could only differentiate light levels of echo intensity or grey scale. Now instruments may have 6-bit memories providing 64 levels of grey scale. As a result it is possible to distinguish different types of tissue boundary more easily since different boundaries return different intensities of echo and hence are depicted as a different shade of grey. Electronic miniaturisation has also allowed the scanners to be made small and portable, increasing their usefulness. An example of the most recently introduced sector scanner is shown in Fig.7.

Combining Pulse-echo And Doppler

Echo-ranging is not the only information that can be obtained from the use of ultrasound. Information about the velocity of a moving object may also be obtained from the doppler effect, described earlier in this article. Instruments using the basic doppler technique are used routinely to listen to the heart beat of the foetus during labour and to detect the flow of blood in its arteries.

Combining the pulse-echo technique with doppler provides even more information and is known as pulsed doppler. Instead of emitting a continuous beam of ultrasound, only a short pulse is emitted. Measuring the time taken for the echo to return gives the position of the object, and the doppler shift gives the velocity of the object. The pulsed doppler technique offers the advantage of the ability to select one moving object when many are in the path of the sound beam. Instruments that combine two-dimensional images and pulsed doppler are now available, which allow the doctor to see a moving object such as blood in the artery and to measure the velocity or flow of the blood and the direction in which it is flowing. Analysis of the doppler shift frequencies can provide valuable information about the flow of blood in the arteries; whether it is laminar or turbulent flow and whether the flow is the same all the way across the blood vessel. From this data the doctor can tell if the artery is occluded (blocked) or stenosed (narrowed) — all without any discomfort to the patient.

Looking Ahead

What of future developments in medical diagnosis? The ultimate end point must surely be fully automatic diagnosis by a small diagnostic computer. However, automatic diagnosis is not yet possible since the doctor often uses the data from diagnostic tests in an intuitive way which the best computers currently available are still not able to do.

Realistic advances in medical electronics will almost certainly be aimed at reducing the workload of the doctors and the nurses. On-line data acquisition and analysis together with a complete listing of the patient's medical history and personal data will provide the doctor with the information he or she needs to make a correct assessment of the patient's condition. Written record-keeping will be minimised, as will routine observations of the patient, so that the nurse will have more time to care for the patient. Current developments in electronic

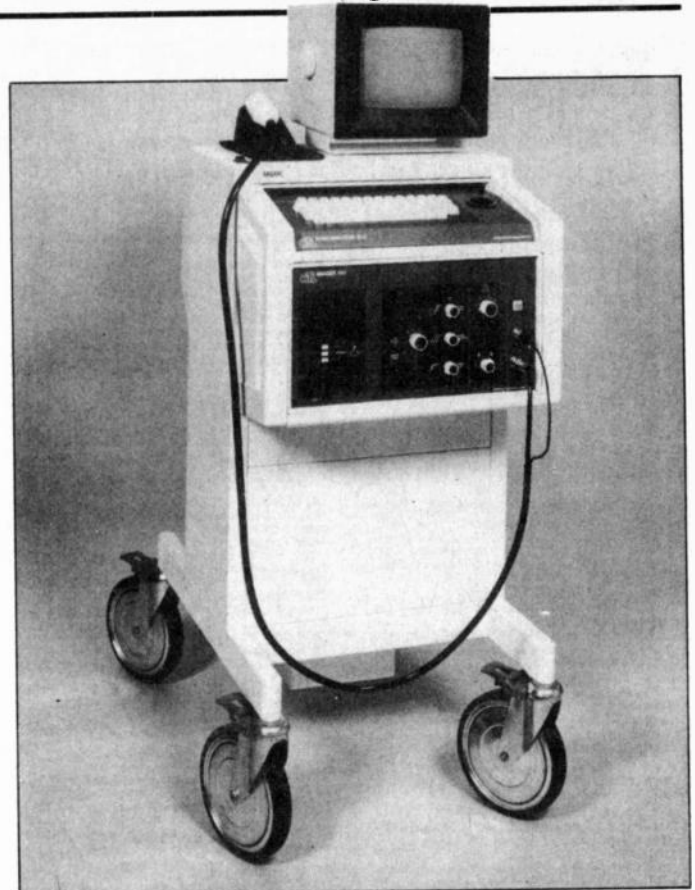
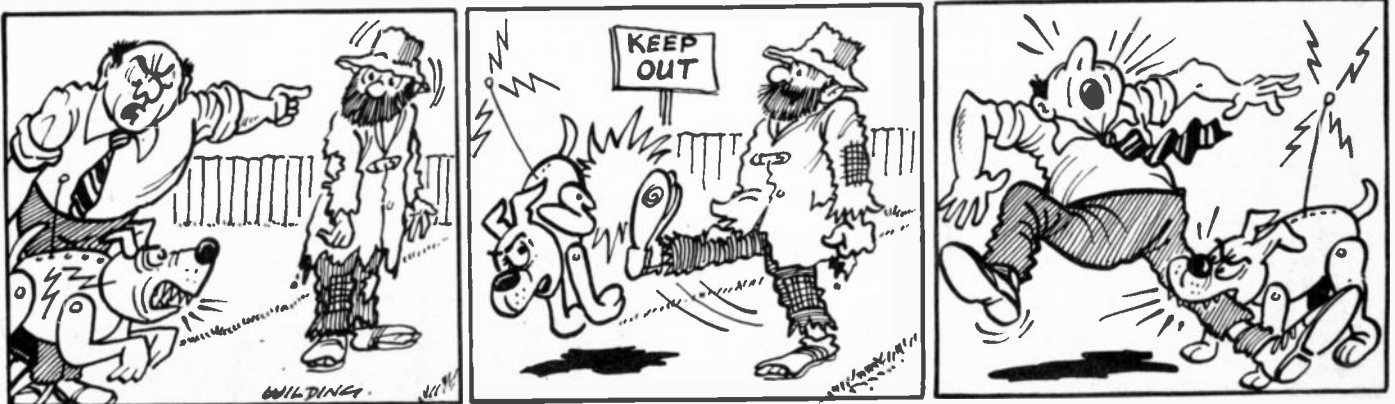

Figure 7. Example of sector scanner from Advanced Technology Labs Inc. The instrument, using microelectronics, provides a real time scan of body tissue derived from different intensities of reflected ultrasound. Tissue boundaries and composition are depicted by variations in shades of grey

technology will almost certainly improve the quality of imaging techniques. Recent advances in analogue delay lines, such as surface acoustic wave devices, have enabled sector scanners to be constructed which are non-mechanical, where the ultrasound beam is steered by delaying the pulses used to excite the transducers. An instrument recently introduced changes the black-and-white image produced by ultrasound scanners into a colour picture and this shows up the small differences between tissues much better. Development of the pulsed doppler technique is aimed at providing a coloured overlay of the flow in the blood vessel or heart on the black-and-white two-dimensional image produced at the same time.

The use of electronics in diagnostic medicine is widespread, and ranges from digital thermometers to complex imaging instruments: only the more interesting techniques have been included in this article. Perhaps next time you visit a hospital you might like to look for some of the sophisticated electronic instruments that are being used there.

HE



GREENWELD

443F Millbrook Road, Southampton, SO1 0HX

All prices include VAT @ 15% - just add 40p post

THE SPECTACULAR 1981 GREENWELD

Component Catalogue

- ★ Bigger and better than ever!!!
- ★ 60p discount vouchers
- ★ First Class reply paid envelope
- ★ Free Bargain List
- ★ Priority Order Form
- ★ VAT inclusive prices
- ★ Quantity prices for bulk buyers

SEND 75p FOR YOUR COPY NOW!!

REGULATED PSU PANEL

Exclusive Greenweld design, fully variable 0-28V & 20mA-2A. Board contains all components except pots and transformer. Only £7.75. Suitable transformer and pots £6. Send SAE for fuller details.

DISC CERAMICS

0.22uF 12V 9mm dia. Ideal for decoupling 100 for £2.75; 1000 £2.0.
0.5uF 12V 15mm dia. 100 £1.50; 1000 £12. Pack of disc ceramics, assorted values and voltages - 200 for £1.

VEROBLOC BREADBOARD

New from Vero, this versatile aid for building and testing circuits can accommodate any size of IC. Blocs can be joined together. Bus strips on X & Y axis - total 360 connexion points for just £4.15.

ALFAC PCB TRANSFERS

Lines, curves, dots, pads, DIL pads, etc. Pack of 13 different sheets £8.15.

DEVELOPMENT PACKS

These packs of brand new top quality components are designed to give the constructor a complete range so the right value is to hand whenever required. They also give a substantial saving over buying individual parts.

K001 50V ceramic plate capacitors 5%, 10 of each value 22pF to 1,000pF, total 210 capacitors. PRICE: £4.80.
K002 Extended range 22pF-1. Values over 1000pF are of a greater tolerance. 10 of each value 22 27 33 39 47 56 68 82 100 120 150 180 220 270 330 390 470 560 680 820 1000 1500 2200 3300 4700 6800 .01 .015 .022 .033 .047 .1. PRICE: £7.66.

K003 C280 or similar Polyester capacitors, 10 of each of the following: .01, .015, .022, .033, .047, .068, .1, .15, .22, .33 and .47uF. PRICE: £5.40.

K004 Mylar capacitors. Small size, vertical mounting 100V, 10 each of the following: .001, .0012, .0015, .0018, .0022, .0027, .0033, .0039, .0047, .0056, .0068, .0082, .01. Total 130 capacitors. PRICE: £4.70.

K007 Electrolytic capacitors 25V working, small physical size axial or radial leads. 10 each of the following: 1, 2.2, 4.7, 10, 22, 47, 100uF. Total 70 capacitors. PRICE: £3.59.

K008 Extended range as above, also including 220, 470 and 1000uF all at 25V. Total 100 capacitors. PRICE: £6.35.

K021 CR25 resistors or similar, miniature 1/4 watt carbon film 5%, as used in nearly all projects. 10 of each value from 10 ohms to 1M. £12 series. Total 610 resistors. PRICE: £5.95.

K041 Zener diodes, 400mW 5%, 10 of each of all the values from 2V7 to 36V. Total 280 zeners. PRICE: £15.95.

K051 LEDs - pack of 60, comprising 10 each red, green and yellow 3mm and 5mm, together with clips. PRICE: £8.95.

BARGAIN LIST No. 13

10 A4 Pages!!! Hundreds of different items!! Switches, pots, relays, Cs, Rs, semis, connectors, panels, etc., etc.
Send 5x4 SAE for your FREE copy of never to be repeated bargains!!!

DISPLAYS

Z635 Seven seg by NEC, type LD8012. This is a wire ended type 43mm high 11mm dia tube requiring a heater supply of 0.6V and 18V to illuminate the segments. Digit height 12mm. 70p

Z636 Futaba 7 seg display type DG1001. Requires same supply as above. Tube size 30mm x 8mm dia. Digit height 8mm. 60p

Z637 JTT nixie tube GNP17A, wire ended 40mm high x 17mm dia. Digit height 15mm. Can be operated from 240V ac mains by putting 56k resistor & rect in series to provide 170V DC. 80p

The above displays are all provided with leadout data, etc.

PLUG TO SOCKET ADAPTERS

- P201 1/4in mono plug to 2.5mm skt
- P202 1/4in mono plug to 3.5mm skt
- P203 1/4in mono plug to phono skt
- P204 3.5mm plug to 1/4in mono skt
- P205 3.5mm plug to 2.5mm skt
- P206 3.5mm plug to phono skt
- P207 Phono plug to 1/4in mono skt
- P208 Phono plug to 3.5mm skt
- P209 Phono plug to 2.5mm skt
- P210 2.5mm plug to 1/4in mono skt
- P211 2.5mm plug to 3.5mm skt
- P212 2.5mm plug to phono skt
- P213 3.5mm plug to 1/4in stereo skt
- P214 1/4in stereo plug to 3.5mm skt
- P215 Car aerial plug to phono skt

All 40p each; 100 Mix £25.30

COMPONENT PACKS

K503 150 wirewound resistors from 1W to 12W, with a good range of values £1.75
K505 20 assorted potentiometers, all types including single ganged, rotary and slider. £1.70

K511 200 small value poly, mica, ceramic caps from a few pF to .02uF. Excellent variety £1.20
K514 100 silver mica caps from 5pF to a few thousand pF. Tolerances from 1% to 10%. £2

K516 Transistor Pack. Small signal NPN/PNP transistors in plastic package. Almost all are marked, full spec. devices, but some have bent leads. Over 30 different types have been found by us, inc. BC184/212/238/307/328 BF196/7; ZTX107/8/9/342/450/550, etc. Look at the low price! 100 for £3; 250 for £7.

K520 Switch Pack, 20 different, rocker, slide, rotary, toggle, push, micro., etc. Only £2. K521, Heatsink pack, 5 diff. sizes each 200mm, 50p.

PANELS

Z521 Panel with 16236 (2N3442) on small heat sink, 2N2223 dual transistor, 2 BC108, diodes, caps, resistors, etc. 50p
Z482 Potted Oscillator Module works from 1.20V, can be used as LED flasher (3V min). Supplied with connection data, suitable R, C & LED. £1

Z527 Reed relay panel - contains 2 x 6V reeds, 6 x 2530 or 25230, 6 x 400V reeds + Rs. 50p

Z529 Pack of ex-computer panels containing 74 series ICs. Lots of different gates and complex logic. All ICs are marked with type no or code for which an identification sheet is supplied. 20 ICs £1; 100 ICs £4
A504 Black case 50x50x78mm with octal base. PCB inside has 24V reed relay, 200V 7A SCR, 4 x 5A 200V reeds, etc. 60p

4 TERMINAL REGS

uA78MG In power mini-dip case, 5-30V at 12A £1

uA79MG Negative version of above £1.20

Only 4 extra components required (50p extra) to make a fully variable supply!! Data supplied.

1W AMP PANELS

A011 Compact audio amp intended for record-player on panel 95 x 65mm including vol. control and switch, complete with knobs. Apart from amp circuitry built around LM380M or TBAB20M, there is a speed control circuit using 5 transistors. 9V operation, connection data supplied. ONLY £1.50

VU METERS

V006 Very attractive 55 x 48mm scaled -20 to +5dB. 250uA movement. Only £1.75, or £3 pr.

OP-AMP PSU KIT

A198 All parts + Instructions to make a 50mA +15.0, -15V supply from mains input. ONLY £1.95

COPPER-CLAD BOARD

K522 All pieces too small for our etching kits. Mostly double-sided fibreglass. 250gsm (approx. 110 sq. in.) for just £1.

JOB LOT OF COMPONENTS

9500 1N4006; 10000 .033/50; 22000 10pF/50; 15000 .22/12; 11000 270pF/50; 15000 88pF/50; 30000 various resistors. Total 112,500 components for £400 inc. V.A.T. and carr.

12-VOLT INDICATORS

Ideal for light chasers, etc. Miniature 12V 75mA wire-ended lamps in yellow, red, green, blue and clear, 10p each. 20 each colour, total 100 for £5.50. 100 clear only £4.50.

BITS AND PIECES

Transformer, mains in, 1770V 10mA out. £2.50
W847 PCB mntg. relay 11 x 33 x 20mm 37R 5-10V. SPCO 3A 99p
901AS Pickering DIL relay 500R. SP make, 3.7-10V, ex-equip. on PCB. 75p
X905 140 x 10mm ferrite rod with LW amp MW windings. 45p
10M 1/2W 5% CF Resistors. pack of 200. £1
40W amp PCB + cct + layout. £1. All parts to make. £3.50
1% 1/2W Rs - 111k, 333k, 500k, 900k, 950k. All 10 25p
FNA5220 2 digit 1/2in. 7-seg. display on PCB, CC. With data. £1.50
7 seg. displays: FND 360, 367, 501, all 50p; 530, 847, 850, all £1.50.
Regs. TO3 case: 7924 120p; 7885 100p; 7808 100p; 7912 100p; 78CB 230p. Others on B/L 13.
Dp Amps: uA4136 130p; uA776 145p; uA777 300p; uA318 245p.
Isolators: FCD831, IL15, TIL118, all 60p.

£1 BARGAIN PACKS

Each pack £1; any 25 packs £22

More on Bargain List

- K101 16 BC239B transistors
- K102 15 BC349A transistors
- K103 10 BC546B transistors
- K104 18 BC182B transistors
- K105 50 1N4148 diodes
- K106 18 BC184L transistors
- K107 18 BC213L transistors
- K108 8 2N5060 thyristors. 30V 0.8A T092 case
- K109 15 BC114 transistors
- K110 4 BD131 transistors
- K111 4 BD132 transistors
- K112 12 3A 100V recta, wire ended
- K113 30 DA002 recta 150V 0.5A
- K114 15 XK8116 (BF241) transistors
- K115 18 SP1218 (2N3702) transistors
- K116 10 MPSL01 NPN 140V T092
- K117 10 BF450 PNP TV IF amp transistor

Right first time.



Portable VOM

Rechargeable Light

If you've never built a kit before, Heathkit have some very pleasant surprises for you. Their kits are easy to build. Simple, but detailed instructions take you through every stage. Everything is included. Even the solder you need is there.

Follow the steps and you'll end up with a hand-crafted, well designed piece of equipment. Much better than shop bought, mass-produced. Because you build it yourself.



Digital Clock

There's a great range of kits to start you off. From a buzzer alarm to a digital electronic clock, or a portable rechargeable fluorescent light to a portable VOM.

With all this going for you, you can count yourself very lucky you started off with Heathkit. Because all first time kit builders will get a free soldering iron and 10% discount off ten selected kits.



Buzzer Alarm

To: Heath Electronics (UK) Limited, Dept (HE9), Bristol Road, Gloucester GL2 6EE.

To start me off, please send me a copy of the Heathkit catalogue. I enclose 28p in stamps.

Name _____

Address _____

You build on our experience



sure you polarise the capacitors correctly.

Now, mount transistors Q1 and 2, checking before you solder each one in that it is the right way round.

Solder in LED1, the same way round as shown in Fig.2. Now, bend it down so that it lies in a horizontal line with the Veroboard.

Finally, solder a couple of coloured leads from the corresponding points (red to +9 V; black to 0 V) long enough to go to the supply points of the equipment into which the project fits.

The circuit board does not need to be fastened down because it is adequately mounted when LED1 is fitted into its panel clip. So, all you need to do now is drill a hole in the panel of your battery-powered equipment to fit the LED panel clip, push in the LED (complete with circuit board) and connect the board to the supply points of the equipment.

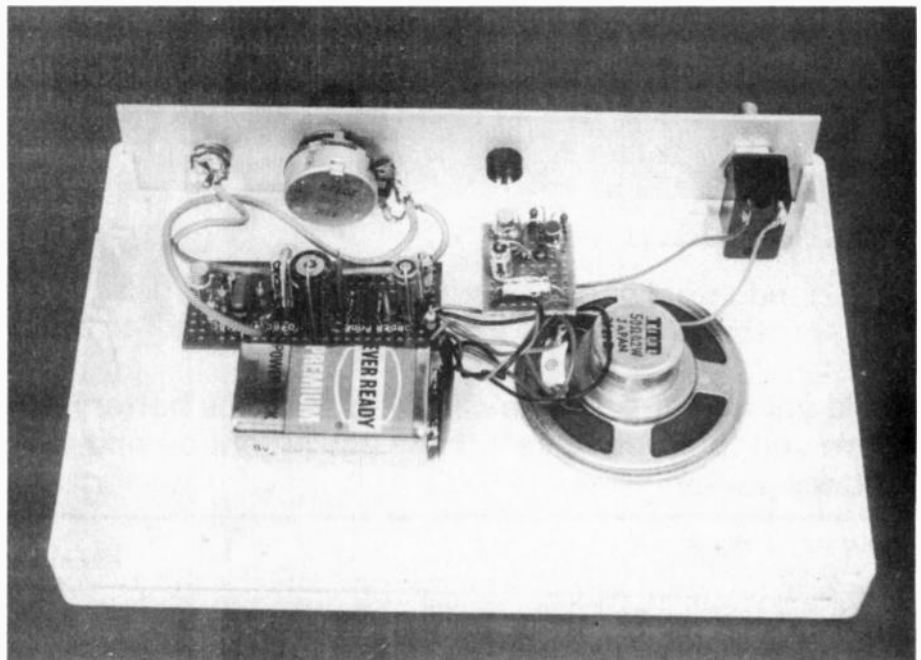

HE

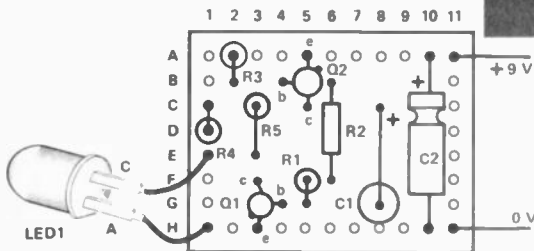

Figure 2. Veroboard layout. Note no track breaks are required

Buylines

You should find no difficulty in obtaining components for this project.

Approximate price for all parts (including Veroboard) is £1.50.

The World of Radio & Electronics

AMBIT INTERNATIONAL



CONCISE PARTS CATALOGUE

OUT NOW!

AMBIT'S NEW CATALOGUE

In an attempt to collate and organize our burgeoning ranges of 'stock' components (now over 7000 line items), we have at last produced a 'concise' 80 page parts catalogue to supplement the popular 'Tecknowledgery' series of 'wordy' applications catalogues, which now lists a wide range of basic components - as well as our unique RF and Communications components. The *World of Radio and Electronics* contains everything the informed electronics user needs, at prices which we guarantee will match the lowest on the market for equivalent product.

Prices appear on the page alongside the part numbers, and the catalogue is now updated quarterly - available either direct from here (60p all inc) or at most newsagents and bookstalls where you can find electronics publications. So as well as all the 'run-of-mill' items like resistor, capacitors, hardware, solder etc - you now have the first genuinely complete parts source for the radio, communication, electronics, computer user.

Ambit International
 200, North Service Road,
 Brentwood,
 Essex, CM14 4SG

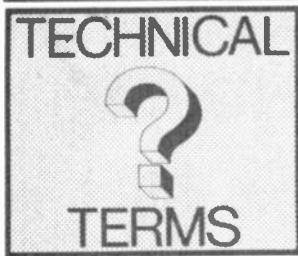

Understanding The Hall Effect

Semiconductors behave very strangely in the field — magnetic, that is. Ian Graham gives a brief explanation of the Hall effect

OF ALL THE EFFECTS depending on the influence of a magnetic field on semiconductor charge carriers, the best known is probably the Hall effect. Edwin Herbert Hall (1855-1938), an American physicist, observed the result of applying a magnetic field to a semiconductor, through which he passed a current at right angles to the field. The arrangement is shown in Fig. 1.

In Fig. 1, a magnetic field of $B \text{ Wm}^{-2}$ (webers per square metre) in the Y-axis acting on a current (I) along the X-axis deflects 'holes' along the Z-axis to the bottom of the P-type semiconductor. Holes (vacant atomic positions in the crystal lattice) are the majority charge carriers in a P-type semiconductor. In N-type, the majority charge carriers, electrons, would be deflected to the bottom of the semiconductor.

Facial Motion

This movement of charges to one face of the semiconductor produces a potential difference at right angles to both the current (Ix) and the magnetic field (By). This potential difference

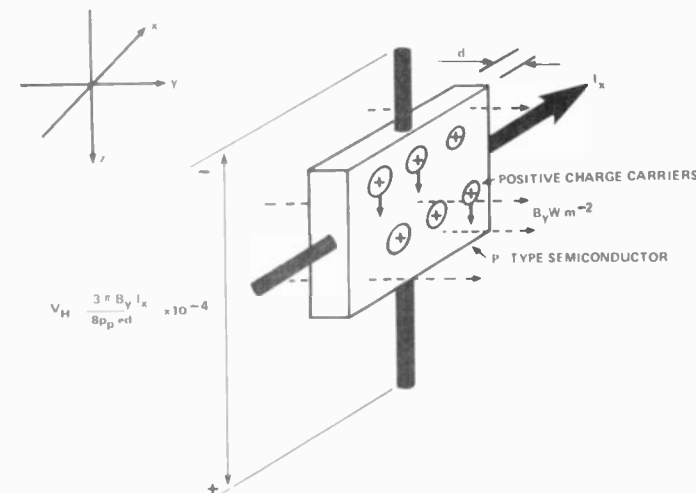

Figure 1. Result of applying a magnetic field to a current-carrying semiconductor — the Hall effect

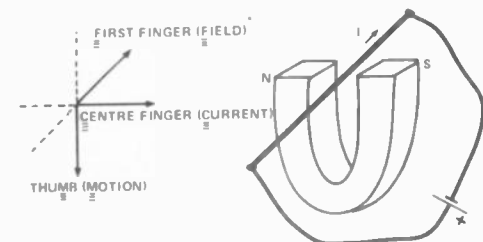

Figure 2. In this example the direction of the force on the wire can be determined from Fleming's Left Hand Rule. Point your first finger in the direction of the magnetic field and your centre finger in the direction of the current. Your thumb should now be pointing downwards. The wire will be deflected downwards. If your thumb is pointing upwards, you've discovered Fleming's Right Hand Rule — change hands

is called the Hall voltage (V_H) and is given by:

$$V_H = \frac{3 \pi B_y I_x}{8 p \cdot e \cdot d} \times 10^4,$$

where e is the charge on an electron, d is the thickness of the semiconductor (cm) p is the hole density (cm^{-3}).

This strange behaviour of charges follows a well-known rule in physics — Fleming's Left Hand Rule — used to predict the behaviour of a current-carrying conductor in a magnetic field.

Applications

Hall discovered an interesting effect, but how can it be used? By fixing any two of the three variables the third can be measured. For example, an unknown magnetic field can be measured by finding how big a Hall voltage it produces compared with a reference field. Many of the devices available use indium antimonide or indium arsenide, because they exhibit a large Hall effect and are not greatly affected by temperature.

The TL170C uses the Hall effect to sense steady-state magnetic fields. It has a built-in output transistor for use on voltages up to 30 V and requires a supply of 5 V at 4 mA (output high) to 6 mA (output low).

Max output current (output low)	20 mA
(output high)	20 uA (max)
Output voltage (at 16 mA, output low)	0.4 V

Table 1. Output characteristics of TL170C Hall effect switch. The TL172C is a normally-off switch. A positive-going magnetic field switches the output low

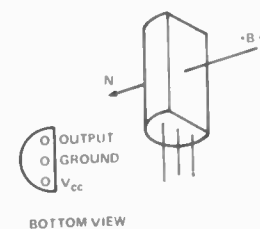

Figure 3. Outlines of TL170C and TL172C Hall effect devices

TYPE	SBV566	EA218	FA22E
I _{max} control (mA)	50	150	200
Hall emf (mV at mT)	130 at 75 at 10	85 at 1000 at 100	120 at 1000 at 100
Control R (ohms)	30	3	2
Hall R (ohms)	30	1.5	1.5
Offset max (V/A)	1.0	0.005	0.002

Table 2. Characteristics of three readily-available Hall effect devices

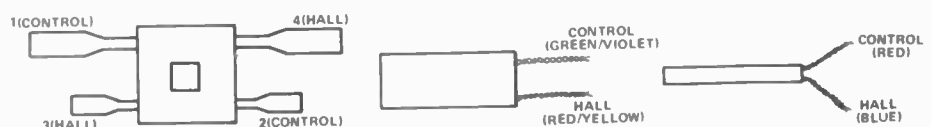
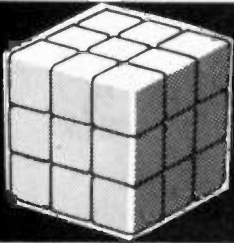

Figure 4. Outlines of the three devices described in Table 2: SBV566 (left), EA218 (centre) and FA22E (right)



PROBABLY THE MOST EDUCATIONAL PUZZLE EVER INVENTED
CUBIK MANIA — FREE OF CHARGE!
WITH STEP-BY-STEP SOLUTION

With purchases totalling over £17.50. Only on request at time of ordering. Offer closes 31/8/81. Subject to availability.

**BECOME AN INSTANT MUSICIAN
 NO EXPERIENCE NECESSARY**

The success story of 1981. Hundreds sold already! As featured on "Tomorrow's World". Create your own music with a VL-TONE. You combine the sound, rhythm and tempo and the VL-1 plays it back... beautifully!
CASIO VL-TONE (VL-1)
 Electronic Musical instrument and calculator.



(RRP £39.95)
ONLY £35.95

VL-1 records and plays back up to 100 notes as a melody. **One Key Play** or **Auto Play** of Piano, Violin, Flute, Guitar and Fantasy, or create your own unique sounds with **A.D.S.R.** 10 built-in **Auto Rhythms** and **Tempo** control. LCD digital readout of notes and tempo. Also a calculator. Battery powered with memory and program retention. Integral amplifier/speaker. Output jack. With Song Book. Dims.: 1 1/8 x 1 1/4 x 3in.

**CASIOTONE POLYPHONIC
 KEYBOARDS**

With built-in amplifier and loudspeaker.

MT-30



(RRP £115)
ONLY £95

22 instruments over 3 octaves. 4-position sound memory. Battery or mains. O/P jack. Dims.: 2 1/2 x 22 3/4 x 6 1/2in. 6lb.

★★ NEW ★★ CASIOTONE CT-202

"Son of success... The two harpsichords demonstrate the Casiotone's talent for sparkling, crystal clear tones. Even more impressive is the clav (Melody Maker).

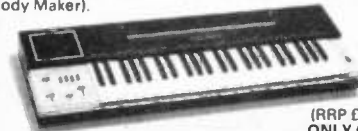

(RRP £325)
ONLY £275

49 instruments over 4 octaves. 4 voice memory function with push-button selection. 3 vibrato settings and sustain. Pitch control. O/P jacks. AC only. 3 3/8 x 34 1/8 x 11 3/16in. 15.8lbs.

CT-301



(RRP £285)
ONLY £245

14 instruments over 4 octaves. 8 x 2 rhythm accompaniments. Vibrato and delayed vibrato. Start/stop, synchro start, tempo control, tempo indicator, and rhythm volume. Pitch control. AC only. O/p jacks. 4 3/8 x 31 3/8 x 12 7/16in. 27lbs.

CT-401



(RRP £345)
ONLY £295

As 301 plus following; 16 rhythm accompaniments, with fill-in. Casio Auto Chord for one finger or auto accompaniment. Plays major, minor and 7th chords with bass. Balance control, C.A.C. lever, chord lever, memory lever and octave switch. Dims. as 301. Weight 28.2lbs.

THE LAST WORD IN POCKET PROGRAMMABLE CALCULATORS

Ultra-high-speed ultra-capacity calculator with "Computer Talk" programming via upper and lower case dot matrix scrolling display

CASIO FX-602P PROGRAMMABLE

- ★ 88 memories, up to 512 functional steps
- ★ Up to 10 programs, or exclusive commands
- ★ A variety of "Jump" commands
- ★ Up to 9 subroutines, up to 9 levels
- ★ 86-character dot matrix scrolling display with upper and lower case alphabet
- ★ A variable range of input capacity from 32 program steps with 88 independent memories, to 512 steps with 22 memories. The data memory expands as required, 1 data memory = 8 steps
- ★ The most powerful programmable in its class, since 1 step equals 1 function in principle
- ★ Memory and program retention when switched off
- ★ Up to 10 pairs of unconditional jumps (GOTO)
- ★ Conditional jumps and count jumps
- ★ Up to 9 subroutines, nesting up to 9 levels
- ★ Password function to protect stored programs
- ★ Ultra-high-speed calculations, 5 to 11 times faster than the opposition. (Decomposition of 379721 into prime numbers in 37 seconds)
- ★ PAM (Perfect Algebraic Method) judges priority with 33 parentheses nestable up to 11 levels
- ★ 50 built-in functions, all usable in programs
- ★ An almost infinite number of programs can be stored on standard cassette tape using the optional FA-1 adaptor (price £19.95)
- ★ Compatible with FX-502P and FX-501P
- ★ Two lithium batteries give approx. 660 hours' continuous use, with battery saving Auto Power Off after approx. 6 minutes non-use
- ★ Thin and lightweight — easy to carry around. Dims.: 9.6 x 71 x 141.2mm (3/8 x 2 3/4 x 5 1/2in.)
- ★ Program manual, batteries and wallet included

ONLY £74.95 (R.R.P. £84.95)

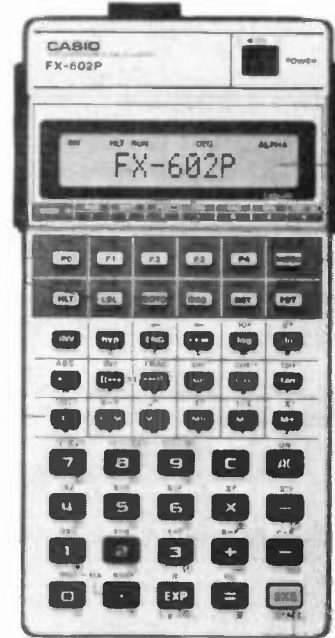

CASIO LCD SCIENTIFICS

FX550
 R.R.P. £21.95
ONLY £19.95



FX3500P
 R.R.P. £25.95
ONLY £22.95



- FX5 Junior scientific (R.R.P. £10.95)..... **ONLY £8.95**
- FX7 Junior scientific with trigs (£12.95) **£10.95**
- FX81 30 sci. funct. AA Batteries (£14.95) **£12.95**
- FX100 10 digits, 44 sci. funct., AA (£18.95) **£16.95**
- FX550 10d. 50f. Wallet size, lithium (£21.95) **£19.95**
- With clock, alarm, countdown alarm and stopwatch
- FX6100 39 scientific functions. AA (£22.95) **£17.95**
- FX8100 46f. Calendar, wallet size (£27.95) **£24.95**
- Programmables with Integrals and Regression
- FX180P 10d. 38 steps. 7 memories. 55f. **£19.95**
- FX3500P Wallet version with Hyps. 61f. **£22.95**

SPECIAL SUMMERTIME OFFERS

- FX502P Programmable. 51f. 22 memories. 256 steps. With **FREE MASTERPACK**. To clear, while stocks last **ONLY £49.95**
- MASTERPACK** Software for FX501P, FX502P To clear **£7.50**
- FX601P. Alpha/numeric dot matrix scrolling display. 50f. 11 memories. 128 steps. **FREE MASTERPACK** + 3 **CUBIKS**..... **£54.95**

2 FOR THE PRICE OF 1

MG880. The very successful basic calculator with Digital Space Invader Game plus **CUBIK** for **ONLY £10.95**
 All items subject to availability

CA90 — NEW LOWER PRICE!

THESE SPACE INVADERS WILL ALARM YOU — THE NEW REDUCED PRICE WON'T!
 Casio's most amazing watches ever!

CA90 (left)
 NOW ONLY
£19.95



CA901 (right)
 R.R.P. £34.95
£29.95



Time and auto. calendar, calculator, alarm, hourly chimes, stopwatch, dual-time. **DIGITAL SPACE INVADER GAME.**

There is still time to buy one of these watches for **SUMMERTIME SPORTS AND LEISURE**
 100m. water resistant with alarm and stopwatch



W100 (resin)
£19.95



W150C (s/s)
£25.95



W150B (s/s)
£32.50

Time and auto. calendar, alarm, hourly chimes, countdown alarm timer with repeat memory function. Time is always on display, regardless of mode.

SEND 20P FOR ILLUSTRATED CATALOGUE

PRICE includes VAT and P&P. Send cheques, P.O. or phone your **ACCESS** or **BARCLAYCARD** number to:

TEMPUS

Dept. HE **FREEPOST**,
 164-167 East Road, Cambridge CB1 1DB
 Tel. 0223 312866

Galaxy 1000

SPECIAL OFFER WHILE STOCKS LAST

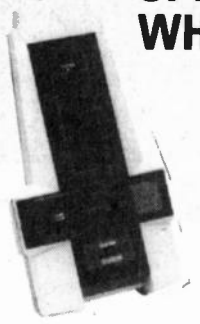

Hand-held Games

£19.50

INC. P.&P. VAT



FREE SET BATTERIES WITH EACH GAME

Order any one of these games:

- Galaxy Invader 1000 ■ Jet Fighters Basketball ■ Invader from Space Race 'n' Chase ■ Entex Space Invader Safari . . . £19.50 each + free set of batteries



EARTH INVADER £24.95 INC.
GRAND PRIX £24.95 INC.

SAE ENQUIRIES. ALL PRICES INCLUSIVE



N.I.C

61 BROAD LANE, LONDON N.15 4DJ
Day 01-808 0377; Eve 01-889 9736



TRAIN FOR SUCCESS

in Radio, Television & Electronics

ICS have helped thousands of ambitious people to move up into higher paid more secure jobs in the field of electronics - now it can be your turn. Whether you are a newcomer to the field or already working in the industry, ICS can provide you with the specialised training so essential to success.

Personal Tuition and Guaranteed Success

The expert and personal guidance by fully qualified tutors, backed by the ICS guarantee of tuition until successful, is the key to our outstanding record in the technical training field. You study at the time and pace that suits you best and in your own home. In the words of one of our many successful students: "Since starting my course, my salary has trebled and I am expecting a further increase when my course is completed."

City and Guilds Certificates

Excellent job prospects await those who hold one of these recognised certificates. ICS can coach you for:

- Telecommunications Technicians
- Radio, T.V. Electronics Technicians
- Radio Amateurs
- Electrical Installation Work

Diploma Courses

- Colour T.V. Servicing
- CCTV Engineering
- Electronic Engineering & Maintenance
- Computer Engineering and Programming
- Radio, T.V. and Audio, Engineering & Servicing
- Electrical Engineering, Installations & Contracting

Other Career Courses

A wide range of other technical and professional courses are available including GCE.

FREE BOOK

To ICS, Dept. Z263, Intertext House, London SW8 4UU

Name _____

Address _____

Age _____

ICS

To ICS, Dept. 263L, Intertext House, London SW8 4UJ or telephone 01-622 9911 (all hours)

Chess Computers
TV Games
Hand Held Games

EGS

A DIVISION OF CIRCOLEC

The Electronic Games Shop

ACTIVISION IS ALMOST HERE!

Watch out for the new Activision Cartridges such as Drag Racing, Ski-ing, Laser Blast, etc. for the Atari T.V. game. Telephone for details of price and delivery.

The new Morphy Encore Chess Computer has now replaced the Sargon as the strongest programme available. Unbeatable value at £148.

FM, CB Radios available
Atar VCS..... £99
Philips G7000 Console

SEPTEMBER

Galaxy Invader 1000 £22.95

Chess Challenger '7' £73
Sensory 'B' Chess..... £113
Voice Sensory Challenger..... £228

Including free mains adaptor. Game and Watch Vermin, etc £14.95
Atari cartridges all discounted.
Philips cartridges all discounted.

All prices include VAT and postage.

FASTEST MAIL ORDER SERVICE ANYWHERE

Please telephone for details of other games in stock. See us at the Personal Computer Show, Cunard Hotel, 10-12 September.

Please make cheques payable to CIRCOLEC and send order to FREEPOST (no postage required), LONDON SW17 8BR.



TELEPHONE
01-767 1233



Credit Orders
Welcome



VISA

Famous Names

This fifth part of our Famous Names series looks at the life of Oliver Heaviside. Like Isaac Newton before him, Heaviside showed original genius in his work and discovery



ONE OF THE most tantalising aspects of writing biographical notes is that our knowledge of a person seldom matches up to our interest in what he has achieved. We may find, for example, that the life of some obscure worthy who did very little for electrical or electronic science is completely documented simply because he served on every committee that he could get to. On the other hand, there is the problem of the towering genius about whom practically nothing is known. Oliver Heaviside definitely falls into the second category. Gradually and painfully, researchers are discovering details of the life of this quite extraordinary man who, had he sought publicity for his theories, might easily have outshone Einstein in popular mythology.

Heaviside was born in 1850, and seems to have had only an ordinary school education. By the age of 20 he was working as a telegrapher — one of the 'glamour' occupations of these mid-Victorian days. He might well have continued this work, which

gave him the opportunity for reading electrical theory, but for the sudden occurrence of deafness which forced him to retire in 1874. From what little we know of these early years we discover that his nature was retiring and introspective, and his deafness was a further burden which made him even more reluctant to communicate with others.

From the time of his retreat at the age of 24 he decided to devote the rest of his life to electrical research, work which was inspired by the problems of telegraphy which he had encountered at first hand.

We are still sorting out some of the work which he did in these years — and what we have found so far points to the conclusion that Heaviside was of that extremely rare species — an original genius, comparable to Isaac Newton. Like Newton, he was prone to write down his results in obscure phrases and notes, and also like Newton, to invent new mathematical methods to cope with the problems on which he was working.

One of the main problems which he solved, and which appeared in his 'Electrical Papers', published in 1892, was that of long-distance telegraphy. It's one thing to transmit sine waves on wires over long distances, but the square waves which are generated by a Morse key are something quite different. A long telegraph line has stray capacitance to earth, and it also has some inductance: these components combine to integrate waveforms, converting the square waves from the key into a rounded shape which was incapable of operating the paper-tape punch at the other end of the line.

Theory Of Transients

We feel now that we know quite a bit about what are called transients — the currents which flow for brief periods when stray capacitances are being charged or discharged. But *do* we? A startling number of examples of malfunction of micro-processor equipment turn out to be the result of the effects of transient currents caused by the very fast rising and falling pulses used in the circuits. Consultants complain that not enough is known or taught about transients, and the most popular bus structure (S100) for small computers positively invites transient troubles. We just don't seem to learn — despite the fact that Heaviside solved all these problems.

In classical legends, the story of Cassandra tells how she was cursed with the ability to prophesy the future with complete accuracy. Cursed? Yes, because no-one would ever believe her. Heaviside must have felt this way after the publication of his papers. Although what he had done was the foundation of modern pulse theory, only a handful of people were able to see what he had done and understand its significance. Two factors contributed to this neglect. One was the fact that Heaviside had invented his own form of algebra to deal with transients. It's now known as the Heaviside Calculus, though it's not used much nowadays. Engineers generally couldn't grasp Heaviside calculus, and were suspicious of such a new approach. Mathematicians were obsessed by the need for rigorous proofs of Heaviside's theorems — and were unable to find any. Heaviside himself was totally uninterested in proving his theorems, which to him seemed so obvious as to need no proof. He also took the traditional engineers' view that the important thing was to get on with making use of his discoveries, rather than deal with the 'nit-picking' business of academic discussion. He had little patience with anyone who wanted to discuss his work, and this intolerant attitude offended many who might have been of great assistance to him. If we think what it must have been like to be such a shy, deaf genius, we

surely cannot pass harsh judgement on either Heaviside or those whom he offended. The results of his work spoke more eloquently than anything that could be said, however, and thanks to a few dedicated engineers who were prepared to try out Heaviside's remarkable conclusions, long-distance telegraphy became possible.

Practical Proof

What was the solution? Heaviside recognised the problem as one which we could now call line matching. He reasoned that a line with the correct ratio of series inductance to stray capacitance would behave like a pure resistance, the quantity we now call the characteristic impedance of the line. Every time we use coaxial cable or turn-line, we're making use of Heaviside's theories — they permeate the whole of electronics. The conclusion which Heaviside reached, which so many of his contemporaries found quite unbelievable, was that a long telegraph line needed extra inductance added, in series, at intervals, so that the characteristic impedance of the line matched the resistance of the receiving equipment. At the time it must have seemed like telling a driver that a road could be covered faster by adding a few Z-bends! Nevertheless, a brief trial confirmed that Heaviside was absolutely right, and long-distance telegraphy arrived. Within a decade, it seemed that the bed of the Atlantic would be covered in telegraph cables!

Meanwhile, Heaviside, embittered by the reception of his 'Electrical Papers', turned back to further research on fundamental electromagnetic theory, building on the firm foundations laid by James Clerk Maxwell, who had died in 1879. Recent studies of Heaviside's work during this period reveal that he had already concluded that the 'mass' of an electron must increase as the speed of the electron approaches the speed of light. This was to be one of the most easily tested conclusions of Einstein's Theory of Special Relativity some 20 years later, and it is only one of an astonishingly well thought out set of conclusions which Heaviside published in his 'Electromagnetic Theory' between 1893 and 1912. One of these conclusions

has caused Heaviside's name to be immortalised in the way which is familiar in Science — by having something named after him.

On 12 December 1901, Marconi succeeded in establishing that radio waves could be transmitted over really long distances, by his transmissions from Newfoundland to Poldhu in Cornwall. He attempted this in the face of a chorus from engineers and scientists that it 'couldn't be done' — three words which have stimulated engineers more than anything else. There was one voice missing. Heaviside knew exactly how it was possible — he had already worked out the theory, and in 1902, secure in the knowledge that no-one could challenge the truth of long-distance radio, he published his theory.

Briefly it was that the radiation from the sun must ionise (split into charged particles) atoms of the gases in the atmosphere, and that these charged ions would then act to reflect radio waves whose wavelength fell between defined limits, encompassing in particular the bands which were to be known as the 'short waves'. For once, Heaviside was not out on a limb of his own because Kennelly, of Harvard, was also working along the same lines.

It was impossible to prove Heaviside's ideas at the time, but two years before his death radar methods showed reflecting regions in the atmosphere between 50 km and 400 km above the surface of the earth. One set of these layers was called the Heaviside, another the Kennelly: each consists of several strata, the distance of which from the earth varies according to the time of day or night. Heaviside died in 1925, with the knowledge that his name would be remembered in at least one sphere of activity.

That was 56 years ago. To this day, we are still finding evidence of his genius. His mathematical system, the Heaviside Calculus, has now been shown to be perfectly sound although it has been superseded by the use of Laplace Transforms. Only time will tell what other remarkable inventions and discoveries are tucked away in the volumes of Heaviside's notes.

HE

SUBSCRIBE TO HE

HELLO, IS THAT SUBSCRIPTIONS DEPARTMENT?



DON'T LEAVE IT TO CHANCE to find your copy of HE: have it delivered to your door every month for a year for only £10.25!
Place a firm order today for a year's subscription — choose between payment by cheque, Postal Order, Barclaycard or Access

Send to HE Subscriptions Department, 513 London Road, Thornton Heath, Surrey CR4 6AR

I would like to subscribe to 12 issues of Hobby Electronics

I enclose a Cheque/Postal Order* made payable to Modmags Limited for £10.25

OR

I wish to pay by Barclaycard. Please charge to my account number



OR

I wish to pay by Access. Please charge to my account number



SIGNATURE

NAME

(BLOCK CAPITALS)

ADDRESS

(BLOCK CAPITALS)

*Delete as appropriate

Quick Project: Light/Water Alarm

A simple yet ingenious circuit for you to build which won't break your piggy-bank. One of our series of Short Circuits which we've selected for a project

The purpose of this circuit is to produce an audible tone when light is detected by a photocell. However, if the photocell is replaced by two strips of metal placed close together but not quite touching (eg. two adjacent copper strips on a small piece of Veroboard), the alarm will respond to water bridging the metal strips rather than to light. The unit can be used, for example, as

an alarm that will trigger if a suitcase in which it is placed is opened, or as a rain alarm, depending on the sensor selected.

The circuit is little more than a standard 555 oscillator driving a loudspeaker so that the required audio tone is generated. Pin 4 of integrated circuit IC1 would normally be connected to the positive supply rail, but in this circuit it is taken to the

negative supply rail via resistor R1. This prevents the oscillator from operating unless the photocell PCC1 is subjected to a reasonably high light level (daylight is more than adequate). The voltage at pin 4 of IC1 then goes positive, and the tone is generated by the unit.

The same basic action occurs if PCC1 is replaced by a water sensor. Normally R1

takes pin 4 to the negative rail, but the low resistance across the sensor when it is bridged by rain or tap water is sufficient to activate the unit. (Pure water has a high resistance and will not trigger the unit.)

The CMOS version of the 555 (the ICM7555) is used in the project to give a low standby supply current of only 80 μ A.

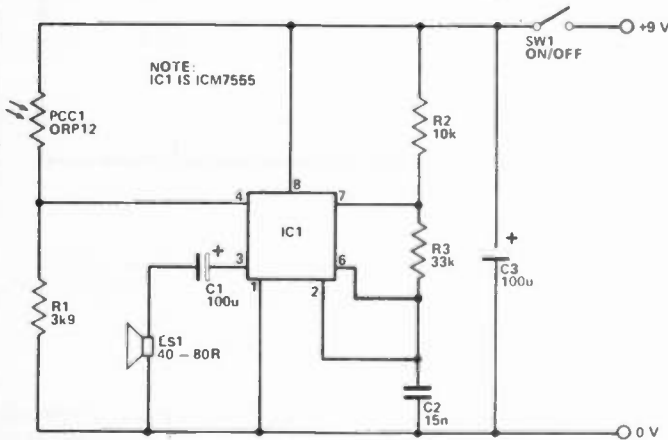

Figure 1. Circuit of the Light/Water Alarm

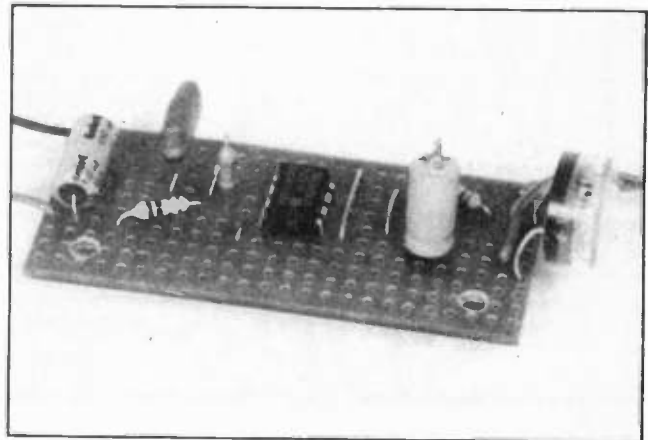

Figure 2. View of the project

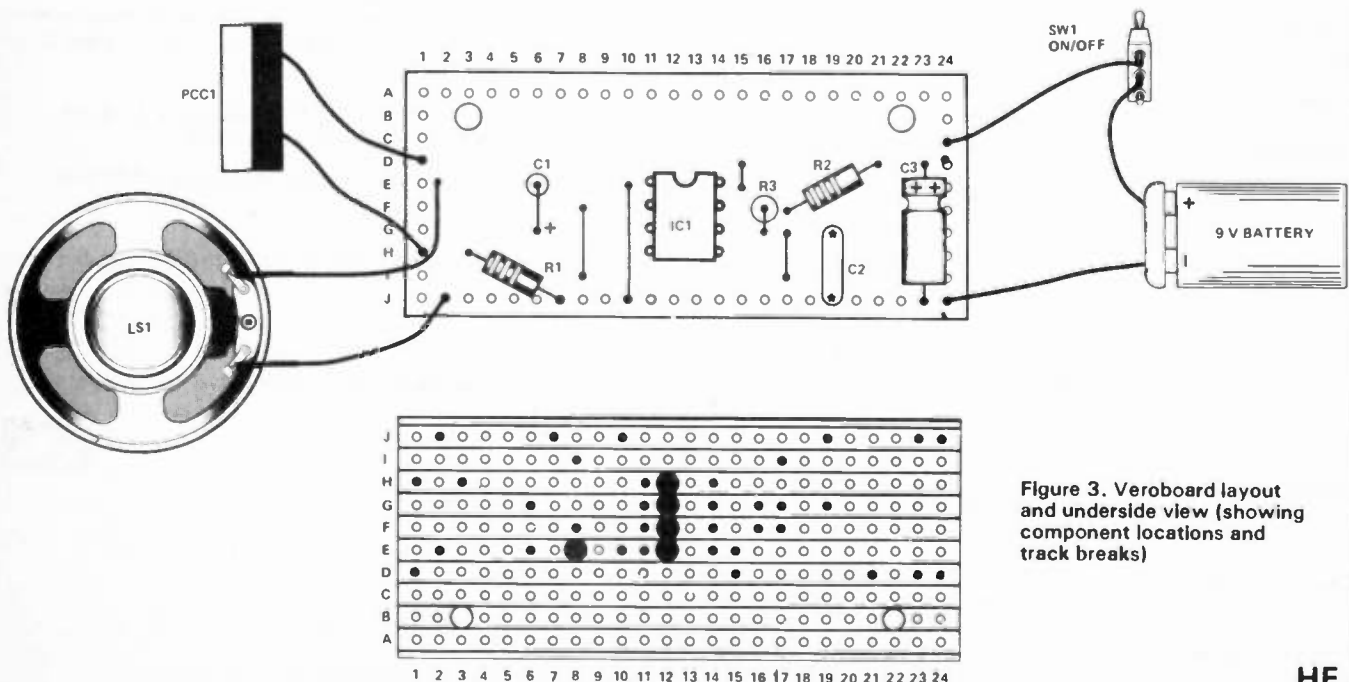
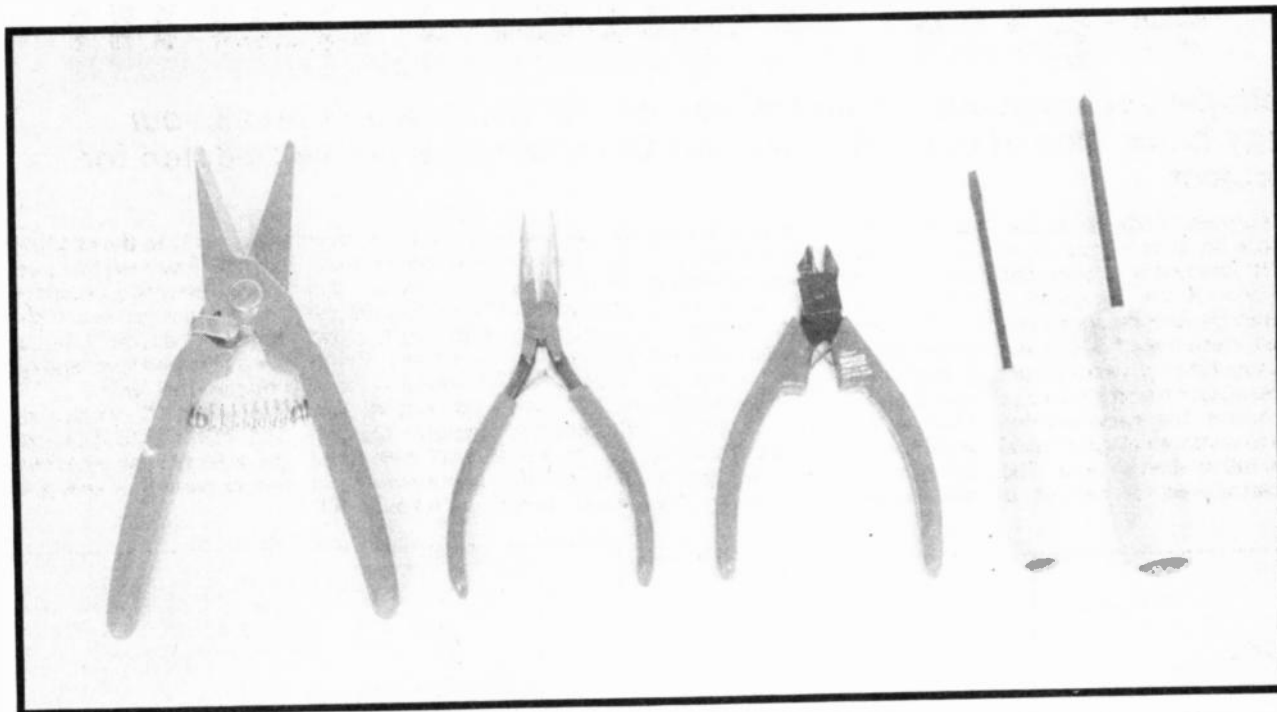

Figure 3. Veroboard layout and underside view (showing component locations and track breaks)

HE

HE Tool Set Offer



High Quality Tool Set

'A GOOD WORKMAN never blames his tools' goes the old saying. But if you buy poor quality tools then your work — and your patience — are bound to suffer.

We have put together a set of high quality tools which should cope with most of the tasks of the electronics hobbyist.

The set comprises:

- ★ **All-purpose Cutter** — for general cutting and shaping work. A safety catch is incorporated and the handles are fitted with a return spring
- ★ **Miniature Cutter** — for circuit work. A cutting guard is fixed to the jaws to prevent the free portion of a piece of wire flying away as a cut is made. Jaws are finished in matt black. Handles are shaped for comfort and are fitted with springs to hold the jaws open
- ★ **Snipe-nose Plier** — invaluable for circuit work. Handles are fitted with springs to hold the jaws open
- ★ **Slot Screwdriver** — handle is shaped for comfort and the blade is finished in matt black
- ★ **Posidriv Screwdriver** — in the same style as the slot screwdriver

So don't blame your tools — instead, buy a set you can depend on for only **£19.95** including VAT and postage and packing.

And choose between *four* methods of payment: Cheque, Postal Order, Barclaycard, or Access

To: HE Tool Set Offer, Modmags Limited, 145 Charing Cross Road, London WC2H 0EE

Please send me HE Tool Set(s) at £19.95 each including VAT and postage and packing.

I enclose a cheque/PO made payable to Modmags Limited for £

OR
I wish to pay by Barclaycard. Please charge to my account number



OR
I wish to pay by Access. Please charge to my account number



Signature

Name

(BLOCK CAPITALS)

Address

(BLOCK CAPITALS)

Please note that this offer applies to UK mainland only. Allow 28 days for delivery

TTLs by TEXAS			
7400	1P	74368	55p
7401	12p	74390	100p
7402	12p	74393	100p
7403	14p	74490	120p
7404	14p		40p
7405	18p		40p
7406	30p	74L500	14p
7407	30p	74L502	14p
7408	16p	74L503	16p
7409	16p	74L504	16p
7410	15p	74L505	18p
7411	20p	74L506	18p
7412	20p	74L509	20p
7413	25p	74L510	17p
7414	35p	74L511	20p
7414C	90p	74L513	25p
7416	27p	74L514	45p
7417	27p	74L520	17p
7420	17p	74L521	20p
7421	30p	74L527	20p
7422	22p	74L530	17p
7423	25p	74L532	27p
7425	30p	74L537	20p
7426	30p	74L538	20p
7427	25p	74L542	50p
7428	30p	74L544	50p
7430	17p	74L551	24p
7432	30p	74L555	30p
7433	30p	74L573	25p
7437	30p	74L574	24p
7438	17p	74L575	28p
7440	17p	74L581	20p
7441	70p	74L583	50p
7442A	50p	74L585	70p
7443	112p	74L586	36p
7444	112p	74L590	35p
7446	80p	74L592	40p
7446A	93p	74L593	35p
7447A	60p	74L596	110p
7448	60p	74L5107	45p
7450	17p	74L5109	60p
7451	17p	74L5112	40p
7453	17p	74L5113	45p
7460	17p	74L5114	45p
7470	36p	74L5123	55p
7472	30p	74L5124	120p
7473	30p	74L5125	30p
7474	25p	74L5126	30p
7475	38p	74L5132	45p
7476	32p	74L5133	30p
7480	50p	74L5136	40p
7481	100p	74L5138	40p
7482	84p	74L5139	40p
7483A	50p	74L5145	75p
7484	100p	74L5147	160p
7485	95p	74L5148	90p
7486	25p	74L5150	40p
7489	210p	74L5153	60p
7490A	30p	74L5154	200p
7491	60p	74L5155	50p
7492A	40p	74L5156	50p
7493A	30p	74L5157	50p
7494	50p	74L5158	60p
7495A	50p	74L5160	60p
7496	50p	74L5161	45p
7497	140p	74L5162	45p
74100	85p	74L5163	45p
74107	34p	74L5164	60p
74109	40p	74L5165	60p
74116	90p	74L5166	120p
74118	75p	74L5170	120p
74119	90p	74L5173	70p
74120	90p	74L5174	70p
74121	30p	74L5175	55p
74122	48p	74L5181	74p
74123	50p	74L5190	55p
74125	40p	74L5191	55p
74126	40p	74L5192	60p
74128	40p	74L5193	60p
74132	45p	74L5195	50p
74136	25p	74L5196	45p
74141	75p	74L5197	85p
74142	200p	74L5221	60p
74145	70p	74L5240	90p
74147	100p	74L5241	90p
74149	75p	74L5242	80p
74150	100p	74L5243	80p
74151A	45p	74L5244	80p
74153	50p	74L5245	90p
74154	80p	74L5247	140p
74155	60p	74L5251	50p
74156	60p	74L5253	40p
74157	50p	74L5257	40p
74159	60p	74L5258	45p
74160	60p	74L5259	90p
74161	60p	74L5266	25p
74162	60p	74L5273	90p
74163	60p	74L5279	45p
74164	90p	74L5281	45p
74165	90p	74L5298	160p
74166	60p	74L5323	250p
74167	20p	74L5324	150p
74170	160p	74L5348	200p
74172	300p	74L5365	36p
74173	75p	74L5365	36p
74174	75p	74L5368	50p
74175	75p	74L5373	100p
74176	70p	74L5374	100p
74177	70p	74L5375	50p
74178	100p	74L5376	90p
74180	60p	74L5378	70p
74181	160p	74L5390	60p
74182	120p	74L5393	60p
74184A	90p	74L5399	200p
74185	120p	74L5445	140p
74186	50p	74L5670	170p
74188	32p		
74190	75p	4000 SERIES	25S10
74191	75p	4000	15p
74192	75p	4001	18p
74193	75p	4002	20p
74194	75p	4006	65p
74195	60p	4007	75p
74196	70p	4008	60p
74197	70p	4009	40p
74198	120p	4010	40p
74199	120p	4011	16p
74201	75p	4012	20p
74202	75p	4013	15p
74203	120p	4014	60p
74204	150p	4015	60p
74205	80p	4016	30p
74206	75p	4017	50p
74207	250p	4018	60p
74208	250p	4019	32p
74209	100p	4020	60p
74210	100p	4021	65p
74211	100p	4022	70p
74212	55p	4023	20p
74213	55p	4024	40p

931 SERIES	74S SERIES	74S114	120p
9301	160p	74S00	60p
9302	175p	74S04	60p
9308	316p	74S05	75p
9310	275p	74S08	75p
9311	275p	74S10	60p
9312	160p	74S20	60p
9314	165p	74S30	60p
9316	225p	74S32	90p
9321	225p	74S37	90p
9322	150p	74S64	60p
9334	360p	74S74	90p
9368	250p	74S85	300p
9370	300p	74S86	180p
9374	200p	74S112	120p

LINEAR ICs	MC1458	45p	
AY1-0212	600p	MC1495L	35p
AY1-1313	668p	MC1496	70p
AY1-1320	320p	MC1340P	120p
AY1-5050	140p	MC3403	90p
AY1-1270	840p	MM57160	620p
AY3-8910	40p	NE531	150p
AY3-8912	650p	NE532	150p
AY5-4007D	520p	NE556	70p
CA3046	70p	NE564	420p
CA3048	225p	NE565	120p
CA3080E	60p	NE566	155p
CA3086	48p	NE567	140p
CA3102E	450p	SL490C	400p
CA3090AO	375p	NE5534A	250p
CA3130E	90p	PL02A	500p
CA3140E	50p	RC4136	30p
CA3160E	100p	SE668	270p
CA3161E	140p	SDA1024A	1250p
CA3162E	225p	SFF96364	800p
CA3189E	30p	SL490C	400p
CA3280	160p	SN76013N	170p
DAC3140-B	200p	SN76477	175p
ICL1388	260p	SP815	750p
ICL7106	850p	TA 7120	250p
ICL8038	300p	TA7204	250p
ICM7555	80p	TA7205	250p
LF351	48p	TA7212	400p
LF369	90p	TA7310	200p
LM100C	425p	TB641811	300p
LM301A	27p	TB6A51	200p
LM311	70p	TB8A00	90p
LM312	200p	TB8A10	100p
LM319	225p	TB8A20	90p
LM324	45p	TB8A90	300p
LM339	65p	TCA220	350p
LM348	75p	TC9A40	175p
LM358P	50p	TD1A004	300p
LM377	175p	TD1A008	320p
LM380	75p	TD1A010	320p
LM381AN	180p	TD1A022	225p
LM386	95p	TD1A024	100p
LM393	100p	TD1A034B	250p
LM709	36p	TD1A170	300p
LM710	50p	IDA2002V	325p
LM725	350p	TD2A020	320p
LM733	100p	LO71/61	45p
LM741	18p	LO72/32	75p
LM747	70p	LO74	130p
LM748	35p	LO78A	110p
LM2917	200p	UL170	175p
LM3302	100p	ULN2003	1000p
LM3900	70p	UPC1156H	300p
LM3911	130p	XR2206	300p
LM3914	225p	ZN414	60p
LM3915	225p	ZN492	225p
LM3916	225p	ZN424E	135p
LM13600	125p	ZN425E	350p
MCB3712	200p	ZN427E	625p
MC1310P	150p	ZN1034	200p

VOLTAGE REGULATORS	ve	ve
Fixed Plastic TO-220	7905	55p
1A	7805	50p
12V	7812	50p
15V	7815	55p
18V	7818	55p
24V	7824	55p
100mA TO-92	79L12	60p
5V	78L05	30p
12V	78L12	30p
15V	78L15	30p

OTHER REGULATORS	78HGKC	600p	
LM309K	135p	78HO5KC	550p
LM317T	200p	78MG2C	135p
LM323K	500p	79HGKC	600p
LM723	37p	TL497	300p

OPTO-ELECTRONICS	ORP60	120p	
N25777	45p	ORP61	120p
OC71	180p	TIL78	55p
ORP12	120p		

OPTO-ISOLATORS	TIL111	90p	
ILD74	130p	TIL112	90p
MCT5400	190p	TIL116	90p

LEDS	0.2"	0.2"	
AD561A	1400p	TL220 Red	16p
AD7524	600p	TL222 Gr	18p
DM8131	375p	TL228 Red	22p
DPB204	460p	Rectangular	
DS8835	250p	LEDs (R, G, Y)	30p
DS8836	18p	NS58581	570p
DS8838	225p	TL131	600p
MC1488	65p	TL131/2/3	110p
MC1489	65p	TL321/2	130p
MC3446	300p	TL330	140p
MC3480	850p	TL750	600p

DISPLAYS	200p	200p	
3015F	140p	TL330	140p
DL707 Red	140p	7750/60	850p
FND557	120p	DRIVERS	825p
FND500	110p	9368	250p
FND507	110p	9370	300p
MAN3640	775p	UDN6118	320p
MAN4640	200p	UDN6184	320p

TRANSISTORS	BFR40	25p	
AC126	25p	BFR41	25p
AC127/B	25p	BFR79	25p
AC176	25p	BFR80	25p
AC187/B	25p	BFR81	25p
AF116	50p	BF29	40p
BF30	34p	BF30	34p
BFY56	40p	BFY56	40p
AD161/2	40p	BFY56/7	30p
AU107	200p	BFX86/7	30p
BC107/8	11p	BFX88	30p
BC109	11p	BFW10	90p
BC117	20p	BFY50	30p
BC147/B	90p	BFY51/2	30p
BC154	20p	BFY56	33p
BC157/8	10p	BFY59	40p
BC159	11p	BRV39	45p
BC169C	12p	BSX120	225p
BC172	12p	BU104	24p
BC177/B	17p	BU105	190p
BC179	10p	BU108	250p
BC182/3	10p	BU109	225p
BC184	11p	BU126	150p
BC187	30p	BU180A	120p
BC212/3	11p	BU205	200p
BC214	12p	BU208	200p
BC237	15p	BU406	145p
BC327	16p	E300	50p

GADGETS GAMES & KITS

Featured this month by Ian Graham – the latest thing in video synthesisers from CEL Electronics, three new games cartridges from Atari, Bib Hi-Fi's video recorder head cleaning kit and two handy pieces of test gear from Lawtronics – pocket-sized continuity and transistor testers

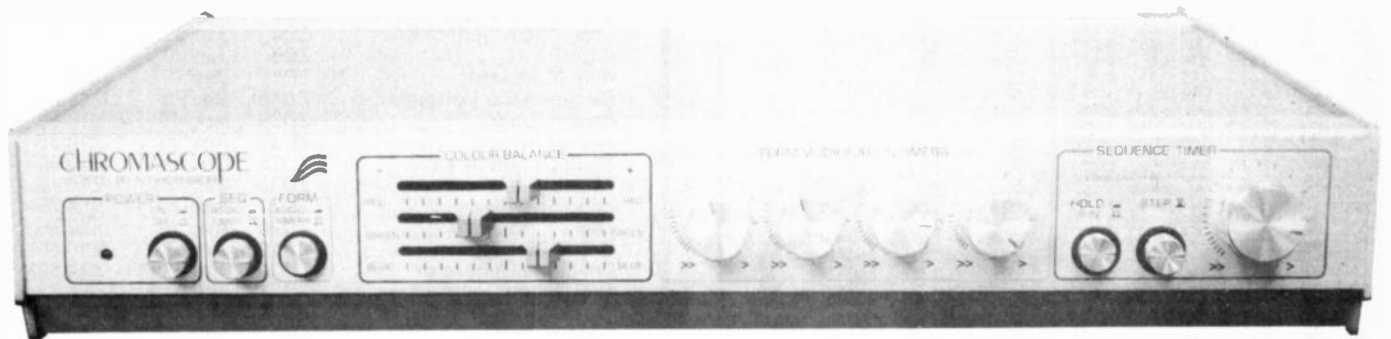

Chromascope – TV Light Show

We first described the two video synthesisers from CEL Electronics, the C-101 (domestic model) and the P-135 (professional model) under Monitor in the August '81 issue. (Note the 'a' in Chromascope, not 'Chromoscope' as printed last month.)

When the C-101 is coupled to the aerial socket of a colour TV receiver, it will produce an almost infinite variety of continuously changing multi-coloured abstract patterns and shapes. If an audio signal is applied to the C-101, the colour of individual patterns, or the sequence in which they change, can be influenc-

ed by the amplitude (volume) or frequency (bass, mid-range or treble) of the signal.

Model C-101

Retail price of the C-101 is £295 plus VAT (but see special introductory offer to HE readers on page 37). It has a smartly finished case with aluminium trim panels and simulated hide cover panels. Sockets are provided for connecting the synthesiser to a TV receiver and, for modulation effects, to an audio system.

The TV aerial is plugged into the C-101: when the synthesiser is switched off the aerial is automatically reconnected to the aerial socket of the TV for normal programme viewing. A separate 15 VDC power supply adaptor is supplied for use with the C-101.

Operation

When the C-101, adaptor, TV receiver and audio system (if you want sound-to-light effects) are all connected up, as described in the instruction manual, the TV is set to a spare channel and a button marked 'Step' is pressed on the synthesiser. When you tune the TV into the signal generated by the C-101 a colour bar pattern – thick vertical bars of white, yellow, cyan, green, mauve, red and blue – appears on the screen. You use this pattern to tune in the TV precisely and to set brightness, contrast and colour controls on the TV.

When you release the Step button the light show begins: coloured patterns and shapes appear and merge in random fashion, at rates determined by the settings of the controls.

Get a great deal from Marshall's

TRANSISTORS - JUST SOME OF OUR LARGE RANGE

2N929 0.20	2N3771 1.85	AC127 0.20	BC172 0.11	BD204 0.70
2N1131 0.20	2N3772 1.90	AC128 0.24	BC173 0.15	BD235 0.35
2N1507 0.12	2N3789 0.90	AC153K 0.20	BC182 0.12	BD240 0.36
2N1637 0.18	2N3790 1.50	AC188 0.30	BC183 0.12	BD242 0.42
2N1638 0.25	2N3791 1.50	AC188K 0.35	BC184 0.12	BD244 0.80
2N1991 0.35	2N3794 0.12	AD161 0.45	BC205 0.17	BD246 0.65
2N2060 3.00	2N3819 0.22	AD162 0.45	BC212 0.12	BD535 0.45
2N2195 0.50	2N3854A 0.20	AF106 0.12	BC213 0.12	BD536 0.45
2N2217 0.25	2N3856A 0.25	AF109 0.12	BC214 0.12	BDY17 1.80
2N2221 0.22	2N3905 0.14	AF126 0.12	BC250 0.12	BF225J 0.15
2N2368 0.24	2N3906 0.15	BC107 0.16	BC347 0.12	BF271 0.20
2N2646 0.45	2N3962 0.25	BC108 0.16	BC350 0.12	BFR39 0.22
2N2714 0.12	2N4036 0.48	BC109C 0.16	BC549 0.12	BFR81 0.22
2N2904 0.28	2N4059 0.13	BC115 0.19	BC559 0.12	BFY50 0.27
2N2905 0.26	2N4060 0.13	BC118 0.19	BCY58 0.20	BSY28 0.30
2N2907 0.28	2N4249 0.13	BC136 0.12	BCY59 0.20	TIP34C 0.85
2N3053 0.30	2N4284 0.15	BC147 0.12	BCY51 0.20	TIP41A 0.55
2N3054 0.70	2N4286 0.12	BC148 0.12	BCY72 0.20	TIP54 1.40
2N3055 0.70	2N4288 0.12	BC149 0.12	BD115 0.25	TIP110 0.67
2N3108 0.25	2N4400 0.15	BC159 0.14	BD116 0.75	TIP117 0.60
2N3393 0.14	2N4822 0.50	BC160 0.34	BD121 0.50	TIP2955 0.65
2N3402 0.11	2N4898 1.00	BC167 0.12	BD138 0.40	ZTX301 0.16
2N3440 0.80	2N4901 1.25	BC168 0.12	BD181 0.75	
2N3441 0.90	2N4903 1.50	BC169 0.12	BD182 0.20	
2N3570 1.95	2N4907 1.75	BC170 0.15	BD201 0.70	
2N3638 0.15	2N5033 0.35	BC171 0.11	BD203 0.70	
2N3642 0.15	2N5220 0.12			
2N3643 0.15	2N5222 0.15			
2N3702 0.12	2N5248 0.15			
2N3705 0.12	2N6109 0.30			
2N3706 0.12	2N6124 0.50			
2N3708 0.12	2N6126 0.64			
2N3709 0.12	40254 0.50			
2N3711 0.12	40312 0.50			
2N3714 1.00	40316 0.50			
2N3716 1.30	40363 0.20			
2N3732 1.50	40389 0.20			

LINEAR INTEGRATED CIRCUITS

AY 2513 3.95	SAA 5030 8.26
DP 8212 2.05	SAA 5040 15.14
LF 1331N 2.95	SAA 5050 8.51
LF 13741H 0.54	SAS 560 1.45
LM 137K 11.52	SAS 570 1.45
LM 301AH 0.72	SAS 580 1.80
LM 317T 1.50	SFF 98800A 6.50
LM 348 0.54	SFF 98810A 3.00
LM 380N14 0.70	SFF 98821A 4.25
LM 381N 1.44	SL 701C 2.50
LM 383 1.60	SN 76003N 2.40
LM 389N 0.95	SN 76033N 1.85
LM 340T5 0.25	SN 76110N 1.85
LM 723CH 0.85	SN 76115N 1.65
LM 723C14 0.80	SN 76228N 1.75
LM 741C14 0.57	SN 76228N 1.75
LM 923 0.44	SN 76116N 1.75
LM 1303 1.25	SN 78666 0.70
LM 1801 2.04	TAA 263 1.00
LM 1871 3.75	TAA 521 0.75
LM 1872 3.75	TAA 700 1.50
LM 3914 2.20	TBA 120 0.65
NE 543K 1.55	TBA 570Q 2.20
NE 544 1.80	TBA 810S 0.90
NE 555 0.25	TBA 990Q 2.95
NE 556 0.80	TCA 270S 3.15
NE 558 3.12	TCA 750 2.85
NE 585 1.05	TCA 830S 1.25
NE 586 1.53	TDA 1005 3.60
NE 570 4.25	TDA 2540 3.85
SAAA 5000 3.04	TDA 2611 1.40
SAA 5010 7.11	TLO 81CP 0.32
SAA 5012 7.11	TLO 82CP 0.72
SAA 5020 5.23	TLO 84CN 1.20

DIGITAL CIRCUITS

CD4000 0.18	CD4099B 1.40
CD4001B 0.20	CD4510B 0.90
CD4002 0.20	CD4511 0.97
CD4007 0.20	CD4514 2.20
CD4008B 0.75	CD4520B 0.90
CD4009 0.40	CD4522 1.10
CD4010 0.46	SN7400 0.19
CD4011B 0.20	SN7401 0.19
CD4012 0.20	SN7403 0.19
CD4013B 0.40	SN7404 0.10
CD4014 0.78	SN7410 0.19
CD4015 0.80	SN7412 0.24
CD4016 0.38	SN7414 0.55
CD4017B 0.72	SN7420 0.16
CD4018B 0.75	SN7423 0.26
CD4019B 0.42	SN7426 0.35
CD4020B 0.90	SN7432 0.24
CD4022B 0.78	SN7440 0.16
CD4024B 0.64	SN7441 0.65
CD4028B 0.75	SN7442 0.49
CD4029B 1.08	SN7445 0.91
CD4034B 2.10	SN7446 0.48
CD4035B 1.09	SN7447 0.48
CD4040 0.85	SN7448 0.45
CD4041B 0.88	SN7450 0.19
CD4042B 0.67	SN7453 0.16
CD4047B 1.02	SN7454 0.16
CD4049 0.34	SN7480 0.15
CD4050B 0.36	SN7472 0.28
CD4051B 0.75	SN7484 0.95
CD4052B 0.75	SN7490 0.33
CD4060B 1.28	SN7491 0.63
CD4063 1.40	SN7492 0.31
CD4066B 0.45	SN7493 0.31
CD4067 4.25	SN7496 0.34
CD4068 0.30	SN74107 0.30
CD4069 0.22	SN74121 0.26
CD4071B 0.22	SN74141 0.50
CD4072 0.24	SN74155 0.74
CD4073B 0.24	SN74157 0.59
CD4075B 0.22	SN74164 0.91
CD4081B 0.24	SN74165 1.15
CD4082 0.24	SN74174 0.77
CD4085 0.94	SN74182 0.80
CD4086 0.88	SN74190 0.85
CD4095 1.35	SN74192 0.80
CD4096 1.35	

PRESENSITISED POSITIVE FOTO RESIST PCB BOARDS 1.6mm THICK

SIZE	single side	double side
100 x 160mm	£1.40	£1.65
100 x 220mm	£1.95	£2.05
203 x 114mm	£1.70	£2.10
233.4 x 220mm	£3.75	£4.50

JUST A TINY
FRACTION OF OUR
RANGE
ALL KINDS OF
COMPONENTS AND
ALSO TEST GEAR

PLEASE ADD POSTAGE/PACKING 60p UNLESS STATED. ALSO 15% VAT ON TOTAL - ALL ITEMS ON THIS ADVERTISEMENT SPECIALLY SELECTED FOR EX-STOCK DELIVERY

A. Marshall (London) Ltd.

Kingsgate House, Kingsgate Place, London NW6 4TA
Industrial Sales: 01-328 1009.

Mail Order: 01-624 8582 - 24-hour service

Also retail shops:

325 Edgware Road, London, W2

40 Cricklewood Broadway, London, NW2

85 West Regent Street, Glasgow & 108A Stokes Croft, Bristol

R.P.M. Meter	ZD125	August'81	£13.75
Electronic Ignition	ZD124	August'81	£18.90
Variable Bench Power Supply	ZD123	August'81	£22.50
Treble Boost	ZD122	July'81	£10.25
Voice Operated Switch	ZD120	May'81	£10.50
Audio Millivoltmeter	ZD121	May'81	£17.25
Super Siren	ZD116	April'81	£16.95
Guitar Tremolo	ZD117	April'81	£11.50
*Russian Roulette Game	ZD118	April'81	£7.95
Windscreen Washer Alarm	ZD119	April'81	£5.50
Fuzz Box	ZD115	March'81	£9.00
Steam Loco Whistle	ZD114	March'81	£11.50
Windscreen Wiper Controller	ZD113	March'81	£6.50
Public Address Amp (no mike/spkrs)	ZD112	March'81	£16.50
Heart Beat Monitor	ZD108	Feb'81	£20.25
Audio Signal Generator	ZD109	Feb'81	£16.00
Background Noise Simulator	ZD110	Feb'81	£6.00
*Two-Tone Train Horn	ZD111	Feb'81	£5.00
Bench Amplifier	ZD107	Jan'81	£8.85
Nicad Charger	ZD106	Jan'81	£6.75
Car Rev Counter	ZD104	Jan'81	£26.80
Digital Speedometer	ZD100	Dec'80	£35.25
Battery Charge Monitor	ZD101	Dec'80	£5.00
Model Train Controller	ZD102	Dec'80	£15.25
Stereo Power Meter	ZD103	Dec'80	£19.25
Double Dice	ZD99	Nov'80	£14.00
Guitar Pre-Amplifier	ZD97	Nov'80	£8.90
Watchdog Intruder Alarm	ZD89	Oct'80	£18.25
Freezer Alarm	ZD91	Oct'80	£9.75
Nobell Doorbell	ZD93	Oct'80	£11.25
Light Dimmer	ZD88	Oct'80	£6.35
Guitar Phaser	ZD85	Sept'80	£12.00
Auto Probe	ZD83	Sept'80	£4.00
Equitone Car Equaliser	ZD52	August'80	£15.30
Car Booster (no speakers)	ZD50	July'80	£23.50
Hazard Flasher	ZD48	July'80	£12.50
Fog Horn	ZD44	June'80	£5.75
*Egg Timer	ZD43	June'80	£9.35
Track Cleaner	ZD12	May'80	£9.65
*R/C Speed Controller	ZD3	April'80	£13.50
Electronic Ignition	ZD2	April'80	£21.45
Digital Frequency Meter	ZD9	April'80	£32.75
Crosshatch Generator	ZD4	Jan'80	£13.85
Digi-Die	ZD5	Jan'80	£7.75
Ring Modulator	ZD1	Dec'79	£11.55
Bargraph Car Voltmeter	ZD40	Dec'79	£8.50
Guitar Tuner	ZD38	Nov'79	£10.50
*R2 D2 Radio	ZD37	Nov'79	£10.35
Multi Option Siren	ZD36	Oct'79	£13.50
*Starburst	ZD30	Sept'79	£16.75
Injector Tracer	ZD27	Aug'79	£4.75
LED Tachometer	ZD26	Aug'79	£17.55
G.S.R. Monitor	ZD19	June'79	£10.65
Envelope Generator	ZD20	June'79	£14.50
Drill Speed Controller	ZD21	June'79	£8.75
White Noise Effects Unit	ZD18	May'79	£18.00
Digibell Project	ZD16	May'79	£6.35
Car Alarm	ZD70	Feb'79	£10.40
Graphic Equaliser	ZD62	Jan'79	£30.50
Audio Mixer	ZD14	Dec'78	£24.00

*ITEMS MARKED NO CASE
REPRINTS OF ABOVE 40p EXTRA
ALL PRICES INCLUDE POST AND 15% VAT
PERSONAL CALLERS PLEASE RING TO CHECK AVAILABILITY OF KITS.

IONISER KIT (MAINS OPERATED)

This negative ion generator gives you the power to saturate your home or office with millions of refreshing ions. Without fans or moving parts it puts out a pleasant breeze. A pure flow of ions pours out like water from a fountain, filling your room. The result? You air feels fresh, pure, crisp and wonderfully refreshing.

All parts, PCB and full instructions£12.50
A suitable case including front panel, neon switch, etc.£10.50

Hours Mon-Friday 9-5.30 p.m. Sat. 9-4.30 p.m.

Callers by appointment only.

Telephone: 01-226 1489

T. POWELL

Advance Works, 44 Wallace Road, London N.1.

Visa/Access cards accepted
Minimum telephone Orders £5
Minimum Mail Order £1



Control Functions

Front panel controls are divided into six groups:

- Power** On/off button and LED indicator. As soon as this button is pressed the synthesiser is connected to the DC supply from the adaptor, and the aerial is disconnected from the TV
- Seq** This button selects two modes of control for the sequence of patterns: timer, where the sequence is determined by a built-in timer, or audio, where it is determined by the content of the incoming audio signal (for example, by the beat of a piece of music)
- Form** This button selects

Colour Balance

Form Modification Timers

Sequence Timer

two modes of control for the movement of form within a pattern: form modification timer (four independent timer controls are provided for this mode) and audio modulated (determined by the content of the incoming audio signal)

Three slider controls enable you to set up the overall hue of the picture, using the primary colour combinations of red, green and blue

Four controls allow the setting of the rates of change for colours and shapes within a particular pattern

Three controls are provided in this group: Hold, Step and Sequence Timer

adjustment. The Hold button stops timer- or audio-controlled pattern sequencing. The display does not freeze, however, because the pattern modification timers continue to change the patterns to a limited extent and the display still responds to audio stimulation. If you like a particular design then you can retain it indefinitely by pressing the Hold button.

The main function of the Step button is to select a colour bar display. Operation of Step will also make the pattern sequencing random, so that the machine will never repeat the display

On Test

We demonstrated the C-101 to two different audiences, of widely differing age groups. Two different makes of TV were used in the demonstrations.

The younger group was enthralled by the patterns displayed, particularly when the picture was modulated with some music by Jean Michel Jarre. The general view seemed to be: 'We like the effects produced by the C-101, but it's too expensive'.

Response from the older group was less demonstrative but nonetheless positive. One of our audience commented on how this compact machine, with the great variety of effects that it produced, was a good example of how modern 'chips' had brought such machines down in size. Comments about the cost echoed those made by the younger group.

The only technical niggles we had was with the power supply adaptor unit. This seemed to get very hot during use. A plus point for the C-101 was its ability to display a colour bar pattern. This is used by TV service engineers to set up TV displays and gives an instant check of the overall colour balance.

Feedback

We spoke to Robin Palmer, director of CEL and designer of Chromascope, after we had tested and

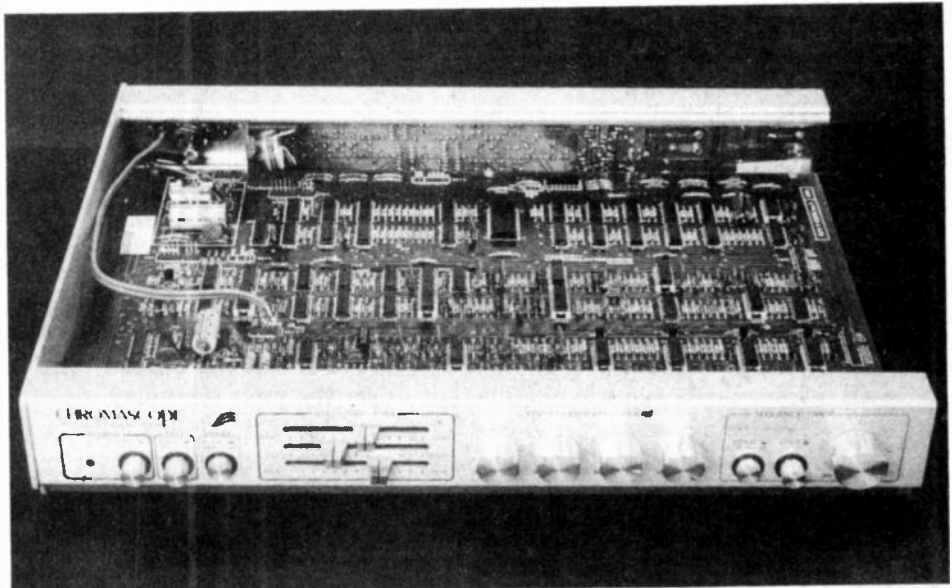

evaluated the C-101. The first question we put to him was about the price. He told HE that Chromascopes use analogue and digital electronics, much of it working in a random fashion, so it was difficult to shrink the design down to a handful of ICs. The enormous PCB, which takes up most of the case was, he said, 'a pig to develop' over a two-year period. He added that he would have loved to have made something cheaper but users would have become bored with it very quickly.

When asked to comment on the heat produced by the adaptor, he said that PSUs from an early batch

do run hot — by design. But these were 'perfectly reliable' and he claimed to have had some running for months without problems. However, his supplier has assured him that adaptors in future batches will run cooler.

Palmer also commented on the professional interest in Chromascope. Professional users are now asking for a version of the P-135 which will give a still picture (static patterns, that is) and plain colours that can be adjusted separately for use as background displays.

He has already designed a version for France (SECAM TV system)

TRANSISTOR TESTER

Test transistor, diodes, Leds, SCR etc. in situ, no need to remove devices from board. Tests for short or open circuits and identifies NPN or PNP transistors.



Reviewed
September
H.E.

£25.30

CONTINUITY TESTER

Only 25MV at Probe Tips so cannot damage any sensitive transistors or ICs, on P.C.B. under tests. Audio tone indicates continuity in programmed range.

0-1-3.0 ohms safe with sets and cmos etc.

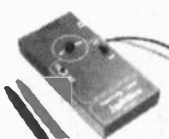

Reviewed
September
H.E.

£2

MULTIMETERS

Miniature 1.9 x 2.7 x 4" NLS LM 300
3 Digits LCD 21 ranges 1%
1 v-kv AC/DC
1 ma-1A AC/DC
1 k-10 Mohm £49

BECKMAN 3020

3½ digit LCD
29 ranges 0.1%
200 mV-1.5 kV AC/DC
200 mA-10A AC/DC
200 Ohms-20 Mohm
(Diode Tester) £99

OSCILLOSCOPES

TR10 CO1303D 5MHZ 10MV
Single Trace..... £125.00
NLS M5215 8MHZ 10MV Dual minia-
ture battery/mains £399.00

GENERATORS

Trio SG402 30MHZ AM mod. £68.00
AG 202A 200KHZ Sign Sq..... £79.50
AG203 A 1MHZ Sign Sq..... £127.50

We are a franchise distributor for Beckman Insts. Global Specialties, Trio Insts, Sinwood, non-linear systems, Coline, GP Industrial and we manufacture our own testers, prom erasers, etc.

Lawtronics

139 High Street
Edenbridge, Kent
Tel: (0732) 865191

Prices include V.A.T.
P&P, Access, Barclaycard or C.W.O.

Conquer the chip.

Be it a career, hobby or interest, like it or not the Silicon Chip will revolutionise every human activity over the next ten years.

Knowledge of its operation and its use is vital. Knowledge you can attain, through us, in simple, easy to understand stages.

Learn the technology of the future today in your own home.

MASTER ELECTRONICS

LEARN THE PRACTICAL WAY
BY SEEING AND DOING

- Building an oscilloscope. ● Recognition of components.
- Understanding circuit diagrams. ● Handling all types Solid State 'Chips'.
- Carry out over 40 experiments on basic circuits and on digital electronics.
- Testing and servicing of Radio, T.V., Hi-Fi and all types of modern computerised equipment.

MASTER COMPUTERS

LEARN HOW TO REALLY UNDERSTAND COMPUTERS, HOW THEY WORK - THEIR 'LANGUAGE' AND HOW TO DO PROGRAMS.

- Complete Home Study library. ● Special educational Mini-Computer supplied ready for use. ● Self Test program
- Services of skilled tutor available. ● exercise.

MASTER THE REST

- Radio Amateurs Licence. ● Logic/Digital techniques.
- Examination courses (City & Guilds etc.) in electronics.
- Semi-conductor technology.
- Kits for Signal Generators - Digital Meters etc.

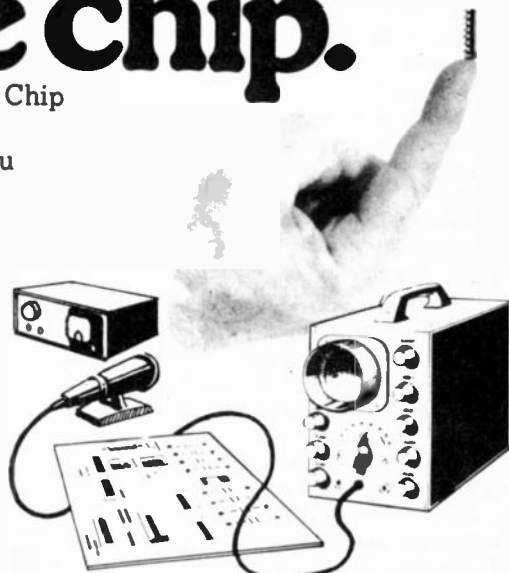

FREE Please send your FREE brochure without obligation to:

Name _____
Address _____

(Block Caps please)

I am interested in
PRACTICAL ELECTRONICS _____
COMPUTER TECHNOLOGY _____
OTHER SUBJECTS (please state your interests) _____

HE/8/813

BRITISH NATIONAL RADIO & ELECTRONICS SCHOOL.
READING, BERKSHIRE RG1 1BR.

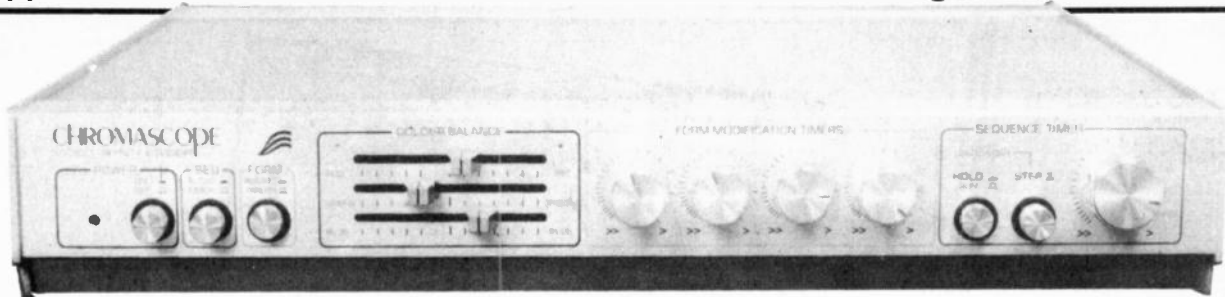

and aims to penetrate Japanese and American markets. The existing machines are suitable for PAL users

in Europe. (The PAL system is used in the UK.)
CEL Electronics Limited, River

Way, Harlow, Essex CM20 2DP (tel 0279 418611).

Bib Compact Video Recorder Maintenance Kit

Until recently, video recorders were the preserve of the BBC and pools winners. Now, as prices plummet, almost 20 manufacturers are producing about 50 standard and portable systems. They're available for sale and hire and there's a growing second-hand market. If your family has invested in a second-hand machine or your service agreement has lapsed, you may be interested in doing the routine maintenance work yourself.

Bib Hi-Fi now have a 'Videophile' range of accessories to serve the growing video market. This month I've been looking at their Compact Video Recorder Maintenance Kit. For a recommended retail price of £5.47 including VAT you get a set of five head cleaning tools, a bottle of tape head cleaning fluid and an aerosol can of Dust-Away air blast. The kit has thoughtfully been packed in a clear container the same size as a VHS cassette so you can store it in your video cassette rack.

The kit contains comprehensive instructions to clean VHS and Betamax heads. The innards of a video cassette recorder are delicate at the best of times, but Bib's instructions feature the necessary do's and don'ts. It does involve taking the cover off your machine, so tread very carefully. All the parts of the kit are available as separate items. The 'Videophile' range also includes title labels, head cleaning cassettes (VHS and Betamax), tape eraser, tape splicer, tape head demagnetiser, TV screen anti-static treatment kit, etc. You should be able to get the Bib Compact Video Recorder Maintenance Kit from any good video/hi-fi store.

Game, Set And Match: Atari Games Cartridges

Game — Football; Set — Television; Match — You versus the Atari Videocomputer System (or a human opponent). Atari has added three new games cartridges to its extensive



range. Pele launched Atari's 'Championship Soccer' cartridge during a recent visit to London. The familiar black plastic box gives you a choice of 54 different games — 1-27, two-player; 28-54, single-player. The game variations are achieved by offering different combinations of team speed, penalties, goal size and game difficulty. There are three players and a goal-keeper on each side, manoeuvred about the pitch by your joystick controllers. You can dribble, kick, tackle and score your

way around the screen in glorious colour. Who needs Match of the Day? Nice touch — when you score, the computer lays on your own personal fireworks display to celebrate.

Atari's Othello cartridge offers four variations: 1-3, you versus the computer at increasing difficulty levels; game 4, a two-player game. The object is to convert as many of your opponent's counters to your colour as possible. In Fig. 1, you are black and it's your turn to move. You can convert

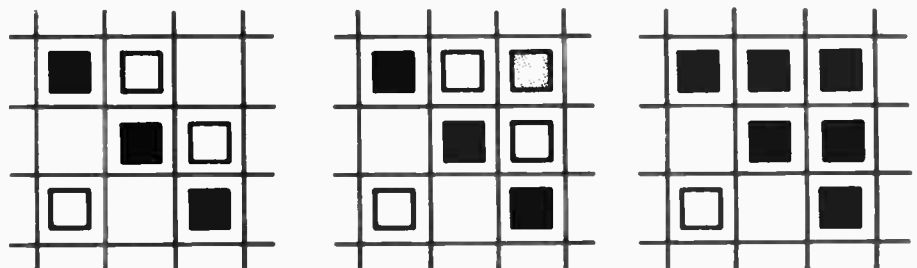
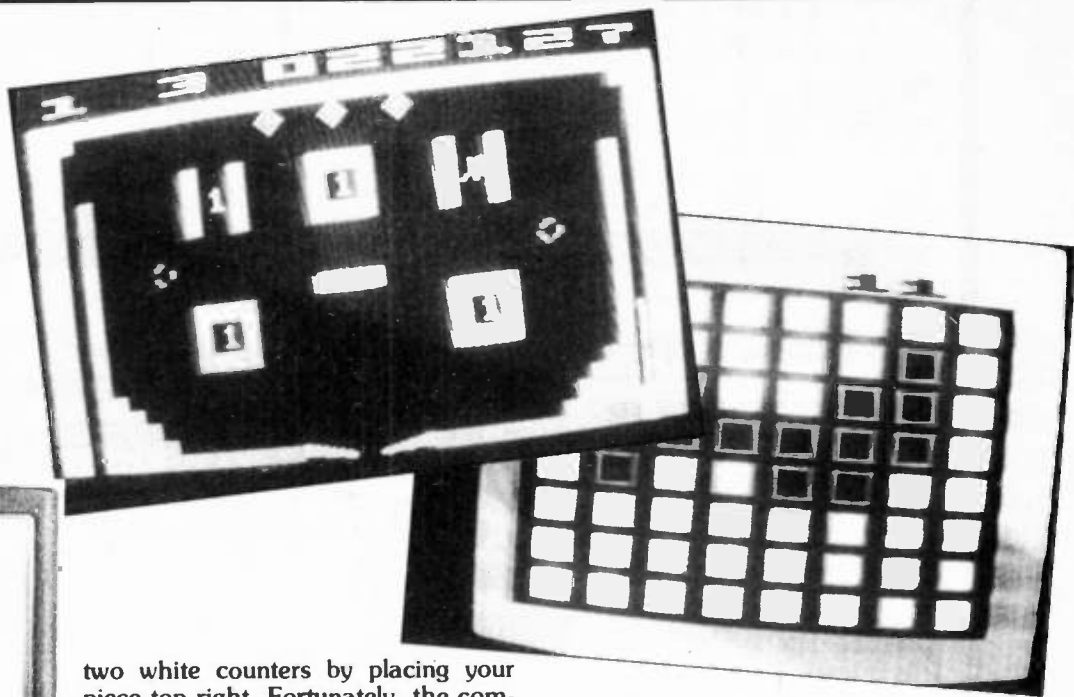

Fig. 1 Playing Othello on Atari



two white counters by placing your piece top right. Fortunately, the computer does make mistakes on the lowest play level, so it can be beaten.

Last, but by no means least, I plugged in Video Pinball to try the four variations — two single-player and two two-player. The screen was immediately filled with drop-targets, rollover indicators, spinners and bumpers. It all happens — as the ball bounces around, lights flash and the score mounts up. You can nudge the ball towards a target, but beware — nudge too much and you incur a tilt penalty.

All three games are played with joystick controllers. Prices — Football £29.95, Othello £23.95, and Pinball £23.95. All prices are inclusive of VAT. You can get hold of an Atari Videocomputer System to plug them into for less than £100.

Testing, Testing, 1,2,3, Lawtronics Test Gear

Lawtronics sent me two interesting pieces of test gear to look at. Its TT2 Transistor Tester is a 'go, no-go' tester for NPN and PNP transistors and

diodes. It's simple to operate. Diagrams on the top of the tester's case show you how to connect the two probes and component operation is indicated by two LEDs. Power is supplied by a PP3 battery.

If you think you have a broken wire somewhere, check it out in no time with the CT2 Continuity Tester. Power this time is from two PP3s. The CT2 has two switched resistance ranges (R25 and 1R) and can easily be calibrated using a single potentiometer adjustment.

The CT2 and TT2 are, I feel, overpriced at £17.50 and £22.00 respectively. Lawtronics can supply an extensive range of test gear including oscilloscopes, counter timers, digital and analogue multimeters, signal sources, logic analysers and breadboards, probes, test leads, etc. Lawtronics Ltd, 139 High Street, Edenbridge, Kent TN8 5AX.

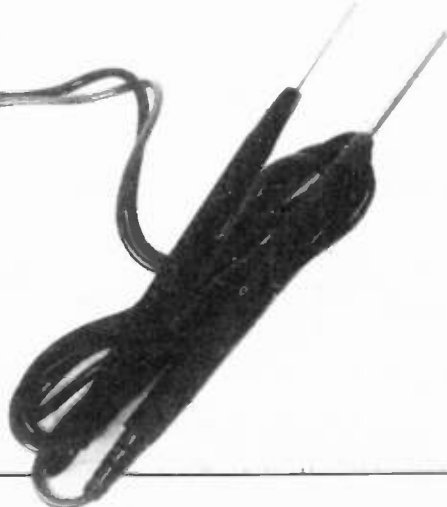
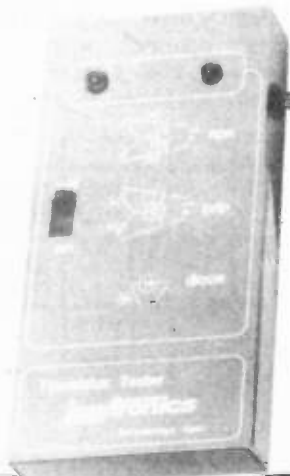



EVERY DOOR SHOULD HAVE ONE

Whatever kind of door you have, our New Electronic Combination Lock will enable you to open it easily but make things very difficult for unwelcome visitors. The unit, which comes complete with a 10-way keypad, requires an easily remembered four digit code to be entered before the door can be opened, while the intruder has over 5,000 combinations to choose from. The code can be easily changed by means of a pre-wired plug and a momentary or latched output version can be made.

The kit has even more uses in a car where it may be used to disable the ignition. Another useful feature is the Save Button. This stores the combination number, enabling the car to be used by authorised persons such as garage personnel without disclosing the code. The complete kit measures 7 x 6 x 3 cms. deep and consumes a mere 40uA when not in use, and will drive a 5V to 15V (750mA) solenoid or relay coil (not supplied) directly. So why not treat your door to a new lock for **ONLY £10.50** and think about all the keys you can lose or forget without ever locking yourself out. As featured in PE, May '81

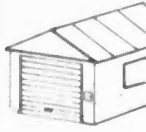
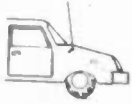

NEW RIDICULOUSLY LOW PRICE FOR DVM/THERMOMETER KIT

£13.50 VAT

Based on ICL7106 DVM chip and a 3 1/2 digit liquid crystal display. This kit will form the basis of a digital multimeter - only a few additional switches and resistors required (details supplied) or make a sensitive digital thermometer (-50° to 150°C) reading to 0.1°C. The basic kit has a sensitivity for full scale of 200mV, automatic polarity and runs from a 9V PP3 battery.

At this price you can use this kit in place of moving coil meters in virtually any application from bathroom scales to bicycle speedometers - the possibilities are endless.

VMOS POWER FETS

VN10VM 0.5A 60V (T092) 52p
VN66AF 2A 60V (T0220) 88p

D.I.L. I.C. SOCKETS

8 pin	8p	18 pin	17p
14 pin	12p	28 pin	24p
16 pin	14p	40 pin	36p

Soldercon Pins 80p/100

DISCO LIGHTING KITS

Each unit has 4 channels (rated at 1KW at 240V per channel) which switch lamps to provide sequencing effects, controlled manually or by an optional opto isolated audio input.

DL 1000K

This kit features a bi-directional sequence, speed of sequence and frequency of direction change being variable by means of potentiometers. Incorporates master dimming control. £14.80

DL21000K

A lower cost version of the above, featuring unidirectional channel sequence with speed variable by means of a preset pot. Outputs switched only at mains zero crossing points to reduce radio interference to minimum. £8.00

Optional Opto Input DLA1 50p



ALL COMPONENTS ARE BRAND NEW AND TO SPECIFICATION. A00 50p P&P and 15% VAT TO TOTAL OVERSEAS CUSTOMERS ADD £1.50 (Europe) & (elsewhere) for P&P. Send see for price list and with all enquiries. Callers welcome 9.30-5.00 (Mon-Fri) 10.00-4.00 (Sat).



TK Electronics

(HE) 11 BOSTON ROAD, LONDON W7 3SJ. 01-579 9794/2842



ARE YOU SITTING COMFORTABLY?

Our new TDR300K Touch Dimmer Kit will ensure that you are. Based on our highly successful TD300K touch controlled dimmer kit, the TDR300K incorporates an infra red receiver, enabling the lamp brightness to be varied and switched on or off by touch or remotely by means of a small hand held transmitter. The complete kit, which includes easy to follow instructions, will fit into a plaster depth box and the plastic front plate has no metal pads to touch, ensuring complete safety. Even a neon is included to help you locate the switch in the dark.



In years to come everyone will be selling remote control dimmers, but you can have your TDR300K kit now for **ONLY £14.30** for the dimmer unit and £4.20 for the transmitter.

For the more athletic of you, the TD300K Touchdimmer kit is still available at £6.50 and the TDE/K Extension kit, for 2-way switching etc., is £2. **DON'T FORGET** to add 50p P&P and 15% VAT to your total purchase.



TRIACS



400V Plastic Case (Texas)

3A TIC206D	49p
8A TIC226D	58p
12A TIC238D	85p
16A TIC246D	95p
25A TIC263D	190p
6A with trigger Q4006LT	80p
8A isolated tab TXAL226B	65p
Diac	18p

INTEGRATED CIRCUITS

55 Timer	55p
741 Op Amp	19p
AY 5-1224 Clock	£2.60
AY-5 1230/2 Clock/Timer	£4.50
AY 3-1270 Thermometer	£8.20
CA3080 Transconductance Op Amp	72p
CA3130 CMOS Op Amp	75p
CA3140 CMOS Op. Amp	45p
ICL7106 DVM (LCD drive)	£7.00
ICM7555 CMOS 555 Timer	79p
LM377 Dual 2 W Amp	£1.45
LM379S Dual 6W Amp	£3.50
LM380 2W Audio Amp	80p
LM382 Dual/Low noise Preamp	£1.00
LM386 250mW low voltage Amp	75p
LM1830 Fluid Level Detector	£1.50
LM2911 V Converter (14 pin)	£1.60
LM3909 LED Flasher/Oscillator	60p
LM3911 Thermometer	£1.20
LM3914 Dot/Bar Driver (linear)	£2.10
LM3915 Dot/Bar (log)	£2.20
MM74C911 4 digit display controller	£6.50
MM74C926 4 digit counter with 7 seg o/p	£4.50
5566B Touchdimmer	£2.50
SL440 AC power control	£1.75
SN75477 Complex Sound Generator	£2.52
TBA800 5W Audio Amp	88p
TBA810AS 7W Audio Amp	£1.00
TDA1024 Zero Voltage Switch	£1.20
TDA2020 20W Audio Amp	£2.85
TDA4290 DC Controlled Preamp	£1.98
TL081 J-FET Op Amp	37p
TL082 Dual J-FET Op Amp	60p
TL084 Quad J-FET Op. Amp	£1.00
TMS 1121 Clock/7 day timer	£8.50
TN1034E Timer	£1.80
ZN414 AM Radio	95p

All ICs supplied with Data Sheets
Data Sheets only per device 100

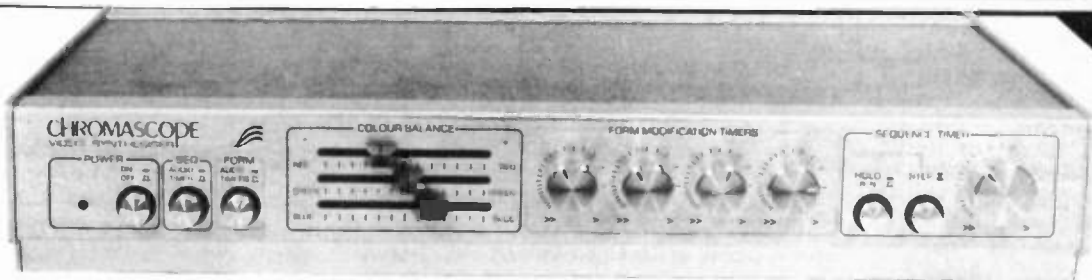

Video Synthesiser Offer

Chromascope Offer for HE Readers

WE REVIEW the Chromascope C-101 Video Synthesiser in this month's Gadgets, Games & Kits supplement.

When the C-101 is connected to your colour TV receiver it will produce a spectacular display of coloured patterns and shapes, which merge and blend in random fashion (see the cover of this month's issue). Connect it to your audio system as well and the display will respond to the audio signal, adding a visual dimension to music.

By special arrangement with CEL Electronics, we are offering the C-101 at an introductory price of £249 plus VAT (normal retail price £295 plus VAT). This offer closes on 30th November 1981.

Choose between three methods of payment: Cheque, Barclaycard, or Access.

To: HE Video Synth Offer, Modmags Limited, 145 Charing Cross Road, London WC2H 0EE

Please send me my C-101 Video Synthesiser at £286.35, including VAT and delivery.

I enclose a cheque made payable to Modmags Limited for £286.35

OR

I wish to pay by Barclaycard. Please charge to my account number



OR

I wish to pay by Access. Please charge to my account number



Signature

Name (BLOCK CAPITALS)

Address (BLOCK CAPITALS)

Please note that the offer applies to UK mainland only. Allow 28 days for delivery

Quick Project: Car Lights Delay

An easy-to-build project for your car, which operates your car lights to let you see your way around after you've parked in the dark. A couple of minutes later, when you're safe and sound in the house, the car's lights are automatically extinguished

When push-button PB1 is pressed this project turns a car's spotlight or headlights on for a fixed period of around two minutes. At the end of this time the lights are turned off automatically. When not in use the project's current consumption is zero.

Circuit operation is simple. Transistor Q1 is connected as an emitter follower (its emitter voltage is always the same as its base voltage) with emitter load R2, and base bias provided by C1. Transistor Q2 forms a common emitter amplifier, with the relay coil RLA as its collector load. Its base bias arises from R2 and Q1 emitter. Power is applied to the circuit via N/O (normally open) relay contacts RLA/1 which are shunted by the push-button PB1.

Initial operation of PB1 connects the circuit to its power supply. At this time C1 is fully discharged, so Q1's base is effectively shorted to the positive supply line. Transistor Q1's emitter 'follows' the base voltage (+12 V) so +12 V appears there. Transistor Q2 is driven on by the current through R2 and thus the relay is turned on. As this takes place, contacts RLA/1 close thus maintaining power after push-button PB1 has been released. Relay contacts RLA/2 also close and power is applied to the spot- or headlights. The above operation occurs almost instantaneously, as the push-button is pressed.

Capacitor C1 now starts to charge slowly, and the base voltage of Q2 (via emitter follower Q1) drops exponentially towards 0 V. After a delay of about two minutes the voltage decreases enough to turn transistor Q2 off. The relay contacts must now open, disconnecting power to the circuit and to the lights.

When construction of the board is complete, mount the project in a suitable case, and install it in your car.

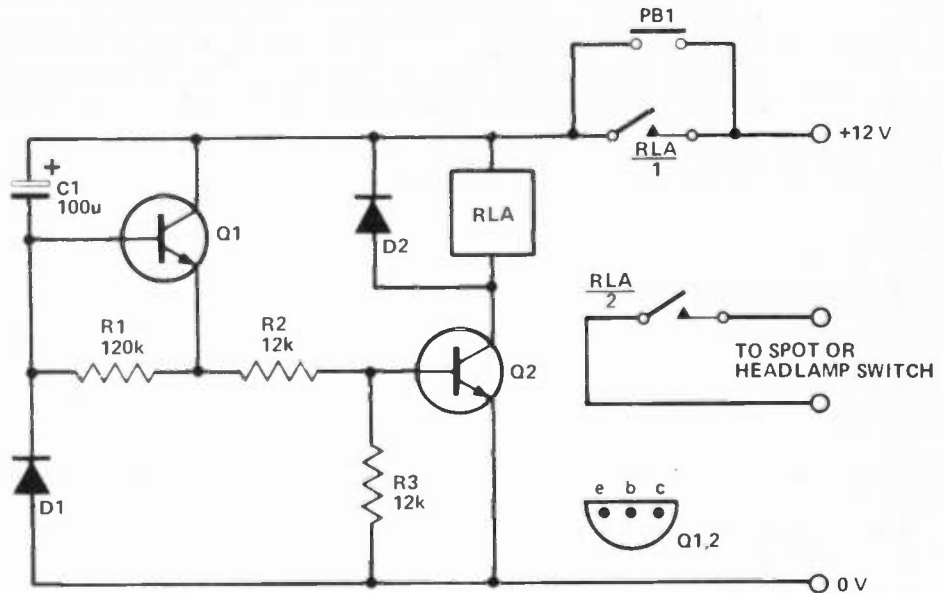

NOTE:
Q1 IS 2N2926
Q2 IS 2N3704
D1 IS 1N4148
D2 IS 1N4001

Figure 1. Circuit of Car Lights Delay

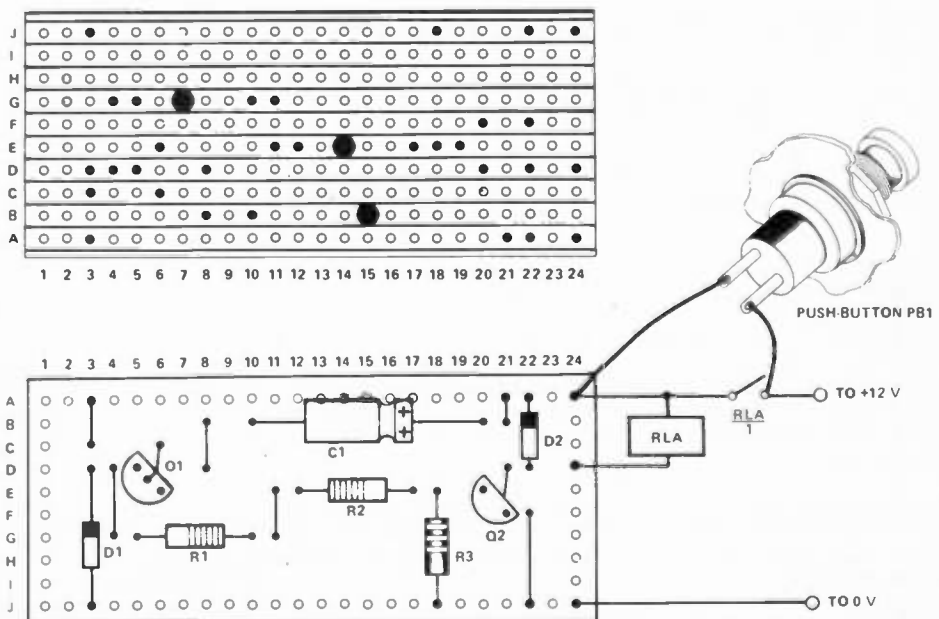

Figure 2. Veroboard layout, connection details and underside track breaks

HE

Building Site

This month, Keith Brindley tells you all about the most often used process in the whole area of electronics — soldering

THERE'S NO DOUBT, one of the first jobs to master in electronics is that of soldering. However you build a project, whether on printed circuit board (PCB) or Veroboard, you will have to solder the components in.

When done properly, a soldered joint (the connection between a component lead and the copper track of the circuit board) is the neatest and most permanent way of making any connection between the separate parts of a project. Of course, one joint which has been badly soldered can render the same project useless. It's very important, therefore, to do the job right.

Practice Makes . . .

There's nothing quite like repeatedly doing a job to improve performance, and soldering is no exception. The more often you build a circuit board the better you'll become at soldering, but even so there are a couple of tips you can follow to help get it right immediately: have the correct tools for the job, and keep everything as clean as possible.

The right tool for the job is a good quality soldering iron, for electronics use. We've come a long way from the time when a soldering iron was simply a wooden-handled rod of iron, the tip (or bit, as it is correctly known) of which was thrust into a hot fire, till glowing red hot. This sort of iron is not meant for electronics but for heavier jobs such as lead pipe plumbing. Nevertheless, the name of the modern tool 'soldering iron' comes from its red-hot predecessor.

A modern iron consists of an electrically heated element at the end of an insulating (usually a form of plastic) handle. A slide-on or screw-on bit fastens over the heated element and it is this bit which is used to heat the circuit board connections before solder is applied. Figure 1 shows how a typical soldering iron is constructed. The element will be rated by its power in watts, eg, 15 W, 25 W, etc, and various bit thicknesses will be obtainable.

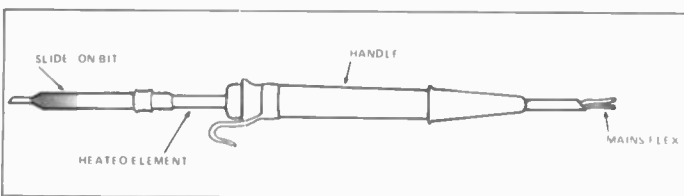

Figure 1. A typical modern mains-powered soldering iron

The power of an iron and its bit thickness are largely matters of the physical size of the connections to be soldered, although personal preference will play a part, too. The larger the area of the connection to be soldered, the more heat will be dissipated away from the bit. Thus, more power will be required to maintain the required temperature to melt the solder. For circuit board use, a 15 W soldering iron is adequate and certainly no greater than 25 W is necessary. If you use a more powerful soldering iron than this you might damage the components by overheating them.

A bit thickness of $\frac{1}{8}$ " to $\frac{3}{16}$ " is ideal for circuit board work.

What's Best?

Most irons are mains-operated but there are exceptions: some are designed to be operated on a lower AC voltage (eg, 50 VAC), and so a step-down transformer is used to provide this from the mains, and some types (see Fig.2) are battery-powered. The iron in Fig.2 contains its battery inside the

handle-type body and the battery is made up of nickel-cadmium cells — so it is rechargeable — hence the recharger you can also see. It features enormous advantages over mains-operated or low-voltage AC-operated irons, mainly because (being battery-powered) it is *cordless*: no more fiddly mains flex getting in the way while you try to solder. With the use of such an iron you are, at last, completely free of having to be within four feet of a mains outlet. For instance, soldering jobs on the car which are usually a nightmare with a mains-operated iron become a very simple job. A cordless soldering iron is also useful if you are soldering CMOS integrated circuits into a PCB, because it has no earth connection, and therefore you can't damage the ICs by static discharge.



Figure 2. Cordless, rechargeable soldering iron plus recharger

The iron takes about four hours to reach its fully charged state, once the recharger is turned on and the iron put into it. The cells inside the iron cannot be overcharged or damaged by leaving the iron in the recharger, so you can leave it in this position till required. Operating the iron is easy — lift it from the charger, press the 'on' button, wait 3-5 s to allow the bit to heat up, then solder the joint as you would with any iron.

Once fully charged the iron can be used for a constant period of about 15 minutes without needing charging, but using the iron for about 20 s at a time every few minutes (an average amount when soldering — remember you're never actually using an iron constantly) will give a working time of well over an hour between charges.

A Clean Sweep

Everything you use when soldering; ie, iron bit, component leads and circuit board *must* be clean and grease-free. The smallest amount of grease or dirt could cause a faulty joint.

Keep the tip of the soldering iron bit clean by wiping it every few minutes, when hot, over a damp sponge or rag — the tip should have a shiny, silvery surface.

Clean the copper track of the circuit board with household

Feature

scouring powder and a damp rag. Figure 3 shows a PCB which has been half cleaned (ie, one half of the board has been cleaned with scouring powder then washed — the other half hasn't). The difference is obvious because the cleaned copper surface has a bright, shiny appearance rather than a dull one. Another way to clean the board is with methylated spirits and a rag, although this doesn't remove any oxide layer on the copper — it just removes grease.

If the component leads are dirty or greasy, rub them lightly with a piece of emery cloth before inserting them into the circuit board.

Insert and solder components one at a time, then cut off the excess component leads using a good pair of side-cutters, close to (but *not on*) the soldered joint.

When you actually apply the soldering iron to the joint to be soldered, remember to heat the copper track rather than the component lead. You see, copper is a good heat conductor and therefore the applied heat from the iron will be dissipated quickly away from the joint, and more heat will be needed. If too much heat is applied to the component lead then obviously the heat is conducted along it to the component body and heat damage might occur.

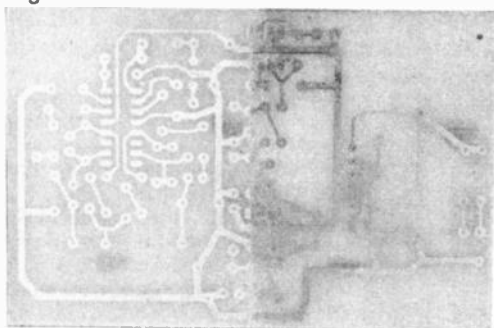

Figure 3. Here you can see how dirty a PCB can get. The left-hand half of this board has been cleaned with household scouring powder, the other half hasn't. Dry joints are easy to make on a dirty PCB

The order of steps in soldering a joint is as follows:

- Apply the hot soldering iron bit to the copper track of the board, about 1/8" away from the component lead and leave it there for a few seconds
- Touch the end of a length of solder to the other side of the hole which the component lead goes through, and wait for it to melt (see Fig.4)
- Move the bit of the iron up to touch the component lead, still keeping it on the copper and at the same time applying more solder until the solder flows all round the hole and up the lead in a concave arc shape
- Remove the iron bit and let the joint cool

Nothing to it, is there, when you know how! Keep practising — see you next month.

You can obtain a cordless rechargeable soldering iron similar to ours, from:

West Hyde Developments Ltd,
Aylesbury
(telephone 0296 2044 1)

for about £25.

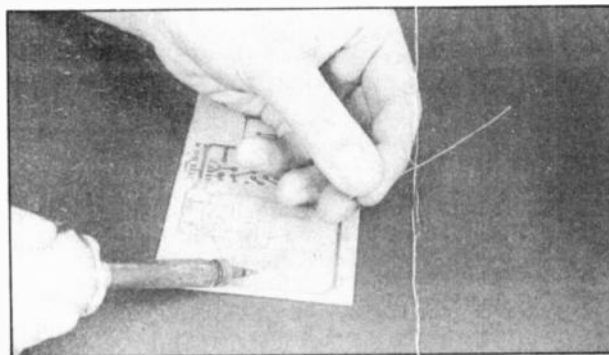

Figure 4. Solder just beginning to melt onto the copper track around the hole of a PCB. When this occurs you know that the joint is hot enough

HE

P.A.T.H. Wholesale & Retail Supply Of Electronic Components

Electronic Services

Electronic Equipment Manufacturers 369 Alum Rock Road, Birmingham, B8 3DR. Tel.021-327-2339

C.B. SPARES

O - P Transistor (4W) 23C1306	£3.70
O - P Transistor (10W) 25C1307	£3.90
Chips TA1295AP	£4.84
TA1722	£5.29

UNMARKED PACKS (10 estd. packs £3.50)

50 Silicon & Germanium Transistors	40p
50 DC71 Type Transistors	40p
50 Silicon Diodes	40p
50 Germanium Diodes	40p
30 BZY88 400mV Zener Diodes	40p
100 Polystyrene Capacitors	40p

TV COAX EQUIPMENT

Std Plastic Coax Plug	10p each, 10 for 90p
Std Coax Coupler	15p each, 10 for £1.30
Single coax skt in std flush plate	85p
Double coax skt in std flush plate	97p
TV Lead with plug, each end 2M long	85p

HEADPHONE JUNCTION BOX
A most popular stereo junction box facility for two pairs of headphones and two speakers. 3-position switch enables you to select headphones, speakers, or both.
£2.50 each 10 for £28.

PLASTIC BOXES WITH LID

71x49x25mm White	50p
71x49x25mm Black	50p
120x80x35mm Black	80p
180x110x55mm Black	£1.35

12V dc Soldering Iron Ideal for jobs on the car!
HURRY! ONLY A FEW AT THIS PRICE £2.30

CIRCUIT BOARD

1	15
2 1/2 x 5"	30p
2 1/2 x 3 1/4"	25p
3 3/4 x 5"	40p

MAKING PRINTED CIRCUIT BOARDS?
Materials from STOCK you can rely on!

6x6mm	1mm SS	1mm DS	24mm SS	24mm DS
6x12mm	£1.20	£1.30	£2.05	£2.15
12x12mm	£2.35	£2.55	£4.02	£4.29

POST AND PACKING please add 50p post and packing to orders under £10. Post free over £10. ADD VAT at the current rate of 15% to total.
BUMPER WHOLESALE LIST AVAILABLE SHORTLY. Send £1 for your copy now!

SALE - BARGAINS

Bargain pack list now ready. Send 24p for your copy + SAE
We still have stocks of all goods advertised last month. Plus much much more - Shop open 10 till 6. Call in and see us

GEC AM/FM STEREO TUNER AMPLIFIER CHASSIS. Originally designed for installation into a music centre. Supplied as two separate built and tested units which are easily wired together.
Note: Circuit diagram and interconnecting wiring diagrams supplied. **Rotary Controls:** Tuning on/off volume, balance, treble, bass. **Push-button controls:** Mono, Tape, Disc, AFC, FM (VHF), LW, MW, SW. **Power Output:** 7 watts RMS per channel, at better than 2% THD into 8 ohms. 10 watts speech and music.
Frequency Response: 60Hz-20kHz within ±3dB. **Tape Sensitivity:** Output typically 150 mV. Input — 300 mV for rated output. **Disc Sensitivity:** 100mV (ceramic cartridge). **Radio:** FM (VHF), 87.5MHz — 108MHz. Long wave 145kHz — 108kHz. Medium wave.

Stereo Cassette Tape Deck Module comprising of a top panel and tape mechanism coupled to a record/play-back printed board assembly. Supplied as one complete unit for horizontal installation into cabinet or console of own choice. These units are brand new, ready-built and tested. Smart black and silver finish.
Features: Three digit tape counter, Auto-stop, Six piano type keys, record, rewind, fast forward, play, stop and eject. Automatic record level control. Main inputs plus secondary inputs for stereo microphones. **Input sensitivity** 100mV to 2V. **Input impedance** 68K. **Output level** 400mV to both left and right-hand channels. **Output impedance** 10K. **Signal to noise ratio** 45dB. **Wow and flutter** 0.1%. **Power supply requirements** 18V D.C. at 300mA. **Connections** the left and right-hand stereo inputs and outputs are via individual screened leads all terminated with phono plugs (phono sockets provided). **Dimensions:** Top panel 5 1/2in. x 11 1/4in., clearance required under top panel 2 1/4in.
Supplied complete with circuit diagram and connecting diagram.
Price £26.70 + £2.50 postage and packing. Supplementary parts for 18V D.C. power supply (transformer, bridge rectifier and smoothing capacitor) £3.

B.K. ELECTRONICS

37 Whitehouse Meadows, Eastwood, Leigh-on-Sea, Essex SS9 5TY

BARCLAYCARD VISA

* SAE for current lists • Official orders welcome • Full prices include VAT • Mail order only • All items packed (where applicable) in special energy absorbing PU foam. Orders welcome by prior appointment, please telephone 0782 527572.

Clever Dick

Shock! Horror! Clever Dick shows rare generosity and gives away two binders this month



BACK IN THE June '81 issue of HE, Clever Dick came to a close with a letter from someone claiming to be Professor S. Unwin. It ended with 'Await deep joy at your reply', and I ended with 'Binder to the reader sending the best suggestion'. Well here it is.

*Dear Clever Dick,
I think I can help your correspondent of last week, Prof. S. Unwin. I suspect that he is an alien of the Planet Arpeggio or has spent some time there.*

My wife and I spent a two-decade holiday in the seventeenth century (their time) and I picked up the language, oh yes!

Prof. Unwin

Your problem Professor, is a question of impedilode. I assumi that you have a single outputilode on the recordi tape contraption and headphone socketer fittilode for an extoni speakibold. If your speakibolds are of equali impedilode and you connectiwire them in serilode, you add the impedilode which gives you approx halfmo outputilode and much reduced musipoo, oh yes.

If howeverlode, you connectiwire the speakibolds in the parallelimode, it then halfmos the impedilode of the combined speakibolds, therebymo giving, approx doublo the outputilode and much increasimo the musipoo with much greater joy, oh yes.

*Yours sinceriwish,
Mr. Viv Reed*

Right, for that you get a bindilode. If the 'Professor' sends me his address then I'll send him suggestions received from other readers.

Two letters were received from readers in response to Martin Portman's request for HEBOT spares in the July '81 issue. The first was from Richard Bradford in Canterbury, Kent and the second was from Ian Fosberry in Thurmaston, Leicester. Thanks for your letters — I'll send them to Martin.

Richard Bradford, incidentally, suggested a camera flash as an HE project: I'll see how it develops in the HE Long-term Ongoing Ideas Laboratory.

Next letter was sent with the aim of helping P. Smith, who wrote in the June '81 CD: 'I would like to know who sells the AY-3-8610 IC and how much it costs'.

*Dear CD,
Having just read a letter from one P. Smith concerning the AY-3-8610 integrated circuit.*

I am NOT a dealer, but I have a few of these circuits.

They are not new, but I can guarantee they will all work.

I would be happy to supply a fellow constructor with this IC for just the price of postage.

*D. R. Jaynes
Harlow, Essex*

Our thanks to Mr Jaynes for his wish to help a fellow constructor. If P. Smith drops me a line I'll pass on his address.

Off to sunny Finland now.

Dear Clever Dick,

I have the honour of being a reader of your excellent magazine, and I would like to ask about three tings.

1. You had an article in HE (May '81) about a microcomputer named ZX81. I would like to know more about it. What shall I do?

2. Is anybody who reads this magazine interested in corresponding with me? I am from Finland but my language is Swedish. I am a sixteen-year-old boy in desperate need of exercise in English.

3. What is this "Binder" that everyone nearly fights about?

I hope you forgive my bad English.

*Peter Degerlund
01490 Vanda 49, Finland*

First tings first. We covered the ZX81 — in kit form — in the Gadgets, Games & Kits supplement in the July '81 issue.

Second, if anyone would like to correspond with Peter, drop me a line.

Third, not only will I send you a copy of HE but I'll also send you a coveted Binder (I'm in a silly and generous mood — for this issue only).

I asked in the July issue if anyone could beat Ben Chaston's letter for brevity — and still make sense.

*Dear CD,
No!
F.R. Maher
Formby, Liverpool*

Any sensible replies?

Another short one, this time written on the noble headed paper of Eton College.

*Dear Clever Namesake,
Please could you tell me where I could*

*get 3.5 mm stereo jack male and female sockets for mini-portable-stereo-tape-players?
Dick Gibbons
Eton College, Windsor, Berks*

I'd like to say 'yes, they're available from . . .' but I can't. After a quick phone round I soon came to the conclusion that these were specialist items. Plenty of mono 3.5 mm sockets and plugs around but no stereo versions. Sorry, but it looks like it's time for a redesign of whatever you're making. (What's wrong with highly-popular old-fashioned 1/8-in diameter types?)

Now one from a desperate reader.

*Dear CD,
I am writing in a state of extreme desperation and hope that you can offer a remedy.*

Recently I purchased components for an LCD multimeter and now am trying to find close tolerance resistors for range setting. I require especially the following values: 9M, 900k, 90k, 9k, 1k. Whilst Lascar Electronics supply 0.25% tolerance values, they are not prepared to supply these independent of a kit.

*P. M. Hitching
Croydon, Surrey*

The MPR24 range of 0.25 W resistors from Mullard Limited covers a wide range of values, temperature coefficients and resistance tolerances extending down to 0.01%. Mullard distributes these through Intel Electronics, Henlow Trading Estate, Henlow, Beds (tel 0462 812505) but, because they are such specialist items, the resistors are very expensive. Minimum orders are 20 of any one type, at 0.05% tolerance, at a cost of £1 each. As suggested by Intel, it would be cheaper to buy 100-off (for example, 0.25% tolerance, 100-off would cost 14½p per resistor). But 100-off of a single value will not, in any configuration, give all the values that you mention.

And that's the end of the page. See you in the next issue.

HE

Mains Adaptor

An ideal project for users of battery-powered calculators, radios, cassette players etc, because the HE Power Pack can be adjusted to give the voltage you require

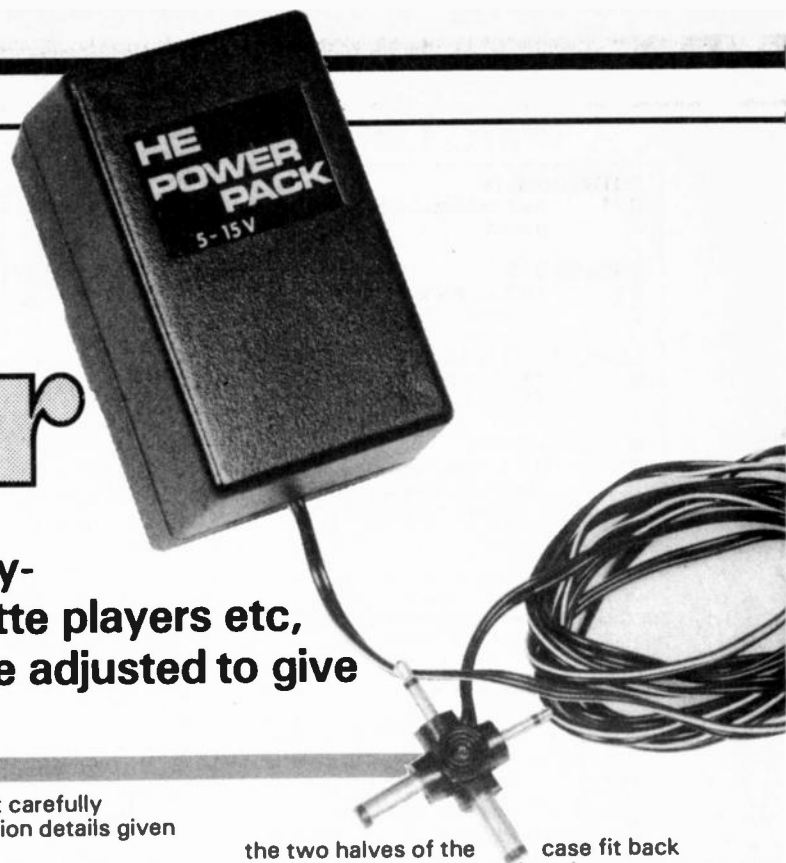

PROJECTS ARE OFTEN designed with a particular case or enclosure in mind. The HE Power Pack is a good example — when we first saw the case, from West Hyde Developments, we knew exactly what to design into it. This case was specifically intended to house mains power supply units, and features three pins (in the shape of the pins of a standard 13 A plug top) which plug straight into a 13 A mains outlet socket.

Our circuit (Fig. 1) gives a regulated output of between 5 V and 15 VDC, adjusted and set by a preset resistor. Current output is anything up to about 350 mA.

An integrated circuit is used in the project to regulate the output voltage and although this IC (the 7805) is normally used in a fixed-voltage (5 VDC) supply we have adapted the circuit so that it will give a variable output voltage.

Construction

Insert and solder the two diodes into the printed circuit board (PCB) making sure that they are the correct way round, as shown in the overlay in Fig. 2. The bodies of the diodes must be mounted as close to the surface of the PCB as possible.

Solder in PCB pins wherever connections are to be made to the circuit board, then insert and solder all remaining components, following the overlay diagram. Clip the heatsink on to IC1.

Now open the plastic power supply case and take out the sub-chassis. Break or cut off the transformer mounting lugs so that the transformer will fit into the case.

Using good quality contact adhesive and following manufacturers' instructions as to use, stick the transformer to the sub-chassis.

Next, using the contact adhesive, stick the PCB to the sub-chassis to fit underneath the edge of the transformer. Figure 3 shows a view of the project in which you can see the details at this stage.

Wire up the project carefully following the connection details given in Fig. 2.

Solder leads to the live and neutral terminals, inside the power supply case, and bend the leads up to the top of the case. Refit the sub-chassis and then solder the remaining ends of the live and neutral leads to the PCB and the transformer, where shown in Fig. 2.

Tightly attach a cable tie to the output lead, so that no damage will occur if it is pulled. A view of the project at this stage is shown in Fig. 4.

Stick a small piece (about 1" by ½") of foam sponge onto the inside lid of the case, positioned so that when

the two halves of the case fit back together, the sponge pushes down onto the transformer, preventing movement.

Finally, plug the supply into a mains outlet, turn on, and measure the voltage at the supply output. By adjusting preset resistor RV1 you should obtain an output voltage variable between about 5 VDC and 15 VDC. Set the output voltage to what you require, switch off, remove the supply from the mains outlet and screw the two halves of the case together.

How It Works

The workhorse of this project is a voltage regulator integrated circuit which sets the output voltage (V_{OUT}) to a value determined by the setting of the preset resistor.

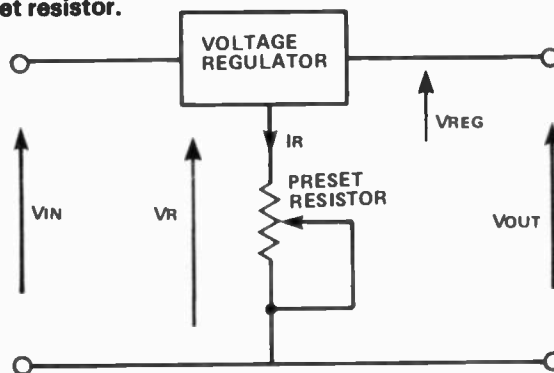

The input voltage (V_{IN}) comes from the rectified output of mains transformer T1. Diodes D1 and 2 give full-wave rectification of the 12 VAC transformer output.

Capacitor C1 provides smoothing of the rectified voltage and V_{IN} will be about 18 VDC.

Integrated circuit IC1 is a 5 V voltage regulator, and whatever the output voltage of the circuit, V_{REG} will always be 5 VDC.

The value of current I_R is 1.5 mA for IC1 (from manufacturers' data) so we can calculate the voltage across the

preset resistor from Ohm's law. For example, if the value of the preset is 1kΩ then:

$$V_R = 1.5 \text{ mA} \times 1000, \\ = 1.5 \text{ V.}$$

The output voltage is simply the sum of the two voltages, i.e.,

$$V_{OUT} = 1.5 + 5 = 6.5 \text{ V.}$$

Thus, by varying the value of the preset resistor the output voltage can be varied.

Parts List

POTENTIOMETER
RV1 4k7 miniature horizontal preset

CAPACITORS
C1 1000u, 25 V electrolytic
C2 220n polyester

SEMICONDUCTORS
IC1 7805, 1 A voltage regulator
D1,2 1N4001, 1 A diodes

MISCELLANEOUS
T1 0-12-0-12 V, 6 VA miniature transformer
Printed circuit board mounting fuse clips
FS1 500 mA, 20 mm fuse
Case (see Buylines)

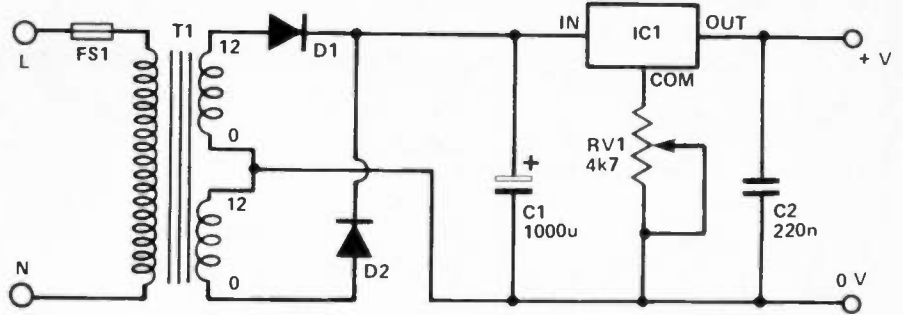

NOTES:
IC1 IS 7805
D1,2 ARE 1N4001

Figure 1. Circuit of the HE Power Pack

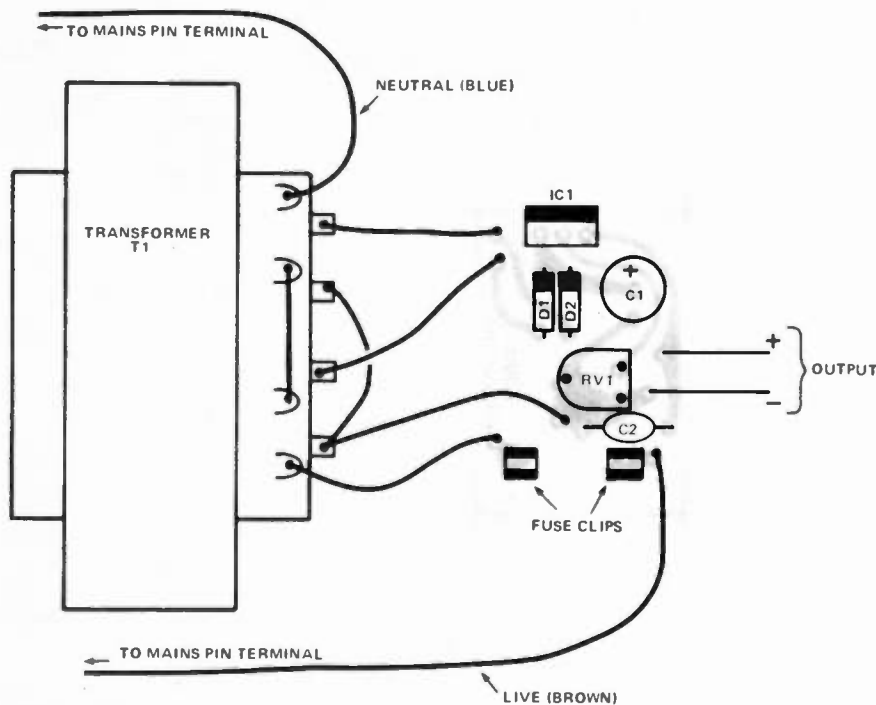

Buylines

You should have few problems obtaining component parts for this project and the approximate price (excluding case and PCB) will be £4.50.

If you have any trouble finding a source of supply for transformer T1, you can buy it direct from:

Verospeed,
Stansted Road,
Boyatt Wood, Eastleigh,
Hants SO5 4ZY

by sending them a cheque for £2.10.
The mains power supply case is obtainable from:

West Hyde Developments Ltd
Aylesbury
(telephone 0296 20441)

and its order code is PSC200K (for a black case) or PSC200W (if you want a white case).

Figure 2. Overlay of the PCB for the project and connection details

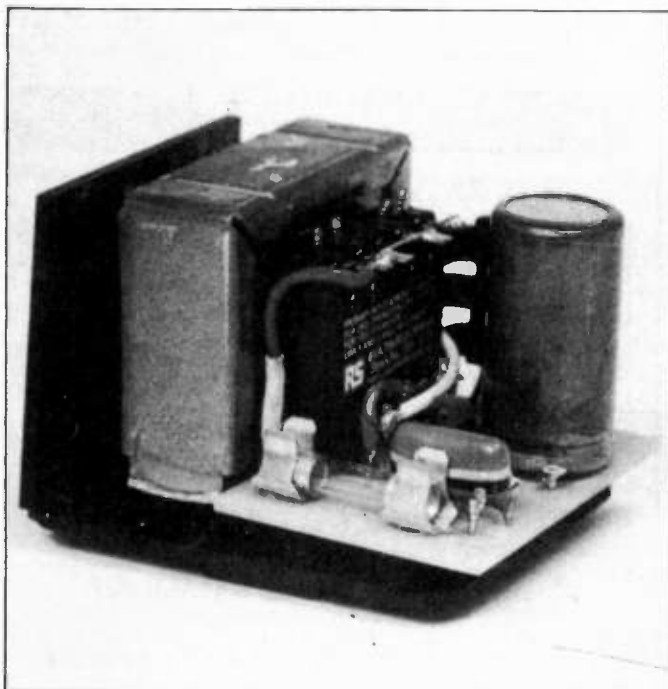

Figure 3. View of the project fitted to the sub-chassis, before insertion into the case

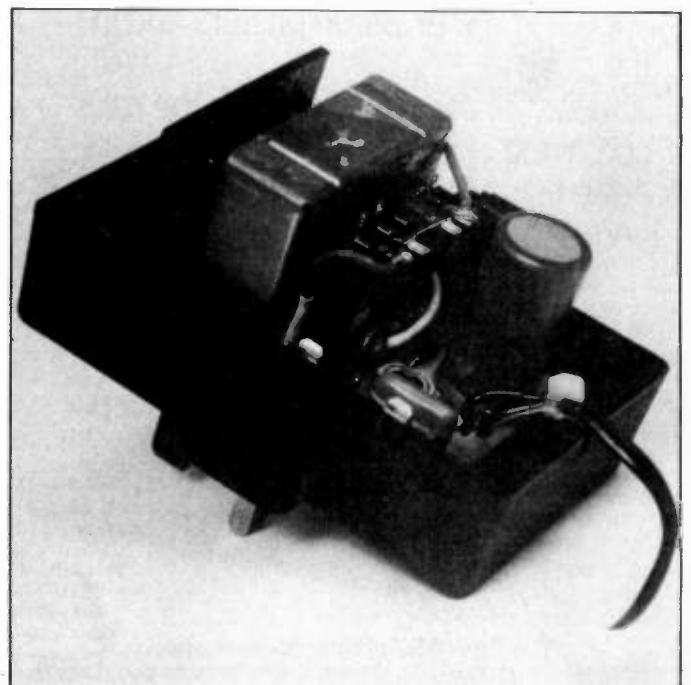

Figure 4. Internal details of the HE Power Pack

HE



"NO~ I DON'T THINK AN HOUR A DAY OF 'COMPUTER JOGGING' COUNTS AS EXERCISE!"

PARNDON ELECTRONICS LTD.

Dept. No. 22, 44 Paddock Mead, Harlow, Essex CM18 7RR. Tel. 0279 32700

RESISTORS: 1/2 Watt Carbon Film E24 range + 5% tolerance High quality resistors made under strictly controlled conditions by automatic machines. Banded and colour coded.
 £1.00 per hundred mixed (Min 10 per value)
 £8.50 per thousand mixed (Min 50 per value)
 Special stock pack 60 values 10 off each £5.50

DIODES: IN4148 3p each Min order quantity 15 items
 £1.60 per hundred

DIL SWITCHES: Gold plated contact in fully sealed case. Suitable for programming problems.
 4 Way 86p each 6 Way £1.00 each 8 Way £1.20 each

DIL SOCKETS: High quality, low profile sockets.
 8 pin - 10p. 14 pin - 11p. 16 pin - 12p. 18 pin - 19p. 20 pin - 21p.
 22 pin - 23p. 24 pin - 25p. 28 pin - 27p. 40 pin - 42p.

ALL PRICES INCLUDE V.A.T. & POST & PACKING — NO EXTRAS
 MIN ORDER: UK £1.00 OVERSEAS £5. CASH WITH ORDER PLEASE

Every week, millions of advertisements appear in the press, on posters and in the cinema.

Most of them comply with the rules contained in the British Code of Advertising Practice and are legal, decent, honest and truthful.

But if you find one that, in your opinion, is wrong in some way, please write to us at the address below.

We would like you to help us keep advertising up to standard.

The Advertising Standards Authority.
 If an advertisement is wrong, we're here to put it right.

A.S.A. Ltd., Brook House, Torrington Place, London WC1E 7HN.

HE PROJECT KITS

Make us your No. 1 SUPPLIER OF KITS and COMPONENTS for H.E. Projects. We supply carefully selected sets of parts to enable you to construct H.E. Projects. Kits include ALL THE ELECTRONICS AND HARDWARE NEEDED. Printed circuit boards (fully etched, drilled and roller tinned) or varo-board are, of course, included as specified in the original article, we even include nuts, screws and I.C. sockets. PRICES INCLUDE CASES unless otherwise stated. BATTERIES ARE NOT INCLUDED. COMPONENT SHEET INCLUDED. If you do not have the issue of H.E. which includes the project — you will need to order the instruction reprint at an extra 46p each.

Reprints available separately 45p each + p&p 40p
 LATEST KITS: S.A.E. OR PHONE FOR PRICES

THERMOMETER, Aug. '81	£11.50
R.P.M. METER, Aug. '81 inc. probe	£14.44
VARIABLE BENCH POWER SUPPLY, Aug. '81	£23.35
ULTRASOUND BURGLAR ALARM, July '81	£16.98
ELECTRONIC DOOR BUZZER, July '81	£5.14
ELECTRONIC METRONOME, July '81	£4.25
TREBLE BOOST, July '81	£9.94
CONTINUITY CHECKER, June '81	£4.86
ENVELOPE GENERATOR, June '81	£15.32
AUDIO MIXER, June '81	£4.55
AUDIO MILLIVOLTMETER, May '81	£16.98
VOICE OPERATED SWITCH, May '81	£9.43
Microphone extra	£1.29
SUPER SIREN, Apr '81	£17.75
DOORBELL MONITOR, Apr '81	£2.99
GUITAR TREMOLO, Apr '81	£11.33
WINDSCREEN WASHER ALARM, Apr '81	£5.26
RUSSIAN ROULETTE GAME, Apr '81	£8.31 less case
PUBLIC ADDRESS AMPLIFIER, Mar '81	£16.56
Extras — horn speakers	£6.83 each
PA mic	£4.40
FUZZBOX, Mar '81	£9.41
WINDSCREEN WIPER CONTROLLER, Mar '81	£6.98
STEAM LOCO WHISTLE, Mar '81	£11.15
PHOTOGRAPHIC TIMER, Mar '81	£2.99
HEARTBEAT MONITOR, Feb '81	£21.28
HIGH IMPEDANCE VOLTMETER, Feb '81	£8.98
AUDIO SIGNAL GENERATOR, Feb '81	£17.21
BACKGROUND NOISE SIMULATOR, Feb '81	£6.43
TWO-TONE TRAIN HORN, Feb '81	£4.77 less case
MEDIUM WAVE RADIO, Feb '81	£6.98
LADDER OF LIGHT (Sound into Light), Jan. '81	£29.98
BENCH AMP, Jan '81	£9.19
NICARD CHARGER, Jan '81	£6.98
CHUFFER, Jan '81, less case	£6.44
CAR REV COUNTER, Jan 81, less case	£21.20
Case extra	£5.98
DIGITAL SPEEDO, Dec. '80	£35.89
MODEL TRAIN CONTROLLER, Dec. '80	£16.86
BATTERY CHARGE MONITOR, Dec. '80	£4.91
JACK LEAD TESTER, Dec. '80	£1.99
STEREO POWER METER, Dec. '80	£18.98
MEMORY BANK — MINI SYNTHESIZER, Nov. & Dec. '80	£33.85
PARTY GRENADE, Nov '80	£7.98
TRANSISTOR TESTER, Nov '80	£5.57 inc. test leads
DOUBLE DICE, Nov '80	£13.80
GUITAR PRE-AMP, Nov 80	£5.65 case (diecast) extra £2.99
BATTERY ELIMINATOR, Nov '80	£14.88

ADVENTURES WITH MICROELECTRONICS by TOM DUNCAN

An easy to follow book suitable for all ages. Ideal for beginners. No soldering. Uses a Bimboard 1 breadboard, gives clear instructions with lots of pictures. 11 projects based on integrated circuits — includes dice, two-tone doorbell, electronic organ, MW/LW radio, reaction timer, etc. Component pack includes a Bimboard 1 breadboard and all the components for the projects. Adventures with Microelectronics £2.35. Component pack £26.95 less battery.

ADVENTURES WITH ELECTRONICS by Tom Duncan

An easy to follow book suitable for all ages. Ideal for beginners. No soldering. uses an S-Dec breadboard. Gives clear instructions with lots of pictures. 16 projects — including three radios, siren, metronome, organ, intercom, timer, etc. Helps you learn about electronic components and how circuits work. Component pack includes an S-Dec breadboard and all the components for the projects. Adventures with Electronics £1.90. Component pack £16.72 less battery.

1981 ELECTRONICS CATALOGUE

KITS
 ICs
 TRANSISTORS
 CAPACITORS

Hundreds of illustrations, product data, circuits and details of all our kits and educational courses. Up to date price list included. All products are stock lines for fast delivery
 Send 70p in stamps or add 70p to your order

TOOLS
 RESISTORS
 HARDWARE
 CASES

MAGENTA ELECTRONICS LTD.

NOBELL DOORBELL, Oct. '80.....	£10.98
INTRUDER ALARM, Oct. '80.....	£17.83
FREEZER ALARM, Oct. '80 with probe	£9.42
TUG O' WAR, Oct. '80.....	£15.98
KITCHEN TIMER, Oct. '80 (2% resistors)	£7.34
MICROMIX, Sept. '80.....	£7.82
AUTO PROBE, Sept. '80.....	£3.67 less case
TOUCH SWITCH, Sept. '80.....	£2.34 less case & contacts
GUITAR PHASER, Sept. '80.....	£13.84
BENCH PSU, Sept. '80.....	£28.50
EQUITONE CAR EQUALISER, Aug. '80.....	£14.98
OP AMP CHECKER, Aug. '80.....	£4.55
MOVEMENT ALARM, Aug. '80.....	£5.68
RADIO TIMER, Aug. '80.....	£6.98
PASS THE LOOP GAME, Aug. '80.....	£13.98
SOUND OPERATED FLASH TRIGGER, July '80, no skt.....	£4.59
18W+18W CAR STEREO BOOSTER, July '80.....	£29.98 (stereo)
FOG HORN, June '80.....	£5.65
SPEED CONTROLLER FOR R/C, April '80.....	£14.92 less case
DIGITAL FREQUENCY METER, April '80.....	£35.78
HOBBYCOM: TWO WIRE INTERCOM, April '80.....	£33.95 (Master)
Sub Station.....	£3.38 each
ELECTRONIC IGNITION (CD), April '80.....	£20.87
WIN INDICATOR, Feb. '80 (with switches).....	£13.92
DIGI-DICE, Jan. '80.....	£9.98
BARGRAPH CAR VOLTMETER, Dec. '79.....	£7.33 less case
RING MODULATOR, Dec. '79.....	£12.95
GUITAR TUNER, Nov. '79.....	£10.98
HOBBYTUNE, Oct. '79.....	£26.98
ANALOGUE FREQUENCY METER, Oct. '79.....	£15.52
MULTI-OPTION SIREN, Oct. '79.....	£15.98
ULTRASONIC SWITCH, Sept. '79.....	£28.85 less 3 pin mains socket
HOME SECURITY UNIT, Aug. '79.....	£28.56 less siren
SIREN.....	£5.09 less case
LED TACHOMETER, Aug. '79.....	£17.98
INJECTOR TRACER, Aug. '79.....	£4.34
CONSTANT VOLUME AMPLIFIER, Aug. '79.....	£15.60
LINEAR SCALE OHMMETER, July '79.....	£15.98
GSR MONITOR, June '79.....	£9.63
ENVELOPE GENERATOR, June '79.....	£14.98
WHITE NOISE EFFECTS UNIT, May '79.....	£17.74
TRANSISTOR GAIN TESTER, April '79.....	£9.98
PHOTOGRAPHIC TIMER, Mar. '79.....	£16.45
CAR ALARM, Feb. '79.....	£10.98
SCRATCH/RUMBLE FILTER, Feb. '79.....	£25.48 Mono
	£29.98 Stereo
PUSH BUTTON DICE, Dec. '78.....	£6.98

The INSTRUCTOR A FULLY CONSTRUCTIONAL PROJECT INCORPORATING AN INS8060 MICROPROCESSOR CHIP

The Instructor is a low cost assembly which provides a practical introduction to microprocessors and their functions. It is not a computer but it is a working circuit which allows microprocessor working to be followed, one program step at a time. Build the Instructor and you will gain microprocessor experience. The series is based on the INS8060 microprocessor IC, also known as the SC/MP Mk. 2. Circuits are built on a plug in Eurobreadboard. Kit is available with or without the breadboard. INSTRUCTOR COMPONENT PACK. Including Eurobreadboard £27.85; or less Eurobreadboard £21.65.

INSTRUCTOR COURSE NOTES AND OPERATING INSTRUCTIONS £2.96 extra.

C106D.....56p	2N5457...58p	BFY51...24p	LINEAR ICs	LM3900N...85p
TIC46...49p	2N5484...63p	BFY52...23p	555...32p	LM3309N...79p
OA47...11p	40673...98p	BFX88...32p	556...79p	LM3911N...£1.55
OA90...9p	AC128...29p	BRY39...48p	741...28p	LM3914N...£2.89
OA202...16p	AC141...38p	MPSA65...39p	748...55p	LM3915N...£2.98
W0.05...33p	AC142...39p	RPY58A	CA3080...£1.21	TB8A20...£1.05
W06...47p	AC176...37p		CA3085A...£1.32	MC3340...£2.59
Z5J...£2.92	BC182...11p	TIP31A...52p	CA3130T...£1.12	TLO64...£2.59
1N4001...52p	BC182L...11p	TIP32A...83p	CA3140E...57p	U237B...£1.69
1N4005...6p	BC183...11p	TIP33A...94p	HA1388...£2.85	ULN2883B
1N4148...5p	BC184...11p	TIP34A...99p	ICL7611...£1.04	
1N5404...18p	BC184L...11p	TIP121...£1.12	ICL8038CC	
TN5408...19p	BC212...11p	TIP2955...69p		£3.92
BF244B...45p	BC212L...11p	TIP3055...69p	ICM7555...£1.19	ZN1034E...£2.19
MPF102...89p	BC213...11p	TIS43...38p	LF351...58p	ZN414...£1.09
TIS88A...57p	BC214...11p	TPSA13...35p	LF353...96p	ZN419CE...£2.59
VN67AF	BC214L...11p	2N3053...25p	LF356...99p	ZN424E...£2.14
	BD131...48p	2N3055...59p	LM301AN...39p	ZN425E...£5.98
	2N3819...28p	2N3702...11p	LM309K...£2.99	
	2N3820...78p	BFY50...25p	LM317K...£3.56	
			LM317T...£2.55	
			LM324N...79p	
			LM380N...99p	
			LM381N...£1.98	
			LM382N...£1.62	
			LM386N...£1.04	
			LM387N...£1.39	
			LM389N...£1.29	
			LM1830...£2.32	
			LM2917N...£2.27	

1/4W, carbon film resistors, E12 series, 1R-10M, 1/2p each. Min. horiz. presets 100R-4M7, 12p each. Midget pots, Linear, 470R-4M7, 37p each. Log 4k7-2M3, 38p each. Switched pots, 4k7-1M, Ln. 75p. Log. 76p.

Polyester (C2B0) capacitors 250V 10nF; 15nF; 22nF; 33nF; 47nF 7p ea. 68nF; 100nF 8p. 150nF; 220nF 12p. 330nF 15p. 470nF 20p. 680nF 28p. 1uF 33p. 1.5uF 49p. 2.2uF 65p.

Sub miniature plate ceramics 63V. Values in pF: 2.2; 3.3; 4.7; 5.6; 6.8; 8.2; 10; 15; 22; 33; 47 & 56pF 7p each. 68pF; 100pF 7p each. 150; 220; 330pF 11p. 390pF; 470pF; 1000pF 5p. 2200pF 6p. 3300pF; 4700pF 7p. 10nF 13p. 100nF 22p. 47nF 14p.

Electrolytic capacitors, AXIAL leads:
 - 1uF/16V 11p; 1uF/63V, 1uF/100V 12p; 2.2uF/63V, 3.3uF/63V, 4.7uF/63V 12p; 10uF/16V 11p; 10uF/63V 12p; 22uF/25V 12p; 22uF/63V 15p; 33uF/40V, 47uF/25V 12p; 47uF/25V 12p; 47uF/40V 15p; 47uF/63V 18p; 100uF/16V 12p; 100uF/25V 15p; 100uF/40V 18p; 100uF/63V 29p; 220uF/10V 15p; 220uF/25V 19p; 470uF/16V 29p; 470uF/40V 55p; 680uF/16V 32p; 1000uF/10V 30p; 1000uF/16V 33p; 1000uF/40V 46p; 1000uF/63V 53p; 1000uF/63V 79p; 2200uF/10V 39p; 2200uF/25V 64p; 2200uF/63V £1.10.
RADIAL leads:
 - 0.47uF/25V 81/2p; 10uF/16V, 22uF/16V, 47uF/16V, 100uF/16V, 100uF/25V 121/2p; 220uF/63V 391/2p; 1000uF/16V 351/2p; 2200uF/16V 641/2p.

Switches
 Min. toggle: spst 59p; spdt 69p; dpdt 79p. Min. push on 18p; push off 22p. Footswitch alt. action: spco £1.39; dpco £1.88. Rotary switches: 1p 12 way, 2p 6w, 3p 4w, 4p 3w 69p each. 12V 185R dpco relay £2.98.

Soldering
 Antex X25 soldering iron, 25W £4.98. Soldering iron stand £1.99. spare bits (for X25) small, std, large 64p each. How to solder sheet 12p. Solder bobbin 30p. Desolder pump £5.98. Desolder braid 69p. Solder, handy size 98p. Heat sink tweezers 15p.

Multimeter type 1, 1000opv with probes, 2" x 3/2" x 1".....	£6.66
Multimeter type 2, 20,000opv inc. transistor tester.....	£14.75
Croc clip test lead set, 10 leads with 20 clips.....	99p
Connecting wire pack, 5x3yd coils.....	65p
Resistor colour code calculator.....	21p
Towards International Transistor Selector.....	£10.35
AM-FM aircraft band portable radio.....	£8.98
2 station desk intercom.....	£8.98
Plug-in power supply, 4.5V, 6V, 9V, 300mW.....	£3.98
Dimmer switch.....	34p
PVC tape - 3 reels.....	£2.85
Dentists inspection mirror.....	£2.85
Jewellers eyeglass.....	£1.50
Hand magnifier, 3".....	£2.99
Illuminated magnifier, 1 1/2".....	£1.14 3"
	£3.19

Opto	ORP12...99p
8FX25...£2.24	TIL32...81p
2N5777...60p	TIL78...74p

I.c. sockets		
8 pin.....16p	18 pin.....22p	
14 pin.....17p	24 pin.....48p	
16 pin.....18p	28 pin.....45p	

L.e.d.s with clips
 3mm: Red 15p; Green 18p; Yellow 20p. 5mm; Red 16p; Green 19p; Yellow 21p. Flashing l.e.d. 78p. Rectangular red 58p. Mains panel neon 32p.

Zener diodes 400mW, BZY88. Range 2V7 to 33V 12p each.

Denco Coils
 DP Green Range 3, Range 4, Range 5 £1.85 each. B9A valveholder 59p.

Jackson
 300pF dilecon £2.36. 500pF dilecon £2.92. C804 var. capac. 10pF £2.28; 25pF £2.46; 50pF £2.48; 100pF £2.83; 150pF £3.48. '01' 365pF £3.48; '02' 365pF £4.49; '02' 208+176pF £3.98. 4511 DAF 6.1 drive £1.74.

Low cost cutters £1.69. Low cost long nose pliers £1.68. Wire strippers and cutters £2.48. P.c.b. assembly jig £11.98. P.c.b. etching kit £4.98. Plastic tweezers 69p. Eurobreadboard £6.20. Bimboard 1 £6.48, S. Dec £3.98.

Speakers miniature, 8 ohm 87p; 64-75 ohm 89p. Crystal earpiece 65p. Magnetic earpiece 15p. Mono headphones £2.98. Stereo headphones £4.35. Telephone pick-up coil 72p. FM aerial 49p. Min. buzzers 6V 50p; 9V £1.10; 12V 65p.

PP3 clips 10p; PP9 clips 11p. Panel meters 60x45mm £4.99 each. 50uA, 100uA, 1uA, 1A, 25V.

Veroboard 0.1" copper
 10 strips, 24 holes £1.20 per 5. 24S 37H 78p. 24S 50H 89p. 36S 37H 89p. 36S 50H 99p. Terminal pins 48p/100. Pin insertion tool £1.69. Spot face cutter £1.23.

INTO DIGITAL ELECTRONICS

Current H.E. series Part 1 in Sept. '80. Covers digital electronics from the basics. Circuits are built on a plug-in Eurobreadboard. Reprints of back issues available 45p each. Eurobreadboard and components for series £18.95 less battery. Components only £12.75.

INTO ELECTRONICS CONSTRUCTION

H.E. 6-part Series: Feb. '80 to July '80. COVERS THE BASICS OF ELECTRONICS - LOTS OF PRACTICAL WORK. Circuits are built on a plug-in Eurobreadboard. REPRINTS AVAILABLE, 45p each part. Eurobreadboard and Components for Series £15.63. Components only £9.43.

INTO ELECTRONIC COMPONENTS

NEW SERIES: Eurobreadboard £6.20. Test Lead Kit Type IEC, parts for 2 leads, croc. clips to 4mm banana plugs 62p. Solid core wire, ideal for making links on Eurobreadboard, 10 metre length, 50p.

MEMORY BANK SYNTHESISER

Miniature synthesiser featuring vibrato, envelope tempo, volume and pitch controls. Uses 24 push button switches in a keyboard style layout. Based on a custom designed IC. The accessible memory stores a 32 beat length sequence of notes and spaces. Can be played 'live'. Fitted with an internal speaker. Jack socket allows the use of an external amplifier if wished.

Memory Bank Synthesiser £33.85

3 BAND S.W. RADIO

Simple TRF Design. Covering most Amateur Bands and Short Wave Broadcast Bands. Five controls. Bandset. Bandspread Reaction Wavechange and Attenuator. Coil section is by Wavechange Switch. Use with Headphones or a Crystal earpiece. Kit contains all the components required including the P.C. Board and Case. Instructions are included with this kit. KIT £18.97. Headphone extra £2.98.

MAGENTA ELECTRONICS LTD.

HL12, 135 HUNTER ST., BURTON-ON-TRENT, STAFFS. DE14 2ST
 0283-65435 - 9-4 MON.-FRI. MAIL ORDER ONLY

ADD 40p P&P TO ALL ORDERS

All prices include 15% VAT
 Official orders welcome

Inish Republic & B.F.P.O. Europe deduct 10% from prices shown. Payment must be in sterling.
 Access and Barclaycard (Visa) orders accepted by phone or post.



Into Electronic Components

The second part of this beginners' series on the components we use in electronics deals with the measurement of voltage, current and resistance. Ian Sinclair tells you how to make these measurements, using the HE Multitester (see special offer on page 50)

I MENTIONED Georg Simeon Ohm last month. His name has been given to a law (Ohm's law) which we use more than any other in electronics, and one which must be understood and used correctly if we are to make any real progress. Even today, more than a century after he lived, Ohm's law is often misunderstood, so this looks like a good time to set the record straight and look at the quantities his law deals with.

Quantities

We can start with the quantities voltage and current. Current is the flow of electricity and is measured in amperes (amps); voltage is the 'push' that drives the current along, and is measured in volts. In a circuit, the more volts you use the harder the 'push'; that is, the current increases.

Our idea of resistance to the flow of current is expressed as the ratio volts/current (ie, voltage divided by current). The unit of this quantity is the ohm, so we could just as easily call the ohm the volt/amp.

A lot of people get that far — and then stick. The trouble is that electric current is invisible, and it can be difficult to concentrate well on invisible quantities. To get around this, it's easy to compare electric current with something more tangible, like water in a pipe. The movement of water in a pipe is something like electric current, and the pressure of the pump that makes the water move through the pipe is something like electric voltage. Let's imagine now that one section of pipe (Fig. 1) is narrower than the rest of the pipe in the 'circuit'. A narrow pipe is a high resistance for the flow of water, and the water will need to have quite a high pressure to keep up a good rate of flow

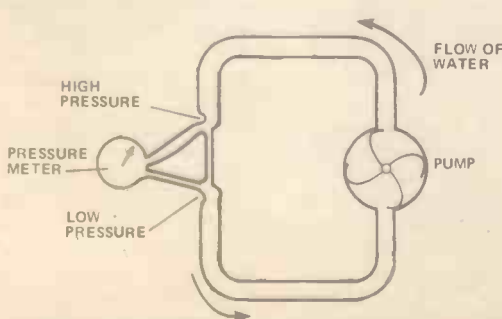

Figure 1. Pressure in water pipes. Most of the pressure caused by the action of the pump is needed just to keep water flowing through the narrow section of pipe

through the narrow piece of pipe. We can measure this pressure difference between the ends of the narrow piece of pipe, using a pressure meter (called a manometer, if you want to know!).

Now the pump provides all of this pressure, and thus we can measure a pressure difference across the pump also; but there's an important difference between these two measurements. Suppose we clamped the pipe closed at each side of the pump (Fig. 2). There is still a pressure difference between the ends of the pump but there is no pressure difference across the narrow piece of pipe, because the pipe is no longer connected to the pump. The pressure across the piece of narrow pipe was caused by the pressure of the pump.

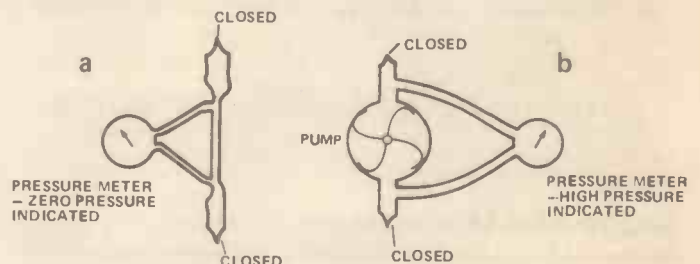

Figure 2. Comparing pressures: (a) the narrow piece of pipe does not cause pressure, it's the pump (b) which causes the pressure

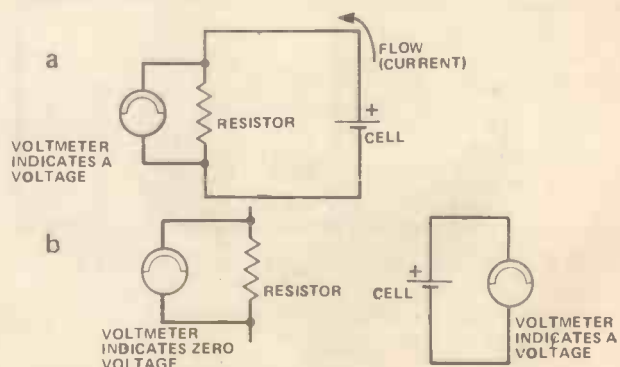

Figure 3. The electrical circuit: (a) there is a voltage across any resistance in the circuit — this is just the amount needed to make current flow. Just like the water circuit, there is no voltage across the resistance by itself (b), only across the 'pump', in this example a battery

Now let's go back to the electric circuit (Fig. 3). The 'pump' for an electric circuit is the battery or generator which can push electrons round a circuit. If we have a resistor anywhere in the circuit, we will measure a voltage across it as long as there is a current flowing (when it's connected to the 'pump'), but not when the circuit is broken, because the resistor is not a generator.

Whenever a current flows through a resistor, then, it's possible to measure a voltage between the ends of the resistor. The amount of this voltage can be expressed by the equation:

$$V = IR,$$

so that if we have a current of 0.2 amps (abbreviated to 0.2 A) and a 20 ohm resistor (ie, a 20R resistor), then the voltage is calculated by

$$V = 0.2 \times 20,$$

which is 4 volts (ie, 4 V). We can also apply this equation to a complete circuit. Suppose the 20R resistor is part of a circuit whose total resistance is 50R. If we connect this to a battery whose voltage is 10 V, then the current (see Table 1) is given by

$$I = V/R,$$

which in this example is 10/50, equal to 0.2 A.

VOLTS, AMPS, OHMS	UNITS
$V = I \times R$	V IN VOLTS
$R = \frac{V}{I}$	R IN OHMS
$I = \frac{V}{R}$	I IN AMPS

Table 1. The three versions of the electrical circuit law which we know as Ohm's law

The common mistake that many of us make is to call the $V = IR$ equation (along with derivatives $I = V/R$ and $R = V/I$) 'Ohm's law'. It isn't, but it's a handy name, because the use that we make of the equation depends so much on Ohm's law. What Ohm's law actually states is simply that the quantity, resistance, is a constant for a sample of metal at a constant temperature. If this wasn't true, we could not use the equation $V = IR$ so freely, because we would have to use a different value of resistance for each different value of voltage or current. You'll appreciate that point a lot more when we come to deal with diodes in Part 6 of this series.

More of that later, because we have to look now at how we are going to use the multimeter in practical measurements, and before we can do that, we need to know some more about the multimeter itself.

Inside The Multimeter

At the heart of the multimeter is a moving-coil movement. This consists of a shaped magnet (Fig. 4), whose poles enclose a tiny coil of wire. The coil is supported by thin wires (which act as

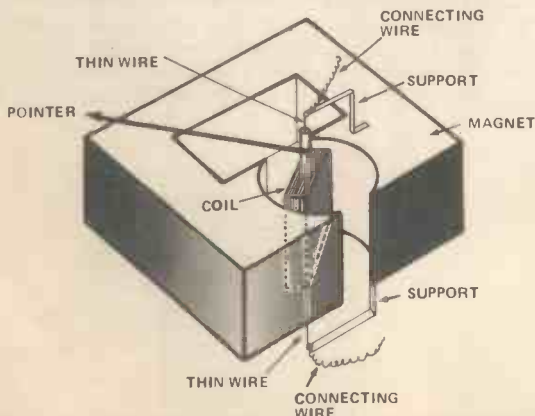

Figure 4. Action of a moving-coil meter. The coil is free to rotate between the poles of a strong magnet, and is retained by a set of thin wire springs. Current flowing through the coil causes a force which rotates the coil

springs), and it carries on its shaft the pointer which swings over the dial to show the readings of the multimeter. Connections are made through the thin wire springs to the ends of the coil, so that current can be passed through the coil.

Yes, that's right — current. That's the quantity that causes the needle to move over the scale, no matter what you think you are measuring. When a wire is close to a magnet, and there is a current flowing through the wire, a force exists between the wire and the magnet. How much force? It depends on how much current is flowing, and that's why we use this principle.

The coil of wire has, of course, a resistance, which is called the internal resistance of the movement. The movement will also deflect full-scale (as far as the pointer can travel) for some measurable amount of current, and this amount is called the FSD (full scale deflection) current. The size of this FSD current depends on how strong the magnet is, and on how many turns of wire are on the coil, and also on the size of the coil — but these are problems for the designer of the movement.

Multimeter Design

Knowing these values, internal resistance and FSD current, we can design a multimeter, using the moving-coil movement. Let's take, just for starters, the current ranges. Suppose we have a movement where FSD is 50 uA and the internal resistance is 500R: fairly typical values for modern movements (the HE meter is better than average, with its FSD of 18 uA). Now, as our imaginary movement comes, it can't measure any amount of current greater than 50 uA, which isn't much good if you want to measure milliamps.

No, you don't have to make a different movement to measure a higher current range! All you have to do is to split the current so that only a constant fraction of it goes through the movement — and design things so that the fraction is no more than 50 uA. It's like saying that only 100 cars per hour can go down the High Street, but cars can go through the town at a rate of 300 per hour. The solution just has to be to send 200 of them along another route, and that's the type of solution we use to measure currents which are larger than the FSD. The 'other route' is a resistor which is connected in parallel with the meter movement, as in Fig. 5. Now this doesn't just send some current another way, it always sends the same fraction of the current the other way. For example, if we fix it so that 3/4 of the total current goes through the resistor and 1/4 through the meter, then these ratios apply to each value of current. Put in 40 uA, and 30 uA goes through the resistor and 10 uA through the meter. Put in 100 uA, and 75 uA goes through the resistor and 25 uA through the meter movement.

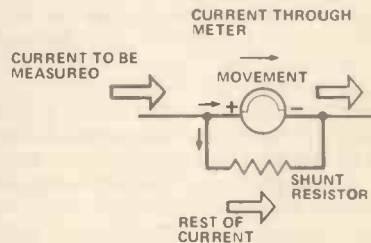

Figure 5. Using a shunt resistor to take a definite fraction of the total current past the coil. This lets us measure currents which are much too high to pass through the coil

By using these resistors, called shunts, we can adapt a moving-coil movement for larger values of current than the FSD current. There's no change in the movement, though. The FSD does not change, it's just that when the needle indicates full-scale, the total amount of current is greater, because there is current passing through the resistor as well.

We can also adapt the movement to read volts, by making use of Ohm's law. Suppose we have a movement with 1 mA FSD, internal resistance of 100R, and we want to be able to measure 10 V. By Ohm's law, if we use metal (or carbon) for the resistor, it will have a constant amount of resistance, so we can use $V = IR$. For 1 mA to flow with 10 V applied means that the total resistance in the circuit must be 10k. We could, of course, wind a coil for the movement which would have a resistance of 10k, but that's not needed. All we need to do is to connect a resistor in series with the movement, as in Fig. 6, so that the total resistance is 10k. Since the meter movement has 100R of

internal resistance, we need to add 9900R to make up the 10k, and that's the value we would need to connect in series with the movement.

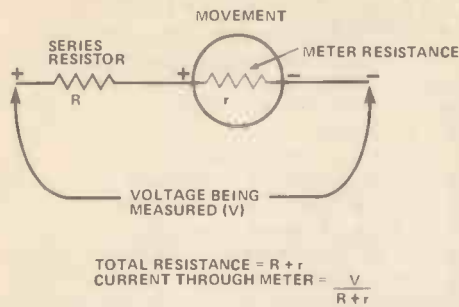

Figure 6. Using a series resistor for voltage ranges. The series resistor will pass an amount of current which depends on the voltage (Ohm's law), so that the meter reading is proportional to voltage

Going Ohm

Next problem — how do we get a multimeter to read in ohms? The answer is to use the meter to indicate the current which a small battery passes through the resistor — and that's why the multimeter contains a dry cell or a battery (both in the HE meter, accessible when you unscrew the two screws at the back and carefully take the two halves of the meter apart).

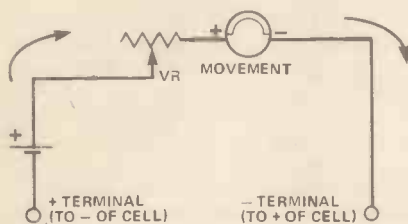

Figure 7. Meter arrangement for resistance measurements. A cell inside the meter is used to provide a voltage to pass current through the resistance, and the movement measures the current. Note the reversed voltages at the terminals

The circuit is shown in Fig. 7. When you switch to the OHMS range, the positive terminal of the internal battery is connected to the '-' of the movement, and the negative terminal of the internal battery is connected to one end of a variable resistor — the OHMS SET resistor. The other end of the variable resistor is connected to the '+' terminal of the meter — which is now a negative terminal because it is connected to the negative terminal of the battery! The negative terminal of the movement is still connected to the negative terminal on the meter case.

Now when we connect the multimeter terminals together, shorting them out, the amount of current that flows depends on the amount of resistance in the circuit — and all of that resistance is in the OHMS SET variable resistor. We can set this so that the amount of current that flows is equal to the FSD current of the meter. Since the terminals of the multimeter are shorted together, this reading corresponds to having zero ohms connected to the terminals, and the FSD of the meter is marked as zero ohms on the ohms scale. When we now connect a resistor between these terminals, this will add to the total resistance in the circuit, so that the current is less, and the reading on the dial is less. The OHMS scale is not linear — equal distances along the scale do not correspond to equal amounts of resistance. For example, if the variable resistor has to be set to 60k (using a 3 V battery and with a meter of 50 uA FSD), so that this passes the FSD current, then connecting a 25k resistor across the terminals will make the total resistance equal to 85k, so that the current becomes 3/85 mA, which is 35 uA. Now if we use a 50k resistor across the terminals, the total resistance will now be 110k, and the current will be 27 uA, which is certainly not half of 35 uA. The first 25k of added resistance causes a drop in current of 50 — 35 uA, equal to 15 uA, and the next 25k we add (to give 50k) causes a drop in current from 35 uA to 27 uA, ie, only 8 uA.

This causes the OHMS scale to have its markings widely

separated at the low-resistance end, but cramped very closely at the high-resistance end of the scale, so that the difference between, for example, 1k and 2k on the OHMS x 1 scale of the HE meter is almost impossible to measure. That's why we need more than one ohms range, and the correct one to use is one which gives a reading around the middle of the scale, definitely not at the cramped left-hand side.

The measurements of voltage, current and resistance are the three important ones for the work that we'll be doing — we won't be using the AC volts range in this series, because everything we need to do can be done using a battery supply. We're dealing with components and their actions, after all, not with large circuits.

Practice Makes Perfect

Now to more practical matters, and a closer look at Ohm's law. Start by placing a 1kO resistor (see Fig.8 for the colour identification) on the Eurobreadboard. The resistor has two leads, and they must never be put into holes on the same line, because if you do, the resistor is not in any kind of circuit. Give yourself some space, put one lead of the 1kO resistor into line Y1 and the other in line 5A. Also in line 5A, plug in a short length (a couple of inches or so) of tinned copper wire, of around 18 SWG. Don't on any account use stranded wire, because it tangles with the Eurobreadboard spring clips and won't come out again without a struggle.

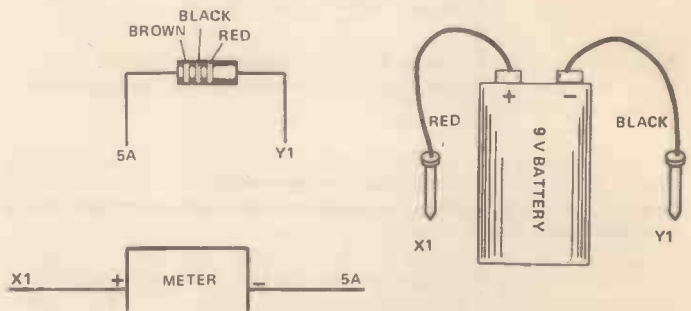

Figure 8. Reading current through a resistor. The markings at the ends of the leads in the drawings are the Eurobreadboard hole reference numbers/letters

Now connect the battery, which by this time you should have fitted with wire leads ending in single-strand wire or pins. The negative ('-', black) lead of the battery should be plugged now into line Y1, and the positive ('+', red) lead into line X1. These are the lines that we'll use throughout this series for the power supply leads.

We can now measure how much current a 9 V battery will send through a 1kO resistor. Set the meter to its 50 mA range, and clip the negative lead of the meter to the piece of tinned copper wire which is in line 5A. Now clip the positive lead of the meter to the end of the battery lead which is in line X1 (see Fig.8). The circuit which you have made is shown in Fig.9 — the battery is pushing current through the meter and also through the 1kO resistor. All the current that flows through the 1kO resistor has had to pass through the meter, so what we measure on the meter is the current through the resistor. If you're using the HE meter, switch to the more sensitive 25 mA range by putting the slider switch to its VA/2 position, and take another reading.

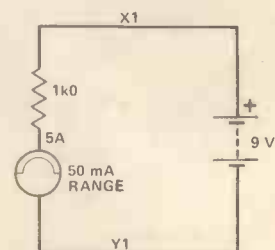

Figure 9. The circuit of the arrangement shown in Fig. 8

We could also calculate how much this current should be.

Using the Ohm's law equation for current I,

$$I = \frac{V}{R}$$

$$= \frac{9}{1000} = 0.009 \text{ A,}$$

ie, 9 mA. The meter reading should be somewhere near this. Why just 'somewhere near'? Well, as we'll see, nothing is ever exact in the world of electronic components. Generally, if you get to within 10% of a calculated value, you're close enough, because mass-produced components are never exactly the values that they claim to be. This is a matter of tolerances, which we'll look into next time.

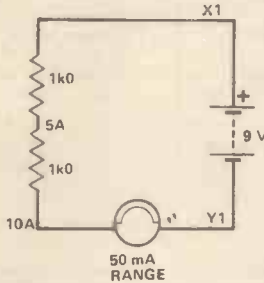

Figure 10. A pair of resistors (both 1kΩ) connected in series. The Eurobreadboard numbers show how the resistors can be positioned on the Eurobreadboard

Now have a look at the circuit in Fig. 10. This is shown as a circuit diagram, with the Eurobreadboard line numbers written in so that you can place the components in the same locations as I am using for the circuit right here in front of me. The way these resistors are connected here is called a series connection, and the meter will measure the current through them. How much current is flowing? Note the value, because the Ohm's law equation can make use of this value to calculate the total resistance, using $R = V/I$. How does this calculated value of total resistance compare with the value you get by adding the values of the two resistors?

This type of connection is a series connection, and the result of a series connection of resistors is always more resistance — the sum of the resistor values. Now try the circuit in Fig. 11. The resistors are in the same lines, so the current will split up, and some of it will flow through each resistor. Measure this total current. How much current do you think should flow through each resistor? Now calculate the total resistance, which is expressed as:

$$\frac{9 \text{ V}}{\text{Total current}}$$

and compare this value with the value for each resistor, 1kΩ.

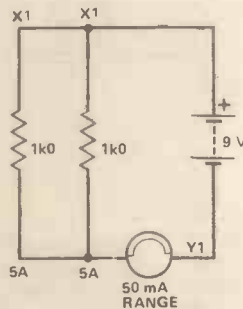

Figure 11. Two resistors in parallel

Connecting resistors in parallel like this always results in a lower total resistance value. Now try the circuit in Fig. 12. The resistors are both 1kΩ, and this time we'll measure the voltage

across just one of them. Switch the meter to its 10 V range (with the slider switch in its VOA position), and clip the - COM lead to the Y1 battery connection. Plug the red probe lead into the + input of the meter, and touch the end of the probe against the resistor wire in line 5A (either wire in this line). Theory tells us that the voltage should be 4.5 V.

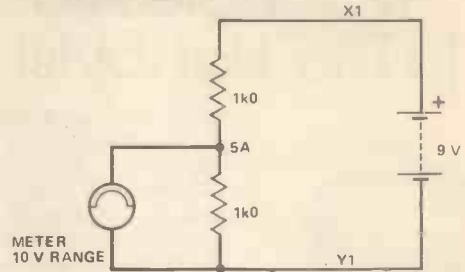

Figure 12. Potential divider circuit. The meter is set to measure the voltage across one of the 1kΩ resistors. This value should be almost exactly half of the battery voltage (remember that the resistors can be 20% high or low)

Now repeat using two 1MΩ resistors (Fig. 13). Theory tells us that the voltage should still be 4.5 V — but see what you measure with the meter 'negative' (black) lead connected to line Y1, and the positive probe lead on line 5A. Less than 4.5 V?

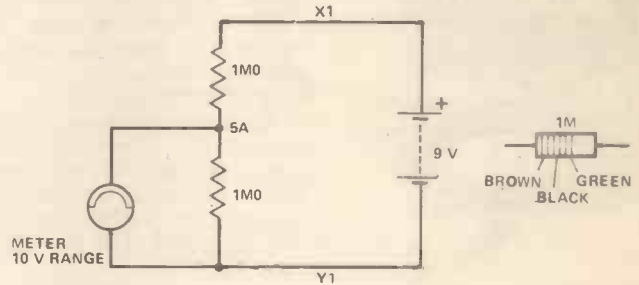

Figure 13. Potential divider circuit, this time using two 1MΩ resistors. What voltage do you find this time? With no meter connected, the voltage is still equal to half the battery voltage

Nothing wrong with the theory — the problem is the way we're using the meter. As we said right at the start, the meter needs current. When it takes that current from a circuit, the voltage in the circuit changes — so the meter reading is of the voltage that has changed in a circuit. How do we know when we can rely on a voltage reading? As it happens, we do know when the readings of voltage should be reliable. For every meter, there's a 'goodness' factor, measured in thousands of ohms-per-volt, or k/volt. This figure, multiplied by the full-scale range of voltage that the meter is set to gives the total resistance of the meter when it is being used as a voltmeter. This resistance should be at the very least 10 times as much as the resistance between the supply + and the point where we are measuring voltage. For example, if we use the HE meter on its 10 V scale, then with a goodness factor of 25k/V, the total resistance of the meter is 250k. This is a lot more than 10 times 1kΩ, which is why we can rely on the measurements of voltage we read across the 1kΩ resistor in Fig. 12, but it's not high enough compared with 1MΩ, which is why the reading for the circuit in Fig. 13 is lower than it should be. There's nothing wrong with the meter — it measures the voltage which is present when it is connected. What it can't do is to measure the voltage that is present when it is not connected and so not affecting the current in the circuit.

Take care, then, with voltage readings in circuits where resistors with large values are present. If in doubt, repeat a reading using a higher range (25 V instead of 10 V, for example, using the slide switch of the HE meter to bring in a range which is of higher voltage and double the goodness factor, 50k/V instead of 25k/V). If the reading on the higher range is of a higher voltage value, then you have meter-resistance problems. The biggest giveaway is when every voltage range gives about the same amount of deflection of the needle — then you know you can't believe any of them!

Next month — we meet some resistance!

HE

Multitester Offer

Special Offer To HE Readers Only Invaluable Aid To The Hobbyist

THIS Multitester offers much more than a standard multimeter, as the specification shows. Apart from DC and AC voltage, DC current, resistance and decibel ranges, the HE Multitester has a range doubler for voltage and current measurements. Thus sensitivity on DC voltage ranges extends to 50k/V.

The meter dial is large (111 mm by 89 mm) and easy to read. It has a mirror strip to improve accuracy of readings.

The new series Into Electronic Components has been written around this Multitester. Although other instruments can be used in conjunction with the series, the HE Multitester is undoubtedly the best choice.

So take advantage of this special offer: the Multitester is supplied complete with test leads with probes attached, batteries and instructions for only £19 plus 95p post and packing.



Specification

- Overload protected by two silicon diodes
- Uses double-jewelled $\pm 2\%$ meter with mirror and $\pm 1\%$ temperature stabilised resistor

Measurement	Ranges	Accuracy	Remarks
DC Voltage	0-125-250 mV	$\pm 4\%$	Sensitivity 50k/V range doubled 25k/V normal
	0-1.25-2.5-5-10 -25-50-125-250 -500-1000 V	125 mV to 2.5 V 500 to 1000 V $\pm 3\%$ except as noted	
AC Voltage	0-5-10-25-50- -125-250-500 -1000 V	$\pm 4\%$ of full scale	Sensitivity 10k/V range doubled 5k/V normal
DC Current	0-25-50 μ A 0-2.5-5-25-50 -250-500 mA 0-5-10 A	Same as for DC voltage	
Resistance	0-2k -20k -200 k 0-2M-20M (centre scale 10)	$\pm 3\%$ of scale length	Batteries: one penlight 1.5 V one rectangular 9 V
Decibels	-20 to +62 dB		8-ranges
Size	H170 x W124 x D50 mm		
Weight	590g (battery and test leads included)		

Multitester-Only £19

To: HE Multitester Offer, Modmags Limited, 145 Charing Cross Road, LONDON WC2H 0EE

Please send me Multitester(s) at £19.95 including post and packing.
I enclose a cheque/PO made payable to Modmags Limited for £.

OR

I wish to pay by Barclaycard /Access. Please charge to my account number

BARCLAYCARD

VISA



Signature

Name
(BLOCK CAPITALS)

Address
(BLOCK CAPITALS)

Please note that the offer applies to UK mainland only: allow 28 days for delivery

HE Electronic Ignition – Additional Information

DESMOND ARMSTRONG, designer of the HE Electronic Ignition project published in last month's issue, asked us to pass on some additional information to readers.

If you refer to the circuit in Fig. 7 on page 13 of the August '81 issue, you will see a ballast resistor connected in series with the ignition switch. Although the circuit will function as shown, it is better to connect the red supply lead from the HE Electronic Ignition directly to the +12 V supply from the ignition switch, but retain the ballast resistor in series with the ignition coil (see revised version of Fig. 7 on this page).

Second point is about the mica washer for transistor Q2. To ensure reliability it is best to use a *thick* mica washer or, as Desmond suggested, two thin ones sandwiched together. Don't forget to smear a small amount of heat-sink compound on both sides of the washer (or washers) to improve heat conduction.

Desmond has just returned from a trip to Israel by Minivan – fitted with the HE Electronic Ignition, of course!

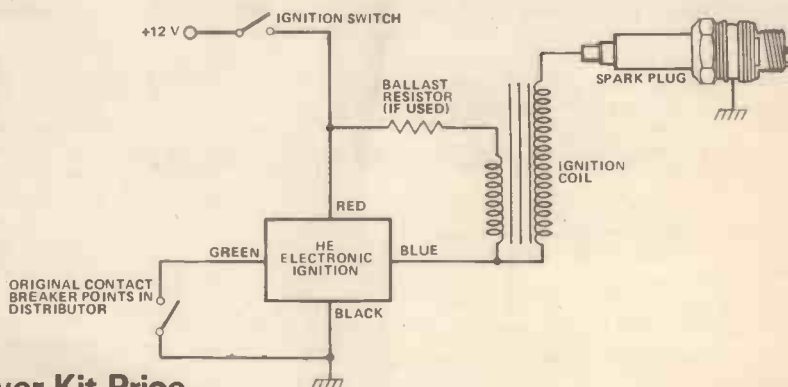

Lower Kit Price

Under Buylines on page 13 of the August '81 issue, we said that Technomatic was producing a kit for the HE Electronic Ignition project for £18.50 including VAT for callers (70p extra for postage and packing for mail order customers).

Technomatic has now reduced the price of its kit to £16 including VAT (add 70p for postage and packing).

Technomatic Limited, 17 Burnley Road, London NW10 (tel 01-452 1500 or 01-450 6597).

HE

HE Electronic Ignition connected to the standard Kettering ignition circuit. This is a corrected version of Fig. 7 shown on page 13 of the August '81 issue, where the ballast resistor was shown in series with the ignition switch. The correct position of the ballast resistor (if your car ignition system has one) is in series with the ignition coil, as shown above

ELECTRONIC IGNITION SAVES PETROL



More and more new cars use electronic ignition to give the best performance and economy. Bring YOUR CAR up to top specification by fitting the latest TOTAL ENERGY DISCHARGE electronic system.

TOTAL ENERGY DISCHARGE gives all the advantages of the best capacitive discharge ignitions:

- ★ **Peak Performance**—higher output voltage.
- ★ **Improved Economy**—consistent high ignition performance.
- ★ **Better Starting**—full spark power even with low battery.
- ★ **Accurate Timing**—prevents contact wear without 'contactless' errors.
- ★ **Smooth Performance**—immune to contact bounce effects.

PLUS

- ★ **SUPER HIGH POWER SPARK**—3½ times the energy of ordinary C.D. systems.
- ★ **OPTIMUM SPARK DURATION**—to get the very best performance and economy with today's lean carburettor settings.
- ★ **DESIGNED IN RELIABILITY**—with the 'ultimate insurance' of a changeover switch to revert instantly to standard ignition.

TECHNICAL DETAILS

HIGH EFFICIENCY INVERTER. A high-power, high efficiency, regulated inverter provides a 400-volt energy source—powerful enough to store twice the energy of other designs and regulated to provide full output even with the battery down to 4 volts.

SUPERS DISCHARGE CIRCUIT. A brand new technique prevents energy being reflected back to the storage capacitor, giving 3½ times the spark energy and 3 times the spark duration of ordinary C.D. systems, generating a spark powerful enough to cause rapid ignition of even the weakest fuel mixtures without the ignition delay associated with lower power 'long burn' inductive systems. In addition this circuit maintains the correct output polarity, thereby preventing unnecessary stress on the H.T. system.

SOPHISTICATED TRIGGER CIRCUIT. This circuit removes all unwanted signals caused by contact volt drop, contact shuffie, contact bounce, and external transients which, in many designs, can cause timing errors or damaging un-timed sparks. Only at the correct and precise contact opening is a spark produced. Contact wear is almost eliminated by reducing the contact breaker current to a low level — just sufficient to keep the contacts clean.

IN MONEY-SAVING KIT FORM at £14.85
Also MOTORCYCLE TWIN OUTPUT KIT at £22.94

Plus £1
UK P&P

All you need is a small soldering iron and a few basic tools — everything else is supplied with easy-to-follow instructions.



FITS ALL 6/12-volt NEGATIVE EARTH VEHICLES
ELECTRONIC DESIGN
 2 Hillside Road, Four Oaks
 Sutton Coldfield, West Midlands, B74 4DQ
 Phone 021-308 5877



ELECTROVALUE

BEST SELLERS...

Rechargeable Cells by SANYO-CADNICA Size AA 99p, C 2.27, D 3.76, PP3 4.10 With tags AA 1.06, C 2.43, D 3.99
 Chargers PP3 4.75, AA 4.95, A.C.D 7.60. Plastic boxes PB1 116 x 77 x 35mm 62p
 Breadboards Euro 5.70N, Veroblock 3.63, Bimboard 8.03, Buzzer 6-15V 80p
 CAPACITORS Polystyrene 47-4700pF ea 7p, C280 01.6p, 1.7p, 22.9p (full range) Polyester (PCM 7.5mm) 001.6p, 0047.7p, 056.8p, 1.9p, (PCM 10mm) 1uF 26p (Many more values in this range). Variable Dilecon 100pF 2.08, 500pF 3.21

ELECTROLYTICS Full range
CONNECTORS ¼ jack plug 32p, skt 12p, 3.5mm jack plug 17p, skt 14p, 2.5mm 12p DIP header 14 pin 38p, 16 pin 43p. Quick test mains block 5.25. Fuse holders 20mm panel 22p, chassis 6p. Hall-effect devices from 1.89N. Heat sinks Power 1.25" C/W 2.85, finger type 103.25p, 10220.25p

INTEGRATED CIRCUITS Hundreds of types 741 18p, 555 23p, CA3140E 40p, LM380N 99p, LM3914N 2.68, S566B 2.14, TCA965 1.20 IC holders 8 pin 9p, 14-40 pin 1p per pin. Knobs, screw fitting ¼ from 16p. Loudspeakers 2½" 8 or 64 ohms 93p. Magneto resistors from 1.60N. Meters, panel 60x45mm 50uA-1A ea 4.80. Opto LEDs red 7p, yellow 9p, green 11p, ultrabright 21p all colours. LED drivers UAA170/UAA180 ea 1.52

POTENTIOMETERS Carbon 20mm dia 100R-2M2 1in, 220R-4M7 log single 29p, 1K-2M2 1in, 4K7-2M2 log duals, ea 81p. Add 51p if required with switch. Sliders mono 72p, stereo 1.18, bezel 34p. Wirewound 25R-10K, 3watt ea 1.50

PRINTED CIRCUIT MATERIALS
 300 x 150mm S/S SRBP 1.25, 1/gl 1.90, 500gm ferric chloride lab grade 3.40
 Positiv 20 photo resist 74ml 1.65. Etch resist pen 1.05, silver paint 3g 4.14N
 Relays 12v coil 3P2W 10A contacts 2.90. Resistors ¼W, ½W, 1W 5% ea 2p. Metal oxide TR5 2% 5p, film NR25 5P. Semiconductors 1N4007 6p, 1N4148 3p, RCA2N3055 70p, BC107-9 family 14p, BC182/212 family 9p, BFR34A 63p, BFT65 1.19, C106D1 45p, TIP31A/32A ea 44p, TIP41A/42A ea 45p, TIP2955/TIP3055 ea 55p. Solder 500gm 60/40 20SWG 7.30N. Irons Antex C, CCN, CX or X25 ea 4.40N. Oxyx50 temperature controlled 11.50N. ISO-TIP cordless with charger 24.00N

SWITCHES Slider DPDT min 18p, std 20p. Wavechange 1P12W, 2P6W, 3P4V, 4P3W ea 40p. Time Switch 13A 3on/3off per day 14.68N. Min toggles silver contacts SPDT 57p, DPDT 80p, 3PDT 1.64, 4PDT 2.75. DIL gold plated DPST 95p, 10PST 2.10
 Miniature drills - 12Vdc TITAN 10.28N. TITAN kit 17.06N. Stand 12.00N. Tools CK pliers - 10, cutters 6.10, strippers 4.95. Vero wiring system kit 4.42, wire 1.17. Computer Nascam 1 built £140.00N.

NASCOM
 2 kit £295.00 complete (less 8X4118's £225.00N) P/S kit, 3amp 32.50N, 16K RAM kit 110.00N
 Add VAT at 15% to all prices.
 Small order surcharge 40p if under 5.75. No inland P&P on CWO orders.

ELECTROVALUE LTD. DEPT. H7, 28 St. Judes Road, Englefield Green, Egham, Surrey TW20 0HB. Phone Egham 33603 (STD 0784. London 87). Telex 264475.
 Northern Branch (Personal Shoppers only) 680 Burnage Lane, Burnage, Manchester M19 1NA. Phone (061) 432 4945.

BEST SERVICE

★ **FOR KEEN BUYERS!**
 S.A.E. brings comprehensive price list (Valid 3 mths). Covering catalogue '81

Access and Barclaycards accepted

Everything brand new & guaranteed

Hard to find items

Keen prices & discounts

Special quantity discounts

Speedy turn round on orders

No P/P charges on U.K. C.W.O. orders over £5.75. (Add handling charge of 40p if under)

★ Please add 15% V.A.T. to total value of all orders

★ Shop hours: 9-5.30; Sats. to 9-1p.m.

BUILD YOUR OWN HIGH ACCURACY 3½ DIGIT PANEL METER

Teledyne Semiconductor has introduced two evaluation kits for the new 7106/7107 3½ Digit Monolithic CMOS A/D Converters. The kits are simple to use and will measure AC and DC voltages, multi-range DVMs, resistance currents, temperatures and other physical dimensions.

The 7106 kit uses a liquid crystal display and is normally powered by a single 9V battery. It is portable, can be used inside or outside and will not fade in sunlight. The 7107 kit uses light emitting diode displays and requires an external power supply. It operates under normal indoor ambient light conditions. Both kits include parts for 200MV full scale. The kits use the I.C. internal reference, which at 100ppm is adequate for most applications. However, they can be modified to operate from an external reference where higher stability is required.

Each evaluation kit contains one I.C. (either 7106 or 7107), one display (either LCD or LED), a PCB, passive components, miscellaneous hardware and a detailed 6-page application note.

The comprehensive application note contains all assembly instructions.

THE 7106 EVALUATION KIT COSTS £17.44 + V.A.T.

THE 7107 EVALUATION KIT COSTS £14.31 + V.A.T.

Greenway Electronic Components

(EAST GRINSTEAD) LTD.

62 MAYPOLE ROAD, ASHURST WOOD, EAST GRINSTEAD, SUSSEX RH19 3RB

TEL: FOREST ROW 3712 (STD 034-282)

D.I.L. MINIATURE SWITCHES Gold-plated contacts. Sealed base ideal for programming 6-position at less than half manufacturer's price. ONLY 75p Will fit into 14-pin DIL socket. Tan at 85p ea., per 100 55p ea.	HONEYWELL PROXIMITY DETECTOR integral amplifier, 8v D.C. £3.50 ea. PHOTO CONDUCTIVE CELL £1.25. High-power Cds cell, 500mW for control circuits. Resistance 800 ohm to 4K. Max. volts 240. Size 1½ x 1½in. RESON MICROPHONE with pre-amp on chassis. £1.75	MULLARD MODULES LP1171 IF Strip £1.75 LP1179 AM, FM Front and Rear Pair £5.75 Complete with Data LP1157 Med. & Long Tuner £2.50 LP1185 varicap £5.00	ULTRA SONIC TRANSDUCERS 40K.C.S. Complete on 18in. Screened cable. £1.75 each, pairs £2.95 ULTRA SONIC TRANSMITTER. Complete unit (uncased requires 1.5V) £2.25. FOSTER DYNAMIC MICROPHONES. 200 ohm impedance. Moving coil. Complete on chassis. £1.75 pair.
DL747 LITRONICS One-inch Jumbo Display. Red Common cathode. £1.35 Dual in-line package with data. Very bright.	LM380 Amplifier 75p LM318N Hi-Slew Op Amp £1.50 LM323K, 5v 3-amp. reg. £3.00 LM310N Volt. Follower Amp. £1.20 LM311H High Perf. Volt. Comparator £1.80 LM384N, 5-watt Amp £1.20 LM393N Dual Comparator 80p	CRYSTALS COLOUR TV 4433619 mcs £1.25 Miniature type sealed 7905 Voltage Regulator 1 amp 10220 Negative - Motorola 80p	CMPS 2102 450 n/s £1.00 2114 300 n/s £1.75 4116 200 n/s £1.50 2132 450 n/s £7.50
SET OF 6 FOR £8.50	MONSANTO Half-inch - 1 Display High Intensity £1 each set of 4 £3.50 Common anode 14 Pin Oil Package	STEREO CASSETTE TAPE HEADS. Quality replacement for most recorders with mounting plate. Record/Replay £2.00 MARROTT TAPE HEADS Quarter track. Type: XRP518 Record/Replay (each) £2.00 XRP536 Record/Replay (each) £3.00 XES11 Erase (each) £1.00	HEWLETT-PACKARD DISPLAYS 15082-7650 HIGH EFFICIENCY ANO VERY BRIGHT Only £1.00 each Set of 6 for £5 Half-inch red common cathode will replace DL707, 14-pin Oil.
RELAY (General-purpose Type) 4/2-9v single-pole changeover. 200 ohms (open type), 1 x 1 x 1 inch. 80p. MINIATURE M.P.C. POTENTIOMETERS. Model M2 High-quality, 5% tolerance, 2-watt, with 1in spindles. All values, 47 ohms-47k only 80p each, per 100, 50p each per 100, 40p each.	RECHARGEABLE BATTERIES VARTA 3.6 volts DEAC. M/AAH 225 £1.50 DRYFIT 6-volt, 4.5 amp £7.50	'CHERRY' ADD-ON KEYPAD A compact 12-button keypad suitable for use with Cherry Keyboard to extend its functions plus four extra keys. Supplied brand new with data. A 3 x 4 non-encoded single mode keyboard in sloped format.	LIST PRICE £22.00 OUR PRICE £3.50 + V.A.T.

QUANTITY DISCOUNTS on ALL items (unless stated), 15% per 10, 20% per 50, 25% per 100. All items BRAND NEW (unless otherwise stated). DELIVERY from stock - All post paid. Please add VAT. EXPORT enquiries invited.



01-723 1008/9

404 EDGWARE ROAD, LONDON W2 1ED

Tune in to the airwaves with this easily-built project which offers worldwide reception of short wave transmissions at a low cost

Short Wave Receiver

A COMPLEX COMMUNICATIONS receiver is a difficult constructional project and is also likely to be quite costly. Fortunately, a sophisticated receiver is not essential if you just want to listen in on some of the transmissions on the short wave bands. A simple TRF (tuned radio frequency) receiver, such as this design, will do the job quite satisfactorily. It will provide many hours of enjoyment and can be built quite easily at a low cost.

Although a TRF receiver is not as selective as a superhet receiver (it cannot sort out closely-spaced stations as well as a superhet can) it is highly sensitive and should be capable, with a suitable aerial, of worldwide reception.

Our design (Fig. 1) covers the entire short wave spectrum in three tuning ranges, with approximate coverage of each as follows:

- Range 3 1.5 MHz to 5 MHz
- Range 4 5 MHz to 17 MHz
- Range 5 10 MHz to 33 MHz

The above range numbers are those used by Denco Limited, the manufacturer of the tuning coils for this project. Band changing is accomplished by simply changing the plug-in tuning coil in the receiver. Plugging in coils is obviously a little less convenient than band switching, but it does simplify

construction and reduces cost. It is a method of band changing that is often used in simple short wave sets.

The receiver requires an external aerial, and quite good results can be obtained using only a short length of wire. The output of the receiver is primarily intended to drive low impedance headphones, but high impedance 'phones can also be used. For short wave reception, headphones are preferable to using a loudspeaker, but the receiver can even be used with a loudspeaker having an impedance in the range 8-80 R.

Construction

House the receiver in a metal case — we used an instrument case measuring 203 by 127 by 51 mm but any metal case of about this size will be suitable. Mount the four controls and phone socket on the front panel.

Drill or punch a 15 mm diameter mounting hole for VC1. Now, glue the variable capacitor in place behind the hole using a good quality adhesive. The capacitor has provision for mounting by way of three short 4BA screws, but it is much easier simply to glue it in place.

Mount sockets SK1 and SK2 onto the rear panel of the case on the left-

hand side (as viewed from the rear).

Drill or punch a 15 mm diameter hole in the rear panel just to the right of the two sockets. This hole enables different tuning coils to be fitted and removed from the receiver without having to remove the lid, and makes changing ranges much quicker and easier.

Make an L-shaped bracket from 18 or 16 SWG aluminium to hold the coilholder about 30 to 35 mm behind the cutout in the case. The coilholder is actually a B9A valve holder.

Most of the components are fitted into one of our standard 10 strip by 24 hole 0.1" matrix Veroboards, and this is constructed using the normal techniques. Figure 2 gives full details of the component board. Check that each semiconductor and electrolytic capacitor is in the board the correct way round before soldering them and insert Veroboard pins at each connection point.

When the circuit board is completed mount it in the case. Now, wire up the project as shown in Fig. 3. Keep the leads as short as possible or the receiver will become less efficient over the higher frequency bands. Use a solder tag fastened to one of the mounting bolts of the coilholder as a chassis connection point.

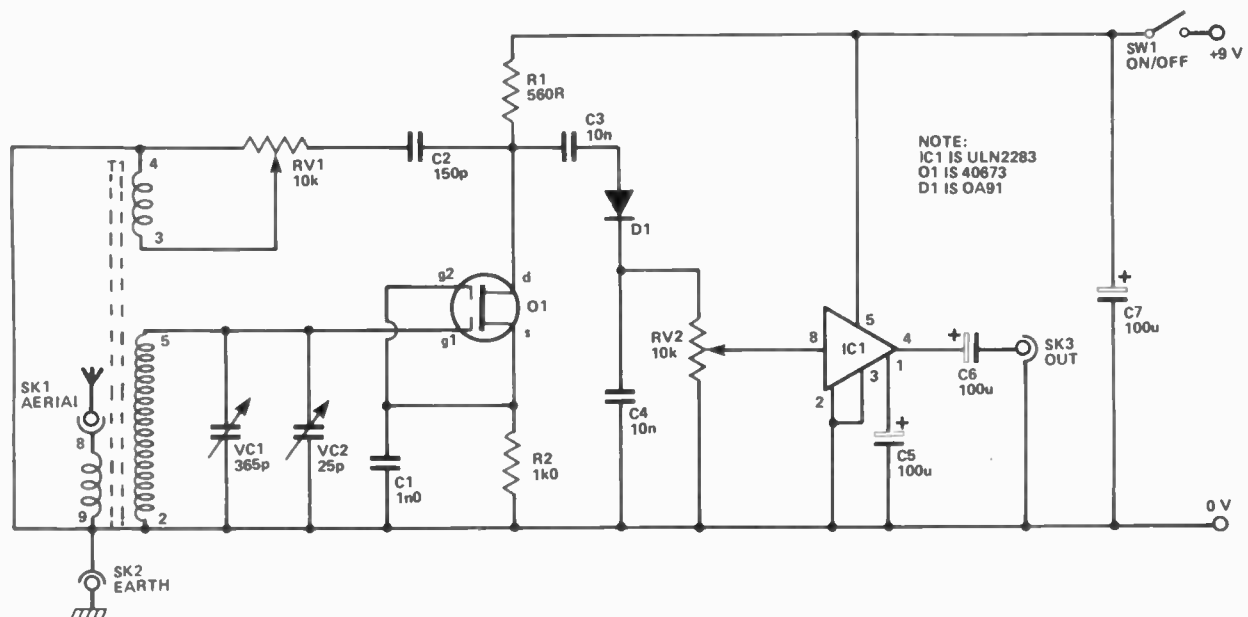

Figure 1. Circuit of the HE Short Wave Receiver



Using The Set

An aerial must be connected to the aerial input, SK 1, if the receiver is to function properly, and a few metres of wire strung around the room will provide reasonable results. However, for good results on the low frequency bands (range 3) a long outdoor aerial is preferable, and this can simply consist of about 10 to 40 m of aerial wire strung between any two convenient points. For best results the wire should be positioned high up and clear of buildings or other large obstructions. (For more information about aerials keep your eyes glued to HE's pages — in a forthcoming issue we plan an aerial feature.)

On low frequency bands an earth connection can also boost signal strengths, and an earth can be made by

attaching a lead to a piece of metal pipe, and then burying the pipe in the ground. The free end of the lead is connected to SK2.

Potentiometer RV2 is the volume and on/off control, variable capacitor VC1 is the coarse tuning control, and VC2 is used for fine tuning. Potentiometer RV1 is the regeneration control, and it is essential that this is adjusted correctly if good results are to be attained. With very little regeneration the radio's performance will be poor. As RV1 is advanced you will find that sensitivity increases and tuning becomes 'sharper'. However, at some point regeneration will become excessive and the RF amplifier will break into oscillation. This will be heard as an increase in the background noise level and an audible tone of varying pitch as the set is tuned over stations. Proper reception of ordinary AM radio transmissions is not possible with the circuit oscillating, and RV1 should be backed off just below the threshold of oscillation. Sensitivity and selectivity

will then both be at maximum. It will be necessary to readjust RV1 each time the tuning is altered, to keep the set at optimum efficiency. With a little practice the set soon becomes easy to operate though, and using a receiver of this type is easier than it may at first seem.

CW (Morse) and SSB (single sideband) are the main types of transmission used on the short wave amateur bands, and can be received by adjusting the regeneration control just beyond the threshold of oscillation. For SSB signals the tuning must be adjusted very carefully or the audible signal will be shifted in pitch. If the tuning is well off the correct setting, the signal may even be completely scrambled.

When first trying out the receiver it is advisable to use the range 4 coil. The main broadcast bands are on this tuning range, and these normally provide a number of strong transmissions whatever the time of day or year.

Parts List

RESISTORS (All 1/4 W, 5%)

R1 560R
R2 1k0

POTENTIOMETERS

RV1 10k linear potentiometer
RV2 10k logarithmic potentiometer with switch (SW1)

CAPACITORS

C1 1n0 ceramic
C2 150p ceramic
C3,4 10n polyester
C5,6,7 100u, 10 V electrolytic
VC1 365p air-spaced (Jackson type 0)
VC2 25p air-spaced (Jackson type C804)

SEMICONDUCTORS

Q1 40673 dual gate MOSFET
IC1 ULN2283 power amplifier
D1 0A91 diode

MISCELLANEOUS

T1 Denco DP coil, green ranges 3,4 and 5
Sk1,2 4 mm sockets
Sk3 3.5 mm jack socket
Case to suit
B9A valveholder
Battery + connector
Control knobs
Veroboard, 24 hole x 10 strip, 0.1" matrix

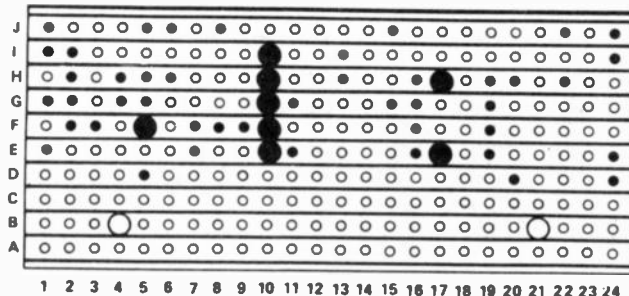
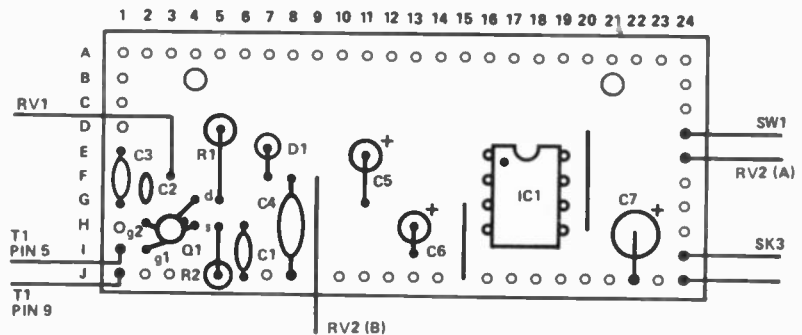
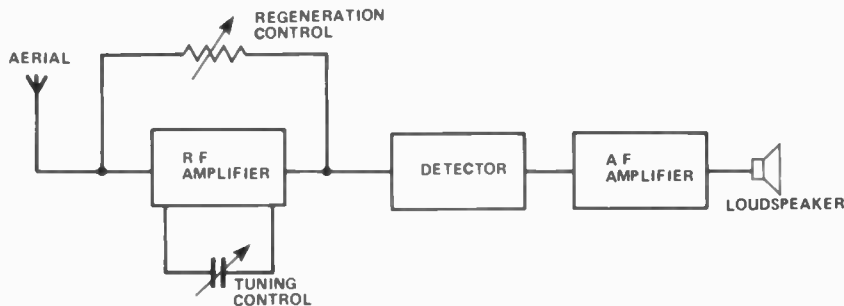

Figure 2. Veroboard layout, and underside view showing component locations and track breaks

How It Works

Signals received by the aerial are fed to a tuned amplifier which selects the desired signal and amplifies it. Some of the amplified signal is fed back to the amplifier input to improve sensitivity and selectivity.

The selected RF (radio frequency) signal is then fed to a detector which recovers the AF (audio frequency) signal from it. The AF signal is then amplified before being fed to a loudspeaker or headphones.



The tuned circuit, which resonates at the desired reception frequency, is formed by the main winding of T1 and the parallel capacitance of VC1 and VC2. Variable capacitor VC1 is the main tuning control, and VC2 is what is termed the 'bandspread' control. This has a much lower value than VC1, and therefore covers only a small part of

each tuning range. This makes fine tuning much easier using VC2 rather than VC1. The aerial signal is coupled into the tuned circuit by a small coupling winding on T1.

Transistor Q1 is a dual gate MOSFET which is used in this application as a common source amplifier. The signal

selected by the tuned circuit is fed direct to the gate 1 terminal of Q1. The main winding of T1 provides gate 1 biasing for Q1.

Some of the amplified output at the drain of Q1 is fed back to the tuned circuit via C2, RV1, and the third winding of T1. This positive feedback (known as 'regeneration') tends to boost the gain of the circuit and thus gives improved sensitivity. Selectivity (ie, the set's ability to 'separate' stations on the crowded SW bands) is also enhanced with this regeneration process.

Most of the output from Q1 is coupled by C3 to a simple diode demodulator which uses D1, C4, and RV1 in a conventional arrangement. Apart from acting as the load resistor for the detector circuit, RV1 is also the volume control and acts as the bias resistor for integrated circuit IC1. The latter is an audio power amplifier IC which has an internally preset voltage gain of 43 dB, which is just about the ideal figure for this application. The only discrete components required by the ULN2283, apart from the volume control/input bias resistor are: a decoupling capacitor for the internal bias circuit (C5), and an output DC blocking capacitor (C6). Capacitor C7 is the supply decoupling capacitor for the entire circuit.

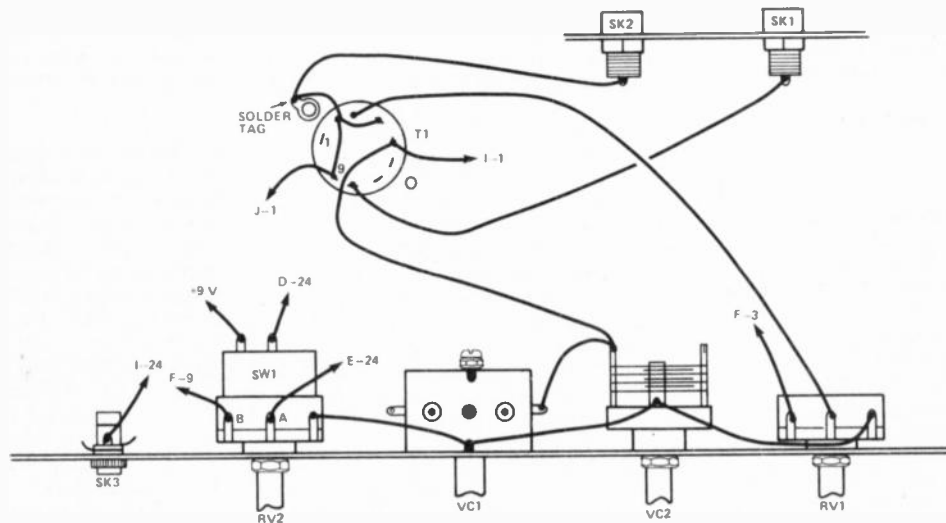
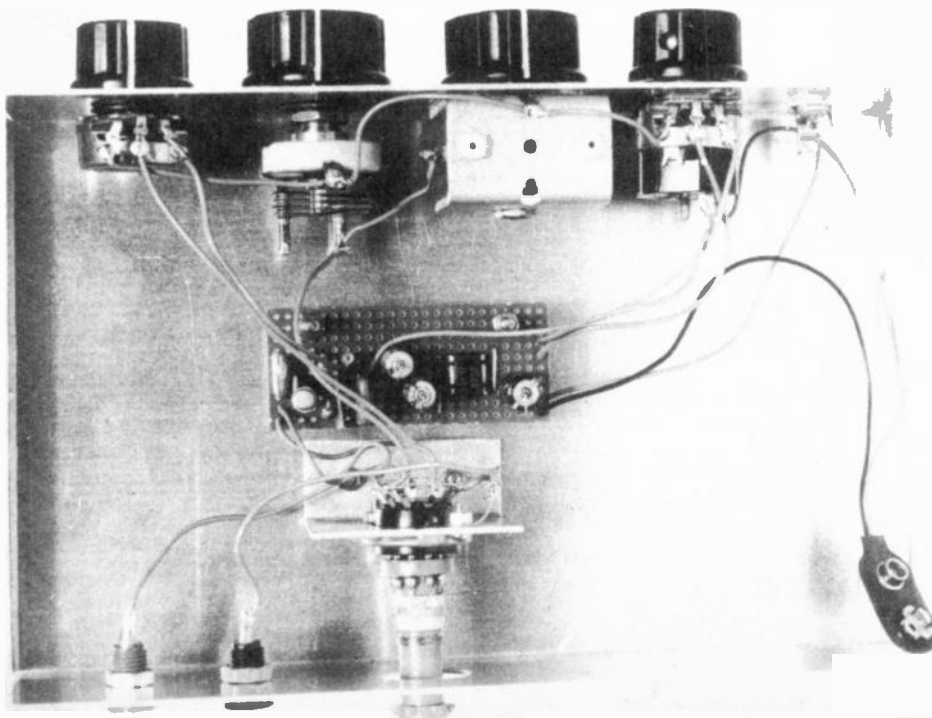

Figure 3. Connection details of the project



Buylines

The two variable capacitors, coils, and B9A holder are available from Watford Electronics.

The ULN2283 IC can be obtained from Ambit International.

There should be no problems in obtaining the other parts which are all standard types, and total cost of parts (excluding case) will be approximately £16.

Your Letters

The Editor replies to a selection of your letters

I RECEIVED SEVERAL letters and enquiries following the publication of Electronic Aids For The Disabled in the July '81 issue of HE. As I had hoped, the article appeared to act as an inspiration to some readers to take part in our Project Design Competition for the International Year of Disabled Persons 1981. Unfortunately, we couldn't avoid printing the coupon for the competition on a page backing onto one of the PCB overlays for the HE Electronic Organ.

Judging from the encouraging response so far, we made the right decision to extend the closing date to 1st September 1981.

The first letter contains details of a course to be held by the Isle of Wight branch of ACTIVE.

Dear Mr Davies,

I was delighted to read your feature article 'Electronic Aids for the Disabled' in your July issue. As a member of ACTIVE I know Roger Jefcoate very well and his enthusiasm and knowledge is quite something when it comes to discussing helping disabled people.

Although we on the Island may appear to be 'out in the sticks' (or even all at sea!) to mainland hobbyists there is, nevertheless, a growing group of electronics enthusiasts who are becoming interested in the formation of an ACTIVE branch here.

This Committee is arranging a week of conferences on disability during the week September 21/26. Of particular interest to those who may feel that they would like to achieve something of real value, using the skills they have acquired through our hobby, is the Day Course, 'Disabled People - Living & Learning'. This will take place on September 25th at the I.O.W. College of Arts & Technology. This course is being organised in consultation with Roger Jefcoate; so, if as a result of your article, readers would like the opportunity of talking with Roger and hearing him talk about the ways people can help, a trip to this lovely Island of ours should prove a great experience in more ways than one. In conjunction with the Course, Southern Vectis Ltd are offering a package trip which will include two nights hotel accommodation, train and boat fares, conference fees and lunches - and for good measure a round the Island trip by coach. All for about £35!

The Course will provide much to interest those who would like to know about ACTIVE and will show the way forward to those who, as yet, are unsure as to how their skills might be utilised. ACTIVE will be well represented and Judy Denziloe, who is the group's development officer, will speak on the role of ACTIVE in the field of disability.

If you are able to print this letter I would be particularly pleased to hear from hobbyists on the Island who may be interested in the formation of an ACTIVE group and would be happy to arrange a meeting to discuss it. My own involvement with electronics came from my interest in the work of the group and I would welcome the opportunity of talking with people similarly attracted.

With all good wishes for the continuing success of your magazine.

Bill Stock,
73/75 High Street,
Ryde, Isle of Wight
PO33 2SU
(tel 0983 63437)

Dear Editor,

Please can you help me? I am looking for a circuit for a guitar practice amp.

I would prefer that it uses batteries, has one input and uses ordinary stereo headphones for the output.

Martin Paffet,
RAF Cosford,
Wolverhampton, West Midlands

PS Great mag, keep it up (creep, creep!)

It appears that you didn't receive an answer to your first letter. This is one suggestion that we will definitely consider for a future project. Perhaps we'll call it the HE Harmony - it will enable electronic guitar players to live in harmony with their neighbours.

If you can't wait until we publish a design, you could refer to the Bench Amplifier project in the January 1981 issue (pp 37-38). Provided you can ensure that the total impedance of your headphones lies within the range 40 to 80R, this amplifier should give reasonable results. I'll make sure you receive a copy of the article.

Dear Mr Davies,

Ref. Letters Page, July 81 & Chuffer Project

I was surprised to read your reply to P. Prodromov's letter regarding the Chuffer project on page 56 of the July 81 issue.

Twelve-year-old young Prodromov didn't stand much of a chance with the Chuffer project in the January 1981 issue. In Fig.1 on page 55 there should not be a connection between the top of RV2 (C2+) and battery +ve (IC1, pins 4 & 8). This error is also in Fig.3 on page 56. With this connection the chuff rate will be fixed, since the voltage on C2 will be fixed at the battery voltage.

Funny that you didn't know this, perhaps no-one else has attempted to make this project.

Dave Mills,
West Bridgford, Nottingham

PS Support the anti-post-script movement.

We rechecked the project file and yes, your comment about Fig.1 was correct. However, apart from the incorrect numbering of capacitor C9 that I mentioned in my earlier reply, the fault in Fig.1 did not find its way onto the Veroboard layout.

The Chuffer, by the way, appears to have been a popular project.

PS The postscripts are sometimes the most amusing parts of letters.

Sir,

I have recently purchased the Kikusui 538A oscilloscope but find, to my dismay, that the probes are not included.

I would be most grateful if you would recommend a type, and place of purchase.

Mr. D. F. O'Gara
Chellaston, Derbyshire

We did not include probes in the price of the HE Special Offer Oscilloscope - the illustration merely showed how the 'scope could be hooked up to a typical circuit layout. Super-deluxe probes are not required for a 'scope of this type (particularly because the bandwidth extends to only 5 MHz). A suitable pair of probes are available from the supplier of the Kikusui 538A, that is:

Telonic-Berkeley UK Limited,
2 Castle Hill Terrace,
Maidenhead, Berks
(tel 0628 28057)

for £3.45 including VAT, post and packing. These come complete with crocodile-clip probe-ends.

Dear Sir,

I am wondering whether you could publish another robot project such as you did in HE November and December '79 and January '80, as I am very interested in this aspect of electronics and cannot obtain a back number for November '79.

R.S. Andrew
Winslow, Bucks

We have no plans at present for a HEBOT 2. I would not advise you to tackle the first HEBOT design because some of the mechanical components are no longer available.

And that brings Your Letters to an end for this issue.

HE

Prize Winners!

Hobby Electronics Wales & West Schools' Electronic Project Competition 1981

On Tuesday 7th July 1981, Nicholas Murphy, of Abingdon School, Oxford and Paul Varischetti of Ashmead School, Reading were presented with their prizes by HE's Editor

WE GAVE DETAILS of the HE Wales and West Schools' Competition on page 28 of the August '81 issue. Tuesday 7th July was selected as 'prize day' and Hugh Davies, accompanied by Peter Freebrey, Modmags' exhibitions manager, visited the schools of Nicholas Murphy, First Prize winner and Pierre Varischetti, Third Prize and Top Junior Prize winner.

Second Prize winner Paul Miller, of Filton High School, Stoke Gifford, Bristol, received a £50 component voucher.

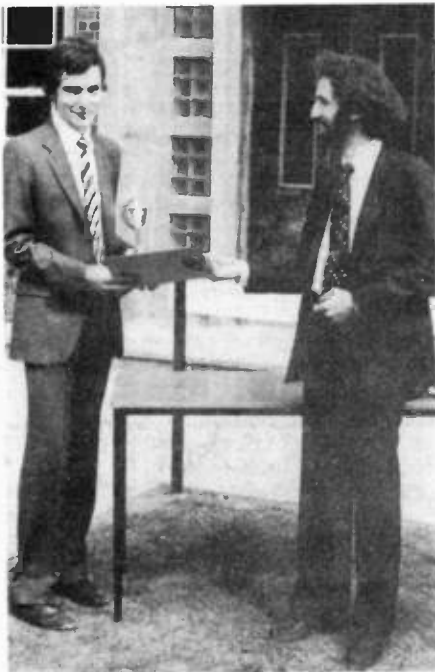

◀ Nicholas receiving his £100 component voucher and the Hobby Electronics Award Trophy for Abingdon School from Hugh Davies. The school also received two Kikusui 538A oscilloscopes



Pierre Varischetti receives his two prizes: a £25 component voucher (Third Prize) and a Galactic Invaders television game (Top Junior Prize) ▶

Here our First Prize winner demonstrates the use of his project. The change in conductivity of the solution under test is converted to a voltage change by Datafeed 1 and this information is processed by an Apple computer and displayed on a visual display unit (VDU) ▶

Nicholas Murphy's prize-winning project, Datafeed 1, which enables chemical reactions to be monitored and plotted by a computer ▼

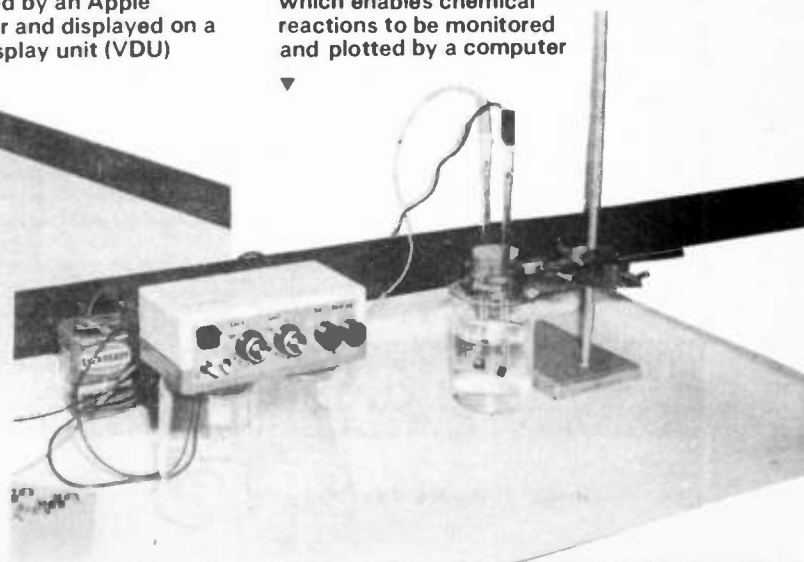
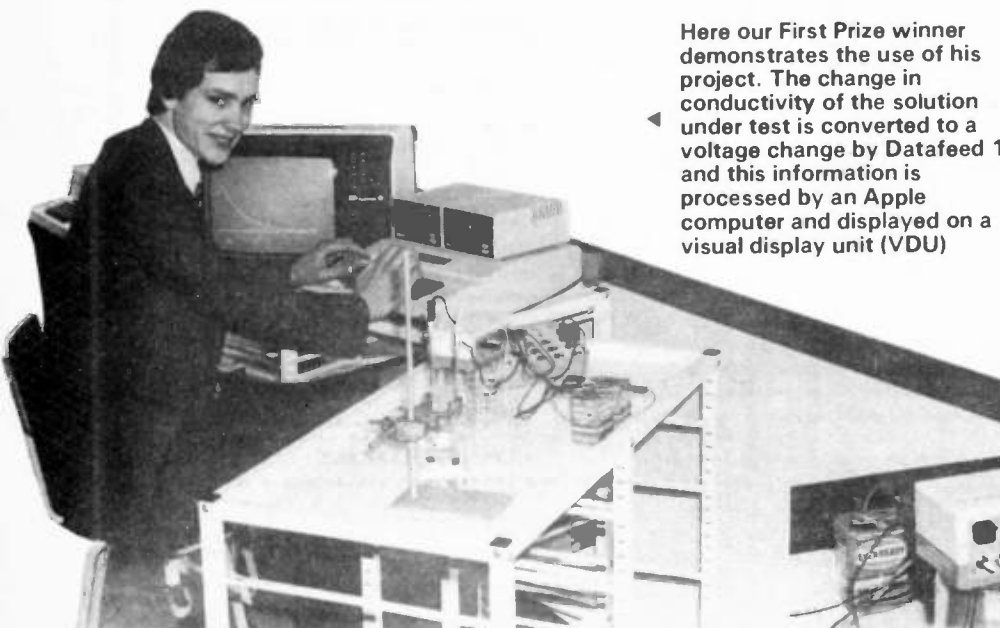

STEREO RECORD-PLAYER

£39.95 incl. V.A.T. + £2 p. & p.

- ★ Stereo Record-Player with Speakers
- ★ 5 + 5 Watts Music Power
- ★ 2-speed Semi-transcription Deck
- ★ Durable White Vinyl with Perspex Cover

7-day MONEY-BACK GUARANTEE

ADJUSTABLE POWER SUPPLY KIT

- ★ Complete Kit
- ★ Fully adjustable from 1.25V. to 30V.
- ★ 100% Output Shortcircuit Protection
- ★ Automatic Current Limiting
- ★ Thermal Shutdown
- ★ 1 Amp, 3 Amp or 5 Amp (please specify)

ELECTRONIC THERMOMETER

£18.50 all incl.

- ★ Complete Unit
- ★ Remote Temperature Sensor
- ★ 33 Metres Cable Fitted
- ★ Temperature Dial Reads 0.50°C.
- ★ PP3 Battery not supplied

INSTRUMENT CASES

Easy Slide-in Assembly with extra slots for PC boards, etc. Anodised aluminium with leather textured finish to top and base.

Size in inches	Width	Height	Depth	Price
	12 x	2 1/2 x	5in.	£11.75
	12 x	3 1/2 x	9in.	£14.25
	12 x	5 1/2 x	9in.	£16.25

Other sizes available, please enquire.

CAR CLOCK MODULE, Green Display	£8.65
CAR WASHER BOTTLE LEVEL SENSOR	£4.30
ALARM CLOCK MODULE, 24 hour, Red LED	£4.35

7-SEGMENT LED DISPLAYS:

0.3in. comm. anode	£0.85
0.5in. c. an/c. cath., dual digit package	£1.50
0.6in. c. an/c. cath.	£1.20

SOCKETS:

Low Profile, dual-in-line. Low price. Send s.a.e.

ALL PRICES EXCLUDE V.A.T. UNLESS STATED. POST AND PACKING ADD 40p TO ALL ORDERS UNDER £10.

SEND S.A.E. FOR PRODUCT INFORMATION AND PRICES TO:

TWO + ONE COMPONENTS LTD.

P.O. BOX 77, GERRARDS CROSS, BUCKS, SL9 0NT
TELEPHONE: 02-407 3568

INCREDIBLE VALUE

MULTI-RANGE METER Type MF15A a.c., d.c., volts 10-50, 250, 500, 1000, mA 0.5, 0-10, 0-100. Sensitivity 2000V. 24 range, diameter 133 by 93 by 46mm including test leads. Price £7.00 plus 50p P. & P. (£8.63 inc. V.A.T. & P.)



SUB-MINIATURE PRECISION-BUILT GEARED MOTOR
3-9V D.C. operation. Speed 2.6 r.p.m. Current consumption incredibly ONLY 2.5mA. Radio 1670-1. Torque approx. 21lb. inch plus. Motor: German; gearbox: Swiss. Size L 48mm. Dia. 16mm. Shaft: L 5mm. Shaft dia.: 2mm. Weight: 30gm. Price £8.30 incl. p. & p. (£9.78 incl. V.A.T. & p.).

MINIATURE SOLENOID FLUID VALVE

12V. d.c. 15 ohm coil normally closed. Stainless-steel body with variable flow adjuster. 1/8in. B.S.T. inlet and outlet. Size: 58 x 27 x 25mm. Weight: 130gr. Price £2.60 + 35p P. & P. (Total incl. V.A.T. £3.39).



BLACK LIGHT Self-Ballasted Mercury U.V. 175W. Bulbs

Available for either E.C. or E.S. fitting. Price incl. p. & p. and V.A.T., £11.50. Black Light U.V. Tubes from 6in to 4ft. from stock. Footscap s.a.e. for details.

FROM STOCK AT PRICES THAT DEFY COMPETITION
A.C. GEARED MOTORS • D.C. MOTORS • MICROSWITCHES • RELAYS • TRANSFORMERS • REED SWITCHES • SOLENOIDS • PROGRAMME TIMERS • C.F. BLOWERS • A.C. CAPACITORS • STROBE KITS • FLASH TUBES • CONTACTORS

SERVICE TRADING

57 BRIDGMAN ROAD, LONDON, W4 5BB - Tel: 01-995 1560

OHIO SCIENTIFIC COMPUTERS. Superboard 3 Poa. Power supply kit £11.95. Modulator £3.50. Guard band kit £10.4K extra ram £10.80. Wemon £19.95. Cegmon £22.50. Case £27. Cassette recorder £19. Assembler/editor £25. Word Processor £10. Display expansion kit 30 lines x 54 characters for superboard 2 only £14. 610 expansion board Poa. Minifloppy disc drive Poa. Colour board £65.

SHARP computers M280K 20K £418 36K £440, 48K £460. PC1211 £82.

PRINTERS supplied with free interface and word processor for Superboard and UK101. Seikosa GP80A £199. Epson MX70 £259. Epson MX80FT £399. OLI Microline 80 £295.

*SINCLAIR PRODUCTS only are post free. sc110 oscilloscope £158.95. adaptor £5.69, rechargeable batteries £8.63. w1 probe £9.78, x10 probe £11.50, carry case £8.95. TM352 £54.95. TM354 £45.95. PFM200 £57.27. adaptor £4. case £3.45. connector kit £11.27. POM35 £32.95. adaptor £5.69. case £3.45. dm235 £60.38. dm350 £87.38. dm450 £136.85. adaptor £5.69. case £8.86. rechargeable batts £8.63. Microvision tv £69. adaptor £8.95.

VIDEO GENIE COMPUTERS £289.

MEMORIES 2114 450ns £1.35. 4115 200ns £1.99. All low current.

*BATTERY ELIMINATOR KITS 100ma radio types with press studs 9v £1.79, 9-9v £2.50, stabilised 8-way types 3/4, 5/6, 7/5, 9/12, 15/18 100ma £3.12 1Amp £8.50, stabilised power kits 2.18v 100ma £3.12, 1-30v 1A £8.50, 1-30v 2A £15.30. TTL and computer supplies 5v stabilised 1.5A £9. 3A £14. 6A £22. 12v car converter 6/7.5/9v 1A £1.62.

*BATTERY ELIMINATORS 3-way type 6/7.5/9v 300ma £3.50 100ma radio types with press studs 9v £4.95, 9-9v £6.25. Car converter 12v input, output 4.5/6/7.5/9v 800ma £3.04.

*TV GAMES AY-38600 kit £12.98. AY-3-8550 kit £9.26.

SWANLEY ELECTRONICS

Dept. HE, 32 Goldsl Rd., Swanley, Kent BR8 8EZ Tel: Swanley 64851.

Postage £3.50 on superboard, £4.50 on Printers and 45p on other orders. Lists 27p post free. Please add VAT except to sections marked with a *.

RADIATION DETECTORS

BE PREPARED

VIEW THRU LENS

Ideal for the experimenter

- THIS DOSIMETER WILL AUTOMATICALLY DETECT GAMMA AND X-RAYS
- UNIT IS SIZE OF FOUNTAIN PEN & CLIPS ONTO TOP POCKET
- PRECISION INSTRUMENT
- MANUFACTURERS CURRENT PRICE OF A SIMILAR MODEL OVER £25 EACH

British design & manufacture

Tested and fully guaranteed. Ex-stock delivery.



FREE RECHARGE SERVICE AFTER PURCHASE

£6.95

inc. VAT Post & Pack 60p

COMPLETE WITH DATA



HENRY'S

01-723 1008/9

404 EDGWARE ROAD, LONDON W2 1ED

★ POWERFET AMPLIFIERS ★

Conservatively rated, high quality designs with substantial heatsink / mounting bracket.

VAT inc. prices

Post & packing 75p on P.F.A. orders

.CA3080E	70p
CA3140E	45p
MC3401	30p
TLO81	28p
TLO82	55p
2102	60p
2114	240p
40018	17p
4011B	17p
4013B	40p
4016B	40p
555	25p
709	15p
710	26p
733	50p
741	18p
78L05	29p
78L12	28p

POWERFETS

BD512 (60v, 1 1/2A Pchan.)	90p
BD527 (60v, 1 1/2A Nchan.)	85p
VN67AF (60v, 2A Nchan.)	80p
2SJ49 (140v, 100w, Pchan.)	340p
2SK134 (140v, 100w, Nchan.)	340p

HI-FI ON TWO CHIPS

HA12017 (Preamp 0.001% distortion 83dB S/N in phono application)	80p
HA1397 (Poweramp 20 watts in 81 0.02% distortion typ) 195p.	

Both with data and circuits

PFA 80

80w into 8Ω
THD < 0.008%
S/N 120dB
Kit £13.95
Built £15.95

PFA 120

120w into 2Ω
THD < 0.005%
S/N 120dB
Kit £20.85
Built £22.85

SCOPE TRACE DOUBLER P.C.B.

Built C.W. shift, chan select, chorate controls and instructions, useful display from DC to 10MHz. Runs from 9V battery £9.95

H.A. 1388 £1.95. Heatsink for above 40p.

H.E. PUBLIC ADDRESS AMPLIFIER. Component set including H.A. 1388 and super low noise input transistor. (Excludes board, box and controls) £2.95.

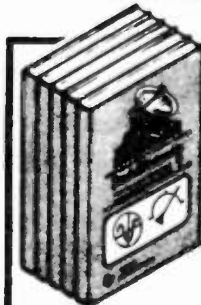

ANNOUNCING A NEW SET OF BASIC ELECTRONICS

This 5 volume set contains over 500 pages. Bound in stiff linen. Cover size 8 1/2in x 5in. Price £10.00 per set (we pay the postage)

- Book 1. Introducing Electronics
- Book 2. Resistors/Capacitors
- Book 3. Inductors/Diodes
- Book 4. Meters/Voltage-dividers
- Book 5. Transistor Project Circuitry

The manuals are unquestionably the finest and most up-to-date available and represent exceptional value.

This series has been written in a fascinating, absorbing and exciting way, providing an approach to acquiring knowledge that is a very enjoyable experience. Suitable for industrial trainees, City and Guilds students, DIY enthusiasts and readers of electronic journals.

Each part explains electronics in an easy-to-follow way, and contains numerous diagrams and half tone blocks with construction details and circuit diagrams for making the following transistor projects: Lamp Flasher, Metronome, Wailer, Photographic/Monostable Timer, Metal Locator, Gelger Counter, Radio Receiver, Intercom., Intruder Alarm, Electronic Organ, Battery Eliminator, Anemometer, Sound Switch, Light and Water-operated Switches, Pressure-operated Switches, Light meter, Radio Thermometer, Ice Alarm,

Order Now:
Selray Book Company
11 Aspen Copse,
Bromley,
Kent. BR1 2NZ

OUR 100% GUARANTEE

Should you decide to return the set after 10 days examination, your money will be refunded by return of post.

Amount enclosed: £

Name:

Address:

HE9

J. W. RIMMER

7&P 35p Mail orders to 148 Quarry Street, Liverpool L25 6HQ. Tel 051 428 2651.

Technical enquiries to 367 Green Lanes, London N4 1DY. Tel 01-800 6667

Reaction Tester Game

Here is a 'game' project, adapted from a design sent to us by a reader. It provides a novel way of testing your reactions — and it's fun, too!

THERE ARE ONLY a limited number of ways you can use a 4017 and a 555. Or so we thought.

We used to think that the stockpile of possible ways of combining the two ICs had been exhausted until we opened the mail one morning and saw this ingenious idea for an electronic game from A. Trafford (see Fig.1).

The game has, as its main feature, a row of coloured LEDs. When you switch on, the bottom LED lights up, ready for play. When the 'GO' button is pressed the light moves up the row. The idea is to get the light as far up the row as possible — the higher up the row, the higher your score — but not past LED5. You see, LED5 gives maximum score (+20 points) and if the light goes further up than this you lose points.

Finally, if the light goes further than LED9 (-20 points) another LED (LED10 - LOSE) lights up, and stays on until you reset the game.

Now, as far as we're concerned, this game must definitely be the very last way that these two ICs can possibly be used together — or do you know different?

Construction

Following the printed circuit board (PCB) overlay details in Fig.2, insert and solder all components into the board, starting with the low-level components (ie, resistors, IC sockets). Solder in PCB pins at all connection points.

Next, insert and solder the two capacitors making sure capacitor C1 is the right way round.

Push the two ICs into their sockets, and insert and solder the thyristor SCR1 into place making sure that the polarity of all semiconductors is correct.

Now, mark and drill the case for switch SW2 and fit it into position.

Using double-sided, self-adhesive pads, stick the 9 V battery and the PCB to the bottom of the case.

Finally, wire up your project, following the connection details of Fig.2. A tip to help prevent your project becoming a 'bird's nest' is to wire each switch or push-button separately, twisting the leads before soldering. Similarly the 11 wires connecting the PCB to the LEDs should be twisted together.



Buylines

None of the component parts will be difficult to obtain. Approximate price of components (excluding, as usual, the PCB and case) is £7.

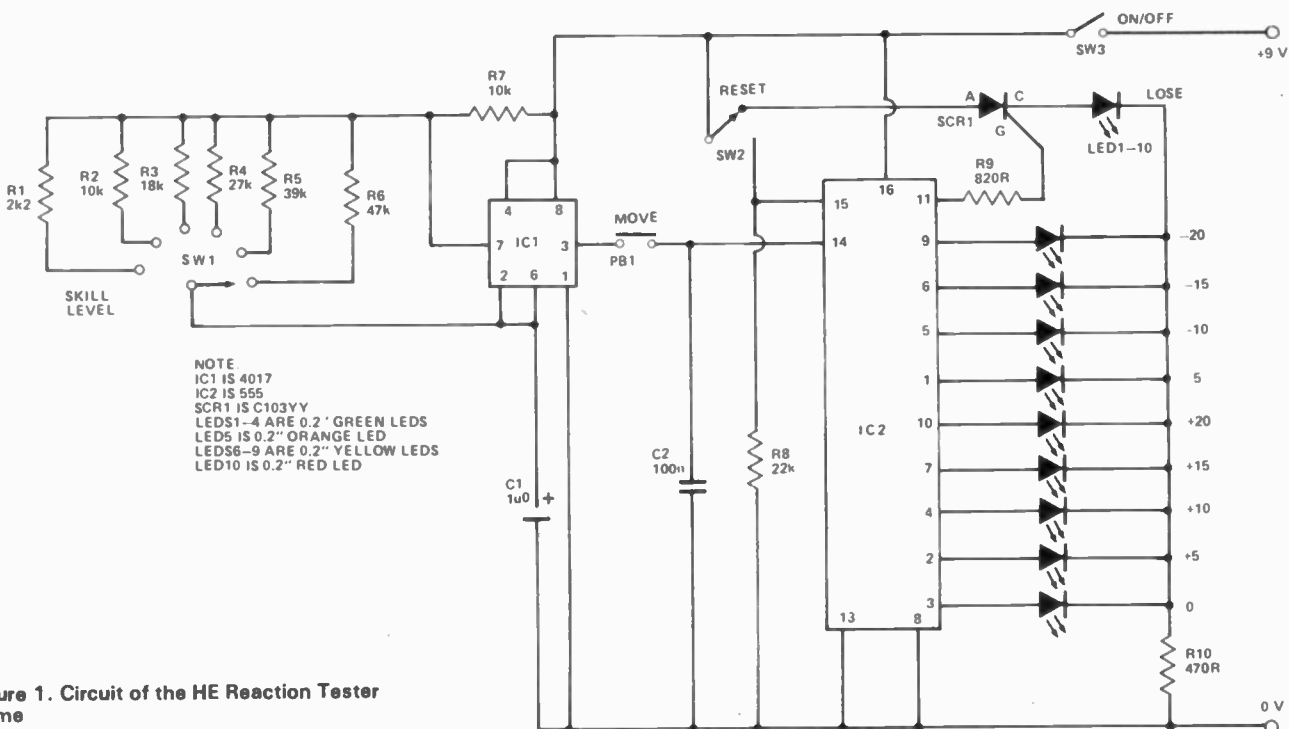
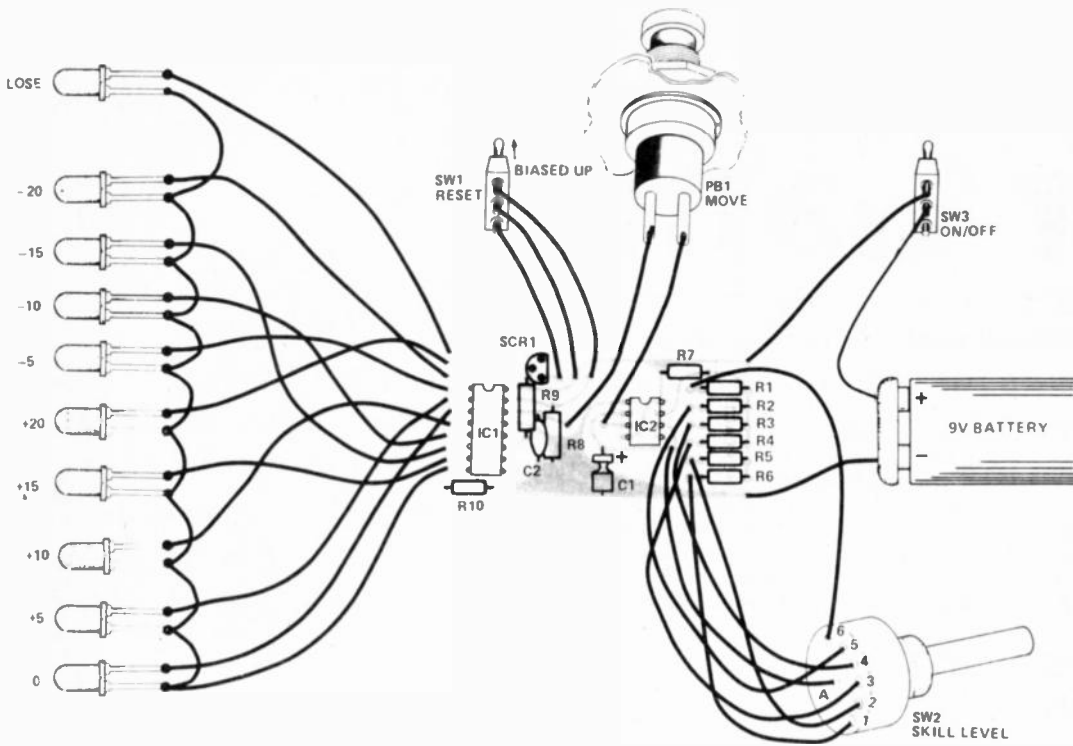

Figure 1. Circuit of the HE Reaction Tester Game



▲ Figure 2. PCB overlay and connection details of the project. From this you can see how one terminal of each LED (ie, their cathodes) are commoned and connected to resistor R10

Parts List

RESISTORS (All 1/4 W, 5%)

R1	2k2
R2,7	10k
R3	18k
R4	27k
R5	39k
R6	47k
R8	22k
R9	820R
R10	470R

CAPACITORS

C1	1u, 10 V electrolytic
C2	100n polyester

SEMICONDUCTORS

IC1	555 timer
IC2	4017 counter
SCR1	C103 thyristor
LED1-4	0.2" green LEDs
LED5	0.2" orange LED
LED6-9	0.2" yellow LEDs
LED10	0.2" red LED

MISCELLANEOUS

SW1	single-pole, six-way rotary switch
SW2	single-pole, double-throw biased toggle switch
SW3	single-pole, single-throw toggle switch
PB1	single-pole, push-to-make release-to-break switch
Case to suit	
Knob to suit	
Battery + clip	

How It Works

An oscillator formed by an astable multivibrator continually oscillates at a set frequency.

Pressing the push-button connects the output of the oscillator to the input of a counter, the outputs of which are connected to a row of LEDs. On every positive pulse from the oscillator the counter counts on and lights the next LED.

When the '10' output of the counter turns on it fires a thyristor, which holds LED10 on, permanently, until power is disconnected.

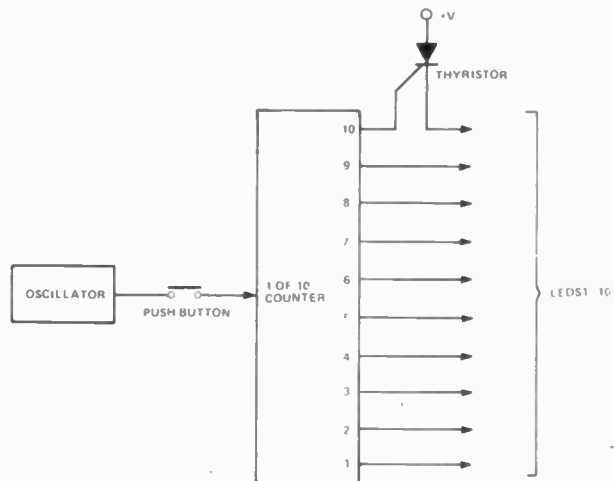

The astable multivibrator oscillator is configured round a 555 timer. The frequency of oscillation is determined by one of the resistors R1-6, and the chosen resistor is switched into circuit by switch SW1.

A 4017 (IC2) is used as a '1 of 10 counter' and every time push-button PB1 is pressed, the 4017 counts the output pulses of the 555 oscillator. The first nine outputs of the counter directly

drive LEDs which give an indication of the state of the count.

Output 10 is connected to the gate of thyristor SCR1 thereby turning on the thyristor on the count of 10. This thyristor drives LED10, the LOSE indicator.

Switch SW2 disconnects power from the thyristor, thus turning off LED10, and also resets the counter to a zero count.

ELECTRONICS DIGEST

IN THE SHOPS
ON AUGUST 21st

Vol.2 No.2 AUTUMN 1981
FROM THE PUBLISHERS OF
ELECTRONICS TODAY INTERNATIONAL

The Autumn edition of Electronics Digest features over 20 DIY projects for the audio and motoring enthusiast . . . plus test gear to build and projects for the home including a complete infra-red control system and full details of a device that can transmit music to any room in a house along the mains wiring. For model train enthusiasts we have included a sophisticated train controller capable of driving up to four track layouts and 16 sets of points and featuring fine speed control, track cleaners and full remote control facilities.

Back copies of Electronics Digest Vol.1 Nos. 1,3 & 4 are still available for £1.75 per copy from:

Back Numbers
Electronics Digest
145 Charing Cross Road
London WC2H 0EE

(Make cheques and POs payable to Modmags Ltd)

COMPUTERS ● AUDIO ● RADIO ● MUSIC ● LOGIC ● TEST GEAR ● CB ● GAMES ● KITS

BREADBOARD 81

Wednesday	11th November	10 a.m.-6 p.m.
Thursday	12th November	10 a.m.-8 p.m.
Friday	13th November	10 a.m.-6 p.m.
Saturday	14th November	10 a.m.-6 p.m.
Sunday	15th November	10 a.m.-4 p.m.

COMPONENTS ● DEMONSTRATIONS ● SPECIAL OFFERS ● MAGAZINES ● BOOKS

ROYAL HORTICULTURAL SOCIETY'S
NEW HALL, GREYCOAT STREET,
WESTMINSTER, LONDON S.W.1.

17,000 PEOPLE CAN'T BE WRONG

For 5 days last year they packed the RHS halls for Breadboard '80. All the leading companies were there

. and they're back again this year for BREADBOARD '81 with larger stands and wider gangways.

Whether you're buying or just browsing, BREADBOARD '81 has something to offer you. The top electronics magazines will be there.

If you're interested in kits, components or computing, BREADBOARD '81 covers it all books, bargains and demonstrations. It's all happening at BREADBOARD '81.

Cost of entry will be £2.00 for adults, and £1.00 for children under 14 yrs and O.A.P.s.

To avoid queueing, Advance tickets will be available from
Advance Tickets BB '81,
Modmags Ltd, 145 Charing Cross Road,
London WC2H 0EE

** Special Advance Booking Price **
Adults £1 75. Children under 14 yrs and O.A.P.s 80p

Please send tickets @ £1 75 tickets @ 80p

To

I enclose PO/cheque for £

Advance tickets MUST be ordered BEFORE 20th October 1981

CB Breaker One Four

The publishers of HOBBY ELECTRONICS would like to point out that it is at present a contravention of the Wireless Telegraphy Act of 1949 and 1968 to use, manufacture, install or import CB transmitting equipment. It is not the intention of Modmegs Ltd to incite, encourage or condone the use of such equipment.

A variety of news items from Rick Maybury this month: criminal CBers, flooded CB food, Hitachi CB, CB sloths, AM crack-down and musical CB

I'M ASHAMED! For nearly three years I have been doing my best to convince people that CB is a good thing. It wouldn't be used by criminals, it wouldn't be used by subversive or political organisations, and what happens? We hear through the media that CB is being used by various groups to co-ordinate riots, to help outwit the police and is generally finding applications for everything that I hoped CB would be useful *against*. All I can say is that anyone hearing messages that are obviously intended for people who are up to no good should pass these messages on to the police pretty sharpish, or we'll be playing right into the hands of the people who did their best to prevent us from getting any kind of CB system in this country.

Back to lighter matters. The CB restaurant I told you about last month has, by an unfortunate act of God, failed to open. The cause? A rather heavy downpour flooded the restaurant to

a depth of several inches. All being well I will report on the destiny of this restaurant next month.

Preparations And Restrictions

Back on the serious side of CB, we have heard of no less than 20 different companies now preparing to set up full-scale production or importation of rigs. The big names are now starting to get interested and if I tell you that Hitachi, well known video and hi-fi manufacturer of this parish, is now dabbling a tentative toe in the CB market, you'll see what I mean.

On the slothful legalisation front things are still crawling along. By this time I had hoped to have details of the licensing restrictions and other news but there is still no word from the HO. Rumour has it that we will see some developments in the next few weeks — we shall see!

A word of warning from my spies at the Customs and Excise: there is a major campaign in progress to relieve CBers of their rigs. On the plus side I understand that prosecutions will not be sought unless, as one mole tells me, '...an excessive number of rigs are involved'.

This tale ties up with some other snippets that have come my way concerning a short training course which certain PO personnel are being sent on. Apparently this is an idiot's guide to CB and teaches you how to tell a CB from a legitimate two-way radio. It seems that there is going to be a considerable crack-down on the AM rigs in the next few months, so don't ring us up if you get busted — it'll be your own fault.

On A Musical Note

CB and music have always gone together in the USA but only now is it beginning to become respectable in this country. The trouble has always been the association of CB with Country and Western music, always a little out of the average Englishman's appreciative range. However, listen out for a purely British CB music album coming from a group called Citizens Banned. The music is good, the lyrics are superbly witty and very up-to-date. Country and Western influences are kept to an absolute minimum. Some of the tracks will never be heard on the Beeb but I can really recommend that you try and listen to a copy.

Well, time's up once again — the next few months will see the run-up to legalisation and we can expect a number of very interesting developments to materialise, so keep your eyes peeled and start saving for that legal rig now.

HE

PCB Foil Patterns

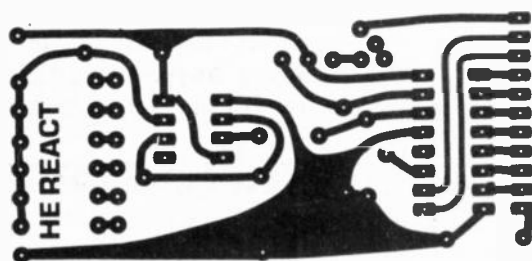

PCB pattern for HE Reaction Tester Game (see page 58)



PCB pattern for HE Power Pack (see page 42)

HE

Have you heard about CB? Citizens' Band radio is to be legalised this Autumn; yes, that's right, our very own personal two-way radio system that can be used in the car, the home — anywhere. As you can imagine, CB will be a real boon to the motorist, the housebound, those who go for outdoor activities — and don't forget that CB can save lives!

With all this in mind **Citizens' Band** magazine, the country's leading CB publication, will be holding a **major** CB exhibition in September, timed as closely as possible to coincide with legalisation. If you want to know more about CB, or you are a CBer, come along to the Royal Horticultural Hall on 11th, 12th, 13th September and see Britain's biggest ever CB show.



There will be stands and exhibits from many of the country's leading CB accessory dealers plus, for the first time ever, working examples of the new legal rigs that will be on sale this Autumn. That's right, a number of manufacturers and importers will be on hand to show the new CB equipment that almost anyone can buy and use.

There's something for everyone, CBers old and new. The latest accessories and antennas, gadgets — in fact everything connected with CB including the new equipment.

Come along in September and see what CB can do for you. Even if you've never heard of CB, you soon will, so don't miss out — whether you're a motorist or a small businessman with an eye to the future, CB is for you! CB is the future of two-way communications

BRITAIN'S FIRST NATIONAL CB SHOW! **ROYAL HORTICULTURAL SOCIETY HALL, VINCENT SQUARE, LONDON SW1 (SEPTEMBER 11th-13th INCLUSIVE)**

WHY QUEUE? ORDER YOUR TICKETS NOW FROM:-

Advance Tickets CB81
Modmags Ltd, 145 Charing Cross Road,
London WC2H 0EE.

Please send tickets @ £2.00
. tickets @ £1.00 (OAP or child under 10 yrs)

To
.
.

I enclose PO / cheque for £

This is the **BIG ONE** for breakers. Whether you're a confirmed fanatic or an interested beginner, this is the place to be in September!

OPENING TIMES

Friday 11th Sept 10am-7pm
Saturday 12th Sept 10am-6pm
Sunday 13th Sept 10am-4pm

Books from the HE Book Service

SPECIAL OFFER TO READERS OF HOBBY ELECTRONICS ONLY

ELEMENTS OF ELECTRONICS
 Book I £2.60
 Book II £2.60
 Book III £2.60
 Usual price is £7.80 inc post and packing for 3 volume set. OUR PRICE £7.00 + FREE slip case for 3 volumes + FREE Resistor Colour Code Disc.

28 TESTED TRANSISTOR PROJECTS by R. Torrens .. £1.50
 The author has designed developed and built some completely new circuits.

BEGINNERS GUIDE TO BUILDING ELECTRONIC PROJECTS by R. A. Penfold £1.50
 Enables the complete beginner to tackle the practical side of electronics.

ESSENTIAL THEORY FOR THE ELECTRONICS HOBBYIST by G. T. Rabaroe £1.50
 Supplies the hobbyist with a background knowledge.

50 PROJECTS USING RELAYS, SCR'S & TRIACS by F. G. Rayer £1.50
 Gives tried and practical working circuits which should present the minimum of difficulty for the enthusiast to construct.

HOW TO BUILD YOUR OWN METAL AND TREASURE LOCATORS by F. G. Rayer .. £1.25

Contains complete electronic and practical details on the simple and inexpensive construction of Heterodyne Metal Locators.

HOW TO MAKE WALKIE-TALKIES by F. G. Rayer £1.75
IC555 PROJECTS by E. A. Parr £2.00

Included in this book are Basic and General Circuits, Motor Car and Model Railway Circuits, Alarms and Noise Makers as well as a section on the 556, 558 and 559 timers.

PRACTICAL ELECTRONIC CALCULATIONS AND FORMULAE by F. A. Wilson ... £2.50
 Units and Constants, Direct Current Circuits, Passive Components, Alternating Current Circuits, Networks and Theorems, Measurements

ELECTRONIC SECURITY DEVICES by R. A. Penfold £1.70
 Includes both simple and more sophisticated burglar alarm circuits using light, infra-red and ultrasonics gas and smoke detectors, flood alarms doorphone and baby alarms, etc.

ELECTRONIC PROJECTS FOR BEGINNERS by F. G. Rayer £1.60

A newcomer to electronics finds a wide range of easily made projects.

POPULAR ELECTRONIC PROJECTS by R. A. Penfold £1.70

Radio Projects, Audio Projects Household Projects and Test Equipment.

HOW TO BUILD YOUR OWN SOLID STATE OSCILLOSCOPE by F. G. Rayer £1.75

Enables the enthusiast to simply and inexpensively build his own oscilloscope.

ELECTRONIC GAMES by R. A. Penfold £2.00

In this book the author has designed and developed a number of interesting electronic game projects using modern integrated circuits.

COUNTER DRIVER AND NUMERAL DISPLAY PROJECTS by F. G. Rayer .. £2.00

Author discusses and features many applications and projects using various types of numeral displays, popular counter and driver IC's etc

BEGINNERS GUIDE TO MICROPROCESSORS AND COMPUTING by E. F. Scott £2.00

Introduction to the basic theory and concepts of binary arithmetic; microprocessor operation and machine language programming.

ELECTRONIC HOUSEHOLD PROJECTS by R. A. Penfold £2.00

Circuits range from such things as '2 tone door buzzer' intercom through Smoke or Gas Detectors to Baby and Freezer Alarms.

A MICROPROCESSOR PRIMER by E. A. Parr .. £2.00

A newcomer to electronics tends to be overwhelmed when first confronted with articles or books on microprocessors. This small book will start by designing a simple computer and because of its simplicity and logical structure the language is hopefully easy to learn and understand.

50 CIRCUITS USING 7400 SERIES IC'S by R. N. Soar .. £1.65

The author has compiled 50 interesting and useful circuits and applications covering different aspects of electronics using these devices.

POPULAR ELECTRONICS BOOKS

Sinclair, I. R., Introducing Electronic Systems £3.10
 Sinclair, I. R., Introducing Amateur Electronics £3.10
 Sinclair, I. R., Electronic Fault Diagnosis £4.00
 Sinclair I. R., Repairing Pocket Transistor Radios £2.90
 Sinclair, I. R., Oscilloscope In Use £4.00
 Sinclair, I. R., Understanding Electronic Components £5.10
 Sinclair, I. R., Understanding Electronic Circuits £5.10
 Kitchen, H. T., Handtools For Electronic Workshop £3.25
 Kitchen, H. T., Electronic Test Equipment £6.20
 Capel, V., How To Build Electronic Kits £3.25
 Darr, J., How to test almost everything electronic £3.75
 Brown, R. M., How to read electronic circuit diagrams £5.60

AUDIO

Earl, J., Audio Technicians Bench Manual £5.00
 Earl, J., Pickups and Loudspeakers £5.00
 Earl, J., Tuners and Amplifiers £4.00
 Earl, J., Cassette Tape Recorders £6.00
 Earl, J., ABC of Hi-Fi £6.00
 Capel, V., Microphones in Action £6.00

Capel, V., Improving Your Hi-Fi £5.00
 Capel, V., Creative Tape Recording £5.00
 Hellyer, H. W., Tape Recorders £5.00
 Sinclair, I. R., Audio Amplifiers For Home Construction £6.00

RADIO CONTROL

Drake, J., Radio Controlled Helicopter Models £4.95
 Jeffries, C. R., Radio Control For Model Yachts £3.85
 Safford, E. L., Radio Control Manual £5.50

COOKBOOKS

Tracton, K., BASIC Cookbook £4.10
 Lancaster, D., TTL Cookbook £7.55
 Lancaster, D., RTL Cookbook £4.65
 Lancaster, D., CMOS Cookbook £8.20
 Jong, W., IC Op Amp Cookbook £10.70
 Lancaster, D., T V Typewriter Cookbook £7.75
 Lancaster, D., Cheap Video Cookbook £6.50
 Jong, W., IC Timer Cookbook £7.65
 Lancaster, D., Incredible Secret Money Machine (a how to cook book for setting up your computer or technical business) £4.95

QUESTIONS AND ANSWERS

SIMPLE AND CONCISE ANSWERS TO MANY QUESTIONS WHICH PUZZLE THE BEGINNER.
 Coker, A. J., Q & A On Electric Motors £2.50
 Hellyer, H., Q & A On Radios and T.V. £2.50
 Hibberd, R., Q & A On Integrated Circuits £2.50
 Jackson, K., Q & A On Electricity £2.50
 Brown, C., Q & A On Hi-Fi £2.50
 Brown, C., Q & A On Transistors £2.50
 Brown, C., Q & A On Electronics £2.50
 Reddihough, J., Q & A On Colour T.V. £2.50
 Miller, H., Q & A On Electric Wiring £2.50

CONSTRUCTOR GUIDES

Graham, P., Simple Circuit Building £3.40
 Colwell, M., Electronic Diagrams £3.40
 Colwell, M., Electronic Components £3.40
 Colwell, M., Printed Circuit Assembly £3.40
 Ainstee, A., Practical Electronic Project Building £3.40
 Colwell, M., Project Planning and Building £3.40

BEGINNER'S GUIDE

Sinclair, I. R., Beginner's Guide To Tape Recording £4.25

Sinclair, I. R., Beginner's Guide To Integrated Circuits £4.25
 Sinclair, I. R., Beginner's Guide to Audio £4.25
 King, G. J., Beginner's Guide To Radio £4.25
 King, G. J., Beginner's Guide To Television £4.25
 King, G. J., Beginner's Guide To Colour T.V. £4.25
 Guilou, F., Beginner's Guide To Electric Wiring £4.25

PROJECT BOOKS

Marston, R. M., 110 Cosmos Digital IC Projects For The Home Constructor £4.95
 Marston, R. M., 110 Wave Form Projects For The Home Constructor £4.95
 Marston, R. M., 110 Op Amp Projects For The Home Constructor £4.95
 Marston, R. M., 110 Semiconductor Projects For The Home Constructor £4.95
 Marston, R. M., 110 Thyristor/SCR Projects For The Home Constructor £4.95
 Marston, R. M., 110 Electronic Alarm Projects For The Home Constructor £4.95
 Marston, R. M., 110 Integrated Circuits Projects For The Home Constructor £4.95
 Marston, R. M., 20 Solid State Projects For The Car and Garage £4.95
 Marston, R. M., 20 Solid State Projects For The Home £4.95

Note that all prices include postage and packing. Please make cheques, etc. payable to Hobby Electronics Book Service (in sterling only please) and send to:

Hobby Electronics Book Service
 Modmags Ltd
 145 Charing Cross Road
 London WC2H 0EE

* Prices may be subject to change without notice.

CLASSIFIED

ETI RATES
 1-4 Insertions £9.00 per scc
 5-11 Insertions £8.00 per scc
 12+ Insertions £7.00 per scc
 30p per word (min 12 words)
 Box No. £2.00
 Closing date 1st Friday in month preceding publication.

HE RATES
 1-3 Insertions £5.00 per scc
 4-11 Insertions £4.50 per scc
 12+ Insertions £4.00 per scc
 18p per word (min 15 words)
 Box No. £1.50
 Closing date 2nd Friday in month preceding publication.

Classified Advertisements must be prepaid.

Advertisements are accepted subject to the terms and conditions printed on the advertisement rate card (available on request).

SEND TO:- ETI/HE CLASSIFIED, 145, CHARING CROSS ROAD, LONDON WC2H 0EE. TEL: 01-437 1002 Ext. 50.

RADIATION DETECTORS

BE PREPARED

VIEW THRU LENS ▶

- THIS DOSIMETER WILL AUTOMATICALLY DETECT GAMMA AND X-RAYS
- UNIT IS SIZE OF FOUNTAIN PEN & CLIPS ONTO TOP POCKET
- PRECISION INSTRUMENT METAL CASED WEIGHT 20Z
- MANUFACTURERS CURRENT PRICE OF A SIMILAR MODEL OVER £25 EACH

British design & manufacture. Tested & fully guaranteed. Ex-stock delivery.

£6.95 inc. VAT Post & Pack 60p

Ideal for the experimenter
COMPLETE WITH DATA

HENRY'S

404 EDGWARE ROAD, LONDON W2 1ED



BARGAIN COMPONENT PACKS: 100 mixed resistors £1; 1,000 for £7.50, post free. - JKS Electronics, 2 Poundfield Rd., Debden, Loughton, Essex.

INTERESTED IN CB? Be first in your street with the very latest receiver. It's legal and covers 2-CB bands, PB/WB and medium wave/AM, FM/VHF aircraft 82M-Ham. In fact everything you ever wanted in a radio. It's just arrived in England so it's not in the shops yet! Send cheque or PO for £24.50 inclusive. - S&M Sales, 99 St. Leonards Road, Windsor, Berks SL4 3BS.

CROFT ALARM EQUIPMENT, send SAE for free list or cheque or PO for £14.60 for our burglar alarm module to - Croft Alarms, Box 89, Stockport SK5 7ER.

50 RESISTORS (mixed) only 95p. 50 Capacitors (mixed) £2.80. 5 Mixed untested i.c.s some unmarked £1. Solder pack, small gauge, useful for i.c. work, only 18p. Plus 25p p&p. - L.B. Supplies, 3 Armscroft Gardens, Barnwood, Glos.

TTLs, CMOS, RAMs, transistors, brand new, home constructors, huge stock, SAE. - Jain, 17 Taylors Lane, London NW10.

ZX81 FLICKER-FREE GAMES, 6 on cassette, £3 (or SAE details). - Kerr, Dept HE, 29 Chadderton Drive, Unsworth, Bury, Lancs.

GUITAR/PA MUSIC AMPLIFIERS

100 watt superb treble/bass overdrive, 12 months' guarantee. Unbeatable at £50; 60 watt £44; 200 watt £68; 100 watt twin channel sep. treble/bass per channel £85; 60 watt £52; 200 watt £78; 100 watt four-channel sep. treble/bass per channel £75; 200 watt £98; slaves 100 watt £34; 200 watt £60; 250 watt £70; 500 watt £140; fuzz boxes, great sound, £12; bass fuzz £12.90; overdriver fuzz with treble and bass boosters, £22; 100 watt combo, superb sound, overdrive, sturdy construction, castors, unbeatable, £98; twin channel, £115; bass combo £118; speakers 15in. 100 watt £36; 12in. 100 watt £24; 60 watt £16; microphone shure unidyn B £25; 3-channel sound/light £26.

Send cheque/P.O. to: **WILLIAMSON AMPLIFICATION**
 62 Thorncliffe Avenue, Dukinfield, Cheshire. Tel. 061-308 2064

AMAZING ELECTRONICS PLANS. Lasers; Super-powered Cutting Rifle, Pistol, Light Show, Ultrasonic Force Fields, Pocket Defence Weaponry, Giant Tesla, Satellite TV Pyrotechnics, 150 more projects. Catalogue 75p. - From Plancentre, 16 Mill Grove, Bilbrook, Codsall, Wolverhampton.

100 MIXED DIODES £1. 1920s onward items. Lists 25p S.A.E. Sole Electronics, HE, 37, Stanley Street, Ormskirk, Lancs.

HAVE YOU SEEN THE GREEN CAT?

1000s of components (C.B., Radio & Electronic). Aerials, Plugs, SWR Meters & Accessories, Audio, Hi-Fi, Experimental devices. In fact anything electronic at unbelievably low prices. Something for everyone. Send 30p for list and receive FREE RECORD SPEED INDICATOR. MAIL ORDER ONLY. MYERS (Dept. HE), 14/16 Clifton Grove, Harehills, Leeds 9. Mail Order Only.

MAIL ORDER PROTECTION SCHEME

If you order goods from mail order advertisers in this magazine and pay by post in advance of delivery, this publication *Hobby Electronics* will consider your for compensation if the advertiser should become insolvent or bankrupt, provided:

- You have not received the goods or had your money returned; and
- You write to the publisher of this publication *Hobby Electronics* explaining the position not earlier than 28 days from the day you sent your order and not later than 2 months from that day.

Please do not wait until the last moment to inform us. When you write, we will tell you how to make your claim and what evidence of payment is required.

We guarantee to meet claims from readers made in accordance with the above procedure as soon as possible after the advertiser has been declared bankrupt or insolvent to a limit of £1,800 per annum for any one advertiser so affected and up to £5,400 p.a. in respect of all insolvent advertisers. Claims may be paid for higher amounts, or when the above procedures has not been complied with, at the discretion of this publication *Hobby Electronics*, but we do not guarantee to do so in view of the need to set some limit to this commitment and to learn quickly of readers' difficulties.

This guarantee covers only advance payment sent in direct response to an advertisement in this magazine (not, for example, payments made in response to catalogues, etc, received as a result of answering such advertisements). Classified advertisements are excluded.



BUY SELL EXCHANGE

WE CAN'T PRODUCE RABBITS BUT WE CAN PRODUCE RESULTS

& whether you are buying, selling or exchanging let HE's classified advertisement section work wonders for you.

**BARGAINS FOR THE ELECTRONIC HANDYMAN
BRANDED L.E.D. DIGITAL
ALARM CLOCKS**

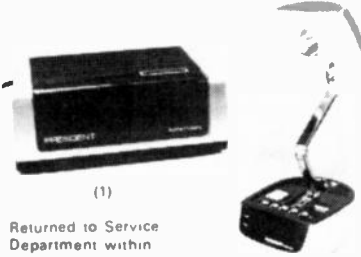

Returned to Service
Department within
guarantee period

- 1 With alarm repeat S R S P of £17.00 Offered at £3.95, inc VAT, or 3 for £9.95, inc VAT
- 2 With luxury lamp and repeat alarm S P S P £31.00 Offered at £7.95 inc VAT each, or 3 for £19.95 inc VAT

These will be sold as received from our customers with the existing fault(s) and without guarantee

U K only
Discounts available on large bulk purchase

**PRESCOTT CLOCK & WATCH CO.
LTD.**

PRESCOTT HOUSE, HUMBER ROAD, LONDON
NW2 6ER

PRINTED CIRCUITS. Make your own simply, cheaply and quickly! Golden Fotolac light-sensitive lacquer - now greatly improved and very much faster. Aerosol cans with full instructions, £2.25. Developer 35p. Ferric Chloride 55p. Clear acetate sheet for master 14p. Copper-clad fibreglass board, approx. 1mm thick £1.75 sq. ft. Post/packing 75p. White House Electronics, Castle Drive, Praa Sands, Penzance, Cornwall.

CENTURION BURGLAR ALARM EQUIPMENT. Send s.a.e. for free list or a cheque/p.o. for £5.95 for our special offer of a full-sized decoy bell cover. To: Centurion, Dept. ET1, 265 Wakefield Road, Huddersfield, West Yorkshire. Access and Barclaycard. Telephone orders 0484 35527.

TWIN 6 AMP mains cable, white, extra flexible. Ideal for speakers or table lamps, etc. 25 metre coil £2.25 inclusive. Longer lengths available. Send cheque or PO to - S&M Sales, 99 St Leonards Road, Windsor, Berks SL4 3BS.

ZX81 GAMES. Six super games on cassette, £3 (plus additional free game and other info.) or SAE list/details. Bobker, 29 Chadderton Drive, Unsworth, Bury, Lancs.

CLOSE ENCOUNTERS GROUP. Personal introductions/dances, parties, talks, social events. Meet interesting attractive people. All areas. Tel. 01-278 0203/051-931 2844.

CONVERT ANY TV into large screen oscilloscope. External unit plus into aerial socket. Circuit and plans £3 (SAE details). - J. Bobker, 29 Chadderton Drive, Unsworth, Bury, Lancs.

WANTED. Electronic components and test equipment. Good prices given. Q Services, 29 Lawford Crescent, Yatley (0252) 871048, Camberley, Surrey.

**PLEASE MENTION
HOBBY ELECTRONICS
WHEN REPLYING TO
ADVERTISEMENTS**

3 INCH 30 OHMS 1.5 Watt loudspeakers, square frame, suitable metronome project, etc. 70p each, 50p p&p per order. Cheques, PO to - AFDEC Electronics Ltd, 17c London St, Basingstoke, Hants.

ADVERTISEMENT INDEX

Ambit International.....	2 & 22
BK Electronics.....	40
B.N.R.S.....	34
J. Bull (Electrical).....	14
Circolec.....	25
Electronize Design.....	51
Electrovalue.....	51
Greenway Electronics.....	51
Greenweld.....	20
Heath Electronics.....	20
Henry's Radio.....	51 & 57
ICS.....	25
ILP.....	4 & 5
Lawtronics.....	34
Magenta Electronics.....	44 & 45
Maplin.....	68
Marshalls.....	32
NIC Models.....	25
Parndon Electronics.....	44
P.A.T.H. Electronics.....	40
T. Powell.....	32
J. W. Rimmer.....	57
Selray Book Co.....	57
Service Trading Co.....	57
Silica Shop.....	67
Swanley Electronics.....	57
Technomatic.....	30
Tempus.....	24
TK Electronics.....	37
Two + One Components.....	57
Watford Electronics.....	9

ELECTRIFY YOUR SALES! • CLASSIFIED ADVERTISEMENT

1	2	3
4	5	6
7	8	9
10	11	12
13	14	15

Please place my advert in: Electronics Today International
(Delete as applicable) Hobby Electronics

Advertise nationally in Electronics Today International/Hobby Electronics. Simply print your advertisement in the coupon here (left), indicating which magazine you require. Or telephone for more information.

Name

Address

Tel. No. (Day)

Send, together with your cheque to:
Jenny Naraine, ETI/HE,
145 Charing Cross Rd., London WC2H 0EE.
Tel: 01-437 1002 Ext. 50.

ELECTRONIC GAMES

COLOUR CARTRIDGE T.V. GAME



SEMI-PROGRAMMABLE T.V. GAME
+ 4 Cartridges + Mains Adaptor
Normal Price £73
NOW REDUCED TO: £39.50 inc. VAT

DATABASE T.V. GAME

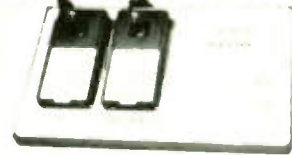

FULLY PROGRAMMABLE CARTRIDGE T.V. GAME
14 Cartridges available
Normal Price £87.86
NOW REDUCED TO: £59 inc. VAT

ATARI T.V. GAME



The most popular T.V. Game on the market with a range of over 40 cartridges including SPACE INVADERS with over 112 games on one cartridge
£95.45 inc. VAT

SPACE INVADERS



Hand held Invaders Games available £19.95
Invaders Cartridges available to fit ATARI RADOFIN ACETRONIC PHILIPS G7000
Cartridges also available for MATTEL TELENG ROWIRON DATABASE INTERION

CHESS COMPUTERS



MANY UNITS ARE COVERED BY THE EXCLUSIVE SILICA SHOP 2 YEAR GUARANTEE

We carry a range of over 15 different Chess computers:
Electronic Chess £29.95
Chess Traveller £39.95
Chess Challenger 7 £79.00
Sensory 8 £119.00
Sensory Voice £259.00
SPECIAL OFFERS
VOICE CHESS CHALLENGER
Normal Price £245 NOW £135.00
SARGON 2.5 BORIS 2.5
Normal Price £273 NOW £199.95
All prices include V.A.T.

TELETEXT



ADD-ON ADAPTOR £199

THE RADOFIN TELETEXT ADD-ON ADAPTOR

Plug the adaptor into the aerial socket of your colour TV and receive the CEEFAX and ORACLE television information services

THIS NEW MODEL INCORPORATES:

- Double height character facility
- True PAL Colour
- Meets latest BBC & IBA broadcast specifications
- Push button channel control
- Unnecessary to remove the unit to watch normal TV programmes
- Gold plated circuit board for reliability
- New SUPERIMPOSE News Flash facility

SPEAK & SPELL

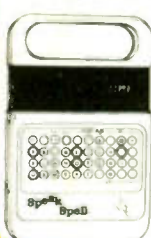

Normal Price £49.95
NOW REDUCED TO: £39.50 inc. VAT

Teach your child to spell properly with this unique learning aid. Fully automatic features and scoring. Additional word modules available to extend the range of words.

ADDING MACHINE



OLYMPIA HHP 1010
Normal Price £57.21
NOW REDUCED TO: £34 inc. VAT

Uses ordinary paper. No need to buy expensive thermal paper! Fast adding. PRINTER CALCULATOR 2 lines per second. 10 digit capacity. Uses normal adding machine rolls. Battery or mains operated. Size 9 1/2" x 4 1/2" x 2 1/2". (Mains adaptor extra)

24 TUNE ELECTRONIC DOOR BELL



Normal Price £19.70
NOW REDUCED TO: £12.70 inc. VAT

Plays 24 different tunes with separate speed control and volume control. Select the most appropriate tune for your visitor, with appropriate tunes for different times of the year!

MATTEL T.V. GAME

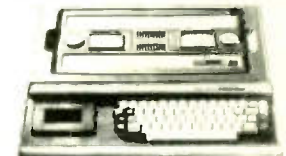

The most advanced T.V. game in the world. 20 cartridges available. Add on KEYBOARD coming £199.95 inc. VAT to convert the MATTEL to a home computer with 16K RAM. Fully expandable and programmable in Microsoft Basic. Other accessories will be available later in the year.

HAND HELD GAMES EARTH INVADERS



These invaders are a breed of creature hitherto unknown to man. They cannot be killed by traditional methods, they must be buried. The battle is conducted in a maze where squads of aliens chase home troops. The only way of eliminating them is by dragging holes and burying them.
£23.95 inc. VAT

THE OLYMPIA — POST OFFICE APPROVED TELEPHONE ANSWERING MACHINE WITH REMOTE CALL-IN BLEEPER

This telephone answering machine is manufactured by Olympia Business Machines, one of the largest Office Equipment manufacturers in the U.K. It is fully POST OFFICE APPROVED and will answer and record messages for 24 hours a day. With your remote call-in bleeper you can receive these messages by telephone wherever you are in the world. The remote call-in bleeper activates the Answer/Record Unit, which will at your command repeat messages, keep or erase them, and is activated from anywhere in the world, or on your return to your home or office. The machine can also be used for message referral if you have an urgent appointment, but are expecting an important call. Simply record the phone number and location where you can be reached. With optional extra



bleepers (£13 each) this facility can be extended to colleagues and members of the family. Using a C90 standard cassette, you can record as many as 45 messages. The announcement can be up to 16 seconds long and the incoming message up to 30 seconds long. The machine is easy to install and comes with full instructions. It is easily wired to your junction box with the spade connectors provided or alternatively a jack plug can be provided to plug into a jack socket. Most important of course, is the fact that it is fully POST OFFICE APPROVED. The price of £135 (inc. VAT) includes the machine, an extra-light remote call-in bleeper, the microphone message tape, A.C. mains adaptor. The unit is 9 1/2" x 6" x 2 1/2" and is fully guaranteed for 12 months. The telephone can be placed directly on the unit — no additional desk space is required.

£135 inc. VAT

PRESTEL VIEWDATA



The ACE TELCOM VDX1000 Prestel Viewdata adaptor simply plugs into the aerial socket of your television and enables you to receive the Prestel Viewdata service in colour or black & white.

Features

- Simplified controls for quick, easy operation
- Special graphics feature for high resolution
- State of the art microprocessor controller
- Standard remote telephone keypad with Prestel keys
- Auto dialler incorporated for easy Prestel acquisition
- True PAL colour encoder using reliable IC, chroma filter and delay line incorporated for minimum picture interference maximum fidelity
- Includes convenient TV Prestel switchbox
- Easily connected to standard home or office telephone lines
- Fully Post Office approved

SPECIAL PRICE £228.85 inc. VAT

HAND HELD GAMES

GALAXY 1000



The 2nd generation Galaxy Invader. The invaders have re-grouped and have a seemingly endless supply of subspace whist the player's arsenal is limited to just 250 missiles to be launched from 3 missile stations. You have to prevent the invaders landing or from destroying your home defences.
£19.95 inc. VAT

FOR FREE BROCHURES - TEL: 01-301 1111

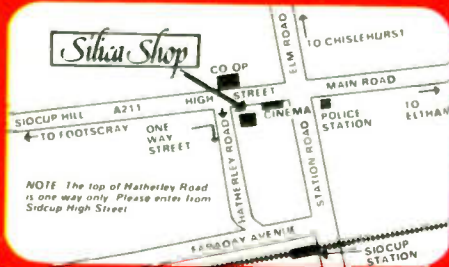

NOTE: The top of Hatherley Road is one way only. Please enter from Sidcup High Street.

For free illustrated brochure and reviews on our range of electronic games, please telephone 01 301 1111. Free delivery service available. To order by telephone please quote your name, address and ACCESSBARCLAYCARD number and leave the rest to us. Post and packing free of charge. Express 48hrs delivery service available.

CALLERS WELCOME Demonstrations daily at our Sidcup shop, open from 9am-6pm Monday-Saturday (Early Closing Thursday 1pm) Late Opening Friday 8pm

2 YEAR GUARANTEE All goods are covered by a full year's guarantee and many are further covered by our exclusive Silica Shop 2 year Guarantee

MONEY BACK UNDERTAKING If you are unsatisfied with your purchase and return it within 7 days we will give you a full refund

AFTER SALES SERVICE Available on all machines, out of guarantee

COMPETITIVE PRICES We are never knowingly undersold

HELPFUL ADVICE Available on the suitability of each machine

CREDIT FACILITIES Full credit facilities available over 12, 24 or 36 months at competitive rates of interest

PART EXCHANGE SCHEME available on selected hand held machines

CREDIT CARDS WELCOME Access, Barclaycard, Diners Club, American Express

SILICA SHOP LIMITED DEPT HE0981
1-4 The Mews, Hatherley Road, Sidcup, Kent DA14 4DX
Telephone: 01-301 1111 or 01-309 1111



MAPLIN make it easy...

in
HAMMERSMITH

159-161 King Street
Hammersmith
London W6
Tel: 01-748 0926
(Closed Mondays)



in
SOUTHEND

284 London Road
Westcliff-on-Sea
Essex
Tel: (0702) 554000
(Closed Mondays)



For personal service visit one of our stores.
Our new store at Hammersmith is conveniently situated near the end of the M4 and the North and South Circular Roads. There is excellent street parking on meters a few steps away and Hammersmith Underground Station is nearby. Call in and see us soon.



in our
CATALOGUE

320 big pages packed with data and pictures of over 5,500 items

Over 100,000 copies sold already!
Don't miss out on your copy.

On sale now in all branches
WH Smith  price £1.

In case of difficulty check the coupon below.

by
MAIL ORDER

A fast service
you can rely on

- * Same day service on in-stock lines
- * Very large percentage of our stock lines in stock
- * All prices include VAT
- * Large range of all the most useful components
- * First class reply paid envelope with every order
- * Quality components—no rejects—no re-marks
- * Competitive prices
- * Your money is safe with a reputable company

On price, service, stock, quality and security it makes sense now more than ever to make **MAPLIN** your first choice for components every time!

make it easy... with **MAPLIN**

The
Maplin Matinée

Amazing value for
only £299.95 plus £99.50
for cabinet if required

Easy to build,
superb specification.
Comparable with organs selling for
up to £1,000. For full construction details
refer to Electronics & Music Maker.



MAPLIN ELECTRONIC SUPPLIES LTD.

Post this coupon now.

Please send me a copy of your 320 page catalogue. I enclose £1.25 (incl. 25p p&p). If I am not completely satisfied I may return the catalogue to you and have my money refunded. If you live outside the U.K. send £1.68 or 12 International Reply Coupons.

Name _____

Address _____

HE981

All mail to: P.O. Box 3, Rayleigh, Essex SS6 8LR. Tel: Southend (0702) 554155 Sales: (0702) 552911