

# HI-FI WORLD

MARCH 2008

UK £3.80

www.hi-fiworld.co.uk

FREE READER CLASSIFIED ADS IN THIS ISSUE!



**EXCLUSIVE!**

**B&W 686**  
standmount loudspeakers



**BUDGET SYSTEMS**  
three compared



**VALVE PHONO STAGES**  
three reviewed

## RAY OF LIGHT

**Raysonic CD128**  
CD player



**COMPETITION**  
WIN A SUPERB  
EDGAR CD-1 CD PLAYER  
WORTH £1,350!



MARCH 2008



9 1770961 766161

- > DENON AVR-4308 AV RECEIVER **EXCLUSIVE**
- > PRO-JECT RPM1 GENIE TURNTABLE
- > ACOUSTIC SOLID CLASSIC WOOD TURNTABLE **EXCLUSIVE**
- > ACCUSTIC ARTS DRIVE 1 MK2 & TUBE DAC 2 CD PLAYER
- > WHARFEDALE OPUS 2-M1, KEF XQ10 & AUROUSAL A1 MK2 SPEAKERS

**PAGES OF YOUR QUESTIONS ANSWERED**

*exposure*



Those who appreciate good sound will prefer the tighter "S."

## New 3010S series:

Tighter bottom-end, livelier sound, more drive...same price

### CD player £1200

- Brand-new "CD solution" – custom-made transport mechanism, servo units and control mechanisms
- Twin Burr-Brown PCM 1704 mono DACs and a discrete output stage
- Low jitter clock and a large toroidal transformer with separate windings for the transport mechanism and audio stages.

### Integrated Amplifier £1000

- Larger power supply
- 110 watts RMS (as compared to 100W for the previous model)
- 6 line inputs, bi-wiring and bi-amping compatible
- Option to fit a MC or MM phono cartridge
- Remote control

### Power Amplifier £800

- Larger power supply
- 110 watts RMS (as compared to 100W for the previous model)
- Capable of driving sophisticated speaker systems, in bi-amping mode or monoblock mode
- Clean and extended low frequency response



**WE ARE THE UK'S FASTEST GROWING AUDIO TITLE!!!**

# welcome

**EDITOR**  
David Price  
tel/fax: +44 (0) 1275 371 386  
e-mail: editorial@hi-fiworld.co.uk

**ASSISTANT EDITOR**  
Adam Smith  
e-mail: editorial@hi-fiworld.co.uk

**DESIGN EDITOR**  
Faiza Chunara  
tel: +44 (0) 20 7625 3129  
fax: +44 (0) 20 7328 1844  
e-mail: adproduction@hi-fiworld.co.uk

**PRODUCTION EDITOR**  
David Noble  
tel: +44 (0) 20 7625 3134  
fax: +44 (0) 20 7328 1844  
e-mail: classifieds@hi-fiworld.co.uk

**ADVERTISING**  
tel: +44 (0) 20 7372 6018  
fax: +44 (0) 20 7328 1844  
e-mail: advertising@hi-fiworld.co.uk

**ACCOUNTS**  
tel: +44 (0) 20 8841 8892  
fax: +44 (0) 20 8841 9144  
e-mail: accounts@hi-fiworld.co.uk

**PUBLISHER**  
Noel Keywood  
e-mail: publisher@hi-fiworld.co.uk

**FREE READERS CLASSIFIEDS**  
tel: +44 (0) 20 7625 3134  
fax: +44 (0) 20 7328 1844  
e-mail: classifieds@hi-fiworld.co.uk

**SUBSCRIPTIONS**  
tel: +44 (0) 1442 879097  
fax: +44 (0) 1442 872279  
e-mail: hifiworld@webscribe.co.uk

**WRITERS**  
Steven Green, Channa Vithana,  
Paul Rigby, David Alcock, Tony Bolton,  
Haden Boardman, Patrick Cleasby.



What springs to mind when you think about your 'dream hi-fi'? Many *Hi-Fi World* readers will picture something along the lines of a stunning turntable hewn from Perspex and glass, beside a brace of valve amplifiers, their tubes glinting against the mirror chromed top plate, between a vast pair of monitor loudspeakers. For most members of the general public however, it's far more likely to be a button-festooned microsystem or an oversized

ghetto blaster from Currys...

In the car world, there's far less of a chasm between an expert's notion of dream car and that of the man on the street. Both would probably agree it would be a knee-high mid-engined Italian job with a V12 nestled where the boot should be. Granted, some might regard a black 4x4 with smoked windows and chrome wheels as their ultimate, but few would ever nominate a 600cc motorised shopping trolley with plastic seats.

Yet it is precisely this – or rather the audio equivalent of it – that most people understand as being 'hi-fi'. The general perception of what inspires us audiophiles is one of complete bewilderment; why would folk want to spend their time and money obsessing about the audio equivalent of dreary little hatchback, they ask?

The point is of course is that we're not interested in lumpen, mass market mediocrity; the joy of hi-fi as a hobby is building up a system that plays music like a Ferrari takes an Alpine road. The sad thing is that most outsiders to our hobby aren't even aware that there is such a thing...

This then begs the question – how do we get 'civilians' - members of the music loving but 'hi-fi unaware' general public - into our club? That's a tricky one, and something that the hi-fi industry has singularly failed to answer. Meanwhile, as we audiophiles argue about the sonic failings of Compact Disc or the respective merits of transistors versus tubes, the rest of the world buys iPod speaker systems and calls them 'hi-fi'.

In its own very modest way, this issue attempts to bridge the gap. We feature three 'affordable' separates systems (p15), with CD, turntable and iPod sources, that – as far as non-audiophiles are concerned – make Rolls Royce music at Arthur Daley prices. They even surprised us hardened hi-fi hacks too. Enjoy!

**David Price, editor**



## testing

To ensure the upmost accuracy in our product reviews, *Hi-Fi World* has extremely comprehensive in-house test facilities, and our test equipment - from big names like Rohde & Schwarz and Hewlett Packard - is amongst the most advanced in the world.

Loudspeakers are measured using a calibrated Bruel & Kjaer microphone feeding a Clio-based computer

analyser, using pulsed and gated sinewaves, in a large room to eliminate the room's influence. Pickup arm vibration is measured with a Bruel & Kjaer accelerometer.

No other UK hi-fi magazine has in-house testing, and none has access to such advanced tests across all types of equipment. That's why you can depend on *Hi-Fi World* reviews.



## hi-fi world

SUITE G4, ARGO HOUSE  
KILBURN PARK ROAD  
LONDON NW6 5LF  
[www.hi-fiworld.co.uk](http://www.hi-fiworld.co.uk)

## verdicts

- ● ● ● ● OUTSTANDING
- ● ● ● EXCELLENT
- ● ● GOOD
- ● ● ● ● MEDIOCRE
- ● POOR
- £ VALUE

- simply the best
- extremely capable
- worth auditioning
- unremarkable
- seriously flawed
- keenly priced

**ELECTRONIC MAGAZINE**  
Go to our website [www.hi-fiworld.co.uk](http://www.hi-fiworld.co.uk) to buy an electronic version of this magazine, individual issues or a subscription. At present we do not offer back issues, but hope to soon.

Distributed by Seymour Distribution Ltd 86 Newman Street London, W1T 3EX Tel: +44 (0) 20 7396 8000 Printed by St.Ives, Plymouth Tel: +44 (0) 1752 345 411  
Our Agents in Malaysia Millennium Hi-Fi & AV Simon Chang Showroom & office, 500-1-3 First Floor Wisma Indah (Shen Court), Jalan Tun Razak 50400 Kuala Lumpur, Malaysia  
Tel: 603 9283 8171 Fax: 603 9281 3762 e-mail: info@millennium-audio.com

All unsolicited submissions and goods are at the owner's risk. We accept no responsibility for such submissions, nor do we undertake to return them. No material may be reproduced from this magazine without the publisher's written permission. © Audio Publishing Ltd

30

Raysonic's CD128 - super valve CD sound.



10

Accoustic Arts CD Drive 1 Mk2/Tube DAC 2 - superlative Compact Disc sound.

43

Mid-price Wharfedale standmounters face off rivals from KEF and Aurousal...



27

Revolver's new Music 5 floorstanders.



90

Magic touch - Pro-ject's new RPM1 Genie.



64

Iconic screen star - Transcriptors' Hydraulic Reference turntable.



### LOUDSPEAKERS

#### REVOLVER MUSIC 5 27

Noel Keywood checks out these slinky new floorstanders.

#### STANDMOUNTER SHOOTOUT 43

Adam Smith listens to three mid-price standmounters from Aurousal, KEF and Wharfedale.

#### B&W 686 48

Haden Boardman is impressed by B&W's new budget boxes.

#### VELODYNE MICROVEE 54

Velodyne's tiny new subwoofer gets a blast from Adam Smith.

### DIGITAL

#### ACCUSTIC ARTS CD DRIVE I MK2 & TUBE

#### DAC 2 10

David Price is wowed by this high-end German CD transport and DAC.

#### RAYSONIC CD128 30

This stylish silver spinner is auditioned by David Price.

#### MP3 PLAYER GROUP TEST 60

David Price hears players from SanDisk, Creative, Samsung, Apple and Sony.

### AMPLIFICATION

#### DENON AVR-4308 52

David Allcock tunes in to this brand new Internet enabled A/V receiver.

#### MYSTERE I A11 57

Noel Keywood puts this affordable new valve amplifier through its paces.

### SYSTEMS

#### BUDGET SYSTEMS 15

David Price, Adam Smith and Channa Vithana pitch three sub-£800 systems against one another.

### RADIO

#### TUNER GROUP TEST 33

Steve Green listens to three DAB/FM/AM tuners from NAD, Onkyo and Yamaha.

### FEATURES

#### HISTORICALLY SPEAKING 39

Adam Smith looks at some of the milestones in the development of the modern loudspeaker.

#### ALMOST BLUE 51

Patrick Cleasby on the latest developments in the high definition format war...

### OLDE WORLDE

#### FLUID MOTION 64

Tony Bolton celebrates Transcriptors' Hydraulic Reference - a film star turntable!

### VINYL SECTION

#### VINYL NEWS 85

Paul Rigby has all the latest black plastic releases.

#### ACOUSTIC SOLID CLASSIC WOOD 86

David Allcock checks out this German company's quirky mid-price turntable.

#### PRO-JECT RPM1 GENIE 90

This new entry level turntable enchants Adam Smith...

#### VALVE PHONO STAGES 94

Tony Bolton compares valve phono stages from Icon Audio, Quad and Eastern Electric.

#### NORDOST HEIMDALL/AUDIOPHILE BASE 98

Two essential vinyl accessories reviewed by David Price.



### 7 NEWS

Words from the front...

### 25, 37 SOUNDBITES

Quick reviews of MIT's AVT series interconnects and loudspeaker cables and Audio Pro's Porto portable MP3 dock/FM radio.

### 50 COMPETITION

Your chance to win a fabulous Edgar CD-1 compact disc player, worth £1,350.

### 62 SUBSCRIPTIONS

Ensure your copy every month and save money too.

### 67, 69, 71, 73, 75 OPINION

The team get to grips with matters music, hi-fi and life!

### 76 AUDIOPHILE VINYL

Paul Rigby rounds up the latest audiophile vinyl releases.

### 79 WORLD CLASSICS

Our favourite designs that have stood the test of time.

### 99 MAIL

Seven pages of your views, opinions and queries.

### 121 DIAL-A-DEALER

A comprehensive guide to UK hi-fi retailers.

### 123 FREE READERS CLASSIFIEDS

Three pages of second-hand bargains.

### 128 NEXT MONTH

What we hope to bring you in the next issue

### 129 ADVERTISERS' INDEX

### 130 CLASSIC CUTS

Paul Rigby remembers Nick Drake's 'Fruit Tree' boxed set.

# Sings Like a Class Leader



## *Gold Signature*

We've claimed that Gold Signature reaches unprecedented standards of design, innovation, performance, technical excellence, build quality and value in its class. But you don't have to take our word for it.

Of the GS10, Hi Fi Choice said '...this one most definitely sings...its appeal is obvious...it is a vice-free, expressive and refined speaker with more than enough subtlety and transparency to suit almost any taste, and the resolving ability required to extract the most from high-quality amplifiers and source components.'

And for Hi Fi World the GS60s 'are a class act...an addictive listen...clear, fast and detailed like little else'. It awards top marks 'for the totality of its engineering, superb finish and great price.'

If you're looking for affordable high-end performance and engineering wrapped in beautiful wood veneers and piano lacquer finishes, just listen to the chorus of acclaim.

[monitoraudio.co.uk](http://monitoraudio.co.uk)

 **MONITOR AUDIO®**



news@hi-fiworld.co.uk

# news



## STREAMING MEDIA

Leema's brand new Stream CD player delivers "breathtaking performance in a beautifully ergonomic package", the company claims. It sports Leema's unique MD2 Active Differential Multi-DAC technology, where sixteen 24bit/192KHz Crystal CS454x multibit Delta-Sigma converters are used, and an unbalanced stereo output is derived from a fully balanced signal that is generated in the digital domain. Apart from the standby button there is just one control: Leema's L-Drive. This "intuitively performs all the usual CD functions" such as CD tray open and close, play, stop, previous and next track as well as allowing direct track access. To match this comes Leema's new Pulse amplifier, said to be "easily capable of driving today's audiophile speakers with a vice-like grip and precise control". Input selection includes an AV input, separate moving magnet and moving coil phono inputs and a front panel mounted MP3 player input. The company claim 80W RMS per channel into 8 Ohms, and nearly twice that into 4. Prices are £1,095 for the Stream CD player and £1,195 for the Pulse integrated amplifier. For more information, click on [www.leema-acoustics.com](http://www.leema-acoustics.com) or call +44(0)1938 811900.



## NEW HORIZONS

The Boston Acoustics brand is back in the UK, and the new Horizon floorstanding range is the latest addition to the portfolio. Its novel moulded self-damping ABS cabinets are said to achieve rigidity equivalent to 3/4-inch MDF, the company says. Extensive ribbing and bracing is used on the inside of the moulding, which further strengthens the structure. The £469 HS450 features dual S 1/4 inch mid-woofers with dual passive radiators, while the pricier £669 HS460 has dual 6 1/2 inch units plus passive radiators. A 1 inch Kortec soft dome tweeter completes the driver count. Both speakers come with an unusual soft-touch finish with colour-coordinated rubber trim, while the Boston Personal Option Plan lets buyers to match speakers to their taste, using replaceable cloth speaker grilles. For more information click on [www.bostonacoustics.com](http://www.bostonacoustics.com) or call +44(0) 1753 287 947.

## DANISH NEW

Davone's stunningly styled new Rithm loudspeaker is described as "a unique design concept which does away with the normal square box format and gives music back its natural form". By using specialised wood moulding technology from the Danish design furniture industry, the company has come up with a fluid shaped, 700x210x600mm cabinet with acoustic properties that surpass the normal square box format, they say. Prices are said to be between 3500 and 4000 Euro per pair, and they come in quarter sawn Oak and slab cut Walnut, with a Black Oak to follow next month. For more information call +45 3323 8811 or click on [www.davoneaudio.com](http://www.davoneaudio.com).





## MONITOR REFERENCE

Harbeth's new reference Monitor M40.1 was unveiled at January's Las Vegas CES show. The new three-way loudspeaker is an evolution of the original Monitor 40, itself "a direct drop-in replacement" for the famous LS5/8 when it suddenly ceased production upon the demise of Rogers. "The Monitor 40 has worked well in the 'dry' acoustic favoured by broadcasters," says Harbeth's Alan Shaw, "and we have sold the speaker to the BBC and a host of commercial programme makers". The new Harbeth-designed bass unit in the M40.1 is the culmination of a twelve-month research programme initiated when the previous model's was no longer available. As part of the design process, a prototype M40.1 was carefully evaluated in the BBC research department's anechoic chamber at Kingswood Warren in Surrey. The company claims "drier, tighter and more extended bass, noticeably increased sensitivity, easier amplifier load and smoother overall balance" for the new speaker. For more details on Harbeth products, click on [www.harbeth.co.uk](http://www.harbeth.co.uk)



## WELL CONNECTED

NAD's new C715 Compact Music System is an affordable music centre bringing together a sensitive FM/AM tuner with 30 station memory (and with the C715DAB, a DAB tuner too), CD player, 2x24W amplifier and a versatile remote control. Its compact size (only 8 1/2 inches wide) makes it perfect for locations where music

is desired but space is at a premium, the company says. Connections for adding portable devices are available on the front panel - a USB port lets users easily transfer music files. All functions are available using the supplied remote control. The NAD C715 costs £325, with the DAB version costing £425. For more information, click on <http://nadelectronics.com>.

## FOR THE RECORD

Clearaudio has made a name for itself as a purveyor of fine turntables, tonearms and cartridges, so it's no surprise that the company now has a test record designed to optimise setup. Phono cartridges need running-in to reach their full sonic potential, which can take anything up to one hundred hours, and the Clearaudio Cartridge Break-In Record is designed to speed this. An endless groove cut with pink noise, a total of twelve continuous tracks are provided along with other tracks to aid the accurate set up of the cartridge, tonearm, turntable and the whole hi-fi system. Pressed onto high quality vinyl, it costs £45. For details call Audio Reference on +44(0)1483 301412 or click on [www.audioreference.co.uk](http://www.audioreference.co.uk).

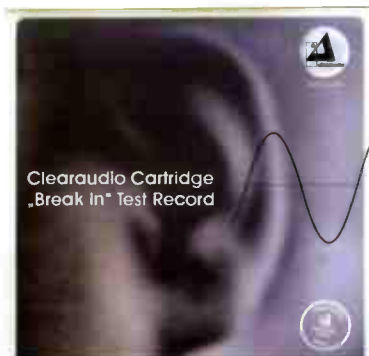

## THE EQUALISER

XTZ's (220 Euro) Room Equaliser is a box "with all you need" for analysing your listening room's acoustics. It features a USB microphone with a built-in soundcard, plus easy PC software "that does not require any greater computer skills", plus a user manual and cables and connectors for hooking up your system and/or subwoofer. It performs frequency response measurement, high resolution room analysis, room mode finder and a spectrogram. For more information click on [www.xtz.se](http://www.xtz.se) or [www.xtz.se](http://www.xtz.se).



## SPOTTED:

Hi-Fi PR svengali Andy Giles whetting his whistle at his much publicised December party. Thousands of fans from all around the world paid hundreds of pounds to come and see him - including his support band Led Zeppelin, also reportedly on fine form too...

## SKY HIGH

AudioQuest's latest flagship interconnect, Sky, has been brought to the UK by Cheltenham based distributor The Multi-Room Company. It uses three solid, high-purity Perfect Surface Silver (PSS) conductors to minimise the distortion caused by the grain boundaries that exist in any metal conductor. The resulting effect is an elimination of harshness and greatly increased clarity compared to other materials, it is claimed. Sky's PSS conductors, contained within the low energy absorption Teflon extruded insulation, have almost nothing but air around them for mechanical isolation.

AudioQuest's renowned Dielectric-Bias System (DBS) utilises a 72 volt charge to bias the dielectric in the cable, "resulting in a considerably more transparent and dynamic performance than that from even a cable in continuous use on a never-switched-off system", the company says. Terminations are via balanced XLR or phono plugs, manufactured from Ohno Continuous Cast Copper (OCC). Price is £1,633 for a 1m stereo pair with phono or XLR connectors. For more information, contact The Multi-Room Company on +44(0)1452 858060.





## FIRE STARTER

Escent's new Fireball S-E500i is a hard disk server described as "an amazingly pain-free way to get the most from your music collection". The latest music server from the American specialist integrates your hi-fi with music stored on everything from a computer to an iPod. Its colossal half terabyte hard disk can hold up to 8,500 hours or almost one year's worth of music, and works with FLAC, WMA, AAC and MP3 files. It also browses, plays and transfers music stored on any Apple Mac or Windows computer. It can import and manage songs purchased from online music stores, such as iTunes, or stream radio stations directly via the Internet. Via the optional Escent FP-I universal dock, the Fireball transfers music to and from an iPod or any MP3 portable. It can be controlled from any PDA and is completely compatible with multi-room control systems from Marantz, Crestron, AMX, Niles and many more. For details call +44(0)1753 680023 or visit [www.escenteuropa.com](http://www.escenteuropa.com).



## ACCUSTIC FEEDBACK

Accustic Arts new £4,995 Tube-Dac II is described as a "state of the art digital to analogue converter" that combines the advantages of both solid state and vacuum tubes. The first component in the company's new Reference Series uses bespoke signal processing technology, routing digital inputs through a 32bit microprocessor containing a high precision quartz crystal-oscillator, 32bit digital filter and 26 parallel operating processors which scan the incoming signal and calculate two 32bit signals for the left and right channels respectively. These are then decoded in two separate DAC chips in full dual mono configuration, and sent to a Tube-Hybrid filter circuit, leaving the unit via balanced XLR-outputs or unbalanced RCA outputs. For more information, click on [www.accusticarts.de](http://www.accusticarts.de). [STOP PRESS: see p10 for a full review]



## CORRECTION

The Sound Mechanics C8 Isolation cones that we reviewed in the February 2008 issue are £75 per set, not £130 as stated. Contact Select Audio on +44(0)1900 813064 for more details

## THE REEL THING

Here's something you don't see very often – new music released on open reel analogue tape! In a world of optical discs and digital downloads, The Tape Project's first title, 'The Number White' by jazz singer Jacqui Naylor has just been released to market on reel to reel tape. This is first in a series of analogue releases "that gives the discerning audiophile an analogue listening experience almost like hearing the original master tape", says the company. Slated for ten releases per year and sold primarily on a subscription basis, the 15ips (inches per second) half-track stereo, reel-to-reel recordings encompass a wide range of musical styles. The company is recommending tape machines and specifications for playback, as well as offering its own specially modified tape decks with custom valve components from Bottlehead Corp. Full descriptions of each music selection is available at The Tape Project website ([www.tapeproject.com/catalog/catalog.htm](http://www.tapeproject.com/catalog/catalog.htm)). There are two tiers of subscription costs: \$1,200 US for a selection of six of the ten releases a year, or charter subscriptions of \$2,000 US a year to get all ten releases. Each album will be also sold individually for \$329 US to non-subscribers. Each tape release comes in a custom box with full-size color artwork. "The highest quality duplicating system that has ever been attempted" is claimed to give "the most involving experience that has ever come from reproduced music", no less! For details, call +1(650) 303 2565 or click on [www.pdbmusic.com](http://www.pdbmusic.com).



## iTIME

PMC's new i series directly replaces the company's DBI+, TB2+, GBI, FBI+ and OBI loudspeakers. Three major technical upgrades are featured, including a new precision built Solonex soft dome tweeter with custom dispersion plate co-developed with SEAS, new PMC designed mid/bass drivers displaying higher power handling and a flatter, lower distortion mid range and hand built high order crossovers featuring French Solen capacitors. These make for "a greater soundstage with a more tangible vocal character and faster, cleaner edged bass", says PMC. The hand finished exterior has also undergone an extensive makeover with the cabinet veneered on all surfaces and a deeper and finer sheen. Prices are £770 for the DBIi, £950 for the TB2i, £1,275 for the GBIi, £1,850 for the FBIi and £2,950 for the OBIi. For further information click on [www.pmc-speakers.com](http://www.pmc-speakers.com).



**When it comes to high end silver disc sound, Accustic Arts' CD Drive 1 Mk2/Tube DAC II can teach the best a thing or two, says David Price...**

# Art School

**A**s regular readers will know, it's not every day that this magazine bestows glowing praise upon boxes of electronics designed to play Compact Discs, so I suppose it is all the more significant when it ever happens. Several months back, Accustic Arts was a rare recipient of the Price purple prose – I found the high end CD Player 1 Mk 2 to be an exceptionally good sounding device.

Well, now I've been let loose with their very best two box machine, costing some



£8,000 in total. The £2,990 CD Drive I Mk 2 and £4,990 Tube DAC II is an interesting package, but not without foibles. Unlike Naim's superb CD555/PS555 – another one of that select group of truly special CD players – the Accoustic Arts duo follows the conventional paradigm for high end CD; namely the transport in one box and the DAC in another (the Naim has both in one box, plus a separate external power supply). The problem is that it seems Accoustic Arts don't advise positioning the transport box on the DAC box, as the latter is a tube design and risks overheating – which makes sitting it on crowded equipment racks such as mine more of a chore than it should be. Can AA really not design a DAC that can keep itself cool?

Other quirks of this package include the excessive size (482x100x375mm) of each box, which I suppose is par for the course for high end stuff, and the slightly clunky top loading arrangement of the CD Drive I Mk2. I didn't really like it on the CD Player I and still don't – the £1,500 Raysonic CDI28 feels nicer to use, and the top loading £14,000 Naim CD555 feels like a work of architectural art by comparison.

Although it lacks the finessed feel of many other top loaders, it's very solidly made indeed. You slide the mirror finish lid of the drive open manually, insert the disc, fit the magnetic disc clamp and slide it closed. Then the Philips CDM Pro 2M Ø drive, with its cast metal frame and clever mechanical decoupling spins up the CD and you're off. But again, the front mounted controls feel crude; the action is smooth but they're simply too big – like a Fisher Price My First CD Player. By comparison with the £10,000 Esoteric X-01, it's like a Casio G-Shock against a Patek Philippe...

Inside its 15kg box, the CD Drive I Mk 2 sports a big magnetically shielded 75VA toroidal core transformer with 45,000 µF capacitors courtesy of four separate supplies, for laser control, digital signal processing, display control and display heating. It is constructed with separate shielded compartments for the drive mechanism, mains power components, digital signal processing and display control. Digital outputs comprise a balanced XLR with HF-transformer plus similarly equipped unbalanced RCA and BNC outputs.

The 12kg Tube DAC II is a fascinating bit of kit; so obviously not just another proprietary digital-to-analogue converter chip stuck in a box. Accoustic Arts use their own

unique '2x32bit' technology, giving simultaneous digital signal processing, separately for left and right channels, via a 32bit microcomputer. This contains a precision crystal oscillator, 32bit digital filter and 26 parallel working multiplier processors. This feeds a full Class A valve analogue output stage, aspirated by a very chunky 84,000 µF power supply section via two magnetically shielded toroidal core transformers. AA say that, "all components used are of outstanding quality".

Instead of following the herd with an upsampling DAC/digital filter, Accoustic Arts have chosen to do things differently. When reading the audio data stream from the transport, the special digital filter takes a mean value via its parallel multiplier network until an accuracy of 32 bits is achieved. "This so-called mean value method is highly precise", compared to upsampling where "the failures are also upsampled", the company says. It also offers automatic de-emphasis, recognising the many classical music discs of the 1990s with pre-emphasis recorded and correcting them via DSP. Finally, the system outputs the separate left and right channels simultaneously via two separate lines, whereas "all other current D/A converters alternately process the left and then the right channel".

**SOUND QUALITY**

As someone once said, it's "déjà vu all over again" hearing this high end Accoustic Arts combination – barely had the first bar of Soul II Soul's 'Back to Life' kicked in and I was remembering moments last year spent with the CD Player I Mk II. This twin box high end cousin is better of course, but it still has that distinctly 'undigital' sound that, as I've

said, I rarely hear from silver disc...

At very first acquaintance, this AA twosome impresses on a hi-fi level. Its tonality is beautiful, by which I don't mean it's as warm as a greenhouse in the tropics – rather, it's very neutral, natural and seemingly distortion-free. The track's female vocals were deep, fruity, breathy and arrestingly direct, as this player portrayed their inherent tonality like few others. Move to Supertramp's 'School' and it did precisely the same thing. Roger

"it comes as close to my sonic ideal from 16bit as makes no difference..."

Hodgson's vocals, often sounding anaemic and chromium-plated on lesser machines, seemed hauntingly real thanks to a total absence of digital artefacts.

Still, within seconds it's not that splendid clarity and immediacy across the midband that you're struck by, but the fact that you're listening to a real musical event without being aware of one's cartridge tracing a vinyl groove. (Normally, I only feel like I'm listening to real musicians playing for me – as opposed to a plastic facsimile of it – when my turntable is rotating...)

For this writer then, what defines the sound of the Accoustic Arts top two-boxer is its wonderfully organic nature, and this ultimately comes down to the special way it times. Interestingly, it doesn't play rhythms like Naim's CD555, which has a very positive, pronounced and explicit sort of style. Rather, just like the CD Player I Mk II before it, this twosome is both deliciously relaxed yet sharp-as-a-knife. Just like a good 300B valve amplifier, it gives all the appearance of being laid back and easy going, and then hits you right between the eyes with its dizzying speed and glassy clarity.

Sony Music's excellent remaster of Peter Gabriel's 'Solsbury Hill' was



Top - Accoustic Arts Drive 1 MK2  
Bottom - Accoustic Arts Tube DAC 2

991527

# Simplicity.

The Aura Note:  
Perfect *Everywhere*.

## Features

- Top-loading mechanism for best CD playback
- 50 Watts/channel stereo amplifier
- AM/FM Tuner with multiple presets
- USB input for use with computer and external USB memory
- One Touch Recording to USB (FM&CD with 128 k bps)
- Aux input for portable music players
- Easy-to-read LED panel
- Simple, intuitive user interface
- On/off timer

## Circuitry and design highlights

- State-of-the-art internal DAC
- Custom-made toroidal transformer
- High-current power supply
- MOSFET output stage
- CS3310 digital volume control
- CD stabilizer
- Glass cover
- Remote control
- Classic British design by Kenneth Grange

## Hate clutter and complication?

Aura Note is the answer for all music lovers who value elegance, ease of use, and stunning sound quality.

[www.hifi500.com](http://www.hifi500.com)

[www.aprilmusic.com](http://www.aprilmusic.com)

UK : +44 1900 813064

**Aura**  
n o t e

**APRIL**  
*music*



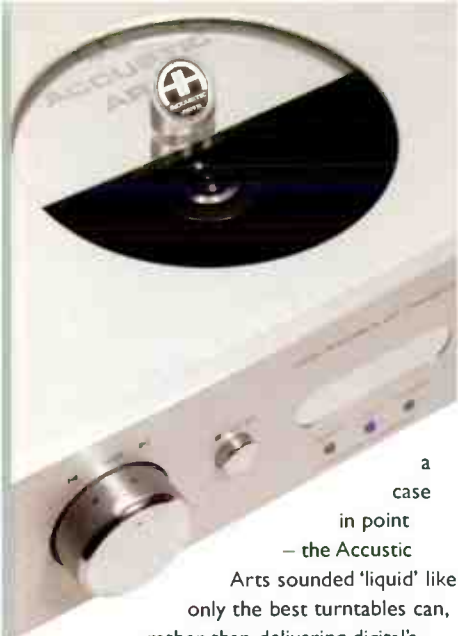

a case in point – the Accustic Arts sounded 'liquid' like only the best turntables can, rather than delivering digital's customary frigid, stilted, mechanical rhythms. It was so easy to spot - everything from the percussion to Gabriel's voice seemed to be doing the right thing at the right time, just as you'd get in the real music event, instead of sounding like it was being triggered from a drum machine.

Seduced as I was by this delicious fluidity, I couldn't stop coming back to the player's hear-through transparency. From top to toe, the Accustic Arts combo impressed. The bass guitar line on Corduroy's 'Don't Wait for Monday' was a joy, the notes starting and stopping with devastating efficiency yet somehow being strung together as only the bassist himself had hitherto heard. Like every self respecting high end machine, the AA combo was tremendously powerful low down yet unlike most it really boogied too. Again, you don't get the sense that the entire music is being driven by the bass as per the Naim, but you do feel the whole frequency band is tremendously well integrated and of a piece from bottom to top.

At the other frequency extreme, the languid hi-hat work on Pink Floyd's 'Shine On You Crazy Diamond' was a pleasure, once again for both the eerily natural way the sticks hit the cymbals and for the sound that ensued, which was delightfully sonorous yet silky smooth.

Dynamics are also delightful; again the AA feels a tad less in-your-face than the supercharged Naim machine, but it can roar like a lion if called upon so to do. The crescendo part to Peter Gabriel's 'Humdrum' was blissful, with the Accustic Arts combo remaining lusciously smooth whilst blasting out the

song's climax without the slightest hint of losing its vice-like hold on the respective positions and parts of all the instruments involved. Such grace under pressure marks this package as truly exceptional - however complex the music becomes it never loses its grip, or descend into harshness or grain.

Unexpectedly perhaps, it's also super in the soundstaging department, the duo opening a wide window onto the world that provides a panoramic view. Inside this, all instruments are locked solid, whilst – depending on the recording – the vocalist or soloist towers high above, behind or in front of the plane of your loudspeakers. Although lacking high end vinyl's truly three dimensional purview, its image width, height and depth are surely about as good as it gets from 16bit digital.

**CONCLUSION**

Accustic Arts CD Drive I Mk 2/Tube DAC I is a hard machine to criticise; it comes as close to my sonic (if not aesthetic or ergonomic) ideal from 16bit as makes no difference. With a sound that's so faithful to the live or studio performance - thanks to its

organic timing, tremendous detailing, breathtaking dynamics and delightful tonality – one struggles to fault it, other than to say that the considerably more expensive Naim CD555/PS555 is even more commanding and imperious by nature, if a little less relaxing over long periods. My own reservations then are minor, petty ones about the way it looks and feels, but I can assure you I soon forget them when I've pressed that big silver 'play' button. It's one of those handful of Compact Disc spinners whose sound simply doesn't feel 'digital' in any way – no mean feat for something playing what's now generally regarded as a somewhat arcane digital format.

**REFERENCE SYSTEM.**  
 Marantz CD63Ki DP CD player  
 MF Audio Passive Preamplifier  
 Quad II-40 power amplifiers  
 Yamaha NS1000M loudspeakers

**MEASURED PERFORMANCE**

High frequencies roll off smoothly with this player, our convolved impulse analysis showing output to be -0.75dB at 20kHz - not much but still just enough to avoid sharpness or glassiness in the sound. It's a nicely judged characteristic, and a popular one too.

Distortion levels were low, if not as low as that of many modern players, including the Edgar CD-1 tested last month. At -60dB solid-state players manage around 0.2% but the Accustic Arts combo returned 0.41%. This is double, or 1.6dB up, so it is not surprising that the EIAJ dynamic range figure is 6dB worse than the norm, measuring 104dB. The Tube Dac 2 measures satisfactorily well in distortion terms, but it isn't up with the best, valve or solid-state.

Similarly, there was some jitter from the transport, although at around 100pS - random and programme related - it wasn't severe. Reclocking in a DAC should suppress this of course.

Output measured 2.1V from the unbalanced output and 4.2V from balanced. Our measurements otherwise showed the two gave similar performances.

The Drive 1 and DAC 2 measured well together, if not quite up with the best. NK

Frequency response (-1dB) CD 4Hz - 21kHz

Distortion	(%)
0dB	0.002
-6dB	0.002
-60dB	0.41
-80dB	3.8
Separation (1kHz)	95dB
Noise (IEC A)	-98dB
Dynamic range	104dB
Output	2.1/4.2V

**FREQUENCY RESPONSE**

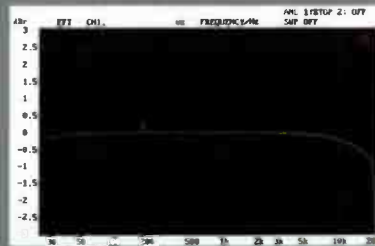

**DISTORTION**

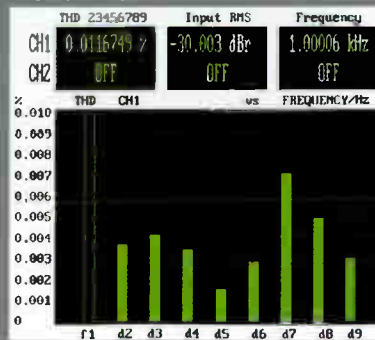

**VERDICT** ●●●●●  
 Quirky presented high end two-box CD player with an arrestingly natural, musical and fluid sound. One of the world's fine CD players.

**ACCUSTIC ARTS**  
 DRIVE 1 MK2 £2,990  
 ACCUSTIC ARTS  
 TUBE DAC 2 £4,990  
[www.accusticarts.de](http://www.accusticarts.de)

- FOR**
- commanding sound
  - breathtaking clarity
  - natural tonality
  - effortless timing, dynamics

- AGAINST**
- bulky styling
  - unfinessed feel

# ELECTROCOMPANIET

## Professional - High End - Lifestyle

Electrocompaniet has been in the High End audio market for 35 years. The last few years have been characterised by continuous innovations and a rapidly expanding international market.

Our products are sold in more than 40 countries, with a range spanning audio, visual, stereo and multichannel technologies.

We have today one of the most complete High End product lines with more than 30 products in all price ranges.

Please visit one of our shops for a demonstration and let us show you why our products are so popular throughout the world.



Electrocompaniet / NSS Ltd.  
Unit 38  
Waterside Trading Estate  
Trumpers Way  
Hanwell, London W7 2QA  
Tel: +44(0)20 8893 5835  
Fax: +44(0)20 8893 5836  
[www.electrocompaniet.no/uk](http://www.electrocompaniet.no/uk)

[www.electrocompaniet.com](http://www.electrocompaniet.com)  
Made in Norway

World Radio History



# Low Life

**Three Hi-Fi World reviewers were tasked to assemble their best budget system below £800 – and they came up with three very different solutions. David Price is your host...**

It's all too easy being *blasé* when you're a hi-fi hack. If you find yourself in a situation where your system's not doing quite what you want it to, you just pick up the phone to a manufacturer and ask them if they've got something that you think will fix it.

This creates an unhealthy state of mind which pervades all journalists across all the magazines – put crudely, we're not terribly in touch with cheap stuff. Whilst our own abodes may not be palatial, we invariably have a healthy throughput of equipment that is. A £10,000 CD player here, a pair of £6,000 speakers there, plus the occasional £2,000 tonearm thrown in for good measure means that we tend to occasionally forget that much of this sort of exotica is out of many audiophiles' reach.

Well, I thought it was time for us to put on, figuratively speaking, a hair shirt and sit on a wooll sack – and assemble systems coming in at a good deal less than £1,000. A little dose of real life wasn't going to hurt us, was it? All that remained for me was to find three victims – I mean *writers* – to rise to the challenge...

Well, the ever diligent Mr. Vithana was the first to get my call – and to give him credit he rather liked the idea. Channa, whose day job is an architect, appreciates "the stripped-down aesthetic", as he put it in his own distinctive way, and didn't seem in the least bit worried. Indeed CV was never a fan of vast sprawling hi-fi boxes, ostentatiously advertising their worth with fussy styling and fripperies. To him, the chance to do a minimalist, low rent system rather appealed.

My next sufferer (I mean reviewer) was our very own Adam Smith. As I explained my plan to do a "real world budget system feature", he looked a little nervous, and when I told him the budget he seemed unhappier still, especially as I stated firmly that eBay and second hand shops were out of bounds! Then I spotted a little twinkle in his eyes, and he said, "Can I do one with a turntable?". Of course said I, and AS suddenly looked as happy as a drunk locked in an off licence. Nanoseconds later, that glint brightened appreciably as he announced, "I'll do a Technics"...

Having press-ganged two hapless hi-fi hacks in on the project, my thoughts turned to my third victim – Noel, perchance? But then I remembered that recently he's been moaning about £5,000 loudspeakers more than a Mancunian complains about rain, so his rarefied sensibilities might not be attuned to £150 CD players right at this very moment. So who else could rise to the low rent hi-fi test? Doh, it had to be me!

Of course, Channa would have already come up with the best possible budget CD system, whereas Adam was already removing the headshell grommet from a new SL1210, so that left me with the audio equivalent of the 'sloppy seconds'. Well, not wishing to be beaten at playing Channa or Adam's games (and they would, of course, be getting the best in that they'd heard at the price), I decided to do something completely different in the shape of an Apple iPod-based set-up. The question was, which one would turn in the best sound quality of the three? Seconds out, round one...





# The Vinyl Countdown

...in which our resident vinyl geek Adam Smith blows most of his budget on the analogue front end...

**T**his is my first Hi-Fi World fixed-price system challenge, and it required a slight brain re-train. You see, when a reader writes in with a request for equipment, we always like to give a few different options - after all, one person's 'laid back and smooth' is another person's 'flat and dull'. So naturally, my mind immediately started to ponder various possibilities and got into a bit of a tangle. That was, until I stopped and reminded myself that I needed to think in terms of what would I buy were it my own precious funds at stake - then it became easier.

Starting at the source, there are some very fine turntables around the £200-£400 mark but I knew straight away what I wanted, and that was a Technics SL-1210Mk2. I realise this may cause some raised eyebrows but it really was no contest for me - this deck has absolutely the best bass you will find on any turntable south of £1,500 or so and the rest of the frequency range is pretty good as well, even in standard form, with a couple of provisos. Firstly, that rubber washer betwixt arm and headshell is best removed so that the headshell can be firmly clamped to the tube and, secondly, the rubber mat that

many still come with is best junked and replaced by a thin felt item.

To briefly recap, the deck is a two speed direct drive design, with variable speed and virtually instantaneous platter start and stop - belt drives seem comically slow and laborious in comparison. It comes fitted with a shiny S-shaped arm that is something of a bone of contention between editor DP and myself. He hates it with a passion, but I personally believe that, although it doesn't allow the full potential of the motor unit to shine through, it can still perform quite nicely [mumble, grumble, etc. - Ed.]. Now, depending



on where you buy it from, the SL-1210 will come without a cartridge or, if you're really unlucky, it will come with a Stanton 500 pre-fitted. Either way, a decent hi-fi cartridge is required and you need look no further than Audio Technica's £30 AT110E as an excellent starting point. It is a definite step up over the £22 AT95E and turns in a remarkably respectable performance for its low price.

My next thought turned to loudspeakers and, sadly, the imposed budget constraint ruled out my favourite Usher S-520s, as their £320 selling price would leave me £60 for amplifier, phono stage and interconnect. As a wise man once said, "miracles are instantaneous; the impossible takes a bit longer"... Consequently, my mind turned to cheaper designs and led me to Mordaunt Short. Their Avant 902i is one heck of a lot of high quality loudspeaker for £150 and this would leave me a decent budget for amplification. The 902is are a compact standmounter, available in Black, Calvados and Honey Maple finishes and use Mordaunt Short's latest generation of drive units, namely a one inch (25mm) aluminium dome tweeter and 5.25 inch (130mm) CPC aluminium bass/mid driver.

For amplification, my first thought was the NAD C315BEE that I reviewed in the January 2008 Issue of *Hi-Fi World*. However, whilst the NAD and MS worked well together on most levels, the amplifier's rather soft bass was not seeming to help the loudspeakers' occasional reticence in bass detail terms. Consequently I dug out its rival, the Cambridge Azur 340A SE and this did the trick perfectly. It is interesting to note that Cambridge Audio and Mordaunt Short equipment generally works so well together, but I suppose this is not a surprise, given that their respective design centres are separated by little more than a staircase at Audio Partnership's headquarters in London!

All that was required now was a phono stage and some cables, so I plumped for Cambridge Audio's 540P plus a 1m length of their Atlantic interconnect and, having exhausted my budget, a few pounds worth of B&Q's finest 6A mains cable for loudspeaker connection duties.

## SOUND QUALITY

I absolutely guarantee that you will not hear bass like this from any other system at the price (sorry, David and Channa!). Take the rock-solid and snappy low end of a Technics DD, combine with the punchy bass

delivered by the Cambridge and send it out to the world through loudspeakers like the Mordaunt Shorts, and you have the recipe for some impressive low end action.

The system sounded tight and deep, with enough low end impact to do a passable impression of small floorstanders, rather than standmounts. Reaching straight for some reggae in the form of Maxi Priest's 'Maxi', the bass line from 'Wild World' was magnificently reproduced. Each bass note was snappy, swift and expertly rendered; the Technics' bass insight working perfectly with the Avants, which can tend to be a little veiled in this area, to ensure that everything shone through perfectly.

Across the rest of the frequency range, the Technics/Cambridge/MS system worked beautifully as well. As would be expected from a good direct drive, instruments were very well defined, with leading edges of strings expertly delineated, and good levels of perception right into the depths of the mix. The system laid the performance out nicely across the soundstage and offered commendable width, pushing the action right up to the loudspeakers and out into the room.

Spinning Diana Krall's 'Christmas Songs', her version of 'Have Yourself a Merry Little Christmas' was sublime, with her vocals suitably husky and intimate. Equally, the backing double bass provided a solid underpinning and the piano sounded just like a piano should, with real presence to each note. Although perhaps not spreading out the performance behind the plane of the loudspeakers as well as a more expensive setup, the system nonetheless created a good sense of spaciousness across the front of the soundstage to wrap the performance around the listener.

At the top end, treble was crisp and detailed, with fine levels of insight into instruments. Cymbals were snappy and had a delicious metallic ring to them but without ever straying into being splashy or messy. Spinning 'Uranus the Magician' from Holst's 'Planets' showed that the Technics/Cambridge/MS setup also has a superb ability to follow orchestral action from a murmur to a soaring crescendo, and hang onto it with impressive dexterity. Never once did I feel that I needed to make any excuses for any aspects of the system's performance as a result of its comparatively low price.

Continuing the acoustic theme and spinning Antonio Forcione's 'Touch Wood', the Technics/Cambridge/MS setup once again



Cambridge Audio Atlantic interconnects.

proved that the intricacies of real instruments held no fear. The fretwork on each of the acoustic guitars was well revealed, and the double bass, which can sometimes shrink into the background somewhat, remained well placed within the mix. Once again, the SL-1210MK2 proved its worth at the low end by picking up on each bass string pluck with commendable accuracy.

## CONCLUSION

This system proves very nicely the theory that we always try to remind everyone of; namely synergy. It shows that setting up a good system is not just a case of gathering a bunch of 'five globe' products and putting them all together. Obviously, each of the system components are fine performers in their own right but, most importantly, they complement each other to gel superbly.

Another nice aspect of the system is its user-friendliness, thanks in no small part to the Technics turntable. The headshell comes off to make cartridge fitment easy, arm VTA adjustment can be carried out with a record playing if you're careful enough and operating it consists of hitting one button to start and stop the deck and two other buttons for speed selection - no messing about with belts and platters to change speed here! Finally, the deck really is built like the proverbial tank and I feel sure will still be spinning silently when we're all long dead and gone.

All in all, The Technics, Cambridge Audio and Mordaunt Short system assembled here is a mightily impressive vinyl playing setup. Even at its fairly modest price, it offers a dynamic, tight and detailed performance that really gets to the heart of what vinyl is about.

## TUNING

The upgrade potential of this setup is another advantage it holds. The first step I would take is to add some proper loudspeaker cable like Black Rhodium's Disco at £4/m. I would also change the phono stage-to-amplifier interconnect for Techlink's Wires XS which I still rate as one of the best sub-£100 performers, at just £20 for a 1m length.

Obviously more expensive amplifiers and loudspeakers can be substituted at any time, but the £60 Cambridge 640P phono stage marks a nice step up over the 540P and also allows the use of an MC cartridge.

Finally, the Technics SL-1210MK2 is capable of taking a better cartridge, such as an Ortofon 2M Blue or Goldring 1012GX, and replacing the standard output cable is well worth doing if you're not averse to a spot of DIY. However, as regular readers will know, the upgrade potential of this deck is immense, with new arms and power supply upgrades shifting its performance to a new level - it could be the last turntable you ever buy!

TECHNICS SL-1210MK2 £340  
Panasonic/Technics UK  
☎ +44(0)844 844 3852  
www.panasonic.co.uk

AUDIO TECHNICA  
AT110E £30  
Audio Technica UK  
☎ +44(0)113 277 1441  
www.audio-technica.com

CAMBRIDGE AUDIO  
AZUR 340A SE £180  
AZUR 540P £40  
ATLANTIC I/C £10  
Cambridge Audio  
☎ +44(0)845 900 1230  
www.cambridgeaudio.com

MORDAUNT SHORT  
AVANT 902i £150  
Mordaunt Short  
☎ +44(0)207 940 2200  
www.mordauntshort.com



# Bit Player

**Channa Vithana's budget Compact Disc system sounds far better than its lowly price-tag suggests, providing it's carefully tuned...**

I didn't instantly recoil in horror when editor David asked me to assemble a sub-£800 Compact Disc-based system, because gone are the dark days of the eighties when most inexpensive CD players would perform sonically-assisted dental filling removal the moment the play button was pressed. Thankfully, modern machines have improved with better build, power supplies and Bitstream DAC implementations, and an excellent example of this digital renaissance is, of course, Cambridge Audio's range of affordable audiophile kit.

Their £149.95 340C CD player is a quintessential low cost, high quality

design. For example, the casework is well constructed and aesthetically pleasing, with its non-standard side panels, flush-mounted fixings and thick aluminium front. Unlike many at the price, rapping it with your knuckles isn't akin to banging a tin drum – rather it resonates very little, which can only be good for sonics. It uses a smooth-loading proprietary acoustically damped transport mechanism with Sony optics and Crystal CS4338 24 bit/96kHz DAC with separate analogue and digital power supplies. The 430x70x310mm machine also has optical and coaxial digital outputs and weighs an impressive (at the price) 4.6kg.

Working with the aforementioned

Cambridge Audio silver disc spinner is the new £180 NAD C315BEE amplifier, the self-same that Adam reviewed in our January 2008 issue. It was awarded the full fat five globes, and under measurement Noel wrung 55 Watts into 8 Ohms and 80 Watts into 4 Ohms from its innards, which is much higher than NAD's factory specification of 40 Watts into 8 Ohms. Indeed, Noel stated that distortion levels were extremely low at all levels and frequencies - just what was needed if I was to better my rivals' systems!

The little NAD integrated has up to seven inputs, including a front-mounted iPod/MP3 socket and switchable tone controls, balance,



headphone and remote-control. Although individual bass and treble knobs will be heresy to purists, let us remember that some people have to live in the real world, and if you're committing 'just' £1,000 on a complete hi-fi system it proves you're more realistic than many reading this magazine, some of whom spend such amounts on interconnects. The NAD comes in the new modern Titanium silver finish or the company's classic military grey, which is my preferred option as this is how a NAD should look; a purposeful and business-like countenance that performs way beyond price and size considerations. Happily, this is precisely what I believe I have achieved with this system.

To complete it, instead of going the obvious Usher S520 route that DP took [hurrumph! - Ed.] I pointed my ears in the direction of the new Acoustic Energy Aegis Neo One standmounter, the very loudspeaker that received five globes in our February 2008 issue. I knew instantly that these would form a good match to the Cambridge and NAD because in my experience, the lower-cost AEs have always timed well and provided a propulsive and clear sound. The single-wired Neo Ones feature a 130mm pressed alloy mid/bass cone and 25mm neodymium ring radiator tweeter. The 357x182x237mm cabinets which weigh 6kg are made of braced 15mm MDF and come in Black Ash, Light Oak and Walnut finishes. The quoted frequency range is 45Hz-45kHz with 8ohm impedance and 89dB sensitivity.

**SOUND QUALITY**

Even cold out of the box, the basic quality of these components shone through, giving a sound that was disproportionately good considering its lowly retail price. This was surprising in itself, but I hadn't bargained on the magnitude of improvement that the extra outlay on interconnects and mains cable would bring. Suitably wired up, the Cambridge Audio/NAD/Acoustic Energy system seemed to gel, proving rhythmically coherent, tight and tuneful across every music I tried.

Listening commenced with the challenging 'String Quartets and Duets' on Sony Classical by György Ligeti. This CD has an edgy music structure - a traditional hallmark of Ligeti's works - and is notable for the destructive ability of the violins with their potential for very strident high-frequencies if the system isn't good enough. Thus, I wasn't expecting great things from my humble budget system; especially since it was a CD-

based one and I'd duly anticipated it being cold...

Well I wouldn't quite call the results warm in the classical analogue sense, but it was nonetheless a satisfyingly smooth sounding set-up. Not only did it capture the deftly layered phrasing of the sinister Ligeti violins, but there was little in the way of high frequency stridency. Instead, I heard real depth and clarity to the cello, making the Ligeti works thoroughly convincing. Powering up my £10,000+ reference Densen/ Sendor CD system showed the budget combo's restricted bandwidth, but it gave nothing away in terms of musical timing which made it just as much fun to listen to. 'The Chauffeur' from Duran Duran's 'Rio' proved a delight via this system, which gave impressive instrumental separation and managed to unwrap the intricate opening layers of the complex recording. The Acoustic Energy speakers delivered an expressive, clear and atmospheric sound, ably capturing the lilting, *nóir* feel of the music.

I next subjected myself to the fire-breathing rock of Guns 'n' Roses' first and best album, 'Appetite For Destruction'. 'Rocket Queen' was an exhilarating power-house rush as Duff McKagan's sinuous bass lines pushed the song along its trajectory. Guitarist Slash could be heard doing his complex rhythm and lead parts with ease, while Axl Rose's powerful voice was also well resolved. I could hear his singing parts and the chord changes of the guitar lines interacting with the perfectly-placed (and

notoriously recorded) sighing female vocals which permeate throughout.

**CONCLUSION**

Whilst this is far from the best system I've ever heard, it does give a tremendous bang for the buck. Costing around £530 for the Cambridge CD player, NAD integrated and Acoustic Energy loudspeakers - plus £102.50 for all the Supra cabling [see TUNING] - this turned out to be one of the nicest integrated systems I have heard in ages. The music was full of life, bristling with detail, depth and a wide-open acoustic canvas that made me want to keep listening.

Previously, Adam noted slightly loose bass within the NAD and AE reviews as their only minor flaws, but with the crisp sounding Cambridge Audio Azur 340C and high-resolution Supra cables, in this case such anomalies were harder to spot. Be it classical Ligeti, electro-pop Duran Duran or hard rocking Guns n' Roses, the system served up rhythmically coherent, tight and tuneful music. Allow it about a week's worth of running-in and it will make you forget all about hi-fi and instead enjoy music much more, for far less money.



Supra Dual interconnect.



Supra Lorad CS-BS Mains 1.5 cable.



Supra Rondo 2.2.5T speaker cable.

**TUNING**

I needed something special to bring this budget system to life, but at a low cost, so I contacted Supra Cables and they supplied me with a rather attractive and nicely made set of wires in Ice Blue! Sweden-based Supra is a rarity amongst cable manufacturers in that their products are made in-house and not merely assembled from outsourced parts. The LoRad 1.5 CS-BS mains cable is fully CE approved and starts at £39.99 for one metre. It has gold-plated connectors with three sets of conductors and 90 x 0.15mm diameter strands of tinned Oxygen Free Copper (OFC). The Dual interconnect costs £44.99 for one metre and uses an aluminium foil screen with 19 x 0.127mm tin-plated strands of OFC.

The Rondo 2x2.5 loudspeaker cable costs a very reasonable £3.50 per metre, and it was recommended by Supra UK to have them terminated as this offers superior sound quality plus keeps the cost down. The Rondo features two conductors and 320 x 0.10mm diameter strands of tin-plated OFC. The Supra cables came in high-quality 'Heat & Ageing Resistant' PVC jackets. In use, the Supras were, well, super compared to a fully run-in set of 'free' interconnects, a standard-issue moulded mains cable (into the Cambridge) and cheap 79-strand loudspeaker cable which cost 50p/m. The Supra upgrade was frankly, enormous by comparison, where they not only revealed the fantastic timing of the Cambridge, NAD and AE combination but also excellent levels of instrumental and vocal resolution and spatiality. These attributes allowed the music to be free-flowing, lacking in harshness and yet remain emotionally involving unlike many a mid to high-end system that concentrate on a few key non-musical 'hi-fi' misnomers like 'sound staging' and 'warmth.'

CAMBRIDGE AUDIO	
AZUR 340C	£149.95
Cambridge Audio	
☎ +44 (0)845 900 1230	
www.cambridge-audio.com	

NAD C315BEE	£180
NAD Electronics	
☎ +44 (0)1279 501 111	
www.nadelectronics.com	

ACOUSTIC ENERGY AEGIS	
NEO ONE	£199
Acoustic Energy	
☎ +44 (0)1285 654 432	
www.acoustic-energy.co.uk	

SUPRA DUAL	
INTERCONNECT	£44.99
SUPRA RONDO 2.2.5T	
SPEAKER	£3.50/M
SUPRA LORAD 1.5	
CS-BS MAINS	£39.99
Supra Cables	
☎ +44 (0)1223 441 299	
www.supracables.co.uk	

# HI-FI WORLD

Come and meet the Hi-Fi World team in  
the conservatory for our latest  
subscription offer at  
The Bristol Show Sound & Vision Show  
on 22nd-24th February 2008  
at The Marriott City Centre Hotel





There you have it – a veritable cornucopia of weird and wonderful inexpensive kit, lovingly assembled to scale the sonic heights by the best hi-fi brains in the business. Oh, and don't forget Adam and Channa's systems too!

Okay, apologies for that cheap jibe, but as I have the worst sounding system of the three, I thought attack was the best form of defence. Actually, my Apple iPod Classic, Arcam rDock, Project Amp Box and Usher S-520 system didn't sound half bad. Indeed, it was actually rather nice – certainly better than any other system the size of a couple of packets of cigarettes. It would certainly surprise anyone who didn't know it was an iPod playing; indeed I'd rather like to do a blind listening test at a hi-fi show with it sometime!

The weak point of my system was, of course, the iPod; its analogue output stage, despite serious remedial help from the superb Arcam rDock, isn't the best around, still erring towards a slightly diffuse, airbrushed sound. Not that it's unpleasant, as it covers everything in a rather relaxing haze – kind of like a French impressionist painting.

The ancillaries – the Project Amp Box and Usher S-520s are absolute crackers. Matched with a Pre Box preamp, you've a £620 combination that's both tiny and brilliantly capable at the price – sophisticated and musical like few other combinations I've heard under a grand.

Still, I do love the petiteness of the system, and the fact that its performance is completely out of kilter with its 'Toy town' looks. I also love the iPod's flexibility; I'm a huge convert to podcasts – basically you can take your pick of the BBC's best radio across all its networks and listen to it whenever you want. It makes DAB tuners seem utterly antiquated, not least because podcasts are 'radio on demand', totally automated and no less bad sounding than British Digital Radio! The new iPod Classic also does well with music running Apple Lossless; if you've only ever heard it playing compressed files, you'd be pleasantly surprised.

So I think it's a firm third place for yours truly, thanks to underperforming (relatively) on sound, running over budget and my heretical use of an iPod. Who then comes second? Enter *Hi-Fi World's* own Captain Sensible – Channa Vithana with his exceedingly well balanced CD system.

Channa gets the silver medal, not because he's bad at assembling systems (quite the reverse) but

because – in my view – CD still cannot match vinyl pound for pound as a music source. It has unquestionably got better at the budget end, as the superb little Cambridge 340C proves, and it's also still quite right to spend your money on a carefully fettled CD separates system at the price than one of the latest 'one box' do-it-all designs. However, it's the brilliance of Adam's analogue source that steals the day, rather than the lack of talent of the Cambridge – more of the former later...

"the combination of Technics turntable, Cambridge Audio amp and Mordaunt Short speakers is big audio dynamite..."

The sound coming from a modest system of carefully matched separates, properly set up and positioned, is a sharp reminder to me – who lives his hi-fi life mostly at the high end – of just how good entry level stuff can be. It's also far easier to make an expensive system sound bad (i.e. by getting one of the many set-up parameters wrong) than it is to get an honest budget one such as Channa's to work badly. I love the functional simplicity of it, and the fact that you can just feed it a disc, whack up the volume and enjoy it.

There's no waiting for your valves to warm up, no worries about whether that £600 you've just lavished on interconnects was money well spent, and no crowding around it at parties lest Auntie Jackle spills her glass of Australian Chardonnay on it. Channa's Cambridge Audio/NAD/Acoustic Energy combo just plays music in a stress-free and enjoyable way that lets you focus on the music itself rather than the hi-fi; and I've heard some £100,000 systems that can't do that.

Keen students of statistics will have deduced that Adam wins our super budget system shootout, then. Not only for having the audacity to use a turntable, but for bringing it in on budget (unlike yours truly). Much has been written about the Technics SL1200 in these pages of late, and once again it proves its worth as a brilliant budget buy. I can't think of anything else for £350-ish that touches it sonically – turntable or CD – but there are some caveats...

As Adam explained, the Technics needs careful setting up with a decent cartridge, and not everyone can do this. It is obviously only of interest to those with a sizeable vinyl collection – or the intention to acquire one – and it's not as compact,

user-friendly or indeed family friendly as a CD player, as anyone with young children will know. So, Adam's system is not for everyone – but boy, the sound is!

Small and cheap though it may be, the combination of a Technics SL1210 mk2, Cambridge Audio 340A SE and Mordaunt Short Avant 902is is big audio dynamite. The scale of the sound is in another league to the other two; despite the tiny speakers it hangs in the room with eerie realism, going wide out of the boxes.

It's nicely dimensional too, with a very believable, 'human' sounding midband and seriously fast and punchy bass. Best of all is the way the system hangs on through musical climaxes, refusing to descend into muddle or mayhem. You put a record on and it plays it in a refreshingly unflappable way that's both smoothly detailed and boundlessly energetic.

Okay then Mr. Smith, you win – but just you wait till the next super system challenge; it won't be a hard disk I'm spinning but a black vinyl one, and you could end up drawing the short straw and having to design a system around a dreary DAB tuner – then who'll be laughing? DP





## POINTS OF REFERENCE...

Specialist handmade speakers,  
from specially handpicked retailers.

'Relative to its peers KEF delivers as much or more  
detail and makes much better use of it.'

Hi-Fi+, October 2007

SOUND & VISION DEPT.  
HARRODS DEPARTMENT STORE  
87-135 BROMPTON ROAD  
KNIGHTSBRIDGE  
LONDON  
SW1X 7XL

GLOBAL HI FI CENTRE LTD  
87A CLAYTON STREET  
NEWCASTLE UPON TYNE  
TYNE & WEAR  
NE1 5PY

KIMBERLEY HIFI (CROYDON)  
352/354 LOWER ADDISCOMBE RD  
CROYDON  
SURREY  
CR0 7AF

HOME MEDIA LTD  
24-26 UNION STREET  
MAIDSTONE  
KENT  
ME14 1ED

LOUD AND CLEAR (Scotland) LTD  
520 ST VINCENT STREET  
GLASGOW  
SCOTLAND  
G3 8XZ

LYRIC HI-FI  
429-431 LISBURN ROAD  
BELFAST  
NORTHERN IRELAND  
BT9 7EY

MARTINS HI-FI H/O  
85-87 BER STREET  
NORWICH  
NORFOLK  
NR1 3EY

MUSICAL IMAGES  
AUDIO VISUAL LIFESTYLE LTD  
173 STATION ROAD  
EDGWARE  
MIDDLESEX  
HA8 7JX

NOTTINGHAM HI-FI CENTRE  
120 ALFRETON ROAD  
NOTTINGHAM  
NOTTINGHAMSHIRE  
NG7 3NS

PRACTICAL HI FI (Warrington)  
88 BRIDGE STREET  
WARRINGTON  
CHESHIRE  
WA1 2RF

SEVENOAKS (PLYMOUTH)  
107 CORNWALL STREET  
PLYMOUTH  
DEVON  
PL1 1PA

SEVENOAKS (CHELTENHAM)  
14 PITTVILLE STREET  
CHELTENHAM  
CLOUCESTERSHIRE  
GL52 2UJ

SEVENOAKS SOUND AND VISION  
109-113 LONDON ROAD  
SEVENOAKS  
KENT  
TN13 1BH

SEVENOAKS (READING)  
3-4 THE WALK SHOPPING CNTR  
READING  
BERKSHIRE  
RG1 2HG

SEVENOAKS (BRISTOL)  
92B WHITE LADIES ROAD  
CLIFTON  
BRISTOL  
BS8 2QN

STONE AUDIO (UK) LTD  
HOLMEAD WALK  
POUNDBURY  
DORCHESTER  
DORSET  
DT1 3GE

UNILET SOUND AND VISION LTD  
35 HIGH STREET  
NEW MALDEN  
SURREY  
KT3 4BY

# REFERENCE





**MIT AVT-1 INTERCONNECTS**  
**£197 - 2metres**  
**AVt-S1 LOUDSPEAKER CABLES**  
**£505 - 3metres**

There can be little that inflames many audiophiles like a debate about cables. *Hi-Fi World* is well aware of the benefits that good ones bring, but still cannot recommend spending silly amounts on them before the basic system hardware (source, amplification, speakers, etc.) is right first. They undoubtedly do make a difference, but on a purely material cost level it's hard to see how some high end prices are justified. Happily though, we can't level such criticism at MIT with their AVT series of interconnects...

The company hails from Rocklin in California, and founder Bruce Bisson first started developing cables back in the 1970s. Many of his designs were licensed to Monster in the 1980s but in 1984 he branched out and founded MIT (Music Interface Technologies) in order to develop his own range of audio, video and mains cables.

Where MIT's designs differ are in their use of passive networks along the cable in order to improve their transmission efficiency over a wide frequency range. MIT state that, "all cables have one ideal area where the capacitance, inductance and resistance are balanced for proper

articulation. This describes a single-pole of articulation. With Multipole networks, we can create additional poles (within the cable) for ideal behaviour over a broader range than just cable".

The AVt (Audio Video terminator) series are second up from the base of MIT's range and the '1' level comes above the '2' and '3' levels in this family. The AVt-S1 loudspeaker cables use 'eight conductor' geometry and P.E. insulation, and incorporate both a multipole network and MIT's 'Iconn' connection system, where each conductor terminates in a gold plated screw thread, to which you can attach the connector of your choice - MIT supply both 4mm plugs and chunky spade terminals.

The AVt-1 interconnects are the matching items, offering '5 Patented Articulation Poles' over a standard cable's one, along with hybrid copper and silver conductor construction, dual shields and some very hefty locking phono plugs. Certainly in terms of build quality and construction, the AVt series items are very impressive, but does their performance convince?

In a word, yes. These are one of the most impressive cables we have auditioned. Listening to the loudspeaker cables first, the AVt-S1s offered a noticeable improvement over the van den Hul Royal Jade that is our normal reference item

at World Towers. The MITs opened up the soundstage to let the whole performance flow from the loudspeakers and out into the room. The Jades are no slouches in this respect, but the AVt-S1s still showed them a clean pair of heels.

In frequency terms, bass was solid and tight and the MIT cables added a crispness and richness to the mid and upper frequencies that made instruments easier to follow, adding precision to leading edges and making it easier to pick up on subtle effects that normally remained tucked away in the back of the performance. Strings were better defined, cymbals sounded more metallic and vocalists gained extra body and scale.

Even more surprising were the AVt-1 interconnects, which did all the above plus more besides. Substituting these between CD player and amplifier was an ear-opening experience, not only in the way that they opened up the image scale, but also made everything snap into focus with real precision. Whether the source material was classical, rock, dance or jazz, the AVt-1s simply made everything sound more real, giving definition and an increased sense of impact to everything. A really impressive product that is worth the asking price in both construction and performance terms. [Contact: [Audibility](mailto:Audibility), +44(0)870 777 2991, [www.audibilityuk.net](http://www.audibilityuk.net)]  
**AS**

**SOUNDBITES**



“This is one of the most impressive hi-fi products I’ve heard this year”

KETAN BHARADIA, TECHNICAL EDITOR WHAT HI-FI? SOUND AND VISION, AWARDS 2007

THE ANTILA CD PLAYER WITH ITS UNIQUE MD<sup>2</sup> ACTIVE DIFFERENTIAL MULTI-DAC CONVERTER TECHNOLOGY PROVIDES BREATHTAKING REALISM AND A TACTILE PANORAMIC IMAGE.

LIPS ENSURES THE ULTIMATE SIMPLICITY IN USE AND FLEXIBILITY FOR THE FUTURE.

ONLY THROUGH HEARING WILL YOU TRULY BELIEVE. TO LOCATE YOUR NEAREST DEALER CALL LEEMA ACOUSTICS ON 01938 811900 OR LOG ON TO [WWW.LEEMA-ACOUSTICS.COM](http://WWW.LEEMA-ACOUSTICS.COM)

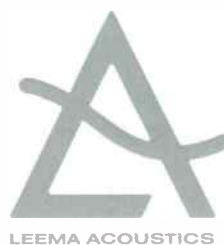

To locate your nearest dealer  
 Visit: [www.leema-acoustics.com](http://www.leema-acoustics.com)  
 Phone: +44 (0)1938 811900  
 Email: [info@leema-acoustics.com](mailto:info@leema-acoustics.com)

BEAUTIFULLY ENGINEERED SOUND



# Velvet Revolver

**As modern loudspeakers get brighter in their sound, Noel Keywood finds a new smoothie from Revolver, the Music 5s...**



still have a pair of Revolver R45 loudspeakers at home as stand ins to partner any amplifier that is giving me matching problems. Being many years old now, they might not have quite the most sophisticated sound going, but they do have a knack of making any amplifier sound balanced, unstressed and basically able to cope with life. As often as not, it is valve amplifiers that benefit most from their easy ways. The result is usually an entertaining sounding combination, for although the metal dome tweeter may be a little 'obvious' and a slight edginess from the glass fibre cones lends bite to the upper midband, underlying strengths such as a composed bass performance, plus a revealing midband can tease more from quality amplifiers than most alternatives available today. Only RRR's FS100s have managed to be the answer to all problems in similar fashion, but they are too large

for most people I suspect. Would Revolver's new Music 5s continue the role of having broad appeal; they are, after all, the same size and have a similar drive unit line up to my old R45s? Or would they build on the subtly different strengths of the Music 3s I reviewed in our November 2007 issue?

Standing 930mm tall the Music 5s are a fraction below the common 1 metre figure of many of today's floorstanders. At 25cms wide and 32cms deep they look compact too and a reasonable 25kgs weight makes them liftable. The Music 5s are as domesticated as the R45s I heave around the house from one floor to another, according to where they are needed; low weight and compact dimensions make them easy to store and easy to move. A big improvement has been made to the standard of finish though. Where the artificial veneer of my 45s is starting to lift under the pressures of a hard

reviewing life, the new Music 5s have a deep gloss black piano lacquer finish that's altogether classier and more professional. Edges are gently radiused and slippery smooth; the rear panel blends into the sides as it too bears the lacquer finish.

The front has a removable grill covered in black cloth. I remove grills simply because the internal edges of the drive unit cutouts set up complex reflections and refractions that degrade imagery. A smooth front face with heavily radiused edges best supports concise imaging in my experience, something the RRR FS100s again demonstrated to me until they were cruelly wrenched from the Keywood household before being declared 'furniture'! With grills removed the Music 5s still look good. Their woven glass fibre cone drive units look smarter than those in my old 45s, although in basic specification they are much alike. The top unit of the trio covers the midrange, matching into a metal dome tweeter at 3.5kHz. Below lie two more of these 165mm drivers to deliver bass, working up to 200Hz according to Revolver.

On the R45 and current RW45s the woven glass fibre cone of these drivers brings a sense of incision to the sound that almost certainly comes from cone breakup modes. Sounds bad perhaps, but in truth I have never found it detracts much from the listening experience - and most cone loudspeakers suffer 'breakup' to a varying degree. As a result vocals carry just a bit more bite than lies in the recording perhaps, but you need to have another loudspeaker for comparison to demonstrate this before it is apparent. Otherwise, the R45 seems natural enough. I mention this because the Music 5s eliminate this

# NEW

## Chord Carnival SilverScreen speaker cable

- Dual foil shielding system
- Oxygen free copper multi-strand conductors
- Twisted conductor configuration
- Low density polyethylene conductor insulation
- Highly flexible and simple to prepare and install
- Highly compatible
- Ideal for both hi-fi and home cinema



Exclusive product launch at  
The Bristol Show

Inspired by our award winning  
Signature speaker cable,  
Carnival SilverScreen sets new  
standards of performance. A truly  
cost effective upgrade to any hi-fi or  
home cinema system

A shielded speaker cable for £6.00  
per metre?

How do we do it?

Why do we do it?

Find out at:  
[www.chord.co.uk/silverscreenworld](http://www.chord.co.uk/silverscreenworld)

THE  
**CHORD**<sup>TM</sup>  
COMPANY

MOVING SOUND & VISION<sup>TM</sup>

World Radio History





feature of the sound, explaining one obvious difference between the two loudspeakers.

The twin bass units work into a ported cabinet, the port being sited close to the floor for best boundary performance, Revolver say. In truth this best drives the vertical mode of a room, livening upper bass. The plinth is tapped to accept spikes for use through carpets, and gold plated bi-wire terminals will accept 4mm plugs, spade connectors or bare wires.

## SOUND QUALITY

In essence the Music 5 offers an altogether smoother sound than the R45 or the later RW45, as I remember it. Whilst the basic construction and drive units are similar the presentation is not: the Music 5s differ by quite some margin. Where the R45s could be a little edgy as the glass fibre mat cone material brought an audible 'crack' to the sound as a result of breakup, no such effect exists in the Music 5s. Quite the reverse: they are now creamily smooth.

Even recordings which are in themselves a little edgy were gently honed to silkiness I noticed, whilst not losing treble sparkle. A Telarc DDD all-digital disc of 1990s Wagner Overtures and Scenes, laced with digitalitis that for me makes it barely playable, came over as rich, warm and full bodied. On the end of a muscular and forthright NAD M3 amplifier horns rasped fruitily, strings were creamy smooth, and kettle drum resonated through the room.

There was seemingly no holding back with grand Wagnerian crescendos; the orchestra had force and majesty, sailing forth from the Music 5s with a gusto that brought the majestic Overture of Reinzi thundering into the room. Where I can jump to turn down edgier sounding loudspeakers as they track a slow Wagnerian crescendo, the Music 5s remained easy sounding, confident smoothies. At times the violins that dance vigorously in Tannhauser were a little recessed for my liking; their contribution is important and not best underplayed like this. A -4dB dip in the Music 5's frequency response at crossover explains the smoothing effect. It existed with the excellent Music 3s but was more noticeable with the Music 5s.

With Rock music, heavy bass lines brought some boom

from the cabinets, an effect that was evident with Angelique Kidjo albums where bass level is substantial. I studied our measurements and there is peaking at 100Hz that likely explains this. Otherwise, bass lines had weight and convincing depth, if not quite to subterranean levels. The complex rhythms were nicely separated and presented, but the Music 5's smoothness did mean there was some lessening of insight into the complex arrangements of percussion instruments, something I was not aware of with Music 3s. Vocals were clean and easy, and stereo images well established between the loudspeakers.

In a direct playoff I found that whilst the R45s brought out the

best in valve amplifiers they were perhaps a little less kind to run of the mill solid-state. By way of contrast the new Music 5s lack the edginess of the 45s and smoothed solid-state amplifiers, so here is their *metier*. Where most modern loudspeakers tend to have a bright, forthright presentation, the Music 5s are relatively relaxed and easy on the ear. They are a good foil to modern transistor amplifiers that are a little bright in themselves, Denons and Marantz for example. The treble unit sounds more refined now, providing a sweet top end that was quite neutral - again good for modern amplifiers that can get almost tizzy at the top. Our measurements clearly identified this property too.

## CONCLUSION

If you find modern loudspeakers overly bright and too forthright, perhaps ragged or revealing in front of a modern solid-state amplifier, then the Music 5s offer a fine alternative. I used them at home and in our office system, driven by a variety of amplifiers, both valve and solid-state and felt they best counterbalance the latter. A Marantz surround-sound receiver suited them - as it suited the Music 3s - and so did a powerful NAD M3. The Music 5s apply a calming hand to over enthusiastic recordings and amplifiers, bringing a relaxing presentation to both Rock and Classical. This makes them quite different to the R/RW45s. Rather, they are weightier versions of the Music 3s.



## MEASURED PERFORMANCE

Much like the Music 3s reviewed back in the November 2007 issue of Hi-Fi World, the Music 5s are relatively flat at the top end and do not have the rise in output towards 20kHz that always used to characterise Revolver designs. They will not be dull, but may lack the sheer sparkle and clarity of the old R45s. Across the mid there is something of a dip in level in the 1-4kHz region which will assuage harshness in the ear's most sensitive region, but may rob atmospherics a little.

At the bottom end, the Music 5s have a slight lift in bass output at 100Hz before driver output rolls off below around 80Hz. The port reinforces this down to its tuning frequency of 30Hz, so the Music 5s should have a decently weighty bass performance.

Electrically the Revolvers are very well damped at the bottom end but do have an impedance peak at 3.5kHz as well as a rise towards 20kHz. Average measured impedance is good at 7.7 Ohms and does not dip below around 6 Ohms. Combined with a high sensitivity of 89dB, this means the Music 5s

are an easy load to drive and will not require many watts to really sing - 20 should be fine. AS

### FREQUENCY RESPONSE

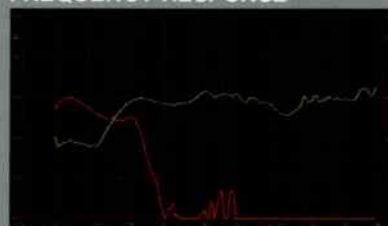

Green - driver output  
Red - port output

### IMPEDANCE



## VERDICT

Silky smooth sound that suits modern transistor amplifiers.

REVOLVER MUSIC 5 £1299

The Acoustic Partnership

+44(0)1752 847779

www.revolveraudio.co.uk

## FOR

- calms bright amplifiers
- superb finish
- compact dimensions

## AGAINST

- lessened insight
- boxy bass



A new name to the UK, but Raysonic's star will shine brightly if the CD128 CD player is anything to go by, writes David Price...

# Ray Of Light

**W**hat floats the audiophile boat in today's digital disc player world is likely to be interestingly or unusually styled – regardless of its intrinsic aesthetic worth. It has more than a passing chance of featuring valves, at least its analogue output stage, and is highly likely to make a styling feature of this rather than hide its light under a bushel (or top plate). Finally, more and more CD spinners are going topless, so to speak, meaning the end of the spectre of a little motorised tray that comes out to take the disc at the touch of the 'open' button.

In themselves, none of these features necessarily improves the sound, but that – it seems – isn't the point. As the insides of CD players become increasingly similar, today's machines at least have to look and feel different. To wit, we've had a number of such mid-price designs, not least the Shanling and Rega I've reviewed in the past couple of months, with striking top-loading styling and/or tube output stages. And now into the fray steps the Raysonic

CD128, which presses all the above buttons – and seems to do so with more aplomb than any other I've tried at the price.

It's a beautifully built machine, feeling better styled and finished than the £1,600 Shanling CDT-1000se reviewed recently, for example. The lift-off disc loader and puck is very tactile, while the four Russian 6922EH valves are neatly inset into the top plate behind it, while the transport controls sit cleanly forward, either side of the tubes and are subtly uplit. It really does feel well conceived and all-of-a-piece, rather than just being contrivedly different for showroom appeal.

Inside the immaculately hewn 8mm thick aluminium (480x300x130mm, 1.1kg) case sits a suspended Sony KSS-213Q mechanism powered by a large C-core transformer, feeding a Burr Brown PCM1732 (quite an old chip that combines the HDCD decoding and filtering from Pacific Microsonics with a 24bit/88.2kHz upsampling DAC). This in turn drives a full Class A triode vacuum-tube output stage giving single-ended and balanced

operation, with a smattering a designer passive components like Mundorf and Solen capacitors.

This Toronto designed, Chinese built machine reminds me of Plinius kit, thanks to the beautifully radiused curves at all four extremes of the large case, and feels so well made that it's a veritable showcase for modern CNC work. The full metal remote – suspiciously similar to some Shanling models I've seen – is also impressive, and it's here that you find the CD128's only special control – the upsampling button. You can also scroll through a three-stage display dimmer, and it's with the display off and the upsampling on where it gives of its best, which as we shall see is nothing to sniff at...

## SOUND QUALITY

Were I to appear on Mastermind, my specialist subject would have to be 'contemporary CD players, £1,000 to £2,000' right now, such is the dizzying number I've reviewed of late, so I shall rather immodestly proclaim to be able to say authoritatively that this is a cracking machine.

The story so far is that the



£1,150 Astin Trew AT3500 pretty much routed all the £1,000 machines in a recent CD player group test, and it's gone on to bring blushes to both Rega's Saturn and Shanling CDT-1000se at around £1,500. It struggled hard to match the Edgar CD-1 recently, but it was still cheaper and didn't so much 'lose' as win on some aspects of its presentation and fall back on others. For the Raysonic to accurately claim to be class of the field at its price, it had to comprehensively beat the Astin Trew, and it almost did!

In truth, it wasn't a rout; the AT3500 sounded a fraction less dynamic and less well resolved, but still it's a rare result for any modern £1,599 machine, as all the similarly priced designs – Edgar notwithstanding – have come out of it 'dazed and confused'. In short, the Raysonic is a fine music maker; and an interesting one too. It has excellent tonality and a truly natural, musical demeanour.

This was brilliantly evinced by Sade's 'Jezebel', which the Raysonic really got into. Without sounding in any way rolled off up top, it managed to give a rich, earthy and fulsome rendition of Ms. Adu's voice. Better still was the saxophone sound, which should not have been as clean and natural as it was. By contrast, the Astin Trew carried the song in a less atmospheric way, offering less insight into the recording, less depth and a less lustrous tonality (and let's not forget that this is rich and fulsome performer in its own right).

Another surprising aspect of the CD128's sound was timing. There seemed just a little more space between on the notes, the percussion on Sade's 'Sweetest Taboo' having more room to breathe compared to the Astin Trew, which made everything just that bit more orderly and less fluid. In conjunction with this, the Raysonic also showed super dynamics; at the very beginning its naturally warm and inviting nature lulls you into a false sense of security, until you reach a dynamic accent and it suddenly jumps out and surprises you. On the same track, the Astin Trew simply let it pass you by...

Tonally, it's actually quite hard to pin the Raysonic down – its not as bright and spry as the rival Shanling or Rega thanks to a big hearted bass, but is airy up top and doesn't sound in any way rolled off. The deliciously transparent midband further confuses; it's both sumptuous on electric piano sounds on 808 State's 'Gorgeous' yet that very same instruments glistens with harmonics in a way I'm not used to hearing from CD. Pink Floyd's 'Us and Them' was a delight, giving an LP-like floaty feel and blissfully natural sounding instrumentation. The Astin Trew AT3500 was also a joy to behold, but just didn't quite have the incision, depth or confidence of the Raysonic.

Pink Floyd's 'Us and Them' showed the Raysonic at its very best, throwing out a canyon-like soundstage that was able to better even the widescreen Astin Trew. Inside this it imaged with precision and was easily able to hang instruments back when needed – only the Edgar CD-1 betters it at the price in this respect. The CD128 was also excellent when the mix got busy, separating all the strands out with ease and maintaining its distinctive easy musicality all the way through. Rarely have I heard 'Dark Side' so engaging and yet so natural on digital disc – at this price.

**CONCLUSION**

Another superb circa £1,500 silver disc player then, and surely the most complete design I've heard for the money. I'd say the Edgar CD-1 just pips it to the post in some respects, but in most the Raysonic is there or thereabouts and it's this mix of all round competence that impresses so. It's an enjoyable music maker with a wide soundstage and

**REFERENCE SYSTEM:**  
Astin Trew AT3500 CD player  
Ikon Audio 300B integrated  
Yamaha NS1000M speakers

wonderful textuality to its midband. It has a powerful and tuneful but not overbearing bass and a sweet treble that times brilliantly.

I can find only a few relatively churlish criticisms; when the display is 'off' you can still see it on slightly in low light, and when you hit a transport button it doesn't momentarily switch on to help you find your track like most Japanese players of fifteen years back. You can't switch its fairy lights off either, which those who've had their fill of blue LEDs won't appreciate. But this is fairly mean-spirited carping; brilliant build, lovely ergonomics, peachy looks and a sound to match make this a super silver disc player – and more than just another novelty with niche appeal.

**VERDICT** ●●●●●  
Super all round machine at the price marries sumptuous natural sound to excellent build, styling and ergonomics.

**RAYSONIC CD128** £1,599  
Rochester Hi-Fi  
☎ +44 (0)1634 880037  
www.rochesterhi-fi.co.uk

**FOR**

- natural tonality
- imaging and depth
- musicality across genres
- build, styling, ergonomics

**AGAINST**

- mediocre display

**MEASURED PERFORMANCE**

The anti-alias filtering of this player was a little unusual, putting a small +0.3dB peak into the response at 10kHz. Although small it is enough to be perceptible, adding a small degree of brightness to the sound, if in a different manner to the occasional peaking at 20kHz some players suffer. A small amount of disturbance in this convolved impulse analysis, seen as lumps and bumps, was caused by the presence of some hum and noise the player suffers. It is not readily audible, but affects this particular test due to the low energy within a raised cosine pulse. Steady tones confirmed the performance depicted, and noise measurement returned a relatively poor -80dB unweighted result, or -87dB IEC A weighted, upsampling on. As CD goes this isn't especially good, being caused by 50Hz, 100Hz and 200Hz hum harmonics at low level. The balanced XLR is quieter, returning -96dB.

Distortion levels were low and much the same through XLR and phono, except at 0dB where XLR lacked the second harmonic of the phono outputs, suggesting XLR bypasses the output valves. XLR output measured 4.84V, double that via phono. Upsampling had no effect upon distortion.

There was a little programme related jitter on the digital output, measuring around 70pS, which is a little higher than well clocked machines.

The CD128 exhibits a few small hlemishes under measurement. However, it still returns a decent set of figures and will likely sound

entertaining. NK

Frequency response (-1dB) CD	4Hz-21kHz
Distortion	(%)
0dB	0.19
-6dB	0.09
-60dB	0.3
-80dB	2.8
Separation (1kHz)	108dB
Noise (IEC A)	-87dB
Dynamic range (EIAJ)	108dB
Output (unbal/bal)	2.4/4.8V

**FREQUENCY RESPONSE**



**DISTORTION**

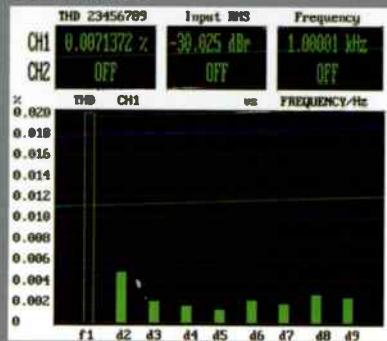

# A new star is born



Each year the European Imaging & Sound Association (EISA) assembles a panel of expert judges from some of the continent's leading hi-fi press to investigate the world's finest technology.

After rigorous evaluation they return to vote on one product in each category that they believe offers not only exceptional levels of performance but also provides incredible value. This year they chose the Cambridge Audio Azur 840A Class XD integrated amplifier.

"...a genuinely novel approach... a highly sophisticated, efficient and attractive-sounding amplifier" EISA citation



 **Cambridge Audio**



To find your nearest approved Cambridge Audio specialist, read extensive reviews and more, visit: [www.cambridge-audio.com](http://www.cambridge-audio.com)





# Radio Three

Steven Green pits three of the best new mid-price tuners against one another...

**A**lthough regular readers will know this magazine's objections to Digital Radio on sonic grounds, for many radio heads it has become a necessary evil these days, as there's no denying the superior selection of stations on DAB. Internet radio has vastly more of course, but it's still a bit fiddly and the quality is variable, whilst we've yet to get a true 'crossover' product that offers a 'plug and play' hi-fi solution. With this in mind, we decided to pit three of the latest and greatest mid-priced hybrid DAB/FM hi-fi tuners against one another, with surprising results...

## NAD C445

Like all tuners in the group-test, the NAD C445 supports both the Band III and L-band frequency ranges for DAB (L-band is used in some European countries), and also provides MW and FM with RDS. The NAD was slightly cheaper than the other tuners in the group-test, costing around £300.

Its design follows NAD's minimalist styling philosophy, which I've always found attractive, but I wasn't very keen on the display because, although the text was readable from a reasonably close distance due to the high-contrast of the white text on black background, the characters were too small and spaced too close together to be read from a distance of more than around three metres.

When setting up the tuner I first tried the 'auto preset' feature, which

is meant to scan for FM stations and automatically enter them into the preset slots. Unfortunately, however, this feature stored too many non-existent stations, and the thirty FM preset locations had been exhausted by the time the frequency had reached 100MHz. Entering stations into the preset slots manually was also slightly fiddlier than it is with most other tuners. In terms of the number of presets provided, there are ninety-nine presets for DAB and thirty presets each for FM and AM. The NAD provides an optical S/PDIF digital audio output in addition

"the best sound from radio is still from FM..."

to the standard phono and aerial connectors.

The NAD was easy to operate, as the tuner responded quickly to button presses on the well-designed remote control, and the tuner was very quick at tuning into stations and switching between frequency bands. I rarely witnessed reception problems on the weakest DAB multiplex I can receive, and reception was solid on the other multiplexes. FM reception was hiss-free on all of the stations I live inside the coverage area for,

and reception quality on MW was significantly better than usual, with the tuner filtering out most of the objectionable interference you normally experience on that band.

## SOUND QUALITY

When delivered with well-engineered audio on FM, such as you find on the classical music stations, the NAD performed very well indeed, delivering a nice crisp sound with a good attack and plenty of detail. One very slight criticism of it when playing back good quality source material, however, was that it could sound a

touch bright. The NAD was also a little disappointing when handling poorly engineered audio, as it had a tendency to sound rather gritty and the soundstage could become rather homogenous. Although it isn't the tuner's fault that some radio stations don't take care of their audio prior to broadcast, this is unfortunately all too common, and a tuner at this price level should be able to handle such audio in a manner that makes the most of the quality delivered to it.





The NAD performed well on DAB, though and this made up for the slightly disappointing performance on FM to a certain extent. The C445 delivered the better-sounding DAB stations with a good deal of finesse, and displayed a particularly good bass response. It also did a good job of adding energy and detail to the poorer-sounding DAB stations.

### ONKYO T-4555

Recently well received in the pages of *Hi-Fi World*, the Onkyo T-4555's price comes in at around £350 discounted. Its design was my favourite out of the three because I liked the fact that the large tuning knob that most tuners use has been replaced by up/down tuning buttons, which gave the tuner a sleeker look. The yellow-on-black display was also attractive, although it was the only tuner that had a single-line display, which meant that it could only show the station name or the additional text information, but not both simultaneously.

The unique selling point of the Onkyo is that it has a replaceable tuner module, which means that the tuner is upgradeable to support other digital radio formats, such as DAB+, DRM/DRM+ and Wi-Fi Internet radio. This feature therefore gives Onkyo owners the peace of mind that the tuner itself won't become obsolete for many years, although Onkyo has said that a replacement tuner module that supports DAB+ would likely cost in the region of £100, so this must be factored into any buying decision.

Setting up the tuner consisted of entering stations into the forty preset locations, which were shared between DAB, FM and MW, so each

preset could store a station from any of the three bands. Operation of the tuner was very good via the remote control, as the tuner responded quickly to button presses and changing frequency bands was quicker than most tuners. One relatively rare feature that the Onkyo provided was that it allowed the FM station's frequency to be entered directly via the remote control, although scrolling through the preset FM stations was so quick that I hardly used this feature at all.

One surprising thing for a DAB tuner, especially for one in this price range, was that it didn't provide an S/PDIF digital audio output and, apart from the standard connectors that all tuners sport, the only connectivity the tuner provided was an RS232 serial port and some connectors to allow it to be operated in conjunction with other equipment via a common Onkyo remote control. Reception quality was good on both DAB and FM, as reception problems on the weakest DAB multiplex I can receive were very infrequent, and reception was hiss-free for all of the FM stations that I can receive. Reception quality on MW was average, as the audio wasn't as smooth on MW as it was on the other tuners.

### SOUND QUALITY

The Onkyo performed very impressively on the better-sounding FM stations, in particular the classical music stations, as it provided a refined and authoritative yet vibrant delivery, with a well-defined soundstage and good stereo separation. The Onkyo also usually kept its composure when playing

back poorly engineered audio, as it managed to squeeze a significant amount of detail from the signal, although it has to be said that it was no match for the Yamaha in this regard. It also fared very well on DAB too, as its refined sound complemented the output of the better-sounding DAB stations, and it made the most of the more mediocre-sounding ones.

### YAMAHA TX-761

Again coming in at around £350, the new Yamaha's rather understated looks grew on me over the time I spent auditioning it, and its wide two-line display was the best of the three tuners being tested, as it was easily readable both from a distance and from a wide angle. Entering stations into the preset locations was very simple using the remote control, and the tuner provided ninety-nine presets for DAB, and thirty presets each for FM and MW.

In operation, the tuner scrolled quickly through the lists of stations following button presses on the remote, but one minor grumble was that when tuning into FM stations it often paused for around three to five seconds before the audio started playing. This issue wasn't apparent when tuning into DAB stations, though, and the tuner was also quick at switching between radio bands. In terms of connectivity, the Yamaha was the only tuner to provide both optical and coaxial S/PDIF digital audio outputs in addition to the standard phono and aerial connectors.

Reception quality was good on DAB, but sensitivity on FM was only average – there was no hiss on the stations I live inside the coverage area for, but there was slightly more hiss than on the other tuners on some of the out-of-area stations. However, a tuner of this calibre deserves to be fed with a signal from a decent aerial to make the most







of its sonic capabilities anyway. MW reception quality was good, and the sound produced was smooth.

**SOUND QUALITY**

The Yamaha's sonic performance raises the bar for tuners in the sub-£400 price range, and I would rate its performance as being closer to that of the superb Creek T50 (a £550 FM/AM tuner) than it is to the performance of the other tuners in this test. It squeezed far more detail out of the FM signal, which led to it delivering a much more precise and dynamic sound, with a vivid soundstage and excellent separation of the different instruments being played.

The Yamaha's ability to extract so much information from the signal also greatly benefited its performance with audio that hadn't been well engineered, and even when the other two tuners had given up the ghost and the soundstage had descended into a homogenous mess, the Yamaha still usually managed to squeeze a respectable amount of detail out of the signal as well as adding some much-needed energy. Put simply, the sound provided by the Yamaha was much more vibrant, engaging and entertaining than that provided by the Onkyo or the NAD, from the very best stations down to the very worst. This also went for its super DAB performance, as the Yamaha's highly detailed sound complemented the better-sounding stations, and it added plenty of energy to the lesser examples.

**CONCLUSION**

The latest generations of mid-price hybrid tuners all offer a respectable

blend of features and sound, but that doesn't mean to say there aren't big differences between brands. Unexpectedly, the least accomplished here was the NAD. Although it sounded good on the better-sounding FM stations and was relatively strong on DAB, the C445 let itself down a little in not handling the poorer-sounding stations as well as the other tuners.

The Onkyo performed well in terms of sound quality, but its unique selling point is that it can be upgraded to support new digital radio formats, such as DAB+, and possibly Wi-Fi Internet radio too. Therefore, for people that place a high value on buying a tuner that is future-proof, the Onkyo would have to be the one to go for out of the three tuners tested. However, the replaceable tuner modules for the Onkyo are likely to cost upwards of £100, and the first product using Frontier-Silicon's new Venice 6 receiver module has recently been launched, which already supports Wi-Fi Internet radio, FM, DAB and DAB+. Therefore, for people that want to buy a future-proof tuner, I would actually recommend waiting for respected hi-fi brands to bring out tuners containing the Venice 6 module.

Digital radio formats are all well and good, but the best quality source of radio is still FM, which is in no danger of being switched off before about 2020, and the Yamaha is simply phenomenal here. As such, the Yamaha TX-761 is the worthy winner and I would have absolutely no reservations in recommending people to buy it even though it won't support any of the future digital radio formats.

**DP SAYS**

Life is not simple for anyone wanting to buy a tuner right now - it's comparable to somebody just about to buy a new computer, unsure about when the new generation of processors, displays and hard drives will appear and not sure if they should wait. Right now we have FM, AM and DAB. Unlike TV, there are no immediate plans to switch off analogue on either FM or AM, and if it does happen it's likely to be more years away than the lifespan of a modern tuner. The question about future compatibility, then, is over DAB. Whether or not its unloved and ancient MP2 audio codec is going to be replaced, or at least partially replaced by a version of AAC (so-called 'DAB+') is still uncertain in the UK market. Expert observers such as *Hi-Fi World's* own Steven Green believe that the writing's on the wall for the old format, but its demise may well take some time. Meanwhile, we're just about to begin to see new tuner chipsets coming out with DAB+ functionality embedded, even if there aren't currently any DAB+ broadcasts yet. This makes it harder to justify spending a lot on a Digital Radio tuner, and just to make life even more complex, it surely can't be long until we see a hi-fi quality Internet radio tuner too, offering tens of thousands of stations and no limit on broadcast bitrates - surely the ultimate future-proof radio format. Our advice is - just like buying a new PC - if you need a new radio right now then just go and buy it, but don't be surprised if the next one you get is likely to look, work and sound very different!



**VERDICT** ●●●●

Fine value for money machine that's a strong performer on DAB, but less convincing on FM.

**NAD C445** £300  
 Armour Home Electronics  
 ☎ +44(0)1279 501111  
 www.nadelectronics.com

- FOR**
- good DAB sound
  - ease-of-use
  - reception quality

- AGAINST**
- disappointing on FM
  - setup

**VERDICT** ●●●●

Good all rounder, but its currently unique DAB+ upgradeability will be less key when the latest chipsets arrive.

**ONKYO T-4555** £350  
 Onkyo  
 ☎ +44(0)1494 681515  
 www.eu.onkyo.com

- FOR**
- future-proof
  - good sound quality
  - ease of use

- AGAINST**
- overall price with DAB+
  - no digital output

**VERDICT** ●●●●●

Superb FM sound at the price, raising the bar of all mid-price tuners, and impressive on DAB too.

**YAMAHA TX-761** £350  
 Yamaha Electronics (UK) Ltd.  
 ☎ +44(0)1923 233166  
 www.yamaha-uk.com

- FOR**
- superb sound quality
  - good display

- AGAINST**
- sensitivity on FM
  - slow FM tuning

# better than gold

The expertly crafted

**Monitor Audio Platinum** range  
on permanent demonstration.



**MONITOR AUDIO**  
MONITORAUDIO.CO.UK

**EXTENSIVE EX DEM & USED LIST ALWAYS AVAILABLE PLEASE PHONE WITH YOUR REQUIREMENTS.**

## Linn Majik System

With two new product launches from Linn, the Majik system now includes the fantastic new Majik-1 integrated amplifier and the stunning new Majik 140 Loudspeakers.

Please call in store to listen to this fabulous system.



### Special Offer

Linn Ninka Loudspeaker

Were £1275

Now £799\*



Price includes nationwide delivery and installation by Linn trained staff.

For more information on purchasing visit [www.petertyson.co.uk](http://www.petertyson.co.uk) or [www.newcastlehifi.co.uk](http://www.newcastlehifi.co.uk)

**Pioneer**  
Latest Pioneer G8  
Plasma TV's

**PDP-LX508XD**  
on permanent demonstration.  
The best prices  
please call for details.

## Special Items

Fatman iTube Valve Dock  
£269.90



Mordaunt Short Avant  
MS908i  
Floorstanding Speaker

Special deal now only  
£399.00

Don't miss out call today.



## Latest Award winning Onkyo Receivers

Award winning AV products on permanent demonstration.



Including TX-SR50SE, 60S and 87S.



Capable of Processing Today's High-Resolution Media  
Including Blu-ray Disc and HD DVD  
with Effortless Efficiency.



**Award winning brands stocked**  
Linn, Arcam, Marantz, B&O, Bose  
Chord Electronics, InFocus, JVC,  
Monitor Audio, Mordaunt Short,  
Pioneer, REL, Roksan, Sim2, Tannoy,  
Teac, Tivoli, Velodyne, Yamaha.  
Plus many more.



6 Abbey Street, Carlisle, Cumbria. CA3 8TX  
Telephone 01228 546756  
[www.petertyson.co.uk](http://www.petertyson.co.uk)  
Email [sales@petertyson.co.uk](mailto:sales@petertyson.co.uk)  
Open Monday-Saturday 9am-5.30pm



153 Kenton Road, Gosforth, Newcastle. NE3 4NQ  
Telephone 0191 2857179.  
[www.newcastlehifi.co.uk](http://www.newcastlehifi.co.uk)  
Email [mark@newcastlehifi.co.uk](mailto:mark@newcastlehifi.co.uk)  
Open Tuesday-Saturday 10am-5.30pm



# Space Port

David Price listens to Audio Pro's Porto portable music system...

It doesn't seem so long ago that Iron Maiden famously scored a number one hit record by releasing the catchily titled 'Bring Your Daughter to the Slaughter' just after Christmas; the one time when no one else was putting records out. The result was massive publicity and the first chart topper of the year.

How quaint that sounds now – the music industry is a very different place, not least because fewer people are actually buying physical media. These days, for most under twenty five year olds (and many older than that) music is something that comes down your telephone line - or even direct into your portable device via the wireless router if you have an iPod Touch.

With this in mind, there are ever more products around designed to turn that digital audiostream on your music portable into living, breathing sound. The good news is that this all means extra choice, and some are actually rather nice to listen to. The iPod, with its brilliant versatility and wondrous accompanying software (i.e. iTunes) has become the Compact Cassette of the noughties, but with far greater flexibility, portability and sound – and Audio Pro's Porto shows how...

Put simply, it's a tallish, slim, small footprint (120x305x140mm) iPod docking station with an amplifier and speaker built in, plus an RDS FM radio and two auxiliary inputs. Interestingly though, it forsakes two weedy little stereo speakers for a single larger mid/bass unit and twin tweeters. Given that similarly sized stereo designs struggle to reproduce either bass or a credible soundstage, Audio Pro have conceded the latter for the Porto but had a real go at the former. It's also unusual for having a leather covered case – whether this has any audio benefit is doubtful but, thanks to this and its understated Swedish design, it certainly looks classy in black hide (with the option of red) – and feels it too.

The front of the Porto has the aforementioned loudspeaker array hidden behind a cloth grille taking up the bottom two thirds of the cabinet. Above this is a paper-white

backlit LCD panel showing source and volume, either side of which are power and source selection buttons, with radio tuning and volume up/down buttons directly above. Between this is the iPod dock recess where you're supposed to attach your little Apple portable. Audio Pro says the Porto works with iPods of generations 1 to 3, plus the iPod video, Mini and Nano, but I also found it worked fine with my latest generation iPod Classic too.

Round the back is a small telescopic aerial for the tuner, plus two small slats which I assume constitute a bass port of sorts. Socketry includes two 3.5mm auxiliary inputs, a 3.5mm subwoofer output, 3.5mm headphone output, S-Video output and a stereo-mono switch. As a portable, the Porto's party piece is its built-in 12V 1800mAh rechargeable battery, which gives about ten hours of playback. In conjunction with its leather carrying handle, this makes the oddly shaped Audio Pro actually a very practical proposition. Finally, a neat little card remote control is provided, which gives full control of the iPod, plus volume up or down.

## SOUND QUALITY

Given the novel dimensions of the Porto, and its rather quirky overall design, I was surprised at just what it was capable of. It's an unexpectedly refined and mature sounding device, even by budget hi-fi standards. Obviously, it wins no prizes for expansive stereo imaging, but still the Audio Pro was capable of filling a room with sound. Listening to The Eurythmics' 'This City Never Sleeps' showed a pretty chunky output stage, with the ability to go right up to maximum volume without signs of undue stress.

Spinning up The Police's 'Wrapped Around Your Finger', via Apple Lossless on a new iPod Classic showed it to be more than capable of signposting the difference between Lossless and a 320kbps AAC version of the same, for example. It was genuinely detailed, with a surprisingly airy treble considering its lowly position on the audio evolutionary scale (by which I mean it's not exactly



a £100,000 Naim system)! Bass was powerful and firm whilst avoiding the usual boom you get with portable audio devices that attempt to reproduce low frequencies – although it did become a tad overpowering when placed in a corner on the floor.

Overall, this is an interesting, quirky mobile music machine that integrates seamlessly with iPods, offers superb build and finish and sounds surprisingly civilised – an average iPod boom box it is not. At under £175 it's competitively priced, and a good deal cheaper than Harman Kardon's superb £250 Go & Play portable which is the one to beat on sonic grounds. Overall then, a charming little music maker offering fine value for money.

## VERDICT ●●●●●

Characterful mobile music maker with superb finish and impressive sonics.

**AUDIO PRO PORTO** £175  
CSE Solutions  
+44 (0) 1423 359054  
www.audiopro.com

## FOR

- sound
- build quality
- crisp, characterful design

## AGAINST

- tough competition

hi audio



*Accessing the Source,  
Unleashing the Performance*



Acoustic  
Solid



Black Rhodium



GRAHAM SLEE



GH



INVIDE



METAvision



NU FORCE



Storm Audio Technology



theCartridgeman

HiAudio - UK Distribution

For your nearest stockist of the HiAudio Range visit [www.hiaudio.co.uk](http://www.hiaudio.co.uk) or call direct on 0845 0525259



# Historically Speaking

Adam Smith charts some of the many milestones in the development of the humble loudspeaker since its invention...

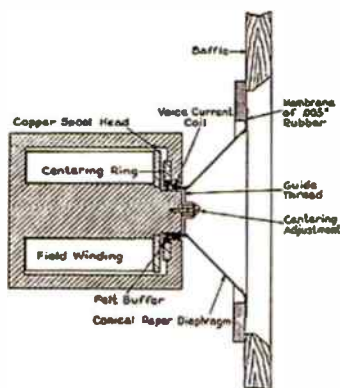

**Where it all started - the original Rice/Kellog speaker design drawing.**

**N**ew recruits to the school of high fidelity are often surprised to hear that loudspeakers are something of a technological throwback.

Despite the applications of space-age materials to cones, computer aided finite element analysis to the design of suspensions, the application of swish materials to motor units and tweeter domes, all topped off with some exotic veneers to cabinets, none of these can alter the fact that the resemblance to the very first moving coil loudspeaker, designed over eighty years ago, is still more than superficial.

However, just because the basic principles remain the same, there have been more than a few steps taken along the road of loudspeaker design, and along that way there have been innovations, frustrations and more than a few ideas that have fallen by the wayside...

## IN THE BEGINNING

Of course it was all much easier in the old days, when all that was required for sound reproduction was

a needle in a groove, which set up vibrations in a sound box, sent these up the "tone arm" and into a nice big horn. Bigger horns meant more volume, a simple flap could be utilised to control output level and that was that. Then, following work from Thomas Edison, John Fleming and Lee DeForest, the amplifying valve took hold and things would never be quite the same again.

It was actually in 1874 that Ernest Siemens was granted a patent for "obtaining the mechanical movement of an electrical coil from electrical currents transmitted through it" but he did not use it for sound reproduction. However, a second patent in 1878, following Alexander Graham Bell's invention of the telephone, did and this formed the basis of a parchment-based diaphragm to be used at the heart of a moving-coil transducer, allied to a suitable horn.

Various improvements quickly followed, such as Oliver Lodge's improved loudspeaker of 1898, with non-magnetic spacers to keep the air gap between the inner and outer poles of the magnet system. The development of what we now know to be the main cone followed and then, in 1909, the suspension used for centering the voice coil arrived. Finally, however, the basis of the modern loudspeaker was finally laid down in 1925 by Chester Rice and Edward Kellog when their General Electric research paper established the basic principles of a directly radiating loudspeaker with a small coil-driven diaphragm in a baffle with a uniform response over a broad frequency range.

## TWO INTO ONE

This was only the first step and development has continued ever

since, even if the modern result is remarkably similar in essence. As the quality of source material and valve amplifiers improved it became apparent that the single drive unit was becoming a limiting factor and in 1928 Herman Fanger invented what came to be known as the coaxial drive unit, featuring a small high frequency horn with its own drive diaphragm that was located in the centre of a larger unit. A patent was granted in 1933 and, as we know, this has led to some interesting developments over the years.

As our very own contributor and guru of all things vintage, Haden Boardman, puts it "lots of crusty old Japanese drivers from the likes of Coral, Pioneer, Diatone and even Panasonic had a mediocre



**Altec Lansing's 604 coaxial drive unit - first unveiled in 1944 and still in production today.**

HF pressure unit poking through the centre of a bass unit". On the UK side of things, the likes of the Whiteley Brothers' 'Stentorian' loudspeaker was one of the first exponents of this type and a little company called Goodmans gradually refined and developed their Triaxiom

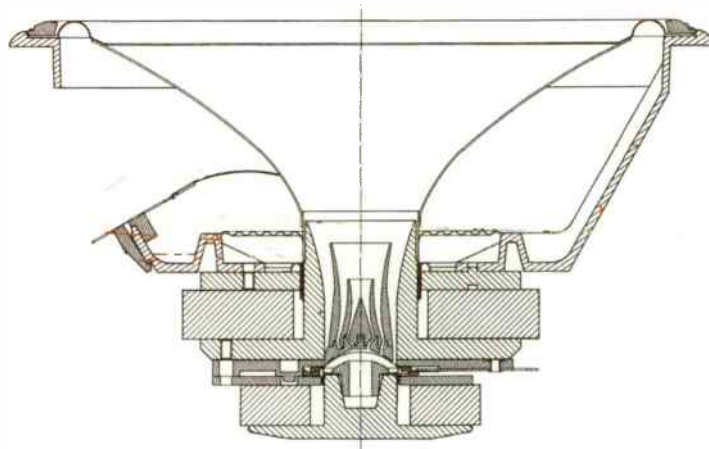

**Tannoy's Dual Concentric drive unit, a design that refined the coaxial loudspeaker and one that forms the basis of the company's output to this day.**

designs. In the US, possibly the most famous of the coaxial drivers was the Altec 604 introduced in 1944 and still in production now, thanks to Oklahoma's Great Plains Audio buying up and utilising the original tooling from Altec Lansing's final owners, the Telex Corporation.

On this side of the pond, however, one of the most notable developments in coaxial technology occurred in 1946, when Tannoy developed the Dual Concentric drive unit. Where this differed from other designs was that it located the tweeter motor unit behind the motor unit of the bass driver and fired it through a specially designed 'acoustic waveguide', named after the analogous behaviour found in microwave electronics. This meant that the bass unit could operate properly and without interference, as there was no horn or other protruberance in the middle of its area of operation, meaning an even 'point-source' response with minimal distortion or reflection problems.

The other famous and successful UK coaxial development did not occur until 1988 when KEF introduced the Uni-Q drive system. Where this was different again



**A B&W bass driver featuring their Rohacell sandwich style cone, some forty years after Leak came up with the idea.**

was that it made use of a, by then conventional, dome tweeter in the throat of the bass driver. Such a move had only recently become possible thanks to the advent of rare

earth magnetic materials such as neodymium that offered the same amount of magnetic flux in a much smaller package than a comparable ferrite item. This did away with the need for unwieldy horns either in the centre of the drive unit or in the middle of the bass cone and meant that the drivers could be made smaller. Of course, it introduced a whole new set of problems such as the siting of a tweeter dome at the centre of not only a cone that acted as a horn, but one that was moving as well! Fortunately KEF's use of computer aided design since the 1970s helped them immensely in taming the problems that arose, and Uni-Q has continued to have a long and successful life.

Of course, not everyone went down the point source route and Bell Labs' 1931 development of what they called the 'divided range' loudspeaker paved the way for multi drive unit applications and the electrical crossover.

**MATERIAL WORLD**

Another area that has undergone continuous development since the early days is in the shape and material composition of the cone itself. In the early days, parchment or paper were the obvious choices, as a result of their light weight and the relatively weak motor units in the early days of the technology. Paper is still popular today, but more exotic materials have gradually become more prevalent. One of the major steps in this was in 1961 when Dr. Don Barlow of Leak announced the debut of their 'Sandwich' cone consisting of a layer of expanded polystyrene between two thin layers of aluminium. This gave the benefit of rigidity, whilst keeping the overall structure relatively light in weight.

The idea has remained popular to this day and one of the most

well-known exponents of the art currently is B&W, whose cones on their larger bass drivers, such as that used on the 801D, consist of a layer of 'Rohacell' material, which is a hard foam designed mainly for the aerospace and automotive industries, between two carbon fibre skins - new materials, certainly, but a tried and trusted formula!

Considering single layer cones, virtually all materials you care to think of have been tried at one time or another. From Kevlar to aluminium, via carbon fibre, some most unlikely results have been obtained. Possibly the strangest was around 2000 when, after twenty years of research, JVC's Toshikatsu Kuwahata discovered that soaking sheets of wood in sake made it pliable enough to form into loudspeaker diaphragms! Apparently Suntory whisky did not work, and this was suspected to be as a result of the extra distillation after fermentation of the whisky (sake is just fermented). Either way, it must have been one heck of a development session...



**JVC's wooden coned loudspeaker drivers were made possible by soaking the wood in sake to prevent it splitting when formed.**

Possibly the most enduring materials however, have been plastics and the most notable exponents of this were Sendor, with their development of the Bextrene cone in the 1960s. Legend has it that the BBC's development work during this time resulted in the need for drive units that exceeded the capabilities of the paper-coned drivers then commonly used. Sendor's Spencer Hughes put an iron bedstead, a compressor working in reverse and an electric fire to uses that their manufacturers could never have envisaged, and finally succeeded in producing the first eight inch cone through the use of this very basic vacuum former. This found its way into the BCI and the rest is history. Sendor never stopped refining the driver design or experimenting with different materials, however,



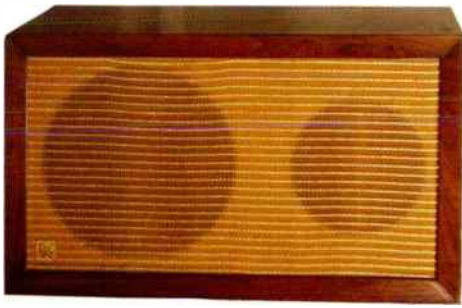

**The Acoustic Research AR1 loudspeaker introduced the concept of the small, sealed box loudspeaker.**

leading to the improved SPI in 1983, featuring a homopolymer polypropylene cone.

**BOXING CLEVER**

Going back to the early days, one of the aspects that was limiting both the abilities of the designers of the times, as well as the visual acceptability of their designs, was that early loudspeakers tended to be either open baffle, infinite baffle with a very large closed space behind the driver, or horn-loaded, using a design like the famous 'Tractrix' developed by Paul Voigt in 1926. Although horns

Here, the driver is located in an enclosed box, with one or more port tubes to the outside world. This does not just act as a vent, but actually sets up a Helmholtz resonance within itself and acts as an independent radiating source, albeit one with a phase shift.

A design that was outwardly

simpler, but technically not necessarily so, came along in 1954 when Acoustic Research's Edgar Villchur invented the 'acoustic suspension' enclosure. As he explains it, the idea was to replace most of the mechanical restoring forces of the drive unit, namely the surround and suspension, with that of a more linear force - the air pressure inside the enclosed box. This method actually lent itself perfectly to shrinking the size of the enclosure, in order to give the air strength required inside the cabinet, so was viewed as a win-win situation.

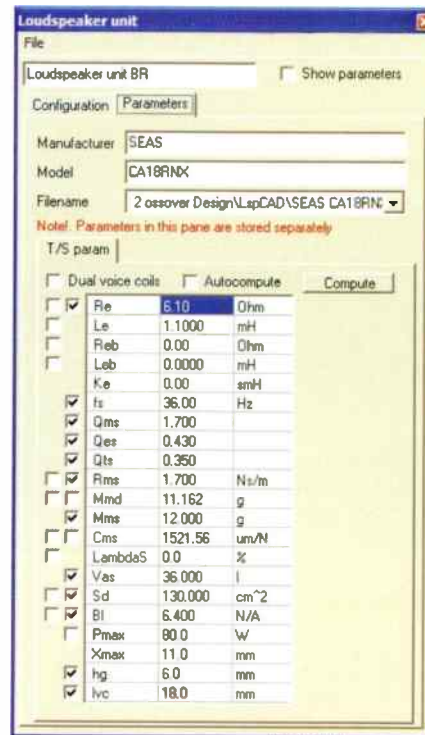

**Thiele Small parameters for the SEAS H1215 drive unit as used in World Designs' WD18BR loudspeaker. These parameters still form the basis of loudspeaker design.**

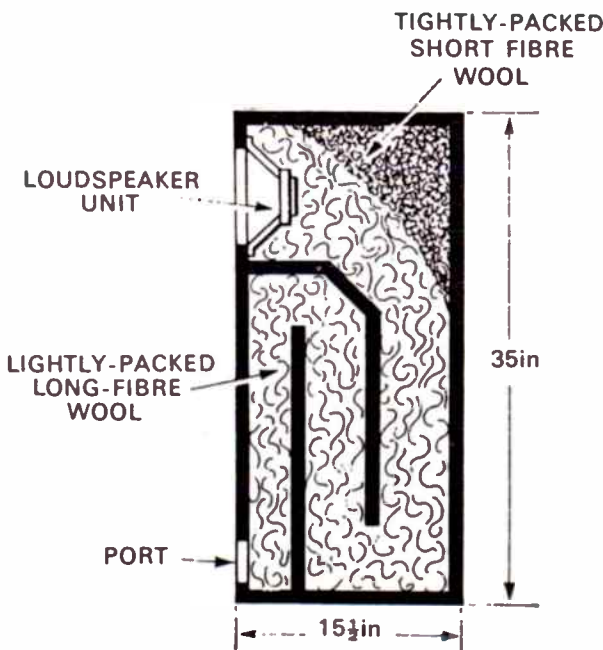

**Cross section of Radford and Bailey's original transmission line enclosure design, first featured in Wireless World in 1965.**

remained in use for many years and still have a strong following today, even Voigt's Folded Corner Horn of 1943 failed to reduce the horn to a domestically acceptable size.

One alternative was discovered by Albert Thuras whilst working at Bell Labs when he filed the patent for the bass reflex enclosure in 1931.

The third main cabinet configuration arrived in 1965, when Arthur Radford and Dr. A Bailey described a design where the rear wave of the loudspeaker was to be completely absorbed without damping the loudspeaker's motion or modulating it from internal reflections and resonance. Their reasoning was that

this rear wave had to be channelled down a tube or channel long enough, and filled with absorbent stuffing, to resist resonance below the desired frequency. In this way, the rear wave is absorbed and, unlike the bass reflex enclosure, not used for reinforcement. In practical terms this meant the line had to be very long and, for domestic applications, the inherent resonance (typically at a quarter wavelength) is exploited to enhance the bass response in this type of enclosure, albeit with a less absorbent filling.

Development of all of these designs tended to be rather hit and miss until the work of Neville Thiele and Richard Small in the early 1970s. They came up with a method of predicting the response of a loudspeaker drive unit, and its behaviour in an enclosure, through its physical properties. Nowadays, Thiele-Small parameters form the basis of any loudspeaker design, whether closed box, ported, transmission line, or some of the more recent variations such as the bandpass enclosure. They changed the way people designed loudspeakers for ever, and life wouldn't be the same again

**Next month - ribbons, electrostatics and planar designs.**

tangent



Tangent Cinque - Your new digital sound centre...

Did you ever notice how many types of digital sound there are today? Wouldn't it be great with a single device that can play them all? Of course!

Please go to [www.sennheiser.com](http://www.sennheiser.com) to find your nearest dealer

FEATURES

- CD-player, DAB/FM or FM/AM
- Audio CD/CD-R/CD-RW/MP3/WMA
- Remote control
- Aux input for iPod, MP3 player
- Line out and headphone jack

UK distributor • Sennheiser UK LTD.

DESIGN | ENGINEERING | PERFECTION

For more information please visit [www.tangent-audio.com](http://www.tangent-audio.com)

1/2 price sale

# iCube™

## stackable vinyl storage

The ultimate vinyl storage system. Simply unpack and stack. Ready-made natural 18mm mdf with stylish contoured edges.



Buy 7  
Get 1  
**FREE!**

7" iCube  
was £37.95  
now only  
**£18.95**

12" iCube  
was £57.95  
now only  
**£28.95**

Also in black

p&p only  
£4.95

### Orderline 01328 730405

Open 7 days a week from 9am-9pm - call now.



# T SERIES

## YPL SPEAKER



T5 MINI SPEAKERS



T6 BOOKSHELF



T7 FLOORSTAND

YIN PU LI CO., LTD.

Address :  
1F, NO. 351, Sec.2, Nantuen Rd.,  
Taicung, Taiwan 408.

FAX : 886-4-24730446

E-mail : [ypl@yplaudio.com.tw](mailto:ypl@yplaudio.com.tw)

<http://www.yplaudio.com.tw>





Aurosal A1

# Stand & Deliver

**Adam Smith is stopped in his tracks by three pairs of mid-priced standmounting loudspeakers from Aurosal, KEF and Wharfedale...**

Since moving coil loudspeakers first appeared in the 1920s, designers have taken many different paths to maximise their potential whilst eliminating their inherent weaknesses. Two methodologies that hark back right to the early days of the technology are represented here by two new arrivals to the market - namely a single, full range drive unit and a coaxial type twin driver.

The full range driver technique is represented by Aurosal and the new Mk2 version of their A1 loudspeaker. Originally introduced last year and reviewed in the June 2007 issue of *Hi-Fi World*, Aurosal's Kevin Warne claims a number of significant improvements to the new version. The Mk2s are visually similar, measuring 360x205x270mm (HxWxD) and available in Piano Black (£50 extra, at £695), Beech and Cherry. They also still make use of a Ted Jordan based driver, albeit one modified to Aurosal's specification and Kevin claims that the Mk2 has undergone "substantial upgrades". Certainly our measurements bear this out, with visible changes in performance at the low end in particular [see MEASURED

PERFORMANCE, p47]. Aurosal also promise "improved sound resolution and enhanced musical depth" from the re-worked driver.

The whole basis of the design of the unit used in the Aurosal A1s is that it seeks to exploit the natural cone breakup and to make use of it by building in a certain amount of tailored flex into the cone. This allows the breakup modes to be harnessed and utilised to extend the driver's frequency range. By obtaining a full frequency spectrum from one driver, the good old 'point-source' theory of a single unit can be exploited to give good imagery.

Of course, the alternative way of achieving this is by a coaxial driver of some description, and the KEF XQ10s use exactly this; namely the latest generation of their Uni-Q driver. This locates a 3/4in (19mm) metal dome tweeter at the centre of the 5.25in (130mm) bass/mid driver as it has always done, but new to the XQ series is the 'tangerine' waveguide that sits around the tweeter. This offers protection for the delicate dome for the first time, and is also claimed to improve HF dispersion. This would seem to be a valid claim as, during measurement, the microphone could be moved off-

axis by quite a margin both vertically and horizontally, without appreciably affecting the frequency response.

The XQ10s are small, measuring 330x190x247mm (HxWxD) and are supported on three spikes fitted to their curved underside. A rubber mat is supplied to fit in between these if the top plate of your chosen loudspeaker stand is too small for the spikes' footprint and KEF also supply three spike 'shoes' per loudspeaker to protect any delicate surfaces upon which they sit. Cabinet finish is immaculate and available in Birdseye Maple, Khaya Mahogany or Piano Black.

The third member of our triumvirate comes in the form of a new Wharfedale and could be considered to be the most conventional of the designs on test. That said, however, dome midranges are not exactly thick on the ground, nor are large three way standmounters and so they still have their own unique areas of interest.

The smallest models in the new Opus 2 range, the M1s measure 510x230x360mm (HxWxD) and weigh in at 12kg so they are the largest units here. Their cabinet finish is stunning and available in a choice of Black, Cherry, Rosewood or Maple



KEF XQ10

Piano colours. Driver-wise, a 7in (170mm) bass driver with a carbon fibre cone and reverse-roll rubber surround handles the low end. Above this is a 1in (25mm) soft dome tweeter using a neodymium magnet and copper-covered aluminium wire which further lightens the moving mass of the dome assembly, increasing responsiveness.

Finally, at the top rests a 75mm midrange dome driver. As mentioned, these are still relatively uncommon despite their theoretical 'rightness' in matching well to a tweeter dome in terms of both character and dispersion pattern. Of course, controlling the breakup of such a large dome is a big problem in itself and many manufacturers have either decided not to take the plunge, or had a go but not quite succeeded!

Wharfedale's driver uses a 75mm voice coil on a hard aluminium former to maintain rigidity and fires out through a specially designed face plate that provides an element of horn loading to maintain an even dispersion. Behind the dome is a perforated baffle and rear chamber with a finned aluminium rear cover to provide pressure equalisation to the dome and facilitate good heatsinking.

### SOUND QUALITY

Kicking things off with the Aurosal A1 Mk2s, I was instantly reminded why I was so impressed with these loudspeakers the last time round. Aurosal really have got the single driver design very well sorted and consequently, the A1 Mk2s integrate very impressively across the frequency range.

Most notable, as might well be

expected, is the midband, which is expressive, well defined and possessed of a sense of uniformity. Instruments were offered up with pleasing definition and each one, be it piano, guitar or something requiring a bit of puff to play, had a pleasing sense of realism to it. Equally, the Aurosal were able to set up a well defined soundstage and place performers solidly within it. I suspect that the lack of crossover point in a region in which the ear is most sensitive helps out immensely with this.

A caveat here, however, is that the Aurosal still remain quite position-sensitive. The cone drive unit is much more directional at high frequencies than a dome tweeter design and, as a result you do really need to position the drivers at ear height in order that the high frequency output does not drop off appreciably. It is also well worth sticking to Aurosal's recommendation to orient the loudspeakers such that their axis of operation crosses just in front of you rather than pointing each one directly at you. Without this, you may well wonder what all the fuss is about, but take time to get it right and everything suddenly falls into place...

The top end has also improved with the loudspeakers' update to Mk2, as the original A1s could be a touch dull at times, but the new variants do not suffer this, offering up high frequencies that are detailed and spacious. Although still not quite as crisp as a good dome tweeter, and thus dulling the likes of cymbal strikes ever so slightly, I have still heard budget domes that offer a worse top end than the A1 Mk2s.

The improvements also continue down the bottom end, as the new A1 Mk2s have a definite extra kick to them. Once again, I found myself impressed at what Aurosal have extracted from a single four inch drive unit! Bass detail is commendable and the Aurosal are tight and punchy across the low end. They are happy to take anything in their stride and the small dimensions of that driver only really become apparent when you start to push the volume higher, when they can start to sound a little strained. All in all, they are musical and enjoyable.

Switching to the KEF XQ10s was quite a culture shock in many ways. Suddenly the top end crispness missing from the A1 Mk2s was back and with reinforcements! The XQ10s straightaway announce themselves as mightily dynamic and bright. Make no mistake, the rising response with frequency offers plenty of treble, as might be expected, but it is always clean and sharp, without any distortion or harshness. Equally impressive is the soundstaging - whereas the Aurosal lay everything out across the plane of the loudspeakers and add a nice sense of air to proceedings, the KEFs fling everything out into your lap. Think of it as the Aurosal putting you in the front row but the XQ10s putting you on stage!

Across the midband, the XQ10s really do project and pick up the slightest change in a voice or instrument. If a trumpeter takes a quick breath in between notes, then the XQ10s will tell you. They captured the essence of Diana Krall's 'breathy' delivery perfectly and made each note from her piano sharp





Wharfedale Opus 2-M1

and clean. Where they did stumble slightly was when both the vocal and a backing instrument became more strident, such as when the piano builds up behind Tori Amos during the first verse of 'Pretty Good Year'. Here, everything just tipped across into being slightly uncomfortable as it all peaked.

Moving to something a bit more upbeat, Angélique Kidjo's 'Sound of the Drums' from her 'Fifa' CD was right up the XQ10s street. They took the rhythm of the track and really ran with it, lapping up the bass line and almost splitting the air with the sharp leading edges they added to the snare drum - dynamic stuff! As might be expected both from the size of the cabinet and the measured performance, the XQ10s do not plumb the depths of the low end but they are remarkably detailed and tight across the upper bass. Combined with their rhythmical alacrity, they thus avoid sounding obviously lightweight.

Heaving the final contenders, the Wharfedales, into place brought a different slant to things once again. Most noticeable was the increase in bass brought about by the larger driver and cabinet. The Opus 2-M1s really do dig quite a bit deeper than the KEFs or the Aurousals and consequently offer a larger-scale window onto the music. My only slight concern was that, although upper bass was taut and expressive, the lowest registers could occasionally feel a little loose. This was mostly noticeable on faster paced music where the Wharfedales occasionally seemed to be only just keeping up, but the rest of the time they played deeply and enthusiastically.

Across the mid, that dome driver

works very well indeed. The slight lift in output does bring vocals to the fore but, as suspected, Wharfedale have put their design knowledge to good use and the midrange never becomes shouty or unpleasantly forward. Mating well to the soft dome tweeter, which is itself a sweet and detailed performer, the midrange dome lays vocalists out perfectly and spreads the soundstage out before the listener in a most inspiring way. Instruments are convincing, leading edges of notes are precise and the Wharfedales turn the finer aspects of each piece of music into an encompassing whole. In this manner the Opus 2-M1s strike an excellent balance between the atmospheric distance of the Aurousals and the dynamic forthrightness of the KEFs.

In fact, balance is a word that can be attached to the Wharfedales generally, as they integrate impeccably across the frequency range. The Aurousals immediately please as a result of their spaciousness and musicality, the KEFs attract through a combination of dynamics and sheer brio, but the Wharfedales remain remarkably even-handed across all aspects of performance. The track that really brought this home to me, and summed up the nature of each 'speaker, was Underworld's 'Jumbo'. This track has a warbling synth note that plays throughout and can often be lost behind the main rhythm when it starts. The Aurousals picked this up expertly and made sure it was not lost, whereas the KEFs held on to the electronic hi-hat with an impressive tenacity that I have not heard from any other loudspeaker before. The Wharfedales on the other hand, kept both of these aspects just where they

wanted to be - noticeable but not dominant.

## CONCLUSION

All in all, these are three quite interesting loudspeakers that offer a different slant to music. The Aurousal A1 Mk2s take a fair amount of tweaking to get really on song but once there they reward with a magnificently smooth, atmospheric and, above all, enjoyably musical performance. The Mk2 changes have made worthwhile improvements, albeit at the expense of a little sensitivity, and they remain the only single-driver loudspeakers I have heard to date that I would willingly give house room to.

The KEF XQ10s are a quite different kettle of fish, however. They major on detail and verve and can leave you breathless with their sheer *jolie de vivre*. Although careful partnering is a wise precaution to ensure that they do not become over-hard, they have a rare ability to really tell you what is going on in the depths of your music and will be just the tonic for a rather too laid-back system.

So that leaves the Wharfedales, and these really are a very fine pair of loudspeakers. Once again, I would advise a hint of caution when matching them so as not to exacerbate their occasionally slightly loose bottom end. However, that done, they combine a healthy pinch of the atmospheric of the Aurousals with a good portion of the detail and clarity of the KEFs. Factor in their fine fit and finish, commensurate bass depth and the overall even-handedness of their performance and you have the icing on a succulent and rather more-ish audio cake.



**A masterful cable that will cause a stir.**

**MIT** Music Interface Technologies™



**MIT Oracle MA loudspeaker cable:  
2007 Golden Ear Award winner.**

*“Instrumental images within the soundstage were presented with more air and space around them...Had I not heard the Oracle MA, Magnum MA would be my reference.”*

**Robert Harley—The Absolute Sound**

Distributed by:



P.O. Box 988, Cheltenham, Glos., GL50 9FJ  
www.audiobility.co.uk  
Telephone: 0870 777 2991

**Audio Destination**

Tiverton, Devon  
01884 243 584

**Brighton Hi-fi**

Flimwell, East Sussex  
01580 878 101

**Divine Audio**

Market Harborough, Leicestershire  
01858 432999

**Doug Brady Hi-fi**

Warrington, Cheshire  
01925 828009

**Loud & Clear**

Bonnington Mill, Edinburgh  
0131 555 3963

**Loud & Clear**

Finnieston, Glasgow  
0141 221 0221

**Mike Manning Audio**

Yeovil, Somerset  
01935 479 361

**Music Matters**

Solihull, Birmingham  
0121 742 0254

**O'Brien Hi-fi**

Wimbledon, London  
0208 946 0331

**Progressive Audio**

Rainham, Kent  
01634 389004

sound proof

Moon Electronics by Sim Audio, manufacturers of high end audio since 1980.

Multi award winning CD Players, Integrated Amplifiers, Pre-amplifiers, Power Amplifiers available only from specially selected dealers.



**redline**

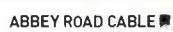

Distributed in the UK by Redline T: 0131 555 3922 E: info@red-line.co.uk www.red-line.co.uk



## MEASURED PERFORMANCE - AUROUSAL A1 Mk2

The A1 Mk2s show a broadly similar response curve to the original A1s but where things have improved is in the low end. Previously, the A1's output started to fall gently below 200Hz, finally dropping off at around 60Hz. The new version maintains a steady level down to around 80Hz before tailing off, still to be augmented by the port at around 40Hz. This should improve bass punch and detail without sacrificing any noticeable extension.

Otherwise the A1s still exhibit an impressively even response for a single driver design. The small lift in the 1-2kHz region will add body and output is well maintained to 20kHz. However, the rather uneven nature of the top end may well mean that positioning and listening aspect are more critical than with other loudspeakers as the A1 Mk2s are very directional, with output tailing off sharply as the measurement microphone is moved off-axis.

Electrically, the A1 Mk2s are still a nice, even, well damped load with an average measured impedance of 8.8 Ohms, dropping to a minimum of around 7 Ohms, so they will be easy to drive. This is good, given that their sensitivity falls short of Aorousal's specification of 86dB, measuring around 83dB. AS

### FREQUENCY RESPONSE

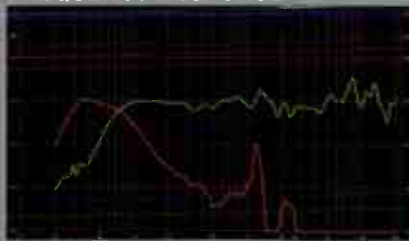

Green - driver output  
Red - port output

### IMPEDANCE

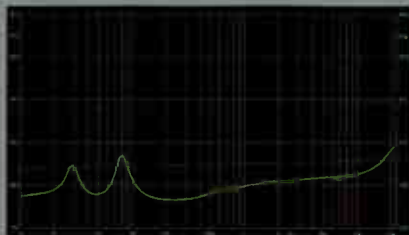

## MEASURED PERFORMANCE - KEF XQ10

KEF's XQ10 loudspeakers show another variation on the loudspeaker frequency response theme. Generally, their output is nicely flat and even across the frequency range, but it does have a rising trend towards high frequencies. This will make the overall sound clear and crisp but may make the balance a little thin sounding. Additionally, there is something of a drop in level in the 300-900Hz region and this may rob some atmosphere from vocals. The dip in output at 10kHz as a result of a cancellation due to the Uni-Q tweeter's positioning is still there as well, but is less prominent than before and should go unnoticed.

Bass output from the small cabinets is not huge, with the main driver working down to 90Hz or so, handing over to the port which has quite a high tuning frequency of 60Hz. Damping is reasonably good, so the XQ10s should be tight at the bottom end, but they are unlikely to satisfy headbangers.

Electrically the XQ10s will work best on a 4 Ohm output thanks to their average impedance of 6.2 Ohms, dipping down to 4 Ohms at higher frequencies, but their sensitivity is quite good given their size, coming in at 86dB. AS

### FREQUENCY RESPONSE

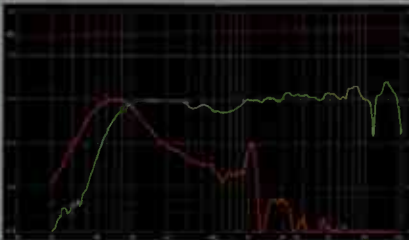

Green - driver output  
Red - port output

### IMPEDANCE

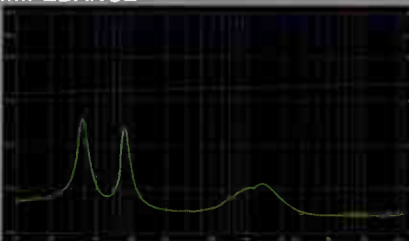

## MEASURED PERFORMANCE - WHARFEDALE OPUS 2-M1

These loudspeakers are quite unusual in that they have something of a gentle lift in response across the 800Hz-4kHz region, whereas designers often reduce this area slightly, as it is where the ear is most sensitive. As a result of this, any problems in this area can be unpleasant if the loudspeaker is less than well designed. Poor design is not an accusation that can usually be laid at Wharfedale's door, though, so whilst I would expect the Opus 2-M1s to have a quite forward balance, they should not be harsh. Treble response is even with just a small peak that will add detail, so this will help.

At the low end, the Opus 2-M1s are quite well damped and offer good extension down to around 80Hz from the main driver, with the port operating over a relatively broad range down to the tuning frequency of around 30Hz. The M1s are large as standmounters go, so they should have good low end weight.

Electrically the Wharfedales offer no surprises, other than something of an inductive peak at around 1kHz but this is not too large. Their average measured impedance is 7.7 Ohms, dipping to a minimum of around 5 Ohms. Combined with an 85dB sensitivity, they should not be too challenging a load. AS

### FREQUENCY RESPONSE



Green - driver output  
Red - port output

### IMPEDANCE

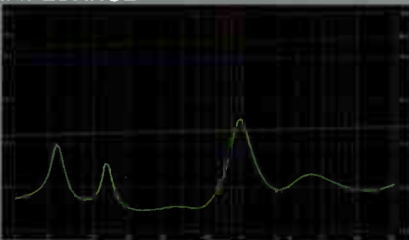

### VERDICT ●●●●£

Subtly updated to Mk2 status, the Aorousals are eloquent musical performers - single driver loudspeakers for people who don't 'do' single drivers, in fact!

**AUROUSAL A1 Mk2** £645

Aorousal Ltd.

+44(0)7837 956069

www.aorousal.com

#### FOR

- atmospheric
- treble clarity
- good bass weight
- musicality

#### AGAINST

- need careful setup
- high volume congestion

### VERDICT ●●●●

Crisp, detailed and dynamic loudspeakers with a bracing sound to pep up smooth systems.

**KEF XQ10** £699

KEF UK Ltd

+44(0)1622 672261

www.kef.com

#### FOR

- detail
- treble insight
- dynamics
- image projection

#### AGAINST

- rather bass shy
- forward at times

### VERDICT ●●●●

Large standmounters with an intoxicating mixture of poise, pace and crisp detailing - and the finish doesn't detract either!

**WHARFEDALE**

**OPUS 2 M1** £999

IAG UK

+44(0)1480 447700

www.wharfedale.co.uk

#### FOR

- effective midrange
- sweet, detailed top end
- fit and finish
- 'big' sound

#### AGAINST

- loose bass at times



Much excitement has surrounded the arrival of B&W's new 600 range. Haden Boardman listens to the babies of the family, the 686s...

# Straight Six

**B**&W are famous for the Nautilus loudspeaker, their range-topping £35,000 tapered transmission line, with actively driven electronics; a speaker in higher demand today than when it was introduced a decade ago. The technologies incorporated within this unique loudspeaker have duly filtered down to the lower models, including the outgoing DM600 range - specifically the Nautilus Tweeter Tube - but it has to be said that the old 600 series was looking a little stale...

After ten years however, the original DM600 range has finally been replaced by the new 600 range (no 'DM' prefix any more). The model numbers have also now been reversed, so that the 686 is the current starting model. A small compact bookshelf, slightly deeper than one may expect, the 686 is beautifully made and well executed. Can this sub-£300 speaker cut the mustard in a way the older 600

models failed?

Technology wise, this small speaker borrows a huge amount from the more expensive CM models; in fact the 686 is based heavily on the CM1 model, which sells for almost double the price. Chinese assembly (all the cabinets and drive units are made in Europe), a vinyl wrap cabinet, (with a thicker front baffle) and a fixed phase plug to the bass unit mark out the more obvious differences.

The tweeter is a huge improvement. Neodymium magnets allow for a much smaller 'footprint' allowing the treble unit to be located much closer to the bass driver. Square section ribbon style aluminium voice coil wire improves drive unit efficiency, power handling, and frequency range.

The matching bass unit is a traditional Bowers & Wilkins speciality; featuring a cone made from Du Pont Kevlar, a diecast chassis and large ceramic magnet. The fixed phase plug helps extend the higher

frequencies covered by the unit, with crossover at 4kHz. The crossover itself is total simplicity, consisting of just three components making up a simple first order, 6dB/octave filter - something I totally condone as a 'full range' speaker fan. There is a coil on the bass unit, a capacitor on the tweeter, and a simple resistor to match the level of the two items. This kind of crossover is not possible with poor quality drive units; the idea is taken directly from the 800 range and, other than the upscaled specification of the components, a virtually identical crossover can also be found in the current Signature Diamond! A first order crossover, and the close location of both drive units, should result in fine integration between the two drive units.

Supplied in the box are a series of port bungs, reminiscent of the Lovington Horn speakers reviewed a few months back. The back of the cabinet supports a small bracket for wall mounting along with the bass port and chunky biwire terminal.



Fit and finish are superb, with a solid trim ring hiding the bass unit mounting screws, and making a smooth transition from the edge of the cone to the cabinet.

With the exception of low 84dB sensitivity, the manufacturer's claimed specifications are very impressive. B&W quote an on-axis +/-3dB frequency response of 55Hz to 22kHz and minimum impedance is said not to drop below 5 Ohms. [see MEASURED PERFORMANCE].

For auditioning, the 686s were placed on heavy 60cm stands, located a metre from the rear wall, 70cm from side walls, and toed in towards the listening position. The speakers had a one hundred hour burn-in before any listening took place.

### SOUND QUALITY

The first track on was from Ernest Ranglin, a bass-heavy reggae track. The little 686s had no problems playing the full force of this one; despite the small size of their enclosures, bass was impressive. Jimmy Smith's 'The Cat' LP has a few tracks mixing Hammond organ bass with acoustic double bass; on some loudspeakers the levels of colouration spoil the timbre differences between the two instruments and it becomes somewhat impossible to tell which is which. The 686s did a magnificent job, letting the clear textures of both come shining through. The speaker has been tuned a little for a slightly more 'impressive' bass performance, than true neutrality, but this is clearly no bad thing, as B&W have done the job well.

Midrange performance was equally impressive. Switching to Ricky Lee Jones's 'Duchess of Coolsville' Anthology displayed a clean, fast and detailed presentation, with low levels of colouration across the board. Upping power, a touch of Dinah Washington's version of 'Mad About The Boy' again underlined the speakers' incredibly smooth and punchy performance, albeit with a mild compression to the sound, compared to absolute references.

A little light opera had the speaker dutifully displaying an equally light touch. There was no overpowering or slowing down on a wide variety of classical material from string quartets to full orchestra, plus a couple of very solid Stravinsky recordings on Decca vinyl. If there was a criticism, this was perhaps that the speaker could be a tad too polite in the midband at times. Playing Tom Waits's first LP seemed to lack a little of the rough edge this recording has; although I admit this may not be

such a bad thing!

Treble-wise, I'll now confess my prejudices; I have never been totally convinced by metal dome tweeters. I still feel that the item used in the earliest 600 range is just about one of the worst I have ever encountered, but admittedly that was a decade ago. So what of the new version? Thankfully a much better animal. There is still a slight top end shimmer which is hard to totally quantify; it is not so much sibilance or extra brightness but there is a certain 'sound' to this tweeter, which is a constant reminder that a metal dome is used. The result is not so much 'spit', but more of a very minor addition to 'T' sounds. However, it is definitely in a different league to the older generation of metal domes, with none of the bell-like ringing exhibited by B&Ws of ten years ago; I am actually quite excited about listening to the high end diamond domes now!

Stereo image was tight but, given the technology, not as explicit as I would have expected. The soundstage was large, but did not step out of the boxes especially well; a peep inside the box revealed the possible source of the problem, with the crossover resistor and capacitor not exactly being the highest of tolerances. Along with the internal cable, improving these items is a possible DIY tweak to consider, once the speakers are out of warranty of course...

Most of the auditioning was completed on a reasonably pricey system but, as the 686 sells for £279, in the interest of balance, a budget system was assembled around the little speaker. Modest in price the 686s may be, but they demand a lot from their ancillaries. No sub-£300 amplifier could offer the level of power and control required by them. Budget amplifiers are simply not in these loudspeakers' vocabulary; they thrive on a high quality source, and a damn good amplifier, preferably one with bags of power. Thus I obtained best results with a mix of Cyrus, Pioneer and Marantz two channel amplifiers. In some ways this could be classed as the speakers' Achilles heel; in system matching

terms they must be classed more as £500 loudspeakers than a sub-£300 compact.



### CONCLUSION

My previous sub-£500 reference has been, for quite some time, the Dynaudio Audience 42. Possibly even more demanding in terms of amplification, I still prefer the Dynaudio's treble quality and elements of the bass; but overall Bowers and Wilkins have more than caught up. The simpler crossover (the Dyn' has impedance correction – something I find 'damps out' the overall sound) allows more spark and emotion to the music, and the 686s cost £120 less...

All in all, B&W's new babies are budget speakers in price, but not in performance or demands. Sophisticated and mature in their sound, the 686s are a little gem. They rank leagues above the older DM600 range, and I can think of no similar loudspeaker that captures the thrill of high fidelity at the price point. Strongly recommended.

**REFERENCE SYSTEM**  
Marantz CD12/CDA12 CD player  
Sowter passive control unit  
HH Electronics TPA50D amplifiers  
Chord Signature interconnects

### VERDICT

Highly accomplished small loudspeakers with a fast, detailed and punchy sound - but careful matching needed.

**B&W 686** £279  
**B&W Loudspeakers**  
☎ +44(0)1903 221500  
[www.bowers-wilkins.com](http://www.bowers-wilkins.com)

### FOR

- overall sound
- astounding value
- build

### AGAINST

- need good ancillaries
- slight treble 'sound'

### MEASURED PERFORMANCE

The overall frequency response of the B&W 686s is smooth and even across the board, with just a slight lift of 2dB or so towards 20kHz, which will add a nice sense of atmosphere to proceedings.

Bass output is good down to 90Hz or so from the main driver, with the port taking over and peaking in output at 60Hz. This is a fine result for such a small loudspeaker and B&W's 'Flowport' technology can be seen in action under measurement as output from the port is very clean.

Electrically, the 686s are fairly benign, although not that well damped and they do have an inductive peak at 2kHz. Average measured impedance was 7.7 Ohms, dipping to a minimum of around 5 Ohms, so they should not be too difficult to drive. However, their low sensitivity of 83dB will require a certain amount of muscle to successfully get them singing - budget for 40-50 watts minimum ideally.

All in all, the 686s turn in the sort of accomplished performance that would be expected of a manufacturer like B&W and should sound good as a

result. The fact that this is achieved with a minimum amount of crossover speaks volumes for the design of their drive units. AS

### FREQUENCY RESPONSE



Green - driver output  
Red - port output

### IMPEDANCE

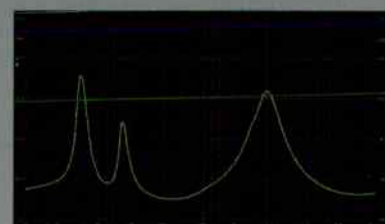



**WIN A SUPERB EDGAR CD-1 CD PLAYER WORTH £1,350 IN THIS MONTH'S GREAT GIVEAWAY!**

**QUESTIONS**

[1] Which car dashboard does the Edgar's fascia remind DP of?  
 [a] Hillman Imp  
 [b] Riley Elf  
 [c] Singer Gazelle  
 [d] Triumph Stag

[2] How many digital outputs does it have?  
 [a] three  
 [b] two  
 [c] one  
 [d] none

[3] Compared to the reference, how expansive did the Edgar sound?  
 [a] a lot less  
 [b] a little less  
 [c] about the same  
 [d] more

[4] According to DP, the Edgar has "superlative sound per..."  
 [a] Dollar  
 [b] Yen  
 [c] Euro  
 [d] Pound

March Competition  
 Hi-Fi World Magazine  
 Unit G4 Argo House  
 The Park Business Centre  
 Kilburn Park Rd.  
 London NW6 5LF

**H**ere's your chance to win one of the best sounding sub-£2,000 CD players we've heard of late – Edgar's superb CD-1! Here's what David Price said about it in February's issue of *Hi-Fi World*...

"Frankly I can't tell you much about this Slovakian company at all, but this new valve regulated and buffered CD-1 not only measured very well but had sonics to match. Suffice to say that if a similarly performing machine from a British or Japanese manufacturer had been sent in for review, it would have been billed as the greatest thing since the digital watch by shiny suited public relations types. What we have here is quite a substantial machine with a lovely wood fascia that for some reason reminded me, as a classic car nut, of the dashboard of an early nineteen seventies Triumph Stag. Inset into the 'dashboard' is a central (wooden) on-off switch which, when depressed, causes an 'Edgar' logo above to glow blue. Unlike so many modern machines, the CD-1 has real charm of its own. No digital outputs, bus connectors, etc. What this tells me, in my role of the hi-fi magazine equivalent of Lloyd Grossman in 'Through the Keyhole' is that

– if nothing else - these guys mean business...

Kicking off with The Police's 'Synchronicity II', and compared to my reference Astin Trew AT3500 I was impressed by the bigger, wider and more expansive sound, with a sweeter and more finessed treble. I could hear a cleaner, better delineated electric guitar sound. Vocals were superb with both players, but there was a touch less nasality to the Edgar and this clarity ran all the way up to the treble, giving a cleaner hi hat sound. The Edgar caught the phrasing of the players better, giving a superior sense of accenting on every first bar of the four bar phrase. The Edgar's wonderful clarity was perhaps most obvious on well recorded piano music, such as in the opening to Al Jarreau's cover of Elton John's 'Your Song'. The reference Astin Trew was

superb, but the Edgar revealed just a fraction more lustre, the instrument's ringing harmonics glistening out of the mix in a way that made its rival sound congested. The Edgar scores with class leading stage width, midband clarity and treble finesse, and meets and matches its arch rival on bass speed and musicality. Overall then, it's a blinder – and just shouldn't sound quite as good at the price. If you're in the market for superlative sound per pound, you may well have just found your dream £1,350 machine."

If you'd like a chance to win this superb silver disc spinner, all you have to do is answer the following four easy questions. Send your entries on a postcard by 29th February 2008 to: March 2008 Competition, *Hi-Fi World* Magazine, Unit G4, Argo House, The Park Business Centre, Kilburn Park Road, London, NW6 5LF.

**RULES AND CONDITIONS OF ENTRY**

- ONLY ONE ENTRY PER HOUSEHOLD
- MULTIPLE ENTRIES WILL BE AUTOMATICALLY DISQUALIFIED
- PURCHASE OF THE MAGAZINE IS NOT A PRE-CONITION OF ENTRY
- NO CORRESPONDENCE WILL BE ENTERED INTO
- THE EDITOR'S DECISION IS FINAL
- NO EMPLOYEES OF AUDIO PUBLISHING LIMITED, OR OF ANY COMPANIES ASSOCIATED WITH THE PRODUCTION OR DISTRIBUTION OF THE PRIZES, MAY ENTER

**entries will be accepted on a postcard only**

**DECEMBER 2008 ANATEK ACOUSTICS PHONOSTAGE & INTERCONNECTS WINNER:  
 Mrs. Bev Vedmore of Cardiff, South Wales**



# Almost Blue

Patrick Cleasby considers recent developments in the Hi-Definition digital wars...

It was back in 2002 that word first began to surface of a higher performance successor to the then still current red-laser (i.e. standard definition) DVD technology – a finer blue laser beam providing the prospect of high definition video (and incidentally audio) encoding on higher-capacity optical discs.

For a while pundits speculated about the ludicrous prospect (given past futile format war debacles) of two incredibly similar but competing formats hitting the market simultaneously. Then the worst thing happened – for the consumer, the electronics manufacturer and ultimately the competing formats' camps – and the infinitesimally small functional differences between the two formats did not manage to force their reconciliation and combination. (As we have outlined before, this was the one factor which had ensured DVD's success a decade earlier.)

The fact that the original purpose of these new 'high definition' formats was video meant that, initially at least, audiophiles would have been right to sit on the side lines and enjoy the prize fight between Blu-ray (essentially Sony, aided and abetted by Panasonic) versus HD-DVD (essentially Toshiba with significant Microsoft backup). Music hadn't really begun to feature in the equation and, as with manufacturers and consumers alike, we held our breath and waited for the inevitable fallout. But early 2008 has brought the news which should finally allow us to establish the basis on which manufacturers will build future high-end video (and by definition, audio) players, and on which the consumer might buy them.

It is ironic that the straw that broke the camel's back was the decision of Warner Bros. to abandon their former stance of releasing in both formats, in favour of moving to Blu-ray only releases by mid-2008. A mere three years ago they were left as the last remaining major label supporter of DVD-Audio (another moribund and predominantly Toshiba format). Maybe they learnt from that experience, and it can surely only

be a matter of time before the two studios still adhering to HD-DVD only release policies, Paramount and Universal, will quietly (or not so quietly) shift allegiance.

But in truth, just as it does not reflect fatuous VHS versus Beta comparisons, the Blu-ray over HD-DVD victory (for it is surely a victory that is to come), the current situation bears few echoes of the double failures of SACD and DVD-Audio.

There are two main factors that put a different complexion on the HD video format war, when compared to the 'hi res' audio one. Firstly, there has always been a drive to push the technology firmly into the computer market - ensuring a techie, early adopter spearhead into the market. More importantly Microsoft pushed HD-DVD with their cheap add-on to the Xbox 360, and Sony played what will be understood as their masterstroke in hindsight – incorporating Blu-ray drives into each and every Playstation 3. It is the latter fact that has meant retailer shelf space has been made for Blu-ray software (accompanied by a minority of HD-DVD alongside, if you're lucky), in a way SACD and DVD-Audio never achieved.

With the threat of downloadable HD Video from both Microsoft and Apple on the horizon, the ultimate success of Blu-ray is not assured even

if it does inevitably triumph over HD-DVD. The reasons for that small victory are, as ever, due to the more heavyweight business machinations of the Sony Corporation. The amount that it is rumoured to have cost the HD-DVD contingent to persuade Paramount/Dreamworks to eschew Blu-ray less than six months ago will doubtless pale into insignificance once the real reason for Sony's predominance in the HD wars is fully revealed. Much as they attempted in the early days of SACD, the Japanese giant are rumoured to

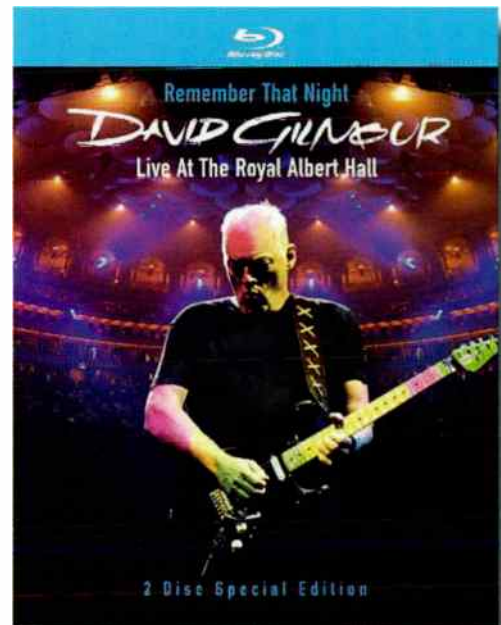

have overcome the hump of closed, prohibitively-priced disc authoring helping the studios by heavy (read zero-priced – for a time) discounting. The true cost of this victory to content producers (and the consumer) will only become evident once this artificial subsidy is removed.

On the plus-side, the reduction of the HD playing field to one (discounting flaky Chinese alternatives) will do one vital thing for the audiophile community. At last, it will remove the block to the involvement of many of the more audiophile-friendly manufacturers. Companies like Meridian and Arcam were never going to jump into HD player manufacture until this pointless war was over. Now, they might just

"Sony's masterstroke was to incorporate Blu-ray into each and every Playstation 3..."

start thinking about it.

In the meantime we may also see more music product being released onto the market, once record companies don't have to consider which format to do it in. There are several Blu-ray discs available with fine uncompressed 24bit stereo and losslessly compressed surround soundtracks, including EMI's premium-priced David Gilmour set [pictured]. Such discs are essential for us audiophiles – downloads are unlikely ever to arrive with such rich audio pickings!

# Wireless World



## David Allcock browses Denon's new AVR-4308 Internet enabled receiver...

Since the introduction of the surround sound receiver in 1986, A/V receivers have grown in sophistication, power and complexity. They started as one box products designed to process Dolby surround sound from LaserDisc and Hi-Fi stereo VCR sources, but have now morphed into all singing, all dancing behemoths handling multiple formats, rooms and zones – and the very latest such as this are even Internet aware. But the breed has always had a poor reputation for stereo sound quality compared with even budget stereo amplifiers, which is why hi-fi buyers have traditionally been sniffy...

Denon's new AVR-4308 is big even by A/V receiver standards, measuring 434x195x455mm and weighing 18.9kg, and comes packaged with more accessories than a teenage girl on a Saturday night out. There is also a small stub aerial which is for the internal Wi-Fi card, as this

A/V receiver is fully internet enabled, containing not only a Wi-Fi card but also a 10/100 Mb Ethernet port. The receiver uses the net for internet radio, remote control (this can not only be controlled via either remote control but also via a PDA or laptop, as this receiver has a web server on board for control and configuration purposes!) and can stream music directly from a server or NAS (Network Attached Storage) device which supports DLNA (this platform is supported across Windows, Mac OS X and Linux). It can also access music connected to either one of its USB ports, from a memory card or hard disk.

It totes 7x130W RMS [see MEASURED PERFORMANCE] which can be used either for a single surround sound system, or 5 channels for surround sound with a stereo pair for a second zone, along with pre outs for two more zones if desired. The mighty Denon has

an MM input for phono, 8 line level inputs plus a 7.1 input, along with 3 S/PDIF and 3 TOSLink digital inputs. This receiver has both DAB and AM/FM tuners, for radio reception anywhere. Needless to say, it can decode every surround sound mode known to man including the bleeding edge Dolby TrueHD, Dolby Digital Plus and DTS HD Master Audio which is only just becoming available on Blu-Ray players. To simplify setup, it even comes with its own microphone for a fully automated setup, which also provide the input for the Audyssey MultiEQ XT which can equalise the sound for six locations in the room automatically.

### SOUND QUALITY

The first surprise was the power amp stages, which were not only able to drive my Rocket speakers with ease, but could also drive my more challenging Leema Xavier and ML Vantage systems, both of which



require considerable current to give their best. Whilst the AVR-4308 is not going to challenge the likes of my Bryston 3B-SST or Leema Tucana amplifier in terms of current delivery, this still surpasses any other A/V amp I have tried, most of which leave the Xavier with flabby, indistinct bass or simply shut down when confronted by the 1 Ohm at 20kHz impedance of the Martin Logan speakers!

On stereo playback in pure direct mode, which shuts down all unnecessary circuits, the AVR-4308 displayed a leaning to fullness in the upper bass/lower midrange region, so the midrange is not quite as transparent as you would hear from the best budget integrated amps, but unlike most A/V receivers this can produce a solid soundstage, even using the internal DACs. The 4308 was able to produce a focused soundstage between the speakers, populated with images which were distinct and identifiable in their own space. It could also portray the depth plane with considerable fidelity, giving a real feeling of layering, but this was improved considerably when I used the Shanling SCD-T200's analogue outputs. At this point the stage expanded beyond the speakers and further towards the back wall, opening up the whole stage and giving more space around and between performers.

High frequencies, whilst clean and extended on the digital input, had a slight splashy quality with cymbals and tambourines and could sound slightly forward. But again, reverting to the analogue inputs rapidly cured this, bringing everything back into its correct balance and perspective. The 4308 has a fine dynamic range with excellent transient attack, can track dynamic shifts in the music effortlessly and represents a substantial improvement over the stodgy presentation from most A/V amplifiers.

Whilst this amplifier clearly has a good quality preamp stage, I was intrigued by the quality of its internal sources, namely DAB, FM and internet radio. DAB and FM failed to impress, though DAB was clearly the weakest. FM was a little better but the tuner was not the most sensitive I've heard, and the sound balance was a little too rich for my taste. I then moved to the internet radio tuner, and was pleasantly surprised. The 4308 was hard wired to my router via a Cat 5e cable and within seconds I was presented with a huge list of channels, and whilst many broadcast at low bitrates (DAB levels) there are a lot which are much better, and I spent a few evenings just listening to the vast range of stations available.

Sonically I was again conscious of the restrictions of the internal DACs and the stations' compression, but on good stations the sound was more open and transparent than the FM tuner, with excellent channel separation and a solid soundstage. The facility which intrigued me most was the 4308's ability to stream music from a household server running DLNA server software. Listening to lossless FLAC tracks the sound was excellent, essentially indistinguishable from the sound using the digital input from an external CD player. I found myself wishing the internal DACs were better, but this would certainly satisfy me for background music or a second, less critical zone such as a garden or kitchen, and Denon are to be applauded for its inclusion. Navigation was easy through my server's large collection of tracks, but sadly this unit cannot play iTunes DRM protected media.

On surround sound material, the 4308 excelled. When given a DTS soundtrack such as the Superbit edition of 'Fifth Element' the sense of space is stunning, the sequence where Bruce Willis shoots his way out of a theatre into the foyer and destroys it is exhilarating; the room was literally being shaken by my subwoofer, whilst the sounds of the people in the foyer were seamless, giving no clue as to the location of the individual speakers. A somewhat more down to earth test was the restaurant sequence in the 1999 remake of 'The Thomas Crown Affair'. This very natural acoustic was incredibly convincing even though it utilises only Dolby Digital, the vocal track being locked to the centre channel solidly with subtle augmentation from left and right mains when necessary, whilst the background music was clean and easy to discern from the rest of the mix.

I was unfortunately unable to obtain a Blu Ray player capable of outputting Dolby TrueHD or DTS-HD Master audio for the review, but listening to these decoded

by a PS3 and fed into the 4308 via HDMI showed me the amazing potential of these formats; it was like moving from a 192kbps MP3 to uncompressed CD on all channels. The remastered Blu Ray edition of 'Fifth Element' with TrueHD sound makes even the excellent superbit version sound subdued, whilst the Vangelis score on the new release of 'Blade Runner - Final Cut' was stunning and more involving than the sound I heard from any other source.

**CONCLUSION**

Denon have turned in a technological *tour de force* here. Massively powerful, able to supply four zones with sound, Internet aware and capable of video upscaling analogue video to 1080p HDMI, the 4308 is cutting edge. Yet it's the basic audio engineering which impresses me most, as the big Denon is fundamentally a very good 7 channel amplifier with a good preamp stage. Mate fine sound with its HDMI switching and future-proofed surround modes, and you have a potent product which will be difficult to match and even tougher to beat. Given its price I would strongly recommend this excellent unit.

**VERDICT** ●●●●●  
Formidable A/V receiver with vast feature count, massive power and incredible flexibility to accommodate any system.

**DENON AVR-4803** £2,000  
D&M Audiovisual Ltd  
+44(0)1234 741200  
<http://www.denon.co.uk>

- FOR**
- massive flexibility
  - high current power amp
  - Internet connectivity
  - multi zone enabled
- AGAINST**
- rich upper bass
  - middling FM & DAB sound

**MEASURED PERFORMANCE**

Surround sound receivers manage to turn out huge amounts of power, the Denon producing 160W per channel into 8 Ohms and 270 Watts into 4 Ohms. Over seven channels it can therefore supply more than 1800W on musical peaks.	Separation	75dB
The AVR-4308 uses conventional Class A/B linear amplifiers possessing respectably low levels of distortion, the worst case value being 0.014%. Our analysis shows a spread of harmonics and a THD meter showed this as classic crossover distortion. A high damping factor value of 54 means the amplifier will keep a grip on attached loudspeakers, but may sound dry with those that are heavily damped acoustically.	Noise	-103dB
The AVR-4308 uses conventional Class A/B linear amplifiers possessing respectably low levels of distortion, the worst case value being 0.014%. Our analysis shows a spread of harmonics and a THD meter showed this as classic crossover distortion. A high damping factor value of 54 means the amplifier will keep a grip on attached loudspeakers, but may sound dry with those that are heavily damped acoustically.	Distortion	0.006%
The VHF tuner will give a warm sound, as its frequency response displays falling treble. With low distortion, good separation and low noise it measured well though and, with a good aerial, it should sound respectable.	Sensitivity	300mV
The phono stage was similarly accurate, but a small amount of lower midband lift will add just a smidgeon of warmth and body to the sound.	Damping factor	54
Like most Denon receivers the AVR-4308 measures well in all respects. It is enormously powerful and suits large rooms. NK	Tuner	
	Frequency response	18Hz-12kHz
	Separation	37dB
	Noise	-70dB
	Distortion (50% mod.)	0.1%
	Sensitivity	38mV

**FREQUENCY RESPONSE - TUNER**

**DISTORTION**

THD 23456789 Input RMS Frequency  
CH1 0.0120785 % 2.7569 V 9.9922 kHz  
CH2 OFF OFF OFF

**Power** 162watts

**CD INPUT**  
Frequency response 1.5Hz-60kHz



**Adam Smith tries not to lose Velodyne's diminutive new subwoofer, the MicroVee...**

# Vee Small

**I**t definitely seems that most things in the world around us are getting smaller. With the possible exception of cars, which are bucking the trend and seemingly growing, think of virtually anything else and, chances are, a modern variant will be more diminutive than a model from yesterday. Take the mobile phone for example, new models from Motorola, Nokia and Sony Ericsson are more tiny than ever and some people need the aid of a toothpick and magnifying glass in order to operate them. Compare this to the brick-sized behemoths that yuppies used to carry around back in the eighties and you can see just how much technology has shrunk.

It is not just in technology terms that this phenomenon is noticeable, either. The rooms of many modern houses are often tiny, with garages likewise - I know my father can just about fit his Vauxhall Vectra into the garage of his eight year old house, but as it would require an undignified exit through the sunroof, he doesn't generally bother! Naturally, hi-fi has not missed out on this trend either and loudspeakers in particular are more compact than they used to be.

As a result of this miniaturisation, the subwoofer is enjoying a great rise in popularity, even outside home theatre circles, in order to return the bass that the smaller main loudspeakers tend to lack, despite the best efforts of their designers.

The thing is, the miniaturisation craze has even reached the subwoofer now, and the Velodyne MicroVee is quite the smallest 'proper' design I have ever seen - smaller even than the tiny REL Quake.

The MicroVee is technologically interesting and comes from a company with a whole raft of technological tricks up their sleeves. These include clever technologies like Digital Drive which is used to optimise room tuning and High Gain Servo technology, which uses a sealed accelerometer-based feedback system to monitor and control the motion of the cone. All this tops out in the mighty Digital Drive DD1812, £11,000 worth of subwoofer, featuring 6,000W of dynamic power,



plus a twelve inch and an eighteen inch drive unit in a two-way configuration!

The MicroVee is rather simpler however, and consists of a 6.5in (170mm) forward-facing main driver flanked on either side of the cabinet by a pair of 6.5in passive radiators. The main driver is powered by an amplifier making use of what Velodyne call a 'Patented Energy Recovery System' to deliver no less than 1000 watts RMS and 2000 watts of dynamic power. This may sound excessive but it is necessary to force low notes out of such a diminutive enclosure.

The MicroVee is truly tiny, measuring 229x229x244mm (HxWxD) and is very well finished, feeling impressively sturdy. On the rear panel are the normal controls for volume, cutoff frequency and phase, plus power configuration switches that allow the MicroVee to come out of standby on application of an input signal and go into standby around 15 minutes after it is removed. Inputs may be provided at line level through phono sockets or mini-jack terminals (for use from an MP3 dock or similar). There is also a full set of speaker level connections for input and output loop-through, disappointingly through spring-clip terminals. Still, I suppose there wasn't really room on the back panel for eight binding posts...

**SOUND QUALITY**

Firing up the MicroVee and setting it up to work with the KEF XQ10 standmounters proved an easy exercise, the Velodyne being relatively uncomplicated to integrate, so it resulted in a sonic disappearing act. This done, the MicroVee proved an ideal partner for a pair of small standmounters that are a little on the bass-shy side. It augmented the

XQ10s very successfully and added a healthy dose of low end solidity to their performance.

Musically the MicroVee was more than able to pick up on a bass line and hang on to it without any boom or wallow. Jennifer Warnes' 'Somewhere, Somebody' from her 'Hunter' album was reproduced very well, the dominant bass guitar having a palpable depth to it, with excellent note detail. The Velodyne also picked up on the deep 'pop' from Jennifer's voice near the beginning of the second verse which passes by unnoticed on most full range loudspeakers.

Pumping the pace up somewhat, some Jazzanova tracks showed that the MicroVee is certainly not lacking punch, even if it cannot quite offer up the full flare-flapping ability of a larger unit. The Velodyne kept up with speedy drum and bass tracks and happily got into the stride of Goldie's 'Inner City Life'. Where it seemed less assured here, however, was in that the deep bass notes were all present and correct, but had a tendency to blur into one another somewhat, rather than starting and stopping smartly with proper division between each one. The MicroVee never sounded fluffy or sluggish, but it is just not the fastest subwoofer I have ever encountered in this respect.

Spinning another old bass favourite in the form of Bela Fleck's 'Flight of the Cosmic Hippo' showed that the MicroVee was well able to confer the individual notes of the deep bass line, but that it lacked the sheer room-rearranging rumble that this can generate. I may be being a little unfair here, given the cabinet size and small driver, but this is something that the Velodyne needs to be able to achieve if it's

going to really mix it with other subwoofers at the price.

The story was the same when set up in a multichannel system and using DVD as a source. Here the MicroVee picked up on the snappy transients offered by the gunfire in 'I, Robot' for example, but couldn't quite get to grips with bigger explosions in the same way that a sub with a bigger drive unit usually can. The MicroVee never distorted or started to make obvious, painful signs that it was running out of puff, but just lacked the impact that many people will expect from their subwoofers.

**CONCLUSION**

It's hard not to be impressed by the Velodyne MicroVee. The designers have clearly put a good deal of thought into the unit and the result is a musically adept device. It is easy to integrate, well able to follow a tune and only really starts to show its limitations a little when really pushed hard into action. Although Velodyne talk about 'bending' the laws of physics, they have not quite succeeded in breaking them yet.

However, as a compact and decor-friendly device for subtly but effectively augmenting the low end of a small pair of hi-fi loudspeakers, or as an addition to a compact MP3 player dock, like the KEF Picoforte for example, it succeeds completely.

**REFERENCE SYSTEMS**

Eastern Electric MiniMax CD player  
NAD M3 amplifier  
KEF XQ10 loudspeakers

Arcam DV139 DVD player  
Denon AVR-4308 amplifier  
KEF XQ10 and Q6c loudspeakers

**VERDICT**

Pleasingly musical subwoofer that performs impressively within the confines of its compact dimensions.

**VELODYNE MICROVEE £575**

Redline Distribution  
+44(0)131 555 3922  
www.red-line.co.uk

**FOR**

- musicality
- diminutive stature
- build quality

**AGAINST**

- doesn't go very deep
- not as fast as some rivals



**MEASURED PERFORMANCE**

As might be expected from its cabinet size, the Velodyne MicroVee does not plumb the very depths of bass like a larger design will, with output starting to drop off appreciably below 50Hz. As with some other designs I have measured, the markings on the frequency cutoff control do not correspond to the measured result, for example the upper limit is stated as being 200Hz, but is closer to 150Hz.

Whilst this is not such a problem if the unit is set up by ear or using a room measurement technique of some sort, it still means that the MicroVee does not operate up to as high a frequency as is suggested in its speci-

cations. This is something that should be borne in mind when considering matching satellite loudspeakers. AS

**FREQUENCY RESPONSE**



Green - crossover at maximum  
Red - crossover at minimum

... over **150 brands** ... with more booking every week!



# SOUND & VISION

## THE BRISTOL SHOW



22<sup>nd</sup> - 24<sup>th</sup> February 2008 10am - 5pm every day at the Bristol Marriott City Centre Hotel

**HI-FI, HOME CINEMA, FLAT SCREENS, PROJECTORS, CUSTOM INSTALLATION - IT'S ALL AT BRISTOL**

and there are lots more surprises in store!

Here's a sneak peek at some early product launches...

- ACOUSTIC ENERGY** - see and hear the new AE22 monitor speakers.
- ARCAM** - European premiere of the Solo Mini music system and the A38 integrated amplifier.
- B&W** - the first public outing for the Zeppelin, a fantastic new iPod speaker system.
- CYRUS** - the official launch of the CD6SE, CD8SE and CDxtSE CD players and transport. All based around Cyrus' new Servo Evolution (SE) platform.
- DENON** - receiving its UK launch... the AVP-A1HD THX Ultra2 High Definition home cinema pre/processor. Approx twice as large and heavy as it's humungous predecessors and sporting more technology than anything else on the planet (possibly!)
- DYNAUDIO** - Celebrating 30 years with the UK's first performance of the Sapphire.
- EXPOSURE** - exposing the new MCX system!
- FOCAL** - debut of the amazing new Chorus 816WSE and the Elektra S range.
- JVC** - See the the "True Black" DLA-HD100 projector.
- KEF** - see the stunning audiophile XQ series and new KIT series.
- MITSUBISHI** - launching the HC6000 anew home cinema projector.
- MJ ACOUSTICS** - launching the XENO speaker system.
- MONITOR AUDIO** - UK show debut of the PL100.
- NAD** - hear the new C515BEE CD player.
- PROJECTIONDESIGN** - First UK showing of the M25 - the worlds smallest full HD projector.
- SIM2** - promising a UK premiere of a brand new range with worlds first technology!
- SPECTRAL** - see the stunning new Closed Series models and Cantena range.
- SYSTEM FIDELITY** - a whole new brand launching at Bristol!
- VITA AUDIO** - look out for the launch of the R4 radio... sure to be another hit!
- WILSON BENESCH** - UK debut of the Trinity loudspeaker and the Full Circle turntable stand.

**GREAT DEALS** and special offers only available at the show. **WIN 21** superb prizes in our 21st Birthday Show Competition!

### GETTING TO THE SHOW

**BY TRAIN:** Temple Meads Station is a short distance from the Marriott.

**BY CAR:** Take the pain and strain from parking and use the Park & Ride from the University of West England just off junction 1 of the M32.

Please be aware that due to redevelopment work in the City Centre not all car parks will be available and we strongly suggest you use the Park & Ride.

Or from the M4 take J19 (M32 - Bristol). Follow signs for City Centre and RAC signs to the Show.

We recommend that you check our website for the latest travel information where links to the relevant sites can be accessed.

### ADMISSION

Adults £8.00;  
Students and Senior Citizens £4.00;  
Accompanied children under 16 free

SOUND & VISION  
THE BRISTOL SHOW



Organised by  
**audio X EXCELLENCE**  
www.audioexcellence.co.uk

**audio T**  
www.audio-t.co.uk

In association with

**WHAT HI-FI? SOUND AND VISION**

**BRANDS ON SHOW INCLUDE:** Accoustic Arts, Acoustic Energy, Acoustic Solid, Aesthetix, Analogue Productions, Apart, Apollo Hi-Fi Furniture, Arcam, Atacama Audio, Audio, Audioblab, Audionet, Audio Technica, AudioQuest, AV Forums, AVI, Black Rhodium, Bowers & Wilkins Loudspeakers, Bryston, C & C Hadcock, Ceratec, Chord Electronics, Claritas, Classic Records, Clearaudio, Clearlight Audio, Connected Accoustic, Cyrus, Da-Lite, Dali, Denon, Diverse Vinyl, Dynaudio, E-Vision, EBTB, Eclipse, Elmob, EMI, Exposure, Faroudja, Fatbaby, Fatboy, Fatman, FIM, Flying Mole, Focal, Funk Firm, Furrtech, GamuT, Graham Slee, Halcro, Hercules, Hi-Fi Choice, Hi-Fi Plus, Hi-Fi World, Hi-Fi Critic, Home Cinema Choice, iUS, Icon Distribution, Icon Stands, Ingenious Audio, InVideo, Isotek, iTube, Just Racks, JVC, KEF, Kubala Sosna Cables, Last, Leema Electro Acoustics, Lehmann, Loewe, Logitech, Marantz, Meridian Audio, Merlin, MetaVision UK, Michell Engineering, Mission, Mitsubishi Electric, MJ Acoustics, Mobile Fidelity, Monitor Audio, Monster Cable, NAD, Naim Audio, Neat Acoustics, Nordost, Nuforce, Onkyo, Optoma, Ortofon, Pioneer, Plinius, PMC, Pro-Ject, ProAc, Progressive Consumer Electronics, Projectiondesign, Pure Pleasure, Q Acoustics, QED, Quadraspire, Radford, REL Acoustics, Rhino, Roksan, Roth, Ruark, Sapphire Screens, Sennheiser, Shakti, Shun Mook, Shure Personal Audio UK, Silvermann, SIM2, Sonoro Audio, Sonos, Sony BMG, Soundstyle, Sparta Cables, Spectral, Spondor, Speakers Corner, Stamford Audio, Stands Unique, Storm Audio, System Fidelity, T3 Magazine, Tannoy, Tech+Link International, Terratec, The Chord Company, The Multi-Room Company, Tivoli, Totem Acoustic, True Colours Industries, Tvonics, Universal, Usher Audio, Uvem, van den Hul, Vienna Acoustics, Vincent, Vinyls Best, Vita Audio, Voix, VPI, What Hi-Fi? Sound & Vision, Wilson Benesch, World Designs and more...

For the very latest information please visit [www.bristolshow.co.uk](http://www.bristolshow.co.uk)

World Radio History





**Fine basic engineering makes Mystere's ia11 integrated amplifier a shining example of valve amplifier design, says Noel Keywood...**

# Stere Quality

**S**tandards are variable in the valve amplifier world. Some are less well made than they should be, others hopelessly complex and fussy to maintain, but I'm happy to say the Mystere ia11 you see before is neither of these. A fairly conventional design from the Netherlands, it is beautifully detailed in terms of electronic design and casework, and also refreshingly neat and affordable at £1,250. You get 40 watts per channel from a compact chassis, free from arcane ceremony such as bias adjustment. As valve amplifiers go, this is as close to plug and play as it comes...

Mystere is a brand name used by a Netherlands based (Eindhoven I believe) Durob audio group who design locally but get their product built in China they say - hence the low price. I am told, though, that Durob used Melody's Chinese factory to produce the Mystere, hence the similar styling. The novel Adaptive Auto-Bias circuit is Prima Luna's apparently, but the output transformers are Melody's, making the Mystere something of a hybrid in terms of technology, but there's nothing wrong with this, especially as both Prima Luna and Melody between them seem to know a thing or two

about valve amplification! In the ia11 you get a strong, beautifully finished modern valve amplifier.

The ia11 is unusually heavy for its compact dimensions, weighing no less than 20.5kgs. It will fit most shelves, measuring 320mm wide, 350mm deep and 200mm high. There are just four switched line inputs, both eight and four Ohm loudspeaker outlets, plus the usual IEC mains socket. The power switch lies on the right hand side panel, just behind the fascia, so it cannot be seen but is easily accessed. Strengthening its audiophile credentials is a switched stepped attenuator with strong detent springs

# INTRODUCING VIVACITY AR from RINGMAT

- Minimises distortion from resonance
- Boosts picture quality of home cinema systems
- Optimises sound reproduction of hi-fi systems

A MODULAR CONTROLLED  
RESONANCE SOLUTION FOR HI-FI  
AND HOME CINEMA SYSTEMS



Wholly NEW concepts for equipment support using NXT  patented Distributed Mode Loudspeaker technology and anti-resonance and anti-vibration designs from QR Design and DNM Design – the creators of RINGMAT.

© RINGMAT DEVELOPMENTS  
PO Box 200  
Brentwood  
Essex CM15 9FB  
++44(0) 1277 200 210

OUT MARCH 2008

PUTTING SOUND  
INTO FOCUS  
[www.ringmat.com](http://www.ringmat.com)

## simply musical



**SUGDEN AUDIO** TEL 01924 404088  
rescuing music from technology

made in England

pure class A





that give it a heavy, solid action.

The valves are protected - or should I say humans are protected - by a cover that can be easily removed. With no top vents it traps heat and gets hot, as do the valves. As manufacturers like GEC once used to specify minimum distances between valves like KT88s to minimise mutual warming effects that cause overheating, this isn't the best cover I have seen, but it can be removed without the exposed amplifier becoming electrically dangerous. The valve complement comprises four 6SN7 triodes for amplification and one pair of EL34 output pentodes in push-pull arrangement per channel. All the valves are affordable, EL34s costing around £14 each for example, making replacement every few years (of normal use) relatively inexpensive.

**SOUND QUALITY**

The EL34 is known for its lucid midband, one that is valued highly in the Far East, where this valve has a strong reputation - and I was reminded of its sound listening to the ia11. The amplifier has a delightful midband lucidity that portrays vocalists in a space of their own, seemingly without the hardness of tone and opaqueness that afflicts solid-state. It offers a 'see through' window without the slightest haze, just a sparkingly clear image set out neatly between the loudspeakers, but not forward of them. The ia11 lays out its stall tidily, with a well ordered stereo stage, if not one that is as expansive as that provided by older valves like the 300B triode. With a musical performance centred on a vocalist like Celine Dion the ia11 shone as a result, bringing the lady alive in front of me as I kicked off the listening session. It made a convincing case for choosing valves in an amplifier as well put together as this one, I thought to myself.

The EL34 also possesses

refined treble, sweet and intricate, if with a little less substance than that from a KT88. Cymbals rang out with vigour and the smallest strike against a triangle in Steve Earle's 'Waiting For You' was picked out adeptly. Even more captivating was the way violins of the Royal Philharmonic had a liveliness about them that made the first movement of the Brandenburg Concerto seem positively boisterous. The ia11 has a well lit upper midband and a refreshing portrayal of musical dynamics that makes it an attractive amplifier to sit in front of. Again, the EL34 within the undoubtedly well honed setting of this amplifier comes across as a lovely performer. The ia11 sounded insightful yet nuanced, both with complex percussion work and classical instruments.

It's more difficult to get EL34s to provide the muscular performance of the KT88 though, and here the ia11 differed little from what I have come to expect. Its initial partnership with our Spondor S8es was unsuccessful, bass sounding slow and soft. Being underdamped in themselves, the S8es generally work well with grippy amplifiers and this isn't one of the ia11's strengths. They were happier with a pair of Usher S-520s, where the amplifier's lovely midband was made obvious, its sweet treble highlighted and bass kept in shape.

Moving the ia11 into my own listening room to partner them with a pair of valve amplifier-friendly Revolver R45s provided the best results, although my overall

impressions were unchanged from those I reached with the Ushers. The amplifier did a fine job with the up tempo 'Somebody', from the Eagles latest album, maintaining a good sense of pace, delivering sparkling clear vocals and ringingly sweet treble, full of fine detail. Kick drum and bass guitar weren't especially impactful though, even though there was enough weight to them.

Rachmaninov's popular Piano Concerto No2 brought forth a lovely swathe of strings, violins again sounding lively and richly detailed. Piano had both body and tone, sounding rich and engaging. I noticed also with the sensitive Revolvers that input switching or adjusting the volume control brought obvious clanking from the loudspeakers, caused by microphony, a phenomenon new to me in valve amplifiers.

**CONCLUSION**

Mystere's ia11 is a delicate performer, distinguished by a super clear midband and sparkling, sweet treble. Partnered with sensitive floorstanders it does a lovely job at the price, although is more convincing with classical and vocals from the likes of James Blunt or Celine Dion than heavy bass lines and kick drums from The Darkness, for example. All the same, the strengths of EL34s in a nicely designed amplifier are there to be heard in all their glory and the asking price isn't great, making the ia11 a fine, real-world starting point for anyone appreciative of the clarity valves can bring.

**MEASURED PERFORMANCE**

Using EL34 output pentodes the Mystere delivered 45W into 8 Ohms and 42W from its 4 Ohms tap, before visual clipping (output overload). It moved into clip smoothly and symmetrically, a testament to its unusually low distortion at high levels. Pushed to 1% thd power reached 50W so the valves are likely run at high voltage and won't have the life of lower power designs, but EL34s are inexpensive to replace.

The transformers behave unusually well, with no sign of core saturation at low frequencies, and low distortion at high frequencies too. Consequently, distortion levels were very low right across the audio band and comprised innocuous second and third harmonics totalling around 0.2%. This amplifier should sound smooth and muddle-free, even at high volume.

Frequency response was wider than usual from a valve amplifier, with an upper limit of 93kHz (-1dB). The lower limit was 5Hz. Damping factor was low though, just 0.46, so underdamped loudspeakers will likely sound boomy.

The Mystere is a highly optimised conventional valve amplifier that should give a lovely sound. NK

Power	45W
Frequency response	5Hz-93kHz
Separation	63dB
Noise	-105dB
Distortion	0.2%
Sensitivity	480mV
Damping factor	0.46

**DISTORTION**

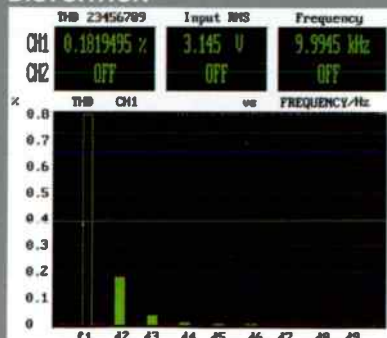

**VERDICT**

With lovely midband and treble, this slick, well built amp is an easy listen.

**MYSTERE IA11** £1,250  
 Pistol Music  
 (+44)(0)20 8971 3909  
 www.pistolmusic.co.uk

- FOR**
- smooth and clear midband
  - sweet treble
  - compact dimensions

- AGAINST**
- lacks bass punch
  - microphonic switches
  - poor valve cover

# Stocking Fillers

Fancy a digital music portable to help you work all those winter pounds off? David Price runs away with five from Apple, Creative Labs, Samsung, Sandisk and Sony...

**G**iven that it isn't just the goose that gets fat each Christmas, the new year always brings the sad sight of thousands of otherwise sofa-bound souls trying to work off the festive flab with a foray into the great outdoors. If you're one of the many, the solemn process of getting fit is always made easier by having music to take your mind off the grim world of exercise beyond the living room couch.

Ten years ago, mobile music was an altogether less inviting proposition. Living in Brighton at the time, I remember my morning constitutionals along the seafront being frequently interrupted by my Sony MiniDisc player going silent as the little disc inside skipped a beat, usually as a result of a tsunami-sized gust of wind off the Atlantic almost bowling me off my feet. Meanwhile, two decades ago, if I so much as looked at my brand new Sony Discman portable CD player in a funny way, it lost its place on the disc, never to find it again.

With its solid-state flash memory, the MP3 portable has made such histrionics a dim and distant memory – you can shake these things up and down like a cocktail flask and they'll keep on playing. The problem of course is that most don't sound anywhere near as good as the old disc-based devices...

"MP3 portables have recently gone from Stone Age to New Age..."

Until recently that is. The so-called MP3 player has been around for almost a decade now, during which time they've gone from Stone Age to New Age in development terms. The very first Diamond Multimedia Rio had 64MB of memory and sold for around £300 in today's money – nowadays you can get a Sandisk Sansa for £30 with 2GB. This means there's more memory for superior sounding higher bitrate files. The latest crop of portables are cheaper and more sophisticated - by

an order of magnitude.

What's really driven prices down and standards up is the Apple iPod. The flash memory-based Nano that launched some two and a half years ago (at £159 for 4GB) was an important product, bringing decent sound and storage to something barely bigger than a half-width Zippo lighter. The second generation (£159, 8GB) that followed a year later actually sounded worse (this is when Apple, for some inexplicable reason, started fitting weedy headphone output stages) but was neater looking still. The latest 3G Nano (£109, 8GB) tested here is very much the market leader and the one to beat.

Sony's NWZA-818 is its arch rival, and in my view Sony's first serious music portable for a long time. Before this, they'd been preoccupied by ATRAC - a moribund format originally conceived for MiniDisc in the early nineties - but this new Sony plays almost everything from generic MP3 and Microsoft's mediocre sounding WMA to Apple's preferred (and superior sounding) AAC codecs.

Snapping at its heels is the latest of a new generation of Samsung players - which have been getting particularly strong of late in terms of both sonics and sophistication - the YP-P2. And the group is topped off by two cheaper designs - Creative's Zen Stone Plus, a tiny pebble-sized player

for under £50, and Sandisk's new Sansa Clip which is cheaper still and only slightly larger, costing just £30!

## SANDISK SANSA CLIP £30

Resembling an iPod Nano that's shrunk in the wash, this matchbox-sized 2GB player's rear panel is taken up with a belt clip, which makes it perfect for joggers everywhere. It measures just 55x35x12mm, so is easily pocketable but its soft plastic body is easy to scratch. It has a central five way control that's easy to

use, and this lights up in a bright blue hue, matching an easily readable two colour display. Getting music to the Sansa works in the same way as all the others here – you just drag and drop the files via Windows Explorer. The downside is that the Sansa only plays MP3, WMA and Audible files – no AAC will be a pain for iTunes users. Considering its pocket-money price however, it doesn't half sound good – a very lively, passionate sounding player with surprising clarity across the midband and a big, bouncy bass. It lacks the finesse and detail of the iPod Nano, but is certainly no less musical. A nice feature given the lo-fi nature of the bundled headphones is the user-adjustable equaliser, but as with all players here they can be easily upgraded by a pair of Sennheiser MX-550s (£30). There's also voice recording and a rough sounding FM radio, and the long fifteen hour battery life puts the Zen Stone to shame. A lot of player at the price, the Sansa Clip is an easy way to play music on the move for minimal money.

## CREATIVE ZEN STONE+ £49

This cute pebble-sized portable comes in selection of six wife, girlfriend or daughter-friendly pretty colours. Its tiny (53x33x10mm) design comprises just a control button and postage stamp-sized display, and as per all the others here except the Sony and Apple, connects up to your PC via a supplied USB lead. It supports MP3, WMA and Audible formats – again sadly there's no AAC - and syncing is a piece of cake as the player works seamlessly with Windows Media Player or you can drag and drop files in Explorer. Given its teeny size, there's a surprisingly listenable FM radio, plus a stopwatch and voice recorder, making it usefully versatile. Weighing just 21g it's a cinch to take out and about, and the five-way control works well on the move. For something so tiny, the sound coming out of the Creative is a revelation. Apple fans will be dismayed to hear it beats the Nano in sonic terms – there's a rich tonality, powerful dynamics and



a generally musical feel to higher bitrate WMA files. Still, this machine has real limitations - a few hours in my jacket pocket saw the plastic Zen's body as pock-marked as the lunar surface. As a cheap and cheerful music machine the Creative works well, offering an affordable, enjoyable, hassle-free listening experience.

**SAMSUNG YP-P2 2GB £99**

Offering one of the first proper fully touch-sensitive user interfaces, this player feels really swish given its modest price. And it's not simply just a poor man's Apple iPod Touch, because it actually works better in some ways - especially sonically. Impressively well built, its 85g black plastic case is just about big enough (100x52x10mm) to hold a wide screen that doubles as the touch control system. This works well, but lacks the pricier iPod Touch's panache; the Samsung feels a whole generation behind. The same goes for its software - it syncs to the bundled Samsung Media Studio or Windows Media Player well enough, but can't match iTunes' ease of use or versatility and only plays WMA or MP3 audio files (along with MPEG-4 and WMV for video), which is a big disappointment as it limits sonic potential and rules out DRM-free iTunes Plus Music Store downloads. Battery life is good at thirty hours on audio and four hours on video, and it's a truly fine sounding little bit of kit. Like all Samsungs of late, it has a big bass, expansive midband and a slick, creamy treble. It's dynamic and grippy too, making this portable pure pleasure to listen to. Even its picture quality is excellent, and features like its built-in Bluetooth and FM radio work well, making it a fine all round package - although we'd go for a slightly pricier, larger memory version to make the most of it.

**APPLE IPOD NANO 8GB £109**

The one that all the others must beat, the new Nano hasn't been universally praised. Its frumpy looks and different form factor from earlier models (necessary to fit a screen wide enough for video viewing) makes it look like it's trying to disguise middle-aged spread with a big suit and shoulder pads. Still, the new one is better made than the last generation, with a slicker anodised aluminium and chrome finish and

a sharper, brighter, wider screen. It's no match for the beautifully hewn Sony however, which feels altogether more aristocratic. The



**Sandisk Sansa clip**



**Creative ZEN Stone Plus 2GB**



**Samsung YP-P2 2GB**



**Apple iPod nano 8GB**



**Sony NWZA818 8GB**

52x70x6mm machine retains Apple's trademark clickwheel which is a joy to use; designer Jonathon Ive's iconic interface is still the best, making all rivals feel clunky by comparison. Battery life is better than before, giving twenty hours on audio and four on video, but the Nano's clinical sound disappoints. It's nicely couth and detailed, but can sound sterile compared to the exuberance of the Sony, compressed dynamically and light in the bass. Although the new Nano's sonics are an improvement over its predecessor, it's still not quite class-competitive. Needless to say, everything integrates beautifully with iTunes - the best music manager around - and is utterly straightforward to use, but the Nano isn't the best all rounder at the price all the same.

**SONY NWZA818 8GB £135**

Sony's latest Walkman is finally good enough to take a bite-sized chunk out of Apple's market. Pitched directly at the iPod Nano, it betters it in almost every respect, and is cheaper too. Similarly shaped to the first generation Nano, at 88x43x9mm it sits easy in the hand and the powder coated light aluminium (53g) body is the best finished here. The display is the equal of all here, and the three button control system as easy to use as all except the iconic iPod. Although it works directly with Windows Media Player and you can easily drag and drop files - even from a Mac computer - you soon miss Apple's superb iTunes that makes the iPod experience so special.

Unlike earlier Sonys, the new Walkie plays a host of formats (including AAC, WMA, MP3, PCM and PlaysForSure) and makes a top job of it too. Bright, vibrant and powerful, it makes both iPods sound positively anaemic, and unlike the Apple has a customisable equaliser so you can tailor the sound precisely to your taste and/or phones. Bass is very strong and dynamics robust, the Sony's analogue output stage being a serious item, unlike that of the iPod. Although smaller than the cheaper Samsung, its screen still gives impressive video playback, cover art display or photo viewing, and flips from vertical to horizontal if needed. Battery life is excellent too - thirty hours and eight hours on audio and video respectively. A brilliant new digital portable from Sony - the Walkman is back.

**VERDICT** **£**  
**SANDISK SANSA CLIP** £30  
[www.sandisk.com](http://www.sandisk.com)

**VERDICT**   
**CREATIVE ZEN STONE+** £49  
<http://uk.europe.creative.com/>

**VERDICT**   
**SAMSUNG YP-P2 2GB** £99  
[www.samsung.com/uk/](http://www.samsung.com/uk/)

**VERDICT**   
**APPLE IPOD NANO 8GB** £109  
[www.apple.com/uk/](http://www.apple.com/uk/)

**VERDICT**   
**SONY NWZA818 8GB** £135  
[www.sony.co.uk/](http://www.sony.co.uk/)

# THE IDEAL ANTIDOTE

VISIT OUR WEBSITE: [www.hi-fiworld.co.uk](http://www.hi-fiworld.co.uk)

## UK SUBSCRIPTION SAVE UP TO



# 12.5%

**SAVE UP TO 12.5%** off the cover price when you subscribe to Hi-Fi World. That's an amazing £3.33 per issue, including postage.



FOR BACK ISSUES ENQUIRIES PLEASE CALL

**01442 879097**

**OVERSEAS SUBSCRIPTIONS** IF YOU LIVE OUTSIDE THE UK,  
PLEASE CALL FOR OUR LATEST PRICES

**+44 (0) 1442 879097**

**SO WHAT ARE YOU WAITING FOR? CALL NOW!!!**

**SUBSCRIPTION HOTLINE 01442 879097**

Lines open Mon-Fri 9.00-5.00 or (weekend answering service available)

**TEXT SUBS.HIFI TO 07797 800 800** and we'll call you back

FOR OUR  
ON-LINE MAGAZINE  
SEE P120

email:  
[hifiworld@webscribe.co.uk](mailto:hifiworld@webscribe.co.uk)

Fax No:  
01442 872279



# TO WINTER BLUES!

## WHY SUBSCRIBE TO HI-FI WORLD?

- 12 issues a year delivered straight to your door.
- Be first to grab a bargain in our "Free Reader Classified Ads" section.
- Run by dedicated hi-fi engineers and enthusiasts.
- Subscribers receive a minimum 10% Discount annually.
- Hi-Fi World has become famous for its informative reviews and radical kit designs.
- PLUS!** Subscribe by Direct Debit and receive a 12.5% discount (UK only).

### Instruction to your Bank or Building Society to pay by Direct Debit



Please fill in this form and send to:

Hi-Fi World, Webscribe Ltd, PO Box 464, Berkhamsted, Herts., HP4 2UR

Originator's Identification Number

4 2 7 0 4 9

#### Name and full Postal Address of your Bank/Building Society

To: The Manager Bank/Building Society

Address

Postcode

#### Name(s) of Account Holder(s)

#### Branch Sort Code

#### Bank/Building Society Account Number

#### Reference

HF

#### Instruction to your Bank or Building Society

Please pay Webscribe Ltd Direct Debits from the account in this Instruction subject to the safeguards assured by the Direct Debit Guarantee. I understand that this instruction may remain with Webscribe Ltd and, if so, details will be passed electronically to my Bank/Building Society.

Signature(s)

Date

Bank and Building Societies may not accept Direct Debits Instructions for some types of accounts

The guarantee should be detached and retained by the Payer

#### The Direct Debit Guarantee



- This Guarantee is offered by all Banks and Building Societies that take part in the Direct Debit scheme. The efficiency and security of the Scheme is monitored and protected by your own bank or Building Society
- If the amounts paid or the payments dates change Webscribe Ltd will notify you 10 working days in advance of your account being debited or as otherwise agreed
- If an error is made by Webscribe Ltd or your Bank or Building Society, you are guaranteed a full and immediately refund from your branch of the amount paid
- You can cancel a Direct Debit at any time by writing to your Bank or Building Society. Please send a copy of your letter to us.

**TERMS & CONDITIONS:** You will receive 12 issues per year. Minimum subscription term is 12 months. Prices include P&P and are correct at the time of going to press. All prices are quoted in sterling. Offer available for UK subscribers only. For enquiries relating to overseas pricing call + 44 (0) 1442 879 097.

I would like a years subscription to Hi-Fi World and receive a discount off the cover price (I have read and accept the terms and conditions).

I would like to pay by Direct Debit - saving 12.5% off the cover price. (Please complete the Direct Debit Form on the left).

I would like to pay by Cheque - saving 10% off the cover price. (Please make payable to Audio Publishing Ltd., and send to the address below).

I would like to pay by Credit / Debit card - saving 10% off the cover price.

### Your Details

Title \_\_\_\_\_ Forename \_\_\_\_\_

Surname \_\_\_\_\_

Address \_\_\_\_\_

Post Code \_\_\_\_\_

Daytime Tel: \_\_\_\_\_

Email: \_\_\_\_\_

Please debit my  VISA  MASTER  MAESTRO  AMEX (SWITCH)

Security No:    (last three digits printed on the signature strip)

Valid from Date: \_\_\_\_/\_\_\_\_/\_\_\_\_ Expiry Date: \_\_\_\_/\_\_\_\_/\_\_\_\_

Switch card issue No:

Cardholder Signature: \_\_\_\_\_

### Outside UK:-

**EUROPE** Airmail **£50.00**

**OVERSEAS** Airmail **£70.00**



## Send this form to:

Hi-Fi World, Subscriptions Department PO Box 464, Berkhamsted, Hertfordshire, HP4 2UR.



**Transcriptors' legendary Hydraulic Reference turntable isn't just a style icon, but a fascinating piece of design, says Tony Bolton...**

# Fluid Motion

**A**nyone who has ever seen the film 'A Clockwork Orange' will have seen a Transcriptors Hydraulic Reference turntable. It appears in several scenes, and is so visually arresting that it's hard not to spot. Indeed, even today it looks positively *avant garde*, with those rotating gold plated weights on a brushed alloy platter, mounted on a black acrylic motorboard. All of this is protected by a clear acrylic lid that comes with a central leg hinged from the back panel, to support its weight when open, and is also detachable by pulling the long shaft out of the hinge.

It also takes a radically different approach to the art of dragging a needle through a twisting groove. Today we're used to decks in all shapes, sizes and materials, but in the heyday of the Garrard 301 and Thorens 124 the design of the Transcriptors would have seemed amazing. Not only did it look breathtakingly futuristic, but it was a beautifully integrated mechanical package, performing all the functions

a turntable needs with tremendous refinement and sophistication.

The name comes from its bath of hydraulic fluid which sits under the centre of the platter. The bearing rotates in this, and speed is fine tuned by adjusting the angle of a paddle, the control for which sticks out from under the platter at the three o'clock position. The drive belt rides in the deep groove that occupies most of the rather narrow edge of the thin platter, and disappears under a casing in the back left corner, which houses the motor. It follows a path from the motor around a strobe disc (lit by a gentle neon orange glow from underneath) and back to the platter.

The motor is switched on and off by a mercury switch operated by rotating the shaft protruding from the casing half way along the left side of the deck. Speed change is accomplished by manipulating a spring-loaded shaft near the back of the motor cover. You push down for 45 and lift for 33. Inside, two prongs engage with the belt and move it to the appropriate pulley.

The late David Gammon founded Transcriptors in 1960, whilst employed as chief engineer at Almer Components. He designed the Transcriptor arm, as well as the sweep arm and stylus brush, due to the lack of professional grade components then available. After getting the interest of *Hi-Fi News* magazine, he started production in his flat in the early nineteen sixties. Soon after this he was approached by an audio research laboratory, and in 1963 began production of the Hydraulic Reference turntable. The following year he left Almer Components to run Transcriptors full time, initially from two rooms in the Holloway Road in North London. Production grew and in 1965 he moved to larger premises in Borehamwood, in Hertfordshire.

Stanley Kubrick visited the factory in 1969, and left with a turntable to use in his new film, 'A Clockwork Orange'. The same year that the film came out, 1971, David received a design award from the London Design Centre. Hydraulic



Reference decks produced after this date carry a logo on the bottom left of the acrylic lid.

1973 saw some major changes in the manufacture of the turntables, with production moving to Carlow in Ireland. It was also in this year that the connection with John Michell came to fruition. Michell had already been doing subcontracting work manufacturing for Transcriptors (their premises were next door to each other) and, following the move to Ireland, a contract was signed that allowed Michell to reproduce the Hydraulic Reference under licence. Thus was born the company that now makes the GyroDec, a visual relative of the Hydraulic.

According to the very informative website set up by David's son Michael ([www.transcriptors.net](http://www.transcriptors.net)), the inspiration for the deck came from a desire for engineering excellence to be on display, rather than be hidden away in a case, in the same way that some clocks have their workings on display. These days, the Transcriptors Hydraulic Reference is no less remarkable an achievement than it was forty years ago – but now what is most striking is how innovative it was for its time.

In a world of Thorens clones housed in resonant wooden boxes, the Transcriptors was surely the first exo-skeletal turntable around; nowadays almost every deck is. And whilst the novel speed control system didn't catch on, the idea of driving the platter by a belt around its periphery certainly did. Cultural icon, style statement, design study and a surprisingly capable sounding record player in its own right – not many vinyl disc spinners have made such an impression.

## GOING FOR A SPIN

The example under review here comes from our old friend Classique Sounds of Leicester ([www.classique-sounds.co.uk](http://www.classique-sounds.co.uk)), and is available for purchase for £799. It has the usual accessories of the sweep arm and stylus brush fitted, but sports a Decca International pick-up arm. Interestingly, although this design is nearly forty years old it is still available. Ah! (pronounced "aha") of Holland, who are the makers of the Njoe Tjoeb CD player, still supply the arms for the princely sum of 25 Euros. I think, therefore, that this makes it the cheapest hi-fi arm currently available!

In this case, the arm created a slight problem. It hung down underneath the deck almost as far as the supporting shelf. The signal is carried via a lockable DIN plug to

a small junction box. From thence, your own choice of interconnects are required which normally would not be a bad thing. The problem was that there was a cigarette paper's clearance between the shelf and the arm base, allowing no space for the plug to go in. I fitted the arm with my Cartridge Man MusicMaker III cartridge, and spent over half an hour getting frustrated, trying to get the uncalibrated counterbalance weight set correctly for tracking force, and the azimuth (left or right tilt, or lack of, when viewed from the front) of the arm correctly applied.

I was curious to hear this machine even though, with the Decca arm, it is not quite in standard form. In so many ways it flies in the face of

"it takes a radically different approach to the art of dragging a needle through a groove..."

modern turntable thinking. Particularly in the way the record is supported. Acrylic is used on a lot of decks for the platter because of its mechanical similarity to vinyl. Others use felt mats and metal or glass platters. No one, to my knowledge, apart from Transcriptors, support the record via six small pads of what appears to be a neoprene type material, each with a smaller area than most little fingernails! Further support is provided by three posts placed so as to support a 7-inch record [Vinyl] anorak firmly in place, I can add that Bang & Olufsen actually used a similar system on some of their early 1970s decks, such as the Beogram 1200, and later 1202/1203 variants - AS]

I was expecting a rather bass-light and thin sound, so to say that I was surprised by the punchy bass line and kick drum that powers Amy Winehouse's 'Back To Black' opening song, 'Rehab', would be an understatement. I would not describe it as particularly deep, but it had a certain impact and drove the music along very pleasantly indeed. This particular combination of arm and deck favours the midband and the low to middle reaches of the treble spectrum. Sounds and voices were quite detailed in a 'spotlit' kind of way, and stereo placement was good with an impressively wide soundstage.

'Ravi Shankar in San Francisco' saw the sitar well lit and the tabla had a beautiful sound, with the detailing of the hand movements over the drum skin a pleasure to listen to. The 1962 John Ogden recording of Rachmaninov's Piano concerto No. 2

was a mono pressing and the rather open top end made me reach for the mono switch on the GSP Audio Jazz Club phonostage. Even with the surface noise subdued I still found it a technically rewarding rendition. The piano tone, although a little forward, was good and the strings had a definition that reminded a bit of the presentation of the Eastern Electric Minimax phonostage. However, I felt that the overall result was a somewhat soulless performance of one of the great romantic pieces of the classical era. I felt I wanted more body, more heart in it.

I personally prefer a slightly fuller bodied sound, but if you like the sort of presentation that you get from mounting speakers on open

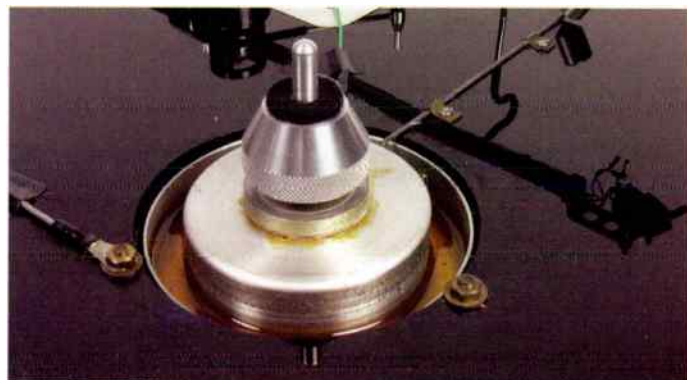
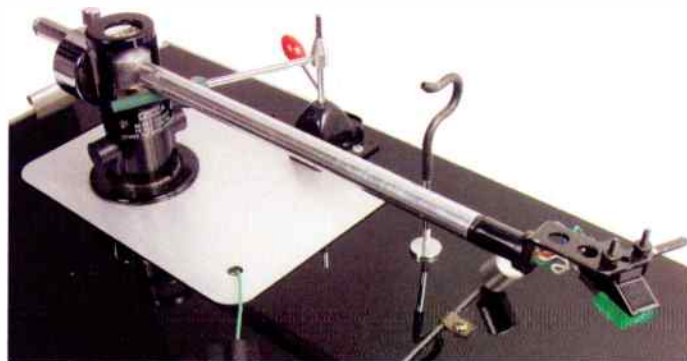

Discover a superb complete music system from the makers of the legendary D200 power amplifier – GamuT.

# Great GamuT system

GamuT is one of the very few companies that can offer a complete music system that has achieved **WORLD-WIDE PRAISE**. See [www.gamutaudio.com/reviews](http://www.gamutaudio.com/reviews)

"As the audiophile press has affirmed for several years now, Gamut is on to something very, very good." (JV Serinus, Stereophile)

GamuT's latest arrival, the CD3 CD player, completes a **SUPERBLY MUSICAL SYSTEM**. The CD3 is in HI-FI Choice's Collection for 2007.

"It has superb resolve of fine detail ... a perfectly judged balance and ... an irresistible ability to draw you into the music." HI-FI Choice

GamuT have merged their excellent D3 preamp with the legendary D200 power amp (an earlier HFC Editor's Choice), making the Di150, an impressively **CAPABLE AND TRANSPARENT** integrated amp.

HI-FI Choice's view on the GamuT Di150: "This is clearly a gorgeous amplifier" – another Editor's Choice!

GamuT make three "L" speakers – the stand-mount L3 and two floor-standers – all cut from the same cloth and using superb drive units such as the Revelator tweeter. There is also now the three-model **PHI** series at lower prices.

Comments on a GamuT system: "The CD3, Di150, and L-7 just flat-out worked for me. Music was alive and filled with the little pleasures that make you smile, nod, tap your foot, or even boogie." (Stereophile)

Customers say we make some of the **BEST SOUNDS** they have ever heard, so you know we can do the same in your home. Our advice will take account of your best components and guide you where change is needed, in stages you can afford. You **AVOID EXPENSIVE MISTAKES**, enjoy music along the way and save money in the long run.

**JUST LISTEN AND YOU'LL KNOW**

**CD:** ACCUSTIC ARTS, BEL CANTO, dCS, GAMUT, RESOLUTION AUDIO, STELLO, WADIA.  
**VINYL:** AESTHETICS, AVID, CLEARAUDIO, DNM, GRAHAM, THE GROOVE, LEHMANN, MICHELL, ORIGIN LIVE, SUMIKO BLUE POINT SPECIAL, TRANSGURATION. **AMPLIFIERS:** BEL CANTO, CAT, DNM, GAMUT, HALCRO, HOVLAND, SONNETER, STELLO.  
**LOUDSPEAKERS:** AUDIO PHYSIC, DALI, ETHOS, GAMUT, NEAT, TOTEM. **CABLES:** CHORD Co., DNM, NORDOST, SILTECH, VERTEX AQ. **MAINS:** Vertex AQ. **SUPPORTS:** ARCI, STANDS UNIQUE, VERTEX AQ

The Right Note  
*Music in the home*



BATH

01225 874728  
 or lo-call  
 0845 230 7570

Audio Components

The No. 1 choice for Speaker Building & AV Components



See our NEW Website [www.audio-components.co.uk](http://www.audio-components.co.uk)

A fresh approach for those who want to save money designing & building their own high-end Loudspeakers or installing their own Home Entertainment system – home cinema, surround sound, multi-room audio-video.

#### For Home Electronics Installers/DIY

- Home Cinema Components
- Audio System Separates
- Cables & Interconnects
- Audio & Video Equipment
- Multi-Room System Components

#### For Speaker Builders

- Loudspeaker Drive Units
- Crossover Components
- Enclosure Accessories
- Loudspeaker Kits
- Design & Measurement Services

Leading brands, Help & advice, Wide product range, Phone or buy on-line **FREE DELIVERY!**

Tel: 0118 989 0151

Email: [enquiries@audio-components.co.uk](mailto:enquiries@audio-components.co.uk)

## More than just an extension

PowerLink is the mains extension suitable for Hi-Fi or Home Cinema systems of all budgets – from entry level to high end.

Fitted with your choice of 1m or 2m award-winning PowerMax™ cable, and low resistance sockets (available in 4- or 6-way versions), use it to help improve your mains quality and enjoy a more detailed and enjoyable sound – with crisper pictures from your Home Cinema.

PowerLink  
 4 way 1m £65



To find out more about improving your system with unique, proven, Russ Andrews upgrades, and to request your free catalogue contact us now at

[www.russandrews.com/hfw](http://www.russandrews.com/hfw)  
 or phone us on 0845 3451550

Exclusive UK Retailer for

**KIMBER KABLE**

Russ Andrews®  
 Solutions for better music & movies

Russ Andrews Accessories Ltd, 2b Moreland Court, Westmorland Business Park, Shap Road, Kendal, LA9 6NS, UK.  
 Tel: +44 (0)1539 797300 Email: [info@russandrews.com](mailto:info@russandrews.com)



"in the audiophile world, there's a tendency for people to think in terms of absolutes..."



## adam smith

In the audiophile world, there's a tendency for people to think in terms of absolutes. Many folk are quite black and white in their views and often extremely unwilling to countenance that a different way of doing things may not necessarily be a bad thing.

As my primary area of interest is turntables, I have lost count of the number of times I have been asked which are best - idler drive, direct drive or belt drive decks, and it always seems to me that the questioner expects me to reply with a definitive, "this one is best and the other two are a load of rubbish". Consequently I sometimes detect a note of disappointment when I give them the answer that I not only always give, but that represents what I feel, namely that the best turntables are well designed ones, and the worst are the badly designed or shoddily made types. How they drive their platters is largely irrelevant!

That said, however, I do always point out that the different drive method tends to make each type sound different. Consequently, whilst it is quite right to find one you prefer, to dismiss all others purely because of the way in which they power themselves is frankly a bit daft. As a result, I am happy to stand up and be counted in that I use and love my Garrard 301 (idler), I lust after a Technics SP10 (direct) and two of the very best modern turntables I have heard are the Michell Orbe and the SME 10A (belt)!

This phenomenon is not exclusive to turntables however, as passions run high over many other facets of our industry; the likes of horn loudspeakers, vinyl versus CD and Blu-ray versus HD-DVD all cause prolonged discussions and there are some people who absolutely refuse

to countenance that two technologies can coexist happily.

The most dominant one of these seems to be the long-standing valves versus solid state debate, and this is something that I have become more involved in since joining *Hi-Fi World* magazine. Prior to this, my main experience of valves had been a Leak TL10 from a car boot sale that didn't work, along with a couple of Russian Rigonda radiograms, where the biggest issue was trying to translate the faded markings on a forty year old Russian valve in order to find an equivalent!

My most 'serious' exposure was when the electronics clearout store of my university turned up a pair of Cape Electroponics VL1 power amplifiers for £20 and I snapped them up. I cannot remember what valves they used but they sounded fabulous, if rather soft in the bass. The trouble was they hummed like crazy and my knowledge of where to buy components for such beasts was very limited in those days. After a frustrating few months I sold them on and never really dabbled much with valves again until recently.

Of course, joining the editorial team here meant that I was immediately immersed in the world of valves again and was surprised to find out just how much equipment uses them nowadays. Publisher Noel is an ardent thermionic fan and has done much to educate me in the technologies of hot bottles and I must confess that I can completely see his point regarding their strengths; I have enjoyed some truly sublime valve sounds over the past year or so.

Going back to my first point, though, there are quite a few enthusiasts around who cannot (or will not) believe that such old

technology can be competitive these days, but yet there are an equal number of people to whom 'transistor' is a swear word, and I have to say the latter band tend to be the most militant - sorry guys!

Most of the solid stagers tend to think that valve amplifiers are all soft, warm, woolly and inaccurate, whilst the valveheads think all transistor amplifiers are hard, steely and harsh. Whilst I certainly know of examples of each that would seem to prove them right, I can also bring up designs like the Tube Amplifier Company's TAC834 and World Designs' WD88VA, which ruin the former group's arguments by being typically open and insightful, but simultaneously dynamic and pacy. Equally no-one could call the Sugden A21a Mk2 harsh and steely, nor even the Naim SuperNait, yet both use those dreaded transistor things.

In fact, if asked to name the best amplifiers I have heard, I could straightaway think of two - the Marantz 'Legend' SC-7S2/MA-9S2 pre and power amplifiers, and the Melody Pure Black 101d preamplifier with Melody Pure Black KT88 monoblocks. These could not be more different, technologically speaking, with the Marantz being a very modern solid state topology and the Melody being an all-valve setup that makes use of one of the earliest valves ever designed! What they had in common though, was a breathtakingly vast soundstage, with clarity and sweetness (yes, even the transistor Marantz!) and superb, tight, deep bass (yes, even the valve Melody!).

All in all, I would say to you all - be open minded next time you consider an upgrade. Don't dismiss something purely because of a particular design methodology it uses - you could be missing out on a treat. ●

Wishing you a very Happy New Year!

# shadow audio

0844 800 0073 or 74 : [www.shadowaudio.co.uk](http://www.shadowaudio.co.uk)

Subject to conditions\*

Chord Cables  
Full range available

### Shocking!!!

Have you joined the FREE Shadow Audio E-Mailing List yet?

If not, then you are missing out on some truly wonderful offers that are quite simply shocking.

Even worse, you won't be receiving our weekly Used Items List, so will be missing out on yet more bargains.

Visit [www.shadowaudio.co.uk](http://www.shadowaudio.co.uk) to join today! Remember - its FREE!



### (NEW) Musical Fidelity A5.5

New from Musical Fidelity is the A5.5 Integrated Amplifier and CD Player. Details are a little scarce at the moment but you can be sure of something very special for the money! Call for details.

FREE UK delivery\*

### ATC SCM 7, 11, 19 and 40

At their respective price points, we don't think any other loudspeaker can tell you more about your music than the ATC range can. They offer exceptional value for money. We like the new and improved styling too!



### (NEW) McIntosh MT10 Turntable

Their first-ever turntable, marries classic McIntosh glass front panel cosmetics with serious mechanics to create a unique, ready-to-play LP solution, that you simply must hear! Exceptional.

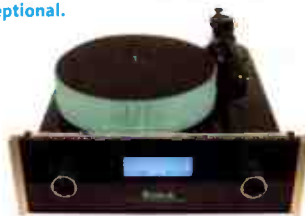

FREE UK delivery\*

## Used Listing

Our list changes daily, so please visit web site for latest up-to-date list.

### DIGITAL

McIntosh MCD201, CD/SACD (£3400)	£2695
Musical Fidelity KW 250S (£4999)	£3795
Musical Fidelity DM25 DAC and Transport (£4000)	£2895
Shanling CDT300 Omega Drive CD player (£4000)	£2295
Stello CDA 720 dac + CDT 200 cd transport	£1495

### AMPLIFIERS

Accuphase E408 Integrated (£5000)	£3995
Anatek CM 0.5 pre amp (£1400)	£995
ATC SCA2 Professional pre amp (£4000+)	£1395
Audio Zone AMP 1 dual mono integrated (£1595)	£1295
Audionet SAM V2 Integrated (£2400)	£1295
AVI Lab Series integrated (£1599)	£995
Bel Canto S300i Integrated (£1799)	£1495
Bel Canto Evo2i integrated amplifier (£2995)	£1495
Cairn 4810 Integrated (£2700)	£1795
Copland CTA 520 stereo power amp (£1900)	£1195
DK Desgn VS-1 Reference (£2500)	£1995
Eastern Electric Minimax Power Amp (£995)	£649
Flying Mole PA-51 Digital Pre (£999)	£795
McIntosh C2200 pre (£4850)	£3695
Musical Fidelity A5 Pre (£1499)	£995
Musical Fidelity KW550 Integrated (£5000)	£2995
Musical Fidelity KW500 Integrated (£4000)	£2495
Musical Fidelity 550K Supercharger (£2998)	£2395
Musical Fidelity Trivista 300 Int amplifier (£4000)	£1795
Qinpu A1.0x Integrated (£300)	£230
Qinpu A-8000 MK II Integrated (£1295)	£795
TacT SDAi 2175 (£1245)	£749

### LOUDSPEAKERS

Acoustic Energy AE1 Classic (£845)	£650
ART Emotion Monitor (£4000)	£3250
ART Loudspeakers Expression V6 (£3500)	£1995
ATC SCM205L (£2400)	£1395
Dali Helicon 400 (£2995)	£2250
JAS Audio - Plato Reference (£13995)	£9995
JAS Audio - Orion (£2300)	£1495
JAS Audio - Orsa (£1399)	£1095
JAS Audio - Supertweeters (£649)	£449
Leema Acoustics Xone (£2245)	£1695
Monitor Audio GR20 (£1500)	£795
Monitor Audio G560 (£2000)	£1395
PMC FB1+ (£1695)	£1095
Soundlab Millennium M3 Electrostatics (£8995)	£2795

### ANALOGUE

Pro-Ject Experience 'X-Pack' (£750)	£495
SME 2072A (£6300)	£4495

### MISC

Hovland Reference Speaker Cable (£1200)	£795
Isotek Nova (£1750)	£1295
Isotek Gil Minisub (£545)	£399
Nordost Blue Heaven Speaker Cable (£695)	£349

For the latest news and special offers - sign-up to the FREE shadow audio weekly newsletter (visit shadow audio home page)

Marantz Legendary  
Full range available



Hi-Fi World  
**VERDICT**

EDITOR'S CHOICE

**HI-FI CHOICE**  
magazine

### New Reference Range

SC-7S2 Pre-amplifier  
MA-9S2 Mono Power Amplifier  
SA-7S1 CD/SACD Player

Hi-Fi Choice September 2007.  
SA-7S1 Review.

Alvin Gold wrote: "If you want a disc player that will do the very finest musical job possible with your CDs and SACDs - the only really serious remaining audio disc formats - the Marantz SA-7S1 can even be considered a bargain at £5,000!"

FREE UK delivery\*

### Specialist Brands include:

Apollo, ART Loudspeakers, Audio Zone, Audio Physic, ATC, AVI, Bel Canto, Bryston, Chord Cables, EAR/Yoshino, Eastern Electric, GamuT, Hovland, Hyperion, IsoTek, JAS Audio, JungSon, Manley Labs, Marantz Legendary, McIntosh, Musical Fidelity, Musical First, Music Tools, Nordost, Opera, Origin Live, Pathos, PMC, Project, Resolution Audio, Shanling, SME, Tannoy Prestige, Unison Research, Vertex AQ, VPI, Wadia, Wilson Benesch and many more.



"had broadcasters properly upgraded DAB, they wouldn't be facing the problems they are now..."



## steven green

According to Ralph Bernard, "digital radio is facing a crisis". He made the comment at a seminar that was considering 'The Future of Radio' in December, just before stepping down as the chief executive of GCap Media, the UK's largest commercial radio group. He went on to claim that, "at GCap, we are seriously considering whether to continue with our digital stations", and although I don't think GCap would seriously consider closing down thejazz or Planet Rock, because both stations now have a considerable number of listeners, GCap has just closed down its pop music station Core. Another of its stations, Life (previously called Capital Life), is expected to close in the near future.

Both of these stations have been transmitting for several years on the Digital One national commercial DAB multiplex (which is itself majority-owned by GCap), and another casualty on Digital One has been the talking books station Oneworld, which also closed in January. The stations that have closed have been replaced by BFBS (British Forces Broadcasting Service) on a trial basis, and by a "station" playing birdsong...

There have also been casualties on the Channel 4 national commercial DAB multiplex that's due to launch later this year, as Virgin Radio has decided not to go ahead with launching its Virgin Viva station. Additionally, the rolling-news station, Sky News Radio, isn't now expected to launch after the company that was going to run the station on Sky's behalf backed out of the joint venture.

Ralph Bernard shed some light on why commercial radio has had such a change of heart regarding investment in Digital Radio by admitting that it costs GCap £15m

per annum to transmit its stations on digital, compared to just £8m to transmit its analogue stations – as an example, it costs £1m per annum to transmit an ordinary 128kbps stereo station nationally on DAB – and he said that GCap is making a net loss of £10m per annum due to having to simulcast so many stations on both analogue and digital. Predictably, he went on to criticise Ofcom and the government for not setting a date for FM to be switched off.

There's another reason why so many national DAB stations have been axed that Ralph Bernard wasn't so forthcoming about, which is that DAB sales are now very badly behind schedule. According to a document published by the DRDB (Digital Radio Development Bureau – UK DAB's marketing and PR arm) last September, this year's annual DAB receiver sales are forecast to be a massive 50% below previous expectations for 2008, and cumulative receiver sales are forecast to be a third below target. The DRDB document also showed that, after being at a high level of 69% in 2005, year-on-year sales growth fell off a cliff in 2006 to just 22%, and it's forecast to be lower still for 2007. The timing of this decline in sales growth coincides exactly with the BBC stopping broadcasting its high-impact TV advertising campaigns for DAB, so it seems that DAB sales growth crumples once the crutch of BBC TV advertising has been removed.

Another major setback for the broadcasters last year was BT's decision to pull the plug on its DAB-IP mobile TV system. The broadcasters had hoped that mobile TV would take off and, due to people replacing their mobile phones so frequently, this would lead to a large increase in the number of people that could receive DAB – phones

enabled to receive DAB-IP mobile TV can also receive DAB radio stations. Not only is this no longer going to happen, but it will also leave a gaping hole in the finances of both of the national commercial multiplexes, because 40% of Digital One's capacity is currently used for mobile TV channels (equivalent to about £3.5m in annual revenue) and a quarter of the capacity of the forthcoming national multiplex had also been set aside for DAB-IP services – with national stations closing down, you have to wonder whether they'll be able to fill the space vacated by mobile TV.

The irony of the current situation is that had the broadcasters upgraded the DAB system prior to properly launching it in 2002 – rather than completely disregarding the audio quality and incompetently adopting the current ridiculously outdated and inefficient system – they wouldn't be facing the problems they now are. For example, if they had upgraded the system by adding the AAC audio codec (which was standardised in 1997) and stronger error correction coding, this would have reduced their DAB transmission costs by approximately a factor of three. And if they had launched such a modernised system, rather than turning their noses up at following the UK's lead due to the system being outdated, lots of countries would be using DAB by now, which would have led to lower receiver prices and consequently much higher sales figures in the UK.

However, as the broadcasters did completely disregard the audio quality, I'm afraid I have absolutely no sympathy for their plight. They have got a ready-made solution to their problems in the form of DAB+ though, but they're even managing to bungle the introduction of that up to now. ●



## Hi-definition audio

Explore your senses with the ultimate in world class Hi-Fi



[www.naimaudio.com](http://www.naimaudio.com)



"for all their foibles, BBC archive recordings are unique and of immense value..."



## paul rigby

**T**he BBC's transcription service discs are an archive of precious gems holding a swathe of unique performances from an array of sources, including music.

The vast majority of all archival radio – especially from the 1960s – survives only on these transcription discs; even the original masters which fed them were reused immediately the disc was created. Hence, master tapes for these discs are even rarer than the discs themselves.

Music fans love transcription performances for two reasons. Firstly, they reveal unique performances of familiar songs. However, as Top Sounds ([www.topsoundsrecords.co.uk](http://www.topsoundsrecords.co.uk)) record label owner Nigel Lees explains, "groups, in most cases, especially the more obscure ones, were told, 'Right, we want a recording of your latest single and then perhaps the B-side or a cover version of a contemporary hit'. It was not very often where a band could walk in off the street and say, 'Here's a batch of three songs we've written, we want to sing these.' The problem was that the BBC worried that, during the airing of the session, the general public wouldn't want to hear three exclusive – and, thus, obscure – tracks from the group, itself. There had to be an element of familiarity in the performance. Hence, you would hear these groups sing unique cover versions of songs that would never be made available elsewhere – the band might never have sung the cover again, anyway." However, despite the element of arm-twisting, occasionally the cover was better than the original!

In many respects, the BBC holds the last untapped archive – although,

like Lees, anyone who wishes to plunder it has to pay a hefty fee to legally use it. Lees himself performed some serious research in his obsession for BBC-related sessions between 1967-1969, that period where music had left the beat era and was into its psychedelic mode, moving towards progressive.

He concentrated on the *Radio Times* from the time, finally managing to obtain a full set of the magazines over this period, which would feature a gamut of information relating to the radio and who was appearing on each programme. Another valuable source for this sort of information, was the *New Musical Express* from the same era, which used to print what groups were playing live on the radio over the coming week. "It was fascinating to see that some group who, perhaps, did a couple of singles and never got anywhere, still got on the Beeb," said Lees. Such musical archaeology had never been done before.

"Where transcription discs are missing, the content can be filled by 'off-air' material," said Lees. "This is literally, music taped off the radio, normally using a reel-to-reel. A lot of the 'off-air' recordings feature the usual material, John Peel for example. No one recorded the mid-afternoon shows. However, I found a guy who did. He's unfortunately dead now. This guy used to tape this music during his lunch hour, around 1970-1972, on reel-to-reel. He had around thirty reels of the stuff. There were a lot of good tracks on there, complete with full information." Two of the tracks, from this particular source, made it to the new album, reviewed in this issue: Catch 22's 'Price Of Love' and The Portrait's 'Born To Be Wild'. Both,

despite some hiss, are good quality.

"Another source might interest you. The Killing Floor track was taped from television, from a programme called 'Disco 2' in January 1971. The original had been wiped decades ago. This particular contact used to plug his reel-to-reel into the back of the TV, an obviously preferable alternative method to many others who used to push their tape machine's microphone next to the TV's speaker output! The Killing Floor track is amazing in quality, and hardly needed any enhancement at all."

Of course, the beauty of the 'found' off-air sources is that this is material the BBC doesn't have and, without diligent archiving, would also be lost to the general public. All Nigel Lees' sources are given to a gentleman who actually used to work for the BBC. Andrew Rose worked for fourteen years as a senior sound engineer (Studio Manager) at the BBC for Radios 1, 2, 3, 4, 5 and the World Service. He is based in France and works under his company name, Pristine Audio.

One problem that Rose couldn't tackle and correct, however, was during a track on the latest album by a group called Timebox. Lees noticed a 'wobble' during a vocal portion of the track. After extensive investigation, Rose's final conclusion was that the BBC producer who recorded the session, knocked the recording desk. "Maybe the guy had five groups in that day and was running off for a cup of coffee – whatever it was, the wobble's now held in perpetuity."

For all of their little foibles, the BBC recordings were unique and of immense value. The question is, what else is out there? ●

# Walrus

11 New Quebec St, London W1



**Teddy the Terrier**  
We like a dog with attitude. Just like his owner in fact!

a2t

Basic 2000 Signature + Vector 3 Transistor (£945) + £220 including initial meter VTA/3 controller for the finest turntable so far

Shanling MC-30 (£500)  
3w/ch Amp, CD, AM-FM, with mp3 player jack input in an aluminium chassis with stunning visuals. mp3 player pictured not included!

Acoustic Signature Challenge (£1350)  
Cabinet powered amp with pre-amp and 2 inputs of subwoofers and 2 tweeters

acoustic signature  
acoustic solid  
acuhorn  
aesthetix  
air tight  
amazon  
amity  
amplifon  
apollo furniture  
audio aero  
basis  
benz micro  
black rhodium  
bocchino  
breuer dynamic  
brinkmann  
cartridge man  
cawsey  
clearaudio  
consonance  
decca london  
duevel  
dynavector  
ear yoshino  
emt  
funk firm  
goldring  
graham (tonearms)  
graham slee  
hadcock  
harmonix  
heed audio  
horning  
hyperion  
incognito  
isolda  
jadis  
kibri  
koetsu  
luxman  
lyra  
mcintosh  
melody  
michell engineering  
morch  
musical fidelity  
nordost  
nottingham analogue  
origin live  
ortofon  
pro-ject  
pure sound  
rega (turntables)  
reimyo  
revolver  
ringmat  
roksan  
shun mook  
shanling  
shelter  
sme  
solid tech  
something solid  
sonneteer  
spendor  
stax  
stirling broadcast  
sumiko  
tannoy prestige  
tci cables  
tom evans  
townshend audio  
transfiguration  
trichord  
van den hul

Pure Sound A30 Amp (£1095)  
British designed and Far Eastern made the A30 is stunning value. It might look plain, but boy, does it sound good!

K2bn Naima (£1950)  
Naim's new Naima "room tone" speakers may be compact and unobtrusive but the sound is huge! Full Wood absolutely loved them. So did you!

Hyperion HPS-938 (£3750)  
We keep featuring these brilliant speakers 'cos we don't think there's anything to touch them at the price!

Amazon Model 2 (£1600) without artwork  
Redesign of the original Model 2. Now with split steel finish and even better performance. Works a treat as featured with the North Drivell

Musical Fidelity 550K  
"Superchargers" (£2998/pair)  
Ever wished for more power and headroom from your present amp? Or maybe you just fancy a pair of top quality monoblocks at an affordable price.  
The 550K Superchargers will fulfil either need - a win-win product!

Acoustic Signature Challenge (£1350) without artwork  
German made amplifier with separate motor and power supply. Turnt VTA

Acoustic Masterpiece AM 201 (£2495)  
Beautifully made, gorgeous sounding. Made by A&M Ltd. The meter has "Air Tight" on it. Hmmm!

**STAX**  
We have two separate and distinctive phono sections as the first you can buy and Al Linton's phono is just here and there. With the widest and flattest frequency response and the most accurate reproduction of the original sound.

2050 Mk2 System (£4495)  
SR-007 Omega System 2 (£2495)

Lyra Skala (£1849)  
The latest in a long and distinguished line, the Skala is the first Lyra to feature a non metallic body. We have this beauty on demo now, and are very, very impressed by it. We are confident you will be too...

We stock several varieties of (Swedish made) SolidTech Isolating feet. The best value of which are the IsoClare. Adjustable by adding/subtracting springs for perfect balance. Due to direct from factory purchase our prices are perfect too!

Set of 3 - £44  
Set of 4 - £55

Luxman L550A (£2795)  
A very complete solution. The usual excellent Luxman sound quality, 20W class A (although measures far more), decent phono stage, balanced inputs, tone controls. I want one. Now.

SolidTech Precision Isolated  
These clever looking and remarkably performing stands are not expensive. And are getting a huge 10% discount on our website for people.



\* Please ask about our ex-demo stock; many items are virtually as new but with large reductions.

We deliver by Business Post 24hr service (subject to stock availability), and internationally by DHL, TNT or UPS. Major credit/debit cards accepted, even known to take cash on occasions! Please visit our website for product, technical and ordering info.

tel: 020 7724 7224 fax: 020 7724 4347 contact@walrus.co.uk www.walrus.co.uk



"hi-fi journalists try their best to be fair, but not every manufacturer would agree..."



## david price

**H**aving spent a good part of my younger life travelling the globe, living and working abroad and partaking in several different countries' hi-fi scenes, I can say with some confidence that British hi-fi magazines generally display high standards of integrity.

Any cynical Brit who balks at this contention might do well to read magazines from certain other countries, some of which seem less concerned with simple sound quality matters than those of publishing politics. For example, I've heard of one foreign hi-fi magazine editor telling the European manufacturer he was visiting that he liked him so much that he was going to make his the biggest brand in his country!

The world of online hi-fi publishing is more unpredictable still. There are some very good Internet magazines and some highly lively forums - although sometimes the latter can be rather febrile at times. They bring a fascinating new dimension to the subject, and sometimes the imagination, breadth of knowledge and attention to detail of some of those who post on forums bowls me over. The trouble is that for every brilliant nugget of wisdom, there might be a correspondingly biased comment which if not plain wrong is certainly misleading.

The other downside of online forums is a tendency to over-personalise issues. Whereas those of us in on the print side of journalism have had it constantly 'banged into us' from an early age that we *can't* just say anything that comes into our heads (and editors, sub-editors, publishers and lawyers all remind us of our responsibilities), posters on forums effectively have direct, unalloyed access to the outside world. This means they can vent their

personal prejudices about individual characters in the hi-fi industry (and there certainly are some 'characters!') without the magazine publishing equivalent of 'peer review'.

Read closely and you'll find the views that appear in magazines are very largely confined to hi-fi products, whereas online posts often opine about the individuals who make them. This goes 'live' immediately, sometimes without even the moderator taking a look (these guys often do this in their spare time, for the love of their website). It makes for quite a heady atmosphere, often generating more heat than light - it's a wild world online, and not always a fair one.

All this said and done, the strangest (and sometimes most amusing) thing about hi-fi writing is the reactions to published equipment reviews. Although most hi-fi journalists try their best to be fair, unfortunately not every manufacturer would agree. You may or may not be surprised to learn that we hacks (across all the titles) sometimes come in for real stick from representatives of certain hi-fi brands, for having the audacity to express our own subjective opinions about the sound of their products in our reviews...

Amusingly, this usually is *not* because we have assassinated a particular product in print - because, as regular readers of this particular magazine will know, we chose not to do this. In truth, we get all manner of stinkers in for testing which have to be politely returned early because either their measured performance isn't up to scratch or we think the product is a lemon, sonically or in build terms. (Indeed, behind the scenes at World Towers it can be something of a white knuckle ride when a product we hoped to run as a lead review, on the front cover

of next month's issue, gets pulled because of 10% distortion or an annoying hum on one channel - or sometimes for going up in smoke on the test bench.)

No, oddly enough, the few manufacturers that moan usually do so when we've given their products 'only' four globes. Summing up a product as 'excellent' (which is what four globes denotes) seems to cause some individuals offence equivalent to questioning the morals of their mother, or the identity of their father. It can be a little perplexing from my point of view, as we really do try to get all review kit working as best as we possibly can; we measure it to check it's in spec, we run it in (even if it's already been done) and keep it switched on all the time in the most sympathetic system and environment we can find for it.

Alas if it doesn't quite match our current reference across the board sonically, it's not going to get five - which is of course the Holy Grail for any hi-fi maker, importer or distributor. A mere four globes is tantamount to a declaration of war for some companies, but amusingly though others act quite the reverse. There are a number of marketing folk and even PR people who will happily admit, off the record of course, that the product is "crap" and they'd rather we didn't review it!

Hi-fi publishing is a funny old world then - and I guess you can't please all the people all the time. For me, my ultimate responsibility is to our readers, who - unlike journalists, manufacturers, distributors or importers - don't actually have unlimited access to cost-no-object kit and (shock horror) actually spend a lot of their own money on the basis of our recommendations. That's a burden to bear, but it's no less enjoyable for it. ●

Precision engineering

A passion for the music

# Ortofon Cartridges

at last you will  
find all the music  
in your vinyl

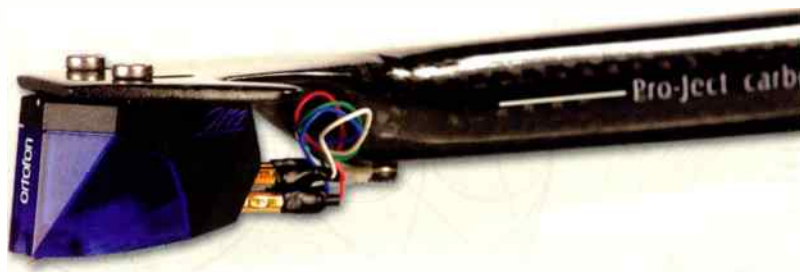

**ortofon**  
accuracy in sound

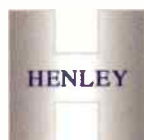

To find out more about the full range of hi-fi cartridges from Ortofon, and where you can buy them visit:  
[www.henleydesigns.co.uk](http://www.henleydesigns.co.uk)

[www.henleydesigns.co.uk](http://www.henleydesigns.co.uk)

# WBT

## nextgen.™



For 20 years now WBT have been developing high quality connectors, sockets and pole terminals for hifi enthusiasts as well as for well-known manufacturers of audiophile hifi devices so that audio reproduction devices can prove their capability and you can enjoy your hifi system at home to the full.

nextgen is the next chapter...

## Anatek Acoustics

In 'A Class' of their own



**Just one of life's little rewards...**



○ MCI Phono Preamp  
HI-FI WORLD  
**VERDICT** ●●●●●



**Designed & Built in Britain**

For all product and dealer enquiries call +44 (0)1903 524 602  
or visit [www.anatekacoustics.co.uk](http://www.anatekacoustics.co.uk)



"what a pity modern digital doesn't come as well packaged as today's turntables..."



## noel keyword

Everybody's ears seemed to perk up at the Edgar CD-1 CD player featured last month and this month many of us were a little bit surprised at the Icon Audio PS1.2 phono stage. Irrespective of the finer points of its sound quality I felt it was an exciting listen - and I can assure you I am attuned to valve phono stages and prepared to be critical about them.

The Audio Innovations P2 valve phono stage I reviewed many moons ago probably left a stronger impression on me than most products I have ever encountered. If you are wondering what beat it then I'll tell you for what it is worth - the 211 amplifier Andy Grove once designed in-house for a rich Hong Kong gentleman. This blew me away into some distant land where music sounds real and - of course - transistors have not been invented.

What a shame 211s, 845s and 212Es - all massive high voltage triodes - are so dangerous the world hasn't yet taken to them (but give it time!). Until then, asking valves to swing a few volts from a phono stage threatens no one but delivers a sonic thrill few could deny. This is the gentle, accessible way of listening to valve purity and soundstaging - as Audio Innovations' P2 so beautifully demonstrated long ago.

It's peculiar that something as intermediary as a phono stage should have such impact sonically within a vinyl system, but it's the case and for the price the Icon Audio PS1.2 offers an affordable step into the world of almost unreasonably good vinyl replay. I shouldn't be 'reviewing' it in a column, I know, but I like to write about at least one exciting product a month in order to convince myself that hi-fi publishing has more to recommend it than pig farming! [Oh my gawd - is Noel going to do a

Reggie Perrin? Ed]

The vinyl LP is a variable beast but at best can deliver a sound that's easy on the ear and emotionally engaging. Like any good analogue medium it hides its sins well, but those sins aren't as great as many critics, wrapped up in the wonders of digital, have come to believe. Reading a long discussion on the internet the other day between 'knowledgeable' engineers about the vinyl revival and the delusional views of LP lovers, I encountered the usual misquotes about distortion levels and all else that is wrong with the LP.

I'm quite proud that on this magazine we are able to measure what goes on and, without getting technical, I can assure you that there's nothing delusional about the wonders of the LP. I realise that most engineers have never measured the medium and their views are no more than simple conjecture that, unchallenged, passes as fact. LP distortion levels are in truth very low - around 0.1%. Better, this being analogue it's a benign sort of distortion that can only become audibly apparent in large quantities, around 0.5% or higher, causing muddle and congestion. So there's no delusion here: vinyl really sounds good for some technically verifiable reasons. It also has weaknesses I'll admit: there's surface noise, although it passes unnoticed in a good system. There's variability: some LPs sound bad. And some care is needed to avoid bending the stylus. Otherwise, I am very happy to report that the deluge of new turntables, arms and - especially - phono stages continues unabated and whilst it does I'm happy to leave pig farming to pig farmers.

Flying pigs are a different breed altogether of course and are more likely to be spotted than high definition music playing machines of the Blu-ray or HD-DVD variety, some industry observers are now starting to speculate. I hope it isn't true.

Surely, I tell myself, it is possible for digital to sound good and challenge the LP: SACD is easy on the ear after all. It seems better able to stand comparison with LP than most PCM, but has already passed into history, it seems...

High quality PCM in the form of Dolby TrueHD and DTS Master Audio is promised by both new high definition discs. But the future of hi def. digital is unassured as Sony and Toshiba battle it out with their overly complex and poorly worked out systems. Disc prices at HMV slid from an astronomical £27 down to £22 at HMV over the Christmas period, but I still do not see many takers at this price. My Samsung BD-P1000 Blu-ray player is fed a limited diet of high def. discs as a result, most coming from Amazon.

Sound quality with 24/96 PCM is very good and I was looking forward to hearing Dolby TrueHD and DTS Master Audio music discs on a player able to handle them. Now though, I am beginning to wonder whether these digital formats will remain as rare as flying pigs, leaving the LP to make a slow comeback as some sort of minority interest, revivalist medium with a peculiar chic attached to it, helped along by the incredibly high standards of product styling and finish that have become a part of the technology.

The Transcriptors Hydraulic Reference we feature this month first brought radical styling to the turntable, all those years ago. Nowadays, natty looking phono stages with glowing valves help maintain the momentum. When did your average CD-based Japanese hi-fi ever look so intriguing? Or sound so good? What a pity modern digital doesn't come so well packaged or so easy to use as today's vinyl systems! If it did we might at last get a decent alternative to the LP. ●

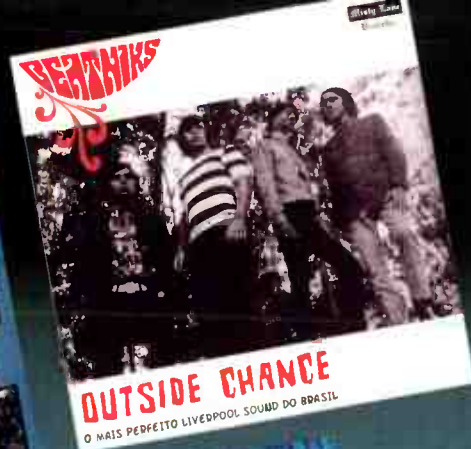
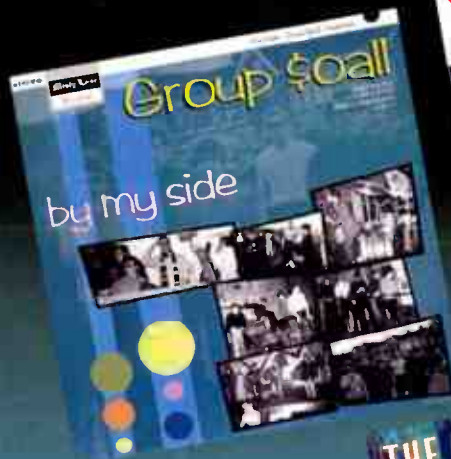

**TRACTOR**  
*Tractor*  
Ozit Morpheus Records

Duo Jim Milne and Steve Clayton were signed by the late John Peel to his then record label Dandelion as *The Way We Live*, on the strength of a multi-tracked demo. Peel was convinced that the duo were a larger group, such was the professional presentation. *The Way We Live* moniker was used for their 1971 debut album release but changed on Peel's insistence, before the outfit's second release, to *Tractor* in 1972. Chris Hewit, Managing Director of Ozit Morpheus Records and band manager for thirty six years, explains that, "as dealers are selling mint vinyl originals of 'Tractor' and *The Way We Live's* 'A Candle for Judith' for between £200-£250 each, the band and I decided to release them on 180gm heavy vinyl."

The label has already had success with the *Tractor* back catalogue on CD, and this limited pressing of 1,000 copies recognises how popular vinyl has once more become. The source for the release was via the original quarter inch tapes, now stored in a temperature-controlled environment but apparently damaged enough to require baking before remastering. The process, which the original band 'kept an eye on', featured playback on a Tascam 32-2 reel-to-reel with Sound Forge coming into play for restoration, editing and the like.

The final released version of the album is admirable in its production.

However, despite the audiophile tag, it's a shame that the inner sleeve is basic paper diecut and not plastic lined. As it is, the paper will slowly scratch the vinyl over time - replace it with a third part inner to protect your investment. Presenting a grand vision of blues-rock, folk and psychedelia, this self-titled album is both compelling and innovative. This was the band's final album release, at the height of their powers - there have been reports of a new album in the works however, so watch this space...

**GROUP \$OALL**  
*By My Side*  
Misty Lane Records

**BEATNIKS**  
*Outside Change*  
Misty Lane Records

**THE GALAXIES**  
*The Galaxies*  
Misty Lane Records

All these new LPs come on the same Italian record label limited to 500 or 700 copies and on 10 inch vinyl, a favourite format amongst nostalgists. The Beatniks', a Brazilian beat group, disc covers their complete singles collection from 1966-1968, including The Kinks' 'Cansado de Esperar (Tired Of Waiting For You)' and arrives complete with lots of trademark 1960s compression. Group \$Oall features all of their 1967 recordings. Self-penned, the style of the tracks will be readily familiar to

any British fan of beat music from the times. Singing in English, the group should be investigated by anyone who enjoyed beat music with a slightly more aggressive vocal style. Again, the recording techniques of the time dominate with some distortion in the higher registers. On to *The Galaxies* and a reproduction of a formerly self-titled 12 inch album release from 1968. The band, formed in Sao Paulo in Brazil, could best be described as garage-psych-tropical mixing typically energetic, fuzz guitar freak outs and mature psyche-pop.

Massimo del Pozzo, President of Misty Lane Records, explained where the releases were sourced from, "I'm in regular touch with music collectors in several countries. A few of them, who knew members of the original 1960s bands, asked me if I was interested in reissuing their material. We managed to remaster using quality analogue equipment. Where we were able to source master tapes, we found that they are often very noisy, due to dirt accumulation. In these cases a mint copy of the record is actually a better source. Such was the case with *The Galaxies*." In addition, the original groups were sometimes able to assist in the research and development of the reissue. Group \$Oall, who hailed from Holland, provided the original master recordings for their release whilst Beatniks went one further and also provided many extra pictures and other relevant recording information.





**HÖLDERLIN**  
*Hölderlins Traum*  
Wah Wah/Pilz

Direct from Spain, this excellent album has now been released on just 500 copies. According to Wah Wah's Marc Argenter, "we tend to license a limited number of copies which we feel are the right quantities to satisfy the small circle of vinyl lovers worldwide." The inspiration for all of Wah Wah's recent 'Kraut' release titles came from the label owner Jordi Segura, who has always been a big fan of the genre. He's been collecting for years. Hölderlin, in particular, was chosen because it's, "one of the most beautiful Kraut-folk LPs from that magic era. It is now long-deleted and we thought another generation of music lovers deserved the chance to have this one on quality vinyl," declared Argenter.

Whilst rarities, such as this example, are welcome to all music connoisseurs, by their very nature source material is often extremely hard to get hold of, as Argenter can testify. "It is detective work to seek for both rights holders and masters locations. I have found myself often calling old pressing plants, were the records were originally pressed, twenty or more years ago, to ask if they still keep the masters which, of course, they never do!" Fortunately, this particular album was saved by German efficiency. "Yes, we have to bless the German efficiency. Our licensor took care of the archives. Not only were they well

organised but they were stored in a safe environment. This meant that our recent releases, including this particular album, could be taken from quality masters."

A German group which was to become more prog rock-like as they grew and matured, this debut release is definitely situated more in the folk field but retains prog elements as well as ingredients that included psychedelia and the East. Centring mostly around analogue instrumentation with the odd electric organ in there, the music, at its best, is haunting. Highly recommend, it is a classic of Kraut-folk.

**SHAPES AND SOUNDS VOL. 2:**  
*SHADES OF DEEPEST PURPLE,*  
**BBC ARCHIVES 67-71**  
Top Sounds

Limited to just 500 copies, this is the second compiled set of previously unreleased tracks of little-known artists who appeared on the BBC in some form. Twelve of the sixteen tracks are taken directly from BBC transcription discs, with the other four from off-air recordings and include outfits such as Mirage, The Association, The Alan Bown and Bystanders, who later spawned space rock legends, Man. Created from Top Sound label owner Nigel Lees' passion for 1960s music, the idea for the series stemmed from Lees' discovery of those BBC transcription discs. These were vinyl records which provided BBC programmes for distribution to varying studios plus

overseas broadcasters but whose musical content was unique, often featuring many rarities.

Using the original BBC transcriptions as the source, it is intriguing to hear just what the sound quality is like. "As good as a normal record," commented Lees, "after all, this is The BBC. The only difference was the attitude of the engineers who were actually doing the sessions. A lot of them were the white-coated, bespectacled, 1950s boys who were more used to Flanagan and Allen than 'these long haired pop groups'. The kit was antiquated and the producers were quite snobbish. The attitude to the artists by the studio guys was, 'get in, do the track and we can go home'. There was virtually no room to do another take, for example. It wasn't a very nice atmosphere for the artists."

There were always exceptions to the norm of course, but the prevailing outlook did filter through to two examples. "My sound restorer found, on this album, on a The Alan Bown track, that the engineer began cross fading too early. A pure mistake on his part. There's another fault on Volume 1 within Montana's 'Hey Grandma', of an increase in the volume after the introductory guitar and Brian Matthews vocal introduction." The problem? The producer moved the knobs up during the recording! An excellent rarities collection and an important piece of archival music history, Top Sounds should be congratulated for its preservation work. **PR**

**CONTACTS:**  
Diverse Vinyl  
+44(0)1633 256261  
[www.diversevinyl.com](http://www.diversevinyl.com)

Stamford Audio  
+44(0) 8456035781  
[www.stamfordaudio.com](http://www.stamfordaudio.com)

The all-new

# M-series

from **ROKSAN**



High performance hi-fi separates  
that will make your heart sing



To find out more about the M-Series of high performance hi-fi separates  
from Roksan, and where you can buy them  
visit: [www.henleydesigns.co.uk](http://www.henleydesigns.co.uk)



[www.henleydesigns.co.uk](http://www.henleydesigns.co.uk)

#### ROKSAN CENTRES OF EXCELLENCE

Audio Merchants, *Glasgow* • Audio Republic Ltd., *Headingley, Leeds* • HG Rapkin, *Northampton* • Hi Fi Sound, *Darlington* • Home Media, *Maidstone*  
Kronos Hi Fi, *Dungannon* • Merlin Music, *Melrose* • Music Unlimited, *Leverton, Boston* • Sevenoaks Sound & Vision, *Yeovil*  
Sevenoaks Sound & Vision, *Southgate* • Sevenoaks Sound & Vision, *Holborn* • Technosound Systems Ltd., *Dunstable*  
Unilet Sound & Vision, *New Malden* • Videotech, *Huddersfield* • Zouch Audio, *Asby-De-La-Zouch*



# WORLD CLASSICS

In this heavily revised section, you'll find the great and the good from audio's glorious past. Most are seminal designs which have earned their place in hi-fi history, but you'll also see some oddities which aren't classic as such, but are great used buys. The year of introduction is given, alongside the original UK launch price. Think we've overlooked something? Then write in and let us know!

## DIGITAL

**CAMBRIDGE AUDIO CD1** 1986 £1500  
Inspired Stan Curtis redesign of Philips CD104, complete with switchable digital filter. Lean but tight and musical performer.

**CAMBRIDGE AUDIO CD4SE** 1998 £200  
A touch soft in the treble and tonally light, but outstanding in every other respect.

**LINN KARIK III** 1995 £1775  
The final Karik was a gem. Superb transport gives a brilliantly tight, grippy dynamic sound, albeit tonally dry.

**MARANTZ CD73** 1983 £700  
A riot of gold brushed aluminium and LEDs, this distinctive machine squeezed every last ounce from its 14x4 DAC -super musical



**MARANTZ SA-1** 2000 £5,000  
The greatest argument for SACD. This sublime Ken Ishiwata design is utterly musically convincing with both CD and SACD, beating most audiophile CD spinners hands down.



**MERIDIAN 207** 1988 £995  
Beautifully-built two-box with pre-amp stage. Very musical although not as refined as modern Bitstream gear. No digital output.

**MUSICAL FIDELITY TRIVISTA** 2002 £4000  
When playing SACDs, the sweetest, most lucid and lyrical digital disc spinner we've heard. Old school stereo, pure DSD design. CD sound is up in the £1000 class, too! Future classic.

**MERIDIAN MCD** 1984 £600  
The first British 'audiophile' machine was a sweeter, more detailed Philips CD100. 14x4 never sounded so good, until the MCD Pro arrived a year later.



**NAIM CDS** 1990 £ N/A  
Classic Philips 16x4 chipset with serious attention to power supplies equals grin-inducing sonics.



**SONY CDP-101** 1982 £800  
The first Japanese CD spinner was powerful and involving. Brilliant transport more than compensated for 16x2 DAC, and you even got remote control!

**SONY CDP-R1/DAS-R1** 1987 £3,000  
Sony's first two boxer was right first time. Tonally lean, but probably the most detailed and architectural sounding machine of the eighties.



**SONY CDP-701ES** 1984 £890  
Sony's first ever bespoke high end audiophile machine used a 16x2 DAC to provide a clinically incisive sound; supreme build quality allied to the pure unadulterated luxury of a paperback-sized remote control.

**TECHNICS SL-P1200** 1987 £800  
CD version of the Technics SL-1200 turntable. Massively built to withstand the rigours of 'pro' use and laden with facilities - a great eighties icon. Sonically, it's pure fun, with hefty bass that can still show weedy modern players a thing or two!

**YAMAHA CD-X1** 1983 £340  
Nicely built 16x2 machine with a very sharp and detailed sound; sometimes too much so. Excellent ergonomics, unlike almost every other rival of the time.

## COMPACT DISC TRANSPORTS

**TEAC VRDS-TI** 1994 £600  
Warm and expansive sound made this a mid price hit. Well built, with a slick mech.



**ESOTERIC P0** 1997 £8,000  
The best CD drive bar none; TEAC's Tokyo boys pushed the boat out in style. Brilliantly incisive, ridiculously over engineered.

**KENWOOD 9010** 1986 £600  
The first discrete Jap transport was beautifully done and responds well to re-clocking even today.

## DACs

**CAMBRIDGE AUDIO DACMAGIC** 1995 £99  
Good value upgrade for budget CD players with extensive facilities and detailed sonics.



**DCS ELGAR** 1997 £8500  
Extremely open and natural performer, albeit extremely pricey - superb.



**DPA LITTLE BIT 3** 1996 £299  
Rich, clean, rhythmic and punchy sound transforms budget CD players.



**PINK TRIANGLE DACAPO** 1993 £ N/A  
Exquisite; the warmest and most lyrical 16bit digital audio we have ever heard. Clever plug-in digital filter modules really worked!



**QED DIGIT** 1991 £90  
Budget bitstream performer with tweaks aplenty. Positron PSU upgrade makes it smooth, but now past it.

**TURNTABLES**

**ARISTON RD11S** 1972 £94  
Modern evolution of Thorens' original belt drive paradigm, Scotland's original super-deck was warm and musical, albeit soft. Still capable of fine results today.

**ADC ACCUTRAC 4000** 1976 £300  
Bonkers 1970s direct drive that uses an infra red beam to allow track selection and programming. More of a visual and operational delight than a sonic stunner.

**PIONEER PL12D** 1973 £36  
The beginning of the end for the British turntable industry. When vinyl was the leading source, this brought new standards of noise performance and stability to the class, plus a low friction S-shaped tonearm. Later PL12D was off the pace compared to rivals



**PIONEER PLC-590** 1976 £600  
Sturdy and competent motor unit that performs well with a wide range of tonearms. Check very thoroughly before buying due to electronic complexity and use of some now-obsolete ICs.

**DUAL CS505** 1982 £75  
Simple high quality engineering and a respectable low mass tonearm made for a brilliant budget buy. Polished, smooth and slightly bland sound.

**GOLDRING LENCO GL75** 1970 £15.65  
Simple, well engineered motor unit with soft, sweet sound and reasonable tonearm. Good spares and servicing support even today from specialists. Eminently tweakable. Similar 88 and 99 motor units are budget 301/TD124 rivals.

**LINN AXIS** 1987 £253  
Simplified cut-price version of the Sondek complete with LVX arm. Elegant and decently performing mid-price package. Later version with Akito tonearm better.

**LINN SONDEK LP12** 1973 £86  
For many, the Brit superdeck; constant mods meant that early ones sound warmer and more lyrical than modern versions. Recent 'SE' mods have brought it into the 21st century, albeit at a price..



**MARANTZ TT1000** 1978 £ N/A  
Beautiful seventies high end belt drive with sweet and clean sound. Rare in Europe, but big in Japan.



**MICHELL GYRODEC** 1981 £599  
Thanks to its stunning visuals, this bold design wasn't accorded the respect it deserved until recently. Early examples sound cold and mechanical, but now right on the pace. Clean, solid and architectural sound.

**TECHNICS SP10** 1973 £400  
Seminal Japanese engineering. Sonics depend on plinths, but a well mounted SP10/II will give any modern a hard time, especially in respect of bass power and midband accuracy.

**REGA PLANAR 3** 1978 £79  
Brilliantly simple but clean and musical performer, complete with Acos-derived S-shaped tonearm. 1983 saw the arrival of the RB300, which added detail at the expense of warmth. Superb budget buy.

**GARRARD 301/401** 1953 £19  
Heavy metal - tremendously strong and articulate with only a veiled treble to let it down. In many respects, better than the seventies 'superdecks' that succeeded it.



**ROKSAN XERXES** 1984 £550  
Supposedly the first to 'better' the LP12. Super tight and clean sound, with excellent transients. Less musical than the Sondek, but more neutral. Sagging plinth top-plates make them a dubious used buy.

**SONY PS-B80** 1978 £800  
First outing for Sony's impressive 'Biotracer' electronic tonearm. Built like a tank with a clean and tidy sound, albeit lacking involvement. Scarily complicated and with no spares support - buy with caution!

**THORENSTD124** 1959 £ N/A  
The template for virtually every 1970s 'superdeck', this iconic design was the only real competition for Garrard's 301. It was sweeter and more lyrical, yet lighter and less impactful in the bass.



**TOWNSHEND ROCK** 1979 £ N/A  
The product of academic research by the Cranfield Institute, this novel machine has an extremely clean and fluid sound. Substantially modified through the years, and capable of superb results even today.

**TRIO LO-7D** 1978 £600  
The best 'all-in-one' turntable package ever made, Trio/Kenwood threw their 'engineering best practice' book at this one with startling results. Clean, powerful and three-dimensional sound, ultimately limited by the tonearm.

**TONEARMS**  
**ACOS LUSTRE GST-1** 1975 £46  
The archetypal S-shaped seventies arm; good, propulsive and involving sound in its day, but ragged and undynamic now.

**AUDIO TECHNICA AT 1120** 1978 £75  
Fine finish can't compensate for this ultra low mass arm's limited sonics - a good starter arm if you've only got a few quid to spend.

**ALPHASON HR100S** 1981 £150  
First class arm, practically up to present-day standards. Buy carefully, though, as there is no service available now. Totally under priced when new, exceptional.



**SME 3009** 1959 £18  
Once state of the art, but long since bettered. Musical enough, but weak at frequency extremes and veiled in the midband. Legendary serviceability and stunning build has made it a cult, used prices unjustifiably high.

**GRACE G707** 1974 £58  
This early Japanese example of the tonearm art has a smooth, lyrical sound. Imported by Linn, fitted to early LP12s. Sonically way off the pace now, though.

**REGA RB300** 1983 £88  
Inspired budget esoterica. Detailed, tight, neutral sound but tonally grey sounding in absolute terms. Responds well to tweaking, and its cheaper RB250 brother better still.



**SME SERIES III** 1979 £113  
Clever variable mass design complete with Titanium Nitride tube tried to be all things to all men, and failed. Charming nonetheless, with a warm and inoffensive sound.

**HADCOCK GH228** 1976 £46  
Evergreen unipivot with lovely sweet, fluid sound. Excellent service backup.



**LINN ITTOK LVII** 1978 £253  
Arguably the first 'superarm'; Japanese design to Linn specs made for a muscular, rhythmic sound with real dynamics. Now off the pace, but the final LVIII version worth seeking out.

**NAIM ARO** 1986 £875  
Truly endearing and charismatic performer - wonderfully engaging mid-band makes up for softened frequency extremes.





**TECHNICS EPA-501** 1979 £ N/A  
Popular partner for late seventies Technics motor units. Nice build and Titanium Nitride tube can't compensate for middling sound.

**INTEGRATED AMPLIFIERS/COMBOS**

**DELTEC** 1987 £1900  
Fast, dry and with excellent transients, this first DPA integrated is the real deal for eighties obsessives. Ridiculously punchy 80W per channel from a tiny, half-size box. Radical, cool and more than a little strange.

**ROGERS A75** 1978 £220  
The prototypical Audiolab 8000a – lots of sensible facilities, a goodly power output and nice sound in one box. The later A75II and A100 versions offered improved sonics and were seriously sweet and open to listen to.

**EXPOSURE VII/VIII** 1985 £625  
Seminal mid-eighties Exposure pre-power, offering most of what rival Naim amps did with just that little bit extra smoothness and sweetness. Still, it's by no means 'sweet' by today's standards, being lean, punchy, musical. It's also possessed of that quintessentially eighties look – frumpy black steel boxes with rough silk screened logos!



**SUGDEN C51/P51** 1976 £130  
Soft sounding early Sugden combo with a plethora of facilities and filters, complete with seventies-tastic DIN socketry. A sweet and endearing performer as you'd expect, but lacking in power and poor load driving ability, so partner carefully.

**VTL MINIMAL/50W MONOBLOCK** 1985 £1,300  
Vacuum Tube Logic was one of the Europe's biggest tube names in the eighties, and it shows. Rugged, professional build and finish allied to a lively and punchy sound (albeit with limited power) make them an excellent used buy.

**A&R A60** 1977 £115  
Sweet and musical feature-packed integrated; the Audiolab 8000A used its blueprint to great effect.



**CREEK CAS4040** 1983 £150  
More musical than any budget amp before it; CAS4140 loses tone controls, gains grip.

**AUDIOLAB 8000A** 1985 £495  
Smooth integrated with clean MM/MC phono stage and huge feature count. Extremely reliable, too. Post '93 versions a top used buy.



**MCINTOSH MA6800** 1995 £3735  
Effortlessly sweet, strong and powerful with seminal styling to match.

**SUGDEN A21** 1969 £ N/A  
Class A transistor integrated with an eminently likeable smoothness and musicality. Limited inputs via DIN sockets.

**MISSION CYRUS 2** 1984 £299  
Classic eighties minimalism combines arresting styling with clean, open, lively sound. Further upgradeable with PSX power supply.



**MUSICAL FIDELITY A1** 1985 £350  
Beguiling Class A integrated with exquisite styling. Questionable reliability.



**NAIM NAIT** 1984 £350  
Superb rhythms and dynamics make it truly musical, but tonally monochromatic. Fine phono stage, very low power.

**NAD 3020** 1979 £69  
Brilliantly smooth, sweet and punchy at the price and even has a better phono stage than you'd expect. The archetypal budget super-amp.



**MYST TMA3** 1983 £300  
Madcap eighties minimalism, but a strong and tight performer all the same.

**ROGERS CADET III** 1965 £34  
Sweet sounding valve integrated, uses ECL86 output valves, even has a half useable phono stage, sweet, warm a good introduction to valves



**ROTEL RA-820BX** 1983 £139  
Lively and clean budget integrated that arguably started the move to minimalism.

**CHAPMAN 305** 1960 £40  
Smooth pre/power combo with a sweet and open sound. Not quite up to Leak/Quad standards but considerably cheaper second-hand.

**PREAMPLIFIERS**

**AUDIOLAB 8000C** 1991 £499  
Tonally grey but fine phono input and great facilities make it an excellent general purpose tool.

**AUDIO RESEARCH SP-8** 1982 £1,400  
Beautifully designed and built high end tube preamplifier with deliciously sweet and smooth sound. Not the last word in incision or grip, but that didn't matter to those who aspired to it.

**CONRAD JOHNSON MOTIV MC-8** 1986 £2,500  
Minimalist FET-based preamplifier from the Yank valve specialists is brilliantly neutral and smooth with a spry, light balance in the mould of Sugden high end stuff. Something of a curio, but worthwhile nonetheless.

**CROFT MICRO** 1986 £150  
Budget valve pre-amp with exceptionally transparent performance.

**LEAK POINT ONE STEREO** 1958 £ N/A  
Good for their time, but way off the pace these days. Use of EF86 pentode valve for high gain rules out ultra performance. Not the highest-fi!

**LINN LK-1** 1986 £499  
A brave attempt by the Glasgow boys to bring remote controlled user-friendliness to hair-shirt audiophile hi-fi. Didn't quite work, but not half bad for under £100.

**NAIM NAC32.5** 1978 £ N/A  
The Salisbury company came of age with this, their classic high end pre. Brilliantly fast and incisive sound that's a joy with vinyl but a tad forward for digital.

**LECSON AC-1** 1973 £ N/A  
Amazing styling courtesy of Allan Boothroyd can't disguise its rather cloudy sound, but a design classic nonetheless.



**QUAD 22** 1958 £25  
The partner to the much vaunted Quad II monoblocks - cloudy and vague sound means it's for anacrophiles only.

**QUAD 33** 1968 £43  
Better than the 22, but Quad's first tranny pre isn't outstanding. Responds well to tweaking/ rebuilding though...

**POWER AMPLIFIERS**

**LEAK STEREO 20** 1958 £31  
Excellent workaday classic valve amplifier with decent power and drive. Surprisingly modern sounding if rebuilt sympathetically. Irrepressibly musical and fluid.



**LECSON API 1973 £ N/A**  
 Madcap cylindrical styling alluded to its 'tower of power' pretensions, but it wasn't. Poor build, but decently clean sounding when working.

**MARANTZ MODEL 9 1997 £8000**  
 Authentic reproduction monoblocks still more than cut the sonic mustard. Highly expensive and highly sought after.

**MICHELL ALECTO 1997 £1989**  
 Crisp, clean and beautifully controlled with gorgeous styling. Partnered with the £1650 Orca this sounds delicious!

**LEAK POINT ONE, TL10, TL12.1 1949 £28**  
 Early classics that are getting expensive. Overhauling is de rigeur before use, using original parts if possible. Surprisingly crisp and musical sound, that's far more modern than Quad IIs. Deeply impressive when in fine fettle.



**MUSICAL FIDELITY XA200 1996 £1000PR**  
 200W of sweet smooth transistor stomp in a grooved tube! Under-rated oddity.



**RADFORD STA25 RENAISSANCE 1986 £977**  
 At the time, very possibly the least cool amplifier on the planet – and we're not talking heat dissipation here. This reworking of Radford's original late sixties design was possessed of a wonderfully rich, old school valve sound with enough power (25W) and lots of subtlety.



**QUAD II 1952 £22**  
 The all-time classic valve amplifier, with a deliciously fluid and lyrical voice. In other respects though, it sounds hopelessly dated. Low power and hard to partner properly.



**QUAD 405 1978 £115**  
 The first of the current dumpers is a capable design with smooth, effortless power and a decently musical sound. 606 and 707 continue the theme with greater detail and incision.

**QUAD 303 1968 £55**  
 Bullet proof build, but woolly sound. Off the pace, but endearing nonetheless. Some pipe smoking slipper wearers swear by them!

**KRELL KMA100 II 1987 £5,750**  
 Ludicrous monoblock version of the giant KSA-100 is one of the seminal eighties transistor power amplifiers. Massive wallop allied to a very clean and open Class A sound makes this one of the best amplifiers of its type, ever.

**PIONEER M-73 1988 £1,200**  
 Monster stomp from this seminal Japanese power amplifier, complete with switchable Class A and Class B operation. Clean, open and assured sounding, albeit a tad behind the pace on high speed dance music. Rosewood side cheeks and black brushed aluminium completes the eighties-tastic experience.



**PHONO STAGES CREEK OBH-8 SE 1996 £180**  
 Punchy, rhythmic character with oodles of detail makes this a great budget audiophile classic. Partner with a Goldring G1042 for an unbeatable budget combination.



**LINN LINNK 1984 £149**  
 Naim-designed MC phono stage built to partner the original Naim NAIT - yes, really! Fine sound, although off the pace these days.

**MICHELL ISO 1988 £ N/A**  
 This Tom Evans-designed black box started the trend for high performance offboard phono stages. Charismatic, musical and punchy - if lacking in finesse.

**TUNERS MARANTZ ST-8 1978 £353**  
 Marantz's finest radio moment. Warm, organic sound plus an oscilloscope for checking the signal strength and multipath.



**CREEK CAS3140 1985 £199**  
 Excellent detail, separation and dynamics - brilliantly musical at the price. T40 continued the theme...

**NAD 4040 1979 £79**  
 Tremendously smooth and natural sound allied to low prices and good availability make this budget analogue esoterica. Needs a good antenna to work properly, however.

**NAIM NAT03 1993 £595**  
 The warm, atmospheric sound is further proof of Naim's proficiency with tuners.

**PIONEER TX-9500 1976 £295**  
 Another of the serious classic solid-staters. Boasts the usual high end Jap package of fine sound, brilliant sensitivity and superb build.

**LEAK TROUGHLINE 1956 £25**  
 Series I an interesting ornament but limited to 88-100MHz only. II and III are arguably the best-sounding tuners ever. Adaptation for stereo easy via phono multiplex socket. Fed by a modern outboard decoder they're deliciously lucid with true dimensionality.



**YAMAHA CT7000 1977 £444**  
 Reputedly the best of the classic Jap analogues, this combines sleek ergonomics, high sensitivity and an explicit, detailed sound.

**QUAD FM4 1983 £240**  
 Supreme ergonomics and styling allied to a pleasingly lyrical sound with plenty of sweetness and detail made this one of the best tuners around upon its launch.



**REVOX B760 1975 £520**  
 More of a semi-pro machine than a domestic bit of kit, the Revox offers superlative measured performance although the sound isn't quite as staggering as the numbers. Fine nonetheless, and surely the most durable tuner here?

**NAD 4140 1995 £199**  
 Brilliant affordable digital tuner has a smooth, detailed musical sound plus sensible real-world facilities.

**ROGERS T75 1977 £125**  
 Superb mid-price British audiophile design, complete with understated black fascia. Fine sound in the true Rogers mould – smooth and sweet with fine dimensionality.

**SANSUI TU-9900 1976 £300**  
 A flagship Japanese tuner designed to steal sales from the likes of Accuphase and Revox, it boasts superlative RF performance and an extremely smooth and lucid sound, along with very fine build and finish.

**SEQUERRA MODEL I 1973 £1300**  
 Possibly the ultimate FM tuner. Massive in terms of technology, size and features dedicated to extracting every ounce of performance from radio, including impressive multi-purpose oscilloscope display.

**SONY ST-5950 1977 £222**  
 One of the first Dolby FM-equipped tuners, a format that came to nought. Still, it was Sony's most expensive tuner to date, and boasted a very good sound quality allied to brilliant ergonomics.





**TECHNICS ST-8080 1976 £180**

National Panasonic's specialist hi-fi brand was a big hitter back then, and this is no exception. Superb FM stage makes for a very clean and smooth listen with lots of detail and depth.

**ANALOGUE RECORDERS**

**YAMAHA TC-800GL 1977 £179**

Early classic with ski-slope styling courtesy of Mario Bellini. Middling sonics by modern standards, but cool nonetheless!



**AIWA XD-009 1989 £600**

Aiwa's Nak beater didn't, but it wasn't half bad nonetheless. Massive spec even included a 16x4 DAC!

**NAKAMICHI CR-7E 1987 £800**

The very best sounding Nakamichi ever - but lacks the visual drama of a Dragon.



**PIONEER CTF-950 1978 £400**

Not up to modern standards sonically, but a great symbol of the cassette deck art nonetheless.



**REVOX A77 1968 £145**

The first domestic open reel that the pros used at home. Superbly made, but sonically off the pace these days. B77 better, but couldn't match the Japanese.



**SONY WM-D6C 1985 £290**

Single capstan transport on a par with a Swiss watch, single rec/replay head better than most Naks. Result: sublime.



**SONY TC-377 1972 £N/A**

A competitor to the Akai 4000D open reel machine, the Sony offered better sound quality and is still no slouch by modern standards

**DIGITAL RECORDERS**

**SONY MDS-JE55SES 2000 £900**

The best sounding MD deck ever, thanks to awesome build and heroic ATRAC-DSP Type R coding.



**PIONEER PDR-555RW 1999 £480**

For a moment, this was the CD recorder to have. Clean and detailed.

**MARANTZ DR-17 1999 £1100**

Probably the best sounding CD recorder made; built like a brick outhouse with a true audiophile sound and HDCD compatibility.



**KENWOOD DM-9090 1997 £500**

Serious and sophisticated sound thanks to well implemented ATRAC 4.5; surprisingly musical MD recorder.

**SONY TCD-8 DATMAN 1996 £599**

Super clean sound makes this an amazing portable, but fragile.

**LOUDSPEAKERS**

**ACOUSTIC RESEARCH**

**AR18S 1978 £125**

Yank designed, British built loudspeaker became a budget staple for many rock fans, thanks to the great speed from the paper drivers, although finesse was most definitely not their forte...

**BBC LS3/5A 1972 £88**

Extremely low colouration design is amazing in some respects - articulation, stage depth, clarity - and useless in others (both frequency extremes). Came in wide variety of guises from various manufacturers building it under licence. Partner with Rogers ABI subwoofers for an extra two octaves of bass!



**LOWTHER PM6A 1957 £18**

**EACH**

This seminal full-range driver is still manufactured. High sensitivity, as fitted to many classic horn designs.

**TANNOY**

**WESTMINSTER 1985 £4500**

Folded horn monsters which certainly sound good if you have the space. Not the last word in tautness but can drive large rooms and image like few others.



**JR 149 1977 £120**

Infamous cylindrical speaker that was ignored for decades but now back in fashion! Based on classic KEFT27 / B110 combo as seen in the BBC LS3/5a. Doesn't play loud, needs a powerful transistor amplifier, but rewards with fine clarity and imaging.



**SPENDOR BCI 1976 £240**

Celestion HF1300 tweeter meets bespoke Spendor Bextrene mid-bass unit - and the result is a beautifully warm yet well focussed sound. A little bass bloom necessitates careful low-stand mounting, but these prove that the seventies did have some fine designs after all!

**QUAD ESL57 1956 £45 EACH**

Wonderfully open and neutral sound puts box loudspeakers to shame. Properly serviced they give superb midband performance, although frequency extremes less impressive. Ideally, use in stacked pairs or with subwoofers and supertweeters.



**KEF R105 1977 £785**

Three way Bextrene-based floorstander (complete with castors!) gave a truly wideband listen and massive (500W) power handling. A very neutral, spacious and polite sounding design, but rhythmically well off the pace. The quintessential nineteen seventies loudspeaker.

**IMF TLS80 1976 £550**

Warm and powerful nineteen seventies behemoth with transmission loading and a mixture of KEF and Celestion drive units. Impressively physical wideband sound but rhythms aren't its forte.

## CLASSICS

### MAGNEPLANAR SMGA 198X £800

Technological loudspeaker with genuinely musical abilities; fast, smooth, open, dry.



### MISSION 770 1980 £375

Back in its day, it was an innovative product and one of the first of the polypropylene designs. Warm, smooth, clean and powerful sound.



### MISSION 752 1995 £495

Cracking Henry Azima-designed floorstanders combined HDA drive units and metal dome tweeters with surprisingly warm results. Benign load characteristics makes them great for valves.

### HEYBROOK HB1 1982 £130

Peter Comeau-designed standmounters with an amazingly lyrical yet decently refined sound. Good enough to partner with very high end ancillaries, yet great with budget kit too. A classic.

### CELESTION SL6 1984 £350

Smallish two way design complete with aluminium dome tweeter and plastic mid-bass unit set the blueprint for nineteen eighties loudspeakers. Very open and clean sounding, albeit coarse at high frequencies and limp in the bass. Speakers would never be the same again...



### LEAK SANDWICH 1961 £39 EACH

Warm sounding infinite baffle that, with a reasonably powerful amplifier can sound quite satisfying.



### QUAD ESL63 1980 £1200

An update of the ESL57, with stiffer cabinets. Until the 989, the best of the Quad electrostatics.



### YAMAHA NS1000 1977 £532

High tech Beryllium midband and tweeter domes and brutish 12" woofers in massive sealed mirror image cabs equals stunning transients, speed and wallop allied to superb transparency and ultra low distortion. Partner carefully!



### MISSION X-SPACE 1999 £499

The first mass production sub and sat system using NXT panels is a sure-fire future classic - not flawless, but a tantalisingly unboxy sound nevertheless!



**To advertise in this space  
please call 020 7372 6018  
or email:  
advertising@hi-fiworld.co.uk**



# vinyl section

## contents

March 2008

[www.hi-fiworld.co.uk](http://www.hi-fiworld.co.uk)

## news

### ACOUSTIC SOLID CLASSIC WOOD 86

David Allcock checks out this German company's quirky mid-price turntable.

### PRO-JECT RPM1 GENIE 90

A new entry-level turntable enchants Adam Smith...

### VALVE PHONO STAGE SUPERTEST 94

Tony Bolton compares valve phono stages from Icon Audio, Quad and Eastern Electric.

### NORDOST HEIMDALL/AUDIOPHILE BASE 98

Two essential vinyl accessories are reviewed by David Price.

## LEOPARD LOUNGE

Warner Jazz has just released a 2LP compilation, the rather wordily titled, 'The Leopard Lounge At The Movies: Swinging Film Tunes From the Atlantic & Warner Vaults'. In fact, what we have here are covers of popular and classic tunes. Often featuring major figures including Jimmy Smith's take on the 'Theme From M.A.S.H.', Shelly Manne's enigmatic version of 'Peter Gunn' or Herbie Mann's all action 'Our Mann Flint'. Other notables are Les Baxter's glorious approach to the 'Theme from Lawrence Of Arabia' or The Markett's kitsch version of the 'Batman Theme'.

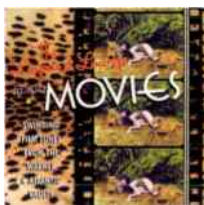

## STATE OF MIND

Just in from Italy is this new release on Teen Sound Records from The Higher State. Called 'From 'Round Here', this contemporary four piece reveal their style right from the off. In fact, over the first three tracks of the album. Track 1 exhibits their garage style with lots of fuzz guitar and energy whilst Track 2 reveals the band's Byrds influences – lots of twangy guitars, Track 3 is very psychedelia. Great for modern nostalgists.



## WAH WAH WAH

Wah Wah also have three additional releases you should check out. Featuring guitar hero, Peter Bursch, Broselmaschine's self-titled debut album from 1971 takes a Fairport Convention or even Pentangle approach to folk rock but inserts a slice of psych-world vibes and plenty of quality acoustic guitar. Featuring admirable melodic structures, this is an excellent Kraut-folk album. 'Peter Bursch Und Die Broselmaschine', originally released on Xenophon in 1976, was Bursch's second release. Psychedelic folk in nature, it helped to establish Krautrock. Continuing the folkish nature, the third release is Emtidi's second album, 'Saat'. Released in 1972, it is the band's best release. Pastoral, ethereal with fragile female vocals, it is the essence of calm.

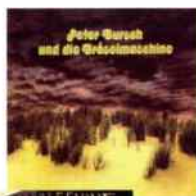

## TREE TOP

Having reached its twentieth anniversary landmark, U2's classic 'The Joshua Tree' album is out again via Universal/Island, having received the remastering treatment and now sitting on 180gm wax. The double vinyl format includes a sixteen page booklet containing lyrics and liner notes by Bill Flanagan, as well as previously unseen Anton Corbijn photos. If you're short of cash post Christmas and can't afford the price of this luxurious reissue, grab yourself a second-hand copy of the original vinyl issue, it's a cracker!



## SLEEP DISTURBANCE

Limited to 1,500 copies each, Peaceville, an imprint of Snapper Records, has released two vinyl editions of albums by the Swedish death/doom metal outfit Katatonia: 'Tonight's Decision' (1999) and 'Last Fair Deal Gone Down' (2001). Issued as double album gatefolds, both exhibit some of the best output from the band. The latter in particular presents an array of melancholy ditties in amongst the heaviest of rock – not necessarily metal, mind you – more Cure-like in tone. 'Tonight...' is just as downbeat but more aggressive in nature. Retaining the high songwriting quality standards, the album once again moves away from the band's earlier black metal style to a more traditional rock approach.



## CLASSIC FOLK

Like Bob Dylan, Vega is an acquired taste. Her whisper-quiet vocal style almost engages you in conversation rather than singing a song at you. Those who look kindly on this singer-songwriter will be glad to hear that this is a recommended release, full of ideas, leaping from one aural canvas to the next. The album is short and sharp, too. Never hanging around, Vega is impatient to get on to the next level of inspiration. Released on 200gm vinyl – a fact that becomes more apparent as you reach to place the record on the spindle, it certainly is weighty. The excellent Classic vinyl recipe comes into play most noticeably during the run-in on side 1 – always the crux of any vinyl sound quality test. In this case it's deathly quiet.



# Instrumental

Acoustic Solid's Classic Wood turntable  
Is a German deck with a difference,  
says David Allcock...



**W**hen I think of German turntables, I'm afraid to say that images of vast, sprawling chrome and acrylic festooned beasts spring to mind, about the size of an offshore oil rig. Whilst visually arresting, it costs a lot of money to machine such materials, so when Acoustic Solid decided to design a new budget deck, they went back to the drawing board and used wood.

The Acoustic Solid Classic Wood is, as the name suggests, something of a departure for this company. The solid wooden plinth measures 470x40x370mm, but with the rear left hand corner removed. This is to accommodate the standalone motor unit. As this turntable has no suspension, the designers faced the obvious problem of trying to deal with the vibrations which would be injected into the turntable via the motor. This has been dealt

with by simply separating the 24v synchronous AC motor unit from the plinth and housing it in its own heavyweight enclosure. The actual step down of voltage is carried out by a 'wall wart' type supply which is sourced from Hewlett Packard, but a more expensive PSU is available at extra cost - the unit supplied with the rest of the range which uses a microprocessor controlled power supply.

Drive is via a stepped, grooved



# Timber



"a powerful, dynamic and energetic sound that suits rock, pop and dance..."

pulley on the motor with drive being transmitted by a 0.4mm nylon thread, which allows plenty of clearance between the motor and the plinth. The arm mounting plate is locked down via a hex head countersunk screw and is easily changed. In this case the turntable was supplied with both a Rega and Hadcock mounting plate. The platter itself is machined from a single piece of aluminium 35mm thick which is then finished with a felt mat placed on top.

The main bearing is a conventional design but uses unconventional materials and assembly - essentially a well with a thrust plate at the bottom and a bearing which runs on it. The thrust plate is manufactured

from Teflon and sits at the base of a brass sleeve into which is poured, during assembly, a plastic coating, this being poured whilst the stainless steel shaft is in situ. The result is that the bearing sleeve is a precise fit for the individual shaft it is mated with. This shaft runs on a polished ceramic ball and the only maintenance required is a few drops of light oil, which is supplied. This bearing is therefore free from wear and noise and very finely toleranced.

The feet are turned from solid aluminium with the front feet on a very coarse thread whilst the back foot is on a much more precise thread for levelling. The finished turntable, sans arm and cartridge,

weighs in at a shade under 15kg and can easily be accommodated on the top plate of most equipment racks.

## SETTING UP

Getting going was relatively easy, with just a couple of small issues. Once I had the turntable levelled on top of my rack, I found the motor pulley on the lower 33 rpm step to run the drive thread very close to the bottom of the platter, something which I quickly remedied with a small piece of MDF under the motor unit, bringing the drive up to the mid point of the platter. The depth of the plinth was more of an issue, as the plinth is so thick and the cut-out in it is so precise, that it was difficult to



t: +44 20 8978 7047  
[www.whestaudio.co.uk](http://www.whestaudio.co.uk)

# You don't know what you're missing

– until you try a van den Hul cable in your hi-fi system

van den Hul cables provide a signal path for your music that will deliver it accurately and as completely as possible

To find out more about the full range of interconnects, a/v, HDMI and speaker cables from van den Hul, and where you can buy them visit: [www.henleydesigns.co.uk](http://www.henleydesigns.co.uk)

*van den Hul*



[www.henleydesigns.co.uk](http://www.henleydesigns.co.uk)







Dorian or the smoother Glider L2 cartridge. The Classic Wood turntable conveyed both power and energy.

Whilst this deck may not have the ultimate resolving power and finesse of its bigger brothers when capturing the subtle phrasing and intonation of Laura Branigan's vocals, it makes up for it in unbridled enthusiasm for the music. Whilst its esteemed siblings, especially the Solid One, have excellent transient tracking ability, the Classic Wood does not sound too far behind and had me reaching for my copies of Van Halen's '1984' and ZZ Top 'Afterburner', which the baby Acoustic Solid adored.

Bass is strong, but you will not mistake it for the likes of the Solid One or the Basis 2100 (both of which cost a lot more). Although it goes down reasonably deep, it lacks their subterranean reach - but if you're using standmount or compact floorstanding speakers, then you are unlikely to miss this aspect of the performance too much. The Classic Wood was also good at allowing the listener to follow complex, multi-layered bass lines, offering great separation without damaging the musical coherency by separating each thread into its own box and losing the plot in terms of the musical performance.

In the midrange, the Classic Wood again showed great enthusiasm, but lacked the finesse I was hoping for. On a more subtle recording such as Nora Jones 'Come Away with Me' the rich, velvety sound of this album was just a little fuller than I would ideally want, and its energy meant that the turntable missed subtleties in the recording, with images not quite as precisely defined as they could have been, a little like a photograph where the optics are not quite good enough.

Although lacking the crystalline quality of the very best analogue sources, I found that high frequencies were very good for the Classic Wood's price. Indeed it made a surprisingly fine match for the Lyra Dorian, the combination giving an extended, open and

highly resolving treble region, allowing cymbals and triangles to have metallic overtones without taking on a hardness or forwardness. Stage width wasn't as good as Michell's rival GyroDec, stereo images being only just able to extend beyond the outer edges of the speakers, whilst stage depth didn't hang back as well as it could. Still, this turntable did prove to be very stable in its performance, as I

"the Classic Wood immediately commanded attention with a driving bass line."

could consistently locate images with no wavering or inconsistencies in image size and location.

**CONCLUSION**

Easy to setup, well built and compact, Acoustic Solid's Classic Wood turntable has a powerful, dynamic, energetic sound which suits rock, pop and dance music, due to excellent timing - this deck consistently sets your toe tapping by conveying great energy. Although not the most subtle or delicate, it offers very good resolution and separation of instruments in complex pieces, allowing threads running through a piece to be teased out of the music, something rarely heard in turntables at the price. Whilst the midband is warmer and richer than I would ideally like, it's very seductive and just the sort of sound you just want to sink into rather than examine and meticulously dissect.

If you are looking for a turntable which is totally dependable, conveys great energy and offers superb timing at a highly competitive price, then the Classic Wood demands inclusion on your shortlist.

**REFERENCE SYSTEM:**  
Aesthetix Rhea phono stage  
Aesthetix Calypso line stage  
Bryston 3B-SST power amplifier  
Martin Logan Vantage loudspeakers  
Leema Acoustics Xavier loudspeakers

**MUSIC USED**  
Rosie Vela, 'Zazu'  
Laura Branigan, 'Self Control'  
Norah Jones, 'Come Away with Me'  
ZZ Top, 'Afterburner'  
Van Halen, '1984'

get a tonearm cable (SME 5 pin DIN type) to mate with the base of my Roksan Nima, especially after its VTA had been adjusted to accommodate the 35mm depth of the platter.

If you're planning on using a Nima with this turntable, you will need straight (not right angle) lead-out cable. Likewise, you will need adjustable VTA on any RB-300 which you plan on using with this turntable as the depth of the platter results in the standard arm being too low to use. I eventually managed to get both the Nima and a Hadcock GH-242 Export tonearm running with this turntable, with both Benz Glider L2 and Lyra Dorian cartridges.

**SOUND QUALITY**

When I cued up 'Fools Paradise' from Rosie Vela's album 'Zazu' I was greeted with one of the most powerful, energetic and dynamic renditions of this track I have heard from a turntable at the price. Whilst absolute dynamic range does not match the likes of its much bigger brother the Solid One, or the Basis turntables, the Classic Wood immediately commanded attention with a driving bass line which propels the music along. The property was reinforced by its rendition of Laura Branigan's 'Self Control'.

This track's complex structure demands a solid bass performance with good timing, and the Classic Wood quickly had my foot tapping to the music, with room-shaking bass notes using either the slightly topky



**VERDICT** ●●●●  
Smooth and engaging sounding turntable that's well built, easy to set up and use.

**ACOUSTIC SOLID CLASSIC WOOD** £999  
Hi Audio Ltd  
+44 (0)8450 525259  
www.hiaudio.co.uk

**FOR**  
- energetic, driving sound  
- fine timing  
- ease of setup

**AGAINST**  
- midband richness  
- soundstage size

**MEASURED PERFORMANCE**

The Acoustic Solid Classic One offered fine measured performance when up and running, although this takes a little time due to the heavy platter and highly polished drive surfaces of both this item and the motor pulley - the drive cord does slip somewhat initially.

However, once up to speed the Classic Wood performed well, running smoothly and returning a very good IEC weighted wow and flutter figure of 0.068%. Speed stability was also good but it was noted that speed accuracy was rather dependent on how the motor's position affected the tightness of the drive cord. With it loose, the

deck ran slightly slow, speeding up as the motor was moved further out to tension the cord. This is something to watch during setup - make sure the deck is running at the correct speed and then do not move the motor. AS

**WOW AND FLUTTER**

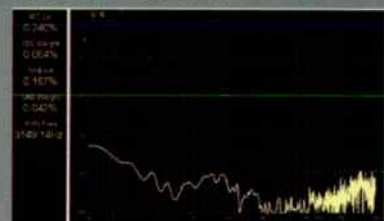



# Genie-us

**Adam Smith is rewarded for his persistent rubbing on Henley Designs' golden lamp with the appearance of a Genie...**

**T**he resurgence in the vinyl market has been very kind to quite a few companies who have stuck with the old format, but I can think of none that have really ridden the crest of the vinyl revival wave like Pro-Ject. Having come a long way since their days as Tesla, Pro-Ject have been manufacturing turntables and precision engineering components for over fifty years from their base in Litovel, near Prague. The company now markets a range of (according to my fingers, and bear in mind I had to use some of them twice...) around twenty different decks, not including those made for other manufacturers like Cambridge Audio and Music Hall.

The main area in which they have really stamped their mark, however, is the budget sector, with the original Debut throwing a curveball into the market as a result of its impressive performance for relatively little money. Regular updates, leading us to the current Debut III have kept it on top of the game, but even decks a little higher up the range like the Xpression models are well designed, fine units that hardly break the bank.

Consequently, with their top model currently being the £1,500 RPM10 you might have expected that any new developments from Litovel might have involved a move further upmarket, but you'd be wrong. Their latest vinyl spinner, the RPM1 Genie, undercuts even their own budget king, the Debut III, coming in at a miserly £125.

The Genie is an absolute masterpiece of economising, and Pro-Ject have very cleverly removed or simplified anything that can usefully be removed or simplified, whilst ensuring that the important bits of the deck remain of good quality. Bias compensation? - not *strictly* necessary, so left out. On/off switch? - a simple in-line switch on the power supply lead, just like your bedside lamp. Lid? - not needed so left out. Plinth? - needs to be just large enough to support the main bearing and arm so that's exactly what Pro-Ject have done. In fact, they have done this so comprehensively that the deck does not actually stand upright on its own until you fit the platter! The more I poked round this little deck, the more impressed I was at just how Pro-Ject have achieved that low price

tag without apparently compromising the quality of the important parts.

What you end up with is a compact unit based around a V-shaped base that supports the main bearing at the front, with the arm at back right and the cutout for the motor on the back left. The motor itself is mounted to another small board that simply sits on the equipment support under the V-shaped plinth, leaving the pulley poking up through the cutout.

Also new for the Genie is the arm, a cute-looking S-shaped design with a headshell that looks remarkably like that from a Technics SL-1200, albeit fixed to the armtube. I think that even the most hardened vinyl enthusiast would have to admit that an S-shaped design does look good, even if there only a handful that really cut the sonic mustard with any conviction - Sumiko's MMT and Alphason's Xenon and the HR-100S that I use being the only ones that spring immediately to mind. The Genie's arm, however, is solidly constructed with no bearing play, and fitted with a damped cueing device. Stylus pressure adjustment involves loosening a grub screw on





the counterweight and moving it fore or aft as required - no calibration is provided so a stylus pressure gauge is required if you change cartridge.

The other beauty of the Genie is that it comes pre-fitted with an Ortofon OM3E cartridge. The tracking force is set for you at the factory and all you need to do is pop on the platter and belt, position the deck and you're ready to go. A decent quality interconnect is supplied but, as the arm has output sockets you can always upgrade this at a later date. One slight problem I did find is that the sturdy interconnect can tend to pull the whole deck around if you're not careful - as it sits on three cone-shaped metal feet there isn't a lot of friction between these and a glass rack, so I added a few blobs of Blu-Tack to keep everything still.

### SOUND QUALITY

So, are all these money saving ideas a step too far? In a word, no, and one of the most surprising aspects of the Genie's performance, for me, was its low end. Although it turned in a very good wow and flutter measurement, [see MEASURED PERFORMANCE] it is still a very basic belt drive turntable and, in my experience, these do not usually plum the very depths of the frequency range with total conviction.

Not so the Genie. Although lacking the sheer solidity and pin-sharp



"a masterpiece of non-essential cost-cutting, it succeeds completely..."







transients of the likes of a Technics SL-1200, it nevertheless comes up with a remarkably solid and impressively deep bass that is actually quite surprising.

Spinning Lloyd Cole and the Commoions 'Forest Fire', the Genie captured the snappiness of the snare drum very well indeed and really punched out the bass drum with gusto, although there was a hint of overhang to the tail end of its notes. The backing bass guitar remained tuneful and well controlled at all times, each note nicely divided from

"the Genie captured the snappiness of the snare drum very well indeed".

the next and setting up the innate pace of the track with pleasing accuracy.

Lloyd's vocals were spot on centre-stage and the Genie set up a very well-defined image within the loudspeakers. The image itself did not stretch back behind the loudspeakers especially far but edged out nicely beyond them and atmospherics were very well rendered. Instruments were crisp and natural and at no time did Pro-Ject's new baby become flustered by any complex material. Classical music held no fears for the Genie and it was well able to pick up on the subtleties of softer moments, whilst following crescendos and climaxes without difficulty.

Ultimately though, a good few hours of disc-flipping proved that it was the likes of a classic piece of eighties nostalgia in the form of the twelve inch single version of The Lotus Eaters' 'First Picture of You' that the Genie really loved. A simple, yet well recorded track, with a solid and pacy low end, it suited the even handed and musical presentation of the Genie to a tee.

Across the top end, the innate nature of the Ortofon cartridge fitted was most dominant. The good old OM range of cartridges has somewhat fallen out of favour with many audiophiles as more modern designs such as the Goldring 1000 and 2000 series, and Ortofon's own 2M models come to the fore, but I personally feel that they are still worthy of merit. The OMs are viewed as dull by many, but I think this is attributable to their smooth nature which can indeed be too laid back in some systems and can tend to lack the spatial extension of other competitors.

However, for a budget deck this smoothness is not necessarily such a bad thing and, as a result, the Genie package has a melliflously flowing treble that is always a very pleasant experience to behold. It doesn't quite have the crispness of the aforementioned more modern designs, but there is no sense of harshness and the Genie's resultant top end really is

supple, sweet and yet detailed.

All in all, the main thought that kept coming back to me as I listened to the Genie was how utterly-confident sounding it is. The deck really does approach every kind of music with infectious enthusiasm and really gets to the nub of what vinyl is about. Musicality is an often over-used term in hi-fi circles but I believe that the Genie embodies it in spades as it just simply transcends its low price to generate a truly impressive result from whatever you care to throw at it.

**CONCLUSION**

Imagine taking a skeletal transcription turntable like an Avid Volvere Sequel or an SME10A, stripping it of all the gubbins that you do not strictly need and then shrinking it in the wash

**TWEAK TIME**

As a born vinyl 'fiddler', the temptation to tweak is never far from my mind, and so I was unable to resist the urge to remove the Ortofon OM3E and fit a £60 Ortofon 2M Red. As expected, the top end gained a notable crispness as the 2M Red's more ebullient nature showed itself over the more considered and laid-back performance of the OM3E.

Additionally the 2M Red had the additional benefit of inflating the soundstage by a decent amount, filling out the plane behind the loudspeakers to increase atmospherics to a notable degree. The deck now took on a more dynamic and forthright nature. This was most interesting, as it proved that, although the OM3E is a fine partner for the deck, the Genie's ostensibly simple arm is more than capable of taking on a cartridge upgrade.

**REFERENCE SYSTEM**

Cambridge Azur 640P phono stage  
Cambridge Azur 340A SE amplifier  
Mordaunt Short Avant 902i loudspeakers

- you're left with the Project RPM1 Genie. As a masterpiece of non-essential cost stripping, and as a plug and play turntable package, it succeeds completely and I feel is more than capable of worrying one or two more expensive decks.

Factor in the consideration that the basic-looking arm is more than capable of coping with a cartridge upgrade and that you can also change the arm interconnect to something more exotic should you choose then, as far as I'm concerned it's time for Pro-Ject to relinquish the Debut's grip on the budget turntable trophy. However, the trophy itself not going anywhere; it will just need the model number that is engraved on it altered a little.

**VERDICT** ●●●●●

A minimalist masterpiece, the Genie has all ingredients necessary to turn in a most impressive performance.

**PRO-JECT RPM1 GENIE £125**

Henley Designs  
+44(0)1235 511166  
www.henleydesigns.co.uk

**FOR**

- musicality
- impressive bass weight
- plug and play ease
- styling

**AGAINST**

- nothing at the price

**MEASURED PERFORMANCE**

The Pro-Ject RPM1 Genie offered up an IEC weighted figure for wow and flutter of 0.07%, which is not only a very good result but actually better than last month's Cambridge TT50 - a Pro-Ject design that comes in at £350. The Genie's motor runs at 12V rather than the 16V of the TT50 (and most other Pro-Ject designs) and is also rigidly coupled to its mounting board, rather than being flexibly mounted and I suspect that both of these aspects help out here.

All in all, the Genie measures very well indeed for such a low-cost product. AS

**WOW AND FLUTTER**



**ARM VIBRATION**

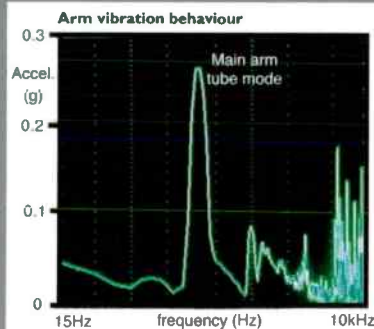

The Genie ran quietly and steadily for hours with no appreciable speed variation, but the 3150Hz test tone was measured as 3140Hz, so our sample was running around 0.3% slow, which should not be noticeable.

Regarding the Genie's arm, the main arm tube mode is at a fairly high level (although not as high as a Rega, for example), the tube looks to be quite well behaved otherwise. Higher up the frequency range the headshell is not too lively, which should bode well for the top end performance.





Tony Bolton puts three of the latest and greatest valve phono stage beauties from Quad, Icon Audio and Eastern Electric against one another...

# Tubular Belles

It was Michell's long-lost ISO that kicked off the phono stage craze back in the late eighties, but in the intervening twenty years the headline news has been the reappearance of the thermionic valve. So popular is the tube becoming, and so suited is it to small-scale applications such as preamplifiers, that it's no surprise to find the little glass bottle appearing in ever more phono stages, like the ones you see before you here...

There are obvious synergies; modern valve circuits aren't noisy, and the tubes themselves are compact, long lived and relatively inexpensive – something you don't find when dealing with big output

valves like the 300B! Best of all is the fact that the cartridge puts out a small signal which – in some people's view - is easily corrupted by the dreaded transistor or, horror of horrors, op-amp. Some are of the opinion that there's nothing like hearing an all-analogue sound without so much as a single transistor in the way! There are problems too however, the main one being the very small gain emanating from the output pins of a moving coil cartridge. As we shall see, however, there are ways of getting around this...

Over the past year, *Hi-Fi World* has got rather fond of the Eastern Electric Minimax Phono – its strong, musical sound providing stiff

opposition for a series of more expensive solid-state designs which we have measured of late. Then, more recently, Quad's Twenty Four P arrived on the scene, instantly winning favour with this magazine's foremost Quaddie, Mr. Keywood. As such, what better two opponents to field against the new Icon Audio PSI.2 phono preamplifier?

## ON THE CATWALK

All three have a very individual appearance. The Quad's looks hark back to the original Quad II/22 series of the nineteen fifties. The front facia contains a power switch, accompanying blue LED and a large volume control knob. The back



sports RCA phono sockets for the input and the variable and fixed outputs, and an IEC socket for the mains. There is also an earth terminal, a button to change from moving magnet to moving coil input, and a three-position rotary switch to adjust gain.

The Minimax is also conventionally styled, having a row of three exposed and one covered valves, and four transformers. The slim front panel has, on the left, a toggle switch for power, along with the inevitable blue LED, and a small knob selecting a muting circuit. The selection of RCA sockets at the back are for the signal output, MM input, and high and low sensitivity MC input. A toggle switch selects cartridge type. The back complement being finished off with the customary earth tag and mains IEC socket.

The Icon Audio PS1.2 takes a different approach. This is a two-box design with an outboard power supply connected to the phono stage via a screened lead with lockable plugs on either end. The phono stage itself is housed in a narrow black metal case, with a porthole at the front displaying the rows of valves inside. Below this are two knobs, one for volume, and the other for MM or MC selection. In between these is a vertical toggle switch for Mono or Stereo. At the back is the mains input socket, RCA input and output, and, above the earth tag, a switch to 'lift' the earth connection (occasionally too many earths in a system can induce a hum. Phono stages, because of the high gain involved, are particularly sensitive to this).

**SOUND QUALITY**

Going in ascending order of price, the £599 Icon Audio PS1.2 was the first to be plugged in. I started off my listening with the St. Germain LP 'Tourist'. The production is good, with nicely defined placement of instruments and some very close-miked flute work by Edouard Labor. The Icon Audio relayed the sounds with great gusto, seemingly revelling in the Dance-influenced rhythms. The breathiness around the flute in the opening riffs of 'So Flute' was nicely portrayed but not overemphasised, as was the synthesised piano that comes in soon after.

Moving onto Tchaikovsky's 'Romeo and Juliet Fantasy Overture', I found the soundstage displaying the classic horseshoe layout of the orchestra. String tone was quite accurate. I was aware of the sound of bows being dragged over a string, without the sound being overly harsh or smooth. At the bottom end of the

frequency range, the tympani in the closing moments rumbled impressively, starting quietly, like the sound of distant thunder, and growing to magnificent, earthquake-like intensity.

Edith Piaf's 1961 concert at the Paris Olympia contains probably her best known track - 'Non, Je Ne Regrette Rien'. Here the PS1.2's imaging abilities were ably demonstrated. Jaques Lesage's orchestra occupied a space just in front of the speakers, with Piaf centre stage and slightly above, surrounded by an inky black background. During her introductions it was possible to hear the echo of her voice reflecting from the back of the stage, and the presentation of the holographic image was further helped by the rustle of her clothing as she moved whilst talking. The 'Little Sparrow's' voice is one of the more difficult ones to reproduce accurately. A little too much top end emphasis and she can sound quite grating. The opposite effect can make her sound too smooth, and lacking in intensity. I felt the PS1.2 struck the right balance here, letting her rawness through but keeping the harshness at bay.

Whilst stereo grooves carry independent information on each sidewall, necessitating vertical stylus movement as well as lateral, a mono recording is cut only laterally. Any vertical movement will be caused by dirt or damage, and comes through the speakers as crackle. Playing a mono record with the vertical compliance of the cartridge negated solves this problem. For some people this is not an issue, but a sizable part of my record collection consists of mono recordings so I tend to appreciate such facilities.

Listening first in stereo, to the (mono) soundtrack to 'High Society', I was aware of the sounds of groove damage (or wear) sitting at the extreme edges of the soundstage. The central musical image was good. There was a good front of back depth and a reasonably big soundstage, occupying about two thirds of the space between the speakers. Switching to mono listening,

the central image didn't really alter but the crackles all but disappeared, only showing themselves between tracks in a centrally placed, but fairly inconspicuous way.

Adding precisely £494.99 to the cost of the Icon Audio will buy you a Quad QC Twenty Four P. I found the sonic presentation to be as far removed from that of the Icon Audio as the styling is. From the first bars of 'Tourist' I was aware of a very different tonal palette. The Quad enjoyed rhythms as much as the Icon Audio, but seemed more focused on the emotions that can drive music. This was very noticeable when listening to Tchaikovsky. Instead of concentrating on the textures and



Rear view of Icon Audio PS1.2.

tonal qualities of the sounds I found myself sitting back and letting this beautifully flowing, slightly lush sound wash over me. The presentation ideally suited the romantic nature of the piece. Strings were smoother and had a slightly more homogenous feel. They didn't have the glossiness of synthetic string sounds and were still very real - the fullness of the presentation made me think of it as the full fat, double cream version. Needless to say, the bass lines of large stringed instruments and tympani were shown off in all their glory.



Rear view of Eastern Electric MiniMax.



Rear view of Quad QC Twenty Four P.

Although the sound was large and full, the imaging was still good with appropriate gaps around performers. Piaf seemed to occupy a slightly greater part of the central image. It was still realistically sized since the soundstage also seemed a little wider, extending perhaps a foot extra either side of the speakers. Her voice had slightly less gravel in it, the roll of the Rs being less obvious, but the richness helped top up the emotional content of her voice and songs. The defiance of "Non, Je Ne Regrette Rien" was more blatant. She genuinely meant every word.

I found myself again lost in appreciation of the details during the Tchaikovsky. The separation and micro-information were such that at one point I actually tried counting the number of violins playing. The trade off for this was a less dramatic rendition. The intensity level seemed lower, switching the concentration from the overall feel of the music, to a study of its constituent parts. Don't misunderstand this as a lack of musicality; that is there, it's just a different way of focusing on the character of the piece.

I felt that some of this may be

due to a slight lightness in the extreme lower registers. The growl of double basses and cellos was a little ethereal compared to the other two phono stages, and the impact of the tympani was definitely reduced. Again, instead of sitting there feeling the power of the drums, I was more focused on the way

the percussionists were causing the sound.

The analytical nature of the Minimax delighted in the complexities of Piaf's voice. Her vibrato, and the unsophistication of her sound were clear, as was the minutiae of her accent. The image was very detailed, but I felt that there was a certain lack of the emotional theatricality which characterises her work.

Moving on to High Society, and I had more awareness of the sound of the groove walls than I did with the Quad. Again, I found

myself listening to the music in a more studious manner than before, appreciating little sonic details that seemed more apparent. Whilst I didn't notice the slight bass lightness as much, I still felt that 'Now You Has Jazz' lacked a touch

of enthusiasm, almost as though Louis Armstrong and his band were minding their manners a little.

Moving over to my other system, I changed to the MM input, fed by a Cartridgeman MusicMaker Mk.III. Of the three, the Quad seemed least happy about this change, losing a little of its *joie de vivre*. This system is based around my Leak Stereo 20, so I also took advantage of the Icon Audio and the Quad's ability to directly drive a power amplifier via the onboard volume controls. The result was impressive, both units produced a bigger and more detailed version of their own take on sounds. The Quad excelled itself at the end of 'Olympia '61' when I found the applause spreading across the room to surround me. For a few moments I found myself in the midst of a crowd of over excited Parisians shouting and stamping their appreciation.

### CONCLUSION

Overall then, there are fairly large differences between the three units, but they all get so much right that the slightest variation from each other's performance is emphasised. I would happily live with any of them. They are all well built, well finished and offer superb performance. I could liken the differences to those between the three box sets of Beethoven symphonies that I own. The Quad is like the Von Karajan recording; somewhat lush in style and very emotional. The Icon Audio is akin to the Toscanini set - impassioned, and energised - whilst the Eastern Electric is more like the Klemperor album: very considered and somewhat cerebral.

If cost is an issue then the Icon Audio PS1.2 offers unbeatable value for money. It sounds good and has very useful facilities. If cost is no object then audition all three, and be prepared to do some serious decision making. Each has its own style, and the final choice will rest on how much you wish to trade emotional involvement for detailed analysis of the sound. Either way, these three tubular belles are a thoroughly modern way to make music - and all the better for it.

### SECOND THOUGHTS

The Globe Ratings here caused - er - 'discussion' in the office. Adam and I agreed the Icon PS1.2 phono stage is superb for the price, but neither of us would rate it categorically above the Minimax. However, even I wavered on this point - and up to now the Minimax has seen off all in my system. The Minimax, like the impressive Edgar CD-1 CD player - uses valve rectification in the power supply (EZ90 full wave rectifier). Both have a light tonality and intense detailing. The PS1.2 sounds 'darker' in its delivery and didn't quite reveal studio reverb so well around Tracey Chapman, but it delivers a beautifully deep feel to the sound stage and wonderfully powerful yet impressively tight bass. On balance - and especially at the price - the PS1.2 would likely have broader appeal I feel. All the same Adam prefers the Minimax for its clarity and detail and I just about agree, so we gave both five globes. NK

There is no provision for switching to mono on the Quad, but with reasonably well preserved records I found this not too much of a problem. There was surface noise present, again at the extreme edges of the soundstage, (incidentally confirming my initial impression of greater width to the image) but again it had a deeper, slightly fuller tone which made it a little less obvious.

At £1,099, the Eastern Electric Minimax is the most expensive of the three here. After the deep pile velvet approach of the Quad, the relative coolness of the Minimax was a surprise. Where the Quad revelled in the passion of sound, this machine seemed to sit back and take a detached, almost hardheaded view of things. I found myself concentrating more on Labor's musical technique, listening to his breathing and the action of the flute's mechanism. The drive of the rhythm seemed marginally reduced, but the attack of a note was more positive.

### REVIEW SYSTEMS:

Clearaudio Master Solution/Carbon Satisfy turntable  
Ortofon Kontrapunkt a MC cartridge  
Leema Acoustics Tucana amplifier  
Chario Ursa Major loudspeakers

Linn LP12 (Origin Live PSU)/Hadcock 242 Cryo turntable  
Cartridgeman MusicMaker Mk.III MM cartridge  
Icon Audio Passive preamplifier  
Leak Stereo 20 power amplifier  
Kelly KT 3 loudspeakers



## MEASURED PERFORMANCE

### ICON AUDIO PS1.2

The Icon Audio PS1.2 is accurately equalised on both MM and MC inputs. Both have a little bass lift below 100Hz, amounting to +0.5dB at 20Hz. It's common for phono stages to have bass roll off as they run out of gain, and because it provides a measure of warp filtering. There's also merit in balancing out the natural low frequency lift pickup cartridges display due to arm/cartridge resonance. The Icon bucks the trend and will have bigger bass, as this sort difference is plainly audible.

The volume control rolls off treble at mid settings, due to stray capacitances acting in conjunction with a high track resistance - a common problem. It was -1dB down at 14kHz, worst case, but as most cartridges are +2dB up or so at this frequency, it will pass unnoticed.

The PS1.2 was very quiet on both MC and MM inputs, had little distortion and wide channel separation. Gain on MM was a usefully high x365, giving around 3V maximum output, whilst gain on MC was x3561, sufficient again to provide 3V or more, so the PS1.2 can drive power amplifiers directly. Overload ceilings were fine.

The PS1.2 is nicely engineered, with not a weakness anywhere. Expect stronger bass and subsonics than usual. NK

### QUAD QC TWENTY FOUR P

The Moving Magnet section of the Quad has three gain options: x184 up to x737, measurement shows, wide enough to accommodate all MM cartridges. An output swing of 19V gives plenty enough volts with the high gain setting to drive power amplifiers directly from the volume control (variable) output. Hiss will be inaudible and there was a negligible hum. Frequency response measured flat from 23Hz up to 35kHz (-1dB) with MM. Our analysis shows output rolls down slowly below 100Hz, due to the presence of a slow warp filter which reduces gain by -10dB at 10Hz. The MC stage has a similar frequency response.

MC gain levels were vast, measuring x1785 (Low) to x7135 (High).

Measurement shows the Quad Twenty Four P can act as a phono stage or preamp. In both roles it measures very well.

### EASTERN ELECTRIC MINIMAX

The Minimax is accurate in its equalisation from 200Hz up to and past 20kHz, within 0.1dB or so. Below 100Hz gain starts to fall. There's more roll off with MC than MM, the former measuring -1dB at 60Hz and -3dB at 22Hz, higher than is common. This isn't always a bad thing, as it suppresses warps. The roll off will audibly lighten bass though.

Gain values were fine at x128 for Moving Magnet cartridges, x627 for High output Moving Coils, and x1797 for Low output ones.

Noise was low. MM cartridges feed the first valve directly. MCs feed a tapped input transformer that in turn feeds the first valve. In use hiss with MC is all but inaudible.

The Minimax phono stage measured well in all respects, but it will have slightly lighter bass than any stage meeting RIAA equalisation requirements down to 20Hz or lower. NK

### ICON AUDIO PS1.2

Frequency response	4Hz - 14kHz (MM) 4Hz - 24kHz (MC)
Separation	76dB
Noise (MM/MC e.i.n.)	0.57mV/0.07mV
Distortion	0.1%
Gain (MM, MC)	x365, x3561
Overload (MM)	60mV in/22V out
(MC)	6.5mV in/22V out

### QUAD QC TWENTY FOUR P

Frequency response	23Hz - 35kHz (MM) 24Hz - 32kHz (MC)
Separation	67dB
Noise (MM/MC e.i.n.)	0.6mV/0.08mV
Distortion	0.025%
Gain (MM)	x184, x366, x737
(MC)	x1785, x3565, 7135
Overload (MM)	110mV/56mV/27mV in/19V out
(MC)	11mV/5.2mV/2.7mV in/19V out

### EASTERN ELECTRIC MINIMAX

Frequency response	60Hz - 30kHz
Separation	66dB
Noise (MM/MC e.i.n.)	0.6/0.06uV
Distortion	0.02%
Gain (MM, MC H/L)	x128, x627, x1797
Overload	26V out

### FREQUENCY RESPONSE

#### Icon Audio PS1.2

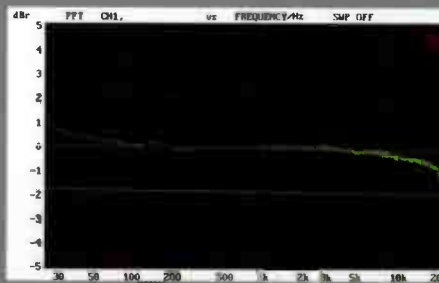

#### Quad QC Twenty Four P

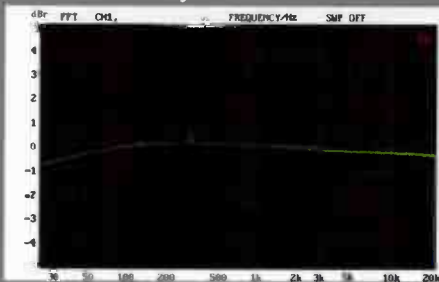

#### Eastern Electric Minimax



### VERDICT ●●●●●

Bargain-priced valve phono stage with excellent build quality and an engagingly uplifting sound.

**ICON AUDIO PS1.2** £599  
Icon Audio  
+44(0)1162 440593  
www.iconaudio.co.uk

### VERDICT ●●●●●

Incisive, accurate and detailed tube phono stage offering fine value for money.

**EE MINIMAX PHONO** £1,099  
Shadow Distribution  
0844 800 0073  
www.shadowdistribution.co.uk

### VERDICT ●●●●●

Powerful and lavish sounding performer with excellent all-round ability.

**QUAD TWENTY FOUR P** £994.99  
IAG  
+44(0)845 4580011  
www.quad-hifi.co.uk

**NORDOST HEIMDALL TONEARM CABLE £250**

Tonearm wires are a subject of much discussion in the analogue audiophile community. For many years, major manufacturers such as Linn and Rega resisted fitting premium priced cables to their tonearms, arguing that they had relatively negligible effect. The result of this stance has been that in 2008 there's a range of companies doing aftermarket rewiring of both the internal arm cable and the arm-to-phono preamplifier cabling. In the case of SME pickup arms, upgrading the cable is far easier than having to remove your arm and sending it off for rewiring, as they use a discrete arm cable connected to the armbase by a small DIN plug. Nordost's Heimdall is such a product that plugs into your tonearm in seconds (providing your turntable is such that you've got an easily accessible arm, that is). It uses four 'dual shielded' silver plated 99.9999% oxygen-free copper conductors, each with Nordost's Mono-Filament technology and Fluorinated Ethylene Propylene

(FEP) insulation, plus dedicated drain wires for grounding. At one end is a high grade SME-type 90 degree mini DIN tonearm connector, and at the other is a choice of Neutrik professional grade RCA or XLR connectors. Prices are £250 per 1.25m terminated with RCA phonos and £280 with XLRs.

The stock cable supplied with SME's Series V tonearm is a high quality product – just as you'd expect – but replacing it with the Nordost interconnect gave a worthwhile improvement. At a stroke it made the SME cable seem a little misty and diffuse. The Series V, especially with fluid damping in use, has quite a dark and silky sound, whereas the Heimdall give it greater incision and low level detailing, whilst casting a slightly brighter light across the soundstage. The results were quite breathtaking with the fitted vdH Frog, the new tonearm cable seemingly opening up the cartridge and bringing it to life. Frequency extremes were marginally improved



too, with more smoothness and air to the treble and a fractionally faster and more dynamic bass. Overall, a fine result, but whether it's worth around £250 depends on your cartridge; with an excellent high end design the answer is an emphatic yes, but those with sub-£1,000 pickups would do better to invest the money on a better one first. [Contact: [www.nordost.com](http://www.nordost.com)] DP

# soundbites

**AUDIOPHILE BASE 01 ISOLATION PLATFORM £129**

One of our most oft-recommended products in *Hi-Fi World's* letters pages is the Audiophile Base subtable, but it's been fourteen years since we first reviewed it, so we decided it was time for a second look. Our 2008 review sample was even better made and finished than before, with a really smart silver paint job. Aesthetics aside, the fundamentals remain the same, with the company's unique, patented suspension system underneath that's designed to dissipate ground and airborne vibrations that can sully the sound of hi-fi separates. Currently available in various sizes and two different finishes to accommodate a

wide range of equipment, our review sample was 360x350mm, making it just right for standard sized components like a Technics SL1200 turntable, for example. Anything bigger, such as a Michell GyroDec, will need the B01 at 430x360mm and £140. All Bases sit 35mm high.

Sitting any turntable on a Base platform is a rather depressing experience – from the turntable manufacturer's point of view. It shows that suspension systems, massive plinths, heavy bases, etc., do not completely remove vibration coming into the deck unaided. The Base filters out a whole extra layer of mechanical noise from the listening



room, letting the turntable perform in a more natural way. Songs flow better, bass is both fuller, tighter and more buoyant. The midband seems clearer and more spacious, with a smoother yet more engaging sound. Even the treble improves, with a more spacious and atmospheric nature. The Base makes quite an improvement to most turntables, then, but remember that results vary depending on how well isolated your deck is in the first place. [Contact: [www.audiophilebase.com](http://www.audiophilebase.com)]. DP



# mail

Visit our website at [www.hi-fiworld.co.uk](http://www.hi-fiworld.co.uk) or send your emails to [letters@hi-fiworld.co.uk](mailto:letters@hi-fiworld.co.uk). Letter of the month wins a pair of Precious Metals Interconnects and one years FREE subscription to Hi-Fi World.



## Letter of the Month

### THE DRUGS DON'T WORK

As a consistent reader of many years standing I have come to the conclusion that direct contact with your advice service is in fact the only solution. My hi-fi has provided me, in various guises during the past few years, with a good deal of pleasure, in both the aural sense and in a strange tartan thermos flask, train spottery, 'I think I'll take my balaclava off now as it's getting very itchy' kind of way!

Reading your letters pages over this time has made me come to the irrefutable fact that I have a serious problem. Using a little sound selection and sample listening techniques, I have found myself with the following system: a Roksan Radius/Roksan Nima turntable setup with Ortofon Rondo Bronze cartridge, a Trichord Dino+1 super-doooper make one's eyes water (how much?) cable, Musical Fidelity A5 amplifier and Acoustic Energy AE1 Mk3 loudspeakers on Partington Dreadnought stands. I also have one or two 'Oh look he's coming this way Hilary, he looks daft enough to buy our turntable de-wobble/anti-skating ointment' treatment!

But after an evening of vinyl recuperation, the sad truth is plain for all to hear. I struggle to admit it through clenched teeth but - brace yourself - I really like my system and can find very little to fault it! There, I've said it!

(This statement is made whilst accepting that it acknowledges that future "tweaking", "fiddling" and general "fanning about" to absolutely NO listening improvement falls within the remit of acceptability by the owner/ listener).

**Brian Oakley**

We're printing this letter, dear readers, to give you an idea of what we have to deal with here at World Towers. Sometimes we receive malevolent mail such as this from bitter, twisted individuals who



**Roksan Radius 5 and Nima arm - at the heart of reader Brian Oakley's 'worries'.**

write in to express nothing but contentment with their hi-fi, music and even life. This sort of nihilism has to be stamped out, as it's tremendously bad for business here in the hi-fi industry, and denotes a reckless attitude that's liable to be the ruination of us all! Readers - if you start having sinister, antisocial feelings such as this, remember to sell your entire system and start again from scratch, buying at random online and only on the recommendation of magazines and internet forums, without any recourse to your own ears whatsoever. That way, we'll all be (un)happy again! **DP**

I must say, Brian, that your letter chilled me to the core and may be one of the first I have ever seen since my arrival at Hi-Fi World Towers that makes me realise that I don't know what advice to give you. Clearly you have fallen into the old trap of choosing your equipment carefully, taking advice where appropriate but with healthy doses of careful listening to the products you are considering, in order to make sure you like them. As a result, I'm afraid that I must be blunt and come right out and say that you really only have yourself to

blame for your current state of total satisfaction with your equipment.

As to where you proceed from here, I'm not quite sure. In order to achieve some true audiophile concern over some aspect of your system, I can only suggest that you perhaps poke one of the AE's tweeters in, maybe run some sandpaper across the stylus or use a few beer mats to make sure that the turntable is nowhere near level. Then write in again and we'll see if we can help you... **AS**

### DIRECT DILEMMA

A friend of mine said, after learning I had sold my entire record collection built up over many years, "if your I.Q. was a point higher, you'd be a plant". This happened six years ago and I am now attempting to buy it all back via car boot sales, eBay and the like. I have bought some great albums in mint condition and some others that are merely okay. The condition does vary and I have found you can't always tell just by looking. As an example, I bought five albums on eBay advertised as "hardly played" and to describe them as rubbish would be to malign the contents of the average dustbin. So, I now have 500 albums of varying quality but the joy I experience in playing vinyl again is

# STOCK CLEARANCE

# SAVE UP TO 35%

Time to pick up a bargain. With savings of at least 25% off the original RRP, these end-of-line\* hi-fi and home cinema separates, speakers and accessories are outstanding value. But hurry, stocks are limited.

## BRISTOL 0117 974 3727

Arcam DIVA AVR280 AV Receiver	£1,199.00
Arcam DIVA AVR350 AV Receiver	£1,549.00
Arcam DIVA DV137 DVD Player	£4,949.00
B&W AS2 Sub Woofer	£349.00
KEF iQ2C Centre Speaker	£149.00
KEF iQ8DS Surround Speakers	£399.00
Linn Classik Musik CD System	£999.00
Linn Ninka Speakers	£1,275.00
Linn Sizmik 10.25 Speaker	£1,259.00
Linn Trikan Centre Speaker	£569.00
Monitor Audio GR20 Speakers	£1,499.00
Sim2 C3X 'Bright' DLP Projector	£9,999.00
Yamaha DSPAX761E AV Amplifier	£499.00
Yamaha DSPAX861SE AV Amplifier	£699.00
Yamaha DVDS1700 DVD Player	£399.00
Yamaha RXV2700 AV Receiver	£1,299.00
Yamaha TX761 DAB Tuner	£399.00

## EALING 020 8579 8777

AVI Labs Series Amplifier	£969.00
Fujitsu P42XHA58 Plasma Display	£1,229.00
Harman Kardon AVR347 AV Receiver	£485.00
Harman Kardon AVR630 AV Receiver	£389.00
Harman Kardon DVD37 DVD Player	£1,559.00
Musical Fidelity KW250S Amplifier	£3,575.00
Primare I21 Amplifier	£485.00
Roksan M Series Amplifier	£485.00
Yamaha RXV759 AV Receiver	£355.00

## EXETER 01392 218895

M&K K5 Surround Speakers	£75.00
M&K KX12 Sub Woofer	£409.00
Marantz CD5001OSE CD Player	£185.00
Marantz PM4001OSE Amplifier	£185.00
Meridian G51 Receiver	£1,299.00
Naim Arrivas Speakers	£875.00
Naim AV2 AV Surround Processor	£1,899.00
Naim NAP175 Amplifier	£1,049.00
Primare CD110 CD Player	£899.00
REL R-305 Sub Woofer	£599.00
REL Stampede Sub Woofer	£405.00
Sim 2 Domino D35 (DLP) Projector	£2,249.00
Sunfire I12 Sub Woofer	£585.00
Yamaha DVDS2700 DVD Player	£749.00

## GLASGOW 0141 332 9655

Arcam DiVA A80 Amplifier	£409.00
Arcam DiVA AV700P AV Processor	£939.00
Arcam DiVA P1000 Power Amplifier	£1,099.00
Audica CS-T1 Speakers	£339.00
Audica CS-C1 Centre Speaker	£89.00
Audica CS-S1 Satellite Speakers	£109.00
Audica ST1 Speaker Stands	£79.00
B&W DM600 (S3) Speakers	£149.00
B&W DM601 (S3) Speakers	£185.00
Bob Carver WBBC D8 Sub Woofer	£419.00
Denon AVR3806 AV Receiver	£649.00
Denon AVR4306 AV Receiver	£969.00
Denon S101 DVD System	£579.00
Denon AVCA11XVA AV Amplifier	£1,799.00
KEF KIT 100 DVD System	£649.00
KEF KIT 100 Stands	£95.00
Marantz SA11-S1 SACD Player	£1,299.00
Marantz PM11-S1 Amplifier	£1,599.00
Monitor Audio i-Deck iPod Dock	£109.00
Monitor Audio GS20 Speakers	£1,125.00
Musical Fidelity X-Ray V8 CD Player	£499.00
Musical Fidelity XT100 Amplifier	£579.00
Primare DVD26 DVD Player	£649.00
Primare SPA21 Amplifier	£1,299.00
Quad 99CDs CD Player	£419.00
Quad 99P Power Amplifier	£349.00
REL Stampede Sub Woofer	£385.00
REL Strata 5 Sub Woofer	£499.00
REL Storm 5 Sub Woofer	£649.00
Wharfedale SW150 Sub Woofer	£159.00
Yamaha RXV459 AV Receiver	£259.00
Yamaha DVDS559 DVD Player	£79.00
Yamaha DSPAX759SE AV Amplifier	£349.00
Yamaha YSTSW1500 Sub Woofer	£449.00

## KINGSTON 020 8547 0717

Arcam AVP700 AV Processor	£939.00
Arcam P1000 Power Amplifier	£1,099.00
Audiolab 8000CD CD Player	£389.00

Audiolab 8000P Power Amplifier	£259.00
Audiolab 8000Q Pre Amplifier	£389.00
Audiolab 8000S Amplifier	£319.00
Cyrus 8 Power Amplifier	£449.00
Cyrus Smart Power Plus Power Amplifier	£449.00
Denon AVR2807 AV Receiver	£519.00
Denon DF-102 CD System	£259.00
Denon DVD1930 DVD Player	£159.00
KEF KHT3005 AV Speaker Package	£649.00
Loewe Concept L32 LCD TV	£779.00
Loewe Individual 32 Selection LCD TV	£1,299.00
Loewe Xelos A26 LCD TV	£649.00
M&K Xenon AV Speaker Package	£1,559.00
Marantz SR4001 AV Receiver	£245.00
Marantz SR7001 AV Receiver	£579.00
Primare CD110 CD Player	£839.00
REL R-205 Sub Woofer	£389.00
REL R-505 Sub Woofer	£649.00
Roksan Kandy KA-1 Amplifier	£419.00
Roksan Kandy KC-1 Pre Amplifier	£419.00
Teac CR-H255 CD System	£179.00
Teac Reference 300 CD System	£339.00

## HOLBORN 020 7837 7540

Arcam FMJ CD36 CD Player	£1,085.00
AVI Pro 9 + Speakers	£675.00
Cyrus CD8x CD Player	£649.00
Denon AVR1907 AV Receiver	£259.00
Denon AVR2807 AV Receiver	£519.00
Denon DVD3930 DVD Player	£715.00
KEF KHT3005 AV Speaker Package	£649.00
KEF iQ5 Speakers	£259.00
Marantz DV9600 DVD Player	£839.00
Marantz SR7001 Universal Remote Control	£649.00
Nevo SL Universal Remote Control	£485.00
Project RPM5 Turntable	£295.00
Q Acoustics 1010 Speakers	£59.00
Q Acoustics 1030 Speakers	£145.00
Yamaha CDRHD1500 CD / HDD Recorder	£389.00
Yamaha RXN6000 AV / DAB Receiver	£449.00

## LEEDS 0113 245 2775

Alphason S520 Speaker Stands	£25.00
Arcam Solo Movie 5.1 DVD System	£1,799.00
Artcoustic 65/50 Surround Speakers	£649.00
Artcoustic Mini Diablo Surround Speakers	£449.00
Atacama Equinox AV Rack Shelf	£245.00
Atacama Equinox Hi-Fi silver base/Shelf	£285.00
Atacama Nexus 10 Speaker Stands	£55.00
Atacama Nexus 5 Speaker Stands	£45.00
Atacama Nexus 6 Speaker Stands	£45.00
Audica CS-C1 Surround Speakers	£105.00
Audica CS-Sub 10 Sub Woofer	£195.00
Audica CS-T1 Speakers	£389.00
B&W AS2 Sub Woofer	£259.00
B&W ASW700 Sub Woofer	£749.00
B&W M1 Speaker Stands	£95.00
B&W VM1 Stands	£75.00
Bose 131 Speakers	£175.00
Bose 151 Outdoor Speakers	£175.00
Bose 161 Speakers	£149.00
Bose 321 Classic DVD System	£749.00
Bose Acoustimass 10 AV Spkr package	£599.00
Bose Acoustimass 15 AV Spkr package	£785.00
Bose AR1 Wireless Audio Receiver	£109.00
Bose Companion 3 Desktop Speakers	£149.00
Bose Floor Stands	£95.00
Bose Lifestyle 28 / III DVD System	£1,499.00
Bose Lifestyle 38 / III DVD System	£2,099.00
Bose Lifestyle 48 / III DVD System	£2,625.00
Bose Room Mate Speaker System	£259.00
Bose Room Mate Speaker System	£209.00
Bose SA2 Amplifier	£179.00
Bose SA3 Amplifier	£225.00
Bose Sound Dock i-Pod Speaker Dock	£175.00
Bose Speaker Stands	£109.00
Cyrus CD8s CD Player	£799.00
Digital Server HDD Music Server	£2,625.00
Cyrus Pre V52 Pre Amplifier	£449.00
Denon AVR3806 AV Receiver	£749.00
Esicent Firewall HDD Recorder	£699.00
KEF iQ1 Speakers	£169.00
KEF iQ5 Speakers	£229.00
KEF iQ6c Centre Speaker	£225.00
KEF iQ7 Speakers	£449.00
KEF KHT2005 AV Speaker Package	£349.00
Kuban KFS400 Equipment Cabinet	£405.00
Marantz DV6001 DVD Player	£219.00

Marantz DV9600 DVD Player	£799.00
Marantz PM4001 Amplifier	£115.00
Marantz SR7001 AV Receiver	£749.00
Marantz SR8001 AV Receiver	£899.00
Monitor Audio Bronze In-Ceiling Speaker	£69.00
Monitor Audio Gold In-Ceiling Speakers	£185.00
Monitor Audio Gold In-Wall Speakers	£225.00
Monitor Audio Radius 270 Speakers	£375.00
Musical Fidelity X-LPS V3 Phono Stage	£199.00
Optimum AV200SL AV Rack	£259.00
Pioneer DVR330H DVD/HDD Recorder	£299.00
Q Acoustic 1000 Sub Woofer	£75.00
Q Acoustics 1000 Centre Speaker	£149.00
Quadraspire Q4 AV Rack Shelf	£255.00
Samsung LE23R86WDX LCD TV	£325.00
Soundstyle ST100 Glass Equipment Rack	£249.00
Soundstyle ST105 Glass Equipment Rack	£275.00
Soundstyle WG3AV Equipment Rack	£285.00
Speaker Craft CRS8/II In-Ceiling Spks	£149.00
Stands Unique Sound Tower	£285.00
Toshiba HDXE1 HD DVD Player	£485.00
Yamaha DSPAX761 AV Amplifier	£299.00
Yamaha RXV461 AV Receiver	£249.00
Yamaha TX761 DAB Tuner	£249.00
Yamaha YSP1100 Sound Projector	£599.00
Yamaha YSP900 Sound Projector	£399.00

## LEICESTER 0116 253 6567

Arcam DiVA AVR300 AV Receiver	£999.00
Arcam DiVA DT81 DAB Tuner	£485.00
Arcam FMJ AV8 AV Amplifier	£2,359.00
Arcam FMJ C30 Pre Amplifier	£1,119.00
Arcam FMJ CD33 CD Player	£1,009.00
Arcam FMJ P1 Power Amplifier	£899.00
Arcam FMJ P35 Power Amplifier	£689.00
Harman Kardon AVR630 AV Receiver	£869.00
Harman Kardon AVR7300 AV Receiver	£1,269.00
Monitor Audio Silver FX Surround Spkr	£259.00
Onkyo DV555 DVD Player	£269.00
Onkyo TXDS989 Tuner	£1,869.00
Pure DRX701ES DAB Tuner	£119.00
Vienna Acoustics Shoneburg Speakers	£969.00
Yamaha DVSL100 DVD Player	£69.00

## NORWICH 01603 767605

Arcam DiVA DV78 DVD Player	£429.00
Arcam DiVA T61 Tuner	£175.00
Arcam Solo Movie 5.1 DVD System	£1,499.00
Atacama Nexus 5 Speaker Stands	£45.00
Atacama SL400 Speaker Stands	£65.00
Audica CS Centre Speaker	£99.00
Audica CS Tower	£389.00
Audica CS-S1 Surround Speaker	£129.00
Audica CS-Sub 10 Sub Woofer	£195.00
Audica MPS1 MP3 Speaker System	£185.00
Audiolab 8000M Monobloc Amplifier	£259.00
Denon AVR1907 AV Receiver	£249.00
KEF 6000 Ace Surround Speakers	£899.00
KEF iQ1 Speakers	£149.00
Lexicon CX7 AV Power Amplifier	£2,275.00
Lexicon MC8 AV Processor	£3,749.00
Lexicon RT10 DVD Player	£1,775.00
Primare A30.2 Power Amplifier	£899.00
Primare Pre 30 Pre Amplifier	£899.00
Rotel RC-03 Pre Amplifier	£199.00
Sound Org Z1 Speaker Stands	£59.00
Spectral PL61 Plasma Stand	£289.00
Spendor C5e Centre Speaker	£419.00
Spendor S8e Speakers	£1,359.00
Van Den Hul The First Interconnect Cable	£129.00
Yamaha MCX1000 MusicCAST Client	£1,349.00
Yamaha RXN6000 AV/DAB Receiver	£449.00
Yamaha YSP1000 Sound Projector	£585.00

## NOTTINGHAM 0115 911 2121

Apollo Concerto LCD-3 AV Stand	£185.00
Apollo Soprano AV Stand	£289.00
Apollo Soprano Hi-Fi Stand	£169.00
Harman Kardon AVR145 AV Receiver	£335.00
Harman Kardon AVR245 AV Receiver	£449.00
Harman Kardon Digital Lounge HS200	£635.00
KEF KHT2005.2 AV Speaker Package	£449.00
KEF KIT100 DVD System	£649.00
Loewe Individual 40 Selection DR+	£1,949.00
Loewe Spheros 32 DR+ LCD TV	£2,249.00
Loewe Viewvision DR+ LCD TV	£395.00

Loewe Xelos A37 LCD TV	£1,349.00
M&K LCR750 / II Surround Speakers	£389.00
M&K Surround 55 Surround Speakers	£519.00
M&K VX860 Sub Woofer	£649.00
Musical Fidelity A5 Amplifier	£999.00
Project Debut III Turntable	£119.00
Quad Lite AV Speaker Package	£599.00
Yamaha DVDS1700 DVD Player	£299.00
Yamaha DVDS2700 DVD Player	£749.00

## PETERBOROUGH 01733 897697

Cyrus CD8x CD Player	£749.00
Fujitsu P42XHA58 Plasma Display	£1,275.00
Harman Kardon AVR745 AV Receiver	£1,275.00
KEF iQ6c Centre Speaker	£195.00
KEF iQ8ds Dipole Surround Speakers	£259.00
Meridian G06 CD Player	£1,269.00
Meridian G08 CD Player	£1,685.00
Meridian G98HD DVD Audio Transport	£2,175.00
Pioneer VSXLX50 AV Amplifier	£559.00
PMC FB1+ Speakers	£1,269.00
PMC GB1 Speakers	£855.00
PMC OB1 Speakers	£2,019.00
PMC TB2+M Centre Speaker	£339.00
Q Acoustics 1000C Centre Speaker	£75.00
Q Acoustics 1000S Sub Woofer	£149.00
Q Acoustics 1020 Speakers	£95.00
Q Acoustics 1030 Speakers	£169.00
Yamaha RXV1700 AV Receiver	£449.00
Yamaha RXV2700 AV Receiver	£649.00

## STAINES 01784 460777

Apollo Mezzo Soprano Hi-Fi Stand	£375.00
Arcam Alto Speakers	£285.00
Audinii AU106 AV Cabinet	£409.00
Blok 400 Hi-Fi Stand	£245.00
Blok 600 AV Stand	£335.00
Denon DV2930 DVD Player	£419.00
Monitor Audio GSLCR Surround Speaker	£319.00
Monitor Audio GS60 Speakers	£1,299.00
Monitor Audio Radius In-Ceiling Speaker	£49.00
Monitor Audio Radius R90 Speakers	£79.00
Monitor Audio RSW12 Sub Woofer	£419.00
Monitor Audio Silver In-Ceiling Speaker	£95.00
Project Xpression 2 Turntable	£185.00
Quadral Argemut 02 Wireless Speakers	£419.00
Quadraspire QAV AV Stand	£359.00
Soundstyle WG3 Hi-Fi Stand	£149.00
Spectral PL60-BG Hi-Fi Stand	£299.00
Yamaha RXV1700 AV Receiver	£649.00
Yamaha RXV2700 AV Receiver	£844.00

## SOUTHAMPTON 023 8033 7770

Arcam DiVA DV135 DVD Player	£669.00
B&W CMC Centre Speaker	£259.00
B&W PV1 Sub Woofer	£709.00
B&W XT4 Speakers	£1,299.00
Cyrus 6 Power Amplifier	£329.00
Denon AVR3808 AV Receiver	£969.00
KEF Model 11 Surround Speakers	£699.00
Marantz CD5001OSE CD Player	£179.00
Marantz PM4001OSE Amplifier	£179.00
Marantz PM7001 Amplifier	£259.00
Marantz SA7001 CD Player	£299.00
Marantz SR4001 AV Receiver	£249.00
Marantz SR6001 AV Receiver	£499.00
Marantz ST15 S1 DAB Tuner	£519.00
Marantz VP11 S1 DLP Projector	£6,499.00
Pioneer BDP-LX70 Blu-Ray Recorder	£649.00
Pioneer DVRLX70 DVD Recorder	£749.00
Q Acoustics 1000 Sub Woofer	£129.00
Samsung PS63P76FDX Plasma	£3,499.00
Teac Ref 300/III CD/DAB System	£399.00
Yamaha DVDS2700 DVD Player	£649.00
Yamaha RXV1700 AV Receiver	£499.00

## YEovil 01935 700078

Cyrus CD6S CD Player	£485.00
Cyrus CD8X CD Player	£749.00
Cyrus CDXT CD Transport	£519.00
Musical Fidelity A5 Amplifier	£975.00
Pioneer VSX1017AV AV Receiver	£409.00
Yamaha MCX2000 MusicCAST Server	£1,169.00
Yamaha MCXA10 MusicCAST Client	£389.00
Yamaha RXN6000 AV Receiver	£389.00
Yamaha RXV2700 AV Receiver	£649.00



hard to describe.

Over the years I have owned many turntables including Dual, Linn Rega etc. This year, intrigued by the debate in your letter pages I bought (nervously) a Technics SL1200 Mk2 and I love it. Okay, it isn't the most revealing and yes an arm upgrade would be a good move but I would not want to lose the wonderful bass and sheer joie de vivre this deck exhibits.

Now the crunch. I bought a Goldring 1042 praised not only in Hi-Fi World but more or less universally. I purchased it from Mantra Audio (who were extremely helpful). They told me, yes it was a great cartridge and then mentioned that the Gyger stylus was very revealing. You can say that again! Albums that had played happily with the Audio Technica AT 120e now revealed all their imperfections, plus that wonderful bass had disappeared.

I want to get the best from the Technics so where do I go from here? I would be reluctant to attempt an arm conversion myself and at the moment could not afford it. I have £100 to spend. Help!

**Doug Hardman.**

Hi Doug - you were right to have upgraded from the Audio Technica AT120e, which is a good basic design but not worthy of your turntable. I'd suggest the increased resolution of the new Goldring is throwing up a few set-up issues. Check you've got it aligned perfectly and tracking towards the upper limit of its range. Try to site the turntable on a Base platform, or if you can't afford it then invest in four FoculPods to go under the Technics' feet. This done, look to changing the platter mat for a Sound Dead Steel Isoplatmat, which works a treat on the SL1200 and brings a smoother, firmer sound. Finally, invest in a set of SME's silver cartridge mounting wires (part number 5899MCS), as fitted to the SME Series V no less, for your Technics headshell - you have already removed its rubber grommet, I trust? This done, you'll have a far more balanced, smooth and three dimensional sounding deck - the joy of the Technics is that it's massively tweakable! **DP**

I am quite surprised that you have suffered such a loss in bass from the 1042 upgrade, as it's not exactly a 'lightweight' cartridge and I suspect that part of the phenomenon may well be that it's getting a better grip on the low end than the old AT120e did. This will certainly be the reason why you are getting more information out of your vinyl, whether you like it or not - the old AT is a decent enough performer

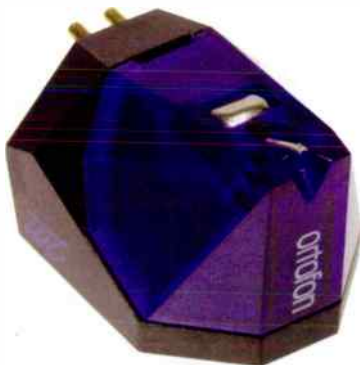

**Ortofon 2M Blue cartridge - will add a bit of dynamism to a Technics SL-1200.**

but is definitely outclassed by the Goldring.

Do also check that the Vertical Tracking Angle (VTA) of the arm has not been altered by the new cartridge if it is a different height to the old one. The arm tube should be parallel with the record when the stylus is in the groove, and this is very easy to adjust on the SL1200 - simply undo the locking knob at the rear of the arm base and twist the adjustment collar in the appropriate direction, before locking the knob again. If you're really careful this can be done with a record playing to set the VTA by ear, but I'd play safe and set it with a stationary platter, and aim for a horizontal arm tube.

However, if all this checks out and you'd still like a bit more punch down the bottom end and have £100 to spend, then I'd personally recommend the Ortofon 2M Blue, which trades a little of the 1042's top end sophistication for a bit more enthusiasm and liveliness. **AS**

**RECORD PURCHASE**

*I am looking at spending around £4,000 on a new turntable, this includes for around £750 I would expect to raise for my current one. My current front end is a Michell GyroDec (Bronze one) with QC power supply, Michell TecnoArm A and a fairly new Dynavector DV-20xH. The rest of my system is an Audio Research SP8 feeding a pair of Audion Silver Night 300B monoblocks that output into a pair of Quad ESLs on Quadrapod stands.*

The obvious one would be an Orbe SE with an SME V arm (the arm being a long term lust for item) keeping my cartridge until funds and a decent step-up transformer permit an upgrade. Alternatively I could keep the arm I have and spend the lot on a turntable. Whatever route I go it will be years before I would consider another front end change. Which way would you suggest for the long term and if it is the latter what turntable would you suggest?

**Kevin Holland**

Well, Kevin, I envy your position and you do indeed have a good choice of models open to you. As you say, the most obvious contender is indeed the Orbe, with the SME V being a perfect partner for it. As I have lusted after a V probably as long as you have, you'll hear no argument from me over the choice of this item and, good though the TecnoArm is, the SME's performance is simply in a different league as far as I am concerned. The Dynavector should work well in the SME until you have further funds for an upgrade and the whole combo should be very impressive.

However, there are some alternatives worth considering. First up is the Basis 2100 Signature, another fine and impressive deck from the U.S., although its £3,100 cost would rule out the SME - the TecnoArm should work fine with it, however. Another contender that I have enjoyed listening to on more than one occasion is the Acoustic Solid Solid Machine, which at £2,500 would still (just!) allow for the Series V. If you're tired of all this 'space age' styling, then the Roksan Xerxes 20 looks more conventional and is a very capable unit for around £2,500, although I generally find it works best with the £1,800-ish Roksan Artemiz tonearm rather than those by any other manufacturer. Finally, I wouldn't be true to my inner turntable anorak if I didn't at least point out to you that deducting the cost of the SME V from £4,000 leaves around £2,200 and that will buy you a heck of a lot of immaculately restored Garrard 301 and serious slate plinthery in



**SME V arm - both Adam and reader Kevin Holland lust after one.**

which to install it - just a thought!

I hope this has given you some items to ponder on, but if you'd like a firm decision, I'll lay my cards on the table and say that, if it was me in your fortunate position, I'd scrimp/save/steal the extra £500 or so and go straight for an SME 10A turntable with the Series V. This deck left a lasting impression on me when it came in for review last summer, and I can quite honestly say is one of only two turntables I have heard so far that would ever make me consider selling my 301, should a suitable windfall come my way (the other, interestingly, being the Orbe!). **AS**

As a long term Michell GyroDec and Orbe user, as well as a TecnoArm and SMEV user too, I can happily report that going from a Gyro/TecnoArm to Orbe/SMEV is dramatic - and you'd have a great time in the first few weeks after the purchase, discovering a whole new record collection. The Orbe is a sizeable upgrade from the Gyro - it brings real stability and depth to the Gyro's superbly expansive sound. It also tightens up the bass, and offers a smoother yet more sonorous treble, with obviously better rendition of instrumental harmonics, for example.

Going from an Orbe with TecnoArm to Orbe with SMEV is more of a mixed bag. Personally I didn't like it in the end, although in some respects it amazed me. The SMEV brings massive bass grip and articulation, a far more dynamic sound and delicious clarity even on complex musical passages, but it's a tad too 'hi-fi' sounding for my tastes on the Michell platform - ultimately I swapped the SMEV for an Origin Live Illustrious which had a considerably more 'free flowing' musicality. It was slightly less grippy and a little looser in the bass, but musically far more exuberant and uplifting, and it just seemed to boogie on the Orbe whereas the SME didn't, no matter how I set it up and what cartridge I put in it.

This isn't a criticism of the SME V which, as we all know, is a piece of art as well as a brilliant tonearm; it's just that sometimes a Picasso doesn't look right in the same room as a da Vinci! One platform which the SME V adores is Avid - which brings me to my next point. For the very best sonics, you should throw as much of your money at the turntable as humanly possible; and here the Avid Volvere Sequel is just the job. At £4,600 it's a bit over budget, but would make sweet music with your TecnoArm until such time as you could afford your SME. It confers a



**Turbosound TSW-124 subwoofer. Not exactly 'front room' material!**

similar order of improvement over the Michell Orbe that the Orbe brings over the Gyro - namely substantially better bass solidity and punch, a cleaner, more transparent and better dimensioned sound and soaring, crystalline treble.

Now that we've knocked you off your feet with all these suggestions, it's down to you to do some legwork and go out and listen for yourself. Ultimately only you know which you like best. **DP**

#### **NIGHT FEVER!**

*You probably don't get asked this question too often nowadays, but in your opinion what are the best loudspeakers for Disco and Latin music? I'm looking at either new or second-hand items, but nothing bigger than a Tannoy Westminster! My amplification is two Rotel RB1080s and my budget is up to £1,500. Previous loudspeakers I've used are TDL RTL3, Naim Intro, Linn Isobariks, Mirage M1, Klipsch Heresy and I'm currently using Turbosound THL-2s with TSW-124 subwoofers (24" horn loaded subwoofers don't really work well in my living room though!) Any suggestion would be most welcome...*

**Jonathan Smith**

Hmm, P.A. subwoofers and monitors in your living room? I assume you are either unmarried or have an even more understanding wife than I do! However, all is not lost as there are a few loudspeakers out there that will fit the bill. First up, I'd counsel the £1,055 RRR FS100s, which are big beasts with plenty of good quality, solid bass (that might be a shock after the Turbosounds). At this point I would also normally mention that they are a bit of a tricky load to drive, but your Rotels will barely break into a sweat with the RRRs on the end, so no worries on that score. If you need more headbanging ability (but most likely a bit less quality) then there is, of course Cerwin Vega. Of their domestic range, the VE-15F

has a fifteen inch bass driver and should cost around £500 per pair but if that's not enough, then the CLS-215s have two fifteen inchers per loudspeaker for £1,100.

Second-hand you have plenty of choice as well. If you liked the TDLs you had, then some of their bigger models like the Monitors or the Reference Standard Transmission Lines (if you can find a pair) will go as loud and deep as you could ever need. This also applies to some of the big IMFs, such as the Professional Monitor and Reference Standard Professional Monitor (RSPM). However, personally I would see if you can track down a pair of Leak 2075s or 3090s. These were both about the size of a small fridge/freezer and featured a fifteen inch bass driver in a transmission line, a six inch lower midrange driver, four inch upper mid and a one inch tweeter. The 3090 basically superseded the 2075 and the main difference between the two was that the 3090 used the Rank group's Isodynamic tweeter, rather than



**RRR FS100 - ideal for disco music.**



the rather edgy Mylar dome that the 2075s sported. I used to own a pair of 2075s and still bitterly regret selling them - I loved them to bits despite their rather uneven top end (which can be managed by appropriate partnering equipment) and Noel tells me that the 3090s were a big improvement. Once again, they are quite rare but £500 or so should secure you a good pair. **AS**

Yes, I owned 2075s then 3090s, at a time when they were unfashionable. Both were great fun and the 3090 was in some areas impressive by any standard. The upper midrange unit in particular was a superb design, as was the smooth sounding Isodynamic treble unit. They are rare birds now, however, and the RRR FS100s are a good, realistic and robust modern alternative. **NK**

### NAKED AMBITION

David, a year or so back you invited comment re Yamaha NS1000s. At that stage I had taken the drivers out of mine and unbundled all the internal wires (beneficially), but I thought "there won't be anything David Price's not up with"...

However yesterday I erred and changed my mind. My 1000s were bought 100% functional but with damaged grilles, and a mid grill was only partly attached around its circumference so I took it off to 'panelbeat' indents out of it (thumbs and a dentist's pick worked). While cleaning the dust from around the driver I thought 'hmm, only three screws and the tri-arm cover over the dome is off', so I briefly ran one channel with the dome nude.

Man, those Berylliums are even better than I thought! I only had time to use one track (Bonnie Raitt on Chieftains' 'Tears of Stone') as I discovered kids were coming with their parents for Christmas drinks. However, it was quickly clear to me that nude was beneficial - there was a wiry hardness gone, giving a greater purity and more sense of air and breathiness (not huskiness).

Additionally, an engineer friend had softly been encouraging me to build a larger box, based on his own experiments (he has built his own speakers purely for engineering fun). So I finally said the easiest way to test that is to undo the connector blocks (originals) and relieve some back pressure - four screws and the sound was better. And so we did what he really wanted me to do - pull the crossover out a bit - presently it's sitting loosely on two screws on its 'bottom' and pulled out 15mm at the top. This gave a lot more freedom to the sound. His thought is to take this further by using longer screws and 'standing'



**Yamaha NS1000M - best to leave the beryllium drivers' protective grilles in place!**

the crossover with spacers off the back somewhat. (I haven't digested any negative affects yet).

I have also had common poled the wires (avoiding crossover traces) where possible on the crossover board. This is hot off the press so haven't figured how to strengthen the mid grilles and run without their protective metal 'caps' yet. I hope you might find something of interest here David, and apologies if this is ten years ago for you!

**John Dolan**

Thanks John - but I'd recommend you refit your drive unit grilles immediately. The reason Yamaha fitted them is that Beryllium is a hazardous substance, rather like asbestos, when broken. It's perfectly safe when complete and formed, but when cracked it can emit dust which can produce an emphysema-like condition if someone is repeatedly exposed to it. Those grilles are there to stop little fingers hitting the Beryllium domes, possibly causing breakage and release of toxic substances. Before you get too paranoid, NS1000s are perfectly safe when untampered with, it's simply when those special metal domes are broken that they may become unstable.

As for unsealing the cabinets,

I think I'd beg to differ. They may sound superficially better - bigger and warmer - in your system, but I'm sure the frequency response will no longer be near ruler-flat, and the bass timing will be affected too. Let's not forget that the some of the best brains in Japan came together to make the NS1000s (the Beryllium drivers were, I am told, originally a government sponsored research project), and tinkering is likely to yield different - not better - results! Personally, I'm of the opinion that the best way to upgrade NS1000Ms is to drive them properly (still looking for that perfect amplifier, but the Sugden IA-4 Masterclass wasn't that far off) and site them properly, on the right stands in the right part of the room. **DP**

### SOURCE MATERIAL

I have a Naim Nait 3 integrated amplifier, KEF Q15 Mk1 loudspeakers on Atacama Nexus 6 stands and an Arcam Diva 61 tuner connected via Chord interconnects. I also use Chord Carnival loudspeaker cables. I would like to add a turntable and CD player to this system and was thinking along the lines of the Shanling CD-T80 and the Rega P3-24, and your comments would be very welcome. I would also like to upgrade the speakers as I feel that the



**Usher's S520 loudspeakers - a Hi-Fi world favourite and a good upgrade over KEF Q15s.**

KEFs are letting the side down a bit, and have a budget of around £1,500 for all three items.

Steven Jenkins

The Rega P3-24 is a fine choice that will take around a third of your budget, if you also allow £100 or so for a cartridge. Here I would personally suggest the Ortofon 2M Red (£100) or the £110 Goldring 1012GX, both of which will work very well with the Rega. The Shanling is a fine CD player but can be rather forward so it would be worth checking that you do not find this aurally disconcerting before purchasing. If you'd prefer something a little more smooth and sophisticated, do check out the Consonance CD120 Linear, which is a very fine player and is only £50 or so more than the Shanling, at £695.

This then leaves you with around £400 for loudspeakers and straightaway I would recommend the Usher S-520s at £320. These will work nicely on your Nexus 6 stands, and do sand fill these if you haven't done so already. If you'd prefer floorstanders, then the £350 Mordaunt Short Avant 916i should perform very decently in your system, as will the ALR Jordan Entry Ls at £500, if you can stretch the budget a little further. **AS**

**CD DEBATE**

Regarding the letter from Mr. B in the January 2008 issue of Hi-Fi World, I don't agree that you are disinterested or biased against CD players. I do, however, believe there is an underlying assumption in your view of CD. This is often expressed explicitly, that you get a better sound per pound with vinyl than CD and it is this that I believe is open



**Origin Live Resolution turntable - more than capable of showing CD a thing or two.**

to question. As you rightly point out, it is ironic, that now vinyl is an "obsolete" or "niche" medium, the best ever equipment is now available. Better in all respects than the kit available in vinyl's heyday in the 1970s. Well I would argue the same about CD replay. Arguably, it is even more obsolete than vinyl, as it is rapidly being strangled by MP3 and downloads, with no audiophile credibility to hide behind.

I would claim that, just as vinyl is experiencing an Indian Summer, so is CD. If you pay a reasonable price for a good CD only player, you get comparable performance at a similar or lesser price. When you factor in the need for turntable, arm, cartridge and phono stage, good vinyl reproduction is not cheap at all. In my own case I use both, with vinyl replay being via an Origin Live Resolution/Illustrious/ ZYX Airy3 cartridge/K&K hybrid phonostage. I didn't pay retail price for this set up, some was second-hand, ex dem etc. However, it still cost about £4,800 and would have been a great deal more at full retail. Now I set it up as well, I am sure it could be done better, but I have been setting up decks for years

and where do you find a real expert at turntable fettle these days?

My CD set up is a Resolution Audio Opus 21, modified at Great Northern Sound in the U.S. I also bought this second-hand in the U.S. and had it modded there, but at full retail price in the UK, it would be about £3,600. I would honestly say it is hard to say which is best, they are just different.

There are a group of high quality, analogue sounding CD players that I would say approach or equal good vinyl reproduction at a lesser price. I would include the Resolution Opus, the Leema Antila, and the ARC 3 Mark 2. The very best CD I have heard, was at a show, with the ARC Ref 7. Now that is very costly at £8,000, but I don't think I have heard better from vinyl, although maybe I haven't listened to enough vinyl systems.

David Wise

Hi David - a most interesting letter, if I may say? Funnily enough, the point you make here has been looming in the back of my mind for a few months now. I've reviewed about fifteen sub-£1,500 CD players this

**Billy Vee**  
SOUND SYSTEMS

248 Lee High Rd, London SE13 5PL (Mon - Sat 10am to 6.30pm Closed Thurs & Sun)

**Display Stock - Rampant Reductions!**  
Call (020) 8318 5755 or 8852 1321. Now!

Web: - www.billyvee.co.uk email: sales@billyvee.co.uk We deliver nationwide from £8. E&OE.

<b>More Ex-Display &amp; Pre-owned bargains can be found at www.billyvee.co.uk</b>		
Arcam Solo Music System <i>E/D</i> (2Yr G/tee) .....	(1000.00)	£699.00
Arcam P1000 Power Amplifier <i>NEW</i> (2Yr G/tee) .....	(1600.00)	£1195.00
Audiolab 8000CD CD Player <i>E/D</i> (2Yr G/tee) .....	(599.00)	£409.00
Audiolab 8000S Amplifier <i>E/D</i> (2Yr G/tee) .....	(499.00)	£369.00
Epos M22 Speakers L/Cherry <i>E/D</i> (2Yr G/tee) .....	(949.00)	£695.00
Linn Exotik D+A Digital Preamp - Sil <i>E/D</i> (2Yr G/tee) ..	(3250.00)	£2195.00
Linn C2200 2x200w Power Amp-Sil <i>E/D</i> (2Yr G/tee) ..	(2530.00)	£1495.00
Linn Majik 2100 2x100w Power Amp <i>E/D</i> (2Yr G/tee) ..	(1400.00)	£975.00
Quad 99 Preamplifier - Grey <i>E/D</i> (2Yr G/tee) .....	(749.00)	£499.00
Quad 909 Power Amplifier - Grey <i>E/D</i> (2Yr G/tee) .....	(899.00)	£695.00





**All items listed below with full two year warranty**

Naim CD5i CD Player <i>E/D</i> .....	(Was 850.00)	Now - £635.00
Naim NAP 150x Power Amp <i>E/D</i> .....	(Was 850.00)	Now - £675.00
Naim NAC 282 Preamplifier <i>E/D</i> .....	(Was 3225.00)	Now - £2475.00
Naim NAC 252 Preamplifier <i>E/D</i> .....	(Was 4620.00)	Now - £3595.00
Naim NAP 250 Power Amp <i>E/D</i> .....	(Was 2575.00)	Now - £1975.00
Naim Headline Headphone amp <i>E/D</i> ..	(Was 314.00)	Now - £219.00
Naim N-Sat Speakers/Pair - Maple <i>E/D</i> ..	(Was 750.00)	Now - £495.00
Naim N-Sub Sub Woofer - Maple <i>E/D</i> ..	(Was 1525.00)	Now - £1075.00





**Audio Research Reference CD7 - the best CD spinner reader David Wise has heard.**

winter, and although not all of them were serious, I can think of at least three or four that I really rate - the Astin Trew AT3500, Rega Saturn, Edgar CD-1 and Raysonic CD-128. I don't think you could have got sound like this at the price a couple of years back, proving your point entirely.

Now, whether they're as good as a vinyl front I think is more debatable. I think a Michell GyroDec SE/Origin Live OLI/Ortofon Rondo Red turntable would better these by a considerable margin in many respects (but then I suppose you have to factor in the cost of a phonostage too, if you haven't already got one). Still, CD is really getting good at some price points now - and it's taken the latest generation of upsampling/tube toting machines to do it. **DP**

### SPINN CYCLE

*Hello, I have been following your ongoing turntable series for some time now - I have been subscribing for many a year. In September I decided to try a second turntable for fun and variety (Adam will understand, even if the wife thinks I have lost a marble or two). Over about four months, I got my hands on the various bits and pieces necessary to create a second complete vinyl source - JBE slate series 3 (direct drive), Bastin Armony adaptor plate, SRM Tech acrylic platter mat, Michell TecnoArm a, Grado Reference Sonata and, since I had a spare Hi-Cap, a Naim Stageline N. I came across a lot of friendly, interesting, helpful people along the way - vinyl seems to attract more colourful enthusiasts and fewer dogmatic egomaniacs than CD! [ooh - steady on! Ed.]*

*Now for the problem... The JBE works so well that it really highlights the weak spots of my Lingo+Cirkus LP12/Ittok/Troika/Linto - vague imaging with poor depth and loose bass. Given that my local Linn dealer checked the LP12 and Troika out when he called to install the Grado (great service) and that, even including the price of a 2nd hand Hi-Cap, the JBE cost me a little less than a Keel, what could I do to the Sondex*

*for £750 or less? Wall shelf instead of the Quadraspire rack (floor and wall are both reinforced concrete)? Send the Ittok for an internal rewire? New arm? I am not looking for the same sound as the JBE but the LP12 does sound too loose in comparison.*

*As for future upgrades, when I carry out my 'threat' to buy a third turntable, what would you suggest one that does not need retuning every other weekend? Nigel Briggs*

Well Nigel, I have to say that the symptoms you describe from your LP12 do really shout "Keel!" at me but as you, and quite a few others, say, it ain't cheap. For your budget of £750, I would personally get in touch with the Funk Firm and have a look at their upgrades that they offer to the LP12. For £939 you can buy the Clarity top plate mod together with a K-Drive motor system and these make an impressively noticeable difference to the performance of a standard Valhalla LP12. The only downside is that you will have to fit them yourself unless you spend a little extra, but they are not too difficult to do and very well worth the effort. If you're still not sure about spending this much money, then give a Heed Audio Orbit power supply a go for £250. This works wonders on the LP12's bass and imagery, although has less of an effect at the top end than the Funk Firm kit.

As to a third deck that requires less fettling than your LP12, it seems to me that you need to stick to something that isn't suspended and, if you like the direct drive JBE's depth and pace, then idler drive or direct drive would seem sensible. In the idler camp, a Garrard 301 or 401, or a Goldring G88/G99 may require some initial restoration and technical work, but will then spin happily for years with the minimum of attention. However, if you still want that plug and play handiness, then stick with direct drive.

Depending on your budget, why not have a play with a Technics SL-1200Mk2 (available new for around £340) or, if your budget can stretch to it, an older SP10, SP15 or SP25 motor unit? These will require a plinth and arm to be fitted, or there are the cheaper SL-150 and SL-110 models that are self contained in plinths but still leave you the option to choose your own arm.

By the way, you really should warn your wife - vinyl is horribly addictive and, if she thinks two turntables are bad, wait until the collection starts to approach thirty. Perhaps I should put her in touch with my wife and they can form a "Vinyl Widows" support group? **AS**

I'd just like to point out that, on hearing the news that Adam's collection has increased by half as much again since I last spoke to him about it, I am getting seriously worried. Was it John Major who once said, "I can hear the rustle of the men in white coats coming...?"

**DP**



**Funk Firm's Clarity Top Plate and K-Drive motor modification. Well worth checking out if you can't afford a Keel.**

### THE CABLE TRAIL

*I have been reading your magazine for several months which has enabled me to update my hi-fi system and I now wish to replace the turntable with probably a Clearaudio Emotion connected to a Cyrus 8VS2 amp.*

*The existing turntable is sited some 11 metres from the amp and I have conflicting views as to practicality, sound quality and cost. One suggestion is that I would need to spend circa £750 on interconnect cables from the phono amp or compromise and put the turntable between the speakers. The alternative is that £60 cables would do the job without a noticeable reduction*

GENETIC EVOLUTION

79 SERIES

Mission loudspeakers have always been afforded the highest respect, both in critical listening tests and for their iconic style.

The new 79 series embraces this tradition with aplomb, elevating the performance and design standards to new heights – a symbiosis of form and function building on over 30 years at the forefront of acoustic design.



MISSION

IAG House Sovereign Court  
Ermine Business Park Huntingdon  
Cambridgeshire PE29 6XU

T 01480 447700  
F 01480 431767  
[www.mission.co.uk](http://www.mission.co.uk)





in sound quality. Any help would be most appreciated as whilst I enjoy the quality of music I do not fully understand electronics.

**D R Flanagan**

One thing I can assure you is that 11 metres of cable between your phono stage and amplifier is a bad idea. Over this length you will suffer from signal degradation and most likely pickup of hum and other unwanted noises, so this is a setup that is definitely best avoided. If you are going to run cables this long then you really need to look at balanced items, but this means running both a balanced output phono stage and amplifier with balanced inputs. I'm afraid that your best bet is to move the turntable closer to the amplifier - it should be fine in between the loudspeakers as long as they are a foot or so away from it as a minimum. **AS**

### PREMIERE CHOICE

It was with surprise and delight that I read your group turntable review in the January 2008 issue. It was refreshing to see reviews of products from different manufacturers than the usual ones. I have had a Scheu Premier for about four years now.

About 2004 I decided to pension off my ageing Source TT after seventeen years of sterling service. I did a lot of research over the internet about a new TT and narrowed it down to the usual suspects - Michell GyroDec SE, Nottingham Analogue Spacedeck, Origin Live Aurora; but two names kept cropping up - Teres from USA ([www.teresaudio.com](http://www.teresaudio.com)) and Scheu from Germany ([www.scheu-analogue.com/en/index.htm#](http://www.scheu-analogue.com/en/index.htm#)).

Both were very similar - all acrylic, high mass, non-suspended, external motor with thread drive. Teres have subsequently moved away from acrylic to wood. But the telling point for me was they were both, to some extent, DIY. Both websites have lots of pictures of their respective TTs and Teres has a gallery of satisfied customers - real eye candy. They were both internet-only businesses then, although Scheu did have distributors in USA, Malaysia and Scandinavia.

To cut a long story short, I finally decided on the Scheu Premier, the Absolute Sound review and Golden Ear award and the fact that the Teres involved a large amount of polishing acrylic swung it. I was originally going to use an Origin Live 250 Silver arm to partner the Scheu but after several e-mails and some telephone calls, I was persuaded to buy their Cantus tonearm. This is also made from acrylic and is an undamped unipivot with no bias but again is real eye candy. I had

obvious misgivings but Scheu were very persuasive, I decided to jump in with both feet. I ordered the TT with 9" arm board, the 9" Cantus arm (both are available as 12" as well as armboards for two arms), heavy record weight and strobe disc and light.

The Diamond looks to share the same platter and motor and, I suspect, bearing as the Premier, but different chassis. Adam's review bears out my findings - the deep bass, the stable imaging and also the superb speed stability of the Scheu. You get used to replacing the thread "belt" and become adept at tying the knot. At the time, the Teres website also gave instructions on tying a more complex knot that looked like a sheepshank on steroids but I could never get the hang of it.

I have subsequently purchased a Michell TecnoArm as I couldn't get my Ortofon Kontrapunkt b to work properly but the Cantus still works very well with a Denon DL103. I intend to get a base with two armboards so that I can use both arms.

The rest of my system includes Teac TI CD transport, MF XDac, Headphone amp and Power Supply; WAD KLPP1; Leak Troughline 3; Nakamichi 582; EAR 859 monoblocks (homebuilt from the plans published in Hi-Fi News) and Wilmslow Fostex Labyrinth back loaded horns. A weird collection but a very immediate and live sound. I'm a recent convert to the low power/high efficiency, valves and horns camp.

The next project is to build new cabinets for the Fostex drive units, probably one of the Double Horns from the Spawn family on the Frugal Horn Project website ([www.frugal-horn.com/index.html](http://www.frugal-horn.com/index.html)). Bigger is better! These would be a great project for your DIY feature - something decidedly different.

**John Murray**

Scheu Analog were a new name to me until speaking to Dave Barker from Sounds4Enjoyment, and him telling me that he was one of their three UK dealers. It was Dave who supplied the Black Diamond for review and I was very impressed indeed by it, both in terms of build quality and performance. Although a relatively unknown name this side of the Channel, I feel sure that this situation will not last.

Incidentally, I also spotted the rather striking Cantus arm and have already made enquiries about grabbing one for review - watch this space! **AS**

### CHANGING ROOMS

I am about to build a new house with a music room, which will be furnished with my hi-fi, a piano and a settee. My equipment consists of a Shanling



**Scheu Analog's Premier turntable - a superb performer and a name that is gradually becoming more well known in the UK.**

CD-A10T (which I bought on a Dutch auction on eBay). My amplifier is a Duevel Shuttle supplying Duevel Venus loudspeakers bought from my local dealer. The interconnects and speaker leads are of various shapes and types of nondescript names. I changed the leads to modify the sound along with the valves in the CD player (wife calls it playing again). At present the speakers have to fill a total of 80 square metres, which is no easy task. However we love the units as the omnis fill the room with sound, and allow anybody to enjoy the music.

The new room will be approximately 25 square metres. My problem, and I look forward to your advice on the subject, is that I might need to put the speakers either side of a 3 metre wide glass door with a plaster wall for reflections. If this turns out to be necessary, what type of cable do I use to go either via the walls which would mean a run of 11 metres for one speaker to get past the door, or under the carpet? My intention is not to do either of these, but it is a possibility and would be very difficult after construction is complete. I have also considered running separate power amps at the speakers and running the interconnects via the walls.

Any advice is greatly appreciated. I look forward to your magazine each month, but it appears to arrive at my book seller via the slow boat to China.

**Andy Lee**  
**New Zealand**

The best solution to this not uncommon problem is to lay an accessible cable duct across the door, one side to the other. You could use plastic water pipe within concrete, or bore holes through joists, as I have done in a suspended wooden floor. On top are short floorboards secured with screws, so they can be easily lifted. The cables can exit the floor space through notches or holes cut in the boards, or via 4mm loudspeaker screw terminals, or sockets, in the skirting board or in wall boxes of the sort used by mains outlets. **NK**

# BIGEARSAUDIO

Quality used vintage & modern equipment bought, sold part-exchange, leased, repaired, audio cables & accessories - biggest selection online and in person. [www.bigearsaudio.com](http://www.bigearsaudio.com)

Free Next-Working-Day Delivery to the South East of England. WE ACCEPT PAYPAL, VISA, MASTERCARD & ALL CREDIT CARDS!



## VALVE AMPS.

HEART RHYTHM 300B SET VALVE AMPLIFIER  
AFFORDABLE VALVE COMPANY MODIFIED  
VR-70E VALVE AMPLIFIER  
AUDIO INNOVATIONS SERIES 500 INT. MINT, BOXED.  
AUDION VALVE PHONO STAGE  
AUDIBLE ILLUSIONS MODULUS 3 VALVE PRE. PHONO. (2500)  
CROFT VITA MINT.  
AUDIO RESEARCH LS2 PRE. MINT.  
AUDIOION 300B INT. MINT, BOXED.  
AUDIO RESEARCH CLASSIC 60, SERVICED, RE-VALVED.  
UK BUILT WATAMP 5-20 VALVE POWER AMPLIFIERS  
27W, VERY PRETTY  
CP DEVELOPMENTS ROMULUS, BOXED, AS NEW, 5881  
(25WATTS), (£2995)  
AUDION STERLING MK1 EL34  
ANTHEM X1 EL34 SINGLE ENDED VALVE INT. AMPLIFIER  
AUDION CD1 PRE  
ARIA 300B, EXCELLENT VALUE-NEW  
ROGERS CADET III, SERVICED, PERFECT.  
BAT 3K1, HYBRID, PHONO STAGE, BOXED

## TRANSISTOR AMPS + TUNERS

KRELL FPB-250MC WITH CAST TECHNOLOGY  
PRIMARE A20 MK II.  
NU-FORCE IAT V2  
NU-FORCE P9/REF 9SEV2'S  
PIONEER M73 EXCELLENT.  
QUANTUM ELECTRONICS 102/202 PRE & POWER AMPS  
CYRUS S MINT  
QED VECTOR REFERENCE PRE-AMP, REMOTE [650].  
NAD C372 INTEGRATED.  
MUSICAL FIDELITY 3A-X PRE-AMP.  
ONIX OAZI  
EXPOSURE SUPER 8.  
NAIM NAIT 51  
AUDIOLAB 8000A, BOXED.  
LED POWERSTAGE PA0, MINT.  
CYRUS 2 WITH PSU, BOXED.  
ROTEL RADA, AS NEW, 6 MONTHS OLD, BOXED, PHONO.  
AREAM ALPHA 8, PHONO, BOXED  
CONRAD JOHNSON SONOGRAPHIE SC-1  
NAIM SNAPS, JUST SERVICED.  
TAG MCLAREN CLASSY PRE-AMP, MM, MC, (£850)  
QUAD 33/306

## SPEAKERS

SONUS FABER GRAND PIANO LOUDSPEAKERS  
VANDERSTEEN AUDIO MODEL TWO (£4000)  
NAIM CREDOS IN CHERRY BEAUTIFUL BOXED  
TANNAY RECTANGULAR GR3'S, 15" GOLDS, AS NEW, (£4499)  
ACOUSTIC ENERGY ELITE 2'S, BOXED, AS NEW, (£4499)  
REVOLVER R33'S, BOXED, AS NEW.  
MORDAUNT SHORT SYSTEM 442 FLAGSHIP SPEAKERS  
SPENDOR BC1'S MINT, ALNICO MAGS.  
TDL STUDIO 10'S, BOXED, (£4999)  
EPOS M12.2'S, AS NEW

WHAREFDALDIAMONDS NEW  
CLASSIC AUDIO '0'S  
QUAD ESL63'S SERVICED PANELS, GUARANTEED.  
GALE 401'S REBUILT, BEAUTIFUL-CHROME  
QUAD ESL 57'S BRONZE, FULLY SERVICED, CLAMPS  
FITTED, BOXED, NEW RECTIFIER BLOCKS.  
ROGERS BBC LS3/5A'S, RAYMOND COOKE SPECIAL ED  
TANHOY 3L2'S 10 GOLDS MINT  
CASTLE 7'S  
ROGER L377'S VERY NICE WITH STANDS.  
QUAD ESL57'S BLACK REBUILT & SERVICED BY BIGEARS BORED.  
JORDAN WATTS EX-88C  
RUARK SABRES, CHERRY  
NAIM ARIVAS EX-DEM (£1300)  
RUARK ICON'S (£350) MINT.  
USHER S-520 PIANO BLACK

## CD PLAYERS

MERIDIAN 504, 20 BIT, BOXED  
AUDIO NOTE CD2.1  
MERIDIAN 563 DAC, MINT.  
SONY PLAYSTATION 1 CD CONVERSIONS AMAZING  
NAD CS411, RUSS ANDREWS DAMPER + POWER UPGRADE.  
TEAC VRDS 10SE, BOXED, MINT.  
MICROMEGA STAGE3 CD, BOXED.  
LECTOR CDP-71, TOP LOADER  
ROKSAN KANDY CD AS NEW, BOXED  
USHER CD-1 [ASTONISHING!!]  
LECTOR DCP-001 VALVE CD PLAYER  
NAIM CDS1  
MARANTZ CD17 MKII (£850)  
CYRUS DAD7 & PSX AS NEW AND BOXED  
REGA PLANET, BOXED

## TURNTABLES/ACCESSORIES

MICHELL ORBE SE  
PROJECT XPRESSION III TURNTABLE WITH MK2 SPEED BOX (£400)  
MUSIC MAKER III CARTRIDGE (£625)  
ORIGIN LIVE SILVER ARM MKII  
MICHELL TECHNO ARM  
MICHELL TRANSCRIPTION TURNTABLE  
LYRA CARTRIDGES  
PROJECT DEBUT III, (£210)  
CLEARAUDIO AVANTGARDE  
DYNAVECTOR 10XS  
GARRARD 401, SHE 3009, DYNAVECTOR 10XS.  
LINN LP12, AFORNOSA, ORIGIN-LIVE DC POWER SUPPLY,  
BASIC PLUS ARM, DYNAVECTOR 10XS  
THE ISOLATOR-UNBELIEVABLE RESULTS!!  
ORIGIN LIVE SILVER ARM AS NEW  
ALL GRAHAM SLEE PHONO STAGES  
OKKI NOKKI RECORD CLEANING MACHINE

christbirchley@btinternet.com

01736 740421

07947 678256



# GT Audio

for the best in analogue replay

The new ZYX 4D - the cartridge everyone's talking about



Avantgarde Acoustic • Jan Allaerts • Dynavector  
Graham • Lindemann • Lyra • Ortofon inc SPUs • SME  
Schröder • TRON • TW Acoustic • Verdier • WSS • ZYX

01895 833099

e: sales@gtaudio.com  
w: www.gtaudio.com

# TUBE SHOP.COM

THE LARGEST SELECTION  
OF QUALITY TUBES ONLINE

WHAT'S HOT AT THE  
TUBESHOP

GIUITAR  
TUBES

HI-FI  
TUBES

NOS  
TUBES



BRIMAR  
Mullard  
SYLVANIA



Tube Rings  
by Duende Criatura



WWW.TUBE-SHOP.COM  
OR CALL US 0870 9220404

audioXpress... It Just Sounds Better

## Your Favorite Audio - One New Magazine!

- PROJECTS
- REVIEWS
- THE NEWEST TECHNOLOGIES
- AUDIO CLASSROOM
- and Much More!



Subscribe To This  
Great Monthly  
Publication Today!

Only \$59.95 US  
for 12 Issues!

audioXpress • PO Box 876 • Peterborough, NH  
03458-0876 USA • Phone: 603-924-9464

Fax: 603-924-9467 • E-mail: [custserv@audioXpress.com](mailto:custserv@audioXpress.com)

ORDER ONLINE AT: [www.audioXpress.com](http://www.audioXpress.com)



CARTRIDGE SELECTION		STYLUS	HEADPHONE SELECTION	
Goldring			Grado	Prestige SR-60 £75
Elektra	£33	£24		Prestige SR-80 £90
1006	£88	£65		Prestige SR-325i £260
1012 GX	£116	£77	Goldring	DR 50 £30
1022 GX	£153	£97		DR 100 £40
1042	£171	£120		DR 150 £70
Eroica LX/H	£153	£122 EX		Active Noise Reduction NS 1000 £140
Elite	£273	£217 EX		
2400	£152	£119		
2500	£175	£133		
<b>Audio Technica</b>				
AT 95 E	£25	£16		
AT 110 E	£30	£18		
AT OC9 ML II	£270	£255 EX		
<b>Denon</b>				
DL 103	£105	£95 EX	N/A	
DL 103R	£190	£170 EX	N/A	
DL 110	£79	£69 EX	N/A	
DL 160	£95	£83 EX	N/A	
DL 304	£210	£190 EX	N/A	
<b>Grado</b>				
Prestige Black	£40	£29		
Prestige Gold	£110	£77		
<b>Lyra</b>				
Dorian	£495	£395 EX	N/A	
Argo	£795	£635 EX	N/A	
<b>Shure</b>				
M 97 XE	£98	£58		
<b>Sumiko</b>				
Blue Point Special	£195	£165 EX		

**HI FI ACCESSORIES**

ARTcessories USB Phono Plus PreAmp £85  
analogue-digital computer interface £15  
Bib Universal Standard Headshell £24  
Shure SFG2 Stylus Force Gauge £24

**REPLACEMENT STYLI**

Swiss Quality Diamond Styli

ADC XLM Mk III £17  
Akai AN 5, AN 60 £13  
AN2, AN 70 £15  
Aiwa AN11 £13  
Dual DN 145 E, DN 165 E £17  
JVC DT 55, DT 60 £13  
National EPS 24 CS, P 30 D, P 33 D £13  
Ortofon FF15/VMS20 EII, OM5/10/10/20 £17  
Pioneer PN 210/220/240 £13  
Shure N75C, N75-6, SC35C £13  
N75ED/EJ T2 N75-3, N95ED/EJ £17  
N 97 HE, VN 35 HE £27  
Sony ND 142/155 G, CN234 £13  
ND 143/150/200 G £15  
Stanton D 681 EEE £21

\*\*\*Over 500 Styli Types Stocked\*\*\*

**EX - Exchange price same make moving coil cartridge**

Order direct online or Tel/Fax (01757) 288652

MANTRA AUDIO (HFW), Town End House, Skipwith, Selby, North Yorkshire YO8 5SQ

# RETRO REPRODUCTION

QUALITY HIGH FIDELITY & VINTAGE

<b>AMPLIFIERS</b>		Tannoy Dimension 10 £5000 new 1 year old £2495
Albarré pre amp with phono	£95	Neat Motive 1 oak finish ex dem £995
Albarré 10008 mono blocs 100W	£495	Neat Vito floorstanding speakers with £1495
Arion TYCHO valve amp	£795	ultimatum upgrade, beech finish, work well with Nam
Audion Premier 0 5 pre	£350	
Audio Lab 8000P late serial number	£350	
Audio Analogue Puccini special addition	£395	
Audio Innovation series 700 integrated amp	£595	
Audio Innovation L2 valve pre	£445	
Audio Innovation series 200 MK2 power amp	£295	
Audio Innovation L1 pre	£195	
Audio Research VT60 valve power re-valved	£995	
Ayre Power amp	£2195	
Bei Canto SAP2 pre upgraded to next model	£995	
Cyrus smart power	£275	
Cyrus pre	£195	
Caim 100W remote integrated amp x dem	£695	
Copland 401 valve integrated with phono	£795	
Crimson 630D mono blocks 100W	£495	
Chord SPM1000B power amp 200W	£995	
Denson DM10 integrated	£695	
EAR 834L Valve Line Stage	£495	
Graaf GM5050	£1295	
Heybrook signature 3 box pre power	£595	
Korato renaissance mono blocs 30W class A	£995	
Krelli KRC3 balanced pre amp remote	£995	
Leema Tucana	£POA	
Leak 12+ mono blocs restored	£595	
Meridian 568 digital surround processor	£995	
Naim NAC92 serial 165888	£175	
Naim 4Z 5	£125	
Quad 2 mono blocs mint original valves	£795	
Quad 99 CD player with digital pre amp, as new, boxed	£595	
Quad 303 Power Amp	£175	
Quad 44 Pre Amp	£195	
Quad 405 Power Amp boxed	£195	
Rotel RA-01 integrated Amp	£245	
Rotel RB-03 Power Amp	£245	
Rotel RB970 BX Power Amp	£145	
Rotel RC990BX blackgate remote pre	£195	
Rotel RB850	£145	
Sugden Transimpedance Amp 6months old	£395	
Unison Research UNICO SE	£795	
<b>SPEAKERS</b>		
ATC SCM20 rose wood finish	£795	
Audionote ANJ silver speaker boxed	£495	
Beauhorn Virtuoso reference lowther	£3995	
B&W DM4	£95	
B&W 604 series 3	£445	
DynAudio contour 1 3 MKII	£595	
Gamma floor standing speaker new £5000	£995	
JBL T1-6K floor standing speakers as new	£795	
Leema XYP	£595	
Linn Ninka 6 months old	£795	
Living Voice Auditorium MKII cherry	£1195	
Mission 750 limited edition anniversary	£195	
Mono Pulse 32A 8 months old ex dem	£595	
ProAc studio 100	£395	
Spendor BC1 with original stands	£395	
Sonus Faber Mirima amator	£695	
<b>MISCELLANEOUS</b>		
Fanfare ft1 tuner, outperforms magnum etude remote control.	£595	
Ben Duncan mains isolation transformer	£245	
Chord cables indigo- signature	£POA	
Nordost Valhala supplied in wooden box.		
<b>DUE IN...</b>		
Mission logo style pre power		
Yamaha CT7000 Boxed		
Leak Varislope/point 1 stereo pre amp various		
Lescon pre amp power amp & tuner RARE		
Russ Andrew Quad 33 303 upgrade		
Garrard 301 first class condition		
Quad 2 pre valve & radio various		

GENEROUS PART-EX ON ALL EQUIPMENT. NEW OR USED. WILL BUY GOOD QUALITY EQUIPMENT AS ABOVE. NEXT DAY MAIL ORDER & UPLIFT FACILITIES

CAIRN

EAR  
of

UC

A

SME

ROD

angelsound audio  
01923 352 479  
www.angelsoundaudio.co.uk

Opening times: 10.30 - 5.30 Tues. to Sat.  
28a Haddington Place, Edinburgh EH7 4AF  
Tel/Fax: 0131 558 9989  
Email: retro.reproduction@virgin.net  
new website www.retroreproduction.co.uk

# HEATHCOTE AUDIO

TEL: 07860 511111 WEB SITE [www.heathcoteaudio.co.uk](http://www.heathcoteaudio.co.uk)

E-MAIL [heathcoteaudio@aol.com](mailto:heathcoteaudio@aol.com)

## VALVE AMPLS

GRAAF 50/50 POWER AMP  
COUNTERPOINT SA-5000A LEGENDARY PRE/PHONO STAGE (2 BOX)  
GAMMA REF. 211 MONOBLOCS  
UNISON RESEARCH 845 MONOBLOCS  
UNISON RESEARCH MYSTERY PRE  
ROGUE AUDIO METIS PRE AMP (REMOTE)  
UNISON RESEARCH FEATHER PRE/35 POWER  
AUDIO RESEARCH SP-9  
TUBE TECHNOLOGY SYNERGY INT.AMP  
AUDIO RESEARCH SP-9 PRE AMP/PHONO STAGE  
ROGUE AUDIO 66 MAGNUM REMOTE PREAMP  
ANTIQUE SOUNDLABS MINI PHONO STAGE 2-BOX  
MEIXING MING DA MC767 RD MM/MC PHONO STAGE  
MICHAELSON AUDIO CHRONOS 2 BOX PRE/MONO'S (£10,000 NEW)

MINT £1395  
SERVICED/BOXED £1995  
EXCLT £1295  
EXCLT £1995  
EXCLT £750  
EX.DEM £695  
MINT/BOXED £1495  
MINT/BOXED £995  
MINT £2999  
MINT/BOXED £995  
MINT/BOXED £1195  
EX.DEM £299  
MINT/BOXED £299  
ULTRA RARE £3995

## VINYL

SIMON YORKE SERIES V TURNTABLE & MK 7 ARM/SUMIKO BPS  
ORACLE DELPHI V & TURBO POWER SUPPLY (£4000)  
CLEARAUDIO EVOLUTION & TANGENT PARALLEL ARM  
ACCOUSTIC SIGNATURE SAMBA MK II & ARM (£2300?)  
GRAHAM 2 TONEARM  
HELIUS CYALINE TONEARM  
FIDELITY RESEARCH 64S? (SILVER WIRED)  
NVA TWO BOX MC PHONO STAGE  
GRAHAM SLEE ELEVATOR STEP UP  
ANTIQUE SOUNDLABS MINI PHONO STAGE 2-BOX  
MEIXING MING DA MC767 RD MM/MC PHONO STAGE  
BILL BEARD MM/MC PHONO STAGE  
McCORMACK MINI PHONO DRIVE (MM/MC)  
ASR MINI BASIS PHONO STAGE (MM/MC)

MINT/BOXED £3450  
MINT £2250  
MINT/BOXED £1895  
NEW £1595  
MINT/BOXED £995  
EXCT £595  
EXCLT £695  
EXCLT £395  
MINT £375  
EX.DEM £299  
MINT/BOXED £299  
EXCLT £375  
EX DEM £349  
NEW/BOXED £495

## TUNERS/MISC

AVI 7 BAND TUNER RDS (S SERIES VERY RARE)  
HITACHI FT-5500 MKII  
PIONEER CT-830S CASSETTE DECK  
MERIDIAN 101B TUNER & PRE AMP  
SONY ST 5950 SD TUNER AM/FM

MINT £395  
EXCLT £175  
MINT/BOXED £195  
VGC £195  
GC £175

## TRANSPORTS/DACS/CD

MARANTZ SA11-S1 SACD/CD PLAYER  
ORELLE EVO-100 CD PLAYER  
RESOLUTION AUDIO CESCIO TRANSPORT  
MICROMEGA CLASSIC SOLO XLR/RCA (NEW MECH)  
MERIDIAN 602/606 TRANS/DAC (STILL EXCELLENT)  
UNISON RESEARCH UNICO (new mech)  
DCS P-81 SACD/CD/VOLUME (8 WEEKS OLD) £7000  
McKINTOSH MCD-201 SACD/CD/VOLUME (£3500)  
EINSTEIN 'THE CD PLAYER'  
PROCEED (LEVINSON) PDT-1 TRANSPORT & DAC  
CONSONANCE LINEAR CD PLAYER  
LECTOR DIGIDRIVE-TL TRANSPORT & PSU  
ACCUPHASE DP-90 TRANSPORT  
THETA CARMEN CD/DVD TRANSPORT  
THETA DATA II TRANSPORT (SILVER)  
THETA DATA TRANSPORT  
AUDIO ALCHEMY DDS III CD/TRANSPORT  
MSB LINK DAC 24/96khz MODULE  
Z SYSTEMS Z-3src UPSAMPLER (£1450 NEW)  
AUDIO ALCHEMY DDE V.III HCD DAC  
AUDIO ALCHEMY DDE V1.2 HCD DAC  
AUDIO ALCHEMY DDE V1.1 HCD DAC.  
DENON 2800 MKII GOLD (HCD)  
PRIMARE V-25 CD/DVD PLAYER (£1000 NEW)  
ARCAM CD 82  
DENON DVD 3300 (PLAYS DVD-A £1000 NEW)

MINT £1375  
MINT/BOXED £795  
EXCLT £995  
EXCLT/BOXED £895  
EXCLT £1195  
MINT/BOXED £795  
ASNEW £3795  
NEW/BOXED £2995  
EXCLT £1500  
MINT/BOXED £895  
NEW/BOXED £595  
MINT/BOXED £1295  
EXCLT £2750  
MINT/BOXED £1295  
MINT/BOXED £795  
VGC £495  
N.O.S. £395  
MINT/BOXED £375  
MINT/BOXED £450  
N.O.S. £350  
N.O.S. £275  
N.O.S. £250  
MINT/BOXED £299  
NEW/BOXED £475  
MINT/BOXED £295  
EXCLT/BOXED £295

## SOLID STATE

MERIDIAN 101 B PRE & MATCHING TUNER  
PASS LABS ALEPH P PRE AMP  
PASS LBS ALEPH P PRE/0 MONOBLOCS  
ROTEL RB-1090 MONSTER POWER AMP (50 KG?)  
ROTEL RB-870BX STEREO/MONO AMPS X 2  
AVI S-2000 MONOBLOCS  
CONRAD JOHNSON PF-1 PRE C/W PHONO STAGE  
PLINIUS SB-300 (RETAIL £4650)  
PLINIUS SA-201 (RETAIL £3600)  
McCORMACK RLD-1 REMOTE PRE & DNA-125 POWER AMPS (4.5K)  
ORELLE EVO-100 PRE AMP/POWER AMP (£3.5K)

VGC £395  
EXCLT £1195  
EXCLT/CRATED £3250  
EXCLT £995  
MINT £299  
MINT £650  
EX.DEM/DIS £2995  
EX.DIS £2395  
MINT/BOXED £2250  
MINT/BOXED £1295

XTC PRE-1 POWER-1AMPS GLOSS BLACK  
ATC SCA-2 PRE AMP  
ADVANTAGE I200 INTEGRATED AMP  
MARANTZ PM66 KI-SIG AMP  
ALCHEMIST FORSETTI PRE & POWER AMPS  
KRELL KMA-100 MONOBLOCS (3 YEARS USE)  
AUDIO RESEARCH LS-3B PRE AMP  
KRELL FPB-200 POWER AMP  
JEFF ROWLAND MC-6 (\$16000?)  
NORTH AMERICAN PRODUCTS H-CAT PRE AMP (£2850)  
LUXMAN M-105 DUAL MONO CLASS A POWER AMP  
SONY TA9000-ES PRE & TAN9-ES STEREO POWER AMP  
CONRAD JOHNSON PFR PR/MF-2500A POWER AMPS

MINT/BOXED £1795  
MINT/BOXED £1795  
EXCLT/BOXED £995  
MINT/BOXED £275  
MINT/BOXED £1595  
MINT/BOXED £2750  
MINT/BOXED £995  
EXCLT £2750  
MINT £3995  
EX.DEM £1475  
MINT/BOXED £1795  
MINT/BOXED £1250  
MINT/BOXED £3450

## LOUDSPEAKERS

KEF REFERENCE 203.2 CHERRY  
EGGLESTONWORKS ROSA  
EGGLESTONWORKS FONTAINE II  
EGGLESTONWORKS ANDRA II  
MARTEN GILES II CHERRY (8k+ NEW)  
TANNOY TRF MEMORY T.W.  
BKS 128 RIBBON HYBRID (STAR GRANITE £2800)  
REGA XEL (ROSEWOOD £1250)  
MONITOR AUDIO GS 10 & STANDS (£1000)  
AURUM CANTUS SUPREME (AWESOME! £10,000)  
A.L.R. JORDAN NOTE 5 FLOORSTANDERS (£2500)  
CURA CA-30 FLOORSTANDERS (MAPLE)  
AUDIO PHYSIC CALDERA II (10K NEW?)  
CELESTION A-3  
CELESTION A-2 SANTOS R/WOOD  
MIRAGE M1si BI POLAR LOUDSPEAKERS  
FAB AUDIO MODEL-ONE (RETAIL £7500)  
FAB AUDIO BRAT (£700)  
AURUM CANTUS VOLLA (RETAIL £2500)  
AURUM CANTUS MUSIC GODDESS £2500  
AURUM CANTUS LEISURE 3SE (£1250)  
AURUM CANTUS LEISURE 2SE  
AURUM CANTUS BLACK ORCHID (£1200)  
AMPHION NEONS

MINT/BOXED £2250  
NEW £4400  
EX.DEM £2295  
EX.DEM £7500  
EXCLT/BOXED £3750  
MINT £3750  
MINT/BOXED £1395  
EXCLT £475  
MINT £595  
BRAND NEW £6995  
EX.DEM £1195  
MINT £995  
MINT/BOXED £2995  
MINT/BOXED £1250  
BRAND NEW £995  
EXCELLENT £2750  
EX.DEM £4750  
EX.DISPLAY £395  
EX.DISPLAY £1750  
NEW £1795  
EX.DIS. £795  
EX.DIS £695  
EX.DIS £795  
EX.DEM £195

## MAINS CABLES/BLOCKS/CONDITIONERS ETC

TARA LABS RSC AIR-2 6FT POWER CORDS  
BLACK RHODIUM SUPER MAINS POWER CORDS  
BLACK RHODIUM SUPER CORD RHODIUM PLATED EASYGRIP PLUG  
ISOTEK POWER CORD

BRAND NEW £225  
BRAND NEW £65  
BRAND NEW £95  
£65

## LOUDSPEAKER CABLE

TARA LABS RSC AIR 2METRE PAIR  
TARA LABS PRIME RSC 18 FEET BIWIRE !!  
DPA BLACK SLINK (£100 PER M.) 4.5 METRE PAIR WBT LOCKING PLUGS  
SONORAM PLATEAU 4 METRE+ PAIR (HI END USAHEAVY COPPER CABLE)  
MINT MH-750 BI WIRE 3 METRE PAIR  
XLO SIGNATURE 2 TYPE 5.2 4 FT PAIR  
TRANSPARENT MUSIC WAVE ULTRA 8FT PAIR  
TRANSPARENT SILVER BI CABLE 10 FT PAIR  
RENAISSANCE SILVER SIG. 3 METRE PAIR (£1300)  
RENAISSANCE SILVER 4 METRE PAIR  
PS AUDIO X-STREAM 3 METRE PAIR (VERY HEAVY!)  
DIAMOND HI SILVER 3 METRE PAIR  
AUDIONOTE AN-L 3 METRE PAIR SILVER SPADES  
CHORD RUMOUR 2 4 METRE PAIR  
BLACK RHODIUM S-300 BI WIRE 5 METRE BI WIRE PAIR (£400)  
BLACK RHODIUM S-300 BI WIRE 4 METRE PAIR (£240)

NEW TBA  
MINT/BOXED £595  
EXCLT £395  
EXCLT £500  
EXCLT £595  
EXCLT £395  
EXCLT £1250  
EXCLT £995  
EXCLT £795  
EXCLT £750  
EXCLT £500  
EX.DEM £500  
NEW £175  
EXCLT £50  
NEW £150  
NEW £100

## INTERCONNECT CABLE

TARA LABS RSC AIR 1 1 METRE RCA INTERCONNECT RCA  
TARA LABS RSC 1 1.5 METRE RCA INTERCONNECT  
BLACK RHODIUM ORATORIO 1 METRE XLR  
BLACK RHODIUM CONCERTO 1 METRE RCA (£180)  
BLACK RHODIUM SYMPHONY 1 METRE RCA  
QED SILVER SPIRAL 1 METRE RCA  
QED SILVER SPIRAL 0.8 METRE  
CHORD CO.COBRA/COBRA2/SILVER SIREN DIN TO RCA

NEW/BOXED £295  
NEW/BOXED £350  
EX.DEM £275  
NEW £95  
NEW £50  
EXCLT £50  
EXCLT £40  
RING

LARGE SELECTION OF INTERCONNECTS ,LOUDPEAKER CABLE & STANDS ON THE WEBSITE

WEB SITE [www.heathcoteaudio.co.uk](http://www.heathcoteaudio.co.uk) UPDATED DAILY!

**QUALITY EQUIPMENT REQUIRED FOR IMMEDIATE PURCHASE.**

To advertise in this space  
please call 020 7372 6018

or email:

[advertising@hi-fiworld.co.uk](mailto:advertising@hi-fiworld.co.uk)



# High End Cable

visit [www.highendcable.co.uk](http://www.highendcable.co.uk)  
For the best prices telephone Dave Jackson on  
01775 761880  
Free P&P worldwide on all interconnects

Analysis Plus  
Audience  
Chord Company  
Ecosse  
Furutech  
Hovland  
Nordost  
MIT  
Oehlbach  
Purist Audio Design  
Stereovox  
Townshend  
True Colour Industries  
van den Hul  
Wyrewizard  
IsoTek  
Cable Tower  
Oehlbach Accessories  
Bel Canto  
Project Turntables  
Audio Physic Speakers  
STAX headphones  
Tannoy  
Echo Busters  
Arye CD - IsoTek CD  
Lyra Moving Coil  
Ortofon Moving Coil  
Sumiko Moving Coil

Component cables  
Digital cables  
HDMI  
Optical cables  
S video  
SCART

Firewire  
XLR cables  
Sub woofer cables  
Chord iPod cables  
Nordost iPod cables  
DIN cables  
Chord cables for Naim  
Mains & Power cables  
Jumpers  
ONLINE SHOP

**CHORD** **NORDOST**  
COMPATIBLE

**stereovox** **TOWNSHEND AUDIO**

**EGOSSE** **analysis plus**  
REFERENCE CABLE

*Purist Audio* **MIT**

*van den Hul* **Isotek**  
A Sound Connection

**Wyrewizard** **FURUTECH**  
PRO SERIES DeStat and DeMag

**bel canto** **TRUE COLOURS INDUSTRIES**  
moved without compromise

**Upto 25% OFF**  
when you trade in your old cable



Reference cables include free Burn In.



Leak Stereo 20 full rebuild using Jensen Paper in oil caps £299.00  
Conversion of Leak valve pre to passive including Silver wired/soldered/rhodium plugs £299.00  
Rothwell Indus SE passive pre amplifier. Now in stock. Awesome. Just £799.00

## wanted classic and modern hiifi eqpt. FOR SALE. PRE/POWER AMPLIFIERS

NEW PASSIVE pre amp 2 inputs. 100% pure silver wire. Silver solder. Alps pot. gold phono	£149
NEW PASSIVE pre amp 2 inputs. 100% pure silver wire. Silver solder. Alps pot. Silver phono	£179
Pinus 2100 Class A B int line amp. Bowed. 100W	£549
Nakanishi CAS pre-amplifier. Ex cond. Cost £750	£375
Quad 405.2. Ex condition & boxed instructions.	£249
Geoson AP1 C/P1 pre power amp. Very rare. Bowed. EPOA	£169
Musical Fidelity 'The Pre-amp'. Full size MLR out.	£189
Arcam Alpha 8 power amplifier. Ex condition.	£159
Musical Fidelity 'The Pre-amp'. Ex cond & boxed.	£159
Leak Vanolpe point 1 pre-amp. Converted to Passive.	£299
Audio Innovations Series 800 tube pre amplifier	£195
Pair Radford MA15 monoblocks. Super condition.	£195
Primare P120. Superb condition with remote.	£379
Denon D90 system CD tuner, cassette amplifier, rem.	£129
Rogers Cadeit III integrated amplifier. Ex condition.	£249
Quad 404 integrated amplifier. Good condition.	£299
NVA P50 2 box passive pre & NVA PSU for phono	£149
Rotel RA-840 BX int ampifier with MM & MC	£99
Leak Stereo 20 rebuilt with quality paper in oils.	£695
Tube Technology Unisus power amp. Chrome boxed	£995
Sugden A48 amp & T48 tuner in wooden sleeve.	£249
Quad 402 pre amplifier. nice condition. Bowed.	£249
Quad 115 in various condition and prices	EPOA
Quad 303 power amplifiers from	£125
Luxman LV-103 int hybrid amplifier. Bowed. Rare.	£349
Quad 405.1. Excellent condition.	£105
Marantz PM66SE K1 signature integrated amplifier	£199
Pair Musical Fidelity MEMS class A monoblocks.	£195
Quad 33 pre amplifiers. From	£75
Musical Fidelity A100 pure class A integrated. 80W	£299
Wilmot Audio Mercury B power amp Ltd edition	£295
Unison Research Mystery One line level pre amplifier. Stunning condition with box/book. Serviced. Cost £1700	£699
Galation MK-2121 amplifier. 60 watts of pure class A. Beautiful Italian styling. Wood checks. Cost new £1400	£699
Harmon Karlon integrated valve amp 110W. V rare	£299
Linn LK1 LK2 pre power amp. Good condition	£299

## TURNTABLES/CD PLAYERS

Trichord Genesis CD player. Bowed with remote	£220
Arista R1081 turntable. Ready to fit SME tone arm	£149
Marantz CD73 CD player. © 1984. Nice condition.	£275
Dual 1019 turntable. 16.33/45 & 78 rpm. Nice.	£79
Arcam Alpha 75i CD player. Award winner.	£159
Arcam Driva CD92 CD player. Nice condition.	£399
Nad 304 CD player. Ex condition. No display	£49
Rotel RP430 turntable with AT cartridge. No lid	£49
Rotel RBX CD player. Two decks. dream machine.	£149
Cyrus DAD 3 CD player and remote. Ex condition.	£199
Roksan ROK D54 PSU for ROK-DA1 DAC. Mint.	£295
Nad CS411 CD player. Mint & bowed.	£199
Trichord Research Pulsar 1 Dac with Michell PSU	£799
SME 3009 series II improved. Excellent condition.	£150
Transcriptors Hydraulic Reference turntable. Nice	£799
Meridian 506 CD player. Bowed with remote.	£449
Dual 1019 turntable. 16.33/45 & 78 rpm. Nice.	£79
Arcam Alpha 75i CD player. Award winner.	£159
Arcam Driva CD92 CD player. Nice condition.	£399
Nad 304 CD player. Ex condition. No display	£49
Rotel RP430 turntable with AT cartridge. No lid	£49
Rotel RBX CD player. Two decks. dream machine.	£149
Cyrus DAD 3 CD player and remote. Ex condition.	£199
Roksan ROK D54 PSU for ROK-DA1 DAC. Mint.	£295
Nad CS411 CD player. Mint & bowed.	£199
Trichord Research Pulsar 1 Dac with Michell PSU	£799

## SPEAKERS

Wharfedale Diamond 9.1 Ex condition & bowed	£129
Rogers L51. Black finish and in nice condition.	£89
Pair Quad ESL57 speakers. Fully reconditioned including 2 new	£99
Genesys LX55. With ribbon tweeters.	£399
Quad ESL57 speakers. All fully serviced with full 3 months warranty.	£1150 pr
Ref Coda 7. Black finish. Bowed & mint.	£69
Apogee Acoustic Centaurus studio monitor speakers. Ribbon tweeters. Bi wireable. Stand mounters. Awesome.	£499
Monitor Audio R252 speakers. Teak finish.	£549
Celestion Little one speakers in white. Bowed.	£49
Rupert stands for Quad ESL57 and EL563 speakers.	£239
Monitor Audio CDS5 CD player with remote.	£49

## OTHER ITEMS

High World HD83 tube headphone amplifier as new	£299
Sugden DR101 stereo CD player. 3.75 & 7.50 IPS.	£99
Mullard Military spec GZ37. New & bowed.	£35
Marshall EL84's specially selected valves. Bowed	£89
Arcam Driva T61 tuner in black.	£89
The Missing Link phono pre amplifier. Ex condition	£349
Troughline 2 tuner in grey finish. Reconditioned/serviced by One Thing Audio. Includes uprated studio 12 decoder.	£375
Denon DR101 stereo CD player. 3.75 & 7.50 IPS.	£99
Nad 402 stereo tuner. Excellent cond. Great sound.	£79
Russian EL84's. Superb quality. Price each	£6.50
Quad RT 840 tuner. LWMWFM. Missing button.	£39
Musical Fidelity T1 FM tuner. Award winner. £300	£95
Linn Tuner. Mint Bowed. Very unusual. Cost £549	£199
SME 3009 2 improved. Bowed as new.	£249
Reston B77 reel to reel player. 3.75 & 7.50 IPS.	£199
Brand new bowed SME3009 tone arm.	£499
Marshall ECC83/12AX7 specially selected valves.	£89
Quad FM4. Bowed with instructions. Yellow buttons	£199
Musical Fidelity Xplorer tuner. Mint & bowed.	£299
Revox T78 tuner. Nice condition and GWO	£375
Nad 602 cassette deck. Bowed with instructions.	£89
Nad 412 tuner. Mint/boxed/booklet/original receipt.	£89
Bulgian plugs for Quad II amplifier. Brand new. Each	£99
SME 3009 series II improved.	£149
Quad FM1 Valve tuners. Various prices from only	EPOA
Quad FM3 tuner in excellent condition. From	£99

## QUAD ESL57 & EL563 PANELS/SERVICING ETC

New One Thing Audio 'Widget'. All round improvement for 57's & a kinder lead for amp £79 pr  
Full rebuild of 57's including latest Otec treble panels for only £1190.00

We sell serviced Quad ESL57 speakers from only £1200.00 pr. Why spend £4000+?

**ESL57 SPEAKERS STANDARD SERVICE £680. PR**

Price includes 2 completely rebuilt treble panels etc. Ring for further info.

Classique Sounds servicing restores the Quads to a position where they can hold their head high. Jon Marks. HIFI WORLD. April 1999. Full servicing facilities available

**TRANSLUCENT** (somewhat of a bargain) Hifi World. Jan 1999  
**PURE SILVER INTERCONNECT CABLE**

99.99% pure silver conductors. Quality gold plated RCA phono plugs.

Half Metre terminated £70.00 One metre terminated £90.00. Available with Eichmann plugs + £30

New Translucent ULTRA + Heavy duty. 99.99% pure silver (4N).

Eichmann 24 Kt gold plate plugs £199.00 per metre. Or £149 per half metre.

7 day money back guarantee if not better than existing cable

# IAN HARRISON HI-FI TEL: 01283 702875

HIFI AT DISCOUNT PRICES. FREE NATIONWIDE DELIVERY

## SALE!

TRADE IN YOUR OLD MOVING COIL CARTRIDGE & SAVE UP TO 60% OFF THE RRP.

CARTRIDGES & STYL	HIFI FURNITURE	HEADPHONES	DVD
VAN DEN HUL	JUAL	DENON	SONY
ZYX	B.C.D.	ERGO	<b>LOUDSPEAKERS</b>
DENON	CUSTOM DESIGN	SHURE	OPERA
CARTRIDGE MAN	OPTIMUM	BEYER	TRIANGLE
AUDIO TECHNICA	ASH DESIGN	STAX	FINAL
GOLDRING	APOLLO	AKG	ELAC
SUMIKO	SOUND STYLE	GRADO	HARBETH
TRANS-	SOUND	AUDIO-	EPOS
FIGURATION	ORGANISATION	TECHNICA	USHER AUDIO
GRADO	ALPHASON	<b>CASSETTE DECKS</b>	DIAPASON
ORTOFON		PIONEER	TANNOY
RESON	<b>CABLES</b>	SONY	AUROUSAL
CLEAR AUDIO	DENON	<b>TUNERS</b>	<b>AMPLIFIERS</b>
KOETSU	VIRTUAL -	PURE DIGITAL	CREEK
SHURE	DYNAMICS	DENON	HALCRO
<b>TO NEARMS</b>	BLACK RHODIUM	SONY	MOTH
SME	TRANSPARENT	CREEK	C.A.T.
GRAHAM	QED	<b>PHONO STAGES</b>	GAMUT
MOTH	ORTOFON	HEED	ALCIA
CARTRIDGE MAN	NORDOST	GRAHAM SLEE	EAR
CLEARAUDIO	SUPRA	WHEST AUDIO	AUDIO VALVE
HADCOCK	WIREWORLD	TRICHORD	ACCUSTIC ARTS
MICHELL	<b>CD PLAYERS</b>	MOTH	GRAAF
<b>TURNTABLES</b>	AUDIO ANALOGUE	CREEK	MONRIO
THORENS	MONRIO	NAD	AUDIO ANALOGUE
MICHELL	GAMUT	EAR	PATHOS -
CLEAR AUDIO	SONY	TOM EVANS	ACCUSTICS
EAR	CREEK	CLEAR AUDIO	UNISON -
ACOUSTIC SOLID			RESEARCH

PLEASE PHONE TO CONFIRM PRICE & AVAILABILITY PRIOR TO ORDERING.  
ALL GOODS ARE BRAND NEW & BOXED WITH FULL U.K. GUARANTEES.  
NO EX. DEM OR EX DISPLAY GOODS. NO GREY IMPORTS. GOODS ARE NOT  
SUPPLIED ON APPROVAL. SORRY, NO GENERAL CATALOGUES. PLEASE  
PHONE OR WRITE FOR SPECIFIC REVIEWS, BROCHURES OR PRICES.  
SUPPLIER OF HIFI PRODUCTS & ACCESSORIES SINCE 1986.  
MAIL ORDER ONLY FROM, IAN HARRISON, 7 MILL HILL, REPTON,  
DERBY, DE65 6GQ. TEL: 01283 702875. 9am - 9pm INCLUDING SUNDAYS.





BRITISH DESIGN AND ENGINEERING AT ITS BEST

After 35 years, Michell is still a family run business with a team of dedicated and proud craftsmen, producing quality turntables and accessories



Orbe SE

The Michell flagship for music lovers who are not prepared to compromise



Gyro SE

The classic Michell turntable, refined over many years of development to its current level of performance.



TecnoDec

Entry level turntable incorporating features from the classic Gyro



MICHELL ENGINEERING

J A Michell Engineering Ltd  
2 Theobald Street, Borehamwood,  
Hertfordshire, England, WD6 4SE

Telephone: 020-8953 0771  
Fax: 020-8207 4688  
michell-engineering.co.uk

See us at the **Bristol Sound & Vision Show, Marriott City Centre Hotel** on 22nd - 24th February 2008.



We are proud to announce that we are dealers for VPI RECORD DECKS, ROKSAN, ORTOFON, GOLDRING, PROJECT, E.A.R., INCA DESIGN, ISOTEK. WE HAVE VARIOUS CARTRIDGES IN STOCK - MORE EQUIPMENT ARRIVING DAILY - please ring, or see web.

**matrix hi-fi**

NEW AND GOOD QUALITY VINTAGE USED HI FI

65-67 DARENTH ROAD, DARTFORD KENT DA11U - UK

TEL: 01322 281787 281700 292391 227663 FAX: 01322 229908

VPI RECORD DECKS, ROKSAN, ORTOFON, GOLDRING, PROJECT, E.A.R. INCA DESIGN, ISOTEK, WE HAVE VARIOUS CARTRIDGES IN STOCK - MORE EQUIPMENT ARRIVING DAILY - PLEASE RING, OR SEE WEB.

POWER/INTEGRATED AMPLIFIERS - SOLID STATE

TUNERS, CASSETTE DECKS ETC.

RECORD DECKS HEAD AMPS/TONE ARMS

CD/HD CD/SACD/DVD/MD PLAYERS

PRE-AMPS

SPEAKERS

POWER CONDITIONERS

MISC

# Cymbiosis

## Linn Products

Sondek LP12 specialist setup, upgrades, rebuilds

25+ years experience with international reputation

## Naim Audio

500 series stockist always available for demonstration including DBL Loudspeakers

Arcam • Atacama  
Chord Company • Denon  
Dynavector • KEF  
Kudos • Neat Acoustics  
Quadraspire • Rega Research  
Spendor & more...

We are hi-fi specialists, so please call us for advice, recommendations and demonstrations

We always carry a selection of quality used hi-fi check our website for more details

6 Hotel Street, Leicester LE1 5AW

Tel: 0116 262 3754

e-mail: shop@cymbiosis.com

[www.cymbiosis.com](http://www.cymbiosis.com)





Heatherdale audio limited



202 Findon Road, Worthing, WEST Sussex. BN14 0EJ  
Tel. 01903-872288 or (after hours) 07860 660001 Fax. 01903-872234  
e-mail: heatherdale@hifi-stereo.com /www.hifi-stereo.com

0% FINANCE AVAILABLE FOR UP TO 3 YEARS ON  
SELECTED ITEMS.  
SUBJECT TO STATUS. CONDITIONS APPLY.

**SPEAKERS**

Revel Salons (mint/boxed)	£7995
Wilson Watt/Puppy 7, superb/crates/accessories.	£9495
Quad 21L speakers	£395
Thiel 2.2 speakers	£895
REL Stadium 11 subwoofer	£495
Acoustic Zen Adagio Junior speakers with stands (new)	£3400
Acoustic Zen Adagio Centre speaker with stand (new)	£1625
Mordaunt Short MS5-40 speakers	£99
Castle Pembroke speakers	£135
Mordaunt Short Avant 902 speakers with stands	£125
New Acoustic Zen Adagio speakers	£3995
New Almarro speakers	£2695
Hales Trancendence 5 speakers	£2895
Dynaudio Audience 7 speakers with stands	£395

**PRE-AMPS;**

Wavac PR-T1 three box pre-amp. As new (£23500) only	£10750
Mark Levinson 26S Balanced pre amp	£2495
Proced PAV pre-amp	£695

**AMPLIFIERS**

Audio Research VT60 power amp boxed	£995
Mark Levinson ML432 power amp, mint/boxed, 2 year guarantee left	£3995.
Wavac MD-805 SET monoblocks	£7950.
Brand new. (£16500) our price	£350.
John Shearne Phase 2 integrated amp with phono	£395
Quad 405 amp with 44 pre-amp	£600
Denon 5 ch amp/processor (£1800)	£5995
ASR 3 piece amplifier brand new (£8000) only	£795
Nakamichi Amp 1 with Cassette Deck 2 & CD Player 3	£3500
Kora Triode 100 SB Monoblocks	

**CD PLAYERS & TRANSPORTS**

Audion "Digital Analogue Company" CD player with HDCD	£1995
Marantz CD 873	£65
Sony CDPMA1 CD Player	£60

**MISCELLANEOUS**

3 mtr pair Acoustic Zen reference speaker cable	£795.
Quad FM 4 tuner	£125
Isoclean Power 50A 111 US power block & noise filter £(as new)	£850
Selection OYAIDE plugs and power strips	POA
Sony AM/FM ST-SE370 Tuner	£75
Technics ST-610L Tuner (FM/MW/LW)	£65
Winds ALM-01 Stylus Gage (New)	£425
Sony ST-SE570 Tuner	£60
15 Foot Transparent Music Wave Super single mono run.	£795

**TURNTABLES, CARTRIDGES & TONEARMS**

Kuzma AIRLINE arm, silver wired as new (£4800)	£3500
Dynavektor 507 MK2 arm (£2995) only	£1995
My Sonic Eminent cartridge (new)	£2750

**Main dealer for Esoteric**

ALL USED CARTRIDGES ARE CHECKED UNDER A MICROSCOPE BEFORE BEING OFFERED FOR SALE.

VISA - SWITCH - MASTER CARD - AMEX - DINERS CLUB WELCOME.  
WE TAKE PART EXCHANGE ON NEW & USED STOCK and buy in for cash

**IAN EDWARDS**  
MAKERS OF FINE HAND MADE FURNITURE

Tel: 01423 500442 Fax: 01423 705200 www.iansbespokefurniture.co.uk

The Old Chapel, 282 Skipton Road, Hamogate, N. Yorks, HG1 3HE

*'Elegant Storage Solutions  
for  
Hi-Fi, Books,  
LPs, CDs,  
DVDs  
Special orders welcome*



'Super 14 Wizard' Rotary Unit. 2296 CDs, etc



74" V-Max can hold 660 CDs etc



JT Hi-Fi CD/Cassette Unit

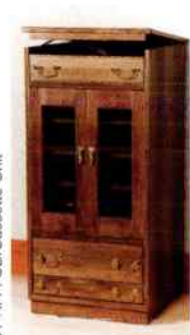

Charlotte Drawer unit for 480 CDs & 75  
Cassettes 32" x 21" x 21"



plug 'n' play 'n' smile

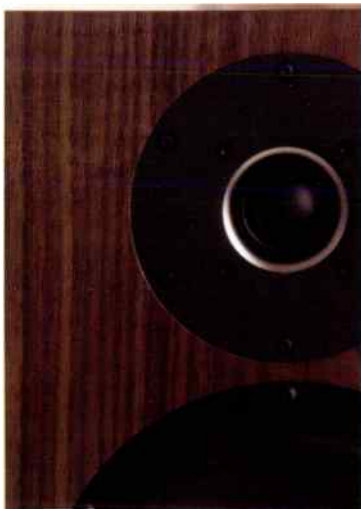

**kudos**  
www.kudosaudio.com

0845 4586698 for details...



**One Decent Wallshelf**

Thoroughly Recommended - David Price, Hi-Fi World Jan 06

featuring:  
steel frame with multipoint fixing  
upto 25mm thick 1/2 metre acrylic isolation platform  
tuning pack for system matching  
available:  
hdw - £129  
odw (pictured) - £249  
odwt (2 shelf) - £349  
all in either silver or black



**The Decentscale**

featuring:  
non metallic construction suitable for all types of cartridge  
record height measuring platform (patent applied for)  
upto 20% more accurate than any other sub £100 scale  
available:  
now! - £35



Wallshelves, Isolation Platforms, Digital Tracking Force Scales, Cables

**Decent Audio 0845 6019390**





Arouse the Full Passion  
Unveil the Source...



# Arousal



For HD, holographic, crossover free reality visit [www.arousal.com](http://www.arousal.com)

World Radio History turn on the emotion

DIY Valve Amplifier Parts - Valves, Capacitors, Connectors, Hardware



We stock a full range of valves (tubes) from famous manufacturers. The list below is a selection of favourites. If you don't see what you want - please ring or e-mail. We are happy to match valves on request.

EL84M Russian (Sovtek)	£11.49
EL84 JJ (to Tesla Specification)	£9.75
JJ 300B (popular and reliable)	£83.50
EH300B Gold Grid	£69.00
Svetlana KT88 (outstanding)	£36.50
Sovtek 6550 WE	£19.49
Sovtek 5881	£12.49
EL34 ElectroHarmonix	£11.85
EL34 JJ (balanced and precise)	£15.49
5U4G Sovtek	£9.94
GZ34 JJ	£16.99
5687 WB Philips NOS (gutsy)	£12.49
Svetlana 6N1P	£6.50
6SN7GT EH (to RCA spec)	£10.25
ECF80 EI	£7.30



VALVE BASES

B7A Chassis Mount	£4.70
B9A Chassis Mount	£4.70
B9A PCB Mount	£4.70
Octal Chassis Mount	£4.70
UX4 Chassis Mount	£16.98

BOOKS

Valve & Transistor Audio Amps by John Linsley Hood	£24.50
Self on Audio by Douglas Self	£26.50
Valve Radio & Audio Repair Handbook by Chas E. Miller	£22.50

Valve Amplifiers by Morgan Jones	£29.50
Building Valve Amplifiers by Morgan Jones	£19.50
Life & Works of A.D. Blumlein by R.C. Alexander	£18.00
Understand Amplifiers by Owen Bishop	£19.50
Audio & Hi-Fi Handbook edited by Ian Sinclair	£34.50



SONIQS SP4 4mm Banana Plugs Gold Plated - pack of 2 - Red/Blk	£2.49
Neutrik Professional Gold Plated phono plugs - pack of 2 - Red/W	£1.69
Gold plated, teflon insulated phono sockets - pack of 2	£4.75
SONIQS TP1 Speaker Terminal Panel Bi-wireable - Gold Plated	£3.60
Twin speaker Terminal Set chassis insulated - Red/Bk	£2.94
Chassis mount earth post nickel plated	£1.23



ALPS Blue Beauty 50k dual log pot.	£13.69
ALPS Blue Beauty 100k dual log pot.	£23.00
Stereo carbon track 100k dual log pot.	£2.95
Cermet 'Humbucker' 2W at 70 C 22R or 100R linear pot.	£8.99
6 way Selector Switch 2 pole 6 way rotary wafer	£1.88
AC 'mains' chassis switch DPST 4A silver contacts	£1.99



WORLD-DESIGNS MCT  
Moving Coil Step Up Transformers  
20:1 & 10:1 ratios - Per Pair £129.00

Hardwire Tag Board twin rows of 18 tags	£2.33
Switched IEC AC 'mains' inlet chassis mount with fuse	£2.88
Unswitched IEC AC 'mains' inlet chassis mount with fuse	£2.34
UK IEC AC 'mains' cable fitted with fused plug, 2m length	£5.36



SONIQS PAPER IN OIL CAPS

UK Manufactured to Ultra-High Spec.  
Superb Performance - Smooth & Clear

0.1uF 630V	£10.99
0.22uF 630V	£11.99
0.33uF 630V	£12.99
0.47uF 630V	£13.99
RIFA 100uF 100V DC PEG Axial Al Electrolytic	£4.25
Polyester 0.1uF 630v DC WIMA Metalised film	£0.55
Polyester 0.47uF 630v DC WIMA Metalised film	£1.29
Panasonic FC 220uF 500V DC Low ESR Al electrolytic	£8.95
Bridge Rectifier 25A 700V 28.5mm x 7.5mm	£3.25

We stock a wide range of parts to facilitate the build of valve amplifiers. Please ring or e-mail for details. See our on-line catalogue at World Designs, 59 Main Street, Great Gidding, Huntingdon, Cambs, PE28 5NU

www.world-designs.co.uk  
Tel: 01832 293320





**SPECIAL INTRODUCTORY OFFER!!!!**

# **HI-FI WORLD ELECTRONIC EDITION**

**VISIT OUR WEBSITE: [www.hi-fiworld.co.uk](http://www.hi-fiworld.co.uk)**

**Queries to - [esubs@hi-fiworld.co.uk](mailto:esubs@hi-fiworld.co.uk)**

**Subscribe to our  
eco-friendly e-edition of  
Hi-Fi World and receive a  
50% discount!!!**

- **Receive your issue a week before on-sale dates.**
- **Be the first to grab a bargain in our Free Reader Classified Ads.**
- **In-house lab. tests to AES and IEC standards**
- **Run by dedicated hi-fi engineers & enthusiasts.**
- **No missed issues, or postal delays.**
- **Access your issues from anywhere in the World.**
- **PC and Mac friendly.**
- **Eco-friendly.**

**Subscribe today and receive 12 issues for  
£20 – that's an amazing £1.90 per issue!**

**check out our free trial issue**

**VISIT OUR WEBSITE:  
[www.hi-fiworld.co.uk](http://www.hi-fiworld.co.uk) and select  
"ELECTRONIC EDITION"**

**To purchase your e-edition click here**

Pay in Sterling, US Dollars or Euros. Non-sterling prices vary according to exchange rate.  
**Cards accepted:** Visa, Maestro (Switch), Mastercard, Solo and Delta.





# DIAL A DEALER

This is a comprehensive directory of Hi-Fi Dealers throughout the UK and Ireland.

## BIRMINGHAM

### MIDLAND RADIO SUPPLIES.

Tel: 0121 706 0313. Vintage & Classics. We buy and sell the best of British Designs and manufactured mono and stereo valve amplifiers radio tuners, turntables, pickups, loudspeakers systems, horns, drive units, tape recorders, microphones, mixers, measuring apparatus, valves and testers. Mono and stereo LPs and Tapes. Quality items required now.

## BERKSHIRE

### M&J DESIGN LTD (MUSIC)

Professional and Semi-Professional reel to reel machines and hi-fi equipment, The Finest Interconnects and Speaker Cables made to measure and guaranteed; User friendly web site will be available from June '07. M&J Design Ltd (Music) Maidenhead, Berkshire. 01628 622115  
John50hifiman@btinternet.com

## BRISTOL & BATH

### THE RIGHT NOTE

Tel: 01225 874728. Happy with your system? Wonder why there's so much for sale secondhand? Avoid the frustration and expense of "upgrades", never quite "there". With infinite patience we'll help you plan longer-term. Brands selection: Accoustic Arts, Audio Physic, Aesthetix, Bel Canto, CAT, Chord Co, Clearaudio, dCS, Gamut, Graham, Halcro, Sumiko, VertexAQ, Wadia.

### V'AUDIO

HiFi Consultants: 36 Druid Hill, Stoke Bishop, Bristol. BS9 1EJ.  
Tel: 0117 968 6005.

ATC, AVI, Alon/Nola, ALR Jordan, Audio Analogue, Avid, Electrocompaniet, Infinity, Origin Live, Ruark, SME, Sugden, Triangle, Unison Research, VPI. Projectors / Sim2, JVC, Mitsubishi, Infocus. Screens/ Stewart, Draper, Da-lite. Demo's by appointment only - Please ring/e-mail for unbiased, honest advice based on 40 years experience. (icvhifi@yahoo.co.uk). We are not a shop!

## CHESHIRE

### ACOUSTICA

17 Hoole Rd, Chester CH2 3NH.  
www.acoustica.co.uk.  
Tel 01244 344227. HiFi & Home Cinema from Amphion, Arcam, ART, Ayre, B&W Nautilus, Classe, Focal, JM Lab, Monitor Audio, Naim Audio, Primare, Rega, REL, Rotel, Spondor, Sugden, Thiel, Wadia. We offer full demonstration facilities, interest free credit, delivery & install systems throughout Cheshire, Merseyside & North Wales. Tuesday to Saturday 10.00 to 5.30.

## ACTON GATE AUDIO

www.acton-gate-audio.co.uk  
4 Ruabon Road, Wrexham, LL13 7PB,  
(01978) 364500  
Arcam, Atlas, Audiolab, Croft, Denon, Grado, JM Labs, KEF, Michell, Monitor Audio, Musical Fidelity, NAD, Ortofon, Opera, Onkyo, Project, QED, Quad, Rel, Roksan, Sugden, Sennheiser, Unison, van-den-Hul, Wharfedale, Yamaha.  
Tuesday - Saturday 9.00 - 17.00  
email: info@acton-gate.com

## ORPHEUS AUDIO

Tel: 0161 4281539  
Email: anything@orpheusaudio.co.uk  
www.orpheusaudio.co.uk.  
Hear the award winners Long term listening is pleasure is our priority. WLM Diva monitors, Almarro amplifiers, Auranote music centre. AMR, Redwine audio, Podiumsound, Albedo silver cables, Whestudio, Shanling, Consonance, EAR/Yoshino, Duevel, Acoustic Zen, Hyperion, Monopulse, Brilliance, Heart audio, custom Design.  
Home demonstrations available, Evening calls welcome

## CLEVELAND

### WAVEFRONT AUDIO

For 2 Channel Music Systems. Hear the Modwright Pre Amplifier, Albedo Cables, Almarro Valve Amplifiers, Cain & Cain Speakers, Rethm Full Range Speakers, Acoustic Zen Adagio, Battery Powered Amplifiers from Red Wine Audio. Digital Amps DAC's, Pre's and Head Amps from Channel Islands Audio. Pure Power APS. Contact andy@wavefrontaudio.co.uk. Web site www.wavefrontaudio.co.uk or Andy 01642 482 393.

## CORNWALL

### BIGEARS AUDIO

To find a system that will allow you to hear the music instead of the equipment phone Bigears Audio, here you will find an interesting array of new and good quality used equipment! my intention is to have satisfied customers whatever their audio preferences. Naim dealer for the South West.  
chrisbirchley@btinternet.com  
Tel: 01736-740421

## KENT

### SUGARBUSH RECORDS

8 Hawkenbury Road, Tunbridge Wells Kent, TN2 5BJ, United Kingdom  
tel: (+44) 01892 541 746  
Free vinyl LP catalogue. Every month-24 pages-rare & deleted ex+ and mint LPs starting at only £4.99. 60's & 70's Rock, Jazz, Blues, Psych, Progressive, Soul, Folk. It is the best regular vinyl catalogue in the UK! Call or write today.

## LANCASHIRE

### HOUSE OF LINN MANCHESTER

Telephone: 0161 766 4837  
Email: info@houseoflinn.com  
www.houseoflinn.com  
The Linn specialists. Independently owned by former Linn staff. Straightforward, professional expertise with demonstration, sales, installation and support for the Linn range of components and systems. The listening experience is so good that demonstrations can last for hours. Discover how we make music sound *real* in your home! Appointments only.

## MIDLANDS (WEST)

### SOUND CINERGY

37 high street. aldridge, WS9 8NL  
01922 457926  
www.soundcinergy.co.uk  
clive@soundcinergy.co.uk  
quality hifi and home cinema from black rhodium, chord co, creek, epos, exposure, linn, marantz, monitor audio, mordaunt short, nad, okki nokki, ortofon, project, rel, roksan, themescene, trichord, vdH. Check our website for ex dem and secondhand bargains. free car parking.  
tues - sat 10 -5.30

## SOMERSET

### ALTERNATIVE AUDIO,

Taunton, Somerset,  
Tel: 01984 624242  
www.alternativeaudio.co.uk.  
Email: peter@alternativeaudio.co.uk  
We specialise in valve amplification and vinyl replay with the accent on high quality musical enjoyment. Ex-Dem and used equipment for sale. Art Audio, Border Patrol, Clearaudio, Diapason, EAR/Yoshino, Experience Filtration, Lector, LFD Audio, Lyra, Music First Audio, Nottingham Analogue, Opera, Quadraspire, Shun Mook, SME, Transfiguration, Unison Research, Vandersteen Audio.

## YORKSHIRE ( EAST )

### THE AUDIO ROOM

2 George Street, Hedon, Hull, HU12 8JH.  
01482 891375. www.theaudiroom.co.uk  
Authorised agents for Ayre, Arcam, Bowers and Wilkins inc 800series, Classe, Cyrus, Densen, Dynaudio, Dynavector, Grado, Hutter, Isoblu, Isotek, Linn, Lyra, Mark Levinson, Meridian, Naim, Nordost, Proac, Quadraspire, Rega, Rotel, Stax, Stereovox and others. 0% finance available, free parking, 3 demonstration suites, friendly and quality staff and advice, mail order service.

**To advertise in this space  
please call 020 7372 6018  
or email:  
advertising@hi-fiworld.co.uk**



A picture can say a  
thousand words so we  
let them do most of  
the talking.

To find out more  
visit [www.tell.uk.com](http://www.tell.uk.com)  
or send an e-mail to  
[incoming@tell.uk.com](mailto:incoming@tell.uk.com)  
with 'tell me' as  
the subject.

[tell.uk.com](http://tell.uk.com)  
Technology let loose

*Every music lover's dream...*

*PS*



FAR/Yashino  
Coombe Grove Farm  
Ermine Way, Arrington  
South Cambridge, SG8 0AL

Tel: 01223 208877  
Fax: 01223 208761  
[www.ear-yoshino.com](http://www.ear-yoshino.com)



**(NEW) EAR 868 Pre-amplifier**

Two Versions Available:

Line stage version : £2650

Line and Phonostage version : £3450

*by world famous designer*

*Tim de Paravicini*



# FREE READER CLASSIFIEDS

**TERMS AND CONDITIONS:** Only one advert per reader. No Trade adverts. This section is strictly for readers selling secondhand hi-fi equipment only. Maximum length per advert is 30 words, Adverts over 30 words will not be accepted. Telephone numbers and E-mail addresses are treated as one word. Model numbers are treated as one word i.e. Quad 303 = two words. Email your advert to; [classifieds@hi-fiworld.co.uk](mailto:classifieds@hi-fiworld.co.uk) or fill in the form on page 129 and post it to Hi-Fi World Free Readers Ads, Suite G4, Argo House, Kilburn Park Road, London NW6 5LF. Sorry, we cannot accept adverts over the telephone. The Publisher reserves the right to judge submissions.

**WHARFEDALE DIAMOND 9.1** speakers. Brand new, 1 week old with receipt & full manufacturers warranty. £120 (£150). Lee, West Midlands 01384 412234 or Email: [lee-t@lycos.co.uk](mailto:lee-t@lycos.co.uk)

**FOR SALE** Brand new Silver Vivid Audio B1 Speakers. Never been used. Cost £8000. Will sell for £5000. No Offers Please. Tel: 01494 774119 or 07968 174674

**MAGNEPAN MG 12 QR** full range ribbon speakers, off white colour, perfect condition, still under warranty, fantastic reviews, boxed, special stands imported from New Zealand (£350). will sell for £595. telephone Colin on 01604 584630 or 07920151588.

**MUSICAL FIDELITY Nu-Vister 300** power amplifiers with new spare set of nu-vistor valves, and nu-vister remote control class A tube preamplifier, all perfect condition with boxes, one of the best sounding amps anywhere. telephone 01604 584630 or 07920151588.

**ELECTROSTATIC RESEARCH** "Vision" hybrid speakers, similar to martin logan aeries, special gloss brown birdseye finish, from the U.S.A, fantastic sound, good condition, size - 49"x14", no boxes, (£3000) will sell for £525 ono, for more details/photo. telephone 01604 584630 or 07920151588.

**CONRAD JOHNSON Premier 11** power amplifier. flawless condition. original box, manual £1200 ono. audiostatics es 100 electrostatic speakers. vgc, black, amazing midrange, like quad 989s in sound. £900. 07710781983, Conrad

**B&W SILVER Signature 30** floorstanding speakers, top of the range in the nineties costing (£8000). silver wound voice coils in mid and tweeter, special red birds eye piano gloss, excellent condition, rare, true high end sound, boxed, gorgeous to look at. £2250. telephone-01604 584630 or 079201515

**WANTED: TOP** quality Hi Fi separates and complete systems, Naim, Linn, Cyrus, Meridian etc, fast, friendly response and willing to travel/pay cash. Please call John on 0781 5892458

**QUAD 405/2** power amplifier very good condition, just been service by Quad £290 ono Tel: 07982865638

**GALE GS402** loudspeakers with Target stands. 40-200watt 3way. Smooth powerful sound. vgc. (see review at [www.kabrna.com/hifi/gale\\_review.htm](http://www.kabrna.com/hifi/gale_review.htm).) £180 ono. Tel. Luton 01582 758049.

**WANTED: MUSICAL Fidelity E300** Elektra series power amplifier. 07789 692777 [iainf@kororaa.com](mailto:iainf@kororaa.com)

**LEAK 2075** speakers £1,000. **JBE Slate Mk3** directdrive turntable £1,000. **FR64S** tonearm £650. **FRB60** elevation base £100. **Audio Alchemy MM/MC** phonostage £175. **B&W 1800** speakers £250. 01798 813133/ [reconcile@bdlrs.freereserve.co.uk](mailto:reconcile@bdlrs.freereserve.co.uk)

**AUDIO SYNTHESIS** Passion pre amp required. Contact Charlie on 07966 849860 or 020 7280 7338.

**I'M AFTER** a Quad 405-2 amp late grey must be in mint condition please E-mail: [ttee\\_34@yahoo.co.uk](mailto:ttee_34@yahoo.co.uk)

**COPLAND CDA 823 CD** player. Cost £2100 new - will sell £1000. mint condition. Copland CTA 405 integrated amp. Cost £2500 new - will sell £1400 mint condition. [alan395shona@btinternet.com](mailto:alan395shona@btinternet.com)

**WANTED FOR** spares faulty or non working Quad 34 and 44 preamps, also boards for Quad 33 preamps. contact Mike on 01758 613790.

**CLASSIC PAIR** of Radford Studio 12 Speakers for sale. Fabulous fidelity; gorgeous sound; awesome presence. Solid hardwood cabinets (no cracks or damage). Superb condition. £250 the pair ono. Tel 01204 693941.

**TAG McLAREN DVD32R** with progressive scan upgrade £1000, Tag McLaren AV32 £500. Good condition and a pleasure to own, very good CD playback plus DVD. Tel. Paul 0118 9845944 (Berkshire office).

**TOWNSHEND ISOLDA 4m Bi-Wire** (4 separate runs) Speaker Cable. Terminated With 12 Solid Silver WBT Spades and Barrels. £550 - Original Cost £1450. Contact Mark Mobile 07958 944 424

**NAIM 72/140** Pre Power. Technics SLP2000 Reference CD Player, Original Epos ES 14 Plus Heybrook Stands. Sony 730 Es Tuner and TCK520 Cassete. All Items Mint. Offers, 07876 597406

**WANTED: TARGET** Hi-Fi rack, TT2, TT4, TT5 etc. Wanted: Garrard GT55P turntable. All must be in mint or vgc. Bracknell area. Tel: 01344 413 719 (W)

**THE CHORD Company** Odyssey 4 bi-wire speaker cable, white, 9 metres length. £250. An original Eighties classic: Audiolab 8000A integrated amplifier, recently serviced, boxed with instruction manual, one careful owner from new. Only £175. East Sussex. Cash buyer collects. 01323 645942.

**SONY TC-KA6ES 3** head cassette deck, barely used, (£800) £195. Musical Fidelity CDPRe24, combined CD Player/ Pre-Amp/Multi-Input DAC, (£2000) £395. SAE PA-10 Pre-Amp, twin phono inputs, £50. Tel: 01424 442802.

**GARRARD 301** turntable, cream finish, strobe platter, oil bearing - £390. Telephone 01189 413708.

**ROTEL RA-05** amplifier, Rotel RCD-06 cd player £400 (£700). Both items 14 months old, boxed & mint. Epos M5 speakers £200 (£350). 6 months old, boxed as new. Kimber Timbre interconnect 0.5m boxed as new £45 (£76). QED XT speaker cable 2m pair with airloc plugs £40 (£62) Brand new & mint with receipt. Lee, West Midlands, 01384 412234 [lee-t@lycos.co.uk](mailto:lee-t@lycos.co.uk)

**ORIGIN LIVE** Aurora (no arm) approx 30 hours use. £625. Tannoy Reveal active speakers 50 wpc, cables/stands. Hi-fi/PC compatible £225. Hitachi FT5500Mk2. Denon TU260L £25 each. 01621 772884 (Essex) [i\\_greenlade@hotmail.com](mailto:i_greenlade@hotmail.com).

**AUDIO ANALOGUE** Puccini SE integrated amplifier. Original 1997 model. Perfect condition. £450. Tel: Mike 01323 645 317

# sounds of music

QUAD SPECIALISTS

We are the UK's  
Quad Specialists,  
with all models available  
for demonstration.

## CLASSIC HI-FI SERIES



QC-twentyfour  
Valve line-only Pre amp



QC-24P  
Valve phono stage



II-classic  
15W Valve mono power amp



II-forty  
40W Valve mono power amp

ESL - 2905

"I know of no  
other speaker  
I'd rather own,  
regardless of  
price."

- Sam Tellig  
Stereophile Magazine



FOR THE TRUE MUSIC LOVER...



### Performance Series

For many customers, buying their first Quad product is a life-changing experience. Quite unlike most hi-fi companies, Quad products are designed to open a window on a recording - to reveal the natural texture and detail without imposing any character of their own.

### Classic Series

This is no nostalgic nod to the past. Beneath the beautiful exterior of each product lies a powerful and superbly musical interior - critically acclaimed throughout the world as the finest in its class.

### Reference Series

The new ESL-2805 and ESL-2905 Electrostatics are Quad's latest reference loudspeakers and like their predecessors should be regarded amongst the finest loudspeakers in the world today. In areas such as transparency, and lack of colouration, they are without peer.

# QUAD

Tel: +44 (0) 1435 865 212, Fax: +44 (0) 1435 865 213, [www.sounds-of-music.co.uk](http://www.sounds-of-music.co.uk)

Firgrove Business Park, Firgrove Road, Cross in hand, Nr Heathfield, East Sussex, TN21 0QL. By appointment only please.



QUAD 303, 33, FM3, Denon TU 260L II tuner, boxed, NAD 4155 tuner, boxed, Leak Stereofetic tuner, Leak Troughline III tuner, Inca Tech Claymore II amplifier, Rega RB300, Rega RB250. Offers on these items. 07956 438 044

DECCA LONDON Gold vgc £135, grey needs service £60. Lentek battery step-up £50, Croft Super Micro totally rebuilt Croft custom coupling Aerovox decoupling caps. Mullard valves, outstanding £375. Tel: 0116 288 2338

ALPHASON SONATA turntable, no arm, rosewood with new spare plinth and two new spare motors, £850. Four Scanspeak 21W/8554 bass and two Scanspeak 02905/97000 tweeters. Tel: Roy 01452 501 955 (evenings)

QUAD ESL 63 for sale, £700 pair, vgc ono. Hadcock GH228 pick up arm for sale, vgc, £200 ono Tel: 0161 494 0517 (Stockport)

E.A.R. 834P phono amp with vol. MC/MM, perfect, £250. Rock deck D/C motor £50. Hafler pre-amp with phono £30. Tel: 01903 260 310 (Worthing)

PAIR QUICKSILVER all valve monoblocks with 8417's plus spare NOS 8417's. Can also use EL34's. Recent Croft precision upgrade, vgc. Conrad Johnson PV12 pre, immaculate, boxed, £2400. Tel: Stanley 07951 553 091 (London)

MONITOR AUDIO Gold Signature speakers. Piano black finish. Three months old. Mint condition, boxed with manual, c/w Atacama stands £425 ono. Tel: 07941 174 804

PURESOUND A30 valve amplifier, as new, boxed, (£1195) selling £750. Tel: 01491 614 325

QUAD ESL 57, mint, matched pair. First reasonable offer secures. Must be seen. Tel: 020 8682 3251 or by letter: 52 Ashvale Road, London SW17 8PW. All answered. Edward.

AUDIO PHYSIC Tempo speakers, mint condition, boxed, (£2195) selling £1300. Tel: 01491 614 329

LINN AKIS Akito, Linn K9. Perfect working condition. Almost new stylus. Minimal use for years. Can be heard working. £180. Croydon. Tel: 020 8251 7179 or Email: dandsh@blueyonder.co.uk

QUAD ELS 63's vgc £700 ono. Hadcock GH228 vgc, £200 ono. Tel: 0161 494 0517 (Stockport)

ALPHASON R5555 five tier hi-fi rack in matt black. Cost £160, accept £70. Unmarked, immaculate. Tel: 01892 534 604

PROAC D15 Response loudspeakers for sale. £2465 (new). Accept £950. Buyer collects. Tel: 01743 363 116 (Shropshire)

PROJECT DEBUT II turntable £40. Ruark Epilogue speakers £75. Musical Fidelity MC5 speakers £150. Goodmans Maxamp 30 exceptional condition £50. Sony MDSJE 770 MiniDisc £70. Tel: 01708 457691

GARRARD 401 The best that you will see. SME 3009 Ser II Shure V15III. All instructions mounting templates setup protractors. Tel: 01252 702 057

BEL CANTO 300i int amp £800. Cardas Golden Cross inters 1m RCA or XLR £100. Tel: 01782 633 088 anytime (Stoke - 1 mile Jct 15 M6)

HITACHI BOOKSHELF loudspeakers, quality build, good sound. New. £50 ono. 1971 Roberts R707 transistor radio. Immaculate, £30. LP12 arm-board for Ittok/LVX, as-new £10. Details - Ring: 01782 205 922 or 07794 732 840 (Staffordshire)

ART SKIBO standmount speakers, beech finish, immaculate condition. Demo welcome. £325, cost new £800. Contact John 01484 423 065 or Email: j.hawdon@ntlworld.com (West Yorkshire)

GRADO 325i headphones £100. Creek OBH-21 SE headphone amplifier £120. Both one year old. No offers. Tel: 07930 878 582 evenings (North London)

WANTED: 130mm injection moulded driver unit as fitted to Castle Keep Isis Tay Severn Harlech Mk1 speakers. Contact: 01952 249 627

THORENS TD160 turntable, Mitchell Tecno silver wired arm, Denon DL304 virtually new cartridge. Good sounding package. All original Thorens parts included. £425. Consider exchange quality phonostage. Location Merseyside. 0787 678 2864 or Email: vladsetiscali.co.uk

PAIR USHERS S520's, piano black, mint, boxed, £210. (See Hi-Fi World February 2008 page 21) World Design speakers WD 25A XL Silver plus Atacama stands. Bargain £450. Must be heard. Will demonstrate. Tel: 0115 975 4070

ORIGIN LIVE Resolution Illustrious with external transformer upgrade, excellent condition, original box. Illustrious has latest arm upgrade. Happy to demonstrate. £1850 ono. (RRP £3650) Tel: 01235 768 606 evenings (Oxfordshire)

UNISON RESEARCH 30wpc integrated single ended valve amp, mint, £850. Unison Research Unico CDP valve CD player, mint, £400. Tel: 07714 216 755

CREEK EVO onboard MM phonostage SCC 1000 brand new unused, genuine offers. Tel: 01794 513 003

WORLD AUDIO 22.5mF 600v Ansar polypropylene capacitor £10. HD83 output transformers £100. Tel: 01344 776 445 (Berks)

TEAC X300 7" open reel tape recorder, almost unused with original take-up spool and handbook plus three 6 hour Maxell 18-180 tapes. £150. You collect. Tel: 07710 828 286 (Brighton)

COPELAND CDA822 CD player (£2100) £900. E.A.R. 834P phonostage (£715) £300. Nordost Solar Wind cables (£300) £100. Soundstyle XS105 equipment rack (£300) £100. Atacama SE24 speaker stands (£50) £20. Tel: 01923 672 664 or 01234 764 147

CHAPTER TWO Plus power amp - worlds best. Boxed, manuals etc. (£5500) £2295. Densen B100 integrated amp £350. Densen B300 power amp £550. Atlas Elektra interconnects. Tel: 07973 189 538 (London)

SPENDOR CLASSIC Series SP2/3E speakers, rosewood, £625 ono (currently £1750). Suitable Acoustic Energy mass loaded stands available £200 (£600 new). Unison Research 'Unico' hybrid valve/Mosfet integrated amplifier, 75w/ch, £525 ono. Tel: 023 8073 8935

AUDIO RESEARCH SP8 £795. Audio Note Anv interconnect £165. Oracle Paris turntable c/w Oracle arm £425. Leak Troughline mono £195. Kelvin Labs Class 'A' integrated £250. VAC PA35 £1695. RATA Torlyte turntable support £175. Wanted: Rehdeko RK 115A's. Tel: 0113 255 9475

MUSICAL FIDELITY The Preamp 2A serviced by manufacturer in December 2005. Has excellent MC/MM phonostage, vgc, £100. Audio Technica MC step-up transformer £80. Tel: 01277 219 639 (Essex)

WHARFEDALE W15/CS Super 8 and Super 3 speakers. 2/3 way separator unit, Garrard 301 turntable, Quad 2 amplifier, Acoustical FM tuner. What offers? Tel: 020 7582 5969 (London, Kennington)

DUNLOP SYSTEMDEK Transcription turntable, original model, Rega R100 tonearm £150, Cambridge CD2, intermittent hum problem, needs service £40, Onix OA21 amplifier, SOAP power supply, mc phono, 1990, mint, £220, 020-8366-2647



BUY/SELL
HOME CINEMA
MULTIROOM INSTALL
HIFI

# www.choice-hifi.com

tel: 020 8392 1959 mob: 07768 720456

info@choice-hifi.com

## WDKEL84 Valve Amplifier Kit

*"The quality that can be gleaned from this amp is a fine introduction to the joys of the valve sound"*

The WDKEL84 features a pair of EL84 valves in Push Pull configuration per channel, providing two channels each 18 Watts into an 8 Ohm load. Described by users as a 'Giant Killer' this kit is available as a 5 input integrated amplifier with ALPS volume control.

WDKEL84 kit £449

WDKEL84 built & tested £599



## WD88VA Valve Amplifier Kit

*"It proved itself to be an engaging valve amplifier that measured well and sounded superb. Quite simply it plays music, and plays it extremely well."*

Adam Smith, Hi-Fi World Dec 06

Often described as a 'sweet sounding' valve, our implementation of the KT88 makes sure that it is driven to its ultimate performance. Available as a 35W stereo power amplifier with single input volume control, or as a relay switched integrated with five inputs.

WD88VA Integrated Amp kit £949

WD88VA built & tested £1249



## WDHD3 Headphone Valve Amplifier Kit

*"Headphone 3 is a single-ended design with the power pentode wired up in triode configuration for added purity and is as quiet as a mouse"*

A beautifully simple stereo headphone amplifier design using Mullard ECL83 valves. It works directly from any source. The circuit uses twin high specification E/I output transformers that can be wired to drive any headphones between 16 to 300 Ohms.

WDHD3S kit £349

WDHD3S built & tested £479



## WDPre3 Modular Preamplifier System

*"So there we have it, a pre-amplifier capable of driving any load and maintaining its linearity no matter what cables or partnering equipment you prefer to use."*

This 5 input line level preamp is essentially an SE triode power amplifier in concept. WDPre3 uses an ECC82 double triode arranged as input voltage amplifier and power output amplifier stages, the latter driving oversize 20:1 output transformers.

WDPre3 kit £369

WDPre3 built & tested £494



## WDPhono3S MM/MC preamplifier

*"...only a few designs meet the requirements of tonal accuracy and maximum retrieval of musical detail."*

Twin input preamp with MM and MC relay switched inputs, passive RIAA equalisation and wide bandwidth MC step-up transformers.

WDPhono3S kit £399

WDPhono3S built & tested £524



## WDPSU3 Power Supply

*Can be used to power either WDPre3 or WDPhono3 units individually or together.*

High performance choke power supply with separate HT and Heater feeds for both WDPre3 and WDPhono3 preamplifiers.

WDPSU3 kit £199

WDPSU3 built & tested £299



All our kits are complete with pictorial easy-to-follow instructions. All parts are included - all you need is a screwdriver and soldering iron.  
World Designs, 59 Main Street, Great Gidding, Huntingdon, Cambs, PE28 5NU

www.world-designs.co.uk  
Tel: 01832 293320



**NORDOST BLUE** Heaven interconnect for sale. £60. (was £125). Excellent transparent sounding cable. Tel: Andrew 01484 427 426 (Huddersfield)

**BOSE LIFESTYLE 5.** Pre-amp, CD, FM/AM tuner with RF remote. Used in dining room only. Complete with original accessories and in as new condition. £275ono Tel: 07952 056746

**GAMUT D200** for sale in excellent condition £1750 John 07921262604

**TEAC Hi-Fi H500i** system 6 components. Stereo Amplifier, CD Record/Rewrite Deck, CD Player, AM/FM/RDS Radio/Tuner, Minidisk, Cassette Deck. All remotes & manuals. Superb, As new £1150. 0121 246 1341 or 0777 932 1663

**EXCELLENT CONDITIONED KEF Q4** in dark apple with QED original bi-wire in 7m & 5m lengths, £230. Project IXpression, carbon arm with OMB10 & 510 mkll cartridges, £130. Tel. 07789902845 email. waynejennings@mac.com

**MARANTZ PM 7200 Amplifier.** Boxed. Superb condition. Class A option. New £350.00 For Sale at £225.00. Phone Mark on; 01423 817137 or email; mark@lovingtonhorn.co.uk

**QUAD ESL57** matched stereo pair bronze grilles original packaging. 495.00. Rel Strata/2 subwoofer brittex black 295.00 Denon 1604AV receiver 120.00. All excellent condition . ono. Tel 01159229176 email aaaa.w2@ntlworld.com.

**PROAC STUDIO 100** speakers in walnut £395.00 beautiful sound, classic speaker. Elemental Audio equipment rack, two shelves, shot filled, 10mm glass shelves £250.00 Tel: 01502 513940 or 07810 108933

**TANNOY PRESTIGE** Glenair 10 loudspeakers, brand new factory sealed boxes, 5 years guarantee £2650 ono (£3300). Collection from SE London. Gordan 07855343330 or naissus@hotmail.co.uk

**NAIM AUDIO** Nac 72 Preamp £300, Hicap £300 (olive), SBL Speakers Black Ash inc. P/Crossovers £500. All mint condition/boxed. Upgrade forces sale. Tel 07970 078653(Worksop)

**PAIR LOWTHER DX4s**, new type. Near mint, in original packaging - less than 100 hours in test enclosure. Welborne Labs DRD300b amps (ultimate upgrade) assembled. Offers - 0789 966 8052 micah.lax@gmail.com

**PAIR OF Rogers** Junior valve power amplifiers carefully converted to monoblocks. Push pull EL84 design. Fully working. £275 ono . Monster Alpha Genesis 1000 M/C Cartridge £100 Tel 01684 (Malvern) 572547.

**MISSION 753** speakers Arcam Alpha 5 amplifier tuner cd (one speaker not working) presets require attention overall immaculate Chichester area offers 01243 513625 info@stanhopephotos.com

**GARRARD 401/SME 3009/Sure V15** MkII £300; Unison Research Smart 845 Monoblocks £1200; Graaf WFB-one Valve Phono/line Preamp £550. Sensible Offers Considered. Tel. 01923 219711 (Watford).

**SOMETHING SOLID** speaker stands. Fully welded construction. Black. 63cm height. Mass filled. Spiked feet. Photo available. Ring for other dimensions. Quality stands.VGC. £80. Tel: 01582 423791 (Beds)

**2 TECHNICS SB-C55 & 2 SB-C575** speakers, SL-J110R turntable, ST-X902L tuner, SU-X520 amplifier, SH-E85 processor, RS-X520 cassette deck & SL-PJ38A CD player. All good condition Wants : £300 ovno contact : jpsteed@beachcroft.co.uk

**MARANTZ SA1.** CD player - wanted Preferrably one owner from new and in excellent order and condition. 01427 678558 / 01623 464272

**SPEAKER BARGAIN.** Wharfedale diamond 9.1 speakers, brand new, purchased 10th December, immaculate & boxed in rosewood, with receipt. £100 (£150). Lee West Midlands 01384 412234. lee-t@lycos.co.uk

**VINYL LP'S** Wanted Rock : Folk : Jazz Soul : Reggae : Blues : Classical : Memorabilia: Must be in Excellent condition: www.tantrel.com tantrel@bigfoot.com 0845 0941997

**LINN ITTOK LV2 12"** tone-arm (black) Scarce item, mint, unused £450 01256 462218 or blackbird@waitrose.com (Basingstoke)

**WHARFEDALE DIAMOND 9.1** speakers. Brand new, 1 week old with receipt & full manufacturers warranty. £120 (£150). Lee, West Midlands 01384 412234 or Email: lee-t@lycos.co.uk

**FOR SALE** Brand new Silver Vivid Audio B1 Speakers. Never been used. Cost £8000. Will sell for £5000. No Offers Please. Tel : 01494 774119 or 07968 174674

**CLASSIC CONTACTS**

When a classic goes 'poof' your troubles have just started, but there may be a good ending. Replacing failing parts can improve the sound, so here is a short listing of all those companies who specialise in getting a classic up and running again after its deposited a small ring of soot on your ceiling!

**CLASSIQUE SOUNDS**  
(Paul Greenfield, Leicester)  
ESL-57s restored, rebuilt, fully renovated or improved. Leak. Quad valves amps etc.  
Tel: 0845 123 5137 / Mob: 0116 2835821 Email: classique\_sounds@yahoo.co.uk www.flashbacksales.co.uk/classique

**GT AUDIO**  
(Graham Tricker, Bucks)  
Leak Troughline specialists. Also Quad and most classic tuners, radios and amplifiers restored, repaired.  
Tel: 01895 833099 / Mob: 07960 962579 www.gtaudio.com

**TECHNICAL AND GENERAL**  
(East Sussex)  
Turntable parts - wide range of spares and accessories, plus arms and cartridges. Tel: 01892 654534

**AUDIOLAB**  
(Phil Pimlott, Leeds)  
Renovation, repair and restoration. Specialist in valve hi-fi, radio transmitters, cinema amps, kit building.  
Tel: 0113 244 0378 www.audio labs.co.uk

**QUAD ELECTROACOUSTICS**  
(Cams)  
Quad's service department, able to repair almost all Quad products, from the very first.  
Tel: 0845 4580011 www.quad-hifi.co.uk

**ARKLESS ELECTRONICS**  
(Northumberland)  
Specialist in repairs, restoration and modifications to all amplifiers, valve or solid state, ancient and modern.  
Tel: 01670 829891 Email: arkless.electronics@btinternet.com

**SOWTER TRANSFORMERS**  
(Brian Sowter, Ipswich)  
Large range of audio transformers for valve amps, cartridges, line drive, interstage plus all associated services.  
Tel: 01473 252794 www.sowter.co.uk

**WEMBLEY LOUDSPEAKER**  
(Paul MacCallam, London)  
Comprehensive loudspeaker servicing.  
Tel: 020 8 743 4567 Email: paul@wembleyloudspeaker.co.uk www.wembleyloudspeaker.com

**EXPERT STYLUS COMPANY**  
(Wyndham Hodgson, Surrey)  
Stylus replacement service for all types of cartridge. Including precise profiling for 78s  
Tel: 01372 276604 Email: w.hodgson@btclick.com

**Dr MARTIN BASTIN**  
(Shropshire)  
Garrard 301/401 restoration, renovation and service. Special plinths; rumble cures, etc.  
Tel: 01584 823446

**ONE THING**  
(Coventry)  
Specialist in electrostatic panel manufacture and repair. Can refurbish ESL 57s and 63s as well as Leak Troughlines and Quad IIs.  
Email: one.thing@ntworld.com www.onethingaudio.com

**D.K. LOUDSPEAKER SERVICE**  
(Dave Smith, Hornchurch, Essex)  
Re-cone of hi-fi loudspeakers, high quality loudspeaker systems, PA, power loudspeakers.  
Tel/Fax: 01708 447 344

**LOCKWOOD AUDIO**  
(London)  
Tannoy loudspeaker parts, restoration and repair. Also Epos and TDL loudspeakers.  
Tel: 020 8 864 8008 www.lockwoodaudio.co.uk

**CLASSIC NAKAMICHI**  
(Paul Wilkins, Worthing, West Sussex)  
Restore, Repair & Service Nakamichi Cassette Decks.  
Tel: 01903 695695 Email: paul@bowersandwilkins.co.uk www.bowersandwilkins.co.uk

**OCTAVE AUDIO WOODWORKING**  
(Bristol)  
Unit 2, 16 Midland Street, 5c Phillips, Bristol.  
Tel: 0117 925 6015 www.octave-aw.co.uk

**LORICRAFT AUDIO**  
(Terry O'Sullivan, Bucks)  
Garrard 301/401 and their own 501 repair, spares and service.  
Tel: 01488 72267 www.garrard501.com

**CARTRIDGE MAN**  
(Len Gregory, London)  
Specialist cartridge re-tipping service and repairs. High quality special cartridges.  
Tel: 020 8 688 6565 www.listen.to/thecartridgeman

**REVOX**  
(Brian Reeves, Cheshire)  
Revox tape recorder spares, service and repair. Accessories also available.  
Tel: 0161 499 2349 Email: brian@revoxservice.co.uk www.revox.freeuk.com

BUY / SELL HOME CINEMA MULTIROOM INSTALL HI - FI

**www.choice-hifi.com**

tel: 020 8392 1959 mob: 07768 720456 info@choice-hifi.com

# NEXT MONTH

Open the pages of April's *Hi-Fi World* and you'll find a veritable shower of great new equipment to read about. If you're thinking about spring cleaning your system, then we have products of every type and price to consider – from Linn's super new high end Akurate DS network music player to Tonearm Audio's Model 9, a wooden pickup selling for under £200! There's everything from the brand new MF Audio Reference, possibly the world's best pre-amp, to Leak's classic Stereo 60 amplifier. Here's just some of what we hope to bring you in next month's bumper issue:

ICON AUDIO MB90 MONOBLOCK POWER AMPLIFIERS  
FEATURE: DIGITAL AUDIO PAST, PRESENT & FUTURE  
GRAHAM SLEE VOYAGER HEADPHONE AMPLIFIER  
MOON i-3 vs. MYSTERE IA21 INTEGRATEDS  
MF AUDIO REFERENCE PASSIVE PREAMPLIFIER  
LINN AKURATE DS NETWORK MUSIC PLAYER  
OLDE WORLDE: LEAK STEREO 60 AMPLIFIER  
AUDIO TECHNICA AT-H1000 HEADPHONES  
ORTOFON MC WINFELD CARTRIDGE  
CAMBRIDGE AUDIO 340R AV RECEIVER  
TONEARM AUDIO MODEL 9 TONEARM  
Q ACOUSTICS 1020i LOUDSPEAKERS  
QUAD 11L ACTIVE LOUDSPEAKERS  
WHEST AUDIO TWO PHONOSTAGE  
B&W ZEPPELIN IPOD DOCK  
TRENDS AUDIO UD-10 DAC  
PMC OB1i LOUDSPEAKERS



**PICK UP THE APRIL 2008 ISSUE OF *HI-FI WORLD* ON SALE FEBRUARY 29TH,  
OR SUBSCRIBE AND GET IT DELIVERED TO YOUR DOOR: p62**



## ADVERTISERS INDEX

2nd Hand HiFi	119
Analogue Seduction	113
Anatek/WBT	74
Angel Sound	109
Audio Components	66
Audio T	56
Audiocraft	113
AudioXpress	108
Auranote	12
Aurousal	117
B&W	OBC
Big Ears	108
Billy Vee	104
Cambridge Audio	32
Choice HiFi	123,125
Chord Company	28
Classique Sounds	111
Cymbiosis	114
Decent Audio	115
Electrocompaniet	14
Exposure	IFC
GT Audio	108
Heathcote Audio	110
Heatherdale Audio	115
Henley Designs	74,78,88
Hi-Fi Sound	119
HiAudio	38
HiEnd Cable	111
Ian Edwards	115
Ian Harrison	111
Icon Audio	113
iCubes	42
KEF	24
Kudos	115
Leema Acoustics	26
Mantra Audio	109
Matrix HiFi	114
Michell Engineering	114
MIT Cables	46
Monitor Audio	6
Naim	70
Newcastle Hifi	36
Origin Live	112
Quad	106
Redline	46
Retro Reproduction	109
Ringmat Developments	58
Rochester Hi-Fi	112
Russ Andrews	66
Sevenoaks	92,100
Shadow Audio Cons.	68
Sounds of Music	124
Sugden	58
SuperFi	116
Tangent	42
Tell.Com	122
The Rightnote	66
Tube Shop	108
Turntable World	119
Usher	IBC
Walrus Systems	72
Whest Audio	88
World Design	118,126
Yinpuli	42

# FREE READER CLASSIFIED ADS ORDER FORM

## STOP PRESS

**TERMS AND CONDITIONS:** Only one advert per reader. Maximum length per advert is 30 words. Adverts over 30 words will not be accepted. No Trade Adverts. This section is strictly for readers selling secondhand hi-fi equipment only. Telephone numbers and E-mail addresses are treated as one word. Model numbers are treated as one word i.e. Quad 303 = two words. Sorry, we cannot accept adverts over the telephone. The Publisher reserves the right to judge submissions.

You can email your advert to us at: [classifieds@hi-fiworld.co.uk](mailto:classifieds@hi-fiworld.co.uk)  
or write or type your advertisement copy in block capitals with one word per box and post it to us at:

**Hi-Fi World Free Readers Ads,**  
Unit G4, Argo House, Kilburn Park Road,  
London, NW6 5LF.

### WE WILL ACCEPT PHOTOCOPIES OF THIS FORM

1	2
3	4
5	6
7	8
9	10
11	12
13	14
15	16
17	18
19	20
21	22
23	24
25	26
27	28
29	30

Name: \_\_\_\_\_

Address: \_\_\_\_\_

Post Code: \_\_\_\_\_

Daytime Tel: \_\_\_\_\_

### FREE READER CLASSIFIED ADVERTS COPY DEADLINES

APRIL 2008 ISSUE - 5TH FEBRUARY 2008

MAY 2008 ISSUE - 6TH MARCH 2008

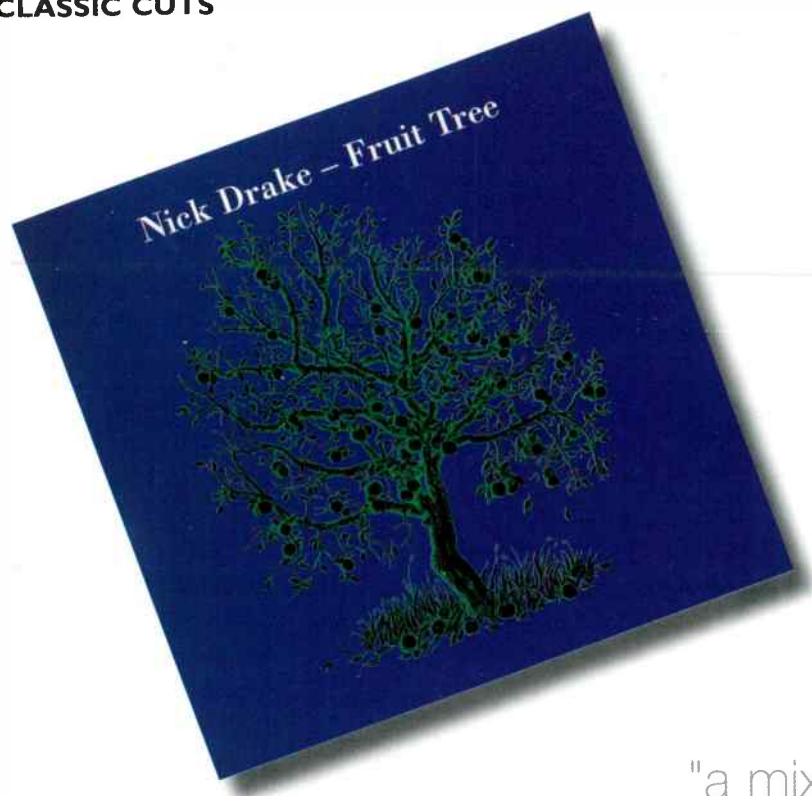

# FRUIT TREE

## NICK DRAKE

### 2007

**A** cult figure, the late Nick Drake's entire musical oeuvre has been hailed by many as 'classic'. Largely ignored as a creative talent when he was alive and making music from 1969 to 1972, mainly because he refused to play live, this folk-rock singer-songwriter's standing has rocketed during the past twenty years. Presenting a mixture of beautifully melodic and sometimes stark and bleak works, Drake is never less than interesting. As such, therefore, rather than recommend a single album, it seems wise to guide you to Drake's entire commercial works, currently available again, collected within a box set in both CD and vinyl forms.

Originally released in 1986 on vinyl, this 2007 version of *Fruit Tree* is a four-disc box set featuring all three of Nick Drake's studio albums: 'Five Leaves Left' (1969), 'Bryter Layter' (1970), and 'Pink Moon' (1972) plus a DVD of the 1986 documentary film 'A Skin Too Few' by Dutch filmmaker Jeroen Berkvens. The box set also features a 108-page book which features comprehensive lyric sheets, exclusive interviews with Nick's producer Joe Boyd, and engineer John Wood who discuss each song Nick recorded under their auspices.

Why release this box set now? The mysteriously named Cally, who manages the estate of Nick Drake for and on behalf of Gabrielle Drake, Nick's sister, elaborated, "It was felt a good idea to re-release the 'Fruit Tree' box set as a cheap way for new fans to buy all three of Nick's albums in one go. So many shops only stock one or, at best, two of Nick's titles at

"a mixture of beautifully melodic and sometimes bleak works..."

any one time."

Cally however had strong feelings about how the sets were to be produced. Take the CD version for example, "I am not a fan of the Jewel Case. I think it's a lazy throwback to the novelty of CD's birth as a format. Record companies have been dictated to by the retailers to retain the hideous plastic case as a format housing, regardless of the fact that it later devalued music to the same level as a home-burned CD copy."

Hence, Cally proposed that, to increase the value of the CD set, 'mini-vinyl' cardboard sleeves should be used. Deciding upon an additional vinyl format came very late and was created purely as a result of customer demand. "That is," said Cally, "Universal thought they could sell enough to make it worthwhile. Seeing the horrible so-called 'Japanese' vinyl bootlegs and now the even worse coloured vinyl variant bootlegs, I thought and hoped that we could do better on a very limited budget. Those hideous cheap packages - gatefold sleeves back to single pockets - were mastered from the appalling first-edition CDs from 1986."

As Cally mentioned, this new box set is relatively cheap. He stated too that his budget was limited. You might conclude, therefore, that his resources were limited and you'd be right. "I had neither time or money to cut the new albums from scratch using the original un-EQ'd quarter inch masters," said Cally.

The production team had

to think a little more creatively, therefore. Initially, Cally and John Wood spent many weeks remastering the CDs during 2000. Many different approaches were tried, including HDCD. Finally, "John worked directly alongside my original vinyl pressings as a source of reference - not the later EMI second-pressings that sound thinner - and I thought he did a magnificent job. What came out had the clarity and warmth of the originals. We later did 5.1 mixes on all of the songs in Nashville, and these made it onto a layer of the 'A Treasury' CD (the Hybrid SACD/CD compilation released in 2004 on Island) but we still returned to the earlier 2000 remastered versions as a definitive sound."

The vinyl production followed, "We mastered the new vinyl with (mastering engineer) Kevin Metcalfe from the tapes used for the current CD formats. Less than perfection but we are not claiming that these vinyl releases are 'audiophile' in any way. They are priced not to be! (However) I think the pressings sound every bit as good as the original Island vinyl first pressings."

For now, we can only imagine what a full set of re-released albums taken directly from the original masters, utilising today's superior processing software (for CD) and analogue chain (for vinyl) would sound like. However, until that day and until sufficient funds are released by Universal, both format sets are admirable productions and well worth your attention. **PR**



**USHER**  
www.usheraudio.com

# Be there.

THE BERYLLIUM EVOLUTION

With the music

The new Usher Beryllium 718

## BE-718

Two-way system

Tweeter: 1.25" (9980-20BEA)

Mid-bass: 7" (8948A)

Sensitivity: 87 dB @ 1 watt / 1m

Nominal impedance: 8 ohms

Frequency response (-3 dB): 42 Hz ~ 35 kHz

Power handling: 80 watts

Crossover frequency: 2.06 kHz

Weight: 14.2 kgs

Dimensions (w x d x h): 25.5 cm x 42.8 cm x 39 cm



## USHER AUDIO TECHNOLOGY

67 Kai-fong Street Sec.1 Taipei 100 Taiwan Tel:886-2-2381 6299 Fax:886-2-2371 1053 E-mail: usher@ms11.hinet.net

## HI AUDIO

3 St Fort Place Wormit Newport on Tay DD6 8NT United Kingdom Tel/Fax:00 44 (0) 845 0 525259 Mob:00 44 (0) 7968 272614  
Web: www.hiaudio.co.uk Email: hugh@hiaudio.co.uk

Audio & Cinema, Bodmin, Tel: 0870 458 4438.

Bigears Hi Fi, Cornwall, Tel: 01736 740421.

Classic Hi Fi, London, Tel: 0208 374 3958.

Hazlemere Audio, Buckinghamshire, Tel: 01494 865 398.

Hi Fi Sound, Co Durham, Tel: 01325 241888.

Hi-Fi Corner, Edinburgh, Tel: 0131 556 7901

Hi-Fi Corner, Glasgow, Tel: 0141 226 5711.

Oxford Audio Consultants, Oxfordshire Tel: 01865 790879

Rochester Hi Fi, Kent, Tel: 01634 880037.

Sound Hi Fi dot com, Devon, Tel: 01803 833366

The Emporium Willow House, Suffolk Tel: 01379 870873

Walrus Systems, London, Tel: 020 7724 7224.



**We're not trying to give the most. We're trying to lose the least.** That was John Bowers' philosophy 40 years ago, and it lives on in our new 600 Series. Speakers that neither add to, nor take away from, the original sound. That requires world-class science – and extremely experienced ears. Because once we've selected exactly the right components, we begin the long, careful process of tuning. Listening and refining, over and over. Until the frequencies combine to conjure a sound so true, so alive, you want to reach out and touch it. *Dr John Dibb, Senior Development Engineer and Fellow of the Society of Sound, on the new 600 Series.*

Visit the Society of Sound at [www.bowers-wilkins.com](http://www.bowers-wilkins.com)

**B&W** Bowers & Wilkins

Listen and you'll see