

# EVERYDAY ELECTRONICS and ELECTRONICS MONTHLY

DECEMBER 1985

£1-10

FREE INSIDE

GREENWELD

CATALOGUE WORTH 70p

ELECTRONIC COMPONENTS

DIGITAL CAPACITANCE METER



FREE ENTRY FUN COMPETITION 100 MULTIMETERS TO BE WON



CHRISTMAS GIFT BUYERS GUIDE

Newcomers Magazine for Electronic & Computer Projects

10 CARS AVE

## £1 BAKERS DOZEN PARCELS

All the parcels listed below are brand new components. Price per parcel is £1.00, but if you order 12 you get one extra free unless marked s.h.

- 1 - 5 13 amp ring main junction boxes
- 2 - 5 13 amp ring main spur boxes
- 3 - 25 13 amp fuses for ring mains
- 4 - 5 surface mounting switches suitable insulated for mains voltage
- 5 - 3 flush electrical switches intermediate type, will also replace 1 or 2 way switches
- 6 - 5 in flex line switches
- 7 - 4 in flex line switches with neons
- 8 - 2 80 watt brass cased elements
- 9 - 2 mains transformers with 6v 1a secondaries
- 10 - 2 mains transformers with 12v 1/2a secondaries
- 11 - 2 extension speaker cabinet for 6 3/2" speaker
- 12 - 5 octal bases for relays or valves
- 13 - 12 glass reed switches
- 14 - 4 OCP 70 photo transistors
- 15 - 25 assorted germanium transistors OC45 etc
- 16 - 4 tape heads, 2 record, 2 erase
- 17 - 2 ultra sonic transmitters and 2 ditto receivers
- 18 - 2 15000 mfd computer grade electrolytics
- 19 - 2 light dependent resistors similar ORP12
- 20 - 5 diff micro switches
- 21 - 2 mains interference suppressors
- 22 - 2 25 watt crossover units
- 23 - 1 40 watt 3 way crossover unit
- 24 - 250 various screws and self tappers
- 25 - 1 of each water switches - 6p 2 way; 4p 3 way; 2p 6 way; 1p 12 way
- 26 - 2 tape deck counters
- 27 - 1 6 digit counter 12v
- 28 - 1 6 digit counter mains voltage
- 29 - 1 BOAC in flight stereo unit (second hand)
- 30 - 2 Nicad battery chargers
- 31 - 1 key switch with key
- 32 - 2 humidity switches
- 33 - 2 aerosol cans of ICI Dry Lubricant
- 34 - 36 x 1 metre lengths colour coded connecting wires
- 35 - 4 battery operated model motors
- 36 - 2 air spaced 2 gang tuning condensers
- 37 - 2 solid dielectric 2 gang tuning condensers
- 38 - 10 compression trimmers
- 39 - Long and Medium wave tuner kit
- 40 - 4 x 465 KC IF-transformers
- 41 - 8 Rocker Switches 10 amp Mains SPST
- 42 - 6 Rocker Switches 10 amp Mains SPDT
- 43 - 5 Rocker Switches 10 amp SPDT Centre Off
- 44 - 4 Rocker Switches 10 amp DPDT
- 45 - 1 24 hour time switch mains operated (s.h.)
- 46 - 1 6 hour clock timeswitch
- 47 - 2 lever switches 4 pole changeover up and ditto down
- 48 - 2 6v operated reed switch relays
- 49 - 10 neon valves - make good night lights
- 50 - 2 x 12v DC or 24V AC 4C 0 relays
- 51 - 1 x 12v 2C 0 very sensitive relay
- 52 - 1 x 12v 4C 0 relay
- 53 - 2 mains operated relays 3 x 8 amp changeovers (secondhand)
- 54 - 10 rows of 32 gold plated IC sockets (total 320 sockets)
- 55 - 1 locking mechanism with 2 keys
- 56 - Miniature Inselector with circuit for electric jigsaw puzzle
- 57 - 5 Dolls' Hous switches
- 58 - 2 telephone hand sets incorporating ear piece and mike (s.h.)
- 59 - 2 flat solenoids - ideal to make current transformer etc.
- 60 - 4 ferrite rods 4" x 5/16" diameter aeralis
- 61 - 4 ferrite slab aeralis with L & M wave coils
- 62 - 4 200 ohm earpieces
- 63 - 1 Mullard Thyristor trigger and modules
- 64 - 10 assorted knobs 1/4 spindles
- 65 - 5 different thermostats, mainly bi-metal
- 66 - Magnetic brake - stops rotation instantly
- 67 - Low pressure 3 level switch
- 68 - Heavy duty 4 pole contactor - 24v coil
- 69 - 2 25 watt pots 8 ohm
- 70 - 2 25 watt pots 1000 ohm
- 71 - 4 wire wound pots - 18, 33, 50 and 100 ohm
- 72 - 1 1250 watt dimmer Ultra ref SE20
- 73 - 4 3 watt wire wound pots 50 ohm
- 74 - 50 1/3 watt carbon film resistors food spread 10 valves
- 75 - 20 2 watt carbon resistors 10 values
- 76 - 30 1 watt carbon resistors 15 diff values
- 77 - 1 time reminder adjustable 1-60 mins
- 78 - 5.5 amp stud rectifiers 400v
- 79 - 4 2a bridge rectifiers 30v
- 80 - 2 10a bridge rectifiers 30v
- 81 - 2 30a panel mounting sydlok fuses
- 82 - 4 porcelain fuse holders and fuses
- 83 - 1 fluorescent choke - your choice - 15, 20, 30, 40 or 65 watt
- 84 - 10 - 1 uf mains voltage suppressor condensers
- 85 - 1 mains shaded ple motor 3/4" shaft - 1/4 shaft
- 86 - 2 5" all fan blades fit 1/4" shaft
- 87 - 2 3" plastic fan blades fit 1/4" shaft
- 88 - Mains motor suitable for above blades
- 89 - 1 mains motor with gear box 1 rev per 24 hours
- 90 - 1 mains motor with gear box 1 rev per 12 hours
- 91 - 2 mains motor with gear box 16rpm
- 92 - 4 fluorescent starters suit 4-80w tubes
- 93 - 4 11 pin moulded bases for relays
- 94 - 5 B7G valve bases
- 95 - 4 skirted B9A valve bases
- 96 - 1 thermostat for fridge
- 97 - 1 infra red fire element 1000 watts
- 98 - 1 motorised stud switch (s.h.)
- 99 - 5 assorted ferrite shapes
- 100 - 3 ferrite magnets
- 101 - 1 1/2 hours delay switch
- 102 - 1 9v mains power supply unit
- 103 - 1 6v mains power supply unit
- 104 - 1 4 1/2v mains power supply unit
- 105 - 1 5 pin flex plug and panel socket
- 106 - 1 12v vibrating reed beepers
- 107 - 5" speaker size radio cabinet with handle
- 108 - 5 different multi way push switches
- 109 - 10 1/4" spindle type volume controls
- 110 - 10 slider type volume controls
- 111 - 2 musical boxes (less keys)
- 112 - 1 heating pad 200 watts
- 113 - 1 1m front and with tuning condenser and data
- 114 - 1 1w amplifier Mullard 1172
- 115 - Wall mounting thermostat 24v
- 116 - 3 pairs small 2prs. medium croc clips
- 117 - 4 pairs large (car size) crocodile clips
- 118 - Teak effect extension 5" speaker cabinet
- 119 - 1 log & 1 coal fibreglass fire fronts
- 120 - p.c.b. with 2 amp full wave and 7 other recs.
- 121 - 13 amp flush switched sockets
- 122 - 10 mtrs twin screened flex white p.v.c. outer
- 123 - 100 plastic with hardened pin flex clips
- 124 - 10 assorted slide switches



Ex-Electricity Board. Guaranteed 12 months.

## 12 volt MOTOR BY SMITHS

Made for use in cars, etc. these are very powerful and easily reversible. Size 3 3/2" long by 3" dia. They have a good length of 1/8" spindle - 1/10 hp £3.45. 1/8 hp £5.75. 1/6 hp £7.50

## SOUND TO LIGHT UNIT



Complete kit of parts for a three channel sound to light unit controlling over 2000 watts of lighting. Use this at home if you wish but it is plenty rugged enough for disco work. The unit is housed in an attractive tone metal case and has controls for each channel, and a master on/off. The audio input and output are by 1/4" sockets and three panel mounting fuse holders provide thyristor protection. A four pin plug and socket facilitate ease of connecting lamps. Special price is £14.95 in kit form.

## THIS MONTH'S SNIP

TOP OF THE POPS LIGHTING if you use our disco switch ONLY £6.90

These have 12" x 10" amp changeover switches each rated at 10 amps so a whole street could easily be lit with one. Switches adjustable and could be set to give a running light, random flashes, etc., etc. 230 volts main operation. Brand new, made by Honeywell. Offered at approximately on third of cost.

## TANGENTIAL BLOW HEATER

by British Solartron, as

used in best blow

heaters. 3Kw £6.95

complete with 'cold', 'half'

and 'full' heat switch,

safety cut out and

connection diagram.

Please add post £1.50 for 1 or 3 for £20 post paid

2.5 Kw KIT Still available: £4.95 + £1.50 post

or have 3 for £16 post paid.

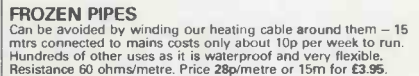

## FROZEN PIPES

Can be avoided by winding our heating cable around them - 15 mtrs connected to mains costs only about 10p per week to run. Hundreds of other uses as it is waterproof and very flexible. Resistance 60 ohms/metre. Price 28p/metre or 15m for £3.95.

## CORDLESS TELEPHONES

"IT'S FOR YOU-OU" even if you are in the bath, it's an infinite extension any room and even in the garden - have one on approval or come and try one here. BT approved £120 not yet approved £59. Both have 10 memory.

SOCKETS PLUGS ETC for BT phones

Master socket (has surge arrester - ringing condenser etc) and takes

B.T. plug ..... £3.95

Extension socket ..... £2.95

Dual adaptors (2 from one socket) ..... £3.95

Cord terminating with B.T. plug 3 metres ..... £2.95

Kit for converting old entry terminal box to new B.T. master socket, complete with 4 core cable, cable clips and 2 BT extension sockets ..... £11.50

## 25A ELECTRICAL PROGRAMMER

Learn in your sleep. Have radio playing and kettle boiling as you wake - switch on lights to ward off intruders - have a warm house to come home to. You can do all these and more. By a famous maker with 25 amp on/off switch. Independent 60 minute memory jogger. A beautiful unit at £2.50

## THE AMSTRAD STEREO TUNER

This ready assembled unit is the ideal tuner for a music centre or an amplifier, it can also be quickly made into a personal stereo radio - easy to carry about and which will give you superb reception.

Other uses are a "get you to sleep radio", you could even take it with you to use in the lounge when the rest of the family want to view programmes in which you are not interested. You can listen to some music instead.

Some of the features are: long wave band 115 - 170kHz, medium wave band 525 - 1650kHz, FM band 87 - 108 MHz, mono, stereo & AFC switchable, fully assembled and fully aligned. Full wiring up data showing you how to connect to amplifier or headphones and details of suitable FM aerial (note ferrite rod aerial is included for medium and long wave bands). All made up on very compact board. Offered at a fraction of its cost only £4.95

## MINI MONO AMP on p.c.b. size 4" x 2" (app.)

Fitted volume control and a hole for a tone control should you require it. The amplifier has three transistors and we estimate the output to be 3W rms. More technical data will be included with the amp. Brand new, perfect condition, offered at the very low price of £1.15 each, or 10 for £10.00.

## J. BULL (Electrical) Ltd.

(Dept. EE), 34 - 36 AMERICA LANE, HAYWARDS HEATH, SUSSEX RH16 3QU. Established 30 YEARS

MAIL ORDER TERMS: Cash, P.O. or cheque with order. Orders under £20 add £1 service charge. Monthly account orders accepted from schools and public companies. Access & B/card orders accepted day or night. Haywards Heath (0444) 454563. Bulk orders: phone for quote. Shop open 9.00 - 5.30, Mon to Fri, not Saturday.

## TWO POUNDERS

Following the popularity of our BAKERS DOZEN £1 PARCELS, we are now introducing some BAKERS DOZEN £2 PARCELS. We feel that you will agree that most are exceptional bargains but you can still get a bit extra, as with the £1 parcel, if you buy 12 you get another free!

- 2P1 - 24 hour time switch with 2 on/offs, an ideal heating programmer
- 2P2 - Wall mounting thermostat, high precision with mercury switch and thermostat
- 2P3 - Variable and reversible 8-12v power supply, ideal for model control
- 2P4 - 24 volt psu with separate channels for stereo made for Mullard UNILEX Amplifiers
- 2P5 - 12 volt psu 750 ma output - plastic cased
- 2P6 - 100 watt taps to 115 volts auto-transformer with voltage tappings
- 2P7 - Mini key, 16 button membrane keyboard, list price over £12, as used on PRESTEL
- 2P8 - Mains motor with gear box and variable speed selector. Series wound so suitable for further speed control
- 2P9 - Time and set switch. Boxed, glass fronted and with knobs. Controls up to 15 amps. Ideal to program electric heaters, battery chargers etc
- 2P10 - 12 volt 5 amp mains transformer - low volt winding on separate bobbin and easy to remove to convert to lower voltages for higher currents
- 2P11 - Power amp module Mullard Unilex EP9000 (note stereo pre-amp module Unilex 9001 is BD216)
- 2P12 - Disk or Tape precision motor - has balanced rotor and is reversible 230v mains operated 1500 rpm
- 2P13 - Sun Lamp switch stays on for 1/2 hr or 1 hr depending on setting of grub screw
- 2P14 - Mug Stop kit - when thrown emit piercing squawk
- 2P15 - Interrupted Beam kit for burglar alarms, counters, etc
- 2P16 - Lockable metal box with 2 keys, ideal for your tools
- 2P17 - 1 rev per minute mains driven motor with gear box, ideal to operate mirror ball
- 2P18 - Liquid/gas shut off valve mains solenoid operated
- 2P19 - Disc switch-motor drives 6 or more 10 amp change over micro switches supplied ready for mains operation
- 2P20 - 20 metres extension lead, 2 core - ideal most Black and Decker garden tools
- 2P21 - 10 watt amplifier, Mullard module reference 1173
- 2P22 - Motor driven switch 20 secs on or off after push
- 2P24 - Clockwork operated 12 hour switch 15A 250V with clutch
- 2P25 - 1000 watt flasher mains motor driven
- 2P26 - Counter resettable mains operated 4 digit
- 2P27 - Goodmans Speaker 6 inch round 8ohm 12 watt
- 2P28 - Drill Pump - always useful couples to any make portable drill
- 2P29 - 24 position Yaxley switch contacts rated 5A - 1/4 spindle
- 2P30 - 15 metres 6 way telephone or interconnecting wire
- 2P31 - 4 metres 98 way interconnecting wire easy to strip to use the cores separately
- 2P32 - Hot Wire amp meter - 4 1/2 round surface mounting - old but working and definitely a bit of history
- 2P33 - 0-30 amp meter 2" round panel mounting with shunt ex ministry equipment
- 2P34 - Solenoid Air Valve mains operated
- 2P35 - Battery charger kit comprising mains transformer, full wave rectifier and meter, suitable for charging 6v or 12v
- 2P36 - 20 Amp meter, with shunt unused but ex-equipment
- 2P37 - 0-100 micro amp meter, 2" square flush mounting good make
- 2P38 - 200 R.P.M. Geared Mains Motor 1" stack quite powerful, definitely large enough to drive a rotating aerial or a tumbler for polishing stones etc.

## IONISER KIT

Refresh your home, office, shop, work room, etc. with a negative ION generator. Makes you feel better and work harder - a complete mains operated kit, case included. £11.95 plus £2.00 post.

## CAR STARTER/CHARGER KIT

Flat Battery! Don't worry you will start your car in a few minutes with this unit - 250 watt transformer 20 amp rectifiers, case and all parts with data £16.50 or without case £15.00 post paid.

## 4/5A BATTERY CHARGER

Transformer and rectifier £3.95 & £1 post, 3 Kits £12.

## SUPER H.F. SPEAKER CABINET

Made for an expensive Hi-Fi outfit. Will suit any decar, is resonance free, cut outs for 8" woofer, 2 3/4" mid range and 2 1/2" tweeter. Front is black and the completed unit most pleasing. Price per pair £6.90 carriage £3.50.

## OTHER POPULAR PROJECTS

- |  |        |
|--|--------|
| Kit .....  | £14.95 |
| Big Ear, listen through walls .....                        | £9.50  |
| Silent Sentinel Ultra Sonic Transmitter and Receiver ..... | £9.50  |
| Car Light 'left on' Alarm .....                            | £3.50  |
| 3 - 30v Variable Power Supply .....                        | £13.80 |
| 2 Short & Medium Wave Crystal Radio .....                  | £3.99  |
| Radio Stethoscope - fault finding aid .....                | £4.80  |
| Morse Trainer - complete with key .....                    | £2.99  |
| Drill Control Kit .....                                    | £3.95  |
| Transmitter Surveillance Kit .....                         | £2.30  |
| Radio Mike .....   | £6.90  |
| FM Receiver Kit - for surveillance or normal FM .....      | £3.50  |
| Insulation Tester - electronic megger .....                | £7.95  |
| Matchbox Radio - receives Medium Wave .....                | £2.95  |
| 40 watt amp - Hi-Fi 20hz-20kHz .....                       | £9.50  |
| 115 Watt Amplifier 5Hz 25kHz .....                         | £13.50 |
| Power Supply for 115 watt amp .....                        | £8.50  |

ISSN 0262-3617

PROJECTS ... THEORY ... NEWS ...  
COMMENT ... POPULAR FEATURES ...

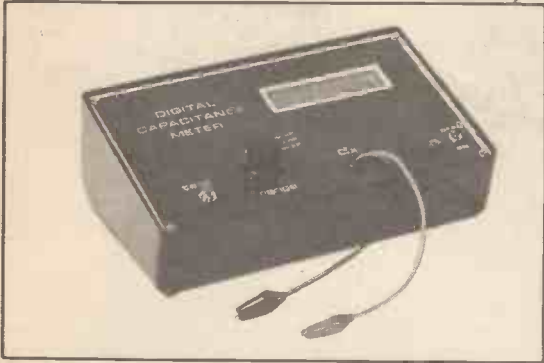

See page 678 for the full story

© IPC Magazines Limited 1985. Copyright in all drawings, photographs and articles published in EVERYDAY ELECTRONICS and ELECTRONICS MONTHLY is fully protected, and reproduction or imitations in whole or in part are expressly forbidden.

## Projects

- DIGITAL CAPACITANCE METER** by Mark Stuart 640  
What value do you put on your capacitors?
- DIODE TESTER/TRANSISTOR** 660  
by Michael Tooley BA & David Whitfield MA MSc CEng MIEE  
Sort out the problems of suspect semiconductors
- SPECTRUM ADC** 664  
Part of *On Spec* article
- TTL LOGIC PROBE** 668  
Testing TTL with a proven probe
- OPTICAL INTENSITY TRANSDUCER** 672  
A simple lightmeter project

## Series

- TEACH-IN '86** 649  
by Michael Tooley BA & David Whitfield MA MSc CEng MIEE  
Part Three: Introduction to the Semiconductor
- ON SPEC** by Mike Tooley BA 664  
Writing machine code, and an ADC for the Spectrum
- ELECTRONIC BUILDING BLOCKS** by Richard Barron 668  
More about op-amps and a little bit of logic
- TRANSDUCERS** by Mike Feather 672  
Part Four: Different methods for determining light intensity
- FUNTRONICS** by Thakery 676  
A light-hearted approach to electronics and television
- ACTUALLY DOING IT** by Robert Penfold 682  
Mounting component boards for reliability

## Features

- EDITORIAL** 639
- SHOPTALK** by Richard Barron 646  
Product news and component buying
- FOR YOUR ENTERTAINMENT** by Barry Fox 648  
Community Radio; War Games
- MAN BEHIND THE SYMBOL** by Morgan Bradshaw 666  
Symbols, and the men they are named after, explained
- COMPETITION** 667  
Free Entry—Your chance to win a multimeter
- COUNTER INTELLIGENCE** by Paul Young 670  
A retailer comments
- PLEASE TAKE NOTE** 670  
Simple Reverb; Halloween Projects
- NEWS** 678  
What's happening in the world of electronics
- PRINTED CIRCUIT BOARD SERVICE** 680
- INDEX VOLUME 14** 683  
January 1985 to December 1985

## Buyers Guide

- CHRISTMAS GIFTS** 656  
A selection of ideas for all the family

Our January 1986 issue will be published on Friday, December 6.  
See page 675 for details.

Readers' Services • Editorial and Advertisement Departments

639

# TEACH-IN '86

As usual, GREENWELD are supplying all TEACH-IN '86 items - as we have done over the past 10 years. Our experience with these projects ensures you receive top quality components as specified at the best possible price, so you can order with confidence. This years kits are available as follows:

- BASIC ITEMS:** M102B2 multimeter; Verobloc, bracket & design sheets, 10 leads with croc clips + FREE - the latest GREENWELD Catalogue and a resistor colour code calculator!! PRICE, inc VAT and post ..... **£21.95**
- EXTRA COMPONENTS** required for parts 1 and 2 ..... **£1.50**
- EXTRA COMPONENTS** required for parts 3 and 4 ..... **£3.60**
- PSU - EE Special Offer** mains adaptor ..... **£4.95**
- REGULATOR UNIT:** All parts including case, also in-line fuseholder, fuse and 2mm plugs for PSU ..... **£16.95**
- LCR BRIDGE:** All parts including case ..... **£23.95**
- DIODE/TRANSISTOR CHECKER:** All parts inc. case ..... **£15.95**

## 1986 CATALOGUE FREE WITH THIS ISSUE OF EVERYDAY ELECTRONICS!

### COMPUTER BOOKS ALL HALF PRICE OR LESS!!

**SUBSTANTIAL DISCOUNTS FOR QUANTITIES -  
ASK FOR LIST OF 50+ TITLES!**

#### EXPLORING ADVENTURES WITH THE BBC

Peter Gerrard

Size 215 x135mm 244pp  
Starting with an introduction to adventures and their early history, this book takes you through the steps necessary to write your own games. Highly readable.  
Pub. Price £6.95 Our Price £2.95

#### BBC PROGRAMS Vol. 1

Carl Graham & Nick Hampshire

Size 215 x134mm 176pp  
27 interesting progs covering games, utilities, graphics etc. A basic book for all Beeb users!  
Pub. Price £6.95 Our Price £2.95

#### EXPLORING ADVENTURES WITH THE ELECTRON

Peter Gerrard

Size 215 x135mm 244pp  
Starting with an introduction to adventures and their early history, this book takes you through the steps necessary to write your own games. Highly readable.  
Pub. Price £6.95 Our Price £2.95

#### ELECTRON PROGRAMS

Carl Graham & Nick Hampshire

Size 215 x135mm 181pp  
24 progs - games, utilities, graphics and functional - uses 3D graphics, 3 adventures, star trek, spreadsheet etc.  
Pub. Price £6.95 Our Price £2.95

#### MY COMMODORE 64 COMPUTER & ME

MY ELECTRON

COMPUTER & ME

MY SPECTRUM

COMPUTER & ME

MY BBC MICRO & ME

Meyer Solomon

Size 196 x125mm 89pp  
For children, these books start at the beginning. Nicely illustrated, well written, finishing with a complete game.  
Pub. Price £2.95 Our Price £1.50

#### SPECTRUM GRAPHICS

Nick Hampshire

Size 215 x135mm 192pp  
Hi-res graphics, graph plotting, using the video memory, 3D and rotating displays are all included. Many progs with full explanations.  
Pub. Price £6.95 Our Price £2.95

#### SPECTRUM PROGRAMMES Vol. 1

Nick Hampshire

Size 315 x134mm 182pp  
A wide range of interesting and useful progs: music, games, utilities, graphics, functional progs etc. - 26 altogether.  
Pub. Price £6.95 Our Price £2.95

#### CBM 64 PROGRAMS Vol. 1

Richard Franklin & Nick Hampshire

Size 215 x134mm 191pp  
20+ progs covering a wide variety of interests. Includes Hi-res graphics, music, games, utilities, sprites etc. plus full length adventures.  
Pub. Price £6.95 Our Price £2.95

#### COMMODORE 64 GAMES

Kevin Bergin

Size 215 x134mm 190pp  
21 exciting games - making full use of graphics and soundcar dodge, air attack, hangman etc. All are accompanied by notes.  
Pub. Price £6.95 Our Price £2.95

#### THE SENSIBLE 64

David Highmore & Liz Page

Size 208 x150mm 122pp  
Covers what the manual doesn't - keyboard, user defined graphics, displays, sprites, sound and music, disk drives and printers.  
Pub. Price £5.95 Our Price £1.95

#### EXPLORING ADVENTURES ON THE VIC

Peter Gerrard

Size 215 x134mm 243pp  
Starting with an introduction to adventures and their early history, this book takes you through the steps necessary to write your own games. Highly readable.  
Pub. Price £6.95 Our Price £2.95

#### THE COMPLETE VIC ROM DISSASSEMBLY

Peter Gerrard & Kevin Bergen

Size 215 x134mm 157pp  
For the serious programmer, complete disassembly of all ROM routines, also complete 6502 m/c instruction set etc.  
Pub. Price £6.95 Our Price £2.95

#### VIC GRAPHICS

Nick Hampshire

Size 215 x134mm 185pp  
How to generate graphic displays - graph and colour plotting, Hi-res graphics, scaling, rotating and 3D displays, all fully explained.  
Pub. Price £6.95 Our Price £2.95

#### VIC PROGRAMMES Vol. 1

Nick Hampshire

Size 215 x134mm 184pp  
Useful and interesting collection including music, games, utilities, graphics and functional programs, 36 altogether.  
Pub. Price £6.95 Our Price £2.95

#### VIC REVEALED

Nick Hampshire

Size 215 x134mm 267pp  
How and why the VIC works, 5 sections in the book covering functional blocks - 6502, 6561, 6522, software and I/O functions plus appendices of codes and circuit diagram.  
Pub. Price £9.95 Our Price £3.95

#### BRAINTASERS FOR THE VIC 20

G. Ludinski

Size 215 x134mm 133pp  
Book of programs built around a competition element - logic, general knowledge, maths, whodunnits etc. Graphics fully exploited.  
Pub. Price £5.95 Our Price £2.95

All prices include VAT; just add 60p P&P  
Min Access order £10. Official orders from schools etc. welcome - min invoice charge £10.  
Our shop has enormous stock of components and is open 9-5.30 Mon-Sat. Come and see us!

443D Millbrook Road Southampton  
SO1 0HX Tel (0703) 772501/783740

**GREENWELD**  
ELECTRONIC COMPONENTS

## Universal Semiconductor Devices Ltd.

17 GRANVILLE COURT, GRANVILLE ROAD,  
HORNSEY, LONDON N4 4EP, ENGLAND.  
TEL. 01-348 9420/9425 \* TLX. 25157 usdco g



WE OFFER ONE OF THE LARGEST RANGES OF SEMICONDUCTORS AT HIGHLY ECONOMICAL PRICES. THE FOLLOWING SEMICONDUCTOR TYPES ARE AVAILABLE FROM STOCK. IF WE DON'T STOCK WHAT YOU NEED THEN WE CAN GET IT FAST FROM OUR FACILITIES IN WEST GERMANY AND USA UPON REQUEST.

**TRANSISTORS - BIPOLARS - GERMANIUM AND SILICON**

SMALL SIGNAL

POWER

DARLINGTONS - ALL SHAPES AND SIZES

VHF/UHF DEVICES - ALL SHAPES AND SIZES



**FETS - POWER MOSFETS**

UNIUNIONS



**DIODES - GERMANIUM AND SILICON**

RECTIFIERS AND BRIDGES

OPTO-ELECTRONIC DEVICES

LEDS OF ALL SHAPES AND SIZES



**THYRISTORS AND TRIACS - ALL**

SHAPES

SIZES

RATINGS



**INTEGRATED CIRCUITS:**

CONSUMER - DIGITAL/ANALOGUE

MICROPROCESSORS AND PERIPHERALS

IC SOCKETS



**JAPANESE COMPONENTS - VAST RANGE OF DISCRETES AND CONSUMER IC's.**

MAIL ORDER CUSTOMERS: PLEASE SEND FOR OUR COMPREHENSIVE PRICE LIST, ENCLOSED 75 PENCE IN STAMPS, CHEQUE OR POSTAL ORDER. THIS SUM IS REFUNDABLE WITH A FIRST ORDER VALUE OF £5.00 OR MORE.

CATALOGUE SENT FREE OF CHARGE, WHEN REQUESTED ON OFFICIAL LETTERHEAD (WITHOUT REFUND), TO OEM'S, SCHOOLS, COLLEGES, UNIVERSITIES, GOVERNMENT INSTITUTIONS, COMPUTER FIRMS, ELECTRONIC REPAIR FIRMS AND DISTRIBUTORS.

**SPECIAL DISCOUNTS AND PAYMENT TERMS ARE AVAILABLE TO ABOVE INSTITUTIONS.**

PLEASE ENQUIRE FOR QUANTITY DISCOUNTS.

WE WELCOME TELEPHONE AND TELEX ENQUIRIES!

## WEST HYDE

THE UK'S LEADING STOCKIST OF BOXES, CASES,  
HANDLES AND ACCESSORIES

- ★ All types available - Plastic, Aluminium, Steel
- ★ Choose from 1100 styles in 750 different sizes
- ★ Large range of Handles, Knobs, Feet, LEDs etc.

Huge, 104 page catalogue - full of illustrations, sizes, drawings and comprehensive information so that picking the right box for your latest project is easy!

Send just £2 for catalogue which contains two £1 discount vouchers for use when you order.

9-10 Park Street Industrial Est.,  
Aylesbury, Bucks. HP20 1ET  
Telephone: (0296) 20441

**Enormous Stocks  
- Fast Delivery**

## CRICKLEWOOD ELECTRONICS LTD.

It's no secret!

that there is a real difference at Cricklewood Electronics. That's why you should never be without the FREE CRICKLEWOOD ELECTRONICS COMPONENTS CATALOGUE, for sheer variety, competitive prices and service from the U.K.'s number one 100% component shop. No gimmicks, no gadgets or computers, just components, millions of them, all easily available by mail order, calling or credit card telephone orders. Just pick up the phone (or a pen) to get your FREE copy now (no SAE required). You have nothing to lose.

**CRICKLEWOOD ELECTRONICS LTD.**  
40 Cricklewood Broadway NW2 3ET.  
01-450 0995 & 01-452 0161  
ALL MAJOR CREDIT CARDS ACCEPTED  
Telex 914877 Phone or write today



**AFFORDABLE ACCURACY  
QUALITY MULTIMETERS FROM ARMON**

ILLUSTRATED  
HC-5010  
£36.50 + VAT



*A comprehensive range of  
Analogue and (Pushbutton or  
Rotary Switched) Digital Models*

**ANALOGUE**

- HM-102BZ  
10ADC Range, 20kΩ/VDC, Buzzer, Battery Test  
Scale ..... £13.00
- 19 measuring ranges
- HM-102R  
Low end voltage & current ranges, Jack for Audio  
o/p Voltages ..... £11.00
- 20 measuring ranges
- HM-1015  
Rugged, Pocked sized meter, for general purpose  
use ..... £7.50
- 16 measuring ranges
- Battery, Test Leads and Manual included with each  
model.

**DIGITAL**

- HC-7030 0.19% Accuracy, Standard Model ..... £39.50
  - HC-6010 0.25% Accuracy, Standard Model ..... £33.50
  - HC-5010T 0.25% Accuracy, TR Test Facility ..... £39.50
  - DM-105 0.5% Accuracy, Pocketable ..... £21.50
- All models have full functions and ranges and  
feature:
- 3 1/2 digit 0.5" LED display
  - Low battery indication
  - Auto zero & Auto polarity
  - ABS Plastic Casing
  - DC AC 10amp Range (not DM-105)
  - Overload Protection on all ranges.
  - Battery, Spare Fuse, Test Leads and Manual.

FULL DETAILS ON APPLICATION FROM:-

**ARMON ELECTRONICS LTD**

DEPT.S HERON HOUSE, 109 WEMBLEY HILL ROAD, WEMBLEY, MIDDLESEX HA9 8AG

TELEPHONE 01-902 4321 TELEX 923985

PLEASE ADD 15% to your order for VAT. P&F Free of charge. Payment by cheque with order  
Offer applicable to mainland UK only

Trade enquiries invited

Please allow 28 days for delivery

**DIGITAL ELECTRONICS**

**MADE  
EASY**



**SUPERKIT £22.00**  
**SUPERKIT II £16.00**  
**(£35.00 if bought together)**

The SUPERKIT series introduces beginners to practical digital electronics. SUPERKIT (SUP I) is the first kit, which contains an instruction manual, a solderless breadboard, and components (7 integrated circuits, switch, resistors, capacitors, LEDs and wire). It teaches boolean logic, gating, flipflops, shift registers, ripple counters and half adders. SUPERKIT II (SUP II) extends SUPERKIT. It contains an instruction manual and components (10 integrated circuits, 7-segment display, resistors, capacitors and wire), and explains how to design and use adders, subtractors, counters, registers, pattern recognisers and 7-segment displays.

**DIGITAL COMPUTER LOGIC £7.00**  
**DIGITAL COMPUTER DESIGN £9.50**  
**MICROPROCESSORS & MICROELECTRONICS £6.50**

The SUPERKIT series is backed by our theory courses. DIGITAL COMPUTER LOGIC (DCL), the beginners' course, covers the use and design of logical circuits, flipflops and registers. DIGITAL COMPUTER DESIGN (DCD), a more advanced course, covers the design of digital computers both from their individual logic elements and from integrated circuits. MICROPROCESSORS and MICROELECTRONICS (MIC) teaches what a microprocessor is, how it evolved, how it is made and what it can do.

**GUARANTEE.** If you are not completely satisfied, return the item to us in good condition within 28 days for a full refund. All prices include worldwide surface postage (ask for prepayment invoice for airmail). Orders despatched within 48 hours. Overseas payment by international credit card or by bank draft drawn on a London bank.

**CAMBRIDGE LEARNING LTD.** Unit 37, Rivermill Site,  
FREEPOST, St. Ives, Huntingdon, Cambs. PE17 4BR, England  
Telephone: 0480 67446.

VAT No. 313026022 Transcash No. 2789159 Reg. No. 1328762

Please send me (initial letters used):

..... SUP I	@ £22.00	..... DCL	@ £7.00
..... SUP II	@ £16.00	..... DCD	@ £9.50
..... SUP I + II	@ £35.00	..... MIC	@ £6.50

Full details of all your courses (please tick)

I enclose a cheque/PO payable to Cambridge Learning Ltd.  
for £.....

Please charge my ..... credit card.

No. .... Expiry date .....

Telephone orders from credit card holders accepted on 0480 67446 (24 hrs).

Name .....

Address .....

Signature .....

**CAMBRIDGE LEARNING LTD**

Unit 37, Rivermill Site, FREEPOST,  
St. Ives, Huntingdon, Cambs PE17 4BR  
England.



You can depend on

**ELECTROVALUE**

to supply the fine  
range of test &  
measurement  
gear by

**thandar**

Made  
in  
U.K.

- counters
- multimeters
- scopes
- signal generators etc.

**FREE 44 PAGE  
PRICED AND  
ILLUSTRATED  
CATALOGUE ON  
REQUEST**

● Over 6000 items stocked

**ELECTROVALUE LTD** 28 St. Jude's Road, Englefield Green, Egham,  
Surrey TW20 0HB Phone Egham (0784) 33603. Telex 264475  
North Branch, 680 Burnage Lane, Manchester M19 1NA  
Telephone 061 432 4945  
Please mention this publication when replying

BRITAINS FOREMOST QUALITY COMPONENT SUPPLIERS

# THREE ACES FROM ALCON!

## TESTER 20 A♣

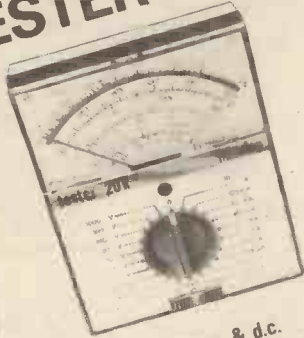

**20kΩ/V a.c. & d.c.**  
**DIODE & FUSE PROTECTION**  
**39 RANGES**  
 Accuracy: d.c. ranges and Ω 2% a.c. 3% (of f.s.d.)  
 39 ranges: d.c. V 100mV, 1.0V, 3.0V, 10V, 30V, 300V, 1000V;  
 d.c. I 50μA, 100μA, 300μA, 1.0mA, 3mA, 10mA, 30mA, 100mA, 1A, 10A  
 a.c. V 10, 30V, 300V, 1000V; a.c. I 3mA, 10mA, 30mA, 100mA, 1.0A, 10A  
 Ω 0-5.0kΩ, 0-50kΩ, 0-500kΩ, 5MΩ, 50MΩ  
 dB from -10 to +61 in 5 ranges.  
 Dimensions: 105 x 130 x 40mm.

**ONLY £29.75**

## MINI 20 A♥

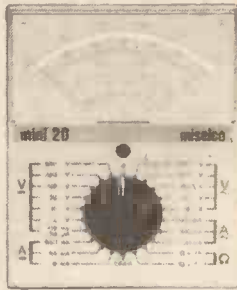

**20kΩ/V d.c. & 4kΩ/V a.c.**  
**28 RANGES WITH PROTECTIVE FUSE**  
 Accuracy: 2% d.c. and resistance, 3% a.c.  
 28 ranges: d.c. V 100mV, 3V, 10V, 30V, 100V, 300V, 600V, d.c. I 50μA, 600μA, 6mA, 60mA, 600mA  
 a.c. V 15V, 50V, 150V, 500V, 1500V; a.c. I 30mA, 300mA, 3.0A, Ohms 0-2kΩ, 0-2MΩ  
 dB from -10 to +62 in 6 ranges.  
 Dimensions: 105 x 130 x 40mm

**ONLY £21.60**

## SUPER 50 A♠

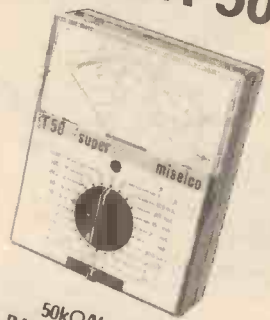

**50kΩ/V a.c. & d.c.**  
**39 RANGES - INDESTRUCTIBLE**  
 automatically protected on all ranges but 3A  
 Accuracy: d.c. ranges and Ω 2% a.c. 3% (of f.s.d.)  
 39 ranges: d.c. V 150mV, 1.0V, 3.0V, 10V, 30V, 100V, 300V, 1000V; d.c. I 20μA, 200μA, 2mA, 20mA, 100μA, 1.0mA, 3mA, 10mA, 30mA, 100mA, 1A, 3A a.c. V 10, 30V, 100V, 300V, 1000V; a.c. I 3mA, 10mA, 30mA, 100mA, 1.0A, 3.0A  
 Ω 0-5.0kΩ, 0-50kΩ, 0-500kΩ, 5MΩ, 50MΩ  
 dB from -10 to +61 in 5 ranges.  
 Dimensions: 105 x 130 x 40mm.

**ONLY £36.30**

## 3 HIGH QUALITY TEST INSTRUMENTS AT SUPERDEAL PRICES

EACH INSTRUMENT HAS A CLEAR MIRRORED SCALE AND COMES COMPLETE WITH A ROBUST CARRYING CASE, LEADS & INSTRUCTIONS.

PRICES Our prices include VAT and postage and goods are normally despatched by return. Please write or telephone for details of these and the many other instruments in the Alcon range, including multimeters, components measuring, automotive and electronic instruments.

# ALCON Instruments Ltd.

19 MULBERRY WALK · LONDON SW3 6DZ · TEL: 01-352 1897 · TELEX: 918867

## PE & EE PUBLISHED EFFECTS



- MONO-STEREO ECHO-REVERB (P.E. Sept. '84) 200ms echo (extendable), lengthy reverb, multitracking. Kit as published. Set 2185K **£57.66**
- ENHANCED PHASER (P.E. Oct '84) Enhanced phasing with modulated filter shifting. Kit as published. Set 226BK **£42.36**
- RING MODULATOR (P.E. NOV. '84) Fabulous effects generation. With multiwaveform VCO, noise gate & ALC. Kit as published. Set 231BK **£45.58**
- MONO-STEREO CHORUS-FLANGER (P.E. Jan. '84) Superb dual mode music enhancement. Kit as published. Set 235BK **£59.99**
- CYBERVOX (E.E. Apr. '85) Amazing robot type voice unit, with ring modulator and reverb. Kits as published. Set 228BK **£44.76**
- STEREO NOISE GATE & VICA (P.E. May '85) Automatic noise reduction circuit for mono or stereo. Kit as published. Set 227BK **£26.61**
- SIGNAL GENERATOR & F-V (P.E. Jan. '85) Audio test equipment. Multiwaveform VCO, & freq. to voltage converter & sweep gen. Kit as pub. Set 233 **£46.96**
- SIMPLE REVERB (E.E. Oct '85) Super little lengthy reverb, mono. Set 232BK **£27.35**
- DISCO LIGHT CONTROLLER (P.E. Nov '85) 3 Chan sound to light, with chasers, auto level & computer interface (BBC, CB4, Pet, etc.) Set 245FBK **£82.50**
- MIXER - 4 Chan Stereo (P.E. Nov '85) Separate input gain, level pan, filters, echo send, PFL. Voltage controlled. Set 229SBK **£89.95**
- MIXER - 4 Chan Mono (P.E. Nov '85) Separate input gain, level, filter, twin output. Voltage controlled. Set 229MBK **£49.95**

## OTHER SUPER SOUND KITS

- BLOW BOX: Voice operated VCF & VCA for fascinating effects **SET 214 BK £29.33**
- COMPANDER: Mono or stereo compression-expansion, switchable **SET 238 BK £22.99**
- ENVELOPE SHAPER: Note triggered ADSR with VCA **SET 98 BK £25.20**
- FREQUENCY DOUBLER: Guitar octave raiser & tone changer **SET 98 BK £15.30**
- FUZZ: Smooth distortion, retains attack & decay character **SET 209F BK £19.58**
- GUITAR SUSTAIN: Extends note decay time, with noise gate **SET 222 BK £25.31**
- GUITAR TO SYNTH INTERFACE: With voltage & trigger outputs **SET 173 BK £41.41**
- HAND CLAPPER: Auto & manual variable clap effects **SET 197 BK £26.69**
- MOCK STEREO: Splits mono signal into stereo simulation **SET 213 BK £24.37**
- MUSIC MODULO: 8 variable tremolo & wah guitar effects **SET 196 BK £23.56**
- RHYTHM GENERATOR: Computer driven, BBC, Apple, 64 & similar **SET 185 BK £34.64**
- STORM EFFECTS: Auto & manual wind, rain & surf effects **SET 154 BK £23.80**
- TOM-TOM SYNTH: Sound triggered, multivariable drum effects **SET 190 BK £19.37**
- TREMULO: Mono variable depth & rate modulation **SET 136 BK £15.82**
- VOCODAVOX: Modular vocoder, 7 chans extendable **SET 152 BK £79.95**
- VODALEK: Simple robot type voice modulator **SET 155 BK £18.31**
- WAH-WAH: Auto, manual & note triggered, switchable **SET 140 BK £24.36**

Boxes are black steel & aluminum. All kits include PCBs, parts, instructions, boxes, wire, solder. For catalogue of over 70 kits send 9 x 4 SAE (for overseas catalogue send £1 or 5 IRC's). Mail Order. Payment to Phonosonics, CWO, CHD, PO. Access. Visa. Insurance cover 50p per £50 (obligatory on credit card orders). Details correct at press. E&OE.

Add 15% VAT. Add P&P £1.50 each kit. (Overseas Rates in Catalogue).

**BECKER-PHONOSONICS, DEPT. EE5D,**  
 8 FINUCANE DRIVE, ORPINGTON, KENT BR5 4ED.  
 TEL: ORPINGTON 37821 (STD 0689, LONDON 66).

## OVERSEAS ORDERS

Overseas readers are reminded that unless otherwise stated, postage and packing charges published in advertisements apply to the United Kingdom only.

Readers wishing to import goods from the United Kingdom are advised to first obtain from the advertiser(s) concerned an exact quotation of the cost of supplying their requirements carriage paid home.

## MAKE YOUR INTERESTS PAY!

More than 8 million students throughout the world have found it worth their while! An ICS home-study course can help you get a better job, make more money and have more fun out of life! ICS has over 90 years experience in home-study courses and is the largest correspondence school in the world. You learn at your own pace, when and where you want under the guidance of expert 'personal' tutors. Find out how we can help YOU. Post or phone today for your FREE INFORMATION PACK on the course of your choice. (Tick one box only!)

Electronics	<input type="checkbox"/>	Radio, Audio and TV Servicing	<input type="checkbox"/>
Basic Electronic Engineering (City & Guilds)	<input type="checkbox"/>	Radio Amateur Licence Exam (City & Guilds)	<input type="checkbox"/>
Electrical Engineering	<input type="checkbox"/>	Car Mechanics	<input type="checkbox"/>
Electrical Contracting/Installation	<input type="checkbox"/>	Computer Programming	<input type="checkbox"/>
<b>GCE over 40 'O' and 'A' level subjects</b>		<input type="checkbox"/>	

**ICS** Name \_\_\_\_\_ P. Code \_\_\_\_\_  
 Address \_\_\_\_\_  
 International Correspondence Schools, Dept EC35 312/314 High St., Sutton, Surrey SM1 1PR. Tel: 01-643 9568 or 041-221 2926 (24hrs).

**CT1000K CLOCK/TIMER KIT**  
24hr Digital clock with presettable ON and OFF time for output. Ideal for use with tape recorders, lighting etc. **£14.90**

**VERO**

**XK113 M.W. RADIO KIT**  
A sensitive radio with wound aerial & earpiece requires 9V battery **£5.50**

**BOOKS**  
By Babani, TI and Elektor

**DIGITAL LOCK KIT**  
operates from 5 to 18Vdc supply and gives 5040 combinations. 10 way keyboard supplied. 750mA output. Ideal for disabling car ignition or for door lock when used with 701 150 lock mechanism **£11.50**  
701 150 **£14.95**

**MULTIMETERS**  
Analogue from **£6.50**  
Digital from **£26.95**

**TRIACS**

**Mk1 THERMOSTAT KIT**  
will control; 1kW heater. Ideal for greenhouse. ONLY **£4.60**

**REGULATORS**  
78 Series 50p  
78L Series 30p

**LINEAR ICs**  
555 21p  
CMOS 555 55p  
741 22p  
LM3914 **£2.65**  
LS7225 **£2.60**  
+ Lots lots more in our Cat.

**ULTRA SENSITIVE DVM/THERMOMETER KIT**  
3½ Digit LCD design drawing a mere 150µA at 9v. 200 mV full scale or -20 to + 150°C thermometer **£15.50**

**ANTEX SOLDERING IRONS**  
15w **£5.60** ST4 stand **£1.90**

**BT Phone connectors starter pack**  
**£9.50**

**FREE 28 page catalogue.** Send 9x6 SAE NOW!  
Telephone orders - Access & Barclaycard  
**RING 01-567 8910 (24hrs)**

**BOXES**  
Plastic, diecast aluminium

**LEDs**  
from 9p

**BEGINNERS PROJECT PACK**  
Build 10 fascinating projects including burglar alarm, intercom, thermostat etc on the solderless breadboard enclosed. Full circuit descriptions and layouts included  
XK118 **£12.50**

**TOOLS**  
Side cutters **£2.10**  
See Cat. for full range.

**CMOS**  
4001 18p  
4017 39p

**XK102 3 NOTE DOOR CHIME**  
complete kit includes box & speaker **£5.50**

**PLUS A WIDE RANGE OF PLUGS, SOCKETS, RESISTORS, POTS, CAPS, VERO etc etc**

**PANTEC KITS**

**VELLEMAN KITS**

## ELECTRONICS

13 BOSTON RD  
LONDON W7 3SJ  
Tel. Orders: 01-567 8910  
Enquiries: 01-579 9794  
Shop Hours: Mon-Fri. 9am-5pm  
Sat. 10am-4pm. Closed Wednesday

### ORDERING INFORMATION: ALL PRICES EXCLUDE VAT

FREE P&P on orders over £20 (UK only), otherwise add 75p + VAT. Overseas P&P: Europe £2.75. Elsewhere £6.50. Send cheque/PO/Barclaycard/Access No. with order. Giro No. 529314002.  
**LOCAL AUTHORITY AND EXPORT ORDERS WELCOME**  
**GOODS BY RETURN SUBJECT TO AVAILABILITY**

## Master Electronics - Microprocessors - Now! The Practical Way!

- Electronics - Microprocessors - Computer Technology is the career and hobby of the future. We can train you at home in a simple, practical and interesting way.
- Recognise and handle all current electronic components and 'chips'.
- Carry out full programme of experimental work on electronic computer circuits including modern digital technology.
- Build an oscilloscope and master circuit diagram.
- Testing and servicing radio - T.V. - hi-fi and all types of electronic/computer/industrial equipment.

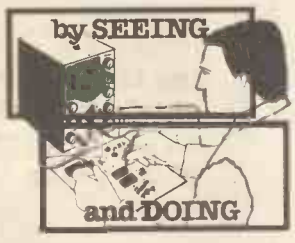

### New Job? New Career? New Hobby? SEND THIS COUPON NOW.

**FREE! COLOUR BROCHURE**  
Please send your brochure without any obligation to

OR TELEPHONE US 062 67 6114  
OR TELEX 22758 (24 HR SERVICE)

I am interested in  ELECTRONICS  
 MICROPROCESSORS  
 RADIO AMATEUR LICENCE  
 CITY & GUILDS EXAMS  
Other Subjects .....

British National Radio & Electronics School P.O. Box 7, Teignmouth, Devon, TQ14 0HS

## PRICES DOWN!

**PLUS 2 YEAR WARRANTY  
ALL MODELS FROM STOCK  
PRICES INCLUDE VAT**

**164M**  
26 Ranges. 20,000 Ohms/Volt. Anti Parallax Mirrored Scale. Taut Band Suspension. Shock and Overload Protection. Max. 1250V AC/DC. 10A AC/DC. 30 Meg Ohms. Carry handle/bench stand (List £43.47)

**£21.95 inc. VAT**  
(UK C/P 85p)

Complete with leads, battery, instructions and CARRY CASE

**SAVE £57.50 ON PREVIOUS PRICE WITH PROBES**

**V212** Hitachi Dual DC to 20MHZ Portable 'Scope. 6" Square CRT. 5mV/DIV. Max 1mV. All Facilities

**NEW LOW PRICE £343.85 inc. VAT**  
(UK TNT delivery £8.00)

**WITH TWO X1/X10 PROBE KITS**

**174M**  
23 Ranges. 50,000 Ohms/Volt. Taut Band Suspension. Anti Parallax Mirrored Scale. Shock and Overload Protection. 2500V AC/DC. 20µA to 10A DC 60 Meg Ohms. Carry handle/bench stand (List £47.15)

**£24.95 inc. VAT**  
(UK C/P 85p)

Complete with leads, battery, instructions and CARRY CASE

**186M**  
26 Range 3½ Digit LCD. AC/DC 0/200µA to 0/10 Amps. AC/DC 0/200mV to 0/1000 Volts 0/200 Ohm to 0/20 Meg Ohms Auto Zero. Auto Polarity. Fuse Protected. etc (List £71.30)

Complete with leads, battery, instructions and CARRY CASE

**£33.95 inc. VAT** (UK C/P 85p)

ORDER BY POST OR PHONE OR CALL IN OPEN 6 DAYS A WEEK

**AUDIO ELECTRONICS**  
301 Edgware Road, London W2 1BN  
Tel: 01-724 3564

**FREE TEST EQUIPMENT CATALOGUE. SEND LARGE S.A.E. 22p**

Full Kits inc. PCBs, or veroboard, hardware, electronics, cases (unless stated). Less batteries.  
If you do not have the issue of E.E. which includes the project - you will need to order the instruction reprint as an extra - 70p each. Reprints available separately 70p each + p&p 60p.

## THIS MONTH'S KITS SAE or 'phone for prices

DIGITAL CAPACITANCE METER Dec 85	£35.98
DIODE/TRANSISTOR TESTER Dec 85	£15.98
UNIVERSAL LCR BRIDGE Nov 85	£23.49
FLUX DENSITY TRANSDUCER Nov 85	£26.15
FLASHING PUMPKIN less case Nov 85	£3.82
SOUSAKING BAT less case Nov 85	£8.63
SCREAMING MASK less case Nov 85	£9.98
STRAIN GAUGE AMPLIFIER Oct 85	£25.46
SIMPLE AUDIO GENERATOR Oct 85	£2.59
SOLDERING IRON POWER CONTROLLER Oct 85	£4.72
VOLTAGE REGULATOR Sept 85	£6.78
PERSONAL STEREO P.S.U. Sept 85	£8.99
R.I.A.A. PRE-AMP Sept 85	£14.49
CARAVAN ALARM Sept 85	£9.37
FRIDGE ALARM Sept 85	£6.82
SEMI-CONDUCTOR TEMP. SENSOR Sept 85	£18.93
RESISTANCE THERMOMETER Sept 85 Less Probe	£18.83
PLATINUM PROBE Extra	£22.00
LOW COST POWER SUPPLY UNIT Aug 85	£16.72
TRI-STATE THERMOMETER (Batt) Aug 85	£8.05
TREMLO/VIBRATO Aug 85	£34.48
STEPPER MOTOR INTERFACE FOR THE BBC COMPUTER less case Aug 85	£13.99
1035 STEPPER MOTOR EXTRA	£14.50
OPTIONAL POWER SUPPLY PARTS	£4.67
EMERGENCY LIGHTS FLASHER less lamps July 85	£6.39
CONTINUITY TESTER July 85	£5.37
TRAIN SIGNAL CONTROLLER July 85	£8.78
AMSTRAD USER PORT July 85	£15.34
CROSS THE RIVER June 85	£17.97
ELECTRONIC DOORBELL June 85	£6.55
COMPUTERISED SHUTTER TIMER June 85	£10.61
GRAPHIC EQUALISER June 85	£23.33
AMSTRAD CPC 464 May 85	£15.34
MAINS VERSION	£22.48
AUTO PHASE May 85	£16.39
INSULATION TESTER Apr. 85	£18.98
LOAD SIMPLIFIER Feb. 85	£39.98
SOLID STATE REVERB Feb. 85	£7.63
GAMES TIMER Jan. 85	£5.98
SPECTRUM AMPLIFIER Jan. 85	£12.36
TV AERIAL PRE-AMP Dec. 84	Optional PSU 12V £2.03, 240V £9.86
MINI WORKSHOP POWER SUPPLY Dec. 84	£34.98
DOOR CHIME Dec. 84	£14.91
BBC MICRO AUDIO STORAGE SCOPE INTERFACE Nov. 84	£28.77
PROXIMITY ALARM Nov. 84	£17.98
MAINS CABLE DETECTOR Oct. 84	£4.39
MICRO MEMORY SYNTHESISER Oct. 84	£47.98
DRILL SPEED CONTROLLER Oct. 84	£6.89
GUITAR HEAD PHONE AMPLIFIER Sept. 84	£6.38
SOUND OPERATED FLASH less lead Sept. 84	£5.91
TEMPERATURE INTERFACE FOR BBC MICRO Aug. 84	£13.87
CAR RADIO BOOSTER Aug. 84	£19.70
CAR LIGHTS WARNING July 84	£7.99
VARIABLE AM RADIO May 84	£10.43
EXPERIMENTAL POWER SUPPLY May 84	£18.72
SIMPLE LOOP BURGLAR ALARM May 84	£13.82
MASTERMIND TIMER May 84	£5.44
FUSE/DIODE CHECKER Apr. 84	£3.45
QUASI STEREO ADAPTOR Apr. 84	£10.90
DIGITAL MULTIMETER add on for BBC Micro Mar. 84	£24.98
NI-CAD BATTERY CHARGER Mar. 84	£9.85
REVERSING BLEEPER Mar. 84	£6.78
PIPE FINDER Mar. 84	£3.60
IONISER Feb. 84	£23.98
Z801 EPROM PROGRAMMER Feb 84	£14.48
SIGNAL TRACER Feb 84	£14.89
CAR LIGHT WARNING Feb 84	£3.76
GUITAR TUNER Jan 84	£17.73
BIOLOGICAL AMPLIFIER Jan 84	£19.16
CONTINUITY TESTER Dec 83	£9.99
CHILDREN'S DISCO LIGHTS Dec 83	£8.42
NOVEL EGG TIMER Dec 83 inc. case	£10.24
SPEECH SYNTHESIZER FOR THE BBC Nov. 83 less cable + sockets	£21.98
MULTIMOD Nov. 83	£16.98

## TOOLS

ANTEX MODEL C IRON	£6.98
ANTEX X5 SOLDERING IRON 25W	£7.25
ST4 STAND FOR IRONS	£2.85
HEAT SINK TWEEZERS	45p
SOLDER HANDY SIZE 5	£1.39
SOLDER CARTON	£2.50
SOLDER REEL SIZE 10	£4.67
LOW COST PLIERS	£1.98
LOST COST CUTTERS	£1.99
BENT NOSE PLIERS	£1.89



MINI DRILL 12V (MD1)	£8.38
MULTIMETER TYPE 1 10000ppv	£6.98
MULTIMETER TYPE 2 20,000ppv	£17.98
MULTIMETER TYPE 3 30,000ppv	£27.98
MULTIMETER TYPE 4 10M DIGITAL	£39.98
DESOLDER PUMP	£5.48
SIGNAL INJECTOR	£2.98
CIRCUIT TESTER	79p
HELPING HANDS JIG & MAGNIFIER	£7.98
MINIATURE VICE (PLASTIC)	£1.85

MINIATURE VICE (PLASTIC)

## FUN WITH ELECTRONICS



Enjoyable introduction to electronics. Full of very clear full colour pictures and easy to follow text. Ideal for all beginners - children and adults. Only basic tools needed. 64 full colour pages cover all aspects - soldering - fault finding - components (identification and how they work). Also full details of how to build 6 projects - burglar alarm, radio, games, etc. Requires soldering - 4 pages clearly show you how.

COMPONENTS SUPPLIED ALLOW ALL PROJECTS TO BE BUILT AND KEPT. Supplied less batteries & cases.  
FUN WITH ELECTRONICS, COMPONENT PACK £16.98  
BOOK EXTRA £1.75.  
Book available separately.

## INTRODUCTION TO ELECTRONICS

An introduction to the basic principles of electronics. With lots of simple experiments. Uses soldering. Lots of full colour illustrations and simple explanations. A lovely book. Ideal for all ages.

INTRODUCTION TO ELECTRONICS COMPONENT PACK £9.99  
BOOK EXTRA £2.45  
Book also available separately.

## TEACH IN 86

MULTIMETER TYPE M102BZ as specified. Guaranteed. Top quality. 20kV, with battery check, continuity tester buzzer and fuse and diode protection. 10A dc range. Complete with leads, battery and manual. £13.98  
VERBLOC BREADBOARD, DESIGN PAD, MOUNTING PANEL AND 10 CROCODILE CLIP CONNECTING LEADS. £6.98.  
REGULATOR UNIT FOR SAFE POWER SUPPLY. All components including the specified case. Also the plugs, fuse and fuseholders to suit the EE mains adaptor. £16.78.  
COMPONENTS FOR PRACTICAL ASSIGNMENTS. Parts 1 and 2 (Oct & Nov) £1.94. Part 3 (Dec) £1.37. Part 4 (Jan) £2.48.

All the above include VAT. P&P 60p. Plus FREE CATALOGUE with Teach In orders over £20.00.

UNIVERSAL LCR BRIDGE Nov 85 £23.49

**THIS MONTH'S PROJECT**  
DIODE/TRANSISTOR TESTER Complete kit including the specified case £15.98

## MOTOR - GEARBOX ASSEMBLIES

Miniature precision made. Complete with quality electric motor. Variable reduction ratios achieved by fitting from 1-6 gearwheels (supplied) as required. Operates from 1.5V to 4.5V. Small unit type MGS speed range 3rpm-2200rpm depending on voltage & gear ratio. Large unit type MGL (higher torque motor) 2rpm-1150rpm. Long 3mm dia output shafts. Ideal for robots and buggies.  
Small Unit (MGS) £3.49. Large Unit (MGL) £9.98.

Pulley wheels 3mm bore. Metal flange with brass hub. 10mm dia 85p. 20mm dia 98p. 30mm dia £1.21.  
Metal collar with fixing screw, 3mm bore 24p. Flexible spring coupling 5mm. Length 31mm 68p.  
Flexible metal coupling (universal) 3mm £2.98

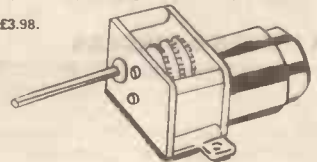

## CATALOGUE

FULLY REVISED 1985 CATALOGUE. Brief details of each kit, our books, & illustrations of our range of tools & components. Also stepper motor, interface kit & simple robotics. Plus circuit ideas for you to build. If you read Everyday Electronics then you need a copy of the MAGENTA catalogue.

CATALOGUE & PRICE LIST - Send £1 in stamps etc or add £1 to your order. Price list - 9x4 size.

Catalogue FREE TO SCHOOLS/COLLEGES REQUESTED ON OFFICIAL LETTERHEAD.

## ADVENTURES WITH ELECTRONICS

An easy to follow book suitable for all ages. Ideal for beginners. No soldering, uses an S-Dec Breadboard. Gives clear instructions with lots of pictures. 16 projects - including three radios, siren, metronome, organ, intercom, timer, etc. Helps you learn about electronic components and how circuits work. Component pack includes an S-Dec breadboard and all the components for the projects.  
Adventures with Electronics £3.58. Component pack £20.98 less battery.

## OUR PRICES INCLUDE VAT

### MAGENTA ELECTRONICS LTD.

EE35, 135 HUNTER ST., BURTON-ON-TRENT STAFFS, DE14 2ST. MAIL ORDER ONLY. 0283 65435, Mon-Fri 9-5. Access/Barclaycard (Visa) by phone or post. 24 hr Answerphone for credit card orders.





# EVERYDAY ELECTRONICS and ELECTRONICS MONTHLY

VOL 14 NO 12 DECEMBER '85

## READERS' ENQUIRIES

We are unable to offer any advice on the use, purchase, repair or modification of commercial equipment or the incorporation or modification of designs published in the magazine. We regret that we cannot provide data or answer queries on articles or projects that are more than five years old. Letters requiring a personal reply must be accompanied by a **stamped self-addressed envelope** or a **self-addressed envelope and international reply coupons**.

## COMPONENT SUPPLIES

Readers should note that we do not supply electronic components for building the projects featured in EVERYDAY ELECTRONICS and ELECTRONICS MONTHLY, but these can be supplied by advertisers.

All reasonable precautions are taken to ensure that the advice and data given to readers is reliable. We cannot, however, guarantee it and we cannot accept legal responsibility for it. Prices quoted are those current as we go to press.

## OLD PROJECTS

We advise readers to check that all parts are still available before commencing any project in a back-dated issue, as we cannot guarantee indefinite availability.

We regret that **we cannot provide data or answer queries on projects that are more than five years old.**

## SUBSCRIPTIONS

Annual subscription for delivery direct to any address in the UK: £13.00. Overseas: £15.00. Cheques should be made payable to Everyday Electronics and Electronics Monthly and sent to EE Subscription Dept., Oakfield House, 35 Perrymount Road, Haywards Heath, West Sussex RH16 3DH. Tel. 0444 459188.

## BACK ISSUES & BINDERS

Certain back issues of EVERYDAY ELECTRONICS and ELECTRONICS MONTHLY are available world-wide price £1.25 inclusive of postage and packing per copy. Enquiries with remittance should be sent to Post Sales Department, IPC Magazines Ltd., Lavington House, 25 Lavington Street, London SE1 0PF. In the event of non-availability remittances will be returned.

Binders to hold one volume (12 issues) are available from the above address for £5.50 inclusive of p&p world-wide.



## GIFTS

WITH winter now approaching fast the time when indoor hobbies become popular is with us once again. We also begin to think of Christmas and the perennial problem of what to give, or even ask for. This issue carries a guide to some gifts to suit a very wide range of pockets. The guide, together with the Greenweld catalogue which we are pleased to be able to give all readers, should at least set you thinking about presents.

There is of course one gift that lasts a whole year and will provide hours of leisure time interest! I am talking about the magazine you are reading. An annual subscription to EE & EM costs £13 (£15 to overseas addresses) and it can be given to a friend or relation very easily—or why not ask someone to buy a year's supply for you? If you wish to make a present of a subscription, simply send a PO, cheque, credit card number plus expiry date and authorisation signature (Access, Visa, American Express or Diners Club) or international money order to the address on the left, together with a letter showing your name and address plus that of the person to whom the issues should be sent. An issue will drop through their door, anywhere in the world, every month for the next year—a constant reminder of your thoughtfulness!

## COMPETITION

It is not often that we run competitions in the magazine but this issue carries one which we have kept simple and tried to make fun. Your response to this free competition will determine the future of similar ideas. If the competition is popular we will carry similar items on a regular basis. We believe companies like West Hyde—who have supplied the 100 meters for prizes this month (thank you West Hyde)—will support us with further items.

## SPECIAL OFFERS

Another area we will be getting into is special reader offers; we have a couple planned for the next months and have ideas for more—again, if they are popular. So watch out next month and perhaps, if you have some money at Christmas, we can interest you in some test gear at discount afterwards.

Obviously all our EE & EM editorial offers are backed by the good name of this magazine and by the resources of IPC. We check the products and ensure excellent prices so the value is outstanding.

### Editorial Offices

EVERYDAY ELECTRONICS EDITORIAL, WESTOVER HOUSE,  
WEST QUAY ROAD, POOLE, DORSET BH15 1JG Phone: Poole (0202) 671191  
We regret that lengthy technical enquiries cannot be answered over the telephone

### Editor

MIKE KENWARD

### Secretary

PAULINE MITCHELL  
0202 671191 Ext 259

### Advertisement Manager

NIGEL BELLWOOD 01-261 6882

### Classified Advertisements

MANDY MORTON 01-261 5846

### Advert Make-Up and Copy Department

JULIE FISH 01-261 6615

### Advertisement Offices

EVERYDAY ELECTRONICS  
ADVERTISEMENTS  
KING'S REACH TOWER  
STAMFORD STREET  
LONDON SE1 9LS  
Telex 915748 MAGDIV-G

# DIGITAL CAPACITANCE METER

MARK STUART

## Unmarked or obscurely coded capacitors from 1p to 1000 $\mu$ may be directly read by this unit

SOME multimeters do have a capacitance range but its use is fiddly. Usually a separate a.c. source is required and the capacitor to be tested is connected between the source and the meter which is set to an a.c. current range. A high value capacitor allows more current to flow than a lower value so the capacitance value can be read off a suitably marked scale. The accuracy and range of values that can be read by this method is very limited, and since a.c. is used it is unsuitable for electrolytic capacitors.

In the laboratory capacitance values can be measured accurately by means of an instrument called a 'Bridge'. A Bridge contains a bank of close tolerance capacitors which can be switched in and out of circuit to make up any value. Circuits inside the Bridge allow the unknown capacitor under test to be compared with the value set by the switches. When the two are equal the Bridge is said to be balanced, the value of the internal capacitor and hence the one under test can then be read off from the switch settings.

Bridges are very accurate but since they contain large numbers of close tolerance capacitors they are expensive. They are also slow to operate and can easily be misread.

What is needed is a simple-to-use direct reading capacitance meter which covers a wide range of capacitance values, and gives clear unambiguous readings. It should also be capable of dealing with electrolytic and non-electrolytic capacitors. The design that follows satisfies all of these needs and is a delight to use.

### DESIGN OBJECTIVES

From the start it was decided that the instrument should have a digital display and cover as wide a range of capacitance values as possible. It was considered essential that the circuit should be battery powered with the option of a mains adaptor. Great care was to be taken to ensure that even a novice could read capacitance values without being confused by such things as range multipliers. Finally, setting up of the circuit after construction was to be eliminated if possible.

### SPECIFICATION

The final practical design is capable of displaying directly capacitance values from a few pF up to 1,000 $\mu$ F. Values above 1,000 $\mu$ F can also be measured easily by extrapolation. Capacitance values are shown on a five digit i.e.d. seven segment display 0.5" high. There are three ranges, giving direct readout of pF, nF and  $\mu$ F. The five digit display means that there is a substantial overlap between ranges. The pF

range reads from 1pF to 99,999pF. The nF range from 0.01nF (10pF) to 999.99nF. The  $\mu$ F range from 0.01 $\mu$ F to 999.99 $\mu$ F. This overlap may not seem to be needed but it has two big advantages. The first is that it allows all values to be displayed to at least three digits. The second advantage is that values may be read in whichever units are preferred. For example a 100nF capacitor will be displayed as 0.1 $\mu$ F on the  $\mu$ F range and 100nF on the nF range. This facility is particularly useful for beginners who are unsure of the multiplying factors.

The accuracy of the circuit is set by the resistors used in critical areas. Using 1% tolerance components enables capacitors to be measured to the same degree of accuracy.

The use of a quartz crystal for the circuit timebase avoids the need for setting up.

### PRINCIPLE OF OPERATION

The principle of operation is simple. The unknown capacitor is charged through an accurately known resistor, and the time taken for the capacitor to charge from zero to a known 'set' voltage is measured. The time is directly proportional to the value of the capacitor.

Fig. 1 shows a simplified block diagram of the whole system.

The monostable circuit controls the charge and discharge of the capacitor under test. It produces an output pulse during the time that the capacitor is charging from zero to half of the supply voltage. This pulse is used to gate the output signal from a stable crystal 'clock' oscillator in such a way that the output from the gate is a burst of clock pulses lasting for the length of the monostable pulse.

The clock pulses passed during the monostable period are counted and displayed on the five digit seven segment display. A large value capacitor produces a long monostable pulse which allows a lot of clock pulses through the gate to be counted. A small value capacitor produces a short monostable pulse and so allows only a few clock pulses to pass to the counter.

By arranging the clock pulse frequency and the charging resistor value correctly the number of pulses counted can be made exactly the same as the capacitance value. In this way a direct read out is obtained.

### CIRCUIT

The entire circuit is shown in Fig. 2. The monostable is made up from IC1, TR1, IC3a, b, c and associated components. IC2 provides the clock pulses, and IC4, IC5d and IC6 along with the displays and driver transistors provide the count and display



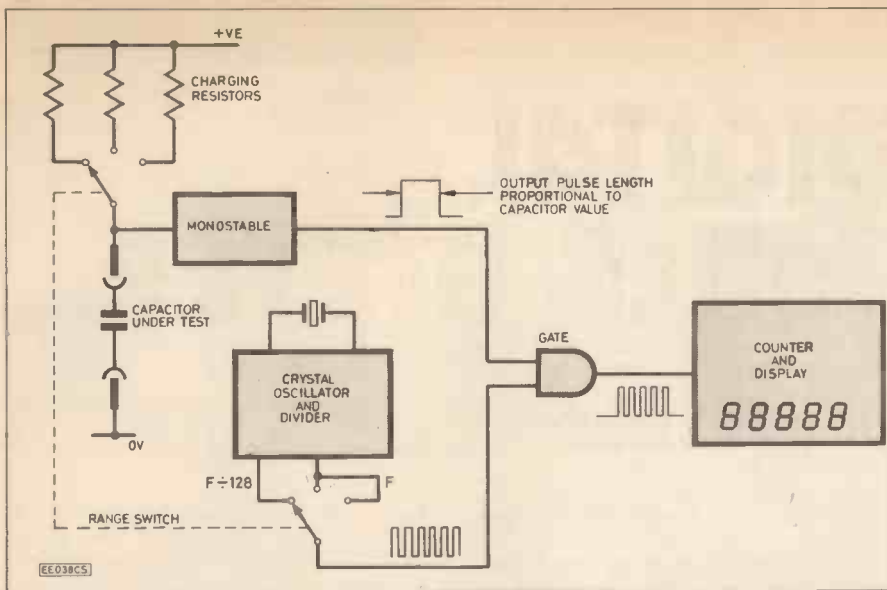

Fig. 1. Block diagram of the Capacitance Meter.

frequency. The lower frequency is necessary on the  $\mu\text{F}$  range to avoid having unreasonable charging resistor values in the monostable.

The clock oscillator outputs pass via the range switch S1b to IC5a where they are gated with the monostable pulses.

### THE MONOSTABLE

This part of the circuit produces a single output pulse the length of which is determined by the time it takes for the capacitor on test to charge from zero to half supply voltage. It was originally intended to use a 555 i.c. in this part of the circuit, however it was found that pulses shorter than 10 microseconds could not be produced even though the appropriate resistors and capacitors were used. Reference to the data books eventually revealed (in the small print) that the lower comparator storage time can be as long as 10 microseconds. This meant that the 555 would be unsuitable for measuring values much below 200pF in the proposed circuit.

After considering various options it was decided to build a monostable from scratch using individual components.

The circuit operates as follows:

Initially the two inputs to IC3b are high. The output of this NAND gate is low and this is linked to one of the inputs of the other NAND gate IC3a. The output of IC3a is high and so TR1 is turned on by the base

function. IC5a is the gate which takes the monostable and clock signals as inputs and provides the burst of clock pulses at its output which are counted and displayed. IC4b and c are used to provide pulses which trigger the monostable, reset the counter and blank the display. For simplicity each section of the circuit will be described separately.

### CLOCK OSCILLATOR

The accuracy of the capacitance meter is determined by the monostable and the clock oscillator. To avoid any setting up

procedures and ensure excellent accuracy a crystal oscillator is used to provide the clock signal. The frequency chosen, 3.579545MHz, is that of American colour TV reference oscillator crystals. These are cheap and readily available. IC2 is a very useful CMOS i.c. which contains an oscillator section and several divider stages. Only three external components are needed. Resistor R5 provides d.c. stabilisation and C1 and C2 give the necessary loading capacitance to the crystal.

Two outputs are used, one at the full crystal frequency, and the other after seven divider stages is at 1/128 of the crystal

Fig. 2. Circuit diagram.

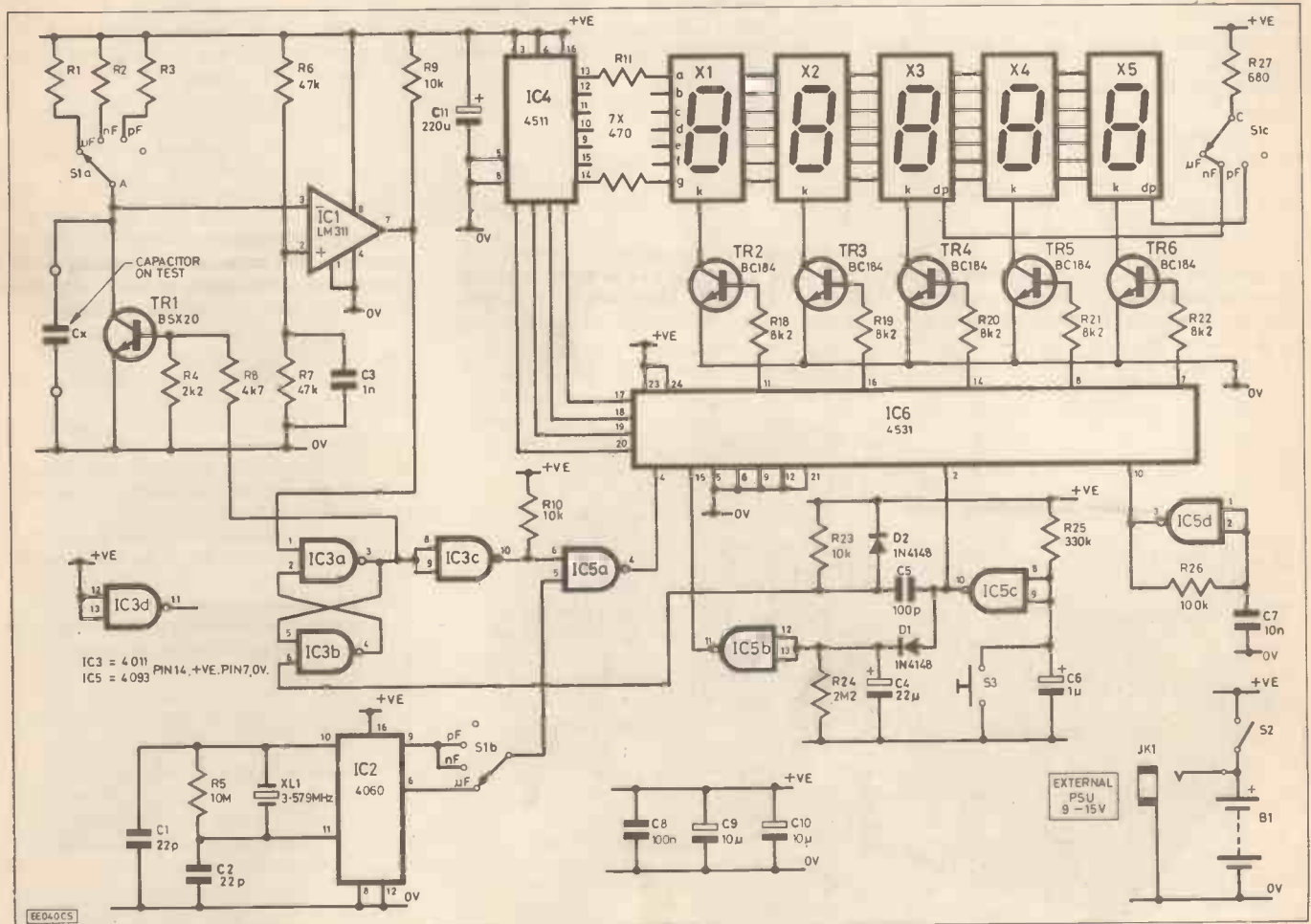

current received via R8. Pin 3 of the voltage comparator, IC1, is held low and as this is an inverting input, the output of IC1 is high. To help in understanding the circuit operation the truth table for a two input NAND gate is given in Fig. 3.

To initiate a capacitor measurement S3 is pressed and released. IC5 and its associated components produce a short negative going pulse just under 1 microsecond long which passes to one of the inputs of IC3b.

From Table 1 it can be seen that when either one of the inputs of the NAND gate is low the output must be high. Thus the output of IC3b changes from low to high so that IC3a now has both inputs high. When both inputs become high Table 1 shows that the output of IC3a must change from high to low. This takes the other input of IC3b low holding its output high even when the original negative pulse has passed. The circuit is now stable in this state and would remain there except for the action of TR1 and IC1.

Input 1	Input 2	Output
H	H	L
H	L	H
L	H	H
L	L	H

H = High, or Logic 1  
L = Low, or Logic 0

Table 1. Two-input NAND gate truth table.

When the output of IC3a changed from high to low the base drive current was removed from TR1 turning it off. With TR1 turned off the capacitor under test (Cx) charges via whichever of the charging resistors (R1, R2 or R3) is in circuit. IC1 compares the voltages applied to its two inputs. Its output stays high as long as the voltage on pin 2 is more positive than that of pin 3. Pin 2 is held at half supply voltage by means of the bias resistors R6 and R7. As Cx charges the voltage across it steadily rises and when it reaches half of the supply voltage the output of IC1 changes from high to low. The affect of this on IC3a and b is the exact reverse of the affect of the original pulse from IC5c. The timing circuit switches back to the starting condition, with IC3a output high and IC3b output low. TR1 is turned on and Cx is discharged.

The important part of this cycle of events is that the output of IC3a is a negative pulse lasting for exactly the time taken by Cx to charge from zero to half of the supply voltage. This pulse is inverted by IC3c and connected to one input of IC5a. Reference to Table 1 shows that when one input of the gate is high the signal on the other input appears (inverted) at the output. Thus clock pulses are passed via IC5a to the counter during the charge time of Cx.

## PULSE COUNTER AND DISPLAY

The train of pulses from IC5a passes to IC6 which contains a five decade counter and multiplexing circuits which enable five seven segment displays to be driven.

The multiplexing works as follows: Each seven segment display consists of seven independent I.e.d.s whose anodes are brought out separately to the pins lettered a

to g. The cathodes of all the I.e.d.s are connected together—hence 'common cathode displays'—and are connected to the pin labelled k. The information for each display appears in sequence as a 4 bit binary number on pins 17–20 of the i.c. This is translated to the necessary code to drive the display anodes by IC4. First the number for X1 appears and simultaneously TR2 is turned on via pin 11 of IC6. Thus X1 turns on and indicates the appropriate number. TR3–TR6 are turned off during this time so the other displays cannot be lit. Next the number for X2 appears and TR3 is turned on, TR2,4,5 and 6 being turned off. Then X3 number appears and TR4 turns on and so on. The speed at which this occurs is sufficiently rapid that the eye perceives all of the displays to be continuously lit each with its own particular number.

The multiplexing speed is determined by IC5d which is a simple Schmitt trigger oscillator.

The display decimal points are lit independently via R27 and the range switch S1c. The  $\mu$ F and nF ranges use the decimal point on the centre display whilst the pF range uses the right hand display.

Two other inputs of IC6 are used. Pin 2 resets the counter to zero whenever it is taken high. This occurs each time S3 is pressed. Pin 15 blanks out the display whenever it is taken high and is used to provide a very useful battery saving feature.

## DISPLAY BLANKING

When S3 is pressed to test a capacitor the input of IC5c is pulled down to ground. IC5c is an inverter so when its input is low its output is high. During this time C4 charges via D1 and IC5b input is pulled high. The output of IC5b (another inverter) goes low and so the display is turned on. When S3 is released the input to IC5c returns to a high level and its output switches from high to low. This removes the reset condition from IC6 which allows it to count and produces the short negative pulse that initiates the monostable.

The input to IC5b is held high by the charge on C4 so its output is low and the display remains on. C4 gradually discharges via R24 and eventually the input to IC5b becomes low, its output changes from low to high and the display is turned off. The time taken for this to occur is set by the values of C4 and R24 and is about 40 seconds. This allows plenty of time for the display to be read. Since the display takes much more current than the rest of the circuit an automatic blanking feature such as this is a very effective way of reducing the standby current, greatly extending battery life.

## CONSTRUCTION

Nearly all of the components are mounted on a single printed circuit board. Fig. 3 shows the component layout and Fig. 4 the track pattern. Before assembling the board it is a good idea to use it as a template to mark the front panel for cutting. Start by drilling a single 9mm diameter for the range switch. Next drill a 3mm diameter hole for a fixing screw in the bottom right hand corner of the board. The display position can be obtained by marking through the display mounting holes with a sharp instrument. These hole positions can then be used as a guide and a rectangle 75mm x 18mm marked around them. The rectangle can be cut out by drilling four corner holes and then using an Abraflex tension file in a junior hacksaw frame. Alternatively rows of

# COMPONENTS

## Resistors

R1	5-515k (5k1 + 47R in series) 1%
R2	40-3k (39k + 1k3 in series) 1%
R3	403k (390k + 13k in series) 1%
R4	2k2
R5	10M
R6,R7	47k 1%
R8	4k7
R9,R10,	10k
R23	
R11–R17	470 (7 off) page 646
R18–R22	8k2 (5 off)
R24	2M2
R25	330k
R26	100k
R27	680

$\frac{1}{4}$ W 5% carbon film unless stated

See  
**Shop  
Talk**

## Capacitors

C1,C2	22p ceramic (2 off)
C3	1n disc ceramic 50V
C4	22 $\mu$ 16V axial electrolytic
C5	100p ceramic
C6	1 $\mu$ radial electrolytic
C7	10n C280 polyester
C8	100n disc ceramic
C9,C10	10 $\mu$ 16V radial electrolytic (2 off)
C11	220 $\mu$ 16V radial electrolytic

## Semiconductors

TR1	BSX20
TR2–TR6	BC184 (5 off)
D1,D2	1N4148
IC1	LM311
IC2	4060
IC3	4011
IC4	4511
IC5	4093
IC6	4534
X1–X5	FND500 common cathode seven segment displays (5 off)

## Miscellaneous

S1	3-pole 4-way rotary switch
S2	SPST toggle switch
S3	Push to make switch
	3-5mm jack socket; 3-579MHz crystal; $\frac{1}{2}$ " mounting pillar, and screw and nut; case—sloping style with aluminium top panel 215 x 130 x 47mm (73); printed circuit board; crocodile clips 1 each red and black; extra flexible wire red and black approx 20mm of each; connecting wire; solder-con pins (50); i.c. sockets—1 8-pin, 2 14-pin, 2 16-pin, 1 24-pin; battery holder (2 x 3 HP7); PP3 battery clip; tinned copper wire; knob for S1; red perspex; grommet, etc.

A kit of parts is available from **Magenta Electronics Ltd.**, 135 Hunter St., Burton-on-Trent, Staffs., DE14 2ST. ☎ 0283 65435. P.c.b. available from *EE PCB Service*, order code EE512.

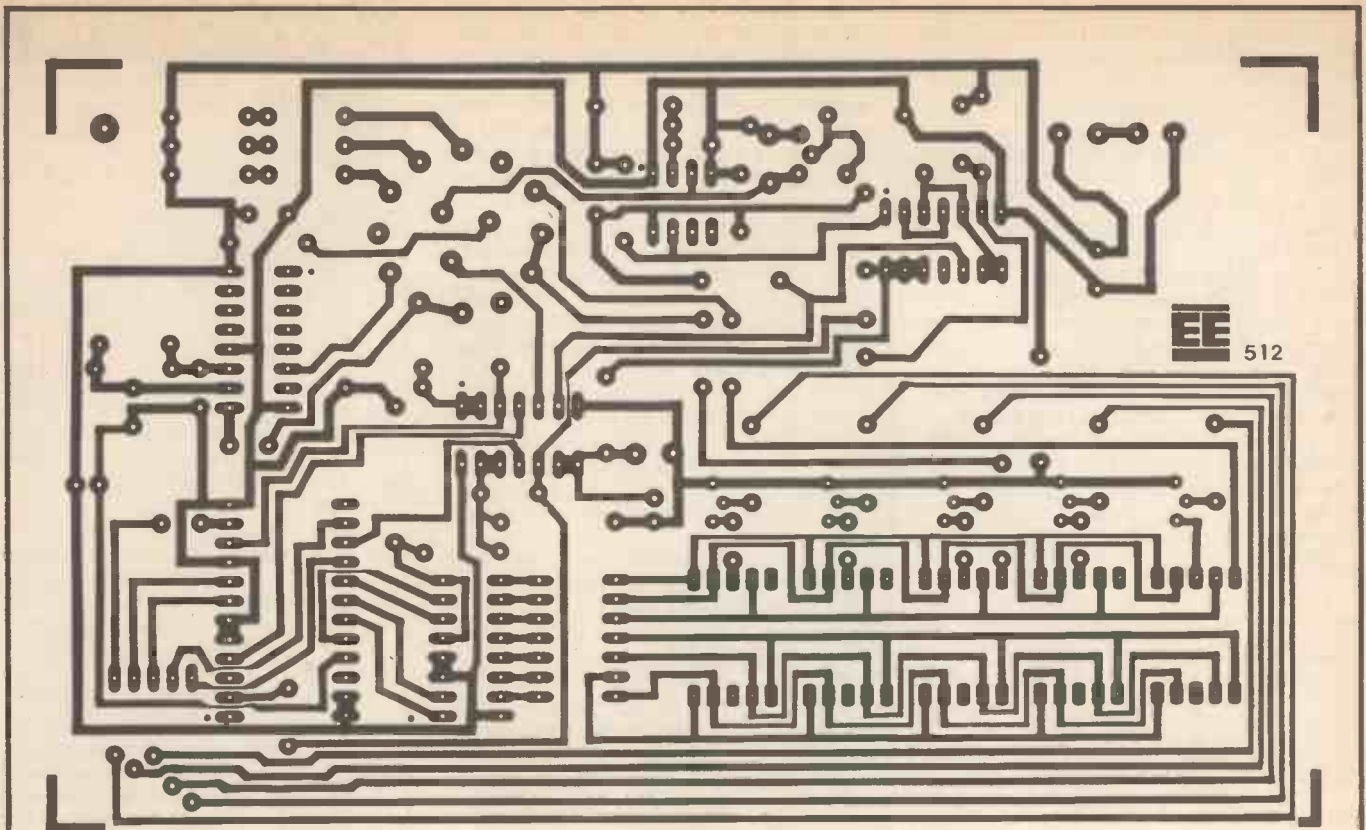

Fig. 3. Printed circuit (actual size).

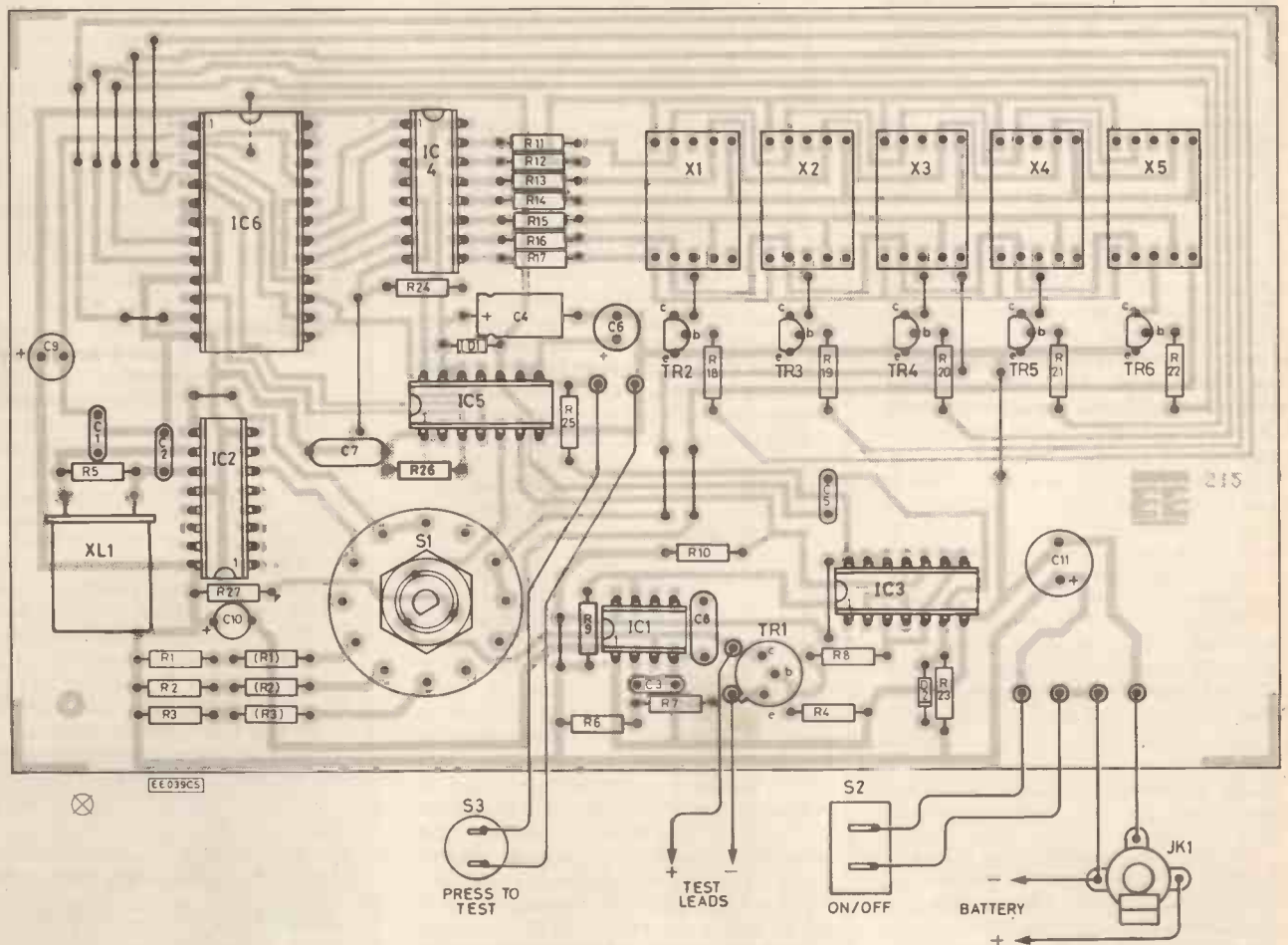
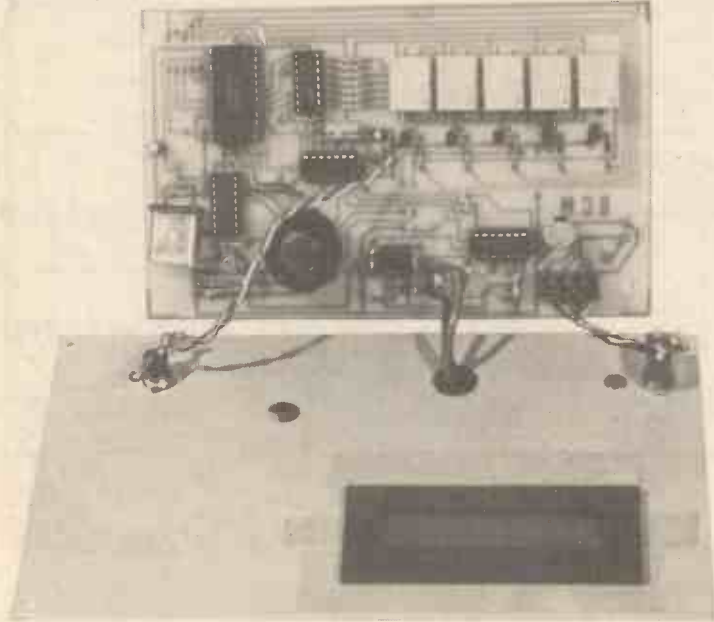

Fig. 4. Component layout and wiring.

holes can be drilled around the cut-out, the centre removed and the edges smoothed with a file. With patience and care a very good cut-out can be obtained. Three other holes are needed in the panel.

Two 6mm diameter for the S3 and S2 and one 9mm diameter for the test leads. Position S3 over the lower left corner of the board ensuring that its tags are clear of the crystal and resistors R1, 2, 3. S2 is too deep to mount over the board and should be positioned just beyond the right hand end. The test leads should be brought directly above their point of connection to the board to minimise stray capacitance.



The case specified comes with a plastic protective film over the front panel. This should be left in position until all the cutting and drilling is complete.

Start the p.c.b. assembly by fitting wire links in the positions shown. There are 19 of them altogether. Bare tinned wire can be used as there is no danger of short circuits to other components provided the links are straight. Next fit the resistors and i.c. sockets. The displays are mounted using 'soldercon' pins. These are single sockets assembled onto a perforated carrier strip. Cut the strip into ten rows of five pins. Cut the strip into ten rows of five pins, and fit each row of five to the board. After the pins have been soldered the carrier strip must be removed by flexing it backwards and forwards until it breaks off. Fit the capacitors, diodes and transistors next, taking care that C4, C6, C9, C10, C11, D1, D2 and all the transistors are the right way round. The crystal leads should be carefully bent 90° whilst supporting the part around the glass seals with pointed nose pliers. A small piece of double-sided tape should be used to secure the crystal can to the board. Eight terminal pins should be fitted to take the connections to S3, S2, the battery and the test leads. Single sided veropins are ideal, inserted from the track side of the board, pressed fully home so that the splined part of the pin engages with the board material and then soldered. Considerable force may be required to push the pins fully home. S1 is of a type normally supplied with solder tags, these tags can be adapted to suit printed circuit board mounting by cutting off the broad looped section at the end of the tag leaving about 6mm of straight lead. The switch will fit in three ways, the correct one being with the spindle flat as shown in Fig. 4 with the switch in its fully anti-clockwise position.

Stranded connecting wire should be used to connect to the off board components. A 3.5mm jack socket is used to connect an external 9-12V d.c. supply if required. The socket should be fitted in the side or rear of the case. When an external supply is connected the internal battery is automatically switched out of circuit by the 'break' contact on the socket.

The test leads in the prototype were made from red and black extra flexible wire 20cm long fitted with small insulated crocodile clips. Longer test leads are not recommended as they add stray capacitance which adds to the readings on the pF range.

The circuit is now ready for the i.c.s and displays to be fitted, after which it can be tested. After testing a red perspex window 100mm x 25mm should be fitted on the rear of the panel by means of double-sided adhesive tape. Stick the tape to the panel first and then press the window into place.

The board is fitted to the panel by means of S1 at one end and with a countersunk screw with a 12mm spacer and nut at the other end. If S1 has a plastic locating 'pip' this should be removed and the locking washer should be discarded. Only three positions out of four are used on the switch. The switch rotation is limited by an adjustable stop which consists of a small metal washer with a tab mounted underneath the switch fixing nut. Remove the washer, set the switch to its fully anticlockwise position and replace the washer with its tab in the slot marked with the number 3. A knob with a suitable skirt should be fitted to S1 so that the fixing nut is not visible. The front panel of the finished unit can be labelled by whatever method is preferred. The use of dry transfer print protected by clear lacquer produces a neat and durable finish.

## TESTING

As the wiring is so simple there is very little that can go wrong provided all of the components are correctly positioned and soldered. It is recommended that some time is spent checking for dry joints, solder bridges and incorrect component positions and values before applying power. If all appears to be correct connect a 9V battery and switch on. Set S1 to the  $\mu\text{F}$  position and check that the display is a row of zeros with a possible 1 in the right hand digit. Switch to the nF range and press and release S3. On this range the right hand digit will probably

be a 1 or 2 with all the other digits reading zero. Now repeat the procedure for the pF range. The stray capacitance indicated on this range will be about 20pF. The effect of this is covered in the 'use' section.

Check the operation of the display blanking circuit which should switch off the display after somewhere between 30 and 90 seconds. Pressing S3 should restore the display for a further period.

If a means of measuring supply current is available the values are 60-80mA running and 8-12mA with the display blanked.

## USE

The meter has been designed with ease of use as a prime consideration. Just connect a capacitor, press and release S3 and wait for the display to settle. The value is displayed in  $\mu\text{F}$ , nF or pF according to the range selected.

Electrolytic capacitors must be connected the right way round of course. Before connecting a capacitor always make sure that it is not charged by touching the two leads together. A charged capacitor will 'dump' its charge into TR1 and so may damage it.

On the pF range the stray capacitance of the leads and printed circuit board tracks will add 20pF or so to the value being measured. This should be subtracted from the value displayed to yield the correct value of the capacitor under test.

When measuring an unknown capacitor always start with the  $\mu\text{F}$  range and work downwards so that the most significant figure of the value is not lost. On the  $\mu\text{F}$  range it takes about three seconds for the circuit to indicate 999.00 $\mu\text{F}$ . If a 2200 $\mu\text{F}$  capacitor is to be measured it is easy to watch the display as it counts to 999.00 twice over. In this way capacitors above 1000 $\mu\text{F}$  can be tested and measured accurately by counting the number of times the display reaches 999.00 and adding 1000 $\mu\text{F}$  each time.

The use of a five digit display means that some values of capacitance are indicated to five digits. For all of these digits to be meaningful the circuit would need to have an accuracy of 0.001 per cent. Since 1 per cent components are used only the first two digits of any displayed value are correct, the following digits are useful for making comparisons when selecting matched capacitors but do not give any more information about the actual capacitance value. When making repeated measurements of the same capacitor the last two digits may vary from reading to reading due to circuit noise, hum pick-up, etc. Since these are not valid figures this effect is insignificant.

It is anticipated that 6 AA size nicad or alkaline cells will be used in a suitable battery holder. An external d.c. source of 9-12V d.c. may be substituted for prolonged bench use.

The first sign of low battery voltage is a dim display after which the readings will become erratic or non-existent. □

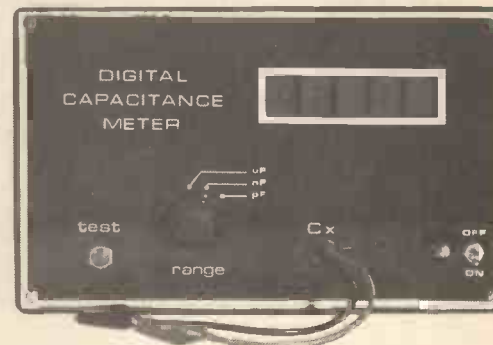

# Intruder Alarms and Accessories

## A COMPLETE SECURITY SYSTEM FOR ONLY £39.95 + V.A.T.

Contains Control Unit Enclosure & mechanical fixings Key Switch & 2 keys 1 E.D.s 5 1/2" Horn Speaker 4 high quality surface mounting Magnetic Switches

With only a few hours of your time it is possible to assemble and install an effective security system to protect your family and property, at the amazingly low cost of £39.95 + V.A.T. No complaints have been made and no corners have been cut. The outstanding value results from volume production and direct supply. Assembly is straightforward with the detailed instructions provided. When installed you can enjoy the peace of mind that results from a secure home. Should you wish to increase the level of security, the system may be extended at any time with additional magnetic switches, pressure pads or ultrasonic sensors. Don't wait until it's too late - order today.

### EXTENDED SYSTEM CS 1480 Price £62.50 + V.A.T.

This system contains, in addition to the CS 1370, an ultrasonic detector type US 5063, its enclosure, an additional horn speaker and a further 2 magnetic switches. This system represents outstanding value for money for the high level of security provided. Order Code CS 1480

### SELF-CONTAINED ULTRASONIC ALARM UNIT CK 5063

only £37.00 + V.A.T.



Requires no installation. Easily assembled using our professionally built and tested modules.

- Adjustable range up to 25ft
- Built in entrance and level delay
- Built in timed alarm
- Key operated switch. Off, Test and Operate
- Provision for an extension speaker
- Fully self contained
- Uses US 5063 PSL 1865 Key Switch 3901
- Speaker 3615

Now you can assemble a really effective intruder alarm at this low price using tried and tested Riscomp modules. Supplied with full instructions, the kit contains everything necessary to provide an effective warning system for your house or flat. With a built in LED indicator and test position the unit is easily set up requiring no installation. It may simply be placed on a cupboard or desk. Movement within its range will then cause the built in siren to produce a penetrating 90db of sound or even 110db with an additional speaker. All parts included and supplied with full instructions for ease of assembly. Size 200 x 180 x 70mm. Order as CK 5063.

**RISCOMP LIMITED**

Dept EE31,  
51 Poppy Road,  
Princes Risborough,  
Bucks. HP17 9DB.  
Princes Risborough (084 44) 6326

### ALARM CONTROL UNIT CA 1250



Price £19.95+V.A.T.

The heart of any alarm system is the control unit. The CA 1250 offers every possible feature that is likely to be required when constructing a system whether a highly sophisticated installation or simply controlling a single magnetic switch on the front door.

- Built in electronic siren drives 2 loud speakers
- Provides exit and entrance delays together with fixed alarm time
- Battery back up with trickle charge facility
- Operates with magnetic switches, pressure pads, ultrasonic or IR units
- Anti tamper and panic facility
- Stabilised output voltage
- 2 operating modes full alarm anti tamper and panic facility
- Screw connections for ease of installation
- Separate relay contacts for external loads
- Test loop facility

### HARDWARE KIT HW 1250

only £9.50 + V.A.T.

This attractive case is designed to house the control unit CA 1250 together with the appropriate LED indicators and key switch. Supplied with the necessary mounting pillars and punched front panel. The unit is given a professional appearance by an adhesive silk screened label. Size 200 x 180 x 70mm

### SIREN & POWER SUPPLY MODULE PSL 1865

only £9.95 + V.A.T.

A complete siren and power supply module which is capable of providing sound levels of 110db at 2 metres when used with a horn speaker. In addition, the unit provides a stabilised 12V output up to 100mA. A switching relay is also included so that the unit may be used in conjunction with the US 5063 to form a complete alarm.

## NEW



### TIMER SWITCH & POWER SUPPLY MODULE DP 3570 Price £13.95 + V.A.T.

The DP 3570 consists of an adjustable timer switch and stabilised 12V power supply for use in a wide range of applications including security, lighting control and automatic switching. The timer section of the module provides switching of loads up to 3A for pre set times, the duration of which may be set by the user to between 10 secs and 5 mins. The timed period may be triggered by the opening of a loop or the closing of external contacts, with the timed period commencing instantaneously or delayed to provide a form of entrance delay. The power supply section of the module provides a 12V output of up to 250mA which is sufficient for most applications. The module operates from either 240V a.c. supply or a 12V battery for which trickle charge facilities are included. Connections to the module are by means of screw terminal connectors with no soldering needed.

For mounting the unit an attractive moulded enclosure is available.

ME 357 only £2.85 + V.A.T.

### INFRARED SYSTEM IR 1470 only £25.61+V.A.T.

Consisting of separate transmitter and receiver both of which are housed in attractive moulded cases, the system provides an invisible modulated beam over distances of up to 50ft operating a relay when the beam is broken. Intended for use in security systems but also ideal for photographic and measurement applications. Size 80 x 50 x 35mm

### DIGITAL ULTRASONIC DETECTOR US 5063

only £13.95 + V.A.T.

This advanced module uses digital signal processing to provide the highest level of sensitivity whilst discriminating against potential false alarm conditions.

### ULTRASONIC MODULE ENCLOSURE

only £2.95 + V.A.T.

Suitable metal enclosure for housing an individual ultrasonic module type US 5063 or US 4012. Supplied with the necessary mounting pillars and screws etc. For US 5063 order SC 5063 for US 4012 order SC 4012

## RISCOMP THE SECURITY SPECIALISTS!

Add 15% to all prices. Add 75p post and packing to all orders. Units on demonstration. Shop hours 9.00 to 5.30 pm. Closed Wednesdays. Please allow 7 days for delivery.

Saturday 9.00 to 1.00 pm. SAE with all enquiries. Order by telephone or post. Using your credit card.

**FULL RANGE OF ACCESSORIES STOCKED SEND SAE FOR DETAILS**

## The MIGHTY MIDGETS SOLDERING IRONS AND ACCESSORIES

	RETAIL PRICE each in VAT	POSTAGE extra
18 WATT IRON FITTED WITH NO. 20 BIT AVAILABLE IN 12V, 110V, or 240V	5.98	40p
SPARE BITS	97p	—
STANDS	2.99	1.00
SOLDER: SAVBIT 20	1.43	20p
" " 10	74p	15p
LOWMELT 10	1.17	20p
I.C. DESOLDERING BIT	1.78	20p

BIT SIZES: NO. 19(1.5mm) NO. 20(3mm)  
NO. 21(4.5mm) NO. 22(6mm)

From your Local Dealer or Direct from Manufacturers

# S & R BREWSTER

86-88 UNION ST. PLYMOUTH PL1 3HG  
0752-665011

PLEASE QUOTE YOUR NUMBER WHEN ORDERING

## TELEVISION/COMPUTER FULL-TIME TRAINING

(FULL TIME COURSES APPROVED BY THE BUSINESS & TECHNICIAN EDUCATION COUNCIL)

**2 YEAR**  
BTEC National Diploma (OND)  
ELECTRONIC & COMMUNICATIONS ENGINEERING  
(Electronics, Computing, Television, Video, Testing & Fault Diagnosis)

**15 MONTHS**  
BTEC National Certificate (ONC)  
ELECTRONIC EQUIPMENT SERVICING  
(Electronics, Television, Video Cassette Recorders, CCTV, Testing & Fault Diagnosis)

**15 MONTHS**  
BTEC National Certificate (ONC)  
COMPUTING TECHNOLOGY  
(Electronics, Computing Software/Hardware, Microelectronic Testing Methods)

**9 MONTHS**  
BTEC Higher National Certificate (HNC)  
COMPUTING TECHNOLOGY & ROBOTICS  
(Microprocessor Based Systems, Fault Diagnosis, ATE, Robotics)

THESE COURSES INCLUDE A HIGH PERCENTAGE OF COLLEGE BASED PRACTICAL WORK TO ENHANCE FUTURE EMPLOYMENT PROSPECTS  
SHORTENED COURSES OF FROM 3 TO 6 MONTHS CAN BE ARRANGED FOR APPLICANTS WITH PREVIOUS ELECTRONICS KNOWLEDGE

NEXT SESSION TO COMMENCE  
ON JANUARY 6th  
H.N.C. SEPTEMBER 1986  
FULL PROSPECTUS FROM

**LONDON ELECTRONICS COLLEGE (Dept EE)**  
20 PENYVERN ROAD, EARLS COURT,  
LONDON SW5 9SU. Tel: 01-373 8721.

# SHOP TALK

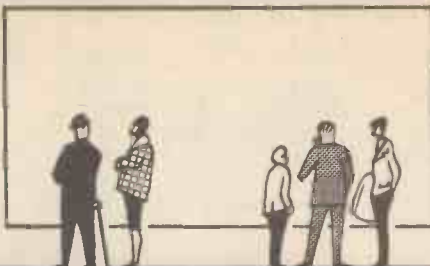

BY RICHARD BARRON

In this month's Shoptalk, we've got a bit of a mixture. There's news of some new products, new services and a special offer.

## Supplying Electronics For Education Music Computing And Fun

Magenta Electronics Ltd. has become an established supplier of kits, tools, books and components to hobbyist, particularly through magazines such as *EE* and our sister publication, *Practical Electronics*. For many years now, Magenta have advertised a comprehensive list of *EE* kits, and are still able to supply parts for selected projects from as far back as 1977.

MAGENTA

# MAGENTA

electronics Ltd.



Supplying Electronics  
For Education, Music,  
Computing and Fun.

MAGENTA  
ELECTRONICS Ltd.  
135 Hunter Street  
Burton-on-Trent  
Staffs DE14 2ST  
0283 85435

For beginners, the educational kits from Magenta are ideal tools for learning through experiment. Each one includes a book containing logical, and easy, learning steps together with an associated pack of components. Music, computing and fun projects are catered for in much the same way, with a large selection of books and project kits, some of which are designed by Magenta themselves and have been published in *EE*.

## Fischertechnik Robots

An exciting new construction kit from Fischertechnik is now available from Magenta. It is designed to provide a unique introduction to the fascinating world of robotics. Combining the popular Fischertechnik 'building module' expertise, with the latest computer technology, these kits allow you to design, build and control your own robot models.

Each kit contains two motors, an electro-magnet, eight switches, two potentiometers, 20-core ribbon cable and connectors for interfacing to your computer. Optional interface circuitry is also available for many popular home micros.

Full details of all these products are listed in the Magenta catalogue which is available for £1 inc. VAT & P&P. To keep you up to date, a separate price list is provided at regular intervals, as the catalogue is only updated yearly.

Orders, catalogues and other details are available from: **Magenta Electronics Ltd., Dept. EE, 135 Hunter St., Burton-On-Trent, Staffs., DE14 2ST. ☎ 0283 65435 (Mon-Fri, 9-5).**

## Your High Street Technology Store

Tandy Corporation (Branch UK), have over 350 stores and dealers nationwide, selling nearly 3000 different products, from Amplifiers to Zener diodes.

Nowadays, it would seem that Tandy concentrate on consumer electronic products including; hi-fi, video, microwaves and computers. Many of these products carry Tandy's own brand names, such as *Realistic*, *Archer* and *Micronta*, all of which have gained 'value for money' reputations.

Maybe not so well known, but of interest to the hobbyist, is Tandy's range of tools, components, kits and test gear. Their component range is not vast by any means, but the convenience of over 300 local stores and dealers makes them a good first choice for those common items such as resistors, capacitors and 'basic' semiconductors which are needed quickly.

Also for the hobbyist and hi-fi enthusiast, Tandy have an excellent range of 'peripheral hardware' such as switches, connectors, plugs, sockets and enclosures. Their range of quality audio plugs and connectors is particularly worth investigating.

Two large, full colour catalogues are produced by Tandy. One covers their complete range of products and the other specialises in computers. The latter is designed to back up their network of Computer Centres which have been developed in recent years.

There are now over sixty dedicated Tandy Computer Centres providing a complete micro service.

Details of the Tandy catalogue or retail stores can be obtained from: **Tandy Corporation (Branch UK), Tameway Tower, Bridge St., Walsall, West Midlands, WS1 1LA.**

## Compact Solution

Compact disc (CD) players are becoming a popular medium for hi-fi reproduction, offering a top quality alternative to tape and traditional discs. **Philips Electronics**, a major force behind compact disc technology, have now extended CD applications to the field of computing.

At Philips Research laboratories, at Redhill, in Surrey, engineers saw compact disc read only memory (CDROM) as a logical progression, as music stored on CD was already in digital form-computer language. All that was required was an interface compatible with computers. This achieved, the result is a low-cost, extremely powerful, program storage medium.

## Prototype

At present, although Philips have a reliable working prototype, CDROMs are not yet in production. However it looks as if, in the not too distant future, they will be.

Because most of the development investment involved in CD memory has been recovered from the audio market, the price, in theory, should not be too high but, be careful. When they first appear, the price will not become stable until market trends such as supply, demand and software back-up has become established. Also, if you are thinking of buying a standard compact disc player in the near future, and hoping to fit an interface later, you will be disappointed as they probably won't be available.

## Super Switch-Super Offer

**Superswitch Electric Appliances Ltd.**, a member of the *MK Electric Group*, have just released a new booklet illustrating a variety of devices for home security and lighting. These include: smoke and intruder alarms, wireless burglar alarms and a range of electronic timers.

Also offered by Superswitch, is a FREE 'In-Car' recharger, worth £7, when you buy a model-4010 rechargeable torch. This is designed to make light work (work light) of car break-downs and emergencies. It retails for around £19 and comes complete with a wall mounting bracket and mains transformer for home use.

Please note however, this offer is only available while stocks last, so buy now to avoid disappointment.

Details of these and other products are available from: **Superswitch Electric Appliances Ltd., 7 Station Trading Estate, Camberley, Surrey GU17 9AH. ☎ (0276) 34556.**





## Technology Surfaces

During the early seventies, electronic technology advanced at an incredible rate. The second industrial revolution was just beginning, and whilst many had just become accustomed to transistors as an alternative to valves, integrated circuits loomed.

To many, this signalled the beginning of the end for that inventive and ingenious breed, the electronic hobbyist. This was not to be; indeed, the hobby went from strength to strength as amateurs mastered the art of p.c.b. design and i.c. usage, and at all times remained at the forefront of technology.

Since those early days of small scale integration (a few transistors in one package), manufacturers have striven to cram as many components onto a single chip as possible. There are now i.c. packages containing hundreds of thousands of transistors. Once again, this has been no problem for the hobbyist as all these i.c.s are available in the familiar, standard d.i.l. packages.

*"By 1990, almost half of all electronic components used in Europe will be surface mounted devices"*

However, the present situation may soon change. In recent years, manufacturers have decided to reduce the size of their i.c. packages to facilitate more efficient and cost-effective production. This has resulted in the ever-increasing availability of small-outline (SO) packages and surface mounted devices (SMDs), a trend certain to continue. According to Dr. Alex Stark of Mullard Ltd, Britain's largest electronic component company. "By 1990, nearly half of all the electronic components used in Europe will be surface mounted devices".

What effect this will have on the availability of their d.i.l. counterparts, is difficult to say, but it seems unlikely that they will become obsolete within the next twenty years. The problem is; is this, once again, an early signal to the beginning of the end for the hobbyist? I think not. Hobbyists, like cats, always land on their feet and after all the appearance of SMDs only marks the beginning of their third or fourth life, which leaves five or six to go at.

Before hobbyists are able to adopt surface mounted technology, if indeed they will ever need to, many problems will have to be overcome. The main concern of *Shoptalk* will be the availability of SMDs in small quantities at reasonable prices. Also, as production of SMDs increases it follows that production of standard d.i.l. packages will probably decrease causing the price to rise. At the moment SMDs are rarely available to hobbyists at all and even many industrial suppliers only deal in vast quantities.

As for the hobby itself, some clever and ingenious designers, whether amateurs or professionals, will have to come up with new ideas for utilising surface mounted technology as, at the moment, they are mainly geared up for automatic production methods. In the meantime, *Shoptalk* and *Everyday Electronics* will be keeping a close eye on developments in this area. We will keep you posted!

## CONSTRUCTIONAL PROJECTS

### Digital Capacitance Meter

A complete kit of parts for the Digital Capacitance Meter is available from Magenta Electronics, Dept. EE, 133 Hunter Street, Burton-on-Trent, Staffs., DE14 2ST. The price is £35.98 and includes VAT but add 60p for P&P per order.

### Diode/Transistor Tester (Teach In '86)

Once again, Teach In is proving to be very popular and response from readers and advertisers has been excellent. There are now several advertisers offering complete kits for parts of this series, so no component buying problems are envisaged.

Although it is our policy to print front panel layout designs for each project in the series, it does not prevent constructors from using different cases if they choose. Be careful though, make sure that all the parts will fit into the case with enough room for appropriate panel labelling.

### TTL Logic Probe (Building Blocks)

Building Blocks projects continue to be inexpensive, each one being built around a small p.c.b. which is part of a larger board available from the PCB Service.

The board published this month is split into five sections, designed to be carefully cut to produce four separate projects (one project uses two boards). Projects which can be built on these boards include a Single-Chip Alarm, TTL Logic Probe, Computer O/P Port and a Light Effects/Games Unit.

As well as the PCB Service, some advertisers may be selling complete kits for this series and to make them even better value, the boards have been modified to allow cheaper components to be used. In particular, standard chassis mounted pots can be used rather than the p.c.b. mounted types used on the prototypes. Also the boards supplied by the PCB Service have been modified to this end.

The TTL Logic Probe, this month's Building Blocks Project, should present no difficulty as far as the bulk of the components go. However, some readers may prefer to use a different type of case to the one used for the prototype. This is no problem, providing it is large enough to contain all the components. A suitable probe may be made from a stainless steel nail or similar item.

### Optical Intensity Transducer

The case used for the Optical Intensity Transducer is the same type used for all the projects in this series. Other than the actual transducer devices, the components are available from a number of advertisers. This month's device is a general purpose photodiode similar to the RS 305-462 and is commonly available from many sources.

Please mention  
**EVERYDAY ELECTRONICS**  
when replying to  
products mentioned  
on this page  
and to Classified Ads

## ★ BAKER ★

GROUP P.A. DISCO  
AMPLIFIERS post £2

150 watt Output, 4 input Mixer pre-amp. Illustrated £99  
150 watt Output, Slave 500 mv. Input 4+8+16 ohm. Outputs... £80  
150+150 watt Stereo, 300 watt Mono Slave 500 mv. Inputs £225  
150 watt P.A. Vocal, 8 inputs. High/Low Mixer Echo Socket £129  
100 watt Valve Model, 4 inputs, 5 Outputs. Heavy duty £125  
60 watt Mobile 240v. AC and 12v DC. 4-8-16 ohm+100v line £89

MIKES Dual Imp £20, Floor Stand £13, Boom Stand £22, PP £2.  
Reverb Unit for Microphone or Musical Instruments £35 PP £1.  
Electronic Echo Machine for mic/elec. £85, Deluxe £95 PP £1.  
**H+H** 1000w mono, 500w stereo quality amplifiers, model SS50D, reconditioned, guaranteed £275 PP £5.

DISCO CONSOLE Twin Decks, mixer pre amp £145, Carr £10.  
Ditto Powered 120 watt £199; or Complete Disco 120 watts £300.  
150 watt £300; 360 watt £410. Carr £30.

DISCO MIXER. 240v, 4 stereo channels, 2 magnetic, 2 ceramic/ tape, 1 mono mic channel, twin v.u. meters, headphone monitor outlet, slider controls, panel or desk mounting, matt black fascia. Tape output facility. £58, PP £1.

DELUXE STEREO DISCO MIXER/EQUALISER as above plus I.E.D. V.U. displays 5 band graphic equaliser, left/right fader, switchable inputs for phone/line, mike/line. £129 PP £2

Headphone Monitor, Mike Talkover Switch  
As above but 3 deck inputs, 4 line/aux inputs, 2 mic inputs, 2 headphone monitors £145.

### FAMOUS LOUDSPEAKERS - SPECIAL PRICES

SIZE	POWER	OHMS	MAKE/	PHYSICAL SIZE IS	ADJ. MAX	FRAME	DIMENSION	PRICE	POST
in	WATTS		APPLICATION	SIZE					
3/2	10	4 or 8	Audax	Mini-Wooler			E4	£1	
5	20	4 or 8	Goodmans	Ford Car Radio			E6	£1	
5/4	60	8	Sound Lab	Hi Fi Twin Cone Full Range			E10	£1	
5/2	25	8	Audax	Bestone Cone Woofer			E9	£2	
6/2	10	8 or 15	Sound Lab	Hi Fi Twin Cone Full Range			E11	£2	
6/2	25	4 or 8	Audax	Wooler			E7.50	£1	
6/2	15	8 or 15	EMI	Wooler			E6.50	£1	
6/2	25	8	Audax	Bestone Cone Woofer			E7.50	£1	
6/2	10	8	Goodmans	Twin Cone, Hi Fi Full Range			E7.50	£1	
8	20	8	Far East	Twin Cone, Hi Fi, Full Range			E5.95	£1	
8	25	4	Goodmans	Wooler			E7.50	£1	
8	30	8	Wharfedate	Roll Surround Woofer			E7.50	£1	
8	30	8	Audax	Hi Fi Woofer			E7.50	£1	
8	50	8	L.M.F.	Ribbed Bestone Cone Woofer			E16	£2	
8	40	8	Audax	Hi Fi Woofer Bestone Cone			E15.50	£2	
8	50	8	Audax	Hi Fi Woofer Bestone Cone			E15.50	£2	
8	50	8	Sound Lab	Hi Fi Twin Cone Full Range			E14	£2	
8	50	8	Goodmans	PA & Hi Fi Systems			E14	£2	
10	30	4 or 8	Far East	Bass Woofer, Hi Fi			E14	£2	
10	50	8	S.E.A.S.	Bass Woofer Hi Fi			E18.50	£2	
10	15	8	Rigonda	General Purpose			E5	£1	
10	20	8 or 16	Celestion	Disco-PA			E15	£2	
10	50	8 or 16	Baker	Disco-Guitar-PA			E18	£2	
10	50	8 or 16	Celestion	Disco-PA			E14.50	£2	
10	30	8	Sound Lab	Twin Cone Full Range			E19.50	£2	
10	300	8	WEM	Wooler			E36	£2	
12	30	4 or 8 or 16	Baker	Twin Cone Full Range			E18	£2	
12	45	4 or 8 or 16	Baker	Disco-Guitar-PA			E16	£2	
12	90	8	Baker	Bass Woofer			E25	£2	
12	75	4 or 8 or 16	Baker	Disco-Guitar-PA			E22	£2	
12	100	8	Goodmans	Wooler			E30	£2	
12	100	8 or 16	Goodmans	Disco-Guitar-PA			E34	£2	
12	100	8	H + H	PA			E39	£2	
12	100	8 or 16	Baker	Disco-Guitar-PA			E28	£2	
12	150	8	Celestion	Disco-Bass Guitar			E65	£3	
12	200	8	H + H	PA-Disco			E68	£3	
12	300	8	WEM	Wooler			E44	£3	
13x8	10	3 or 8	EMI (450)	Wooler with Tweeter			E5	£1	
15	100	8	Celestion	Disco + Group			E69	£3	
15	100	8 or 16	Baker	Disco-Guitar-PA			E26	£2	
15	100	4 or 8 or 16	H + H	Disco + Group			E49.50	£3	
15	250	8	Goodmans	Disco + Group			E74	£3	
18	230	8	Goodmans	Disco + Group			E97	£4	
18	250	8 or 16	Celestion	Disco + Group			E110	£4	

P.A. CABINETS (empty) Single 12 £34; Double 12 £40, carr £10.  
WITH SPEAKERS 45W £52; 75W £56; 90W £75; 150W £84,  
200 Watt £100, 400 Watt £150, carr £12.  
300 WATT MID-N-TOP SYSTEM Complete £125 carr £12.  
TWEETER HORNBOXES 200 Watt £32, 300 Watt £38, PP £2.

WATERPROOF HORN SPEAKERS 8 ohms, 25 watt £20, 30 watt £23,  
40 watt £29, 20v plus 100 volt line £38, Post £2.  
MOTOROLA PIEZO ELECTRONIC HORN TWEETER, 3 $\frac{1}{2}$ in. square £5  
100 watts. No crossover required 4-8-16 ohm,  $\frac{7}{8}$  x  $\frac{3}{8}$ in. £10

METAL GRILLES 8in £3, 10in £3.50, 12in £4.50, 15in £5.50, 18in £7.50

### R.C.S. DISCO LIGHTING EQUIPMENT

READY BUILT DELUXE 4 CHANNEL 4,000 WATT sound chaser +  
speed + 4 programs £69. Mk2 16 programs, £89 PP £2.  
PARTY LIGHT 4 coloured Flood Lamps Flashing to Music,  
Self-contained Sound to Light 410 x 196 x 115mm £34.95 PP£2.  
FULL STOCK OF COMPONENTS, PLUGS, LEADS, ETC.

MAINS TRANSFORMERS Price Post  
250-0-250V 80mA, 6.3V 3.5A, 6.3V 1A. £7.00 £2  
350-0-350V 250mA, 6.3V 6A CT £12.00 £2

LOW VOLTAGE MAINS TRANSFORMERS £5.50 each post paid  
3V, 3A; 12V, 3A; 18V, 2A; 20V, 1A; 30V, 1.2A; 30V, 5A-4 17.0-17V,  
2A; 35V, 2A; 20-0-20V, 1A; 12-0-12V, 2A; 20-0-20V, 1A; 50V, 2A.

£8.50 post 50p MINI MULTI TESTER  
Pocket size instrument, AC/DC volts, 15-150-500-1000.  
DC current 0-150mA. Resistance 0-100K 1000 ohms.  
De-Luxe Range Doubler Meter, 50,000 o.p.v. 7 x 5 x 2in.  
Resistance 0/20 meg in 5 ranges. Current 50mA to 10A.  
Volts 0.25/1000V DC, 10v/1000V AC. £25.00 PP £1

PANEL METERS 50mA, 100mA, 500mA, 1mA, 5mA, 100mA, 500mA,  
1 amp, 2 amp, 5 amp, 25 volt, VU 2 $\frac{1}{4}$ x2 $\frac{1}{4}$ in. £5.50 post 50p

PROJECT CASES. Black Vinyl Covered Steel Top. All Base  
4 x 2 $\frac{1}{2}$  x 2 $\frac{1}{2}$ in. £2.50; 6 x 4 x 1 $\frac{1}{2}$ in. £3.60; 8 x 5 x 2in. £4.00; 11 x  
6 x 3in. £5.50; 11 $\frac{1}{4}$  x 6 x 5in. £9.00; 15 x 8 x 4in. £12.00.

ALUMINIUM PANELS 18 s.w.g. 12 x 12in. £1.80; 14 x 9in. £1.75;  
6 x 4in. 55p; 12 x 8in. £1.30; 10 x 7in. 95p; 8 x 6in. 90p; 14 x 3in.  
7x2 x 5in. 90p; 16 x 10in. £2.10; 16 x 6in. £1.30.

ALUMINIUM BOXES. MANY OTHER SIZES IN STOCK.  
4 1/2 x 2 1/2 x 2in. £1.20; 3 x 2 x 1in. £1.60; 5 x 2in. £1.90; 8 x 6 x 3  
in. £3; 12 x 5 x 3in. £3.60; 6 x 4 x 3in. £2.20; 10 x 7 x 3in. £3.60

HIGH VOLTAGE ELECTROLYTICS 32 x 32/500V £2  
16/450V 50p 22/0400V £2 32 x 32/350V 50p  
20/500V 75p 8-8/450V 75p 32 x 32 x 32/450V £1.50  
32/350V 45p 20 x 20/350V 75p 16 x 32 x 32/500V £2

### RECORD PLAYER DECKS. P&P £2.

Make Drive Model Cartridge Price  
BSR Single Belt 12 volt Ceramic £22  
BSR Single Rim P207 Ceramic £22  
AUTOCHANGER BSR Ceramic £22  
AUTOCHANGER GARRARD Ceramic £24  
Many others in stock. Phone for details.



DECCA TEAK VENEERED PLINTH space for small amplifier.  
Board cut for BSR or Garrard 18 $\frac{3}{4}$ in. x 14 $\frac{1}{4}$ in. x 4in. £5, Post £1

### RADIO COMPONENT SPECIALISTS

Dept 4, 337, WHITEHORSE ROAD, CROYDON  
ACCESS SURREY, U.K. Tel: 01-684 1665 VISA  
Post 65p Minimum. Callers Welcome.  
Full Lists 34p Stamps Same day despatch Closed Wednesday

# FOR YOUR ENTERTAINMENT

BY BARRY FOX

## Community Radio

For a while it looked as if the Home Office's handling of Community Radio licensing was a classic case of cock-up. The Home Office takes its technical advice from the DTI's radio department and when one non-technical government department has to mouth the words of engineers from another department, the communications wires can easily get crossed.

But the cock-up theory no longer holds water. It really does begin to look as if the Home Office, and probably the DTI as well, don't want community radio to succeed. They have simply gone through the motions of offering licences to keep critics off their backs.

Consider the facts . . .

The Home Secretary announced on 25 July that he would licence 21 experimental community radio stations in Britain, for a two year experimental period. Five will be in London.

The Home Office said in guidance notes that it wants community stations to offer listeners a broader choice of programming, rather than ape existing BBC and commercial services. Because of the risk of interference on the crowded airwaves, the Home Office has also published a strict technical specification for transmitter power and warns that it will take a particularly serious view if anyone exceeds the permitted power level. Offenders risk losing their licences.

The maximum permissible power on the v.h.f. frequencies made available for community radio will be 10W for small neighbourhood stations or 100W for "community of interest" stations. Anyone reading the Home Office rules would be entitled to expect the licences to cover stereo. The Home Office expects a mix of speech and music programming. As a community of interest the Home Office instances "enthusiasts for a particular kind of music".

To be effective, music transmissions must be in f.m. stereo, like the BBC and commercial stations—and pirates. The licence notes do not specifically exclude stereo, they just make it impossible or at least impractical to transmit!

In accordance with normal f.m. broadcast practice, the carrier signal for community radio will be able to deviate by 75kHz up or down from the allocated frequency. But the transmitted f.m. signal may spread over only a 200kHz band. This is enough for mono, but stereo needs at least 250kHz.

## Borderline

The Home Office limits on sidebands are even tighter. In any f.m. transmission there are sideband frequencies which in theory have infinite spread. In practice, they can be reduced in level by filters so that they do not interfere with other stations.

The Home Office insists that at 100kHz away from the main carrier frequency, the sidebands must be at a power of at least 40 decibels below the power of the carrier. Mono radio stations round the world achieve only around 30 decibels at

100kHz; stereo signals have a much wider bandwidth and stronger side bands.

I spoke with Angus McKenzie, a well-known consultant in audio and radio technology, technical specification. "I just cannot see how the community stations will be able to broadcast in stereo and stay within the limits," he says. "Even high-quality mono will be on the borderline."

When I quizzed the Home Office on the point it took them a couple of days to remember that although the notes said nothing about it, they had never intended people to broadcast in stereo. The idea of community radio was born out of pirate radio, much of which is in f.m. stereo. But according to the Home Office: "Stereo was never envisaged because it is only an experiment. We are quite satisfied that our rules allow mono. But we might reconsider if there is any demand."

Do people applying for community licences realise that they will get one for mono only? Says Bevan Jones, Chairman of the Community Radio Association, "Certainly not. It's ridiculous. I expect most stations to be half music. Obviously they will want stereo."

## Poles Apart

Prospective licensees dare not push the Home Office too hard. They fear they will not get a licence if they do. Even while the government was supposed to be reconsidering its stance on stereo, the Home Office issued another set of technical notes. And these created another problem.

They specify that transmissions must be vertically polarised.

For vertical polarisation, the transmitter aerial has vertical rods which radiate waves aligned in a vertical plane. These must be picked up by a vertical aerial, such

as a vertical rod or "whip" on a portable radio or car. They are largely ignored by a horizontal aerial. Horizontally polarised signals are picked up by horizontal rods. Broadcasters exploit this phenomenon to prevent interference between stations operating on closely related frequencies in the same area. One works with vertical polarisation; the other with horizontal.

The BBC and Independent Broadcasting Authority radio stations currently use mixed or circular polarisation, which can be received on either vertical or horizontal aerials. But until recently the BBC used horizontal polarisation. As a result, many roof aerials in Britain are horizontal and will reject vertical signals. There has been no need for people to spend money on changing their system because a horizontal aerial will receive mixed polarisation signals.

So many roof aerials will treat community radio as an unwanted signal. The Home Office says it is insisting on vertical polarisation "to avoid potential sources of interference". But it does not say what these may be, and a vertical signal will still interfere with the mixed signals put out by the BBC and IBA.

The Community Radio Association is split on the issue. Some members want to broadcast to listeners with hi-fi systems. Bevan Jones says "their reception will be knocked out". Grant Pearson, of Thamesmead Radio, a community station already operating legally on cable in London, does not see it as a problem. He says that mixed aerial systems are "more difficult and expensive to engineer . . . and many stations will be interested mainly in reaching people with portables".

BBC and IBA engineers are watching with bemusement as the Home Office makes life difficult for their competition. "It is a crazy scheme," said one, "the Home Office must want community radio to fail."

## War Games

Future wars will be fought, like video games, with the military commanders controlling both conventional and nuclear strikes from a computer keyboard and TV screen.

Chips will compare predictions and display options. But someone somewhere will have to pull the trigger by touching a touch-sensitive screen, keying "ACCEPT" or pressing "ENTER". A war zone, with real bombs dropping, may not prove the easiest place to think things through.

Yesterday, I was running a multi-tasking program called Xchange, written by British software firm Psion. Xchange runs with a clever anti-piracy system, which requires the user to insert a master source disc every time the program is loaded. Although the bulk of files can be copied or installed onto the computer A disc drive, some data has to stay on the master disc which is run in the B drive.

As the program loads the computer

juggles A and B, checking matching code numbers. In this way Psion hope that no-one can make an unauthorised copy. But the user can't make a back-up safety copy of the master source disc. If you spill coffee on it, Psion will promptly provide a replacement at nominal cost.

I was running Xchange, and formatting blank discs at the same time. The phone rang, and without thinking I hit "ACCEPT" with the Psion master source disc in the wrong drive. Immediately the computer started to format the source disc, wiping vital data chunks. My own fault? Yes. Stupid? Yes. But it's the kind of thing that happens with computers, especially when you are distracted.

So what happens on the battle-field when the military strike commander has to choose between "ACCEPT" and "ESCAPE", and the field telephone rings, or a bomb drops, or a Harrier jet hovers overhead?

## PART 3 • Michael Tooley BA David Whitfield MA MSc CEng MIEE

In electronics, we often categorise materials as either conductors (e.g. copper or aluminium) or insulators (e.g. mica or polystyrene). There is, however, a third category of material upon which the whole of our modern solid-state technology depends—the semiconductor.

### SEMICONDUCTORS

The controlled diffusion of impurities into the crystal lattice structure of materials such as silicon or germanium (which would both be normally classified as insulators in the pure form) allows us to produce materials which are neither conductors nor insulators. These materials are semiconductors and their electrical conductivity is a function of the amount of impurity present. (For the curious, the level of impurity is usually somewhat less than one part in  $10^{10}$ ).

Due to superior characteristics at high temperatures, the majority of modern semiconductors are fabricated from silicon (Si) rather than germanium (Ge). There are still, however, a few applications in which germanium devices may be preferred (as we shall see later) but, for the purpose of our explanation of semiconductor action, we will confine our discussion to silicon, and its atomic structure.

The nucleus of a silicon atom is

Fig. 3.1. Model of a silicon atom.

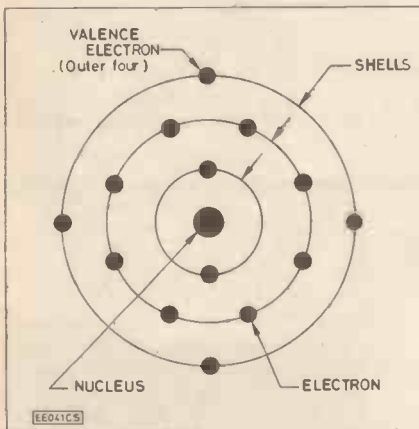
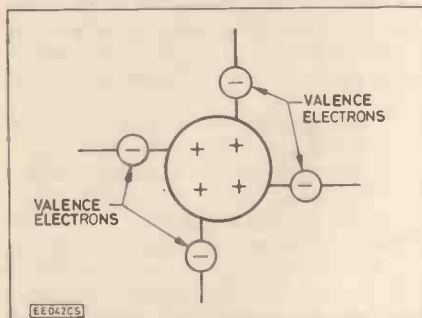

Fig. 3.2. Simplified silicon atom.



surrounded by three distinct electron shells. The inner shell contains two electrons, the middle shell contains eight electrons, and the outer shell has four electrons, as shown in Fig. 3.1. Since these four outer (valence) electrons are available for bonding with adjacent atoms, silicon is said to exhibit a valency of four (i.e. it is "tetravalent").

Bearing in mind that the number of protons (+) in the nucleus is exactly equal to the number of orbiting electrons (-), we can simplify the atom as shown in Fig. 3.2. Only the four protons which "balance" the valence electrons are shown.

In pure silicon each one of the four valence electrons is shared between adjacent atoms, as shown in Fig. 3.3. The result is a crystal lattice in which electrons form covalent bonds and, since there are no "free" electrons available to carry charge, the material behaves like a near perfect insulator.

Fig. 3.3. Lattice structure of pure silicon showing covalent bonds.

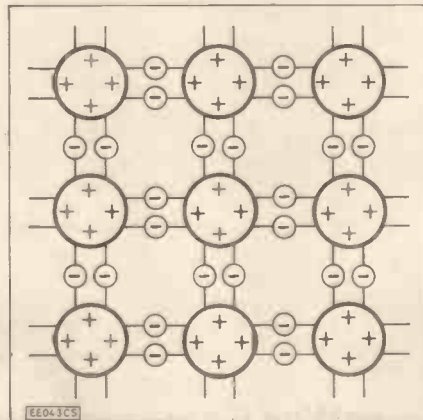

If we now introduce a number of impurity atoms, each having a valency of five (i.e. "pentavalent"), into the regular crystal lattice of silicon atoms it will then contain a number of "free" electrons which are not involved in the bonding process and which are therefore available to take an active role as charge carriers (see Fig. 3.4). It should, however, be noted that the material will still be electrically neutral (i.e. the total number of positive charges will exactly balance the total number of negative charges).

Since the pentavalent element produces a surfeit of electrons, we call it a "donor" impurity. The semiconduc-

Fig. 3.4. Effect of introducing a pentavalent impurity.

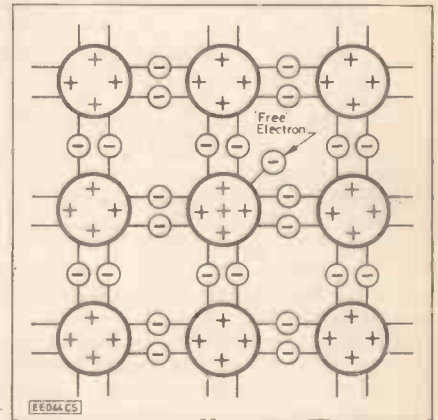

tor material produced is said to be n-type as the majority charge carriers present are negatively charged electrons.

If, on the other hand, we now introduce an impurity element which has a valency of three (i.e. "trivalent") into the regular crystal lattice, we will produce a material which again is electrically neutral but which now has a number of incomplete bonds known as "holes" (see Fig. 3.5). These holes are simply gaps into which electrons can be fitted; as electrons travel within the lattice other holes will be created so we can think of the holes as being mobile positive charge carriers.

Since the trivalent element produces a shortage of electrons we call it an "acceptor" impurity. The semiconductor material is said to be p-

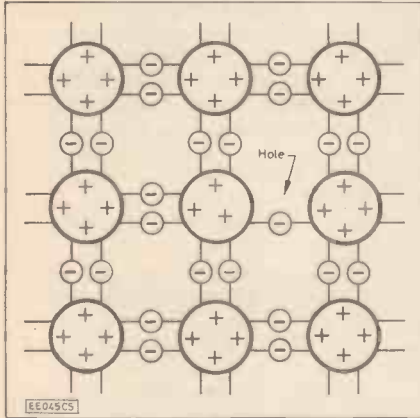

Fig. 3.5. Effect of introducing a trivalent impurity.

type as the majority charge carriers are holes.

The process of introducing impurity elements into pure semiconductor material is known as "doping". Suitable impurities are phosphorous, P, or arsenic, As (both pentavalent) and boron, B, or aluminium, Al (both trivalent).

By means of a sophisticated manufacturing process in which both types of impurity are employed, regions of n-type and p-type material can be produced within the same slice of silicon. The result is called a p-n junction.

## THE P-N JUNCTION

When a p-n junction is formed, some of the free electrons within the n-type material diffuse across the junction into the p-type region and recombine with some of the vacant holes. Conversely, some of the holes within the p-type region diffuse across the junction and recombine with free electrons in the n-type region.

This process (illustrated in Fig. 3.6) results in the creation of a region either side of the junction boundary in which no free charge carriers exist (i.e. it contains no free electrons or vacant holes). For this reason it is known as the "depletion region" or "depletion layer".

The process of diffusion across the junction boundary continues until equilibrium is eventually reached. At this point the p-type material has

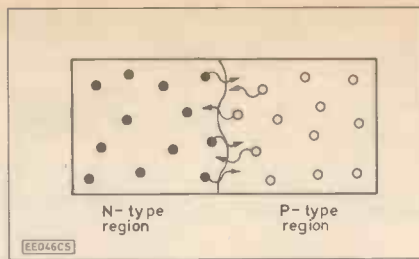

Fig. 3.6. Diffusion of electrons and holes within a p-n junction.

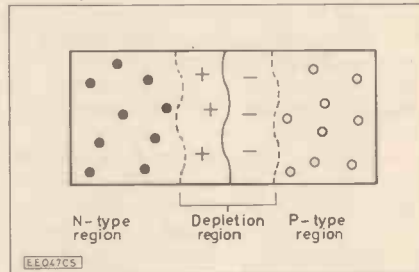

Fig. 3.7. The depletion region.

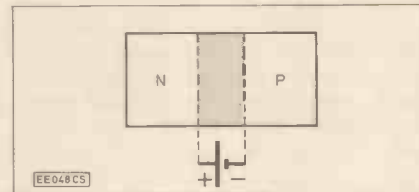

Fig. 3.8. Equivalent potential associated with the depletion region.

acquired a small negative charge and the n-type material has acquired an equally small positive charge, as shown in Fig. 3.7. This difference of charge can be considered as equivalent to a small internal voltage source, as shown in Fig. 3.8.

In order to remove the depletion region it is necessary to apply an external potential to the junction which is exactly equal but of opposite polarity to that which results from the junction's own internal charge, as shown in Fig. 3.9. This potential effectively negates the internal charge imbalance and reduces the width of the depletion region to zero. Thereafter, and with increasing applied potential, charge carriers are able to move across the junction boundary; electrons freely moving from the n-

Fig. 3.9. Forward biased p-n junction.

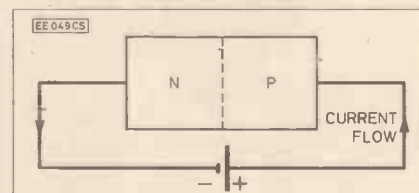

Fig. 3.10. Reverse biased p-n junction.

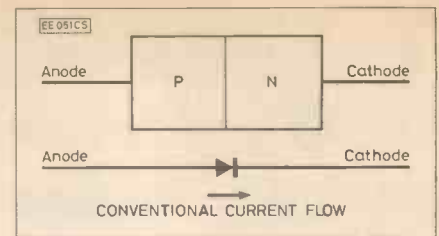
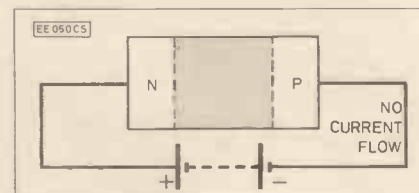

Fig. 3.11. Diode symbol.

type region into the p-type region. This is known as the forward biased condition and an appreciable value of conventional current will flow from the p-type region (anode) to the n-type region (cathode).

If the external potential is applied with the same polarity as that which results from the junction's own internal charge, the depletion region widens and movement of charge carriers across the junction is further inhibited (see Fig. 3.10). The symbol for a diode is shown in Fig. 3.11. Readers should note that the arrow of the symbol shows the direction of conventional current flow.

## DIODE CHARACTERISTICS

The properties of any particular diode are best described by means of characteristic graphs showing current plotted against applied voltage. Typical characteristics for low power silicon and germanium diodes are shown in Figs. 3.12 and 3.13 respectively. The following general points should be noted:—

1. For clarity, different scales have been used for the forward and reverse voltage and current axes of both graphs. In particular it should be noted that the forward current has been shown in milliamps whereas the reverse current scale has been shown in microamps.
2. Since the voltage axis is horizontal and the current axis is vertical, the steepness (or slope) of the graph provides an indication of the equivalent resistance of the device. Readers should note that, steepness of the graphs vary according to the applied voltage. The steeper the characteristic the lower the equivalent resistance will be. (Readers seeking further clarification should refer back to Assignment 1.2 in Teach-in Part 1.)

Readers should now devote some time to comparing the characteristics of the two types of diode and should note the following specific points:—

1. Silicon diodes do not start to conduct until the forward voltage reaches approximately 0.6V. Beyond this point the current rises rapidly.
2. Germanium diodes do not start to conduct until the forward voltage reaches approximately 0.2V. The increase of

current beyond this point is somewhat less rapid than for the silicon type.

3. Silicon diodes consume very much less reverse current and can generally withstand very much higher reverse voltages than their germanium counterparts.
4. Silicon diodes have steeper forward characteristics and can generally withstand higher forward currents than their germanium counterparts.

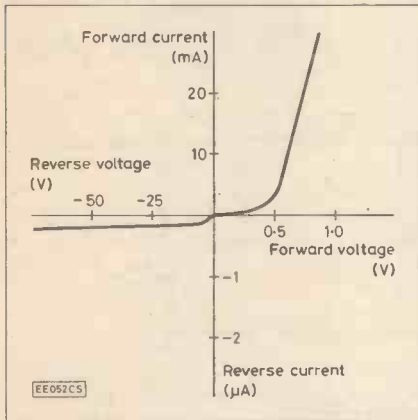

Fig. 3.12. Typical silicon diode characteristic.

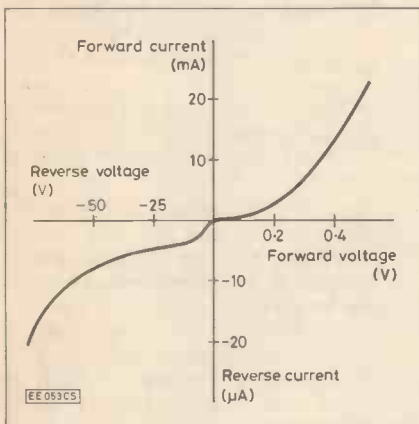

Fig. 3.13. Typical germanium diode characteristic.

Although the significance of the forward voltage drop (0.6V approx. for silicon and 0.2V approx. for germanium) may not at this stage be apparent, readers should bear these values in mind for future reference. As an example of their significance we shall now briefly consider the functioning of a simple diode checker.

### SIMPLE DIODE CHECKER

The type and functional state of a diode may be easily checked if we simply measure the voltage drop that appears across it in the forward and reverse biased conditions. A forward voltage drop of between 0.1V and 0.3V would indicate that the device was a functional germanium type whereas an indication of between 0.5V and 0.7V would indicate a functional silicon type.

Since a functional diode should consume negligible current in the reverse biased condition, the reverse voltage drop should be virtually the same as the supply voltage. Any other indica-

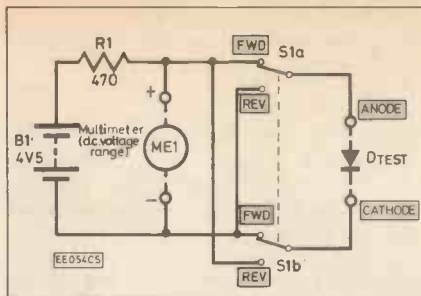

Fig. 3.14. A simple diode checker.

tion, or deviation from the expected forward biased voltage, would be suspect.

A simple diode checker based on these principles is shown in Fig. 3.14. A forward current of less than 10mA is applied to the diode and the forward and reverse voltage drops are then measured using a multimeter. Some typical indications for the diode checker are given in Table 3.1.

Unfortunately, "in circuit" diode testing is not quite so simple unless one can be certain that the conditions within the circuit remain static and the diode remains in a continuously forward biased state. It is, therefore, usually safer to remove a diode from the circuit before testing it.

Table 3.1. Typical indications produced by the simple diode checker.

Forward Reading (V)	Reverse Reading (V)	Type of Diode	Comments
0	0	Either	Faulty (Short Circuit)
0.3	4.5	Germanium	O.K.
0.6	4.5	Silicon	O.K.
4.5	4.5	Either	Faulty (Open Circuit)

### PEAK REVERSE VOLTAGE

Readers have already seen in Figs. 3.12 and 3.13 how an appreciable reverse voltage may be applied with only negligible reverse current flow. However, if the reverse voltage is increased beyond a certain point, the reverse current rapidly increases and the diode breaks down due to excessive power dissipation. (The power dissipated by the diode being equal to the product of the reverse voltage and the reverse current.)

The maximum reverse voltage which can safely be applied to a diode is known as the "peak reverse voltage", or simply PRV. (Note that some books refer to this as the "peak inverse voltage", or PIV). Germanium diodes have typical PRV ratings in the

Fig. 3.15. Bi-phase rectifier arrangement.

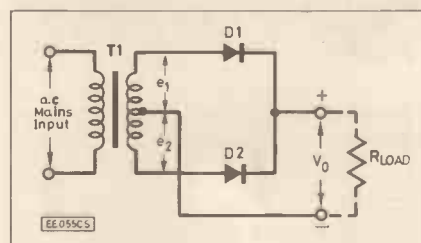

region 30V to 100V whilst their silicon counterparts have typical PRV ratings of between 50V and 800V.

### THE BI-PHASE RECTIFIER

Readers may recall that we discussed the operation of a rudimentary low voltage power supply in Part One and went on to effect a few improvements to the circuit in Part Two. We shall now develop this theme a little further and incorporate some further enhancements.

The efficiency of our simple power supply can be greatly improved by making use of negative, as well as positive, half cycles of the incoming mains supply. This can be achieved using the "bi-phase" rectifier arrangement shown in Fig. 3.15. Here a split (or "centre-tapped") secondary winding is used.

The alternating voltages at either end of the secondary winding are said to be in "anti-phase"; i.e. when the voltage at one end goes positive with respect to the centre-tap the voltage at the other end goes negative. The two diodes thus conduct alternately, as shown in Fig. 3.16. The net result of all this is that the charge lost by a reservoir capacitor can be replenished at twice the rate (i.e. every 10ms rather than every 20ms when the supply is at 50Hz). This, in turn, leads to more effective smoothing and so the output contains less ripple.

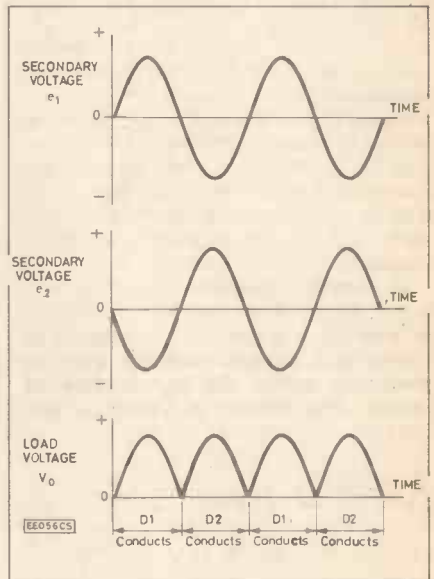

Fig. 3.16. Waveforms for the bi-phase rectifier.

### THE BRIDGE RECTIFIER

An alternative to the bi-phase rectifier arrangement is the use of a bridge rectifier, as shown in Fig. 3.17. Here four diodes are used with opposite pairs of diodes conducting on alternate half cycles of the mains input, as shown in Fig. 3.18.

The bridge rectifier arrangement obviates the need for a split secondary winding and often makes use of a specially encapsulated rectifier (in which all four diodes are contained within an epoxy resin block).

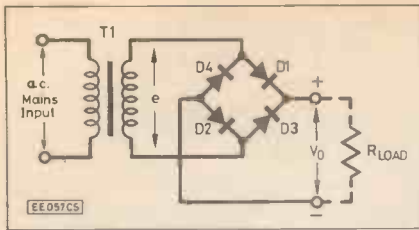

Fig. 3.17. Bridge rectifier arrangement.

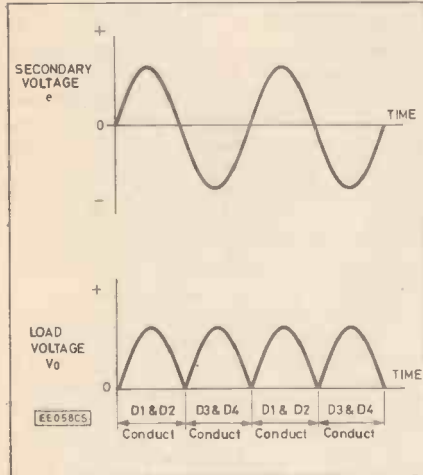

Fig. 3.18. Waveforms for the bridge rectifier.

## THE ZENER DIODE

Whereas reverse breakdown is an unpleasant fact of life when designing rectifier circuits it can be quite useful in other areas! Silicon diodes can be manufactured so that they exhibit a controlled reverse breakdown and, provided the current is limited to a safe working value, the diode will not suffer permanent damage. Devices of this type are called zener diodes and they can be purchased with accurate breakdown voltages of between 2.7V and 68V in the same E12 and E24 series used for resistors.

A typical characteristic for a 4.7V zener diode is shown in Fig. 3.19. It should be noted that whereas the forward characteristic is the same as that for a conventional silicon diode, reverse breakdown occurs very much earlier. Once the reverse zener voltage has been exceeded, the voltage drop across the diode remains substantially constant. The zener can thus be used to provide an accurate voltage source; all we need to do is

Fig. 3.19. Typical characteristic for a 4.7V zener diode.

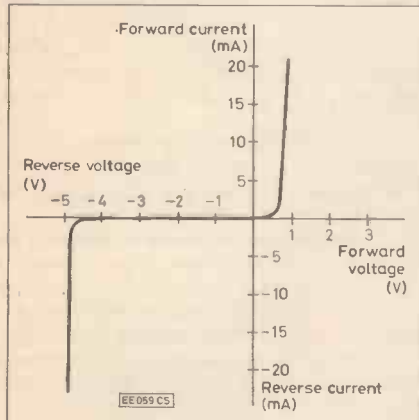

supply an appropriate value of current using a series resistor connected from a higher potential supply.

Fig. 3.20 shows a simple zener diode regulator. Provided the load current does not exceed a critical value, the output voltage remains close to the nominal zener voltage regardless of moderate load current and input voltage variations. Finally, Fig. 3.21 shows how our enhanced power supply can be modified to incorporate a regulated output.

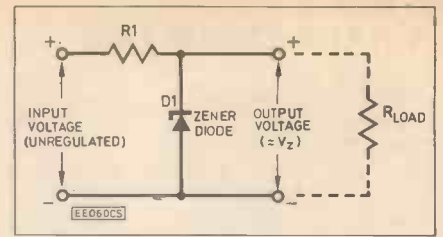

Fig. 3.20. Simple zener diode voltage regulator.

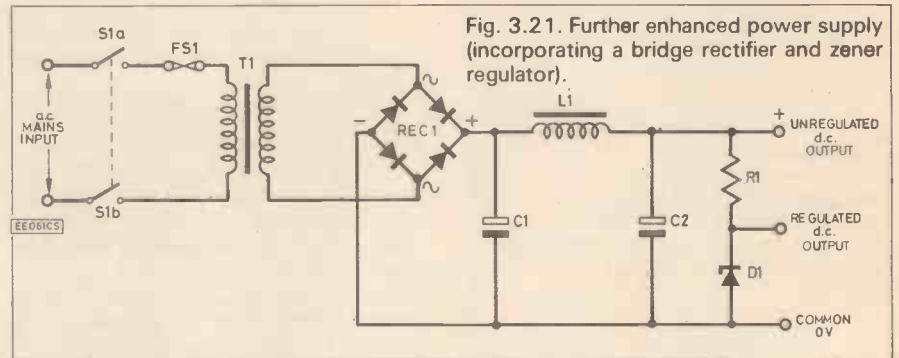

Fig. 3.21. Further enhanced power supply (incorporating a bridge rectifier and zener regulator).

Fig. 3.22. Basic construction of *npn* and *pnp* transistors.

## THE TRANSISTOR

Whereas diodes have only one junction, transistors comprise two semiconductor junctions fabricated on a single slice of germanium or silicon. Two varieties are possible; *npn* and *pnp* as shown in Fig. 3.22. In either case, the junctions are formed between the emitter-base and collector-base. This allows us to develop the simple "diode models" of *npn* and *pnp* transistors shown in Fig. 3.23.

The symbols used for *npn* and *pnp* transistors are shown in Fig. 3.24. Readers should take particular note of the direction of the arrow at the emitter which indicates the direction of conventional current flow.

In normal use, the base-emitter junction is forward biased whilst the collector-base junction is reverse biased. Fig. 3.25 shows the biasing arrangement for an *npn* transistor. Electrons present at the emitter will move into the base region where they become "minority carriers". Some electrons will recombine with holes in the base region but, since the base is made very narrow and the collector is positively charged, the greater proportion of electrons leaving the emitter are swept across into the collector region.

The emitter and collector currents are thus almost equal, the difference between them being equal to the base current (i.e. that which results from recombination of electrons and holes within the base region). We can, therefore, establish the following relationship between the currents in a transistor:—

$$I_E = I_B + I_C$$

Typical currents for a small silicon transistor would be:—

$$I_E = 2\text{mA}, I_C = 1.98\text{mA}$$

and

$$I_B = 20\mu\text{A (i.e. } 0.02\text{mA)}$$

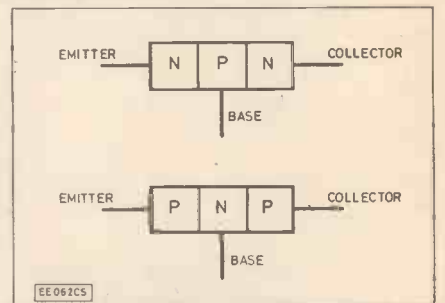

Fig. 3.23. Diode equivalent models for *npn* and *pnp* transistors.

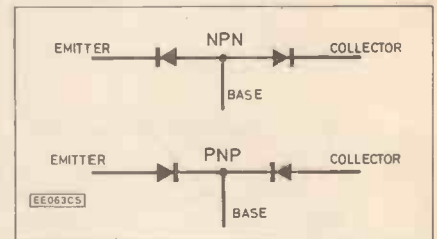

Fig. 3.24. Symbols used for *npn* and *pnp* junction transistors.

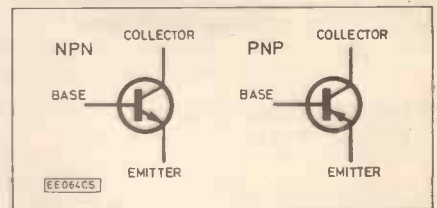
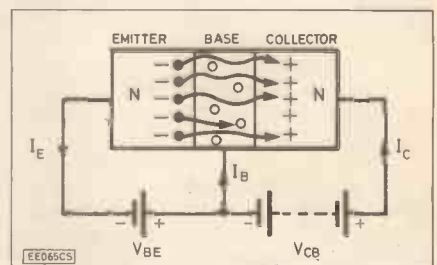

Fig. 3.25. Bias voltages and currents within an *npn* transistor.



## TRANSISTOR CHARACTERISTICS

Since transistors have three terminals, their characteristics are somewhat more difficult to show graphically than was the case with diodes. In most cases we can adequately specify a transistor's characteristics using just three graphs:—

- the "input characteristic";  $I_B$  plotted against  $V_{BE}$  with  $V_{CE}$  held constant.
- the "transfer characteristic";  $I_C$  plotted against  $I_B$  with  $V_{CE}$  held constant.
- the "output characteristic";  $I_C$  plotted against  $V_{CE}$  with  $I_B$  held constant.

We have shown a typical set of characteristics for an *npn* silicon transistor in Figs. 3.26 to 3.28. Readers should note that the input characteristic is simply that of a forward biased junction diode and that the transfer characteristic is substantially linear

Fig. 3.26. Typical input characteristic for a silicon transistor ( $V_{CE}$  constant).

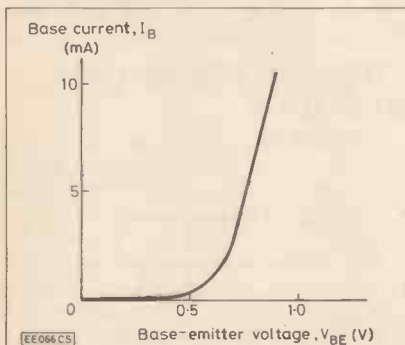

Fig. 3.27. Typical transfer characteristic for a silicon transistor ( $V_{CE}$  constant).

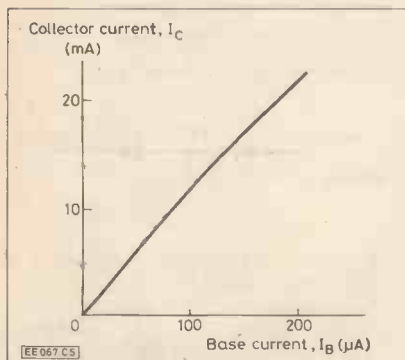
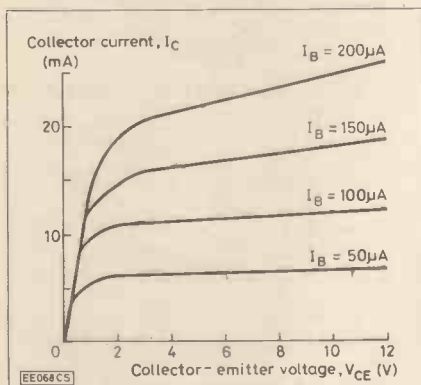

Fig. 3.28. Typical output characteristic for a silicon transistor ( $I_B$  constant).



(i.e. doubling the value of base current results in a doubling of the value of collector current, and so on). This latter effect is important since it leads to the concept of "current gain"; a small change in input current at the base of a transistor results in a corresponding, but very much larger, current change at the collector.

Thus, assuming that we input current to the base of a transistor and take our output current from the collector of the transistor, current gain can be defined as:

$$\text{Current gain} = \frac{\text{Collector current}}{\text{Base current}} = \frac{I_C}{I_B}$$

Typical values for the current gain of small silicon transistors range from around 100 to over 300.

Next month we shall be returning to this topic again, and will show how the output characteristics of a transistor can be used to predict the performance of a transistor amplifier.

## PROBLEMS

Difficulty rating (e) easy; (m) moderate.

- Which of the lamps shown in Fig. 3.29 will be illuminated? (e)
- Assuming that all four of the diodes shown in Fig. 3.30 are silicon types, estimate the voltage drop between A and B. Also determine the current in the resistor. (e)
- A transistor operates with collector and base currents of 1.95mA and 50 $\mu$ A respectively. What will the emitter current be? (e)
- Determine the current gain for the transistor in question 3.3. (e)
- A transistor, connected as a simple d.c. amplifier, is to operate a relay which requires a minimum operating current of 60mA. Determine the minimum value of current gain if the circuit is to operate reliably from a base current of 150 $\mu$ A. (m)

*The answers to these problems will appear in Teach-In Part 4*

## Practical Assignments

### COMPONENTS

Besides the items used for Parts One and Two, you will need the following components in order to complete the practical assignments described in this part of Teach-In:

**Resistors** 0.25W, 5%; 100 $\Omega$  (1); 220 $\Omega$  (1); 2.7k $\Omega$  (1).

**Variable resistor** 100k $\Omega$

**Diodes** OA91; 1N4148; BZY88 C3V9; BZY88 C4V7.

**Transistors** BFY50; 2N3053.

### ASSIGNMENT 3.1

#### Diode Characteristics

This assignment allows readers to derive and compare the forward characteristics of typical germanium and silicon diodes.

## ANSWERS TO LAST MONTH'S PROBLEMS

- 216kJ
- (a) metal oxide; (b) wirewound; (c) metal oxide
- 330nF 10% 250V
- (a) electrolytic; (b) mica; (c) polyester or polystyrene
- 800 $\mu$ C
- 500nF
- 100ms
- A fixed resistor of 10k wired in series with a variable resistor of 100k and a capacitor of 100nF. (Other component values are possible.)
- (a) 63V; (b) 86V
- 1.65V

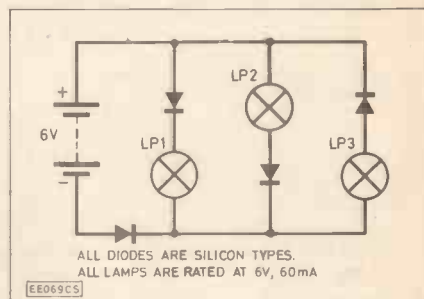

Fig. 3.29. Circuit diagram for Problem 3.1.

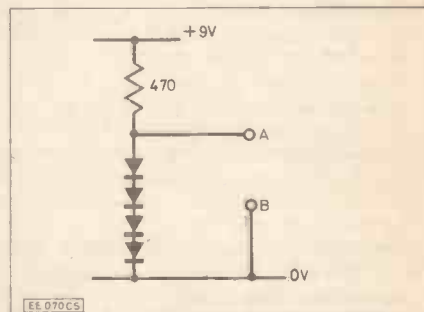

Fig. 3.30. Circuit diagram for Problem 3.2.

## PROCEDURE AND RESULTS

Connect the circuit shown in Fig. 3.31 using the wiring diagram shown in Fig. 3.32. The germanium diode (OA91) should be used for the first set of results.

After connecting the circuit, initially set the variable resistor to the extreme anti-clockwise position (corresponding to 0V output). Connect the multimeter (switched to the 50mA d.c. range) in the milliammeter position and ensure that the shorting link is removed. Check that the diode current is zero then reconnect the multimeter in the voltmeter position (switched to the 2.5V d.c. range) and replace the shorting link.

Now adjust the variable resistor for a reading of 0.1V and then repeat the current measurement (this should again be zero!). Increase the voltage in 0.1V steps up to a maximum of 0.5V. At each step, measure and compare the values of current flowing with those printed in Table 3.2.

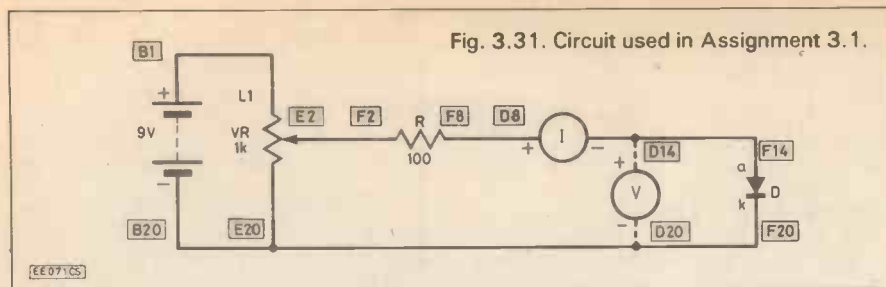
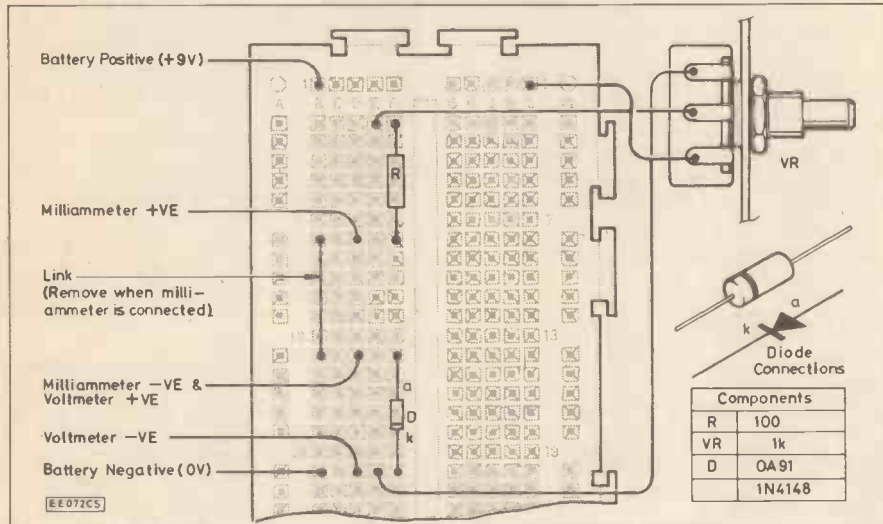

Fig. 3.32. Wiring diagram for Assignment 3.1.



TR = BFY50	$I_b$ (mA)	0	0.1	0.2	0.3	0.4	0.5	0.6	0.7	0.8	0.9	1.0
	$I_c$ (mA)	0	20	38	55	73	90	108	125	145	160	180
TR = 2N3053	$I_b$ (mA)	0	0.1	0.2	0.3	0.4	0.5	0.6	0.7	0.8	0.9	1.0
	$I_c$ (mA)											

Table 3.2. Table of results for Assignment 3.1.

Remove the OA91 and replace with the 1N4148. Repeat the foregoing procedure, this time increasing the voltage in 0.1V steps to a maximum of 0.8V. Enter the results in Table 3.2.

Forward Characteristics should then be plotted for each diode and compared with the characteristics shown in Figs. 3.12 and 3.13.

Some of you may be wondering why we have not taken any readings in the reverse biased condition. The currents involved are so small that they would just not produce any indication on the multimeter. If you don't believe it—try it and see!

## ASSIGNMENT 3.2

### Zener Diode Voltage Regulator

This assignment illustrates the operation of a simple zener diode voltage regulator.

### PROCEDURE

Connect the circuit shown in Fig. 3.33 using the wiring diagram shown in Fig. 3.34. The 3.9V zener diode should be used for the first set of results.

Initially set the variable resistor to its extreme anti-clockwise setting (corresponding to 0V output). Connect the voltmeter first to read the input voltage ( $V_{IN}$ ) and then to read

the output voltage ( $V_{OUT}$ ). (The position of the voltmeter negative lead does not have to be changed during this process).

Compare values of  $V_{IN}$  and  $V_{OUT}$  with those in Table 3.3 (initially they should both be zero). Then return the voltmeter to the  $V_{IN}$  position and increase the setting of VR to obtain input voltages increasing in 1V steps to a maximum of 8V. At each step transfer the voltmeter to the output and measure the value of  $V_{OUT}$ . Now finally, exchange the diode for a 4.7V zener and repeat the procedure.

## RESULTS

Results should be recorded in Table 3.3, and then plotted graphically showing  $V_{OUT}$  (on the vertical axis) plotted against  $V_{IN}$  (on the horizontal axis). Readers should note how the output voltage remains substantially constant once the input voltage exceeds the zener value.

## ASSIGNMENT 3.3

### Transistor Current Gain

This assignment introduces the concept of transistor current gain and also allows readers to compare the transfer characteristics of two common silicon transistors.

## PROCEDURE AND RESULTS

Connect the circuit shown in Fig. 3.35 using the wiring diagram shown in Fig. 3.36. Insert the BFY50 transistor taking care to observe the correct polarity.

Initially set the variable resistor to the extreme anti-clockwise position (corresponding to zero base current). Connect the multimeter (switched to

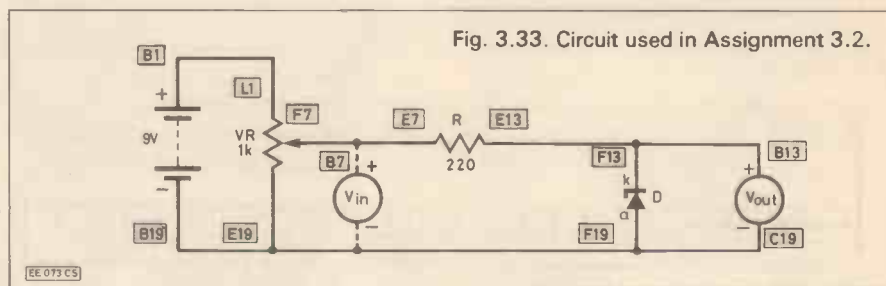
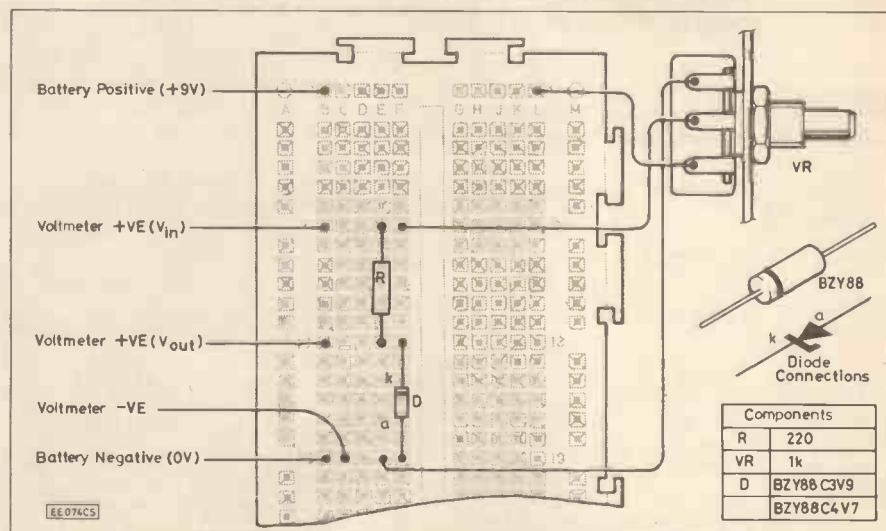

Fig. 3.34. Wiring diagram for Assignment 3.2.





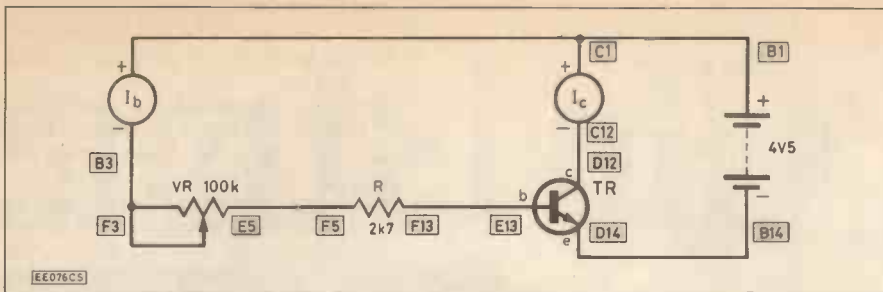

Fig. 3.35. Circuit used in Assignment 3.3.

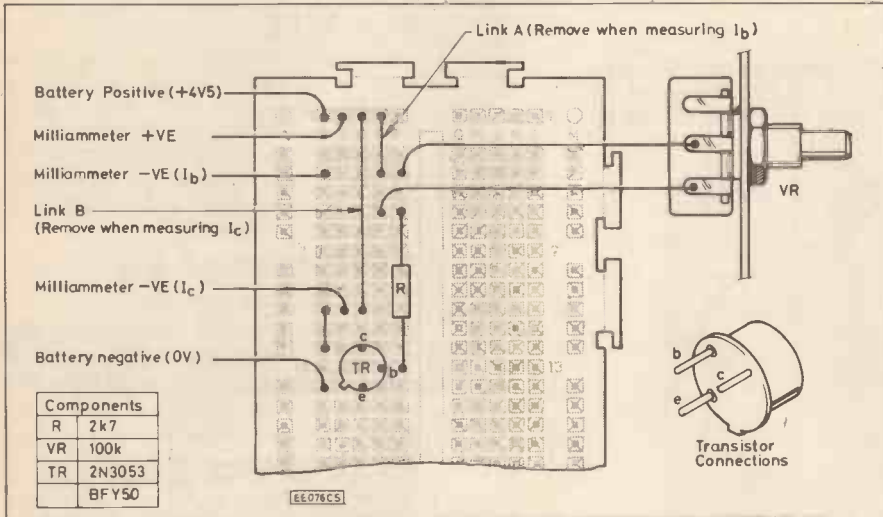

Fig. 3.36. Wiring diagram for Assignment 3.3.

the 5mA d.c. range) in the base current position and ensure that a link is connected in place of the collector milliammeter. Verify that the base current is zero.

Now connect the multimeter (switched to the 500mA d.c. range) to read the collector current. The link should be transferred so as to replace the base current milliammeter. Check that the collector current is also zero.

Now revert to the original meter position, connecting the multimeter to read base current and changing range accordingly. Replace the collector link and increase the base current in steps of 0.1mA up to a maximum of 1mA. At each step measure and compare the collector current with those in Table 3.4.

Now replace the transistor with a 2N3053 and repeat the entire procedure to obtain a second set of results. Again show these in Table 3.4.

It is important to note that the collector current should not be allowed to exceed 250mA (this corresponds to a collector power dissipation of approximately 1.25W).

Transfer Characteristics should then be plotted for each transfer and compared with those depicted in Fig. 3.28. Finally, readers may like to calculate the current gain for each device using values of collector current of, say, 20mA and 150mA. (Readers should find that the current gain decreases slightly at the higher value of collector current.)

**NEXT MONTH** you will need the following additional components in order to carry out the practical assignments.

**Resistors** ( $\frac{1}{2}$  Watt, 5% carbon), 2.2 $\Omega$  (2 off); 470 $\Omega$  (2 off); 1k $\Omega$  (1 off); 2.2k $\Omega$  (1 off); 15k $\Omega$  (1 off); 47k $\Omega$  (1 off), 330k (1 off).

**Capacitors** (16V, electrolytic), 10 $\mu$ F (2 off); 100 $\mu$ F (1 off). The "radial" type will be easier to use but is not essential—ask when ordering.

**Diodes** IN4148 (2 off).  
**Transistors** BC108 (1 off); BC461 (1 off); BFY50 (1 off).

**Miscellaneous** Small 40–80 $\Omega$  loud-speaker.

D = 0A91	Voltage, V (v)	0	0.1	0.2	0.3	0.4	0.5			
	Current, I (mA)	0	0	0.5	2.5	12	32			

D = 1N4148	Voltage, V (v)	0	0.1	0.2	0.3	0.4	0.5	0.6	0.7	0.8
	Current, I (mA)									

Table 3.3. Table of results for Assignment 3.2. (Above).

Table 3.4. Table of results for Assignment 3.3. (Below).

D = BZY88 C3V9	V <sub>IN</sub> (v)	0	1	2	3	4	5	6	7	8
	V <sub>OUT</sub> (v)	0	1.0	2.0	2.9	3.5	3.9	3.95	4.05	4.1

D = BZY88 C4V7	V <sub>IN</sub> (v)	0	1	2	3	4	5	6	7	8
	V <sub>OUT</sub> (v)									

## THIS MONTH'S TEACH-IN PROJECT IS A DIODE/TRANSISTOR TESTER (PAGE 660)

The most fundamental parts of most circuits today are semiconductor-based. An ability to check transistors and diodes is a very useful addition to any hobbyist's workshop, the Teach-In project this month will allow you to do just that. Besides being able to identify faulty components this unit will allow the sorting and testing of surplus and unmarked devices.

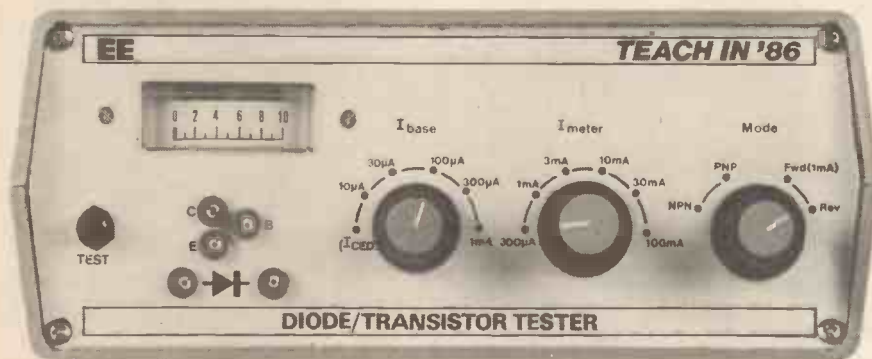

## TEACH-IN SOFTWARE NEWS

To complement each published part of the Teach-In series, we have produced an accompanying computer program. The Teach-In Software is available for both the BBC Microcomputer (Model B) and the Sinclair Spectrum (48k) or Spectrum-Plus. The programs are designed to reinforce and consolidate important concepts and principles introduced in the series. The software also allows readers to monitor their progress by means of a series of multi-choice tests, with scores at the end.

Tap 1 (Teach-In parts 1, 2 and 3) is now available for £4.95 (inclusive of VAT and postage) from Everyday Electronics and Electronics Monthly, Westover House, West Quay Road, Poole, Dorset, BH15 1JG.

**Please Note.** When ordering don't forget to state—BBC or Spectrum. Allow 28 days for delivery.

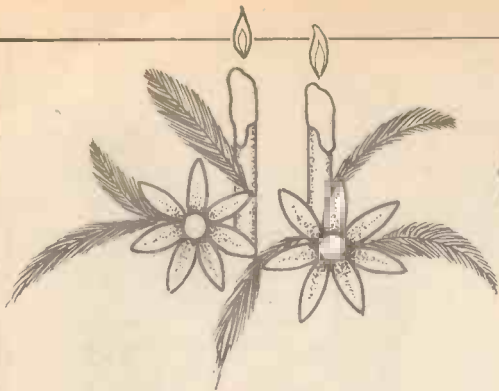

# Christmas

Having problems selecting a suitable gift for the family? Taking advantage of the season of goodwill, we have selected a few special items that have passed through our postbag. We have also included items that we uncovered at various shows during the year and "special buys" from advertisers.

We hope that the next few pages will help solve some of the problems.



Starting with the most important members of the family—the young, the Robotix range from Milton Bradley enables young people to invent, build, power and control mobiles. The R1000 Basic Set contains a high torque, bi-directional motor, over 50 precision-fit components and a "Commander X" action station—**Milton Bradley Ltd., Dept EE, Spencer House, 23 Shea Road, Richmond upon Thames, Surrey, TW9 1AL. ☎ 01-940 6069.**



For the driver, Systema are marketing a new safety device which could help to prevent accidents.

Called Drive Alert (retailing for around £10.95) it fits behind the driver's ear and sounds a warning at the instant the driver's head nods forward—**Systema (UK) Ltd., Dept EE, 12 Albany Close, Lovelock Road, Reading, RG3 1BB. ☎ 073 502223.**

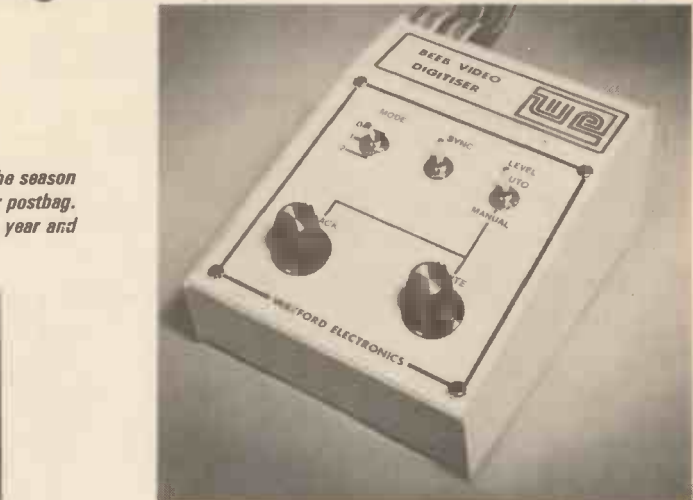
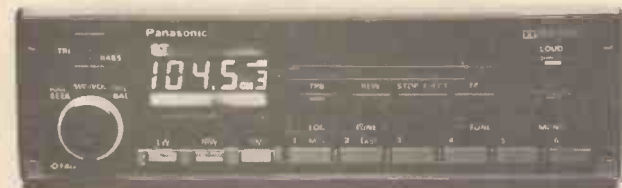

For computer buffs we suggest the Beeb Video Digitiser from Watford Electronics. Using the full graphics capacity of the BBC micro in modes 0, 1 or 2, the video source may be a camera, video recorder or TV. The unit connects into the User Port and is claimed to scan a complete picture in seconds—**Watford Electronics, Dept EE, 250 Lower High Street, Watford, WD1 2AN. ☎ 0923 37774.**

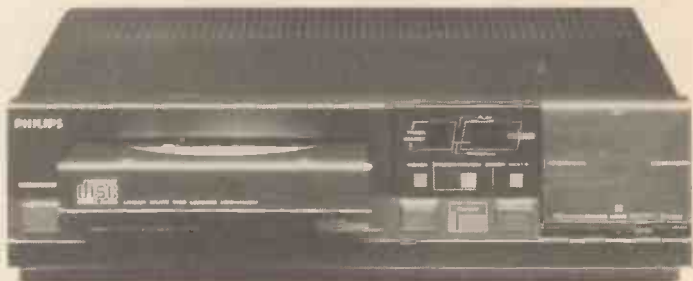

The biggest talking point at the moment in the audio field is the sudden boom in sales of CD equipment. We have chosen the front loading compact disc machine from Philips. Available for £249, the CD104B features a digital display of track and running time, playback programming for up to 20 tracks and fast music search—**Philips Consumer Electronics, Dept EE, 420/430 London Road, Croydon, Surrey, CR9 3QR.**

A personal programmable robot with a memory, Omnibot from Tomy Toys, leads the way for robot enthusiasts. Use the remote MIC to announce that dinner is ready. Insert a programmed tape and he becomes a "waiter" at the family picnic. Put the robot in tape mode and you can play your favourite music—**Tomy UK Ltd., Dept EE, Wells House, 231 High Street, Sutton, Surrey, SM1 1LD. ☎ 01-661 1547.**

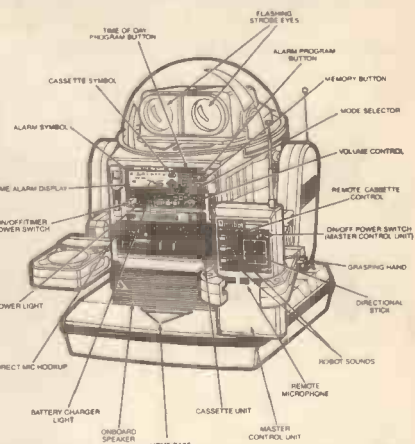

The Panasonic CQ-977 (around £314.95) is a PLL quartz synthesiser electronic tuning f.m. stereo/m.w./l.w. in-car radio/cassette player with auto-reverse and 20W per channel output. Features include: 18 station preset, with instant recall and Dolby B noise reduction—**Panasonic UK Ltd., Dept EE, 300-318 Bath Road, Slough, SL1 6JB. ☎ 0753 34522.**

# Gifts Buyers Guide



A new complete in-car kit from Sanyo comprises a model FT400LE "Red Sound" stereo radio/cassette player, twin cone speakers, two C90 cassette tapes and a head cleaner tape—**Sanyo Marubeni (UK) Ltd., Dept EE, Sanyo House, Otterspool Way, Watford, Herts, WD2 8JX. ☎ 0923 46363.**

For newcomers to electronics, a soldering iron would be an invaluable gift which should last for years. The SK5-BP soldering kit from Antex contains an iron stand with sponge, 18W soldering iron with "flexi coil" lead and 3-pin plug and details of how to solder—**Antex (Electronics) Ltd., Dept EE, Mayflower House, Armada Way, Plymouth, Devon. ☎ 0752 667377.**



For the sailing enthusiast we have selected the Casio WW31C. This digital watch combines a compass on the strap and is claimed to be able to withstand 50 metres static water pressure.

The watch, costing £17.95, features a daily alarm, one hundredth second stopwatch and an hour time signal—**Casio Electronics, Dept EE, Unit 6, 1000 North Circular Road, London, NW2 7JD. ☎ 01-450 9131.**



The Ferguson Videostar 3V48 Hi Fi Video Cassette Recorder, at around £550, is claimed to make programming simpler and easier than previous. With most recorders sited close to floor level, it has a unique second display system which faces upwards, making programme setting effortless—**Thorn EMI Ferguson Ltd., Dept EE, Cambridge House, Great Cambridge Road, Enfield, EN1 1UL. ☎ 01-363 5353.**

You may not have a hope of beating your local professional, but you will certainly have a laugh with the Bob Hope Golfer from Amazon Industries, price £79.95.

Probably the most novel use of radio control for many years, the golfer allows complete freedom of movement; forward, reverse, left and right, fast to slow. He will swing, drive, putt, chip and slice and, by using a unique tilting device, perform most strokes.

Designed for indoor and outdoor use, the golfer set comes complete with buggy (receiver), radio transmitter, 3 interchangeable clubs, tees, 4 coloured metallic golf balls and 2 golf bags. Three magnetic flag/holes and an illustrated booklet of rules and instructions complete the set—**Amazon Industries Ltd., Dept EE, 4 The Avenue, Blaby, Leicester, LE8 3GW. ☎ 0533 776161.**

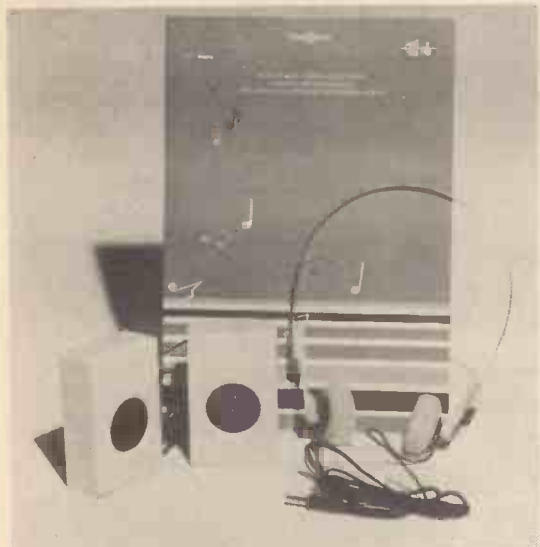

At £6.95 a set of mini speakers and a pair of stereo headphones should go down well with owners of personal radios or "walkmans" and also prove popular in the playroom.

The Altai GH606S pack is available from: **Greenweld Electronics, Dept EE, 443 Millbrook Road, Southampton, SO1 0HX. ☎ 0703 772501.**



For the busy housewife and the "green fingers" member of the family, we offer the Bio-time clock. Originally called the two-potato clock, it can be powered by two indoor plants, oranges, apples or carrots. Great fun for the children's room.

It works like a car battery, with the copper and zinc probes embedded in the plant's soil. The clock also gives date—*The Conservation Catalogue, Dept EE, 11A West Halkin Street, London, SW1X 8JL. ☎ 01-235 1743.*

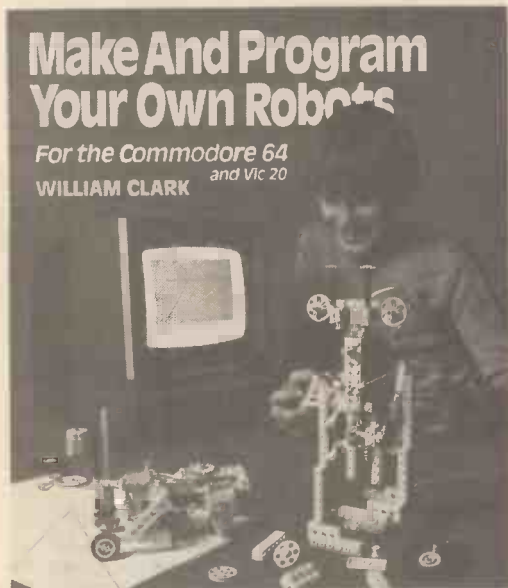

With many children likely to receive a Lego building kit, we looked around for a suitable gift to complement these excellent kits. The "Make and Program Your Own Robots" by William Clark (£2.95 softback), published by Arrow Books (under their Beaver Books titles) is very well conceived and excellently illustrated.

Editions for Commodore 64 or Spectrum home computers are available and should fit the bill nicely—*Arrow Books Ltd., Dept EE, 17-21 Conway Street, London, W1P 6JD.*

#### Bargain Buys . . .

For youngsters and beginners Magenta are offering a book and a set of components to allow learning by experiment. "Adventures with Electronics" uses a breadboard, no soldering. The Component Pack, including breadboard, costs £20.98. The book £3.58—*Magenta Electronics Ltd., Dept EE, 135 Hunter Street, Burton-on-Trent, Staffs, DE14 2ST. ☎ 0283 65435.*

A complete kit for the beginner is on offer from C.P.L. Electronics for the sum of £35 (p&p £1). It consists of a pocket multimeter; soldering kit; Veroblock breadboard; tools; 160 page book and a selection of components—*C.P.L. Electronics, Dept EE, 8 Southdean Close, Hemlington, Middlesbrough, TS8 9HE. ☎ 0642 591157.*



Component packs always make useful "stocking fillers" and the latest offering from Marco Trading is worth considering. The resistor pack contains a total of 610 resistors, various values, and costs £5.75. The ceramic capacitor kit contains 125 various value capacitors and costs £4.75—*Marco Trading, Dept EE, The Maltings, High Street, Wem, Shrops, SY4 5EN. ☎ 0939 32763.*

For the busy executive continually on the move, the latest in-car telephone answering system from Elcom Systems may be just the gift, but at a price. The main advantage appears to be that the driver can receive messages whilst still on the move or away from the vehicle—*Elcom Systems Ltd., Dept EE, 19 Station Approach, Fleet, Hants, GU13 8QY. ☎ 02514 28018.*



## PLEASE NOTE

*We would like to point out that readers buying from the guide are not protected by the Mail Order Protection Scheme unless the company concerned have advertised the product in a display advertisement in this issue.*

This rugged action toy (see below) from Bandai begins as a 4-wheel drive pick-up with a working winch. A few quick changes transforms it into a machine robot with winch climbing action. The approximate selling price is £30—*Bandai UK Ltd., Dept EE, 246A High Street, Guildford, Surrey, GU1 3JF. ☎ 0483 63311.*





From Cirkit there's a tool kit (40-00007) with soldering iron and various hand tools for around £12. The books are extra. Also a "joggers" stopwatch (40-20001 for £11.50) with lap time and pace maker facilities—*Cirkit, Dept EE, Park Lane, Broxbourne, Herts, EN10 7NQ. ☎ 0992 444111.*

Few jobs are more frustrating than the one that needs "three hands". The Gripmate tool produced by Kemplant is a small clamp device that provides up to four extra "hands" able to grip small components, wire and numerous other small items—*Kemplant Ltd., Dept EE, Durfold Wood, Plaistow, Billingshurst, West Sussex, RH14 0PN. ☎ 048 649 344.*



For the games person, the Heber BBC Bridge Companion carries full BBC approval and was put through exhaustive tests before being able to carry the BBC emblem—*Heber Ltd., Dept EE, Belvedere Mill, Chalfond, Stroud, GL6 8NT. ☎ 0453 88 6000.*



CK-5063/Kit from Riscomp comprises: 1 Siren; 2 Ready-assembled p.c.b.s; 1 Key switch; Fixings; Casing. Price: £37.95. Features include stand-alone unit generates a 110dB alarm signal when triggered; Entry/Exit delay incorporated, also three levels of discrimination. Some soldering/assembly reqd., mains operation (catalogue available)—*Riscomp Ltd., 51 Poppy Road, Princes Risborough, Bucks. ☎ 08444 6326.*



A novel gift for the slimmer or diet conscious person would be the X-cel Diet Calculator (£16) from Systema. This continuous memory machine logs your daily calorie allowance and deducts calories consumed throughout the day. It is supplied with a calorie booklet written by a dietician—*Systema (UK) Ltd., Dept EE, 12 Albury Close, Loverock Road, Reading, RG3 1BB. ☎ 0734 502223.*



The DM105 from Armon is claimed to be a truly pocket-sized digital multimeter. It measures current from 2mA to 2A, in 4 ranges; d.c. volts from 2V to 1000V; a.c. volts 200V to 750V and ohms from 0 to 2000k in four ranges—*Armon Electronics Ltd., Dept EE, Heron House, 109 Wembley Hill Road, Wembley, Middx, HA9 8AG. ☎ 01-902 4321.*

**Happy Christmas**

# DIODE/TRANSISTOR TESTER

PROJECT 3

Michael Tooley BA David Whitfield MA MSc CEng MIEE

TRANSISTORS and diodes are essential components in almost every electronic circuit today. A simple but reliable means of checking these components is therefore a valuable addition to any constructor's workshop. It assists in troubleshooting by identifying any faulty components, and allows surplus and unmarked devices to be identified and tested.

The tester to be described is suitable for both silicon and germanium devices. It allows both *npn* and *pnp* transistors, and diodes to be simply and quickly tested.

## CIRCUIT OPERATION

The diagram of Fig. 3.1 is too involved to get a clear picture of how each type of test is performed. After looking at the common elements of all of the tests, therefore, we will look separately at how each type of test is performed.

The tester operates from a +5V supply, drawing a current of up to 100mA. A suitable supply is readily available from the unit described as the first project in this series, or any other convenient supply may be used. It should be noted that the calibration of the unit assumes that the supply is +5V, and so the accuracy of the supply voltages will affect the accuracy of any readings. S4 is a spring-loaded switch which is pressed whenever you are ready to carry out a test, but it *should not* be pressed while changing range. This procedure prevents accidental damage to the meter, and avoids overheating the transistor because it is not possible to accidentally leave it passing a lot of current. The remaining circuitry is selected by S2 depending on the nature of the test to be carried out.

Diode forward conduction is tested with S2 in position 3, and reverse conduction

mately 1mA by the combination of the meter resistance and R14. Hence the meter range switch (S3) should be set to position 2 for this test. In the reverse conduction test, little or no current is expected since the diode is reverse biased.

The test circuits for *npn* (S2 position 1) and *pnp* (S2 position 2) transistors are shown in Fig. 3.3a and Fig. 3.3b, respectively. These circuits show slight differences (to minimise the switching complexity), but as we shall see, these differences are of little practical importance. The base current ( $I_B$ ) in the transistor under test is set by the resistor selected by S1, according to the following equation:—

$$I_B = \frac{V_{CE} - V_{BE}}{R}$$

$V_{BE}$  is the base-emitter voltage of the transistor, and is approximately 250mV for

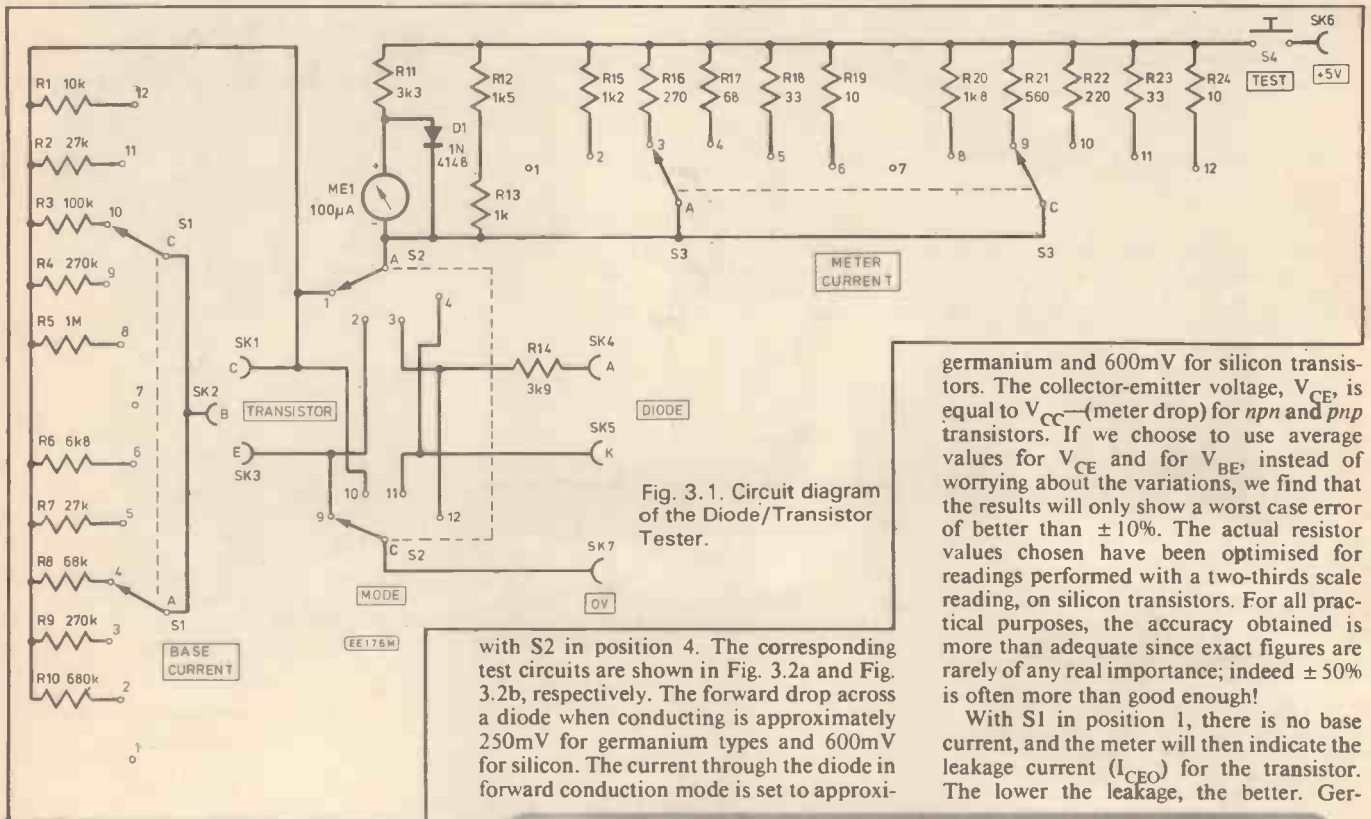

Fig. 3.1. Circuit diagram of the Diode/Transistor Tester.

ME1 is a basic 100µA meter which is protected against severe overload by D1. The sensitivity of the overall meter circuit is set to 300µA by R11, R12 and R13. In this arrangement, full-scale deflection on the meter coincides with a voltage drop across the meter circuit of 500mV. For measurement of higher currents, the additional current is shunted away from the meter by resistors selected by S3. The two poles of the switch are used to select the two resistors (in parallel) for each setting so that readily available values can be used.

with S2 in position 4. The corresponding test circuits are shown in Fig. 3.2a and Fig. 3.2b, respectively. The forward drop across a diode when conducting is approximately 250mV for germanium types and 600mV for silicon. The current through the diode in forward conduction mode is set to approxi-

germanium and 600mV for silicon transistors. The collector-emitter voltage,  $V_{CE}$ , is equal to  $V_{CC}$  (meter drop) for *npn* and *pnp* transistors. If we choose to use average values for  $V_{CE}$  and for  $V_{BE}$ , instead of worrying about the variations, we find that the results will only show a worst case error of better than  $\pm 10\%$ . The actual resistor values chosen have been optimised for readings performed with a two-thirds scale reading, on silicon transistors. For all practical purposes, the accuracy obtained is more than adequate since exact figures are rarely of any real importance; indeed  $\pm 50\%$  is often more than good enough!

With S1 in position 1, there is no base current, and the meter will then indicate the leakage current ( $I_{CEO}$ ) for the transistor. The lower the leakage, the better. Ger-

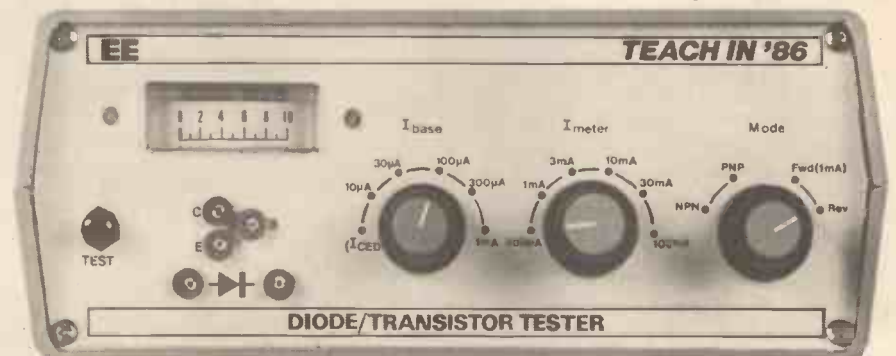

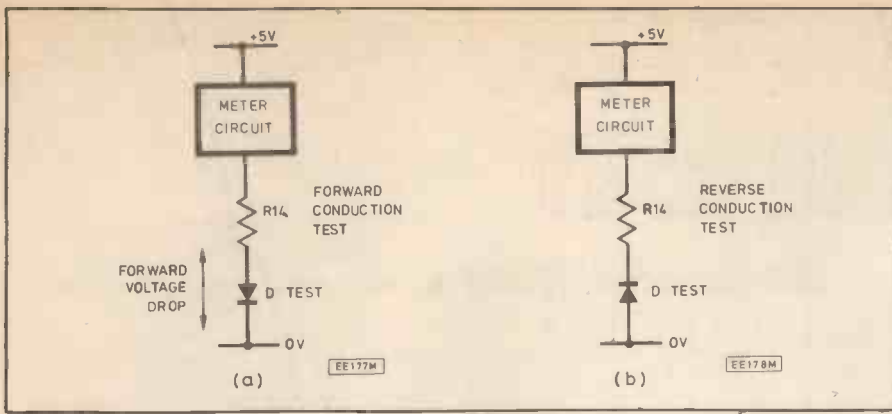

Fig. 3.2. Diode test circuits.

manium transistors usually have a significantly higher leakage current than silicon types. A typical germanium transistor may show a leakage 100µA–2mA, whereas a silicon device will have a negligible leakage. Higher power transistors usually show a higher leakage than small signal types.

With S1 in position 2 to position 6, the gain of the transistor may be measured. If we ignore the leakage current as negligible, the gain of a transistor is given by:—

$$h_{FE} = I_C / I_B$$

If the leakage current is significant when compared with  $I_C$ , then this can be taken account of by replacing  $I_C$  in the equation by  $(I_C - I_{CEQ})$ . The circuit for *npn* transistors uses the meter to measure collector current ( $I_C$ ) directly. For *pnp* transistors, on the other hand, the circuit measures emitter current ( $I_E$ ). However, collector current and emitter current are related by the following equation:—

$$I_E = I_C + I_B$$

In practice, this will make negligible difference, since we find that the gain equation for *pnp* transistors using the meter measuring emitter current now becomes:—

$$(h_{FE} + 1) = I_E / I_B$$

With most transistors, the gain is usually large enough to ignore the "1" in the equation. After all, it is of little practical use to know whether the gain of a BC213 is 349 or 350, given that its gain range is specified as being typically 80 to 400.

In summary, the gain of a transistor is approximately given by:—

$$\text{Gain} = \text{meter current} / \text{base current}$$

Where more exact gain figures are required for *pnp* devices, subtract one from the answer above, but this is only likely to be significant for very low gain devices.

Table 3.1. Switch functions.

Switch Position	Function		
	S1 ( $I_{BASE}$ )	S2 (Mode)	S3 ( $I_{METER}$ )
1	0µA	<i>npn</i>	300µA
2	10µA	<i>pnp</i>	1mA
3	30µA	Diode (Fwd)	3mA
4	100µA	Diode (Rev)	10mA
5	300µA		30mA
6	1mA		100mA

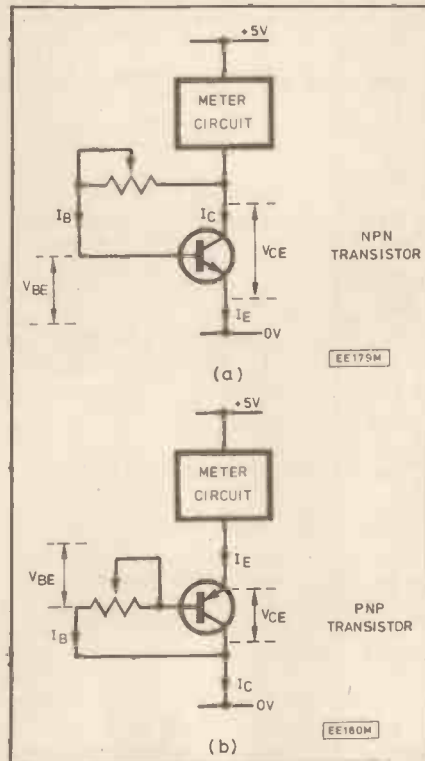

Fig. 3.3. Transistor test circuits.

### CONSTRUCTIONAL DETAILS

The transistor and diode tester is built in the same type of case as used for the previous projects in this series. Unlike most of the projects in this series, however, it does not require any circuit board, since all of the components are mounted on the front panel. Indeed, it would actually make the project more difficult to build if a circuit board was used!

The first step is to drill the front panel in accordance with the layout in Fig. 3.4. The exact dimensions of cut-out for the meter may differ very slightly, depending on the actual components used. The front panel overlay in Fig. 3.4 (or a photocopy) should then be fixed to the panel. It is suggested that this overlay is protected with self adhesive library film since this will help to maintain the finished appearance of the unit when in use.

The majority of the components in the diode and transistor tester are resistors mounted on the back of S2 and S3. It should be noted that the accuracy of tester is substantially dependent on the resistors used, and 5% types are recommended. There are 10 resistors mounted on each switch, and both sets are arranged in identical fashion; Fig. 3.5 shows the construction in more detail.

First, the resistors should all be mounted on the back of the switch, parallel to each other, and in line with the shaft. One end of each resistor is thus connected to a separate tag on the switch. The circuit diagram (Fig. 3.1) and the overall layout (Fig. 3.6) show the correspondence of resistors to switch tags. When all ten resistors have been soldered to their respective switch tags, their free ends should then all be looped over a ring of copper wire and soldered. The ring should be a length of tinned copper wire (16 s.w.g. or similar is suitable) made into a circular loop of approximately 25mm diameter, with the two ends soldered together.

The meter, sockets, and switches should then be mounted in place on the front panel. The remaining components (R11 to R14 and D1) should then be fitted, and interconnection wiring completed as shown in Fig. 3.6. The meter used in the prototype was a 100µA unit with a movement resistance of 1750Ω. If the meter used has a different movement resistance, the value of R11 should be adjusted accordingly; the total resistance of (meter + R11) should be as close as possible to 5k.

The final step is to drill the rear panel, mount SK6 and SK7, and complete the wiring to the front panel. A final check should be made to ensure the wiring is correct (e.g. by checking that the correct number of connections are made to each switch tag), and the case re-assembled using

## COMPONENTS

### Resistors

R1	10k
R2,R7	27k (2 off)
R3	100k
R4,R9	270k (2 off)
R5	1M
R6	6k8
R8	68k
R10	680k
R11	3k3
R12	1k5
R13	1k
R14	3k9
R15	1k2
R16	270
R17	68
R18,23	33 (2 off)
R19,24	10 (2 off)
R20	1k8
R21	560
R22	220
All 0.25W	5%

### Semiconductor

D1 IN4148

### Miscellaneous

SK1-SK5	1mm sockets (5 off)
SK6	4mm socket (red)
SK7	4mm socket (black)
ME1	100µA edgewise meter
S1	2 pole-6 way rotary switch
S2	3 pole-4 way rotary switch
S3	2 pole-6 way rotary switch
S4	Push-to-make switch knobs with pointers (3 off); stick-on plastic feet (4 off); case (West Hyde Developments type TEK A22)

Approx. cost Guidance only **£16.00**

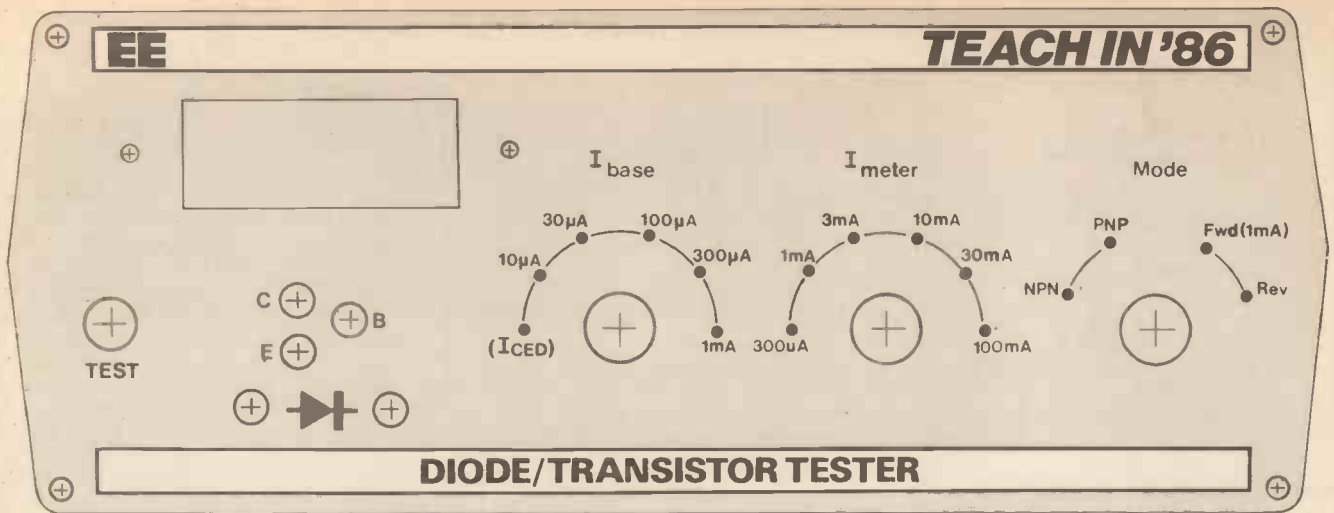

Fig. 3.4. Front panel layout for the Diode/Transistor Tester.

the 8 screws provided. The self-adhesive feet should be fitted, and the unit is then ready for use.

The best way to test the unit is to use it with some known good devices. If there are any unexpected test results, check the wiring and the values of the resistors.

### TESTING DIODES

Testing diodes is a question of ensuring that they are effective one-way conductors of current. The diode under test should be connected to SK5 to SK6, and the meter switch set to 1mA. With S2 in the 'diode forward' position, pressing S4 should cause a current of 1mA to flow through the diode, causing approximately full-scale deflection on the meter. Due to the increased forward voltage drop in silicon diodes, they will give a slightly different (about 5% lower) meter indication than germanium types. If you have a known example of each type, the unit can even be calibrated to allow germanium and silicon diodes to be identified in this way.

Changing to 'diode reverse' should cause show a very small current on the meter. With a silicon diode this will usually be undetectable, even on the 300µA range, while a few germanium types may give a very small deflection.

A normal diode will behave as described above. One of the most common faults to be expected is that a reading of around or a little over 1mA is obtained in both forward and reverse directions. This usually indi-

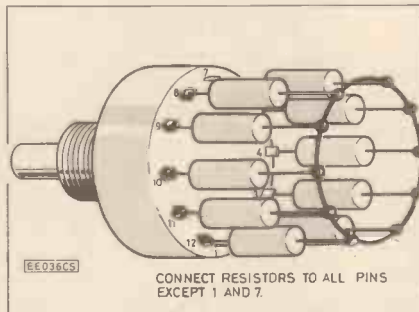

Fig. 3.5. Construction detail for S1-S3.

cates a diode which is short circuit (and hence which should be discarded). However, it could also indicate that the diode is a zener diode rated at less than approximately 4V. A simple test for the latter case is to wire the diode in series with a 1k resistor, and connect the combination across a variable 5V to 10V d.c. supply, with the diode reverse biased. If it is a zener, the voltage measured across the diode (with a suitable meter) should remain substantially constant (at the Zener voltage) as the supply output is varied over the range. The other common fault is where no current is detected in either direction, and this indicates a diode which is open circuit (and hence which should be discarded).

### TESTING TRANSISTORS

The transistor under test should be inserted into SK1-SK3. It is then always best to

start with the meter current range set to maximum (100mA) in case the transistor is short circuit in any way. If the type of transistor is unknown, the leakage and gain test should be repeated with the mode switch first in the npn position, and then in the pnp position. This should not damage the device under test, and the order reflects that npn transistors are most common today. The polarity of the device will be indicated by the setting which produces sensible gain figures (typically in the range 40-400). When testing transistors, there are two main measurements to make; leakage and gain, and we shall look at each in turn.

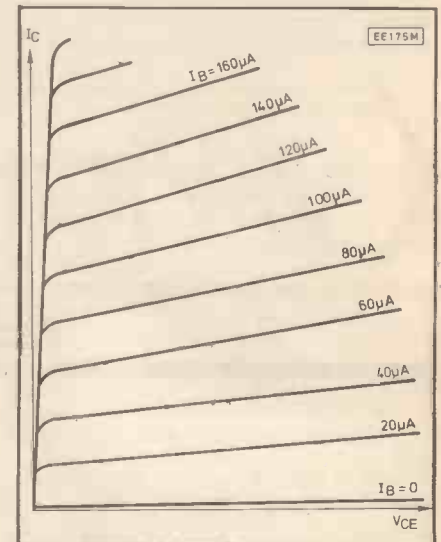

Fig. 3.7. Transistor characteristics.

The value of leakage current is measured with a base current of zero. In the case of a collector-emitter short circuit, which is quite a common fault, there will be a significant current indicated; the device should be discarded. Otherwise, the sensitivity of the meter should be increased (releasing S4 before changing the setting each time) until either a measurable current is obtained or the maximum sensitivity range is reached. The leakage current should give a strong clue as to whether the device is silicon (negligible leakage) or germanium (measurable leakage). Typical leakage for a germanium transistor is 200µA, but values of up to 10 times this may be encountered, particularly for power devices. Any significant leakage in silicon transistors should be treated with suspicion.

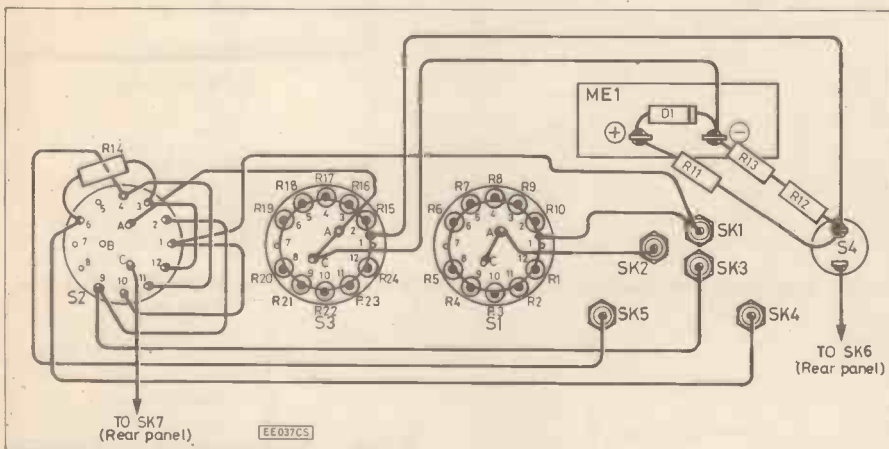
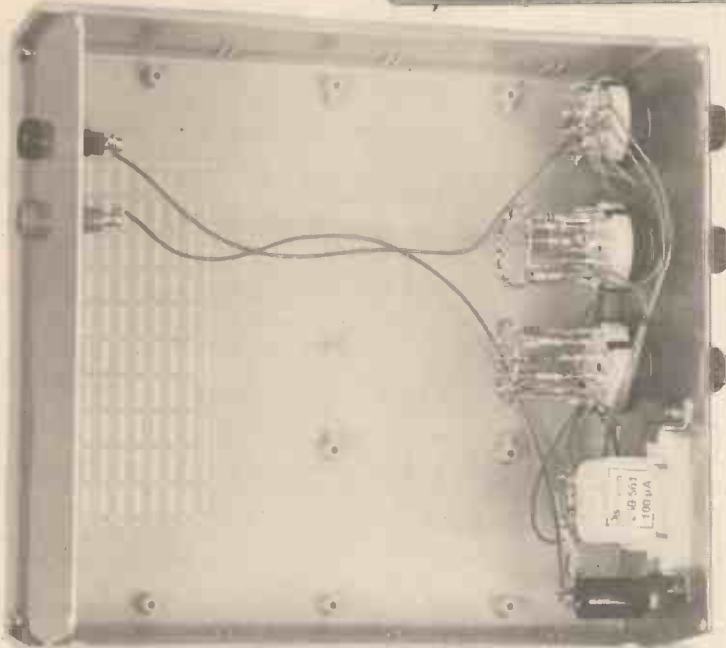
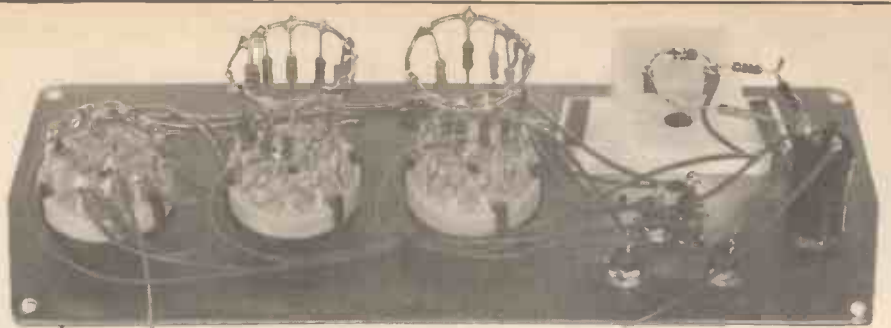

Fig. 3.6. Overall wiring diagram of the Diode/Transistor Tester.



Photographs illustrating the internal constructional details of the Diode/Transistor Tester.



When measuring the gain of a transistor, it is worth remembering that the answer may be up to 1000. The procedure should therefore be to start off with the minimum value of base current ( $10\mu\text{A}$ ), and the meter set to its highest range (100mA). Then progressively change the base current and/or meter range until a reading of more than approximately half-scale is obtained. The gain is then calculated from the equations shown previously.

With most transistors (particularly lower gain types) it may be possible to measure the gain for more than one value of base current. The measured gains will show some variation. The characteristics of a typical transistor are shown in Fig. 3.7, and these indicate that slight differences in gain figures are to be expected with different values of base current and collector voltage.

**NEXT MONTH:** Project 4 will be a useful Audio Signal Tracer.

# Marshall's

A. MARSHALL (LONDON) LTD

A. Marshall (London) Ltd.  
Electronic Component Distributors  
85 WEST REGENT STREET  
GLASGOW G2 2AW  
TELEPHONE: 041 332 4133

## TEACH-IN '86 KITS

Multimeter M-102BZ .....	£12.25
Vero Plug Block with panel .....	£5.25
Test Leads .....	£1.50
PSU Components Complete .....	£16.50
PSU Components Without Case .....	£10.00
Regulator Unit Complete .....	£21.00
Regulator Unit Without Case .....	£14.50
LCR Bridge Complete .....	£23.85
LCR Bridge Without Case .....	£17.35
Diode Transistor Tester .....	£18.76
Diode Transistor Tester Without Case .....	£13.26
Practical Assignments Parts 1 & 2 Oct, Nov '85 .....	£1.75
Part 3 Dec '85 .....	£1.30
Part 4 Jan '86 .....	£3.68

**PLEASE ADD  
P+P 50p PER  
ITEM U.K.  
+ VAT @ 15%**

**CATALOGUE  
£1.00 U.K.  
£1.50 EUROPE  
£2.00 REST OF WORLD  
75p CALLERS**

### WHERE TO FIND US

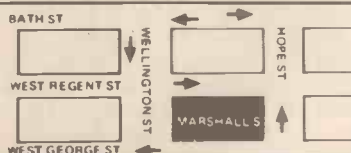

### CALL IN AND SEE US

9-5.30 MON TO FRI  
9-5.00 SAT  
EXPRESS MAIL ORDERS  
ACCESS/BARCLAYCARDS  
WELCOME  
SAME DAY SERVICE



### MAIL ORDER

WE REGRET WE CANNOT  
ANSWER MAIL ORDER/  
STOCK ENQUIRIES  
WITHOUT AN S.A.E.  
SAME DAY SERVICE  
TRADE AND EXPORT  
ENQUIRIES WELCOME

### TELEPHONE

MAIL ORDER  
041-332-4133  
SHOP AND STOCK  
ENQUIRIES  
041-332-4133/5  
TELEX  
261507 REF 2194

# ON SPEC

*a regular  
feature for  
the Spectrum  
Owner...*

by Mike Tooley BA

IN THE past few months, several readers have written to ask about learning Z80 machine code, the question most often posed being simply: "How can I get started?" This is a topic about which there is a good deal of mystique and, whilst there are numerous books on the topic, my own firmly held conviction is that machine code programming is best learned by actually doing it.

A word of warning is necessary at the outset; don't underestimate the effort required. So, if the thought of numerous late nights (or should I say early mornings!) at the keyboard is daunting, machine code programming is best left well alone!

## Writing Good Code

The pre-requisites for successful machine code programming are as follows:

1. A comprehensive list of Z80 instructions (including, for each instruction, the hex code, assembler mnemonic and a brief description of its action).

These are given in a variety of publications (including the "official" Z80 technical manual published by Zilog); however, "Z80 Assembly Language Programming" by Lance Leventhal (Osborne/McGraw-Hill, ISBN 0-931988-21-7) is undoubtedly the best reference text.

2. A piece of software known as an "assembler" or "editor/assembler". This accepts standard Z80 mnemonics placed in a text file (produced by the editor) and, after checking that no errors have crept into the assembly language "source code", it generates ("assembles") the machine language "object code" which is directly executable by the Z80 microprocessor.

My own favourite is Picturesque's "Editor Assembler", though Hi-Soft's "Devpac" and Sinclair's "Zeus" assembler can both be recommended.

3. A "monitor" or "debugger". This piece of software may be supplied with the assembler (as is the case with "Devpac") or may have to be purchased separately and should

```
100 REM Hex code loader
110 REM Everyday Electronics December 1985
120:
130 REM Initialise
140:
150 PAPER 1: BORDER 1: INK 6: CLS
160 POKE 23658,8: REM Caps lock
170 POKE 23609,100: REM Extend pip
180 INPUT £0;AT 0,0;"RAMTOP value? ";r$
190 IF r$<25200 OR r$>65367 THEN BEEP 0.5,0.5: GO TO 180
200 LET start=r$+1
210 LET address=start
490:
500 REM Load memory
510:
520 PRINT INVERSE 1;"Address","Contents"
530 PRINT "(dec)","(hex)"
540 PRINT
550 INPUT £0;AT 0,0;"Enter byte or <Q> to quit: ";h$
560 IF h$="Q" THEN GO TO 650
570 PRINT address,h$
580 LET z1=CODE h$(1)
590 IF z1>57 THEN LET z1=z1-7
600 LET z2=CODE h$(2)
610 IF z2>57 THEN LET z2=z2-7
620 POKE address,z1*16+z2-816
630 LET address=address+1
640 GO TO 550
650 CLS
660 LET length=address-r$-1
670 PRINT AT 0,0; INVERSE 1;"Total = ";length;" bytes"
680 PAUSE 100
690:
700 REM Options
710:
720 CLS
730 PRINT AT 8,4;"Press <E> to EXECUTE code"
740 PRINT AT 9,10;"<P> to PROTECT code"
750 PRINT AT 10,10;"<R> to RESTART"
760 PRINT AT 11,10;"<S> to SAVE code"
770 LET r$=INKEY$
780 IF r$="E" THEN GO SUB 1000
790 IF r$="P" THEN CLEAR ramtop: NEW
800 IF r$="R" THEN GO TO 100
810 IF r$="S" THEN GO SUB 2000
820 IF r$="" THEN GO TO 770
830 GO TO 690
990:
1000 REM Execute code
1010:
1020 RANDOMIZE USR start
1030 CLS
1040 PRINT AT 0,0; INVERSE 1;"Code executed"
1050 BEEP 0.5,25
1060 PRINT £0;AT 0,4; FLASH 1;"Press any key to continue"
1070 PAUSE 0
1080 RETURN
1990:
2000 REM Save code
2010:
2020 CLS
2030 INPUT £0;"Filename? ";n$
2040 SAVE n$CODE start,length
2050 RETURN
```

LISTING 1:  
Hex Code Loader  
Note that "£" should  
be entered as #

at least be capable of:

- (a) displaying (in hex) the contents of the CPU registers
- (b) displaying (in hex) the contents of a block of memory
- (c) disassembling the contents of a block of memory (i.e. performing the reverse of the assembly process)
- (d) executing a block of code from a given start address

A useful added facility is that of allowing "breakpoints" to be inserted into the program (these allow the CPU registers to be displayed at crucial stages). A "single step" facility is also useful. This permits execution of one instruction at a time, pausing so that the contents of the CPU registers may be examined.

Finally, one machine code learning aid that I can recommend without hesitation is New Generation Software's "Complete Machine Code Tutor". This comprises a simplified assembler/monitor which may be loaded with a very comprehensive set of demonstration routines. Each routine can be single-stepped, allowing the user to simultaneously display the assembly language source code, the object code, CPU register and memory contents.

### Hex Loader

To assist readers who would like to "have a go" but cannot easily afford the initial outlay necessary to acquire an assembler, Listing 1 shows a simple program which allows users to enter instructions and data in hexadecimal form. The code can then be tested and/or saved.

It is, of course, necessary for users to "hand assemble" their instructions before entry. Small routines (of around 50 bytes or less) can be assembled quite easily using this technique and then called from BASIC using statements of the form,

```
RANDOMIZE USR nnnnn
```

where nnnnn is the decimal start address of the machine code routine.

### Analogue To Digital Converter

Some months ago we described a simple Digital-to-Analogue Converter. This month we shall turn our attention to the opposite problem, converting an analogue input to a digital output suitable for interfacing with the Spectrum.

The complete circuit diagram of the analogue-to-digital converter is shown in Fig. 1. IC3 is a CMOS 8-bit analogue-to-digital converter i.e. which incorporates a tri-state output data latch, thus permitting direct connection to a microcomputer's data bus. This greatly simplifies the interfacing logic.

IC3 contains its own internal clock which operates at a frequency determined by C5 and R1. An external voltage reference is provided by a precision band-gap voltage reference, D2, and scaling of the analogue input is provided by means of a simple attenuator arrangement comprising R4 and R5/VR1. With the values shown, the input resistance of the converter is approximately

1MΩ and a full-scale reading corresponds to an input of 25.5V (i.e. 255 steps of 100mV).

Address decoding is provided by IC1 which, together with IC2c, generates a logic 0 output whenever a decimal address of 191 appears. The output of IC1 is gated with the IORQ line within IC2b and then inverted by IC2a in order to provide an active low enable signal for IC3. If desired, the port address can be easily changed to 255 decimal by simply omitting IC2c and linking A6 directly to pin 11 of IC1.

### Construction

The analogue-to-digital converter is assembled on a piece of Veroboard measuring approximately 80mm x 100mm. The precise dimensions of the board are uncritical; however, as with other projects, it must have a minimum of 28 tracks aligned in the vertical plane so that a 28-way double-sided edge connector can be mounted along the bottom edge of the board. This connector requires approximately five rows of holes across the full width of the stripboard and is arranged so that the board stands vertically when the connector is mated with the Spectrum.

Before soldering any of the components it is important to allow some clearance for the rear "overhang" of the case. For the Spectrum this gap should correspond to 8 rows of holes (20mm approx.), whilst for the Spectrum Plus the gap should be increased to 12 rows of holes (30mm approx.).

Component layout is generally uncritical although care should be taken to ensure that the supply decoupling capacitors, C1 to C4, are distributed around the board (each preferably associated with an individual integrated circuit supply). Great care should be taken to ensure that all unwanted tracks are cut (including those which link the upper and lower sides of the 28-way connector). A purpose designed "spot-face" cutter

may be used for this task or, if such a device is not obtainable, a small sharp drill bit may be used.

## COMPONENTS

See  
**Shop  
Talk**  
page 646

### Resistors

R1	33k
R2	270
R3	680
R4	820k
R5	47k
All	1/4W ±5%

### Potentiometers

VR1	100k
-----	------

### Capacitors

C1,C6	10μ 16V p.c. elect. (2 off)
C2,C3,C4	100n polyester (3 off)
C5	150p

### Semiconductors

D1	Red l.e.d.
D2	ZN423
IC1	74LS30
IC2	74LS27
IC3	ADC0804

### Miscellaneous

14-pin d.i.l. sockets (2 off); 20-pin d.i.l. socket; 2-pin 2.54mm pitch p.c. mounting connector; 28-way open end double-sided 2.54mm pitch connector (e.g. Vero part number 838-24826A); 2.54mm hole pitch stripboard measuring approx. 80mm x 100mm (minimum 28 strips).

Approx. cost **£8.50**  
Guidance only

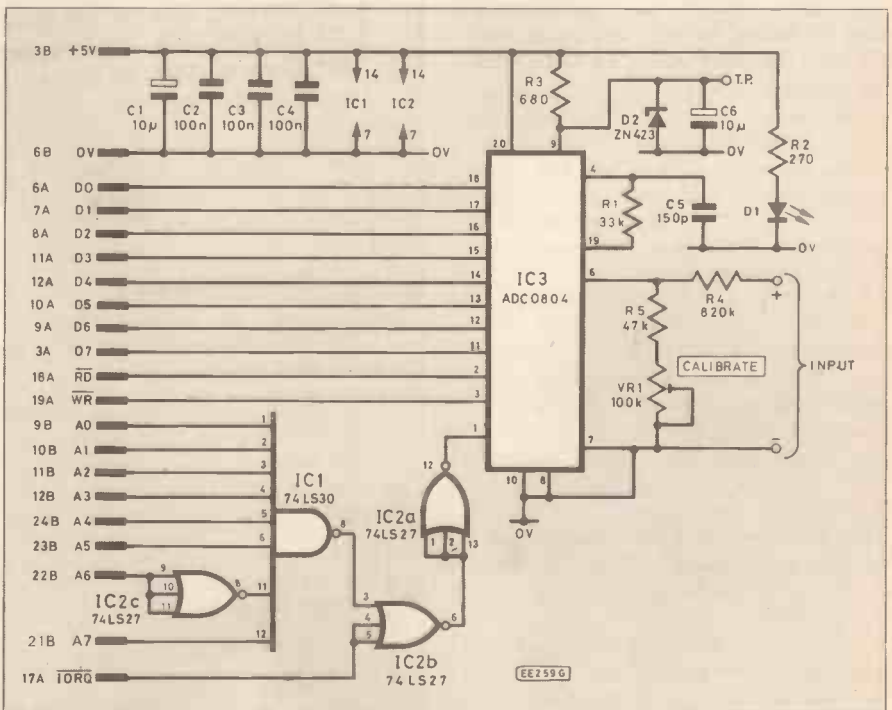

Fig. 1. Complete circuit diagram for the analogue-to-digital converter.

Links on the underside of the board should make use of appropriate lengths of miniature insulated wire (of the type normally used for wire wrapping). Readers requiring further information on the connector should refer to *March On Spec* or send for our latest "Spectrum Update".

When the stripboard wiring is complete, the integrated circuits should be inserted into their sockets (taking care to ensure correct orientation) and the entire board should be carefully checked before connecting to the Spectrum.

Note that the Spectrum should *always* be disconnected from its supply before either connecting or disconnecting any interface module. This point is made repeatedly because the Spectrum may be seriously damaged—the destruction of all the memory chips is not unknown—if this precaution is not observed. If all is well, when power is re-applied, the normal copyright message should appear. If not, disconnect the power, remove the interface and check again.

If you have any comments or suggestions

please drop me a line at:  
Department of Technology,  
Brooklands Technical College,  
Heath Road,  
WEYBRIDGE, Surrey KT13 8TT  
P.S. Don't forget to include a stamped addressed envelope if you would like to receive a copy of our latest "Update"!  
**NEXT MONTH:** The software required for setting-up and driving the analogue-to-digital converter. Also, a few routines for you to enter using our hex Loader.

# The Man Behind the Symbol

## NO5 JAMES WATT

THE year is 1755; the place Greenock on the Clyde, and we meet our first British pioneer, not a physicist nor a mathematician engaged in proving any electrical theory but an inventor "extraordinary" James Watt. The man after whom the unit of power is named (see Table 1).

Nineteen-year-old James Watt says goodbye to his family and sets off for London, the hard way, by horseback to look for work. His father, a small merchant, had lost his trade and fortune through bad speculation. Because of this and ill health, Watt had been unable to go to school regularly and was, therefore, largely self taught.

Arriving in London some 12 days later, the young James obtained employment at the instrument works of John Morgan. The work was hard and the pay only eight shillings per week. He lived frugally, dodging the press gangs, but all the time learning. After twelve months he returned home but was forbidden by the Glasgow City Guild to start a business as an instrument maker because he had not served a full apprenticeship.

Watt obtained work with the college of Glasgow in a model making and repair

shop. The college asked him to repair their model of Newcomen's engine which had been invented some sixty years earlier and had only been used to pump water out of coal mines.

Having got the model working, Watt was amazed at the great loss of steam from the engine, and he reasoned that he could produce a better version. He made many models and studied the scientific properties of steam, its density and its pressure. In 1765 he made a large scale engine, which was erected at Kinneil near Linlithgow. This gave Watt the opportunity to go into the construction in more detail.

Large scale trials and patent fees took what little money he had, and Watt was forced to agree to Dr John Roebuck founder of the Carron Ironworks, taking two thirds of any profits from the invention in return for bearing costs, but the two partners did not get on well together and after a few years uneasy collaboration they parted.

Once again shortage of money prevented Watt from bringing his invention before the public, but his reputation as a civil engineer was growing, and he was employed to make a survey for the proposed Forth and Clyde canal.

### BOULTON AND WATT

In 1768 Watt met Matthew Boulton, a man of considerable vision who could see that steam engines need not be confined to pumping machines and that they had a great future. Boulton, a Birmingham manufacturer, was owner of one of the most modern engineering works in Great Britain. He agreed to take Roebuck's share in the invention and a new and famous partnership was born.

Then in 1769, Watt obtained his first patent. Although his machine produced more power for its size than Newcomen's and used less fuel, it was still only usable as a steam pump.

In 1774 Watt and his family moved to Birmingham. The partnership with Boulton worked well and, free from all business and

by Morgan Bradshaw

### Table 1: The Watt (W)

*The Watt might be termed the "horse-power" unit of electronics, in fact 746 watts are equal to 1 HP. The power needed to maintain a current of one ampere (A) through a conductor, and a potential of one volt (V) across its ends is equal to one watt (W).*

*The unit was first proposed by C. W. Siemens in his presidential address to the British Association in 1889.*

financial worries, Watt was able to carry on with his experiments. In 1781, he patented his second engine which converted the reciprocating motion of the piston rod into a rotary motion and "drove a wheel round". This opened up new frontiers and was the start of the real steam age, and set Britain on the road as a great manufacturing power.

By 1783 The Boulton and Watt engines were in use everywhere and grateful users were paying royalties on the basis of time and labour saved.

Now wealthy and famous, Watt built Heathfield Hall, a mansion on Handsworth Heath, Staffs, on a forty acre site. He worked constantly in his garret workshop\*. His restless brain invented a sculpture copying machine, a machine for drawing in perspective, and a press for copying manuscripts.

Watt died at Heathfield on August 19 1819 and is buried in the parish church of Handsworth, whilst a memorial stone lies in Westminster Abbey commemorating a truly remarkable man, inventor and Civil Engineer.

*Photo: Courtesy Science Museum*

*\* A reproduction of this complete with interesting contents can be seen at the Science Museum, South Kensington, London.*

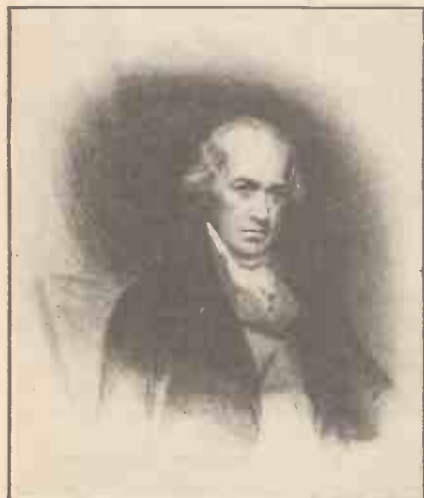



# FREE ENTRY FUN COMPETITION... 100 MULTIMETERS TO BE WON!

*Everyday Electronics* has got together with West Hyde Developments Limited in this festive season to offer you the opportunity of winning an Ishii 301 multimeter. Our prize multimeters have a 40mm anti-parallax mirror scale, 10 switched ranges and the movement uses two jewels for longer life.

West Hyde Developments Limited specialise in supplying instrument cases, sealed enclosures and panelware for housing electronic and electrical equipment. Cases are available in a variety of materials, styles and sizes and there is also a wide range of housings for computer equipment. Add to this items like the prize multimeters, i.e.d.s and switches and you have some idea of the comprehensive range offered by West Hyde.

Their 104 page catalogue, fully detailed with photographs, is available for £2 (redeemable against your first purchase) from: West Hyde Developments Ltd., 9-10 Park Street Industrial Estate, Aylesbury, Bucks, HP20 1ET. You could be a winner!

**HOW TO ENTER**  
Shown is a photograph of a typical hi-tech office scene (courtesy of STC). Eight possible captions are listed underneath. Simply place the captions in the order you consider they most aptly and amusingly fit the photograph.

Write the key letters of the captions, *in ink* in the spaces on your entry coupon, each under its order of choice. For example, if you consider "Wire we all tangled up?" is the best of them all, put C in the first space; the letter of your next choice goes under 2, and so on for all eight.

Complete the coupon with your own full name and address, and post in a sealed envelope to: **EVERYDAY ELECTRONICS WEST HYDE COMPETITION, LONDON SE99 6YP**, to arrive not later than Monday, 6th January, 1986.

**RULES**

There is no entry fee but each attempt must be on a proper entry coupon cut from *Everyday Electronics* and must bear the entrant's own name and address.

All accepted entries will be examined and the judges will award the prizes to the 100 entrants they consider have shown the greatest skill and judgement in placing the eight captions in order of suitability for the photograph. No entrant may win more than one award. Prizes must be accepted as offered—there can be no alternative awards, cash or otherwise.

In the event of any ties, those tying will take part in a postal eliminating contest to determine the winner(s).

Entries arriving after the closing date will not be considered, and no responsibility can be accepted for entries lost or delayed in the post or elsewhere. Entries received illegible, altered or not complying with the instructions and rules will be disqualified.

The competition is open to all readers in Great Britain, Northern Ireland, the Channel Islands and Isle of Man other than employees (and their families) of IPC Magazines Ltd, West Hyde Developments Limited and the printers of *Everyday Electronics*.

Decisions of the judges, and of the Editor in all other matters affecting the competition, will be final and legally binding. No correspondence will be entered into.

Winners will be notified, and the result will be published later in *Everyday Electronics*.



- A. Technology at its best!
- B. Crossed lines?
- C. Wire we all tangled up?
- D. It's B.T. asking if the new 'phone system's O.K.
- E. The robot wants to talk to you.
- J. Tell Santa, this year I'll settle for a toupee.
- K. It's still engaged—must be E.T. phoning home.
- L. And a Happy New Year to you too!

**IMPORTANT**

Before sealing, copy out, on the outside back of the envelope, the eight key letters in the same order as they appear on your completed coupon. **YOUR ENTRY MAY NOT BE CONSIDERED IF THIS IS NOT DONE.** Do not enclose any correspondence or matter other than the coupon.

1	2	3	4	5	6	7	8

*In entering this competition, I agree to abide by the rules and to accept the published result as final and legally binding.*

NAME \_\_\_\_\_

ADDRESS \_\_\_\_\_

\_\_\_\_\_

\_\_\_\_\_

# ELECTRONIC BUILDING BLOCKS

## PART FIVE

RICHARD BARRON

LAST month, we took a fairly cursory look at the operation of transistor amplifiers and op-amps. Continuing with this theme, we will now highlight some more op-amp circuits which should demonstrate their versatility and thus explain their popularity. Incidentally, readers may have noticed a reduction in the theoretical content of *Building Blocks*; this is intentional as we feel that while running the series at the same time as Teach In '86, some material would be duplicated, obviously a pointless exercise.

### DOING SUMS

In addition to basic amplifiers, op-amps are capable of adding, subtracting or comparing voltages. Also functions such as, filtering, integration and differentiating are possible.

The basic summing amplifier is shown in Fig. 1. In this mode, it is connected as an inverting amplifier whose output is proportional to the sum of the input ratios of voltage and resistance, the gain being set by R4. This gives us:

$$V_{out} = -R4 (V1/R1 + V2/R2 + V3/R3)$$

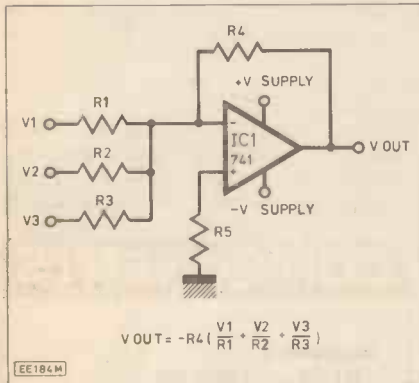

Fig. 1. Inverting summing amplifier.

### COMPARISON

By providing additional inputs connected to the non-inverting input of the op-amp, subtraction can be provided. This gives us:

$$V_{out} = V4 + V5 + V6 - V1 - V2 - V3$$

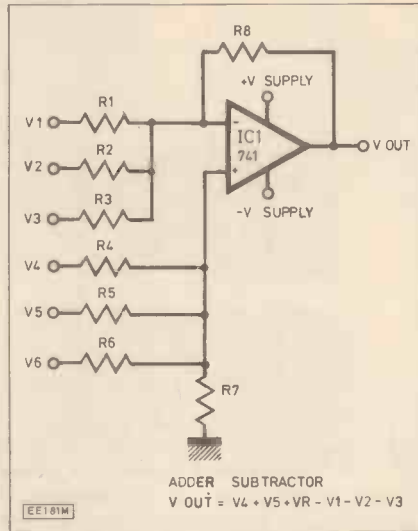

Fig. 2. Adder-Subtractor.

This is shown in Fig. 2 and as can be seen, by keeping the resistance values the same, there is no need to work out proportions.

Because op-amps are high gain devices with directly coupled, differential inputs, they are well suited to comparison applications. In the simplest terms, if no feedback is employed to reduce the gain, the output will either swing high or low, unless the inverting and non-inverting terminals are at exactly the same potential and the amplifier is perfect, ie no offset.

Basically, this means that the output can be easily controlled via the two inputs. If the non-inverting input is at a higher potential than the inverting input, then the output will be close to the positive supply. Alternatively if the non-inverting input is at a lower potential, then the output will go low.

The action of a comparator circuit is illustrated in Fig. 3. In this circuit the output will remain close to the negative supply until the potentiometer, VR1, causes the test voltage,  $V_{test}$ , to exceed the reference voltage,  $V_{ref}$ .

Comparators are available as standard i.c.s, making it unnecessary to use op-amps unless fast switching is specifically required. Both standard and op-amp comparators can

be easily operated from a single rail supply which makes them useful devices for use in digital logic circuits.

### LOGIC

The ideas and concepts we have examined so far have, essentially, been concerned with analogue signals. However, much of today's electronic circuitry deals exclusively with logic signals based on the binary system. In these types of circuits only two valid signals are recognised, either 1 or 0 or high or low. These two signals states are represented by voltages which are determined by the logic convention used, the most common being TTL or CMOS.

TTL (transistor-transistor logic) is designed to be operated from a 5V supply and the logic levels remain consistent within this range. CMOS (complementary metal oxide semiconductor) logic may be operated from a 3V to 18V supply and the logic levels are based on a proportion of the supply used ( $\frac{1}{3}V_{cc}$  and  $\frac{2}{3}V_{cc}$ ).

Other than this difference, the logical operations of the two types of circuit are

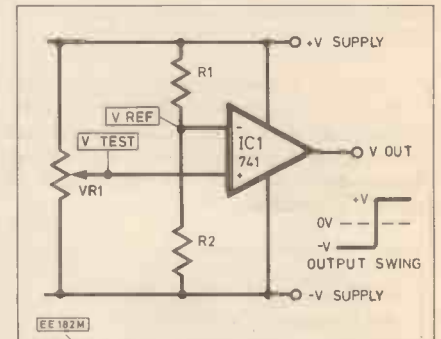

Fig. 3. Comparator test circuit.

very much alike. Therefore, to explain the concepts and practical applications of logic circuits, *Building Blocks* will concentrate mainly on TTL devices.

**NEXT MONTH:** Logic circuits and concepts.

## TTL LOGIC PROBE

This month's constructional project is a logic probe, a practical piece of test equipment for any TTL circuit. To keep the project simple and inexpensive, but still useful, a compromise was made between price and performance. The result is a single chip circuit and a few associated components.

### LEVELS

TTL logic circuits operate from a 5V supply, a high voltage representing a high logic level, and a low voltage, low logic.

However, as can be seen from Table 1, a high logic level for a TTL input may differ to a high logic level for a TTL output. This is due to the way in which TTL input and outputs are constructed. In practical terms, this does not present too much of a problem, as in most cases, a high level is higher than the accepted minimum, usually 2.5V.

### THE CIRCUIT

The complete circuit diagram of the TTL Logic Probe is shown in Fig. 4. An LM324 i.c. (quad 741 type op-amp) forms the heart

of the circuit. Three of the amplifiers are wired as comparators configured to switch at predetermined levels, and one is simply a buffer.

Since there is a slight difference between accepted input and output levels in TTL circuits, it was decided to compromise and set the switching threshold to those shown in Table 2. As can be seen, these thresholds allow indication of; open circuit, high, low, indeterminate and pulsing conditions.

The voltage references for the op-amps are taken from potential dividers supplied

from the same 5V supply as used by the logic under test. These references are connected to the inverting inputs of IC1a, IC1c and IC1d. Thus, when the reference voltage is exceeded by the probe voltage, their outputs will go close to 5V.

## VOLTAGE DETECTION

IC1a is supplied with a very low reference voltage from the potential divider, R2 and R4. The inverting input is connected to the probe but held at ground potential via a 1M resistor, R3. Therefore, unless the probe is connected to a voltage greater than about 60mV, the output of IC1a will remain low. Also the output of IC1c and IC1d will remain low and as can be seen no l.e.d.s will light thus indicating an open circuit.

Now if the probe is connected to a TTL level voltage, ie between 0V and 5V, the output of IC1b will go high following the output of IC1a. This will allow the low indicator, D2 to light, providing the output of IC1d is low. This condition is satisfied only when the probe voltage is less than about 1V.

If the probe voltage is above 1V but below 2.1V, then the output of IC1d will be high and the output of IC1c, low. This will cause D3 to illuminate, indicating an intermediate logic level.

Table 1. TTL signal levels

Condition	Voltage (V)
Gate input high	>2
Gate input low	0 to 0.8
Gate output high	>2.4
Gate output low	0 to 0.8

Similarly, when the probe voltage exceeds 2.1V, D4 will light indicating a high level. Unfortunately, this cannot be distinguished between a high logic level and a high voltage indication. This should not be too much of a problem, but it should be borne in mind.

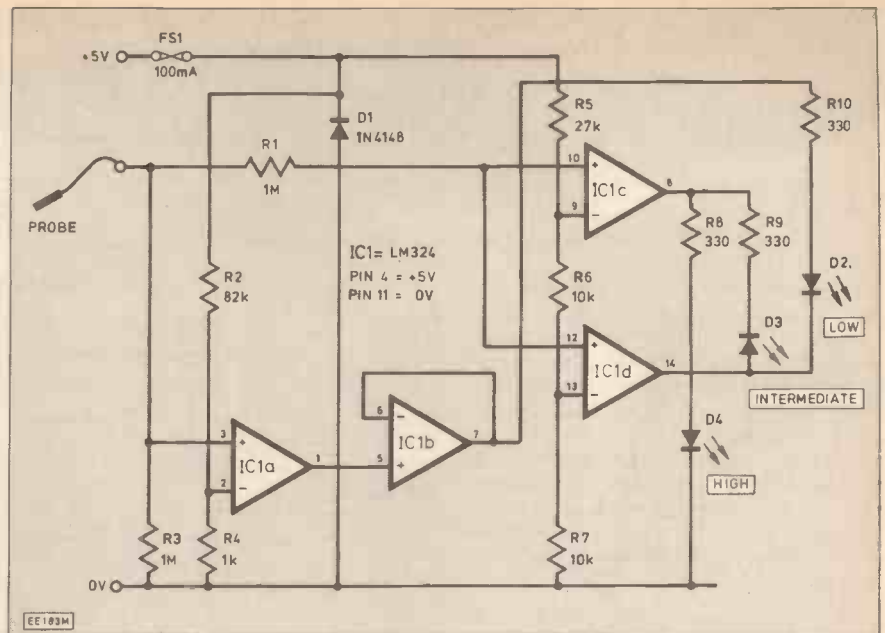

Fig. 4. Circuit of the TTL Logic Probe.

If the circuit under test is pulsing, i.e. alternating between logic levels, then at least two l.e.d.s should appear to be permanently lit, depending on the frequency. In general if the test point is predominantly high, then D4 and D2 will light. If predominantly low then D2 and D3 will light.

## CONSTRUCTION AND USE

Once again, construction should be fairly straightforward as all the components, other than the fuse are mounted on a small p.c.b. The p.c.b. is part of a larger board which should be cut into five sections as indicated in Fig. 5. As before, providing several circuits on one p.c.b. makes each project much cheaper.

Construction of this project follows that of most other projects with the smaller

Table 2. Logic probe indications

Probe Voltage (V)	Indication	Meaning
Open circuit	None	Open circuit
0.06 to 1	D2	Low
> 1 to 2.1	D3	Intermediate
> 2.1 to 5	D4	High
Pulsing	D2,3 or 3,4	Pulsing

components such as the resistors and the diodes being mounted first. These are followed by l.e.d.s, the i.c. socket and the terminal pins used for interwiring connection.

For the prototype, a purpose designed case was used and the l.e.d. spacing was designed accordingly. However, should another case be used, the l.e.d.s may be

Fig. 5. Building Blocks 5-8 p.c.b.s. Enables a Light Chaser/Game, Logic Probe, Alarm and Computer Port to be built.

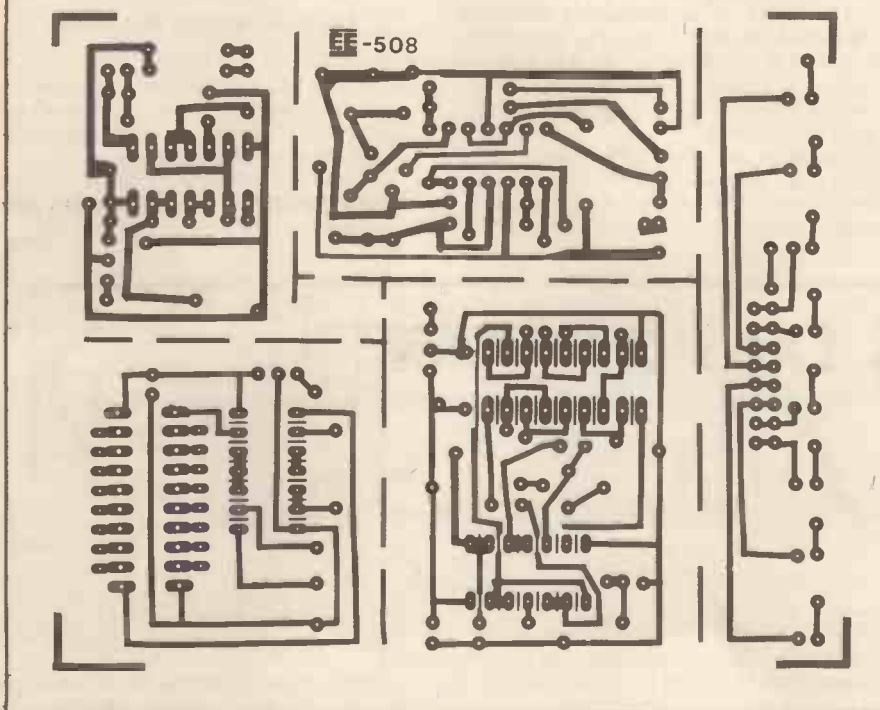

## COMPONENTS

### Resistors

R1, R3	1M (2 off)
R2	82k
R4	1k
R5	27k
R6, R7	10k (2 off)
R8-R10	330 (3 off)

### Semiconductors

D1	1N4148
D2-D4	miniature l.e.d.s (3 off)
IC1	LM324 op-amp (quad)

### Miscellaneous

Case to suite; probe, if not supplied with case; 100mA fuse and holder; wire; solder; terminal pins, etc.

See  
**Shop  
Talk**

page 646

Approx. cost  
Guidance only

£6

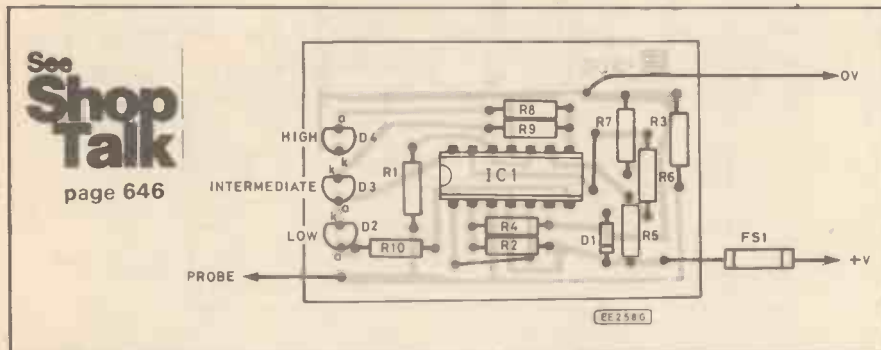
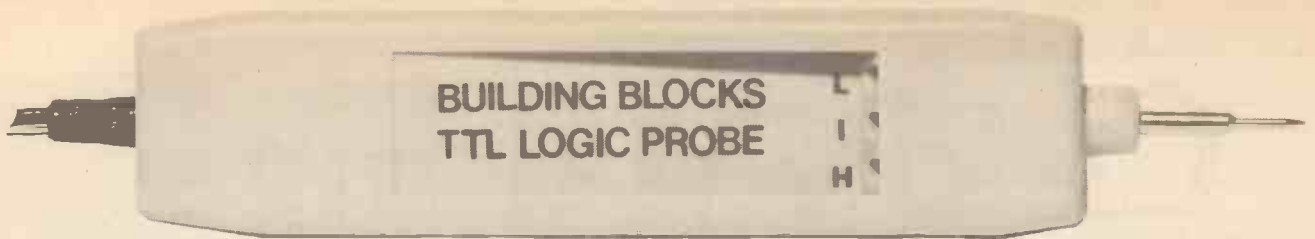

Fig. 6. Component layout of the TTL Logic Probe.

mounted separately using interconnecting wires. The component overlay is shown in Fig. 6 together with the wiring details of the fuse and probe.

To use the logic probe, it is simple. Connect the probe to the power supply of the logic circuit to be tested and start checking various logic levels. If the probe power supply connections are the wrong way round, then the fuse, S1 will blow. The only precaution to take is: *Make sure* not to touch the probe onto any voltage higher than 5V.

**NEXT MONTH: A one chip alarm circuit with a variety of applications.**

See  
**Shop  
Talk**  
page 646

# COUNTER INTELLIGENCE

BY PAUL YOUNG

## Body Batteries

An interesting programme on the BBC entitled, *Body Matters* set my mind on a train of thought not entirely unconnected with our hobby. Namely this, the medical profession have known for many years that our bodies are activated by small currents of electricity and I suppose most of us became aware of it with the invention of the electronic heart pacer. What I would like to know is, how is it generated, and if it is stored, where is it stored?

I know of a limited number of ways it could be produced and, excluding static, they are, electromagnetically, chemical reaction, heat differential and Piezo crystals. I think the most likely choice would be chemical reaction. The programme still has about four instalments to run, so there is just a possibility that they may tackle this problem.

In the meantime, I am hoping we have a few medicos among our readers because I

often wake up in the morning with the distinct impression that my battery is flat. Perhaps they could advise poor old Young how he could obtain a jump start when he feels like this.

## Most Popular

If I were asked to name the most popular constructional article, I should unhesitatingly plump for the simple short wave receiver. It began way back about 1950 when a firm called "Johnsons" made one they called "The Globe King". It used a 2V triode valve powered by a 3V cycle battery via a resistor and a ninety volt h.t. battery.

A little later, we produced a similar one which sold well. Then two things happened causing a change in design. The arrival of the transistor and the sharp increase in the price of h.t. batteries. I asked Frank Rayer if he would transistorise the kit, which he did most successfully.

The next problem was the increase in the price of the metal work and I overcame this by putting it into a small plastic box. Alas at that moment the price of the tuning capacitors went through the ceiling making the whole project unviable, rather a sad finale.

## Computer Museum

In Boston, Massachusetts, is the world's first computer museum. The museum has grown out of a private collection started by the Digital Equipment Corporation ten years ago and has amongst its collection the original IBM Q7 constructed in 1943. It is about the size of a senior bank manager's house, but it can do no more than the small computers children play with, who talk to each other casually about Bytes and Fractals. Curator Oliver Strimpel, who has a Doctorate in theoretical astrophysics and came from the London Science Museum, says anyone who does not know what a Fractal is, belongs in a museum, as an exhibit. So next time you visit Madame Tussauds you will most likely find Old Young in there, probably in the Chamber of Horrors. I know all our readers know what a Fractal is, but I'm going to remind them anyway. A Fractal is a mathematical entity with an infinite number of transitional states.

PLEASE  
**TAKE  
NOTE**

Simple Reverb  
(Oct. '85)

Fig. 4, page 530, the arrows at the top

of the board should be labelled 1 and 2 (from left to right), the arrow at the bottom should be labelled 5. The component above C5, marked C8, should be marked R8. The preset marked VR1 (right-hand side of board) should be labelled VR5. All textual references to VR7 should read VR3.

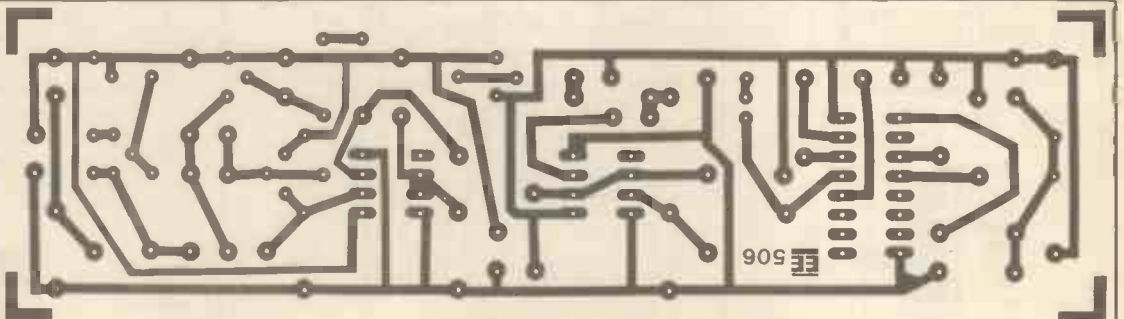

## Hallowe'en Projects (Nov '85)

The p.c.b. diagram should show the 555 Timer pin 5 unconnected, pin 4 should go to +9V (published circuits are correct). The correct master is shown above. Figs. 4 D1 and D2 anode (a) and cathode (k) annotations should be transposed.

Fig. 3 (Mask), D2 and D3 anode (a) and cathode (k) annotations should be transposed, also C3 right-hand corner should read C8.



# Cirkit. Making it bigger and better.

Bumper new edition of the Cirkit Catalogue out now, containing 128 pages packed full of electronic components and accessories. Available from your local newsagents or by post from us. The Catalogue includes:



BATTERIES  
 BOOKS  
 CABLE  
 CALCULATORS  
 CAPACITORS  
 COMPUTER ADD-ONS  
 PRINTERS  
 CONNECTORS  
 CRYSTALS  
 FILTERS  
 BOXES  
 KNOBS  
 AEROSOLS  
 HEATSINKS  
 INDUCTORS  
 KITS AND MODULES  
 METERS  
 PCB MATERIALS  
 RELAYS  
 RESISTORS  
 SEMICONDUCTORS  
 MEMORIES  
 MICROPROCESSORS  
 LEDs  
 LOUDSPEAKERS  
 SWITCHES  
 TEST EQUIPMENT  
 SOLDERING IRONS  
 TOOLS  
 TRANSFORMERS

## Kits & Modules

<b>7254 TUNERSET</b> Complete FM Tunerset from RF input to stereo audio output	40-07254	£28.50
<b>TV PRE-AMP</b> UHF masthead TV-Pre-Amp with mains PSU	40-06200	£12.80
<b>18W AMPLIFIER</b> Mono 18W power amp based around HA1388	40-91388	£8.38
<b>5W AMPLIFIER</b> A very compact 5W power amplifier. 12V supply	41-01406	£4.60
<b>MONO REVERB</b> Spring line mono reverb unit.	41-01602	£11.30
<b>TEMPERATURE SWITCH</b> Thermistor based, temperature controlled switch. Can be set to trip between -5° and 100°C.	41-01303	£6.20
<b>3-NOTE CHIME</b> Simple, easy to build 3-note doorbell.	41-01503	£7.00
<b>LAMP DIMMER</b> Power controller for both inductive and resistive loads.	41-01305	£5.70
<b>LOCO SOUND</b> A steam locomotive sound generator with speed controlled from a pot or the train controller.	41-01304	£9.20
<b>WATER LEVEL ALARM</b> Audible alarm when water reaches a pre-set level	41-01601	£2.70
<b>I.R. LINK</b> A short range, 2.5-3m, single channel Infra Red Link	41-01300	£9.60
<b>RADIO CHANNEL TX</b> A 4-channel proportional FM radio control transmitter. 500mW output.	40-94445	£9.48
<b>RADIO CONTROL RX</b> Companion receiver. 27MHz, FM, based around KB4446 IC.	40-94446	£13.65
<b>AUDIO FUNCTION GENERATOR</b> Function generator with sine, triangle and square wave output from 1Hz to 1MHz.	41-01302	£27.00

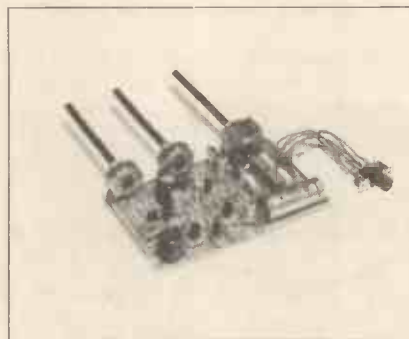

Tone Generator & Detector

<b>TONE GEN AND DETECTOR</b> Signal generator and detector for signal tracing and fault finding in audio circuits.	41-01603	£10.46
<b>LOGIC PROBE</b> Universal logic probe for both CMOS and TTL.	40-01010	£8.90
<b>1-30V 1.5A PSU</b> Variable voltage, 1-30V, mains power supply with current overload at 1.5A	41-01402	£10.45
<b>5-12V PSU</b> Stabilised power supply with output presettable between 5 and 12V. 1A max. output.	41-01504	£6.45

## Books

<b>BEGINNERS GUIDE TO ELECTRONICS</b> A readable introduction to the world of electronics for the enthusiast with little knowledge of electronics.	02-04134	£6.68
<b>BEGINNERS GUIDE TO AMATEUR RADIO</b> If you are new to radio, you will find here a great deal of information which will help to prepare you for the Radio Amateurs' Examination.	02-11262	£4.33
<b>DESIGN OF OP-AMP CIRCUITS WITH EXPERIMENTS</b> A complete introduction to almost every op-amp application.	02-21537	£10.95
<b>555 TIMER APPLICATIONS SOURCEBOOK</b> A host of applications for using this device ranging from voltage regulation to signal generation.	02-21538	£6.95
<b>BUILDING AND INSTALLING ELECTRONICS INTRUSION ALARMS</b> Written for the novice who wants to install a security system in his home and the technician who wishes to enter the field of security electronics.	02-21465	£9.95
<b>DESIGNING AND CREATING PRINTED CIRCUITS</b> An in-depth guide to the design, layout, manufacture and assembly of printed circuits.	02-40964	£8.79
<b>ELECTRONIC PROJECTS IN PHOTOGRAPHY</b> 15 useful photographic projects written for the electronics enthusiast and the photographer.	02-21301	£3.80
<b>ELECTRONICS - BUILD AND LEARN</b> If you hope to become proficient in electronics you will need to master some basic theory as well as to acquire a practical skill in construction.	02-04541	£3.80
<b>ELECTRONIC TELEPHONE PROJECTS</b> Information long needed which could be used by electronics hobbyist and others to increase the utility of their telephones.	02-21618	£10.73
<b>PRACTICAL ELECTRONICS CALCULATIONS</b> Written as a workshop manual for the electronics enthusiast.	02-00174	£2.95

Please add 15% VAT to all advertised prices and 60p post and packing. Minimum order value £5 please. We reserve the right to vary prices in accordance with market fluctuation.  
 Just send for our catalogue or visit one of our three outlets at:

200 North Service Road, Brentwood, Essex. CM14 4SG - (0277) 211490;  
 53 Burrfields Road, Portsmouth, Hampshire. PO3 5EB - (0705) 669021;

Cirkit, Park Lane, Broxbourne, Hertfordshire. EN10 7NQ - (0992) 444111.

To: Cirkit Holdings PLC, Park Lane, Broxbourne, Hertfordshire. EN10 7NQ.  
 I enclose £1.15. Please send me your latest catalogue and 4 x £1 discount vouchers!  
 If you have any enquiries please telephone us on Hoddesdon (0992) 444111.

Name

Address

EE12

**Cirkit**  
 Bigger Stock. Better Service.

New Autumn Catalogue Out Now!

# TRANSDUCERS

## PART 4 OPTICAL INTENSITY MEASUREMENT - AND A SIMPLE LIGHTMETER PROJECT... MIKE FEATHER BSc

THREE basic types of light-sensitive devices are used for the determination of optical intensity. These are described briefly in this article and the use of one of them as a practical optical intensity transducer forms the basis of this month's practical project.

### PHOTOVOLTAIC CELLS

These are sometimes referred to as solar cells and they consist of a number of p-n junctions connected in series with each other. One of the regions (n or p) is extremely thin so that the incident light is able to pass through it without a significant loss of energy.

The energy in the light causes the release of charge carriers (holes and electrons) at the junctions and this develops voltages across them. The voltage developed is proportional to the intensity of the light.

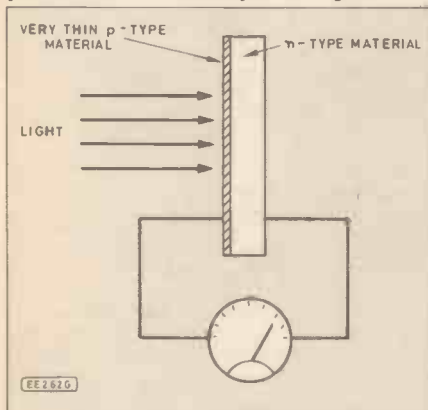

Fig. 4.1. A photovoltaic cell.

Since photovoltaic cells actually generate a voltage from the incident light, they are useful for applications such as camera exposure meters. Fig. 4.1 shows the physical arrangement of this type of photocell.

### PHOTOCONDUCTIVE CELLS

This type of photocell uses a material whose electrical conductivity varies with the intensity of the light falling on it.

Cadmium sulphide is normally used in this type of cell and an increase in the light intensity causes a decrease in the resistance; they are often called light dependent resistors (LDR's).

The response of these cells to the spectral colours varies in much the same way as that of the human eye and this makes them useful for lightmeter type applications. The construction of a typical LDR, the ORP12, is shown in Fig. 4.2.

The cadmium sulphide film is deposited on an insulating substrate. Connections are made at each end of the film and the arrangement is encapsulated in epoxy resin with a clear window in order to allow light entry.

The change in resistance with incident light intensity is quite large for the ORP12.

Its resistance when dark is about 10M and this falls to around 100 ohms under strong illumination.

The response time of cadmium sulphide cells is rather slow and they are best suited to measuring slowly-changing light levels in applications such as smoke detectors and automatic lighting controllers.

### PHOTODIODES AND PHOTOTRANSISTORS

Like photovoltaic cells, photodiodes use a p-n junction which is illuminated by the incident light. Hole-electron pairs are formed and a current flows in the diode.

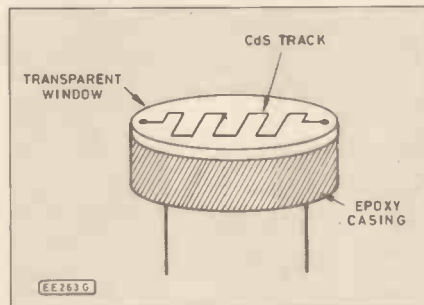

Fig. 4.2. A light-dependent resistor.

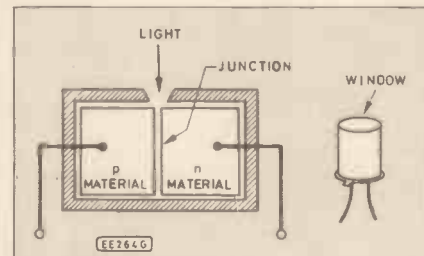

Fig. 4.3. Photodiode structure.

The diode is usually connected so as to be reverse biased and the dark current is

therefore very small indeed. As the illumination is increased, the current through the diode rises, the relationship between current and light intensity being very linear. Fig. 4.3 shows the arrangement of p- and n-type regions in a photodiode.

Phototransistors employ the same principle, but the amplifying action of the transistor makes these devices more sensitive. Both photodiodes and phototransistors offer very fast response times; the output of a typical general purpose photodiode increases from 10% to 90% of its final value in only 250ns.

This device is used as the sensor in this month's constructional project—a transducer for optical intensity measurements.

### THE CIRCUIT

As described above, the photodiode is connected into the circuit so as to be reverse biased, i.e. its anode is made negative with respect to its cathode: see Fig. 4.4.

Increasing the illumination causes the diode current  $I_d$  to increase and this causes a corresponding change in the output voltage of the operational amplifier IC1. The size of the output voltage is determined by the feedback resistor  $R_f$  and is given by  $V_{out} = I_d \times R_f$ .

In this application,  $R_1$  and  $VR_1$  together form the feedback resistor and the output can be adjusted so as to produce 0V to 1V for a fairly wide range of incident light intensity. The calibration of the unit is described following the construction procedure.  $VR_2$  is the usual offset null potentiometer and this provides a zero set facility for the unit.

IC2 and IC3 are positive and negative 5V regulators to provide stable supplies for the operational amplifier and the reverse bias voltage for the photodiode; the l.e.d. and its series resistor  $R_2$  provide a visual "ON" indication for the unit.

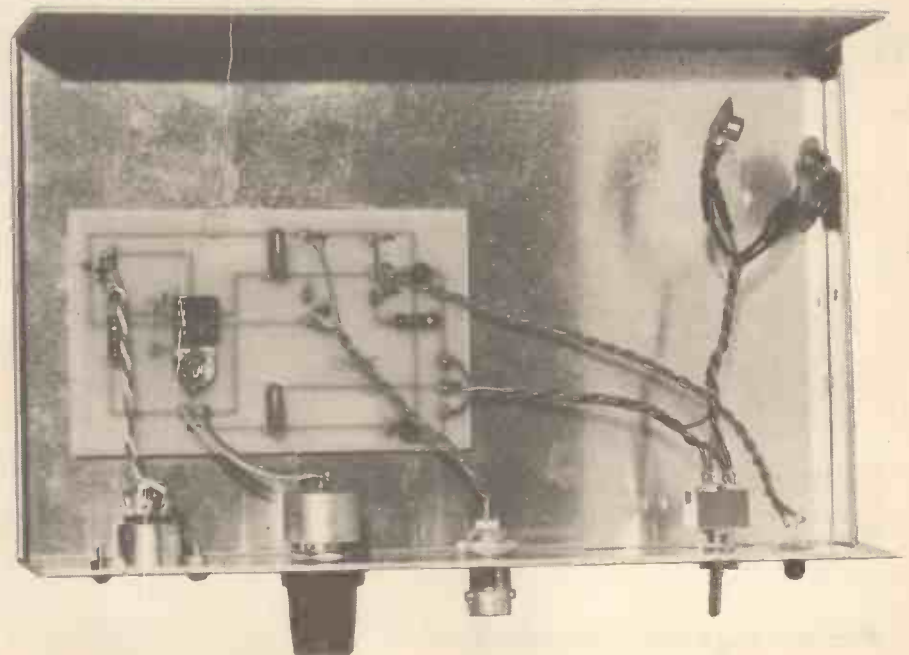

## CONSTRUCTION

The circuit is very straightforward and is easily constructed by means of the p.c.b. arrangement shown in Fig. 4.5. Alternatively, a small piece of Veroboard can be used.

Components should be positioned as shown in the overlay diagrams and soldered in carefully. Care should be taken with the orientation of the two voltage regulators; note that the pin-out arrangements of input, output and ground differ for these two devices. Veropins are used for connections to the off-board components and these should be inserted and soldered into the positions indicated. Check the board for dry joints, solder bridges etc.

The completed board is then mounted in a suitable case (see components list) and the connections with off-board components are made as shown in Fig. 4.6, and the photograph.

The 741 operational amplifier can now be inserted into its socket, noting carefully the orientation. Two PP6 batteries were used in the prototype and these should be connected up as shown in Fig. 4.6.

The photodiode is conveniently mounted in a small probe, which may simply be an empty pen-barrel. Connection between this and the main unit is via a length of screened cable and a three-pin DIN plug.

## TESTING AND CALIBRATION

Before dealing with testing and calibration of the unit, it is useful to consider briefly the units used in the measurement of illumination.

Sources of light produce luminous energy and the amount of energy emitted per second is known as the luminous flux,

which is measured in lumens.

The actual quantity of light falling on a surface is known as the illuminance and this is measured in lumens per square metre or lux. Bright sunlight produces an illuminance of about 25 000 lux whilst at a distance of 1 metre from a 60 watt lamp, the illuminance has a value of approximately 50 lux.

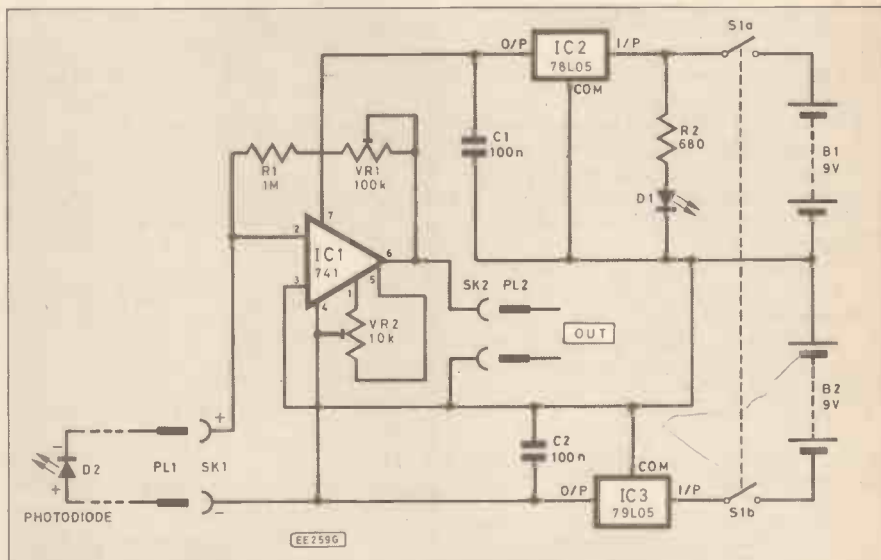

Fig. 4.4. Complete circuit diagram for the Optical Intensity Transducer.

## COMPONENTS

### Resistors

R1 1M  
R2 680  
¼W ±5% carbon film

### Potentiometers

VR1 100k lin. rotary  
VR2 10k min. horiz. skeleton

### Capacitors

C1, C2 100n polyester (2 off)

### Semiconductors

D1 red l.e.d.  
D2 general-purpose photodiode  
IC1 741 op-amp  
IC2 78L05 voltage regulator  
IC3 79L05 voltage regulator

### Miscellaneous

B1, B2 9V PP6 batteries (2 off)  
PL1 3 pin DIN plug  
PL2 BNC plug  
S1 d.p.d.t. toggle switch  
SK1 3 pin DIN socket  
SK2 BNC socket

Case—203 x 127 x 51mm; printed circuit board, available from the EE PCB Service, order code EE-509; knob for VR1; battery connector clips (2 off); 8-pin i.c. holder; adhesive feet for case.

Approx cost  
Guidance only **£18.50**

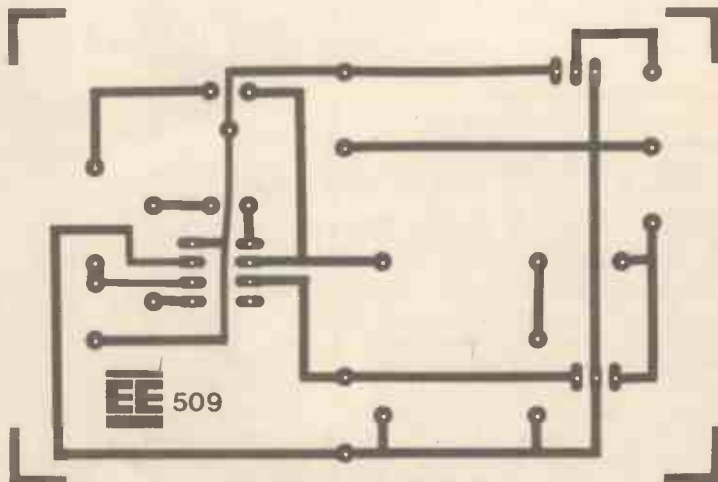
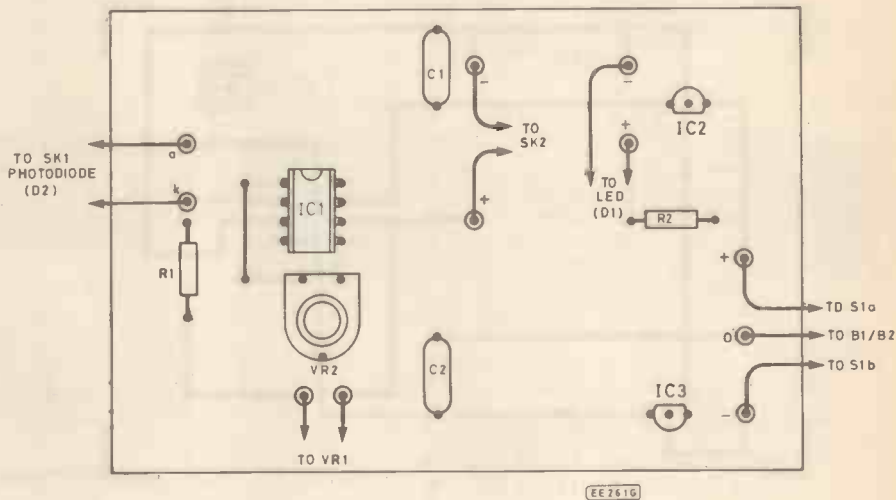

Fig. 4.5. Top, layout of components on the p.c.b., and leadout wires (see also Fig. 4.6). Above, the actual-size p.c.b.

When construction of the main unit and the probe has been completed, all wiring should be checked carefully. The batteries can now be connected and the unit switched on. At this point it is advisable to measure the +5V and -5V power supply lines. The voltages present should not differ appreciably from these values.

Connect up to a 0 to 1V voltmeter (preferably digital) to the output of the unit and cover the window of the photodiode so as to prevent any light from entering. Adjust the offset zero control VR2 until the voltmeter reads zero.

The photodiode can now be uncovered and this should produce an indication on the voltmeter. As it stands, the unit can now be used for comparing the luminous energy of different sources or the illuminance of different surfaces.

Calibration of the unit may be achieved by direct comparison with a conventional lightmeter or exposure meter. The sensitivity control VR1 should be set at a value which will allow the unit to be used within the range of illuminance required.

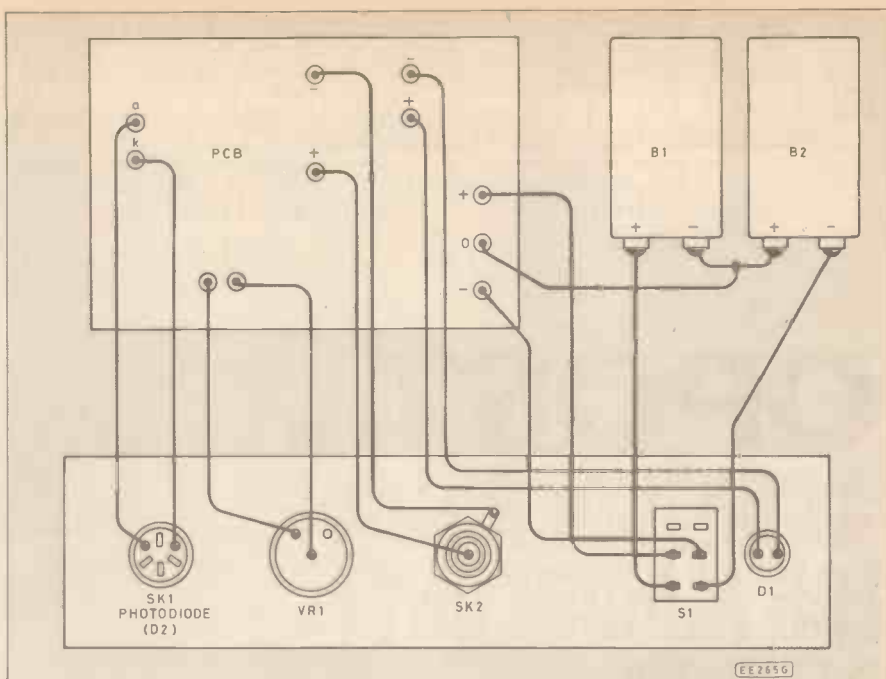

Fig. 4.6. Interwiring details, p.c.b. to front panel.

**NEXT MONTH:** Frequency measurement transducers.



## BENNING CROSS ELECTRONICS

67 Vicarage Road, Watford, Herts. WD1 8EJ

Telephone WATFORD (0923) 36234

Export orders welcome. All deliveries within 7 days.

Postage & Packaging 75p. Orders over £15 FREE

No V.A.T. to add

### INTRODUCTION TO ELECTRONICS

30 Projects to construct on breadboard.

"NO SOLDERING" kit includes breadboard and all components to make any of 30 projects as described in 150 page instruction book ..... £28.95.

BEGINNERS TOOL KIT. Soldering iron, solder, heatshunt, stripper/cutter, pliers, screwdriver ..... £14.95

'3 WATTS FM TRANSMITTER' 85 to 115 MHz. Range 3-4 miles ..... £10.99

★ SPECIAL OFFERS - SEND S.A.E. FOR LISTS ★

	Each
2114 (200NS) .....	£1.99
4116 (300NS) .....	£0.98
BC108 (Pack of Ten) .....	£1.00
Red L.E.D.'s TIL 209 (Pack of Ten) .....	£1.00
Soldering Iron .....	£2.95
Stereo Headphone .....	£4.99

## 'GRIPMATE'...

THOSE 'EXTRA HANDS' FOR SOLDERING, GLUEING AND ASSEMBLING JOBS...

\* This essential compact tool holds your small components positively and rapidly with infinite positioning.....

**SUPER KIT**  
£9.35

**BASIC KIT**  
£5.99

ALL PRICES INCLUDE POST, PKG & VAT SEND CHQ/PO TO MAKERS:

KEMPLANT LTD  
DURFOLD WOOD, PLAISTOW, BILLINGSHURST,  
WEST SUSSEX, RH14 0PN, UK.

KEMPLANT

## TEACH IN 86



BASIC ITEMS Multimeter, Verobloc, Bracket, Design Sheets + 10 Connecting Leads		£24.50
REGULATOR UNIT KIT	Project 1	£17.95
UNIVERSAL BRIDGE KIT	Project 2	£20.50
DIODE/TRANSISTOR TESTER KIT	Project 3	£12.45
EXTRA COMPONENTS Part 1, 70p; Part 2, £1.00; Part 3, £1.45; Part 4, £2.00		

### SOLDERING EQUIP./ TOOLS

Antex 15 watt Soldering Iron	6.75
Antex 17 watt Soldering Iron	6.85
Antex 25 Soldering Iron	6.95
Antex SK5 Kit (17w. iron, stand, solder etc)	8.95
Griffin 3000, 25w. Soldering Iron	5.50
MLXS 12v. Soldering Kit 25 watt	7.55
Soldering Iron Stand	2.35
Pocket Multimeter	7.50
Verobloc, bracket and design sheets	5.95
Miniature Side Cutters	2.45
Miniature Snipe Nose Pliers	2.45

### COMPACT ACCURACY

New Compact L.C.D. Multimeter measures only 115x65x24mm.

Full size L.C.D., 3 1/2 digit display, Transistor Test facility, Overload Protection, Auto Polarity and Zero Adjustment. Housed in a handy 'book opening' box, complete with Test Leads, Battery, Manual and Spare Fuse

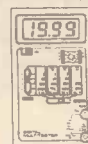

UNBEATABLE VALUE AT ONLY £38.95 INCLUDING V.A.T.

### BOOKS - BABANI

Beginners - Micros and Computing	1.95
Electronics Projects For Beginners	1.95
30 'Breadboard' Projects Book 1	2.25
30 'Breadboard' Projects Book 2	2.25
Modern OP Amp Projects	1.95
50 CMOS I.C. Projects	2.50
Projects for Cars and Boats	1.95
Electronic Timer Projects	1.95
Electronic Security Devices	1.95
Audio Projects	1.95
Electronic Household Projects	1.75
Electronic Games	1.75

ALL PRICES INCLUDE VAT PLEASE ADD 60p P&P PER ORDER

Cheque or Postal Order to:

C.P.L. ELECTRONICS

8 Southdean Close, Hemlington, Middlesbrough, Cleveland TS8 9HE.

Tel: 0642 591157.

Write or telephone for free pricelist of Components, Kits, Books, Tools, Hardware, etc.

### EE AND EM KITS

#### SPECIAL OFFER - 10% OFF

All the prices listed below - Kits Only

EVERYDAY ELECTRONICS	£
Graphic Equaliser June '85	22.50
Across The River (Game) June '85	13.45
Caravan P.S.U.	9.95
ELECTRONICS MONTHLY	£
Visual Doorbell (PCB Version) June '85	14.60
Footpedal Flanger (Musical Effects) June '85	22.85
Heartbeat Monitor July '85	22.90
Hot Water Indicator (with ABS box) Aug '85	8.95
A.F. Signal Generator (Excl. Case) Sept '85	21.95

All kits complete (less batteries), unless specified. Includes components, PCB or Vero, case, and hardware. Article reprints 60p if required.

# JANUARY '86 FEATURES...

## OPORT... A CONTROL OUTPUT FOR ALMOST ANY COMPUTER

An opto-coupled output port for an unbelievably low cost. The Oport will allow you to directly control external devices from the screen of your TV set, under computer control. A sensationally original way to achieve computer control—with *no* wiring to the computer itself.



### TEACH IN '86 PROJECT... Audio Signal Tracer

Another useful piece of test gear from Teach In '86. Ideal for trouble shooting audio equipment—or simply proving projects.

## MUSICAL DOORBELL

The electronic doorbell is one of the most useful and popular projects in the field of hobby electronics. The circuit uses the AY-3-1350 integrated circuit which provides a total of 25 tunes and three chimes.

## EVERYDAY ELECTRONICS and ELECTRONICS MONTHLY

JANUARY 1986 ISSUE ON SALE FRIDAY, DECEMBER 6

# FUNTRONICS ON T.V.

THAKERY

## The CAMERA

### The PHOTO-CATHODE

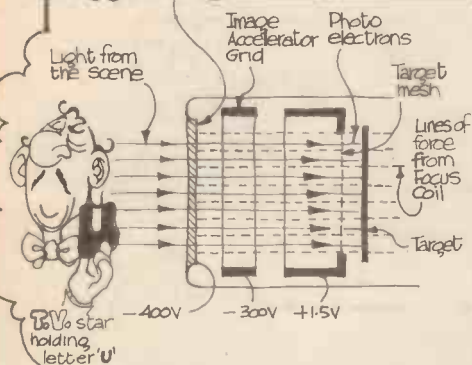

The inside face of the glass-end window of the tube is coated with a mixture of ANTIMONY, CAESIUM, & SILVER which forms a semi-transparent photo-electric surface — this coated window is the photo-cathode.

The number of electrons released from the photo-cathode (caused by the impact of light) are directed towards the TARGET by the potential difference between the -400V on the photo-cathode and the -300V on the Image accelerator and the +1.5V on the TARGET MESH.

The electrons must of course travel in a straight line and this is made possible by passing a direct current through the focus coil so producing an axial magnetic field with 'lines of force' for the electrons to follow.

### The TARGET

As a result of 'Secondary emission' a positive charged image is formed on the Target.

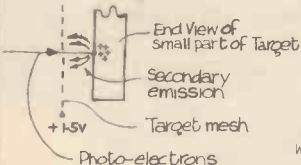

'Secondary emission' means electrons are made free from the Target and of course, they must NOT return to the target. These are in fact collected by the Target mesh which is a closely woven mesh of VERY fine wire about .025mm from the TARGET and dissipated in the supply circuit.

The TARGET is approximately 50mm x 40mm rectangular in shape and is typically .125mm thick. The reason for the extreme thinness is to permit the charge image to leak through a very low electrical resistance onto the scanning side.



Very low resistance. (NOTE: thickness is drawn exaggerated as .125mm would be thinner than a pencil line)

But why make the TARGET OF GLASS? Well, the answer is a very simple one. GLASS possesses a high lateral resistance to the movement of electrons and so avoids destroying the whole pattern of the charge image.

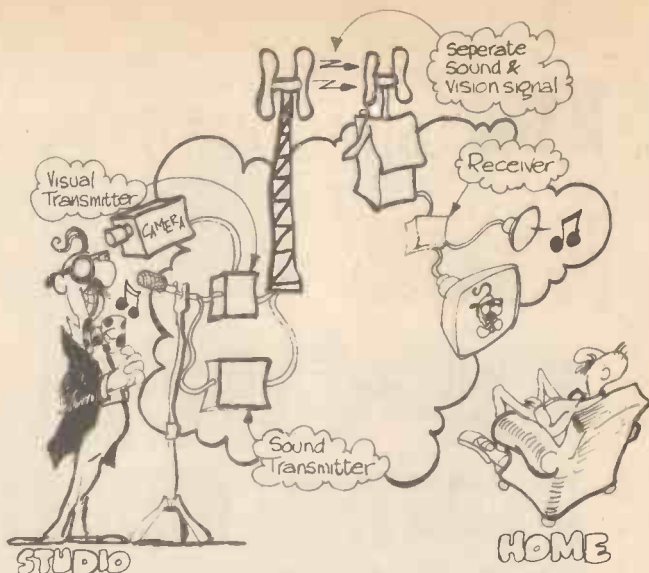

# FUNDAMENTAL FACTS

## Secondary Emission RATIO

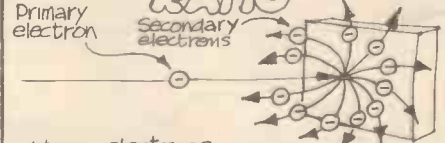

When electrons bombard a conducting material above a certain velocity electrons are emitted from the surface. The bombarding electron is the 'Primary' and the emitting electron is the 'secondary'. The most secondary emissive material used is 'caesiated silver'. The number of secondary electrons released for every primary electron is known as the 'secondary emission ratio'. The diagram shows ten electrons being released by one electron giving a ratio of 10.

"I also wish that the 'one over ten' was the 'secondary emission ratio'!"

# The ELECTRON MULTIPLIER

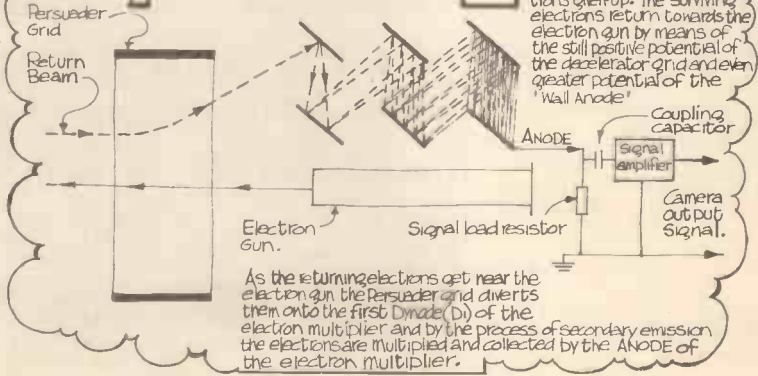

The charge image on the Target has been neutralized by the electron beam. The electron beam gives just enough electrons for neutralization. The brighter (or more positive) the image the more electrons given up. The 'surviving' electrons return towards the electron gun by means of the still positive potential of the decelerator grid and then greater potential of the 'Wall Anode'.

As the returning electrons get near the electron gun the Persuader grid diverts them onto the first Anode (A1) of the electron multiplier and by the process of secondary emission the electrons are multiplied and collected by the ANODE of the electron multiplier.

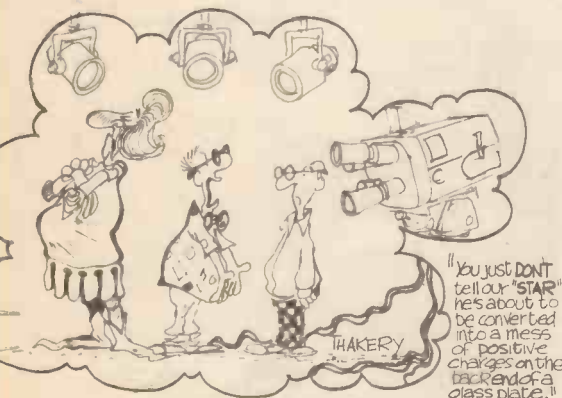

# HOW THE IMAGE ORTHICON TUBE WORKS

1. The TRANSPARENT PHOTO-CATHODE at one end of the tube has light focused on to it from the scene to be televised. As this happens electrons are emitted from the PHOTO-CATHODES inner surface in numbers corresponding to the tonal composition of the scene.
2. These electrons are then propelled toward an exceedingly thin glass target on which they produce a positive charge image of the scene by the action of secondary emission. The charge image has still to be reproduced on its photo-cathode side - this is made possible by the thinness of the glass target. The charge image actually "leaks through" the very thin glass.
3. A low-velocity electron beam then scans this reverse side of the glass target.
4. All electrons not given up by the beam as it scans each individual area of charge are reflected back toward the electron gun.
5. However, before these surplus electrons return to the gun they are deflected towards an electron multiplier assembly which is capable of producing an output signal which is exactly proportional to every variation in the density of the returning electrons.

## The Image Orthicon

The Image Orthicon is 115 mm diameter and about 480mm long and is cylindrical in shape. Its tube has a sensitivity more than a THOUSAND times greater than its predecessor the Iconoscope, as a matter of fact some Image Orthicons are even more sensitive than the HUMAN eye.

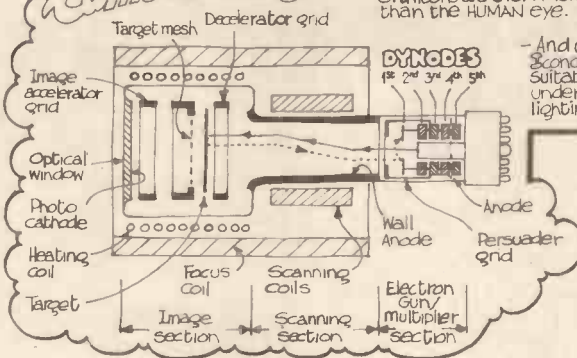

- And unlike the Iconoscope it is suitable for use under almost any lighting conditions.

## The SCANNING BEAM

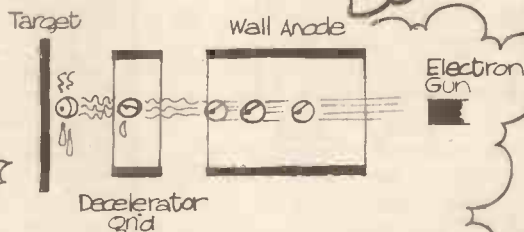

The electron beam in the Image Orthicon overcomes the problem of "Secondary emission" as found in the Iconoscope.

The 'Wall Anode' accelerates the electrons towards the Target and just before reaching the Target the 'Decelerating grid' slows the electrons down hence avoiding the electrons hitting the Target with a force that would cause "secondary emission" and "Shedding signals".

by  
**Thakery**

## 4-WORD LINK-UP

START	C	E	L	N	O
↓	O	T	L	O	S
N	P	H	O	I	C
O	A	N	A	E	P
I	T	I	N	O	D
	M	U	L	L	I

Make a chain of 4-words related to TELEVISION by joining the above letters

Solutions on page 681

## FUNdamental FACTS

### The BLANKING PULSE

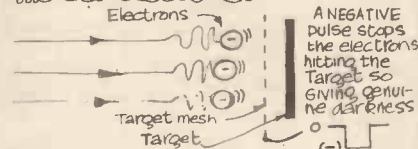

The Iconoscope never really successfully achieved the Black-level reference voltage from the introduction of a genuinely black object in every scene. The Image Orthicon tube DID obtain an accurate Black-level reference signal by simulating conditions of darkness at the target face for short periods at the end of every line and scanfield.

NORMAL SERVICE WILL BE RESUMED AS SOON AS POSSIBLE BUT IN THE MEANTIME FOR YOUR ENTERTAINMENT WE TRANSMIT OUR "BLACK LEVEL" REFERENCE SIGNAL



## EASY LOOK AT MATHS CALCULUS

The metho of calculating called Calculus was discovered in 1666 by Isaac Newton, who called it the "Method of Fluxions".



"Tell me when I've had Six of the best, teach!"  
- I can't count without my calculator!"

Calculus deals with changing quantities and with the rates at which they change.

Differential Calculus enables the rates to be calculated from the change in quantity.

Integral calculus can be used to find the quantities themselves from a knowledge of their rate of change

Here's a typical problem easily solved by calculus that would have been solved by trial and error or drawing a graph.

What proportion should a tin's height bear to its diameter so as to use the least amount of tinplate?

WINE A GO!  
and look in next episode for solution.  
Let the volume = 27π cubic inches!





## VIRGIN CHALLENGER'S RACE WITH TIME

A report from Barry Fox on the role played by electronics in the titanic struggle to capture the world water speed record for crossing the Atlantic

At six pm on a hot Thursday evening last August a crowd of engineers, TV and radio reporters, journalists and publicity people were sweating in the Virgin Challenger Mission Control. Virgin's boat *Challenger* was trying to win the Blue Riband for fastest Atlantic crossing by a passenger boat.

They were sweating because it was overcrowded and stuffy in the temporarily converted restaurant above the Virgin Megastore in London's Oxford Street; they were also sweating because the catamaran was nearing the UK, after leaving America on the Monday.

The crowd cheered as the news came up on a TV set in the corner. The *Virgin Challenger* was two hours from the finishing line.

It had been racing at 45 knots across the Atlantic, laden with hi-tech electronics. An hour later all was worry and gloom. The *Challenger* had sunk.

The Virgin boat and control centre relied on an impressive array of communications and computer hardware. Surprisingly the linchpin was a radio link which carried messages by the 50 year old technology of telex, but with modern computer implementation.

By the time the boat hit a piece of flotsam, thought by the crew to be a piece of stray wreckage from the crashed Air India Jumbo, some of its hardware had failed. The technicians' consolation is that no amount of electronics could have averted the disaster.

When the *Virgin Challenger* sank much of her electronics was still working. "I am amazed the electronics stood up to the punishment" navigator Dag Pike told me, "of course some things did go wrong and the pity is that we'll never be able to do a post mortem and find out why for next time."

### Communications

But why use telex, instead of ordinary voice radio? The crew believed telex would be more reliable than speech, and for much of the journey it was. Only bad luck shut down the main link.

To provide the telex link for communications, Data General installed a Desktop Model 20 computer, ruggedised for marine use. Twelve sensors round the boat continually monitored engine performance, water and air speed and trim angle. Analogue data from these sensors was fed to the DG computer and stored as digital code every 25 milliseconds.

Every minute a data update appeared on a screen in the cockpit, in jumbo size print to make readout easy. Every five minutes the computer automatically selected a sub-set of the

the data which had not already been sent. Unfortunately there was quite a bit of it.

The telexes were sent by marine radio to the Portishead station, at Burnham, on the h.f. band. Lower frequencies were used as the boat got closer. For marine telex-by-radio, the standard 5-bit telex code words are converted to 7-bit ASCII words and transmitted in blocks of three by a modem which converts digital pulses to analogue tones. Transmission is synchronous, with the transmitter and receiver locked together. This allows data to be sent at twice the normal telex rate of 50 baud. Because there are only six radio telex channels in the Atlantic, the *Challenger* used a speech channel in the h.f. band (3MHz-30MHz) for sending telexes. Portishead polled all unread telexes every hour.

*"I'm amazed the electronics stood up to the punishment"*

most important readings from the sensors, compiled a telex message and loaded it into a buffer memory.

In this way all the sensor data was logged for the future and only the most significant items stored for transmission. When the boat went down, so did all

The collated data travelled by telex land line from Portishead to the Oxford Street control centre.

The telex link proved its worth early in the trip. For two days messages flowed smoothly, and the control centre received a constant stream of data about



fuel consumption, speed and boat behaviour. When the *Challenger* hit an electrical storm on

whether anything other than the breaker had failed. Now they never can.

*"Anyone like to loan us a satellite channel?"*

the second night voice communication proved impossible but some telex messages, keyed manually into the computer, got through.

In the pounding which caused the much-publicised fuel loss, the Racal Decca radar and DG computer terminal kept working even though the shock waves made the pictures on their video screens collapse rhythmically into an oval shape. DG believe this was because the shocks were strong enough to distort the metal framework of the electron guns and coils in the cathode ray tubes.

During the storm the onboard computer failed. The inverter, an electronic circuit which converts the 24V d.c. boat supply to 240V a.c., blew a 20A circuit breaker. It wouldn't re-set.

When the computer failed, the crew switched to voice communications and stayed that way until the end.

Back in London Data General were waiting to get their hands on the gear and see

No radar can pick up driftwood or small lumps of submerged ice. "It's all down to Mark One Eyeball" says Pike. By coincidence an airline pilot had told me exactly the same thing a few weeks before when I asked him how jumbos steered clear of small planes flying in their path...

### Next Time

Already the boat and land crew are planning "next time". Dag Pike would like to see the next boat built round the technology, rather than the technology modified to fit the boat.

"It was so noisy. We couldn't listen for incoming radio calls. And we had no time to sit by a radio and wait. So we had to initiate all calls. Better layout would mean we could work near the radio and listen".

Data General would like to do it again, but this time with a satellite link for communications. "So" says DG "if anyone would like to loan us a satellite channel..."





# MARCO TRADING

☆☆☆☆☆  
**A VERY HAPPY XMAS TO ALL NEW CUSTOMERS & OLD FROM ALL AT MARCO**

☆☆☆☆☆  
**CLOCK RADIO - L.W./M.W.**  
 Mems. digital display alarm clock/radio. Alarm control/Wake to music, Sleep control - 10 min. Snooze/On/Off. Minute Time Setting. Brightness Control. £3.99 each (plus additional postage 75p per set).

☆☆☆☆☆  
**TRANSISTORS**

AC128	£0.30	BFK29	£0.28
AC176	£0.30	BFK84	£0.28
AF239	£0.50	BFK85	£0.35
BC107	£0.10	BFK87	£0.44
BC108	£0.10	BFV50	£0.22
BC109	£0.10	BFV51	£0.22
A.C.1	£0.10	BS200	£0.40
BC147	£0.18	BSX20	£0.30
BC182	£0.10	BU208	£0.10
BC182L	£0.12	BU326	£0.10
BC214	£0.10	OC45	£0.60
BC184L	£0.10	OC71	£0.60
BC212	£0.10	OC72	£0.70
BC212L	£0.09	PT31A	£0.38
BCY70	£0.16	TP32A	£0.35
BD131	£0.36	TP33C	£0.70
BD133	£0.10	TP34A	£0.70
BD135	£0.26	TP2955	£0.58
BD136	£0.26	TP3055	£0.58
BF115	£0.32	TS43	£0.88
BF184	£0.30	TS58	£0.50
BF185	£0.28	2N3055	£0.65
BF194A	£0.15	2SC1096	£0.94
BF195	£0.12	2SC1173Y	£1.70
BF200	£0.38	2SC1306	£0.92
BF224	£0.34	2SC1307	£0.92
BF244	£0.34	2SC1957	£0.70
BF244A	£0.30	2SC2028	£0.73
BF244B	£0.28	2SC2029	£0.70
BF259	£0.30	2SC2078	£1.05
BF262	£0.34	2SC2166	£1.20
BF263	£0.38	3SK88	£0.60
BF337	£0.28	40673	£0.60
BF338	£0.28		£1.80

☆☆☆☆☆  
**400mm ZENNER PACK 55 ZENNERS - £3.75**

☆☆☆☆☆  
**MARCO TRADING (DEPT ED12)**  
 ☆The Matings  
 ☆High Street  
 ☆Wem, Shropshire SY4 5EN  
 ☆Tel: 0939 32763 Telex: 35565

## SWITCHES

Sub-Minature Toggle SPST 60p SPDT	63p DPDT	66p
Miniature Toggle SPST 80p SPDT	65p DPDT	72p
DPDT Centre Off 85p		
Standard Toggle SPST On/Off Plate DPDT On/Off Plate		48p
Miniature DPDT Side Push-To-Make		210p
Push-To-Break		25p

## ROTARY POT'S ROTARY SWITCH

0.25W Carbon Log & Lin 1K-2M2	each 32	1 pole 12 way, 2 pole 6 way, 3 pole 4 way, 4 pole 3 way
Any 100 £28	All 50V. 1p to 10n 4p each, 10p for £2.75	50p

## INTEGRATED CIRCUITS (£) EACH

709	0.35	LM23713	2.30	TDAS60C	1.50	4000	£0.19
741	0.25	NE555	0.25	TDAB90	0.80	4001	£0.24
747	0.70	SA2750	4.00	TDAB10S	1.20	4002	£0.24
AN214Q	3.80	SAS560	2.50	TDAB902A	3.00	4006	£0.24
AN240P	3.42	SAS570	1.85	TCA2075	4.00	4007	£0.24
BT76218	1.98	SA5580	2.85	TD1003A	5.00	4009	£0.44
CA301AT	2.88	TA7146P	2.00	TD1004	4.95	4010	£0.39
CA358	0.66	SN76033N	2.50	TD1006A	2.45	4011	£0.23
OC71	1.20	SN76131N	1.99	TD1035S	2.40	4012	£0.24
CA3020	2.10	SN76262DN	1.70	TD1170S	1.99	4013	£0.35
CA3065	1.60	SN76272N	1.10	TD1152A	1.80	4014	£0.58
CA3080E	0.68	SN76660N	1.05	TD2002	1.80	4015	£0.58
CA3140	0.45	SN76660NO	1.40	TD2020	3.00	4016	£0.58
HA1366W	1.59	SKT015	6.20	TD2030	1.90	4017	£0.54
LA4422	3.20	TA7146P	0.60	TD2142	2.90	4018	£0.59
LC7131	4.90	TA7023P	2.76	TD2160	2.50	4019	£0.78
LC7137	5.40	TA7024P	1.50	TD2522	2.75	4020	£0.58
LM324N	0.48	TA7205P	1.30	TD2530	3.20	4021	£0.58
LM3808N8-P	1.50	TA7222P	2.32	TD2532	2.80	4022	£0.68
LM3808N14-P	1.80	TA6550	0.50	TD2560	2.20	4023	£0.30
LM1011N	3.20	TA6611A12	3.50	TD2561	1.48	4024	£0.24
LM1488N	0.98	TD1001	2.90	UPC57562	4.65	4025	£0.89
LM3390N	1.50	TA1170S	2.32	UPC741G	2.50	4026	£0.89
ME1513L	3.18	AS/S5B/T/U	0.80	UPC1156H	2.75	4027	£0.44
MS1515L	3.18	TD1A208	1.30	UPC1182H	2.75	4028	£0.44
MC1307P	1.99	SA/SOAUQ	1.30	UPC1201H	1.78	4029	£0.73
MC1327P	1.50	TA1170S	2.32	UPC2128H	2.78	4030	£0.30
MC1330P	1.60	TB4500	1.20	UPC2000V	2.78	4031	£1.25
LM23213	2.10	TB4540	1.54	UPC2002V	2.78	4032	£1.40

☆☆☆☆☆  
**MARCO SPECIAL OFFER (DECEMBER ONLY) DESOLDER PUMP**  
 (Normally £4.50). This month £2.99. (Only available with orders over £10). Look out for a New Marco Special Offer in Everyday of Every Month!!!

☆☆☆☆☆  
**ORDERING.** All components are brand new and of full specification. Please add 60p postage/packing unless otherwise specified to all orders then add 15% V.A.I. to the total. Either send cheque/cash/postal order or send/telephone your Access or Visa number. Official orders from schools, universities, colleges, etc. most welcome. (Do not forget to send for our 1985 catalogue - only £1.00 per copy. All orders despatched by return of mail. (Min order £5.00)  
 NEW RETAIL 1,000 sq. ft. shop now open. Mon-Fri 9.00-5.00, Sat 9.00-12.00.

## SOLDERING SECTION

Soldering Station complete with 30W or 40W	10/0.85
Istate which 495 X25 W iron kit complete with steel	10/0.10
& plug attached 10.00	10/1.00
CS 18W, as above 9.95	
Antex 15W iron	5.25
Antex 18W iron	5.50
Antex 25W iron	5.75
Antex 30W iron	6.00
Antex bits	0.90
Antex stands	2.10
Soldersucker	4.50
Spare nozzles	0.65

## TERMINAL BLOCKS

2 amp 12 way	0.20
5 amp 12 way	0.24
15 amp 12 way	0.47

## C-MOS

4000	£0.19
4001	£0.24
4002	£0.24
4006	£0.24
4007	£0.24
4009	£0.44
4010	£0.39
4011	£0.23
4012	£0.24
4013	£0.35
4014	£0.58
4015	£0.58
4016	£0.58
4017	£0.54
4018	£0.59
4019	£0.78
4020	£0.58
4021	£0.58
4022	£0.68
4023	£0.30
4024	£0.24
4025	£0.89
4026	£0.89
4027	£0.44
4028	£0.44
4029	£0.73
4030	£0.30
4031	£1.25
4032	£1.40
4033	£0.68
4034	£1.40
4035	£0.68
4036	£2.48
4037	£0.78

☆☆☆☆☆  
**Orders received by 4pm by post: Telephone or Telex. Despatched same day. Subject to availability.**

## B.T. TELEPHONES

Viscount £32.00, Statesman £29.50, Simitel £22.50, Viscount 12 £39.50. All telephones listed carry British Telecom 12 month guarantee.	
--	--

## TELEPHONE SPECIAL

BT App Telephone Plug + 3m Lead	£1.25
BT App Master Socket inc Wiring Instructions	£1.85
BT App Secondary Socket £1.95	
4-way plug 50p each	£0.50
BT 4-Core Cable per metre	15p
Cable clips for above	100 75p

## PLASTIC BOXES

3 x 2 x 1"	0.35
3 x 2 1/2 x 1"	0.65
4 x 3 x 1 1/2"	0.83
6 x 4 x 2 1/2"	1.15
8 1/2 x 5 x 3 1/4"	2.15

## IC SOCKETS

DIP to DIP	
8 pin 0.80 0.70/10	
14 pin 0.10 0.95/10	
18 pin 0.11 1.00/10	
28 pin 0.21 1.95/10	
28 pin 0.30 2.75/10	

## PVC TAPE

10 for £1.50	
Assorted Colours	

## IEC MAINS LEADS

6 amp - 250V	
£1.25 each	
(Black: 1mm).	

## TRANSFORMERS

British made transformers at very attractive prices	
Primary Secondary Current + 1+ 10+ 100+ 240V:	6-0-6V 100mA £0.58 £0.52 £0.43
240V:	6-0-6V 500mA £0.65 £0.60 £0.48
Carriage 45p transformer £1.60 per 100	

## TRIM TOOL SET

A handy set of four double ended plastic trim tools of varying sizes supplied in wallet £1.40

## RESISTORS - CARBON FILM 5%

1/4W 1R0 to 10M (E2 Range)	2p each, 15p/10, 75p/100
1/2W 2R2 to 10M (E2 Range)	2p each, 15p/10, 75p/100
1W 1R0 to 2M (E2 Range)	7p each, 65p/10, 6.00/100
2W 1R0 to 2M (E2 Range)	8p each, 70p/10, 6.00/100

## RESISTOR KITS - each value individually packed

1/4W pack 10 each value E12 - 10R to 1M 610 pieces	5.75
1/4W pack 5 each value E12 - 10R to 1M 305 pieces	3.35
1/2W pack 10 each value E12 - 2R2 to 2M2 395 pieces	7.95
1W pack 5 each value E12 - 2R2 to 1M 353 pieces	15.00
2W pack 5 each value E6 - 10R to 2M2 317 pieces	18.50 VAT.

## RESISTORS - WIREWOUND Generally 5%

2.5W - 0.22 to 270R - Available in preferred values	0.20
4W - 1R0 to 10K - Available in preferred values	0.21
7W - 0.47R to 22K - Available in preferred values	0.25
10W - 1R0 to 22K - Available in preferred values	0.29

## NI-CAD CHARGER PRESETS

Universal Ni-Cad charger, charges PP3, AA, C, D	£6.00
Rechargeable Batteries	
AA (HP7)	85p 10/75p each
C (HP11)	£1.75 10/£1.85 each
D (HP2)	£2.05 10/£1.95 each
PP3	£3.80 10/£3.70 each
Dry Cell Batteries - Button type for Multimeters - set of 3 £1.75	

## CHART RECORDER SPECIAL

Brand new 3 channel pen recorders complete with charts Full spec. Once only price £40 + £10 p&p + VAT.

## SERVICE AIDS

Switch Cleaner	1.18
Circuit Freezer	1.24
Foam Cleanser	1.16
Aero Kiene	1.10
Plastic Seal	1.28
Excess Polish	1.12
Antistat Spray	1.18
Aero Duster	1.40
Super 40	1.82
Vision Head Cleaner	1.06
Free Estergisher	1.18
Silicone Grease Aero 1.42	
Otto Tube	1.64
Heat Sink Compound 1.80	
Sonix Mop 0.12mm 0.74	
Dmo 0.06mm 0.76	

## NEW 1985-6 CATALOGUE AVAILABLE

Range of components greatly increased - over 125 pages fully illustrated. Price £1.00 per copy. (Free upon request with orders over £15). Includes 50p Credit Note, Special Offer Sheets, Order Form and Pre-Paid Envelopes.

**MARCO 85/86**  
 Electronics Components Catalogue

CMOS	4095	58p	74LS75	28p	74LS256	28p	PL95	140p	HA-1197	150p
	4098	56p	74LS78	34p	74LS273	72p	PL500	110p	HA-1306W	170p
4000	16p	4099	56p	74LS83	46p	74LS279	46p	PL504	95p	
4001	16p	4002	16p	74LS85	50p	74LS290	30p	PL519	450p	
4006	50p	4003	16p	74LS86	30p	74LS293	30p	PY81	70p	
4007	18p	4004	60p	74LS90	30p	74LS296	42p	PY88	48p	
4008	16p	4005	26p	74LS91	75p	74LS298	44p	PP504A	160p	
4009	30p	4006	60p	74LS92	46p	74LS367	43p			
4010	32p	4007	33p	74LS93	40p	74LS368	41p			
4011	16p	4008	85p	74LS96	52p	74LS373	58p			
4012	16p	4009	42p	74LS99	35p	74LS375	58p	7400	22p	
4013	30p	4010	51p	74LS107	35p	74LS375S	58p	7401	22p	
4014	40p	4011	40p	74LS109	36p	74LS399	80p	7402	18p	
4015	40p	4012	40p	74LS112	38p	74LS367	80p	7403	22p	
4016	27p	4013	39p	74LS113	32p		7404			
4017	39p	4014	51p	74LS114	38p		7406			
4018	40p	4015	130p	74LS122	44p	DAF96	60p	7407	40p	
4019	33p	4016	45p	74LS124	44p	DF96	56p	7408	75p	
4020	50p	4017	50p	74LS125	85p	DL92	47p	7409	50p	
4021	45p	4018	45p	74LS126	36p	DY87	50p	7413	35p	
4022	45p	4019	45p	74LS126	42p	D				

# PCB SERVICE

Printed circuit boards for certain constructional projects are now available from the PCB Service, see list. These are fabricated in glass-fibre, and are fully drilled and roller tinned. All prices include VAT and postage and packing. Add £1 per board for overseas airmail. Remittances should be sent to: The PCB Service, Everyday Electronics and Electronics Monthly Editorial Offices, Westover House, West Quay Road, Poole, Dorset BH15 1JG. Cheques should be crossed and made payable to IPC Magazines Ltd.

Please note that when ordering it is important to give project title as well as order code. Please print name and address in Block Caps. Do not send any other correspondence with your order.

Readers are advised to check with prices appearing in the current issue before ordering.

**NOTE: Please allow 28 days for delivery. We can only supply boards listed in the latest issue.**

PROJECT TITLE	Order Code	Cost
— JULY '83 —		
User Port Input/Output <i>M.I.T. Part 1</i>	8307-01	£4.82
User Port Control <i>M.I.T. Part 1</i>	8307-02	£5.17
— AUGUST '83 —		
Storage Scope Interface, BBC Micro	8308-01	£3.20
Car Intruder Alarm	8308-02	£5.15
High Power Interface <i>M.I.T. Part 2</i>	8308-03	£5.08
Pedestrian Crossing Simulation <i>M.I.T. Pt 2</i>	8308-04	£3.56
— SEPTEMBER '83 —		
High Speed A-to-D Converter <i>M.I.T. Pt 3</i>	8309-01	£4.53
Signal Conditioning Amplifier <i>M.I.T. Pt 3</i>	8309-02	£4.48
Stylus Organ	8309-03	£6.84
— OCTOBER '83 —		
D-to-A Converter <i>M.I.T. Part 4</i>	8310-01	£5.77
High Power DAC Driver <i>M.I.T. Part 4</i>	8310-02	£5.13
— NOVEMBER '83 —		
TTL/Power Interface for Stepper Motor <i>M.I.T. Part 5</i>	8311-01	£5.46
Stepper Motor Manual Controller <i>M.I.T. Part 5</i>	8311-02	£5.70
Speech Synthesiser for BBC Micro	8311-04	£3.93
— DECEMBER '83 —		
4-Channel High Speed ADC (Analogue) <i>M.I.T. Part 6</i>	8312-01	£5.72
4-Channel High Speed ADC (Digital) <i>M.I.T. Part 6</i>	8312-02	£5.29
Environmental Data Recorder	8312-04	£7.24
Continuity Tester	8312-08	£3.41
— JANUARY '84 —		
Biological Amplifier <i>M.I.T. Part 7</i>	8401-02	£6.27
Temp. Measure & Control for ZX Compr Analogue Thermometer Unit	8401-03	£2.35
Analogue-to-Digital Unit	8401-04	£2.56
Games Scoreboard	8401-06/07	£9.60
— FEBRUARY '84 —		
Oric Port Board <i>M.I.T. Part 8</i>	8402-02	£9.56
Negative Ion Generator	8402-03*	£8.95
Temp. Measure & Control for ZX Compr Relay Driver	8402-04	£3.52
— MARCH '84 —		
Latched Output Port <i>M.I.T. Part 9</i>	8403-01	£5.30
Buffered Input Port <i>M.I.T. Part 9</i>	8403-02	£4.80
VIC-20 Extension Port Con. <i>M.I.T. Part 9</i>	8403-03	£4.42
CBM 64 Extension Port Con. <i>M.I.T. Part 9</i>	8403-04	£4.71
Digital Multimeter Add-On for BBC Micro	8403-05	£4.63
— APRIL '84 —		
Multipurpose Interface for Computers	8404-01	£5.72
Data Acquisition "Input" <i>M.I.T. Part 10</i>	8404-02	£5.20
Data Acquisition "Output" <i>M.I.T. Part 10</i>	8404-03	£5.20
Data Acquisition "PSU" <i>M.I.T. Part 10</i>	8404-04	£3.09
A.F. Sweep Generator	8404-06	£3.55
Quasi Stereo Adaptor	8404-07	£3.56

— MAY '84 —		
Simple Loop Burglar Alarm	8405-01	£3.07
Computer Controlled Buggy <i>M.I.T. Part 11</i>	8405-02	£5.17
Interface/Motor Drive	8405-03	£3.20
Collision Sensing	8405-04	£4.93
Power Supply		
— JUNE '84 —		
Infra-Red Alarm System	8406-01	£2.55
Spectrum Bench PSU	8406-02	£3.99
Speech Synthesiser <i>M.I.T. Part 12</i>	8406-03	£4.85
Train Wait	8406-04	£3.42
— JULY '84 —		
Ultrasonic Alarm System	8407-01	£4.72
Electronic Code Lock		
Main Board	8407-03	£2.70
Keyboard	8407-04	£3.24
— AUGUST '84 —		
Microwave Alarm System	8408-01	£4.36
Temperature Interface—BBC Micro	8408-02	£2.24
— SEPTEMBER '84 —		
Op-Amp Power Supply	8409-01	£3.45
— OCTOBER '84 —		
Micro Memory Synthesiser	8410-01*	£8.20
Drill Speed Controller	8410-04	£1.60
— NOVEMBER '84 —		
BBC Audio Storage Scope Interface	8411-01	£2.90
Proximity Alarm	8411-02	£2.65
— DECEMBER '84 —		
TV Aerial Pre-Amp	8412-01*	£1.60
Digital Multimeter	8412-02/03*	£5.20
Mini Workshop Power Supply	8412-04	£2.78
Power Lighting Interface	8501-01	£8.23
Games Timer	8501-02	£1.86
Spectrum Amplifier	8501-03	£1.70
— JAN '85 —		
Solid State Reverb	8502-01	£3.68
Computerised Train Controller	8502-02	£3.38
— FEB '85 —		
— MARCH '85 —		
Model Railway Points Controller	8503-01	£2.78
— APRIL '85 —		
Insulation Tester	8504-02	£2.53
Fibre Alarm	8504-03	£3.89
Auto Phase	8505-01	£3.02
Amstrad CPC464 Amplifier		
Mains Unit	8505-02	£2.56
Micro Unit	8505-03	£2.56
Voltage Probe	8505-04	£2.67
— MAY '85 —		
Graphic Equaliser	8506-01	£3.21
Computerised Shutter Timer	8506-02	£2.09
Mono-Bi-Astables (Experimenters Test Bed)	8506-03	£2.45
Across The River	8506-04	£2.63
— JUNE '85 —		
Amstrad User Port	8507-01	£3.17
Nascom Printer Handshake	8507-02	£1.90
— JULY '85 —		
Electronic Building Blocks—1 to 4†	8508-01	£2.98
Tremolo/Vibrato	8508-02	£4.03
Stepper Motor Interface	8508-03	£2.40
Drill Control Unit	8508-04	£2.90
— AUGUST '85 —		
— SEPTEMBER '85 —		
RIAA Pre-amplifier Input Selector	8509-01	£2.36
Transducers Resistance Thermometer	8509-03	£2.64
Transducers Semiconductor Temp. Sensor	8509-04	£2.72
— OCTOBER '85 —		
Transducers Strain Gauge	501	£2.87
Soldering Iron Power Controller	504	£2.09
— NOVEMBER '85 —		
Transducers—		
Magnetic Flux Density Amplifier	505	£3.93
Hallowe'en Projects (single board price)	506	£2.68
— DECEMBER '85 —		
Electronic Building Block — 5 to 8†	508	£3.07
Opto Intensity Transducer	509	£2.70
Digital Capacitance Meter	512	£5.22

\*Complete set of boards.

*M.I.T.*—Microcomputer Interfacing Techniques, 12-Part Series.

†Four separate circuits.

Prices for **ELECTRONICS MONTHLY** PCBs are shown below.

PROJECT TITLE	Order Code	Cost
Cymbal Synth The Thing — DEC '84 —	EM/8412/2 EM/8412/4	£4.86 £3.18
Speak Board — JAN '85 —	EM/8501/2	£3.97
Headphone Amp Intelligent Nicad Charger Anti Phaser — FEB '85 — Logical Lock Touch Dimmer	EM/8502/1 EM/8502/2 EM/8502/3 EM/8502/4 EM/8502/5	£2.08 £3.50 £4.56 £3.58 £3.29
Courtesy Light Extender Disco Light Chaser — MAR '85 —	EM/8503/4 EM/8503/5	£3.29 £8.11
Sound to Light Unit Car Audio Booster — APRIL '85 — Short Wave Converter	EM/8504/1 EM/8504/2 EM/8504/3	£4.02 £3.12 £4.15
Car Burglar Alarm — MAY '85 —	EM/8505/3	£2.88
Metal Detector Power Supply Module — JUNE '85 — Flanger	EM/8506/1 EM/8506/3 EM/8506/4	£4.24 £3.20 £4.29
El Tom/El Tom+ El Cymb — JULY '85 — Heartbeat Monitor Real Time Clock	EM/8507/1 EM/8507/2 EM/8507/3 EM/8507/4	£4.10 £4.10 £3.98 £4.62
Intelligent Windscreen Wiper (incl. Terminal Board) HiFi Intercom (2 boards) Plug Power Supply — AUG '85 — Hot Water Alarm	EM/8508/1/2 EM/8508/3 EM/8508/4 EM/8508/5	£4.12 £2.92 £2.28 £1.93
Sinewave Generator — SEPT '85 — Household Battery Checker Audio Signal Generator	EM/8509/1 EM/8509/2 EM/8509/3	£2.76 £1.97 £3.65
Compressor Pedal Computer Cont Filter — OCT '85 — Spectrum MIDI Interface	EM/8510/1 EM/8510/2 EM/8510/3	£2.87 £2.94 £3.20

# FUNTRONICS ANSWERS

## 4-WORD LINK-UP

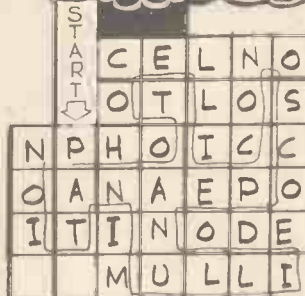

- 1<sup>st</sup> WORD: PHOTOCCELL
- 2<sup>nd</sup> WORD: ICONOSCOPE
- 3<sup>rd</sup> WORD: ANODE
- 4<sup>th</sup> WORD: ILLUMINATION

**"If last month's issue of EVERYDAY ELECTRONICS and ELECTRONICS MONTHLY hadn't sold out, I'd have got the thing off the ground by now."**



Sell-out disappointment can upset even the less ambitious reader! So why not take out a year's subscription and make sure of every issue, straight from the Publisher? Complete the order form below and post to EVERYDAY ELECTRONICS and ELECTRONICS MONTHLY, Subscription Dept., Oakfield House, 35 Perrymount Road, Haywards Heath, West Sussex, RH16 3DH. Tel. 0444 459188.

**Annual subscription rates:**  
**UK £13. Overseas £15**

**EVERYDAY ELECTRONICS and ELECTRONICS MONTHLY**  
Annual subscription rates: **SUBSCRIPTION ORDER FORM**  
UK £13. Overseas £15

To: Everyday Electronics and Electronics Monthly, Subscription Dept., Oakfield House, 35 Perrymount Road, Haywards Heath, West Sussex RH16 3DH.

Name \_\_\_\_\_

Address \_\_\_\_\_

\_\_\_\_\_

I enclose payment of £\_\_\_\_\_ (cheque/PO payable to Everyday Electronics)

Charge my credit card account the amount of £\_\_\_\_\_

Card no. \_\_\_\_\_

\_\_\_\_\_

Name of card \_\_\_\_\_ valid from \_\_\_\_\_ to \_\_\_\_\_

Signature \_\_\_\_\_

51

# Actually Doing it!!

SO FAR in this series we have been mainly concerned with identifying components and building up circuit boards. However, few projects consist of just a printed circuit board assembly, and in the majority of cases projects are built into cabinets and made as neat and serviceable as possible. Things such as nuts and bolts are every bit as much a part of electronics construction as integrated circuits and other high technology electronic parts. The "nuts and bolts" side of electronics construction is perhaps a little less intimidating for the beginner than the pure electronics aspect, since the items concerned are low-tech and in many cases mundane. It is still something that should be approached with some care and thought though, if the finished article is to achieve a high standard.

Do not worry if finished projects do not look like professionally produced items. In order to compete with ready-made gadgets in this respect it would be necessary for the electronics to take second place, and for the mechanical finishing to be allotted the lion's share of the construction time (and possibly the available funds as well). Most constructors are primarily interested in the electronics, and reasonably aim for no more (and no less) than a neat and functional piece of equipment without the frills of modern ready-made electronic gadgets. This is something that anyone reasonably practical should be able to achieve after learning a few simple skills.

## BOARD MOUNTING

The mechanical construction of most projects just boils down to mounting the circuit board inside the case, fitting the controls on the front panel, and then adding a few finishing touches. In this article we will only deal with the basics of board and control mounting, starting with circuit board mounting. The board could simply be bolted in place, and either 6BA or M3 screws are suitable for this purpose. There is a slight problem with this approach, and it is caused by the soldered joints protruding on the underside of the board. This has the effect of causing the board to buckle as the mounting nuts are tightened, since the board in the immedi-

ate vicinity of the mounting nuts will be forced against the case, but elsewhere the joints will hold the board slightly clear of the case as shown in Fig. 1(a). Stresses placed on the board will not necessarily cause any damage, but at best it will do nothing for the reliability of the unit, and at worst the board will shatter, making it necessary to remove every component and fit them onto a new circuit board. This problem can be avoided simply by adding an extra nut under the board as a spacer (b).

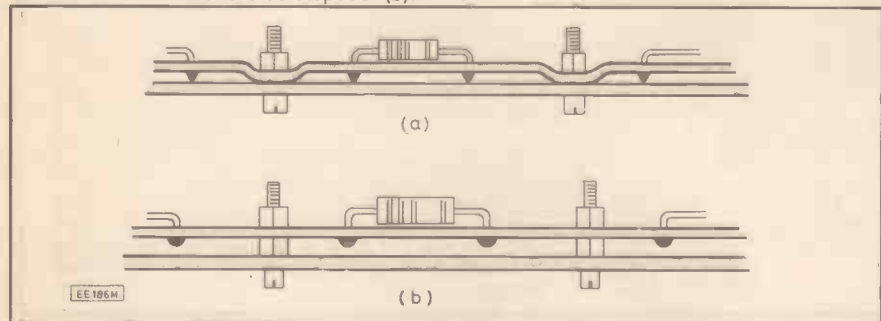

If the part of the case on which the board is mounted is made of metal, then it is essential to have the board mounted well clear of the casing. Otherwise the connections on the underside of the board will be short circuited through the case. I would recommend the use of spacers no less than about six millimetres in length, fitted in the way shown in Fig. 2(a). There are two types of spacer, the plain and the threaded types. The plain types simply slip over the mounting bolts, whereas the threaded type have to be screwed on like a nut. Where there are several mounting bolts which are well spread out it can be difficult to hold everything in place while the mounting nuts are fitted when using the plain type. Threaded spacers avoid this problem, but the positions of the mounting holes in the case must be drilled very accurately or it could be difficult to fit the board onto the bolts.

An alternative to using nuts, bolts, and spacers is to use the plastic mounting pillars that are now readily available. These

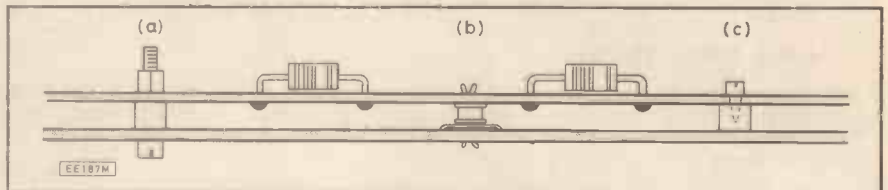

Fig. 2. Various types of spacer materials are available to ensure that the connections are clear of the case. Metal (a), plastic (b), moulded (c).

just clip into the holes drilled in the case and the board as shown in Fig. 2(b), and the board can be unclipped when required. This may seem like the ideal solution, but

the mounting holes have to be precisely the correct diameter if this system is to work well, and by the nature of things the mounting is less reliable than that provided by nuts and bolts. Plastic mounting pillars are also likely to be slightly more expensive. With something like this it is probably best to try both methods to determine which one suits you best overall. Some cases have built in mounting pillars, and a few designs utilize these. The board is mounted on these using self-tapping screws (usually supplied with the case) as shown in Fig. 2(c).

There is actually another and totally different method of board mounting, and one which seems to be gaining in popularity. This is to fit the board into guide rails moulded into the case. This obviously only applies where a plastic case having the moulded guide rails is used, and the circuit board has been designed to fit these rails. The only difficulty with this method is that the board must be accurately cut to size if it is to fit into the rails properly. If you buy a ready-made board there should be no problem, but if you make your own or use stripboard then accurate cutting is essential. Cutting the board marginally too large is not a major blunder, since it can be filed down to size. On the other hand, making the board fractionally too small will result in it tending to slip out of the guide rails, and the only solution might then be to resort to some other method of mounting.

Probably the easiest way of marking the positions of the mounting holes on the case is to use the board itself as a sort of template. In order to produce good drilling accuracy it is a good idea to make indentations at the centres of the required holes using a sharp pointed tool such as a bradawl, and then drill small (about 1.5 millimetre diameter) guide holes before drilling the full-size mounting holes. 3.2 or 3.3 millimetre diameter holes are suitable for M3 and 6BA mounting screws.

If the heads of the board's mounting bolts are on the underside of the case, I would strongly recommend that a set of cabinet feet should be fitted to the case

(the small self-adhesive type will suffice). If this is not done there is a danger of the screws scratching any surface on which the project is placed.

## CONTROLS

Usually controls are mounted directly on the front panel. There is a system which uses a dummy front panel to conceal the mounting nuts for the controls, but this was never used widely in home-constructor designs, and is not normally worthwhile these days as most control knobs have a recess to conceal the mounting nut. The standard size of mounting hole for controls is 10 millimetres in diameter.

*Robert Penfold*

### JANUARY 1985 TO DECEMBER 1985

Pages	Issue	Pages	Issue
1-64	January	353-408	July
65-128	February	409-464	August
129-184	March	465-520	September
185-240	April	521-576	October
241-296	May	577-632	November
297-352	June	633-688	December

### CONSTRUCTIONAL PROJECTS

ACROSS THE RIVER <i>by W. D. Philips BSc, PhD</i>	317	LIGHTING INTERFACE, POWER	8
ALARM, CARAVAN	504	LIGHTS CONTROL, CARAVAN	288
ALARM, FIBRE-OPTIC	220	LIGHTS FLASHER, EMERGENCY	400
ALARM, FRIDGE	482	LOAD SIMPLIFIER <i>by A. Flind</i>	98
ALFRED HOBBY ROBOT <i>by Alan Green</i>	44	LOGIC PROBE, TTL	668
AMPLIFIER, AMSTRAD CPC464	248		
AMPLIFIER, SIMPLE AUDIO	625	MAGNETIC FLUX DENSITY AMPLIFIER	614
AMPLIFIER, SPECTRUM	34	MAINS MONITOR <i>by A. R. Winstanley</i>	110
AMSTRAD CPC464 AMPLIFIER <i>by P. Dooley</i>	248	MASK, SCREAMING	589
AMSTRAD USER PORT <i>by R. A. Penfold</i>	360	MICROPHONE PREAMPLIFIER <i>by R. A. Penfold</i>	48
ASTABLE TEST-BED	338	MODEL RAILWAY POINTS CONTROLLER	
AUTO PHASE <i>by R. A. Penfold</i>	260	<i>by R. A. Penfold</i>	142
		MODEL TRAIN CONTROLLER, COMPUTERISED	72
BAT, SQUEAKING	586	MONOSTABLE TEST BED	338
BISTABLE TEST-BED	338	MULTIMETER, HIGH IMPEDANCE	308
BRIDGE, UNIVERSAL LCR	604		
		NASCOM PRINTER HANDSHAKE <i>by G. D. Southern</i>	396
CAMERA SHUTTER TESTER, COMPUTERISED	320	NICAD CHARGER <i>by J. R. W. Barnes</i>	158
CAPACITANCE METER	640		
CARAVAN ALARM <i>by T. R. de Vaux Balbirnie</i>	504	OPTICAL INTENSITY TRANSDUCER	672
CARAVAN INDICATOR CONTROL			
<i>by T. R. de Vaux Balbirnie</i>	228	PERSONAL STEREO PSU <i>by T. R. de Vaux Balbirnie</i>	490
CARAVAN PSU <i>by T. R. de Vaux Balbirnie</i>	326	PHASER, AUTO	260
CB FIELD STRENGTH METER <i>by T. R. de Vaux Balbirnie</i>	392	POINTS CONTROLLER, MODEL RAILWAY	142
CHARGER, NICAD	158	POWER CUTS WARNING	110
COMPUTERISED SHUTTER TIMER <i>by R. A. Penfold</i>	320	POWER LIGHTING INTERFACE <i>by M. P. Horsey</i>	8
COMPUTERISED TRAIN CONTROLLER <i>by R. A. Penfold</i>	72	POWER SUPPLY UNIT, LOW COST	424
CONTINUITY TESTER <i>by A. R. Winstanley</i>	364	POWER SUPPLY UNIT, PERSONAL STEREO	490
CYBERVOX ROBOT VOICE <i>by M. H. Becker</i>	192	PREAMPLIFIER INPUT SELECTOR, RIAA	510
		PREAMPLIFIER, MICROPHONE	48
DIODE TESTER, TRANSISTOR/	660	PRINTER HANDSHAKE, NASCOM	396
DIGITAL CAPACITANCE METER <i>by Mark Stuart</i>	640	PROBE, VOLTAGE	252
DOORBELL, ELECTRONIC	346	PSU CARAVAN	326
DRILL CONTROL UNIT <i>by A. R. Winstanley</i>	432	PUMPKIN, FLASHING	584
DUAL-RAIL POWER SUPPLY	424		
		REGULATOR, VOLTAGE	480
ELECTRONIC DOORBELL <i>by L. S. Cook</i>	346	RESISTANCE THERMOMETER	500
EMERGENCY LIGHTS FLASHER <i>by M. G. Argent</i>	400	REVERB, SOLID STATE	90
EXPERIMENTER'S TEST BED <i>by Stephen Ibbs</i>	338	REVERB UNIT <i>by John M. H. Becker</i>	528,670
EXPOSURE UNIT, UV	472	RIAA PREAMPLIFIER INPUT SELECTOR <i>by R. A. Penfold</i>	510
		ROBOT, ALFRED	44
FIBRE ALARM <i>by Gideon Tearle</i>	220	ROBOT VOICE, CYBERVOX	192
FIELD STRENGTH METER, CB	392		
FLASHING PUMPKIN	584	SCREAMING MASK	589
FRIDGE ALARM <i>by R. A. Penfold</i>	482	SEMICONDUCTOR TEMPERATURE SENSOR	502
		SIMPLE AUDIO AMPLIFIER	625
GAME, ACROSS THE RIVER	317	SOLID STATE REVERB <i>by Mark Stuart</i>	90
GAMES TIMER <i>by W. English</i>	30	SPECTRUM AMPLIFIER <i>by Mark Stuart</i>	34
GRAPHIC EQUALISER <i>by R. A. Penfold</i>	304	SQUEAKING BAT	586
		STEPPER MOTOR INTERFACE	418
HALLOWEEN PROJECTS <i>by R. A. Penfold</i>	584	STORAGE HEATER SETTING INDICATOR <i>by T. A. Priest</i>	172
HEADLIGHT ACTIVATED SWITCH		SWITCH, HEADLIGHT ACTIVATED	136
<i>by T. R. de Vaux Balbirnie</i>	136		
HEATER CONTROLLER, IMMERSION	230	TEMPERATURE SENSOR, SEMICONDUCTOR	502
HIGH IMPEDANCE MULTIMETER <i>by L. S. Cook</i>	308	TESTER, CONTINUITY	364
		TESTER, INSULATION	200
IMMERSION HEATER CONTROL		THERMOMETER, RESISTANCE	500
<i>by T. R. de Vaux Balbirnie</i>	230	THERMOMETER, TRI-STATE	454
INPUT SELECTOR, RIAA PREAMPLIFIER	510	TIMER, GAMES	30
INSULATION TESTER <i>by Mark Stuart</i>	200	TRAIN CONTROLLER, COMPUTERISED	72
INTERFACE, POWER LIGHTING	24	TRAIN SIGNAL CONTROLLER <i>by A. P. Donleavy</i>	382
INTERFACE, STEPPER MOTOR	418	TRANSISTOR/DIODE TESTER	660
		TREMOLO/VIBRATO <i>by R. A. Penfold</i>	441
KARNAUGH MAP	8	TRI-STATE THERMOMETER <i>by T. R. de Vaux Balbirnie</i>	454
		TRUTH TABLE DISPLAY <i>by O. J. Bruere</i>	192
LCR BRIDGE, UNIVERSAL	604	TTL LOGIC PROBE	668
LED VOLTAGE PROBE	252		

UNIVERSAL LCR BRIDGE <i>by Michael Tooley BA &amp; David Whitfield MA, MSc, CEng, MIEE</i>	604	VOICE, CYBERVOX ROBOT	192
USER PORT, AMSTRAD	360	VOLTAGE PROBE <i>by R. A. Penfold</i>	252
UV EXPOSURE UNIT <i>by C. J. Bowes</i>	472	VOLTAGE REGULATOR	480
VIBRATO/TREMOLO	441	WASHING MACHINE ALERT <i>by A. Robson</i>	52

### SPECIAL SERIES

ACTUALLY DOING IT <i>by Mike Abbott &amp; Robert Penfold</i>	394, 427, 507, 565, 627, 682	2—Alexandre Volta	458
CIRCUIT EXCHANGE 35, 56, 120, 169, 210, 341, 371, 398		3—André Marie Ampère	514
COMPUTER CLUB	96, 212, 324, 436	4—Charles Augustin de Coulomb	620
DIGITAL ELECTRONICS <i>by D. W. Crabtree</i>	20, 114, 175, 226, 282	5—James Watt	666
4—Clock systems and bistables	20	ON SPEC <i>by Mike Tooley BA</i>	155, 214, 258, 314, 366, 448, 494, 550, 618
5—Counting systems in electronics	114	1—Introduction	155
6—Memory devices and numbering system	175	2—4-Channel Intruder Alarm Interface	214
7—Computer design considerations	226	3—Sensors and Signal Generator	258
8—Putting computers to practical use	282	4—4-Channel Output Interface	314
ELECTRONICS BUILDING BLOCKS <i>by Richard Barron</i>	422, 478, 569, 624	5—Using the O/P Interface	366
1—Introduction and Power Supplies	422	6—Joystick Interface	448
2—Voltage references	478	7—Digital-to-Analogue	494
3—Series RC circuit, time delays and oscillators	569	8—Camera Shutter Speed Tester	550
4—Transistor and operational amplifiers	624	9—Audio and Video Upgrade	618
5—Op-amps and logic	668	10—Machine Code and an ADC for the Spectrum	664
FAULT FINDING <i>by E. A. Rule</i>	54, 104, 170, 218, 276	SPECIAL REPORTS	16, 316, 386, 429, 451
3—Fault analysis on newly built equipment	54	Amstrad CPC464 Microcomputer <i>by David Shortland</i>	16
4—Multimeter, signal generator and oscilloscope techniques	104	Currah Microspeech <i>by Mike Tooley BA</i>	386
5—Locating the notorious intermittent fault	170	Microprofessor MPF 1/88 <i>by Mike Tooley BA</i>	429
6—Cassette player problems and remedies	218	Robotek I/O for the Spectrum <i>by Mike Tooley BA</i>	316
7—Service aids and aerosols	276	Spectrum Disc Operating System <i>by Mike Tooley BA</i>	451
FUNTRONICS <i>by Thakery</i>	32, 156, 286, 380, 492, 622	SQUARE ONE	42, 123
4—The battery	32	Atoms and Electricity	42
5—Radio Control—1	156	Electricity	123
6—Radio Control—2	286	TEACH-IN '86 <i>by Michael Tooley BA &amp; David Whitfield MA, MSc, MIEE</i>	531, 594
7—Radio Control—3	380	1—Basic principles, a.c./d.c., voltages, resistance	531
8—Aerials	492	2—Resistance, capacitance, inductance and the Wheatstone bridge	594
9—TV—How It Works Pt 1	622	3—Introduction to the transistor	649
10—TV—How It Works Pt 2	676	TRANSDUCERS <i>by Mike Feather</i>	499, 556, 613
MAN BEHIND THE SYMBOL <i>by Morgan Bradshaw</i>	378, 458, 514, 620	1—Resistance Thermometer; Semiconductor Thermal Indicator	499
1—Benjamin Franklin	378	2—Strain gauge measurement techniques	556
		3—Measuring magnetic strength	613

### GENERAL FEATURES

BOOK REVIEWS	49, 330, 398	NEW PRODUCTS	38, 88, 164, 235, 291, 344, 370, 398, 460, 516, 572
COMPARATORS <i>by T. Prichard</i>	78	PLEASE TAKE NOTE	49, 169, 284, 403
CONSUMER ELECTRONICS SHOW CHICAGO <i>by Rik Hooper</i>	486	Computer Club (Feb '85)	169
COUNTER INTELLIGENCE <i>by Paul Young</i>	58, 112, 179, 229, 281, 343, 395, 450, 515, 629, 670	Digital Electronics Pt 5 (Feb '85)	284
DOWN TO EARTH <i>by George Hylton</i>	209, 280, 332, 379, 459, 508	Doorchime (Dec '84)	49, 169
EDITORIAL	7, 71, 135, 191, 247, 303, 359, 415, 471, 527, 583, 639	Headlight Activated Switch (Mar '85)	284
EVERYDAY NEWS	36, 102, 162, 216, 274, 328, 388, 438, 496, 566, 612, 678	Immersion Heater Controller (April '85)	403
FOR YOUR ENTERTAINMENT <i>by Barry Fox</i>	52, 87, 149, 224, 278, 311, 385, 447, 498, 567, 592, 648	Mini Workshop Power Supply (Dec '84)	169
MAKING PRINTED CIRCUIT BOARDS <i>by Stephen Ibbs</i>	204	Motorcycle Codelock (Circuit Exchange—Feb '85)	284
MONOSTABLES—BISTABLES—ASTABLES <i>by Stephen Ibbs</i>	334	Sound Operated Flash (Sept '84)	284
		PRINTED CIRCUIT BOARD SERVICE	50, 124, 180, 236, 292, 348, 404, 461, 517, 573, 628, 680
		RADIO WORLD <i>by Pat Hawker G3VA</i>	40, 107
		SHOPTALK	18, 84, 146, 199, 256, 312, 377, 421, 477, 554, 602, 646
		SOLITONS <i>by George Hylton</i>	403
		STEPPING MOTORS <i>by Mark Stuart</i>	416
		TOUCH SWITCHES <i>by Owen Bishop</i>	342

### BUYERS' GUIDES and SPECIAL OFFERS

CHRISTMAS GIFTS	656	MULTIMETERS	264
MAINS ADAPTOR (Special Offer)	539	SMALL TOOLS	608
MONITORS	150	SOLDERING INSTRUMENTS	542



# EVERYDAY ELECTRONICS and computer PROJECTS

Reach effectively and economically today's enthusiasts anxious to know of your products and services through our semi-display and classified pages. Semi-display spaces may be booked at £8-19 per single column centimetre (minimum 2.5cm). The prepaid rate for classified advertisements is 35 pence per word (minimum 12 words), box number 60p extra. All cheques, postal orders, etc., to be made payable to Everyday Electronics and Computer Projects and crossed "Lloyds Bank Ltd." Treasury notes should always be sent registered post. Advertisements, together with remittance, should be sent to the Classified Advertisement Department, Everyday Electronics and Computer Projects, Room 2612, IPC Magazines Limited, King's Reach Tower, Stamford St., London SE1 9LS. (Telephone 01-261 5846).

## Receivers & Components

TURN YOUR SURPLUS capacitors, transistors etc., into cash. Contact COLES HARDING & CO., 103 South Brink, Wisbech, Cambs. 0945-584188. Immediate settlement.

VHF MICRO TRANSMITTER. Super sensitive 90-110 MHz, good range & stable frequency. 9V operation, ready built & tested £12.50. Micro transmitter housed in a normal 2 way mains adaptor (which still functions as a 2 way adaptor) £25.00 (inc VAT). ELECTRONIC SERVICES, 69 Fistril Crescent, Stalybridge, Cheshire SK15 3HN.

## For Sale

FREQUENCY COUNTER HPS381A 80MHz. As new. What offers? Phone 0249 815889.

## Service Sheets

BELL'S TELEVISION SERVICE for service sheets on Radio, TV etc £1.50 plus SAE. Service Manuals on Colour TV and Video Recorders, prices on request, SAE with enquiries to BTS, 190 Kings Road, Harrogate, N. Yorkshire. Tel. 0423 55885.

SOLE SUPPLIERS TV/Video repair manuals/circuits. 1000s s/manuals supplied by return. S/sheets £2.50 except CTV/M. centres/stereos £3.50 LSAE with every order/query please brings free pricelist/magazine inc s/sheet - or phone 0698 884585 (883334 outwith business hours) TIS(EE) 76 Church Street Larkhall Lanarkshire.

## Disco

AUTOMATIC DISCO LIGHTS plug into 240V ac and have sound to light. No connections to amplifier required. Supplied in black rexine covered box with bulbs (up to 60W per channel) £39.95 plus £2.50 p&p (inc VAT). ELECTRONIC SERVICES, 69 Fistril Crescent, Stalybridge, Cheshire SK15 3HN.

## Wanted

WANTED: Apple real time clock software. Telephone 05255 2918 reverse charges. Cash payment.

## Miscellaneous

THE SCIENTIFIC WIRE COMPANY 11 Forest Road, London E17. Telephone 01-531 1568				
ENAMELLED COPPER WIRE				
SWG	1 lb	8 oz	4 oz	2 oz
8 to 34	3.63	2.09	1.10	0.88
35 to 39	3.82	2.31	1.27	0.93
40 to 43	6.00	3.20	2.25	1.61
44 to 47	8.67	5.80	3.49	2.75
48	15.96	9.58	6.38	3.69
SILVER PLATED COPPER WIRE				
14 to 30	9.09	5.20	2.93	1.97
TINNED COPPER WIRE				
14 to 30	3.97	2.41	1.39	0.94
Fluxcore				
Solder	5.90	3.25	1.82	0.94

Prices include P&P VAT. Orders under £2 add 20p.  
SAE for list of copper and resistance wire.  
Dealer enquiries welcome.

## Miscellaneous - Cont.

LEARN  
**ELECTRONICS WITHOUT  
SOLDER**

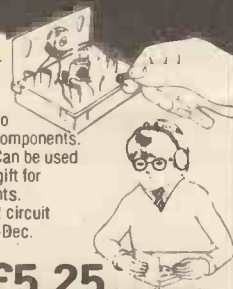

Build electronic circuits without solder on a Roden S-Dec. This has built-in contacts and holes into which you plug your components. Suitable for all ages. Can be used time after time. Ideal gift for students or experiments. Full Instructions and 2 circuit diagrams with each S-Dec.

Send Cheque or P.O. to:  
Roden Products, Dep EE  
High March, Daventry,  
Northants, NN11 4QE.

**£5.25** including p & p

## Computing

### MOST ADVANCED COMPUTER TAPE EVER ADVERTISED FOR 48K SPECTRUM

Fair sale circuitry at sophisticated levels for business and hobbyists. Input specification required and output is circuit diagram and PCB layout, and box and construction details in full when required. All components available from MAPLIN. Send £18.00 inclusive of post and packing to the following address:

N. J. Edwards  
68 Woodhill Rise, Costessey, Norwich

## ORDER FORM PLEASE WRITE IN BLOCK CAPITALS

Please insert the advertisement below in the next available issue of **Everyday Electronics** for ..... Insertions. I enclose Cheque/P.O. for £ .....  
(Cheques and Postal Orders should be crossed Lloyds Bank Ltd. and made payable to Everyday Electronics)

HEADING REQUIRED:

NAME .....  
ADDRESS .....

### EVERYDAY ELECTRONICS and COMPUTER PROJECTS

Classified Advertisement Dept, H.H.,  
King's Reach Tower, Stamford Street, London SE1 9LS  
Telephone 01-261 5846

Rate: 35p per word, minimum 12 words. Box No. 60p extra.



# GREAT NEW ADVENTURE GAME...

## SHINDERG'S TOMB IN PROTEUS No. 3.

A complete fantasy adventure game magazine for the young and for the young at heart! To play the game you just need dice, pencil and paper, plus lots of concentration and luck. This futuristic fantasy set in 2058 A.D. will keep the kids quiet for hours.

# FREE POSTER

FULL-COLOUR (approx. 40 x 29cms)

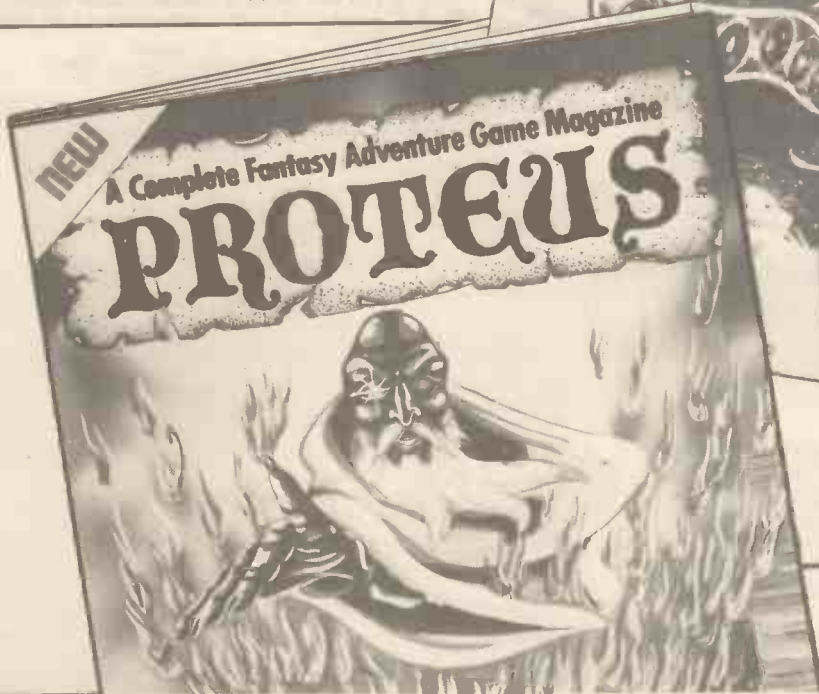

**No. 3  
OUT NOW  
ONLY 80p**

Britain's least expensive  
fantasy adventure  
game magazine

**IDEAL STOCKING  
FILLER**

# What's new in scanning receivers

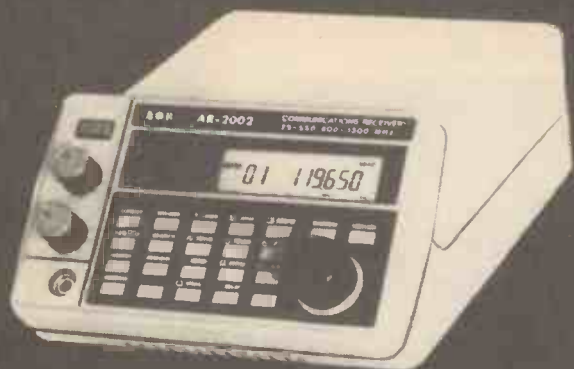

The latest developments and a review of the AR 2002

## PLUS

- \* **Christmas Presents**  
Radio accessories, tools and test equipment for the radio amateur.
- \* **Broadside and Endfire Antenna Systems Part 2:** the use of half-wave elements or radiators.

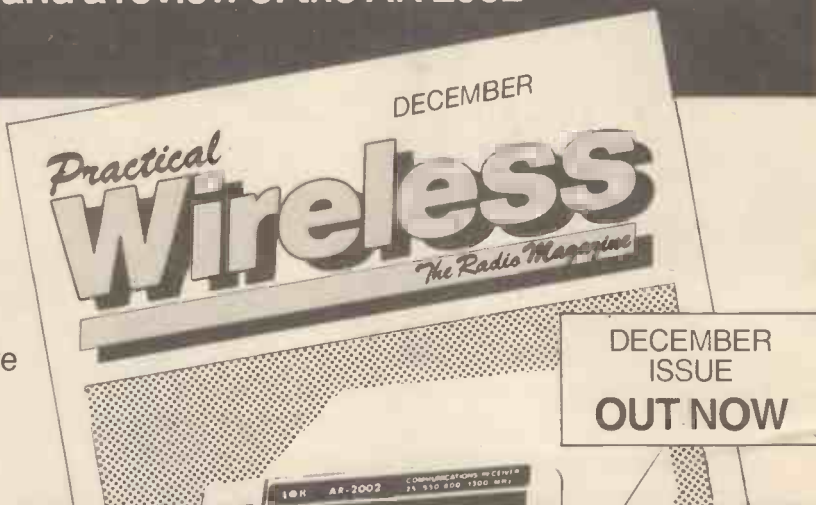

## MAIL ORDER ADVERTISING

### British Code of Advertising Practice

Advertisements in this publication are required to conform to the British Code of Advertising Practice. In respect of mail order advertisements where money is paid in advance, the code requires advertisers to fulfil orders within 28 days, unless a longer delivery period is stated. Where goods are returned undamaged within seven days, the purchaser's money must be refunded. Please retain proof of postage/despatch, as this may be needed.

### Mail Order Protection Scheme

If you order goods from Mail Order advertisements in this magazine and pay by post in advance of delivery, EVERYDAY ELECTRONICS will consider you for compensation if the Advertiser should become insolvent or bankrupt, provided:

- (1) You have not received the goods or had your money returned; and
- (2) You write to the Publisher of EVERYDAY ELECTRONICS summarising the situation not earlier than 28 days from the day you sent your order and not later than two months from that day.

Please do not wait until the last moment to inform us. When you write, we will tell you how to make your claim and what evidence of payment is required.

We guarantee to meet claims from readers made in accordance with the above procedure as soon as possible after the Advertiser has been declared bankrupt or insolvent.

This guarantee covers only advance payment sent in direct response to an advertisement in this magazine not, for example payment made in response to catalogues etc, received as a result of answering such advertisements. Classified advertisements are excluded.

## INDEX TO ADVERTISERS

ALCON INSTRUMENTS .....	636
ARMON ELECTRONICS .....	635
AUDIO ELECTRONICS .....	637
BENNING CROSS .....	675
B K ELECTRONICS .....	Cover III
B.N.R.E.S. ....	637
BREWSTER, S. & R. ....	645
BULL, J. ....	Cover II
CAMBRIDGE LEARNING .....	635
CIRKIT HOLDINGS .....	671
C P L ELECTRONICS .....	675
CRICKLEWOOD ELECTRONICS .....	634
CROYDON DISCOUNT ELECTRONICS .....	679
ELECTROVALUE .....	635
GRANDATA .....	679
GREENWELD .....	634
ICS INTERTEXT .....	636
KEMPLANT .....	675
LONDON ELECTRONICS COLLEGE .....	645
MAGENTA ELECTRONICS .....	638
MAPLIN ELECTRONICS .....	Cover IV
MARCO TRADING .....	679
MARSHALLS .....	663
PHONOSONICS .....	636
RADIO COMPONENT SPECIALISTS .....	647
RAPID ELECTRONICS .....	685
RISCOMPLTD .....	645
T.K. ELECTRONICS .....	637
UNIVERSAL SEMICONDUCTOR DEVICES LTD. ....	634
WEST HYDE DEVELOPMENTS .....	634

# OMP POWER AMPLIFIER MODULES

\* PRICES INCLUDE V.A.T. \* PROMPT DELIVERIES \* FRIENDLY SERVICE \* LARGE S.A.E. 28p STAMP FOR CURRENT LIST

## OMP POWER AMPLIFIER MODULES

Now enjoy a world-wide reputation for quality, reliability and performance at a realistic price. Four models available to suit the needs of the professional and hobby market. i.e. Industry, Leisure, Instrumental and Hi-Fi, etc. When comparing prices, NOTE all models include Toroidal power supply, Integral heat sink, Glass fibre P.C.B., and Drive circuits to power compatible Vu meter. Open and short circuit proof. **Supplied ready built and tested.**



**OMP 100 Mk II Bi-Polar Output power 110 watts R.M.S. into 4 ohms, Frequency Response 15Hz - 30KHz -3dB, T.H.D. 0.01%, S.N.R. -118dB, Sens. for Max. output 500mV at 10K, Size 355 X 115 X 65mm. PRICE £33.99 + £3.00 P&P.**



**OMP/MF100 Mos-Fet Output power 110 watts R.M.S. into 4 ohms, Frequency Response 1Hz - 100KHz -3dB, Damping Factor 80, Slew Rate 45V/uS, T.H.D. Typical 0.002%, Input Sensitivity 500mV, S.N.R. -125dB, Size 300 X 123 X 60mm. PRICE £39.99 + £3.00 P&P.**



**OMP/MF200 Mos-Fet Output power 200 watts R.M.S. into 4 ohms, Frequency Response 1Hz - 100KHz -3dB, Damping Factor 250, Slew Rate 50V/uS, T.H.D. Typical 0.001%, Input Sensitivity 500mV, S.N.R. -130dB, Size 300 X 150 X 100mm. PRICE £62.99 + £3.50 P&P.**



**OMP/MF300 Mos-Fet Output power 300 watts R.M.S. into 4 ohms, Frequency Response 1Hz - 100KHz -3dB, Damping Factor 350, Slew Rate 60V/uS, T.H.D. Typical 0.0008%, Input Sensitivity 500mV, S.N.R. -130dB, Size 330 X 147 X 102mm. PRICE £79.99 + £4.50 P&P.**

NOTE: Mos-Fets are supplied as standard (100KHz bandwidth & Input Sensitivity 500mV). If required, P.A. version (50KHz bandwidth & Input Sensitivity 775mV). Order — Standard or P.A.



**Vu METER** Compatible with our four amplifiers detailed above. A very accurate visual display employing 11 L.F.D. diodes (7 green, 4 red) plus an additional on/off indicator. Sophisticated logic control circuits for very fast rise and decay times. Tough moulded plastic case, with tinted acrylic front. Size 84 X 27 X 45mm. **PRICE £8.50 + 50p P&P.**

## LOUDSPEAKERS 5" to 15" up to 400 WATTS R.M.S. Cabinet Fixing in stock. Huge selection of McKenzie Loudspeakers available including Cabinet Plans. Large S.A.E. (28p) for free details.

**POWER RANGE**  
 8" 50 WATT R.M.S. Hi-Fi/Disco.  
 20 oz. magnet. 1 1/2" ally voice coil. Ground ally fixing escutcheon. Res. Freq. 40Hz. Freq. Resp. to 6KHz. Sens. 92dB. PRICE £10.99 available with black grille £11.99 P&P £1.50 ea.  
 12" 100 WATT R.M.S. Hi-Fi/Disco  
 50 oz. magnet. 2" ally voice coil. Ground ally fixing escutcheon. Die-cast chassis. White cone. Res. Freq. 25Hz. Freq. Resp. to 4KHz. Sens. 95dB. PRICE £28.60 + £3.00 P&P ea.

**McKENZIE**  
 12" 85 WATT R.M.S. C1285GP Lead guitar/keyboard/Disco.  
 2" ally voice coil. Ally centre dome. Res. Freq. 45Hz. Freq. Resp. to 6.5KHz. Sens. 98dB. PRICE £28.76 + £3.00 P&P ea.  
 12" 85 WATT R.M.S. C1285TC P.A./Disco 2" ally voice coil. Twin cone.  
 Res. Freq. 45Hz. Freq. Resp. to 14KHz. PRICE £29.80 + £3.00 P&P ea.  
 15" 150 WATT R.M.S. C15 Bass Guitar/Disco.  
 3" ally voice coil. Die-cast chassis. Res. Freq. 40Hz. Freq. Resp. to 4KHz. PRICE £54.99 + £4.00 P&P ea.  
 10" 60 WATT R.M.S. 1060GP Gen. Purpose/Lead Guitar/Keyboard/Mid. P.A.  
 2" voice coil. Res. Freq. 75Hz. Freq. Resp. to 7.5KHz. Sens. 99dB. PRICE £19.15 + £2.00 P&P.  
 10" 200 WATT R.M.S. C10200GP Guitar, Keyboard, Disco.  
 2" voice coil. Res. Freq. 45Hz. Freq. Resp. to 7KHz. Sens. 101dB. PRICE £51.00 + £3.00 P&P.  
 15" 200 WATT R.M.S. C15200 High Power Bass.  
 Res. Freq. 40Hz. Freq. Resp. to 5KHz. Sens. 101dB. PRICE £59.45 + £4.00 P&P.  
 15" 400 WATT R.M.S. C15400 High Power Bass.  
 Res. Freq. 40Hz. Freq. Resp. to 4KHz. Sens. 102dB. PRICE £85.00 + £4.00 P&P.

**WEM**  
 5" 70 WATT R.M.S. Multiple Array Disco etc.  
 1" voice coil. Res. Freq. 52Hz. Freq. Resp. to 5KHz. Sens. 89dB. PRICE £19.99 + £1.50 P&P ea.  
 8" 150 WATT R.M.S. Multiple Array Disco etc.  
 1" voice coil. Res. Freq. 48Hz. Freq. Resp. to 5KHz. Sens. 92dB. PRICE £29.49 + £1.50 P&P ea.  
 10" 300 WATT R.M.S. Disco/Sound re-enforcement etc.  
 1 1/2" voice coil. Res. Freq. 35Hz. Freq. Resp. to 4KHz. Sens. 92dB. PRICE £33.49 + £2.00 P&P ea.  
 12" 300 WATT R.M.S. Disco/Sound re-enforcement etc.  
 1 1/2" voice coil. Res. Freq. 35Hz. Freq. Resp. to 4KHz. Sens. 94dB. PRICE £41.49 + £3.00 P&P ea.

**SOUNDLAB (Full Range Twin Cone)**  
 5" 60 WATT R.M.S. Hi-Fi/Multiple Array Disco etc.  
 1" voice coil. Res. Freq. 63Hz. Freq. Resp. to 20KHz. Sens. 86dB. PRICE £9.99 + £1.00 P&P ea.  
 6 1/2" 60 WATT R.M.S. Hi-Fi/Multiple Array Disco etc.  
 1" voice coil. Res. Freq. 56Hz. Freq. Resp. to 20KHz. Sens. 89dB. PRICE £10.99 + £1.50 P&P ea.  
 8" 60 WATT R.M.S. Hi-Fi/Multiple Array Disco etc.  
 1 1/4" voice coil. Res. Freq. 38Hz. Freq. Resp. to 20KHz. Sens. 89dB. PRICE £12.99 + £1.50 P&P ea.  
 10" 60 WATT R.M.S. Hi-Fi/Disco etc.  
 1 1/4" voice coil. Res. Freq. 35Hz. Freq. Resp. to 15KHz. Sens. 89dB. PRICE £16.49 + £2.00 P&P

## PAFTEC HOBBY KITS. Proven designs including glass fibre printed circuit board and high quality components complete with instructions.

**FM MICROTRANSMITTER (BUG)** 90/105MHz with very sensitive microphone. Range 100/300 metres. 57 x 46 x 14mm (9 volt) Price: £8.62 + 75p P&P.  
**3 WATT FM TRANSMITTER** 3 WATT 85/115MHz varicap controlled professional performance. Range up to 3 miles 35 x 84 x 12mm (12 volt) Price: £14.49 + 75p P&P.  
**SINGLE CHANNEL RADIO CONTROLLED TRANSMITTER/RECEIVER** 27MHz. Range up to 500 metres. Double coded modulation. Receiver output operates relay with 2amp/240 volt contacts. Ideal for many applications. Receiver 90 x 70 x 22mm (9/12 volt). Price: £17.82 Transmitter 80 x 50 x 15mm (9/12 volt). Price: £11.29 P&P + 75p each. S.A.E. for complete list.



3 watt FM Transmitter

## BURGLAR ALARM

Better to be 'Alarmed' than terrified. Thandar's famous 'Minder' Burglar Alarm System. Superior microwave principle. Supplied as three units, complete with interconnection cable. **FULLY GUARANTEED.**  
**Control Unit** — Houses microwave radar unit, range up to 15 metres adjustable by sensitivity control. Three position, key operated fascia switch — off — test — armed. 30 second exit and entry delay.  
**Indoor alarm** — Electronic swept freq. siren. 104dB output.  
**Outdoor Alarm** — Electronic swept freq. siren. 98dB output. Housed in a tamper-proof heavy duty metal case.  
 Both the control unit and outdoor alarm contain rechargeable batteries which provide full protection during mains failure. Power requirement 200/260 Volt AC 50/60Hz. Expandable with door sensors, panic buttons etc. Complete with instructions.  
**SAVE £138.00** Usual Price £228.85  
**BKE's PRICE £89.99 + £4.00 P&P**  
 ? Why buy a collection of self-assembly boards!

IDEAL for Workshops, Factories, Offices, Home, etc. Supplied ready built.



## OMP LINNET LOUDSPEAKERS

The very best in quality and value. Made specially to suit today's need for compactness with high sound output levels. Finished in hard wearing black vinyl with protective corners, grille and carry handle. All models 8 ohms. Full range 45Hz - 20KHz. Size 20" X 15" X 12". Watts R.M.S. per cabinet. Sensitivity 1W. 1mtr. dB.

**OMP 12-100 Watts 100dB. Price £149.99 per pair.**  
**OMP 12-200 Watts 102dB. Price £199.99 per pair.** Delivery: Securicor £8.00 per pair



## OMP 19" STEREO RACK AMPS



**Professional 19" cased Mos-Fet stereo amps. Used the World over in clubs, pubs, discos etc. With twin Vu meters, twin toroidal power supplies, XLR connections. MF600 Fan cooled. Three models (Ratings R.M.S. into 4ohms). Input Sensitivity 775mV**  
**MF200 (100 + 100)W. £169.00 Securicor**  
**MF400 (200 + 200)W. £228.85 Delivery**  
**MF600 (300 + 300)W. £274.85 £10.00**

## 1 K-WATT SLIDE DIMMER

\* Control loads up to 1Kw  
 \* Compact Size 4 1/2" X 1" X 2 1/2"  
 \* Easy snap in fixing through panel/cabinet cut out  
 \* Insulated plastic case  
 \* Full wave control using 8 amp triac  
 \* Conforms to BS800  
 \* Suitable for both resistive and inductive loads. Innumerable applications in industry, the home, and disco's, theatres etc.  
**PRICE £13.99 + 75p P&P**

## BSR P295 ELECTRONIC TURNTABLE

\* Electronic speed control 45 & 33 1/3 r.p.m. \* Plus/Minus variable pitch control \* Belt driven \* Aluminium platter with strobed rim \* Cue lever \* Anti-skate (bias device) \* Adjustable counter balance \* Manual arm \* Standard 1/2" cartridge fixings \* Supplied complete with cut out template \* D.C. Operation 9-14v O.C. 65mA  
**Price £36.99 — £3.00 P&P.**



ADC Q4 mag. cartridge for above. Price £4.99 ea. P&P 50p.

## PIEZO ELECTRIC TWEETERS — MOTOROLA

Join the Piezo revolution. The low dynamic mass (no voice coil) of a Piezo tweeter produces an improved transient response with a lower distortion level than ordinary dynamic tweeters. As a crossover is not required these units can be added to existing speaker systems of up to 100 watts (more if 2 put in series). **FREE EXPLANATORY LEAFLETS SUPPLIED WITH EACH TWEETER.**

**TYPE 'A' (KSN2036A)** 3" round with protective wire mesh, ideal for bookshelf and medium sized Hi-fi speakers. Price £4.90 each + 40p P&P.  
**TYPE 'B' (KSN1005A)** 3 1/2" super horn. For general purpose speakers, disco and P.A. systems etc. Price £5.99 each + 40p P&P.  
**TYPE 'C' (KSN6016A)** 2" X 5" wide dispersion horn. For quality Hi-fi systems and quality discos etc. Price £6.99 each + 40p P&P.  
**TYPE 'D' (KSN1025A)** 2" X 6" wide dispersion horn. Upper frequency response retained extending down to mid range (2KHz). Suitable for high quality Hi-fi systems and quality discos. Price £9.99 each + 40p P&P.  
**TYPE 'E' (KSN1038A)** 3 3/4" horn tweeter with attractive silver finish trim. Suitable for Hi-fi monitor systems etc. Price £5.99 each + 40p P&P.  
**LEVEL CONTROL** Combines on a recessed mounting plate, level control and cabinet input jack socket. 85 X 85 mm. Price £3.99 + 40p P&P.

## STEREO DISCO MIXER

**STEREO DISCO MIXER** with 2 X 5 band L. & R. graphic equalisers and twin 10 segment L.E.D. Vu Meters. Many outstanding features 5 Inputs with individual faders providing a useful combination of the following:—  
 3 Turntables (Mag), 3 Mics, 4 Line plus Mic with talk over switch. Headphone Monitor. Pan Pot. L. & R. Master Output controls. Output 775mV. Size 360 X 280 X 90mm.  
**Price £134.99 — £3.00 P&P**

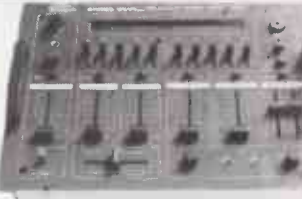

# B. K. ELECTRONICS

UNIT 5, COMET WAY, SOUTHEND-ON-SEA, ESSEX, SS2 6TR TEL: 0702-527572

POSTAL CHARGES PER ORDER £1.00 minimum. OFFICIAL ORDERS WELCOME, SCHOOLS, COLLEGES, GOVERNMENT BODIES, ETC. PRICES INCLUSIVE OF V.A.T. SALES COUNTER VISA/ACCESS/C.O.D. ACCEPTED.



# Maplin

**WELCOME TO  
THE MAPLIN  
ADVENTURELAND  
IN 1986...**

The new Maplin catalogue for 1986 is a real adventureland for the electronics enthusiast. With hundreds of new lines and details of Maplin's new low low prices, it's the one event in the electronics year that no-one should miss. Packed with data and information on all the latest electronic products. Pick up a copy from any branch of W.H. Smith for just £1.45. Alternatively you can order your copy by post for just £1.85. For overseas customers the prices are as follows: Europe surface mail £2.50; Europe air mail £3.75. Outside Europe surface mail £2.50; Outside Europe air mail depending on distance £4.25/£5.50/£6.25. For surface mail anywhere in the world you may send eleven International Reply Coupons for payment in full.

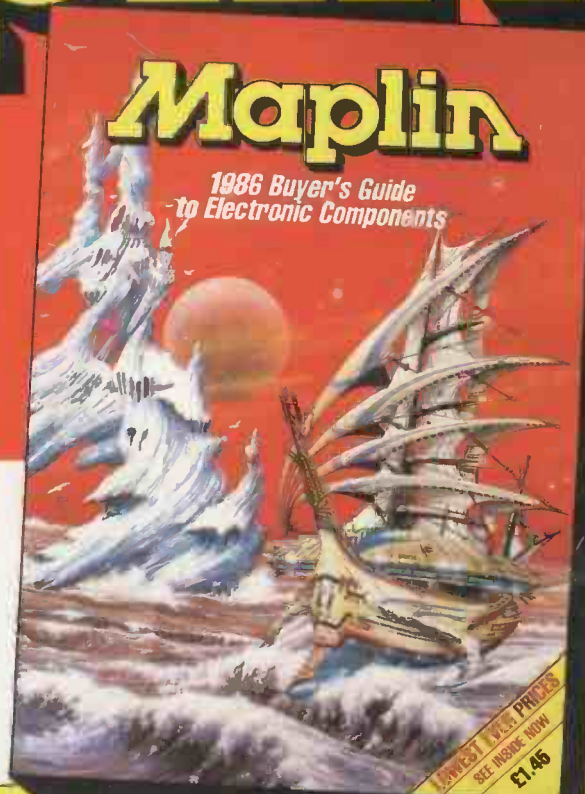

Post this coupon now for your copy of the 1986 catalogue.  
Price £1.45 + 40p post and packing. If you live outside the U.K.  
send £2.50 or 11 International Reply Coupons. I enclose £1.85.

Name .....

Address .....

.....

.....

EE.12.85

#### MAPLIN ELECTRONIC SUPPLIES LTD.

Mail Order: P.O. Box 3, Rayleigh, Essex SS6 8LR. Tel: Southend (0702) 552911

- SHOPS
- BIRMINGHAM Lynton Square, Perry Barr, Tel: 021-356 7292.
  - LONDON 159-161 King Street, Hammersmith, W6. Tel: 01-748 0926.
  - MANCHESTER 8 Oxford Road, Tel: 061-236 0281.
  - SOUTHAMPTON 46-48 Bevois Valley Road, Tel: 0703 225831.
  - SOUTHEND 282-284 London Rd, Westcliff-on-Sea, Essex. Tel: 0702-554000
- Shops closed all day Monday.

**ON SALE  
9th NOV  
1985**

**ORDER YOUR COPY NOW**