

BRITAIN'S DYNAMIC NEW MONTHLY

JULY 1972 20p

electronics

TODAY

INTERNATIONAL



SPECIAL ISSUE

4-CHANNEL
SOUND

TTL 7400 SERIES INTEGRATED CIRCUITS

- * MIX PRICES
- * FULLY GUARANTEED
- * LARGE QUANTITY PRICES ON REQUEST

Type No.	1-24	25-99	100 Plus	Type No.	1-24	25-99	100 Plus
SN 7400	.18	.16	.14	SN 7491	1.00	.95	.90
SN 7401	.18	.16	.14	SN 7492	.75	.70	.65
SN 7402	.18	.16	.14	SN 7493	.75	.70	.65
SN 7403	.18	.16	.14	SN 7494	.80	.75	.70
SN 7404	.18	.16	.14	SN 7495	.80	.75	.70
SN 7405	.18	.16	.14	SN 7496	1.00	.97	.95
SN 7406	.30	.27	.25	SN 7497	6.25	5.50	5.00
SN 7407	.30	.27	.25	SN 74100	2.50	2.30	2.00
SN 7408	.20	.19	.18	SN 74104	1.45	1.35	1.20
SN 7409	.45	.42	.35	SN 74105	1.45	1.35	1.20
SN 7410	.18	.16	.14	SN 74107	.50	.45	.40
SN 7411	.23	.22	.20	SN 74110	.80	.70	.60
SN 7412	.42	.40	.35	SN 74111	1.45	1.35	1.20
SN 7413	.30	.27	.25	SN 74118	1.00	.95	.90
SN 7416	.30	.27	.25	SN 74119	1.90	1.78	1.65
SN 7417	.30	.27	.25	SN 74121	.60	.55	.50
SN 7420	.20	.18	.16	SN 74122	1.35	1.25	1.10
SN 7422	.48	.44	.40	SN 74123	2.70	2.55	2.47
SN 7423	.48	.44	.40	SN 74141	1.00	.95	.90
SN 7425	.48	.40	.35	SN 74145	1.50	1.40	1.30
SN 7427	.42	.38	.35	SN 74150	3.35	2.95	2.15
SN 7428	.50	.45	.42	SN 74151	1.10	.95	.90
SN 7430	.20	.18	.16	SN 74153	1.35	1.27	1.20
SN 7432	.42	.39	.35	SN 74154	2.00	1.75	1.55
SN 7433	.70	.61	.44	SN 74155	1.55	1.47	1.35
SN 7437	.65	.60	.50	SN 74156	1.55	1.47	1.35
SN 7438	.65	.60	.50	SN 74157	1.80	1.70	1.50
SN 7440	.18	.16	.14	SN 74160	2.60	2.40	2.25
SN 7441	.75	.72	.70	SN 74161	2.60	2.40	2.25
SN 7442	.75	.72	.70	SN 74162	3.60	3.40	3.25
SN 7443	1.00	.95	.90	SN 74163	3.60	3.40	3.25
SN 7444	1.75	1.60	1.45	SN 74164	2.75	2.30	2.10
SN 7445	2.00	1.75	1.60	SN 74165	4.00	3.50	3.00
SN 7446	2.00	1.75	1.60	SN 74166	4.00	3.50	3.00
SN 7447	1.75	1.60	1.45	SN 74167	6.25	5.80	5.10
SN 7448	1.75	1.60	1.45	SN 74170	4.10	3.55	3.05
SN 7449	1.00	.95	.90	SN 74174	2.00	1.75	1.30
SN 7450	.18	.16	.14	SN 74175	1.35	1.27	1.15
SN 7451	.18	.16	.14	SN 74176	1.60	1.35	1.20
SN 7453	.18	.16	.14	SN 74177	1.60	1.35	1.20
SN 7454	.18	.16	.14	SN 74180	1.55	1.30	1.20
SN 7460	.18	.16	.14	SN 74181	7.00	6.00	5.50
SN 7470	.30	.27	.25	SN 74182	2.00	1.80	1.60
SN 7472	.30	.27	.25	SN 74184	2.40	2.00	1.80
SN 7473	.40	.37	.35	SN 74185A	2.40	2.00	1.80
SN 7474	.40	.37	.35	SN 74190	2.95	2.85	2.75
SN 7475	.55	.52	.50	SN 74191	2.95	2.85	2.75
SN 7476	.45	.42	.39	SN 74192	2.00	1.90	1.80
SN 7480	.80	.75	.67	SN 74193	2.00	1.90	1.80
SN 7481	1.25	1.15	1.10	SN 74194	2.50	2.25	1.90
SN 7482	.87	.80	.70	SN 74195	1.85	1.70	1.60
SN 7483	1.00	.90	.85	SN 74196	1.50	1.40	1.30
SN 7434	.90	.85	.80	SN 74197	1.50	1.40	1.30
SN 7485	3.50	3.30	3.00	SN 74198	4.60	3.70	3.35
SN 7486	.45	.41	.38	SN 74199	4.60	3.70	3.35
SN 7490	.75	.70	.65	SN 74200	21.00	18.60	13.40

DON'T FORGET THE £1 VOUCHER ON PAGE 53

Type No.	1-24	25-99	100 Plus	Type No.	1-24	25-99	100 Plus	Type No.	1-24	25-99	100 Plus
AC 107	.45	.40	.35	C 450	.15	.12	.10	2N 3614	.50	.42	.35
AC 126	.22	.20	.18	OC 22	1.80	1.40	1.10	2N 3615	.50	.40	.35
AC 127	.20	.18	.15	OC 25	1.10	.90	.70	2N 3616	.50	.38	.35
AC 128	.20	.18	.15	OC 26	.40	.30	.24	2N 3617	.70	.60	.54
AC 176	.35	.31	.27	OC 28	.70	.50	.44	2N 3618	.70	.60	.54
ACY 17	.30	.25	.20	OC 29	.75	.60	.48	2N 3638	.15	.12	.10
ACY 18	.18	.15	.13	OC 35	.56	.48	.38	2N 3638A	.15	.12	.10
ACY 19	.22	.18	.15	OC 36	.62	.50	.40	2N 3641	.15	.12	.10
ACY 20	.18	.15	.13	OC 44	.40	.35	.28	2N 3692	.15	.12	.10
ACY 21	.17	.14	.12	OC 45	.38	.32	.26	2N 3643	.16	.13	.10
ACY 22	.14	.12	.10	OC 71	.35	.28	.20	2N 3644	.18	.15	.12
ACY 40	.15	.13	.11	OC 72	.35	.28	.20	2N 3645	.18	.15	.12
ACY 41	.16	.14	.12	OC 83	.18	.16	.13	2N 3646	.25	.20	.15
AD 149	.44	.38	.35	OC 139	.45	.36	.28	2N 3691	.15	.12	.10
AD 161/2	.25	.21	.18	OC 140	.70	.55	.46	2N 3692	.15	.12	.10
AF 114	.25	.21	.18	OC 141	.90	.80	.70	2N 3693	.15	.12	.10
AF 115	.25	.21	.18	OC 170	.28	.24	.21	2N 3694	.15	.12	.10
AF 116	.26	.22	.19	OC 171	.32	.27	.24	2N 3715	1.60	1.40	1.00
AF 117	.25	.21	.18	OC 200	.45	.35	.28	2N 3716	1.70	1.45	1.00
AF 118	.32	.25	.21	OC 201	.80	.64	.52	2N 3740	1.50	1.25	.95
BC 107	.14	.10	.07	OC 202	.85	.75	.60	2N 3741	1.60	1.40	1.00
BC 108	.10	.08	.06	OC 203	.45	.40	.32	2N 3771	2.60	2.20	1.80
BC 109	.15	.12	.08	OC 204	.45	.36	.30	2N 3772	2.20	1.80	1.40
BC 113	.15	.12	.10	OC 205	1.13	.90	.70	2N 3773	2.60	2.20	1.80
BC 114	.15	.12	.10	OC 206	1.00	.86	.68	2N 3790	2.50	2.10	1.70
BC 115	.15	.12	.10	OC 207	1.00	.82	.60	2N 3792	2.60	2.20	1.80
BC 116	.15	.12	.10	OC 211	.80	.70	.50	2N 4036	.52	.46	.40
BC 125	.15	.12	.10	V 435	.15	.12	.10	2N 4037	.48	.42	.35
BC 126	.20	.18	.15	2N 896	.14	.12	.10	2N 4140	.15	.12	.10
BC 132	.15	.12	.10	2N 897	.14	.12	.10	2N 4141	.16	.13	.11
BC 134	.15	.12	.10	2N 706	.10	.08	.07	2N 4142	.16	.13	.11
BC 135	.15	.12	.10	2N 706A	.11	.09	.08	2N 3740	1.50	1.25	.95
BC 136	.15	.12	.10	2N 707	.12	.09	.07	2N 3741	1.60	1.40	1.00
BC 137	.15	.12	.10	2N 743	.15	.12	.10	2N 3771	2.60	2.20	1.80
BC 147	.10	.08	.07	2N 744	.16	.12	.10	2N 3772	2.20	1.80	1.40
BC 148	.09	.07	.06	2N 918	.42	.35	.29	2N 3773	2.60	2.20	1.80
BC 149	.09	.07	.06	2N 920	.18	.15	.12	2N 3790	2.50	2.10	1.70
BC 157	.12	.09	.08	2N 929	.20	.16	.13	2N 3792	2.60	2.20	1.80
BC 158	.11	.08	.07	2N 930	.24	.19	.16	2N 4036	.52	.46	.40
BC 159	.12	.09	.08	2N 1131	.24	.20	.17	2N 4037	.48	.42	.35
BC 167	.14	.10	.08	2N 1132	.24	.20	.17	2N 4140	.15	.12	.10
BC 168	.12	.09	.07	2N 1613	.15	.12	.10	2N 4141	.16	.13	.11
BC 169	.15	.11	.09	2N 1711	.20	.15	.12	2N 4142	.16	.13	.11
BC 197	.16	.13	.10	2N 1900	.38	.34	.30	2N 4288	.15	.12	.10
BC 178	.14	.12	.09	2N 1983	.45	.40	.35	2N 4289	.15	.12	.10
BC 179	.18	.15	.12	2N 1899	.30	.28	.26	2N 4290	.15	.12	.10
BC 257	.14	.09	.08	2N 1990	.40	.35	.30	2N 4291	.15	.12	.10
BC 258	.12	.09	.07	2N 2017	.80	.65	.50	2N 4292	.15	.12	.10
BC 259	.15	.11	.09	2N 2120	.50	.44	.34	2N 4293	.15	.12	.10
BC 330	.35	.30	.25	2N 2218	.22	.17	.14	2N 4294	.15	.12	.10
BCY 31	.45	.40	.35	2N 2218A	.25	.13	.13	2N 4295	.15	.12	.10
BCY 32	.90	.80	.70	2N 2219	.23	.17	.14	2N 4296	.15	.12	.10
BCY 33	.35	.28	.23	2N 2219A	.36	.27	.22	2N 4297	.18	.15	.12
BCY 34	.35	.30	.24	2N 2221	.23	.17	.14	2N 4298	.15	.12	.10
BCY 70	.16	.12	.10	2N 2221A	.25	.18	.15	2N 4299	.15	.12	.10
BCY 71	.22	.14	.13	2N 2222	.23	.17	.14	2N 4300	.15	.12	.10
BCY 71A	.23	.20	.15	2N 2222A	.25	.18	.15	2N 4301	.15	.12	.10
BCY 72	.13	.10	.08	2N 2646	.42	.37	.34	2N 4302	.15	.12	.10
BF 115	.18	.14	.13	2N 2904	.18	.16	.14	2N 4303	.15	.12	.10
BF 167	.18	.14	.13	2N 2904A	.32	.24	.20	2N 4304	.15	.12	.10
BF 173	.20	.16	.15	2N 2905	.32	.24	.20	2N 4305	.15	.12	.10
BF 180	.35	.28	.25	2N 2905A	.35	.27	.23	2N 4306	.15	.12	.10
BF 194	.14	.12	.10	2N 2906	.24	.20	.16	2N 4307	.15	.12	.10
BF 195	.15	.13	.11	2N 2906A	.33	.25	.20	2N 4308	.15	.12	.10
BFX 12	.30	.25	.20	2N 2907	.30	.22	.18	2N 4309	.15	.12	.10
BFX 13	.30	.25	.20	2N 2907A	.35	.26	.23	2N 4310	.15	.12	.10
BFX 29	.30	.25	.20	2N 2923	.12	.10	.08	2N 4311	.15	.12	.10
BFX 30	.32	.27	.22	2N 2924	.12	.10	.08	2N 4312	.15	.12	.10
BFX 84	.24	.20	.16	2N 2925	.10	.08	.08	2N 4313	.15	.12	.10
BFX 85	.30	.26	.22	2N 2926 Red	.08	.06	.06	2N 4314	.15	.12	.10
BFX 86	.24	.21	.17	2N 2926 Org.	.09	.07	.05	2N 4315	.15	.12	.10
BFX 87	.27	.23	.18	2N 2926 Yel.	.10	.08	.06	2N 4316	.15	.12	.10
BFX 88	.25	.20	.16	2N 2928 Grn.	.10	.08	.07	2N 4317	.15	.12	.10
BFY 39	.90	.80	.70	2N 3053	.16	.12	.10	2N 4318	.15	.12	.10
BFY 50	.16	.13	.10	2N 3054	.60	.50	.40	2N 431			

electronics TODAY INTERNATIONAL

JULY

Vol. 1 No 4

main features

HIGHLIGHTS OF THE IEA EXHIBITION	11
Special Report from Olympia	
BATTERY REVOLUTION	14
New lightweight power sources challenge conventional devices	
FOUR-CHANNEL - THE STATE OF THE ART	20
Equipment and recording companies make 4-channel commitments	
THE SQ RECORD	28
Helically modulated grooves encode 4-channel data - full story	
THE COCKTAIL PARTY PHENOMENON	36
Electronics and theories of human attention have many parallels	
TRANSDUCERS IN MEASUREMENT & CONTROL - 3	38
In part 3, Dr Sydenham discusses auto angle measurement	
NEW ANTENNA	52
Novel antenna guides energy along air-earth or air-water interface	
NEUTRON RADIOGRAPHY	61
New test method uses radio-active neutrons to see through lead walls	
A PRACTICAL GUIDE TO ZENER DIODES	70
Principle and applications of these versatile circuit components	

product tests

JCV NIVICO CD-4 RECORD SYSTEM	32
Four discrete channels on a single groove - here's how it sounds	
AKAI 1800 SS FOUR-CHANNEL TAPE RECORDER	44
Versatile 4-channel unit accepts reel-to-reel and cartridge tapes	
CBS-SONY SQ RECORD SYSTEM	48
Is this matrix system true 4-channel sound? Louis Challis reports	
FOUR-CHANNEL SOUND IN YOUR CAR	64
Clarion 8-track 4-channel cartridge player - full report	

projects

INFRA-RED INTRUDER ALARM	54
This 200 ft infra-red beam defeats even professional burglars	
FET FOUR-INPUT MIXER	66
4-channel audio mixer combines gain plus input isolation	

reviews

Recordings - classical, 78; Recordings - jazz, 80;
Recordings - pop, 81; Book Reviews, 77.

news & information

News digest, 6; Equipment news, 73; Component news, 76;
Input gate, 82; Tech-tips, 83.

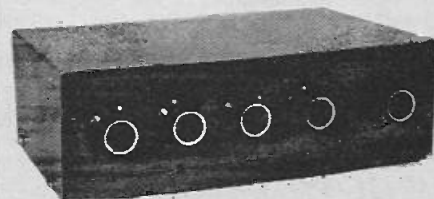
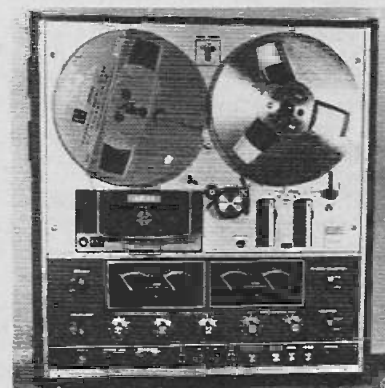
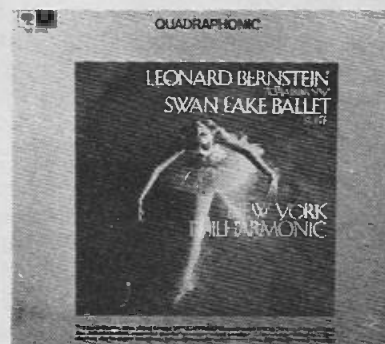

ELECTRONICS TODAY INTERNATIONAL,
107 Fleet Street, London EC4. Phone 01-353 1040.
Published by **WHITEHALL PRESS LIMITED**,
29 Palace Street, London SW1. Phone
01-834 0423/4. Australia: Modern Magazines
(Holdings) Ltd, 21-23 Bathurst Street, Sydney
2000. Phones 26-2296, 26-6129. USA: A.C.P.,
Room 401, 1501 Broadway, New York. Japan:
Bancho Media Service, Shinanomachi,
Shinjuku-ku, Tokyo. Distributed by Argus
Press Ltd. Printed in England by Alabaster
Passmore & Sons Ltd, London and Maidstone.
©Copyright Worldwide.

AUGUST ISSUE ON SALE 21 JULY 1972

Full range 'SIGNETICS' 74 series T.T.L. avail. 'H' high speed also 'S' super high speed also avail. S.A.E. for list.

S.C.S. COMPONENTS

P.O. BOX No. 26, WEMBLEY, MIDDLESEX, HA0 1YY

the 'PROFESSIONAL' amateur supplier

74 SERIES T.T.L.

Devices may be mixed to qualify for quantity pricing.

Part No.	Description	1-11 £	12-24 £
7400	Quad 2-input NAND gates	·20	·18
7401	Quad 2-input open collector NAND gates	·20	·18
7402	Quad 2-input NOR gates	·20	·18
7403	Quad 2-input open collector NAND gates	·20	·18
7404	Hextuple inverters	·20	·18
7405	Hex inverters with open collector outputs	·20	·18
7410	Triple 3-input NAND gates	·20	·18
7413	Dual 4-input Schmitt triggers	·30	·27
7420	Dual 4-input NAND gates	·20	·18
7430	Single 8-input NAND gates	·20	·18
7440	Dual 4-input NAND buffer gates	·20	·18
7441	BCD-Decimal decoder/Nixie driver	·75	·72
7442	BCD-Decimal decoder (4 to 10 line) TTL O/P	·75	·72
7443	Excess 3-Decimal decoder TTL outputs	1·00	·95
7447	BCD-Decimal 7 seg. decoder/indicator driver	1·75	1·60
7448	BCD-Decimal 7 seg. decoder/driver TTL O/P	1·75	1·60
7450	Expand dual 2-input AND-OR-INVERT gates	·20	·18
7451	Dual 2-wide 2-input AND-OR-INVERT gates	·20	·18
7453	Quad 2-input expand AND-OR-INVERT gates	·20	·18
7454	4-wide 2-input AND-OR-INVERT gates	·20	·18
7460	Dual 4-input expanders	·20	·18
7470	Single J-K flip-flop (gated inputs)	·30	·27
7472	Single J-K flip-flop (gated inputs)	·30	·27
7473	Dual J-K flip-flop	·40	·37
7474	Dual D flip-flop	·40	·37
7475	Quadruple bistable latch	·45	·42
7476	Dual J-K flip-flops with Preset and Clear	·40	·37
7480	Gated Full Adder	·80	·75
7481	16-bit read/write memory	1·25	1·15
7482	2-bit binary Full Adder	·87	·80
7483	4-bit binary Full Adder	1·00	·90
7484	16-RAM with gated write inputs	·90	·85
7486	Quadruple 2-input Exclusive OR gates	·45	·41
7490	BCD decade counter	·75	·70
7491	8-bit shift register	1·00	·95
7492	Divide twelve counter	·75	·70
7493	4-bit binary counter	·75	·70
7494	Dual entry 4-bit shift register	·80	·75
7495	4-bit up-down shift register	·80	·75
7496	5-bit parallel/serial in/out shift register	1·00	·97
74100	8-bit bistable latch	2·50	2·30
74118	Hextuple Set-Reset latches	1·00	·95
74121	Monostable multivibrators	·60	·55
74141	BCD-Decimal decoder/Nixie driver	1·00	·95

RESISTORS

½-watt C/Film high stability. E12 series values 5% 1p.

S-Min POLYESTER CAPS

50-volt 10% radial leads. ·001-, ·002-, ·0047-, ·0056-, ·0068, ·01-, ·022-, ·033, all 5p. ·047-, ·068, 7p. ·1, 10p. ·47, 18p.

Special Offer

MEL 12 50p LM301A 90p
EM401 8p 2N5459 49p
TT3643 30p BC108 10p
BZY88C9V1 9·5

ELECTROLYTICS

Min. W/Ended.

1µf	50v	7p
2·2µf	35v	6p
3·3µf	50v	7·5p
4·7µf	35v	7p
10µf	16v	7p
10µf	50v	8·5p
22µf	35v	9p
33µf	35v	10p
47µf	35v	10p
100µf	6·3v	13p
100µf	35v	13p
220µf	6·3v	8·5p
220µf	25v	19p
470µf	16v	19p
470µf	25v	25p
1000µf	10v	22p
1000µf	25v	36p
2200µf	6·3v	30p

SEMICONDUCTORS

AA 119 9p	BC 136 20p	BF 161 45p	OA 81 10p
AA 119 10p	BC 137 20p	BF 178 25p	OA 85 12p
AA 30 10p	BC 139 25p	BF 179 30p	OA 90 8p
AAZ 13 10p	BC 142 21p	BF 180 35p	OA 91 7p
AC 107 34p	BC 143 23p	BF 184 20p	OA 95 7p
AC 126 25p	BC 147 12p	BF 185 20p	OA 200 7p
AC 127 25p	BC 148 10p	BF 194 15p	OA 202 10p
AC 128 25p	BC 149 12p	BF 195 15p	OAZ 223 45p
AC 141K 25p	BC 152 20p	BF 196 15p	OAZ 230 45p
AC 142K 18p	BC 153 20p	BF 197 15p	OC 28 65p
AC 153 25p	BC 157 15p	BF 200 35p	OC 35 50p
AC 153K 22p	BC 158 12p	BF 222 30p	OC 36 65p
AC 175K 36p	BC 159 15p	BF 224J 15p	OC 44 15p
AC 176 25p	BC 170 15p	BF 256L 30p	OC 45 15p
AC 176K 20p	BC 171 15p	BF 256LC 34p	OC 70 15p
AC 187 25p	BC 171A 17p	BFS 36A 37p	OC 71 11p
AC 187K 25p	BC 177 20p	BFW17A £1·22	OC 74 25p
AC 188K 25p	BC 177B 23p	BFX 37 30p	OC 75 23p
AC 193K 25p	BC 178B 16p	BFX 84 23p	OC 170 23p
AC 194K 27p	BC 179 20p	BFX 85 25p	R 2008 £3·5
ACY 20 20p	BC 182L 10p	BFY 50 20p	R 2009 £2·5
ACY 21 20p	BC 182LB 10p	BFY 51 20p	R 2010 £2·5
ACY 22 12p	BC 183 10p	BFY 52 20p	SP 8385 £1·0
AD 143 45p	BC 183L 10p	BFY 90 59p	TAA 700 £2·4
AD 161 35p	BC 183LB 10p	BSX 20 15p	TAD 100 £1·3
AD 162 35p	BC 184LC 12p	BSX 60 50p	TBA 500 £2·0
AF 115 25p	BC 186 25p	BSX 61 35p	TBA 510 £2·0
AF 117 20p	BC 187 25p	BT 106 85p	TBA 520 £2·5
AF 121 30p	BC 208A 14p	BU 105/02 £2	TBA 520Q £2·5
AF 124 25p	BC 212 10p	BY 126 15p	TBA 530 £1·8
AF 126 20p	BC 212L 12p	BY 127 15p	TBA 530Q £1·8
AF 127 20p	BC 212LA 13p	BY 147	TBA 540 £2·0
AF 139 30p	BC 213L 12p	BY 164 35p	TBA 550 £3·0
AF 170 25p	BC 214 15p	BZY 88 ser 9·5p	TBA 550Q £3·0
AF 178 55p	BC 214L 15p	BZY 94 ser 9·5p	TBA 570Q £1·2
AF 179 60p	BC 250B 14p	BR 100 26p	TBA 750 £1·4
AF 239 40p	BC 261 16p	BRC 4443 90p	TBA 750Q £1·4
ASZ 17 50p	BC 268 11p	BRY 39 30p	TIC 46 40p
BA 102 30p	BC 308A 17p	E 1222 40p	TIP 29A 50p
BA 145 15p	BC 317 20p	E 5024 40p	TIS60M/61M 37p
BA 148 15p	BCY 21 96p	GET 102 39p	TIS 61 20p
BA 154 9p	BCY 31 40p	GET 103 25p	TIS 91 17p
BA 155 10p	BCY 42 30p	IS 921 8p	2N 404 15p
BA 163 90p	BCY 70 15p	IS 923 12p	2N 697 12p
BAX 12 12p	BCY 71 20p	ME 0404 11p	2N 706 9p
BAW 63 36p	BCY 72 15p	ME 0412 15p	2N 708 12p
BAW 65 36p	BCY 89 97p	ME 0413 12p	2N 753 10p
BAW 67 35p	BD 115 75p	ME 0462 19p	2N 919 45p
BB 105 37p	BD 124 80p	ME 2002 8p	2N 920 42p
BBY 20 37p	BD 131 75p	ME 4003 12p	2N 1302 17p
BC 107 10p	BD 132 80p	ME 4102 10p	2N 1304 21p
BC 107B 12p	BD 135 75p	ME 4104 8p	2N 1306 24p
BC 108 10p	BD 175 44p	ME 6002 12p	2N 1307 24p
BC 108A 10p	BD 181 90p	ME 6101 12p	2N 1308 24p
BC 108C 15p	BD 184 £1·3	ME 6102 13p	2N 1309 24p
BC 109 12p	BF 121 25p	ME 8001 12p	2N 3053 20p
BC 113 15p	BF 123 30p	ME 8003 13p	2N 3054 50p
BC 116 20p	BF 125 25p	MEF 104 34p	2N 3055 55p
BC 117 20p	BF 127 30p	MEL 11 30p	IN 914 6p
BC 119 30p	BF 153 20p	MP 8112 34p	IN 916 10p
BC 121 25p	BF 154 20p	MP 8113 40p	IN 4148 6p
BC 125B 25p	BF 160 25p	OA 47 10p	

SILICON RECTIFIERS BY GENERAL INSTRUMENT

1 amp Min Plastic.				1·5 amp Min Plastic.					
PIV	1+	100+	1000+	PIV	1+	100+	1000+		
IN4001	50	6p	4·5p	3·2p	PL4001	50	8p	6p	4·6p
IN4002	100	7p	4·5p	3·3p	PL4002	100	9p	7·2p	5·4p
IN4003	200	8p	4·5p	3·5p	PL4003	200	10p	7·5p	5·8p
IN4004	400	8p	4·5p	3·5p	PL4004	400	10p	8·3p	6·7p
IN4005	600	10p	5p	3·7p	PL4005	600	12p	9·6p	7·9p
IN4006	800	12p	6·5p	5p	PL4006	800	15p	12p	10p
IN4007	1000	15p	8p	6p	PL4007	1000	16p	15·8p	12·1p

BRIDGE RECTIFIERS

PIV	1 amp	5 amp	10 amp
50	W05 23p	KBH5005 £1·25	KBH10005 £1·60
200	W02 25p	KBH502 £1·40	KBH1002 £1·65
400	W04 27p	KBH504 £1·55	KBH1004 £1·75
600	W06 28p	KBH506 £1·75	KBH1006 £1·95

WE CAN OFFER A FULL RANGE OF DEVICES BY:- MOTOROLA, SIGNETICS, R.C.A., MULLARD, G.I.M. GENERAL INSTRUMENT, FERRANTI, and FAIRCHILD, PLUS SELECTED TYPES FROM S.G.S. ATEs, SIEMENS, TELEFUNKEN AND TEXAS INSTRUMENTS. SEND FOR YOUR COMPREHENSIVE LIST TODAY.

TERMS. Retail mail order subject to £1·00 minimum order. Cash with order only. Trade and educational establishments M/AC on application (minimum £5). Postage 10p inland, 25p Europe. GUARANTEE. All goods carry full manufacturer's warranty. Special Enquiries etc. Please enclose stamped addressed envelope.



COVER: Four-channel sound, and orchestral music — symbolized by this bronze cast of Beethoven surrounded by JBL's latest Lancer speakers.

Collyn Rivers
Editorial Director

Shaun Kannan
Editor, British Edition
Electronics Today International

Donn Donovan
Advertisement Manager,
British Edition
Electronics Today International

International Editions

Engineering Manager:
Barry Wilkinson

Production Manager:
Bob Izzard

Projects Adviser:
Kim Ryrie

Laboratory Technician:
Rob Giumelli

Review Editor:
John Clare

Acoustical consultants
Louis A. Challis & Associates

Art Director:
Clive Davis

Advertisement Manager:
Howard Jenkins

1984 minus 12 —and counting

Since the Doomsday Book, governments have demanded and recorded data about people and their activities. About births and deaths, marriages and divorces, incomes and taxes.

And this is not unreasonable, for in a democracy, privacy cannot be an absolute right. Democracy requires participation by its members at least some of the time and unreasonable privacy can threaten internal security and prejudice the rights of a society to those of an individual. But there must be limits to the extent to which such privacy may be given up.

The advent of computers with multi-million bit storage capacity has provided an enormous capacity to collect, collate, classify and process data about anything and everyone. It has offered enormous benefits in data assembly, retrieval and analysis — and enormous threats to the security of the individual.

As Professor Zelman Cowen stated in his 1969 Boyer Lecture, "the invaders of privacy are a massing army: they come from government and officialdom, from commerce and industry, from the mass media . . . they have little sympathy with the private man's claim to be left alone."

The problems and implications of privacy in today's computer society are many and diverse, but with the imminent introduction of data banks it is essential that society defines the degrees of freedom that it considers reasonable.

At a minimum level it is surely not too much to expect that operators of data banks be registered, and that written records be kept of data extractions, including a record of the nature of the data, the purpose for which the data was required and the person to whom the data was supplied.

Further than this, and of paramount importance — any person about whom information is stored in a data bank must be entitled upon payment of a reasonable fee, to have a print out of that data at any time. And as it is possible for false or slanderous data to be inputted, either the data bank must seek the validity of all data from the individual concerned or be held legally liable if inaccurate personal data causes damage to that individual.

If the present freedom of computerized data bureaux is allowed to continue unchecked, the public at large will surely suffer unwarranted intrusion into its private affairs by public and private agencies — and this may have disastrous consequences.

Article 12 of the Universal Declaration of Human Rights adopted by the United Nations in 1948 states explicitly 'no one shall be subjected to arbitrary interference with his privacy, family, home or correspondence, or to attacks upon his honour and reputation.'

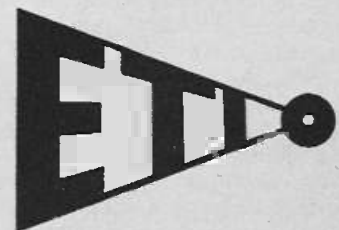

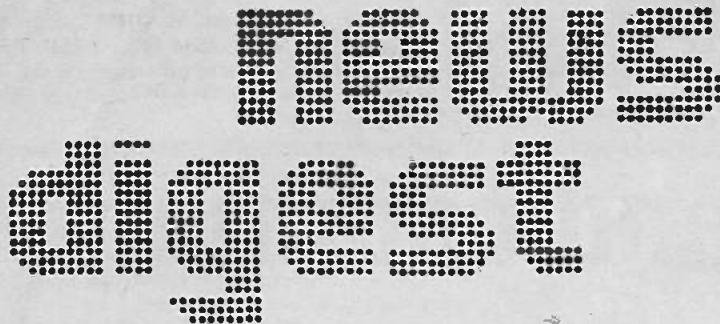

TALKING IN TRAINS

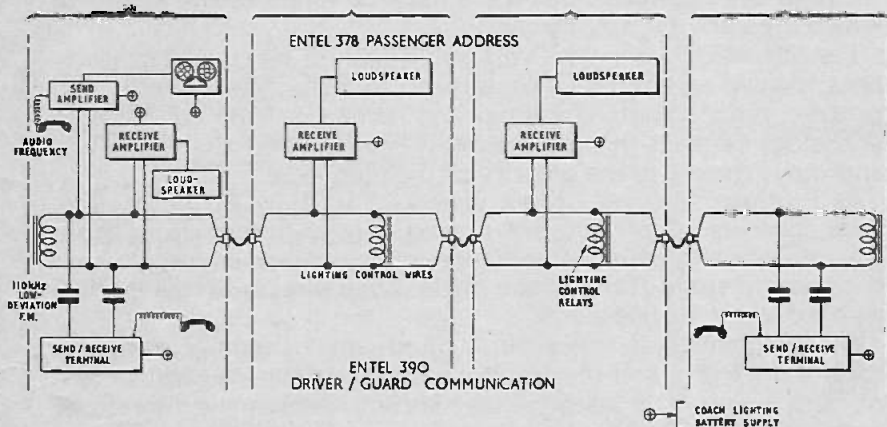

British Rail's plans for 150 mph trains include improved communication systems between drivers and guards. Also planned are passenger address systems.

A range of equipment — known as EMTEL — has been designed specifically for this task by Britain's Nelson Tansley Ltd.

The main problem to be overcome was the impossibility of providing a special cable, running the length of the train, on which to carry the signals. The equipment was therefore designed to accommodate any continuous circuit, for example, the control wires for the lighting relays which (in British Rail), are the only conductors always connected throughout any passenger train. In this case, departure from the ideal of a 600 ohm noise-free line is caused by the connexion across the wires of many relay solenoids, the impedance of which is not only complex, but variable.

In the case of the passenger address system — consisting of a "SEND" amplifier driving "RECEIVE" amplifiers and loudspeakers in each coach — the terminal impedance of the line, and the audio-frequency signal is transmitted at a high level (10V at 1 kHz for rated 10W output to the loudspeakers). This reduces the effects of

superimposed noise. Further noise reduction is obtained by a curtailed bandwidth of 300 — 5,000 Hz. The system is operated by the guard, who is provided with a telephone hand-set. Announcements, recorded on tape, may also be made.

Another system designed solely for communication between driver and guard, is capacitively coupled to the same pair of wires as the passenger address system, but the signal is transmitted as a low-deviation frequency-modulated signal at 110 kHz. Although well above frequencies used for train-control signals, this frequency does not cause too many matching and attenuation problems. A "SEND/RECEIVE" terminal is located in the driver's cab (or cabs, if more than one locomotive is in use) and in as many guards' compartments of the train as required. Each terminal is provided with a hand-set, with "Press-to-Talk" button, and a bulkhead-mounted electronics panel. The hand-set emits a call tone when a remote call button is pressed, the call being acknowledged by lifting the hand-set and pressing the "talk" button. Simultaneous operation of "talk" buttons gives duplex operation of the system, with a side tone caused by the heterodyne beat between the two carriers, which differ in frequency by a

few hundred hertz. The tone helps to discourage indiscriminate "talking-through" which, it is felt, could result in vital information being misheard.

CONCORDE BAN?

Whilst we are currently bombarded with PR material extolling the 'virtues' of the Concorde supersonic airliner it is interesting to note that in the USA Senator Alan Cranston has introduced a bill, co-sponsored by Senators Edward Muskie and Calborne Pell, to prohibit overseas supersonic transports from landing at any US airports or flying over US territory at supersonic speeds.

The SSTs which carry less than half the passenger load of a 747 make ten times as much noise on take-off and landing.

WORLD'S LARGEST RADIO TELESCOPE

A radio telescope, consisting of three arrays — arranged in a 'Y' formation — is to be built near Albuquerque, New Mexico, by the US National Science Foundation.

Costing more than \$30 million, the telescope will be the world's largest scientific instrument.

Each of the three arms of the telescope is 13 miles long and consists of a railway track carrying nine fully steerable dish antennae. Resolution and sensitivity of the instrument should be at least one order of magnitude better than existing instruments.

NEW IC MANUFACTURING TECHNIQUE

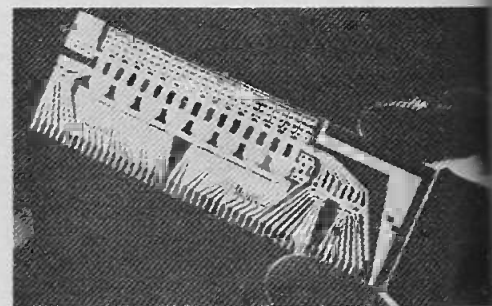

In the USA, Bell Telephone Labs. have developed an experimental process for forming IC patterns directly onto ceramic substrates — in one operation.

The technique is said to eliminate many processing steps, including mask making, photo-resist application, and chemical milling. Apart from this clean-room facilities are not required.

A computer controlled neodymium YAG laser — with 960 Watts output and 250 nano-second pulse width — selectively vapourizes, or passes over, the drum rotated substrates which are coated with a thin gold film.

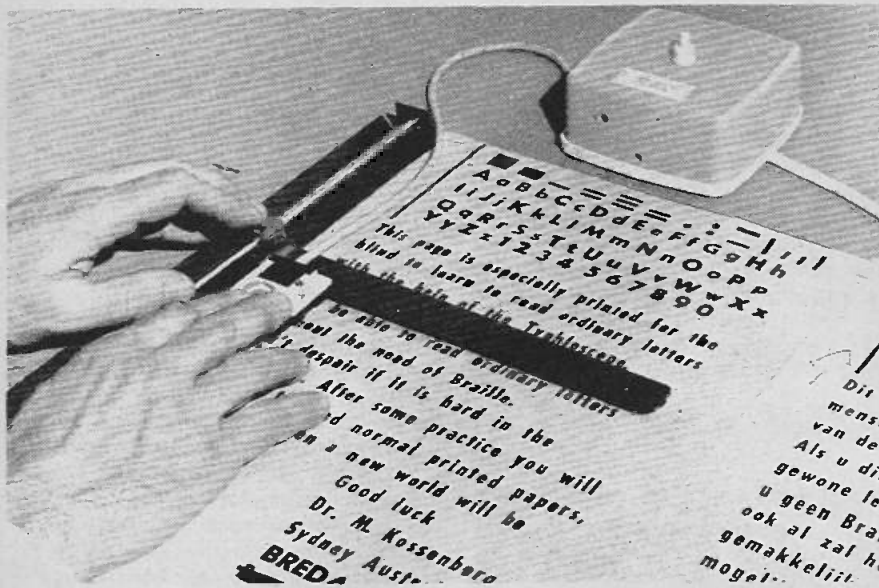

BLIND READ ELECTRONICALLY

An electronic device that enables blind people to 'read' ordinary type has been invented by Dr. M. Kossenburg, an Australian currently living in Breda, Holland.

Theory is that the entire alphabet is composed of only four different kinds of lines: horizontal, vertical, oblique and curved. When the small 'reader' unit is moved slowly along a line of type, guided by a rule, three photo-transistors on its underside detect the shapes of the lines forming the individual letters. Three corresponding magnetic vibrators signal the resultant patterns to the user's finger-tips. With practice, the combination and sequence of finger sensations enables the user to identify letters and numbers.

Following its presentation at the recent International Inventors Exhibition in Brussels, Dr. Kossenburg was awarded the "Prix Bernadotte" of 60,000 Belgian francs at a ceremony at the Swedish Embassy in Brussels.

PICTURES ON 'PHONE LINES

Japan's Matsushita company has developed a transmission system that enables pictures to be transmitted over ordinary voice telephone lines at relatively high speed.

The system uses a normal TV camera but transmits only one of the 50 fields normally transmitted per second. Data from the selected field is stored initially onto magnetic video tape at normal recording speed. Once the selected field has been recorded the data is then recovered but this time the machine is slowed down so that the selected field is extended in time from a fiftieth of a

second to about 30 seconds. In effect this reduces the bandwidth required from 3MHz down to 3.4kHz.

The signals are then transmitted via the normal switched telephone network and recorded at the far end on video recorder. The recorded data is then speeded up and re-recorded onto a second video recorder. The system is arranged so that whilst one field is being transmitted and recorded, the previous field is displayed on a TV monitor.

Signal noise ratio of the system is claimed to 30dB, resolution is 200 lines horizontally and 170 vertically.

ARTILLERY COMPUTING SYSTEMS FOR AUSTRALIA

First-round accuracy, and speed and economy of firepower are major advantages of the new Field Artillery Computing Equipment (FACE), which has been ordered for the Australian Artillery from Marconi Space and Defence Systems Limited.

This very advanced fire control system not only provides greater accuracy but also eliminates the human errors which can occur if the efficiency of the Command Post team falls off due to battle fatigue. It also considerably reduces the training period compared with that required for previous manual methods.

The FACE system, already in service with British artillery regiments, both at home and overseas, provides complete firing data for field artillery. Target information and meteorological data

as well as propellant type, charge temperature, and muzzle velocity for each gun, together with the type of ammunition, and the position of the gun are all fed into the computer system, using a specially-designed keyboard input in conjunction with a display which ensures that all relevant information is entered in the correct form. The firing data can be presented to the operators at each gun position on a compact display panel by the add-on Artillery Weapon Data Transmission System (AWDATS), or relayed by radio or telephone. The guns are then ready to fire.

Each unit consists of a control and display console and a general purpose digital computer. To this is added a programme loading unit, which enables the computer to be programmed rapidly for any type of gun, from a standard tape cassette.

The complete system can be mounted in a wide variety of military vehicles, from a Land Rover to an armoured Command Post Vehicle.

The order, worth approximately \$2 million, has been placed by the Australian Department of Supply with Amalgamated Wireless (Australasia) and the equipment will be built by Marconi Space and Defence Systems, Hillend in Scotland. All of the equipment will be installed and commissioned by Amalgamated Wireless (Australasia), who are expected to start deliveries in the latter part of this year.

NS ELECTRONICS ENTER SYSTEMS MARKET

NS Electronics Pty. Ltd. this week delivered its first electronic computer memory system to the PMG.

The system is the largest MOS integrated circuit system designed and built in Australia comprising 640,000 bits of buffer memory arranged in 8x80,000 bit format. It will be used as a frame store or television frame delay line by the Department in the development of video telephone and telephone conference facilities. Mr. W. (Bill) Lavery and the PMG Department's engineer worked closely with the Company's engineering staff in successfully producing this unique buffer store.

Jack Rutherford, NS Managing Director pointed out that as the complexity and density of integrated circuits increased, so the semiconductor manufacturer assumed the responsibility for some of the systems design. He therefore forecast an increase in systems engineering involvement by semiconductor manufacturers in the near future.

TELEPHONE FOR THE DEAF



A telephone handset with an inbuilt volume control has been developed in the USA by Bell Telephone Laboratories. A switch in the handle enables users with impaired hearing to select a louder than normal listening level.

LITHIUM ORGANIC BATTERIES

Mallory & Co. has been granted an exclusive worldwide licence to manufacture and market lithium organic batteries under the patents and technologies of American Cyanamid Company, it was announced recently. Terms of the licence agreement were not disclosed.

J. David Ehlers, Managing Director of Mallory Batteries (Australasia) Pty. Ltd., said "The company plans initially to concentrate on the further development and manufacture of a three-volt lithium organic battery with characteristics considered especially suitable for government-related portable power applications". He said, "The battery has exceptionally high energy density, constant voltage discharge characteristics, a long shelf life and can be used over a wide range of environmental conditions".

Mr. Ehlers said that Mallory Batteries (Australasia) Pty. Ltd., will market those products in Australia in 1973. The parent firm, The Mallory Battery Company (U.S.A.) is establishing a pilot line facility in Tarrytown, N.Y., to produce several cell sizes of lithium organic batteries. Mallory also is developing other lithium battery systems, including a family of solid-state batteries with rating of from 2 to 200 volts, or higher". He said "These batteries have potential use in medical electronics, time pieces, military devices and in other applications where high voltage density and reliability are required".

CD-4 LATEST



Latest from RCA is that the company has now solved their initial manufacturing problems with CD-4 four-channel discs, and production discs will be commercially available about the time that this issue of Electronics Today International is published.

The CD-4 system employs a high frequency sub-carrier as well as the normal two audio frequency channels.

By using a new vinyl compound which includes antistatic and anti-friction materials, disc life has been extended to the point where a satisfactory four-channel signal can still be obtained despite previous playing at least 100 times on a conventional low price stereo record player using a standard stereo stylus tracking at five grammes.

The new RCA CD-4 records produce normal two-channel sound if played via a suitable cartridge, stylus and decoder.

As these new RCA records are compatible with existing stereo systems the company intends eventually to market all their records in the CD-4 format, thus avoiding the necessity for dealers to carry double inventories.

The titles of the recordings to be released are not yet known, nor have

the company released the name under which the discs will be marketed. We understand that the CD-4 designation will not be used.

STANDARD GRAPHICAL SYMBOLS FOR SEMICONDUCTOR DEVICES

A new Australian standard for symbols for semiconductor devices used in electrotechnology has been published by the Standards Association.

It is issued as Australian Standard 1102, Part 5 and specifies graphical symbols for use in circuit diagrams and defines the principles governing their use. It establishes a number of basic elements and demonstrates a method of combining these to produce symbols describing complete devices.

Qualifying symbols indicating special functions or properties essential to the operation of the circuit containing the device are also defined and examples given of their use.

The symbols included are identical with those recommended by the International Electrotechnical Commission (IEC) in order to facilitate the exchange of information on equipment using semiconductor devices.

The standard also specifies reference designations for components. These are intended for uniquely identifying and locating discrete items on diagrams and for correcting them in parts lists, circuit descriptions and catalogues.

Copies of AS 1102 Part 5 may be obtained from the various offices of the Standards Association for \$1.60 each.

LARGE SCALE INTEGRATION

Our Cape Town (South Africa) correspondent tells us that a local chemical manufacturing organisation is entering the field of electronic equipment.

It is understood that the first electronic product from the organisation — Aparth-8 Products Ltd — will be an automatic colour bar generator. The company expects the unit to sell in large numbers throughout South Africa, Rhodesia, Angola, and certain parts of Queensland, Australia.

The company, located in Pasmé Ajambok — are well known for their product called 'Klux — the ultimate detergent'.

Printed Circuit Design Made Easier

From a concept born in a small factory in Surrey Nevin Electric have added their own niceties and introduced a brand new idea in printed circuit design to the market. They have even formed a new company to handle it, Palma Electronics Ltd.

The idea, known as Palmaplan, is based on the finding that 95% of all printed circuits conform to a relatively small family of shapes.

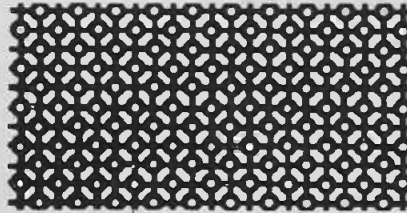

Above: A portion of unused film prior to amendment

Right: A portion of amended film

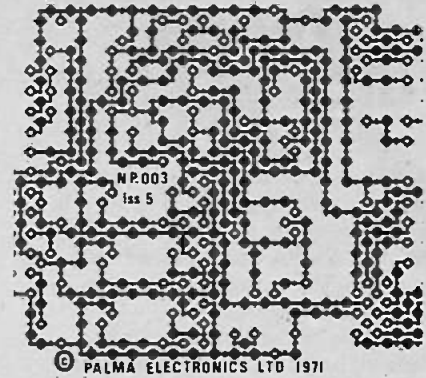

Furthermore they have found that some 80% of all orders are for redesigns or modifications to old designs. Coupled to this is the general acceptance throughout the industry of the matrix method of component location and it becomes easy to see where the Palmaplan film matrices fit in.

These are sold under the name of Palmafilm and consist of a complete matrix of tracks reproduced onto film. To use this all one has to do is to blank out the unwanted portions of the film.

PALMAPLAN EXPLAINED

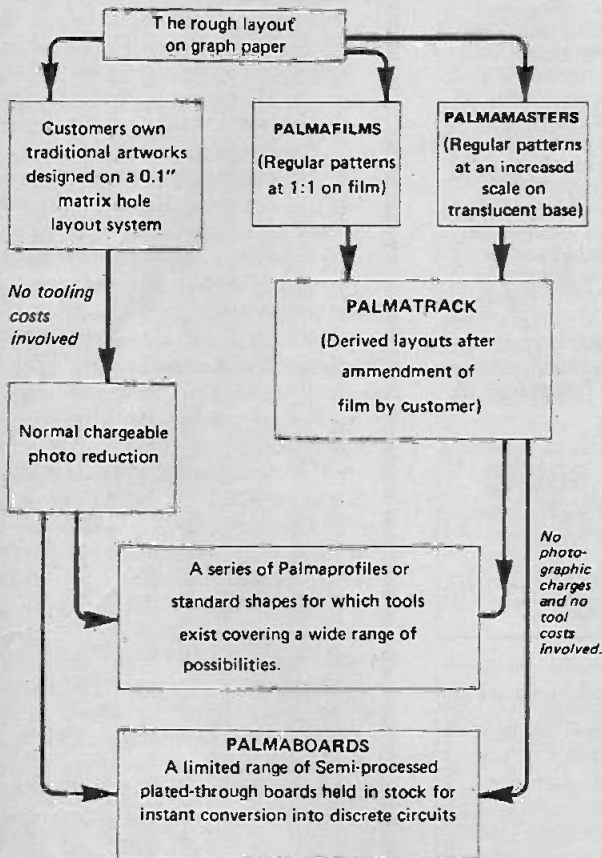

Prestwick Circuits Limited

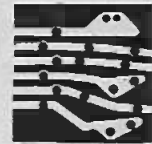

PRINTED CIRCUIT BOARDS FOR ETI PROJECTS
Very low priced glass fibre FR4 boards printed, etched and roller tinned (undrilled and unprofiled) for the enthusiast to finish. PRICE - 25p each plus P + P 10p.

PRESTWICK CIRCUITS specialise in through hole plated boards, as well as manufacturing standard single and double sided Print and Etch boards on glass fibre only. Our customers include the 50 top Computer and Electronics Firms in the North who take production as well as rapid prototype quantities.

Make sure your Buying Department have asked us to quote for your work. Our Delivery, Price or Quality could help you. Full Photographic Facilities Available.

Dept. 672
Glenburn House, Prestwick, Ayrshire.
Tel. Prestwick 70531

THE PRINTED CIRCUIT BOARDS SHOWN IN THIS ISSUE OF ELECTRONICS TODAY INTERNATIONAL ARE AVAILABLE NOW

Top quality fibre glass P.C.B.s drilled ready for assembly will be available month by month as the journal is published. P.C.B.s from issues 1 to 3 are also available.

COST? 6p per square inch - just calculate the area and send P.O. or cheque. Telephone orders welcome (COD only, 25p extra) 24 hour telephone answering service.

SCHOFIELD ELECTRONICS, GILMORTON, RUGBY, Warks. Tel LUTTERWORTH 3578

Industrial enquiry for P.C.B. design and manufacture invited.

A portion of used and unused film is illustrated. For applications where it is more convenient to photo-reduce the finished artwork Palmamasters are supplied. These come in two ratios 2:1 and 4:1.

To make the whole procedure that little bit easier the company has also announced their Palmboards. These are a range of standard boards with plated through holes already *in situ* — on a matrix.

Thus a new circuit can be designed and tried out in a form closely approximating to the final production model at a cost of only the fraction of conventional printed circuitry. As an introductory offer Palma Electronics have introduced a Palmamac kit which explains all — it costs £75.

Mosquito 1

A highly sensitive wind speed and direction measuring system has recently been announced by Spemby Ltd, of Andover.

The system, which is capable of fully unmanned operation of long periods, was originally developed for use in Kenya by a medical team studying the movements of malaria-carrying mosquitoes. The whole concept is based on the standard Porton windvane and anemometer, which are manufactured by Spemby as part of the company's Metsen range of meteorological equipment.

For its prime entomological purpose the design of the system was controlled by two main criteria: environmental and the operating altitude of the mosquitoes. Added to these was the fact that unattended operation was called for in the specification.

Thus the end result is an instrument package capable of measuring the speed and direction of the wind at altitudes between 15 inches and eight feet from the ground. The sensitivity is such that the system is able to detect wind speeds down to half a knot — a feature which was vital in the original application.

To take care of environmental considerations the whole has been packaged in a rugged casing designed by the RAE at Farnborough. This ensures that the high humidity experienced will have no adverse effects on the equipment. Due to the remoteness of

the observation sites it was decided to make the equipment capable of unattended operation, as well as portable.

Coupled to this was the fact that the mosquitoes are most active during the first four hours in the morning and for a similar period during the evening, this meant that an automatic switching system was necessary.

Because of the long unattended periods it was decided that in the interests of mechanical reliability any wild fluctuations of the pen recorder, such as those when the wind direction vane moves from zero to 360 degrees, would be removed.

Thus in this particular two overlapping voltages are used which overcomes the problem.

Electronic Speech Recognition

A system being developed in the US allows human voices to be "understood". The equipment is designed to recognise words and numerals despite speech variations. This it does by storing a recording of its operator's voice and matching instructions given to it to this recording. At present, capacity is 21 words on a cassette, but this number can readily be increased to around 100. First likely application for the system is as an eight-point check-out installation for supermarkets where cashiers will be able to record lists of goods purchased while having both hands free to handle them. Inventory, cash flow, bills and receipts will all be automatically provided. The development of the system has been undertaken by Threshold Technology of New Jersey.

RECORD T.V. SOUND

using our loudspeaker isolating transformer. Provides safe connection for recorders and Hi-Fi equipment.
£1 post free. Instructions included.
CROWBOROUGH ELECTRONICS (ETD)
Eridge Road, Crowborough, Sussex.

Fascia panels, dials, nameplates etc (single or multiples) in etched aluminium to individual specifications. Hardware supplies for constructors. 4p stamps for list.

Ramar Constructor Services,
29 Shelbourne Road,
Stratford-on-Avon, Warwicks.

MEN! You can earn £50 p.w.
Learn computer programming.

Send for FREE brochure—

Academy of Computer Training,
K52 Oxford House,
9-15 Oxford Street, London W.1.

STAR BARGAINS. MFRS BRANDED FULLY GUARANTEED.



S/Ended P.C. mounting sub-min electrolytics. 1-2-5 and 10uf 10v 2.5p
Send for our free catalogue for a full range of caps.

409B 15amp 100P.I.V. 250amp surge stud mounting rectifiers. Ideal for heavy duty battery chargers or power supplies
35p or 4 for £1.25.

O.C. 44-45-70-71-74 and 75s 15p.
IN 914 and IN 4148s 3.5p each
2N 1304s 17p 2N 3053s 16p
Min Slide Switches 2amp 2 pole c/o 10p

7400 series T.T.L. special offers.
7420 dual 4 input NAND gate 17p
7440 dual 4 input NAND buffer 20p
7460 dual 4 input expander 17p
7474 dual D type edge trig. flip flop 38p

full range of SIGNETICS TTL. send see for free catalogue.



SEMICONDUCTORS

AA 119 9p	BC 182L8 10p	IS 921 8p
AA 119 10p	BC 183 10p	IS 923 12p
AA 13 10p	BC 183L 10p	ME 0402 11p
AC 107 34p	BC 184L 12p	ME 0412 15p
AC 126 25p	BC 186 25p	ME 0413 12p
AC 127 25p	BC 187 25p	ME 0462 19p
AC 128 25p	BC 208A 14p	ME 2002 8p
AC 141K 25p	BC 212 10p	ME 4003 12p
AC 142K 18p	BC 212L 12p	ME 4104 8p
AC 153 25p	BC 212LA 13p	ME 5002 12p
AC 153K 22p	BC 213L 12p	ME 6101 12p
AC 175K 36p	BC 214 15p	ME 6102 13p
AC 176 25p	BC 214L 15p	ME 8001 12p
AC 176K 20p	BC 250B 14p	ME 8003 13p
AC 187 25p	BC 261 16p	MEF 104 34p
AC 187K 25p	BC 268 11p	MEL 11 30p
AC 188K 25p	BC 308A 17p	MP 8112 34p
AC 193K 25p	BC 317 20p	MP 8113 40p
AC 194K 27p	BCY 21 96p	OA 47 10p
ACY 20 20p	BCY 31 40p	OA 81 10p
ACY 21 20p	BCY 42 30p	OA 85 12p
ACY 22 12p	BCY 70 15p	OA 90 8p
AD 143 45p	BCY 71 20p	OA 91 7p
AD 161 35p	BCY 72 15p	OA 85 7p
AD 162 35p	BCY 89 71p	OA 200 7p
AD 115 25p	BD 115 50p	OA 202 10p
AF 117 20p	BD 124 80p	OAZ 223 45p
AF 121 30p	BD 131 75p	OAZ 230 45p
AF 124 25p	BD 132 80p	OC 28 55p
AF 126 20p	BD 132 75p	OC 35 50p
AF 127 20p	BO 175 44p	OC 36 55p
AF 139 30p	BO 181 50p	OC 44 15p
AF 170 25p	BO 184 11.3	OC 45 15p
AF 172 55p	BF 121 25p	OC 70 15p
AF 170 60p	BF 123 30p	OC 71 11p
AF 239 40p	BF 125 25p	OC 74 25p
ASZ 17 50p	BF 125 20p	OC 75 23p
BA 102 30p	BF 153 20p	OC 170 25p
BA 145 15p	BF 154 10p	R 2008 £3.5
BA 148 15p	BF 160 25p	R 2009 £2.5
BA 154 9p	BF 161 45p	R 2010 £2.5
BA 155 10p	BF 178 25p	SP 8385 £1.0
BA 163 30p	BF 179 30p	TAA 700 £2.4
BAX 12 12p	BF 180 15p	TAO 100 £1.3
BAW 63 36p	BF 184 20p	TBA 500 £2.0
BAW 65 36p	BF 185 20p	TBA 510 £2.0
BAW 67 35p	BF 194 15p	TBA 520 £2.5
BB 105 37p	BF 195 15p	TBA 520 £2.5
BBY 20 37p	BF 196 15p	TBA 530 £1.8
BC 107 10p	BF 197 15p	TBA 530 £1.8
BC 107B 12p	BF 200 35p	TBA 540 £2.0
BC 108 10p	BF 222 30p	TBA 550 £3.0
BC 108A 10p	BF 224J 15p	TBA 550 £3.0
BC 108C 15p	BF 256L 30p	TBA 5700 £1.2
BC 109 12p	BF 256LC 34p	TBA 750 £1.4
BC 113 15p	BFS 36A 37p	TBA 750 £1.4
BC 116 20p	BFW17 11p	TIC 48 40p
BC 117 20p	BFX 37 30p	TIP 29A 50p
BC 119 30p	BFX 84 23p	TIS60M/61M
BC 121 25p	BFX 85 25p	TIS 61 20p
BC 125B 25p	BFY 50 20p	TIS 91 17p
BC 136 20p	BFY 51 20p	2N 404 15p
BC 137 20p	BFY 52 20p	2N 697 12p
BC 139 25p	BFY 90 59p	2N 697 12p
BC 142 21p	BSX 20 15p	2N 706 9p
BC 143 23p	BSX 60 50p	2N 708 12p
BC 147 12p	BSX 61 35p	2N 753 10p
BC 148 10p	BT 106 85p	2N 919 45p
BC 149 12p	BU 105/02 £2	2N 920 42p
BC 152 20p	BY 126 15p	2N 1302 17p
BC 153 20p	BY 127 15p	2N 1304 21p
BC 157 15p	BY 147 15p	2N 1306 24p
BC 158 12p	BY 164 35p	2N 1307 24p
BC 159 15p	BZY 88 ser 9 5p	2N 1308 24p
BC 170 15p	BZY 94 ser 9 5p	2N 1309 24p
BC 171 15p	BR 100 26p	2N 3053 20p
BC 171A 17p	BRC 4443 90p	2N 3054 50p
BC 177 20p	BRY 39 30p	2N 3055 55p
BC 177B 23p	E 122 40p	IN 914 6p
BC 178 16p	E 5024 40p	IN 916 10p
BC 179 20p	GET 102 35p	IN 4148 6p
BC 182L 10p	GET 103 25p	

Terms CWO. if less than £5 10p P&P.

TRANIC COMPONENTS

89/90 WARDOUR STREET,
LONDON, W.1.

Protronic 24
for the best in prototype
and pre-production
PCBs
Mount Road Hanworth Middlesex Tel: 01-898 2427

HIGHLIGHTS OF THE IEA EXHIBITION

THE annual five-day international exhibition of instruments, electronics and automation, held at the Olympia exhibition site in London, is now over, leaving time for reflection.

Though not as dynamic as those seen a few years ago, when some stands had half-hour queues, it attracted several hundred exhibitors from many (but not all) major companies. The United States had a grouped exhibit; so did Ireland, and a few industrial areas of Britain. Japanese products were noticeably absent.

The task of seeing and comprehending was as great as ever, due to the broad reference of the products. Most interested people will have seen a preview or a "while-running" exhibition report, for the controlled-circulation magazines have devoted considerable space to the subject. Having no axe to grind, let us now look at a few exhibits that were intrinsically interesting.

Coin-changing machines are a familiar sight, but few of us have used a banknote-changer. On the Sodoco stand was such a device, soon to become a familiar sight at some locations in British Rail terminals. These note acceptors are already in use in Germany, Switzerland, Holland and Italy. The note is inserted into a slot and transported to a test channel. Seven test conditions – such as size, thickness, metal strip position and opacity – are checked. If genuine by these standards, the note is accepted and a signal generated to operate the required device. It isn't available for high-denomination notes, and it will reject a small percentage of good notes.

There were a handful of light-emitting-diode (LED) displays. Monsanto exhibited green and amber circuits in which phosphor coatings provide the colour change from the usual red. There were hints of other companies releasing coloured LEDs, but no details were available. One had to look hard for a liquid crystal display – one was found as a Digilin readout display unit in a panel meter. Its readability was certainly inferior to LED displays, but the cost was claimed to be less and the power consumption also much less, so there will be cases where liquid-crystal displays are

a good choice once they become freely available. In all, the development of integrated displays is now reaching a flattening-off point, as cost reductions are no longer as dramatic in an absolute sense.

On a more specialized note, two companies released digital transient recorders. These equipments sample and store the analogue values of a transient signal in digital form. Reconstruction can then be made on a more convenient time scale. Datalabs offered a DL 905 recorder for the lower-price market, whilst Bruel and Kjaer (B & K) had a model 7502 which is up to their usual standard of design and presentation.

A first for B & K at this exhibition was a noise-dose meter (model 4423) which is the first available unit to comply with the new British Department of Employment's "code of practice for reducing the exposure of employed persons to noise". The instrument combines the important factors of noise duration and intensity via a standard ear response filter to provide an equivalent continuous noise-dose measurement.

Transducers were much in evidence. Dynamic Transmission Ltd exhibited an

interesting system for fitting to existing orifice-plate flow meters. Although these meters are simple – a restricting hole in the flow produces a pressure change between both sides – the output is not linearly related to the flow rate. However, if the pressure differential across the plate is nulled with a motor-driven pressure generator (Fig 1), the speed of the motor is proportional to flow rate. Motor speed is measured as a frequency rate.

A Saratoga ultrasonic flow meter was on demonstration. This system uses two send-receive sonar displacement transducers mounted across the stream at a small angle to the normal. By a doppler effect it is possible to determine flow with little influence in precision resulting from the temperature or density of the fluid. Nixon Instrumentation had an interesting NOVAR turbine flow meter on display. This miniature device has a small exposed PVC rotor of about 11mm diameter which rotates in jewels at the end of a slender rod. Rotation of the rotor is sensed using inductance variations as the tips of the blades move past the support spindle.

One cannot imagine an exhibition like this one without a computer-controlled

Fig 1. Linearized frequency output from an orifice-plate flow meter.

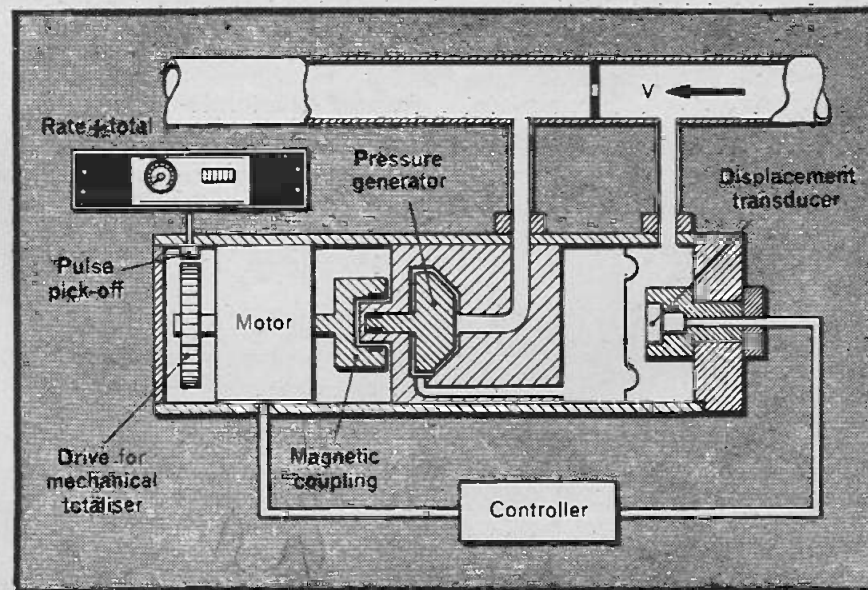

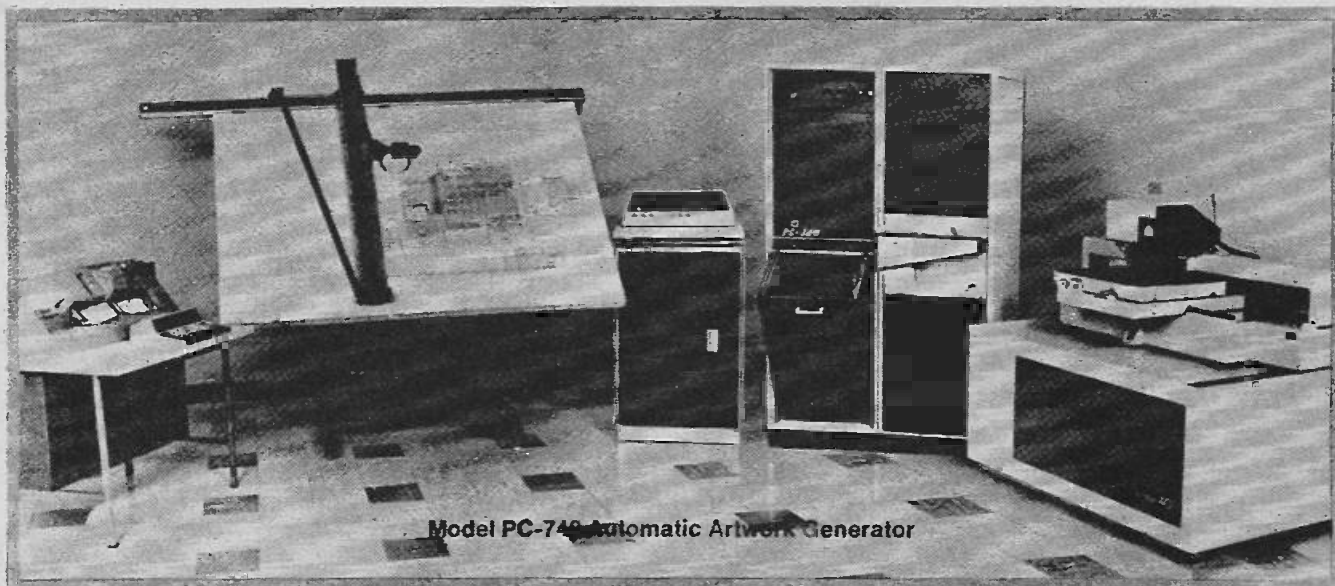

Model PC-740 Automatic Artwork Generator

Fig 2. Gerber automatic artwork generator system.

exhibit. There may be many, but the attraction was obviously slight as the glamour is rapidly fading.

Gerber had a PC-740 automatic artwork generator complex working. In this system (Fig 2) the operator indexes the input table onto each part of the roughly prepared printed circuit board. At each key position he commands the computer to read and store the coordinates. Repetitive features such as I.C. mounts and lines need be specified by key positions only. The computer fills in the repetitive features, including putting the lines, etc. on the nearest grid location. Punched cards are produced which are then used to operate an x-y digitally-controlled plotting table that moves an exposure head over film to produce the finished artwork. Gerber also operated a new large-size drum plotter capable of plots to 1 by 40m, with an acceleration capability of from 0 to 45m/min in a mere 30 milliseconds.

The requirement for chart and drawing digitizers is widespread, and in recent years the trend has gone to puck-operated tables. In these the operator moves only a small circular sensor having cross-hairs in its centre. The units on display by D-MAC chase the puck from underneath the board. Once balanced, the x, y values are read out. This method greatly reduces operator fatigue, compared with methods in which the whole slide must be moved manually.

Their display attempted to accentuate

The Hi-Power Strobe (June 1972 issue)
 The pulse transformer T1 is vitality ZTC1. Our apologies to the many readers who bombarded us with letters enquiring about this item - Editor

the general-purpose use of such machines when coupled to visual display units (VDUs) and computers. Drafting for highways, buildings, circuits - in fact any drawing where rules exist - can possibly make use of such a facility, and a Bureau (MCB graphics) has been established at the Imperial College of Science and Technology to provide systems availability on contract basis.

Although lasers are usually obvious at any exhibition, they also are losing glamour and laser applications had to be sought out. On display by Laser Associates who combined with the Royal Radar Establishment (RRE) for the development, was a thick film resistor trimmer. This equipment uses a Nd:YAG c-w laser delivering 10 watts continuous power, which is converted to 10KW peak pulse power by switching. It has been built to trim thick-film circuits made on ceramic substrates. Other lasers on display were incorporated into the now familiar optical tooling heads for industrial and survey alignment testing.

Printed armature motors are regarded as giving the ultimate in acceleration, especially for units rated in the kilowatt region. Even so, they have been slow to

find extensive use because suitable amplifiers had not been available. Printed Motors, who manufacture printed armature motors in Britain, released details of greatly improved amplifiers and complete controlled units for numerically controlling an existing machine tool.

Another reason for not using printed motors is that the full acceleration benefits are not usually attainable because practical design factors do not enable the load to be mechanically matched to the motor, thus losing much of the response. For example, in a machine tool direct-coupled installation the motor is very much mismatched as a gearbox is undesirable. Moore Read's answer has been to market dc torque motors of frameless design (Fig 3). Although having greater inertia than printed motors, they are more convenient to mount and may obtain overall better performance.

Stepping motors were represented, and the SLO-SYN agent had an interesting tape-reader on display. Most tape-readers have detents, gears or belts to advance the tape in rapid steps. The SLO-SYN design (Fig 4) uses only a stepping motor drive, which results in simplicity in itself.

An advance in batteries is the release by

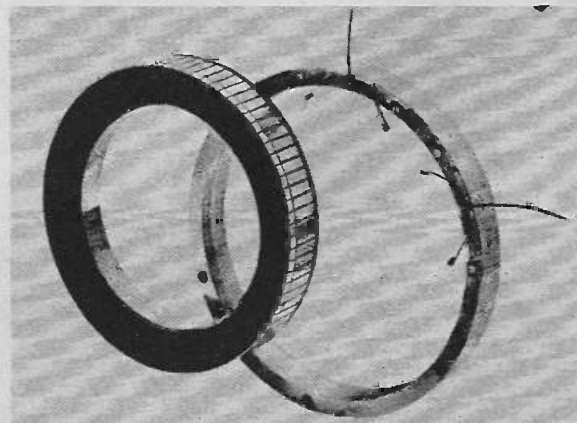

Fig 3. DC torque motors of the unframed type.

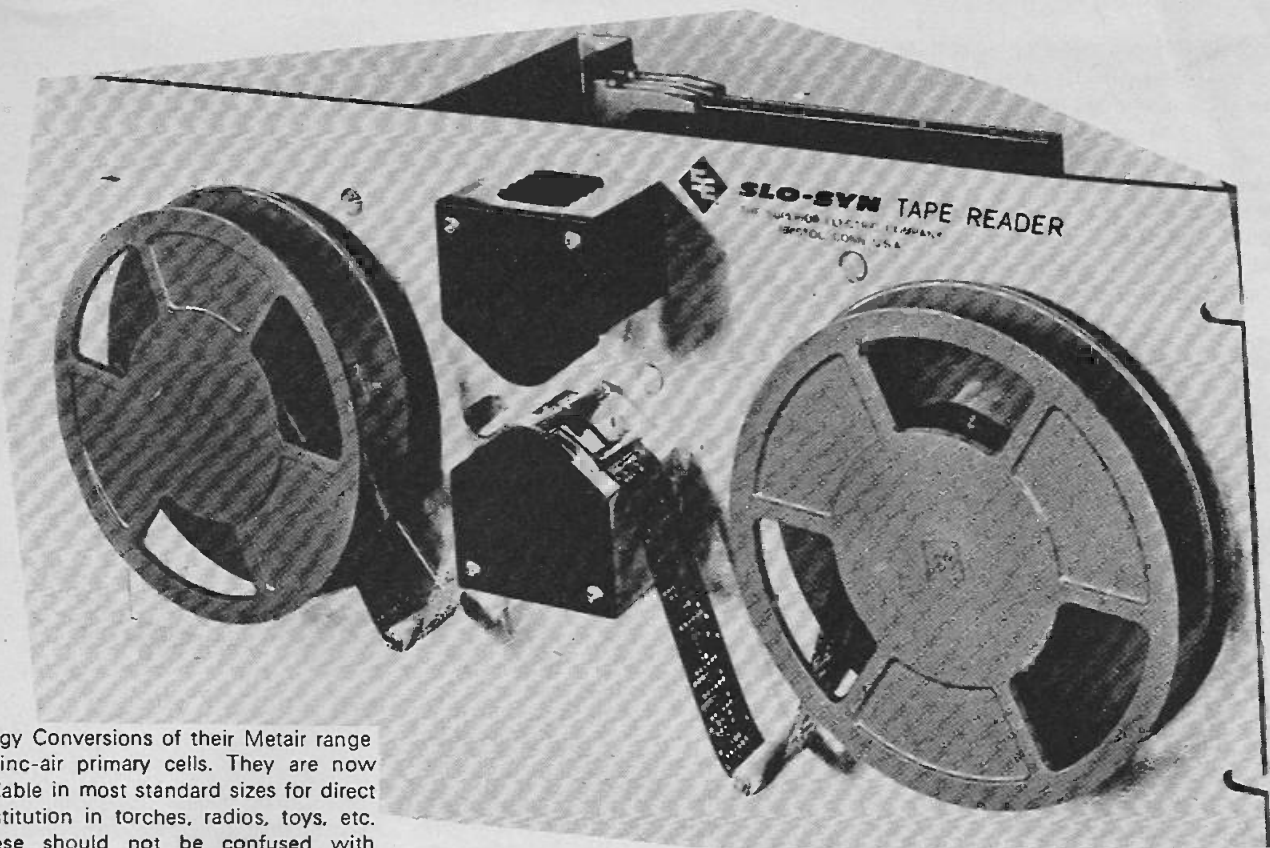

Fig 4. A simple stepping-motor tape reader.

Energy Conversions of their Metair range of zinc-air primary cells. They are now available in most standard sizes for direct substitution in torches, radios, toys, etc. (These should not be confused with zinc-air secondary cells under development for use in electric cars.) The batteries consist of an outer porous cathode and an inner zinc anode. Considerably longer life and reduced weight are distinctive features, as seen in the comparison chart of Figure 5.

The Department of Trade and Industry exhibited several current projects. From the Laboratory of the Government Chemist came an automatic method for rapidly determining the specific gravity of liquids at a rate of 20 tests per hour by completely automatic equipment. The liquid is sent into a test chamber, where a precision float is deflected by the buoyancy effect. Inductive proximity sensors detect the position, and their output is digitized and recorded.

The National Engineering Laboratory (NEL) exhibited a rugged, general-purpose

mechanical transmission testing circuit that uses optical gratings to provide angular signals of the input and output of the gearbox to be tested. The advance has been to build a portable unit that can be applied *in-situ* to an existing unit. After frequency changing of the output to obtain the same frequency as at the input, phase errors are a measure of total gear error.

The National Physical Laboratory (NPL) ran a new-design scanning electron microscope which uses field emission cathodes to obtain a smaller size instrument with much the same performance as existing units.

The Scientific Instrument Research Association (SIRA) displayed several equipments, including an automatic surface-defect monitor for in-process

paper and powder inspection.

Warren Springs Laboratory (WSL) is the Government centre for process control research in the main. They displayed time-sharing of a central computer bureau using the Post Office modern telephone-line links. Also shown was in-process viscosity measurement for substances such as paint, emulsions, creams and foodstuffs.

To sum up, the industry is still showing signs of hard times, but the exhibition was of great value to those who could afford a day or two to see it properly. It also gave manufacturers a chance to assess their position in this highly competitive area of marketing.

Fig 5. Comparing the performance of conventional batteries with the new Metair (zinc-air) cells.

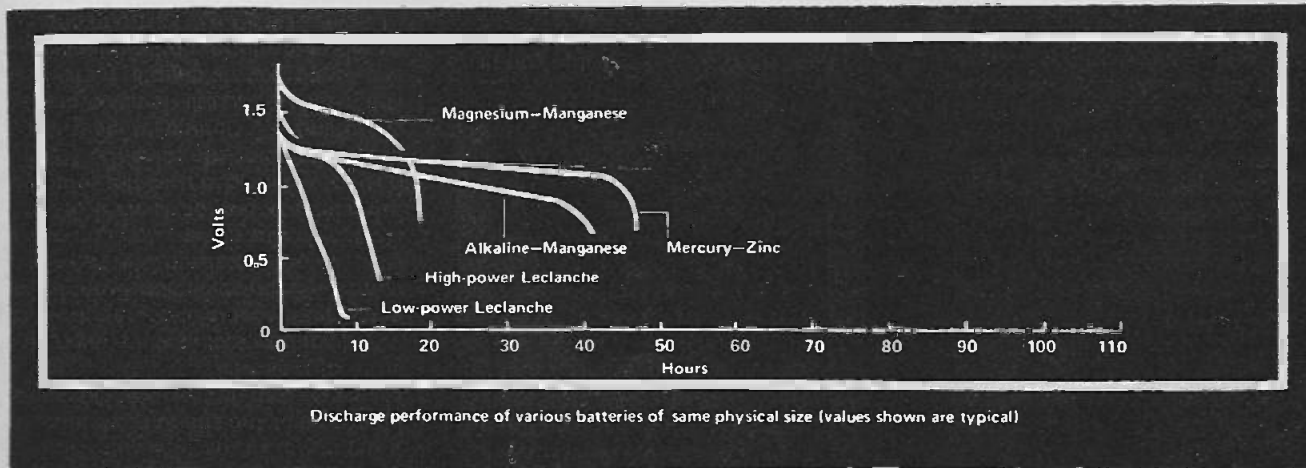

Leclanche and lead-acid batteries have been used since 1870, nickel-alkaline since 1900; and these three types account for the greater part of all batteries sold today. But not for much longer — say manufacturers of a whole new breed of power sources — who claim that their revolutionary new products will oust many conventional systems — Collyn Rivers reports.

Recent Apollo 15 Lunar Roving Vehicle was powered by two 36 volt silver-zinc batteries.

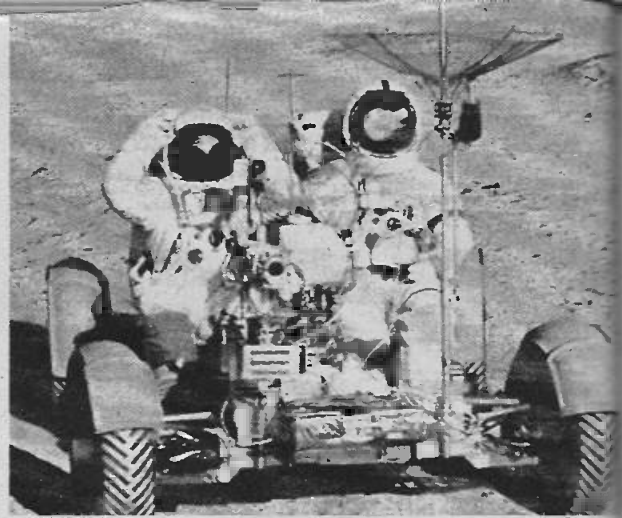

BATTERY REVOLUTION

A POLLO 15's dramatically successful Lunar Roving Vehicle was electrically driven.

Power for each of the four ¼ hp wheel-motors came from two 36 volt 121 ampere hour batteries. These batteries — designed specifically for the LRV by USA's Eagle Pilcher Industries — used silver-zinc plates operating in a potassium hydroxide electrolyte.

The silver-zinc battery was developed in the 1930s by Professor Henri Andre of Paris. The battery utilises the principle of the silver-zinc electro-chemical couple. The active materials are contained within two 'sacks' together with the electrolyte which is in an absorbed state.

But the success of this relatively new

type of battery does not for a moment imply that the traditional lead-acid cell is on its way out.

Britain's Lucas organisation has just announced that after four years they've dropped their zinc-air research and have gone back to researching lead-acid batteries. In their opinion the 'lead-acid battery will continue to be used... for mass produced cars... during the foreseeable future'.

Their latest polypropylene-cased 'Pacemaker' series are claimed to be 10% smaller, weigh 20% less, yet provide 25% more power with 35% more stored energy per lb. than the existing range.

Apart from variations of the lead-acid cell, zinc mercury and alkaline-manganese dioxide cells have

established their place as medium energy density sources. And since their introduction, products have been developed utilising their reduced size and weight.

They are essentially primary 'one-shot' systems although both are capable of a small number of charge-discharge cycles.

THE MERCURY CELL

The mercury cell was designed during World War II by Dr. Samuel Ruben to fulfill a need for a primary battery that would retain its potential over long periods of storage in adverse conditions, and be rugged enough to withstand the rigours of combat use.

Mercury cells are produced in cylindrical and flat pellet or button

Fig. 1. Construction of mercury cells.

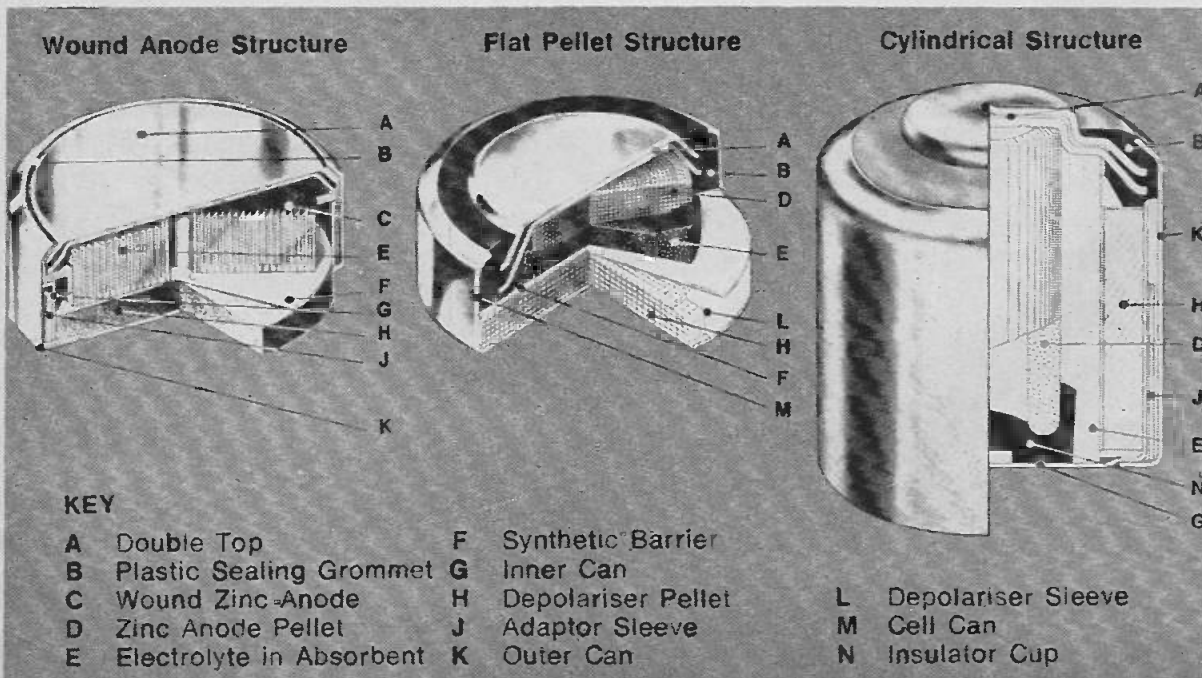

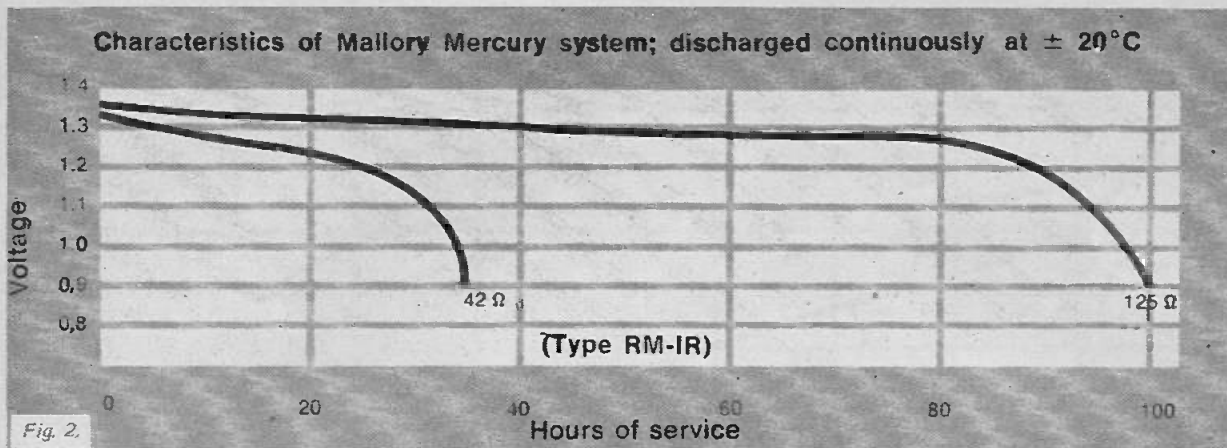

structure. Electrochemically both forms are identical and differ only in container design and internal arrangement. The basic constructions are illustrated in Fig. 1.

The anode is formed from high purity amalgamated zinc. The cathode is mercuric oxide/graphite and separated from the anode by an ion permeable barrier. The electrolyte is a solution of alkaline hydroxyde whose ions act as carriers for the chemical action of the cell, but is not consumed.

In operation this combination produces a neutral film of mercury which does not inhibit current flow. Thus the terminal voltage remains steady on discharge and recuperation periods are unnecessary. To ensure maximum efficiency, the inner cell top is plated to provide an internal surface with which the zinc anode is electro-chemically compatible.

Cell containers are nickel plated steel to resist corrosion and offer the greatest passivity to the electrolyte.

Mercury batteries may be stored for periods of two to three years with only a slight deterioration of their stored energy.

The stable characteristics of this type of battery are little affected over a wide range of temperatures and one manufacturer has reported successful operation at temperatures above 120°C . A typical discharge curve is shown in Fig. 2.

It was in fact a mercury battery that was employed to power the timer on the seismic experimental package that the first lunar astronauts left behind on the moon. The battery, little larger than a thimble, is capable of lasting for two years and is similar to the one used in medicine's heart pacemaker.

ALKALINE MANGANESE DIOXIDE CELL

For more general applications where voltage stability and small size are not so important, the alkaline manganese

battery is often chosen.

Alkaline manganese cells are similar in construction to mercury cells, and whilst their voltage is not as constant as mercury cells they are far more uniform than ordinary batteries.

The construction of the alkaline manganese battery is shown in Fig. 3. The positive terminal is formed by a stud at the top of the cell and is in contact with the depolariser via the steel case. The depolariser (or cathode) is a mixture of manganese dioxide and graphite compressed into cylinders that fit around the anode. The electrolyte is a solution of potassium hydroxide.

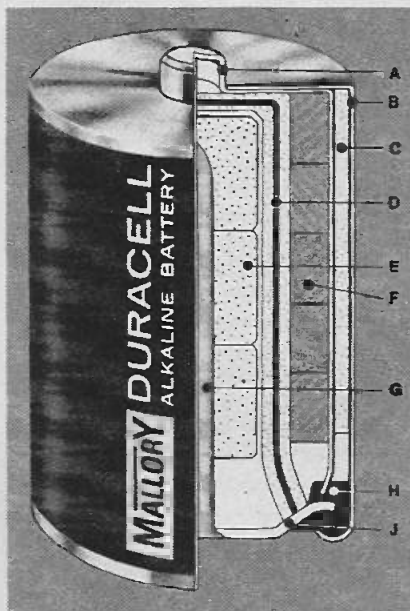

- A Inner Can
- B Outer Can
- C Adaptor Sleeve
- D Electrolyte in Absorbent
- E Zinc Anode Pellets
- F Depolariser Pellets
- G Collector
- H Plastic Sealing Grommet
- J Top

Fig. 3. Cutaway view of alkaline-manganese cell.

Alkaline manganese cells are capable of providing heavy currents for long periods, and in a similar manner to mercury cells, they have the ability to operate over a wide range of temperatures.

A comparison of discharge characteristics for conventional zinc carbon, alkaline manganese and mercury batteries is shown in Fig. 4; other characteristics are tabled in Fig. 5.

ZINC-AIR CELLS

The zinc-air cell was developed originally by Leeson Moos Laboratories in the US and was, in fact, a spin-off from their research on fuel cells.

Their major advance was the development of air-breathing cathodes that operated efficiently on oxygen absorbed directly from the surrounding atmosphere.

Leeson also contributed to the development of high performance zinc anodes to match these air cathodes, to produce cells combining high power-weight and capacity-weight ratios. They have utilised these advances in a range of mechanically rechargeable batteries developed for military use, as well as continuing research and development on primary and secondary batteries.

The Leeson Company have subsequently licensed Crompton Parkinson in the UK, Hitachi in Japan, and Gould in the USA in an arrangement that gives them full access to all Leeson's patents in this field.

A cut-away showing the important features of a rectangular zinc-air cell is shown in Fig. 6.

A tough plastic outer case contains the anode, which is prepared from amalgamated zinc powder and incorporates the negative terminal of the cell. The anode is in contact with the electrolyte, which is a concentrated solution of potassium hydroxide. This combination allows

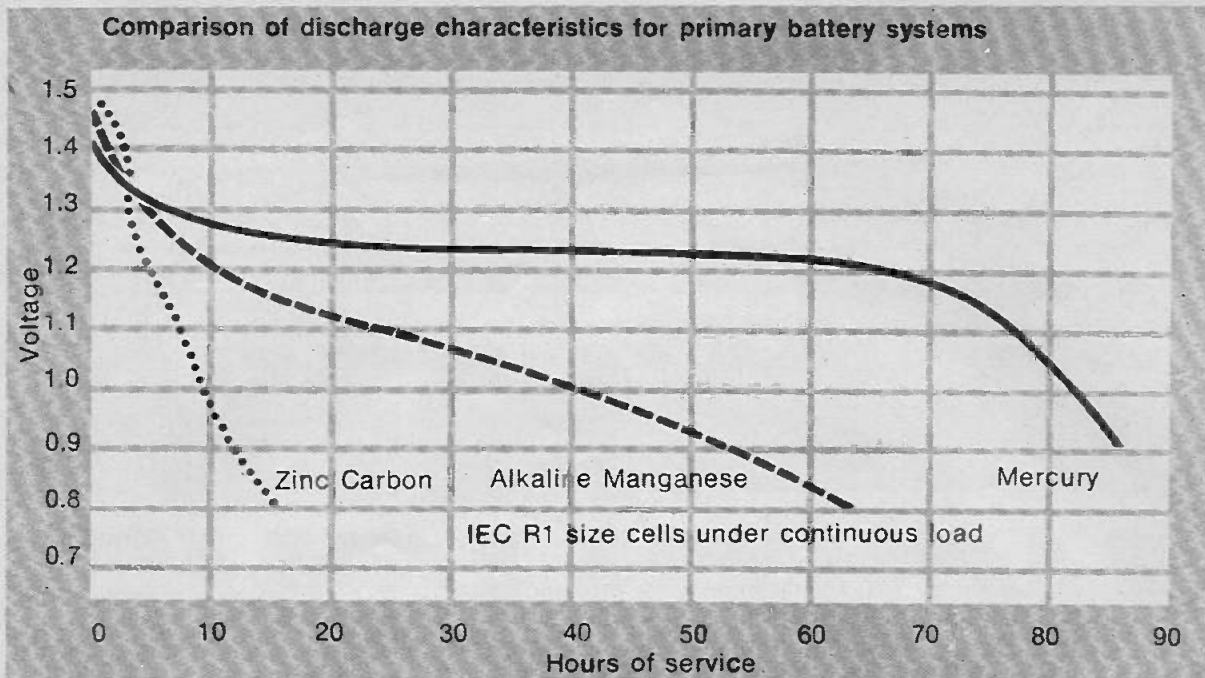

Fig. 4. Graph shows discharge performance of zinc-carbon, alkaline manganese and mercury batteries.

BATTERY REVOLUTION

large currents to be drawn without serious polarisation of the anode.

The cathode structure consists of several layers, held in an external plastic frame. The outer layer of the cathode is a micro-porous PTFE film, which allows oxygen from the atmosphere to diffuse through it into the cell. Since this is a hydrophobic material, it also serves to contain the liquid electrolyte so that the battery can be used in any position.

The inside face of the PTFE carries a layer of catalyst. This, being also in contact with the electrolyte, converts the oxygen to hydroxyl ions without itself being consumed or changed in the process. An effective but relatively inexpensive catalyst has been developed to provide a high current density at the cathode.

The current generated at the catalyst layer is collected by a metal mesh connected to the positive terminal of the cell.

The final layer is a permeable separator, which, although allowing free passage of the conducting ions, prevents direct electrical contact between the anode and cathode.

CHARACTERISTICS OF ZINC AIR CELLS

The market for primary batteries is mainly in the relatively small sizes, and

considerable research and development has been necessary to design such cells in forms suitable for economic large-scale production, without sacrificing the high performance of the zinc-air system. Cells are now being produced on a pilot scale which exceed in current output and capacity, the equivalent sizes of alternative premium cells, (such as alkaline manganese and mercury cells) by a useful margin. The cost of these zinc-air cells is already comparable, and could reduce further as production expands.

It is more difficult to compare zinc-air cells realistically with the common Leclanche dry cells, since the former operate best in continuous or semi-continuous service at high currents, whereas Leclanche cells can only operate intermittently at high currents or continuously at much lower currents. However, due to their low cost and ready availability Leclanche cells are sometimes used in applications for which their characteristics are not well suited, and in some of these zinc-air cells can offer very considerable advantages in size, weight and effective cost for the power delivered.

The maximum current output of a zinc-air primary cell is mainly governed by the cathode area. The capacity, however, depends on the volume available for the zinc anode, since the cathode will operate continuously as long as there is access of air to its surface.

System	Nominal Voltage	Storage to 80% Capacity (months)	Watt Hrs./ Lb.	Watt Hrs./ Cu. In.
Mercury	1.35 or 1.4	30	46	6.0
Alkaline-Manganese	1.5	30	35	3.5
Zinc Carbon	1.5	6-12	22	2.0

Fig. 5. Characteristics of mercury, alkaline manganese and zinc carbon cells.

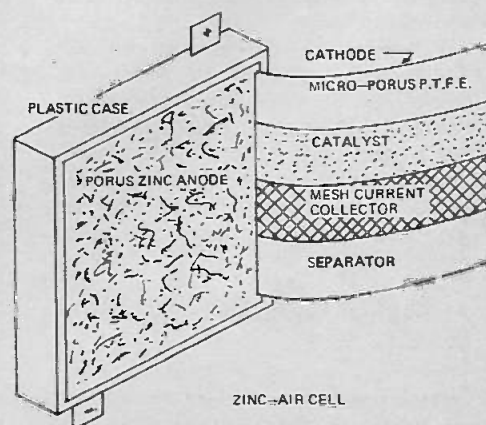

Fig. 6. Section of rectangular zinc-air cell.

BATTERY REVOLUTION

Depending on the type of application, a zinc-air cell can produce six to eight times the output of an equivalent high-performance Leclanche cell, or alternatively, a weight saving of a similar order. The systems are not, of course, strictly comparable in that, size for size, the Leclanche system would not be capable of the higher discharge rates which zinc-air can provide.

In addition, this high current is delivered, continuously if required, at a voltage which remains very nearly constant throughout the discharge. This is in strong contrast to the sharply declining voltage characteristic of the Leclanche system.

The curve Fig. 7 compares the output of two Crompton Parkinson ZETA A cells with equivalent size standard and high performance Leclanche, alkaline manganese dioxide and mercury-zinc cells.

Typical weights of the AA size cells and of the zinc-air equivalent are as follows:—

Leclanche, ordinary:	15 g.
Leclanche, high power:	15.5 g.
Alkaline manganese:	21.5 g.
Mercury:	27.5 g.
ZETA zinc-air: (each)	16 g.

The output of the zinc-air cell corresponds to 185 watt-hours/kilogram. Specification of the Zeta cells are given in Fig. 8.

ISOTOPE POWERED BATTERIES

Isotope batteries and power supplies utilise the heat generated when the energy of ionising radiations emitted by a radio-active source is absorbed.

A proportion of this heat is then converted to dc electrical power by the thermo-electric effect. This effect was discovered by Johann Seebeck nearly 150 years ago. In 1822 Seebeck observed that a magnetic needle was deflected when placed near a closed loop of two dissimilar metals when a

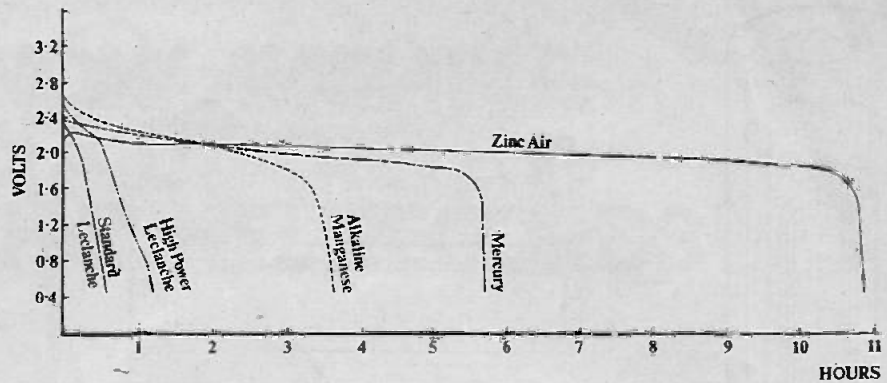

Fig. 7. Discharge curves of various types of cell compared to a zinc-air battery of the same physical size.

temperature difference was maintained across their two junctions.

The effect was largely ignored, except for temperature measurement, (i.e. thermocouples) until the advent of the transistor in 1948. It was then discovered that by doping certain pure metals a valence could be obtained as in transistors. Considerable power could be generated by making a closed loop, and then heating one junction and cooling the other.

And this is the principle used in isotope batteries made today.

The radio-isotopes used as a source of heat in the isotope batteries are recovered from spent nuclear reactor elements. The radio-isotopes generate heat as they decay — a process that takes many years.

An isotope battery suitable for use in implantable heart pacemakers is being developed at the Atomic Energy Research Establishment, Harwell. It converts the spontaneous heat generated by the radioactive isotope plutonium-238 into electricity using a thermopile, as shown in Fig. 9.

The battery is matched to the pacemaker circuit by a dc to dc convertor, which can be designed to enable any circuit to be used. A schematic view of a completed pacemaker is given in Fig. 10.

The ultimate lifetime of this battery is limited by the decay of the isotope but, with PU-238 (half-life about 90 years), lifetimes of greater than 10

years are feasible.

Pu-238 is primarily an alpha-emitting isotope and, with reliable canning, an ultra-safe source capsule can be produced; it will neither emit radiation harmful to the patient nor constitute a hazard to the general public even if — and this is highly unlikely — it is heated to 850°C.

The battery is a heat engine which uses an isotopic heat source, with a thermopile to convert the heat to electrical power. It therefore has no moving parts. Heat losses are minimised because the source and the thermopile are surrounded with thermal insulation inside an outer can, which also serves as a secondary containment of the isotope.

The can, which is made of stainless steel and is hermetically sealed, will maintain its integrity up to 600°C. The thermopile, however, may be damaged by temperatures in excess of 150°C. Even so, this is more than sufficient for sterilization and it does mean that the temperature to which the complete unit can be raised will be limited by the electronics rather than by the battery as at present.

RECHARGEABLE ZINC-AIR BATTERIES

Although the development of an electrically rechargeable zinc-air battery remains an important long term objective, it has not yet reached a

Voltage	—	Open-circuit: 2.8V. On-load: initially 2.4-2.2V, depending on load.
Current:	—	End-point: 1.8 volts. Recommended continuous maximum: 250mA peak; 500mA.
Capacity:	—	2.5Ah after 3 months sealed storage under temperate conditions.
Dimensions:	—	50mm x 28mm x 14mm (2in. x 1.1in. x 0.6in).
Battery size and terminal layout make it a direct replacement for two conventional cylindrical penlight AA cells, mounted side by side and connected in series.		
Weight:	—	32g. (1.1 oz).

Fig. 8. Characteristics of the zinc-air battery shown in Fig. 7.



This isotope battery powered heart pacemaker was successfully implanted in a patient on July 15, 1970. The unit is expected to operate for at least ten years.

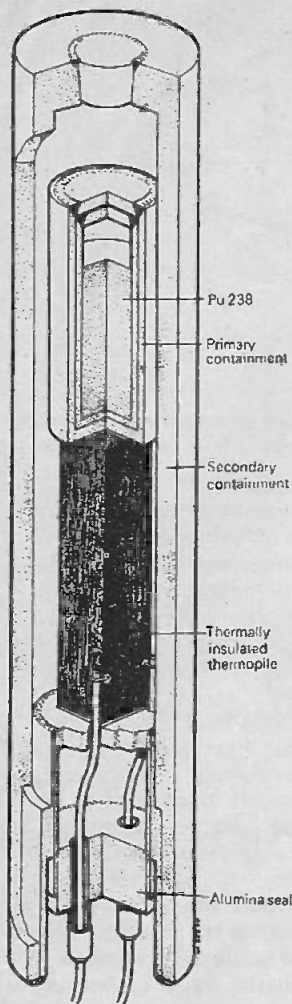

Fig. 9. Isotope battery developed for experimental heart pacemaker. Approximate size is 1.75" x 0.7".

stage when market evaluation can be considered.

The cycle life so far attained is insufficient for an immediate practical application in electrical vehicles. A design to be competitive with the conventional long cyclic life lead-acid traction batteries, must approach the same level of cost per unit of capacity per cycle as those batteries, otherwise the economics accruing from the increased pay load in delivery vehicles using zinc-air batteries will be swallowed up in a greater annual investment cost.

So far it has not been possible to achieve the same order of cost per watt-hour per charge/discharge cycle as the lead acid cell.

Although Lucas have abandoned their research project, development work still progresses at other organisations since with the rising cost of labour the economic balance can significantly shift and the effect of a higher annual cost per watt hour per cycle be diluted.

Another type of battery currently under evaluation by Mallory Battery Corporation in the USA is the

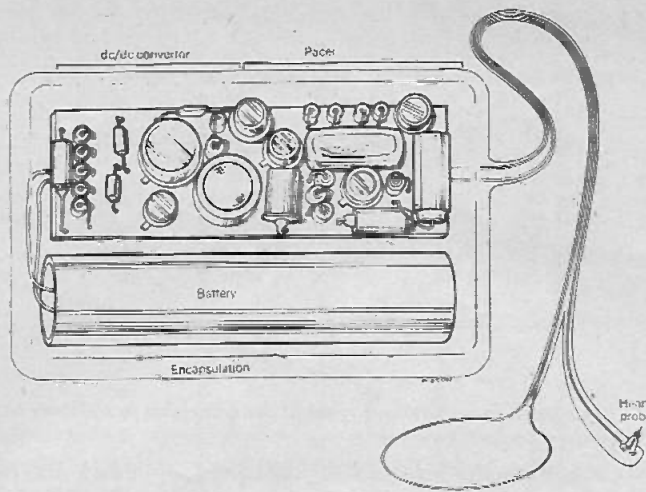

Fig. 10. Drawing of complete isotope powered pacemaker.

titanium system. The battery is in many ways similar to conventional lead-acid units except that nitrated titanium is used instead of lead. It is said to be about half the weight and two thirds the volume of conventional lead-acid batteries.

But despite all the effort and research no truly high energy density system has yet emerged that is commercially viable with the possible exception of the fuel cell.

FUEL CELLS

The fuel cell is an extraordinarily attractive concept — that of producing electrical energy continuously by direct conversion of the energy stored in chemical substances.

The first practical fuel cell was developed by Cambridge University's F.T. Bacon in 1959. This unit combined nickel electrodes with an aqueous potassium hydroxide electrolyte.

Considerable development was subsequently undertaken by a number of American organisations as part of the NASA programme. Fuel cells

Zinc-air cells manufactured by Energy Conversion Ltd. in England.

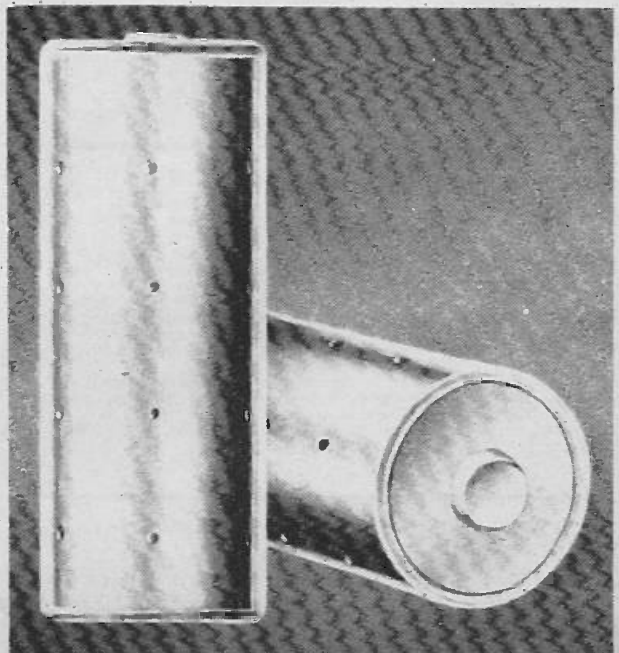

developed for space craft operated by combining hydrogen and oxygen gases in an electro-chemical reaction — electrolysis in reverse as it were.

The cutback in the NASA programme slowed down fuel cell development and interest appeared to be waning, until quite recently, when a totally new type of natural gas powered fuel cell was announced by a 32 member non-profit organization called TARGET.

This organisation (Team to Advance Research for Gas Energy Transformation) together with Pratt and Whitney have developed the new system as a method of generating on-site electricity in substantial quantities.

The new method uses the same non-combustive reaction as the smaller space-craft cells, but the hydrogen is obtained from natural gas, and the oxygen is recovered from the air.

In this new system natural gas is firstly broken up into its carbon and hydrogen elements. The carbon is transformed into carbon dioxide, and is fed into the fuel cell together with the hydrogen.

The hydrogen and carbon dioxide are fed to a porous fuel electrode. Hydrogen ions are thus formed releasing a flow of electrons that pass through the external electrical load and then to an air electrode on the fuel cell. At this point the electrons transform oxygen from the air into an ionic state: oxygen-bearing ions are thus released into the electrolyte and these migrate to the porous fuel electrode, thus completing the electrical circuit.

The new method is claimed to be one third more efficient than any previous method of generating electricity and it appears feasible to construct units with outputs up to several megawatts.

Whether or not the method can be used for small scale power generation remains to be seen. ●

NOW AVAILABLE: JVC CD-4 DISCRETE 4-CHANNEL RECORDS

World's first discrete 4-channel records now at all JVC dealers

Hear Bizet's fiery *Carmen Suite* and your favorite themes from the movies like you've never heard them before at your nearest JVC dealer. These are the first in many planned JVC discrete 4-channel record releases in the coming weeks and months. Your dealer has all the facts on the records and on the simple add-on equipment you'll need to hear them. If you can't find a JVC dealer in the phone-book, write to the nearest JVC distributor listed below for your dealer's name and address.

The missing link in 4-channel sound

Until now the only discrete 4-channel sources available were tapes and cartridges. Prohibitively expensive in themselves for most people, these sources also required special 4-channel decks for playback. The discrete 4-channel disc—the biggest 4-channel source of all—was missing. Today, thanks to JVC, this is no longer true.

Big breakthrough in recording

How to put four separate signals on the walls of the standard v-shaped record groove while maintaining the same tonal quality and price factor of existing 2-channel records was a major obstacle to the development of the 4-channel record. JVC solved it by major breakthroughs in the record cutting process. So far, some ninety patents have been applied for in the JVC CD-4 system. Some of the breakthroughs include a modulated recording system, low speed cutting, carrier level control, Neutrex process, automatic noise reduction system and new Shibata stylus.

Discrete 4-channel sound

Discrete, by definition, means that where a plurality of sound transmission systems is present, each transmission system is independent. This is the JVC CD-4 system. It gives the kind of separation which makes it possible to orientate sound to a required location. And to reproduce the original musical properties recorded. And to give the listener more freedom in movement in listening to the music. Matrix-type or encoded 4-channel systems do not have this complete separation. Which means that no matter how sophisticated, they just can't qualify as real high fidelity systems.

Equipment needed

Other than a basic 4-channel reproducing system and quality turntable, the only equipment you need to hear JVC discrete 4-channel records are the JVC 4MD-10X 4-Channel/2-Channel Playback Cartridge and JVC 4DD-10 Disc Demodulator. This equipment is now available at all JVC dealers.

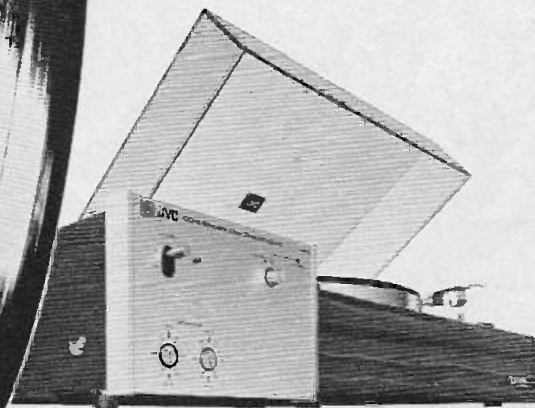

JVC
NIVICO

CD-4 SECTION, AUDIO EQUIPMENT DIVISION, VICTOR COMPANY OF JAPAN, Shimotsuruma, Yamato City, Kanagawa Pref., Japan
VICTOR COMPANY OF JAPAN LIMITED, 1, 4-chome, Nihonbashi-Honcho, Chuo-ku, Tokyo, Japan
Nippon Victor (Europa) GmbH 2 Hamburg 76, Shellingstrasse 12, W. Germany · Dicorop 23, Avenue Germain 06-CAGNES-SUR-MER France
U.J. Fiszman Schliessfach 90 03 65 Breitlacher Strasse 96 6000 FRANKFURT/M. 90 W. Germany
Denham & Morley (Overseas) Ltd. 453 Caledonian Road LONDON N. 7 England
E.M.I.-Belgium Boulevard Maurice Lemonnierlaan 171 1000 BRUXELLES Belgium
Spitzer Electronec Bachstrasse 2-6 41404 OBERWIL Switzerland · General Sound Company Via Lattuada, 26 20135 MILANO, Italy
Bovema-E.M.I. Tulpenkade 1 HAARLEM Holland · Arthur Rydin Spangavagen 399-401 163 55 SPANGA Sweden

SOUND

- THE STATE OF THE ART

All over the world, leading hi-fi equipment manufacturers and recording companies have committed themselves to four-channel sound. Collyn Rivers reports.

IN her book 'The Shadow of Man', Jane van Lawick-Goodall graphically describes how primates establish tribal supremacy by displays of aggression — generally stopping short of actual physical violence.

But these displays are nothing compared with the atavistic behaviour of the leading contenders for market supremacy in the field of quadriphonic sound.

For during the past twelve months we have seen major companies metaphorically beating their chests in order to impress upon the public that each manufacturer's particular (and deliberately incompatible) system is the system for all to follow.

And in a similar fashion as Ms Lawick-Goodall's primates, the general public treated it all with a great big yawn — until all the donner und blitzen had died down and only the finalists remained.

But now we *have* these finalists — and very strong finalists they are.

Basically there are two approaches to quadriphonic sound. These are known as 'discrete' four-channel, and 'matrix' four-channel, and both systems use speakers placed in front and behind the listener — generally in each corner of the room.

WHAT DOES IT DO?

Quadriphonic equipment and programme material can create a number of different effects. For the listener to classical music — four-channel sound can to some extent re-create the ambience of the original concert hall. (Ambience, broadly speaking is the reverberant characteristics of a concert hall, studio, or room) Contrary to general belief this is particularly effective in small rooms when, if correctly applied, the room seems very much larger — one can almost imagine one is in a large hall. (Strangely, four-channel sound is less effective in large buildings. In fact one of the worst possible places to hear it is in the average hi-fi dealer's

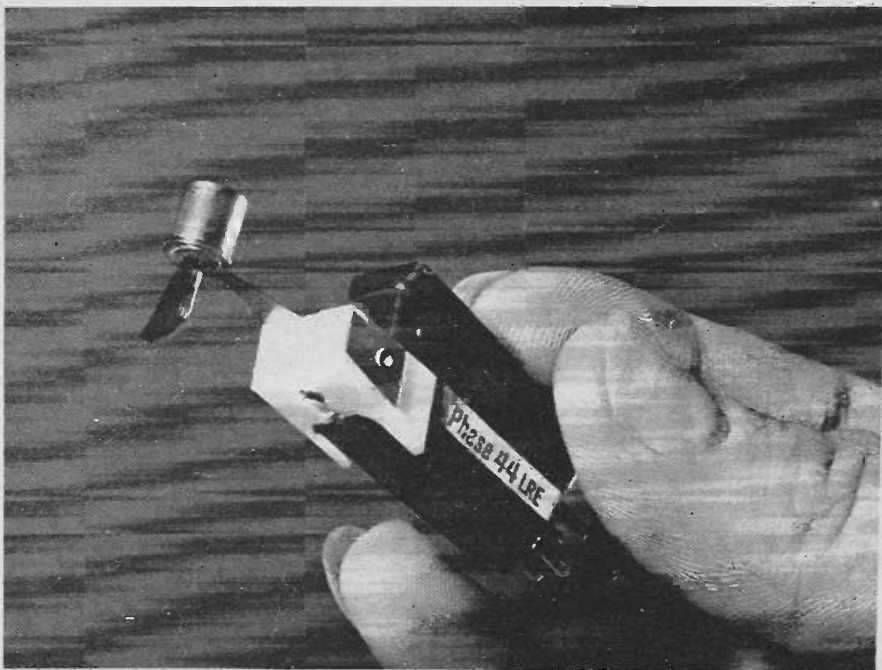

Phase 44 pick-up cartridge is specifically intended for playing 'matrixed' records.

showroom.) So if you think it sounds impressive there — you will be positively ecstatic when you hear it at home.

For the 'pop' music enthusiast, four-channel sound can create a totally new experience in the reproduction of recorded sound. Many 'pop' fans have described it in McLuhanesque terms — as a total involvement with the sound. As a well-known American observer puts it 'the young use sound the way their elders use alcohol'.

An unexpected bonus for 'pop-haters' is that people listening to quadriphonically reproduced 'pop' music invariably select a sound level at least 6dB below that which they would use were the same sound to be reproduced using normal two-channel equipment.

For the jazz lover, four-channel sound is probably a matter of individual taste. Certainly it can provide one with an experience of being up on the stage as one of the group — whether or not this is as it should be is another matter.

DISCRETE FOUR-CHANNEL SYSTEMS

Discrete four-channel sound is a technique in which four quite separate

channels are recorded onto individual tracks on one magnetic tape, or by a process of frequency multiplexing, onto a gramophone record. During replay, each channel is detected and amplified individually so that each of the four speakers in the system can reproduce its associated programme material, without unintended interaction with or from any other channel.

REEL-TO-REEL TAPE

Reel-to-reel tape was the first medium used for discrete quadriphonic sound. Technically, it is still the best, for it can offer optimum conditions for both channel separation and sound reproduction. But against its technical superiority is its cost, for it is also the most costly of the competing quadriphonic systems. This is because it requires a tape deck with four heads (or at least a head with four gaps), four playback amplifiers and of course the mandatory four speakers.

Some excellent four-channel tape decks are currently available — these include models from Akai, Teac, Sony, Pioneer, Sansui, Kenwood, JVC etc. Nevertheless despite the almost unquestioned superiority of the reel-to-reel four-channel approach, this

FOUR-CHANNEL SOUND



Four-channel amplifier and decoder from Kenwood has decoding circuitry for both SQ and non-SQ matrix systems.

superiority is largely academic, for with the exception of a few tapes made by Vanguard, JVC, Project 3, and a few small US companies, there is little pre-recorded programme material available.

THE Q8 CARTRIDGE

From a commercial aspect a far more promising tape format is RCA's Q8 tape cartridge system. Like all tape cartridges, this is basically a sealed plastic case containing an endless loop of tape wound on a single hub and driven by a capstan shaft and wheel.

The Q8 system was originally known as Quad 8 — the name was changed following action taken by Britain's Acoustical Manufacturing Company, who feel quite strongly that the name Quad belongs to them. The Q8 format is in effect a logical extension of the standard stereo eight-track cartridge. The main difference between the Q8 and the standard cartridge is that whilst the standard eight-track cartridge has four pairs of twin-tracks running side by side, the Q8 cartridge has two pairs — each of four tracks, again running side by side. Thus the playing time of the Q8 cartridge is necessarily shorter.

At present most Q8 four-channel systems are being manufactured specifically for car installation — where, as recent experience with a Peugeot 504 fitted with a Clarion unit showed, the format is extraordinarily (and unexpectedly) effective. Nevertheless Q8 cartridge players intended for home use are available from a number of leading manufacturers and at least one manufacturer (Akai) produces a deck that accommodates both reel-to-reel tapes and Q8 cartridges.

Many of these cartridge players can provide performance, that whilst not yet as good as can readily be obtained from gramophone records, is nevertheless at least as good as the majority of better class cassette machines.

The present performance limitation is simply that few of the very many

manufacturers producing pre-recorded Q8 cartridges attempt to extend the programme frequency response much beyond 8 to 10kHz. But this may well be merely a temporary limitation and no doubt Dolbyized chromium dioxide tapes will be produced.

Plenty of Q8 programme material is readily available. Regretably most of it is ineptly recorded and the benefits of quadriphonic sound are not really exploited. But this also was true of the early days of stereo and after a brief period of ping-pong type recordings the current well-balanced material became the norm.

Final contender in the tape format is the cassette machine. In Japan the JVC Nivico organisation claim that they have successfully developed a four-channel cassette system in which four channels are recorded on one-half width of the standard cassette tape.

As Philips hold world patents on the cassette system — and they have yet to make an official announcement on four-channel cassette material — the future of this system is currently unknown, however it is understood that JVC Nivico and Philips are jointly studying JVC's proposed format.

THE JVC NIVICO CD-4 SYSTEM

Technically, the most interesting and ingenious 'discrete' technique comes from JVC.

This is the CD-4 system in which four channels are recorded onto a disc using a multiplex process. In exactly the same way as with stereo records, each groove wall of the disc carries a single channel. However in the CD-4 technique each of these channels contains mixed front plus rear information — in other words left-front plus left-rear on one groove wall, right-front plus right-rear on the other. Apart from this each groove wall carries a 30 kHz sub-carrier that is frequency modulated by the left or right front-minus-back difference signal.

A decoder connected between the record player and amplifier sorts out the various signals and the resultant channel separation is more or less the same as between the two channels of a normal two-channel stereo system.

As the CD-4 discs carry signals at frequencies as high as 45 kHz (30 kHz carrier plus 15 kHz modulation) a special cartridge and stylus must be used. But despite many (uninformed) opinions to the contrary, the JVC CD-4 cartridge and Shibata stylus really does track signals of this high frequency (a frequency response graph of this unit is shown in our full review of the CD-4 system elsewhere in this issue). Apart from the special cartridge and stylus the CD-4 discs can be played on any otherwise conventional turntable. In Japan the JVC CD-4 system has been adopted by the Japanese Record Manufacturers Association as an industry standard, and RCA in America will be using CD-4 as their standard four-channel disc format.

The President of RCA Records, Rocco Laginestra says that RCA CD-4 records will be offered to the

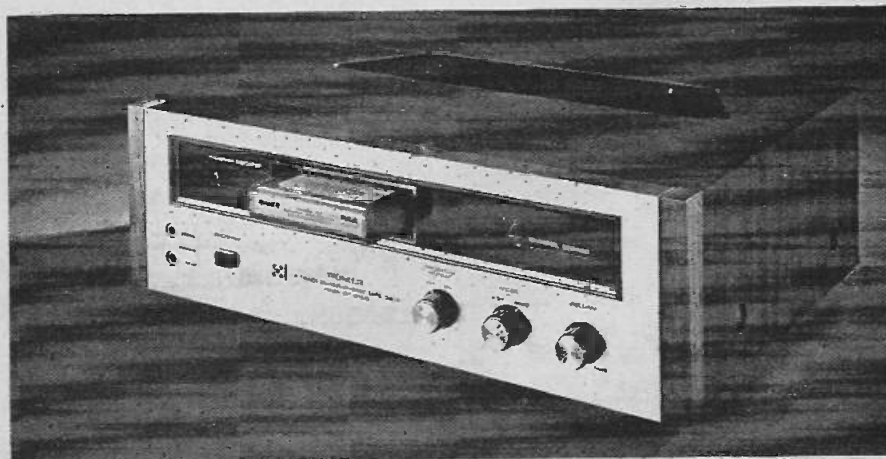

Cartridge player from Pioneer accepts standard RCA Q8 cartridges.

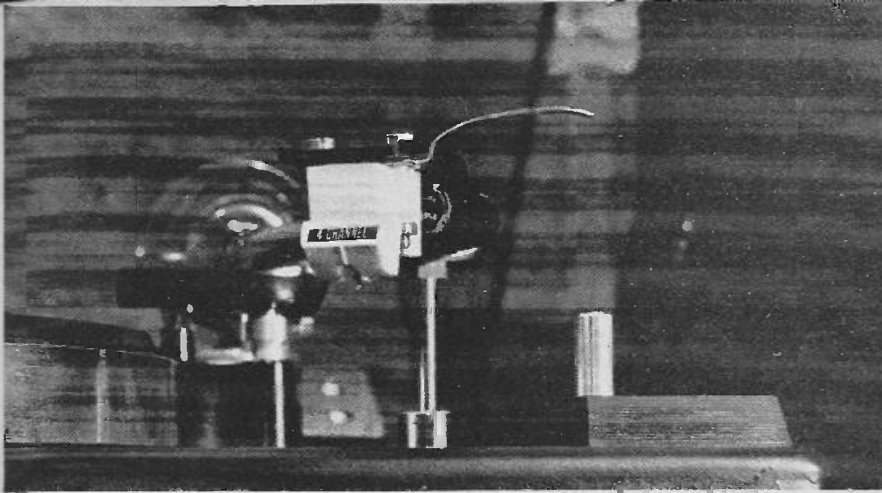

Shibata stylus of JVC Nivico turntable successfully tracks 45 kHz signal of CD-4 records.

consumer at the same prices as normal stereo records — the company's director of record operations, Bill Dearborn says that 'RCA have offered a large quantity of a hard vinyl material and will start pressing quadriphonic albums at the end of April (on a mass production basis) for engineering evaluation.

The 'mothers' are produced in New York and shipped to the company's Indianapolis plant for pressing.

The RCA company have demanded that the CD-4 disc must be playable at least 100 times on a standard record player equipped with a standard stereo cartridge and stylus yet still subsequently be capable of reproducing high quality quadriphonic sound when played through a JVC system.

Apart from RCA, advertisements in the Japanese press indicate that CD-4 records will shortly be available from the Philips group i.e. Mercury, Deutsche Grammophon etc.

The CD-4 system — which includes a wide range of decoders, amplifiers and control units — is readily available in many parts of the world — including Australia.

One possible drawback of the CD-4 system is that because of its inherently wide bandwidth requirement the signal cannot be legally broadcast in countries having stereo FM.

MATRIX SYSTEMS

'Matrix' systems encode four signals into two channels by mixing them together in various complex phase and amplitude relationships. During replay a decoder is used to direct sound information to the 'correct' speaker.

All records using matrix systems may be played on standard turntables. Again a standard cartridge and stylus may be used — but most manufacturers say that best results are obtained by using cartridges with fairly high compliance.

Matrixed records played through normal two-channel equipment sound just like two-channel records.

The fundamental limitation of matrix systems is that it is impossible to record four channels of information within the bandwidth used for two such channels without losing a certain amount of data. For this reason matrix systems cannot reproduce unique signals from any chosen speaker, indeed there is very considerable cross-talk — especially between diagonally opposed speakers — the separation may barely exceed 3dB. Despite this however, psychoacoustical factors — not yet totally understood — cause the theoretically doubtful matrix systems to be reasonably effective on a wide range of programme material.

A fairly large number of manufacturers produce matrix systems — and in theory nearly all are incompatible with one another. But in practice a record produced peculiarly for one manufacturer's system can be replayed with fairly good results on another. An exception to this, unfortunately, is the CBS-Sony SQ

system, and if non-SQ discs are replayed via an SQ decoder — or an SQ disc is played via a non-SQ decoder — there is considerable 'directional confusion'.

The major contenders in the field of matrix equipment include Electrovoice, Dynaco, Sansui, Pioneer, Kenwood and CBS-Sony.

Whilst the issue is far from clear the probable current market leaders are Electrovoice and CBS-Sony. Of these the CBS-Sony SQ — developed by Benjamin Bauer at CBS Laboratories — does seem to have a marketing lead over competitive systems.

CBS-SONY SQ

In a standard stereo record groove, modulations in the two groove walls transmit signal voltages to left and right channels through the pickup stylus.

The SQ system retains the two basic stereo groove modulations, (this is the reason for the SQ system's compatibility with all two-channel replaying equipment). But when the SQ record is made, the four channels of information from the quadriphonic master tape are passed through an encoder. This encoder preserves two of these four signals in their original form as signals for the two front speaker channels.

For the two rear channels, the encoder produces two additional modulations in the form of helices (spirals). As the record rotates and the groove advances under the stylus, a clockwise helix is produced for the left back channel and an anti-clockwise helix is produced for the right back channel.

This picture shows the complexity of a four-channel decoder — this is the JVC Nivico CD-4 unit.

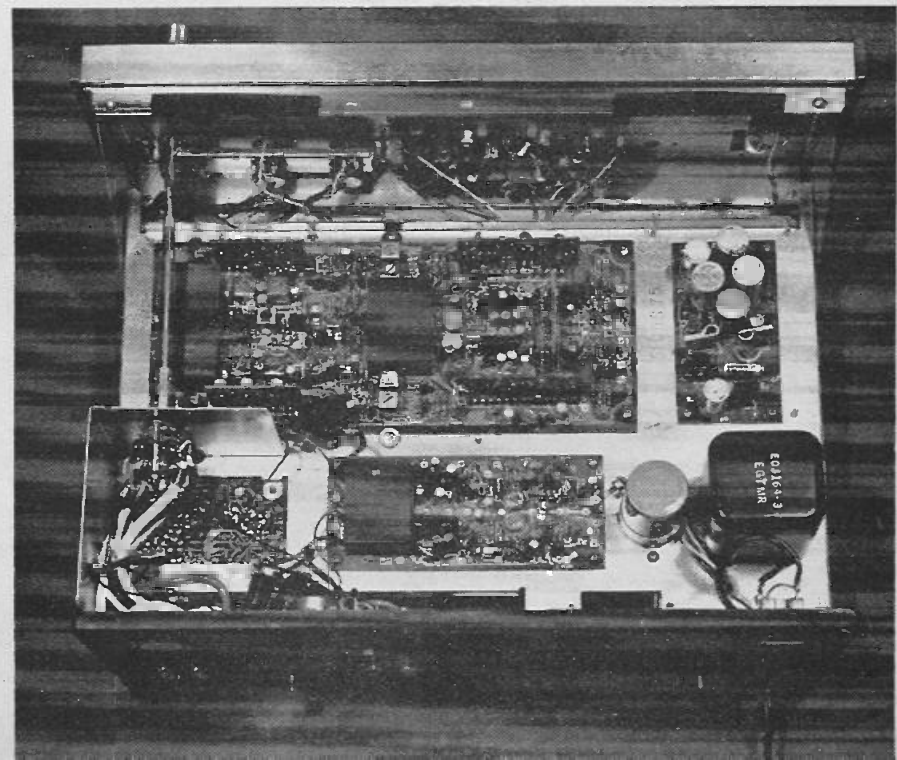

Title	SQ Disc	Q8 Cartridge
Johnny Cash at San Quentin	CQ 30961	CAQ 30961
Santana/Abraxas	CQ 30130	CAQ 30130
Funny Girl/Original Soundtrack	SQ 30992	SAQ 30992
Ray Conniff/Love Story	CQ 30498	CAQ 30498
Ray Stevens' Greatest Hits	ZQ 30770	ZAQ 30770
Kris Kristofferson/The		
Silver Tongued Devil and I*	ZQ 30679	No Tape
Andy Williams/Love Story	CQ 30497	CAQ 30497
Janis Joplin/Pearl	CQ 30322	CAQ 30322
The Raiders/Indian Reservation	CQ 30768	CAQ 30768
Lynn Anderson/Rose Garden	CQ 30411	CAQ 30411
Ray Price/For the Good Times	CQ 30106	CAQ 30106
Percy Faith/Romeo and Juliet	CQ 31004	CAQ 31004
Jim Nabors/Help Me		
Make It Through the Night	CQ 30810	CAQ 30810
Barbra Streisand/Stoney End	CQ 30378	CAQ 30378
Walter Carlos/Switched-On Bach	MQ 31018	MAQ 31018
Simon and Garfunkel		
Bridge Over Troubled Water*	CQ 30995	CAQ 30995
Blood, Sweat and Tears*	CQ 30994	CAQ 30994
Subotnick/Touch	MQ 31019	MAQ 31019
No, No, Nanette/ Original Cast	SQ 30563	SAQ 30563
Leonard Bernstein/ Also Sprach Zarathustra	MQ 30443	MAQ 30443
Poco/Deliverin'	EQ 30209	EAQ 30209
Bob Dylan/Nashville Skyline*	CQ 31007	CAQ 31007
Tammy Wynette/ We Sure Can Love Each Other	EQ 30658	EAQ 30658
Sly & The Family Stone/ Greatest Hits	EQ 30235	EAQ 30235
Kooper, Bloomfield, Stills/ Super Session	CQ 30991	CAQ 30991
Leonard Bernstein/Verdi Requiem	M2Q 30060	QMA 30060
Ten Years After/A Space in Time*	CQ 30801	CAQ 30801
Johnny Mathis/ You've Got a Friend	CQ 30740	CAQ 30740
Chase	EQ 30472	EAQ 30472
Leonard Bernstein/Mass*	M2Q 31008	QMA 31008

*Coming soon

CD4B-5001E	WONDERFUL CD-4 SOUND
CD4B-5002E	NEW CREATIVE SOUNDS/THE DOCK OF THE BAY
CD4B-5003E	THE APRIL FOOL/THE LATEST FILM THEMES
CD4B-5004E	I DREAM OF NAOMI
CD4B-5005E	LOVE STORY AND OTHER GREAT MOVIE THEMES
CD4B-5006E	4 DIMENSIONS BY 4 SAXES
CD4B-5007E	TOSHIKO AKIYOSHI/THE PERSONAL ASPECT IN JAZZ
CD4B-5008E	LATIN RHYTHM FESTIVAL
CD4B-5009E	ROCK & DRUMS/ELEANOR RIGBY
CD4B-5012E	ROCK & DRUMS/FREE
CD4K-7501E	CARMEN SUITE (Bizet)
CD4K-7502E	CONCERTOS BY MAKOTO MOROI
CD4K-7503E	DEUTSCHE BACHSOLISTEN
CD4K-7504E	KHACHATURIAN : VIOLIN CONCERTOS in D Major
CD4K-7507E	FAMOUS ORGAN WORKS BY J.S. BACH

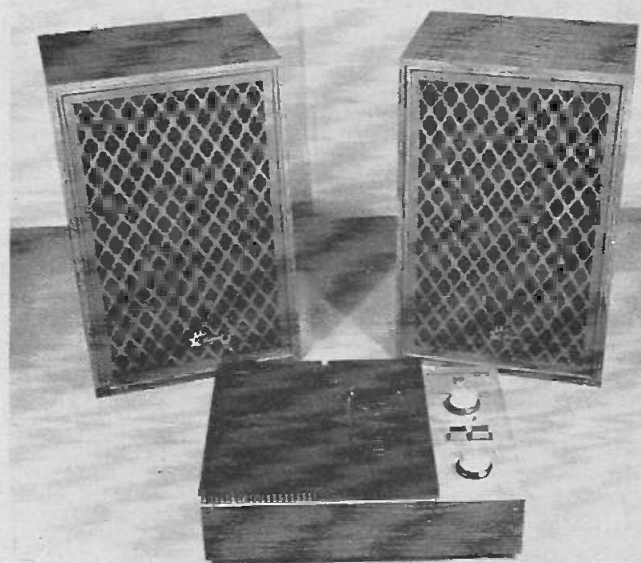

Simple but effective. This 'add-on' four channel unit – the QSP 10 from Sansui – is supplied complete with in-built amplifier and two bookshelf type speakers. Unit can decode 'matrixed' records and can also synthesize four-channel sound from standard stereo discs.

The SQ disc, then, carries in its grooves two different kinds of signals: vectored modulations for the two basic stereo or front speakers, and helical modulations for the two back speakers.

However, no special pickup is needed. All stereo pickup cartridges are capable of translating all of these modulations.

To decipher these four signals and recreate the quadruphonic sources, the SQ decoder is needed. The decoder senses the four basic modulations and produces four signals containing predominantly the sounds of the corresponding original four quadruphonic tape channels. These signals are then directed to power amplifiers and four loudspeakers placed in the respective corners of the listening area. (A complete technical description is included elsewhere in this issue).

A more complex decoder is also available for SQ records and this contains logic circuitry which by sensing relative strength and phase angle relationships can increase the effective separation between individual speakers.

At present SQ decoders are being manufactured by Sony (Sony and CBS have a joint operation in Japan for distributing recordings). Licencing arrangements to build SQ equipment are currently being arranged by CBS and a number of US manufacturers including Lafayette, Radioshack, Sherwood Electronics etc.

A major advantage that the CBS-Sony SQ system has over many of its competitors is the fairly ready availability of programme material. Already CBS have produced a quite comprehensive range of SQ discs and we found these readily available for sale in the USA. In the UK, CBS has licenced the giant EMI group to produce SQ records and we hear that these will also be on sale very soon in Australia. The quality of the CBS SQ discs is very high indeed and in most instances the four-channel format is intelligently handled.

-Apart from the SQ matrix system, a number of other less complex matrix systems are marketed by companies such as Pioneer, Sansui, Dynaco, Electrovoice etc. Some of these are specifically intended only to decode the manufacturer's own brand of records – others are more versatile. The latest Dynaco and Electrovoice units have circuitry to enable them to decode nearly all 'matrixed' discs including those using the CBS-Sony SQ system.

These non-SQ type encoders operate by taking the four input information channels and combining them in a combination of in-phase and out-of-phase conditions. The decoders then take the two pairs of stereo signals and using a technique which is in effect the inverse of the encoding process, extract four separate signals. A resultant front-left plus front-right



DYNACO QUADAPTOR utilizes ambience information existing on many standard stereo records to produce a 'synthesized' four-channel effect. No other equipment is needed except of course two more speakers.

signal appears half-way between the two front speakers and an out-of-phase left minus right appears between the two rear speakers. The resultant apparent sound source can then be made to 'appear' somewhere between the front and rear speakers.

Generally speaking the apparent separation is not as good as with the CBS-Sony SQ technique but that system is far more complex and naturally more expensive.

SYNTHESIZED FOUR-CHANNEL SOUND

All matrix decoders have the ability to synthesize four-channel sound from two-channel records. This ability is limited to recreating the ambience of the hall in which the recording was originally made and varies very considerably from record to record. The technique works because complex phase and amplitude relationships on standard two-channel stereo records contains this data in otherwise 'hidden' form. It is there — but by accident. Some records — notably those produced by Dynaco — are

The records listed below are those we have found particularly effective in demonstrating the extra information-retrieval capabilities of the Dynaquad (and similar) simple matrix circuits. All these records will produce added ambience, those preceded by (*) exhibit substantial directional effects as well.

- * Beach Boys: "Sunflower" (Reprise S 6382) In *Cool, Cool Water* the back speaker seems to get wet.
- Beatles: "Let It Be" (Apple 34001)
- Berlioz: "Requiem" (Philips 6700.019) The acoustics of Westminster Cathedral are clearly evident.
- Bizet/Shchedrin: "Carmen Ballet" (Melodlya/Angel S 40067)
- * Blood, Sweat and Tears (Columbia CS 9720) In *Spinning Wheel* in particular the soloists are decidedly in front, with unexpected instrumental effects in the rear.
- Boston Pops Orchestra: "An Evening At The Pops" (RCA Red Seal LSC 2827) and "Irish Night At The Pops" (RCA Red Seal LSC 2946) Both discs were recorded live.
- * Britten: "Noye's Fludde" (London OS 25331) Deleted, though according to London, current pressings on Argo ZNF 1 are presumably made from the same masters.
- Eileen Farrell: "I've Got A Right To Sing The Blues" (Columbia CS 8256) Deleted.
- * Fiddler On The Roof (Original Cast; RCA Victor LSO 1093)
- * The Last Night Of The Proms (Phillips 6502.001) Stunning audience involvement, particularly in *Pomp and Circumstance* and *Rule Britannia*.
- * Lee Michaels (A & M 4199) *Hearty Hi* is recorded live, and the audience sings along.
- * Pink Floyd: "Ummagumma" (Harvest STBB 388) *Grantchester Meadows* and *Several Species of Small Furry Animals Gathered Together in a Cave Grooving With a Pict* are particularly delightful.
- Shakespeare: *Macbeth* (Caedmon SRS S 231) Act 1, Scene 1 Jimmy Smith: "The Best Of Jimmy Smith" (Verve 68721)
- * Stereo Checkout — Demonstration Record (Westminster WSS 1) Deleted.
- * Stockhausen: "Electronic Music" (Deutsche Grammophon SPLM 138811) *Kontakte* has extreme four directional effects. It was originally recorded on 4-channel tape, then mixed down to two channels.
- * Simon and Garfunkel: "Bridge Over Troubled Water" (Columbia KCS 9914) *Cecilia* and *Bye Bye Love* especially.
- * Stockhausen: "Kurzwellen" (Deutsche Grammophon 2707045)
- * Wagner: "Siegfried" (London OSA 1508) Side 5 in particular

ALSO

any disc recorded in the Electro-Voice 4-D matrix format

especially recorded to enhance this effect.

A sub-group of matrix systems are designed solely to exploit this 'accidental' matrixing data described above. These are available at very low prices, and are produced by many companies including Dynaco, Lafayette, Koyo, Palm, EV etc. The technique, which requires no other components except of course two loudspeakers is described as a constructional project elsewhere in this issue. The method is simple but effective on many recordings. (It may also be used with stereo tape recorders).

The whole matrix technique has been considerably snarled up by the recent award of US Patent No 3,632,886 to Peter Scheiber covering encoding and decoding matrix systems for four-channel recording and broadcasting.

This patent is said to be basic and 'will cover all present and future matrixing systems'. Peter Scheiber is now associated with the Electro-voice organisation. Howard Durbin, technical director of Electro-voice says

that 'Our basic interest is in establishing the four-channel concept as an industry with playback equipment in all price classes'.

IS IT ALL WORTHWHILE

A year ago we would have said 'no'. At that time most demonstrations of the new media were unconvincing — mainly because the programme material was so awful that it was practically impossible to judge whether the system was worth the trouble and expense.

Today the situation is rather different — a number of quite excellent four-channel recordings are commercially available and we state quite unequivocally that given the right surroundings (and programme material) four channel sound — discrete or matrix — adds very considerably indeed to one's enjoyment of music. Sometimes the difference is practically as marked as that between mono and stereo.

But this statement must be qualified by repeating that the room in which the gear is heard must be suitable for four-channel sound. The main requirements seem to be that the room

Three low-priced four-channel 'synthesizers', Unit (far right) is specifically intended for converting a car two-channel cartridge player to 'four-channel'. Like the Dynaco unit the only other bits required are two more speakers.

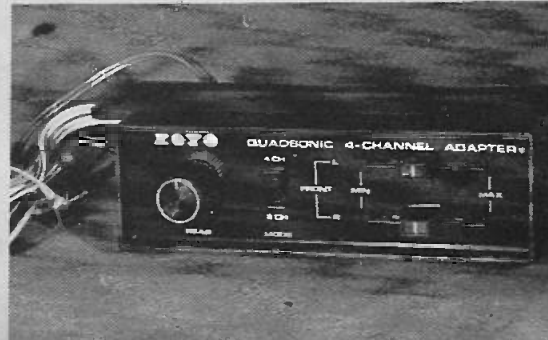
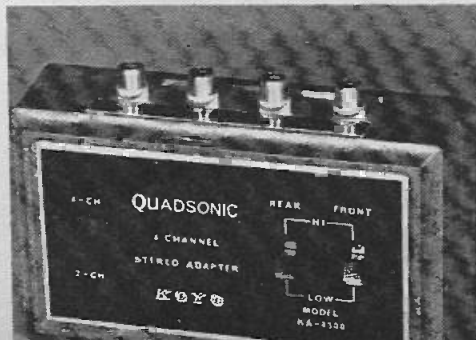

FOUR-CHANNEL SOUND

should not be overly large and acoustically should be fairly dead. The average domestic living room with normal soft furnishings, carpeted floor and curtained windows is just fine.

As this article has explained, there are various four-channel media — from reel-to-reel tape to gramophone records. Of these the best system technically must be reel-to-reel tape, for despite the cost of equipment this technique provides superb channel separation and excellent sound quality.

The reel-to-reel enthusiast has no problems if he can make his own material — if not his choice of ready made programme material is very limited indeed — although at the time of writing (May 29) there are rumours that a major US recording company may be entering this field.

The cartridge system will appeal to the car owner especially if he also has a domestic four-channel cartridge player in his home. At present few cartridge players can provide the sound quality of the other four-channel systems — but most of them provide at least 'medium-fi'! However as our review of the Akai 1800S combined open-reel and cartridge recorder (pages 44-47 of this issue) show — true hi-fi sound *can* be obtained from cartridges if good quality tape (and associated electronics) is used.

It is also quite probable that JVC Nivico four-channel amplifier.

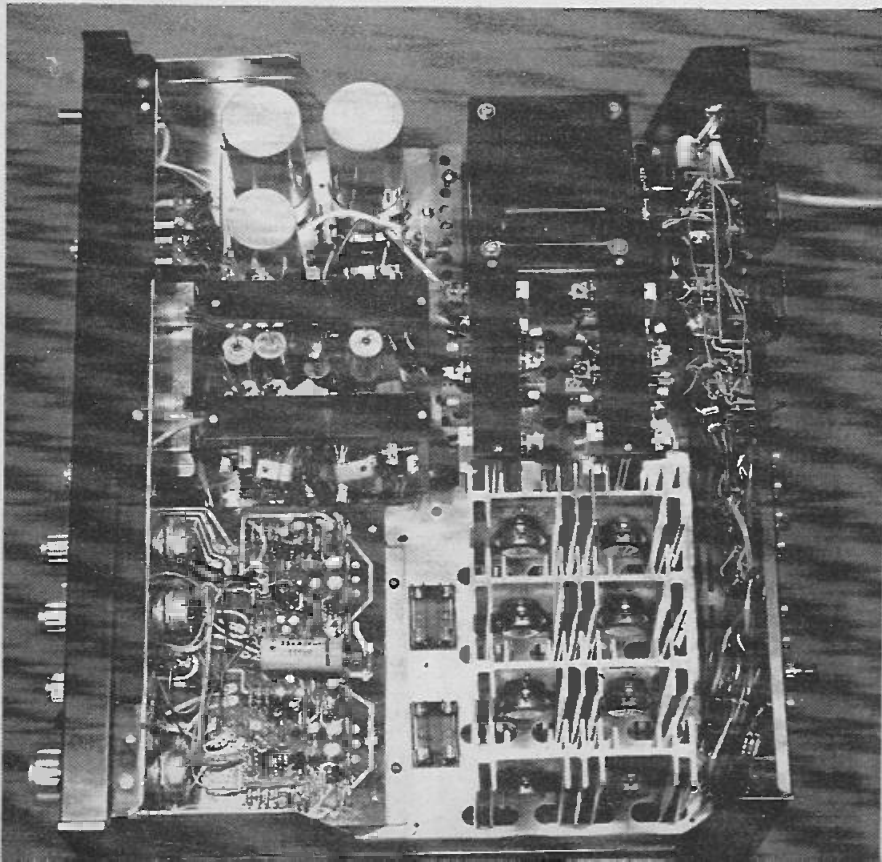

EXPERT COMMENT

In the early days of stereo, it was customary to sit fairly well back from the loudspeakers so the angle subtended by the speakers to the listener was less than 90°.

With the introduction of four-channel, most of the manufacturers have suggested a square arrangement for the speakers. But this tends to produce a 'hole in the middle' and is possibly one reason why a few reviewers have commented that while four-channel sound great — it does not sound quite like the real thing.

If the speakers are arranged in a curve, the length of which is about 120° to 180°, the stereo image is vastly enhanced but the feeling of sound surrounding the listener is lost.

Another possibility, primarily when the rear speakers contain primarily reverberant information, is to point the speaker at the side or rear wall to provide a greater degree of diffusion by increasing the number of reflections.

I think that there is still a long way to go before we will really be able to tell how good four-channel will be.

Murray Wood, B.E., B.Sc. M.E.
Louis Challis & Associates.

cartridge systems will be available with circuitry suitable for chromium dioxide tapes — and inbuilt Dolby system.

The four-channel cassette is very much an unknown quantity at the time of writing — however developments in this new field are taking place so quickly that there may well be a four-channel cassette format

in the reasonably near future. It all depends on the Philips group. They hold all the patents!

It is extremely probable that both cartridge and cassette tapes will soon be produced in matrix form — if this transpires they will be reproducible through the same encoders that are now produced for gramophone record use.

For the record enthusiast the big question must be whether to go for the JVC Nivico/RCA system of discrete four channel sound — or rather to choose the CBS-Sony SQ or other matrix systems. The two systems are currently quite incompatible — their records and decoders can only be used with the system for which they were made.

Massive investments have been made by manufacturers backing both the JVC and SQ record systems and it is unlikely in the extreme that either system will become obsolete in the near future.

At present only JVC decoding equipment can be used to decode JVC CD-4 records and theoretically at least, an SQ decoder should be used for the SQ records. But if licencing arrangements permit, it is logical for companies to produce decoders that can be used for either type of record — it would not be too difficult for such decoders automatically to detect the ultrasonic carrier in the JVC disc and switch accordingly.

One problem, that whilst not yet too serious — may become more so in the near future, is the difficulty of broadcasting the JVC signal over stereo FM. This signal just cannot be accommodated within the existing frequency bandwidth allocations. Legal changes must be made if it is to be used. Apart from the legalities, FM broadcasting stations may well oppose transmitting the signal, for it would mean expense in modifying equipment to relocate the 38kHz stereo FM subcarrier etc. The SQ signal, on the other hand, can be transmitted without any changes at all, and in the USA, Lafayette's new model LR-440 stereo FM receiver has an SQ decoder inbuilt.

As far as record players are concerned the special JVC CD-4

QUAD-WRANGLE

Japan's JVC Nivico organization are reported to be seeking a way to use the term 'Quad' on its four-channel systems and RCA are also strongly considering the use of this name on their products — although a firm decision has not yet been reached. The problem is that the name 'Quad' is a registered trade name of a British manufacturer producing hi-fi amplifiers, tuners etc.

QUAD-QUESTIONS

Q. I appreciate that I need two further speakers for the rear channels — do these have to be of any particular type or quality?

A. The better the four-channel system then the better the speakers that should be obtained. This is especially true of discrete four-channel sound. Generally however it is not necessary for these rear speakers to have the power handling capability of the front units. About 50% is adequate.

For the simpler matrix systems use speakers with good bass and midrange response but preferably with not too much treble. If existing units are used it may be worthwhile disconnecting the tweeter. This is because such systems do tend to increase surface noise.

Many authorities suggest that omni-directional speakers be used for the rear channels — we agree with this. If only uni-directional units are available try them actually facing the rear wall, so that one uses reflected sound.

Q. Must the extra speakers be at the rear of the room?

A. Not necessarily. In fact an interesting effect is to place them about four feet behind the front speakers and facing toward them. This creates a 'sound stage' — most effective for orchestral music.

Q. I have only a limited budget — is it better to buy a medium quality four-channel system — or a good quality two-channel system?

A. This depends upon what you want from your equipment. If you are merely interested in music as a pleasant background experience then a medium price four-channel set-up may well be worth considering. On the other hand if you enjoy listening to music then without any doubt buy good quality two-channel equipment

and consider extending it to four-channel at a later date.

Q. Do you think that we shall see a single universally accepted four-channel disc?

A. No. But there may well be equipment made that will play both JVC and SQ discs. It's a matter of commercial politics — the engineering required is quite feasible.

Q. I have seen adverts for four-channel headphones. Are they for real?

A. Yes. Each earpiece contains two drive units — one in front of the other. They provide a four-channel effect to some extent but not to the same extent as do four speakers in a room.

Q. Is four-channel sound worthwhile in a very small room?

A. Definitely yes! The most impressive four-channel sound that we have heard to date was in a car.

Q. Conversely then is it worthwhile in a very large hall?

A. This depends very much upon the programme material. For organ music — such as Bach or Palestrina — it is as long as the rear channels reproduce only reverberant data. But in general most programme material will sound rather odd.

Q. Do four-channel records have the same playing time as normal LP's?

A. Yes — but at present only 12" discs are available.

Q. Can I play the JVC CD-4 discs with a standard stylus?

A. Not at present — but RCA say that when they commence production — which will be very soon they will not be damaged if a normal stylus is used to play them. The proper Shibata stylus of course must still be used if four-channel reproduction is required.

it is necessary to switch on as many as four separate units and adjust a multiplicity of controls. Many of these set-ups are an ergonomist's nightmare.

Four-channel sound really can do a great deal of what its protagonists claim for it. It cannot yet — and possibly never will — recreate the total ambience of a concert hall, for one cannot create a new ambience without first removing the old one. But it certainly does create a feeling of spaciousness that we have never obtained before from any two-channel equipment, no matter how costly.

Four-channel sound has too many positive advantages for it merely to be dismissed as yet another industry gimmick — although with little doubt it is a 'manufactured need' that people had not previously been aware that they required.

But like electricity it is probably here to stay.

LATEST EQUIPMENT

Among the latest four-channel equipment now on sale in England is a range of units marketed under the National and Panasonic brands from Matsushita Electric and also equipment from Onkyo, marketed by J. Parker & Co.

The National range includes the Model RS 840S four-channel cartridge player. This unit's mode of operation (two-channel or four-channel) is automatically selected when a cartridge is inserted into the tape slot, a lever in the tape slot detecting the special groove on four-channel tape cartridges.

A new type of tape head has been developed for this machine, in which the four head elements are aligned with their head gaps in a straight line. Matsushita claim that this provides optimum sound reproduction without unwanted phase shifts.

Also from Matsushita is the National Panasonic Modem RE 7750B stereo radio, incorporating what the company describes as "quadriplex" four-channel sound. This is presumably a matrix system synthesizing four channels from two channels, as described elsewhere in this issue. This unit is supplied as a system, complete with four matched loudspeakers. A joystick remote control is also included.

Onkyo's X Series and Y Series systems are unusual in that they appear to be able to decode the JVC CD-R discs as well as material coded by the various matrix systems.

It is an interesting thought that the same matrix decoding circuit appears to be used for all matrix systems, including SQ discs. We have no actual experience with this unit, however, and cannot at this stage comment upon its effectiveness.

Another interesting feature is the rear speakers which, measuring only 13 in by 16 in by 4 in, are thin enough to hang on the rear wall of the room.

Both Onkyo systems include front and rear speaker systems, record player, four-channel stereo, AM-FM receiver and four-channel amplifier, plus the necessary decoders.

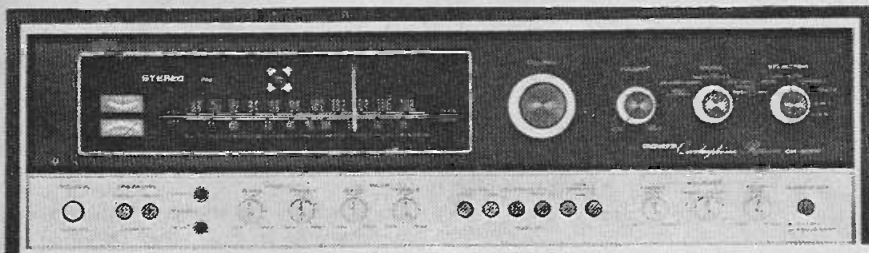

For those countries that have it — stereo FM broadcasts can be synthesized into 'four-channel' sound by units such as this Pioneer QX 8000 receiver.

cartridge and Shibata stylus may be fitted to any record player — and of course can be used to play SQ records.

Currently some decoders have amplifiers in-built for the two rear channels — others rely on the user supplying a separate amplifier, or buying a special four-channel amplifier. Certainly if one is seriously considering present or even future investment in four-channel equipment one could consider purchasing a four-channel amplifier.

By far the cheapest way to try (rudimentary) four-channel sound is either to make or buy one of the simple quadriphonic synthesizers. These are obtainable at very low prices, and unlike the more complex four-channel equipment, these synthesizers do not require a second amplifier. They connect directly to a second pair of speakers. This type of system has some major limitations but

at least it does provide a good idea of the possibilities of true four-channel sound, and if later one decides to go into four-channel sound 'totus porcus' one will still require the speakers anyway. The speakers should be of good quality, but unless one is definitely planning eventually to buy full 'discrete' equipment the speakers need not necessarily be of as high a quality as the front units.

This approach to four-channel sound will not for one moment provide the quality of a true four-channel installation but it does give some idea as to what is possible without spending a lot of money.

Having for the past month used practically every item of four-channel equipment currently available — one thing is clearly apparent. This is that with the exception of the simpler 'synthesizers', most of the hardware is far too complex to use. In some cases

ALL ABOUT 4-CHANNEL SOUND



THE SQ

by Benjamin B. Bauer,
CBS Laboratories,
Stamford,
USA.

A full review of the CBS-Sony SQ system is included in this issue (pages 48-51)

A record groove is a two-channel medium. It is possible to record on it only two "orthogonal", or independent channels. But the orthogonality can be chosen in various ways for example, with $45^\circ/45^\circ$ or lateral-vertical stylus motions, and, as we have discovered during our matrix studies, with clockwise and counter-clockwise circles.

The two channels of any other orthogonal set one may choose will be independent of each other, but not from another set — some information will be transferred from one set into the other. This in essence, is the problem of placing four channels on a disc — how to minimize the effect of information transfer, and thus to portray a credible four-channel sound display.

STEREO COMPATIBILITY

Before describing the SQ record, let us consider briefly the philosophy that

must be adopted to produce a truly compatible stereo-quadrasonic system. We take it for granted that such a record must exhibit full frequency response, output level, and freedom from distortion and noise, which characterize the present high fidelity stereo disc and we believe precludes the use of carrier systems since they wear so rapidly and take up so much "modulation space."

For the moment let us return to our initial premise — that the SQ record in the quad mode should produce a sound which for all intents and purposes is the same as that of the original four-channel master tape. But what about the listener who hears the same record on a two-channel stereophonic system? What should he hear?

This question is an extremely important one if we are to attain full compatibility. Suppose a room is equipped with quadrasonic

loudspeakers in the corners and you are standing in the centre facing in the forward direction. The performance of a symphony orchestra spans the space between the front loudspeakers. The reverberant energy of the hall is reproduced by the whole system including the rear loudspeakers. Or perhaps the performance is a rock quartet with the artists placed in the corners. The general arrangement is shown in Fig. 1. How should we "fold", or transform, this performance from four loudspeakers to two with maximum listener satisfaction?

Before we answer this question we call to the attention of the reader that the sounds from the front loudspeakers in Fig. 1 are shown to follow straight-line arrows, while those from the rear loudspeakers appear to follow a bent path! This is not a physical perturbation, but rather a physiological one which we discovered during our psychoacoustic studies related to quadrasonic reproduction. The fact is that the width of a sound image in the back of us appears to be greatly contracted compared with that which we sense from the front with an

identical array of sources.

If you have a stereophonic components system you can prove this to yourself with very little difficulty. Stand in the centre facing the stereo loudspeakers while a record with good channel separation is playing and make a mental note of the image width; next, turn around rapidly and you will sense the image to collapse to perhaps 1/3 of its original width! The discovery of this phenomenon, which I call "back image contraction" has played an important role in determining the most propitious way of transforming a quadrasonic performance into one which is fully satisfying artistically in the stereophonic mode.

Keeping in mind the above-described experiments, only one method provides a satisfactory quad-to-stereo transformation: the orchestral stage must remain undiminished, i.e. the front channels should stay where they originally had been — in front,

spanning the full interspeaker space. Any discrete back channel sounds have to be transferred into the front channels in such a manner that a symmetrically located listener perceives a minimum change in the aspect of sound as a result of the transfer. This latter objective is realized if the sounds originally coming from the rear loudspeakers remain at full strength but are positioned in front as if they had been reflected from the front wall bouncing back toward the listener (as illustrated in Fig. 2). This latter aspect causes them to arrive at the same included angle from the front that they appeared to sustain when they originated from the rear loudspeakers. Any front centre signal, C_F in the quad presentation should, of course, remain at the centre of the stereo display. And if the "reflected" sounds carry with them a feeling of being more distant, a depth illusion is created which helps to provide a

quadrasonic identification to the stereo display.

With the quad-to-stereo transformation described above, a symmetrically placed centre observer notices the least change when the system is switched from quadrasonic to stereo, and this in itself is proof that a satisfactory "fold" has been achieved. As a matter of fact, the best place from which to observe the impact of quadrasonic sound is *not* at the centre of symmetry. One of the virtues of quadrasonic is that it frees the listener from the centre-of-the-room spot. Its impact is widely distributed over the listening area.

COMPATIBILITY REQUIREMENTS

We can set forth some of the requirements to be expected from a compatible stereo-quadrasonic record and from the playback system on which it is to be reproduced.

1. In the compatible stereo mode the record should exhibit full front-channel separation. This is in accord with the above-described experiments.

2. Since with the quadrasonic capability at hand the producer is able to place the performers everywhere and to "pan" the signals anywhere around a 360° circle, the system should possess *omnidirectional stereo fidelity*; which means that if a constant signal is panned around the encoder, the total sound power delivered to the stereophonic loudspeakers should remain constant regardless of the angle of pan.

3. Upon decoding into four-channels, at least the front pairs of channels should exhibit as complete a channel separation as possible. (Additionally, the greater the channel separation between the other adjacent pairs of channels, the better the quadrasonic illusion.)

4. For the same reason as in (2), above, the system should display *omnidirectional quadrasonic fidelity*, i.e. with a signal panned into the encoder around a 360° angle, the total encoded energy applied to the four loudspeakers should remain constant.

5. Since the signals recorded on the disc will be used to produce an unambiguous quadrasonic performance, there should be no ambiguity in the encoded signal as to direction with a signal panned around the encoder input over a 360° angle; or to put it in reference to the decoder, there should be no ambiguity in the set of decoded signals over the full circle of sound arrival.

6. In principle, the system should be able to handle at least single *discrete* channel sounds *discretely* through the corresponding loudspeakers. This, we will show,

RECORD

-how it works

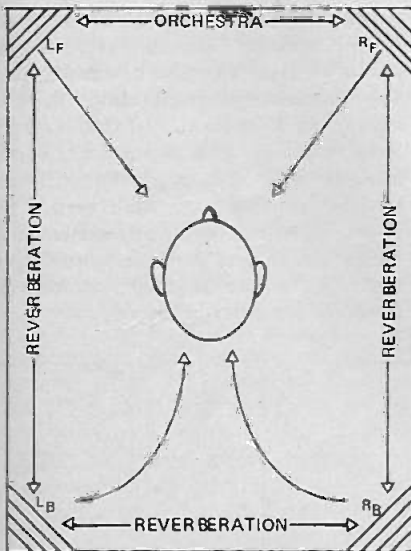

Fig. 1. Typical four-channel sound: For classical music the main sound appears from front speakers — rear speakers mainly supply reverberant sound. A 'pop' quartet however may well be recorded such that each performer is placed in a separate corner.

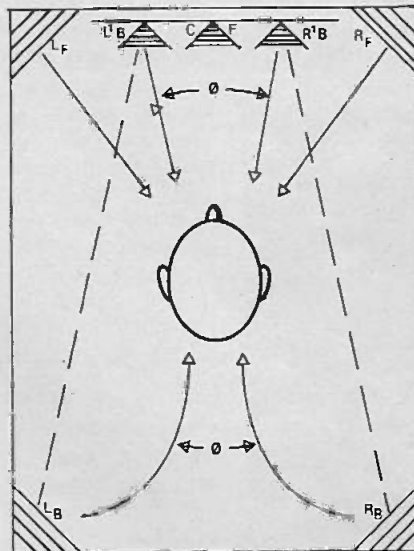

Fig. 2. How a quadrasonic record may be satisfactorily reproduced on a two-channel system. The two rear channels L_B and R_B have been transferred to the front channels and appear as a 'reflected sound' from an imaginary front wall.

THE SQ RECORD

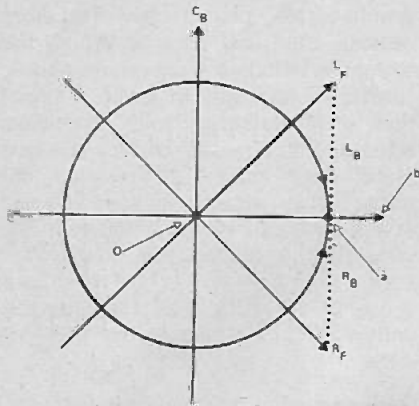

Fig. 3. SQ record modulations.

requires the use of a suitable electronic logic added to the matrix system. The logic is a rather expensive refinement which has proven to be unnecessary in the majority of home-type reproduction equipments. However, the matrix system should preferably be such that a suitable logic can be used with it.

7. When the matrixed signal is broadcast through an AM station or is played on a monophonic phonograph, all four channels should be transmitted without loss in level. In the case of the rock group it would not do for the back performers to drop in level significantly relative to the front ones, thus depriving the listeners of the full measure of performance.

THE SQ RECORD

We can now proceed to describe the SQ record system. Since we have decided to leave the front channel

sounds unaltered when changing from quad to stereo, we cause our LF and RF channels to become the Left and Right stereo channels, respectively. This also means that any centre-front sound, CF, becomes equal to the centre sound of conventional stereo resulting in lateral modulation.

Next, we have to accommodate the LB and RB channels. During our investigations, we have discovered that two circular stylus motions, namely clockwise and counterclockwise, also form an orthogonal-set. It turns out to be favourable to assign to the LB channel the clockwise motion and to the RB channel the counterclockwise motion. The two motions, in combination with the longitudinal motion of the groove create a double helix, which then carries our back channel sounds. When a centre-back channel is recorded the two oppositely directed helices combine into a vertical modulation. The above-described six cardinal modulations of the SQ record in vector form are shown in Fig. 3, and a microphotograph of a portion of the groove exhibiting the four principal modulations is shown in Fig. 4.

The method of encoding an SQ record is shown in Fig. 5. After the recording director has approved the edited version of the master tape which appears on four loudspeakers in the editing room, the corresponding channels, namely LF, RF, LB, and RB, of the master tape are connected to the SQ encoder, resulting in a pair of encoded signals defined by the phasor groups LT and RT. It is noted that LF and RF are precisely in-phase at the output terminals and are completely isolated from each other: that is, there is no LF present in RT, and no RF in LT. Thus, the front-channel separation

remains infinite, meeting our first condition for a properly performing stereo-quadrasonic system. The back channels, LB and RB, are in quadrature with the $0.707L_B$ term at LT leading the equivalent term at RT, and the $0.707R_B$ term at RT leading the equivalent term at LT. This quadrature relationship is what provides the circular stylus motion described previously. This quadrature relationship produces an unexpected benefit: introduced into the stereo loudspeaker they result in an image which is somewhat spread (suggesting distance) and predominantly placed to the left and right respectively, for LB and RB channels. This is precisely the format for quadrasonic identification in a compatible stereo-quadrasonic display, as prescribed from our previously-mentioned psychoacoustic studies.

At first glance the two phasor groups in Fig. 5, (LT and RT) appear to exhibit an asymmetrical phasor orientation. However, a bit of analysis shows at once that in practice this is not the case. In fact, since the signals of the four channels are all different or "incoherent," it is not in the best of orthodox tradition to display them all on the same phasor diagram. We can draw proper conclusions only with respect to phasor relationship between the equally named phasors. The grouping that we use is of principal value in performing mathematical analyses with respect to the SQ system. For example, if a signal is panned around the four channel positions in such manner that its power delivered to the encoder remains constant, we are readily able to calculate the relative voltages and phase positions at the output terminals of the encoder. This operation is best performed on a digital computer, and the readout corresponding to this condition is shown in Table 1. It is seen that as the signal is panned around 360° the total stereo power remains precisely constant at a 0 dB level. Thus, our encoding system also meets the second condition prescribed for a satisfactory compatible stereo-quadrasonic record.

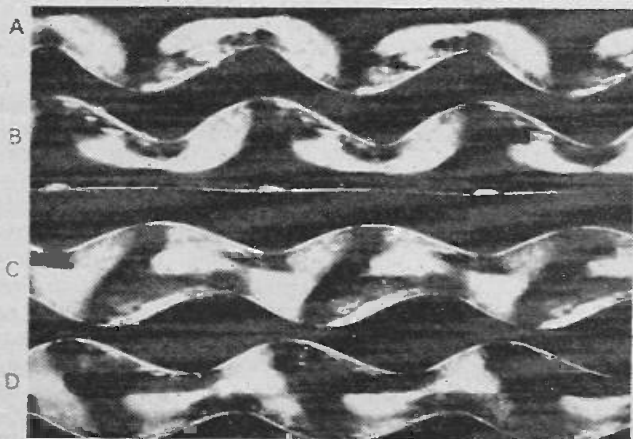

Photomicrograph shows the CBS SQ groove with signals in (A) left front only, (B) right front only, (C) left rear only, and (D) right rear only. (Note that the groove is made visible by light reflected from its walls; black areas are the "land" between the grooves.) Grooves embodying the front channels show modulation only on the appropriate groove wall; each rear channel, however, employs both groove walls, one wall or the other "leading" depending on whether right or left rear is recorded.

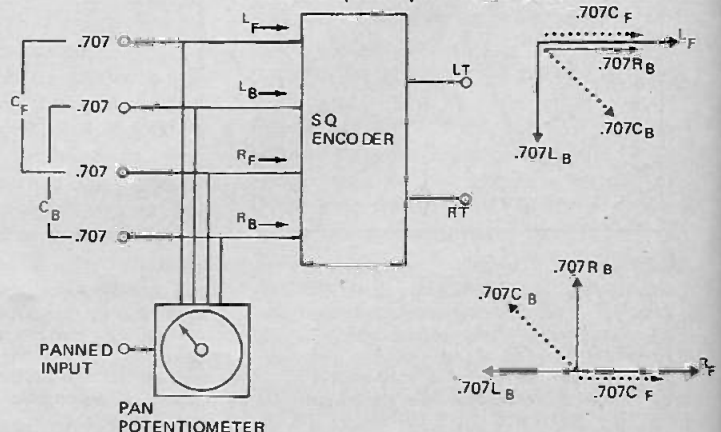

Fig. 5. How the SQ record is encoded.

BEARING (DEGREES)	LEFT TOTAL AMP (VOLT)	PHASE (DEG)	RIGHT TOTAL AMP (VOLT)	PHASE (DEG)	STEREO POWER (dB)
0	.707	360.0	.707	360.0	-00
22.5	.383	360.0	.924	360.0	-00
45.0	.000	360.0	1.000	360.0	-00
67.5	.271	360.0	.963	16.3	-00
90.0	.500	360.0	.866	35.2	-00
112.5	.653	360.0	.757	59.5	-00
135.0	.707	360.0	.707	89.9	-00
157.5	.707	337.5	.707	112.4	-00
180.0	.707	315.1	.707	134.9	-00
202.5	.707	292.6	.707	157.5	-00
225.0	.707	270.1	.707	180.0	-00
247.5	.757	300.4	.653	180.0	-00
270.0	.866	324.8	.500	180.0	-00
292.5	.963	343.7	.271	180.0	-00
315.0	1.000	360.0	.000	360.0	-00
337.5	.924	360.0	.383	360.0	-00
360.0	.707	360.0	.707	360.0	-00

Table 1 — Relative amplitudes and phases of output signals from SQ encoder, and total stereo power level as a function of the bearing angle of "panned" signal.

BEAR (DEG)	T.P.R. (dB)	LFAMP (VOLT)	LFPHA (DEG)	LBAMP (VOLT)	LBPHA (DEG)	RFAMP (VOLT)	RFPHA (DEG)	RBAMP (VOLT)	RBPHA (DEG)
0	3.0	.707	360.0	.707	135.1	.707	360.0	.707	315.1
22.5	3.0	.383	360.0	.707	157.5	.924	360.0	.707	292.6
45.0	3.0	.000	360.0	.707	180.0	1.000	360.0	.707	270.1
67.5	3.0	.271	360.0	.654	179.9	.963	16.3	.757	300.4
90.0	3.0	.500	360.0	.500	180.0	.866	35.2	.866	324.8
112.5	3.0	.653	360.0	.271	180.0	.757	59.5	.962	343.7
135.0	3.0	.707	360.0	.001	180.0	.707	89.8	1.000	360.0
157.5	3.0	.707	337.6	.381	0	.707	112.3	.924	0
180.0	3.0	.707	315.1	.706	0	.707	134.9	.707	0
202.5	3.0	.707	292.6	.923	0	.707	157.4	.383	0
225.0	3.0	.707	270.2	1.000	1	.707	180.0	.001	0
247.5	3.0	.757	300.5	.962	16.4	.653	180.0	.271	0
270.0	3.0	.866	324.8	.866	35.3	.500	180.0	.500	0
292.5	3.0	.963	343.7	.757	59.7	.271	180.0	.653	0
315.0	3.0	1.000	360.0	.707	90.1	.000	360.0	.707	360.0
337.5	3.0	.924	360.0	.707	112.6	.383	360.0	.707	337.5
360.0	3.0	.707	360.0	.707	135.1	.707	360.0	.707	315.1

Table 2 — Total power level, relative amplitudes and phases of output signals of SQ decoder as a function of the bearing angle of "panned" signal.

DECODING THE SQ RECORD

To decode the SQ record into four signals which correspond to the original four input channels into the encoder, a decoding matrix can be used. Each input signal is modified by two psi networks, which are all-pass networks shifting the phase of the signal as a function of frequency without in any way altering its frequency response or output level. The networks in each pair are similar, except that one of the pair provides a basic phase-shift $\psi + 90^\circ$ (f), basic phase-shift ψ (f), while the other provides a phase shift $(\psi + 90^\circ)$ (f). Networks of this type are commonly used in broadcasting practice to improve the modulation capabilities of radio transmitter. The outputs of the psi networks are combined linearly with two summing junctions and presented through four isolating amplifiers to the output terminals L'F, L'B, R'F, and R'B, respectively.

We observe the following facts: The principal decoded signals, L'F L'B R'B and R'F at the output terminals are precisely equal and in phase. This assures that high-fidelity capability is inherent in the decoded signal. We note further, that not only in the front channels, L'F, and R'F, are the original signals L'F and R'F completely isolated from each other, but also that in the back channels, L'B and R'B, the signals L'B and R'B are completely isolated from each other. This is because the two components of the double helical modulations are orthogonal and become completely isolated after SQ decoding. Thus, in the SQ matrix, both the front and the back channels exhibit total channel separation. This clearly meets the requirements of our condition 3 for stereo-quadrasonic performance.

We can further programme our computer to show what happens to the signals of any one decoded channel as well as to calculate the total power in all four channels as a signal is panned around the encoder. The result appears in Table II, demonstrating that the power remains strictly constant during the panning process — therefore, complete omnidirectional

quadrasonic fidelity exists, fulfilling condition 4 for high-fidelity stereo-quadrasonic performance.

With respect to unambiguity of directional response, we refer back to Table I and observe that in no sense are the pairs of output signals of the set identical or proportional in their amplitudes and phase angles, demonstrating that condition 5 is applicable. For each position of the panning potentiometer there is a unique set of phasors which characterizes the direction of the output signal from the encoder.

REPRODUCING DISCRETE SIGNALS

While there is total channel separation between the front and the back signal pairs, there is transference of signals between the front and back channels. For example, the presence of a front left signal, L'F in its proper channel, also results in two transferred signals of identical amplitude, 0.707 L'F, but in a quadrature position in the back channels. This means that in this signal condition there is also infinite separation between the left R'F and the R'B channels, but only a 3dB separation between the L'F and L'B channels. Similar signal relationship can be shown to exist for all the four individual channels.

The front-back channel isolation can be greatly improved by adding an electronic "logic" to the matrix. Such a logic can be described within the scope of this article only in general terms. Thus, if we provide a logic circuit which can detect the presence of equal in quadrature signals in the front and back channel pairs and equip the decoder outputs with gain control amplifiers, we can cause the circuit to diminish the gain of the channel pairs in which the transferred signals are found and correspondingly to raise the gain of opposite channels so that overall power remains unchanged; and this will leave the primary signal with the correct total power and at its proper loudspeaker only. The action is made rapid enough as to be inaudible

and is applicable equally to all four channels. The effect is precisely the same as if there existed four separate lines between the master tape and the loudspeakers.

In practice, however, quadrasonic signals seldom appear in isolation. Instead, there virtually is a constant interplay between the channels. As the sounds from various channels overlap in rapid sequence the action of the logic is less significant because the hearing mechanism becomes too confused assuredly to tell the direction from which a particular sound originates. With simultaneous and complex sound patterns the difference between the master tape and the reproduced matrix sounds becomes imperceptible even with diminution of logic action. Under all the conditions usually encountered, i.e., whether there are isolated discrete sounds or a constant interplay between the channels, the listener almost invariably is unable to differentiate between the master tape and the reproduced record.

Thus, condition 6 for stereo-quadrasonic reproduction of decoded sound has been met in the SQ record system.

MATRIX DECODER PERFORMANCE

While there is little doubt that the addition of a logic to the matrix produces superior performance, especially with discrete channel sounds, it is also true that with the majority of quadrasonic selections the four channels are operating more or less continuously, thereby justifying the possibility of omitting the logic circuit from quadrasonic reproducers in the moderate price categories. Many engineers and artists who have listened to the SQ system with and without the logic mode have indicated that the latter would be perfectly satisfactory in the majority of applications, even if discrete channels are not reproduced without a measure of dilution. With

ALL ABOUT 4-CHANNEL SOUND

THE JVC CD-4 QUADRIPHONIC SYSTEM

electronics
TODAY
INTERNATIONAL
product test

JVC Nivico's four-channel system provides true four-channel sound.

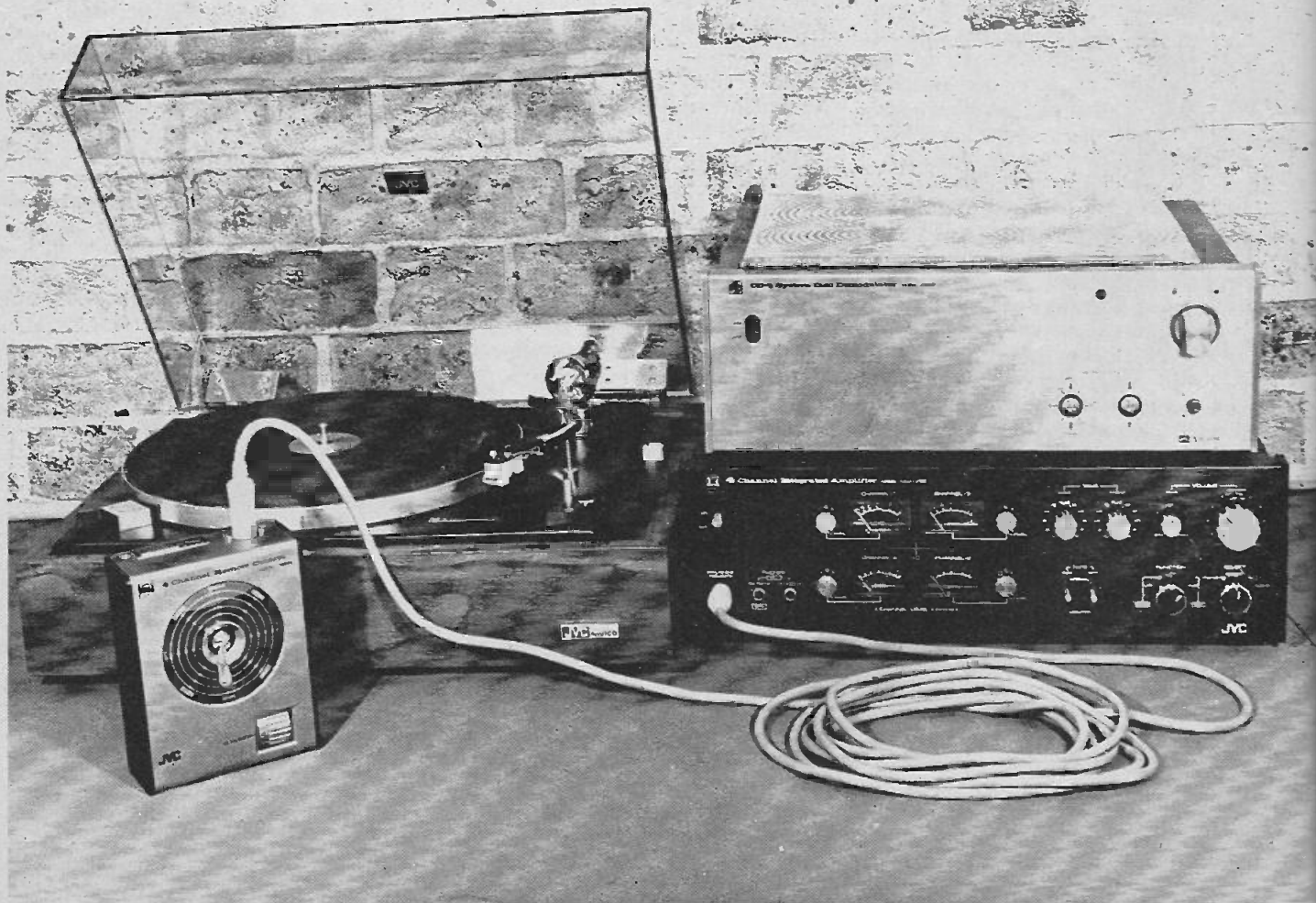

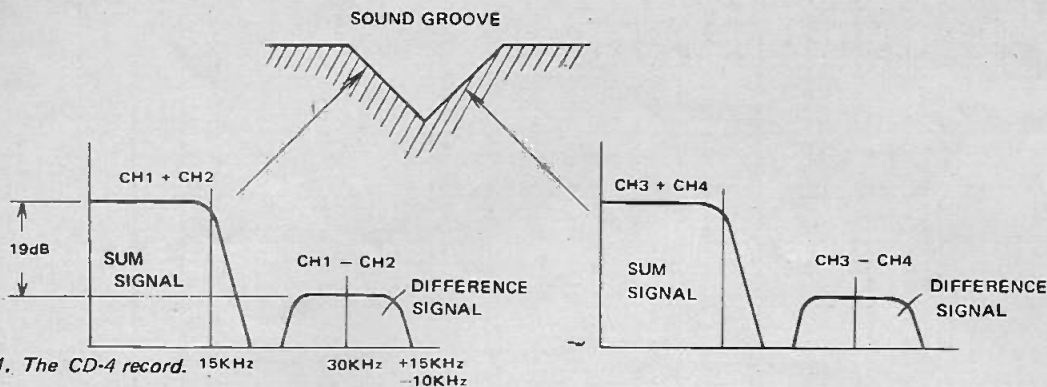

Fig. 1. The CD-4 record. 15KHz 30KHz +15KHz -10KHz

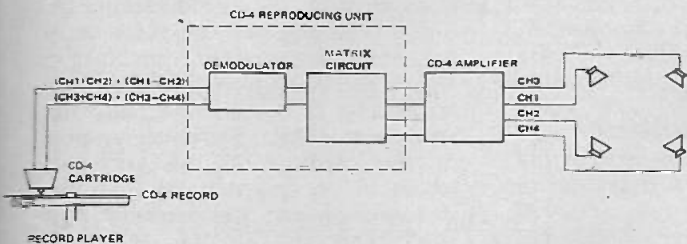

Fig. 2. How the signal is reproduced.

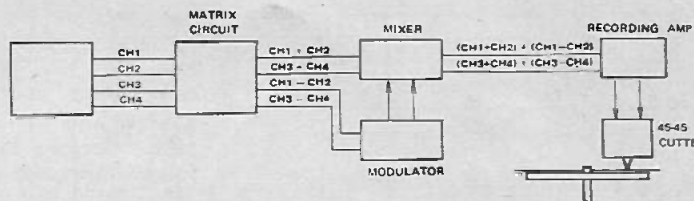

Fig. 3. The recording process.

UNLIKE the various matrix techniques, JVC's CD4 is a true four-channel system.

The record groove walls are each at 45° angles to the vertical, but, instead of one signal being recorded on each groove wall, there are two — in the form of a sum and difference signal.

One groove has the right-front plus right-rear signal together with the right-front minus the right-rear signal. The other groove contains the left-front plus the left-rear signal together with the difference signal for those channels.

Basically the system records the *sum* signals in the normal manner, whilst the *difference* signals are modulated on a 30 kHz carrier using narrow-band frequency modulation (ie — a modulation index of approximately 0.5). The difference signal is of course completely inaudible because its lowest frequency deviations lie well above the audible frequency range, (Fig. 1) To convert the signal into four usable channels a complex demodulator unit is inserted between the two output channels of the record player cartridge and the four channel amplifier, (Fig. 2).

THE RECORDING PROCESS

The recording process used for the CD4 records is rather interesting. Firstly, four-channel signals are converted into sum signals and difference signals through matrix circuits.

The sum signals are recorded in the



same way as in a conventional two-channel record, while the difference signals are modulated (the carrier frequency is 30 kHz) and then added to the sum signals.

With regard to the difference signal, the ranges *lower* than 80 Hz and higher than 6 kHz are frequency modulated (FM) and the range *between* 800 Hz and 6 kHz is phase modulated (PM).

To enable the record master to be cut calls for a considerable amount of ingenuity. Firstly, most record cutter heads such as the Neumann 5 X 68 have a frequency response with the following (typical) linearity characteristics:—

40Hz to 16kHz ± 1dB.

and is typically — 20 decibels at 8Hz and —4dB at 20kHz.

To maintain the linearity, or signal to noise ratio, above 16kHz is extremely difficult because of the equalisation problems in the cutter head feedback amplifier. To overcome these problems the CD4 disc is cut at the unusual rotational speed of 1/2.7 times the normal speed of 33-1/3 rpm. By this means the frequency range is reduced from 30Hz to 48kHz down to a far more tractible 11Hz to 16kHz using a system such as is shown in Figure 3. Apart from the possible vagaries in the range 11Hz to 30Hz (ie. true frequency 30Hz to 80Hz) the technique is in every way compatible with the normal cutter head characteristics.

In order to provide for the requirements and limitations of modulated side band components

THE JVC CD-4 QUADRIPHONIC SYSTEM

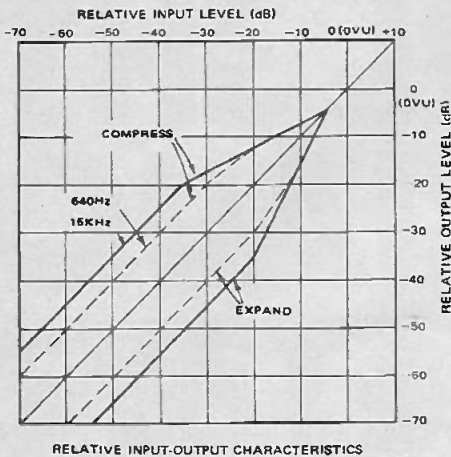
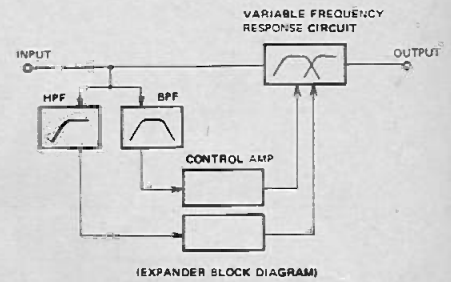
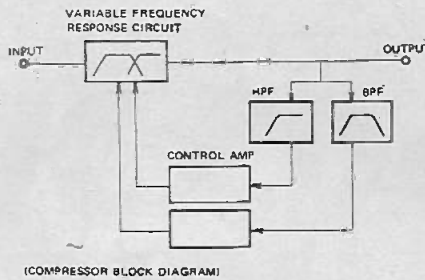

Fig. 4. Characteristics of record/replay compander.

above 30kHz, JVC had to undertake a massive research programme.

Primarily the aims were:—

Firstly, to reduce stylus velocity for the frequency components above 20kHz. This was necessary because stylus and record groove surfaces could not tolerate high velocities or accelerations without groove damage, or degradation of the linearity characteristics of the system. JVC's solution to this problem was to use a compressor/expander (compander) in the record/replay process. (Fig. 4). The compressor is used at the time of recording, whilst the expander is



incorporated within the replay demodulator unit.

Apart from the use of a compander, the level of the modulated 30kHz carrier is kept at least 20dB below the level of the primary sum signal components in the range 30Hz to 16kHz. This significantly reduces the peak velocities that the stylus has to follow during the replay.

Secondly, the vinyl materials used for the current generation of stereo records were too soft for the quadriphonic format. The JVC/RCA solution to this problem was the use of a harder vinyl.

This new material will be used for the range of RCA quadriphonic records to be released in the USA in May this year.

Thirdly, and possibly the most difficult problem, was the inability of standard stylus configurations to cope with the extended frequency range required for this system. Here the answer was the Shibata stylus which provides excellent frequency performance and good interchannel cross-talk characteristics when used

with the CD4 records. As the Bruel & Kjaer recordings — reproduced in Figs. 5 and 6 clearly show, the response of this cartridge is very flat from 20Hz to 15kHz and apart from a resonant rise at 24 kHz it is then essentially flat right up to 46kHz. The rising response of the cartridge in the ultrasonic region in no way detracts from the performance, and the trackability of the cartridge at the ultrasonic frequencies is apparently dependant on the Shibata stylus.

Other merits claimed for the Shibata stylus are very low stylus tip wear, better signal to noise ratio resulting from lower groove deformation, and lower phase distortion because of the improved shaping of the stylus tip. Surprisingly the Shibata stylus is claimed to be easier to produce in volume than an equivalent elliptical stylus.

HOW IT PERFORMED

The JVC company have produced an extensive range of four-channel equipment that can be used with their four-channel discs. For our subjective appraisal we selected the following:—

- JVC Nivico stereo player type SRP 473E fitted with a Shibata cartridge.
- Model CD4 — 1 Disc demodulator.
- Model MCA-V5E four-channel amplifier.
- Advent speakers — four matched units.

Unfortunately we were only supplied with one record — this was JVC's 4-Channel Sound Demonstration No. 1. 4-D-101 and as with so much currently available quadriphonic material this record is rather gimmicky. Nevertheless the record clearly showed the need for careful positioning of loudspeakers (and listeners) if a fully balanced four-channel effect is desired.

The JVC four-channel amplifier is supplied with a delightful joystick control that provides full level and balancing control simultaneously for all four channels. While this may at first appear to be a gimmick, it is, none the less worthwhile. In fact,

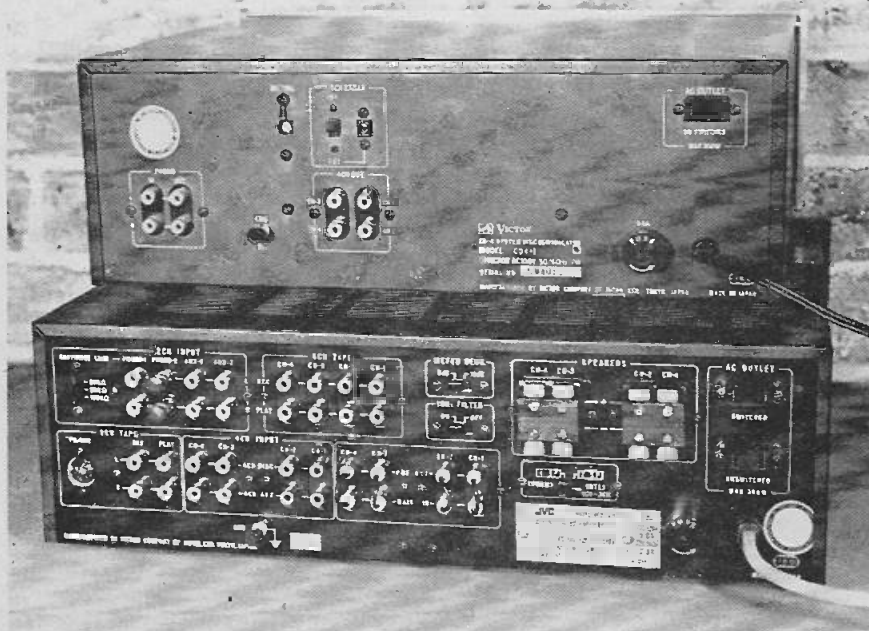

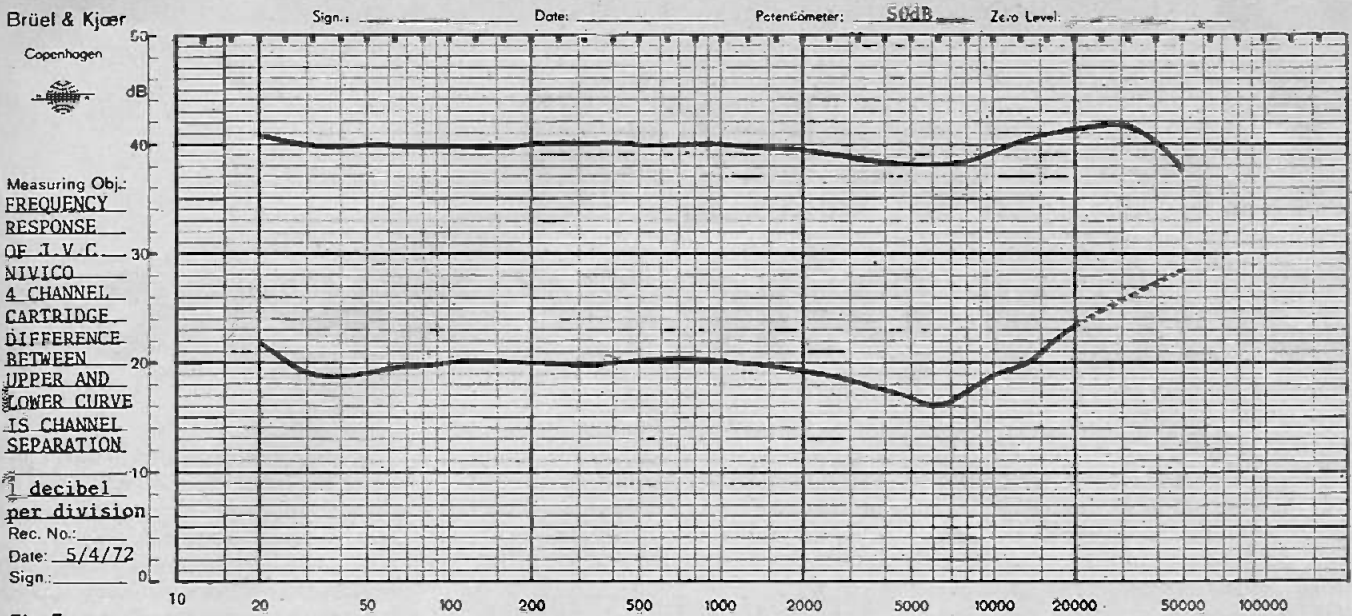
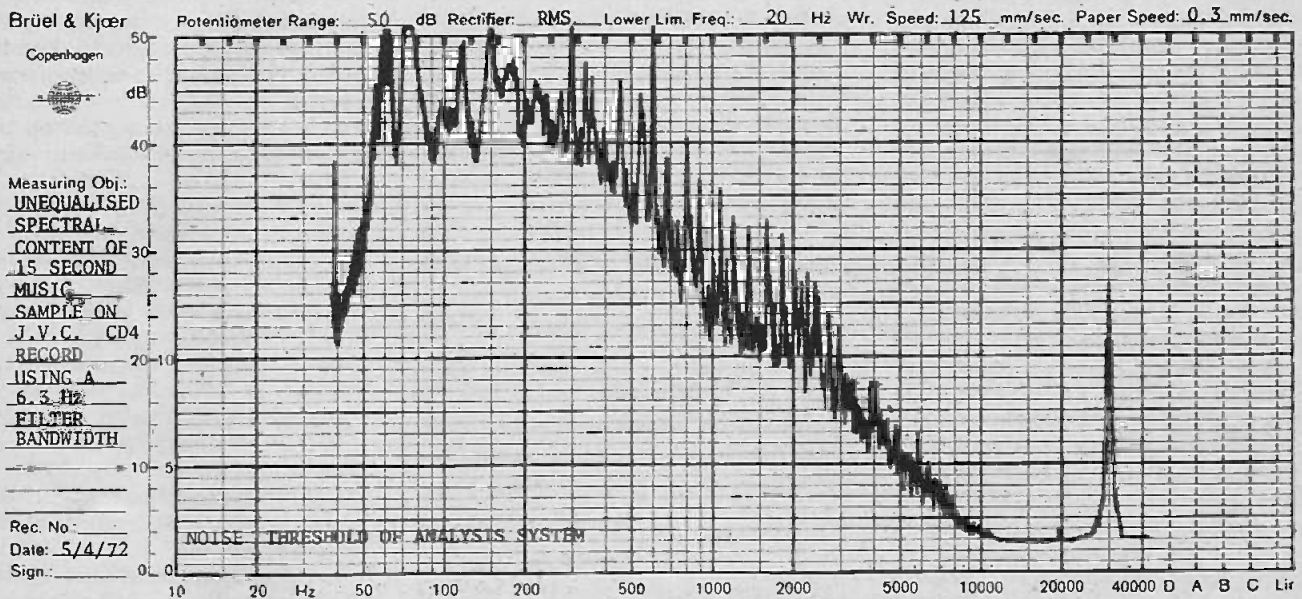

Fig. 5.

Fig. 6.



without it, balancing the system would be very difficult.

The CD4-1E demodulator has a number of interesting features. One of the most valuable of these is a control that varies the front to back separation ratio. This is particularly useful for 'aged' records where it facilitates a reduction of the rear channel content (which tends to deteriorate with surface wear).

Performance of the amplifier was good and its frequency response and distortion was completely adequate for both four-channel discs and four-channel tapes.

CONCLUSIONS

Although our programme material was limited, our subjective impression is that the CD4 system is viable and compatible with standard stereo material. A switch is provided on the decoder to select either two or four channel material. If one tries to play a

normal two-channel stereo record with the switch in the incorrect position the results are most strange as the demodulator responds to surface noise in the 30kHz region and switches the signal between the four speakers more or less at random.

To describe how the system really sounded is akin to describing how a concert sounded to someone who was not there, but let it suffice to say that the quality of envelopment and realism, provided the speaker systems are good, is far better than can be achieved by a good two-channel stereo system. The feeling of being centrally placed in the concert hall is achieved, as is the feeling of realism in the music.

At the present time the CD4 quadriphonic system is the only disc system that is capable of providing discrete true four-channel sound. Whether this will be sufficient to guarantee its success when one

considers the cost of the equipment, the complexity, and—the strong promotion of the competing systems it is too early to say. However, we do believe that this system, or a very similar one, will be the eventual standard for four-channel discs. ●

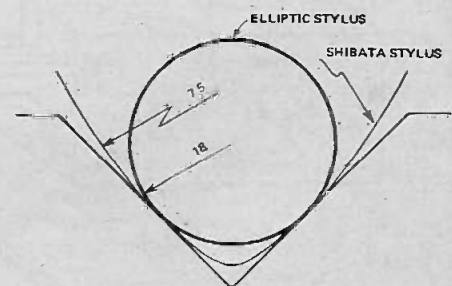

Fig. 7. The Shibata stylus — note the difference in contact area between the Shibata stylus and the elliptical stylus.

The cocktail party phenomenon

THE EFFECTS of attention are apparent to everyone. We cannot fully attend to all that takes place at any one time. When we concentrate fully on one conversation, others fade from consciousness: when our thoughts wander during a play, we find ourselves unable to recall the dialogue, although we were aware it was taking place.

Attention may be defined as the ability to concentrate on one source of information out of several potentially distracting sources of information.

The first complete theory of attention was that proposed by Donald Broadbent in 1958. He

suggested that the limit to the ability to understand competing messages is perceptual — only a limited amount of the information arriving at the sensory inputs can be analysed and identified.

“SELECTIVE FILTER” THEORY

Broadbent proposed that a ‘selective filter’ can be tuned to accept the desired message and ‘reject’ all others.

A flow diagram of his proposed system is shown in Fig. 1.

Information enters the system through a number of parallel sensory channels which feed their information to a short-term store — which, in turn, is followed by a selective filter.

The filter has the ability to select any one of the input channels and allow its information direct access to a limited capacity decision channel.

The handling capacity of this decision channel is very much smaller than the total capacity of the parallel input lines, and thus the action of the short-term memory store and the selective filter is to prevent overloading of the decision channel by acting as a parallel to serial processor.

Inputs to the decision channel are selected on the basis of their pitch, loudness and spatial position.

Lines which are not selected hold their messages in the short-term store for a few seconds, during which time the representation becomes progressively degraded, so that signals which are delayed before selection may be ‘read’ erroneously.

Signals from the decision channel can be returned to the short-term store (as when rehearsing) and there is access to and from a long-term store of learnt associations (long-term memory) at the output of the decision channel. There is also access to the motor response channel.

As the recognition of any incoming signal necessarily implies access to long-term memory, the limited capacity decision channel probably deals with the conscious perception of signals.

THEORY MODIFIED

In Broadbent’s system attention is switched at an early stage on the basis of physical characteristics such as direction of sound, intensity and pitch — and this happens before any of the meaning has been extracted.

Unfortunately for Broadbent a couple of undergraduates named Gray and Wedderburn rejected the idea that attention was based on physical characteristics of sensory channels and suggested that psychological attributes played an important role in selection.

They proved their point by presenting a number of divided words alternately to either ear, finding that attention switched from ear to ear and that words were reconstructed

Scanners, selective filters and serializers are just a few of the terms used by behavioural scientists to describe their latest theories of attention.

This report by Jan Vernon indicates parallels which will be familiar to anyone involved with data logging or communications.

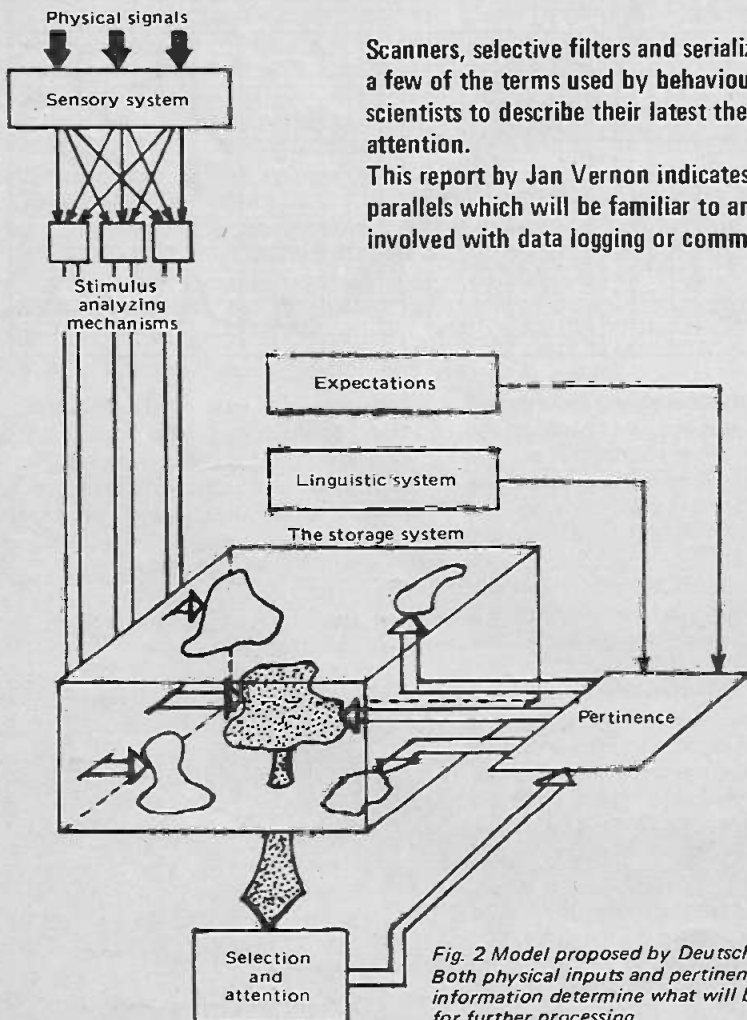

Fig. 2 Model proposed by Deutsch and Deutsch. Both physical inputs and pertinence of information determine what will be selected for further processing.

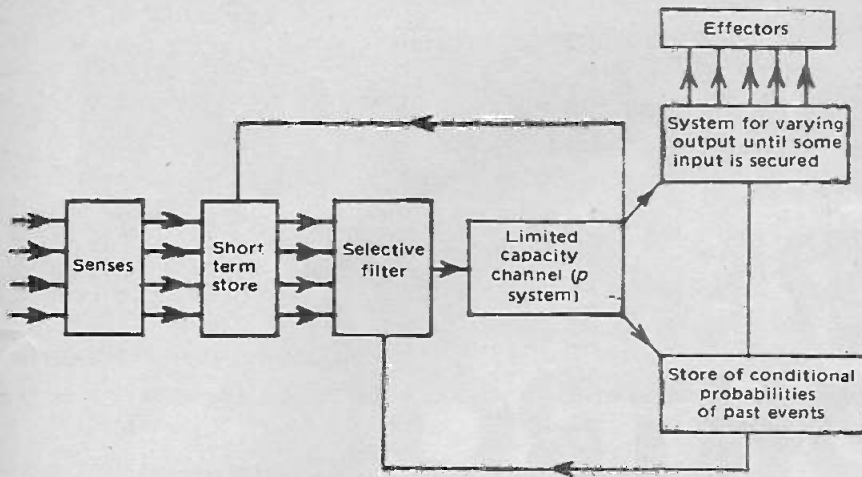

Fig. 1 Broadbent's selective filter model.

correctly. They concluded that the attention mechanism must be able to extract meaning.

These experiments caused Broadbent to modify his theory: he now holds that the channels which the filter may select are much more varied in kind than he originally envisaged and include such things as verbal classes and languages.

ANNE TREISMAN'S VERSION

A far more detailed filter theory was proposed by Anne Treisman in her doctoral thesis at Oxford University in 1961.

Anne Treisman had found that unattended signals are not blocked completely — that, despite a subject's intense concentration upon a task, he would frequently respond to his own name if it were included among otherwise unrecognised background material.

Her experiments showed that sensory cues alone are not sufficient for selection to take place.

In some respects her model for selective attention is similar to Broadbent's in that information flows into the organism through a number of parallel channels. Messages are then analysed for crude physical properties such as loudness, pitch, position, colour, brightness, etc. — and this information is available for reporting, regardless of what happens to the message beyond this point.

The mechanism can also act to attenuate the signal strength of the output of these analysers, and it is in this way that the filter works.

Thus the weakened messages, and the one unweakened message, pass deeper into the nervous system and eventually reach the pattern recogniser, which consists of a larger number of dictionary units.

Messages entering this unit traverse a logic tree with probabilistic nodes;

when they reach the end of the tree, a single dictionary unit 'fires' and the word is recognised by the observer.

This theory postulates selection during input by the attenuation of incoming rejected messages. Attenuation in this model is a two-stage process, since first there is filtering on the basis of channel characteristics, and then a second filtering, based on the threshold settings of the dictionary units.

DEUTSCH & DEUTSCH VERSION

In 1963 psychologists Anthony and Diana Deutsch criticised Anne Treisman's theory, as they felt that some aspects were redundant. They suggested that, by suitably altering the properties of the dictionary, the lower level filter is made unnecessary.

The Deutsch-and-Deutsch model is shown in Fig. 2. As can be seen, the filter for physical characteristics is omitted and the input lines run directly to the dictionary. Every signal is then analysed and recognised for the particular signal which it is.

All sensory signals excite their stored representation in memory, and at the same time an analysis of previous signals is going on.

This establishes a class of events deemed to be pertinent to the ongoing analysis. The set of pertinent items also excite their representation in memory.

The item most highly excited by the combination of sensory and pertinence inputs is selected for further analysis. Thus the most important stimulus captures the attention.

'ANALYSIS-BY-SYNTHESIS'

Ulrich Neisser, of Cornell University, has a theory quite different from those previously held.

He believes that 'analysis-by-synthesis' is the mechanism of auditory attention, and that, to follow one conversation in preference to

others, is to synthesize a series of linguistic units which match it successfully.

Irrelevant, unattended streams of speech are neither 'filtered out' nor 'attenuated'. They just fail to enjoy the benefits of 'analysis-by-synthesis'.

'Pre-attentive processes' establish localization, form crude segments and guide responses to certain simple situations, but their capacity for detail is strictly limited.

Neisser does not say how his theory deals with sounds other than speech, or with a foreign language that the listener may not have heard before but may be 'paying attention' to.

MORAY'S THEORY

One of the latest theories is that proposed in 1969 by Neville Moray.

Moray's theory of attention is really a modified version of Broadbent's original hypothesis. He says that 'at any moment a listener is sampling only one message'. All others are totally rejected, and sampling may continue on one channel indefinitely, until the switch is 'called' by another channel.

Neville Moray's model is similar to Broadbent's (shown in Fig. 1). The main difference is that, as the parallel channels enter the short-term memory, the linkage with the limited capacity channel switches from channel to channel. The concept of a selective filter blocking rejected messages is not necessary.

Controversy about attention concerns whether incoming messages are attenuated, or whether responses are selected.

Broadbent's model was questioned because it was shown that channels are not necessarily physical, and that rejected messages are not always completely blocked.

Anne Treisman's attenuation theory is convincing to a certain point, but does not account for the fact that information in a rejected message can sometimes go completely unheard. It is also hard to see how her filter saves work in selection, for it would seem necessary to extract the meaning of all incoming signals to determine what to attend to.

Moray's theory may be a basis for the study of individual differences.

People who say they can attend to two things at once may in reality be able to switch rapidly from one thing to another — in the same way that a high-speed data logger, or a time-sharing computer, may appear to be concentrating simultaneously on a number of different events. Some individuals appear to have the switching mechanism under conscious control and can concentrate while others are easily distracted. ●

PART 3

TRANSDUCERS IN MEASUREMENT AND CONTROL

In this, the third article in this continuing series, Peter Sydenham, M.E., Ph.D., M. Inst.M.C., describes automatic angle measurements.

SO far in this series we have covered how lengths, ranging from microscopic to macroscopic, can be transduced into electronic signals using electrical, mechanical and optical techniques. We have discussed this parameter

thoroughly because length is a fundamental parameter often leading indirectly to the measurement of other secondary variables. In fact it has been said that some 85% of all measurements involve length.

Another very common transducer

group includes devices that convert rotation into the common electronic language with which technical systems are interconnected. Angle transducers go under a variety of names — the terms, resolvers, encoders, angle transducers, rotary transducers, digitisers, shaft position indicators and synchros, all are used depending upon the principle employed. Often the names are applied synonymously — and incorrectly.

Angle is dimensionless. It is defined as subdivision of a circle, in a number of ways. Commonly used units are the degree and the radian. There are 360 degrees in a circle (and 2π radians). The latter comes about by defining radian measure as the ratio of the arc length to radius for a segment of a circle. Radians are easily used when small angles are involved for they approximately express the deviation per unit distance, for example, a milliradian is a divergence of 1 part in 1000. There is another system, used extensively in Europe, which has 400 divisions, called grades, in a full circle. This gives a convenient 100 grades per quadrant. Grades are subdivided into centigrades and centi-centi-grades, i.e., subdivided in hundreds compared with sixties in the degree-minute-second system.

As angle is dimensionless, it is defined completely by a mathematical expression. No physical standards are needed from a theoretical viewpoint. (Compare this with length for instance, which uses quite arbitrary units, chosen by man to suit his convenience). However, it is more practicable to maintain angular standards in the form of divided circles, angle gauges and optically-worked multi-sided polygons made of metal or glass. A commercial

Calibration of precision turntable at Moore Special Tool Co, USA.



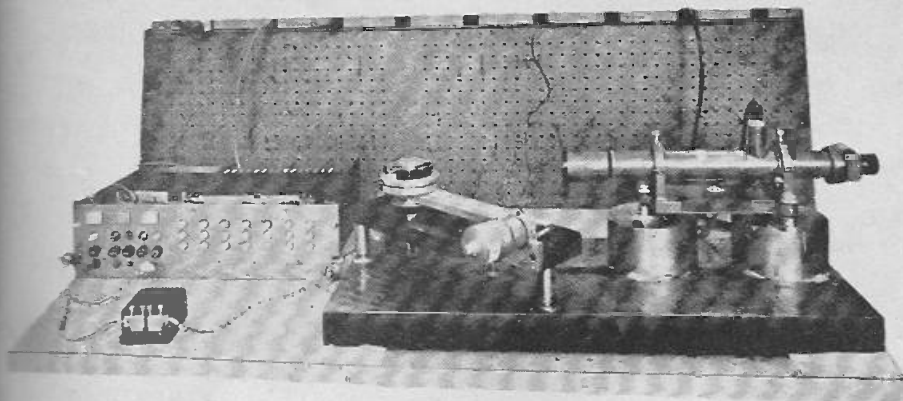

Fig. 1. Test set up used by Data Technology. The resolver is mounted underneath the plate holding the micrometer. On top is a standard angle polygon which enables the resolver to be rotated in exactly known angular steps. The autocollimator, on the right is used to set the rotation by an optical lever action on the polished flats of the polygon.

test set is shown in Figure 1 where a polygon is being used to check a resolver system.

As angle is defined in terms of two lengths, and it is clear that angle transducers generally use devices that measure displacements by fixing one length and measuring the other as it varies. There is, however, one important difference, for angular transducers can use mechanical components of rotation that can be manufactured more precisely than linear components for equal costs. This enables closer tolerances to be maintained between two measuring surfaces. Also it enables the simple incorporation of both spatial and time averaging to improve the precision of the device. These features will become clearer later.

As with length measurement, there is a distinct difference between the technique that may be used to measure small angles of less than say a few degrees and those required to cover greater angular excursions. A broad assumption is that the smaller the angle to be measured the higher the precision that can be obtained. At one end of the scale are devices capable of measuring 10-10 radians over a range of 10-6 radians (about an arc second). At the other are devices capable of arc second resolution with a continuous full circle range.

So much for a general background to angle measurements. Let us now consider the techniques that have proven practicable.

SMALL RANGE ANGLE TRANSDUCERS

The most obvious means by which a small angle can be monitored is to measure the linear displacement of the free end of a hinged arm of fixed length using one of the length

transducers described earlier in this series. This concept has been used in the force-balance principle, see Figure 2, used mainly in process control and weighing balances. In this a beam is hinged in the centre. The force to be measured is applied at one end of the see-saw beam. At the other end is a magnetic solenoid to which variable current is applied in order to balance the unknown force. The current in the coil at balance is then a measure of the applied force.

The beam is considered balanced when it is at reference position. To establish when balance is achieved, the small rotations of the beam must be

transduced. Virtually all fine displacement techniques have been used to monitor the displacement of the beam, ranging from simple on-off contacts to devices providing a proportional output.

In some applications, such as torsion balance and galvanometer readouts, it is not permissible to load the driving force with a relatively massive lever that would be needed to operate a transducer. In these cases the optical-lever comes into its own.

The optical-lever is generally attributed to Poggendorf who described it in the literature in 1826. No doubt it was used even before that. In the days before electronics, that is before this century, the optical-lever was the only sensitive way to sense small angular movements and displacements. The principle is simple. A source of light, collimated to a near-parallel beam, is reflected from a mirror surface mounted longitudinally on the axis of rotation to be monitored. In the purely mechanical use of the lever the reflected beam impinges on the rear of a transparent graduated scale. The sensitivity of the method derives from the optical phenomena of angle-doubling at the mirror and from the ability to place the limited-resolution graduated scale at a considerable distance from the mirror.

In most modern applications, however, the aim is to provide an electrical recording readout and keep the size of the angle transducer down to small dimensions. In 1920, Wilson

Fig. 2. The principle of the force balance.

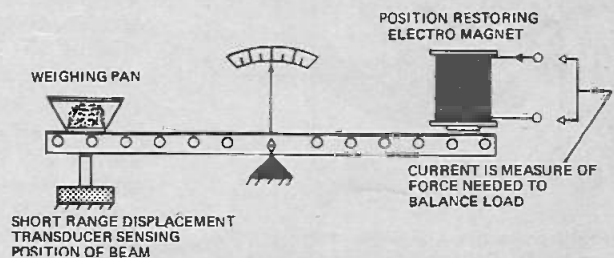
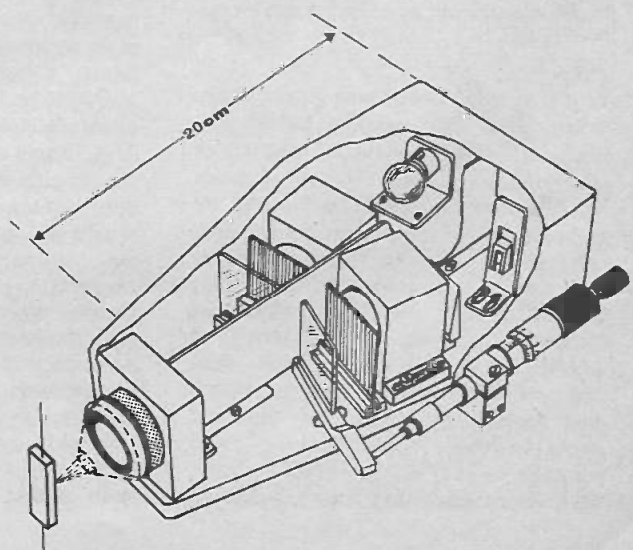

Fig. 3. Construction of the 'Jones' optical lever. Two grids are used as bar-space gratings to enhance the sensitivity. The micrometer rotates the optical parallel plate to displace the beam for fine adjustment.



TRANSDUCERS IN MEASUREMENT AND CONTROL

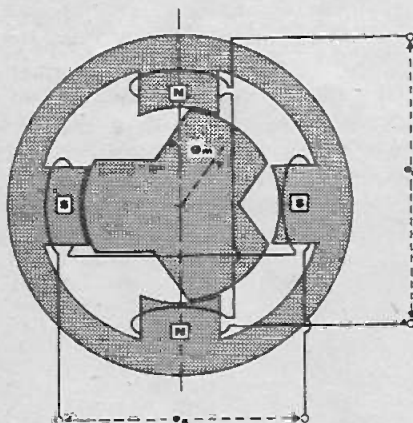
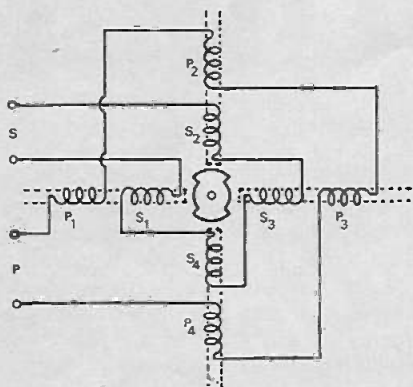
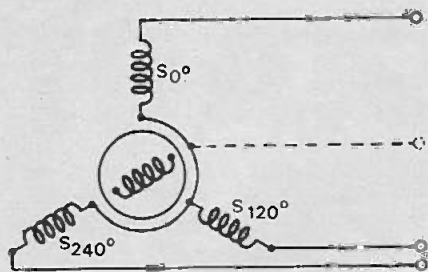

Fig. 4. Inductive rotary transmitters. a. The Synchro b. Reluctance resolver c. Vernier resolver (excitation windings are also on each pole).

and Epps proposed that two thermopiles be used to detect the position of the light spot instead of relying on the relatively poor resolution of the eye. (Thermopiles are a bank of thermoelectric elements cascaded in series to form a sensitive heat-sensing device). If the two thermopiles are connected in opposition, the resultant current flow would be a measure of the spot position upon them. Such a system was soon constructed and the first ultra-sensitive angle sensor was created. It was so sensitive, in fact, that it could detect the Brownian

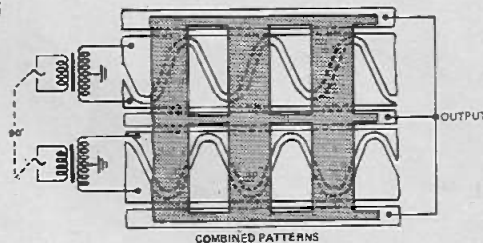
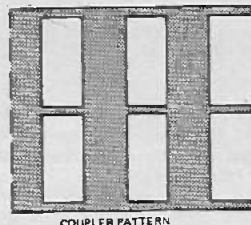
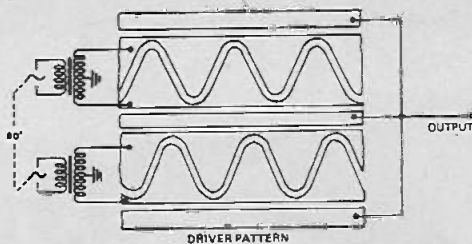

Fig. 5. Section of metallic pattern photo etched on glass supporting disk. The coupler pattern runs close to, but not touching the driver pattern, forming a capacitive bridge network.

movement of the mirror suspension. Then came photo-electric cells which were able to detect much smaller quantities of light energy. A great exponent and developer of the optical lever is Professor Jones and his colleagues of Scotland's Aberdeen University. They have built extremely elegant lever systems that can detect angular excursions of around 10⁻¹⁰ radians. One of these is shown in Figure 3. With these, Professor Jones has studied many interesting physical phenomena, including measurement of the radiation pressure of a liquid at atmospheric pressure (this is much harder than measuring it in a vacuum), determination of the length changes of an X-ray irradiated lithium-fluoride crystal, observation of an I-R energy level of 10⁻¹¹W, and verification that a light beam is not slowed by a magnetic field. The latter has been done to an extraordinary degree of precision. Most recently Professor Jones has used the optical lever to verify the Fresnel drag effect, (predicted by Fresnel many years ago).

Not all applications need such exacting stability and precision, so most optical levers are no more than a lamp, a collimating lens with spot aperture built in, a mirror, and a dual photo-cell position-sensitive detector. This simple arrangement has been used to provide electrical readout from a bourdon-tube microbarograph, from sensitive galvanometers, recording autocollimators (used in industry for alignment — to be described in our next article) and in sensitive microbalances, in other words, in applications where the angular excursion is small and the driving force cannot tolerate any load being imposed upon it by the transducer. The main disadvantage of the optical lever is that the light-source generates

a considerable amount of heat and this may cause error due to thermal expansion effects. The ever-reducing price of continuous wave laser sources (now down to \$180 for units suited to this work) makes them attractive, for the beam is as well collimated as would normally be required. A divergence of 1 mrad is typical.

Alignment devices for measuring deviation from a straight line involve the measurement of small angles. This class of transducers, however, deserve an article to themselves as they are extensively developed. The reader is, therefore, referred to the next article for many details of small angle measurement over long distances.

LARGE RANGES

It can be seen that the use of optical lever (or microdisplacement transducer) angle measurements cannot cover more than a few degrees of rotation unless mechanical angle amplifiers (gears, belts, friction wheels) are used. Other methods, therefore, have been devised to cope with larger excursions.

Early this century, divided circular scales could be made to a precision of better than one arc second. Geodetic-grade theodolites have glass scales of 100 mm diameter. These can be read to around 0.1 arc second (that is, the circle is divisible into 12,960,000 parts!) using a reasonably simple optical viewing system.

The majority of wide-range angle transducers can be grouped into those having mechanical movement no faster than their input slewing rate, and those in which continuous rotation at a speed higher than the slewing rate has been deliberately added. The reason for the latter will become clearer as we proceed. For simplicity these will be referred to as static and active systems.

TRANSDUCERS IN MEASUREMENT AND CONTROL

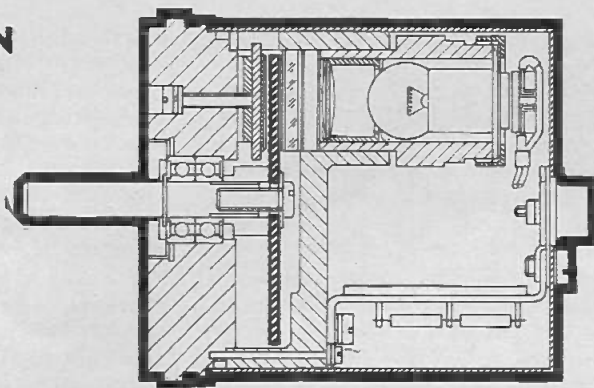

Fig. 6. Cross sectional view of optical shaft encoder.

RESISTANCE POTENTIOMETERS

Large-range angle is very simply measured with rotary potentiometers provided the contact friction and wear disadvantages can be tolerated. But it is difficult to produce a full 360°, continuously rotatable unit, as the wiper shorts the start and finish of the resistance track unless a dead zone is used. On top of this problem is the very rapid change of signal level at the end. Multiturn units are used if the order of a few complete rotations is needed but these cannot cater for infinite rotation.

The problem can be overcome by using a complete circle resistance track in which the end is joined to the start. If a supply is connected at diametrically opposite points, the track forms a bridge network. A single wiper will produce a signal varying from positive to negative without any abrupt signal level change. It is necessary, however, to add a system that can recognize which half the slider is on, for there are two positions giving the same output.

INDUCTIVE AND CAPACITIVE STATIC METHODS

A similar technique can be used with a toroidal transformer but again brushes are needed. Avoiding the need for sliding contacts leads logically to the inductive synchro (also known as a mag-slip transmitter). Inductive resolvers are in this class being only slightly different in construction. The synchro consists of an armature under a simple rotating bar magnet which is fed with ac alternating current — via slip rings — see Figure 4a. The stator houses three, equally phase-shifted identical windings, similar to those found in a three phase induction motor. The ac excitation in the armature induces voltages in each of the rotor windings which are phase shifted with respect to each other. At any given position the amplitudes of the outputs from the stator are unique. Position is thus defined in an absolute sense. By feeding these signals

to a similar synchro receiver the position can be reproduced remotely (hence the name transmitter). This method still uses brushes but these are not in the measurement circuit. They are there to provide high-level ac energy to the system. Better quality synchros can resolve around 1 minute of arc — this is adequate for many tasks. To obtain greater precision, accurate gear trains may be used, and the designer has to decide whether a synchro combined with expensive gears is a better economic choice than the use of more sensitive direct methods. If the object whose rotation is to be measured is large, for instance a steerable radio telescope, the physical size of the transducer is of no importance and gears or a large diameter resolver can be employed. If a small size is essential then tea-cup size devices are needed. The need for brushes is avoided if excitation is provided by windings placed on the stator pole-pieces using the rotor to vary the reluctance and thus vary induced voltages, (as shown in Figure 4b).

Before leaving the synchro it is worth mentioning a development in 1956 which uses the variable reluctance transmitter combined with the Vernier principle. The latter effect (named after Pierre Vernier who lived at the turn of the 17th century) is a way to subdivide the minor divisions of a scale using a similar sized scale but having, say, 10 divisions when the main scale has 9. Whatever the position of the Vernier scale there will be one line upon it that is aligned with the main scale division. The Vernier scale line in coincidence gives the subdivision of the scale interval. In the Vernier resolver, shown diagrammatically in Figure 4c, the ac-fed armature has one less pole than there are stator poles. Processing of stator outputs enables the position within each electrical cycle to be resolved more finely than with a standard synchro. In units built with 33 rotor teeth a repeatability of ± 3 arc seconds was obtained.

One feature that gives the Vernier resolver high precision is that the

output signals are formed as the average of inductive coupling between many iron circuits around the multipole core. This is a powerful measurement principle and is termed spatial averaging. It also relaxes the centering tolerances needed for a given angular accuracy. Being an ac method, a measurement is available with each cycle of the driving frequency. In this case the system uses 400Hz. If the time response can be lengthened, the output can be time-averaged to gain further improvement again. A general law of errors states that such averaging processes (if they involve random errors) improve the precision as the square root of number of measurements involved, so in this case a hundred-fold improvement is theoretically possible for a 1Hz bandwidth and 30 odd poles.

Whereas time-averaging can be incorporated into linear transducer systems, complete spatial averaging over the whole measurement device usually cannot. For this reason angle-transducers can be quite small for a given performance. But more of this when active methods are discussed.

It can be readily seen that the more poles there are, the finer the resolution, so in cases where space permits, a circular form of the linear inductosyn (mentioned last month) can be used in which radial, rather than linear, fixed plated windings are inductively coupled with a rotating pickup plate. Radial systems have the distinctive advantage that they can be manufactured cheaply by contact photo-mechanical methods whereas cylindrical devices must be individually machined when high resolution is needed.

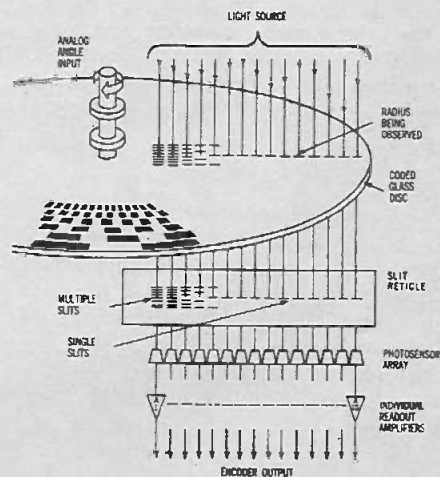

Fig. 7. The multiple slit optical encoder system used by Computer Control Company.

TRANSDUCERS IN MEASUREMENT AND CONTROL

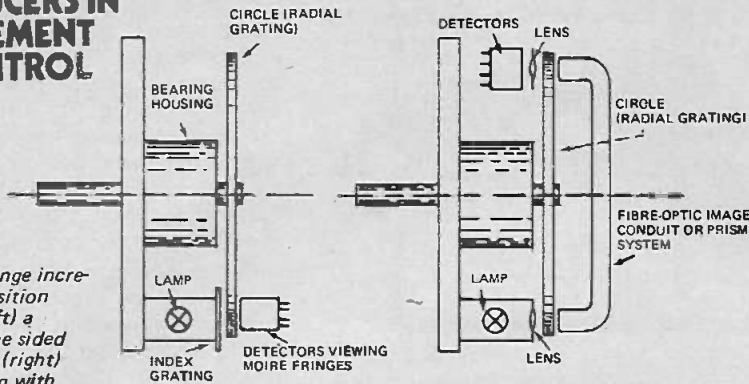

Fig. 8. Moire fringe incremental shaft position transducers. (left) a conventional one sided reading system. (right) optical averaging with transferred image.

Virtually all that has been said for inductive systems can be applied to capacitive coupling but, in the main, only the pancake radial method has been adopted for continuous rotation measurement. Figure 5 shows the construction of this.

STATIC METHOD - OPTICAL

Although the earliest angle measuring machine was the divided scale, it was not automated until the late 1950s. As inductive synchros could not provide arc second resolution at that time, attempts were made to read ruled scales automatically.

Mechanical contacts were far too large so it was logical to use optical sensing as this was the method by which the then available scales were read. At that time there was also a growing need for digital computers. One difficulty encountered with the design of fine resolution optical absolute-encoded binary disk systems (similar to the absolute digital length scale mentioned last month) is that the apertures of the lower significant-digit tracks are extremely fine, thus restricting the amount of light transmitted. A cross sectional view of a low cost encoder is given in Figure 6. Although expensive, absolute encoders are now available with around one arc second resolution. In these, discharge

flash lamps are used to illuminate photo-diodes positioned on the opposite side in order to read the code. One unit, shown in Figure 7, uses multiple slits to ease the illumination difficulty. It is, however, far easier to make a 21 bit encoder in rotary form than it is to produce satisfactorily in linear form as the disk can be made to rotate with adequately constant clearance more simply than in the latter case.

It is also quite practicable to use the linear moire-fringe principle, originally devised as a length measuring method, in a rotary form. Numerous moire-fringe shaft digitizers are available commercially. The optical gratings have radial lines produced around a disk by photographic or photomechanical methods. Full circle radial gratings having over 30,000 lines have been made, the main institutions responsible for their development being the National Physical Laboratory (NPL) and the National Engineering Laboratory (NEL) in Britain. The absolute grating method, using incremental gratings, is also available in rotary form (see last month's issue for illustration).

In the moire fringe method, (Figure 8a), counting is necessary to determine angular movement, and hybrid systems have been marketed using

phase-analogue subdivision of relatively coarse gratings. The National Electrical Manufacturers Association of America (NEMA) has standardised the name of these and other incremented methods, as rotary incremental digital position transducers (RIDPT for short).

Theodolite scales are read to the highest precision by viewing diametrically opposite values simultaneously. This averages the bearing centering error. The idea has been used in some moire-fringe resolvers by forming fringes at one radial position of the disk using the other side of the disk as an index grating. A coherent fibre-optic bundle, Figure 8b, or a prism system, transfers the image. Still further improvement is possible if the signals from four reading heads placed at 90° around the grating are averaged and this has been attempted at the NEL.

MECHANICALLY ACTIVE SYSTEMS

Taking it to the limit, the ideal therefore, is to have an infinite number of reading heads placed around the grating to produce complete spatial averaging. Practical limits are set on this idea by the accuracy of the grating lines, for spatial grating errors must lie within certain limits if the signals are to be useful in practice. Bearing eccentricity also enters the picture, for slop or out of roundness of the bearing support system will allow the main grating to move, radically changing the shape and pitch of moire fringes quite considerably. This can be overcome by adding a continuous rotation to the system, a method that evolved first as a capacitive device.

In 1957 Richard Webb of the U.S.A., filed a patent application for a then quite unusual angle encoder. The device is shown diagrammatically in Fig. 9. A reasonably constant speed motor drives two toothed rotors each

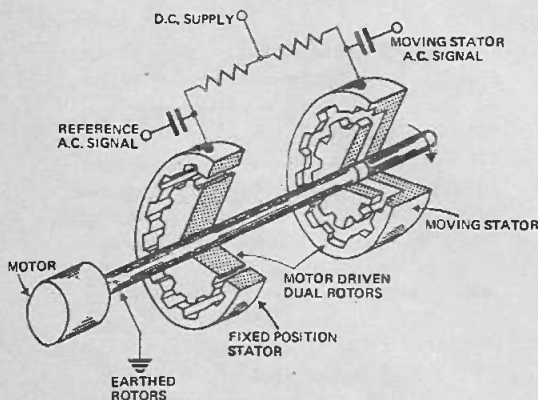

Fig. 9. The capacitive dual generator angle transducer (United Aircraft Corporation).

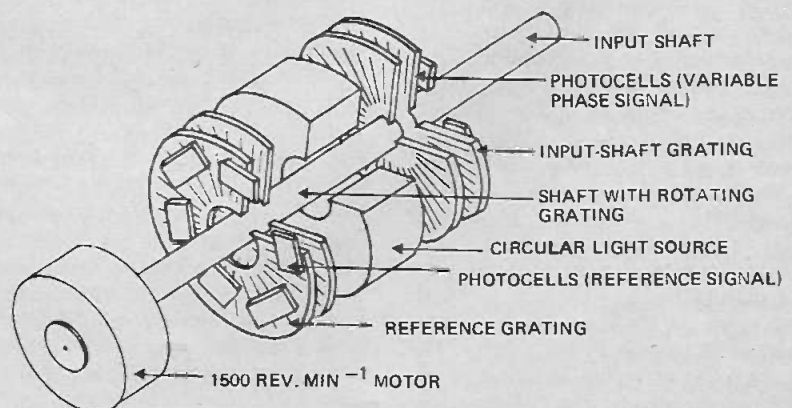

Fig. 10. Optical equivalent of capacitive system in Figure 9.

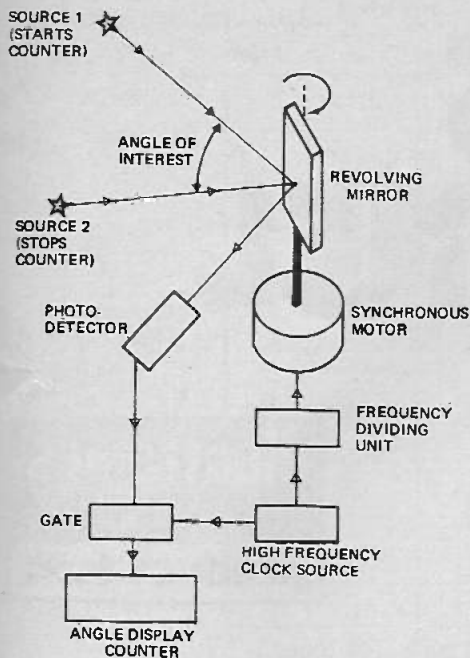

Fig. 11. Chronometric method of measuring angle.

spinning inside toothed stators. One stator is fixed, the other rotates as it is connected to the input shaft whose rotation is to be measured. As the stators turn, the capacitances between the electrically insulated stators and the grounded rotors vary. This is used to produce two ac output signals. If the input-shaft rotor is rotated with respect to the fixed one, the phase of its generated signal varies with respect to the other. Hence the phase difference between the two signals is proportional to the extent of rotation within one pitch of the stator teeth. This is in reality the phase-analogue technique and to complete the system, a coarse angle resolver is needed to form a complete hybrid arrangement.

The original device containing both fine and coarse resolvers was only two inches in diameter — but a rack of electronics was needed to interpret the device. To obtain direct degree readout, 360 teeth were cut. As each cycle could be subdivided into 1000 parts by electrical phase methods the transducer could resolve 3.6 arc seconds. The rotors were spun at 900 rpm. This method, therefore, incorporates both spatial and time averaging to advantage. The principle was subsequently used with inductive coupling and the makers of one device claimed 0.1 arc second resolution from a unit 5 inches in diameter.

It was obvious that an optical equivalent existed to these, and in 1967 an experimental unit using rotating radial gratings was made (Fig. 10). This crude unit used low quality 360 line gratings made on plastic sheet. The accuracy of subdivision over one degree of rotation was tested

and found to be ten times better than the known errors of the grating, thus showing the power of incorporating averaging. The advantage of the optical form is that optical gratings can be used with a far higher density of lines than magnetic or capacitive as the light rays are not as subject to fringing errors when coupling the two grids. Secondly, optical gratings have been extensively developed and are available with 1 arc second accuracy in 2 inch disks. Finally, but by no means the least factor, radial gratings can be copied inexpensively (as has been mentioned above). It seems that a well made optical dual-modulator angle transducer might realise 0.01 arc second accuracy using normal precision ball bearings instead of needing the hydrostatic systems that have been used in extreme precision experiments.

CHRONOMETRIC METHODS

Another interesting method for converting angular rotation into electrical signals is known as the chronometric method by which angle is transformed into time.

Consider a shaft being driven by a synchronous motor which is energized by a divided-down higher clock frequency (as shown in Fig. 11). If on the shaft is a trigger mechanism that responds to stationary objects (these could be two distant signal lights placed at different locations and for which the subtended angle is needed), then this trigger can be used to gate the clock source into a counter. As the speed is synchronously related to time the angle can be determined in terms of time, to high accuracy. Time averaging could be added if the system were driven fast enough.

This chronometric system is akin to another angle dividing and measuring system. A magnetic wheel is driven with a synchronous motor and the periphery of the wheel is magnetized from the same ac signal forming magnetic zones around the wheel which are exact integers of the circumference. It is then used to measure position using sensing heads.

The full potential of chronometric method has not been realised. Nano-second rise-time signals are now commonplace and a shaft driven at 600 rpm could probably be resolved into 10^8 parts — but that remains to be seen.

INTERFEROMETRIC METHODS

Interferometers can resolve extremely small distances and yet have an enormous range. Attempts have been made to measure angles with interferometers and one device capable of 0.01 arc second resolution over a

30° arc has been described. A schematic of this method is given in Fig. 12. A light source, such as a spectral lamp or laser, is used to illuminate the interferometer. As the reflecting corner cubes rotate together, the relative lengths of the two arms change and the fringes move.

Another recently devised laser method that shows promise is the ring laser. Instead of the laser having the usual linear cavity made between two end mirrors, it has a 'ring' cavity. The simplest approximation to the ideal ring is a triangular system. One feature of the cavity is that it can support independent oscillations in both the clockwise and anticlockwise directions. If the ring is rotated about an axis perpendicular to its plane, the two oscillations vary in frequency and upon square-law device-mixing a beat-frequency is produced that is dependant upon the velocity of rotation. The ring laser has been developed mainly for gyroscope applications but an angle transducer version is possible if use is made of this velocity signal output. One advantage of the method is that the centre of rotation is left clear and the ring can be built around a central object.

Next month we will consider ways to transduce a level line of sight or a vertical plumb-line and how to determine alignment along a line. It will then be possible to discuss how we combine these with angle and length transducers in order to determine position on a plane or in a three dimensional space.

FURTHER READING

"Some developments and applications of the optical lever", R. V. Jones, J. Sci. Instrum., 1961, 38, 37-45.

"Linear and angular transducers for positional control in the decametre range", P. H. Sydenham, Proc. IEE, 1968, 115, 7, 1057-1066.

"The design of optical digital instruments", I. R. Young, Electronic Engineering, 1960, 132, 388, 359-365.

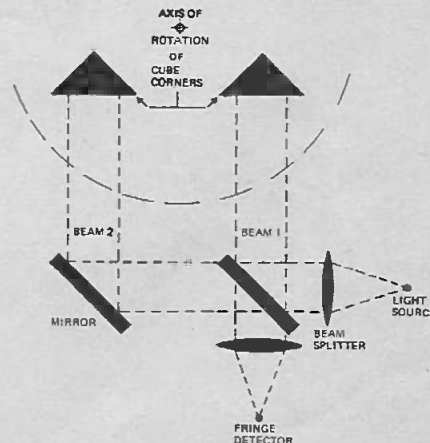

Fig. 12. Differential-length angle measuring interferometer.

AKAI 1800SS FOUR-CHANNEL TAPE RECORDER

electronics
TODAY
INTERNATIONAL
product test

This versatile four-channel recorder accommodates both reel-to-reel and cartridge tapes.

AKAI are one of the leading Japanese manufacturers of hi-fi equipment and have gained a reputation for advanced engineering techniques.

It is not surprising then that the company was one of the very first to enter the field of four-channel sound;

in fact their four-channel tape decks were probably the first four-channel units of any type to be commercially available on a wide scale.

The Akai Model 1800S combination recorder reviewed here follows the company trend. It is a four-channel machine that can accept both

reel-to-reel tapes and four-channel 8 track cartridges.

MECHANICAL CONSTRUCTION

Externally the unit is very similar to other Akai stereo tape recorders, the only immediately obvious difference is two additional VU meters.

The top section of the tape recorder has the characteristic head assembly and dual control levers of most Akai units. This head assembly panel, which is brushed aluminium, contains the speed selector switch in the top centre with the reel hubs on either side. Below the left-hand reel hub is the head assembly containing two erase heads (one full track, the other two track stereo) and one combination four-channel record/playback head, all covered with a black plastic cover finished with a silver trim.

Below the heads is the three figure index counter with reset button.

In the centre of the panel is a screw operated switch for 50Hz or 60Hz operation and below it the capstan and pinch wheel. Directly below the right-hand wheel hub are two control levers; the left-hand one with 'off', 'forward' and 'record' positions and the right-hand one with 'rewind', 'off', and 'fast forward' positions.

To the left of the first lever is a red transfer/record interlock button and between the two levers is an automatic shut-off switch. To the right of the second lever is the pause lever and the pause lever release button.

The bottom section of the control panel is matt dark-grey and contains all the audio controls. These consist of four VU meters arranged in pairs (two for the front channels, and two for the rear channels) in the centre of the



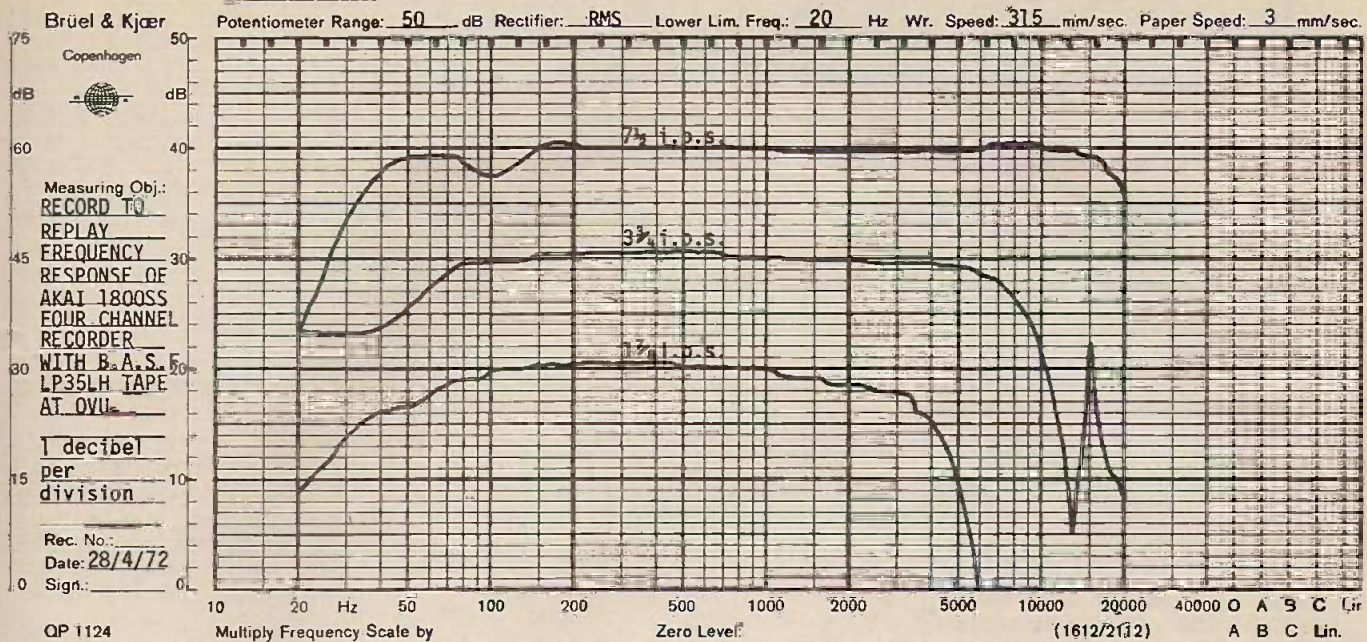

panel. On the left of the VU meters is the power on/off switch and on the right the two channel/four channel select lever. Below the power switch is the equalization switch with three positions; 7½ i.p.s., 3¾ i.p.s. and 1-7/8 i.p.s. Below the front channel meters is the right front and left front combination record and playback level control knobs. An identical pair of controls are located under the rear channel meters. Between these two pairs of level control knobs is a dual concentric tone control for the left and right channels.

FACILITIES

On a narrow strip across the bottom of the recorder, defined by a silver trim, are the following facilities, from left to right:—

- a bias selection push button for standard or low noise tape
- four microphone input sockets
- four cartridge programme indicator lamps
- cartridge programme select push button
- cartridge mode select push button
- reel mode select push button
- transfer mode select push button
- stereo headphone output socket

All auxiliary input and output sockets are located on two panels recessed into the back panel. In the top left hand corner, opposite the forced draught fan air intake, is the on/off switch for the built in monitor speakers, one in each side panel behind hinged metal covers.

The second panel is located at the bottom of the back panel and contains:—

- a socket for remote cartridge programme select control

MEASURED PERFORMANCE OF AKAI 1800SS 4 CHANNEL TAPE RECORDER SERIAL NO 60721-0021

Record to replay frequency response (BASF LP35 LH tape)

	0VU	-10VU
Open reel 7-1/2 i.p.s.	35Hz to 20kHz $+1_{-3}$ dB	30Hz to 20kHz $+1_{-3}$ dB
3-3/4 i.p.s.	60Hz to 8kHz $+1_{-3}$ dB	60Hz to 10kHz $+1_{-3}$ dB
1-7/8 i.p.s.	60Hz to 3.5kHz $+1_{-3}$ dB	60Hz to 5kHz $+1_{-3}$ dB
Cartridge 3-3/4 i.p.s.	70Hz to 12kHz $+2_{-3}$ dB	70Hz to 17kHz $+2_{-3}$ dB

Total harmonic distortion at 0VU

	100Hz	1kHz	6.3kHz
Open reel	1%	0.6%	0.6%
(7½ i.p.s.)			
Cartridge	2%	1.5%	1%

Intermodulation distortion (1kHz & 960Hz signal at 0VU)

Open reel	7½ i.p.s.	1%
Cartridge	3¾ i.p.s.	1%

Signal to noise ratio (at 0VU re 1kHz unweighted)

Open reel	7½ i.p.s.	49dB
Cartridge	3¾ i.p.s.	38dB

Erase ratio (for 1kHz signal pre-recorded at 0VU)

Open reel	7½ i.p.s.	66dB
Cartridge	3¾ i.p.s.	58dB

Cross talk (re 1kHz at 0VU with respect to Channel 1)

Channel 2	52dB
Channel 3	50dB
Channel 4	63dB

Wow and flutter

Open reel	7-1/2 i.p.s.	0.1% RMS
	3-3/4 i.p.s.	0.12% RMS
	1-7/8 i.p.s.	0.2% RMS
Cartridge	3-3/4 i.p.s.	0.15% RMS

Line input sensitivity (for 0VU - 1kHz)

typically 250mV

Microphone input sensitivity (for 0VU - 1kHz)

typically 1.5mV

Line output sensitivity (for 0VU - 1kHz)

typically 500mV

Dimensions

17.8" high x 16.8" wide x 9.6" deep

Weight

51 lbs.

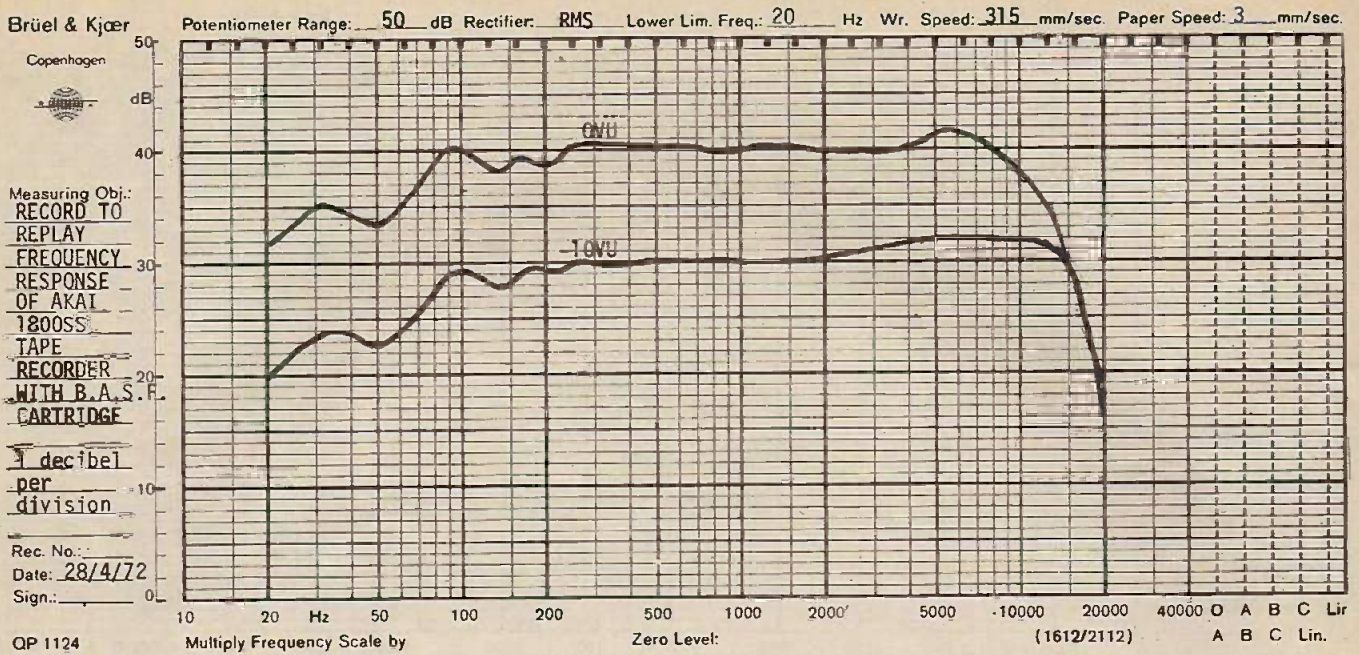

AKAI 1800SS FOUR-CHANNEL TAPE RECORDER

- b) rear channel output tip and sleeve sockets (left and right)
- c) rear channel combination DIN input, output socket (left and right)
- d) rear channel input tip and sleeve sockets (left and right)
- e) DIN sockets, high or low switch to match input levels
- f) front channel input tip and sleeve sockets (left and right)
- g) front channel combination DIN input, output socket (left and right)
- h) front channel output tip and sleeve sockets (left and right)

The mains input voltage selector and fuse holder is located at the top right hand corner on a recessed panel which also contains a 50Hz/60Hz selector switch. Cartridge tapes fit into a deeply recessed opening in the right hand side panel just below the built in monitor speakers. These speakers are provided with hinged covers to improve frontal directivity at the higher frequencies. A switch located in the opening selects continuous play or automatic stop.

The accessories supplied with the unit included:—

- 1) two dynamic microphones with stands
- 2) a four channel demonstration tape (which is gimmicky & poorly recorded)
- 3) an empty metallic 7" take up spool
- 4) one DIN to RCA patch cord for two channel operation

- 5) an Akai ACT-200 blank cartridge tape
- 6) an operator's manual (17 pages of useable instructions)

The operator's manual includes descriptions of all the facilities on the recorder, together with comprehensive operating procedures. The first four pages detail the performance specification and the front panel controls. Two items not clearly discussed are the reel retainers and the dual tone controls. The reel retainers are spring loaded and must be stretched and twisted about 30° to retain the reels. These retainer were roughly finished at the rear creating difficulties with some spools. The tone controls are only effective on the inbuilt power amplifiers and do not affect the auxiliary outputs.

Operation of the tape recorder is rather complex and one has to be careful that all functions have been selected correctly, particularly when recording. However, this is the penalty one must pay if one wants a truly versatile machine — particularly one that also incorporates a cartridge recorder.

A typical setting-up procedure for recording could include the following steps:—

- 1) switch power on
- 2) select high or low speed on tape speed switch
- 3) select correct capstan and pinch roller to give desired reel tape speed

- 4) select desired equalization
- 5) select two or four channel record mode
- 6) select standard or special tape bias
- 7) press reel mode push button
- 8) switch internal monitor speakers on or off
- 9) *thread tape
- 10) push pause lever to hold position
- 11) press record button and simultaneously switch play lever to record position.

*Threading the tape was rather awkward, due to the positioning of the two main control levers just below the take-up reel.

SUBJECTIVE IMPRESSIONS

Our subjective impressions of this machine were obtained in several ways. Firstly we recorded a number of our standard test records onto cartridges — when these cartridges were replayed through the machine the resultant clarity and frequency response was most impressive.

We then used a number of pre-recorded JVC Nivico four-channel tapes and cartridges to evaluate each section of the recorder.

Providing four high-quality speakers were used, the resultant sound could only be described as truly exciting. However to obtain these results, four high-quality speakers must be used, for if the two internal speakers are used

there is a significant loss of sound quality.

The performance of the cartridge tape playing section of the machine was of particular interest. Here the general performance was exceptionally good — the wow and flutter figures in particular were better than the manufacturer's specifications by a considerable degree.

The frequency range of the machine on playback at $7\frac{1}{2}$ "/sec (reel to reel), or on cartridge is affected by the quality of the tape used. At $3\frac{3}{4}$ "/sec it is necessary to use a high quality tape if an acceptable frequency response is desired.

Laboratory measurements confirmed these subjective impressions and we found that with BASF LP 35LH tape loaded into a cartridge we obtained the rather remarkable frequency response of plus or minus 3dB from 70 Hz to 17 kHz (at -10VU). We

understand that BASF cartridge tapes will be available through Akai distributors in the near future.

One feature which we would have liked to have seen on the unit is a common output volume control so that once the four speakers were balanced it would be possible to adjust the overall level by a single control. This, of course, would not be necessary if the tape recorder was operated with an external four-channel amplifier.

The measured performance was good and exceeded the manufacturer's specification in most respects.

Akai's 1800S tape recorder is a truly versatile machine, and with the recent introduction of four-channel cartridge machines in cars, this unit will be an ideal 'centre' for producing four-channel cartridges from reel-to-reel tapes or from discrete four-channel records. ●

THE SQ RECORD

Continued from page 31

this qualification it is possible to provide excellent quadrasonic sound even in the most modest home reproducers.

COMMERCIAL APPARATUS

A typical SQ decoder as for example produced by the Sony Corporation, first CBS licensee in Japan, is described in detail on pages 50-55 of this issue. This decoder works in combination with any components-type stereo phonograph. The stereo output is connected to the decoder, from which four new outputs emerge. Two are plugged back into the existing stereo preamplifier, while the other two are connected through suitable power amplifiers to two additional loudspeakers in the back of the room. A deluxe model with a comprehensive logic also is available.

BROADCASTING SQ ENCODED SOUND

An SQ record or an SQ encoded two-channel tape can be transmitted directly through an FM-multiplex transmitter, being heard in a normal FM-multiplex receiver as conventional stereo. With the addition of a decoder and two loudspeakers to the receiver output, reproduced quadrasonic sound is obtained.

The question arises, what does the listener to an AM broadcast hear? The answer is readily obtained by inspection of Fig. 3. The circular modulation of L_B and R_B channels intersects the horizontal axis at point *a*. The L_F and R_F signals are projected on the axis also falling on *a*, as shown in broken lines. Therefore, the four corner sounds are reproduced at full strength. The centre front sound, C_F , is reproduced at a 3dB higher level as in conventional stereo. The centre back sound, C_B , which has a zero projection on the axis disappears unless special recording procedure (outside the scope of this article) are used.

Therefore, while the centre back channel is reproduced fully in both the quadrasonic and the stereo modes, we advise our producers not to place soloists at the dead back of the audience.

With the understanding on part of the producer of the capabilities of the SQ system, totally satisfactory monophonic broadcasting and reproduction of SQ program are obtained, thus fulfilling the seventh and last condition set forth in our qualifications of stereo-quadrasonic systems. ●

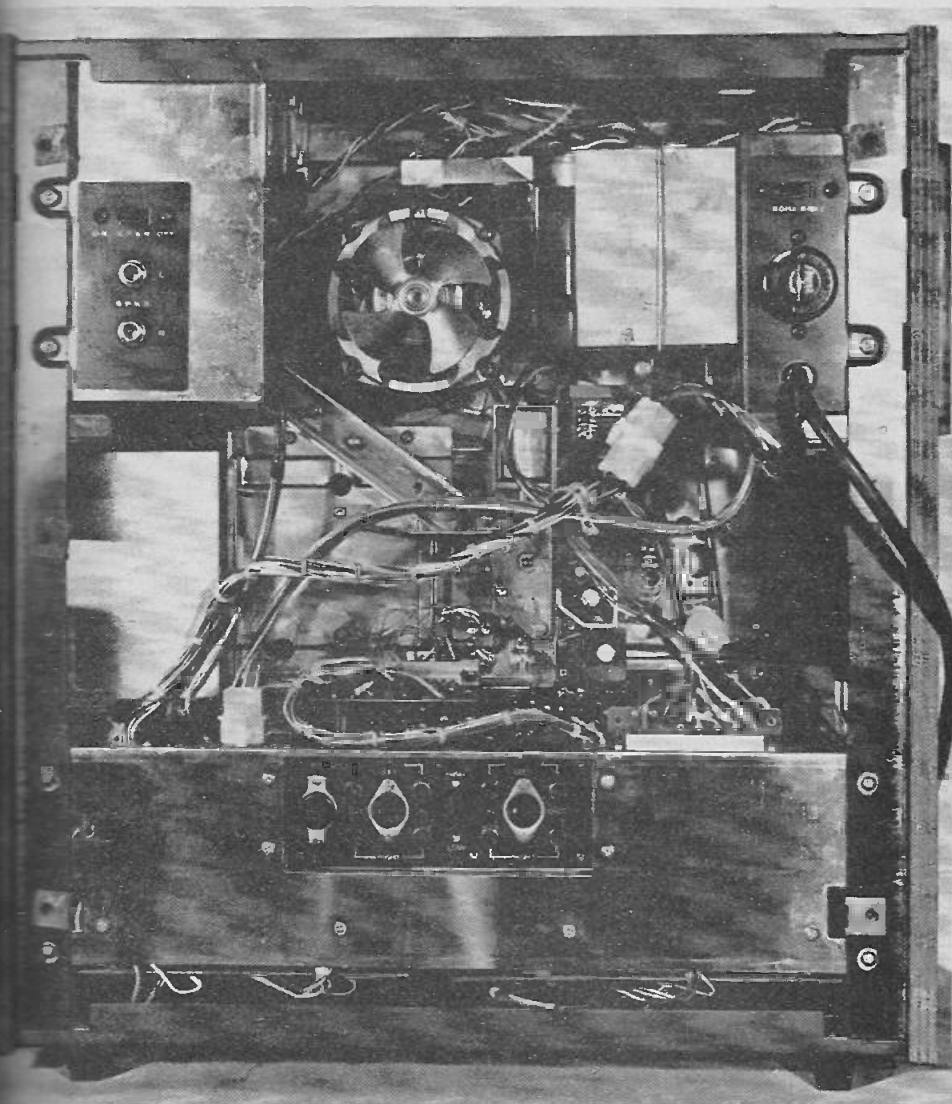

ALL ABOUT 4-CHANNEL SOUND



CBS-SONY SQ QUADRIPHONIC SYSTEM

electronics
TODAY
INTERNATIONAL

product test

This matrix system is compatible with existing record playing equipment.

Without doubt, the main difficulty that proponents of four-channel sound have had to overcome is that of compatibility of four-channel recordings with existing record players, tape recorders and, in some countries, F.M. stereo broadcasting.

It is for this reason that the basically compatible matrix systems have gained popularity, and of these, the CBS-Sony SQ system is one of the most promising.

The principle behind all the matrix systems is the "encoding" of four channels of information onto two

channels. Obviously the encoding cannot be perfect, since it is impossible to double the amount of information contained in the same bandwidth. Hence the matrix systems use the psychoacoustical effects of phase relationships to give a four-channel effect.

The CBS-Sony SQ System uses a fairly complex method of encoding which combines the two rear channels with each of the front channels.

The system is based upon the possible orthogonal sets of information that can be recorded on a single record groove. An orthogonal

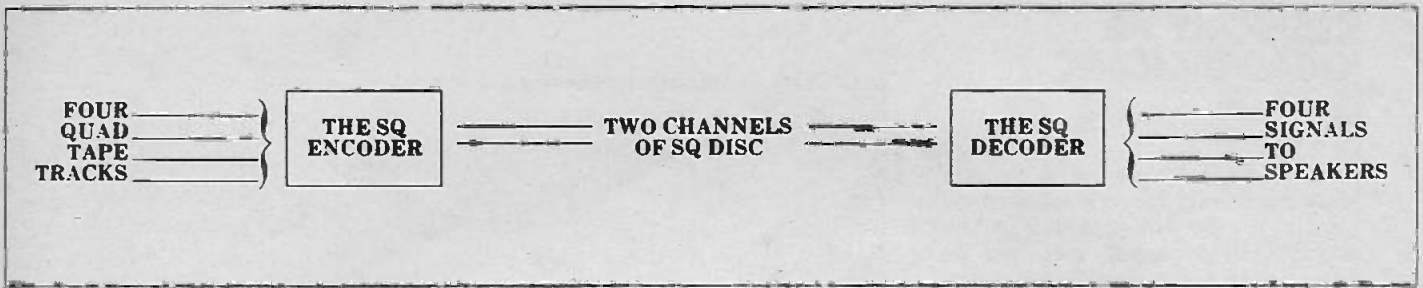

set of co-ordinates is a choice of co-ordinates which are completely independent. Thus, on a sheet of paper one has an orthogonal set of two lines each of which can be chosen independently. These are the vertical and horizontal directions. If one wishes to draw a graph with more than two variables it is necessary to either plot them in three dimensions, or lose some of the data and plot the remainder as a family of curves (such as valve or transistor data). The limitation of a flat sheet of paper is accepted for its convenience, for it is obviously far easier to use paper than to mould transistor data in the form of blocks of plastic. Similarly, a record groove can only contain two-dimensional data in the form of suitably chosen orthogonal sets. The most obvious set is two components at 90° to each other, and this is the one which has been used for years for stereo recording.

The only other orthogonal set is a pair of helices with opposite directions of rotation. A helix consists of one component of the stylus motion in one plane combined with the same component phase shifted 90° in the other plane. Depending upon whether the phase shift is forward or reverse, a left handed or right handed helix results.

Such a set could equally well be used for stereo recordings. The reasons that it was not used originally is because of the complexity of the decoding required. The CBS-Sony system uses

both orthogonal sets. The conventional set contains the information from the front microphones, while the helical sets contain the information from the rear microphones.

A major problem arises because the helical co-ordinates are not orthogonal to the rectangular co-ordinates.

What does this mean in practical terms?

While the left and right front speakers can produce information separately and the left and right rear speakers can produce information independently, a signal which should appear in the left front speaker *will also appear, with 3dB attenuation (and a phase shift), in the left and right rear*

speakers. And similarly for the other signals.

Another major weakness occurs if a signal is supposed to appear in the front centre or rear centre, since, because of the lack of orthogonality, approximately equal signals will appear in all four speakers.

To improve this obviously poor channel separation, "logic circuitry" is incorporated in the more expensive decoders. This circuitry detects whether the vector sum of the signals to the front speakers exceeds the vector sum of the signals to the rear speakers. If it does, then the gain of the front channels is increased and the gain of the rear channels is decreased. The reverse situation occurs if the

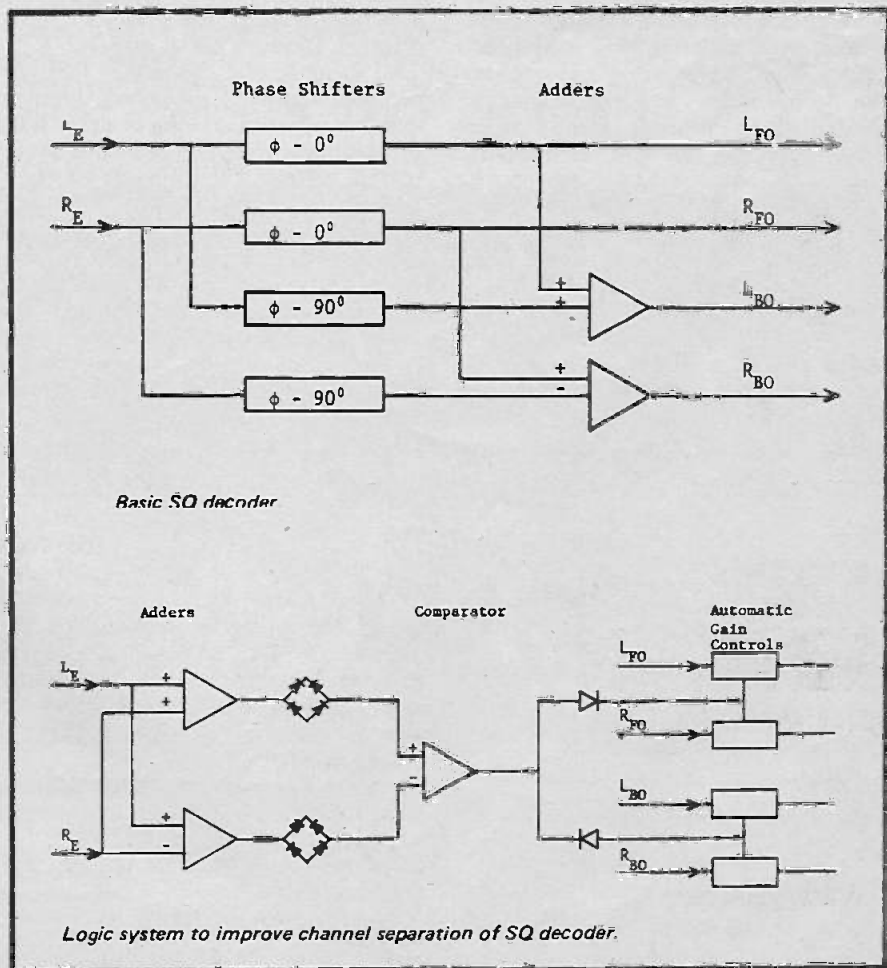

CBS-SONY SQ QUADRIPHONIC SYSTEM

vector sum of the signals to the rear speakers exceeds the vector sum of the signals to the front speakers. This artificial enhancement can lead to some rather odd effects, especially on conventional stereo records.

Much has already been written on the psychoacoustical aspects of the various matrix systems, so for this review instead of our usual custom of thorough analytical testing, we spent an unusually large amount of time on the subjective evaluation of the SQ system using ordinary stereo records, mono records and SQ encoded records. This was necessary since based on the measured (or calculated) effects of the system, in terms of what goes in to the encoder and what comes out of the decoder, almost anything could happen.

Since this system relies heavily on the phase relationships of the signals, we used a four-channel amplifier rather than two stereo amplifiers or a combined decoder rear amplifier. As with our test of the JVC system published elsewhere in this issue, we also used four matched Advent speakers. The record that we used for most of our tests was a vocal solo with instrumental backing. This should, of course, have had the vocalist located in the front centre and the orchestra located fairly diffusely around him. Presumably the rear speaker content could be expected to reproduce reverberant sound, together with some sound from the outer instruments of the orchestra. However the result was quite unusual and not entirely satisfactory. When the vocalist was singing loudly he was located in the front centre; the orchestra was located between the front speakers and the

rear speakers did not appear to be producing any significant information. But when the vocalist sang quietly his voice tended to wander; sometimes coming from the right side, some of the time from the front.

We found that listening to such a fleet-footed vocalist tended to spoil the listening pleasure. On other less exacting music the results were pleasing, although rather diffuse.

We came to the conclusion that no demonstrations of ping-pong doubles matches or trains arriving at either side of a platform would be produced using the SQ system. Yet for music which is normally heard in a highly reverberant area, such as a church, the effect was outstanding. Since one did not expect to be able to pinpoint the instrument, the diffuseness enhanced the performance and provided a far more lifelike presentation.

One of the more spectacular

successes was with an ordinary stereo record of 'Switched on Bach' played on the Moog Synthesizer. Normally this record is rather poor as a test record for coloration and distortion because its effects are unnatural. Having heard a discrete four-channel reproduction of this record where the mixer had let his hair down and used movement as part of the performance, we wondered what the SQ decoder would produce.

The result was electronic music which was every bit as spectacular as the discrete four-channel material as a result of the apparently arbitrary manner in which it was recorded.

Similar results were obtained with other stereo material. Sometimes the effects were pleasing, sometimes distracting, depending very much upon the type of music.

Monophonic records were played to see how effective the logic circuits

MEASURED PERFORMANCE OF SONY DECODER MODEL SQQ-1000 SERIAL NO 801713A

FREQUENCY RESPONSE 20Hz to 20kHz $\pm 2dB$

SOURCE	LEFT FRONT OUTPUT		RIGHT FRONT OUTPUT		LEFT REAR OUTPUT		RIGHT REAR OUTPUT	
	Phase Angle	Relative Level	Phase Angle	Relative Level	Phase Angle	Relative Level	Phase Angle	Relative Level
1kHz Signal								
Left Input	225°	1.00	—	—	135°	0.66	225°	0.76
Right Input	—	—	225°	0.98	45°	0.69	315°	0.72
Both Inputs	225°	1.00	225°	0.98	90°	0.31	270°	0.36
100Hz Signal								
Left Input	90°	1.00	—	—	In Phase	0.66	90°	0.76
Right Input	—	—	90°	0.98	270°	0.69	180°	0.72
Both Inputs	90°	1.00	90°	0.98	315°	0.31	135°	0.36

NOTE: All phase angles and output levels measured with respect to input signal, all phase angles are lagging with respect to input.

90% attack time on voltage controlled gain 200 msec.

90% decay time on voltage controlled gain 15 sec.

Conventional disc

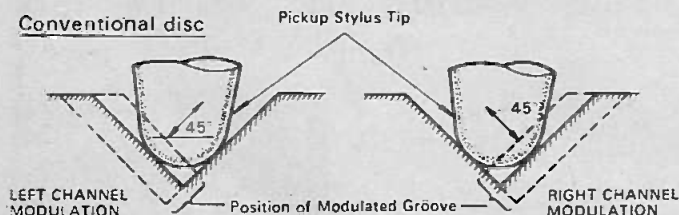

SQ disc

The stereo record has two channels for recording sound.

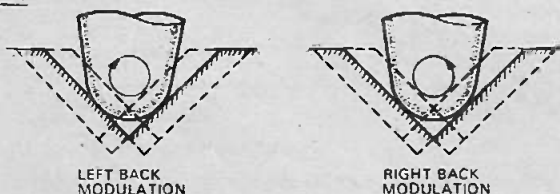

Disc and stylus motion in the SQ system

The sound groove on an SQ disc meanders somewhat irregularly with its changing depth. As a cartridge stylus traces this sound groove, four sound components are picked up according to the four modes of stylus motions as illustrated right.

Such four motions are sensed out as two combinations of electric signals which are separated into four audio electrical signals by means of a decoder so as to finally drive four speakers installed in the left front, the right front, the left back and the right back. When playing the SQ disc with an ordinary stereo player, the two electric signals are led directly to the right and the left channels. In this case, neither separation characteristics nor the distortion factor is deteriorated at all so that the playback sound remains unchanged as in the case of the ordinary stereo system. Further, this SQ disc is also applicable to a monaural player.

CBS-SONY SQ QUADRIPHONIC SYSTEM

were in producing a fixed sound image. The result was quite effective and was, in fact, a reminder that monophonic records are extremely lifeless by comparison with stereo or quadrasonic sound of any sort.

A problem that exists with the SQ decoder is that sound with components phase shifted 90° appears in speakers other than the 'desired ones.' The system relies heavily on these components not being in phase with the desired signals. This is reasonable, for tests performed on subjects — with in phase and out of phase signals — have shown that out of phase signals do not reinforce each other to provide localisation of the source.

But while this is true, phase is relatively unimportant in acoustical phenomena since the phase of signals varies so much with distance.

Above 300 Hz, the position of a microphone need only be shifted less than one foot with respect to the source, to produce a 90° phase shift. Reflection from walls, floors and other objects can also readily create quite large phase shifts between speakers to produce channel separation.

Hence the major weakness in the matrix type quadrasonic reproducers is that, not being a completely

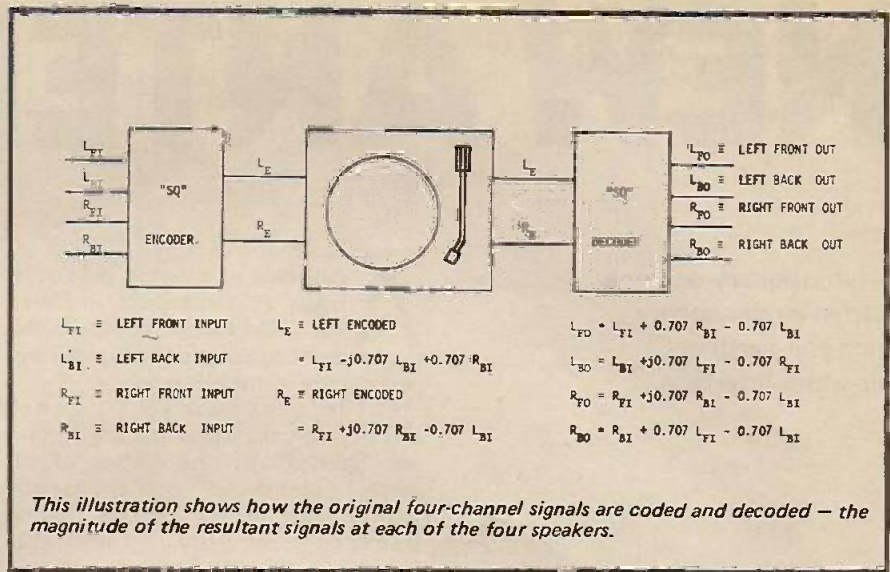

orthogonal set it is impossible to produce, from the available information, a given sound with a given location at will. The question which must be asked is whether the sounds that *can* be produced justify the matrix technique with its obvious advantages of compatibility with existing equipment and techniques.

This is a question that can only be answered in the end by the final user. It is the opinion of all the staff who were asked to comment on the tests that, in general, the effects were not significantly better than could be obtained from stereo records and a

synthesizer (such as the Sansui QS1) at about the same order of cost.

It would seem that either the goal is completely faithful reproduction of sound or something which is pleasing for its own sake. If the user wants completely faithful reproduction then the discrete system with its attendant disadvantages and limitations must be used. If it is a pleasing sound which is the goal then it would not appear to matter much whether a synthesizer or the QS decoder is used.

In either case the sound has a more lifelike character. ●



This unit has an amplifier and decoder combined.

NEW ANTENNA

Revolutionary antenna design guides energy along air-earth or air-water interface

A new type of antenna, developed by A. F. Wickersham, of Menlo Park, California, could revolutionise point to point communications, particularly in the HF range.

These antennae launch electromagnetic waves such that they are "guided" by the surface of the earth, improving over-the-horizon performance of HF circuits that at present employ unreliable ionospherically reflected waves.

The designer predicts that using a power of 100 Watts and a surface wave launcher, received power, at a distance of 3,700 miles over seawater, would be at a level of -105 dBm, a level easily handled by modern communications receivers.

The new antennae are of particular interest to short range VHF services as the launchers are mounted very close to the ground and the resultant surface wave propagation can be used to delimit the service area of a transmitter and reduce interference between neighbouring stations. They are also of interest to point to point services operating in the HF bands because this mode gives a rapid decrease in signal strength with increasing range from the transmitter (useful for short range working), and no fading is experienced on long range communications networks such as occurs when using ionospherically reflected sky waves.

VHF EXPERIMENTS

Most present antenna designs radiate electromagnetic energy in what is termed the Transverse Electro-Magnetic (TEM) mode. These new launchers are designed to radiate purely in the Transverse Magnetic (or TM) mode such that the energy is guided along the air-earth or air-water interface.

The attenuation of received power with range follows a predictable law for TM surface waves, being exponential over clay soil for ranges less than thirty wavelengths and inverse cubic for ranges greater than thirty wavelengths.

Over salt water the attenuation is exponential for ranges less than 250 wavelengths and the inverse cubic law starts beyond (approximately) 500 wavelengths. The signal actually increases between these two limits.

These results apply to launchers developed for uses at VHF. Two types are illustrated in Fig. 1. (a) and (b).

The feed point impedance varies with height above ground, being constant for heights over $\frac{\lambda}{8}$ (approximately) decreasing below this height, being near 50 ohms for heights around $\frac{\lambda}{16}$.

The flat plate type launcher has a greater bandwidth and improved efficiency (as much as 20 dB in received signal strength) over the tubular type of launcher.

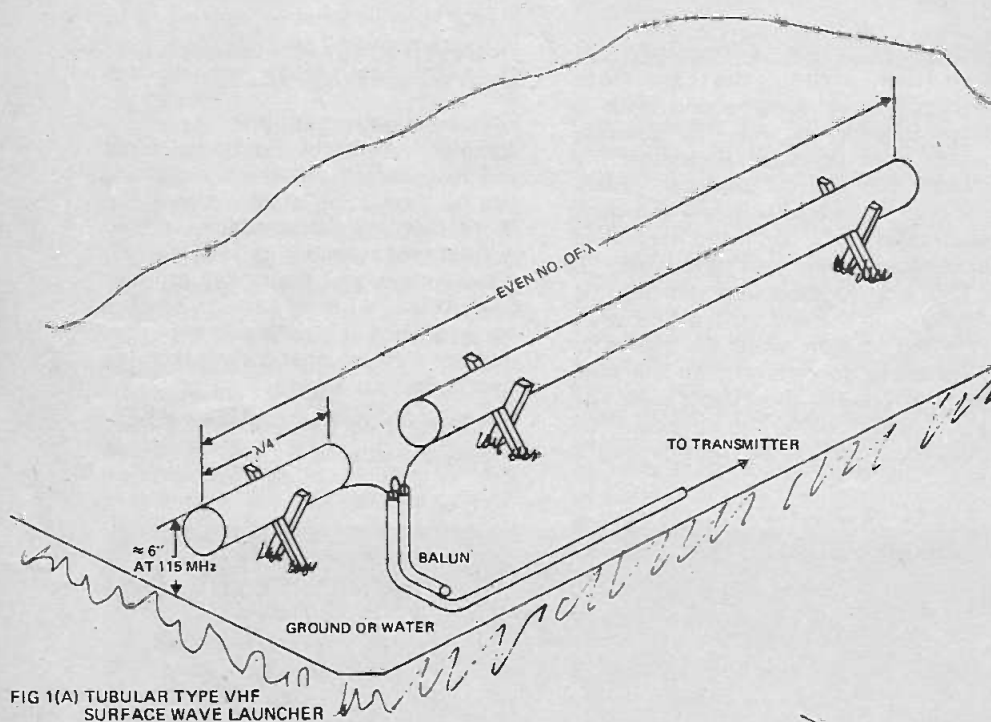

FIG 1(A) TUBULAR TYPE VHF SURFACE WAVE LAUNCHER

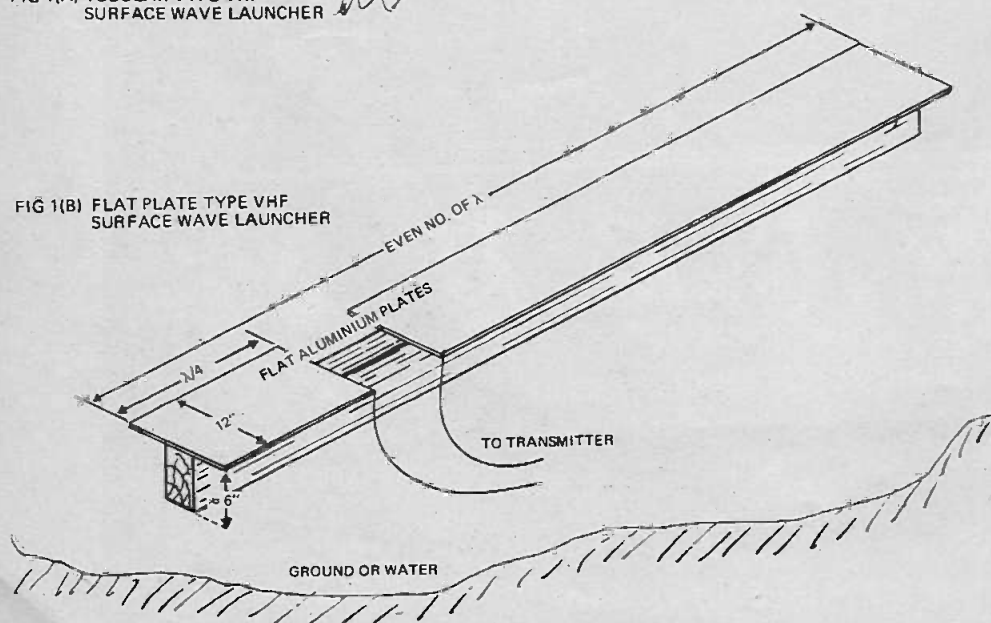

FIG 1(B) FLAT PLATE TYPE VHF SURFACE WAVE LAUNCHER

NEW ANTENNA

HF EXPERIMENTS

Experiments carried out with a vertical launcher near 7 MHz have shown surprising results.

The signal attenuation followed an inverse quadratic law in this case, from close range to long range (beyond 100 miles).

The constancy (lack of fading) of received signal strength at long ranges was very good. Compared with ionospherically reflected signals, the reliability of the surface wave (TM) mode of propagation is excellent.

By using this type of propagation it will be possible to predict what the received signal strength will be at a given range for a given transmitter output power. The result will be a vast improvement in communications circuit reliability.

The transmitting antenna used for the HF tests was a vertical dipole with the lower limb buried in wet sand. The upper limb was a quarter wavelength (in air) long, the lower limb in a quarter wavelength (in wet sand). Receiving antennas were identical. ●

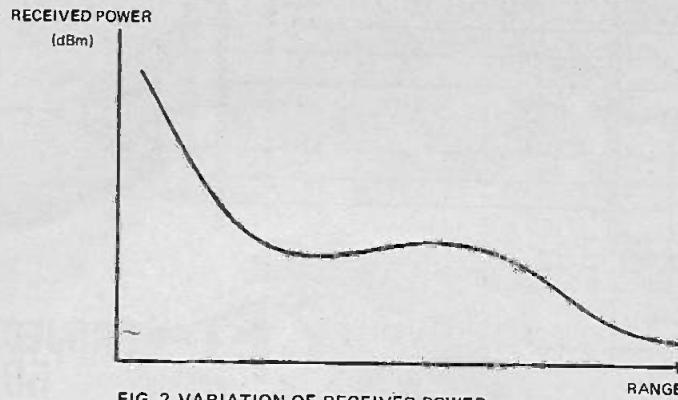

FIG. 2 VARIATION OF RECEIVED POWER VERSUS RANGE (VHF/EXPERIMENTS)

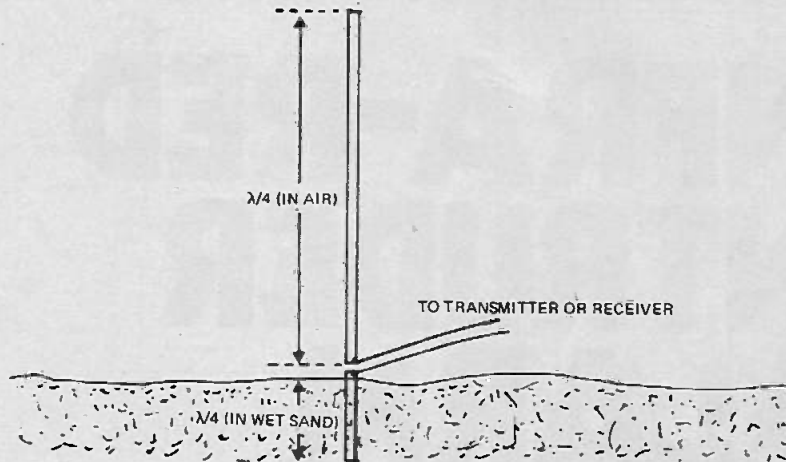

FIG 3 ANTENNA USED FOR HF EXPERIMENTS

DON'T MISS . . .

THESE TWO VALUABLE COUPONS

EACH coupon is worth 50p with every order valued £5.00 or over from Semiconductor Supplies Limited.

WORTH 50p

NAME _____
ADDRESS _____

WORTH 50p

NAME _____
ADDRESS _____

See advertisement inside front cover

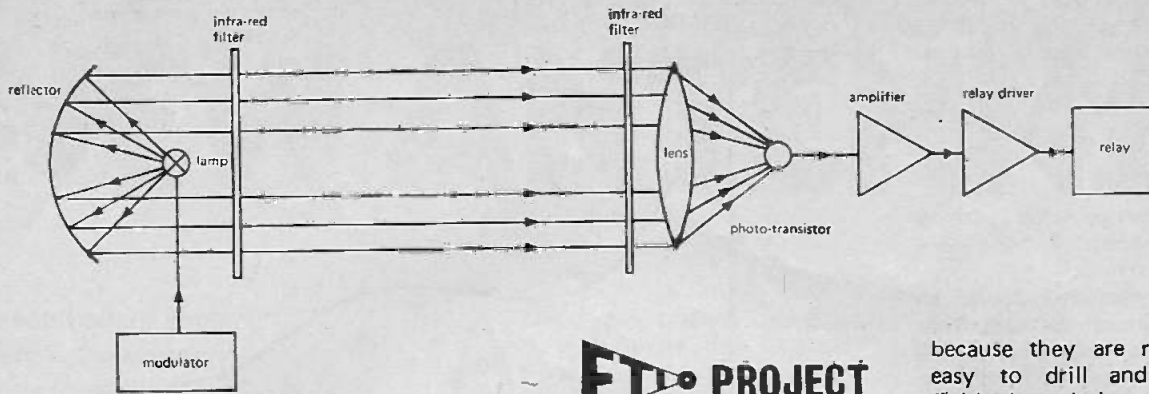

FIG. 1. PRINCIPLE OF OPERATION

ETI PROJECT 506

INFRA-RED INTRUDER ALARM

Sophisticated infra-red intruder alarm has over 200ft. range.

One of the most reliable and efficient devices that can be used to detect the presence of a burglar is the infra-red beam.

The beam described in this project is fail safe and virtually tamper proof. It can be constructed from readily available parts, is easily installed and can be used over a range of at least 200 feet.

An alarm will be given the instance that an intruder passes through any part of the beam.

PRINCIPLE OF OPERATION

The basic principle of operation is shown in Fig. 1.

The transmitter consists of a source of infra-red energy (a tungsten filament lamp) modulated and focussed into a beam by a concave reflector and filtered to remove all visible light.

To make the beam tamper proof, and at the same time insensitive to ambient light, the transmitter is modulated at a low frequency. A burglar attempting to bypass the beam with a torch will discover this to his cost.

The receiver consists of a condenser lens which focuses the energy from the transmitter onto a phototransistor. The output of the phototransistor is

amplified and used to drive the alarm relay. A filter is fitted in front of the lens to eliminate unwanted ambient light (such as that from fluorescent tubes).

CONSTRUCTION DETAILS

(a) Mechanical

An excellent method of construction is to build this alarm unit into a pair of diecast boxes. These were chosen

because they are readily obtainable, easy to drill and cut, and when finished result in a really professional product. An alternative construction might well employ timber boxes made out of marine quality plywood.

A sealed beam lamp was chosen as the transmitter because it simplifies the optics and it produces a beam wide enough to facilitate easy alignment. The relatively wide beam width also reduces the risk of false alarms due to vibration of the beam mounting points.

For suggested mechanical details the reader is referred to Fig. 2.

The lamp can be glued to its mounting platform using silicone rubber, Plastibond or Perma-bond. Although this is a difficult glass to metal joint, we have found the Dow Corning silicone rubber in particular, to be very effective.

(b) Electrical

The electronic components for both transmitter and receiver are contained in the receiver unit. This results in compactness, and because only one printed circuit board is used, construction is relatively easy.

The circuit diagram of the complete unit is shown in Fig. 3.

The component layout, and copper foil side of the printed circuit board are shown in Figs. 4 and 5.

While assembling the board, check carefully the polarity of the electrolytic capacitors, and avoid overheating the transistors whilst soldering.

When the board is complete, recheck carefully, and connect the transformer, voltage regulator transistor Q2, and other components — as shown in the circuit diagram and illustrated in Fig. 7.

In this form the unit is mains operated, and a power failure will result in alarm operation. For some applications this may not be a serious problem; but if required, automatic changeover to battery operation may be provided by including the extra components shown in Fig. 6.

These components should be wired as shown and connected to the points marked X and Y on Fig. 3. If this facility is included, the mains on/off switch (SW1) must be changed to a double-pole type to enable the battery as well as the 240V supply to be

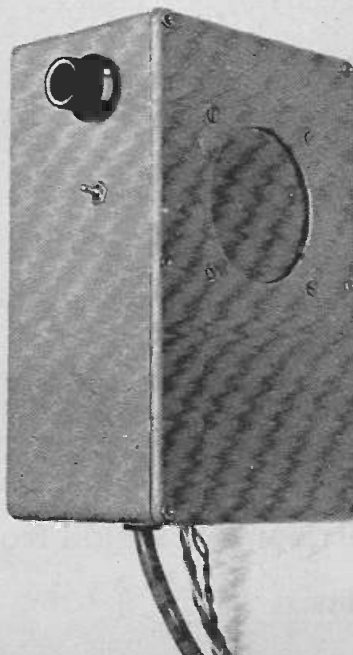

switched off when the beam is not required to be in use. The recommended batteries are two Eveready type 731 in series.

TESTING THE UNIT

1. Contact the lamp supply on the printed circuit board to the lamp in the transmitter.
2. Temporarily remove the filters from both transmitter and receiver.
3. Locate the transmitter some 10 to 20 feet from the receiver.
4. Set the latching switch on the receiver to the 'non-latch' position.
5. Connect the 240V supply to the receiver unit and switch on. The lamp in the transmitter should be flickering at a fairly high rate.
6. Align the transmitter so that the beam falls onto the lens of the receiver.
7. Adjust the receiver lens so that the light beam is focussed squarely onto the photo-transistor.
8. Adjust VR1 so that the relay is held closed by the light beam. The relay should open when the light beam is interrupted, but should reclose when the beam again falls on the receiver.
9. Switch the latching switch to the 'latch' position, and again momentarily interrupt the beam. This time the relay should open and stay open.

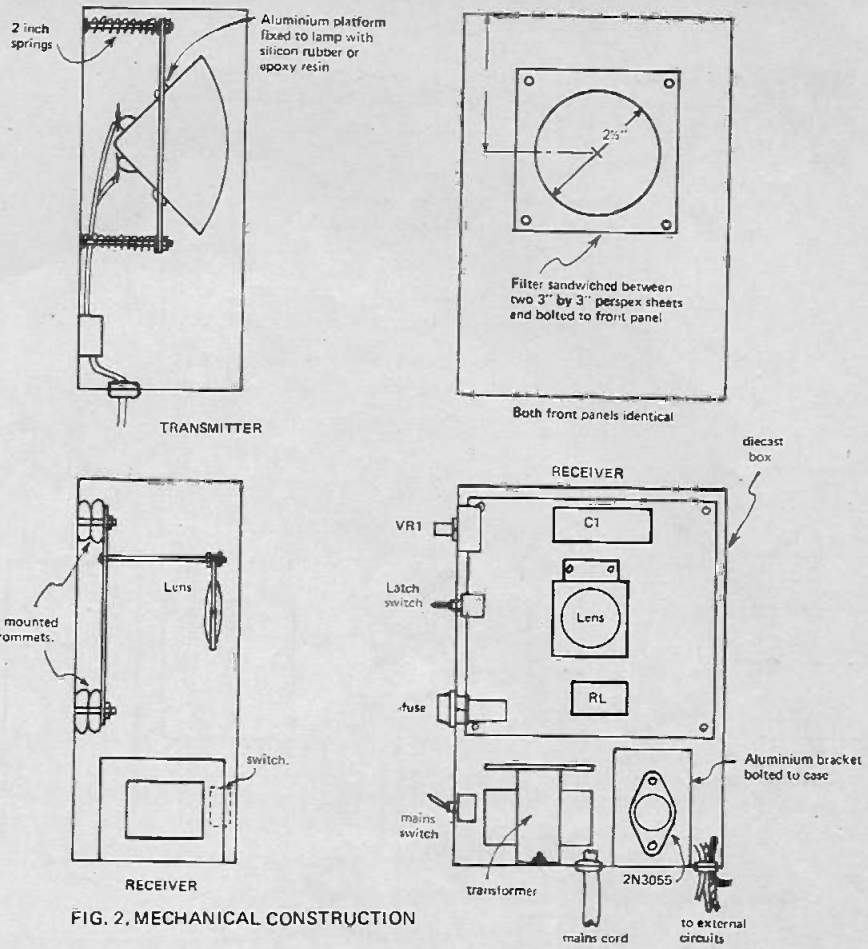

FIG. 2. MECHANICAL CONSTRUCTION

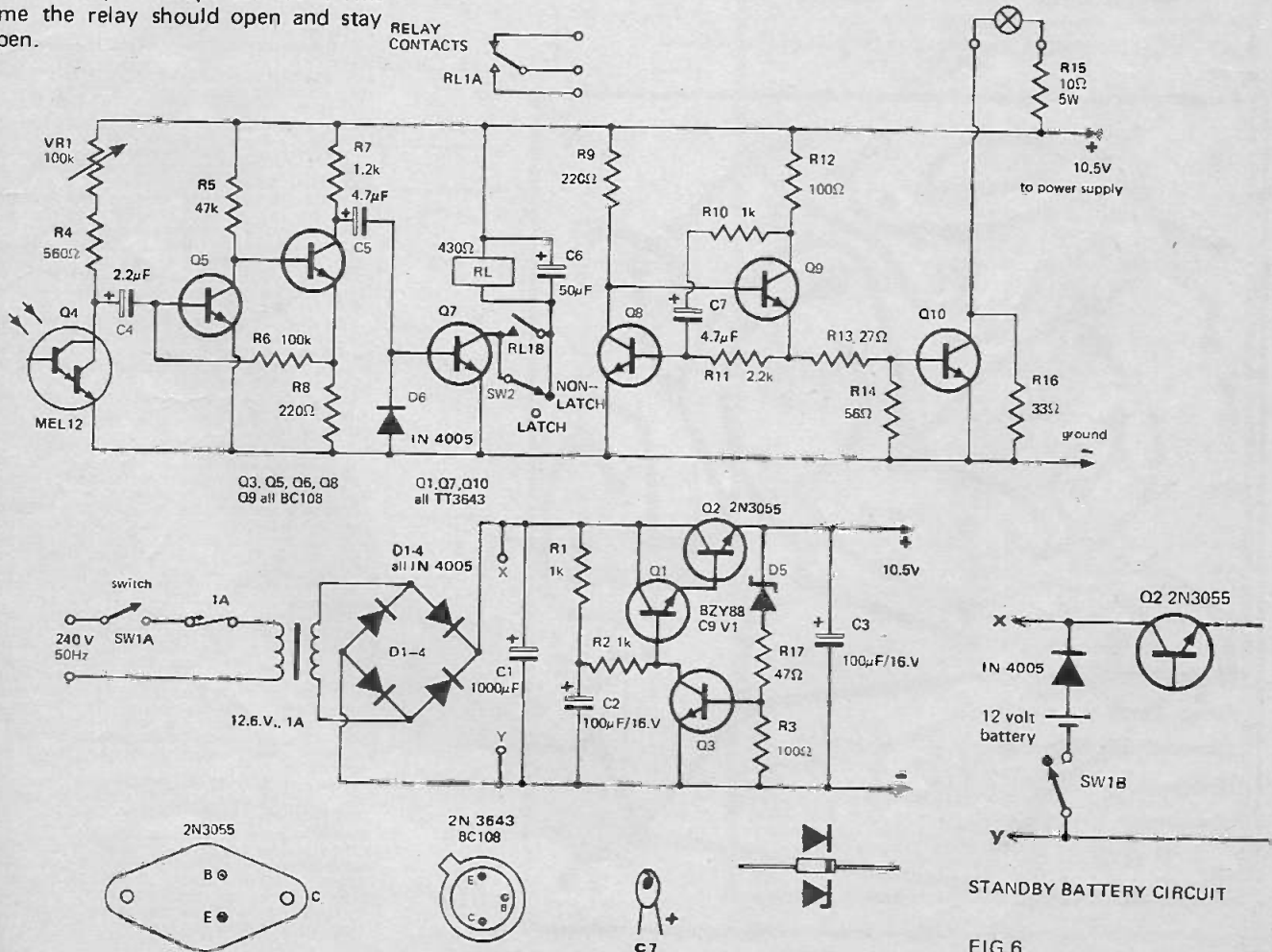

FIG. 3. CIRCUIT DIAGRAM OF COMPLETE UNIT.

FIG. 6.

INFRA-RED INTRUDER ALARM

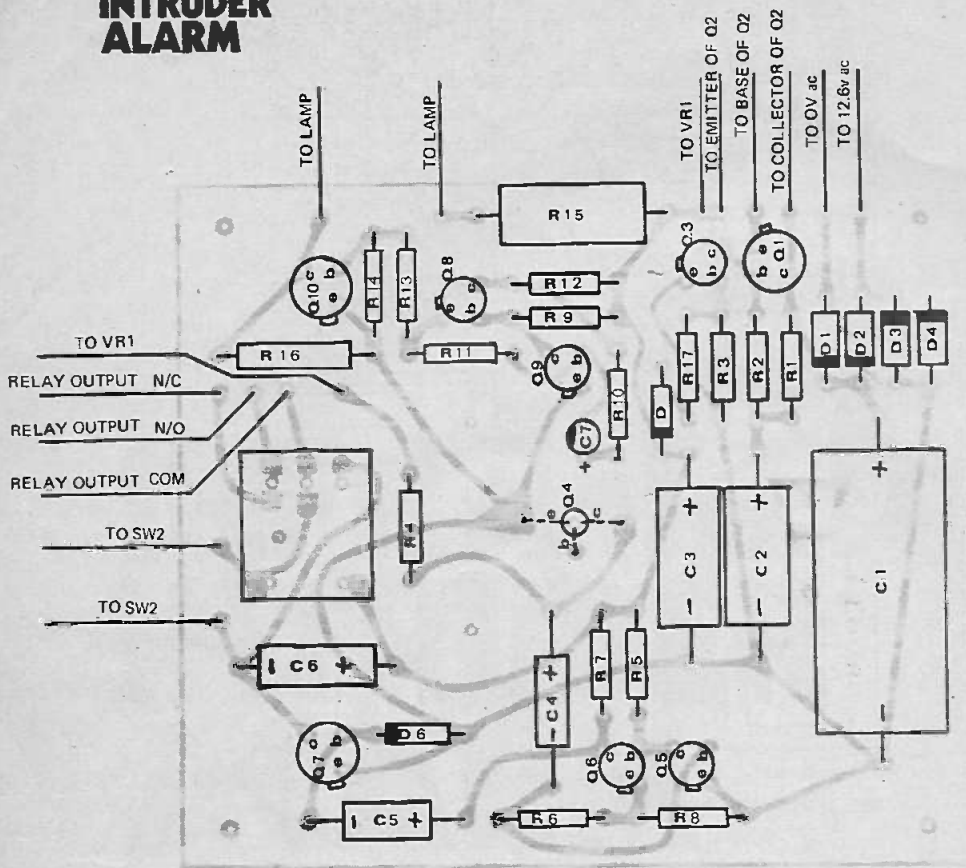

Fig. 4. How the components are located on the printed circuit board.

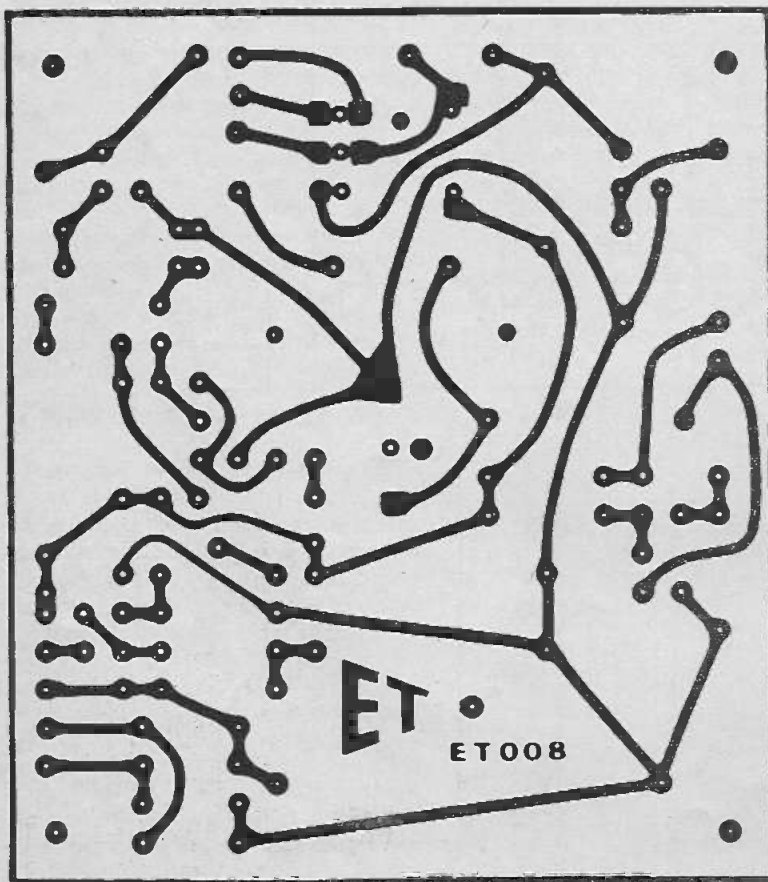

Fig. 5. Foil-pattern for printed circuit board — full size.

INSTALLATION

The lamp mounting platform has been mounted on springs to enable the beam alignment to be adjusted after the transmitter box has been finally located.

However a useful precaution is to temporarily locate the transmitter at the designated point, connect the beam, and with the filter removed, ensure that the light beam falls on the point designated for the receiver.

Temporarily remove the filters from both transmitter and receiver and align the beam so that it falls squarely onto the photo-transistor.

Refit the filters and with the latching switch in the non-latch position adjust RV1 so that the relay is held in by the

HOW IT WORKS

Transmitter

Transistors Q8 and Q9 form a type of astable multivibrator of which the frequency of oscillation is determined primarily by C7.

Lamp driving transistor Q10 is switched by the positive pulses appearing across potential divider R13/R14. Resistor R16 biases the lamp, and by so doing, reduces the current flow through Q10.

For the lamp specified in this project, R16 should be approximately 33 ohms. The correct value should be such, that with the base of Q10 disconnected, the lamp filament can be seen just barely glowing when viewed in the dark.

Receiver

The receiver consists essentially of three stages:—

- (a) photo-transistor detector stage
- (b) amplifier
- (c) relay driver

The photo-transistor stage consists of a Darlington-pair photo-sensitive transistor connected to a variable load resistor. The base of the photo-transistor is left disconnected. As this transistor is prone to saturate at high light levels, VR1 has been included to enable the sensitivity to be adjusted under operating conditions.

The output of the photo-transistor is capacitively coupled to a two-stage amplifier, Q5 and Q6. Transistor Q5 is stabilised by negative feedback through the 100k resistor R6.

The output of the amplifier is capacitively coupled to the relay driver Q7. The base end of C5 is clamped to ground by diode D6 to ensure that Q7 receives positive going pulses to drive the output relay (RL).

Capacitor C6 prevents this relay chattering due to the relatively low frequency of lamp modulation.

Latching Operation

A single-pole single-throw switch (SW2) is used, (in conjunction with one normally open set of relay contacts — RL1B), to provide a latching function. The purpose of this is to lock the contacts of the relay in the 'alarm' condition when the beam is interrupted, thus ensuring that they do not reclose when the beam is again restored. This facility may be switched in or out as required.

The unit is initially switched 'on' with the latching switch in the 'non-latch' position. With the beam operating normally, the relay RL is held in, and the normally open contacts close, shorting out the switch contacts of SW2. The latching switch is now set to the 'latch' position. If the beam is interrupted, relay RL will be de-energised and the normally-open contacts will be released thus preventing the relay from re-closing.

The unit is reset by momentarily switching the latching switch to the non-latch position and then returning it 'latch'.

Power supply

The power supply unit is a full-wave series regulated unit which has a fixed output of approx 10.50 volts. A high degree of stabilisation is required to prevent the fluctuating load of the transmitter lamp from modulating the receiver circuit.

beam; check that there is some reserve 'power' by momentarily blanking off part of the receiver lens. The relay should not drop out.

Set the latching switch in the 'latch' position and check that the relay remains locked out when the beam is momentarily interrupted.

The relay specified has two sets of change-over contacts. One set (RLIB) is used for the latching function, the second set (RLIA) is used for the alarm output. These latter contacts may be used in the conventional way to switch an external battery and bell circuit, or may be wired to the normally closed inputs of any commercial alarm system.

The maximum range of the beam depends upon whether or not it is to be used in daylight. The range at night may exceed 500 feet, but if daylight operation is required the range may be restricted to 100 feet to 200 feet.

Try to arrange the receiver so that direct sunlight never falls onto the lens. If necessary fit a round metal or cardboard tube, (the diameter of the lens and about 6" to 12" long), to shield the receiver lens from ambient

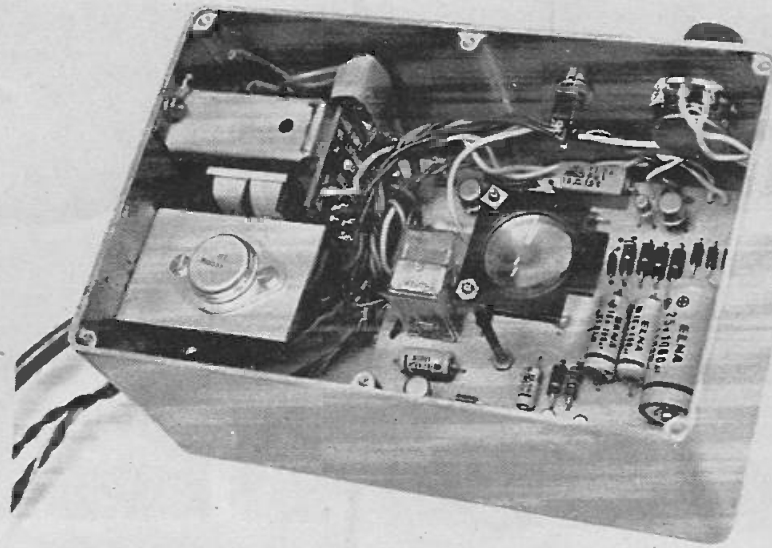

Interior of prototype unit.

light. The inside of the tube should be painted matt black.

Final alignment should be carried out at night as it is easier to see the beam (with the filters removed).

Infra-red radiation behaves much as visible light, and so mirrors may be used if it is necessary to direct the beam around corners. Shaving mirrors are ideal for this purpose.

VIEW OF TOP SIDE OF P.C. BOARD

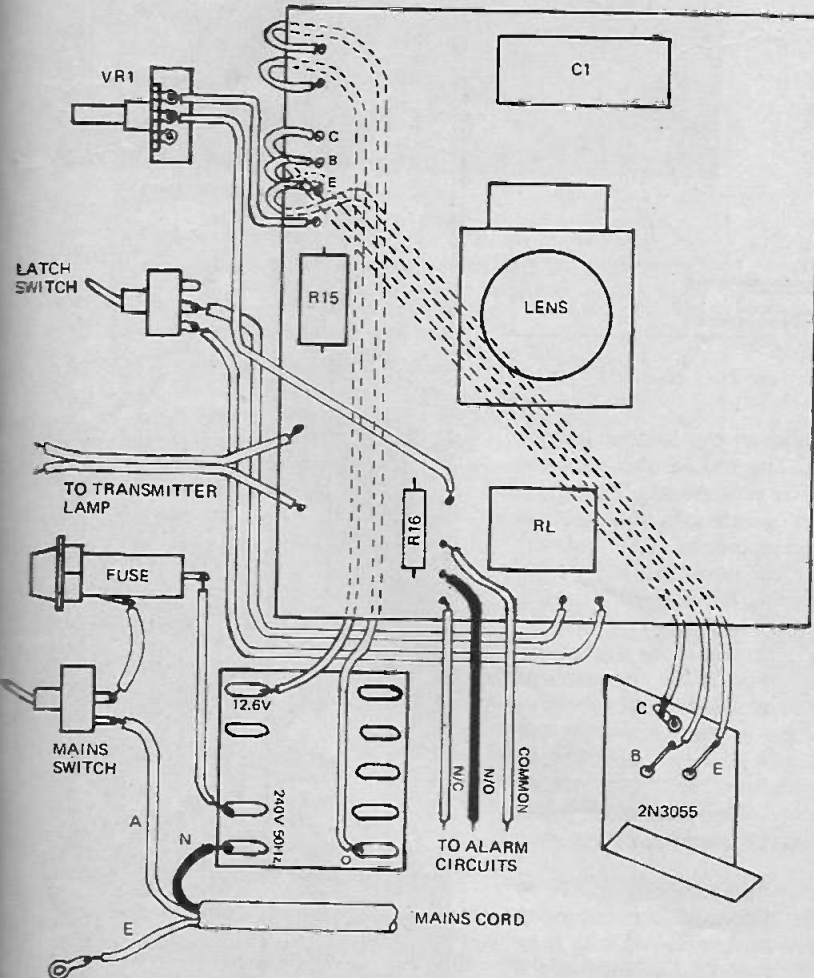

PARTS LIST

R1	resistor	1k,	1/2W,	5%
R2	"	"	"	"
R3	"	100 ohm	"	"
R4	"	560 ohm	"	"
R5	"	47k,	1/2W	5%
R6	"	100k,	"	"
R7	"	1.2k,	"	"
R8	"	220 ohm	"	"
R9	"	"	"	"
R10	"	1k	"	"
R11	"	2.2k	"	"
R12	"	100 ohm	"	"
R13	"	27 ohm	"	"
R14	"	56 ohm	"	"
R15	"	10 ohm	5W	"
R16	"	33 ohm	1W	"
R17	"	47 ohm	1/2W	"
VR1	potentiometer	100k	linear	
C1	capacitor	1000UF,	25V,	
C2	"	100UF,	16V,	
C3	"	100UF,	16V,	
C4	"	2.2UF,	25V,	
C5	"	4.7UF,	25V,	
C6	"	50UF,	16V,	
C7	"	4.7UF,	16V,	
Q1	transistor	2N 3643		
Q2	"	2N3055		
Q3	"	BC108		
Q4	phototransistor	MEL 12 or equivalent		
Q5	transistor	BC108.		
Q6	"	BC108.		
Q7	"	2N 3643		
Q8	"	BC108		
Q9	"	BC108		
Q10	"	2N 3643		
D1 through D4	silicon diode	1N 4005 or equivalent.		
D5	zener diode	BZY88/C9V1		
D6	silicon diode	1N 4005		
Transformer	transformer	12.6 volt, 1 amp output.		
Relay	Cradle type relay	double pole changeover. 430 ohm coil, Varley VP2 or equivalent.		
SW1	switch toggle type,	240 volt single or double pole (see text).		
SW2	switch toggle type,	single pole, single throw.		
Lamp	G.E. Sealed beam lamp type	GE 4546. Infra-red filters —		
Infra-red filters — Kodak type 87 or 88A. Sundries, two diecast boxes, one 2 way connecting block, rubber grommets, printed circuit board, three core cable and plug, four 2" compression springs, front loading fuse holder and one amp fuse, one small condenser lens, (2" focal length), perspex sheet, pointer knob, hook-up wire, assorted nuts and bolts.				

◀ Fig. 7. Connections to and from the printed circuit board.



ZERO TRACKING ERROR

This zero tracking error turntable was designed over 40 years ago!

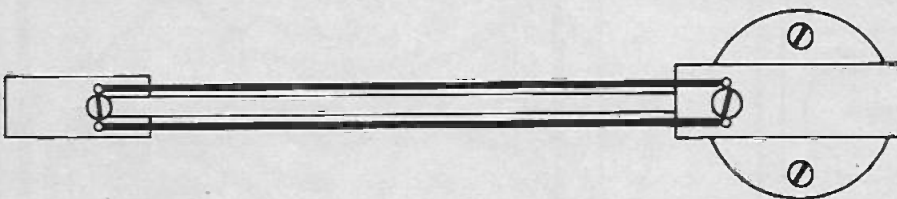

Our May issue featured a test of Garrard's Zero 100 turntable — which as readers will be aware has a pick-up arm designed to minimize tracking error.

Following publication, we received the following letter from Mr Jim Davis of Latrobe (Tasmania).

Dear Sir,

Your article on the Garrard Zero Tracking Error Arm is exactly 41 years late!

I have just added to my collection a magnificent Radiogram which was built in 1931 for a client in Tasmania.

The turntable of this unit consists of one of the very earliest crystal pick-ups and features a ZERO TRACKING ERROR ARM. I've never seen one like it before — but there it is!

The main pick-up arm is pivoted at both ends, that is, on the head shell at

one end — and on the balance weight at the other. The two parallel arms are also pivoted at either end. Thus there are six pivot points. As you can see from the photographs, the balance weight does not move sideways with the pick-up arm, it's a fixture to the base, it pivots up and down.

Now the interesting thing is that, no matter where you place the pick-up needle on any position of the arc from the outer edge of the record to the inner edge, the pick-up head always remains parallel to the fixed counterweight. The device provides the most perfect tracking I have ever seen.

Unfortunately I have been unable to discover the name of the company that built the machine — whoever they were it is a first class bit of engineering and the person concerned must have had a fantastic foresight into the future when he designed it. ●



Antex X25

for people who want perfection

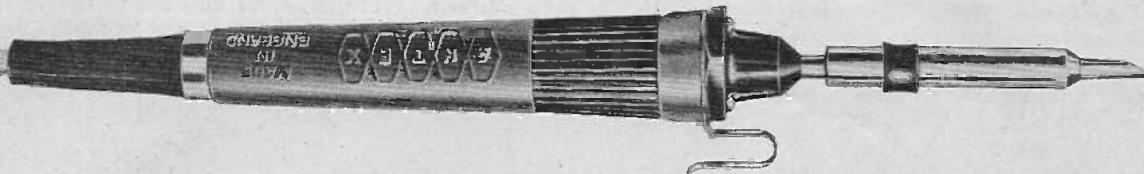

This new 25 watt model combines near-perfect insulation with exceptionally high heat-capacity. Leakage under working conditions is only 3-5 microamps and there is no risk of damage to transistors and delicate components. Every iron is tested at 1500 volts A.C. and fitted, as standard, with a 1/8" long life iron-coated bit. **Price £1.75.**



CN.240/2 Miniature soldering iron 15 watt 240 volts, fitted with nickel plated 3/32" bit and packed in transparent display box. Also available for 220 volts. **Price £1.70**

CN.240 Miniature soldering iron 15 watt 240 volts, fitted with iron coated 3/32" bit. Up to 18 interchangeable spare bits obtainable. This iron can also be supplied for 220, 110, 50 or 24 volts. **Price £1.70**

G.240 Miniature soldering iron 18 watt 240 volts extensively used by H.M. Forces. Suitable for high speed soldering and fitted with iron coated 3/32" bit. Also available for 220 volts. Spare bits 1/8", 3/16" and 1/4" are obtainable. **Price £1.83**

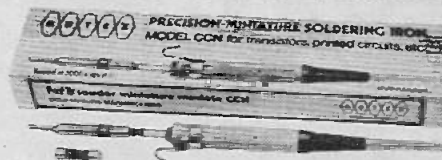

CCN.240 New model 15 watt 240 volts miniature soldering iron with ceramic shaft to ensure perfect insulation (4,000 v A.C.) Will solder live transistors in perfect safety: fitted with 3/32" iron coated bit. Spare bits 1/8" 3/16" and 1/4" available. Can also be supplied for 220 volts. **Price £1.80**

CCN.240/7 The same soldering iron fitted with our new 7-star high efficiency bit for very high speed soldering. The triple-coated bits are iron, nickel and chromium plated. **Price £1.95**



SK. 2 SOLDERING KIT

This kit contains a 15 watt 240 volts soldering iron fitted with a 3/16" bit, nickel plated spare bits of 5/32" and 3/32", a reel of solder, Heat Sink, 1 amp fuse and booklet "How to Solder"

Price £2.40.

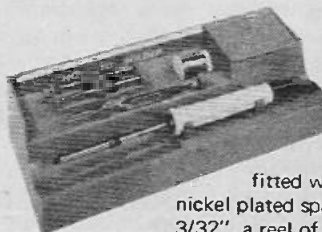

SK. 1 SOLDERING KIT

The kit contains a 15 watt 240 volts soldering iron fitted with a 3/16" bit, nickel plated spare bits of 5/32" and 3/32", a reel of solder, heat sink, cleaning pad, stand and booklet "How to Solder". Also available for 220 volts.

Price £2.75



from electrical, radio or car accessory shops or from Antex Ltd., Freeport (no stamp required) Plymouth PL1 1BR Telephone 0752 67377/8

Please send the Antex colour catalogue.

Please send the following:

I enclose cheque/P.O./Cash (Giro No. 2581000)

Name _____

Address _____

E.T.7

Gravity waves or not?

Gravitational radiation, the so called "gravity-waves", have now made their appearance in the press. But whether they have really been detected has not yet been proved. The whole question of detecting them is the subject of international collaboration and a number of detectors are being built in laboratories in countries the world over.

DETECTING such waves needs extraordinarily sensitive instruments. Basically, they must work by detecting the relative acceleration of two masses separated by some distance, and sensitivity will vary according to the direction of the arrival of the gravity wave. The relative force is turned into an electrical signal by piezoelectric material, a material that will produce a charge if its shape is changed, for example by pressure.

Experiments in the USA with one detector at Maryland University and another at the Argonne Laboratory a thousand kilometres away have been done, using an aluminium cylinder, suspended in a vacuum. The cylinder's lowest normal frequency of oscillation along its length is 1660 Hz. Piezoelectric material glued to the surface of the cylinder converts mechanical oscillations into electrical ones which can be amplified and recorded.

A gravity wave can produce tiny oscillations in the cylinder, which, of course, may be masked by random "noise", so the results from one detector are compared with those from another to see if there is a match of signals, evidence of a gravity wave. A signal, nevertheless, could still be caused by seismic, electromagnetic or cosmic ray disturbance and other arrangements have to be made to sort these out, too, so that what is left is a gravity wave signal.

Results so far appear to show that gravitational waves have arrived at a rate of about one a day and that they cluster as if the sources of the waves are at the centre of the Galaxy.

The origin and causes of gravitational radiation mean navigating the difficult stretches of Einsteinian physics. But, assuming that waves are radiated, they would certainly be extremely weak compared with electromagnetic waves. Most of the power of gravitational waves in the solar system, expected to be produced by planets moving round the Sun, is produced by Jupiter and amounts to about 450 Watts and a similar amount comes from the Sun.

Yet the power of electromagnetic waves from the Sun is about 10^{24} times larger. More powerful

gravitational waves could come from a collapsing stellar mass but even so a gravitational pulse received at the Earth from it would last only a minute time. A collapsing star ten times as massive as the Sun would produce a pulse lasting probably less than a thousandth of a second.

Professor P. B. Fellgett of Reading University and Dr D. W. Sciama of the Department of Astrophysics at Oxford, in a survey of gravitational wave astronomy, say that if the US observations are correct, they provide some difficulties to astronomers.

The rate of events is high, so it may be that processes occurring in the centre of the Galaxy are different from those that can be studied in detail in the nearer parts to us. Secondly, the Galaxy must be losing energy and mass by gravitational radiation at a rate of several hundred solar masses a year. Through these difficulties are not insurmountable, the claims must be tested by independent experiments with other detectors.

They say also that, as well as the piezoelectric method, others, including capacitive and optical methods, ought to be explored in detecting the relative acceleration of the two masses. The preferred form of detector at present is a cylindrical bar, split into two halves with the piezoelectric material sandwiched between the two halves.

The wave form of a gravitational signal from the most likely source of radiation — the gravitational collapse of a stellar body or the capture of one collapsed object by another — can be predicted, as also can its duration.

Assuming that the waves travel on average over the distance from the Earth to the centre of the Galaxy, the energy needed to produce a detectable signal and the signal's frequency can be calculated.

This frequency is near to that at which detectors have been resonated. But it is hard to believe that an object of the necessary mass, collapses or captures another almost every day, which is what results so far seem to imply. Perhaps, Fellgett and Sciama say, it would be better to make a detector more sensitive to the

occasional slow event that could be produced by a super-massive object or to concentrate on fast events taking place close to Earth on a galactic scale.

They conclude that, theoretically, it would be surprising if gravitational radiation did not exist, though it is not proved. Probably, uncertainties will be resolved one way or another in the next twelve months. ●

END THE SEARCH FOR THOSE "HARD TO FIND" COMPONENTS

ELECTRO SPARES are now supplying ALL the components for the constructional articles in this magazine.

Just forward a foolscap-sized S.A.E., and state which project in "Electronics Today International" you intend to build, and we will forward to you a complete price list of all the specified components, p.c. boards, etc.

No further searching for those difficult and specialised "bits and pieces", no further purchasing of those expensive catalogues in the hope they may contain what you want!

Please Note: All our components are brand new, first quality and to specification.

ELECTRO SPARES

21 BROOKSIDE BAR,
CHESTERFIELD, DERBYSHIRE

Neutron Radiography

By HAROLD BERGER/Senior Physicist, Argonne National Laboratory, U.S.A.

A new testing technique using a source of radioactive neutrons permits inside views of object that would be impossible with x-rays

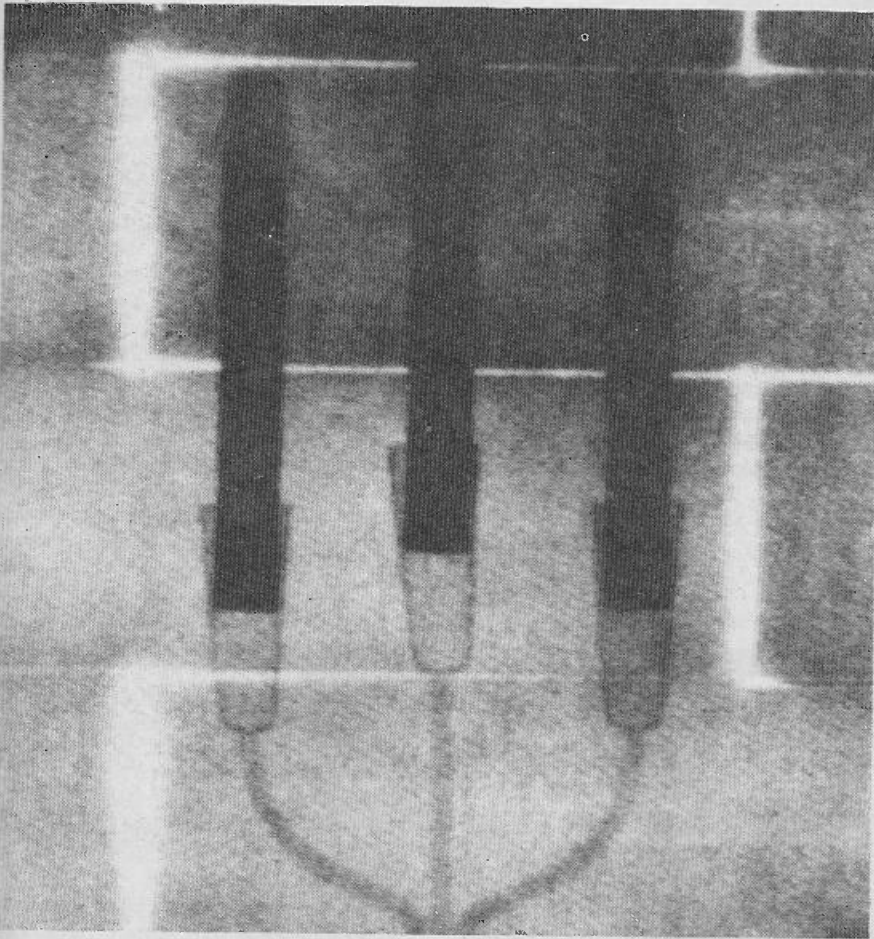

Fig. 1. This thermal neutron radiograph showing wax candles in steel holders was taken through a four-inch-thick lead-brick wall!

THE world of electronics is becoming more and more aware of the value of nondestructive testing.

X-ray, infrared, and ultrasonic techniques have become useful diagnostic tools that complement the normally used electrical tests.

Neutron radiography supplies an additional capability to this arsenal of test methods; it should prove to

be useful in a variety of inspection applications. In addition, the impact of neutron radiography on electronics is significant because of the use of electron image devices, accelerator neutron sources, and various electronic techniques. There should be an increasing awareness of neutron radiography within the field of electronics. — Ed.

TO an x-radiographer, the prospects of obtaining a good radiographic image of a column of water in a lead pipe, an insulator within a metal connector, or a rubber "O" ring in a metal valve are very poor.

This is because the high x-ray energy needed to penetrate the metal goes right through the water, insulator, or rubber with minimum attenuation. But the recent emergence of neutron radiography changes that situation.

Thermal neutrons are strongly attenuated by several materials containing hydrogen, lithium, and boron; hence such materials are almost opaque to such neutrons. On the other hand, such materials as lead, bismuth, and uranium are practically transparent to thermal neutrons. Therefore, it becomes a simple matter to get a picture of common hydrogen-containing materials, such as plastic, wax, rubber, wood, paper, water, or other liquids, even when contained in a metal assembly.

As an example, Fig. 1 shows a thermal-neutron radiograph of wax candles in steel holders, taken through a four-inch-thick lead-brick wall. A good contrast shadow is obtained simply because wax has a high attenuation for thermal neutrons whereas the lead is essentially transparent. Of course, for an x-radiograph of the same object, the attenuation pattern would be reversed. The x-radiograph would show, primarily, the lead with little, if any, observable shadow of the wax.

An interesting comparison of neutron and x-radiographs of a battery is shown in Fig. 2, and several differences are apparent. A high contrast is obtained on the neutron image of the plastic battery cap and electrolyte (upper photo). The x-ray image, on the other hand, presents high contrast of the upper metal contact but the metal case tends to reduce the contrast of the internal battery details.

These examples of neutron and x-radiographs illustrate some of the possibilities for the application of

Neutron Radiography

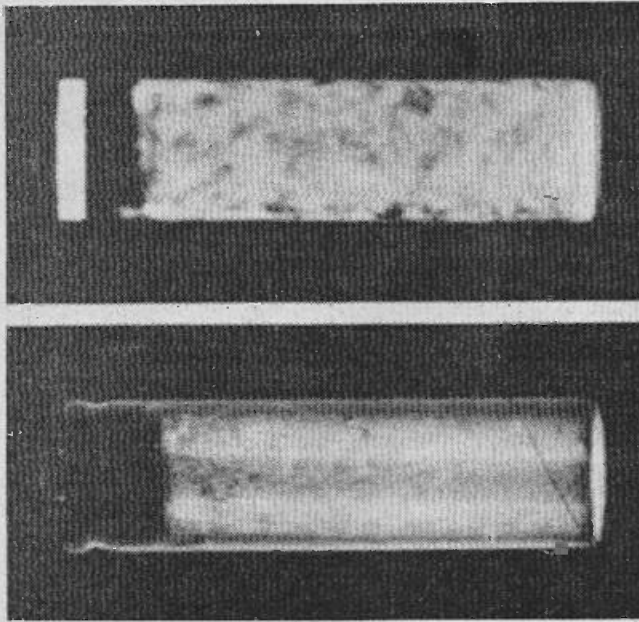

Fig. 2. Radiographs of battery using thermal neutrons at top, x-rays at bottom. Note high contrast of plastic battery cap at the top of the cell and the electrolyte mix within the cell in the top photo. The x-ray photo shows the metal casing.

neutron radiography. Let's consider the technique and its applications in the electronics field.

RADIATION SOURCES AND DETECTORS

The methods used to perform neutron radiography are fairly simple. The object is placed in a thermal-neutron beam in front of an image detector. The neutron beam may be obtained from a nuclear reactor, a radioactive neutron source, or an accelerator.

The highest quality neutron radiographs have been produced by a reactor source because more neutrons are available in the thermal-energy range. More neutrons mean that collimation of the neutron beam can be tighter; therefore, the beam will be more nearly parallel and the resultant images of thick objects will be sharper. Better collimation in thermal-neutron radiography is comparable to reduced focal spot size in x-radiography.

The collimation, that is the bringing out of a beam of neutrons from a large source, is necessary for thermal-neutron radiography because there are no useful point sources of thermal or low-energy neutrons. Fortunately, the fast neutrons emitted from sources can be slowed to lower energies simply by surrounding the source with a moderator containing light material, such as water, paraffin, beryllium, or carbon.

A diagram of a simple arrangement for an accelerator source is shown in Fig. 3. In the illustration, the ion beam could be a deuteron beam, striking a

tritiated target to produce neutrons by a relatively prolific and inexpensive reaction. Alternately, the centre of the moderator could contain a radioactive neutron source, or even the core of a nuclear reactor. The principle remains the same.

Detectors for thermal-neutron radiography are usually commercially

available x-ray films exposed in conjunction with an intensifying screen. The common screens are neutron scintillators, or metal foils of gadolinium. The scintillators are made of a boron or lithium compound mixed with a phosphor powder, such as ZnS. Several scintillators for neutron radiography are also commercially available.

Prompt *alpha* emission is produced in the lithium or boron by thermal-neutron capture; the *alpha* particle stimulates the phosphor and the resultant light exposes the film. This technique can produce very fast results. Total thermal-neutron exposures as small as a few hundred thousand neutrons/cm² produce useful images.

Somewhat better quality radiographs are normally produced by the slower techniques with gadolinium foils. Exposures may be about a hundred times higher for the metal intensifier method, but results are normally improved in terms of less graininess and improved image sharpness. The battery neutron radiograph that is shown in Fig. 2, for example, is a good-quality radiograph obtained with a gadolinium foil.

Among other detectors for neutron radiography is a dynamic approach in which the neutron image is converted to light and then detected by a

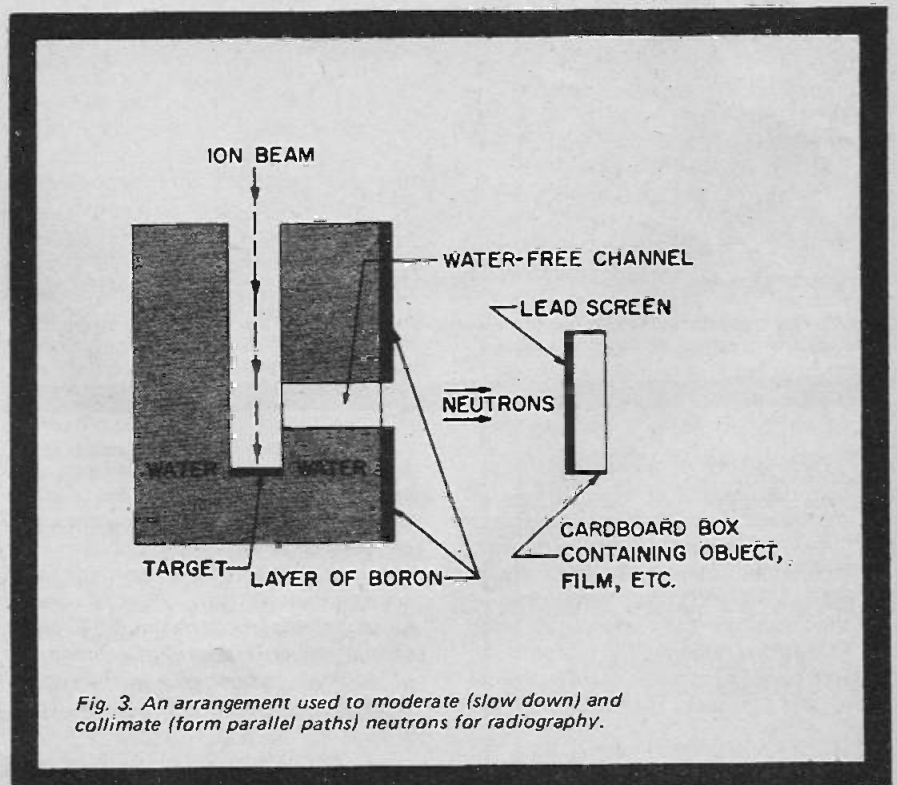

Fig. 3. An arrangement used to moderate (slow down) and collimate (form parallel paths) neutrons for radiography.

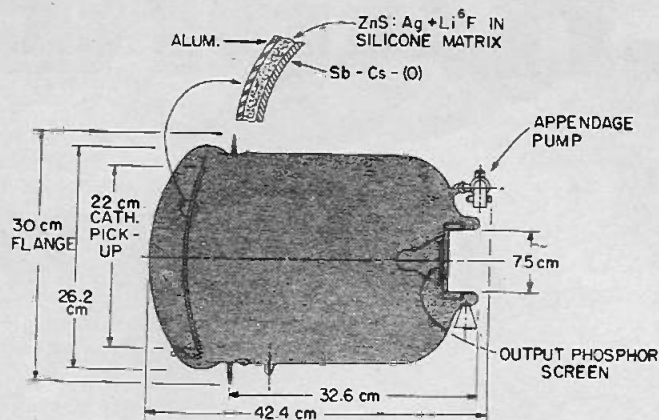

Fig. 4 Outline drawing of thermal neutron image-intensifier.

television camera. Intermediate light amplification by either a light image-intensifier tube or an integrated neutron image-intensifier tube (see Fig. 4) permits the use of an inexpensive vidicon camera. A commercially available neutron image-intensifier tube optically coupled to a vidicon camera can provide thermal-neutron images with incident intensities of about 10^5 neutrons/cm²-second. However, for dynamic viewing at TV frame rates, one needs at least ten times this magnitude of neutron intensity for good-quality images.

The TV approach is attractive because it offers the possibility of obtaining useful images of an object in motion, and also because it would permit rapid neutron inspection of devices on a production line. Although the TV image has less contrast and spatial resolution than the x-ray film method, the basic information may suffice for many inspection problems.

Neutron radiography is now being used routinely for many inspection problems in the nuclear and aerospace industries. Radioactive materials and explosive devices account for the major efforts in the two industries, although a large variety of materials and components have been inspected by neutron radiography.

In the electronics area, neutron radiography may prove to be useful for observing plastics, rubber, other insulators, or fluids in various devices. As an example, consider the object pictured in Fig. 5.

Here we have radiographs of a BNC connector. The x-radiograph at the left shows the metal components, and the interior insulators are well displayed

on the neutron radiograph at the right. Together the two radiographs provide a relatively complete inspection. The break in the insulation at the crossover point, easily observed on the neutron radiograph, could be a potential failure point.

This and other examples illustrate a few specific areas in which neutron radiography could be useful as an inspection, process-control, or research and development tool. Additional application possibilities are almost unlimited.

HOW SAFE?

Neutron radiographic application work presents no significant problem

from the point of view of radiation hazard. Shielding of the neutron beam can be accomplished with materials such as paraffin, plastic, or water. The addition of a lead or similar shield for the gamma radiation produced in these hydrogenous materials is often also necessary. Shielding with earth or concrete blocks is very effective.

A radiation hazard unique to neutron radiography is that of radioactivity produced in the objects or detectors used in the neutron beam. There is occasionally some activity produced in radiographic samples, a fact easily recognized with the use of a good radiation survey meter. On these occasions it may be necessary to allow objects to decay a few hours before they are moved out of the radiation-controlled area.

Although there is essentially no radioactivity problem with the detectors described, there are situations (such as an inspection of a radioactive object) which call for a detection method in which film is not exposed directly to the neutron beam. In that case, foils of materials, such as indium or dysprosium, are used to make a radioactive image later made visible by an autoradiograph. Such foils are primarily emitters of beta radiation, easily shielded for handling by a millimeter or so of aluminium. Although there are some radiation hazard problems with neutron radiography, they can be handled in a straightforward manner. ●

Reprinted by arrangement with *Electronic World*, Aug. '71.

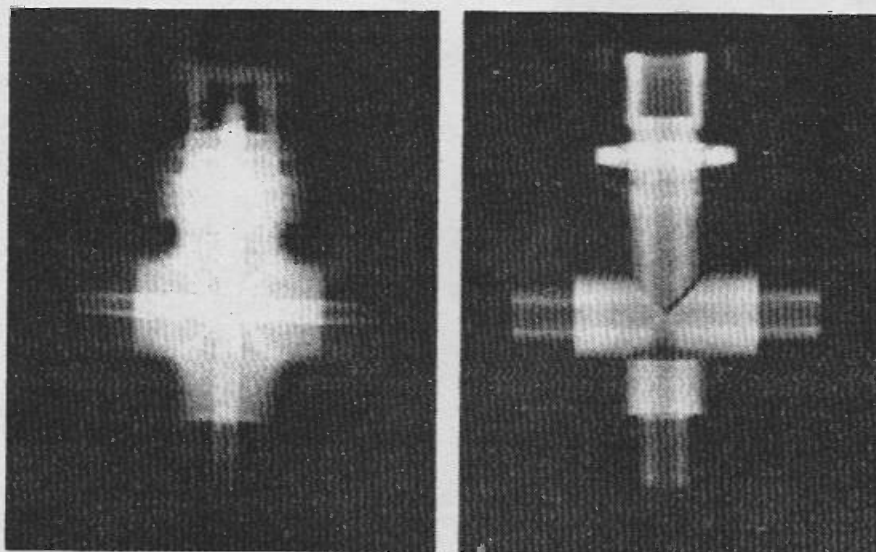

Fig. 5. Radiographs of BNC connector taken at Los Alamos Scientific Laboratory. Note the void in the insulation at right.

FOUR-CHANNEL SOUND

A SIMPLER WAY

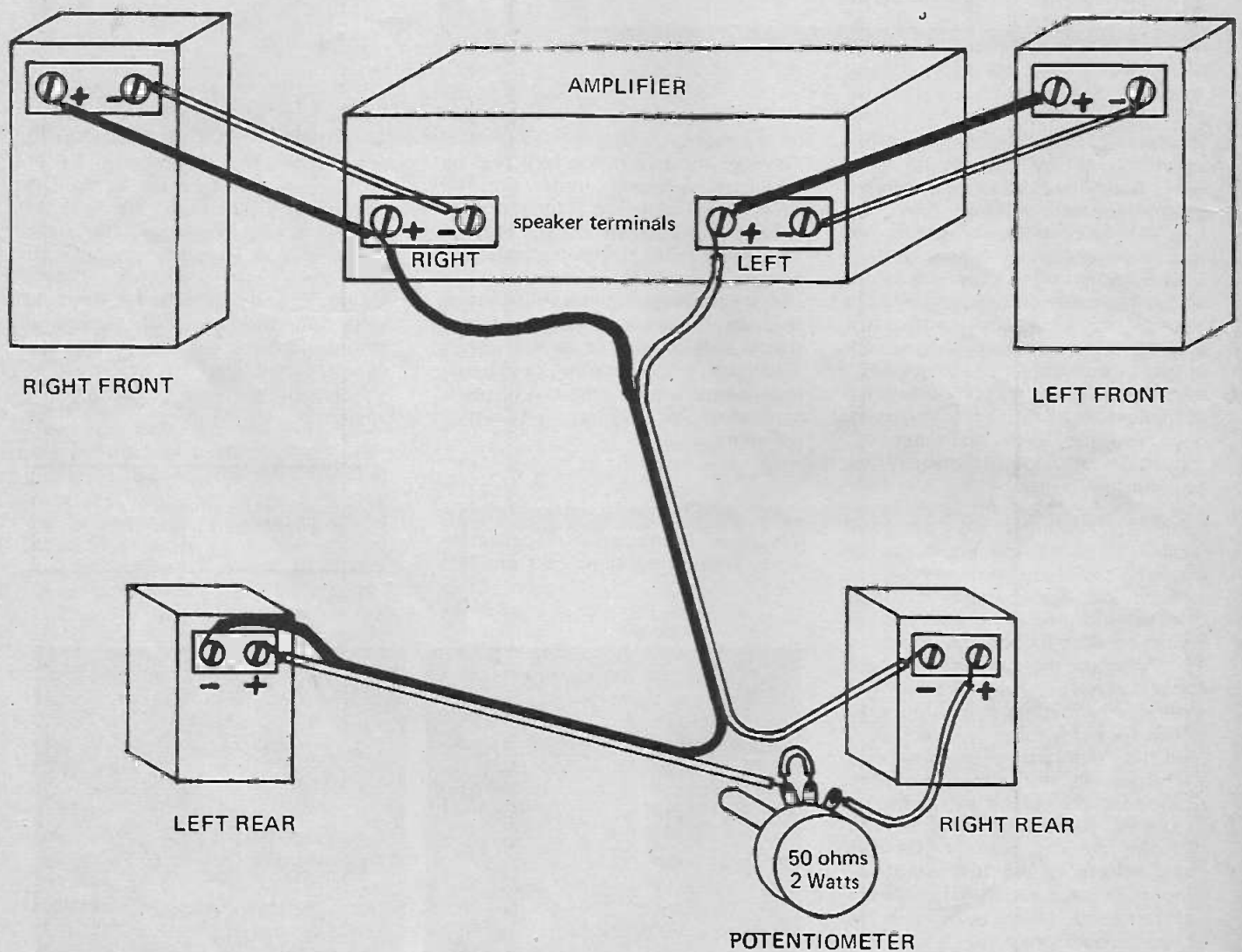

Fig. 1. How the connections are made. Note that all the speakers and the amplifier are shown as seen from the rear. Just connect them exactly as shown in this drawing and then position the speakers as shown in Fig. 2.

Some amplifiers may have the terminals arranged vertically but if in doubt be guided by the 'L' and 'R' markings that will appear somewhere near the terminals.

Terminal markings may also vary. The terminals that we have indicated as '+' may be marked 'hot' or 'high', or just with a red dot. Some may be unmarked but a red wire will be connected to the equivalent terminal that we have marked '+'

Again, the terminals that we have marked with a '-' may be labelled 'common', 'ground', 'earth' or 'low'.

ETI PROJECT
402

Want to sample four-channel sound?
Here's how to do it at very low cost.

AS we have described elsewhere in this issue, many audio equipment manufacturers are actively promoting four-channel versions of their products — despite the lack of any internationally accepted standards.

In some ways it's like inventing the motor car before defining the shape of the wheels.

Four-channel programme material is now fairly readily available but a lot of it is too gimmicky to enable one realistically to assess the system for which it is intended. It reminds one of the early days of stereo, only now the trains come at you from all four corners.

Ironically, some of the most 'natural' four-channel sound that we have heard is that synthesized from normal two-channel recordings.

This can be done very efficiently and effectively by units such as the Sansui QS1 Quadphonic Synthesizer or very cheaply, but with rather less versatility by connecting extra speakers differentially across the existing stereo amplifier.

Of course discrete four-channel sound can reproduce distinctly separated sounds from each of the four associated speakers, but whilst reasonable separation is essential (and this is by no means necessarily achieved with many commercial available matrix systems) it is doubtful whether it should be absolute — after all, a violin played in one corner of a room is not heard at 45dB down in the other three corners.

RECREATING ORIGINAL ACOUSTICS

The claim most commonly made for four-channel systems is that they recreate the ambience of reverberant characteristics of the hall in which the original sound was recorded.

This claim is exaggerated.

There is no way in the world in which you can reproduce the ambience of a concert hall in a domestic sized room without first removing the ambience that you already have.

Lining the room with acoustic tiles is one solution, but this will make the room acoustically impossible for anything other than four-channel sound.

The only way to recreate the characteristics of the Albert Hall at home is to put all four speakers outside on the lawn.

Nevertheless what four-channel sound (both true and simulated varieties) can do, is to introduce a very pleasant 'richness' of sound. It also reduces the effect of apparently

Fig. 2. How the speakers are positioned.

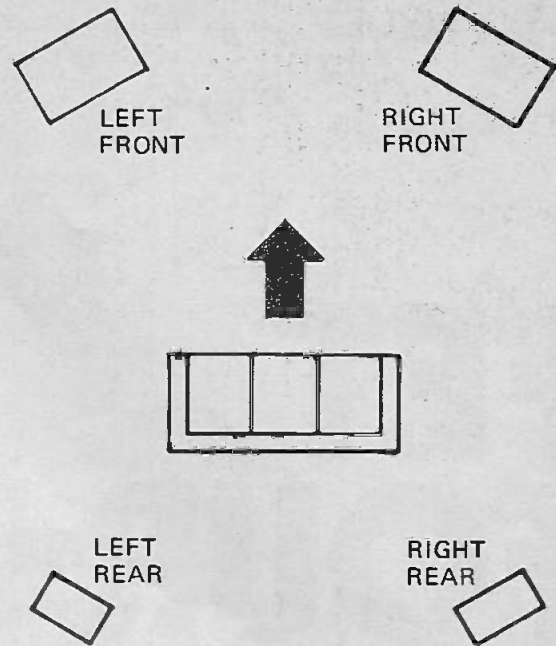

listening to the sound through a window in the wall of the recording hall.

And for hi-fi enthusiasts this may well be sufficient to justify the considerable expense involved.

SIMULATED FOUR-CHANNEL SOUND

In its simplest form, simulated four-channel sound is surprisingly easy to achieve. All that is required is a couple of speakers, a few yards of wire and a 50 ohm potentiometer.

The two rear channel speakers and the potentiometer should be connected as shown in Fig. 1. Use 'figure-of-eight' flex with one lead colour coded, alternatively use two different coloured wires.

Connect the leads marked A and B to the two speaker terminals on your amplifier that are marked with a +. The two existing front speakers remain connected in the normal manner.

The choice of speakers and enclosures is not critical. Expensive speakers produce good results but are by no means essential. We obtained surprisingly effective results from £2 speakers mounted on hardboard baffles.

If speakers are obtained specifically for this project, they should have a frequency response that is reasonably flat from 100 Hz to 5 kHz. Above this the response should preferably decrease as there is little ambience signal above 4 to 5 kHz and this system is prone to increase the level of high frequency noise.

A pair of bookshelf speakers without tweeters will be very effective.

Use eight ohm speakers if possible, regardless of the impedance of the existing main speakers. The potentiometer will enable you to compensate for any 'mismatching' that may occur.

The extra load placed on the amplifier by the two extra speakers is negligible, it rarely exceeds two or three percent.

The potentiometer may be housed in a small case and located close to the main amplifier controls, or housed within one of the additional speaker enclosures. Actual sound level settings are not very critical, and once the level has been set, it is unlikely that it will need to be altered.

THE RESULTS

Place the speakers in the two rear corners of the room (observing the relationships shown in Fig. 2) and play a well-balanced classical record, preferably a symphony or concerto. Adjust the potentiometer so that the rear speakers contribute to the overall sound but cannot be identified as actual sound sources from more than a few feet away.

The results that you will hear largely depend on the recording.

The system is at its most effective when reproducing classical music from well-balanced recordings, and we emphasise the well-balanced bit, for a number of companies produce records and tapes with grossly exaggerated stereo spacing — and with these and 'reprocessed' mono the system has little value.

If, subsequently, you upgrade the system to true four-channel sound, all you have wasted is a 50 ohm pot! ●

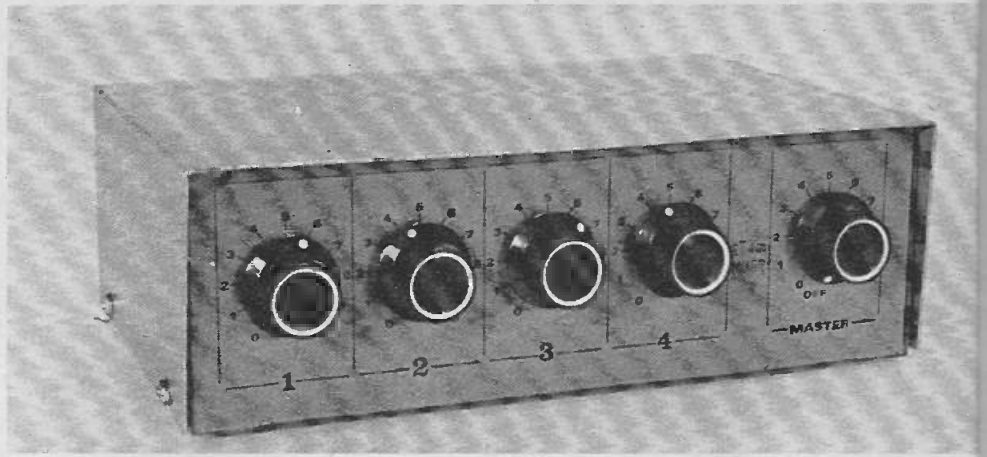

FET FOUR-INPUT MIXER

Mix any combination of four audio signals with this easily constructed unit.

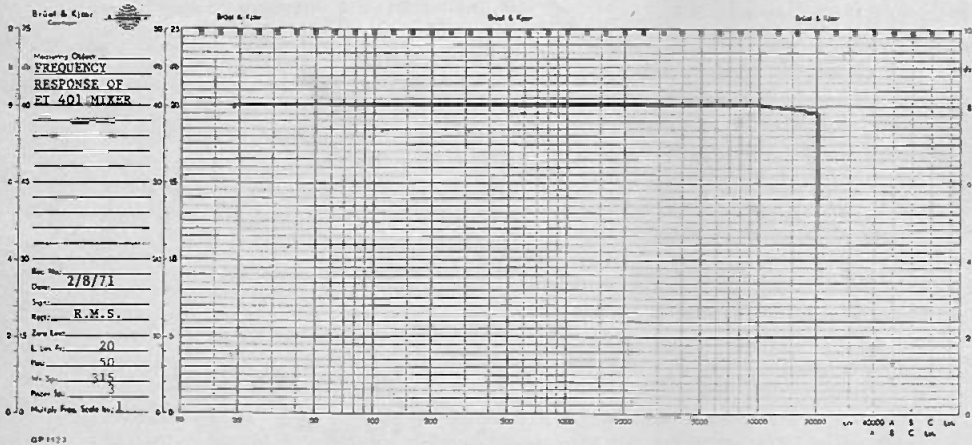

THREE guitars and a microphone. One record player, two tape decks and an electronic organ. Or any combination you like of two, three or four separate audio signals can be smoothly blended together by using this simply constructed Input Mixer.

The unit can handle input levels from 10mV to 2V, input impedances from 4 ohms to 1 Megohm. It provides a maximum gain of 20dB, and has a frequency response that is absolutely flat from 20Hz to 10kHz and is still within 1dB at 20kHz. The response curve is shown in Fig 1.

Battery operation has ensured that internally generated noise is kept to a very low level, and the unit is suitable for all types of inputs except high performance microphones and cartridges with outputs below 10mV. Life expectancy of the batteries specified in the parts list is at least 100 hours of continuous use.

CONSTRUCTION

The circuit diagram of the complete unit is shown in Fig. 2, the circuit board pattern is shown in Fig. 3, and the component layout in Fig. 4.

Make sure that the electrolytics are connected the right way round, and do not use excessive heat when soldering

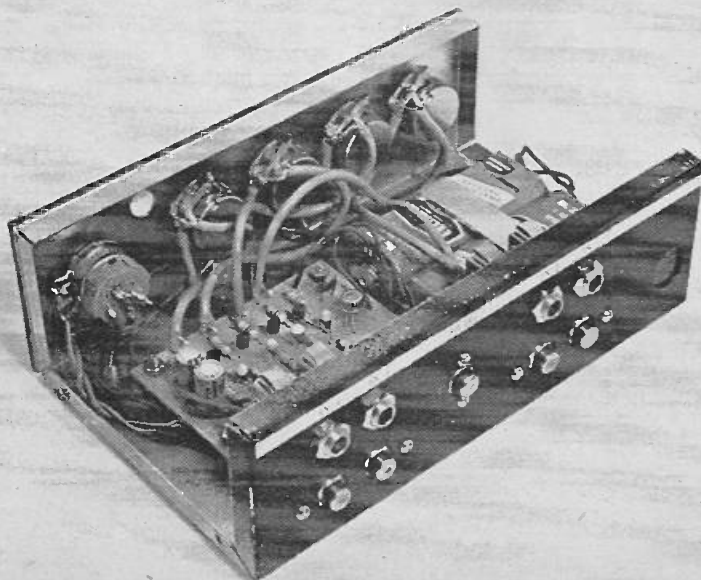

Interior of completed unit.

HOW IT WORKS

The mixer consists of four identical input stages and one summing amplifier.

Each input stage consists of a variable attenuator and a FET source follower. The attenuators are one megohm potentiometers, and since the input impedance of a FET is very high, the input impedance of the mixer is that of the attenuator — i.e. 1M.

Input signals are coupled to the mixer via standard jack plugs and sockets or RCA connectors. Both types of input connector were fitted to each input of the prototype unit — each pair being wired in parallel. Provision for both types has been made on the sheet metalwork drawings and included in the parts list. Either type may be omitted if required.

The output impedance of the FET stage is approximately 1k, and the internal gain of the FET is unity.

The summing amplifier is a LM 301A operational amplifier. This has an open loop gain of around 100,000 and a cut off frequency of approximately 10 MHz. Gain control is varied by the feedback potentiometer RV5.

Output impedance of the mixer is less than 100 ohms. It is desirable that the load impedance should exceed 2k. The mixer is however, short circuit proof, and the only effect of excess load is distortion. The output is dc coupled, and the offset voltage (dc component) is typically 2mV.

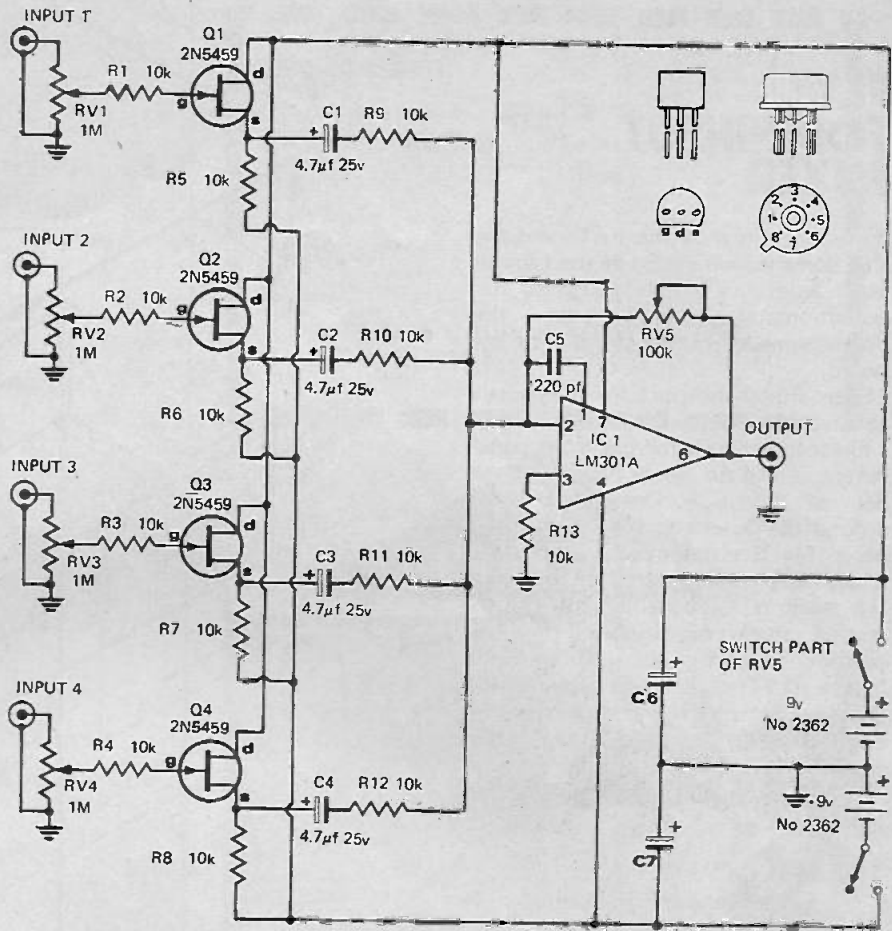
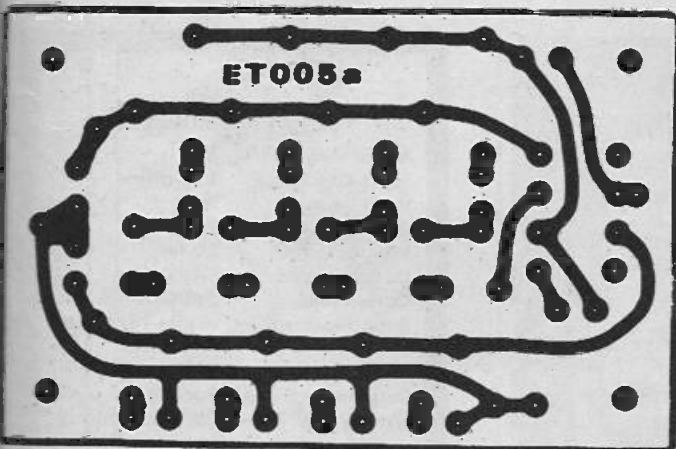

Fig. 2. Circuit diagram of complete unit



PARTS LIST

- R1-R13 — resistor 10k, 1/2W, 5%
 - RV1-RV4 — potentiometer, 1 Megohm, logarithmic.
 - RV5 — potentiometer, 100k, logarithmic, with double pole switch.
 - Q1-Q4 — field effect transistors, 2N5459
 - C1-C4 — Tag tantalum capacitors, 4.7µF.
 - C5 — capacitor, 220µF
 - C6-C7 — capacitor, pc board mounting, 100µF electrolytic.
 - IC1 — integrated circuit LM 301A (National Semiconductor) metal can type, or µA 301A Fairchild metal can type.
- Plus — 4 closed circuit jack sockets, McMurdo type 1291-06-01 or similar.
 2 double type RCA sockets.
 1 single type RCA socket
 1 printed circuit board — ET 005a
 2 nine volt batteries, Eveready type 2362 or equivalent.
 1 metal case and cover.
 4 spacers for pc board.
 1 perspex front panel.
 5 control knobs.
 Coax cable, screws etc.

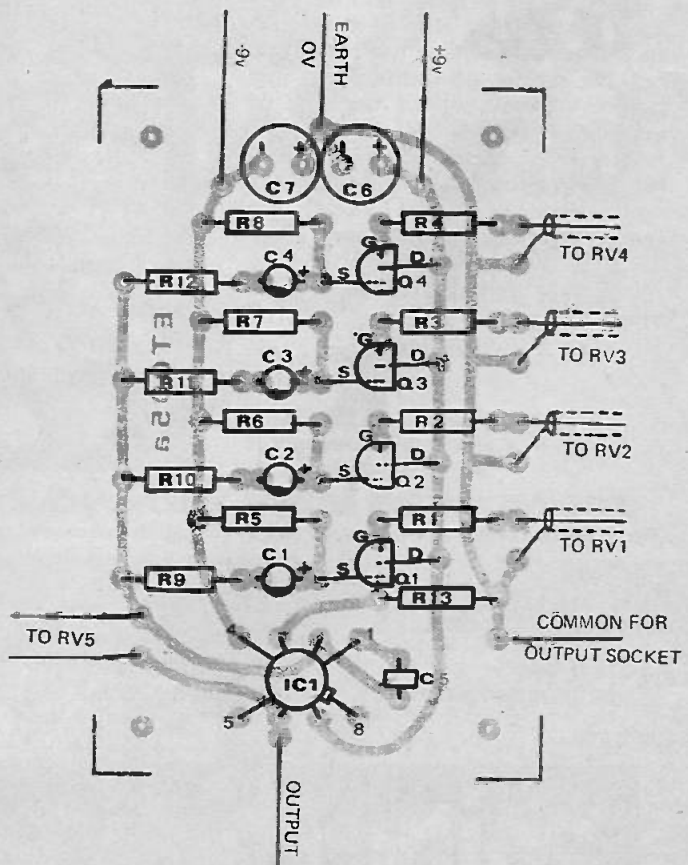

Fig. 4. How components are mounted on the printed circuit board — seen from components side.

FET FOUR-INPUT MIXER

the connections of the FETs and the I/C. Screened wire must be used for all leads from the input sockets to the potentiometers, and from the potentiometers to the printed circuit board.

Sheet metal drawings for the chassis and cover are shown in Figs. 5 and 6.

Finished artwork for the front panel is reproduced on glossy paper on page 69 of this issue. Cut the artwork around the outer edges, punch out the holes for the potentiometer bushes, and then clamp the artwork between the front metal panel of the chassis and a sheet of perspex (smoked perspex looks superb — if you can locate it). The complete assembly of chassis, artwork and perspex is sandwiched together by the potentiometer mounting nuts.

This will result in a very professional looking unit.

THE UNIT USE

The mixer may be connected, via screened cable, to any tape recorder or amplifier.

Connect the required audio inputs — again via screened lead — and set all four channel input controls to zero. Set the master gain control to just beyond halfway. Adjust the level of your amplifier (or if you are using a tape recorder, to the normal recording level) and bring up the level of each signal input as required. Leave the level of all unused inputs at zero.

Adjust the overall sound level by using the master gain control on the mixer.

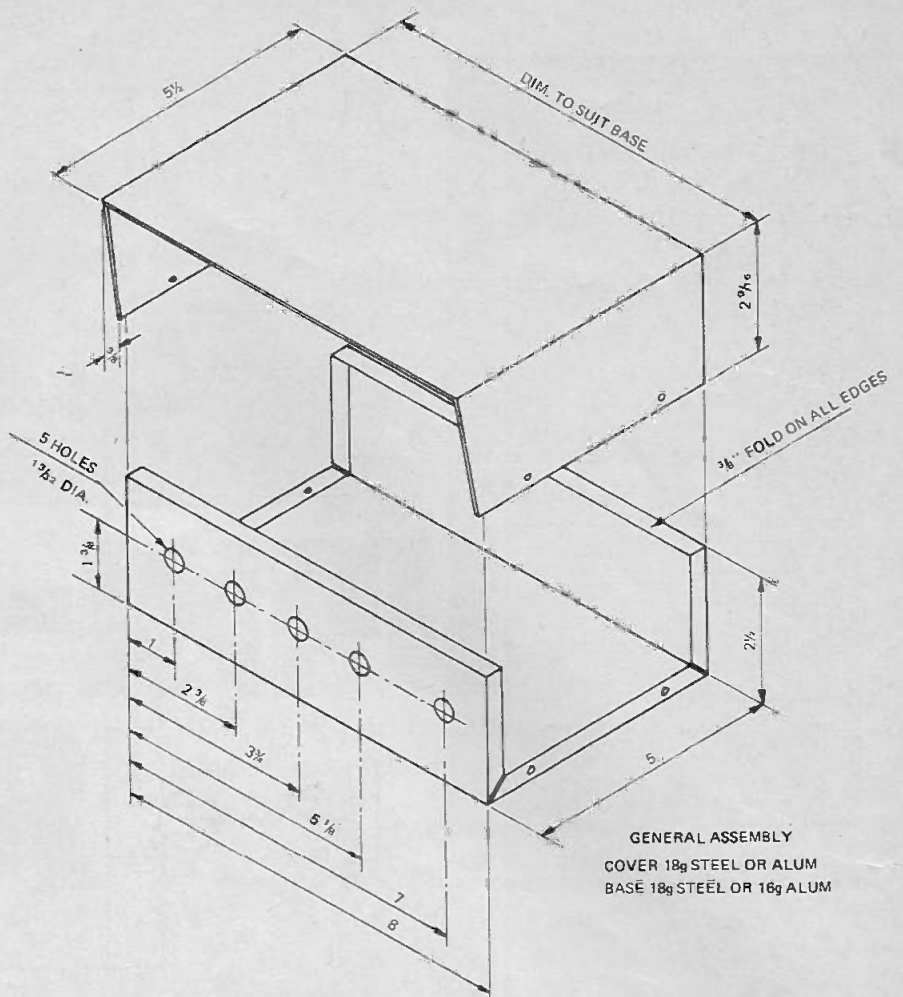

GENERAL ASSEMBLY
COVER 18g STEEL OR ALUM
BASE 18g STEEL OR 16g ALUM

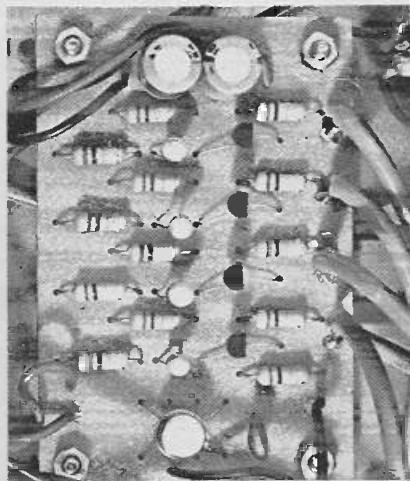

Compare this photograph of finished board with Fig. 4.

ET 40 $\frac{1}{2}$ MIXER	
No. of inputs	— 4
Input impedance	— 1 Megohm
Input voltages	— 2mV - 2V
Gain - max.	— 20 dB
Max. output V.	— 3V rms
Output impedance	— <100 ohms
Output load	— >2000 ohms
Freq. response	— within 1dB (20Hz to 20kHz)
Power supply	— 18V at 15ma
Batteries	— 2 x 2362
Battery life	— 100 hours approx.

Fig. 6. Drilling details etc., of (below) base of chassis, (below centre) rear panel of chassis, (below right) perspex cover.

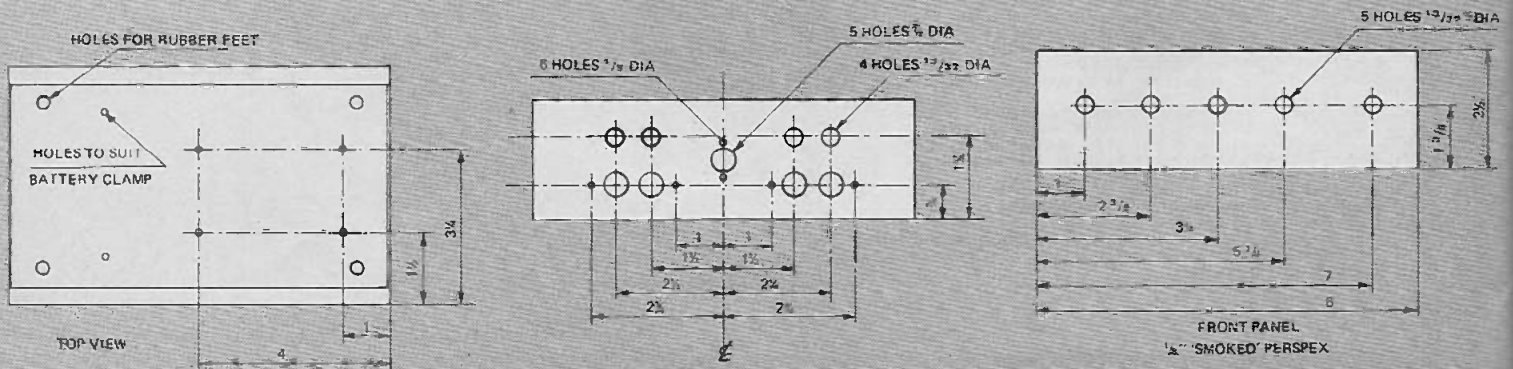

FET-FOUR INPUT MIXER

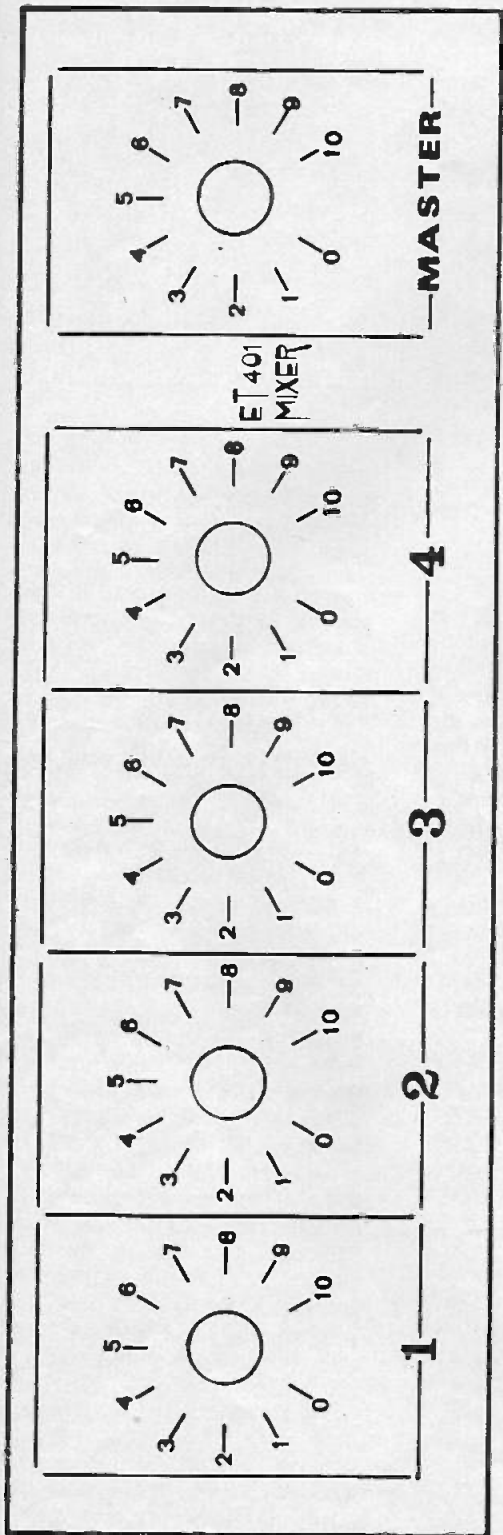

This is the front panel layout reproduced exactly full size. Carefully cut around the outer edge, cut out the centre holes and mount it on the front panel behind a thin sheet of perspex.

NEWSAGENT: _____

Please deliver **ELECTRONICS TODAY INTERNATIONAL** for 12 months, starting with the _____ issue:

NAME _____

ADDRESS _____

GIVE THIS COUPON TO YOUR LOCAL NEWSAGENT

USE
THIS COUPON

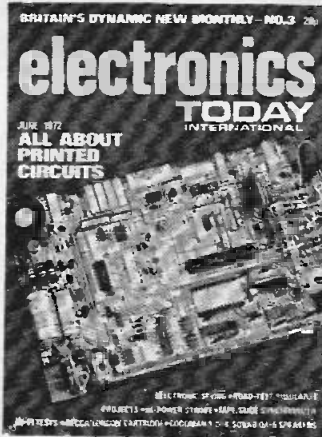

**costs
no
more
delivered
to your
door ...**

...by your local newsagent

For only £2.40 a year (12 issues at 20p each) you ensure that every copy of **ELECTRONICS TODAY INTERNATIONAL** will arrive on your doorstep as soon as it is published — and that you'll never miss out on it if an issue happens to sell out.

**electronics
TODAY
INTERNATIONAL**

A PRACTICAL GUIDE TO ZENER DIODES

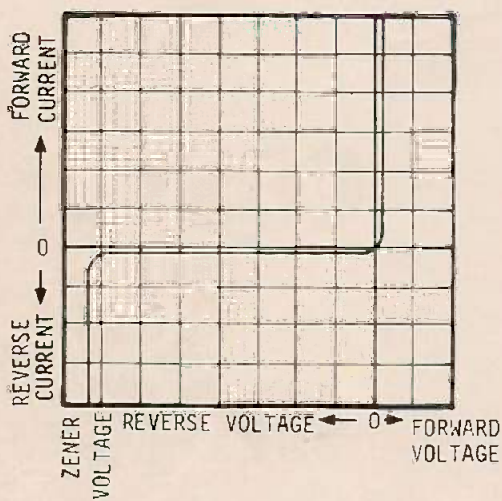

FIG. 1

In this two-part article we explain how to use this versatile circuit component

LIKE the Establishment, but of more obvious value, Zener diodes remain constant and unperturbed by external change.

Zener diodes — named after Dr. Carl Zener — are used primarily as voltage references. They are devices that maintain an almost constant voltage across them despite various changes in circuit conditions.

Externally, Zener diodes look much the same as conventional diodes and are manufactured in axial lead, and stud mounting forms; furthermore Zener diodes are capable of rectifying alternating current into pulsating direct current as are their conventional counterparts.

But unlike conventional diodes,

Zener diodes are deliberately intended to be used with the anode connected to a negative potential and the cathode connected to a positive potential.

When connected in this manner, Zener diodes have a very high resistance below a certain, critical, voltage (called, appropriately, the Zener voltage).

But if this critical voltage is exceeded, the dynamic resistance of Zeners drop to a very low level. And in this region, essentially constant voltages will be maintained across the Zeners, and these constant voltages will be maintained despite quite large changes in the applied currents.

This characteristic is illustrated graphically in Fig. 1 from which it may be seen that beyond the 'Zener voltage' the reverse voltage remains practically constant despite changes in reverse current.

Because of this characteristic, Zener diodes may be used to provide a constant voltage drop, or reference voltage, across their internal resistance.

Zener diodes are manufactured in a number of wattage ratings and with Zener voltages ranging from 2.7 Volts to 200 Volts. (In practice, Zener diodes with ratings exceeding 30 Volts are rarely used.)

THE BASIC CIRCUIT

A basic voltage regulator circuit, using one resistor and one (idealized) Zener diode, is shown in Fig. 2. In the example shown, the Zener diode is rated at 5.6 Volts and the applied

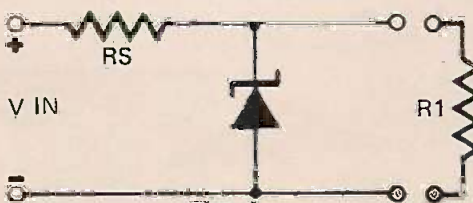

FIG. 2

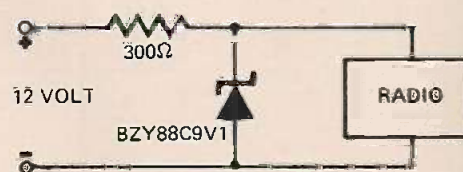

FIG. 3

voltage V in is 8.0 Volts. With no load applied to the output terminals, 5.6 Volts will be dropped across the Zener diode and the remaining 2.4 Volts will be dropped across resistor R_s .

If the input voltage is now changed, say, from 8.0 Volts to 9.0 Volts, then the voltage drop across the Zener will still remain at its nominal 5.6 Volts but the voltage drop across R_s will increase, from 2.4 Volts, to 3.4 Volts. The voltage drop across the (ideal) Zener will remain constant.

In practice, the voltage will increase slightly due to the dynamic resistance of the Zener. (The method of calculating the change in Zener voltage is simply to multiply the dynamic resistance of the Zener diode by the change in Zener current.)

The resistor R_1 , in Fig. 2, represents an external load. If this load is connected across the circuit, then some of the current that was flowing through the Zener will now pass through the load. Providing the current in R_s is greater than the load current, some current will still pass through the Zener and a substantially constant voltage will be maintained across the Zener/load.

The series resistor R_s is selected so that the minimum current passing through the Zener is not less than the level required for stable regulation.

This level begins just below the 'knee' of the reverse voltage/reverse current curve (as shown in Fig. 1). Curves such as this are available for all makes and types of Zener diodes.

It is also necessary to ensure that the value of R_s is such that current flow

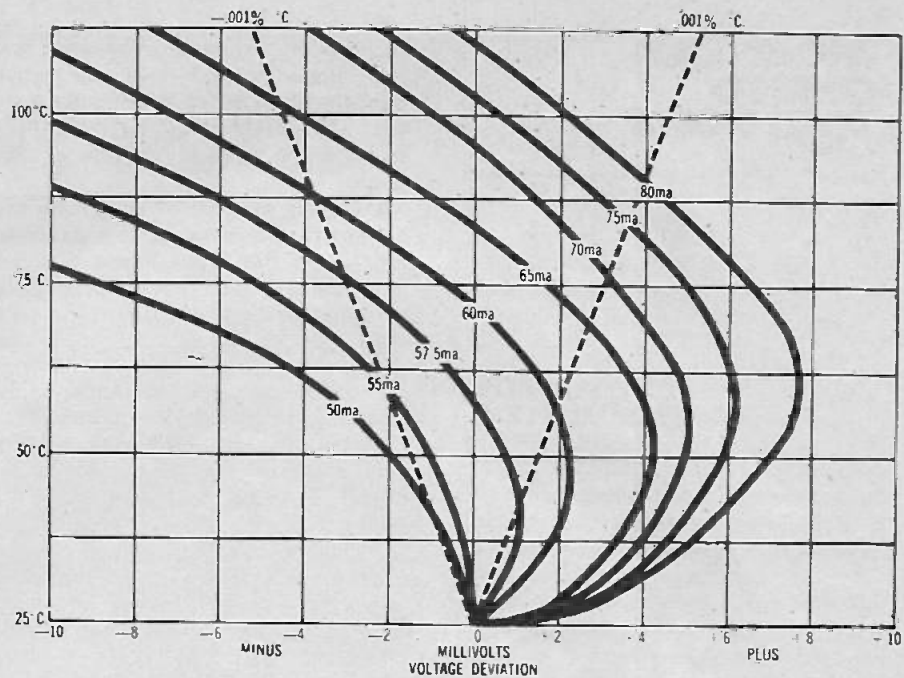
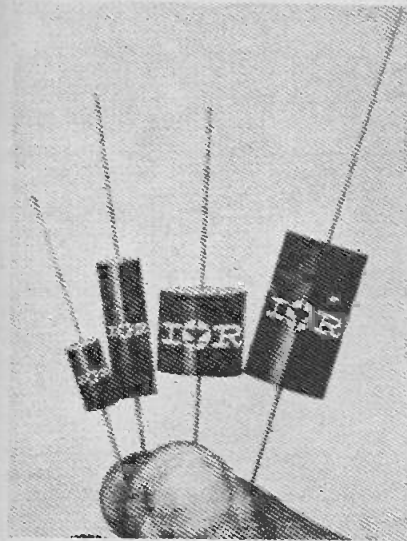

through the Zener diode cannot exceed its specified power rating: which is the Zener voltage multiplied by the Zener current. In the circuit shown in Fig. 2, maximum current will flow through the Zener diode when the load is disconnected.

The design procedure for this circuit is quite simple.

1. Specify the maximum and minimum load current (I_L), say 10 mA and 0 mA.
2. Specify the maximum supply voltage that is likely to occur (say, 12 Volts), but ensure that the minimum supply voltage will always be at least 1.5 Volts higher than the Zener voltage of the diode to be used.
3. In the circuit shown in Fig. 2, the required output voltage, and hence the Zener voltage, is 5.6 Volts, and the specified minimum Zener current is 100 microamps. Thus the maximum Zener current is 100 microamps plus 10 milliamps — which is 10.1 milliamps.

4. The series resistor R_s must conduct 10.1 mA at the lowest input supply voltage: and so allowing 1.5 Volts minimum voltage drop across R_s (i.e. input voltage minus Zener voltage):—

$$R_s = \frac{1.5}{10.1 \times 10^{-3}} = 148.5 \text{ ohms}$$

5. The value of R_s is thus 148.5 ohms, and the nearest preferred value to this is 150 ohms.
6. At the maximum supply voltage (12 Volts), the voltage drop across R_s is $I_z R_s$, (I_z being Zener current):—

$$\text{thus } I_z = \frac{(12 - 5.6) \text{ mA}}{150} = 42.6 \text{ mA}$$

7. This is the maximum current that will flow through the Zener at any time, i.e., maximum input voltage and zero external load. The power dissipated by the Zener under these conditions is:—

$$I_z V_z = 5.6 \times 42.6 = 238 \text{ mW.}$$

8. Having calculated that the correct value for R_s is 150 ohms, and that the Zener diode must be capable of dissipating 238 mW all that remains is to choose the correct type of 5.6 Volt Zener. This is, in fact, well within the capabilities of most small Zener diodes which are generally rated at 400 mW.

A PORTABLE RADIO IN YOUR CAR

A practical example of the circuit described above is illustrated in Fig. 3. This shows how to run a transistor radio from your car's power supply.

The voltage required for the radio is 9 Volts — and the nearest Zener diode to this is 9.1 Volts.

The maximum current drawn by the radio is measured at — say — 10 mA, and, as the load does not vary greatly, this is also the minimum current. (As 10 mA is well above the 'knee' current of most small diodes, the addition of a minimum operating current is not required.)

The maximum supply voltage is around 14 Volts, (when the battery is fully charged).

Thus the series resistor R_s must conduct 10 mA at the lowest supply voltage (12 Volts) and its value is calculated by:—

$$R_s = \frac{12 - 9.1}{10 \times 10^{-3}} = 290 \text{ ohms}$$

At the maximum supply voltage (14 Volts) the voltage drop across R_s is $I_z R_s$:—

$$I_z = \frac{(14 - 9.1)}{290} = 16.8 \text{ mA}$$

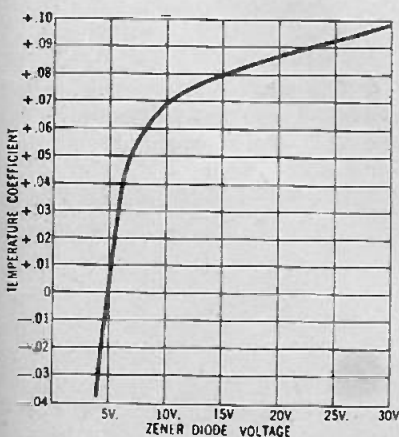

FIG. 4

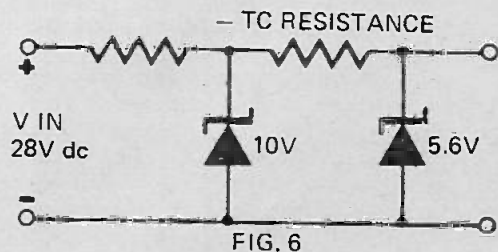

FIG. 6

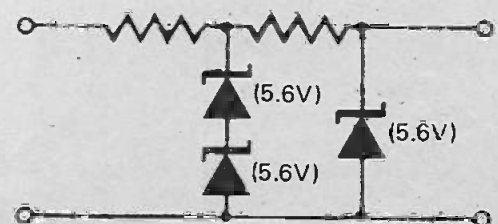
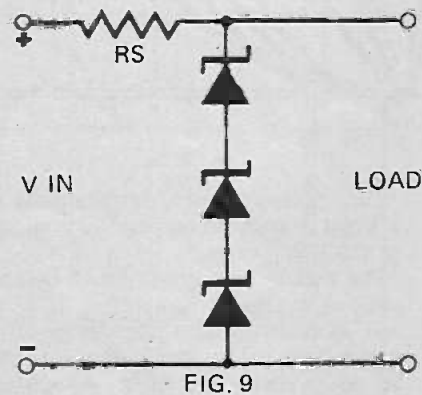
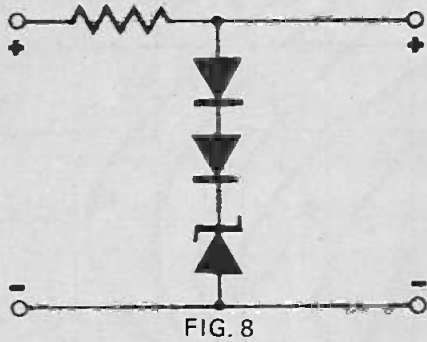

FIG. 7

A PRACTICAL GUIDE TO ZENER DIODES



The maximum power dissipated in the Zener is:—

$$9.1 \times 16.8 \text{ mA} = 152.8 \text{ mW}$$

This is well within the capabilities of a standard 400 mW Zener, such as a BZY 88 C9V1.

TEMPERATURE DRIFT

Although Zener diodes are relatively immune to changes in supply voltage and load, they are to varying extents affected by changes in ambient and operating temperature. Fig. 4 shows a typical Zener diode temperature coefficient curve, and, as can be seen, the coefficient, although approaching 0.1% per degree Centigrade at the higher voltages, passes through zero at about 5 Volts and then becomes negative for lower voltages, reaching -0.04%/C° at approximately 3.5 Volts.

The transition between a negative and a positive temperature coefficient is not well defined and a 5.6 Volt Zener may have either a positive or negative coefficient depending upon the current flow through it. But by careful control of the operating current it is possible to hold a standard 5.6 Volt Zener diode to a temperature coefficient of $\pm 0.001\%$ over a temperature range of +25°C to +75°C (Fig. 5 refers).

The only difficulty is to provide a constant current source for the Zener diode. One method is to use a 10 Volt Zener diode to act as a regulator for the reference diode. (Fig. 6). The

current limiting resistor between the two diodes should have a negative temperature coefficient to compensate for the positive (+0.07%/°C) temperature coefficient of the 10 Volt Zener.

A second method of stabilizing the current to the Zener diode is shown in Fig. 7. In this arrangement two 5.6 Volt Zeners, each having practically zero temperature coefficient, in turn stabilize the current through the voltage reference.

Another approach to compensation for temperature change is shown in Fig. 8 where the temperature coefficient of forward-biased silicon diodes is used to counteract the opposite temperature coefficient of the Zener diode. This method may be used to compensate for voltage drift over quite wide ranges of both temperature and voltage, Zener voltage stabilities of 0.01% are readily achieved.

As can be seen from Fig. 4, the temperature coefficient of Zener diodes increases considerably at the higher Zener voltages. An alternative method of temperature stabilizing to that shown in Fig. 8, is to use a number of 5.6 Volt Zeners in series. (Fig. 9).

TEMPERATURE SENSING

The apparent disadvantage of a Zener diode's temperature coefficient may be put to a useful purpose in the form of a temperature sensing device. Fig. 10 shows how a bridge consisting of two resistors and two similar Zener diodes may be constructed so as to indicate a temperature level when one of the diodes is held at a reference temperature and the other is subject to the conditions to be monitored. The average small 10 Volt Zener has a temperature coefficient of +0.07%/°C — this corresponds to 7 millivolts per °C change. The sensing element will, therefore, indicate an imbalance of 0.7 Volts when undergoing a 100°C temperature change.

NON-STANDARD VOLTAGES

Occasionally it is necessary to obtain a regulated voltage other than that obtainable from a single Zener, this

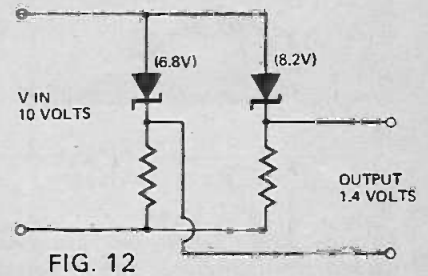
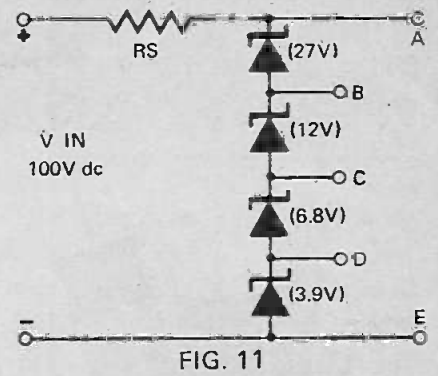
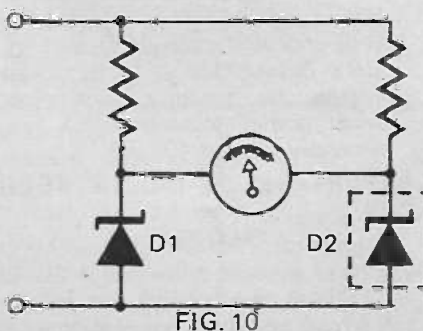

can be achieved by connecting a number of Zener diodes in series (Fig. 9). The diodes need not have equal breakdown voltages since the arrangement is self equalizing. However, the power handling ability of each diode should be the same. In addition, the current ranges should be similar or the loads so arranged to avoid damaging any of the diodes. A group of Zener diodes may be used as a voltage divider to obtain several regulated voltages simultaneously. (Fig. 11). This circuit may be used as a meter or 'scope calibrator. The four diodes shown in the circuit will supply 10 possible voltages:—

Voltage	Terminals
3.9	E - D
6.8	C - D
10.7	C - E
12.0	B - C
18.8	B - D
22.7	B - E
27.0	A - B
39.0	A - C
45.8	A - D
49.7	A - E

It may also be necessary at times to provide a regulated voltage lower than the 2.7 Volts minimum normally obtainable from a Zener diode. Voltages lower 2.7V may be obtained by using the difference in potential between a pair of Zeners, (Fig. 12). The temperature compensation of this circuit is excellent, for both Zener diodes tend to drift in the same direction, thus maintaining the difference voltage.

The second part of this series — to be published next month — describes various ways in which Zener diodes are used in both ac and dc applications. ●

EQUIPMENT NEWS

NEW ELECTROSTATIC PRINTER



Information displayed on computer video display terminals is now available in printed form with a new electrostatic page printer introduced by SE Computer Peripherals, of Feltham, Middlesex, an EMI subsidiary. This high definition printer can provide as many as ten copies of a complete video screen of data, each copy taking only three seconds to produce.

Further details from EMI Electronics and Industrial Operations, Blyth Road, Hayes, Middlesex.

ALL-WEATHER TV CAMERA

A special-purpose monochrome television camera designed to operate in conditions unsuitable for conventional closed-circuit equipment has been introduced in Britain by Bell & Howell. Intended primarily for surveillance tasks like industrial process or traffic control, it is able to accommodate a wide range of light levels, from 30 to 100,000 lux.

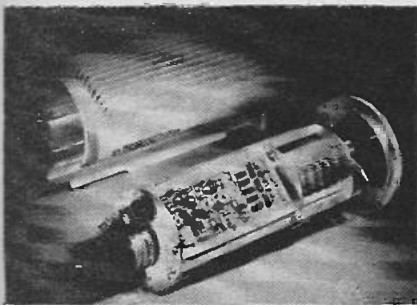

Self-contained and highly automated, the camera may be sited outdoors or in other unsheltered environments, protected only by its own all-weather housing. This consists of a cast aluminium cylinder with longitudinal corrugations and a toughened glass window. The entire housing is hermetically sealed and includes a built-in heating system automatically switched on if the ambient temperature falls below a given level. The camera is claimed to operate over a temperature variation of -40 to $+45^{\circ}\text{C}$.

Made in France by Thomson-CSF Audio Visuel, the camera can be fitted with any of a range of wide-aperture lenses, either zoom or fixed focal length, with automatic iris and, if required, remote control facilities. Demonstrated at the Didacta exhibition of audio-visual equipment (at Hanover, earlier this year), the camera is to be marketed as the THV 1160.

Equipped with a 1 in vidicon tube, the THV 1160 has modular integrated circuitry and, to ensure optimum signal/noise ratio, an FET transistor at the video preamplifier input. Black level is adjustable and independent from both temperature and the video signal. Moreover, by the action of the automatic iris and of a peak chopper device, the output video signal remains substantially constant, despite changes in lighting. The camera is not affected by mains frequency variations.

The THV 1160 measures 58.4 by 22 cm and weighs 18.2 kg, complete with lens and housing.

Further details from Bell & Howell A-V Ltd, Alpertown House, Bridgewater Road, Wembley, Middlesex HA0 1EG.

PORTABLE INSTRUMENTATION TAPE RECORDER

Using standard commercially available C120 tape cassettes, the ATR-1 instrumentation recorder accepts analogue, digital or servo inputs, and by multiplexing provides four recording channels.

The recorder employs a standard BRC tape-deck with a special high quality stereo head. A control module multiplexes two channels on to each track and also inserts a digital pattern to facilitate data acquisition during play-back, whilst a sampling oscillator is incorporated to control the maximum rate at which data can be recorded.

Inputs to the unit are processed by special encoding/decoding modules, whose function is to convert the input signal to a digital form for recording, and to convert recorded digital information back into an analogue output signal.

The analogue module will accept two analogue input channels, encode them, and present them to the multiplexer in the control module. Its linearity is claimed to be $\pm 1\%$ with an input voltage range of $\pm 4\text{V}$ maximum.

Similarly, two digital inputs of 11-bit words - which are read in parallel form - are accepted by the digital module which will set up two words on the output in the "playback" role. These can be read by any other equipment. Response time is 5ms and read time 100ns.

Two further modules are available for use with synchros and resolvers respectively. In both cases the module converts the servo data into a digital angle prior to multiplexing and recording. A 400 Hz reference sine wave is the only requirement to reconstitute the original servo signal on playback.

As each module provides two input/output channels, only two modules are needed to

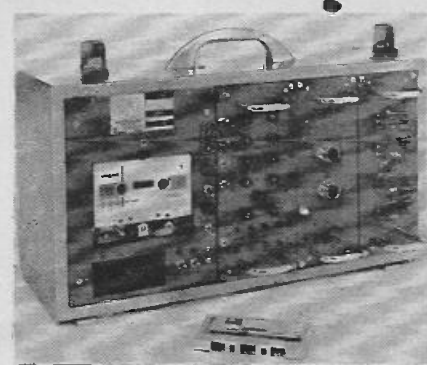

EQUIPMENT NEWS

obtain four-channel record/playback facilities and as any two modules can be employed at any one time, it is thus possible to record in one mode and replay in another. Servo data, for instance, could be replayed through an analogue module and fed to a pen recorder to give an analogue waveform of angular change.

Any of the digital channels can be employed for event recording and, using both digital modules, 44 binary channels are available for this purpose, plus a further four on the control module. These latter event channels accept two state information either via switches on the front panel or through their external inputs.

Pilot lights on the control module indicate the output state of the event channels and the outputs of either pair of signal channels can be "frozen" for as long as desired, using the two "hold" inputs which are provided.

Another simple, but extremely useful feature, is the provision of a "space" in each analogue module which can incorporate an additional circuit board. Pre-amplification, wave-shaping or filtering of the input signal could thus be provided with ease should this prove to be necessary in a particular application.

Further details from Engineering System Developments, Allweather House, High Street, Edgware, Middlesex.

TSA 1500 15-A TRANSFORMERLESS SUPPLY

Coutant Electronics have just announced a further unit in their range of "transformerless" switching-mode power supplies the type TSA 1500. This power supply exemplifies the compactness possible with the switching mode technique, for its 15-A, 0 to 6V output is produced from an overall module size of only 48 x 127 x 178 mm and a weight of only 1 kg.

The key to this high power: weight ratio is the replacement of the bulky 50 Hz mains transformer by a high-frequency switching technique, enabling complete isolation between input and output to be achieved with miniature high-frequency transformers. A further advantage of the technique is a reduction in power dissipation within the device. This is said to yield an efficiency as high as 70% and permit operation in temperatures of up to 70°C. without forced-air cooling. A temperature coefficient of better than 0.01% per °C. is claimed.

Combined ripple and noise are limited to less than 40 mV peak to peak, while the line regulation keeps the output voltage to within 0.05% for a ±10% input voltage change. The load regulation is 0.2% for a no load to full load change.

Internal overvoltage protection is in-



cluded and the unit maintains its output with negligible change for transient input interruptions.

Thick-film hybrid microcircuitry is employed for the control and regulation circuits to enhance the reliability of the unit and to maintain its compactness, despite the fact that the control circuitry is more complex than in conventional power supplies.

Further details from Coutant Electronics Ltd, 3 Trafford Road, Reading RG1 8JR.

NEW RECORDER FROM RACAL-THERMIONIC

A new recorder known as "Store 4" offers four channels on ¼ in magnetic tape with seven operating speeds. It also has bi-directional record and replay facilities and is said to be capable of recording on all four tracks simultaneously for 18 continuous hours on a single 8 in spool of tape.

Intended for fixed or mobile stations, the Store 4 is claimed to have a bandwidth from dc to 20 kHz and is particularly suited to storing scientific and medical research data for future detailed analysis. It also has wide applications in industry for general-purpose monitoring.

The transport, which contains only six moving parts, holds the tape speed within very fine tolerances, and the heads are positioned as close as possible to a low inertia, stainless steel, wrap-around capstan which is servo controlled by reference to an internal crystal oscillator. It is a system which not only enables accurate control of tape speed past the heads, but also permits the wide range of speeds to be selected electrically.

The Store 4 utilises solid state electronics and operates from the normal ac mains supply or from any positive or negative



earth 12V or 24V dc source.

Further details from Racal-Thermionic Limited, Hythe, Southampton SO4 6ZH.

NEW KEYLESS LOCK INTRODUCED

A new all-British security scheme which eliminates the use of key or plastic card has been introduced by J. Donne Holdings Ltd. The system - Data-Lock 2000 - is a small 10-digit push-button panel which is placed on the outside of a door. A four-figure combination will open the door. This combination can be changed by setting a panel on the inside of the door. The system's control box has a memory logic panel and any attempt to foil the lock will result in automatic alarm signals being transmitted.

The Data-Lock 2000 could have wide application in many industries - specifically the hotel and retail fields. Its main advantage is said to be that it can be set to allow only selective people to enter a room or building and is entirely flexible.

Further details from J. Donne Holdings Ltd., Canberra House, 312/319 Regent Street, London W1R 57B.

DIGITAL CASSETTE TAPE DRIVE WITH PC-800 CASSETTE

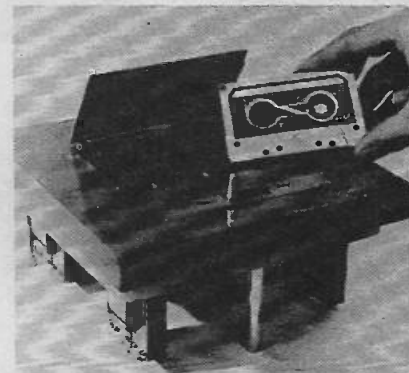

The Ampex model TMC digital cassette tape drive is a computer-class instrument with standard tape speeds of 3, 6, 9 or 12 inches per second, packing densities of 556 and 800 bits per inch and NRZI recording format. It has a maximum error rate of one in ten to the 7th (10 million) bits. The TMC offers manufacturers a precision on-line storage device for many data and computer systems and subsystems.

Further details from Ampex International, 72 Berkeley Avenue, Reading, Berkshire.

COSSOR UNVEIL HIGH FREQUENCY 'SCOPE

Said to be the highest frequency oscilloscope for its size and weight ratio ever produced in the UK, the model 4100 has a 75 MHz bandwidth.

The model 4100 is aimed primarily at the computer and digital equipment servicing market, its small size and light weight making it easy to transport by hand. With comprehensive triggering and large display,

EQUIPMENT NEWS

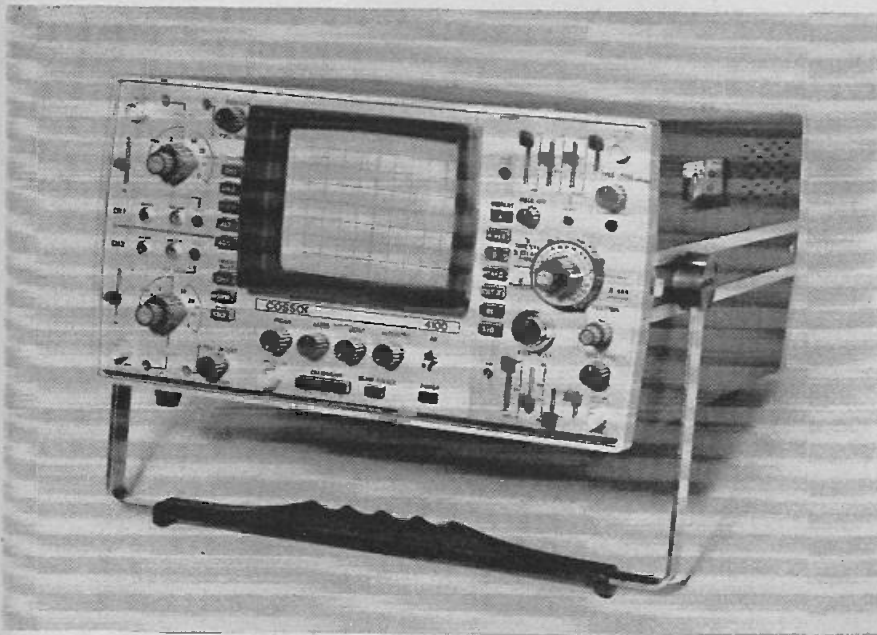

the unit will also find many laboratory and production test instrument applications in the high-frequency area and is ideal for field work.

The instrument has an 8 × 10 cm bright display and utilises a new short-length tube. Cossor is believed to be the first company in the world to use this tube.

Also available is a rack mount version, model 4100R. Identical in all electrical aspects to the model 4100, it has been modified for standard 19 in rack mounting and is supplied as a factory fitted option or as a conversion kit.

The 4100 features a bandwidth of dc-75 MHz at sensitivities from 5mV/div to 2V/div, with dc coupled dual channel operation at 1mV/div to 20 MHz. A high brightness (20kV) 8 × 10 cm CRT, and fully comprehensive time-base facilities are incorporated to ensure that 4100 can cope with laboratory work, as well as digital and analogue field service applications. The weight of the oscilloscope is 27 lb and overall dimensions, including storage cover, is 7 in high × 12½ in wide × 19 in deep.

Further details from Cossor Electronics Limited, The Pinnacles, Elizabeth Way, Harlow, Essex.

NEW MULTI-PURPOSE RECEIVER RANGE

A completely new range of medium-price receivers, the 1000 Series, designed on a modular basis to cater for a wide variety of applications, has been announced by Eddystone Radio Limited, a GEC-Marconi Electronics company operating as part of Marconi Communication Systems Limited.

The 1000 Series is based on a modular

form of construction which allows the fundamental design to be adapted simply to provide a wide range of specialist functions to cover many different applications. All of the receivers are completely solid state, and incorporate a number of advanced techniques to provide high performance and great reliability.

This form of construction is completely flexible in production, requiring only the selection of appropriate modules and chassis, to build up any one of the five receivers in the range. Approximately 70% of the circuitry is common to all of the sets in the range.

Five models are initially being announced, covering high quality, general purpose receivers for medium and high frequency use, a very high quality broadcast receiver with facilities for stereo fm reception in the vhf band, a specialized marine receiver, and a specialized facsimile receiver.

The performance of the 1000 Series sets has been designed to cover the requirements of the professional user, while the cost has been kept within the reach of the enthusiastic amateur and the keen short wave listener.

A prototype receiver, type 1004, designed for marine applications, has already been approved by the British Ministry of Posts and Telecommunications for use as a reserve receiver.

The five models which have been announced cover a wide range of applications for professional and amateur use.

Model 1000. Basic model—general purpose hf/mf communications receiver.

Model 1001. Similar to model 1000, but with up to ten crystal-controlled channels.

Model 1002. High quality broadcast receiver covering hf and mf bands with

amplitude modulation, and the vhf band with frequency modulation. Stereo reception is provided in the vhf band.

Model 1004. Receiver designed for maritime applications. Approved as reserve receiver for use on ships.

Model 1005. General purpose receiver designed to provide facsimile reception. Crystal controlled.

Further details from GEC-Marconi Electronics, Marconi House, Chelmsford CM1 1PL.

MODULAR SOLID STATE LASER SYSTEM

Survey and General Instrument Company Limited have just introduced the System 2000, a new concept in solid state lasers, which has been designed to give maximum versatility and high reliability at a competitive cost.

The new system has been developed on a completely modular basis in which each module can be used separately as laboratory components or built into a complete laser system for use in industry and research.

This theme of a completely modular system extends to all parts of the laser head, control panel and power supply.

Routine maintenance can be carried out simply and quickly and without lengthy adjustments. Even when the mirrors are removed, cleaned and replaced the system is said to be operational immediately. In conventional systems this relatively simple operation has meant the re-alignment of the mirrors to micrometer accuracy.

Applications for the System 2000 will cover almost all areas where solid state lasers are in use today. These include micro welding and micro drilling; research into non-linear optics; photo chemistry; range finding; dynamic balancing of motors and resistor trimming techniques for both thick and thin film.

Further details from Survey and General Instrument Co. Ltd., Fircroft Way, Edenbridge, Kent.

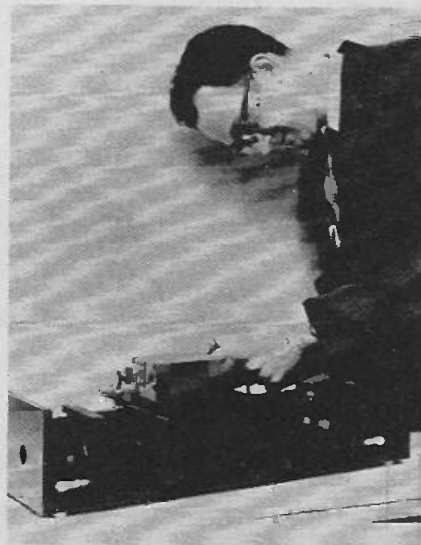

COMPONENT NEWS

MINIATURE LED RANGE

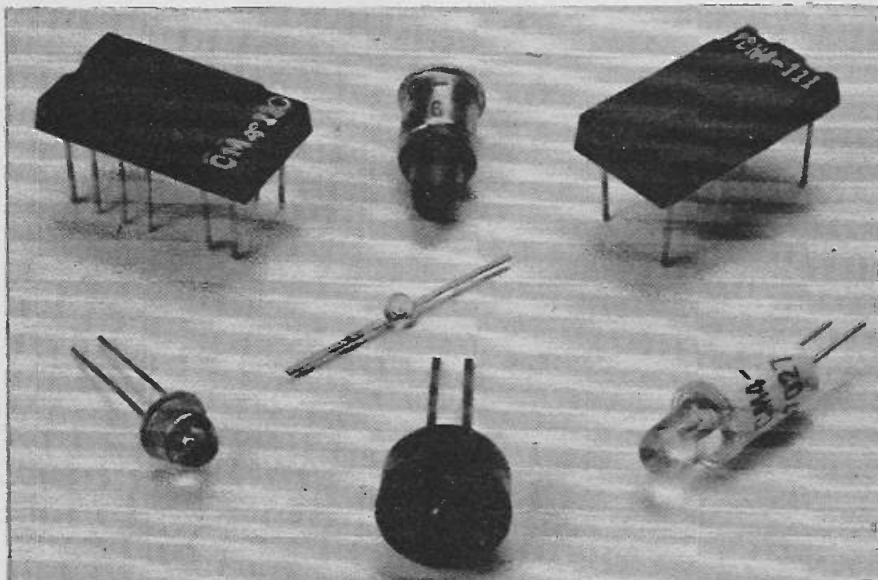

The complete range of LED (Light Emitting Diode) products from the Chicago Miniature Lamp Works is now available in the UK from Magnus Electronics (UK) Limited.

This major new product line, which complements Chicago's incandescent range of miniature lamps in similar applications, is said to be by far the most comprehensive available in the visible LED field and includes Gallium Arsenide Phosphide for red and amber LED's, Gallium Phosphide for green, Sub-miniature LED Indicators, LED Cartridge Indicators, Alpha-Numeric LED Readouts, Polarity and Overflow LED Readouts.

All products, including LED Bi-Pin Indicators, LED Midget Flanged Indicators and LED Cartridge Indicators, are claimed to meet MIL spec dimensional requirements, and can be interchanged with all existing Chicago incandescent products. Changeover to LED lamps can therefore be made by the user to suit requirements.

Further details from Magnus Electronics (UK) Ltd, 23-31 King Street, London W3 9LH.

FLEXIBLE DATA CABLES

Vari-Z flexible data cable, launched on the UK market in June last year, is a ribbon cable comprising individually insulated wires held in a polyester or nylon mesh. Vari-Z gives the equipment manufacturer a cable which, it is claimed, can cut his harness assembly prices while improving the electrical performance of his equipment.

For large orders there is the possibility of customers having these flat, flexible cables made up to their own specification, giving the desired electrical characteristics.

FibaTEK, the newest flat flexible in the family, was announced in mid-'71. A

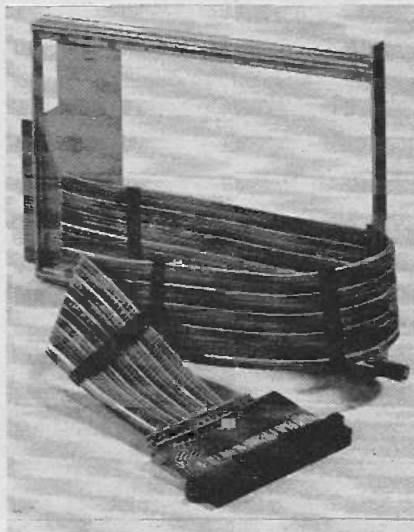

similar woven construction is used, but standard insulated wires may be specified by the customer, as well as the wire size, the pitch, and the number of conductors. There is no length limitation for either type of cable. To back up these products, Tekdata has a harness manufacturing facility, whereby almost any connector may be terminated to their range of ribbons.

Further details from Tekdata Ltd., Pentagon House, Bucknall New Road, Hanley, Stoke-on-Trent, Staffs. ST1 2BA.

CAVITY-FREE RECTIFIERS CAN HANDLE 1KW SURGES

A new generation of glass rectifiers announced by General Instrument (UK) Ltd, are hermetically sealed cavity-free diffused junction devices, designated Glass-Amp II. The company claims that the new range, rated up to 3A, has unsurpassed operating and surge characteristics at high temperature, enabling it to withstand repetitive reverse avalanche power surges up to 1kW.

Each device has a specially designed cavity-free construction which utilises an extremely pure glass in direct contact with the silicon junction. The accurately matched expansion characteristics of the glass and metal parts, together with the direct contact of glass and silicon junction, are claimed to make the device impervious to surface contamination, moisture or other external chemical agents. In this way, also, the long-term degradation normally associated with

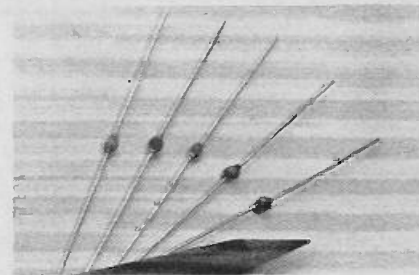

organic junction protection is thus evaded.

The small size of the Glass-Amp II (maximum body size 0.25 in x long 0.25 in dia) permits very high packing densities in electronic assemblies. Reliability is said to be very high, since the junction contacts are made using only a high temperature brazing operation—high to withstand the 650° C necessary for heating and fusing the glass to the junction. By eliminating solder joints the mechanical strength and temperature rating of the device is greatly enhanced.

Because of the manufacturing and quality assurance techniques used, every type in the Glass-Amp II range is claimed to withstand environmental extremes in excess of MIL-S-19500/286 and of meeting the requirements of MIL-S-19500E, MIL-STD-883, MIL-Q-9858 and MIL-I-45208.

Four major types of rectifier are available in the Glass-Amp II range, with the following capabilities:

Max recurrent P.I.V., 50-1,000V; max average forward current I_F , 1-3A; max surge overload current 1FM (surge), 25-125A; operating temp range, -65° C to +200° C.

Further details from General Instrument (UK) Ltd., Cock Lane, High Wycombe, Buckinghamshire.

BOOK REVIEWS

REVIEWER *Brian Chapman*

"ABCs of Integrated Circuits" by Rufus P. Turner, Ph.D. Published by Foulsham-Sams Technical Books, England 1971. 96 pages 8 $\frac{3}{4}$ " x 5 $\frac{1}{2}$ ", hard covers.

Few people can now be unaware of the impact on modern living that the development of solid state devices such as the transistor has made. Without the transistor our computer, space age would not be possible.

Less well-known, is the impact of integrated circuits. These devices combine in one 14 or 16 pin case, measuring approximately one inch long by three-eighths of an inch wide, up to several hundred transistors and their associated resistors and capacitors (all in solid state form). ICs, as they are commonly known, are increasing in complexity every day and it is possible to buy such things as dual differential amplifier, 4096 bit random access memories, phased locked loop and complete TV detector, audio output stages, all complete in the one chip and only requiring a few extra components and power supplies to perform the desired function.

An example of the cost reduction effectiveness of these devices is that of the latest generation of small computers. These machines costing approx. \$30,000 occupy about 9 inches in height of a standard 19" rack and have the same capabilities as discrete component machines of 10 years ago which were housed in approximately three full 6' high 19" racks and which bore price tags of \$200,000 or more.

Yet another example of the impact of ICs is in the space industry. The accuracy and precision required for the Apollo moon landings can only be obtained by enormous electronic complexity. Several computers are required for the various functions of launch guidance, space navigation, spacecraft housekeeping and lunar landing control, etc. With discrete components the equipment weight would be prohibitive. Here the extra functional packaging density is of utmost importance.

So much for the areas of science and computation, but additionally, ICs are now invading the domestic scene and there unobtrusively finding their way into the most seemingly unlikely applications such as washing machine control. As unit prices continue to come down and chip complexity increases we can expect to see ICs take over more and more applications which have been traditionally mechanical.

As well as offering increased reliability the new solid state controls will offer increased versatility and by their unified black box construction, dramatically reduce prices of the equipment to which they are applied.

All technicians should note, therefore, that it is imperative to gain a good working knowledge of the operation and application of these devices as the revolution will be in many ways more far reaching than that engendered by the change over from valves to transistors.

At every technological change some people inevitably find themselves, if not redundant, relegated to a lower income bracket. Remember radio mechanics were 30 years ago highly paid and eagerly sought after people. Now it is just another not-too-well paid trade. So be warned - keep moving with times or you will be left behind.

This book offers a simple introduction to the integrated circuits of one of the two main families of devices. These families are:-

1. Linear: Where the output of the circuit is proportional to the input and usually varies linearly with the input.
2. Digital: Where the output has only two stable states dependant on the input level and the built-in logic function.

Although digital ICs are described briefly, the main accent of the book is on the linear devices which are finding increasing application as operational amplifiers, IF amplifiers, modulators, video amplifier, voltage comparator and voltage regulator, to mention just a few.

The text is well written in simple unmathematical terms and is ideally suited to the needs of technicians who wish to improve their scope or to the electronic hobbyist who wants to use these devices in his projects. Many typical applications are provided under the

general headings of Amplifier, Oscillators, Controls, Communications, Test Instrument and Supplementary Applications. Well worth the modest outlay. - B.C.

"Novel Experiments with Electricity", by John Potter Shields. Published by W. Foulsham & Co. Ltd., England, 1971. 96 pages 8 $\frac{3}{4}$ " x 5 $\frac{1}{2}$ ", hard covers.

Here is a book for all you dads who have young sons and need an excuse to fiddle in the garage. An ideal book for the above purpose, it progresses from basic theory through a range of experiments designed to introduce a lad to the wonders of the world of electricity in a most fascinating manner.

The experiments are designed specifically for home construction at a minimum of cost. In many cases the projects can be assembled from junk box parts.

The parts which have to be bought have been carefully selected so that they can be readily obtained from any local electronics distributor.

Apart from the many classical experiments in electrostatics and magnetics, there are many novel experiments such as home construction of electromagnetics and solenoids, a ground path telephone, magnetic metal finder, simple synchronous motor, simple relay and a host of others.

Keep an eye on junior, however, Dad, some of the experiments show connections direct to mains which is reasonably safe on the U.S. 110 Volt system but could be lethal on our 240 Volts.

The book is well written and illustrated and must be considered to achieve its aim exceedingly well. - B.C.

"ABCs of Infra Red" by Burton Bernard. Published by W. Foulsham & Co. Ltd., England, 1971. 144 pages 8 $\frac{3}{4}$ " x 5 $\frac{1}{2}$ ", hard covers. Australian price \$4.75, available from Modern Books & Plans and other leading booksellers.

"The infrared spectrum was discovered 170 years ago but very little technical progress took place in the field for the first 130 years".

"The Second World War renewed interest in the infrared spectrum, and rapid advances in the state of the art have taken place". "Today, infrared techniques are commonplace in domestic, industrial, military, medical, and space applications".

This introduction to the book is given by the author in the preface, and exemplifies how many discoveries, made decades, and in some cases, centuries ago, have only recently found useful application. The reason for this is that it is one thing to know what needs to be done, but quite another to develop the tools and technology to do it.

The first four chapters of the book deal with the history of infrared, the laws and principles of electromagnetic radiation, infrared sources and infrared detectors.

Chapters 5 and 6 deal with practical instrumentation and systems based on the previously developed theory. Data is included on such topics as infrared thermometers, spectrometers, communications, temperature measurement and control, gas analysers, etc.

Chapter 7 provides a further treatment of infrared applications in astronomy, space technology, ecology, fishing, air pollution, criminology and the study of oil paintings - a fascinating and varied cross-section.

Each chapter is followed by a series of questions designed to consolidate the reader's understanding of the subject matter. Answers to questions are provided in an appendix, and an index provides quick access to the appropriate text.

Mathematical equations are provided wherever necessary, but the text is not obscured by mathematics and can, therefore, still be understood even if the sums are passed over.

The text is well written and adequately illustrated and the book provides a well rounded coverage of the topic for those who are interested in the field. - B.C.

RECORDINGS... CLASSICAL

REVIEWER: John Araneta



LISZT - HUNGARIA, MAZEPPA, HAMLET - Haitink, London Philharmonic Orchestra. PHILIPS 6500 046.

This disc represents the second in an admirable series that aims to record all thirteen Liszt symphonic poems. While I can hardly emphasize enough the importance of such a venture, especially in view of the fact that Liszt is not exactly well represented on records, and despite that I consider myself a rather avid Lisztian, I must admit to finding some of these symphonic poems very hard going. *Hungaria*, for instance, is I am sure, a bad joke which only seems to conjure up elaborate westerns of a historical variety. *Mazeppa* is a bit better, and not much at that, but I suppose if this is the only way to get some of the better works heard, one must submit.

Philips has rather intelligently coupled the dross works with the infrequently heard good ones and I can hardly blame them. On this disc, we do get a fine work, the *Hamlet*, unfortunately not better known. Haitink, whom I would not ordinarily associate with Liszt, does very well by these symphonic poems, presenting them in straight-forward fashion. But I do wish at times a Stokowski were at the helm. These works must be played with all the storm and fury possible for them to be effective. Such a performance would certainly be closer to 19th century practices, at least with regard to these works. Even a terrible work like *Mazeppa* can sound effective if not good under a Mengelberg. A bit more rubato would surely not go amiss here. Haitink does seem a bit restrained for these works, although I could not say he is uncomfortable in the performance of them. But better than not at all, and I doubt very much someone else can and would do better these days. - J.A.A.

SMETANA - MA VLAST Kubelik, Boston Symphony. DGG 2Lp 2707054

Personally I must admit finding most of *Ma Vlast* far too bombastic a la Liszt, especially *Vysehrad* and *Sarka*. Or perhaps as in the case of Liszt's symphonic poems one seldom gets performances of conviction that also avoid superficial emphasis. Of

three other recorded performances I have heard, only Ancerl's on Supraphon seriously competes with this new recording. Ancerl is exciting, but also somehow frenetic, especially in *Moldau*. I have not heard the Neumann, Leipzig Gewandhaus performance available on (Am.) LONDON, and it might be useful to hear that set first before any purchase is made,

This DGG recording makes Kubelik's third recording of *Ma Vlast*. By and large, his most exciting performance was his first with the Chicago Symphony (now deleted). His second recording, until recently available on DECCA ACE OF DIAMONDS preserved a rather sluggish performance, and in any case, the recording was rather wiry. In this third recording, with the Boston Symphony, Kubelik opts for generally reflective tempos. He is perhaps at his best in Bohemia's *Woods and Fields*. In more fiery moments, *Sarka*, for example, he is either not fiery enough or the vulgarity of these pieces are hardly minimised. But the latter problem may have a lot to do with the music itself. I find *Moldau*, the only still fresh piece in this cycle but here Kubelik is strangely out of control. The brass playing in the *Waldjagd* (*Eulenburg* p.19) especially is hardly impeccable. In the *TEMPO I* (commencing on p. 61) his treatment of the accents on the first violin is strangely mannered. Finally, there is unprepared rush at the start of the coda which is rather out of place and Kubelik does slow down a bit later. The sound on these discs may well be the best we have had for this cycle but it does lack definition while percussion seems muffled but curiously prominent at times as far as the rest of the orchestra is concerned.

In sum therefore, not the best performance available, and if you agree with me that *Moldau* is perhaps the appealing section of this cycle, certainly there are any number of other recordings preferable to the one here and one might try to get the Szell-Cleveland performance (now on Classics for Pleasure). That recording preserves a fiery and remarkably virtuoso rendering while the sound makes for still acceptable sound. - J.A.A.

MASSENET-MANON (Original Version). Sills, Gedda, Bacquier, Souzay, Ambrosian Opera Chorus New Philharmonia Orchestra. Julius Rudel (conductor). 4-HMV SLS.800/4.

Despite a dearth of French opera on records, it must be admitted that Massenet has been fairly well served by some gramophone companies - and doesn't somebody especially at EMI love French opera? To EMI we owe rather splendid recordings of (alas) excerpts from *Herodiade* and *Thais*, and a fairly good, complete *Werther*. The same company also gave us an excellent, near complete *Manon* some twenty years ago, and I can still recall the surprise of most critics at the mere fact of

its release, so unfashionable French opera was and still is. True, one wishes EMI had given us complete recordings of the abovementioned *Herodias* and *Thais* and where is *Cleopatre*, *Sapho*, or *Esclarmonde* (Massenet's own favourite)? But perhaps if this new recording of *Manon* is any indication a more favourable view of French opera may yet be in the offering, and one cannot be ungrateful here, after all we do owe most of the respectable performances of French operas, even other than those of Massenet, to EMI.

The Monteux-directed *Manon* (still available on American Seraphim) has served well so long that any new set necessarily invites comparison with the older. That venerable recording had a great *Manon* in Victoria de los Angeles and conductor Pierre Monteux *inspiring* everyone concerned. Well, this new recording does not eclipse Monteux's achievement but it is a very fine performance indeed.

To begin with, this recording attempts to approximate Massenet's original intentions. We are given the original ensemble finale to Act I (unquestionably the most important restoration), a complete *Entr'acte* to Act III, and the Act III *Fabliau* sensibly included as an appendix at the end of this recording these among other restorations not to be heard in the *Seraphim Manon*.

Conductor Julius Rudel is no Monteux but he does love this work and is generally more careful about details. Because of the undeniably better recording we are also more aware of how subtle is Massenet's writing for the orchestra and Rudel takes care to emphasize its use particularly with regard to the psychological development of characters (an idea not commonly associated with Massenet's operatic achievement). And how Massenet's orchestra continually underlines, develops, sings: never a dull moment in this very great score. I thought, however, that certain loud passages, especially the opening to Act I seemed ragged but this may very well be due to faulty balances.

Beverly Sills as *Manon* does not possess the beautiful seamless tone, de los Angeles gave to the role, nor the rather wistful pathos which is very much a part of the tonal quality of that voice, but she is very much the fine actress and the thinner girlish quality - never just simply naive sound - she delivers is very appropriate. It is mainly to her credit that this supposedly faded story comes humanly to life. To my mind, Sills here is most moving in the first Act and especially when she is joined by Gerard Souzay (*des Grieux*). The latter, sounding now a bit vocally frayed, nevertheless triumphs over his present limitations by a never failing artistry and *elan* (what beautiful French): in the first act alone Souzay manages to reflect every turn of the *Chevalier's* character - when he appears drunk he is quite believable without any trace of sham. The rest of the cast is very fine indeed and always at least on a par with

those in the older set. If I have singled only Sills and Souzay it is simply because their performances are definitely outstanding.

Recording is quite good with the exception of loud passages from orchestra alone when everything does tend to sound ragged. Oddly enough the large ensembles with chorus sound quite acceptable. Dramatic effects, "stage noises" are used to good effect and never to my mind exaggerated, but I do wish a better idea of space had been conveyed: Des Grieux sings from a tavern admittedly close by, in Act I but his voice sounds as much in the foreground as other voices *outside* the tavern with the result that his later appearance hardly comes off with the desired effect.

All in all, a very exciting recording of a great musical work — one that, I feel, more people should get to know. — J.A.A.

MOZART - Symphony No 41 "JUPITER". Decca SXL 6225. **HAYDN - Symphony No 103 "DRUM ROLL".** Decca SXL 6067.

Formerly available on RCA, this reissue on Ace of Diamonds is very welcome. For one thing, Karajan's older recordings with the Vienna Philharmonic and Philharmonia orchestras are with few exceptions finer than his remakes with the Berlin Philharmonic. The latter are often lush and carefully made but they also seem to me pretentious, and in any case, disturbingly lacking in spirit. A case in point is last year's reissue of his Vienna recording of the Mozart Fortieth. His recent recording for HMV is by comparison fussy and antiseptic. The older performance, however, paid special attention to the peculiar atmosphere of unrest which is very much part of even Mozart's earliest music. This approach is, I feel, closer to Mozart than the numerous "classical" or musicological renditions now in fashion. I am all for emphasizing chamber music qualities in Mozart and the observance of 18th century practices, but Mozart is not simply a "child of the *Encyclopedie*", as Dent would have it, any more than Blake is just another 18th century writer.

Between the fashionable high Baroque masters and the ever popular Romantics we usually hear mainly Mozart and Haydn. Perhaps when we get to play more "gallant" music and play it with more "affekt" we shall come to understand that Mozart is neither an extension of the "affekt" school nor as classical as his contemporaries. The literary term "pre-romantic" may be in disrepute today but used with caution it may perhaps illuminate certain aspects of Mozart's position in music.

Karajan's approach to the so-called "Jupiter" is dictated by the same terms with which he approached the G minor. He is not prepared to take all the joy and order that this symphony projects, without reservations. He invests his performance

with a sense of regret and uncertainty. This, I feel, is correct. Mozart may use high Baroque forms in this work but it is almost in the spirit of one looking back to a more assured age. Thus, while the first movement definitely harks back to the older Overture-Suite style, in Karajan's reading we also get already a feeling of the uncertain. The second movement is not an incarnation of the simple "aristocratic pathos of the mature Viennese classicism". Karajan plays it as an intense expression, which it is. The minuet is not just a dance, while the fugue-finale seems ironic in this performance. One must admit that Karajan's intentions met with greater success in the G minor Symphony. There are times here when one feels he is not quite certain what to do, or how to look at this work. But it is good to see someone trying to grapple at the dualities inherent in this work, rather than passing it off as the olympian work everyone likes to think it is. The Vienna Philharmonic plays beautifully but this Mozart hardly prepares one for the aural splendours in the Haydn. What playing! Once again musicologists might well quibble at the style of performance and the largish orchestra: one does not get any notion of the concerto grosso manner in the opening allegro, for instance. Nevertheless, this is a performance of power and grace. Nor is Karajan immune to the work's wit and irony. The opening adagio is very *serioso* indeed. Does Karajan think that "all is not well" in this symphony as well? Perhaps a little more sparkle would not have been amiss. But there is certainly a melancholic quality to this symphony which Karajan sees fit to project.

A rather unusual approach to this work but very successfully conveyed. In sum then, two rather unusual interpretations, worth listening to particularly for those who think these works are "all sunshine and grace". — J.A.A.

WAGNER - TANNHAUSER (Paris Version). Soloists, Vienna St Opera Chorus, Vienna Boys Choir, Vienna Philharmonic, Georg Solti (conductor). DECCA SET 506-9.

After a somewhat disappointing Boris it is good to see DECCA accomplishing an opera project more in keeping with its past achievements. Let me say at once that this is probably as fine a recording of Tannhauser, as we shall ever get, simply magnificent in almost every aspect, and certainly superior to any other version available. In deciding on the Paris version, DECCA has, of course, hit on a fine commercial advantage but it is performing a fine service in showing everyone, once and for all, the superiority of the Paris to the Dresden text.

Tannhauser in its original Dresden version (1845) was Wagner's first opera to make headway in the musical world of the time. It was after a performance of Tannhauser in 1846 that made, of all people, the young

Kanslick write of Wagner as the only real hope of German opera. It is intriguing to wonder what Hanslick would have thought of Wagner's revisions but in any case, for the Paris production of 1860, Wagner was undoubtedly aware of the greater resources of the Paris Opera as compared to those of his Dresden. On the other hand a production in Paris meant a ballet in the middle of an opera (a convention not even flouted by Verdi), and generally a less free hand over the forces involved. With the rich experience of Tristan behind him, Wagner recomposed the opening Venusberg Scene, transforming it into a moment of richness and power. The insertion of a ballet at this point made strong dramatic sense but it also made a rude reception for the opera a foregone conclusion. Elsewhere Wagner revised numerous details and, also substantially revised the Singing Contest.

Solti and DECCA have obviously gone to great trouble determining which sections of the Paris version were to be used, but they have commendably gone back to the Dresden text when this seemed to conform to Wagner's intentions more exactly. Thus, Walther's aria is included although Wagner deleted it because the Paris Walther was not good enough, while Wagner's other revisions here are kept to because they heighten the situation. But the very musical management involved in this production goes further than a study of Paris and Dresden alternatives. An augmented percussion score later used by Wagner for the Bacchanale is used. Boys are used for the shepherd, the young pilgrims, and pages. The shepherd-boy is heard to play a shawm-sounding instrument.

The production efforts involved for this recording are in fact nothing short of staggering. Recording is gorgeous: for once the vision of Venus in Act III is plausible. But I am glad to say the performance is on the whole on the same high standard. Solti conducts with power and precision, and his orchestra (Vienna Philharmonic) plays beautifully. Solti does his best to minimise the banality of Wagner's themes in the overture by his rather unusual phrasing. His choruses are excellent and for once quite believable and well differentiated. As for the singers, one must immediately put Christa Ludwig's Venus at the top of the list. Here is a Venus with not only ravishing voice but also temperament. Helga Dernesch projects a dignified and human Elizabeth not a Valkyrie. Her "Dich, teure Halle" sounds a bit taxed, and I do not find her Prayer moving enough but her characterization and singing elsewhere is first rate. Rene Kollo (Tannhauser), I would never consider a heldentenor as many seem to these days. He sounds more like the young Set Svanholm. Be that as it may, he does deliver a very fine performance of Tannhauser, fine enough to make me forget at times that Wagner wrote some very tiresome passages for the role. His outbursts particularly in the Rome Narrative are dramatically convincing. Hans Sotin has the right ring of authority in his voice for the Landgrave. The Minnesingers are generally well sung, if rather light weight sounding. At "O du mein holder Abendstern" it was quite impossible for me not to think of Fischer-Dieskau, but one cannot have everything, and this set does give us a great deal. This Tannhauser is a definite necessity for any Wagnerian. — J.A.A.

RECORDINGS... JAZZ

REVIEWER: John Clare.



LOUIS ARMSTRONG – Very Special Old Phonography. Volume Two. Side one: Louis Armstrong and his Hot Five (Lonesome Blues, Sweet Little Papa, Jazz Lips, Skid-Da-De-Dat, Big Butter and Egg Man etc). Side Two: Louis and his Hot Seven (Willie The Weeper, Wild Man Blues, Chicago Breakdown, Alligator Crawl, Potato Head Blues, Melancholy Blues, Weary Blues, Twelfth Street Rag). French CBS 62 471.

This is one of eight in the V.S.O.P. series which covers most of the essential Armstrong from 1925 to 1932. Swaggie records have covered most of the same territory, but it's damn good to see these classics around in the bigger record shops again.

Jazz buffs need only glance at the titles to know everything I could ever say about them, but a few words might be of interest to newcomers to the amazingly diverse world of jazz music.

This is Armstrong in the first full flowering of his genius. The Hot Five recordings are much poorer in sound quality than the Hot Sevens but the attentive listener will experience the full glory of the music as it were through the haze of time. In fact there is a strange magic in hearing Armstrong's cornet burning through the acoustic sediment, which is akin to watching the genius of Chaplin or Keaton on grainy old film.

Armstrong and clarinetist Johnny Dodds are the giants who unify the often quaint and primitively simple contributions of trombonist Kid Ory, banjo man Johnny St. Cyr and pianist Lil Armstrong, and lift the whole into the realms of great art. One would not wish to change a single note.

The Hot Seven side (Chicago Breakdown is in fact by Louis Armstrong and His Stompers, a group which includes the great Earl Hines on piano) contains two of the most astonishing Armstrong performances of all time. They are Wild Man Blues and Twelfth Street Rag. Beneath Armstrong's and Dodds' solos on Wild Man the piano accompanies for two bars, stops for two, and so on. Armstrong's trumpet pours into the silences with a combination of emotional force and musical brilliance that

is a profound experience to this day. Dodds, completely uncowed, follows Louis with everything he can muster, and by the end of his solo he has made almost as great an impression as Armstrong.

Twelfth Street Rag begins with Louis playing the melody in a perky, almost corny fashion which is both foil and basis for the brilliant embellishments which begin to flower, spilling into double time and back, until the melody finally disappears, is virtually shattered by an explosion of musical ideas. The lurching trombone solo which follows this is hysterically funny by comparison. To cap it all off, before Dodds' final break Louis leads the ensemble by playing the melody backwards. Too much altogether. – J.C.

ART ENSEMBLE OF CHICAGO – Art Ensemble with Fontella Bass. America 30 AM 6117. "How Strange, Ole Jed, Horn Web. Joseph Jarman, Malchi Favors, Don Moye, Lester Bowie, Roscoe Mitchell, Fontella Bass.

Friends who heard this before I did, told me that it was even better than The Chicago Art Ensemble Phase One – also on America. I just can't quite see it. Phase One was such a complete recording to me because it had one side of the best straight ahead jazz blowing you could reasonably expect to hear (albeit in the style generally called avant garde) and one side of fascinating textures and melodic fragments, which though largely improvised on the spot by the ensemble sounded almost orchestrated in their cohesive development.

Side one of this recording consists largely of a strange recitative by Singer Fontella Bass. The words "How Strange" and "Old Jed Fell into the Well" are sung over and over again with sundry additions while all the ensemble members interject or create exotic mosaic effects on their many and varied instruments. Though the point of it all eludes me, the performance is full of delights, notably the shattering trumpet blasts from Lester Bowie and the fantastic drumming and chanting which precede the main vocal. Towards the end the bass begins to walk and Bowie plays a marvellously satisfying, forceful but contained trumpet solo, the beat dissolves again and everyone, swapping about between flute, bass sax (what a glorious sound that makes) and clarinets, joins in a brilliant free conversation.

Side two begins with a drum solo, but after a couple of odd punctuations, figures which seem unresolved in the more conventional sense come and go over a slow barely felt pulse or replace each other in an unmeasured drift, moving space, in contrast to the softly clattering thicket of percussion which surrounded the solos, cries and instrumental conversations on the Phase One recording. Where the latter seemed at times like a brooding distillation of jazz, this has more of the limpid stealing motion of



some recent classical music (sometimes I am reminded of Carl Ruggles) though it is all improvised and jazz intonation is brilliantly employed.

Favors' bass, used like a deep dark guitar is most effective. Bowic here demonstrates just how directly much avant garde trumpet playing stems from Miles Davis, particularly his work on Sketches Of Spain. An instrument which sounds like the chanter from a bagpipe provides some textures and soft bells create an ethereal effect.

It's all great stuff, though obviously many will find it somewhat alien at first. You can't half listen to it. You've got to relax and shut everything else out. It's worth it. J.C.

B. B. KING – B. B. King Live At The Regal. EMI Stereo SPBA 3034. Every Day I Have The Blues, Sweet Little Angel, It's My Own Fault, You Upset Me Baby, Worry Worry, Woke Up This Mornin', You Done Lost Your Good Thing Now, Help The Poor etc.

If ever you felt that Cream or Grand Funk or the Rolling Stones generated a bit of excitement, just drop everything and listen to this! That this record has remained in obscurity since 1964 is testimony to the efficiency of the big publicity machine in getting people to hear only what suits its purposes at the time.

This is what the blues are about. Not dull clubbing riffs repeated ad nauseum, not interminable exhibitionist guitar solos, but tremendous rolling oratory, full of ominous pauses (in which the audience nearly wets its pants in anticipation) and ecstatic climaxes.

Now that the white listening public has discovered B. B. King (after about twenty years), he has seen fit to put out several good, but somewhat restrained studio recordings – Indianola Mississippi Seeds was one to which Leon Russell and Carole King contributed. This one records King's approach to a live audience in the ghetto of Chicago nearly eight years ago. The two approaches cannot be compared. This is, as they say, something else again. At times the audience sounds to be frothing at the mouth

RECORDINGS... POP TRENDS

REVIEWER:
Michael Delaney.



KILLER – Alice Cooper. Kinney. Stereo. K56005. Under My Wheels, Be My Lover, Halo Of Flies, Desperado, You Drive Me Nervous, Yeah, Yeah, Yeah, Dead Babies, Killer.

Alice's total environment theatre has finally found the perfect compromise between stage presentation and punch drunk rock'n'roll. This Detroit quintet uses all the old tricks from aggressive volume through to feedback and still makes them work like thunder. Their approach is completely flexible, integrating the dynamism of pop with an intense dramatic appeal otherwise distorted out of all belief by such acts as Grand Funk Railroad. It's neither obscene nor self-indulgent. They keep a healthy balance no matter what the cost.

Alice Cooper plays mainstream rock with a technical resourcefulness that removes the least threat of repetition. This band is determined to fill the gap left by the Stones. That's their charisma in a nutshell. They have that self same chemistry needed to produce commercial songs – solid stuff build on the verse/chorus frame. Alice's music has a real horny edge capable of the excitement once generated by Mick Jagger. "Under My Wheels" should be a hit single. It hurtles along a stylized riff/rhythm similar to the classic "Jumpin' Jack Flash – gruff and cocksure. Yeah. Alice Cooper actually contains the potential needed to shape a large chunk of the forthcoming attitudes toward rock as a consistent art form.

Each song rocks off with guts and ends with gusto. They're loud and brutal. "You Drive Me Nervous" is one of those pacey speed raves locked in range by the strutting instrumentation. "Yeah, Yeah, Yeah" and "Halo Of Flies" follows in much the same way with a slightly less manic arrangement geared to the standard triple guitar front. Alice has the prestige to make Grand Funk appear as weak as supermarket shandy. "Killer" and "Dead Babies" are the two standout cuts specializing in the dutiful hypnotic atmosphere that only this crew could ever hope to get away with. "Desperado" is the archetypal mood piece complemented by mellotron and

counterpoint strings. I'll leave the rest to you. This latest album – the second for Kinney – helps to assess the dual career as both a guitar-oriented rock band and a modern theatrical troupe. It's not going to be long before Alice will be splattered all over top forty radio. Get in now and beat the hype. – M.D.



"FARTHER ALONG" – The Byrds. C.B.S. Stereo. 64676 – Tiffany Queen – Get Down Your Line – Farther Along – B.B. Class Road – Bugler – America's Great National Pastime – Antique Sandy – Precious Kate – So Fine – Lazy Waters – Bristol Steam Convention Blues.

The Byrds are simply wonderful. You would've expected them to have split years ago what with all those hassling character/personnel alterations but the thing is that they didn't. And isn't it just fine. I for one couldn't have coped half as well with the current pace had McGuinn not decided to keep doing his level best to survive and continue and create and make people warm inside.

The Byrds stand as an ever faithful reminder of the niceties that one can find in music if an effort is made without demanding immediate return. Their songs kind of settle gently around a need to communicate. They make you serene. "Farther Along" balances their harmonic tradition with a more spatial grasp of straight rock'n'roll. This revised concept has given the band a greater idea of how to project instrumental freedom without detracting from the voice capacities.

"Antique Sandy" and "Precious Kate" are two of the loveliest tunes only because both seem to attach themselves more to your emotional response than anything McGuinn has done since "Chestnut Mare". His sense of melody tends to be roughneck detailed and broken beyond repair and that's the reason they're so beautiful. "America's Great National Pastime" parallels "I Wanna Grow Up To Be A Politician" from the "Byrdsmanix" album for pointed humour: the theme is pretty much a typical message

concerning split generation loyalties. It's nothing new apart from the remarkable lack of dual guitar. "So Fine" is an ultimate rip-off not so much because the band couldn't handle its interpretation but because the song itself is just nowhere to start with.

The personalities behind the band seem to have lost that programmatic closeness with regard to their individual identity: each has cleared the rubbish from his own backyard. McGuinn and Battin complement Gene Parsons whilst Clarence White has retrogressed back behind a veneer of bluegrass phrasing. The range is more definite. "Get Down Your Line" follows "Tiffany Queen" and "America's Great National Pastime" to form the first recognizable blend of Chuck Berry/Byrds Memphis rock. The wait has been worthwhile. The group is no longer subject to the whims of four separate statesmen.

"Farther Along" holds a certain majesty because it's captured the band undergoing style change. It looks set that their rural era is about to be phased out as part of a massive reorganization with McGuinn abdicating as dictator and spokesman. The general temperament is less esoteric. "Lazy Waters" and "Bugler" would be the two most stable tracks as both seem to fit securely into the White/McGuinn tribute vein. They seem to come closest in design to the Byrds as an electric folk group a la "Oil In My Lamp". The latter is an animal song that completes the trilogy with "Old Blue" and "Chestnut Mare" – precocious yet submissive. McGuinn endures. As a lyricist he leaves little to be desired: "Can I Sing Your Praises From The Bottom Of My Heart/Perhaps I Want You Too Much/At Times I've Tried So Hard/But I've Been Lonely Too Long/Just Let Me Say I Love You . . . There's nobody who can touch this group called The Byrds. Oh Yeah! – M.D.

"The Morning After" – J. Geils Band. Kinney. Stereo. K40293 I Don't Need You No More – Whammer Jammer – So Sharp – The Usual Place – Gotta Have Your Love – Looking For A Love – Gonna Find Me A New Love – Cry One More Time – Floyd's Hotel – It Aint What You Do.

The trouble with the most recent American blues has been its inability to project pure feeling. Both Paul Butterfield and The Allman Brothers Band have sublimated all their muscle in favour of virtuoso gymnastics that gain in excellence an equal to the loss in personal magnetism. They've started to play super musicians instead of settling down into their role as dedicated bluesmen. I guess they just got tired and didn't feel angry enough to belt it out anymore. Butterfield has become an introvert whereas The Allmans have found themselves a rather questionable niche somewhere between rock and pop/jazz a la Brian Auger's Trinity. The results have been

Continued on page 86

SPECIFICATIONS

I have taken the first two issues of E.T.I. and am very impressed. It could be the best widely available magazine of its type. I like the project layouts with the "How it works" bit, but one criticism I would like to make concerns the specification of semiconductors for the projects.

Type numbers are not enough for diodes, zeners and SCR's. They should be qualified by their specifications - e.g., for zener diode give the type number, zener voltage and wattage. Suggest alternative transistors where possible - e.g., "or any similar high gain, medium current u-pin".

We do not all have access to every manufacturer's catalogue, nor do we want to chase around the country trying to buy a specific device when the one we were first offered was suitable. About 80% of my constructing time seems to be taken up with getting the components together. Full specifications also help me make quick assessments of whether the project is worth constructing.

Please do a good practical series on logic applications, right from the beginning. Especially using TTL or DTL in quite mundane circuits. Show me how to use gates for constructing multivibrators and schmitt triggers, flip-flop, etc., and tell me how they work.

It seems pointless to wish you success because you are bound to succeed. - S.W.B., Sawbridgeworth, Herts.

SPEAKER ENCLOSURES

The two articles on hi-fi speakers in your first issue filled me with joy! Even if some of the conclusions drawn by me are a bit optimistic (details later), the definite facts are still damn good.

The day before I purchased E.T.I., an article in another magazine filled me with gloom and explained a long-observed phenomenon - i.e., that many quite expensive units sound husky and indistinct right at the bottom of the frequency range. This despite the fact that the specifications of the base drivers proclaim performance down to 30-40 eps with basic resonances from say 30-45, which should, on the face of it, largely preclude such behaviour.

That this is not so is explained by the fact that putting a speaker in quite a large sealed enclosure, even, adds considerably to the fundamental resonance of the joint effort.

The following example (converted from the metric) is given:

A speaker of resonance 45 eps is placed in an enclosure of 5.2 cu. ft. Resulting

fundamental - 60 eps! Even if it had been a vastly expensive object, with a fundamental of only 10 eps, the result would be 46.5 eps, which, after all, is still only marginal (the rot really setting in at 50 eps). To achieve satisfactory results, our first speaker - assuming an 8 in diameter and a somewhat lower fundamental - would need a cabinet of no less than 9 cu. ft.

Some marginal improvements can be obtained by juggling with speaker compliance, diameter, and the mass of the moving parts. Practical aspects (doppler, linearity, velocity, etc.) strictly limit the first two. It is what happens when you mess about with the latter that is really startling. Efficiency is in inverse proportion to the square of this mass; which may, it appears, vary from 2.5 gms to 80 gms - although I sincerely doubt if the latter is ever approached in practice.

Now let us suppose a speaker whose moving parts have a mass of 5 gms and which produces a satisfactory sound when driven at 10 watts. To obtain the same sound level from one whose figure is 20 gms would require an input of no less than 160 watts - 16 times as much!

Thank you, then, for a method of increasing efficiency which, whilst not producing startling results, at least does much better than any of the above methods (apart from another one, employing a lot of expensive and involved electro-mechanical gadgetry).

However, we have yet to tackle the original problem of total basic resonance - and it is here that I have placed my greatest hopes, albeit based on guesswork. It is merely that your enclosure is at least an open one, even if the "openness" is limited in degree. The speaker should, then, perhaps be nearer the "free hanging" state and its resonance thus less affected by the presence of a cabinet???

My last point is that your article, whilst steering clear of the question of resonance (at least in this context), also fails to tabulate the relative merits of the two methods explained, assessment of end size by (a) speaker diameter and (b) final resonance, plus the various factors in the second method.

Information on both resonance and efficiency over a cross-section of the dimensions and volumes given would be greatly appreciated.

Any "gen" you may have on the moving mass of popular speakers would also be most useful, as would compliances; these important factors appear never to be mentioned!

And now, to digress - some of the latest moderately priced but fairly low-powered

amplifiers produce truly astonishing performance (I have the Teletron SAQ 307 in mind, but there are others).

When up-grading power rises, therefore, it would appear a shame to throw out such lovely equipment only to acquire - at vastly greater expense - something that, whilst having 2 to 3 times the power, may fail to come up to these delightfully delicate responses.

How, then, about a couple of post-amps - with attendant power supply? The gain involved is only small, so massive feedback should be readily available, together with relatively simple circuitry. Thus it is hoped that there would be little, if any, deterioration in sound quality. - A.K.R., Hanwell (London).

● *Dealing with your last point first - you must have been reading our minds, for we have been working on just such a post-amp project for the past three months. We hope to publish it soon.*

As far as reflex enclosures are concerned, the fundamental resonant frequency of a bass drive unit is raised only slightly by mounting in an enclosure. It is difficult to calculate but rarely exceeds 10% to 20%.

Basically, the two methods of design described in our article are approximations to a design approach in which all data is available. The second approach is far more accurate and is in fact used by many professional companies (plus one more since the article was published).

We hope to publish another article later this year, describing the design of infinite baffle enclosures. This should contain details of moving mass, resonance and compliance.

PROJECT KITS

I am interested in building the wide-range voltmeter project featured in your April issue. From what I have read, it seems there is no way of building this without buying the components singly.

Is there any possibility of obtaining a complete kit of parts for building this voltmeter, or some other comparable unit? I am an instrument fitter, and a meter of this type would be a great asset to me. - G.M.D., Holbury, Hants.

● *We are currently negotiating with kit and parts suppliers to produce complete kits for ELECTRONICS TODAY INTERNATIONAL projects - as yet nothing is finalised, but we hope to have something firm very soon.*

Believe us, we do appreciate the difficulties that the home constructor has in obtaining supplies.

TECH-TIPS

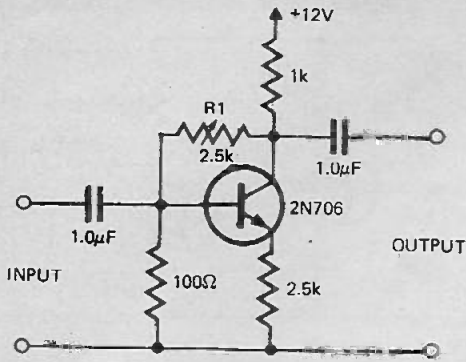

AUDIO DOUBLER

Audio frequencies may be doubled by this circuit which relies on the non-linear characteristic of a transistor to provide half-wave rectification. R1 is a feedback control and is adjusted to obtain a pure output waveform.

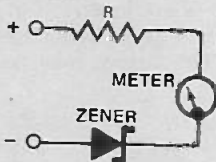

SUPPRESSED ZERO METER

A Zener diode placed in series with a voltmeter will prevent the meter from reading until the applied voltage exceeds the Zener voltage. Thus a 10 volt Zener in series with a 5 volt meter will allow the condition of a 12v car battery to be monitored with much greater sensitivity than would be possible with a meter reading 0-15 volts.

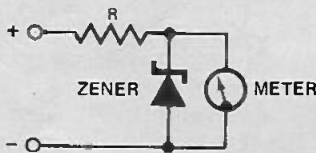

METER PROTECTION WITH ZENER

A Zener diode may be used to protect a meter from overloads without greatly reducing its accuracy. The Zener is connected in parallel with the meter and under normal circumstances has such a high impedance that the accuracy of the meter is not affected. If the meter is overloaded, the diode breaks down and the meter is shunted by about 10 ohms, preventing damage to the bearings and pointer of the movement.

Breakdown voltage of the Zener should be about 1.5 to three times the full scale deflection voltage of the meter.

The Zener also prevents the meter from reading on reversed voltages and thus gives dual protection.

TECH TIPS

Circuits described and illustrated in this section are derived from manufacturers' application notes, readers' letters etc. They have not necessarily been tested by this magazine.

The section is intended primarily as a source of ideas for electronic engineers.

Because of the nature of the information we cannot enter into any correspondence concerning any of these circuits, nor can we provide any constructional details.



SAVE POUNDS!

Compare our prices with other leading brands. Every reel factory fresh and fully guaranteed. SEND TODAY!



	List	Our Price
C.60	£0.75	£0.35
C.90	£1.01	£0.49
C.120	£1.51	£0.64

CHROMIUM DI-OXIDE CASSETTES

	List	Our Price
C.60	£1.35	£0.86
C.90	£1.75	£1.10

LOW NOISE TAPE

Long Play—Type PE 36

in plastic library boxes
Double Play—Type PE 46

	List	Our Price
5" 900'	£1.63	£0.99
5½" 1200'	£2.03	£1.24
7" 1800'	£2.94	£1.79

	List	Our Price
5" 1200'	£2.01	£1.24
5½" 1800'	£2.93	£1.79
7" 2400'	£3.69	£2.25

SPECIAL OFFER! Agfa 10½" 4200' PE 36 Low Noise.

List Price: £6.21 **OUR PRICE: £3.80**
(specify cine centre or N.A.B. when ordering)

mastertape

Low Noise Cassettes

	List	One	Three	Six	Ten	100
C.60	£0.63	£0.31	£0.88	£1.73	£2.75	£25.00
C.90	£0.87	£0.44	£1.26	£2.49	£3.75	£35.00
C.120	£1.17	£0.57	£1.66	£3.29	£4.75	£45.00

Post & Packing: Cassettes 3p each—6 or more post free. Tapes 10p each—3 or more post free. (Overseas orders 20% extra on all prices)

E.P.S.

MAIL ORDER ONLY
(Dept. ET) 75 HOLLOWAY ROAD,
LONDON, N.7

THIS CATALOGUE



CAN SAVE YOU POUNDS

It lists transistors by the hundred; it lists i.c.s and shows wiring diagrams. Resistors, capacitors, accessories, and materials. Technical information. Equivalents, tables and many other helpful diagrams. Tools. Publications. 96 pages in all plus covers — and there are very attractive discounts to be taken on already attractively priced goods. Everything we sell is brand new and to specification — no seconds, rejects or "clearance bargains". Yours for 10p post free — ELECTROVALUE CATALOGUE No. 6.

ELECTROVALUE

Dept ETD 4
28 St James Road
Englefield Green
Egham, Surrey TW20 0HB

Telephone Egham 2603; Telex 264475; Hours 9-5.30 daily; 1.0 pm Saturday

CAREER OPPORTUNITIES

Traffic Control Engineering

Career opportunities in London for electrical engineers to contribute to the development, installation and assessment of traffic control systems, including the use of computers for communication and signalling systems. This is an area of work of growing importance. Successful candidates will be expected to design experiments, evaluate performance and undertake statistical analysis.

Candidates must be corporate members of IEE or IERE (those awaiting election will be considered) and have had at least three years' experience in electronics or electrical engineering. Experience of statistical or traffic engineering work would be an advantage. Starting salary: up to £3571.

There are also vacancies for less experienced engineers and those who have a 1st or 2nd class honours degree in electrical engineering, physics or applied physics and have received practical training, or who have satisfied the training and examination requirements of one of the above Institutions. Salaries: £1713-2758. Salaries are under review. Non-contributory pension scheme and prospects of promotion.

Further details and an application form (to be returned by 13 July 1972) from Civil Service Commission, Alencon Link, Basingstoke, Hants, tel: Basingstoke 29222 ext 500 or 01-839 1696 (24-hr Ansafone service) quoting T/7983/4.

Department of the Environment

Qualified electronic engineer with a wide and up-to-date engineering background required for an interesting and challenging position with a technical publication in France. He should be at least 40 years old, a French National, fluent in English, and would be expected to be earning no less than 50,000 French Francs (£4,200) per annum. The successful applicant would be located in Paris. Apply in the first instance, by letter only, to H. Dvoretzky, European Editor, Modern Magazines (Holdings) Limited, 107 Fleet Street, London EC 4.

TECH-TIPS

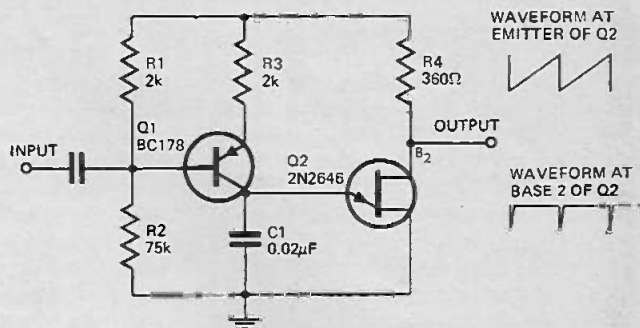

SIMPLE VOLTAGE CONTROLLED OSCILLATOR

With the component values shown the unijunction oscillator has a centre frequency of 8kHz. When an input signal is applied to the base of Q1 the current flowing through Q1 is varied, thus varying the time required to charge C1. Due to the phase inversion in Q1 the direction of output frequency change is 180 degrees out of phase with the input signal. The output may be used to trigger a bistable flipflop.

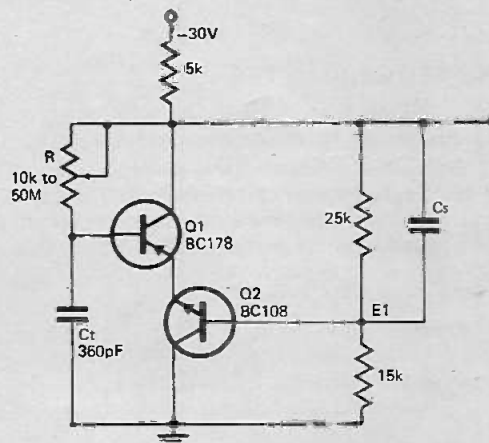

WIDE RANGE OSCILLATOR

An oscillator with a frequency range of 5000 to 1 may be constructed using the circuit shown. The timing resistor R may be adjusted to any value between 10k and 50Meg to obtain a frequency range from 400kHz down to almost 100Hz. Returning the timing resistor to the collector of Q1 ensures that Q1 draws its base current only from the timing capacitor Ct. The timing capacitor recharges when the transistors are off, to a voltage equal to the base emitter voltage of Q2 plus the base emitter drops of Q1 and Q2. The transistors then start into conduction. Capacitor Cs is used to speed up the transition, a suitable value would be in the region of 100pF.

TECH TIPS

Circuits described and illustrated in this section are derived from manufacturers' application notes, readers' letters etc. They have not necessarily been tested by this magazine.

The section is intended primarily as a source of ideas for electronic engineers.

Because of the nature of the information we cannot enter into any correspondence concerning any of these circuits, nor can we provide any constructional details.

READER INFORMATION SERVICE

For further information on Suppliers listed below, complete the coupon/s stating information required, including company and position held (if relevant). Cut out the coupon and post to:

ELECTRONICS TODAY INTERNATIONAL, 107 Fleet St., London, EC4.

ADVERTISERS	Page No
Antex	59
B.I.E.T.	87
Civil Service Commission	84
Crowborough Electronics	10
Electrospares	60
Electrovalve	83
JVC Nivico	19
E.P.S.	83
Preswick	9
Ramar Constructor Services	10
Sansui	88
Schofield Electronics	9
SCS Components	4
Semiconductor Supplies	2
Tranic Components	10
SOME EDITORIAL REFERENCES	
Akai	44
Ampex	74
Bell & Howell	73
CBS - Sony	48
Clarion	64
Cossor	75
Dana	74
Engineering System Develop- ments	74
EMI	73
GEC - Marconi	75
Racal Thermionic	74
Survey & General Instrument	75



Send to **ELECTRONICS TODAY INTERNATIONAL, 107 Fleet St., London, EC4.**

ADVERTISER.....

PRODUCT.....

NAME.....

ADDRESS.....

COMPANY.....

POSITION.....

7:72



Send to **ELECTRONICS TODAY INTERNATIONAL, 107 Fleet St., London, EC4.**

ADVERTISER.....

PRODUCT.....

NAME.....

ADDRESS.....

COMPANY.....

POSITION.....

7:72



Send to **ELECTRONICS TODAY INTERNATIONAL, 107 Fleet St., London, EC4.**

ADVERTISER.....

PRODUCT.....

NAME.....

ADDRESS.....

COMPANY.....

POSITION.....

7:72



Send to **ELECTRONICS TODAY INTERNATIONAL, 107 Fleet St., London, EC4.**

ADVERTISER.....

PRODUCT.....

NAME.....

ADDRESS.....

COMPANY.....

POSITION.....

7:72



Four reply coupons are provided here for your convenience. Please list only ONE supplier and ONE product on each coupon. If you require information on more than four individual products, make as many copies of the coupons as you like (preferably typed) - again using one coupon form for each product.

JAZZ

with excitement, and if anyone had a heart attack at the Regal Theatre that night, I should not be at all surprised.

The band is a bit under-recorded, but it is right off the ground at all times. There is a wailing tenor sax solo on 'You Upset Me Baby' - otherwise all the solos are taken by King's guitar. His guitar is what had always impressed me until I heard this album and the recent 'Live At Cook County Jail'. In fact, I would not have rated him as being an outstanding blues singer on the strength of his studio recordings. Here he is much rougher, more rhythmically daring, and he uses the kind of freezing hoarse falsetto which Buddy Guy employs to such great effect.

My only complaint is that some of the songs are cut rather short, by King himself: sometimes we only get three choruses and they are into the next one.

My favourite in this area is still Buddy Guy, but I wouldn't be without this record by the truly great B. B. King. - J. C.

THE BLUES IN MODERN JAZZ - The Blues in Modern Jazz. Atlantic 1337. Blues performances by Dizzy Gillespie, Charles Mingus, Thelonius Monk, Art Blakey, Jimmy Giuffre, Milt Jackson, Lennie Tristano, Ray Charles, The Modern Jazz Quartet.

There have been a lot of pretty scrappy jazz anthologies over the years, most of them garnered from record companies' cutting room floors, so to speak. A good general rule is to look with suspicion upon records which sport about two dozen big names. This is one of the exceptions.

Obviously what makes this collection so satisfying is that each track has been chosen to complement and contrast with everything else on the record, and most tracks are masterpieces or near masterpieces. Here is some of the very best jazz played in the late fifties. I think many of us who bought it when it was first released will be buying it again to replace worn copies.

The first thing that strikes one is the great range of highly personalised expression that the blues will support. The next thing is the great range of highly personalised expression that jazz musicians have been able to create within apparently limited forms.

Mostly this is a totally different approach to the blues than that of musicians who play nothing but the blues. It is less predictable, less cathartic, more arrogant mostly, more take it or leave it. You do not get the feeling that you could get up on the stage and do the same thing with a few under the belt. But most of these men are black men, many of whom have played with blues bands, and they know what the blues is. The blues is there beneath it all, and if you want to listen you may hear in the angular harried flights, the sudden scornful virtuosity, the real meaning of the blues for that particular man.

But when I think about it, everything I've said is true of some of the most traditional blues. All this is, is the blues. Dig it.

The rechanneling for stereo has taken something from the sound, as usual, but not enough to disqualify this record as an essential buy. - J. C.

far too clinical in outlook. It's simply a case of bluffing the blues and that's not the way talent was meant to be handled.

The J. Geils Band has come along at a crucial-point. They're an American sextet whose basic style directly parallels the Butterfield band of some six years ago. This group gets their kick from playing root blues with just a touch of musical ego mania thrown in to pressure-seal each song. The arrangements are total energies geared to highlight the incisive and vigorous aspects of their composite approach. Geils and his band have an intuitive skill at being themselves. Their music commands with authority and penetrates with ease. It swings like mad and never lets up right from the first chord.

'The Morning After' is an unqualified success because it features that essential spontaneity so much a part of good music whether it be Chicago blues or showbiz bubblegum. 'I Don't Need You No More' and 'Whammer Jammer' find the group at its most energetic - pungent rhythms diced with superlative guitar/harp. 'The Usual Place' is the typical mid-tempo performance documenting their transition from urban blues through to the less stylistic attitude much in the vein adapted by Steve Miller. 'Floyd's Hotel' and 'Gonna Find Me A New Love' tend to sound more like the obligatory 12-bar - all form and function with the emphasis on their dues. Both communicate.

The greatest thing about J. Geils is their belief in blues as the ultimate music transcending all other characters with regard to both sensibility and depth of motion. They've fused the most vital elements of Chicago phrasing with the strength of loud rock'n'roll. 'So Sharp' realizes their potential as a group joined together by the will to stir that self-same excitement once left up to Negroid soul. They've served an apprenticeship based on the earlier white exponents without trying to prove anything outside their own worth. Their style is brisk; the images passionate and mean. J. Geils Band has a gut appeal evolved from their fluency in coping with mood. Their message is shouted with heaving flashes of brimstone



POP TRENDS

and hellfire that lay it right down home the way that blues should. It's such a good album. - M.D.

"THE VERY BEST OF ARLO GUTHRIE" - Arlo Guthrie, Kinney. Stereo. RS. 5258. Washington County - Percy's Song - Highway In The Wind - Oklahoma Hills - Alice's Restaurant - Valley To Pray - Ballad of Tricky Fred - The Motor Cycle Song - Living In The Country - Shackles & Chains - Running Down The Road.

Perhaps one of the most satisfying things for any musician to achieve is to bend the rules and still succeed. Arlo suffered an immediate handicap due to the mystique that surrounds his father. The late Woody Guthrie has been acclaimed as the legitimate founder of modern American folk-blues and a huge slice of the associated tradition. It wasn't until Arlo recorded the classic 'Alice's Restaurant' that his career started to look as though it'd give dad a run for his money. This one track held critics in complete awe with its wry social comment. It served as a catalyst for what has since developed into one of the most articulate contemporary rock figures this side of Peter Seeger.

'The Very Best Of Arlo Guthrie' is a somewhat misleading title as the content does more to paraphrase his style than to offer a selection of so-called greatest hits. 'Valley To Pray' has been his one Australian chart success disregarding the gold certified 'Alice's Restaurant' album. Guthrie draws most of his character from a combination of related forms not the least of which is mainstream folk and gospel. He likes to play the satirist thus pushing the acknowledged musical boundaries a little further away from straight country. His style contains a depth drawn from the continuous contrast between the spiritual and political aspects. He places a great deal of merit behind the choice of subject matter especially as the basic form adheres to the talkin' blues first made commercial by Bob Dylan.

The songs that evoke a response detached from the lyric make their mark by virtue of the fine arrangements. 'Running Down The Road' plus the instrumentals 'Living In The Country' and 'Washington County' fall into this area. All three owe impact to the crisp guitar accompaniments - subtle and concise. 'Ballad of Tricky Fred' is the up-tempo paranoia song all about the current American climate - violence; lack of foresight. Guthrie tries to incorporate as many facets of thought into his music as possible. 'Percy's Song' is traditional Dylan whilst 'Oklahoma Hills' has firm root within Nashville progressive. This album is recommended to the mild rock fiend who's yet to pass beyond the record of the month. Arlo Guthrie should not be missed. His distinctive vocals add an extra sheen seldom found on similar exercises within the country format. - M.D.

In just 2 minutes, find out how you can qualify for promotion or a better job in Engineering . . .

That's how long it will take you to fill in the coupon below. Mail it to B.I.E.T. and we'll send you full details and a free book. B.I.E.T. has successfully trained *thousands* of men at home—equipped them for higher pay and better, more interesting jobs. We can do as much for YOU. A low-cost B.I.E.T. Home Study Course gets results fast—makes learning easier and something you look forward to. If you'd like to know how just a few hours a week of your spare time, doing something constructive and enjoyable, could put you out in front, post the coupon today. No obligation.

WHICH SUBJECT WOULD INTEREST YOU?

Mechanical
A.M.S.E. (Mech.)
Inst. of Engineers
Mechanical Eng.
Maintenance Eng.
Welding
General Diesel Eng.
Sheet Metal Work
Eng. Inspection
Eng. Metallurgy
C. & G. Eng. Crafts
C. & G. Fabrication

Draughtsmanship
A.M.I.E.D.
Gen. Draughtsmanship
Die & Bress Tools
Elec. Draughtsmanship
Jig & Tool Design
Design of Elec. Machines
Technical Drawing
Building

Electrical & Electronic
A.M.S.E. (Elec.)
C. & G. Elec. Eng.
General Elec. Eng.
Installations & Wiring
Electrical Maths.
Electrical Science
Computer Electronics
Electronic Eng.

Radio & Telecomms.
C. & G. Telecomms.
C. & G. Radio Servicing
Radio Amateur's Exam.
Radio Operators' Cert.
Radio & TV Engineering
Radio Servicing
Practical Television
TV Servicing
Colour TV
Practical Radio & Electronics (with kit)

Auto & Aero
A.M.I.M.I.
MAA/IMI Diploma
C. & G. Auto Eng.
General Auto Eng.
Motor Mechanics
A.R.B. Certs.
Gen. Aero Eng.

Management & Production
Computer Programming
Inst. of Marketing
A.C.W.A.
Works Management
Work Study
Production Eng.
Storekeeping
Estimating
Personnel Management
Quality Control
Electronic Data Processing
Numerical Control
Planning Engineering
Materials Handling
Operational Research
Metrication

Constructional
A.M.S.E. (Civ.)
C. & G. Structural
Road Engineering
Civil Engineering
Building
Air Conditioning
Heating & Ventilating
Carpentry & Joinery
Clerk of Works
Building Drawing
Surveying
Painting and Decorating
Architecture
Builder's Quantities

General
C.E.I.
Petroleum Tech.
Practical Maths.
Refrigerator Servicing
Rubber Technology
Sales Engineer
Timber Trade
Farm Science
Agricultural Eng.
General Plastics

General Certificate of Education
Choose from 58 'O' and 'A' Level subjects including:
English
Chemistry
General Science
Geology
Physics
Mathematics
Technical Drawing
French
German
Russian
Spanish
Biology
B.I.E.T. and its associated schools have recorded well over 10,000 G.C.E. successes at 'O' and 'A' level.
WE COVER A WIDE RANGE OF TECHNICAL AND PROFESSIONAL EXAMINATIONS.

Over 3,000 of our Students have obtained City & Guilds Certificates. Thousands of other exam successes.

THEY DID IT— SO COULD YOU

"My income has almost trebled . . . my life is fuller and happier." — Case History G/321.

"In addition to having my salary doubled, my future is assured." — Case History H/493.

"Completing your Course meant going from a job I detested to a job I love." — Case History B/461.

FIND OUT FOR YOURSELF

These letters—and there are many more on file at Aldermaston Court—speak of the rewards that come to the man who has given himself the specialised know-how employers seek. There's no surer way of getting ahead or of opening up new opportunities for yourself. It will cost you a stamp to find out how we can help you.

Free!

Why not do the thing that really interest you? Without losing a day's pay, you could quietly turn yourself into something of an expert. Complete the coupon (or write if you prefer not to cut the page). We'll send you full details and a FREE illustrated book. No obligation and nobody will call on you . . . but it could be the best thing you ever did.

BRITISH INSTITUTE OF ENGINEERING TECHNOLOGY

Dept. B28, Aldermaston
Court, Reading RG7 4PF.

POST THIS COUPON TODAY

To: B.I.E.T., Dept. B28, Aldermaston Court, Reading RG7 4PF
Please send me book and details of your Courses in

Name

BLOCK CAPITALS PLEASE

Address

Subject of Interest

Age

Accredited by the Council for the Accreditation of
Correspondence Colleges.



Write if you prefer not to cut this page.

B.I.E.T. - IN ASSOCIATION WITH THE SCHOOL OF CAREERS - ALDERMASTON COURT, BERKSHIRE

The entrancing world
of SANSUI's quadrasonic 4-channel stereo.

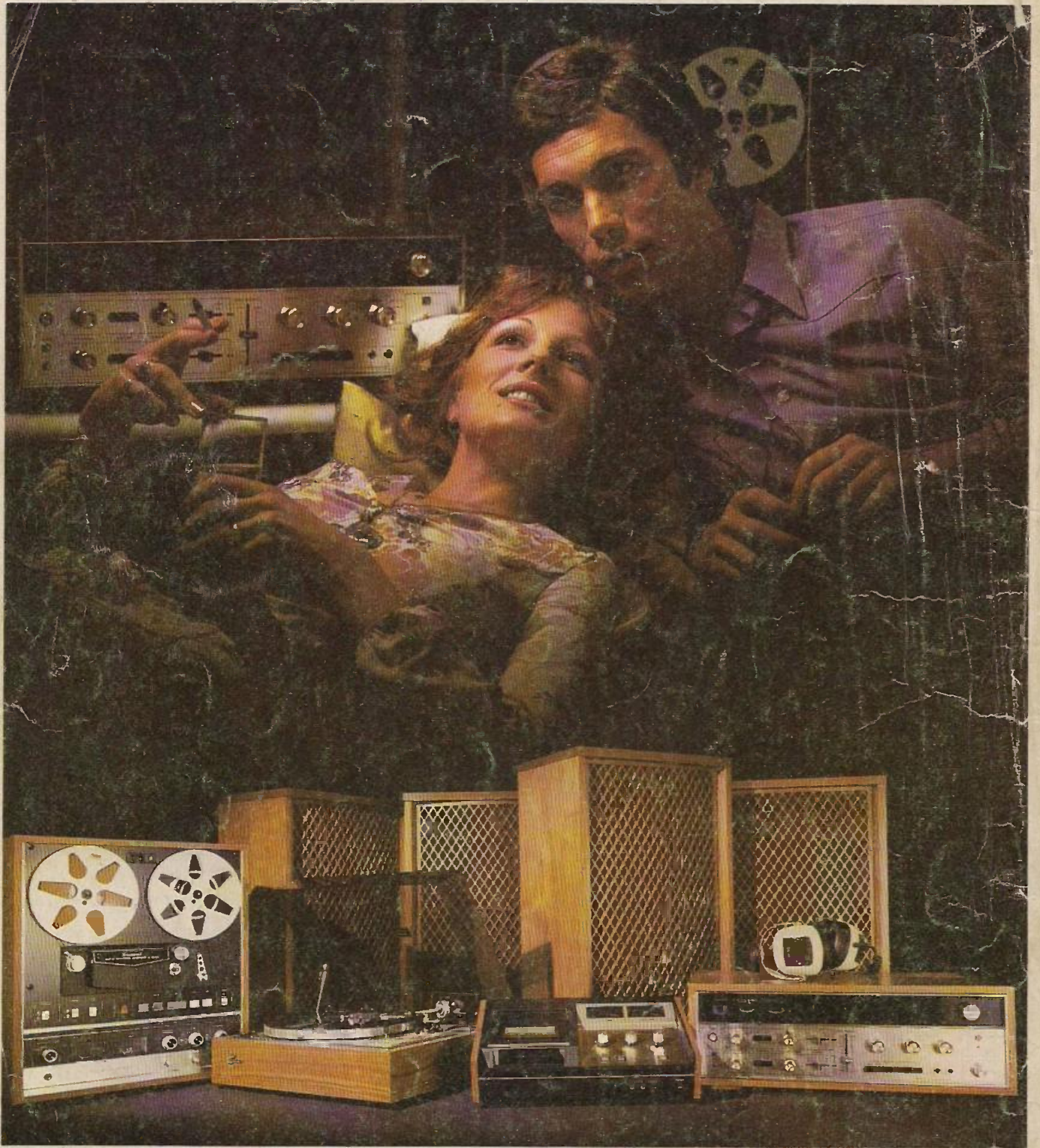

The complete range of Sansui's sophisticated
4-channel equipment at your dealer's now!

Sansui



4-CHANNEL STEREO

England : VERNITRON(UK)LTD, Thornhill Southampton SO9 5DF Tel : Southampton 44811

SANSUI AUDIO EUROPE S.A. Diacem Bldg., Vestingstraat 53-55, 2000 Antwerp, Belgium
SANSUI ELECTRIC CO., LTD. 14-1, 2-chome, Izumi, Suginami-ku, Tokyo, Japan

SANSUI ELECTRONICS CORPORATION 32-17 61st Street, Woodside, New York 11377, U.S.A.