

G30SS BOOK LAUNCH

**On test:
Yaesu FT-767GX HF Transceiver**

**Delta loop beam
for the 30m band**



DX Diary

**Make the most
of your Nicads**

For all two-way radio enthusiasts

QRP

Amateur

R. WITHERS COMMUNICATIONS LTD

Manufacturers, importers and suppliers of world famous communications products
 584 HAGLEY ROAD WEST OLDBURY, WARLEY, BIRMINGHAM B68 0BS
 021-421 8201/2/3. CELLNET 0860 323056. PRESTEL MBX 214218216 FAX 0215614074
 Amateur Radio. Business Radio. Radio Telephones. Sales. Service Accessories and antenna systems.



YAESU



**THE TECHNICALLY ORIENTATED
 RADIO COMMUNICATIONS
 SPECIALISTS.**

SPECIAL OFFER Icom IC271E 2mtr Base Station



**Christmas
 Special**

*Or 10% deposit (£69.00) and £27.00 per month, or 50% deposit (£349.50) and six equal payments of £65.00 (£739.50)
 *(Subject to status)

OPTIONS AVAILABLE . . . for a real 2mtr DX station!

ICAG20 internal pre-amp	£62.50
ICAG25 masterhead pre-amp	£79.00
EX309 CPU parallel interface	£47.50
EX310 voice synthesizer	£43.50
PS25 internal 8A PSU	£112.00

* See Raycom PSUs below!

We only have a small quantity of these superb Rolls-Royce quality 2mtr Base Stations at this special price while present stocks last. Please call for further information and colour brochures. Full Icom range stocked at best prices.

We rarely see used Icom 2mtr Base Stations; this is an opportunity to purchase one now!

NEW PRODUCTS

Raycom Power Units

For some time we have been looking for a good quality, reasonably priced power supply; we could not find one! So we designed our own and had them assembled by a UK manufacturer. We offer two models at present. Both models are designed to operate 25W multimode etc with ease!

Raycom 13.8V 10 amp (12 amp max) @ £52.50 p&p £5.00
 Raycom 13.8V 6 amp (8 amp max) current meter @ £49.50 p&p £3.50.

Full Jaybeam range in stock.

Tel: 021 421 8201 (24hr answerphone)
Telex: 334303 G TXAGWM



Amateur RADIO

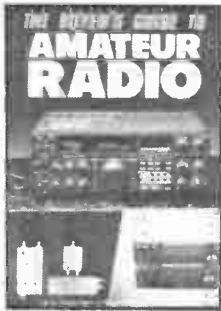

Editor:

Anita Ley
Assistant Editor:
 Jane Berry
Advertisement Manager:
 Marian Vidler
Advertisement Executive:

Karen Turner
Subscriptions:
 01-760 0409

Accounts:
 Clare Brinkman

Publisher:
 Peter Williams

On sale: Last Thursday of the month preceding cover date

Next issue: Cover date January 1987 on sale 24 December 1986

Published by: Amateur Radio Magazines, Sovereign House, Brentwood, Essex CM14 4SE, England (0277) 219876

Printed: In England
ISSN: 0264-2557

News Trade Sales by: Argus Press Sales & Distribution Ltd, 12-18 Paul Street, London EC2A 4JS. 01-247 8233

Front cover: Yaesu FT767 (p19)
 Photo by Jay Moss-Powell G6XIB

Whilst every care is taken when accepting advertisements we cannot accept responsibility for unsatisfactory transactions. We will, however, thoroughly investigate any complaints. The views expressed by contributors are not necessarily those of the publishers.

Every care is also taken to ensure that the contents of *Amateur Radio* are accurate, we assume no responsibility for any effect from errors or omissions

© Copyright 1986
 Amateur Radio Magazines

6 Straight and Level

All the latest news, comment and developments on the amateur radio scene

12 On the Shelf

Some interesting reading for the holiday period

13 Letters

Your opinions on topics of interest

15 Showing Off

Were you there to see us at the Leicester Show

16 DX Diary

Don Field G3XTT with this month's DX news

19 Angus McKenzie Tests

This review of the Yaesu FT767 contains over 7,000 words, yet only 50 of these are derogatory. Speaks for itself, really!

28 The Reviewer Reviewed

John Heys G3BDQ takes a discerning look at the new rig buyer's gospel (according to G3OSS)

30 Delta Loop Beam for the 30m Band

G3AAG discusses the theory behind this beam and illustrates a version erected at his QTH

35 SWL

Trevor Morgan GW4OXB gives a few tips to those who have just discovered how addictive listening can be

38 Make the Most of Your NiCads

Some useful advice from Tony Smith G4FAI

42 Who Wants Third Party?

An asset or a nuisance? How do you view the idea?

44 The National HRO

Brian Kendal G3GDU takes an in-depth look at this classic receiver, which is still sought after fifty years after its introduction

48 On the Beam

Glen Ross G8MWR with all the latest news from VHF, UHF and microwaves

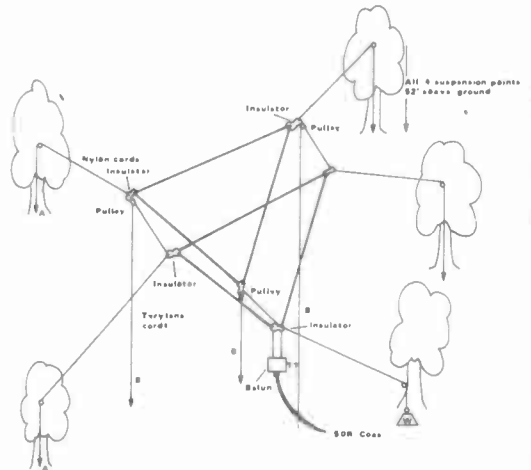

49 Coming Next Month

What's in store for you

50 Secondhand

Hugh Allison looks at a piece of secondhand amateur radio furniture(?)

53 Free Classified Ads

The market for buying and selling

SERVICES

- 41 Newsagents order form
- 51 Subscription order form
- 55 Free classified ad order form
- 58 Advertisers index
- 58 Advertising rates and information

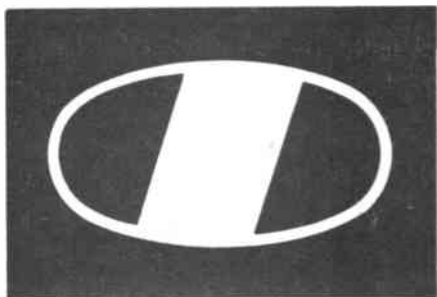

VHF/UHF FM Handportables.

If you want a handheld with exceptional features, quality built to last and a wide variety of interchangeable accessories, take a look at the ICOM range of FM transceivers. All ICOM handhelds come with an IC-BP3 nicad battery pack, flexible antenna, AC wall charger, belt clip, wrist strap and personal earpiece as standard.

IC-2E/4E, 2 metre and 70cm thumbwheel handportable.

These popular handhelds from ICOM are still available. For those Amateurs who require a simple but effective FM transceiver the IC-2E and 4E take some beating. Frequency selection is by means of thumbwheel switches (with 5kHz up-switch) and duplex or simplex facility. Power output is 1.5 watts or 150 milliwatts (2.5 watts possible with IC-BP5A battery pack).

IC-02E/04E 2 metre and 70cm keypad handportable.

These direct-entry CPU controlled handhelds utilize a 16-button keypad allowing easy access to frequencies, memories and scanning. Ten memories store frequency and offset. Three scanning systems, priority, memory and programmable band scan, (the IC-02E now with an improved CPU retains duplex offset). These handhelds have an LCD readout indicating frequency, memory channel, signal strength, transmitter output and scanning functions. Power output is 3 watts or 0.5 watt in low power position for the IC-02E and 2.5 watts or 0.5 watt for the IC-04E. (5 watts is possible with the IC-BP7 battery pack or external 13.8V.DC.)

IC-12E 23cm Keypad Handportable.

The IC-12E has a 16 button Keypad allowing direct access to frequencies, scanning and memories. Ten memory channels store operating frequency as well as simplex/duplex and duplex offset. A priority function allows another frequency such as a repeater or calling frequency to be monitored. The IC-12E is equipped with a 1750Hz tone generator for repeater access. Frequency coverage 1260-1299-9875MHz with 5 frequency step rates. An internal power module provides 1 watt or low 100mW as standard.

Also available for ICOM handhelds are a large range of optional extras including a variety of rechargeable nicad power packs, dry-cell battery pack, desk charger, headset and boom mic, speaker mic, leatherette cases and mobile mounting brackets.

For more information on these handportables and other ICOM Amateur equipment contact your local authorised ICOM dealer or Thanet Electronics Ltd.

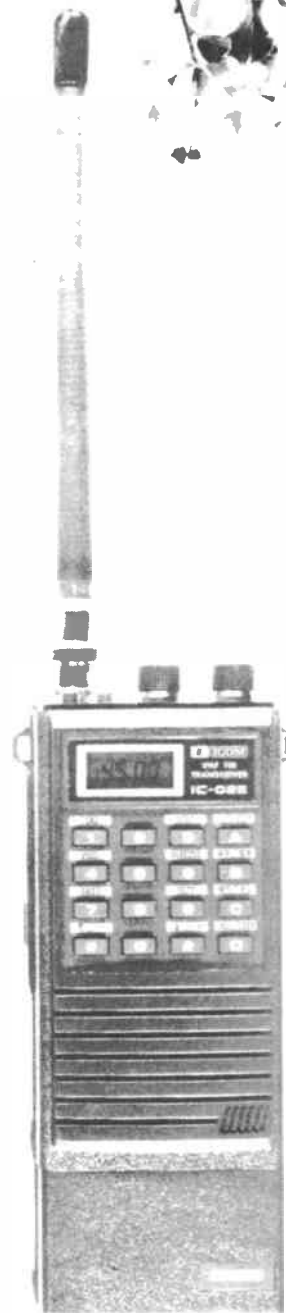

Seasons Greetings to ICOM users the world over

NEW! IC-MICRO TWO, Mini-handportable.

This is the smallest handportable transceiver from ICOM. The MICRO-TWO, 2 metre FM measures only 148 x 61 x 31mm. with BP22 battery pack (not shown here). The MICRO-TWO is a hand-size transceiver which will equally fit most pockets.

On the top panel a clear LCD readout gives frequency and memory channel number. Tuning is made easy using up/down toggle switches to select 1MHz, 100kHz or 12.5kHz steps as well as the 10 memory channels. Full repeater and reverse duplex operation facilities are featured including repeater access tone. An automatic power saving function reduces battery power consumption when in receive mode. Output power is 1 watt or 100 milliwatts (low) with the BP22 nicad pack.

The ICOM MICRO-TWO is the ultimate in 2 metre miniature handheld transceivers, yet despite it's small size the receiver sensitivity and performance has not been compromised. This handy transceiver comes complete with the BP22 nicad pack (not shown here), A.C. wall charger, helical antenna. Most existing ICOM accessories can also be used.

An optional extra, the BC50 desk charger will rapidly charge the BP22 battery in just one hour. Other options include the BP23 long-life, low-power and BP24 medium-life, high-power nicad battery packs. Contact us or your local ICOM dealer for more details on this exciting new product.

Actual Size Photograph.

This shows the non-standard low capacity battery pack. N.B. Standard battery pack is normally the higher capacity BP22 as mentioned in text.

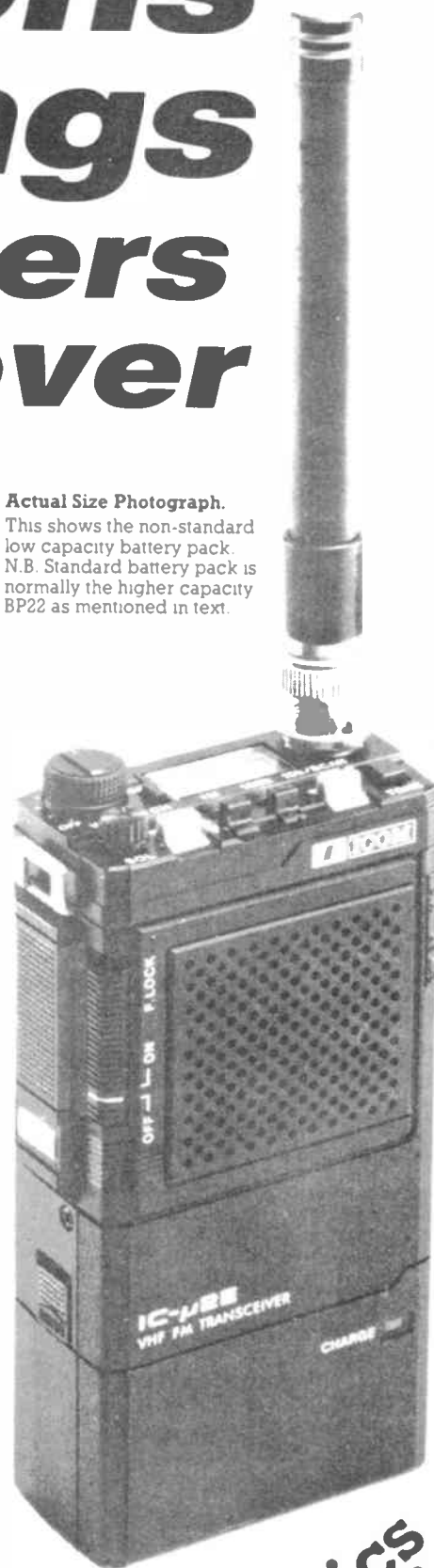

ICOM
Thanet ICOM
Thanet ICOM
Thanet ICOM
Thanet ICOM
Thanet ICOM
Thanet ICOM
Thanet ICOM
Thanet ICOM

Thanet Electronics
Sea Street, Herne Bay, Kent CT16 8LD
Tel: (0227) 363859
Dept. REW

STRAIGHT & LEVEL



LITTLE GEMS

Icom have announced two new products, the Micro-Two 2m FM hand-portable transceiver and the IC-48E 70cm FM mini mobile.

The Micro-Two is the smallest hand-portable transceiver the company produces, measuring 148 x 61 x 31mm.

On the top panel a clear LCD readout gives frequency and memory channel number. Tuning is made easy using up/down toggle switches to select 1MHz, 100kHz or 12.5kHz steps as well as the 10 memory channels. Full repeater and reverse duplex operation facilities are featured including repeater access tone. An automatic power saving function reduces battery power consumption when in receive mode. Output power is 1 watt or 100 milliwatts (low) with the BP22 NiCad pack.

This handy transceiver comes complete with the BP22 NiCad pack, ac wall charger and helical antenna. Most existing Icom accessories can also be used.

The IC-48E 70cm band transceiver is so small that it will fit almost anywhere in your vehicle or shack. Power output is 25 watts or 5 watts low, and the IC-48E is sup-

plied complete with an internal loudspeaker. The large front panel LCD readout is designed for wide-angle viewing, with an automatic dimmer circuit to control the back lighting of the display for day or night operating. The front panel of the IC-48E is straightforward, to make mobile operation safe and easy. The unit contains 21 memory channels with duplex and memory skip functions. All memories and frequencies can be scanned by using the HM15 hand mic provided.

IC-48E options include the PS45 13.8V 8 amp power supply, SP8 and SP10 external loudspeakers, HS15/SB mobile flexible microphone and PTT switchbox.

Further information is available from: *Thanet Electronics Ltd, Unit 9, Sea Street, Herne Bay, Kent CT6 8LD. Tel: (0227) 363859.*

STORNO MOD

A new modification kit for the Storno CQM 713 radiotelephone is now available from R Withers Communications.

This compact solid-state synthesized unit was designed to operate on the 158/163MHz bands, and Withers provide the necessary 7th



overtone crystals, two small PCBs, two ICs and the discrete components (including switches and pots), and instructions to enable easy conversion to the 2m band. BCD or decimal switches can be used.

The company believes that this would be an ideal first project. After only a few hours

All the latest news, views, comment and developments on the amateur radio scene

work you will have a 25W synthesized rig with repeater shift (toneburst optional) and the option of local or remote control. There are no components to change inside the basic unit, just the addition of two wires plus crystals and the construction of the new control PCB are necessary.

The kit is priced at £29.50 plus 45p p&p. Not surprisingly, Withers Communications also sell ex-service CQM 713 radiotelephones priced at £30 upwards, depending on condition.

Further information is available from: *R Withers Communications, 584 Hagley Road West, Oldbury, Warley, Birmingham B68 0BS. Tel: (021) 421 8201/2.*

GEN COV Rx

The HF-125 short wave receiver was conceived, designed and built in Britain for the DX enthusiast by Lowe Electronics. Its ability to perform on a crowded band with strong adjacent stations was a major consideration in its design. The HF-125 is also easy to use, the controls being simple and sensible. Essential bandwidth filters, which are often options on other equipment, are fitted as standard. Unnecessary frills are not included and their omission is deliberate. The result is an affordable receiver.

The HF-125 has continuous coverage from 30kHz to 30MHz. Operating modes are AM, USB, LSB and CW. An optional board (D-125) adds FM and synchronous AM. Unlike other receivers, the HF-125 comes complete with a comprehensive range of bandwidths: a 2.5kHz filter for SSB transmissions or for resolving an AM station using SSB mode and ECSS technique (exalted carrier, selectable sideband), a 4kHz, 7kHz or 10kHz filter for AM reception, the width chosen dependent on the signal and band conditions (10kHz for BBC Radio 4, 7kHz for Vatican Radio on 6185kHz and 4kHz to resolve a signal when conditions are not ideal). For the CW

enthusiast a 400Hz audio filter is included as standard.

Operating the HF-125 is refreshingly simple. The receiver is switched on by a combined on/off volume knob and displays the last frequency used on a large backlit liquid crystal display.

The HF-125 has 30 memories which are available in two banks of fifteen. There are four memory functions: review, where by pressing the MEMORY SELECT button frequencies stored in memory are briefly displayed (during memory select the receiver is still tuned to the original VFO frequency); RECALL, which transfers memory frequency to VFO; RESTORE, which returns the receiver to the original VFO frequency; and STORE, which transfers a frequency from VFO to memory.

Typical values for frequencies greater than 500kHz are a sensitivity on SSB of 0.3µV for 10dB S/N and on AM, 0.7µV for 10dB S/N at 70% modulation. Dynamic range is greater than 90dB at 50kHz from the tuned frequency (both IMD and spurious responses have a greater than 80dB rejection.

Connections are included

for both 50 and 600 ohm impedance aerials (SO239 and a terminal block). The receiver has a 6mm jack socket for headphones on the front panel and two 3.5mm sockets on the rear panel.

The HF-125 operates from 12 volts dc and, as such, is suitable for use from an external battery. For home use an ac mains adaptor is supplied with the receiver. For portable listening, in the garden or on a hilltop, an internal rechargeable battery, charger and active whip aerial option (P-125) is available. Operation on a fully charged NiCad pack is around 10 hours.

Compact and lightweight, the HF-125 is 255mm wide, 100mm high and 200mm deep, a portable high performance short wave receiver.

More information can be obtained from: *Lowe Electronics Ltd, Chesterfield Road, Matlock, Derbyshire DE4 5LE. Tel: (0629) 2817.*

CIRKIT CATALOGUE

The winter 1986 catalogue from Cirkit urges readers to 'dust off the soldering iron and finally get down to building some of those projects

you have been mulling over during the summer months'. To tempt you, the company has included the usual extensive section covering kits and modules at reasonable prices.

In this season's catalogue the Hameg range of oscilloscopes has been introduced. These may be familiar to students on ONC or HNC electronics courses, as they are widely used in schools and colleges. Until now they have not been generally available to the hobbyist.

Sections are included on the following: batteries; books; cable and wire; capacitors; computers; connectors; crystals and resonators; filters; inductors; kits and modules; meters; PCBs; relays; resistors; semiconductors; speakers and sounders; switches; test equipment; tools; and transformers.

There is also a chance to win a Hameg HM205 scope, and £8 worth of discount vouchers are included in each catalogue.

The catalogue costs £1.20 and is available from: *Cirkit, 53 Burrfields Road, Portsmouth, Hants. Tel: (0705) 669021.*



BRITAIN'S LEADING SUPPLIERS
OF QUALITY COMPONENTS

ELECTROVALUE

**CATALOGUE
OCTOBER
1986**

Valid until
31st January
1987

ELECTROVALUE LTD 28 St Judes Road, Englefield Green, Egham,
Surrey TW20 0HB. Telephone Egham (0784) 33603, Telex 264475
Northern Branch, 680 Burnage Lane, Manchester M19 1NA
Telephone 061 432 4945

PACKET RADIO

Grosvenor Software has launched a new product for radio amateurs with Dragon 32/64 or Tandy Color computers. The AX25 system is the first software solution to AX25 packet radio developed in the UK for any computer. A particular feature is that any other AX25 radio station can be used as a 'digipeater' or digital repeater, enabling far greater distances to be achieved. AX25 includes complete error checking with automatic retransmission as necessary. With the advent of digipeater satellites – such as the Japanese JAS-1 (already in orbit) and PACSAT (soon to be launched), the possibility of reliable world-wide communication at 1200 baud using low power VHF transceivers has become reality. AX25 can also be used on HF where the standard is 300 baud.

Up to now it has been expensive to get active on packet radio as a TNC (Terminal Network Controller) was needed at a typical cost of £200 for a built unit. Grosvenor's approach, developed by

Mike Kerry G4BMK, halves the cost for a 'plug in and go' system by enabling a Dragon or Tandy Color computer to be used with a conventional modem – which does not need to be BT approved.

The software is available on ROM cartridge or disc, and supports 300 and 1200 baud operation. It is a complete implementation of version 2 of level 2 AX25, and can also communicate in version 1 for contact with stations using the earlier protocol. Up to eight intermediate repeater stations can be specified as relays. Six contacts can be conducted simultaneously, together with digipeater operation and optional beacon. The text for any contact is individually selectable on the display – with full scrolling even while in conversation. The disc facilities allow the reliable transfer of text files and programs to and from disc (DragonDOS). Received text can be automatically spooled to disc. The software 'listens' on the frequency before transmitting, to avoid collision with other

ELECTROVALUE

Electrovalue's latest catalogue lists thousands of components of interest to home constructors, experimenters, manufacturers, laboratories, educational establishments, etc.

Many items are produced by Siemens, who give Electrovalue preferential delivery arrangements. The company

retails from two shops at Egham in Surrey and Manchester, and also operates a mail order service which is detailed in the catalogue.

The company provides regular updates of the catalogue.

For more information contact: *Electrovalue Ltd, 28 St Judes Road, Englefield Green, Egham, Surrey TW20 0HB. Tel: (0784) 33603.*

packets. Priority is given to digipeating. The operator can choose whether to delay transmission while any carrier is heard – or only while valid AX25 signals are heard.

Other features of the software include printer support, 24 hour clock, and user memories which can be saved on tape or disc. One of the memories acts as a 'connect message' which is automatically sent to anyone connecting to your system. Full monitoring facilities are included for just reading other traffic on the band. While in QSO, monitored text which is not specifically addressed to you is stored under a separate 'channel' for later viewing, so your conversation is not broken up. You are kept informed of the arrival of messages or connections on other program channels. You are also kept aware when others are using your system as a digipeater, and the digipeater mode can be switched off. Any of the 6 program channels can be put into non-protocol mode for sending CQ calls etc, and these can be routed via repeaters to reach a desired target area.

As the software has been designed from the outset to make multi-connect operation simple, the operator is allowed full control all the time on an individual channel basis. Although this AX25 system is cheaper than the alternatives, the software makes it a far more sophisticated solution than the TNC plus driver program approach. The art of AX25 communication has taken several strides forward. All this has been achieved without the need for any intelligent electronics or timing circuitry outside of the computer. Connection of the modem (which has the same function as a 'terminal unit' for RTTY) is via plugs and sockets – no modifications

are needed to computer or transceiver. PTT changeover timing is not critical with packet radio, as it is with AmTOR.

The AX25 system is available as a complete package – software on ROM cartridge or disc (DragonDOS), plus a built 1200 baud VHF modem – for £99. An HF modem adaptor will be available soon. Please state your amateur radio call-sign (if any) when ordering, and your computer model. Tandy computers need extended Basic and a minimum of 32K RAM. For those wanting to build their own modems, or use telephone modems (Bell tones), the software is available on its own for £49.

Other products available by G4BMK are RTTY, ASCII, Morse and AmTOR receive and transmit, and SSTV receive software. Up to 3 different programs can be supplied in one cartridge, depending on the particular program sizes. In an AX25 cartridge, any one other mode of RTTY (includes ASCII), CW or SSTV can be added for £10 extra.

For further details, send an SAE to: *Grosvenor Software, 2 Beacon Close, Seaford, East Sussex BN25 2JZ. Tel: (0323) 893378.*

AMSTRAD INTERFACE

Amstrad CPC664/464 computer users can now benefit from the highly versatile I/O expansion capabilities of the Velleman interfacing system. Available from Electronic and Computer Workshop Ltd (ECW), the system consists of a series of kits or ready-built units based on a four-slot motherboard. The motherboard connects to the computer's disc drive port and provides an additional drive connector to allow simultaneous use of the I/O system, an external disc drive and other peripherals.

The Velleman system

makes it simple to extend the I/O of an Amstrad to interface with the 'real world', using a range of plug-in interface cards. The plug-in series now includes an eight-channel analogue input multiplexer, A/D and D/A conversion, centronics printer port, eight-channel logic input, real time clock and a general purpose output card with a choice of relay and triac outputs.

A breadboard plug-in allows users to develop their own I/O projects.

Easy-to-build, the kits are based on high-quality PCBs and contain all the necessary components to assemble a successful working end result. Full instructions and applications data is provided.

The K2640 Amstrad motherboard kit is offered by ECW at a mail order price of £42.20, including post/packing and VAT.

For further information contact: *Electronic and Computer Workshop Ltd, 171 Broomfield Road, Chelmsford, Essex CM1 1RY. Tel: (0245) 262149.*

DIGITAL STORAGE SCOPE

Levell Electronics can now supply what they claim is the world's lowest cost dual channel digital storage oscilloscope. The HM205 is priced at £498 plus VAT including 2 probes and mainland UK delivery.

The HM205 permits storage and display of events from 50S to 0.1mS in addition to providing the features of a well designed 20MHz real time oscilloscope.

With a maximum sampling rate of 100kHz, the resolution of 1024x256 points for the X- and Y- axes is great enough to register and display even the most minute waveform details. In the 'refresh' mode, waveform, amplitude and frequency changes are visible immediately. Signals recorded in the storage mode can be stored until the instrument is switched off, even if the instrument is operated in any of its real time modes. With an optional add-on, the memory contents can be retrieved as hard copy using a chart or X-Y recorder.

In addition to the standard features of a 20MHz real time or analogue oscilloscope, the HM205 incorporates a component tester, variable 'Hold-Off' control and sockets for

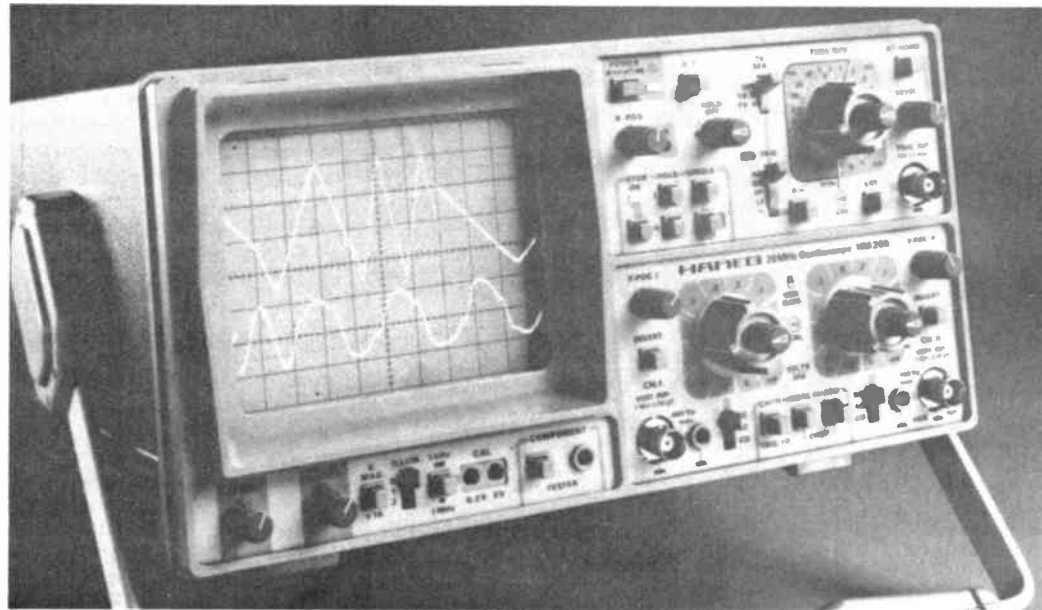

vertical signal out, sweep out and Z modulation input. Also incorporated is a specially designed active video trigger that permits stable triggering of even noisy and distorted TV signals.

Further information can be obtained from: *Levell Electronics Ltd, Moxon Street, Barnet, Herts EN5 5SD. Tel: 01-449 5028.*

ANOTHER FIRST?

Also claiming the world's first ever digital storage oscilloscope to cost less than £500, Electronic Brokers recently introduced the Hameg HM205, available at a price of £448.

The HM205 combines the performance of a 20MHz real time oscilloscope with a digital storage section offering a sampling rate of 100kHz, a memory capability of 1kbyte on each of its two channels, and a resolution variable from 5 seconds to 1mS per division.

The instrument operates in both single-shot and refresh modes, and incorporates a built-in calibrator and component tester in addition to the normal oscilloscope functions.

The calibrator functions not only at the usual 1kHz frequency but is easily switched to 1MHz, with an approximate rise time of only 3 nanoseconds.

High quality probes with an HF adjustment can be precisely adapted to the HM205, enabling the user to control continuously the transient response from probe tip to screen.

The component tester facility permits non-destructive testing of semiconductors as well as passive components both in-circuit and externally. When trouble-shooting complex circuits and components, deviations from normal performance can be located precisely by making comparison measurements.

The HM205's analogue timebase has 18 settings whilst the digital timebase has 12 settings. Using the crystal-controlled digital timebase, events ranging from 0.1mS/div (including magnification x10) to 50 seconds duration can be captured and observed. The analogue timebase permits convenient viewing of high frequency signals to beyond 20MHz. If the timebase range chosen does not correspond to the selected operating mode, an acoustic and an optic alarm signal give a warning.

Easily portable, the HM205 weighs only 7.7kg and has a

lockable tilt handle.

More information is available from: *Electronic Brokers Ltd, 140-146 Camden Street, London NW1 9PB.*

FAST ANSWER

The Galatrek FAST (Fuse And Socket Tester) is a 13 amp socket testing device shaped like an ordinary 13 amp plug. It will test 6 fault conditions on 13 amp wall mains sockets when plugged into them. The FAST also has a simple to use safe receptacle for testing any plug fuse. It is a useful safety item which, with its fuse testing capability, makes life safer and easier, claim Galatrek.

The FAST is priced at £14.95 including postage, packing, transit insurance and VAT. Delivery is 7 to 21 days direct from the company.

For further information contact: *Galatrek International Ltd, Scotland Street, Llanrwst, Gwynedd LL26 0AL. Tel: (0492) 640311.*

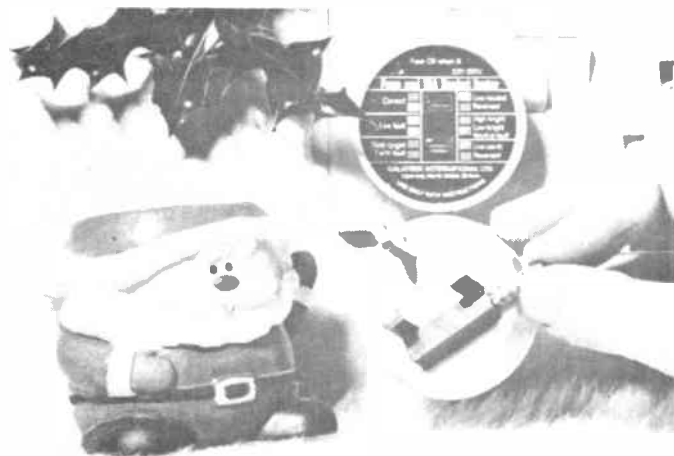

CLUB NEWS

TV anniversary

On 2 November 1936 the BBC began the first high-definition television service in the world. The first picture, watched by an audience of about 2,000, was transmitted from Alexandra Palace in North London. By the start of the war in 1939, audiences were reaching 50,000 when transmissions abruptly ceased.

Today the audience for BBC programmes can reach 1,500 million, as they did during relay of the Live Aid concert to a world-wide audience last summer. In just half a century it has become the most powerful communications medium.

To commemorate this anniversary, the BBC Club's Ariel Radio Group mounted a special exhibition amateur radio station from Alexandra Palace. Using special licences granted by the Post Office, transmissions took place on the short wave and VHF bands, as well as amateur television pictures on UHF frequencies. A special card was produced and sent to everyone the station contacted. The event ran from 30 October until 2 November.

Further information regarding the Aerial Radio Group may be obtained from the honorary secretary, Trevor Butler, on 01-927 4372.

Good news for ATV

EATWG (European Amateur Television Working Group) is a recently formed international ATV organisation. The organisers believe that, apart from AMSAT, it is possibly the first time that a specialty mode has organised itself internationally.

EATWG is an umbrella organisation aiming to protect and promote the interests of ATVers via national amateur radio societies, government licensing authorities and the IARU (International Amateur Radio Union).

ATV currently finds itself threatened from several directions, say EATWG. This threat comes in the form of

governments wishing to reallocate parts of the amateur spectrum for their own use (as in Belgium), or even amateur organisations who consider that a wideband mode is not of interest to the hobby as a whole. It is EATWG's opinion, however, that 'wideband modes are the sole justification for a full 10MHz allocation at 70cm'.

The organisation will seek to get a fair deal for amateurs. They consider it unfair, for instance, that in Switzerland ATV on 70 has been banned, not by the government but by the national radio club, USKA!

EATWG will undertake the tasks of promoting ATV operation, maintaining cooperation between all users of the amateur UHF and microwave bands, and coordination of bandplans, technical standards and contests on an international basis.

The group has a healthy financial base and is developing into a strong organisation. There will be an annual meeting and regular newsletters will be circulated.

Worth weekend

On the weekend of 11/12 October young people gathered at Worth Abbey in Sussex for an event aimed at increasing the involvement of young people in the PHAB (Physically Handicapped and Able-Bodied) and MENCAP organisations.

The Sussex Raynet group was actively involved, providing radio control all weekend with the help of local CBers.

School, hospitals and youth groups participated in a wide range of sporting and outdoor activities, commencing at East Grinstead, where able-bodied youngsters met their disabled partners for a hike along Worth Way. This bridle path proved a challenging cross country route for wheelchair drivers.

After a well-earned break for tea, participants tackled the final stage of the journey to Worth, where camp had been established in the local school grounds.

Sunday's schedule of events included archery, chess, bridge, snooker, sailing, abseiling, etc.

All in all it was a very successful weekend, with local radio hams and CBers providing valuable help.

Quality assurance

The Department of Trade and Industry recently published a consultative document entitled: 'Proposal for the establishment within the radio communications industry of an independent third party quality assurance scheme under the aegis of the National Accreditation Council for Certification Bodies'.

The Government believes that such a scheme would enable the radio industry to make substantial savings, as has been the case with similar quality assurance schemes in other industries. The provision of this would lead to better management and good quality products which are well installed and properly used. It would also boost confidence in British products internationally.

Copies of the document are available from the DTI RRD at Room 409, Waterloo Bridge House, Waterloo Road, London SE1 8UA.

Data communications

The British Amateur Radio Teleprinter Group (BARTG) is dedicated to all aspects of data communications. Membership is open to clubs and individuals world-wide who have an interest in RTTY, computers, construction, Amtor, packet radio, digital data transmission, FAX, contests and awards.

Members receive four copies of the group's journal, *Datacom*. It contains many interesting items and articles on various aspects of data communications.

Subscription rates for 1987 are as follows: UK - £7.00; Europe and Eire - £10; overseas surface mail - £10; overseas airmail - £16. Applications should be made to the membership secretary, Mrs Pat Beedie GW6MOJ, 'Ffynnonlas', Salem, Llandeilo, Wales SA19 7NP. Tel: (0558) 822286.

Award information

Sue Squibb G1TZU, who has been mentioned from time to time in Trevor Morgan's SWL column and is the proud holder of an *Amateur Radio Gold Prefix Award*, was an SWL for five years before passing the RAE this year. She hopes to gain her Class A licence soon.

During this period she has applied for many awards,

obtaining much information on the subject in the process. As a result, she has compiled a booklet listing full details of over 250 awards and diplomas.

If you are interested in obtaining a copy of the booklet, it costs £3.00, US\$8 or 15 IRCs and is available from Sue at 36 Frognaal Gardens, Teynham, Sittingbourne, Kent ME9 9HU.

Rally successful

The South Bristol Amateur Radio Club reports that this year's rally, which took place in October, was a great success, and plans for next year's event are already under way.

History buffs may be interested in a lecture to be hosted by this club on 3 December, entitled 'Amateur Radio in the 1930s' and presented by Ken G5KT.

On the 10th there will be a video evening and a look back at the events of 1986, followed on the 17th by a Christmas 'families evening'.

The venue for all meetings will be the Whitchurch Folk House, East Dudry Road, Whitchurch, Bristol BS14 0LN. Regular meetings are held on Wednesdays.

Further information is available from Len Baker G4RZY, c/o 62 Court Farm Road, Whitchurch, Bristol BS14 0EG. Tel: (0272) 834282.

More junk

Following a Christmas social on 10 December, the South Essex Amateur Radio Society (SEARS) is holding a junk sale on the 17th.

The society publishes a newsletter, *Newsflash*, every month and the editor is currently appealing for contributions and feedback.

SEARS meets each Wednesday at The Paddocks in Canvey Island at 7.30pm. Correspondence and enquiries should go to Albert Smith G4FMK, 8 The Parkway, Canvey Island, Essex. Tel: 683805.

New secretary

Readers may be interested to learn that the Basingstoke Amateur Radio Club has elected a new secretary.

Henceforth, information on club activities and membership details can be obtained from Mr A Windsor G1OQU, 28 Mendip Close, Buckskin 2, Basingstoke, Hampshire RG22 5BP.

More festive bargains

Christmas junk sales are definitely in vogue this year, and the Mid Lanark ARS has one scheduled for 12 December.

On the 19th, Gordon Hunter GM3ULP will present a Christmas film show.

All meetings are held at Wrangholm Hall, Community Centre, Jerviston Street, New Stevenston, Motherwell ML1 4UQ.

Further information is available from the secretary, David Williams GM1SSA, 32/34 Carfin Street, New Stevenston, Motherwell ML1 4JL.

Ham junk

On 11 December the Edgware and District Radio Society is holding a junk sale (who isn't?), so junk junkies in the area should get there early to avoid missing any bargains.

December's 80m club net is on 28 December from 9.15am on 3.775MHz \pm QRM.

Further information is available from Richard Cottrell G3SHY on Garston 672711.

Anti-Christmas

The Spen Valley Amateur Radio Society is refusing to take Christmas seriously this year. On 4 December 'Breathalyser' is the title of Derrick Allan G1DWA's lecture, and on the 18th an 'Anti-Christmas Anti-Social' is scheduled.

Meetings are held on Thursdays at 8.00pm at the Old Bank Working Men's Club, Mirfield in Yorkshire.

Details are available from Ian Jones G4MLW on Heckmondwike 409739.

A festive air

The Maltby Amateur Radio Society's December schedule kicks off on the 5th with an activity night on the air. This is followed on the 12th by a lecture 'Direct Conversion Receiver for 80m'.

The 19th of the month takes on a more festive air with the society's annual Christmas Junk Sale and Buffet.

All meetings commence at 7.30pm at the Community Centre, Clifford Road, Helaby (just off the M18, Junction 1), between Rotherham and Maltby.

More details of these events and the society generally can be obtained from the secretary, Keith Johnson G1PQW, on (0709) 814135.



G4ULD, who is also a group scout leader, supervises the construction of electronic devices at the Surbiton District Scouts JOTA station GB2BG. Successful completion of the project earned Scouts a credit towards obtaining the Electronics badge. The project design and kits of parts were provided by the Wimbledon and District ARS.

It's Christmas!

A busy December schedule has been arranged by the Mid Lanark Amateur Radio Society, beginning on the 12th with the annual Christmas bring and buy sale.

On 19 December Gordon GM3ULP will be presenting his traditional Christmas film show, which will include his other hobby, steam railways, among other things.

The society meets every Friday at 7.30 at the Wrangholm Hall Community Centre, New Stevenston in Motherwell, where weekly RAE classes are held and a constructors' club tackles projects suggested by members.

More information can be obtained from David Williams GM1SSA, 32/34 Carfin Street, New Stevenston, Motherwell ML1 4JL. Tel: Holytown 732403.

CQ-TV subs

Readers are reminded that subscriptions for membership of the British Amateur Television Club (BATC) are due on 1 January 1987. A full year's subscription costs £5.00, or £1.25 for each quarter.

Members receive four issues of the BATC's informative and well presented journal, CQ-TV. The winter edition includes satellite TV and contest news, a project to build a satellite TV receiver, a modification for the Robot-

400 and a lot more. The editor welcomes contributions.

Membership application forms are available by sending a SAE to Dave Lawton G0ANO, 'Grenehurst', Pine-wood Road, High Wycombe, Bucks HP12 4DD.

Contributions for CQ-TV should be submitted to the editor, John Wood G3YQC, 47 Crick Road, Hillmorton, Rugby CV21 4DU.

Wirral ARS

The Wirral Amateur Radio Society meets on the first and third Wednesdays of each month at Ivy Farm, Arrowe Park, Wirral. All meetings commence at 8.00pm and visitors are welcome.

On 3 December the society has a lecture lined up entitled 'RTTY and other things' by Bill Evans G3VQT and Peter Stein G8WQB.

A bi-monthly newsletter is published which goes to all society members. Further details can be obtained from Roy Bridson G3VEB, 17 Zig Zag Road, Wallasey.

Fareham and District

The December programme of events for the above club includes a lecture, 'Decoding Morse with a Micro' by Trevor G6TJT on the 3rd and a natter night on the 10th.

The Fareham and District ARC meets every Wednesday at 7.30pm. Details of venue, etc can be obtained from the secretary, A S Chester

G3CCB, at 'Deva Wood', 44 The Ridgeway, Down End, Fareham, Hants PO16 8RE. Tel: (0329) 288139.

QRP

Low power communications enthusiasts may be interested in a talk on QRP equipment kits by G3ZOM, to be hosted by the Stourbridge and District Amateur Radio Society on 15 December.

Club meetings are held on the first and third Mondays of each month at 8.00pm. The venue is the Robin Woods Centre, School Street, off Enville Street, Stourbridge.

Further information on the club can be obtained from Clive Williamson G4IEB on Stourbridge 392006.

In CARS

The Coventry Amateur Radio Society is hosting a talk, 'All About Raynet', on 5 December, followed on the 12th by a night on the air.

Just to show what a sociable lot CARS members are, it's all down to the Bull and Butcher on the 19th for a very informal meeting.

Meetings take place every Friday at 8.00pm at Baden Powell House, 121 St Nicholas Street, Radford, Coventry.

If you would like further details on the Coventry AmRad Society activities, get in touch with the club secretary, Bill Hahn G3UOL, at 91 The Chesils, Coventry CV5 9NA. Tel: (0203) 414684.

ON THE SHELF . . .

Modern Electronic Test Equipment, by Keith Brindley. Published by Heinemann Newnes. Price £6.95. ISBN 0-434-90567-4

Modern electronic appliances are often digital in nature, microprocessor-based in technique and more and more complex in operation. But complex appliances require correspondingly complex test equipment, and sometimes completely new types of test instrument (such as the logic analyser).

Modern Electronic Test Equipment describes in a down-to-earth manner how the main categories of test equipment work, allowing the reader to compare available instruments, make an informed choice and then to use the equipment to the best advantage.

The subjects covered include analogue and digital meters, oscilloscopes, signal sources, frequency, time and event counters, spectrum and logic analysers, displays and automatic test equipment.

Keith Brindley has been a technical writer specialising in electronics for over eight years.

Modern Electronic Test Equipment is obtainable from William Heinemann Ltd, Upper Grosvenor Street, London W1X 9PA. Tel: 01-493 4141.

Radio Database International 1987. Published by Interbooks. Price £12.50 + £1.00 P&P (airmail £6.00 and sea mail £2.00)

The 1987 edition of *Radio Database International* will enable you to keep abreast of the developments in international radio.

It features up-to-date world-scan schedules presented in frequency order in a clear, easy to read fashion.

Major stations are listed alphabetically by country, with quick access schedules.

A buyer's guide section is also included, with reviews on equipment ranging from inexpensive portable travel radios to high performance receivers.

Radio Database International is available from Interbooks, Stanley, Perth PH14QQ. Tel: (0738) 828575

The Complete Shortwave Listener's Handbook - 3rd edition by Hank Bennet, Harry L Helms and David T Hardy. Published by TAB Books Inc. Price £15.30. ISBN 0-8306-2655-7

The first edition of *The Complete Shortwave Listener's Handbook* was compiled by Hank Bennett and printed initially in 1974. It is Hank's ability to communicate his extensive radio knowledge to non technicians that has made the book such a success.

Even if the reader has experienced little more complicated than trying to find Radio 4 on the air waves, this book will introduce them to the more complicated and exotic side of listening with little confusion.

Although it has been revised, initially by Harry L Helms and for the 3rd edition by David T Hardy, and has been written primarily for the American market, the book retains its simple approach and interest to listeners of all levels.

All the basics of listening are covered in the book, including receivers, antennas, frequencies, radio wave propagation, Q-codes, log book upkeep and how to prepare and send reception

reports.

The latest revision has included the most recent equipment and changes in stations, procedures and operating practices.

Whether you've been SWLing for years or have just been drawn into the hobby, this book contains reams of useful information that will help you to get the most from your hobby.

The Complete Shortwave Listener's Handbook is distributed in this country by John Wiley & Sons Ltd, 1 Oldlands Way, Bognor Regis, West Sussex PO22 9SA, but is available on order through local emporiums.

A TV-DXers Handbook by R Bunney. Published by Bernard Babani (publishing) Ltd. Price £5.95. ISBN 0-85934-150-x

Roger Bunney is one of the leading authorities in the country on this subject and an active TV-DXing enthusiast. In the *TV-DXers Handbook* he discusses the possibilities and problems of receiving television signals over long distances and resolving a picture with minimum of distortion on the TV screen.

To produce this new book he has extensively revised, enlarged and completely updated his previous works on the subject. The satellite TV section has been greatly expanded to include further information, as 'direct-to-home' transmissions are expected to herald the most dramatic changes ever in the broadcasting field.

Also included are many units and devices which have been designed by experienced enthusiasts, and often considerable ingenuity and thought have gone into their practical development to overcome individual problems.

The information in this book is sure to be a practical guide for the beginner and a usefull source of reference for the established enthusiast.

A TV-DXers Handbook is available direct from Bernard Babani (publishing) Ltd, The Grampians, Shepherds Bush Road, London W6 7NF, or on order through your local book shop.



L·E·T·T·E·R·S

ZC4 PROJECT

The reason for this letter is to give notice of a proposed project, hopefully to be undertaken by the ZC4 clubs from both the eastern and western sovereign base areas here in Cyprus, to attempt to establish a 2m link between these areas and the United Kingdom.

The plan is that as we have just re-activated the Episkopi Radio Club we try for a worthwhile project to get the club and ZC4 on the map, as it were. Accordingly, we have decided that we should try for a project that would give the majority of members and the amateur radio fraternity as a whole the most satisfaction and also stand a good chance of succeeding!

We understand that a two-way link was achieved on 4m between 5B4AZ and GW4ASR/P in 1981 but, as stated, we are endeavouring to make a 2m contact, which we believe has not been done

before. It is proposed to attempt this during the last week of May 1987 and the whole of June 1987.

The station itself will hopefully be located somewhere in the Troodos mountain range, the highest point of which is somewhat in excess of 2000m asl. At this moment in time we are unsure of the callsign to be used, but we are naturally hopeful that it will be a full ZC4 call. However, there is a bit of a problem about the legality of this and we may well have to use ZC4---/5B4 (a good combination nevertheless).

We envisage using CW to make any initial contact and if conditions are then judged to be favourable to switch to SSB. We also hope to be able to provide some form of meteor-scatter equipment. As well as this, we shall aim to establish some form of engineering link either on 50 or 70MHz to enable us to monitor the band conditions.

This will be of necessity receive only as we are not permitted these bands at the moment. It is also proposed to use an HF link for establishing any initial contact with stations and to use for talk-back if required.

We require several types of assistance. Firstly, and most importantly, any information that anyone has on the type of equipment that we may need and any other information in the way of sound technical advice that people may wish to give us. Also we need a contact in the UK to do any arranging that may be necessary. We may also need the loan of some specialist equipment unavailable here in Cyprus, but I think that any particular needs cannot at the moment be highlighted.

I look forward to hearing from any club, society and/or individual who would like to partake in this experiment and to anyone who may be able to offer any advice.

**A L Poore ZC4AP/GOCAC,
JSB, BFPO 53, London**

GOLIATH

I am engaged on a programme of research into a very low frequency transmitting radio station established in Germany in late autumn 1941. The station, called 'Goliath', was near the village of Kalbe (Saxony, Prussia) and partially straddled the River Milde.

I seek any information on this station, no matter how small or seemingly trivial, such as drawings, photographs, technical details or personal memories by German or Allied personnel. Any documents loaned to me would be treated with care and postage refunded.

Mr T F Bernascone (Goliath Research Project), Teesside Polytechnic, Borough Road, Middlesbrough, Cleveland TS1 3BA

WE ARE IN COLOUR!!! COMPLETE BUDGET-PRICE COLOUR VIEWDATA TERMINALS

Deccafax colour terminals with 14" display for PRESTEL or other 1200/75 V23 systems

Deccafax Terminal 781/VP1

£108.75 inc VAT

or with 8-Channel Remote Control Colour TV and Teletext

Deccafax Terminal 780/VP2

£175 inc VAT

VP1 Plinths are new; other items are used but in good working order
ALSO

Deccafax Plinth VP1 £19.95 inc VAT

Deccafax Plinth VP3 (RS232) £15.95 inc VAT

AND FOR MESSAGES OR TELEX VIA PRESTEL

Alpha numeric Keyboard £63.00 inc VAT

Carriage on plinths, add £5, complete terminals according to distance
SAE for details to:-

**M E M, 166 Maney Hill Road, Sutton Coldfield,
West Midlands B72 1JW
TEL: 021-354 7375**

R.S.P. ELECTRONICS 109 Eastgate Street, Gloucester GL1 1PY Tel: 0452 23034

TRANSFORMERS

6 0 5v 250ma
12 0 12v 150ma
24 0 24v 100ma
20 0 20v 1A
35v 2A
7.5/160v 250ma
0 12 18v 3A
17 0 12 3A
40 0 40 1A

CAPACITORS

100uf 63v
47uf 160v
47uf 25v
220uf 40v
1000uf 16v
1250uf 25v
2200uf 25v Radial
2000uf 4v
32 - 32uf 350v
2500uf 50v
4700uf 30v Radial

150p

260p

240p

280p

300p

180p

290p

320p

230p

SEMICONDUCTORSICs

AU 103
AC 128K
AF 180
BA 182
BD 253
BF 159
LA 3350
MC 1310p
MB 3712
TCA 160B
TBA 810AS
W02 220v 1A Rec
2N 5294
DPDT Min Slide
DPDT Toggle 2A

160p

35p

65p

20p

80p

25p

72p

140p

150p

48p

70p

35p

70p

15p

50p

CARBON COMP RESISTORS

50p per 100 1 value £3.00 per 1000 1 value

MANY VALVES AVAILABLE

ADD 70p p&p - 15% VAT

SECURITY

Systems, Modules, Accessories

COMPLETE
SECURITY
SYSTEMS
START FROM

ONLY £39.95
+ VAT



US 5063 £13.95 + VAT
DIGITAL ULTRASONIC
MOVEMENT DETECTOR

CA 1250 £19.95 + VAT
CONTROL
UNIT



CK 5063 £37.00 + VAT
SELF CONTAINED ULTRASONIC ALARM KIT



IR 1470
£25.61 + VAT
50 FOOT I.R.
BEAM
SYSTEM

Shown above is a small sample of our comprehensive range which includes:
★ Magnetic contacts ★ Vibration switches ★ Bell boxes
★ P.A. switches ★ Cable ★ Door ★ Window locks etc. etc.

Send for full
details or come
to our Showroom
and see the
units on
demonstration.

Monday to Friday
9am to 5pm
Closed Wednesday
Saturday 9am to 1pm

FROM THE SECURITY SPECIALISTS **RISCOMP LTD.**

Printed in
England
Printed in
Bucks HP17 9QB
Tel: (064 44) 5326

Add 15% VAT to all prices
Add 75p post and packing to all orders
Order by telephone or post
using
your credit card

COMASID INT (UK) LTD

ARE IMPORTERS OF:

SIRIO: ANTENNA FROM HF TO UHF mobile and base including Amateur Marine PMR radio phone

R F COAX: RG213 - RG214 - RG58 - RG59 in qualities ranging from standard to military specs all stamped with quality

PSU's: From/30amp fixed and variable metred/unmetred.

**ALL FIRST CLASS QUALITY
TRADE ONLY**

**TEL: 0905 29118
TELEX 336655**

**CALL US WITH YOUR
ENQUIRIES**

**VIEWING AT THE
HAM SHOP
WESTBURY HOUSE
RAINBOW HILL
WORCESTER**

NEW BBC LOCATOR AND WORLD MAP

Shows world map with daylight and darkness zones continually updated with dual time clock. Automatically accepts any input of lat/long, either locator, NGR or one of nearly 250 worldwide placenames and gives you the distance, heading, contest score, long path details and plots the great circle from you to the other station. **Tape £7**

For CBM64, VIC20, SPECTRUM we have our original locator program (no map) at the same price.

TX-3 RTTY/CW/ASCII TRANSCEIVE

The most comprehensive transceive program around with so many features we can't list them all here (see previous adverts). Can use an interface or a terminal unit. For **BBC-B** and **CBM64**. **Tape £20**. If you have our RTTY/CW transceive program, return it with your order for a **£10 discount**. For **VIC20** we still have the RTTY/CW transceive program at the same price.

RX-4 RTTY/CW/SSTV/AMTOR RECEIVE

This bestselling program has all the features and performance for the discerning listener. Full printer support. Uses interface or T.U. on CW and RTTY for **BBC-B**, **CBM64**, **VIC20**. **No hardware needed for SPECTRUM**. **Tape £25**.

You don't need an expensive terminal unit for these programs, our **TIF1 INTERFACE** has 2-stage RTTY and CW filters for excellent performance. Kit (assembled and tested PCB, connectors, cables) £15. Boxed with all connections £25.

We also have **MORSE TUTOR**, **RAE MATHS**, **LOGBOOK** programs for **BBC-B**, **ELECTRON**, **CBM64**, **VIC20**, **SPECTRUM**. All BBC and CBM64 programs are available on **disc at £2 extra**.

Prices include VAT and p&p, 1st Class inland, airmail overseas, normally by return. Eire, C.I., BFPO deduct 13%.



technical software (AR)



**Fron, Upper Llandwrog, Caernarfon LL54 7RF.
Tel: 0286 881886**

STAMFORD ELECTRONICS

3½" 8 OHM 2W Speaker - **65p**, 1¼" 15 OHM 100mW Speaker - **32p**, 5mm Red Leds - 10 for **70p**, 12 Way Barrier Strip - **30p**, Vero 2 x 24 Way Edge Connector - **£1.50**, Burgess Microswitches - **30p**, 2N1595 1A 50v Thyristor - 10 for **40p**, 50-0-50µA Meter - **£1.25**, Printer Tape O.K. for Creed 75, 54, 444 etc. - **90p**, Chassis with 100KHZ Crystal & 4 valves ex Ministry - **£3.85** (p&p **£1.25**), BNC 75 OHM Plugs (Crimp) - **50p**, BNC 75 OHM Socket (Crimp) - **50p**, Plastic Box 3½" x 1¼" x 1" - **65p**, Plastic Box 6" x 3¼ x 1¼" - **90p** (p&p **£1.00**), IN4001 Diodes - 10 for **20p**, 50v 1 Amp Diodes - 10 for **15p**, Asstd. Polyester Caps - 10 for **20p**, Miniature Motors 1.5 volts - **30p**, 28 Way Tag Strips - **30p**.

Resistor Kits: Carbon Film - ¼w 5%, 10 ea. E12 values 10HM - 10M (850 pieces) - **£5.95**. Metal Oxide - ¼w 1%, 10 ea. E12 values 10 OHM - 1M (510 pieces) **£9.50**. CMOS 4001B, 4002B, 4007UB, 4011B, 4012B, 4023B, 4069B, 4078B - 10 Asstd. for **£1.50**. Transistors: BFR90 - **80p**, BFR91 - **95p**.

Mosfets: 3SK88 - **68p**, BF960 - **65p**, BF961 - **65p**, BF963 - **65p**, BF966 - **72p**.

Electrolytics: Radial 100MF 10v, 22MF 16, 100MF 16v - 10 Asstd. for **50p**. Radial 220MF 16v, 470MF 40v, Axial 100MF 40v - 10 Asstd. for **65p**.

Variable Power Supply with LM317T Reg. 2-20v 1.5A with info - **£3.95** (p&p **£1.00**).

Metal P.C.B. Pillars with screws - 10 for **20p**, Pack of Asstd. dia. Heat Shrink Sleeving - **£1.45**.

Stockists of: Resistors, Capacitors, Diodes, Intergrated Circuits, Transistors, Wire, Conneters, Switches, Keyboards, Relays, Indicators, Solder & Irons, Transformers, Hardware, boxes, Books.

Please add 75p p&p unless otherwise stated

STAMFORD ELECTRONICS

219-221 Old Street, Ashton-U-Lyne, Lancs OL6 7SR
Tel: 061-344 0517



SHOWING OFF

A report on this year's Leicester Amateur Radio Show

One of the rally calendar's major events, the Leicester Amateur Radio Show, was held on the weekend of 24/25 October this year at its usual venue, the Granby Halls.

Attendance figures were slightly up on last year, at approximately 7,000. Lessons

learned on previous years obviously contributed to the efficient manner in which the show was organised, and there were no noticeable hiccups.

The bring-and-buy stand drew the usual crowds, but visitors were also forking out



Tony, of Spectrum Communications drives a hard bargain



*Take a tip from me . . .
Glen Ross G8MWR on the Microwave Society's stand*

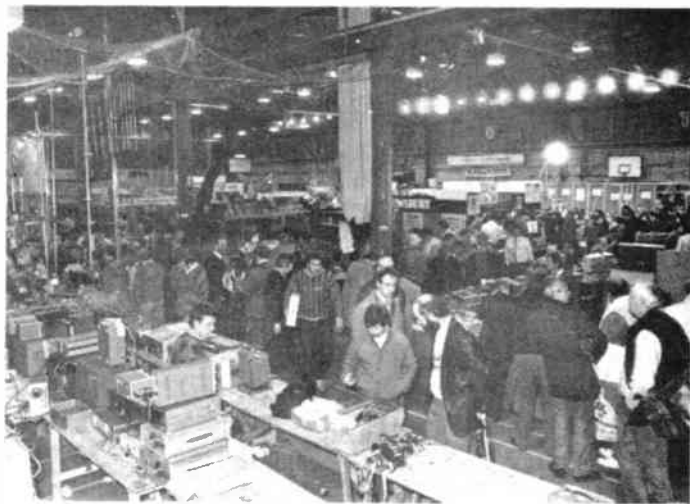

The Leicester Amateur Radio Show 1986



*'Take it while I'm smiling!'
We were happy to oblige Leicester's Repeater Group*

for new equipment, judging by the reports from exhibitors. Ray Withers, of R Withers Communications, looked like the cat that got the cream at the end of the show. He had chosen this event to launch the Storno CQM 713 modification kit, which proved so popular it sold out on the first day! Stocks were hurriedly replenished for the Saturday.

The RSGB launched Angus McKenzie G3OSS's book at the show, *The Buyer's Guide to Amateur Radio*, which is reviewed by John Heys G3BDQ in this issue. Angus himself put in a welcome appearance on the stand we shared with our sister publication, *Radio and Electronics World*.

Other 'faces' at the show were funny man Kevin Fox, Roger Alban GW3SPA, Ken Michaelson G3RDG, and, of course, the sprightly(!) Glen Ross G8MWR, who was on the Microwave Society stand with XYL, Val.

We were pleased to get the opportunity to talk to so many of our readers, and

appreciated your comments and suggestions. We had brought a car full of the November issue of *Amateur Radio*, and these proved so popular that we had sold out by 3.30pm on Saturday.

Totting up at the end, the organisers patted each other on the backs and proclaimed the rally a success. See you there next year?



Wake me up before you go go . . .



DX DIARY

News for HF operators compiled by Don Field G3XTT

Sunspots are back in fashion! Or at least they were during October, much to the delight of operators in the CQ WW SSB Contest. After a long spell of almost no sunspot activity during the summer, sunspot numbers suddenly increased to 31 on 3 October and stayed at that level for some time, rising to 92 by the contest weekend. Solar flux, which is the more scientific measure, started to creep up a little later, but was up to 98 by the start of contest, from a level of around 70 for several months previously.

Consequences

The consequence of all this solar activity was that ten metres opened to Australia and the Far East, with excellent contest signals from Indonesia and Thailand (HS0A), as well as most VK call areas. Indeed, one British operator reports hearing W9OBE/KH2 in Guam. There were also openings to the USA, and 15 metres provided a 'pipeline' into the west coast of the USA with literally hundreds of W6s and 7s pounding in. The other bright spot on 15 was the level of activity from China. At least one G station worked no less than five BY stations on the Saturday morning of the contest.

Whether all this is an indication that we are over the worst of the sunspot minimum, or whether it is just a temporary improvement, I don't know (and the experts aren't prepared to commit themselves at the moment either). But it certainly gave a boost to HF DXers and contesters.

CQ World-wide review

While on the subject of the October contest, it's worth recording that, as always, there was a lot of DX to be worked on all bands. For example, I worked some 51 countries on Top Band, and I know of at least 11 more which were there for the taking. Some of the unusual prefixes in the contest included P36 (Cyprus), J48 (Greece), J49 (Crete) and YE0 (Indonesia). I haven't included QSL information here for the many contest stations, but if you need help with any of it please drop me a line, with return postage please.

What next?

Supposing that propagation remains favourable, what will there be to look out for during December?

Peter ZL8HV (ex ZL9AA) is now operational from Ker-madec Island with an IC720A and wire antennas. He is there for a year and will be active on all bands. Unfortunately he is asking for QSLs to be sent direct to him on the island, which could lead to long delays as ships do not call there very often.

JA4GXS/JD1 was due to be operational from Ogasawara Island during the last week of November and the first week of December.

TP2CE, from the Council of Europe in Strasbourg, is due to be activated again from 5-7 December. This one, of course, is not a separate 'country' but is an interesting one to put in the log, if only for the unusual prefix.

The following weekend, 13/14 December, look out for

FY9IS from Salut Island. This is off the coast of French Guiana and counts for the Islands on the Air Award.

YASME

The YASME expedition to Africa appeared on the bands at the end of October, signing FR/W6QL from Reunion Island. They were having problems getting licences from some of the other Southern African countries they had hoped to visit, but intend to spend about three weeks in each of a number of spots, through to next spring. Look for them around midday on 15 metres CW, which is where they often put in an appearance (try 21010kHz).

The YASME Supreme Award is now available free of charge to amateurs providing evidence of contacts with at least 60 YASME callsigns, including those of YASME officials. The award takes the form of a trophy representing the original YASME yacht. Further information can be obtained from G McKercher, WOMLY, RFD 1, Perry, IA 50220, USA.

WA2HZR, well known for his operations from the Southern African homelands, was expecting to put in an appearance from the Caribbean island of St Kitts in late November/early December.

ZD9CL has been replaced on Tristan da Cunha by Allen ZD9CK, who will be there for a year and promises to be operational on all the HF bands.

SM0AGD was due to have been operational once again from Tanzania during November. He now has all his earlier

5H logbooks from his QSL manager, SM3CXS, so if you are still in need of the card, send it direct to him.

HZ1AB, the club station in Saudi Arabia, is reported to be back on the bands after a protracted absence. Unfortunately, they only have an FT902 to a vertical, a far cry from the enormous antenna farm they used to possess. They do, however, hope to be using a linear again shortly.

Malawi

Les 7Q7LW is back in Malawi, but only until 11 May when he leaves after living there for 45 years. He will also be absent from the UK between 13 December and 15 January. When in Malawi he is restricted to generator power, which is available only at the following times: 0200-0600, 1000-1200 and 1500-2200GMT. He is still the only station active from there, so if you still need it for a new one I suggest you get it quickly! From my own experience Les is always prepared to help with requests for a CW contact or a QSY to another band.

JF1IST, who was responsible for the last operation from Okino-Torishima before it was deleted from the ARRL list, arrived in Egypt in October for a 2 month business trip. While there he hoped to operate from Abu Ail and perhaps elsewhere in the area. I have no idea of exact dates, but it could well be worth keeping an ear to the bands.

I have a letter from N3QA to the effect that he will be back in Chagos from mid November to mid March. Readers

will probably be aware that the Chagos Islands, although under British jurisdiction, host a major US military base, and activity from there on the amateur bands tends to vary dramatically according to whether the fleet is in.

As mentioned in my October column, JA5DQH was due to sign as XX9XX from 25 to 28 November, going on to Hong Kong the following day to operate as NN7S/VS6 in the CQ WW CW Contest through until 5 December. The frequencies to check are 1822, 1831, 1909, 3506, 7006, 10101, 14026, 21026 and 28026kHz. Aki is a real LF 'nut', and a regular on 160 metres from his home QTH during the winter season (he was my first JA contact on Top Band, and by far the strongest signal from Japan on the band on that particular occasion).

3G9SBY is the unusual call to be aired from Antarctica for one month by a group of Chilean amateurs. They will be active from 5 December on 10-160 metres, on CW, SSB, RTTY and Amtor.

The Long Island DX Bulletin reports rumours that K6EDV and others will operate from the Spratly Islands in January. More certain are the rumours of a major operation from Revilla Gigedo (XF4) in March. This remote island has always been a difficult one for European DXers to work because the propagation path is not an easy one and because previous expeditions have tended to operate in Spanish! If this joint Mexican/US initiative comes off it ought to improve matters considerably. Watch this column for more details.

KD7P

Bob KD7P is currently aboard the USCGC Polar Sea, the world's most powerful non-nuclear icebreaker. He will be in the vicinity of Peter 1st Island around Christmas and was hoping to put this potential new DXCC country on the air for the first time. However, the Norwegians, who claim the island as theirs, have not responded to requests for landing permission, presumably because a major landing by a unit of the US military would undermine Norway's claim to the island. Although no Norwegian has set foot on the island since 1929, Norway is anxious to protect its territorial claim in

order to safeguard its fishing rights and possible future exploitation of undersea mineral deposits.

I suspect, on this basis, that it will be some years before we see the first amateur radio operation from Peter 1st Island. However, Bob is determined to operate from some of the other more hospitable locations on the ship's itinerary. These include the Galapagos Islands, Chile, Antarctica, the Solomon Islands, New Caledonia, Guam, and other Pacific locations. Finally, he has already said that he hopes to be operational from China as BY4AA in next March's CQ WPX Contest.

Awards

Martin Atherton G3ZAY, who chairs the RSGB HF Committee, makes a request for feedback from UK amateurs on problems they may have had obtaining awards from overseas societies and clubs. Various one-off instances have been reported, but it is difficult to make representations to the countries concerned without a clearer picture of where the problems lie. If you have had difficulties then write to Martin at PO Box 146, Cambridge, giving the details.

10MHz

Last month I mentioned that there appeared to be a 10MHz allocation for USSR amateurs. Lo and behold, about two days after I wrote those words the band was released to them. The result can only be regarded as beneficial: increased activity on the band when it seemed to be declining to an all-time low.

At the same time controversy continues to rage over whether SSB activity should be allowed on the band. The RSGB is, I know, trying to fairly represent the views of UK amateurs, while abiding by the existing IARU agreement to stick with CW. Anyone who listens or operates on the band will be aware that there is still a high level of activity from commercial stations, and interference to them by amateur stations would prejudice our prospects for retaining use of the band.

At the same time, if no amateur signals are to be heard on 10MHz, the powers



Andy VE1ASJ, who has operated from Sable and the St Paul Islands, and VU2RBI, who was at this year's HF Convention



that be could argue that we don't need an allocation there at all! Perhaps the best way forward for the moment is to wait and see what happens to activity now that a major new block of countries has access to the band, and now that more and more organisations are allowing 10MHz contacts to count towards their various awards.

Top Band mailbox

DX News Sheet reports that Bob KA1SR, editor of *The 160 Meter Bulletin*, runs a mailbox on 14082kHz dedicated to Top Band information. The machine runs at 45.5 baud/60wpm and is accessed by sending 'CR-LF DX CR-LF'. Further information is available from Bob at 5 Watson Drive, Portsmouth, RI 02871, USA.

Contests

After the hustle and bustle of the October and November contest season, December is a month for relaxing. The major events are all single band affairs: the TOPS 80 Metre CW Contest on 6/7 December (from 1800GMT Saturday for 24 hours); the ARRL 160 Metre CW Contest running for the whole of the same weekend; and the ARRL 10 Metre Contest (both CW and SSB) the following weekend (13/14 December), which may well be worth a

look if propagation continues to be favourable.

Marion Island

Finally, *DX News Sheet* recently carried news about ZS2MI, the callsign used for operations from Marion Island. The station appeared on the bands on 30 August, quite out of the blue, leading to accusations that it was a pirate. In actual fact it was the real thing, but unfortunately the operation will not count because the two operators, who held VHF only licences, had failed to clear their operation with the South African authorities (previously such VHF only licences have been allowed to operate from ZS2MI on the HF bands, but only with prior permission).

The two operators in August were scientists there with an expedition to deal with an increasing problem with cats. Apparently the rapid rise in the feline population has been to the detriment of the island's population of birds.

The good news following on from all this is that ZS1EH is looking at the possibility of taking a long period of leave from work and mounting an official DXpedition to Marion Island. However, don't hold your breath as it is only an idea at the moment, and there are plenty of hurdles still to be overcome.

JUST PUBLISHED

3rd EDITION OF

U.K. LISTENERS CONFIDENTIAL FREQUENCY LIST

**50% LARGER, SMARTLY BOUND
with semi-stiff cover.**

**Completely revised:- Now includes lots more
information on MILITARY, CIVIL, AIR,
MARITIME, PRESS BULLETINS, RTTY etc.**

£5.95 + p.p 75p

**4 PUBLICATIONS
YOU SHOULDN'T BE WITHOUT!**

UK LISTENERS CONFIDENTIAL FREQUENCY LIST NEW EDITION

This publication has now sold well over 2500 copies since it was advertised only a few months ago. Now the recent updated version is selling even better. No self respecting listener should be without a copy. If you enjoy exploring the short wave bands then this publication will add to your enjoyment. It covers the hf spectrum from 2 to 30 MHz and gives details of transmissions outside the amateur bands. Specially designed for the UK and European listener it sets out in a very easy way a comprehensive list of hundreds of interesting transmissions that will keep you occupied for days on end! Only a fraction of the cost of other similar publications it contains details of Marine, Air, Military, Embassy, Press and News agencies. Many listings have time schedules included together with comprehensive RTTY details. It tells you the frequencies used by civil and military aircraft whilst flying the Atlantic, when and where to pick up the press bulletins, long distance marine traffic etc and much more. Send today for your copy of this worthwhile publication.

£5.95 p&p 75p

VHF-UHF AIRBAND FREQUENCY LIST

This frequency manual is without doubt the most comprehensive list of VHF/UHF aircraft listings available in the UK. Of vital importance to the airband enthusiast or indeed any keen VHF/UHF listener it sets out in a very easy to follow manner full details of a whole host of stations. Every known UK airfield quencies, etc. Included are Civil, RAF, USAF, MOD, Naval fields on both VHF and UHF bands. There are also air to air frequencies, the Red Arrows frequency, and much more. Send today for your copy and find out just how much you have been missing!

£3.95 p&p 40p

THE COMPLETE UHF-VHF FREQUENCY GUIDE 26-2000 MHz

Many listeners have asked for a guide to the wide VHF/UHF spectrum and to meet this request we have recently published this frequency manual. It covers the range 26 to 2000 MHz and has been specially prepared for the UK listener. Anybody who has used a scanning receiver will know that the wide frequency range involved means that it is difficult to know exactly where to listen. This guide takes all the guessing out of monitoring. It lists all the services throughout the spectrum together with both simplex and duplex frequency splits. If you've spent your hard earned money on a scanning receiver or are considering buying one you'll find that this publication contains a wealth of information that has previously remained un-published!

£4.95 p&p 40p

HF OCEANIC AIRBAND RADIO SUPPLEMENT NEW SECOND ADD.

Prepared in response to many requests for more information about the air traffic on the hf bands this little guide sets out to explain to the beginner how the hf band works in relation to air traffic. It contains full details of the world aircraft frequency bands in the range 2 to 23 MHz together with control frequencies and those commonly used for Oceanic control. Also included are many VOLMET frequencies, the Search and Rescue frequencies used by RAF helicopters and Nimrods, the Hf RT network, London Company frequencies, European control centres etc. An ideal companion for the hf airband listener. Send today for your copy.

£2.95 p&p 35p

**WATERS
& STANTON
ELECTRONICS**

18-20 MAIN ROAD, HOCKLEY, ESSEX - 12 NORTH STREET, HORNCHURCH, ESSEX.
MAIL ORDER TO: 18-20 MAIN ROAD, HOCKLEY, ESSEX TEL: (0702) 206835



ANGUS MCKENZIE

TESTS

We have all been waiting for about three years to see what Yaesu would produce as the successor to the FT980 and FT757 HF transceivers. There have been many rumours about Yaesu beaver-ing away in their design department, and for over a year I have been hearing about the new FT767GX. As long ago as the summer of 1985 I heard that the rig was to have slots in the back for carrying optional VHF transverters, and I understand that it was originally intended to be launched in very early 1986. I do not know the reasons for its long delay, but many will regard it as a rig that has been worth waiting for as it has some excellent radically new features, some of which I consider very important.

The Yaesu FT767 is a general coverage receiver, tuning from 0-30MHz, and transceiving on all amateur bands from 1.8 to 28MHz. It offers multimode facilities, FM, AM, CW, SSB and RTTY, giving up to 100W RF output on all bands. Optional modules can be added to give transceive operation on 50, 144 and 432MHz, and thus in one box you can transmit on all the amateur bands up to 432MHz with the exception of 70MHz, the VHF modules giving just 10W RF output.



YAESU FT767GX

HF transceiver

Innovative features

Before detailing the main facilities of the rig, I feel it would be worthwhile to mention some of the many innovative features, which put this rig into a totally new class. Some may find these features most useful, although others may feel that there are too many eggs in one basket. The transceiver incorporates four microprocessors which provide some incredible new functions. Above the tuning knob are up and down buttons, and not only can you program the up and down steps to be anywhere from 10Hz to 99.9kHz, but there is a simple facility for programming different steps for the different modes of operation, eg 5kHz steps on AM, 1kHz on SSB, and 10kHz on FM. This is a superb ergonomic feature, and I think completely new to amateur radio.

Since the rig has to be capable of operating with the different repeater splits used on 10 metres, 2 metres and 70cm, it is useful to be able to program in a 100kHz minus shift on 10 metres, 600kHz minus on 2m, and 1.6MHz plus on 70cm. The fixed split is achieved using VFOs A and B, and when programmed correctly the BVFO used for Tx, for example, moves as you shift VFO A. This has been one of the main problems when using other HF transceivers with an external transverter, but Yaesu have provided a neat way to overcome the problem!

The rig includes an auto toneburst facility and there is an optional sub-audible tone board available (type FTS-8). You are able to switch on the auto

toneburst facility when you want it, and this allows a 1750Hz tone (very accurate) to be superimposed on an FM carrier for a fraction of a second at the beginning of a transmit period. Operation in the repeater mode is simplicity itself: you just have to press an offset button followed by 'split' to get the preselected and stored repeater shift for the frequency in use. If you wish for the offset to be maintained as you tune across a band, you can press the 'track' button, in which case the repeater shift is maintained. Note that different repeater offsets can be stored for HF, VHF and UHF bands, as appropriate.

These facilities are unique enough in an HF rig, but another amazing first, as far as I can ascertain, is the fact that the IF shift (BPT) is available independently on Tx as well as Rx. A button on the front panel called 'Tx shift' (when depressed) enables a small potentiometer above it to vary the position of the transmitted passband with reference to the carrier position. This allows optimum punch to be given for many different voices, and can correct the tonal balance of various microphones.

Some of the features are unusual, but not unique: the provision of three speeds of AGC, as well as off; the inclusion of an electronic keyer with variable speed and with full break-in capability; the provision of external computer control of almost all the functions; and the supply

of an internal automatic aerial tuning unit which is not an optional extra.

One astonishing feature is that the user has a digital readout of output power and standing wave ratio at the push of a button, and this has only been available before on one or two very expensive pieces of dedicated test equipment.

Front panel facilities

The main VFO is synthesizer tuned in either 10Hz or 1kHz steps, on all modes, selectable with a slow/fast selector button. The tuning knob runs smoothly and can be rotated extremely rapidly, a finger hole (nice and large!) running in a bearing to prevent finger friction. Above the tuning knob are up and down buttons which can be preset to shift frequency by a predetermined shift for each mode. These are called 'program up and down' keys; and have other functions.

To the right of the tuning knob are two more up and down keys which are used for changing from one amateur band to the next in the normal mode, changing frequency in 500kHz jumps in the general coverage mode, or changing memories when the memory mode is selected. The rig includes ten memories, which hold frequency and mode, any offset information being independently stored. On the left of the rig are buttons for selecting VOX on/off, full break-in keying on/off, speech processor on/off, CW side-

tone/monitor on/off, Tx shift, toneburst enable, narrow/wide filters, active on CW and AM, RF preamplifier on/off and 20dB antenna attenuator on/off.

Above these buttons is a row of mini pots or switches for controlling VOX gain, speech processor level, monitor level, Tx shift, AGC (off, fast, medium, slow and dim), this three-position switch having a marginal effect on the various and status readouts and slightly more effect on the S-meter lighting, which is, however, not particularly well lit even at best. On the top left-hand corner of the rig is a five-position meter switch to select PA current, ALC level, compression level, power output and collector voltage.

On Rx, the meter becomes an S-meter with a separate button to turn this into a centre zero meter for FM tuning. Other buttons on the left are for mains on/off, MOX Tx/Rx, notch filter enable, audio peak frequency filter enable (for CW), noise blanker on/off, audio mute on/off and frequency dial lock. Dual concentric rotary pots vary RF carrier and mic gain (fixed gain for FM), noise blanker level and squelch control and audio and RF receive gains.

More buttons

At the top right of the front panel are buttons to switch in the automatic ATU and to enable its tuning, and two microprocessor control buttons for operating the digital forward power and SWR readings. Below these is a matrix pad (five by three), which includes 0 to 9 and various operation buttons concerned with the microprocessor programming. You can select direct frequency entry with this pad and insert VFO frequencies into memory, and vice versa.

These buttons provide switching VFO into memory and memory to VFO on a temporary basis, and are also used to access all the special facilities, including

VFO A/B, VFO tracking, split operation, offset mode, various display modes, memory write and recall, programmable steps for the up and down keys, programming searching and scanning facilities, selecting amateur or general coverage modes, clarifier (RIT in 10Hz steps), and a function key which precedes any second function of many of the buttons, including subaudible frequency toneburst enable and direct numerical frequency entry, etc.

To the left of this pad are buttons for mode selection, LSB, USB, CW, FM, AM and FSK. Three further buttons below the matrix pad select slow/fast tuning steps (this button also being used in some programming functions), mic up/down selection, which enables the mic to operate either the selected VFO tuning steps or the chosen programmable steps, and finally the CW auto keyer on/off. Beneath the keyer switch is a pair of controls to select the keyer speed and the frequency offset, this being switchable to 600, 700 or 800Hz. Two further dual concentric rotaries adjust Rx bandpass tuning and audio tone, audio peak frequency and notch tuning.

The mic socket is a standard Yaesu eight pin one, and beside this is a stereo headphone jack with left and right connections paralleled. The digital readout can resolve down to 10Hz and the display indicates many status functions, including memory data, Tx offset and programming information. When you select digital power output or SWR the frequency display changes to watts full scale or SWR.

On the top panel is a massive heatsink towards the back, and the built-in speaker is mounted at the front, throwing sound upwards. Four small square rubber feet are fitted on the left side cheek and there is a large carrying handle on the right cheek. Underneath the rig are four plastic feet and ventilation holes.

The rear panel

The back panel has been well thought out and, considering the excellent interfacing facilities, is rather less cluttered than one might imagine. The ac mains input is on the usual IEC socket and the rig can be switched to work from the usual variety of ac voltages, a large fuse also being provided. The main antenna socket for the HF bands is an SO239, but I cannot comment as yet on the various plug-in optional transverters as they were not supplied with the review sample.

Separate phono sockets are fitted to switch the receive output from the co-ax relay to an external receiver and to plug an Rx signal directly into the HF receiver, thus bypassing the antenna relay. A push-button selects normal or external connections for these. An 8-pin DIN socket supplies band and linear operation lines for direct use with the new Yaesu FL7000 linear, which I reviewed for this magazine last month. A 6-pin DIN is fitted for interconnecting the rig with a computer, the CAT system being employed allowing complete control of the microprocessors in the rig and PTT/squelch connections for automatic transmission and reception of data.

More sockets

The CW key jack is a stereo quarter inch type, and you must use a stereo plug with it. A miniature stereo 3.5mm jack is used for data in/out to the FM sections of the rig, the input loading being 600 ohms (30mV) whilst the output source impedance is stated as being 10kohms, giving a level of around 800mV. A mono 3.5mm jack can be used for feeding an external speaker, and a phono jack provides around 100mV of audio at fixed gain from before the receiver audio gain control.

A small RF output phono socket can be used to deliver up to 0.25mW of HF for feeding external transverters or an oscilloscope. Another phono socket is for ALC in, and around -4V is required for cutting down the Tx output. A short circuit on Tx socket can be used for grounding external equipment on Tx, the maximum low voltage current being 2A at up to 30V, but at 250V the shorting current must not exceed 100mA. An internal switch, S2002, on the RF unit must be set to 'on' if this grounding on Tx socket is used. Two additional phono sockets provide 13.8V dc at up to 200mA and 8V at a maximum of 100mA for operating external equipment. A phono socket is also provided for external PTT, the open circuit voltage being 8V dc, with short circuit current typically of 8mA.

A patch-in socket accepts the input of a phone patch or AFSK unit, an input level of around 2mV being ideal. This input, incidentally, is controlled by the mic gain. A phono socket called 'FSK' provides 8V dc when the FSK mode is selected, but this mode requires the usual audio tones on the phone patch input for AFSK, and as far as I can tell the rig is designed for high rather than low tone operation.

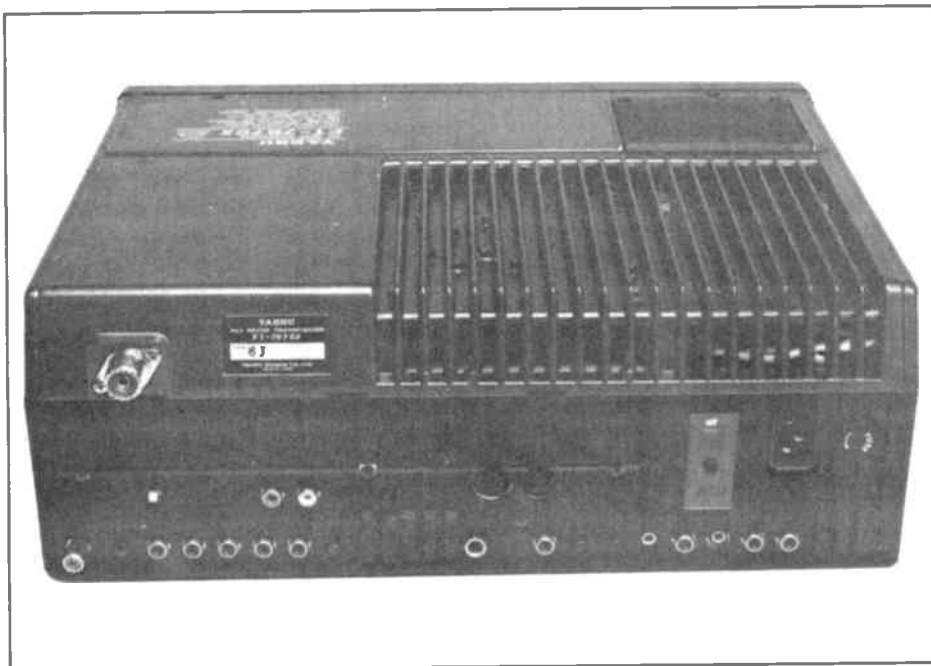

There does not seem to be any true FSK facility, unlike that provided on some other rigs. This rig has one serious disadvantage when AFSK is used, for it is necessary to unplug the microphone from the front panel when using this mode. I very much prefer the arrangement in the Trio TS940S, where the rig is provided with a mic amp muting pin which switches over the modulator from the output of the mic amp to the data input. This allows the use of SSB positions for data in/out, with instant external switching back to mic.

There is a lithium memory back up battery internally which can be switched off from the back panel if the rig is to be stored or transported, thus saving the battery. Other switches and adjustments include front panel meter power reading adjustment (this does not affect the digital power indications), VOX delay and VOX anti trip controls, with switches for normal linear or special linear control (push switch in to 'special' for fast break-in operation of Yaesu FL7000 linear), and finally a 25kHz marker on/off switch.

I must have a little grumble here, for we all found it extremely difficult to see the labelling of the various sockets and switches on the back panel. This is because not only is the whole panel finished in black, but the labelling is in raised black letters. This seems quite difficult it would be to identify a socket with your head upside down staring at the back of the rig. The rig itself, though, is very well styled, the front, top and sides being finished in black.

The layout of the front panel controls seems very sensible to me, and once I had mastered the controls operation was most effective, although I have to admit that I had to resort again and again to the instruction book for details of the complex microprocessor functions controlled by the matrix pad. Whilst the instruction book is generally good, I note with a degree of dismay that there is no nominal description of circuitry. Unfortunately, I did not have time to study the circuit diagram at length in an effort to find out some of the technical details that are not given in the instruction book, but which may have proved interesting for users to learn about.

Subjective comments

Before even attempting to use the transmitter section, I spent quite a few hours using the set as a receiver in all of its modes. AM reception was of excellent quality, and the audio quality seemed a lot better than that of previous Yaesu rigs. The wider filter was just about right whilst the narrow one was useful in desperate cases, although the SSB bandwidth produced a very muffled sound on AM, of course. Long and medium wave reception was good and I could pick out quite a few very weak stations, although I found an external Yaesu ATU and low pass filter (FRT7700 and FF5, Rx path only) necessary to reduce the colossal signal strengths that

I received from stations at the HF end of medium wave.

There were quite a number of inter-modulation products audible on Top Band and it was clear that the high pass filter was inadequate for the set to be used on 160m without an external Rx ATU. There did not seem to be any filter below 1.8MHz, some filtering action below 1.5MHz being noted, however, which is too far into the MW band.

Excellent sensitivity

When listening to SSB I was struck by the excellent sensitivity on the 10m band, allowing extremely weak ground wave signals to be received without any noise degradation from the set. I never found it necessary to use the RF pre-amp below 21MHz, and I usually found that the LF bands were easier to listen to with the 20dB antenna attenuator switched in. Although the passband tuning was useful, I rather missed the facility of varying each side of the selectivity skirt independently, and I would have preferred this to the tone control facility, which I hardly ever used. Both the audio frequency peaking on CW and the notch filter on CW and SSB worked very well indeed, the notch width being narrower than usual and giving an excellent notch, which barely disrupted audio quality.

When I was listening to strong SSB signals I found that the AGC slow position was not slow enough, which is particularly unfortunate as the other two speeds were quite well compromised. Furthermore, I noted a slight clicky graininess on speech peaks and I made dozens of comparisons on many transmissions between the audio output from this rig, and from the Trio TS940S tuned to the same frequency. The Trio always seemed clean on transients, but the Yaesu did not clean up until the RF gain control was backed off quite a long way, to the point where weaker signals in a net almost disappeared. This might not bother many users, but if you hear a comparison you may see what I mean. The SSB passband was just a little too wide and there was plenty of volume from the internal speaker.

In tuning around the LF bands I have to say that I noticed a lot more muck around very strong stations, and it seems that Yaesu have still not improved on the reciprocal mixing performance of their synthesizers. This is rather a shame, for in so many other ways I found this rig a delight to use.

The NBFM performance, whilst being adequate, was limited by the over wide selectivity, and the rig could not handle 10kHz spaced stations around 29.6MHz. The same would obviously apply to the 2m band, but it may be possible to install a narrower FM filter of around 8kHz bandwidth to do the job properly. However, the audio quality on FM was excellent and it was so very useful to set the up and down program buttons to 10kHz steps for use on 29.6MHz FM.

Although I had previously checked that the rig transmitted satisfactorily on SSB,

I did not actually have a QSO on CW until I had been receiving on the 10MHz band for quite a while. Quite suddenly I heard an amateur who I knew well calling CQ, and I very rapidly plugged my paddle in the back, switched on the key on the front and commenced calling. In a complete panic I realised that the key connections were reversed, so Yaesu are out of step with Morsematic! This gave my brain an awful pain, but I managed to cope moderately for an over or two, after which I held the key upside down with my left hand whilst paddling with my right.

After another over I acquired a temporary frozen shoulder and put the thing down on the bench again as I preferred mental to physical exertion. Having signed off fairly rapidly, explaining my predicament, plus the fact that my brain hurt and that I desperately needed a whiskey, I was promptly called by another station, K2OZ, who gave me a good report, in my dire circumstances! The moral of this story is to check your key connections before you start on the air.

Break-in keying worked superbly well and I found the 800Hz offset facility most useful, although many of my friends prefer 600Hz. The keying range is very wide, thus coping with very slow CW up to incredibly fast, which should be fine for almost all mortals except the 50 wpm+ brigade! The narrow filter was very well optimised and was just about right, although I did note some noise when trying to copy very weak stations extremely close to a very strong one. The audio peaking filter was particularly useful, and tended to clean up some of the noisier signals.

Mic adaptability

Although the transmitted audio quality seemed to be very good, a few stations noticed a hum which I could hear when monitoring on headphones. This was particularly marked on the Yaesu desk mic, type MD-1, but a little less noticeable on a Heil microphone.

I spent a lot of time experimenting with the Tx shift, and whilst I did obtain some quite good reports with the Yaesu mic after careful shift adjustment, the Heil microphone gave superlative readability and punch when carefully optimised. This control can in fact allow the user to match very precisely the passband of someone's receiver if they do not have PBT, thus gaining optimum system response. It was also useful to be able to switch Tx shift in and out so that you could return to a nominal setting as pre-set by Yaesu. VOX control worked very well, but I found it a little annoying that the delay and anti trip adjustments were on the rear panel, as from time to time I like to alter them. I did not have any problems with the transmitter, and it really was wonderful to have the digital readout of power and SWR. The automatic ATU system absorbed very little power and matched a wide range of impedances, up to about 4:1 and occa-

sionally even worse; a wider range than that claimed by Yaesu.

In almost all cases the ATU matched down to better than 1.2:1, the digital SWR reading quite frequently being 1.0:1. The ATU sometimes took quite a time to match, however, which could be irritating if you were used to the incredibly rapid Icom models, which are external. The tuning up speed was about the same as the ATUs in the latest Trios, but it will often pass through 1.0:1 and continue whirring backwards and forwards for several seconds until it eventually comes to rest, and the 'ready' sign comes up. There would be a lot to be said for having an 'accept' button to stop the tuning when the user feels the SWR is good enough. This would remove the frustration of tuning up continuing whilst you are waiting to call that rare DX station!

Tied in knots

I found the matrix pad a little difficult to get my fingers round, and I have to rely on sighted friends to make fair comments on this. They found it easy to use, and once they had got used to the functions they found that in general use all the facilities worked well and rapidly. Many of the problems in the FT980 ergonomics have been put right in the 767, and you can change mode from memory very easily. It is a lot easier to understand than the 980 and more effective, too. However, whilst one would normally be content with 10 memories and many users joke about rigs with 40 or even 99 memories, I have to criticise Yaesu for not providing a lot more memories, for one would normally want at least 10 for each of the VHF and UHF bands, and thus at least 40 in all. Readers might think it perverse of me to require more memories after my critical comments in the past about bells and whistles, but this rig is unusual in providing operation on 12 bands, and they could so easily have provided more memories for calling frequencies and beacons as well as repeaters.

I noted one rather strange occurrence when I switched from 1.930MHz operation to 29.6MHz FM. For some reason there was no transmitted power at all, although my vertical antenna is a good match. I just could not clear the problem, so I turned the rig off and then on again after a few seconds, to find that it worked perfectly. This problem did not reoccur, but it seemed that there must have been some form of lock-out temporarily in operation on the PA stage, which has to remain a mystery.

Remote controlling

The Yaesu MD-1 desk microphone includes up and down frequency stepping buttons, as well as PTT, and these can be switched to QSY in steps (or continuously) at either the VFO stepping rate or that chosen for the up/down buttons on the rig. I found this a great asset when using the rig on 10m FM, and it will be of particular use when the rig is

fitted with transverters. I found the many different ways of accessing a frequency useful, and so much more convenient than on the earlier FT One and FT980 models. I programmed a 1kHz stepping rate in to the up/down buttons on the rig, and when I switched the mic QSY buttons to operate the 1kHz steps I found that I could QSY at a rate of 50kHz per second when pressing 'up' and 'fast' on the mic, whilst a single depression gave a 1kHz step. Hopping around a band is thus made very simple, especially as the stepping rate can be set differently for each mode.

I am sure that many purchasers of the FT767 will get to grips with the computer interfacing, and they will be able to add as many stored frequencies as they like, kept on floppy disc. This will allow very rapid search facilities, especially when the receiver is being used for AM short wave reception. The auto ATU, incidentally, remembers the last settings used on each band, but it is a great pity that the ATU is only in the transmit path, for it could have been a very great asset on receive.

The very rapid QSK facility will be superb for packet and Amtor use as well as for CW operation, and note that the FL7000 linear can also change over extremely rapidly when used with this particular rig.

Laboratory tests

When I first measured the sinad sensitivity on SSB I could hardly believe the figures, for they were the best I had ever measured on an HF transceiver, all the way from the 1.8 to the 28MHz bands! You will not need the phenomenal sensitivity on the LF bands, and I would advise you to avoid using the RF pre-amp below 21MHz unless you have a very poor antenna and you are using the rig for short wave listening.

On the 28MHz band, even the band noise in the middle of the night, which was picked up by my vertical antenna, exceeded the input noise of the receiver, and this allowed me to hear extremely weak ground wave signals. The pre-amp gave a gain of around 11dB at HF, rising to 13dB or so at LF, while the attenuator gave approximately 20dB loss.

Front end intermodulation tests at HF gave a measured intercept point which was adequate with the pre-amp on and superb with pre-amp off. However, the IM performance of the pre-amp was poor at LF, although this is of no serious significance. I did have a serious problem, however, when I attempted to measure the close in IM performance, for all the readings were badly affected by the poor reciprocal mixing performance.

Very close in, and after considerable trouble, I found that the blocking performance was reasonably adequate, the effective dynamic range, however, being controlled far more by the synthesizer noise than by the input intercept point. To put this into perspective, the 5kHz offset local oscillator noise

measurement was in the same area as that of earlier Yaesu synthesizer rigs – about 18dB inferior to the modified Trio TS940S and 23dB inferior to the remarkable Icom 751A.

After all the criticism that this parameter has received from Peter Hart in *Radcom* and from myself in *Amateur Radio*, I would have thought that Yaesu would have fixed this by now, as Icom have done so successfully.

Lengthy tests of intermodulation on the 160m band showed that there was very little high pass filter action below the 1.8MHz band, and thus very strong medium wave stations caused severe blocking and distortion products. I did not notice any improvement in effective intercept point until I used tones at 1.5 and 1.7MHz while monitoring 1.9MHz, the improvement being very marginal. With carriers at 1.3 and 1.6MHz, there was an improvement of 4dB in apparent intercept point, and so this seems to prove quite conclusively the lack of an efficient high pass filter.

Not insurmountable

You may well not be troubled by this if you are at least 25 miles from any powerful medium wave transmitter, and so only a trial will show you if you can ignore my criticism. A good way of overcoming this would be to build a multi-section high pass filter cutting steeply below 1.8MHz and insert it in the receiver break points, if you are a keen 1.8MHz operator. In any case, the filter would be quite a good idea, as it should improve the noise floor of the receiver by stopping the accumulated MW signals from generating reciprocal noise.

My new method of plotting Rx selectivity was published in the September issue of this magazine, and the plots for SSB and CW show that this rig is in fact very good. The new method is able to partly exclude the effects of reciprocal mixing, and so the plots show selectivity down to -70dB. Plot 1 shows the SSB bandpass, which does prove to be rather wide but with steep skirts. Note, however, that there is quite an appreciable roll-off between 1kHz and 2.5kHz of around 5dB before the real skirt is reached, and this is probably due to too much HF roll-off in the audio amplifier. This would have the effect of improving the measured 12dB sinad sensitivity, incidentally.

Note also that with the IF shift central, the LF skirt is a little too close to the carrier frequency of 14.2MHz. You will see some little nicks in the curve, especially at HF. These correspond to harmonics of the 1kHz probe carrier and to beat distortion products between the probe carrier and the sweeping carrier, caused by slight distortions in the product detector and audio output stages. As explained in the aforementioned measurement article, please ignore the large spike 1kHz to the left of plot centre as it is completely irrelevant.

The CW selectivity, illustrated in plot 2, uses a different horizontal scale, just 200Hz per division, the equivalent carrier

position this time being at the left-hand margin. The high plotted level on the left margin is caused by breakthrough of an external local oscillator, which is irrelevant but shows a snag in the test method. What is important is the remarkably steep skirt up to the passband followed by the very rapid attenuation above it, showing the CW filter to be excellent – around 500Hz bandwidth.

Conventional manual selectivity measurements showed a far wider bandwidth at -60dB because of the reciprocal mixing problem, and so this plot shows far more readily that the real selectivity is much better than normal manual measurements would illustrate. The AM selectivity shows about the right bandwidth on 'wide', but the skirts are not quite steep enough. You are therefore likely to get some adjacent channel chatter from strong stations, which is when you might find it advantageous to switch to narrow selectivity.

FM selectivity proved to be very wide, and it was lopsided at $\pm 12.5\text{kHz}$, but well down at $\pm 25\text{kHz}$. The FM filter is clearly good enough for 20kHz channelling, but completely inadequate for 10 or 12.5kHz rejection. The wide passband also causes a degraded 12dB sinad FM sensitivity, although this was in fact good. It could, however, have been around 3dB better, with a much narrower filter and steeper roll-off above 2.8kHz. The FM response, in fact, was surprisingly flat from 50Hz to 3kHz, as was the AM response from LF to around 2.5kHz.

I checked the response by noting the audio output levels produced from various carrier offsets with the generator set to give a very high level, and with AGC fast. This thus becomes a test of the audio response from the output of the product detector to the speaker output socket, which confirmed that there was considerable HF roll-off in the audio, as inferred by the selectivity plot, so that 2kHz was already -3.25dB, and 2.5kHz -5dB. This roll-off would tend to decrease the intelligibility of speech transients, although it can be partly offset in effect by careful use of the PBT control.

S-meter

On SSB we noted 32dB difference between S1 and 9, and this shows a reasonably logarithmic scale, which is useful. However, a $65\mu\text{V}$ signal was required for S9, which is perhaps rather mean! The 20dB divisions above S9 were quite accurate. On FM, the range was almost identical, but S9 corresponded to $50\mu\text{V}$. I should add here that too rigid a use of S-meter readings can be very misleading, as $50\mu\text{V}$ on 28MHz is an extremely strong signal, whilst it is a fairly poor one on the LF bands! For this reason, it is probably more realistic to give S-meter readings on LF with the attenuator in and the RF pre-amp switched out. Incidentally, always set the RF gain control flat out when using the S-meter.

The fast and medium AGC speeds were

well optimised, but I found the slow speed rather too quick, strong stations in a net thus tending to cause a degree of pumping. The weaker ones, though, were about right. If you have heard really slow AGC, you will know what I mean, for it allows you to gain a much better effective dynamic range on a strong signal unless the transmission ceases for several seconds.

Detector and audio performance

The product detector gave around 1% distortion on a continuous carrier with a 1kHz beat. FM distortion was adequate at lower deviations, but was a little high at 5kHz deviation. The maximum power output into 8 ohms was just slightly limited, which is surprising for a mains supply rig, but there was a useful power boost into 4 ohms. The AM distortion

performance shows a major improvement over that of many earlier Yaesu models, and even 90% modulation at 1kHz measured just 3.6%. Distortion at 80Hz was acceptable with AGC set to medium or slow, but this of course rose considerably with AGC fast. These figures confirmed the good subjective impression of AM reception.

Stability

In performing the selectivity tests on the receiver, not only did we note that superb stability was reached in only a minute or two, but the receiver did not budge more than 10Hz over a period of an hour. This is quite remarkable, and shows that the synthesizer crystal oscillator is a very stable one. The frequency accuracy was also very good, being within 10Hz of the nominal frequency!

Yaesu FT767 RF/AF selectivity plot. Rx USB IF shift centre. Tone max RF -33dBm. Resolution bandwidth 30Hz. 1kHz per division

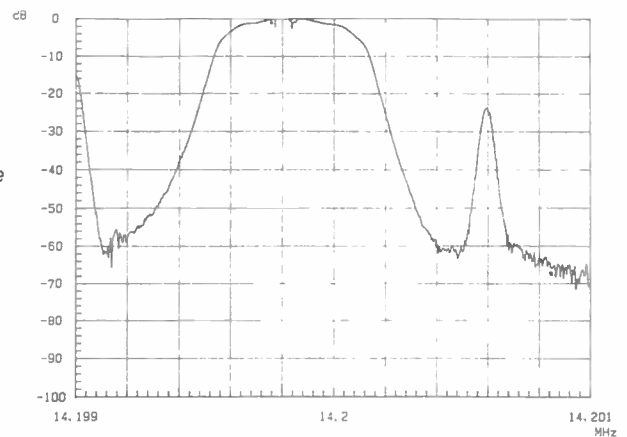

Yaesu FT767 RF/AF selectivity plot. Rx NAR CW IF shift centre. Tone max RF -33dBm. Resolution bandwidth 30Hz. 200Hz per division

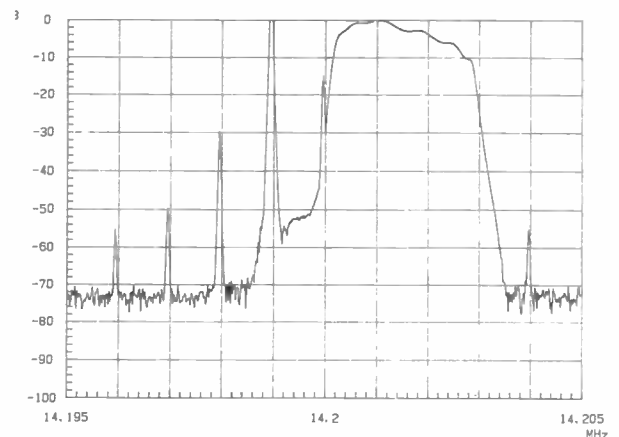

Yaesu FT767 two-tone test 700/1700Hz LSB 110W PEP. Resolution bandwidth 100Hz. 2kHz per division

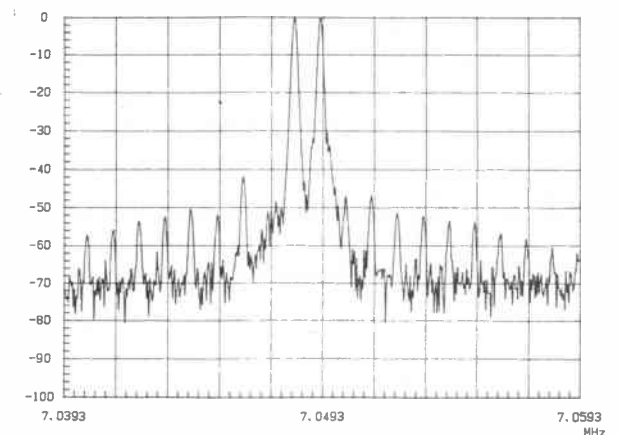

When we were setting up the selectivity system, I did notice one odd thing concerning the claimed 10Hz steps. In tuning around over quite a wide degree of offset, and with a frequency counter on the audio output, we noted that steps varied almost at random from around 7Hz to as much as 25Hz, the step always being the same when we returned to the same beat note. I have noticed a similar, but nowhere near so marked, effect on other rigs and it would be nice if Yaesu could improve on this; a 25Hz step is a little too much if you are trying to tune CW or SSB on the nose.

Quite an achievement

I tuned over the entire LF and HF bands in an effort to find annoying sprogs. There were none of any consequence on the amateur bands, but just a few fairly strong ones on some strange frequencies, for example 17.9 at S4, 20.38 at S8, 23.865 at S5 and 29.832 at S2. They all attenuated dramatically when the RF pre-amp was switched out, but they did not change when the attenuator was pushed in, so they must have been getting into the RF preamplifier input circuitry from the synthesizer, etc. I consider this performance to be quite an achievement, as the number of other sprogs which were weak and not in amateur bands would be overcome by band noise. Incidentally, when tuning below long wave down to 0kHz, the noise came up very dramatically indeed, showing that the synthesizer noise really was rather poor.

When measuring a notch filter I prefer to use two carriers and note the effect of notching one of them with reference to the other. The 767 filter is extremely good, as it gave an average depth ratio of 35dB with tones spaced 1kHz apart, and even at 300Hz spacing the ratio was still between 20 and 25dB. However, the filter did introduce noticeable harmonic distortion of the remaining signal. The audio peaking filter, used on the CW mode, allowed two signals 300Hz apart to be improved by around 20dB in their level ratios, which is quite effective. This of course satisfactorily narrows the apparent CW bandwidth. Both filters were variable over a wide frequency range, which is excellent.

Transmitter output tests

Maximum power outputs measured out at 100 to 105W on all modes (FM, SSB, PEP and CW) on all bands. We checked the accuracy of the digital power meter and found that it was optimistic by a maximum of 10% and an average of 5%. This is as accurate as a Bird through-line wattmeter, and thus within 0.5dB. I consider that this is very good, and most useful. The auto ATU through loss was substantially less than 0.5dB, and the SWR digital indications were also quite accurate. It really was rather impressive to see a 50 ohm dummy load read 1.0:1, and a reading of 1.2:1 corresponded very closely to the readings from external test equipment, higher SWRs also being usefully accurate. The carrier power control could reduce power right down

to the order of 40mW if desired, power increasing quite smoothly as the carrier knob was rotated clockwise.

We checked the second and third harmonic outputs with and without the ATU switched in, on all bands, and the performance was most creditable. Third harmonic averaged at around -70dBc but was often as low as -78dBc, whilst second harmonic was typically -68 to -71dBc. The worst harmonic was the third of 28.4MHz, with ATU out, at -58dBc, but this improved to -62dBc with ATU in. Particularly good measurements were noted on the LF bands.

Two-tone plots

We checked the performance of the PA on 1.9, 3.7, 7.05, 14.2, 21.2 and 28.4MHz, using audio tones of 700Hz and 1.7kHz. All the plots were made with 2kHz per division and with the tones offset to allow higher orders to be seen on one of the sides. On the LF bands the performance is typified by plot 3, which shows an extremely low third order intermodulation, but the very high orders do not fall rapidly enough. This is quite usual unfortunately, even with the best solid-state PAs.

The 14MHz performance was only slightly inferior, and whilst low order products fell even further at lower powers there was no significant drop in high order intermodulation, eg products up to ± 10 kHz from the two carriers. The poorest performance was on 21 and 28MHz, plot 4 showing the 28.4MHz results, which I would still rate as good. Yaesu have obviously designed their PA very well, and the high order products would only be significantly reduced if more standing current was set up through the PA. However, in such a state one would have to hold the maximum PEP right down to avoid the PA stages overheating, so until there is radical new thought in solid-state PA design we are left with the high order IM performance as it is. This is certainly not poor, although a valve PA is much better.

Transmitted SSB passbands

The AF/RF transmitted SSB response in plot 5 shows the overall audio in, RF out performance with peak output substantially below any compression point. You will see that the skirts are extremely steep, the transmitted bandwidth being typically from around 400Hz to 2.8kHz. Note that by 1kHz higher the response had fallen to around -65dB! We took plots with fully clockwise and anti-clockwise Tx shift and these showed the passband to move by just under ± 100 Hz, which is perhaps not quite enough to cope with some of the woofy and squeaky voices that I know! The carrier breakthrough is typically at least 60dB down on peak output, whilst alternate sideband breakthrough is completely insignificant. Very careful examination of a two-tone 14.2MHz plot, taken with 30Hz resolution bandwidth which took an age, shows that second order distortions in the mic amp and modulator were well

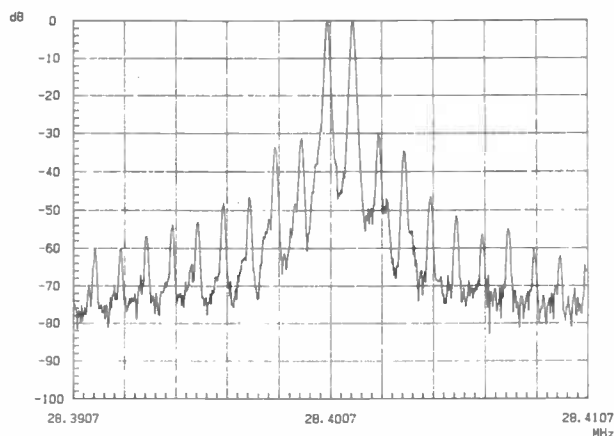

Yaesu FT767 two-tone test,
700/1700Hz, 100W PEP.
Resolution bandwidth
100Hz, 2kHz per division

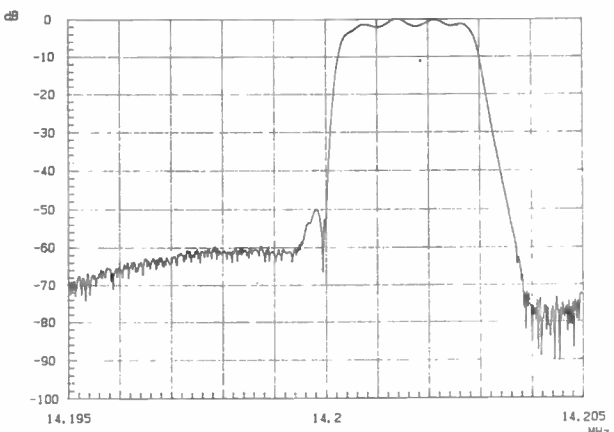

Yaesu FT767 AF/RF plot,
10W PEP output with no Tx
shift/USB. Resolution band-
width 30Hz, 1kHz per
division

below 1%, whilst third order was only just above 0.1%, showing the mic amp, etc to be very clean – a credit to Yaesu.

The FM transmitted response was reasonably flat from 250Hz to 2.8kHz, LF falling off rapidly but HF not quite falling off fast enough for the rig to be used on closer channellings without high frequency spreading. The audio quality was superb, but the signal-to-noise ratio was limited to around 40dB by some mush in the background, presumably again due to local oscillator phase noise. Maximum deviation, when shouting into the mic, was around 5.5kHz, and a 1kHz tone gave a maximum of 4.8kHz, the deviation being absolutely right for 20kHz channelling. Toneburst was extremely close to 1750Hz, and at a reasonable deviation. Transmitted frequency accuracy on FM was within 100Hz, whilst SSB was within 20Hz.

Conclusions

Yaesu's 767GX is a fascinating new trend-setter, for so many of its innovative features are useful ones rather than just more and more redundant bells and whistles. Of course, there are many bells and whistles on the rig, but ergonomically they are very well designed. The amazing microprocessor controlling, both from the push-buttons on the rig and from external computer control, will be a computer enthusiast's delight, and hopefully purchasers will get down to actually using the rig with pleasure after they have spent hours (or days?) writing endless programs to provide additional fun features.

The rig is clearly very comprehensive, and most of the performance areas measured very well, the transmitter being particularly good. It is a pity that Yaesu still seem to be designing synthesizers with poor phase noise characteristics, hence giving poor reciprocal mixing measurements. To put this into perspective, you may very well not be disturbed by this phase noise if you are an average operator who wants to have a lot of fun on the LF, HF, VHF and UHF bands, but if you are a really serious DX operator you may choose to go for alternatives, such as the Icom IC751A or the Lowe-modified Trio TS940S, both of which are rather more expensive.

Just before going to press Amcomm looked into the reciprocal mixing noise problem, and report that they hope to be coming up with a modification which they will put into any FT767GX purchased from them, without extra charge. If this modification is as effective as that for the TS940S, it could well transform the rig into a super DX one.

I often hear that rigs are much too costly these days, the FT767GX normally retailing at around £1,550, with the 6m and 2m transverters an additional £169. The 70cm transverter will cost around £215. At first, this price seems high, but included in the cost are narrow CW and wide AM filters as well as a very good automatic ATU operating on all bands from 1.8 to 28MHz. The rig is essentially a

home base station, as it requires mains input, but here again you save the cost of a power supply. Now that the £/Y exchange rate is not very favourable, we will have to accept the cost, but don't forget that many of the so-called bargains of 15 or 20 years ago, when subjected to appropriate inflation, will work out at not that much less, and how can one possibly compare an FT200 with an FT767! Clearly a rig that will delight

many owners and very nearly in the DX class, but held back from this just by the reciprocal noise.

I would like to thank Amcomm Ltd for loaning me the review sample so shortly after it had come into their shop. Jeff Ginn helped take many of the two-tone plots and my wife, Fiona, assisted me for about three days with all the measurements. I hope to review the transverters when they become available.

Yaesu FT767GX laboratory results

Receiver tests

RF sensitivity (12dB sinad) SSB
 LF: -126dBm (0.11µV), HF -125dBm (0.13µV) pre-amp on, approx 9.5dB worse pre-amp off
 RF sensitivity (12dB sinad) FM
 29.6MHz -119, 5dBm (pre-amp on)

Effective RF input intercept point

Pre-amp on 100/200kHz spacing	28.55MHz	+4dBm
	14.2MHz	+1dBm
	3.7MHz	-6dBm
	1.9MHz	-4dBm
Pre-amp off 100/200kHz spacing	28.55MHz	+19dBm
	14.2MHz	+23dBm
	1.9MHz	+20dBm

RF pre-amp gain approx 11dB at HF, 13dB at LF

Reciprocal mixing performance, ratio between offset carrier and noise floor for 3dB degradation (28.55MHz)

5kHz	69dB
10kHz	75dB
20kHz	86dB
50kHz	98dB
100kHz	106dB
200kHz	116dB

S-meter	SSB	FM
S1	-103dBm	-106dBm
S3	-99dBm	-102dBm
S5	-94dBm	-98dBm
S7	-86dBm	-89dBm
S9	-71dBm	-73dBm
S9+20	-51dBm	-53dBm
S9+40	-31dBm	-33dBm
S9+60	-11dBm	-13dBm

Selectivity: CW/SSB – see plots; FM – ±12.5kHz -1.8/+17.5dB
 ±25kHz +62.7/+67.5dB

Notch filter tone discrimination ratio

1kHz tone spacing	35dB
300Hz spacing	25 - 30dB, distortion 3.7%

CW audio peaking filter, peaking ratio between two tones, 300Hz apart 20 - 25dB

Audio distortion and power output

Product detector, SSB/CW, 1kHz beat tone	1% THD
FM 4.5k deviation of 1kHz tone	6.2%
	2.5kHz deviation 5.2%
	0.5kHz deviation 1.9%
AM distortion, 90% modulation of 1kHz tone	3.6%
Max audio output power for 10% THD	8 ohms 2.3W 4 ohms 3.4W
FM capture ratio	6.4dB

Transmitter tests

Typical maximum output power, CW, FM and SSB – 100 to 105W,
 Minimum power approx 40mW
 SSB carrier rejection typically 60dB
 Alternate sideband rejection typically >60dB
 Max FM deviation 5.5kHz (loud speech), max for 1kHz tone 4.8kHz

THE REVIEWER

The regular and impressive reviews of amateur equipment written by Angus McKenzie, and presented in this magazine each month, have a completeness and depth unequalled by similar articles in other contemporary publications. If anything, they are often too darned detailed and tell us much more about the gear than we often need to know! One thing, however, is certain: Angus explains the shortcomings or good features of the particular black box under review in a most interesting and often amusing way.

I have, on more than one occasion, 'held fire' when contemplating the purchase of something new and waited to read the inevitable 'Angus McKenzie Review'. This is a course which is no doubt followed by a large number of our amateur transmitting and SWL fraternity.

A couple of years ago the RSGB invited Angus to write a new book, the likes of which had never been seen before in this country, or indeed anywhere in the world. It was to review more than sixty (it later turned out to be more than a hundred!) pieces of equipment available on the market in this country. After hundreds of man-hours, G3OSS and his

laboratory staff produced *The Buyer's Guide to Amateur Radio*, which has only recently gone on sale.

I was very pleased (and flattered) to be asked to write this review, for I have been a personal friend of Angus for several years. However, this is a fact which will not colour my judgement, or prevent me from being critical where criticism is needed. I have attempted to be as objective as possible in my review of his book. There was an inauspicious start to the reviewing process, however, for my advance copy of Angus's book was a printer's 'dud' and had more than a dozen blank unprinted pages! Panic stations were manned, but it was soon discovered that my incomplete copy was the only one to be found. This episode no doubt shows that 'Murphy's Law' (or is it Sod's Law?) often strikes when G3BDQ is around.

Not everyone knows that Angus McKenzie is blind, and the fact that he dictated almost 200,000 words, considered hundreds of test figures and spent hundreds of hours 'on air' testing on all bands from 1.8MHz to 2320MHz, puts the tremendous amount of labour involved in the book's preparation into

perspective. G3OSS does not just detail laboratory results, he actually uses the gear under normal amateur working conditions from his North London home.

The problem with writing a book of this kind is that new gear is coming on to the market all the time, so something inevitably has to be left out. A last minute update was completed in May/June this year and many new items were tested and written up, so the book is really smack up to date. Older gear has not been neglected either, with veterans like the CR100, the AR88D and the KW2000B included. A variety of ancillary equipment has been covered, and a whole range of SWR/power meters, linears, pre-amps, transverters, microphones, ATUs, filters and even earphones are well described.

The book is not just a collection of reviews; ten chapters (some 118 pages) describe in clear language such matters as receiver performance, microphones, ATUs, antennas, RF cables and connectors etc, together with a lucid explanation of the numerous technical tests and measurements Angus has made. This first part is recommended reading for all amateur operators, and I think that it could have been published quite successfully on its own, without the reviews!

One chapter in particular is quite unique and is entitled 'Your Relationship with the Dealer'. This includes a blow-by-blow description of your legal standing as a purchaser of gear, be it new or secondhand, and is itself well worth the price of the whole book. Do you know, for example, all the pitfalls that are associated with part-exchange deals? If not, peruse chapter ten and avoid future aggravation.

The chapter entitled 'Receiver Performance' goes into the 'Ideal and Reality' of receiver parameters, and should be compulsory reading for all those Far Eastern designers who seem to lay more and more emphasis on the 'bells and whistles' of radio equipment, to the neglect of such essentials as front-end selectivity, RF intermodulation distortion, RF intercept points, reciprocal mixing and blocking and synthesizer noise, etc. If only those chaps in their white coats would design effective rigs which are up to contest standard with good internal front-ends, low noise figures and low intermodulation products. For some years now we have had to rely upon the effective muTek front-ends in our VHF gear.

Twelve pages are dedicated to the topic of RF cables and connectors, where the most comprehensive coverage of this topic yet seen in an amateur radio publication can be found. Not only does Angus detail the pros and cons of the various types of coaxial cable, but he also examines the many

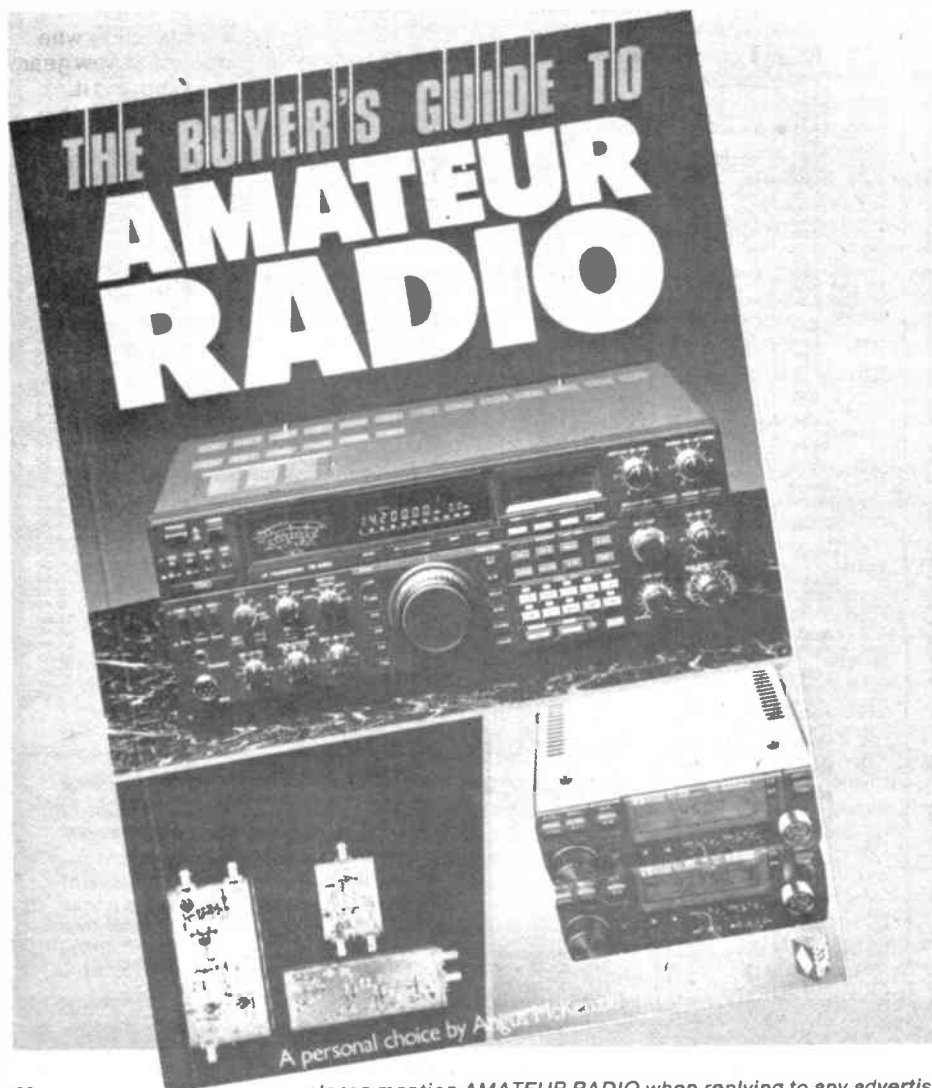

REVIEWED

by John Heys G3BDQ

different plugs and sockets which are available. His particular horrors are the nasty versions of the phono plug which will fall to pieces after a few hours use! He also warns of the cheapo N type plug found at rallies, which is often of 75 ohm impedance and has a much smaller centre pin than the standard 50 ohm version, and which consequently will not mate with these.

Antennas are a special interest of mine, and it was interesting to read of G3OSS's experiences with them over the years. He is not too keen on random wires, '...whilst lurking wires of indeterminate length can be moderately effective at HF, their directivity patterns on the different bands can be very odd.... This is a statement I fully endorse! He gives lots of tips and dodges for matching stacked VHF antennas and even devotes half a page to the humble rubber duck.

The equipment reviews follow a set pattern: initially the 'Facilities' of the item under review are detailed and this section is followed by a section dealing with 'Subjective Tests and Ergonomics'. Following this are the 'Laboratory Test Results' and finally the all important 'Conclusions', where Angus outlines his personal feelings on the gear under review. When he does not like a rig he plainly says so, and always gives good reasons why. The lab results on each piece of equipment are tabulated in a readily understandable form.

Angus's review of the Belcom LS202E 144MHz multimode hand-held rig is devastating! He says of this rig: 'Judging by the sample, and several that I have heard, I think this is one of the worst rigs produced for the 144MHz band since the notorious Liner 2...'. A sense of humour is essential if a reviewer is to maintain his sanity, and Angus really knows how to keep his readers informed and yet amused. His review of the Icom ICAT500 HF auto ATU is full of praise and strongly recommends its purchase, although he mentions its little snags: '... if an antenna is swaying in the wind, the ATU tends to hunt slightly and you may hear a motor whirring every now and then. If the SWR is very poor the ATU tends to cluck like a chicken, which is a useful warning that something is wrong...'.
There remain many proud owners of what may be described as 'ancient technology', and lots of these elderly radios have been tested by G3OSS. The shortcomings of the AR88, BRT400, Racal RA17 series and even the once highly desirable Collins 75A4 receivers are all examined, and their strong points are highlighted. It is the inclusion of the reviews of elderly non state-of-the-art equipment which makes the book exceptional. Not everyone can afford the latest shiny new box, and many of us still seek out bargains at rallies and junk sales. It is always nice to read about the

gear one actually has installed in the shack too! This is especially the case if Angus gives it a good review. My elderly TS530s receives more loving care now that I have read that Angus states that it remains a very good buy!

Mistakes always seem to creep in somehow, and the *Buyer's Guide* is no exception to this rule, but apart from a handful of spelling mistakes there are few slip ups. One unfortunate error, however, is displayed in the circuit diagram of the SPC3000 ATU. This is an excellent piece of equipment (Angus loaded up his desk lamp with it), but the diagram shows the output switching so arranged that the output goes to ground in every switch position. Beware those of you who would make up a 'Chinese Copy' of this unit; you might end the day without your PA transistors!

I have one or two other niggles, the chief one being the absence of a proper index. All the equipment reviewed in the book is listed in alphabetical sequence, but the listing at the back does not give any page numbers. Because of this omission looking up a piece of gear can take a little while. This arrangement also means that HF transceivers, linears, ATUs, VHF rigs etc are all arranged haphazardly through the text. A better arrangement would have been to have had separate sections for the different equipment categories, with, for example, all the linears being together etc. There is no overall table in the style of the popular *Which* reports to show the best buys, so it is necessary to plough diligently through all the reviews to reach any conclusions. However, Angus

told me that such a listing would be difficult to do sensibly, for there are so many different features on each piece of equipment, and it is only possible to compare 'like with like'. The text of the book is clear and easy to read, and although the paper used is non-gloss the photographs have reproduced well.

Inevitably there must be some omissions, but I would personally have liked a review of the popular Yaesu FL2100Z HF linear, with a report on its inherent overheating problem. Another item missed is the little Daiwa active AF filter (AF-406K), which in my opinion outperforms the Datong filter. Many readers will probably be disappointed that their 'pet' piece of gear does not receive a mention, but Angus just could not include everything. His book has 472 pages of text (plus some advertising) and is quite a weighty tome. A halt had to be called at some point.

Whether you are an old-timer, one of the most recently licensed recruits to the hobby, or perhaps an SWL with ambitions to obtain a callsign, this new book will be an invaluable reference work to have to hand. Eventually it will date and need revision, but this first edition will still remain useful for a long time to come. Its purchase could save you a lot of money and heartache if it is used sensibly when contemplating the purchase of new gear. I can wholeheartedly recommend it.

The Buyer's Guide to Amateur Radio by Angus McKenzie MBE G3OSS is published by the Radio Society of Great Britain, and is available to members at £6.88 postage paid. Non-members must pay the full price of £8.09.

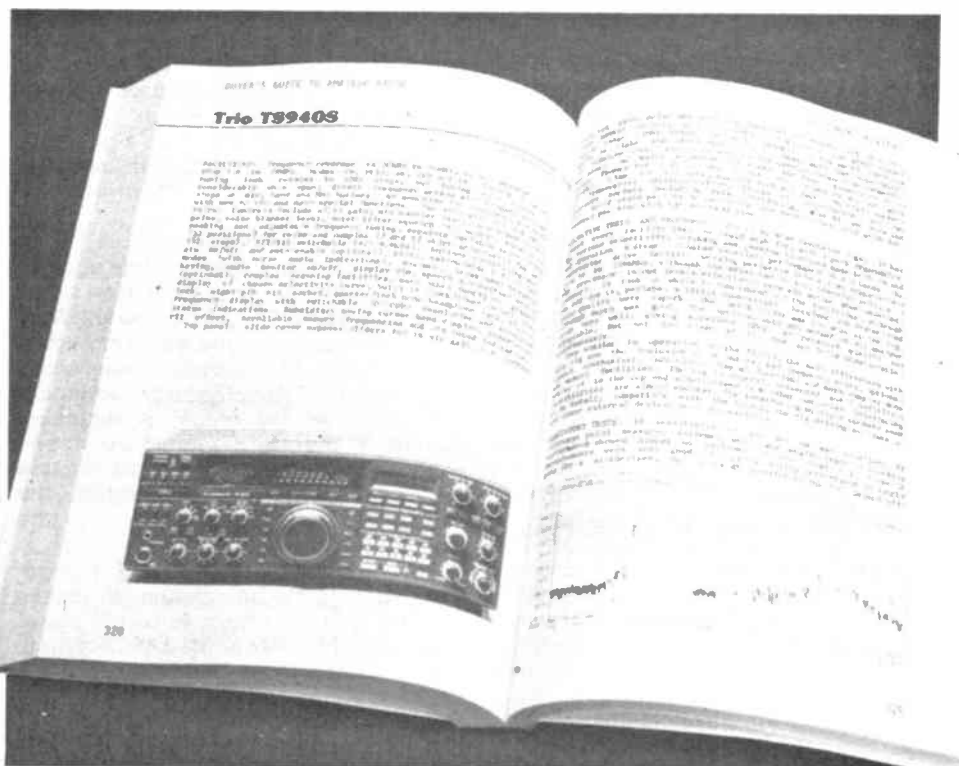

Delta Loop Beam for the 30 metre band

by Vic Copley-May G3AAG

This article discusses the theory of the delta loop beam and illustrates a version erected at the author's QTH. Particular reference is made to the sloping ground situation.

Whilst it is appreciated that a limited number of amateurs will have the space available to construct an antenna of this size, it is believed that the layout is novel and would be a useful design to use where one is fortunate enough to be close to woodland with sufficiently tall trees.

The article does not break new ground in the analysis of delta loop beam antennas, although some practical suggestions are made.

Liberal reference has been made to various sources. The author particularly wishes to thank Les Moxon G6XN, who read the article and made many helpful suggestions, most of which have been incorporated.

The delta loop

Delta loops are usually constructed with a circumference of one half wave or a full wave. Loops may, in fact, be of any size, although if too large problems arise with the excitation of unwanted modes. If too small, they will be inefficient and the polarisation will tend towards vertical and end fire.

The half wave loop could be considered as an 'opened out' folded dipole. The essential difference between the two is that a half-wave loop has substantial end fire radiation whilst a full wave loop is a broadside antenna. The latter is an antenna in which the propagation is at right angles to the plane of the elements.

An advantage of the full wave version lies in the fact that the spacing between the supporting points is less than that required for a dipole resonant at the same frequency.

For a given effective height the full wave loop exhibits a gain in the region of 0.67dB over a half wave dipole, but is

slightly inferior (0.32dB) to a full wave quad loop. This is because the separation of the high current points is less than for a quad loop. Theoretically, the ideal shape to give maximum gain would be a circle¹.

On the other hand, the practical construction of the delta loop is simpler and the theoretical loss in gain is negligible. The quad could be said to have an advantage in that the angle of radiation is somewhat lower than that for the delta loop. Where delta and quad loops are compared in a beam configuration, the quad has a theoretical gain advantage of about 1dB only. This was shown in an exhaustive analysis by Bill Myers K1GQ² using the NEC computer program. It must be emphasised that such small theoretical gain figures should be ignored in practice as they do not take account of second order effects. Computer analyses which produce figures below 1dB are of no significant importance in a practical antenna design.

Feed point impedance

Because the gain over a dipole is small, the full wave loop is seldom used on its own. This may also be because the feed point impedance, as one would expect, is between that of a simple dipole and a folded dipole. Typically the impedance is 106 ohms¹ or 120 ohms². A matching device is therefore necessary if one wishes to use 50 or 75 ohm coaxial cable to feed the antenna. In practice, the radiation resistance will vary with the diameter of the conductor.

Any discussion of feed point impedance and gain of an antenna has to take into account the effective height above ground. Any figures quoted in this article relate therefore to either theoretical considerations or the particular configuration of the author's antenna.

A delta loop may be erected either with the apex of the triangle uppermost

(Figure 1a) or inverted (Figure 1b). The advantage of the inverted triangle lies in the fact that the effective height is greater. In the case of a 30m loop the effective height is about 5 metres higher. This increase in height contributes towards the gain of the antenna.

Polarisation

The wave polarisation depends upon the feed point. If the feed point is symmetrical, as shown in Figures 1a and 1b, the polarisation will be horizontal. On the other hand, if the loop is fed at a corner or at any other asymmetrical point on its circumference, then the polarisation becomes complex and is a mixture of both vertical and horizontal components. Bill Myers' findings² from his NEC computer analysis were somewhat surprising. Polarisation asymmetry could have been predicted. What was unexpected was the fact that when the loop is fed asymmetrically there is a significant loss of gain. The loss was shown to be 3.32dB in the case of a two element 80m beam with the apex uppermost. Therefore, feeding at any point other than the top or the bottom should be avoided at all costs according to this analysis.

Despite what the computer told Bill Myers, it should be understood that if a factor for ground proximity and conductivity had not been fed in the result should have shown no difference in gain at any feed point. The figure for a computed gain loss of 3.32dB for an asymmetrically fed loop beam must be treated with suspicion and needs further investigation. Asymmetrical feeding leads to an asymmetrical polar diagram.

At this point, perhaps it should be emphasised that two thirds of the power radiated by the delta loop comes from the horizontal element. Therefore, where it is necessary to add wire to bring the loop into resonance, this should be done to the horizontal side. The fact that

DELTA LOOP BEAM

the triangle will no longer be equilateral will have no significant effect upon its performance.

With the particular configuration of the author's antenna, which consists of a driven element and a parasitic reflector, the feedpoint impedance is a function of the spacing between the two elements. Wherever the driven element is driven the feedpoint impedance will remain the same; only the gain and the polar diagram will change. Myers also showed that, provided the antenna was fed symmetrically, it really made no significant difference to the performance whether it was fed at the top or the bottom.

Spacing

Antennas of the type described have been constructed with various spacings between driven element and reflector, according to the designer's whims regarding gain, height, etc. Optimum spacing for maximum gain is 0.12 wavelength⁴. The spacing may be varied between approximately 0.10 and 0.175 wavelength with a gain variation of less than 0.25dB. The spacing also has an important effect upon the radiation resistance.

The author wanted to avoid having to use any matching device other than a simple 1:1 balun⁵. A matching device would need adjustment and any such adjustment would be confused by the actual tuning of the antenna itself. It has always been found to be a time consuming operation to get both the tuning and matching optimised, since one affects the other. The mismatch which would have occurred had optimum spacing been chosen would have been of no particular consequence on 10MHz. The feeder loss would have been negligible, the mismatch of the 'system' being correctable by an ATU. Nonetheless, the author chose to direct feed the antenna without an ATU and wished to achieve a 1:1 SWR without any matching device.

The relationship between the spacing and radiation resistance of the driven element is approximately linear between spacings from 0.1 to 0.25 with the radiation resistance rising from around

60 ohms to 150 ohms. Although the radiation resistance falls rapidly below spacings of less than 0.075 wavelength. At approximately 0.08 wavelength the radiation resistance will be close to 50 ohms and the driven element may be fed with 50 ohm coaxial cable via a balun. The radiation resistance is also affected by the height above ground. Experimentally it was found that at a height of 52 feet for the top of the driven element, which corresponded to an effective height of the beam of 44 feet and a spacing of 9ft 10½in (ie 0.102 wavelength at 10.133MHz), the radiation resistance was 48 ohms as measured with a noise bridge. The loss in gain from the optimum spacing of 0.12 wavelength (only 0.25dB) was traded off against the advantage of being able to direct feed the antenna without any matching device.

Optimum angle

At the effective height of 44ft (nearly one half wavelength) the optimum angle of radiation is theoretically about 27 degrees. Any increase in this effective height would cause the appearance of a secondary high angle lobe at the expense of the main lobe. Therefore, 52ft was selected as the optimum height for the top of the triangle.

The delta loop would not be as efficient at cancelling high angle radiation as the quad loop, as the horizontal sections are more effective in this respect. Nonetheless, the delta loop is simpler to erect, needing two instead of four supporting points for each loop.

The objective was to produce a 'quiet' antenna, so a good front to back ratio was necessary with minimal signal pick-up from secondary lobes.

Element lengths

The circumference of the driven element may be calculated from the formula:

$$\frac{1005 \text{ ft}}{f \text{ MHz}}$$

That of the reflector is calculated from the formula:

$$\frac{1033 \text{ ft}}{f \text{ MHz}}$$

Each leg was made to be 1/3 of the circumferential length obtained by the above formulae.

In constructing the antenna it is preferable to use values which are likely to require an increase in length to obtain resonance rather than a reduction, and to add the additional length required to the uppermost element rather than to all three. As stated previously, this is because two thirds of the radiation is from the top element and any unbalancing of the equilateral triangle as a result of this addition will have minimal effect upon other electrical parameters.

Gain

The theoretical gain of the free spaced beam to this design is in the order of 7dB. Close to the ground (in the case of a beam having horizontal polarisation) the gain will be enhanced by the image of the antenna in the ground below it. The theoretical maximum increase in gain over a free space antenna would be 6dB, although this figure applies to low angles of radiation only⁵. In the author's case, the effective height of the beam approaches one half wavelength. However, the antenna is erected above steeply sloping ground inclined at an angle of approximately 14° (1 in 4) for a distance of 7 wavelengths. The beam is aligned on a heading of 255° to maximise propagation on long paths into the VK5 call areas. The angle subtended by a point at the effective height of the antenna and the local horizon is -2.5°.

A little persuasion

Perhaps Bill Myers K1GQ could be persuaded to extend his research using the NEC program to establish the theoretical gain enhancement and change in radiation angle which may be expected from an antenna erected on sloping ground, since it may not be as simple a calculation as described later.

Les Moxon G6XN⁵ quotes the ideal shack as a castle in Spain, where the land in all directions slopes away at a critical angle for a considerable distance to enhance the gain and reduce the radiation angle of simple antennas. This is an important observation. *Figure 2a*

Fig 1

Delta loop antennas; 1b inverted. Feed shown is symmetrical. The circumference may be $\lambda/2$, in which case propagation will be in the same plane as the paper (end fire): If the circumference is a full wave, propagation will be at right angles to the plane of the loop (broadside)

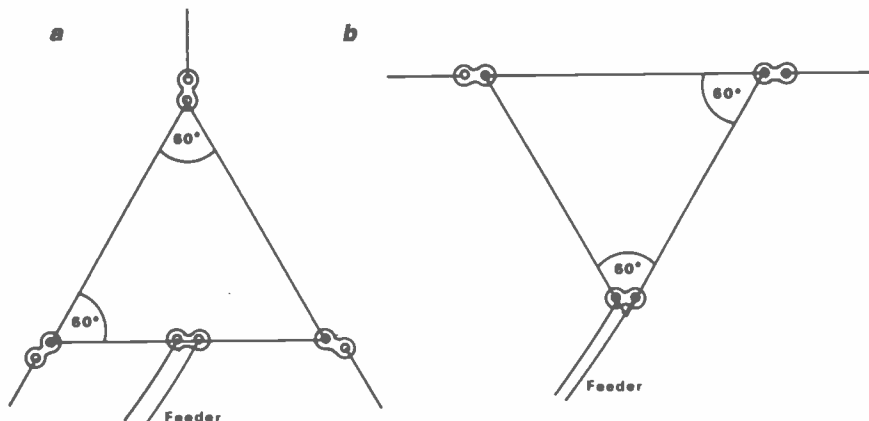

DELTA LOOP BEAM

illustrates how the reflected wave reinforces the direct wave. In a particular configuration where the reflected wave has a phase lag of one half wavelength, the enhancement of the direct wave would be 6dB.

In fact the castle in Spain is a special situation where, due to the steeply sloping ground, the theoretical gain could be much more than 6dB since the effective height of the antenna is increased.

Estimating effect

It is not difficult to determine geometrically the angle at which this occurs. The incident wave subtends the same angle to the ground as the reflected wave. What complicates the calculations is not knowing where the true electrical ground is, relative to the antenna. Nonetheless, it is not unreasonable to theorise on the basis of an assumed effective height with the object of estimating what effect sloping ground will have on the angle of radiation.

Figure 2a shows the antenna mounted at an effective height (h) above the assumed ground, which is level. The angle θ is the angle at which maximum radiation will occur, since the distance BC is one half wavelength and the wave from the image antenna, which is in antiphase, arrives one half wavelength later at point C, and is thus in phase with the direct wave. The direct wave then receives the maximum reinforcement.

In the diagram of Figure 2a, given that $\lambda/2=15\text{m}$ and $h=13.41\text{m}$:

$$\theta = 90^\circ - \cos \lambda/4h = 34^\circ$$

For the given height this would therefore appear to be the angle of maximum radiation. It has been found experimentally for a quad beam that the angle of maximum radiation is about 27° . Nonetheless, let us proceed with an analysis of the sloping ground situation.

In the case of an antenna constructed above sloping ground having an inclination of 14° , the distance between the antenna and its image is reduced to $2h'$ where:

$$h' = h \cdot \sin(90^\circ - \text{inclination})$$

The angle of radiation is now:

$$\theta = 90^\circ - \cos \lambda/4h' = 14^\circ = 21^\circ$$

It can be seen that the effective angle of radiation appears to have been lowered to 21° . The author believes that perhaps a number of additional factors should have been taken into account. For instance, the distance in wavelengths for which the ground continues to slope away from the antenna and the fact that the ground rises behind the antenna. Even so, there seems to be little doubt that the erection of a beam antenna on sloping ground will significantly lower the angle of radiation, provided the slope is in the desired direction. There may be a disadvantage in the fact that the rearward lobe is probably raised by an angle also close to the slope inclination. It would seem that in the case where mono-directionality is desired there is

no point in erecting an antenna on the top of a hill.

There are additional angles where the direct and reflected wave will be in phase, for example 540° , 900° , etc⁷. The addition of elements for a fixed height will lower the angle of radiation. With the author's configuration of the delta loop beam, the angle of maximum radiation is probably somewhere near 14° . This upward inclination of the main lobe is still substantial and there would need to be extremely high unwanted obstructions relatively close to the antenna (20 wavelengths) to interfere with propagation along the maximum path.

Desired path

If H is the height of unwanted obstructions along the desired path, then:

$$H = 20\lambda \cdot \tan \theta + h'$$

In the author's case there would have to be obstructions at a height of 533 feet above the base of the antenna at a distance of only 20 wavelengths away.

It has been argued that the lower the angle of radiation the better for DX working. The author's experience over a number of years suggests that this is not necessarily so. Often, when switching from one antenna to another or lowering the tri-band Yagi beam whilst conducting a QSO with a DX station, it has been found that the actual signal strength has increased.

Statistical analysis of several hundred QSOs does confirm that the antenna with the lowest angle of radiation has proved to be the best for DX working, and the reason for the occasional anomaly is a mystery.

There have been explanations for this anomaly⁷ which refer to absorption in the D layer. However, since absorption principally affects the lower frequencies, it cannot explain the anomaly on the higher frequencies.

Trees

The author lives in a heavily wooded area. Many scots pines and oak trees in the immediate vicinity rise to upwards of 70 or 80 feet. The main 10m/15m/20m TH6DXX beam can be raised to 65 feet. In certain directions, even at this height, some of these trees are within a wavelength of the beam on 20m. No detrimental effect has been observed. Other antennas for both 70cm and 2m have been mounted on the same mast with polarising devices at the operating position. With these antennas a marked reduction in signals has been observed when firing through the trees, although much less so when they are adjusted for horizontal polarisation.

Clearly, trees have an effect upon electromagnetic waves as is illustrated by military aircraft and satellite radars which are able to identify types of forest even at ranges of 30km. At HF frequencies, however, these effects seem to be limited. Reliable communication over the ground is required by the military and much research has been done to study

Fig 2

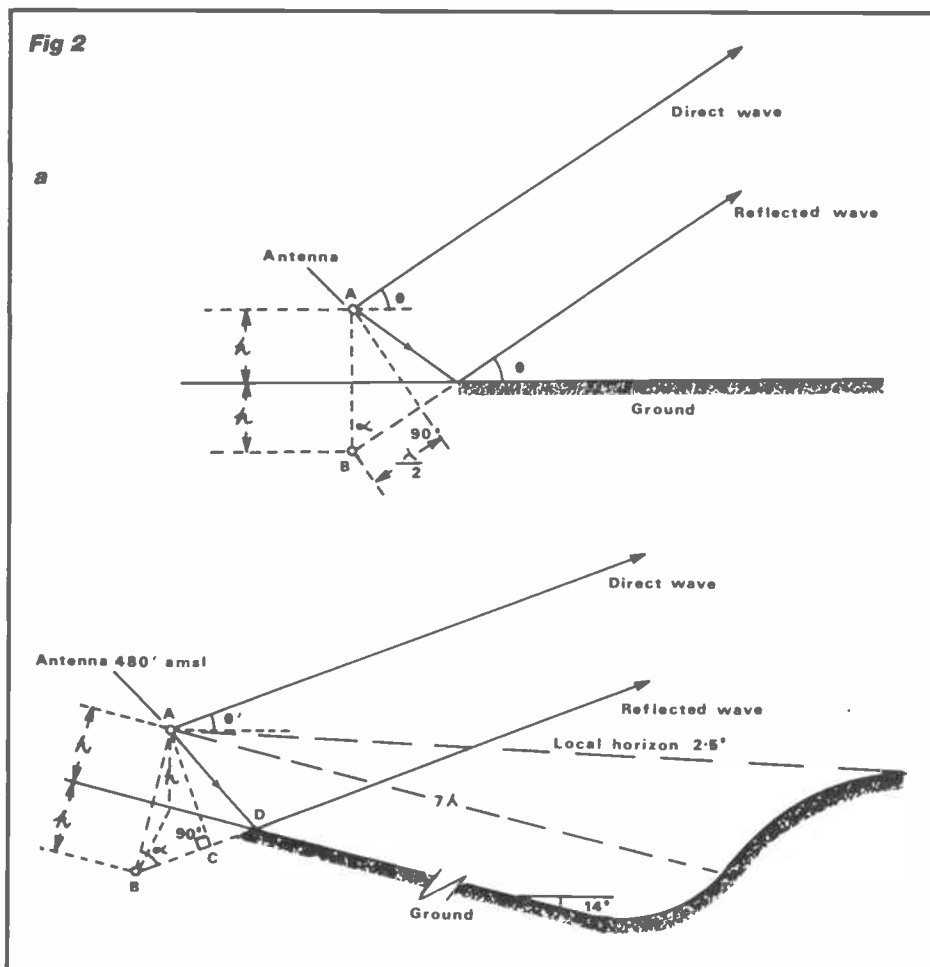

DELTA LOOP BEAM

the effect of trees within the groundwave path. It is not inconceivable that the shape of a particular forest close to an HF antenna could enhance the radiation pattern as a result of refraction, concentrating this radiation on a particular bearing.

Prior to erecting the present antenna for 30m, two 20m dipoles were erected at the same height above ground. One of these was buried in dense woodland with trunks, branches and foliage extending to at least 20 feet above the dipole. The other was erected and orientated in exactly the same direction, but some 200 feet away from the first and completely in the clear, the nearest trees more than 150 feet away.

A series of tests over a period of several months, involving switching from one antenna to the other whilst in QSO, revealed no significant difference between the two. This was found to be so even in heavy rain. It had been hoped to reveal that the trees inhibited propagation to some measurable extent. Even a statistical analysis of several hundred reports was not significant.

Thus encouraged, it was decided to erect the 30m beam in the woodland taking care to ensure that the feed method would give horizontal polarisation. Tests using a field strength meter with a ferrite rod as its antenna revealed very little vertical polarisation. The only observation regarding polarisation which might be worth mentioning was that measurements at a distance in excess of 10 wavelengths broadside to the antenna showed a small increase in the vertically polarised wave.

Delta loop beam

Figure 3 shows the construction of the beam. The wire used is 18swg hard drawn copper which was stretch tested before construction.

Four trees were selected which were very approximately at the corners of a rectangle. Its longest sides were about one wavelength apart and shorter sides were more than a quarter wavelength apart. The idea was that with four suspension points at 52 feet on these four trees it would be possible to orientate the beam on a heading of 255° and also to adjust the spacing of the driven element from the reflector by pulling on cords at ground level, as illustrated in the drawing.

The spacing adjustment cords are marked at 3in intervals with coloured PVC tape so that it is possible (with binoculars) to vary the spacing without having to lower the antenna. Admittedly, this proved to be a somewhat more complicated operation than was intended. After repeated adjustment of the six down cords it was, however, possible to set both orientation and spacing as desired.

As mentioned earlier, the chosen spacing (by calculation) was to be 0.102 wavelength. So initial tests were carried out at a spacing of 9ft 10½in. This gave a feedpoint resistance of 48 ohms. To

increase the radiation resistance to 50 ohms would require only a very small increase in the spacing. It was rather satisfying to find by noise bridge measurements that the resonant frequency was only 12kHz above the design frequency of 10.133MHz, a sharp null being found at 10.145MHz.

A 1:1 balun³ is connected at the feedpoint and the driven element is fed with 77.7 feet of RG8U foam 50 ohm coaxial cable. This length was chosen so that the cable would have an electrical length of one wavelength ($V_f = 0.8$) and any measurements taken at the transmitter end would reproduce the constants at the feed point.

On test, the reactance was almost impossible to measure but very slightly capacitive. Fortunately, without any adjustment whatsoever, the SWR was 1:1 at 10.145MHz.

Results

The original single delta loop was left in place as a reference antenna. Analysing 45 contacts with VK5s over a period of two weeks showed an average improvement in reports of 1.7 S points when compared with the reference antenna. The average signal reports of these 45 contacts was 7.18 S points based on peak readings. Nine of these contacts reported S9+ signals. During a period of extremely low sunspot activity the performance has been very satisfying.

The erection of a similar beam for 40m

is now planned using the same formulae. Final trimming of the 30m antenna has still to be carried out, although the adjustment necessary will be minimal.

The next stage will be to erect a single wire horizontal parasitic director at the effective height of the beam and move the reflector further away from the driven element so as to maintain the good matching. Had the beam been a Yagi there would have been little difficulty in deciding upon the optimum spacing away from the driven element. Determining the spacing which is likely to have any useful effect upon the gain and F/B ratio is going to present problems (and may be beyond the author's capabilities!).

References

1. *Loops and Dipoles. A Comparative Analysis*, James L Dietrich WA0RDX. QST, September 1985.
2. *Analysing 80 Metre Delta Loop Arrays*, Bill Myers K1GQ. Ham Radio Today, September 1986.
3. *Balanced Feeders and Baluns*, V J Copley-May G3AAG. Amateur Radio, August 1986.
4. *All About Cubical Quad Antennas*, William I Orr W6SAI. 2nd edition.
5. *HF Antennas for all Locations*, L A Moxon G6XN. 1982.
6. *ARRL Antenna Book*. 1982.
7. *Dipole Antenna Over Sloping Ground* Randy Rhea N4HI. Ham Radio Today, May 1982.

Fig 3 The 30m delta loop beam. Support points are 52ft above ground. Points marked A are hoisting ropes and points marked B are spacing adjustment ropes

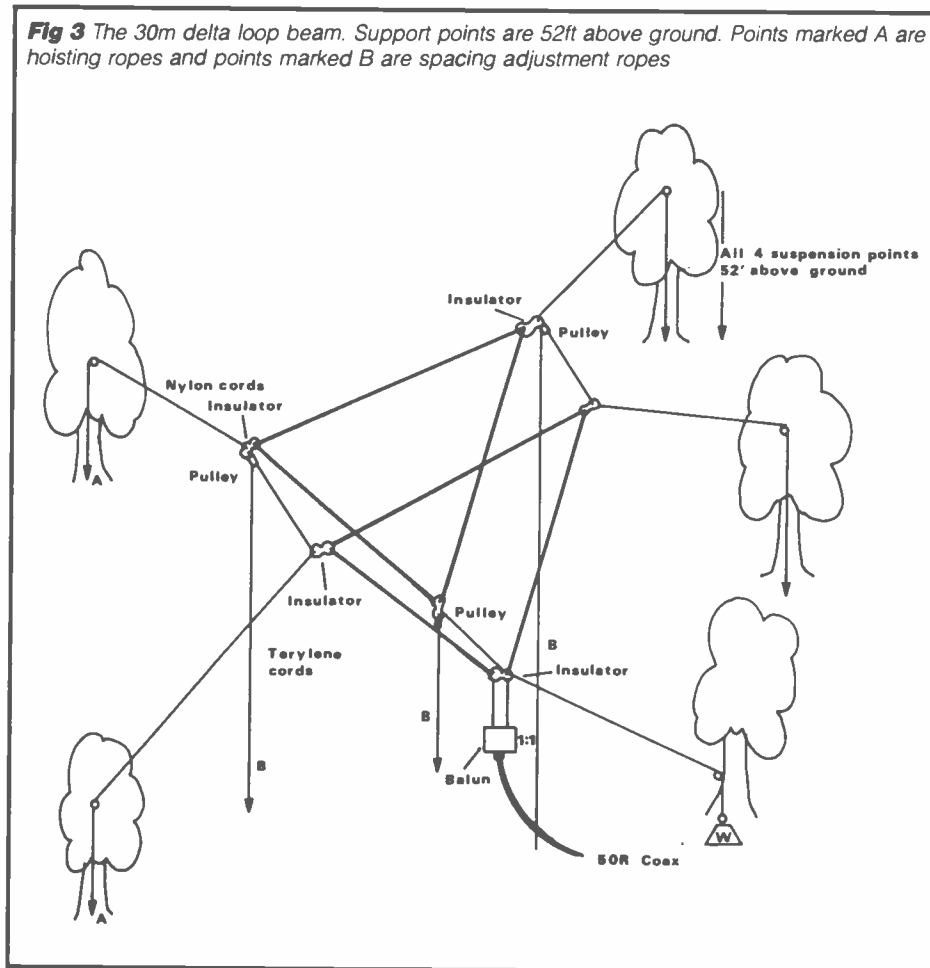

ARRANDECK LIMITED
FOR SPEEDY COMPONENTS
XMAS SPECIAL OFFERS

TOP TEN COMPONENT PACKS 99p each		COMPUTERS	
Pack 1 200 Mixed Resistors		PCW8256 £399.00	
Pack 2 40 Mixed Capacitors		PCW8512 £499.00	
Pack 3 50 Mixed Diodes		Speech and sound interface for PCW8512 £49.99	
Pack 4 20 14-pin DIL Sockets		GET 5 FREE DISKETTES WHEN YOU ORDER A PCW8256/8512	
Pack 5 15 16-pin DIL Sockets		CF2 Diskets £3.99 each	
Pack 6 10 Mixed CMOS ICs			
Pack 7 10 Mixed 74LS ICs			
Pack 8 10 Mixed LEDs			
Pack 9 5 Mixed Voltage Regs			
Pack 10 20" Breadboard offcuts			
COMPUTER ICs		***** *** STOCKING FILLERS *** ***** Solderless electronic project kits	
2114 RAM 200nS	£1.40	30 Project kit	£12.95
6116 RAM	£1.00	80 Project kit	£21.95
2716 EPROM 450nS 5V	£3.10	Soldering kit	£9.99
2732 EPROM 450nS	£2.99	Comprising of:-	
6800 CPU	£1.99	15W iron, 2M solder, desolder braid and tweezers	
Z80 CPU	£2.50		
Z80 CTC	£2.99		
6402 UART	£2.99		
SP0256-AL2	£8.50		
ARRANDECK LIMITED 50 Laburnum Way Sampsons Wood Yeovil BA20 25A Phone (0935) 706244	TERMS OF TRADING Payment with order P&P 55p. Free if order is over £20.00. VAT add 15% to total order value.	SEND FOR OUR 30-PAGE CATALOGUE (Price 60p) AND RECEIVE OUR FREE COMPONENT SAMPLE PACK WORTH 99p	

L F HANNEY

77 Lower Bristol Road, Bath, Avon
TEL: 0225 24811

Your electronic component specialist for Avon, Wilts & Somerset

Closed Thursdays

Selectronic

The UK's leading suppliers of 934MHz personal radio equipment

203 High Street
Canvey Island, Essex
Tel: 0268 691481
(Open Mon-Sat 9-5.30)

Amateur radio equipment also in stock

BEST EVER VALUE END-OF-LINE BARGAINS!

● COMPUTER SYSTEMS

SAMURAI S-16 MSDOS COMPUTER SYSTEM. 8086 based true 16 bit machine with high-res green screen, 128K memory (do-it-yourself expandable to 512K), twin DSD0 8" floppy disc drives (total 2.3 MB); CENTRONICS parallel interface, 2 x RS232 interfaces, MSDOS with full manuals INCLUDED in the price are PEACHTEXT word processing software, PEACHCALC spreadsheet, and PEACHTREE TELECOMMUNICATIONS. All BRAND NEW with original manuals £299.00

TRIUMPH-ADLER P40 COMPUTER. 128K dual processor machine (8085 & 8088) with high res monitor, single DSD0 80 track floppy, 12.5 MB half height WINCHESTER drive. CP/M & MSDOS are included in the price. BRAND NEW £295.00

TRIUMPH-ADLER P30 COMPUTER. As above, but with twin floppy disc drives BRAND NEW £195.00

PYRAMID Model 501 CP/M MICROCOMPUTER SYSTEM (Manufactured by HTE Ltd). With 4MHz Z80A processor, 64K memory & twin TEAC Model FD-55F DSD0 80 track half height 5 1/4" floppy disc drives (total 1.5 MB). With serial RS232 & CENTRONICS parallel interfaces & provision for a second serial interface. These very compact (2 1/2" high) machines are S-100 based (with one spare slot), and are software compatible with NORTH STAR HORIZON. CP/M Ver. 2.2 & some TELEX software is included in the price. BRAND NEW or EX DEMO condition (requires terminal) £195.00

MATMOS PC. Available without disc drives only. 64KB Z80A based machine with RGB, composite video outputs & UHF modulator. Serial, parallel, cassette & peripheral bus interfaces are provided. MICROSOFT BASIC is in ROM. A terminal emulation ROM is available at £20.00 £49.00

● PERIPHERALS

HITACHI Model 305S 3" disc drives. With SHUGART compatible interface (34 way edge connector) & suitable for BBC with DFS, AMSTRAO 664 6128, TATUNG EINSTEIN & many others. 250K (double density unformatted) per side reversible, 40 track, standard power connector for 12V & 5V, overall power consumption typically 3.7W. Supplied BRAND NEW with connector pin-out details etc. but uncased. Data cables only are available for AMSTRAO & BBC (£7.50) and TATUNG (£10.00) £29.95

HITACHI Model 3050 double sided 3" disc drives. As above, but double sided (500KB unformatted accessible without turning disc over). Not suitable for AMSTRAO 664 6128 £39.95

HITACHI COLOUR MONITOR Model 1480P. High resolution 14" monitor with RGB, intensity & sync inputs at positive TTL levels. Horizontal frequency is 15.75kHz & resolution is 640 x 200. IBM compatible. BRAND NEW £149.00

HITACHI COLOUR MONITOR Model CD2053 high resolution (720 x 416) 20" colour monitor with RGB & sync input at positive TTL levels. Horizontal frequency is 24.2kHz. Suitable for Olivetti M24. BRAND NEW UNCASSED (We have various other new uncased colour monitors still available at £95.00) £195.00

HITACHI MONO MONITOR. All BRAND NEW but uncased and for 12VDC. 15.625kHz. 15.75kHz horizontal frequency, 50-60Hz vertical. Positive TTL video & sync. 9, 12 & 14" available £18.50

● WORD PROCESSOR

ITT SCRIBE III WORD PROCESSING SYSTEM. Dual processor (Z80H & TI 9995) machine with 128K memory, QUME printer interface & RS232 comms interface. With dual 5 1/4" floppy disc drives (double density, double sided), high resolution green screen monitor & low profile keyboard. Excellent professional word processing software with many advanced features including extensive help files, slow scrolling, mail-merge, information retrieval, integrated data base, etc. is included in the price together with BASIC. Originally selling at over £5000.00. BRAND NEW £295.00



ITT SCRIBE III as above with 10MB Winchester & single floppy, 256K & NEC Model 7700 SPINWRITER 55cps daisy wheel printer. All BRAND NEW £995.00

Please note: *VAT & CARRIAGE must be added to all items. Carriage is £3.00 - VAT for 3" disc drives, and £10.00 - VAT for all other items. *A complete stock list (which includes test equipment & other items) is available on request.

AVAILABLE ONLY FROM
MATMOS Ltd., 1 Church Street, Cuckfield, W. Sussex RH17 5JZ.
Tel: (0444) 414484 454377

COMPUTER APPRECIATION, 111 Northgate, Canterbury, Kent CT1 1BH. Tel: (0227) 470512 Telex: 966134 COMPAP

Visa & Access accepted

SHORT WAVE LISTENER

TREVOR MORGAN GW40XB

This year has been one of peculiar conditions, with some excellent DX being heard one minute and a dead band a few minutes later. Even the high powered broadcast stations have found it difficult to get their signals out to 'target' areas without a mass of off noises and fading. I often wonder just how amateur signals get out to the distant places they do under the sometimes appalling conditions, and I am frequently amazed at the distances worked by low power operators.

No experience

According to my mail, there are newcomers to the hobby who have often had no experience whatsoever of radio and find things a bit strange, especially the terms used by amateurs during a contact. Even some amateurs find the jargon a bit of a problem at first. Not too many years ago, it was the normal thing for someone interested in amateur radio to spend a period on the receiver before attempting the RAE. However, there seem to be fewer licensees who have cut their teeth in this way and, in fact, many of them have never owned a receiver. This is a great shame, as apart from the enjoyment that can be had from the listening hobby a lot of useful experience is gained during this time which can prove invaluable when the RAE is attempted and the licence obtained.

What's it all about?

Short wave listeners often spend hours alone in the shack, which can consist of anything from a corner of the bedroom to a custom built outhouse, intently listening for signals being transmitted from all over the globe. Incidentally, the term 'short wave' is a generalised one as, in fact, listeners often explore frequencies far above and below the short wave spectrum.

Many listeners never stray from the broadcast bands, ie

the bands set aside for use by the many international radio stations for transmitting news, music, general interest programmes and, of course, propaganda... and don't run away with the idea that all propaganda comes from the Eastern Bloc!

For many, the introduction to serious listening occurs after hearing the kind of broadcast from a foreign station that makes you want to tune in again. It may be a programme on stamp collecting, railways, nature, tourism or even folk music that takes your fancy. At some time during the programme, the announcer will give the details of regular frequencies used and times of programmes you are interested in and you will be encouraged to 'tune in next time'. It's not a big step from there to be looking around the bands for other stations with equally interesting programmes.

The radio bug

Many of these stations will be offering inducements to listen regularly and send in reports on conditions. They want to know whether the signals were clear or distorted, whether there was any interference or deliberate jamming, etc, and they will also ask for your comments on the content of the programmes. Some offer prizes for reporting on different aspects of the programme.

It doesn't matter what your original reasons were for listening to specific stations; there are stations transmitting from all over the world twenty-four hours a day and it is easy to be attracted to the art of catching the unusual ones. It soon becomes obvious that certain stations are only on the air at set times and use specific frequencies at those times. Signal strengths on these frequencies will vary from time to time and anyone with a little curiosity will want to find out why. It does not take much to catch the radio bug and, once you are bitten, it can become

more than just a passing fancy!

Initially, most listening is done with a simple receiver, often part of the family hi-fi system, but it's not long before it becomes a chore having to miss a wanted programme because someone else in the family wants to use the other part of the system. What is really needed is a receiver made for the job. Listening to a purpose-designed communications receiver instead of the music centre radio is like driving a car after having ridden a bike for years... the bike got you there, but the car makes the job so much easier, and has more to offer on the journey!

Most interesting

The communications receiver has lots of features that were missing from the old radio you used before. Most interesting for the new owner is the BFO (beat frequency oscillator). The usual broadcast stations use a mode of transmission called AM (amplitude modulation), which consists of a signal carrier wave supporting two sidebands on frequencies above and below it. Early experiments proved that signals could be transmitted using one of the sidebands and a suppressed carrier wave and, providing the receiver had a means of reinserting the carrier, this method was quite acceptable for speech. This meant that the transmitted signals would take up a narrower portion of the valuable radio spectrum. Although this mode is used extensively by the amateur fraternity, broadcast stations do not use it in general, which is why the average receiver does not have the facility.

Strictly illegal

Specific ranges of frequencies are set aside for use by amateur radio users and it is strictly illegal for the amateur to stray outside of these areas, even accidentally, which is why the amateur has to fully understand the laws gov-

erning his hobby. He can be very quickly shut down for infringement!

Whether you listen to the amateur bands or the broadcast bands, regular listening enables the enthusiast to learn which bands are 'live' at what times, where particular stations can be heard, and what effects the weather or other external influences have on reception. He also learns much about the performance of the various types of aerials and the various techniques and procedures used by amateurs.

Short wave listening is a hobby in itself, with thousands of devotees who are content to remain listeners and are supported by many organisations. It is also an important, and often underrated, stepping stone to the world of amateur radio.

Mailbag

So, to the mail spot for this month. As far as the awards go, this has been a particularly interesting and enjoyable month for me. When I introduced the *Amateur Radio Prefix Awards* in 1985 I little realised just how keen readers would be to spend their time listening for long periods to log the required number of prefixes. The relatively recent *Lifeboat Award* set a seemingly simpler task which, in the event, rather taxed the skills of some of our most ardent award hunters.

The reason for my elation this month is that I've not only had the pleasure of presenting the first two *Lifeboat Awards*, but also the first 'Premier' Prefix Award for logging no less than 2,000 amateur prefixes!

So, first honours then to Howard Done of Barry, to whom I had the pleasure of presenting the first *ILA Lifeboat Award* last week. The requirement of logging 100 amateurs living in a town served by a lifeboat does not seem to be a difficult task on the surface. However, first appearances are deceiving

and Howard spent many hours logging before he hit the target. His equipment consists of the Trio R2000 and a G5RV rigged up in an extremely small garden, alongside his aerials for two metres and seventy centimetres. He has been associated with the sea for many years and, like any other 'old salt', has many a tale to tell and we had a good old chat. Congratulations, Howard!

The second Lifeboat Award went to Mick Hudson BRS87259, of Canterbury, who used his WAB index to trace the locations of his loggings and remarked on the enjoyment he's had working for the award. However, not satisfied with this one, Mick went on to claim the Premier award for logging 2,000 prefixes and, to cap it all, the ILA Broadcast Award for logging 100 broadcast stations, too!

Mick still uses the Trio 9R59DS with an end-fed wire aerial to do his listening, once more proving that you don't need a 'super station' to get in on the action if you've a mind to. A superb effort, Mick!

In a frenzy

Between bouts of frenzied activity at the receiver, Mick has been compiling a list of available awards from round the world. Not a task to be taken on lightly but Mick noted that the RSGB list was out of print and decided to do something about it. If you would like a list or can help Mick, drop him a line at 29 Priores Road, Canterbury CT2 8NT.

Next out of the bag is Stuart Seymour G4CPJ, of Bes-thorpe, Near Newark, who put in his claim for the Gold award for working 1,000 prefixes on SSB only. Stuart uses the JRC JST100 and a TS440S, coupled to the TL922 linear amplifier. Antennas consist of the Hy-Gain TH7DXX and dipoles for Top Band, eighty and forty and he has regular skeds with friends in ZL country on twenty. Well done, Stuart!

Double claim

N Fox of Wakefield put in a double claim this month for Bronze and Silver awards using his Trio R600 and FRG7 fed with a half-sized G5RV and a trapped inverted 20m Marconi. AA4, AP2, BV2, BY1, HH2, HK1, PT7, VP9, XE1, 5B4 and 5W1 featured amongst the lists. Great going.

Jon Baker G1PGH, of Selsey, claimed the Silver award plus a single-bander for twenty metres for Bronze. Jon is also working his way toward the Broadcast Award to make a change from the hurley-burley of the amateur bands but is not having much joy in getting a QSL card from Iran, even though they asked for reports! Anyway, Jon has more important things to think about with his 'A' levels and his Morse ticket to aim for. Best of luck, Jon!

All that jazz

On to the general mail, and Peter Ward of Bath has been giving the broadcast bands a listen too, but for different reasons. Peter is a jazz musician and has been looking for foreign broadcasts featuring his favourite style of music and has been compiling a list of them. Anyone who is interested in joining him in the task can contact him at Flat 1, 7 Fountain Buildings, Bath BA1 5DU.

A very complimentary letter from Ron Young G3RGF, of Chelmsford, who read my review of the Sony ICF7600D back in August and decided to try one for himself. Ron states: 'I am hearing everything on it that I can on my home base TS430 and RA17L... ' which says a lot for the little Sony! Ron also does a lot of broadcast listening, so gets a lot of pleasure from his shack.

Ray Williams of Grantham has been having a few problems with scanners lately with his Bearcat doing the nasty on him. He is having difficulty in getting it repaired - it seems the chips are scarce. Now his AR2002 has started playing up too! It's a pity as it's only four months old! Maybe the DX hunting has worn the poor things out, Ray!

Masochism

Angela Sitton of Stevenage is still swotting hard for the RAE and working on the Morse too (masochist!), and is also going to try some homebrew for her station. Among her recent loggings using the old Philips receiver are KP2AH from the Virgin Islands, 4U1VIC from the UN station transmitting to CE, and 4N0CW on the Isle of Latore. The latter was interesting to Angie because it was a Yugoslav CW club!

Another interesting letter

has arrived from Les Hollis of Grantham. Les is interested in the broadcast bands in particular and mentioned Radio DLF from West Germany on 1269kHz medium wave starting at 1815UTC. The programme includes DX Circle, which is of interest to serious listeners. His favourite station is HCJB in Ecuador from whom he has received a number of QSL cards, books and leaflets and a detailed description of their hydroelectric scheme. Les uses the FRG7 and a Trio QR666 running through an end-fed wire.

50MHz band

Now on to a letter from Norman G Hyde G2AIH, who wrote regarding the comment by Howard Done in the August edition about the 50MHz band and its apparent lack of support. He says: 'There are valid reasons for the unpopularity of the 50MHz band. Firstly, it is a very noisy band with excessive QRM (local computer QRM is often S9++ right across the band from 0700 until late in the day) which is extremely frustrating. Another deterrent has been the recent poor propagation conditions. The dismal sporadic-E season this year has severely curtailed the possibility of DX working. Changes in conditions are unlikely to improve to any spectacular degree due to the little appreciated fact that the present 11 year sunspot cycle is superimposed on a 100 year cycle and that we are at a period of low solar activity within that 100 year cycle.'

'Another disadvantage is that no Continental countries have a 6m allocation so activity is virtually restricted to inter G working.'

Well, that has answered Howard's query... and put me right too! Thanks for your comments, Norman. I, for one, was not aware of the 100 year cycle and many of us make comments blissfully unaware of the problems others have!

UBA SWL Competition

This competition is an annual event organised by the Belgian Radio Society. The contest runs throughout the year and is a good test of listening techniques and ability. The UBA SWL Trophy is based on the prefix system. It takes place in March for SSB and May for CW. Details of

both of these competitions are available from the ILA, 1 Jersey Street, Hafod, Swansea SA1 2HF. Please enclose an SAE.

Good service

It's always a pleasure to receive a letter from a reader complimenting a retailer on his service. Gordon Garraway of Keynsham had a problem with his FRG8800 so sent it off to SMC for a service. He'd previously used the same firm to have a modification done to the receiver. On neither occasion did they charge carriage and, using Interlink, the set was picked up within two hours of his phone call to SMC!

Following on from the Sony story earlier in this piece, I had a Gold award claim from Cyril Ball of Doncaster. When he claimed the Silver award Cyril had remarked to me that he would be getting a new receiver. However, when he claimed the Gold award this month, he stated that he had decided to stick with the Sony ICF7600D to see what it was capable of. As a result, he has earned the Gold using the smallest receiver on the market!

There must be a moral there somewhere! Maybe some of us are so busy updating our equipment that we don't get the best performance from the equipment we've already got. With new receivers and transceivers coming onto the market constantly, we are tempted to upgrade from what we have to something with a few more features... often when they are of no real benefit to our results.

Some progress

Of course, progress is made in manufacturing techniques and receivers get more sophisticated, but do those improvements show anywhere else aside from the oscilloscope?

Wouldn't we be better off with better filter systems built into the receiver rather than more memory and a minute increase in the performance rating in the laboratory?

Well, that's it for now, folks. Thanks a lot for all your letters and your comments. If you have any queries on this month's offering, please write to me at the usual address (1 Jersey Street, Hafod, Swansea) or give me a ring on (0792) 467541.

C.M.HOWES COMMUNICATIONS

139, Highview, Vigo,
Meopham, Kent,
DA13 0UT England.
Fairseat(0732)823129



Surprisingly long distances can be covered with simple QRP (low power) equipment! Many of our customers have worked over 30 countries in their first couple of weeks on the air with our **CTX80**, 80M CW transmitter. Some have worked most of the USA call areas in the same period! The CTX80 runs up to 5W RF output (adjustable) and comes complete with one crystal. The transmitted "note" is very clean, in fact superior to many expensive transceivers. We also have CW transmitters for 40 and 20 Meters in the form of the **CTX40** and **MTX20**. The MTX20 with its 10W RF output has no trouble in working around the globe.

You can use our transmitters with your existing receiver, or with our **DcRx** Direct Conversion Communications Receiver. This receiver is a good example of how effective simple equipment can be, if it is well designed. Try running a DcRx side by side with the most expensive receiver you can lay your hands on, you will be amazed how well our little set stands up to the comparison! These receivers have also been an introduction to shortwave listening for hundreds of newcomers to the hobby. Add a **CVF** VFO to the DcRx and CTX/MTX and you have the full transceiver facilities of single knob tuning and IFT (clarifier). **HOWES** equipment is great for holiday and portable use, as well as for the fun of QRP operating from home!

	Kit	Assembled PCB
DcRx Direct Conversion Receiver (versions for 160, 80, 40, 30 or 20 Meters)	£15.30	£20.90
CTX80 80M QRP CW Transmitter (up to 5W RF)	£13.40	£19.40
CTX40 40M QRP CW Transmitter (up to 3W RF)	£13.40	£19.40
MTX20 20M QRP CW Transmitter (up to 10W RF)	£21.90	£27.70
CVF VFOs for above TXs (one version per band)	£9.90	£15.90
CTU30 Antenna Tuner for all HF bands up to 30W RF	£24.90	£29.90

Tuning capacitors for the DcRx receiver (except 160M version) are available at £1.50 each, you need two per receiver. One of the same devices can also be used for the CVF.

All the above kits are to build PCB modules. They include a circuit board, full instructions and all board mounted components. For more information on the above, or the rest of our range, simply drop us a line enclosing an SAE. We will send you a copy of our catalogue, and an information sheet on any kit you are particularly interested in.

P&P is 90p per order. Export prices are as above, but add £2.00 per kit for airmail delivery outside Europe. UK delivery is normally within 7 days.

73 from Dave G4KQH, Technical Manager.



EASY TO BUILD KITS BY MAIL ORDER

AKD

TEL.
0438 351710

Unit 5
Parsons Green Estate
Boulton Road
Stevenage
Herts SG1 4QG

MAIL ORDER DEPT.
Stock Items Normally
Despatched within 48 hours,
21 days latest.

People said we had disappeared from the face of the earth. They were wrong
WE MOVED!!

Our new larger premises allow us to hold bigger stock and to introduce **NEW** products. Watch this space over the coming months.

Still going strong in its 4th year at the original price. How do we do it?

WA1 WAVEMETER £24.95



Our Waveabsorption meter for 2 Mtre transmitters meets licensing requirements range 120Mhz to 450Mhz, very sensitive, can also be used as field strength meter within its range. Requires PP3 type battery (not supplied).

HFC1 CONVERTER £49.00



For the FRG 9600/965 our new HF Converter, connects to the aerial socket, and powered direct from the 8 Volt o/p of the FRG 9600. Tune from 100, 1Mhz to 160Mhz, gives tuning range of 100kHz to 60Mhz, uses double balanced mixer, with low pass filter on input.
* Can be supplied with BNC termination for other scanners *

GPA1 PRE-AMP £24.95



2 Mtre RF Pre-amp using BF961 dual gate FET 18 db gain; Low noise, 2Mhz Bandwidth 50 239 termination 25 watts through power. Failsafe switching, can be left in line when not required, auto RF sensing even at 1/2 watt, can be factory tuned between 28-170Mhz.
* Can also be tuned for 6-4 mtrs *

A SELECTION OF OUR MOST POPULAR FILTERS (SEND SAE FOR FULL RANGE DATA SHEET)

RBF1
A range of UHF notch filters (for inner only) stocked at the following frequencies: 435MHz (70cms) channel 36 (for radar blips), 846MHz (RAF Boulmer interference) can be factory tuned from 420MHz to 890MHz. £6.75 each
To order quote RBF1/ followed by type.

HPF1
Low insertion loss high pass filter with capacitive braid breaker for use with UHF TV, VIDEO & PRE-AMPS. £6.75 each

HPFS
High pass filter with transformer braid breaker, better performance than HPF1 but the insertion loss is a little higher. 1-2db best for severe problems for UHF only. £7.00 each

TNF2
A range of notch filters specifically tuned for the frequency of interference on inner and outer bandwidth >1Mhz (2Mhz above 100Mhz). VERY LOW INSERTION LOSS TYPICALLY <0.5db. Stocked for the following frequencies: 14Mhz, 21Mhz, 27.5Mhz (CB), 29Mhz, 50Mhz, 71Mhz, 145Mhz. Also spot tuned at any frequency to 300Mhz. £6.75 each
To order quote TNF2 and the frequency.

BB1
Transformer braid breaker >25db at 30Mhz, often used with other filters in our range for very severe interference. Ideal at the input of VCR and PRE-AMPS. £6.75 each

IDEAL FOR CLUBS OR EMC GROUPS FOR EVALUATION OF INDIVIDUAL SITUATIONS

DK1 FILTER KIT
Kit of 38 filters in our range (11 in all) except for RBF1/846Mhz. £41.70

WE ALSO STOCK TORROID RINGS @ £2.50 PER PAIR.

RSGB NOW STOCK OUR FILTERS AND MEMBERS CAN OBTAIN THEM AT A DISCOUNT FROM RSGB HQ.

ALL PRICES QUOTED ARE CORRECT AT TIME OF GOING TO PRESS AND INCLUDE VAT, POSTAGE & PACKING

ALL OUR PRODUCTS CARRY THE USUAL 2 YEAR GUARANTEE
ALSO AVAILABLE FROM LEADING AMATEUR RADIO DEALERS

* EMC PROBLEMS *

PHONE OUR TECHNICAL HELPLINE ON THE ABOVE PHONE NO. BETWEEN 10am & 12 NOON ANY WEEKDAY.

Props: R T & V E L Wagstaffe Technical Adviser: John Armstrong

MAKE THE MOST OF YOUR NICADS

Nickel cadmium rechargeable batteries (NiCads) are increasingly used today in place of primary cells, which cannot be recharged. The initial cost of NiCads, plus charger, can be high, but this is more than offset by the savings which can be made when the batteries are used and re-used many hundreds of times. The following notes give some basic information about them, and a simple timer is described which will help to avoid shortening of battery life through unnecessary overcharging.

Some basic facts

When purchased, NiCads must be charged before they can be used. Specially designed chargers, providing constant current, are required. These can be purchased or constructed. In the latter case, it is advisable to make a unit which charges cells in parallel. Charging in series can result in faulty individual cells having an adverse effect on others charging at the same time.

Fully charged NiCads have a typical voltage of 1.2V, dropping to 1.0V when exhausted, compared with 1.5 to 0.8V in primary cells which they can replace cell for cell in equivalent sizes. Sometimes, when a high total voltage is required, equipment designed for use with NiCads uses extra cells to provide the full voltage.

In normal use, NiCads are very robust. They work best in a temperature range of about 25-30°C, but will function, with increasingly lower efficiency, at temperatures as low as -40°C or as high as +60°C. They are resistant to shock and vibration and are fully sealed. A safety vent is provided in cylindrical cells which releases gas under conditions of abuse, such as too high a charging rate or excessive reverse charging. They can be stored indefinitely without harm, no matter what the state of charge. When not in use they will slowly discharge themselves, but this does not affect their capability for recharge.

The fact that they hold a fairly high voltage to the end of their charge means that it is not always possible to anticipate battery exhaustion. When it is important to keep equipment running, there is really a need to have a spare set of fully charged NiCads available for replacement purposes.

They are not suitable for use in very low power equipment, such as electric clocks, where primary cells would normally be replaced only once a year. With such a low current demand, a NiCad would self-discharge to exhaustion in something like half that time. Care should always be taken to avoid shorting

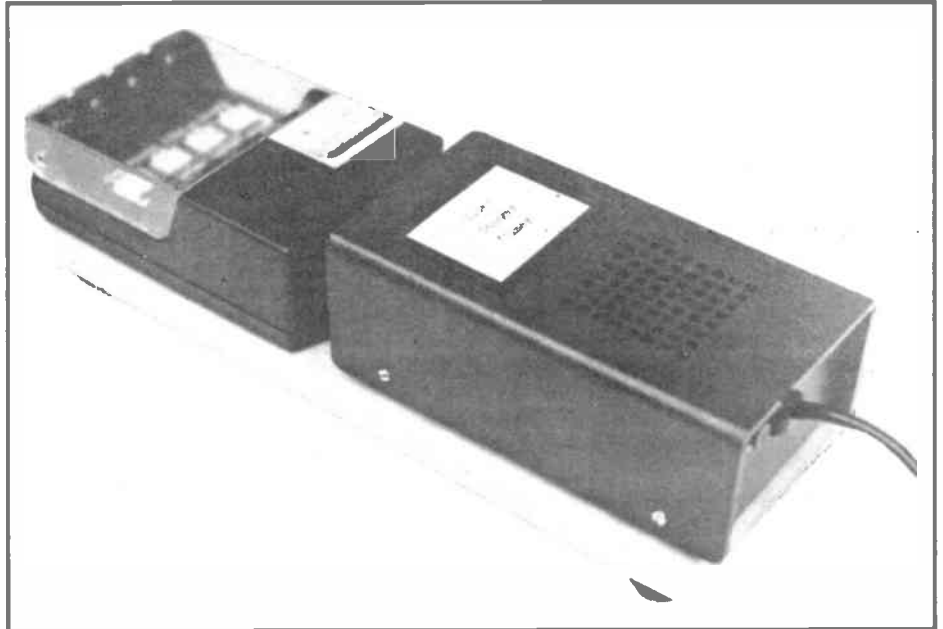

Tony Smith G4FAI gives us a few ideas on how to squeeze the dregs of life from those trusty NiCads

NiCads. They have a low internal resistance and high current will flow, causing damage to the cell.

Charging

Manufacturers recommend using a NiCad until it is discharged, and then recharging it for a specified period at a current appropriate for the particular size of cell. Variations in time and current, eg for rapid charging, are possible, but the maker's recommendations should always be referred to before attempting this.

NiCads can be put on charge before they are fully discharged with the recharge period correspondingly reduced. Some estimate of use needs to be made, adding about 20% to the estimated expired capacity. If frequent, however, this practice carries the risk of overcharging and reducing the potential life of the cells. Additionally, they may acquire a 'memory' for the reduced charge/discharge cycle, resulting in an inability to take the full charge.

The normal procedure when a cell is fully discharged is to charge it at the maker's recommended charging rate for 14-16 hours. Ideally, the ambient temperature should be in the optimum range mentioned earlier. Extremes should always be avoided, particularly in cold weather when low temperatures can

cause increased internal pressure of a cell during charging, with possible harmful results.

Advertisements for NiCads sometimes suggest that cells will not be harmed if they are charged for longer periods. This is quite true in the short term. The charging rates recommended are such that cells may safely receive overcharge for indefinite periods, but frequent excessive charging can reduce the overall life of a cell. It is worth noting that, because of its construction, the PP3 equivalent size NiCad is particularly vulnerable in this connection.

A simple way to avoid overcharging fully discharged cells is to use a timer to switch off the charger when the specified time has elapsed. There are various domestic time switches available on the market which could be used, but in most cases if a switch is not disconnected

Typical charging details for NiCads

Type	(Conventional equivalent)	Nominal voltage	Charging current
D	(HP2)	1.2	120mA
C	(HP11)	1.2	120mA
AA	(HP7)	1.2	45mA
PP3	(PP3)	8.4	11mA

Charging time in all cases = 14-16 hours

MAKE THE MOST OF YOUR NICADS

from the mains when the timing period is completed it will switch on again during the next 24 hour cycle.

Purpose built timing circuit

A circuit based on the Ferranti ZN1034E timer IC provides the answer. The timing period is initiated by pressing a push-button switch – the only external control on the unit. When 14-16 hours have elapsed the unit switches off the mains and will not switch on again unless the button is re-pressed.

The ZN1034E requires only two external components, R1 and C1, to obtain a particular timing period. An additional

component, VR1, initially set at mid-point, enables the period to be adjusted approximately $\pm 25\%$. When the timing period begins, ie when voltage is applied to pin 4 of IC1, pin 3 goes 'high'. When the period elapses, pin 3 goes 'low'.

The output from pin 3 biases transistor Tr1 so that it conducts while pin 3 is high, thus activating the relay to switch on the mains supply to the charging unit. When pin 3 goes low, Tr1 switches off the relay. This in turn switches off the mains supply to the charger and the power supply for the timer.

Nothing further can happen unless SW1 is pressed to short circuit the relay.

This switches on the power to IC1, and restarts the timing sequence. Once pin 3 is high, the relay conducts again and the push-button can be released.

Simple power supply

A simple power supply, using an inexpensive miniature mains transformer, provides a nominal 12V unregulated. This is applied to IC1 via a voltage dropping resistor (R2+R4), utilising a built-in regulator (pin 5) to provide the 5V required by the IC. The supply decoupling capacitor, C2, also stabilises the internal regulator.

The voltage applied to IC1 should be 5V $\pm 6\%$. During a timing period a drop below (typically) 3.6V of any duration will reset the timer, and resumption of full voltage will initiate a new timing period. In the circuit described here, a voltage failure or drop-out will, of course, result in the unit switching off completely.

No indicator light is provided, as chargers usually have their own indicator to show they are working. If required, there would be no difficulty in fitting an LED, with resistor, driven by the 12V supply to the timer or from pin 3. A neon indicator, with a suitable resistor across the switched mains, would also serve the purpose.

Charge retention with time for Nickel-Cadmium cells

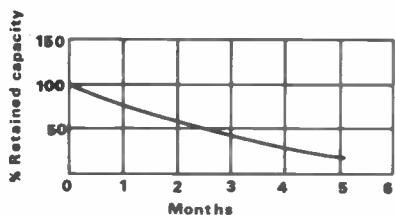

Mains relay connections, viewed from above

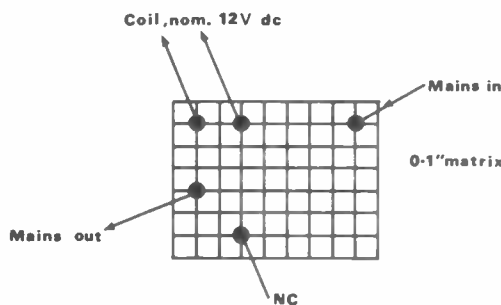

NiCad charger wiring arrangements



Numbered connections to terminal block. See circuit diagram.

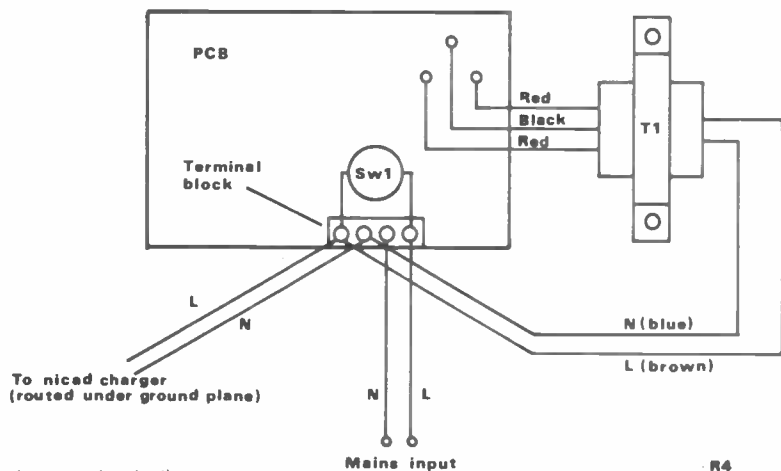

NiCad charger circuit diagram

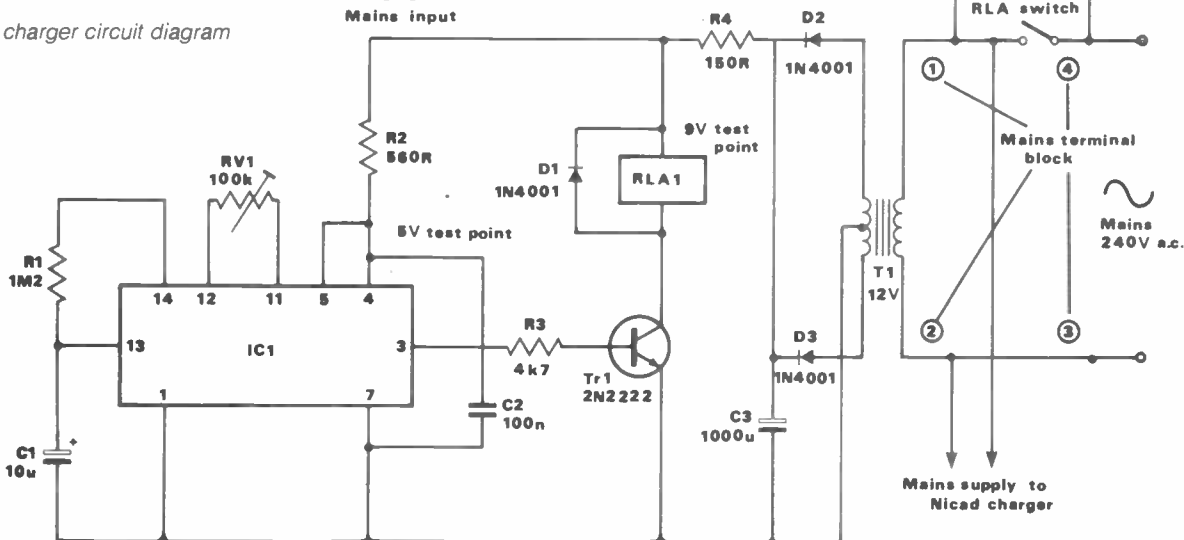

Making the unit

Construction is quite straightforward using the printed circuit illustrated. All components are soldered directly on the board, except the ZN1034E, which plugs into a Soldercon IC socket. The prototype was fitted in a plastic case and permanently wired to the NiCad charger, both units being mounted on a wooden base. The case used was intended for small power supplies (Maplin PB301). Whatever case is used, it is important to provide ventilation holes to disperse the heat from the transformer.

The existing mains cable on the charger was shortened to a few inches to

MAKE THE MOST OF YOUR NICADS

connect to the timer and the remainder of the cable was used to connect the timer to the mains.

Care should be taken to ensure that the mains wiring is kept completely isolated from the timer circuitry, and the mains cable entering and leaving the timer case should be securely fastened with strain relief grommets as an additional safety precaution. The mains output lead, running to the charger, should be routed underneath the ground plane on the PCB.

The PCB is made from double-sided copper clad board, with a ground plane on the component side, as illustrated, to prevent mains interference effecting the timing operation of IC1. Most component holes on this side are opened up (ie countersunk) slightly with a small hand-held twist drill, or Vero spot-face cutter, to ensure that component wires passing through the holes do not connect with the ground plane. The exceptions are pins 1 and 7 of IC1 and the earth connections of C1, C2 and Tr1, which must all be soldered on both sides of the board.

Soldercon strip terminals are used for the IC socket to facilitate the ground plane connections. The terminals are soldered in before the connecting strip is broken off. Care should be taken when soldering pins 1 and 7 to the ground plane to ensure that no solder flows into the spring terminals, as this will prevent the IC pins from entering the socket.

Setting up

When the timer is completed, it should be tested before connection to the charging unit. Fit a mains plug with 2A fuse to the mains lead. Route a temporary mains carrying wire from the output screw terminals which will normally go to the NiCad charger. Make sure this wire runs under the ground plane. Connect the wire to a mains electric clock. Make sure that VR1 is at mid-setting. Carefully recheck that all mains wiring has been properly connected.

Screw the lid on the case. Plug the unit into the mains and press the push-button

NiCad charging timer components list

Resistors

R1	1.2m ¼W
R2	560 ohms ¼W
R3	4.7k ¼W
R4	150 ohms ½W
VR1	100k preset, miniature

Capacitors

C1	10µF, 10V, electrolytic
C2	.1 polycarbonate
C3	1000µF, 16V, min electrolytic, single-ended

Semiconductors

IC1	ZN1034E timer
Tr1	2N2222
D1,2,3	1N4001

Relay

RLA1	Ultra min mains relay, 12V (Maplin YX97F)
------	---

Transformer

T1	Ultra min mains transformer, 12-0-12V secondary, 100mA (Maplin WBO2C)
----	---

Switch

SW1	Push to make, non-locking, mains, 240V ac
-----	---

Miscellaneous

PCB, as illustrated; IC socket (Soldercon); mounting nuts and bolts; spacers ¼in (4); plastic case, see text; cable strain relief grommets (2); PC terminal block, 4-way; optional wooden base, see text

PCB – component side

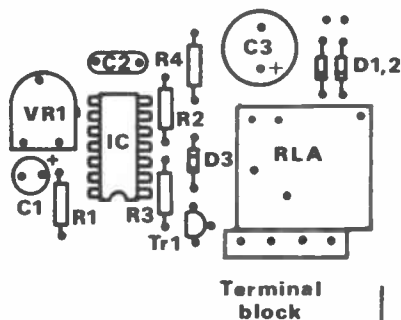
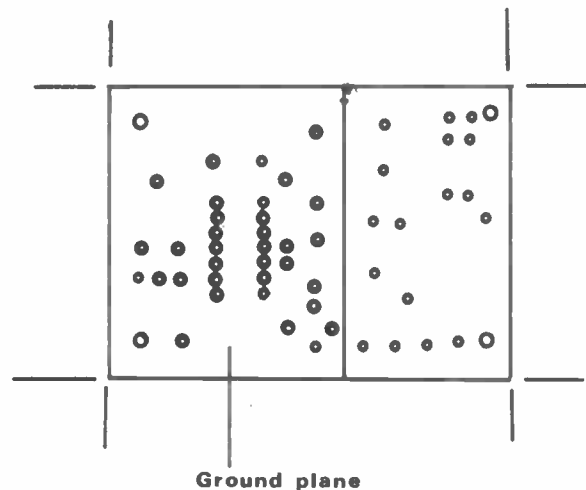

PCB – component side. Part of the board is left unetched to provide a ground plane for IC1. The copper is cleared from around the holes where shown, leaving 5 holes untouched where components are soldered on both sides of the board

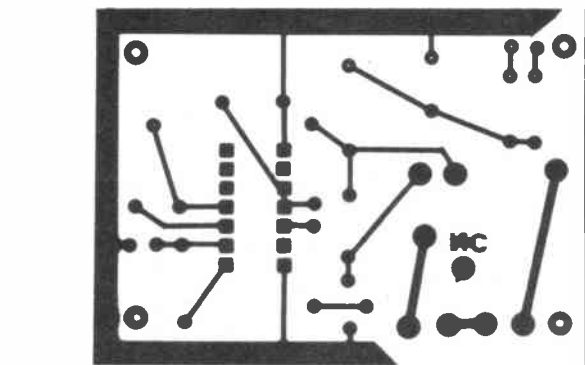

PCB – track side. Note thicker tracks for carrying mains. During assembly these should be tinned to increase their current carrying capacity, and ensure good separation where mains track is close to 12V circuitry

MAKE THE MOST OF YOUR NICADS

switch. The clock should now be working. Make a note of the time indicated. Go away, then come back after 16 hours have elapsed to check the time the lock stopped and to determine the timing period of the unit.

If it is between 14 and 16 hours, no adjustment will be necessary. If it is outside this period, adjustment of VR1 clockwise increases the period and anticlockwise will shorten it. A further time test will then be necessary to confirm the effect of the adjustment made.

In the prototype, the components shown provided a timing period of 14 hours 56 minutes, with VR1 set mid-way. Variations in the tolerance of similar value timing components may, however, result in a different timing period which can be adjusted as required by VR1.

When all is well, disconnect the clock. Connect the charging unit in its place, replace the lid and the timer controlled charger is ready for use. If no electric clock is available it will, of course, be necessary to devise some other way to check the timing period, but always remember the output terminals provide a mains supply.

Warning!

Always disconnect the unit from the mains before removing the case cover for any purpose. With the supply con-

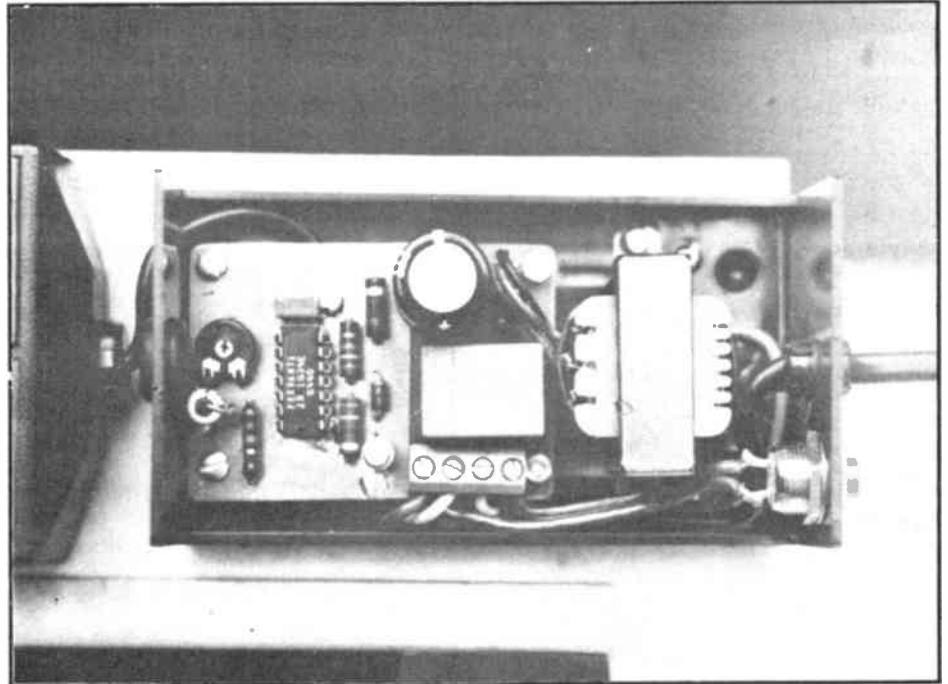

Interior view of the NiCad charging timer

nected part of the relay circuit is at mains potential, even when the relay is not switched on.

The prototype unit was designed and constructed for the specific function described, which involves carrying low

current at 240V. It has not been tested for other functions. The timing circuit may be adversely affected by the presence of higher currents, and almost certainly a more substantial wiring arrangement to and from the relay would be required.

S.M.C. 16

A series of Eurocards which together form a very powerful microcomputer
SMC 16 uses a 16-bit databus memory expandable to 16 megabytes
SMC 32 uses a 32-bit databus memory expandable to 4 096 megabytes

Description	Ki	Build	Board only
CPU 16 (12.5 MHz 68000 & optional numerical processor)	83.95	99.95	18.95
68811 co-processor for above board)	295.00	N/A	N/A
RAM 16 (1 megabyte dynamic RAM)	175.00	199.95	18.95
ROM 16 (1 megabyte eeprom) no empros supplied	45.95	55.95	18.95
I/O 16 (2 serial ports, 4 parallel ports)	69.95	85.95	18.95
SBP (backplane 21 slot upgradeable to SMC 32 later)	N/A	390.00	N/A
PRO 16 (prototyping board for your own circuits)	N/A	N/A	18.95
VMP 32 (68020, 68851, 68851 virtual memory processor)		995.00	29.95
VMP 16 (available to order only uses 16 or 32 bit databus)			
DKK 16 (floppy & hard disk interface board)	85.95	99.95	18.95

Other boards planned include colour graphics, RTC, A/D D/A Speech in/out and video interfaces
 Multi-tasking operating system available soon
 Minimum system CPU 16, ROM 16 (can use static RAMs), I/O 16 SBP 16 complete systems supplied to order

S.M.C. Electronics

Unit 29, Portsmouth Enterprise Centre
 Quartermaine Road, Portsmouth PO3 5QT
 Tel No: 0705 478881 Telex No: 869455 Fax No: 673647
 Please add 70p P&P and 15% VAT

Amateur Radio – the monthly magazine for all two-way radio enthusiasts

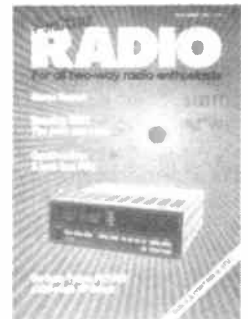

Don't take a chance on being able to get your copy

AVOID DISAPPOINTMENT

Place a regular order with your newsagent

Should you have any difficulties obtaining a copy, phone (0277) 219876 or write to Circulation Department, **Amateur Radio**, Sovereign House, Brentwood, Essex, CM14 4SE.

NEWSAGENT ORDER FORM

To (name of newsagent)
 Please order a copy of **Amateur Radio** for me every month
 NAME
 ADDRESS
 POSTCODE.....

Newtrade distributors: Argus Press Sales & Distribution Ltd, 12-18 Paul Street, London EC2A 4JS. (Tel: 01-247 8233)

SANDPIPER COMMUNICATIONS

AERIALS (STAINLESS STEEL ELEMENTS)

	STANDARD	DIY	RAP	
145/2 mtrs				Other frequencies available dual banders 4 and 6mtr 10 and 6mtr etc.
2 x 98 collinear	£22 00	£16 00	£3 00	
3 x 98 collinear	£30 00	£22 00	£4 00	
6 EL yagi				2 EL quads 20/15/10 mtrs or single band 20/15/11/10 mtr from £50.00
10 EL yagi				
6 EL crossed				
10 EL crossed				Weather satt aerials 137/1690 etc
436/70 cms				P.M.R. suppliers to BBC/ITV M.O.D. Telemetry/vidio links etc.
4 - Fibreglass collinear	£25 00	—	£3 00	Fibreglass/aluminium Masts/tubing
23 element yagi				
8 turn helical				SAE for Full Lists
1299/23 CMB/834/32 cms				
Mobile collinear 4-	£12 00	—	£2 50	
Base collinear 4-	£25 00	—	£2 50	
20 turn helical	£33 00	—	£3 00	
18 EL loop yagi	£40 00	£30 00	£3 00	
27 EL loop yagi	£50 00	£40 00	£3 00	
Para Delta	£40 00	—	£4 00	

Pentwyn House
 Penyard
 Llywdloed
 Aberdare
 Mid Glam CF44 0TU

Tel: 0685/870425

At the RSGB's HF Convention in September 1986 a 'Question and Answer' forum, with a panel comprising the society's secretary and the various committee chairmen, discussed a number of matters of interest to amateurs, including the question of third party operating. At one point the chairman of the panel asked for a show of hands from those present to indicate who would, or would not, favour full third

provide some factual information on this interesting aspect of amateur radio operating.

The only third party message handling facility we have in the UK relates to emergency situations, as defined in the amateur licence conditions. Some relaxation of the regulations was negotiated by the RSGB in 1982 when, on an experimental basis, and under the control of a licensee, non-licensed

third party traffic restricted to emergency situations. The Wireless Institute of Australia submitted proposals to the Department of Communications in 1977, and in August 1980 it was announced that Australian amateurs could forthwith pass third party traffic over the air under conditions very similar to those in the USA. Namely: There must be no material compensation of any kind to amateurs or other persons;

WHO WANTS THIRD PARTY?

party working in the UK. To the obvious surprise of the platform, there was a majority of almost two to one in support of having such a facility.

Readers may recall that in the December 1985 issue of *Amateur Radio* I described the work of authorised third party nets in Australia who passed messages for relatives of families affected by the Mexico City earthquake disaster. Following that article I received a number of letters, including one which read: '....my last correspondence with the then president (of the RSGB).... elected the response that this was not a facility the majority of members wanted as it would only add to the congestion on the bands'.

A misunderstanding

It would appear from the view indicated at the HF Convention that the (then) president's views may be a little wide of the mark. However, judging from remarks made at the forum, both from the platform and the floor, there is some misunderstanding as to what third party working really is. This article sets out to

persons were allowed to speak into the microphone of a special event station to send simple greetings to other amateur stations within the UK. Since then, the society has negotiated with the DTI to extend the experiment to contacts between UK special event stations and amateur stations in a limited number of other countries.

North America

So far, so good. However, these limited arrangements hardly compare with what is available to amateurs in the USA, who have had third party working since the inception of amateur radio.

Over the years, national and international nets have been built up to facilitate message passing, and two-way agreements have been negotiated with over forty different countries. Every amateur can pass third party messages, either on an individual basis or by calling-in regular traffic nets.

Australia

In Australia the position until 1980 was much the same as in this country, with

Messages must be non-commercial; Messages must only be passed within Australia or to countries overseas which have entered into a two-way third party agreement with Australia.

The following month, amateurs planning a radio display in Sydney organised a network of stations to allow members of the public to send greetings anywhere in Australia. This impromptu net attracted considerable interest, both from the public and from amateurs generally, and from that beginning an Australian Traffic Network has evolved, linking Australia nationwide and connecting into international nets controlled from the United States.

Eventually, Australia hopes to link directly with all those countries that have agreements with the US, but in the meantime VK stations can relay messages to those other countries via the American networks. Because they hope to work directly with countries already using the American system, ATN has adopted the ARRL's well tried system of procedures, codes, abbreviations and practices. Undoubtedly, a major objective is to achieve a two-way third party agreement with the United Kingdom.

So what is third party?

The basic idea of third party working is that any amateur can send a simple message to another amateur on behalf of someone else, without charge to that person. Any expenses incurred, for example in the delivery of the message—by telephone, post, or in person, are met by the amateurs themselves.

Messages are handled solely for the pleasure of operating. There is no guarantee that the message will be accurately relayed, or even that delivery can be made. There is just an implied promise that everyone involved in handling a message will try very hard indeed to ensure that it will rapidly, and accurately, reach its destination.

No amateur is obliged to accept a message from a member of the general public or from another amateur station, but once a message is accepted there is a responsibility to deliver it or relay it further as necessary. No station should agree to accept a message unless there is a reasonable expectation of being able to do this. The contents of any message are subject to all existing licence conditions.

The back of VK2BVS and Craig VK2POL (holding aerial) at the Sydney harbour brigade 50th celebration

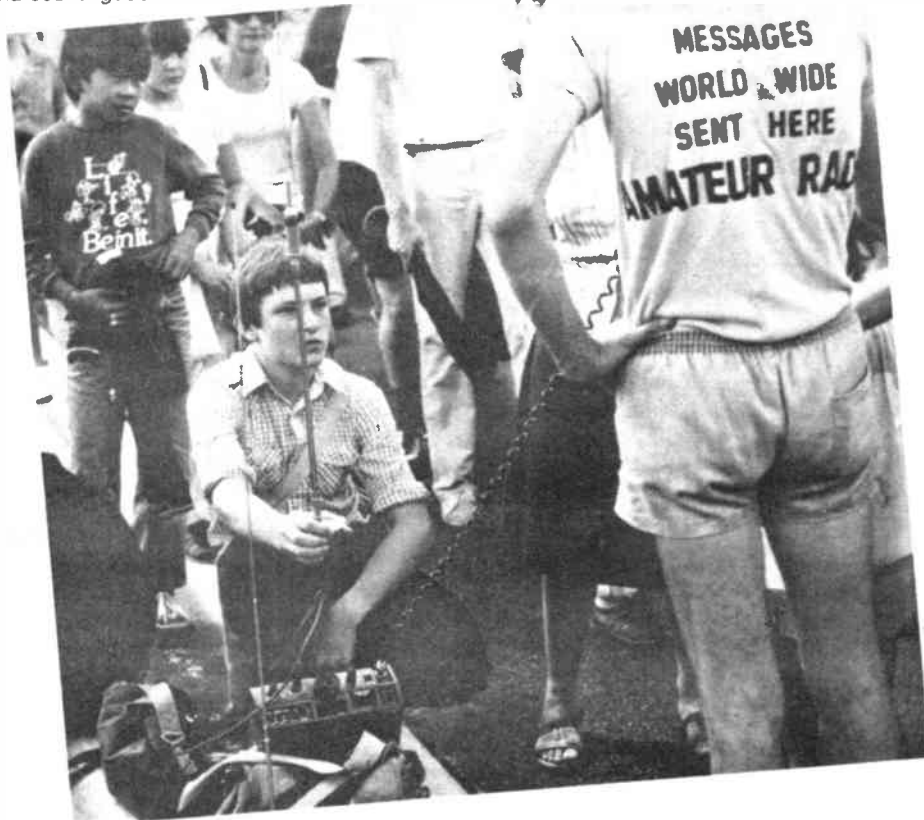

Networks

On an individual basis this is an interesting challenge, but when there are a number of messages involved a more formal organisation is required. Traffic nets evolve at this point, accepting messages from individual stations, taking over responsibility for passing traffic along organised routes to national or international destinations.

Nets having formal procedures provide invaluable experience in message handling for members of emergency organisations, and great satisfaction and enjoyment for everyone involved in them.

Phone patching

Another aspect of third party involves interconnection between an amateur radio station and the public telephone network. Known as phone patching, this enables conversation or other communication to take place end-to-end via both systems. In the USA this facility is used to link servicemen or scientific expeditions overseas with their families at home. It is also used as a personal facility by individual amateurs, eg by mobile stations linking into the telephone system via special repeaters.

Patching has its greatest potential in emergency situations, where the relaying of messages can be greatly simplified by putting the parties concerned in direct contact with each other. Overseas links, however, can only be established between countries having appropriate two-way third party agreements.

It is the responsibility of the amateurs involved to ensure that all licence conditions are observed while patching is in progress. It is the view of the ARRL that few activities create a more favourable image for amateur radio than phone patching does.

Interconnection

Although patching constitutes third party working, it does not automatically follow on from the granting of third party privileges. Agreement by the telephone authority is required and this involves, at the very least, the use of approved interface units between the radio and telephone systems, and possibly an interconnection charge.

In Australia, Telecom has so far held back from full double-ended phone patch, that is, telephone-radio-telephone interconnection, fearing a loss of revenue on its long distance routes. The Wireless Institute of Australia does not accept that amateur patching will have such an impact on telephone revenue and continues to press for double-ended patch for all radio amateurs.

The present position is, therefore, that normal phone patch interconnection is only permitted at a home station at one end of a radio communication link. Telecom Australia has agreed, however, that in emergency situations or during official emergency exercises, double-ended patching will be permitted as a special exception.

The WIA is designing an interface unit



VK2BVS filling out a message from a passerby at this general amateur radio display – Sydney

for construction and use by amateurs. After Telecom approval of the design, amateurs will be authorised to use the unit, subject to them certifying that they have constructed it in accordance with the approved specifications.

A challenge

Apart from telephony, third party working can involve all authorised modes. RTTY, CW, Amtor and packet all come within the scope of this activity. For those who are so inclined it represents a challenge and an opportunity to extend and test these systems to their limits and to prove their true communication potential and ability.

Like anything else in amateur radio, third party can be different things to different people. It can be ignored completely, it can be used occasionally, or it can be used daily. It can be totally informal, or very formal. It can be used only on a personal basis, or to provide a service for others.

Opponents

The Australian experience is that third party working is more of a convenience than a nuisance, simply an extra facility in day-to-day operating, available if required but not a dominant activity. Naturally, not everyone agrees with this, and some opponents choose to interfere with network transmissions. This practice is not entirely unknown in the UK in the field of repeater operation, although, of course, it is never accepted as an argument against the use of repeaters.

The RSGB says that the UK previously had third party privileges 'which were withdrawn back in the 'sixties as a result of abuse'. I have asked a number of amateurs who operated in those days for their recollections of these privileges, but no one seems to be able to remember them. From comments made, it seems more likely that there was, perhaps, a clamp-down on illegal third party operating at that time.

Of course, most radio amateurs are responsible people already operating within, and observing, comprehensive regulations. They know the importance

of preserving their privileges and, provided third party facilities are properly defined, there seems no reason to suppose that any relaxation of present restrictions would be abused.

Try now?

So why shouldn't our society try now to obtain for us the right to pass on simple greetings, or news of family and friends, on behalf of others? It would surely add an interesting new dimension to amateur radio operating, and would improve our public image enormously.

The RSGB insists that progress beyond the existing special event station concessions will require negotiations over a long period of time. But how long is long? The Americans have had third party for something like 75 years. The Australians finally woke up to the situation and have had it for the last six years. It is in daily use in over 40 countries.

We were told at the HF convention that current negotiations with the DTI on the proposed amateur licence revision include the provision of digipeaters which, as they would relay packet transmissions from one amateur station to another, would constitute 'third party working', representing yet another step forward.

I must admit I find this difficult to understand. Apart from differences in the technology involved, a digipeater performs the same function as a repeater, and whoever claimed that a repeater is a step towards obtaining third party privileges?

What we are discussing in this article is an interesting and potentially valuable addition to amateur radio operating in the UK. Full third party working can simply mean the opportunity to send greetings to someone else in the other operator's shack without fear of contravening the regulations. It can also represent a useful and on-going public service facility. We have an unfulfilled world-wide 'communication' potential in the true sense of the word. Third party facilities in the UK would represent a major step towards making that a reality.

by Tony Smith G4FAI

THE NATIONAL HRO

BRIAN KENDAL G3GDU DESCRIBES A CLASSIC RECEIVER

The term 'classic' is not easy to define. No one would argue against the idea that a Rolls Royce Silver Ghost is a classic car, neither would an aviation buff consider the Supermarine Spitfire anything but a classic aircraft. Likewise a play by Shakespeare or Beethoven's 9th (Choral) Symphony.

In our hobby or profession, classics also exist: Watson-Watt's Daventry experiment, which proved the viability of radar; the Collins KWM1 transceiver of the 1950s; the RCA AR88; and the National HRO receiver.

The HRO receiver first saw the light of day fifty years ago, in 1935, at the factory of the National Co in Malden, Massachusetts, in the US and was an immediate success. This gave rise to the apocryphal story that the name 'HRO' was given because the demand was so great that it was a 'Hell of a Rush Order'.

The receiver was originally available in four versions: the Senior; the HRO 'B', which was similar but optimised for a lower HT voltage for use with battery power units; the HRO 'Junior', which was similar to the Senior except for the omission of the crystal filter; and a 'B' version of the Junior.

With just nine valves in a straightforward circuit and no frills by modern solid-state standards, the circuit seems almost ridiculously simple. But the beauty is actually in this simplicity, for every part of the circuit was optimised for maximum performance.

The original versions used American series UX based valves with the choice of either 2.5 or 6.3 volt heaters. During the war further versions were introduced using octal valves. On the front panel of

the HRO, two features predominate: the very large and beautifully engineered tuning control and the coil unit, a separate one of which is used for each waveband. Other controls are: RF and AF gain; BFO on/off/tune; and crystal filter phasing and selectivity. Three switches provide on/off switching for HT, AGC and S-meter. The illuminated S-meter provides indications from S1 to S9+40. There is only one internal control, this being to balance the S-meter bridge.

Tuning control

The tuning control is one of the glories of the HRO receiver. It consists of a knob, four and a half inches in diameter, the periphery of which is marked in divisions at 0.3 inches spacing. Set within the knob are five windows, showing a series of numbers arranged in such a way that those in the upper two windows calibrate the peripheral markings to give a total logging scale of 0 to 500 with a total effective length of nearly thirteen feet!

The dial is attached by a spring-loaded 20:1 worm drive to the main four gang tuning capacitor, which is mounted parallel to, and behind, the front panel. The overall effect of dial and drive is to provide a silky tuning control with negligible backlash and convenient tuning rate.

The provision of a separate coil unit for each waveband conferred a number of advantages. The simplicity of the arrangement obviated the need for a bulky coil pack, thus enabling the weight and size of the basic equipment to stay within reasonable limits; RF leads could be kept to a minimum length and potentially troublesome bandswitching

arrangements could be avoided.

Each coil unit comprises four cans, each containing the inductors for one tunable stage of the receiver: two RF stages, frequency changer and local oscillator. All four units are attached to the back of a panel, on the front of which are mounted either a calibration graph and a memo panel or, in the case of bandspread coil-sets, two graphs – one for general coverage operation and one for bandspread.

The connection between the coil unit and the receiver is made by a line of contacts along the top of each can, which engage with spring 'fingers' in the receiver unit.

This interconnection technique has proved to be extremely reliable, and even after nearly fifty years the author has not heard of it causing any serious problems. The mounting of the coils in separate cans also ensures excellent screening which undoubtedly assists in maintaining stability.

Coil units for nine wavebands covering 50kHz to 430kHz and 500kHz to 30MHz are available. However, such a number is extremely bulky and it was rare, even in commercial practice, to carry a complete set, only those actually needed normally being supplied. Most amateurs confined themselves to the 900 to 2000kHz and the 3.5 to 30MHz bandsread units.

The units covering 1.7MHz to 30MHz are each designed to cover from the LF end of one amateur band to the HF end of the next one higher. Two versions of these are available, the 'general coverage' and the 'bandsread', the latter being capable of being modified from a 2:1 frequency coverage to only the

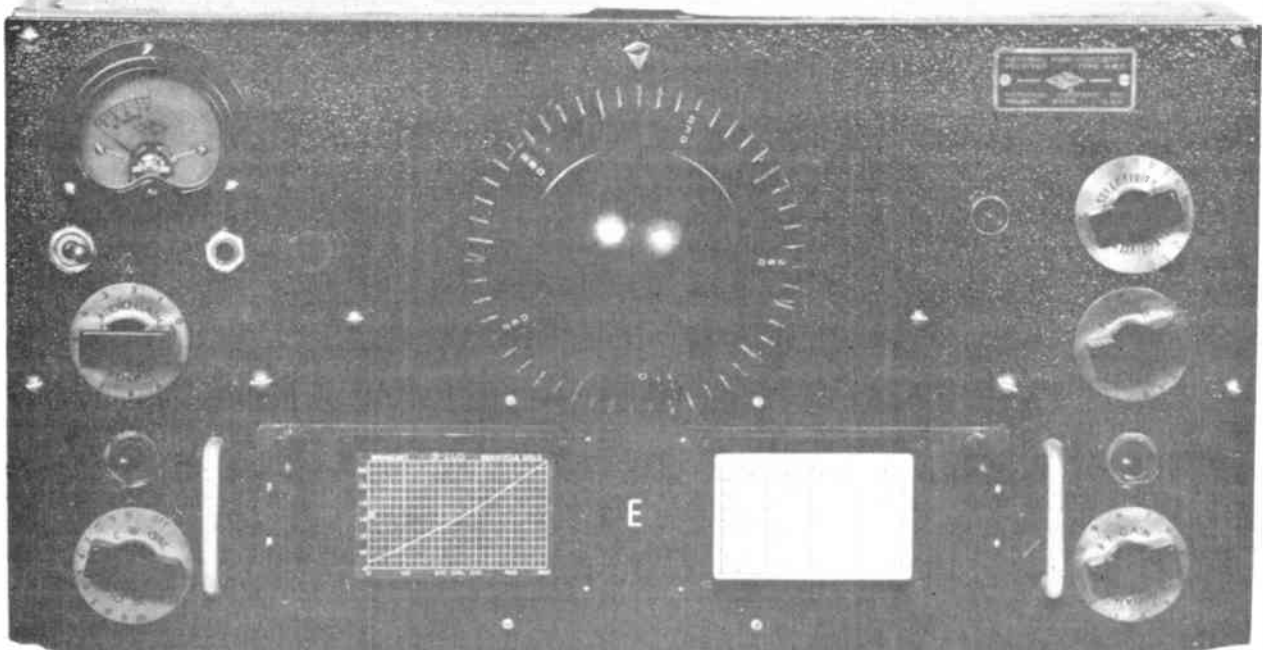

amateur band at the upper end of the range. This is achieved by moving a single screw from one hole to another in each of the four sections which comprise each coil unit. In this mode the tuning rate is approximately 1kHz per division on each band except 30MHz.

The circuit

As stated before, the circuit is almost ridiculously simple. From the aerial, the signal is first amplified by two 6D6 pentode amplifier stages. Automatic gain control is applied to both stages and the cathode of the second is also attached to the RF gain potentiometer. The signal then passes to a 6C6 pentode frequency changer stage which has a further 6C6 as a local oscillator. The latter employs a cathode coupled Hartley (electron-coupled oscillator) circuit with the output being taken from the cathode and injected on the screen grid of the frequency changer.

This stage of the receiver caused many amateurs considerable trouble in the early post-war years, for the oscillator is quite powerful and on the higher frequency bands the output contained sufficient harmonic to cause trouble to adjacent Band I TV receivers. It did not, however, seem to detract from the performance of the receiver! From the frequency changer the incoming signal, now at 456kHz, passes to the second glory of the HRO design: the crystal filter.

In the late 1920s and the early 1930s, the selectivity of superhet receivers was only that which could be gained by the number and quality of the intermediate frequency transformers. In the mid-1930s, the crystal filter was developed which gave rise to the introduction of the so-called 'single signal receiver' such as the HRO. By modern standards, the single crystal filter is simple and the shape factor cannot match a modern multiple pole filter. However, such a unit can, when correctly adjusted, provide an extremely sharp peak response which for CW reception can hardly be bettered

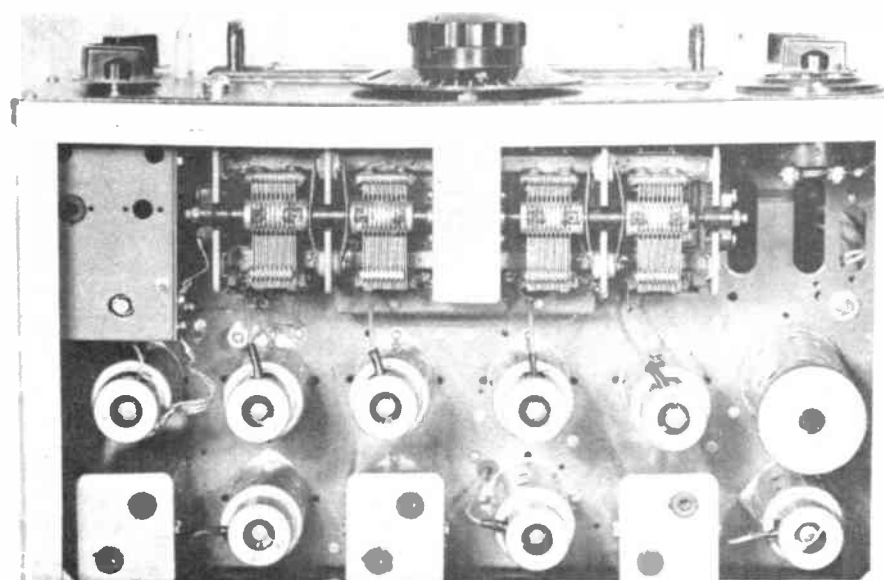

Top view showing the simplicity of the chassis layout

today. Furthermore, the simple filter response exhibits a deep notch adjacent to the peak. The position of this may be altered to some degree by the adjustment of the controls and experienced operators could make use of this characteristic to assist reception in heavy QRM conditions.

The HRO has two filter controls: phasing and bandwidth. Both are variable capacitors and the purpose of the former is to neutralise the capacity of crystal and its associated holder whilst the second tunes the filter input transformer. By careful adjustment of these, a very sharp peak may be obtained or, alternatively, the response may be broadened or the notch frequency varied.

From the crystal filter, the signal passes via a preset variable capacitor (which also acts as a fixed IF gain control) to two intermediate frequency amplifiers. These are 6D6 pentodes which operate in a conventional circuit arrangement. The gain of these stages is controlled by the AGC and, with the

second RF stage, by the RF gain control.

The voltage for the screen grids of all RF and IF valves except the frequency changer are fed through a single resistor. Due to the AGC action, the current consumed by the screen grids of these stages will vary with the strength of the incoming signal. This is used to energise the S-meter by placing additional low value fixed and preset variable resistors at the high voltage end of the screen resistor and connecting the S-meter between the junction and a low value resistor feeding the anode circuits of the IF stages. The preset resistor is adjusted to give zero indication under no-signal conditions when the RF control is at maximum.

Second detector

From the second IF stage the signal passes to the second detector. This employs a 6B7 double diode pentode valve. The two diodes are used for signal and AGC detection respectively, whilst the pentode is an audio amplifier. The beat frequency oscillator is a further 6C6

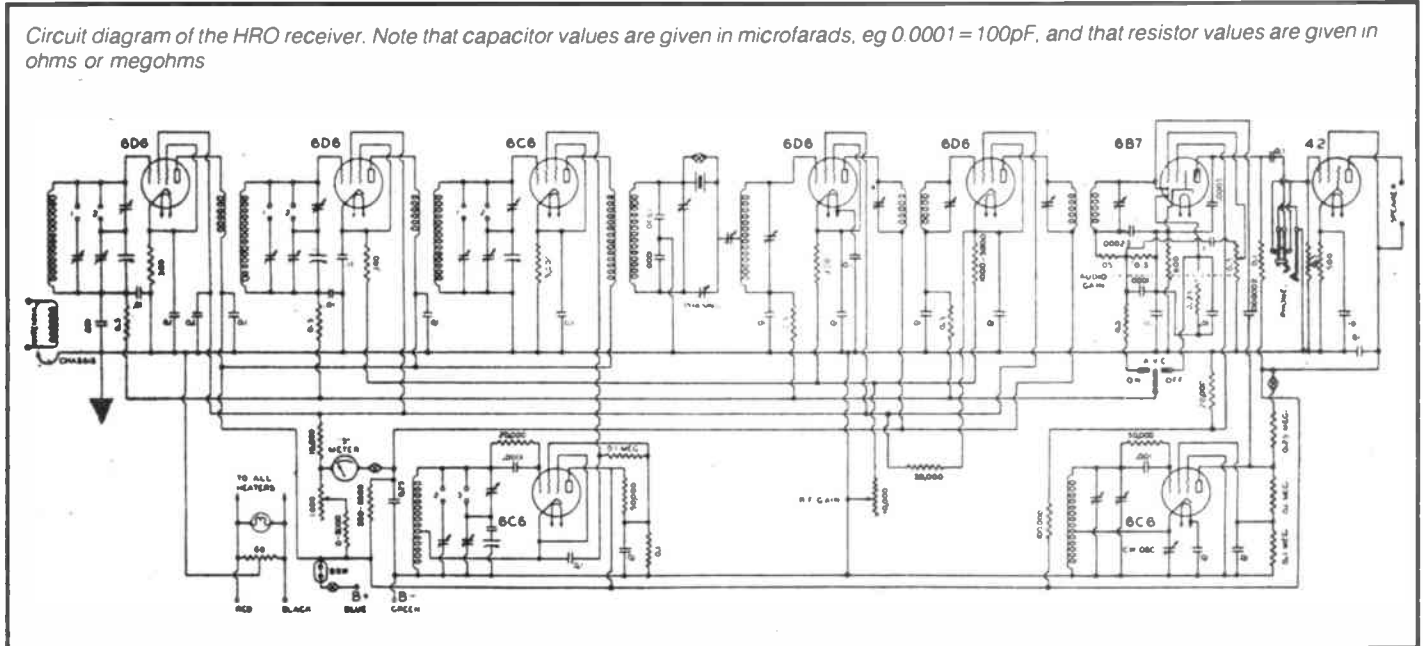

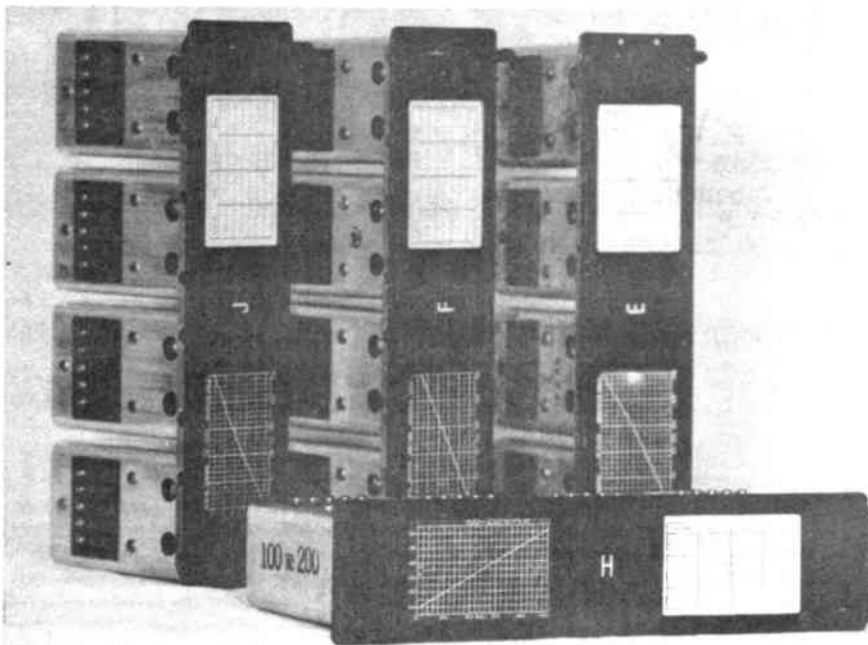

A selection of HRO coil-units

valve operating in an electron-coupled oscillator circuit.

The audio output from the 6B7 passes via a break jack to the grid of the output stage, a 42 output pentode, the purpose of the jack being to enable the use of high impedance headphones from a low level source while at the same time disconnecting the input to the output stage. The only unusual feature of the output stage is that the output transformer is not located on the receiver chassis but within the loudspeaker cabinet.

Modifications

In the immediate post-war period the HRO was an extremely popular receiver among amateur operators. However, the receivers were freely available and relatively inexpensive and, in contrast with the present interest in 'restoration', owners wished to take advantage of the considerable improvements in valve technology during the wartime period.

The chassis of the HRO is uncluttered and in consequence modifications were relatively simple to devise, the most common being the replacement of the

two RF stages by 6BA6s, the frequency changer by a 6BE6 and the local oscillator by almost any miniature pentode. Less frequently, the remainder of the valves were also replaced by more modern types. It is to the considerable credit of the original designers that such modifications, using much higher gain valves, should be possible without serious stability problems.

The overall effect of such modifications was to considerably improve the performance on the higher frequencies, but on 20 metres and lower, unless the set had previously been in poor condition, the improvement was less evident, for the original performance was more than adequate for the lower frequency bands.

Operating the HRO

The HRO was designed for the reception of AM and CW signals only, for SSB did not come into common use until some 25 years after the receiver was introduced. In consequence, there is no provision for the use of AGC while the BFO is operating. The adjustment of the receiver for this mode of operation is

therefore somewhat different to more modern equipment.

For receiving AM signals, however, with the AGC switched on, the RF gain control may be turned well up and the appropriate coil unit selected. The signal is tuned as with any conventional receiver. Should additional selectivity be necessary, the crystal filter should be switched in and the phasing dial set to approximately mid scale. The selectivity control should then be adjusted for minimum selectivity, as indicated by maximum noise as the control is rotated backwards and forwards. In such a condition, due to the very 'peaky' response of the filter, the sidebands of the received signal will be found to be severely attenuated, but this may well be acceptable under the circumstances.

CW operation

For CW operation, as the BFO needs to be switched on, the AGC must be switched off. Under such circumstances it will be found advisable to set the audio gain to about half way and make any further gain adjustments on the RF control. Additional selectivity may be gained with the crystal filter as described in the previous paragraph. This time, however, the selectivity control may be set for a much narrower bandwidth. As the peak selectivity is reached, a little 'to-ing and fro-ing' between this and the phasing control will produce a sharpness which few modern sets will equal.

The HRO was not designed for SSB operation but, nevertheless, it is capable of quite commendable results. For this mode, the receiver should be set as for AM operation, with the filter operative but with the AGC switched off and the BFO on. When receiving SSB, the BFO injection has to substitute for the suppressed carrier and therefore the level of the incoming signal must be kept down to a quarter of that of the BFO. For SSB reception, therefore, the AF gain should be fairly high and the RF gain kept at the lowest possible level.

The crystal filter should be in circuit after it has been adjusted in a similar manner as for AM, but the bandwidth can be reduced by use of the selectivity control. Even when adjustment is optimum, it is hardly surprising that the result is unlikely to match a modern multiple pole crystal or mechanical filter.

Final thoughts

To gain the maximum advantage from the HRO circuit takes a little experience, but even the most casual acquaintance with the receiver will surprise the user with the quality and ability of the equipment. The fact that the receiver is still a sought after item, fifty years after its introduction, is undoubtedly the highest possible praise for the designers of this classic receiver.

Thanks

I would like to express my thanks to Peter Haynes G8MGZ for the loan of the HRO, which he most carefully restored and which is the subject of the photographs accompanying this article.

Valve complement		
	2.5V heater	6.3V
First RF	58	6D6
Second RF	58	6D6
Mixer	57	6C6
Oscillator	57	6C6
First IF	58	6D6
Second RF	58	6D6
Detector,		
AVC, audio	2B7	6B7
Output	2A5	42
BFO	57	6C6

Coil units available	
A	14 - 30MHz
B	7.0 - 14.4MHz
C	3.5 - 7.3MHz
D	1.7 - 4.0MHz
E	900 - 2050kHz
F	500 - 1000kHz
G	180 - 430kHz
H	100 - 200kHz
J	50 - 100kHz

Coils A, B, C and D are available in general coverage or bandspread versions

Valve base connections							
Pin	1	2	3	4	5	6	TC 57,58
6C6,6D6	H	A	G2	G3	K	H	G1
2B7,6B7	H	A	G2	D2	D1	K	H
42,2A5	H	A	G2	G1	K	H	G1



AERIAL TUNING UNITS FOR AMATEUR AND COMMERCIAL USE

OUR NEW RANGE OF PRODUCTS INCLUDING:

MAKE A CAP

REF:

- CAP25S Single gang 250 pfd 8kv **£15.50**
- CAP25T Twin gang 250pfd 8kv **£18.95**
- CAP31T Twin gang 250pfd 12kv . **£22.95**
- CAP50S Single gang 500pfd 12kv **£24.95**

**Range of Capacitors Available
Send or Phone for more Details**

- Roller Coaster** 28 Micro henries **£22.95**
- Baluns** Fully encapsulated 4:1 and 1:1 1kw **£15.50**
- Aerial Kit** G40GP Clip on Spreaders **£5.30**
- Turns counter** Digital 100 turns includes crank handle knob **£22.50**
- Also** 6 to 1 reduction drives in line couplers

If you want an ATU which will be used for as long as you're licensed – remember the CAPCO motto: "Stay tuned forever with a CAP CO ATU – once bought – never replaced"

SPC-300D
Handling Capability
1Kw P.E.P.
ONLY £225.00 INC VAT

SPC-3000D
Handling Capability
3Kw P.E.P.
ONLY £325.00 INC VAT

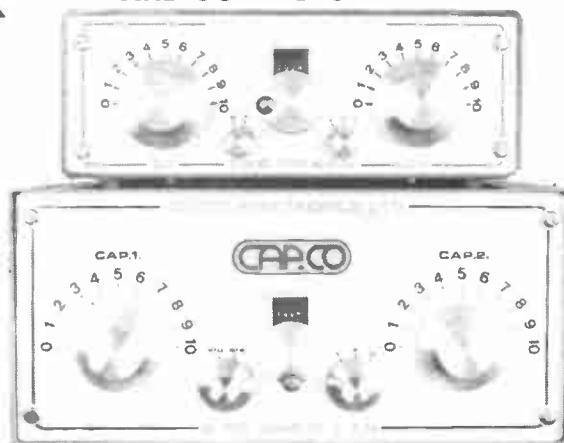

- ★ Both units have a unique Cap. Co. built-in lightning protection circuit. No need to unplug aerials
- ★ Unique Cap-Co modular composite robust structure
- ★ Tunes continuous 1 to 30 MHz with no gaps
- ★ Will tune a piece of wire or a logaperiodic
- ★ Unique switching for A.T.U. or bypass position
- ★ Choice of three aerial input sockets
- ★ Built-in 4 to 1 balun for balanced or unbalanced feeder input
- ★ Featured in the latest book from Angus McKenzie (MBE G3OSS) "The Buyers Guide to Amateur Radio"

OUR RETAIL OUTLETS: All BRANCHES OF SOUTHMIDLANDS COMMUNICATIONS LTD ANCOMM/ARE, REG WARD & CO LTD. ARROW ELECTRONICS RADIO SHACK LTD, AJH COMMUNICATIONS

63 Hallcroft, Birch Green, Skelmersdale, Lancs WN8 6QB 0695 27948 (24hrs)

IF YOU BUY a kit or module from us the chances are it will be from the top best sellers listed below. We are pleased to say that they just sell and sell and sell. . . **Shouldn't you have at least one in your shack?**

70cms Modules	Assembled	Kit	24cms Modules	Assembled	Kit
70FM05T4 500mW NBFM Transmitter.....	£63.40	£39.85	1250DC50 TV Down Converter	£79.95	-
70 FM05R5 NBFM Receiver	£79.40	£59.95	1250PA2 TV Preampifier	£49.95	-
70 FM10 10W Power Amplifier.....	£56.45	£45.50	1240TVT Frequency Locked Transmitter...£145.00	-	-
70LIN3/LT 500mW Linear Amplifier	£39.90	£30.55	UFM01 420MHz FMTV Exciter.....	£41.25	£28.25
70PA2/S RF-switched Preampifier	£30.56	£19.10	VIDIF IF Processor/Demodulator.....	£63.75	-
70PA5 GaAs FET Preampifier	£23.60	£14.75	SCT-2 Transmit Sound Modulator	£16.50	-
TVUP2 70cms TV Converter	£38.40	£28.75	SCR-2 Receive Sound Demodulator.....	£24.95	-
TVM1 70cms Modulator.....	£11.60	£ 7.25	VD/P1 Pre-emp/De-emp Module	£10.50	-
2m Modules			General Accessories		
144PA4 2m MOSFET Preampifier.....	£17.20	£10.75	B2 Toneburst.....	£7.50	£4.70
144PA4/S RF-switched Preampifier	£31.20	£19.50	PT3 Piptone	£8.45	£5.10
144LIN25B RF-switched 25W Linear.....	£49.20	£35.75	MPA2 Microphone Preampifier	£6.25	£4.60

All prices include VAT but please add £1.00 for postage and handling. Delivery is usually from stock or with in 28 days. A copy of our full list of modules and kits for practising amateurs is available for the cost of an A4 size SAE.

**Unit 12-13
Youngs Industrial Estate
Aldermaston, Reading
Berkshire RG7 4PQ
Telephone: (07356) 71444 Telex: 846630**



WOOD & DOUGLAS
VHF/UHF COMMUNICATIONS PRODUCTS

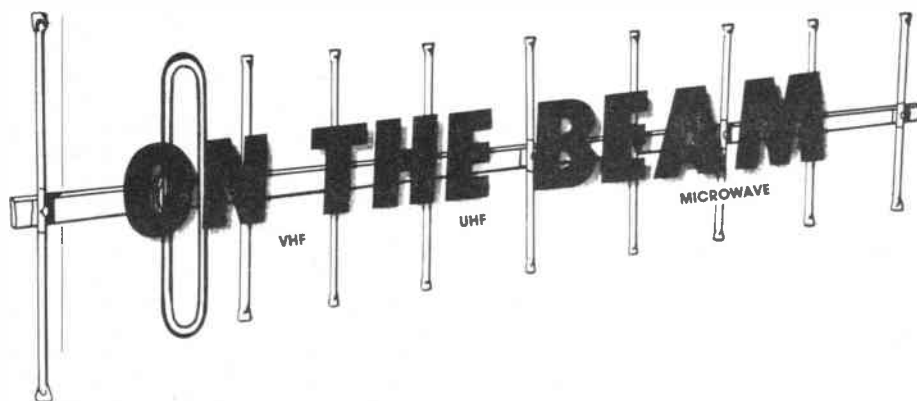

News and comment from Glen Ross G8MWR

Christmas is coming, so let us take a look in the bag and see what goodies may be arriving for us in the near future. The first hint of something special for the microwave man comes in a report from our mole, who brings a hint of two new bands.

Many people have made the point that they thought the RSGB should have put in a request for an allocation for us around 220MHz when the TV boys closed down and the frequencies were, so to speak, up for grabs. They have kept a complete silence on this one, but the news is now out that they did submit a request and that there seems a fair possibility that we may get some space in the not too distant future.

Even more

Not only did they ask for an allocation at 220, but they also went for a band at around 980MHz as well! As far as I know the USA is the only country to enjoy privileges at this frequency at the moment, so we would be breaking new ground here. Once again the position looks good. There will, of course, be a lot more discussion before anything concrete arrives, but at least it looks as though we have our collective foot in two more doors.

The RSGB will, I do not doubt, once again accuse me of getting my information from a badly printed copy of *Wee Tots*. In fact it came from a reliable informant inside the RSGB itself who, for obvious reasons, does not wish to be named.

More good news

A couple of months ago I mentioned that it looks as though we should be OK for a general release of 50MHz in the future. This was based on the idea that due to the lack of activity on the band by the Class A operators, there was little chance of any interference problems. The complete lack of any such problems has been confirmed by an independent source and so we seem to have pulled

the rug from under the feet of the authorities as far as a refusal to make a general allocation on these grounds is concerned.

That is not the same as saying we are going to get it, but hopes must be high. There was general unrest when the allocation was made to Class A only, but it seems that in the long run it has turned out to be a good idea.

Novice licence

This Loch Ness monster of the amateur radio world keeps raising its head above water to start the arguments for and against all over again. One thing that is certain is that there was outline planning approval by the Government for a novice licence back in the 1960s, when a statement was made in the House of Commons to the effect that the Government had no objection in principle to the idea.

It did not seem to get anywhere because so many objections and difficulties to its implementation have been made by various departments over the years that it ran out of steam.

A different mole

I have got more spies than the KGB, and a mole who is closely connected with the ARRL (happy, RSGB?) has informed me that the DTI have been in contact with the American authorities on an informal basis to find out more about the novice licence, how it is run and so on. Perhaps this shows an awakening interest in the idea of a possible implementation over here? The idea of a novice licence should not be dismissed out of hand; it deserves more serious thought.

Upgrade

If a novice entry is to be used only as a means of getting easy use of the HF bands using limited power etc, then it is probably not a good thing – although many who are not enthusiastic enough to take the Morse test will probably disagree with me!

If, however, it is made part of an incentive licensing structure which actually encourages people to go for a better class of licence with extra facilities then, perhaps, there is something to be said for it. This system works well in the States and there seems to be no reason why it should not do so here.

Trouble

This is the point at which all the trouble sets in because, even if you can get people to agree on the desirability of a novice licence, and that is not easy, everyone has their own ideas as to how it should be put into practice. The big snag seems to be that so far there has never been a national platform where people can air their views or where a general consensus of opinion can be taken. Perhaps if a collective input of ideas could be presented we might get somewhere, even if it was only to show that the majority did not want a novice licence.

The platform

Why not write to me and let me know about your ideas? Please do not just say 'No way!' without actually backing up your opinion, we need to know why you think that way.

Also, bear in mind that we know most licensed amateurs are probably not in favour. They believe that they have had to work for the licence and they do not see why anyone should do it the easy way. Also, having already obtained a call, they may see no real interest in the proposal.

However, please look at it from the point of view of the person who is sitting on the edge of the hobby. Should we be giving active encouragement to get them on the inside with us?

The boom years of the huge influx of people from the CB world are behind us, but pressure on our airspace is going to increase and a large user base is a handy piece of clout when the pressure is on. I believe that if a suitable format could be established, then a novice licence could be a good thing.

Please drop me a line and let me know what your ideas are and I will pass the results on to the proper quarter for consideration. Now is your chance to put your view forward.

Against the rules

One subject that came up for discussion at the recent Telford VHF Convention was the desirability of moving to 12.5kHz spacing for two metre operation, due to congestion on the band in urban areas.

Someone made the point that we were not allowed to do so because the bandplan shows 25kHz spaces. This is complete nonsense; you can operate on any frequency in the band under the terms of your licence and the present system is purely a sensible agreed way of operating.

Another point brought up was that you would need to fit narrower filters into your rig to avoid adjacent channel QRM. This is only true if there is a strong signal on every 'S' frequency in the band. If you

move half a step from a strong signal you are going to get trouble but, if you do, why not just move down a bit more? It is highly unlikely that there will be a 20 over 9 signal everywhere.

Spot points

If the proliferation of special interest groups continue to demand spots for calling and working frequencies then we won't have any space to call our own anyway. The latest to claim a couple of spots are the new repeaters for packet radio and these are going on 145.275 and 144.650MHz. There are proposals for at least fourteen of these devices at present with the DTI and, with the exception of one at Harrogate, they are all in the southern end of the country so we can expect to see many more coming up soon.

The original proposal, to be fair, was to have them on 70cm but apparently the DTI did not want any more activity on that band (I wonder if that could be due to the arrival of Pave Paws?).

To repeat or not?

These are not repeaters in the normal sense of the word, in that they do not receive and transmit at the same time on different frequencies. What happens is that a 'packet' of information is sent to the repeater where it is stored for later

retransmission on the same frequency to another station. This retransmission could take place at once if the other station is logged on to the system, or it could be held in memory for days waiting for the other station to call in to collect stored messages.

All good top technology stuff in the true spirit of the hobby, but if things go on the way they are we shall soon have a two metre band that is only used for specific interests rather than general communication. The last available listing of the packet directory shows only around 200 people known to be using this mode, so do they really need 14 repeaters or is it just the repeater groups constantly looking for a new excuse to build another box?

Beacons and things

One beacon that has been missed for some time is the 70cm one, GB3SUT, located at Sutton Coldfield and operating on 432.89MHz. This was due to the BBC taking the supporting mast down and the group using this as a good time to revamp the rather ageing unit. All is now well and the beacon is back on again, even if only running four watts.

The other good news is that perhaps Oscar 10 is not lost for ever. There is still a bit of life left in the batteries and the beacons are being heard regularly. It is

due to go into permanent shadow for some time, but will emerge into daylight around 23 December when it is hoped that enough charge can be put back into the cells to enable some more operation. There have been tremendous problems, and repatching has been going on without much being achieved over the last few weeks. If I were you, I would not start to get too optimistic about the chances of recovery.

The new Japanese bird is still doing its thing but the digital transponder was still not switched on at the time of writing. It is hoped that the 1200 baud PSK beacon will be switched on some time during the first week of November.

Odds and ends

To get some activity on 50MHz there is a proposal for an activity night on Friday evenings between 7pm and midnight. Stations interested should call using USB on the calling frequency of 50.2MHz. Be careful about the interference you may cause on the Continent.

Before I sign off let me wish you a really great Christmas and I look forward to hearing from you with your news and views. Do not forget to let me have your ideas on the novice licence, and please send all correspondence to me at 81 Ringwood Highway, Coventry CV22GT or on Prestel 203616941.

NEXT MONTH

Amateur

RADIO

all the regulars. . .

DX Diary
On the Beam
Secondhand
SWL
Straight and Level
Your letters and
features covering
the whole of
Amateur Radio

- **ANGUS MCKENZIE TESTS**
Under scrutiny next month are the FT727 2m/70cm hand-held and the FT290 MkII 2m portable
- **PITFALLS IN PROCESSING**
Ian Poole explains how to overcome the problems associated with speech processing
- **FIRST ACROSS THE POND**
The first 2-way transatlantic contact between radio hams was achieved on 28 November 1923. Stan Crabtree gives the background

DON'T MISS THE JANUARY ISSUE
On sale 24 DECEMBER

SECONDHAND EQUIPMENT GUIDE

by Hugh Allison G3XSE

I will open this month with a description of the 'sideboard' or, to give it its proper name, the FS1007P. The styling has got to make this the oddest two metre FM rig ever produced since it is cased in a large wooden box (hence its nickname) and even sports a digital, though mechanical, clock with alarm. The machine can be mains or 12 volt powered, though you would need a furniture van to use it mobile, and its crystal controlled.

It features a 16 channel scan system with skip facility that will either auto or manual scan, plus front panel 'priority' crystal sockets. You also get a built-in SWR bridge, receiver fine tune and a narrow/wide deviation switch (not too useful, that). The transmitter chucked out the normal ten watts and the receiver, through no particularly special measures, was surprisingly sensitive and usable, many examples giving about fifteen dB of quietening for around a quarter of a microvolt.

Quite a few of these seem to be appearing secondhand nowadays and the average price seems to be about £45, dependent on crystals fitted and overall condition. Price new depended on when, exactly, it was bought, since there was heavy discounting at the end, but the seller could have paid anything from £120 to £75. If you have the room you might be pleasantly surprised with one of these.

FTC212

It is not often that your scribe makes a mistake when parting with his hard-earned cash at a rally, but in a way I did at Telford. On the flea-market table a seller had just arrived and was unloading a cardboard box. Out came a 2 metre transceiver, marked Yaesu, and there was a £15 price tag on it! I whipped out my wallet and seconds later the wife was carrying it out to the car.

A couple of days later I was playing with the box, which seemed active but full of very weird crystals all well outside the band. It was only when I waved a frequency counter at it that I realised it was a four metre FM box. Apparently these were quite expensive new (£190 in 1976) and not too many were sold, so it's not surprising that I hadn't heard of it. The story does, however, have a happy ending since, discussing my woe over a pint that evening, a happy buyer emerged from among the amateurs present. Take care, an FTC212 may not be what you think it is, but if you are looking for a four metre machine then a good sensitive receiver and a clean 10 watts on the transmit side may well make it an

ideal buy for you. I can't give a guide to the price secondhand, though, as mine is the only one I've ever seen.

The Telford Rally

In years gone by the Telford Rally has been held in the massive central shopping centre, well able to hold hundreds of tables and produce dozens of bargains every year. I was thus a bit worried at this year's change of venue to a racquets centre. On the day, however, my fears turned out to be groundless; if anything the hall was bigger. There was plenty of room to get about and the bargains were still there. The newer Sinclair flat screen TVs were much in evidence secondhand, with the going rate being £15 for a non-worker or £35 for a good one. Take note that the flat batteries for these are difficult to obtain at times.

Also at Telford I was lucky enough to buy a cubic yard of small black and white TV cameras, all not working, for what worked out at a couple of quid each. Most were easy to repair but one had me foxed. I must confess to spending three hours on it, trying to stop it producing a picture of concentric circles on an attached monitor, before it dawned on me that this one had only seven wires to the videcon whereas all the rest had eight. I think I know which one the seller was referring to when he said one of them had never worked! A six inch length of wire between the tube and the appropriate rat hole in the board produced a very stable pin sharp picture.

Mega tracker CB1100

A few months ago I alerted readers to the desirability of these British made CB sets. I bumped into a reader at Telford, who I vaguely knew, who said he would like to buy one but hadn't seen any. He was standing only yards away from a stall selling them, and the reason he had not noticed was that the 'M' of Mega is so styled that it looks like a 'V' and thus could be read as Vega. There were loads of them freely available at Telford and the reader was quickly able to pick up a very good clean example for £20.

Car boot sale

Imagine a row of car boots all the way round an airfield and you have an idea of the sheer number of sellers at what must now rate as the British flea-market of the year. The bargains at the Old Warden car boot sale were too numerous to mention individually, but an EC10 for £10 does stand out in my mind (teeny bit scruffy but well worth £40 normally), as does an FRG7 (with digital display) for £30, which

would normally change hands for £60/70. Like last year it was mainly amateurs selling to amateurs, hence the low prices. Truly an excellent and well organised event, and next year we are promised no clashes with Harlow or Peterborough, so roll on 1987!

Icom IC255E

At Old Warden your scribe bought a non-working example of the above 2 metre FM box, sold as non-working, at a very reasonable price. The seller told me that the PA module was probably defective and it was intermittent. The PA trouble was no real aggro; there were no volts on the driver part of the module. This is quite common when the high/low transistor fails, which is why I looked there for starters. The problem turned out to be a dodgy plated through hole by the high/low switching transistor and was no trouble to repair.

The intermittency was really frustrating. If you stood the rig upside down (ie speaker up) the rotten thing failed all the time, but in the correct position was sometimes good, sometimes bad. It took me hours to find that the metal bracket holding the LED light chopper (ie the tuning gubbins) was shorting down to a 4.7kΩ resistor on the board below. A miniscule bend and a sliver of insulating tape seems to have cured the problem.

I have since met another amateur over the air who had exactly the same problem, so this is worth bearing in mind. When the trouble occurs, the synthesizer has a tendency to lock up (with rude, disgusting noises) about six megs low in frequency on receive, Tx being disabled.

Plated through holes

Your scribe was watching an engineer trying to suck the solder out of a plated through hole. The problem was that there was a lot of track on the other side of the board which was conducting the heat away. Try as he might, he was only sucking solder away from the bottom, leaving the hole half full of solder. Since access was not available to a hot soldering iron from the top, the air was full of phrases which were unknown to me, having lead such a sheltered life.

'Why don't you use a length of bare tinned copper wire?' I asked.

The trick is to push your BTCW (Bare Tinned Copper Wire) into the hole and heat the wire, not the board. The wire acts as an extension of the iron, transmitting the heat to the solder and melting it. I have found that the best bet is to keep pushing the wire through, heated at first, then remove the iron and

keep pushing. Be wary of the wire soldering itself into the hole. If it does, don't just pull – you will have the plating out of the hole before you know it – simply reheat the wire and push again. In an emergency a resistor lead-out wire can be used.

A couple of months ago I mentioned the Microwave Modules digital counter. One reader wrote into me saying that he had seen these available at rallies but had not bought one as he didn't know its frequency limitation. He didn't seem too amused that I hadn't given this vital point in my column whilst mentioning it.

The MMD050 counter was a 50MHz unit

at 50mV rms, though in practice most go to about 70MHz. It took 250mA at a nominal 12V and cost £66 new in 1975. The matching prescaler, MMD500P, was a divide by ten 500MHz unit, sold as 200mV sensitivity but exceeding this handsomely. In practice you could go on to, normally, 650MHz at 50mV. The price new was £27. This took 100mA at 12V.

The prescaler can, of course, be used with other counters, which makes it preferable to the old (but accurate and solidly built) Hewlett Packard counters that are now coming onto the second-hand market. These are good to 50MHz and have an accessory hole about four

inches square into which range extenders can be fitted. These extenders are, unfortunately, tunable mixers. The idea is that a 50MHz xtal bashes its heart out (full of harmonics) into a mixer, the other port of which is tuned. The most common extender goes to 500MHz and is marked every 50MHz. You tune to, say, 100MHz and the display reads 45.000. You thus know you are feeding in 145.000MHz. The trouble is, if the pointer is a bit out it will read 5.000 for the same input. Why? Because it is now doing the subtractive mix from the 150MHz point. Solution? Chuck the mixer extender in the bin and use an MMD500P!

LOOK WHAT YOU GET EVERY MONTH IN

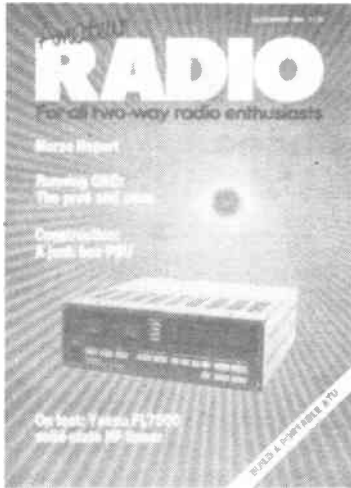

Amateur RADIO

- ★ **DX DIARY** Don Field G3XTT with all the news of rare DX, contests and DXpeditions
- ★ **ON THE BEAM** Glen Ross G8MWR with all the news and comment from bands above 50MHz
- ★ **G3OSS TESTS** Angus McKenzie – the fairest, most comprehensive reviews available anywhere

MORE NEWS, MORE FEATURES, MORE FUN, MORE STYLE THAN ANY MAGAZINE AVAILABLE ON THE MARKET TODAY

Make sure of your copy by placing a regular order at your newsagents or by taking out a post free, inflation proof subscription, with early delivery to your door each month

AMATEUR RADIO SUBSCRIPTION ORDER FORM

To: Subscription Department • Amateur Radio •
1 Clarendon Road • Croydon •
Surrey • CR0 3ST Tel: 01-760 0409

PLEASE SUPPLY: (tick box) for 12 issues, all rates include P & P

Inland World-Surface Europe-Air World-Air
£18.20 £18.00 £22.10 £27.10

NAME

PAYMENT ENCLOSED: £ - Cheques should be made payable to Amateur Radio. Overseas payment by international Money Order, or credit card

ADDRESS

CREDIT CARD PAYMENT VISA

.....

.....

Postcode

Signature

K T ELECTRONICS

The first Radio Amateur equipment manufacturers in the Republic of Ireland - presents

2m Masthead RF-switched Pre-amplifier: AP2M86

Amplification: 27dB
Noise figure: 1dB typical
Max thru power: 30W

Supply voltage: 9-16V dc
Supply current: at 12V=65mA
Bandwidth: 3dB

PRICE: IR£24.50

4m Masthead RF-switched Pre-amplifier: AP4M86

Frequency range: 70.1-70.5MHz
Amplification: 27dB
Noise figure: 1dB typical

Supply voltage: 9-16V dc
Supply current: at 12V=65mA
Max thru power: 30W

PRICE IR£24.50

Meteosat Masthead Pre-amplifier: MP2M86

Frequency: 137.5MHz
Amplification: 27dB
Noise figure: 1dB typical

Bandwidth: 3dB
Supply voltage: 9-16V dc
Supply current: at 12V=25mA

PRICE: IR£14.50

2m Receive Converter: RC2M86

Input frequency range: 144-146MHz
Output frequency range: 28-30MHz
Amplification: 27dB

Noise figure: 1.5dB typical
Supply voltage: 9-16V dc

PRICE IR £25.00

All items are RF-shielded, and all Masthead amplifiers are water protected.

Also in our range - TV low noise Masthead amps and power supplies.

FOR FURTHER INFORMATION AND CATALOGUE CONTACT:

K T ELECTRONICS
Attn: Tina Keil - E19FW
Newbawn, Rathdrum
Co Wicklow. Tel: 0404 46521
From England: 010-353 40446521

Amateur Radio smart blue binders, each holding up to 12 issues keeping them in prime condition

BINDERS!

Only
£4.75
inc p&p

Overseas readers please add 30p
Please allow 28 days for delivery

Send your orders to
Edwardschild Ltd, 28 Shenfield Cres
Brentwood, Essex CM15 8BN

SCOPES

Repaired and recalibrated. All makes - all models. Nationwide collection and delivery. Copies of handbooks and spares for most popular models including golden oldies.

Phone
Mendascope Ltd 069-172 597

The Archer Z80 SBC

The SDS ARCHER - The Z80 based single board computer chosen by professionals and OEM users.

- ★ Top quality board with 4 parallel and 2 serial ports, counter-timers, power-fail interrupt, watchdog timer, EPROM & battery backed RAM.
 - ★ **OPTIONS:** on board power supply, smart case, ROMable BASIC, Debug Monitor, wide range of I/O & memory extension cards.
- from £185 + VAT.

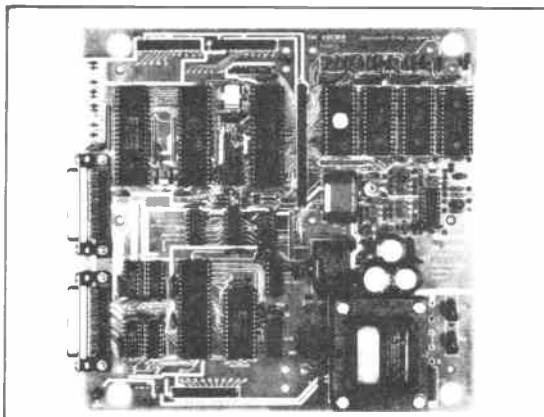

The Bowman 68000 SBC

The SDS BOWMAN - The 68000 based single board computer for advanced high speed applications.

- ★ Extended double Eurocard with 2 parallel & 2 serial ports, battery backed CMOS RAM, EPROM, 2 counter-timers, watchdog timer, powerfail interrupt, & an optional zero wait state half megabyte D-RAM.
 - ★ Extended width versions with on board power supply and case.
- from £295 + VAT.



Sherwood Data Systems Ltd

Sherwood House, The Avenue, Farnham Common, Slough SL2 3JX. Tel. 02814-5067

FREE CLASSIFIED ADS

FREE CLASSIFIED ADS CAN WORK FOR YOU

We are pleased to be able to offer you the opportunity to sell your unwanted equipment advertise your wants.

Simply complete the order form at the end of these ads. feel free to use an extra sheet of paper if there is not enough space. We will accept ads not on our order form.

Send to: **Amateur Radio Classified Ads**, Sovereign House, Brantwood, Essex CM14 4SE.

DEADLINE AND CONDITIONS

Advertisements will be published in the first available issue on a first come first served basis. We reserve the right to edit or exclude any ad. Trade advertisements are not accepted.

FOR SALE

■ Leson DT-252A desk microphone, £10. John Higgins, 30 Underwood Road, Portishead, Bristol BS20 8PJ. Tel: (0272) 845351

■ Sony CRF320, FM/MW/LW/SW 32 band professional Rx. Excellent condition, £350 - or exchange above for Icom R70 or 71E. Tel: (061) 7431570

■ Icom IC720A with power supply, mint condition, hardly used, £575 ono. Tel: Epping 75129

■ Cobra 148 GTLDX, gwo, ±20kHz shift no gaps! £95.00. Also Tristar 777 ±5kHz shift, gwo, £75 ono WHY? Or may exchange for 2m multimode in good nick. Tel: (0934) 511604. All easily converted to 10m

■ Yaesu FT290R 2m portable transceiver, complete with carry case, NiCads, charger and rubber ant. Boxed, one year old, used very little, £255. Tel: Leic (0533) 875192 (evenings)

■ Tuning condenser, 3 gang, 500pF per section, 4¼in long, £4. Xtal calibrator No 10, 500kHz xtal, VFO harmonics to 30MHz, requires 3V (2-U2), 90V, book, £4. Flexible drive, ¼in m-f ends, 7¼in or 10½in long, £2 each. Valve xtal converter to tune 160m on 80m, requires 6.3V, 200V, £4. Yaesu FSP1 mobile or extension speaker, 8 ohm, £4.50. LFC 20H, 100mA, 300Ω £2.50. Post extra. Edwards, 32 Heldhaw Road, Bury St Edmunds, Suffolk IP32 7ES. Tel: (0284) 60984

■ Trio TS820 transceiver, CW filter fitted, MC50 mic, £500 ono. Consider two metre multimode or receiver in part exchange. Glenn King, 31 Rose Valley, Newhall, Burton-on-Trent, Staffs DE11 0QN. Tel: (0283) 223154

■ FT101ZD, mint cond, recently new matched pair valves fitted, n/w CW fan fitted, £495 ovno. Ham Multi II. Very good cond, still in maker's box, hardly used, £40. Tel: (0992) 38619 (Herts)

■ Creed 444, £15. Big rolls of paper, 50p each. Large rolls of ticker tape for Creed 444, 50p each. Very clean Murphy B40C with fitted S meter and fine tune, MW through to 30MHz, ideal for SWL, £30. Welz CH20A ant switch dc, to 900MHz, still in box, unwanted gift, half price, £15. Small 70cm TV converter, home-brew, £8, and the part built 70cm beam comes free! G8UCN QTHR. Tel: (0742) 887088

■ Kenwood TR9130 2 metre multimode, £365.00. Breml 10 amp power supply, £60.00. Eddystone 840C HF receiver, mint, £135.00. Seven element X-Yagi, £18.00. Buyer collect or carriage extra. Mr C Richardson, 47 Leighton Close, Cross-Gates, Scarborough YO12 4LA Tel: (0723) 863035 (after 6pm)

■ Sony ICF2001 air, FM, SW, full coverage, 32 memory mode, memory scan, timer, preselector, vgc, £225. Bargain. AOR2002 scanner 25-550, 800, 1300 AM, FM, NFM, 20 memory PSU, £335, like new. Icom 735 HF Tx, 100kHz, 30MHz, 100 watt, £700. Swap 2001D, 2002 for R7000, cash difference paid or R71E plus cash for 735. All radio gear perfect, vgc. 31C Anlerley Park, Penge SE20, write

■ Have Polaroid Polavision instant movie outfit playback monitor, movie camera, zoom lens, as new condition, in original box, swap for anything useful re amateur radio, ie receiver HF ant WHY. Any deal considered or offers. G0CIG. Tel: 01-906 4206, Edware

■ Hitachi dual beam scope, 15MHz, model U-152F, probes carry case, vgc £175. Tel: (031 668) 3451 after 6pm

■ Bargains, 2m 50W linear, 10W input, with variable pre-amp, £35. FDK M700EX 2m, 25W trnscvr, variable power output, £120. Both items as new, post paid. Mr G Denman 24 Ascot Rd, Cupnar, Portsmouth, Hants PO3 6EY. Tel: (0705) 820315

■ Handic VHF scanner, 50 memories, £135. AOR2001 VHF scanner, 25-550MHz, £165. Tel: Preston (0772) 721805

■ DNT B40FM CB, ideal ten conversion, £25. 35mm enlarger, timer, chemicals, dishes, paper etc, safelight, £35. HW101, PSU, CW SSB, 80 to 10, gwo,

£80. Minox B camera, as new, £60. Marconi s/gen TF144G vgc, £40 ono. IC2E plus sp/mic, NiCads, etc, vgc £140. All items, buyer collect or carriage. Tel: (0582) 872407 (Whipsnade)

■ Yaesu FT726R 2m + 70cm, narrow CW filter, with Tono 90 watt linear. Boxed with manuals, pristine condition, £650 ono. Tel: (0203) 456128, Coventry

■ Heathkit SB104 solid-state transceiver. SB804 PSU/speaker. SB644 remote VFO. SB634 console SWR/PWR 24hr clock. Manuals, £375. Heathkit Apache Tx-1, Mohawk Rx-1, SB10U sideband adaptor, one complete Tx-1 spares or repair, manuals, £95. DX200 receiver 0.15 - 30MHz AM/SSB/CW manual. Mint condition, £75. Richardson, 'Becksyde', Cowmoor Bridge, Stockton Lane, York YO3 9UA. Tel: 424817

■ Grove Scanverter, converts any scanner with airband 118 to 136MHz to military airband 225 to 400MHz, £35.00. Pair of hand-held transceivers crystallised 29MHz, £15.00. AVO transistor and diode tester type TT537 with instruction manual, £15.00. ENM dot matrix computer printer, paper width up to 15 inches, traction drive, excellent print quality, price includes comprehensive manual and several new ribbons, £45.00 ovno. Mr KL Phillips, 3 Linden Court, Frithville Gardens, London W12 7JJ. Tel: 01-743 0811

■ Eddystone 640C comm receiver with SSB and CW capability, 5 bands, 1-30MHz, very rare model. Good working order, tatty casing, £80. 3 Pye FMB Pocket Fones set at 170MHz, rechargeable batts and batt checker unit, £100 the lot, or swap items above for 934 rig and PSU. Can deliver in W Sussex or E Hants area. Phone Mike after 6pm on (024356) 523.

■ Trio 430S GC Rx, 100W Tx FM & narrow SSB filter fitted, £625. Px smaller ham band only rig. Garry. Tel: (0625) 530200, Nr Manchester

■ UHER report stereo professional recorder, mic, leather case (as used by BBC/OB), £350. Marconi sig gen TF801D/1/S, 10-485MHz, £80. Advance sig gen S2, 100kHz-100MHz, £22. Belco BR-8 LCR bridge, .1ohm-11.1Mohm/1µH-111H/10pF-1110µF. £15. Dawe decade resistance box 200J, £5. Airmec electronic voltmeter 314A, £25. TT145 transistor checker, £5. B/W 18 inch TV, £8. Azden 2m FM mobile, remote head and cable, £170. IFR audio/visual training course, £50. Canon 110ED, flash, £30. Polaroid 350 + 581A and flash, £70. Hezzanith sextant, cert 66127, as new, £200. Hy-Gain, hi-range V, easily converted 10m, mic, £75. Microlog ATR-6800 dedicated RTTY/Morse, with modules and all manuals (the best, cost over \$2000) with monitor, £500. SX200N scanner with SSB kit, £170. Jaybeam 12XY/70, £20. 5XY/2m, £15. Many other VHF/UHF beams, come and see. All cheap. All the above in vgc, most as new. Must clear space. May G3AAG, Hants. Tel: (0730) 892143 or 893534

■ Realistic DX200 receiver, 5-bands, 150-400kHz, 520-1600kHz, 1.6-4.5MHz, 4.5-13MHz, .13-30MHz crystal calibrator main tuning and bandsread dials. AGC fast and slow, BFO antenna trimmer - in original box with workshop manual, good condition, hardly used, £50. Mr SR Davies. Tel: (061 494) 2729 Stockport, Cheshire

■ Good quality HF, VHF, UHF, WHY? Will buy, swap and haggle. Have lots to swap, PX, etc. SAE for list of gear. Have 7700 Rx, VHF linear, BT free phone, Scarab and 48K specy for RTTY, CW, SSTV, £15 ono. Martyn Bolt G4SUI, 112 Leeds Road, Mirfield, West Yorks WF14 0JE. Tel: (0924) 495916

■ Yaesu Rx FRG7700 (gen cov), mint cond, box, manual. Yaesu FRT7700 ATU, Y4 55 phones, ideal SWL set. RTTY CW SSTV? 48K Spectrum, Scarab MPTU1 TU interface, etc, £15. Yaesu YC7B digital readout, as rare as rockin horse, offers? Mirage VHF linear with pre-amp, 160W out. Martyn Bolt G4SUI 112 Leeds Road, Mirfield, West Yorks WF14 0SE. Tel: (0924) 495916

■ Cybernet Delta 1 934MHz Tx/Rx, with mic and mounting bracket. Never used mobile, perfect condition, £200. Prefer buyer inspects and collects, or might exchange for good gen cov rec of same condition and value. Tel: (0492) 514718 (Colwyn Bay)

■ AOR2001 scanner, 25 - 550MHz, good condition, £240. Or will exchange for 2m multimode, ie Trio 9130, Yaesu 480R, cash adjustment either way or what have you. Mr Peter Hill, 45 Southgate, Suttonhill, Telford, Shropshire. Tel: Telford 581916

■ Yaesu FT101ZD MK3, fan, WRAC bands, mike, unmarked, superb receiver, £525.00. Trio Kenwood TS430S AM filter and FM board, £650. Sony video camera b/white zoom lens suitable for SSTV etc, £85.00. Wharfedale hi-fi speakers, type 708, in mint condition. G4GPL QTHR. Tel: 01-953 9021/6921

■ Trio TS820S and complete station, mint condition, £600. Also Trio TR2400 2m hand-held with accessories, £195. Tel: Ayr (0292) 285281

■ Jaybeam eight element quad. Condition as new, fully assembled and tested, £25. Tel: Verwood (0202) 826763 after 6pm

■ Ham International Jumbo AM, FM, USB, LSB, super low, mid, high switch. Two antenna sockets, Silver Eagle mic to match, plus standard ham hand mic, price £100, buyer to collect. Tel: Gordon (0273) 812215, Sussex

■ FT790R, fair condition. Tel: Nottm (0602) 580996. G0FVI, buyer collects

■ Eddystone S770R receiver for sale. 19MHz, 165MHz, 6 ranges, 19 valves with muting, CW, AM, NFM, FM, later model, black facia, Eddystone Lighthouse emblem on top. Unmarked, pristine condition, revalued, recondensed, realigned, works standard, £90. Buyer collects. Eyles, 41 Bredon Grove, Poolbrook, Malvern WR14 3JS

■ FDK mobile 750E multimode transceiver, very good condition, £200 ono. FRG Yaesu receiver, very good condition, £100 ono. Antenna rotator and control box, £40 ono. Power supply 12V 4 amp for transceiver, £25. Two metre 5/8 whip antenna, £18 ono. Tel: 01-574 7887

■ Sony ICF2001 + mains power supply and packing. Mint condition, £100. Free courier delivery in UK. Call evenings or weekends, Dave. Tel: (0227) 364607

■ D83 Telequipment 60MHz oscilloscope with EMI fault. Sale or swap for wobulator, colour bar generator, Sony 7600, or WHY? K Lee - Rand, 7 Jersey Road, Ferring, Worthing, West Sussex BN12 5PZ. Tel: (0903) 42927, Office 205531

■ DX400 communications Rx, mint condition, only one year old, 500kHz 29.999kHz, £150. David Tel: 610553, Newcastle-U-Lyme

■ AOR2001 scanning Rx, 25-550MHz, no gaps. As new, £200. Heath HW-101 trncvr, 80-10m SSB/CW 100W out. Superb rig. Plus PS-23 ac PSU, Heath desk mike, manuals, etc. All for £200. Sony ICF2001 FM/AM SSB/CW Rx. 150kHz - 30MHz plus 76MHz - 108MHz FM. As new, £75. Buyers to collect or arrange transport. Tel: (0224) 743039 evenings. Steve GM4GTU (QTHR)

■ FRG9600 all mode scanning receiver, 60-900MHz. 5 months since new, £300. W McWilliams, 16 Chapel Street, Hunwick, Crook, Co Durham. Tel: Bishop Auckland 663324

■ Revco VHF/UHF discone antenna, covers 50 to 500MHz, with length of coaxial cable attached. Good condition, £20, post paid. Tel: Elgin (0343) 45478

■ Datong indoor antenna AD270, complete with mains unit, spare dipole wires, £25. Blanchard, 1 Kent Gardens, Hetton-le-Hole, Tyne and Wear DH5 9LA

■ Shack clearance of valves for all ex-WD receivers or transmitters: ie R1155, R103, R107, R109, TR123, TR19 set, 18 set, 17 set, 21 set, 29 set, 46 set, and so on; all Rascal to R217, all Eddystone to 770s, CR100 to CR300, ex-US Army equipment no

problem. All valves for ex-gov both UK and USA. If it uses valves, give us a ring or write. Mr R J Shaw, 86A High Street, Poole, Dorset BH15 1DB. Tel: Poole 680500. Or Mr T Hill. Tel: Poole 622051

■ Aerial transformers, 1-30MHz, 600-75 ohms, unused, £20. Or swap B2 Rx/Tx, prefer buyer inspects, collects. Tel: Cheltenham (0242) 513395

■ Tono 550 communication terminal, manual, 12 inch Novex monitor, PSU, books: *RTTY Today*, *World Press Services*, *Radio Teletype Press Broadcast*, *Introducing RTTY*, all 2 years old. Good condition, £275 ono. Buyer collects. Tel: Chelmsford (0245) 356531

■ Pair Pye Bantams low band AM with NiCads and charger, working order, £25 the pair. Midland 3001 AM CB rig with mic, £8. PT40 FM CB rig, £15. Service manual Pye Lynx video camera, £2. Technical SW Morse Tutor tape for C64, £4. RTTY/CW Tx/Rx SW for C64 with circuit diagram of simple interface, £8. Tel: Worthing (0903) 40072

■ Trio R600 synthesized receiver, £210 ono. Also Yamaha PSS401 Porta Sound keyboard, 3½ octaves and octave down, 10 voices, 6 rhythms, £65, or both for £260; to include 100 miles delivery. Tel: Bury St Edmunds (0284) 704152, evenings/weekends

■ New ZX microdrive, £20. Pye PF1 Tx, £5. New Currah microspeech for ZX Spectrum, £15. Microwave Modules 144MHz converter, £20. SSTV Tx/Rx program for ZX Spectrum, £5. Prefix locator for ZX Spectrum, ideal for HF work, £5. Tape heads, 50p each. Heatsink compound, 50p a tube. 800 4Ba crimp spade connectors, 50p per 100. Spectrum ULA, £10. Z80A CPU, £250. ROM, £10. Paul Goodrum, 9 Ryston Close, Downham Market, Norfolk PE38 9BD. Tel: (0366) 388615

■ BBC model B microcomputer, OS 1.2 Basic 2, fitted with Pace Amcom DFS, 62 files per disc, complete with manuals, £250. Tel: (051) 355 9325

■ AOR scanner, as new, a few weeks old, £350. Jack Wingrove, 114 Wakehurst Road, London SW11 6BT. Tel: 01-228 4835

■ IC745 PS15 mint SM6, want new rig, £820. Tel: Robby, (0698) 459301 after 7pm

■ Sony ICF200ID air FM, AM, brand new and boxed with manual, £250. T Watson, 7 Pennington Park, Belfast BT8 4GJ. Tel: Belfast 703281

■ Wood & Douglas TVUP2 up-converter, good condition, with instructions and diags, 8, Philips N1502 video recorder with two tapes and Philips VR2020 video recorder with missing solenoid, both not working hence £9 each (for spares or repair, N1502 supplied with instructions and service manual), the lot for £24. Mark Partridge, 16 The Spinney, Delamere Park, Cuddington, Nr Northwich, Cheshire CW8 2UH. Tel: (0606) 888863

■ Atari 800XL, 64K RAM, Basic manual, unused and in genuine brand new condition. Any reasonable offers considered. Swap or p/ex also considered. Tel: (0606) 888643

■ Yaesu FT209RH 5 watt hand-held. Soft case, NC-18C compact charger, £200. Trio TH21E, smallest hand-held, soft case, spare Ni-Cad, dc converter/adaptor, boom mike/headphone with VOX, BNC adaptor, £200. Both boxed, immaculate with manuals. G4IOF. Tel: 01-722 7040

■ Complete collection of *Breaker* mags, offers. Tel: Mike 01-831 0648 daytime

■ TS430S HF transceiver/general coverage receiver. Fitted YK88SN SSB filter and FM board. Free service manual, good condition, £620 ono. FT480R 2 metre multimode transceiver, good condition, £280 ono. Terry G4OXD. Tel: Hitchin (0462) 35248, after 6pm

■ Portable radio: Ingersoll XK700 7 band AM, FM, LW, MW, SW 1, 2, 3, 4 and 24-hour LCD clock, battery or mains, £35. Buyer collects. G H Fern, 25 Fulleylove Court, Bolsover, Chesterfield, Derbys S44 6EZ. Tel: 824257

■ Receiver: Philips keyboard, memory search, BFO, SSB, 17 watts, N2999, 0.30MHz, 105-108 FM. New and boxed, £280. Exchange for Trio R600, must be in good condition. Hitachi stereo radio cassette recorder, large portable, 4 band, new and boxed, £130. CB transceiver: Audioline 134, Ham Master mic, £70. Tel: 01-207 2326 or 207 0706

■ 2m FM mobile transceiver standard C8800, 1 or 10 watts, fully synthesized, mobile mount, ideal base or mobile, scan on rig and mike, memory, excellent condition, £115. Tel: 01-764 6767, Chas, evenings and weekends

■ LA200 26-30MHz 200 watt RF amp, AM, FM, SSB plate and load controls, 240V mains, and fan cooled, £50 plus postage. Also Ham Major 588 AM, FM, SSB and legal FM rig, not working but complete, £20 plus postage. Or swap for Echo unit for CB, 40ch CB rig working on 10, £25 or WHY? Maguire, 49 Galbary Road, Holyhead, N.Wales. Tel: (0407) 4260

■ 934MHz Commtel transceiver with mobile antenna and other extras, £330 ovno. Buyer must collect or pay postage and insurance. AR88D receiver, in working order, will exchange for Revco PA2 in-line masthead pre-amp, over the range of 20-700MHz, or sell, £60. Buyer collects. Trio 120V HF transceiver, 10 watts, 25 PEP with mobile bracket and in maker's box, £270. Tel: (0704) 892088 afternoons or evenings, ask for Mike

■ SEM trans/Z match ATU with Easytune, £45, or exchange for FRG7 or Eddystone EC10 and pay difference. Tel: (01) 794 9790

■ Valves: over 1,000 brand new boxed valves, many with manuf guarantee. All quality makes like Mazda, Mullard, etc. Some very rare types advertised elsewhere at over £12 each. My prices only a fraction - so cheap you will be surprised. Just tell me which type numbers you require and I will give you an instant quote. Please telephone or write enclosing sae. K Bailey, 40 Seymour Close, Selly Park, Birmingham B29 7SD. Tel: (021) 472 3688

■ Advance mainframe storage oscilloscope, dual-trace type OS2200 with OS2006 and OS2007 plugs, including instruction manual. Not working, requires new transformer, hence very low price, £75.00 ovno. AVO transistor and diode tester type TT537 with instruction manual, £20.00. Prinz Concorde IQ 2500 remote control 35mm slide projector with 3 rotary slide magazines, £35.00. Dot matrix computer printer, paper width 15 inches, traction drive, £50.00 ovno. Mr K L Phillips, 3 Linden Court, Frithville Gardens, London W12 7JJ. Tel: (01) 743 0811

■ FRG9600 all-mode scanning receiver, modified 60-950MHz no gaps, £350.00 ovno. FDK ATC720 hand-held airband receiver, 118-136MHz, 720 synthesized channels, £125.00 ovno. FDK RX40 hand-held VHF monitor receiver, 141-180MHz, 15,600 synthesized channels, £100.00. Signal R517 hand-held airband receiver, full tuning of airband 118-136MHz plus 3 crystal controlled channels anywhere in airband. Price includes several crystals, £50.00 or near offer. Tel: (01) 743 0811, London

WANTED

■ Any literature relating to Hacker radios. Sales leaflets, service manuals, circuit data, etc. Also wanted, Hacker RP35 Herald and RP75 Super Sovereign radio sets in excellent condition. Tel: Reading (0734) 883799

■ Swap Grundig Traveller superhet 220 FM, LW, MW, SW 5.9 to 18MHz ac or battery, Ricoh 35mm camera lens f2.8, mint, for good working ATU. H C Bach, 52 Tudor Close, Belsize Ave, London NW3 4AG. Tel: (01) 794 9790

■ Old age pensioner wants for short wave listener grandson, Sicura Globe Trotter wrist-watch in complete working order, or not working but complete and repairable. Moderate price please, only have pension. Mr Richard Pattinson, 135 Meriden Court, Birmingham New Road, Wolverhampton, West Midlands WV4 6BP. Tel: Bilston 403887

■ *Sub-Miniature Electric Motors* by R H Warring. Price and condition to F Hill, 19 Leith Road, Sale, Cheshire M33 2LR. Tel: (061) 973 3559

■ Manual for Wayne Kerr component bridge CT492, will buy or borrow to copy, costs refunded. Write to P Austin, 30 Hamilton Road, Thame, Oxon OX9 3XZ. Tel: (084 421) 6451

■ Circuit, handbook for army C11 solid-state, with valve PA. Will purchase or photocopy. All costs, p+p will be paid. Gerard Fitzgerald E16DP, 40 Maigue Way, John Carew Park, Limerick, Ireland. Tel: (061) 43584

■ PCB servicing extender boards for Pye Olympic M201 and M202 radio telephones. Tel: (0407) 741879

■ Electronics and radio magazines from the year 1980 to 1985. If you have any please write to Mr A M Elkendi, 154 West Way, Highfields, Stafford ST17 9YF

■ Service manuals for all variations of Pye

Cambridge radio telephone, must be original manuals and in good condition. Tel: (0407) 741879

■ I would like to see a Spectrum working with radio reception of any kind. If you live in or near Camden Town, London and you would not mind my having a look then please contact me. Mike Breslin. Tel: 387 1224

■ Manual or any information on Kay DRM1 memory rhythm machine to help disabled OAP pass time when not DXing. Mr Turner, 5 Alexandra St, Thorne, Doncaster, S Yorks DN8 4EE. Tel: (0405) 813694

■ Cheap working or complete but non-working 6C6, 6D6 HRO Rx for rebuild or spares, with or without coils and power unit. Also Heathkit alignment generator model HFW-1 in full working order with manual and any correction sheets. Service sheet or manual for original metal-cased All Systems Sinclair Microvision, or how to get the metal case off without damage to insides? M J Shepherd, 66 Westerland Avenue, Canvey Island, Essex SS8 8JS

■ Green screen monitor. Would exchange Heathkit lab scope 5 inch model 10-12 with leads and manual. Also Hallicrafters short wave radio model S38C, 6-valve, old but works very well, four new valves fitted. Or could come to some arrangement. S Deacon G6HVS, 25 Moseley Road, Bebington, Wirral, Merseyside L63 9NT. Tel: (051) 334 6859

■ Exchange ST5MC RTTY terminal unit, as new, for DXTV Waltham Minister 6 inch mono UHF/VHF TV or DXTV Plustron TVR5D TV. Clive Powis, 28 Kingston Gardens, Chelmsley Wood, B'ham B37 5HS. Tel: (021) 788 8447

■ Beginner seeks offers of suitable equipment or advice on what to buy. Requirement is portable short wave receiver for reliable reception in Mallorca of BBC SW broadcasts. Reduction of background interference and fading is primary object. What controls are necessary to improve audio quality? Keypad selection of frequencies in memory and calibrated VU meter for rapid comparison of strengths seem desirable. B J Munyard, 208 Rivermead Court, Hurlingham, London SW6 3SG

■ Scope, Solarton CD523-S, working or not. Also manual and Z759 valves. B Bromley, 52 Thirlmere Rd, Chorley, Lancs PR7 2JH. Tel: (025 72) 76480

■ Video sync processor design as published in BATC (British Amateur TV Club) *CQTV* magazine No.129, ready constructed and in full working order. Would also be interested in a commercially produced video sync processor unit. Details and asking price please to Mr D J Oliver, 100 May Lane, Kings Heath, Birmingham B14 4AG

■ Reward! For circuit diagrams, handbooks, WHY for following items to enable repair: Sony open reel VTR type, AV3700 (spares/non-worker required, worker considered), Racal DFM type 806-R2, AVO sig gen type CT378B, MPIO 40TSS 5¼ f/height disc drive type 51/SOR92A. Has anyone had problems mating a 5¼ Shurtgatt drive with a PNP Communications Dragon 32 i/face? All letters/costs refunded, info appreciated. G1AGM-QTHR. Tel: (0229) 29152 evenings 5-9 or weekends

■ Service information, circuit manual, any help with the following: P58 VHF/UHF receiver, also R1132A receiver. Will buy or borrow to copy and return promptly. Please help, expenses reimbursed. The P58 receiver as far as I can make out was made by BTH so any info on the maker would be welcome. Mark G1RGL, 107 Spicer Close, Brixton, London SW9 7UE. Tel: (01) 733 2338

■ Amateur interested in DXTV and amateur TV is interested in items for these hobbies such as aerial amps etc. I am also looking for a video sync processor to reduce picture jitter/roll when receiving/recording weak signals from abroad when using a standard domestic TV. Details please to D J Oliver, 100 May Lane, Kings Heath, Birmingham B14 4AG

■ Urgently wanted: *Television and Electronics & Wireless World* magazines, 1975 onwards. Good price paid. Contact immediately. J G M Andrew, 738 Pershore Road, Birmingham B29 7NJ. Tel: (021) 471 4084

■ Crystals wanted 8MHz range: 8.700, 8.600, 8.775, any size up to FT243, HC25U preferred, any help appreciated. Ron G3VCJ. Tel: (042) 43 4726

■ FL2 audio filter, also book for radio club 2m FM mobile rig, also any video tapes on home radio and

FREE CLASSIFIED ADS

cassette tapes on ham radio, etc. Would pay for a copy. Tel: (0288) 4892

■ 5-6ft rack cabinet, with doors if possible and on casters, suitable for Racal gear. Also select/protect unit and RTTY de-mod unit. Possibly collect. Tel: Milton Keynes 314095

■ Mint Yaesu FT707, FT77 HF rig and Yaesu FT480, or Trio TR9000 2m multimode. Prefer in maker's carton. Sensible prices please. Also 10 in, 50 out 2m linear amp with pre-amp. Tel: Luton (0582) 36961 office hours, ask for Bob

■ Sony air 7 receiver. Sony TV511UK. Sony KV9000UB. Also Lowe Mk1024 electronic keyer. Tel: (0206) 394336, Essex

■ Service manual for W15U Pye Westminster, original or photocopy. Also April 1986 edition of *Ham Radio Today*. Write to Mr A Holmes, 61 Surtees Street, Bishop Auckland, Co Durham DL14 7DJ

■ Exchange Blaupunkt New York car radio cassette with amp, graphic equaliser and six speakers, superb quality unit, cost over £900. Wanted: HF linear, dual mode mobile, or handhelds, WHY? Tel: (0733) 231639 G4VNG

■ Superstar 360, Cobra 148, HyGain V. must be in perfect condition. Tel: Belfast 795783

■ Daiwa CN630 SWR meter. Must be in perfect condition. Tel: Denis (0670) 824788, after 5pm or weekends

■ Handicapped operator urgently requires Kenwood T-599S Tx, any condx but prefer working. Cash or exchange for all or any of: Cobra 148 GTL-DX 10m m/mode, CW, FM, AM, USB, LSB, 28.0 to 29.7MHz. Any of three 2m FM mobile tcvrs. All letters/cards replied to. Genuine enquiries only. The T-599S is required very urgently and I will collect if required. Please contact me by post. Peter G1TXI, 2 Mayes Close, Norwich, Norfolk NR5 9AR

■ TS830, TS530, FT102, FT902. Your price paid, or exchange for Icom IC740 PSU, SP3, FM, mint cond. Tel: Dave, (0248) 354022. If not in, leave your number and I will phone you

■ KW Ten-Tec Century 22 CW transceiver and any

accessories. Also any Meccano crystal set hardware, any photograph of the Marconi station at Alum Bay (IOW), and any Murphy Radio Sales aids, also an HR050 or HR060 Rx; the post-war HRO with the slide-rule dial. Alan Williams G3KSU, 11 Grange Avenue, Ryde, IOW PO33 3LS. Tel: (0983) 65551

■ Expert advice from a GPO or 'Sony' colour Prestel engineer. Can the Sony KTX-1400UB Trinitron View-Data terminal, which appears to have some sort of R-G-B input, be modified to 'composite video' input for use with a standard colour CCTV camera or domestic VCR? All info gladly received and paid for. I do have full circuit info, but still foxed! Write Nev Kirk, 54 Allendale Road, Rotherham, Yorks S65 3BY. Tel: Wickersley 541606

■ Redifon, Marconi or Sait marine band Rx. Also interested in Collins 51J, 75A4 and R390. Please phone with realistic price requested for first class condition gear. Tel: (061) 743 1570

■ Mains BC221, complete and ready for use, with instruction manual. Also multimode CB rig, preferably already converted for full 10m operation. Must be within easy collection distance of Redcar. G0FLR, not QTHR, Tel: (0642) 472337

■ Radio/radar equipment wanted by private collector, receivers: CR100, BC348, HRO Senior, Collins 75A4, APR4 and tuning units. Other 'surplus' equipment required, eg T1082, R1083, T1154, T3065, TR3191, TR3151, R1335, R1388, modulators, indicator units, Magnetrons CV38, CV64, Klystrons CV67, GL446, GL464, and any other units, British, American and German circa WWII, will collect. P Bristow, 6 Finmere, North Lake, Bracknell, Berks RG12 4WF

■ FT225RD with muTek F/E. MM 432/50 50W 70cm linear. Mr G Denman, 24 Ascot Rd, Cupnor, Portsmouth, Hants PO3 6EY. Tel: (0705) 820315

■ Standard C58 mobile mount & linear. Small ham band only rig. Solid-state. FT707, FT77 type or similar. Tel: Garry (0625) 530200

■ Circuit layout or AT5 Coda, will pay for photocopy and postage. Tel: (0268) 282373

■ Codar PR-30 or PR-40 preselector needed quickly. Cash waiting. Tel: Ian (0224) 636828, after 5.30pm

■ HF linear or dual band mobile rig or WHY. Exchange for Blaupunkt New York radio cassette system with graphic equaliser, 6 speakers and 80 watt amp, superb car system, as new, cost over £900. J McCallum G4VNG, 3 Brudenell, Orton Goldmay, Peterborough, Cambs. Tel: (0733) 231639

■ Swap BBC B micro, boxed, unused, Sony ICF7600D receiver, Spectrum + 48K, h/ware, s/ware, inc SSTV, dual waffer drive, Datong active antenna outdoor, GAF cine camera and projector, RC oscillator, Harrier CB base station for 2m base rig, FT209R, NC15 base charger, UHF wavemeter, 23cm ATV gear, 2m+70cm linears or WHY. G6RBK. Tel: (0923) 662817, after 9pm

■ 16mm Bell & Howell GSAP gun camera, 24V operation, ex-govt. Also N9 American 16mm cine camera. Both above used in aircraft, 10mm CMT lens wanted. Have Bendix RAIB Class D wavemeter. WHY? Tel: Bath (0225) 706795

■ Single channel FM receiver, xtal operated for 156.375MHz, 12V operated, in good working order. Will exchange for Daiwa 1000 2 metre receiver or buy outright. Must be low in price, this is for a disabled person. Eric Allen, 19 Railway Street, Berwick-on-Tweed TD15 1NF. Tel: (0289) 308607

■ Lowe Mk-1024 electronic keyer with memory. Also Sony TV-511UK and Sony KV-9000UB. Must be in first class condition. Tel: (0206) 394336, Essex

■ HF linear amp, commercial or home-brew. Any condition considered. Tel: (0608) 811102

■ HF and 2m tcvrs required to set up QTH again. Late models wanted. Please give details and prices. G3GZT. Tel: (0273) 503869 after 6pm

■ Good quality used amateur radio equipment, HF, VHF, UHF, WHY? Cash waiting for the right article. I have lots to swap, p/ex, etc. so phone (0924) 495916, Mirfield

■ I require a pair of high band FM Storno transceivers, complete, batt case, antenna. Mr P Bacheil, 885 High Road, Chadwell Heath, Romford, Essex RM6 4HR

FREE CLASSIFIED AD FORM

Send to: Amateur Radio Classified Ads · Sovereign House · Brentwood · Essex CM14 4SE

Classification: (tick appropriate box) If you want to insert ads under more than one classification use separate sheets for second and subsequent ads

For Sale Wanted.....

USE BLOCK CAPITALS (One word per box)

To avoid mistakes please write clearly and punctuate your ad

Name/Address							
Postcode/Telephone							

USE SEPARATE SHEET FOR MORE WORDS

Ensure that you have included your name and address, and/or telephone number

CONDITIONS: Ads will be published in the first available issue on a first come first served basis. We reserve the right to edit or exclude any ad. Trade advertisements are not accepted

Amateur RADIO SMALL ADS

JAYCEE ELECTRONICS

JOHN GM30PW

20 Woodside Way, Glenrothes,
Fife KY7 5DP

Tel: 0592 756962

Open: Tues-Sat 9-5

Quality secondhand equipment in stock. Full range of TRIO goodies. Jaybeam - Microwave Modules - LAR.



HEATHERLITE MOBILE MICROPHONES

You've probably seen one and heard one, they're well tried and tested. Lightweight and inconspicuous, good audio quality, ease of operation, worn around the collar or over the head. Control box with mic gain control, scan buttons, LED indicator on transmit, made individually and plugged to suit your rig.

with plug and scan buttons **£25.00**
with plug without scan buttons **£23.00**
with plug and extra amplifier for 8 pin Icom rigs eg IC 255 etc .. **£23.00**
Mic band and coax, no control box, circuit to make your own box **£7.00**

Post & Packing **£1.50 per order**

Cheques to:
HEATHER RODMELL
G8SAV QTHR:
Tel: (0401) 50921

MAXI - Q

COILS AND CHOKES
PREVIOUSLY MADE BY
DENCO SAE PRICE LIST

**8 BRUNEL UNITS, BRUNEL
ROAD, GORSE LANE IND
ESTATE, CLACTON, ESSEX
CO15 4LU.**
TEL: (0255) 424152

GROSVENOR SOFTWARE (G4BMK)

AX25 Packet Radio
Dragon 32/64 and Tandy Color

A breakthrough in Packet Radio - AX25 stand-alone software in ROM cartridge, plus a built VHF 1200 Baud modem for just £99!

Full AX25 implementation with up to 6 simultaneous connections, optional beacon, and digipeater operation. HF kit available soon. Send an SAE for full details of this and RTTY CW SSTV and AMTOR.

**2 Beacon Close, Seaford,
East Sussex BN25 2JZ**
Tel: (0323) 893378

G4 DXX Video Electronics

For Icom, Dray, Wells, DAIWA, Datong, N934 MHz equipment, logbooks, rotators, cable, etc.

OPEN 9-5pm, Closed Wednesdays

141 Lancaster Road, Morecombe, Lancashire LA4 5QJ

Phone: **(0524) 418873**

TELECOM DIY EXTENSION SOCKET KIT

Includes 10 metres cable extension socket clips and diagram. £8.95 inclusive (SAE for price list)

CABLELEC
14 TILMAN CLOSE
GREENLEYS, MILTON KEYNES MK12 6AQ

DW ELECTRONICS G3 XCF

Amateur Radio Supplies

71 Victoria Rd, Widnes

Tel: 051-420 2589



Open Mon-Sat 9.30-6 (closed all day Thurs)
We supply YAESU, ICOM, Tonna, Jaybeam,
Microwave Modules, Datongs etc

MORSE CODE PREPARATION

Cassette A. 1-12 wpm for amateur
Cassette B. 12-25 wpm for professional examination preparation
Each cassette is type C90

Price of each cassette (including booklets) **£3.95**.
Morse key with separate battery (PP3) - driven solid-state oscillator and sound transducer produces clear tone for sending practice. Price of key with electronic unit **£8.95**.

MW ELECTRONICS (Dept AR)
12 Longshore Way, Milnor, Portsmouth PO4 8LS

PNP Communications Communications Interface for RTTY - Morse - AMTOR

Our popular range of communication modules is now available, fully boxed and tested under the model number.

CTU 20

The CTU20R is RTTY only & costs **£62.50** whilst the CTU20RM is for morse as well and costs **£75.25**
For shortwave listeners the MF2-DX gives the option of 170Hz, 425Hz or 850Hz shift reception and costs **£56.95**

Send a large (A4) SAE for full Cat
Please add VAT at the current rate.
Access & Barclaycard (VISA) welcome.

62 Lawes Avenue, Newhaven
East Sussex BN9 9SB
Tel: (0273) 514465

SMALL ADS

This method of advertising is available in multiples of a single column centimetres - (minimum 2cms). Copy can be changed every month.

RATES

per single column centimetre:
1 insertion £7.00, 3 - £6.60, 6 - £6.30, 12 - £5.60.

AMATEUR RADIO SMALL AD ORDER FORM

TO: **Amateur Radio - Sovereign House**
Brentwood - Essex CM14 4SE - England - (0277) 219876

PLEASE RESERVE.....centimetres by.....columns

FOR A PERIOD OF 1 issue..... 3 issues..... 6 issues..... 12 issues.....

COPY enclosed..... to follow.....

PAYMENT ENCLOSED: (Add 15%VAT).... £

Cheques should be made payable to
Amateur Radio. Overseas payments
by International Money Order and
Credit Card

CHARGE TO MY ACCOUNT.....

COMPANY

ADDRESS

SIGNATURE TELEPHONE.....

C P I

NEXT ISSUE OF *Amateur* RADIO ON SALE Thursday 24th December

D.P. HOBBS (Norwich) Ltd
13 St Benedicts Street, Norwich Tel: 615786
Open Mon-Sat 9.5-5.30
Closed Thurs 1.00pm 
Stockists of:
YAESU, FDK, ICOM, JAYBEAM
& Electronic Component Specialists

RF DEVICES AT ROCK BOTTOM PRICES! Nobody beats us!

Over 30,000 RF devices at low prices
REPLACEMENT RF TRANSISTORS
MRF454 HF/SSB 80W £18.20
MFR450 HF/SSB 50W £11.60
MRF238 VHF/FM 25W £12.80
MRF475 HF/SSB 20W £2.99
2SC1969 HF/SSB 18W £2.50
2SC2043/1307 HF 16W £2.00
2SC1947 VHF 3.5W £7.60
2SC1946A VHF 32W £14.30

REPLACEMENT RF POWER MODULES

M57704/SAU3 UHF 15W £36.00
M57712/SAV7 VHF/FM 25W £39.00
M57713/SAV8 VHF/SSB 15W £39.00
M57716/SAU4 UHF/SSB 15W £49.00
M57719 VHF/PMR 15W £29.00
M57727 VHF/SSB 38W £45.00
M57749/SAU11 934/FM 7W £29.00

Send £1.00 p&p and SAE for full list
All prices inc. VAT
Many Ic's and other types in stock

RAYCOM LTD
DEPT AR 584 HAGLEY RD WEST
QUINTON BIRMINGHAM
B68 OBS
021 421 8201-3
 (24hr answer phone) 

12 VOLT 12AH POWER PACK
Portable. Battery operated.
for Video lights, TV, Portable Radio Equipment.
Black case with handle and DIN socket contains two
unspillable, rechargeable batteries.
Size: 12 1/2" long x 3 1/4" wide x 6 1/2" high
SPECIAL PRICE £29.50 (P&P £3.50)
CHARGER £7.00 (P&P £1.50)
APS BATTERIES LIMITED
001 Unit A East Cross Centre
Waterden Road Stratford CWO
Tel: 01-363 8793 London E15 2HN SAE for leaflet

SERVICE MANUALS

For most Makes, Models Age of electronic equipment
Amateur Radio, Test equipment, Audio, Television, Video, Vintage,
Military etc. Thousands Stocked SAE enquiries.

MAURITRON TECHNICAL SERVICES
Dept AR, 8 Cherry Tree Road, Chinnor, Oxon OX9 4QY.

USED AMATEUR EQUIPMENT?



I Buy, Sell & Exchange!

SPELLING? I pay the
BEST POSSIBLE PRICES for your Clean
Used Equipment! BUYING? I have the
BEST SELECTION
of top Quality Used
Equipment Available!

For the Deal You've been Looking for Phone Dave, G4TNY
ANYTIME ON HORNCHURCH (04024) 57722 or Send SAE
G4TNY AMATEUR RADIO
132 Albany Road, Hornchurch, Essex RM12 4AQ

AGRIMOTORS

MERTON CB AND RADIO CENTRE
MERTON GARAGE AND POST OFFICE, MERTON.
Nr OAKHAMPTON, DEVON EX20 3DZ

OPEN 6 DAYS 9-6 LUNCH 1-2pm
(SUNDAYS BY APPOINTMENT)
SPECIALIST IN 934 MHz
SUPPLIERS OF ALL 27MHz AND 934 MHz EQUIPMENT
AMATEUR ACCESSORIES CATERED FOR
08053 200

IAN FISHER COMMUNICATIONS OF STANHOPE

**CB Works, Bondisle Way, Stanhope,
Bishop Auckland Co Durham DL13 QTY
(0388) 528464**

Main Distributors of 27MHz CB radios and the
NEW DELTA 1 series 2 model transceiver with
the latest cybernet board. Also the NEW
Nevada range of 934MHz aerials to suit, also
934MHz pre-amplifiers and VSWR meters and
GREENPAR BNC and 'N' type plugs.

Large stocks of coaxial cable, plugs, sockets
and adaptors.
All available via mail order.

OPEN: MON-SAT 10.30am-6.00pm
RING FOR DETAILS
(0388) 528464

NORTH WALES AMATEUR RADIO MART

AMATEUR RADIO - CB RADIO - MARINE
RADIO - PMR
25 ABBEY STREET
RHYL

Open Monday-Saturday: 11am-5.30pm
All repairs and accessories available ex
stock Mail order welcome
 Tel: 0745-51579 

ICOM PORTABLES MRZ COMMUNICATIONS LTD STOKE-ON-TRENT

Desk DC Supply and Base for
Icom-Yaesu Portables.

Icom-Amateur/PMR/Marine/
Air/Yaesu/Amateur UK and
Export

Tel: (0782) 619658
7 day service

SP ELECTRONICS

48 Limby Road
Huckhall, Nottingham
Tel: (0602) 640377
Open Monday-Saturday
8.30-5.30

2 METRE COLLINEAR UVRAL X2 5/8 over 5/8

An omni directional antenna
giving low angle radiation. The
ideal base station vertical.
Ruggedly constructed for long life.

Technical Specification

Gain - 6 dB
Impedance - 50 Ohms
Max Power - 100 Watts
Length - 3.14 metres
SWR 144 to 146Mhz - Less than 1.5
Wind Loading - 4.6 Kgf at 100mph
Weight - 1.2 Kgs
Mounting Diameter - 25mm
Termination - Free 'N' Socket

Send cheque or postal order for
£29.95 plus £2.50 postage to:

**BUCKLEYS (UVRAL) LTD.,
BETA WORKS,
RANGE ROAD,
HYTHE, KENT CT21 6HG
Tel. No. (0303) 60127/60128**

CHEAP LED DISPLAYS.

7600 pieces, 0.3 inch, common anode, left hand
decimal, high light output, standard red,
industry standard pinout, graded and colour
coded, minimum quantity 100. Price 20p each.
Also lots more cheap opto, fibre-optics
etcetera. Trade enquiries welcome.

Ring Ian at
FIBRE-DATA LIMITED
Tel: (07356) 77444

**VALUABLE
SPACE FOR
SALE!**

**Telephone
the advertising
department on:
0277 219876
for details**

ADVERTISERS INDEX

AKD Armstrong.....	37	Matmos.....	34
Arrandeck Ltd.....	34	M E M.....	13
J Bull.....	59	Mendascope.....	52
Capco Elec.....	47	Riscomp.....	13
P M Components.....	26,27	Sandpiper.....	41
Edwardschild.....	52	Selectronic.....	34
R S P Electronic.....	52	Sherwood Data.....	52
K T Electronic.....	52	Stamford Electronics.....	14
S M C Electronics.....	41	Technical Software.....	14
The Ham Shop.....	14	Telecomms.....	60
L F Hanney.....	34	Waters & Stanton.....	18
C M Howes.....	37	R Withers.....	2
Icom.....	4,5	Wood & Douglas.....	47

Amateur RADIO

ADVERTISING RATES & INFORMATION

DISPLAY AD RATES		series rates for consecutive insertions			
depth mm x width mm	ad space	1 issue	3 issues	6 issues	12 issues
61 x 90	1/8 page	£66.00	£62.00	£59.00	£53.00
128 x 90 or 61 x 186	1/4 page	£115.00	£110.00	£105.00	£92.00
128 x 186 or 263 x 90	1/2 page	£225.00	£210.00	£200.00	£180.00
263 x 186	1 page	£430.00	£405.00	£385.00	£345.00
263 x 394	double page	£830.00	£780.00	£740.00	£660.00

COLOUR AD RATES		series rates for consecutive insertions			
depth mm x width mm	ad space	1 issue	3 issues	6 issues	12 issues
128 x 186 or 263 x 90	1/2 page	£305.00	£290.00	£275.00	£245.00
263 x 186	1 page	£590.00	£550.00	£530.00	£470.00
263 x 394	double page	£1,130.00	£1,070.00	£1,010.00	£900.00

SPECIAL POSITIONS	
Covers: Bleed: Facing Matter:	Outside back cover 20% extra, inside covers 10% extra 10% extra [Bleed area = 307 x 220] 15% extra

DEADLINES				
issue	colour & mono proof ad	mono no proof & small ad	mono artwork	on sale thurs
Jan 87	27 Nov 86	3 Dec 86	5 Dec 86	24 Dec 86
Feb 87	19 Dec 86	7 Jan 87	9 Jan 87	29 Jan 87
Mar 87	29 Jan 87	4 Feb 87	6 Feb 87	26 Feb 87
Apr 87	26 Feb 87	4 Mar 87	6 Mar 87	25 Mar 87

CONDITIONS & INFORMATION		
<p>SERIES RATES Series rates also apply when larger or additional space to that initially booked is taken. An ad of at least the minimum space must appear in consecutive issues to qualify for series rates. Previous copy will automatically be repeated if no further copy is received. A 'hold ad' is acceptable for maintaining your series rate contract. This will automatically be inserted if no further copy is received. Display Ad and Small Ad series rate contracts are not interchangeable.</p>	<p>If series rate contract is cancelled, the advertiser will be liable to pay the unearned series discount already taken.</p> <p>COPY Except for County Guides copy may be changed monthly. No additional charges for typesetting or illustrations (except for colour separations). For illustrations just send photograph or artwork. Colour Ad rates do not include the cost of separations. Printed - webb-offset.</p>	<p>PAYMENT Above rates exclude VAT. All single insertion ads are accepted on a pre-payment basis only, unless an account is held. Accounts will be opened for series rate advertisers subject to satisfactory credit references. Accounts are strictly net and must be settled by the publication date. Overseas payments by International Money Order or credit card.</p> <p>FOR FURTHER INFORMATION CONTACT Amateur Radio, Sovereign House, Brentwood, Essex CM14 4SE (0277) 219876</p> <p>Commission to approved advertising agencies is 10%.</p> <p>CONDITIONS 10% discount if advertising in both Amateur Radio and Radio & Electronics World. A voucher copy will be sent to Display and Colour advertisers only. Ads accepted subject to our standard conditions, available on request.</p>

TELECOMMS BUMPER CATALOGUES



CB £1
 934 MHz £1
 29 MHz £1

Each catalogue is packed full of info. and includes a £2 voucher.

2MTR EQUIPMENT

2 MTR HANDHELD CTE CT1300

A superbly sensitive new handheld covering 142-149MHz

- Repeater shift
- High/low power 1.5/0.5 Watt
- Thumbwheel selector

£199



VHF MOBILE AMP

B110 144MHz 110 Watt W/Pre Amp
 B42 144MHz 40 Watt
 LA05435 144MHz 45 Watt

£169
 £64.66
 £69.75

934 MHz PERSONAL RADIO

CYBERNET DELTA I TRANSCEIVER

- Scan
- Memories

£355



NPR 900 934 MHz Handheld
 We are the UK's leading distributor of 934MHz equipment. Send £1 for our full catalogue containing technical info and details of this exciting New Radio Band. Catalogue includes £2 voucher

£459

29 MHz BASE ANTENNAS

NEVADA TC52

This top class half wave uses high grade aluminium and a low loss coil handling up to 1 KW

WIND RESISTANCE: 75 MPH
GAIN: 25 dB
FREQ: 28-30MHz

£27.82

NEVADA TC58

Using high grade aluminium and a low loss coil complete with small radials this antenna is our most popular amongst the 29MHz fraternity

POWER: 1kW
GAIN: 35 dB
FREQ: 28-30MHz
LENGTH: 66 METRS

£29.75

SALUTE

Using a unique base hoop this antenna offers exceptional ground wave coverage on 10 FM

POWER: 2kW
GAIN: 45 dB
FREQ: 28-30MHz
LENGTH: 91 METRS

£49.72



R/F AMPLIFIERS

All amplifiers except broadband models are tuned for 29.6MHz centre freq. Should you require a lower freq i.e. 28.5MHz please state when ordering. Export models available for 26-30MHz

MOBILE AMPLIFIERS CTE MOD 767

£49.90

76 Watts FM
 INPUT: 0.5-10 Watts
 SWITCHABLE: Class AB Class C
 SUPPLY: 13.8 Volt
 REMOTE CONTROL FACILITY



CTE MOD 737 50W FM AM/SSB/CW £44.76
 CTE MOD 767 80W FM AM/SSB/CW £49.90
 CTE MOD 757 150W FM Broadband £116.87
 ZETAGI B35 25W FM 26-30MHz £22.23
 ZETAGI B150 70W FM 26-30MHz £49.96
 ZETAGI B300 150W FM (2-30MHz) £136.00
 NEVADA TC35 30W FM 26-30MHz £23.75

MAINS OPERATED AMPLIFIERS

CTE DC9 Solid State 150W FM (Broadband) £199.31
 ZETAGI B132 150W FM Solid State (Broadband) £119.00

NEVADA AMATEUR PRODUCTS

HIGH QUALITY BRITISH MADE HIGH POWER VARIABLE CAPACITORS

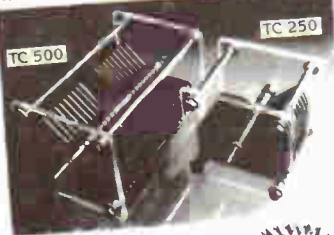

IDEAL FOR ATU'S OR AMPLIFIERS

TC 500
 (113-500) pF variable cap
 2mm air gap 78kV B/Down voltage

£27
 plus £2 p&P

TC 250
 (113-250) pF variable cap
 2mm air gap 78kV B/Down voltage

£19.95
 plus £1 p&P

NEVADA PSDL PROFESSIONAL DUMMY LOAD

FREQ: DC to 3000 MHz
 POWER: 15 Watts
 Made to the highest standards. This unit is a must for UHF VHF and HF operators offering wide Freq. coverage at an affordable price.

£36



NEVADA

HIGH QUALITY BRITISH MADE 29MHz FM PRODUCTS

NEVADA TC35 DX

R.F. POWER AMP WITH HARMONIC FILTER

INPUT: 1-4 Watts
 OUTPUT: 25-30 Watts
 SUPPLY: 13.8v DC
 FREQ: 26-30 MHz



£23.75

NEVADA TC27 RX

RECEIVER PRE-AMP FOR 26-30MHz

A superior low noise pre-amplifier for 29MHz FM operation. Variable gain -6dB to -18dB suitable for use with transceivers up to 25 Watts output.



£23.99

NEVADA TM27 ANTENNA MATCHER

Idea for both home and mobile use. This matcher really works allowing full coverage of the 29MTR band and handling 100 Watts

£11.64



TC2 2 WAY ANTENNA SWITCH

A robust unit with unique double screening handling up to 200 Watts and exceptionally low insertion loss. FREQ: 1-100MHz

£6.81



NEVADA TC27 RXM MOBILE PRE-AMPLIFIER FOR 29MHz FM

An FET low noise pre-amplifier with variable gain. Designed to improve reception on even the best transceiver.

GAIN: -6 to -20dB

£19.95



TELECOMMS

HOTLINE (24 HOURS)
0705 662145
 189 LONDON ROAD, PORTSMOUTH,
 HANTS, PO2 9AE,
 TELEX 869107 TELCOM G

USE YOUR CREDIT CARD (AMERICAN EXPRESS, ACCESS OR VISA) FOR IMMEDIATE DESPATCH

TRADE ENQUIRIES WELCOME.

WORLDWIDE DISTRIBUTORS OF AMATEUR & PERSONAL RADIO EQPT.