

# ENERPAC

POWERFUL SOLUTIONS. GLOBAL FORCE.



GB

E 3 2 9 e

# INDUSTRIAL TOOLS

# Table of Contents

## Introduction

The World Class Brand ..... 2-3

## Cylinders & Lifting Products 4 - 69

Introduction & Overview ..... 4 - 5

RC-Series, Single-Acting, General Purpose Cylinders ..... 6 - 9

A, CAT, JBI, RB, RE-Series, Cylinder Accessories ..... 10

RA-Series, Aluminium Cylinders, Introduction ..... 11

RAC-Series, Single-Acting, Aluminium Cylinders ..... 12 - 13

RACL-Series, Single-Acting,

Aluminium Lock Nut Cylinders ..... 14 - 15

RACH-Series, Single-Acting,

Aluminium Hollow Plunger Cylinders ..... 16 - 17

RAR-Series, Double-Acting,

Aluminium Cylinders ..... 18 - 19

RT-Series, Telescopic Cylinders ..... 20 - 21

RSM, RCS-Series, Single-Acting,

Low-Height Cylinders ..... 22 - 23

CULP-Series, Ultra-Flat Cylinders with Stop Ring ..... 24

CUSP-Series, Ultra-Flat Cylinders, High Tonnage ..... 25

LPL-Series, Single-Acting,

Low-Height High Tonnage Lock Nut Cylinders ..... 26 - 27

BRC, BRP-Series, Single-Acting, Pull Cylinders ..... 28 - 29

RCH-Series, Single-Acting,

Hollow Plunger Cylinders ..... 30 - 31

RRH-Series, Double-Acting,

Hollow Plunger Cylinders ..... 32 - 33

BRD-Series, Double-Acting,

Precision Production Cylinders ..... 34 - 35

RR-Series, Double-Acting,

Long Stroke Cylinders ..... 36 - 39

High Tonnage Cylinders,

HCG, HCR, HCL, HCRL-Series

Introduction & Quick Selection ..... 40 - 43

HCG-Series, Single-Acting,

High Tonnage Cylinders ..... 40 - 47

HCR-Series, Double-Acting,

High Tonnage Cylinders ..... 40 - 43, 48 - 51

HCL-Series, Single-Acting,

High Tonnage Lock Nut Cylinders ..... 40 - 43, 52 - 55

HCRL-Series, Double-Acting,

High Tonnage Lock Nut Cylinders ..... 40 - 42, 56 - 57

SC-Series, Cylinder-Pump Sets ..... 58 - 59

P, RC, V-Series, Extreme Environment Products ..... 60

SC, SL, SR, SW-Series, Power Box Sets,

Portable Tool Box ..... 61

JH, JHA-Series, Aluminium and Steel Jacks ..... 62

GBJ-Series, Steel Bottle Jacks ..... 63

PR-Series, POW'R-RISER® Mobile Lifting Jacks ..... 64 - 65

PL-Series, POW'R-LOCK® Mobile Lifting Systems ..... 66 - 67

Custom Hydraulic Cylinders & Pumps ..... 68 - 69

## Pumps & Directional Control Valves 70 - 119

Introduction & Overview ..... 70 - 71

P-Series, Lightweight Hand Pumps ..... 72 - 73

P-Series, Steel Hand Pumps ..... 74 - 75

P-Series, Low Pressure Hand Pumps ..... 76 - 77

MP-Series, Multifluid Hand Pumps ..... 78

P-Series, Foot Pump ..... 79

P, 11-Series, Ultra-High Pressure Hand Pumps ..... 80 - 81

XC-Series, Cordless Hydraulic Pumps ..... 82 - 83

PU-Series, Economy Electric Pumps ..... 84 - 85

PE-Series, Submerged Electric Pumps ..... 86 - 89

Z-Class Power Pumps Introduction ..... 90 - 91

ZU4-Series, Portable Electric Pumps ..... 92 - 97

ZE-Series, Electric Pumps ..... 98 - 103

PA-Series, Air Hydraulic Foot Pumps ..... 104

PAM-Series, Air Hydraulic Pumps ..... 105

PATG-Series, Turbo II, Air Hydraulic Pumps ..... 106 - 107

XA-Series, Air Driven Foot Pumps ..... 108 - 109

ZA4-Series, Modular Air Hydraulic Pumps ..... 110 - 111

ZG-Series, Gasoline Hydraulic Pumps ..... 112 - 113

## Directional Control Valves 114 - 119

Introduction & Overview ..... 114 - 115

VM, VE-Series, Pump Mounted Valves ..... 116 - 117

VC-Series, Remote Mounted Valves ..... 118

VC, VM, VE-Series, Valve Dimensions ..... 119

## System Components & Control Valves 120 - 137

Introduction & Overview ..... 120 - 121

H700-Series, High Pressure Hoses ..... 122 - 123

A, C, F, T-Series, Hydraulic Couplers ..... 124 - 125

HF-Series, Hydraulic Oil ..... 126

A, AM-Series, Manifolds ..... 126

FZ, BFZ, XSC-Series, Fittings ..... 127

GF, GP-Series, Force & Pressure Gauges ..... 128 - 129

G, H-Series, Pressure Gauges ..... 130 - 131

T-Series, Test System Gauges ..... 132

DGR-Series, Digital Pressure Gauge ..... 133

GA45-Series, Gauge Adaptor Assembly ..... 134

AMGC-Series, 4-Way Manifold Assemblies ..... 134

GA, NV, V-Series, Gauge Accessories ..... 135

V-Series, Pressure and Flow Control Valves ..... 136 - 137

## Hydraulic Presses 138 - 147

Introduction & Overview ..... 138 - 139

XLP, VLP-Series, Bench & Workshop Presses ..... 140 - 141

BPR-Series, Roll-Frame Presses ..... 142 - 143

A-Series, C-Clamp and Arbor Presses ..... 144 - 145

A, BSS, IPL, VB, VHJ-Series, Press Accessories ..... 146

TM-Series, Tension Meter ..... 147

LH-Series, Load Cells ..... 147

## Pullers 148 - 161

Introduction & Overview ..... 148 - 149

BHP-Series, Master Puller Sets ..... 150

BHP-Series, Grip Puller Sets ..... 151

BHP-Series, Cross Bearing Puller Sets ..... 152

BHP-Series, Bearing Cup and Bearing Pullers ..... 153

EP-Series, Posi Lock® Mechanical Grip Pullers ..... 154 - 157

EPH-Series, Posi Lock® 10 - 50 ton

Hydraulic Pullers and Accessories ..... 158 - 160

EPH-Series, Posi Lock® 100 ton Hydr. Grip Pullers ..... 161

## Tools 162 - 181

Introduction & Overview ..... 162 - 163

MS-Series, Maintenance Sets ..... 164 - 167

SP-Series, Lightweight 35 ton Hydraulic Punch ..... 168 - 169

SP-Series, 50 ton Double-Acting Punch ..... 170 - 171

LW-Series, Hydraulic Vertical Lifting Wedge ..... 172

SOH-Series, Hydraulic Machine Lifts ..... 173

ER-Series, Heavy Duty Load Skates ..... 174 - 175

CM-Series, Industrial Storage Cases ..... 176

A, WR-Series, Wedgie & Spread Cylinders ..... 177

WHC, WHR-Series, Hydraulic Cutterheads ..... 178

WMC-Series, Self-Contained Hydraulic Cutters ..... 179

STB-Series, Pipe Bender Sets ..... 180 - 181

## Bolting Tools and Pumps 182 - 237

Introduction & Overview ..... 182 - 183

E-Series, Manual Torque Multipliers ..... 184 - 185

S-Series, Square Drive

Hydraulic Torque Wrenches ..... 186 - 188

TSP, RTE, SRS-Series, Accessories for S-Series ..... 189

BSH-Series, Heavy-Duty Impact Sockets ..... 190

Bolting Application Ideas, S-Series ..... 191

W-Series, Low Profile Hexagon

Hydraulic Torque Wrenches ..... 192 - 201

W-SL-Series, Ultra-Slim Stepped Width

Bi-Hexagonal Torque Wrenches ..... 202 - 203

WCR-Series, Roller Cassette Wrenches ..... 204

TSP, WTE, WRP-Series, Accessories for W-Series ..... 205

PTW-Series, Pneumatic Torque Wrenches ..... 206 - 207

ETW-Series, Electric Torque Wrenches ..... 208 - 209

BLT, DSA, ED, RAT, SLR-Series,

Accessories for PTW and ETW-Series ..... 210

Application Examples PTW and ETW-Series ..... 211

Selection Matrix Wrench-Pump Combinations ..... 212

PME, PMU-Series,

Portable Electric Torque Wrench Pumps ..... 213

TQ-Series, Electric Torque Wrench Pumps ..... 214 - 215

ZU4T-Series, Electric Wrench Pumps ..... 216 - 219

ZE-Series, Electric Torque Wrench Pumps ..... 220 - 221

ZA4T-Series, Air Driven Torque Wrench Pumps ..... 222 - 225

ZUTP-Series,

Electric Tensioning Pump, 1500 bar ..... 226 - 227

HT, B-Series, Hoses and Couplers, 1500 bar ..... 227

ATP-Series, Air Pump 1500 bar ..... 228

NC-Series, Hydraulic Nut Splitters ..... 229

NS-Series, Hydraulic Nut Splitters ..... 230 - 231

FS-Series, Hydraulic Flange Spreaders ..... 232

FSH, FSM-Series, Wedge Spreaders ..... 233

ATM-Series, Flange Alignment Tools ..... 234 - 235

FF-Series, QuickFace Mechanical

Pipe Flange Face Tool ..... 236 - 237

## Heavy Lifting Technology 238 - 262

Introduction & Overview ..... 238 - 239

SFP-Series, Electric Split-Flow Pumps ..... 240 - 241

EVOB-Series,

Basic Synchronous Lifting Systems ..... 242 - 243

EVO-Series,

Standard Synchronous Lifting Systems ..... 244 - 245

BLS-Series, Climbing Jacks ..... 246 - 247

JS-Series, Jack-Up Systems ..... 248 - 249

HSL-Series, Heavy Lifting Strand Jacks ..... 250 - 251

SHS-Series, Synchoist,

Synchronous Hoisting Systems ..... 252 - 253

SHAS-Series, Synchoist, Autonomous

Wireless Synchronous Hoisting System ..... 254 - 255

SL, SBL, MBL-Series,

Telescopic Hydraulic Gantries ..... 256 - 257

HSK, LH-Series, Skidding Systems ..... 258 - 259

SPMT-Series, Self-Propelled Modular Transporter ..... 260

Custom Solutions – Experience & Expertise ..... 261

Project Gallery – Custom Heavy Lifting Solutions ..... 262

## Yellow Pages 263 - 277

Introduction & Overview ..... 263

Safety Instructions ..... 264 - 265

Pump Selection ..... 266

Selection Worksheet ..... 267

Basic System Set-ups ..... 268 - 269

Basic Hydraulics ..... 270 - 271

Conversion Tables ..... 272

Cylinder Speed Charts ..... 273

Valve Information ..... 274

Hexagon Nut and Bolt Sizes ..... 275

Bolting Theory – Torque Tightening ..... 276 - 277

**About Enerpac** ..... 278

**Enerpac Academy** ..... 279

**Enerpac Maintenance Program (EMP)** ..... 279

**Enerpac Worldwide Locations** ..... 280

# Model Number Index

# Section Index

Page(s) ▼ Page(s) ▼ Page(s) ▼ Page(s) ▼

<b>A</b>	<b>EMB</b> ..... 174
A5-A10 ..... 166	EP ..... 154-157
A12 ..... 10	EPH ..... 158-161
A13-A28 ..... 166	EPP ..... 155-157
A29-A53 ..... 10	EPX ..... 157
A64-A66 ..... 126	ER-ES ..... 174-175
A92 ..... 166, 177	ETW ..... 208-210
A102 ..... 10, 37	EVO ..... 242-245
A128-A192 ..... 166	<b>F</b>
A183 ..... 144	F ..... 124-125
A185 ..... 144, 166	FF ..... 236-237
A200R ..... 146	FH ..... 124-125
A205-A220 ..... 144	FR ..... 124-125
A218-A305 ..... 166	FRL ..... 207
A252 ..... 10, 37	FS ..... 232
A310, A330 ..... 144	FSB ..... 172, 233
A530-A595 ..... 166	FSH ..... 233
A604 ..... 124-125	FSM ..... 233
A607 ..... 166	FZ ..... 127
A630 ..... 124-125	<b>G</b>
A650 ..... 166	G ..... 130-131
AH ..... 124-125	GA ..... 134-135
AM ..... 126, 134	GBJ ..... 63
AR ..... 124-125	GF ..... 128-129
ATM ..... 234-235	GP ..... 128-129
ATP ..... 228	<b>H</b>
AW ..... 10	H ..... 122-123, 131
<b>B</b>	HA ..... 123
B ..... 227	HB ..... 123
BAD ..... 35	HC ..... 123
BFZ ..... 127	HCG ..... 40-47
BH ..... 227	HCL ..... 40-43, 52-55
BHP ..... 150-153	HCR ..... 40-43, 48-51
BLS ..... 246-247	HCRL ..... 40-42, 56-57
BLT ..... 210	HF ..... 126
BPR ..... 142-143	HP ..... 31, 33
BR ..... 227	HSK ..... 258-259
BRC ..... 28-29	HSL ..... 250-251
BRD ..... 34-35	HT ..... 227
BRP ..... 28-29	<b>I</b>
BSA ..... 129, 131	IPL ..... 146
BSH ..... 190	<b>J</b>
BSS ..... 146	JBI ..... 10
BW ..... 229	JH ..... 62
BZ ..... 180-181	JHA ..... 62
<b>C</b>	JS ..... 248-249
C ..... 124-125	<b>L</b>
CAT ..... 10, 23	LH ..... 147, 258-259
..... 37, 53, 55	LPL ..... 26-27, 40-41
CATG ..... 13, 15, 19	LW ..... 172
..... 45, 47, 49, 53	<b>M</b>
CD-CF-CH ..... 125	MBL ..... 256-257
CM ..... 176	MP ..... 78
CMF ..... 125	MS ..... 164-167
CR ..... 124-125	MSP ..... 169
CU ..... 24-25	MZ ..... 164-167
CW ..... 166	<b>N</b>
<b>D</b>	NC ..... 229
DGR ..... 133	NS ..... 230-231
DSA ..... 210	NV ..... 135
<b>E</b>	
E ..... 184-185	
ED ..... 210	
ELP ..... 174-175	

<b>P</b>	<b>T</b>
P ..... 72-79	T ..... 125, 132
P142AL ..... 60	TH ..... 125
P392AL ..... 60	THC ..... 212-213, 219
P392FP ..... 79	..... 221-222, 224
PA ..... 104-107	THQ ..... 212-214, 219
PAM ..... 105	..... 221-222, 224
PAMG ..... 106-107	TM ..... 147
PATG ..... 106-107	TSP ..... 186, 189
PARG ..... 106-107	..... 192, 205
PC ..... 72, 74	TQ ..... 212, 214-215
PE ..... 86-89	<b>V</b>
PF25 ..... 100	V ..... 60, 135-137
PL ..... 66-67	VA2 ..... 105
PM ..... 212-213	VB ..... 141, 146
PR ..... 64-65	VC ..... 118-119
PTW ..... 206-207	VE ..... 116-119
PU ..... 84-85	VHJ ..... 146
<b>R</b>	VLP ..... 140-141
RA ..... 11	VM ..... 116-119
RAC ..... 12-13	VMC ..... 117-119
RACH ..... 16-17	<b>W</b>
RACL ..... 14-15	W ..... 192-203
RAR ..... 18-19	WCB ..... 178-179
RAT ..... 210	WCR ..... 204
RB ..... 10	WHC ..... 178
RC ..... 6-9, 58-61	WHR ..... 178
RCH ..... 30-31	WMC ..... 179
RCS ..... 22-23	WR ..... 167, 177
..... 58, 61	WRP ..... 205
RE ..... 10	WTE ..... 205
RFL ..... 105-109	<b>X</b>
RR ..... 36-39	XA ..... 61
RRH ..... 32-33	..... 108-109, 231
RSM ..... 22-23, 61	XC ..... 61, 82-83, 231
RT ..... 20-21	XLK ..... 108
RTE ..... 189	XLP ..... 140-141
RWH ..... 150	XPG ..... 108
<b>S</b>	XSC ..... 82, 108, 127
S ..... 186-189	<b>Z</b>
SB ..... 172, 233	Z ..... 125
SBL ..... 256-257	ZA4 ..... 91, 110-111
SBZ ..... 94, 100	ZA4T ..... 91, 212
..... 218, 224	..... 222-225
SC ..... 58-59, 61	ZCF ..... 94-95
SDA ..... 188	..... 100-101
SFP ..... 240-241	ZCP ..... 101
SHAS ..... 254-255	ZE ..... 91, 98-103
SHS ..... 252-253	..... 212, 220-221
SL ..... 256-257	ZG ..... 112-113
SLR ..... 210	ZHE ..... 95, 101, 218
SOH ..... 173	ZLS ..... 94-95, 100-101
SP ..... 168-171	ZPF ..... 94-95, 100-101
SPD ..... 169	ZU4 ..... 91-97
SPK ..... 168	ZU4T ..... 91, 212
SPMT ..... 260	..... 216-219
SRA ..... 210	ZUTP ..... 226-227
SRS ..... 61, 189	ZR ..... 94-95
STB ..... 180-181	..... 100-101, 224
STC ..... 178	<b>5</b>
STF ..... 232-233	11 - 45 ..... 80-81
STN ..... 229	72 - 83 ..... 80-81
STP ..... 169	
SWH ..... 186,	
..... 192, 202	
SWR ..... 61	

## Cylinders & Lifting Products



Page 4-69

## Pumps & Directional Control Valves



Page 70-119

## System Components & Control Valves



Page 120-137

## Presses



Page 138-147

## Pullers



Page 148-161

## Tools



Page 162-181

## Bolting Tools



Page 182-237

## Heavy Lifting Technology



Page 238-262



# The World Class Brand

**A** complete range of quality high pressure hydraulic tools, controlled force products and solutions for all industrial applications, with local availability and after sale service anywhere in the world... this is what has made Enerpac the undisputed global market leader in high pressure hydraulics.

Across every continent, Enerpac's network of authorized distributors and service centers can reach even the most remote locations, supplying and servicing products that are designed to enhance productivity and performance, while making the workplace safer.

With over 150 sales specialists and a network of service and engineering support in 22 countries across the globe, Enerpac has become the product of choice in industries such as heavy lifting, manufacturing, construction, energy, oil & gas, shipbuilding, railroads, mining, and metals transformation.

Always at the leading edge of technology, Enerpac has continued to develop its range of time and cost-savings tools, utilizing modern engineered materials to improve productivity and minimize operator fatigue.

Enerpac's commitment to the continued development of quality high force tools ensures that the products you purchase are the best tools in the industry.

We will continue to lead the way in the development of quality high force tools for all industrial applications.





# 10 Reasons to Work with Enerpac

- Expert Design
- Highly Reliable
- Service Excellence
- Worldwide Experience
- Application Support
- Availability
- Quality
- Value
- Innovative Products
- Systems Solutions



## Total Quality

Our products are tested to the most exacting standards. These high standards guarantee the quality, price and performance requirements of the markets we serve around the globe.

## Global Network, Support and Service

Enerpac has an extensive network of authorized distributors and service centers located in more than 90 countries worldwide. You can rely on Enerpac for the products and technical support you need to get your job done, anywhere in the world.

## Logistics Excellence

Enerpac's mission is to maintain service excellence in the ever-changing world of modern distribution. Providing our extensive range of products to our thousands of distributors worldwide demands a logistic expertise only a market leader can provide.



## A Tradition of Innovation

Enerpac has a long history of finding new solutions to better meet the challenges of the industries we serve. We were the first to develop a composite hand pump and the first to offer a computerized lifting system.

Our latest innovations include the next generation ultra-flat, low height and high tonnage cylinders, and telescopic cylinders with highest level of durability, the new XA-Series of air driven foot pumps, designed for less operator fatigue – with the unique XVARI® Technology, delivering variable oil flow and fine metering for precise control, a full range of aluminium cylinders with the strength of steel and the advantages of aluminium and the Z-Class series of power pumps ..... pumps that were designed to run cooler, use less electricity and are easy to service.

We design and manufacture heavy lifting equipment. For more than 60 years, we've combined high pressure hydraulics and controls to deliver intelligent and innovative solutions that maintain the highest level of quality, reliability and safety.

**ENERPAC**   
POWERFUL SOLUTIONS. GLOBAL FORCE.

Enerpac hydraulic cylinders are available in hundreds of different configurations. Whatever the industrial application... lifting, pushing, pulling, bending, holding... whatever the force capacity, stroke length, or size restrictions... single- or double-acting, solid or hollow plunger, you can be sure that Enerpac has the cylinder to suit your high force application. Enerpac jacking cylinders fully comply to ASME B30.1 (except BRD-Series).



### GR2 Bearing Technology

The exclusive GR2 is a unique bearing design on RC-Series DUO general purpose cylinders which absorbs eccentric load stresses to protect your cylinder against abrasion, over-extending or plunger blow-outs and jamming or top-end mushrooming. As a result, RC-Series DUO cylinders provide long, trouble-free operation.

### Improved saddle retention

Hardened plunger saddle protects plunger end during all lifting operations. Easily removable for access to plunger mounting threads.

### Thread protector

Protector is easily attached and removed with oily hands or whilst wearing gloves.

### Easy assembly and disassembly

External access to fasteners requires only standard shop tools for simplified maintenance.

### Heavy-Duty return spring

Pre-tensioned return spring improves retraction performance, reducing retraction times.

### Unique GR2 Bearing System

GR2 design surrounds seal of longer stroke models for improved life and reduced bearing loads. Bearing surface area increases side-load resistance and significantly improves cylinder life.



### Coupler Protector

Coupler Dust Cap has new shape and more pliable material for easy push-on/pull-off operation. Protector is easily attached and removed with oily hands or whilst wearing gloves.





































### Easy assembly and disassembly

External access to fasteners requires only standard shop tools for simplified maintenance.



Note: The cut-away drawing is representative of typical cylinder construction, and may not represent all cylinders in this section.

# Hydraulic Cylinders and Lifting Products Section Overview

Capacity <sup>1)</sup> ton (kN)	Stroke Range (mm)	Cylinder Type and Functions	Series	Page
<b>5 - 95</b> (45 - 933)	<b>16 - 362</b>	<b>General Purpose Cylinders, Single-Acting</b> Accessories: Saddles, Base Plates, Mounting Attachments	 RC A, CAT JBI, RE	 <b>6</b> ▶ <b>10</b> ▶
<b>20 - 150</b> (229 - 1589)	<b>50 - 250</b>	<b>Aluminium Cylinders, Single-Acting, Lock Nut, Hollow Plunger</b>	  RAC RACL RACH	 <b>12</b> ▶ <b>14</b> ▶ <b>16</b> ▶
<b>20 - 150</b> (229 - 1589)	<b>50 - 250</b>	<b>Aluminium Cylinders, Double-Acting, Solid Plunger</b>	 RAR	 <b>18</b> ▶
<b>14 - 31</b> (137 - 309)	<b>270 - 600</b>	<b>Multi-Stage Telescopic Cylinders, Single-Acting, Load Return</b>	 RT	 <b>20</b> ▶
<b>5 - 150</b> (45 - 1386)	<b>6 - 62</b>	<b>Flat-Jac® Cylinders, Single-Acting</b> Low-Height Cylinders, Single-Acting	 RSM RCS	 <b>22</b> ▶
<b>10 - 1000</b> (97 - 10.165)	<b>6 - 17</b>	<b>Ultra-Flat Cylinders, Single-Acting, Load Return with Stop Ring or Tilting Function</b>	 CULP CUSP	 <b>24</b> ▶ <b>25</b> ▶
<b>60 - 500</b> (606 - 5114)	<b>45 - 50</b>	<b>Low Height Lock Nut Cylinders Single-Acting, Load Return</b>	 LPL	 <b>26</b> ▶
<b>2,5 - 50</b> (24 - 506)	<b>127 - 154</b>	<b>Pull Cylinders, Single-Acting, Spring Return</b>	 BRC BRP	 <b>28</b> ▶
<b>13 - 145</b> (125 - 1429)	<b>8 - 258</b>	<b>Hollow Plunger Cylinders, Single- and Double-Acting</b>	  RCH RRH	 <b>30</b> ▶ <b>32</b> ▶
<b>4 - 23</b> (35 - 222)	<b>28 - 260</b>	<b>Precision Production Cylinders, Double-Acting (including Mounting Attachments)</b>	 BRD	 <b>34</b> ▶
<b>10 - 520</b> (101 - 5108)	<b>16 - 1219</b>	<b>Long Stroke Cylinders, Double-Acting</b>	 RR	 <b>36</b> ▶
<b>50 - 1000</b> (550 - 10.644)	<b>50 - 300</b>	<b>High Tonnage Cylinders, Single- and Double-Acting</b>	  HCG HCR	 <b>44</b> ▶ <b>48</b> ▶
<b>50 - 1000</b> (550 - 10.644)	<b>50 - 300</b>	<b>High Tonnage Lock Nut Cylinders, Single- and Double-Acting</b>	  HCL HCRL	 <b>52</b> ▶ <b>56</b> ▶
<b>1 - 95</b> (8,9 - 933)	<b>11 - 362</b>	<b>Cylinder - Pump Sets, Single-Acting</b> Extreme Environment Products Power Box, Portable Tool Sets	 SC RC, P, V SL, SR, SW	 <b>58</b> ▶ <b>60</b> ▶ <b>61</b> ▶
<b>2 - 150</b> (20 - 1335)	<b>62 - 460</b>	<b>Aluminium and Steel Jacks</b> Industrial Steel Bottle Jacks	 JH, JHA GBJ	 <b>62</b> ▶ <b>63</b> ▶
<b>54 - 181</b> (533 - 1778)	<b>356 - 686</b>	<b>POW'R RISER® Mobile Lifting Jacks</b> POW'R LOCK® Mobile Lift System	 PR PL	 <b>64</b> ▶ <b>66</b> ▶

<sup>1)</sup> All ton values specified in this catalog are metric ton and are for cylinder class identification only. Please refer to the kN data for calculations.



# RC-Series DUO, Single-Acting Cylinders

▼ From left to right: RC-506, RC-50, RC-2510, RC-154, RC-10010, RC-55, RC-1010



- **Unique GR2 Bearing Design, reduces wear, extending life**
- **Collar threads, plunger threads and base mounting holes enable easy fixturing (on most models)**
- **Designed for use in all positions**
- **High strength alloy steel for durability**
- **Redesigned cylinder thread protector for ease of use**
- **Heavy-duty, pretensioned spring improves retraction speed**
- **Baked enamel finish for increased corrosion resistance**
- **CR-400 coupler and dust cap included on all models**
- **Plunger wiper reduces contamination, extending cylinder life.**

▼ *Foundation repair: to re-stabilize the foundation, the 308 ton silo needed to be lifted, levelled and structurally supported. 25 ton RC-Series hydraulic jacks were attached to a bracket on the top of each steel pier. Powered by a Z-Class pump, the hydraulic jacks applied 20 ton of force at each placement to lift the silo 5,1 cm.*



## The Industry Standard General Purpose Cylinder



### Saddles

All RC cylinders (except RC-50, 101) are equipped with hardened removable grooved saddles. For tilt and flat saddles, see the RC-Series accessory page.

Page: 10



### Base Plates

To ensure the stability of cylinders for lifting applications, base plates are available for 10, 25 and 50 ton RC cylinders.

Page: 10



### Specialty Attachments

For solving all kinds of application problems, specialty attachments are available for 5, 10 and 25 ton RC cylinders.

Page: 166

▼ *Synchronous lifting set-up for 200 ton petrochemical process module using twelve RC-2510 cylinders. To ensure the stability of the cylinders JBI-25 base plates are installed.*



# Single-Acting, General Purpose Cylinders



## GR2 Bearing Technology

The exclusive GR2 is a unique bearing design on RC-Series DUO cylinders which absorbs eccentric load stresses to protect your cylinder against

abrasion, over-extending or plunger blow-outs and jamming or top-end mushrooming. As a result, RC-Series DUO cylinders provide long, trouble-free operation.

### ▼ QUICK SELECTION CHART

For complete technical information see next page.

Cylinder Capacity	Stroke	Model Number	Cylinder Effective Area	Oil Capacity	Collapsed Height	
ton (kN)	(mm)		(cm <sup>2</sup> )	(cm <sup>3</sup> )	(mm)	(kg)
<b>5</b> (45)	16	<b>RC-50</b>	6,5	10	41	1,0
	25	<b>RC-51</b>	6,5	16	110	1,0
	76	<b>RC-53</b>	6,5	50	165	1,5
	127	<b>RC-55 *</b>	6,5	83	215	1,9
	177	<b>RC-57</b>	6,5	115	273	2,4
	232	<b>RC-59</b>	6,5	151	323	2,8
<b>10</b> (101)	26	<b>RC-101</b>	14,5	38	89	1,8
	54	<b>RC-102 *</b>	14,5	78	121	2,3
	105	<b>RC-104</b>	14,5	152	171	3,3
	156	<b>RC-106 *</b>	14,5	226	247	4,4
	203	<b>RC-108</b>	14,5	294	298	5,4
	257	<b>RC-1010 *</b>	14,5	373	349	6,4
	304	<b>RC-1012</b>	14,5	441	400	6,8
	356	<b>RC-1014</b>	14,5	516	450	8,2
<b>15</b> (142)	25	<b>RC-151</b>	20,3	51	124	3,3
	51	<b>RC-152</b>	20,3	104	149	4,1
	101	<b>RC-154 *</b>	20,3	205	200	5,0
	152	<b>RC-156 *</b>	20,3	308	271	6,8
	203	<b>RC-158</b>	20,3	411	322	8,2
	254	<b>RC-1510</b>	20,3	516	373	9,5
	305	<b>RC-1512</b>	20,3	619	423	10,9
	356	<b>RC-1514</b>	20,3	723	474	11,8
<b>25</b> (232)	26	<b>RC-251</b>	33,2	86	139	5,9
	50	<b>RC-252 *</b>	33,2	166	165	6,4
	102	<b>RC-254 *</b>	33,2	339	215	8,2
	158	<b>RC-256 *</b>	33,2	525	273	10,0
	210	<b>RC-258</b>	33,2	697	323	12,2
	261	<b>RC-2510</b>	33,2	867	374	14,1
	311	<b>RC-2512</b>	33,2	1033	425	16,3
	362	<b>RC-2514 *</b>	33,2	1202	476	17,7
<b>30</b> (295)	209	<b>RC-308</b>	42,1	880	387	18,1
<b>50</b> (498)	51	<b>RC-502</b>	71,2	362	176	15,0
	101	<b>RC-504</b>	71,2	719	227	19,1
	159	<b>RC-506 *</b>	71,2	1131	282	23,1
	337	<b>RC-5013</b>	71,2	2399	460	37,6
<b>75</b> (718)	156	<b>RC-756</b>	102,6	1601	285	29,5
	333	<b>RC-7513</b>	102,6	3417	492	59,0
<b>95</b> (933)	168	<b>RC-1006</b>	133,3	2239	357	59,0
	260	<b>RC-10010</b>	133,3	3466	449	72,6

\* Available as set, see note on this page.

## RC Series



Capacity:

**5 - 95 ton**

Stroke:

**16 - 362 mm**

Maximum Operating Pressure:

**700 bar**



### Think Safety

Manufacturer's rating of load and stroke are maximum safe limits.

Good practice encourages using only 80% of these ratings.

Page: 264



### Lightweight Aluminium Cylinders

If you need a higher cylinder capacity-to-weight-ratio the **RAC-Series** are the perfect choice.

Page: 13



### Gauges

Minimize the risk of overloading and ensure long, dependable service from your equipment. Refer

to the System Components Section for a full range of gauges.

Page: 121

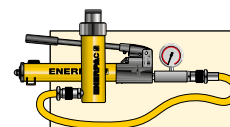

### Cylinder-Pump Sets

All cylinders marked with an \* are available as **sets** (cylinder, gauge, couplers, hose and pump) for your ordering convenience.

Page: 58

# RC-Series DUO, Single-Acting Cylinders

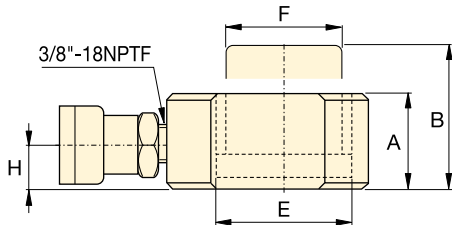
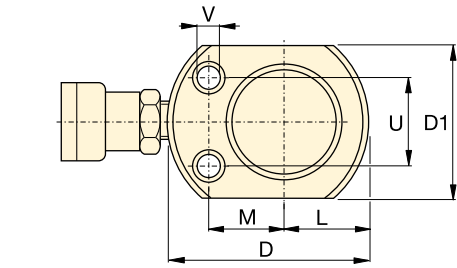

**RC-50**

**RC-101 only**  
(U1 = 19 mm)

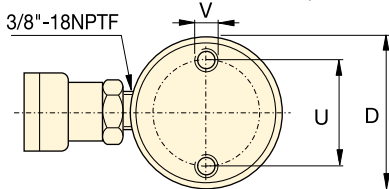
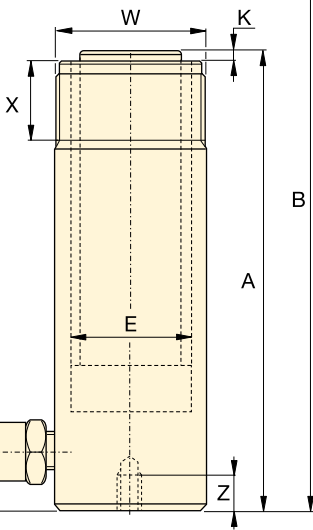
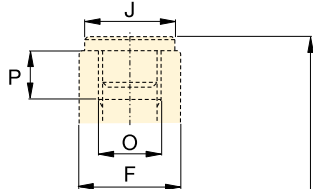
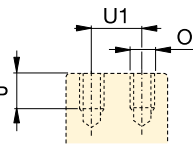

**RC-51 - RC-5013**

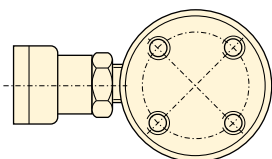

**RC-1006, RC-10010**



## Speed Chart

See the Enerpac Cylinder Speed Chart in our 'Yellow Pages' to determine your approximate cylinder speed.

Page: **273**

◀ For full features see previous page.

Cylinder Capacity	Stroke	Model Number	Cylinder Effective Area	Oil Capacity	Collapsed Height	Extended Height	Outside Dia.
ton (kN)	(mm)		(cm <sup>2</sup> )	(cm <sup>3</sup> )	A (mm)	B (mm)	D (mm)
<b>5</b> (45)	16	<b>RC-50</b> <sup>2)</sup>	6,5	10	41	57	58 <sup>3)</sup>
	25	<b>RC-51</b>	6,5	16	110	135	38
	76	<b>RC-53</b>	6,5	50	165	241	38
	127	<b>RC-55</b> <sup>1)</sup>	6,5	83	215	342	38
	177	<b>RC-57</b>	6,5	115	273	450	38
232	<b>RC-59</b>	6,5	151	323	555	38	
<b>10</b> (101)	26	<b>RC-101</b> <sup>4)</sup>	14,5	38	89	115	57
	54	<b>RC-102</b> <sup>1)</sup>	14,5	78	121	175	57
	105	<b>RC-104</b>	14,5	152	171	276	57
	156	<b>RC-106</b> <sup>1)</sup>	14,5	226	247	403	57
	203	<b>RC-108</b>	14,5	294	298	501	57
	257	<b>RC-1010</b> <sup>1)</sup>	14,5	373	349	606	57
	304	<b>RC-1012</b>	14,5	441	400	704	57
356	<b>RC-1014</b>	14,5	516	450	806	57	
<b>15</b> (142)	25	<b>RC-151</b>	20,3	51	124	149	69
	51	<b>RC-152</b>	20,3	104	149	200	69
	101	<b>RC-154</b> <sup>1)</sup>	20,3	205	200	301	69
	152	<b>RC-156</b> <sup>1)</sup>	20,3	308	271	423	69
	203	<b>RC-158</b>	20,3	411	322	525	69
	254	<b>RC-1510</b>	20,3	516	373	627	69
	305	<b>RC-1512</b>	20,3	619	423	728	69
356	<b>RC-1514</b>	20,3	723	474	830	69	
<b>25</b> (232)	26	<b>RC-251</b>	33,2	86	139	165	85
	50	<b>RC-252</b> <sup>1)</sup>	33,2	166	165	215	85
	102	<b>RC-254</b> <sup>1)</sup>	33,2	339	215	317	85
	158	<b>RC-256</b> <sup>1)</sup>	33,2	525	273	431	85
	210	<b>RC-258</b>	33,2	697	323	533	85
	261	<b>RC-2510</b>	33,2	867	374	635	85
	311	<b>RC-2512</b>	33,2	1033	425	736	85
362	<b>RC-2514</b> <sup>1)</sup>	33,2	1202	476	838	85	
<b>30</b> (295)	209	<b>RC-308</b>	42,1	880	387	596	101
<b>50</b> (498)	51	<b>RC-502</b>	71,2	362	176	227	127
	101	<b>RC-504</b>	71,2	719	227	328	127
	159	<b>RC-506</b> <sup>1)</sup>	71,2	1131	282	441	127
<b>75</b> (718)	337	<b>RC-5013</b>	71,2	2399	460	797	127
	156	<b>RC-756</b>	102,6	1601	285	441	146
<b>95</b> (933)	333	<b>RC-7513</b>	102,6	3417	492	825	146
	168	<b>RC-1006</b>	133,3	2239	357	525	177
<b>95</b> (933)	260	<b>RC-10010</b>	133,3	3466	449	709	177

<sup>1)</sup> Available as set, see note on page 7.

<sup>2)</sup> RC-50 cylinder has a non removable grooved saddle and no collar thread.

<sup>3)</sup> RC-50: D1 = 41 mm, L = 20 mm, M = 25 mm.

<sup>4)</sup> RC-101 has plunger thread and non-removable saddle.



# Single-Acting, General Purpose Cylinders

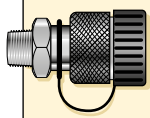

## Couplers Included!

CR-400 couplers included on all models. Fits all HC-Series hoses.

Capacity:  
**5 - 95 ton**

Stroke:  
**16 - 362 mm**

Maximum Operating Pressure:  
**700 bar**

## RC Series



Cylinder Bore Dia. E (mm)	Plunger Dia. F (mm)	Base to Adv. Port H (mm)	Saddle Dia. J (mm)	Saddle Protr. from Plgr. K (mm)	Plunger Internal Thread O	Plunger Thread Length P (mm)	Base Mounting Holes			Collar Thread W	Collar Thread Length X (mm)	 (kg)	Model Number
							Bolt Circle U (mm)	Thread V	Thd. Depth Z (mm)				
28,7	25,4	19	2)	2)	2)	2)	28	5,6 mm	—	—	—	1,0	RC-50 <sup>2)</sup>
28,7	25,4	19	25	6	3/4" - 16 UN	14	25	1/4" - 20 UN	14	1 1/2" - 16 UN	28	1,0	RC-51
28,7	25,4	19	25	6	3/4" - 16 UN	14	25	1/4" - 20 UN	14	1 1/2" - 16 UN	28	1,5	RC-53
28,7	25,4	19	25	6	3/4" - 16 UN	14	25	1/4" - 20 UN	14	1 1/2" - 16 UN	28	1,9	RC-55 <sup>1)</sup>
28,7	25,4	19	25	6	3/4" - 16 UN	16	25	1/4" - 20 UN	14	1 1/2" - 16 UN	28	2,4	RC-57
28,7	25,4	19	25	6	3/4" - 16 UN	16	25	1/4" - 20 UN	14	1 1/2" - 16 UN	28	2,8	RC-59
42,9	38,1	19	—	—	#10 - 24 UN	6	39	5/16" - 18 UN	12	2 1/4" - 14 UN	26	1,8	RC-101 <sup>4)</sup>
42,9	38,1	19	35	6	1" - 8 UN	19	39	5/16" - 18 UN	12	2 1/4" - 14 UN	26	2,3	RC-102 <sup>1)</sup>
42,9	38,1	19	35	6	1" - 8 UN	19	39	5/16" - 18 UN	12	2 1/4" - 14 UN	26	3,3	RC-104
42,9	38,1	19	35	6	1" - 8 UN	19	39	5/16" - 18 UN	12	2 1/4" - 14 UN	26	4,4	RC-106 <sup>1)</sup>
42,9	38,1	19	35	6	1" - 8 UN	19	39	5/16" - 18 UN	12	2 1/4" - 14 UN	26	5,4	RC-108
42,9	38,1	19	35	6	1" - 8 UN	19	39	5/16" - 18 UN	12	2 1/4" - 14 UN	26	6,4	RC-1010 <sup>1)</sup>
42,9	38,1	19	35	6	1" - 8 UN	19	39	5/16" - 18 UN	12	2 1/4" - 14 UN	26	6,8	RC-1012
42,9	38,1	19	35	6	1" - 8 UN	19	39	5/16" - 18 UN	12	2 1/4" - 14 UN	26	8,2	RC-1014
50,8	41,4	19	38	9	1" - 8 UN	25	48	3/8" - 16 UN	12	2 3/4" - 16 UN	30	3,3	RC-151
50,8	41,4	19	38	9	1" - 8 UN	22	48	3/8" - 16 UN	12	2 3/4" - 16 UN	30	4,1	RC-152
50,8	41,4	19	38	9	1" - 8 UN	22	48	3/8" - 16 UN	12	2 3/4" - 16 UN	30	5,0	RC-154 <sup>1)</sup>
50,8	41,4	25	38	9	1" - 8 UN	25	48	3/8" - 16 UN	12	2 3/4" - 16 UN	30	6,8	RC-156 <sup>1)</sup>
50,8	41,4	25	38	9	1" - 8 UN	25	48	3/8" - 16 UN	12	2 3/4" - 16 UN	30	8,2	RC-158
50,8	41,4	25	38	9	1" - 8 UN	25	48	3/8" - 16 UN	12	2 3/4" - 16 UN	30	9,5	RC-1510
50,8	41,4	25	38	9	1" - 8 UN	25	48	3/8" - 16 UN	12	2 3/4" - 16 UN	30	10,9	RC-1512
50,8	41,4	25	38	9	1" - 8 UN	25	48	3/8" - 16 UN	12	2 3/4" - 16 UN	30	11,8	RC-1514
65,0	57,2	25	50	10	1 1/2" - 16 UN	25	58	1/2" - 13 UN	19	3 5/16" - 12 UN	49	5,9	RC-251
65,0	57,2	25	50	10	1 1/2" - 16 UN	25	58	1/2" - 13 UN	19	3 5/16" - 12 UN	49	6,4	RC-252 <sup>1)</sup>
65,0	57,2	25	50	10	1 1/2" - 16 UN	25	58	1/2" - 13 UN	19	3 5/16" - 12 UN	49	8,2	RC-254 <sup>1)</sup>
65,0	57,2	25	50	10	1 1/2" - 16 UN	25	58	1/2" - 13 UN	19	3 5/16" - 12 UN	49	10,0	RC-256 <sup>1)</sup>
65,0	57,2	25	50	10	1 1/2" - 16 UN	25	58	1/2" - 13 UN	19	3 5/16" - 12 UN	49	12,2	RC-258
65,0	57,2	25	50	10	1 1/2" - 16 UN	25	58	1/2" - 13 UN	19	3 5/16" - 12 UN	49	14,1	RC-2510
65,0	57,2	25	50	10	1 1/2" - 16 UN	25	58	1/2" - 13 UN	19	3 5/16" - 12 UN	49	16,3	RC-2512
65,0	57,2	25	50	10	1 1/2" - 16 UN	25	58	1/2" - 13 UN	19	3 5/16" - 12 UN	49	17,7	RC-2514 <sup>1)</sup>
73,2	57,2	57	50	10	1 1/2" - 16 UN	25	—	—	—	3 5/16" - 12 UN	49	18,1	RC-308
95,2	79,5	33	71	2	—	—	95	1/2" - 13 UN	19	5" - 12 UN	55	15,0	RC-502
95,2	79,5	33	71	2	—	—	95	1/2" - 13 UN	19	5" - 12 UN	55	19,1	RC-504
95,2	79,5	35	71	2	—	—	95	1/2" - 13 UN	19	5" - 12 UN	55	23,1	RC-506 <sup>1)</sup>
95,2	79,5	35	71	2	—	—	95	1/2" - 13 UN	19	5" - 12 UN	55	37,6	RC-5013
114,3	95,2	30	71	5	—	—	—	—	—	5 3/4" - 12 UN	44	29,5	RC-756
114,3	95,2	30	71	5	—	—	—	—	—	5 3/4" - 12 UN	44	59,0	RC-7513
130,3	104,9	41	71	2	—	—	140	3/4" - 10 UN	25	6 7/8" - 12 UN	44	59,0	RC-1006
130,3	104,9	41	71	2	—	—	140	3/4" - 10 UN	25	6 7/8" - 12 UN	44	72,6	RC-10010

# Accessories for RC-Series Cylinders

## ▼ SELECTION CHART

For use with Cylinder Capacity ton (kN)	Saddles			Base Plate	Mounting Block	Clevis Eyes	
	Flat	Grooved <sup>1)</sup>	Tilt			Base <sup>4)</sup>	Plunger
5 (45)	A-53F <sup>2)</sup>	A-53G <sup>2)</sup>	-	-	RB-5 <sup>2)</sup> , AW-51 <sup>2)</sup> , AW-53 <sup>2)</sup>	REB-5 <sup>2)</sup>	REP-5 <sup>2)</sup>
10 (101)	A-12 <sup>3)</sup> , A-102F <sup>3)</sup>	A-102G <sup>3)</sup>	CAT-10 <sup>3)</sup>	JB-10 <sup>3)</sup>	RB-10, AW-102	REB-10	REP-10 <sup>3)</sup>
15 (142)	-	A-152G	CAT-10	-	RB-15	REB-15	REP-10
25 (232)	A-29 <sup>5)</sup>	A-252G	CAT-50	JB-25	RB-25	REB-25	REP-25
30 (295)	A-29 <sup>5)</sup>	A-252G	CAT-50	-	RB-25	-	REP-25
50 (498)	-	-	CAT-100	JB-50	-	-	-
75 (718)	-	-	CAT-100	-	-	-	-
95 (933)	-	-	CAT-100	-	-	-	-

<sup>1)</sup> Standard on 5-30 ton RC-cylinders   <sup>2)</sup> Except RC-50   <sup>3)</sup> Except RC-101   <sup>4)</sup> Mounting screws are included.   <sup>5)</sup> Used with Bender Sets.

## ▼ DIMENSION CHARTS

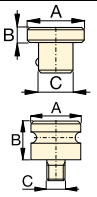
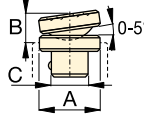
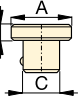
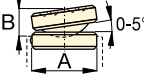
Model Number	Saddle Dimensions (mm)			A-53F, A-102F A-12, A-29	Model Number	Tilt Saddle Dimensions (mm)			Diagram
	A	B	C			A	B	C	
<b>Flat</b>					<b>Tilt</b>				
A-53F	25	6	17		CAT-10	35	20	22	
A-102F	35	6	22		CAT-50	50	23	35	
A-12	51	48	1"-8 UNC						
A-29	51	48	1 1/2"-16 UNC						
<b>Grooved</b>					<b>Tilt</b>				
A-53G	25	6	17		CAT-100	71	24	-	
A-102G	35	6	22						
A-152G	38	9	22						
A-252G	50	9	35						

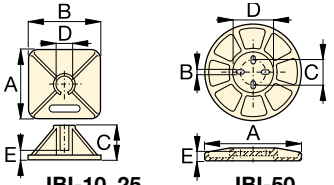
Model Number	Base Plate Dimensions (mm)					Diagram
	A	B	C	D	E	
JB-10	228	228	135	58	20	
JB-25	279	279	140	86	26	
JB-50	304	15	95	131	31	

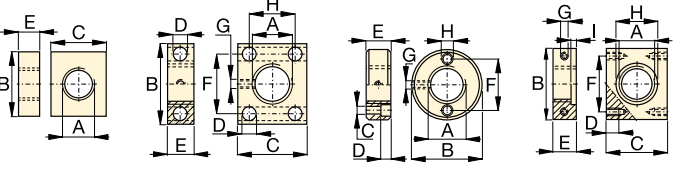
Model Number	Mounting Block Dimensions (mm)								Diagram
	A	B	C	D	E	F	G	H	
RB-5	1 1/2"-16UN	88	76	-	25	-	-	-	
AW-51	1 1/2"-16UN	70	59	10	24	54	1/4"-16 UN	41	
AW-53	1 1/2"-16UN	72	7	7	19	57	1/4"-20 UN	10	
RB-10	2 1/4"-14UN	114	88	-	25	-	-	-	
AW-102	2 1/4"-14UN	100	82	16	30	76	7/16"-20 UN	58	
RB-15	2 3/4"-16UN	101	114	-	38	-	-	-	
RB-25	3 5/16"-12UN	127	165	-	50	-	-	-	

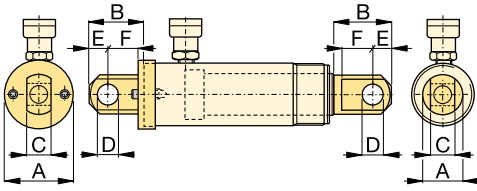
Type	Model Number	Clevis Eye Dimensions (mm)						Pin-to-Pin * (mm)	Diagram
		A	B	C	D	E	F		
Base <sup>4)</sup>	REB-5	44	47	14	16	16	25	60,2	
	REB-10	63	66	25	22	25	35	78,0	
	REB-15	76	66	25	22	25	35	78,0	
	REB-25	95	79	38	31	31	41	87,6	
Plunger	REP-5	28	45	14	16	16	19	-	
	REP-10	42	61	25	22	25	28	-	
	REP-25	57	71	38	31	31	35	-	

<sup>4)</sup> Mounting screws are included.

\* Pin to Pin – REB and REP Clevises fitted. Add cylinder collapsed height.

# The Enerpac Lightweight Aluminium Cylinders

▼ From left to right: RAC, RACL, RACH, RAR



- **Lightweight, easy to carry and position to allow a higher cylinder capacity-to-weight-ratio**
- **Non-corrosive by design, aluminium has always been a good material for use in many caustic environments**
- **Composite Bearings on all moving surfaces guarantee no metal-to-metal contact, to resist side loads and increase cylinder life.**



## RA Series

Capacity:  
**20 - 150 ton**

Stroke:  
**50 - 250 mm**

Maximum Operating Pressure:  
**700 bar**



**Think Safety**

**Manufacturer's rating of load and stroke are maximum safe limits.**

**Good practice encourages using only 80% of these ratings.**

Page: **264**



### Aluminium versus Steel

Aluminium cylinders, while offering the most lightweight solution, also have some unique limitations due to material properties. It differs from steel in that it has a lower finite fatigue life. Aluminium cylinders should **NOT** be used in high-cycle applications such as production.

The Enerpac line of aluminium cylinders are designed to provide 5000 cycles at their recommended pressure. **This limit should not be exceeded.** In normal lifting and many maintenance applications, this should provide a lifetime of use.



### Steel Base Plate

The steel base plate protects the cylinder from damage, it should not be removed.

The base holes in these aluminium cylinders are designed for securing the steel base plate. **They will not withstand the capacity of the cylinder.** Do not use the base holes in these aluminium cylinders to attach any device to the cylinder.



# RAC-Series, Aluminium Cylinders

▼ Shown from left to right: RAC-5010, RAC-15010, RAC-304, RAC-208



## Lightweight for Maximum Portability



### Saddles

All RAC-cylinders are equipped with bolt-on removable hardened steel saddles. For Tilt Saddles see next page.

Page: **13**



### Lightweight Hand Pumps

The Enerpac composite lightweight hand pumps P-392 or P-802 make the optimal lightweight set.

Page: **72**

- Composite bearings prevent metal-to-metal contact, increasing cylinder life and resistance to side-loads of up to 10%
- Hard-Coat finish on all surfaces resists damage and extends cylinder life
- Handles included on all models
- Steel base plate and saddle for protection against load-induced damage
- Integral stop ring prevents plunger over-travel and is capable of withstanding the full cylinder capacity
- High strength return spring for rapid cylinder retraction
- CR-400 coupler and dustcap included on all models
- All cylinders meet ASME B-30.1 and ISO 10100 standards.

Cylinder Capacity @ 700 bar ton (kN)	Stroke (mm)	Model Number	Cylinder Effective Area (cm <sup>2</sup> )
20 (218)	50	RAC-202	31,2
	100	RAC-204	31,2
	150	RAC-206	31,2
	200	RAC-208	31,2
	250	RAC-2010	31,2
30 (309)	50	RAC-302	44,2
	100	RAC-304	44,2
	150	RAC-306	44,2
	200	RAC-308	44,2
	250	RAC-3010	44,2
50 (496)	50	RAC-502	70,9
	100	RAC-504	70,9
	150	RAC-506	70,9
	200	RAC-508	70,9
	250	RAC-5010	70,9
100 (1002)	50	RAC-1002	143,1
	100	RAC-1004	143,1
	150	RAC-1006	143,1
	200	RAC-1008	143,1
	250	RAC-10010	143,1
150 (1589)	50	RAC-1502	227,0
	100	RAC-1504	227,0
	150	RAC-1506	227,0
	200	RAC-1508	227,0
	250	RAC-15010	227,0



◀ The unique Enerpac RA-Series cylinders – lightweight and made of aluminium alloy – these RAC-506 cylinders are ideal for the positioning of tunnel elements under the river (High Speed Train Line, The Netherlands).

# Single-Acting, Aluminium Cylinders

Optional Bolt-on Tilt Saddle Dimensions (mm)			
For Cylinder Model / Capacity ton	Tilt Saddle * Model Number	Tilt Saddle Diameter J1	Saddle Protrusion from Plunger K1
RAC-50	CATG-50	50	24
RAC-100	CATG-150	91	31
RAC-150	CATG-200	118	35

\* Tilt saddles not available for less than 50 ton.

## RAC Series



Capacity:

**20 - 150 ton**

Stroke:

**50 - 250 mm**

Maximum Operating Pressure:

**700 bar**

Steel Base Plate Mounting Holes			
Cylinder Model / Capacity ton	Bolt Circle U (mm)	Thread V (mm)	Thread Depth <sup>1)</sup> Z (mm)
RAC-20	70	M6	12
RAC-30	80	M6	12
RAC-50	110	M6	12
RAC-100	150	M10	12
RAC-150	200	M10	12

<sup>1)</sup> Including Base Plate Height of 6 mm and four (4) base plate bolts M6.

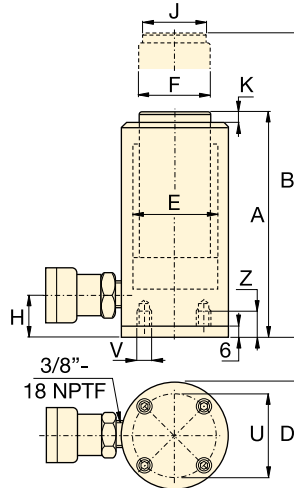

Oil Capacity (cm <sup>3</sup> )	Collapsed Height A (mm)	Extended Height B (mm)	Outside Diameter D (mm)	Cylinder Bore Diameter E (mm)	Plunger Diameter F (mm)	Bottom to Advance Port H (mm)	Saddle Diameter J (mm)	Saddle Protrusion from Plunger K (mm)	Weight (kg)	Model Number
156	174	224	85	63	50	27	40	3	3,6	RAC-202
312	224	324	85	63	50	27	40	3	4,1	RAC-204
468	274	424	85	63	50	27	40	3	4,6	RAC-206
624	324	524	85	63	50	27	40	3	5,1	RAC-208
780	374	624	85	63	50	27	40	3	5,6	RAC-2010
221	181	231	100	75	60	32	40	3	4,5	RAC-302
442	231	331	100	75	60	32	40	3	5,2	RAC-304
663	281	431	100	75	60	32	40	3	5,9	RAC-306
884	331	531	100	75	60	32	40	3	6,6	RAC-308
1105	381	631	100	75	60	32	40	3	7,3	RAC-3010
354	186	236	130	95	80	30	50	3	8,5	RAC-502
709	236	336	130	95	80	30	50	3	9,8	RAC-504
1063	286	436	130	95	80	30	50	3	11,1	RAC-506
1417	336	536	130	95	80	30	50	3	12,4	RAC-508
1771	386	636	130	95	80	30	50	3	13,7	RAC-5010
715	221	271	180	135	110	46	94	3	17,3	RAC-1002
1431	271	371	180	135	110	46	94	3	19,6	RAC-1004
2147	321	471	180	135	110	46	94	3	21,9	RAC-1006
2863	371	571	180	135	110	46	94	3	24,2	RAC-1008
3578	421	671	180	135	110	46	94	3	26,5	RAC-10010
1135	243	293	230	170	140	51	113	3	25,3	RAC-1502
2270	293	393	230	170	140	51	113	3	29,3	RAC-1504
3405	343	493	230	170	140	51	113	3	33,3	RAC-1506
4540	393	593	230	170	140	51	113	3	37,3	RAC-1508
5675	443	693	230	170	140	51	113	3	41,3	RAC-15010

# RACL-Series, Aluminium Lock Nut Cylinders

▼ Shown from left to right: RACL-1006, RACL-504, RACL-5010



- Aluminium Lock Nut provides mechanical load holding for extended periods
- Hardened steel stop ring increasing cylinder life and resistance to side-loads of up to 5%
- Hard-Coat finish on all surfaces resists damage and extends cylinder life
- Composite bearings increase cylinder life and side load resistance
- Handles included on all models
- Steel base plate and saddle for protection against load-induced damage
- Integral stop ring prevents plunger over-travel and is capable of withstanding the full cylinder capacity
- High strength return spring for rapid cylinder retraction
- CR-400 coupler and dustcap included on all models
- All cylinders meet ASME B-30.1 and ISO 10100 standards.



◀ The portable lock nut cylinder RACL-1506 used for extended load supports during epoxy injection for bridge reinforcement.



## Saddles

All RACL-cylinders are equipped with bolt-on removable hardened steel saddles. For Tilt Saddles see next page.

Page: 15



## Hoses

Enerpac offers a complete line of high quality hydraulic hoses. To ensure the integrity of your system, specify only Enerpac hydraulic hoses.

Page: 122

Cylinder Capacity @ 700 bar ton (kN)	Stroke (mm)	Model Number	Cylinder Effective Area (cm <sup>2</sup> )
20 (218)	50	RACL-202	31,2
	100	RACL-204	31,2
	150	RACL-206	31,2
	200	RACL-208	31,2
	250	RACL-2010	31,2
30 (309)	50	RACL-302	44,2
	100	RACL-304	44,2
	150	RACL-306	44,2
	200	RACL-308	44,2
	250	RACL-3010	44,2
50 (496)	50	RACL-502	70,9
	100	RACL-504	70,9
	150	RACL-506	70,9
	200	RACL-508	70,9
	250	RACL-5010	70,9
100 (1002)	50	RACL-1002	143,1
	100	RACL-1004	143,1
	150	RACL-1006	143,1
	200	RACL-1008	143,1
	250	RACL-10010	143,1
150 (1589)	50	RACL-1502	227,0
	100	RACL-1504	227,0
	150	RACL-1506	227,0
	200	RACL-1508	227,0
	250	RACL-15010	227,0



# Single-Acting, Aluminium Lock Nut Cylinders

Optional Bolt-on Tilt Saddle Dimensions (mm)				
For Cylinder Model / Capacity ton	Tilt Saddle * Model Number	Tilt Saddle Diameter J1	Saddle Protrusion from Plunger K1	
RACL-50	CATG-50	50	24	
RACL-100	CATG-150	91	31	
RACL-150	CATG-200	118	35	

\* Tilt saddles not available for less than 50 ton.

Steel Base Plate Mounting Holes			
Cylinder Model / Capacity ton	Bolt Circle U (mm)	Thread V (mm)	Thread Depth <sup>1)</sup> Z (mm)
RACL-20	70	M6	12
RACL-30	80	M6	12
RACL-50	110	M6	12
RACL-100	150	M10	12
RACL-150	200	M10	12

<sup>1)</sup> Including Base Plate Height of 6 mm and four (4) base plate bolts M6.

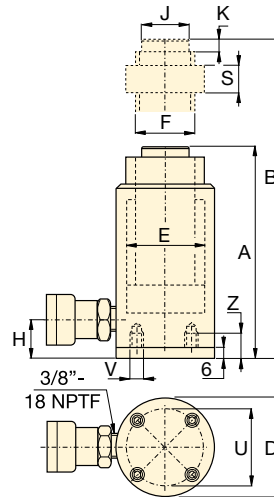

## RACL Series



Capacity:

**20 - 150 ton**

Stroke:

**50 - 250 mm**

Maximum Operating Pressure:

**700 bar**

Oil Capacity (cm <sup>3</sup> )	Collapsed Height A (mm)	Extended Height B (mm)	Outside Diameter D (mm)	Cylinder Bore Diameter E (mm)	Plunger Diameter (Threaded) F (mm)	Bottom to Advance Port H (mm)	Saddle Diameter J (mm)	Saddle Protrusion from Plunger K (mm)	Lock Nut Height S (mm)	Weight (kg)	Model Number
156	224	274	85	63	Tr 55 x 4	27	40	3	50	4,0	RACL-202
312	274	374	85	63	Tr 55 x 4	27	40	3	50	4,6	RACL-204
468	324	474	85	63	Tr 55 x 4	27	40	3	50	5,2	RACL-206
624	374	574	85	63	Tr 55 x 4	27	40	3	50	5,8	RACL-208
780	424	674	85	63	Tr 55 x 4	27	40	3	50	6,4	RACL-2010
221	231	281	100	75	Tr 60 x 4	33	40	3	50	5,4	RACL-302
442	281	381	100	75	Tr 60 x 4	33	40	3	50	6,1	RACL-304
663	331	481	100	75	Tr 60 x 4	33	40	3	50	6,8	RACL-306
883	381	581	100	75	Tr 60 x 4	33	40	3	50	7,5	RACL-308
1105	431	681	100	75	Tr 60 x 4	33	40	3	50	8,2	RACL-3010
354	236	286	130	95	Tr 80 x 4	30	50	3	50	9,3	RACL-502
709	286	386	130	95	Tr 80 x 4	30	50	3	50	10,6	RACL-504
1063	336	486	130	95	Tr 80 x 4	30	50	3	50	11,9	RACL-506
1417	386	586	130	95	Tr 80 x 4	30	50	3	50	13,2	RACL-508
1771	436	686	130	95	Tr 80 x 4	30	50	3	50	14,5	RACL-5010
716	296	346	180	135	Tr 110 x 6	46	94	3	75	21,9	RACL-1002
1431	346	446	180	135	Tr 110 x 6	46	94	3	75	24,2	RACL-1004
2147	396	546	180	135	Tr 110 x 6	46	94	3	75	26,5	RACL-1006
2863	446	646	180	135	Tr 110 x 6	46	94	3	75	28,8	RACL-1008
3578	496	746	180	135	Tr 110 x 6	46	94	3	75	31,1	RACL-10010
1135	323	373	230	170	Tr 140 x 6	51	113	3	80	32,2	RACL-1502
2270	373	473	230	170	Tr 140 x 6	51	113	3	80	36,2	RACL-1504
3405	423	573	230	170	Tr 140 x 6	51	113	3	80	40,2	RACL-1506
4540	473	673	230	170	Tr 140 x 6	51	113	3	80	44,2	RACL-1508
5675	523	773	230	170	Tr 140 x 6	51	113	3	80	48,2	RACL-15010

▼ Shown from left to right: RACH-1504, RACH-15010, RACH-206, RACH-306



## The Lightweight Solution for Tensioning and Testing



### Saddles

All RACH-cylinders are equipped with bolt-on hollow removable saddles of hardened steel.



### Lightweight Hand Pumps

The Enerpac composite lightweight hand pumps P-392 or P-802 make the optimal lightweight set.

Page: 72

- Hollow plunger design allows for both pull and push forces
- Composite bearings increase cylinder life and sideload resistance
- Hard-Coat finish on all surfaces resists damage and extends cylinder life
- Floating center tube increases seal and product life
- Handles standard on all models
- Steel base plate and saddle for protection against load-induced damage
- Integral stop ring prevents plunger over-travel and is capable of withstanding the full cylinder capacity
- High strength return spring for rapid cylinder retraction
- CR-400 coupler and dustcap included on all models
- All cylinders meet ASME B-30.1 and ISO 10100 standards.



◀ An RACH-306 powered by a P-392 hand pump used to extract corroded carriage pins of refuse collection vehicles.

Cylinder Capacity @ 700 bar ton (kN)	Stroke (mm)	Model Number	Cylinder Effective Area (cm <sup>2</sup> )
20 (229)	50	RACH-202	32,7
	100	RACH-204	32,7
	150	RACH-206	32,7
	200	RACH-208	32,7
	250	RACH-2010	32,7
30 (358)	50	RACH-302	51,1
	100	RACH-304	51,1
	150	RACH-306	51,1
	200	RACH-308	51,1
	250	RACH-3010	51,1
60 (596)	50	RACH-602	84,7
	100	RACH-604	84,7
	150	RACH-606	84,7
	200	RACH-608	84,7
	250	RACH-6010	84,7
100 (1157)	50	RACH-1002	164,6
	100	RACH-1004	164,6
	150	RACH-1006	164,6
	200	RACH-1008	164,6
	250	RACH-10010	164,6
150 (1588)	50	RACH-1502	225,8
	100	RACH-1504	225,8
	150	RACH-1506	225,8
	200	RACH-1508	225,8
	250	RACH-15010	225,8

# Single-Acting, Aluminium Hollow Plunger Cylinders

## Steel Base Plate Mounting Holes

Cylinder Model / Capacity ton	Bolt Circle U (mm)	Thread V (mm)	Thread Depth <sup>1)</sup> Z (mm)
RACH-20	80	M6	12
RACH-30	110	M6	12
RACH-60	160	M6	12
RACH-100	220	M10	12
RACH-150	245	M10	12

<sup>1)</sup> Including Base Plate Height of 6 mm and four (4) base plate bolts M6.

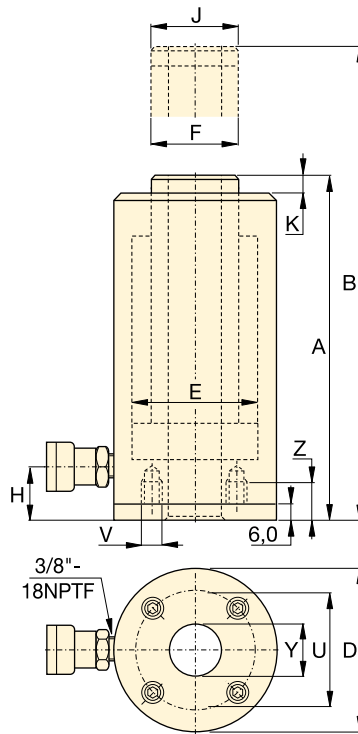

## RACH Series

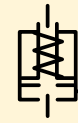

Capacity:

**20 - 150 ton**

Stroke:

**50 - 250 mm**

Center Hole Diameter:

**27 - 79 mm**

Maximum Operating Pressure:

**700 bar**

Oil Capacity (cm <sup>3</sup> )	Collapsed Height A (mm)	Extended Height B (mm)	Outside Diameter C (mm)	Cylinder Bore Diameter D (mm)	Plunger Diameter E (mm)	Bottom to Advance Port H (mm)	Saddle Diameter G (mm)	Saddle Protrusion from Plunger K (mm)	Center Hole Diameter Y (mm)	Weight (kg)	Model Number
164	188	238	100	75	55	29	55	10	27	5,2	RACH-202
327	251	351	100	75	55	29	55	10	27	6,1	RACH-204
491	315	465	100	75	55	29	55	10	27	7,1	RACH-206
654	378	578	100	75	55	29	55	10	27	8,0	RACH-208
818	442	692	100	75	55	29	55	10	27	9,0	RACH-2010
256	208	258	130	95	70	29	70	10	34	8,0	RACH-302
511	267	367	130	95	70	29	70	10	34	9,5	RACH-304
766	333	483	130	95	70	29	70	10	34	11,2	RACH-306
1022	395	595	130	95	70	29	70	10	34	12,9	RACH-308
1277	458	708	130	95	70	29	70	10	34	14,5	RACH-3010
423	251	301	180	130	100	61	100	12	54	16,2	RACH-602
847	315	415	180	130	100	61	100	12	54	19,5	RACH-604
1270	380	530	180	130	100	61	100	12	54	25,6	RACH-606
1694	445	645	180	130	100	61	100	12	54	26,0	RACH-608
2117	510	760	180	130	100	61	100	12	54	29,6	RACH-6010
823	258	308	250	185	145	61	145	14	79	33,8	RACH-1002
1646	325	425	250	185	145	61	145	14	79	39,8	RACH-1004
2487	391	541	250	185	145	61	145	14	79	46,2	RACH-1006
3291	459	659	250	185	145	61	145	14	79	52,2	RACH-1008
4114	527	777	250	185	145	61	145	14	79	58,8	RACH-10010
1129	280	330	275	205	150	61	145	14	79	48,9	RACH-1502
2258	360	460	275	205	150	61	145	14	79	55,7	RACH-1504
3387	430	580	275	205	150	61	145	14	79	63,0	RACH-1506
4517	500	700	275	205	150	61	145	14	79	70,1	RACH-1508
5646	570	820	275	205	150	61	145	14	79	77,2	RACH-15010

# RAR, Double-Acting Aluminium Cylinders

▼ Shown from left to right: RAR-5010, RAR-308, RAR-204



### Saddles

All RAR-cylinders are equipped with bolt-on removable hardened steel saddles.

For Tilt Saddles see next page.

Page: **19**



### Hoses

Enerpac offers a complete line of high quality hydraulic hoses. To ensure the integrity of your system, specify only Enerpac hydraulic hoses.

Page: **122**

- Double-acting for rapid retraction, regardless of hose lengths or system losses
- Composite bearings increase cylinder life and sideload resistance
- Hard-Coat finish on all surfaces resists damage and extends cylinder life
- Handles included on all models
- Steel base plate and saddle for protection against load-induced damage
- Integral stop ring prevents plunger over-travel and is capable of withstanding the full cylinder capacity
- Built-in safety valve prevents accidental over-pressurization.

Cylinder Capacity @ 700 bar ton	Stroke (mm)	Model Number	Max. Cylinder Capacity (kN) Push	Cylinder Effective Area (cm <sup>2</sup> )		Oil Capacity (cm <sup>3</sup> )	
				Push	Pull	Push	Pull
20	50	RAR-202	218	31,2	18,6	156	93
	100	RAR-204	218	31,2	18,6	312	186
	150	RAR-206	218	31,2	18,6	468	279
	200	RAR-208	218	31,2	18,6	624	372
	250	RAR-2010	218	31,2	18,6	780	465
30	50	RAR-302	309	44,2	24,5	221	123
	100	RAR-304	309	44,2	24,5	442	245
	150	RAR-306	309	44,2	24,5	663	368
	200	RAR-308	309	44,2	24,5	884	490
	250	RAR-3010	309	44,2	24,5	1105	613
50	50	RAR-502	496	70,9	26,7	354	134
	100	RAR-504	496	70,9	26,7	709	267
	150	RAR-506	496	70,9	26,7	1063	401
	200	RAR-508	496	70,9	26,7	1417	534
	250	RAR-5010	496	70,9	26,7	1771	668
100	50	RAR-1002	1002	143,1	79,5	715	398
	100	RAR-1004	1002	143,1	79,5	1431	795
	150	RAR-1006	1002	143,1	79,5	2147	1193
	200	RAR-1008	1002	143,1	79,5	2863	1590
	250	RAR-10010	1002	143,1	79,5	3578	1988
150	50	RAR-1502	1589	227,0	132,0	1135	660
	100	RAR-1504	1589	227,0	132,0	2270	1320
	150	RAR-1506	1589	227,0	132,0	3405	1980
	200	RAR-1508	1589	227,0	132,0	4540	2640
	250	RAR-15010	1589	227,0	132,0	5675	3300

▼ An RAR-506 was easy to position under a bulldozer for repair of frame member.





# Double-Acting, Aluminium Cylinders

Optional Bolt-on Tilt Saddle Dimensions (mm)			
For Cylinder Model / Capacity ton	Tilt Saddle * Model Number	Tilt Saddle Diameter J1	Saddle Protrusion from Plunger K1
RAR-50	CATG-50	50	24
RAR-100	CATG-100	73	29
RAR-150	CATG-150	91	31

\* Tilt saddles not available for less than 50 ton.

**RAR Series**



Capacity:  
**20 - 150 ton**

Stroke:  
**50 - 250 mm**

Maximum Operating Pressure:  
**700 bar**

Steel Base Plate Mounting Holes			
Cylinder Model / Capacity ton	Bolt Circle U (mm)	Thread V (mm)	Thread Depth <sup>1)</sup> Z (mm)
RAR-20	93	M6	12
RAR-30	105	M6	12
RAR-50	110	M6	12
RAR-100	165	M6	12
RAR-150	200	M6	12

<sup>1)</sup> Including Base Plate Height of 6 mm and four (4) base plate bolts M6.

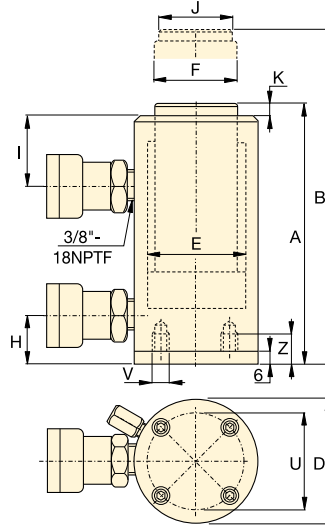

Collapsed Height A (mm)	Extended Height B (mm)	Outside Diameter D (mm)	Cylinder Bore Diameter E (mm)	Plunger Diameter F (mm)	Bottom to Advance Port H (mm)	Top to Retract Port I (mm)	Saddle Diameter J (mm)	Saddle Protrusion from Plunger K (mm)	(kg)	Model Number
189	239	113	63	40	30	50	30	3	7,4	RAR-202
239	339	113	63	40	30	50	30	3	8,0	RAR-204
289	439	113	63	40	30	50	30	3	8,6	RAR-206
339	539	113	63	40	30	50	30	3	9,2	RAR-208
389	639	113	63	40	30	50	30	3	9,8	RAR-2010
201	251	125	75	50	30	55	40	3	8,6	RAR-302
251	351	125	75	50	30	55	40	3	9,5	RAR-304
301	451	125	75	50	30	55	40	3	10,4	RAR-306
351	551	125	75	50	30	55	40	3	11,3	RAR-308
401	651	125	75	50	30	55	40	3	12,2	RAR-3010
201	251	145	95	75	30	56	50	3	11,1	RAR-502
251	351	145	95	75	30	56	50	3	12,7	RAR-504
301	451	145	95	75	30	56	50	3	14,3	RAR-506
351	551	145	95	75	30	56	50	3	15,9	RAR-508
401	651	145	95	75	30	56	50	3	17,5	RAR-5010
251	301	185	135	90	43	80	75	3	16,4	RAR-1002
301	401	185	135	90	43	80	75	3	19,3	RAR-1004
351	501	185	135	90	43	80	75	3	22,2	RAR-1006
401	601	185	135	90	43	80	75	3	25,1	RAR-1008
451	701	185	135	90	43	80	75	3	28,0	RAR-10010
248	298	230	170	110	38	75	113	3	24,2	RAR-1502
298	398	230	170	110	38	75	113	3	28,9	RAR-1504
348	498	230	170	110	38	75	113	3	33,2	RAR-1506
398	598	230	170	110	38	75	113	3	37,9	RAR-1508
448	698	230	170	110	38	75	113	3	42,6	RAR-15010

▼ RT-2111 Telescopic Cylinder (shown with plunger extended and retracted)



- Nitrocarburized surface treatment inside and out provides corrosion protection
- 3% side-load of full capacity
- Double or triple wear bearings support lifting stages
- Tilting saddles with 5 degrees of maximum tilt standard on all models
- Design Safety factor complies with ASME B30.1 & EN1494
- Certified lifting eyes for safe handling and positioning
- CR-400 coupler for compatibility with standard product
- Steel cylinder base for maximum strength.

## Moving a load a greater distance



### RT-Series, Multi-Stage Cylinders

Enerpac compact, multi-stage telescopic cylinders are available with two or three pistons, and can lift loads up to 600 mm in a single movement.

Nitrocarburized surface treatment inside and out provides unparalleled sideload resistance and corrosion protection for safe use in the harshest conditions. The longer stroke length of telescopic cylinders will save you time and simplify projects by moving a load a greater distance and eliminating the use of temporary cribbing.



### Tilt Saddles

All RT-Series cylinders include integral tilt saddles with maximum tilt angles up to 5 degree.



◀ *The longer stroke length of telescopic cylinders will save you time and simplify projects by moving a load a greater distance and eliminating the use of temporary cribbing.*

Cylinder Capacity at Maximum Stroke ton (kN)	Maximum Stroke (mm)	Model Number	Collapsed Height (mm)	Extended Height (mm)
14,0 (137)	270	RT-1510	283	553
	435	RT-1817	345	780
20,2 (198)	300	RT-2111	317	617
	500	RT-2119	395	895
31,5 (309)	300	RT-3311	352	652
	600	RT-3323	476	1076

# Multi-Stage Telescopic Cylinders, Single-Acting, Load Return

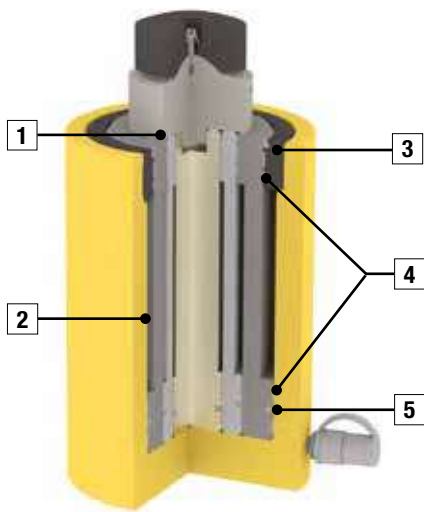

- 1 **Wiper Ring** on each stage to minimize contamination.
- 2 **Nitrocarburized Coating** for maximum corrosion protection and surface hardness. Exterior in nitrided and Enerpac yellow epoxy.
- 3 **Stop Ring** full load capable to prevent plunger overstroke.
- 4 **Wear Bearings.** Double or triple wear bearings for maximum sideload capability and wear resistance.
- 5 **Seals** for maximum compliance and high wear resistance.

## RT Series



Capacity:  
**14 - 31,5 ton**

Stroke:  
**270 - 600 mm**

Maximum Operating Pressure:  
**700 bar**

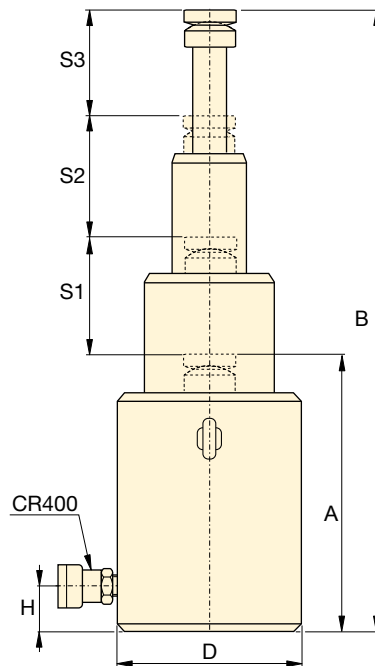
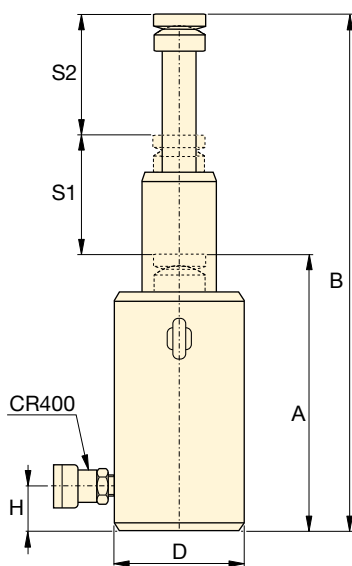
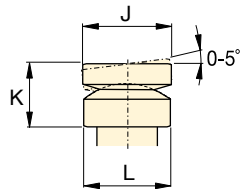

### Multi-Stage Cylinders

**1st Stage:** maximum load capacity at lowest maximum stroke

**2nd Stage:** extended stroke but at lower maximum capacity than the 1st stage

**Final Stage:** maximum stroke extension but lowest maximum capacity.



### Hoses

Enerpac offers a complete line of high quality hydraulic hoses. To ensure the integrity of your system, specify only Enerpac

hydraulic hoses.

Page: 122

Oil Capacity (cm <sup>3</sup> )	1st Stage		2nd Stage		3rd Stage		Outside Diameter D (mm)	Bottom to Advance Port H (mm)	Saddle Diameter J (mm)	Saddle Height K (mm)	Saddle Support Diameter L (mm)	Model Number	
	Capacity ton (kN)	Stroke S1 (mm)	Capacity ton (kN)	Stroke S2 (mm)	Capacity ton (kN)	Stroke S3 (mm)							
944	36 (352)	135	14 (137)	135	-	-	110	20	60	49	60	15,1	RT-1510
3092	95 (929)	145	41 (397)	145	17,0 (166)	145	170	27	80	73	85	40,3	RT-1817
1487	51 (496)	150	20 (198)	150	-	-	125	23	60	53	66	21,8	RT-2111
4661	126 (1237)	170	51 (496)	170	20,2 (198)	160	200	34	90	83	100	67,3	RT-2119
2359	81 (792)	150	32 (309)	150	-	-	160	25	80	66	89	39,9	RT-3311
8816	202 (1985)	200	81 (792)	200	31,5 (309)	200	250	44	110	111	123	124,0	RT-3323

▼ Shown from left to right: RSM-1000, RSM-300, RSM-50, RCS-1002, RCS-302



## Maximum Power-to-Height Ratio



### Saddles

All RCS-Series cylinders have plunger mounting holes for installation of tilt saddles. See table for selection and dimensional information.

Page: **23**



### Low Clearance Lifting

The LW-16 Lifting Wedge and SOH-Series Machine Lifts are the perfect choice for lifting the first few millimeters.

Page: **172**

### RSM-series, Flat-Jac® Cylinders

- Compact, flat design for use where most other cylinders will not fit
- Single-acting, spring return
- RSM-750, 1000 and 1500 have handles for easy carrying
- Mounting holes permit easy fixturing
- Baked enamel finish for increased corrosion resistance
- CR-400 coupler and dust cap included on all models<sup>1)</sup>
- Hard chrome plated high quality steel plungers
- Grooved plunger ends require no saddle.

### RCS-series, Low-Height Cylinders

- Lightweight, low profile design for use in confined spaces
- Single-acting, spring return
- Baked enamel finish for increased corrosion resistance
- Plunger wiper reduces contamination, extending cylinder life
- CR-400 coupler and dust cap included on all models
- Grooved plunger end with threaded holes for mounting tilt saddles
- Integral handle on RCS-1002 for easy carrying
- Plated steel plungers.

▼ Only a couple of centimeters will do for an RSM-cylinder to lift a large construction.



Cyl. Capacity	Stroke	Model Number	Cylinder Effective Area	Oil Capacity
ton (kN)	(mm)		(cm <sup>2</sup> )	(cm <sup>3</sup> )
5 (45)	6	RSM-50 <sup>1)</sup>	6,5	4
10 (101)	11	RSM-100 *	14,5	18
20 (201)	11	RSM-200 *	28,7	32
30 (295)	13	RSM-300 *	42,1	55
45 (435)	16	RSM-500 *	62,1	99
75 (718)	16	RSM-750	102,6	164
90 (887)	16	RSM-1000	126,7	203
150 (1386)	16	RSM-1500	198,1	317
10 (101)	38	RCS-101 *	14,5	55
20 (201)	45	RCS-201 *	28,7	129
30 (295)	62	RCS-302 *	42,1	261
45 (435)	60	RCS-502 *	62,1	373
90 (887)	57	RCS-1002 *	126,7	722

<sup>1)</sup> RSM-50 is fitted with an AR-400 coupler.

\* Available as set, see note on next page.



# Single-Acting, Low-Height Cylinders

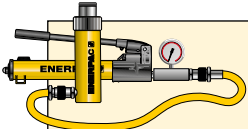

## Cylinder-Pump Sets

All cylinders marked with an \* are available as (cylinder, gauge, couplers, hose and pump) for your ordering convenience.

Page: **58**

## RSM, RCS Series



Capacity:

**5 - 150 ton**

Stroke:

**6 - 62 mm**

Maximum Operating Pressure:

**700 bar**

### Optional Bolt On Tilt Saddle Dimensions (mm)

For Cylinder Model:	Model Number	A	B	C*
RCS-101	CAT-11	35	11	21
RCS-201, -302, -502	CAT-51	50	15	29
RCS-1002	CAT-101	71	17	35

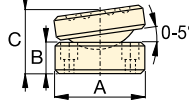

\* 'C' dimension equals saddle protrusion from plunger. Mounting screws are included.

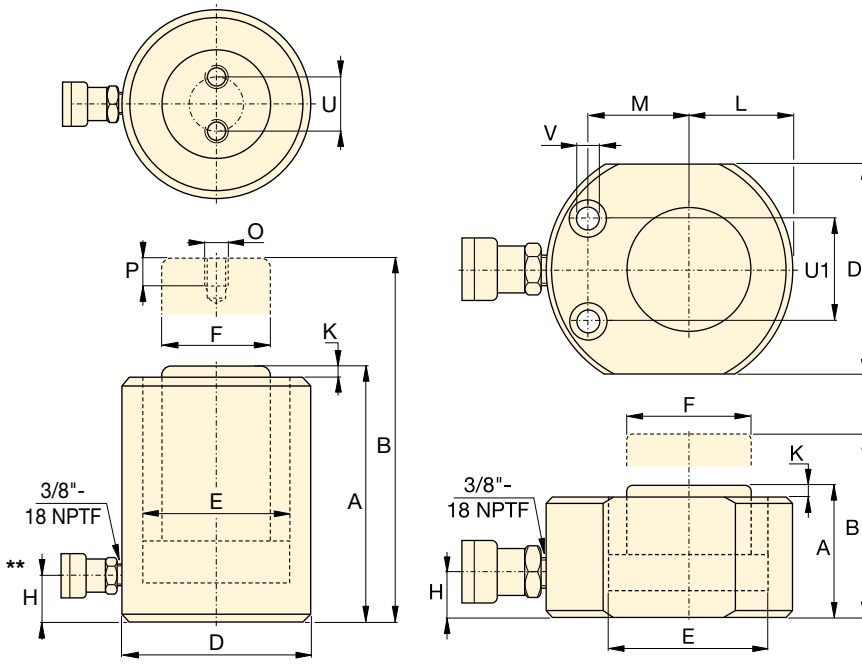

RCS-Series

RSM-Series



### Power Box

Tool box with hand pump, gauge adaptor assembly, hose and RSM or RCS-cylinders.

Page: **61**

### RSM Cylinder Mounting Hole Dimensions (mm)

Model Number	Bolt Circle U1	Hole Dia. V	Counter Bore Dia.	Counter Bore Depth
RSM-50	28,5	5,5	9,1	4,3
RSM-100	36,6	7,1	10,7	7,9
RSM-200	49,3	10,0	15,1	9,9
RSM-300	52,3	10,0	15,9	11,2
RSM-500	66,5	11,0	19,0	12,7
RSM-750	76,2	13,5	20,6	14,2
RSM-1000	76,2	13,5	20,6	14,2
RSM-1500	117,3	13,5	20,6	14,2

Collapsed Height A (mm)	Extended Height B (mm)	Outside Diameter D (mm)	Cylinder Bore Dia. E (mm)	Plunger Dia. F (mm)	Base to Advance Port H (mm)	Plunger Protrusion from Base K (mm)	Plunger to Base L (mm)	Plunger to Mtg. Hole M (mm)	Thread O (mm)	Thread Depth P (mm)	Bolt Circle U (mm)	Weight (kg)	Model Number
32	38	58 x 41	28,7	25,4	16	1	20	22	-	-	-	1,0	RSM-50 <sup>1)</sup>
43	54	82 x 55	42,9	38,1	19	1	27	34	-	-	-	1,4	RSM-100 *
51	62	101 x 76	60,5	50,8	19	1	39	39	-	-	-	3,1	RSM-200 *
58	71	117 x 95	73,2	63,4	19	2	47	44	-	-	-	4,5	RSM-300 *
66	82	140 x 114	88,9	69,8	19	2	57	53	-	-	-	6,8	RSM-500 *
79	95	165 x 139	114,3	82,6	19	2	69	66	-	-	-	11,3	RSM-750
85	101	178 x 153	127,0	92,2	19	2	76	74	-	-	-	14,5	RSM-1000
100	116	215 x 190	158,8	114,3	23	2	95	82	-	-	-	26,3	RSM-1500
88	126	69	42,9	38,1	17	5	-	-	M4	8	26	2,7	RCS-101 *
98	143	92	60,5	50,8	17	3	-	-	M5	8	40	5,0	RCS-201 *
117	179	101	73,2	66,5	19	3	-	-	M5	8	40	6,8	RCS-302 *
122	182	124	88,9	69,8	23	2	-	-	M5	8	40	10,0	RCS-502 *
141	198	165	127,0	92,2	31	1	-	-	M8	10	55	20,7	RCS-1002 *

\*\* 5° angle position of coupler on RCS-101, 201, 302.

# Ultra-Flat Cylinders with Stop Ring

▼ CULP-Cylinder, Ultra-Flat Cylinder, with Stop Ring



- Up to 4% side load of maximum capacity
- Stop ring for maximum stroke limitation
- Extremely low collapsed height
- Nitrocarburized surface treatment for harsh conditions.

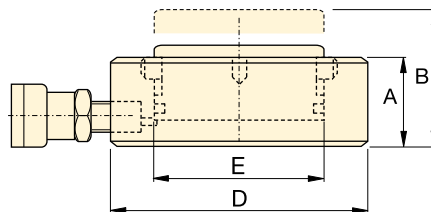

Cylinder Capacity @ 700 bar ton (kN)	Stroke (mm)	Model Number	Cyl. Effective Area (cm <sup>2</sup> )	Oil Capacity (cm <sup>3</sup> )	Collapsed Height A (mm)	Extended Height B (mm)	Outside Diam. D (mm)	Cyl. Bore Diam. E (mm)	 (kg)
10 (97)	6	CULP10 <sup>1)</sup>	13,9	8,3	27,5	33,5	72	42	1,0
20 (198)	6	CULP20 <sup>1)</sup>	28,3	17,0	32,0	38,0	90	60	1,7
30 (310)	6	CULP30 <sup>1)</sup>	44,2	26,5	35,0	41,0	105	75	2,5
50 (550)	6	CULP50 <sup>1)</sup>	78,5	47,1	44,5	50,5	140	100	5,4

<sup>1)</sup> Coupler AR630 including dustcap: Use HB7206 hose including AH630 coupler to connect to your pump.

## CULP Series

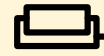

Capacity:

**10 - 50 ton**

Stroke:

**6 mm**

Maximum Operating Pressure:

**700 bar**



### IMPORTANT!

All Ultra-Flat Cylinders require a solid lifting surface for correct support. The use of these flat cylinders on surfaces such as sand, mud or dirt, may result in cylinder damage.



**INCORRECT!**

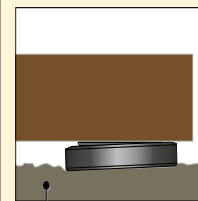

Rough soil



**CORRECT!**

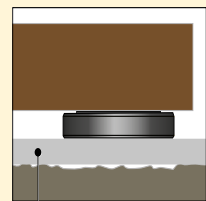

Flat lifting surface

For more safety instructions see our 'Yellow Pages'.

Page: 264



### Hoses

Enerpac offers a complete line of high quality hydraulic hoses. To ensure the integrity of your system, specify only Enerpac

hydraulic hoses.

Page: 122

- ▼ The Ultra-Flat cylinders are designed for applications where high lifting forces are required in confined spaces starting at 2,8 cm.



# High Tonnage, Ultra-Flat Cylinders

▼ CUSP-Series, Ultra-Flat High Tonnage Cylinders, integrated tilting function.



- Up to 4% side load of maximum capacity
- Extremely low collapsed height
- Integrated tilting function up to 4 degrees to evenly distribute the load
- Nitrocarburized surface treatment for harsh conditions
- “Red Line” for visual maximum stroke limitation.

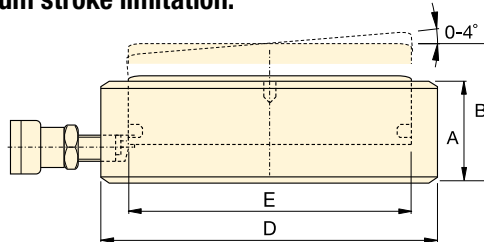

## CUSP Series

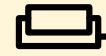

Capacity:

**10 - 1000 ton**

Stroke Straight / Tilted Stroke:

**7 - 17 mm / 6 - 10 mm**

Integrated:

**Tilting Function**

Maximum Operating Pressure:

**700 bar**



**IMPORTANT!**

**CUSP-Cylinders DO NOT have a Stop Ring for stroke limitation!**



**IMPORTANT!**

**All Ultra-Flat Cylinders require a solid lifting surface for correct support. The use of these flat cylinders on surfaces such as sand, mud or dirt, may result in cylinder damage.**

See instructions on page 24 or more safety instructions in our Yerlow Pages.

Page: **264**

Cylinder Capacity @ 700 bar	Tilted Stroke	Straight Stroke	Model Number	Tilting +/-	Cylinder Effective Area A	Oil Capacity	Collapsed Height	Extended Height	Cylinder Outside Diameter D	Cylinder Bore Diameter E	
ton (kN)	(mm)	(mm)		(degree)	(cm <sup>2</sup> )	(cm <sup>3</sup> )	A (mm)	B (mm)	(mm)	(mm)	(kg)
10 (97)	6	6,7	CUSP10 <sup>1)</sup>	2	13,9	9,3	35,5	41,5	72	42	1,2
20 (198)	6	7,0	CUSP20 <sup>1)</sup>	2	28,3	19,8	40,5	46,5	90	60	1,9
30 (310)	6	7,3	CUSP30 <sup>1)</sup>	2	44,2	32,1	42,5	48,5	105	75	2,7
50 (550)	10	13,3	CUSP50 <sup>1)</sup>	4	78,5	104	57,0	67,0	130	100	5,6
75 (792)	10	14,0	CUSP75 <sup>1)</sup>	4	113,1	158	60,5	70,5	150	120	8,0
100 (1078)	10	14,7	CUSP100 <sup>2)</sup>	4	153,9	226	63,5	73,5	170	140	10,8
150 (1589)	10	14,3	CUSP150 <sup>2)</sup>	3	227,0	324	65,0	75,0	200	170	15,3
200 (2090)	10	14,9	CUSP200 <sup>2)</sup>	3	298,6	446	69,0	79,0	229	195	21,5
250 (2542)	10	15,5	CUSP250 <sup>2)</sup>	3	363,1	569	72,5	82,5	252	215	27,3
300 (3167)	10	14,1	CUSP300 <sup>2)</sup>	2	452,4	637	72,5	82,5	282	240	34,4
400 (4008)	10	14,6	CUSP400 <sup>2)</sup>	2	572,6	837	77,5	87,5	316	270	46,2
500 (5115)	10	15,2	CUSP500 <sup>2)</sup>	2	730,6	1111	82,5	92,5	356	305	62,7
600 (5987)	10	15,6	CUSP600 <sup>2)</sup>	2	855,3	1334	87,5	97,5	386	330	78,4
800 (7527)	10	16,3	CUSP750 <sup>2)</sup>	2	1075,2	1757	93,5	103,5	432	370	105,2
1000 (10.165)	10	17,4	CUSP1000 <sup>2)</sup>	2	1452,2	2531	103,0	113,0	502	430	157,0

<sup>1)</sup> Coupler AR630 including dustcap: Use HB7206 hose including AH630 coupler to connect to your pump.

<sup>2)</sup> Coupler CR400 including dustcap: Use HC-Series hose including CH604 coupler to connect to your pump.

# LPL-Series, Low-Height Lock Nut Cylinders

▼ LPL-Series, Low-Height Lock Nut Cylinders



- Lock nut provides mechanical load holding for a safe work environment
- Integrated tilt saddle allows for up to 5 degrees of misalignment
- Extreme low height for use in confined areas
- Side-load resistance 5-10% of maximum capacity
- Overflow port as stroke limiter to prevent plunger blow-out
- Single-acting, gravity-return.

▼ Only the extreme low-height LPL-cylinder fits in this confined area to lift the construction. The lock nut provides positive and safe mechanical load holding over a long period of time.



### Integrated Tilt Saddles

All LPL-Series cylinders include integral tilt saddles with maximum tilt angles up to 5°.



### The Summit Edition

Innovation is at the heart of the new Summit Edition of cylinders, delivering the high quality construction that you expect from Enerpac. The durability ensures your job gets done safely and reliably.

- Replaceable plunger support bearing adds support for eccentric loads \*
- Nitrocarburization surface treatment for improved load and wear resistance and corrosion protection
- Low wear, high pressure seals provide longer service life.

\* Eccentric load (or "side-load") is inevitable in heavy lifting. Our unique Summit Edition features provide the ultimate protection against side load. Increased bearing surface maintains stability and nitrocarburization treatment prevents scoring on the inside of the cylinder. Side-load poses a real problem.... our new cylinder features are the solution!

Cylinder Capacity	Stroke	Model Number	Maximum Cylinder Capacity at 700 bar ton (kN)	Side-load Resistance of Maximum Capacity	Cylinder Effective Area
ton	(mm)				(cm <sup>2</sup> )
60	50	LPL-602	62 (606)	10%	86,6
100	50	LPL-1002	102 (1002)	10%	143,1
150	45	LPL-1602	162 (1589)	8%	227,0
200	45	LPL-2002	202 (1985)	8%	283,5
250	45	LPL-2502	259 (2541)	5%	363,1
400	45	LPL-4002	409 (4008)	5%	572,6
500	45	LPL-5002	522 (5114)	5%	730,6



# Single-Acting, Low-Height Lock Nut Cylinders



## IMPORTANT!

All LPL-Series cylinders require a solid lifting surface for correct support. The use of these cylinders on surfaces such as sand, mud or dirt, may result in cylinder damage.

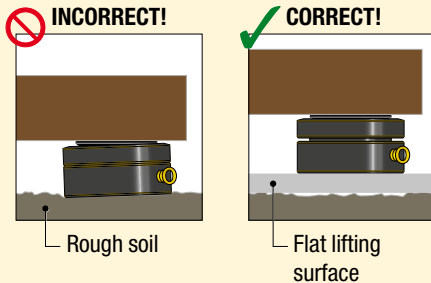

For more safety instructions see our 'Learning Center' on [www.enerpac.com](http://www.enerpac.com)

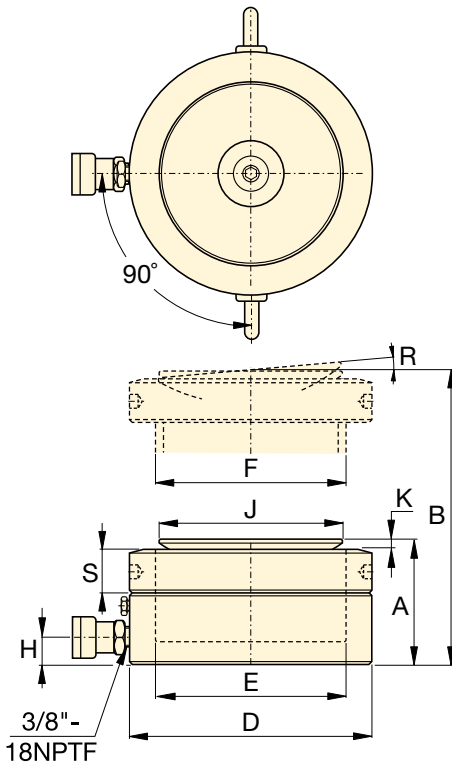

## LPL Series



Capacity:

**60 - 500 ton**

Stroke:

**45 - 50 mm**

Maximum Operating Pressure:

**700 bar**



### Longer Stroke Lock Nut Cylinders

For longer stroke applications **HCL and HCRL-Series** lock nut cylinders are the perfect choice.

Page: 42



### Split-Flow Pumps

SFP-Series Pumps with multiple outlets with equal oil flow. For lifting and lowering applications on multiple points

these pumps are a far better alternative than using separately operated pumps.

Page: 240



### Synchronous Lifting Systems

Pumps for multiple lift point capabilities. The economical **EVOB-Series** for basic applications and the multi-functional **EVO-Series** lifting system.

Page: 242

Oil Capacity	Collapsed Height	Extended Height	Outside Diameter	Cylinder Bore Diameter	Plunger Diameter	Base to Advance Port	Saddle Diameter	Saddle Protrusion from Plgr.	Saddle Max. Tilt Angle	Lock Nut Height		Model Number
(cm <sup>3</sup> )	A (mm)	B (mm)	D (mm)	E (mm)	F (mm)	H (mm)	J (mm)	K (mm)	R	S (mm)	(kg)	
433,0	126	176	140	105	Tr 105 x 4	19	96	7	5°	28	15	LPL-602
715,7	137	187	173	135	Tr 135 x 6	21	126	8	5°	31	25	LPL-1002
1021,4	148	193	220	170	Tr 170 x 6	27	160	9	5°	40	43	LPL-1602
1275,9	155	200	245	190	Tr 190 x 6	30	180	10	5°	43	55	LPL-2002
1633,7	159	204	275	215	Tr 215 x 6	32	200	12	5°	43	70	LPL-2502
2576,5	178	223	350	270	Tr 270 x 6	40	250	12	4°	55	129	LPL-4002
3287,8	192	237	400	305	Tr 305 x 6	49	290	10	3°	61,5	183	LPL-5002

▼ Shown from left to right: BRC-25, BRC-46, BRP-306, BRP-606, BRP-106C



- High strength alloy steel construction
- Hard chrome-plated plunger for long life
- Replaceable links on BRP-models
- Baked enamel finish for increased corrosion resistance
- CR-400 coupler and dust cap included on all models
- Plunger wiper reduces contamination, extending cylinder life
- Single-acting, spring return.

▼ Lifting mining conveyor belt using pull cylinders for bearing maintenance.



## The Ultimate in Pulling Power



### Gauges

Minimize the risk of overloading and ensure long, dependable service from your equipment. Refer to the System Components Section for a full range of gauges.

Page: 121



### Attachments and Accessories

BRC-25 and BRC-46 units have base, collar and plunger threads to affix a range of optional attachments and accessories, such as chains, saddles and extension tubes.

Page: 165

▼ To lift a load bearing mast into place, BRP-series cylinders were used to tension the supporting cables.



# Single-Acting, Pull Cylinders

BRC Cylinder Mounting Dimensions (mm)				
Model Number	Base Mounting Hole V	Collar Thread W	Collar Thd. Lgth. X	Mtg. Thd. Lgth. Z
<b>BRC-25</b>	3/4" - 14 NPT	1 1/2" - 16 UN	24	17
<b>BRC-46</b>	1 1/4" - 11 1/2 NPT	2 1/4" - 14 UN	26	24
<b>BRC-106</b>	M30 x 2	M85 x 2	25	24

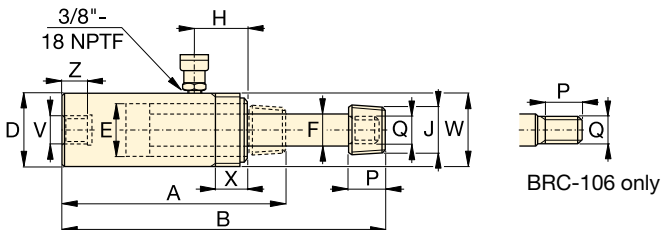

**BRC-25, -46, 106**

**BRC,  
BRP  
Series**



Capacity:  
**2,5 - 50 ton**

Stroke:  
**127 - 154 mm**

Maximum Operating Pressure:  
**700 bar**

Cylinder Capacity	Stroke	Model Number	Cylinder Effective Area	Oil Capacity	Coll. Height	Ext. Height	Outside Dia.	Cylinder Bore Dia.	Plunger Dia.	Top to Inlet Port	Saddle Diameter	Plunger Thread Length	Plunger Outside Thread	Weight
ton (kN)	(mm)		(cm <sup>2</sup> )	(cm <sup>3</sup> )	A (mm)	B (mm)	D (mm)	E (mm)	F (mm)	H (mm)	J (NPT)	P (mm)	Q	(kg)
<b>2,5 (24)</b>	127	<b>BRC-25</b>	3,5	45	264	391	48	28,4	19,0	45	3/4" - 14	28	1 1/16" - 24	1,8
<b>5 (51)</b>	140	<b>BRC-46</b>	7,3	101	301	441	57	42,9	30,2	42	1 1/4" - 11 1/2	32	1 3/16" - 16	4,5
<b>10 (105)</b>	151	<b>BRC-106</b>	15,0	228	289	440	85	54,1	31,8	39	-	25	M30x2	9,5

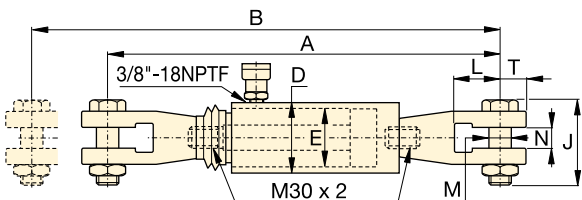

**BRP-106C**

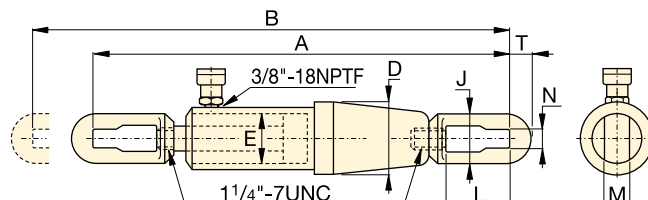

**BRP-306**

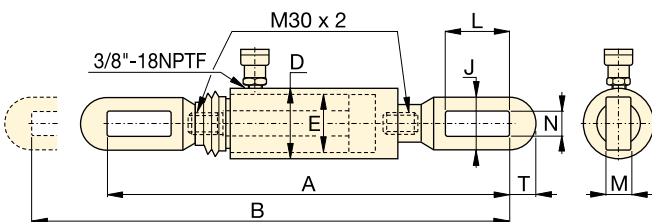

**BRP-106L**

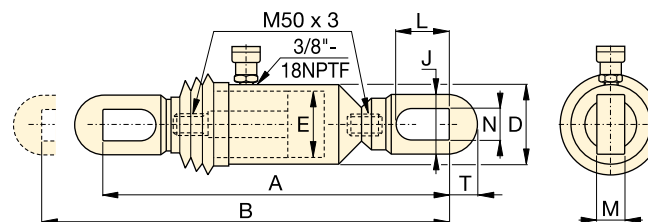

**BRP-606**

Cylinder Capacity	Stroke	Model Number	Cylinder Effective Area	Oil Capacity	Coll. Height	Ext. Height	Outside Dia.	Cyl. Bore Dia.	Link Height	Link Opening	Link Thickness	Link Width	Slot to Link End	Weight
ton (kN)	(mm)		(cm <sup>2</sup> )	(cm <sup>3</sup> )	A (mm)	B (mm)	D (mm)	E (mm)	J (mm)	L (mm)	M (mm)	N (mm)	T (mm)	(kg)
<b>10 (110)</b>	150	<b>BRP-106C</b>	15,8	238	601	751	85	54,1	105	87	30	35	32	15,3
	150	<b>BRP-106L</b>	15,8	238	581	751	85	54,1	64	119	22	34	32	13,3
<b>30 (325)</b>	154	<b>BRP-306</b>	46,4	715	1110	1264	137	88,9	114	155	35	43	55	63,1
<b>50 (506)</b>	153	<b>BRP-606</b>	72,1	1096	718	871	140	110,1	130	151	40	48	65	58,3

▼ Shown from left to right: RCH-306, RCH-120, RCH-1003



- Hollow plunger design allows for both, pull and push forces
- Single-acting, spring return
- Nickel-plated, floating center tube on models over 20 ton increases product life
- Baked enamel finish for increased corrosion resistance
- Collar threads for easy fixturing
- RCH-120 includes AR-630 coupler and has 1/4" NPTF port
- RCH-121 and RCH-1211 have FZ-1630 reducer and AR-630 coupler, all other models feature CR-400 coupler.

▼ Hollow plunger cylinder RCH-1003 used in an application for intermediate boom suspension on a dragline.



## Versatility in Testing, Maintenance and Tensioning Applications

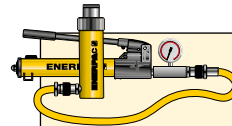

### Cylinder-Pump Sets

All cylinders marked with an \* are available as **sets** (cylinder, gauge, couplers, hose and pump) for your ordering convenience.

Page: **58**



### Ultra-Lightweight Aluminium Cylinders

If you need a higher cylinder capacity-to-weight-ratio the lightweight **RACH-Series** are the perfect choice.

Page: **16**



### Saddles

Most RCH-Series cylinders are equipped with smooth saddles. See table at next page for optional threaded saddles and all dimensional information.

Page: **31**

Cylinder Capacity	Stroke	Model Number	Cylinder Effective Area	Oil Capacity
ton (kN)	(mm)		(cm <sup>2</sup> )	(cm <sup>3</sup> )
13 (125)	8	<b>RCH-120</b>	17,9	14
	42	<b>RCH-121*</b>	17,9	75
	42	<b>RCH-1211</b>	17,9	75
	76	<b>RCH-123</b>	17,9	136
20 (215)	49	<b>RCH-202*</b>	30,7	150
	155	<b>RCH-206</b>	30,7	476
30 (326)	64	<b>RCH-302*</b>	46,6	298
	155	<b>RCH-306</b>	46,6	722
60 (576)	76	<b>RCH-603*</b>	82,3	626
	153	<b>RCH-606</b>	82,3	1259
95 (931)	76	<b>RCH-1003*</b>	133,0	1011

\* Available as set, see note on this page.



# Single-Acting, Hollow Plunger Cylinders



## Hoses

Enerpac offers a complete line of high quality hydraulic hoses. To ensure the integrity of your system, specify only Enerpac hydraulic hoses.

Page: **122**

## RCH Series

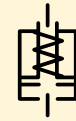

Capacity:

**13-95 ton**

Stroke:

**8-155 mm**

Center Hole Diameter:

**17,3-79,0 mm**

Maximum Operating Pressure:

**700 bar**

### Optional Threaded Hollow Saddles

Saddle Type	Cylinder Model Number	Saddle Model Nr.	Saddle Dimensions (mm)		
			A	B	C
Threaded Hollow	RCH-202, 206	HP-2015	53	1" - 8	9
	RCH-302, 306	HP-3015	63	1 1/4" - 7	9
	RCH-603, 606	HP-5016	91	1 5/8" - 5 1/2	12
	RCH-1003	HP-10016	126	2 1/2" - 8	13

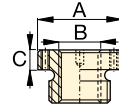

Smooth hollow saddles are standard on all RCH-models (except RCH-120, RCH-1211).

RCH-121 and RCH-1211 have a 47 mm dia. boss that protrudes 6 mm from base.

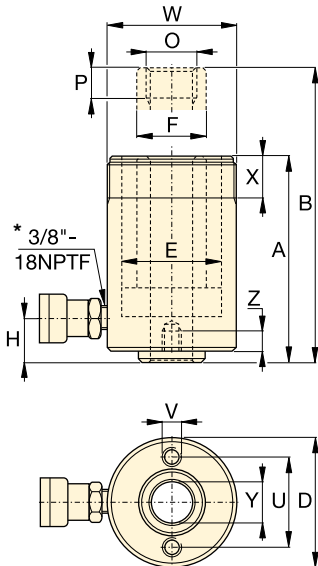

**RCH-120 to RCH-123 models**

\* 1/4" NPTF for RCH-120 only

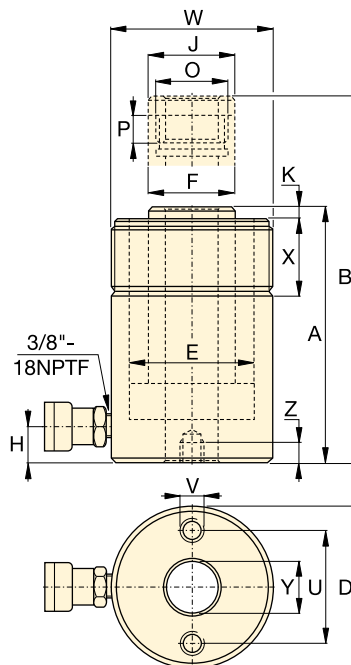

**RCH-202 to RCH-1003 models**

### Base Mounting Hole Dimensions (mm)

Model Number	Bolt Circle U	Thread V	Thread Depth Z
RCH-120	50,8	5/16" - 18 UNC	9,0
RCH-121	-	-	-
RCH-1211	-	-	-
RCH-123	50,8	5/16" - 18 UNC	12,7
RCH-202	82,6	3/8" - 16 UNC	9,4
RCH-206	82,6	3/8" - 16 UNC	9,4
RCH-302	92,2	3/8" - 16 UNC	14,0
RCH-306	92,2	3/8" - 16 UNC	14,0
RCH-603	130,3	1/2" - 13 UNC	14,0
RCH-606	130,3	1/2" - 13 UNC	14,0
RCH-1003	177,8	5/8" - 11 UNC	19,0

Coll. Height A (mm)	Ext. Height B (mm)	Outside Dia. D (mm)	Cyl. Bore Dia. E (mm)	Plgr. Dia. F (mm)	Cyl. Base to Advance Port H (mm)	Saddle Dia. J (mm)	Saddle Protrusion from Plgr. K (mm)	Plunger Internal Thread O	Plunger Thread Length P (mm)	Collar Thread W	Collar Thread Length X (mm)	Center Hole Dia. Y (mm)	Weight (kg)	Model Number
55	63	69	54,1	35,1	9	-	-	3/4" - 16 UN	16	2 3/4" - 16	30	17,3	1,5	RCH-120
120	162	69	54,1	35,1	25	-	-	-	-	2 3/4" - 16	30	19,5	2,8	RCH-121*
120	162	69	54,1	35,1	25	-	-	3/4" - 16 UN	16	2 3/4" - 16	30	17,3	2,8	RCH-1211
184	260	69	54,1	35,1	25	-	-	-	-	2 3/4" - 16	30	19,5	4,4	RCH-123
162	211	98	73,1	54,1	19	54	9,7	1 9/16" - 16 UN	19	3 7/8" - 12	38	26,9	7,7	RCH-202*
306	461	98	73,1	54,1	25	54	9,7	1 9/16" - 16 UN	19	3 7/8" - 12	38	26,9	14,1	RCH-206
178	242	114	88,9	63,5	21	63	9,0	1 13/16" - 16 UN	22	4 1/2" - 12	42	33,3	10,9	RCH-302*
330	485	114	88,9	63,5	25	63	9,0	1 13/16" - 16 UN	22	4 1/2" - 12	42	33,3	21,8	RCH-306
247	323	159	123,9	91,9	31	91	12,0	2 3/4" - 16 UN	19	6 1/4" - 12	48	53,8	28,1	RCH-603*
323	476	159	123,9	91,9	31	91	12,0	2 3/4" - 16 UN	19	6 1/4" - 12	48	53,8	35,4	RCH-606
254	330	212	165,1	127,0	38	126	12,0	4" - 16 UN	25	8 3/8" - 12	60	79,0	63,0	RCH-1003*

▼ Shown from left to right: RRH-3010, RRH-1001, RRH-6010



- Relief valves prevent damage in case of over-pressurisation
- Baked enamel finish for increased corrosion resistance
- Collar threads enable easy fixturing (except RRH-1001 and RRH-1508)
- Double-acting version for fast retraction
- Nickel-plated, floating center tube increases product life
- Hollow plunger allows for both pull and push forces
- CR-400 coupler and dust cap included on all models
- Plunger wiper reduces contamination, extending cylinder life.

## Versatility in Testing, Maintenance and Tensioning Applications



### Pump Selection

A double-acting cylinder must be powered by a pump with a 4-way valve.

Page: 115



### Gauges

Minimize the risk of overloading and ensure long, dependable service from your equipment. Refer to the System Components Section for a full range of gauges.

Page: 121



### Saddles

All RRH-Series cylinders are equipped with smooth saddles. See table at next page for optional threaded saddles and all dimensional information.

Page: 33

▼ Double-acting hollow plunger cylinders are applied for bridge launching systems.



Cylinder Capacity ton	Stroke (mm)	Model Number	Max. Cylinder Capacity (kN)		Cylinder Effective Area (cm <sup>2</sup> )		Oil Capacity (cm <sup>3</sup> )	
			Advance	Retract	Advance	Retract	Advance	Retract
30	178	RRH-307	326	213	46,6	30,4	829	541
	258	RRH-3010	326	213	46,6	30,4	1202	784
60	89	RRH-603	576	380	82,3	54,2	733	482
	166	RRH-606	576	380	82,3	54,2	1366	900
	257	RRH-6010	576	380	82,3	54,2	2115	1393
95	38	RRH-1001	931	612	133,0	87,4	505	333
	76	RRH-1003	931	612	133,0	87,4	1011	666
	153	RRH-1006	931	612	133,0	87,4	2035	1337
	257	RRH-10010	931	612	133,0	87,4	3420	2246
145	203	RRH-1508	1429	718	204,1	102,6	4144	2083

# Double-Acting, Hollow Plunger Cylinders



## Hoses

Enerpac offers a complete line of high quality hydraulic hoses. To ensure the integrity of your system, specify only Enerpac hydraulic hoses.

Page: **122**

## RRH Series

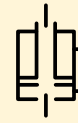

Capacity:

**30 - 145 ton**

Stroke:

**38 - 258 mm**

Center Hole Diameter:

**33,3-79,2 mm**

Maximum Operating Pressure:

**700 bar**

Optional Threaded Hollow Saddles					
Saddle Type	Cylinder Model Number	Saddle Model Nr.	Saddle Dimensions (mm)		
			A	B	C
Threaded Hollow	RRH-307, 3010	HP-3015	63	1¼" - 7	9
	RRH-603, 606, 6010	HP-5016	91	1½" - 5½	12
	RRH-1001, 1003, RRH-1006, 10010	HP-10016	126	2½" - 8	13

Smooth hollow saddles are standard on all RRH-models.

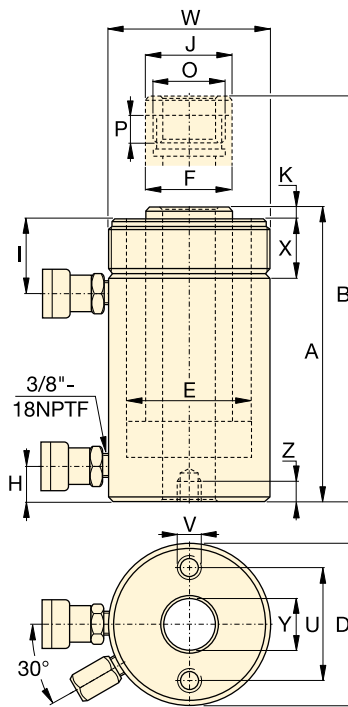

Base Mounting Hole Dimensions (mm)			
Model Number	Bolt Circle U	Thread V	Thread Depth Z
RRH-307	92,2	3/8" - 16	15,7
RRH-3010	92,2	3/8" - 16	15,7
RRH-603	130,0	1/2" - 13	14,0
RRH-606	130,0	1/2" - 13	14,0
RRH-6010	130,0	1/2" - 13	14,0
RRH-1001	177,8	5/8" - 11	19,0
RRH-1003	177,8	5/8" - 11	19,0
RRH-1006	177,8	5/8" - 11	19,0
RRH-10010	177,8	5/8" - 11	19,0
RRH-1508	-	-	-

Coll. Height A (mm)	Ext. Height B (mm)	Out. Dia. D (mm)	Cyl. Bore Dia. E (mm)	Plgr. Dia. F (mm)	Cyl. Base to Adv. Port H (mm)	Cyl. Top to Return Port I (mm)	Saddle Dia. J (mm)	Saddle Protr. fr. Plgr. K (mm)	Thread O	Plunger Thread Length P (mm)	Collar Thread W	Collar Thread Length X (mm)	Center Hole Dia. Y (mm)	Weight (kg)	Model Number
330	508	114	88,9	63,5	25	60	63	9	1 <sup>13</sup> / <sub>16</sub> " - 16	22	4 <sup>1</sup> / <sub>2</sub> " - 12	42	33,3	21	RRH-307
431	689	114	88,9	63,5	25	60	63	9	1 <sup>13</sup> / <sub>16</sub> " - 16	22	4 <sup>1</sup> / <sub>2</sub> " - 12	42	33,3	27	RRH-3010
247	336	159	123,9	91,9	31	66	91	12	2 <sup>3</sup> / <sub>4</sub> " - 16	19	6 <sup>1</sup> / <sub>4</sub> " - 12	48	53,8	28	RRH-603
323	489	159	123,9	91,9	31	66	91	12	2 <sup>3</sup> / <sub>4</sub> " - 16	19	6 <sup>1</sup> / <sub>4</sub> " - 12	48	53,8	35	RRH-606
438	695	159	123,9	91,9	31	66	91	12	2 <sup>3</sup> / <sub>4</sub> " - 16	19	6 <sup>1</sup> / <sub>4</sub> " - 12	48	53,8	45	RRH-6010
165	203	212	165,1	127,0	38	44	126	12	4" - 16	25	-	-	79,2	33	RRH-1001
254	330	212	165,1	127,0	38	85	126	12	4" - 16	25	8 <sup>3</sup> / <sub>8</sub> " - 12	60	79,2	61	RRH-1003
342	495	212	165,1	127,0	38	85	126	12	4" - 16	25	8 <sup>3</sup> / <sub>8</sub> " - 12	60	79,2	79	RRH-1006
460	717	212	165,1	127,0	38	85	126	12	4" - 16	25	8 <sup>3</sup> / <sub>8</sub> " - 12	60	79,2	106	RRH-10010
349	552	247	190,5	152,4	38	60	127	4	4 <sup>1</sup> / <sub>4</sub> " - 12	25	-	-	79,2	111	RRH-1508

▼ Shown from left to right: BRD-2510, BRD-96, BRD-256, BRD-41, BRD-166



## High Precision and High Cycle Performance



### Speed Chart

See the Enerpac Cylinder Speed Chart in our 'Yellow Pages' to determine your approximate cylinder speed.

Page: **273**

- Designed for long life, the best choice for production applications
- Unique mounting configurations simplify fixturing
- Baked enamel finish for increased corrosion resistance
- Double-acting operation develops force in both directions, providing maximum versatility
- Plunger wiper reduces contamination, extending cylinder life
- Imperial models (RD-series) available on request.

▼ Clamping application using Enerpac BRD cylinders (with clevis eye attachments on both ends) for their high pressure capability and mounting flexibility.



Cylinder Capacity (ton)	Stroke (mm)	Model Number	Max. Cylinder Capacity (kN)		Cylinder Effective Area (cm <sup>2</sup> )		Oil Capacity (cm <sup>3</sup> )		Coll. Height A (mm)	Extended Height B (mm)	Body Length C (mm)	Outside Dia. D (mm)	Cylinder Bore Dia. E (mm)	Plunger Dia. F (mm)
			Advance	Retract	Advance	Retract	Advance	Retract						
4	28	BRD-41	35	16	5,1	2,2	14	6	186	214	162	50	25,4	19,0
	79	BRD-43	35	16	5,1	2,2	40	17	237	316	213	50	25,4	19,0
	155	BRD-46	35	16	5,1	2,2	79	34	313	468	289	50	25,4	19,0
8	28	BRD-91	80	44	11,4	6,3	32	18	223	251	198	63,5	38,1	25,4
	79	BRD-93	80	44	11,4	6,3	90	50	274	353	249	63,5	38,1	25,4
	155	BRD-96	80	44	11,4	6,3	177	98	350	505	325	63,5	38,1	25,4
	257	BRD-910	80	44	11,4	6,3	293	162	452	709	427	63,5	38,1	25,4
15	159	BRD-166	142	77	20,3	10,6	323	169	389	548	359	80	50,8	35,0
	260	BRD-1610	142	77	20,3	10,6	528	276	491	751	461	80	50,8	35,0
23	159	BRD-256	222	98	31,7	13,7	504	218	424	583	397	92	63,5	47,8
	260	BRD-2510	222	98	31,7	13,7	824	356	526	786	499	92	63,5	47,8



# Double-Acting, Precision Production Cylinders

## ▼ BRD CYLINDER ATTACHMENTS

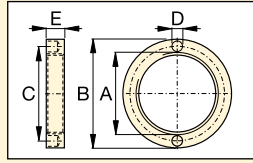

### Retainer Nut

For locking foot or flange mountings. Tightens onto cylinder collar threads (Included with foot and flange mounting kits).

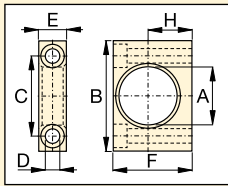

### Foot Mounting

Mounts onto cylinder collar.

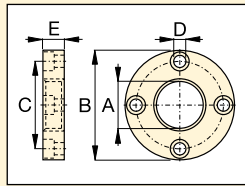

### Flange Mounting

Mounts onto cylinder collar.

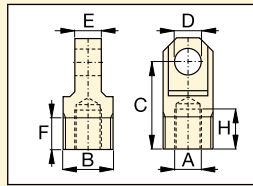

### Clevis Eye

Threads onto plunger into cylinder base.

Model Number	BRD-Cyl. (ton)	Dimensions (mm)						
		A	B	C	D	E	F	H
<b>Foot Mounting with Retainer Nut</b>								
BAD-141	4	42,1	80	58,0	10,5	20,0	57,0	31,8
BAD-171	8	56,1	105	78,0	13,5	25,0	82,5	44,5
BAD-181	15	70,1	127	95,2	20,0	35,0	100,0	52,4
BAD-191	23	85,1	159	117,5	26,5	45,0	125,0	63,5
<b>Flange Mounting with Retainer Nut</b>								
BAD-142	4	42,1	98,4	78,6	11,0	19,0	-	-
BAD-172	8	56,1	121	98,4	11,0	25,4	-	-
BAD-182	15	70,1	143	115,9	16,0	35,0	-	-
BAD-192	23	85,1	165	135,7	17,0	44,5	-	-
<b>Retainer Nut</b>								
BAD-143	4	M42 x 1,5	57	49,5	6,3	9,5	-	-
BAD-173	8	M56 x 2	75	65,5	6,7	12,7	-	-
BAD-183	15	M70 x 2	92	81,0	6,7	19,0	-	-
BAD-193	23	M85 x 2	108	96,5	6,7	25,4	-	-
<b>Clevis Eye (See chart below for mounting dimensions L, L1 and M)</b>								
BAD-150	4	M16 x 1,5	M30 x 1,5	52,4	16,0	15,9	19,1	23,8
BAD-151	8	M22 x 1,5	M42 x 1,5	57,1	20,0	25,4	25,4	23,8
BAD-152	15	M30 x 1,5	M56 x 2	77,8	25,0	31,8	25,4	30,2
BAD-153	23	M42 x 1,5	M70 x 2	77,8	32,0	38,2	25,4	27,0

## BRD Series



Capacity:

**4 - 23 ton**

Stroke:

**28 - 260 mm**

Maximum Operating Pressure:

**700 bar**

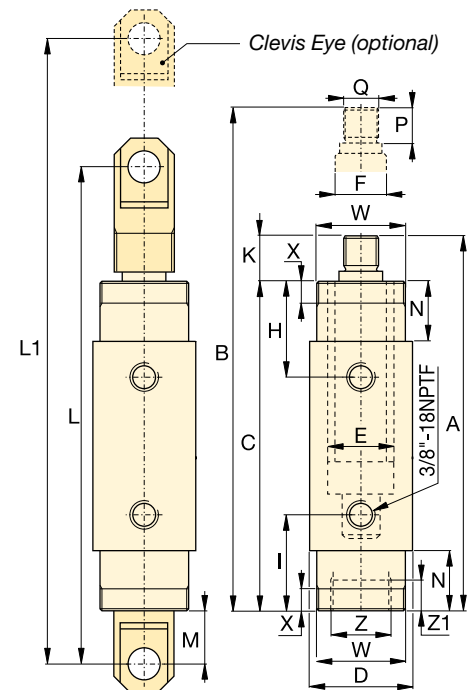

	Top to Retract Port H (mm)	Bottom to Advance Port I (mm)	Plunger Protrusion K (mm)	Clevis Eye Mounting Dimensions			Neck Length N (mm)	Plunger Thread Length P (mm)	Plunger External Thread Q (mm)	Cylinder Mounting Dimensions (mm)				Model Number	
				L (mm)	L1 (mm)	M (mm)				Collar Thread W	Collar Thread Length X	Internal Base Thread Z	Int. Base Thread Length Z1		
	47	47	24	258	286	41	29	22	M16 x 1,5	M42 x 1,5	11	M30 x 1,5	9	2,0	BRD-41
	47	47	24	308	387	41	29	22	M16 x 1,5	M42 x 1,5	11	M30 x 1,5	9	2,6	BRD-43
	47	47	24	385	540	41	29	22	M16 x 1,5	M42 x 1,5	11	M30 x 1,5	9	3,6	BRD-46
	57	57	25	295	323	38	38	22	M22 x 1,5	M56 x 2	14	M42 x 1,5	14	3,0	BRD-91
	57	57	25	346	425	38	38	22	M22 x 1,5	M56 x 2	14	M42 x 1,5	14	4,2	BRD-93
	57	57	25	422	577	38	38	22	M22 x 1,5	M56 x 2	14	M42 x 1,5	14	5,6	BRD-96
	57	57	25	524	781	38	38	22	M22 x 1,5	M56 x 2	14	M42 x 1,5	14	7,3	BRD-910
	73	73	30	492	651	52	54	28	M30 x 1,5	M70 x 2	22	M56 x 2	24	10,2	BRD-166
	73	73	30	593	853	52	54	28	M30 x 1,5	M70 x 2	22	M56 x 2	24	14,5	BRD-1610
	89	89	27	524	683	53	70	25	M42 x 1,5	M85 x 2	29	M70 x 2	26	16,0	BRD-256
	89	89	27	626	886	53	70	25	M42 x 1,5	M85 x 2	29	M70 x 2	26	20,3	BRD-2510

# RR-Series, Double-Acting Cylinders

▼ Shown from left to right: RR-10013, RR-1502, RR-20013, RR-1010, RR-7513



- Collar threads, plunger threads and base mounting holes for easy fixturing (on most models)
- Baked enamel finish for increased corrosion resistance
- Removable hardened saddles protect plunger during lifting and pressing
- Built-in safety valve prevents accidental over-pressurization
- CR-400 couplers and dust caps included on all models
- Plunger wiper reduces contamination, extending cylinder life.

▼ A lateral bridge slide method was utilized to slide the new bridge into position. Two RR-Series double acting hydraulic cylinders with ZU4-Series electric pumps were used to push the bridge into position over PTFE sliding elements.



## Most Versatile Performers

Rugged enough for the toughest job site uses and precision designed for high-cycle industrial uses.



## Saddles

RR-Series cylinders up to 75 ton have plunger mounting holes for installation of CAT-Series tilt saddles.

Page: **37**



## Optimum Performance

Enerpac's range of Z-Class electric pumps, fitted with manual or solenoid operated 4-way valves, offer optimum combinations with RR-Series cylinders.

Page: **90**

▼ RR-cylinders provide power and precision in a special hydraulic press.



# Double-Acting Long Stroke Cylinders



## Pump Selection

A double-acting cylinder must be powered by a pump with a 4-way valve.

Page: **71**

## ▼ QUICK SELECTION CHART

For complete technical information see next page.

Cylinder Capacity ton (kN)	Stroke (mm)	Model Number	Cylinder Effective Area (cm <sup>2</sup> )		Oil Capacity (cm <sup>3</sup> )		Coll. Height (mm)
			Push	Pull	Push	Pull	
<b>10</b> (101)	254	<b>RR-1010</b>	14,5	4,8	368	122	409
	305	<b>RR-1012</b>	14,5	4,8	442	147	457
<b>30</b> (295)	209	<b>RR-308</b>	42,1	19,1	879	400	395
	368	<b>RR-3014</b>	42,1	19,1	1549	703	549
<b>50</b> (498)	156	<b>RR-506</b>	71,2	21,5	1111	335	331
	334	<b>RR-5013</b>	71,2	21,5	2378	718	509
	511	<b>RR-5020</b>	71,2	21,5	3638	1099	733
<b>75</b> (718)	156	<b>RR-756</b>	102,6	31,4	1601	490	347
	333	<b>RR-7513</b>	102,6	31,4	3417	1046	525
<b>95</b> (933)	168	<b>RR-1006</b>	133,3	62,2	2238	1045	357
	333	<b>RR-10013</b>	133,3	62,2	4439	2071	524
	460	<b>RR-10018</b>	133,3	62,2	6132	2861	687
<b>140</b> (1386)	57	<b>RR-1502</b>	198,1	95,4	1129	544	196
	156	<b>RR-1506</b>	198,1	95,4	3090	1488	385
	333	<b>RR-15013</b>	198,1	95,4	6597	3177	582
	815	<b>RR-15032</b>	198,1	95,4	16145	7775	1116
<b>200</b> (1995)	152	<b>RR-2006</b>	285,0	145,3	4332	2209	430
	330	<b>RR-20013</b>	285,0	145,3	9405	4795	608
	457	<b>RR-20018</b>	285,0	145,3	13025	6640	765
	610	<b>RR-20024</b>	285,0	145,3	17385	8863	917
	914	<b>RR-20036</b>	285,0	145,3	26049	13280	1222
<b>325</b> (3201)	1219	<b>RR-20048</b>	285,0	145,3	34741	17712	1527
	153	<b>RR-3006</b>	457,3	243,2	6997	3721	485
	305	<b>RR-30012</b>	457,3	243,2	13947	7418	638
	457	<b>RR-30018</b>	457,3	243,2	20889	11114	790
	609	<b>RR-30024</b>	457,3	243,2	27850	14811	943
	915	<b>RR-30036</b>	457,3	243,2	41843	22253	1247
<b>440</b> (4292)	1219	<b>RR-30048</b>	457,3	243,2	55745	29646	1552
	152	<b>RR-4006</b>	613,1	328,1	9319	4987	538
	305	<b>RR-40012</b>	613,1	328,1	18700	10007	690
	457	<b>RR-40018</b>	613,1	328,1	28018	14995	843
	610	<b>RR-40024</b>	613,1	328,1	37400	20014	995
	914	<b>RR-40036</b>	613,1	328,1	56037	29988	1300
	1219	<b>RR-40048</b>	613,1	328,1	74737	39996	1605
<b>520</b> (5108)	153	<b>RR-5006</b>	729,7	405,4	11164	6203	577
	305	<b>RR-50012</b>	729,7	405,4	22256	12365	730
	457	<b>RR-50018</b>	729,7	405,4	33347	18526	882
	609	<b>RR-50024</b>	729,7	405,4	44440	24689	1035
	915	<b>RR-50036</b>	729,7	405,4	66768	36973	1339
	1219	<b>RR-50048</b>	729,7	405,4	88951	49418	1644

## RR Series



Capacity:

**10 - 520 ton**

Stroke:

**57 - 1219 mm**

Maximum Operating Pressure:

**700 bar**

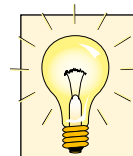

### Enerpac HCR-Series

If your application does not require high cycle, Enerpac HCR-Series cylinders may be the right alternative.

Page: **48**



### Speed Chart

See the Enerpac Cylinder Speed Chart in our 'Yellow Pages' to determine your approximate cylinder speed.

Page: **273**



### Optional Snap-in Saddles

Optional snap-in saddles for RR-Series double-acting cylinders:

Saddle Type	Cylinder Model Number	Saddle Model Number
Flat	RR-1010, 1012	<b>A-102F</b>
	RR-1010, 1012	<b>CAT-10</b>
Tilt	RR-308, 3014	<b>CAT-50</b>
	RR-506, 5013	<b>CAT-100</b>
	RR-5020, 756	
	RR-7513	

### Standard Saddles:

Grooved	RR-1010, 1012	<b>A-102G</b>
	RR-308, 3014	<b>A-252G</b>

For additional information on saddles:

Page: **10**



# RR-Series, Double-Acting Cylinders

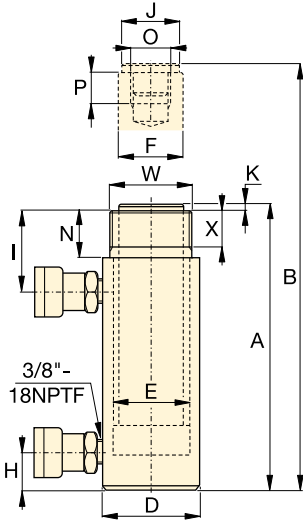

**RR-1010 - RR-3014**

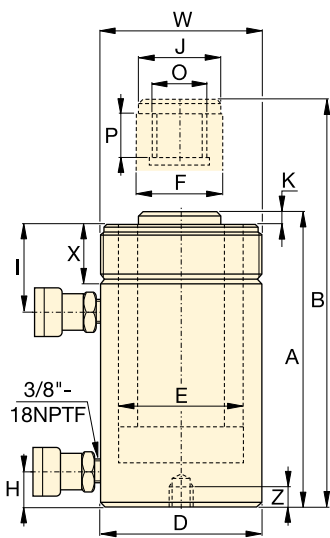

**RR-506 - RR-50048**

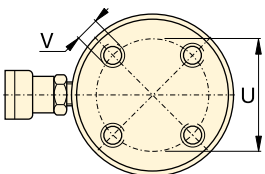

**RR-1006 - RR-30048**

No mounting holes on:  
RR-506, 5013  
RR-756, 7513  
RR-1502, 15032

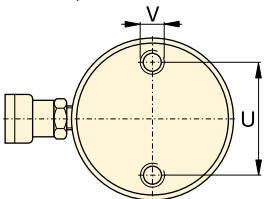

**RR-4006 - RR-50048**

Base mounting hole location is for reference only, as it is affected by assembly.



Cylinder retract capacity for certain RR cylinders may be less than theoretical values, as a result of reduced relief valve pressure settings:

RR-308/3014: 275 bar  
RR-506/5013/5020: 480 bar  
RR-756/7513: 495 bar

◀ For full features see previous page.

Cylinder Capacity	Stroke (mm)	Model Number	Max. Cylinder Capacity (kN)		Cylinder Effective Area (cm <sup>2</sup> )		Oil Capacity (cm <sup>3</sup> )		Coll. Height	Ext. Height	Outside Dia.
			Push	Pull	Push	Pull	Push	Pull	A (mm)	B (mm)	D (mm)
10 ton	254	RR-1010 *	101	33	14,5	4,8	368	122	409	663	73
	305	RR-1012 *	101	33	14,5	4,8	442	147	457	762	73
30	209	RR-308 *	295	53	42,1	19,1	879	400	395	604	101
	368	RR-3014 *	295	53	42,1	19,1	1549	703	549	917	101
50	156	RR-506	498	103	71,2	21,5	1111	335	331	487	127
	334	RR-5013	498	103	71,2	21,5	2378	718	509	843	127
	511	RR-5020	498	103	71,2	21,5	3638	1099	733	1244	127
75	156	RR-756	718	156	102,6	31,4	1601	490	347	503	146
	333	RR-7513	718	156	102,6	31,4	3417	1046	525	858	146
95	168	RR-1006	933	435	133,3	62,2	2238	1045	357	525	177
	333	RR-10013	933	435	133,3	62,2	4439	2071	524	857	177
	460	RR-10018	933	435	133,3	62,2	6132	2861	687	1147	177
140	57	RR-1502	1386	668	198,1	95,4	1129	544	196	253	203
	156	RR-1506	1386	668	198,1	95,4	3090	1488	385	541	203
	333	RR-15013	1386	668	198,1	95,4	6597	3177	582	915	203
	815	RR-15032	1386	668	198,1	95,4	16145	7775	1116	1931	203
200	152	RR-2006	1995	1017	285,0	145,3	4332	2209	430	582	247
	330	RR-20013	1995	1017	285,0	145,3	9405	4795	608	938	247
	457	RR-20018	1995	1017	285,0	145,3	13025	6640	765	1222	247
	610	RR-20024	1995	1017	285,0	145,3	17385	8863	917	1527	247
	914	RR-20036	1995	1017	285,0	145,3	26049	13280	1222	2136	247
	1219	RR-20048	1995	1017	285,0	145,3	34741	17712	1527	2746	247
325	153	RR-3006	3201	1703	457,3	243,2	6997	3721	485	638	311
	305	RR-30012	3201	1703	457,3	243,2	13947	7418	638	943	311
	457	RR-30018	3201	1703	457,3	243,2	20889	11114	790	1247	311
	609	RR-30024	3201	1703	457,3	243,2	27850	14811	943	1552	311
	915	RR-30036	3201	1703	457,3	243,2	41843	22253	1247	2162	311
	1219	RR-30048	3201	1703	457,3	243,2	55745	29646	1552	2771	311
440	152	RR-4006	4292	2297	613,1	328,1	9319	4987	538	690	358
	305	RR-40012	4292	2297	613,1	328,1	18700	10007	690	995	358
	457	RR-40018	4292	2297	613,1	328,1	28018	14995	843	1300	358
	610	RR-40024	4292	2297	613,1	328,1	37400	20014	995	1605	358
	914	RR-40036	4292	2297	613,1	328,1	56037	29988	1300	2214	358
	1219	RR-40048	4292	2297	613,1	328,1	74737	39996	1605	2824	358
520	153	RR-5006	5108	2838	729,7	405,4	11164	6203	577	730	397
	305	RR-50012	5108	2838	729,7	405,4	22256	12365	730	1035	397
	457	RR-50018	5108	2838	729,7	405,4	33347	18526	882	1339	397
	609	RR-50024	5108	2838	729,7	405,4	44440	24689	1035	1644	397
	915	RR-50036	5108	2838	729,7	405,4	66768	36973	1339	2254	397
	1219	RR-50048	5108	2838	729,7	405,4	88951	49418	1644	2863	397

\* For RR-1010 and RR-1012: N = 32 mm; for RR-308 and RR-3014: N = 55 mm.



# Double-Acting Long Stroke Cylinders

Capacity:  
**10 - 520 ton**

Stroke:  
**57 - 1219 mm**

Maximum Operating Pressure:  
**700 bar**

**RR**  
Series



Cyl. Bore Dia. E (mm)	Plgr. Dia. F (mm)	Base to Adv. Port H (mm)	Top to Ret. Port I (mm)	Saddle Dia. J (mm)	Saddle Protr. fr. Plgr. K (mm)	Plunger Internal Thread O	Plunger Thread Length P (mm)	Base Mounting Holes			Collar Thread W	Collar Thread Length X (mm)	Model Number	
								Bolt Circle U (mm)	Thread V	Thread Depth Z (mm)				
42,9	34,9	36	57	35	6	1" - 8	25	-	-	-	2 1/4" - 14	26	12	RR-1010*
42,9	34,9	36	57	35	6	1" - 8	25	-	-	-	2 1/4" - 14	26	14	RR-1012*
73,2	54,1	39	81	50	10	1 1/2" - 16	25	-	-	-	3 5/16" - 12	49	18	RR-308*
73,2	54,1	39	81	50	10	1 1/2" - 16	25	-	-	-	3 5/16" - 12	49	29	RR-3014*
95,2	79,5	28	76	71	2	1" - 12	25	-	-	-	5" - 12	44	30	RR-506
95,2	79,5	28	76	71	2	1" - 12	25	-	-	-	5" - 12	44	52	RR-5013
95,2	79,5	57	76	71	2	1" - 12	25	76	1/2" - 13	25	5" - 12	44	68	RR-5020
114,3	95,2	30	76	71	6	1" - 12	38	-	-	-	5 3/4" - 12	38	41	RR-756
114,3	95,2	30	81	71	6	1" - 12	38	-	-	-	5 3/4" - 12	38	68	RR-7513
130,3	95,2	38	71	76	3	1 3/4" - 12	35	139	3/4" - 10	25	6 7/8" - 12	50	61	RR-1006
130,3	95,2	38	71	76	3	1 3/4" - 12	35	139	3/4" - 10	25	6 7/8" - 12	50	93	RR-10013
130,3	95,2	41	92	76	3	1 3/4" - 12	35	139	3/4" - 10	25	6 7/8" - 12	50	117	RR-10018
158,8	114,3	22	66	95	19	-	-	-	-	-	-	-	49	RR-1502
158,8	114,3	49	84	114	19	3 3/8" - 16	35	158	3/4" - 16	28	8" - 12	55	93	RR-1506
158,8	114,3	49	84	114	19	3 3/8" - 16	35	158	3/4" - 16	28	8" - 12	55	124	RR-15013
158,8	114,3	76	88	114	19	3 3/8" - 16	35	-	-	-	8" - 12	55	238	RR-15032
190,5	133,4	57	96	133	22	-	-	127	1" - 8	25	-	-	147	RR-2006
190,5	133,4	57	96	133	22	2 1/2" - 12	63	127	1" - 8	25	9 3/4" - 12	54	199	RR-20013
190,5	133,4	85	101	133	22	2 1/2" - 12	63	127	1" - 8	25	9 3/4" - 12	54	204	RR-20018
190,5	133,4	85	101	133	22	2 1/2" - 12	63	127	1" - 8	25	9 3/4" - 12	54	279	RR-20024
190,5	133,4	85	101	133	22	2 1/2" - 12	63	127	1" - 8	25	9 3/4" - 12	54	383	RR-20036
190,5	133,4	85	101	133	22	2 1/2" - 12	63	127	1" - 8	25	9 3/4" - 12	54	483	RR-20048
241,3	165,1	88	114	165	28	2 1/2" - 12	82	158	1 1/4" - 7	44	12 1/4" - 12	58	200	RR-3006
241,3	165,1	88	114	165	28	2 1/2" - 12	82	158	1 1/4" - 7	44	12 1/4" - 12	58	312	RR-30012
241,3	165,1	88	114	165	28	2 1/2" - 12	82	158	1 1/4" - 7	44	12 1/4" - 12	58	385	RR-30018
241,3	165,1	88	114	165	28	2 1/2" - 12	82	158	1 1/4" - 7	44	12 1/4" - 12	58	469	RR-30024
241,3	165,1	88	114	165	28	2 1/2" - 12	82	158	1 1/4" - 7	44	12 1/4" - 12	58	628	RR-30036
241,3	165,1	88	114	165	28	2 1/2" - 12	82	158	1 1/4" - 7	44	12 1/4" - 12	58	780	RR-30048
279,4	190,5	108	133	190	28	3" - 12	95	203	1 1/2" - 6	50	14 1/8" - 8	65	303	RR-4006
279,4	190,5	108	133	190	28	3" - 12	95	203	1 1/2" - 6	50	14 1/8" - 8	65	399	RR-40012
279,4	190,5	108	133	190	28	3" - 12	95	203	1 1/2" - 6	50	14 1/8" - 8	65	453	RR-40018
279,4	190,5	108	133	190	28	3" - 12	95	203	1 1/2" - 6	50	14 1/8" - 8	65	597	RR-40024
279,4	190,5	108	133	190	28	3" - 12	95	203	1 1/2" - 6	50	14 1/8" - 8	65	792	RR-40036
279,4	190,5	108	133	190	28	3" - 12	95	203	1 1/2" - 6	50	14 1/8" - 8	65	980	RR-40048
304,8	203,2	120	152	203	28	3 1/4" - 12	108	203	1 3/4" - 5	57	15 5/8" - 8	79	432	RR-5006
304,8	203,2	120	152	203	28	3 1/4" - 12	108	203	1 3/4" - 5	57	15 5/8" - 8	79	589	RR-50012
304,8	203,2	120	152	203	28	3 1/4" - 12	108	203	1 3/4" - 5	57	15 5/8" - 8	79	680	RR-50018
304,8	203,2	120	152	203	28	3 1/4" - 12	108	203	1 3/4" - 5	57	15 5/8" - 8	79	816	RR-50024
304,8	203,2	120	152	203	28	3 1/4" - 12	108	203	1 3/4" - 5	57	15 5/8" - 8	79	1002	RR-50036
304,8	203,2	120	152	203	28	3 1/4" - 12	108	203	1 3/4" - 5	57	15 5/8" - 8	79	1224	RR-50048

▼ HCL-2006, HCG-2002, HCR-2006



## Reaching the Summit Edition:

- Nitrocarburized hardened surfaces offers improved protection against side-load scoring and cyclic wear
- Weather protected, inside and out
- Low-friction locking rings spin easy, save time and effort <sup>1)</sup>
- State of the art bearing materials reduce wear and avoid bore damage even in high side-load conditions

## Low wear, high pressure seals

- Improved seal design and material selection increases seal performance even in harsh conditions
- Low friction for faster retraction, longer life

## Versatile

- Over 220 models in 5 configurations <sup>1)</sup>
- Certified lifting eyes, base mounting holes and collar threads are included for secure handling and cylinder mounting <sup>1)</sup>

<sup>1)</sup> See specific models technical data for more information.

## Highest Level of Durability



### The Summit Edition

Innovation is at the heart of the new Summit Edition cylinders, delivering the high quality construction you expect from Enerpac. The design and durability add safety and reliability to your job.

- Plunger support bearing adds support for eccentric loads <sup>2)</sup>
- Nitrocarburization surface treatment for improved wear resistance and corrosion protection
- Low wear, high pressure seals provide longer service life.

<sup>2)</sup> Eccentric load (or "side-load") is inevitable in heavy lifting. Our unique Summit Edition features provide the ultimate protection against side-load. Increased bearing surface maintains stability and nitrocarburization treatment prevents scoring on the inside of the cylinder. Side-load poses a real problem.... our new cylinder features are the solution!

▼ Bridge lifting and launching system. The load is balanced on groups of lock nut cylinders. The hydraulic movements are synchronised using the Enerpac PLC-controlled synchronous lift system.





## High Tonnage Cylinders

The Enerpac High Tonnage Cylinders are particularly suitable for (multipoint) lifting applications.

### HCG, HCR, HCL-Series Cylinders

- 50 - 1000 ton lifting capacity
- 50 - 300 mm stroke

### HCG-Series - single-acting

- gravity return
- stop ring to prevent plunger blow-out
- designed to withstand up to 10% side-load of maximum capacity.

### HCR-Series - double-acting

- hydraulic advance and retract for controlled movement
- designed to withstand up to 10% side-load of maximum capacity.

### HCL-Series - lock nut, single-acting

- gravity return
- lock nut for mechanical load holding
- overflow port to prevent plunger blow out
- designed to withstand 10% side-load up to 90% of maximum stroke.

### HCRL-Series - lock nut, double-acting

- hydraulic advance and retract
- designed to withstand up to 10% side-load of maximum capacity
- integrated tilt saddle
- lock nut for mechanical load holding
- 50 - 300 ton lifting capacity
- 150 - 300 mm stroke

### LPL-Series - lock nut, low height, single-acting (see page 26)

- 60 - 500 ton lifting capacity;
- 45 - 50 mm lifting stroke
- integrated tilt saddle
- gravity return
- lock nut for mechanical load holding
- 5-10% side-load of maximum capacity.

In combination with our state of the art power packs, you will have a world class hydraulic system to perform the most challenging lifting jobs in a safe and professional manner. See page 71 for more information on our pump offering.

Page: 42

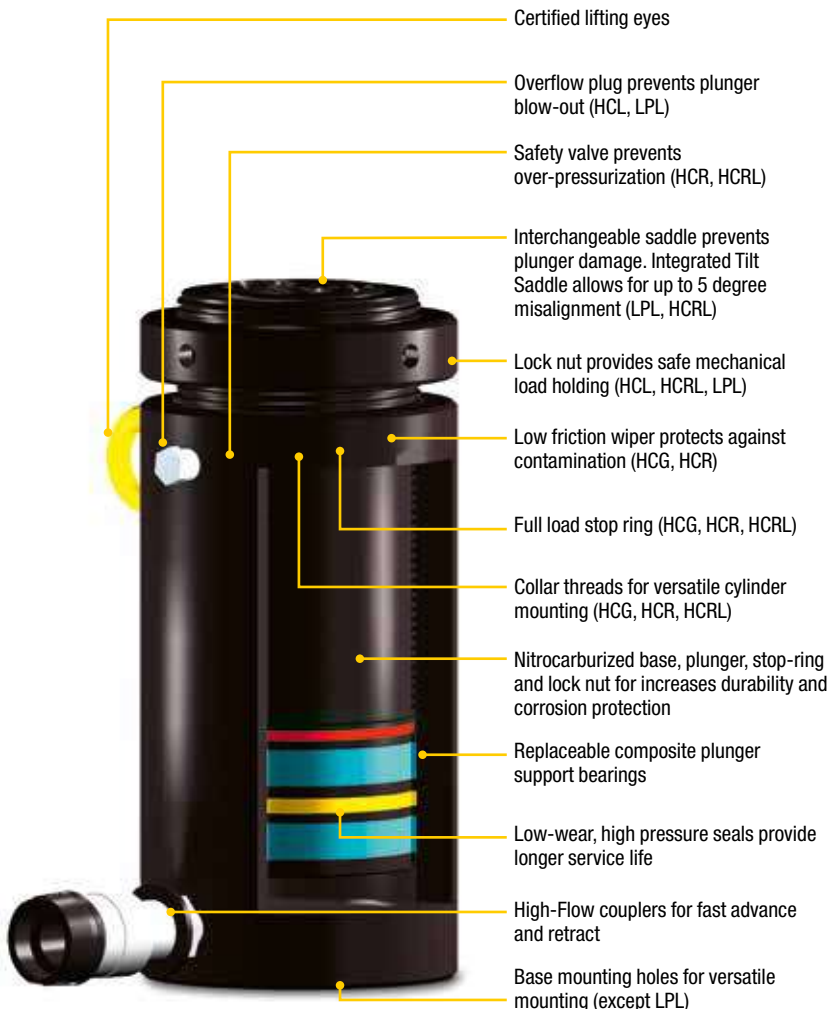

## HCG HCR HCL HCRL Series



Capacity:

**50 - 1000 ton**

Stroke:

**50 - 300 mm**

Maximum Operating Pressure:

**700 bar**



### Assisted Return Pumps

Enerpac HCG, HCL and LPL-Series cylinders are hydraulic advance and gravity return. To improve productivity and plunger retraction

Enerpac offers assisted return on ZU4 and ZE-Series pumps featuring Enerpac Venturi valve technology, specifically to facilitate the faster return of single-acting, spring and gravity return cylinders. See [enerpac.com](http://enerpac.com) for details.

Page: 91



### Split-Flow Pumps

SFP-Series pumps with multiple outlets with equal oil flow. For lifting and lowering applications on multiple points these pumps

are a far better alternative than using separately operated pumps.

Page: 240



### Synchronous Lifting Systems

Pumps for multiple lift point capabilities. The economical **EVOB-Series** for basic applications and the multi-functional **EVO-Series** lifting system.

Page: 242



**QUICK SELECTION**

Cylinder Capacity ton	Stroke (mm)	Maximum Cylinder Capacity at 700 bar ton (kN)	HCG-Series		HCR-Series		HCL-Series		HCRL-Series *	
			Model Number Single-Acting <i>Page: 44</i>	Collapsed Height (mm)	Model Number Double-Acting <i>Page: 48</i>	Collapsed Height (mm)	Model Number Single-Acting With Lock Nut <i>Page: 52</i>	Collapsed Height (mm)	Model Number Double-Acting With Lock Nut <i>Page: 56</i>	Collapsed Height (mm)
50	50	56 (550)	HCG-502	183	HCR-502	183	HCL-502	164	-	-
	100		HCG-504	233	HCR-504	233	HCL-504	214	-	-
	150		HCG-506	283	HCR-506	283	HCL-506	264	HCRL-506	310
	200		HCG-508	346	HCR-508	346	HCL-508	314	HCRL-508	377
	250		HCG-5010	396	HCR-5010	396	HCL-5010	364	HCRL-5010	427
	300		HCG-5012	446	HCR-5012	446	HCL-5012	414	HCRL-5012	477
100	50	102 (1002)	HCG-1002	202	HCR-1002	202	HCL-1002	187	-	-
	100		HCG-1004	252	HCR-1004	252	HCL-1004	237	-	-
	150		HCG-1006	302	HCR-1006	302	HCL-1006	287	HCRL-1006	346
	200		HCG-1008	379	HCR-1008	379	HCL-1008	337	HCRL-1008	421
	250		HCG-10010	429	HCR-10010	429	HCL-10010	387	HCRL-10010	471
	300		HCG-10012	479	HCR-10012	479	HCL-10012	437	HCRL-10012	521
150	50	153 (1497)	HCG-1502	220	HCR-1502	220	HCL-1502	209	-	-
	100		HCG-1504	270	HCR-1504	270	HCL-1504	259	-	-
	150		HCG-1506	320	HCR-1506	320	HCL-1506	309	HCRL-1506	359
	200		HCG-1508	397	HCR-1508	397	HCL-1508	359	HCRL-1508	434
	250		HCG-15010	447	HCR-15010	447	HCL-15010	409	HCRL-15010	484
	300		HCG-15012	497	HCR-15012	497	HCL-15012	459	HCRL-15012	534
200	50	202 (1985)	HCG-2002	231	HCR-2002	231	HCL-2002	238	-	-
	100		HCG-2004	281	HCR-2004	281	HCL-2004	288	-	-
	150		HCG-2006	331	HCR-2006	331	HCL-2006	338	HCRL-2006	399
	200		HCG-2008	408	HCR-2008	408	HCL-2008	388	HCRL-2008	469
	250		HCG-20010	458	HCR-20010	458	HCL-20010	438	HCRL-20010	519
	300		HCG-20012	508	HCR-20012	508	HCL-20012	488	HCRL-20012	569
250	50	259 (2541)	HCG-2502	241	HCR-2502	241	HCL-2502	249	-	-
	100		HCG-2504	291	HCR-2504	291	HCL-2504	299	-	-
	150		HCG-2506	341	HCR-2506	341	HCL-2506	349	HCRL-2506	416
	200		HCG-2508	431	HCR-2508	431	HCL-2508	399	HCRL-2508	491
	250		HCG-25010	481	HCR-25010	481	HCL-25010	449	HCRL-25010	541
	300		HCG-25012	531	HCR-25012	531	HCL-25012	499	HCRL-25012	591
300	50	310 (3036)	HCG-3002	296	HCR-3002	296	HCL-3002	278	-	-
	100		HCG-3004	346	HCR-3004	346	HCL-3004	328	-	-
	150		HCG-3006	396	HCR-3006	396	HCL-3006	378	HCRL-3006	421
	200		HCG-3008	446	HCR-3008	446	HCL-3008	428	HCRL-3008	496
	250		HCG-30010	496	HCR-30010	496	HCL-30010	478	HCRL-30010	546
	300		HCG-30012	546	HCR-30012	546	HCL-30012	528	HCRL-30012	596

\* See page 56 for HCRL-cylinder maximum capacity.



# Enerpac High Tonnage Cylinders

Capacity:  
**50 - 1000 ton**

Stroke:  
**50 - 300 mm**

Maximum Operating Pressure:  
**700 bar**

**HCG  
HCR  
HCL  
HCRL  
Series**



## QUICK SELECTION

Cylinder Capacity ton	Stroke (mm)	Maximum Cylinder Capacity at 700 bar ton (kN)	HCG-Series		HCR-Series		HCL-Series	
			Model Number Single-Acting  Page: 46	Collapsed Height (mm)	Model Number Double-Acting  Page: 50	Collapsed Height (mm)	Model Number Single-Acting With Lock Nut  Page: 54	Collapsed Height (mm)
400	50	409 (4008)	HCG-4002	321	HCR-4002	321	HCL-4002	317
	100		HCG-4004	371	HCR-4004	371	HCL-4004	367
	150		HCG-4006	421	HCR-4006	421	HCL-4006	417
	200		HCG-4008	471	HCR-4008	471	HCL-4008	467
	250		HCG-40010	521	HCR-40010	521	HCL-40010	517
	300		HCG-40012	571	HCR-40012	571	HCL-40012	567
500	50	522 (5114)	HCG-5002	344	HCR-5002	344	HCL-5002	357
	100		HCG-5004	394	HCR-5004	394	HCL-5004	407
	150		HCG-5006	444	HCR-5006	444	HCL-5006	457
	200		HCG-5008	494	HCR-5008	494	HCL-5008	507
	250		HCG-50010	544	HCR-50010	544	HCL-50010	557
	300		HCG-50012	594	HCR-50012	594	HCL-50012	607
600	50	611 (5987)	HCG-6002	352	HCR-6002	352	HCL-6002	380
	100		HCG-6004	402	HCR-6004	402	HCL-6004	430
	150		HCG-6006	452	HCR-6006	452	HCL-6006	480
	200		HCG-6008	502	HCR-6008	502	HCL-6008	530
	250		HCG-60010	552	HCR-60010	552	HCL-60010	580
	300		HCG-60012	602	HCR-60012	602	HCL-60012	630
800	50	831 (8149)	HCG-8002	404	HCR-8002	404	HCL-8002	430
	100		HCG-8004	454	HCR-8004	454	HCL-8004	480
	150		HCG-8006	504	HCR-8006	504	HCL-8006	530
	200		HCG-8008	554	HCR-8008	554	HCL-8008	580
	250		HCG-80010	604	HCR-80010	604	HCL-80010	630
	300		HCG-80012	654	HCR-80012	654	HCL-80012	680
1000	50	1085 (10.644)	HCG-10002	442	HCR-10002	442	HCL-10002	484
	100		HCG-10004	492	HCR-10004	492	HCL-10004	534
	150		HCG-10006	542	HCR-10006	542	HCL-10006	584
	200		HCG-10008	592	HCR-10008	592	HCL-10008	634
	250		HCG-100010	642	HCR-100010	642	HCL-100010	684
	300		HCG-100012	692	HCR-100012	692	HCL-100012	734

# HCG-Series, High Tonnage Cylinders

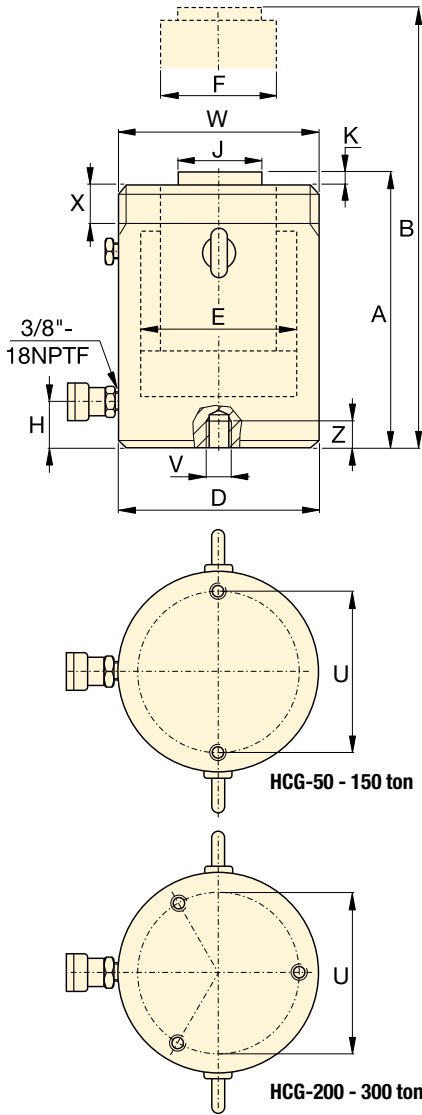

## HCG-Series, Single-Acting, Gravity Return Cylinders

- Hardened surface resists side-loading and cyclic wear
- Designed to withstand 10% side-load of maximum capacity <sup>1)</sup>
- Stop ring to prevent plunger blow-out
- Weather protected, inside and out
- Upper and lower replaceable bearings enclose the cylinder plunger for support throughout the stroke
- Certified lifting eyes, base mounting holes and collar threads.

### SELECTION CHART 50 - 300 TON HCG-MODELS

For 400 - 1000 ton models, see pages 46-47.

For full product features see pages 40-41.

Cylinder Capacity ton	Stroke (mm)	Model Number	Maximum Cylinder Capacity at 700 bar ton (kN)	Cylinder Effective Area (cm <sup>2</sup> )	Oil Capacity (cm <sup>3</sup> )	Collapsed Height A (mm)
50	50	HCG-502	56 (550)	78,5	393	183
	100	HCG-504			785	233
	150	HCG-506 <sup>1)</sup>			1178	283
	200	HCG-508			1571	346
	250	HCG-5010			1963	396
	300	HCG-5012 <sup>1)</sup>			2356	446
100	50	HCG-1002	102 (1002)	143,1	716	202
	100	HCG-1004			1431	252
	150	HCG-1006			2147	302
	200	HCG-1008			2863	379
	250	HCG-10010			3578	429
	300	HCG-10012			4294	479
150	50	HCG-1502	153 (1497)	213,8	1069	220
	100	HCG-1504			2138	270
	150	HCG-1506			3207	320
	200	HCG-1508			4276	397
	250	HCG-15010			5346	447
	300	HCG-15012			6415	497
200	50	HCG-2002	202 (1985)	283,5	1418	231
	100	HCG-2004			2835	281
	150	HCG-2006			4253	331
	200	HCG-2008			5671	408
	250	HCG-20010			7088	458
	300	HCG-20012			8506	508
250	50	HCG-2502	259 (2541)	363,1	1815	241
	100	HCG-2504			3631	291
	150	HCG-2506			5446	341
	200	HCG-2508			7261	431
	250	HCG-25010			9076	481
	300	HCG-25012			10.892	531
300	50	HCG-3002	310 (3036)	433,7	2169	296
	100	HCG-3004			4337	346
	150	HCG-3006			6506	396
	200	HCG-3008			8675	446
	250	HCG-30010			10.843	496
	300	HCG-30012			13.012	546

Collar Thread (mm)		
Model / Capacity ton	Thread Size	Thread Length
	W	X
HCG-50	M130 x 2	30
HCG-100	M175 x 3	46
HCG-150	M215 x 3	55
HCG-200	M250 x 3	63
HCG-250	M280 x 3	64
HCG-300	M305 x 3	73

The collar thread length is designed for the full rated cylinder capacity.

Base Mounting Holes (mm)					
Model / Capacity ton	Bolt Circle	Thread Size	Minimum Thread Depth	Number of Holes	Angle from Coupler
	U	V	Z		
HCG-50	105	M12 x 1,75	22	2	90°
HCG-100	150	M12 x 1,75	22	2	90°
HCG-150	185	M12 x 1,75	22	2	90°
HCG-200	215	M12 x 1,75	22	3	60°
HCG-250	245	M12 x 1,75	22	3	60°
HCG-300	260	M16 x 2	25	3	60°

<sup>1)</sup> HCG-506 and HCG-5012: 7% side-load of maximum capacity.

# Single-Acting, High Tonnage Cylinders

Capacity:  
**50 - 300 ton**

Stroke:  
**50 - 300 mm**

Maximum Operating Pressure:  
**700 bar**

**HCG**  
Series

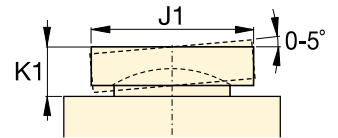

CATG-Serie Tilt Saddle

	Extended Height B (mm)	Outside Diameter D (mm)	Cylinder Bore Diameter E (mm)	Plunger Diameter F (mm)	Base to Advance Port H (mm)	Standard Saddle Diameter J (mm)	Saddle Protrusion from Plunger K (mm)	 (kg)	Model Number	Optional Tilt Saddle		
										Diameter J1 (mm)	Height K1 (mm)	Saddle Model Number
	233	130	100	70	38	50	3	17	HCG-502	50	24	CATG-50
	333							20	HCG-504			
	433							24	HCG-506 <sup>1)</sup>			
	546							29	HCG-508			
	646							32	HCG-5010			
	746							36	HCG-5012 <sup>1)</sup>			
	252	175	135	95	38	75	3	33	HCG-1002	73	29	CATG-100
	352							40	HCG-1004			
	452							46	HCG-1006			
	579							58	HCG-1008			
	679							65	HCG-10010			
	779							71	HCG-10012			
	270	215	165	120	41	94	3	56	HCG-1502	91	31	CATG-150
	370							66	HCG-1504			
	470							76	HCG-1506			
	597							94	HCG-1508			
	697							104	HCG-15010			
	797							115	HCG-15012			
	281	250	190	140	47	113	3	81	HCG-2002	118	35	CATG-200
	381							95	HCG-2004			
	481							109	HCG-2006			
	608							136	HCG-2008			
	708							150	HCG-20010			
	808							164	HCG-20012			
	291	280	215	170	53	145	4	107	HCG-2502	144	47	CATG-250
	391							125	HCG-2504			
	491							144	HCG-2506			
	631							182	HCG-2508			
	731							201	HCG-25010			
	831							219	HCG-25012			
	346	305	235	200	58	177	4	158	HCG-3002	160	64	CATG-300
	446							182	HCG-3004			
	546							206	HCG-3006			
	646							230	HCG-3008			
	746							254	HCG-30010			
	846							278	HCG-30012			

## HCG-Series, Single-Acting, Gravity Return Cylinders

- Hardened surface resists side-loading and cyclic wear
- Designed to withstand 10% side-load of maximum capacity
- Stop ring to prevent plunger blow-out
- Weather protected, inside and out
- Upper and lower replaceable bearings enclose the cylinder plunger for support throughout the stroke
- Certified lifting eyes, base mounting holes
- Optional collar threads on 400 ton models and higher capacities.

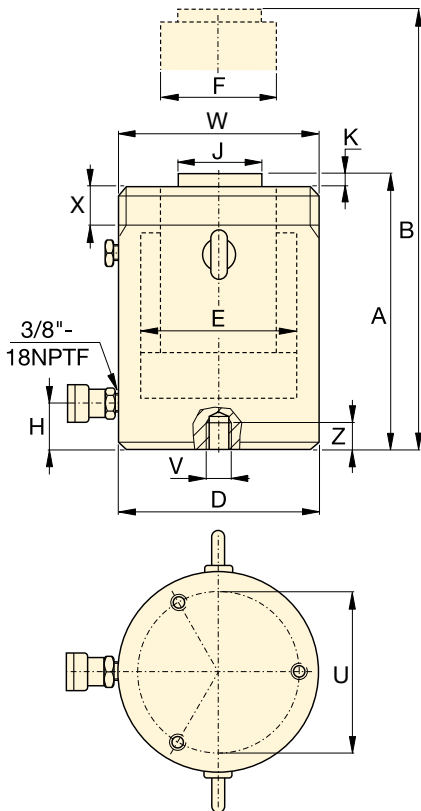

Optional Collar Thread (mm)		
Model / Capacity ton	Thread Size	Thread Length
	W	X
HCG-400	M350 x 3	83
HCG-500	M400 x 4	90
HCG-600	M430 x 4	100
HCG-800	M505 x 5	122
HCG-1000	M570 x 5	137

Collar thread is optional on 400 ton models and higher. For collar thread on cylinder add suffix "E002" to model number. Example: **HCG4006E002**

The collar thread length is designed for the full rated cylinder capacity.

Base Mounting Holes (mm)					
Model / Capacity ton	Bolt Circle	Thread Size	Minimum Thread Depth	Number of Holes	Angle from Coupler
	U	V	Z		
HCG-400	300	M16 x 2	25	3	60°
HCG-500	340	M24 x 3	36	3	60°
HCG-600	370	M24 x 3	36	3	60°
HCG-800	440	M24 x 3	36	3	60°
HCG-1000	500	M24 x 3	36	3	60°

## SELECTION CHART 400 - 1000 TON HCG-MODELS

For 50 - 300 ton models, see pages 44-45.

For full product features see pages 40-41.

Cylinder Capacity ton	Stroke (mm)	Model Number	Maximum Cylinder Capacity at 700 bar ton (kN)	Cylinder Effective Area (cm <sup>2</sup> )	Oil Capacity (cm <sup>3</sup> )	Collapsed Height A (mm)
400	50	HCG-4002	409 (4008)	572,6	2863	321
	100	HCG-4004			5726	371
	150	HCG-4006			8588	421
	200	HCG-4008			11.451	471
	250	HCG-40010			14.314	521
	300	HCG-40012			17.177	571
500	50	HCG-5002	522 (5114)	730,6	3653	344
	100	HCG-5004			7306	394
	150	HCG-5006			10.959	444
	200	HCG-5008			14.612	494
	250	HCG-50010			18.265	544
	300	HCG-50012			21.918	594
600	50	HCG-6002	611 (5987)	855,3	4276	352
	100	HCG-6004			8553	402
	150	HCG-6006			12.829	452
	200	HCG-6008			17.106	502
	250	HCG-60010			21.382	552
	300	HCG-60012			25.659	602
800	50	HCG-8002	831 (8149)	1164,2	5821	404
	100	HCG-8004			11.642	454
	150	HCG-8006			17.462	504
	200	HCG-8008			23.283	554
	250	HCG-80010			29.104	604
	300	HCG-80012			34.925	654
1000	50	HCG-10002	1085 (10.644)	1520,5	7603	442
	100	HCG-10004			15.205	492
	150	HCG-10006			22.808	542
	200	HCG-10008			30.411	592
	250	HCG-100010			38.013	642
	300	HCG-100012			45.616	692



# Single-Acting, High Tonnage Cylinders



▲ Offshore wind turbines levelling: Enerpac's synchronous lifting system was the solution for levelling support cross pieces on 80 wind turbines.

## HCG Series



Capacity:  
**400 - 1000 ton**

Stroke:  
**50 - 300 mm**

Maximum Operating Pressure:  
**700 bar**

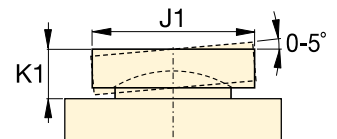

CATG-Series Tilt Saddle

Extended Height B (mm)	Outside Diameter D (mm)	Cylinder Bore Diameter E (mm)	Plunger Diameter F (mm)	Base to Advance Port H (mm)	Standard Saddle Diameter J (mm)	Saddle Protrusion from Plunger K (mm)	Model Number	Optional Tilt Saddle		
								Diameter J1 (mm)	Height K1 (mm)	Saddle Model Number
371	350	270	220	74	196	4	227 HCG-4002	193	59	CATG-400
471							257 HCG-4004			
571							287 HCG-4006			
671							317 HCG-4008			
771							347 HCG-40010			
871							378 HCG-40012			
394	400	305	250	79	228	4	319 HCG-5002	228	63	CATG-500
494							359 HCG-5004			
594							399 HCG-5006			
694							439 HCG-5008			
794							479 HCG-50010			
894							519 HCG-50012			
402	430	330	270	85	247	4	378 HCG-6002	241	78	CATG-600
502							424 HCG-6004			
602							470 HCG-6006			
702							516 HCG-6008			
802							562 HCG-60010			
902							608 HCG-60012			
454	505	385	320	100	297	4	606 HCG-8002	287	87	CATG-800
554							671 HCG-8004			
654							735 HCG-8006			
754							800 HCG-8008			
854							864 HCG-80010			
954							929 HCG-80012			
492	570	440	340	114	323	4	840 HCG-10002	311	93	CATG-1000
592							916 HCG-10004			
692							992 HCG-10006			
792							1068 HCG-10008			
892							1145 HCG-100010			
992							1221 HCG-100012			

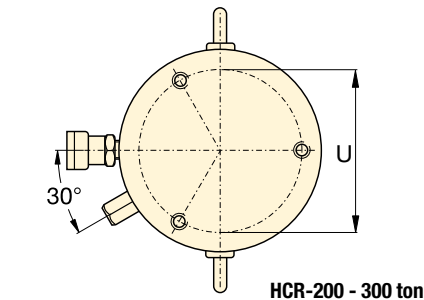
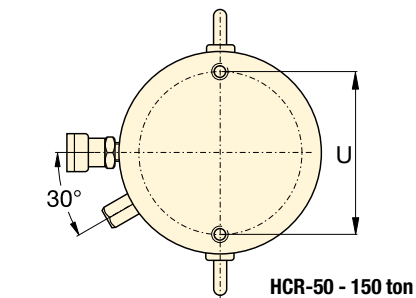
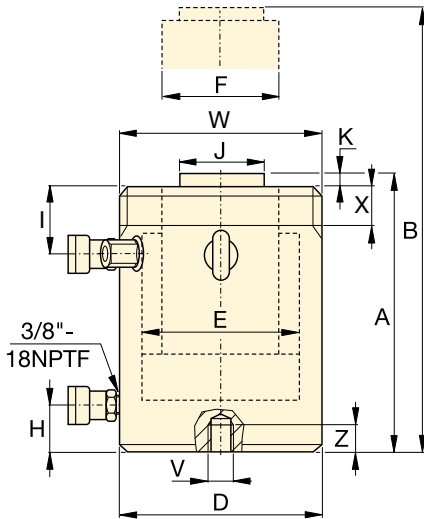

Collar Thread (mm)		
Model / Capacity ton	Thread Size	Thread Length
	W	X
HCR-50	M130 x 2	30
HCR-100	M175 x 3	46
HCR-150	M215 x 3	55
HCR-200	M250 x 3	63
HCR-250	M280 x 3	64
HCR-300	M305 x 3	73

The collar thread length is designed for the full rated cylinder capacity.

Base Mounting Holes (mm)					
Model / Capacity ton	Bolt Circle	Thread Size	Minimum Thread Depth	Number of Holes	Angle from Coupler
	U	V	Z		
HCR-50	105	M12 x 1,75	22	2	90°
HCR-100	150	M12 x 1,75	22	2	90°
HCR-150	185	M12 x 1,75	22	2	90°
HCR-200	215	M12 x 1,75	22	3	60°
HCR-250	245	M12 x 1,75	22	3	60°
HCR-300	260	M16 x 2	25	3	60°

## HCR-Series, Double-Acting Cylinders

- Fast advance and retract
- Designed to withstand 10% side-load of maximum capacity<sup>1)</sup>
- Hardened surface resists side-loading and cyclic wear
- Weather protected, inside and out
- Upper and lower replaceable bearings enclose the cylinder plunger for support throughout the stroke
- Certified lifting eyes, base mounting holes and collar threads.

### SELECTION CHART & DETAILS OF 50 - 300 TON HCR-MODELS

For 400 - 1000 ton models, see pages 50-51.

For full product features see pages 40-41.

Cylinder Capacity	Stroke	Model Number	Maximum Cylinder Capacity at 700 bar ton (kN)	Cylinder Effective Area	Oil Capacity	Collapsed Height
ton	(mm)			(cm <sup>2</sup> )	(cm <sup>3</sup> )	A (mm)
50	50	HCR-502	56 (550)	78,5	393	183
	100	HCR-504			785	233
	150	HCR-506 <sup>1)</sup>			1178	283
	200	HCR-508			1571	346
	250	HCR-5010			1963	396
	300	HCR-5012 <sup>1)</sup>			2356	446
100	50	HCR-1002	102 (1002)	143,1	716	202
	100	HCR-1004			1431	252
	150	HCR-1006			2147	302
	200	HCR-1008			2863	379
	250	HCR-10010			3578	429
	300	HCR-10012			4294	479
150	50	HCR-1502	153 (1497)	213,8	1069	220
	100	HCR-1504			2138	270
	150	HCR-1506			3207	320
	200	HCR-1508			4276	397
	250	HCR-15010			5346	447
	300	HCR-15012			6415	497
200	50	HCR-2002	202 (1985)	283,5	1418	231
	100	HCR-2004			2835	281
	150	HCR-2006			4253	331
	200	HCR-2008			5671	408
	250	HCR-20010			7088	458
	300	HCR-20012			8506	508
250	50	HCR-2502	259 (2541)	363,1	1815	241
	100	HCR-2504			3631	291
	150	HCR-2506			5446	341
	200	HCR-2508			7261	431
	250	HCR-25010			9076	481
	300	HCR-25012			10.892	531
300	50	HCR-3002	310 (3036)	433,7	2169	296
	100	HCR-3004			4337	346
	150	HCR-3006			6506	396
	200	HCR-3008			8675	446
	250	HCR-30010			10.843	496
	300	HCR-30012			13.012	546

<sup>1)</sup> HCR-506 and HCR-5012: 7% side-load of maximum capacity.

# Double-Acting, High Tonnage Cylinders

Capacity:  
**50 - 300 ton**

Stroke:  
**50 - 300 mm**

Maximum Operating Pressure:  
**700 bar**

**HCR Series**

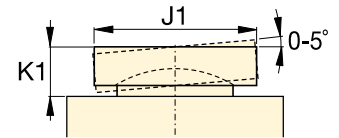

CATG-Series Tilt Saddle

	Extended Height B (mm)	Outside Diameter D (mm)	Cylinder Bore Diameter E (mm)	Plunger Diameter F (mm)	Base to Advance Port H (mm)	Top to Retract Port I (mm)	Standard Saddle Diameter J (mm)	Saddle Protrusion from Plunger K (mm)	 (kg)	Model Number	Optional Tilt Saddle		
											Diameter J1 (mm)	Height K1 (mm)	Saddle Model Number
	233	130	100	70	38	45	50	3	17	HCR-502	50	24	CATG-50
	333								21	HCR-504			
	433								25	HCR-506 <sup>1)</sup>			
	546								31	HCR-508			
	646								34	HCR-5010			
	746								38	HCR-5012 <sup>1)</sup>			
	252	175	135	95	38	65	75	3	34	HCR-1002	73	29	CATG-100
	352								41	HCR-1004			
	452								48	HCR-1006			
	579								59	HCR-1008			
	679								66	HCR-10010			
	779								73	HCR-10012			
	270	215	165	120	41	70	94	3	56	HCR-1502	91	31	CATG-150
	370								67	HCR-1504			
	470								78	HCR-1506			
	597								95	HCR-1508			
	697								106	HCR-15010			
	797								116	HCR-15012			
	281	250	190	140	47	79	113	3	81	HCR-2002	118	35	CATG-200
	381								96	HCR-2004			
	481								111	HCR-2006			
	608								139	HCR-2008			
	708								153	HCR-20010			
	808								168	HCR-20012			
	291	280	215	170	53	79	145	4	107	HCR-2502	144	47	CATG-250
	391								127	HCR-2504			
	491								146	HCR-2506			
	631								184	HCR-2508			
	731								207	HCR-25010			
	831								227	HCR-25012			
	346	305	235	200	58	101	177	4	159	HCR-3002	160	64	CATG-300
	446								183	HCR-3004			
	546								208	HCR-3006			
	646								232	HCR-3008			
	746								257	HCR-30010			
	846								281	HCR-30012			

## HCR-Series, Double-Acting Cylinders

- Fast advance and retract
- Designed to withstand 10% side-load of maximum capacity
- Hardened surface resists side-loading and cyclic wear
- Weather protected, inside and out
- Upper and lower replaceable bearings enclose the cylinder plunger for support throughout the stroke
- Certified lifting eyes, base mounting holes and optional collar threads.

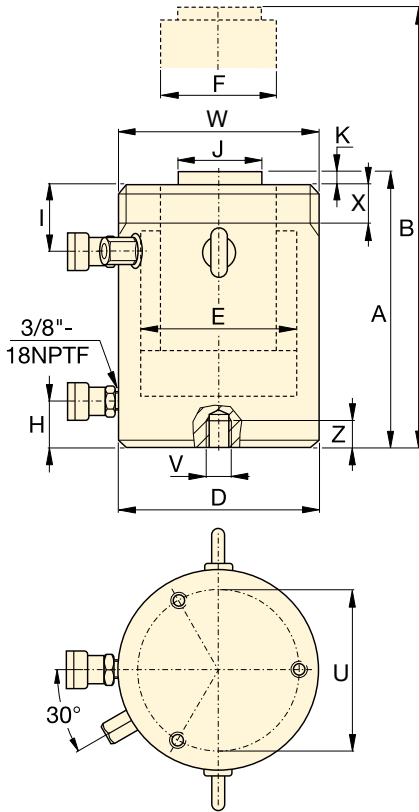

### SELECTION CHART & DETAILS OF 400 - 1000 TON HCR-MODELS

For 50 - 300 ton models, see pages 48-49.

For full product features see pages 40-41.

Cylinder Capacity	Stroke	Model Number	Maximum Cylinder Capacity at 700 bar ton (kN)	Cylinder Effective Area (cm <sup>2</sup> )	Oil Capacity (cm <sup>3</sup> )	Collapsed Height A (mm)
ton	(mm)					
400	50	HCR-4002	409 (4008)	572,6	2863	321
	100	HCR-4004			5726	371
	150	HCR-4006			8588	421
	200	HCR-4008			11.451	471
	250	HCR-40010			14.314	521
	300	HCR-40012			17.177	571
500	50	HCR-5002	522 (5114)	730,6	3653	344
	100	HCR-5004			7306	394
	150	HCR-5006			10.959	444
	200	HCR-5008			14.612	494
	250	HCR-50010			18.265	544
	300	HCR-50012			21.918	594
600	50	HCR-6002	611 (5987)	855,3	4276	352
	100	HCR-6004			8553	402
	150	HCR-6006			12.829	452
	200	HCR-6008			17.106	502
	250	HCR-60010			21.382	552
	300	HCR-60012			25.659	602
800	50	HCR-8002	831 (8149)	1164,2	5821	404
	100	HCR-8004			11.642	454
	150	HCR-8006			17.462	504
	200	HCR-8008			23.283	554
	250	HCR-80010			29.104	604
	300	HCR-80012			34.925	654
1000	50	HCR-10002	1085 (10.644)	1520,5	7603	442
	100	HCR-10004			15.205	492
	150	HCR-10006			22.808	542
	200	HCR-10008			30.411	592
	250	HCR-100010			38.013	642
	300	HCR-100012			45.616	692

#### Optional Collar Thread (mm)

Model / Capacity ton	Thread Size	Thread Length
	W	X
HCR-400	M350 x 3	83
HCR-500	M400 x 4	90
HCR-600	M430 x 4	100
HCR-800	M505 x 5	122
HCR-1000	M570 x 5	137

Collar thread is optional on 400 ton models and higher. For collar thread on cylinder add suffix "E002" to model number. Example: **HCR4006E002**

The collar thread length is designed for the full rated cylinder capacity.

#### Base Mounting Holes (mm)

Model / Capacity ton	Bolt Circle	Thread Size	Minimum Thread Depth	Number of Holes	Angle from Coupler
	U	V	Z		
HCR-400	300	M16 x 2	25	3	60°
HCR-500	340	M24 x 3	36	3	60°
HCR-600	370	M24 x 3	36	3	60°
HCR-800	440	M24 x 3	36	3	60°
HCR-1000	500	M24 x 3	36	3	60°



# Double-Acting, High Tonnage Cylinders



▲ The superlifting and launch of a 43.000-ton floating oil production system in Malaysia for the Gumusut-Kakap offshore field has set high benchmarks for safety through its use of sophisticated EVO-Series synchronous hydraulics to lift, balance, weigh and smoothly launch massive resource structures.

## HCR Series



Capacity:  
**400 - 1000 ton**

Stroke:  
**50 - 300 mm**

Maximum Operating Pressure:  
**700 bar**

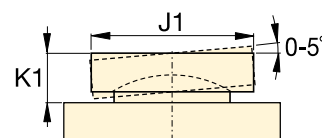

CATG-Series Tilt Saddle

Extended Height B (mm)	Outside Diameter D (mm)	Cylinder Bore Diameter E (mm)	Plunger Diameter F (mm)	Base to Advance Port H (mm)	Top to Retract Port I (mm)	Standard Saddle Diameter J (mm)	Saddle Protrusion from Plunger K (mm)	 (kg)	Model Number	Optional Tilt Saddle		
										Diameter J1 (mm)	Height K1 (mm)	Saddle Model Number
371	350	270	220	74	111	196	4	227	HCR-4002	193	59	CATG-400
471								258	HCR-4004			
571								289	HCR-4006			
671								321	HCR-4008			
771								352	HCR-40010			
871								383	HCR-40012			
394	400	305	250	79	121	228	4	320	HCR-5002	228	63	CATG-500
494								361	HCR-5004			
594								402	HCR-5006			
694								443	HCR-5008			
794								484	HCR-50010			
894								525	HCR-50012			
402	430	330	270	85	121	247	4	379	HCR-6002	241	78	CATG-600
502								427	HCR-6004			
602								474	HCR-6006			
702								521	HCR-6008			
802								568	HCR-60010			
902								615	HCR-60012			
454	505	385	320	100	143	297	4	608	HCR-8002	287	87	CATG-800
554								674	HCR-8004			
654								740	HCR-8006			
754								806	HCR-8008			
854								872	HCR-80010			
954								938	HCR-80012			
492	570	440	340	114	153	323	4	843	HCR-10002	311	93	CATG-1000
592								921	HCR-10004			
692								1000	HCR-10006			
792								1079	HCR-10008			
892								1158	HCR-100010			
992								1236	HCR-100012			

# HCL-Series, High Tonnage Lock Nut Cylinders

## HCL-Series, Single-Acting, Gravity Return Cylinders

- Lock nut provides positive and safe mechanical load holding
- Low-friction locking rings spin easy, save time and effort
- Designed to withstand 10% side-load up to 90% of maximum stroke
- Hardened surface resists side-loading and cyclic wear
- Overflow port as stroke limiter to prevent plunger blow-out
- Weather protected, inside and out
- Replaceable bearings enclose the plunger for support throughout the stroke
- Certified lifting eyes and base mounting holes.

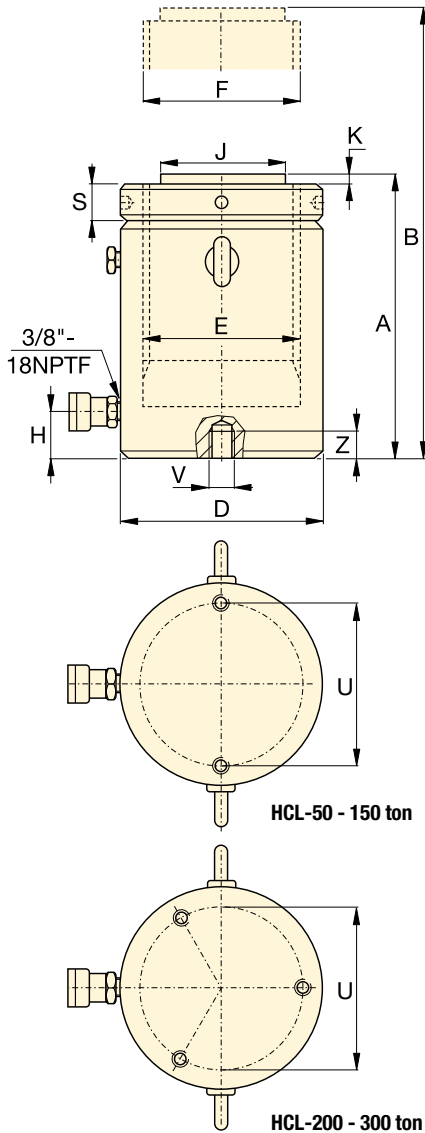

## SELECTION CHART 50 - 300 TON HCL-MODELS

For 400 - 1000 ton models, see pages 54-55.

For full product features see pages 40-41.

Cylinder Capacity ton	Stroke (mm)	Model Number	Maximum Cylinder Capacity at 700 bar ton (kN)	Cylinder Effective Area (cm <sup>2</sup> )	Oil Capacity (cm <sup>3</sup> )	Collapsed Height A (mm)
50	50	HCL-502	56 (550)	78,5	393	164
	100	HCL-504			785	214
	150	HCL-506			1178	264
	200	HCL-508			1571	314
	250	HCL-5010			1963	364
	300	HCL-5012			2356	414
100	50	HCL-1002	102 (1002)	143,1	716	187
	100	HCL-1004			1431	237
	150	HCL-1006			2147	287
	200	HCL-1008			2863	337
	250	HCL-10010			3578	387
	300	HCL-10012			4294	437
150	50	HCL-1502	153 (1497)	213,8	1069	209
	100	HCL-1504			2138	259
	150	HCL-1506			3207	309
	200	HCL-1508			4276	359
	250	HCL-15010			5346	409
	300	HCL-15012			6415	459
200	50	HCL-2002	202 (1985)	283,5	1418	238
	100	HCL-2004			2835	288
	150	HCL-2006			4253	338
	200	HCL-2008			5671	388
	250	HCL-20010			7088	438
	300	HCL-20012			8506	488
250	50	HCL-2502	259 (2541)	363,1	1815	249
	100	HCL-2504			3631	299
	150	HCL-2506			5446	349
	200	HCL-2508			7261	399
	250	HCL-25010			9076	449
	300	HCL-25012			10.892	499
300	50	HCL-3002	310 (3036)	433,7	2169	278
	100	HCL-3004			4337	328
	150	HCL-3006			6506	378
	200	HCL-3008			8675	428
	250	HCL-30010			10.843	478
	300	HCL-30012			13.012	528

Base Mounting Holes (mm)					
Model / Capacity ton	Bolt Circle U	Thread Size V	Minimum Thread Depth Z	Number of Holes	Angle from Coupler
HCL-50	105	M8 x 1,25	10	2	90°
HCL-100	150	M12 x 1,75	17	2	90°
HCL-150	185	M12 x 1,75	22	2	90°
HCL-200	215	M12 x 1,75	22	3	60°
HCL-250	245	M12 x 1,75	22	3	60°
HCL-300	260	M16 x 2	25	3	60°

# Single-Acting, Lock Nut Cylinders

Capacity:  
**50 - 300 ton**

Stroke:  
**50 - 300 mm**

Maximum Operating Pressure:  
**700 bar**

**HCL Series**

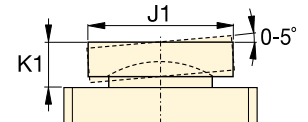

CAT-Series Tilt Saddle

	Extended Height B (mm)	Outside Diameter D (mm)	Cylinder Bore Diameter E (mm)	Plunger Diameter (threaded) F (mm)	Base to Advance Port H (mm)	Standard Saddle Diameter J (mm)	Saddle Protrusion from Plunger K (mm)	Lock Nut Height S (mm)	 (kg)	Model Number	Optional Tilt Saddle		
											Diameter J1 (mm)	Height K1 (mm)	Saddle Model Number
	214	130	100	Tr 100 x 4	24	71	2	25	17	HCL-502	71	24	CAT-100
	314								22	HCL-504			
	414								27	HCL-506			
	514								32	HCL-508			
	614								38	HCL-5010			
	714								43	HCL-5012			
	237	175	135	Tr 135 x 6	33	71	2	33	35	HCL-1002	71	24	CAT-100
	337								44	HCL-1004			
	437								54	HCL-1006			
	537								63	HCL-1008			
	637								73	HCL-10010			
	737								82	HCL-10012			
	259	215	165	Tr 165 x 6	41	130	2	40	59	HCL-1502	130	19	CAT-200
	359								73	HCL-1504			
	459								87	HCL-1506			
	559								102	HCL-1508			
	659								116	HCL-15010			
	759								130	HCL-15012			
	288	250	190	Tr 190 x 6	47	130	2	45	85	HCL-2002	130	19	CAT-200
	388								105	HCL-2004			
	488								124	HCL-2006			
	588								143	HCL-2008			
	688								163	HCL-20010			
	788								182	HCL-20012			
	299	280	215	Tr 215 x 6	53	150	2	52	119	HCL-2502	150	19	CAT-250
	399								143	HCL-2504			
	499								167	HCL-2506			
	599								192	HCL-2508			
	699								216	HCL-25010			
	799								240	HCL-25012			
	328	305	235	Tr 235 x 6	58	140	2	56	158	HCL-3002	195	73	CAT-300
	428								186	HCL-3004			
	528								215	HCL-3006			
	628								244	HCL-3008			
	728								272	HCL-30010			
	828								301	HCL-30012			

# HCL-Series, High Tonnage Lock Nut Cylinders

## HCL-Series, Single-Acting, Gravity Return Cylinders

- Lock nut provides positive and safe mechanical load holding
- Low-friction locking rings spin easy, save time and effort
- Designed to withstand 10% side-load up to 90% of maximum stroke
- Hardened surface resists side-loading and cyclic wear
- Overflow port as stroke limiter to prevent plunger blow-out
- Weather protected, inside and out
- Replaceable bearings enclose the plunger for support throughout the stroke
- Certified lifting eyes and base mounting holes.

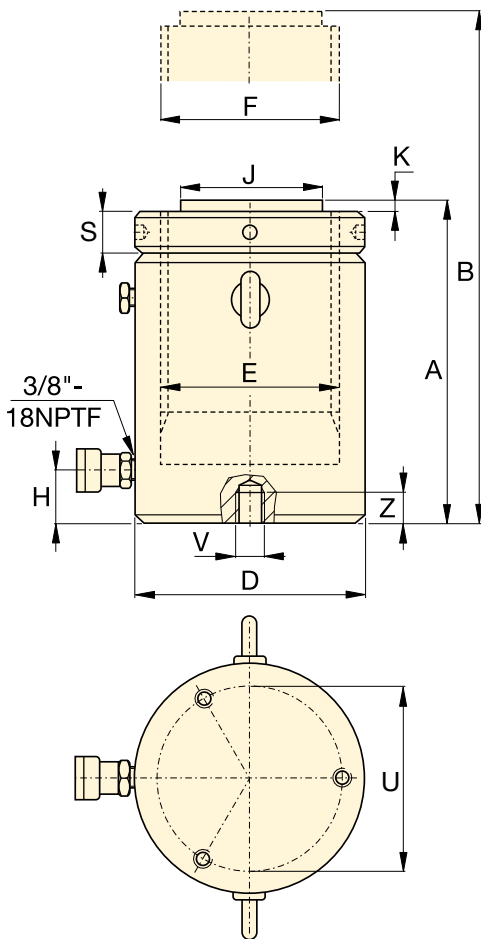

### SELECTION CHART 400 - 1000 TON HCL-MODELS

For 50 - 300 ton models, see pages 52-53.

For full product features see pages 40-41.

Cylinder Capacity	Stroke	Model Number	Maximum Cylinder Capacity at 700 bar ton (kN)	Cylinder Effective Area	Oil Capacity	Collapsed Height
ton	(mm)			(cm <sup>2</sup> )	(cm <sup>3</sup> )	A (mm)
400	50	HCL-4002	409 (4008)	572,6	2863	317
	100	HCL-4004			5726	367
	150	HCL-4006			8588	417
	200	HCL-4008			11.451	467
	250	HCL-40010			14.314	517
	300	HCL-40012			17.177	567
500	50	HCL-5002	522 (5114)	730,6	3653	357
	100	HCL-5004			7306	407
	150	HCL-5006			10.959	457
	200	HCL-5008			14.612	507
	250	HCL-50010			18.265	557
	300	HCL-50012			21.918	607
600	50	HCL-6002	611 (5987)	855,3	4276	380
	100	HCL-6004			8553	430
	150	HCL-6006			12.829	480
	200	HCL-6008			17.106	530
	250	HCL-60010			21.382	580
	300	HCL-60012			25.659	630
800	50	HCL-8002	831 (8149)	1164,2	5821	430
	100	HCL-8004			11.642	480
	150	HCL-8006			17.462	530
	200	HCL-8008			23.283	580
	250	HCL-80010			29.104	630
	300	HCL-80012			34.925	680
1000	50	HCL-10002	1085 (10.644)	1520,5	7603	484
	100	HCL-10004			15.205	534
	150	HCL-10006			22.808	584
	200	HCL-10008			30.411	634
	250	HCL-100010			38.013	684
	300	HCL-100012			45.616	734

Base Mounting Holes (mm)					
Model / Capacity ton	Bolt Circle U	Thread Size V	Minimum Thread Depth Z	Number of Holes	Angle from Coupler
HCL-400	300	M16 x 2	25	3	60°
HCL-500	340	M24 x 3	36	3	60°
HCL-600	370	M24 x 3	36	3	60°
HCL-800	440	M24 x 3	36	3	60°
HCL-1000	500	M24 x 3	36	3	60°



# Single-Acting, Lock Nut Cylinders



▲ Heavy lifting and foundation levelling. The lock nut provides mechanical load holding over a long period of time.

## HCL Series



Capacity:  
**400 - 1000 ton**

Stroke:  
**50 - 300 mm**

Maximum Operating Pressure:  
**700 bar**

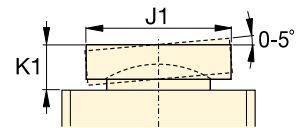

CAT-Series Tilt Saddle

Extended Height B (mm)	Outside Diameter D (mm)	Cylinder Bore Diameter E (mm)	Plunger Diameter (threaded) F (mm)	Base to Advance Port H (mm)	Standard Saddle Diameter J (mm)	Saddle Protrusion from Plunger K (mm)	Lock Nut Height S (mm)	 (kg)	Model Number	Optional Tilt Saddle		
										Diameter J1 (mm)	Height K1 (mm)	Model Number
367	350	270	Tr 270 x 6	67	159	5	65	236	<b>HCL-4002</b>	225	85	<b>CAT-400</b>
467								274	<b>HCL-4004</b>			
567								311	<b>HCL-4006</b>			
667								349	<b>HCL-4008</b>			
767								387	<b>HCL-40010</b>			
867								425	<b>HCL-40012</b>			
407	400	305	Tr 305 x 6	75	179	5	72	341	<b>HCL-5002</b>	250	91	<b>CAT-500</b>
507								390	<b>HCL-5004</b>			
607								439	<b>HCL-5006</b>			
707								489	<b>HCL-5008</b>			
807								538	<b>HCL-50010</b>			
907								587	<b>HCL-50012</b>			
430	430	330	Tr 330 x 6	81	194	5	80	427	<b>HCL-6002</b>	275	99	<b>CAT-600</b>
530								484	<b>HCL-6004</b>			
630								541	<b>HCL-6006</b>			
730								598	<b>HCL-6008</b>			
830								655	<b>HCL-60010</b>			
930								712	<b>HCL-60012</b>			
480	505	385	Tr 385 x 6	95	224	5	90	668	<b>HCL-8002</b>	320	124	<b>CAT-800</b>
580								746	<b>HCL-8004</b>			
680								825	<b>HCL-8006</b>			
780								904	<b>HCL-8008</b>			
880								982	<b>HCL-80010</b>			
980								1061	<b>HCL-80012</b>			
534	570	440	Tr 440 x 6	110	249	5	105	959	<b>HCL-10002</b>	360	136	<b>CAT-1000</b>
634								1059	<b>HCL-10004</b>			
734								1160	<b>HCL-10006</b>			
834								1260	<b>HCL-10008</b>			
934								1360	<b>HCL-100010</b>			
1034								1460	<b>HCL-100012</b>			

# HCRL-Series, Double-Acting Lock Nut Cylinders

▼ HCRL-2006, HCRL-506



- Hydraulically controlled fast retraction
- Lock nut provides mechanical load holding for a safe work environment
- Designed to withstand up to 10% side-load of maximum capacity
- Integrated tilt saddle allows up to 5 degrees of misalignment
- Hardened surface resists side-loading and cyclic wear
- Weather protected, inside and out
- Replaceable bearings enclose the plunger external and internally for support
- Certified lifting eyes, base mounting holes and collar thread as standard
- Stop-ring to prevent plunger blow-out
- Low friction lock nut, to spin easily, save time and effort.

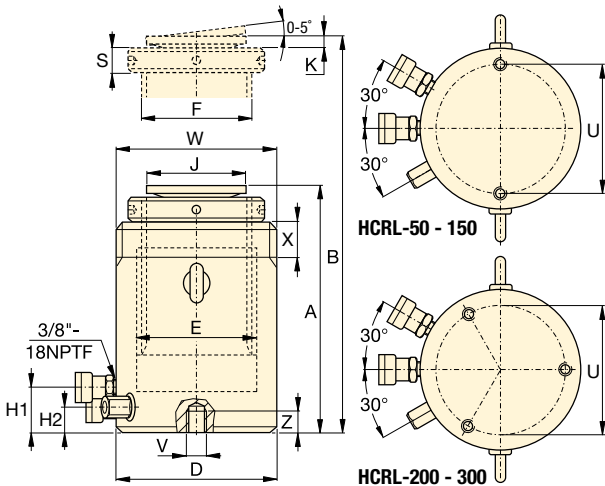

## SELECTION CHART 50 - 300 TON HCRL-MODELS

For full product features see pages 40-41.

Cylinder Capacity *	Stroke *	Model Number	Maximum Cylinder Capacity at 700 bar ton (kN)	Cylinder Effective Area (cm <sup>2</sup> )	Oil Capacity (cm <sup>3</sup> )
50	150	HCRL-506	49 (479)	68,4	1025
	200	HCRL-508			1367
	250	HCRL-5010			1709
	300	HCRL-5012			2051
100	150	HCRL-1006	101 (990)	141,4	2121
	200	HCRL-1008			2827
	250	HCRL-10010			3534
	300	HCRL-10012			4241
150	150	HCRL-1506	153 (1501)	214,4	3216
	200	HCRL-1508			4288
	250	HCRL-15010			5360
	300	HCRL-15012			6432
200	150	HCRL-2006	204 (2001)	285,9	4288
	200	HCRL-2008			5718
	250	HCRL-20010			7147
	300	HCRL-20012			8577
250	150	HCRL-2506	251 (2463)	351,9	5278
	200	HCRL-2508			7037
	250	HCRL-25010			8796
	300	HCRL-25012			10.556
300	150	HCRL-3006	303 (2969)	424,1	6362
	200	HCRL-3008			8482
	250	HCRL-30010			10.603
	300	HCRL-30012			12.723

\* Up to 2000 ton and additional stroke lengths available on request.

Collar Thread (mm)		
Model / Capacity ton	Thread Size W	Thread Length X
HCRL-50	M130 x 2	42
HCRL-100	M185 x 2	57
HCRL-150	M222 x 3	70
HCRL-200	M260 x 3	79
HCRL-250	M290 x 3	85
HCRL-300	M315 x 3	94

The collar thread length is designed for the full rated cylinder capacity.

Base Mounting Holes (mm)			
Model / Capacity ton	Bolt Circle U	Thread Size V	Minimum Thread Depth Z
HCRL-50	105	M12 x 1,75	22
HCRL-100	150	M12 x 1,75	22
HCRL-150	185	M12 x 1,75	22
HCRL-200	215	M12 x 1,75	22
HCRL-250	245	M12 x 1,75	22
HCRL-300	260	M16 x 2	25

# Double-Acting Lock Nut Cylinders



## Higher Capacities, Larger Strokes

The HCRL-Series Cylinders are available up to 2000 ton capacity and additional stroke lengths available on request.

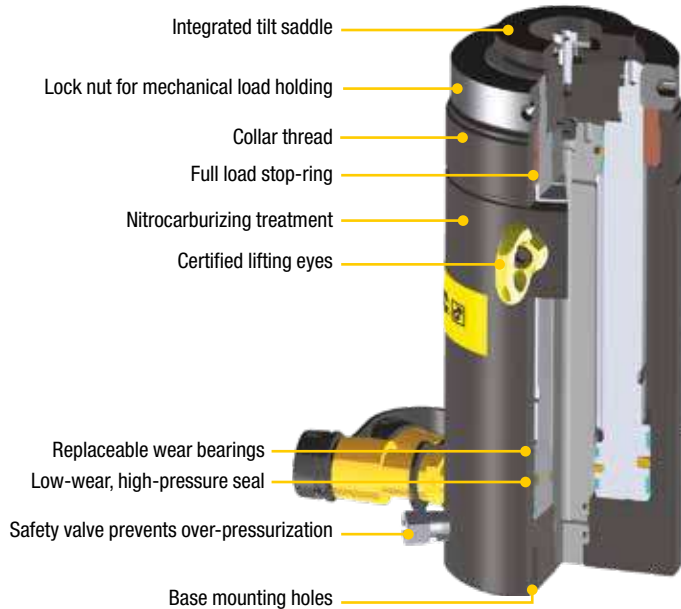

## HCRL Series

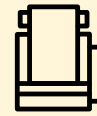

Capacity:

**50 - 300 ton**

Stroke:

**150 - 300 mm**

Maximum Operating Pressure:

**700 bar**



## Synchronous Lifting Systems

Pumps for multiple lift-point capabilities. The economical **EVOB-Series** for basic applications and the multi-functional **EVO-Series** lifting system.

Page: **242**

Collapsed Height A (mm)	Extended Height B (mm)	Outside Diameter D (mm)	Cylinder Bore Diameter E (mm)	Plunger Diameter (threaded) F (mm)	Base to Advance Port H1 (mm)	Base to Retract Port H2 (mm)	Saddle Diameter J (mm)	Saddle Protrusion K (mm)	Lock Nut Height S (mm)	(kg)	Model Number
310	460	130	100	Tr 90 x 4	41	27	77	15	26	30	HCRL-506
377	577									36	HCRL-508
427	677									40	HCRL-5010
477	777									45	HCRL-5012
346	496	185	140	Tr 120 x 6	50	36	77	15	36	64	HCRL-1006
421	621									77	HCRL-1008
471	721									85	HCRL-10010
521	821									94	HCRL-10012
359	509	222	170	Tr 150 x 6	46	32	126	13	45	97	HCRL-1506
434	634									116	HCRL-1508
484	734									129	HCRL-15010
534	834									142	HCRL-15012
399	549	260	200	Tr 170 x 6	71	49	126	13	50	145	HCRL-2006
469	669									168	HCRL-2008
519	769									184	HCRL-20010
569	869									200	HCRL-20012
416	566	290	220	Tr 190 x 6	71	49	160	15	55	190	HCRL-2506
491	691									224	HCRL-2508
541	791									244	HCRL-25010
591	891									265	HCRL-25012
421	571	315	240	Tr 210 x 6	71	49	160	15	55	230	HCRL-3006
496	696									269	HCRL-3008
546	796									294	HCRL-30010
596	896									319	HCRL-30012

▼ SCR-1010H cylinder-pump set



## The Quickest and Easiest Way to Start Working Right Away





**Speed Chart**

See the Enerpac Cylinder Speed Chart in our 'Yellow Pages' section.

Page: **273**

- Optimum match of individual components
- All sets are ready-for-use
- Sets include 1,8 m safety hose and gauge with gauge adaptor
- All pumps are two-speed.

1 Cylinder Selection (See Cylinder Section of this catalog for full product descriptions)		Set Capacity ton (kN)	Cylinder Model Number	Stroke (mm)	Collapsed Height (mm)
 <p><b>RC-Series, Single-Acting, General Purpose Cylinders</b> For maximum versatility.</p>	<p>Page: <b>6</b></p>	5 (45)	RC-55	127	215
		10 (101)	RC-102	54	121
			RC-106	156	247
			RC-1010	257	349
		15 (142)	RC-154	101	200
			RC-156	152	271
		25 (232)	RC-252	50	165
			RC-254	102	215
			RC-256	158	273
			RC-2514	362	476
50 (498)	RC-506	159	282		
 <p><b>RCS-Series, Single-Acting, Low-Height Cylinders</b> Ideal where space is restricted.</p>	<p>Page: <b>22</b></p>	10 (101)	RCS-101	38	88
		20 (201)	RCS-201	45	98
		30 (295)	RCS-302	62	117
		45 (435)	RCS-502	60	122
		90 (887)	RCS-1002	57	141
 <p><b>RCH-Series, Single-Acting, Hollow Cylinders</b> For pushing and pulling applications.</p>	<p>Page: <b>30</b></p>	13 (125)	RCH-121	42	120
		20 (215)	RCH-202	49	162
		30 (326)	RCH-302	64	178
		60 (576)	RCH-603	76	247
		95 (933)	RCH-1003	76	254



# Single-Acting Cylinder-Pump Sets

## SET SELECTION:

- 1 Select the cylinder
- 2 Select the pump
- 3 Find the set model number in the gray matrix

## SELECTION EXAMPLE

### Selected cylinder:

- RC-106, Single-Acting cylinder with 156 mm stroke

### Selected pump:

- P-392, Lightweight hand pump

### Set model number:

- SCR-106H

### Included:

- HC-7206 hose
- GF-10B gauge
- GA-2 adaptor

## SC Series



Capacity:

**5 - 95 ton**

Stroke:

**38 - 362 mm**

Maximum Operating Pressure:

**700 bar**



### Power Box

Tool box with hand pump, gauge adaptor assembly, hose and LW-, RC-, RCS, RSM- or WR-Series cylinder.

Page: **61**

2

**Pump selection** (See the Pump Section in this catalog for full product descriptions.)

**Accessories included**

3

Hand Pump P-142	Hand Pump P-392	Hand Pump P-80	Foot Pump P-392FP	XA-Series Air Pump XA-11	XC-Series Cordless Pump XC-1201ME <sup>2)</sup>	Hose Model Number	Gauge Model Number	Gauge Adaptor Model Nr.
SCR-55H	-	-	-	-	-	HC-7206	GP-10S	GA-4
-	SCR-102H	-	SCR-102FP	SCR-102XA	SCR-102XCE	HC-7206	GF-10B	GA-2
-	SCR-106H	-	SCR-106FP	SCR-106XA	SCR-106XCE	HC-7206	GF-10B	GA-2
-	SCR-1010H	-	SCR-1010FP	SCR-1010XA	SCR-1010XCE	HC-7206	GF-10B	GA-2
-	SCR-154H	-	SCR-154FP	SCR-154XA	SCR-154XCE	HC-7206	GP-10S	GA-2
-	SCR-156H	-	SCR-156FP	SCR-156XA	SCR-156XCE	HC-7206	GP-10S	GA-2
-	SCR-252H	-	SCR-252FP	SCR-252XA	SCR-252XCE	HC-7206	GF-20B	GA-2
-	SCR-254H	-	SCR-254FP	SCR-254XA	SCR-254XCE	HC-7206	GF-20B	GA-2
-	SCR-256H	-	-	SCR-256XA	SCR-256XCE	HC-7206	GF-20B	GA-2
-	-	SCR-2514H	-	SCR-2514XA <sup>1)</sup>	-	HC-7206	GF-20B	GA-2
-	-	SCR-506H	-	SCR-506XA <sup>1)</sup>	-	HC-7206	GF-50B	GA-2
-	SCL-101H	-	SCL-101FP	SCL-101XA	-	HC-7206	GF-10B	GA-2
-	SCL-201H	-	SCL-201FP	SCL-201XA	-	HC-7206	GF-230B	GA-2
-	SCL-302H	-	SCL-302FP	SCL-302XA	SCL-302XCE	HC-7206	GF-230B	GA-2
-	SCL-502H	-	SCL-502FP	SCL-502XA	SCL-502XCE	HC-7206	GF-510B	GA-2
-	-	SCL-1002H	-	-	SCL-1002XCE	HC-7206	GF-510B	GA-2
SCH-121H	-	-	-	-	-	HB-7206	GF-120B	GA-4
-	SCH-202H	-	SCH-202FP	SCH-202XA	SCH-202XCE	HC-7206	GF-813B	GA-3
-	SCH-302H	-	SCH-302FP	SCH-302XA	SCH-302XCE	HC-7206	GF-813B	GA-3
-	-	SCH-603H	-	SCH-603XA <sup>1)</sup>	SCH-603XCE	HC-7206	GF-813B	GA-3
-	-	SCH-1003H	-	-	-	HC-7206	GP-10S	GA-2

<sup>1)</sup> With XA-12 air pump.

<sup>2)</sup> Cordless Pump includes 230V Charger. For 115V charger replace the "E" by the "B" in the model number.

▼ From left to right: P-142ALSS, P-392ALSS, V-152NV, V-66NV, RC-256NV, RC-106NV, RC-53NV



- Corrosion resistant, nickel-plated valves and cylinders
- Stainless steel pump inserts will not corrode
- Viton® Seals provide heat and chemical resistance
- Anodized aluminum pump reservoirs and plastic encapsulated pump bodies resist wet environments
- Two-speed operation reduces pump handle strokes 78% compared to single-speed pumps
- Pump handles lock for easy carrying.

## RC, P, V Series

Cylinder Capacity:  
**5 - 25 ton**

Stroke:  
**51 - 156 mm**

Maximum Operating Pressure:  
**700 bar**



### Applications



For use in wet environments such as food processing, pulp and paper, mining, construction and applications in high temperature or in welding areas.







### Multifluid Hand Pumps

MP-Series corrosion resistant hand pumps for low pressure filling and high pressure testing applications, suitable for a wide range of fluids.

Page: **78**

	Cylinder Capacity	Stroke	Model Number *	Oil Capacity	Pressure Rating	Collapsed Height	Extended Height	Outside Diameter	
	ton (kN)	(mm)		(cm <sup>3</sup> )	(bar)	(mm)	(mm)	(mm)	(kg)
	5 (45)	76	RC-53NV	50	700	165	241	38	1,5
	10 (101)	51	RC-102NV	78	700	121	175	57	2,3
	10 (101)	156	RC-106NV	225	700	247	403	57	4,4
	25 (232)	156	RC-256NV	528	700	273	431	85	10,0

	Pump Type	Oil Capacity	Model Number *	Pressure Rating	Oil Displacement per Stroke	Port Dimension	Piston Stroke	
		(cm <sup>3</sup> )		(bar)	(cm <sup>3</sup> )	(NPTF)	(mm)	(kg)
	Two Speed	327	P-142ALSS	14 / 700	3,62 / 0,90	1/4"-18	12,7	2,0
		901	P-392ALSS	14 / 700	11,26 / 2,47	3/8"-18	25,4	4,1

	Valve Type	Model Number *	Function	Pressure Rating (bar)	
	Manual Check Valve	V-66NV *	Load holding with cylinders	700	1,8
	Pressure Relief Valve	V-152NV *	Limits system pressure, ± 3% repeatability	55-700	1,6

\* For cylinder details see pages 7-9; for pump details see pages 72-73; for valve details see pages 136-137.

# Power Box – Portable Tool Sets

▼ SCR154PGH



- Easy to carry sturdy tool box
- Complete and ready-to-use hydraulic sets
- Includes a single-acting cylinder, P-392 two-speed lightweight hand pump, gauge adaptor assembly, 1,8 metre hose and couplers
- All components ship inside tool box as one package.

**SC,  
SL,  
SR,  
SW  
Series**



Capacity:

**1 - 45 ton**

Stroke:

**11 - 156 mm**

Maximum Operating Pressure:







**700 bar**



#### Gauge Adaptor Assembly

Power Box Sets include 45 degree angled gauge adaptor assembly for improved safe working conditions.

Page: 134

	Cylinder Model	Cylinder Stroke (mm)	Cylinder Capacity ton (kN)	 (kg)	Power Box Model Number
	<b>Lifting Wedge</b>				
	LW-16	21	16 (157)	9,0	SLW16PGH
	<b>Wedge Spread Cylinder</b>				
	WR-5	94 <sup>1)</sup>	1,0 (8,9)	12,0	SWR5PGH
	<b>General Purpose Cylinders</b>				
	RC-102	54	10 (101)	12,3	SCR102PGH
	RC-106	156	10 (101)	14,4	SCR106PGH
	RC-154	101	15 (142)	15,0	SCR154PGH
	RC-156	152	15 (142)	16,8	SCR156PGH
	<b>Low Height Cylinders</b>				
	RCS-101	38	10 (101)	14,1	SCL101PGH
	RCS-201	45	20 (201)	15,0	SCL201PGH
	<b>Flat-Jac® Cylinders</b>				
	RSM-100	11	10 (101)	11,4	SRS100PGH
	RSM-200	11	20 (201)	13,1	SRS200PGH
	RSM-300	13	30 (295)	14,5	SRS300PGH
	RSM-500	16	45 (435)	16,8	SRS500PGH

<sup>1)</sup> Maximum spread of WR-5.

▼ The Power Box – the portable tool set – applicable everywhere



▼ Shown from left to right: JHA-356, JHA-156



## JH, JHA Series

Capacity:  
**7 - 150 ton**

Stroke:  
**76 - 155 mm**

Maximum Operating Pressure:  
**700 bar**

- All-directional operation on 7, 15 and 35 ton JHA-series
- Internal relief valve to prevent overloading
- Machined flat front and bottom surfaces permit flush alignment in tight corners
- Chrome plated plungers
- Pumping handle included
- Automatic by-pass port to prevent over-extension (JH-series).



### Lifting Wedge and Machine Lifts

Ideal to lift the load the first few centimeters. The LW-16 Lifting Wedge requires a very small access gap of only 10 mm.

Page: **172**



### Load Skates

For moving heavy loads easily and safely.

Page: **174**

Style	Jack Capacity ton (kN)	Stroke (mm)	Model Number	Jack Effective Area (cm <sup>2</sup> )	Collapsed Height (mm)	Extended Height (mm)	Bottom Plate Dimensions W x L (mm)	Plunger Diameter (mm)	Pump Speed	 (kg)
Aluminium Jacks	7 (62)	76	JHA-73	9,6	133	209	73 x 158	30,2	Single	5,0
	15 (133)	153	JHA-156	20,3	247	401	92 x 238	41,4	Single	13,2
	35 (311)	155	JHA-356	45,6	257	412	117 x 254	54,1	Single	18,1
	75 (667)	153	JHA-756	102,6	285	439	174 x 325	114,3	Single	42,6
	150 (1335)	155	JHA-1506	197,9	327	482	241 x 407	158,8	2-Speed	95,3
Steel Jacks	30 (267)	155	JH-306	38,3	254	409	95 x 242	69,9	Single	26,8
	50 (445)	154	JH-506	62,1	260	414	127 x 258	88,9	2-Speed	40,8
	100 (890)	153	JH-1006	133,1	287	440	181 x 328	130,1	2-Speed	74,4



# Industrial Steel Bottle Jacks

▼ Shown: GBJ010A, GBJ030A, GBJ003A



- Lower handle effort reduces operator fatigue
- Fully serviceable
- High-strength beam and pump linkage for long life
- Pumping handle included on all models
- Safety relief valve to prevent overload
- Automatic by-pass port to prevent over-extension
- Wiper seal for extended life
- Thick base material with large area for increased strength and stability during lifting
- Positioning handle on 20 ton through 50 ton models.

## GBJ Series



Capacity:

**2 - 100 ton**

Stroke:

**62 - 460 mm**



### Screw Extension Feature

Heat treated, adjustable extension screw with cleated saddle on selected GBJ models helps adjusting and prevents slipping.

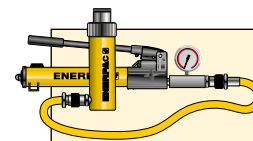

### Cylinder-Pump Sets

As an alternative to bottle jacks where the operator is required to stand remote from the jacking point, see our range of cylinder-pump sets.

Page: **58**

Capacity ton (kN)	Stroke (mm)	Model Number	Screw Extension (mm)	Min. Height (mm)	Max. Height (mm)	Plunger diameter (mm)	Saddle Diameter (mm)	Bottom Dimensions W x L (mm)	 (kg)
2 (19,6)	460	GBJ002LA	-	570	1030	29	-	75 x 116	6,0
2 (19,6)	100	GBJ002A	165	168	338	24	23,5	75 x 116	3,6
3 (29,4)	105	GBJ003A	65	168	338	24	23,5	75 x 116	3,7
5 (49,0)	150	GBJ005A	75	212	437	29	28,5	75 x 125	4,5
8 (78,4)	150	GBJ008A	75	219	444	37	38,0	90 x 114	6,2
10 (98,0)	150	GBJ010A	75	219	444	37	38,0	90 x 114	6,4
10 (98,0)	62	GBJ010SA	30	131	223	37	38,0	90 x 114	5,0
15 (147,0)	150	GBJ015A	75	228	453	45	45,0	112 x 163	8,8
20 (196,0)	150	GBJ020A	75	234	459	51	61,0	120 x 172	10,6
20 (196,0)	105	GBJ020SA	55	190	350	51	61,0	120 x 172	9,5
30 (294,0)	150	GBJ030A	75	242	467	58	69,0	144 x 196	15,5
50 (490,0)	150	GBJ050A	-	252	402	80	80,0	180 x 230	27,0
100 (980,0)	150	GBJ100	-	300	450	110	94,0	296 x 333	87,0

All GBJ Jacks meet or exceed: ANSI, PALD, CE.

▼ Enerpac heavy-duty bottle jacks make lifting loads easier.



▼ Shown: PRASA10027L and accessory Locking U-Rings



## Safe, Efficient, Mobile Load Lifting



### Pendant cord

Supplied with 3,5 m pendant cord for air driven units with pneumatic valves and 6 m pendant cord for electric driven units keeps operator away from the load.

- 54, 90, 136 and 181 ton capacities with pneumatic or electric pumps for the toughest jobs
- 102 mm ground clearance for transport over rail and rough terrain
- Double-acting cylinder
- Three position handle provides easy tilt back and transport
- Complies with ASME/ANSI B30:1 2015 and CE specifications
- Easy to change external filter minimizes down time
- Rugged, fully enclosed 610 mm wide frame with no exposed fittings or hoses
- SUP-R-STACK™ Extension System allows lifting at all heights without blocking.



### POW'R LOCK – Self-Locking Mobile Lift System

A self-locking jack that performs automatic locking during lifting, lowering and holding.

See the Enerpac PL-Series

Page: **66**



◀ Enerpac POW'R-RISER® used in mining operations to lift heavy equipment.

Capacity ton (kN)	Stroke (mm)	Model Number with Electric Pump (230V - 1 ph - 50Hz)	 (kg)
54 (533)	356	PREME06014L	177
	686	PREME06027L	272
90 (889)	406	PREME10016L	231
	686	PREME10027L	272
	406	-	-
	686	-	-
136 (1333)	394	-	-
	673	-	-
	394	PREME15016L	258
	673	PREME15027L	321
181 (1778)	388	-	-
	617	-	-

# POW'R-RISER® Lifting Jack



## SUP-R-STACK Extensions

Increase useful height from 127 to 457 mm.

Model No.	Size (mm)	Model No.	Size (mm)
PRE5	127	PRE11	279
PRE7	178	PRE14	356
PRE9	229	PRE18	457
PRES6024	Extension set includes PRE5, PRE7, PRE11 and PRE18.		



## Spacers

Fine tune your extension stack height.

Model No.	Size (mm)	Model No.	Size (mm)
PRS1	25	PRS3	76
PRS2	51	-	-
PRS4	Set includes (2x) PRS1, (1x) PRS2 and (1x) PRS3.		

## PR Series



Rated Lifting Capacity:

**54 - 181 ton**

Stroke:

**356 - 686 mm**

Maximum Operating Pressure:

**700 bar**

Cap. (kN)	Swivel Load Saddle	Locking U-Rings					Set Model Number	Locking U-Ring Sets Include:								
		25 mm	76 mm	114 mm	140 mm	254 mm		Quantity & model numbers								
533	PRTS60	PRU11	PRU13	PRU14	-	PRU110	<sup>1)</sup> PRUS126	PRU11	PRU13	PRU14	-	<sup>2)</sup> PRUS137	PRU11	PRU13	PRU14	PRU110
889	PRTS60	PRU11	PRU13	PRU14	-	PRU110	<sup>1)</sup> PRUS126	PRU11	PRU13	PRU14	-	<sup>2)</sup> PRUS137	PRU11	PRU13	PRU14	PRU110
1333	PRTS150	PRU151	PRU153	-	PRU155	PRU1510	<sup>3)</sup> PRUS1526	PRU151	PRU153	PRU155	-	<sup>2)</sup> PRUS1537	PRU151	PRU1510	PRU155	-
1778	PRTS200	PRU201	PRU203	-	PRU205	PRU2010	<sup>3)</sup> PRUS2026	PRU201	PRU203	PRU205	-	<sup>2)</sup> PRUS2037	PRU201	PRU2010	PRU205	-

<sup>1)</sup> For 356 mm and 406 mm stroke models

<sup>2)</sup> For 686 mm stroke models

<sup>3)</sup> For 394 mm stroke models.

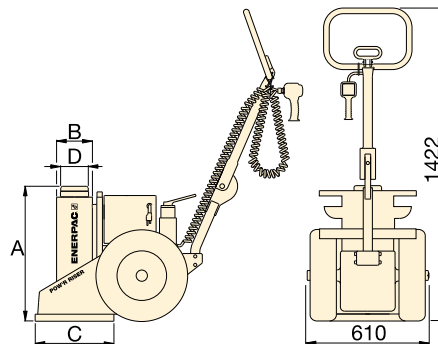

## WARNING!

**Extensions:** Any two extensions may be stacked for loads up to 54 ton. For loads over 54 ton or strokes over 356 mm only one extension and one spacer can be used.

**Spacers:** Never exceed 76 mm in total spacer height.

Model Number with Air Pump	(kg)	A (mm)	B (mm)	C (mm)	D (mm)	Max. Additional Stack Height Using Optional Extension (mm)	Valve Type
PRAMA06014L	177	610	162	356	102	813*	Manual
PRAMA06027L	272	940	162	356	102	279	
PRAMA10016L	231	660	178	457	102	533**	
PRAMA10027L	272	940	178	457	102	279	
PRASA10016L	231	660	178	457	102	533**	Pneumatic
PRASA10027L	272	940	178	457	102	279	
PRASA15016L	258	660	203	457	127	533**	
PRASA15027L	321	940	203	457	127	279	Manual
-	-	660	203	457	127	533**	
-	-	940	203	457	127	279	Pneumatic
PRASA20016L	290	660	241	508	165	533**	
PRASA20027L	374	940	241	508	165	279	

\* Based on one 457 mm and one 279 mm extension and one 76 mm spacer.

\*\* Based on one 457 mm extension and one 76 mm spacer.

www.enerpac.com

For power source, the following characters should be inserted in the 5th space of the model number.

## Ordering Example:

**Model No. PREME06014L** is a 356 mm stroke, 54 ton model, with a manual valve and a 230 VAC, 1-ph, 50 Hz electric motor.

**A** Air Pump, 1416 l/min air consumption at 5,5 bar

**B** 115 VAC, 1-ph., 50-60 Hz, 20 A

**E** 208-240 VAC, 1-ph., 50-60 Hz, Euro Plug, 10 A

**I** 208-240 VAC, 1-ph., 50-60 Hz, USA Plug, 10 A

**G** <sup>1)</sup> 208-240 VAC, 3-ph., 50-60 Hz

**W** <sup>1)</sup> 380-415 VAC, 3-ph., 50-60 Hz

**J** <sup>1)</sup> 440-480 VAC, 3-ph., 50-60 Hz

**R** <sup>1)</sup> 575 VAC, 3-ph., 50-60 Hz.

<sup>1)</sup> Not available for 54 ton capacity.

▼ Shown: PL20025-ASA and PL20014-ASA



- Provides continuous locking protection during lift, lower and hold functions
- Patent-pending control technology synchronizes cylinder and lock nut for smooth and efficient lifting and lowering
- Unique double-acting cylinder offers a low collapsed height to accommodate more lifting applications
- Simple 2-button pendant allows operation of raise and lower functions from up to 6,1 metres away
- All load-bearing cylinder components have a nitrocarburized treatment to improve wear characteristics and resist corrosion
- Ergonomic handle has six positions for comfortable handling and folds when not in use
- Meets ANSI/ASME B30.1-2015, AS/NZS-2538, AS/NZS-2693 certification criteria.



## Efficient Lifting with Continuous Automatic Load Locking



### POW'R-LOCK™ Self-Locking Lift System

Only the POW'R-LOCK™ Lift System provides continuous positive locking of the load through all stages of lifting and lowering. No operator intervention is required to activate or de-activate the automatic locking system.

Two different stroke lengths are available. Both models are powered by an external compressed air system (user-supplied).

A convenient two-button pendant controls operation of the Lift System's air motor and directional control valve.



### Tilt Load Cap

All POW'R-LOCK™ Lift System models feature a Tilt Load Cap to reduce side-loading.



### Safety First

When lifting large, heavy vehicles certain precautions must be followed. Follow your published safety directions for lifting and cribbing your loads. The Pow'R-LOCK™ Lift System provides load/lock protection, but you must follow the safety directions for load cribbing operations.

◀ The PL-Series POW'R-LOCK™ Portable Lift System.



# POW'R-LOCK™ Mobile Lift System



## Accessories

**Flat Load Cap** – Non-tilt load cap has lower profile for tight lifting spaces.

**Spacers** – Minimize gap between load cap and lifting point to maximize hydraulic stroke of the jack.

**Extensions** – Stackable, with large alloy steel locating studs to resist effects of side-loading.

**Extension Base Adapter** – Extension Base Adapter design eliminates risk of improper stacking when using more than one extension.

## PL Series



Rated Lifting Capacity:

**181 ton**

Stroke:

**356 - 622 mm**

Maximum Operating Pressure:

**700 bar**

Model Number	Description	Height (mm)	PL20014-ASA	PL20025-ASA
PLC1	Flat Load Cap	34	x	x
PLS1	Spacer	26	x	x
PLS2	Spacer	51	x	x
PLE5	Extension	127	x	x
PLE7	Extension	178	x	x
PLE9	Extension	229	x	x
PLE11	Extension	280	x	–
PLE14	Extension	356	x	–
PLB12	Extension base adapter	305	x	–



### WARNING!

**PLE11 and PLE14 Extensions and PLB12 Extension Base Adapter** are to be used with the "short" model **PL20014-ASA** only. Use of these extensions on the "tall" model **PL20025-ASA** will result in an excessive maximum lifting height. Load could become unstable and drop, resulting in possible personal injury and/or property damage.

Model Number	Maximum Additional Stack Height *
PLS20014-ASA	712 mm
PLS20025-ASA	229 mm

\* Using optional PLB and PLE-Series extensions and PLS-Series spacers. Load cap height is NOT included in the stack height.

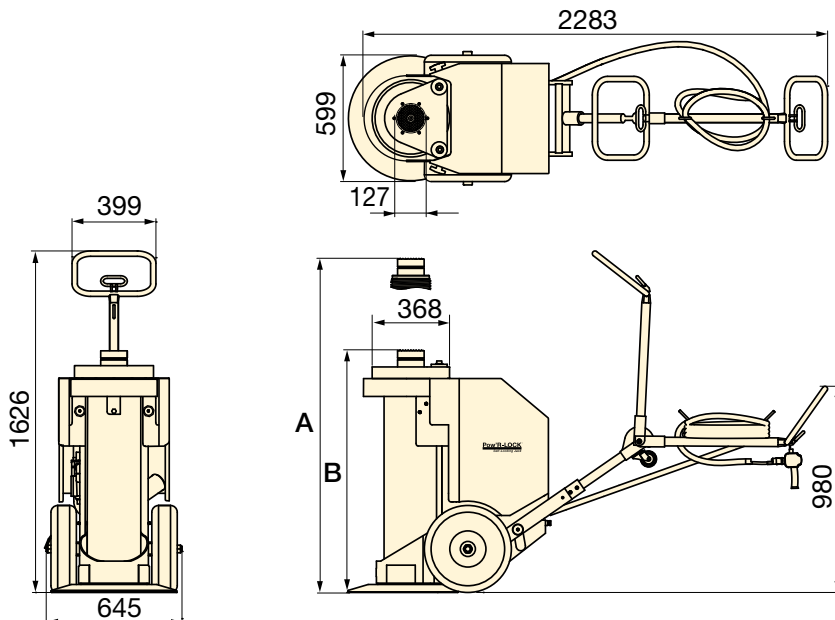

### PR-Series, POW'R-RISER® Mobile Lifting Jack

When automatic load-locking is not required, the POW'R-RISER® jack provides a mobile lifting solution.

Page: 64

Capacity ton (kN)	Stroke (mm)	Model Number with Air Pump	Cylinder Lifting Speed <sup>1)</sup> (mm/min)		Recommended Air Supply <sup>2)</sup>		A <sup>3)</sup> (mm)	B <sup>3)</sup> (mm)	(kg)
			Load	No Load	(l/min)	(bar)			
181 (1779)	356	PL20014-ASA	51	61	3681 - 4247	3,8 - 6,9	1219	864	501
	622	PL20025-ASA	51	61			1778	1156	599

<sup>1)</sup> Depending on available airflow, regulator setting, pump speed and load weight.

<sup>2)</sup> Minimum dynamic air pressure of 3,8-4,1 bar. 6,2-6,9 bar required to achieve 1779 kN capacity.

<sup>3)</sup> Height A and B are with Swivel Load Cap installed. Subtract 51 mm if flat load cap is used.

There's no substitute for experience in customizing hydraulic cylinders and Enerpac meets the needs of the most demanding applications.

Cylinders are the primary workhorse in hydraulic systems required to push or pull. Although Enerpac offers a wide variety of cylinders to fit many application requirements, there are many applications that require customization.

These may include special corrosion protection, ability to handle extreme side loads, or having special mounting needs.



◀ Large capacity, double-acting lock nut cylinders with an external lock ring used for bridge work.



◀ Double-acting cylinders with pilot-operated check valves and rod eyes on both ends for lifting and positioning applications.



◀ Custom private-label cylinders for OEM applications.

## Overview Custom Cylinders



▲ Custom 500 ton double-acting cylinders with 1.83 m stroke for lifting electric rope shovels.

### CUSTOMIZABLE FEATURES:

- Stroke
- Capacity
- Paint
- Pressure Rating
- Fitting
- Special Attachments
- Seals
- Imbedded Sensors
- Collapsed Height
- Rod Modifications
- Special Mounting
- Corrosion Resistance

**Enerpac offers a wide variety of hydraulic pumps for all your custom needs. Still, many applications require a customized pump to operate the system.**

Hydraulic pumps are at the heart of any hydraulic system. Different systems require different flow, pressure and control.

Enerpac offers a wide variety of hydraulic pumps from small hand-operated pumps to large gasoline-powered pumps.

Still, many applications require a customized pump to operate the system. These may include larger reservoir capacity, custom valve configurations or added electrical controls. Enerpac also specializes in power units and controls used for synchronous lifting/lowering of multiple jacking points.



◀ *Private-label hand or foot pumps with fire-resistant oil and special exterior paint.*



◀ *XC-Series Cordless Pump with custom black shroud for private-label OEM customer to be used with a variety of hand held hydraulic tools.*



◀ *Electric pump with large cooler and controls for high-temperature applications.*

## Overview Custom Pumps



▲ *Custom hydraulic pump for a bridge deck launching system.*

### CUSTOMIZABLE FEATURES:

- Reservoir and Frame
- Valves
- Controls
- Oil
- Seals
- Pressure and Flow
- Coolers and Heaters
- Paint
- Motor Type

Enerpac hydraulic pumps are available in over 1000 different configurations. Whatever your high-pressure pump needs are... speed, control, intermittent or heavy duty cycle you will find an Enerpac pump suited to the application.

Featuring Hand, Battery, Electric, Air and Gasoline powered models, with multiple reservoir and valve configurations, Enerpac offers the most comprehensive pump line available.



### Pump Selection

For help in selecting the correct pump for your application, please view our 'Yellow Pages'.

If you require further assistance, contact the Enerpac office located near you.

Page: 266



### Torque Wrench Pumps



















System matched air and electric pumps provide control to operate Enerpac Torque Wrenches.

Page: 212





# Pumps and Directional Valves Section Overview

Power Source	Pump Types	Maximum Reservoir Capacity (litres)	Max. Flow at Rated Pressure (l/min)	Max. Power Consumption	Series		Page
<b>Manual</b>	<b>Lightweight Hand Pumps</b> Exclusively from Enerpac	<b>2,5</b>	<b>2,50</b> (cm <sup>3</sup> /stroke)	–	<b>P</b>		<b>72</b> ▶
	<b>ULTIMA Steel Hand Pumps</b>	<b>7,4</b>	<b>4,75</b>	–	<b>P</b>		<b>74</b> ▶
	<b>Low Pressure Hand Pumps</b>	<b>3,3</b>	<b>9,50</b>	–	<b>P</b>		<b>76</b> ▶
	<b>Multifluid Hand Pumps</b> Pumping Fluids up to 1000 bar	–	<b>20,6</b> (cm <sup>3</sup> /stroke)	–	<b>MP</b>		<b>78</b> ▶
	<b>Foot Pump</b> For Hands Free Operation	<b>0,5</b>	<b>2,47</b> (cm <sup>3</sup> /stroke)	–	<b>P</b>		<b>79</b> ▶
	<b>Ultra-High Pressure Hand Pumps</b> Pressure up to 2800 bar	<b>1,0</b>	<b>2,49</b> (cm <sup>3</sup> /stroke)	–	<b>P 11</b>		<b>80</b> ▶
<b>Electric</b>	<b>Battery Powered Hydraulic Pumps</b> Cordless Hydraulic Power	<b>2,0</b>	<b>0,25</b>	<b>0,37</b> (kW)	<b>XC</b>		<b>82</b> ▶
	<b>Economy Series</b> Compact and Portable	<b>3,8</b>	<b>0,32</b>	<b>0,37</b> (kW)	<b>PU</b>		<b>84</b> ▶
	<b>Submerged Series</b> Powerful and Low-Noise	<b>5,5</b>	<b>0,27</b>	<b>0,37</b> (kW)	<b>PE</b>		<b>86</b> ▶
	<b>Z-Class Pumps,</b> Portable	<b>40</b>	<b>1,0</b>	<b>1,25</b> (kW)	<b>ZU</b>		<b>92</b> ▶
	<b>Z-Class Pumps</b> Powerful and Heavy-Duty	<b>40</b>	<b>2,73</b>	<b>5,60</b> (kW)	<b>ZE</b>		<b>98</b> ▶
<b>Air</b>	<b>Air Hydraulic Pumps</b> Single and Twin-Air Motor	<b>1,3</b>	<b>0,13</b>	<b>255</b> (l/min)	<b>PA</b>		<b>104</b> ▶
		<b>8,0</b>	<b>0,15</b>	<b>510</b> (l/min)	<b>PAM</b>		<b>105</b> ▶
	<b>Turbo II Air Hydraulic Pumps</b> Compact Air Over Hydraulic	<b>5,0</b>	<b>0,16</b>	<b>340</b> (l/min)	<b>PAT</b>		<b>106</b> ▶
	<b>Air Hydraulic Pumps</b> For Productivity and Ergonomics	<b>2,0</b>	<b>0,25</b>	<b>991</b> (l/min)	<b>XA</b>		<b>108</b> ▶
	<b>Z-Class Air Hydraulic Pumps</b> Modular Air Pumps	<b>40,0</b>	<b>1,31</b>	<b>2840</b> (l/min)	<b>ZA</b>		<b>110</b> ▶
<b>Gasoline</b>	<b>Z-Class Gasoline Hydraulic Pumps</b> Gas Powered High Flow Pumps	<b>40,0</b>	<b>1,64</b>	<b>4,8</b> (kW)	<b>ZG5</b>		<b>112</b> ▶
	<b>Z-Class Gasoline Hydraulic Pumps</b> Gas Powered High Flow Pumps	<b>40,0</b>	<b>3,30</b>	<b>9,7</b> (kW)	<b>ZG6</b>		<b>112</b> ▶
<b>Directional Control Valves</b>					<b>VM, VC VE</b>		<b>114</b> ▶

# P-Series, Lightweight Hand Pumps

▼ Shown from top to bottom: P-802, P-842, P-202, P-142



- Lightweight and compact design
- Durable glass-filled nylon reservoir and nylon encapsulated aluminium pump base for maximum corrosion resistance
- Two-speed operation reduces handle strokes by as much as 78% over single speed pumps
- Lower handle effort to minimize operator fatigue
- Integral 4-way valve on P-842 for operation of double-acting cylinders
- Handle lock and lightweight construction for easy carrying
- Large oil capacities to power a wide range of cylinders or tools
- Non-conductive fiberglass handle for improved operator safety
- Internal pressure relief valve for overload protection.

▼ Cylinder-pump set SCR-254H used to support the construction while monitoring pressure and load with the gauge.



## Exclusively from Enerpac



### Cylinder Matching Chart

For help in selecting the correct hand pump for your application, please refer to the Cylinder Matching Chart located in the 'Yellow Pages'.

Page: 266



### Speed Chart

To determine how a specific pump will operate your cylinder, see the Pump-Cylinder Speed Chart in the 'Yellow Pages'.

Page: 273



### Tank Kits:

When a return-to-tank port is required, the Tank Kits provide a 7/16"-20 UN port at the rear of the reservoir.

PC-20	Fits P-141, P-142
PC-25	Fits P-202, P-391, P-392



### Power Box

Portable tool box with P-392 hand pump, gauge adaptor assembly, hose and RC-, RCS, RSM- or WR-Series cylinder.

Page: 61

Pump Type	Usable Oil Capacity (cm <sup>3</sup> )	Model Number	Pressure Rating <sup>2)</sup> (bar)		Oil Displacement per Stroke (cm <sup>3</sup> )		Max. Handle Effort (kg)
			1 <sup>st</sup> stage	2 <sup>nd</sup> stage	1 <sup>st</sup> stage	2 <sup>nd</sup> stage	
Single-Speed	327	P-141	-	700	-	0,90	32,7
	901	P-391	-	700	-	2,47	38,6
Two-Speed	327	P-142 <sup>1)</sup>	13	700	3,62	0,90	35,4
	901	P-202	13	700	3,62	0,90	28,6
	901	P-392 <sup>1)</sup>	13	700	11,26	2,47	42,2
	2540	P-802	27	700	39,33	2,47	43,1
	2540	P-842 <sup>3)</sup>	27	700	39,33	2,47	43,1

<sup>1)</sup> Available as set, see note on next page. P-392 also available in Power Box Set (page 61).

<sup>2)</sup> Contact Enerpac for applications where operating pressure is less than 10% of pressure rating.

<sup>3)</sup> P-842 for use with double-acting cylinders

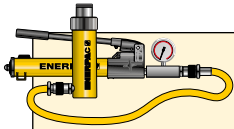

### Pump-Cylinder Sets

All pumps marked with an \* are available as sets (pump, cylinder, gauge, couplers and hose) for your ordering convenience.

Page: 58

## P Series



Reservoir Capacity:

**327 - 2540 cm<sup>3</sup>**

Flow at Rated Pressure:

**0,90 - 2,47 cm<sup>3</sup>/stroke**

Operating Pressure:

**700 bar**

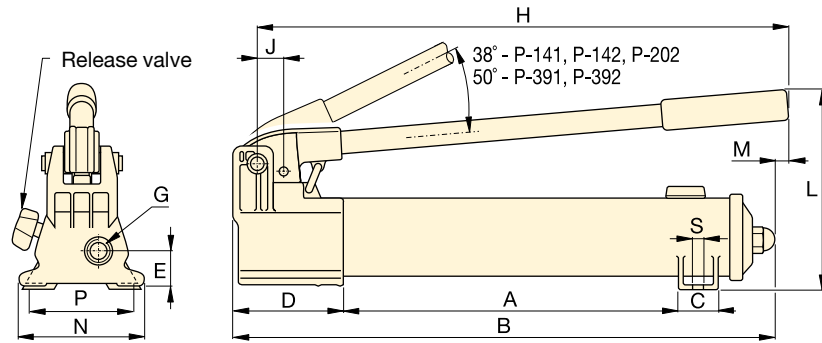

**P-141, P-142, P-202, P-391, P-392**

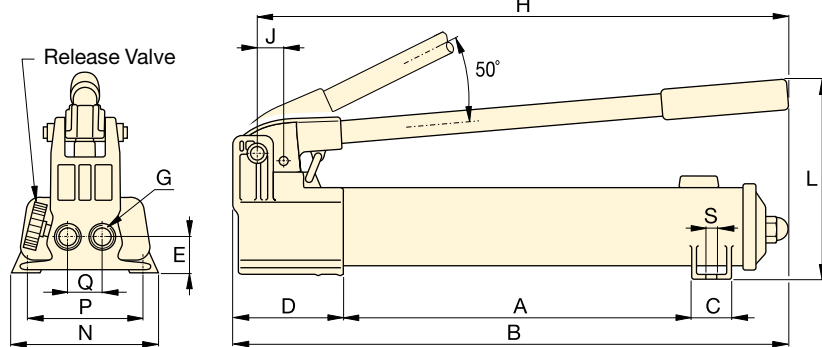

**P-802**

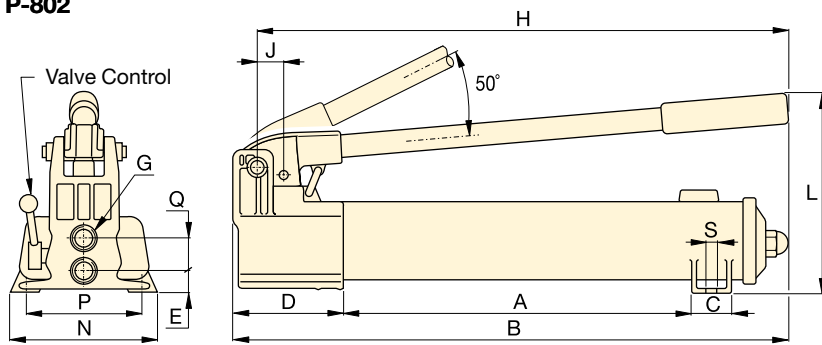

**P-842**



### Hoses

Enerpac offers a complete line of high quality hydraulic hoses. To ensure the integrity of your system, specify only genuine Enerpac hydraulic hoses.

Page: 122



### GA45GC Gauge Adaptor

Protect yourself from system overloading by simply ordering one part number for a pre-assembled gauge, adaptor block and coupler.

Page: 134



### Foot Pump P-392FP

For handsfree operation the lightweight and robust P-392FP Foot Pump is the perfect choice.

Page: 79

Piston Stroke	Dimensions (mm)															Model Number
	(mm)	A	B	C	D	E	G	H	J	L	M	N	P	Q	S	
12,7	185	336	28	85	28	1/4"-18 NPTF	319	19	143	-	95	80	-	7	2,4	<b>P-141</b>
25,4	344	533	36	99	33	3/8"-18 NPTF	522	30	177	16	120	-	-	-	4,1	<b>P-391</b>
12,7	185	336	28	85	28	1/4"-18 NPTF	319	19	143	-	95	80	-	7	2,4	<b>P-142 <sup>1)</sup></b>
12,7	344	509	36	85	28	1/4"-18 NPTF	400	19	144	16	95	-	-	-	3,4	<b>P-202</b>
25,4	344	533	36	99	33	3/8"-18 NPTF	522	30	177	16	120	-	-	-	4,1	<b>P-392 <sup>1)</sup></b>
25,4	337	552	45	133	35	3/8"-18 NPTF	527	30	228	-	181	153	35	10	8,2	<b>P-802</b>
25,4	337	552	45	133	20	3/8"-18 NPTF	527	30	228	-	181	153	36	10	10,0	<b>P-842 <sup>3)</sup></b>

▼ Shown from left to right: P-77, P-80, P-84, P-801, P-39



- Reduced handle effort and ergonomic grip for less operator fatigue
- Two-speed operation for fast and easy operation (except P-39)
- Vent free reservoir eliminates spills
- Quick grip handle allows for easy transport
- Integral reservoir over-pressurization protection
- All steel construction, chrome plated plunger and wiper system for durable, long lasting performance
- 4-way valving on the P-84 and P-464 for operation of double-acting cylinders.

▼ In the absence of a power supply, the P-80 Hand Pump offers a powerful solution.



## The Solution for Tough Jobs



### Two Speed Pumps

Recommended for applications where cylinder plunger must advance rapidly to load contact, and applications where greater oil capacities are required, such as multiple cylinder hook-ups.



### Foot Pump Conversion Kits

Convert your P-39, P-77, P-80 or P-801 to foot power with the **PC-11** Kit. Includes instructions for easy conversion.



### GA45GC Gauge Adaptor

Protect yourself from system overloading by simply ordering one part number for a pre-assembled gauge, adaptor block and coupler.

Page: 134



### 4-Way Control Valve

**P-84** and **P-464** feature a manual 4-way control valve, designed for use with one double-acting or two single-acting cylinders. For system set-up information:

Page: 268

Pump Type	Usable Oil Capacity (cm <sup>3</sup> )	Model Number	Pressure Rating <sup>2)</sup> (bar)		Oil Displacement per Stroke (cm <sup>3</sup> )		Max. Handle Effort (kg)
			1 <sup>st</sup> stage	2 <sup>nd</sup> stage	1 <sup>st</sup> stage	2 <sup>nd</sup> stage	
Single	672	<b>P-39</b>	-	700	-	2,46	39
Two-Speed	672	<b>P-77</b>	34	700	16,39	2,46	40
	2200	<b>P-80</b> <sup>1)</sup>	34	700	16,39	2,46	35
	4100	<b>P-801</b>	34	700	16,39	2,46	35
	2200	<b>P-84</b> <sup>3)</sup>	34	700	16,39	2,46	35
	7423	<b>P-462</b>	14	700	126,20	4,75	49
	7423	<b>P-464</b> <sup>3)</sup>	14	700	126,20	4,75	49

<sup>1)</sup> Available as a set, see note on next page.

<sup>2)</sup> Contact Enerpac for applications where operating pressure is less than 10% of pressure rating.

<sup>3)</sup> P84, P-464 is for use with double-acting cylinders.



# ULTIMA Steel Hand Pumps



## Speed Chart

To determine how a specific pump will operate your cylinder, see the Pump-Cylinder Speed Chart in the 'Yellow Pages'.

Page: 273

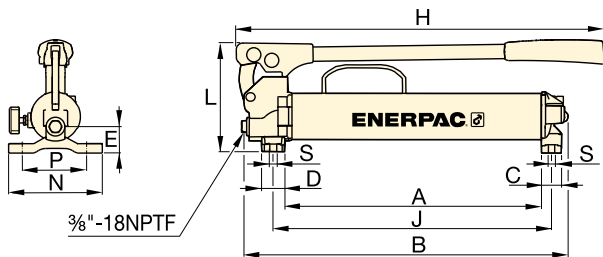

P-39, P-77

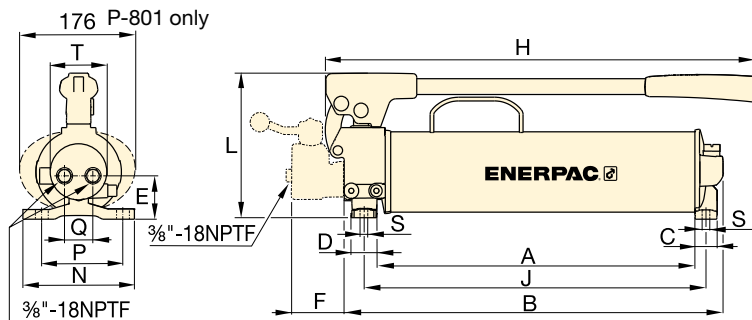

P-80, P-801, P-84

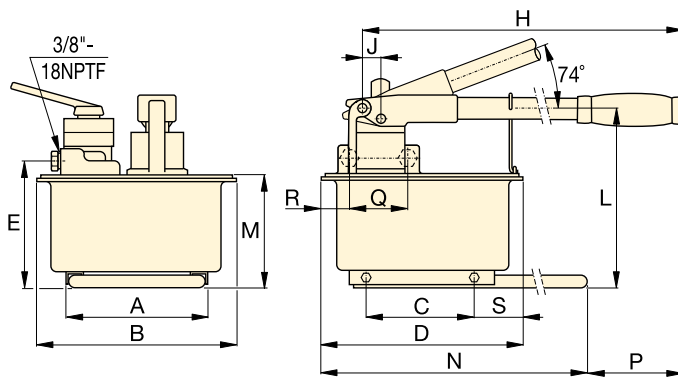

P-462, P-464

## P Series



Reservoir Capacity:  
**672 - 7423 cm<sup>3</sup>**

Flow at Rated Pressure:  
**2,46 - 4,75 cm<sup>3</sup>/stroke**

Maximum Operating Pressure:  
**700 bar**



### Extra Capacity Hand Pumps

P-462 and P-464 feature extra large reservoirs and high first-stage flow rate.

These pumps are ideally suited for powering high-capacity cylinders.

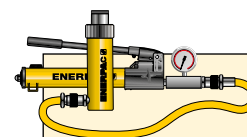

### Pump-Cylinder Sets

The P-80 is also available as set (pump, cylinder, gauge, couplers and hose) for your ordering convenience.

Page: 58



### Cylinder Matching Chart

For help in selecting the correct hand pump for your application, please refer to the Cylinder Matching Chart located in the 'Yellow Pages'.

Page: 266

Piston Stroke	Dimensions (mm)																Model Number	
	(mm)	A	B	C	D	E	F	H	J	L	M	N	P	Q	R	S		T
25,4	383	480	30	35	37	-	550	416	163	-	140	111	-	-	8,4	-	6,2	P-39
25,4	391	487	30	35	47	-	550	424	163	-	140	111	-	-	8,4	-	7,1	P-77
25,4	428	511	30	35	55	-	579	460	195	-	150	121	42	-	8,4	74	10,7	P-80 <sup>1)</sup>
25,4	428	511	30	35	55	-	579	460	195	-	150	121	42	-	8,4	74	14,1	P-801
25,4	428	510	30	35	55	70	579	460	195	-	150	121	38	-	8,4	74	11,8	P-84 <sup>3)</sup>
38,1	210	308	163	320	195	-	671	25	270	175	650	92	-	-	80	-	27,7	P-462
38,1	210	308	163	320	195	-	671	25	270	175	650	92	89	68	80	-	27,7	P-464 <sup>3)</sup>

▼ Shown from left to right: P-25, P-51, P-18



## When Less Than 700 Bar is All You Need



### GA45GC Gauge Adaptor

Protect yourself from system overloading by simply ordering one part number for a pre-assembled gauge, adaptor block and coupler.

Page: 134



### Hoses

Enerpac offers a complete line of high quality hydraulic hoses. To ensure the integrity of your system, specify only genuine Enerpac hydraulic hoses.

Page: 122

- P-25 and P-50 pump oil in both forward and reverse handle movement improving overall efficiency, ideal when mounting space is restricted
- External load-release valve
- Internal pressure-relief valve for overload protection
- For use with single-acting cylinders and tools.

▼ P-18 hand pump used for locking the rotating table for marble polishing.



Pump Type	Usable Oil Capacity (cm <sup>3</sup> )	Model Number *	Pressure Rating (bar)	Oil Displacement per Stroke (cm <sup>3</sup> )	Max. Handle Effort (kg)
Single-Speed	360	P-18	200	2,46	16
	3277	P-25	175	9,50	27
	3277	P-50	350	4,75	27
	819	P-51	200	4,10	27

\* For use with single-acting cylinders and tools

# Low Pressure Hand Pumps

## P Series



Reservoir Capacity:  
**360 - 3277 cm<sup>3</sup>**

Flow at Rated Pressure:  
**2,46 - 9,50 cm<sup>3</sup>/stroke**

Maximum Operating Pressure:  
**175 - 350 bar**

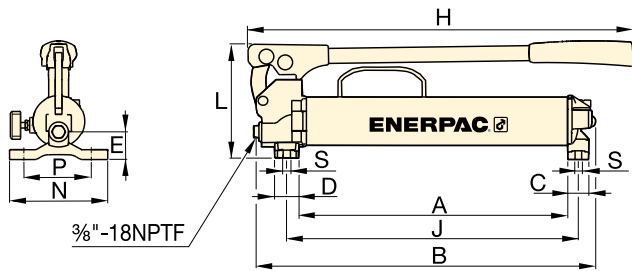

**P-18**

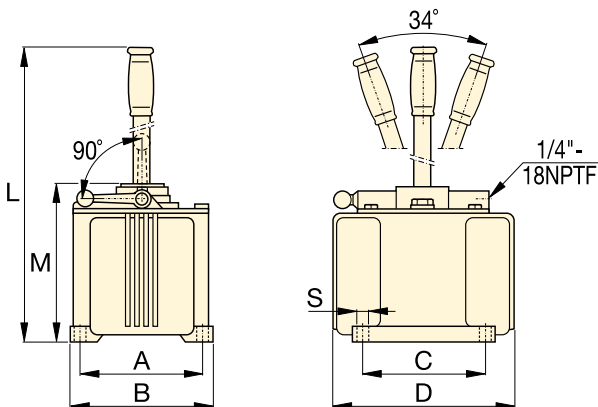

**P-25, P-50**

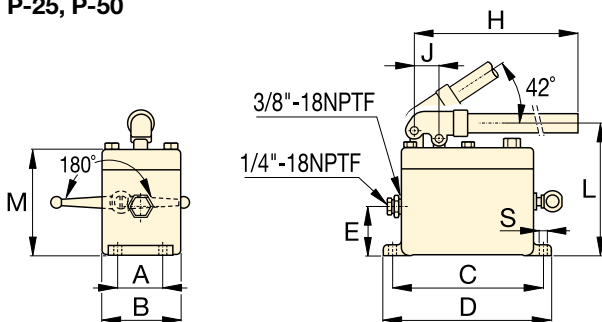

**P-51**



### MP-Series Multifluid Hand Pumps

Corrosion resistant hand pumps for low pressure filling and high pressure testing applications, suitable for a wide range of fluids.

Page: 78

▼ P-51 hand pumps used with RC-series cylinders to keep wooden layers under pressure during lamination of plates.



Piston Stroke	Dimensions (mm)												Model Number *
	(mm)	A	B	C	D	E	H	J	L	M	N	S	
25,4	221	316	30	35	37	385	254	163	-	140	8,4	5,0	<b>P-18</b>
38,1	152	173	152	240	-	-	-	684	200	-	10	16,3	<b>P-25</b>
38,1	152	173	152	240	-	-	-	684	200	-	10	16,8	<b>P-50</b>
25,4	52	92	181	200	57	610	29	160	129	-	9	5,4	<b>P-51</b>

# MP-Series, Multifluid Hand Pumps

▼ Shown: **MP-110**



- Superior corrosion resistance
- Standard Nitrile seals – can be used for a wide range of fluids such as demineralised water, oil/water emulsions, waterglycols, mineral oils
- Two speed pumps up to 1000 bar pressure
- Buna Nitrile seals can be exchanged with optional EPDM seal for use with Skydrol or brake fluids
- Impregnated aluminium anodized pump housing with stainless steel internal pumping components
- Externally adjustable pressure relief valve
- 1/4" NPTF gauge port
- For use with single-acting cylinders and tools.

## MP Series

Flow at Rated Pressure:

**1,6 - 20,6 cm<sup>3</sup>/stroke**

Maximum Operating Pressure:

**110 - 1000 bar**



### Optional Reservoir Kit

Includes 10 litres tank with skid frame, top plate with reservoir seal, suction pipe and mounting bolts.

Useable oil capacity is 7,4 litres. Order model number: **MP-10T**.



### Stainless Steel Hand Pump

Also available as stainless steel hand pump, model number **11-400**.

Page: **80**

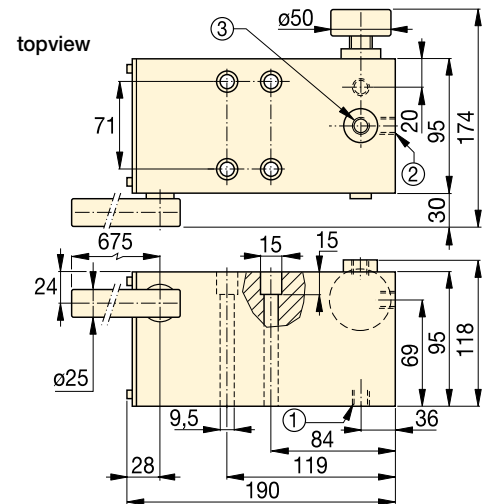

### MP-110, 350, 700, 1000

- ① Suction / Tank return port 3/8"-18 NPTF
- ② Pressure port 3/8"-18 NPTF
- ③ Gauge port 1/4"-18 NPTF

Pump Type	Usable Oil Capacity * (cm <sup>3</sup> )	Model Number **	Pressure Rating (bar)		Oil Displacement per Stroke (cm <sup>3</sup> )		Max. Handle Effort (kg)	Piston Stroke (mm)	Weight (kg)
			1st stage	2nd stage	1st stage	2nd stage			
Two Speed	*	<b>MP-110</b>	35	110	52,6	20,60	45	27,1	6,6
	*	<b>MP-350</b>	35	350	52,6	7,15	45	27,1	6,6
	*	<b>MP-700</b>	35	700	52,6	2,63	45	27,1	6,6
	*	<b>MP-1000</b>	35	1000	52,6	1,60	45	27,1	6,6

\* MP-Pump includes 1,5 mm thick gasket for reservoir mounting. MP-Series pumps requires the use of an external reservoir.

\*\* MP-Series pumps are for use with single-acting cylinders and tools.

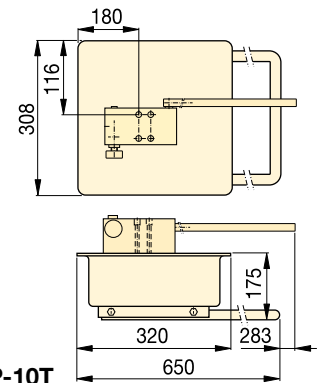

**MP-10T**



# Lightweight Hydraulic Foot Pump

▼ Shown: P-392FP



- Robust, durable and compact
  - Steel frame for maximum stability
  - Steel pumping handle
  - Aluminium reservoir
- Foot pedal lock and lightweight construction for easy carrying
- Two-speed operation reduces foot pedal strokes
- Large foot-pad release valve for controlling load descent
- Internal pressure relief valve for overload protection.

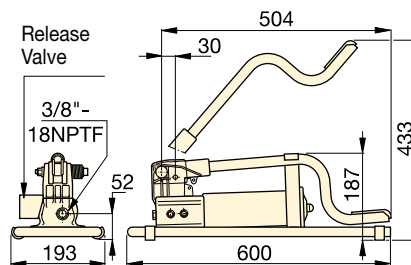

Usable Oil Capacity (cm <sup>3</sup> )	Model Number	Pressure Rating (bar)		Oil Displacement per Stroke (cm <sup>3</sup> )		Max. Handle Effort (kg)	Piston Stroke (mm)	Piston Weight (kg)
		1st stage	2nd stage	1st stage	2nd stage			
492	P-392FP *	15	700	11,26	2,47	42	25,4	7,0

\* Available as set, see note on this page.

## P Series



Reservoir Capacity:

**492 cm<sup>3</sup>**

Flow at Rated Pressure:

**2,47 cm<sup>3</sup>/stroke**

Maximum Operating Pressure:

**700 bar**

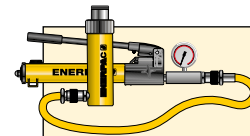

### Pump-Cylinder Sets

The P-392FP is available as set (pump, cylinder, gauge, couplers and hose) for your ordering convenience.

Page: 58



### Hoses

Enerpac offers a complete line of high quality hydraulic hoses. To ensure the integrity of your system, specify only genuine Enerpac hydraulic hoses.

Page: 122

▼ P-392FP offers the advantage of hands free operation to handle and control the tool or cylinder.



# Ultra-High Pressure Hand Pumps

▼ Shown from left to right: 11-100, P-2282



- Two-speed operation on the P-2282 allows for faster fill operation, reducing cycle times for many testing applications
- 303 Stainless steel construction on the 11-100 and 11-400 models enable use with many different fluids, such as distilled water, diesters, silicones, soluble oils and petroleum
- Large release knob for improved control of pressure release
- Outlet ports are 3/4"-16 cone for 2800 bar rating
- Ultra-high pressure fittings feature all stainless steel construction except adaptor 41-366 which features nickel plated carbon steel construction.

## Ultra-High Pressure up to 2800 bar



### 2-Way Shut-Off Valve Model Nr. 72-750

For 2800 bar applications requiring a shut-off valve or gauge snubber.

Made of 318 Stainless Steel and utilizing .38 inch cone fittings, it is the perfect selection for use with your ultra-high pressure hand pump.



### Test System Gauges

Ideal for monitoring pressure in your hydraulic circuit.

Test System Gauges, such as the **T6010L**, are available

with cone threads or NPTF threads and a variety of pressure ranges.

Page: 132

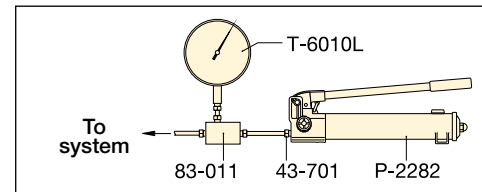

▲ Typical Test System

### Cone Seal

Stainless Steel High Pressure fittings seal on a 'cone' surface and do not require pipe sealer. The Gland Nut holds the sleeve and tubing tight against the cone surface to provide a 2800 bar seal.

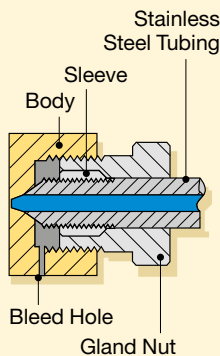

Pump Type	Usable Oil Capacity (cm <sup>3</sup> )	Model Number	Pressure Rating* (bar)		Oil Displacement per Stroke (cm <sup>3</sup> )		Max. Handle Effort (kg)
			1 <sup>st</sup> stage	2 <sup>nd</sup> stage	1 <sup>st</sup> stage	2 <sup>nd</sup> stage	
Two-Speed	983	P-2282	13	2800	16,22	0,61	48,1
Single-Speed	737	11-100	-	700	-	2,49	54,4
	737	11-400	-	2800	-	0,62	54,4

\* Contact Enerpac for applications where operating pressure is less than 10% of operating pressure.

# Ultra-High Pressure Hand Pumps

## ▼ Optional Ultra-High Pressure Fittings and Tubings

Description	Connection	Model Nr.
<b>2800 bar</b>		
Gland Nut Plug	.38" cone	43-001
Elbow	.38" cone	43-200
Tee	.38" cone	43-300
Gauge Tee	.38" cone side/ .25" cone gauge port	43-301
Gauge Adaptor	.38" cone side/ .25" cone gauge port	83-011
Coupling	.38" cone	43-400
Cross	.38" cone	43-600
Gland Nut with Sleeve	.38" cone	43-701
Gauge Connector	.25" cone	43-704
Tubing	100 mm tube, O.D. .38" * 200 mm tube, O.D. .38" * 300 mm tube, O.D. .38" *	45-116 45-126 45-136
<b>700 bar only</b>		
Adaptor	.38" F cone to 1/4" M NPTF	41-146
	.38" F cone to 3/8" M NPTF	41-166
Adaptor	.38" F cone to 1/4" F NPTF	41-246
	.38" F cone to 3/8" F NPTF	41-266
Adaptor	.38" M cone to 3/8" F NPTF	41-366

Note: .25" cone fittings use 9/16"-18 threads, 3/8" cone fittings use 3/4"-16 threads.  
\* Actual tubing lengths are 19 mm less than nominal size shown. These dimensions make distance between centers of valves and fittings multiples of 100 mm spaces.

## P 11 Series



Reservoir Capacity:  
**737 - 983 cm<sup>3</sup>**

Flow at Rated Pressure:  
**0,61 - 2,49 cm<sup>3</sup>/stroke**

Maximum Operating Pressure:  
**700 - 2800 bar**



**Ultra-High Pressure pumps DO NOT have an internal safety pressure relief valve.**



### Stainless Steel Construction

Ultra-high Pressure Fittings feature all stainless steel construction except adaptor 41-366, which features nickel plated carbon steel construction.

11-100  
11-400

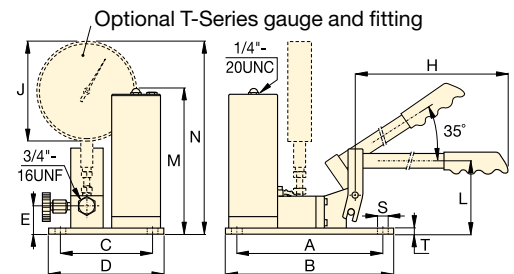

P-2282

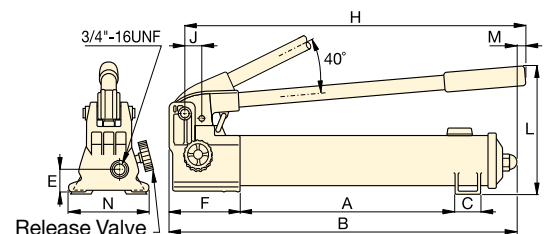

Piston Stroke	Dimensions (mm)														Model Number
	(mm)	A	B	C	D	E	F	H	J	L	M	N	S	T	
25,4	344	558	35	-	31	133	527	29	228	7	120	-	-	6,4	P-2282
19,8	240	266	151	177	45	-	635	162	114	237	314	7	9	10,0	11-100
19,8	240	266	151	177	45	-	635	162	114	237	314	7	9	10,0	11-400

▼ Shown: XC-1201ME



- Lightweight design with integrated handle and carrying strap for portability
- Bladder reservoir prevents contamination and allows pump usage in any position
- Powerful 0,37 kW motor and 28 Volt Lithium-Ion battery deliver exceptional speed and run time
- High-strength fiberglass reinforced composite shroud for superior durability in demanding job site environments
- Cordless technology eliminates tripping hazards found in other electric or air powered pumps
- Available in both single- and double-acting valve configurations.



## Performance of a Powered Pump

## Portability of a Hand Pump



### GA45GC Gauge Adaptor Assembly

Protect yourself from system overloading by simply ordering one part number for a pre-assembled gauge, adaptor block and coupler.

Page: **134**



Battery packs contain no cadmium, so they are environmentally friendly. Enerpac encourages recycling.



### 28-Volt Battery

The XC-28V with Lithium-Ion technology for maximum battery performance.



### Battery Charger

1-hour quick charger.

Model Nr.	Voltage
XC-115VC	115 VAC
XC-230VC	230 VAC



### 3/8" Swivel Connector

Customer installed 360 degree swivel coupler for optimal orientation of the hydraulic hose. See details on page 127.

Order Model Number <sup>1)</sup> **XSC1**

<sup>1)</sup> Accessories must be ordered separately.

◀ Portable power and simplicity for the toughest jobs.





## XC-Series Cordless Hydraulic Pumps

The XC-Series cordless pump is ideal for jobs that require a combination of portability, speed, and safety. These cordless pumps are perfect for remote locations without access to power, but also indoors where trip hazards, ergonomics or size is a concern.

The XC-Series cordless pump is compatible with all Enerpac hydraulic tools and small to medium sized cylinders.

The XC-Series cordless pump is CSA and CE compliant.



## The Lithium-Ion battery provides superior run time:

- 270 cuts of 10 mm reinforcing bar using a WHC-750 Cutter
- 112 lifts with a WR-5 Spreader
- 45 splits on M27 - 8.8 nuts using a NC-3241 Nut Cutter
- 30 times lifting with a RC-104 cylinder (10 ton, 100 mm stroke).

Note: Actual number of cycles per charge will vary depending on condition of battery, tool and ambient conditions. Battery life with double-acting tools is approximately 75% of that for comparable, single-acting tools.

## XC Series



Reservoir Capacity:

**1,0 - 2,0 litres**

Flow at Rated Pressure:

**0,25 l/min**

Maximum Operating Pressure:

**700 bar**

- ① Outlet "Advance" Port 3/8"-18 NPTF
- ② Oil Fill (must use funnel)
- ③ User Adjustable Relief Valve Access Port
- ④ Directional Control Valve
- ⑤ Shoulder Strap Connection Points
- ⑥ Safety Lock Feature
- ⑦ On/Off Switch
- ⑧ Inlet "Retract" Port (double-acting models only)

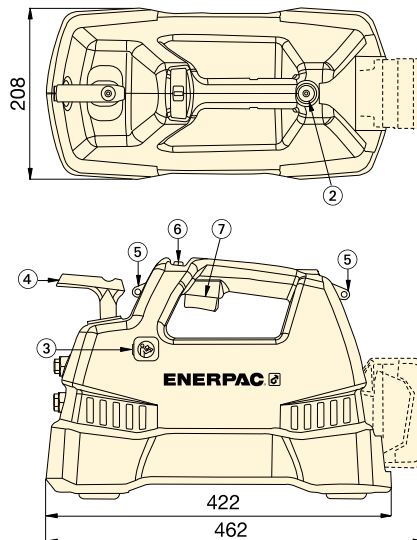
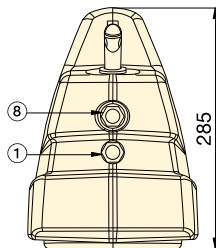

OIL FLOW vs. PRESSURE

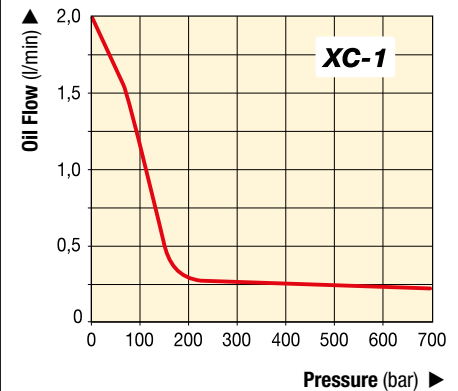

### SELECTION CHART

Pump Type (Used with cylinder)	Useable Oil Capacity (litres)	Model Number	Output Flow Rate (l/min)			Valve Function	Charger Voltage (VAC)	Weight (kg)
			No Load	140 bar	700 bar			
Single-Acting	1,0	XC-1201MB <sup>1)</sup>	2,0	0,50	0,25	3-way, 2-pos.	115	10
	2,0	XC-1202MB	2,0	0,50	0,25	3-way, 2-pos.	115	11
	1,0	XC-1201ME <sup>1)</sup>	2,0	0,50	0,25	3-way, 2-pos.	230	10
	2,0	XC-1202ME	2,0	0,50	0,25	3-way, 2-pos.	230	11
	1,0	XC-1201M <sup>2)</sup>	2,0	0,50	0,25	3-way, 2-pos.	-	10
	2,0	XC-1202M <sup>2)</sup>	2,0	0,50	0,25	3-way, 2-pos.	-	11
Double-Acting	1,0	XC-1401MB	2,0	0,50	0,25	4-way, 3-pos.	115	10
	2,0	XC-1402MB	2,0	0,50	0,25	4-way, 3-pos.	115	11
	1,0	XC-1401ME	2,0	0,50	0,25	4-way, 3-pos.	230	10
	2,0	XC-1402ME	2,0	0,50	0,25	4-way, 3-pos.	230	11
	1,0	XC-1401M <sup>2)</sup>	2,0	0,50	0,25	4-way, 3-pos.	-	10
	2,0	XC-1402M <sup>2)</sup>	2,0	0,50	0,25	4-way, 3-pos.	-	11

<sup>1)</sup> Available as a cylinder pump set, see page 58.

<sup>2)</sup> Batteries and charger not included.

Take the battery pump anywhere without power cords or air hoses.



▼ Shown: PUJ-1200E



## Heavy on Performance, Light on Weight



### Gauges

Minimize the risk of overloading and ensure long, dependable service from your equipment. For use with the Economy pump the **G-2535L** gauge and **GA-3** gauge adaptor are suggested.

For a full range of gauges, please refer to the System Components section.

Page: 130



### Hoses

Enerpac offers a complete line of high quality hydraulic hoses. To ensure the integrity of your system, specify only genuine Enerpac hydraulic hoses.

Page: 122



### Speed Chart

To determine how a specific pump will operate your cylinder, see the Pump-Cylinder Speed Chart in the 'Yellow Pages'.

Page: 273

- Lightweight and compact design: 11,8 to 18,6 kg
- Large easy-carry handle for maximum portability
- Two-speed operation reduces cycle times for improved productivity
- 230 VAC 50/60-cycle universal motor will operate under poor voltage supply
- 24 VAC remote motor control, 3 m length for operator safety
- Starts under full load
- High strength molded shroud, with integral handle, protects motor from contamination and damage
- Designed for intermittent duty cycle.

▼ An Economy Pump PUJ-1200E is used with a low-height cylinder RCS-302 to reposition a Scissor lift to simplify maintenance.



Pump Type  (Used with cylinder)	Usable Oil Capacity  (litres)	Model Number *	Pressure Rating (bar)	
			1 <sup>st</sup> stage	2 <sup>nd</sup> stage
Single-Acting	1,9	PUD-1100E	13	700
	3,8	PUD-1101E	13	700
	1,9	PUJ-1200E	13	700
	3,8	PUJ-1201E	13	700
	1,9	PUD-1300E	13	700
	3,8	PUD-1301E	13	700
Double-Acting	1,9	PUJ-1400E	13	700
	3,8	PUJ-1401E	13	700

\* For 115 volt applications replace 'E' suffix with 'B'.

\*\* Electric dump valve for auto-retract of cylinders.

# Economy Electric Pumps



## About the Economy Pump

The Economy pump is best suited to power small to medium size cylinders or hydraulic tools. Its lightweight and compact design make it ideal for applications which require easy transport of the pump. The universal motor works well on long extension cords or generator-driven electrical power supplies.

For further application assistance refer to the 'Yellow Pages'.

### PUD-1100 Series

- Provides advance-retract of single-acting cylinders
- Ideal for punching applications
- For applications not requiring load holding
- 3 m cord with pendant controls motor and valve operation.

### PUD-1300 Series

- Provides advance-hold-retract of single-acting cylinders
- Ideal for applications requiring load-holding
- For applications requiring solenoid valve operations
- 3 m cord with pendant controls motor and valve operation.

### PUJ Series

- Manual valves provide advance-hold-retract tool operation
- Available with 3- and 4-way valves for single or double-acting cylinders
- 3 m cord with pendant controls the motor operation.



Page: 263

## PU Series



Reservoir Capacity:

**1,9 - 3,8 litres**

Flow at Rated Pressure:

**0,32 l/min**

Motor Size:

**0,37 kW**

Maximum Operating Pressure:

**700 bar**

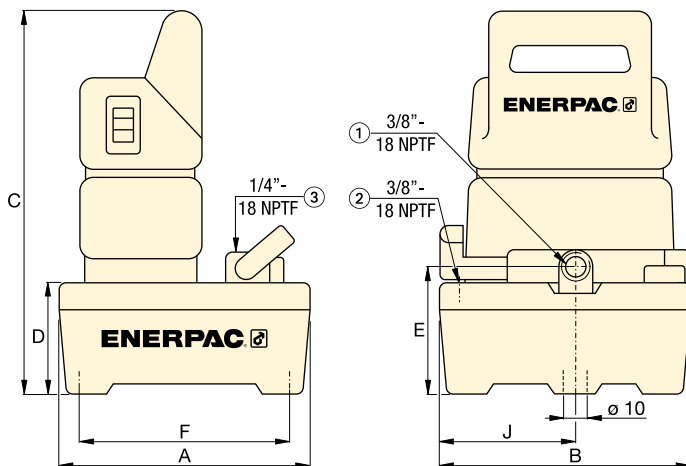

- ① Oil Outlet Port
- ② Tank Port
- ③ Gauge Port (PUJ-1200 and PUJ-1201 models only)

### OIL FLOW VERSUS PRESSURE

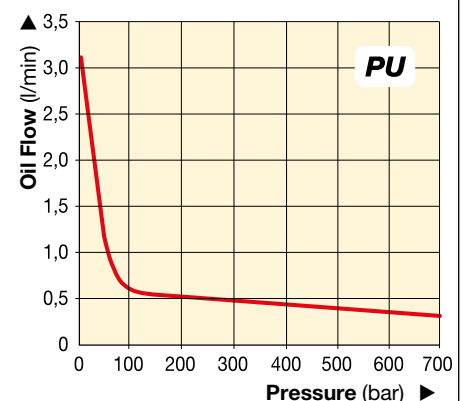

Output Flow Rate (l/min)	Valve Type	Valve Function	Current Draw (Amps)	Motor Voltage (VAC)	Sound Level (dBA)	Dimensions (mm)							Weight (kg)	Model Number *
						1 <sup>st</sup> stage	2 <sup>nd</sup> stage	A	B	C	D	E		
3,31	Dump**	Advance/Retract	3,2	230	85	244	244	362	101	119	203	133	11,8	PUD-1100E
0,32			3,2	230	85	368	309	373	105	130	323	142	17,2	PUD-1101E
3,31	3/2 manual	Advance/ Hold/Retract	3,2	230	85	244	244	362	101	119	203	133	10,0	PUJ-1200E
0,32			3,2	230	85	368	309	373	105	130	323	142	15,4	PUJ-1201E
3,31	3/2 solenoid	Dump & Hold	3,2	230	85	244	244	362	101	119	203	133	12,0	PUD-1300E
0,32			3,2	230	85	368	309	373	105	130	323	142	17,5	PUD-1301E
3,31	4/3 manual	Advance/ Hold/Retract	3,2	230	85	244	244	362	101	119	203	133	13,2	PUJ-1400E
0,32			3,2	230	85	368	309	373	105	130	323	142	18,6	PUJ-1401E

▼ Shown: PEJ-1401E



- Two-speed operation reduces cycle times for improved productivity
- Powerful 0,37 kW induction motor is submerged in the oil reservoir to run cooler, protect the motor, simplify the pump interface, save space and reduce noise
- Large 5,5 litres reservoir allows operation of a wide range of cylinders
- 24 VDC remote pendant control on certain models for improved safety
- Externally adjustable relief valve allows control of operating pressure without opening the pump
- 40-micron internal return line filter keeps oil clean, promoting longer pump life
- Full length side tube for easy monitoring of oil level.



◀ The Remote Jog model (PEJ-Series) of the Submerged Pump simplifies maintenance on this machine.

## Best Performance for Mid-Range Cylinders and Tools

### ▼ SELECTION CHART

For more technical information see next page.

#### 5 BASIC PUMP TYPES

Select the model that suits your application. For special requirements see page 89 or contact your Enerpac office.

#### PEM Series: with Manual Valve

- Ideal choice for most applications
- Manual valve control, for both single-acting and double-acting applications
- Manual motor control.

#### PER Series: with Solenoid Valve

- Ideal for production and lifting
- All valves are 3 position for Advance-Hold-Retract
- Control pendant with 3 m cord for remote valve operation.

#### PEJ Series: with Remote Jog

- For light production and lifting applications
- Manual valve control for single-acting or double-acting cylinders
- Control pendant with 3 m cord for remote motor operation.

#### PES Series: with Pressure Switch

- Designed for continuous pressure applications, such as clamping, workholding and testing
- All versions include manual valves for directional control.



# Submerged Electric Pumps



## PE-Series Submerged Pump Application

The Submerged pump is best suited to power small to medium size cylinders or hydraulic tools, or whenever quiet, intermittent duty cycle is needed.

With its low sound level and the addition of the optional oil cooler, the Submerged pump is suited to light production work as well.

Its lightweight and compact design also make it ideal for applications which require some transport of the pump.

For further application assistance see the 'Yellow Pages' or contact your local Enerpac office.

Page: 263

## PE Series



Reservoir Capacity:

**5,5 litres**

Flow at Rated Pressure:

**0,27 l/min**

Motor Size:

**0,37 kW**

Maximum Operating Pressure:

**700 bar**

Pump Type	Used with Cylinder	Valve Function	Valve Type	Usable Oil Capacity (litres)	Model Number 230 VAC, 1 ph *	Weight (kg)
	Single-Acting	Advance/Retract	Manual, 3-way, 2-position	5,5	<b>PEM-1201E</b>	24,0
	Single-Acting	Advance/Hold/Retract	Manual, 3-way, 3-position	5,5	<b>PEM-1301E</b>	24,0
	Double-Acting	Advance/Hold/Retract	Manual, 4-way, 3-position	5,5	<b>PEM-1401E</b>	24,0
	Single-Acting	Advance/Hold/Retract	Solenoid, 3-way, 3-position	5,5	<b>PER-1301E</b>	29,5
	Double-Acting	Advance/Hold/Retract	Solenoid, 4-way, 3-position	5,5	<b>PER-1401E</b>	29,5
	Single-Acting	Advance/Retract	Manual, 3-way, 2-position	5,5	<b>PEJ-1201E</b>	24,9
	Single-Acting	Advance/Hold/Retract	Manual, 3-way, 3-position	5,5	<b>PEJ-1301E</b>	24,9
	Double-Acting	Advance/Hold/Retract	Manual, 4-way, 3-position	5,5	<b>PEJ-1401E</b>	24,9
	Single-Acting	Advance/Retract	Manual, 3-way, 2-position	5,5	<b>PES-1201E</b>	28,1
	Double-Acting	Advance/Hold/Retract	Manual, 4-way, 3-position	5,5	<b>PES-1401E</b>	28,1

\* For 115V replace suffix "E" with "B" in the model number.

# PE-Series, Submerged Electric Pumps

◀ For full features see previous page.

SUBMERGED PUMP PERFORMANCE							
Motor Size (kW)	Pressure Rating (bar)		Output Flow Rate at 50 Hz (l/min)		Motor Electrical Specifications *	Sound Level (dBA)	Relief Valve Adjustment Range (bar)
	1 <sup>st</sup> stage	2 <sup>nd</sup> stage	1 <sup>st</sup> stage	2 <sup>nd</sup> stage			
0,37	70	700	2,0	0,27	13 @ 115-1-50/60 6,75 @ 230-1-50/60	62-70	70-700

\* At full load. See ordering matrix footnote for frequency notations.

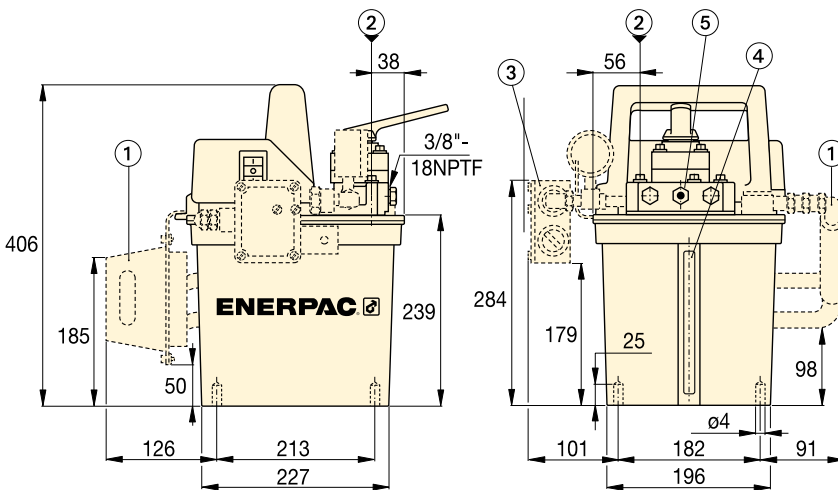
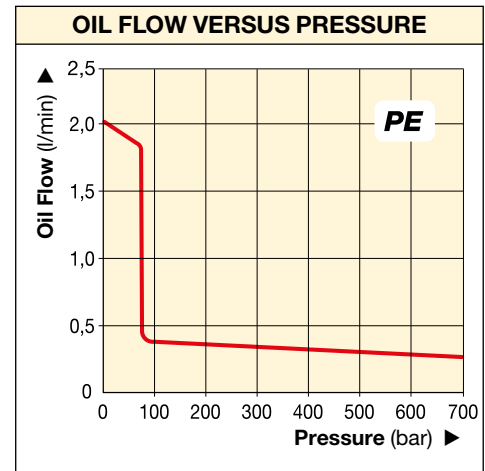

- ① Heat Exchanger (optional for all models)
- ② Fill Port
- ③ Pressure Switch (PES-series, optional for other models)
- ④ Oil Level Indicator
- ⑤ Adjustable relief valve



### Speed Chart

To determine how a specific pump will operate your cylinder, see the Pump-Cylinder Speed Chart in the 'Yellow Pages'.

Page: 273



◀ This Submerged pump quickly and quietly powers a hydraulic nut cutter in this maintenance application.

# Submerged Electric Pumps

## CUSTOM BUILD YOUR SUBMERGED PUMP

If the Submerged Pump that would best fit your application cannot be found in the chart on page 87, here you can easily build your custom submerged pump.

▼ This is how a Submerged Pump Model Number is built up:

<b>P</b>	<b>E</b>	<b>M</b>	<b>-</b>	<b>1</b>	<b>3</b>	<b>01</b>	<b>E</b>
1	2	3		4	5	6	7
Product Type	Motor Type	Pump Type		Pump Series	Valve Type	Reservoir Size	Motor Voltage

### 1 Product Type

**P** = Pump

### 2 Motor Type

**E** = Electric Motor

### 3 Pump Type

**J** = Jog  
**M** = Manual  
**R** = Remote (Solenoid) <sup>1) 2)</sup>  
**S** = Pressure Switch

### 4 Pump Series

**1** = 0,37 kW, 700 bar

### 5 Valve Type

**0** = No valve (PER only)  
**2** = 3-way, 2-position, normally open  
**3** = 3-way, 3-position, tandem center  
**4** = 4-way, 3-position, tandem center  
**5** = Modular solenoid valve (PER only)

### 6 Reservoir Capacity

**01** = 5,5 litres

### 7 Motor Voltage and Heat Exchanger

**B** = 115 V, 1 Ph, 50/60 Hz <sup>1)</sup>  
**D** = 115 V, 1 Ph, 50/60 Hz <sup>1)</sup> with Heat Exchanger  
**E** = 230 V, 1 Ph, 50/60 Hz <sup>2)</sup>  
**F** = 230 V, 1 Ph, 50/60 Hz <sup>2)</sup> with Heat Exchanger  
**I** = 230 V, 1 Ph, 60 Hz

<sup>1)</sup> Solenoid valves operate only at 60 Hz. Can run on 50 Hz with manual valves.

<sup>2)</sup> Solenoid valves operate only at 50 Hz. Can run on 60 Hz with manual valves.

The following submerged pump models include a modular solenoid valve and pilot operated check valve:

PER-1301B  
 PER-1301D  
 PER-1301E  
 PER-1401B  
 PER-1401D  
 PER-1401E

## Ordering Example

### Model Number: PER-1301E

The PER-1301E is a 0,37 kW, 700 bar, submerged electric pump, with 5,5 litres usable oil capacity, a 3-way, 3-position, remote solenoid valve and a 230 V, 1 Phase, 50/60 Hz motor.

## PE Series



Reservoir Capacity:

**5,5 litres**

Flow at Rated Pressure:

**0,27 l/min**

Motor Size:

**0,37 kW**

Maximum Operating Pressure:

**700 bar**



### Hoses

Enerpac offers a complete line of high quality hydraulic hoses. To ensure the integrity of your system, specify only genuine Enerpac hydraulic hoses.

Page: 122



### Gauges

Minimize the risk of overloading and ensure long, dependable service from your equipment. Refer to the System Components section for a full range of gauges.

Page: 130

# Z-Class Enerpac Power Pumps

Introducing the **Z-Class** power pumps from Enerpac – pumps that run cooler, use less electricity and are easy to service.

Enerpac has used the latest metallurgical, bearing and seal technologies to produce a pump whose features and benefits far surpass the electric pumps that are available today. By reducing the number of moving parts, improving flow dynamics and decreasing friction, Z-Class pumps will stay on the job longer, require less energy to operate and when needed, have lower service costs.



**Z-Class** power pumps from Enerpac – simply the best pump you will ever use.

**Z** Tough.  
Dependable.  
Innovative.  
**CLASS**





# Z-Class, An Innovation in Pump Design

## Z-Class Pumping Element – The Heart of Your Hydraulic System

**Highly efficient design** provides increased flow rates, reduced heat generation and a decrease in power consumption. This means improved tool speed and increased service life – which results in higher productivity and lower operating costs.

**Heavy-duty bearings** extend pump life by reducing friction, reducing surface-loading and lowering bearing stresses.

**Pump cavity oil bath** extends pump life by reducing heat, improving lubrication and reducing wear.

**Self-priming, high-flow 1st stage pump** increases pump performance by super-charging the 2nd stage piston pump – improving oil flow in both hot and cold weather operation.

**Balanced rotating components reduce vibration** creating a smoother running pump – reducing wear, friction and sound levels.

**Replaceable piston check-valves** increase service life of major pump components.

**Ergonomic pendant** features sealed switches and operates at 24 V for improved operator safety.

### Z-Class factory options & accessories

Extensive list of accessories including heat exchanger, roll cage, skid bar, pressure transducer, return line filter and level and temperature switches, allow complete pump control over a wide range of industrial applications.

### Z-Class power pumps for your application

Available in one flow range for universal motor and eight flow ranges for induction motor. Choose from single or two-stage models to provide the optimum cylinder and tool performance for almost any industrial application.

### Back-lit LCD on select Z-Class pumps

- pump usage information, hour and cycle counts
- low-voltage warning and recording
- offers self-test and diagnostic capabilities
- information displayed in 6 languages
- pressure read-out (when used with the optional pressure transducer)
- adjustable trigger pressure setting (when used with the optional pressure transducer).



Back-lit LCD available on ZU and ZE-Series Electric Pumps. ▶



### ZU-Series Pump Applications

- **Mobile:** when frequent pump transport is required and/or on remote locations
- **Universal motor:** 1-phase, runs well under poor voltage supply, using generator power supply or using long extension cord
- **Duty-cycle:** for intermittent applications
- **Cylinders and tools:** for medium to large size single and double-acting applications and high speed
- **Pump speed:** two stage pump unit.



### ZE-Series Pump Applications

- **Stationary:** when pump remains in one location
- **Induction motor:** 1 and 3-phase for high cycle usage
- **Duty-cycle:** for heavy-duty, extended cycle application
- **Cylinders and tools:** for medium to large size single and double-acting applications and high speed
- **Pump speed:** single or two stage pump unit.

Oil Flow Rate at 700 bar (l/min)	Z-Class Pump Series *	Electric Motor Power (kW)	Air Motor-Consumption (l/min)	Gasoline Engine Power (kW)	Page:
0,55	ZE3	0,75	–	–	98
0,82	ZE4(T)	1,12	–	–	98, 220
1,00	ZU4(T)	1,25	–	–	92, 216
1,30	ZA4(T)	–	2840	–	110, 224
1,60	ZG5	–	–	4,8	112
1,64	ZE5(T)	2,24	–	–	98, 220
2,73	ZE6	5,60	–	–	98
3,30	ZG6	–	–	9,7	112

\* ZA4T, ZU4T, ZE4T and ZE5T-Series are Torque Wrench Pumps.

# ZU4-Series, Portable Electric Pumps

▼ Shown from left to right: ZU4304ME, ZU4420SE-H, ZU4304PE-K



- High-efficiency two-speed pump design – higher oil flow and bypass pressure
- Powerful 1,25 kW universal electric motor provides high power-to-weight ratio and excellent low-voltage operating characteristics
- High-strength, moulded composite shroud protects motor and electronics, while providing an ergonomic, non-conductive handle for easy transport.

## Pro-Series models only

- \* Back-lit LCD readout provides pressure display and a number of diagnostics and readout capabilities never offered on a portable pump before:
  - pump usage information, hour and cycle counts
  - self-test, diagnostic and read-out capabilities
  - pressure readout and auto-mode pressure settings.



◀ Designed to be tough, the ZU4-Series with steel reservoirs will take the abuse of today's construction sites.

**Z** Tough.  
Dependable.  
Innovative.  
**CLASS**



### Assisted Return Pumps with Venturi Valve Technology

To improve productivity and plunger retraction, Enerpac offers valve configurations designed to accelerate your cylinder retraction speeds, ZU4-Series pumps feature **Venturi Valve Technology** to facilitate the faster return of single-acting gravity return cylinders. See valve type in ordering matrix and details in section Directional Control Valves.

## ▼ COMMON PUMP MODELS

For technical information and other options see next page.

### BASIC PUMP TYPES

Select the model that suits your application. For special requirements contact your Enerpac office.

#### Manual Valve

- Ideal choice for most applications.
- For single-acting or double-acting applications.
- Venturi Valve Technology (VM33VAC) for faster retract of single-acting cylinders.
- Motor control on shroud.

#### Manual Valve with Pendant \*

- For light production and lifting applications.
- For single- or double-acting cylinders.
- Venturi Valve Technology (VM33VAC) for faster retract of single-acting cylinders.
- Manual valve with power seat (VM43LPS), ideal for post-tensioning applications.

#### Dump Valve \*

- Ideal for punching, crimping and cutting.
- For use when load-holding is not required.

#### Solenoid Valve \*

- Ideal for lifting applications and where remote control is required.
- Venturi Valve Technology (VE33VAC) for faster retract of single-acting cylinders.
- With VE32 valve, motor only runs during the advance function, while holding and retracting, the motor is off.
- Motor runs continuously on pumps with VE33 and VE43 valves.

\* Pendant with 3 m. cord controls valve and motor.

# ZU4-Series, Electric Pumps



## Z-Class – A Pump For Every Application

Patented Z-Class pump technology provides high by-pass pressures for increased productivity – important in applications using long hose runs and high pressure-drop circuits, like heavy lifting or certain double-acting tools.

Enerpac ZU4-Series Pumps are built to power small to large-sized cylinders or hydraulic tools, or wherever high-speed, intermittent duty, remote hydraulic power is needed.

### Classic Electric Pumps

- The Classic has traditional electro-mechanical components (transformers, relays and switches) in place of solid-state electronics.

The Classic delivers durable, safe and efficient hydraulic power for demanding markets like construction, post-tensioning and foundation repair.

### Standard Electric Pumps

- For applications that do not require digital display features of the Premium Pump. Available in all manual or jog versions.

### Pro Electric Pumps

- Digital (LCD) display features a built-in hour meter and shows self-diagnostic, cycle-count and low voltage warning information.
- Pressure can also be displayed when the pump is equipped with an optional pressure transducer.



## ZU4 Series



Reservoir Capacity:

**4 - 40 litres**

Flow at Rated Pressure:

**1,0 l/min**

Motor Size:

**1,25 kW**

Maximum Operating Pressure:

**700 bar**

Pump type	Used with Cylinder		Valve Function			Valve Type <sup>1)</sup>	Pump Control	Useable Oil Capacity (litres)	Model Number 230 V - 1 phase - 50 Hz <sup>2)</sup>			Pro Electric Weight <sup>3)</sup> (kg)
									Classic Electric	Standard (STD) Electric	Pro Electric (incl. LCD)	
	●		●		●	VM32	Manual	4,0	ZU4204RE	ZU4204ME	ZU4204LE	27
	●		●		●	VM32	Manual	8,0	ZU4208RE	ZU4208ME	ZU4208LE	32
	●		●	●	●	VM33VAC	Manual	8,0	ZU41008RE	ZU41008ME	ZU41008LE	33
	●		●	●	●	VM33	Manual	20,0	ZU4320RE	ZU4320ME	ZU4320LE	50
		●	●	●	●	VM43	Manual	8,0	ZU4408RE	ZU4408ME	ZU4408LE	32
		●	●	●	●	VM43	Manual	20,0	ZU4420RE	ZU4420ME	ZU4420LE	50
	●		●		●	VM32 <sup>4)</sup>	Remote (Man.)	4,0	ZU4704PE <sup>4)</sup>	ZU4204JE	ZU4204KE	27
	●		●		●	VM33VAC	Remote (Man.)	8,0	ZU41008PE	ZU41008JE	ZU41008KE	33
	●		●		●	VM32 <sup>4)</sup>	Remote (Man.)	20,0	ZU4720PE <sup>4)</sup>	ZU4220JE	ZU4220KE	50
	●		●	●	●	VM33	Remote (Man.)	8,0	ZU4308PE	ZU4308JE	ZU4308KE	32
		●	●	●	●	VM43	Remote (Man.)	8,0	ZU4408PE	ZU4408JE	ZU4408KE	32
		●	●	●	●	VM43	Remote (Man.)	20,0	ZU4420PE	ZU4420JE	ZU4420KE	50
	●		●		●	VE32D	Remote	4,0	N/A	N/A	ZU4104DE	29
	●		●		●	VE32D	Remote	8,0	N/A	N/A	ZU4108DE	33
	●		●		●	VE32D	Remote	20,0	N/A	N/A	ZU4120DE	51
						–	–	–	–	–	–	–
						–	–	–	–	–	–	–
						–	–	–	–	–	–	–
	●		●	●	●	VE32	Remote	4,0	N/A	N/A	ZU4204SE	29
	●		●	●	●	VE32	Remote	8,0	N/A	N/A	ZU4208SE	33
	●		●	●	●	VE33	Remote	8,0	N/A	N/A	ZU4308SE	39
	●		●	●	●	VE33VAC	Remote	8,0	N/A	N/A	ZU41108SE	40
		●	●	●	●	VE43	Remote	8,0	N/A	N/A	ZU4408SE	39
		●	●	●	●	VE43	Remote	20,0	N/A	N/A	ZU4420SE	56
						–	–	–	–	–	–	–
						–	–	–	–	–	–	–

<sup>1)</sup> See valves section for technical information on valve types. <sup>2)</sup> See custom order matrix on page 89 for other voltage options.

<sup>3)</sup> Subtract 1,4 kg for Standard (STD) Electric models. <sup>4)</sup> ZU47... pump models have VM22 3-way, 2 position manual valve for foundation repair applications.





## Pressure Transducer \*

- More durable than analog gauges (against mechanical and hydraulic shock)
- More accurate than analog gauges (0,5% full scale of pump)
- Calibration can be fine tuned for certification
- "Set pressure" feature turns off motor at user defined pressure (or shifts valve to neutral on models with VE33/VE43 valves)
- Display pressure in bar, psi or MPa.

\* Requires LCD Electric

Accessory Kit Model Number	Adjustable Pressure Range (bar)	Switch-point repeatability	Dead-band (bar)
ZPT-U4 *	3,5 - 700	± 0,5%	3,5

\* Add suffix **T** for factory installation.

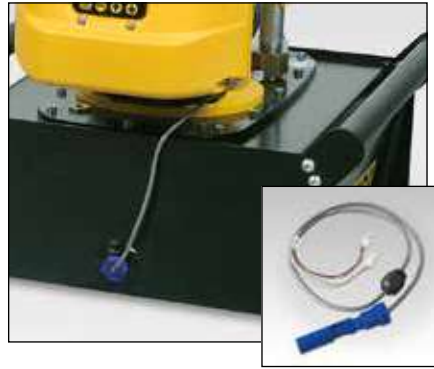

## Level/Temperature Switch

- Ensures feedback on pump oil level and temperature
- Drop-in design allows for easy installation to pump reservoir
- Plugs directly into pump electrical enclosure
- Built-in thermal sensing shuts off pump when unsafe operating temperature is reached
- Oil level switch shuts down pump before oil reaches an unsafe operating level.

Model Number	Operating Temperature (°C)	Maximum Pressure (bar)	 (kg)
ZLS-U4 *	5-110	10	0,1

\* Add suffix **L** for factory installation.



## Hoses

Enerpac offers a complete line of high-quality hydraulic hoses. To ensure the integrity of your system, specify only Enerpac hydraulic hoses.

Page: 122



## Gauges

Minimize the risk of overloading and ensure long, dependable service from your equipment. Refer to the System Components section for a full range of gauges.

Page: 130



## Foot Switch

- Hands-free remote control on solenoid dump and 3-position valves
- With 3 metres cord.

Accessory Kit Modelnr.	Can be used on ZU4-Series Pumps with
ZCF-2 *	Solenoid VE-Series valves

\* Add suffix **U** for factory installation.



## Roll Cage

- Protects pump
- Provides greater pump stability.

Accessory Kit Modelnr.	Fits on reservoir
ZRC-04 *	4 and 8 litres <sup>1)</sup>
ZRC-04H *	4 and 8 litres <sup>2)</sup>
ZRB-10 *	10 litres
ZRB-20 *	20 litres
ZRB-40 *	40 litres

\* Add suffix **R** for factory installation.

<sup>1)</sup> Without heat exchanger

<sup>2)</sup> With heat exchanger.



## Skid Bar

- Provides easy two-hand lift
- Provides greater pump stability on soft or uneven surfaces.

Accessory Kit Modelnr.	Fits on reservoir	 (kg)
SBZ-4 *	4 and 8 l without heat exchanger	2,2
SBZ-4L *	4 and 8 l with heat exchanger	3,2

\* Add suffix **K** for factory installation.



# ZU4-Series, Options & Accessories



## ZU4-Series Options

Accessory Kits can be installed by the customer.

See chart below for all possible options on ZU4-Series pumps:

- Classic Electric,
  - Standard (STD) Electric (no LCD)
  - Pro Electric (with LCD).
- Refer to page 97 for ordering matrix.

ZU4-Series Options	Factory Installed			Accessory Kits		
	Classic Electric	Standard Electric	Pro Electric	Classic Electric	Standard Electric	Pro Electric
Return Line Filter	F	F	F	ZPF	ZPF	ZPF
Skid Bar <sup>1)</sup>	K	K	K	SBZ	SBZ	SBZ
Roll Cage	R	R	R	ZRC	ZRC	ZRC
Heat Exchanger	H	H	H	ZHE	ZHE	ZHE
1000 bar Pressure Gauge	G	G	G	G	G	G
Pressure Transducer	-	-	T	-	-	ZPT-U4
Level/Temperature Switch	-	-	L	-	-	ZLS-U4
Foot Switch	-	-	U	-	-	ZCF-2

<sup>1)</sup> Skid Bar not in combination with Roll Cage.

## ZU4 Series



Reservoir Capacity:

**4 - 40 litres**

Flow at Rated Pressure:

**1,0 l/min**

Motor Size:

**1,25 kW**

Maximum Operating Pressure:

**700 bar**



### Return Line Filter

- 25 micron filter removes contaminants from return oil flow
- By-pass valve prevents damage if filter is dirty
- With maintenance indicator.

Accessory Kit Modelnr.	Maximum Pressure (bar)	Maximum Oil Flow (l/min)	By-pass Setting (bar)
ZPF *	13,8	45,4	1,7

\* Add suffix **F** for factory installation.



### Heat Exchanger

- Removes heat from by-pass oil to provide cooler operation
- Stabilizes oil viscosity, increasing oil life and reduces wear of pump and other hydraulic components.

Accessory Kit Nr.	Can be used on	(kg)
ZHE-U115 *	115 V pumps	4,1
ZHE-U230 *	230 V pumps	4,1

\* Add suffix **H** for factory installation.



### Heat Exchanger

Can be factory installed on ZU4-Series Classic, Standard Electric and Pro Electric models.

- Extends system life.
- Stabilizes oil temperature at a maximum of 54 °C at 21 °C ambient temperature.

Do not exceed maximum oil flow and pressure ratings. Heat exchanger is not suitable for water-glycol or high water based fluids.

Thermal Transfer *		Maximum Pressure	Maximum Oil Flow	Voltage
Btu/h	kJoule	(bar)	(l/min)	(VDC)
900	950	20,7	26,5	12

\* At 1,9 l/min at 21 °C ambient temperature.

# ZU4, Specifications and Dimensions

## OIL FLOW VERSUS PRESSURE

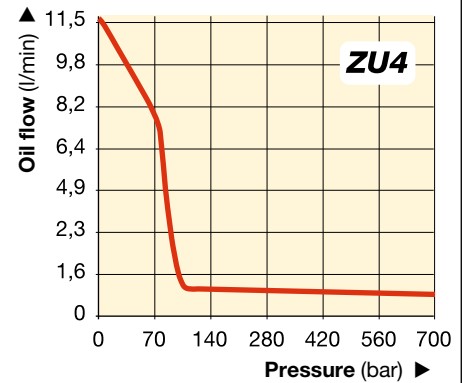

## ZU4-SERIES PERFORMANCE CHART

Motor Size (kW)	Output Flow Rate at 50 Hz (l/min)				Motor Electrical Specifications (Volts-Ph-Hz)	Sound Level (dBA)	Relief Valve Adjustment Range (bar)
	7 bar	50 bar	350 bar	700 bar			
1,25	11,5	8,8	1,2	1,0	115-1-50/60 230-1-50/60	85-90	140-700

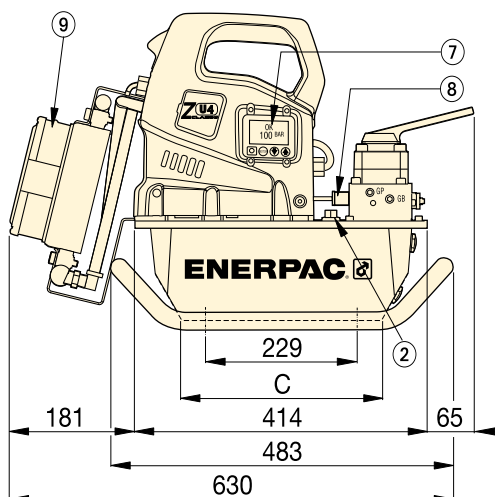

ZU4-Series with 4 and 8 litres reservoirs

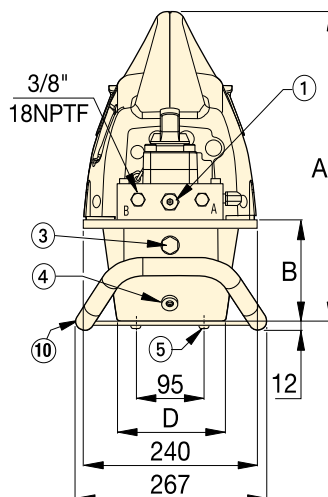

3/8"-18 NPTF Advance and Retract Ports

- ① User adjustable relief valve
- ② Oil fill port SAE #10 7/8"-14 UNF-2B
- ③ Oil level sight gauge
- ④ Oil drain 1/2" NPTF
- ⑤ M8, 6 mm deep
- ⑥ Handles on all 10, 20 and 40 litres reservoirs.

Options (see chart on page 95):

- ⑦ Back-lit LCD Electric
- ⑧ Pressure transducer
- ⑨ Heat Exchanger
- ⑩ Skid Bar  
Fits 4 and 8 litres reservoirs
- ⑪ Handle guard installed on all 10, 20 and 40 litres reservoirs
- ⑫ Reservoir handles (not shown) included on all 10, 20 and 40 litres reservoirs.

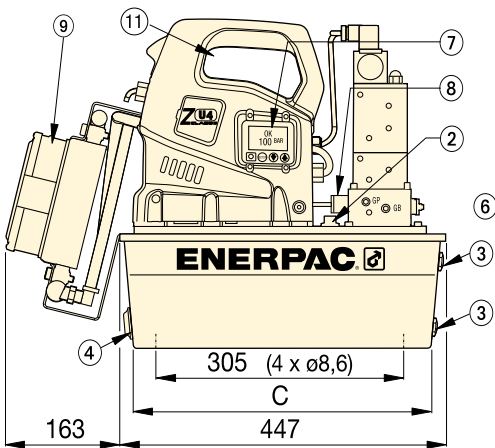

ZU4-Series with 10, 20 and 40 litres reservoirs  
(left view shown without side handle)

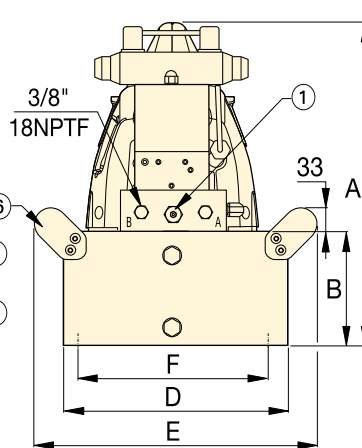

## Pump Dimensions (mm)

Usable Reservoir Capacity (litres)	A	B	C	D	E	F
4,0	424	142	279	152	-	-
8,0	424	142	279	206	-	-
10,0	439	157	413	305	384	279
20,0	465	180	413	422	500	396
40,0	551	269	399	503	576	480

# ZU4-Series, Pump Ordering Matrix

## CUSTOM BUILD YOUR ZU4-SERIES PUMP

If the ZU4-Series pump that would best fit your application cannot be found in the chart on page 93, you can easily build your custom ZU4-Series pump here.

▼ This is how a ZU4-Series pump model number is built up:

<b>Z</b>	<b>U</b>	<b>4</b>	<b>1</b>	<b>04</b>	<b>D</b>	<b>E</b>	<b>-</b>	<b>H</b>	<b>K</b>	<b>T</b>
1	2	3	4	5	6	7		8		
Product Type	Motor Type	Flow Group	Valve Type	Reservoir Size	Valve Operation	Voltage		Options and Accessories		

### 1 Product Type

**Z** = Pump Series

### 2 Motor Type

**U** = Universal electric motor

### 3 Flow Group

**4** = 1,0 l/min @ 700 bar

### 4 Valve Type (see page 116-117 for more details)

- 1** = Dump (**VE32D**)
- 2** = 3 way/2 position manual or electric (**VM32** or **VE32**)
- 3** = 3 way/3 position manual or electric (**VM33** or **VE33**)
- 4** = 4 way/3 position manual or electric (**VM43** or **VE43**)
- 6** = 3 way/3 position locking manual w/po check (**VM33L**)
- 7** = 3 way/2 position manual (**VM22**)
- 8** = 4 way/3 position locking manual w/po check (**VM43L**)
- 9** = 4 way/3 position manual w/power seating (**VM43LPS**)
- 10** = 3 way/3 position manual Venturi valve (**VM33VAC**)
- 11** = 4 way/3 position electric Venturi valve (**VE33VAC**)
- 12** = 3 way/3 position manual locking Venturi valve (**VM33LVAC**)

### 5 Reservoir Size (useable capacity)

- 04** = 4 litres
- 08** = 8 litres
- 10** = 10 litres (reservoir includes side handles)
- 20** = 20 litres (reservoir includes side handles)
- 40** = 40 litres (reservoir includes side handles)

### 6 Valve Operation

- D** = Dump (solenoid valve w/pendant and LCD Electric)
- J** = Jog (manual valve w/pendant and Standard Electric (i.e. w/o LCD))
- K** = Jog (manual valve w/pendant and LCD Electric)
- L** = Manual valve w/LCD Electric (w/o pendant)
- P** = Manual valve w/pendant and classic electric (i.e. w/o LCD)
- R** = Manual valve w/Classic electric (i.e. w/o LCD) [w/o pendant]
- M** = Manual valve w/Standard Electric (i.e. w/o LCD) [w/o pendant]
- S** = Solenoid valve w/pendant and LCD Electric

### 7 Voltage

- B** = 115V, 1 ph, 50/60Hz
- E** = 208-240V, 1 ph, 50/60 Hz (with European plug and CE EMC compliant)
- I** = 208-240V, 1 ph, 50/60 Hz (with NEMA 6-15 plug)

### 8 Options and Accessories (see pages 95-96 for possibilities)

- F** = Filter
- G** = 0-1000 bar pressure gauge (ø 63,5 mm) <sup>1)</sup>
- H** = Heat exchanger
- K** = Skid Bar (4 and 8 litres reservoirs only)
- L** = Level/temperature switch <sup>2),3)</sup>
- N** = No reservoir handles (includes lifting eyes)
- R** = Roll Cage
- T** = Pressure transducer <sup>2)</sup>
- U** = Foot switch

- <sup>1)</sup> Pressure gauge not available on pump models with pressure transducer
- <sup>2)</sup> These options require Pro Electric
- <sup>3)</sup> Not available on 4 and 8 litres reservoirs

## ZU4 Series



Reservoir Capacity:

**4 - 40 litres**

Flow at Rated Pressure:

**1,0 l/min**

Motor Size:

**1,25 kW**

Maximum Operating Pressure:

**700 bar**



### Speed Chart

To determine how a specific pump will operate your cylinder, see the Pump-Cylinder Speed Chart in the 'Yellow Pages'.

Page: 273



### Assisted Return Pumps with Venturi Valve Technology

To improve productivity and plunger retraction, Enerpac offers valve configurations designed to accelerate your cylinder retraction speeds, ZU4 and ZE-Series pumps feature **Venturi Valve Technology** to facilitate the faster return of single-acting gravity and spring return cylinders. See valve type in ordering matrix and details in section Directional Control Valves.

Page: 116



### Ordering Example: ZU4108DE-HKT

is a Pro Electric model pump with LCD, 1,0 l/min oil flow at 700 bar, pump with a dump valve, an 8 liter reservoir, operates on 230V, heat exchanger, pressure transducer and skid bar.



### Spring Centred Valve Kits

VM and VC-Series manual 3-position valves can be easily converted into spring centred valves. With these retro-fit kits the handle will automatically move into the neutral valve position when released.

Page: 117

# ZE-Series, Electric Pumps

▼ Shown from left to right: ZE3304ME-K, ZE4110DE-FHR













**Z** Tough.  
Dependable.  
Innovative.  
**CLASS**



### Assisted Return Pumps with Venturi Valve Technology

To improve productivity and plunger retraction, Enerpac offers valve configurations designed to accelerate your cylinder retraction speeds, ZE-Series pumps feature **Venturi Valve Technology** to facilitate the faster return of single-acting gravity return cylinders. See valve type in ordering matrix and details in section Directional Control Valves.

PUMP CONFIGURATIONS		Pump Type	Used with Tool or Cylinder		Valve Function <sup>1)</sup>			Valve <sup>1)</sup> Model Number	Useable Oil Capacity (litres)	
For options and other model numbers see ordering matrix or contact your Enerpac office. (For Z-Class pumps with air motor see ZA-series pumps on page 110).  Page: 										
<b>No valve, without electric box <sup>2)</sup> or LCD</b> • For remote valves or pump mounting Enerpac VM-series valves.								–	4,0	
								–	10,0	
								–	20,0	
								–	40,0	
MANUAL VALVE CONTROL	<b>With manual valve, without electric box or LCD</b> • Ideal choice for most application • Manual valve control, for single and double-acting applications • Venturi Valve (VM33VAC) for faster retract of single-acting cylinders. • Manual motor control • On/Off switch on 1-phase electric motor.		●	–	●	–	●	VM32	4,0	
			●	–	●	●	●	VM33	8,0	
			●	–	●	●	●	VM33VAC	10,0	
			–	●	●	●	●	VM43	20,0	
			–	●	●	●	●	VM43L	40,0	
MANUAL VALVE CONTROL	<b>With manual valve, with electric box and LCD</b> • For single-acting or double-acting applications • Venturi Valve Technology (VM33VAC) for faster retract of single-acting cylinders. • On/off switch on 1-phase electric motor • All options available.		●	–	●	–	●	VM32	4,0	
			●	–	●	–	●	VM32	8,0	
			●	–	●	●	●	VM33VAC	10,0	
			●	–	●	●	●	VM33L	10,0	
			–	●	●	●	●	VM43	20,0	
			–	●	●	●	●	VM43L	40,0	
REMOTE VALVE CONTROL	<b>With solenoid dump valve, with electric box and LCD</b> • Ideal for punching, crimping and cutting • For use when load holding is not required • Push-button pendant <sup>3)</sup> controls valve and motor • All options available.		●	–	●	–	●	VE32D	4,0	
			●	–	●	–	●	VE32D	8,0	
			●	–	●	–	●	VE32D	10,0	
			●	–	●	–	●	VE32D	20,0	
			●	–	●	–	●	VE32D	40,0	
		<b>With solenoid 3-position valve, with electric box and LCD</b> • Ideal for production and lifting applications • 3-position valves (advance/hold/retract) • Venturi Valve Technology (VE33VAC) for faster retract of single-acting cylinders. • Push-button pendant <sup>3)</sup> controls valve and motor • All options available.		●	–	●	●	●	VE33	4,0
				●	–	●	●	●	VE33VAC	8,0
				●	–	●	●	●	VE33	10,0
				–	●	●	●	●	VE43	10,0
				–	●	●	●	●	VE43	20,0
	–	●	●	●	●	VE43	40,0			

<sup>1)</sup> See Valve Section (page 117) for hydraulic symbols and details.

<sup>2)</sup> For No Valve, with Electric Box, see ordering matrix on page 103.

<sup>3)</sup> Pendant includes 3 meters cord.



# ZE-Series, Electric Pumps

- High-efficiency pump design – higher oil flow and by-pass pressure
- High-strength, moulded electrical box protects electronics, power supplies and LCD readout and stands up to harsh industrial environments
- IP54 protection and isolation class
- Back-lit LCD provides self test, diagnostic and read-out capabilities never before offered on an industrial pump (included on pump with electric valves, optional on other models)
- Totally enclosed, fan-cooled industrial electric motors for extended life
- User adjustable relief valve built-in on manual and solenoid valves. Oil ports on valves are 3/8" NPTF
- Steel fan guard on all electric motors
- Full sight oil level glass on 10, 20 and 40 litres reservoirs, oil level indicators on 4 and 8 litres reservoirs.
- 40 micron filter breather with splash guard
- Durable steel reservoirs.

## ZE Series



Reservoir Capacity:

**4 - 40 litres**

Flow at Rated Pressure:





**0,55 - 2,73 l/min**

Motor Size:

**0,75 - 5,60 kW**

Maximum Operating Pressure:

**700 bar**

ZE3-Series 0,55 l/min at 700 bar Two-stage pump		ZE4-Series 0,82 l/min at 700 bar Two-stage pump		ZE5-Series 1,64 l/min at 700 bar Two-stage pump		ZE6-Series 2,73 l/min at 700 bar Two-stage pump	
Model Nr. <sup>4)</sup> 400V / 3 phase	 (kg)	Model Nr. <sup>4)</sup> 400V / 3 phase	 (kg)	Model Nr. <sup>4)</sup> 400V / 3 phase	 (kg)	Model Nr. <sup>4)</sup> 400V / 3 phase	 (kg)
ZE3004NW	36	ZE4004NW	40	–	–	–	–
ZE3010NW	45	ZE4010NW	49	ZE5010NW	54	ZE6010NW	72
ZE3020NW	57	ZE4020NW	61	ZE5020NW	66	ZE6020NW	84
ZE3040NW	80	ZE4040NW	84	ZE5040NW	89	ZE6040NW	107
ZE3204MW	39	ZE4204MW	43	–	–	–	–
ZE3308MW	44	ZE4308MW	48	–	–	–	–
ZE31010MW	51	ZE41010MW	55	ZE51010MW	60	ZE61010MW	78
ZE3420MW	60	ZE4420MW	64	ZE5420MW	69	ZE6420MW	87
ZE3840MW	85	ZE4840MW	89	ZE5840MW	94	ZE6840MW	112
ZE3204LW	42	ZE4204LW	46	–	–	–	–
ZE3208LW	47	ZE4208LW	51	–	–	–	–
ZE31010LW	52	ZE41010LW	56	ZE51010LW	61	ZE61010LW	79
ZE3610LW	53	ZE4610LW	57	ZE5610LW	62	ZE6610LW	80
ZE3420LW	63	ZE4420LW	67	ZE5420LW	72	ZE6420LW	90
ZE3840LW	88	ZE4840LW	92	ZE5840LW	97	ZE6840LW	115
ZE3104DW	44	ZE4104DW	48	–	–	–	–
ZE3108DW	49	ZE4108DW	53	–	–	–	–
ZE3110DW	53	ZE4110DW	57	ZE5110DW	62	ZE6110DW	79
ZE3120DW	65	ZE4120DW	69	ZE5120DW	74	ZE6120DW	92
ZE3140DW	88	ZE4140DW	92	ZE5140DW	97	ZE6140DW	115
ZE3304SW	49	ZE4304SW	53	–	–	–	–
ZE31108SW	55	ZE41108SW	59	–	–	–	–
ZE3310SW	58	ZE4310SW	62	ZE5310SW	67	ZE6310SW	85
ZE3410SW	58	ZE4410SW	62	ZE5410SW	67	ZE6410SW	85
ZE3420SW	70	ZE4420SW	74	ZE5420SW	79	ZE6420SW	97
ZE3440SW	93	ZE4440SW	97	ZE5440SW	102	ZE6440SW	120

<sup>4)</sup> See custom ordering matrix on page 95 for other voltages.



### Adjustable Relief Valve

All VM and VE-Series have a user adjustable relief valve to allow the operator to easily set the optimum working pressure.



### Locking Valves

For applications requiring positive load holding, VM-Series valves (except VM32) are available with a pilot-operated check valve. This

provides hydraulic locking of the load until the valve is shifted into the retract position. To order this feature on your ZE-series pump see the valve type in the order matrix.

Page: 103



### Single or Two-Stage

Choose **single-stage** pumps for applications that require constant flow regardless of pressure such as testing or clamping.

**Two-stage** pumps have an increased output flow at low pressure to allow fast movement towards the load, for reduced cycle times and increased productivity.



## Electric Box <sup>1)</sup>

- Back-lit LCD
- Pump usage information, hour and cycle counts
- Low-voltage warning and recording
- Self-test and diagnostic capabilities
- Pressure read-out <sup>2)</sup>
- Auto-mode pressure setting <sup>2)</sup>
- Information can be displayed in six languages <sup>3)</sup>

<sup>1)</sup> Included on pumps with solenoid valves. Can be factory installed on pumps with manual valve.

<sup>2)</sup> When used with optional pressure transducer.

<sup>3)</sup> English, French, German, Italian, Spanish and Portuguese.



## Level/Temperature Switch <sup>4)</sup>

- Shuts down pump before oil level reaches an unsafe level, avoiding damage due to cavitation
- Shuts down pump when unsafe oil temperature is reached
- Ideal if pump is used in remote area without visual access to oil level.

<sup>4)</sup> 24 V, requires Electric Box. Available for 10, 20 and 40 litres reservoirs.

Accessory Kit Modelnr.	Fixed Temperature Signal (°C)	Operating Temperature (°C)	Max. Pressure (bar)
ZLS-U4 *	80	5 - 110	10

\* Add suffix **L** for factory installation.



## Return Line Filter

- 25 micron nominal filter removes contaminants from return oil flow before allowing it back into tank
- Internal by-pass valve prevents damage if filter is dirty
- With maintenance indicator
- Replaceable filter element PF25.

Accessory Kit Modelnr.	Maximum Pressure (bar)	Maximum Oil Flow (l/min)	By-pass Setting (bar)
ZPF *	13,8	45,4	1,7

\* Add suffix **F** for factory installation.



## Roll Cage

- For easy portability and hoisting
- Protects pump and electric box
- Available for all reservoir sizes.



## Skid Bar

- Provides easy two-hand lift
- Provides greater pump stability on soft or uneven surfaces.



## Foot Switch <sup>5)</sup>

- Hands-free remote control on solenoid dump and 3-position valves
- With 3 meters cord.

<sup>5)</sup> 15 V, requires Electric Box.

Accessory Kit Nr.	Fits on reservoir size:	 (kg)
ZRC-04 *	4 and 8 litres <sup>5)</sup>	5,5
ZRC-04H *	4 and 8 litres <sup>6)</sup>	6,5
ZRB-10 *	10 litres	6,0
ZRB-20 *	20 litres	6,0
ZRB-40 *	40 litres	6,0

\* Add suffix **R** for factory installation.

<sup>5)</sup> For pump without heat exchanger

<sup>6)</sup> For pump with heat exchanger.

Accessory Kit Nr.	Fits on reservoir size:	 (kg)
SBZ-4 *	4 and 8 litres <sup>5)</sup>	2,2
SBZ-4L *	4 and 8 litres <sup>6)</sup>	3,2

\* Add suffix **K** for factory installation.

Accessory Kit Nr.	Can be used on ZE-Series pumps with
ZCF-2 *	Solenoid VE-Series valves

\* Add suffix **U** for factory installation.

# ZE-Series, Options & Accessories



## Pressure Transducer <sup>1)</sup>

- Displays pressure on LCD in bar, MPa or psi
- More accurate than analog gauge
- Calibration can be fine-tuned for certification
- Easy-viewing variable rate display
- “Set pressure” feature turns off motor at user defined pressure <sup>2)</sup>.

<sup>1)</sup> 24 V, requires Electric Box.

<sup>2)</sup> Or shifts valve to neutral position on pump models with VE33 and VE43 solenoid valves.

Accessory Kit Modelnr.	Adjustable Pressure Range (bar)	Switch-point repeatability	Dead-band (bar)
ZPT-U4 *	3,5 - 700	± 0,5%	3,5

\* Add suffix **T** for factory installation.



## Pressure Switch <sup>3)</sup>

- Controls pump, monitors system
- Adjustable pressure 35-700 bar
- Includes glycerine filled 1000 bar pressure gauge G2536L
- Accuracy ± 1,5% of full scale.

<sup>3)</sup> 24 V, requires Electric Box. Not available in combination with pressure transducer. Not available on LCD-electronics.

Accessory Kit Modelnr.	Switch-point repeatability	Deadband (bar)	Oil Ports (NPTF)
ZPS-E3 *	± 2%	8 - 38	3/8"

\* Add suffix **P** for factory installation.



## Options

**Accessory Kits** can be installed by customer. See chart below for options on **Standard Electric** (without electric box) or **LCD Electric** (with electric box). Refer to page 103 for ordering matrix.

ZE-Series Options	Factory Installed		Accessory Kits	
	Std. Electr.	LCD Electr.	Std. Electr.	LCD Electr.
Return Line Filter	F	F	ZPF	ZPF
Skid Bar <sup>1)</sup>	K	K	SBZ	SBZ
Roll Cage	R	R	ZRB	ZRB
Single-stage	S	S	-	-
Heat Exchanger	-	H	-	ZHE
Pressure Gauge <sup>2)</sup>	G	G	-	-
Pressure Switch <sup>3)</sup>	-	P	-	ZPS-E3
Pressure Transducer <sup>4)</sup>	-	T	-	ZPT-U4
Level/Temp Switch <sup>5)</sup>	-	L	-	ZLS-U4
Foot Switch <sup>6)</sup>	-	U	-	ZCF-2

<sup>1)</sup> Available for 4 and 8 litres reservoirs.

<sup>2)</sup> Not available on pumps with pressure transducer.

<sup>3)</sup> Includes 1000 bar gauge. Only available on manual valves without locking feature.

<sup>4)</sup> Electric box can accept either pressure switch or pressure transducer, but not both.

<sup>5)</sup> Available for 10, 20 and 40 litres reservoirs.

<sup>6)</sup> For control of solenoid dump and 3-position valves.



## Pendants <sup>4)</sup>

- For pump types with valve operation “W” (No Valve, with Electric Box, without pendant).

<sup>4)</sup> When ordering Enerpac VE-Series solenoid valve the pendant must be ordered separately. Pendant connection to be plugged into electric box.

Pendant Model Nr.	To be used with solenoid valve:
ZCP-1	VE32D
ZCP-3	VE32, VE33, VE43



## Heat Exchanger <sup>5)</sup>

- Removes heat from by-pass oil to provide cooler operation
- Stabilizes oil viscosity, increasing oil life and reduces wear of pump and other hydraulic components.

Accessory Kit Nr.	Fits on reservoir size:	(kg)
ZHE-E04 *	4 and 8 litres	4,1
ZHE-E10 *	10, 20 and 40 litres	4,1

<sup>5)</sup> 24 VDC, requires electric box.

\* Add suffix **H** for factory installation.



## ZPT-U4 Pressure Transducer

More durable against mechanical and hydraulic shock than analog gauges.

- Digital pressure read-out provides accuracy of 0,5% of full scale.
- Easy-viewing variable rate display automatically varies increments between 3, 14, 35 and 145 bar as rate of pressure change increases.
- “Set pressure” feature turns off motor at user defined pressure (or shifts valve to neutral on VE33 and VE43 valves).



## ZHE-Series Heat Exchangers

Heat exchanger stabilizes oil temperature at 54 °C at 21 °C ambient temperature. Thermal transfer at 1,9 l/min and 21 °C ambient temperature: 900 Btu/hour [950 kJ].

Do not exceed max. oil flow of 26,5 l/min and max. pressure of 20,7 bar. Not suitable for water-glycol or high water based fluids.



# ZE-Series, Specifications & Dimensions

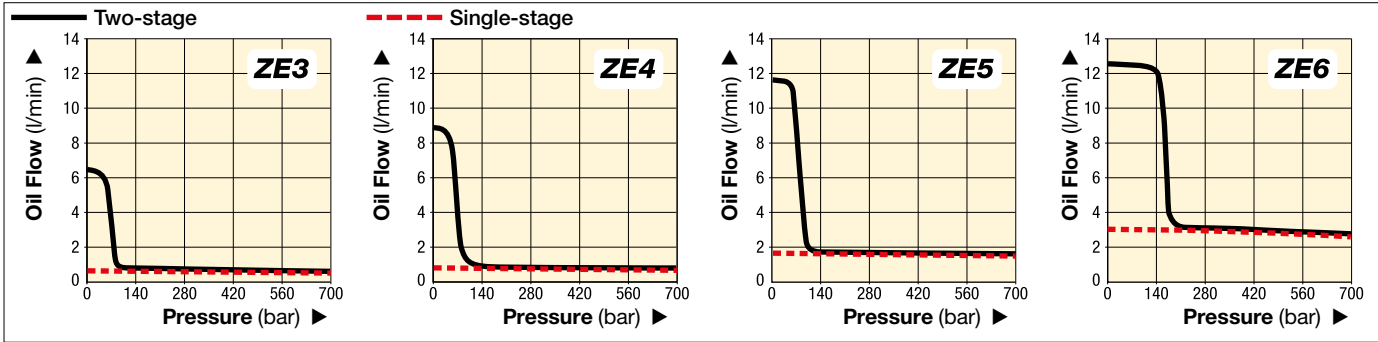

## ▼ ZE-SERIES PERFORMANCE CHART

Pump Series	Output Flow Rate at 50 Hz * (l/min)				Pump Unit	Available Reservoir Sizes (useable oil) (litres)	Motor Size (kW)	Relief Valve Adjustment Range (bar)	Sound Level (dBA)
	low pressure at 7 bar	low pressure at 50 bar	high pressure at 350 bar	high pressure at 700 bar					
ZE3	0,59	0,59	0,57	<b>0,55</b>	Single-stage	4-8-10-20-40	0,75	70-700	75
	6,15	5,26	0,57	<b>0,55</b>	Two-stage				
ZE4	0,87	0,87	0,84	<b>0,82</b>	Single-stage	4-8-10-20-40	1,12	70-700	75
	8,88	8,20	0,84	<b>0,82</b>	Two-stage				
ZE5	1,75	1,72	1,68	<b>1,64</b>	Single-stage	10-20-40	2,24	70-700	75
	11,61	11,27	1,68	<b>1,64</b>	Two-stage				
ZE6	3,00	2,94	2,86	<b>2,73</b>	Single-stage	10-20-40	5,60	70-700	80
	12,29	12,15	2,86	<b>2,73</b>	Two-stage				

\* Oil flow will be approximately 6/5 of these values at 60 Hz.



### Single or Two-Stage

Choose single-stage pumps for applications that require constant flow regardless of pressure such as testing or clamping. Two-stage pumps have an increased output flow at low pressure to allow fast movement towards the load, for reduced cycle times and increased productivity.

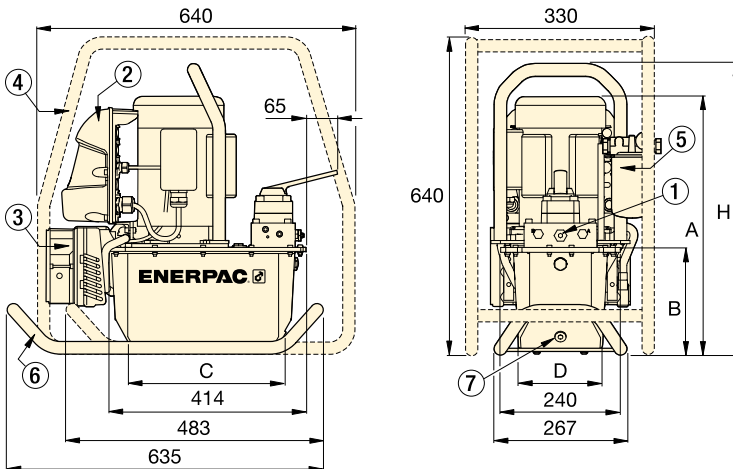

## ZE-Series Pumps with 4 - 8 litres reservoir

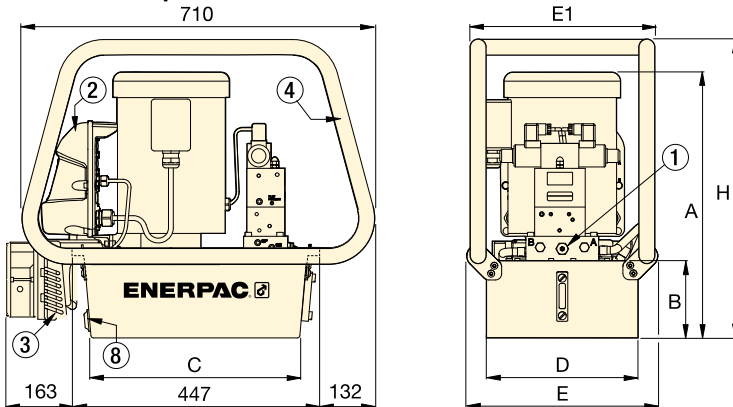

## ZE-Series Pumps with 10 - 20 - 40 litres reservoir

- ① User adjustable relief valve on all manual and solenoid valves.  
3/8" NPTF on A and B ports;  
1/4" NPTF on auxiliary ports.
- ② Electric Box
- ③ Heat Exchanger
- ④ Roll Cage
- ⑤ Return Line Filter
- ⑥ Skid Bar
- ⑦ Magnetic Oil Drain
- ⑧ Oil Drain / Oil Level/Temperature Switch

Reservoir Size (useable oil in litres)	ZE-Series Pump Dimensions (mm)						
	A	B	C	D	E	E1	H
4,0	457	143	279	152	-	-	513
8,0	457	143	279	206	-	-	513
10,0	533	158	419	305	384	371	600
20,0	558	180	419	422	501	488	625
40,0	648	270	399	505	576	572	715



# ZE-Series, Pump Ordering Matrix

▼ This is how ZE-Series pump model numbers are built up:

<b>Z</b>	<b>E</b>	<b>4</b>	<b>1</b>	<b>10</b>	<b>D</b>	<b>W</b>	<b>-</b>	<b>F</b>	<b>H</b>	<b>L</b>	<b>T</b>
1	2	3	4	5	6	7		8			
Product Type	Motor Type	Flow Group	Valve Type	Reservoir Size	Valve Operation	Motor Voltage		Options and Accessories			

## 1 Product Type

**Z** = Pump Class

## 2 Prime Mover

**E** = Induction electric motor

## 3 Flow Group

- 3** = 0,55 l/min @ 700 bar (0,75 kW)
- 4** = 0,82 l/min @ 700 bar (1,12 kW)
- 5<sup>1)</sup>** = 1,64 l/min @ 700 bar (2,24 kW)
- 6<sup>1)</sup>** = 2,73 l/min @ 700 bar (5,60 kW)

## 4 Valve Type

- 0** = No valve, with cover plate
- 1** = 3/2 Dump valve **VE32D**
- 2** = 3/2 manual **VM32**
- 3** = 3/3 manual **VM33** or electric **VE33**
- 4** = 4/3 manual **VM43** or electric **VE43**
- 6** = 3/3 manual locking valve **VM33L** with pilot operated check.
- 8** = 4/3 manual locking valve **VM43L** with pilot operated check.
- 9** = 4 way/3 position manual with power seating (**VM43-LPS**)
- 10** = 3 way/3 position manual **Venturi** valve (**VM33VAC**)
- 11** = 4 way/3 position electric **Venturi** valve (**VE33VAC**)
- 12** = 3 way/3 position manual locking **Venturi** valve (**VM33LVAC**)

## 8 Options and Accessories

- F** = Return Line Filter
- G<sup>6)</sup>** = 1000 bar gauge
- H<sup>7)</sup>** = Heat exchanger
- K** = Skid Bar (only on 4 and 8 litres)
- L<sup>7)</sup>** = Oil Level/Temperature Switch<sup>8)</sup>
- N** = No reservoir handles (includes lifting eyes)

## 5 Reservoir Size, useable oil

- 04<sup>2)</sup>** = 4 litres
- 08<sup>2)</sup>** = 8 litres
- 10** = 10 litres
- 20** = 20 litres
- 40** = 40 litres

## 6 Valve Operation

- D** = Dump valve (solenoid), with pendant and Electric Box (LCD)
- L** = Manual valve, without pendant, with Electr. Box (LCD)
- M** = Manual valve, without pendant, without Electric Box
- N** = No valve, without Electric Box
- S** = Solenoid valve, with pendant and Electric Box (LCD)
- W** = No valve, with Electric Box (LCD), without pendant<sup>10)</sup>

## 7 Motor Voltage

### Single phase motor<sup>3)</sup>

- B<sup>3)</sup>** = 115V, 1 ph, 50-60Hz
- E<sup>3)</sup>** = 208-240V, 1 ph, 50-60 Hz<sup>4)</sup>
- I** = 208-240V, 1 ph, 50-60 Hz USA plug

### Three phase motor<sup>5)</sup>

- M<sup>5)</sup>** = 190-200V, 3 ph, 50-60Hz
- G<sup>5)</sup>** = 208-240V, 3 ph, 50-60 Hz
- W<sup>5)</sup>** = 380-415V, 3 ph, 50-60 Hz
- K<sup>5)</sup>** = 440V, 3 ph, 50-60 Hz
- J<sup>5)</sup>** = 460-480V, 3 ph, 50-60 Hz
- R<sup>5)</sup>** = 575V, 3 ph, 60 Hz

**P<sup>7)</sup>** = Pressure Switch (only available on manual valves without locking feature)

- R** = Roll Cage
- S** = Single-stage pump unit
- T<sup>7)</sup>** = Pressure transducer<sup>9)</sup>
- U<sup>7)</sup>** = Foot Switch

<sup>1)</sup> ZE5 and ZE6-Series only available with 3-phase electric motors.

<sup>2)</sup> 4 and 8 litres only available on ZE3 and ZE4-Series.

<sup>3)</sup> 1-phase motors only available on ZE3 and ZE4-Series

<sup>4)</sup> 208-240V, 1 ph with European plug EMC directive compliant.

<sup>5)</sup> Models with 3-ph motors without Electric Box shipped without cord, motor starter or overload protection.

<sup>6)</sup> Not available on pumps with pressure transducer (T).

<sup>7)</sup> Requires Electric Box.

<sup>8)</sup> Not available on 4 and 8 litres reservoir.

<sup>9)</sup> Provides digital pressure read-out on LCD-display of electric box.

<sup>10)</sup> When using solenoid valve on valve type "W" order optional pendant.

All Z-Class electric pumps comply with TÜV and CE requirements.



## ZE Series



Reservoir Capacity:

**4 - 40 litres**

Flow at Rated Pressure:

**0,55 - 2,73 l/min**

Motor Size:

**0,75 - 5,60 kW**

Maximum Operating Pressure:

**700 bar**



### How to Order Single-Stage Pumps

To specify a single-stage pump, place the letter "S" at the end of the model number. For example:

#### ZE4210ME-S

ZE4-Series pump, oil flow 0,82 l/min at 700 bar, VM32 manual valve, 10 litres reservoir, without electrical box, without pendant, 240 Volt 1-phase electric motor and single-stage pump unit.



### Assisted Return Pumps

To improve productivity and plunger retraction, Enerpac offers valve configurations designed to accelerate your cylinder retraction speeds, ZU4 and ZE-Series pumps feature **Venturi Valve Technology** to facilitate the faster return of single-acting gravity and spring return cylinders. See valve type in ordering matrix and details in section Directional Control Valves.

# PA-Series, Air Hydraulic Foot Pumps

▼ Shown: PA-1150, PA-133



## PA Series

Reservoir Capacity:  
**0,6 - 1,3 litres**

Flow at Rated Pressure:  
**0,13 l/min**

Air Consumption:  
**255 l/min**

Maximum Operating Pressure:  
**700 bar**



### Reservoir Conversion Kit

Double the reservoir capacity of your existing PA-133 with this easy to install conversion kit.

Model Number

**PC-66**

- Rugged construction – built for long life and easy service
- Swivel coupling simplifies hydraulic connection and pump operation
- Three-position treadle provides cylinder advance, hold or retract operation
- Operates in all positions for increased versatility in use and mounting (except PA-1150)
- Base mounting slots provided on PA-133.

### OIL FLOW VERSUS PRESSURE

at 6,9 bar air pressure

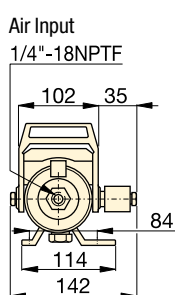
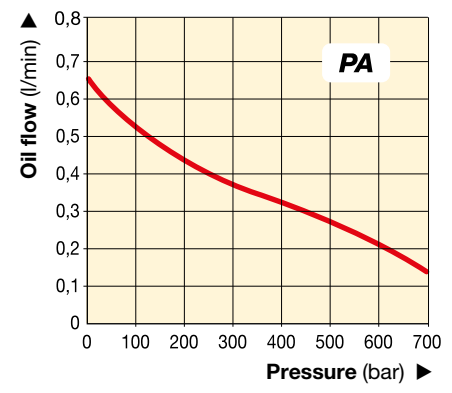

PA-133

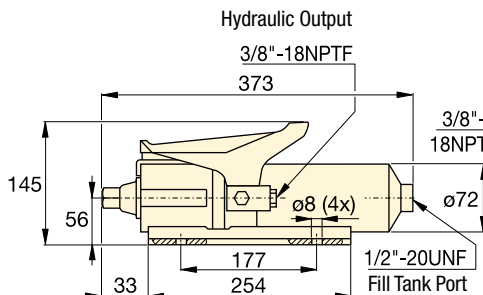

PA-1150

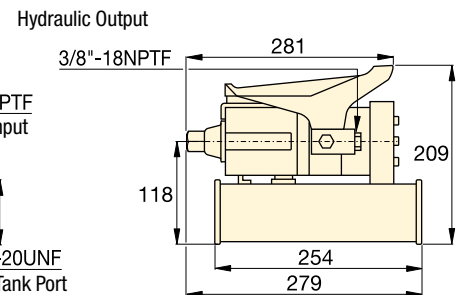
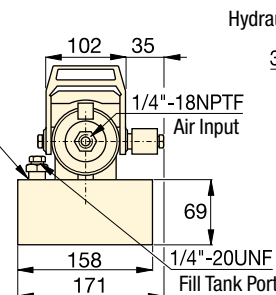

Used with Cylinder	Usable Oil Capacity (cm <sup>3</sup> )	Model Number	Pressure Rating (bar)	Output Flow Rate (l/min)		Valve Function	Air Pressure Range * (bar)	Air Consumption (l/min)	Sound Level (dBA)	Weight (kg)
				No load	Load					
Single-Acting	589	PA-133	700	0,65	0,13	Advance / Hold / Retract	4,1 - 8,3	255	85	5,4
	1311	PA-1150	700	0,65	0,13	Advance / Hold / Retract	4,1 - 8,3	255	85	8,2

\* Recommended Regulator-Filter-Lubricator: RFL-102.

# PAM-Series, Air Hydraulic Pumps

▼ Shown: PAM-1041



## PAM Series

Reservoir Capacity:  
**4,0 - 8,0 litres**

Flow at Rated Pressure:  
**0,15 l/min**

Air Consumption:  
**510 l/min**

Maximum Operating Pressure:  
**700 bar**



### Locking Valves

Pumps with 4/3 manual valves are available with 4/3 manual locking valves instead. Add suffix "L" to pump model number.

Page: 116



### Remote Air Valve

For remote operation of PAM-Series air pumps. Permits either hand or foot operation.

Model Number

VA-2

- Twin air motor configuration delivers high-flow performance in first stage, up to 14 bar, for rapid cylinder advance
- 4 and 8 litres reservoirs for use with a wide range of cylinders
- Integral shroud protects air motors and provides easy portability.

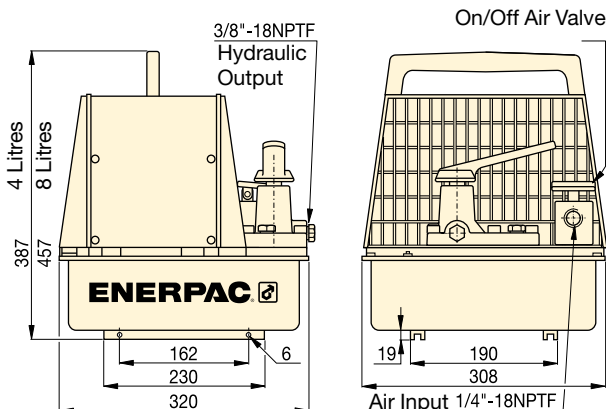

## OIL FLOW VERSUS PRESSURE

at 6,9 bar air pressure

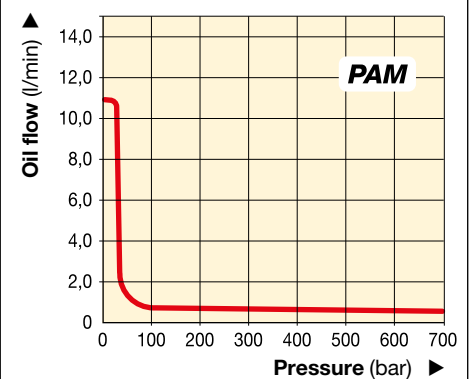

Used with Cylinder	Usable Oil Cap. (litres)	Model Number with Shroud	Pressure Rating (bar)	Output Flow Rate (l/min)		Valve Function	Valve Type	Air Pressure Range * (bar)	Air Consumption (l/min)	Sound Level (dBA)	Weight (kg)
				1 <sup>st</sup> stage	2 <sup>nd</sup> stage						
Single-Acting	2,6	PAM-1021	700	10,65	0,15	Advance / Hold / Retract	3/2	4,1 - 8,3	510	87	22,7
	7,6	PAM-1022	700	10,65	0,15	Advance / Hold / Retract	3/2	4,1 - 8,3	510	87	27,2
Double-Acting	2,6	PAM-1041	700	10,65	0,15	Advance / Hold / Retract	4/3	4,1 - 8,3	510	87	22,7
	7,6	PAM-1042	700	10,65	0,15	Advance / Hold / Retract	4/3	4,1 - 8,3	510	87	27,2

\* Recommended Regulator-Filter-Lubricator: RFL-102.

▼ Shown from top to bottom: PAMG-1402N, PARG-1102N, PATG-1102N, PATG-1105N



- External adjustable pressure relief valve (behind sight glass)
- Return-to-tank port for use in remote valve applications
- Internal pressure relief valve provides overload protection
- Quieter operation – reduced noise level to 76 dBA
- Operating air pressure: 2,8 - 8,8 bar, enables pump to start at extremely low pressure
- High efficiency cast aluminium air motor
- Reinforced heavy-duty lightweight reservoir for applications in tough environments
- Air pendant for remote control operation.

## Compact Air Over Hydraulic



### Regulator-Filter-Lubricator

Recommended for use with all Turbo air pumps. Provides clean, lubricated air and allows for air pressure adjustment. Steel bowl guards are standard.

Model Number

**RFL-102**



### Large Reservoir Models

The Turbo II Air Pump is also available with an enlarged reservoir: **PATG-1105N**, **PAMG-1405N** and **PARG-1105N**.



### Hoses

Enerpac offers a complete line of high quality hydraulic hoses. To ensure the integrity of your system, specify only genuine Enerpac hydraulic hoses.

Page: **122**

▼ Easily operated by hand or by foot.



Used with Cylinder	Usable Oil Capacity (cm <sup>3</sup> )	Model Number
Single-Acting	2081	<b>PATG-1102N</b>
	3770	<b>PATG-1105N</b>
Single-Acting	2081	<b>PARG-1102N</b>
	3770	<b>PARG-1105N</b>
Double-Acting	2081	<b>PAMG-1402N</b>
	3770	<b>PAMG-1405N</b>



# PA-Series, Turbo II Air Hydraulic Pumps



PATG-models use a foot or hand operated treadle to control air and valve functions.

PAMG-models use a treadle with a locking feature to control air, and a 4-way manual valve to control hydraulics.

PARG-models use air pendant for remote control.

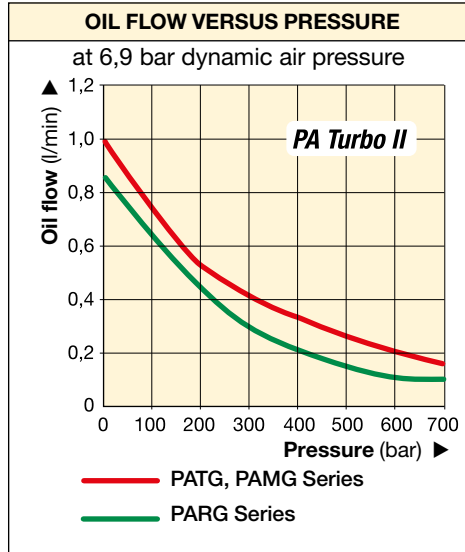

## PATG PAMG PARG Series



Reservoir Capacity:  
**2,5 - 5,0 litres**

Flow at Rated Pressure:  
**0,10 - 0,16 l/min**

Air Consumption:  
**227 - 340 l/min**

Maximum Operating Pressure:  
**700 bar**

Maximum Pressure (bar)	Output Flow Rate (l/min)		Pump Series	Valve Function	Air Pressure Range (bar)	Air Consumption at 5,2 bar air (l/min)	Sound Level (dBA)
	No Load	Load					
700	1,00	0,16	PATG	A / H / R *	2,8 - 8,8	340	76
700	0,76	0,10	PARG	A / H / R *	2,8 - 10,3	227	76
700	1,00	0,16	PAMG	A / H / R *	2,8 - 8,8	340	76

\* Valve function: Advance / Hold / Retract.



### Speed Chart

To determine how a specific pump will operate your cylinder, see the Pump-Cylinder Speed Chart in the 'Yellow Pages'.

Page: 273

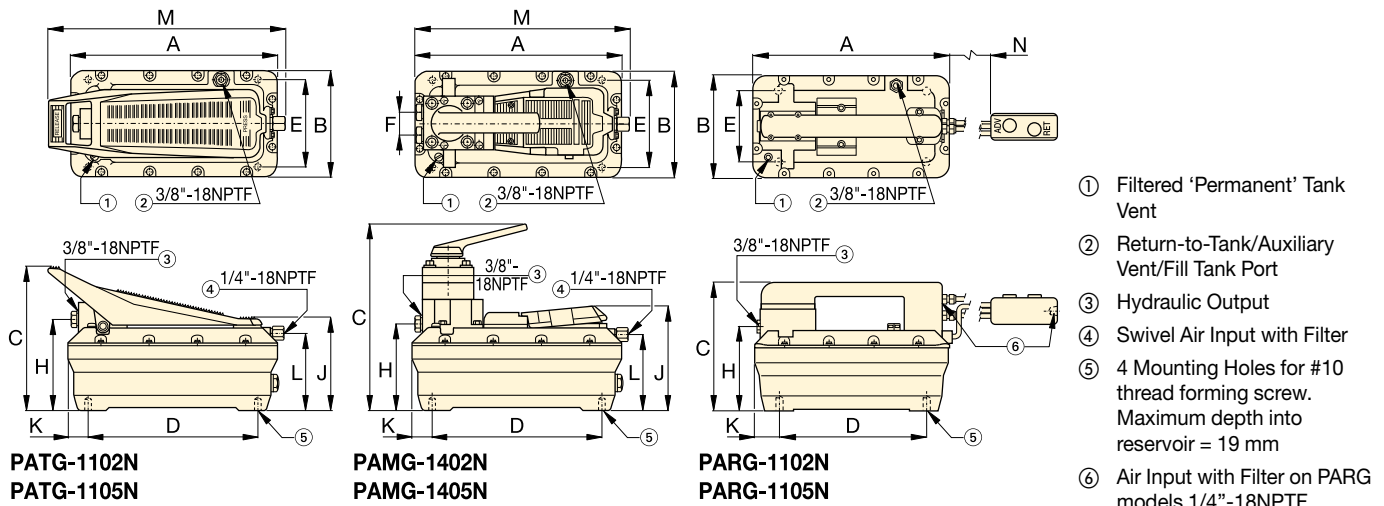

Valve Operation	Turbo II Dimensions (mm)													Model Number
	A	B	C	D	E	F	H	J	K	L	M	N	(kg)	
Treadle 3/3	313	165	211	230	102	—	129	146	42	113	347	—	8,2	PATG-1102N
	396	201	209	230	102	—	131	146	86	112	437	—	9,9	PATG-1105N
Air Pendant 3/3	313	165	200	230	102	—	129	—	42	—	—	4500	10,0	PARG-1102N
	396	201	209	230	102	—	131	—	86	—	—	4500	11,7	PARG-1105N
Manual 4/3	313	165	267	230	102	36	130	152	42	113	315	—	11,0	PAMG-1402N
	396	201	267	230	102	36	132	152	86	112	405	—	12,7	PAMG-1405N

▼ Shown: XA11G



- Ergonomic design for less operator fatigue
- Variable oil flow & fine metering for precise control
- Higher oil flow for increased productivity
- Closed hydraulic system prevents contamination and allows pump usage in any position
- Pedal lock function for retract position
- External adjustable pressure setting valve
- Ground screw for improved ATEX explosion safety.

 II 2 GD ck T4

▼ Easy operated by foot. No need to fully lift up foot – rest bodyweight on heel, resulting in a handsfree and stabile working position.



## Productivity & Ergonomics



### Optional Pressure Gauge

Integrated gauge with calibrated scale reading in bar, psi and MPa for actual pressure reading.



### 4/3 Control Valve

For powering double-acting hydraulic cylinders and tools.



### 2 Litres Reservoir

Double oil capacity for powering larger hydraulic cylinders and tools.



### Pedal Safety Guard

Customer installed frame protects both pedals against accidental activation.

Model Number<sup>1)</sup>

**XPG1**



### "Joy-stick" Lever Kit

Customer installed set of handles for manual operation of both pedals.

Model Number<sup>1)</sup>

**XLK1**



### Swivel Connector

Customer installed swivel connector for optimal orientation of the hydraulic hose. See page 127 for details.

Model Number<sup>1)</sup>

**XSC1**

<sup>1)</sup> Accessories must be ordered separately.

# Air Driven Hydraulic Foot Pumps



## Production Application

XA11 pump is used with a 13 tons hollow cylinder to compress and position diesel engine valve springs.

The operator benefits from the fine metering capacities of this pump to apply the mandatory precise stroke and force.

## XA Series



Reservoir Capacity:

**1,0 - 2,0 litres**

Flow at Rated Pressure:

**0,25 l/min**

Air Consumption:

**283 - 991 l/min**

Maximum Operating Pressure:

**700 bar**

## ▼ XA-SERIES PERFORMANCE CHART

Maximum Pressure (bar)	Output Flow Rate (l/min)		Pump Series	Valve Function	Dynamic Air Pressure (bar)
	No load	Load			
700	2,0	0,25	<b>XA1</b>	Advance / Hold / Retract	2,1 - 8,6

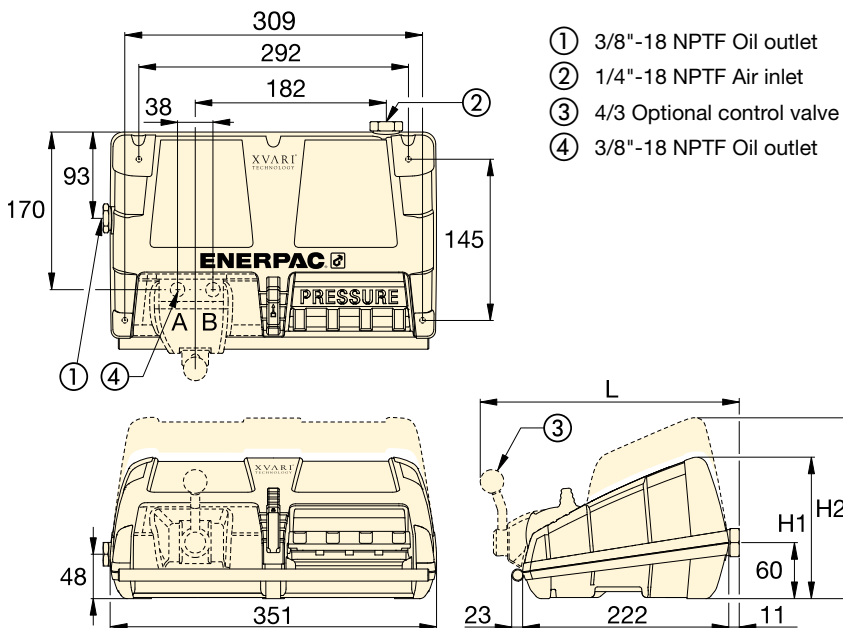

## OIL FLOW VERSUS PRESSURE

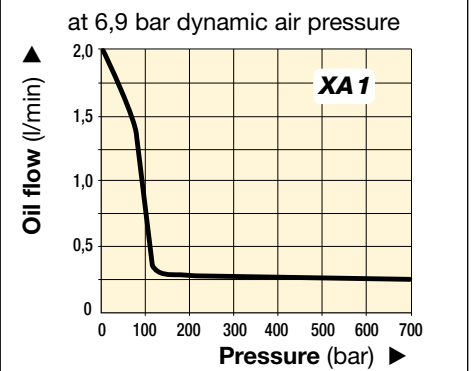

## Regulator-Filter-Lubricator

Recommended for use with all XA-Series Air pumps. Provides clean, lubricated air and allows for air pressure adjustment.

Model Number <sup>1)</sup>

**RFL-102**

## ▼ SELECTION CHART

For use with cylinder or tool	Usable Oil Capacity (litres)	Model Number <sup>1)</sup>	Pressure Gauge	3-way 3-pos. Valve	4-way 3-pos. Valve	Dimensions (mm)			 (kg)
						H1	H2	L	
Single-acting	1,0	<b>XA 11</b> <sup>2)</sup>	–	•	–	152	–	–	8,6
	2,0	<b>XA 12</b> <sup>2)</sup>	–	•	–	–	170	–	10,2
Single-acting	1,0	<b>XA 11G</b>	•	•	–	152	–	–	8,8
	2,0	<b>XA 12G</b>	•	•	–	–	170	–	10,4
Double-acting	1,0	<b>XA 11V</b>	–	–	•	152	–	279	10,1
	2,0	<b>XA 12V</b>	–	–	•	–	170	279	11,7
Double-acting	1,0	<b>XA 11VG</b>	•	–	•	152	–	279	10,3
	2,0	<b>XA 12VG</b>	•	–	•	–	170	279	11,9

<sup>1)</sup> High-Flow coupler CR-400 and accessories must be ordered separately. <sup>2)</sup> Available as cylinder-pump set, see page 58.

▼ Shown: ZA4208MX, ZA4420MX



## Z Tough Dependable Innovative CLASS



### ATEX 95 Certified

The Enerpac ZA4-series air pumps are tested and certified according to the **Equipment Directive 94 / 9 / EC "ATEX Directive"** for equipment and protective systems intended for use in potentially explosive atmospheres.



**II 2 GD ck T4**  
DEKRA 0602

Page: **263**

- ATEX 95 certified for use in potentially explosive atmospheres
- Features Z-Class high efficiency pump design, higher oil flow and bypass pressure
- Two-speed operation reduces cycle time for improved productivity
- User adjustable relief valve built-in on manual valves. Oil ports on valves are 3/8" NPTF
- Optional heat exchanger warms exhaust air to prevent freezing and cools the oil
- Full sight oil level glass on 10, 20 and 40 litres reservoirs, oil level indicators on 4 and 6,6 litres reservoirs.



### Speed Chart

To determine how a specific pump will operate your cylinder, see the Pump-Cylinder Speed Chart in the 'Yellow Pages'.

Page: **273**



### Hoses

Enerpac offers a complete line of high quality hydraulic hoses. To ensure the integrity of your system, specify only genuine Enerpac hydraulic hoses.

Page: **122**

Used with Cylinder	Usable Oil Capacity (litres)	Manual Valve <sup>1)</sup> Model Number	Valve Function	Model Number	Output Flow Rate <sup>2)</sup>				Relief Valve Adjustment Range (bar)	Maximum Air Consumption <sup>3)</sup> (l/min)
					at 7 bar	at 50 bar	at 350 bar	at 700 bar		
–	4,0	–	–	<b>ZA4004NX</b>	14,0	11,0	1,8	<b>1,3</b>	–	2840
Single-acting	4,0	VM32	Advance / Retract	<b>ZA4204MX</b>	14,0	11,0	1,8	<b>1,3</b>	70 - 700	2840
	6,6	VM33	Advance / Hold /Retract	<b>ZA4308MX</b>	14,0	11,0	1,8	<b>1,3</b>	70 - 700	2840
	10,0	VM33L	Advance / Hold /Retract	<b>ZA4610MX</b>	14,0	11,0	1,8	<b>1,3</b>	70 - 700	2840
Double-acting	4,0	VM43	Advance / Hold /Retract	<b>ZA4404MX</b>	14,0	11,0	1,8	<b>1,3</b>	70 - 700	2840
	6,6	VM43	Advance / Hold /Retract	<b>ZA4408MX</b>	14,0	11,0	1,8	<b>1,3</b>	70 - 700	2840
	10,0	VM43L	Advance / Hold /Retract	<b>ZA4810MX</b>	14,0	11,0	1,8	<b>1,3</b>	70 - 700	2840
	20,0	VM43	Advance / Hold /Retract	<b>ZA4420MX</b>	14,0	11,0	1,8	<b>1,3</b>	70 - 700	2840
	40,0	VM43	Advance / Hold /Retract	<b>ZA4440MX</b>	14,0	11,0	1,8	<b>1,3</b>	70 - 700	2840

<sup>1)</sup> See pages 116-117 for hydraulic symbols of these valves.

<sup>2)</sup> Actual oil flow will vary with air supply.

<sup>3)</sup> Dynamic air pressure range: 4 - 7 bar.



# Modulair Air Hydraulic Pumps

▼ This is how a ZA4-Series pump model number is built up:

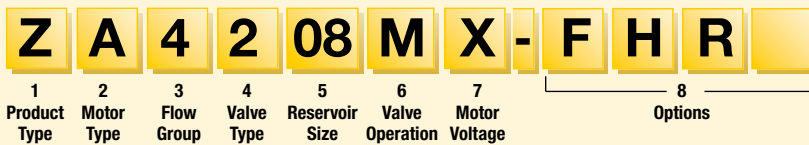

### 1 Product Type

**Z** = Pump Class

### 2 Prime Mover

**A** = Air motor

### 3 Flow Group

**4** = 1,3 l/min @ 700 bar

### 4 Valve Type

- 0** = No valve, with cover plate
- 2** = 3/2 manual valve VM32
- 3** = 3/3 manual valve VM33
- 4** = 4/3 manual valve VM43
- 6** = 3/3 manual locking valve VM33L with pilot operated check
- 7** = 3/2 manual valve VM22
- 8** = 4/3 manual locking valve VM43L with pilot operated check.

### 5 Reservoir Size, useable oil

- 04** = 4 litres
- 08** = 6,6 litres
- 10** = 10 litres
- 20** = 20 litres
- 40** = 40 litres

### 6 Valve Operation

- M** = Manual valve
- N** = No valve

### 7 Motor Voltage

- X** = Not applicable

### 8 Options

- F** = Return Line Filter
- G** = 1000 bar gauge
- H** = Heat exchanger (on 4 and 6,6 litres reservoir only)
- K** = Skid Bar (on 4 and 6,6 litres reservoir only)
- N** = No reservoir handles (includes lifting eyes on 10, 20 and 40 litres)
- R** = Roll Cage

### Ordering Example

Model Number: **ZA4208MX-FHK**  
 ZA4208MX-FHK is an air operated pump with a 3-way, 2-position manual valve, 6,6 litres reservoir, filter, heat exchanger and skid bar.

## ZA4 Series



Reservoir Capacity:

**4 - 40 litres**

Flow at Rated Pressure:

**1,3 l/min**

Air Consumption:

**2840 l/min**

Maximum Operating Pressure:

**700 bar**

- ① User adjustable relief valve on all manual valves. 3/8" NPTF on A and B ports; 1/4" NPTF on auxiliary ports.
- ② Air inlet 1/2" NPTF
- ③ Return Line Filter (optional)
- ④ Oil Sight Gauge
- ⑤ Roll Cage (optional)
- ⑥ Oil Drain
- ⑦ Lifting eyes (optional)
- ⑧ Handles
- ⑨ Skid Bar (Modelnr. SBZ-4) (optional)

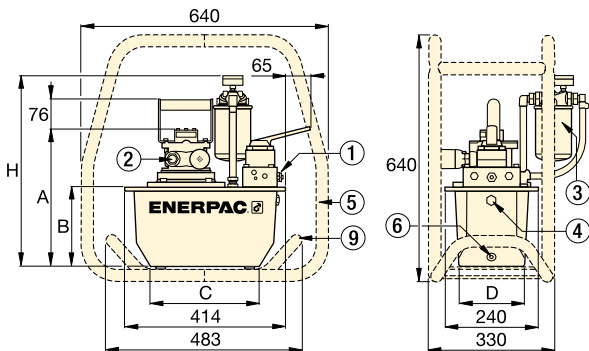

ZA4-Series Pumps with 4 - 6,6 litres reservoir

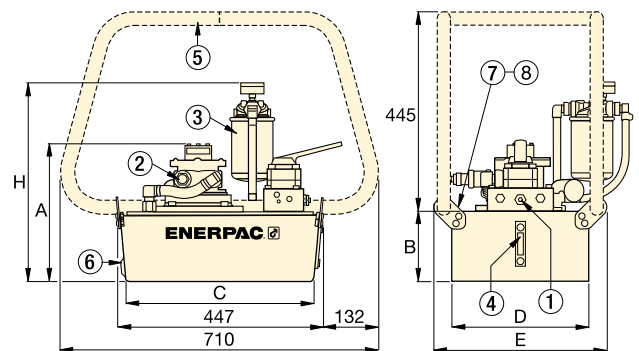

ZA4-Series Pumps with 10, 20 and 40 litres reservoir

Sound Level (dBA)	Motor Size (kW)	Dimensions (mm)							Model Number
		A	B	C	D	E	H		
80 - 95	3,0	295	142	279	152	-	429	27	ZA4004NX
80 - 95	3,0	295	142	279	152	-	429	30	ZA4204MX
80 - 95	3,0	356	203	279	205	-	490	34	ZA4308MX
80 - 95	3,0	330	180	414	421	500	467	51	ZA4610MX
80 - 95	3,0	295	142	279	152	-	429	31	ZA4404MX
80 - 95	3,0	356	203	279	205	-	490	35	ZA4408MX
80 - 95	3,0	305	155	419	305	384	442	40	ZA4810MX
80 - 95	3,0	330	180	414	421	500	467	52	ZA4420MX
80 - 95	3,0	419	269	399	505	584	556	75	ZA4440MX

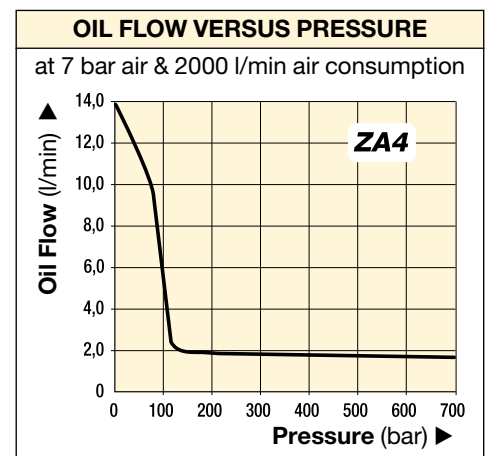

# ZG-Series, Gasoline Hydraulic Pumps

▼ Shown from left to right: ZG6440MX-BFCH, ZG5420MX-B



**Z** Tough,  
Dependable,  
Innovative  
**CLASS**



### Speed Chart

To determine how a specific pump will operate your cylinder, see the Pump-Cylinder Speed Chart in the 'Yellow Pages'.

Page: **273**

- Features Z-Class high efficiency pump design, higher oil flow and bypass pressure
- Two-speed operation reduces cycle time for improved productivity
- User adjustable relief valve built-in on manual valves. Oil ports on valves are 3/8" NPTF
- Available in three 4-cycle engine sizes: 4,1 kW Honda and 4,8 kW and 9,7 kW Briggs & Stratton
- Full sight oil level glass on all reservoirs allow quick and easy oil level monitoring.

### ZG6-Series

- Easy serviceable 9,7 kW, 4-cycle gasoline engine with electric start, pressurized oil and 12 Volt charge output for accessories
- Dual forced air heat exchangers stabilizes hydraulic oil temperature
- Sturdy wheeled cart with collapsible handles.



### GA45GC Gauge Adaptor Assembly

Protect yourself from system overloading by simply ordering one part number for a pre-assembled gauge, adaptor block and coupler.

Page: **134**



### User Adjustable Relief Valve

All VM-Series directional valves have a user adjustable relief valve to allow the operator to easily set the optimum working pressure.

Page: **116**

### ▼ SELECTION CHART

Used with Cylinder	Usable Oil Capacity (litres)	Manual Valve <sup>1)</sup> Model Number	Valve Function	Model Number with Roll Cage	Output Flow Rate (l/min)				4-Cycle Engine Type and Size
					at 7 bar	at 50 bar	at 350 bar	at 700 bar	
Single-Acting	10	VM33	Advance / Hold / Retract	ZG5310MX-R	11,5	10,7	1,8	<b>1,6</b>	Honda 4,1 kW
	20	VM33	Advance / Hold / Retract	ZG5320MX-R	11,5	10,7	1,8	<b>1,6</b>	
Double-Acting	10	VM43	Advance / Hold / Retract	ZG5410MX-R	11,5	10,7	1,8	<b>1,6</b>	
	20	VM43	Advance / Hold / Retract	ZG5420MX-R	11,5	10,7	1,8	<b>1,6</b>	
Single-Acting	10	VM33	Advance / Hold / Retract	ZG5310MX-BR	6,5	6,2	1,8	<b>1,6</b>	Briggs & Stratton 4,8 kW
	20	VM33	Advance / Hold / Retract	ZG5320MX-BR	6,5	6,2	1,8	<b>1,6</b>	
Double-Acting	10	VM43	Advance / Hold / Retract	ZG5410MX-BR	6,5	6,2	1,8	<b>1,6</b>	
	20	VM43	Advance / Hold / Retract	ZG5420MX-BR	6,5	6,2	1,8	<b>1,6</b>	
	40	VM43L	Advance / Hold / Retract	ZG5840MX-BR	6,5	6,2	1,8	<b>1,6</b>	
Double-Acting	40	VM43	Advance / Hold / Retract	ZG6440MX-BCFH	14,7	14,5	3,7	<b>3,3</b>	
	40	VM43L	Advance / Hold / Retract	ZG6840MX-BCFH	14,7	14,5	3,7	<b>3,3</b>	

<sup>1)</sup> See pages 116-117 for hydraulic symbols of these valves.

# Gasoline Hydraulic Pumps



## ZG-Series, Gasoline Pump Performance

Elevation can affect the performance of any gasoline engine. ZG-Series pumps are designed to develop rated performance at elevations up to 1500 m. For applications above this elevation, please consult your Enerpac office.

### Optional: Diesel Engine

ZG-Series pumps can also be equipped with a Diesel Engine. Contact Enerpac for details.

## ZG Series



Reservoir Capacity:  
**10 - 20 - 40 litres**

Flow at Rated Pressure:  
**1,6 - 3,3 l/min**

Engine Size:  
**4,1 - 4,8 - 9,7 kW**

Maximum Operating Pressure:  
**700 bar**

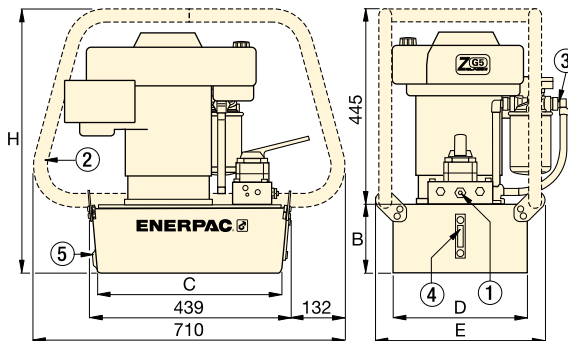

- ① User adjustable relief valve on all manual valves. 3/8" NPTF on A and B ports; 1/4" NPTF on auxiliary ports.
- ② Roll Bar
- ③ Return Line Filter
- ④ Oil Level Gauge
- ⑤ Oil Drain

### ZG5-Series

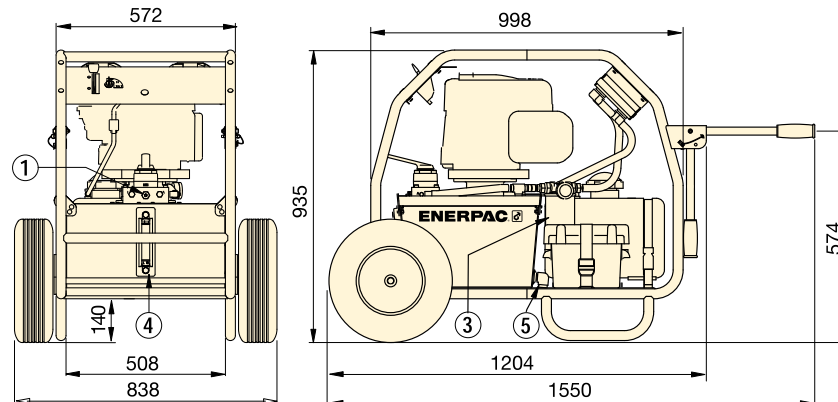

### ZG6-Series



### High Pressure Hoses

Enerpac offers a complete line of high quality hydraulic hoses. To ensure the integrity of your system, specify only genuine Enerpac hydraulic hoses.

Page: 122



### Speed Chart

To determine how a specific pump will operate your cylinder, see the Pump-Cylinder Speed Chart in the 'Yellow Pages'.

Page: 273

Relief Valve Adjustment Range (bar)	Sound Level (dBA)	Dimensions (mm)					Model Number with Roll Cage (kg)	
		B	C	D	E	H		
70 - 700	88 - 93	155	419	305	384	600	52	ZG5310MX-R
		180	414	421	500	625	64	ZG5320MX-R
		155	419	305	384	600	52	ZG5410MX-R
		180	414	421	500	625	64	ZG5420MX-R
70 - 700	88 - 93	155	419	305	384	600	50	ZG5310MX-BR
		180	414	421	500	625	63	ZG5320MX-BR
		155	419	305	384	600	50	ZG5410MX-BR
		180	414	421	500	625	63	ZG5420MX-BR
		269	399	505	557	714	86	ZG5840MX-BR
70 - 700	88 - 93	-	-	-	-	-	152	ZG6440MX-BCFH
		-	-	-	-	-	155	ZG6840MX-BCFH

### OIL FLOW VERSUS PRESSURE

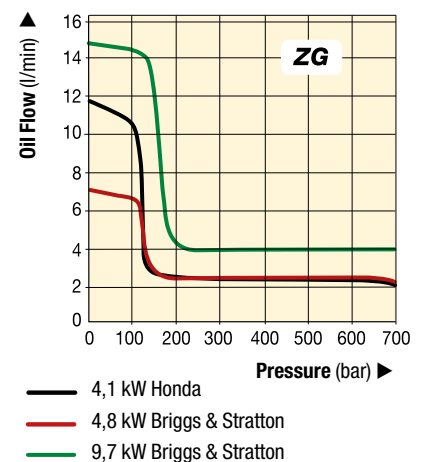

Enerpac hydraulic valves are available in a wide variety of models and configurations.

Whatever your requirements... directional control, flow control, or pressure control... you can be sure that Enerpac has the correct valve to match your application exactly.

Designed and manufactured for safe operation up to 700 bar, the range of Enerpac valves allows for direct pump mounting, remote mounting, manual or solenoid actuation, and in-line installation, giving you flexible solutions to control your hydraulic system.



### Assisted Return Pumps

To improve productivity and plunger retraction, Enerpac offers valve configurations designed to accelerate your cylinder retraction speeds.

ZU4 and ZE-Series pumps feature **Venturi Valve Technology** to facilitate the faster return of single-acting gravity and spring return cylinders.



### Pressure & Flow Control Valves

For more hydraulic system control with pressure relief valves, shut-off valves, check valves and sequence valves see our "System Components".

Page: 136



### Valving Help

See Basic System Set-Up and Valve Information in our 'Yellow Pages'.

Page: 274





# Directional Control Valves Section Overview

Valve Type	Series	Page
Pump Mounted Manual and Solenoid Directional Control Valves	VM VE	116 ▶
Remote Mounted Manual Directional Control Valves	VC	118 ▶
Valve Dimensions	VM VE VC	119 ▶

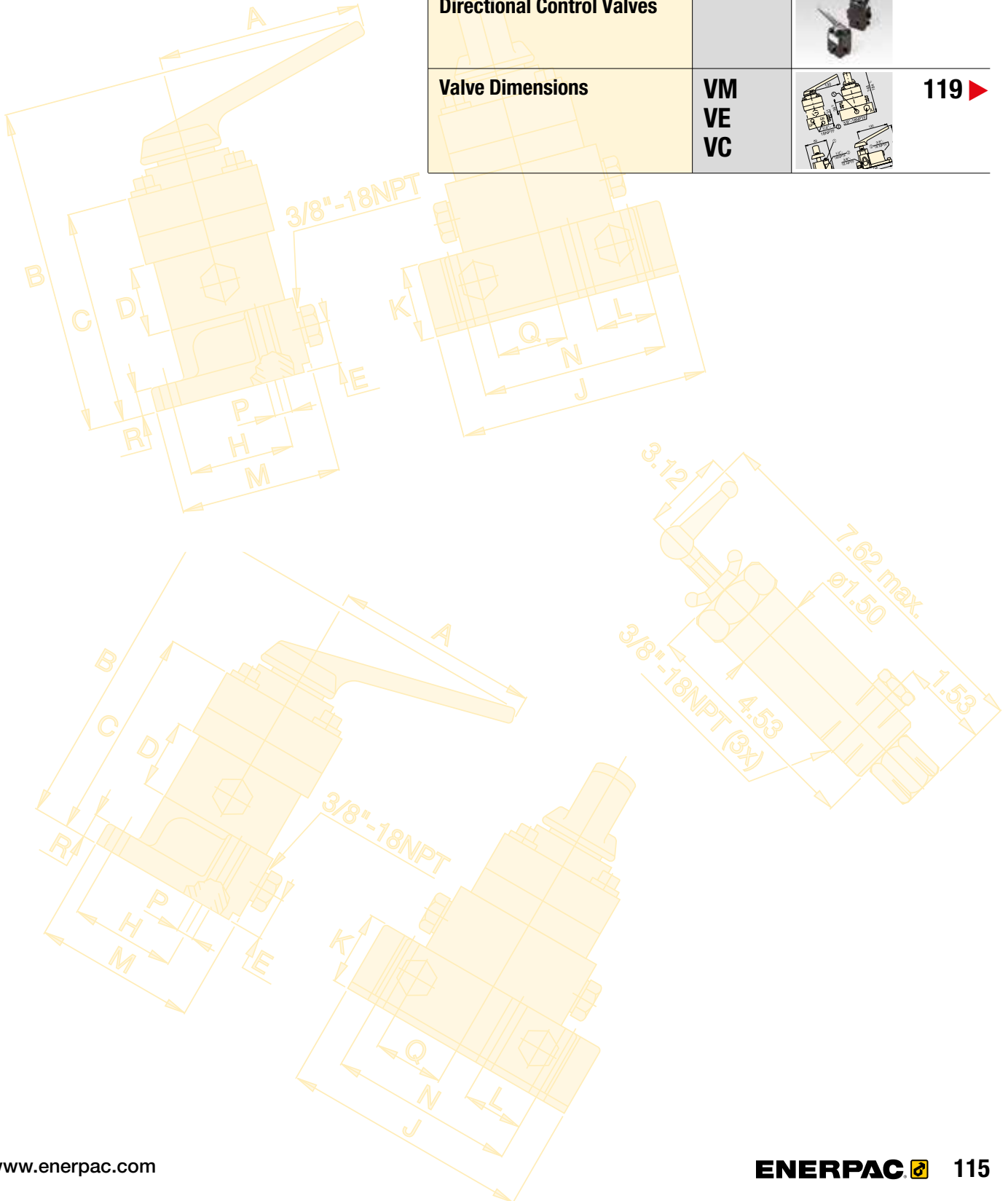

▼ Shown from left to right: VM32, VE33, VM33, VM43L, VE43



- Advance/Retract and Advance/Hold/Retract operation of single- and double-acting cylinders and tools
- Manual or solenoid operation
- Pump mounting will retrofit on most Enerpac pumps
- Available “locking” option on VM-Series valves for load-holding applications
- Standard “locking” feature on VE-Series 3-position valves
- User adjustable relief valve allows the operator to easily set the working pressure.

### Venturi Valve Technology

- For fast return of single-acting gravity and spring return cylinders
- Available as manual or solenoid valve on ZU4- and ZE-Series electric pumps
- Retrofit Venturi valve kits for field installation on existing ZU4- and ZE-Series electric pumps.



#### Adjustable relief valve

All valves feature several gauge ports for “system”, A port and B port pressure monitoring. User adjustable relief valves are included on all models to allow the operator to easily set the optimum working pressure for each application.

VM33 and VE43 valves include “System Check” feature, for more precise pressure holding and improved system control.

The VM33 has improved porting which provides faster cylinder retraction while motor is running.

#### Locking Valves

For applications that require positive load holding, VM-Series valves (except VM22 and VM32) are available with a pilot-operated check valve. This option provides hydraulic locking of the load until the valve is shifted into the retract position.

## Reliable Control of Single and Double-Acting Cylinders and Tools

Valve Operation	Used with Cylinder	Valve Type	
Manual	Single-acting	3-Way, 2-Position	
Manual	Single-acting	3-Way, 2-Position	
Manual	Single-acting	3-Way, 3-Position, Tandem Center	
Manual	Single-acting	3-Way, 3-Position, Tandem Center, Venturi Return Assist	
Manual	Double-acting	4-Way, 3-Position, Tandem Center	
Manual	Single-acting	3-Way, 3-Position, Tandem Center, Locking	
Manual	Double-acting	4-Way, 3-Position, Tandem Center, Locking	
Solenoid 24 VDC	Single-acting	3-Way, 2-Position	
Solenoid 24 VDC	Single-acting	3-Way, 2-Position, Dump	
Solenoid 24 VDC	Single-acting	3-Way, 3-Position, Tandem Center, Venturi Return Assist	
Solenoid 24 VDC	Single-acting	3-Way, 3-Position, Tandem Center	
Solenoid 24 VDC	Double-acting	4-Way, 3-Position, Tandem Center	

For remote valve information, see page 118.  
See page 119 for valve dimensions.

# Pump Mounted Directional Control Valves

## VM VE Series



Maximum Flow Capacity:

**17 l/min**

Maximum Operating Pressure:

**700 bar**

Model Number	Hydraulic Symbol	Schematic Flowpath			⚖️ (kg)
		Advance	Neutral	Retract	
VM22					2,5
VM32					2,5
VM33					3,0
VM33VAC					3,5
VM43					3,1
VM33L					4,8
VM43L					4,9
VE32 <sup>1)</sup>					3,9
VE32D <sup>1)</sup>					3,9
VE33VAC					10,0
VE33 <sup>1)</sup>					9,3
VE43 <sup>1)</sup>					9,3

<sup>1)</sup> When ordering Enerpac VE-Series solenoid valves, the pendant must be ordered separately for Z-Class. See page 101 for pendant ordering details.



### Assisted Return Pumps with Venturi Valve Technology

To improve productivity and plunger retraction, Enerpac offers valve configurations designed to

accelerate your cylinder retraction speeds, ZU4 and ZE-Series pumps feature **Venturi Valve Technology** to facilitate the faster return of single-acting gravity and spring return cylinders.

See valve type in ZU4 and ZE-pump ordering matrix on pages 97 and 103.

### Venturi Valve Retrofit Kits

For field installation on existing ZU4, ZE and ZA-Series pumps, Retrofit Kits are available for manual and solenoid operated valves.

For valve model	For valve operation	Retrofit Kit Model Nr.
VM33, VM33L	Manual	<b>VM33RVK</b>
VE33	Solenoid	<b>VUV5</b>



### Spring Centred Valve Kits

VM and VC-Series manual 3-position valves can be easily converted into spring centred valves. With these retro-fit kits the

handle will automatically move into the neutral valve position when released.

For valve model	Model Number
VM33, VM43	<b>VMC3343K</b>
VM33L, VM43L	<b>VMC3343KL</b>
VC3, VC15, VC4, VC20	<b>VMC34K</b>
VC3L, VC15L, VC4L, VC20L	<b>VMC34KL</b>

▼ Shown from left to right: VC-20, VC-4L



## Remote Control of Single and Double-Acting Cylinders and Tools



### Locking Valves

For applications that require positive load holding, VC-Series valves are available with a pilot-operated check valve. This option provides hydraulic locking of the load until the valve is shifted into the retract position.

- Advance/Hold/Retract operation for use with single-acting or double-acting cylinders and tools
- Return line kit included with remote valves.

Valve Operation	Used with Cylinder	Valve Type	Model Number	Hydraulic Symbol	Schematic Flowpath			Weight (kg)
					Advance	Hold	Retract	
Manual	Single-Acting	3-Way, 3-Position, Tandem Center	<b>VC-3</b>					2,9
Manual	Single-Acting	3-Way, 3-Position, Tandem Center, Locking	<b>VC-3L</b>					4,7
Manual	Single-Acting	3-Way, 3-Position, Closed Center	<b>VC-15</b>					2,9
Manual	Single-Acting	3-Way, 3-Position, Closed Center, Locking	<b>VC-15L</b>					4,7
Manual	Double-Acting	4-Way, 3-Position, Tandem Center	<b>VC-4</b>					2,9
Manual	Double-Acting	4-Way, 3-Position, Tandem Center, Locking	<b>VC-4L</b>					4,7
Manual	Double-Acting	4-Way, 3-Position, Closed Center	<b>VC-20</b>					2,9
Manual	Double-Acting	4-Way, 3-Position, Closed Center, Locking	<b>VC-20L</b>					4,7



# Directional Control Valves Dimensions

## Pump Mounted Directional Control Valves

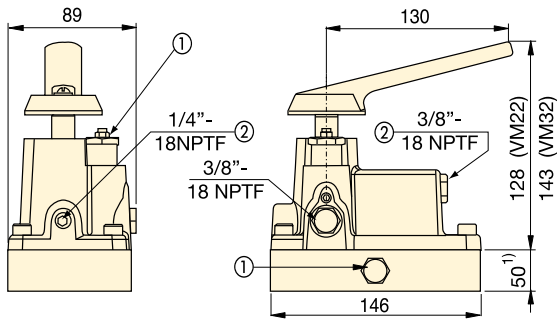

**VM22, VM32**

<sup>1)</sup> VM22 only

- ① User Adjustable Relief Valve
- ② Auxiliary Port

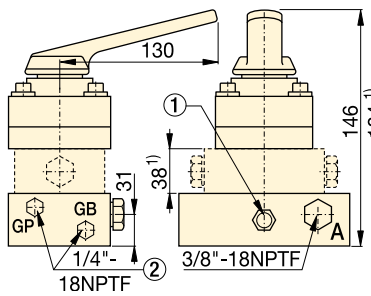

**VM33, VM33L, VM33VAC, VM43, VM43L**

<sup>1)</sup> VM33VAC, VM33L and VM43L only

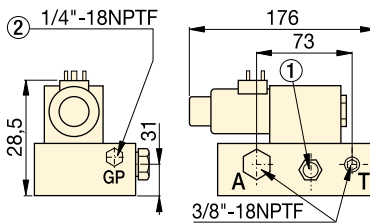

**VE32D**

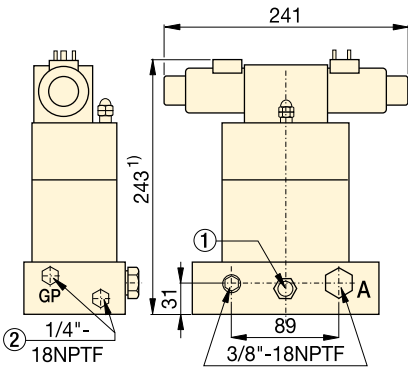

**VE33, VE33VAC**

<sup>1)</sup> VE33VAC is 38 mm higher: 281 mm

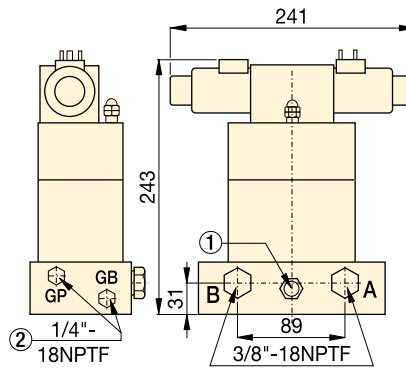

**VE43**

## Remote Manual Directional Control Valves

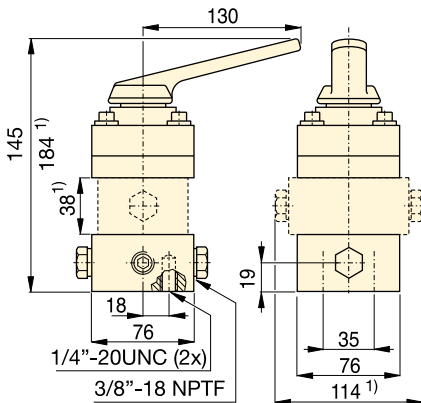

**VC-3, VC-3L, VC-15, VC-15L**

**VC-4, VC-4L, VC-20, VC-20L**

<sup>1)</sup> VC-3L, VC-15L, VC-4L and VC-20L only

## VM VE VC Series



Maximum Flow Capacity:

**17 l/min**

Maximum Operating Pressure:

**700 bar**



### Spring Centred Valve Kits

VM and VC-Series manual 3-position valves can be easily converted into spring centred valves. With these retro-fit kits the

handle will automatically move into the neutral valve position when released.

For valve model	Model Number
VM33, VM43	<b>VMC3343K</b>
VM33L, VM43L	<b>VMC3343KL</b>
VC3, VC15, VC4, VC20	<b>VMC34K</b>
VC3L, VC15L, VC4L, VC20L	<b>VMC34KL</b>



### Gauges

Minimize the risk of overloading and ensure long, dependable service from your equipment. Refer to the System Components

Section for a full range of gauges.

Page: **130**



### Fittings

For additional fittings see the fitting page of the System Components section in this catalogue.

Page: **127**



### Valving Help

See Basic System Set-Up and Valve Information in our 'Yellow Pages'.

Page: **274**

## Enerpac System Components:

All the additional elements you need to complete your high pressure hydraulic system and get started.

Engineered to work with your Enerpac cylinders, pumps and tools, all Enerpac components are designed to the most exacting standards.

With this complete line of hydraulic hoses, couplers, fittings, manifolds, oil and gauges, Enerpac has the accessories to complement your system and ensure the efficient operation, long life and safety of your hydraulic equipment.



### Yellow Pages

For sample system set-ups and how to correctly specify your system components, please view the Enerpac "Yellow Pages" section in this catalogue.

Page:  263











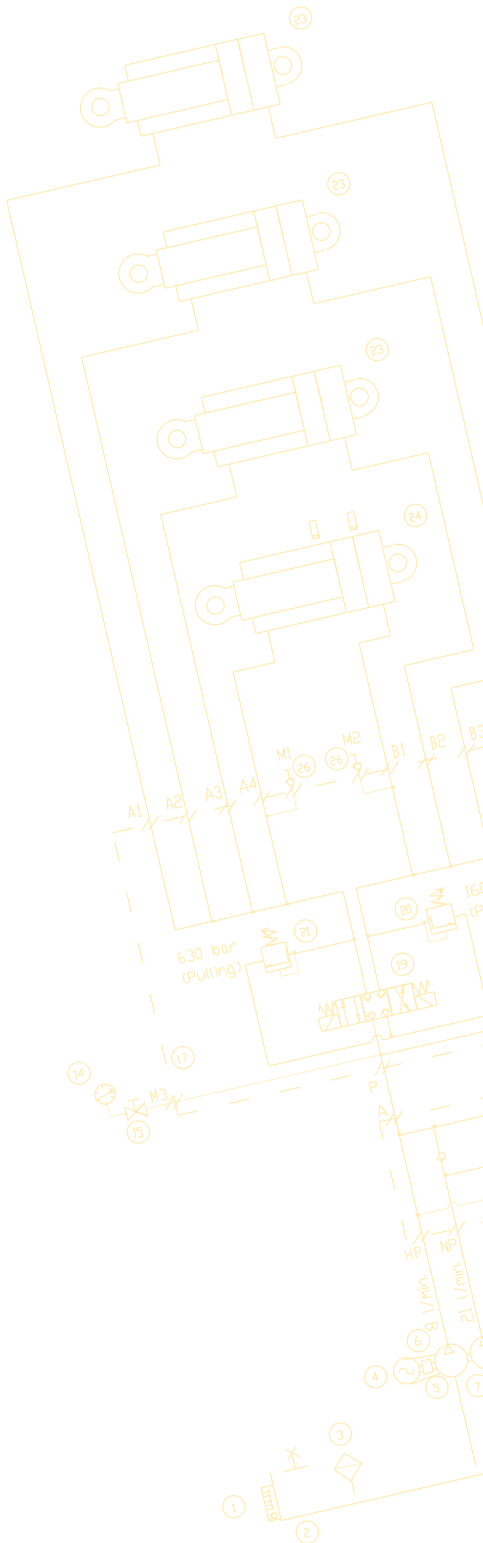





### Maintain System Integrity

Use Enerpac System Components, designed to interface with Enerpac cylinders, pumps and tools to ensure your system operates at peak performance.



# System Components & Control Valves Overview



Component Type	Series		Page
<b>Hoses</b>	H700		122 ▶
<b>Couplers</b>	A, C, F, T		124 ▶
<b>Hydraulic Oil</b>	HF		126 ▶
<b>Manifolds</b>	A		126 ▶
<b>Control Manifolds</b>	AM		126 ▶
<b>Fittings</b>	BFZ, FZ XSC		127 ▶
<b>Force Gauges Pressure Gauges</b>	GF GP		128 ▶
<b>Pressure Gauges, glycerine filled Pressure Gauges, dry</b>	G H		132 ▶
<b>Test System Gauges</b>	T		132 ▶
<b>Digital Pressure Gauges</b>	DGR		133 ▶
<b>Gauge Adaptor Assembly</b>	GA45		134 ▶
<b>4 Way manifold assembly with gauges</b>	AMGC		134 ▶
<b>Gauge Accessories</b>	GA NV, V		135 ▶
<b>Pressure and Flow Control Valves</b>	V		136 ▶

# H700-Series, High Pressure Hoses

▼ Shown: HC-7206



## Thermo-Plastic Safety Hoses (700-Series)

- For demanding applications, featuring a 4:1 safety factor
- Maximum working pressure of 700 bar
- Outside jacket is polyurethane, to provide maximum abrasion resistance
- Exhibits low volumetric expansion under pressure to enhance overall system efficiency
- Crimped-on rubber strain relief for improved life and durability on all models.

▼ To prevent back pressure and to increase cylinder retraction speed, when using long hoses with single-acting cylinders, the Enerpac HC-7300-Series of hoses with increased internal diameter is the best choice.



## Safety and Quality



To ensure the integrity of your system, specify only Enerpac hydraulic hoses.

### WARNING !

- Do not exceed 700 bar maximum pressure.
- Do not handle hoses which are under pressure.

More safety instructions in our 'Yellow pages'.

Page: **264**

## ▼ Hose End Couplings

1/4" NPTF	
3/8" NPTF	
A-604	
A-630	
AH-604	
AH-630	
C-604	
CH-604	





## Hose Oil Capacity

When using greater hose lengths, it is sometimes necessary to fill the pump reservoir after filling the hoses.

To determine the hose oil capacity, use the following:

For 6,4 mm inside diameter hoses:

Capacity (cm<sup>3</sup>) = 32,1699 x Length (m)

For 9,7 mm inside diameter hoses:

Capacity (cm<sup>3</sup>) = 73,8981 x Length (m)

Internal Diameter (mm)	Hose End Assemblies and Couplers *		Hose Length (m)	Model Number	Weight (kg)			
	End one	End two						
6,4	1/4" NPTF		-	-	-			
			-	-	-			
		A-630	1,8	HB-7206QB	1,1			
		CH-604	1,8	HC-7206Q	1,0			
	3/8" NPTF			0,6	H-7202	0,5		
				0,9	H-7203	0,7		
				1,8	H-7206	0,9		
				3,0	H-7210	1,4		
				6,1	H-7220	2,8		
				9,1	H-7230	4,5		
				15	H-7250	7,0		
			A-604		-	-	-	-
				1,8	HA-7206B	1,1		
				-	-	-	-	
				-	-	-	-	
		AH-604			-	-	-	-
					1,8	HA-7206	1,0	
					3,0	HA-7210	1,5	
		AH-630			1,8	HB-7206	1,0	
				0,9	HC-7203B	1,0		
	C-604		1,8	HC-7206B	1,3			
			3,0	HC-7210B	1,8			
	CH-604		0,9	HC-7203	0,8			
			1,8	HC-7206	1,0			
		3,0	HC-7210	1,5				
		6,1	HC-7220	2,9				
CH-604	CH-604		1,8	HC-7206C	1,1			
			15	HC-7250C	7,0			
9,7	3/8" NPTF		1,8	H-7306	1,6			
			-	-	-			
			3,0	H-7310	2,4			
			6,1	H-7320	4,5			
		CH-604		9,1	H-7330	7,3		
				15	H-7350	11,5		
				1,8	HC-7306	1,7		
				3,0	HC-7310	2,5		
		6,1	HC-7320	5,1				

\* For technical information on couplers see next page.

## H700 Series



Inside Diameter:

**6,4 - 9,7 mm**

Length:

**0,6-15 m**

Maximum Operating Pressure:

**700 bar**



### GA45GC Gauge Adaptor

Protect yourself from system overloading by simply ordering one part number for a pre-assembled gauge, adaptor block and coupler.

Page: 134



### Torque Wrench Hoses

Use Enerpac twin safety hoses with double-acting wrenches to ensure the integrity of your hydraulic system.

Page: 212



### Fittings

For additional fittings see the fitting page of the System Components section.

Page: 127



### Premium Hydraulic Oil

Use only genuine Enerpac hydraulic oil. Wrong fluid can destroy seals and pump and will render your warranty null and void your guarantee.

Page: 126

▼ Shown: FH-604, FR-400, AR-630, C-604, AH-604, AR-400



### 3/8" High Flow Couplers

- Standard equipment on most Enerpac cylinders
- Recommended for use on all Enerpac pumps and cylinders where space and porting permits
- Includes "2-in-1" dust cap for use on male and female couplers

### 3/8" High Pressure 'Flush-face' Couplers

- Featuring "Push-to-connect" operation, to guarantee good connection every time
- Flush-face, zero-leak operation for minimal spillage and reduced pressure drop
- HTMA\* recognized for safety and performance
- Will not interchange with low pressure couplers

### 3/8" Regular Spee-D-Couplers®

- For medium duty applications with hand pumps
- Includes female aluminium dust cap

### 1/4" Regular Couplers

- For use with small cylinders and hand pumps
- Includes female aluminium dust cap

### 1/4" Spin-on Torque Wrench Couplers

- For use with 700 bar S and W-Series torque wrenches, THQ-Series hoses and 700 bar torque wrench pumps

### 1/4" Lock-ring Torque Wrench Couplers

- For use with 800 bar HXD and SQD-Series torque wrenches, THC-Series hoses and 800 bar torque wrench pumps.

\* Hydraulic Tool Manufacturers Association.

## Quick Connection of Hydraulic Lines

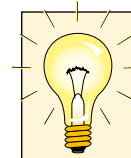

### Thread sealer

To seal NPTF threads use one of the new anaerobic thread sealers or Teflon paste. When using Teflon Tape, apply the tape one thread from the end of a fitting to prevent it from winding up in the hydraulic system.



### WARNING!

Couplers should be pressurized only when completely connected and should not be coupled or uncoupled when pressurized.

More safety instructions in our 'Yellow Pages'.

Page: 264



### F-Series

Flush-faced couplers provide reduced pressure drop versus other types and are preferred in dirty, grimy construction and mining environments due to easy clean, non-dirt trapping faces.

▼ With the use of Enerpac high flow couplers, hoses are easily installed for multiple hydraulic line connections in this 34 points PLC-controlled lifting system.



# Hydraulic Couplers



## CT-604 Safety Tool

Use the Enerpac CT-604 to relieve hydraulic back pressure by safely bleeding the hydraulic coupler.

Minimize injuries from projectile parts and under-skin hydraulic fluid injections by eliminating unsafe coupler bleeding practices. The CT-604 is Enerpac-engineering safe for use at 700 bar.

NOTE: For use on C-Series 700 bar High-Flow Couplers only

## A, C, F, T Series



Maximum Flow Capacity:  
**6,1 - 40,0 l/min**

Thread:  
**1/4" - 3/8" NPTF**

Maximum Operating Pressure:  
**700 - 800 bar**

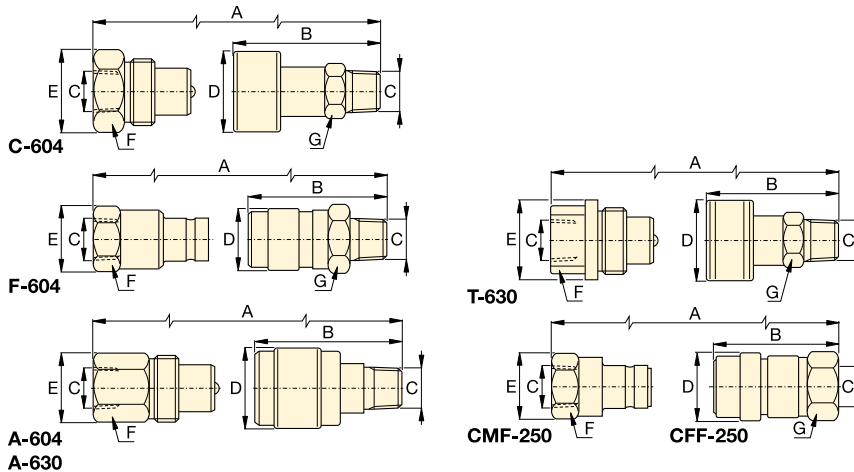

### Metal Dust Caps

Steel dust caps are available for the C-604 series couplers.

Order model number:

**CD-411M** for female half

**CD-415M** for male half

Maximum Flow Capacity (l/min)	Coupler Type	Model Numbers			Dimensions (mm)							Dust Cap(s) Modelnr.
		Complete Set	Female Half	Male Half	A*	B	C	D	E	F	G	
35	700 bar High-Flow Coupler 	C-604	CR-400	CH-604	83	64	3/8" NPTF	35	36	32	25	(2x) CD-411
40	700 bar Flush-Face coupler 	F-604	FR-400	FH-604	111	72	3/8" NPTF	31	31	27	29	-
7,6	700 bar Regular Spee-D-Coupler® 	A-604	AR-400	AH-604	77	42	3/8" NPTF	28	26	23	19	Z-410 female only
7,6	700 bar Regular Coupler 	A-630	AR-630	AH-630	66	35	1/4" NPTF	22	20	19	15	Z-640 female only
11,4	700 bar Spin-on Coupler 	T-630	TR-630	TH-630	73	60	1/4" NPTF	29	29	19	21	-
6,1	800 bar Lock-ring Coupler 	-	CFF-250	CMF-250	76	58	1/4" NPTF	23	28	24	22	-

\* Value A is total length when male and female half are connected.





# Hydraulic Oil, Manifolds and Fittings



## 3/8" Swivel Connector

360 degree swivel coupler for optimal orientation of the hydraulic connection on cylinders, pumps and hoses.  
Order Model Number. **XSC-1**

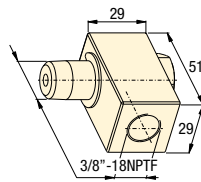

**A, AM  
BFZ  
FZ  
HF  
Series**



700 bar Fittings		Model Number	Dimensions (mm)		C	D	Diagram	
			A	B				
<b>Street Elbow</b>			<b>FZ-1616</b>	23	33	3/8"-18 NPTF	3/8"-18 NPTF	
From: 3/8"-NPTF Male	To: 3/8"-NPTF Female							
<b>Reducing Connector</b>			<b>FZ-1615</b>	28	25	3/8"-18 NPTF	1/4"-18 NPTF	
From: 3/8"-NPTF Female	To: 1/4"-NPTF Female							
			<b>FZ-1625</b>	47	29	1/2"-14 NPTF	3/8"-18 NPTF	
From: 1/2"-NPTF Female	To: 3/8"-NPTF Female							
<b>Hexagon Nipple</b>			<b>FZ-1608</b>	38	16	1/4"-18 NPTF	1/4"-18 NPTF	
From: 1/4"-NPTF	To: 1/4"-NPTF							
From: 3/8"-NPTF	To: 3/8"-NPTF							
From: 3/8"-NPTF	To: 3/8"-NPTF							
<b>Coupling</b>			<b>FZ-1614</b>	29	23	3/8"-18 NPTF	3/8"-18 NPTF	
From: 3/8"-NPTF	To: 3/8"-NPTF							
			<b>FZ-1605</b>	29	19	1/4"-18 NPTF	1/4"-18 NPTF	
From: 1/4"-NPTF	To: 1/4"-NPTF							
<b>Cross</b>			<b>FZ-1613</b>	45	25	3/8"-18 NPTF	-	
From: 3/8"-NPTF Female	To: 3/8"-NPTF Female							
<b>Tee</b>			<b>FZ-1612</b>	45	25	3/8"-18 NPTF	-	
From: 3/8"-NPTF	To: 3/8"-NPTF							
From: 1/4"-NPTF	To: 1/4"-NPTF							
			<b>FZ-1637</b>	45	24	1/4"-18 NPTF	-	
From: 1/4"-NPTF	To: 1/4"-NPTF							
From: 1/4"-NPTF	To: 1/4"-NPTF							
<b>Street Tee</b>			<b>BFZ-16312</b>	56	26	3/8"-18 NPTF	3/8"-18 NPTF	
From: 3/8"-NPTF Female	To: 3/8"-NPTF Male							
<b>Elbow</b>			<b>FZ-1610</b>	33	20	3/8"-18 NPTF	-	
From: 3/8"-NPTF	To: 3/8"-NPTF							
			<b>FZ-1638</b>	36	24	1/4"-18 NPTF	-	
From: 1/4"-NPTF	To: 1/4"-NPTF							
<b>Reducer</b>			<b>FZ-1630</b>	19	19	1/4"-18 NPTF	3/8"-18 NPTF	
From: 3/8"-NPTF	To: 1/4"-NPTF							
From: 1/4"-NPTF	To: 1/2"-NPTF							
			<b>BFZ-1630</b>	28	22	1/4"-18 NPTF	1/2"-14 NPTF	
From: 1/4"-NPTF	To: 1/2"-NPTF							
From: 3/8"-NPTF	To: G1/4"							
			<b>BFZ-16301</b>	19	19	G1/4"	3/8"-18 NPTF	
From: 3/8"-NPTF	To: G1/4"							
From: 3/8"-NPTF	To: G1/4"							
<b>Adaptor</b>			<b>BFZ-16411</b>	35	19	1/4"-18 NPTF	G1/4"	
From: G1/4"	To: 1/4"-NPTF							
From: G1/4"	To: 1/8"-NPTF							
From: G3/8"	To: 1/4"-NPTF							
			<b>BFZ-16421</b>	31	19	1/8"-27 NPTF	G1/4"	
From: G3/8"	To: 1/4"-NPTF							
From: G3/8"	To: 1/4"-NPTF							
From: G3/8"	To: 3/8"-NPTF							
			<b>BFZ-16323</b>	43	24	1/4"-18 NPTF	G3/8"	
From: G3/8"	To: 1/4"-NPTF							
From: G3/8"	To: 1/4"-NPTF							
From: G3/8"	To: 3/8"-NPTF							
			<b>BFZ-16324</b>	43	24	3/8"-18 NPTF	G3/8"	
From: G3/8"	To: 3/8"-NPTF							
From: G3/8"	To: 3/8"-NPTF							
From: G3/8"	To: 3/8"-NPTF							
<b>Adaptor</b>			<b>FZ-1055</b>	44	23	1/4"-18 NPTF	3/8"-18 NPTF	
From: 1/4"-NPTF	To: 3/8"-NPTF							
From: 1/4"-NPTF	To: 1/8"-NPTF							
			<b>FZ-1642</b>	30	19	1/8"-27 NPTF	1/4"-18 NPTF	
From: 1/4"-NPTF	To: 1/8"-NPTF							
From: 1/2"-NPTF	To: 3/8"-NPTF							
			<b>FZ-1634</b>	42	28	3/8"-18 NPTF	1/2"-18 NPTF	
From: 1/2"-NPTF	To: 3/8"-NPTF							
From: 1/2"-NPTF	To: 3/8"-NPTF							
<b>Swivel Fitting</b>			<b>FZ-1660</b>	40	22	3/8"-18 NPTF	3/8"-18 NPTF	
From: 3/8"-NPTF Male	To: 3/8"-NPTF Female							

▼ Shown from left to right: GF-230B, GF-835B, GP-10S



- **GF-series gauges:** calibrated with dual scale reading for pressure (bar) and force (kN)
- **GF-series gauges:** all pressure sensing parts are sealed and dampened by glycerine for long life
- **GP-series gauges:** calibrated with dual scale reading for pressure in bar and psi
- **Excellent readability:** gauge face dimensions 100 mm
- **Fast, easy installation**
- **Stainless steel gauge cases for corrosion resistance.**

▼ A GP-10S gauge is used on this press to check the hydraulic pressure required to bend flat steel bar.



## Visual Reference for System Pressure and Force



### Auto-Damper Valve V-10

For automatic control of gauge fluctuations, the V-10 Auto-Damper Valve controls the movement of the gauge needle

by restricting oil flow in and out of the gauge. No adjustments needed.

Page: 136





### Snubber Valve V-91

Infinitely adjustable for metering oil out of a gauge. The V-91 Snubber Valve is also suitable as a shut-off valve to protect the gauge during

high cycle applications.

Page: 136

### Used With

	All cylinders
	All cylinders
	5 ton RC, RSM-cylinders
	10 ton RC, RCS, RSM-cylinders
	All 25 ton RC-cylinders
	All 50 ton RC, RR-cylinders
	13 ton RCH-Series
	RCS-201, 302
	RCS-502, 1002
	RCH-202, 302, 603
	25, 30, 50 ton RC, RCS, RSM, RR
	75 and 95 ton RC, RR-cylinders
	150 and 200 ton RR-cylinders
	10 ton VLP Presses
	25 ton XLP Presses
	50 ton XLP, BPR Presses
	100 ton VLP, BPR Presses
	200 ton VLP, BPR Presses

# Hydraulic Force & Pressure Gauges



### Maximum Indicator Pointer

Indicator retains peak readings of pressure or force generated by the system.

Can easily be installed on GP and H-Series gauges.  
Order model nr: **BSA-881**.



### Pressure Gauges

To measure the input pressure into cylinders or high pressure systems. Also for all testing applications.

### Force Gauges

To measure external load supported by a cylinder or jack in kN. For pressing parts together under pre-determined loads, weighing, testing, etc.

**GP-Series** are dry gauges.

**GF-Series** are glycerine filled gauges.

## GF GP Series



Pressure Range:

**0 - 1000 bar**

Force Range:

**0 - 2000 kN**

Gauge Face Diameter:

**100 mm**

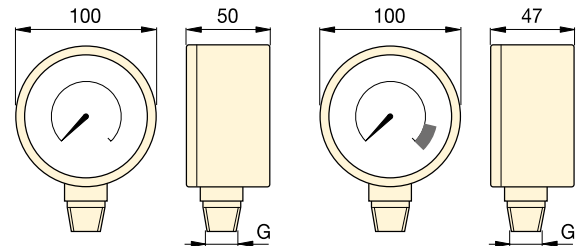

Accuracy, % of full scale:

**± 1%**



GP-serie

GF-serie

Gauge Type and Calibration				Units per Division	Model Number *	Thread G	Gauge Adaptor		
							 135		
bar	psi	bar	kN				GA-1	GA-2	GA-3
0-700	0-10.000	-	-	10 bar, 100 psi	<b>GP-10S</b>	1/2" NPTF	●	●	
0-1000	0-15.000	-	-	10 bar, 200 psi	<b>GP-15S</b>	1/2" NPTF	●	●	
-	-	0-700	0-45	10 bar, 0,5 kN	<b>GF-5B</b>	1/2" NPTF	●	●	
-	-	0-700	0-100	10 bar, 1 kN	<b>GF-10B</b>	1/2" NPTF	●	●	
-	-	0-700	0-232	10 bar, 2 kN	<b>GF-20B</b>	1/2" NPTF	●	●	
-	-	0-700	0-500	10 bar, 5 kN	<b>GF-50B</b>	1/2" NPTF	●	●	
-	-	0-700	0-124	10 bar, 1 kN	<b>GF-120B</b>	1/2" NPTF	●	●	
-	-	0-700	0-175/275	10 bar, 2 + 5 kN	<b>GF-230B</b>	1/2" NPTF	●	●	
-	-	0-700	0-450/900	10 bar, 5 + 10 kN	<b>GF-510B</b>	1/2" NPTF	●	●	
-	-	0-700	0-210/320/570	10 bar, 5 kN	<b>GF-813B</b>	1/4" NPTF			●
-	-	0-700	0-232/300/500	10 bar, 5 kN	<b>GF-835B</b>	1/4" NPTF			●
-	-	0-700	0-720/930	10 bar, 10 kN	<b>GF-871B</b>	1/4" NPTF			●
-	-	0-700	0-1400/2000	10 bar, 25 kN	<b>GF-200B</b>	1/4" NPTF			●
-	-	0-700	0-100	10 bar, 1 kN	<b>GF-10B</b>	1/2" NPTF	●	●	
-	-	0-700	0-232	10 bar, 2 kN	<b>GF-20B</b>	1/2" NPTF	●	●	
-	-	0-700	0-500	10 bar, 5 kN	<b>GF-50B</b>	1/2" NPTF	●	●	
-	-	0-700	0-720/930	10 bar, 10 kN	<b>GF-871B</b>	1/4" NPTF			●
-	-	0-700	0-1400/2000	10 bar, 25 kN	<b>GF-200B</b>	1/4" NPTF			●

\* GF-Series Force gauges with imperial scale reading (psi, lbs) are available by changing the suffix 'B' into 'P'.

▼ Shown from left to right: H4049L, G-2534R, G-4089L, G-2535L, G-4040L



## Visual Reference of System Pressure

### Glycerine Filled (G-Series)

- Dual scale reading calibrated in bar and psi
- All pressure sensing parts sealed and dampened by glycerine for long life
- Includes safety blow-out disk and pressure equalizing membrane
- Gauge snubbers or needle valves recommended for high cycle applications.

### High Cycle Dry Gauges (H-Series)

- Dual scale reading calibrated in bar and psi
- Ideal for use in many applications, specifically for high cycle and harsh environments
- Gauge snubbers or needle valves recommended to shut off gauge when not in use.



#### Gauge adaptor assembly

45° Angled gauge adaptor **GA45GC** improves safe working conditions.

Page: **134**



#### Gauge Adaptor

For easy gauge installation into almost any system, Enerpac offers a complete line of gauge adaptors.

Page: **135**



#### Snubber Valve V-91

Infinitely adjustable for metering oil out of a gauge. The V-91 Snubber Valve is also suitable as a shut-off valve to protect the gauge during

high cycle applications.

Page: **136**

◀ When lifting or pressing, always use a gauge. A gauge is your 'window' to the system. It lets you see what's going on.



# Hydraulic Pressure Gauges



**CAUTION! When lifting or pressing, always use a gauge**  
Do not override factory setting of relief valves. Always use a gauge to check system pressure. A gauge is your 'window' to the system. It lets you see what's going on. See our Safety Instructions.

Page: 265

## G H Series



Pressure Range:  
**0 - 1000 bar**

Face Diameter:  
**63 - 100 mm**

Accuracy, % of full scale:  
**± 1,0 - 1,5%**

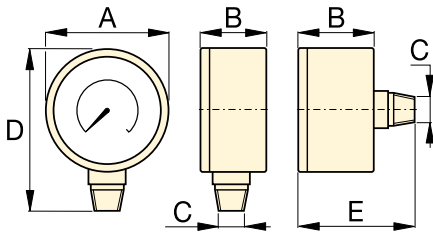

Size (mm)	Connection	Dimensions (mm)				
		A	B	C	D	E
63	Lower Mount	63	37	¼" NPTF	84	-
63	Center Rear	63	37	¼" NPTF	-	63
100	Lower Mount	100	29	¼" NPTF	121	-
100	Lower Mount	100	49	½" NPTF	136	-

Note: dimensions for reference only.



**Maximum Indicator Pointer**  
Indicator retains peak readings of pressure or force generated by the system.

Can easily be installed on GP and H-Series  
ø 100 mm gauges. Order model nr: **BSA-881**.

### ▼ SELECTION CHART

Gauge Series	Pressure Range		Model Number				Major Graduation		Minor Graduation		Major Graduation		Minor Graduation	
			ø 63 ¼" NPTF Lower Mount	ø 63 ¼" NPTF Center Rear	ø 100 ¼" NPTF Lower Mount	ø 100 ½" NPTF Lower Mount	bar		psi		bar		psi	
	(bar)	(psi)	Accuracy: ± 1,5 %		Accuracy: ± 1,0 %		ø 63	ø 100	ø 63	ø 100	ø 63	ø 100	ø 63	ø 100
G-Series	0-7	0-100	G2509L	-	-	-	1	-	0,01	-	10	-	2	-
	0-11	0-160	G2510L	-	-	-	1	-	0,02	-	10	-	2	-
	0-14	0-200	G2511L	-	-	-	1	-	0,02	-	50	-	5	-
	0-20	0-300	G2512L	-	-	-	5	-	0,50	-	50	-	5	-
	0-40	0-600	G2513L	-	-	-	10	-	1	-	100	-	10	-
	0-70	0-1.000	G2514L	G2531R	-	-	10	-	1	-	100	-	20	-
	0-140	0-2.000	G2515L	-	-	-	10	-	5	-	500	-	50	-
	0-200	0-3.000	G2516L	-	-	-	50	-	5	-	500	-	50	-
	0-400	0-6.000	G2517L	G2534R	-	-	100	-	10	-	1000	-	100	-
	0-700	0-10.000	G2535L	G2537R	G4088L	G4039L	100	100	10	10	2000	1000	200	100
0-1000	0-15.000	G2536L	G2538R	G4089L	G4040L	100	100	20	20	3000	3000	200	200	
H-Series	0-700	0-10.000	-	-	H4049L	H4071L	-	100	-	10	-	1000	-	100

# T-Series, Test System Gauges

▼ Gauge shown: T-6003L



- Dual scale reading calibrated in bar and psi
- All gauges have spring-loaded backs with rubber blow-out plugs to protect case assembly in case of over-pressurization
- Integral maximum indicator pointer standard included
- 2800 and 3500 bar models include flange mounting
- ½" NPTF versions are made of high strength alloy steel
- 0.25" cone models are made of 316 stainless steel, with 403 stainless steel on 2800 and 3500 bar models.

## T Series

Pressure Range:  
**0 - 3500 bar**

Face Diameter:  
**162 - 192 mm**

Accuracy, % of full scale:  
**± 0,5 - 1,5%**



### Cone Mount Gauge Adaptor

Contains fittings to connect ¼" cone fitting gauge to ¾" cone system. Kit includes 43-301 tee, 43-704 gauge adaptor and 45-116 tubing. Order model number: **83-011**.

Page: **81**



### Cone Mount Gauge Connector

For connecting gauges with 0.25" cone fitting directly to model number **11-100** or **11-400** pump (page 80). May be used with other

0.25" cone systems  
Order model number: **43-704**

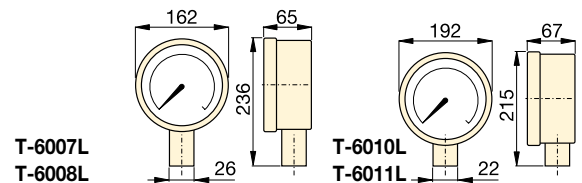
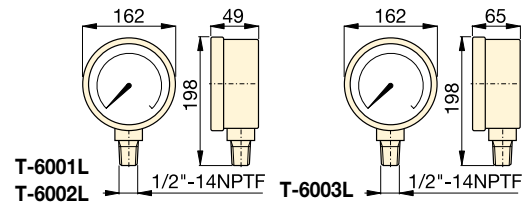

▼ An Enerpac P-2282 hand pump equipped with a T-6011L test system gauge is used for proof pressure testing of hydraulic valves.



Pressure Range (bar)	Pressure Range (psi)	Model Number		Number Intervals (bar)	Graduation Intervals (bar)	Number Intervals (psi)	Graduation Intervals (psi)
		Alloy Steel ½" NPTF	Stainless Steel 0,25 cone				
0-70 <sup>1)</sup>	0-1000	<b>T-6001L</b>	–	10	1	100	10
0-350 <sup>1)</sup>	0-5000	<b>T-6002L</b>	–	50	5	500	50
0-700 <sup>1)</sup>	0-10.000	<b>T-6003L</b>	<b>T-6007L</b>	100	10	1.000	100
0-1400 <sup>1)</sup>	0-20.000	–	<b>T-6008L</b>	200	20	1.000	100
0-2800 <sup>2)</sup>	0-40.000	–	<b>T-6010L</b>	500	20	5.000	200
0-3500 <sup>2)</sup>	0-50.000	–	<b>T-6011L</b>	500	50	5.000	200

<sup>1)</sup> Accuracy ± 0,5%

<sup>2)</sup> Accuracy ± 1,5%

# Digital Hydraulic Pressure Gauge

▼ Gauge shown: **DGR-2**



- Rated for system pressure up to 1380 bar
- Displays in bar, psi, MPa and kg/cm<sup>2</sup>
- Zero reset - ensures that gauge reads actual pressure
- IP65 protection, UL listed, CE and RoHS compliant
- Batteries included, condition indicator on read-out
- Shut-off selectable – menu driven
- Back-lit readout allows easy reading in less than ideal lighting
- Protective cover included.

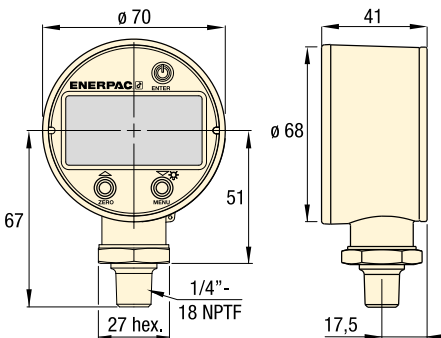

High Pressure Rating (bar)		High Pressure Rating (MPa)		Model Number	High Pressure Rating (psi)		High Pressure Rating (kg/cm <sup>2</sup> )	
Range	Resolution	Range	Resolution		Range	Resolution	Range	Resolution
0-1380	0,1	0-140	0,01	<b>DGR-2</b>	0-20.000	1	0-1400	0,1

Weight: 0,23 kg.

## DGR Series

Pressure Range:

**0 - 1380 bar**

Voltage:

**3 Volt (battery)**

Accuracy, % of full scale:

**± 0,25%**



### Gauge Adaptor

For easy gauge installation into almost any system, Enerpac offers a complete line of gauge adaptors. Maximum operating pressure 700 bar.

Page: 135

▼ Greater accuracy and easier to read: enhance your ability to monitor and control hydraulic system pressure up to 1380 bar.



▼ Shown: GA45GC



- 45° angled gauge improves visibility
- Slim and narrow design
- Easy to fit in a broad range of systems
- Maximize controlled load movement
- Glycerin dampened gauge with dual scale
- Enerpac High-Flow female coupler CR400.

## GA45GC, AMGC Series

Connection 1:  
**3/8" NPTF male**

Connection 2:  
**CR-400 coupler**

Maximum Operating Pressure:  
**700 bar**



### 4 Way Manifold assembly complete with gauges

Offering ease of portability and convenience with an ergonomic robust design, ready for use.

Enerpac's CR400 female couplers on all ports allow the manifold to be quickly connected to up to 4 cylinders. Glycerine filled, 700 bar gauges allow operators to work safely. All protected by the robust protection frame.

Manifold Type (Used for cylinders)	Model Number
4x Single-acting	<b>AMGC41</b>
4x Double-acting	<b>AMGC42</b>



### Power Box

Portable tool box with hand pump, GA45GC gauge adaptor assembly, hose and RC, RSM, RCS-cylinder, WR5 wedgie or LW16-lifting wedge.

Page: **61**

▼ The Gauge Adaptor Assembly is the window to your system; allows easy reading of the pressure for safe operation.

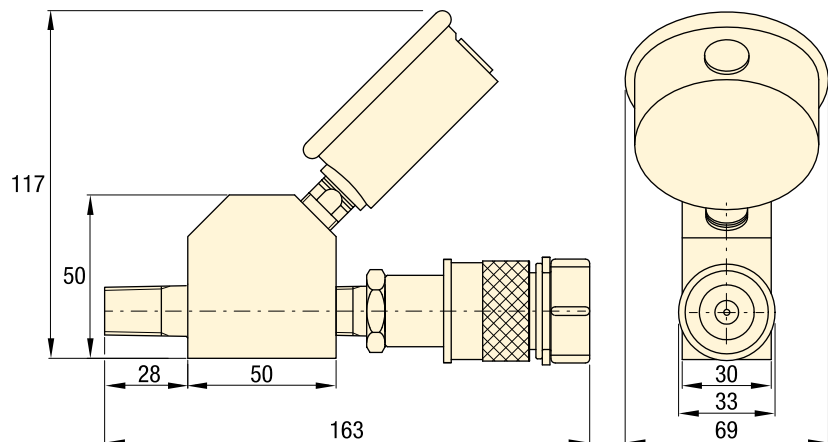

Model Number	Gauge Port (1/4" NPTF)	Male End (NPTF)	Female End (3/8" NPTF)	Gauge Range	
				(bar)	(psi)
<b>GA45GC</b>	G2535L	3/8" -18	CR-400	0 - 700	0 - 10,000



# Gauge Accessories

▼ Shown from left to right: GA-3, V-91, GA-1, GA-2, GA-4, NV-251, GA-918



## GA, NV, V Series

Maximum Operating Pressure:  
**700 bar**

▼ A gauge is easily installed into your hydraulic system using a gauge adaptor.



### Gauge Adaptors (GA-Series)

- For easy mounting of a pressure gauge onto your system
- Male end screws into pump or cylinder port, female end accepts hose or coupler, 3<sup>rd</sup> port is for gauge connection
- GA-918 provides for swivel connection.

Model Number	Gauge Port (NPTF)	Male End (NPTF)	Female End (NPTF)	Dimensions (mm)					
				A	B	C	D	E	F
GA-1	1/2"	3/8"	3/8"	71	31	1/2" NPTF	3/8" NPTF	3/8" NPTF	32
GA-2	1/2"	3/8"		155	35	1/2" NPTF	3/8" NPTF	3/8" NPTF	32
GA-3	1/4"	3/8"		133	35	1/4" NPTF	3/8" NPTF	3/8" NPTF	32
GA-4	1/2"	1/4"		111	35	1/2" NPTF	1/4" NPTF	3/8" NPTF	32

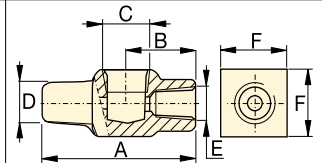

GA-1

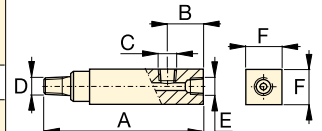

GA-2, GA-3, GA-4



### Swivel Adaptor (GA-918)

- Simplifies gauge installation and reading.

Model Number	Dimensions (mm)							
	A	B	C	D	E	S	S1	
GA-918	117	43	1/2" NPTF	28,5	1/2" NPTF	29	38	

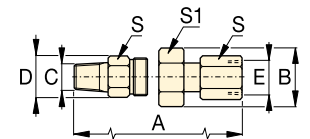

### Needle Valves (V- and NV-Series)

- Both NV-251 and V-91 provide positive shut-off
- 303 stainless steel stem, 16 threads/in (NV-251).

Model Number	Orifice (mm)	Thread Size	Dimensions (mm)						
			A	B	C	D	E	F	H
NV-251	4,3	1/4" NPTF	57	29	1/4" NPTF	57	46	19	19
V-91	4,8	1/2" NPTF	89	32	1/2" NPTF	64	32	37	37

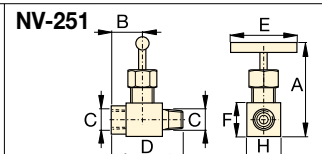

V-91

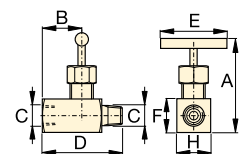

▼ From left to right: V-152, V-66, V-82, V-161, V-42, V-17



## Your Hydraulic Control Solution



### Valve Applications

To see these valves used in typical hydraulic circuits, please see our 'Yellow Pages'.

Page: **268**

▼ The V-152 pressure relief valve limits the pressure or force developed in the hydraulic system.



- All valves are rated for 700 bar operating pressure
- All valves feature NPTF porting to insure against leakage at rated pressure
- All valves are painted, coated, or plated for corrosion resistance
- Viton® seals (in V-66NV and V-152NV) for high temperature applications, nickel-plated for maximum corrosion resistance.

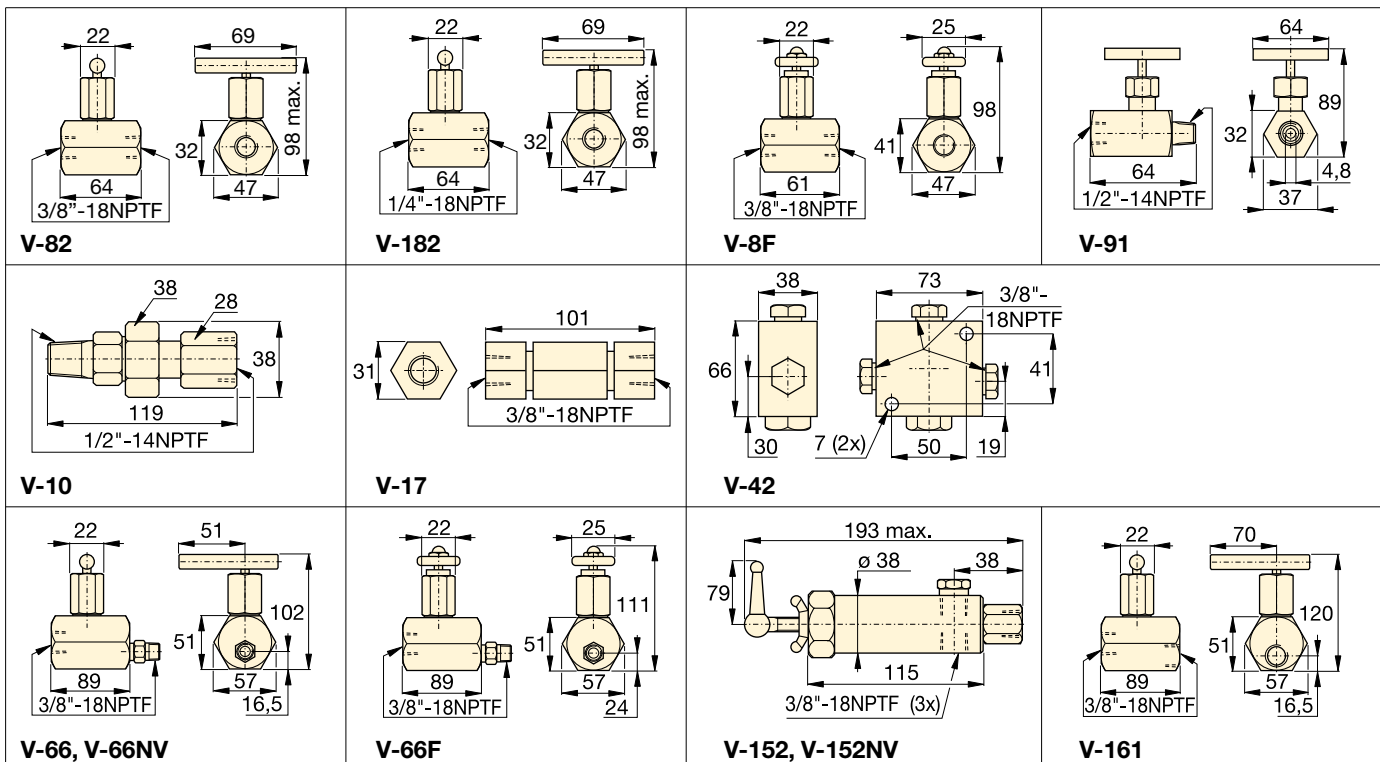

Valve dimensions in mm

# Pressure and Flow Control Valves



## Control Manifolds

For two or four port manifolds with integral flow control valves, see the manifold page of the System Components section.

Page: 126



## Fittings

For additional fittings see the fitting page of the System Components section in this catalogue.

Page: 127

## V Series



Maximum Operating Pressure:

**700 bar**

Valve Type and Model Number		Description		Hydraulic Symbol
Needle Valve V-82 V-182 V-8F		<b>V-82:</b> To control cylinder speed. Can also be used as shut-off valve for temporary load holding. 3/8" NPTF ports, nickle plated. <b>V-182:</b> Same as V-82, but with 1/4" NPTF female ports, nickle plated.	Also suitable for gauge snubbing (also V-82). <b>V-8F:</b> Like V-82, but with very fine metering for precise flow control 0,16-14,7 l/min at 275 bar. <b>Not recommended as shut-off valve.</b>	
Snubber Valve V-91		<b>V-91:</b> Infinitely adjustable for metering oil out of a gauge to prevent snapping of gauge pointer when load or pressure is suddenly released.	Also suitable as shut-off valve to protect the gauge during high cycling applications. 1/2" NPTF male and female threads for use with GA-1, GA-2 or GA-4 gauge adaptors.	
Auto Damper® Valve V-10		<b>V-10:</b> To be used when gauge pressure must be monitored during high cycle applications. Creates a flow resistance when load is released suddenly. No adjustments are necessary.	1/2" NPTF male and female threads for use with GA-1, GA-2 or GA-4 gauge adaptors.	
Check Valve V-17		<b>V-17:</b> Ruggedly built to resist shock and operate with low pressure drop. Closes smoothly without pounding. 3/8" NPTF female port.		
Pilot Operated Check Valve V-42		<b>V-42:</b> Can be mounted at the cylinder to hold the load in case of system pressure loss. Normally used with double-acting cylinders where pilot port receives pressure from a Tee-fitting in the cylinder retract line.	3/8" NPTF female ports. Pilot pressure ratio 14% (6,5:1).	
Manually Operated Check Valve V-66, V-66NV * V-66F		<b>V-66, V-66NV:</b> For load holding applications with single and double acting cylinders. Valves allow oil to flow back to tank when cylinder retracts. V-66NV with Viton seals, nickel-plated.	V-66F: Similar to V-66, but with very fine metering capability for precise flow control. V-66F is not designed for load holding.	
Pressure Relief Valve V-152 V-152NV *		<b>V-152:</b> Limits pressure developed by the pump in hydraulic circuit, thus limiting the force imposed on other components. Valve opens whenever preset pressure is reached.	To increase pressure setting, turn handle clockwise. Includes: • 0,9 m return line hose kit, • ± 3% repeatability, • 55-700 bar adjustment range.	
Sequence Valve V-161		<b>V-161:</b> To control oil flow to a secondary circuit. Flow is blocked until system pressure rises to the V-161 setting. When this pressure level is reached, the V-161 opens to allow flow to the secondary circuit.	A pressure differential is always maintained between the primary and secondary circuit. <b>Minimum operating pressure: 140 bar.</b>	

\* See page 60 for more information about products for use in high temperature and extreme environment applications.



Enerpac Hydraulic Presses are available in a variety of capacities and sizes. The press frames are designed for maximum strength and durability. Strong frames and powerful high-pressure hydraulics will provide years of dependable service in many applications.

Enerpac Presses are available in Bench, C-Frame, Arbor, Workshop and Roll-Frame models.

These Press features increase productivity and broaden the range of applications:

**Side-to-side cylinder movement**

Lateral movement capability of cylinder in upper bed.



**Press Kits**

The 50 and 75 ton XLP-Series presses come as unassembled kits, and include complete press frame, winch, cylinder, pump with gauge, couplers and hose.









**Winch**

Movable upper and lower bed with self-braking winch on XLP-Series presses.





# Hydraulic Presses Section Overview

Capacity ton (kN)	Press type and functions	Series		Page
10 (101)	Bench Presses	VLP		140 ▶
25 - 200 (232 - 1995)	Workshop Presses	XLP VLP		140 ▶
50 - 200 (498 - 1995)	Roll-Frame Presses	BPR		142 ▶
5 - 20 (45 - 178)	C-Clamp Presses	A		144 ▶
10 - 30 (101 - 295)	Arbor Presses	A		144 ▶
10 - 200 (101 - 1995)	Press Accessories Press Application Idea	VB, A, IPL		146 ▶
900 - 90.000 kg	Tension Meters Load Cells	TM LH		147 ▶

Available in capacities from 10 to 200 ton, each Enerpac press consists of three basic high quality components: a press frame, a power source and a cylinder.

## Press Frame

Press frames include features like workpiece side-loading and height adjustment of the upper and lower bed.

## Power Source

Depending on the production requirements, Enerpac presses can be powered by manual, air-hydraulic and electric-drive power sources.

## Cylinder

Depending on the application, double-acting cylinders offer increased efficiency. Check out the Selection Charts for the press best suited for your needs.

## Gauge

All Workshop presses and Roll-Frame Presses feature an easy to monitor pressure/force gauge for increased safety.



### IMPORTANT!

The pressframe of the workshop presses are exclusively designed for pressing operations, not for pulling. For pulling applications please contact Enerpac.

In order to fully comply with CE regulations, some presses must be equipped with specific safety components, such as spring centered valves, two-hand control devices, guards or others.

Enerpac standard general purpose presses are supplied without guards, and have a plunger speed of less than 10 mm/second. However, your application may require that measures should be taken to reduce the risk of injury to operators and other personnel by providing appropriate safeguarding, training and conducting a risk assessment, which eliminates or reduces danger.

Health & safety within your workplace is your responsibility, not that of Enerpac.

Advice on such matters is available from your local enforcement agency. If you require any further information on Enerpac accessories that may help you conform to the Machinery Directive or European legislation contact Enerpac.



▼ From left to right: XLP-506XA12G, XLP-256XA11G



## No Workshop can do without one



### XA-Series Foot Pump

The XLP-press with XA-Series air powered foot pump: no need to fully lift up foot – rest bodyweight on heel, resulting in a handsfree and stable working position – safe and controlled press operation (see page 108 for XA-Series Pumps).



### Gauges

All press models include a gauge and gauge adaptor, matching the press capacity.



### Easy grip forklift access

Cut-away in lower frame for pallet truck access allows easy transportation of 50 and 75 ton XLP-series presses.



### Side-to-side cylinder movement

Cylinder can be positioned horizontally side-to-side on all XLP-Series presses.



### XLP-Series Presses

- Multi-functional presses in kit form (50 and 75 ton presses)
- Easy grip forklift access on 50 and 75 ton presses
- Height adjustment of upper or lower bed with winch (50 & 75 ton)
- Width adjustment allows cylinder to move from side-to-side
- Pump options include XA-Series air-operated foot pump
  - pressure gauge integrated in pump for optimal control
  - suitable for delicate pressing jobs from variable oil flow.

### VLP-Series presses

- Unique “Hydrajust” bed positioning device on 100 and 200 ton VLP-presses allows adjustment of the lower bed.

### ▼ SELECTION CHART

Press Capacity ton (kN)	Maximum Daylight (mm)		Press Model Number	Power Source					Cylinder						
	Vertical	Horizontal		Pump Type			Valve Type		Pump Model Nr.	Page:			Stroke (mm)	Cylinder Model Nr.	Page:
				Man.	Elec.	Air	Man.	Elec.							
10 (101)	430	435	VLP-106P142	●			●		P-142	72	●		156	RC-106	6
	430	435	VLP-106PAT1			●	●		PATG-1102N	106	●		156	RC-106	6
25 (232)	1228	510	XLP-256P392	●			●		P-392	72	●		158	RC-256	6
	1228	510	XLP-256XA11G			●	●		XA-11G	108	●		158	RC-256	6
50 (498)	980	990	XLP-506P802 *	●			●		P-802	74	●		159	RC-506	6
	980	990	XLP-506XA12G *			●	●		XA-12G	108	●		159	RC-506	6
	980	990	XLP-506ZES *		●			●	ZE4410SE-E050	98		●	156	RR-506	36
	980	990	XLP-5013ZES *		●			●	ZE4410SE-E050	98		●	334	RR-5013	36
75 (718)	970	990	XLP-756XA12G *			●	●		XA-12G	108	●		156	RC-756	6
100 (933)	989	990	VLP-1006ZES		●			●	ZE5420SW-E050	98		●	168	RR-1006	36
	989	990	VLP-10013ZES		●			●	ZE5420SW-E050	98		●	333	RR-10013	36
200 (1995)	1340	1220	VLP-20013ZES		●			●	ZE6420SW	98		●	330	RR-20013	36

\* 50 and 75 ton XLP-Series presses can be ordered as factory assembled press frame. Add suffix “M” to press model number. Example: XLP-506XA12G-M.



= Single-Acting



= Double-Acting

# Bench and Workshop Presses



## Optional V-Blocks

To facilitate positioning of pipes and bars, or placed upside-down, to serve as a convenient worktable. Featuring precise fit into the press bolster. Each model number includes two V-blocks.

press bolster. Each model number includes two V-blocks.

To be used with press (ton)	V-Blocks Model Number
10	VB-10
25	VB-25
50	VB-501
75, 100	VB-101
200	A-200

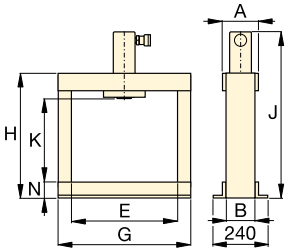

VLP 10 ton

## "Hydrajust" Bed Positioning

Allows vertical adjustment of the lower bed on 100 and 200 ton VLP presses.

**IMPORTANT:** The "Hydrajust" bed positioning is not designed to withstand full cylinder capacity, only to be used for bed adjustment.

Page: 146

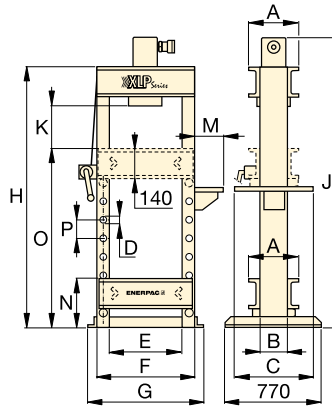

XLP 25 ton

## XLP, VLP Series



Capacity:

**10 - 200 ton**

Maximum Daylight x Width:

**1340 x 1220 mm**

Maximum Operating Pressure:

**700 bar**



### IMPORTANT!

The pressframe of the workshop presses are exclusively designed for pressing operations, not for pulling. For pulling applications please contact Enerpac.

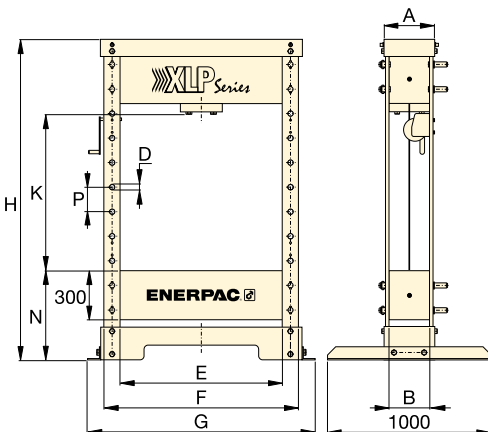

XLP 50 and 75 ton

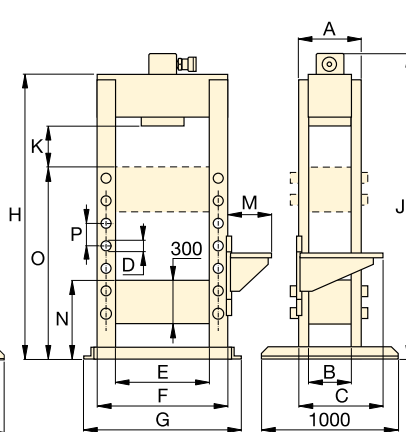

VLP 100 ton

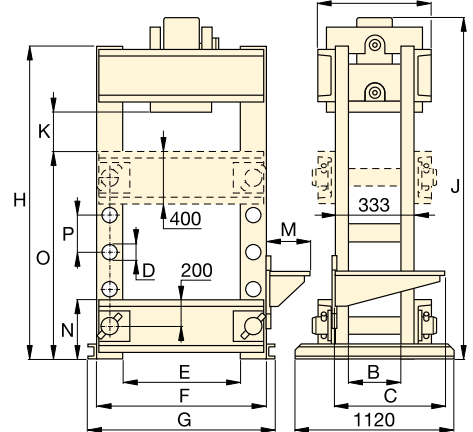

VLP 200 ton

Speed (mm/s) **		Dimensions (mm)															Press Model Number
Rapid Advance	Pressing	A	B	C	D	E	F	G	H	J	K	M	N	O	P	(kg)	
{2,5} **	{0,6} **	110	80	-	-	435	-	542	620	748	430	-	80	-	-	49	VLP-106P142
10,0	1,8	110	80	-	-	435	-	542	620	748	430	-	80	-	-	54	VLP-106PAT1
{3,4} **	{0,7} **	260	140	510	32	510	630	700	1622	1740	370-1228	140	212	1070	122	165	XLP-256P392
10,0	1,3	260	140	610	32	510	630	700	1622	1740	370-1228	323	212	1070	122	170	XLP-256XA11G
{5,5} **	{0,3} **	310	240	-	32	990	1190	1390	1995	-	210-980	-	540	-	150	595	XLP-506P802 *
4,7	0,6	310	240	-	32	990	1190	1390	1995	-	210-980	-	540	-	150	600	XLP-506XA12G *
10,0	2,0	310	240	-	32	990	1190	1390	1995	-	210-980	-	540	-	150	660	XLP-506ZES *
10,0	2,0	310	240	-	32	990	1190	1390	1995	-	210-980	-	540	-	150	700	XLP-5013ZES *
3,2	0,4	420	330	-	40	990	1240	1430	1995	-	210-970	-	540	-	150	900	XLP-756XA12G *
10,0	2,1	400	340	560	40	990	1240	1400	1879	1885	239	425	540	1290	150	970	VLP-1006ZES
10,0	2,1	400	340	560	40	990	1240	1400	1879	2050	239	425	540	1290	150	993	VLP-10013ZES
6,6	1,6	553	233	560	76	1220	1620	1740	2285	2370	377	425	453	1415	254	1992	VLP-20013ZES

\*\* {...} = advance speed in mm per handpump stroke.

▼ Shown: BPR-5075



## Expert Designed Versatility

- Quality welded frame for maximum strength and long life
- Frame rolls easily on 4 steel roller bearings
- Exclusive 'Hydra-Lift' bolster for effortless adjustment of the vertical daylight
- Standard roller head design allows lateral movement and locking of the cylinder up to 300 mm left or right of centre
- All models in the quick selection chart have been matched to an electric pump, double-acting cylinder, hose and gauge, offering the complete package
- Roll-Frame design features a stationary bed with the ability to support heavy loads
- Hydraulic clamp cylinder locks roll-frame into position.



### Cylinder adjustment

Cylinder adjustment allows horizontal side to side cylinder positioning.



### Hydra-Lift

Allows easy, effortless daylight adjustment. Standard on all Roll-Frame presses.

Page: 146



### Optional V-Blocks

These V-Blocks are designed for easy fixturing of round stock and other non-uniform materials. Featuring precise fit into the press bolster.

Page: 146

### ▼ SELECTION CHART

Press Capacity ton (kN)	Vertical Daylight A (mm)		Maximum Bed Width E (mm)	Electric Pump		Press Model Number	Double-Acting Cylinder			Speed (mm/sec)	
	min.	max.		Model Number	Page		Stroke (mm)	Model Number	Page	Rapid Advance	Pressing
50 (498)	152	942	730	ZE5420SW-S	98	BPR-5075	334	RR-5013	36	4,1	3,9
100 (933)	159	1048	889	ZE3420SW	98	BPR-10075	333	RR-10013	36	7,7	0,7
200 (1995)	279	1295	1219	ZE4420SW	98	BPR-20075	330	RR-20013	36	5,2	0,5



# Roll-Frame Presses



▲ For offshore application high capacity spring loaded cylinders need to be assembled and tested. A special 100 ton roll frame press, with long stroke cylinder has been constructed. All movements are operated and monitored through a PLC controlled pendant.



### IMPORTANT!

The frameworks of the presses are exclusively designed for pressing operations, not for pulling. For pulling applications please contact Enerpac.

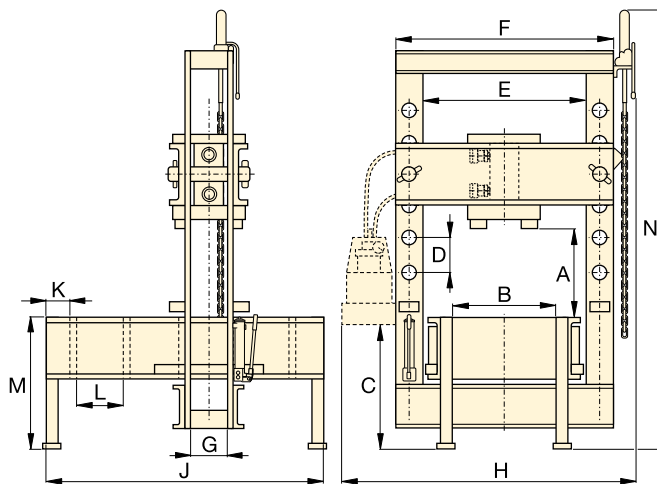

## BPR Series



Capacity:

**50 - 200 ton**

Maximum Daylight x Width:

**1295 x 1222 mm**

Maximum Operating Pressure:

**700 bar**



### Gauges

All press models include a gauge and gauge adaptor, matching the press capacity:

Press Capacity	Gauge Model Number	Adaptor Model Number
ton		
50	<b>GF-50B</b>	<b>GA-2</b>
100	<b>GF-871B</b>	<b>GA-3</b>
200	<b>GF-200B</b>	<b>GA-3</b>

For more information on gauges, please refer to the System Components section.

Page: 128



### Spring Centred Valves

Manual valves on electric and air pumps of Enerpac presses are Spring Centred Valves. The handle will automatically move into the neutral valve position when released.

Page: 117

Roll-Frame Press Dimensions (mm)													Press Model Number	
A (min.-max.)	B	C	D	E	F	G	H	J	K	L	M	N		(kg)
152 - 942	526	971	264	730	933	127	1420	1626	203	270	762	2870	917	<b>BPR-5075</b>
159 - 1048	673	965	222	889	1143	146	1605	1676	203	270	813	3021	1767	<b>BPR-10075</b>
279 - 1295	984	933	254	1219	1626	232	2150	2197	203	381	915	3200	4186	<b>BPR-20075</b>

▼ Shown from left to right: A-220, A-330 and A-310



## The Standard Workshop Tools

### C-Clamp Press

- 5, 10 and 20 ton capacity
- Operational in all positions.

### Arbor Press

- 10 and 30 ton capacity
- Foot mounting holes for horizontal or vertical positioning
- Machined working surfaces for easier fixturing
- Slotted back to simplify loading and unloading of longer parts.

▼ A-310 Arbor Press



#### Push Pin A-183

For applications requiring precision pressing, such as shaft removal and insertion. This attachment fits 10 ton cylinders and requires the use of a threaded adaptor saddle (A-13).

Page: 66



#### Smooth Saddle A-185

For pressing applications of delicate parts, such as aluminium castings, this saddle decreases surface marks during the pressing application. Requires 10 ton cylinder and threaded adaptor saddle (A-13).

Page: 167



#### 10 ton Bench Presses

For 10 ton VLP-Series Bench Presses selection see:

Page: 140

### ▼ SELECTION CHART

Press Type	Press Capacity ton (kN)	Maximum Vertical Daylight (mm)	Maximum Bed Width (mm)	Press Model Number	Cylinder Model Number *	Page:
C-Clamp	5 (45)	165	51	A-205	5 ton RC-cylinder *	6
	10 (101)	228	57	A-210	10 ton RC-cylinder *	6
	20 (178)	305	70	A-220	25 ton RC-cylinder **	6
Arbor	10 (101)	227	135	A-310	10 ton RC-cylinder *	6
	30 (295)	260	178	A-330	RC-308 *	6

\* Recommended cylinder must be ordered separately.

\*\* Must be limited to 20 ton.

# C-Clamp and Arbor Presses



▲ RC-308 cylinder mounted in A-330 Arbor Press powered by a PATG-Turbo Air pump for controlled pressing of bearings for sprockets of weaving machines. The V-152 Pressure Relief Valve controls the pressing force.

## A Series



Capacity:

**5 - 30 ton**

Maximum Daylight x Width:

**305 x 178 mm**

Maximum Operating Pressure:

**700 bar**



### IMPORTANT!

For high-cycle production applications, the C-Clamp and Arbor presses should be limited to 50% of their capacity.



### Hydraulic Cylinders

Cylinders for C-Clamps and Arbor Presses must be ordered separately.

Page: **6**



### Hydraulic Pumps

Pumps for C-Clamps and Arbor Presses must be ordered separately.

Page: **71**

Top View Working Surface

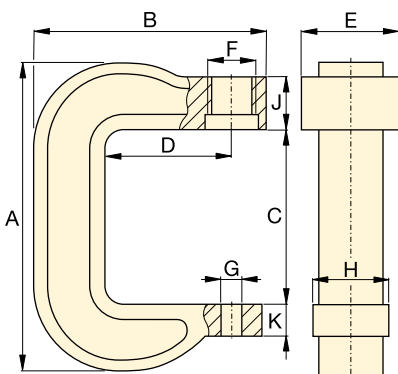
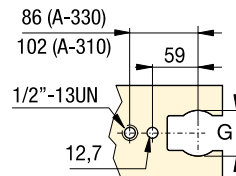

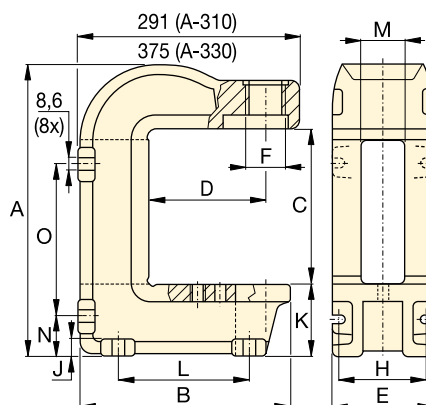

A-205, A-210, A-220

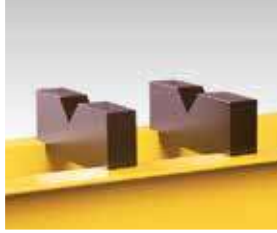

A-310, A-330

Press Dimensions (mm)																Press Model Number
A	B	C	D	E	F	G	H	J	K	L	M	N	O	(kg)		
291	203	165	95	73	1½" -16 UNS	26	51	66	25	-	-	-	-	7	A-205	
406	283	228	152	83	2¼" -14 UNS	26	76	64	41	-	-	-	-	17	A-210	
540	346	305	152	121	3⅝" -12 UNS	26	95	70	44	-	-	-	-	38	A-220	
414	281	230	152	135	2¼" -14 UNS	63	122	19	97	175	65	54	219	27	A-310	
557	353	260	152	178	3⅝" -12 UNS	63	140	25	165	203	67	98	276	86	A-330	

Description	Press Capacity and Press Series	Model Number		Features
<b>V-Blocks</b>	10 ton Bench VLP-Presses 25 ton Workshop XLP-Presses 50 ton Workshop XLP-Presses 75 ton XLP- and 100 ton VLP-Presses 200 ton Workshop VLP-Press 200 ton BPR-Roll-Frame Press	<b>VB-10</b> <b>VB-25</b> <b>VB-501</b> <b>VB-101</b> <b>A-200</b> <b>A-200R</b>		<ul style="list-style-type: none"> <li>Facilitate positioning of pipes and bars</li> <li>All V-Block model numbers include 2 V-blocks.</li> </ul>
<b>Hydra-Lift</b>	50 ton BPR-Roll-Frame Press 100 ton BPR-Roll-Frame Press 200 ton BPR-Roll-Frame Press	<b>IPLR-100</b> <b>IPLR-100</b> <b>IPLR-200</b>		<ul style="list-style-type: none"> <li>Allows easy, effortless daylight adjustments</li> <li>Includes accessory chain.</li> </ul>
<b>Hydrajust Bed Positioning</b>	100 ton Workshop VLP-Presses 200 ton Workshop VLP-Press  IMPORTANT! The "Hydrajust" bed positioning is not designed to withstand full cylinder capacity, only to be used for bed adjustment.	<b>VHJ-100</b> <b>BSS-5380</b>		<ul style="list-style-type: none"> <li>Allowing effortless daylight adjustment by moving the lower bed up and down</li> <li>Can be used with presses equipped with double-acting cylinder.</li> </ul>

## ▼ PRESS APPLICATION IDEAS



### ◀ 600 Ton High-Accuracy Collar Press

For production of accelerator coils, sheet metal needs to be formed into a specific shape and size. The end product of this forming is a cylindrical collar, which has a very solid structure, specific shape, and a tight tolerance for circularity and concentricity.

The Enerpac team was consulted to accomplish this task using proven high-pressure technology. The 600-ton press consisted of two separate hydraulic systems. The first system featured eight 25-ton cylinders, to position the sheets, while the second system featured eight 75-ton cylinders, to press the sheets into the correct shape. The results were a hydraulic press system that increased productivity and lowered operating costs.

### Fully Automated PLC-Controlled 1800 Ton High-Accuracy Press ▶

The pressing and heating cycle, during the production of magnetic acceleration coils, required high force and high-accuracy to ensure absolute quality.

Enerpac was consulted to assist in the design of a high accuracy production press. Control of the press force is monitored along with the temperature of the coils during forming by a PLC Control System.





# Tension Meter and Load Cells

▼ Shown: LH-102 and TM-5 (in middle)



## TM LH Series



Capacity:

**900 - 90.000 kg**

Accuracy, % of full scale:

**± 2%**



TM and LH models are 100% tested to verify accuracy within a ± 2% range.

If your application requires a calibrated tool, it must be submitted for certification testing. Certification is NOT available from Enerpac.

### Tension Meter TM-5

- Accuracy ± 2% of full scale
- Zinc and bronze plated to resist corrosion
- Dual-range readout in kilograms and pounds
- Maximum indicating pointer reading for pre-selected forces or to maintain force readings
- Cushioned metal case provides safe storage and transport.

### Load Cells LH-Series

- Accuracy ± 2% of full scale
- Swivel loading pad reduces eccentric loading for improved accuracy
- Maximum indicating pointer reading pre-selected forces or to maintain maximum force readings
- Dual-range readout in kilograms and pounds.

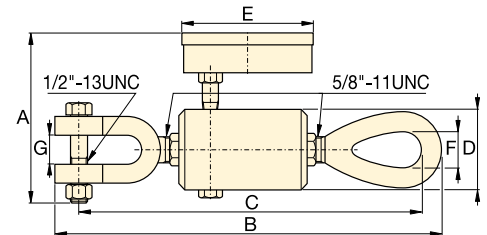

TM-5

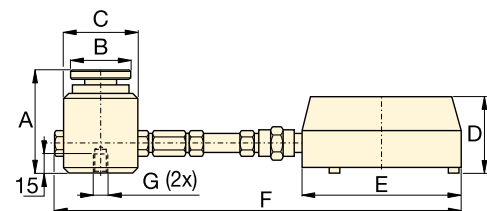

LH-Series

### ▼ SELECTION CHART

Type	Gauge Capacity		Model Number	Minimum Reading		Gauge Scale Increments		Dimensions (mm)						
	(kg)	(lbs)		(kg)	(lbs)	(kg)	(lbs)	A	B	C	D	E	F	G*
Direct Mounted	4.500	10.000	<b>TM-5</b>	500	1.000	100	100	120	247	236	50	93	22	19
Direct Mounted Load Cell	900	2.000	<b>LH-10</b>	100	200	20	20	77	44	57	60	101	215	¼" - 20, 44,5 BC
	4.500	10.000	<b>LH-50</b>	500	1.000	100	100	77	44	57	60	101	215	¼" - 20, 44,5 BC
Remote Mounted with 0,6 m Hose	900	2.000	<b>LH-102</b>	100	200	20	20	77	44	57	60	147	846	¼" - 20, 44,5 BC
	4.500	10.000	<b>LH-502</b>	500	1.000	100	100	77	44	57	60	147	846	¼" - 20, 44,5 BC
	9.000	20.000	<b>LH-1002</b>	1.000	2.000	200	200	77	44	57	60	147	846	¼" - 20, 44,5 BC
Remote Mounted with 1,8 m Hose	21.000	50.000	<b>LH-2506</b>	3.000	5.000	500	500	101	69	85	60	147	2094	¾" - 24, 63 BC
	45.000	100.000	<b>LH-5006</b>	5.000	5.000	1.000	1.000	132	101	127	60	147	2135	¾" - 24, 89 BC
	90.000	200.000	<b>LH-10006</b>	10.000	10.000	1.000	2.500	158	127	158	60	147	2166	¾" - 24, 102 BC

\* BC = Bolt Circle

Enerpac offers a complete line of pullers with the widest range of sizes, capacities and styles. Whether your application requires mechanical, hydraulic or the patented Posi Lock® system, Enerpac can satisfy your requirements.

Made of high strength steel alloys, you can depend on Enerpac pullers to provide years of trouble-free operation, even in the harshest environments.



### Hydraulic Pullers

These hydraulic pullers eliminate time-consuming and unsafe hammering, heating or prying. Damage to parts is minimized through the use of controlled hydraulic power.



### Posi Lock® Pullers

The puller that meets the safety challenge. A control cage holds the pulling jaws securely in working position. This patented feature reduces the possibility of the puller jaws slipping off the work surface, thereby increasing productivity and tool life and

reducing dangerous situations for the user. The Posi Lock® feature is available in a mechanical or hydraulic version.



### WARNING

Do not exceed 50% of the rated puller capacity when using two jaw configurations, a double crosshead (2 grip arms) or when using puller legs in combination with bearing puller attachments.



### CAUTION!

Not all puller components and configurations are rated at the set capacity. Please contact Enerpac for details.



### IMPORTANT!

Always wear Safety Goggles and Gloves while using pullers.

# Puller Section Overview

When selecting a puller it is important to consider 3 basic specifications:

### 1. The Capacity:

is the amount of force the puller is capable of producing.

Typically, the capacity required for a job can be determined by using the shaft diameter of the part being pulled.

For manual pullers, the center bolt diameter of the puller should be at least half the diameter of the shaft being pulled from.

For hydraulic pullers, the capacity in tons should be 0,28 to 0,4 times the shaft diameter in mm. Use the following chart:











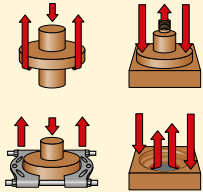

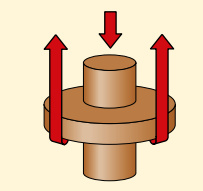

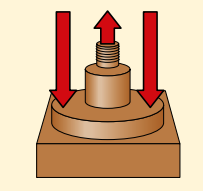

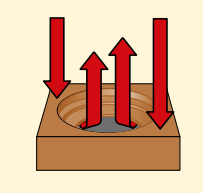
Shaft Diameter	Puller Capacity
0 - 25 mm	13 ton
25 - 50 mm	22 ton
50 - 89 mm	33 ton
89 - 140 mm	45 ton

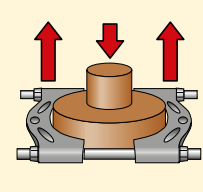
### 2. The Reach:

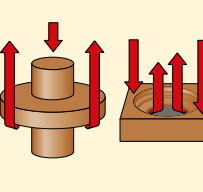
is the distance between the bottom of the base and the jaw flats. The puller's reach must equal or exceed the same distance of the part being pulled.

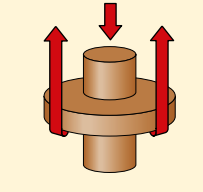
### 3. The Spread:

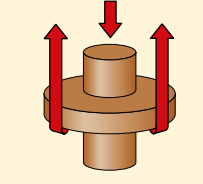
is the distance between the jaws. The puller's spread needs to be greater than the width of the part being pulled.

Puller Function	Capacity ton	Puller Type	Series	Page
	13-45	<b>Master Puller Sets</b> Max. Reach: 252 - 700 mm Max. Spread: 247 - 1100 mm	<b>BHP</b>	 <b>150</b> ▶
	13-45	<b>Grip Puller Sets</b> Max. Reach: 252 - 700 mm Max. Spread: 249 - 1100 mm	<b>BHP</b>	 <b>151</b> ▶
	6-22	<b>Cross Bearing Puller Sets</b> Max. Reach: 357 - 864 mm Max. Spread: 260 - 580 mm	<b>BHP</b>	 <b>152</b> ▶
	6-22	<b>Bearing Cup Pullers</b> Max. Reach: 115 - 150 mm Max. Spread: 145 - 240 mm	<b>BHP</b>	 <b>153</b> ▶
	6-22	<b>Bearing Separators</b> Max. Width: 110 - 260 mm Max. Spread: 110 - 250 mm	<b>BHP</b>	 <b>153</b> ▶
	2-40	<b>Posi Lock® Mechanical Pullers</b> Max. Reach: 101 - 355 mm Max. Spread: 12 - 635 mm	<b>EP</b> <b>EPP</b> <b>EPX</b> <b>EPPMI</b>	 <b>154</b> ▶
	10-50	<b>Posi Lock® Hydraulic Pullers</b> Max. Reach: 203 - 355 mm Max. Spread: 304 - 635 mm	<b>EPH</b> <b>EPHR</b> <b>EPHS</b>	 <b>158</b> ▶
	100	<b>Posi Lock® Hydraulic Pullers</b> Max. Reach: 1219 mm Max. Spread: 190 - 1778 mm	<b>EPH</b>	 <b>161</b> ▶

▼ Shown: Master Puller Set BHP-3751G



## Multi Purpose Puller Set



**WARNING**

Do not exceed 50% of the rated puller capacity when using two jaw configurations, a double crosshead (2 grip arms) or when using puller legs in combination with bearing puller attachments.

- Supplied with a full hydraulic set including pump, hose, cylinder, gauge, gauge adaptor and wooden case
- High quality, forged steel components provide superior reliability and service
- Sets include speed crank and adjusting screw for fast contact to work before hydraulics are applied
- All Master Puller Sets include a Grip Puller, a Cross Bearing Puller, a Bearing Cup Puller and a Bearing Separator, which can be ordered separately, see items nr. 10, 20, 30 and 40.

▼ Maintenance engineers throughout the industry greatly appreciate the Enerpac Master Puller sets

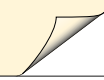

▼ SELECTION CHART

Master Puller Set Capacity *		13 ton	22 ton	33 ton	45 ton **	Page:
Model Number ▶		BHP-1752 <sup>1)</sup>	BHP-2751G	BHP-3751G	BHP-5751G	
Included Hydraulics	Set Weight ▶	37 kg	90 kg	172 kg	298 kg	
• Hand Pump		P-142	P-392	P-392	P-80	
• Cylinder		RWH-121	RCH-202	RCH-302	RCH-603	<b>30</b> ▶
• Saddle		–	HP-2015	HP-3015	HP-5016	<b>31</b> ▶
• Hose		HB-7206QB	HC-7206	HC-7206	HC-7206	<b>122</b> ▶
• Gauge		GF-120B	GF-813B	GF-813B	GF-813B	<b>128</b> ▶
• Gauge Adaptor		GA-4	GA-3	GA-3	GA-3	<b>135</b> ▶
<b>Included Pullers</b>						
<b>10</b> Grip Puller		BHP-1762	BHP-252	BHP-352	BHP-552	<b>151</b> ▶
<b>20</b> Cross Bearing Puller		BHP-1772	BHP-262	BHP-362	BHP-562	<b>152</b> ▶
<b>30</b> Bearing Cup Puller		BHP-180	BHP-280	BHP-380	BHP-580	<b>153</b> ▶
<b>40</b> Bearing Separator		BHP-181	BHP-282	BHP-382	BHP-582	<b>153</b> ▶
• Case		CM-6	CW-350	CW-350	CW-750	

\* See warning on this page.

\*\* Puller capacity at 540 bar; maximum cylinder capacity at 700 bar is 60 ton.

<sup>1)</sup> Includes Adaptor FZ-1630.



▼ Shown: Grip Puller Set BHP-351G



- Precise hydraulic control allows fast, efficient and safe pulling
- High quality, forged steel components provide superior reliability and service
- Available with and without full hydraulic set.

## BHP Series



Capacity:

**13, 22, 33 and 45 ton**

Reach:

**252 - 700 mm**

Spread:

**249 - 1100 mm**

Maximum Operating Pressure:

**700 bar**

### Ordering Example

#### Model Number BHP-251G:

includes Grip Puller BHP-252 and a full hydraulic set. (Hand pump, cylinder, saddle, hose, gauge and gauge adaptor).

#### Model Number BHP-252:

includes Grip Puller mechanical parts only, for use with your existing hydraulics.

### ▼ SELECTION CHART

Grip Puller Set Capacity **		13 ton	22 ton	33 ton	45 ton ***	
Model Number ►		<b>BHP-152 <sup>1)</sup></b>	<b>BHP-251G</b>	<b>BHP-351G</b>	<b>BHP-551G</b>	
Included Hydraulics						
Set Weight ►		22 kg	56 kg	91 kg	160 kg	
• Hand Pump		P-142	P-392	P-392	P-80	
• Cylinder		RWH-121	RCH-202	RCH-302	RCH-603	
• Saddle		–	HP-2015	HP-3015	HP-5016	
• Hose		HB-7206QB	HC-7206	HC-7206	HC-7206	
• Gauge		GF-120B	GF-813B	GF-813B	GF-813B	
• Gauge Adaptor		GA-4	GA-3	GA-3	GA-3	
<b>10</b>	<b>Grip Puller</b>	Model Number ►	<b>BHP-1762 *</b>	<b>BHP-252 *</b>	<b>BHP-352 *</b>	<b>BHP-552 *</b>
Maximum Spread (mm)						
2-jaw		249	400	593	899	
3-jaw		249	499	800	1100	
Maximum Reach (mm)						
2-jaw		252	300	387	700	
3-jaw		252	300	387	700	
Jaw (mm)						
Thickness		15	20	24	30	
Width		23	27	38	39	
Adjusting Screw (mm)						
Thread		¾" - 16 UNF	1" - 8 UNC	1¼" - 7 UNC	1½" - 5.5 UNS	
Length		400	670	790	975	
• Case		CW-166	CW-166	CW-350	CW-750	

<sup>1)</sup> Includes Adaptor FZ-1630.

\* Grip Puller order number without hydraulics.

\*\* See warning on page 150.

\*\*\* Puller capacity at 540 bar; maximum cylinder capacity at 700 bar is 60 ton.

# BHP-Series, Cross Bearing Puller Sets

▼ Shown: Cross Bearing Puller Set BHP-361G



- Precise hydraulic control allows fast, efficient and safe pulling
- High quality, forged steel components provide superior reliability and service.

## BHP Series



Capacity:

**6, 11, 16 and 22 ton**

Reach:

**357 - 864 mm**

Spread:

**260 - 580 mm**

Maximum Operating Pressure:

**350 bar**



The cross bearing puller without hydraulics, bearing cup puller and a bearing separator can be ordered separately, see items nr. 10, 20, 30 and 40.

### ▼ SELECTION CHART

Cross Bearing Puller Set Capacity		6 ton	11 ton	16 ton	22 ton
	Model Number ▶	<b>BHP-162</b> <sup>1)</sup>	<b>BHP-261G</b>	<b>BHP-361G</b>	<b>BHP-561G</b>
<b>Included Hydraulics</b>	Set Weight ▶	26 kg	62 kg	121 kg	185 kg
• Hand Pump		P-142	P-392	P-392	P-80
• Cylinder		RWH-121	RCH-202	RCH-302	RCH-603
• Saddle		–	HP-2015	HP-3015	HP-5016
• Hose		HB-7206QB	HC-7206	HC-7206	HC-7206
• Gauge		GF-120B	GF-813B	GF-813B	GF-813B
• Gauge Adaptor		GA-4	GA-3	GA-3	GA-3
<b>20 Cross Bearing Puller</b> <sup>2)</sup>	Model Number ▶	<b>BHP-1772</b>	<b>BHP-262</b>	<b>BHP-362</b>	<b>BHP-562</b>
Spread (mm)	Maximum	260	345	440	580
	Minimum	115	140	180	220
Reach (mm)	Maximum	357	570	710	864
Adjusting Screw (mm)	Diameter	3/4" - 16 UNF	1" - 8 UNC	1 1/4" - 7 UNC	1 5/8" - 5.5 UNS
	Length	400	675	795	975
Leg (mm)	Length	105	239	203	609
	Length	357	419	457	863
	Length	–	571	711	–
	Length	–	114	–	–
Upper Leg Ends (mm)	Thread	3/4" - 16 UNF	3/4" - 16 UNF	1-14 UNS	1 1/4" - 12 UNF
Lower Leg Ends (mm)	Thread	5/8" - 18 UNF	5/8" - 18 UNF	1-14 UNS	1 1/4" - 12 UNF
<b>30 Bearing Cup Puller</b> <sup>2)</sup>	Model Number ▶	<b>BHP-180</b>	<b>BHP-280</b>	<b>BHP-380</b>	<b>BHP-580</b>
<b>40 Bearing Separator</b> <sup>2)</sup>	Model Number ▶	<b>BHP-181</b>	<b>BHP-282</b>	<b>BHP-382</b>	<b>BHP-582</b>
• Wooden Case		CM-6	CW-187	CW-350	CW-750

<sup>1)</sup> Includes Adaptor FZ-1630.

<sup>2)</sup> Can be ordered separately without hydraulic components, see next page.

# Bearing Cup Pullers and Bearing Separators

▼ Shown: BHP-380



## Bearing Cup Puller

- Made of high strength steel alloy
- Easily adapted to Cross Bearing Pullers for fast and efficient removal of the most difficult parts
- Adjustable to fit a variety of bearings and seals.

## BHP Series



Capacity:

**6, 11, 16 and 22 ton**

Maximum Reach:

**115 - 150 mm**

Spread Range:

**145 - 240 mm**

Maximum Operating Pressure:

**350 bar**

### ▼ SELECTION CHART

Capacity *		6 ton	11 ton	16 ton	22 ton
<b>30 Bearing Cup Puller</b>					
Model Number ▶		BHP-180	BHP-280	BHP-380	BHP-580
Spread (mm)	Max.	145	160	240	240
	Min.	40	32	60	60
Reach (mm)	Max.	115	140	150	150
Center Screw	Thread	3/4" - 16 UNF	1" - 8 UNC	1 1/4" - 7 UNC	1 5/8" - 5.5 UNS

\* Puller capacity, not attachment capacity. See warning on this page.



### WARNING

Do not exceed 50% of the rated puller capacity when using a double crosshead (2 grip arms) or when using puller legs in combination with bearing puller attachments.

▼ Shown: BHP-382



## Bearing Separator

- Made of high strength steel alloy
- Wedge-shaped edges allow removal of the most hard-to-grip components
- Easily adapted to Cross Bearing Pullers for fast and efficient removal of the most difficult parts.

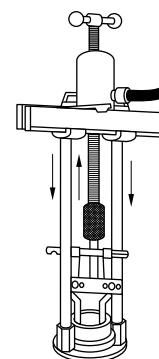

◀ Bearing Cup Puller shown with Crosshead Puller Attachment.

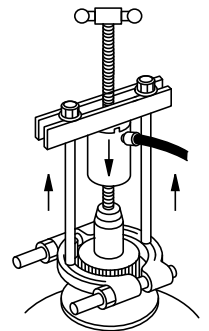

Bearing Separator shown with Crosshead Puller Attachment. ▶

### ▼ SELECTION CHART

Capacity *		6 ton	11 ton	16 ton	22 ton
<b>40 Bearing Puller</b>					
Model Number ▶		BHP-181	BHP-282	BHP-382	BHP-582
Spread (mm)	Max.	110	134	250	250
	Min.	10	12	17	17
Width (mm)		110	155	260	260
Thread		5/8" - 18 UNF	3/4" - 18 UNF	1" - 14 UNS	1 1/4" - 12 UNF

\* Bearing Separator rated at 50% of puller capacity. See warning on this page.



### Bearing Separator

Bearing Separator has wedge shaped edges for placing puller behind hard to reach bearings, gears, etc., where clearance prevents direct application of grip puller arms.

The Bearing Separator can be used with the Cross Bearing Puller or the Grip Puller.

▼ Shown from left to right: EP-206, EP-108



- Patented 'Safety Cage' jaw retention system
- Roll threaded shafts for less effort when applying high torque
- Slim tapered jaws for improved gripping in tight spots
- Available in 2 and 3 jaw design and inside and outside pulling configuration
- More efficient pulling, as one man can do the job where manual pullers often require two operators.



## For Safer and Faster Pulling



### Long Jaws

Long Jaws are used to increase the reach and spread of manual pullers. They maintain the same pulling capacity as the standard jaws, but reduce clamping force by 25%.

Page: 157



### Shaft Attachments

Shaft protectors and extenders are live centers that fit over the standard puller shaft for tip protection and additional reach.

Page: 157



### Application Tip

Because of the unique safety cage design, Posi Lock® pullers will grip on surfaces where normal pullers would slip off; e.g. tapered bearings.

◀ Positioning an EP-104, 3-jaw puller on the drive pulley of an electric motor.



# Posi Lock® Mechanical Grip Pullers

## External Posi Lock® Pullers

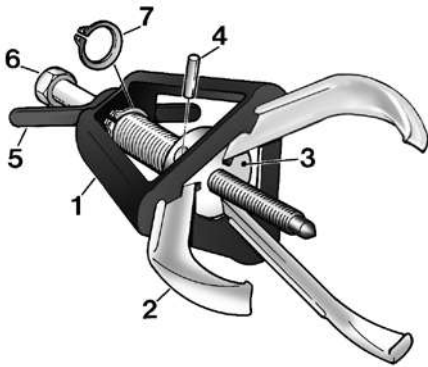

- 1 Patented 'Safety Cage' guides jaws, holding them securely onto the part.
- 2 Durable forged jaws provide positive grip.
- 3 Jaw head provides pivot and reaction point for jaws.
- 4 Pin, for easy jaw removal and replacement.
- 5 T-handle provides control of the puller jaws.
- 6 Drive bolt with rolled threads for increased force with reduced input torque.
- 7 Snap-ring retains cage to drive bolt and provides quick removal for easy service.

## EP EPP Series



Capacity:

**2 - 40 ton**

Maximum Reach:

**101 - 355 mm**

Spread Range:

**12 - 635 mm**

### ▼ QUICK SELECTION CHART EXTERNAL PULLERS

For quick technical information see next page.

Number of Jaws	Maximum Reach	Spread (min. - max.)	Capacity	Model Number	Center Bolt Diameter	
	(mm)					
2	101	12 - 127	<b>2</b> (17)	<b>EP-204</b>	14	1,4
3	101	12 - 127	<b>5</b> (45)	<b>EP-104</b>	14	1,8
2	152	12 - 178	<b>6</b> (53)	<b>EP-206</b>	16	3,2
3	152	12 - 178	<b>10</b> (89)	<b>EP-106</b>	16	3,6
2	203	19 - 304	<b>12</b> (106)	<b>EP-208</b>	20	5,4
3	203	19 - 304	<b>17</b> (151)	<b>EP-108</b>	20	6,4
2	245	25 - 381	<b>14</b> (124)	<b>EP-210</b>	20	5,9
3	245	25 - 381	<b>20</b> (178)	<b>EP-110</b>	20	7,3
2	304	63 - 457	<b>25</b> (222)	<b>EP-213</b>	29	17,2
3	304	63 - 457	<b>30</b> (267)	<b>EP-113</b>	29	20,0
2	355	76 - 635	<b>35</b> (311)	<b>EP-216</b>	31	25,8
3	355	76 - 635	<b>40</b> (356)	<b>EP-116</b>	31	30,8



### IMPORTANT!

Always wear Safety Goggles and Gloves while using pullers.

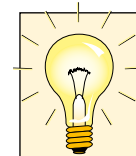

### Application Tip

In determining the correct manual puller capacity for your application, use the following rule:

The center bolt diameter of the puller should be at least ½ the diameter of the shaft being pulled on.

### Example:

A part being pulled from a shaft with a diameter of 38 mm would require a puller with a center bolt diameter of at least 19 mm.

## Internal Posi Lock® Puller

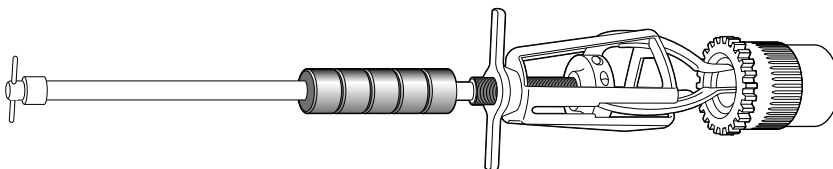

### ▼ QUICK SELECTION CHART INTERNAL PULLERS

Number of Jaws	Maximum Reach	Spread (min. - max.)	Jaw Style	Model Number	Jaw Length	
	(mm)					
3	168	14 - 101	Standard *	<b>EPPMI-6</b>	168	3,9
	218	25 - 133	Long *		218	3,9

\* Both Standard and Long Jaws are included with EPPMI-6.

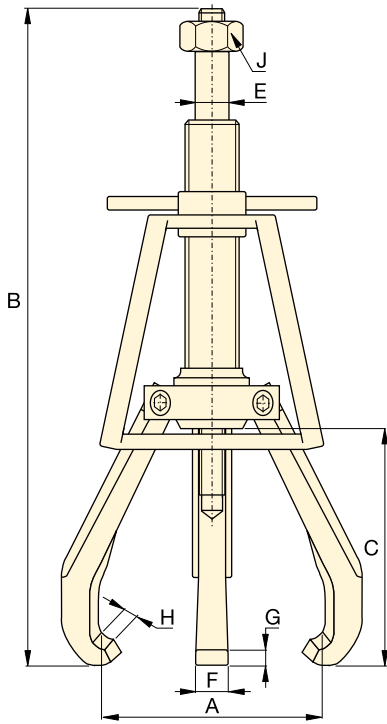

**2 and 3 Jaw External Puller  
EP-Series**

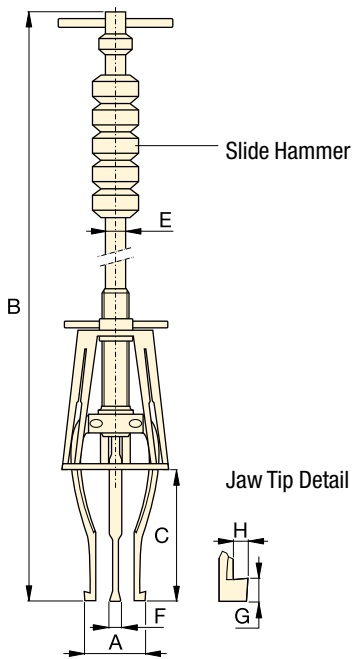

**Internal Puller  
EPPMI-6**



▲ EP-204 2 jaw puller positioned to pull a water pump drive pulley.

### ▼ QUICK SELECTION CHART EXTERNAL PULLERS

Number of Jaws	Maximum Reach (mm)	Spread min. - max. (mm)	Capacity ton (kN)	Model Number	Center Bolt Diameter (mm)	Maximum Torque (Nm)
2	101	12 - 127	2 (17)	EP-204	14	27
3	101	12 - 127	5 (45)	EP-104	14	54
2	152	12 - 178	6 (53)	EP-206	16	102
3	152	12 - 178	10 (89)	EP-106	16	176
2	203	19 - 304	12 (106)	EP-208	20	203
3	203	19 - 304	17 (151)	EP-108	20	298
2	245	25 - 381	14 (124)	EP-210	20	237
3	245	25 - 381	20 (178)	EP-110	20	373
2	304	63 - 457	25 (222)	EP-213	29	644
3	304	63 - 457	30 (267)	EP-113	29	814
2	355	76 - 635	35 (311)	EP-216	31	1085
3	355	76 - 635	40 (356)	EP-116	31	1153

### ▼ QUICK SELECTION CHART INTERNAL PULLERS

Number of Jaws	Maximum Reach (mm)	Spread min. - max. (mm)	Jaw Style	Model Number	Jaw Length (mm)	Slide-hammer weight (kg)
3	168	14 - 101	Standard *	EPPMI-6	168	1,1
	218	25 - 133	Long *		218	1,1

\* Both Standard and Long Jaws are included with EPPMI-6.

# Posi Lock® Mechanical Pullers



## Shaft Attachments

Shaft protectors and extenders are live centers that fit over the standard puller shaft for tip protection and additional reach.



## Long Jaws

Long Jaws are used to increase the reach and spread of pullers. They maintain the same pulling capacity as the standard jaws, but reduce clamping force by 25%.

## EP EPP Series



Capacity:

**2 - 40 ton**

Maximum Reach:

**101 - 355 mm**

Spread Range:

**12 - 635 mm**



### ▼ SHAFT ATTACHMENTS

Length (mm)	Dia- meter (mm)	Increases Center Bolt Length (mm)	Model Number
25	19	9	<b>EPP-4</b>
50	19	38	<b>EPX-4</b>
31	22	12	<b>EPP-6</b>
50	22	38	<b>EPX-6</b>
31	25	12	<b>EPP-10</b>
50	25	38	<b>EPX-10</b>
50	35	21	<b>EPP-1316</b>

### ▼ LONG JAWS

Spread min. - max. (mm)	Max. Reach (mm)	Model Number
57 - 381	245	<b>EP-11054</b>
38 - 558	400	<b>EP-11054L</b>
38 - 762	508	<b>EP-11354L</b>
25 - 133	218	<b>EP-10554L*</b>

\* for EPPMI-6 only

Dimensions (mm)									Model Number	Optional Accessories		
Spread min. - max.  A	Overall Length  B	Max. Reach  C	Center Bolt Diam.  E	Jaw Width  F	Tip Clearance  G	Tip Depth  H	Hex Socket Size (inch) J					
12 - 127	245 - 323	101	14	15	4,1	4,6	7/8	<b>EP-204</b>	<b>EPP-4</b>	<b>EPX-4</b>	-	
12 - 127	245 - 323	101	14	15	4,1	4,6	7/8	<b>EP-104</b>	<b>EPP-4</b>	<b>EPX-4</b>	-	
12 - 178	323 - 476	152	16	19	8,1	6,1	1 1/16	<b>EP-206</b>	<b>EPP-6</b>	<b>EPX-6</b>	-	
12 - 178	323 - 476	152	16	19	8,1	6,1	1 1/16	<b>EP-106</b>	<b>EPP-6</b>	<b>EPX-6</b>	-	
19 - 304	412 - 615	203	20	22	6,4	9,1	1 1/4	<b>EP-208</b>	<b>EPP-10</b>	<b>EPX-10</b>	<b>EP-11054</b>	
19 - 304	412 - 615	203	20	22	6,4	9,1	1 1/4	<b>EP-108</b>	<b>EPP-10</b>	<b>EPX-10</b>	<b>EP-11054</b>	
25 - 381	489 - 736	245	20	25	6,4	9,1	1 1/4	<b>EP-210</b>	<b>EPP-10</b>	<b>EPX-10</b>	<b>EP-11054L</b>	
25 - 381	489 - 736	245	20	25	6,4	9,1	1 1/4	<b>EP-110</b>	<b>EPP-10</b>	<b>EPX-10</b>	<b>EP-11054L</b>	
63 - 457	660 - 965	304	29	31	12,7	9,7	1 11/16	<b>EP-213</b>	<b>EPP-1316</b>	-	<b>EP-11354L</b>	
63 - 457	660 - 965	304	29	31	12,7	9,7	1 11/16	<b>EP-113</b>	<b>EPP-1316</b>	-	<b>EP-11354L</b>	
76 - 635	800 - 1155	355	31	36	13,5	11,7	1 13/16	<b>EP-216</b>	<b>EPP-1316</b>	-	-	
76 - 635	800 - 1155	355	31	36	13,5	11,7	1 13/16	<b>EP-116</b>	<b>EPP-1316</b>	-	-	

Note: Overall length (B) is dependent on position of center bolt.

Dimensions (mm)							Model Number
Spread min. - max. A	Overall Length B	Max. Reach C	Slide Rod Dia. E	Jaw Width F	Tip Clearance G	Tip Depth H	
14 - 101	736	168	14,2	8	3,0	1,5	<b>EPPMI-6</b>
25 - 133	787	218	14,2	8	7,6	4,6	



Always wear Safety Goggles and Gloves while using pullers.

▼ Shown: EPHR-110



- Patented 'Safety Cage' jaw retention system
- High force hydraulic system for effortless pulling of large components
- Slim tapered jaws for better gripping in tight spots
- Available in 2 and 3 jaw design
- More efficient pulling, as one man can do the job where manual pullers often require two operators.

## High-Tech Pulling



### Transport and Store

Conveniently stores and transports hydraulic pullers and accessories. Order the **EPT-2550** Storage Cart and make your job easier to do!



### Long Jaws

Used to increase the reach and spread of pullers. They maintain the same pulling capacity as the standard jaws, but reduce clamping force by 25%.

Page: **160**



### Application Tip

Because of the unique safety cage design, Posi Lock® pullers will grip on surfaces where normal pullers would slip off; e.g. tapered bearings.

▼ An EPH-113 hydraulic Posi Lock® puller easily removes machined parts from a heavy-production press.



### ▼ SELECTION CHART

Number of Jaws	Maximum Spread (mm)	Capacity ton (kN)	Model Number *
2	304	10 (101)	EPH-208
3	304		EPH-108
2	381	15 (142)	EPH-210
3	381		EPH-110
2	457	25 (232)	EPH-213
3	457		EPH-113
2	635	50 (498)	EPH-216
3	635		EPH-116

\* Cylinder is not included.



# Posi Lock® Hydraulic Grip Pullers

## ▼ SETS SELECTION CHART

Style	Capacity (ton)	Basic Puller	Cylinder	Stroke (mm)	Pump Set	Set Model Number **	 (kg)
2 Jaw Puller	10	EPH-208	RC-106	152	-	EPHR208	10
	10	EPH-208	RC-106	152	EP-1E	EPHS208E	27
	15	EPH-210	RC-1510	254	-	EPHR210	22
	15	EPH-210	RC-1510	254	EP-1E	EPHS210E	38
	25	EPH-213	RC-2514	362	-	EPHR213	44
	25	EPH-213	RC-2514	362	EP-1E	EPHS213E	53
	50	EPH-216	RC-5013	336	-	EPHR216	87
3 Jaw Puller	10	EPH-108	RC-106	152	-	EPHR108	11
	10	EPH-108	RC-106	152	EP-1E	EPHS108E	28
	15	EPH-110	RC-1510	254	-	EPHR110	23
	15	EPH-110	RC-1510	254	EP-1E	EPHS110E	39
	25	EPH-113	RC-2514	362	-	EPHR113	48
	25	EPH-113	RC-2514	362	EP-1E	EPHS113E	57
	50	EPH-116	RC-5013	336	-	EPHR116	91
	50	EPH-116	RC-5013	336	EP-2E	EPHS116E	127

\*\* Standard set EPHS models shipped with 230 VAC pump.

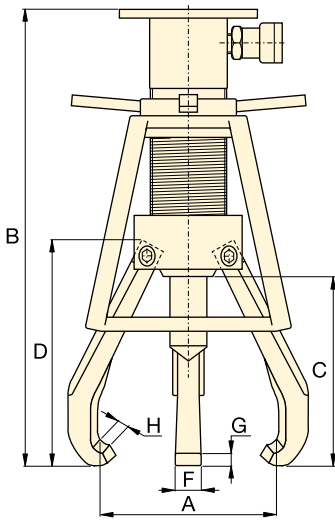

## EPH Series



Capacity:

**10 - 50 ton**

Maximum Reach:

**203 - 355 mm**

Spread Range:

**19 - 635 mm**

Maximum Operating Pressure:

**700 bar**

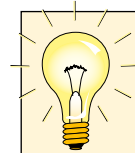



### Pump Sets

All Posi Lock® Hydraulic Puller Sets that include 230 VAC pumps, will feature the following components:

	EP-1E Pump Set	EP-2E Pump Set
Pump	PUJ-1200E	ZE4210ME
Hose	HC-7210	HC-7210
Gauge	G-2535L	G-2535L
Adaptor	GA-3	GA-3



Components for 115 VAC pumps are available on request.

### Accessories (see next page for details)

Standard included	Standard included	Optional
		
Ram Point Sets	Lift Plates	Long Jaws
19 - 304	EPH-155	EPH-11052
19 - 304	EPH-155	EPH-11052
25 - 381	EPH-155	EPH-11052
25 - 381	EPH-155	EPH-11052
63 - 457	EPH-257	EPH-11352
63 - 457	EPH-257	EPH-11352
76 - 635	EPH-508	EPH-11652
76 - 635	EPH-508	EPH-11652

Dimensions (mm)								Model Number *
Spread min. - max.	Overall Length	Maximum Reach	Jaw Length	Jaw Width	Tip Clearance	Tip Depth	(kg)	
A	B	C	D	F	G	H		
19 - 304	498	203	237	22	7,4	6,9	6,4	EPH-208
19 - 304	498	203	237	22	7,4	6,9	7,3	EPH-108
25 - 381	665	245	270	25	11,2	9,1	10,0	EPH-210
25 - 381	665	245	270	25	11,2	9,1	11,3	EPH-110
63 - 457	846	304	348	31	12,9	9,7	21,3	EPH-213
63 - 457	846	304	348	31	12,9	9,7	25,0	EPH-113
76 - 635	919	355	413	36	15,0	11,7	40,8	EPH-216
76 - 635	919	355	413	36	15,0	11,7	45,4	EPH-116

## ▼ RAM POINT SETS SELECTION CHART

Fits Puller Set Model Number	EPH-208, EPH-210 EPH-108, EPH-110	EPH-213 EPH-113	EPH-216 EPH-116
			
Ram Point Set <sup>1)</sup> Model Number	<b>EPH-155</b>	<b>EPH-257</b>	<b>EPH-508</b>
Ram Points Included:	Ram Point Dimensions Diameter x Length (mm)		
Flat Ram Points	ø25 x 25	ø38 x 57	ø51 x 76
	ø25 x 76	ø51 x 57	ø70 x 76
	–	ø51 x 102	ø70 x 127
Tapered Ram Points	ø25 x 38	ø38 x 64	ø51 x 95
	ø25 x 89	ø51 x 64	ø51 x 95
	–	ø51 x 114	ø70 x 140
Ram Point Adaptor	–	–	ø70 x 57

<sup>1)</sup> Standard included in EPH-Series Posi Lock Pullers.

## EPH Series



Capacity:

**10 - 50 ton**

Maximum Reach:

**246 - 508 mm**

Spread Range:

**57 - 762 mm**



**IMPORTANT!**



Always wear Safety Goggles and Gloves while using pullers.

## ▼ LIFT PLATE SELECTION CHART

Fits Puller Set Model Number	Model Number *	Thick-ness (mm)	Dia-meter (mm)	
EPH-208	EPH-11052	6,4	ø153	
EPH-108	EPH-11052	6,4	ø153	
EPH-210	EPH-11052	6,4	ø153	
EPH-110	EPH-11052	6,4	ø153	
EPH-213	EPH-11352	9,7	ø203	
EPH-113	EPH-11352	9,7	ø203	
EPH-216	EPH-11652	9,7	ø254	
EPH-116	EPH-11652	9,7	ø254	

\* Mounting screws included. Lifting plates are standard included with EPH-Series Pullers.

## ▼ LONG JAW SELECTION CHART

Fits Puller Set Model Number	Model Number	Number of Jaws required	Spread (mm)	Reach (mm)	 (kg)		Used to increase the reach and spread of pullers. They maintain the same pulling capacity as the standard jaws, but reduce clamping force by 25%.
EPH-208	EP-11054	2	57 - 381	246	1,1		
EPH-108	EP-11054	3	57 - 381	246	1,1		
EPH-210	EPH-11054L	2	38 - 559	401	2,5		
EPH-110	EPH-11054L	3	38 - 559	401	2,5		
EPH-213	EPH-11354L	2	38 - 762	508	4,8		
EPH-113	EPH-11354L	3	38 - 762	508	4,8		

# Posi Lock® 100 Ton Hydraulic Grip Pullers

▼ EPH-1003E



- Roller cart with power lift
- Hydraulically actuated lift cylinder on cart extends puller from ground to a height of 1,69 m
- Adjustable jaw tips
- Includes ZE3-Series 230 Volt electric one stage pump with remote pendant for fingertip control of the removal process

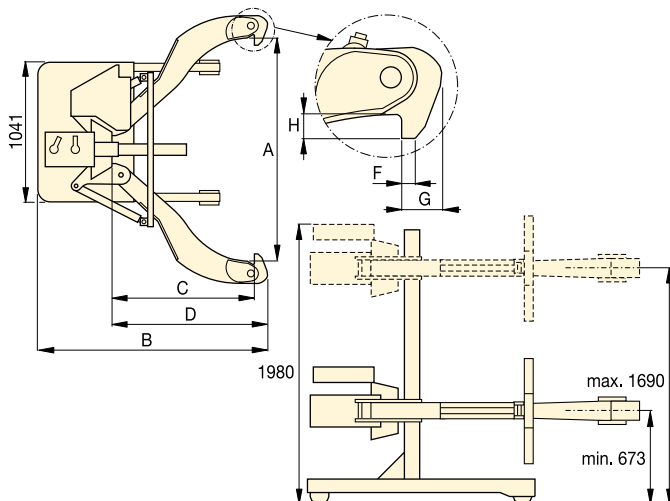

## EPH Series



Capacity:  
**100 ton**

Maximum Reach:  
**1219 mm**

Spread Range:  
**190 - 1778 mm**

Maximum Operating Pressure:  
**700 bar**

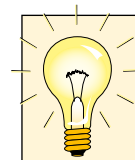

### Pushing Adaptors

All Posi Lock® 100 Ton Hydraulic Pullers include following pushing adaptors.

Diameter (mm)	Length (mm)	Model Number
89	737	EPHT-1162
89	483	EPHT-1163
89	229	EPHT-1164

▼ The EPH-1002E quickly and easily removes this drive coupler from its shaft.



Number of Jaws	Spread Range A (mm)	Capacity ton (kN)	Model Number	Cylinder Stroke (mm)	Overall Length B (mm)	Reach C (mm)	Jaw Length D (mm)	Jaw Width F (mm)	Tip Clearance G (mm)	Tip Depth H (mm)	Weight (kg)
2	190 - 1778	100 (980)	EPH-1002E	250	1955	1219	1346	32	89	89	771
3	190 - 1778	100 (980)	EPH-1003E	250	1955	1219	1346	32	89	89	907

Enerpac offers an extensive range of dedicated tools for a variety of specific and flexible applications.

Whatever your requirement... cutting, punching, spreading or bending... you can be sure that Enerpac has the correct tool to do your job safely and efficiently.

Featuring maintenance sets, machine lifts and load skates, as well as hole punches, pipe benders and cable cutters, Enerpac has the tools to ensure that even your most demanding applications can be undertaken with the highest degree of safety and accuracy.

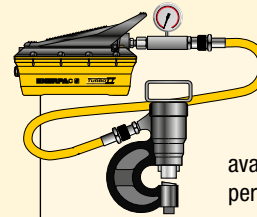

### Tool-Pump Sets

Most hydraulic tools in this section are available in sets, for a perfect tool-pump match.



### Hydraulic System Set-up

Check out our 'Yellow Pages' section for help on system set-ups and valving configurations.

Page: 268



### Bolting Tools











More Enerpac Tools you will find in our Bolting Tools section in this catalogue.

Page: 182





# Hydraulic Tools Section Overview

Capacity ton (kN)	Tool type and functions	Series		Page
<b>2,5 - 12,5</b> (22 - 116)	<b>Maintenance Sets</b>	<b>MS</b>		<b>164</b> ▶
<b>35 - 50</b> (311 - 498)	<b>Punch Punch-Pump Sets</b>	<b>MSP</b>		<b>168</b> ▶
		<b>SP</b>		<b>170</b> ▶
<b>16</b> (157)	<b>Lifting Wedge</b>	<b>LW</b>		<b>172</b> ▶
<b>8,5 - 20</b> (75 - 178)	<b>Machine Lifts</b>	<b>SOH</b>		<b>173</b> ▶
<b>1 - 80</b> (8,9 - 712)	<b>Heavy-Duty Load Skates</b>	<b>ER ES ELP</b>		<b>174</b> ▶
<b>19 - 453 litres</b>	<b>Industrial Storage Cases</b>	<b>CM</b>		<b>176</b> ▶
<b>0,75 - 1,0</b> (6 - 8,9)	<b>Hydraulic Wedgie Spread Cylinders</b>	<b>A WR</b>		<b>177</b> ▶
<b>3 - 20</b> (26 - 178)	<b>Hydraulic Cutterheads Cutterhead-Pump Sets</b>	<b>WHC WHR STC</b>		<b>178</b> ▶
<b>3 - 20</b> (26 - 178)	<b>Self-Contained Hydraulic Cutters</b>	<b>WMC</b>		<b>179</b> ▶
<b>Nominal Bore</b> ½ - 4 inch	<b>Pipe Bender Sets</b>	<b>STB</b>		<b>180</b> ▶

▼ Shown: MS2-10



- All sets include Enerpac pump, hose, cylinder and gauge
- Lock-on or threaded connectors
- Complete maintenance set for almost every maintenance application.

## The Universal Hydraulic Tool Box



### Maintenance Sets

Enerpac Maintenance sets are a complete assortment of hydraulic powered tools. Using these sets allows you to quickly configure a unique tool to meet your most difficult jobs.

Built around the Enerpac lightweight hand pump, hose and cylinder, these sets enable you to push, pull, lift, press, straighten, spread and clamp with forces up to 12,5 ton.



### More Information







For detailed information on all included attachments, see the next pages.

Page: 166



*Clamping a workpiece is just one of the many applications for the Enerpac maintenance sets.*

### ▼ QUICK SELECTION CHART

Capacity using attachments* ton (kN)	Set Model Number						Number of Attachment Components	 (kg)
2,5 (22)	<b>MS2-4</b>	P-142	HC-7206	RC-55	GP-10S	GA-4	33	26
2,5 (22)	<b>MSFP-5</b>	P-142	HC-7206	RC-55	GP-10S	GA-4	24	20
5,0 (50)	<b>MSFP-10</b>	P-392	HC-7206	RC-106	G2535L	GA-3	23	48
5,0 (50)	<b>MS2-10</b>	P-392	HC-7206	RC-106	GP-10S	GA-2	35	63
12,5 (116)	<b>MS2-20</b>	P-392	HC-7206	RC-256	GP-10S	GA-2	13	95
5,0-12,5 (50-116)	<b>MS2-1020</b>	P-392	HC-7206	RC-102, -106, -256	GP-10S	GA-2	53	158

\* If no attachments are being used, capacity is double these values. Maximum operating pressure is then 700 bar.

# Universal Maintenance Sets



### CAUTION!

When cylinders are used with maintenance set attachments or components, the maximum system pressure must be limited to half the rated pressure (350 bar).



### WARNING!

Only use attachments provided with set. Non-Enerpac attachments and longer extension tubes will reduce column strength, potentially creating unsafe conditions.

## MS Series



Capacity (using attachments):

**2,5 - 12,5 ton**

Maximum Operating Pressure:

**350 bar**

### ▼ APPLICATION EXAMPLES



# MS-Series, Maintenance Sets



**CAUTION!** When cylinders are used with maintenance set attachments or components, the maximum system pressure must be limited to half the rated pressure (350 bar).

Note: All dimensions in millimetres.

Set Model Number	MS2-4	MSFP-5	MSFP-10	MS2-10	MS2-20	MS2-1020
Base, Collar and Plunger Attachments	2,5 ton	2,5 ton	5,0 ton	5,0 ton	12,5 ton	5,0 - 12,5 ton
Cylinder Model(s)	RC-55	RC-55	RC-106	RC-106	RC-256	RC-102, 106, 256
1	A-23	A-23	A-13	A-13	A-28	A-13, A-28
2	A-25	A-25	A-21	A-21	A-27	A-21, A-27
3	A-1034	A-1034	A-20	A-20	A-595	A-20, A-595
4	MZ-4010	MZ-4010	A-14	A-14	A-243	A-14, A-243
5	A-545	A-545	A-10	A-10	-	A-10 (2x)
6	-	-	-	A-8	-	A-8
7	A-530	A-530	A-6	A-6	-	A-6
8	MZ-4011	-	-	A-192	-	A-192
9	-	-	-	A-305	-	A-305
10	A-531	A-531	A-18	A-18	-	A-18
11	-	-	-	A-185	-	A-185
12	A-532	A-532	A-15	A-15	-	A-15
13	-	-	-	-	A-607	A-607
14	A-629	A-629	A-129	A-129	-	A-129
15	A-539	A-539	A-128	A-128	-	A-128
Chains and Attachments for Pulling Applications	2,5 ton	2,5 ton	5,0 ton	5,0 ton	12,5 ton	5,0 - 12,5 ton
16	A-558	-	-	A-132	A-238	A-132, A-238
17	-	-	-	A-5 (2x)	-	A-5 (2x)
18	A-557 (2x)	-	-	A-141 (2x)	A-218 (2x)	A-141 (2x), A-18 (2x)
Extension Tubes, Connectors and Adaptors	2,5 ton	2,5 ton	5,0 ton	5,0 ton	12,5 ton	5,0 - 12,5 ton
19	A-544	-	-	A-19 (2x)	A-242 (2x)	A-19 (2x) A-242 (2x)
20	WR-5	WR-5	WR-5	A-92	-	A-92
21	MZ-4013 (4x)	MZ-4013 (4x)	A-16 (4x)	A-16 (4x)	-	A-16 (4x)
22	MZ-4007 (3x)	MZ-4007 (3x)	MZ-1050 (3x)	MZ-1050 (2x)	-	MZ-1050 (3x)
23	MZ-4008 (2x)	-	-	MZ-1051	-	MZ-1051 (2x)
24	MZ-4009	MZ-4009	MZ-1052	MZ-1052	-	MZ-1052
25	-	-	-	A-285	-	A-285
26	A-650	-	-	-	-	-
27 Length (mm)	76	MZ-4002	MZ-4002	-	-	-
	127	MZ-4003	MZ-4003	MZ-1002	MZ-1002	-
	254	MZ-4004	MZ-4004	MZ-1003	MZ-1003	A-239
	254	-	-	-	-	A-239
	457	MZ-4005 (2x)	MZ-4005	MZ-1004	MZ-1004	A-240
	457	-	-	-	-	A-240
	584	MZ-4006	MZ-4006	-	-	-
762	-	-	MZ-1005	MZ-1005	A-241	
762	-	-	-	-	-	
28 Storage Case	CM-6	CM-6	CW-350	CW-350	CW-350	CW-750
Set Weight (kg)	26	20	48	63	95	158

## Base, Collar and Plunger Attachments

### 1 Threaded Adaptor

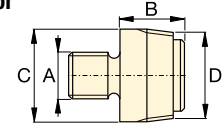

ton	Model Nr.	A	B	C	D
2,5	A-23	3/4" - 16 UN	28	26	3/4" - 14 NPT
5,0	A-13	1" - 8 UN	31	42	1 1/4" - 11 1/2 NPT
12,5	A-28	1 1/2" - 16 UN	47	69	2" - 11 1/2 NPT

### 2 Base Attachment

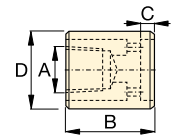

ton	Model Nr.	A	B	C	D
2,5	A-25	3/4" - 14 NPT	50	12	44
5,0	A-21	1 1/4" - 11 1/2 NPT	57	12	65
12,5	A-27	2" - 11 1/2 NPT	63	12	98

### 3 Collar Toe

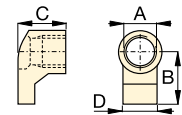

ton	Model Nr.	A	B	C	D
2,5	A-1034	1 1/2" - 16 UN	54	50	31
5,0	A-20	2 1/4" - 14 UN	80	57	57
12,5	A-595	3 5/16" - 12 UN	103	51	80

### 4 Flat Base

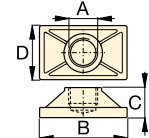

ton	Model Nr.	A	B	C	D
2,5	MZ-4010	3/4" - 14 NPT	114	31	63
5,0	A-14	1 1/4" - 11 1/2 NPT	165	35	88
12,5	A-243*	2" - 11 1/2 NPT	165	58	165

\* A-243 is a round base model.

### 5 Threaded Connector

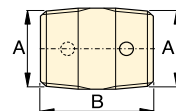

ton	Model Nr.	A	B
2,5	A-545	3/4" - 14 NPT	35
5,0	A-10	1 1/4" - 11 1/2 NPT	41

### 6 Lock-on Clamp Toe

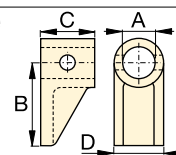

ton	Model Nr.	A	B	C	D
5,0	A-8	43	105	50	57



# Universal Maintenance Sets, MS-Series

## 7 Threaded Plunger Toe

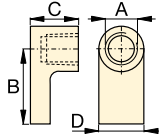

ton	Model Nr.	A	B	C	D
2,5	A-530	3/4" - 14 NPT	57	25	33
5,0	A-6	1 1/4" - 11 1/2 NPT	82	31	57

## 8 Collar Clamp Head

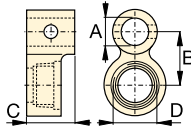

ton	Model Nr.	A	B	C	D
2,5	MZ-4011	3/4" - 14 NPT	49	76	1 1/2" - 16 UN
5,0	A-192	42	63	50	2 1/4" - 14 UN

## 9 Spreader Toe

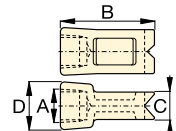

ton	Model Nr.	A	B	C	D
5,0	A-305	1 1/4" - 11 1/2 NPT	114	25	50

## 10 Serrated Saddle

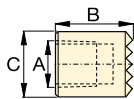

ton	Model Nr.	A	B	C
2,5	A-531	3/4" - 14 NPT	27	31
5,0	A-18	1 1/4" - 11 1/2 NPT	38	50

## 11 Smooth Saddle

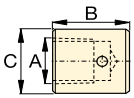

ton	Model Nr.	A	B	C
5,0	A-185	1 1/4" - 11 1/2 NPT	38	50

## 12 90° V-Base

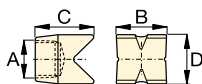

ton	Model Nr.	A	B	C	D
2,5	A-532	3/4" - 14 NPT	38	47	25
5,0	A-15	1 1/4" - 11 1/2 NPT	54	57	54

## 13 Plunger Base

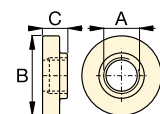

ton	Model Nr.	A	B	C
12,5	A-607	2" - 11 1/2 NPT	166	38

## 14 Wedge Head

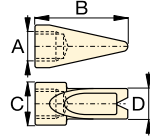

ton	Model Nr.	A	B	C	D
2,5	A-629	3/4" - 14 NPT	69	33	28
5,0	A-129	1 1/4" - 11 1/2 NPT	101	50	44

## 15 Rubber Flex Head

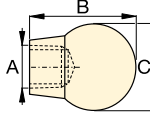

ton	Model Nr.	A	B	C
2,5	A-539	3/4" - 14 NPT	44	69
5,0	A-128	1 1/4" - 11 1/2 NPT	86	86

## Chains and Attachments for Pulling

### 16 Single Chain Plate

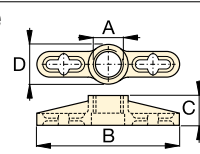

ton	Model Nr.	A	B	C	D
2,5	A-558	1 1/2" - 16 UN	196	39	44
5,0	A-132	2 1/4" - 14 UN	307	63	79
12,5	A-238	3 5/16" - 12 UN	450	102	125

### 17 Double Chain Plate

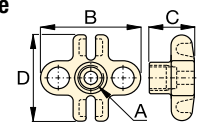

ton	Model Nr.	A	B	C	D
5,0	A-5	1 1/4" - 11 1/2 NPT	130	50	126

### 18 Chain with Hook



ton	Model Nr.	Chain Length
2,5	A-557	1,5 metres
5,0	A-141	1,8 metres
12,5	A-218	2,4 metres

## Tubes, Connectors and Adaptors

### 19 Pipe Coupling

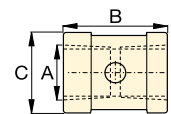

ton	Model Nr.	A	B	C
2,5	A-544	3/4" - 14 NPT	42	33
5,0	A-19	1 1/4" - 11 1/2 NPT	49	54
12,5	A-242	2" - 11 1/2 NPT	88	82

## 20 Spreader

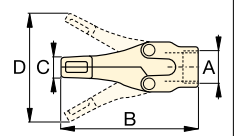

ton	Model Nr.	A	B	C	D
1,0	WR-5	—	223	12,8	94
1,0	A-92	2 1/4" - 14 UN	244	35	158

## 21 Lock Pin

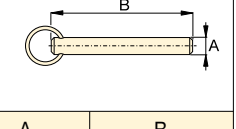

ton	Model Nr.	A	B
2,5	MZ-4013	7,9	41
5,0	A-16	11,2	82

## 22 Lock-on Connector

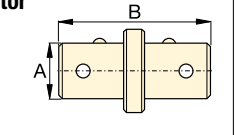

ton	Model Nr.	A	B
2,5	MZ-4007	19	79
5,0	MZ-1050	33	127

## 23 Male Lock-on Adaptor

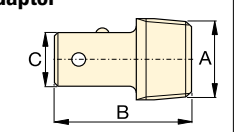

ton	Model Nr.	A	B	C
2,5	MZ-4008	3/4" - 14 NPT	60	19
5,0	MZ-1051	1 1/4" - 11 1/2 NPT	90	33

## 24 Female Lock-on Adaptor

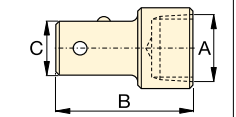

ton	Model Nr.	A	B	C
2,5	MZ-4009	3/4" - 14 NPT	65	19
5,0	MZ-1052	1 1/4" - 11 1/2 NPT	96	33

## 25 Adjustable Extension

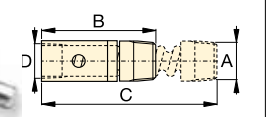

ton	Model Nr.	A	B	C	D
5,0	A-285	1 1/4" - 11 1/2 NPT	335	441	33

## 26 Slip-on Extension

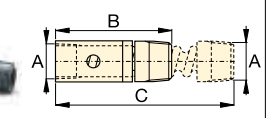

ton	Model Nr.	A	B	C
2,5	A-650	3/4" - 14 NPT	200	365

# SP-Series, Lightweight Hydraulic Punch

▼ Shown: SP-35S



- 12,7 mm thick capacity through mild steel
- Round, oblong and square punches and dies are available to solve your punching applications
- Long life Enerpac single-acting, spring return design
- Durable steel case keeps tools and dies together and provides for easy carrying and storage
- CR-400 coupler included.

## Much Faster than Drilling



### Tool Kit SPK-10

Included with all 35 Ton punches, this tool kit is used to remove and install the punch into the head. Can be ordered as a replacement under model number **SPK-10**.

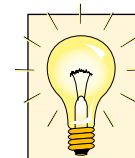

### Ordering Information

The 35 ton hydraulic Punch may be ordered by itself or as a set, including a pump. A punch or die may also be ordered separately or as a matched set. Please refer to the Quick Selection Chart information on top of the next page.

### ▼ STANDARD PUNCHES AND DIES SELECTION CHART

Hole Shape	Imperial <sup>1)</sup> (inch)		Metric <sup>1)</sup> (mm)	
	Hole Size	Bolt Size	Hole Size	Bolt Size
●	0,31	1/4	7,9	–
●	0,38	5/16	9,5	M8
●	0,44	3/8	11,1	M10
●	0,53	7/16	13,5	M12
●	0,56	1/2	14,3	–
●	0,69	5/8	17,5	M16
●	0,78	–	19,8	M18
●	0,81	3/4	20,6	–
■	0,31	1/4	7,9	–
■	0,38	5/16	9,5	M8
■	0,44	3/8	11,1	M10
■	0,50	7/16	12,7	M12
■	.31 x .75	1/4	7,9 x 19	–
■	.38 x .75	5/16	9,5 x 19	M8
■	.44 x .75	3/8	11,1 x 19	M10
■	.50 x .75	7/16	12,7 x 19	M12



<sup>1)</sup> Material thickness should not exceed hole diameter

▼ SP-Series, Lightweight Hydraulic Punch – Much Faster than Drilling.



# Single-Acting, Spring Return Hydraulic Punch

## ▼ QUICK SELECTION CHART

* 	Punch & Die Set	Included				Model Number	 (kg)
		Pump	Hose	Gauge	Gauge Adaptor		
SP-35	Standard**	P-392	HC-7206	GP-10S	GA-2	<b>STP-35H</b>	25
SP-35	Standard**	PATG-1102N	HC-7206	GP-10S	GA-2	<b>STP-35A</b>	29
SP-35	-	-	-	-	-	<b>SP-35</b>	16
SP-35	Standard**	-	-	-	-	<b>SP-35S</b>	18
SP-35	Standard**	PUD-1100E	HC-7206	-	-	<b>SP-35SPE</b>	29
SP-35	Metric***	-	-	-	-	<b>MSP-351</b>	21
SP-35	Metric***	PUD-1100E	HC-7206	-	-	<b>MSP-351PE</b>	32

\* Punch oil capacity: 76 cm<sup>3</sup>

Includes the following punch and die sets:

\*\* SPD-438, SPD-688, SPD-563 and SPD-813

\*\*\* SPD-375, SPD-531, SPD-438 and SPD-688

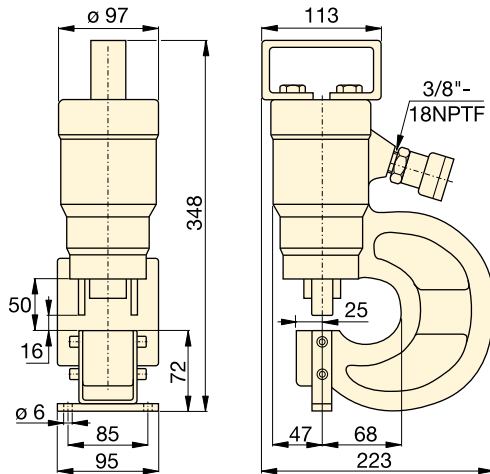

## MSP SP STP Series



Capacity:

**35 ton**

Hole Sizes:

**7,9 - 20,6 mm**

Maximum Operating Pressure:

**700 bar**



### CAUTION!

The chart below is for reference only! Maximum allowable material thickness to be punched varies with set wear.



### CAUTION!

Material thickness should not exceed hole diameter.

### Steel Qualities (see table):

- 1) Mild A-7
- 2) Boiler Plate
- 3) Structural A-36
- 4) Struct Corten (ASTM A242)
- 5) Cold Rolled C-1018
- 6) Hot Rolled C-1050
- 7) Hot Rolled C-1095
- 8) Hot Rolled C-1095 Annealed
- 9) Stainless Annealed
- 10) Stainless 304 Hot Rolled
- 11) Stainless 316 Cold Rolled

Model Nr. Standard Punch & Die Set	Maximum allowable material thickness to be punched (mm) Material thickness should not exceed hole diameter										
	1)	2)	3)	4)	5)	6)	7)	8)	9)	10)	11)
 <b>SPD-313</b>	7,9	7,9	6,4	6,4	6,4	6,4	3,3	4,8	6,4	6,4	6,4
<b>SPD-375</b>	9,7	9,7	7,9	7,9	7,9	7,9	4,8	6,4	7,9	7,9	7,9
<b>SPD-438</b>	11,2	11,2	9,7	9,7	9,7	7,9	4,8	7,9	7,9	7,9	7,9
<b>SPD-531</b>	12,7	12,7	11,2	11,2	11,2	9,7	6,4	7,9	9,7	9,7	9,7
<b>SPD-563</b>	12,7	12,7	12,7	11,2	12,7	11,2	6,4	9,7	11,2	11,2	11,2
<b>SPD-688</b>	12,7	12,7	12,7	11,2	12,7	10,2	6,4	7,9	10,2	10,2	10,2
<b>SPD-781</b>	12,7	12,7	12,7	11,2	12,7	9,7	6,4	7,9	9,7	9,9	9,7
<b>SPD-813</b>	12,7	12,7	12,7	11,2	12,7	7,9	4,8	7,9	7,9	7,9	7,9
<b>SPD-458</b>	7,9	7,9	6,4	6,4	6,4	6,4	3,3	4,8	6,4	6,4	6,4
<b>SPD-549</b>	9,7	9,7	7,9	7,9	7,9	7,9	4,8	6,4	7,9	7,9	7,9
<b>SPD-639</b>	11,2	11,2	9,7	9,7	9,7	7,9	4,8	7,9	7,9	7,9	7,9
<b>SPD-728</b>	12,7	12,7	11,2	11,2	11,2	9,7	6,4	7,9	9,7	9,7	8,6
<b>SPD-106</b>	7,9	7,9	6,4	6,4	6,4	6,4	3,3	4,8	6,4	6,4	6,4
<b>SPD-125</b>	9,7	9,7	7,9	7,9	7,9	7,9	4,8	6,4	7,9	7,9	7,9
<b>SPD-188</b>	11,2	11,2	9,7	9,7	9,7	7,9	4,8	7,9	7,9	7,9	7,9
<b>SPD-250</b>	12,7	12,7	11,2	11,2	11,2	9,7	6,4	7,9	9,7	9,7	9,7

▼ The hydraulic punch cuts the time spent forming holes.



# SP-Series, 50 Ton Hydraulic Punch

▼ Shown: SP-50100



- Available as a complete set including electric pump and hoses
- Double-acting cylinder design for fast cycle times
- Punch and die changeover tools included
- Lifting bracket included
- Adjustable power stripper prevents movement of the metal during stripping
- CR-400 female couplers included.

## Cuts the Time Spent Forming Holes



### Depth Stop

For simplified repetitive punching applications an adjustable Depth Stop is available. Order model number: **SP-110**.



### Foot Mounting Kit

A foot mounting kit for easy mounting of the 50 ton punch to workbench or fixture is available. Order model number: **SP-120**.



### Ordering Information

The 50-ton Hydraulic Punch may be ordered by itself or as a set with an electric pump. A punch and die may be ordered as a matched set.

Please refer to the selection chart information.



◀ Save time using the 50-ton Enerpac Punch.

▼ Shown below is the 50 ton punch with SP-120 and SP-110 assembled.





# 50 Ton Double-Acting Hydraulic Punch

## ▼ QUICK SELECTION CHART PUNCH SETS

Included				Set Model Number	 (kg)
Model Number Punch*	Punch & Die Sets	Electric Pump	Hydraulic Hose (2x)		
SP-50	All **	-	-	SP-50100	116
SP-50	All **	ZE4410SE	HC-7206	SP-5000E	174

\* Punch Oil Capacity:

Advance: 278 cm<sup>3</sup>

Retract: 229 cm<sup>3</sup>

\*\* All standard sets from chart below.

## SP Series



Capacity:

**50 ton (490 kN)**

Hole Sizes:

**13,5 - 26,2 mm**

Maximum Operating Pressure:

**700 bar**

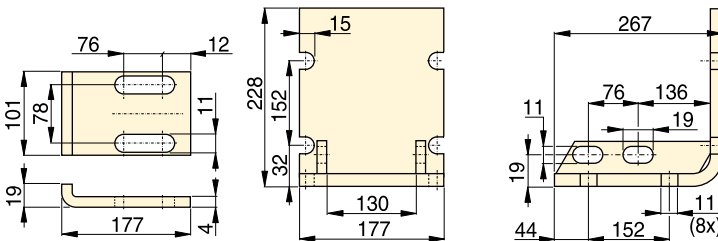

SP-110

SP-120

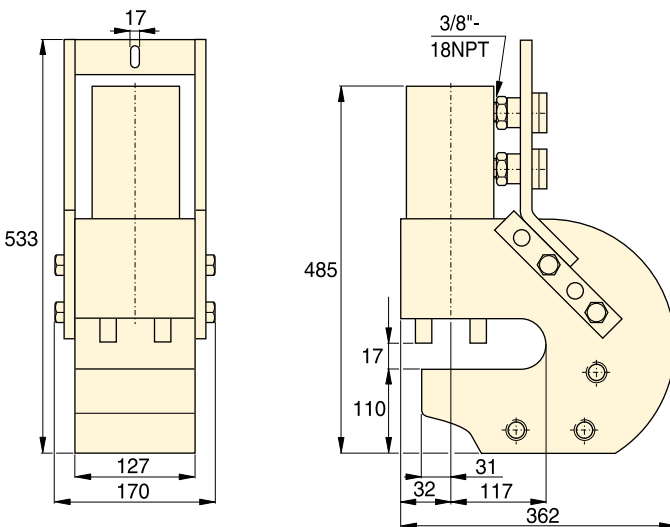

SP-50



### CAUTION!

Material thickness should not exceed hole diameter.



### CAUTION!

Chart below is for reference only! Maximum allowable material thickness to be punched varies with set wear.

### Steel Qualities (see table below):

- 1) Mild A-7
- 2) Boiler Plate
- 3) Structural A-36
- 4) Struct Corten (ASTM A242)
- 5) Cold Rolled C-1018
- 6) Hot Rolled C-1050
- 7) Hot Rolled C-1095
- 8) Hot Rolled C-1095 Annealed
- 9) Stainless Annealed
- 10) Stainless 304 Hot Rolled
- 11) Stainless 316 Cold Rolled

## ▼ STANDARD PUNCH AND DIE SELECTION CHART

Hole Shape	Hole Size (mm)	Bolt Size (mm)	Model Numbers Standard Punch and Die Set	Maximum Allowable Material Thickness To Be Punched (mm)										
				1)	2)	3)	4)	5)	6)	7)	8)	9)	10)	11)
●	13,5	M12	SP-150	13,5	13,5	13,5	13,5	13,5	12,4	8,1	10,2	12,4	12,4	12,4
●	16,7	M16	SP-170	-	-	-	-	-	13,0	8,1	10,2	13,0	13,0	13,0
●	19,8	M18	SP-190	-	-	-	-	-	12,4	8,1	10,2	12,4	12,7	12,4
●	23,1	M20	SP-121	14,2	14,2	14,2	12,7	14,2	8,9	5,6	8,9	8,9	8,9	8,9
●	26,2	M24	SP-123	14,2	14,2	14,2	11,2	14,2	7,9	4,8	7,9	7,9	7,9	7,9

# LW-Series, Hydraulic Vertical Lifting Wedge

▼ LW-16 with SB-2 and optional LWB-1



- Requires very small access gap of only 10 mm
- Lifting force 16 ton at 700 bar hydraulic pressure
- Each step can spread under full load
- Straight vertical lifting
- Unique interlocking wedge design: no first step bending and risk of slipping out
- Single-acting, spring return cylinder
- Lifting wedge LW-16 includes safety block SB-2
- Includes RC-Series Cylinder with CR-400 coupler.

▼ For lifting heavy equipment with minimum floor clearance the LW-16 is the ideal tool.



## LW Series

Maximum Lifting Force:

**16 ton (157 kN)**

Lifting Stroke:

**21 mm**

Tip Clearance / Maximum Spread \*:

**10 mm / 81,5 mm**

Maximum Operating Pressure:

**700 bar**



### Power Box

Tool box with P-392 hand pump, gauge adaptor assembly, hose and LW-16.

Page: 61



### Control Manifolds

Control Manifold to control two or four lifting wedges simultaneously.  
AM-21 with 3 ports 3/8" NPTF  
AM-41 with 5 ports 3/8" NPTF.

Page: 126

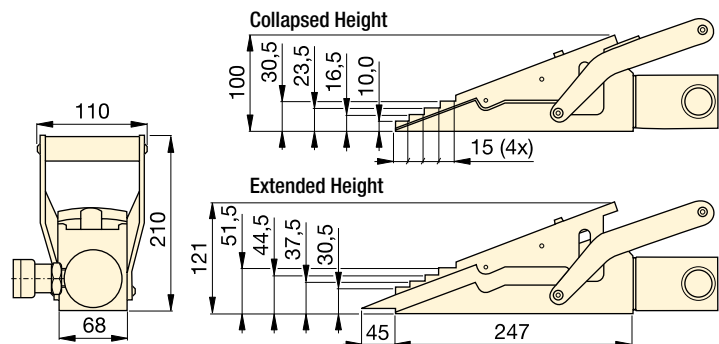
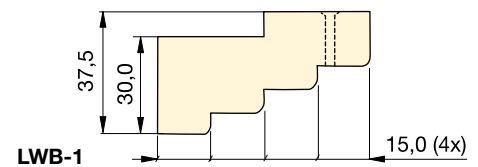

Maximum Lifting Force	Lifting Stroke	Model Number	Tip Clearance	Maximum Operating Pressure	Oil Capacity	
ton (kN)	(mm)		(mm)	(bar)	(cm <sup>3</sup> )	(kg)
16 (157)	21	LW-16	10	700	78	9,0

Use optional stepped block LWB-1 to increase wedge lifting height by 30 mm.

\* Using LWB-1.

▼ SOH-10-6



## SOH Series

Lifting Capacity:  
**8,5 - 20 ton**

Stroke:  
**136 - 157 mm**

Toe Clearance:  
**20 mm**

Maximum Operating Pressure:  
**700 bar**



### RSM-Series Flat-Jac®

Low height, single acting spring-return cylinders are ideal for space restricted applications.

Page: 22



### Load Skates

In combination with the Enerpac Machine Lifts we recommend Load Skates for moving heavy loads.

Page: 174

- For lifting heavy equipment with minimum available access
- Remote hydraulic pump enhances safety
- Low height lifting toe
- Precision guided to reduce friction and isolate cylinder from side-loads
- Two extendable support feet provide extra stability
- Includes RC-Series DUO Cylinder with CR-400 coupler.

▼ Limited access under this machine makes the Enerpac hydraulic machine lift the perfect solution.

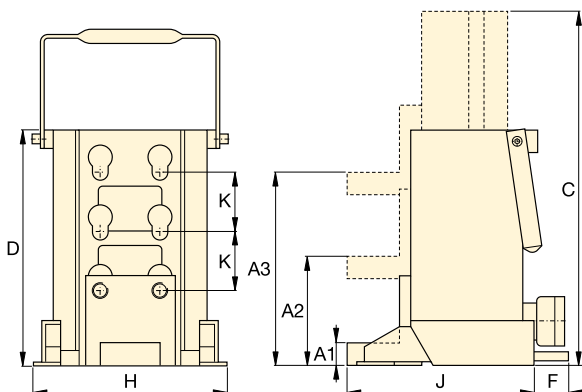

Capacity	Toe Clearance (mm)			Stroke	Model Number	Oil Capacity	Dimensions (mm)						
	Minimum	Central	Maximum				Total Ext. Height	Total Body Height	F	H	J	K	Weight
ton (kN)	A1	A2	A3	(mm)		(cm <sup>3</sup> )	C	D					(kg)
8,5 (75)	20	95	169	136	SOH-10-6	224	430	294	–	190	214	74	26
20 (178)	30	110	190	157	SOH-23-6	525	472	320	65	265	250	80	45

▼ Shown: Set ERS-20

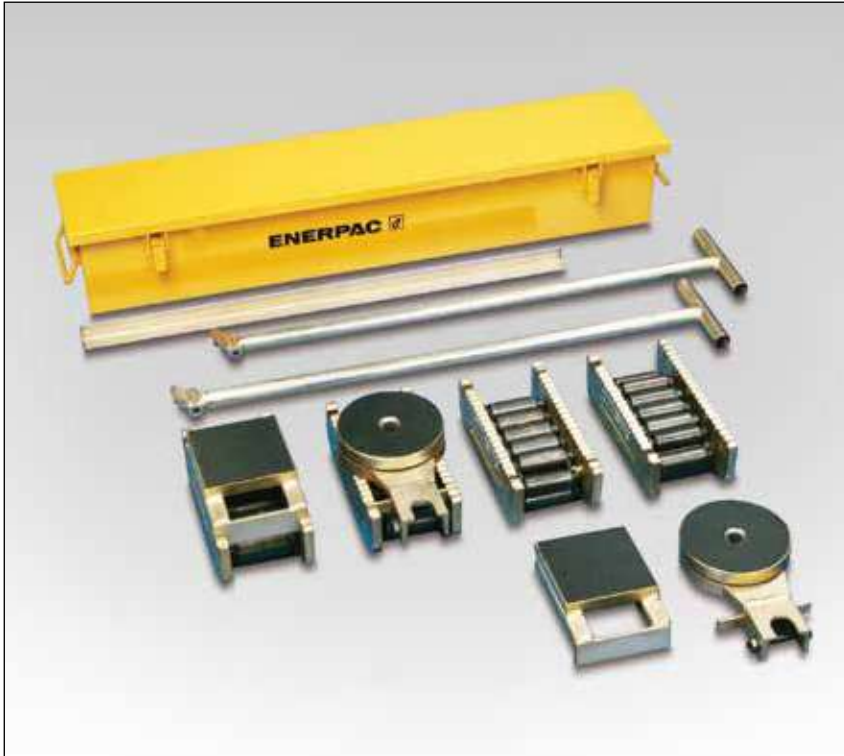

- Rugged and sturdy construction for long life
- Low profile construction for increased stability
- Low rolling-resistance allows for easy transportation
- Attachable load leveling plates and swivel turntables for turning corners.

## Move Heavy Loads Easily and Safely



Sets (see table) include all components necessary to handle a variety of applications.

Two **ELB-1** link-up bars, two **ERH-1** handles (875 mm long) and one **EMB-1** metal box are included.

Optional long handle **ERH-2** (1180 mm) available for 60 and 80 ton only.



### Lifting Wedge and Machine Lifts

To place the Load Skates, the load must first be lifted. This can be done easily and safely using the Enerpac Lifting Wedge or Machine Lifts.

Page: 172

▼ Heavy transport using Load Skates. The machine is first lifted, using SOH-Series Enerpac Machine Lifts.



▼ Chemical tank transportation: The first few centimetres the load was lifted with RCS-Series low height cylinders and then moved on to load skates for transportation.





# Heavy Duty Caterroller™ Load Skates

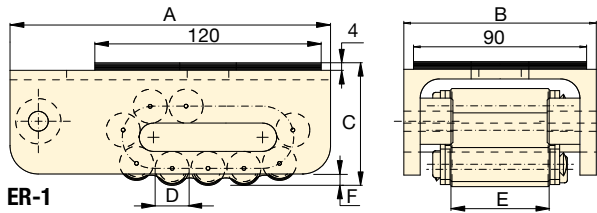

ER-1

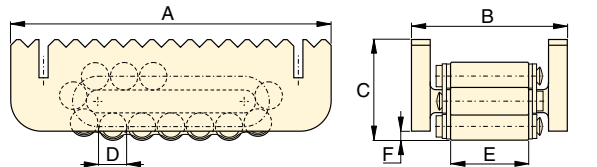

ER-10, ER-15, ER-30

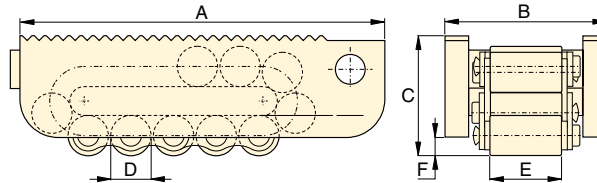

ER-60, ER-80

**EL  
ER  
ES  
Series**



Maximum Carrying Capacity:  
**80 ton (711 kN)**

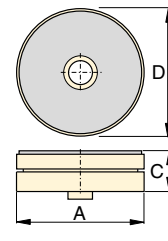

ES-1,  
Turntable Swivel

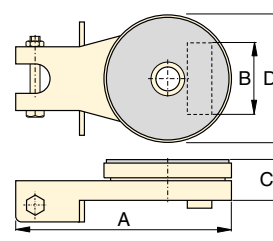

ES-10, ES-15, ES-30  
Turntable Swivel

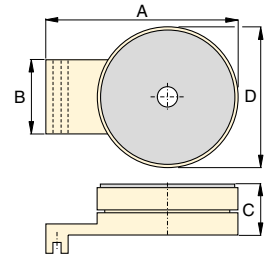

ES-60, ES-80,  
Turntable Swivel

Load Skates may be ordered separately or as a matched set.					
Set Capacity *	Set Model Number	Load Skates (4x)	Turntable Swivels (2x)	Leveling Plates (2x)	Weight including handles and metal box (kg)
20 (178)	ERS-20	ER-10	ES-10	ELP-10	49
30 (267)	ERS-30	ER-15	ES-15	ELP-15	55
60 (533)	ERS-60	ER-30	ES-30	ELP-30	75

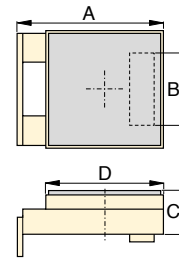



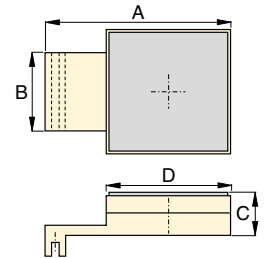

ELP-10, ELP-15, ELP-30  
Levelling Plate



ELP-60, ELP-80  
Levelling Plate

\* Sets are designed to enable two skates to take full load for extra safety on uneven floor surfaces

	Capacity ton (kN)	Model Number	Dimensions (mm)						Contact Rolls per Skate	Rollers per Skate	Weight (kg)
			A	B	C	D	E	F			
<b>Load Skates</b>   	1 (8,9)	ER-1	170	100	65	18	51	6	4	11	3,8
	10 (89)	ER-10	210	102	66	18	51	6	5	15	5,2
	15 (133)	ER-15	220	115	75	24	60	10	4	13	7,3
	30 (267)	ER-30	270	130	92	30	68	10	4	13	13,0
	60 (533)	ER-60	380	168	125	42	76	16	4	13	31,9
<b>Turntable Swivel</b>   	1 (8,9)	ES-1	207	-	26	90	-	-	-	-	1,1
	10 (89)	ES-10	220	73	42	130	-	-	-	-	3,7
	15 (133)	ES-15	220	86	42	130	-	-	-	-	3,7
	30 (267)	ES-30	250	96	48	150	-	-	-	-	5,3
	60 (533)	ES-60	275	114	61	190	-	-	-	-	13,7
<b>Levelling Plate</b>  	10 (89)	ELP-10	149	73	42	120	-	-	-	-	3,7
	15 (133)	ELP-15	149	86	42	120	-	-	-	-	3,7
	30 (267)	ELP-30	178	96	48	130	-	-	-	-	5,3
	60 (533)	ELP-60	270	114	61	180	-	-	-	-	13,8
	80 (711)	ELP-80	350	128	61	200	-	-	-	-	18,8

▼ CM-16



- Protect your equipment from dust, water, grease and dirt
- Reduce losses on the jobsite, maintenance area or shop
- Durable steel, painted with rust-resistant primer and finished in durable enamel
- Heavy duty hinges and lifting handles
- Lockable.

▼ When not storing the lifting system, this heavy-duty storage case doubles as a work station.



## CM Series

Case Size:

**19 - 453 litres**

## Protect your Equipment



### Maintenance Sets

Enerpac Maintenance sets are a complete assortment of hydraulic powered tools.

Using these sets allows you to quickly configure a unique tool to meet your most difficult jobs.

Built around the Enerpac lightweight hand pump, hose and cylinder, these sets enable you to push, pull, lift, press, straighten, spread and clamp with forces up to 12,5 ton.

Page: **164**



### Hydraulic Pullers

These hydraulic pullers eliminate time-consuming and unsafe hammering, heating or prying.

Damage to parts is minimized through the use of controlled hydraulic power.

Page: **151**

Case Size (litres)	Model Number	Inside Dimensions L x W x H (mm)	Thickness (mm)	 (kg)
19	<b>CM-6</b>	597 x 178 x 203	0,9	7
32	<b>CM-1</b>	622 x 282 x 165	0,9	8
127	<b>CM-4</b>	778 x 454 x 354	1,5	16
212	<b>CM-7</b>	1210 x 387 x 457	1,9	57
453	<b>CM-16</b>	1216 x 606 x 557	1,5	55

# Hydraulic Wedgie and Spread Cylinders

▼ Shown clockwise from top: **WR-15, WR-5, A-92**



- **WR-5:** For use in very confined work areas
- **WR-15:** For long stroke spreading applications
- **Single-acting, spring return**
- **A-92:** Spreader attachment; threads on 10 ton RC-Series cylinders \* (except RC-101).

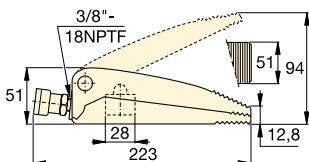

**WR-5**

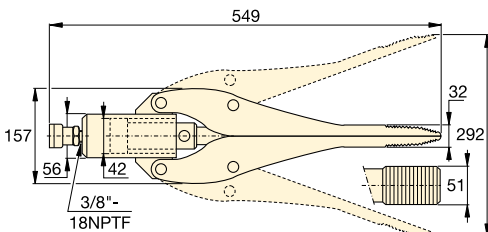

**WR-15**

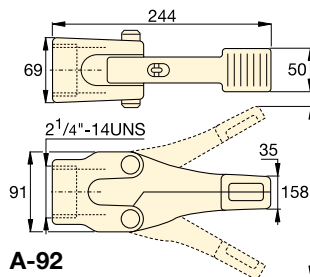

**A-92**

Cylinder Capacity	Tip Clearance	Model Number	Maximum Spread	Cylinder Effective Area	Oil Capacity	
ton (kN)	(mm)		(mm)	(cm <sup>2</sup> )	(cm <sup>3</sup> )	(kg)
1,0 (8,9)	12,8	<b>WR-5</b>	94	6,5	10	2,3
0,75 (6)	32,0	<b>WR-15</b>	292	14,5	64	11,3
1,0 (8,9)	35,0	<b>A-92 *</b>	158	–	–	3,6

\* Maximum system pressure must be limited to half the rated pressure (350 bar).

## A WR Series



Capacity:

**0,75 - 1,0 ton**

Tip Clearance:

**12,8 - 35 mm**

Maximum Spread:

**94 - 292 mm**

Maximum Operating Pressure:

**700 bar**



### RC-Series Cylinders

10 ton RC-Series DUO cylinders (except RC-101) fit into A-92 Spreader Attachment.

Page: **6**



### Power Box

Tool box with P-392 hand pump, gauge adaptor assembly, hose and WR-5.

Page: **61**



### Best Match Hand Pump

To power your WR-5 and WR-15 the **P-392** hand pump is an ideal choice. Use Enerpac H700-Series hose (page 122) for hydraulic connection.

Page: **72**

▼ A WR-5 wedgie cylinder is used to loosen a bridge bearing.

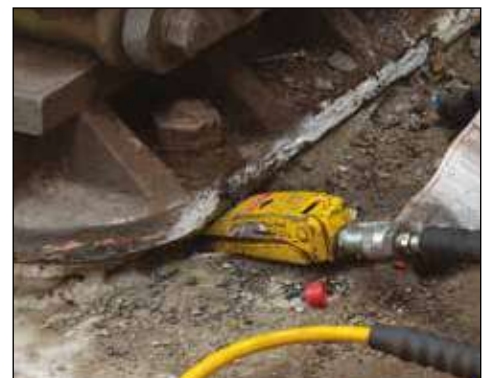

# WHC, WHR-Series, Hydraulic Cutterheads

▼ Shown from left to right: WHC-4000, WHC-750



- Single-acting, spring return on all models, except WHR-1250
- Guillotine action for smooth cutting operation
- Lifting handles on larger models for easy transport
- Carrying bag included for easy carrying and tool protection
- Ideal for use with most Enerpac pumps featuring 3-way valve or dump valve and 700 bar pressure rating (except WHR-1250, which requires 4-way valve)
- CR-400 coupler and dust cap included on all models.

## WHC, WHR, STC Series

Capacity:

**3 - 20 ton**

Cutting Capacity:

**∅ 13 - 101 mm**

Maximum Operating Pressure:

**700 bar**

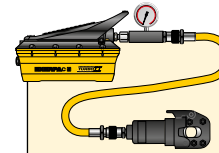

### Tool-Pump Sets

Cutterheads marked with an \* are available as sets (pump, tool, gauge, couplers and hose) for your ordering convenience.

Cutterhead Model Nr.	Pump Model Nr.	Set Model Number
WHC-750	P-392	<b>STC-750H</b>
WHC-750	P-392FP	<b>STC-750FP</b>
WHC-750	PATG-1102N	<b>STC-750A</b>
WHC-1250	P-392	<b>STC-1250H</b>
WHC-1250	P-392FP	<b>STC-1250FP</b>
WHC-1250	PATG-1102N	<b>STC-1250A</b>

▼ Steel rope is easily cut with the smooth guillotine action of an Enerpac cutterhead.



### ▼ Selection Chart Maximum Cutting Capacities (∅ in mm)

Cutter Head Operation	Capacity ton	Model Number	Oil Capacity (cm <sup>3</sup> )	Length (mm)	Steel Wire Rope, Hemp-core or IWRC 6x7 6x12 6x19	Round Bar				Wire Strand				Cable		Replacement Blades (kg)	
						Copper Wire or Bar	Aluminum Wire or Bar	Soft Steel Bolts	Reinforcing Bar	Bare Copper Wire Strands	Bare Aluminum Wire Strands	ACSR	Guy Steel Wire Strands	Telephone Cable CPP	Underground Cable (Power)		
Single-Acting	4	<b>WHC-750*</b>	19,7	127	19	19	19	19	13	19	19	19	16	☆	☆	3,2	<b>WCB-750</b>
	20	<b>WHC-1250*</b>	134,4	279	31	31	31	31	25	31	31	31	22	☆	☆	11,3	<b>WCB-1250</b>
	13	<b>WHC-2000</b>	119,6	381	25	31	31	22	☆	50	50	50	19	☆	☆	10,4	<b>WCB-2000</b>
	3	<b>WHC-3380</b>	65,5	482	☆	☆	☆	☆	☆	76	76	☆	☆	85	85	9,1	<b>WCB-3380</b>
	8	<b>WHC-4000</b>	137,7	609	☆	☆	☆	☆	☆	89	89	☆	☆	101	101	14,5	<b>WCB-4000</b>
Dbl.-Act.	20	<b>WHR-1250</b>	122,9	419	31	31	31	31	25	31	31	31	22	☆	☆	11,8	<b>WCB-1250</b>

\* Available in sets with P-392 Hand Pump, P-392FP Foot Pump or PATG-1102N Turbo Air Pump.

☆ Will not cut designated material.



# Self-Contained Hydraulic Cutters

▼ Shown from left to right: WMC-2000, WMC-750



- Rotating heads for operator convenience
- Guillotine action for smooth cutting operation
- Carrying bag included for easy carrying and tool protection
- Velcro straps to secure handles on larger models for easy carry
- Spring return for easy operation
- Light weight self-contained tool, can be used anywhere.

## WMC Series



Capacity:

**3 - 20 ton**

Cutting Capacity:

**Ø 14 - 85 mm**



### Replacement Blades

60-62HRc hardened replacement blades.

For Cutter Model Number	Order Blades Model Number
WMC-580	<b>WCB-750</b>
WMC-750	<b>WCB-750</b>
WMC-1000	<b>WCB-1000</b>
WMC-1250	<b>WCB-1250</b>
WMC-1580	<b>WCB-1580</b>
WMC-2000	<b>WCB-2000</b>
WMC-3380	<b>WCB-3380</b>



### CAUTION !:

A "☆" in the charts on these pages means that this hydraulic cutter is not designed to cut this size or type of material. Any attempt to do so may result in personal injury and damage to the unit and will void the warranty.

### ▼ Selection Chart Maximum Cutting Capacities (Ø in mm)

Capacity ton	Model Number	Length (mm)	Steel Wire Rope, Hempcore or IWRC  6x7 6x12 6x19	Round Bar				Wire Strand					Cable		Weight (kg)
				Copper Wire or Bar	Aluminum Wire or Bar	Soft Steel Bolts	Reinforcing Bar	Bare Copper Wire Strands	Bare Aluminum Wire Strands	ACSR Wire Strands	Guy Steel Wire Strands	Guy Steel Wire Strands	Telephone Cable CPP	Underground Cable (Power)	
4	<b>WMC-580</b>	381	16	16	16	16	10	16	16	16	14	14	☆	☆	3,6
4	<b>WMC-750</b>	381	17	19	19	17	13 **	19	19	19	14	14	☆	☆	3,6
20	<b>WMC-1000 *</b>	679	☆	19	19	19	19	☆	☆	☆	☆	☆	☆	☆	11,3
20	<b>WMC-1250</b>	679	31	28	31	31	22	31	31	31	22	22	☆	☆	10,4
6	<b>WMC-1580</b>	558	19	19	19	19	☆	38	38	38	16	16	☆	☆	6,8
13	<b>WMC-2000</b>	628	25	31	31	22	☆	50	50	50	19	19	☆	☆	10,9
3	<b>WMC-3380</b>	660	☆	☆	☆	☆	☆	76	76	☆	☆	☆	85	85	10,0

\* Cuts 12 mm alloy chain grade 70 (type G7 transport or tie-down) or grade 80 (for overhead lifting applications).

\*\* Low Alloy. ☆ Will not cut designated material.

# STB-Series, Pipe Bender Sets

▼ Shown: STB-101H



## Quick, Safe and Wrinkle-free Bending



### 'One Shot' and 'Sweep'

**One shot shoes** give up to a 90° bend without resetting.





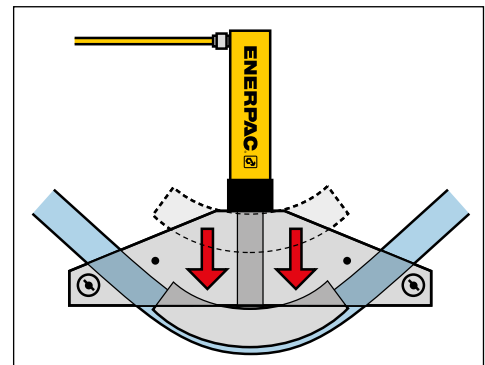



**Sweep shoes** are used where increasing radii are required for multiple parallel pipe installations.

- Makes smooth, wrinkle-free bends
- Sets include genuine Enerpac cylinder, hose and manual, air or electric pump
- Sets are also available without hydraulics
- Bending shoes and bending frame are lightweight, heat-treated aluminium
- All sets include sturdy steel storage case
- All sets include BZ-12091 angle indicator for accurate bending
- BZ-12377 Shoe Lock Pin included in every set
- Eject-O-Matic™ benders (STB-202 models) have double-acting cylinder to eject pipe from the bending shoe.



▲ Typical one shot bending operation.

### ▼ SELECTION CHART

Pipe Range Nominal Size (inch)		Bender Set Model Number	Hand Pump *	Air Pump *	Electric Pump *		Cylinder *	Hose *	Saddle *	 (kg)
One Shot	Sweep									
½ - 2	-	STB-101X	-	-	-	-	-	-	A-12	40
		STB-101N	-	-	-	-	RC-1010	HC-7206	A-12	48
		STB-101H	P-392	-	-	-	RC-1010	HC-7206	A-12	52
		STB-101A	-	PATG-1102N	-	-	RC-1010	HC-7206	A-12	54
		STB-101E	-	-	PUJ-1200E <sup>2)</sup>	-	RC-1010	HC-7206	A-12	57
1 - 2	2½ - 4	STB-221X	-	-	-	-	-	-	A-29	104
		STB-221N	-	-	-	-	RC-2510	HC-7206	A-29	119
		STB-221H	P-80	-	-	-	RC-2510	HC-7206	A-29	130
1¼ - 4	-	STB-202X <sup>1)</sup>	-	-	-	-	-	-	A-29	143
		STB-202N <sup>1)</sup>	-	-	-	-	RR-3014	HC-7206 (2x)	A-29	174
		STB-202E <sup>1)</sup>	-	-	-	ZU4408SE <sup>2)</sup>	RR-3014	HC-7206 (2x)	A-29	212

\* See corresponding sections in this catalog for more detailed specifications.

<sup>1)</sup> Eject-O-Matic™

<sup>2)</sup> For 115 volt applications replace the last digit of Set Model Number and pump from 'E' to 'B'.

# Pipe Bender Sets

Nominal Pipe Size (inch)	Wall Thickness (mm)	Schedule Pipe *	Pipe Bend Inside Radius (inch)	STB-101	STB-221 ø 1 - 2" One Shot	STB-202	One Shot Bending Shoe Model Number	Sweep Bending Shoe Model Number
				ø ½ - 2" One Shot	ø 2¼ - 4" Sweep	ø 1¼ - 4" One Shot		
½	2,8	40	27/8	Yes	-	-	BZ-12011	-
	3,7	80		Yes	-	-		
	4,7	160		WS	-	-		
	7,5	DEH		WS	-	-		
¾	2,9	40	4	Yes	-	-	BZ-12021	-
	3,9	80		Yes	-	-		
	5,5	160		WS	-	-		
	7,8	DEH		WS	-	-		
1	3,4	40	5½	Yes	Yes	-	BZ-12031	-
	4,5	80		Yes	Yes	-		
	6,4	160		WS	WS	-		
	9,1	DEH		-	WS	-		
1¼	3,6	40	67/16	Yes	Yes	Yes	BZ-12041	-
	4,9	80		Yes	Yes	Yes		
	6,4	160		WS	WS	Yes		
	8,7	DEH		-	WS	WS		
1½	3,7	40	75/16	Yes	Yes	Yes	BZ-12051	-
	5,1	80		Yes	Yes	Yes		
	7,1	160		WS	WS	Yes		
	10,2	DEH		-	WS	WS		
2	3,9	40	85/16	-	Yes	Yes	BZ-12061	-
	5,5	80		-	Yes	Yes		
	8,7	160		-	WS	Yes		
2½	5,2	40	9½	-	Yes	Yes	BZ-12341	BZ-12382
	7,0	80		-	WS	Yes		
	9,5	160		-	WS	Yes		
3	5,5	40	11¼	-	Yes	Yes	BZ-12351	BZ-12383
	7,6	80		-	WS	Yes		
3½	5,7	40	15½	-	Yes	Yes	BZ-12391	BZ-12384
	8,1	80		-	WS	Yes		
4	6,0	40	17¾	-	Yes	Yes	BZ-12392	BZ-12385
	8,6	80		-	-	Yes		

\* Schedule Pipe: 40 = Standard; 80 = Extra Heavy; 160 = Double Extra Heavy;  
DEH = Double Extra Heavy (slightly thicker than 160);  
WS = Can be bent using wider spacing for swivel shoes.

## STB Series



Nominal Pipe Size:

**ø ½ - 4 inch**

Maximum Bending:

**90°**

Maximum Operating Pressure:

**700 bar**



All bender sets are designed to bend mild steel pipe. For other material please consult Enerpac.

Frame Assembly	Pivot Pins (2x)	Pivot Shoes (2x)	Bending Shoes included (Shoes with <sup>3)</sup> are Sweep, all other shoes are One Shot)									Bender Set Model Number	
BZ-12371	BZ-12375	BZ-12071	BZ-12011	BZ-12021	BZ-12031	BZ-12041	BZ-12051	BZ-12061	-	-	STB-101X		
												STB-101N	
													STB-101H
													STB-101A
													STB-101E
BZ-12372	BZ-12376	BZ-13401	BZ-12031	BZ-12041	BZ-12051	BZ-12061	BZ-12382 <sup>3)</sup>	BZ-12383 <sup>3)</sup>	BZ-12384 <sup>3)</sup>	BZ-12385 <sup>3)</sup>	STB-221X		
											STB-221N		
												STB-221H	
BZ-12374	BZ-12376	BZ-13401	-	BZ-12041	BZ-12051	BZ-12061	BZ-12341	BZ-12351	BZ-12391	BZ-12392	STB-202X <sup>1)</sup>		
											STB-202N <sup>1)</sup>		
												STB-202E <sup>1)</sup>	

**Enerpac's Bolting Solutions cater to the complete bolting work-flow, ensuring joint integrity in a variety of applications throughout the industry:**

### Joint Assembly

From simple pipe alignment to complex joint positioning of large structural assemblies, our comprehensive line of joint assembly products range from hydraulic and mechanical alignment tools to synchronized PLC-controlled multi-point positioning systems.

### Controlled Tightening

Enerpac offers a variety of controlled tightening options to best meet the requirements of your application. From mechanical torque multipliers to hydraulic, pneumatic and electric square drive wrenches and from low profile torque wrenches to interconnectable bolt tensioning tools; we offer the products you need for accurate and simultaneous tightening of multiple bolts.

### Joint Separation

Enerpac also provides hydraulic nut splitters and a variety of mechanical and hydraulic spreading tools for joint separation during inspection, maintenance and decommissioning operations.

High quality bolting solutions from the brand you can trust.

See how Enerpac can make your bolting work-flow more accurate, safer and efficient.



### Bolting Integrity Software

Visit [www.enerpac.com](http://www.enerpac.com) to access our free on-line bolting software application and obtain information on tool selection, bolt load calculations and tool pressure settings. A combined application data sheet and joint completion report is also available.



### Torque Tightening



















See our 'Yellow Pages' for information on torque tightening. See our Bolting Safety Instructions on [enerpac.com](http://enerpac.com).

Page: **276**





# Bolting Tools & Pumps Section Overview

Applications	Capacity	Tool type and functions	Series	Page	
Controlled Tightening and Loosening	1015 - 10.845 Nm 750 - 8000 Ft.lbs	<b>Manual Torque Multipliers</b>	E		184 ▶
	1952 - 35.455 Nm 1440 - 26.150 Ft.lbs	<b>Square Drive Hydraulic Torque Wrenches</b> Rigid steel design & maximum versatility	S		186 ▶
	19 - 155 mm ¾ - 6⅞ inch	<b>Heavy-Duty Impact Sockets</b> Square drive	BSH		190 ▶
	2766 - 47.454 Nm 2040 - 35.000 Ft.lbs	<b>Hexagon Hydraulic Torque Wrenches</b> <b>Ultra-Slim Stepped Width Cassettes</b>	W W-SL		192 ▶ 202 ▶
	5762 Nm 4250 Ft.lbs	<b>Roller Cassette Torque Wrench</b> Versatile high performance limited access tools	WCR		204 ▶
	1356 - 8135 Nm 1000 - 6000 Ft.lbs	<b>Pneumatic Torque Wrenches</b> <b>Electric Torque Wrenches</b>	PTW ETW		206 ▶ 208 ▶
		<b>Selection Matrix</b> Torque Wrenches - Pumps - Hoses			212 ▶
	Flow: 0,34 l/min Power: 0,37 kW	<b>Portable Electric Torque Wrench Pumps</b> Compact Economy	PME PMU		213 ▶
	Flow: 0,50 l/min Power: 0,75 kW	<b>Electric Torque Wrench Pumps</b> Lightweight	TQ		214 ▶
	Flow: 0,90 l/min Power: 1,25 kW	<b>Portable Electric Torque Wrench Pumps</b> Z-Class innovation	ZU4T		216 ▶
	Flow: 0,82-1,64 l/min Power: 1,1 - 2,2 kW	<b>Electric Torque Wrench Pumps</b> Z-Class innovation	ZE4T ZE5T		220 ▶
	Flow: 0,90 l/min Air: 2840 l/min	<b>Air Driven Torque Wrench Pumps</b> Z-Class innovation	ZA4T		222 ▶
	Flow: 0,13 l/min Power: 1,25 kW	<b>Electric Tensioning Pumps &amp; Accessories</b> Z-Class Tensioning pumps upto 1500 bar	ZUTP		226 ▶
	Flow: 0,07 l/min Air: 590 l/min	<b>Ultra-High Pressure Air Pump</b> Upto 1500 bar	ATP		228 ▶
	Joint Assembly and Joint Separation	10 - 75 mm hexagon 70 - 130 mm hexagon	<b>Hydraulic Nut Cutters</b>	NC NS	
5 - 10 ton (45 - 101 kN)		<b>Pin-type Hydraulic Flange Spreaders</b>	FS		232 ▶
8 - 14 ton (72 - 125 kN)		<b>Step-type Industrial Spreaders</b> Mechanical and Hydraulic	FSH FSM		233 ▶
1 - 9 ton (10 - 90 kN)		<b>Flange Alignment Tools</b> Mechanical and Hydraulic	ATM		234 ▶
∅ 1 - 12 inch flanges		<b>QuickFace – Mechanical Pipe Flange Face Tool</b> Refacing of flat pipe flange surfaces	FF		236 ▶

▼ Shown from left to right: E291, E393, E494



- High-efficiency planetary gear sets achieve high output torque from low input torque
- Operator protected by anti-backlash device
- Torque multiplier accuracy  $\pm 5\%$
- Reversible, tighten or loosen bolts
- Reaction bar or reaction plate style
- Angle-of-turn protractor standard on E300-Series models
- Reaction plate models offer increased versatility with reaction point locations
- E300 and E400-Series have replaceable shear drives, providing overload protection of internal power train
- One replacement shear drive is included with each E300 and E400-Series models.

## Accurate, Efficient Torque Multiplication

When accurate make-up or break-out of stubborn fasteners requires high torque



### Typical Torque Multiplier Applications

- Locomotives
- Power plants
- Pulp and paper mills
- Refineries
- Chemical plants
- Mining and construction
- Off-road equipment
- Shipyards
- Cranes.



◀ Enerpac Reaction Bar Torque Multiplier E393 used to manually torque bolts up to 4300 Nm.

### ▼ SELECTION CHART

Torque Multiplier Type	Nominal Torque Output		Model Number
	(Nm)	(Ft.lbs)	
Reaction Bar Multiplier	1015	750	E290PLUS
	1355	1000	E291
	1625	1200	E391
	2980	2200	E392
	4340	3200	E393
Reaction Plate Multiplier	2980	2200	E492
	4340	3200	E493
	6780	5000	E494
	10845	8000	E495



## Manual Torque Multipliers

Enerpac manual torque multipliers provide efficient torque multiplication in wide clearance applications and when external power sources are not available.

Manual torque multipliers are used in most industrial, construction, and equipment maintenance applications. Hydraulic torque wrenches are better suited for tight tolerance, flange and repetitive bolting applications.

### Use Reaction Bar Models:

- Where space is limited,
- Where multiple reaction points are available,
- when portability is desirable.

### Use Reaction Plate Models:

- Above 4300 Nm output torque,
- On flanges and applications where neighbouring bolt or nut is available to react against
- When extreme reaction forces are generated.

## E Series



Nominal Torque Output:

**1015 - 10.845 Nm**

Torque Ratio:

**3:1 - 52:1**

Output Ratio Accuracy:

**± 5 %**



### CAUTION!

Never use impact air tools for power driving torque multipliers. Torque multiplier drive train damage will occur.

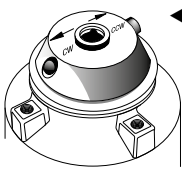

### Selector Pawl

Models with anti-backlash protection have directional selector pawls. Set the pawl for clockwise or counter-clockwise rotation.

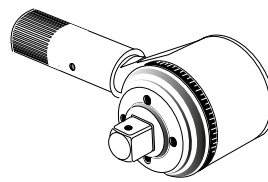

### Angle-of-Turn Protractor

E391, E392 and E393 models include an angle-of-turn protractor (scale) to tighten fasteners using a "torque turn" method. Allows accurate measuring a specific number of degrees of rotation.

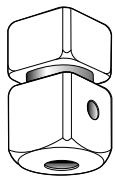

### Shearable Square Drive

Provides overload protection on E300- and E400-series multiplier's power train by shearing when the rated capacity of the tool is exceeded. Internal shear pin prevents tool from falling off bolt.

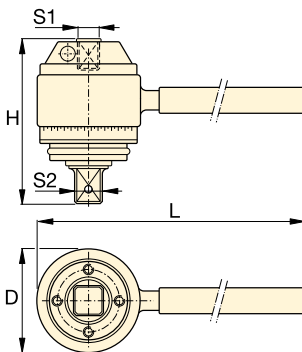

Reaction Bar Type<sup>1)</sup>

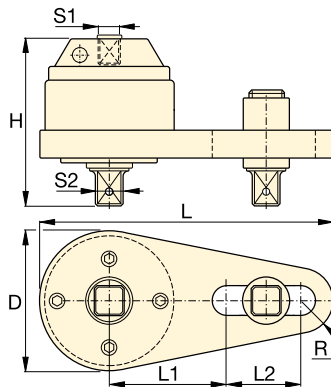

Reaction Plate Type<sup>1)</sup>



### Hydraulic Torque Wrenches

Enerpac offers a complete range of square drive and hexagon cassette torque wrenches.

Page: 186



### BSH-Series Sockets

Heavy-Duty Impact Sockets for power driven torqueing equipment.

Page: 190

Input Torque <sup>2)</sup>	Torque Ratio	Input Female Square Drive	Output Male Square Drive		Over-load protection	Anti-Backlash	Dimensions (mm)						Model Number	
			S2 (inch)	Replaceable Shear Drive Model Nr.			D	H	L	L1	L2	R		
338 (Nm) / 250 (Ft.lbs)	3 : 1	1/2 (inch)	3/4 (inch)	-	No	No	71	84	218	-	-	-	1,8 (kg)	E290PLUS
451 (Nm) / 333 (Ft.lbs)	3 : 1	1/2 (inch)	3/4 (inch)	-	No	No	71	84	442	-	-	-	2,5 (kg)	E291
271 (Nm) / 200 (Ft.lbs)	6 : 1	1/2 (inch)	3/4 (inch)	E391SDK	Yes	No	100	102	498	-	-	-	6,3 (kg)	E391
219 (Nm) / 162 (Ft.lbs)	13,6 : 1	1/2 (inch)	1 (inch)	E392SDK	Yes	Yes	103	146	498	-	-	-	6,9 (kg)	E392
234 (Nm) / 173 (Ft.lbs)	18,5 : 1	1/2 (inch)	1 (inch)	E393SDK	Yes	Yes	103	165	498	-	-	-	8,3 (kg)	E393
219 (Nm) / 162 (Ft.lbs)	13,6 : 1	1/2 (inch)	1 (inch)	E392SDK	Yes	Yes	124	140	356	140	124	32	7,8 (kg)	E492
234 (Nm) / 173 (Ft.lbs)	18,5 : 1	1/2 (inch)	1 (inch)	E393SDK	Yes	Yes	124	163	356	140	124	32	10,6 (kg)	E493
256 (Nm) / 189 (Ft.lbs)	26,5 : 1	1/2 (inch)	1 1/2 (inch)	E494SDK	Yes	Yes	143	222	378	178	89	42	15,4 (kg)	E494
208 (Nm) / 154 (Ft.lbs)	52 : 1	1/2 (inch)	1 1/2 (inch)	E495SDK	Yes	Yes	148	273	386	178	89	48	22,8 (kg)	E495

<sup>1)</sup> E200 and E400-series do not have an Angle-of-Turn Protractor (scale).

<sup>2)</sup> User must verify manual torque wrench accuracy prior to use to ensure accurate final output torque.

▼ Shown: S3000PX



## Setting New Standards in Safety, Simplicity and Performance

### Safety and Performance

- Compact, high-strength uni-body construction provides a small operating radius without sacrificing endurance
- 35° rotation angle and rapid return stroke for fast operation
- Tough manifold design with added safety feature for enhanced operator safety

### Simplicity

- 360° click-on reaction arm with quick release lever provides easier handling, even with gloves on
- Includes robust handle which mounts on both sides of tool for extra maneuverability
- Push button square drive release for quickly reversing the square drive for tightening or loosening

### Versatility

- Available with optional enhanced tilt and swivel TSP300 manifold for horizontal and vertical maneuverability, with greater durability <sup>1)</sup>

### Accuracy

- Constant torque output provides accuracy of  $\pm 3\%$  across full stroke
- Optional Angle-of-Turn Indicator provides measurement of rotation.



#### Two Handle Styles

Robust angled positioning handle comes standard with every S-Series (X-Edition) tool. Straight positioning handles are available as accessories.

Compatible S-Series (X-Edition) wrenches	Model Nr. Angled positioning handles (standard)	Model Nr. Straight positioning handles (optional)
S1500X, S3000X	<b>SWH6A</b>	<b>SWH6S</b>
S6000X, S11000X	<b>SWH10A</b>	<b>SWH10S</b>
S25000X	<b>SWH10EA</b> <sup>2)</sup>	

<sup>2)</sup> SWH10EA is an eyebolt handle.



#### TSP - Pro Series Swivel

The optional TSP300 tilt and swivel manifold with robust interlocking design provides 360° X-axis rotation and 160° Y-axis rotation.

#### How to Order <sup>1)</sup>

Factory fitted to S-Series (X-Edition) wrenches: Insert a "P" prior to the "X" in the tool model number, example: **S1500PX**.

Order as an accessory using the model number: **TSP300**, which can be fitted to existing S-Series (X-Edition) wrenches. Includes male and female couplers.

Page: 189



#### ATEX declared. Calibration certificate included.

All X-edition tools are CE - ATEX declared and are shipped complete with a calibration certificate.

<sup>1)</sup> TSP300 is designed for X-Edition tools only, and is not compatible with previous edition tools. For replacement components for existing tools, refer to repair sheet on [www.enerpac.com](http://www.enerpac.com)



# X-Edition, Square Drive Torque Wrenches

Standard are: ① ② ⑥ ⑧  
Other items are optional.

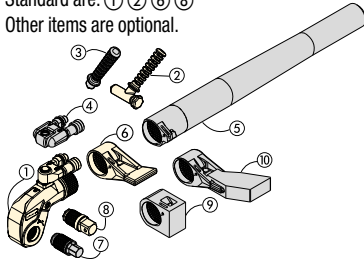

- ① Drive Unit
- ② Angeled Positioning Handle
- ③ Straight Positioning Handle
- ④ Pro Series Swivel
- ⑤ Reaction Tube Extension
- ⑥ Standard Reaction Arm
- ⑦ Allen Drive
- ⑧ Square Drive
- ⑨ Short Reaction Arm
- ⑩ Extended Reaction Arm

**Select the Right Torque**  
Choose your Enerpac Torque Wrench using the untightening rule of thumb:  
Loosening torque equals about 250% of tightening torque.

## S Series X-Edition



Nominal Torque Output:  
**35.455 Nm**

Square Drive Range:  
**3/4 - 2 1/2 inch**

Nose Radius:  
**25 - 64 mm**

Maximum Operating Pressure:  
**690 bar**

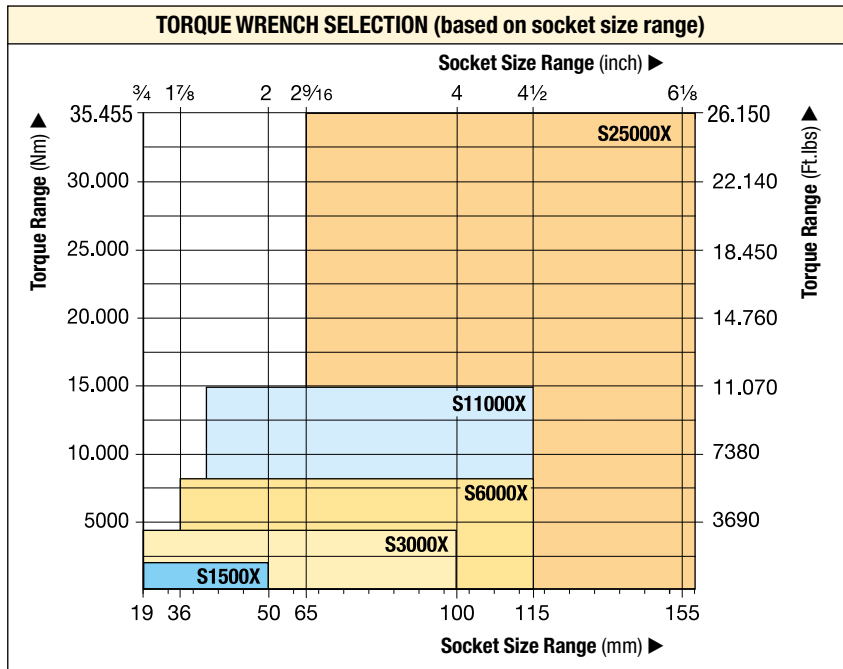

### Accessory Options

A full list of optional accessories is available for maximum versatility.

Page: **189**

▼ The rigid steel design of the S-Series torque wrenches provides durability, reliability and safety.



**Use only Heavy Duty Impact Sockets**  
For power driven torquing equipment, according to ISO2725 and ISO1174; DIN 3129 and DIN 3121 or ASME-B107.2/1995.

Page: **190**

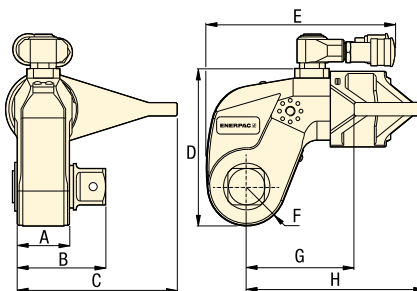

Nominal Torque at 690 bar		Minimum Torque at 69 bar		Square Drive Size (inch)	Model Nr. (included with wrench)	Angle-of-Turn Model Nr. (optional)	Torque Wrench Model Number *	Dimensions (mm)								(kg)
(Nm)	(Ft.lbs)	(Nm)	(Ft.lbs)					A	B	C	D	E	F	G	H	
1952	1440	195	144	3/4	SD15-012	AOT15	<b>S1500X</b>	39	65	108	97	136	25	70	129	3,2
4373	3225	438	323	1	SD30-100	AOT30	<b>S3000X</b>	48	78	135	128	173	33	90	161	5,6
8338	6150	834	615	1 1/2	SD60-108	AOT60	<b>S6000X</b>	55	92	169	157	192	40	110	188	9,2
15.151	11.175	1516	1118	1 1/2	SD110-108	AOT110	<b>S11000X</b>	72	114	197	190	228	50	133	229	15,8
35.455	26.150	3545	2615	2 1/2	SD250-208	AOT250	<b>S25000X</b>	89	143	246	244	287	64	182	295	32,2

\* To order a S-Series (X-edition) torque wrench fitted with a TSP300 tilt and swivel manifold, insert a "P" prior to the "X" in the tool model number, example: **S1500PX**.

Maximum Torque at 690 bar:

**35.455 Nm**

Hexagon Size Allen Drive:

**½ - 2¼ inch**

Hexagon Size Allen Drive:

**14 - 85 mm**

For  
**S**  
Series

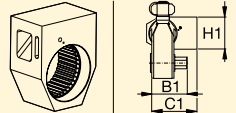

Torque Wrench 	Optional Allen Drives, Imperial				Optional Allen Drives, Metric				Short Reaction Arm for Allen Drives 		
	Hexagon Size <sup>1)</sup> (inch)	Maximum Torque (Nm)	Model Number	Dim. B1 (mm)	Hexagon Size <sup>1)</sup> (mm)	Maximum Torque (Nm)	Model Number	Dim. B1 (mm)	Model Number	Dimensions (mm) C1   H1	
<b>S1500X</b> (1952 Nm)	½	481	<b>SDA15-008</b>	66	<b>14</b>	644	<b>SDA15-14</b>	66	<b>SRA15X</b>	67,5	74
	5/8	936	<b>SDA15-010</b>	67	<b>17</b>	1152	<b>SDA15-17</b>	68			
	¾	1620	<b>SDA15-012</b>	71	<b>19</b>	1607	<b>SDA15-19</b>	70			
	7/8	1952	<b>SDA15-014</b>	74	<b>22</b>	1952	<b>SDA15-22</b>	73			
	<b>1</b>	1952	<b>SDA15-100</b>	77	<b>24</b>	1952	<b>SDA15-24</b>	74			
<b>S3000X</b> (4373 Nm)	5/8	936	<b>SDA30-010</b>	77	<b>17</b>	1152	<b>SDA30-17</b>	77	<b>SRA30X</b>	80,0	74
	¾	1620	<b>SDA30-012</b>	80	<b>19</b>	1607	<b>SDA30-19</b>	79			
	7/8	2569	<b>SDA30-014</b>	83	<b>22</b>	2488	<b>SDA30-22</b>	82			
	<b>1</b>	3830	<b>SDA30-100</b>	86	<b>24</b>	3234	<b>SDA30-24</b>	84			
	<b>1 1/8</b>	4373	<b>SDA30-102</b>	88	<b>27</b>	4373	<b>SDA30-27</b>	85			
	<b>1 1/4</b>	4373	<b>SDA30-104</b>	89	<b>30</b>	4373	<b>SDA30-30</b>	87			
	-	-	-	-	<b>32</b>	4373	<b>SDA30-32</b>	88			
<b>S6000X</b> (8338 Nm)	5/8	936	<b>SDA60-010</b>	85	<b>17</b>	1152	<b>SDA60-17</b>	86	<b>SRA60X</b>	91,5	89
	¾	1620	<b>SDA60-012</b>	89	<b>19</b>	1607	<b>SDA60-19</b>	88			
	7/8	2569	<b>SDA60-014</b>	92	<b>22</b>	2488	<b>SDA60-22</b>	91			
	<b>1</b>	3830	<b>SDA60-100</b>	95	<b>24</b>	3234	<b>SDA60-24</b>	93			
	<b>1 1/8</b>	5457	<b>SDA60-102</b>	97	<b>27</b>	4603	<b>SDA60-27</b>	94			
	<b>1 1/4</b>	7484	<b>SDA60-104</b>	98	<b>30</b>	6311	<b>SDA60-30</b>	96			
	-	-	-	-	<b>32</b>	7660	<b>SDA60-32</b>	97			
<b>S11000X</b> (15.151 Nm)	<b>1 1/4</b>	7484	<b>SDA110-104</b>	115	<b>30</b>	6311	<b>SDA110-30</b>	112	<b>SRA110X</b>	127,5	106
	<b>1 3/8</b>	9958	<b>SDA110-106</b>	117	<b>32</b>	7660	<b>SDA110-32</b>	114			
	<b>1 1/2</b>	12.928	<b>SDA110-108</b>	118	<b>36</b>	10.901	<b>SDA110-36</b>	117			
	<b>1 5/8</b>	15.151	<b>SDA110-110</b>	122	<b>41</b>	15.151	<b>SDA110-41</b>	121			
	<b>1 3/4</b>	15.151	<b>SDA110-112</b>	125	<b>46</b>	15.151	<b>SDA110-46</b>	127			
<b>S25000X</b> (35.455 Nm)	<b>1 1/2</b>	12.928	<b>SDA250-108</b>	141	<b>36</b>	10.901	<b>SDA250-36</b>	140	<b>SRA250X</b>	158,5	135
	<b>1 5/8</b>	16.433	<b>SDA250-110</b>	145	<b>41</b>	16.107	<b>SDA250-41</b>	144			
	<b>1 3/4</b>	20.520	<b>SDA250-112</b>	148	<b>46</b>	22.744	<b>SDA250-46</b>	148			
	<b>1 7/8</b>	25.245	<b>SDA250-114</b>	149	<b>50</b>	29.211	<b>SDA250-50</b>	151			
	<b>2</b>	30.635	<b>SDA250-200</b>	151	<b>55</b>	35.455	<b>SDA250-55</b>	154			
	<b>2 1/4</b>	35.455	<b>SDA250-204</b>	154	<b>60</b>	35.455	<b>SDA250-60</b>	158			
	-	-	-	-	<b>65</b>	35.455	<b>SDA250-65</b>	161			
	-	-	-	-	<b>70</b>	35.455	<b>SDA250-70</b>	164			
	-	-	-	-	<b>75</b>	35.455	<b>SDA250-75</b>	168			
	-	-	-	-	<b>85</b>	35.455	<b>SDA250-85</b>	175			

<sup>1)</sup> See page 275 for table of hexagon sizes of bolts, nuts and related thread diameters.

# Accessories for S-Series, X-Edition Wrenches

## TSP RTEX SRSX Series



### TSP-Series, Pro Series Swivel

- Robust interlocking design
- 360° X-axis and 160° Y-axis rotation
- Increases tool fit in restricted access areas
- Simplifies hose placement
- Includes male and female couplers

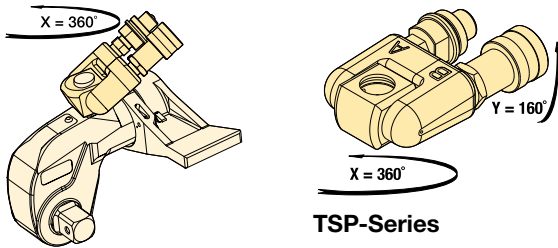

For Torque Wrench Model Number	Model Number <sup>1)</sup>	Maximum Pressure (bar)	Weight (kg)
S1500X, S3000X, S6000X, S11000X, S25000X	TSP300	690	0,2

<sup>1)</sup> To order a S-Series (X-edition) torque wrench fitted with a TSP300 tilt and swivel manifold, insert a "P" prior to the "X" in the tool model number, example: **S1500PX**. TSP300 is designed for X-Edition tools only, and is not compatible with standard edition tools. For replacement components for existing tools, refer to repair sheet on [www.enerpac.com](http://www.enerpac.com)

### RTEX-Series, Reaction Tube Extensions

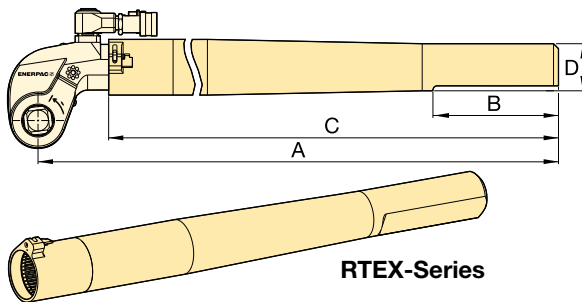

- Full torque rated
- Increases tool fit in restricted access areas

For Torque Wrench Model Number	Model Number	Dimensions (mm)				Weight (kg) *
		A	B	C	D	
S1500X	RTE15X	706	152	636	58	4,6
S3000X	RTE30X	733	152	647	57	5,5
S6000X	RTE60X	747	152	659	65	7,7
S11000X	RTE110X	769	152	675	76	11,2
S25000X	RTE250X	813	152	685	100	17,3

\* Weights indicated are for the accessories only and do not include the wrench.

### SRSX-Series, Extended Reaction Arms

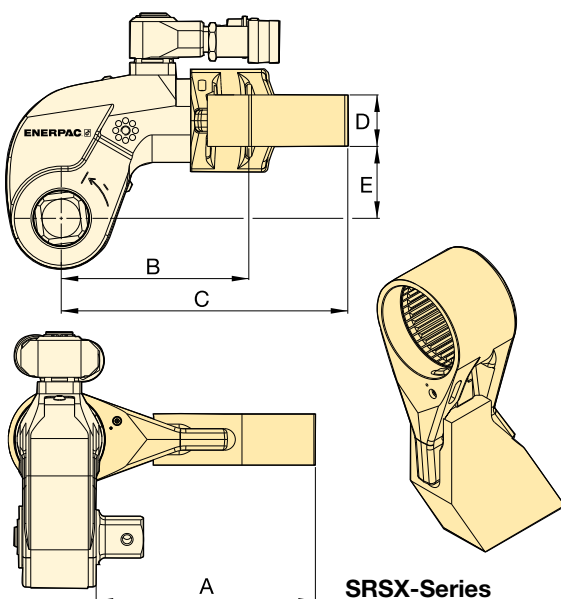

- Lightweight interchangeable design

For Wrench Model	Max. Torque (Nm)	Model Number	Dimensions (mm)					Weight (kg) *
			A	B	C	D	E	
S1500X	1801	SRS151X	94	86	127	24	34	0,8
	1641	SRS152X	119	97	138	24	34	1,0
	1533	SRS153X	145	109	148	24	34	1,2
S3000X	3918	SRS301X	111	106	168	34	48	1,6
	3712	SRS302X	137	117	182	34	48	2,0
	3574	SRS303X	162	132	198	34	48	2,5
S6000X	7842	SRS601X	138	128	192	39	62	2,3
	7454	SRS602X	163	144	207	39	62	2,7
	7175	SRS603X	189	159	222	39	62	3,4
S11000X	14.650	SRS1101X	149	157	232	46	76	4,4
	13.957	SRS1102X	175	172	247	46	76	5,1
	13.391	SRS1103X	200	187	261	46	76	5,8
S25000X	33.538	SRS2501X	183	209	295	50	100	7,6
	32.049	SRS2502X	208	222	310	50	100	8,4
	30.750	SRS2503X	233	236	326	50	100	10,0

\* Weights indicated are for the accessories only and do not include the wrench.

# BSH-Series, Heavy-Duty Sockets

- Heavy-duty impact sockets
- Supplied with "Pin and Ring"

## METRIC SOCKETS

¾" Square Drive		1" Square Drive		1½" Square Drive		2½" Square Drive	
Model Number	A/F (mm)	Model Number	A/F (mm)	Model Number	A/F (mm)	Model Number	A/F (mm)
BSH7519	19	BSH1019	19	BSH1536	36	BSH2565	65
BSH7524	24	BSH1024	24	BSH15163	41	BSH2570	70
BSH7527	27	BSH1027	27	BSH1546	46	BSH2575	75
BSH7530	30	BSH1030	30	BSH1550	50	BSH2580	80
BSH7532	32	BSH1032	32	BSH1555	55	BSH2585	85
BSH7536	36	BSH1036	36	BSH1560	60	BSH2590	90
BSH75163	41	BSH10163	41	BSH1565	65	BSH2595	95
BSH7546	46	BSH1046	46	BSH1570	70	BSH25100	100
BSH7550	50	BSH1050	50	BSH1575	75	BSH25105	105
-	-	BSH1055	55	BSH1580	80	BSH25110	110
-	-	BSH1060	60	BSH1585	85	BSH25115	115
-	-	BSH1065	65	BSH1590	90	BSH25120	120
-	-	BSH1070	70	BSH1595	95	BSH25125	125
-	-	BSH1075	75	BSH15100	100	BSH25135	135
-	-	BSH1080	80	BSH15105	105	BSH25140	140
-	-	BSH1085	85	BSH15110	110	BSH25145	145
-	-	BSH1090	90	BSH15115	115	BSH25150	150
-	-	BSH1095	95	-	-	BSH25155	155
-	-	BSH10100	100	-	-	-	-

## BSH Series



Hexagon Size:

**19 - 155 mm | ¾" - 6 1/8"**



### Select the Right Torque

Choose your Enerpac Torque Wrench using the untightening rule of thumb: Loosening torque equals about 250% of tightening torque.

Page: 276

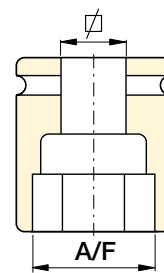

### Hexagon Bolt and Nut Sizes

See the table of hexagon sizes of bolts, nuts and related thread diameters.

Page: 275

## IMPERIAL SOCKETS

¾" Square Drive		1" Square Drive				1½" Square Drive				2½" Square Drive			
Model Number	A/F (inch)	Model Number	A/F (inch)	Model Number	A/F (inch)	Model Number	A/F (inch)	Model Number	A/F (inch)	Model Number	A/F (inch)	Model Number	A/F (inch)
BSH7519	¾"	BSH1019	¾"	BSH10231	2 5/16"	BSH15144	1 7/16"	BSH15281	2 13/16"	BSH25244	2 7/16"	BSH25419	4 3/16"
BSH75088	7/8"	BSH10088	7/8"	BSH10238	2 3/8"	BSH1538	1 1/2"	BSH15288	2 7/8"	BSH25250	2 1/2"	BSH25425	4 1/4"
BSH75094	15/16"	BSH10094	15/16"	BSH10244	2 7/16"	BSH15156	1 9/16"	BSH1575	2 15/16"	BSH2565	2 13/16"	BSH25110	4 5/16"
BSH7527	1 1/16"	BSH1027	1 1/16"	BSH10250	2 1/2"	BSH15163	1 5/8"	BSH15300	3"	BSH25263	2 5/8"	BSH25438	4 3/8"
BSH7530	1 3/16"	BSH1030	1 3/16"	BSH1065	2 9/16"	BSH1543	1 11/16"	BSH15306	3 1/16"	BSH25269	2 11/16"	BSH25450	4 1/2"
BSH75125	1 ¼"	BSH10125	1 ¼"	BSH10263	2 5/8"	BSH15175	1 ¾"	BSH15313	3 1/8"	BSH2570	2 ¾"	BSH25463	4 5/8"
BSH75131	1 5/16"	BSH10131	1 5/16"	BSH10269	2 11/16"	BSH1546	1 13/16"	BSH15319	3 3/16"	BSH25281	2 11/16"	BSH25475	4 ¾"
BSH7535	1 3/8"	BSH1035	1 3/8"	BSH1070	2 ¾"	BSH15188	1 7/8"	BSH15325	3 ¼"	BSH25288	2 7/8"	BSH25488	4 7/8"
BSH75144	1 7/16"	BSH10144	1 7/16"	BSH10281	2 13/16"	BSH15194	1 15/16"	BSH15338	3 3/8"	BSH2575	2 15/16"	BSH25500	5"
BSH7538	1 ½"	BSH1038	1 ½"	BSH10288	2 7/8"	BSH15200	2"	BSH15350	3 1/2"	BSH25300	3"	BSH25513	5 1/8"
BSH75156	1 9/16"	BSH10156	1 9/16"	BSH1075	2 15/16"	BSH15206	2 1/16"	BSH15363	3 5/8"	BSH25306	3 1/16"	BSH25519	5 3/16"
BSH75163	1 5/8"	BSH10163	1 5/8"	BSH10300	3"	BSH15213	2 1/8"	BSH1595	3 ¾"	BSH25313	3 1/8"	BSH25525	5 1/4"
BSH7543	1 11/16"	BSH1043	1 11/16"	BSH10306	3 1/16"	BSH15219	2 3/16"	BSH15388	3 7/8"	BSH25319	3 3/16"	BSH25538	5 3/8"
BSH75175	1 ¾"	BSH10175	1 ¾"	BSH10313	3 1/8"	BSH15225	2 ¼"	BSH15100	3 15/16"	BSH25325	3 ¼"	BSH25140	5 1/2"
BSH7546	1 13/16"	BSH1046	1 13/16"	BSH10319	3 3/16"	BSH15231	2 5/16"	BSH15400	4"	BSH25338	3 3/8"	BSH25575	5 ¾"
BSH75188	1 7/8"	BSH10188	1 7/8"	BSH10325	3 ¼"	BSH15238	2 3/8"	BSH15105	4 1/8"	BSH25350	3 1/2"	BSH25150	5 7/8"
BSH75194	1 15/16"	BSH10194	1 15/16"	BSH10338	3 3/8"	BSH15244	2 7/16"	BSH15419	4 3/16"	BSH25363	3 5/8"	BSH25600	6"
BSH75200	2"	BSH10200	2"	BSH10350	3 1/2"	BSH15250	2 1/2"	BSH15425	4 ¼"	BSH2595	3 ¾"	BSH25613	6 1/8"
-	-	BSH10206	2 1/16"	BSH10363	3 5/8"	BSH1565	2 9/16"	BSH15110	4 5/16"	BSH25388	3 7/8"	-	-
-	-	BSH10213	2 1/8"	BSH1095	3 ¾"	BSH15263	2 5/8"	BSH15438	4 3/8"	BSH25100	3 15/16"	-	-
-	-	BSH10219	2 3/16"	BSH10388	3 7/8"	BSH15269	2 11/16"	BSH15450	4 1/2"	BSH25400	4"	-	-
-	-	BSH10225	2 ¼"	-	-	BSH1570	2 ¾"	BSH15463	4 5/8"	BSH25105	4 1/8"	-	-



Enerpac professional series steel torque wrenches provide reliable controlled tightening solutions across the industry.

### ***S3000X Square Drive Torque Wrench on wind tower erection and maintenance***

*S3000X used to connect wind tower segments during assembly and maintenance. A robust but compact solution is required for tightening of bolts on wind tower sections. Large numbers of fasteners require precise application of torque to ensure joint integrity is achieved and maintained. The Enerpac S-Series wrench was selected as it offers simple and reliable operation while providing accurate and repeatable results.*



### ***W4000X Low Profile Torque Wrench on an API Pipe Flange***

*Throughout the Oil and Gas, Petrochemical and Processing Industries, pipeline joints, valves, pumps and machinery present challenges for controlled bolting. The restricted access on this flange was easily overcome with an Enerpac W-Series Torque Wrench. These wrenches offer reliability and control, ensuring even and consistent torque is applied to all bolts.*



### ***S3000X on an oil and gas flange***

*During maintenance quick turnaround times are essential; S-Series wrenches are chosen as they provide a large angle of nut rotation per stroke, offering speed and accuracy in a compact ergonomic tool.*

▼ Shown: W4206X hexagon cassette with W4000PX drive unit



## Safety and Performance

- Superior strength to size ratio provides easy access to difficult to reach applications without sacrificing endurance
- 30° rotation angle and rapid return stroke provide fast operation
- Tough manifold design with added safety feature for enhanced operator safety

## Simplicity

- Fast release drive unit enables rapid exchange of cassettes, no tools required
- Quick and easy disassembly for maintenance without special tools
- Include robust handle which mounts on both sides and the tops of cassettes to allow for extra maneuverability

## Versatility

- Available with optional enhanced tilt and swivel TSP300 manifold for horizontal and vertical maneuverability, with greater durability <sup>1)</sup>
- X-Edition drive units, cassettes and most accessories are compatible with standard edition tools <sup>1)</sup>
- Drive unit compatible with UltraSlim and WCR-Series cassettes

## Accuracy

- Constant torque output provides accuracy of  $\pm 3\%$  across full stroke.

## Setting New Standards in Safety, Simplicity and Performance



### Two Handle Styles

Robust angled positioning handle comes standard with every W-Series (X-Edition) cassette.

Straight positioning handles designed for extreme limited access applications are available as accessories.

Compatible with W-Series (X-Edition) Cassettes	Model Nr. Angled positioning handles (standard)	Model Nr. Straight positioning handles (optional)
W2000X, W4000X	<b>SWH6A</b>	<b>SWH6S</b>
W8000X, W15000X	<b>SWH10A</b>	<b>SWH10S</b>
W22000X, W35000X	<b>SWH10EA</b> <sup>2)</sup>	

<sup>2)</sup> SWH10EA is an eyebolt handle.



### TSP - Pro Series Swivel

The optional TSP300 tilt and swivel manifold with robust interlocking design provides 360° X-axis rotation and 160° Y-axis rotation.

### How to Order <sup>1)</sup>

Factory fitted to W-Series (X-Edition) drive units: Insert a "P" prior to the "X" in the tool model number, example: **W2000PX**.

Order as an accessory using the model number: **TSP300**, which can be fitted to existing W-Series (X-Edition) drive units. Includes male and female couplers.

Page: **205**



### ATEX declared. Calibration certificate included.

All X-edition tools are CE - ATEX declared and are shipped complete with a calibration certificate.



<sup>1)</sup> TSP300 is designed for X-Edition tools only, and is not compatible with previous edition tools. For replacement components for existing tools, refer to repair sheet on [www.enerpac.com](http://www.enerpac.com)

# Double-Acting Hydraulic Hexagon Torque Wrenches, X-Edition

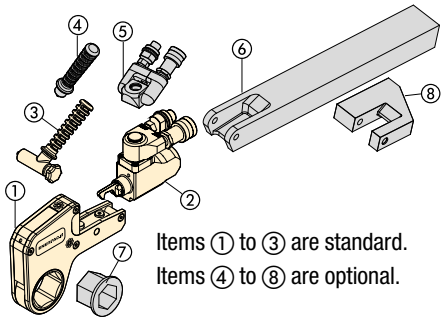

- ① Hexagon Cassette (pages 194-201)
- ② Drive Unit (page 193)
- ③ Angled Positioning Handle (page 192)
- ④ Straight Positioning Handle (page 192)
- ⑤ Pro Series Swivel (page 205)
- ⑥ Extended Reaction Arm (page 205)
- ⑦ Reducer Insert (pages 194-201)
- ⑧ Reaction Paddle (page 205)

Items ① to ③ are standard.  
Items ④ to ⑧ are optional.

## W Series X-Edition



Nominal Torque at 690 bar:

**47.454 Nm**

Hexagon Range:

**30 - 155 mm / 1 1/16 - 6 1/8"**

Nose Radius:

**31 - 115 mm**

Maximum Operating Pressure:

**690 bar**

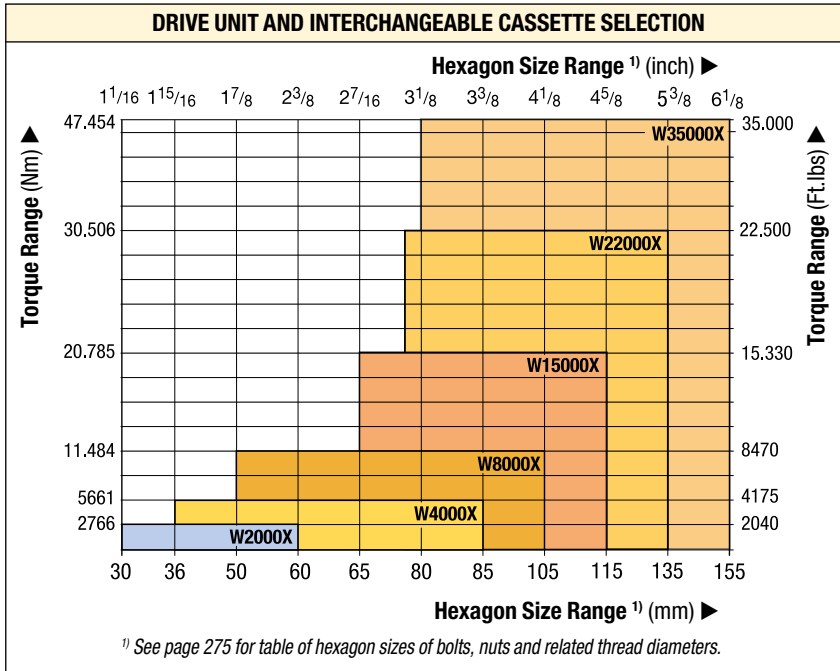

### Torque Wrench Pump Selection Matrix

For optimum speed and performance see the torque wrench and pump matrix.

Page: **212**

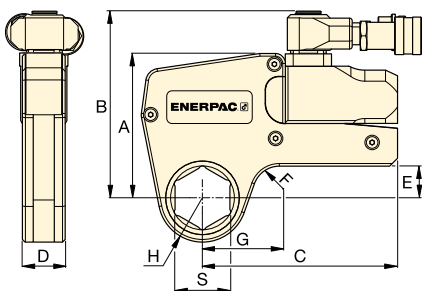

These rigid steel wrenches with low profile interchangeable hexagon cassettes guarantee durability and maximum versatility in bolting applications. ▶



### ▼ SELECTION CHART

Hexagon Range *		Nominal Torque at 690 bar		Drive Unit Model Number **	Minimum Torque		Dimensions (mm) (see pages 194-201 for dimensions G, H and S)						Weight (drive unit without hexagon cassette) (kg)
(mm)	(inch)	(Nm)	(Ft.lbs)		(Nm)	(Ft.lbs)	A	B	C	D	E	F	
30 - 60	1 1/16 - 2 3/8	2766	2040	<b>W2000X</b>	276	204	109	141	148	32	24	20	1,4
36 - 85	1 5/16 - 3 3/8	5661	4175	<b>W4000X</b>	566	417	136	167	178	41	33	20	2,0
50 - 105	1 7/8 - 4 1/8	11.484	8470	<b>W8000X</b>	1148	847	172	205	208	53	42	25	3,0
65 - 115	2 7/16 - 4 5/8	20.785	15.330	<b>W15000X</b>	2078	1533	207	240	253	63	50	20	5,0
75 - 135	2 15/16 - 5 3/8	30.506	22.500	<b>W22000X</b>	3050	2250	227	266	297	77	48	35	7,7
80 - 155	3 1/8 - 6 1/8	47.454	35.000	<b>W35000X</b>	4745	3500	268	301	345	91	69-73	50	11,4

\* With in-line reaction foot.

\*\* To order a W-series wrench fitted with the TSP swivel, suffix the model number with "-P". Example: **W2000PX**.

www.enerpac.com



# W2000X, Inch-Cassettes & Reducer Inserts

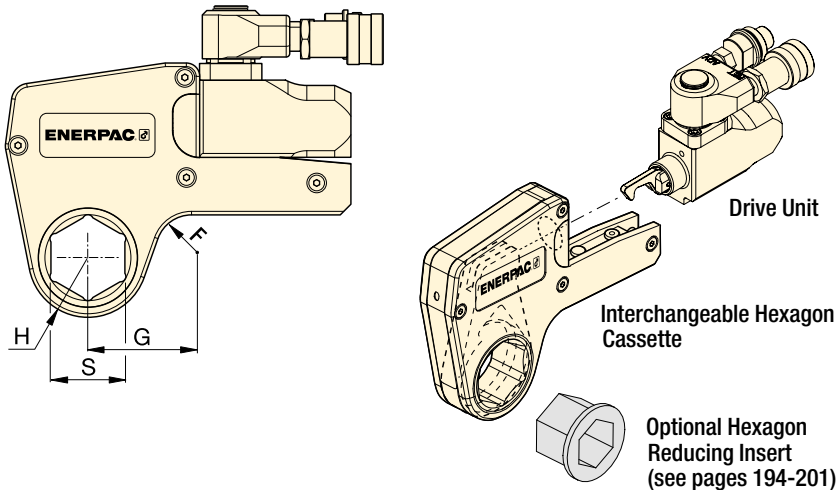

## W Series X-Edition



Nominal Torque at 690 bar:

**2766 Nm**

Hexagon Range:

**1<sup>1</sup>/<sub>16</sub> - 2<sup>3</sup>/<sub>8</sub> inch**

Maximum Operating Pressure:

**690 bar**



### Metric Sizes

For metric sizes of hexagon cassettes and reducer inserts see:

Page: **200**



### Hexagon Bolt and Nut Sizes

See the table for hexagon sizes of bolts, nuts and related thread diameters.

Page: **275**

## ▼ SELECTION CHART

Drive Unit Model Number	Hexagon Size <sup>1)</sup>	Nose Radius	Dim.	Model Number	Weight (kg)	Hexagon Reducer		Hexagon Reducer		Hexagon Reducer	
						Hexagon Reducer (inch)	Model Number	Hexagon Reducer (inch)	Model Number	Hexagon Reducer (inch)	Model Number
<b>W2000X</b>	1 <sup>1</sup> / <sub>16</sub>	31,0	53,7	<b>W2101X</b>	2,1	-	-	-	-	-	-
	1 <sup>1</sup> / <sub>8</sub>	31,0	53,7	<b>W2102X</b>	2,1	-	-	-	-	-	-
	1 <sup>3</sup> / <sub>16</sub>	31,0	53,7	<b>W2103X</b>	2,1	-	-	-	-	-	-
	1 <sup>1</sup> / <sub>4</sub>	31,0	53,7	<b>W2104X</b>	2,1	-	-	-	-	-	-
	1 <sup>5</sup> / <sub>16</sub>	31,0	53,7	<b>W2105X</b>	2,1	-	-	-	-	-	-
	1 <sup>3</sup> / <sub>8</sub>	31,0	53,7	<b>W2106X</b>	2,1	-	-	-	-	-	-
	1 <sup>7</sup> / <sub>16</sub>	31,0	53,7	<b>W2107X</b>	2,1	1 <sup>7</sup> / <sub>16</sub> - 1 <sup>1</sup> / <sub>8</sub>	<b>W2107R102</b>	-	-	-	-
	1 <sup>1</sup> / <sub>2</sub>	33,5	58,2	<b>W2108X</b>	2,2	-	-	-	-	-	-
	1 <sup>9</sup> / <sub>16</sub>	33,5	58,2	<b>W2109X</b>	2,2	-	-	-	-	-	-
	1 <sup>5</sup> / <sub>8</sub>	33,5	58,2	<b>W2110X</b>	2,2	1 <sup>5</sup> / <sub>8</sub> - 1 <sup>1</sup> / <sub>4</sub>	<b>W2110R104</b>	1 <sup>5</sup> / <sub>8</sub> - 1 <sup>3</sup> / <sub>16</sub>	<b>W2110R103</b>	-	-
	1 <sup>11</sup> / <sub>16</sub>	36,5	60,5	<b>W2111X</b>	2,2	-	-	-	-	-	-
	1 <sup>3</sup> / <sub>4</sub>	36,5	60,5	<b>W2112X</b>	2,2	-	-	-	-	-	-
	1 <sup>13</sup> / <sub>16</sub>	36,5	60,5	<b>W2113X</b>	2,2	1 <sup>13</sup> / <sub>16</sub> - 1 <sup>7</sup> / <sub>16</sub>	<b>W2113R107</b>	1 <sup>13</sup> / <sub>16</sub> - 1 <sup>1</sup> / <sub>4</sub>	<b>W2113R104</b>	-	-
	1 <sup>7</sup> / <sub>8</sub>	39,0	63,1	<b>W2114X</b>	2,2	-	-	-	-	-	-
	1 <sup>5</sup> / <sub>8</sub>	39,0	63,1	<b>W2115X</b>	2,2	-	-	-	-	-	-
	2	39,0	63,1	<b>W2200X</b>	2,2	2 - 1 <sup>5</sup> / <sub>8</sub>	<b>W2200R110</b>	2 - 1 <sup>7</sup> / <sub>16</sub>	<b>W2200R107</b>	-	-
	2 <sup>1</sup> / <sub>16</sub>	41,8	68,6	<b>W2201X</b>	2,3	-	-	-	-	-	-
	2 <sup>1</sup> / <sub>8</sub>	41,8	68,6	<b>W2202X</b>	2,3	-	-	-	-	-	-
	2 <sup>3</sup> / <sub>16</sub>	41,8	68,6	<b>W2203X</b>	2,3	2 <sup>3</sup> / <sub>16</sub> - 1 <sup>13</sup> / <sub>16</sub>	<b>W2203R113</b>	2 <sup>3</sup> / <sub>16</sub> - 1 <sup>5</sup> / <sub>8</sub>	<b>W2203R110</b>	2 <sup>3</sup> / <sub>16</sub> - 1 <sup>7</sup> / <sub>16</sub>	<b>W2203R107</b>
	2 <sup>1</sup> / <sub>4</sub>	44,5	64,8	<b>W2204X</b>	2,2	-	-	-	-	-	-
2 <sup>5</sup> / <sub>16</sub>	44,5	64,8	<b>W2205X</b>	2,2	-	-	-	-	-	-	
2 <sup>3</sup> / <sub>8</sub>	44,5	64,8	<b>W2206X</b>	2,2	2 <sup>3</sup> / <sub>8</sub> - 2	<b>W2206R200</b>	2 <sup>3</sup> / <sub>8</sub> - 1 <sup>7</sup> / <sub>8</sub>	<b>W2206R114</b>	2 <sup>3</sup> / <sub>8</sub> - 1 <sup>13</sup> / <sub>16</sub>	<b>W2206R113</b>	
-	-	-	-	-	-	2 <sup>3</sup> / <sub>8</sub> - 1 <sup>1</sup> / <sub>2</sub>	<b>W2206R108</b>	2 <sup>3</sup> / <sub>8</sub> - 1 <sup>7</sup> / <sub>16</sub>	<b>W2206R107</b>	2 <sup>3</sup> / <sub>8</sub> - 1 <sup>5</sup> / <sub>16</sub>	<b>W2206R110</b>

<sup>1)</sup> See page 275 for table of hexagon sizes of bolts, nuts and related thread diameters.



# W4000X-Series, Inch-Cassettes & Reducer Inserts

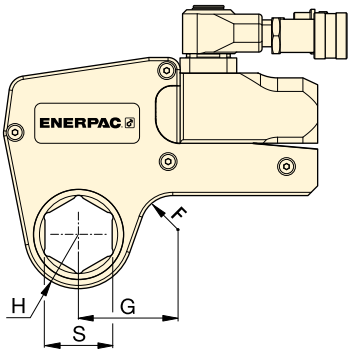

Nominal Torque at 690 bar:

**5661 Nm**

Hexagon Range:

**1<sup>5</sup>/<sub>16</sub> - 3<sup>3</sup>/<sub>8</sub> inch**

Maximum Operating Pressure:

**690 bar**

**W**  
Series  
X-Edition



Drive Unit Model Number	Hexagon Size <sup>1)</sup>	Nose Radius	Dim.	Model Number	Weight (kg)	Hexagon Reducer		Hexagon Reducer		Hexagon Reducer	
						Hexagon Reducer (inch)	Model Number	Hexagon Reducer (inch)	Model Number	Hexagon Reducer (inch)	Model Number
<b>W4000X</b>	1 <sup>5</sup> / <sub>16</sub>	37,0	61,0	<b>W4105X</b>	3,7	-	-	-	-	-	-
	1 <sup>3</sup> / <sub>8</sub>	37,0	61,0	<b>W4106X</b>	3,7	-	-	-	-	-	-
	1 <sup>7</sup> / <sub>16</sub>	37,0	61,0	<b>W4107X</b>	3,7	-	-	-	-	-	-
	1 <sup>1</sup> / <sub>2</sub>	37,0	61,0	<b>W4108X</b>	3,7	-	-	-	-	-	-
	1 <sup>9</sup> / <sub>16</sub>	37,0	61,0	<b>W4109X</b>	3,7	-	-	-	-	-	-
	1 <sup>5</sup> / <sub>8</sub>	37,0	61,0	<b>W4110X</b>	3,7	-	-	-	-	-	-
	1 <sup>11</sup> / <sub>16</sub>	39,5	64,0	<b>W4111X</b>	3,8	-	-	-	-	-	-
	1 <sup>3</sup> / <sub>4</sub>	39,5	64,0	<b>W4112X</b>	3,8	-	-	-	-	-	-
	1 <sup>13</sup> / <sub>16</sub>	39,5	64,0	<b>W4113X</b>	3,8	-	-	-	-	-	-
	1 <sup>7</sup> / <sub>8</sub>	41,5	66,7	<b>W4114X</b>	3,9	-	-	-	-	-	-
	1 <sup>15</sup> / <sub>16</sub>	41,5	66,7	<b>W4115X</b>	3,9	-	-	-	-	-	-
	2	41,5	66,7	<b>W4200X</b>	3,9	2 - 1 <sup>7</sup> / <sub>16</sub>	<b>W4200R107</b>	-	-	-	-
	2 <sup>1</sup> / <sub>16</sub>	44,0	73,4	<b>W4201X</b>	4,0	-	-	-	-	-	-
	2 <sup>1</sup> / <sub>8</sub>	44,0	73,4	<b>W4202X</b>	4,0	-	-	-	-	-	-
	2 <sup>3</sup> / <sub>16</sub>	44,0	73,4	<b>W4203X</b>	4,0	2 <sup>3</sup> / <sub>16</sub> - 1 <sup>5</sup> / <sub>8</sub>	<b>W4203R110</b>	2 <sup>3</sup> / <sub>16</sub> - 1 <sup>7</sup> / <sub>16</sub>	<b>W4203R107</b>	2 <sup>3</sup> / <sub>16</sub> - 1 <sup>1</sup> / <sub>4</sub>	<b>W4203R104</b>
	2 <sup>1</sup> / <sub>4</sub>	46,5	70,6	<b>W4204X</b>	4,1	-	-	-	-	-	-
	2 <sup>5</sup> / <sub>16</sub>	46,5	70,6	<b>W4205X</b>	4,1	-	-	-	-	-	-
	2 <sup>3</sup> / <sub>8</sub>	46,5	70,6	<b>W4206X</b>	4,1	2 <sup>3</sup> / <sub>8</sub> - 2	<b>W4206R200</b>	2 <sup>3</sup> / <sub>8</sub> - 1 <sup>13</sup> / <sub>16</sub>	<b>W4206R113</b>	2 <sup>3</sup> / <sub>8</sub> - 1 <sup>7</sup> / <sub>16</sub>	<b>W4206R107</b>
	-	-	-	-	-	2 <sup>3</sup> / <sub>8</sub> - 1 <sup>3</sup> / <sub>8</sub>	<b>W4206R106</b>	-	-	-	-
	2 <sup>7</sup> / <sub>16</sub>	49,5	76,2	<b>W4207X</b>	4,1	2 <sup>7</sup> / <sub>16</sub> - 2	<b>W4207R200</b>	-	-	-	-
	2 <sup>1</sup> / <sub>2</sub>	49,5	76,2	<b>W4208X</b>	4,1	2 <sup>1</sup> / <sub>2</sub> - 2	<b>W4208R200</b>	2 <sup>1</sup> / <sub>2</sub> - 1 <sup>7</sup> / <sub>16</sub>	<b>W4208R113</b>	2 <sup>1</sup> / <sub>2</sub> - 2 <sup>1</sup> / <sub>16</sub>	<b>W4208R201</b>
	2 <sup>9</sup> / <sub>16</sub>	49,5	76,2	<b>W4209X</b>	4,1	2 <sup>9</sup> / <sub>16</sub> - 2 <sup>3</sup> / <sub>16</sub>	<b>W4209R203</b>	2 <sup>9</sup> / <sub>16</sub> - 2 <sup>1</sup> / <sub>8</sub>	<b>W4209R202</b>	2 <sup>9</sup> / <sub>16</sub> - 2 <sup>1</sup> / <sub>16</sub>	<b>W4209R201</b>
	-	-	-	-	-	2 <sup>9</sup> / <sub>16</sub> - 2	<b>W4209R200</b>	2 <sup>9</sup> / <sub>16</sub> - 1 <sup>13</sup> / <sub>16</sub>	<b>W4209R113</b>	-	-
	2 <sup>5</sup> / <sub>8</sub>	52,5	78,3	<b>W4210X</b>	4,2	-	-	-	-	-	-
	2 <sup>11</sup> / <sub>16</sub>	52,5	78,3	<b>W4211X</b>	4,2	-	-	-	-	-	-
	2 <sup>3</sup> / <sub>4</sub>	52,5	78,3	<b>W4212X</b>	4,2	2 <sup>3</sup> / <sub>4</sub> - 2 <sup>3</sup> / <sub>8</sub>	<b>W4212R206</b>	2 <sup>3</sup> / <sub>4</sub> - 2 <sup>3</sup> / <sub>16</sub>	<b>W4212R203</b>	2 <sup>3</sup> / <sub>4</sub> - 2 <sup>1</sup> / <sub>8</sub>	<b>W4212R202</b>
	2 <sup>13</sup> / <sub>16</sub>	55,3	81,6	<b>W4213X</b>	4,3	-	-	-	-	-	-
	2 <sup>7</sup> / <sub>8</sub>	55,3	81,6	<b>W4214X</b>	4,3	-	-	-	-	-	-
	2 <sup>15</sup> / <sub>16</sub>	55,3	81,6	<b>W4215X</b>	4,3	2 <sup>15</sup> / <sub>16</sub> - 2 <sup>9</sup> / <sub>16</sub>	<b>W4215R209</b>	2 <sup>15</sup> / <sub>16</sub> - 2 <sup>3</sup> / <sub>8</sub>	<b>W4215R206</b>	2 <sup>15</sup> / <sub>16</sub> - 2 <sup>3</sup> / <sub>16</sub>	<b>W4215R203</b>
	-	-	-	-	-	2 <sup>15</sup> / <sub>16</sub> - 2	<b>W4215R200</b>	-	-	-	-
	3	58,5	83,5	<b>W4300X</b>	4,4	3 - 2 <sup>9</sup> / <sub>16</sub>	<b>W4300R203</b>	-	-	-	-
	3 <sup>1</sup> / <sub>16</sub>	58,5	83,5	<b>W4301X</b>	4,4	-	-	-	-	-	-
	3 <sup>1</sup> / <sub>8</sub>	58,5	83,5	<b>W4302X</b>	4,4	3 <sup>1</sup> / <sub>8</sub> - 2 <sup>3</sup> / <sub>4</sub>	<b>W4302R212</b>	3 <sup>1</sup> / <sub>8</sub> - 2 <sup>9</sup> / <sub>16</sub>	<b>W4302R209</b>	3 <sup>1</sup> / <sub>8</sub> - 2 <sup>3</sup> / <sub>8</sub>	<b>W4302R206</b>
	-	-	-	-	-	3 <sup>1</sup> / <sub>8</sub> - 2 <sup>5</sup> / <sub>16</sub>	<b>W4302R205</b>	3 <sup>1</sup> / <sub>8</sub> - 2 <sup>1</sup> / <sub>4</sub>	<b>W4302R204</b>	3 <sup>1</sup> / <sub>8</sub> - 2 <sup>3</sup> / <sub>16</sub>	<b>W4302R203</b>
	-	-	-	-	-	3 <sup>1</sup> / <sub>8</sub> - 2 <sup>3</sup> / <sub>16</sub>	<b>W4302R203</b>	3 <sup>1</sup> / <sub>8</sub> - 2 <sup>1</sup> / <sub>8</sub>	<b>W4302R202</b>	3 <sup>1</sup> / <sub>8</sub> - 2	<b>W4302R200</b>
	3 <sup>3</sup> / <sub>16</sub>	62,0	85,5	<b>W4303X</b>	4,5	-	-	-	-	-	-
3 <sup>1</sup> / <sub>4</sub>	62,0	85,5	<b>W4304X</b>	4,5	-	-	-	-	-	-	
3 <sup>5</sup> / <sub>16</sub>	62,0	85,5	<b>W4305X</b>	4,5	-	-	-	-	-	-	
3 <sup>3</sup> / <sub>8</sub>	62,0	85,5	<b>W4306X</b>	4,5	-	-	-	-	-	-	

<sup>1)</sup> See page 275 for table of hexagon sizes of bolts, nuts and related thread diameters.

# W8000X-Series, Inch-Cassettes & Reducers

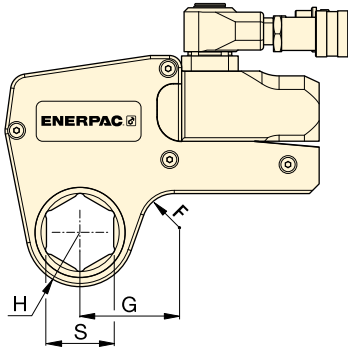

Nominal Torque at 690 bar:

**11.484 Nm**

Hexagon Range:

**1<sup>7</sup>/<sub>8</sub> - 4<sup>1</sup>/<sub>8</sub> inch**

Maximum Operating Pressure:

**690 bar**

**W**  
Series  
X-Edition



▼ SELECTION CHART

Drive Unit Model Number	Hexagon Size <sup>1)</sup>	Nose Radius	Dim.	Model Number	Weight (kg)	Hexagon Reducer		Hexagon Reducer		Hexagon Reducer	
						Hexagon Reducer (inch)	Model Number	Hexagon Reducer (inch)	Model Number	Hexagon Reducer (inch)	Model Number
W8000X	S (inch)	H (mm)	G (mm)		(kg)	Hexagon Reducer (inch)	Model Number	Hexagon Reducer (inch)	Model Number	Hexagon Reducer (inch)	Model Number
	1 <sup>7</sup> / <sub>8</sub>	45,0	78,2	W8114X	8,1	–	–	–	–	–	–
	1 <sup>15</sup> / <sub>16</sub>	45,0	78,2	W8115X	8,1	–	–	–	–	–	–
	2	45,0	78,2	W8200X	8,1	–	–	–	–	–	–
	2 <sup>1</sup> / <sub>16</sub>	48,0	80,0	W8201X	8,1	–	–	–	–	–	–
	2 <sup>1</sup> / <sub>8</sub>	48,0	80,0	W8202X	8,1	–	–	–	–	–	–
	2 <sup>3</sup> / <sub>16</sub>	48,0	80,0	W8203X	8,1	–	–	–	–	–	–
	2 <sup>1</sup> / <sub>4</sub>	51,0	82,5	W8204X	8,1	–	–	–	–	–	–
	2 <sup>5</sup> / <sub>16</sub>	51,0	82,5	W8205X	8,1	–	–	–	–	–	–
	2 <sup>3</sup> / <sub>8</sub>	51,0	82,5	W8206X	8,1	–	–	–	–	–	–
	2 <sup>7</sup> / <sub>16</sub>	52,5	85,9	W8207X	8,1	–	–	–	–	–	–
	2 <sup>1</sup> / <sub>2</sub>	52,5	85,9	W8208X	8,1	–	–	–	–	–	–
	2 <sup>9</sup> / <sub>16</sub>	52,5	85,9	W8209X	8,1	2 <sup>9</sup> / <sub>16</sub> - 2	W8209R200	–	–	–	–
	2 <sup>5</sup> / <sub>8</sub>	56,0	84,8	W8210X	8,1	–	–	–	–	–	–
	2 <sup>11</sup> / <sub>16</sub>	56,0	84,8	W8211X	7,9	–	–	–	–	–	–
	2 <sup>3</sup> / <sub>4</sub>	56,0	84,8	W8212X	7,9	2 <sup>3</sup> / <sub>4</sub> - 2 <sup>3</sup> / <sub>16</sub>	W8212R203	–	–	–	–
	2 <sup>13</sup> / <sub>16</sub>	58,0	85,0	W8213X	7,9	–	–	–	–	–	–
	2 <sup>7</sup> / <sub>8</sub>	58,0	85,0	W8214X	7,9	–	–	–	–	–	–
	2 <sup>15</sup> / <sub>16</sub>	58,0	85,0	W8215X	7,9	2 <sup>15</sup> / <sub>16</sub> - 2 <sup>3</sup> / <sub>8</sub>	W8215R206	2 <sup>15</sup> / <sub>16</sub> - 2 <sup>3</sup> / <sub>16</sub>	W8215R203	–	–
	3	60,5	89,5	W8300X	8,0	–	–	–	–	–	–
	3 <sup>1</sup> / <sub>16</sub>	60,5	89,5	W8301X	8,0	–	–	–	–	–	–
	3 <sup>1</sup> / <sub>8</sub>	60,5	89,5	W8302X	8,0	3 <sup>1</sup> / <sub>8</sub> - 2 <sup>9</sup> / <sub>16</sub>	W8302R209	3 <sup>1</sup> / <sub>8</sub> - 2 <sup>3</sup> / <sub>8</sub>	W8302R206	3 <sup>1</sup> / <sub>8</sub> - 2 <sup>9</sup> / <sub>16</sub>	W8302R203
	–	–	–	–	–	3 <sup>1</sup> / <sub>8</sub> - 2	W8302R200	–	–	–	–
	3 <sup>3</sup> / <sub>16</sub>	66,0	92,2	W8303X	8,2	–	–	–	–	–	–
	3 <sup>1</sup> / <sub>4</sub>	66,0	92,2	W8304X	8,2	–	–	–	–	–	–
	3 <sup>5</sup> / <sub>16</sub>	66,0	92,2	W8305X	8,2	–	–	–	–	–	–
	3 <sup>3</sup> / <sub>8</sub>	66,0	92,2	W8306X	8,2	–	–	–	–	–	–
	3 <sup>7</sup> / <sub>16</sub>	66,0	92,2	W8307IX	8,2	–	–	–	–	–	–
	3 <sup>1</sup> / <sub>2</sub>	66,0	92,2	W8308X	8,2	3 <sup>1</sup> / <sub>2</sub> - 3	W8308R300	3 <sup>1</sup> / <sub>2</sub> - 2 <sup>15</sup> / <sub>16</sub>	W8308R215	3 <sup>1</sup> / <sub>2</sub> - 2 <sup>3</sup> / <sub>4</sub>	W8308R212
	3 <sup>9</sup> / <sub>16</sub>	74,0	102,9	W8309X	8,8	–	–	–	–	–	–
	3 <sup>5</sup> / <sub>8</sub>	74,0	102,9	W8310X	8,8	–	–	–	–	–	–
	3 <sup>11</sup> / <sub>16</sub>	74,0	102,9	W8311X	8,8	–	–	–	–	–	–
3 <sup>3</sup> / <sub>4</sub>	74,0	102,9	W8312X	8,8	3 <sup>3</sup> / <sub>4</sub> - 3 <sup>1</sup> / <sub>8</sub>	W8312R302	3 <sup>3</sup> / <sub>4</sub> - 2 <sup>15</sup> / <sub>16</sub>	W8312R215	3 <sup>3</sup> / <sub>4</sub> - 2 <sup>3</sup> / <sub>4</sub>	W8312R212	
3 <sup>13</sup> / <sub>16</sub>	74,0	102,9	W8313X	8,8	–	–	–	–	–	–	
3 <sup>7</sup> / <sub>8</sub>	74,0	102,9	W8314X	8,8	3 <sup>7</sup> / <sub>8</sub> - 3 <sup>1</sup> / <sub>8</sub>	W8314R302	3 <sup>7</sup> / <sub>8</sub> - 2 <sup>15</sup> / <sub>16</sub>	W8314R215	–	–	
3 <sup>15</sup> / <sub>16</sub>	79,5	110,0	W8315X	9,3	–	–	–	–	–	–	
4	79,5	110,0	W8400X	9,3	–	–	–	–	–	–	
4 <sup>1</sup> / <sub>16</sub>	79,5	110,0	W8401IX	9,3	–	–	–	–	–	–	
4 <sup>1</sup> / <sub>8</sub>	79,5	110,0	W8402X	9,3	–	–	–	–	–	–	

<sup>1)</sup> See page 275 for table of hexagon sizes of bolts, nuts and related thread diameters.

# W15000X-Series, Inch-Cassettes & Reducer Inserts

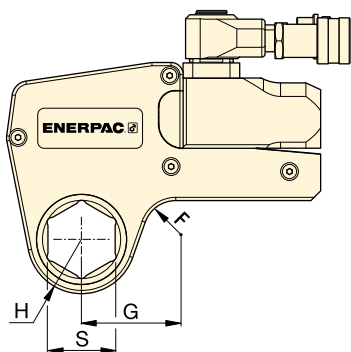

Nominal Torque at 690 bar:

**20.785 Nm**

Hexagon Range:

**2<sup>1</sup>/<sub>8</sub> - 4<sup>5</sup>/<sub>8</sub> inch**

Maximum Operating Pressure:

**690 bar**

**W**  
Series  
X-Edition



▼ SELECTION CHART

Drive Unit Model Number	Hexagon Size <sup>1)</sup>	Nose Radius	Dim.	Model Number	Weight	Hexagon Reducer		Hexagon Reducer		Hexagon Reducer	
						Hexagon Reducer (inch)	Model Number	Hexagon Reducer (inch)	Model Number	Hexagon Reducer (inch)	Model Number
W15000X	S (inch)	H (mm)	G (mm)		(kg)						
	2 <sup>7</sup> / <sub>16</sub>	59,0	88,6	W15207X	13,6	-	-	-	-	-	-
	2 <sup>1</sup> / <sub>2</sub>	59,0	88,6	W15208X	13,6	-	-	-	-	-	-
	2 <sup>9</sup> / <sub>16</sub>	59,0	88,6	W15209X	13,6	-	-	-	-	-	-
	2 <sup>5</sup> / <sub>8</sub>	59,0	88,6	W15210X	13,6	-	-	-	-	-	-
	2 <sup>11</sup> / <sub>16</sub>	59,0	88,6	W15211X	13,6	-	-	-	-	-	-
	2 <sup>3</sup> / <sub>4</sub>	59,0	88,6	W15212X	13,6	-	-	-	-	-	-
	2 <sup>13</sup> / <sub>16</sub>	62,0	90,5	W15213X	13,7	-	-	-	-	-	-
	2 <sup>7</sup> / <sub>8</sub>	62,0	90,5	W15214X	13,7	-	-	-	-	-	-
	2 <sup>15</sup> / <sub>16</sub>	62,0	90,5	W15215X	13,7	-	-	-	-	-	-
	3	64,5	92,9	W15300X	13,8	3 - 2 <sup>1</sup> / <sub>8</sub>	W15300R202	-	-	-	-
	3 <sup>1</sup> / <sub>16</sub>	64,5	92,9	W15301X	13,8	-	-	-	-	-	-
	3 <sup>1</sup> / <sub>8</sub>	64,5	92,9	W15302X	13,8	3 <sup>1</sup> / <sub>8</sub> - 2 <sup>9</sup> / <sub>16</sub>	W15302R209	-	-	-	-
	3 <sup>3</sup> / <sub>16</sub>	69,5	96,6	W15303X	14,1	-	-	-	-	-	-
	3 <sup>1</sup> / <sub>4</sub>	69,5	96,6	W15304X	14,1	-	-	-	-	-	-
	3 <sup>5</sup> / <sub>16</sub>	69,5	96,6	W15305X	14,1	-	-	-	-	-	-
	3 <sup>3</sup> / <sub>8</sub>	69,5	96,6	W15306X	14,1	-	-	-	-	-	-
	3 <sup>7</sup> / <sub>16</sub>	69,5	96,6	W15307IX	14,1	-	-	-	-	-	-
	3 <sup>1</sup> / <sub>2</sub>	69,5	96,6	W15308X	14,1	3 <sup>1</sup> / <sub>2</sub> - 2 <sup>15</sup> / <sub>16</sub>	W15308R215	3 <sup>1</sup> / <sub>2</sub> - 2 <sup>3</sup> / <sub>4</sub>	W15308R212	-	-
	3 <sup>9</sup> / <sub>16</sub>	75,0	101,8	W15309X	14,6	-	-	-	-	-	-
	3 <sup>5</sup> / <sub>8</sub>	75,0	101,8	W15310X	14,6	-	-	-	-	-	-
	3 <sup>11</sup> / <sub>16</sub>	75,0	101,8	W15311X	14,6	-	-	-	-	-	-
	3 <sup>3</sup> / <sub>4</sub>	75,0	101,8	W15312X	14,6	3 <sup>3</sup> / <sub>4</sub> - 3 <sup>1</sup> / <sub>8</sub>	W15312R302	3 <sup>3</sup> / <sub>4</sub> - 2 <sup>15</sup> / <sub>16</sub>	W15312R215	-	-
	3 <sup>13</sup> / <sub>16</sub>	75,0	101,8	W15313X	14,5	-	-	-	-	-	-
	3 <sup>7</sup> / <sub>8</sub>	75,0	101,8	W15314X	14,5	3 <sup>7</sup> / <sub>8</sub> - 3 <sup>1</sup> / <sub>8</sub>	W15314R302	3 <sup>7</sup> / <sub>8</sub> - 2 <sup>15</sup> / <sub>16</sub>	W15314R215	-	-
	3 <sup>15</sup> / <sub>16</sub>	80,5	103,1	W15315X	14,8	-	-	-	-	-	-
	4	80,5	103,1	W15400X	14,8	-	-	-	-	-	-
	4 <sup>1</sup> / <sub>16</sub>	80,5	103,1	W15401IX	14,8	-	-	-	-	-	-
	4 <sup>1</sup> / <sub>8</sub>	80,5	103,1	W15402X	14,8	4 <sup>1</sup> / <sub>8</sub> - 3 <sup>1</sup> / <sub>2</sub>	W15402R308	4 <sup>1</sup> / <sub>8</sub> - 3 <sup>5</sup> / <sub>16</sub>	W15402R305	4 <sup>1</sup> / <sub>8</sub> - 3 <sup>1</sup> / <sub>4</sub>	W15402R304
	4 <sup>3</sup> / <sub>16</sub>	80,5	103,1	W15403IX	14,8	-	-	-	-	-	-
	4 <sup>1</sup> / <sub>4</sub>	80,5	103,1	W15404X	14,8	4 <sup>1</sup> / <sub>4</sub> - 3 <sup>1</sup> / <sub>2</sub>	W15404R308	4 <sup>1</sup> / <sub>4</sub> - 3 <sup>1</sup> / <sub>8</sub>	W15404R302	-	-
	4 <sup>5</sup> / <sub>16</sub>	87,5	114,8	W15405X	15,1	-	-	-	-	-	-
4 <sup>3</sup> / <sub>8</sub>	87,5	114,8	W15406X	15,1	-	-	-	-	-	-	
4 <sup>7</sup> / <sub>16</sub>	87,5	114,8	W15407X	15,1	-	-	-	-	-	-	
4 <sup>1</sup> / <sub>2</sub>	87,5	114,8	W15408IX	15,1	-	-	-	-	-	-	
4 <sup>9</sup> / <sub>16</sub>	87,5	114,8	W15409IX	15,1	-	-	-	-	-	-	
4 <sup>5</sup> / <sub>8</sub>	87,5	114,8	W15410IX	15,1	4 <sup>5</sup> / <sub>8</sub> - 3 <sup>15</sup> / <sub>16</sub>	W15410R315	4 <sup>5</sup> / <sub>8</sub> - 3 <sup>7</sup> / <sub>8</sub>	W15410R314	4 <sup>5</sup> / <sub>8</sub> - 3 <sup>3</sup> / <sub>4</sub>	W15410R312	
-	-	-	-	-	-	4 <sup>5</sup> / <sub>8</sub> - 3 <sup>1</sup> / <sub>2</sub>	W15410R308	-	-	-	
-	-	-	-	-	-	-	-	-	-	-	

<sup>1)</sup> See page 275 for table of hexagon sizes of bolts, nuts and related thread diameters.

# W22000X, Inch-Cassettes & Reducers

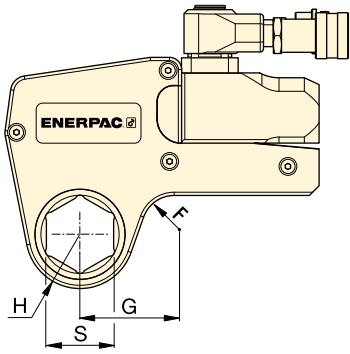

Nominal Torque at 690 bar:

**30.506 Nm**

Hexagon Range:

**2<sup>15</sup>/<sub>16</sub> - 5<sup>3</sup>/<sub>8</sub> inch**

Maximum Operating Pressure:

**690 bar**

**W**  
Series  
X-Edition



▼ **SELECTION CHART**

Drive Unit Model Number	Hexagon Size <sup>1)</sup> S (inch)	Nose Radius H (mm)	G (mm)	Model Nr. Cassette	Weight (kg)	Hexagon Reducer		Hexagon Reducer		Hexagon Reducer	
						Hexagon Reducer (inch)	Model Number Reducer	Hexagon Reducer (inch)	Model Number Reducer	Hexagon Reducer (inch)	Model Number Reducer
<b>W22000X</b>	2 <sup>15</sup> / <sub>16</sub>	67,0	102,1	<b>W22215X</b>	22,1	-	-	-	-	-	-
	<b>3</b>	67,0	102,1	<b>W22300X</b>	22,0	-	-	-	-	-	-
	3 <sup>1</sup> / <sub>16</sub>	67,0	102,1	<b>W22301X</b>	21,9	-	-	-	-	-	-
	3 <sup>1</sup> / <sub>8</sub>	67,0	102,1	<b>W22302X</b>	21,6	3 <sup>1</sup> / <sub>8</sub> - 2 <sup>3</sup> / <sub>8</sub>	<b>W22302R206</b>	3 <sup>1</sup> / <sub>8</sub> - 2 <sup>3</sup> / <sub>16</sub>	<b>W22302R203</b>	-	-
	3 <sup>3</sup> / <sub>16</sub>	72,4	107,4	<b>W22303X</b>	22,9	-	-	-	-	-	-
	3 <sup>1</sup> / <sub>4</sub>	72,4	107,4	<b>W22304X</b>	22,8	-	-	-	-	-	-
	3 <sup>5</sup> / <sub>16</sub>	72,4	107,4	<b>W22305X</b>	22,6	-	-	-	-	-	-
	3 <sup>3</sup> / <sub>8</sub>	72,4	107,4	<b>W22306X</b>	22,5	-	-	-	-	-	-
	3 <sup>7</sup> / <sub>16</sub>	72,4	107,4	<b>W22307IX</b>	22,8	-	-	-	-	-	-
	3 <sup>1</sup> / <sub>2</sub>	72,4	107,4	<b>W22308X</b>	22,2	3 <sup>1</sup> / <sub>2</sub> - 2 <sup>3</sup> / <sub>4</sub>	<b>W22308R212</b>	3 <sup>1</sup> / <sub>2</sub> - 2 <sup>9</sup> / <sub>16</sub>	<b>W22308R209</b>	3 <sup>1</sup> / <sub>2</sub> - 2 <sup>3</sup> / <sub>8</sub>	<b>W22308R206</b>
	3 <sup>9</sup> / <sub>16</sub>	77,9	113,0	<b>W22309X</b>	23,4	-	-	-	-	-	-
	3 <sup>5</sup> / <sub>8</sub>	77,9	113,0	<b>W22310X</b>	23,3	-	-	-	-	-	-
	3 <sup>11</sup> / <sub>16</sub>	77,9	113,0	<b>W22311X</b>	23,1	-	-	-	-	-	-
	3 <sup>3</sup> / <sub>4</sub>	77,9	113,0	<b>W22312X</b>	22,9	3 <sup>3</sup> / <sub>4</sub> - 2 <sup>15</sup> / <sub>16</sub>	<b>W22312R215</b>	-	-	-	-
	3 <sup>13</sup> / <sub>16</sub>	77,9	113,0	<b>W22313X</b>	22,8	-	-	-	-	-	-
	3 <sup>7</sup> / <sub>8</sub>	77,9	113,0	<b>W22314X</b>	22,6	3 <sup>7</sup> / <sub>8</sub> - 3 <sup>1</sup> / <sub>8</sub>	<b>W22314R302</b>	3 <sup>7</sup> / <sub>8</sub> - 2 <sup>15</sup> / <sub>16</sub>	<b>W22314R215</b>	3 <sup>7</sup> / <sub>8</sub> - 2 <sup>3</sup> / <sub>4</sub>	<b>W22314R212</b>
	3 <sup>15</sup> / <sub>16</sub>	85,1	119,9	<b>W22315X</b>	24,3	-	-	-	-	-	-
	<b>4</b>	85,1	119,9	<b>W22400X</b>	24,1	-	-	-	-	-	-
	4 <sup>1</sup> / <sub>16</sub>	85,1	119,9	<b>W22401IX</b>	24,0	-	-	-	-	-	-
	4 <sup>1</sup> / <sub>8</sub>	85,1	119,9	<b>W22402X</b>	23,6	-	-	-	-	-	-
	4 <sup>3</sup> / <sub>16</sub>	85,1	119,9	<b>W22403IX</b>	23,6	-	-	-	-	-	-
	4 <sup>1</sup> / <sub>4</sub>	85,1	119,9	<b>W22404X</b>	24,6	4 <sup>1</sup> / <sub>4</sub> - 3 <sup>1</sup> / <sub>2</sub>	<b>W22404R308</b>	4 <sup>1</sup> / <sub>4</sub> - 3 <sup>1</sup> / <sub>8</sub>	<b>W22404R302</b>	4 <sup>1</sup> / <sub>4</sub> - 2 <sup>15</sup> / <sub>16</sub>	<b>W22404R215</b>
	4 <sup>5</sup> / <sub>16</sub>	89,9	125,0	<b>W22405X</b>	24,6	-	-	-	-	-	-
	4 <sup>3</sup> / <sub>8</sub>	89,9	125,0	<b>W22406X</b>	24,5	-	-	-	-	-	-
	4 <sup>7</sup> / <sub>16</sub>	89,9	125,0	<b>W22407X</b>	24,3	-	-	-	-	-	-
	4 <sup>1</sup> / <sub>2</sub>	89,9	125,0	<b>W22408IX</b>	24,1	-	-	-	-	-	-
	4 <sup>9</sup> / <sub>16</sub>	89,9	125,0	<b>W22409IX</b>	23,9	-	-	-	-	-	-
	4 <sup>5</sup> / <sub>8</sub>	89,9	125,0	<b>W22410IX</b>	23,6	4 <sup>5</sup> / <sub>8</sub> - 3 <sup>7</sup> / <sub>8</sub>	<b>W22410R314</b>	4 <sup>5</sup> / <sub>8</sub> - 3 <sup>3</sup> / <sub>4</sub>	<b>W22410R312</b>	4 <sup>5</sup> / <sub>8</sub> - 3 <sup>1</sup> / <sub>2</sub>	<b>W22410R308</b>
	4 <sup>3</sup> / <sub>4</sub>	95,0	130,0	<b>W22412X</b>	24,7	-	-	-	-	-	-
	4 <sup>7</sup> / <sub>8</sub>	95,0	130,0	<b>W22414X</b>	24,3	-	-	-	-	-	-
	<b>5</b>	95,0	130,0	<b>W22500X</b>	23,8	5 - 4 <sup>1</sup> / <sub>4</sub>	<b>W22500R404</b>	5 - 4 <sup>1</sup> / <sub>8</sub>	<b>W22500R402</b>	5 - 3 <sup>7</sup> / <sub>8</sub>	<b>W22500R314</b>
	5 <sup>1</sup> / <sub>8</sub>	100,0	134,8	<b>W22502X</b>	25,0	-	-	-	-	-	-
5 <sup>3</sup> / <sub>16</sub>	100,0	134,8	<b>W22503X</b>	24,8	-	-	-	-	-	-	
5 <sup>1</sup> / <sub>4</sub>	100,0	134,8	<b>W22504X</b>	24,5	-	-	-	-	-	-	
5 <sup>3</sup> / <sub>8</sub>	100,0	134,8	<b>W22506X</b>	23,9	5 <sup>3</sup> / <sub>8</sub> - 4 <sup>5</sup> / <sub>8</sub>	<b>W22506R410</b>	5 <sup>3</sup> / <sub>8</sub> - 4 <sup>1</sup> / <sub>4</sub>	<b>W22506R404</b>	5 <sup>3</sup> / <sub>8</sub> - 4 <sup>1</sup> / <sub>8</sub>	<b>W22506R402</b>	
-	-	-	<b>W22506X</b>	23,9	5 <sup>3</sup> / <sub>8</sub> - 3 <sup>7</sup> / <sub>8</sub>	<b>W22506R314</b>	-	-	-	-	

<sup>1)</sup> See page 275 for table of hexagon sizes of bolts, nuts and related thread diameters.



# W35000X, Inch-Cassettes & Reducer Inserts

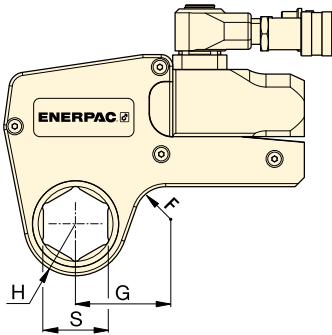

## ▼ SELECTION CHART

Drive Unit Model Number	Hexagon Size S	Nose Radius H	G	Model Nr. Cassette	Weight (kg)	Reducer	
						Hexagon Reducer (inch)	Model Number Reducer
W35000X	3 1/8	76,0	126,8	W35302X	32,8	3 1/8 - 2	W35302R200
	3 3/16	76,0	126,8	W35303X	32,7	-	-
	3 1/4	76,0	126,8	W35304X	32,5	-	-
	3 5/16	76,0	126,8	W35305X	32,4	-	-
	3 3/8	76,0	126,8	W35306X	32,2	-	-
	3 7/16	76,0	126,8	W35307X	32,0	-	-
	3 1/2	76,0	126,8	W35308X	31,8	3 1/2 - 2 5/16	W35308R205
	3 9/16	81,5	132,5	W35309X	32,4	-	-
	3 5/8	81,5	132,5	W35310X	33,3	-	-
	3 11/16	81,5	132,5	W35311X	33,1	-	-
	3 3/4	81,5	132,5	W35312X	32,9	-	-
	3 13/16	81,5	132,5	W35313X	32,7	-	-
	3 7/8	81,5	132,5	W35314X	32,4	3 7/8 - 2 11/16	W35314R211
	3 15/16	87,0	137,0	W35315X	34,1	3 15/16 - 2 13/16	W35315R213
	4	87,0	137,0	W35400X	33,9	-	-
	4 1/16	87,0	137,0	W35401IX	33,7	-	-
	4 1/8	87,0	137,0	W35402X	33,5	-	-
	4 3/16	87,0	137,0	W35403IX	33,3	-	-
	4 1/4	87,0	137,0	W35404X	33,0	4 1/4 - 3 1/16	W35404R301
	4 5/16	93,0	143,0	W35405X	34,9	-	-
	4 3/8	93,0	143,0	W35406X	34,7	-	-
	4 7/16	93,0	143,0	W35407X	34,5	-	-
	4 1/2	93,0	143,0	W35408X	34,3	-	-
	4 9/16	93,0	143,0	W35409X	34,1	-	-
	4 5/8	93,0	143,0	W35410IX	33,7	4 5/8 - 3 5/8	W35410R310
	4 3/4	98,5	148,5	W35412X	35,6	4 3/4 - 3 3/4	W35412R312
	4 7/8	98,5	148,5	W35414X	34,9	-	-
	5	98,5	148,5	W35500X	34,3	5 - 4	W35500R400
	5 1/8	103,0	153,0	W35502X	35,8	5 1/8 - 4 1/8	W35502R402
	5 3/16	103,0	153,0	W35503IX	35,6	-	-
	5 1/4	103,0	153,0	W35504X	35,2	-	-
	5 3/8	103,0	153,0	W35506X	34,6	5 3/8 - 4 5/16	W35506R405
5 1/2	108,5	158,5	W35508X	36,2	-	-	
5 9/16	108,5	158,5	W35509X	36,0	-	-	
5 5/8	108,5	158,5	W35510X	35,6	-	-	
5 3/4	108,5	164,0	W35512X	34,9	5 3/4 - 4 3/4	W35512R412	
5 7/8	114,0	164,0	W35514X	36,7	5 7/8 - 4 7/8	W35514R414	
6	114,0	164,0	W35600X	36,1	-	-	
6 1/8	114,0	164,0	W35602X	35,3	6 1/8 - 5 1/8	W35602R502	

## W Series X-Edition



Nominal Torque at 690 bar:

**47.454 Nm**

Hexagon Range:

**3 1/8 - 6 1/8 inch**

Maximum Operating Pressure:

**690 bar**



### Hexagon Bolt and Nut Sizes

See the table for hexagon sizes of bolts, nuts and related thread diameters.

Page: 275

# W-Series, Metric Cassettes and Reducers

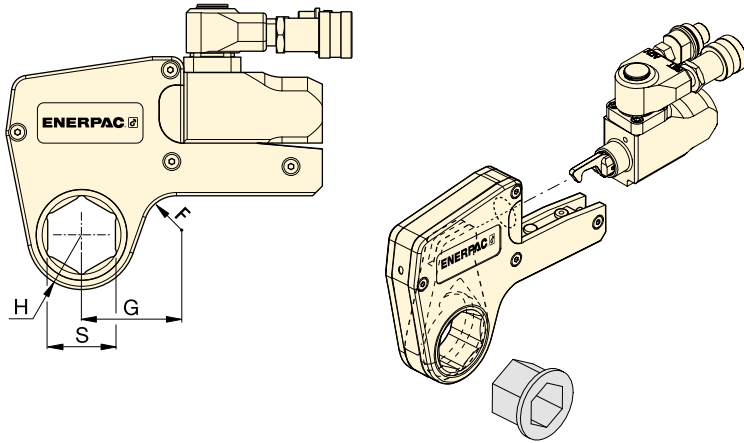

## W Series X-Edition







Hexagon Range:

**24 - 105 mm**

Maximum Operating Pressure:

**690 bar**

### ▼ SELECTION CHART

Drive Unit Model Number	Hexagon Size <sup>1)</sup>	Nose Radius	Dim.	Model Nr. Cassette							
						Hexagon Reducer (mm)	Model Number Reducer	Hexagon Reducer (mm)	Model Number Reducer	Hexagon Reducer (mm)	Model Number Reducer
<b>W2000X</b> (2766 Nm)	30	31	54	W2103X	2,1	-	-	-	-	-	-
	32	31	54	W2104X	2,1	-	-	-	-	-	-
	36	31	54	W2107X	2,1	-	-	-	-	-	-
	38	34	58	W2108X	2,2	-	-	-	-	-	-
	41	34	58	W2110X	2,2	41 - 32	W2110R104	41 - 30	W2110R103	41 - 24	W2110R024M
	46	34	61	W2113X	2,2	46 - 36	W2113R107	46 - 32	W2113R104	-	-
	50	39	63	W2200X	2,2	50 - 41	W2200R110	50 - 36	W2200R107	-	-
	55	42	69	W2203X	2,3	55 - 46	W2203R113	55 - 41	W2203R110	55 - 36	W2203R107
	60	45	65	W2206X	2,2	60 - 50	W2206R200	60 - 46	W2206R113	60 - 41	W2206R110
	-	-	-	-	-	-	60 - 36	W2206R107	-	-	-
<b>W4000X</b> (5661 Nm)	36	37	61	W4107X	3,7	-	-	-	-	-	-
	41	37	61	W4110X	3,7	-	-	-	-	-	-
	46	40	64	W4113X	3,8	-	-	-	-	-	-
	50	42	67	W4200X	3,9	50 - 36	W4200R107	-	-	-	-
	55	44	73	W4203X	4,0	55 - 41	W4203R110	55 - 36	W4203R107	55 - 32	W4203R104
	60	47	71	W4206X	4,1	60 - 50	W4206R200	60 - 46	W4206R113	60 - 36	W4206R107
	65	50	76	W4209X	4,1	65 - 55	W4209R203	65 - 50	W4209R200	65 - 46	W4209R113
	70	53	78	W4212X	4,2	70 - 60	W4212R206	70 - 55	W4212R203	-	-
	75	55	82	W4215X	4,3	75 - 65	W4215R209	75 - 60	W4215R206	-	-
	-	-	-	W4215X	-	75 - 55	W4215R203	75 - 50	W4215R200	-	-
	80	59	84	W4302X	-	-	-	80 - 70	W4302R212	80 - 65	W4302R209
-	-	-	W4302X	-	80 - 55	W4302R203	80 - 50	W4302R200	-	-	
85	62	86	W4085MX	4,5	-	-	-	-	-	-	
<b>W8000X</b> (11.484 Nm)	50	45	78	W8200X	8,1	-	-	-	-	-	-
	55	48	80	W8203X	8,1	-	-	-	-	-	-
	60	51	83	W8206X	8,1	-	-	-	-	-	-
	65	56	85	W8209X	8,1	65 - 50	W8209R200	-	-	-	-
	70	56	85	W8212X	7,9	70 - 55	W8212R203	-	-	-	-
	75	58	85	W8215X	7,9	75 - 60	W8215R206	75 - 55	W8215R203	-	-
	80	61	90	W8302X	8	80 - 65	W8302R209	80 - 60	W8302R206	80 - 55	W8302R203
	-	-	-	-	-	80 - 50	W8302R200	-	-	-	-
	85	66	92	W8085MX	8,2	85 - 70	W8085R070M	85 - 65	W8085R065M	85 - 60	W8085R060M
	-	-	-	-	-	85 - 55	W8085R055M	-	-	-	-
	90	74	103	W8090MX	8,8	90 - 75	W8090R075M	-	-	-	-
	95	74	103	W8312X	8,8	95 - 80	W8312R302	95 - 75	W8312R215	-	-
	100	80	110	W8315X	9,3	-	-	-	-	-	-
105	80	110	W8402X	9,3	-	-	-	-	-	-	

<sup>1)</sup> See page 275 for table of hexagon sizes of bolts, nuts and related thread diameters.

# W-Series, Metric Cassettes and Reducers

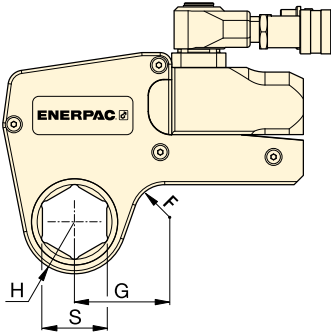

Hexagon Range:  
**50 - 155 mm**

Maximum Operating Pressure:  
**690 bar**

**W**  
Series  
X-Edition



## ▼ SELECTION CHART

Drive Unit Model Number	Hexagon Size <sup>1)</sup>	Nose Radius	Dim.	Model Nr. Cassette	Weight (kg)	Hexagon Reducer		Model Number Reducer	
						Hexagon Reducer (mm)	Model Number Reducer	Hexagon Reducer (mm)	Model Number Reducer
<b>W15000X</b> (20.785 Nm)	65	59	89	W15209X	13,6	-	-	-	-
	70	59	89	W15212X	13,6	-	-	-	-
	75	62	91	W15215X	13,7	-	-	-	-
	80	65	93	W15302X	13,8	80 - 65	W15302R209	-	-
	85	70	97	W15085MX	14,1	85 - 70	W15085R070M	-	-
	90	75	102	W15090MX	14,5	90 - 75	W15090R75M	-	-
	95	75	102	W15312X	14,6	95 - 80	W15312R302	95 - 75	W15312R215
	100	81	103	W15315X	14,8	-	-	-	-
	105	81	103	W15402X	14,8	105 - 90	W15402R090M	-	-
	110	88	115	W15405X	15,1	110 - 95	W15110R095M	-	-
	115	88	115	W15115MX	15,1	115 - 100	W15115R100M	-	-
<b>W22000X</b> (30.506 Nm)	75	67	102	W22215X	22,0	-	-	-	-
	80	67	102	W22302X	21,6	80-60	W22302R206	80 - 55	W22302R203
	85	73	107	W22085MX	22,5	85-65	W22085MR209	85 - 60	W22085MR206
	90	78	113	W22090MX	23,4	90-70	W22090M212	90 - 60	W22090MR206
	95	78	113	W22312X	22,9	95-75	W22312R215	-	-
	100	85	120	W22315X	24,3	-	-	-	-
	105	85	120	W22402X	23,4	-	-	-	-
	110	90	125	W22405X	24,6	-	-	-	-
	115	90	125	W22115MX	24,0	-	-	-	-
	120	95	130	W22412X	24,7	-	-	-	-
	123	95	130	W22123MX	24,4	-	-	-	-
	130	100	135	W22502X	25,0	-	-	-	-
	135	100	135	W22506X	23,9	135 - 105	W22506R402	-	-
<b>W35000X</b> (47.454 Nm)	80	77	129	W35302X	32,8	80 - 50	W35302R200	-	-
	85	77	129	W35085MX	32,3	-	-	-	-
	90	82	135	W35090MX	33,5	90 - 60	W35090R206	-	-
	95	82	135	W35312X	32,9	-	-	-	-
	100	88	139	W35315X	34,1	-	-	-	-
	105	88	139	W35402X	33,5	-	-	-	-
	110	94	146	W35405X	34,9	110 - 85	W35405R085M	-	-
	115	94	146	W35115MX	34,2	-	-	-	-
	120	100	153	W35412X	35,6	120 - 95	W35412R312	-	-
	123	100	153	W35123MX	35,0	-	-	-	-
	130	104	160	W35502X	35,8	130 - 105	W35502R402	-	-
	135	104	160	W35506X	34,6	135 - 110	W35506R405	-	-
	140	110	163	W35508X	36,2	140 - 115	W35508R115M	-	-
	145	110	163	W35512X	34,9	145 - 120	W35512R412	-	-
	150	115	169	W35514X	36,7	-	-	-	-
	151	115	169	W35151MX	36,5	-	-	-	-
	155	115	169	W35602X	35,3	155 - 130	W35602R502	-	-

<sup>1)</sup> See page 275 for table of hexagon sizes of bolts, nuts and related thread diameters.

# W-SL, Series, UltraSlim Bi-Hexagonal Cassettes

▼ W4206SL ultraslim bi-hexagonal stepped width cassette with W4000X drive unit



## Versatility

- Lean, stepped width design allows tool to be mounted over bolts where other tools won't fit
- Bi-Hexagonal cassette allows twice as many positioning points on nut or bolt
- Robust top mounted handle stays out of the way, providing safe fastening in hard to reach areas
- Uses same drive unit as standard W-series hexagon cassettes

## Performance

- Premium components provide best-in-class endurance compared to other limited access tools

## Ease of Use

- Few moving parts are easily accessible for quick field maintenance
- Fast release drive unit enables rapid exchange of cassettes, no tools required
- Top mounted straight handle for improved tool handling and safety

## Accuracy

- Constant torque output provides accuracy of  $\pm 3\%$  across the full stroke
- Calibration certificate shipped with every cassette.

*Slim enough to fit and tough enough to last. This UltraSlim wrench is the perfect controlled bolting solution for this oil and gas flange. ►*

## Your easy and long lasting solution to difficult access bolting applications



### UltraSlim: Designed for Tight Spots

Stepped width design provides easy access in confined areas. UltraSlim cassettes fit where standard solutions won't.



### Built to Outperform

High endurance components keep working when others fail.



### Top Mounted Straight Handle

The top mounted straight handle is standard and provides safe and easy positioning and access to hard to reach fasteners.

Straight handle (standard)	<b>SWH6S</b>
Angled handle (optional)	<b>SWH6A</b>



### ATEX declared. Calibration certificate included.

All UltraSlim Series cassettes are CE - ATEX declared and are shipped complete with a calibration certificate.

CE  II 2 GD T4





# UltraSlim Bi-Hexagonal Cassettes



## UltraSlim Bi-Hexagonal Cassettes

Accessing narrow spaces normally requires significantly reducing the width of the torque wrench. For the tool operator, this has always meant vastly reduced tool durability, and/or reduced torque output.

By using the highest grade materials, perfecting the geometry, and placing the positioning handle on top of the tool for safe fastening, Enerpac UltraSlim cassettes are able to provide greater torque, get into tighter spaces, and vastly outperform the competition in product durability\*.

## Durability of Key Components\*

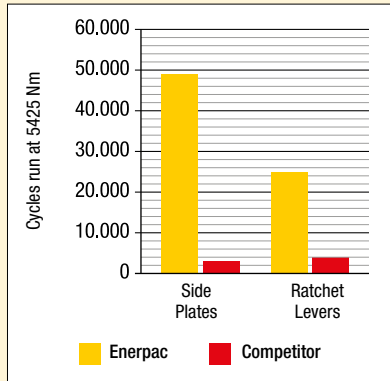

\* Average test results, whereby three Enerpac 46 mm UltraSlim cassettes and three competitor 46 mm cassettes were tested at 5425 Nm for 50,000 cycles. The Enerpac side plates never broke for the full duration of the test.

## W-SL Series UltraSlim



Nominal Torque Output:

**5911 Nm**

Bi-Hexagonal Range:

**46 - 75 mm**

Maximum Operating Pressure:

**690 bar**



## Torque Wrench Pumps

System matched air and electric torque wrench pumps that are ideal for use with hydraulic torque wrenches.

Page: 212



## Torque Wrench Hoses

Use Enerpac THQ-700 Series torque wrench hoses with W-Series torque wrenches to ensure the integrity of your hydraulic system.

6 m long, 2 hoses	<b>THQ-706T</b>
12 m long, 2 hoses	<b>THQ-712T</b>

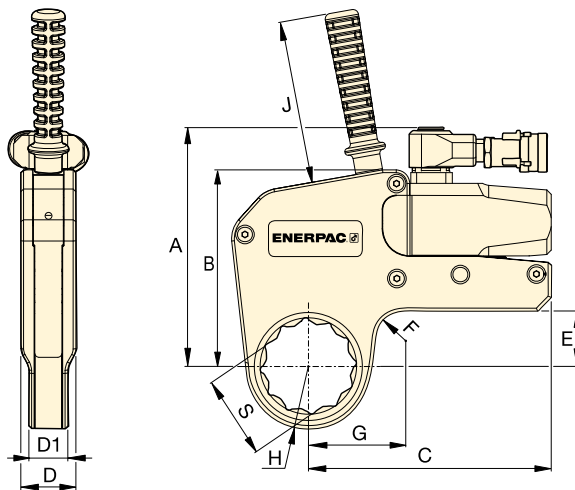

## SELECTION CHART

Bi-Hexagonal Size	Nominal Torque @ 690 bar	UltraSlim Cassette * Model Nr.	Minimum Torque @ 69 bar	Nose Radius	Dimensions (mm)										Drive Unit Model Nr. ** (sold separately)																
					H	G	A	B	C	D	D1	E	F	J		(kg)															
S (mm) (inch)	(Nm)		(Nm)	H (mm)	G	A	B	C	D	D1	E	F	J	(kg)																	
																46	1 <sup>3</sup> / <sub>16</sub>	2685	<b>W2113SL</b>	269	36,5	59,6	140,7	109,3	147,7	32,4	25,4	24,0	20,0	120	2,2
																55	2 <sup>3</sup> / <sub>16</sub>	2685	<b>W2203SL</b>	269	41,5	63,2									2,2
60	2 <sup>3</sup> / <sub>8</sub>	2685	<b>W2206SL</b>	269	44,5	65,1	2,2																								
S	(Nm)		(Nm)	H (mm)	G	A	B	C	D	D1	E	F	J	(kg)																	
																55	2 <sup>3</sup> / <sub>16</sub>	5911	<b>W4203SL</b>	591	44,0	68,7	175,6	144,5	178,5	40,5	28,6	40,8	20,0	120	4,6
																60	2 <sup>3</sup> / <sub>8</sub>	5911	<b>W4206SL</b>	591	48,0	71,6									4,7
																65	2 <sup>3</sup> / <sub>16</sub>	5911	<b>W4209SL</b>	591	50,5	74,1									4,7
																70	2 <sup>3</sup> / <sub>4</sub>	5911	<b>W4212SL</b>	591	53,5	75,6									4,7
75	2 <sup>15</sup> / <sub>16</sub>	5911	<b>W4215SL</b>	591	56,0	76,0	4,7																								

\* Bi-Hexagonal Cassette includes top mounted straight handle.

\*\* Cassette may also be used with W2000PX and W4000PX drive units, featuring double-swivel manifolds. Weight of drive unit W2000X = 1,4 kg; W4000X = 2,0 kg.

# WCR-Series, Roller Cassette Torque Wrench

▼ WCR4000 Roller Cassette with Spanner and W4000X Drive Unit



- Provides a safe and reliable controlled bolting solution for flanges with limited access
- Spanners available to fit most commonly used API flanges
- Small nose radius – resolves bolt to pipe restrictions
- Slim spanner design – reduces bolt height restrictions
- Wide range of spanners ranging from 36 - 80 mm (1<sup>7</sup>/<sub>16</sub> - 3<sup>1</sup>/<sub>8</sub> inch)
- Includes handle to improve tool handling and safety
- Rigid steel body for maximum endurance and minimum downtime.

Bi-Hexagonal Spanner Size:

**36 - 80 mm, 1<sup>7</sup>/<sub>16</sub> - 3<sup>1</sup>/<sub>8</sub>"**

Spanner Nose Radius:

**31 - 55 mm**

Nominal Torque:

**5762 Nm (4250 Ft.lbs)**

Maximum Operating Pressure:

**690 bar**





### WCR-4000 Applications

The WCR4000 helps resolve narrow clearance restrictions in bolting of API and BOP flanges.

The Enerpac WCR4000 Roller Cassette has been developed for applications where there are severe clearance restrictions, particularly in height above the nut or between the bolt center and the inside of the joint.

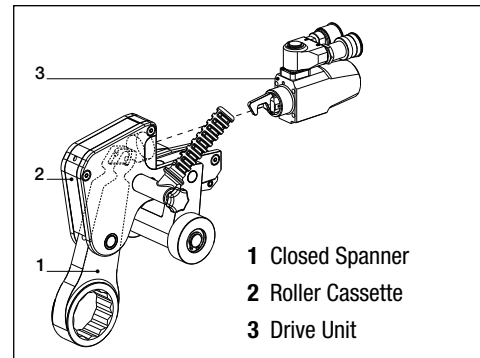
Powered by the standard W4000X drive unit which is compatible with standard W-Series hexagon cassettes. The WCR-wrench must be removed and repositioned after each wrench cycle by operating the pump in the retract direction. The tool contains no spring return.



Closed Spanner Hexagon Size S (inch)   (mm)	Closed Spanner Model Number	Nominal Torque (Nm)	Spanner Radius R (mm)	 * (kg)	Roller Cassette Assembly Model Nr.	Drive Unit Model Nr.
1 <sup>7</sup> / <sub>16</sub>   36	W4107CS	5762	31	1,9	WCR4000	W4000X
1 <sup>1</sup> / <sub>2</sub>   38	W4108CS	5762	33	2,0		
1 <sup>5</sup> / <sub>8</sub>   41	W4110CS	5762	33	1,9		
1 <sup>3</sup> / <sub>16</sub>   46	W4113CS	5762	36	1,9		
1 <sup>7</sup> / <sub>8</sub>   48	W4114CS	5762	38	2,1		
2   50	W4200CS	5762	38	1,9		
2 <sup>3</sup> / <sub>16</sub>   55	W4203CS	5762	41	2,0		
2 <sup>3</sup> / <sub>8</sub>   60	W4206CS	5762	45	2,1		
2 <sup>9</sup> / <sub>16</sub>   65	W4209CS	5762	47	2,1		
2 <sup>3</sup> / <sub>4</sub>   70	W4212CS	5762	50	2,1		
2 <sup>15</sup> / <sub>16</sub>   75	W4215CS	5762	52	2,1		
3 <sup>1</sup> / <sub>8</sub>   80	W4302CS	5762	55	2,2		

\* Spanner weight. For total weight add 6,3 kg for WCR4000 and 2,0 kg for W4000X.

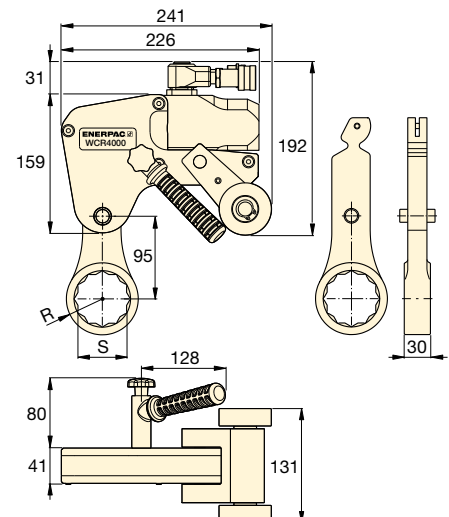

# Accessories for W-Series, X-Edition Wrenches

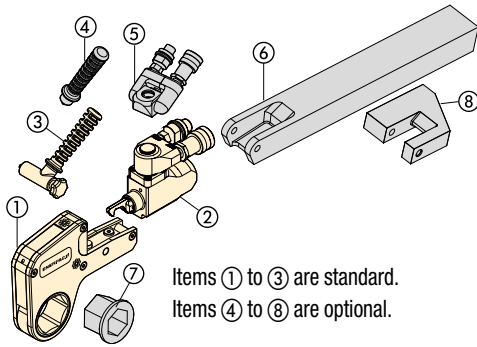

- ① Hexagon Cassette
- ② Drive Unit
- ③ Angled Positioning Handle
- ④ Straight Positioning Handle
- ⑤ Pro Series Swivel
- ⑥ Extended Reaction Arm
- ⑦ Reducer Insert
- ⑧ Reaction Paddle

Items ① to ③ are standard.  
Items ④ to ⑧ are optional.

## TSP WTE WRP Series



### TSP-Series, Pro Series Swivel

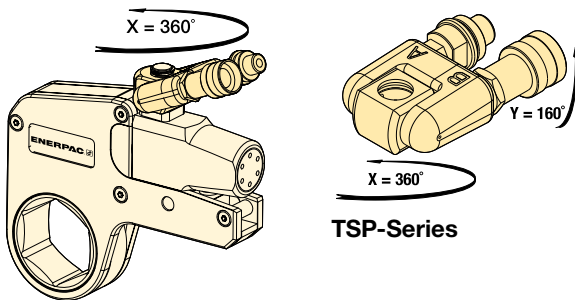

- Robust interlocking design
- 360° X-axis and 160° Y-axis rotation
- Increases tool fit in restricted access areas
- Simplifies hose placement
- Includes male and female couplers

For Torque Wrench Model Number	Model Number <sup>1)</sup>	Maximum Pressure (bar)	Weight (kg)
W2000X, W4000X, W8000X, W15000X, W22000X, W35000X	TSP300	690	0,2

<sup>1)</sup> To order a W-Series (X-edition) drive unit fitted with a TSP300 tilt and swivel manifold, insert a "P" prior to the "X" in the tool model number, example: **W2000PX**. TSP300 is designed for X-Edition tools only, and is not compatible with standard edition tools. For replacement components for existing tools, refer to repair sheet on [www.enerpac.com](http://www.enerpac.com)

### WTE-Series, Extended Reaction Arm

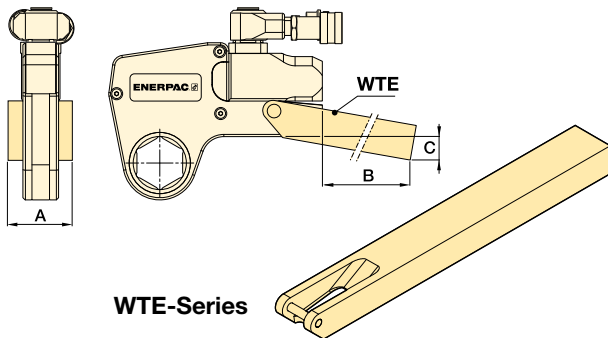

- Full torque rated
- Increases tool fit in restricted access areas.

For Torque Wrench Model Number	Model Number	Dimensions (mm)			Weight (kg) *
		A	B	C	
W2000X	WTE20	56	398	76	2,6
W4000X	WTE40	66	436	74	4,6
W8000X	WTE80	85	449	55	7,6
W15000X	WTE150	102	498	72	12,0
W22000X	WTE220	114	524	77	17,3
W35000X	WTE350	127	419	133	17,8

\* Weights indicated are for the accessories only and do not include the wrench.

### WRP-Series, Low Profile Reaction Paddles

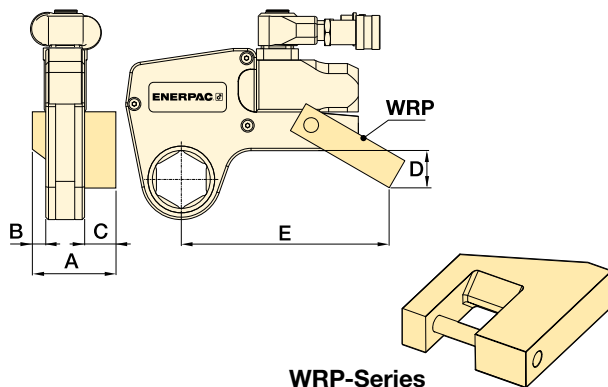

- Lightweight interchangeable design
- Allows for offset reaction when in-line reaction is not available.

For Torque Wrench Model Nr.	Model Number	Dimensions (mm)					Weight (kg) *
		A	B	C	D	E	
W2000X	WRP20	84	16	35	45	148	0,4
W4000X	WRP40	109	21	47	59	190	0,8
W8000X	WRP80	137	26	57	69	223	2,0
W15000X	WRP150	165	32	69	87	257	3,9
W22000X	WRP220	207	37	91	134	317	7,2
W35000X	WRP350	225	42	91	182	367	10,6

\* Weights indicated are for the accessories only and do not include the wrench.

▼ PTW1000



## Productivity

- High speed continuous rotation for constant torque output
- Low friction planetary gearbox design minimizes wear and extends uptime.

## Safety

- Ergonomic, low vibration design reduces fatigue and the risk of vibration related injuries for the operator
- Low noise air motor provides quiet, consistent performance for indoor and outdoor applications.

## Convenience

- Provided with standard reaction arm; wide assortment of custom arms and accessories are available
- Available with or without Filter-Regulator-Lubricator (FRL)
- Unique calibration certificate provided with each tool.



◀ The PTW1000 makes quick work of this flange maintenance job.

## Continuous Rotation Controlled Torque



### Calibration Certificate

All PTW-Series tools are CE declared and are shipped complete with a calibration certificate.



### Typical Pneumatic Torque Wrench Applications

#### Oil and Gas, MRO

- Pipe flanges
- Valves
- Man-way covers
- Pressure vessels.

#### Power Generation

- Turbine bolts
- Tower segments
- Turbine casings.

#### Mining

- Track maintenance
- Undercarriage maintenance
- Wheel maintenance
- Shovel maintenance.

▼ PTW-Series Pneumatic Torque Wrenches are ideal for applications where speed and precision are critical, such as track maintenance.





# Pneumatic Torque Wrenches



## PTW-Series, Pneumatic Torque Wrenches

Enerpac PTW-Series Pneumatic Torque Wrenches are designed for applications that require speed and control.

The standard package includes a Torque Wrench with a calibration certificate, an FRL (Filter/Regulator/Lubricator), and a 3 m long, ½" inch (13 mm) diameter air hose, which connects the FRL to the wrench.

Once the air hoses are connected, the operator simply adjusts the air pressure on

the FRL to achieve the desired torque using the calibration certificate. After this, the tool is ready to go to work! \*

The air source used with the PTW system must be regulated and/or limited to 8,3 bar, and must be capable of providing a volume of at least (85 m³/h) at 6,9 bar. A separate ½" inch hose (not included) must be used to connect the FRL to the air supply.

\* See instruction manual for comprehensive instructions.

## PTW Series



Nominal Torque Output:

**8135 Nm**

Square Drive Range:

**1 - 1½ inch**



### Accessories

Enerpac offers a full line of accessories including a range of reaction arms and drives.

Page: **210**



### FRL120C, Filter-Regulator-Lubricator with air hose

All PTW-Series tools are shipped complete with standard reaction arm, and Filter-Regulator-Lubricator (FRL120C).



### BSH-Series Sockets

Heavy-Duty Impact Sockets for power driven torquing equipment.

Page: **190**



### Hydraulic Torque Wrenches

Enerpac offers a complete range of square drive and hexagon cassette torque wrenches.

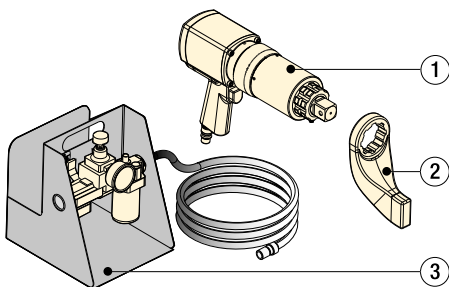

- ① PTW Torque Wrench
- ② Standard Reaction Arm
- ③ FRL120C Filter-Regulator-Lubricator with 3 meters air hose

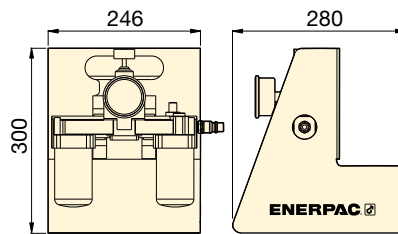
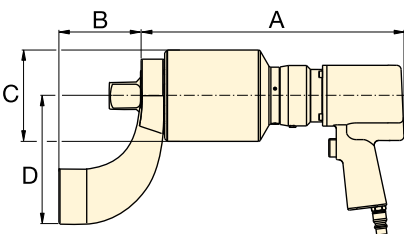

## ▼ SELECTION CHART

All tools are shipped complete with standard reaction arm and FRL120C.

Minimum Torque		Nominal Torque		Square Drive (inch)	Model Number <sup>1)</sup> (FRL120C included)	Speed (RPM)	Dimensions (mm)				Weight (kg) <sup>2)</sup>
(Nm)	(Ft.lbs)	(Nm)	(Ft.lbs)				A	B	C	D	
407	300	1356	1000	1	<b>PTW1000C</b>	12,6	272	83	72	130	8,2
678	500	2712	2000	1	<b>PTW2000C</b>	8,0	286	83	79	133	8,8
1220	900	4067	3000	1	<b>PTW3000C</b>	3,1	343	83	95	133	10,4
1763	1300	8135	6000	1½	<b>PTW6000C</b>	2,5	366	114	127	178	17,7

<sup>1)</sup> To order without FRL120C, remove "C" suffix from model number (example: **PTW3000**).

<sup>2)</sup> Weight does not include reaction arm. Reaction arm weight for PTW1000, PTW2000, PTW3000 is 1,3 kg and for PTW6000 is 3,5 kg.

▼ TW3000EI (torque wrench shown without servo motor cable)



## Versatility

- Patented firmware design provides accurate fastening on soft or pre-tightened joints when accuracy is critical
- Single control box may be used to operate multiple wrench models
- Wrenches and control boxes may be purchased separately or as a calibrated set.

## Performance

- High speed continuous rotation gets the job done faster
- Torque and angle functionality allows input of nominal torque value followed by a specific angle of rotation
- Pass/Fail LED indicator on back of tool verifies fastening has been completed according to specified input.

## Simplicity

- Control box with 7-inch touchscreen simplifies tool operation
- Controls on back of wrench enable operator to monitor and manage the fastening process without returning to the control box
- Brightly lit three line LED display on wrench is easy to read in any environment, even in bright sunlight.

## Traceability

- Fastening record can be viewed on-screen and transferred through standard USB connection on the control box
- Each tool is performance tested and shipped complete with a factory calibration certificate.

## Safety

- Lift points on wrench enable use with positioning handle or lifting device for greater handling safety
- Ground fault detector protects operator in the event of insufficient grounding.

## Your Simple Solution for Smart Bolting



### Touchscreen Control Box

ETW-Series tools feature an easy to use, interactive touch-screen control box, which helps make even the most complex jobs simple to complete.

Single control box may be used to operate multiple wrench models.

Firmware upgrades may be uploaded online and easily transferred to the tool via a USB connection.



### Easy Access to Controls

Controls on back of wrench with LED display allow user to directly input desired torque, change direction of rotation, and monitor the fastening process.



### Certifications and Declarations

All ETW-Sets and TW-tools are:

- CE declared
- Shipped complete with a calibration certificate
- Certified for North American Electrical Safety by CSA International
- Carry a CSA US and Canada mark.



▼ ETW-Series Electric Torque Wrenches are ideal for high volume fastening applications that require precision and traceability, such as this wind tower job.





## ETW-Series, Electric Torque Wrenches

Enerpac ETW-Series Electric Torque Wrenches are particularly well suited to complex jobs which demand precision and traceability.

The ETW-Series tools feature an automatic mode, which helps simplify and automate complex jobs, including those with torque and angle specifications, through the creation of presets.

Using the touchscreen, simply input the number of fasteners and desired torque value for each fastening step, followed by the required angle of turn. This sequence may then be saved as an automatic preset for future use.

For simpler jobs, torque values may be input with a digital slider on the touchscreen, or directly into the rear control panel of the wrench.

Once the input torque is achieved, the tool stalls, and a pass/fail indicator verifies that it is ready to move on to the next fastener.

When the job is completed, the fastening record can be viewed on the touch screen, or exported to a computer via a USB connection on the control box.

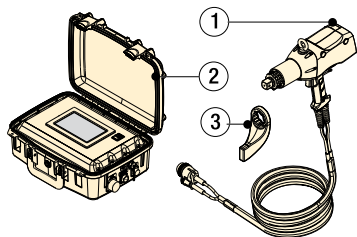

### ETW-Set

- ① ETW Torque Wrench with 6m servo motor cable
- ② Control Box with 2m power cord
- ③ Standard Reaction Arm

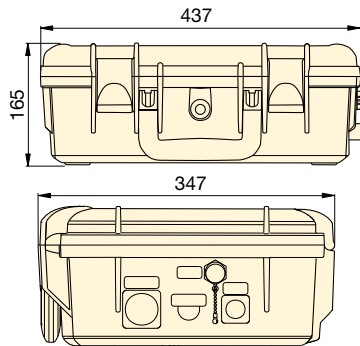
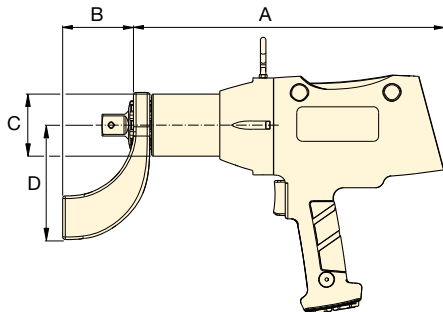

ETW-torque wrench

ETWCB-control box

Minimum Torque		Nominal Torque		Square Drive (inch)	ETW-Set Model Number	ETW-Set includes		Voltage	Nominal Speed (RPM)	Dimensions (mm)				Weight (kg) <sup>1)</sup>
(Nm)	(Ft.lbs)	(Nm)	(Ft.lbs)			Wrench Model Nr. <sup>2)</sup>	Control Box Model Nr. <sup>2)</sup>			A	B	C	D	
270	200	1355	1000	1	ETW1000B	TW1000B	ETWCB-B	115V 60 Hz	9,8	365	83	72	130	8,2
270	200	1355	1000	1	ETW1000I	TW1000EI	ETWCB-I	230V 60 Hz	15,2	365	83	72	130	8,2
270	200	1355	1000	1	ETW1000E	TW1000EI	ETWCB-E	230V 50 Hz	15,2	365	83	72	130	8,2
540	400	2710	2000	1	ETW2000B	TW2000B	ETWCB-B	115V 60 Hz	5,8	380	83	79	133	8,9
540	400	2710	2000	1	ETW2000I	TW2000EI	ETWCB-I	230V 60 Hz	9,0	380	83	79	133	8,9
540	400	2710	2000	1	ETW2000E	TW2000EI	ETWCB-E	230V 50 Hz	9,0	380	83	79	133	8,9
810	600	4065	3000	1	ETW3000B	TW3000B	ETWCB-B	115V 60 Hz	2,8	436	83	95	133	11,9
810	600	4065	3000	1	ETW3000I	TW3000EI	ETWCB-I	230V 60 Hz	4,3	436	83	95	133	11,9
810	600	4065	3000	1	ETW3000E	TW3000EI	ETWCB-E	230V 50 Hz	4,3	436	83	95	133	11,9
1625	1200	8135	6000	1½	ETW6000B	TW6000B	ETWCB-B	115V 60 Hz	1,9	453	114	127	178	19,1
1625	1200	8135	6000	1½	ETW6000I	TW6000EI	ETWCB-I	230V 60 Hz	2,9	453	114	127	178	19,1
1625	1200	8135	6000	1½	ETW6000E	TW6000EI	ETWCB-E	230V 50 Hz	2,9	453	114	127	178	19,1

<sup>1)</sup> Wrench weight does not include reaction arm. Standard reaction arm weight for ETW1000, ETW2000, ETW3000 is 1,3 kg and for ETW6000 is 3,5 kg. Standard reaction arm included with TW-model. Weight of the control box is 9 kg.

<sup>2)</sup> Use of ETW requires both wrench and control box. These may be purchased separately, or as a calibrated set.

## ETW Series



Nominal Torque Output:

**8135 Nm**

Square Drive Range:

**1 - 1½ inch**



### Accessories

Enerpac offers a full line of accessories including a range of reaction arms and drives.

Page: **210**



### BSH-Series Sockets

Heavy-Duty Impact Sockets for power driven torquing equipment.

Page: **190**

**Voltage: (Model Number ending with suffix)**

**B** = 115V, 60 Hz

**I** = 230V, 60 Hz (with NEMA 6-15 plug)

**E** = 230V, 50 Hz (with commonly used European (SCHUKO) plug)

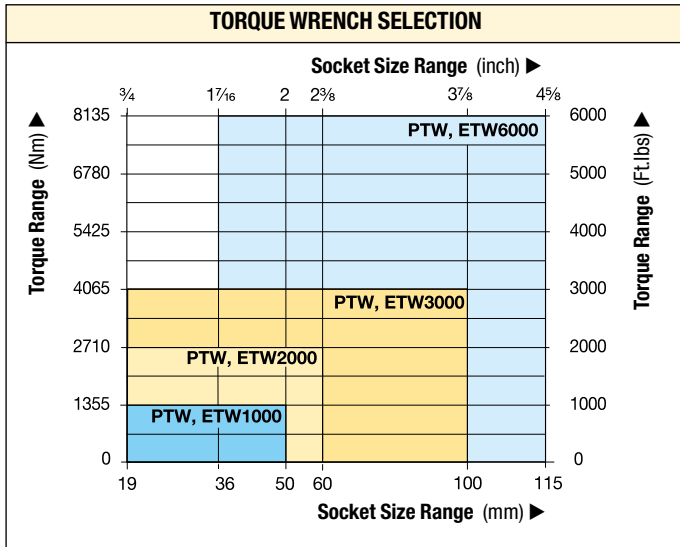

## PTW, ETW Series



Nominal Torque Output:

**8135 Nm**

Square Drive Range:

**1 - 1 1/2 inch**

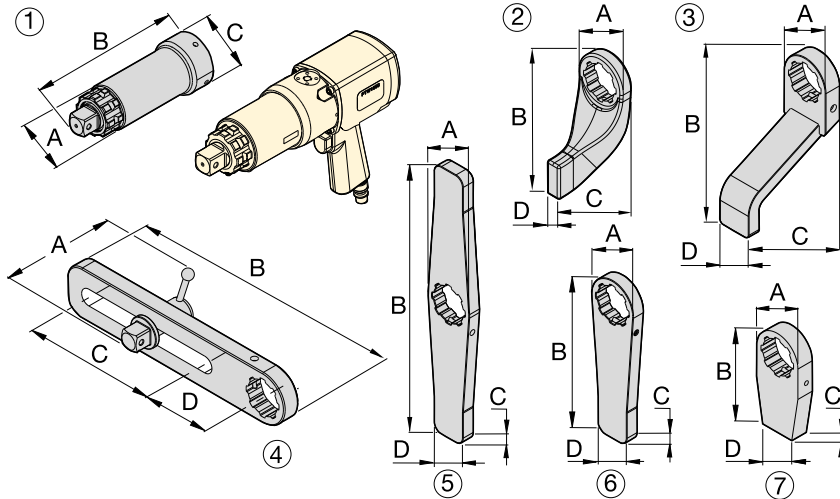

### BSH-Series Sockets

Heavy-Duty Impact Sockets for power driven torquing equipment.

Page: **190**



### PTW and ETW-Accessories

Enerpac offers the following accessories to support a wide variety of applications in industries such as mining, power generation and oil & gas. For additional custom accessories not pictured here, please contact Enerpac.

### Optional Accessories

For use with PTW and ETW1000, 2000, 3000-models

Nr.	Description	Model Nr.	Application	Dimensions (mm)			
				A	B	C	D
1	Extended Drive, 6 inch (152 mm)	ED6TWS	Nose extension, primarily for truck wheel bolts	62	206	73	–
1	Extended Drive, 12 inch (305 mm)	ED12TWS	Nose extension, primarily for truck wheel bolts	62	384	73	–
1	Extended Drive, 18 inch (457 mm)	ED18TWS	Nose extension, primarily for truck wheel bolts	62	511	73	–
2	Standard Reaction Arm	RATWS	Standard arm included with PTW and ETW model	76	172	102	21
3	Extended Reaction Arm	ERATWS	Long plate for use with deep well sockets	73	150	202	51
4	Sliding Reaction Arm	SLRATWS	For widely spaced and uneven bolt centers	112	381	203	102
5	Double Straight Reaction Arm	DSATWS	Reduces time to reposition arm *	73	406	19	102
6	Straight Reaction Arm	SRATWS	Long plate for wide spaced reaction points	73	240	19	51
7	Blank Reaction Arm **	BLTWS	Weldable blank for custom applications **	72	151	25	51

For use with PTW and ETW6000-models

1	Extended Drive 6 inch (152 mm)	ED6TWL	Nose extension, primarily for truck wheel bolts	84	232	102	–
1	Extended Drive 12 inch (305 mm)	ED12TWL	Nose extension, primarily for truck wheel bolts	84	384	102	–
2	Standard Reaction Arm	RATWL	Standard arm included with PTW and ETW model	102	229	146	32
3	Extended Reaction Arm	ERATWL	Long plate for use with deep well sockets	102	254	184	64
4	Sliding Reaction Arm	SLRATWL	For widely spaced and uneven bolt centers	152	419	190	114
5	Double Straight Arm	DSATWL	Reduces time to reposition arm *	102	508	32	57
6	Straight Reaction Arm	SRATWL	Long plate for wide spaced reaction points	102	305	32	57
7	Blank Reaction Arm **	BLTWL	Weldable blank for custom applications **	102	152	32	57

\* Time to reposition arm when repeatedly moving from tightening to loosening.

\*\* WARNING: Blank reaction arms must be heat treated to HRc 38-42 prior to use.



# Typical PTW and ETW-Series Torque Wrench Applications

## Mining

- Track maintenance
- Undercarriage maintenance
- Wheel maintenance
- Shovel maintenance



## Power Generation

- Turbine bolts
- Tower segments
- Turbine casings



















## Oil & Gas

- Pipe flanges
- Valves
- Manway covers
- Pressure vessels



## Optimum Torque Wrench and Pump Combinations

For optimum speed and performance Enerpac recommends the following system set-up with wrench-pump-hose combinations. For other combinations, consult your Enerpac bolting expert or your authorized Enerpac distributor.

		ELECTRIC PUMPS				AIR DRIVEN PUMPS
		PME, PMU-Series	ZU4-Series	TQ-Series	ZE-Series	ZA4-Series
						
		Page: 213	Page: 216	Page: 214	Page: 220	Page: 222
<b>Speed:</b>						
<b>Reservoir Capacity:</b>	1,9 - 3,8 litres	4,0 - 8,0 litres	4,0 litres	4,0 - 40 litres	4,0 - 8,0 litres	4,0 - 8,0 litres
<b>Duty Cycle:</b>	Standard	Standard	Medium	Heavy-Duty	Heavy-Duty	Heavy-Duty
<b>Weight:</b>						
<b>Field/Factory Work:</b>	Field	Field	Field/Factory	Factory	Field	Field
<b>S-Series</b>  186	S1500X	Optimal	Optimal	Optimal	Optimal	Optimal
	S3000X			Optimal		
	S6000X			-		
	S11000X			Acceptable		
	S25000X			Optimal		
<b>W-Series</b>  192	W2000X	Optimal	Optimal	Optimal	Optimal	Optimal
	W4000X	Optimal	Optimal	Optimal	Optimal	Optimal
	W8000X	-	Optimal	Optimal	Optimal	Optimal
	W15000X	-	Optimal	Optimal	Optimal	Optimal
	W22000X	-	Optimal	Optimal	Optimal	Optimal
	W35000X	-	Optimal	Acceptable	Optimal	Optimal



### ZU4T – Electric Wrench Pumps

Utilizing a universal motor, the ZU4-Series has excellent low voltage characteristics. It works well with long extension cords or generator driven electrical power supplies. A field proven, efficient design ensures this pump is dependable and will draw less current – lowering your operating cost. ZU4-pumps are available in **Pro** and **Classic** formats.

**ZU4T Pro pumps** have an LCD feature to display torque or pressure, selectable torque wrench, and self-diagnostics – premium features not available on any other pump.

**ZU4T Classic pumps** feature an analogue gauge and a basic electrical package to deliver durable, safe and efficient hydraulic power.

### ZE4T, ZE5T-Series Electric Wrench Pumps

The ZE-Series features premium options, such as the LCD to display torque or pressure values, and self-diagnostics. These pumps utilize an induction motor, making the ZE-Series the coolest and quietest pumps in their class.

### ZA4T-Series Air Driven Wrench Pumps

Utilizing the highly efficient design of the Z-Class pumping element, this air driven pump is best suited to power medium to large size torque wrenches.

### TQ-700 Series Electric Wrench Pumps

Designed for both portability and production, the TQ-700 features optimized flow technology to deliver superior bolting speed.



### Torque Wrench Hoses

Use Enerpac twin safety hoses to connect your torque wrench to the pump.

For S & W	Modelnr.
6 m long, 2 hoses	THQ-706T
12 m long, 2 hoses	THQ-712T
For SQD & HXD	
6 m long, 2 hoses	THC-7062
12 m long, 2 hoses	THC-7122



### Torque Wrench Couplers

For torque wrench couplers see our "System Components" section in this catalogue.

# Portable Electric Torque Wrench Pumps

▼ PMU-10422



- Powerful two-speed pump is lightweight and easy to carry
- Standard heat exchanger package on PMU-Series keeps pump cool under extreme use
- Glycerin filled gauge with scales reading in psi and bar
- Transparent overlays in Nm and Ft.lbs for all Enerpac torque wrenches provide a quick torque reference
- Universal motor for a high power-to-weight ratio; generates full pressure on as little as 50% of the rated line voltage
- Adjustable pressure relief valve for accurate torque adjustments and precise repeatability.

## PME PMU Series



Reservoir Capacity:

**1,9 - 3,8 litres**

Flow at Rated Pressure:

**0,33 l/min**

Motor Size:

**0,37 kW**

Maximum Operating Pressure:

**700 - 800 bar**



### Torque Wrench Hoses

Use Enerpac twin safety hoses to connect your torque wrench to the pump.

For 700 bar	Model-Nr.
6 m long, 2 hoses	THQ-706T
12 m long, 2 hoses	THQ-712T
For 800 bar	
6 m long, 2 hoses	THC-7062
12 m long, 2 hoses	THC-7122



### Gauge with Overlay Kit

Available separately for use with PMU-Series pumps:

**GT-4015-Q** includes gauge and overlays for all S- and W-Series wrenches. **GT-4015** includes gauge and overlays for all SQD and HXD Series wrenches.

## ▼ SELECTION CHART

For Use With Torque Wrenches		Maximum Pressure Rating (bar)		Oil Flow Rate (l/min)		Model Number with Heat Exchanger *	Useable Oil Capacity (litres)	Electric Motor (Volt-phase-Hz)	Dimensions L x W x H (mm)	Weight (kg)
		1 <sup>st</sup> stage	2 <sup>nd</sup> stage	1 <sup>st</sup> stage	2 <sup>nd</sup> stage					
S1500X S3000X	W2000X W4000X	48	700	3,3	0,33	PMU-10427-Q	1,9	115 - 1 - 50/60	431x280x381	21
		48	700	3,3	0,33	PMU-10447-Q	3,8	115 - 1 - 50/60	431x330x381	24
		48	700	3,3	0,33	PMU-10422-Q	1,9	230 - 1 - 50/60	431x280x381	21
		48	700	3,3	0,33	PMU-10442-Q	3,8	230 - 1 - 50/60	431x330x381	24
SQD-25-I SQD-50-I	HXD-30 HXD-60	48	800	3,3	0,33	PMU-10427	1,9	115 - 1 - 50/60	431x280x381	21
		48	800	3,3	0,33	PMU-10447	3,8	115 - 1 - 50/60	431x330x381	24
		48	800	3,3	0,33	PMU-10422	1,9	230 - 1 - 50/60	431x280x381	21
		48	800	3,3	0,33	PMU-10442	3,8	230 - 1 - 50/60	431x330x381	24

\* For pump without heat exchanger change PMU into PME. Example **PME-10442-Q**.

PME-Series pump size: 250 x 250 x 360 mm. Weight 18 kg (1,9 litres) and 21 kg (3,8 litres).



▼ TQ-700E



- **Optimized flow technology – three stage pump maximizes productivity of the pump and tool while minimizing heat build-up and down time**
- **Heat exchanger is standard included**
- **A quiet (<85 dBA), lightweight pump with a compact footprint – easy to move around and through the work site**
- **Durable roll cage with an ergonomically sized handle and shielded gauge – a pump that is easy to put into position and safe from on site operational hazards**
- **Maintenance made simple with a brushless motor designed for continuous usage**
- **Straightforward operation with a simple pressure set and convenient to use 6 m pendant control – immediate productivity for crews operating the pump**
- **IP55 Rating for Superior Dust and Water Protection**
- **Transparent gauge overlays in Nm and Ft.lbs for all Enerpac S and W-Series torque wrenches provide a quick torque reference.**

## Lightweight Torque Wrench Pumps



### Four Port Manifold

The TQ-700 offers an optional four wrench manifold as an accessory factory installed. (Add suffix "M" at the end of the model number.

For example: **TQ-700EM**).



### Hydraulic Torque Wrenches

Enerpac offers a complete range of square drive and hexagon cassette torque wrenches.

Page: 183



### Torque Wrench Hoses

Use Enerpac THQ-700 series twin hoses with 700 bar pumps.

For 700 bar	Model Nr.
6 meters long, 2 hoses	<b>THQ-706T</b>
12 meters long, 2 hoses	<b>THQ-712T</b>



*The TQ-700E and the W-Series wrenches are a productive combination in wind applications. ▶*



# Electric Torque Wrench Pumps



## TQ-700 Applications

The TQ-700 Series pump is ideal for powering hydraulic wrenches for the Power Generation and Wind Markets.

Bolting speed is more complex than how much flow per minute the pump produces. The key is optimising the flow rate across the entire bolting cycle. With more oil flowing at the right time and at the right volume, you achieve the optimized flow for a hydraulic bolting system.

The result of this optimized flow is more bolts tightened faster and a more productive work team.

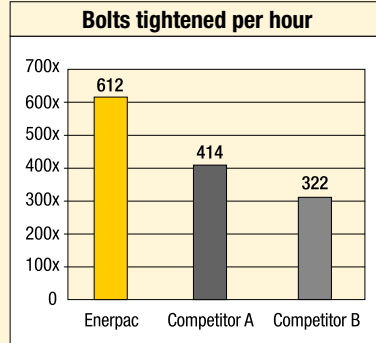

Internal laboratory testing based on standard torquing procedure on a pipe flange with 14, 1 1/2" bolts.

## TQ Series



Reservoir Capacity:

**4,0 litres**

Flow at Rated Pressure:

**0,5 l/min**

Motor Size:

**0,75 kW**

Maximum Operating Pressure:

**700 bar**



## Torque Wrench Pump Selection Matrix

For optimum speed and performance see the torque wrench, pump and hose selection matrix.

Page: 212

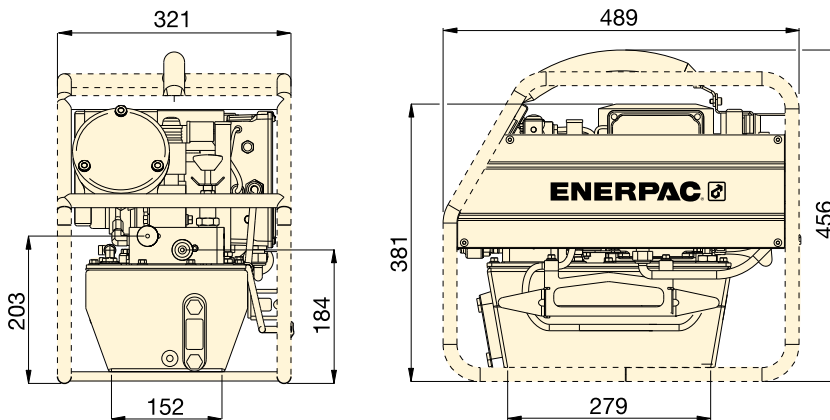

For Use with Torque Wrenches	Pressure Rating (bar)	Model Number <sup>1)</sup>	Useable Oil Capacity (litres)	Motor Size (kW)	Motor Electrical Specifications (Volt - Ph - Hz)	Sound Level (dBA)	Weight (kg)
All S and W-Series	700	<b>TQ-700B</b>	4,0	0,75	115 - 1 - 50/60	82 - 85	31
	700	<b>TQ-700E</b> <sup>2)</sup>	4,0	0,75	230 - 1 - 50	82 - 85	30
	700	<b>TQ-700I</b> <sup>3)</sup>	4,0	0,75	230 - 1 - 60	82 - 85	30

<sup>1)</sup> All models meet CE safety requirements and all TÜV requirements.

<sup>2)</sup> TQ-700E with European plug and CE EMC directive compliant.

<sup>3)</sup> TQ-700I with NEMA 6-15 plug.

▼ The TQ-700E and the W-Series wrenches are a productive combination.



# ZU4T,-Series, Electric Torque Wrench Pumps

**ENERPAC**   
POWERFUL SOLUTIONS. GLOBAL FORCE.

▼ ZU4204TE-Q (Pro-Series), ZU4204BE-Q (Classic)



# Z

Tough,  
Dependable  
Innovative  
**CLASS**



### Classic Electrical

Basic electrical package includes mechanical contactor, ON/OFF toggle switch, pendant with electro-mechanical push buttons, 24V transformer timer and operator accessible circuit breaker.



### Pro-Series

Back-lit LCD and Pressure Transducer featuring Auto-Cycle Technology.

- Features Z-Class high-efficiency pump design; higher oil flow and bypass pressure, cooler running and requires 18% less current draw than comparable pumps
- Powerful 1,25 kW universal electric motor provides high power-to-weight ratio and excellent low-voltage operating characteristics
- High-strength, molded composite shroud protects motor and electrical components, while providing an ergonomic, non-conductive handle for easy transport
- Low-voltage pendant provides additional safety for the operator.

### Pro Series pump only

- LCD readout provides pressure display and a number of diagnostic and readout capabilities never before offered on a portable electric pump
- AutoCycle feature provides continuous cycle operation of the torque wrench as long as the advance button is pressed (pump can be used with or without auto cycle feature).

- Torque wrench model is selectable
- “Auto cycle” setting easily programmable.
- Digital read-out and “Autocycle” setting
- Pump usage information, hour and cycle counts
- Low-voltage warning and recording
- Self-test and diagnostic capabilities
- Information can be displayed in English, French, German, Italian, Spanish and Portuguese
- Pressure transducer is more accurate and durable than analog gauges
- Easy-viewing variable rate display
- Display pressure in bar, MPa or psi.



◀ Any brand of hydraulic torque wrench can be powered by the portable ZU4-Series torque wrench pump.

# ZU4T-Series, Torque Wrench Pumps



## Z-Class – A Pump For Every Application

Patented Z-Class pump technology provides high bypass pressures for increased productivity – important in applications using long hose runs and high pressure-drop circuits, like heavy lifting or certain double-acting tools.

Enerpac ZU4T-Series pumps are built to power small to large torque wrenches. Choosing the right ZU4T-Series torque wrench pump for your application is easy.

### Classic Electric Torque Wrench Pump

- The Classic has traditional electro-mechanical components (transformers, relays and switches) in place of solid-state electronics. The Classic delivers durable, safe and efficient hydraulic power.

### Pro Series Electric Torque Wrench Pump

- Digital (LCD) display features a built-in hour meter, pressure display and shows self-diagnostic, cycle-count and low voltage warning information. These premium features are not available on any other pump – anywhere!
- Auto-Cycle feature provides continuous cycle operation of the torque wrench as long as the advance button is pressed (pump can be used with or without Auto-Cycle feature).

## ZU4T Series



Reservoir Capacity:

**4,0 - 8,0 litres**

Flow at Rated Pressure:

**1,0 l/min**

Motor Size:

**1,25 kW**

Maximum Operating Pressure:

**700 - 800 bar**



### Torque Wrench Pump Selection Matrix

For optimum speed and performance see the torque wrench pump and hose selection matrix.

Page: 212

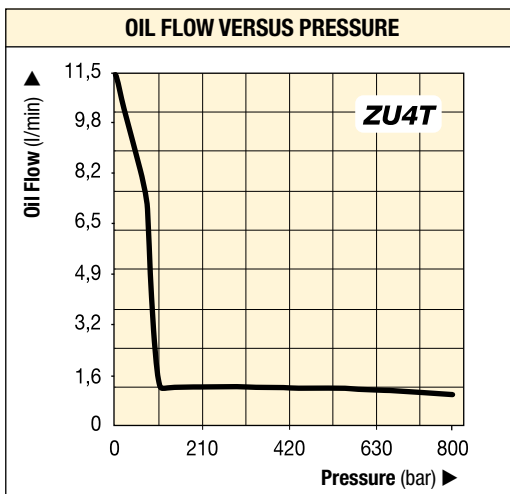

### COMMON PUMP MODELS

	For Use With Torque Wrenches	Model Number <sup>1) 4)</sup>	Motor Electrical Specification	Usable Oil Capacity (litres)	Weight (kg)
Pro Series	All wrenches	ZU4204TB-Q	115 VAC, 1-ph	4,0	32
		ZU4208TB-Q	115 VAC, 1-ph	8,0	34
		ZU4204TE-Q <sup>2)</sup>	208-240 VAC, 1-ph	4,0	32
		ZU4208TE-Q <sup>2)</sup>	208-240 VAC, 1-ph	8,0	34
		ZU4204TI-Q <sup>3)</sup>	208-240 VAC, 1-ph	4,0	32
		ZU4208TI-Q <sup>3)</sup>	208-240 VAC, 1-ph	8,0	34
Classic	All wrenches	ZU4204BB-QH	115 VAC, 1-ph	4,0	37
		ZU4204BB-Q	115 VAC, 1-ph	4,0	33
		ZU4208BE-QH <sup>2)</sup>	208-240 VAC, 1-ph	8,0	38
		ZU4204BE-Q <sup>2)</sup>	208-240 VAC, 1-ph	4,0	34
		ZU4208BI-QH <sup>3)</sup>	208-240 VAC, 1-ph	8,0	40
		ZU4208BI-Q <sup>3)</sup>	208-240 VAC, 1-ph	8,0	36



### Pump Ratings

-Q suffix pumps are for 700 bar torque wrenches, and include spin-on couplers.

-E suffix pumps are for use with 800 bar torque wrenches, and include polarized lock-ring safety couplers.

Page: 219



### Overlay Kit with Gauge

Available separately for use with ZU4T-Series Classic: **GT-4015Q** includes gauge and torque overlays for all S- and W-Series

torque wrenches.

**GT-4015** includes gauge and overlays for all SQD and HXD torque wrenches.

<sup>1)</sup> All models meet CE safety requirements and all CSA requirements.

<sup>2)</sup> European plug and CE EMC directive compliant

<sup>3)</sup> With NEMA 6-15 plug

<sup>4)</sup> Select -E suffixed pumps for Enerpac SQD and HXD 800 bar torque wrenches, see page 219.



### 4-Wrench Manifold

- For simultaneous operation of multiple torque wrenches
- Can be factory installed or ordered separately.

Accessory Kit * Model Nr.	Can be used on ZU4-Series torque wrench pumps
ZTM-E	for 800 bar torque wrenches
ZTM-Q	for 700 bar torque wrenches

\* Add suffix **M** for factory installation.

Ordering Example: ZU4208TE-QM



### Skid Bar

- Provides greater pump stability on soft or uneven surfaces
- Provides easy two-handed lift.

Accessory Kit * Model Nr.	Can be used on ZU4-Series torque wrench pumps
SBZ-4	4 and 8 litres reservoir <sup>1)</sup>
SBZ-4L	4 and 8 litres reservoir <sup>2)</sup>

\* Add suffix **K** to pump model number for factory installation.

<sup>1)</sup> Without heat exchanger 2,2 kg.

<sup>2)</sup> With heat exchanger 3,2 kg.

Ordering Example: ZU4208TE-QK



### Heat Exchanger

- Removes heat from the bypass oil to provide cooler operation
- Stabilizes oil viscosity, increasing oil life and reduces wear of pump and other hydraulic components.

Accessory Kit * Model Nr.	Can be used on ZU4-Series torque wrench pumps
ZHE-U115	115 V pumps
ZHE-U230	230 V pumps

\* Add suffix **H** to pump model number for factory installation.

Heat Exchanger adds 4,1 kg to pump weight.

Ordering Example: ZU4208TE-QH

▼ Most hydraulic torque wrenches can be powered by the Enerpac ZU4T-Series torque wrench pump.



### Roll Cage

- Protects pump
- Provides greater pump stability.

Accessory Kit * Model Nr.	Can be used on ZU4-Series torque wrench pumps
ZRC-04	4 and 8 litres reservoir <sup>1)</sup>
ZRC-04H	4 and 8 litres reservoir <sup>2)</sup>

\* Add suffix **R** for factory installation.

<sup>1)</sup> Without heat exchanger.

<sup>2)</sup> With heat exchanger.

Ordering Example: ZU4208TE-QR

Thermal Transfer *	Max. Pressure	Max. Oil Flow	Voltage
(Btu/h)	(bar)	(l/min)	(VDC)
900	20,7	26,5	12

\* At 1,9 l/min at 21 °C ambient temperature. Do not exceed maximum oil flow and pressure ratings. Heat exchanger is not suitable for water-glycol or high water-based fluids.



# ZU4T-Series, Ordering Matrix and Specifications

▼ This is how a ZU4T-Series pump model number is built up:



## 1 Product Type

**Z** = Pump series

## 2 Motor Type

**U** = Universal electric motor

## 3 Flow Group

**4** = 1,0 l/min @ 700 bar

## 4 Valve Type

**2** = Torque wrench valve

## 5 Reservoir Size (useable oil)

**04** = 4 litres

**08** = 8 litres

## 6 Valve Operation

**T** = **Pro Serie** pump with solenoid valve and pendant, LCD Electric and pressure transducer

**B** = **Classic pump** with solenoid valve and pendant.

## 7 Voltage

**B** = 115V, 1 ph, 50/60 Hz

**E** = 208-240V, 1 ph, 50/60 Hz (with European plug CE RF compliant)

**I** = 208-240V, 1 ph, 50/60 Hz (with NEMA 6-15 plug)

## 8 Options

**E** = **800 bar couplers** for use with HXD and SQD-Series or other wrenches

**Q** = **700 bar couplers** for use with S and W-Series or other wrenches

**H** = Heat exchanger

**K** = Skid bar

**M** = 4-wrench manifold

**R** = Roll cage

## ZU4T Series



Reservoir Capacity:

**4 - 8 litres**

Flow at Rated Pressure:

**1,0 l/min**

Motor Size:

**1,25 kW**

Maximum Operating Pressure:

**700 - 800 bar**



**How to order your ZU4T-Series torque wrench pump**

### Ordering Example : Modelnr. ZU4208TE-QMHK

700 bar Pro Series pump for use with Enerpac S and W-Series and other 700 bar torque wrenches, 230V motor, 8 litres reservoir, 4-wrench manifold, heat exchanger and skidbar.

Refer to the torque wrench pump selection matrix for optimum wrench, pump and hose combinations.

Page: 212

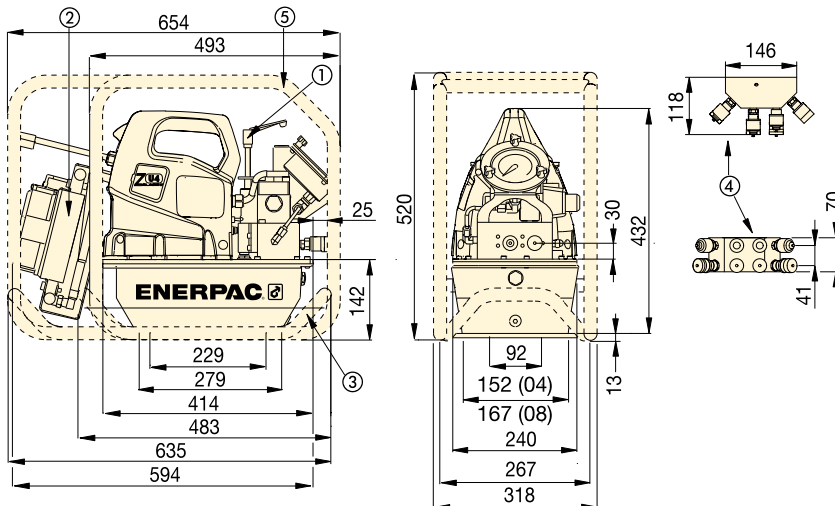

## ZU4T-Series Torque Wrench Pumps

① User adjustable relief valve

② Heat Exchanger (optional)

③ Skidbar (optional)

④ 4-wrench manifold (optional)

⑤ Roll cage (optional)

ZU4T-Series Performance Chart									
Motor Size (kW)	Output Flow Rate (l/min)				Motor Electrical Specification (Volt - Phase - Hz)	Sound Level (dBA)	Relief Valve Adjustment Range (bar)		
	7 bar	50 bar	350 bar	700 bar					
1,25	11,5	8,8	1,2	1,0	115 - 1 - 50/60 208-240 - 1 - 50/60	85-90	124-700 *		

\* Pump type (-Q) shown, (-E) range is 124-800 bar.



### Torque Wrench Hoses

Use Enerpac twin safety hoses to connect your torque wrench to the pump.

For 700 bar	Model-Nr.
6 m long, 2 hoses	<b>THQ-706T</b>
12 m long, 2 hoses	<b>THQ-712T</b>
For 800 bar	
6 m long, 2 hoses	<b>THC-7062</b>
12 m long, 2 hoses	<b>THC-7122</b>

▼ ZE4204TE-QHR



**Z** Tough,  
Dependable  
Innovative  
**CLASS**

- **Auto-Cycle feature provides continuous cycle operation of the torque wrench as long as the advance button is pressed (pump can be used with or without auto cycle feature)**
- **LCD readout provides pressure and torque display and a number of diagnostic and readout capabilities never before offered on a portable electric pump**
- **Totally enclosed, fan-cooled industrial electric motors supply extended life and stand up to harsh industrial environments**
- **High-strength, molded electrical enclosure protects electronics, power supplies and LCD readout from harsh environments.**



#### Pro-Series

Back-lit LCD and Pressure Transducer featuring Auto-Cycle Technology.

- Torque wrench model is selectable
- "Auto cycle" setting easily programmable.
- Digital read-out and "Autocycle" setting
- Pump usage information, hour and cycle counts
- Low-voltage warning and recording
- Self-test and diagnostic capabilities
- Information can be displayed in English, French, German, Italian, Spanish and Portuguese
- Pressure transducer is more accurate and durable than analog gauges
- Easy-viewing variable rate display
- Display pressure in bar, MPa or psi.



◀ *The ZE4T-Series torque wrench pumps are perfectly matched for this W2000X wrench.*

# Electric Torque Wrench Pumps

ZE4T AND ZE5T-SERIES OIL FLOW VERSUS PRESSURE

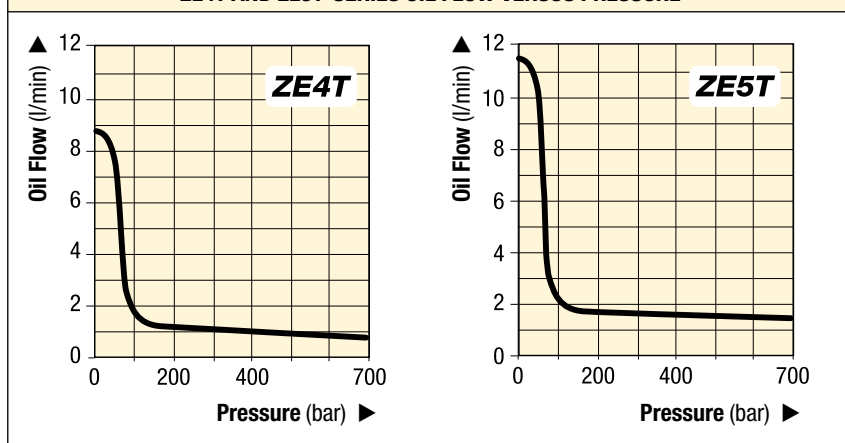

## ZE4T ZE5T Series



Reservoir Capacity:

**4 - 40 litres**

Flow at Rated Pressure:

**0,82 - 1,64 l/min**

Motor Size:

**1,1 - 2,2 kW**

Maximum Operating Pressure:

**700 bar**

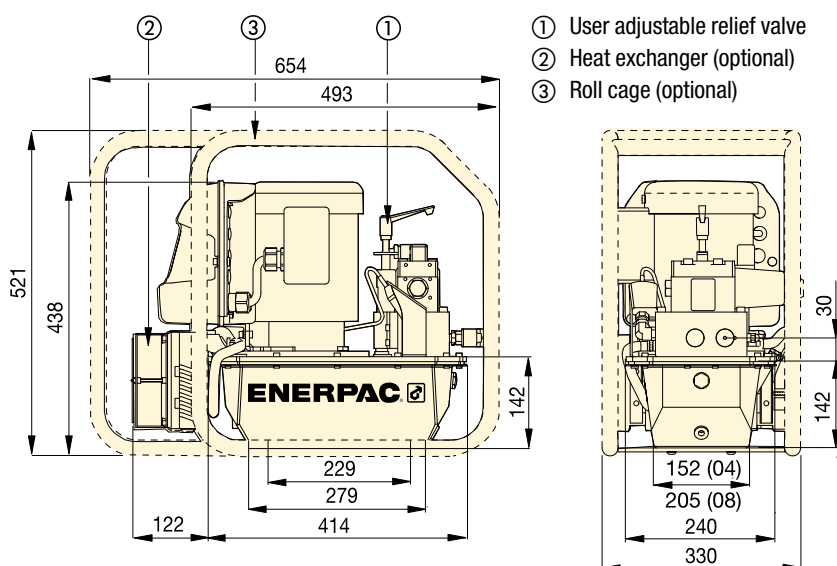

ZE4T and ZE5T-Series, 4 and 8 litres reservoirs

### ▼ COMMON TORQUE WRENCH PUMP MODELS

For Use With Torque Wrenches	Max. Operating Pressure (bar)	Model Number with Heat Exchanger and Roll Cage	Motor Electrical Specification (Volt - Ph - Hz)	Usable Oil Capacity <sup>1)</sup> (litres)	Weight (kg)
all S and W-Series	700	ZE4204TB-QHR	115 - 1 - 50/60	4,0	61
	700	ZE4204TE-QHR	230 - 1 - 50/60	4,0	61
	700	ZE4204TG-QHR	230 - 3 - 50/60	4,0	62
	700	ZE5204TW-QHR	400 - 3 - 50/60	4,0	62

<sup>1)</sup> Larger reservoirs (8, 10, 20 and 40 litres) are available. Contact Enerpac.

### ▼ PERFORMANCE CHART

Pump Series	Output Flow Rate at 50 Hz <sup>2)</sup> (l/min)				Motor Size (kW)	Relief Valve Adjustment Range (bar)	Sound Level (dBA)
	7 bar	50 bar	350 bar	700 bar			
ZE4T	8,8	8,1	0,9	0,8	1,1	70 - 700	75
ZE5T	11,8	11,2	1,7	1,6	2,2	70 - 700	75

<sup>2)</sup> Flow rate will be approximately 6/5 higher at 60 Hz.



### Torque Wrench Pump Selection Matrix

For optimum speed and performance see the torque wrench pump and hose selection matrix.

Page: 212



### Torque Wrench Hoses

Use Enerpac twin safety hoses to connect your torque wrench to the pump.

For 700 bar	Model Nr.
6 m long, 2 hoses	THQ-706T
12 m long, 2 hoses	THQ-712T

▼ ZA4204TX-ER



- Two-speed operation and high by-pass pressure reduces cycle time for improved productivity
- Glycerin filled pressure gauge with transparent overlays in Nm and Ft.lbs for Enerpac torque wrenches provide a quick torque reference
- Standard Regulator-Filter-Lubricator with removable bowls and auto drain
- Heat exchanger warms exhaust air to prevent freezing and cools the oil
- Ergonomic pendant allows remote operation up to 6 m.

#### Complete 700 bar Pump-Hose Set ZA4208TX-QRU105

- Fine air pressure adjustment for very accurate torque control
- High bypass pressure (200 bar) for faster torque cycles
- Improved wrench performance at low pressure
- Standard with THQ706T twin hose.



## Z Tough, Dependable Innovative CLASS



#### Torque Wrench Hoses

Use Enerpac twin safety hoses to connect your torque wrench to the pump.

For 700 bar	Model Nr.
6 m long, 2 hoses	<b>THQ-706T</b>
12 m long, 2 hoses	<b>THQ-712T</b>
For 800 bar	
6 m long, 2 hoses	<b>THC-7062</b>
12 m long, 2 hoses	<b>THC-7122</b>



#### Gauge with Overlay Kit

Gauge Overlay Kits are available separately for use with ZA4T-Series pumps:

**GT-4015-Q** includes gauge and overlays for all S- and W-Series torque wrenches.  
**GT-4015** includes gauge and overlays for all SQD and HXD torque wrenches.



#### Torque Wrench Pump Selection Matrix

For optimum speed and performance see the torque wrench pump and hose selection matrix.

Page: **212**

◀ Most hydraulic torque wrenches can be powered by the Enerpac ZA4T-Series torque wrench pump.



# Air Driven Torque Wrench Pumps



## ZA4T-Series Pump Applications

The ZA4T-Series pump is best suited to power medium to large size torque wrenches.

Patent-pending Z-Class technology provides high by-pass pressures for increased productivity.

Its high power to weight ratio and compact design make it ideal for applications which require easy transport of the pump.

All ZA4T-Series pump models meet CE, CSA and TÜV safety requirements. For further application assistance contact your local Enerpac office.

## ATEX 95 Certified

The ZA4T-Series pumps are tested and certified according to the Equipment Directive 94 / 9 / EC "ATEX Directive".

The explosion protection is for equipment group II, equipment category 2 (hazardous area zone 1), in gas and/or dust atmospheres. The ZA4T-Series pumps are marked with: **Ex II 2 GD ck T4**.



## ZA4T Series



Reservoir Capacity:

**4,0 - 8,0 litres**

Flow at Rated Pressure:

**0,8 - 1,0 l/min**

Air Consumption:

**600 - 2840 l/min**

Maximum Operating Pressure:

**700 - 800 bar**

## OIL FLOW VERSUS PRESSURE

6,9 bar dynamic air pressure at 2840 l/min

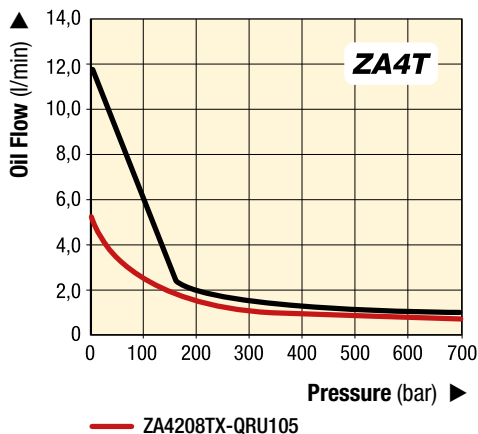

## COMMON PUMP MODELS

For Use With Torque Wrenches	Maximum Operating Pressure (bar)	Model Number	Usable Oil Capacity (litres)	Weight (kg)
all S and W-Series	700	ZA4208TX-QRU105 *	6,6	45
	700	ZA4204TX-Q	2,7	42
	700	ZA4208TX-Q	6,6	47
	700	ZA4204TX-QR	2,7	46
	700	ZA4208TX-QR	6,6	51
all SQD and HXD-Series	800	ZA4204TX-E	2,7	42
	800	ZA4208TX-E	6,6	47
	800	ZA4204TX-ER	2,7	46
	800	ZA4208TX-ER	6,6	51

\* Standard with THQ706T hose and fine air pressure adjustment for very accurate torque control. Pump weight 45 kg, complete set weight 58 kg.



## Accessory Options

Available by placing the following additional suffix at the end of the model number:

- K** = Skid bar
- M** = 4-wrench manifold
- R** = Roll cage.

▼ ZA4208TX-QRU105 for improved wrench performance and torque control at low pressure.





### Skid Bar

- Provides greater pump stability on soft or uneven surfaces
- Provides easy two-handed lift.



### 4-Wrench Manifold

- For simultaneous operation of multiple torque wrenches
- Can be factory installed or ordered separately.



### Roll Cage

- Protects pump
- Provides greater pump stability.

Accessory Kit * Model Nr.	Can be used on ZA4T-Series torque wrench pumps
<b>SBZ-4</b>	Reservoir 04 and 08

\* Add suffix **K** for factory installation.  
Weight skid bar 2,2 kg.  
**Ordering Example: ZA4208TX-QK**

Accessory Kit * Model Nr.	Can be used on ZA4T-Series torque wrench pumps
<b>ZTM-E</b>	for 800 bar torque wrenches
<b>ZTM-Q</b>	for 700 bar torque wrenches

\* Add suffix **M** for factory installation.  
Weight manifold 4,5 kg.  
**Ordering Example: ZA4208TX-QM**

Accessory Kit * Model Nr.	Can be used on ZA4T-Series torque wrench pumps
<b>ZRC-04</b>	Reservoir 04 and 08

\* Add suffix **R** for factory installation.  
Roll cage weight 3,4 kg.  
**Ordering Example: ZA4208TX-QR**



### 700 bar Spin-on Couplers

- Mounted on:
  - Torque wrench pumps with suffix "Q"
  - S and W-Series wrenches
  - THQ-Series hoses
  - 4-Wrench manifold ZTM-Q.



### 800 bar Lock-ring Couplers

- Mounted on:
  - Torque wrench pumps with suffix "E"
  - HXD and SQD-Series wrenches
  - THC-Series hoses
  - 4-Wrench manifold ZTM-E.



### Torque Wrench Hoses

Use Enerpac twin safety hoses to connect your torque wrench to the pump.

For 700 bar	Model Nr.
6 m long, 2 hoses	<b>THQ-706T</b>
12 m long, 2 hoses	<b>THQ-712T</b>
For 800 bar	
6 m long, 2 hoses	<b>THC-7062</b>
12 m long, 2 hoses	<b>THC-7122</b>



### Torque Wrench Couplers

For Enerpac torque wrench couplers see our "System Components" section in this catalogue.

# Ordering Matrix and Specifications

▼ This is how a ZA4T-Series pump model number is built up:

<b>Z</b>	<b>A</b>	<b>4</b>	<b>2</b>	<b>08</b>	<b>T</b>	<b>X</b>	<b>-</b>	<b>Q</b>	<b>M</b>	<b>R</b>
1 Product Type	2 Motor Type	3 Flow Group	4 Valve Type	5 Reservoir Size	6 Valve Operation	7 Voltage		8 Must be E or Q	8 Options	8 Options

### 1 Product Type

Z = Pump series

### 2 Motor Type

A = Air motor

### 3 Flow Group

4 = 1,0 l/min @ 700 bar

### 4 Valve Type

2 = Torque Wrench Valve

### 5 Reservoir Size

(useable capacity)

04 = 2,7 litres

08 = 6,6 litres

### 6 Valve Operation

T = Air operated valve with pendant

### 7 Voltage

X = Not applicable

### 8 Options

E = 800 bar couplers for use with HXD and SQD-Series or other wrenches

Q = 700 bar couplers for use with S and W-Series or other wrenches

K = Skid bar

M = 4-wrench manifold

R = Roll cage

## ZA4T Series



Reservoir Capacity:

**4 - 8 litres**

Flow at Rated Pressure:

**0,8 - 1,0 l/min**

Air Consumption:

**600 - 2840 l/min**

Maximum Operating Pressure:

**700 - 800 bar**



How to order your ZA4T-Series torque wrench pump

Model No. ZA4208TX-QMR

700 bar pump for use with Enerpac S- and W-Series and other 700 bar torque wrenches, 8 litres reservoir, 4-wrench manifold, and roll cage.

Refer to the torque wrench pump selection matrix for optimum wrench, pump and hose combinations.

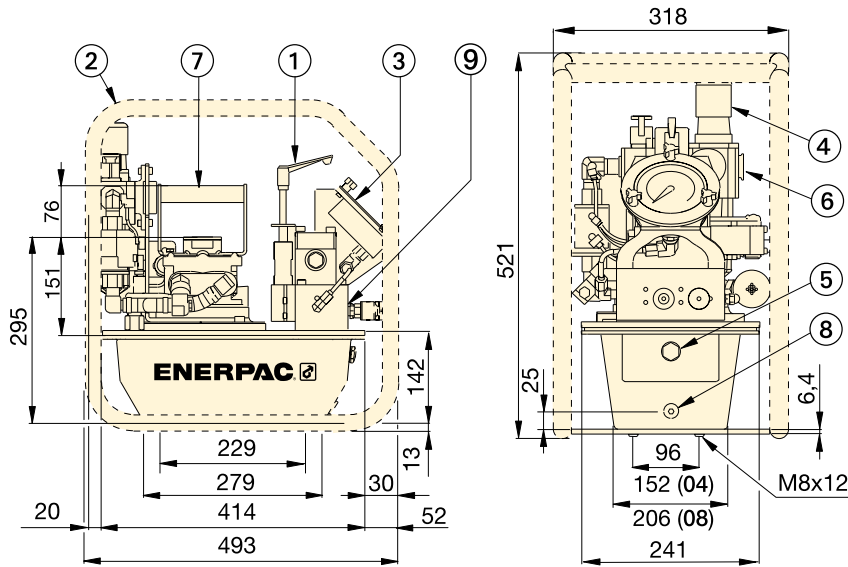

- ① User adjustable relief valve
- ② Roll Cage (optional)
- ③ Gauge with overlays
- ④ Filter/lubricator/regulator
- ⑤ Oil level sight gauge

- ⑥ Air input 1/2" NPTF
- ⑦ Standard handle
- ⑧ Oil drain
- ⑨ 1/4"-18 NPTF Oil outlet

### ZA4T-Series Performance

Output Flow Rate (l/min)				Dynamic Air Pressure Range (bar)	Air Consumption (l/min)	Sound Level (dBA)	Relief Valve Adjustment Range (bar)
7 bar	50 bar	350 bar	700 bar				
11,5	8,8	1,2	1,0	4,0 - 6,9	600 - 2840	85-90	124-700 *
5,4 **	4,8 **	1,1 **	0,8 **	7,0 **			

\* Pump type (-Q) shown, (-E) range is 124-800 bar.

\*\* ZA4208TX-QRU105 only.

www.enerpac.com

▼ Most hydraulic torque wrenches can be powered by the Enerpac ZA4T-Series torque wrench pump.

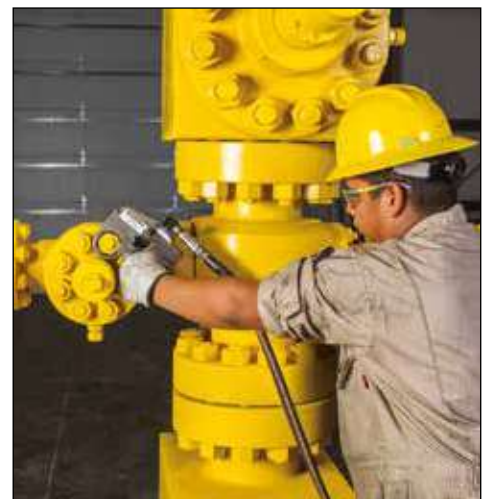

▼ ZUTP-1500E



- Two-stage pump design provides high flow at low pressure for fast system fills and controlled flow at high pressure for safe and accurate operation
- Z-Class high-efficiency pump design runs cooler and requires less current draw which is especially helpful in remote locations
- 6 m pendant cord enables motor control from a distance
- Angled 153 mm pressure gauge, with polycarbonate cover, built into a protective metal shroud for improved visibility and protection
- Safety relief valve limits output pressure
- Compact, lightweight and rugged aluminium frame for increased durability and ease of handling.



◀ *The ZUTP-1500 pump is rugged, lightweight, compact for tight openings, and delivers hassle-free operation of bolt tensioning in remote locations with up to two times the speed of competitive pumps.*

## Reliability, Power and Precision



### Applications

The Enerpac ZUTP-Series electric pump is ideally suited for use with hydraulic bolt tensioning tools and hydraulic nuts. See our Bolting Tools catalogue and website.



### Ultra-high pressure

This pump operates at ultra-high pressure, use only the specified fittings and hoses designed for these pressures.

Page: 227



### Bolting Integrity Software

Visit [www.enerpac.com](http://www.enerpac.com) to access our free on-line bolting software application and obtain information on tool selection, bolt load calculations and tool pressure settings. A combined application data sheet and joint completion report is also available.



# Electric Tensioning Pumps

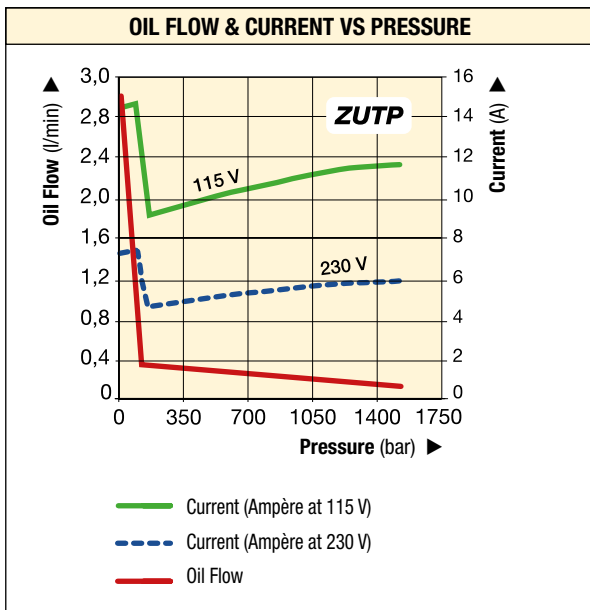

## ZUTP Series



Reservoir Capacity:

**4,0 litres**

Flow at Rated Pressure:

**0,13 l/min**

Motor Size:

**1,25 kW**

Maximum Operating Pressure:

**1500 bar**

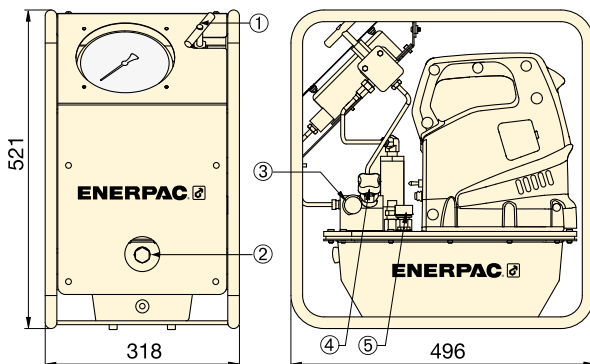

- ① Release Valve
- ② Sight Glass
- ③ Out Port 1/4" BSPM and BR-150 female coupler
- ④ User Adjustable Relief Valve
- ⑤ Breather

### 1500 bar HIGH PRESSURE PUMP

Pump Type	Useable Oil Capacity (litres)	Model Number <sup>1)</sup>	Pressure Rating (bar)	Output Flow Rate at 0 bar (l/min)	Output Flow Rate at 1500 bar (l/min)	Motor Electrical Specification	Motor Size (kW)	Sound Level (dBA)	Weight (kg)
Two speed	4,0	<b>ZUTP-1500 B</b>	1500	2,90	0,13	115 VAC, 1-ph	1,25	89	29,5
	4,0	<b>ZUTP-1500 E <sup>2)</sup></b>	1500	2,90	0,13	230 VAC, 1-ph <sup>2)</sup>	1,25	89	29,5
	4,0	<b>ZUTP-1500 I <sup>3)</sup></b>	1500	2,90	0,13	230 VAC, 1-ph <sup>3)</sup>	1,25	89	29,5

<sup>1)</sup> All models meet CE safety requirements and all TÜV requirements.

<sup>2)</sup> European plug and CE EMC directive compliant.

<sup>3)</sup> With NEMA 6-15 plug.

### 1500 bar HOSES

Model Number	Hose End 1	Hose End 2	Length (m)
HT-1503	1/4" BSPM 120° Cone	1/4" BSPM 120° Cone	1,0
HT-1510	1/4" BSPM 120° Cone	1/4" BSPM 120° Cone	3,0
HT-1503HR*	BH-150	BR-150	1,0
HT-1510HR*	BH-150	BR-150	3,0

\* Includes dust caps.

### 1500 bar COUPLERS

Description	Complete Set	Female Half	Male Half
Quick Disconnect Coupler*	B-150	BR-150	BH-150
Quick Disconnect Coupler and Adaptor Kit*	BW-150AW	-	-
Quick Disconnect Blanking Coupler Set*	B-150B	-	-

\* Includes dust caps.

# ATP-Series, Ultra-High Pressure Air Pump

▼ ATP-1500



- General purpose, high pressure air driven two speed pump unit for products requiring up to 1500 bar hydraulic pressure
- Compact, lightweight, rugged steel frame for protection and easy handling
- Prelubricated pump element, does not require an airline lubricator
- Easily adjustable output pressure control
- Integrated and protected easy to read glycerin filled gauge
- Safety relief valve limits output pressure.

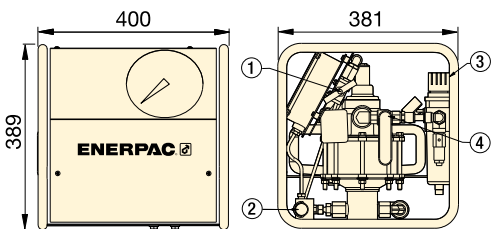

- ① Shut-off Valve
- ② Out Port 1/4" BSPM with BR-150 coupler
- ③ Filter/Regulator
- ④ Air On/Off Valve Air Inlet 1/2" NPTF

## ATP Series

Reservoir Capacity:  
**3,8 litres**

Flow at Rated Pressure:  
**0,07 l/min**

Maximum Operating Pressure:  
**1500 bar**



This pump operates at ultra-high pressure, use only the specified fittings and hoses designed for these pressures.

Page: 227



### Applications

The ATP-pump is ideally suited for use with GT-Series hydraulic bolt tensing tools and hydraulic nuts. See our Bolting Tools

catalogue or [enerpac.com](http://enerpac.com)



### ATEX Certified

The ATP-Pump is tested and certified according ATEX.



II 2 GD ck T4

Page: 263

### OIL FLOW VERSUS PRESSURE

Flow (l/min) at 6,2 bar air input

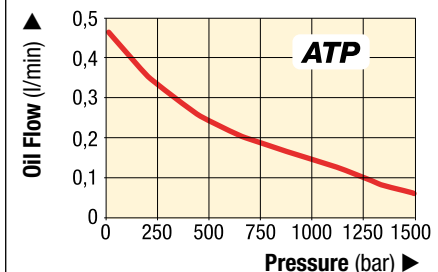

### 1500 bar HIGH PRESSURE AIR PUMP

Pump Type	Useable Oil Capacity (litres)	Pressure Rating (bar)	Model Number	Output Flow Rate at 0 bar (l/min)	Output Flow Rate at 1500 bar (l/min)	Air Pressure Range (bar)	Air Consumption (l/min)	Sound Level (dBA)	 (kg)
Two speed	3,8	1500	<b>ATP-1500</b>	0,43	0,07	5,5 - 6,2	594	70	32

# Single-Acting Hydraulic Nut Splitters

▼ Shown from left to right: NC-3241, NC-1319, NC-1924



## NC, STN Series



Capacity:

**49 - 882 kN (5-90 ton)**

Bolt Range:

**M6 - M48**

Maximum Operating Pressure:

**700 bar**

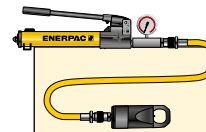

### Tool-Pump Sets

Hydraulic Nut Splitters are available as sets (pump, tool, gauge, gauge adaptor, couplers and hose) for your ordering convenience.

- Compact and ergonomic design, easy to use
- Unique angled head design
- Two blade design (NC-D models) for time saving operation – nuts are split from two sides in one action
- Single-acting, spring return cylinder
- Heavy duty chisels can be reground
- Nut Splitters include spare chisel, spare set screw and wrench used to secure the chisel. A CR-400 coupler is standard.

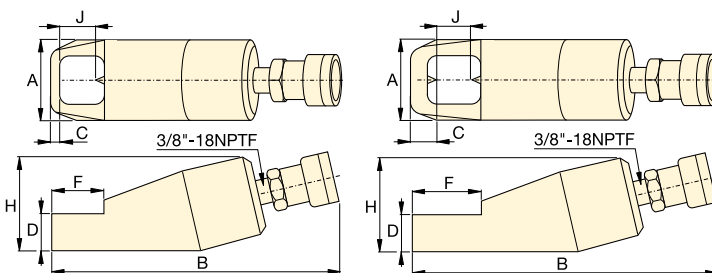

Single Blade Models (NC)

Double Blade Models (NC-D)

Nut Splitter Model Nr.	Hand Pump Model Nr.	Set Model Nr
NC-1924	P-392	STN-1924H
NC-2432	P-392	STN-2432H
NC-3241	P-392	STN-3241H

For Nut Splitter Model Nr.	Replacement Chisel Model Numbers	
	Moving	Static
NC-1319	<b>NCB-1319</b>	-
NC-1924	<b>NCB-1924</b>	-
NC-2432	<b>NCB-2432</b>	-
NC-3241	<b>NCB-3241</b>	-
NC-4150	<b>NCB-4150</b>	-
NC-5060	<b>NCB-5060</b>	-
NC-6075	<b>NCB-6075</b>	-
NC-1924D	<b>NCB-1924</b>	<b>NCB-1924D</b>
NC-2432D	<b>NCB-2432</b>	<b>NCB-2432D</b>
NC-3241D	<b>NCB-3241</b>	<b>NCB-3241D</b>

	Bolt Range (mm)	Hexagon Nut Range (mm)	Capacity ton (kN)	Oil Capacity (cm <sup>3</sup> )	Model Number	Dimensions (mm)						Weight (kg)	
						A	B	C	D	F	H		J
	<b>M6 - M12</b>	10 - 19	<b>5</b> (49)	15	<b>NC-1319</b>	40	170	7	19	28	48	21	1,2
	<b>M12 - M16</b>	19 - 24	<b>10</b> (98)	20	<b>NC-1924 *</b>	54	191	10	26	40	62	25	2,0
	<b>M16 - M22</b>	24 - 32	<b>15</b> (147)	60	<b>NC-2432 *</b>	64	222	13	29	51	72	33	3,0
	<b>M22 - M27</b>	32 - 41	<b>20</b> (196)	80	<b>NC-3241 *</b>	75	244	17	36	66	88	43	4,4
	<b>M27 - M33</b>	41 - 50	<b>35</b> (343)	155	<b>NC-4150</b>	94	288	21	45	74	105	54	8,2
	<b>M33 - M39</b>	50 - 60	<b>50</b> (490)	240	<b>NC-5060</b>	106	318	23	54	90	128	60	11,8
	<b>M39 - M48</b>	60 - 75	<b>90</b> (882)	492	<b>NC-6075</b>	156	393	26	72	110	181	80	34,1
	<b>M12 - M16</b>	19 - 24	<b>10</b> (98)	20	<b>NC-1924D</b>	54	168	22	25	50	66	26	3,8
	<b>M16 - M22</b>	24 - 32	<b>15</b> (147)	60	<b>NC-2432D</b>	64	275	25	31	65	78	33	5,4
	<b>M22 - M27</b>	32 - 41	<b>20</b> (196)	80	<b>NC-3241D</b>	77	305	31	37	80	90	43	7,2

Ordering Notes: Maximum allowable hardness to split is HRc-44. Not to be used on square nuts or stainless steel.

\* Available as Tool-Pump Set, see note on this page.

▼ Shown: NS-Series Hydraulic Nut Splitters



- Specially designed to suit standard ANSI B16.5 / BS1560 flanges
- Single-acting (spring return) cylinder
- Tri-blade technology provides three cutting surfaces on a single blade
- Interchangeable heads provide maximum nut range flexibility
- Preset scale allows controlled blade extension, which avoids damage to bolt threads
- Grip tape and handle included for more secure manoeuvrability
- Nickel-plated cylinder body for excellent corrosion protection and improved durability in harsh environments
- Internal Pressure Relief Valve for overload protection
- CR-400 coupler and dustcap included on all models.



◀ Heavily corroded and weathered nuts are quickly split and removed using a NS-Series Nut Splitter.

## Power and Precision High Performance Nut Splitter



### Blade Cutting Depth Scale

Adjustable cutting depth scale for controlled blade extension, which avoids damage to bolt threads. The scale indicates the bolt range in metric and imperial values on each cutting head.



### NC-Series, Hydraulic Nut Cutters

The NC-Series models are available featuring an angle-head design for 10 - 75 mm hexagon nuts.

Page: 229



### Joint Separation Tools

FS and FSH-Series parallel wedge spreaders provide quick and easy joint separation using hydraulic or mechanical force.

Page: 232



### Flange Alignment Tools

The ATM-Series provide safe and high-precision flange alignment tools that fit most commonly used ANSI, API, BS and DIN flanges.

Page: 234



# Hydraulic Nut Splitters



## Nut Splitter Sets

To provide maximum flexibility, NS-Series Nut Splitters can also be ordered in sets (NS-xxxSy). Select Nut Splitter size and pump style from the chart below. To order additional Cutting Heads (NSH-xxxxxx), Cylinders (NSC-xxx) or Replacement Blades (NSB-xxx), see Selection Chart below.

### SET SELECTION:

- 1 Select your Nut Splitter
- 2 Select your pump type

## NS Series



Capacity:

**917 - 1711 kN**

Hexagon Nut Size:

**70 - 130 mm**

Bolt Range:

**M45 - M90**

Maximum Operating Pressure:

**700 bar**

### TOOL-PUMP SET SELECTION CHART

Nut Splitter Model Nr.	Tool-Pump Set Model Nr.	Pump Selection				Accessories Included			
		Hand Pump Model Nr.	Air Pump Model Nr.	Cordless Pump (230V) Model Nr.	Electric Pump (230V) Model Nr.	Pressure Gauge Model Nr.	Gauge Adaptor Model Nr.	Hydraulic Hose Model Nr.	Storage Case Model Nr.
NS-70105	NS-70105SH	P-392	-	-	-	GP-10S	GA-2	HC-7206	CM-4
	NS-70105SA	-	XA-11G <sup>2)</sup>	-	-	<sup>2)</sup>	-	HC-7206	CM-4
	NS-70105SCE <sup>1)</sup>	-	-	XC-1202ME	-	GA45GC <sup>3)</sup>		HC-7206	CM-4
	NS-70105SEE <sup>1)</sup>	-	-	-	PUD-1100E	GP-10S	GA-2	HC-7206	CM-7
NS-110130	NS-110130SH	P-802	-	-	-	GP-10S	GA-2	HC-7206	CM-4
	NS-110130SA	-	XA-11G <sup>2)</sup>	-	-	<sup>2)</sup>	-	HC-7206	CM-4
	NS-110130SCE <sup>1)</sup>	-	-	XC-1202ME	-	GA45GC <sup>3)</sup>		HC-7206	CM-4
	NS-110130SEE <sup>1)</sup>	-	-	-	PUD-1100E	GP-10S	GA-2	HC-7206	CM-7

<sup>1)</sup> For set with 115 Volt pump application replace last suffix "E" with "B" in model number.

Example : **NS-70105SCB** (set with XC-cordless pump, 115V);

Example: **NS-110130SEB** (set with PU-Series electric pump, 115 V)

<sup>2)</sup> XA-11G air pump features an integrated pressure gauge.

<sup>3)</sup> See page 134 for GA45GC details.

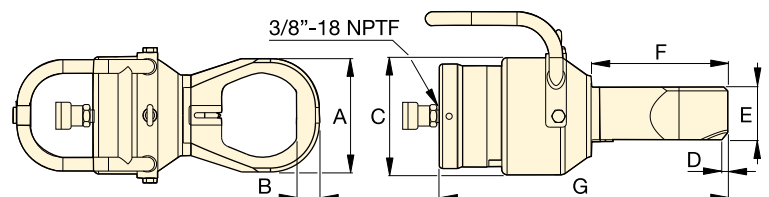

### NUT SPLITTER SPECIFICATIONS

Bolt Range	Hexagon Nut Range <sup>1)</sup>	Capacity	Oil Capacity	Model Number <sup>2)</sup>	Dimensions (mm)							Cylinder <sup>3)</sup>	Cutting Head <sup>3)</sup>	Replacement Blade	
					A	B	C	D	E	F	G				
(mm)	(mm)	ton (kN)	(cm <sup>3</sup> )									(kg)			
<b>M45 - M52</b>	70 - 80	<b>103</b> (917)	377	<b>NS-7080</b>	132	28	180	8,0	81	186	412	37,0	NSC-70	NSH-7080	NSB-70
<b>M45 - M56</b>	70 - 85	<b>103</b> (917)	377	<b>NS-7085</b>	145	30	180	8,0	81	196	422	37,0	NSC-70	NSH-7085	NSB-70
<b>M45 - M64</b>	70 - 95	<b>103</b> (917)	377	<b>NS-7095</b>	160	32	180	8,0	81	201	432	38,5	NSC-70	NSH-7095	NSB-70
<b>M45 - M72</b>	70 - 105	<b>103</b> (917)	377	<b>NS-70105</b>	174	35	180	9,0	81	209	443	39,5	NSC-70	NSH-70105	NSB-70
<b>M76 - M80</b>	110 - 115	<b>193</b> (1711)	819	<b>NS-110115</b>	189	36	234	3,7	111	234	472	69,0	NSC-110	NSH-110115	NSB-110
<b>M76 - M90</b>	110 - 130	<b>193</b> (1711)	819	<b>NS-110130</b>	219	41	234	2,5	111	242	493	71,5	NSC-110	NSH-110130	NSB-110

<sup>1)</sup> Maximum allowable hardness to split is HRC-44. See page 275 for hexagon bolt and nut sizes and related thread diameters.

<sup>2)</sup> NS-Series Nut Splitters ship in two cases: One containing the NSC-Cylinder and one containing the NSH-Cutting Head. Assembly required.

<sup>3)</sup> Both, the NSH-head and the NSC-cylinder include a cutting blade.

# FS-Series, Hydraulic Flange Spreaders

▼ FS-56



- Lightweight, ergonomic design for ease of use
- Adjustable jaw widths from 70 mm to 216 mm for a wide range of applications
- Single-acting, spring return RC-Series DUO cylinders for fast trouble-free operation.

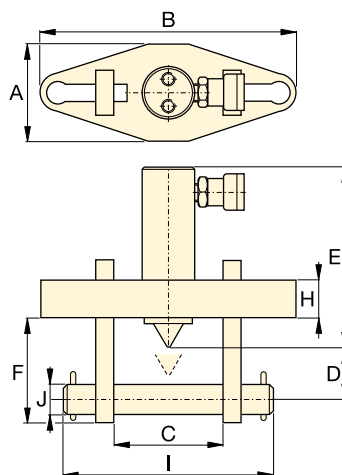

Maximum Flange Thickness (mm)	Stud Size (mm)	Standard Wedge (mm)	Capacity (ton)	Stroke (mm)	Oil Capacity (cm <sup>3</sup> )	Model Number	Dimensions (mm)										 (kg)
							C		D	E	F	H	I	J			
A	B	Min.	Max.														
2 x 57	19 - 28	3 - 28	5	38	24,6	FS-56*	76	209	70	155	32	196	88	25	206	19	11,5
2 x 92	31 - 41	3 - 28	10	54	78,7	FS-109*	108	279	104	216	50	152	114	38	273	31	18,1

\* Available as Tool-Pump Set, see note on this page.

## FS, STF Series



Capacity:

**5 and 10 ton**

Spread:

**70 - 216 mm**

Maximum Operating Pressure:

**700 bar**

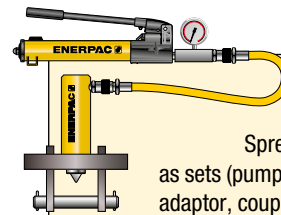

### Tool-Pump Sets

Both Flange Spreaders are available as sets (pump, tool, gauge, gauge adaptor, couplers and hose) for your ordering convenience.

Spreader Model Nr.	Pump Model Nr.	Set Model Number
FS-56	P-392	STF-56H
FS-109	P-392	STF-109H
FS-109	PATG-1102N	STF-109A



### Wedge Spreaders

Friction-free, smooth and parallel wedge movement with unique interlock wedge design. Eliminates flange damage and risk of spreading arm failure.

Page: 233

### Flange Spreader Matching Chart

ASA Rating (bar)	Pipe Size (mm)	
	FS-56	FS-109
10	127 - 508	558 - 1066
20	63 - 355	406 - 711
27	63 - 304	355 - 609
35	63 - 254	304 - 508
62	12 - 152	203 - 406
103	12 - 88	101 - 203
172	12 - 63	76 - 101

# Hydraulic and Mechanical Wedge Spreaders

▼ FSH-14 and FSM-8 with safety blocks SB-1



- **Integrated wedge concept:** Friction-free, smooth and parallel wedge movement eliminates flange damage and spreading arm failure
- **Unique interlocking wedge design** - no first step bending and risk of slipping out of joint
- **Requires very small access gap of only 6 mm**
- **Stepped spreader arm design** - each step can spread under full load
- **Few moving parts mean durability and low maintenance**
- **Safety block SB-1 and ratchet spanner SW-22 included with FSM-8 mechanical wedge spreader**
- **Safety block SB-1 and Enerpac RC-102 single-acting cylinder included with FSH-14 hydraulic wedge spreader.**

## FSH, FSM, STF Series

Tip Clearance / Maximum Spread <sup>1)</sup>:

**6 mm / 80 mm**

Maximum Spread Force:

**8 - 14 ton**

Maximum Operating Pressure:

**700 bar (FSH-14)**



### Stepped Blocks FSB-1

Use stepped blocks to increase wedge opening up to 80 mm. Fits both FSH-14 and FSM-8.



### AM-Series Control Manifolds

For simultaneously and even spreading of flange joints, 180° apart with FSH-14.

Page: 126

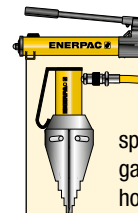

### Tool-Pump Sets

The hydraulic flange spreader is available as set (pump, tool, gauge, gauge adaptor, couplers and hose) for your ordering convenience.

Spreader Model Nr.	Handpump Model Nr.	Set Model Number
FSH-14	P-392	STF-14H

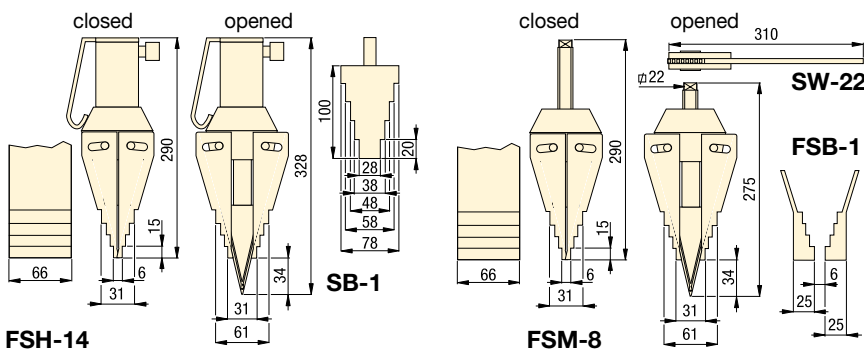

Maximum Spreading Force ton (kN)	Model Number	Tip Clearance (mm)	Maximum Spread <sup>1)</sup> (mm)	Spreader Type	Oil Capacity (cm <sup>3</sup> )	Weight (kg)
14 (125)	FSH-14*	6	80	Hydraulic	78	7,1
8 (72)	FSM-8	6	80	Mechanical	-	6,5

<sup>1)</sup> Using stepped blocks FSB-1

\* Available as pump-tool set, see note on this page.

▼ Flange maintenance and joint separation with FSH-14 Hydraulic Wedge Spreader.



# ATM-Series, Flange Alignment Tools

▼ From left to right: ATM-4, ATM-9, ATM-2 (ATM-9 shown without pump and hose)



- Enerpac ATM-Series tools rectify twist and rotational misalignment quickly, safely and without the need for an external power source
- Appropriate for use on most ANSI, API, BS and DIN flanges
- Reduces set-up time: no need for chains, pulleys or rigs
- Safety strap helps provide secure operation
- Can be installed and used in any position
- Stays stable in position under full load
- Portable, lightweight design enables easy transport and use, even in remote locations
- Each ATM-model contains a tool and kit box.

▼ The compact ATM-2 is actuated by simply hand turning the crank.



## The faster, simpler and safer way to align flanges.



### Adjustable Reach

The highly adjustable reach of the wing and drop leg on ATM-4 and ATM-9 allow precise alignment.



### Gauge and Adaptor

The ATM-9 includes P-142 hand pump and HC-7206C 1,8 m long hose. Enerpac recommend the use of the pressure gauge **GP-10S** and gauge adaptor **GA-4** for easy mounting of the gauge onto your system or use **GA45GC** Gauge Adaptor Assembly.

Page: 128

▼ The ATM-9 is shown here with optional pressure gauge and gauge adaptor.







## Applications

Enerpac ATM-Series Tools help correct flange misalignment, and allow bolts to be placed into joints. This alignment takes place during pipework construction, or maintenance.

These tools provide pipe installers and maintenance personnel with some of the simplest, safest and most productive solutions available for flange alignment in the market today.

- ① Extendable wing provides usage on wide variety of flanges.
- ② Portable, light weight design enables easy transport and use.
- ③ Hand-adjustable base for easy positioning by a single operator.
- ④ Safety strap helps provide secure operation from a horizontal or vertical position.

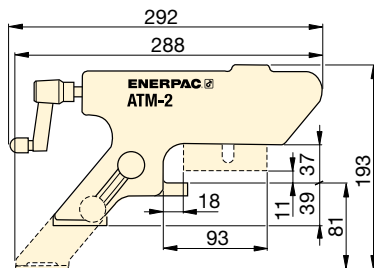
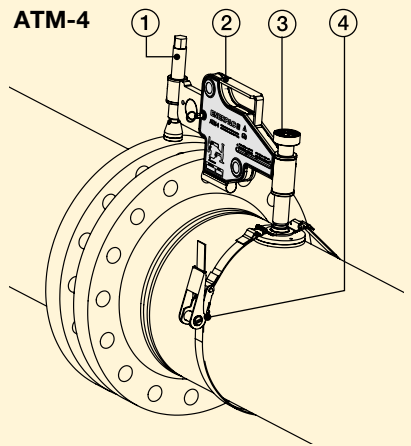

ATM-2

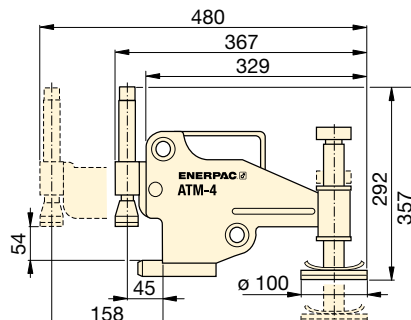

ATM-4

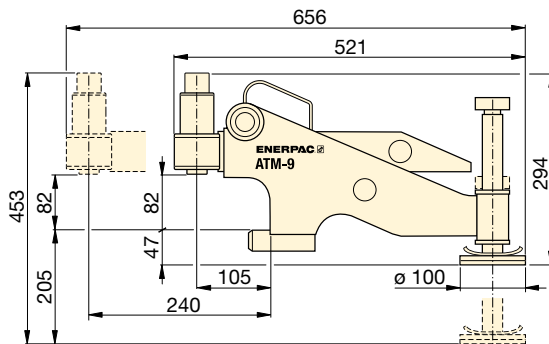

ATM-9

Maximum Lifting Force		Model Number	Minimum Bolt Size		Flange Wall Thickness		Weight (kg)
(ton)	(kN)		(mm)	(inch)	(mm)	(inch)	
1	10	ATM-2	16	.63	14 - 82	.55 - 3.29	1,6
4	40	ATM-4	24	.95	30 - 133	1.18 - 5.23	8,6
9	90	ATM-9 *	31,5	1.24	93 - 228	3.66 - 9.00	14,5

\* ATM-9 includes an Enerpac hand pump and hydraulic hose (gauge and adaptor sold separately). ATM-9 weight includes tool only.

## ATM Series



Minimum Bolt Size:

**16 - 31,5 mm**

Flange Wall Thickness:

**14 - 228 mm**

Maximum Lifting Force:

**1 - 9 ton (10 - 90 kN)**



## Cylinder-Pump Sets

Hydraulic cylinders, jacks and lifting wedges can also be used to assist in pipe line positioning and aligning.

Page: 58



## Pipe Flange Face Tool

The portable, hand powered tool FF-120 makes even the hardest to reach pipe flanges resurfaceable in a safe and convenient way.

Page: 236

▼ The ATM-Series – the faster, simpler and safer way to align flanges.



▼ FF-120



- Makes refacing easy – hand operated machine tool can be set up anywhere without the need for air, electric or hydraulic power
- Lightweight and portable (15 kg in storage box)
- Adjustable cutting head for reface of flat flange surfaces of pipes with flange outside diameter facing range 25,4 - 304,8 mm [1 - 12 inch]
- Interchangeable collets for ID mounting range 25,4 - 152,4 mm [1-6 inch] allow the user to work on many different flanges with minimal time between set-ups
- Interchangeable lead screws suitable for refacing damaged raised-face (RF), flat-face (FF) or lens-ring joint flanges
- Tool body with expanding collets centers itself providing real concentric operation.

▼ The Enerpac FF-120 used to face a pipe flange.



## Safe, efficient and accurate refacing of flat pipe flange surfaces



### Complete in Wheeled Carrying Case

The FF-120 comes as portable set (15 kg). Can be transported, easy set-up and operated by a single

technician. Set includes:

**FFL-kit** with locators, O-Rings and extensions;  
**FSS-kit** with feed screw and nut ½"-20 UN for surface roughness Ra 1,6 - 2,4 μ.

**FSF-kit** with feed screw and nut ½"-11 UNF for surface roughness Ra 3,2 - 6,3 μ.



### Joint Separation Tools

FS and FSH-Series parallel wedge spreaders provide quick and easy joint separation using hydraulic or mechanical force.

Page: 232



### Flange Alignment Tools

The ATM-Series provide safe and high-precision flange alignment tools that fit most commonly used ANSI, API, BS and DIN flanges.

Page: 234



### Controlled Tightening and Loosening

Use Enerpac Bolting Tools to seal the joint to the precise torque or tension required: torque

multipliers, torque wrenches and hydraulic bolt tensioners.

Page: 183

# QuickFace – Mechanical Pipe Flange Face Tool



## Mechanical Flange Face Tool

Portable, hand powered tool makes even the hardest to reach pipe flanges resurface-able in a safe and convenient way.

### Makes refacing easy

A simple and cost effective solution – the FF-120 turns a two man operation with heavy equipment, compressors and portable generators into a one man job.

The FF-120 has interchangeable lead screws that make it suitable for resurfacing damaged flat-faced, raised-face or lens-ring joint flanges to the high safety standards required. After selecting the correct lead screw for the operation, the tool body is inserted in the pipe end and centres itself with adjustable locators to provide real concentric operation.

The tool arm is then rotated by hand using a worm-gear mechanism to provide a perfect spiral “gramophone” finish. The tool can be adjusted with a calibrated slide to define cut depth and the correct finish.

### Surface finish & accuracy

A serrated finish with 30-55 grooves per inch and a resultant roughness of between Ra 3,2-12,5  $\mu$  (125-500 micro inches). The FF-120 has same precision and quality of finish as a lathe.

### Cost effective solution

Small and portable enough to be a permanent addition to your equipment range, Enerpac’s FF-120 is the perfect solution to all of your small diameter facing problems.

## FF Series



Pipe Flange Cutting Diameter Range:

**Ø 25-305 mm / 1-12"**

Internal Pipe Mounting Range:

**Ø 25-152 mm / 1-6"**

Cutting Resultant Roughness:

**Ra 3,2 - 12,5  $\mu$**



- 1 Hand-operated cold work tool – no need for external power and hot work permits.
- 2 Calibrated cross slide for accurate cutting control.
- 3 Adjustable cutting head for reface of flat flange surfaces of pipes with flange OD facing range  $\varnothing$  25,4-304,8 mm [1-12 inch].
- 4 Interchangeable lead screws enable selection of surface finish between Ra 3,2-12,5  $\mu$ .
- 5 Utilizes standard 3/8 inch or 10 mm tool steel.
- 6 Range of interchangeable collets allow the tool to accommodate  $\varnothing$  25,4 - 152,4 mm (1 - 6 inch) pipe ID.
- 7 Tool body with expanding collets centers in the bore ensuring concentric and accurate set-up.

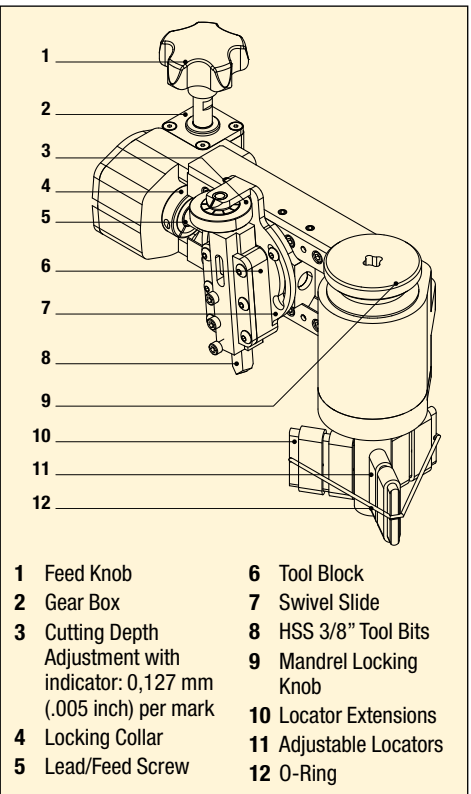

- |                                                                          |                        |
|--------------------------------------------------------------------------|------------------------|
| 1 Feed Knob                                                              | 6 Tool Block           |
| 2 Gear Box                                                               | 7 Swivel Slide         |
| 3 Cutting Depth Adjustment with indicator: 0,127 mm (.005 inch) per mark | 8 HSS 3/8" Tool Bits   |
| 4 Locking Collar                                                         | 9 Mandrel Locking Knob |
| 5 Lead/Feed Screw                                                        | 10 Locator Extensions  |
|                                                                          | 11 Adjustable Locators |
|                                                                          | 12 O-Ring              |

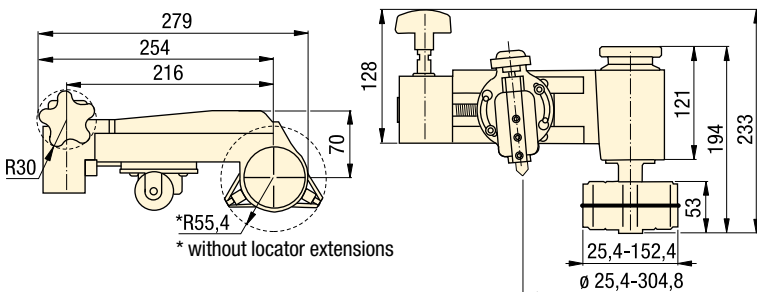

### SELECTION CHART

Pipe Flange Cutting Diameter Range		Internal Pipe Mounting Diameter Range		Cutting Resultant Roughness	Model Number	Weight
(mm)	(inch)	(mm)	(inch)	(Ra $\mu$ )		(kg)
25,4 - 304,8	1,0 - 12,0	25,4 - 152,4	1,0 - 6,0	3,2 - 12,5	FF-120	6,8

▼ The Enerpac FF-120 QuickFace has same precision and quality of finish as a lathe.





Enerpac Heavy Lifting Technology provides customers with tailored solutions, combining hydraulics, steel fabrication and electronic control technology. Global Leader providing best in class solutions for safe and precise positioning of heavy loads.

With more than 50 years supporting industrial markets, Enerpac has gained the unique and in-depth expertise that is respected by industrial professionals around the world. Across every continent, Enerpac's network of application engineers, authorized distributors and technical service centers can reach any location, and deliver innovative solutions, technical assistance and quality products.

Enerpac's complete line of standard and customized products and a unique systems approach offers the benefits of safety and efficiency to applications where high forces are required.

Whether constructing a signature bridge across a deep valley, lifting a national landmark for seismic retrofit or simultaneously testing hundreds of foundation pilings to support a new building, Enerpac will supply the hydraulic solutions to get the job done.



Precision lift and position of heavy loads



Synchronous superlift and launch



Bridge lifting and launching



Jacking with high capacity precision control



Synchronous hoisting and load positioning



Incremental bridge lifting















Transportation



Special high tonnage cylinders for the Pioneering Spirit lifting beams



# Heavy Lifting Technology - Section Overview

Capacity ton (kN)	Capabilities	Series	Page
–	<b>Split-Flow Hydraulic Pumps</b> Multiple outlets with equal oil flow	<b>SFP</b>	 <b>240</b> ▶
–	<b>Synchronous Lifting Systems, basic models</b> The economical solution to basic applications	<b>EVOB</b>	 <b>242</b> ▶
–	<b>Synchronous Lifting Systems, standard models</b> The multi-functional synchronous lifting system	<b>EVO</b>	 <b>244</b> ▶
<b>50 - 200</b> (498 - 1995)	<b>Climbing Jacks</b> A simple solution to incremental lifting	<b>BLS</b>	 <b>246</b> ▶
<b>125 - 750</b> (1250 - 7500)	<b>Jack-Up Systems</b> Synchronously lift, mechanically hold	<b>JS</b>	 <b>248</b> ▶
<b>15 - 1250</b> (147 - 12.250)	<b>Heavy Lifting Strand Jacks</b> High capacity precision control	<b>HSL</b>	 <b>250</b> ▶
<b>55 - 110</b> (539 - 1078)	<b>Synchronous Hoisting Systems - SyncHoist</b> Precision positioning jacks	<b>SHS</b>	 <b>252</b> ▶
<b>110 - 225</b> (1078 - 2205)	<b>Autonomous Hoisting Systems - SyncHoist</b> Wireless remote control, integrated hydraulics	<b>SHAS</b>	 <b>254</b> ▶
<b>60 - 1100</b> (600 - 10.484)	<b>Telescopic Hydraulic Gantries</b> Precision lift and position of heavy loads	<b>SL</b> <b>SBL</b> <b>MBL</b>	 <b>256</b> ▶
<b>100 - 250</b> (860- 2500)	<b>Skidding Systems</b> The ideal jack and slide solution	<b>HSK</b> <b>LH</b>	 <b>258</b> ▶
<b>60</b> (600)	<b>Self-Propelled Modular Transporters</b> Hydraulic strength in a linear drive transport system	<b>SPMT</b>	 <b>260</b> ▶
–	<b>Custom Solutions - Experience and Expertise</b> <b>Project Gallery – Custom Heavy Lifting Solutions</b>		 <b>261</b> ▶ <b>262</b> ▶

▼ SFP613SW with 150 litres reservoir (shown with 6 split-flow outlets)



- Smart valve technology allows both controlled lifting and lowering of multiple points
- 2, 4, 6 or 8 split-flow outlets
- Valve operation with advance/hold/retract function
- Joystick (manual) or pendant (solenoid) control
- Flow per outlet from 0,27 to 4,2 l/min at 700 bar
- For double and single-acting cylinders
- Pressure compensated flow control per circuit
- Adjustable pressure relief valve per circuit
- All models include pressure gauge per circuit
- Reservoir: 20, 40 or 150 litres.



## Multiple Outlets with Equal Oil Flow



### Split-Flow Pump Applications

Split-Flow pumps distribute an equal amount of hydraulic oil to a maximum of 8 outlets. Smart valve technology allows both controlled lifting and lowering of heavy loads.

### Pressure compensated flow control

This unique feature to our Split-Flow Pumps will ensure both smooth lifting and lowering, independent of load distribution.

For lifting applications Split-Flow Pumps are an efficient and safer alternative than using individual pumps. Where synchronization of maximum 4% is acceptable, Split-Flow pumps are a safe and economical solution.

### Application examples:

- Bridge deck lifting for bearing maintenance
- Stage lifting in construction and shipbuilding
- Skidding to move structures and buildings.
- Levelling of constructions such as wind turbines.



### Remote Control Pendant

Split-Flow pumps with solenoid valves include a remote pendant with selector switches for each individual outlet, allowing single or multiple cylinder operation.

◀ During manufacturing of container units, the Enerpac SFP404SW Split-Flow Pump with 4 outlets provide both lifting and load distribution function. The container units weight between 70 and 120 ton and are complete equipped as full operational shelter for specific applications in power-generation, mining and construction industries for on-site use.

# Split-Flow Hydraulic Pumps

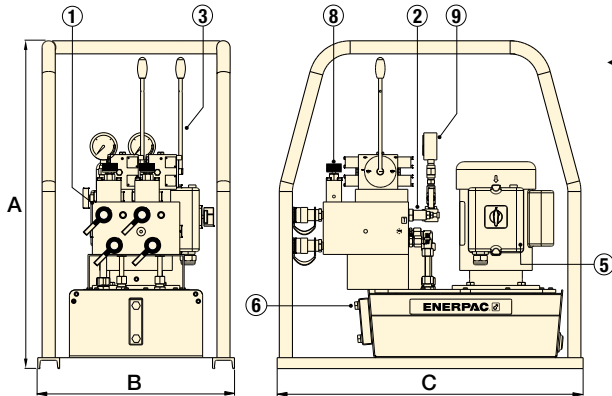

◀ SFP-Series with 20 litres reservoir (shown with 2 split-flow outlets)

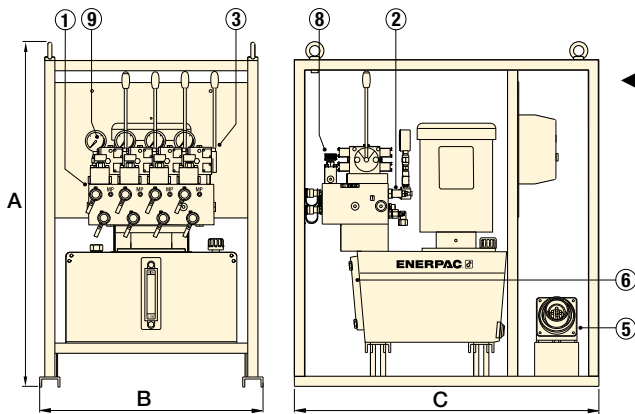

◀ SFP-Series with 40 litres reservoir (shown with 4 split-flow outlets)

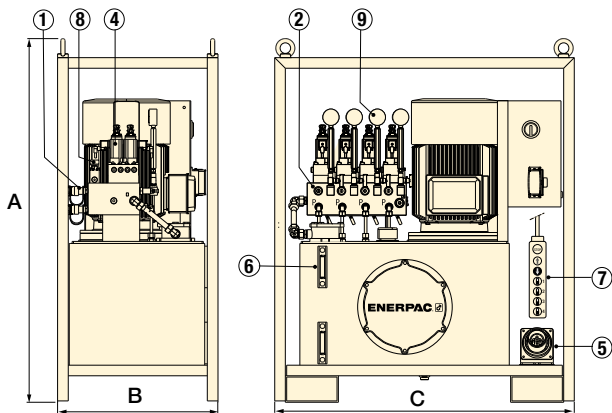

◀ SFP-Series with 150 litres reservoir (shown with 4 split-flow outlets)

## SFP Series



Reservoir Capacity:

**20 - 40 - 150 litres**

Split-Flow Outlets:

**2, 4, 6 and 8 outlets**

Flow at Rated Pressure:

**0,27 - 4,20 l/min**

Maximum Operating Pressure:

**700 bar**



### Lifting Cylinders

For a complete line of Enerpac cylinders, see the Cylinder and Lifting Products in our catalogue.

Page: 5

- ① Manifold with split-flow outlets and CR-400 couplers
- ② Adjustable pressure relief valve per circuit
- ③ Manual 4/3 control valves with joysticks
- ④ Solenoid 4/3 control valves (24 VDC)
- ⑤ Power receptacle
- ⑥ Oil sight gauge(s)
- ⑦ Remote control pendant with 10 m cord
- ⑧ Return flow control valve in each circuit
- ⑨ Hydraulic pressure gauge in each circuit

Number of Split-Flow Outlets	Reservoir Size (litres)	Oil Flow per Outlet @ 700 bar (l/min)	Pump Model Number		Motor Size 400 V, 3ph 50 Hz (kW)	Dimensions (mm)			Weight (kg)
			4/3 Valve Operation Advance/Hold/Retract Manual (Joystick)	24 V Solenoid (Pendant)		A	B	C	
2	20	0,27	SFP 202MW	—	0,75	750	450	700	86
	40	1,30	SFP 213MW	SFP 213SW	5,5	1019	660	900	240
	150	2,80	SFP 228MW	SFP 228SW	7,5	1372	605	1130	488
	150	4,20	SFP 242MW	SFP 242SW	11	1372	605	1130	526
4	40	0,45	SFP 404MW	SFP 404SW	5,5	1019	660	900	240
	150	0,90	SFP 409MW	SFP 409SW	5,5	1372	605	1130	475
	150	1,40	SFP 414MW	SFP 414SW	7,5	1372	605	1130	488
	150	2,10	SFP 421MW	SFP 421SW	11	1372	605	1130	526
6	40	0,45	—	SFP 604SW	5,5	1019	660	900	240
	150	1,30	—	SFP 613SW	11	1372	805	1200	550
8	150	1,30	—	SFP 813SW	15	1372	805	1200	590

▼ Split-Flow Pump SFP409MW with 4 outlets and manual valves.



▼ EVOB 816W



- Pumps to control 4 to 8 lifting points
- Intuitive user interface provides easy set-up and control
- For use with standard single- or double-acting cylinders
- Built in warning and stop alarms for optimum safety
- Available in two oil flow options.

▼ Bridge maintenance: A 200 ton bridge was lifted using 8 cylinders to replace the old bearings.



## The economical solution to basic lifting applications



### The Basic EVOB-System

Leveraging Enerpac's market leading Z-Class pumps and components from the standard EVO, the Basic EVOB offers an economical solution to basic applications requiring stroke only control for a maximum of 8 lifting points.

The Basic EVOB-System has three work modes. The operator can navigate to any of these menus:

1. Manual
2. Automatic
3. Depressurize.



### Typical Synchronous Lifting Applications

- Bridge lifting and repositioning
- Bridge launching
- Bridge maintenance
- Incremental launching and box jacking
- Lifting and lowering of heavy equipment
- Lifting, lowering, levelling and weighing of heavy structures and buildings
- Structural and pile testing
- Lifting and weighing of oil platforms
- Foundation levelling of onshore and offshore wind turbines
- De-propping/load transfer from temporary steel work
- Foundation shoring.

▼ Foundation repair: Synchronous lift system used to lift a 1000 ton building.





# Basic Synchronous Lifting Systems



## What is Synchronous Lifting?

To achieve high-precision movement of heavy objects it is necessary to control and synchronize the movements of multiple lifting points.

The PLC-control uses feedback from multiple sensors to control the lifting, lowering and positioning of any large, heavy or complex structure, regardless of weight distribution.

By varying the oil flow to each cylinder, the system maintains very accurate positional control. By eliminating manual intervention, the sync lift helps maintain structural integrity and increases the productivity and safety of the lift.

PLC-controlled synchronous lifting systems reduce the risk of bending, twisting or tilting, due to uneven weight distribution or load-shifts between the lift points.



## Wire Stroke Sensors

- Ordered separately, requires one for each lifting point
- Provides stroke feedback to controls
- Includes magnets for mounting.



## Stroke Sensor Cables

- Ordered separately, requires one for each stroke sensor
- Can be connected together for additional length.

Stroke Sensor Model Number	Measuring Range (mm)
EVO-WSS-500	500
EVO-WSS-1000	1000

Sensor Cable Model Number	Cable Length (metres)
EVO-SC-25	25
-	-

**Voltage Options:** To select voltage, change suffix W into required suffix.

- B** = 115 V, 1 Ph, 50-60 Hz
- E** = 208-240 V, 1 Ph, 50-60 Hz
- G** = 208-240 V, 3 Ph, 50-60 Hz
- W** = 380-415 V, 3 Ph, 50-60 Hz
- J** = 460-480 V, 3 Ph, 50-60 Hz
- R** = 575 V, 3 Ph, 60 Hz.

Example: **EVOB408E**. EVOB Basic Pump for 4 lift points, 0,82 l/min at 700 bar, and 1,12 kW motor 208-240 V, 1 Ph, 50-60 Hz.

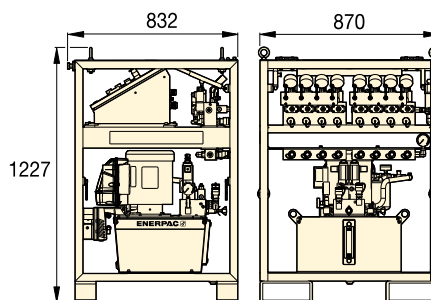

## EVOB-Series (Basic)

Lifting Points	Oil Flow at 50 Hz <sup>1)</sup> (l/min)		Model Number <sup>2)</sup>	Usable Oil Capacity (litres)	Motor Size (kW)	Motor Weight (kg)
	(< 80 bar)	(> 80 bar)				
4	8,88	0,82	<b>EVOB408E</b>	40	1,12	278
4	11,61	1,64	<b>EVOB416W</b>	40	2,24	284
8	8,88	0,82	<b>EVOB808E</b>	40	1,12	278
8	11,61	1,64	<b>EVOB816W</b>	40	2,24	284

<sup>1)</sup> Oil flow will be approximately 6/5 of these values at 60 Hz.

<sup>2)</sup> For other voltages options see information above this selection chart.

## EVOB Series



Number of Lifting Points:

**4 - 8**

Reservoir Capacity:

**40 litres**

Flow at Rated Pressure:

**0,82 - 1,64 l/min**

Motor Size:

**1,12 - 2,24 kW**

Maximum Operating Pressure:

**700 bar**



## Lifting Cylinders

For a complete line of Enerpac cylinders, see the Cylinder and Lifting Products in our catalogue.



## Multi-functional Synchronous Lifting Systems

For more than 8 lifting points, to link up to 4 systems together and weighing system see the EVO-Standard Series.

▼ **Box jacking:** Multi-point synchronous system to push hydraulically the tunnel segments under the railway.



▼ EVO 841460W



- Modular lifting pumps to control 4, 8 or 12 lifting points
- Can be connected to single- or double-acting cylinders with the same or different lifting capacities
- PLC-controlled system with integrated 700 bar hydraulic power unit and 250 litres reservoir
- Network capability to link up to 4 HPU's to a separate master control box via wireless control
- Intuitive user interface providing easy set up, control and navigation
- Data storage and recording capabilities
- Variable frequency drive motor (VFDM) and PLC for precise synchronization and oil flow control.



## The multi-functional synchronous lifting systems



### EVO-System Work Modes

The application possibilities are infinite with the standard EVO-System, powering interlinked hydraulic cylinders – single or double-acting, push or pull, stage lift, hollow plunger or lock nut cylinders. The EVO-System has 9 work modes. The operator can navigate to any of these menus:

1. Manual
2. Pre-Load
3. Automatic
4. Retract Fast
5. Depressurize
6. Tilting
7. Stage Lift
8. Weighing \*
9. Center of Gravity determination \*

\* Available in the EVO-W-models.



### Typical Synchronous Lifting Applications

- Bridge lifting and repositioning
- Bridge launching
- Bridge maintenance
- Incremental launching and box jacking
- Lifting and lowering of heavy equipment
- Lifting, lowering, levelling and weighing of heavy structures and buildings
- Structural and pile testing
- Lifting and weighing of oil platforms
- Foundation levelling of onshore and offshore wind turbines
- De-propping/load transfer from temporary steel work
- Foundation shoring.

◀ *The superlifting and launch of a 43.000-ton floating oil production system in Malaysia for the Gumusut-Kakap offshore field has set high benchmarks for safety through its use of sophisticated EVO-Series synchronous hydraulics to lift, balance, weigh and smoothly launch massive resource structures.*



## Benefits of the EVO-Series System

### Precise control of multiple lift points

- Comprehensive understanding and management of a lifting operation from a central control system improves safety and operational productivity.
- Programmable synchronized lifting.
- Automatic stop at pre-set cylinder stroke or load limit.

### Safe and efficient movement of loads

- System secured with warning and stop features to realize optimal safety.

### High accuracy

- Variable frequency drive (VDFM) and PLC for precise synchronization and control of oil flow, stroke and speed.
- Depending the cylinder capacities used, an accuracy of 1,0 mm between lifting points is achieved.

### Ease of operation

- User friendly interface: visual screens, icons, symbols and color coding.
- A single operator controls the entire operation.

### Monitoring and Data Recording

- Displays data of the operation.
- Data recording at user-defined intervals.
- Data storage and read-out for reporting.

### Network capability

- Ethernet IP protocol for communication between hydraulic power units, allow easy "plug and play".

### EVO-W Weighing System

#### Weighing applications with 1% accuracy

- Includes calibrated sensors and auto-calibration of external load cells.
- Center of gravity determination functionality.
- Parameters for "waiting time for stabilization" and "number of cycles".

### Global standardized system

- Enerpac global coverage ensures local support.

## EVO Series



Number of Lifting Points:

**4 - 8 -12 (up to 48)**

Reservoir Capacity:

**250 litres**

Flow at Rated Pressure:

**0,75 - 4,80 l/min**

Motor Size:

**3,50 - 7,50 kW**

Maximum Operating Pressure:

**700 bar**



### Stroke Sensors and Cables

Optional accessories required for each lifting point and stroke sensor.

Page: **243**

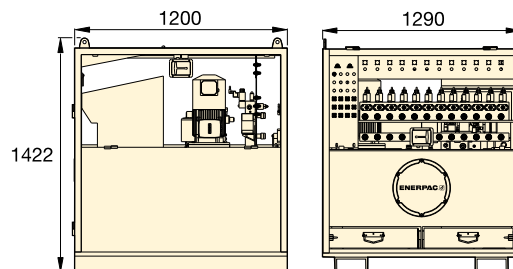

### Master Control Box

Required to link up to 4 standard EVO-pumps together to achieve a maximum of 48 lifting points. Contact Enerpac for more information.

### EVO-Series (Standard)

Lifting Points	Variable Oil Flow at 50 Hz <sup>1)</sup> (l/min)		Model Number <sup>2)</sup> 380-415 V, 3ph, 50-60Hz	Usable Oil Capacity (litres)	Motor Size (kW)	Motor Speed <sup>4)</sup>	(kg)
	(< 125 bar)	(> 125 bar)					
4	4,0 - 13,3	0,75 - 2,51	<b>EVO 421380</b>	250	3,5	VFDM	910
4	4,0 - 13,3	0,75 - 2,51	<b>EVO 421380 W<sup>3)</sup></b>	250	3,5	VFDM	910
4	4,7 - 15,6	1,44 - 4,80	<b>EVO 440380</b>	250	7,5	VFDM	1005
4	4,7 - 15,6	1,44 - 4,80	<b>EVO 440380 W<sup>3)</sup></b>	250	7,5	VFDM	1005
8	4,0 - 13,3	0,75 - 2,51	<b>EVO 821380</b>	250	3,5	VFDM	910
8	4,0 - 13,3	0,75 - 2,51	<b>EVO 821380 W<sup>3)</sup></b>	250	3,5	VFDM	910
8	4,7 - 15,6	1,44 - 4,80	<b>EVO 840380</b>	250	7,5	VFDM	910
8	4,7 - 15,6	1,44 - 4,80	<b>EVO 840380 W<sup>3)</sup></b>	250	7,5	VFDM	910
12	4,0 - 13,3	0,75 - 2,51	<b>EVO 1221380</b>	250	3,5	VFDM	920
12	4,0 - 13,3	0,75 - 2,51	<b>EVO 1221380 W<sup>3)</sup></b>	250	3,5	VFDM	920
12	4,7 - 15,6	1,44 - 4,80	<b>EVO 1240380</b>	250	7,5	VFDM	1025
12	4,7 - 15,6	1,44 - 4,80	<b>EVO 1240380 W<sup>3)</sup></b>	250	7,5	VFDM	1025

<sup>1)</sup> Oil flow will be approximately 6/5 of these values at 60 Hz. <sup>2)</sup> For 460-480 VAC, 3 phase, 50-60 Hz change 380 in model number into 460. Example **EVO421460**.

<sup>3)</sup> Model numbers with suffix **W** are pumps for weighing systems. <sup>4)</sup> VFDM = Variable Frequency Drive 15-50 Hz.

▼ Precision levelling caisson pier box: 3 EVO-Systems connected with 32 jacks lowered the 1100 ton bascule pier box.





▼ BLS-1006



- Climbing jacks include integral tilt saddles with maximum tilt angles up to 5 degree
- Large base with anti-rotation rod for stability and safety
- Built-in safety valve prevents accidental over-pressurization
- Ideal in combination with the stage lift work mode of the EVO-Series synchronous lifting system
- Baked enamel finish for increased corrosion resistance
- CR400 couplers included on all models.

▼ Synchronous Stage Lifting: 48 double-acting jacks (25 and 50 ton) are networked in to a 16 points synchronous system to lift this 50 metres long, 1000 ton building up to a height of 2,5 metres to construct a new floor level.



## A Simple Solution to Incremental Lifting



### Lifting Height

Climbing Jacks overcome the usual limitation of lifting height imposed by the cylinder's plunger stroke length. Large objects, such as oil tanks, can be lifted, held and lowered for maintenance without sending for a crane.



### Split-Flow Pumps

SFP-Series Pumps with multiple outlets with equal oil flow. For lifting and lowering applications on multiple points Split-Flow Pumps are a far better alternative than using separately operated pumps.

Page: 240



### Synchronous Lifting System

The standard EVO-Series System is ideal for stage lifting, powering interlinked hydraulic cylinders. The EVO-system has 9 work modes including the stage lift work mode.

Page: 244



### Jack-Up Systems

For incremental lifting with higher lifting capacities and up to 20 m lifting height, see our JS-Series Jack-Up Systems.

Page: 248

Cylinder Capacity	Stroke	Model Number	Max. Cylinder Capacity (kN)	
			Push	Pull
ton	(mm)			
50	150	BLS-506	498	103
95	161	BLS-1006	933	435
140	151	BLS-1506	1386	668
200	151	BLS-2006	1995	1017



# Double-Acting Climbing Jacks



◀ Typical stage-lift application using a custom built Enerpac system to lift the 360 ton Akkerwinde wooden bridge in the Netherlands.

## BLS Series



Capacity per Lifting Point:

**50 - 200 ton**

Stroke per Stage:

**150 - 161 mm**

Maximum Operating Pressure:

**700 bar**

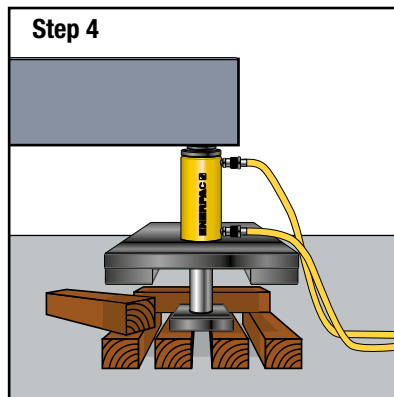
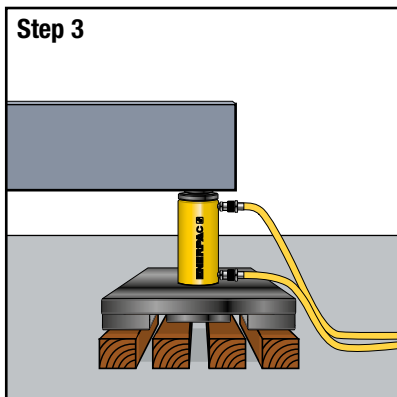
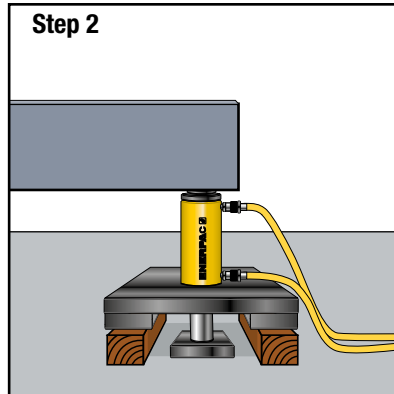
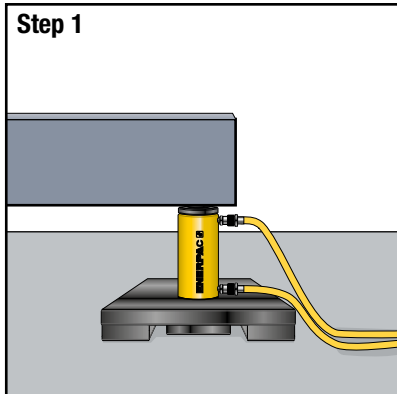

### ▲ Stage Lifting Sequence

**Step 1:** The climbing jack is placed on a solid support under the load (retracted plunger).

**Step 2:** Plunger extends, lifting the load and giving clearance to insert two outer blocks under the spreading plate.

**Step 3:** Plunger retracts, giving clearance to position the central blocks which will support the plunger plate for the next extension.

**Step 4:** Plunger extends, lifting the load, giving clearance to insert two new blocks, placed crosswise under the spreading plate.

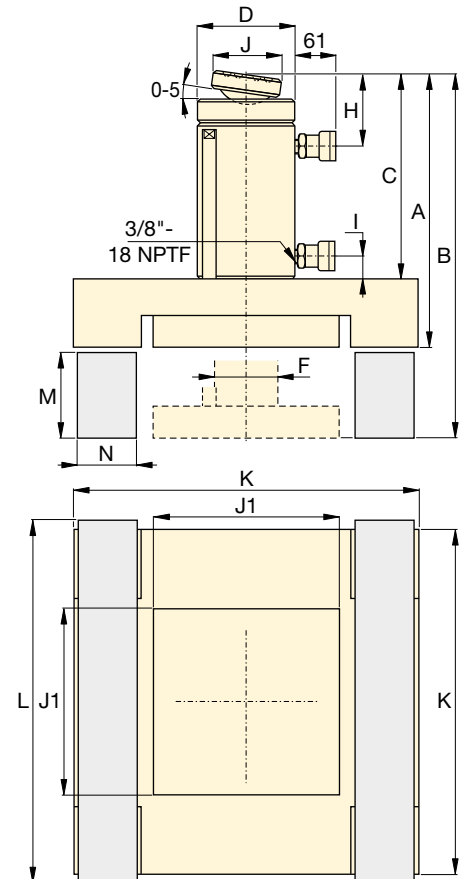

Cylinder Effective Area (cm <sup>2</sup> )		Oil Capacity (cm <sup>3</sup> )		Dimensions (mm)										Cribbing Blocks * and Dimensions (mm)			Model Number		
Push	Pull	Push	Pull	A	B	C	D	F	H	I	J	J1	K	Material	L	M	N	(kg)	
71,2	21,5	1111	335	406	556	318	127	79	56	36	50	240	515	Azobe	565	140	120	170	<b>BLS-506</b>
133,3	62,2	2238	1045	445	606	343	177	95	76	24	71	330	670	Wood	720	150	160	315	<b>BLS-1006</b>
198,1	95,4	3090	1488	472	624	370	203	114	94	39	130	230	475	Solid Aluminium or Steel	500	140	115	322	<b>BLS-1506</b>
285,6	145,6	4332	2209	510	661	387	248	133	102	37	130	270	550		575	140	135	373	<b>BLS-2006</b>

\* Cribbing blocks are not supplied by Enerpac.

▼ JS-250, Enerpac Jack-Up System (one lifting tower shown)



- Self-contained hydraulics in each jack-up unit for uncluttered work area
- Synchronously lift loads with multiple jack-up units. The most common system set-up includes 4 jack-up units
- Lifting barrels are stacked together to mechanically hold the load
- Up to 5% side load capacity depending on lifting height
- Computer controls for operating the jack-up system with automatic and manual lifting settings.

## Incremental Lifting System – Synchronously Lift and Mechanically Hold



### Typical Applications

- Bridge maintenance
- Lifting and lowering of heavy equipment
- Lifting, lowering and levelling of heavy structures and buildings
- De-propping/load transfer from temporary steel work.



### Computer Controls

- Enerpac Jack-up Systems provide precision control suitable for many demanding lifting/lowering applications. The comprehensive self-contained design features simple to use software.
- Automatic synchronization of multiple networked lift points.
  - Overload and stroke alarms
  - Emergency stop switch at jack-up units and controls.

▼ Enerpac has been awarded a contract by Burkhalter to extend the height of Enerpac's 2000 ton (500 ton per tower) jack-up system from 20m to 36m for future projects.



▼ A load is lifted in increments as barrels are slid into the system, lifted, and stacked; forming 'lifting towers'.



▼ Lifting barrels are stacked together to mechanically hold the load



# Enerpac Jack-Up Systems



## Enerpac Jack Up Systems

The jack up system is a custom developed multi-point lifting system. A typical system setup includes four jack up units positioned under each corner of a load.

Example: A four unit setup with JS250 has a lifting capacity of 1000 ton (250 ton per unit). The lifting frame of a jack up unit contains four hydraulic lifting cylinders, one in each corner, which lift the load using the stacked steel barrels.

A load is lifted in increments as barrels are slid into the system, lifted, and stacked; forming 'lifting towers'. A jack up system is operated and controlled by a computer control unit.

Each unit's lifting and lowering operations occur simultaneously; the computer control unit's synchronous technology maintains the balance of the load.

## JS Series



Capacity Per Lifting Tower:

**125 - 750 ton**

Lifting Height:

**Up to 6 - 20 metres**

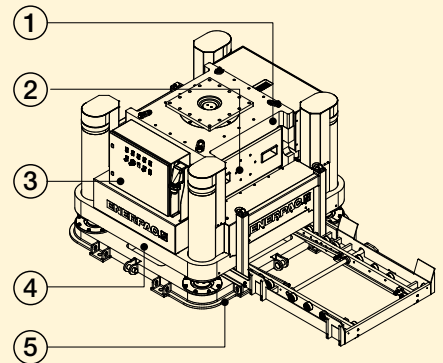
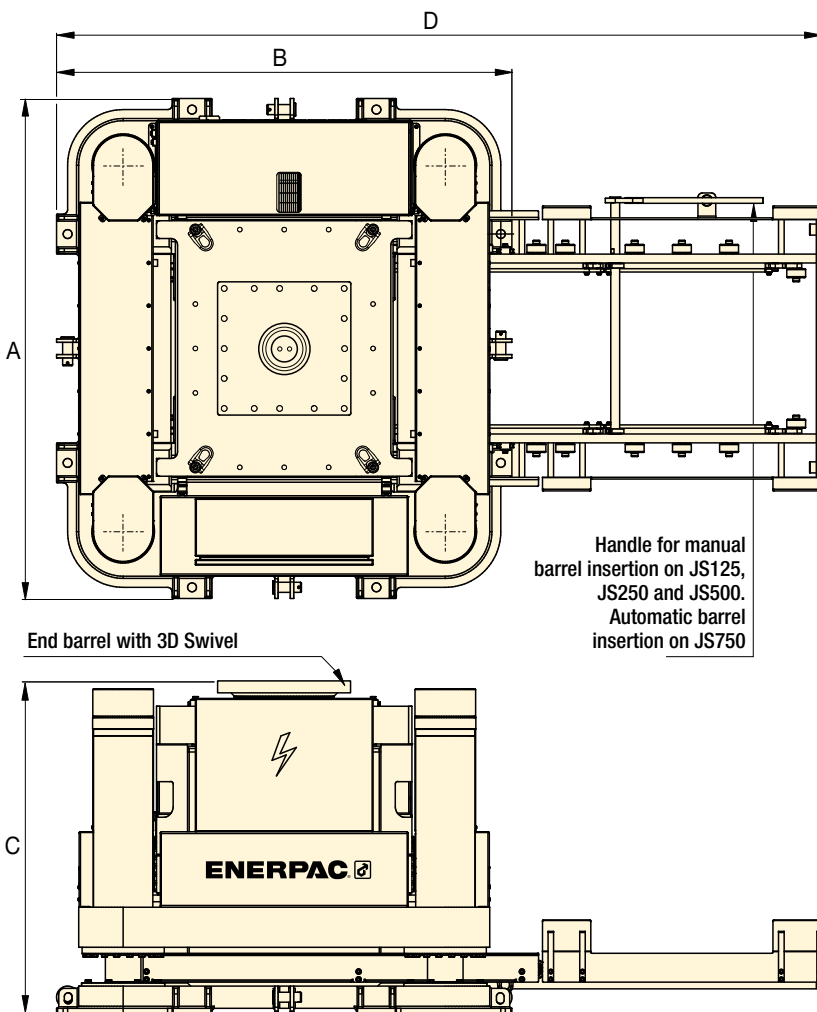

### Enerpac Jack Up Systems

- ① End Barrel
- ② Barrel
- ③ Electric Powerpack
- ④ Lifting Frame
- ⑤ Base Frame



### Contact Enerpac!

Contact the Enerpac office nearest to you for advice and technical assistance in the layout of your ideal Lifting

System or visit us at: [www.enerpac.com](http://www.enerpac.com).

Or ask Enerpac for assistance:

[enerpac.com/contact-us](http://enerpac.com/contact-us)

▼ Enerpac jack-up system hoists 1500 ton span on Fore River Bridge.



### Jack-Up Systems

Capacity per Tower ton (kN)	Model Number	Maximum Sideload	Base Frame Dimensions (mm)				Barrel Dimensions L x W x H (mm)	Weight (kg) *
			A	B	C	D		
125 (1250)	JS-125	3% @ 6m	1200	1100	950	1850	600x600x300	2400
250 (2500)	JS-250	3,5% @ 10m	2250	2050	1475	3450	1150x1150x500	7500
500 (5000)	JS-500	4% @ 15m	2800	2300	1700	4500	1700x1700x700	13.000
750 (7500)	JS-750	5% @ 20m	3670	3250	2375	6100	2300x2300x1000	24.000

\* Weight per jack up unit, excluding barrels.

▼ Shown: HSL50006 Strand Jack



- Precision control of synchronous lifting and lowering
- Can be controlled by a single operator from a central location for increased safety
- Automated locking - unlocking operation
- Two strand sizes: 15,7 mm and 18 mm (.62 and .71 inch)
- Telescopic strand guide pipes prevent bird caging
- Internal components are coated with Lunac, an anti-corrosion coating, making it suitable for marine environments
- Lifting anchor included with all strand jacks
- Lloyd's witness tested to 125% of maximum working load.

▼ *Songdo Bridge, South Korea: Four HSL85007 strand jacks were installed on top of a temporary bent tower and simultaneously lifted both pylons up to their permanent position at 75 degrees. The lift was monitored and controlled using a computer controlled strand jack system with 30 kW hydraulic power units.*



## High Capacity Precision Control



### Heavy Lifting Strand Jacks

Enerpac strand jacks are the strand jacks of choice for customers seeking precise synchronous control with heavy-lifting capacity in an economical, compact, and reliable foot print.

Enerpac strand jacks are powered by electrical or diesel driven hydraulic power packs and controlled by Enerpac's proprietary SCC-Smart Cylinder Control System to ensure full control of lifting and lowering operations.

Enerpac continually improves reliability, durability, and safety of their strand jacks, making them an industry standard for heavy lifting.

▼ *HSL85007 Strand Jack System used on Enerpac custom Self Erecting Tower.*





# Heavy Lifting Strand Jacks



## Strand Jacks

A strand jack can be considered a linear winch. In a strand jack, a bundle of steel strands are guided through a main "lifting" jack.

Above and below the cylinder are anchor systems with wedges that grip the strand bundle simultaneously. Lifting and lowering a load is achieved by hydraulically controlling the main jack and both mini jacks alternately.

In the case of system pressure loss, the wedges are mechanically closed automatically, holding the suspended load in place.

Today strand jacks are widely recognized as the most sophisticated heavy lifting solution. They are used all over the world to erect bridges, load out offshore structures, and lift/lower heavy loads where the use of conventional cranes is neither economical nor practical.

## HSL Series



Capacity:  
**15 - 1250 ton**

Stroke:  
**250 - 600 mm**

Maximum Operating Pressure:  
**350 bar**

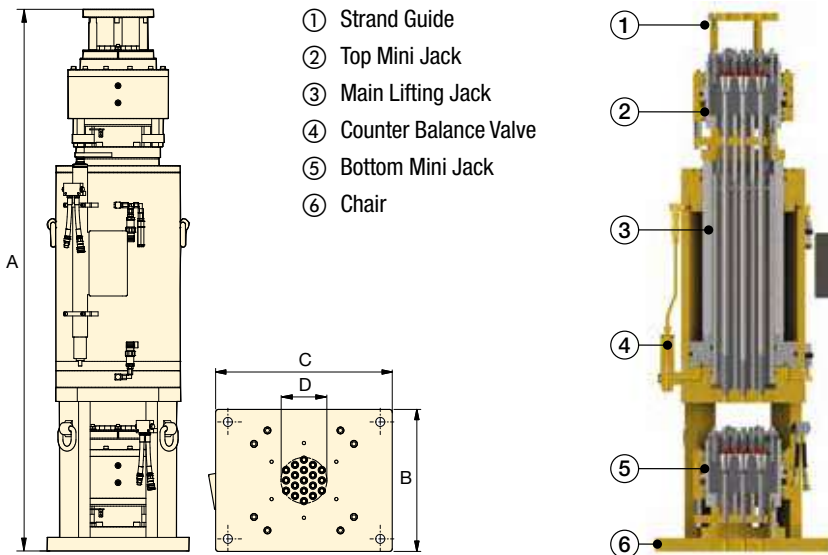

### ▼ Strand Jack Accessories

Contact Enerpac for assistance by email at [integratedsolutions@enerpac.com](mailto:integratedsolutions@enerpac.com)



#### Hydraulic Power Packs

Enerpac offers a comprehensive range of hydraulic power packs that are optimized for use with their industry leading heavy lifting strand jacks.



#### Strand Guides

Provides a guide for the strand as a strand jack lifts the load.



#### Strand Recoilers

Passively pays in or pays out strands while jacking and lowering.



#### Strand Dispenser

Essential to safely unbundle a new strand coil.



#### Lifting Anchor

Each Strand Jack includes a lifting anchor for attaching strand to the load.

Strand Diameter mm (inch)	Capacity *		Model Number	Number of Strands	Stroke (mm)	Dimensions (mm)				Weight (kg)
	ton	(kN)				A	B	C	D	
15,7 (.62)	30	(300)	HSL3006	3	480	1851	350	500	59	500
	70	(700)	HSL7006	7	480	1915	360	575	93	640
	200	(2000)	HSL20006	19	480	1992	522	650	169	1300
	300	(3000)	HSL30006	31	480	2046	673	673	216	2180
	500	(5000)	HSL50006	48	480	2136	733	733	273	3150
18 (.71)	15	(150)	HSL1507	1	250	1242	220	220	20	100
	45	(450)	HSL4507	3	480	1728	350	500	73	500
	60	(600)	HSL6007	4	480	1752	400	625	88	650
	100	(1000)	HSL10007	7	480	1926	408	625	116	850
	200	(2000)	HSL20007	12	480	2001	522	650	165	1400
	300	(3000)	HSL30007	19	480	2055	673	673	210	2180
	450	(4500)	HSL45007	31	480	2223	733	733	272	3050
	650	(6500)	HSL65007	43	480	2237	850	850	351	3950
	850	(8500)	HSL85007	55	480	2402	900	900	364	5000
	1000	(10.000)	HSL100007	66	480	2558	1092	1092	436	7650
1250	(12.500)	HSL125007	84	600	2658	1100	1100	458	8300	

\* Capacity is based on 2,5 minimum safety factor over strand breaking load.

▼ SHS-Series 4-Point SyncHoist System



- High precision load manoeuvring, vertically and horizontally – using one crane
- Reduces the risk of damage from oscillations of wire rope due to crane jogging and sudden starts/stops
- Vastly improving worker safety, operating speed and control
- Weather conditions play less critical role
- PLC-controlled hydraulics turn lifting into high accuracy hoisting and load positioning system
- Double-acting push/pull cylinders with load holding valves for added safety in case of hose rupture or coupler damage
- Cost reduction compared to conventional load positioning methods.

**Options for system management & control:**

- Manual control: system warning functions
- Automatic control: fully PLC-monitored system with programmable functions using touch screen and system warning functions.

▼ Bridge segments are hoisted from the ground, being positioned with a 4-point SyncHoist system with fully monitored cylinders.



▼ An SyncHoist system used to align steel blocks of the ship's control tower sections allowing gradual lift and positioning of the load.



## Accurate Hoisting and Load Positioning Enhancing a Crane's Capability



**Synchronous Hoisting**

Enerpac SyncHoist is a unique crane product for below-the-hook positioning of heavy loads that require precision placement. The SyncHoist system may reduce the number of cranes needed and reduce the costs of multiple picks.

**Functions**

- High precision horizontal and vertical load positioning
- Pre-programmed positioning, tilting and aligning.

**Applications**

- Positioning of rotor, stator and propeller blades of wind turbines
- Positioning of roof sections, concrete elements, steel structures
- Positioning of turbines, transformers, fuel rods
- Precise machinery loading, mill rod changes, bearing changes
- Precise positioning of pipe lines, blow out valves
- Positioning and aligning of ship segments prior to assembly.

▼ SyncHoist lifts and positions Brisbane Riverwalk concrete girders



# SyncHoist - High Precision Load Positioning



## What is SyncHoist?

Enerpac SHS-Series SyncHoist is a hydraulically operated auxiliary attachment for high precision load positioning for cranes.

The automatic version with PLC-controlled hydraulic pump monitors and guides the powerful double-acting push-pull cylinders integrated into the lifting points above the load. The SyncHoist system can be used for pre-programmed positioning, tilting and aligning of loads.

- Patented system
- Complete system tested in compliance with European lifting directive and safety requirements

### SyncHoist improves safety, operating speed and control of load movement

Geometric positioning of heavy loads in a horizontal and vertical plane are frequently done using more than one crane.

Synchronising movements between cranes are difficult and risky. The lifting inaccuracy can result in damage to the load and support structures and puts workers at risks.

The SyncHoist system can be used for controlled hydraulic horizontal and vertical material handling.

## System management and control

Contact Enerpac for the following options, or other customised stroke, capacity and control configurations.

### 1. Manual control

- Valves with manual levers
- Warnings for thermal motor protection
- Visual check: oil level, filter indicator.

### 2. Automatic control

- Load and stroke monitoring, and stroke control
- PLC-control and touch screen
- Solenoid valves with pendant
- Pre-programmable motions and data recording
- System warnings for:
  - maximum cylinder load control setting
  - stroke and position control
  - thermal motor protection
  - oil level and filter indicator.

### SyncHoist Power Packs

SyncHoist Power Packs are specifically designed to work with the SyncHoist cylinders to insure proper operation of the system. Contact Enerpac for assistance at [enerpac.com/contact-us](http://enerpac.com/contact-us)

### SHAS-Series, Wireless SyncHoist

See next page for wireless remote control system with integrated hydraulics.

## SHS Series



Capacity Per Lifting Point:

**55 - 85 - 110 ton**

Maximum Stroke:

**500 - 1000 - 1500 mm**

Accuracy Over Full Stroke:

**± 1,0 mm**

Maximum Operating Pressure:

**700 bar**

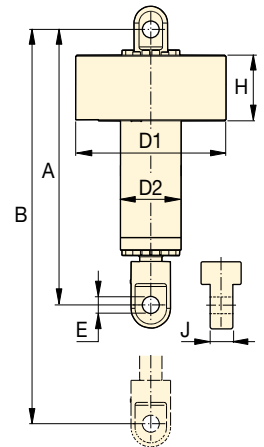

Capacity	Total Load	Cylinder Stroke	Model Number <sup>1)</sup>	Control System	Motor Size	Number of Pump Outlets and Oil Flow <sup>2)</sup>	Cylinder Dimensions (mm)							Weight (kg) <sup>3)</sup>
							A	B	D1	D2	E	H	J	
4 x 55 (539)	220 (2156)	500	SHS 45520 MW	Manual	7,5	4 x 1,4	1300	1800	690	245	59	385	80	450
		1000	SHS 45540 MW				1800	2800						625
		1500	SHS 45560 MW				2300	3800						800
		500	SHS 45520 AW	Automatic	15	4 x 2,1	1300	1800	450					
		1000	SHS 45540 AW				1800	2800	625					
		1500	SHS 45560 AW				2300	3800	800					
4 x 85 (833)	340 (3332)	500	SHS 48520 MW	Manual	11	4 x 2,1	1330	1830	690	265	72	385	100	500
		1000	SHS 48540 MW				1830	2830						700
		1500	SHS 48560 MW				2330	3830						900
		500	SHS 48520 AW	Automatic	15	4 x 2,1	1330	1830	500					
		1000	SHS 48540 AW				1830	2830	700					
		1500	SHS 48560 AW				2330	3830	900					
4 x 110 (1078)	440 (4312)	1000	SHS 411040 MW	Manual	11	4 x 2,1	1855	2855	780	315	85	395	124	970
		1500	SHS 411060 MW				2355	3855						1235
		1000	SHS 411040 AW	Automatic	15	4 x 2,1	1855	2855	970					
		1500	SHS 411060 AW				2355	3855	1235					

<sup>1)</sup> With 4 cylinders and one 400 VAC-3 phase-50 Hz Powerpack (suffix W). For 460-480 VAC-3 phase-60 Hz Powerpack change suffix W into J. Example: SHS 45560 MJ.

<sup>2)</sup> Pump and cylinders include 4x 25 meters hydraulic hoses with couplers.

<sup>3)</sup> Weight per cylinder



▼ SHAS411040WE Autonomous SyncHoist System demonstrated using a load simulation



- High precision load manoeuvring using one crane
- Vastly improving worker safety, operating speed and control
- Integrated PLC-controlled hydraulics in each lifting device – no need for external powerpack and hydraulic hoses
- Wireless control for safe operation
- Quick installation, set-up and operation - one electric connection per lifting point
- Cost reduction compared to conventional load positioning methods.

▼ A single operator controls and oversees the entire hoisting job - the portable wireless control allows him to be at a safe distance.



▼ Rigging engineers used the SyncHoist system to precisely monitor and adjust each lifting point independently, or together in a synchronized manner to position the 1140 ton nuclear plant module.



## Accurate Hoisting and Load Positioning Enhancing a Crane's Capability



### Autonomous SyncHoist System

Enerpac Autonomous SyncHoist System is a unique crane product for below-the-hook positioning of heavy loads that require precision placement. The SyncHoist system may reduce the number of cranes needed.

#### Functions

- High precision horizontal and vertical load positioning
- Pre-programmed positioning, tilting and aligning.

#### Applications

- Positioning of rotor, stator and propeller blades of wind turbines
- Positioning of roof sections, concrete elements, steel structures
- Positioning of turbines, transformers, fuel rods
- Precise machinery loading, mill rod changes, bearing changes
- Precise positioning of pipe lines, blow out valves
- Positioning and aligning of ship segments prior to assembly.

▼ Offshore wind turbine base foundations installed with a wireless SyncHoist System to ensure the foundation remained vertical during lowering and positioning.





# SyncHoist - High Precision Load Positioning



## What is SyncHoist?

Enerpac SHAS-Series SyncHoist is a hydraulically actuated auxiliary attachment for high precision load positioning for cranes.

The autonomous system (SHAS) with integrated PLC-controlled hydraulics, monitors and guides the powerful double-acting push-pull cylinders which are integrated into the lifting points.

The SyncHoist system can be used for pre-programmed positioning, tilting and aligning of loads.

- Complete system in compliance with European lifting directive and safety requirements

## SyncHoist improves safety, operating speed and control of load movement

Geometric positioning of heavy loads in a horizontal and vertical plane are frequently done using more than one crane. Synchronising movements between cranes are difficult and risky. The lifting inaccuracy can result in damage to the load and support structures and puts workers at risk. The SyncHoist system can be used for controlled hydraulic horizontal and vertical material handling.

## Autonomous system

- Wireless remote control
- Only one electric power connection per lifting point
- Integrated hydraulics, PLC and controls
- No need for hydraulic hoses and cables
- No need for mid-hoist disconnection of hoses and movement of pump.

## Modular system

- Standard with four lifting devices.
- Quick installation, set-up and operation.

## PLC-controlled system

- Pre-programmable motions
- Data recording
- Load control
- Stroke control
- Alarms for overload
- Real time indication of force and stroke per lifting point
- Controlled adjustment of forces per lifting point during entire operation.

## Wireless controls

- Operate from safe distance
- Portable, no cables
- Siemens wireless 7 inch touch screen control panel
- Emergency stop, TÜV certified in PROFISAFE.

## SHAS Series



Capacity Per Lifting Point:

**110 - 225 ton**

Maximum Stroke:

**1000 - 1500 mm**

Accuracy Over Full Stroke:

**± 1,0 mm**

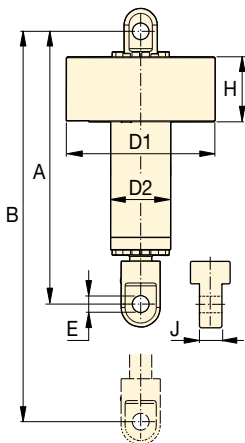

SyncHoist system mounted in an auxiliary frame for levelling and positioning steel structures during construction of an oil & gas installation. ▶



Capacity	Total Load	Cylinder Stroke	Model Number <sup>1)</sup> 400-500 VAC, <sup>2)</sup> 3ph - 50-60Hz	Control System	Motor Size	Dimensions (mm)							(kg) <sup>3)</sup>
						A	B	D1	D2	E	H	J	
4 x 110 (4 x 1078)	440 (4312)	1000	SHAS 411040 WE	Wireless	4 x 4,0	1855	2855	1063	315	85	540	124	1183
		1500	SHAS 411060 WE			2355	3855	1063	315	85	540	124	1448
4 x 225 (4 x 2204)	900 (8820)	1000	SHAS 422540 WE	Wireless	4 x 8,0	2140	3140	1235	420	142	580	190	3219
		1500	SHAS 422560 WE			2640	3640	1235	420	142	580	190	3414

<sup>1)</sup> Standard with 4 lifting points. For more or less lifting points contact Enerpac.

<sup>2)</sup> WE = with European electrical wiring. Change into suffix "WU" for US-market. Example: SHAS 411060WU. <sup>3)</sup> Weight per cylinder.

▼ SBL1100 with optional skid tracks, header beams, powered side shifts and lifting anchors



- Self-contained hydraulics and electronics
- Intelli-Lift wireless control system
- Self-propelled wheels or tank rollers
- Foldable boom on SBL900, SBL1100, MBL500 and MBL600
- Full range of supplementary equipment: header beams, lifting anchors, side shifts and skid tracks
- Designed and tested to meet ASME B30.1-2015 safety standards
- Lloyds witness tested to 125% of maximum working load.

▼ Two SBL1100 telescopic hydraulic gantry systems lifted the 1300 ton hydrocracker off the barge onto a SPMT Self-Propelled Modular Transporter.



## Precision Lift and Position of Heavy Loads

The Ultimate in Safety and Control



### Intelli-Lift Wireless Control

The Intelli-Lift wireless control system is included with all Enerpac hydraulic gantries.

The Intelli-Lift controller offers superior safety and control and includes the following features:

- Encrypted bi-directional communication that eliminates interference from other devices
- Remote operation using multi channel wireless (2.4 GHz) or wired (RS-485) control
- High and low speed settings
- Automatic synchronization of lifting with an accuracy of 24 mm (0.95 inch)
- Automatic synchronization of travelling with an accuracy of 15 mm (0.60 inch)
- Overload and stroke alarms
- Remote side shift control
- Emergency stop switch.

Maximum Capacity (with 4 towers)	Model Number (4 towers)	Retracted Height
(kN)		A (mm)
600	SL 60	2004
1250	SL 125	2640
3000	SL300	2705
4000	SL 400	3166
5000	SBL 500	3028
8976	SBL 900	5004
10.484	SBL 1100	4370
5000	MBL 500	6098
6000	MBL 600	6553

# Telescopic Hydraulic Gantries



## Hydraulic Gantries

Telescopic Hydraulic Gantries are a safe, efficient way to lift and position heavy loads in applications where traditional cranes will not fit and permanent overhead structures for job cranes are not an option.

Hydraulic Gantries are placed on skid tracks to provide a means for moving and placing heavy loads, many times with only one pick.

Enerpac offers three series of Hydraulic Gantry systems:

- **SL-Series Super Lift**

The cost-effective SL-Series Super Lift offer control and stability for everyday lifting applications below 4000 kN up to 9 metres

- **SBL-Series Super Boom Lift**

The heavy-duty SBL-Series Super Boom Lift boom style gantries offer increased lifting capacity of over 4000 kN to heights of almost 12,2 metres.

- **MBL-Series Mega Boom Lift**

The massive MBL-Series Mega Boom Lift offers capacities and lifting heights of over 6000 kN at almost 14,6 metres extreme lifting conditions.

All Enerpac gantries are delivered with specific properties and control systems to ensure optimum stability and safety.

## SL, SBL, MBL Series



Capacity with 4 towers:

**600 - 10.484 kN**

Lift Height:

**3,49 - 14,55 meters**

### ▼ Optional Gantry Accessories

Contact Enerpac for assistance by email at [enerpac.com/contact-us](mailto:enerpac.com/contact-us)



#### Skid Tracks

Allows for easy levelling of the gantry tower and reduce ground bearing pressure, available in two standard lengths, 3 and 6 m.



#### Header Beams

Sold in pairs and includes lifting points and fork pockets for easy positioning on gantry towers. Available in standard lengths of 8, 10 and 12 meters

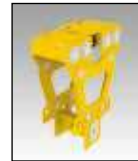

#### Powered Side Shift

Electric propulsion controlled by standard gantry controls. Each set consists of 4 units.



#### Lifting Anchors

Designed to transfer the load to the top of the header beam. Can accommodate a 250 ton shackle or attach directly to the lifted load.

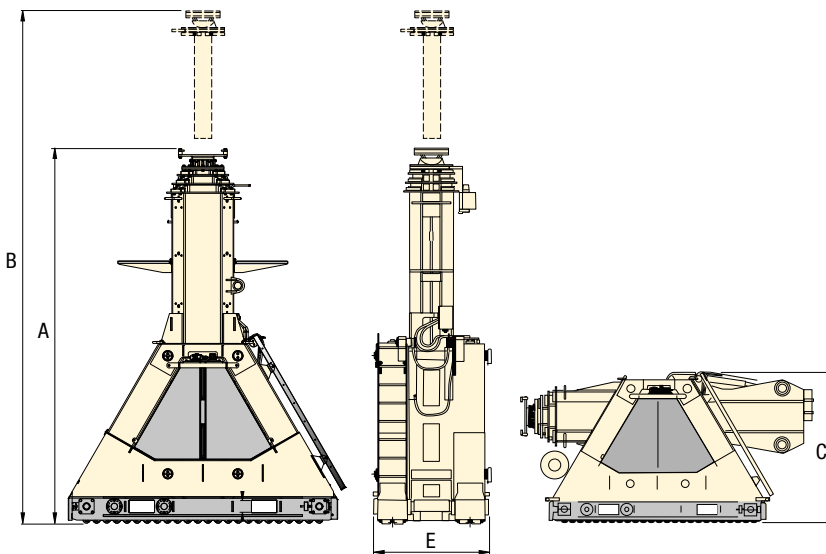

Stage 1		Stage 2 <sup>1)</sup>		Stage 3		Transport Height	Skid Track Width	(kg) <sup>2)</sup>	Model Number (4 towers)
Max. Height	Max. Capacity	Max. Height	Max. Capacity	Max. Height	Max. Capacity				
B (mm)	(kN)	B (mm)	(kN)	B (mm)	(kN)	C (mm)	E (mm)		
3404	150	4704	150	-	-	2034	769	1050	<b>SL 60</b>
4575	313	6640	313	-	-	2762	812	2130	<b>SL 125</b>
4605	750	6700	500	-	-	2705	830	3250	<b>SL300</b>
5224	1000	7232	1000	9140	460	3170	1218	4600	<b>SL 400</b>
4998	1300	6908	1300	8618	750	3028	1218	6300	<b>SBL 500</b>
8304	2244	11.304	1481	-	-	2243	1218	13.350	<b>SBL 900</b>
7004	2621	9668	1699	12.002	945	2244	1218	11.950	<b>SBL 1100</b>
-	1250	12.867	1250	-	-	2243	1682	19.750	<b>MBL 500</b>
-	1500	14.552	1500	-	-	2525	1982	20.950	<b>MBL 600</b>

<sup>1)</sup> MBL500 and MBL600 are two stage gantries; stages 1 and 2 extend simultaneously and provide full capacity at any height. <sup>2)</sup> Weight per tower



▼ Shown: HSK1250 Skidding System



## HSK-Series, Skidding System

- PTFE skid pads with dimpled surface for low friction and long lifetime
- Easy to replace skid pads, no tools necessary
- Bi-directional operation using push-pull cylinders avoid the need to reposition cylinders for switching direction
- Large load support surface on the skid beams for distributing load
- Bottom of skid shoes equipped with stainless steel sliding plates.

## LH-Series, Low-Height Skidding System

- 2-in-1 track design for added support
- Intuitive pump controls (SFP-Series Split-Flow Pump)
- Easily reversible to change skidding direction
- Portable design for quick setup
- 400 ton skidding capacity with two push-pull units.

▼ A custom hydraulic Low-Height Skidding System will provide the maintenance team with the ability to maneuver and transport transformers with physical access limitations.



## The Ideal Jack and Slide Solution



### Skidding Systems

The skidding system is comprised of a series of skid beams moved by hydraulic push-pull cylinders, travelling over a pre-constructed track.

A series of special PTFE coated pads are placed on the skid tracks. The PTFE surface is matched with a sliding plate under the Enerpac skid beams, designed to achieve minimum friction coefficients. The skid beams are connected by hoses to a hydraulic electric or diesel driven power pack.

In addition to our standard skidding systems, we have the capability to create customized skidding systems to meet your specific requirements.



### Controls

Enerpac offers several options for controlling our skidding systems. Wireless Controls allows the operator the freedom to view

the skidding operation from multiple locations while providing complete control of all system functions.

Manual controls offer a cost-effective solution by utilizing manual hydraulic valves mounted directly on the skidding system power unit.

▼ HSKJ-2500 Skid Shoe Jack.







## Skidding Systems

Enerpac Skidding Systems are available in several versions:

- **B-Series (Skid Beam)** utilizes a tall skid beam with built-in push-pull cylinders. Skidding direction can be easily switched by flipping a lever on the attached gripper box.
- **J-Series (Skid Jack)** provides the same functionality as the B-Series with the added benefit of having a built-in cylinder for lifting or leveling the load.

- **LH-Series (Low-Height)** includes low-height skid beams that can fit in tight spaces while still offering high capacity. We also offer a track support for added rigidity when the surface is not fully supported.

## HSK LH Series



Capacity:  
**100 - 250 ton**

Push/Pull Stroke:  
**600 mm**

Lifting Stroke:  
**175 mm**

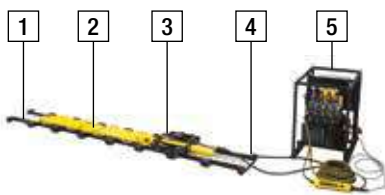

### LH-Series Skidding System Requirements

- 1 Skid Track (required)
- 2 Skid Beam (required)
- 3 Push-Pull Cylinder Unit (required)
- 4 Hydraulic Hoses (required)
- 5 Split-Flow Electric Pump (required)
- 6 Track Support (optional, not shown)
- 7 Storage/Transport Frame (optional, not shown)
- 8 Pump Cart (optional, not shown)

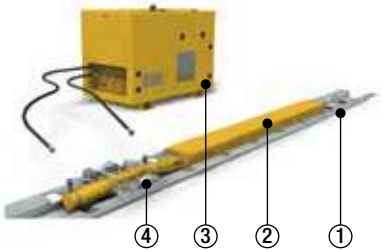

### HSK-Series Skidding System Requirements

- ① Skid Track
- ② Skid Beam
- ③ Hydraulic Power Pack
- ④ Hydraulic Push-Pull Unit



### Skid Tracks

Include specially constructed and easily replaceable PTFE coated pads. Skid track is sold separately.



### Hydraulic Power Packs

Enerpac offers a comprehensive range of hydraulic power packs that are optimized for use with Skidding Systems.

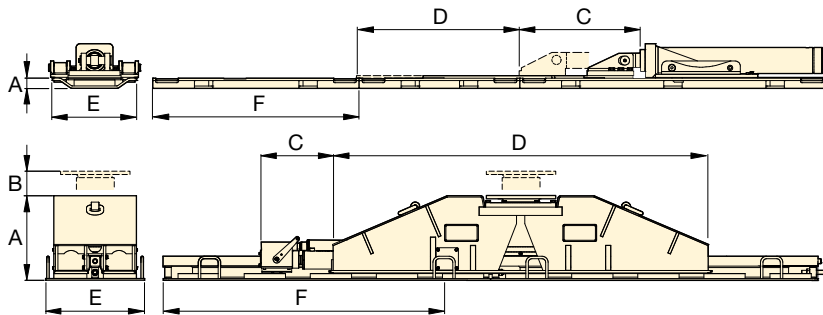

▼ Low-Height Skidding System assembly (LH400).



## Skidding Systems

Maximum Capacity (per beam)	Maximum Push-Pull Capacity ton (kN)		Model Number	Skid Beam Height (with track)	Lifting Stroke	Push-Pull Stroke	Skid Beam Length	Skid Beam Weight	Skid Track Width	Skid Track Length	Skid Track Weight
	ton (kN)	Push									
100 (860)	25 (255)	11 (98)	LH400	92	–	600	1080	63	250	955	67
125 (1250)	22 (220)	16 (160)	HSKB1250	309	–	600	2500	740	400	1983	120
125 (1250)	22 (220)	16 (160)	HSKJ1250	502	175	600	1690	790	400	1983	120
200 (2000)	25 (255)	14 (141)	HSKLB2000	204	–	600	2902	340	540	1998	120
250 (2500)	40 (400)	26 (260)	HSKB2500	374	–	600	3000	1020	600	1946	290
250 (2500)	40 (400)	26 (260)	HSKJ2500	600	175	600	1784	1450	600	1946	290



# SPMT, Self-Propelled Modular Transporter

▼ SPMT600-360 with MTPP-360 hydraulic power unit (HPU)

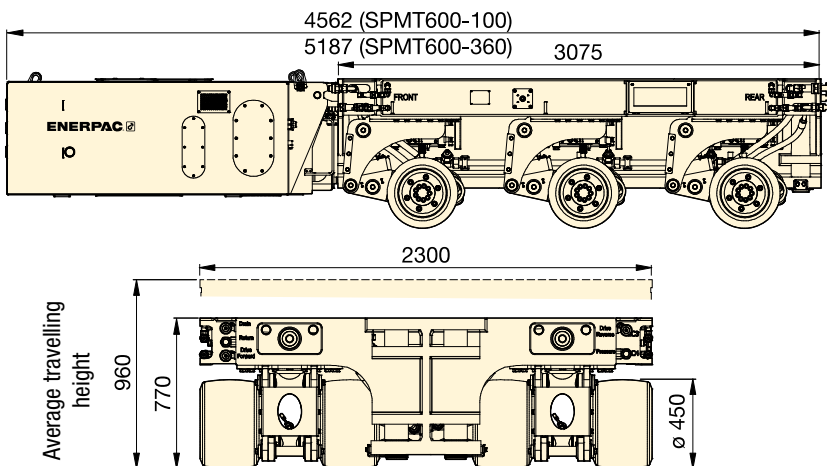

- Modular design for multiple configurations.
- Minimized height and slim design are ideal for in-plant operation
- Intelli-Drive wireless control system is intuitive and easy to use
- One power pack can operate 2-3 trailers maximum depending on model
- Two trailers and power pack can be shipped inside a 20 ft. container
- Hydraulic power unit is tier-4 diesel engine for reduced emissions.



Capacity (per trailer)	Model Number	Maximum Configuration	Steering Range	Lifting Stroke	 HPU *	 Trailer
ton (kN)		(trailer in rows)	(degrees)	(mm)	(kg)	(kg)
60 (600)	SPMT600-100	4 x 2	-50° - +50°	384	2500	8000
	SPMT600-360	6 x 2	-179° - +179°	384	2800	8300

\* HPU = 54 kW Power Pack Diesel is sold separately.

## SPMT Series

Capacity:

**60 ton (600 kN)**

Transport Speed (unloaded - loaded):

**3 - 1,5 km/h**

Motor Size:

**54 kW**



### Self-Propelled Modular Transporter

The Enerpac Self-Propelled Modular Transporter (SPMT) features a minimized height and slim design, which makes it very easy to operate in confined spaces. Each wheel unit has a steering function as well as a lifting cylinder at its disposal. Two axles are driven, the centre axle is non-driven. Wheel propulsion is established by wheel drives.

The SPMT is operated by the Intelli-Drive Remote Controller. This remote controller can be used both hard wired and wireless (based on radio frequency).

The SPMT is a modular system and can be built up to a maximum configuration of six transporters in a row and two in the width. This is the maximum setup of units that can work together on just one Intelli-Drive Remote Controller.

The SPMT is a modular system comprised of trailers with 3 axle lines each and diesel hydraulic power units (HPU). Depending on the model number, the trailers and HPUs can be configured to a maximum of 4 trailers in 2 rows (4x2) or 6 trailers in 2 rows (6x2).

▼ Turbine rotor transport.



# Custom Heavy Lifting Solutions

When your application requires something other than our standard product offering, look to Enerpac Heavy Lifting Technology, Experience and Expertise.

Our group of engineers, designers and specialist, will work with you to understand your specific application and provide a turn-key solution that will exceed your expectations.



## STEEL FABRICATION

Enerpac has a dedicated facility for steel fabrication and welding. We design and manufacture custom structures used in demanding heavy-lifting applications.



## ENGINEERING

Enerpac has a multi-disciplined engineering team capable of design and development of all aspects of an Heavy Lifting system. Leveraging design and application experience with the latest in computer software, rapid prototyping and analysis methods ensures delivery of the highest quality systems.



## ELECTRONICS

Enerpac designs all control systems in-house. This capability keeps control technology close to the design engineers who are developing the rest of the system. In doing so, we can tailor the control system to match unique project requirements.



## MACHINING

Enerpac utilizes the latest in CNC machining technologies and manufactures all large and special hydraulic cylinders in-house. We can machine diameters up to 1000 mm with lengths to 6000 mm.



## FIELD SUPPORT

Enerpac Heavy Lifting Technology is available to provide on-site support including training and troubleshooting of systems. We also stock repair parts and consumable items at several locations to ensure fast delivery and minimal downtime.



## HYDRAULIC POWER UNITS

Enerpac designs, assembles and tests small to large hydraulic power units in-house. Power units range from 0,5 to 240 kW and are tested with the system they are intended to operate.



## MAINTENANCE and REPAIR

Due to the unique nature of Enerpac Heavy Lifting Technology, we offer complete maintenance and repair services. Our M&R group is available to assist customers who do not have access to local service facilities qualified to work on these systems.





## OFFSHORE GANTRY CRANE

The Enerpac Over Head Travel Crane (OHTC) comprises two pairs of lifting beams, with an overall width of 30m, and a lifting capacity of 4800 ton for lifting, moving and lowering the concrete blocks for the offshore highway.



## STRAND JACK GANTRY

The strand jack gantry is a steel structure to facilitate erection and skidding back, forth and sideways of heavy loads. The Enerpac strand jack gantry can be used with either skidding systems or hydraulic gantries on top.



## TRAVEL GANTRY

The travel gantry combines the safety and efficiency of a hydraulic gantry with the ease of use of SPMT (self-propelled modular transporter) technology. With a lifting capacity of 67 ton, the travel gantry sets a new standard in equipment and container handling.



## BRIDGE LAUNCHING SYSTEMS

**Spindle Bar System:** group of in-line hollow plunger cylinders. The hollow plungers allow the steel bars to be inserted through the cylinders, which are used for pushing, pulling and braking. **Enerpac Enerlauncher** is an automatic and synchronous incremental hydraulic tandem launching system with a 800 ton lifting section and an 300 ton push/pull section.



## JACK-UP SYSTEMS

The jack-up system is a custom developed multipoint lifting system – synchronically lift and mechanically hold. A typical system setup includes four jack-up units positioned under each corner of a load.



## ROTOR REMOVAL AND INSTALLATION SYSTEM

The generator rotor removal and installation system is a custom developed product for removing and installing the rotor (field) in a power plant's generator. The system is designed to comply with the varying dimensions and challenging accessibility of a plant's generator.



## CUSTOM HYDRAULIC PRESSES

Our hydraulic presses can be configured to fulfill a broad range of applications. Each press is designed and manufactured according to customer specifications and in cooperation with our engineering team.



## SELF-ERECTING TOWER

The Enerpac Self Erecting Tower (ESET) is a self-erecting tower lift system that enables you to build a free standing gantry from ground level. The ESET can be supplied in various capacities and lifting heights and is built with standard modular components, enabling a flexible solution to future project demands.



## LAS VEGAS WHEEL

Our expertise has been acknowledged by the world's leading industrial professionals and has contributed to the successful movement of a number of the most recognizable structures on earth. At the time of construction the Las Vegas High Roller was the largest observation wheel in the world. A custom hydraulic drive system was developed to propel the wheel for daily use and was also used to construct the wheel in sections.





## Enerpac 'Yellow Pages' stand for Hydraulic Information!

If selecting hydraulic equipment is not your daily routine, then you will appreciate these pages. The 'Yellow Pages' are designed to help you work with hydraulics. They will help you to better understand the basics of hydraulics, of system set-ups and of the most commonly used hydraulic techniques. The better your choice of equipment, the better you will appreciate hydraulics. Take the time to go through these 'Yellow Pages' and you will benefit even more from Enerpac High Pressure Hydraulics.

Section		Page
Safety Instructions		264-265 ▶
Pump Selection Selection Worksheet		266 ▶ 267 ▶
Basic System Set-ups		268-269 ▶
Basic Hydraulics		270-271 ▶
Conversion Tables Cylinder Speed Charts		272 ▶ 273 ▶
Valve Information Hexagon Bolt and Nut Sizes		274 ▶ 275 ▶
Torque Tightening		276-277 ▶



### ENERPAC WARRANTY STATEMENT

Visit our web site for the complete Global Lifetime Warranty or call your Authorized Service Center.



Enerpac is certified for several quality standards. These standards require compliance with standards for management, administration, product development and manufacturing. Enerpac worked hard to earn the quality rating ISO 9001, in its ongoing pursuit of excellence.

### ISO 1402, ISO 4672, ISO 6803

Enerpac thermoplastic hoses are related to the criteria set forth in these standards.



### ATEX 95 Certified

The ATP, ZA and XA-Series air pumps and S and W-Series torque wrenches are tested and certified according to the Directive 2014/34/EU "ATEX Directive".

The explosion protection is for equipment group II, equipment category 2 (hazardous zone area 1), in gas and/or dust atmospheres. ATP, ZA and XA-Series air pumps are marked: Ex II 2 GD ck T4.

### Product Design Criteria

All hydraulic components are designed and tested to be safe for use at maximum 700 bar (10.000 psi) pressure unless otherwise specifically noted.



Where specified, Enerpac electric power units meet the design, assembly and test requirements of the Standards Council of Canada (CAN C22.2 No. 68-92), and UL73 for the United States. Units were tested and certified for both USA and Canada by TÜV and by CSA, national recognized testing laboratories.

### EMC Directive

Where specified, Enerpac electric power pumps meet the requirements for Electromagnetic Compatibility per EMC Directive 2004/108/EC.



### CE Marking & Conformity

Enerpac provides a Declaration of Conformity and CE marking for products that conform with the European Community Directives.

### ASME B30.1-2015

Our cylinders fully comply with the criteria set forth by the American National Standards Institute (except RD and BRD-Series).



# Safety Instructions



When used correctly, hydraulic power is one of the safest methods of applying force to your work. And to that end we offer some DO's and

DON'Ts, simple common sense points which apply to practically all Enerpac hydraulic products.

- Lift slowly and check the load often
- Avoid standing in the line of force
- Anticipate possible problems and take steps to avoid them.

The line drawings and application photo's of Enerpac products throughout this catalog are used to portray how some of our customers have used hydraulics in industry.

In designing similar systems, care must be taken to select the proper components that provide safe operation and fit your needs.

Check to see if all safety measures have been taken to avoid the risk of injury and property damage from your application or system.

Enerpac can not be held responsible for damage or injury, caused by unsafe use, maintenance or application of its products.

Please contact the Enerpac office or a representative for guidance when you are in doubt as to the proper safety precautions to be taken in designing and setting up your particular system.

In addition to these tips, every Enerpac product comes with instructions spelling out specific safety information. Please read them carefully.

## Jacks

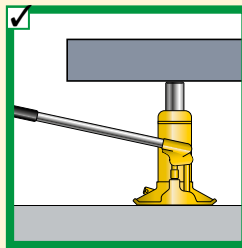
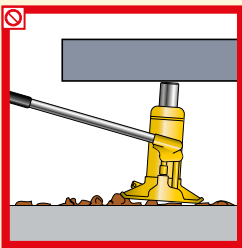

Provide a level and solid support for the entire jack base area.

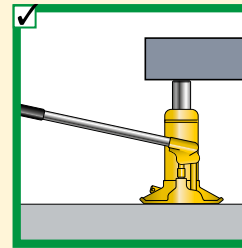
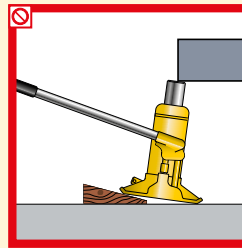

The entire jack saddle must be in contact with the load. Movement of the load to be in the same direction as jack plunger.

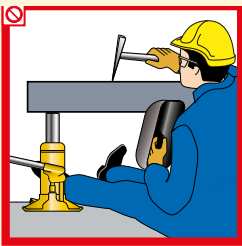

Never place any part of your body under the load. Ensure the load is on a solid support before venturing under.

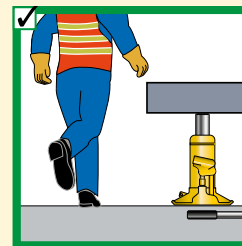
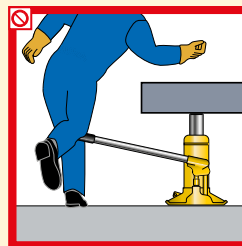

Remove the jack handle when it is not being used.

## Cylinders

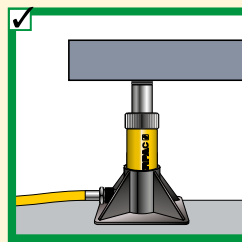
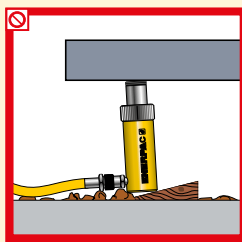

Provide a solid support for the entire cylinder base area. Use cylinder base attachment for more stability.

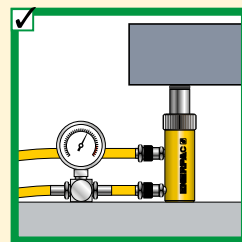
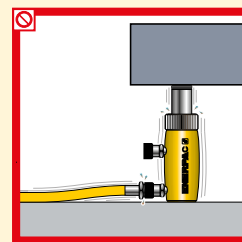

Both couplers must be connected when using double-acting cylinders. Ensure return hose is fitted.

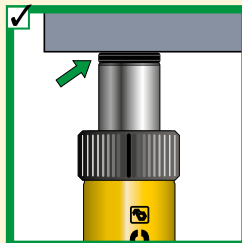
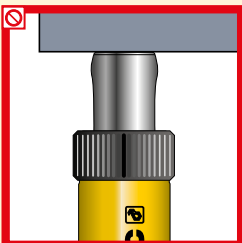

Do not use cylinder without saddle. This will cause plunger to "mushroom". Saddles distribute load evenly on the plunger.

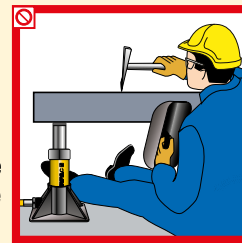

As with jacks, never place any part of your body under the load. Load must be on cribbing before venturing under.



Always protect cylinder threads for use with attachments.

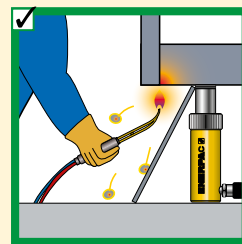
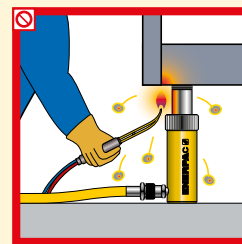

Keep hydraulic equipment away from open fire and temperatures above 65 °C (150 °F).



## General

**80%** Manufacturer's rating of load and stroke are maximum safe limits. **80%** Good practice encourages using only 80% of these ratings!

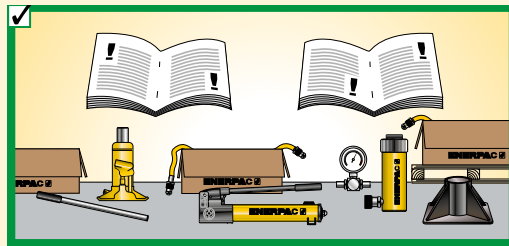

Always read instructions and safety warnings that come with your Enerpac hydraulic equipment.

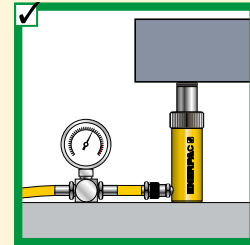
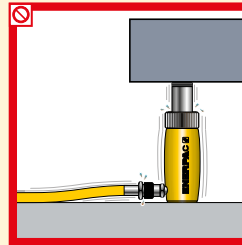

Don't override the factory setting of relief valves. Always use a gauge to check system pressure.

## Pumps

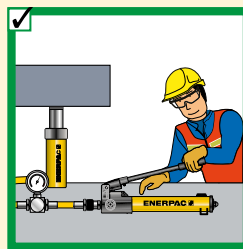
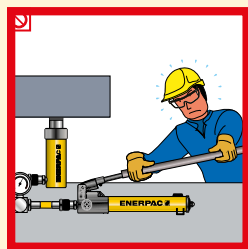

Don't use handle extenders. Hand pumps should be easy to operate when used correctly.

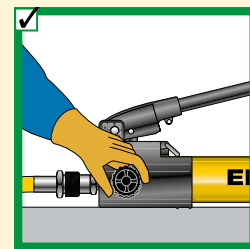
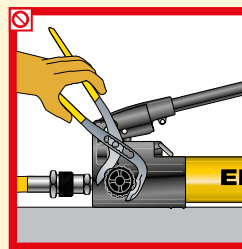

Close release valve finger tight. Using force will ruin the valve.

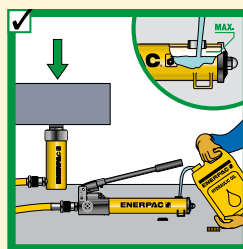
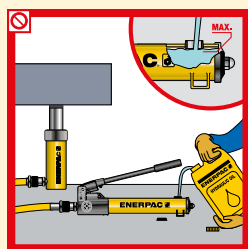

Fill pump only to recommended level. Fill only when connected cylinder is fully retracted.

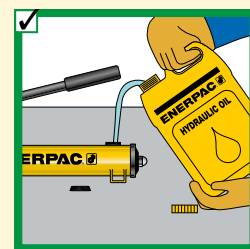
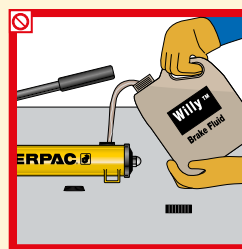

Use only genuine Enerpac hydraulic oil. Wrong fluid can destroy seals and pump and will render your warranty null and void your guarantee.

## Hoses and couplers

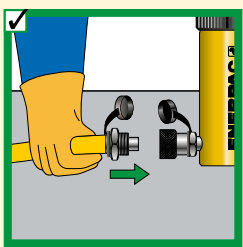
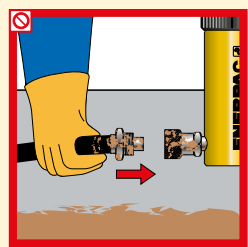

Clean both coupler parts before connecting. Use dust caps when coupler parts are not connected.

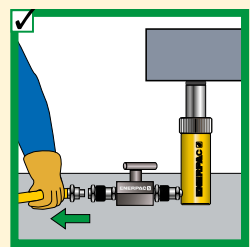
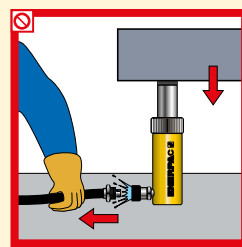

Detach cylinder only when fully retracted or use shut-off valves or safety valves to lock-in cylinder pressure.

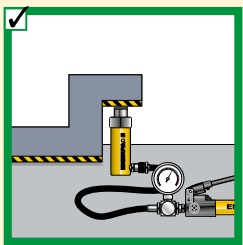
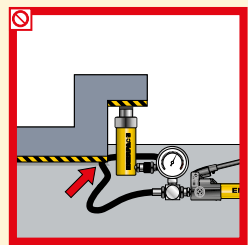

Keep hoses away from the area beneath loads.

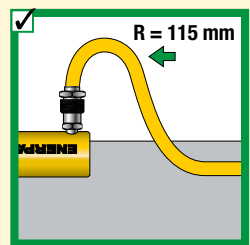
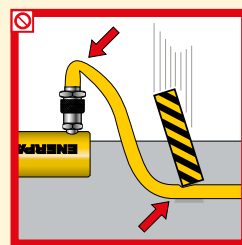

Don't kink hoses. Bending radius should be at least 115 millimetres. Don't drive over or drop heavy objects on hoses.

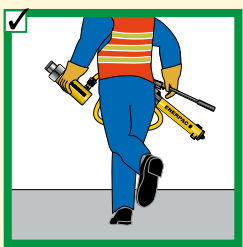
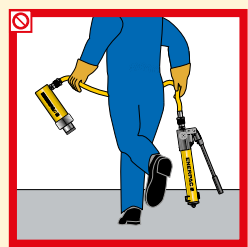



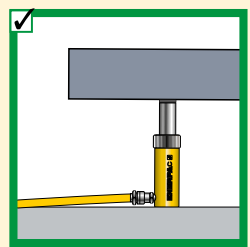
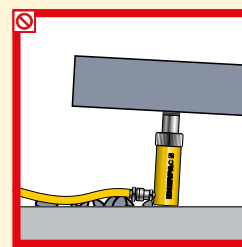

Don't lift hydraulic equipment by the hoses.



Never allow the cylinder to be lifted off of the ground through the couplers.









## ▼ HAND PUMP AND SINGLE-ACTING CYLINDER MATCHING CHART

Capacity (ton) ▶ ▼ Stroke	5 t	10 t	15 t	25 t	30 t	50 t	60 t	75 t	100 t	150 t
< 25 mm										
25 mm										
50 mm										
75 mm										
100 mm										
125 mm										
150 mm										
175 mm										
200 mm										
225 mm										
250 mm										
300 mm										
325 mm										
350 mm										
  <b>P-392</b> <i>Page: 72</i>			 <b>P-80</b> <i>Page: 74</i>			 <b>P-462</b> <i>Page: 74</i>				

Note: Selection based on oil capacity requirements of cylinders.

## ▼ POWER PUMP SELECTION CHART

Oil Flow *	Low (0,1 - 0,3 l/min)		Medium (0,5 - 2,0 l/min)		High (2,0 - 4,2 l/min)	
Usable Oil Capacity	1,9 - 3,8 litres	5,7 litres	4 - 40 litres	4 - 40 litres	10 - 40 litres	20 - 150 litres
Duty Cycle **	Intermittent	Extended	Intermittent	Extended	Extended	Extended
Portability ***	Portable	Stationary	Portable	Stationary	Stationary	Stationary
Recommended Series	<b>PU-Series Economy</b>	<b>PE-Series Submerged</b>	<b>ZU4-Series</b>	<b>ZE3-, ZE4- and ZE5-Series</b>	<b>ZE6-Series</b>	<b>SFP-Series</b>
						
	<i>Page: 84</i>	<i>Page: 86</i>	<i>Page: 92</i>	<i>Page: 98</i>	<i>Page: 98</i>	<i>Page: 240</i>

\* Oil Flow

- Determined by motor size
- Directly affects electrical power requirements
- Determines cylinder or tool speed

\*\* Duty Cycle

- Extended applications require more than one hour of uninterrupted pump use
- Intermittent would be used less than one hour, depending on reservoir capacity.

\*\*\* Portability

- |                                                                                                                                     |                                                                                                                                         |
|-------------------------------------------------------------------------------------------------------------------------------------|-----------------------------------------------------------------------------------------------------------------------------------------|
| <p><b>Portable</b></p> <ul style="list-style-type: none"> <li>• Ergonomic handles</li> <li>• Flexible power requirements</li> </ul> | <p><b>Stationary</b></p> <ul style="list-style-type: none"> <li>• Mounting options</li> <li>• Normally requires stable power</li> </ul> |
|-------------------------------------------------------------------------------------------------------------------------------------|-----------------------------------------------------------------------------------------------------------------------------------------|





▼ Complete the following information to select the right products:

Cylinder Selection	Question:	Tips/help	Data	Model Number
	<b>Total force required (ton):</b>	Total load	<input style="width: 100%;" type="text"/>	
	<b>Number of cylinders required:</b>	Number of lifting points	<input style="width: 100%;" type="text"/>	
	<b>Force per cylinder (ton):</b>	Should be 80% of total cylinder capacity	<input style="width: 100%;" type="text"/>	
	<b>Stroke required:</b>	Plunger travel	<input style="width: 100%;" type="text"/>	
	<b>Single or double-acting (D/A):</b>	D/A used when pull force is required, or retract speed is critical	<input style="width: 100%;" type="text"/>	
	<b>Type of plunger required:</b>	Hollow or solid	<input style="width: 100%;" type="text"/>	
	<b>Collapsed height required:</b>		<input style="width: 100%;" type="text"/>	
	<b>Optional saddle required:</b>	Tilt, Grooved, Flat	<input style="width: 100%;" type="text"/>	
	<b>Cylinder base:</b>	Improves stability	<input style="width: 100%;" type="text"/>	
	<b>Cylinder attachments: (RC-series)</b>	Expanded functions	<input style="width: 100%;" type="text"/>	
<b>Selected cylinder model:</b>			▶	<input style="width: 100%;" type="text"/>
<b>Including coupler model:</b>			<input style="width: 100%;" type="text"/>	

## Pump Selection

The three most commonly selected pumps are hand pumps, electric pumps and air-driven pumps. Gas powered pumps, however can be selected in the same way.

Available power source:  Manual  Battery  Electric  Compressed Air  Petrol

<b>Hand Pump</b>	Not for high cycle applications	<input style="width: 100%;" type="text"/>
<b>Single- or double-acting operation</b>	Use 4-way valve for D/A applications	<input style="width: 100%;" type="text"/>
		Check speed chart on page 273 for number of mm per stroke)

<b>Selected Hand Pump:</b>	▶	<input style="width: 100%;" type="text"/>
----------------------------	---	-------------------------------------------

<b>Electric or Compressed Air Pump</b>		
<b>Need for portability:</b>		<input style="width: 100%;" type="text"/>
<b>Duty cycle:</b>	Intermittent or extended	<input style="width: 100%;" type="text"/>
<b>Required useable oil capacity:</b>	Intermittent = 1,2 x oil capacity high cycle = 2 x oil capacity	<input style="width: 100%;" type="text"/>
<b>Available Voltage:</b>		<input style="width: 100%;" type="text"/>
<b>Lifting speed (Important/not important):</b>	Use speed chart on page 273	<input style="width: 100%;" type="text"/>
<b>Type of control:</b>	Manual / remote pendant	<input style="width: 100%;" type="text"/>
<b>Type of actuation/function:</b>	Advance / Hold / Retract	<input style="width: 100%;" type="text"/>
<b>Accessories:</b>	Filter Kit, Level Switch, Roll Bar ...	<input style="width: 100%;" type="text"/>

<b>Selected Pump:</b>	▶	<input style="width: 100%;" type="text"/>
-----------------------	---	-------------------------------------------

<b>Including Coupler:</b>	Oil connection	<input style="width: 100%;" type="text"/>
---------------------------	----------------	-------------------------------------------

## System Components

<b>Number of hoses and length required:</b>	<input style="width: 100%;" type="text"/>
---------------------------------------------	-------------------------------------------

<b>Selected Hoses:</b>	▶	<input style="width: 100%;" type="text"/>
------------------------	---	-------------------------------------------

<b>Manifold or Tee-fitting:</b>	▶	<input style="width: 100%;" type="text"/>
<b>Extra hose per manifold (2):</b>	▶	<input style="width: 100%;" type="text"/>
<b>Gauge (kN or bar scale):</b>	▶	<input style="width: 100%;" type="text"/>
<b>Gauge Adapter:</b>	▶	<input style="width: 100%;" type="text"/>
<b>Fittings:</b>	▶	<input style="width: 100%;" type="text"/>
<b>Pressure Relief Safety Valve:</b>	▶	<input style="width: 100%;" type="text"/>
<b>Load-holding Valve(s):</b>	▶	<input style="width: 100%;" type="text"/>
<b>Hydraulic Oil:</b>	▶	<input style="width: 100%;" type="text"/>



**1 Cylinder**  
Applies hydraulic force.  
Page 5

**2 Cylinder Base Plate**  
For applications like lifting where additional cylinder stability is required.  
Page 10

**3 Pump**  
Provides hydraulic flow.  
Page 71

**4 Hose**  
Transports hydraulic fluid.  
Page 122-123

**5 Male Coupler**  
For quick connection of the hose to system components.  
Page 124-125

**6 Female Coupler**  
For quick connection of the hose end to the system components.  
Page 124-125

**7 Gauge**  
To monitor pressure of the hydraulic circuit.  
Page 128-134

**8 Gauge Adaptor**  
For quick and easy gauge installation.  
Page 134-135

**9 Swivel Connector**  
Allows proper alignment of valves and/or gauges. Used when units being connected cannot be rotated.  
Page 135

**10 Auto-Damper Valve V-10**  
Used to protect gauge from damage due to sudden pressure pulses in the system. Needs no adjustment and allows correct positioning of gauge, prior to tightening.  
Page 136-137

**11 4-Way Directional Control Valve**  
Controls the direction of hydraulic fluid in a double-acting system.  
Page 116-117

### Single-acting push application, such as in a press.

The hand pump offers controlled cylinder advance, but may require many hand pump strokes in longer stroke applications when the cylinder capacity is 25 ton or above.

Examples of pump, hose and cylinder sets can be found on pages 58-61.

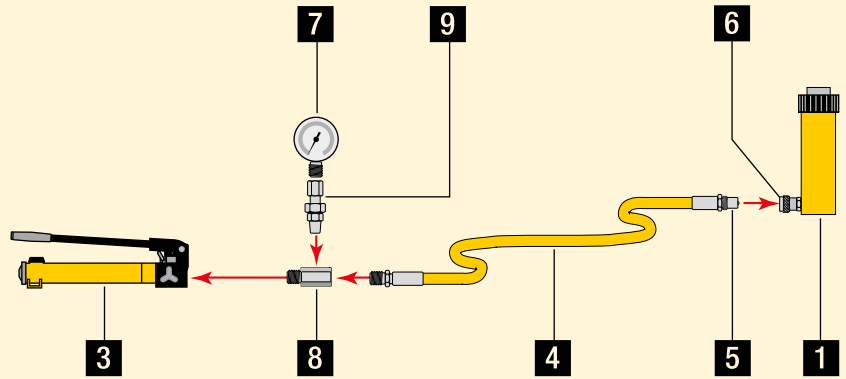

Single-acting cylinder with longer stroke used for lifting applications.

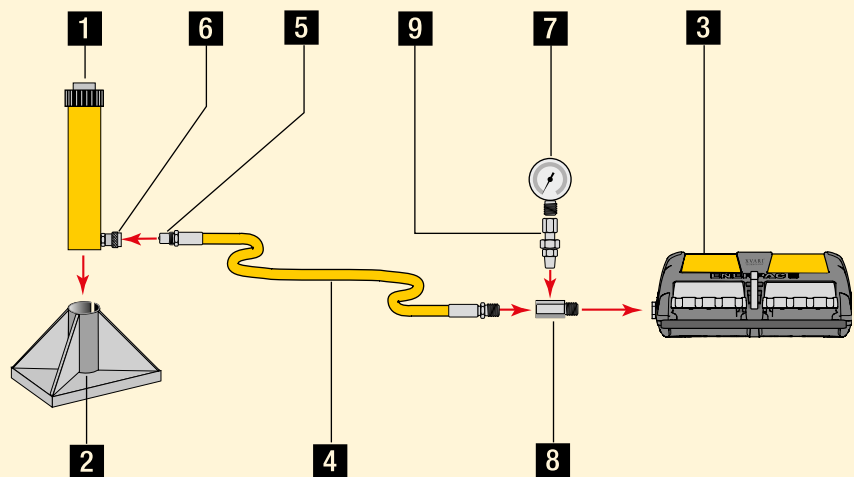

### Double-acting cylinder set-up used for lifting applications where a slow controlled descent of the load must be maintained.

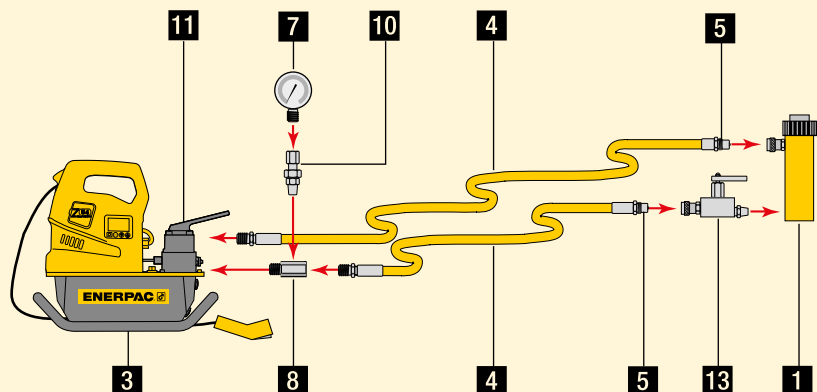



**Double-acting cylinder set-up** used in a push/pull application.

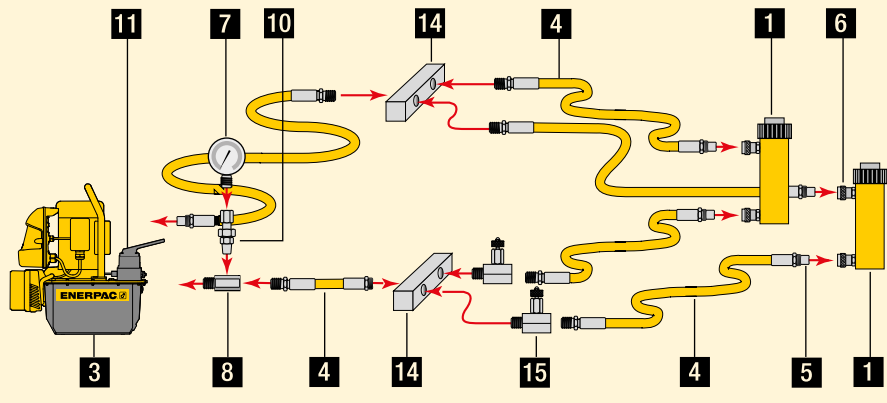

**12 3-Way Directional Control Valve**  
Controls the direction of hydraulic fluid in a single-acting system.  
Page 116-117

**13 Safety Holding Valve**  
Controls load descent in lifting applications.  
Page 136-137

**14 Manifold**  
Allows distribution of hydraulic fluid from one power source to several cylinders.  
Page 126

**15 Needle valve**  
Regulates the flow of hydraulic fluid to or from the cylinders.  
Page 136-137

**Two point lifting set-up** using single-acting cylinders.

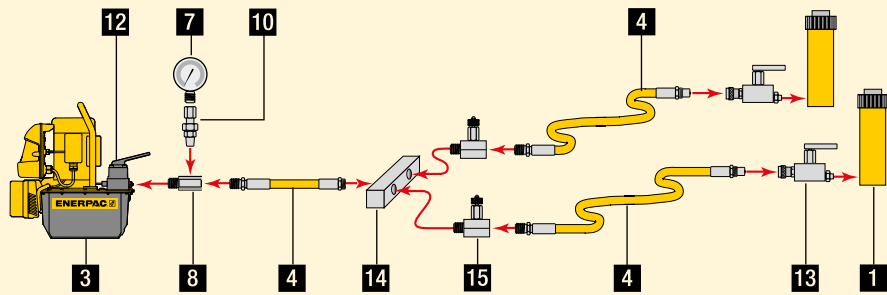

**Four point lifting set-up, using single-acting cylinders and directional control valves.**

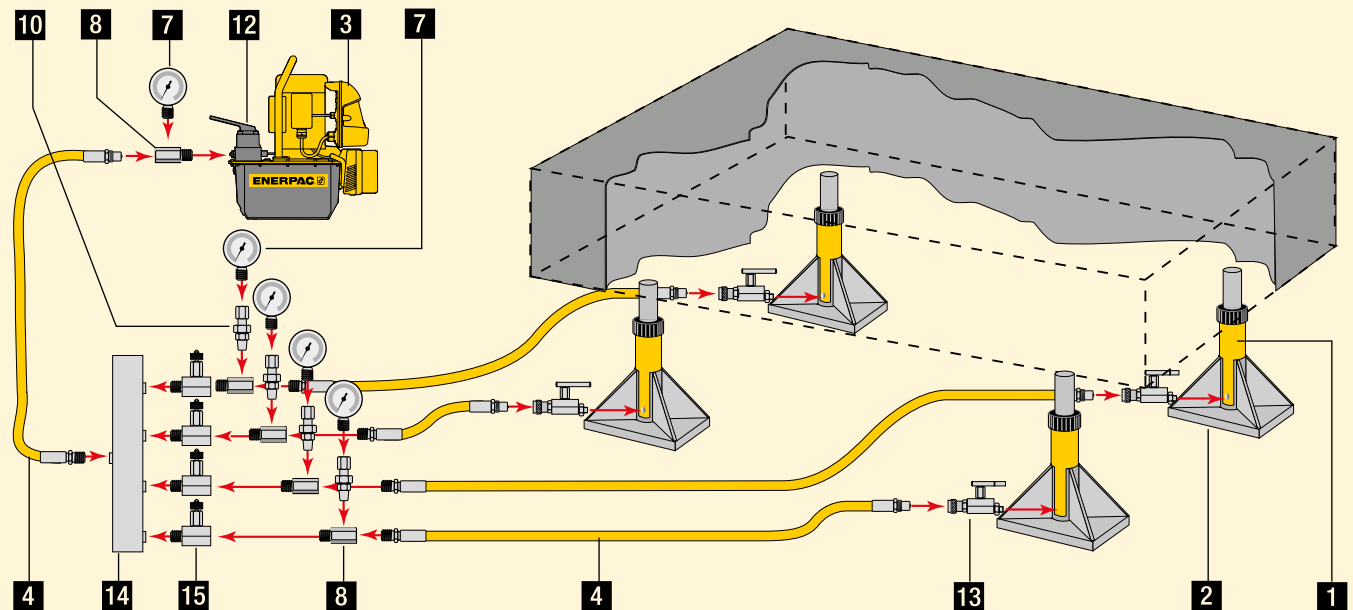

**www.enerpac.com**  
Visit our web site to learn more about hydraulics and system set-ups.



## Flow

A hydraulic pump produces flow.

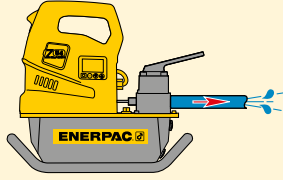

## Pressure

Pressure occurs when there is resistance to flow.

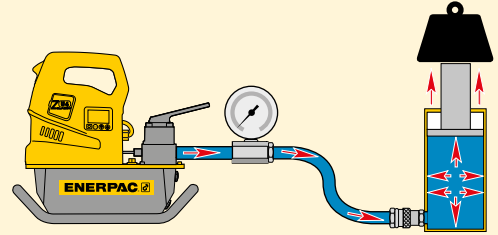

## Pascal's Law

Pressure applied at any point upon a confined liquid is transmitted undiminished in all directions (Fig.1). This means that when more than one hydraulic cylinder is being used, each cylinder will lift at its own rate, depending on the force required to move the load at that point (Fig. 2).

Cylinders with the lightest load will move first, and cylinders with the heaviest load will move last (Load A), as long as the cylinders have the same capacity.

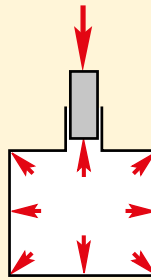
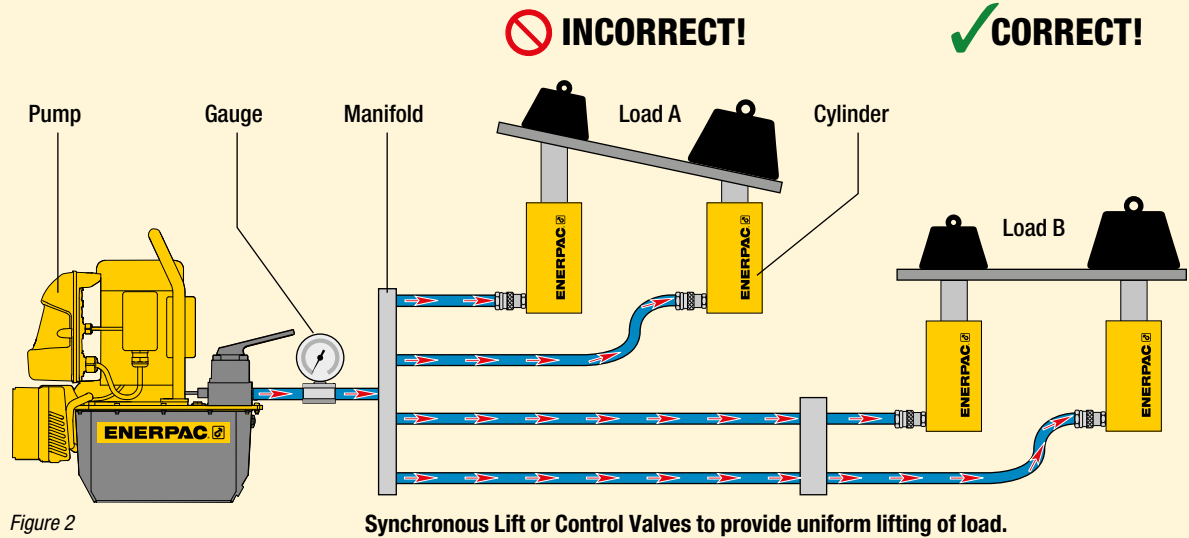

Figure 1

To have all cylinders operate uniformly so that the load is being lifted at the same rate at each point, either control valves (see Valve section) or Synchronous Lift System components (see section Heavy Lifting Technology) must be added to the system (Load B).



**CAUTION!**  
When lifting or pressing,  
always use a gauge.

A gauge is your 'window' to the system. It lets you see what's going on. You will find the gauges in the System Components section.



Learn more about hydraulics

Visit [www.enerpac.com](http://www.enerpac.com) to learn more about hydraulics and system set-ups.





## Force

The amount of force a hydraulic cylinder can generate is equal to the hydraulic pressure times the “effective area” of the cylinder (see cylinder selection charts).

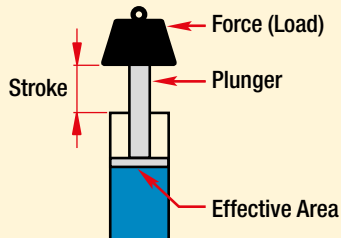

<b>Force</b>	=	<b>Hydraulic Working Pressure</b>	x	<b>Cylinder Effective Area</b>
<b>F</b>	=	<b>P</b>	x	<b>A</b>

Use this formula to determine either force, pressure or effective area if two of the variables are known.

### Example 1

An RC-106 cylinder with 14,5 cm<sup>2</sup> effective area operating at 700 bar will generate what force?

$$\text{Force} = 7000 \text{ N/cm}^2 \times 14,5 \text{ cm}^2 = 101500 \text{ N} = 101,5 \text{ kN}$$

### Example 2

An RC-106 cylinder lifting 7000 kg will require what pressure?

$$\text{Pressure} = 7000 \times 9,8 \text{ N} \div 14,5 \text{ cm}^2 = 4731,0 \text{ N/cm}^2 = 473 \text{ bar.}$$

### Example 3

An RC-256 cylinder is required to produce a force of 190.000 N. What pressure is required?

$$\text{Pressure} = 190.000 \text{ N} \div 33,2 \text{ cm}^2 = 5722,9 \text{ N/cm}^2 = 572 \text{ bar.}$$

### Example 4

Four RC-308 cylinders are required to produce a force of 800.000 N. What pressure is required?

$$\text{Pressure} = 800.000 \text{ N} \div (4 \times 42,1 \text{ cm}^2) = 4750,6 \text{ N/cm}^2 = 476 \text{ bar.}$$

*Remember, since four cylinders are used together, the area for one cylinder must be multiplied by the number of cylinders used.*

### Example 5

A HCL-2506 cylinder is going to be used with a power source that is capable of 500 bar. What is the theoretical force available from that cylinder?

$$\text{Force} = 5000 \text{ N/cm}^2 \times 363,1 \text{ cm}^2 = 1.815.500 \text{ N} = 1815 \text{ kN.}$$

## Cylinder Oil Capacity

The volume of oil required for a cylinder (cylinder oil capacity) is equal to the effective area of the cylinder times the stroke\*.

<b>Cylinder Oil Capacity</b>	=	<b>Cylinder Effective Area</b>	x	<b>Cylinder Stroke</b>
------------------------------	---	--------------------------------	---	------------------------

\* Note: these are theoretical examples and do not take into account the compressibility of oil under high pressure.

### Example 1:

An RC-158 cylinder with 20,3 cm<sup>2</sup> effective area and 200 mm stroke requires what volume of oil?

$$\text{Oil Capacity} = 20,3 \text{ cm}^2 \times 20 \text{ cm} = 406 \text{ cm}^3$$

### Example 2:

An RC-5013 cylinder has an effective area of 71,2 cm<sup>2</sup> and a stroke of 320 mm. How much oil will be required?

$$\text{Oil Capacity} = 71,2 \text{ cm}^2 \times 32 \text{ cm} = 2278,4 \text{ cm}^3$$

### Example 3:

An RC-10010 cylinder has an effective area of 133,3 cm<sup>2</sup> and a stroke of 260 mm. How much oil will it require?

$$\text{Oil Capacity} = 133,3 \text{ cm}^2 \times 26 \text{ cm} = 3466 \text{ cm}^3$$

### Example 4:

Four RC-308 cylinders are being used, each with an effective area of 42,1 cm<sup>2</sup> and a stroke of 209 mm. How much oil will be required?

$$\text{Oil Capacity} = 42,1 \text{ cm}^2 \times 20,9 \text{ cm} = 880 \text{ cm}^3 \text{ for one cylinder}$$

Multiply by four to obtain the required capacity: 3520 cm<sup>3</sup>

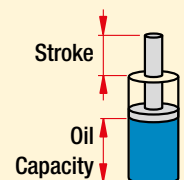

### CAUTION!

Enerpac oil will compress 2,28% at 350 bar and 4,1% at 700 bar.



# Conversion Tables

## Key to cylinder dimensions

Dimensions shown in the Selection Charts of the cylinder section are identified on the relevant drawings by the capital letter references listed here: A for collapsed height through Z1 for depth of internal base thread.

- |                                                 |                                       |
|-------------------------------------------------|---------------------------------------|
| A = Collapsed height                            | L = Plunger centre to side of base    |
| B = Extended height                             | M = Mounting holes to plunger centre  |
| C = Cylinder body length                        | N = Length of smaller cylinder part   |
| D = Cylinder outside diameter                   | O = Plunger hole or thread of saddle  |
| D1 = Cylinder width                             | P = Plunger thread length             |
| E = Cylinder inside diameter                    | Q = Plunger outside thread            |
| F = Plunger rod diameter                        | U = Pitch (BC) of mounting holes      |
| G = Oil inlet thread                            | V = Thread of cylinder mounting holes |
| H = Cylinder bottom to advance port             | W = Collar thread                     |
| I = Cylinder top to retract port                | X = Collar thread length              |
| J = Saddle outside diameter                     | Y = Centre hole diameter              |
| K = Cylinder rod protrusion at collapsed height | Z = Internal base thread              |
|                                                 | Z1 = Depth of internal base thread    |

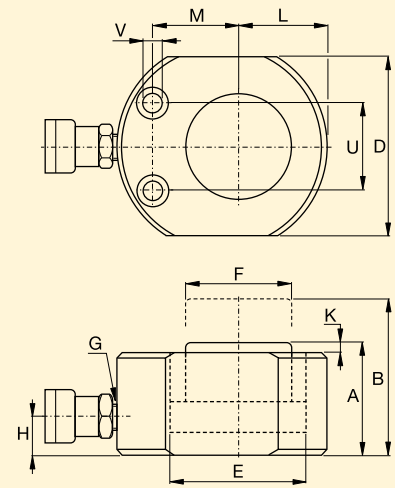
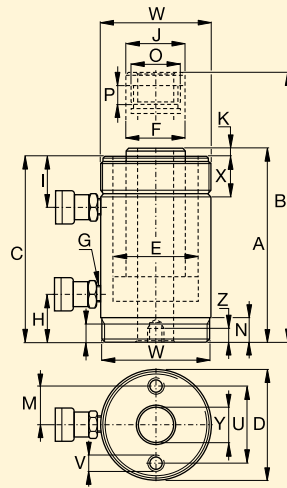

## Key to measurements

All capacities and measurements in the catalogue are expressed in uniform values.

The conversion chart provides helpful information for their translation into equivalent systems.

All ton values specified in this catalogue are metric tonnes and are for cylinder class identification only.

**Please refer to the kN data for calculations.**

### Free Conversion Calculator

Visit [enerpac.com](http://enerpac.com) and download the free conversion calculator.

### Pressure:

- |       |                         |
|-------|-------------------------|
| 1 psi | = 0,069 bar             |
| 1 bar | = 14,50 psi             |
|       | = 9,8 N/cm <sup>2</sup> |
|       | = 100.000 Pa            |
| 1 kPa | = 0,145 psi             |
| 1 MPa | = 145 psi               |

### Volume:

- |                   |                          |
|-------------------|--------------------------|
| 1 in <sup>3</sup> | = 16,387 cm <sup>3</sup> |
| 1 cm <sup>3</sup> | = 0,061 in <sup>3</sup>  |
| 1 litre           | = 61,02 in <sup>3</sup>  |
|                   | = 0,264 gal              |
| 1 USgal           | = 3785 cm <sup>3</sup>   |
|                   | = 3,785 l                |
|                   | = 231 in <sup>3</sup>    |

### Weight:

- |               |             |
|---------------|-------------|
| 1 pound (lb)  | = 0,4536 kg |
| 1 kg          | = 2,205 lbs |
|               | = 9,806 N   |
| 1 metric ton  | = 2205 lbs  |
|               | = 1000 kg   |
| 1 ton (short) | = 2000 lbs  |
|               | = 907,18 kg |

### Torque:

- |          |                |
|----------|----------------|
| 1 Nm     | = 0,738 Ft.lbs |
|          | = 0,102 kgf.m  |
| 1 Ft.lbs | = 1,356 Nm     |
|          | = 0,138 kgf.m  |

### Temperature:

To Convert °C to °F:

$$T^{\circ F} = (T_{\circ C} \times 1,8) + 32$$

To Convert °F to °C:

$$T^{\circ C} = (T_{\circ F} - 32) \div 1,8$$

### Other measurements:

- |                   |                         |
|-------------------|-------------------------|
| 1 in              | = 25,4 mm               |
| 1 mm              | = 0,039 in              |
| 1 in <sup>2</sup> | = 6,452 cm <sup>2</sup> |
| 1 cm <sup>2</sup> | = 0,155 in <sup>2</sup> |
| 1 hp              | = 0,746 kW              |
| 1 kW              | = 1,359 hp              |
| 1 kN              | = 225 lbs               |

### Imperial to metric

Inches	Decimal	mm
1/16	.06	1,59
1/8	.13	3,18
3/16	.19	4,76
1/4	.25	6,35
5/16	.31	7,94
3/8	.38	9,53
7/16	.44	11,11
1/2	.50	12,70
9/16	.56	14,29
5/8	.63	15,88
11/16	.69	17,46
3/4	.75	19,05
13/16	.81	20,64
7/8	.88	22,23
15/16	.94	23,81
1	1.00	25,40

# Cylinder Speed Charts



## Cylinder Speed

This chart will help you calculate the time required for an Enerpac cylinder to lift a load when powered by a 700 bar Enerpac hydraulic pump.

The Cylinder Speed Chart can also be used to determine the pump type and model best suited for an application when you know the plunger speed required.

## To determine: Cylinder plunger speed

An RC-256 cylinder (25 ton) is powered by a ZE3-Series two stage pump. While lifting the load, the cylinder plunger travels at 2,8 mm per second. While extending towards the load, the cylinder plunger travels at 30,9 mm per second.

## To determine: Best matching pump

Your 25 ton cylinder needs to move a load at a speed of 3,0 mm per second. Simply go down from the top of the chart, to the value of 2,8 mm per second. Follow the chart to the right to find that the ZE3-Series pump is most suitable for your application.

## Millimetres of RC-Series cylinder plunger travel per hand pump plunger stroke

Cyl. Capacity ▶	5 ton		10 ton		15 ton		25 ton		30 ton		50 ton		75 ton		100 ton		Pump Type	Page:
	No Load	Load	No Load	Load	No Load	Load	No Load	Load	No Load	Load	No Load	Load	No Load	Load	No Load	Load		
▼ Power Source																		
Manual	1,4	1,4	0,6	0,6	0,4	0,4	0,3	0,3	0,2	0,2	0,1	0,1	0,1	0,1	0,1	0,1	<b>P-141</b>	<b>72</b>
	3,9	3,9	1,7	1,7	1,2	1,2	0,7	0,7	0,6	0,6	0,3	0,3	0,2	0,2	0,2	0,2	<b>P-391</b>	<b>72</b>
	17,6	3,9	7,8	1,7	5,5	1,2	3,4	0,7	2,6	0,6	1,6	0,3	1,0	0,2	0,8	0,2	<b>P-392</b>	<b>72</b>
	25,3	3,8	11,2	1,7	7,9	1,2	4,9	0,7	3,7	0,6	2,3	0,3	1,5	0,2	1,1	0,2	<b>P-77/80/801/84</b>	<b>74</b>
	61,4	3,9	27,1	1,7	19,3	1,2	11,8	0,7	9,0	0,6	5,5	0,3	3,5	0,2	2,8	0,2	<b>P-802/842</b>	<b>74</b>
	197	7,4	87,1	3,3	61,8	2,3	37,9	1,4	29,0	1,1	17,7	0,7	11,4	0,4	8,8	0,3	<b>P-462/464</b>	<b>74</b>

## Millimetres per Second of RC-Series Cylinder Plunger Travel

Cyl. Capacity ▶	5 ton		10 ton		15 ton		25 ton		30 ton		50 ton		75 ton		100 ton		Pump Type	Page:
	No Load	Load	No Load	Load	No Load	Load	No Load	Load	No Load	Load	No Load	Load	No Load	Load	No Load	Load		
▼ Power Source																		
Electric Pumps (speed based on 50 Hz)	51,3	6,4	23,0	2,9	16,4	2,1	10,0	1,3	7,9	1,0	4,7	0,6	3,2	0,4	2,5	0,3	<b>XC Cordless Pump</b>	<b>82</b>
	86	8,3	38	3,7	27	2,6	17	1,6	13	1,3	7,7	0,7	5,4	0,5	4,1	0,4	<b>PU Economy</b>	<b>84</b>
	53	7,1	24	3,2	17	2,2	10	1,4	8,1	1,1	4,8	0,6	3,3	0,4	2,6	0,3	<b>PE Submerged</b>	<b>86</b>
	295	25,6	132	11,5	94,4	8,2	57,7	5,0	45,5	4,0	26,9	2,3	18,7	1,6	14,4	1,3	<b>ZU4-Series</b>	<b>90, 92</b>
	15,1	14,1	6,8	6,3	4,8	4,5	3,0	2,8	2,3	2,2	1,4	1,3	1,0	0,9	0,7	0,7	<b>ZE3 one stage</b>	<b>90, 98</b>
	158	14,1	70,7	6,3	50,5	4,5	30,9	2,8	24,3	2,2	14,4	1,3	10,0	0,9	7,7	0,7	<b>ZE3 two stage</b>	<b>90, 98</b>
	22,3	21,0	10,0	9,4	7,1	6,7	4,4	4,1	3,4	3,2	2,0	1,9	1,4	1,3	1,1	1,0	<b>ZE4 one stage</b>	<b>90, 98</b>
	228	21,0	102	9,4	72,9	6,7	44,6	4,1	35,2	3,2	20,8	1,9	14,4	1,3	11,1	1,0	<b>ZE4 two stage</b>	<b>90, 98</b>
	44,9	42,1	20,1	18,9	14,4	13,5	8,8	8,2	6,9	6,5	4,1	3,8	2,8	2,7	2,2	2,1	<b>ZE5 one stage</b>	<b>90, 98</b>
	298	42,1	133	18,9	95,3	13,5	58,3	8,2	46,0	6,5	27,2	3,8	18,9	2,7	14,5	2,1	<b>ZE5 two stage</b>	<b>90, 98</b>
	76,9	70,0	34,5	31,4	24,6	22,4	15,1	13,7	11,9	10,8	7,0	6,4	4,9	4,4	3,8	3,4	<b>ZE6 one stage</b>	<b>90, 98</b>
	315	70,0	141	31,4	101	22,4	61,7	13,7	48,7	10,8	28,8	6,4	20,0	4,4	15,4	3,4	<b>ZE6 two stage</b>	<b>90, 98</b>
	53,8	53,8	24,1	24,1	17,2	17,2	10,5	10,5	8,3	8,3	4,9	4,9	3,4	3,4	2,6	2,6	<b>SFP421 (11 kW)</b>	<b>240</b>
Air Driven Pumps (at 6,9 bar air pressure)	51,3	6,4	23,0	2,9	16,4	2,1	10,0	1,3	7,9	1,0	4,7	0,6	3,2	0,4	2,5	0,3	<b>XA-Series</b>	<b>108</b>
	25,9	4,2	11,6	1,9	8,2	1,3	5,0	0,8	4,0	0,6	2,3	0,4	1,6	0,3	1,3	0,2	<b>PATG-serie Turbo II Air</b>	<b>106</b>
	17	3,4	7,6	1,5	5,4	1,1	3,3	0,7	2,6	0,5	1,5	0,3	1,1	0,2	0,8	0,2	<b>PA-Series</b>	<b>104</b>
	277	3,8	123	1,7	88	1,2	53	0,7	42	0,6	25	0,3	17	0,2	13,0	0,2	<b>PAM-Series</b>	<b>105</b>
	357	33,6	160	15,1	114	10,8	69,9	6,6	55,1	5,2	32,6	3,1	22,6	2,1	17,4	1,6	<b>ZA-Series</b>	<b>110</b>
Gasoline Engine	295	41	132	18,4	94,4	13,1	57,7	8,0	45,5	6,3	26,9	3,7	18,7	2,6	14,4	2,0	<b>ZG5-Series 4,1 kW</b>	<b>112</b>
	166	41	74,7	18,4	53,4	13,1	32,6	8,0	25,7	6,3	15,2	3,7	10,6	2,6	8,1	2,0	<b>ZG5-Series 4,8 kW</b>	<b>112</b>
	376	85	169	37,9	121	27,1	73,8	16,6	58,2	13,1	34,4	7,7	23,9	5,4	18,4	4,1	<b>ZG6-Series 9,7 kW</b>	<b>112</b>

**No Load** indicates the plunger speed as the plunger extends towards the load (1st stage).

**Load** indicates the plunger speed as the load is lifted at a system pressure of 700 bar (2nd stage).

**Example:** At what speed (V) will the RC-256 (25 ton) cylinder move when powered by a ZE3-Series pump?  
 RC-256 Cylinder Effective Area = 33,2 cm<sup>2</sup>  
 ZE3-Series pump oil Flow (no load) = 6150 cm<sup>3</sup>/min

$$\text{Cylinder Plunger Speed (mm/sec)} = \frac{\text{Pump Oil Flow (cm}^3\text{/min)} \times 10}{\text{Cylinder Effective Area (cm}^2\text{)} \times 60}$$

$$\text{Speed V} = \frac{6150 \text{ cm}^3\text{/min} \times 10}{33,2 \times 60} = 30,9 \text{ mm/sec}$$



## Ways

The (oil) ports on a valve.

A 3-way valve has 3 ports: pressure (P), tank (T), and cylinder (A).

A 4-way valve has 4 ports: pressure (P), tank (T), advance (A) and retract (B).

**Single-Acting** cylinders require at least a 3-way valve, and can, under certain instances, be operated with a 4-way valve.

**Double-Acting** cylinders require a 4-way valve, providing control of the flow to each cylinder port.

## Positions

The number of control points a valve can provide. A 2-position valve has the ability to control only the advance or retraction of the cylinder. To be able to control the cylinder with a hold position, the valve requires a 3rd position.

## Centre Configuration

The centre position of a valve is the position at which there is no movement required of the hydraulic component, whether a tool or cylinder.



The most common is the **Tandem**

**Centre**. This configuration provides for little to no movement of the cylinder and the unloading of the pump. This provides for minimum heat build-up.



The next most common is the **Closed**

**Centre** configuration, which is used mostly for independent control of multi-cylinder applications. This configuration again provides for little to no movement of the cylinder, but also dead-heads the pump, isolating it from the circuit.

Use of this type of valve may require some means of unloading the pump to prevent heat build-up.

There are many more type of valves, such as Open Centre and Float Centre. These valves are used mostly in complex hydraulic circuits and require other special considerations.



Open Centre

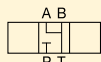

Float Centre

## Directional Control Valves

**3-Way Valves** are used with single-acting cylinders.

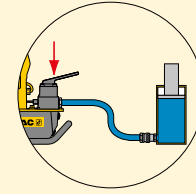

**4-Way Valves** are used with double-acting cylinders.

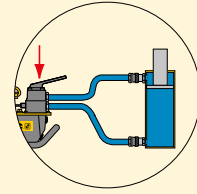

Valves may be either pump mounted or remote mounted.

## Pump Mounted

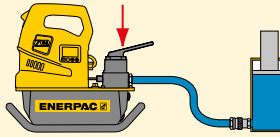

## Remote Mounted

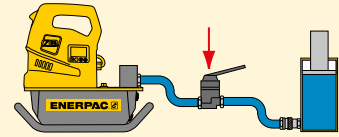

Valves may be either manually or solenoid operated.

## Manually Operated

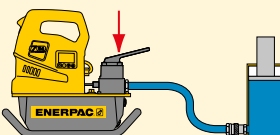

## Solenoid Operated

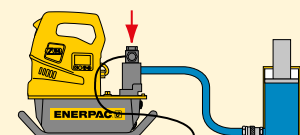

## Advance Hold Retract

**Single-acting cylinder** Controlled by a 3-way, 3-position valve.

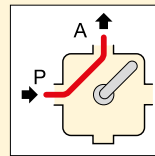

cylinder plunger will extend.

**Double-acting cylinder** Controlled by a 4-way, 3-position valve.

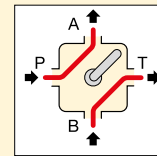

cylinder port B to tank T.

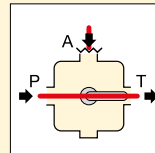

A is closed: the cylinder plunger will maintain its position.

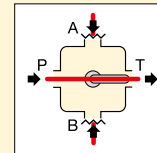

ports A and B are closed: the cylinder plunger will maintain position.

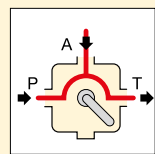

plunger will retract.

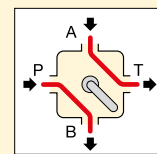

from cylinder port A to tank T: the cylinder plunger will retract.



# Hexagon Nut and Bolt Sizes



METRIC SIZES		
Thread Size D (mm)	Hexagon Size S (mm)	Hexagon Size J (mm)
M 10	17	8
M 12	19	10
M 14	22	12
M 16	24	14
M 18	27	14
M 20	30	17
M 22	32	17
M 24	36	19
M 27	41	19
M 30	46	22
M 33	50	24
M 36	55	27
M 39	60	27 (30)
M 42	65	32
M 45	70	-
M 48	75	36
M 52	80	36
M 56	85	41
M 60	90	46
M 64	95	46
M 68	100	50
M 72	105	55
M 76	110	60
M 80	115	65
M 85	120	70
M 90	130	70 (75)
M 95	135	-
M 100	145	85
M 105	150	-
M 110	155	-
M 115	165	-
M 120	170	-
M 125	180	-
M 130	185	-
M 140	200	-
M 150	210	-

IMPERIAL SIZES		
Thread Size D (inch)	Hexagon Size * S (inch)	Hexagon Size J (inch)
5/8"	1 1/16"	1/2"
3/4"	1 1/4"	5/8"
7/8"	1 7/16"	3/4"
1"	1 5/8"	3/4"
1 1/8"	1 13/16"	7/8"
1 1/4"	2"	7/8"
1 3/8"	2 3/16"	1"
1 1/2"	2 3/8"	1"
1 5/8"	2 9/16"	-
1 3/4"	2 3/4"	1 1/4"
1 7/8"	2 15/16"	1 3/8"
2"	3 1/8"	1 5/8"
2 1/4"	3 1/2"	1 3/4"
2 1/2"	3 7/8"	1 7/8"
2 3/4"	4 1/4"	2"
3"	4 5/8"	2 1/4"
3 1/4"	5"	2 1/4"

\* Heavy hexagon nuts.



Determine the maximum torque according to the bolt (nut) size and grade. Always consult the manufacturers instructions or engineering recommendations when making bolted connections.



### IMPORTANT

The hexagon sizes shown in the tables should be used as a guide only. Individual sizes should be checked before specifying any equipment.



### BSH-Series Heavy Duty Sockets

Use only Heavy Duty Impact Sockets for power driven torquing equipment, according to ISO2725 and ISO1174; DIN3129 and

DIN3121 or ASME-B107.2/1995.



## Tightening Methods

Principally there are two modes of tightening: "Uncontrolled" and "Controlled".

### Uncontrolled tightening

Uses equipment and/or procedures that cannot be measured. Preload is applied to a bolt and nut assembly using a hammer and spanner or other types of impact tools.

### Controlled tightening

Employs calibrated and measurable equipment, follows prescribed procedures and is carried out by trained personnel.

## Advantages of Controlled Tightening

### Known, controllable and accurate bolt loads

Employs tooling with controllable outputs and adopts calculation to determine the required tool settings.

### Uniformity of bolt loading

Especially important on gasketed joints as an even and consistent compression is required for the gasket to be effective.

### Safe operation following prescribed procedures

Eliminates the dangerous activities of manual uncontrolled tightening and requires that the operators be skilled and follow procedures.

### Reduces operational time resulting in increased productivity

Reduces tightening time and operator fatigue by replacing manual effort with the use of controlled tooling.

### Reliable and repeatable results

Using calibrated, tested equipment, following procedures and employing skilled operators achieves known results consistently.

### The right results first time

Many of the uncertainties surrounding in-service joint failures are removed by ensuring the correct assembly and tightening of the joint the first time.



### Bolting Tools

For further information on Torque Tightening or other controlled tightening methods, please visit our website or ask for our **Bolting Tools Catalogue**.

### Bolting Integrity Software

A comprehensive free on-line software solution for Bolted Joint Integrity.

Integral databases hold data for:

- BS1560, MSS SP44, API 6A and 17D flanged joints
- Common gasket materials and configurations
- Comprehensive range of bolt materials
- Comprehensive range of lubricants
- Enerpac's Controlled Bolting Equipment including: Torque Multipliers, Hydraulic Wrenches and Bolt Tensioning tools.

Custom Joint information can also be entered.

The software offers Tool selection, Bolt Load calculations and Tool pressure settings, as well as a combined Application data sheet and Joint completion report.

## What is Torque?

It is a measure of how much force acting on an object causes that object to rotate.

## What is Torque Tightening?

The application of preload to a fastener by the turning of the fastener's nut.

## Torque Tightening and Preload

The amount of preload created when torqueing is largely dependant on the effects of friction.

Principally there are three different "torque components":

- torque to stretch the bolt
- torque to overcome the friction in bolt and nut threads
- torque to overcome friction at the nut spot face (bearing contact surface).

## Torque Tightening

Turning movement

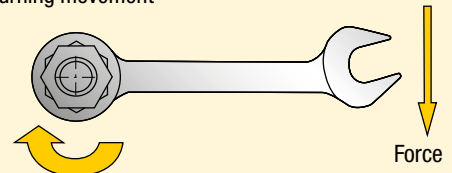

Stretch of Fastener (Pre-load)

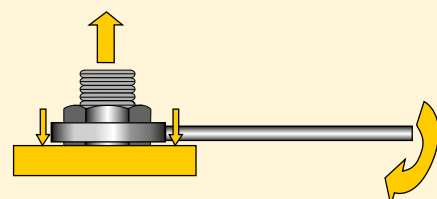



**Preload (residual load) = Applied Torque *minus* Frictional Losses**

## Lubrication Reduces Friction

Lubrication reduces the friction during tightening, decreases bolt failure during installation and increases bolt service life. Variation in friction coefficients affect the amount of preload achieved at a specified torque. Higher friction results in less conversion of torque to preload. The value for the friction coefficient provided by the lubricant manufacturer must be known to accurately establish the required torque value.

Lubricant or anti-seizure compounds should be applied to both, the nut bearing surface and the male threads.

## Frictional Losses

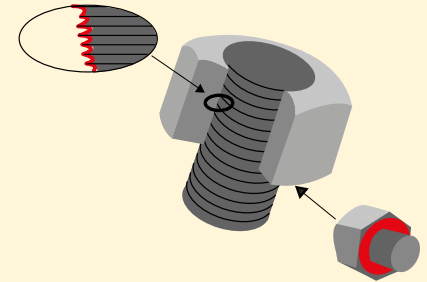
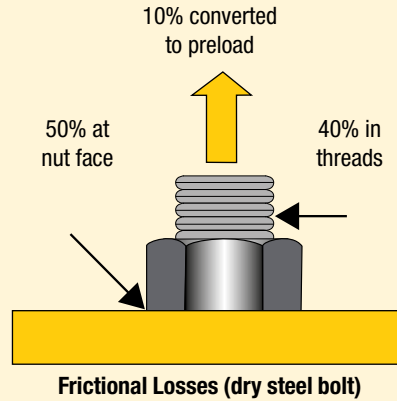

*Friction points should always be lubricated when using the torque tightening method.*



## Select the Right Torque Wrench

Choose your Enerpac torque wrench using the untightening rule of thumb:

- When loosening a nut or bolt, more torque is usually required than when tightening.
- For general conditions it can take up to **2½ times** the input torque to breakout.
- Do not apply more than 75% of the maximum torque output of the tool when loosening nuts or bolts.

## Conditions of bolted joints

- Humidity corrosion (rust) requires up to **twice** the torque required for tightening.
- Sea water and chemical corrosion requires up to **2½ times** the torque required for tightening.
- Heat corrosion requires up to **3 times** the torque required for tightening.

## Torque Procedure

When torquing it is common to tighten only one bolt at a time, which can result in Point Loading and Load Scatter.

To avoid this, torque is applied in stages following a prescribed pattern:

## Torque Sequence

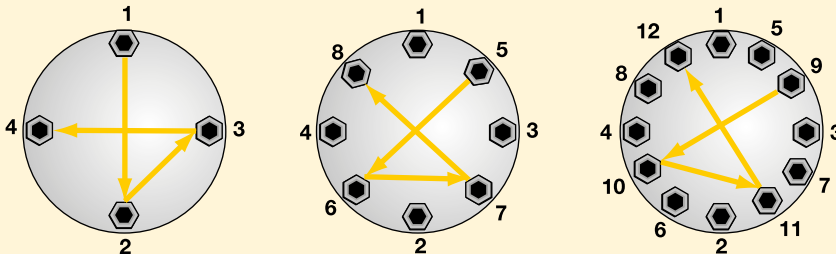

- Step 1** Spanner tight ensuring that 2 - 3 threads extend above nut.
- Step 2** Tighten each bolt to one-third of the final required torque following the pattern as shown above.
- Step 3** Increase the torque to two-thirds following the pattern shown above.

- Step 4** Increase the torque to full torque following the pattern shown above.
- Step 5** Perform one final pass on each bolt working clockwise from bolt 1, at the full final torque.



## Breakout Torque

When loosening bolts a torque value higher than the tightening torque is normally required. This is mainly due to corrosion and deformations in the bolt and nut threads.

Breakout torque cannot be accurately calculated, however, depending on conditions it can take up to **2½ times** the input torque to breakout.

The use of penetrating oils or anti-seize products is always recommended when performing breakout operations.

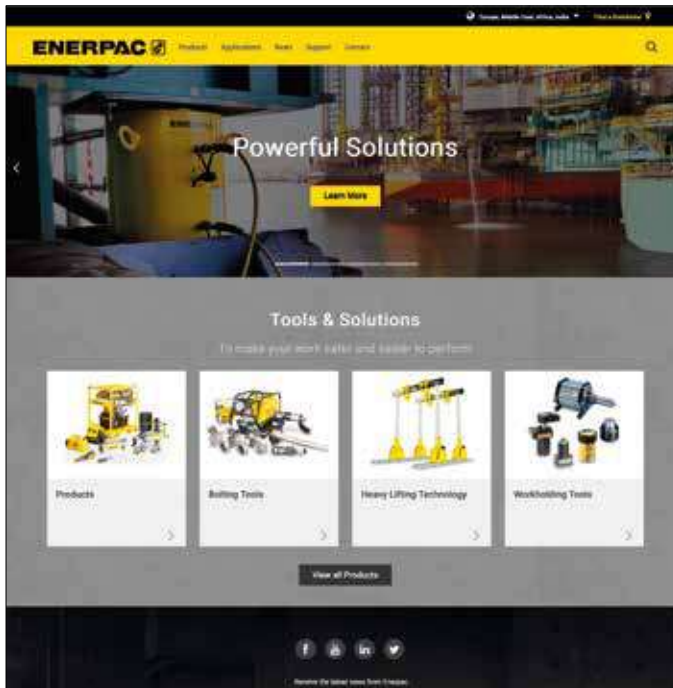

Enerpac is the leading global provider of high-pressure hydraulic tools and solutions with a broad range of products, local expertise and worldwide distribution network. With a proven track record in a wide range of markets, Enerpac designs and manufactures high-quality tools and solutions for all industrial applications.

Enerpac has gained unique experience in delivering hydraulic solutions for the controlled movement and positioning of heavy objects. Enerpac supports your business by offering the right solutions and service to help you get your work done efficiently and safely.

**www.enerpac.com**

- Learn more about hydraulics
- Promotions
- New products
- Electronic Catalogues
- Trade shows
- Manuals (instruction & repair sheets)
- Nearest Distributors & Service Centers
- Enerpac products in action
- Heavy Lifting Technology

**Ordering Products and Catalogues**

**9508 Heavy Lifting Capability Brochure**

Enerpac Heavy Lifting Technology provides solutions to meet customer requirements for safe, precise control of movement and positioning of heavy loads.

**E414e, Bolting Tools Catalogue**

Caters to the complete bolting workflow, ensuring joint integrity in a variety of applications throughout industry, including: joint assembly, controlled tightening and joint separation.

**E215e Workholding Catalogue**

Offers innovative products and solutions to provide powerful clamping and positioning force to every type of manufacturing process. Workholding solutions increase product quality and production output.

**E414e**



**E215e**



**9508**



While every care has been taken in the preparation of this catalogue and all data contained within is deemed accurate at the time of printing, Enerpac does reserve the right to make changes to the specifications of any product, or discontinue any product, contained within this catalogue without prior notice.

All illustrations, performance specifications, weights and dimensions reflect the nominal values and slight variations may occur due to manufacturing tolerances. Please consult Enerpac if final dimensions are critical.

All information in this catalogue can be changed due to product improvements without prior notice.

**© Copyright 2018, Enerpac. All rights reserved. Any copying or other use of material in this catalogue (text, illustrations, drawings, photo's) without express written consent is prohibited.**

**Worldwide Catalogue Coverage**

Enerpac Catalogues are printed in many languages. If your requirements call for product use in a different country, please send your request to the applicable country listed on page 280 or **enerpac.com**. The Enerpac catalogue of the country serving your specific market area will be forwarded promptly.





# Enerpac Academy & EMP – Enerpac Maintenance Program



Do you work with high-pressure hydraulic tools regularly or even every day? Operating such tools requires sound knowledge of how they work and this should be maintained. Effective use of

these tools boosts safety and reduces risk - both for you as the operator and for the environment within which the tools are used. Having the right training will enable you to use the tools safely and properly.

Enerpac Academy is our in-house training centre, set up exclusively for Enerpac business partners, Enerpac users and Enerpac employees: training programs ranging from tool expertise, repairs and maintenance, to safe operation of high-pressure hydraulic tools.

## Putting theory into practice

The training courses are interactive and benefit from a highly diverse program that puts the covered theory into practice right away. Our training services are grounded in many years of experience in providing and applying Enerpac tools.

## Tailored training

Enerpac Academy offers you the exclusive opportunity to train your (new) employees in making proper use of Enerpac tools. Our trainings can also be done on-site.

**Safety training:** Safe use of Enerpac high pressure hydraulic tools, user and environmental safety.

**Controlled bolting trainings:** Bolting tool theory, tool applications, hands-on training on safe and efficient use of torque wrenches, tensioners and pumps.

**General hydraulic sales training:** Knowledge of hydraulics, hydraulic tools and applications.

**Tool repair training:** Repair and maintenance of general Enerpac tools.

**Application training:** Tool feature and benefits, tool application review, safe use of hydraulic tools and market information.



## Enerpac Academy – The Power of Knowledge

- Specialist in-house Enerpac training center
- Standard and tailored training programs
- Highly experienced trainers
- Selection of training courses with a proven (value adding) track record
- Knowledge and experience sharing
- User and tool safety come first.

## Training Centre Locations

- Ede (The Netherlands)
- Hosur, Tamil Nadu (India)
- Columbus, Wisconsin (USA)
- Sydney (Australia)
- Singapore

## EMP – Enerpac Maintenance Program

EMP is a preventive maintenance program. Your Enerpac Authorized Service Centre will check the tools on essential points: leaking, oil level and quality, maximum pressure setting, and damage. EMP reduces operational risks, increases safety and minimises extremely expensive delays in your operations. You will be advised about regular maintenance of the Enerpac tools.

- Work more safely
- Minimise operational risk
- Ensure tools are always available and in tip-top shape
- As good as new after repair
- Prevent downtime
- Advice on safe and effective use
- Maintenance when tools are not used.

[www.enerpac.com/en/enerpac-locations](http://www.enerpac.com/en/enerpac-locations)

## **Australia and New Zealand**

Actuant Australia Ltd.  
P.O. Box 6867, Wetherill Park, NSW 1851  
Block V Unit 3, Regents Park Estate  
391 Park Road, Regents Park NSW 2143  
Australia  
Tel: +61 287 177 200  
Fax: +61 297 438 648

## **Brazil**

Power Packer do Brasil Ltda.  
Rua Luiz Merenda, 489  
09930-760 - Diadema (SP)-Brasil  
T +55 11 5687 2211  
Toll Free: 0800 891 5770

## **China (Taicang)**

Actuant (China) Industries Co.Ltd.  
No. 6 Nanjing East Road,  
Taicang Economic Dep Zone  
Jiangsu, China  
T +86 0512 5328 7500  
F +86 0512 5335 9690  
Toll Free:  
T +86 400 885 0369

## **Enerpac Heavy Lifting Technology B.V.**

Zuidelijke Havenweg 3, 7554 RR Hengelo  
P.O. Box 421, 7550 AK Hengelo  
The Netherlands  
T +31 74 242 20 45  
F +31 74 243 03 38

## **France, Switzerland, North Africa and French speaking African countries**

ENERPAC  
Une division d'ACTUANT France S.A.S.  
Zone Orlytech, Bâtiment 516,  
1 allée du commandant Mouchotte CS 40351  
91550 Paray-Vieille-Poste, France  
T +33 1 60 13 68 68  
F +33 1 69 20 37 50

## **Germany and Austria, Central and Eastern Europe, Baltic States, Greece, Turkey and CIS countries**

Actuant GmbH  
P.O. Box 300113, D-40401 Düsseldorf  
Willstätterstrasse 13, D-40549 Düsseldorf  
Germany  
T +49 211 471 490  
F +49 211 471 49 28

## **India**

Actuant India Private Limited  
No. 10, Bellary Road, Sadashivanagar,  
Bangalore, Karnataka - 560 080 India  
T +91 80 3928 9000

## **Italy**

ENERPAC S.p.A.  
Via Leonardo da Vinci, 97  
20090 Trezzano sul Naviglio (Milano)  
T +39 02 4861 111  
F +39 02 4860 1288

## **Japan**

Enerpac Co., Ltd.  
Besshocho 85-7  
Kita-ku, Saitama-shi 331-0821, Japan  
T +81 48 662 4911  
F +81 48 662 4955

## **Middle East, Egypt and Libya**

ENERPAC Middle East FZE  
Plot M00737m 1242nd Street  
Jebel Ali Free Zone North  
P.O. Box 18004, Dubai  
United Arab Emirates  
T +971 (0)4 8872686  
F +971 (0)4 8872687

## **Norway**

Sales Office Norway  
Unit 546, Nydalsveien 28, 0484 Oslo  
P.O. Box 4814, Nydalen 0422 Oslo  
Norway  
Tel: +47 91 578 300

## **Russia**

Rep. office Enerpac  
Russian Federation  
Admirala Makarova Street 8  
125212 Moscow, Russia  
T +7 495 98090 91  
F +7 495 98090 92

## **Southeast Asia, Hong Kong and Taiwan**

Actuant Asia Pte Ltd.  
83 Joo Koon Circle,  
Singapore 629109  
T +65 68 63 0611  
F +65 64 84 5669  
Toll Free:  
T +1800 363 7722

## **South Korea**

Actuant Korea Ltd.  
3Ba 717, Shihwa Industrial Complex  
Jungwang-Dong, Shihung-Shi  
Kyunggi-Do  
Republic of Korea 429-450  
T +82 31 434 4506  
F +82 31 434 4507

## **Spain and Portugal**

ENERPAC SPAIN, S.L.  
Avenida Valdelaparra N° 27 3ª - L8  
28108 Alcobendas (Madrid), Spain  
T +34 91 884 86 06  
F +34 91 884 86 11

## **South Africa and other English speaking African countries**

ENERPAC AFRICA (PTY) Ltd.  
Cambridge Office Park, Block E  
5 Bauhinia Avenue  
Highveld Techno Park, Centurion 0157  
Republic of South-Africa  
T 0027 (0) 12 940 0656

## **Sweden, Denmark, Finland and Iceland**

Enerpac Scandinavia AB  
Box 83  
82222 Alfta, Sweden  
Tel: +46 (0) 415 000

## **The Netherlands, Belgium, Luxembourg**

ENERPAC B.V.  
Galvanistraat 115, 6716 AE Ede  
P.O. Box 8097, 6710 AB Ede  
The Netherlands  
T +31 318 535 911  
F +31 318 535 848

## **United Kingdom and Ireland**

ENERPAC Ltd.  
5 Coopies Field  
Morpeth, Northumberland  
NE61 6JR, England  
T +44 1670 5016 50  
F +44 1670 5016 51

## **USA, Latin America and Caribbean**

ENERPAC World Headquarters  
P.O. Box 3241  
Milwaukee, WI 53201-3241 USA  
N86 W12500 Westbrook Crossing  
Menomonee Falls, Wisconsin 53051  
T +1 262 293 1600  
F +1 262 293 7036  
User inquiries:  
+1 800 433 2766  
Distributor inquiries/orders:  
+1 800 558 0530  
+1 800 628 0490

# Model Number Index

# Section Index

Page(s) ▼ Page(s) ▼ Page(s) ▼ Page(s) ▼

<b>A</b>	<b>EMB</b> ..... 174
A5-A10 ..... 166	EP ..... 154-157
A12 ..... 10	EPH ..... 158-161
A13-A28 ..... 166	EPP ..... 155-157
A29-A53 ..... 10	EPX ..... 157
A64-A66 ..... 126	ER-ES ..... 174-175
A92 ..... 166, 177	ETW ..... 208-210
A102 ..... 10, 37	EVO ..... 242-245
A128-A192 ..... 166	<b>F</b>
A183 ..... 144	F ..... 124-125
A185 ..... 144, 166	FF ..... 236-237
A200R ..... 146	FH ..... 124-125
A205-A220 ..... 144	FR ..... 124-125
A218-A305 ..... 166	FRL ..... 207
A252 ..... 10, 37	FS ..... 232
A310, A330 ..... 144	FSB ..... 172, 233
A530-A595 ..... 166	FSH ..... 233
A604 ..... 124-125	FSM ..... 233
A607 ..... 166	FZ ..... 127
A630 ..... 124-125	<b>G</b>
A650 ..... 166	G ..... 130-131
AH ..... 124-125	GA ..... 134-135
AM ..... 126, 134	GBJ ..... 63
AR ..... 124-125	GF ..... 128-129
ATM ..... 234-235	GP ..... 128-129
ATP ..... 228	<b>H</b>
AW ..... 10	H ..... 122-123, 131
<b>B</b>	HA ..... 123
B ..... 227	HB ..... 123
BAD ..... 35	HC ..... 123
BFZ ..... 127	HCG ..... 40-47
BH ..... 227	HCL ..... 40-43, 52-55
BHP ..... 150-153	HCR ..... 40-43, 48-51
BLS ..... 246-247	HCRL ..... 40-42, 56-57
BLT ..... 210	HF ..... 126
BPR ..... 142-143	HP ..... 31, 33
BR ..... 227	HSK ..... 258-259
BRC ..... 28-29	HSL ..... 250-251
BRD ..... 34-35	HT ..... 227
BRP ..... 28-29	<b>I</b>
BSA ..... 129, 131	IPL ..... 146
BSH ..... 190	<b>J</b>
BSS ..... 146	JBI ..... 10
BW ..... 229	JH ..... 62
BZ ..... 180-181	JHA ..... 62
<b>C</b>	JS ..... 248-249
C ..... 124-125	<b>L</b>
CAT ..... 10, 23	LH ..... 147, 258-259
CATG ..... 37, 53, 55	LPL ..... 26-27, 40-41
CATG ..... 13, 15, 19	LW ..... 172
..... 45, 47, 49, 53	<b>M</b>
CD-CF-CH ..... 125	MBL ..... 256-257
CM ..... 176	MP ..... 78
CMF ..... 125	MS ..... 164-167
CR ..... 124-125	MSP ..... 169
CU ..... 24-25	MZ ..... 164-167
CW ..... 166	<b>N</b>
<b>D</b>	NC ..... 229
DGR ..... 133	NS ..... 230-231
DSA ..... 210	NV ..... 135
<b>E</b>	
E ..... 184-185	
ED ..... 210	
ELP ..... 174-175	

<b>P</b>	<b>T</b>
P ..... 72-79	T ..... 125, 132
P142AL ..... 60	TH ..... 125
P392AL ..... 60	THC ..... 212-213, 219
P392FP ..... 79	..... 221-222, 224
PA ..... 104-107	THQ ..... 212-214, 219
PAM ..... 105	..... 221-222, 224
PAMG ..... 106-107	TM ..... 147
PATG ..... 106-107	TSP ..... 186, 189
PARG ..... 106-107	..... 192, 205
PC ..... 72, 74	TQ ..... 212, 214-215
PE ..... 86-89	<b>V</b>
PF25 ..... 100	V ..... 60, 135-137
PL ..... 66-67	VA2 ..... 105
PM ..... 212-213	VB ..... 141, 146
PR ..... 64-65	VC ..... 118-119
PTW ..... 206-207	VE ..... 116-119
PU ..... 84-85	VHJ ..... 146
<b>R</b>	VLP ..... 140-141
RA ..... 11	VM ..... 116-119
RAC ..... 12-13	VMC ..... 117-119
RACH ..... 16-17	<b>W</b>
RACL ..... 14-15	W ..... 192-203
RAR ..... 18-19	WCB ..... 178-179
RAT ..... 210	WCR ..... 204
RB ..... 10	WHC ..... 178
RC ..... 6-9, 58-61	WHR ..... 178
RCH ..... 30-31	WMC ..... 179
RCS ..... 22-23	WR ..... 167, 177
..... 58, 61	WRP ..... 205
RE ..... 10	WTE ..... 205
RFL ..... 105-109	<b>X</b>
RR ..... 36-39	XA ..... 61
RRH ..... 32-33	..... 108-109, 231
RSM ..... 22-23, 61	XC ..... 61, 82-83, 231
RT ..... 20-21	XLK ..... 108
RTE ..... 189	XLP ..... 140-141
RWH ..... 150	XPG ..... 108
<b>S</b>	XSC ..... 82, 108, 127
S ..... 186-189	<b>Z</b>
SB ..... 172, 233	Z ..... 125
SBL ..... 256-257	ZA4 ..... 91, 110-111
SBZ ..... 94, 100	ZA4T ..... 91, 212
..... 218, 224	..... 222-225
SC ..... 58-59, 61	ZCF ..... 94-95
SDA ..... 188	..... 100-101
SFP ..... 240-241	ZCP ..... 101
SHAS ..... 254-255	ZE ..... 91, 98-103
SHS ..... 252-253	..... 212, 220-221
SL ..... 256-257	ZG ..... 112-113
SLR ..... 210	ZHE ..... 95, 101, 218
SOH ..... 173	ZLS ..... 94-95, 100-101
SP ..... 168-171	ZPF ..... 94-95, 100-101
SPD ..... 169	ZU4 ..... 91-97
SPK ..... 168	ZU4T ..... 91, 212
SPMT ..... 260	..... 216-219
SRA ..... 210	ZUTP ..... 226-227
SRS ..... 61, 189	ZR ..... 94-95
STB ..... 180-181	..... 100-101, 224
STC ..... 178	<b>5</b>
STF ..... 232-233	11 - 45 ..... 80-81
STN ..... 229	72 - 83 ..... 80-81
STP ..... 169	
SWH ..... 186,	
..... 192, 202	
SWR ..... 61	

## Cylinders & Lifting Products



Page 4-69

## Pumps & Directional Control Valves



Page 70-119

## System Components & Control Valves



Page 120-137

## Presses



Page 138-147

## Pullers



Page 148-161

## Tools



Page 162-181

## Bolting Tools



Page 182-237

## Heavy Lifting Technology



Page 238-262



## Cylinders & Lifting Products

Page 4-69



## Pumps & Directional Control Valves

Page 70-119



## System Components & Control Valves

Page 120-137



## Presses

Page 138-147



## Pullers

Page 148-161



## Tools

Page 162-181



## Bolting Tools

Page 182-237



## Heavy Lifting Technology

Page 238-262

**Australia and New Zealand**  
Actuant Australia Ltd.  
T +61 287 177 200 – F +61 297 438 648

**Brazil**  
Power Packer do Brasil Ltda.  
T +55 11 5687 2211  
Toll Free: 0800 891 5770

**China**  
Actuant (China) Industries Co.Ltd.  
T +86 0512 5328 7500  
F +86 0512 5335 9690  
Toll Free: T +86 400 885 0369

**Enerpac Heavy Lifting Technology B.V.**  
T +31 74 242 20 45 – F +31 74 243 03 38

**France, Switzerland, North Africa and French speaking African countries**  
ENERPAC, Une division d'ACTUANT France S.A.S.  
T +33 1 60 13 68 68 – F +33 1 69 20 37 50

**Germany and Austria, Central and Eastern Europe, Baltic States, Greece, Turkey and CIS countries**  
Actuant GmbH  
T +49 211 471 490 – F +49 211 471 49 28

**India**  
Actuant India Private Limited  
T +91 80 3928 9000

**Italy**  
ENERPAC S.p.A.  
T +39 02 4861 111 – F +39 02 4860 1288

**Japan**  
Enerpac Co., Ltd.  
T +81 48 662 4911 – F +81 48 662 4955

**Middle East, Egypt and Libya**  
ENERPAC Middle East FZE  
T +971 4 8872686 – F +971 4 8872687

**Norway**  
Tel: +47 91 578 300

**Russia**  
Rep. office Enerpac  
T +7 495 98090 91 – F +7 495 98090 92

**Southeast Asia, Hong Kong and Taiwan**  
Actuant Asia Pte Ltd.  
T +65 68 63 0611 – F +65 64 84 5669  
Toll Free: T +1800 363 7722

**South Korea**  
Actuant Korea Ltd.  
T +82 31 434 4506 – F +82 31 434 4507

**Spain and Portugal**  
ENERPAC SPAIN, S.L.  
T +34 91 884 86 06 – F +34 91 884 86 11

**Sweden, Denmark, Finland and Iceland**  
Enerpac Scandinavia AB  
Tel: +47 91 578 300

**The Netherlands, Belgium, Luxembourg**  
ENERPAC B.V.  
T +31 318 535 911 – F +31 318 535 848

**South Africa and other English speaking African countries**  
ENERPAC AFRICA (PTY) Ltd.  
T 0027 (0) 12 940 0656

**United Kingdom and Ireland**  
ENERPAC Ltd.  
T +44 1670 5016 50 – F +44 1670 5016 51

**USA, Latin America and Caribbean**  
ENERPAC  
T +1 262 293 1600 – F +1 262 293 7036

User inquiries: +1 800 433 2766  
Distributor inquiries/orders:  
T +1 800 558 0530 – F +1 800 628 0490

# ENERPAC®

POWERFUL SOLUTIONS. GLOBAL FORCE.