



## **Cisco IP Conference Phone 8832 User Guide**

**First Published:** 2017-09-15

**Last Modified:** 2020-11-18

### **Americas Headquarters**

Cisco Systems, Inc.  
170 West Tasman Drive  
San Jose, CA 95134-1706  
USA  
<http://www.cisco.com>  
Tel: 408 526-4000  
800 553-NETS (6387)  
Fax: 408 527-0883

THE SPECIFICATIONS AND INFORMATION REGARDING THE PRODUCTS IN THIS MANUAL ARE SUBJECT TO CHANGE WITHOUT NOTICE. ALL STATEMENTS, INFORMATION, AND RECOMMENDATIONS IN THIS MANUAL ARE BELIEVED TO BE ACCURATE BUT ARE PRESENTED WITHOUT WARRANTY OF ANY KIND, EXPRESS OR IMPLIED. USERS MUST TAKE FULL RESPONSIBILITY FOR THEIR APPLICATION OF ANY PRODUCTS.

THE SOFTWARE LICENSE AND LIMITED WARRANTY FOR THE ACCOMPANYING PRODUCT ARE SET FORTH IN THE INFORMATION PACKET THAT SHIPPED WITH THE PRODUCT AND ARE INCORPORATED HEREIN BY THIS REFERENCE. IF YOU ARE UNABLE TO LOCATE THE SOFTWARE LICENSE OR LIMITED WARRANTY, CONTACT YOUR CISCO REPRESENTATIVE FOR A COPY.

The following information is for FCC compliance of Class A devices: This equipment has been tested and found to comply with the limits for a Class A digital device, pursuant to part 15 of the FCC rules. These limits are designed to provide reasonable protection against harmful interference when the equipment is operated in a commercial environment. This equipment generates, uses, and can radiate radio-frequency energy and, if not installed and used in accordance with the instruction manual, may cause harmful interference to radio communications. Operation of this equipment in a residential area is likely to cause harmful interference, in which case users will be required to correct the interference at their own expense.

The following information is for FCC compliance of Class B devices: This equipment has been tested and found to comply with the limits for a Class B digital device, pursuant to part 15 of the FCC rules. These limits are designed to provide reasonable protection against harmful interference in a residential installation. This equipment generates, uses and can radiate radio frequency energy and, if not installed and used in accordance with the instructions, may cause harmful interference to radio communications. However, there is no guarantee that interference will not occur in a particular installation. If the equipment causes interference to radio or television reception, which can be determined by turning the equipment off and on, users are encouraged to try to correct the interference by using one or more of the following measures:

- Reorient or relocate the receiving antenna.
- Increase the separation between the equipment and receiver.
- Connect the equipment into an outlet on a circuit different from that to which the receiver is connected.
- Consult the dealer or an experienced radio/TV technician for help.

Modifications to this product not authorized by Cisco could void the FCC approval and negate your authority to operate the product.

The Cisco implementation of TCP header compression is an adaptation of a program developed by the University of California, Berkeley (UCB) as part of UCB's public domain version of the UNIX operating system. All rights reserved. Copyright © 1981, Regents of the University of California.

NOTWITHSTANDING ANY OTHER WARRANTY HEREIN, ALL DOCUMENT FILES AND SOFTWARE OF THESE SUPPLIERS ARE PROVIDED "AS IS" WITH ALL FAULTS. CISCO AND THE ABOVE-NAMED SUPPLIERS DISCLAIM ALL WARRANTIES, EXPRESSED OR IMPLIED, INCLUDING, WITHOUT LIMITATION, THOSE OF MERCHANTABILITY, FITNESS FOR A PARTICULAR PURPOSE AND NONINFRINGEMENT OR ARISING FROM A COURSE OF DEALING, USAGE, OR TRADE PRACTICE.

IN NO EVENT SHALL CISCO OR ITS SUPPLIERS BE LIABLE FOR ANY INDIRECT, SPECIAL, CONSEQUENTIAL, OR INCIDENTAL DAMAGES, INCLUDING, WITHOUT LIMITATION, LOST PROFITS OR LOSS OR DAMAGE TO DATA ARISING OUT OF THE USE OR INABILITY TO USE THIS MANUAL, EVEN IF CISCO OR ITS SUPPLIERS HAVE BEEN ADVISED OF THE POSSIBILITY OF SUCH DAMAGES.

Any Internet Protocol (IP) addresses and phone numbers used in this document are not intended to be actual addresses and phone numbers. Any examples, command display output, network topology diagrams, and other figures included in the document are shown for illustrative purposes only. Any use of actual IP addresses or phone numbers in illustrative content is unintentional and coincidental.

All printed copies and duplicate soft copies of this document are considered uncontrolled. See the current online version for the latest version.

Cisco has more than 200 offices worldwide. Addresses and phone numbers are listed on the Cisco website at [www.cisco.com/go/offices](http://www.cisco.com/go/offices).

Cisco and the Cisco logo are trademarks or registered trademarks of Cisco and/or its affiliates in the U.S. and other countries. To view a list of Cisco trademarks, go to this URL: <https://www.cisco.com/c/en/us/about/legal/trademarks.html>. Third-party trademarks mentioned are the property of their respective owners. The use of the word partner does not imply a partnership relationship between Cisco and any other company. (1721R)

© 2017–2020 Cisco Systems, Inc. All rights reserved.



# CONTENTS

---

## CHAPTER 1

### Your Phone 1

Your Cisco IP Conference Phone 8832 and 8832NR	1
Feature Support	2
New and Changed Information	2
New and Changed Information for Firmware Release 12.8(1)	2
New and Changed for Firmware Release 12.7(1)	2
New and Changed Information for Firmware Release 12.6(1)	3
New and Changed Information for Firmware Release 12.5(1)SR3	3
New and Changed Information for Firmware Release 12.5(1)SR2	3
New and Changed Information for Firmware Release 12.5(1)SR1	3
New and Changed Information for Firmware Release 12.5(1)	3
New and Changed Information for Firmware Release 12.1(1)	3
Phone Setup	4
Connect to the Network	4
Set Up Wi-Fi Client	6
Connect to a Preconfigured Wi-Fi Network	6
Connect with Activation Code Onboarding	7
Connect to Expressway	7
Install the Wired Expansion Microphones	7
Install the Wireless Expansion Microphones	8
Pair a Wireless Microphone	9
Unpair a Wireless Microphone	9
Install the Wireless Microphone Charging Cradle	10
Charge a Wireless Microphone	11
Daisy Chain Mode	11
Install the Conference Phone in Daisy Chain Mode	11

Replace Your Existing Phone with a New Phone	13
Self Care Portal	14
Speed-Dial Numbers	15
Cisco IP Conference Phone 8832 Buttons and Hardware	16
Conference Phone Navigation	17
Conference Phone Softkeys	17
Phone Icons	17
Phone Keypad Characters	18
Clean the Phone Screen	19
Wired Expansion Microphone	19
Wireless Expansion Microphone	19
Phone Firmware and Upgrades	20
Postpone a Phone Upgrade	21
View the Progress of a Phone Firmware Upgrade	21
Energy Savings	21
Turn On Your Phone	22
Additional Help and Information	22
Accessibility Features	22
Hearing-Impaired Accessibility Features	22
Vision-Impaired and Blind Accessibility Features	24
Mobility-Impaired Accessibility Features	26
Third-Party Accessibility Applications	27
Troubleshooting	28
Find Information About Your Phone	28
Report Call Quality Issues	28
Report All Phone Issues	29
Lost Phone Connectivity	29
Cisco One-Year Limited Hardware Warranty Terms	29

---

**CHAPTER 2****Calls 31**

Make Calls	31
Make a Call	31
Make a Call with a Phone Address	31
Redial a Number	32

Speed Dial	32
Make a Speed-Dial Call with Your Conference Phone	32
Make a Call With a Speed-Dial Code	33
Get Notified When a Contact is Available	33
Dial an International Number	33
Secure Calls	33
Answer Calls	34
Answer a Call	34
Answer Call Waiting on Your Conference Phone	34
Decline a Call	34
Turn On Do Not Disturb	34
Answer a Call Within Your Hunt Group	35
Sign In and Out of a Hunt Group	35
View the Call Queue in a Hunt Group	35
Trace a Suspicious Call	36
Mute Your Call	36
Hold Calls	36
Put a Call on Hold	36
Answer a Call Left on Hold for Too Long	36
Swap Between Active and Held Calls	37
Call Park	37
Place a Call on Hold with Call Park	37
Retrieve a Call on Hold with Call Park	38
Forward Calls	38
Transfer Calls	38
Transfer a Call to Another Person	39
Consult Before You Complete a Transfer	39
Conference Calls and Meetings	39
Add Another Person to a Call	40
Swap Between Calls Before You Complete a Conference	40
View and Remove Conference Participants	40

---

**CHAPTER 3****Contacts 41**

Corporate Directory	41
---------------------	----

- Dial a Contact in the Corporate Directory 41
- Personal Directory 41
  - Sign In and Out of a Personal Directory 42
  - Add a New Contact to Your Personal Directory 42
  - Search for a Contact in Your Personal Directory 42
  - Call a Contact in Your Personal Directory 43
  - Assign a Fast-Dial Code to a Contact 43
  - Call a Contact with a Fast-Dial Code 43
  - Edit a Contact in Your Personal Directory 44
  - Remove a Contact from Your Personal Directory 44
  - Delete a Fast-Dial Code 44
- Cisco Web Dialer 45

---

**CHAPTER 4**

**Recent Calls 47**

- Recent Calls List 47
- View Your Recent Calls 47
- Return a Recent Call 47
- Clear the Recent Calls List 48
- Delete a Call Record 48

---

**CHAPTER 5**

**Voicemail 49**

- Voicemail 49
- Check for New Voice Messages 49
- Access Your Voicemail Messages 50

---

**CHAPTER 6**

**Settings 51**

- Change the Ringtone 51
- Adjust the Phone Ringer Volume 51
- Adjust the Volume During a Call 52
- Phone Display Language 52

---

**CHAPTER 7**

**Applications 53**

- Available Applications 53
- View Active Applications 53

Switch to Active Applications 53

Close Active Applications 54

---

**CHAPTER 8**

**Product Safety and Security 55**

Compliance Statements 55

Compliance Statements for the European Union 55

CE Marking 55

Compliance Statements for Canada 55

FCC Compliance Statements 56

FCC Part 15.21 Statement 56

FCC RF Radiation Exposure Statement 56

FCC Receivers and Class B Digital Statement 56

Cisco Product Security Overview 56

Important Online Information 57







# CHAPTER 1

## Your Phone

---

- [Your Cisco IP Conference Phone 8832 and 8832NR](#), on page 1
- [New and Changed Information](#), on page 2
- [Phone Setup](#), on page 4
- [Self Care Portal](#), on page 14
- [Cisco IP Conference Phone 8832 Buttons and Hardware](#), on page 16
- [Phone Firmware and Upgrades](#), on page 20
- [Energy Savings](#), on page 21
- [Additional Help and Information](#) , on page 22

## Your Cisco IP Conference Phone 8832 and 8832NR

The Cisco IP Conference Phone 8832 and 8832NR provide high-definition (HD) audio performance and 360-degree coverage for medium to large conference rooms and executive offices. The conference phone has sensitive microphones that let you speak in a normal voice and be clearly heard from up to 10 feet (2.1 m) away.

**Figure 1: Cisco IP Conference Phone 8832**



You can connect two wired expansion microphones to the phone to increase coverage in larger conference rooms.

The phone also supports an optional set of two wireless expansion microphones.

The Cisco IP Conference Phone 8832NR (non-radio) version does not support Wi-Fi or wireless expansion microphones.

The phone can be used for a 20 x 20 foot (6.1 x 6.1 m) room and up to 10 people. When you add the expansion microphones, coverage extends to a 20 x 34 foot (6.1 x 10 m) room and up to 22 people.

You can connect two base units to increase the coverage for a room. This configuration requires the optional Daisy Chain kit and can support two expansion microphones (either wired or wireless, but not a mixed combination). If you are using wired microphones with the Daisy Chain kit, the configuration provides coverage for a room up to 20 x 50 feet (6.1 x 15.2 m) and up to 38 people. If you are using wireless microphones with the Daisy Chain kit, the configuration provides coverage for a room up to 20 x 57 feet (6.1 x 17.4 m) and up to 42 people.

## Feature Support

This document describes all the features that the device supports. However, not all features may be supported with your current configuration. For information on supported features, contact your administrator.

## New and Changed Information

You can use the information in the following sections to understand what has changed in the document. Each section contains the major changes.

### New and Changed Information for Firmware Release 12.8(1)

*Table 1: New and Changed Information for Firmware Release 12.8(1)*

Feature	New or Changed Content
Phone Data Migration	<a href="#">Replace Your Existing Phone with a New Phone, on page 13</a>

### New and Changed for Firmware Release 12.7(1)

The following table shows the changes made for Firmware Release 12.7(1).

*Table 2: Cisco IP Conference Phone 8832 User Guide Revisions for Firmware Release 12.7(1)*

Revision	Updated Section
Updated for hunt group calls on Call Alert	<a href="#">Answer a Call Within Your Hunt Group, on page 35</a>

Revision	Updated Section
General changes	<p>In certain circumstances, users who dialed a number that was busy received the reorder tone. With this release, the user hears the busy tone.</p> <p>New sections <a href="#">Conference Phone Navigation, on page 17</a>, <a href="#">Conference Phone Softkeys, on page 17</a>, <a href="#">Phone Icons, on page 17</a>, and <a href="#">Clean the Phone Screen, on page 19</a>.</p>

## New and Changed Information for Firmware Release 12.6(1)

No user guide updates were required for Firmware Release 12.6(1).

## New and Changed Information for Firmware Release 12.5(1)SR3

The following table shows the changes that were made for Firmware Release 12.5(1)SR3.

*Table 3: Cisco IP Conference Phone 8832 User Guide Revisions for Firmware Release 12.5(1)SR3*

Revision	New or Updated Section
New topic	<a href="#">Phone Keypad Characters, on page 18</a>

## New and Changed Information for Firmware Release 12.5(1)SR2

No User Guide updates were required for Firmware Release 12.5(1)SR2.

Firmware Release 12.5(1)SR2 replaces Firmware Release 12.5(1) and Firmware 12.5(1)SR1. Firmware Release 12.5(1) and Firmware Release 12.5(1)SR1 have been deferred in favor of Firmware Release 12.5(1)SR2.

## New and Changed Information for Firmware Release 12.5(1)SR1

No updates were required for Firmware Release 12.5(1)SR1.

## New and Changed Information for Firmware Release 12.5(1)

No updates were required for Firmware Release 12.5(1).

## New and Changed Information for Firmware Release 12.1(1)

The following table shows the changes that were made for Firmware Release 12.1(1).

Table 4: Cisco IP Conference Phone 8832 User Guide Revisions for Firmware Release 12.1(1)

Revision	New or Updated Section
Updates to support for Cisco IP Conference Phone 8832 PoE Injector	<a href="#">Connect to the Network, on page 4</a>
Support for Wireless Microphone	<ul style="list-style-type: none"> <li>• <a href="#">Your Cisco IP Conference Phone 8832 and 8832NR, on page 1</a></li> <li>• <a href="#">Wireless Expansion Microphone, on page 19</a></li> <li>• <a href="#">Install the Wireless Expansion Microphones, on page 8</a></li> <li>• <a href="#">Pair a Wireless Microphone, on page 9</a></li> <li>• <a href="#">Unpair a Wireless Microphone, on page 9</a></li> <li>• <a href="#">Install the Wireless Microphone Charging Cradle, on page 10</a></li> <li>• <a href="#">Charge a Wireless Microphone, on page 11</a></li> </ul>
Support for Daisy Chain	<ul style="list-style-type: none"> <li>• <a href="#">Your Cisco IP Conference Phone 8832 and 8832NR, on page 1</a></li> <li>• <a href="#">Daisy Chain Mode, on page 11</a></li> </ul>
Support for Cisco IP Conference Phone 8832 Non-PoE Ethernet Injector	<a href="#">Connect to the Network, on page 4</a>
Support for Wi-Fi	<ul style="list-style-type: none"> <li>• <a href="#">Connect to the Network, on page 4</a></li> <li>• <a href="#">Set Up Wi-Fi Client, on page 6</a></li> <li>• <a href="#">Connect to a Preconfigured Wi-Fi Network, on page 6</a></li> </ul>
Support for Mobile and Remote Access Through Expressway	<ul style="list-style-type: none"> <li>• <a href="#">Connect to the Network, on page 4</a></li> <li>• <a href="#">Connect to Expressway, on page 7</a></li> </ul>
Support for CMC and FAC	<a href="#">Calls That Require a Billing Code or Authorization Code</a>

## Phone Setup

Your administrator sets up your phone and connects it to the network. If your phone is not set up and connected, contact your administrator for instructions.

### Connect to the Network

You need to connect the phone to the network.

- Wired network connection—All wired network connections use one of the following:

- **PoE deployment:** Connect the phone to the **Cisco IP Conference Phone 8832 PoE Injector** (CP-8832-POE) and connect the injector to the network with an Ethernet cable.
- **Non-PoE deployment:** Connect the phone to the **Cisco IP Conference Phone 8832 Non-PoE Ethernet Injector** (CP-8832-ETH or CP-8832-ETH-WW). Then, connect the injector to the network with an Ethernet cable and plug the injector into the electric outlet.
- **Wireless connection**—The Cisco IP Conference Phone 8832 can connect to a Wireless Access Point using Wi-Fi. This deployment requires the power supply (CP-8832-PWR or CP-8832-PWR-WW).

Mobile and Remote Access Through Expressway—If your administrator sets up Mobile and Remote Access Through Expressway and you connect your phone to the network, it connects to the Expressway server.



**Note** CP-8832-ETH and CP-8832-PWR are for North America. CP-8832-ETH-WW and CP-8832-PWR-WW are for other locations.

**Figure 2: PoE Deployment**

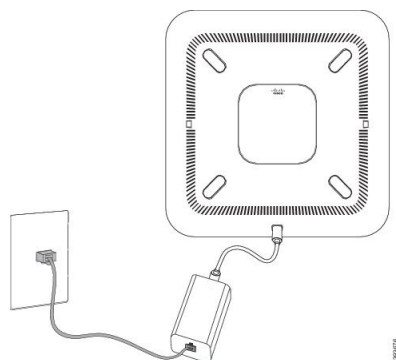

**Figure 3: Non-PoE Deployment**

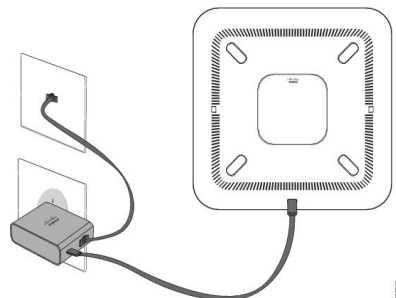
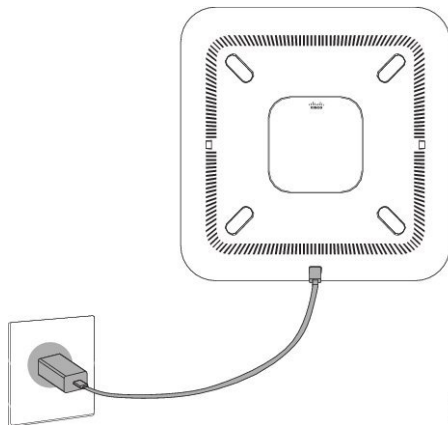

Figure 4: Wi-Fi Network Connection



## Set Up Wi-Fi Client

The Cisco IP Conference Phone 8832 can access a Wi-Fi network. You need a power adapter to power the phone. The Cisco IP Conference Phone 8832NR cannot be used with a Wi-Fi network.

### Before you begin

Your administrator needs to configure settings on the call control system to enable Wi-Fi access.

### Procedure

- 
- Step 1** If the phone is plugged into the Ethernet, unplug the Ethernet cable.
  - Step 2** Press **Settings**.
  - Step 3** Navigate to **Admin settings > Network setup > Wi-Fi client setup**.
  - Step 4** Navigate to **Wireless** and press **On**.
  - Step 5** Press **Apply** to save the changes, or press **Revert** to cancel the changes.
  - Step 6** Navigate to **Network name**.
  - Step 7** When the phone finishes scanning the SSID, choose a network to join.
  - Step 8** Enter your Wi-Fi credentials and press **Connect**.
- 

## Connect to a Preconfigured Wi-Fi Network

You can connect your Cisco IP Conference Phone 8832 to the network using Wi-Fi, but, for security, enter your username and password. But, the Cisco IP Conference Phone 8832NR does not support Wi-Fi.

Depending upon how your phone is configured, you could be required to sign in when you join a Wi-Fi network or when your phone powers up.

You cannot dismiss the Wi-Fi sign-in window without entering the correct username and password.

### Procedure

---

- Step 1** Enter your Wi-Fi credentials when prompted.
  - Step 2** Select **Sign-in**.
- 

## Connect with Activation Code Onboarding

If your network has been configured to support this feature, then you can use Activation Code Onboarding to connect to your company's phone network.

### Enter an Activation Code

Activation codes are used to set up your new phone. They can only be used once, and expire after 1 week. Contact your administrator if you don't know your code or if you need a new one.

### Procedure

---

- Step 1** Enter your activation code on the activation screen.
  - Step 2** Press **Submit**.
- 

## Connect to Expressway

You can use Mobile and Remote Access Through Expressway to connect to your corporate network when you are working away from your office.

### Procedure

---

- Step 1** Reset service mode through **Settings > Admin Settings > Reset Settings > Service mode**.
  - Step 2** Press **Select** when prompted to change the service mode.
  - Step 3** Enter the service domain and press **Continue**.
  - Step 4** Enter your username and password.
  - Step 5** Select **Sign in**.
- 

## Install the Wired Expansion Microphones

The phone supports an optional kit with two wired expansion microphones. You can extend the microphones up to 7 feet (2.13m) from the phone. For best results, place the microphones between 3 feet (0.91 m) and 7 feet (2.1 m) away from the phone.

## Procedure

**Step 1** Plug the end of the microphone cable into the port on the side of the phone.

**Step 2** Extend the microphone cable to the desired position.

The following figure shows installation of a wired expansion microphone.

**Figure 5: Wired Expansion Microphone Installation**

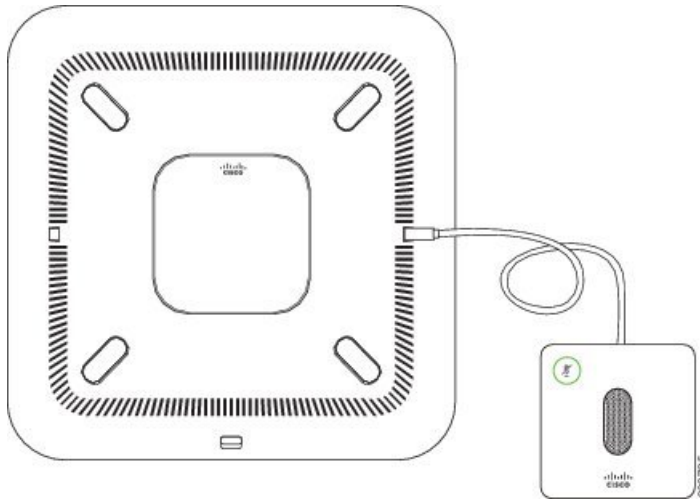

## Related Topics

[Wired Expansion Microphone](#), on page 19

# Install the Wireless Expansion Microphones

The conference phone provides the option of connecting two wireless expansion microphones.



**Note** You must use either two wired microphones or two wireless microphones with the phone, but not a mixed combination.

When the phone is in a call, the LED on the expansion microphone is lit green. To mute the expansion microphone, press the **Mute** key. When the microphone is muted, the LED is lit red. When the battery in the microphone is low, the battery indication LED blinks rapidly.

## Before you begin

Disconnect the wired expansion microphones before you install wireless expansion microphones. You cannot use both wired and wireless expansion microphones at the same time.



### Procedure

---

- Step 1** Position the table mount plate on the table surface location where you want to place the microphone.
- Step 2** Remove the adhesive for the double-stick tape on the bottom of the table mount plate. Place the table mount plate to adhere to the table surface.
- Step 3** Attach the microphone to the table mount plate. Magnets are embedded in the microphone to snap the unit into place.
- You can move the microphone and attached table mount to a different location on the table surface as needed. Use care when moving to protect the unit.

---

### Related Topics

- [Wireless Expansion Microphone](#), on page 19
- [Install the Wireless Expansion Microphones](#), on page 8

## Pair a Wireless Microphone

### Before you begin

Unplug any wired microphones.

### Procedure

---

- Step 1** Press **Settings**.
- Step 2** Select **Admin Settings** > **Microphones** > **Wireless microphones**.
- Step 3** Select either **Microphone 1** or **Microphone 2** and press **Pair**.
- If a microphone is already linked to a particular channel, the phone screen shows that the microphone is paired.
- Step 4** Press **Mute**  on the wireless microphone until the microphone LED blinks white.
- If the pairing succeeds, the phone screen displays a success message.
- Step 5** (Optional) Press **Cancel** to revert to the **Wireless microphones** menu.

---

### Related Topics

- [Wireless Expansion Microphone](#), on page 19

## Unpair a Wireless Microphone

### Procedure

---

- Step 1** Press **Settings**.
- Step 2** Select **Admin Settings** > **Microphones** > **Wireless microphones**.

- Step 3** Select either **Microphone 1** or **Microphone 2**.  
If the selected channel is paired, the **Unpair** softkey displays on the phone screen.
- Step 4** Press **Unpair**.

---

**Related Topics**

[Wireless Expansion Microphone](#), on page 19

## Install the Wireless Microphone Charging Cradle

You use the charging cradle to charge the wireless microphone battery.

**Procedure**

---

- Step 1** Plug the charging cradle power adapter into an electrical outlet.
- Step 2** Plug one end of the USB-C cable to the charging cradle and the other end into the power adapter.

The following figure shows installation of a wireless microphone charging cradle.

*Figure 6: Wireless Microphone Charging Cradle Installation*

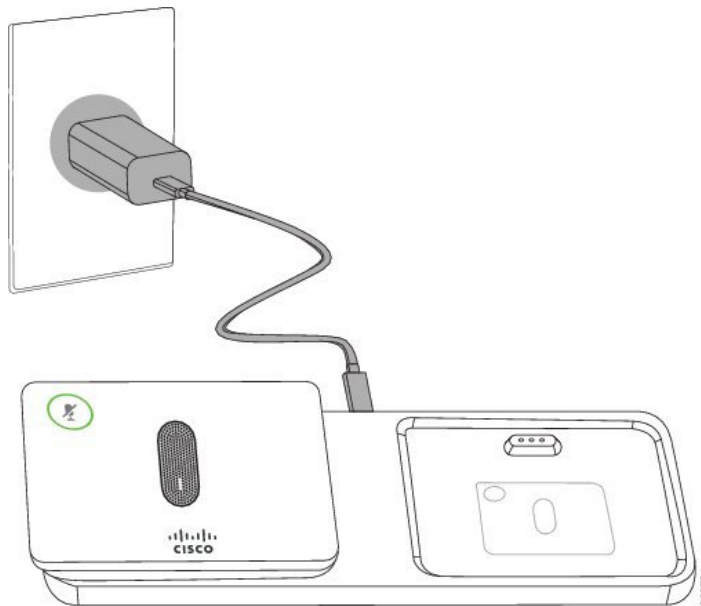

---

**Related Topics**

[Wireless Expansion Microphone](#), on page 19

## Charge a Wireless Microphone

### Before you begin

Install the wireless microphone charging cradle. For more information, see [Install the Wireless Microphone Charging Cradle, on page 10](#).

### Procedure

- 
- Step 1** Place the microphone in the charging cradle.
- Step 2** If the LED on the cradle is not white, remove the microphone and replace it in the cradle.
- 

### Related Topics

[Wireless Expansion Microphone, on page 19](#)

## Daisy Chain Mode

You can connect two conference phones using a Smart Adapter and the USB-C cables that are provided in the daisy chain kit to expand the audio coverage area in a room.

In daisy chain mode, both units receive power though the Smart Adapter which is connected to a power adapter. You can use only one external microphone per unit. You can use either a pair of wired microphones with the units or a pair of wireless microphones with the units, but not a mixed combination of the microphones. When a wired microphone is connected to one of the units, it unpairs any wireless microphones that are connected to the same unit. Whenever there is an active call, the LEDs and the menu options on the phone screen of both units are synchronized.

### Install the Conference Phone in Daisy Chain Mode

The daisy chain kit contains a Smart Adapter, a short LAN cable, two long, thicker USB-C cables, and a shorter, thinner USB-C cable. In daisy chain mode, the conference phones require external power from an electrical outlet. You must use the Smart Adapter to connect the phones together. The long USB-C cables go to the phone and the short one goes to the power adapter. Refer to the following figure when you connect the power adapter and the LAN port to the Smart Adapter.

**Figure 7: Smart Adapter Power Port and LAN Port**

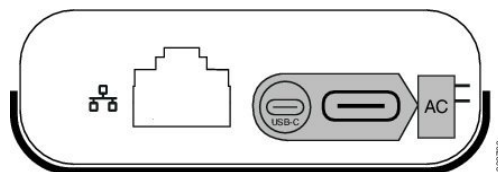

You can use only one microphone per unit.



**Note** You must use either two wired microphones or two wireless microphones with the phone, but not a mixed combination.

---

The USB-C cable for the power adapter is thinner than the USB-C cables that connect to the phone.

### Procedure

- Step 1** Plug the power adapter into the electrical outlet.
- Step 2** Connect the short, thinner USB-C cable from the power adapter to the Smart Adapter.

*Figure 8: Smart Adapter USB Port Connected to the Power Outlet*

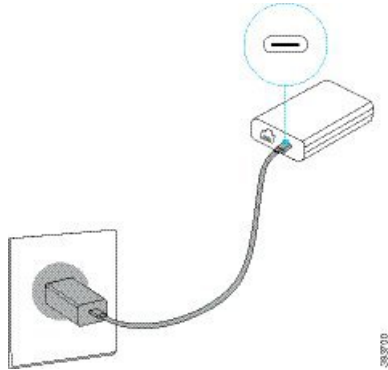

- Step 3** Required: Connect the Ethernet cable to the Smart Adapter and the LAN port.

*Figure 9: Smart Adapter LAN Port Connected to the LAN Port on the Wall Outlet*

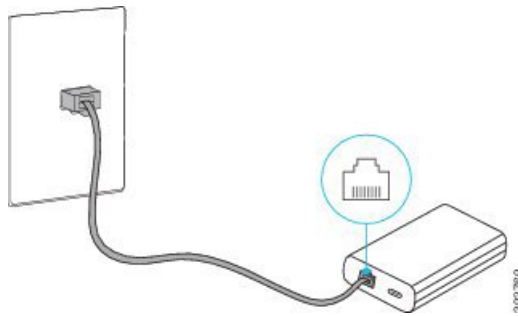

- Step 4** Connect the first phone to the Smart Adapter using the longer, thicker USB-C cable.
- Step 5** Connect the second phone to the Smart Adapter using a USB-C cable.
- The following figure shows installation of the conference phone in daisy chain mode.

**Figure 10: Conference Phone Installation in Daisy Chain Mode**

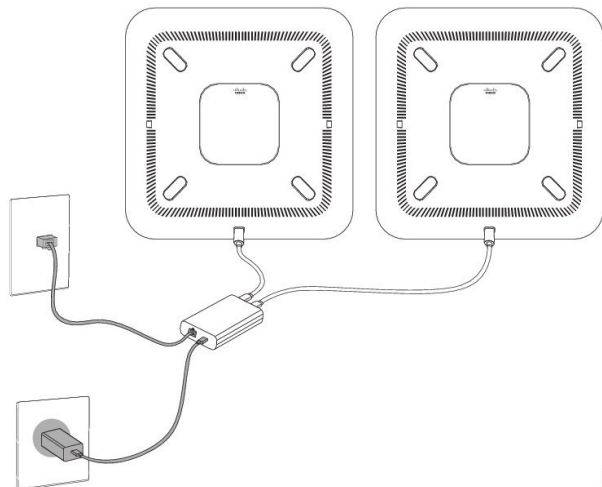

## Replace Your Existing Phone with a New Phone

You can change your phone model. The change can be required for a number of reasons, for example:

- You have updated your Cisco Unified Communications Manager (Unified CM) to a software version that doesn't support the phone model.
- You want a different phone model from their current model.
- Your phone requires repair or replacement.

**Limitation:** If the old phone has more lines or line buttons than the new phone, the new phone doesn't have the extra lines or line buttons configured.

The phone reboots when the configuration is complete.

### Before you begin

Your administrator needs to set up Cisco Unified Communications Manager to enable the phone migration.

You need a new phone that hasn't been connected to the network or previously configured.

### Procedure

- Step 1** Power off the old phone.
- Step 2** Power on the new phone.
- Step 3** If prompted, enter your activation code.
- Step 4** Select **Replace an existing phone**.
- Step 5** Enter the primary extension of the old phone.
- Step 6** If the old phone had a PIN assigned, enter the PIN.

**Step 7** Press **Submit**.

**Step 8** If you have several devices, select the device to replace from the list and press **Continue**.

## Self Care Portal

You can customize some phone settings with the Self Care portal web site, which you access from your computer. The Self Care portal is part of your organization's Cisco Unified Communications Manager.

Your administrator gives you the URL to access the Self Care portal, and provides your user ID and password.

In the Self Care portal, you can control features, line settings, and phone services for your phone.

- Phone features include speed dial, do not disturb, and your personal address book.
- Line settings affect a specific phone line (directory number) on your phone. Line settings can include call forwarding, visual and audio message indicators, ring patterns, and other line-specific settings.
- Phone services can include special phone features, network data, and web-based information (such as stock quotes and movie listings). Use the Self Care Portal to subscribe to a phone service before you access it on your phone.

The following table describes some specific features that you configure with the Self Care portal. For more information, see the Self Care portal documentation for your call control system.

**Table 5: Features Available on the Self Care Portal**

Features	Description
Call forward	Use the number that receives calls when call forward is enabled on the phone. Use the Self Care portal to set up more complicated call forward functions, for example, when your line is busy.
Additional phones	Specify the additional phones such as your mobile phone that you want to use to make and receive calls with the same directory numbers as your desk phone. You can also define blocked and preferred contacts to restrict or allow calls from certain numbers to be sent to your mobile phone. When you set up additional phones, you can also set up these features: <ul style="list-style-type: none"> <li>• Single number reach—Specify whether the additional phone should ring when someone calls your desk phone.</li> <li>• Mobile calls—If the additional phone is a mobile phone, you can set it up to allow you to transfer mobile calls to your desk phone or desk phone calls to your mobile phone.</li> </ul>
Speed dial	Assign phone numbers to speed-dial numbers so that you can quickly call that person.

### Related Topics

[Speed Dial](#), on page 32

[Forward Calls](#), on page 38

## Speed-Dial Numbers

When you dial a number on your phone, you enter a series of digits. When you set up a speed-dial number, the speed-dial number must contain all the digits you need to make the call. For example, if you need to dial 9 to get an outside line, you enter the number 9 and then the number you want to dial.

You can also add other dialed digits to the number. Examples of additional digits include a meeting access code, an extension, a voicemail password, an authorization code, and a billing code.

The dial string can contain the following characters:

- 0 to 9
- Pound (#)
- Asterisk (\*)
- Comma (,)—This is the pause character, and gives a 2 second delay in the dialing. You can have several commas in a row. For example, two commas (,,) represent a pause of 4 seconds.

The rules for dial strings are:

- Use the comma to separate the parts of the dial string.
- An authorization code must always precede a billing code in the speed-dial string.
- A single comma is required between the authorization code and the billing code in the string.
- A speed-dial label is required for speed dials with authorization codes and additional digits.

Before you configure the speed dial, try to dial the digits manually at least once to ensure that the digit sequence is correct.

Your phone does not save the authorization code, billing code, or extra digits from the speed dial in the call history. If you press **Redial** after you connect to a speed-dial destination, the phone prompts you to enter any required authorization code, billing code, or additional digits manually.

### Example

To set up a speed-dial number to call a person at a specific extension, and if you need an authorization code and billing code, consider the following requirements:

- You need to dial **9** for an outside line.
- You want to call **5556543**.
- You need to input the authorization code **1234**.
- You need to input the billing code **9876**.
- You must wait for 4 seconds.
- After the call connects, you must dial the extension **56789#**.

In this scenario, the speed-dial number is **95556543,1234,9876,,56789#**.

### Related Topics

[Calls That Require a Billing Code or Authorization Code](#)

[Phone Keypad Characters](#), on page 18

# Cisco IP Conference Phone 8832 Buttons and Hardware



The following figure shows the Cisco IP Conference Phone 8832.

**Figure 11: Cisco IP Conference Phone 8832 Buttons and Features**



The following table describes the buttons on the Cisco IP Conference Phone 8832.

**Table 6: Cisco IP Conference Phone 8832 Buttons**

1	LED bar	Indicates call states: <ul style="list-style-type: none"> <li>• Green, solid—Active call</li> <li>• Green, flashing—Incoming call</li> <li>• Green, pulsing—Held call</li> <li>• Red, solid—Muted call</li> </ul>
2	Expansion microphone port	The wired expansion microphone cable plugs into the port.
3	<b>Mute</b> bar	 Toggles the microphone on or off. When you mute the microphone, the LED bar lights red.
4	Softkey buttons	 Access functions and services.

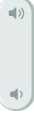

5	Navigation bar and <b>Select</b> button	 <p>Scroll through menus, highlight items, and select the highlighted item.</p>
6	<b>Volume</b> button	 <p>Adjusts the speakerphone volume (off hook) and the ringer volume (on hook). When you change the volume, the LED bar lights white to show the volume change.</p>

## Conference Phone Navigation

Use the Navigation bar to scroll through menus. Use the inner **Select** button of the Navigation bar to select menu items.

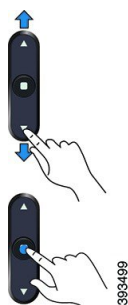

If a menu item has an index number, you can enter the index number with the keypad to select the item.

## Conference Phone Softkeys

You can interact with the features on your phone with the softkeys. Softkeys, located below the screen, give you access to the function displayed on the screen above the softkey. The softkeys change depending on what you are doing at the time.



The ●● and ●● softkeys indicate more softkey functions are available.

## Phone Icons

Your phone screen displays many icons. This section gives images of the common icons

Icons are in color or grayscale, depending on the screen.



**Recents**

Icon	Description
	Incoming call
	Outgoing call
	Missed call

**Wi-Fi Network Icons**

If your phone is connected to the Wi-Fi network, you see these icons.

*Table 7: Network Icons*

Icon	Description
	Wi-Fi connected and the number of bars indicates the signal strength.
	There is no Wi-Fi connection

**Phone Keypad Characters**

The phone keypad allows you to enter letters, numbers, and special characters. You press the **Two (2)** to **Nine (9)** keys to get the letters and numbers. You use the **One (1)**, **Zero (0)**, **Asterisk (\*)**, and **Pound (#)** keys for special characters. The following table lists the special characters for each key for the English locale. Other locales will have their own characters.

*Table 8: Special Characters on the Keypad*

Keypad Key	Special Characters
<b>One (1)</b>	/ . @ : ; = ? - _ & %
<b>Zero (0)</b>	(space) , ! ^ ' "
<b>Asterisk (*)</b>	+ * ~ ` < >
<b>Pound (#)</b>	# \$ £ □ \ ( ) { } [ ]

## Clean the Phone Screen

### Procedure

If your phone screen gets dirty, wipe it with a soft, dry cloth.

**Caution** Do not use any liquids or powders on the phone because they can contaminate the phone components and cause failures.

## Wired Expansion Microphone

The Cisco IP Conference Phone 8832 supports two wired expansion microphones, available in an optional kit. Use the expansion microphones in larger rooms or in a crowded room. For best results, we recommend that you place the microphones between 3 feet (0.91 m) and 7 feet (2.1 m) away from the phone.

*Figure 12: Wired Expansion Microphone*

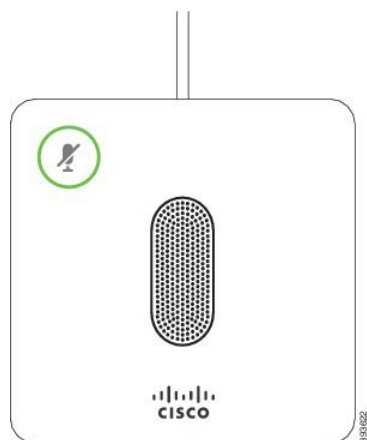

When you're in a call, the expansion microphone LED around the **Mute**  button is green.

When you mute the microphone, the LED is red. When you press the **Mute** button, the phone and the expansion microphones are muted.

### Related Topics

[Install the Wired Expansion Microphones](#), on page 7

## Wireless Expansion Microphone

The Cisco IP Conference Phone 8832 supports two expansion wireless microphones, available with a charging cradle in an optional kit. When the wireless microphone is placed on the charging cradle for charging, the LED on the cradle is lit white.

Figure 13: Wireless Microphone

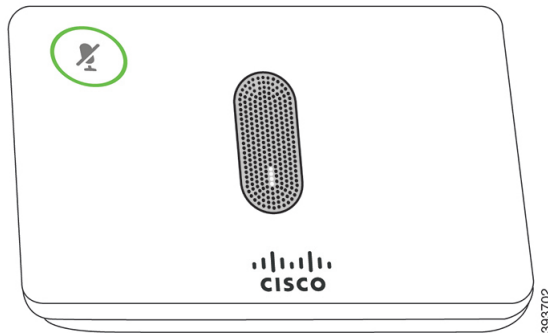
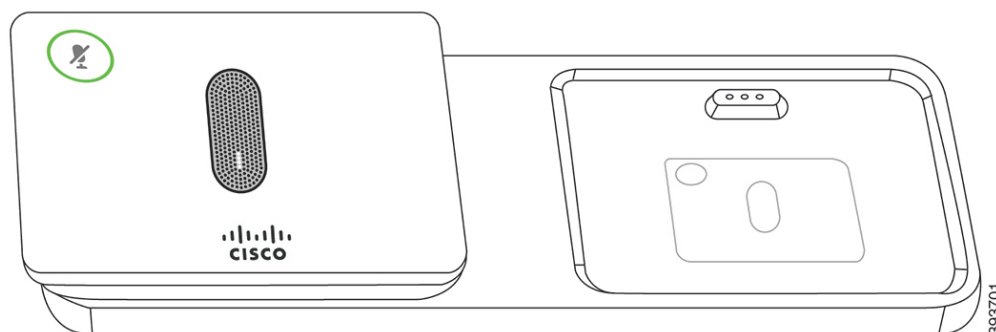



Figure 14: Wireless Microphone Mounted on the Charging Cradle



When the conference phone is in a call, the expansion microphone LED around the **Mute**  button is lit green.

When the microphone is muted, the LED is lit red. When you press the **Mute** button, the phone and the expansion microphones are muted.

If the phone is paired with a wireless microphone (for example, Wireless microphone 1) and you connect the wireless microphone to a charger, pressing the **Show detail** softkey indicates the charge level for that microphone.

When the phone is paired with a wireless microphone and you connect a wired microphone, the wireless microphone gets unpaired and the phone is paired with the wired microphone. A notification appears on the phone screen indicating that the wired microphone is connected.

#### Related Topics

[Install the Wireless Expansion Microphones](#), on page 8

[Pair a Wireless Microphone](#), on page 9

[Unpair a Wireless Microphone](#), on page 9

[Install the Wireless Microphone Charging Cradle](#), on page 10

[Charge a Wireless Microphone](#), on page 11

## Phone Firmware and Upgrades

Your phone comes pre-installed with firmware that is specific to the call control system.

Occasionally, your administrator upgrades the phone firmware for you. This upgrade happens in the background even if you are using your phone.

## Postpone a Phone Upgrade

When new firmware is available, the **Ready to upgrade** window is displayed on your phone and a timer begins a 15-second countdown. If you do nothing, the upgrade proceeds.

You can postpone your firmware upgrade for 1 hour and up to 11 times. The upgrade is also postponed if you make or receive a phone call.

### Procedure

---

Select **Delay** to postpone a phone upgrade.

---

## View the Progress of a Phone Firmware Upgrade

During a phone firmware upgrade, you can view the upgrade progress.

### Procedure

---

- Step 1** Press **Applications** .
  - Step 2** Press **Settings**.
  - Step 3** Select **Phone information** > **Show detail**.
  - Step 4** Select **System information**, and press **Show details**.
  - Step 5** Press **Exit**.
- 

## Energy Savings

Your administrator can reduce the amount of power your phone screen uses with the following options:

- **Power Save**—The backlight or screen turns off when the phone is inactive for a set interval.
- **Power Save Plus**—Your phone screen turns on and off at times that are based on your work schedule. If your work hours or work days change, you can contact your administrator to reconfigure your phone.

For example, your administrator can set your phone to alert you 10 minutes before it turns off. You see the **Select** button light up and you get a message that your phone is turning off soon. You get notifications at these intervals:

For example, your administrator can set your phone to alert you 10 minutes before it turns off. You get a message that your phone is turning off soon and you get notifications at these intervals:

- Four rings at 10 minutes before power off

- Four rings at 7 minutes before power off
- Four rings at 4 minutes before power off
- 15 rings at 30 seconds before power off

If your phone is active, it waits until it has been inactive for a set interval before it notifies you of the pending power shutdown.

## Turn On Your Phone

When your phone turns off to save energy, the phone screen is blank and the **Select** button lights up.

### Procedure

---

Press **Select** to turn your phone back on.

---

## Additional Help and Information

If you have questions about the functions available on your phone, contact your administrator.

The Cisco website (<https://www.cisco.com>) contains more information about the phones and call control systems.

## Accessibility Features

The Cisco IP Conference Phone 8832 provides accessibility features for the blind, and for the visually, hearing, and mobility impaired. Because many of these features are standard, users with disabilities can access them without any special configuration.

In this document, the term *phone support pages* refers to the web pages that users can access to set up certain features. For Cisco Unified Communications Manager (Release 10.0 and later), these pages are the Self Care Portal. For Cisco Unified Communications Manager (Release 9.1 and earlier), these pages are the User Options web pages.

For additional information, see the phone User Guide, located here: <http://www.cisco.com/c/en/us/support/collaboration-endpoints/unified-ip-phone-8800-series/products-user-guide-list.html>

Cisco is committed to designing and delivering accessible products and technologies to meet the needs of your organization. You can find more information about Cisco and its commitment to accessibility at this URL: <https://www.cisco.com/go/accessibility>

## Hearing-Impaired Accessibility Features

Your conference phone comes with standard accessibility features that require little or no setup.

Figure 15: Hearing-Impaired Accessibility Features

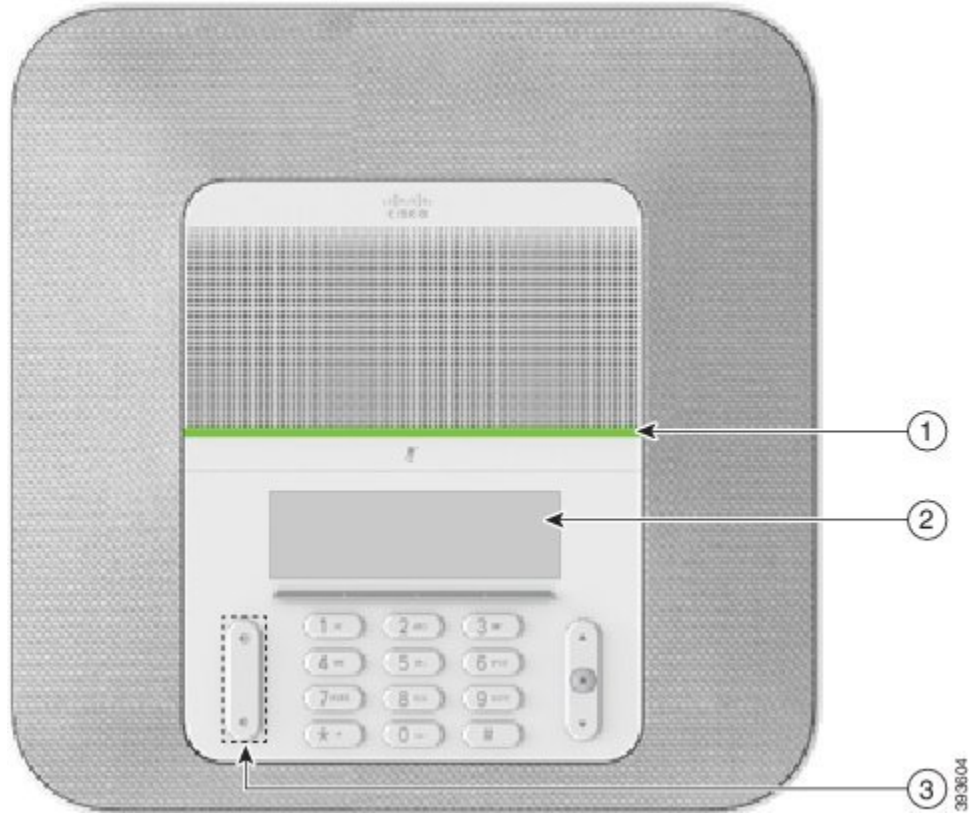

The following table describes the hearing-impaired accessibility features on the Cisco IP Conference Phone 8832.

Table 9: Hearing-Impaired Accessibility Features

Item	Accessibility Feature	Description
1	LED bar	The phone screen displays the current state and the LED bar displays: <ul style="list-style-type: none"> <li>• Green, solid—Active call</li> <li>• Green, flashing—Incoming call</li> <li>• Green, pulsing—Held call</li> <li>• Red, solid—Muted call</li> </ul>

Item	Accessibility Feature	Description
2	Visual notification of phone state and message-waiting indicator	<p>The phone screen displays the current state.</p> <p>When you have a message, a message is displayed on the phone screen. Your phone also provides an audible message-waiting indicator.</p> <p>To change the audible voice-message indicator, sign in to the Self Care portal and access the message-indicator settings. You can change each setting to on or off.</p> <p>Your administrator can also change your settings.</p>
3	Adjustable ringtone, pitch, and volume	<ul style="list-style-type: none"> <li>• Select <b>Settings &gt; Preferences</b> to change the ringtone.</li> <li>• Adjust the volume level for the phone ring. When not in a call, press <b>Volume</b> to raise or lower the volume.</li> </ul> <p>When you adjust the volume, the LED bar lights white to show the volume increase or decrease.</p> <p>Your administrator can also change your settings.</p>

## Vision-Impaired and Blind Accessibility Features

Your phone comes with standard accessibility features that require little or no setup.



Figure 16: Vision-Impaired and Blind Accessibility Features

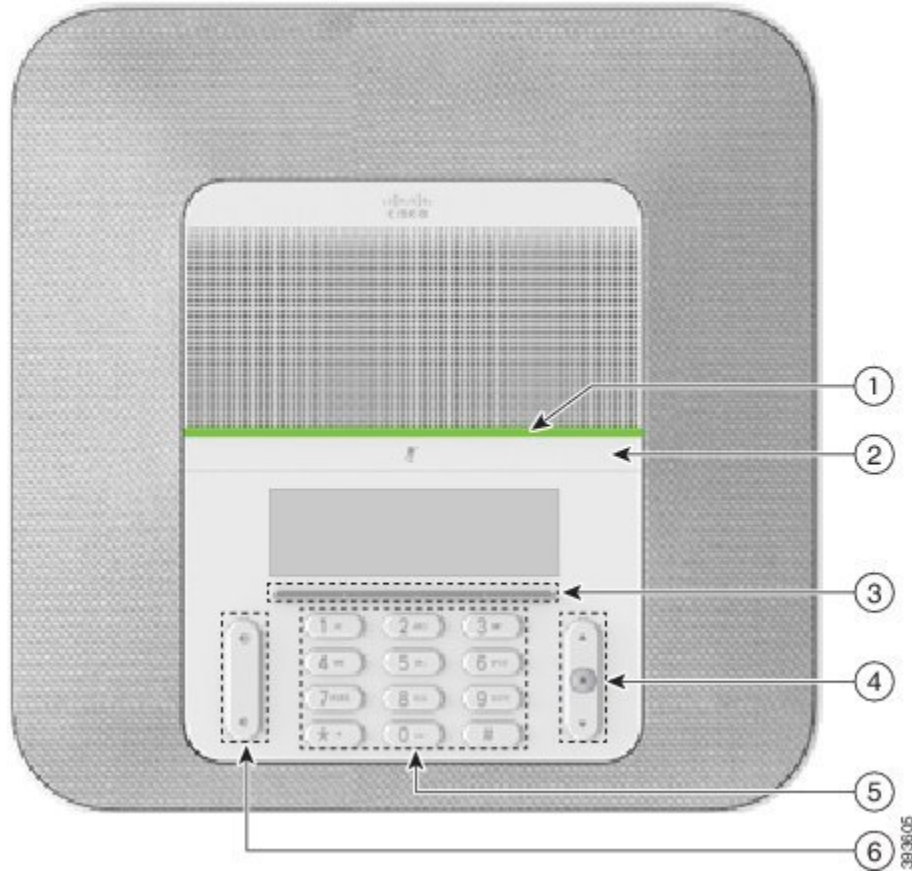

The following table describes the vision-impaired and blind accessibility features on the Cisco IP Conference Phone 8832.

Table 10: Vision-Impaired and Blind Accessibility Features

Item	Accessibility Feature	Description
1	High-contrast visual and audible alert of incoming call with the LED bar <ul style="list-style-type: none"> <li>The LED bar is located above the <b>Mute</b> button and the screen.</li> </ul>	Use the <b>Mute</b> button to toggle the microphone on or off. When the microphone is muted, the LED bar lights red. When you turn on Mute, your phone beeps once; when you turn off Mute, your phone beeps twice.

Item	Accessibility Feature	Description
2	<p><b>Mute</b> button</p> <ul style="list-style-type: none"> <li>This button is located between the LED bar and the screen.</li> </ul>	<p>Alerts you to an incoming call. The LED flashes during incoming calls.</p> <p>Colors indicate your phone's status:</p> <ul style="list-style-type: none"> <li>Green, solid—Active call</li> <li>Green, flashing—Incoming call</li> <li>Green, pulsing—Held call</li> <li>Red, solid—Muted call</li> </ul>
3	<p>Softkeys</p> <ul style="list-style-type: none"> <li>These are buttons just below the LCD.</li> </ul>	<p>Provide access to special functions. The LCD displays the functions.</p>
4	<p>Navigation cluster (includes the Navigation bar and the <b>Select</b> button)</p> <ul style="list-style-type: none"> <li>The Navigation cluster is located to the right of the keypad.</li> </ul>	<p>Use the Navigation bar to move up and down in the phone LCD. The <b>Select</b> button is in the center of the Navigation bar.</p>
5	<p>Standard 12-key layout</p>	<p>Allows you to use existing or familiar key positions. Key 5 has a nib.</p>
6	<p><b>Volume</b> key</p> <ul style="list-style-type: none"> <li>This key is located to the left of the keypad.</li> </ul>	<p>Allows you to increase or decrease the ring volume or the sound.</p> <p>Press up on the rocker key to increase the volume. Press down on the rocker key to decrease the volume.</p> <p>When you adjust the volume, the LED bar lights white to show the volume increase or decrease.</p>

## Mobility-Impaired Accessibility Features

Your conference phone comes with standard accessibility features that require little or no setup.

Figure 17: Mobility-Impaired Accessibility Features



The following table describes the mobility-impaired accessibility features on the Cisco IP Conference Phone 8832.

Table 11: Mobility-Impaired Accessibility Features

Item	Accessibility Feature	Description
1	LED bar	Indicates your phone's status: <ul style="list-style-type: none"> <li>• Green, solid—Active call</li> <li>• Green, flashing—Incoming call</li> <li>• Green, pulsing—Held call</li> <li>• Red, solid—Muted call</li> </ul>
2	Tactile-discernible buttons and functions, including a nub on Key 5	Allow you to easily locate your phone's keys. For example, Key 5 has a nub, which you can use to locate other key positions.

## Third-Party Accessibility Applications

Cisco works closely with partners to provide solutions that complement the accessibility and usability of Cisco products and solutions. There are third-party applications such as real-time captioning on Cisco IP Phones,

Text Telephones for the Deaf (TDD/TTY), Real Time Text (RTT), hearing/voice carry over (HCO/VCO), audible caller ID, inline amplifiers for handsets for louder call sound, “busy lights”, audio/visual emergency notifications through Cisco IP Phones (supporting users with disabilities), etc.

For more information about third-party applications, contact your administrator.

## Troubleshooting

You may experience issues related to the following scenarios:

- Your phone cannot communicate with the call control system.
- The call control system has communication or internal problems.
- Your phone has internal problems.

If you experience problems, your administrator can help troubleshoot the root cause of the problem.

### Find Information About Your Phone

Your administrator may ask for information about your phone. This information uniquely identifies the phone for troubleshooting purposes.

#### Procedure

---

- Step 1** Select **System information**.
- Step 2** Press **Exit**.
- 

### Report Call Quality Issues

Your administrator may temporarily configure your phone with the Quality Reporting Tool (QRT) to troubleshoot performance problems. Depending on the configuration, use the QRT to:

- Immediately report an audio problem on a current call.
- Select a general problem from a list of categories and choose reason codes.

#### Procedure

---

- Step 1** Press **Report quality**.
- Step 2** Scroll and select the item that closely matches your problem.
- Step 3** Press the **Select** softkey to send the information to your system administrator.
-

## Report All Phone Issues

You can use the Cisco Collaboration Problem Report Tool (PRT) to collect and send phone logs, and to report problems to your administrator. If you see a message that the PRT upload has failed, the problem report is saved on the phone and you should alert your administrator.

### Procedure

---

- Step 1** Press **Applications** .
  - Step 2** Select **Settings > System information > Report problem**.
  - Step 3** Enter the date and time that you experienced the problem in the Date of problem and Time of problem fields.
  - Step 4** Select **Problem description**.
  - Step 5** Select a description from the displayed list, then press **Submit**.
- 

## Lost Phone Connectivity

Sometimes your phone loses its connection to the phone network. When this connection is lost, your phone displays a message.

If you are on an active call when the connection is lost, the call continues. But, you don't have access to all normal phone features because some functions require information from the call control system. For example, your softkeys might not work as you expect.

When the phone reconnects to the call control system, you'll be able to use your phone normally again.

## Cisco One-Year Limited Hardware Warranty Terms

Special terms apply to your hardware warranty and services that you can use during the warranty period.

Your formal Warranty Statement, including the warranties and license agreements applicable to Cisco software, is available on Cisco.com at this URL: <https://www.cisco.com/go/hwwarranty>.





## CHAPTER 2

# Calls

---

- [Make Calls, on page 31](#)
- [Answer Calls, on page 34](#)
- [Mute Your Call, on page 36](#)
- [Hold Calls, on page 36](#)
- [Forward Calls, on page 38](#)
- [Transfer Calls, on page 38](#)
- [Conference Calls and Meetings, on page 39](#)

## Make Calls

Your phone works just like a regular phone. But we make it easier for you to make calls.

### Make a Call

Use your phone just like any other phone to make a call.

#### Procedure

---

Enter a number and press **Call**.

---

### Make a Call with a Phone Address

Sometimes, instead of just having someone's phone number, you might also have a phone address that you can use to place the call instead.

This address might look like an email address, such as `username1@example.com`, or it might contain numbers like `username2@209.165.200.224`.

#### Procedure

---

**Step 1** Press **New call**.

- Step 2** Press **ABC** and you'll be able to enter text using the keypad.
- Step 3** Press a number on the keypad to see the available options, and then press the number again to move through the choices.
- For example, press the number **1** three times to enter the **@** symbol.
- Step 4** Press **Call**.
- 

## Redial a Number

You can call the most recently dialed phone number.

### Procedure

---

Press **Redial**.

---

## Speed Dial

You can assign codes to quickly dial the numbers of people you call often. Before you can use speed-dial features on your phone, set up speed dial in the Self Care portal. Speed-dial codes allow you to phone number from a code (sometimes referred to as abbreviated dialing).

- Speed-dial buttons—Dial a phone number from one or more line buttons set up for speed dialing.
- Speed-dial codes—Dial a phone number from a code (sometimes referred to as abbreviated dialing).

### Related Topics

[Self Care Portal](#), on page 14

[Speed-Dial Numbers](#), on page 15

## Make a Speed-Dial Call with Your Conference Phone

### Before you begin

Set up speed-dial codes in the Self Care portal.

### Procedure

---

- Step 1** Press down on the Navigation bar or press **Favorites**.
- Step 2** Select a speed-dial entry and press **Call**.
-



## Make a Call With a Speed-Dial Code

### Before you begin

Set up the codes in the User Options Web Pages.

### Procedure

---

- Step 1** Enter the speed-dial code and press **Speed Dial**.
  - Step 2** Enter the speed-dial code and press **Abbr dial**.
- 

## Get Notified When a Contact is Available

If you call someone and their line is busy or they do not answer, you can be notified with a special ringtone and a message when they are available.

### Procedure

---

- Step 1** Press **Callback** while you are listening to the busy tone or ring sound.
  - Step 2** Press **Exit** to exit the confirmation screen.
  - Step 3** When you hear the ringtone that the person is available and see the message, press **Call** to place the call again.
- 

## Dial an International Number

You can dial international calls when you prefix the phone number with a plus (+) sign.

### Procedure

---

- Step 1** Press and hold **star (\*)** for at least 1 second.  
The plus (+) sign is displayed as the first digit in the phone number.
  - Step 2** Enter the phone number.
  - Step 3** Press **Call** or wait 10 seconds after the last key press to automatically place the call.
- 

## Secure Calls

Your administrator can take steps to protect your calls from tampering by people outside your company. When a lock icon is displayed on your phone during a call, your phone call is secure. Depending upon how your phone is configured, you may have to sign on before you make a call or before a security tone plays over your handset.

# Answer Calls

Your Cisco phone works just like a regular phone. But we make it easier for you to answer calls.

## Answer a Call

### Procedure

---

Press **Answer**.

---

## Answer Call Waiting on Your Conference Phone

When you're on an active call, you know that a call is waiting when you hear a single beep and see a message on the conference phone screen.

### Procedure

---

Press **Answer**.

---

## Decline a Call

You can send a ringing call to your voicemail system (if configured). If not set up, the call is rejected and the caller hears a busy tone.

### Procedure

---

Press **Decline**.

---

## Turn On Do Not Disturb

Use do not disturb (DND) to silence your phone and ignore incoming call notifications when you need to avoid distractions.

When you turn on DND, your incoming calls are forwarded to another number, such as your voicemail, if it is set up.

### Procedure

---

- Step 1** Press **Do not disturb** to turn on DND.  
**Step 2** Press **Turn off DND** to turn off DND.
- 

## Answer a Call Within Your Hunt Group

Hunt groups allow organizations that receive many incoming calls to share the call load. Your administrator sets up a hunt group with a series of directory numbers. Phones ring based on the hunt sequence that your administrator specifies for a hunt group. If you are a member of a hunt group, you sign into a hunt group when you want to receive calls. You sign out of the group when you don't want calls to ring on your phone.

The feature configuration determines if you see your hunt group name or pilot number displayed on your Incoming Call Alert.

### Before you begin

You must be signed into the hunt group to receive hunt group calls.

### Procedure

---

When a hunt group call rings on your phone, answer the call.

---

## Sign In and Out of a Hunt Group

Sign out of your hunt group to stop receiving calls from it. You continue receiving calls placed directly to you.

## View the Call Queue in a Hunt Group

You can use the queue statistics to check the status of the hunt group queue. The queue status display provides the following information:

- The phone number used by the hunt group
- Number of queued callers on each hunt group queue
- Longest waiting time

### Procedure

---

- Step 1** Press **Queue Status**.  
**Step 2** Press **Update** to refresh the statistics.  
**Step 3** Press **Exit**.
-

## Trace a Suspicious Call

If you receive unwanted or harassing calls, use malicious call identification (MCID) to alert your administrator. Your phone sends a silent notification message to your administrator with information about the call.

### Procedure

---

Press **Report caller**.

---

## Mute Your Call

While you are on a call, you can mute the audio, so that you can hear the other person, but they cannot hear you.

When you have a call muted, the LED bar lights red.

### Procedure

---

**Step 1** Press **Mute**  on the phone or **Mute**  on an expansion microphone.

When you press **Mute** on an expansion microphone, the phone and all microphones are muted.

**Step 2** Press **Mute** again to turn mute off.

---

## Hold Calls

### Put a Call on Hold

You can put an active call on hold and then resume the call when you're ready.

### Procedure

---

**Step 1** Press **Hold**.

**Step 2** To resume a call from hold, press **Resume**.

---

### Answer a Call Left on Hold for Too Long

When you've left a call on hold too long, you'll be notified with these cues:

- Single ring, repeating at intervals
- Flashing amber line button
- Flashing message indicator on the handset
- Flashing LED bar
- Visual notification on the phone screen

**Procedure**

---

Press the flashing amber line button or **Answer** to resume the held call.

---

## Swap Between Active and Held Calls

You can easily switch between active and held calls.

**Procedure**

---

Press **Swap** to switch to the held call.

---

## Call Park

You can use your phone to park a call.

A parked call is monitored by your network so you won't forget about it. If the call remains parked for too long, you hear an alert. You can then answer, decline to answer, or ignore the call on your original phone. You can also continue retrieving it from another phone.

If you don't answer the call within a certain length of time, it's routed to voicemail or another destination, as set by your administrator.

## Place a Call on Hold with Call Park

You can park an active call that you answered on your phone and then use another phone in the call control system to retrieve the call.

You can park only one call at the call park number.

**Before you begin**

Your call must be active.

### Procedure

---

- Step 1** Press **Park**, and then hang up.
- Step 2** (Optional) Communicate the parked number to the person who needs to answer the call.
- 

## Retrieve a Call on Hold with Call Park

You can pick up a parked call from anywhere in your network.

### Before you begin

You need the number that was used to park the call.

### Procedure

---

Enter the number where the call is parked to retrieve the call.

---

## Forward Calls

You can forward calls from your phone to another number.

There are two ways of forwarding your calls:

- Forward all calls
- Forward calls in special situations, such as when the phone is busy or there is no answer.

When a phone is forwarded, you see the Forward all  icon on the screen.

### Procedure

---

- Step 1** When the phone is inactive, press **Forward All**.
- Step 2** Enter the call forward target number exactly as you would dial it from your phone, or select an entry from your list of recent calls.
- 

### Related Topics

[Self Care Portal](#), on page 14

## Transfer Calls

You can transfer an active call to another person.

## Transfer a Call to Another Person

When you transfer a call, you can stay on the original call until the other person answers. This way, you can talk privately with the other person before you remove yourself from the call. If you don't want to talk, transfer the call before the other person answers.

You can also swap between both callers to consult with them individually before you remove yourself from the call.

### Procedure

---

- Step 1** From a call that is not on hold, press **Transfer**.
  - Step 2** Enter the other person's phone number.
  - Step 3** (Optional) Wait until you hear the line ring or until the other person answers the call.
  - Step 4** Press **Transfer** again.
- 

## Consult Before You Complete a Transfer

Before you transfer a call, you can talk to the person that you're transferring the call to. You can also swap between that call and the call that you're transferring, before you complete the transfer.

### Before you begin

You have an active call that needs to be transferred.

### Procedure

---

- Step 1** Press **Transfer**.
  - Step 2** Enter the other person's phone number.
  - Step 3** Press **Swap** to return to the held call.
  - Step 4** Press **Transfer** to complete the transfer.
- 

## Conference Calls and Meetings

You can talk with several people in a single call. You can dial another person and add them to the call. If you have multiple phone lines, you can join two calls across two lines.

You can talk with several people in a single call. You can dial another person and add them to the call.

When you add more than one person to a conference call, wait a few seconds between adding participants.

As the conference host, you can remove individual participants from the conference. The conference ends when all participants hang up.

## Add Another Person to a Call

When you are on a call, you can add someone else to your conversation.

### Procedure

---

- Step 1** From an active call, press **Conf**.
  - Step 2** Enter a number.
  - Step 3** (Optional) Wait until you hear the line ring or until the other person answers the call.
  - Step 4** Press **Conf**.
- 

## Swap Between Calls Before You Complete a Conference

You can talk to a person before you add them to a conference. You can also swap between the conference call and the call with the other person.

### Procedure

---

- Step 1** Call a new conference participant, but do not add the participant to the conference.  
Wait until the call is connected.
  - Step 2** Press **Swap** to toggle between the participant and the conference.
- 

## View and Remove Conference Participants

If you create a conference, you can view the details of the last 16 participants who join the conference. You can also remove participants.

### Procedure

---

- Step 1** While you are in a conference, press **Show Details** to view a list of participants.
  - Step 2** (Optional) Highlight a participant and press **Remove** to drop the participant from the conference.
-





## CHAPTER 3

# Contacts

---

- [Corporate Directory](#), on page 41
- [Personal Directory](#), on page 41
- [Cisco Web Dialer](#), on page 45

## Corporate Directory

You can look up a coworker's number from your phone, which makes it easier to give them a call. Your administrator sets up and maintains the directory.

### Dial a Contact in the Corporate Directory

#### Procedure

---

- |               |  |
|---------------|--|
| <b>Step 1</b> | Press <b>Contacts</b> .                              |
| <b>Step 2</b> | Select <b>Corporate Directory</b> .                  |
| <b>Step 3</b> | Select a search criteria.                            |
| <b>Step 4</b> | Enter your search criteria and press <b>Submit</b> . |
| <b>Step 5</b> | Select the contact and press <b>Dial</b> .           |
- 

## Personal Directory

Use the personal directory to store the contact information for friends, family, or coworkers. You can add your own contacts to the personal directory. You can add special speed-dial codes for people who you often call.

You can set up your personal directory from your phone or from the Self Care portal. Use your phone to assign speed-dial codes to the directory entries.

#### Related Topics

- [Self Care Portal](#), on page 14

## Sign In and Out of a Personal Directory

### Before you begin

Before you can sign in to your personal directory, you need your user ID and PIN. Contact your administrator if you don't know this information.

### Procedure

---

- Step 1** Press **Contacts**.
  - Step 2** Select **Personal directory**.
  - Step 3** Enter your user ID and PIN, and press **Submit**.
  - Step 4** To sign out, select **Log out**, press **Select**, and then press **OK**.
- 

## Add a New Contact to Your Personal Directory

### Procedure

---

- Step 1** Press **Contacts**.
  - Step 2** Sign in to your personal directory.
  - Step 3** Select **Personal Address Book** and press **Submit**.
  - Step 4** Press **New**.
  - Step 5** Enter first name, last name, and optionally a nickname.
  - Step 6** Press **Phones**, enter the phone number along with any required access codes, and then press **Submit**.
- 

## Search for a Contact in Your Personal Directory

### Procedure

---

- Step 1** Press **Contacts**.
  - Step 2** Sign in to your personal directory.
  - Step 3** Select **Personal Address Book**.
  - Step 4** Select a search criteria.
  - Step 5** Enter your search criteria and press **Submit**.
-

## Call a Contact in Your Personal Directory

### Procedure

---

- Step 1** Press **Contacts**.
  - Step 2** Sign in to your personal directory.
  - Step 3** Select your **Personal directory** and search for an entry.
  - Step 4** Select the personal address book entry that you want to dial.
  - Step 5** Select the required fast-dial code and press **Call**.
- 

## Assign a Fast-Dial Code to a Contact

A fast-dial code makes it easier to call a contact.

### Procedure

---

- Step 1** Press **Contacts**.
  - Step 2** Sign in to your personal directory.
  - Step 3** Select **Personal Address Book**.
  - Step 4** Select a search criteria.
  - Step 5** Enter the search criteria information and press **Submit**.
  - Step 6** Select the contact.
  - Step 7** Press **FastDial**.
  - Step 8** Select a number and press **Select**.
  - Step 9** Scroll to an unassigned fast-dial index and press **Submit**.
- 

## Call a Contact with a Fast-Dial Code

### Procedure

---

- Step 1** Press **Contacts**.
  - Step 2** Sign in to your personal directory.
  - Step 3** Select **Personal Fast Dials** and scroll to a fast-dial code.
  - Step 4** Select the required fast-dial code and press **Call**.
-

## Edit a Contact in Your Personal Directory

### Procedure

---

- Step 1** Press **Contacts**.
  - Step 2** Sign in to your Personal directory.
  - Step 3** Select **Personal address book** and search for an entry.
  - Step 4** Press **Select**, then **Edit**.
  - Step 5** Modify the entry information.
  - Step 6** Press **Phones** to modify a phone number.
  - Step 7** Press **Update**.
- 

## Remove a Contact from Your Personal Directory

### Procedure

---

- Step 1** Press **Contacts**.
  - Step 2** Sign in to your personal directory.
  - Step 3** Select **Personal Address Book** and search for an entry.
  - Step 4** Press **Select**, then **Edit**, then **Delete**.
  - Step 5** Press **OK** to confirm the deletion.
- 

## Delete a Fast-Dial Code

### Procedure

---

- Step 1** Press **Contacts**.
  - Step 2** Sign in to your personal directory.
  - Step 3** Select **Personal Fast Dials** and search for a fast-dial code.
  - Step 4** Select the required code and press **Remove**.
  - Step 5** Select the index and press **Remove**.
-

## Cisco Web Dialer

You can use Cisco Web Dialer, a web browser, and your Cisco IP phone to make calls from web and desktop applications. Use your web browser and go to a website or your company directory, and then click a hyperlinked phone number to begin your call.

You need a user ID and password to make a call. Your administrator can give you this information. First-time users have to configure their preferences before a call.

For more information, see the “Cisco Web Dialer” document in <https://www.cisco.com/c/en/us/support/unified-communications/unified-communications-manager-callmanager/products-installation-and-configuration-guides-list.html>





## CHAPTER 4

# Recent Calls

---

- [Recent Calls List, on page 47](#)
- [View Your Recent Calls, on page 47](#)
- [Return a Recent Call, on page 47](#)
- [Clear the Recent Calls List, on page 48](#)
- [Delete a Call Record , on page 48](#)

## Recent Calls List

Use the Recents list to see the 150 most recent individual calls and call groups.

If your Recents list reaches the maximum size, the next new entry overwrites the oldest entry in the list.

Calls in the Recents list are grouped if they are to and from the same number and are consecutive. Missed calls from the same number also get grouped.

## View Your Recent Calls

Check to see who's called you recently.

### Procedure

---

Select **Recents**.

When the phone is in the idle state, you can also view the Recent calls list by pressing the Navigation cluster up.

---

## Return a Recent Call

You can easily call someone who has called you.

**Procedure**

---

- Step 1** Select **Recents**.
  - Step 2** Select the number that you want to dial.
  - Step 3** Press **Call**.
- 

## Clear the Recent Calls List

You can clear the Recents list on your phone.

**Procedure**

---

- Step 1** Select **Recents**.
  - Step 2** Press **Clear**.
  - Step 3** Press **Delete**.
- 

## Delete a Call Record

You can edit Recents to remove a single call from your history. This helps preserve important contact information because Recents holds only 150 calls.

**Procedure**

---

- Step 1** Select **Recents**.
  - Step 2** Highlight the individual record or call group that you want to delete.
  - Step 3** Press **Delete**.
  - Step 4** Press **Delete** again to confirm.
-





## CHAPTER 5

# Voicemail

---

- [Voicemail](#), on page 49
- [Check for New Voice Messages](#), on page 49
- [Access Your Voicemail Messages](#), on page 50

## Voicemail

You can access your voice messages directly from your phone. Your administrator must set up your voicemail account and set up your phone before you can access the voicemail system.

The **Messages** softkey on your phone acts as a speed dial into the voicemail system.



---

**Note** If the conference phone is a shared phone used in a conference room, the **Messages** softkey may not display.

---

When you aren't at your desk, you can call your voicemail system to access your voicemail. Your administrator can give you the external phone number of the voicemail system.



---

**Note** This document has limited voicemail information because voicemail is not part of your phone. It is a separate component with a server and firmware that are purchased by your company. For information on setting up and using your voicemail, see the *User Guide for the Cisco Unity Connection Phone Interface* at <https://www.cisco.com/c/en/us/support/unified-communications/unity-connection/products-user-guide-list.html>.

---

## Check for New Voice Messages

To find out whether you have new voicemail messages, the number of missed calls and voicemail messages is displayed on your screen. If you have more than 99 new messages, a plus (+) sign is displayed.

You will also hear a stutter tone played on the speaker when you use off-hook dialing. This stutter tone is line-specific. You only hear it when you use a line that has voice messages.

### Related Topics

[Self Care Portal](#), on page 14

# Access Your Voicemail Messages

You can check your current voicemail messages or listen to your old messages again.

## Before you begin

Each voicemail system is different so check with your administrator or IT department to find out which system your company uses. This section is for Cisco Unity Connection because most Cisco customers use that product for their voicemail system. But your company may use a different product.

## Procedure

---

- Step 1** Press **Messages**.
  - Step 2** Follow the voice prompts.
-



## CHAPTER 6

# Settings

---

- [Change the Ringtone, on page 51](#)
- [Adjust the Phone Ringer Volume, on page 51](#)
- [Adjust the Volume During a Call, on page 52](#)
- [Phone Display Language, on page 52](#)

## Change the Ringtone

You can change the sound that your phone uses for incoming calls.

### Procedure

---

- Step 1** Select **Settings** > **Preferences** > **Ringtone**.
  - Step 2** Select a line.
  - Step 3** Scroll through the list of ringtones and press **Play** to hear a sample.
  - Step 4** Press **Set** to use the ringtone.
- 

## Adjust the Phone Ringer Volume

If your phone ringer is too loud or too soft when you get an incoming call, you can change the ringer volume. Changes to the ringer volume do not affect the call volume you hear when you are on a call.

### Procedure

---



Press **Volume** up or down to adjust the volume when the phone is not in use.

---

## Adjust the Volume During a Call

If the sound in your handset, headset, or speakerphone is too loud or too soft, you can change the volume while you are listening to the other person. When you change the volume during a call, the change only affects the speaker you're using at the time. For example, if you adjust the volume while you're using a headset, the handset volume doesn't change.

### Procedure



Press **Volume** up or down to adjust the volume while you are on a call.

---

## Phone Display Language

Your phone can display text in many languages. Your administrator sets the language the phone uses. If you want the language changed, contact your administrator.



## CHAPTER 7

# Applications

---

- [Available Applications](#), on page 53
- [View Active Applications](#), on page 53
- [Switch to Active Applications](#), on page 53
- [Close Active Applications](#), on page 54

## Available Applications

Cisco phones don't include these applications by default. But your company might have added applications such as the weather, stock information, company news, to-do lists, or similar information and services.

## View Active Applications

You can easily see what applications you already have open.

### Procedure

---

- Step 1** Press **Settings**.
  - Step 2** Select **Running applications**.
  - Step 3** Press **Exit**.
- 

## Switch to Active Applications

### Procedure

---

- Step 1** Press **Settings**.
- Step 2** Select **Running applications**.
- Step 3** Select a running application and press **Switch to** to open and use the selected application.

**Step 4** Press **Exit**.

---

## Close Active Applications

### Procedure

---

**Step 1** Press **Settings**.

**Step 2** Select **Running applications**.

**Step 3** Select a running application and press **Close app** to close the application.

**Step 4** Press **Close**, then press **Exit**.

---



## CHAPTER 8

# Product Safety and Security

- [Compliance Statements](#), on page 55
- [Cisco Product Security Overview](#), on page 56
- [Important Online Information](#), on page 57

## Compliance Statements

### Compliance Statements for the European Union

#### CE Marking

The following CE mark is affixed to the equipment and packaging.



### Compliance Statements for Canada

This device complies with Industry Canada license-exempt RSS standard(s). Operation is subject to the following two conditions: (1) this device may not cause interference, and (2) this device must accept any interference, including interference that may cause undesired operation of the device. Privacy of communications may not be ensured when using this phone.

This product meets the applicable Innovation, Science and Economic Development Canada technical specifications.

#### Avis de Conformité Canadien

Cet appareil est conforme aux normes RSS exemptes de licence RSS d'Industry Canada. Le fonctionnement de cet appareil est soumis à deux conditions : (1) ce périphérique ne doit pas causer d'interférence et (2) ce périphérique doit supporter les interférences, y compris celles susceptibles d'entraîner un fonctionnement non souhaitable de l'appareil. La protection des communications ne peut pas être assurée lors de l'utilisation de ce téléphone.

Le présent produit est conforme aux spécifications techniques applicables d'Innovation, Sciences et Développement économique Canada.

## FCC Compliance Statements

The Federal Communications Commission requires compliance statements for the following:

### FCC Part 15.21 Statement

Changes or modifications not expressly approved by the party responsible for compliance could void the user's authority to operate the equipment.

### FCC RF Radiation Exposure Statement

This equipment complies with FCC radiation exposure limits set forth for an uncontrolled environment. End users must follow the specific operating instructions for satisfying RF exposure compliance. This transmitter must be at least 20 cm from the user and must not be collocated or operating in conjunction with any other antenna or transmitter.

### FCC Receivers and Class B Digital Statement

This product has been tested and complies with the specifications for a Class B digital device, pursuant to Part 15 of the FCC Rules. These limits are designed to provide reasonable protection against harmful interference in a residential installation. This equipment generates, uses, and can radiate radio frequency energy and, if not installed and used according to the instructions, may cause harmful interference to radio communications. However, there is no guarantee that interference will not occur in a particular installation.

If this equipment does cause harmful interference to radio or television reception, which is found by turning the equipment off and on, the user is encouraged to try to correct the interference by one or more of the following measures:

- Reorient or relocate the receiving antenna
- Increase the separation between the equipment or devices
- Connect the equipment to an outlet other than the receiver's
- Consult a dealer or an experienced radio/TV technician for assistance

## Cisco Product Security Overview

This product contains cryptographic features and is subject to U.S. and local country laws that govern import, export, transfer, and use. Delivery of Cisco cryptographic products does not imply third-party authority to import, export, distribute, or use encryption. Importers, exporters, distributors, and users are responsible for compliance with U.S. and local country laws. By using this product, you agree to comply with applicable laws and regulations. If you are unable to comply with U.S. and local laws, return this product immediately.

Further information regarding U.S. export regulations can be found at <https://www.bis.doc.gov/policiesandregulations/ear/index.htm>.



# Important Online Information

## **End User License Agreement**

The End User License Agreement (EULA) is located here: <https://www.cisco.com/go/eula>

## **Regulatory Compliance and Safety Information**

Regulatory Compliance and Safety Information (RCSI) is located here:

