

Tektronix[®]
COMMITTED TO EXCELLENCE

**DC 509
UNIVERSAL
COUNTER/TIMER
With Options**

INSTRUCTION MANUAL

Tektronix[®]
COMMITTED TO EXCELLENCE

**DC 509
UNIVERSAL
COUNTER/TIMER
With Options**

INSTRUCTION MANUAL

Tektronix, Inc.
P.O. Box 500
Beaverton, Oregon 97077

Serial Number _____

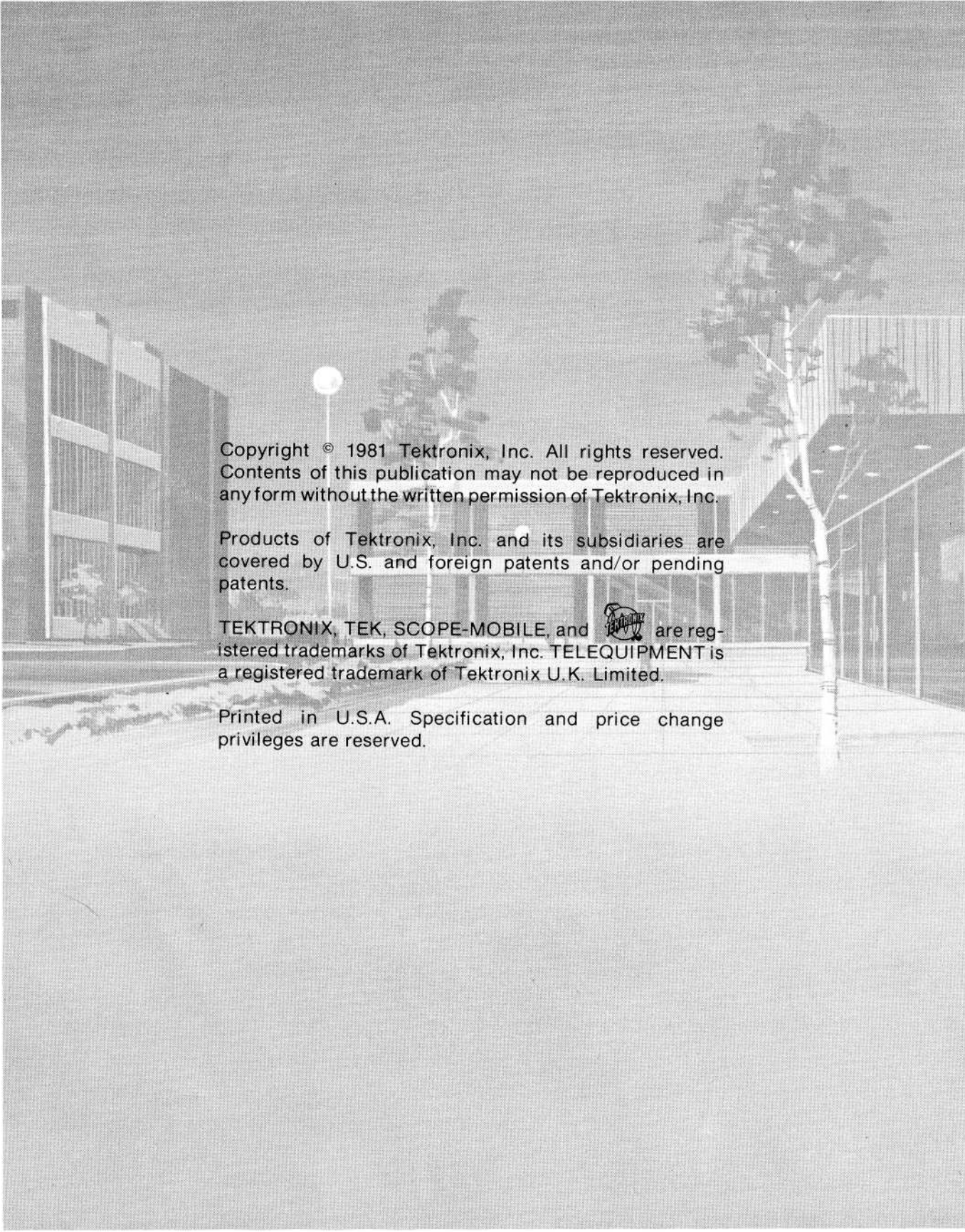

Copyright © 1981 Tektronix, Inc. All rights reserved.
Contents of this publication may not be reproduced in
any form without the written permission of Tektronix, Inc.

Products of Tektronix, Inc. and its subsidiaries are
covered by U.S. and foreign patents and/or pending
patents.

TEKTRONIX, TEK, SCOPE-MOBILE, and  are reg-
istered trademarks of Tektronix, Inc. TELEQUIPMENT is
a registered trademark of Tektronix U.K. Limited.

Printed in U.S.A. Specification and price change
privileges are reserved.

TABLE OF CONTENTS

	Page		Page
LIST OF ILLUSTRATIONS	i	Section 3 Theory of Operation	3-1
OPERATOR'S SAFETY SUMMARY	ii	Section 4 Calibration	4-1
SERVICE SAFETY SUMMARY	iii	Performance Check Procedure	4-1
Section 1 Specification	1-1	Adjustment Procedure	4-17
Section 2 Operating Instructions	2-1	Section 5 Maintenance	5-1
		Section 6 Options	6-1
		Section 7 Replaceable Electrical Parts	7-1
		Section 8 Diagrams and Illustrations	8-1
		Section 9 Replaceable Mechanical Parts	9-1

WARNING

THE FOLLOWING SERVICE INSTRUCTIONS ARE FOR USE BY QUALIFIED PERSONNEL ONLY. TO AVOID PERSONAL INJURY, DO NOT PERFORM ANY SERVICING OTHER THAN THAT CONTAINED IN OPERATING INSTRUCTIONS UNLESS YOU ARE QUALIFIED TO DO SO.

LIST OF ILLUSTRATIONS

Fig. No.	Page	Fig. No.	Page
		4-3	Check setup for Performance Check steps 6, 7, and 8
2-1	iv	4-4	Check setup for Performance Check step 9
2-2	2-2	4-5	Check setup for Performance Check step 10
		4-6	Check setup for Performance Check step 14
2-3	2-4	4-7	Check setup for Performance Check steps 16 and 17
2-4	2-7	5-1	Partial right view of instrument with cover removed (pictorial)
2-5	2-9	5-2	Screw locations for digital circuit board removal
2-6	2-10	5-3	Method of removing magnetic latch relay armature
2-7	2-10	5-4	Typical square pin assembly
2-8	2-11	5-5	Exploded view of circuit board pin and ferrule
2-9	2-11	5-6	Dual entry circuit board pin socket
4-1	2-13	5-7	Bottom entry circuit board pin socket
4-2	4-4	5-8	Orientation and disassembly of multipin connectors
		5-9	Rear interface connector assignments
		5-10	Kernel Signature Analysis connections

OPERATORS SAFETY SUMMARY

The general safety information in this part of the summary is for both operating and servicing personnel. Specific warnings and cautions will be found throughout the manual where they apply, but may not appear in this summary.

TERMS

In This Manual

CAUTION statements identify conditions or practices that could result in damage to the equipment or other property.

WARNING statements identify conditions or practices that could result in personal injury or loss of life.

As Marked on Equipment

CAUTION indicates a personal injury hazard not immediately accessible as one reads the marking, or a hazard to property including the equipment itself.

DANGER indicates a personal injury hazard immediately accessible as one reads the marking.

SYMBOLS

In This Manual



This symbol indicates where applicable cautionary or other information is to be found.

As Marked on Equipment



DANGER — High voltage.



Protective ground (earth) terminal.



ATTENTION — refer to manual.

Power Source

This product is intended to operate from a power module connected to a power source that will not apply more than 250 volts rms between the supply conductors or between either supply conductor and ground. A protective ground connection by way of the grounding conductor in the power cord is essential for safe operation.

Grounding the Product

This product is grounded through the grounding conductor of the power module power cord. To avoid electrical shock, plug the power cord into a properly wired receptacle before connecting to the product input or output terminals. A protective ground connection by way of the grounding conductor in the power module power cord is essential for safe operation.

Danger Arising From Loss of Ground

Upon loss of the protective-ground connection, all accessible conductive parts (including knobs and controls that may appear to be insulating) can render an electric shock.

Use the Proper Fuse

To avoid fire hazard, use only the fuse of correct type, voltage rating and current rating as specified in the parts list for your product.

Refer fuse replacement to qualified service personnel.

Do Not Operate in Explosive Atmospheres

To avoid explosion, do not operate this product in an explosive atmosphere unless it has been specifically certified for such operation.

Do Not Operate Without Covers

To avoid personal injury, do not operate this product without covers or panels installed. Do not apply power to the plug-in via a plug-in extender.

SERVICE SAFETY SUMMARY

FOR QUALIFIED SERVICE PERSONNEL ONLY

Refer also to the preceding Operators Safety Summary.

Do Not Service Alone

Do not perform internal service or adjustment of this product unless another person capable of rendering first aid and resuscitation is present.

Use Care When Servicing With Power On

Dangerous voltages may exist at several points in this product. To avoid personal injury, do not touch exposed connections and components while power is on.

Disconnect power before removing protective panels, soldering, or replacing components.

Power Source

This product is intended to operate in a power module connected to a power source that will not apply more than 250 volts rms between the supply conductors or between either supply conductor and ground. A protective ground connection by way of the grounding conductor in the power cord is essential for safe operation.

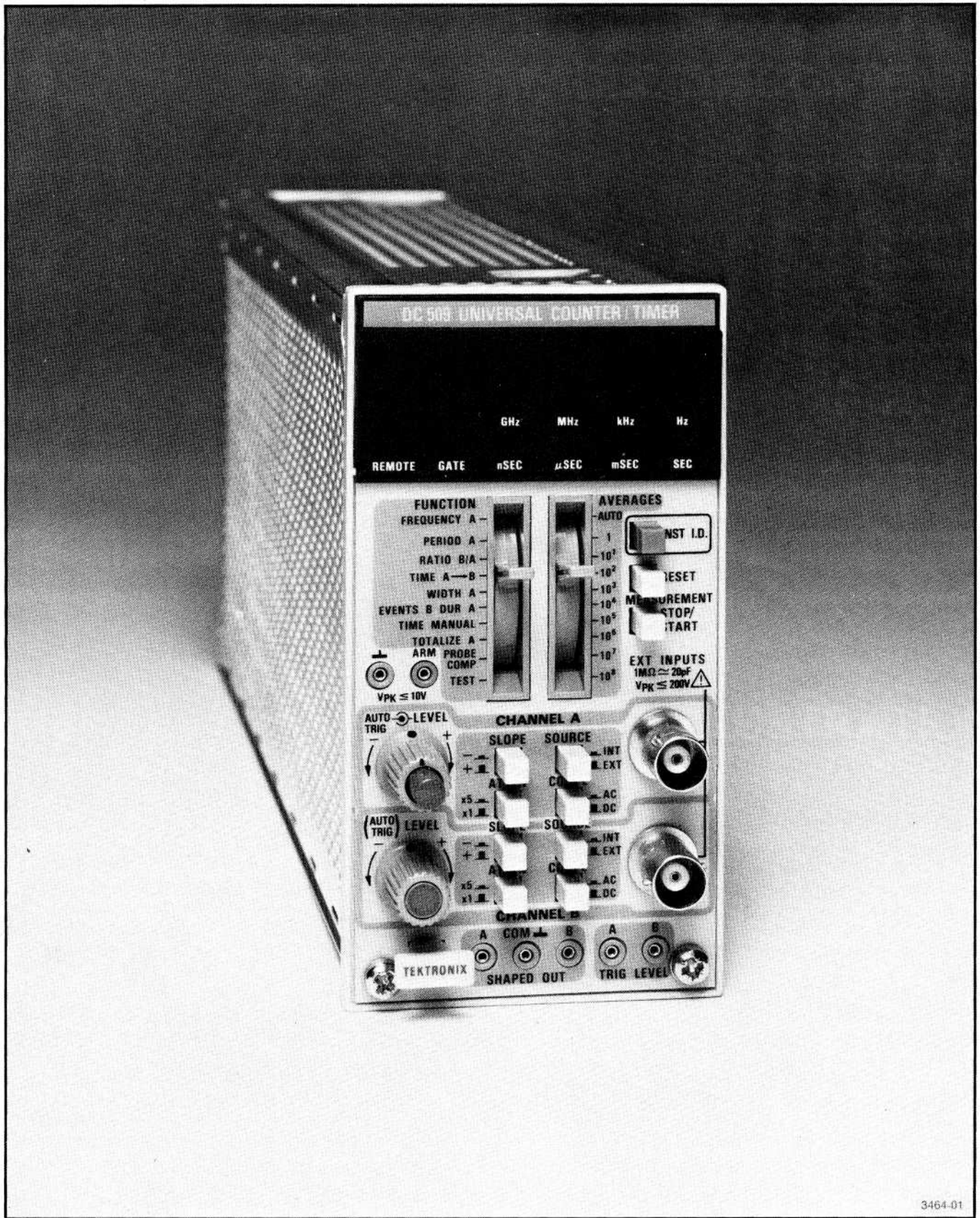

3464-01

DC 509 Universal Counter/Timer

SPECIFICATION

Instrument Description

The DC 509 is a one-wide, universal counter/timer plug-in. It features reciprocal frequency, period, events B during A and Totalize measurements to 135 MHz, time interval and widths features 10 ns single-shot resolution, for timing measurements. For repetitive timing measurements, averaging and pseudo-random time base modulation circuitry provides increased accuracy over a wide range of input signals.

The DC 509 provides trigger level outputs at both the front panel and rear interface for increased measurement convenience. Shaped outputs and an arming input are individually available at either the front panel or the rear interface. Both Channel A and Channel B may also be sourced from either the front panel or the rear interface using the front panel switch.

Measurement results are displayed in an eight-digit LED readout, with the decimal point automatically positioned. The displayed count overflow is indicated by a flashing display. The counter also uses three digits of the seven-segment LED display to indicate internal or operating error codes and two digits for external signal probe compensation results.

The DC 509 can be equipped with an optional, oven controlled, 10 MHz crystal oscillator to obtain a highly stable and precise internal time base.

Instrument Options

Option 01 replaces the internal 10 MHz time base (clock) circuit with a self-contained proportional temperature controlled oven oscillator for increased accuracy and stability.

Standard Accessories

- 1 Instruction Manual
- 1 Cable assembly, bnc-to-tip jack

NOTE

Refer to the tabbed Accessories page at the rear of this manual for more information.

Performance Conditions

The limits stated in the Performance Requirements columns of the following tables are valid only if the DC 509 has been calibrated at an ambient temperature between +20°C and +30°C and is operating at an ambient temperature between 0°C and +50°C, unless otherwise stated.

Information given in the Supplemental Information and Description columns of the following tables is provided for user information only and should not be interpreted as Performance Check requirements.

The DC 509 must be operated or stored in an environment whose limits are described under Environmental Characteristics.

Allow at least 20 minutes warm-up time for operation to specified accuracy, 60 minutes after storage in a high humidity environment.

**Table 1-1
ELECTRICAL CHARACTERISTICS**

Characteristics	Performance Requirements	Supplemental Information
CHANNEL A and CHANNEL B INPUTS		
Input Frequency Range Front Panel(Ext) DC Coupled	$> 0 \text{ Hz to } \geq f_{\text{FUNCTION}}$	See Functions Specifications
AC Coupled	$\leq 10 \text{ Hz to } \geq f_{\text{FUNCTION}}$	
Rear Interface (Int) DC Coupled	$> 0 \text{ Hz to } \geq 50 \text{ MHz.}$	
AC Coupled	$\leq 10 \text{ Hz to } \geq 50 \text{ MHz.}$	
Input Sensitivity X1 Attenuation DC Coupled	$\leq 20 \text{ mV rms (56.6 mV p-p) from } > 0 \text{ Hz to } \geq 100 \text{ MHz.}$ $\leq 40 \text{ mV rms (113 mV p-p) from } 100 \text{ MHz to } \geq f_{\text{FUNCTION}}$	Rms values for Sine Waves from 25 Ω source
AC Coupled	$\leq 20 \text{ mV rms (56.6 mV p-p) from } \leq 10 \text{ Hz to } \geq 100 \text{ MHz.}$ $\leq 40 \text{ mV rms (113 mV p-p) from } 100 \text{ MHz to } \geq f_{\text{function}}$	
X5 Attenuation Accuracy (AC or DC Coupled)		Typically $\leq 5\%$ p-p aberrations. $\leq 2\%$ at DC
Minimum Input Pulse Width	3 ns @ 115 mV p-p.	
Input Dynamic Range		$-3.2 \leq V_{\text{in}} \leq +3.2$
X1		V_{in} p-p $\leq 3 \text{ V.}$ (For Input Signal risetimes $\leq 5 \text{ ns}$)
X5		V_{in} p-p $\leq 15 \text{ V.}$ (For Input Signal risetimes $\leq 5 \text{ ns}$)
Trigger Levels Manual Range	$\geq \pm 3.2 \text{ V.}$	
AUTO TRIG Range	+3.200 to -3.175 V with 25 mV resolution.	
Accuracy		$\pm 15 \text{ mV } \pm 40 \mu\text{V}/^\circ\text{C}$ referenced to 25°C. (Typical)
Auto-Trigger Sensitivity	$\leq 125 \text{ mV p-p times attenuator. } \leq 20 \text{ Hz to } \geq 100 \text{ MHz.}$	Duty cycle independent. Trigger point is set once (each time the button is depressed) to a nominal 50% of the p-p input signal. For signals from DC to 20 Hz the level will still be set between 0% and 100% but will not necessarily be the 50% point.

Characteristics	Performance Requirements	Supplemental Information
CHANNEL A and B INPUTS (cont)		
Trigger Level Output Accuracy	Within ± 10 mV of internal DC trigger level voltage. (Actual triggering voltage is subject to changes in input signal-to-noise ratio and risetime.) See resolution and accuracy statements.	
Maximum Input Voltage Front Panel X1		$V_{pk} \leq 200$ $V_{p-p} \leq 400$, DC to 50 kHz $V_{p-p} \leq 20/f$ MHz, 50 kHz to 1.33 MHz. $V_{p-p} \leq 15$, 1.33 MHz to 150 MHz.
X5		$V_{pk} \leq 200$ $V_{p-p} \leq 400$ DC to 5 MHz. $V_{p-p} \leq 2000/f$ MHz, 5 MHz to 80 MHz. $V_{p-p} \leq 25$, 80 MHz to 150 MHz.
Rear Interface X1, X5		$V_{pk} \leq 3.6$ V.
Input Impedance Front Panel X1, X5	$1\text{ M}\Omega \pm 2\%$, ≤ 30 pF	$(-13\text{ V} \leq V_{in} \leq +13\text{ V}, \text{X1})$ $(-65 \leq V_{in} \leq +65\text{ V}, \text{X5})$
Rear Interface X1, X5	$50\ \Omega \pm 10\%$ @ dc.	
Slope	Independently selectable. (+) for counting positive pulses. (-) for counting negative pulses.	
ARMING INPUT, SHAPED OUTPUTS		
Arming Input		Arming is not recommended for Channel A frequencies ≥ 70 MHz.
Pulse Response	$P_w \leq 100$ ns ($V_H \geq 2.4$, $V_L \leq 0.4$)	Armed when $V_{in} \geq 2.4$. Disarmed when $V_{in} \leq 0.4$ V.
Maximum Safe Input Voltage	$V_{pk} \leq 10$ V.	$I_{in\ low} \approx 3.2$ mA (2 standard TTL loads)
Shaped Outputs Delay from front panel		13 ns typically
Amplitude	0 to $\geq +0.3$ V from $50\ \Omega$ ground referenced source.	
Risetime		3 ns into $50\ \Omega$ (typical)

Table 1-1 (cont)

Characteristics	Performance Requirements	Supplemental Information
FUNCTIONS		
FREQUENCY A Range	$\leq 100 \mu\text{Hz}$ to $\geq 135 \text{ MHz}$	
Resolution		$\pm \text{LSD} \pm 1.4 \times \text{Trigger Jitter Error}/N \times (\text{Freq A})^2$
Accuracy		Resolution \pm (Timebase Error X Frequency)
PERIOD A Range	$\leq 7.40 \text{ ns}$ to $\geq 3.05 \text{ hours}$.	
Repetition Rate	$\geq 135 \text{ MHz}$	
Clock Period Counted		10 ns
Resolution		$\pm \text{LSD} \pm 1.4 \times \text{Trigger Jitter Error}/N$
Accuracy		Resolution \pm (Timebase Error X Period A)
RATIO B/A Range	10^{-7} to 10^8	Averaged by A
Frequency Range CH A	≥ 0 to $\geq 135 \text{ MHz}$	
CH B	≥ 0 to $\geq 125 \text{ MHz}$	
Resolution		$\pm \text{LSD} \pm 1.4 \times \text{B Trigger Jitter Error} \times \text{FREQ B}/N$
Accuracy		Same as Resolution.
TIME A-B Range	$\leq 15 \text{ ns}$ (10 ns typical) to $\geq 3.05 \text{ hours}$	
Resolution		$\pm \text{LSD} (\pm \text{CH A Trigger Jitter Error} \pm \text{CH B Trigger Jitter Error}) \sqrt{\quad}$. Usable resolution $\leq 5 \text{ ps}$
Accuracy		Resolution \pm (Timebase Error X TI) + (CH B Slew Rate Error - CH A Slew Rate Error) \pm Channel Delay Mismatch
Clock Period Counted		10 ns
Channel Delay Mismatch		
External Input (Front)	$\leq 2 \text{ ns}$	
Internal Input (Rear)		$\leq 3 \text{ ns}$
Minimum Dead Time (Time B-A)	15 ns (10 ns typical)	

Table 1-1 (cont)

Characteristics	Performance Requirements	Supplemental Information
FUNCTIONS (cont)		
EVENTS B DUR A Range	10^{-7} to 10^8	Averaged by A
Maximum B Frequency	125 MHz	
Minimum A Pulse Width	15 ns (10 ns typical).	
Minimum Time Between A Pulses	15 ns	
Minimum Time Between A Start Edge and first B Event	15 ns (7 ns typical)	
Resolution		
Accuracy		$\text{Resolution} + \text{FREQ B (Stop Slew Rate Error} - \text{Start Slew Rate Error)}$
WIDTH A Range	≤ 15 ns (10 ns typical) to ≥ 3.05 hours.	
Resolution		$\pm \text{LSD} + (\pm \text{Start Trigger Jitter Error} \pm \text{Stop Trigger Jitter Error})/\sqrt{N}$
Accuracy		$\text{Resolution} \pm (\text{Timebase Error X Width}) + (\text{Stop Slew Rate Error} - \text{Start Slew Rate Error}) \pm 5$ ns (2 ns typical)
Clock Period Counted		10 ns
Minimum Dead Time Between Pulses	15 ns (10 ns typical).	
Time Manual Range	0 to 3.05 hours.	Electronic Stopwatch—accumulates time from Start until Stop.
Resolution	$\pm \text{LSD}$	
Accuracy	$\pm \text{Resolution} \pm (\text{Timebase Error X TIME})$	
LSD	100 ms	
TOTALIZE A Range	0 to 2^{40} (1.09×10^{12}) Counts	Accumulates A events from Start to Stop
Repetition Rate	> 0 to ≥ 135 MHz	
Display Scaling	Displayed Result = A EVENTS/N Where N = 1, 10, 10^2 to 10^8 selected by the AVERAGES control. In AUTO, N = 1.	

Table 1-1 (cont)

Characteristics	Performance Requirements	Supplemental Information
FUNCTIONS (cont)		
Probe Comp	Displays 0 or 1 for each channel 0—Under Compensated 1—Over Compensated	Requires external square wave signal of ≈ 2 V amplitude at the counter input. Frequency should be ≈ 1 kHz.
Accuracy		\leq Probe Atten. X 50 mV X 100 (%) / V_{in} at Probe Accuracy (2.5% nominal for X5 probe with 10 V p-p at the probe.

Resolution and Accuracy
Definitions

$$\text{Trigger Jitter Error (Seconds RMS)} = \frac{\sqrt{[(e_{n1})^2 + (e_{n2})^2]} (V \text{ rms})}{\text{Input} \mid \text{Slew Rate} \mid \text{at Trigger Point (V/S)}}$$

Where e_{n1} = 120 μ V rms typical Counter Input Noise
 e_{n2} = V rms Noise Voltage of Input signal at Trigger Point measured with a 150 MHz bandwidth.

$$\text{Slew Rate Error (Seconds)} = \frac{\text{Input Hysteresis}/2 (V)}{\text{Input} \mid \text{Slew Rate} \mid \text{at Trigger Point (V/S)}}$$

Note: Input hysteresis is typically 20 mV p-p.

N = Number of Averages

The minimum number of averages is selected by the AVERAGES control in decade steps from 1 to 10^8 . At Channel A repetition rates above approximately 250 Hz the actual number of averages will be:

$$N \approx [\text{FREQ A (Hz)} \times 4 \text{ mSec}] + \text{AVERAGES setting}$$

$$N = \text{AVERAGES setting (below 250 Hz)}$$

In the AUTO mode the counter measures with a fixed measurement time of about 300 ms.

$$N (\text{auto}) \approx \text{FREQ A (Hz)} \times 0.3 \text{ seconds.}$$

N is always ≥ 1 .

LSD: (Rounded up the nearest decade)

FREQUENCY A	$(\text{Freq A})^2 / (N \times 10^8)$
PERIOD A	10 ns/N
RATIO B/A	Freq A / (Freq B X N)
TIME A-B	10 ns / \sqrt{N}
WIDTH A	10 ns / \sqrt{N}
EVENTS B DUR A	Period B X (EVENTS B DUR A) / (Width A \sqrt{N})

Time Base Error is the sum of all errors specified for the time base used.

MEASUREMENT TIMING		
Minimum Display Time		100 ms (typical)
Auto Averages Measurement Time		300 ms (typical)

Table 1-1 (cont)

Characteristics	Performance Requirements	Supplemental Information
INTERNAL TIME BASES		
Standard Time Base Frequency (at calibration)	10 MHz $\pm 1 \times 10^{-7}$	
Error Terms Temperature Stability (0°C to +50°C)	$\leq 5 \times 10^{-6}$	<i>5 ppm 2.5 ppm 1 ppm</i>
Aging	$\leq 1 \times 10^{-6}$ /year	
Adjustment Resolution	$\pm 1 \times 10^{-7}$ or better	
Option 01 Time Base Frequency (at calibration)	10 MHz $\pm 2 \times 10^{-8}$	
Error Terms Temperature Stability (0°C to +50°C)	$\pm 2 \times 10^{-7}$ after warmup.	<i>± 1.22 ppm</i>
Warmup Time	Within $\pm 2 \times 10^{-7}$ of final frequency in less than 10 minutes when cold started at 25°C ambient.	
Aging At time of shipping	1×10^{-8} /day maximum.	
After 30 days of continuous operation	4×10^{-8} /week maximum.	
After 60 days of continuous operation	1×10^{-6} /year maximum.	
Short Term Stability		$\leq 1 \times 10^{-9}$ rms based on 60 consecutive second measurements.
Adjustment Resolution	$\pm 2 \times 10^{-8}$ or better.	
Adjustment Range		Sufficient for 8 years of aging.

Table 1-2
MISCELLANEOUS

Characteristics	Description
Typical Power Consumption at 25°C and nominal ac line voltage DC 509	TM 500 Series Mainframes ≈ 11.1 W.
Option 01	≈ 14.5 W.
MTBF (Calculated) DC 509	10,512 hours @ 25°C
Recommended Calibration Interval	2000 hours or 6 months whichever occurs first.

Table 1-3
ENVIRONMENTAL^a

Characteristics	Description
Temperature Operating Non-operating	Meets MIL-T-28800B, class 5. 0°C to +50°C –55°C to +75°C
Humidity	Exceeds MIL-T-28800B, class 5. 95% HF, 0°C to 30°C 75% HF to 40°C 45% HF to 50°C
Altitude Operating Non-operating	Exceeds MIL-T-28800B, class 5. 4.6 Km (15,000 ft.) 15 Km (50,000 ft.)
Vibration	Meets MIL-T-28800B, class 5, when installed in qualified power modules. ^b 0.38 mm (0.015") peak-to-peak, 5 Hz to 55 Hz, 75 minutes
Shock	Meets MIL-T-28800B, class 5 when installed in qualified power modules. ^b 30 g's (1/2 sine) 11 ms duration, 3 shocks in each direction ^d along 3 major axes, 18 total shocks.
Bench Handling ^c	Meets MIL-T-28800B, class 5, when installed in qualified power modules. ^b 12 drops from 45°, 4" or equilibrium whichever occurs first.
Transportation ^c	Qualified under National Safe Transit Association Preshipment Test Procedures 1A-B-1 and 1A-B-2.
EMC ^e	Within limits of F.C.C. regulations, Part 15, Subpart J, Class A; VDE 0871 and MIL-461A tests RE01, RE02, CE01, CE03, RS01, RS03, CS01, and CS02, with exceptions. ^f Unused plug-in compartments must be covered with a blank plug-in.
Electrical Discharge	20 kV maximum charge applied to instrument case.

^a With power module.

^b Refer to TM 500/5000 power module specifications.

^c Without power module.

^d Requires retainer clip in plug-in exit direction.

^e System performance subject to exceptions of power module or other individual plug-ins.

^f Within 20 dB of RE02 limits at 100, 300, 350, 400, and 600 MHz. Within 30 dB of RE02 limits at 150 and 200 MHz.

Table 1-4
PHYSICAL CHARACTERISTICS

Characteristics	Description
Finish	Plastic-aluminum laminate front panel. Anodized aluminum chassis.
Net Weight DC 509 Option 01	2 lbs., 4 oz. 2 lbs., 8 oz.
Maximum Overall Dimensions Height Width Length	≈ 126.0 mm (4.96 inches). 66.8 mm (2.63 inches). 296.6 mm (11.68 inches).
Enclosure Type and Style per MIL-T-28800B Type Style	III E (style F in rackmount power modules)

OPERATING INSTRUCTIONS

FRONT PANEL OPERATION

INTRODUCTION

First Time Inspection

Inspect the instrument for visible damage (dents, scratches, etc.). Keep the original shipping container and packing material for future use. If the instrument is damaged, notify the carrier and the nearest Tektronix Service Center or representative.

Repackaging for Shipment

Should it become necessary to return the instrument to a Tektronix Service Center for service or repair, attach a tag to the instrument showing the owner (with address) and the name of the individual to be contacted, complete instrument serial number, option number, and a description of the service required.

If the original container and packaging material is unfit for use or not available, repackage the instrument as follows:

1. Obtain a carton of corrugated cardboard having inside dimensions no less than six inches more than the instrument dimensions; this will allow for cushioning. The shipping carton test strength for your instrument is 200 pounds.
2. Surround the instrument with polyethylene sheeting to protect the finish.
3. Cushion the instrument on all sides by tightly packing dunnage or urethane foam between carton and instrument, allowing three inches on all sides.
4. Seal the carton with shipping tape or industrial staples.
5. Mark the shipping carton "FRAGILE INSTRUMENT" to indicate special handling.

Operating and Non-Operating Environments

The instrument may be operated, stored, or shipped within the environmental limits stated in the Specification section of this manual. However, the counter should be protected at all times from temperature extremes which can cause condensation to occur within the instrument.

PREPARATION FOR USE

Rear Interface Considerations

A slot between pins 21 and 22 on the rear connector identifies this instrument as a member of the TM 500 counter family. If you desire to use your counter to build a system, insert a family barrier key (Tektronix Part No. 214-1593-02) in the corresponding position of the selected power module jack in order to prevent plug-ins belonging to a different family from being used in that compartment of the power module.

WARNING

To avoid electric shock, disconnect the power module power cord before inserting the family barrier key in the power module jack. Refer the barrier key insertion to qualified service personnel.

The DC 509 has the following rear interface input and output features:

- CH A and CH B Inputs
- Trigger Level Outputs (CH A and CH B)
- Shaped Outputs (CH A and CH B)
- Measurement Gate Output
- Arming Input
- 10 MHz Clock Output
- External Clock Input (1, 5, 10 MHz)
- Prescaler Function
- Reset Input

NOTE

Rear interface information will be found in the Maintenance section of this manual. Refer the interface connections to qualified service personnel.



To prevent damage to the instrument, turn the power module off before installation or removal from the power module. Do not use excessive force to install or remove the instrument from the power module.

Installation and Removal

NOTE

Refer to the Operator's Safety Summary in the front of this manual before installing this instrument in the power module.

Check to see that the plastic barrier keys on the interconnecting jack of the selected power module compartment match the cutouts in the rear interface connector for the counter. If they do not match, do not insert the counter until the reason is investigated.

If the cutouts and barrier keys match, align the chassis of the counter with the upper and lower guides of the selected compartment. See Fig. 2-1. Insert the counter into the compartment and press firmly to seat the rear interface connector. Apply power by operating the POWER switch on the power module.

Refer to the power module instruction manual and make sure that the line selector block is positioned correctly for the line voltage in use. Check the counter and the power module for the proper fuses. Be certain that the power plug for the power module has the proper grounding conductor.

To remove the counter from the power module, turn off the POWER switch, pull the release latch knob (located in the lower left front corner) until the interconnecting jack disengages. Pull the counter straight out of the power module compartment.

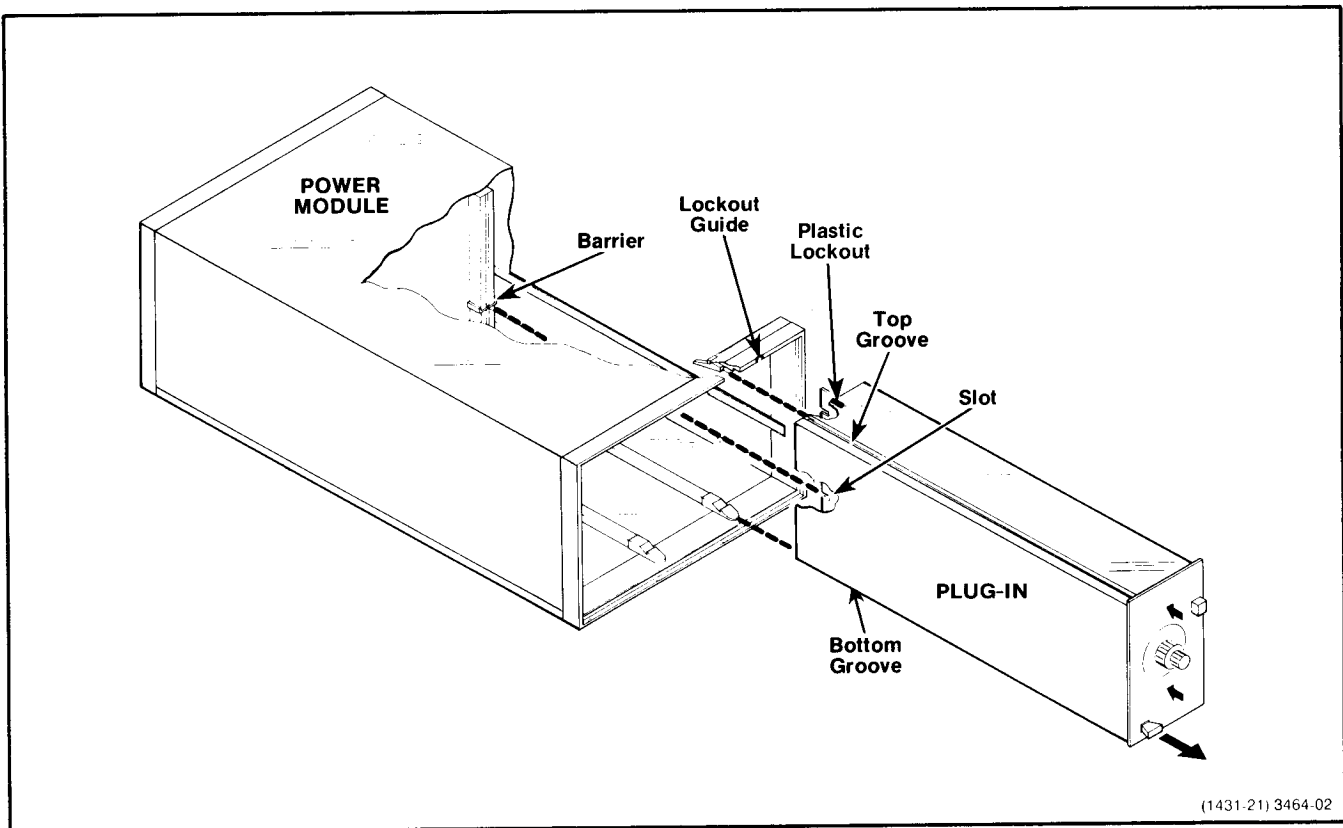

(1431-21) 3464-02

Fig. 2-1. Plug-in installation and removal.

FRONT PANEL DISPLAY, CONTROLS AND CONNECTORS

Display

The display contains eight seven-segment LEDs and six annunciators. All measurement results are displayed with the best possible resolution. The readout (result) for the measurement is always displayed in a right-hand justified format with the decimal point automatically positioned. Displayed count overflow is indicated by a flashing display.

Four of the annunciators are used to indicate the units of measurements: Hz/SEC for Hertz or seconds, kHz/mSEC for kilohertz or milliseconds, MHz/ μ SEC for megahertz or microseconds, and GHz/nSEC for gigahertz or nanoseconds.

The GATE annunciator, when illuminated, indicates that the counter is in the process of accumulating counts for the measurement. The REMOTE annunciator is not used in the DC 509.

In addition to displaying the measurement results the counter uses a three-digit, seven-segment LED display to indicate internal or operating error codes, and two digits to report the results of compensating an external signal probe. See Self Test Display and Probe Compensation.

Controls and Connectors

The following information is a brief functional description of the front panel controls and connectors. These items are referenced by number (see Fig. 2-2) and described as follows:

FUNCTION—a lever switch used to select the following measurement and special purpose functions for the counter:

- | | |
|--------------------|--|
| FREQUENCY A | Measures CHANNEL A signal period and converts result to frequency units. |
| PERIOD A | Measures CHANNEL A signal period and displays answer in units of time. |
| RATIO B/A | Measures and displays the ratio of signal events occurring on Channel B to the signal events occurring on Channel A. The decimal point is appropriately located for the selected number of averages chosen for the Channel A signal. |

TIME A-B Measures the time interval between the triggering event on Channel A to the succeeding triggering event on Channel B and displays answer in units of time.

WIDTH A Measures the time interval between the triggering point on the leading edge of a pulse applied to Channel A to the corresponding triggering point on the trailing edge of the same pulse. Polarity of the leading edge is selected by the CHANNEL A SLOPE pushbutton. Answer displayed in units of time.

EVENTS B DUR A Counts and displays the number of triggering events (pulses) applied to Channel B during a preselected gating interval applied to Channel A. Polarity of the leading edge of the Channel A gating interval selected by the CHANNEL A SLOPE pushbutton.

TIME MANUAL A stop watch function. Measures and displays the time interval (to the nearest one-tenth of a second) between two successive depressions of the MEASUREMENT STOP/START pushbutton. Time count may be reset to zero and restarted immediately by pressing and then releasing the RESET pushbutton while in the start mode.

TOTALIZE A This mode of operation is essentially the same as TIME MANUAL, except that the events counted are the triggering events (pulses) on Channel A rather than the internal clock. For this function the position of the AVERAGES lever switch can be used as a power-of-ten scaling factor, effectively increasing the number of displayable digits.

PROBE COMP A probe compensation function. This function allows the operator to use the counter display to adjust the frequency response of signal probes. The most significant digit is the indicator for a probe connected to CHANNEL A input, the least significant digit for a CHANNEL B probe.

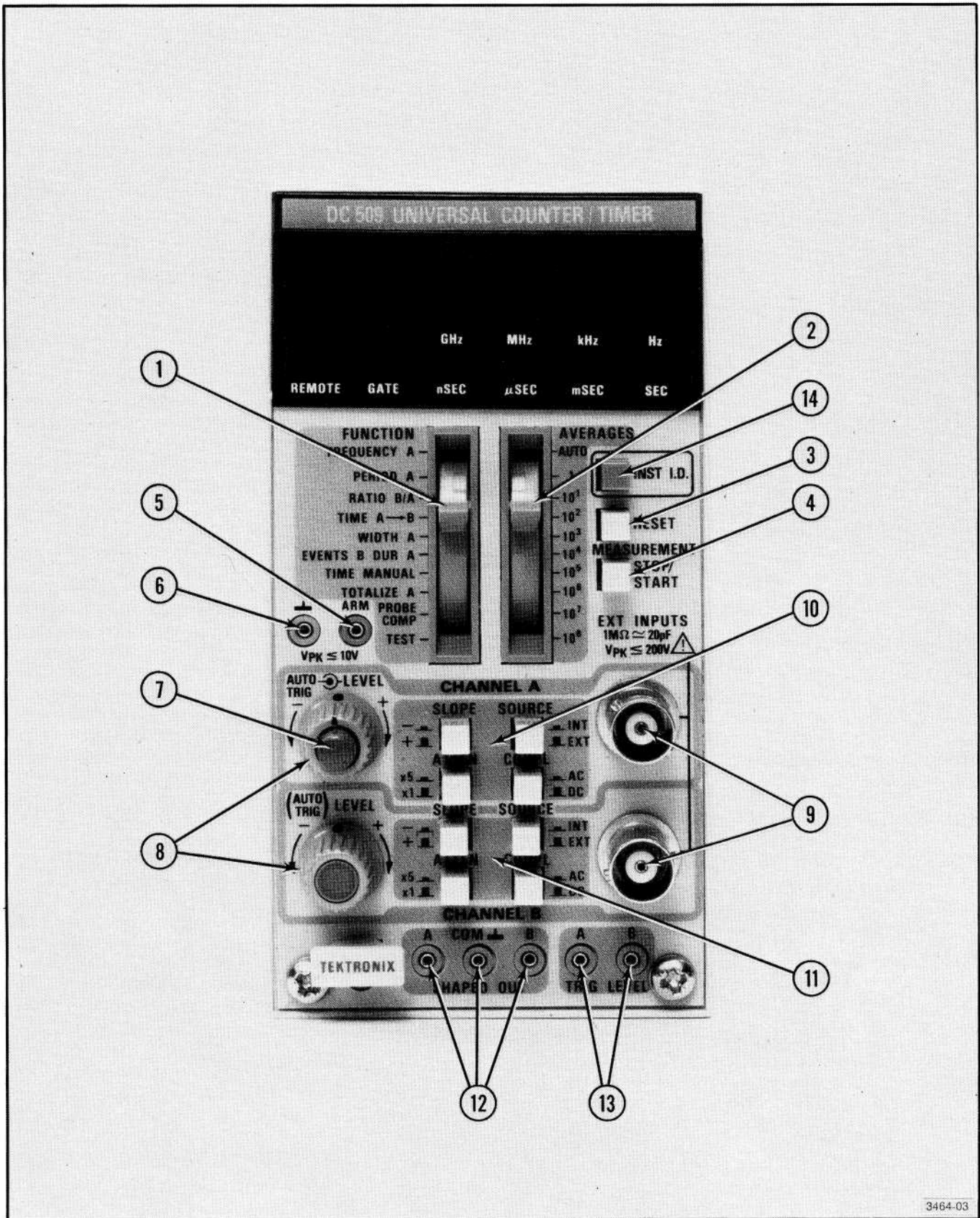

3464-03

Fig. 2-2. DC 509 front panel display, controls, and connectors.

TEST A self-test function. This mode checks the functionality of the program memory, the internal data paths, and the integrity of the internal counters.

AVERAGES—a lever switch used to select the number of Channel A signal events over which the count is to be averaged. Changing the position of this switch automatically resets the counter.

AUTO This position provides the best resolution possible with a measurement gate time of approximately 300 ms.

1—10⁶ As the switch is changed from the 1 position to the 10⁶ position, the counter displays the averaged measurement result accumulated over more and more cycles of the Channel A input signal. For example, a 1 MHz signal input and a setting of 10⁶ results in a measurement time interval of at least one second (10⁷; for at least 10 seconds, etc.). For the TOTALIZE A function the AVERAGES control allows scaling of the display in decade steps. For example, with a setting of 10⁶, the least significant digit will increment every one million events. However, the exact number of events may still be seen by changing the AVERAGES switch to 1. If the number is larger than eight digits, the display will flash to indicate overrange. This allows totalizing to more than thirteen digits.

NOTE

The 1 position of the AVERAGES switch is used for single-shot measurements (measurement for the selected FUNCTION is averages for at least one event). The AVERAGES switch has no effect in the TIME MANUAL, PROBE COMP, and TEST functions.

MEASUREMENT RESET—Holding this pushbutton in aborts the current measurement process for all selected functions and causes all digits in the display to read 8.8.8.8.8.8.8.8. All six annunciators are also illuminated. When this pushbutton is released, a new measurement process is initiated for the selected FUNCTION and operating conditions. If a TIME MANUAL or TOTALIZE A measurement has been stopped by the MEASUREMENT STOP/START pushbutton, pressing MEASUREMENT RESET causes the previous measurement to be reset to zero, but does not start a new measurement.

MEASUREMENT STOP/START—used to start and stop the measurement process for all operating modes except the TEST and PROBE COMP functions. The current measurement process is aborted for the STOP mode (GATE annunciator not illuminated) and a new measurement process generated for the START mode (GATE annunciator on). The STOP mode does not reset the accumulated count. Changing the FUNCTION switch while in the STOP mode causes the counter to enter the START mode.

ARM—a tip jack input normally at a TTL high level. When set to a TTL low state the counter is prevented from making a measurement until the input goes to a TTL high state.

⏏ —Arming input ground, tip jack connected to chassis (frame) ground.

AUTO TRIG—used to automatically set the triggering levels of both channels to their mid point values; (maximum value + minimum value)/2. The levels are set each time the AUTO TRIG button is pressed after having been released (out). When released (out), the triggering levels are returned to the values set by each individual LEVEL control.

LEVEL—controls used to adjust the triggering level for Channel A and Channel B.

EXT INPUTS—bnc connectors for Channel A and Channel B input signals.

CHANNEL A SLOPE, SOURCE, ATTEN, and COUPL—pushbuttons that select the positive (+) or negative (−) SLOPE of the input signal, the front panel (EXT) or rear interface (INT) input SOURCE, attenuation (ATTEN, X1 or X5), and the AC or DC coupling (COUPL) modes for the Channel A input amplifier.

CHANNEL B SLOPE, SOURCE, ATTEN, and COUPL—pushbuttons that select the positive (+) or negative (−) SLOPE of the input signal, the front panel (EXT) or rear interface (INT) input SOURCE, attenuation (ATTEN, X1 or X5), and the AC or DC coupling (COUPL) modes for the Channel B input amplifier.

SHAPED OUT (A, B, with COM)—tip jack outputs that provide an exact replica of the internal signals being used for the measurement. Used as an aid to proper triggering on complex waveforms. COM tip jack connected to chassis.

TRIG LEVEL (A, B)—tip jack outputs that provide the dc levels from Channel A and Channel B that correspond to the actual internal triggering levels set by the LEVEL controls. Use SHAPED OUT COM as ground.

INST ID—blanks the DC 509 display when pressed.

OPERATORS FAMILIARIZATION

INTRODUCTION

General Operating Characteristics

The DC 509 is a universal counter based on a microprocessor system. The counter is capable of eight measurement functions with full eight-digit resolution, plus two specialized functions; probe compensations (PROBE COMP) and self-test (TEST).

The microprocessor system automatically sets the measurement gate interval, performs the necessary calculations on the acquired data, and causes the result to be displayed with the best possible resolution for the selected measurement FUNCTION, number of averages (AVERAGES), and operating conditions.

Self Test Display

When power is applied, one of the error codes listed in Table 2-1 may appear in the display window if the counter fails its self-test routine. Refer the error code condition to qualified service personnel.

NOTE

At power up, a signal with a large dc offset voltage connected to the input terminals for either channel may cause the entire input signal to be outside the triggering level range. If this condition exists, an error code may be displayed. Disconnect all inputs or reduce the offset and reapply power. This error condition can also be caused by low level ARM input signal during power up.

Table 2-1

POWERUP AND TEST FUNCTION ERROR CODES

Displayed Error Code	Error Condition
000	No error, passed self-test routine. Displayed while in TEST function.
320 through 326	Channel A failure.
330 through 336	Channel B failure.
340	RAM test failure (power up only)
361	ROM placement (location) error.
381	ROM checksum error.

NOTE

Refer error code conditions to qualified service personnel.

INPUT CONSIDERATIONS

Maximum Safe Input Voltage Limits



To avoid instrument damage, make certain that the input voltages to the front panel connectors or rear interface inputs do not exceed their specified limits. See Specification section.

The outer shell of the front panel bnc connectors is connected to earth ground through the ground connection for the power module power cord. Do not allow the active lead of the input signal connection to touch these outer shells.

Always use a step-down isolation transformer (less than 15 V output) when measuring power line frequencies (50 or 60 Hz).

Be careful with high-frequency, high-amplitude signals (above 80 MHz). The front panel maximum safe input voltage at these high frequencies is 25 V, peak-to-peak.

Connecting External and Internal Signal Sources

The DC 509 can be used to measure input signals to either channel from the front panel or the rear interface. Pushing a SOURCE switch selects the rear interface input (INT). The SLOPE, ATTEN, and COUPL pushbuttons are effective in conditioning the signal from either source.

If a high impedance signal probe is to be used between the front panel bnc connectors and the measurement source, use a probe capable of compensating for the input capacitance of the counter (less than 30 pF). A high impedance probe such as the TEKTRONIX P6125, is recommended for all digital logic applications.

The counter retains the last reading when the input signal source is disconnected. Reconnecting the signal source causes the counter to update its display with new data. This feature is especially convenient when using a probe in crowded circuits.

MEASUREMENT CONSIDERATIONS

Input Coupling, Noise, and Attenuation

You can use either the ac coupling (AC COUPL) or dc coupling (DC COUPL) mode to couple the input signal to the CH A or CH B input amplifiers. If the signal to be measured is riding on a dc level, its amplitude limits may not fall within the triggering level range. The AC COUPL mode should be used for repetitive signals having a fixed frequency and a constant duty cycle when they are riding on a large dc level. SLOPE selection is relatively unimportant when measuring sine-wave frequencies.

If the signal duty cycle changes during a measurement, the triggering point will shift, possibly causing erroneous results. Use the DC COUPL mode for low frequency ac signals without large dc offset, signals with a low duty cycle, and during time interval measurements.

Noise may be coupled to the input amplifiers along with the signal to be measured. Noise may originate from the operating environment, the signal source, or be caused by improper connections. If the noise is of sufficient amplitude, it can result in inaccurate measurements due to false triggering. Using an external attenuator may solve the problem. See Fig. 2-3.

The input dynamic range specification describes the largest amplitude signal with a risetime or falltime less than about 5 ns that will not cause ringing and distortion internal to the counter. This is primarily of concern in TIME A-B when measuring rise or fall times. Ringing may cause mistriggering near the positive or negative peaks of the signal.

The minimum signal amplitudes are defined by the input sensitivity requirements for the AC COUPL and DC COUPL modes (see Specification section). Proper use of the ATTEN (attenuation) controls will ensure operation within the maximum limits; ± 3.2 V for X1 ATTEN, ± 16 V for X5 ATTEN.

Triggering the Counter

The dc triggering level is determined by the SLOPE and LEVEL controls, or by the AUTO TRIG switch concentric with the CHANNEL A LEVEL control.

The manual LEVEL controls are used to adjust the triggering hysteresis window continuously up or down through a ± 3.2 V range. The hysteresis window is typically 20 mV (peak-to-peak) for low frequency signals, 40 mV (peak-to-peak) for high frequency signals. The + and - areas designated for the LEVEL controls provide only a coarse indication of the trigger level setting. To determine a more accurate trigger level, measure (or use the LEVEL controls to set) the internal dc level at the TRIG LEVEL output tip jacks.

NOTE

The actual triggering level is subject to changes in the input signal-to-noise ratio, duty cycle changes (AC COUPL) and risetime.

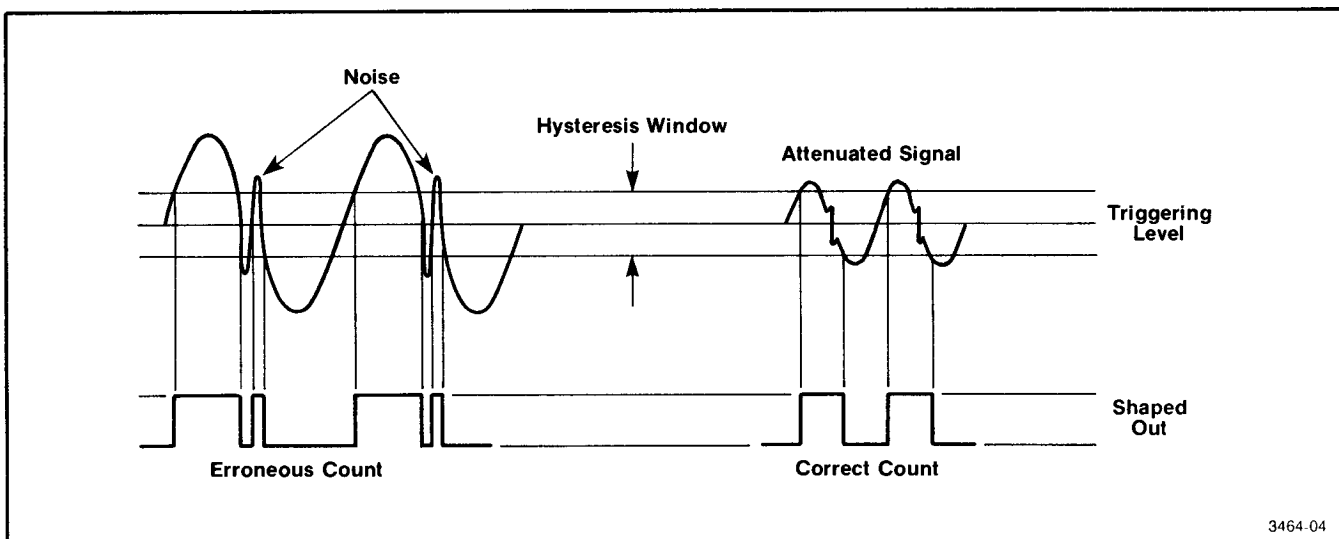

Fig. 2-3. Advantages in signal attenuation.

When the AUTO TRIG mode is depressed (in), the microprocessor performs a software routine to determine the maximum and minimum peak voltage values of the input signal and automatically sets the triggering levels for **both** channels to the midpoint (median) value. These values are maintained until the AUTO TRIG button is depressed again (out-manual level control) or depressed twice (in) to initiate another AUTO TRIG. The AUTO TRIG mode is useful when making pulse width measurements (WIDTH A function) at the 50% level, or when the triggering level is not critical, as is usually the case in FREQUENCY A, PERIOD A, RATIO B/A, and TOTALIZE A.

The use of AUTO TRIG does not reduce the need to consider input noise amplitudes, coupling modes, and attenuation factors. Large amounts of overshoot and ringing of the input signal may cause erroneous measurements due to an undesirable level setting. The median value of the input signal may be measured at the TRIG LEVEL outputs. For midpoint settings, the low frequency limit for the AUTO TRIG mode is 20 Hz. Below 20 Hz, the automatic triggering level will still be set, but not necessarily at the midpoint.

Figure 2-4 illustrates typical trigger level settings and shows the importance of setting trigger levels properly in order to avoid errors due to input signal risetimes (falltimes), or where the transition times of the start and stop pulses are different, or just slow. Observation of the SHAPED OUT signals on an oscilloscope while setting the trigger levels can aid in reducing trigger errors.

NOTE

The ARM input signal must be high when the AUTO TRIG routine is being executed.

Reducing Measurement Errors

As an aid in reducing measurement errors, keep in mind the following factors:

- Use the proper ATTEN controls and high impedance attenuator type probes when measuring signals from high impedance circuits.
- Consider trigger errors caused by input signals with slow rise or falltimes.
- Average the measurement over a larger number of cycles of the input signal (greater number of AVERAGES).
- Maintain the counter environment at a constant temperature.

- Apply a 1 MHz, 5 MHz, or 10 MHz external time reference standard (NBS) to the rear interface inputs.
- Recalibrate, if necessary.

MEASUREMENT EXAMPLES

Frequency A and Period A

When the counter is in either the FREQUENCY A or PERIOD A modes, it always measures the period of the Channel A input signal. For FREQUENCY A, the microprocessor computes the frequency as

$$f = \frac{1}{T} (T = \text{period})$$

and displays the answer in frequency units. For PERIOD A, the answer is displayed in units of time. See Fig. 2-5 for measurement examples.

Ratio B/A

In RATIO B/A mode, the counter measures the number of events on both channels during the time it takes to accumulate the selected number of Channel A events (averaged by A events). The total number of Channel B events is then divided by the total number of Channel A events and the answer displayed without units of time or frequency.

The ratio range is from 10^{-7} to 10^8 . Applying the higher frequency to Channel B produces a ratio greater than one; applying the lower frequency to Channel B produces a ratio less than one. For best resolution with large ratios, apply the higher frequency signal to Channel B.

Width A and Time A-B (Time Interval)

Figure 2-6 illustrates measurements for the WIDTH A and TIME A-B functions. The WIDTH A function measures the time interval between the first selected positive or negative edge (\pm SLOPE) of the waveform applied to Channel A and the next opposite polarity edge.

The TIME A-B function measures the time interval between the first selected edge (\pm SLOPE) of an event on Channel A to the first selected edge (\pm SLOPE) of an event on Channel B. The measurement can be averaged (AVERAGES) by the selected number of Channel A events because there is one Channel B event per Channel A event.

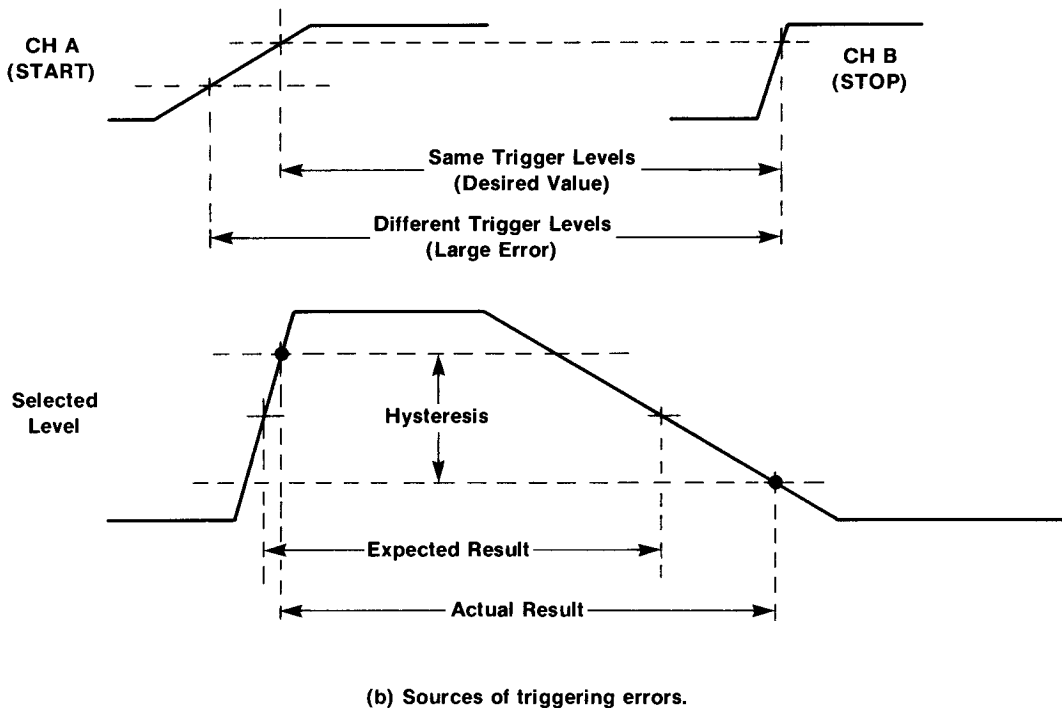
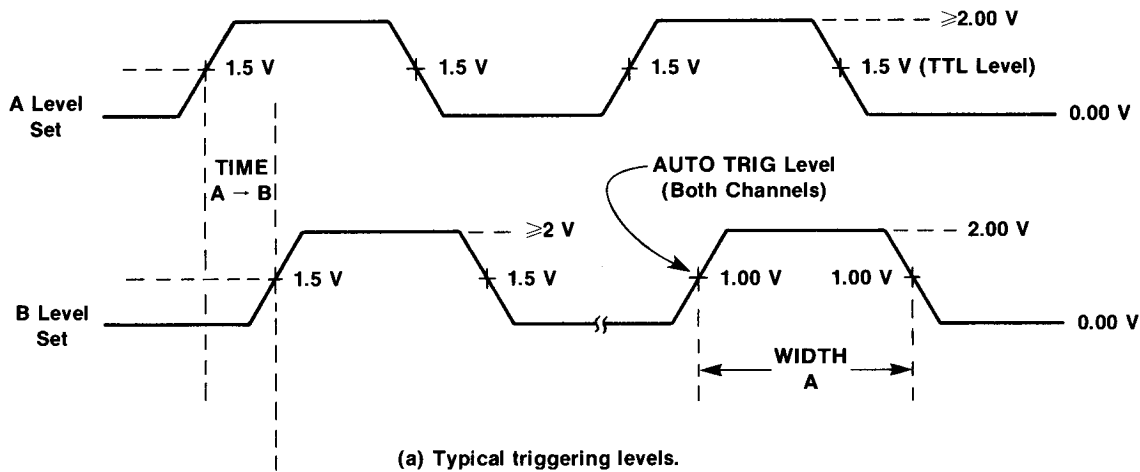

3464.05

Fig. 2-4. Typical triggering levels and sources of triggering errors.

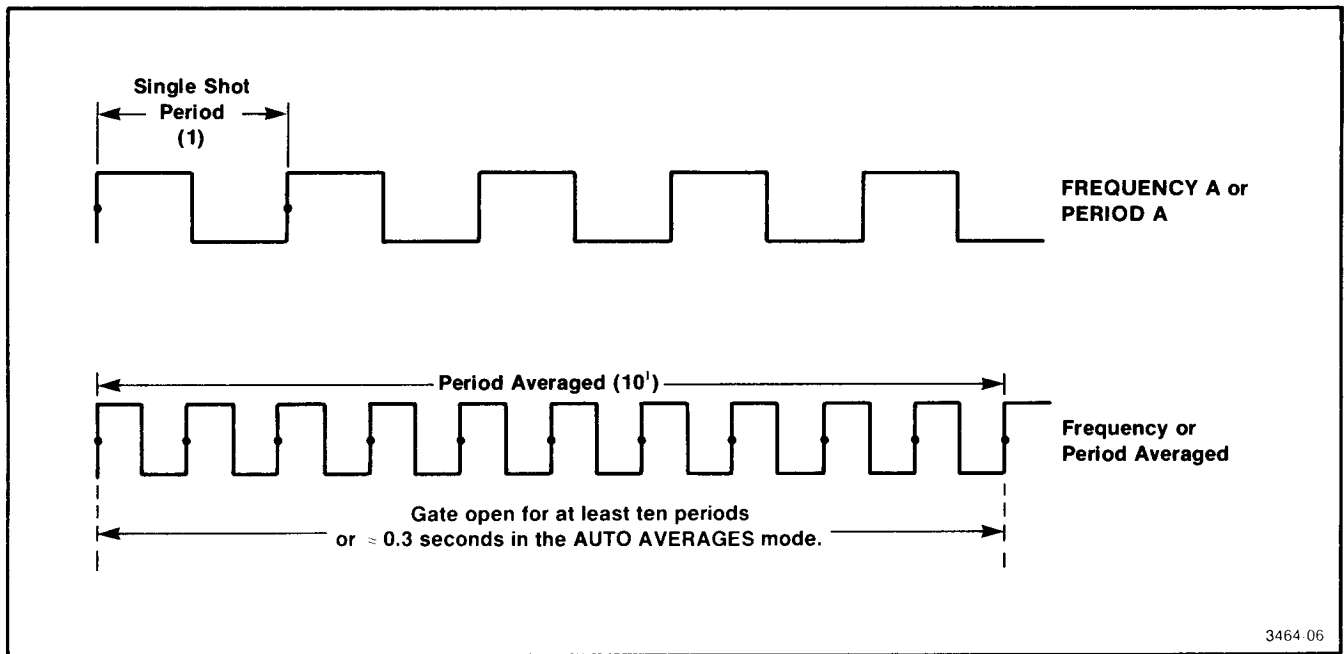

Fig. 2-5. Measurement examples for FREQUENCY A or PERIOD A.

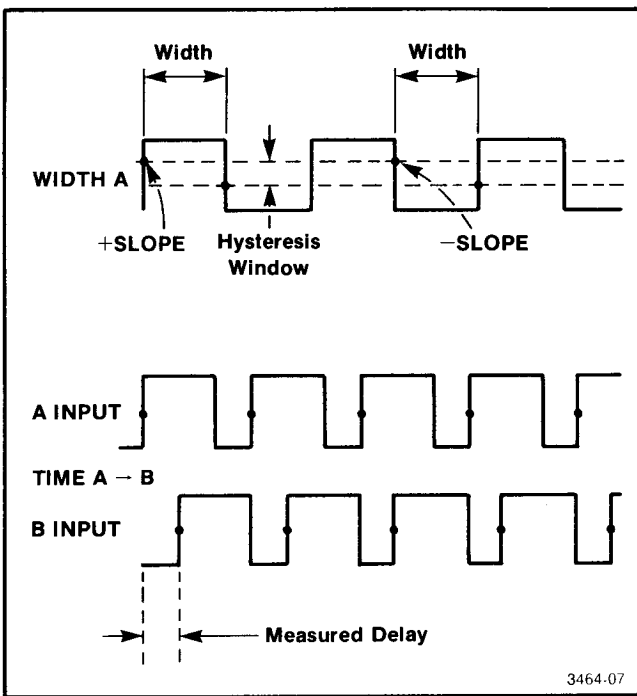

Fig. 2-6. Measurement examples for WIDTH A and TIME A - B.

When either the WIDTH A or TIME A-B functions are activated, an internal pseudo-random noise generator is enabled that phase modulates the internal 10 ns time base, allowing the counter to properly average input signals that are synchronous with its time base. See Fig. 2-7.

In Fig. 2-7 the time interval (15 ns, WIDTH A) cannot be measured accurately with a non-modulated time base or by making a single-shot measurement. The pseudo-random phase-modulated clock causes the counter to count one clock pulse one-half of the time and two clock pulses one-half of the time. For example, if ten widths were averaged, the total time for the count is at least 150 ns. Ten averages yields 15 counts (5 counts + 10 counts). Dividing the total count by the number of averages gives an answer of 1.5 counts, or 15 ns.

Events B During A

The EVENTS B DUR A function is basically the same as WIDTH A, except that the counter counts the selected number of positive-going or negative-going events (\pm SLOPE, Channel B) occurring during a selected positive or negative pulse width occurring on Channel A (\pm SLOPE, Channel A). The internal time base is not counted for this function. See Fig. 2-8 for a measurement example. The Channel B events are averaged over the selected number (AVERAGES) of Channel A pulse widths.

Time Manual

The TIME MANUAL function measures and displays the time interval (to the closest one-tenth of a second) between the first and second depressions of the MEASUREMENT STOP/START pushbutton. The time count can be reset to zero and restarted by pressing and then releasing the RESET pushbutton. The AVERAGES switch has no effect in the TIME MANUAL mode.

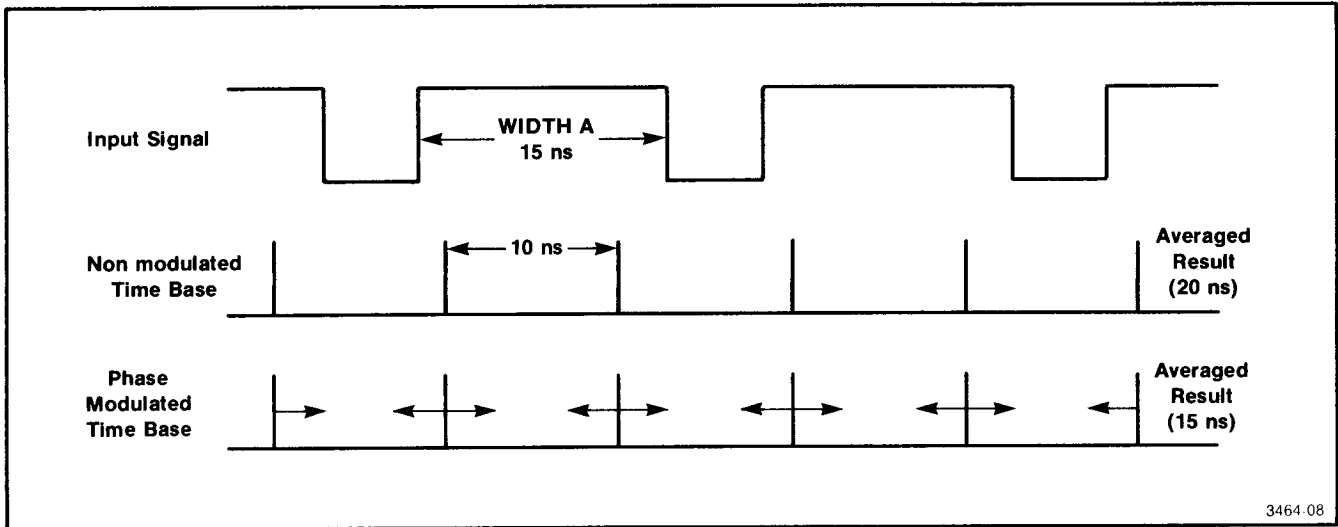

Fig. 2-7. Measurement example for synchronous input signals.

Totalize A

The TOTALIZE A function is basically the same as TIME MANUAL, except that, instead of counting the internal time base pulses, the counter counts the total number of Channel A events occurring between two successive depressions of the MEASUREMENT STOP/START pushbutton and the AVERAGES switch is active in this mode. The AVERAGES switch operates as a power-of-ten scaling indicator (allows totalizing to more than eight digits). For example, with a 1 MHz input signal and the AVERAGES switch set to 10^6 , the least significant digit represents 10^6 counts and will increment at one count per second ($10^6 \text{ Hz}/10^6 = 1 \text{ Hz}$).

NOTE

The most significant digit (far left) is for CHANNEL A, the least significant digit (far right) is for CHANNEL B. The GATE light will flash, indicating the rate at which the input is checked for compensation.

1. Insert adjustment tool in the probe compensation adjustment slot.
2. Select the PROBE COMP function and press RESET.
3. Slowly rotate (≈ 90 degrees per 5 seconds) the probe compensation adjustment in either direction until the display for the channel being compensated changes to a "1".

Probe Compensation

The PROBE COMP function allows the operator to compensate an external probe for the input capacitance of the counter without an oscilloscope.

This function requires an external square-wave signal of approximately 500 Hz to 1 kHz and an amplitude of approximately 2 V times the probe attenuation factor (for 2.5 percent accuracy). For example, a 5X high impedance probe would require about 10 V amplitude for this accuracy. The larger the signal the more accurate the compensation will be, providing that the positive peak value of the input to the counter is less than 3 V.

With a probe connected to either CHANNEL A or CHANNEL B input and the square-wave signal applied, perform the following steps:

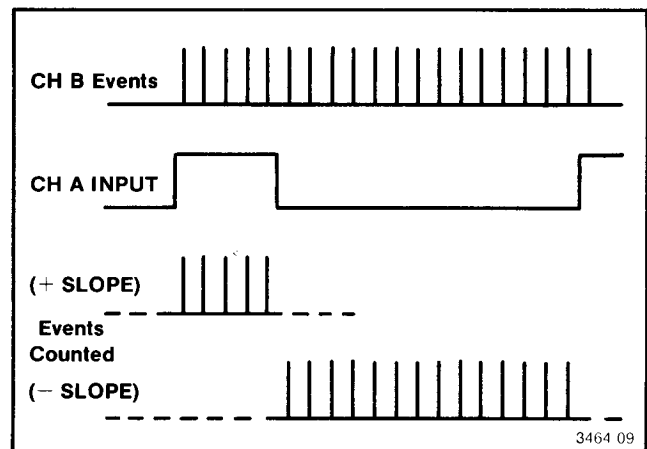

Fig. 2-8. Measurement example, TIME A - B using the ARM input.

Operating Instructions—DC 509

4. Reverse direction of rotation and again slowly turn the adjustment until the display just changes to a "0".
5. Reverse direction again until the display goes to a "1" (only a few degrees of rotation will be required).
6. Once again reverse the direction of rotation and very slowly turn the adjustment until the display just changes to a "0" (only a few degrees will be required). At this point the probe will be compensated.

If at any point in the procedure the display should remain a "1" for more than one complete rotation, press the RESET and start again. This may be caused by one of several problems.

- The adjustment is rotated too fast or with a jerking motion.
- The applied signal has too much low frequency noise (amplitude jitter).
- The connection to the probe is intermittent.

NOTE

If at any time the display alternates between 0 and 1 without the compensation adjustment being varied, slightly change the amplitude of the square-wave input signal and repeat the procedure.

Test Function

A 000 display for the TEST function is an indication that the microprocessor has checked the read-only memory, the internal serial data path, the integrity of its internal counter chain (accumulators) and, as a by-product, the operation of the digital-to-analog converter and input amplifier circuits.

The random-access memory space (RAM) is not checked during this self-test; the RAM is checked only at power up.

NOTE

If the CHANNEL A or CHANNEL B inputs are connected, the input signals peak must be within the triggering level range of the counter. An arming (ARM) signal, if connected, must also be at a high TTL level.

The GATE annunciator flashes each time the complete test routine is successfully completed. If one of the tests fails, the GATE annunciator will stop flashing and a three-digit error code will be displayed. The test routine is halted at this point and will not continue until the RESET is depressed. This provides a memory for intermittent problem troubleshooting.

NOTE

Refer all front panel error code conditions to qualified service personnel.

Arming (ARM Input)

Arming provides a means by which single events or sets of events can be selected for measurement within a complex analog or digital signal.

The ARM input requires TTL signal levels. With no signal attached the ARM input is normally pulled high and is thus continuously armed. When the ARM input is pulled low, the counter is prevented from starting a measurement. Arming may be used in all measurement functions with the exception of TIME MANUAL, PROBE COMP, and TEST. In these three functions the ARM signal must be high.

The ARM signal must be high when the active start edge of an event occurs. It must then remain high as long as successive events are to be included in the measurement. The ARM signal must then be low before another active start edge occurs.

When operating in the FREQUENCY A, PERIOD A, or RATIO B/A functions and a single armed "burst" does not satisfy the averages condition, the displayed resolution will be greater than the actual measurement resolution. This occurs because the display is formatted for the standard single ± 1 count error in each measurement; whereas with arming, there will be instead a ± 1 count for each burst. For example, if the input repetition rate is 1 kHz and the arming signal selects 10 periods to measure with the AVERAGES control set for 10^2 , the 10 "bursts" of 10 each will be included in each measurement. See Fig. 2-9 for examples of arming for each of the major measurement functions.

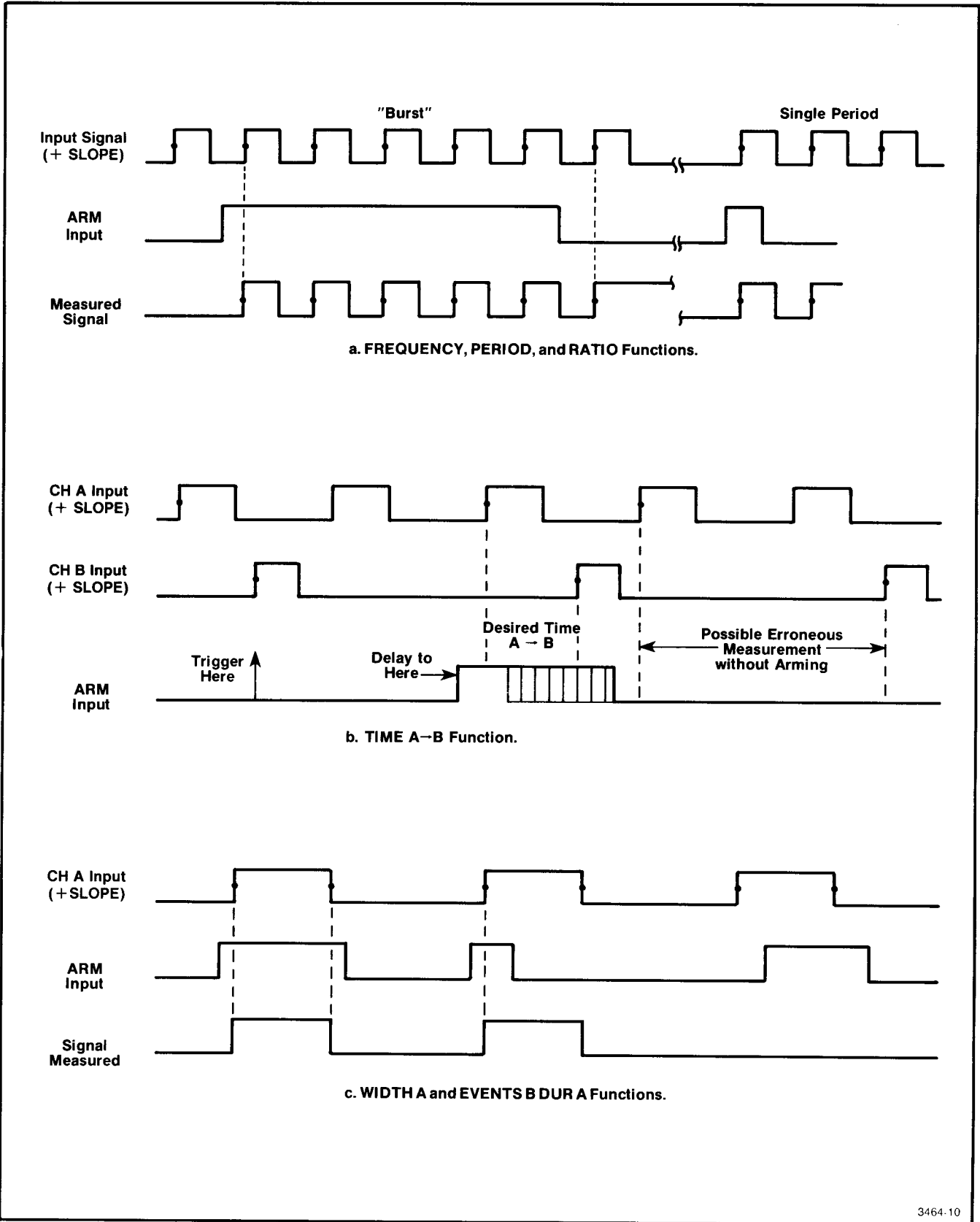

3464-10

Fig. 2-9. Examples of arming.



WARNING

THE FOLLOWING SERVICING INSTRUCTIONS ARE FOR USE BY QUALIFIED PERSONNEL ONLY. TO AVOID PERSONAL INJURY, DO NOT PERFORM ANY SERVICING OTHER THAN THAT CONTAINED IN OPERATING INSTRUCTIONS UNLESS YOU ARE QUALIFIED TO DO SO.

THEORY OF OPERATION

BLOCK DIAGRAM DESCRIPTION

Introduction

Refer to the Block Diagram illustration located in the foldout pages at the rear of this manual during the following discussion.

Channel A and Channel B Amplifiers

The functional blocks for the Channel A and Channel B Amplifiers are essentially identical. Each channel amplifier circuit contains three magnetic latching relays that control the selection of the front panel or rear interface input signals, the ac or dc coupling modes, and the $\times 1$ or $\times 5$ attenuation factor. The data for these relays are sent from the microprocessor via data shifted through serial to parallel shift registers in these functional blocks. The trigger slope selection data is also latched in these same registers. The slope selection circuits are located on schematic 3.

Each amplifier channel contains an input differential amplifier, two cascode amplifiers, and Schmitt trigger circuits that provides the hysteresis window for the overall amplifier. The outputs of the Schmitt circuits are buffered before application to the slope selection gates.

The +5 V power for both input channels is regulated by a three terminal regulator that uses the interchannel shield for a heat sink.

Trigger Level and D-A Converters

This functional block contains triggering level controls and digital-to-analog converters for Channel A and Channel B. The microprocessor, depending on the mode, selects the setting of the front panel triggering LEVEL controls or the outputs of the D-A Converters to be applied to the input differential amplifier circuits located on schematics 1 and 2.

The D-A Converters are driven by 8-bit parallel words latched in two serial to parallel shifter registers in this functional block.

Gating, Arming and Synchronizers

After slope selection, the signals to be measured are routed through the proper logic gates for the operating mode selected. These gates are enabled (or disabled) via latched data in a serial to parallel shift register located in this functional block.

The A and B SHAPED OUT signals originate in this block and provide exact replicas of the signals that the counter is measuring. These outputs provide a 50 Ω output impedance capable of driving a 50 Ω load.

The counter has what is sometimes called a "ratio architecture". That is, events are always accumulated in one count chain, called Accumulator A, and a time related or Channel B event count is accumulated in another counter chain, called Accumulator B. The microprocessor actually controls the measurement interval, which is always asynchronous with the input signals. The Synchronizers in this functional block guarantee that the accumulators always see a whole number of pulses of input signals or a whole number of pulses from the internal time base that is being counted.

The arming input (ARM) from the front panel or rear interface is also applied to this block where it is logically ANDed with the measurement GATE generated by the microprocessor.

Time Base, 100 MHz PLL, and Noise Generator

This block contains the 10 MHz crystal controlled time base, a 100 MHz PLL (phase locked loop) and a pseudo-random noise generator that is activated for time interval averaging measurements.

The 100 MHz PLL circuit contains a frequency and phase comparator, a filter circuit, a Varactor diode for 100 MHz tuning, and a divide by 100 feedback loop.

CH A and CH B Accumulators

The Channel A signal is divided or counted by two ECL binary stages, six TTL binary stages, and then by four binary stages in a single CMOS counter. The CARRY A output from the CMOS counter is then applied to a microprocessor peripheral device on schematic 7, where the signal is counted by another 16 binary stages internal to that device.

The CH B Accumulator is similar to the CH A Accumulator with two ECL binary stages, six TTL binary stages, followed by 16 binary stages in two CMOS counters. The CARRY B signal is also applied to the microprocessor peripheral device on schematic 7. Both accumulator circuits have ECL to TTL translator circuits where required.

The outputs of these counters are applied to the parallel inputs of five parallel to serial shift registers (two for CH A and three for CH B). To obtain the binary count accumulated in these counters, the microprocessor asserts the Serial Read Latch Line at least once for every measurement interval.

Microprocessor, Control Logic, and Memory

The microprocessor uses a serial data loop, an 8-bit parallel data bus, and a 16-bit address bus to communicate with the instrument functions. The microprocessor fetches instructions from memory via the parallel data path, decodes the desired operation, and executes the instruction. The activities of the microprocessor occur in cycles generated by its own 1 MHz system clock.

The 8-bit parallel data bus is also used to set up the Display Drive circuits and to read the settings of the front panel pushbuttons and switches.

The serial data loop is used to set up the digital-to-analog converters, input relays, the gating and arming circuits for proper operation, and to read the count contained in the CH A and CH B Accumulators.

The microprocessor controls the measurement gate interval, generates the relay strobe signal, and by using ad-

dress decoding circuits enables the shift registers, display strobe circuits, and the data buffer for the front panel settings.

This functional block also has a microprocessor peripheral device containing a 128×8 static RAM, a 16-bit programmable counter, an 8-bit serial data channel, bidirectional data lines, and interrupt inputs. Program memory space is provided by a 4096×8 ROM device.

Front Panel Keyboard and Display Drive

The key element in this functional block is a ten-state decade counter that provides the time slot decoding for scanning the front panel pushbuttons and other controls. The counter also provides the multiplexing functions for the seven-segment LED display and annunciators. Information is presented to the display by latching six bits of data from the microprocessor parallel data bus. Four bits of the latched data are then decoded from binary coded decimal to seven-segment information. The remaining two bits are used to drive the annunciators and decimal points.

Display

The display consists of eight seven-segment LEDs and six annunciators. The time slot lines generated by the ten-state decade counter drives the cathodes of the seven-segment LEDs and scans the annunciators. The anodes of the seven-segment LEDs are connected to a buffer circuit through current limiting resistors.

Power Supplies

The +12 Vdc supply is derived from the +33.5 V raw dc from the mainframe (power module). The -12 V regulated supply is derived from the -33.5 V raw dc from the mainframe. The +5 V regulated supply is derived from the +11.5 V raw dc from the mainframe. These supplies are individually protected by their own fuses. The +3.2 V supply is derived from the +12 V regulated supply, while the +2.7 V supply is derived from the +5 V regulated supply. The +3.2 V supply operates as the reference for the -12 V supply and the digital-to-analog converters.

DETAILED CIRCUIT DESCRIPTION

CH A and CH B Amplifiers and Relay

Control  

NOTE

Since the CH B Amplifier and Relay Control circuit is essentially identical to the CH A Amplifier and Relay Control circuit, this description discusses the theory of operation for the CH A Amplifier and Relay Control circuit with the associated circuit component for the equivalent Channel B circuit in parenthesis.

The input signal enters the instrument either from the front panel bnc connector J500 (J510) or from the rear interface input connection P1625-16A (P1625-17B). The external or internal signal source is selected by K1031 (K1041). When the internal signal source is selected, the microprocessor also activates K1621 (K1622).

The AC COUPL or DC COUPL mode is selected by K1032 (K1042), while the $\times 1$ or $\times 5$ ATTEN modes are selected by K1033 (K1043). The $\times 5$ attenuation network includes R1023 (R1043), R1131 (R1141) and their compensating capacitors, C1022 (C1042) and C1031 (C1043).

The input differential amplifier stage Q1121 (Q1141) is a matched dual DMOS FET with high input impedance and low offset between the triggering level and signal input gate terminals. Transistor Q1122 (Q1142) and associated components operate as a current source, providing good common mode rejection for the differential amplifier stage.

The +5 V drain supply for the input differential stage in both channels is obtained from a three terminal regulator, U500. This regulator uses the interchannel shield for a heat sink.

Input protection for the DMOS FET differential amplifier is provided by CR1121 (CR1131), CR1123 (CR1141), CR1124 (CR1142), and CR1122 (CR1132). These diodes clamp the input signal amplitude to about +13 V and -13 V.

The first cascode amplifier stage consisting of Q1223 (Q1241), Q1221 (Q1233), Q1222 (Q1234), and Q1224 (Q1242), and associated components provides a gain of about three. The second cascode stage, Q1225 (Q1235),

Q1226 (Q1243), Q1228 (Q1245), Q1227 (Q1244), and associated components provides a gain of about three and drives the Schmitt trigger circuit consisting of Q1232 (Q1248), Q1229 (Q1247), and associated components. The Schmitt trigger circuit sets the hysteresis window for the overall input amplifier. The ECL line receiver, U1331B (U1331C), operates as a buffer between the Schmitt trigger and the slope selection circuits on schematic 3.

The input relays for each channel are the magnetic-latching type. They are set to their proper positions by the binary data latched in the serial to parallel shift register U1101 (U1111). The parallel data from these registers is buffered by U1110 (U1112), a Darlington driver integrated circuit. The most significant bit (pin 11) from the shift registers determines the triggering slope for each channel.

The relay strobe circuit for both channels consists of Q1101, Q1102, Q1103, and associated components. The relay strobe signal is programmed by the microprocessor. The strobe signal generated at the collector of Q1103 is a positive pulse of about 7 V, and strobes all of the relays simultaneously. However, the state of only one relay is changed with each strobe event. The feedback connection from R1103 and R1104 to the emitter of Q1101 operates to regulate the pulse amplitude under all supply conditions. Diode CR1211 prevents the strobe pulse from going more negative than about 0.6 V.

Gating, Arming, and Synchronizers

Transistors Q1411 and Q1412 form a differential comparator. The base of Q1411 is at approximately 3.5 V; set by the voltage divider network, R1413 and R1414. The base of Q1412 is biased by R1404, R1403 and R1415, with R1403 providing positive feedback to generate the hysteresis at the arming input. Diode CR1401 and the measurement gate buffer, Q1401, are in a conducting state before the measurement gate signal on J1410-2 goes negative. The wired-OR junction at the emitter of Q1401 must be low during the measurement interval. If the arming input signal on the base of Q1411 is held low the wired-OR junction is held high, preventing the counter from making a measurement.

Setting the counter up to accept the arming signal via the rear interface requires only that qualified service personnel reverse the connections of P1402 and P1403.

Both the inverted and non-inverted forms of the input signals from the Channel A and Channel B amplifiers are available; Channel A signals at the emitters of Q1331 and

Theory of Operation—DC 509

Q1332, Channel B signals at the emitters of Q1333 and Q1334. Only one of the two transistors for each channel is active at any one time, depending on the selected slope; Q1332 and Q1333 for positive slope selection, Q1331 and Q1334 for negative slope selection.

After slope selection, the signals are buffered by U1332A and U1331A, and then level shifted by common base amplifiers, Q1442 and Q1441, before application to the front panel shaped outputs via J540 and J560, or to the rear interface via P1625-23A and P1625-24B.

The microprocessor determines the measurement gate interval on pin 12 of U1332B. Integrated circuits, U1421A and U1421B, operate as Synchronizers to ensure that the accumulator gates, U1332C and U1431C, open and close at the proper time for the desired measurement. Synchronizing the accumulator gates with the signals to be counted ensures that the accumulators will contain a count corresponding to a whole number of input and time base pulses. The signals to be counted clock the Synchronizers on pins 6 (U1421A) and 11 (U1421B).

Before each measurement is initiated by the microprocessor U1421A and U1421B are set by the MR (master reset) pulse on J1410-1; U1332C and U1431C are disabled by the high levels on pins 2 and 15 of the Synchronizers.

For those modes that use the CH A Amplifier with positive slope triggering, negative-going edges are generated on pin 2 of U1331A. Pin 14 of shift register U1411 is latched high for all operating modes except the time interval modes (TIME A - B, WIDTH A, and EVENTS B DUR A). With pin

14 of U1411 high Q1343 and U1431B are enabled. The CH A signal is then inverted by U1431B and clocks U1421A on pin 6. The CH A complement signal also appears on pin 6 of U1431B.

NOTE

Transistors Q1342, Q1344, Q1341, Q1423, Q1422, Q1421, and Q1343 operate as switches to route the CH A, CH B, and 100 MHz time base signals through the proper logic gates for the selected front panel FUNCTION. Transistor Q1344 is used to disable U1431A. See Table 3-1.

FREQUENCY A and PERIOD A. If the gate signal from the microprocessor and the arming signal on pin 11 of U1332B are both low, a low is set on the D input (pin 7) of U1421A. This low is transferred to pin 2 on the first CH A edge that clocks U1421A after the measurement gate started. The low on pin 2 enables the second synchronizer, U1421B, and the CH A Accumulator gate, U1332C. With U1332C enabled the next negative edge of the CH A signal is allowed to pass through U1332C in its inverted form and be counted by the first binary stage of the CH A Accumulator on schematic 4.

For the FREQUENCY A and PERIOD A functions, pin 7 of shift register U1411 is latched high. This turns on Q1422, allowing the 100 MHz time base signal to clock U1421B on pin 11. The first time base edge to clock U1421B after U1421A changed state sets a low on pin 10 of U1431C and turns on Q1433, enabling the CH B Accumulator gate and indicating that a measurement cycle is in progress. The next negative edge of the 100 MHz time base signal then passes through U1431C in its inverted form and counted by the first binary stage of the CH B Accumulator (schematic 4).

Table 3-1
SIGNAL ROUTING SWITCHING LOGIC
(X = Saturated, Blank = Off)

Function	Q1342	Emitter Q1344	Q1341	Q1423	Q1422	Q1421	Q1343
FREQUENCY A		High			X		X
PERIOD A		High			X		X
RATIO B/A		High		X			X
TIME A → B		Low	X		X	X	
WIDTH A	X	Low			X	X	
EVENTS B DUR A	X	Low		X		X	
TIME MANUAL		High			X		X
TOTALIZE A		High		X			X
COMP		High		X			X
TEST		High		X			X

After the Synchronizers and accumulator gates have been enabled, all succeeding input pulses are counted by the CH A Accumulator and all succeeding time base pulses are counted by the CH B Accumulator.

The counting process continues until the selected number of averages have been satisfied or the time out period while in the AUTO mode has been satisfied. At this point the gate signal from the microprocessor goes high, setting the D input (pin 7) of U1421A high. The next positive edge of the input signal then clocks U1421A and pin 2 goes high, disabling U1421B and U1332C. The next 100 MHz time base edge then clocks U1421B, disabling U1431C and turning off Q1433 to tell the microprocessor that the measurement cycle has ended.

When the measurement cycle has ended, the microprocessor reads the total counts in both accumulators. The CH A Accumulator contains the number of events or periods and the CH B Accumulator contains the number of time base clock pulses counted over the same interval. The microprocessor divides the number of events in the CH A Accumulator by the total time in the CH B Accumulator to obtain the frequency (FREQUENCY A) or divides the total time in the CH B Accumulator by the number of events in the CH A Accumulator to obtain the period, or time per CH A event (PERIOD A).

Ratio B/A. The RATIO B/A mode is the same as FREQUENCY A and PERIOD A, except that instead of counting 100 MHz time base pulses, Q1422 is disabled by a low on pin 7 of shift register U1411 and Q1423 is enabled for the CH B signal to clock U1421B. The counts are accumulated over the time interval determined by the number of averages selected. The RATIO B/A result is then calculated by dividing the number of CH B events by the number of CH A events.

TIME A → B. For the TIME A → B function, Q1343 is disabled; Q1421, Q1422, Q1341, and U1431B are enabled. The first CH A pulse slope is selected, passes through U1332A and applied to pin 6 of U1431B. The Synchronizers have been set by the MR (master reset) pulse and the CH A pulse clocks U1421A on pin 6.

As soon as the gate signal from the microprocessor sets pin 11 of U1332 B low, the next CH A clock edge to U1421A transfers the low on pin 7 to pin 2 and sets pin 3 high. The high on pin 3 passes through Q1421, disables U1431B, and prevents U1421A from being clocked by succeeding CH A pulses. The Q output of U1421A (pin 2), being low, enables U1431A and allows the first succeeding CH B pulse edge to clock U1421A, setting pin 2 high and pin 3 low, again. Pin 3 going low with the CH B edge, also enables U1431B again for the next CH A edge to clock U1421A.

Theory of Operation—DC 509

During the period of time that pin 2 of U1421A is low, U1421B is enabled. The 100 MHz time base clock pulses are synchronized and gated by U1421B and U1431C, and then counted by the binary stages in the CH B Accumulator.

Since Q1343 is off, U1332C is enabled with a low on pin 12 and each TIME A → B interval appears as a negative pulse on pin 13. This negative time interval is converted to a positive time interval pulse by U1332C and then counted by the binary stages in CH A Accumulator. Thus, for each TIME A → B interval, a count is accumulated in the CH A Accumulator and during each of these intervals the 100 MHz clock pulses are accumulated in the CH B Accumulator.

The microprocessor is continually reading the counts (accumulated time intervals) in the CH A Accumulator. When the selected number of averages (10^N) or the measurement time in the AUTO mode (≈ 0.3 seconds) has been satisfied, the microprocessor sets the gate signal on pin 11 of U1332B to a high level. The next CH B pulse clocks a high through U1421A to pin 10 of U1421B and disables U1431A. The next 100 MHz clock pulse then toggles U1421B, disabling U1431C and allowing the collector of Q1433 to go low. This tells the microprocessor that the measurement cycle has been completed. The microprocessor then makes a final reading of both accumulators, divides the total time by the number of intervals, and updates the display during the next measurement cycle.

WIDTH A. The WIDTH A function is essentially the same as the TIME A → B except that Q1341 is disabled and Q1342 is enabled. This then allows the leading edge of the pulse width to be measured, to be applied to pin 6 of U1431B and the trailing edge to be applied to pin 5 of U1431A.

The Synchronizers (U1421A and U1421B) and the accumulator gates (U1332C and U1431C) function exactly like they did in TIME A → B. The pulse widths are regenerated on pin 2 of U1421A and during each of the negative pulse intervals, U1421B and U1431C are enabled so that the 100 MHz clock pulses (via Q1422) can be counted by the CH B Accumulator. Also, each regenerated pulse is passed through U1332C and counted by the CH A Accumulator. Again, when the averages conditions have been satisfied the microprocessor stops the measurement gate, reads both the accumulators, and divides the total time by the number of regenerated time intervals to obtain the average pulse width.

EVENTS B DUR A. The EVENTS B DUR A function is the same as WIDTH A except that instead of counting 100 MHz clock pulses via Q1422, the instrument is counting CH B events during the selected CH A pulse width via

Q1423. To do this, Q1342, Q1423, and Q1421 are enabled. The leading and trailing edges of the CH A pulse are again applied to pin 6 of U1431B and pin 5 of U1431A.

The CH B signal passes through Q1423 to clock the second synchronizer, U1421B. When the gate signal on pin 12 of U1332B goes low, the Synchronizers and accumulator gates function exactly as they did in WIDTH A (and described for TIME A → B). With U1332C enabled on pin 12 the CH A pulse widths are counted in the CH A Accumulator while the CH B events are counted in the CH B Accumulator. In EVENTS B DUR A the instrument is counting CH B events during CH A pulse widths and averaging by the selected number of CH A events.

When the selected or AUTO averages condition has been satisfied the gate signal on pin 11 of U1332B goes high, the next CH A trailing edge disables U1421A (pin 2 high) and the succeeding CH B edge sets a low on pin 14 of U1421B, completing the measurement cycle.

TIME MANUAL and TOTALIZE A. For the TIME MANUAL and TOTALIZE A functions, the microprocessor asserts the gate signal on pin 11 of U1332B when the START/STOP pushbutton on the front panel is depressed to start the measurement. The gate is unasserted (set high) when the pushbutton is depressed to stop the measurement.

For TIME MANUAL Q1344, Q1422, and Q1343 are enabled. Immediately after asserting the gate signal the microprocessor momentarily changes the CH A Level on pin 14 of U1321D from its current setting to -3.175 V to $+3.2$ V and then back again to its original setting. This provides an artificial CH A signal which enables U1421A and allows the 100 MHz clock signal count to be accumulated in the CH B Accumulator. The accumulation continues until the measurement is stopped, at which time the microprocessor unasserts the gate signal and provides another trigger level change to disable U1421A and stop the accumulation of time base clock count. The results in the CH B Accumulator is then directly displayed with the proper annunciator illuminated.

For TOTALIZE A Q1344, Q1343, and Q1423 are enabled. When the gate signal is asserted, CH A events are counted (totalize) in the CH A Accumulator until the measurement is stopped. In this case, the microprocessor does not read the CH B Accumulator, only the CH A Accumulator counts are displayed. Display scaling is accomplished by the microprocessor using the position of the AVERAGES switch to select the desired scaling factor (power-of-ten). Time or frequency units are not displayed for this function.

PROBE COMP and TEST. For the PROBE COMP function, the operator applies probe compensating signals to either Channel A or Channel B. For either of these modes, the counter is set up (internally) in RATIO B/A. This allows the Channel A or Channel B signals to pass straight through to the accumulators. For the TEST function the microprocessor generates artificial signals by programming the digital-to-analog converters (schematic 5) through their full range. The outputs of the digital-to-analog converters are applied as trigger level changes to the differential amplifier circuits in the CH A and CH B Amplifiers (schematic 1).

NOTE

A complete description of the self test function is described in the Maintenance section. Front panel procedures for the PROBE COMP function are found in the Operating Instructions.

CH A and CH B Accumulators

Before each measurement is initiated by the microprocessor, the MR (master reset) signal is asserted via pin 26 of U1332 on schematic 7. This reset signal is inverted by U1202E and U1202F and level shifted by Q1201 to provide an ECL compatible reset signal to the Synchronizers on schematic 3, and to provide both ECL and TTL compatible reset signals for all of the count stages in the CH A and CH B Accumulators.

The CH A Accumulator signal clocks U1221A on pin 6 while the CH B Accumulator signal clocks U1221B on pin 11. The first two binary stages for each accumulator are ECL stages, U1221A and U1211A for the CH A Accumulator, U1221B and U1211B for the CH B Accumulator. The next two binary stages for each count chain are TTL; CH A — U1201A and U1113A, CH B — U1201B and U1113B. Transistors Q1213, Q1211, Q1221, and Q1212 operate as ECL to TTL translators.

The individual TTL binary stages for each accumulator are then followed by TTL 4-bit counters, U1112A and U1112B, and then by CMOS 4-bit counters, U1111A and U1111B. The CH B Accumulator has an additional 12-bit CMOS counter, U1012. The CH A Accumulator also has an additional 16-bit counter internal to U1332 on schematic 7. This arrangement provides a total of 28 hardwired bits for the CH A Accumulator and 24 hardwired bits for the CH B Accumulator. Since each accumulator requires 40 bits, the CH A Accumulator has 12 bits supplied by a firmware counter and the CH B Accumulator has 16 bits supplied by a firmware counter.

Five parallel to serial shift registers, U1102, U1101, U1103, U1011, and U1002, are used by the microprocessor

to read out the contents of the CH A and CH B Accumulators. When the parallel/serial control line (pin 9 of each register) is low, data is shifted through the registers synchronously with the positive transition of the serial clock signal (pin 10). When pin 9 is pulsed high to read these registers, data is put into the registers asynchronously with the clock. The serial data path is further described under Microprocessor and Control Logic (schematic 7).

Trigger Level Control and D-A Converters

This circuit contains two digital-to-analog converters: U1201 for Channel A and U1211 for Channel B. The converters are used by the microprocessor for the COMP and TEST functions, and for the AUTO TRIG mode. The converters are driven by 8-bit words latched in two serial to parallel shift registers, U1202 and U1212. The output currents of U1201 and U1211 are converted to voltage levels by R1203 and R1214. Output current is differentially shared between pins 2 and 4 on each converter. Output current can vary between 0 and -2 mA, corresponding to $+3.2$ V and -3.175 V trigger levels, respectively.

The outputs of the front panel trigger level controls, R500 and R510, are attenuated by voltage dividers, R1303—R1302 and R1306—R1309. The attenuated levels from the front panel controls and the voltage outputs from the converters are then applied to a CMOS analog switch, U1311.

The microprocessor, depending on the mode, selects either the outputs from the converters or the front panel controls. Output selection is determined by bits 6 and 7 latched in shift register U1411 located on schematic 3. These bits turn on or turn off Q1312 and Q1311; both transistors are never on at the same time. For example, if the base of Q1311 is low while the base of Q1312 is high, the microprocessor has selected the converter outputs to be applied to the inputs of the unity-gain operational amplifiers, U1321A and U1321B. The buffered trigger levels are isolated by R1322 and R1321 and then applied to the front panel via J580 (J570) and the rear interface outputs, pins 22A and 22B.

Operational amplifiers U1321D and U1321C, with their associated components, operate as summing amplifiers, providing adjustable offset levels that compensate for the offset voltages in the CH A and CH B Amplifier circuits.

The adjustable reference voltage ($+3.2$ V) circuit for both converters is located on schematic 10. With this reference voltage set properly, the gain of the converters is adjusted by potentiometers R1102 and R1211.

Time Base, 100 MHz PLL and Noise Generator

The 10 MHz standard time base consists of a 10 MHz crystal Y1601, along with a Colpitts oscillator circuit, Q1611 and associated components. The frequency of the standard time base is adjusted by C1602.

The Option 01 high stability time base consists of a self contained, oven controlled 10 MHz oscillator, Y1531. This time base is adjusted via a hole in the rear of the case (accessed through the instrument back plate).

The 18 V input to this time base is derived from the fused +33.5 V source in the mainframe and regulated by a three terminal regulator circuit, U1601 and associated components. If the Option 01 time base is installed, the components for the standard time base circuit are removed from the board.

The 10 MHz output from either of the internal time bases or from an external source (1, 5, 10 MHz) is applied to the base of Q1612. Diode CR1611 allows C1612 to discharge during the negative portions of the input signal. The buffered signal at the collector of Q1612 can be either 1 MHz, 5 MHz, or 10 MHz. If the input signal frequency is 1 MHz, jumper P1511 is placed between pins 4 and 5 of J1511 to apply the signal to the base of Q1502. A 5 MHz input signal requires that U1611A divide by five and P1511 must then be placed between pins 2 and 3 or pins 3 and 4 of J1511. A 10 MHz time base signal requires that U1611A divide by five, U1611B divide by two, and P1511 be placed between pins 1 and 2 of J1511. The signal to the base of Q1502 must, in all cases, be 1 MHz.

Emitter follower Q1502 and associated components operate as a single-pole filter, generating a saw-tooth signal at the negative input terminal of comparator U1501. For the TIME A - B, WIDTH A, and EVENTS B DUR A functions the base of Q1501 is set low via pin 14 of shift register U1411 (schematic 3). For those functions, the noise generator U1502 is enabled by applying +5 V to the V_{ss} input (pin 4). The output from U1502 will then be a -12 V to +5 V signal with a pseudo-random edge distribution. This signal is then attenuated by R1504 and applied to the positive input terminal of U1501.

For the previously mentioned functions U1501 operates as a phase modulator circuit. The output of U1501 will be a 1 MHz signal with the negative edges phase modulated by the noise signal generated by U1502. For the remaining functions Q1501 is turned off, U1502 is disabled, and U1501 operates only as a buffer stage.

Integrated circuit U1522 operates as a frequency/phase comparator circuit, comparing the divided down 1 MHz feedback signal on pin 3 with the 1 MHz time base reference signal on pin 1. The output of the phase comparator (pins 5 and 10) consists of a series of positive-going or negative-going pulses. These pulses are integrated (smoothed) by the filter circuit consisting of U1521B and associated components. The output of U1521B is then amplified and inverted by operational amplifier U1521A. The output of U1521A is a dc level applied to the voltage-controlled capacitor diode (Varactor), CR1521.

Integrated circuit U1523A, along with CR1521 and associated components, operate as a 100 MHz, Varactor tuned, voltage-controlled oscillator circuit. The 100 MHz output from U1523A is fed back via C1523 and then divided down to a 1 MHz signal on pin 2 of U1524 for comparison with the 1 MHz time base reference. The 100 MHz signal is buffered by U1523B before entering the gating logic on schematic 3.

Microprocessor and Control Logic

Introduction. The DC 509 is a digital counter based on a microcomputer system. The microprocessor, U1311, controls the internal operations of the DC 509. The microprocessor recognizes, accepts, and decodes commands (keypushes and control settings) from the front panel logic circuits on schematic 8 and sets the operating parameters in response to these commands.

The microprocessor is an 8-bit parallel processor with an 8-bit data bus (D0—D7, pins 18 through 25) and a 13-bit address bus (A0—A12, pins 5 through 17). The data bus is bidirectional, the address bus is not. The address bus is used by the microprocessor to address specific locations in program memory and to address the other internal functions of the instrument. The 13 address lines provide up to 8192 discrete addresses, commonly referred to as 8 kilobytes of memory. Basically, any device addressed by the microprocessor is considered to be a memory device.

Bit patterns, called firmware, are permanently stored in the read only memory (ROM), U1312. These bit patterns are prerecorded messages (instructions) and data conversion tables that specify the microprocessor's activity in causing the various operations of the instrument to be performed. The ROM contains a maximum of 4096 8-bit bytes of firmware. Data in ROM are placed in the device during manufacturing and cannot be changed by the microprocessor; the firmware can be changed only by installing a new programmed ROM in the instrument.

Integrated circuit U1332 contains a random access memory (RAM) space that provides a maximum of 128 locations (addresses) which the microprocessor uses to temporarily store 8-bit data bytes. This data is not permanent and will be destroyed whenever the instrument power is turned off. When power is applied, the RAM data occurs as random bits and is therefore meaningless. During instrument operation, the microprocessor writes data into the RAM at various addresses for later recall and use.

When a command is received, the microprocessor performs a routine called an "instruction fetch", where one or more successive data bytes from the program memory are loaded into the microprocessor. The instrument word is then decoded and U1311 generates the machine states and control logic signals necessary to execute the command.

NOTE

Due to the complexity of the internal operation of a microprocessor, a detailed description of U1311 will not be attempted in this manual. If more detailed information is needed, refer to the manufacturer's data sheets.

System Clock. The microprocessor contains a single phase internal clock generator (U1311, pins 27 and 28) whose 1 μ s period (approximately) is controlled by inverter U1321D and the RC feedback network consisting of R1203 and C1202. The activity of U1311 when it is reading data from or writing data to a memory device occurs in machine (U1311) cycles. A machine cycle is defined as the interval between two successive negative going transitions of the system clock. An instruction cycle consists of two to twelve machine cycles required to fetch and execute the instruction words or data from memory. The number of machine cycles required depends on the instruction and addressing modes used for the microprocessor.

Power Up Reset Cycle. When the instrument is powered up comparator U1222 (and associated components) operates as a delay/comparator circuit to provide a pulse to reset the microprocessor to its reset vector address location.

Pin 1 of U1222 is held low for approximately 1.5 seconds. During this time all of the internal registers of U1332 (except the 16-bit counter and serial shift register) are cleared to logic zero. This action places all of the bidirectional input/output lines of U1332 in the input state and disables the internal shift register, timer input (pin 37), and the interrupt output (pin 4). Also, during the low level period of the microprocessor reset signal, the writing of data to or from U1311 is inhibited.

When the positive edge is detected on pin 1 of U1311, the internal mask interrupt flag will be set and the microprocessor will load its internal program counter from the reset vector address listed in Table 3-2. This is the start location for program control.

Table 3-2
DC 509 INTERRUPT VECTORS

Vector Address		Type of Interrupt
High Byte	Low Byte	
\$1FFC	\$1FFD	Power Up Reset
\$1FFE	\$1FFF	Interrupt Request (U1332)

NOTE

Dollar sign (\$) means that address code is in hexadecimal notation.

Interrupt Vector (IRQ). Integrated circuit U1332 has two internal registers for interrupt control, an interrupt enable register and interrupt flag register. Corresponding bits in these registers are logically ANDed to set an interrupt request pending flag. When U1332 detects the pending flag bit it asserts pin 4 as a low output, generating an interrupt request to the microprocessor.

When a low level is set on pin 4 of U1332, the microprocessor completes the current instruction before recognizing the interrupt request and examining its own interrupt mask flag bit. If the interrupt mask flag bit is not set, the microprocessor starts an interrupt routine. The contents of its program counter and status register are temporarily stored in RAM, the interrupt mask flag bit will be set to prevent further interrupts, and the program counter will then be loaded with the high and low bytes of the interrupt vector address listed in Table 3-2. This is the start location for the interrupt routine for U1332.

There are three possible reasons why U1332 sets an interrupt pending flag, two external events and one internal event. The two external events are: a negative edge detected on pin 36 (Carry B signal) or a negative edge detected on pin 37 (Front Panel Interrupt Clock); the one internal event occurs when the 16-bit counter (U1332) overflows.

Address Decoding. The microprocessor addresses U1312, U1332, and U1333 when communicating with the instrument functions. Table 3-3 lists the hexadecimal address ranges for these devices.

Table 3-3
DC 509 MEMORY ADDRESS RANGES

Hexidecimal Address Range	Comments
\$1000—\$1FFF	U1312 (4K × 8 ROM)
\$0000—\$007F or \$0100—\$017F	U1332 (128 × 8 RAM)
\$0080—\$0087	U1333 (Front Panel, Display, Serial Data Latches)

Memory select decoder U1331 and inverter U1321A, along with address bits A12 and A7, operate to select the proper memory device during program control. See Table 3-4.

Table 3-4
MEMORY SELECT CODE

Address Bits		Device Selected
A12	A7	
0	0	RAM (U1332), Input/Output
0	1	U1333
1	0/1	ROM (U1312)

The input/output sections internal to U1332 are accessed by the microprocessor using address bits A0 through A3 for specific control of the internal functions. See Table 3-5.





Table 3-5
ADDRESS CODE FOR U1332
(\$0700-\$070F)

Address Bits				Internal Functions
A3	A2	A1	A0	
0	0	0	0	Port A
0	0	0	1	Port B
0	1	0	0	Read Lower Counter/Write Lower Latch
0	1	0	1	Read Upper Counter/Write Upper Latch and Download
0	1	1	0	Write Lower Latch
0	1	1	1	Write Upper Latch
1	0	0	0	Serial Data Register
1	0	0	1	Interrupt Flag Register
1	0	1	0	Interrupt Enable Register
1	0	1	1	Auxiliary Control Register
1	1	0	0	Peripheral Control Register
1	1	0	1	Data Direction Register—Port A
1	1	1	0	Data Direction Register—Port B





NOTE

Due to the complexity of the internal functions associated with U1332, a detailed description of this device will not be attempted in this manual. If more detailed information is needed, refer to the manufacturer's data sheets.

Serial Data Path. The serial data path is shown on the block diagram. Serial data is written, via pins 38 and 40 of U1332, to five serial to parallel shift registers located on the Analog circuit board (A12 assembly). This is done when the microprocessor sets the instruments internal circuits for the desired function. These registers are, in sequence:

- A12—U1202 
- A12—U1212 
- A12—U1101 
- A12—U1111 
- A12—U1411 

The serial data output from A12—U1411 then goes, via P1310-6 (schematic 4) to five parallel to serial shift registers (CH A and CH B Accumulators) located on the Digital circuit board (A16 assembly). Serial data is shifted through these registers and returned to the microprocessor via the data buffer U1322B. Serial data is read from the following parallel to serial shift registers:

- A16—U1101 
- A16—U1102 
- A16—U1002 
- A16—U1011 
- A16—U1103 

Pin 40 of U1332 serves both as an input and output for serial data. When the microprocessor is in the serial write mode, pin 40 is configured as an output and bytes of information are loaded into the internal serial data registers of U1332. They are then shifted out serially to the shift registers on the A12 assembly (Analog board). During the writing of serial data the three-state data buffer, U1322B, is disabled with a high level on pin 15, preventing the serial data input from contending with the serial data output via J1310-1. The microprocessor addresses U1333, causing a negative pulse on pin 11 (Serial Write Latch) to latch the serial data in the serial to parallel shift registers.

When the microprocessor is reading the serial data from the CH A and CH B Accumulators, pin 15 of U1322B is set low at the same time pin 40 of U1332 is configured as an input. The serial data is then read in as five consecutive bytes. During this time pin 13 of U1322B is held high, preventing the serial data being read from reaching the Analog board via J1310-1. The microprocessor addresses U1333 and uses pin 10 (Serial Write Latch) to latch data during the serial read process.

Front Panel Interrupt Clock. The front panel keyboard and displays are interrupt driven by the timing circuit consisting of U1321B, U1321C, and associated components. This circuit operates at about 1.1 kHz. The negative edges of the signal on pin 37 of U1332 interrupt the microprocessor, telling it to update the display and search for a new key push or control setting. The microprocessor addresses U1333 and uses pins 12, 13, 14, and 15 during this process.

Power Up Sequence. After the microprocessor and peripheral device U1332 have been reset at power up, the DC 509 microprocessor generates the following sequence of events:

1. Loads a 0 in the most significant bit position of the front panel display.
2. Tests the RAM, starting at address \$0000. If a RAM failure is found, error code 340 will be displayed.
3. Tests the ROM for byte location and determines the checksum. If a ROM error is found, error code 361 or 381 will be displayed.
4. Checks the logic state on pin 35 of U1332 to see if the instrument is in the signature analysis (SA) test mode. The SA test mode is indicated if P1331 is disconnected from J1331. If the SA mode is not indicated, the interrupt registers in U1332 are enabled.
5. Initializes peripheral device U1332.
6. Performs a serial input/output test. If an error is found, error code 313 will be displayed.
7. Sets up the hardware to determine the state of the front panel, loads the serial to parallel shift registers, and generates the relay strobe signals via pin 32 of U1332 and Q1301.
8. Performs the counter chain (CH A and CH B Accumulators) integrity test. If this test fails an error code, 320 through 326 for CH A or 330 through 336 for CH B, will be displayed.
9. Starts the measurement cycle by pulsing the master reset line (pin 26 of U1332).
10. After the master reset pulse, the measurement gate on pin 29 of U1332 is started. During the measurement gate interval, the microprocessor is continually reading the contents of the CH A Accumulator for a count that is greater than or equal to the number of averages indicated by the front panel AVERAGES switch. When that count is reached, the measurement gate is unasserted and the microprocessor waits for the signal on pin 28 of U1332 to go low, indicating the end of the measurement cycle. The accumulators are then read again for their final count and a new measurement cycle is started after the result is calculated and the display is updated.

Rear Interface Signals. The Prescale line for U1332 (pin 27) operates as an input which indicates to the microprocessor the presence of an external prescaling counter. When an external prescaler is used, the microprocessor multiplies the Channel A accumulated counts by 16 before the display is updated.

The measurement GATE signal to the rear interface is via U1202B and P1410-4 (J1410-4). The microprocessor interprets the reset input from U1321F to pin 33 of U1332 as the electrical equivalent of the front panel MEASUREMENT RESET pushbutton.

NOTE

Complete data for all of the rear interface signals are given in the Maintenance section of this manual.

Front Panel Keyboard and Display Drive

The microprocessor uses four control lines and the 8-bit data bus to communicate with the Front Panel and Display Drive circuits. The four control lines (Display Latch Enable, TSClock, TS Reset, and Keyboard Read Enable) are all derived from U1333 located on schematic 7.

The interrupt signal from the Front Panel Clock (Timer) circuit to U1332 (schematic 7, previously discussed) occurs approximately once every 900 μ s. Each interrupt causes the microprocessor to start a software routine for servicing the Front Panel Keyboard and Display Drive circuitry.

Theory of Operation—DC 509

Each digit and annunciator in the display, each position of the FUNCTION and AVERAGES switches, and each control or pushbutton is assigned a time slot period approximately equal to the period between successive interrupts. The time slots, TS0 through TS9, are generated by U1432, a decade counter with 10 decode decimal outputs. The counter provides time slot decoding for scanning the front panel controls and multiplexing the seven-segment LEDs and the annunciators located on schematic 9.

Each interrupt signal causes the microprocessor to clock U1432 with a negative pulse of about 500 ns on pin 14, advancing the count to the next time slot. Immediately after clocking U1432 the microprocessor updates the digit associated with that time slot by sending data to U1431, which contains six D-type flip-flops. Data is latched in U1431 when pin 9 goes low and transfers to the outputs on the positive edge of the Display Latch Enable signal. The BCD output of U1431 is then decoded to seven-segment information by U1421. The seven-segment information is buffered by display driver U1411 to activate the desired segments of an LED in the display. The display drive power supply filter is a pi-network consisting of C1402, L1401, and C1403. This filter circuit prevents display noise pulses from disturbing the sensitive instrument circuits. Data bits D4 and D5 on the internal data bus are also latched in U1431 and directly buffered by Q1432 and Q1431 to drive the decimal point and annunciator displays.

After updating the display, the microprocessor asserts the Keyboard Read Enable signal on pin 1 of data buffer U1322A and reads data bits D0 through D3 to determine the status of the front panel pushbuttons and the AUTO TRIG switch (D2 and D3) associated with that particular time slot. At the same time the microprocessor proceeds to check the status of the FUNCTION and AVERAGES switches (S1511 and S1512) via data bits D0 and D1.

After updating the display and checking the front panel status, the microprocessor returns to the routine of resetting the input circuits (if necessary), monitoring the measurement cycle, or collecting the data for the selected function. This continues until the next front panel interrupt signal occurs, when it again clocks U1432 for the next time slot and repeats the above procedure.

Display

The eight digits in the display are seven-segment, common cathode LEDs; DS1002 is the most significant digit and DS1305 is the least significant digit. Time slots TS0 through TS7 are connected to the cathodes (pin 6) of each LED, while the anodes of the individual segments are connected to common lines (a through dp) and driven by the display drive buffer through P1411 (J1411). The microprocessor sends all 1's (D0-D3) for the seven-segment information

when leading zero suppression is indicated. All 1's are decoded by U1421 (schematic 8) as a blank.

To illuminate the proper annunciator or indicator in the display, the microprocessor sets pin 1 of P1412 (J1412) high only during the time slot (TS2 through TS5) that corresponds to the displayed units of measurement or indicator.

The illumination interval of the GATE light (CR1012) during time slot TS1, is only approximately equal to the actual measurement gate interval. The GATE light is turned on and then off only to tell the operator that the counter has been triggered and that the microprocessor has completed the functional measurement for the selected number of averages.

Power Supplies

The +12 V supply is derived from the unregulated +33.5 Vdc power in mainframe. The +12 V supply is regulated by a three terminal regulator, U1641. The -12 V supply is derived from the unregulated -33.5 Vdc power in the mainframe, while the +5 V supply is derived from the unregulated +11.5 Vdc power. The three supplies are short-circuit protected and reverse polarity protected by F1541, CR1641, F1542, CR1621, F1641, CR1421, respectively. The +12 V supply provides power for the -12 V, +5 V and +3.2 V regulator circuits.

The +5 V regulator circuit consists of U1531 and associated components. Load current for this supply passes through R1435, the current limiting resistor, and the npn series-pass transistor in the mainframe. The +5 V supply is regulated within design limits by varying the voltage on the base of the npn series-pass transistor via pin 10 of U1531. Should the load current exceed about 2 A, the voltage drop across R1435 becomes great enough to limit the current. The over-current voltage is sensed between pins 2 and 3 of U1531 and reduces the base-to-emitter voltage of the npn series-pass transistor. Feedback signals for voltage regulation of the +5 V supply occur on pin 5 of U1531 with C1531 providing frequency compensation.

The voltage at junction of the R1308 and R1307 is regulated to about 9.4 V by the operational amplifier circuit consisting of U1401A, Zener diode VR1301, and R1305. The +3.2 V at the junction of R1307 and R1304 is adjusted by R1301 and applied through unity-gain buffer U1401B to serve as a reference for the -12 V supply and the digital-to-analog converters, U1201 and U1211, on schematic 5. The -12 V supply is referenced to a +3.2 V source via the voltage divider network consisting of R1541 and R1542.

The -12 V supply consists of error amplifier Q1445 and Q1444, error signal amplifier Q1531, current limit sense amplifier Q1443, and associated components. The reference voltage on the base of Q1445 is about 0 V and diode CR1422 provides temperature compensation for the error amplifier circuit. This supply is regulated within design limits by varying the voltage on the base of the pnp series-pass transistor in the mainframe via the collector of Q1531. Should the load current through R1534 exceed about 220 mA , Q1443 increases conduction, the bases of Q1445 and Q1531 go more negative, and the base of the pnp series-pass transistor goes more positive; thereby reducing the load current below the design limit.

The $+2.7\text{ V}$ supply, located on the Digital circuit board (A16 assembly), is used as a terminating supply for all of the

pull-down resistors located in the ECL circuits on schematics 3 and 4. The $+2.7\text{ V}$ supply is derived from the $+5\text{ V}$ supply on the Analog circuit board (A12 assembly) and consists of error amplifier Q1002, amplifier stage Q1001, emitter-follower output stage Q1003, and associated components.

This is a temperature compensated supply that tracks the ECL output levels and maintains essentially constant current through the ECL terminations. Temperature compensation is obtained by connecting Q1002 as a common-base error amplifier whose offset voltage (base-emitter drop) approximates the ECL output level temperature coefficient.

CALIBRATION

PERFORMANCE CHECK PROCEDURE

Introduction

This procedure checks the electrical performance requirements as listed in the Specification section in this manual. Perform the Adjustment Procedure if the instrument fails to meet these checks. In some cases, recalibration may not correct the discrepancy; circuit troubleshooting is then indicated. Also, use this procedure to determine acceptability of performance in an incoming inspection facility.

Calibration Interval

To ensure instrument accuracy, check the calibration every 2000 hours of operation or at a minimum of every six months if used infrequently.

Services Available

Tektronix, Inc. provides complete instrument repair and adjustment at local field service centers and at the factory

service center. Contact your local Tektronix field office or representative for further information.

Test Equipment Required

The following test equipment (or equivalent) listed in Table 4-1 is suggested to perform the Performance Check and Adjustment Procedure.

WARNING

Dangerous potentials exist at several points throughout this instrument. Caution must be exercised. When the instrument is operated with the covers removed, do not touch exposed connections or components.

Table 4-1
LIST OF TEST EQUIPMENT REQUIREMENTS

Description	Performance Requirements	Perfor. Check	Adjust Proc.	Example
Power Module		X	X	TEKTRONIX TM 503 or TM 504
Oscilloscope Mainframe	DC to 250 MHz bandwidth	X		TEKTRONIX 7704A
Vertical Plug-In	Bandwidth, dc to 200 MHz	X		TEKTRONIX 7A16A
Horizontal Plug-In	Fastest sweep rate 10 ns	X		TEKTRONIX 7B80
Leveled Sinewave Generator	Calibrated amplitude >135 MHz	X		TEKTRONIX SG 503
Pulse Generator	Risetime <1 ns	X		TEKTRONIX PG 502
Function Generator	Range, Sinewave 10 Hz to 1 MHz; Offset +7.5 V level		X	TEKTRONIX FG 501A
Digital Multimeter	4-1/2 digits, 0.5%		X	TEKTRONIX DM 501A
1 MHz Frequency Stnd	1 MHz $\pm 1 \times 10^{-9}$		X	VARIAC
50 Ω Feedthrough Termination (3) ea.	Bnc connectors	X	X	Tektronix Part No. 011-0049-01
Coaxial cable, 50 Ω Precision 36 inch (2) ea.	Bnc connectors	X	X	Tektronix Part No. 012-0482-00
Adapter, BNC Female to Dual Banana			X	Tektronix Part No. 103-0090-00
Cable Assembly RF (bnc-to-tip jack connector)	50 Ω coaxial cable		X	Tektronix Part No. 175-3765-01
50 Ω , 10X Attenuator	Bnc connectors		X	Tektronix Part No. 011-0059-02
Flexible Extender			X	Tektronix Part No. 067-0645-01
Power Divider GR		X		Tektronix Part No. 017-0082-00
GR to BNC Female adapter (3)		X		Tektronix Part No. 017-0063-00
Adapter, BNC T		X		Tektronix Part No. 103-0030-00
Probe (10 \times)		X		
Probe tip ground cover		X		Tektronix Part No. 166-0404-01
Probe, 5 \times		X		TEKTRONIX P6125

Preliminary Control Settings

7000 Series Oscilloscope Mainframe

POWER	ON
FOCUS	As desired for a well-defined display
INTENSITY	LEFT
VERTICAL MODE	LEFT
HORIZONTAL MODE	B
B TRIGGER SOURCE	VERT MODE

Vertical Plug-In

VOLTS/DIV	.1
VARIABLE (CAL IN)	in
POLARITY	+ UP
AC-GND-DC	DC

Horizontal Plug-In

TRIGGERING	
SLOPE	+ (cw)
MODE	P-P AUTO
COUPLING	AC
SOURCE	INT
TIME/DIV	2 μ s
VARIABLE (CAL IN)	in
MAG	X1 (in)

DC 509

FUNCTION	FREQUENCY A
AVERAGES	10 ⁶
AUTO TRIG	out
CHANNEL A and CHANNEL B	
SLOPE	+ (out)
ATTEN	X1 (out)
SOURCE	EXT (out)
COUPL	DC (out)

1. Check Oscillator Frequency (Standard time base)

NOTE

The timebase accuracy is a function of temperature and time. The temperature stability for the standard time base is ± 5 ppm (0°C to 50°C) with an aging rate of ± 1 ppm/year.

After one year of operation (since the time base was calibrated), the 1 MHz frequency standard should read 1.0000000 ± 6.0 ppm for any temperature between 0°C to 50°C . The ± 6.0 ppm are determined by ± 5 ppm, due to temperature; ± 1 ppm due to aging; and ± 1 count to synchronization error. After this check is completed, the user should determine if a time base re-calibration is required.

a. Connect a coaxial cable from the 1 MHz Frequency Standard output to the DC 509 CHANNEL A EXT INPUT.

b. Adjust the DC 509 CHANNEL A LEVEL control for a stable readout on the DC 509 display.

c. CHECK—that the DC 509 readout is within 999.99399 kHz and 1.0000061 MHz (± 6.0 ppm, ± 1 count).

2. Check Time Base Oscillator Frequency (Option 01)

NOTE

The temperature stability for the Option 01 time base is 0.2 ppm (0°C to 50°C) with an aging rate of ± 1 ppm/year and ± 1 count.

a. Connect a coaxial cable from the 1 MHz Frequency Standard output to the DC 509 CHANNEL A EXT INPUT.

b. Adjust the DC 509 CHANNEL A LEVEL control for a stable display readout.

c. CHECK—that the DC 509 readout is within 999.99879 kHz and 1.0000013 MHz.

d. Remove all cable connections from the DC 509.

3. Check Trigger Level Range, $\geq \pm 3.2$ V

Refer to Fig. 4-1 check setup and preliminary control settings with the following exceptions.

DC 509

AVERAGES	AUTO
----------	------

Digital Multimeter

INPUT	EXT (out)
RANGE/FUNCTION	20 V

a. Connect a coaxial cable from the DC 509 A TRIG LEVEL (black lead to COM) using a cable assembly RF (bnc-to-tip jack connector) to the digital multimeter LOW and VOLTS/ Ω input connectors using a bnc female-to-dual banana adapter.

**Calibration—DC 509
Performance Check**

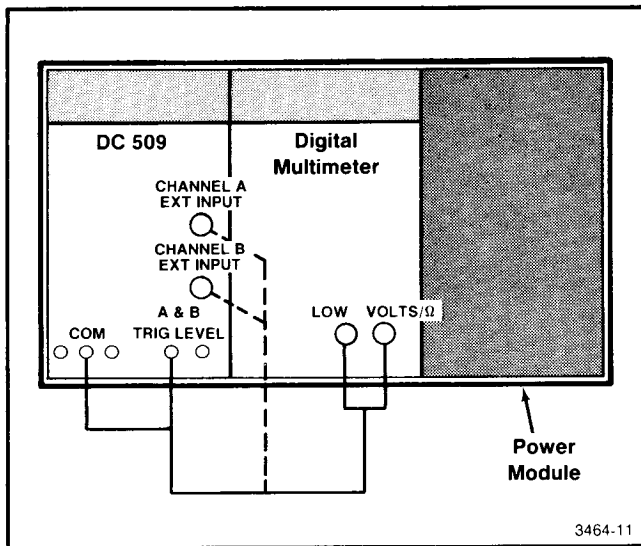

Fig. 4-1. Check setup for Performance Check steps 3 and 11.

b. Adjust the DC 509 CHANNEL A LEVEL control to clockwise and counterclockwise positions and note the digital multimeter display readout.

c. CHECK—that the digital multimeter readout indicates $> +3.2 \text{ V}$ (cw) and $< -3.2 \text{ V}$ (ccw).

d. Repeat above steps with tip jack connected to B TRIG LEVEL adjusting the CHANNEL B LEVEL control to check the CHANNEL B Trigger Level Range.

e. Remove the digital multimeter cable connections.

4. Check the CHANNEL A TRIGGER LEVEL Output Accuracy; $\pm 10 \text{ mV}$ of Internal DC Trigger Level Voltage

Refer to Fig. 4-2 check setup and preliminary control settings with the following exceptions.

	Function Generator
0 dB	in
(triangle)	in
OFFSET	out
AMPL	cw
FREQUENCY Hz	10
MULTIPLIER	10^4
FREERUN	in

	DC 509
FUNCTION	PERIOD A

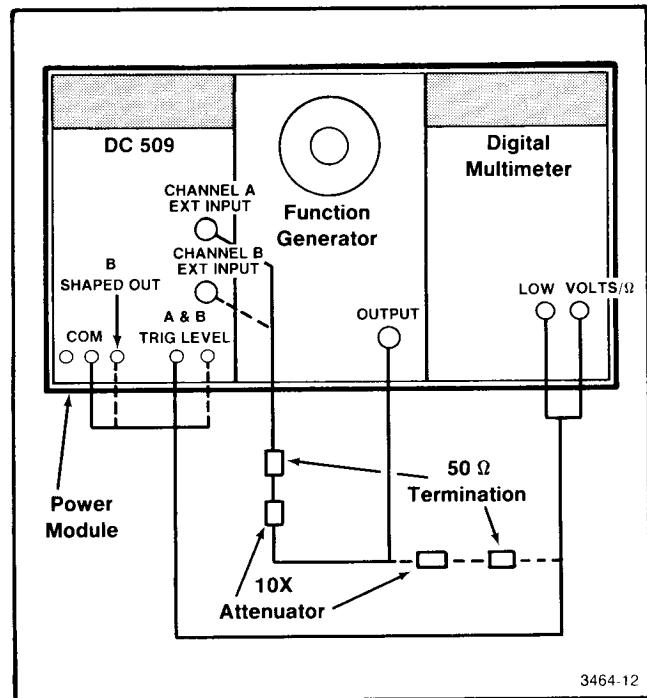

Fig. 4-2. Check setup for Performance Check steps 4 and 5.

a. Connect a coaxial cable with a $10\times$ attenuator and 50Ω termination to a bnc-to-dual banana adapter. Connect this adapter to the digital multimeter LOW and VOLTS/ Ω jacks (observe polarity). Connect the other cable end to the function generator OUTPUT connector.

b. Adjust the function generator OFFSET control until the digital multimeter readout indicates $.000 \text{ V}$.

c. Move the coaxial cable with the $10\times$ attenuator and 50Ω termination from the digital multimeter to the DC 509 CHANNEL A EXT INPUT. Then connect a bnc-to-tip jack connector from the digital multimeter bnc-to-dual banana adapter to the DC 509 A TRIG LEVEL output. Adjust the DC 509 CHANNEL A LEVEL control for a stable display readout.

d. Adjust the function generator FREQUENCY Hz dial until the DC 509 readout indicates $10.00XXX \mu\text{S}$ (the last three digits are unimportant for the check).

e. Set the DC 509 FUNCTION switch to WIDTH A.

f. Adjust the DC 509 CHANNEL A LEVEL control until the DC 509 readout indicates $5.00XXXX \mu\text{S}$ (the last four digits are unimportant for the check).

g. CHECK—that the digital multimeter readout indicates between $-.010$ and $+.010$ V.

5. Check the CHANNEL B TRIGGER LEVEL Output Accuracy

Refer to Fig. 4-2 check setup for the following.

a. Move the DC 509 A TRIG LEVEL output connection to the B TRIG LEVEL.

b. Move the DC 509 CHANNEL A EXT INPUT cable connection to the CHANNEL B EXT INPUT.

c. Adjust the DC 509 CHANNEL B TRIG LEVEL control until the digital multimeter display readout indicates 0.000 V.

d. Move the DC 509 B TRIG LEVEL connection to the B SHAPED OUT and the cable end from the digital multimeter connected bnc-to-banana adapter to the DC 509 CHANNEL A EXT INPUT.

e. Adjust the CHANNEL A LEVEL control for a stable display.

f. Adjust the DC 509 CHANNEL B LEVEL control until the DC 509 readout indicates $5.00XXXX \mu s$ (the last four digits are unimportant for the check).

g. Move the coaxial cable from the B SHAPED OUT to the B TRIG LEVEL.

h. Move the other end from CHANNEL A EXT Input to the bnc-to-banana adapter on the DMM.

i. CHECK—that the digital multimeter readout indicates between $-.010$ and $+.010$ V.

j. Remove the cable connections.

6. Check the Input Sensitivity: $\times 1$ Attenuation, DC Coupled; 56.6 mV to ≥ 100 MHz

Refer to Fig. 4-3 check setup and preliminary control settings with the following exceptions.

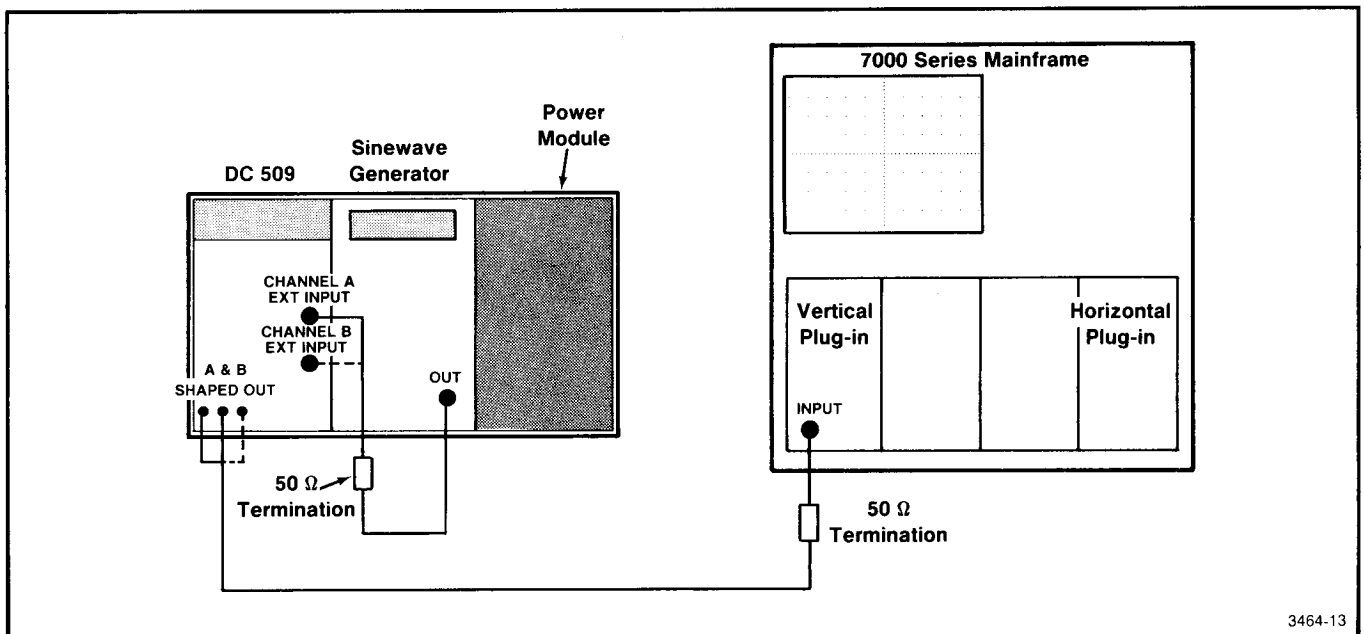

Fig. 4-3. Check setup for Performance Check steps 6, 7, and 8.

**Calibration—DC 509
Performance Check**

DC 509

AVERAGES	AUTO
CHANNEL A	
LEVEL	midrange
COUPL	DC (out)
CHANNEL B	
LEVEL	midrange

Horizontal Plug-in

TIME/DIV	20 ns
VARIABLE (CAL IN)	in

Sinewave Generator

FREQUENCY RANGE	50-100
(MHz)	
OUTPUT AMPLITUDE	0.57
FREQUENCY VARIABLE	100
AMPLITUDE MULTIPLIER	$\times .1$

a. Connect a coaxial cable from the DC 509 A SHAPED OUT (black lead to COM) using a bnc-to-tip jack connector through a 50 Ω termination to the vertical plug-in INPUT.

b. Connect a coaxial cable with a 50 Ω termination to the DC 509 CHANNEL A EXT INPUT. Connect the unterminated cable end to the sinewave generator OUTPUT connector.

c. Adjust the DC 509 CHANNEL A LEVEL control for a stable display readout on both the DC 509 and oscilloscope. The crt display is a sinewave.

d. CHECK—that the DC 509 readout indicates approximately 100 MHz.

e. Change the CHANNEL A COUPL switch to AC and check that the DC 509 display still reads approximately 100.

f. Remove the DC 509 CHANNEL A EXT INPUT cable connection and connect to the CHANNEL B EXT INPUT.

g. Change the DC 509 FUNCTION switch to the RATIO B/A position.

h. Move the DC 509 A SHAPED OUT connection to the B SHAPED OUT.

i. Connect a coaxial cable from the 1 MHz Frequency Standard output to the DC 509 CHANNEL A EXT INPUT.

j. Adjust the DC 509 CHANNEL B LEVEL control for a stable display on both the DC 509 and the oscilloscope.

k. CHECK—that the DC 509 readout indicates approximately 100 MHz.

l. Change the CHANNEL A COUPL switch to AC and check that the DC 509 display still reads approximately 100 MHz.

**7. Check the Auto-Trigger Sensitivity
 ≤ 125 mV p-p Times Attenuator, ≥ 100 MHz**

Refer to Fig. 4-3 check setup.

a. Set the sinewave generator OUTPUT AMPLITUDE control to 1.25.

b. Depress the DC 509 AUTO TRIG switch (in).

c. CHECK—that the DC 509 readout indicates approximately 100 MHz.

d. Remove the 1 MHz Frequency Standard output from the DC 509 CHANNEL A EXT INPUT connector.

e. Set the DC 509 FUNCTION switch to FREQUENCY A and move the 50 Ω termination and coaxial cable from the CHANNEL B EXT INPUT to the CHANNEL A EXT INPUT.

f. Depress the DC 509 AUTO TRIG switch twice (out to in) for new trigger.

g. CHECK—that the DC 509 readout indicates approximately 100 MHz.

**8. Check the Input Sensitivity: $\times 1/\times 5$
Attenuation, DC and AC Coupled; 113 mV to
135 MHz**

Refer to Fig. 4-3 check setup.

a. Change the sinewave generator OUTPUT AMPLITUDE control to 1.13 and set the FREQUENCY RANGE (MHz) switch to 100-250. Rotate the FREQUENCY VARIABLE control to 135.

b. Move the DC 509 B SHAPED OUT connection to the A SHAPED OUT.

c. Adjust the DC 509 CHANNEL A LEVEL control for a stable display readout on both the oscilloscope and DC 509. The crt display may be used as a guide for triggering.

d. CHECK—that the DC 509 readout indicates approximately 135 MHz.

e. Change the sinewave generator OUTPUT AMPLITUDE control to .565 and the AMPLITUDE MULTIPLIER to $\times 1$. Set the DC 509 CHANNEL A ATTEN switch to $\times 5$ (in).

f. Adjust the DC 509 CHANNEL A LEVEL control for a stable readout on the DC 509 display.

g. CHECK—that the DC 509 readout indicates approximately 135 MHz.

h. Press the DC 509 CHANNEL A COUPL switch to AC (in) and adjust the CHANNEL A LEVEL control for a stable readout on the DC 509 display.

i. CHECK—that the DC 509 display readout indicates approximately 135 MHz.

j. Move the DC 509 CHANNEL A EXT INPUT cable connection to the CHANNEL B EXT INPUT, and the A SHAPED OUT connection to the B SHAPED OUT.

k. Set the DC 509 FUNCTION switch to the RATIO B/A position.

l. Reconnect the 1 MHz Frequency Standard signal to the DC 509 CHANNEL A EXT INPUT.

m. Set the DC 509 CHANNEL A ATTEN switch to $\times 1$ (out) and the CHANNEL B ATTEN switch to $\times 5$ (in).

n. Adjust the Sinewave Generator FREQUENCY VARIABLE control for a 125 MHz readout.

o. Adjust the DC 509 CHANNEL B LEVEL control for a stable readout on the DC 509 display.

p. CHECK—that the DC 509 readout indicates approximately 125.

q. Set the DC 509 CHANNEL B ATTEN switch to $\times 1$ (out) and switch the sinewave generator AMPLITUDE MULTIPLIER to $\times .1$. Set the OUTPUT AMPLITUDE control to 1.13.

r. Adjust the DC 509 CHANNEL B LEVEL control for a stable display readout.

s. CHECK—that the DC 509 readout indicates approximately 125.

t. Change the DC 509 CHANNEL B COUPL switch to AC (in) and adjust the CHANNEL B LEVEL control for a stable display readout.

u. CHECK—that the DC 509 readout indicates approximately 125.

v. Remove the Frequency Standard signal from the DC 509 CHANNEL A EXT INPUT.

9. Check the Input Sensitivity: $\times 1$ Attenuation, DC and AC Coupled; 56.6 mV at ≤ 10 Hz

Refer to Fig. 4-4 check setup and the preliminary control settings with the following exceptions.

Function Generator	
Frequency Hz	10, \curvearrowright
MULTIPLIER	1
OFFSET	in, cw
-20 dB	in

Vertical Plug-In	
VOLTS/DIV	10 mV

Horizontal Plug-In	
TRIGGERING	
MODE	NORM
COUPLING	DC

Calibration—DC 509
Performance Check

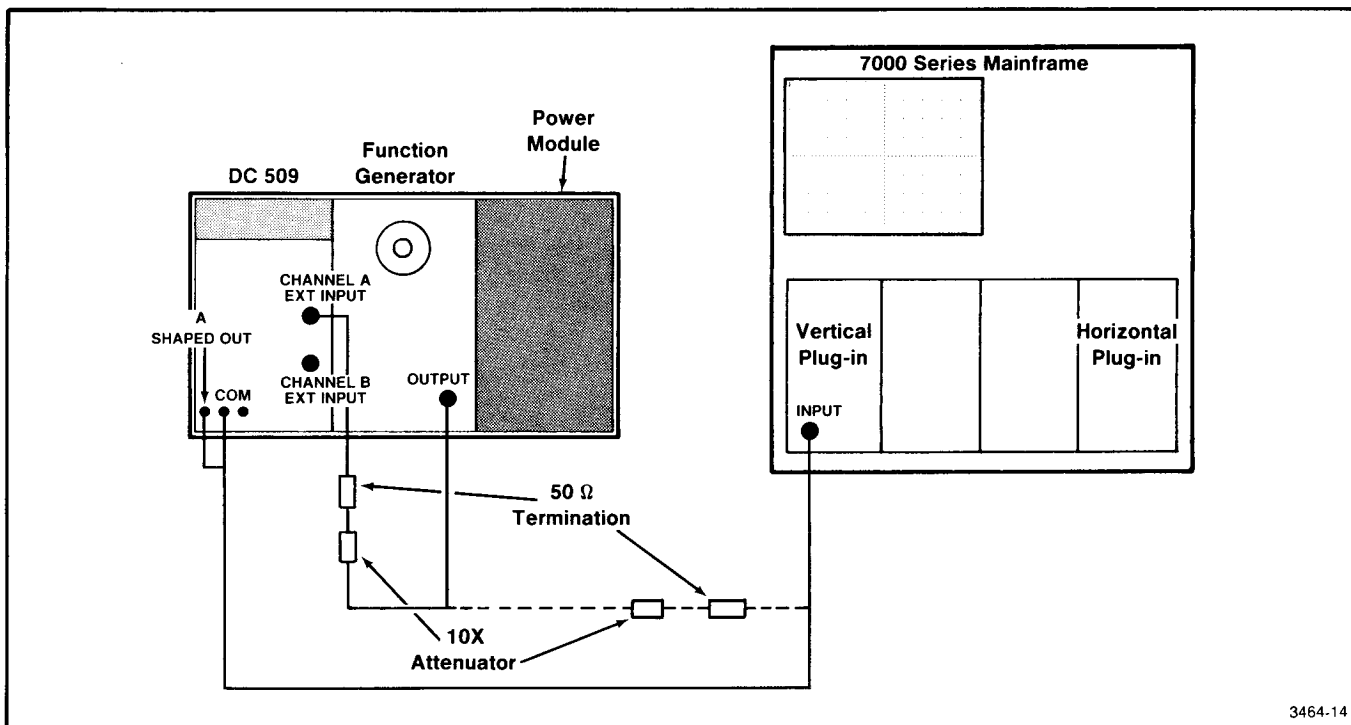

Fig. 4-4. Check setup for Performance Check step 9.

- a. Set the CHANNEL A and CHANNEL B COUPL switches to DC (out).
- b. Connect a coaxial cable with a 10× attenuator in series with a 50 Ω termination from the vertical plug-in INPUT to the FUNCTION generator OUTPUT.
- c. Adjust the function generator AMPL control to 56 mV (5-1/2 major vertical graticule divisions).
- d. Move the terminated cable end from the vertical amplifier INPUT and connect it to the DC 509 CHANNEL A EXT INPUT.
- e. Set the vertical amplifier VOLTS/DIV switch to .1.
- f. Move the B SHAPED OUT connection to the A SHAPED OUT and connect the other cable end to the vertical amplifier INPUT.
- g. Adjust the DC 509 CHANNEL A LEVEL control for a stable readout on the DC 509 using the oscilloscope crt display as a guide.
- h. CHECK—that the DC 509 readout indicates approximately 10 Hz.
- i. CHECK—that the A SHAPED OUT signal is ≥ 0.3 V p-p.
- j. Set the DC 509 CHANNEL A COUPL switch to AC (in).
- k. Pull the function generator OFFSET control out.
- l. CHECK—that the DC 509 readout indicates approximately 10 Hz. (The CHANNEL A LEVEL control may need to be adjusted slightly.)
- m. Remove the DC 509 CHANNEL A EXT INPUT connection and connect to the CHANNEL B EXT INPUT.
- n. Move the DC 509 A SHAPED OUT connection to the B SHAPED OUT.
- o. Connect the 1 MHz frequency standard to the DC 509 CHANNEL A EXT INPUT.

p. Adjust the CHANNEL A LEVEL control for a stable display of approximately 1 MHz.

q. Set the DC 509 FUNCTION switch to RATIO B/A.

r. Push the function generator OFFSET control In (off).

s. Adjust the CHANNEL B LEVEL control for a stable readout on the DC 509 using the oscilloscope crt as a guide.

t. Set the DC 509 AVERAGES switch to 10^6 .

u. CHECK—that the DC 509 readout indicates approximately 0.000010.

v. CHECK—that the B SHAPED OUT signal is ≥ 0.3 V p-p.

w. Set the DC 509 CHANNEL B COUPL switch to ac (in). (The CHANNEL B LEVEL control may have to be adjusted slightly.)

x. Pull the function generator OFFSET control OUT (on).

y. CHECK—that the DC 509 readout still indicates 0.000010. (The CHANNEL B LEVEL control may have to be adjusted slightly.)

**10. Check the Arming Input Pulse Response;
Pulse Width ≤ 100 ns ($V_H \geq 2.4$, $V_L \leq 0.4$)**

Refer to Fig. 4-5 check setup and use the following control settings.

	DC 509
AVERAGES	AUTO
	Pulse Generator
PULSE DURATION	SQUAREWAVE
PERIOD	$.1 \mu\text{s}$
BACK TERM (PULL)	in
	Horizontal Plug-in
TIME/DIV	50 ns

a. Change the vertical plug-in VOLTS/DIV switch to 1 and adjust the POSITION control to center the trace on the crt graticule.

b. Connect the pulse generator OUTPUT to the vertical plug-in INPUT using a coaxial cable with 50Ω termination.

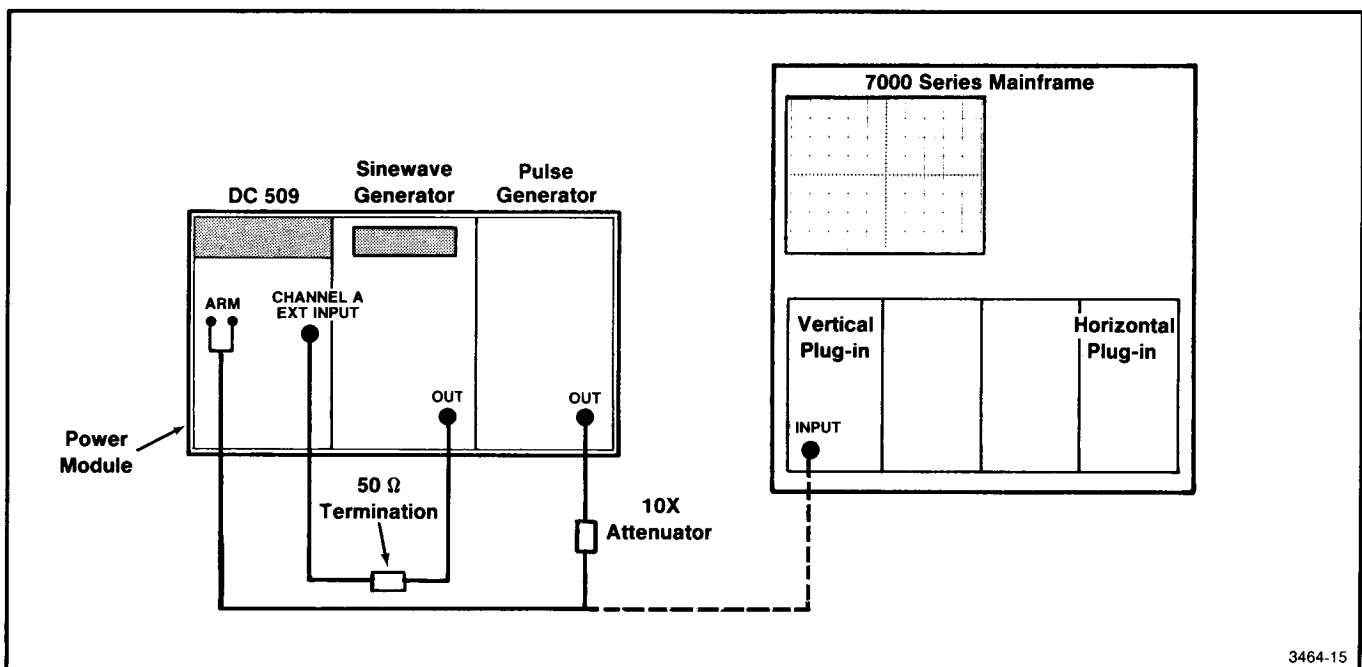

Fig. 4-5. Check setup for Performance Check step 10.

**Calibration—DC 509
Performance Check**

c. Adjust the pulse generator PERIOD VARIABLE control for a 200 ns period on the crt.

d. Adjust the pulse generator OUTPUT controls for a low level of 0.4 V and a high level of 2.4 V.

e. Disconnect the vertical plug-in INPUT cable connection.

f. Set the sinewave generator FREQUENCY RANGE (MHz) switch to 50-100 and the FREQUENCY VARIABLE control for a display readout of 70.0. Set the OUTPUT AMPLITUDE control to 1.25.

g. Connect a coaxial cable with a 50 Ω termination from the sinewave generator OUTPUT to the DC 509 CHANNEL A EXT INPUT.

h. Depress the DC 509 AUTO TRIG switch (in).

i. Connect a tip jack-to-bnc connector from the DC 509 ARM input to a 50 Ω termination to the pulse generator OUTPUT connector.

j. CHECK—that the DC 509 readout indicates approximately 70.00000 with the display GATE light blinking.

k. Disconnect the pulse generator OUTPUT cable connection with 50 Ω termination still attached to the bnc end.

l. CHECK—that the DC 509 readout indicates approximately 70 MHz and the display GATE light not blinking (but may be lit).

m. Remove all cable connections.

11. Check Input Impedance (1 MΩ ±2%)

Refer to Fig. 4-1 check setup and use the following control settings.

	DM 501A
2000 kΩ	in
INPUT	EXT
kΩ	in

a. Connect a coaxial cable with a female-to-dual banana adapter from the digital multimeter LOW and VOLTS/Ω input connectors to the DC 509 CHANNEL A EXT INPUT.

b. CHECK—that the digital multimeter readout indicates between 980.0 and 1020.0 (kΩ).

c. Change the DC 509 CHANNEL A EXT INPUT connection to the CHANNEL B EXT INPUT.

d. CHECK—that the digital multimeter readout indicates between 980.0 and 1020.0 (kΩ).

e. Remove the connections.

12. Check Input Capacitance, ≤30 pF

NOTE

The check procedure in steps 12a through 12j require qualified personnel only.



Install the probe tip ground cover (insulating sleeve) to prevent surrounding component damage.

Refer to the Adjustment locations (in pullout pages) and use the preliminary control settings with the following exceptions.

	Horizontal Plug-In
TIME/DIV	100 μs
	Vertical Plug-In
VOLTS/DIV	2 V
COUPLING	AC
	DC 509
AVERAGES	AUTO
CHANNEL A and CHANNEL B LEVEL	ccw
AUTO TRIG	out
	Function Generator
FREQUENCY Hz	1
MULTIPLIER	10 ³
FUNCTION	⌋ (squarewave)
OFFSET	OFF (in)
OUTPUT	midrange

- a. Turn off the power, then pull the DC 509 from the power module and remove the right side cover.
- b. Connect the DC 509 to the power module using the flexible plug-in extender and turn on the power.
- c. Connect the test probe to the vertical plug-in INPUT connector. Make certain the test probe is compensated to the oscilloscope.
- d. Connect a coaxial cable with a 50 Ω termination and 30 pF normalizer from the function generator OUTPUT to the DC 509 CHANNEL A EXT INPUT.
- e. Carefully connect the test probe tip to the junction of transistor Q1122 collector, located on the analog board.
- f. Adjust the function generator OUTPUT control for ≈ 1 V peak-to-peak squarewave on the crt display.
- g. CHECK—that the displayed squarewave is over compensated (over-peaked).
- h. Remove the DC 509 CHANNEL A EXT INPUT connection and connect to the CHANNEL B EXT INPUT.
- i. Remove the test probe tip from transistor Q1122 and connect to the junction of transistor Q1142 collector, also located on the analog board.
- j. Repeat steps 12f and 12g.

13. Check Probe Compensation Function

Refer to the Adjustment Locations (in pullout pages) and use the following control settings.

NOTE

The check procedure in steps 13k through 13q require qualified personnel only.

	Function Generator
OFFSET	OFF (in)
	Vertical Plug-In
COUPLING	AC

- a. Disconnect the DC 509 CHANNEL B EXT INPUT connection and remove the 30 pF normalizer and the 50 Ω termination. Reconnect this cable to the vertical plug-in INPUT.
- b. Adjust the function generator OUTPUT control for approximately 10 V peak-to-peak.
- c. Remove the coaxial cable from the function generator.
- d. Connect the instrument probe to the DC 509 CHANNEL A EXT INPUT. Attach the probe tip to the function generator OUTPUT using the probe tip-to-bnc connector.
- e. Set the DC 509 FUNCTION switch to PROBE COMP, insert the adjustment tool in the probe compensation adjustment slot, and press RESET.
- f. Slowly rotate (≈ 90 degrees per 5 seconds) the probe compensation adjustment in either direction until the display for the channel being used changes to a "1". If the adjustment has not been rotated at least 180 degrees, continue rotating the adjustment until the display changes to a "0" and then to a "1".

NOTE

The MDS digit (far left) is for Channel A, the LSD digit (far right) is for Channel B. The GATE light will flash, indicating the rate at which the input is checked for compensation.

- g. Reverse direction of rotation and again slowly turn the probe adjustment until the display changes to a "0".
- h. Reverse direction of probe adjustment again until the display goes to a "1" (only a few degrees will be required).
- i. Once again reverse direction of probe adjustment and very slowly turn the adjustment until the display just changes to a "0". At this point the probe will be compensated.

NOTE

If at any point in the procedure the display should remain a "1" for more than one complete rotation of the probe adjustment, press the DC 509 RESET button and repeat steps 13f through 13i. If at any time the display alternates between "0" and "1" without the probe adjustment being varied, slightly change the input signal amplitude and repeat this procedure.

**Calibration—DC 509
Performance Check**

j. Change the DC 509 FUNCTION switch to FREQUENCY A (or any function except PROBE COMP or TEST).

k. Connect the test probe to the vertical plug-in INPUT connector and carefully connect the probe tip to the collector of transistor Q1122, located on the analog board (or transistor Q1142 collector, if Channel B is used).

l. Change the vertical plug-in VOLTS/DIV switch to 100 mV.

m. CHECK—that the displayed waveform overshoot (aberration on positive going edge) is ≤ 50 mV (approximately 1/2 major graticule division).

n. Remove the probe connection from the DC 509 CHANNEL A EXT INPUT and connect to the CHANNEL B EXT INPUT.

o. Repeat steps 13e through 13i.

p. Remove the test probe tip from transistor Q1122.

q. Repeat steps 13j and 13k.

r. Remove probe and cable connections.

14. Check the Minimum Input Pulse Width (3 ns @ 115 mV p-p)

Refer to Fig. 4-6 check setup and the following control settings.

Pulse Generator	
PULSE DURATION	≤ 2 ns
PERIOD	≤ 4 ns
VARIABLE	cw
OUTPUT (VOLTS)	
LOW LEVEL	0
HIGH LEVEL	2
BACK TERM (PULL)	out
COMPLEMENT	NORM (out)

DC 509	
FUNCTION	FREQUENCY A
AVERAGES	AUTO
CHANNEL A and CHANNEL B	
LEVEL	midrange
SLOPE, ATTEN, COUPL	(all out)
SOURCE	out

Vertical Plug-In	
VOLTS/DIV	50 mV
BANDWIDTH	FULL
POLARITY	+ UP
AC-GND-DC	DC
POSITION	trace centered

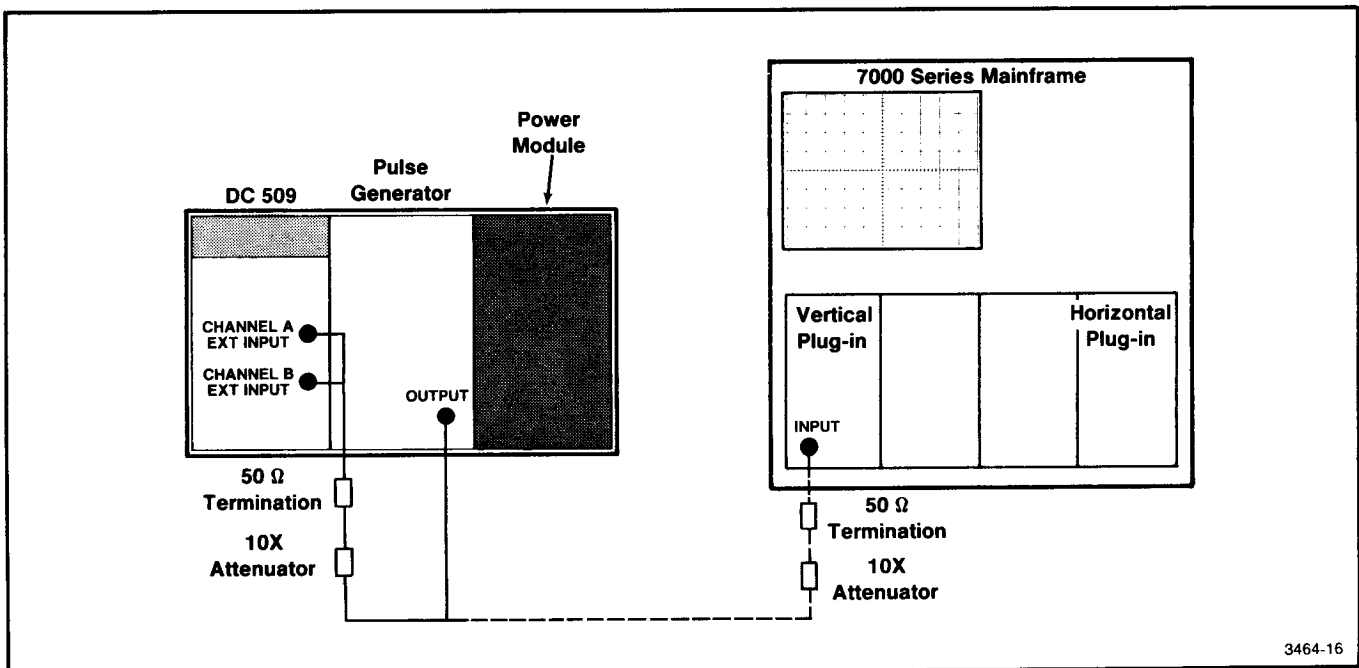

Fig. 4-6. Check setup for Performance Check step 14.

Horizontal Plug-In

TRIGGERING	
MODE	P-P AUTO
COUPLING	AC
SOURCE	INT
POSITION	as desired
TIME/DIV	20 ns
VARIABLE	in
MAG	×10 (out)

a. Connect a coaxial cable with a 10× attenuator and a 50 Ω termination from the pulse generator OUTPUT connector to the vertical plug-in INPUT connector.

b. Adjust the pulse generator LOW LEVEL control to position the displayed bottom of the waveform on the crt center graticule line.

c. Adjust the pulse generator HIGH LEVEL control until the crt displayed waveform is 2.3 major graticule divisions high.

d. Adjust the pulse generator PERIOD VARIABLE control until the crt displayed waveform indicates a period of 4.0 major divisions.

e. Adjust the pulse generator PULSE DURATION VARIABLE until the crt displayed positive pulse width is 1.5 major divisions.

f. Move the vertical plug-in INPUT cable connection to the DC 509 CHANNEL A EXT INPUT.

g. Adjust the DC 509 CHANNEL A LEVEL control for a stable readout.

h. CHECK—that the DC 509 display readout indicates approximately 125.00000 (MHz).

i. Disconnect the DC 509 CHANNEL A EXT INPUT and connect to the CHANNEL B EXT INPUT.

j. Connect the 1 MHz Frequency Standard signal to the DC 509 CHANNEL A EXT INPUT. Adjust the DC 509 CHANNEL A LEVEL control for a stable display of approximately 1 MHz.

k. Set the DC 509 FUNCTION switch to RATIO B/A position.

l. Adjust the DC 509 CHANNEL B LEVEL control for a stable readout.

m. CHECK—that the DC 509 display readout indicates approximately 125.00000.

n. Remove all connections.

15. Check Width A Range (≤15 ns) and minimum Dead Time (≤15 ns)

Refer to Fig. 4-6 check setup and the following control settings.

Pulse Generator

PULSE DURATION	5 ns
PERIOD	10 ns

DC 509

FUNCTION	WIDTH A
CHANNEL A and CHANNEL B LEVEL	midrange

Vertical Plug-In

VOLTS/DIV	.2 V
-----------	------

Horizontal Plug-In

TIME/DIV	5 ns
----------	------

a. Connect a coaxial cable with a 50 Ω termination from the pulse generator OUTPUT to the vertical plug-in INPUT.

b. Adjust the pulse generator OUTPUT (VOLTS) LOW LEVEL and HIGH LEVEL controls for a 1 V peak-to-peak crt displayed pulse (referenced to ground).

c. Adjust the pulse generator PERIOD and PULSE DURATION controls for a crt displayed squarewave with a 30 ns period.

d. Move the vertical plug-in INPUT connection to the DC 509 CHANNEL A EXT INPUT.

e. Depress the DC 509 AUTO TRIG switch.

f. CHECK—that the DC 509 display readout indicates approximately 15.00 (ns).

g. Remove all connections.

16. Check Channel Delay Mismatch (≤ 2 ns)

Refer to Fig. 4-7 check setup for the following.

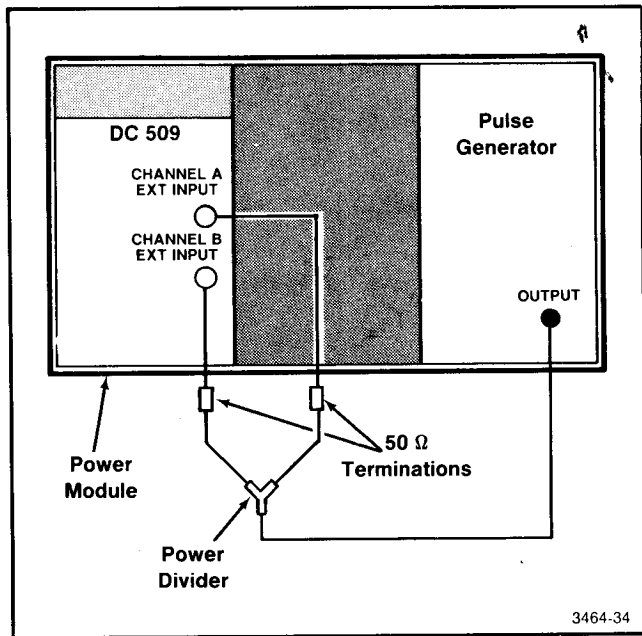

Fig. 4-7. Check setup for Performance Check steps 16 and 17.

a. Connect a coaxial cable from the pulse generator OUTPUT to one port of a 50 Ω power divider (using the GR-to-bnc adapter).

b. Connect two short equal length coaxial cables to the remaining ports (2) of the power divider (using the GR-to-bnc adapter).

c. Connect one of these cables with a 50 Ω termination to the DC 509 CHANNEL A EXT INPUT. Connect the other cable with a 50 Ω termination to the CHANNEL B EXT INPUT.

d. Set the DC 509 FUNCTION switch to TIME A \rightarrow B and depress the AUTO TRIG twice (out then in).

e. Note the DC 509 display readout.

f. Set the DC 509 FUNCTION switch to PERIOD A.

g. Note the DC 509 readout.

h. CHECK—that the difference between the two readings is less than 2 ns.

17. Check EVENTS B DUR A Minimum Response (15 ns)

Refer to Fig. 4-7 check setup.

a. Set the DC 509 FUNCTION switch to EVENTS B DUR A.

b. Set the DC 509 CHANNEL B SLOPE switch to — (in).

c. Depress the DC 509 AUTO TRIG switch twice (out then in).

d. CHECK—that the DC 509 display readout indicates 1.000.

REAR INTERFACE CHECKS

NOTE

This procedure requires the removal of the power module top cover. Coaxial cable (50 Ω) interfacing is required between the power module and DC 509. Good high frequency connection techniques are also required.

WARNING

When instruments are operated with covers removed, DO NOT touch exposed connections or components. This procedure is to be completed by qualified technical personnel only.

18. Check CHANNEL A and CHANNEL B Rear Interface Input Frequency Range (≥ 50 MHz, DC and AC) and Input Impedance ($50 \Omega \pm 10\%$ @ DC)

A signal source capable of ≥ 50 MHz frequency with an amplitude of ≥ 20 mV rms, 56 mV p-to-p and a 1 MHz frequency standard is required for this check.

- a. Turn off the power module.
- b. Remove the top cover from the power module, exposing the interface connectors (refer to the Maintenance Section in the power module instruction manual).
- c. Using an appropriate length 50 Ω coaxial cable (no connectors), attach one end of the cable center conductor to pin 16A of the DC 509 rear interface connector. Attach the shielded conductor (same cable end) to pin 17A of the rear interface connector.
- d. Attach the other cable end (center conductor and shield) to the appropriate output connections on the signal generator. Set the generator for 56 mV p-to-p at 50 MHz.
- e. Set the DC 509 FUNCTION switch to FREQUENCY A, AVERAGES switch to AUTO, and the CHANNEL A SOURCE switch to INT (in).
- f. Connect the tip jack-to-bnc cable from the DC 509 A SHAPED OUT (black lead to COM) to the vertical plug-in INPUT.
- g. Adjust the DC 509 CHANNEL A LEVEL control for a stable display on the DC 509 and oscilloscope crt.
- h. CHECK—that the DC 509 readout indicates approximately 50 (MHz).
- i. Change the CHANNEL A COUPL switch to AC (in) and check that the display readout remains approximately 50 (MHz).
- j. Move the signal generator cable connections to the digital multimeter LOW and VOLTS/ Ω input connectors.
- k. Set the digital multimeter INPUT switch to EXT and press the 200 Ω switch in. Make sure the k Ω switch is in.
- l. CHECK—that the digital multimeter readout indicates between 45 and 55 (Ω).
- m. Detach the coaxial cable center conductor from pin 16A and attach to pin 17B of the DC 509 rear interface connector. Detach the shield conductor from pin 17A and attach to pin 16B of the interface connector.
- n. CHECK—that the digital multimeter readout indicates between 45 and 55 (Ω).
- o. Move the digital multimeter connections back to the signal generator.
- p. Connect the 1 MHz frequency standard to the DC 509 pin 16A (shield to pin 17A) and adjust the CHANNEL A LEVEL control for a stable display on both the DC 509 and oscilloscope crt.
- q. Change the DC 509 FUNCTION switch to RATIO B/A, and the CHANNEL B SOURCE switch to INT (in).
- r. Move the DC 509 A SHAPED OUT connection to the B SHAPED OUT.
- s. Adjust the DC 509 CHANNEL B LEVEL control for a stable display readout.
- t. CHECK—that the DC 509 readout indicates approximately 50.

Calibration—DC 509
Performance Check

u. Change the DC 509 CHANNEL A COUPL switch to AC (in) and check that the display readout still indicates approximately 50.

v. Remove the cable connections.

This completes the Performance Check.

ADJUSTMENT PROCEDURE

Introduction

Use this Adjustment Procedure to restore the DC 509 to original performance requirements. This Adjustment Procedure need not be performed unless the instrument fails to meet the Performance Requirements of the electrical characteristics listed in the Specification section, or if the Performance Check procedure cannot be completed satisfactorily. If the instrument has undergone repairs, the Adjustment Procedure is recommended. Allow thirty minutes warmup time for operation to specified accuracy (sixty minutes after storage in a high humidity environment).

Satisfactory completion of all adjustment steps in this procedure assures that the instrument will meet the Performance Requirements.

Test Equipment Required

The test equipment (or equivalent) listed in Table 4-1 is required for adjustment of the DC 509. Specifications given for the test equipment are the minimum necessary for accurate adjustment. All test equipment is assumed to be correctly calibrated and operating within specifications.

If other test equipment is substituted, the calibration setup may need to be altered to meet the requirements of the equipment used.

Preliminary Control Settings

DC 509	
FUNCTION	FREQUENCY A
AVERAGES	10 ⁶
AUTO TRIG	out
CHANNEL A	
SLOPE	+ (out)
ATTEN	X1 (out)
SOURCE	EXT (out)
COUPL	AC (in)
CHANNEL B	
SLOPE	+ (out)
ATTEN	X1 (out)
SOURCE	EXT (out)
COUPL	AC (in)

Preparation

Access to the internal adjustments is achieved most easily when the DC 509 is connected to the power module with a flexible plug-in extender. Remove the right side cover of the DC 509 to reach the adjustments on the analog board. Refer to the Adjustment Locations and Setups in the pullout pages at the rear of this manual.

NOTE

Make adjustments at an ambient temperature between +20°C and +30°C.

1. Adjust R1301, +3.2 V ADJ

a. Set the digital multimeter to the 20 V dc range.

b. Connect the digital multimeter LOW test lead to the DC 509 COM tip jack connector. Connect the VOLTS/Ω test lead to TP1341, located on the Analog board.

c. ADJUST—R1301 until the digital multimeter readout indicates 3.200 volts.

d. Remove the VOLTS/Ω test lead from TP1341.

2. Check the – 12 V Supply Accuracy

a. Connect the digital multimeter VOLTS/Ω test lead to TP1631, located on the Analog board.

b. CHECK—that the digital multimeter readout indicates between – 11.400 V and – 12.600 V.

c. Remove all test leads from the DC 509.

3. Adjust the Standard Timebase Accuracy, C1602, OSC ADJ

a. Connect a coaxial cable from the 1 MHz frequency standard to the DC 509 CHANNEL A EXT INPUT.

b. Set the DC 509 CHANNEL A LEVEL control for a stable readout.

**Calibration—DC 509
Adjustment Procedure**

c. ADJUST—C1602 until the DC 509 readout indicates between 999.99990 and 1.0000001 MHz.

NOTE

This sets the DC 509 oscillator within 1 part in 10⁷. It will take approximately 1 second for the display to update.

4. Adjust the Optional Timebase Accuracy, Y1531

NOTE

The Option 01 timebase adjustment is made through an access hole in the back of the oven timebase. Y1531 is located on the back side of the Analog board.

a. Connect a coaxial cable from the 1 MHz frequency standard to the DC 509 CHANNEL A EXT INPUT.

b. Set the DC 509 CHANNEL A LEVEL control for a stable readout.

c. ADJUST—Y1531 until the DC 509 readout indicates 1.0000000.

d. Change the DC 509 FUNCTION switch to PERIOD A.

e. ADJUST—Y1531 until the DC 509 readout indicates 999.99998 or 999.99999.

f. Remove the cable connections from the DC 509.

5. Adjust R1102, CH A DAC GAIN

NOTE

Refer to Fig. 8-2 in the foldout section for adjustment setup. Use the following control settings.

DC 509

CHANNEL A	
COUPL	DC (out)
CHANNEL B	
COUPL	DC (out)

Function Generator

0 dB	in
OFFSET	out (cw)
AMPL	ccw
FREQUENCY Hz	10
MULTIPLIER	10 ⁴
~ (TRIANGLE)	(in)

a. Connect an RF cable assembly (bnc-to-tip jack connector) from the DC 509 A TRIG LEVEL (black lead to COM) to the digital multimeter LOW and VOLTS/ Ω connectors using a bnc female-to-dual banana adapter.

b. Connect a coaxial cable from the DC 509 CHANNEL A EXT INPUT connector to the function generator OUTPUT connector. This provides a dc offset level greater than +5 V to the input of the DC 509.

c. Press the DC 509 AUTO TRIG switch (in).

d. ADJUST—R1102 for a digital multimeter readout of -3.175 V.

6. Adjust the CH B DAC GAIN, R1211

NOTE

Refer to Fig. 8-2 in the foldout section for adjustment setup.

a. Disconnect the DC 509 CHANNEL A cable connection and connect to the CHANNEL B connector.

b. Move the A TRIG LEVEL connection to the B TRIG LEVEL connector.

c. Press the DC 509 AUTO TRIG switch (out), then press it again (in).

d. ADJUST—R1211 for a digital multimeter readout of -3.175 V.

e. Remove the digital multimeter cable connections from the DC 509.

e. Rotate the function generator FREQUENCY Hz dial until the DC 509 display readout indicates 10.00 XXX μ s (the last three digits are negligible).

7. Adjust R1317, CHANNEL A OFS

f. Set the DC 509 FUNCTION switch to WIDTH A.

NOTE

Refer to Fig. 8-3 in the foldout section for adjustment setup. Use the following control settings.

g. ADJUST—R1317 until the DC 509 display readout indicates 5.00, \pm .01 μ s.

8. Adjust R1323, CHANNEL B OFS

Function Generator

OFFSET	out (centered)
0 dB	(in)
MULTIPLIER	10^4
FREQUENCY Hz	10, \sim
AMPL	cw

NOTE

Refer to Fig. 8-3 in the foldout section for adjustment setup.

DC 509

FUNCTION	PERIOD A
AUTO TRIG	out

a. Retain the function generator settings and move the DC 509 CHANNEL A EXT INPUT cable connection to the CHANNEL B EXT INPUT.

a. Connect a coaxial cable from the function generator OUTPUT with a 10X attenuator and 50 Ω termination to the digital multimeter LOW and VOLTS/ Ω input jacks using a bnc-to-dual banana adapter.

b. Move the DC 509 A TRIG LEVEL connection to the B TRIG LEVEL output.

b. Rotate the function generator OFFSET control until the digital multimeter display readout indicates .000 V.

c. Rotate the DC 509 CHANNEL B LEVEL control until the digital multimeter display readout indicates 0.000 V.

c. Move the coaxial cable with the 10X attenuator and 50 Ω termination from the digital multimeter to the DC 509 CHANNEL A EXT INPUT. Then connect a coaxial cable from the digital multimeter bnc-to-dual banana adapter to the DC 509 A TRIG LEVEL using a bnc-to-tip jack connector.

d. Move the DC 509 B TRIG LEVEL connection to the B SHAPED OUT and remove the cable end from the bnc-to-banana adapter on the digital multimeter and connect to the DC 509 CHANNEL A EXT INPUT.

d. Rotate the DC 509 CHANNEL A LEVEL control until the digital multimeter display readout indicates 0.000 V.

e. Adjust the DC 509 CHANNEL A LEVEL control for a stable display readout.

f. ADJUST—R1323 until the DC 509 display readout indicates 5.00, \pm .01 μ s.

g. Remove all cable connections and replace the DC 509 side cover. This completes the Adjustment Procedure.

MAINTENANCE

Static-Sensitive Components

CAUTION

Static discharge may damage semiconductor components in this instrument.

This instrument contains electrical components that are susceptible to damage from static discharge. See Table 5-1 for relative susceptibility of various classes of semiconductors. Static voltages of 1 kV to 30 kV are common in unprotected environments.

Observe the following precautions to avoid damage:

1. Minimize handling of static-sensitive components.
2. Transport and store static-sensitive components or assemblies in their original containers, on a metal rail, or on conductive foam. Label any package that contains static-sensitive assemblies or components.
3. Discharge the static voltage from your body by wearing a wrist strap while handling these components. Servicing static-sensitive assemblies or components should be performed only at a static-free work station by qualified service personnel.
4. Nothing capable of generating or holding a static charge should be allowed on the work station surface.
5. Keep the component leads shorted together whenever possible.
6. Pick up components by the body, never by the leads.
7. Do not slide the components over any surface.
8. Avoid handling components in areas that have a floor or work surface covering capable of generating a static charge.

9. Use a soldering iron that is connected to earth ground.

10. Use only special antistatic suction type or wick type desoldering tools.

Test Equipment

Before using any test equipment to make measurements on static-sensitive components or assemblies, be certain that any voltage or current supplied by the test equipment does not exceed the limits of the component to be tested.

Table 5-1
RELATIVE SUSCEPTIBILITY TO
STATIC DISCHARGE DAMAGE

Semiconductor Classes	Relative Susceptibility Levels ^a
MOS or CMOS microcircuits or discretes, or linear microcircuits with MOS inputs (Most Sensitive)	1
ECL	2
Schottky signal diodes	3
Schottky TTL	4
High-frequency bipolar transistors	5
JFETs	6
Linear microcircuits	7
Low-power Schottky TTL	8
TTL (Least Sensitive)	9

^a Voltage equivalent for levels:

1 = 100 to 500 V 4 = 500 V 7 = 400 to 1000 V (est.)
 2 = 200 to 500 V 5 = 400 to 600 V 8 = 900 V
 3 = 250 V 6 = 600 to 800 V 9 = 1200 V

(Voltage discharged from a 100 pF capacitor through a resistance of 100 ohms.)

Circuit Board Removal and Replacement

1. Remove the snap-on side covers.
2. Remove the rear cover which is secured by two philips screws (top of cover) and two 3/16 inch hex bullet connectors (bottom cover).
3. Remove the relay hold-down cover by removing the two screws which secure the cover to the analog board. (See Fig. 5-1.) Pull the cover away.

4. Remove the front cover by unsoldering the four analog board connections from the front panel input connectors. (See Fig. 5-1.) Then remove the front panel display lens by releasing the two plastic tabs (as seen from the top front panel) that secure the lens to the front panel. Be careful not to overstress the plastic tabs. The lens rotates out from the top. With lens removed, locate the two corner screws securing the display board and remove. Remove the four front panel corner screws, securing the panel to the top and bottom covers. Carefully pull the front panel cover away, clearing the panel pushbuttons and levers.

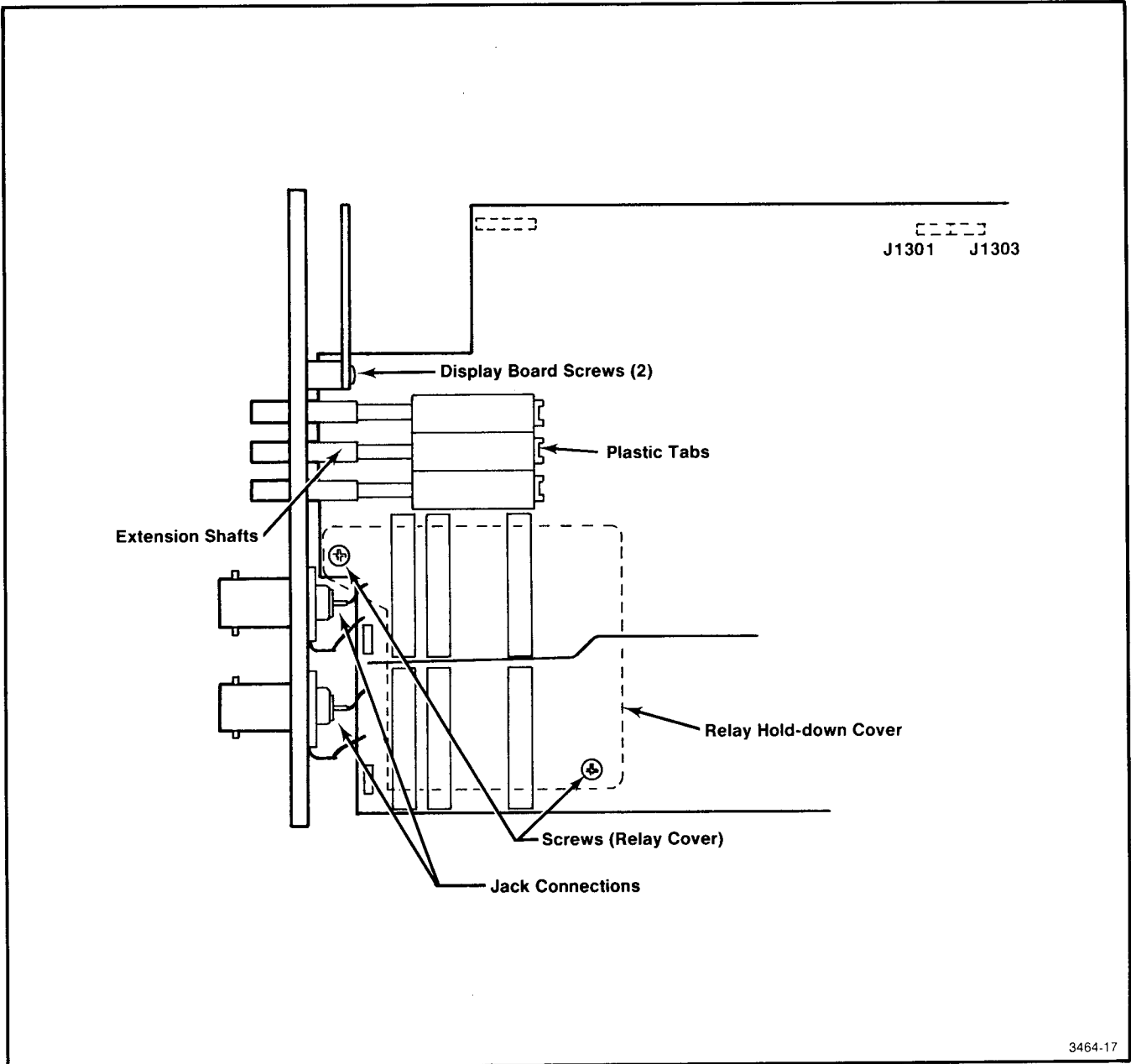

Fig. 5-1. Partial right view of instrument with cover removed (pictorial).

5. Remove the two connectors, from J1301 and J1303 located on the analog board (back side). (See Fig. 5-1.)

6. Remove the five screws that secure the digital board to the analog board. (See Fig. 5-2.)

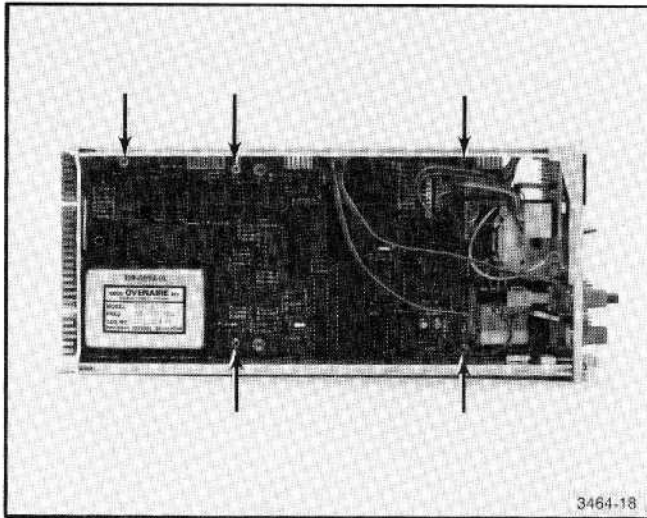

Fig. 5-2. Screw locations for digital circuit board removal.

7. Separate the digital board from the analog board using care not to overstress or bend the interconnecting jack pins.

8. To replace the board, reverse the order of the above procedure.

Switch Maintenance

After separating the two boards, the front panel lever switches may be removed by removing the three screws attaching each lever switch to the circuit board. Use care when removing or assembling the lever switches to the circuit boards to prevent bending the contact fingers. When re-assembling, carefully align the screw holes on the switch cover with the board. Place the switch cover on the board in the proper position before inserting the screws.

To remove the front panel pushbutton switches, refer to Fig. 5-1. Pull to remove the extension shafts. Carefully bend the plastic tab back and raise the rear of the switch clear of the tab.

To clean the board and switch contacts, use a lubricated contact cleaner such as, No Noise Contact Restorer¹. However DO NOT USE THIS CLEANER on the magnetic latching relays (refer to proper cleaning procedure).

Front Panel Latch Removal

To replace the latch, remove the screw under the pull tab. Carefully pry up the pull tab from the latch assembly.

¹ Electronic Chemical Corporation, 813 Communipaw Avenue, Jersey City, N.J. 07304

MAGNETIC LATCH RELAYS

To prevent damage to these relays, do not remove them from the Analog circuit board unless absolutely necessary. If the relay contacts become noisy or the relay fails to operate, remove the relay from the circuit board. Remove the two screws, attaching the hold-down relay cover, from the front of the board. The relays may then be individually removed.

Clean the circuit board contacts with a small brush and isopropyl alcohol. Do not use any solvent that may attack polycarbonates such as hydrocarbon chlorides, ketones, esters, etc. Do not use a cotton swab as small cotton filaments may remain on the contact area.

Clean the contact fingers on the relay armature by lightly brushing the contacts with a brush dipped in isopropyl alcohol.

To remove the relay armature from the relay, obtain a wire or tool with a diameter less than 0.040 inch, such as a paperclip. Before removing the armature, mark the orientation of the armature to the housing. Orientation is important for proper operation. Place the tool in the slot on the side of the housing and gently lift the relay armature. (See Fig. 5-3.)

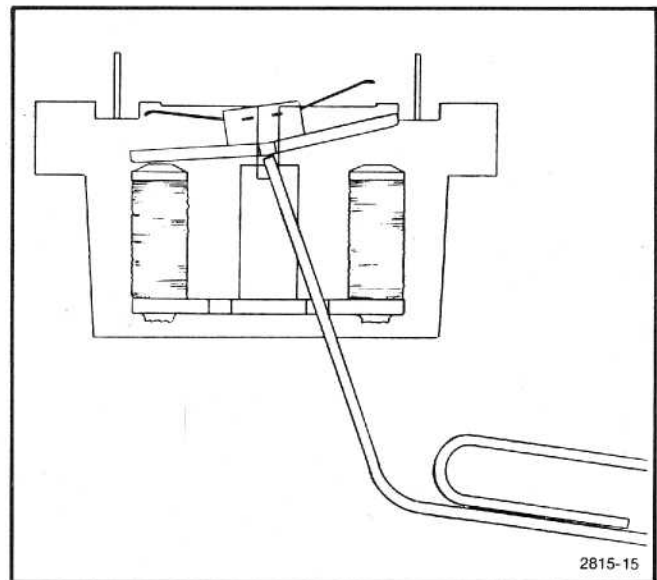

Fig. 5-3. Method of removing magnetic latch relay armature.

Clean the interior of the relay, around the pole pieces, with isopropyl alcohol. The interior of the relay must be completely dry before reinstalling the armature. Use air to dry excess alcohol from the housing. Make sure that the relays are perpendicular to the board before replacing the cover.

NOTE

Do not spray contact cleaners of any type on the relays or the board contacts. Any foreign material, including lubricants, can cause faulty operation.

Cleaning Instructions

This instrument should be cleaned as often as operating conditions require. Accumulation of dirt on components acts as an insulating blanket and prevents efficient heat dissipation that can cause overheating and component breakdown.



Avoid the use of chemical cleaning agents that might leave a film or damage the plastic material used in this instrument. Use a nonresidue type of cleaner; preferably, isopropyl alcohol or totally denatured ethyl alcohol. Before using any other type of cleaner, consult your Tektronix Service Center or representative.

Exterior. Loose dust accumulated on the front panel can be removed with a soft cloth or a small brush. Dirt that remains can be removed with a soft cloth dampened with a mild detergent and water solution. Abrasive cleaners should not be used.

Interior. Dust in the interior of the instrument should be removed occasionally, due to its electrical conductivity under high humidity conditions. The best way to clean the interior is to blow off the accumulated dust with dry, low pressure air then use a soft brush. If further cleaning is required, use a mild detergent and water solution, flushing well with clean water.



Do not clean the circuit board with water, air, or any solvent, unless the pushbutton switches and relays are removed first. Any dirt forced or carried under the contacts can cause intermittent operation. Circuit boards and components must be dry before applying power to prevent damage from electrical arcing.

Drying can be accomplished with dry, low-pressure air or by placing in an oven at 40°C to 60°C for approximately four hours.

After making minor board repairs, cleaning is best accomplished by carefully flaking or chipping the solder flux from the repaired area.

Isopropyl alcohol can be used to clean major repairs to the circuit board; however, flush the board well with clean, isopropyl alcohol. Make certain that resin or dirt is carefully removed from the board.

Obtaining Replacement Parts

Electrical and mechanical parts can be obtained through your local Tektronix Field Office or representative. However, many of the standard electronic components can be obtained from a local commercial source. Before purchasing or ordering parts from a source other than Tektronix, Inc., check the Replaceable Electrical Parts list for the proper value, rating, tolerance, and description.

Ordering Parts

When ordering replacement parts from Tektronix, Inc., it is important to include all of the following information.

1. Instrument type (include modification or option numbers).
2. Instrument serial number.
3. A description of the part (if electrical, include the component number).
4. Tektronix part number.

Soldering Techniques



To avoid electric shock hazard, disconnect the instrument from the power source before soldering.

The reliability and accuracy of this instrument can be maintained only if proper soldering techniques are used when repairing or replacing parts. General soldering techniques which apply to maintenance of any precision electronic equipment should be used when working on this instrument. Use only 60/40 rosin-core, electronic grade solder. The choice of soldering iron is determined by the repair to be made.

CAUTION

The Analog and Digital circuit boards in the DC 509 are multilayer type boards with conductive paths laminated between the top and bottom board layers. All soldering on these boards should be done with extreme care to prevent breaking the connections to this conductive path. Only experienced maintenance personnel should attempt to repair these boards. Do not allow solder or solder flux to flow under printed circuit board switches. The printed circuit board is part of the switch contacts; intermittent switch operation can occur if the contacts are contaminated.

When soldering on circuit boards or small wiring, use only a 15 watt, pencil type soldering iron. A higher wattage soldering iron can cause the etched circuit wiring to separate from the board base material and melt the insulation from small wiring. Always keep the soldering iron tip properly tinned to ensure the best heat transfer to the solder joint. Apply only enough heat to remove the component or to make a good solder joint. To protect heat sensitive components, hold the component lead with a pair of long-nose pliers between the component body and the solder joint. Use a solder removing wick to remove excess solder from connections or to clean circuit board pads.

To remove in-line integrated circuits use an extracting tool. This tool is available from Tektronix, Inc.; order Tektronix Part Number 003-0619-00. If an extracting tool is not available, use care to avoid damaging the pins. Pull slowly and evenly on both ends of the integrated circuit. Try to avoid disengaging one end before the other end.

Interconnecting Pins

Several methods of interconnection, including square pin and circuit board pin and ferrule are used to electrically connect the circuit boards with the other boards and components.

Several types of mating connectors are used for these interconnecting pins. If the mating connector is mounted on a plug-on circuit board, special sockets are soldered into the board. If the mating connector is on the end of a lead, an end-lead pin connector is used. This connector mates with

the interconnecting pin. The following information provides the removal and replacement procedure for the various interconnecting methods.

Square Pin Assemblies

See Fig. 5-4. These pins are of various lengths. They are attached to each other with a plastic strip. To remove them simply unsolder from the circuit board.

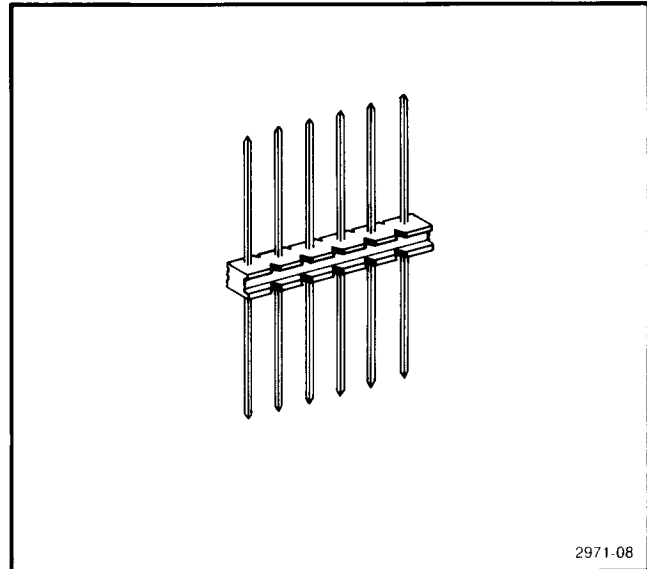

Fig. 5-4. Typical square pin assembly.

Circuit Board Pins and Ferrules

See Fig. 5-5. A circuit board pin replacement kit (including necessary tools, instructions, and replacement pins with attached ferrules) is available from Tektronix, Inc.; order Tektronix Part Number 040-0542-00. Replacing circuit board pins on multilayer boards is not recommended. (The multilayer boards in this instrument are listed under Soldering Techniques in this section.)

To replace a damaged pin, first disconnect any pin connectors. Then unsolder the damaged pin and pull it from the board with a pair of pliers, leaving the ferrule in the circuit board, if possible. If the ferrule remains in the circuit board, remove the spare ferrule from the replacement pin and press the new pin into the hole in the circuit board. If the ferrule is removed with the damaged pin, clean out the hole using a solder removing wick and a scribe. Then press the replacement pin, with attached spare ferrule, into the circuit board.

Position the replacement pin in the same manner as the original. Solder the pin to the circuit board on each side of

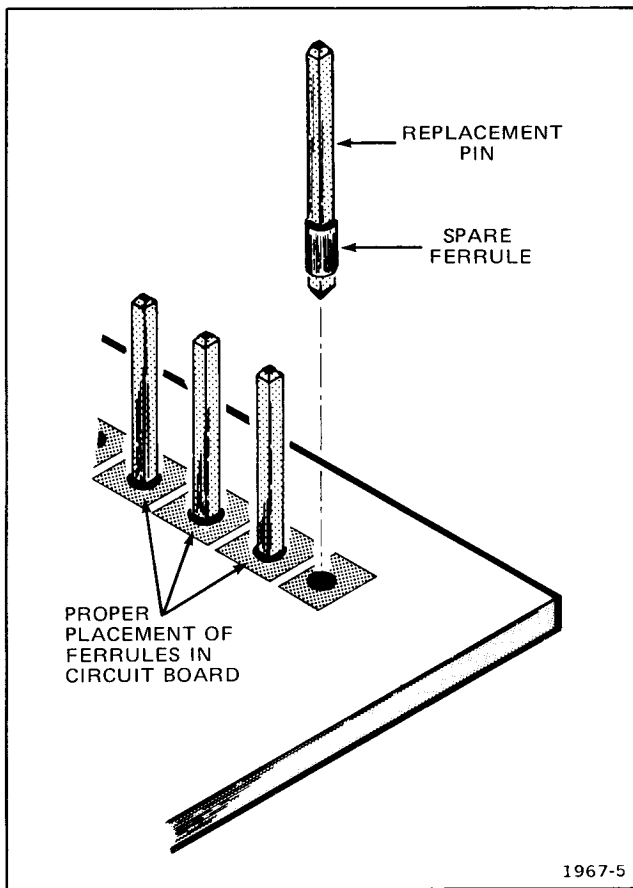

Fig. 5-5. Exploded view of circuit board pin and ferrule.

the board. If the original pin was bent at an angle to mate with a connector, carefully bend the new pin to the same angle. Replace the pin connector.

Dual Entry Circuit Board Pin Sockets

The pin sockets on the circuit boards are soldered to the back of the board. See Fig. 5-6. To remove or replace one of these sockets, first unsolder the pin (use a vacuum-type desoldering tool to remove excess solder). Then straighten the tabs on the socket and remove the socket from the board.

Place the new socket in the circuit board hole and press the tabs down against the board. Solder the tabs of the socket to the circuit board. Be careful not to get solder inside the socket.

NOTE

The spring tension of the pin sockets ensure a good connection between the circuit board and the pin. This spring tension can be destroyed by using the pin sockets as a connecting point for spring loaded probe tips, alligator clips, etc.

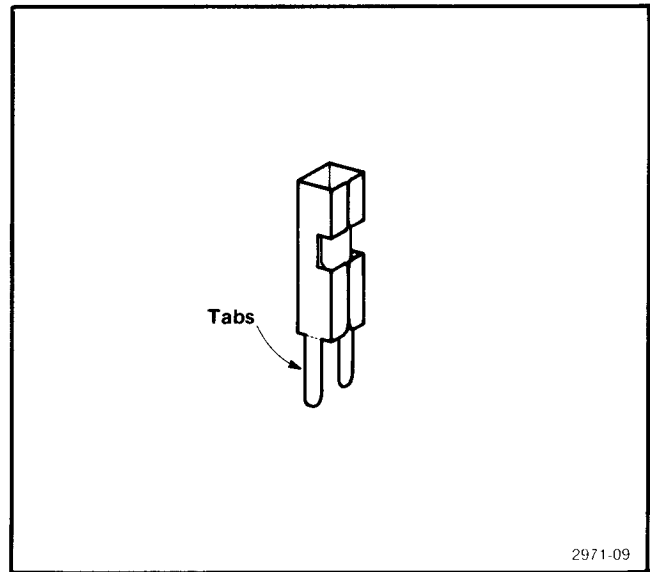

Fig. 5-6. Dual entry circuit board pin socket.

Bottom Entry Circuit Board Pin Sockets

To remove or replace these sockets unsolder the pins from the circuit board. Use a vacuum or other type desoldering tool to remove excess solder. Use caution to prevent circuit board damage. See Fig. 5-7.

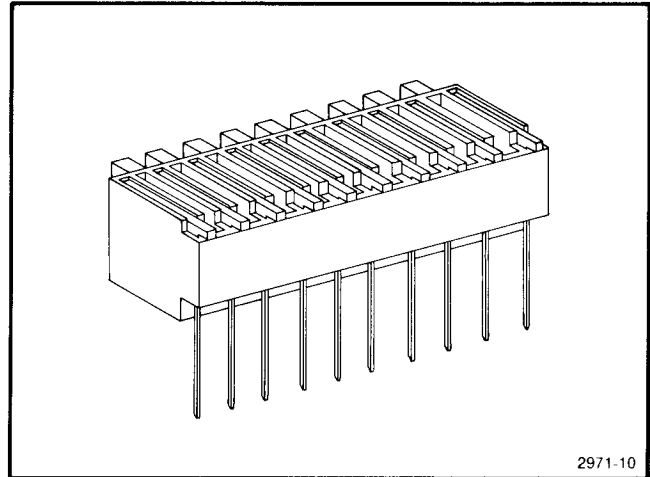

Fig. 5-7. Bottom entry circuit board pin socket.

Multipin Connectors

The pin connectors used to connect the wires to the interconnecting pins are clamped to the ends of the wires. To replace damaged multipin connectors, remove the old pin connector from the holder. Do this by inserting a scribe between the connector and the holder and prying the connector from the holder. Clamp the replacement connector to the wire. Reinstall the connector in the holder.

If the individual end lead pin connectors are removed from the plastic holder, note the order of the individual wires for correct replacement in the holder. For proper replacement see Fig. 5-8.

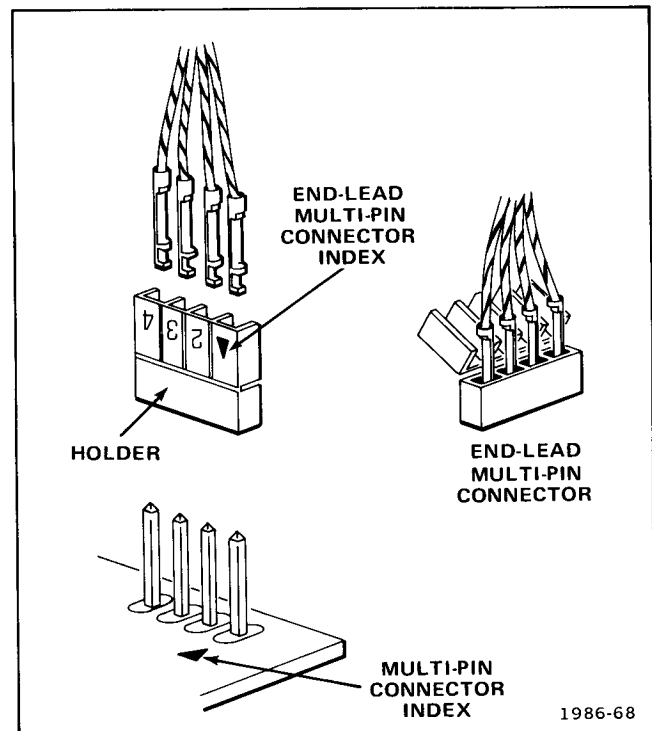

Fig. 5-8. Orientation and disassembly of multipin connectors.

REAR INTERFACE CONNECTOR

Introduction

Refer to Fig. 5-9 for the following.

A slot between pins 21 and 22 on the rear connector identifies this instrument as a member of the TM 500 counter family. Insert a barrier in the corresponding position of the power module jack to prevent noncompatible plug-ins from being used in that compartment. Consult the power module manual for further information.

Display

The display contains eight seven-segment LEDs and six annunciators. The decimal point is automatically positioned. Display count overflow is indicated by a flashing display.

Functions Available at Rear Connector

Pin 14A. External Clock Input—This input allows an external 1, 5, or 10 MHz frequency standard to be used in place of the internal timebase. The input is ac coupled and has a 1 k Ω input resistance. The peak-to-peak input voltage required is ≥ 3 V.

Pin 14B. Prescale—When this available line is held low, the counter automatically adjusts the displayed answer for use with a divide-by-16 prescaler in FREQUENCY A, PERIOD A, RATIO A, and TOTALIZE A modes (≤ 1 TTL load).

Output or Input	Pin B		Pin A	Output or Input
Measurement Gate Out	28	Barrier Slot	28	Arming Input Ground
	27		27	Arming Input
Remote Start	26		26	Reset Input
	25		25	
Shaped Out, CH B	24		24	Shaped Out, CH B Ground
Shaped Out, CH A, Ground	23		23	Shaped Out, CH A
Trigger Level Out CH B	22		22	Trigger Level Out CH A
	21	TM 500 barrier slot	21	
	20		20	
	19		19	
	18		18	
CH B Input	17		17	CH A Input Ground
CH B Input Ground	16		16	CH A Input
10 MHz Clock Out	15		15	10 MHz Clock Out Ground
Prescale	14		14	External Clock Input
	13		13	
+33.5 V dc	12		12	+33.5 V dc
Collector lead of PNP series pass	11		11	Base lead of PNP series pass
	10		10	Emitter lead of PNP series pass
±33.5 V common	9		9	±33.5 V common
-33.5 V dc	8		8	-33.5 V dc
Collector lead of NPN series pass	7		7	Emitter lead of NPN series pass
	6	Rear view of plug-in	6	Base lead of NPN series pass
	5		5	
+11.5 V common	4		4	+11.5 V common
+11.5 V common	3		3	+11.5 V common
+11.5 V dc	2		2	+11.5 V dc
	1		1	

3464-21

Fig. 5-9. Rear interface connector assignments.

- Pin 15A. 10 MHz Clock Out Ground—This terminal is the ground return for the clock input-output signals.
- Pin 15B. 10 MHz Clock Out—This available output line will drive one TTL load. This line is not intended to drive large capacitance loads and cable length should be kept to a minimum.
- Pin 16A. CH A Input—This is the Channel A input connection when the front panel CHANNEL A SOURCE switch is in the INT position. This input is terminated in $50\ \Omega$ with a maximum input of 3.6 V peak (10 V rms, sinewave).
- Pin 16B. CH B Input Ground—This terminal is the ground return for the rear interface Channel B input.
- Pin 17A. CH A Input Ground—This terminal is the ground return for the rear interface Channel A input.
- Pin 17B. CH B Input—This is the Channel B input connection when the front panel CHANNEL B SOURCE switch is in the INT position. This input is terminated in $50\ \Omega$ with a maximum input of 3.6 V peak (10 V rms, sinewave).
- Pin 22A. Trigger Level Out CH A—The voltage at this connection follows the Channel A front panel trigger LEVEL control. The signal level is approximately $\pm 3.2\ \text{V}$.
- Pin 22B. Trigger Level Out CH B—The voltage at this connection follows the Channel B front panel trigger LEVEL control. The signal level is approximately $\pm 3.2\ \text{V}$.
- Pin 23A. Shaped Out, CH A—This terminal provides an exact replica of the internal signals being used for the measurement. Used as an aid to proper triggering on complex waveforms. This signal when routed to the rear interface is not available at the front panel.
- Pin 23B. Shaped Out, CH A Ground—This terminal is the ground return for the rear interface shaped out Channel A signal.
- Pin 24A. Shaped Out, CH B Ground—This terminal is the ground return for the rear interface shaped out Channel B signal.
- Pin 24B. Shaped Out, CH B—This terminal provides an exact replica of the internal signals being used for the measurement. Used as an aid to proper triggering on complex waveforms. This signal when routed to the rear interface is not available at the front panel.
- Pin 26A. Reset Input—When this line is set low, the current measurement process is aborted for all selected functions and causes all digits in the display to read 8.8.8.8.8.8.8. All six annunciators are also illuminated. When this line is set high, a new measurement process is initiated for the selected FUNCTION and operating conditions. (CMOS $V_{IL} \leq 1.5\ \text{V}$ and $V_{IH} \geq 3.5\ \text{V}$ with a minimum pulse width of $\approx 10\ \text{ms}$.)
- Pin 27A. Arming Input—This terminal is normally at a TTL high level. When pulled to a TTL low state with a TTL signal or transistor collector, the counter is prevented from making a measurement until the input goes to a TTL high state. When this input is routed to the rear interface it is not available at the front panel. ($V_H \geq 2.4\ \text{V}$, $V_r \leq 0.4\ \text{V} \approx 2\ \text{TTL loads}$).
- Pin 28A. Arming Input Ground—This terminal is the ground return for the rear interface arming input signal.
- Pin 28B. Measurement Gate Out—This line is in the high state during the current measurement process and is capable of driving five TTL loads. The gate duration is dependent on the input signal frequency and the AVERAGES selected.

DIAGNOSTICS

Introduction

The following information is intended to aid in the diagnosis and repair of a malfunctioning instrument. With signature analysis checks and other troubleshooting data, the qualified service personnel will be able to verify proper operation or detect malfunction in this instrument.

All of the instrument faults may not be isolated by this information or indicated by the instruments built-in self test features. The service personnel should then refer to the Theory of Operation section, in this manual for a better understanding of the circuit details.

Equipment Required

The recommended diagnostic tests require the following equipment or equivalent.

Data analyzer.	TEKTRONIX Type SA 501 or Type 308 Data Analyzer (for signature analysis)
Digital counter.	TEKTRONIX type DC 503A (for timebase frequency checks)
Digital multimeter.	TEKTRONIX Type DM 501A (for checking power supplies)

Also refer to the equipment list in the Calibration section of this manual for suggestions on oscilloscope systems, probes, adapters, terminations and other equipment that may be useful for troubleshooting purposes.

Adjustment and Test Point Locations

When locating adjustable components and test points, refer to the Adjustment Locations and Setups in the pullout pages of this manual.

Self Test

The DC 509 has two modes of self test. The automatic test sequence at Power On and the TEST function selected by the front panel FUNCTION switch.

The automatic test sequence at Power On (Power On Self Test) is initiated each time the power is applied to the instrument. The microprocessor sequences through special data patterns to test the operation of the circuits in the instrument. At power on, after the microprocessor reset line

has been released, the following sequence of events takes place:

1. The display (time slot generator, schematic 8) is reset to the most significant digit (digit to extreme left) and a 0 readout is displayed.

2. The RAM in the address range 0000 to 007F hexidecimal is tested first. By writing a known bit pattern into the RAM and reading it back, each byte in the RAM is verified. If any byte does not verify, the RAM test error code is displayed on the front panel and the test sequence stops. The patterns written are FF, AA, 55, 00 (hexidecimal) in succession leaving the RAM cleared when the test is finished. If this test is not successfully completed the proper error code is displayed and the self test sequence stops.

3. Next, the automatic test sequence sets the instruments gating to the RATIO B/A function and sets the control of the trigger levels to the digital-to-analog converters (D/A converters). If the digital board jumper connection, P1331 is disconnected, the instrument is ready to enter the internal signature analysis mode. This mode will be described later.

4. The serial I/O data loop is checked next, by writing out a data pattern to the serial-to-parallel shift registers. The data pattern is read back through the parallel-to-serial shift registers. If the data is correct, the Power On sequence continues. If the data is not correct, the error code for this test is displayed and the test sequence stops. This test checks the shift registers and the data path, including the serial clock but does not check the input or output stages of the shift registers or the latch control lines. Troubleshooting of the serial I/O loop is best accomplished using signature analysis.

5. The next test is the counter integrity test. This test first resets the instrument's Channel A and Channel B accumulators by pulsing the MR (master reset) line. It then checks each of the tested counter stages to verify that all bits are reset. If any bits are not reset, the proper error code is displayed and the test sequence stops. Next, the GATE signal, schematic 7 is asserted. The instrument then inputs counts to the accumulators. These counts are generated by changing the trigger levels for both Channel A and Channel B using the D/A converters. The D/A converter level changes (cycles) from its current setting to +3.2 V then to -3.175 and back to +3.2 V. This cycle represents one count if the Channel A and Channel B input voltages are

within this voltage range and the ARM signal, schematic 3 is in the high state.

After each cycle or set of cycles, the accumulators are read and checked to see if the proper count has been reached. If the proper count has not been accumulated, the error code for that accumulator stage is displayed and the self test sequence stops.

NOTE

The signal path starts at the D/A converters and the cycle must pass through the amplifiers, gating, and the accumulators.

5. If the counter integrity test fails for any of the described reasons, control of the triggering levels is returned to the front panel LEVEL controls. This allows qualified service personnel to manually change these levels while troubleshooting the amplifiers. The gating, schematic 3 remains in the RATIO B/A function and by applying a signal to the appropriate channel input, the service personnel can trace this signal through the amplifier, gating, and accumulator circuits. Also refer to Table 8-2 in the pullout pages.

TEST Function

The TEST function is similar to the Power On Self Test sequence with two exceptions. The RAM test is not executed, preventing the instruments settings from being lost while in the TEST function. The signature analysis mode cannot be entered (even if the digital board jumper connection, P1331 is removed).

TROUBLESHOOTING

The following is a general troubleshooting procedure to use when the instrument malfunctions.

First, verify that the instrument is properly connected to the appropriate mainframe and that this mainframe is operable. Then refer to Fig. 8-4, General Troubleshooting Flowchart in the pullout pages. This flowchart is a guide for qualified service personnel to locate various areas of circuitry, depending on the instrument symptoms. It may also refer the service personnel to the following signature analysis procedure.

SIGNATURE ANALYSIS

Introduction

The DC 509 was designed to provide two signature analysis methods. Internal signature analysis—this is a microprocessor driven pattern generator contained in the ROM. This method will only work when the microprocessor and its associated ROM, RAM, and connections (kernel) are functional.

Kernel signature analysis—this requires the use of an external kernel test service kit (Tektronix part number 067-1007-00). This method allows qualified service personnel to test and isolate problems in the kernel of the instrument.

Internal Signature Analysis

The internal signature analysis mode is entered at power on when jumper connection P1331, located on the digital board, has been removed. This mode will not operate if the instrument fails the power on RAM test. Refer to Fig. 8-5 and Fig. 8-6 in the pullout pages, for the internal signatures setup information for each circuit board.

In the internal signature analysis mode, the serial loop and display circuitry are most easily diagnosed. The START, STOP, and CLOCK edge polarities must be properly set as shown on the appropriate signature diagram. When the instrument is in this mode, all segments and annunciators in the display are lighted.

Kernel Signature Analysis



The digital board microprocessor, U1311 is removed (observing proper static handling procedures) before making the kernel test.

The kernel signature analysis mode is used to diagnose problems which prevent the microprocessor kernel circuitry from functioning properly. It is used with a signature analyzer to verify signatures in the kernel circuitry.

Refer to Fig. 5-10 for the following.

Make certain the mainframe power is off when connecting this service kit to the instrument. Then connect J1002 and J1003 of the Kernel Test Board to J1210 and J1211 on the instrument Digital Board (A16) respectively using the cables and square pin adapters provided with the kit. Observe that the cables do not get twisted. Connect the START, STOP, CLOCK, and GROUND connections of the analyzer to the test points as indicated on the appropriate Kernel Signature (Fig. 8-7) in the pullout pages. Also make sure that the START, STOP, and CLOCK polarities have been properly selected on the analyzer.

In troubleshooting the kernel, the following information may be helpful.

Two physically adjacent points having the same signature, whether one or both are incorrect, may indicate they are shorted together.

A point with a 0000 signature is grounded or in a low state. A point with the +5 V signature (noted on each signature diagram) may be open or the driving mode may be stuck in the high state.

When the malfunction has been identified and corrected, carefully re-insert the digital board microprocessor, making certain that pin 1 is properly oriented and all pins insert in the socket properly. DO NOT FORCE the pins.

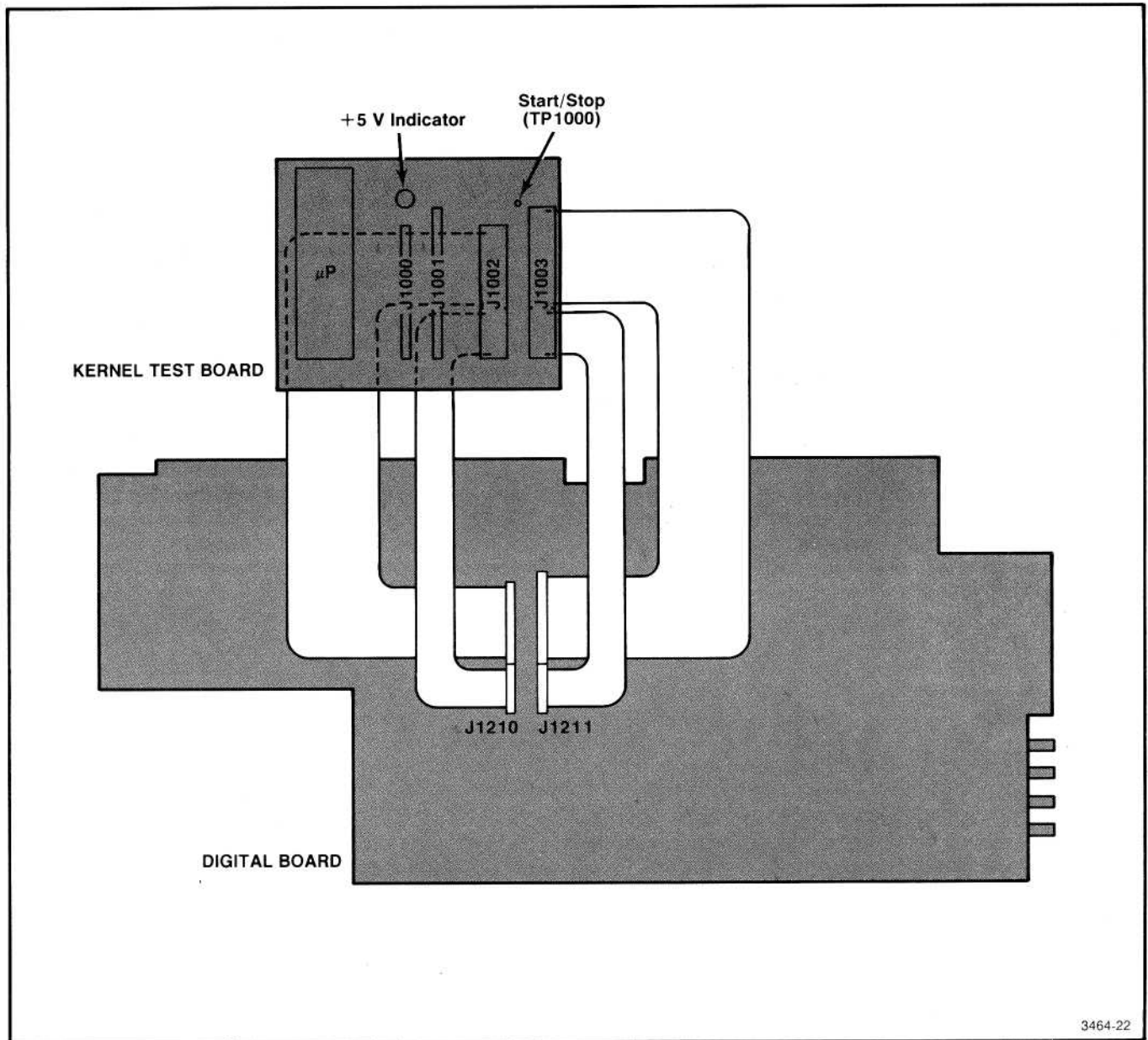

Fig. 5-10. Kernel Signature Analysis connections.

OPTIONS

Your instrument may be equipped with one or more instrument options or optional accessories. A brief description of each instrument option is given below. For further information on instrument options or optional accessories, see your Tektronix Catalog or contact your Tektronix Field Office. If additional options are made available for this instrument, they may be described in a Change Information insert at the back of this manual or in this section.

OPTION 01

Replaces the standard 10 MHz oscillator with a self contained, proportional temperature controlled oven oscillator for increased accuracy and stability. Information relative to Option 01 can be found on schematic 6, and in the Specification, Calibration, and Theory of Operation sections.

REPLACEABLE ELECTRICAL PARTS

PARTS ORDERING INFORMATION

Replacement parts are available from or through your local Tektronix, Inc. Field Office or representative.

Changes to Tektronix instruments are sometimes made to accommodate improved components as they become available, and to give you the benefit of the latest circuit improvements developed in our engineering department. It is therefore important, when ordering parts, to include the following information in your order: Part number, instrument type or number, serial number, and modification number if applicable.

If a part you have ordered has been replaced with a new or improved part, your local Tektronix, Inc. Field Office or representative will contact you concerning any change in part number.

Change information, if any, is located at the rear of this manual.

LIST OF ASSEMBLIES

A list of assemblies can be found at the beginning of the Electrical Parts List. The assemblies are listed in numerical order. When the complete component number of a part is known, this list will identify the assembly in which the part is located.

CROSS INDEX-MFR. CODE NUMBER TO MANUFACTURER

The Mfr. Code Number to Manufacturer index for the Electrical Parts List is located immediately after this page. The Cross Index provides codes, names and addresses of manufacturers of components listed in the Electrical Parts List.

ABBREVIATIONS

Abbreviations conform to American National Standard Y1.1.

COMPONENT NUMBER (column one of the Electrical Parts List)

A numbering method has been used to identify assemblies, subassemblies and parts. Examples of this numbering method and typical expansions are illustrated by the following:

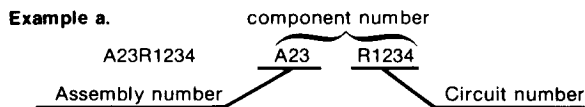

Read: Resistor 1234 of Assembly 23

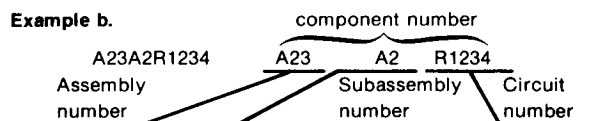

Read: Resistor 1234 of Subassembly 2 of Assembly 23

Only the circuit number will appear on the diagrams and circuit board illustrations. Each diagram and circuit board illustration is clearly marked with the assembly number. Assembly numbers are also marked on the mechanical exploded views located in the Mechanical Parts List. The component number is obtained by adding the assembly number prefix to the circuit number.

The Electrical Parts List is divided and arranged by assemblies in numerical sequence (e.g., assembly A1 with its subassemblies and parts, precedes assembly A2 with its subassemblies and parts).

Chassis-mounted parts have no assembly number prefix and are located at the end of the Electrical Parts List.

TEKTRONIX PART NO. (column two of the Electrical Parts List)

Indicates part number to be used when ordering replacement part from Tektronix.

SERIAL/MODEL NO. (columns three and four of the Electrical Parts List)

Column three (3) indicates the serial number at which the part was first used. Column four (4) indicates the serial number at which the part was removed. No serial number entered indicates part is good for all serial numbers.

NAME & DESCRIPTION (column five of the Electrical Parts List)

In the Parts List, an Item Name is separated from the description by a colon (:). Because of space limitations, an Item Name may sometimes appear as incomplete. For further Item Name identification, the U.S. Federal Cataloging Handbook H6-1 can be utilized where possible.

MFR. CODE (column six of the Electrical Parts List)

Indicates the code number of the actual manufacturer of the part. (Code to name and address cross reference can be found immediately after this page.)

MFR. PART NUMBER (column seven of the Electrical Parts List)

Indicates actual manufacturers part number.

CROSS INDEX—MFR. CODE NUMBER TO MANUFACTURER

Mfr. Code	Manufacturer	Address	City, State, Zip
01121	ALLEN-BRADLEY COMPANY	1201 2ND STREET SOUTH	MILWAUKEE, WI 53204
01295	TEXAS INSTRUMENTS, INC., SEMICONDUCTOR GROUP	P O BOX 5012, 13500 N CENTRAL EXPRESSWAY	DALLAS, TX 75222
03508	GENERAL ELECTRIC COMPANY, SEMI-CONDUCTOR PRODUCTS DEPARTMENT	ELECTRONICS PARK	SYRACUSE, NY 13201
04713	MOTOROLA, INC., SEMICONDUCTOR PROD. DIV.	5005 E MCDOWELL RD, PO BOX 20923	PHOENIX, AZ 85036
07263	FAIRCHILD SEMICONDUCTOR, A DIV. OF FAIRCHILD CAMERA AND INSTRUMENT CORP.	464 ELLIS STREET	MOUNTAIN VIEW, CA 94042
12697	CLAROSTAT MFG. CO., INC.	LOWER WASHINGTON STREET	DOVER, NH 03820
13511	AMPHENOL CARDRE DIV., BUNKER RAMO CORP.		LOS GATOS, CA 95030
14433	ITT SEMICONDUCTORS	3301 ELECTRONICS WAY P O BOX 3049	WEST PALM BEACH, FL 33402
18324	SIGNETICS CORP.	811 E. ARQUES	SUNNYVALE, CA 94086
22229	SOLITRON DEVICES, INC., SEMICONDUCTOR GROUP		SAN DIEGO OPERS, CA 92123
22526	BERG ELECTRONICS, INC.	8808 BALBOA AVENUE	NEW CUMBERLAND, PA 17070
24546	CORNING GLASS WORKS, ELECTRONIC COMPONENTS DIVISION	YOUK EXPRESSWAY	
27014	NATIONAL SEMICONDUCTOR CORP.	550 HIGH STREET	BRADFORD, PA 16701
33096	COLORADO CRYSTAL CORPORATION	2900 SEMICONDUCTOR DR.	SANTA CLARA, CA 95051
34333	SILICON GENERAL, INC.	2303 W 8TH STREET	LOVELAND, CO 80537
34576	ROCKWELL INTERNATIONAL CORP. ELECTRONIC DEVICES DIVISION	7382 BOLSA AVE.	WESTMINSTER, CA 92683
50434	HEWLETT-PACKARD COMPANY	3310 MIRALBMA AVE.	ANAHEIM, CA 92803
55210	GETTIG ENG. AND MFG. COMPANY	640 PAGE MILL ROAD	PALO ALTO, CA 94304
55680	NICHICON/AMERICA/CORP.	PO BOX 85, OFF ROUTE 45	SPRING MILLS, PA 16875
56289	SPRAGUE ELECTRIC CO.	6435 N PROESEL AVENUE	CHICAGO, IL 60645
71279	CAMBRIDGE THERMIONIC CORP.	87 MARSHALL ST.	NORTH ADAMS, MA 01247
71400	BUSSMAN MFG., DIVISION OF MCGRAW-EDISON CO.	445 CONCORD AVE.	CAMBRIDGE, MA 02138
72982	ERIE TECHNOLOGICAL PRODUCTS, INC.	2536 W. UNIVERSITY ST.	ST. LOUIS, MO 63107
73138	BECKMAN INSTRUMENTS, INC., HELIPOT DIV.	644 W. 12TH ST.	ERIE, PA 16512
74970	JOHNSON, E. F., CO.	2500 HARBOR BLVD.	FULLERTON, CA 92634
80009	TEKTRONIX, INC.	299 10TH AVE. S. W.	WASECA, MN 56093
91637	DALE ELECTRONICS, INC.	P O BOX 500	BEAVERTON, OR 97077
95348	GORDOS CORPORATION	P. O. BOX 609	COLUMBUS, NE 68601
		250 GLENWOOD AVENUE	BLOOMFIELD, NJ 07003

Component No.	Tektronix Part No.	Serial/Model No. Eff Dscont	Name & Description	Mfr Code	Mfr Part Number
A10	670-6826-00		CKT BOARD ASSY:DISPLAY	80009	670-6826-00
A12	670-6795-00		CKT BOARD ASSY:ANALOG	80009	670-6795-00
	-----		(STANDARD ONLY)		
A12	670-6854-00		CKT BOARD ASSY:ANALOG	80009	670-6854-00
	-----		(OPTION 01 ONLY)		
A16	670-6796-00		CKT BOARD ASSY:DIGITAL	80009	670-6796-00
A10	-----		CKT BOARD ASSY:DISPLAY		
A10CR1011	150-1036-00		LAMP,LED:RED,3.0V,40MA	01295	TIL 209A
A10CR1012	150-1036-00		LAMP,LED:RED,3.0V,40MA	01295	TIL 209A
A10CR1111	150-1036-00		LAMP,LED:RED,3.0V,40MA	01295	TIL 209A
A10CR1211	150-1036-00		LAMP,LED:RED,3.0V,40MA	01295	TIL 209A
A10CR1215	150-1036-00		LAMP,LED:RED,3.0V,40MA	01295	TIL 209A
A10CR1311	150-1036-00		LAMP,LED:RED,3.0V,40MA	01295	TIL 209A
A10DS1002	150-1011-02		LAMP,LED RDOUT:RED,7 SEG,1.0 DIGIT	07263	FND5136
A10DS1005	150-1011-02		LAMP,LED RDOUT:RED,7 SEG,1.0 DIGIT	07263	FND5136
A10DS1102	150-1011-02		LAMP,LED RDOUT:RED,7 SEG,1.0 DIGIT	07263	FND5136
A10DS1105	150-1011-02		LAMP,LED RDOUT:RED,7 SEG,1.0 DIGIT	07263	FND5136
A10DS1202	150-1011-02		LAMP,LED RDOUT:RED,7 SEG,1.0 DIGIT	07263	FND5136
A10DS1205	150-1011-02		LAMP,LED RDOUT:RED,7 SEG,1.0 DIGIT	07263	FND5136
A10DS1302	150-1011-02		LAMP,LED RDOUT:RED,7 SEG,1.0 DIGIT	07263	FND5136
A10DS1305	150-1011-02		LAMP,LED RDOUT:RED,7 SEG,1.0 DIGIT	07263	FND5136
A10J1411	131-1857-00		TERM. SET,PIN:36/0.025 SQ PIN,ON 0.1 CTRS	22526	65500136
A10J1412	131-1857-00		TERM. SET,PIN:36/0.025 SQ PIN,ON 0.1 CTRS	22526	65500136
A10J1413	131-1857-00		TERM. SET,PIN:36/0.025 SQ PIN,ON 0.1 CTRS	22526	65500136
A10W1009	131-0566-00		BUS CONDUCTOR:DUMMY RES,2.375,22 AWG	55210	L-2007-1
A10W1011	131-0566-00		BUS CONDUCTOR:DUMMY RES,2.375,22 AWG	55210	L-2007-1
A10W1012	131-0566-00		BUS CONDUCTOR:DUMMY RES,2.375,22 AWG	55210	L-2007-1

Replaceable Electrical Parts—DC 509

Component No.	Tektronix Part No.	Serial/Model No. Eff Dscont	Name & Description	Mfr Code	Mfr Part Number
A12	-----		CKT BOARD ASSY: ANALOG		
A12C1021	283-0057-00		CAP., FXD, CER DI: 0.1UF, +80-20%, 200V	56289	274C10
A12C1022	281-0578-00		CAP., FXD, CER DI: 18PF, 5%, 500V	72982	301-050C0G0180J
A12C1023	281-0812-00		CAP., FXD, CER DI: 1000PF, 10%, 100V	72982	8035D9AADX7R102K
A12C1031	281-0799-00		CAP., FXD, CER DI: 62PF, 2%, 100V	72982	8035D2AADCO6620G
A12C1041	283-0057-00		CAP., FXD, CER DI: 0.1UF, +80-20%, 200V	56289	274C10
A12C1042	281-0716-00		CAP., FXD, CER DI: 13.8PF, 1%, 500V	72982	374-014C0G01389F
A12C1043	281-0622-00		CAP., FXD, CER DI: 47PF, 1%, 500V	72982	308-000C0G0470F
A12C1101	290-0804-00		CAP., FXD, ELCTLT: 10UF, +50-10%, 25V	55680	25ULA10V-T
A12C1104	281-0773-00		CAP., FXD, CER DI: 0.01UF, 10%, 100V	72982	8005H9AADW5R103K
A12C1111	281-0775-00		CAP., FXD, CER DI: 0.1UF, 20%, 50V	72982	8005D9AABZ5U104M
A12C1121	283-0359-00		CAP., FXD, CER DI: 1000PF, 10%, 200V	72982	8131N203C0G0102K
A12C1122	281-0812-00		CAP., FXD, CER DI: 1000PF, 10%, 100V	72982	8035D9AADX7R102K
A12C1123	281-0775-00		CAP., FXD, CER DI: 0.1UF, 20%, 50V	72982	8005D9AABZ5U104M
A12C1131	281-0775-00		CAP., FXD, CER DI: 0.1UF, 20%, 50V	72982	8005D9AABZ5U104M
A12C1132	281-0773-00		CAP., FXD, CER DI: 0.01UF, 10%, 100V	72982	8005H9AADW5R103K
A12C1133	281-0812-00		CAP., FXD, CER DI: 1000PF, 10%, 100V	72982	8035D9AADX7R102K
A12C1141	283-0359-00		CAP., FXD, CER DI: 1000PF, 10%, 200V	72982	8131N203C0G0102K
A12C1142	281-0775-00		CAP., FXD, CER DI: 0.1UF, 20%, 50V	72982	8005D9AABZ5U104M
A12C1143	281-0775-00		CAP., FXD, CER DI: 0.1UF, 20%, 50V	72982	8005D9AABZ5U104M
A12C1144	281-0773-00		CAP., FXD, CER DI: 0.01UF, 10%, 100V	72982	8005H9AADW5R103K
A12C1201	281-0775-00		CAP., FXD, CER DI: 0.1UF, 20%, 50V	72982	8005D9AABZ5U104M
A12C1202	281-0773-00		CAP., FXD, CER DI: 0.01UF, 10%, 100V	72982	8005H9AADW5R103K
A12C1211	281-0775-00		CAP., FXD, CER DI: 0.1UF, 20%, 50V	72982	8005D9AABZ5U104M
A12C1212	281-0773-00		CAP., FXD, CER DI: 0.01UF, 10%, 100V	72982	8005H9AADW5R103K
A12C1221	281-0797-00		CAP., FXD, CER DI: 15PF, 10%, 100V	72982	8035D9AADCOG150K
A12C1222	281-0517-00		CAP., FXD, CER DI: 39PF, +/-3.9PF, 500V	72982	308-000C0G0390K
A12C1223	281-0775-00		CAP., FXD, CER DI: 0.1UF, 20%, 50V	72982	8005D9AABZ5U104M
A12C1231	281-0773-00		CAP., FXD, CER DI: 0.01UF, 10%, 100V	72982	8005H9AADW5R103K
A12C1232	281-0773-00		CAP., FXD, CER DI: 0.01UF, 10%, 100V	72982	8005H9AADW5R103K
A12C1233	281-0797-00		CAP., FXD, CER DI: 15PF, 10%, 100V	72982	8035D9AADCOG150K
A12C1241	281-0517-00		CAP., FXD, CER DI: 39PF, +/-3.9PF, 500V	72982	308-000C0G0390K
A12C1242	281-0775-00		CAP., FXD, CER DI: 0.1UF, 20%, 50V	72982	8005D9AABZ5U104M
A12C1243	281-0773-00		CAP., FXD, CER DI: 0.01UF, 10%, 100V	72982	8005H9AADW5R103K
A12C1245	281-0773-00		CAP., FXD, CER DI: 0.01UF, 10%, 100V	72982	8005H9AADW5R103K
A12C1301	281-0775-00		CAP., FXD, CER DI: 0.1UF, 20%, 50V	72982	8005D9AABZ5U104M
A12C1321	281-0775-00		CAP., FXD, CER DI: 0.1UF, 20%, 50V	72982	8005D9AABZ5U104M
A12C1334	281-0775-00		CAP., FXD, CER DI: 0.1UF, 20%, 50V	72982	8005D9AABZ5U104M
A12C1341	281-0775-00		CAP., FXD, CER DI: 0.1UF, 20%, 50V	72982	8005D9AABZ5U104M
A12C1342	290-0804-00		CAP., FXD, ELCTLT: 10UF, +50-10%, 25V	55680	25ULA10V-T
A12C1343	281-0775-00		CAP., FXD, CER DI: 0.1UF, 20%, 50V	72982	8005D9AABZ5U104M
A12C1345	281-0775-00		CAP., FXD, CER DI: 0.1UF, 20%, 50V	72982	8005D9AABZ5U104M
A12C1347	283-0204-00		CAP., FXD, CER DI: 0.01UF, 20%, 50V	72982	8121N061Z5U0103M
A12C1348	281-0775-00		CAP., FXD, CER DI: 0.1UF, 20%, 50V	72982	8005D9AABZ5U104M
A12C1349	290-0804-00		CAP., FXD, ELCTLT: 10UF, +50-10%, 25V	55680	25ULA10V-T
A12C1411	281-0775-00		CAP., FXD, CER DI: 0.1UF, 20%, 50V	72982	8005D9AABZ5U104M
A12C1421	281-0775-00		CAP., FXD, CER DI: 0.1UF, 20%, 50V	72982	8005D9AABZ5U104M
A12C1441	281-0775-00		CAP., FXD, CER DI: 0.1UF, 20%, 50V	72982	8005D9AABZ5U104M
A12C1442	290-0267-00		CAP., FXD, ELCTLT: 1UF, 20%, 35V	56289	162D105X0035CD2
A12C1501	281-0773-00		CAP., FXD, CER DI: 0.01UF, 10%, 100V	72982	8005H9AADW5R103K
A12C1503	281-0786-00		CAP., FXD, CER DI: 150PF, 10%, 100V	72982	8035D2AADX5P151K
A12C1511	281-0775-00		CAP., FXD, CER DI: 0.1UF, 20%, 50V	72982	8005D9AABZ5U104M
A12C1512	281-0775-00		CAP., FXD, CER DI: 0.1UF, 20%, 50V	72982	8005D9AABZ5U104M
A12C1521	281-0773-00		CAP., FXD, CER DI: 0.01UF, 10%, 100V	72982	8005H9AADW5R103K
A12C1522	283-0220-00		CAP., FXD, CER DI: 0.01UF, 20%, 50V	72982	8121N075X7R0103M
A12C1523	281-0773-00		CAP., FXD, CER DI: 0.01UF, 10%, 100V	72982	8005H9AADW5R103K
A12C1525	283-0024-00		CAP., FXD, CER DI: 0.1UF, +80-20%, 50V	72982	8121N083Z5U0104Z

Replaceable Electrical Parts—DC 509

Component No.	Tektronix Part No.	Serial/Model No. Eff Dscont	Name & Description	Mfr Code	Mfr Part Number
A12C1526	281-0773-00		CAP., FXD, CER DI:0.01UF,10%,100V	72982	8005H9AADW5R103K
A12C1531	281-0770-00		CAP., FXD, CER DI:0.001UF,20%,100V	72982	8035D9AADX5R102M
A12C1541	281-0773-00		CAP., FXD, CER DI:0.01UF,10%,100V	72982	8005H9AADW5R103K
A12C1542	281-0775-00		CAP., FXD, CER DI:0.1UF,20%,50V	72982	8005D9AABZ5U104M
A12C1601	281-0775-00		CAP., FXD, CER DI:0.1UF,20%,50V (OPTION 01 ONLY)	72982	8005D9AABZ5U104M
A12C1602	281-0153-00		CAP., VAR, AIR DI:1.7-10PF,250V (STANDARD ONLY)	74970	187-0106-005
A12C1603	281-0564-00		CAP., FXD, CER DI:24PF,5%,500V (STANDARD ONLY)	72982	301-000C0G0240J
A12C1604	281-0775-00		CAP., FXD, CER DI:0.1UF,20%,50V (STANDARD ONLY)	72982	8005D9AABZ5U104M
A12C1605	281-0630-00		CAP., FXD, CER DI:390PF,5%,500V (STANDARD ONLY)	72982	630000Y5D391J
A12C1611	281-0630-00		CAP., FXD, CER DI:390PF,5%,500V (STANDARD ONLY)	72982	630000Y5D391J
A12C1612	281-0773-00		CAP., FXD, CER DI:0.01UF,10%,100V	72982	8005H9AADW5R103K
A12C1621	281-0775-00		CAP., FXD, CER DI:0.1UF,20%,50V (OPTION 01 ONLY)	72982	8005D9AABZ5U104M
A12C1622	290-0804-00		CAP., FXD, ELCTLT:10UF,+50-10%,25V	55680	25ULA10V-T
A12C1641	281-0775-00		CAP., FXD, CER DI:0.1UF,20%,50V	72982	8005D9AABZ5U104M
A12C1642	283-0220-00		CAP., FXD, CER DI:0.01UF,20%,50V	72982	8121N075X7R0103M
A12C1643	283-0220-00		CAP., FXD, CER DI:0.01UF,20%,50V	72982	8121N075X7R0103M
A12CR1121	152-0246-00		SEMICONV DEVICE:SW,SI,40V,200MA	03508	DE140
A12CR1122	152-0246-00		SEMICONV DEVICE:SW,SI,40V,200MA	03508	DE140
A12CR1123	152-0141-02		SEMICONV DEVICE:SILICON,30V,150MA	01295	1N4152R
A12CR1124	152-0141-02		SEMICONV DEVICE:SILICON,30V,150MA	01295	1N4152R
A12CR1131	152-0246-00		SEMICONV DEVICE:SW,SI,40V,200MA	03508	DE140
A12CR1132	152-0246-00		SEMICONV DEVICE:SW,SI,40V,200MA	03508	DE140
A12CR1141	152-0141-02		SEMICONV DEVICE:SILICON,30V,150MA	01295	1N4152R
A12CR1142	152-0141-02		SEMICONV DEVICE:SILICON,30V,150MA	01295	1N4152R
A12CR1211	152-0066-00		SEMICONV DEVICE:SILICON,400V,750MA	14433	LG4016
A12CR1224	150-1036-00		LAMP,LED:RED,3.0V,40MA	01295	TIL 209A
A12CR1244	150-1036-00		LAMP,LED:RED,3.0V,40MA	01295	TIL 209A
A12CR1401	152-0141-02		SEMICONV DEVICE:SILICON,30V,150MA	01295	1N4152R
A12CR1411	152-0141-02		SEMICONV DEVICE:SILICON,30V,150MA	01295	1N4152R
A12CR1412	152-0141-02		SEMICONV DEVICE:SILICON,30V,150MA	01295	1N4152R
A12CR1421	152-0066-00		SEMICONV DEVICE:SILICON,400V,750MA	14433	LG4016
A12CR1422	152-0322-00		SEMICONV DEVICE:SILICON,15V,HOT CARRIER	50434	5082-2672
A12CR1442	152-0141-02		SEMICONV DEVICE:SILICON,30V,150MA	01295	1N4152R
A12CR1521	152-0269-00		SEMICONV DEVICE:SILICON,VAR VCAP.,4V,33PF	80009	152-0269-00
A12CR1541	152-0141-02		SEMICONV DEVICE:SILICON,30V,150MA	01295	1N4152R
A12CR1611	152-0141-02		SEMICONV DEVICE:SILICON,30V,150MA	01295	1N4152R
A12CR1621	152-0066-00		SEMICONV DEVICE:SILICON,400V,750MA	14433	LG4016
A12CR1641	152-0066-00		SEMICONV DEVICE:SILICON,400V,750MA	14433	LG4016
A12F1541	159-0025-00		FUSE,CARTRIDGE:3AG,0.5A,250V,FAST-BLOW	71400	AGC 1/2
A12F1542	159-0025-00		FUSE,CARTRIDGE:3AG,0.5A,250V,FAST-BLOW	71400	AGC 1/2
A12F1641	159-0015-00		FUSE,CARTRIDGE:3AG,3A,250V,FAST-BLOW	71400	AGC 3
A12J1010	131-1934-00		TERM. SET,PIN:1 X 36,0.1 CTR,0.9 L	22526	65539-001
A12J1031	131-0608-00		TERMINAL,PIN:0.365 L X 0.025 PH BRZ GOLD (QTY 2)	22526	47357
A12J1041	131-0608-00		TERMINAL,PIN:0.365 L X 0.025 PH BRZ GOLD (QTY 2)	22526	47357
A12J1301	131-0608-00		TERMINAL,PIN:0.365 L X 0.025 PH BRZ GOLD (QTY 3)	22526	47357
A12J1303	131-0608-00		TERMINAL,PIN:0.365 L X 0.025 PH BRZ GOLD (QTY 3)	22526	47357

Replaceable Electrical Parts—DC 509

Component No.	Tektronix Part No.	Serial/Model No. Eff Dscont	Name & Description	Mfr Code	Mfr Part Number
A12J1310	131-1934-00		TERM. SET,PIN:1 X 36,0.1 CTR,0.9 L	22526	65539-001
A12J1331	131-0608-00		TERMINAL,PIN:0.365 L X 0.025 PH BRZ GOLD (QTY 2)	22526	47357
A12J1341	131-0608-00		TERMINAL,PIN:0.365 L X 0.025 PH BRZ GOLD (QTY 2)	22526	47357
A12J1402	131-0608-00		TERMINAL,PIN:0.365 L X 0.025 PH BRZ GOLD (QTY 2)	22526	47357
A12J1403	131-0608-00		TERMINAL,PIN:0.365 L X 0.025 PH BRZ GOLD (QTY 2)	22526	47357
A12J1410	131-1934-00		TERM. SET,PIN:1 X 36,0.1 CTR,0.9 L	22526	65539-001
A12J1411	131-0608-00		TERMINAL,PIN:0.365 L X 0.025 PH BRZ GOLD (QTY 2)	22526	47357
A12J1420	131-1634-00		CONTACT ASSY,EL:(31)0.025 SQ X 0.825 L	22526	65311-4
A12J1421	131-1634-00		CONTACT ASSY,EL:(31)0.025 SQ X 0.825 L	22526	65311-4
A12J1441	131-0608-00		TERMINAL,PIN:0.365 L X 0.025 PH BRZ GOLD (QTY 2)	22526	47357
A12J1442	131-0608-00		TERMINAL,PIN:0.365 L X 0.025 PH BRZ GOLD (QTY 2)	22526	47357
A12J1443	131-0608-00		TERMINAL,PIN:0.365 L X 0.025 PH BRZ GOLD (QTY 2)	22526	47357
A12J1501	131-0608-00		TERMINAL,PIN:0.365 L X 0.025 PH BRZ GOLD (QTY 2)	22526	47357
A12J1511	131-0608-00		TERMINAL,PIN:0.365 L X 0.025 PH BRZ GOLD (QTY 5)	22526	47357
A12J1521	131-0608-00		TERMINAL,PIN:0.365 L X 0.025 PH BRZ GOLD (QTY 2)	22526	47357
A12J1522	131-0608-00		TERMINAL,PIN:0.365 L X 0.025 PH BRZ GOLD (QTY 2)	22526	47357
A12J1621	131-0608-00		TERMINAL,PIN:0.365 L X 0.025 PH BRZ GOLD (QTY 3)	22526	47357
A12J1622	131-0608-00		TERMINAL,PIN:0.365 L X 0.025 PH BRZ GOLD (QTY 2)	22526	47357
A12J1623	131-0608-00		TERMINAL,PIN:0.365 L X 0.025 PH BRZ GOLD (QTY 2)	22526	47357
A12K1031	148-0128-00		RELAY,ARMATURE:1 FORM X & 1 FROM V,8VDC	80009	148-0128-00
A12K1032	148-0128-00		RELAY,ARMATURE:1 FORM X & 1 FROM V,8VDC	80009	148-0128-00
A12K1033	148-0128-00		RELAY,ARMATURE:1 FORM X & 1 FROM V,8VDC	80009	148-0128-00
A12K1041	148-0128-00		RELAY,ARMATURE:1 FORM X & 1 FROM V,8VDC	80009	148-0128-00
A12K1042	148-0128-00		RELAY,ARMATURE:1 FORM X & 1 FROM V,8VDC	80009	148-0128-00
A12K1043	148-0128-00		RELAY,ARMATURE:1 FORM X & 1 FROM V,8VDC	80009	148-0128-00
A12K1621	148-0076-00		RELAY,REED:1 FORM A,5V,0.25A,100V	95348	F81-1447
A12K1622	148-0076-00		RELAY,REED:1 FORM A,5V,0.25A,100V	95348	F81-1447
A12L1331	120-0382-00		XFMR,TOROID:14 TURNS,SINGLE	80009	120-0382-00
A12L1333	120-0382-00		XFMR,TOROID:14 TURNS,SINGLE	80009	120-0382-00
A12L1521	108-0643-00		COIL,RF:FIXED,54NH	80009	108-0643-00
A12Q1101	151-0190-00		TRANSISTOR:SILICON,NPN	07263	S032677
A12Q1102	151-0188-00		TRANSISTOR:SILICON,PNP	04713	SPS6868K
A12Q1103	151-0335-00		TRANSISTOR:SILICON,PNP	04713	SJE917
A12Q1121	151-1117-00		TRANSISTOR:FE,DUAL,N-CHANNEL,SI,DMOS	22229	MD1000
A12Q1122	151-0427-00		TRANSISTOR:SILICON,NPN	80009	151-0427-00
A12Q1141	151-1117-00		TRANSISTOR:FE,DUAL,N-CHANNEL,SI,DMOS	22229	MD1000
A12Q1142	151-0427-00		TRANSISTOR:SILICON,NPN	80009	151-0427-00
A12Q1221	151-0367-00		TRANSISTOR:SILICON,NPN,SEL FROM 3571TP	01295	SKA6516
A12Q1222	151-0333-00		TRANSISTOR:SILICON,NPN,SEL FROM MPS918	04713	SPS1752
A12Q1223	151-0367-00		TRANSISTOR:SILICON,NPN,SEL FROM 3571TP	01295	SKA6516
A12Q1224	151-0333-00		TRANSISTOR:SILICON,NPN,SEL FROM MPS918	04713	SPS1752
A12Q1225	151-0369-00		TRANSISTOR:SILICON,PNP	01295	SKA6664

Component No.	Tektronix Part No.	Serial/Model No. Eff Dscont	Name & Description	Mfr Code	Mfr Part Number
A12Q1226	151-0369-00		TRANSISTOR: SILICON, PNP	01295	SKA6664
A12Q1227	151-0221-00		TRANSISTOR: SILICON, PNP	04713	SPS246
A12Q1228	151-0221-00		TRANSISTOR: SILICON, PNP	04713	SPS246
A12Q1229	151-0367-00		TRANSISTOR: SILICON, NPN, SEL FROM 3571TP	01295	SKA6516
A12Q1231	151-0427-00		TRANSISTOR: SILICON, NPN	80009	151-0427-00
A12Q1232	151-0367-00		TRANSISTOR: SILICON, NPN, SEL FROM 3571TP	01295	SKA6516
A12Q1233	151-0367-00		TRANSISTOR: SILICON, NPN, SEL FROM 3571TP	01295	SKA6516
A12Q1234	151-0333-00		TRANSISTOR: SILICON, NPN, SEL FROM MPS918	04713	SPS1752
A12Q1235	151-0369-00		TRANSISTOR: SILICON, PNP	01295	SKA6664
A12Q1241	151-0367-00		TRANSISTOR: SILICON, NPN, SEL FROM 3571TP	01295	SKA6516
A12Q1242	151-0333-00		TRANSISTOR: SILICON, NPN, SEL FROM MPS918	04713	SPS1752
A12Q1243	151-0369-00		TRANSISTOR: SILICON, PNP	01295	SKA6664
A12Q1244	151-0221-00		TRANSISTOR: SILICON, PNP	04713	SPS246
A12Q1245	151-0221-00		TRANSISTOR: SILICON, PNP	04713	SPS246
A12Q1246	151-0427-00		TRANSISTOR: SILICON, NPN	80009	151-0427-00
A12Q1247	151-0367-00		TRANSISTOR: SILICON, NPN, SEL FROM 3571TP	01295	SKA6516
A12Q1248	151-0367-00		TRANSISTOR: SILICON, NPN, SEL FROM 3571TP	01295	SKA6516
A12Q1311	151-0188-00		TRANSISTOR: SILICON, PNP	04713	SPS6868K
A12Q1312	151-0188-00		TRANSISTOR: SILICON, PNP	04713	SPS6868K
A12Q1331	151-0220-00		TRANSISTOR: SILICON, PNP	07263	S036228
A12Q1332	151-0220-00		TRANSISTOR: SILICON, PNP	07263	S036228
A12Q1333	151-0220-00		TRANSISTOR: SILICON, PNP	07263	S036228
A12Q1334	151-0220-00		TRANSISTOR: SILICON, PNP	07263	S036228
A12Q1341	151-0220-00		TRANSISTOR: SILICON, PNP	07263	S036228
A12Q1342	151-0220-00		TRANSISTOR: SILICON, PNP	07263	S036228
A12Q1343	151-0220-00		TRANSISTOR: SILICON, PNP	07263	S036228
A12Q1344	151-0190-00		TRANSISTOR: SILICON, NPN	07263	S032677
A12Q1401	151-0190-00		TRANSISTOR: SILICON, NPN	07263	S032677
A12Q1411	151-0190-00		TRANSISTOR: SILICON, NPN	07263	S032677
A12Q1412	151-0190-00		TRANSISTOR: SILICON, NPN	07263	S032677
A12Q1421	151-0220-00		TRANSISTOR: SILICON, PNP	07263	S036228
A12Q1422	151-0220-00		TRANSISTOR: SILICON, PNP	07263	S036228
A12Q1423	151-0220-00		TRANSISTOR: SILICON, PNP	07263	S036228
A12Q1433	151-0221-00		TRANSISTOR: SILICON, PNP	04713	SPS246
A12Q1441	151-0221-00		TRANSISTOR: SILICON, PNP	04713	SPS246
A12Q1442	151-0221-00		TRANSISTOR: SILICON, PNP	04713	SPS246
A12Q1443	151-0432-00		TRANSISTOR: SILICON, NPN	80009	151-0432-00
A12Q1444	151-0453-00		TRANSISTOR: SILICON, PNP	80009	151-0453-00
A12Q1445	151-0453-00		TRANSISTOR: SILICON, PNP	80009	151-0453-00
A12Q1501	151-0188-00		TRANSISTOR: SILICON, PNP	04713	SPS6868K
A12Q1502	151-0190-00		TRANSISTOR: SILICON, NPN	07263	S032677
A12Q1531	151-0302-00		TRANSISTOR: SILICON, NPN	07263	S038487
A12Q1611	151-0190-00		TRANSISTOR: SILICON, NPN	07263	S032677
	-----		(STANDARD ONLY)		
A12Q1612	151-0190-00		TRANSISTOR: SILICON, NPN	07263	S032677
A12R1022	315-0102-00		RES., FXD, CMPSN: 1K OHM, 5%, 0.25W	01121	CB1025
A12R1023	321-0891-00		RES., FXD, FILM: 800K OHM, 1%, 0.125W	91637	MFF1816G80002F
A12R1024	317-0910-00		RES., FXD, CMPSN: 91 OHM, 5%, 0.125W	01121	BB9105
A12R1030	315-0200-00		RES., FXD, CMPSN: 20 OHM, 5%, 0.25W	01121	CB2005
A12R1031	315-0510-00		RES., FXD, CMPSN: 51 OHM, 5%, 0.25W	01121	CB5105
A12R1032	317-0510-00		RES., FXD, CMPSN: 51 OHM, 5%, 0.125W	01121	BB5105
A12R1039	317-0910-00		RES., FXD, CMPSN: 91 OHM, 5%, 0.125W	01121	BB9105
A12R1040	315-0200-00		RES., FXD, CMPSN: 20 OHM, 5%, 0.25W	01121	CB2005
A12R1041	315-0102-00		RES., FXD, CMPSN: 1K OHM, 5%, 0.25W	01121	CB1025
A12R1042	315-0510-00		RES., FXD, CMPSN: 51 OHM, 5%, 0.25W	01121	CB5105
A12R1043	321-0891-00		RES., FXD, FILM: 800K OHM, 1%, 0.125W	91637	MFF1816G80002F
A12R1045	317-0510-00		RES., FXD, CMPSN: 51 OHM, 5%, 0.125W	01121	BB5105

Replaceable Electrical Parts—DC 509

Component No. *	Tektronix Part No.	Serial/Model No. Eff Dscnt	Name & Description	Mfr Code	Mfr Part Number
A12R1102	311-1236-00		RES., VAR, NONWIR: 250 OHM, 10%, 0.50W	73138	72X-22-0-251K
A12R1103	315-0431-00		RES., FXD, CMPSN: 430 OHM, 5%, 0.25W	01121	CB4315
A12R1104	315-0301-00		RES., FXD, CMPSN: 300 OHM, 5%, 0.25W	01121	CB3015
A12R1105	315-0121-00		RES., FXD, CMPSN: 120 OHM, 5%, 0.25W	01121	CB1215
A12R1106	315-0512-00		RES., FXD, CMPSN: 5.1K OHM, 5%, 0.25W	01121	CB5125
A12R1121	321-0481-00		RES., FXD, FILM: 1M OHM, 1%, 0.125W	24546	NA4D1004F
A12R1122	315-0154-00		RES., FXD, CMPSN: 150K OHM, 5%, 0.25W	01121	CB1545
A12R1123	315-0680-00		RES., FXD, CMPSN: 68 OHM, 5%, 0.25W	01121	CB6805
A12R1124	315-0820-00		RES., FXD, CMPSN: 82 OHM, 5%, 0.25W	01121	CB8205
A12R1125	315-0820-00		RES., FXD, CMPSN: 82 OHM, 5%, 0.25W	01121	CB8205
A12R1126	315-0513-00		RES., FXD, CMPSN: 51K OHM, 5%, 0.25W	01121	CB5135
A12R1127	315-0561-00		RES., FXD, CMPSN: 560 OHM, 5%, 0.25W	01121	CB5615
A12R1131	321-0618-00		RES., FXD, FILM: 250K OHM, 1%, 0.125W	91637	MFF1816G25002F
A12R1132	315-0751-00		RES., FXD, CMPSN: 750 OHM, 5%, 0.25W	01121	CB7515
A12R1133	315-0162-00		RES., FXD, CMPSN: 1.6K OHM, 5%, 0.25W	01121	CB1625
A12R1134	315-0301-00		RES., FXD, CMPSN: 300 OHM, 5%, 0.25W	01121	CB3015
A12R1135	315-0510-00		RES., FXD, CMPSN: 51 OHM, 5%, 0.25W	01121	CB5105
A12R1136	315-0201-00		RES., FXD, CMPSN: 200 OHM, 5%, 0.25W	01121	CB2015
A12R1137	315-0513-00		RES., FXD, CMPSN: 51K OHM, 5%, 0.25W	01121	CB5135
A12R1139	315-0820-00		RES., FXD, CMPSN: 82 OHM, 5%, 0.25W	01121	CB8205
A12R1140	315-0510-00		RES., FXD, CMPSN: 51 OHM, 5%, 0.25W	01121	CB5105
A12R1141	321-0618-00		RES., FXD, FILM: 250K OHM, 1%, 0.125W	91637	MFF1816G25002F
A12R1142	321-0481-00		RES., FXD, FILM: 1M OHM, 1%, 0.125W	24546	NA4D1004F
A12R1143	315-0154-00		RES., FXD, CMPSN: 150K OHM, 5%, 0.25W	01121	CB1545
A12R1144	315-0680-00		RES., FXD, CMPSN: 68 OHM, 5%, 0.25W	01121	CB6805
A12R1145	315-0820-00		RES., FXD, CMPSN: 82 OHM, 5%, 0.25W	01121	CB8205
A12R1146	315-0301-00		RES., FXD, CMPSN: 300 OHM, 5%, 0.25W	01121	CB3015
A12R1147	315-0561-00		RES., FXD, CMPSN: 560 OHM, 5%, 0.25W	01121	CB5615
A12R1148	315-0751-00		RES., FXD, CMPSN: 750 OHM, 5%, 0.25W	01121	CB7515
A12R1149	315-0162-00		RES., FXD, CMPSN: 1.6K OHM, 5%, 0.25W	01121	CB1625
A12R1201	321-0210-00		RES., FXD, FILM: 1.5K OHM, 1%, 0.125W	91637	MFF1816G15000F
A12R1202	321-0214-00		RES., FXD, FILM: 1.65K OHM, 1%, 0.125W	91637	MFF1816G16500F
A12R1203	321-0242-00		RES., FXD, FILM: 3.24K OHM, 1%, 0.125W	91637	MFF1816G32400F
A12R1211	311-1236-00		RES., VAR, NONWIR: 250 OHM, 10%, 0.50W	73138	72X-22-0-251K
A12R1212	321-0210-00		RES., FXD, FILM: 1.5K OHM, 1%, 0.125W	91637	MFF1816G15000F
A12R1213	321-0214-00		RES., FXD, FILM: 1.65K OHM, 1%, 0.125W	91637	MFF1816G16500F
A12R1214	321-0242-00		RES., FXD, FILM: 3.24K OHM, 1%, 0.125W	91637	MFF1816G32400F
A12R1220	315-0121-00		RES., FXD, CMPSN: 120 OHM, 5%, 0.25W	01121	CB1215
A12R1221	315-0130-00		RES., FXD, CMPSN: 13 OHM, 5%, 0.25W	01121	CB1305
A12R1222	315-0130-00		RES., FXD, CMPSN: 13 OHM, 5%, 0.25W	01121	CB1305
A12R1223	315-0200-00		RES., FXD, CMPSN: 20 OHM, 5%, 0.25W	01121	CB2005
A12R1224	315-0200-00		RES., FXD, CMPSN: 20 OHM, 5%, 0.25W	01121	CB2005
A12R1225	315-0200-00		RES., FXD, CMPSN: 20 OHM, 5%, 0.25W	01121	CB2005
A12R1226	315-0111-00		RES., FXD, CMPSN: 110 OHM, 5%, 0.25W	01121	CB1115
A12R1227	315-0681-00		RES., FXD, CMPSN: 680 OHM, 5%, 0.25W	01121	CB6815
A12R1228	315-0680-00		RES., FXD, CMPSN: 68 OHM, 5%, 0.25W	01121	CB6805
A12R1229	315-0680-00		RES., FXD, CMPSN: 68 OHM, 5%, 0.25W	01121	CB6805
A12R1231	315-0510-00		RES., FXD, CMPSN: 51 OHM, 5%, 0.25W	01121	CB5105
A12R1232	315-0302-00		RES., FXD, CMPSN: 3K OHM, 5%, 0.25W	01121	CB3025
A12R1233	315-0821-00		RES., FXD, CMPSN: 820 OHM, 5%, 0.25W	01121	CB8215
A12R1234	315-0510-00		RES., FXD, CMPSN: 51 OHM, 5%, 0.25W	01121	CB5105
A12R1235	315-0131-00		RES., FXD, CMPSN: 130 OHM, 5%, 0.25W	01121	CB1315
A12R1236	315-0101-00		RES., FXD, CMPSN: 100 OHM, 5%, 0.25W	01121	CB1015
A12R1237	315-0680-00		RES., FXD, CMPSN: 68 OHM, 5%, 0.25W	01121	CB6805
A12R1238	315-0680-00		RES., FXD, CMPSN: 68 OHM, 5%, 0.25W	01121	CB6805
A12R1239	315-0130-00		RES., FXD, CMPSN: 13 OHM, 5%, 0.25W	01121	CB1305
A12R1240	315-0821-00		RES., FXD, CMPSN: 820 OHM, 5%, 0.25W	01121	CB8215

Component No.	Tektronix Part No.	Serial/Model No. Eff Dscont	Name & Description	Mfr Code	Mfr Part Number
A12R1241	315-0201-00		RES., FXD, CMPSN: 200 OHM, 5%, 0.25W	01121	CB2015
A12R1242	315-0510-00		RES., FXD, CMPSN: 51 OHM, 5%, 0.25W	01121	CB5105
A12R1243	315-0200-00		RES., FXD, CMPSN: 20 OHM, 5%, 0.25W	01121	CB2005
A12R1244	315-0200-00		RES., FXD, CMPSN: 20 OHM, 5%, 0.25W	01121	CB2005
A12R1245	315-0200-00		RES., FXD, CMPSN: 20 OHM, 5%, 0.25W	01121	CB2005
A12R1246	315-0111-00		RES., FXD, CMPSN: 110 OHM, 5%, 0.25W	01121	CB1115
A12R1247	315-0681-00		RES., FXD, CMPSN: 680 OHM, 5%, 0.25W	01121	CB6815
A12R1248	315-0302-00		RES., FXD, CMPSN: 3K OHM, 5%, 0.25W	01121	CB3025
A12R1249	315-0130-00		RES., FXD, CMPSN: 13 OHM, 5%, 0.25W	01121	CB1305
A12R1301	311-1248-00		RES., VAR, NONWIR: 500 OHM, 10%, 0.50W	73138	72X-23-0-501K
A12R1302	315-0332-00		RES., FXD, CMPSN: 3.3K OHM, 5%, 0.25W	01121	CB3325
A12R1303	315-0752-00		RES., FXD, CMPSN: 7.5K OHM, 5%, 0.25W	01121	CB7525
A12R1304	321-0238-00		RES., FXD, FILM: 2.94K OHM, 1%, 0.125W	91637	MFF1816G29400F
A12R1305	321-0158-00		RES., FXD, FILM: 432 OHM, 1%, 0.125W	91637	MFF1816G432R0F
A12R1306	315-0752-00		RES., FXD, CMPSN: 7.5K OHM, 5%, 0.25W	01121	CB7525
A12R1307	321-0269-00		RES., FXD, FILM: 6.19K OHM, 1%, 0.125W	91637	MFF1816G61900F
A12R1308	315-0331-00		RES., FXD, CMPSN: 330 OHM, 5%, 0.25W	01121	CB3315
A12R1309	315-0332-00		RES., FXD, CMPSN: 3.3K OHM, 5%, 0.25W	01121	CB3325
A12R1311	321-0481-00		RES., FXD, FILM: 1M OHM, 1%, 0.125W	24546	NA4D1004F
A12R1312	321-0281-00		RES., FXD, FILM: 8.25K OHM, 1%, 0.125W	91637	MFF1816G82500F
A12R1313	315-0103-00		RES., FXD, CMPSN: 10K OHM, 5%, 0.25W	01121	CB1035
A12R1314	315-0103-00		RES., FXD, CMPSN: 10K OHM, 5%, 0.25W	01121	CB1035
A12R1315	315-0103-00		RES., FXD, CMPSN: 10K OHM, 5%, 0.25W	01121	CB1035
A12R1316	315-0103-00		RES., FXD, CMPSN: 10K OHM, 5%, 0.25W	01121	CB1035
A12R1317	311-1245-00		RES., VAR, NONWIR: 10K OHM, 10%, 0.50W	73138	72-28-0
A12R1318	321-0481-00		RES., FXD, FILM: 1M OHM, 1%, 0.125W	24546	NA4D1004F
A12R1319	321-0281-00		RES., FXD, FILM: 8.25K OHM, 1%, 0.125W	91637	MFF1816G82500F
A12R1321	315-0103-00		RES., FXD, CMPSN: 10K OHM, 5%, 0.25W	01121	CB1035
A12R1322	315-0103-00		RES., FXD, CMPSN: 10K OHM, 5%, 0.25W	01121	CB1035
A12R1323	311-1245-00		RES., VAR, NONWIR: 10K OHM, 10%, 0.50W	73138	72-28-0
A12R1324	321-0481-00		RES., FXD, FILM: 1M OHM, 1%, 0.125W	24546	NA4D1004F
A12R1325	321-0281-00		RES., FXD, FILM: 8.25K OHM, 1%, 0.125W	91637	MFF1816G82500F
A12R1326	321-0481-00		RES., FXD, FILM: 1M OHM, 1%, 0.125W	24546	NA4D1004F
A12R1327	321-0281-00		RES., FXD, FILM: 8.25K OHM, 1%, 0.125W	91637	MFF1816G82500F
A12R1328	315-0510-00		RES., FXD, CMPSN: 51 OHM, 5%, 0.25W	01121	CB5105
A12R1329	315-0101-00		RES., FXD, CMPSN: 100 OHM, 5%, 0.25W	01121	CB1015
A12R1332	315-0131-00		RES., FXD, CMPSN: 130 OHM, 5%, 0.25W	01121	CB1315
A12R1333	315-0122-00		RES., FXD, CMPSN: 1.2K OHM, 5%, 0.25W	01121	CB1225
A12R1335	307-0707-00		RES., NTWK, FXD FI: 4, 4.7K OHM, 2%, 0.2W	01121	208B472
A12R1338	315-0511-00		RES., FXD, CMPSN: 510 OHM, 5%, 0.25W	01121	CB5115
A12R1341	315-0510-00		RES., FXD, CMPSN: 51 OHM, 5%, 0.25W	01121	CB5105
A12R1342	315-0131-00		RES., FXD, CMPSN: 130 OHM, 5%, 0.25W	01121	CB1315
A12R1343	315-0101-00		RES., FXD, CMPSN: 100 OHM, 5%, 0.25W	01121	CB1015
A12R1344	315-0101-00		RES., FXD, CMPSN: 100 OHM, 5%, 0.25W	01121	CB1015
A12R1345	315-0122-00		RES., FXD, CMPSN: 1.2K OHM, 5%, 0.25W	01121	CB1225
A12R1346	315-0510-00		RES., FXD, CMPSN: 51 OHM, 5%, 0.25W	01121	CB5105
A12R1347	315-0511-00		RES., FXD, CMPSN: 510 OHM, 5%, 0.25W	01121	CB5115
A12R1348	315-0131-00		RES., FXD, CMPSN: 130 OHM, 5%, 0.25W	01121	CB1315
A12R1349	315-0121-00		RES., FXD, CMPSN: 120 OHM, 5%, 0.25W	01121	CB1215
A12R1401	315-0512-00		RES., FXD, CMPSN: 5.1K OHM, 5%, 0.25W	01121	CB5125
A12R1402	315-0512-00		RES., FXD, CMPSN: 5.1K OHM, 5%, 0.25W	01121	CB5125
A12R1403	315-0112-00		RES., FXD, CMPSN: 1.1K OHM, 5%, 0.25W	01121	CB1125
A12R1404	315-0181-00		RES., FXD, CMPSN: 180 OHM, 5%, 0.25W	01121	CB1815
A12R1411	315-0512-00		RES., FXD, CMPSN: 5.1K OHM, 5%, 0.25W	01121	CB5125
A12R1412	315-0511-00		RES., FXD, CMPSN: 510 OHM, 5%, 0.25W	01121	CB5115
A12R1413	315-0122-00		RES., FXD, CMPSN: 1.2K OHM, 5%, 0.25W	01121	CB1225
A12R1414	315-0511-00		RES., FXD, CMPSN: 510 OHM, 5%, 0.25W	01121	CB5115

Replaceable Electrical Parts—DC 509

Component No.	Tektronix Part No.	Serial/Model No. Eff Dscont	Name & Description	Mfr Code	Mfr Part Number
A12R1415	315-0242-00		RES., FXD, CMPSN: 2.4K OHM, 5%, 0.25W	01121	CB2425
A12R1416	315-0511-00		RES., FXD, CMPSN: 510 OHM, 5%, 0.25W	01121	CB5115
A12R1421	307-0707-00		RES., NTWK, FXD FI: 4, 4.7K OHM, 2%, 0.2W	01121	208B472
A12R1423	315-0512-00		RES., FXD, CMPSN: 5.1K OHM, 5%, 0.25W	01121	CB5125
A12R1425	315-0152-00		RES., FXD, CMPSN: 1.5K OHM, 5%, 0.25W	01121	CB1525
A12R1431	307-0695-00		RES., NTWK, FXD FI: 9, 150 OHM, 2%, 0.2W	01121	210A151
A12R1432	307-0695-00		RES., NTWK, FXD FI: 9, 150 OHM, 2%, 0.2W	01121	210A151
A12R1433	315-0122-00		RES., FXD, CMPSN: 1.2K OHM, 5%, 0.25W	01121	CB1225
A12R1434	315-0362-00		RES., FXD, CMPSN: 3.6K OHM, 5%, 0.25W	01121	CB3625
A12R1435	308-0244-00		RES., FXD, WW: 0.3 OHM, 10%, 2W	91637	RS2B162ER3000K
A12R1441	315-0510-00		RES., FXD, CMPSN: 51 OHM, 5%, 0.25W	01121	CB5105
A12R1442	315-0820-00		RES., FXD, CMPSN: 82 OHM, 5%, 0.25W	01121	CB8205
A12R1443	315-0820-00		RES., FXD, CMPSN: 82 OHM, 5%, 0.25W	01121	CB8205
A12R1444	315-0510-00		RES., FXD, CMPSN: 51 OHM, 5%, 0.25W	01121	CB5105
A12R1445	315-0272-00		RES., FXD, CMPSN: 2.7K OHM, 5%, 0.25W	01121	CB2725
A12R1446	315-0152-00		RES., FXD, CMPSN: 1.5K OHM, 5%, 0.25W	01121	CB1525
A12R1447	315-0102-00		RES., FXD, CMPSN: 1K OHM, 5%, 0.25W	01121	CB1025
A12R1501	315-0103-00		RES., FXD, CMPSN: 10K OHM, 5%, 0.25W	01121	CB1035
A12R1502	315-0512-00		RES., FXD, CMPSN: 5.1K OHM, 5%, 0.25W	01121	CB5125
A12R1503	315-0102-00		RES., FXD, CMPSN: 1K OHM, 5%, 0.25W	01121	CB1025
A12R1504	315-0474-00		RES., FXD, CMPSN: 470K OHM, 5%, 0.25W	01121	CB4745
A12R1505	315-0393-00		RES., FXD, CMPSN: 39K OHM, 5%, 0.25W	01121	CB3935
A12R1510	315-0512-00		RES., FXD, CMPSN: 5.1K OHM, 5%, 0.25W	01121	CB5125
A12R1511	315-0562-00		RES., FXD, CMPSN: 5.6K OHM, 5%, 0.25W	01121	CB5625
A12R1512	315-0113-00		RES., FXD, CMPSN: 11K OHM, 5%, 0.25W	01121	CB1135
A12R1513	315-0223-00		RES., FXD, CMPSN: 22K OHM, 5%, 0.25W	01121	CB2235
A12R1514	315-0182-00		RES., FXD, CMPSN: 1.8K OHM, 5%, 0.25W	01121	CB1825
A12R1515	315-0332-00		RES., FXD, CMPSN: 3.3K OHM, 5%, 0.25W	01121	CB3325
A12R1516	315-0332-00		RES., FXD, CMPSN: 3.3K OHM, 5%, 0.25W	01121	CB3325
A12R1517	315-0102-00		RES., FXD, CMPSN: 1K OHM, 5%, 0.25W	01121	CB1025
A12R1518	315-0102-00		RES., FXD, CMPSN: 1K OHM, 5%, 0.25W	01121	CB1025
A12R1519	315-0332-00		RES., FXD, CMPSN: 3.3K OHM, 5%, 0.25W	01121	CB3325
A12R1521	315-0133-00		RES., FXD, CMPSN: 13K OHM, 5%, 0.25W	01121	CB1335
A12R1522	315-0471-00		RES., FXD, CMPSN: 470 OHM, 5%, 0.25W	01121	CB4715
A12R1526	307-0103-00		RES., FXD, CMPSN: 2.7 OHM, 5%, 0.25W	01121	CB27G5
A12R1528	315-0471-00		RES., FXD, CMPSN: 470 OHM, 5%, 0.25W	01121	CB4715
A12R1531	315-0101-00		RES., FXD, CMPSN: 100 OHM, 5%, 0.25W	01121	CB1015
A12R1532	315-0102-00		RES., FXD, CMPSN: 1K OHM, 5%, 0.25W	01121	CB1025
A12R1533	315-0512-00		RES., FXD, CMPSN: 5.1K OHM, 5%, 0.25W	01121	CB5125
A12R1534	307-0103-00		RES., FXD, CMPSN: 2.7 OHM, 5%, 0.25W	01121	CB27G5
A12R1535	315-0102-00		RES., FXD, CMPSN: 1K OHM, 5%, 0.25W	01121	CB1025
A12R1541	321-0242-00		RES., FXD, FILM: 3.24K OHM, 1%, 0.125W	91637	MFF1816G32400F
A12R1542	321-0297-00		RES., FXD, FILM: 12.1K OHM, 1%, 0.125W	91637	MFF1816G12101F
A12R1543	315-0102-00		RES., FXD, CMPSN: 1K OHM, 5%, 0.25W	01121	CB1025
A12R1544	315-0132-00		RES., FXD, CMPSN: 1.3K OHM, 5%, 0.25W	01121	CB1325
A12R1545	315-0202-00		RES., FXD, CMPSN: 2K OHM, 5%, 0.25W	01121	CB2025
A12R1547	315-0202-00		RES., FXD, CMPSN: 2K OHM, 5%, 0.25W	01121	CB2025
A12R1548	315-0100-00		RES., FXD, CMPSN: 10 OHM, 5%, 0.25W	01121	CB1005
A12R1601	315-0183-00 -----		RES., FXD, CMPSN: 18K OHM, 5%, 0.25W (STANDARD ONLY)	01121	CB1835
A12R1602	315-0562-00 -----		RES., FXD, CMPSN: 5.6K OHM, 5%, 0.25W (STANDARD ONLY)	01121	CB5625
A12R1603	321-0105-00 -----		RES., FXD, FILM: 121 OHM, 1%, 0.125W (OPTION 01 ONLY)	91637	MFF1816G121R0F
A12R1604	321-0213-00 -----		RES., FXD, FILM: 1.62K OHM, 1%, 0.125W (OPTION 01 ONLY)	91637	MFF1816G16200F
A12R1605	315-0152-00 -----		RES., FXD, CMPSN: 1.5K OHM, 5%, 0.25W (STANDARD ONLY)	01121	CB1525

Component No.	Tektronix Part No.	Serial/Model No. Eff Dscont	Name & Description	Mfr Code	Mfr Part Number
A12R1611	315-0102-00		RES.,FXD,CMPSN:1K OHM,5%,0.25W (STANDARD ONLY)	01121	CB1025
A12R1612	315-0511-00		RES.,FXD,CMPSN:510 OHM,5%,0.25W	01121	CB5115
A12R1613	315-0102-00		RES.,FXD,CMPSN:1K OHM,5%,0.25W	01121	CB1025
A12S1010	263-0033-01		SWITCH PB ASSY:1 MOMENTARY,7.5MM	80009	263-0033-01
A12S1011	263-0033-01		SWITCH PB ASSY:1 MOMENTARY,7.5MM	80009	263-0033-01
A12S1012	263-0033-01		SWITCH PB ASSY:1 MOMENTARY,7.5MM	80009	263-0033-01
A12TP1341	214-0579-00		TERM,TEST POINT:BRS CD PL	80009	214-0579-00
A12TP1410	214-0579-00		TERM,TEST POINT:BRS CD PL	80009	214-0579-00
A12TP1411	214-0579-00		TERM,TEST POINT:BRS CD PL	80009	214-0579-00
A12TP1431	214-0579-00		TERM,TEST POINT:BRS CD PL	80009	214-0579-00
A12TP1510	214-0579-00		TERM,TEST POINT:BRS CD PL	80009	214-0579-00
A12TP1520	214-0579-00		TERM,TEST POINT:BRS CD PL	80009	214-0579-00
A12TP1621	214-0579-00		TERM,TEST POINT:BRS CD PL	80009	214-0579-00
A12TP1631	214-0579-00		TERM,TEST POINT:BRS CD PL	80009	214-0579-00
A12TP1632	214-0579-00		TERM,TEST POINT:BRS CD PL	80009	214-0579-00
A12U500	156-1263-00		MICROCIRCUIT,LI:VOLTAGE REGULATOR	27014	LM341P-5.0TB
A12U1101	156-0796-00		MICROCIRCUIT,DI:8 STG SHF & STORE BUS RGTR	80009	156-0796-00
A12U1110	156-1245-00		MICROCIRCUIT,LI:7 XSTR,HV/HIGH CUR	04713	MC1413PDS
A12U1111	156-0796-00		MICROCIRCUIT,DI:8 STG SHF & STORE BUS RGTR	80009	156-0796-00
A12U1112	156-1245-00		MICROCIRCUIT,LI:7 XSTR,HV/HIGH CUR	04713	MC1413PDS
A12U1201	156-1255-00		MICROCIRCUIT,LI:D/A CONVERTER 8 BIT	80009	156-1255-00
A12U1202	156-0796-00		MICROCIRCUIT,DI:8 STG SHF & STORE BUS RGTR	80009	156-0796-00
A12U1211	156-1255-00		MICROCIRCUIT,LI:D/A CONVERTER 8 BIT	80009	156-1255-00
A12U1212	156-0796-00		MICROCIRCUIT,DI:8 STG SHF & STORE BUS RGTR	80009	156-0796-00
A12U1311	156-0644-00		MICROCIRCUIT,DI:QUAD BILATERAL SWITCH	80009	156-0644-00
A12U1321	156-1200-00		MICROCIRCUIT,LI:OPERATIONAL AMPL	01295	TL074CN
A12U1322	156-0494-00		MICROCIRCUIT,DI:HEX INVERTER/BUFFER	80009	156-0494-00
A12U1331	156-0369-00		MICROCIRCUIT,DI:TRIPLE LINE RECEIVER	80009	156-0369-00
A12U1332	156-0182-00		MICROCIRCUIT,DI:TRIPLE 2-3-2 INPUT GATE	80009	156-0182-00
A12U1401	156-1191-00		MICROCIRCUIT,LI:DUAL BI-FET OP-AMPL,8 DIP	01295	TL072CP
A12U1411	156-0796-00		MICROCIRCUIT,DI:8 STG SHF & STORE BUS RGTR	80009	156-0796-00
A12U1421	156-0880-00		MICROCIRCUIT,DI:DUAL D MASTER SLAVE FF	80009	156-0880-00
A12U1431	156-0205-00		MICROCIRCUIT,DI:QUAD 2-INPUT NOR GATE	80009	156-0205-00
A12U1433	156-1263-00		MICROCIRCUIT,LI:VOLTAGE REGULATOR	27014	LM341P-5.0TB
A12U1501	156-1126-00		MICROCIRCUIT,LI:VOLTAGE COMPARATOR	34333	SG311M
A12U1502	156-1433-00		MICROCIRCUIT,DI:NOISE SOURCE	27014	MM5837N
A12U1521	156-0158-00		MICROCIRCUIT,LI:DUAL OPERATIONAL AMPLIFIER	18324	MC1458V
A12U1522	156-0124-00		MICROCIRCUIT,DI:SGL FREQ/PHASE DETECTOR	80009	156-0124-00
A12U1523	156-0182-00		MICROCIRCUIT,DI:TRIPLE 2-3-2 INPUT GATE	80009	156-0182-00
A12U1524	156-1248-00		MICROCIRCUIT,DI:PRESCALER/DIVIDE BY 100	80009	156-1248-00
A12U1531	156-0071-00		MICROCIRCUIT,LI:VOLTAGE REGULATOR	04713	MC1723CL
A12U1601	156-1161-00		MICROCIRCUIT,LI:VOLTAGE REGULATOR (OPTION 01 ONLY)	27014	LM317T
A12U1611	156-0079-00		MICROCIRCUIT,DI:DECADE COUNTER,TTL	80009	156-0079-00
A12U1641	156-0285-02		MICROCIRCUIT,LI:VOLTAGE REGULATOR	27014	LM340T-12
A12VR1301	152-0317-00		SEMICOND DEVICE:ZENER,0.25W,6.2V,5%	80009	152-0317-00
A12VR1302	152-0647-00		SEMICOND DEVICE:ZENER,0.4W,6.8V,5%	80009	152-0647-00
A12VR1321	152-0278-00		SEMICOND DEVICE:ZENER,0.4W,3V,5%	04713	SZG35009K20
A12VR1341	152-0278-00		SEMICOND DEVICE:ZENER,0.4W,3V,5%	04713	SZG35009K20
A12W1220	131-0566-00		BUS CONDUCTOR:DUMMY RES,2.375,22 AWG	55210	L-2007-1
A12W1230	131-0566-00		BUS CONDUCTOR:DUMMY RES,2.375,22 AWG	55210	L-2007-1
A12Y1531	119-0894-01		OSCILLATOR,RF:10MHZ,18V (OPTION 01 ONLY)	80009	119-0894-01
A12Y1601	158-0129-00		XTAL UNIT,QTZ:10MHZ,0.001%,PARALLEL (STANDARD ONLY)	33096	PB1109

Replaceable Electrical Parts—DC 509

Component No.	Tektronix Part No.	Serial/Model No. Eff Dscont	Name & Description	Mfr Code	Mfr Part Number
A16	-----		CKT BOARD ASSY: DIGITAL		
A16C1001	281-0773-00		CAP., FXD, CER DI: 0.01UF, 10%, 100V	72982	8005H9AADW5R103K
A16C1002	281-0775-00		CAP., FXD, CER DI: 0.1UF, 20%, 50V	72982	8005D9AABZ5U104M
A16C1101	281-0775-00		CAP., FXD, CER DI: 0.1UF, 20%, 50V	72982	8005D9AABZ5U104M
A16C1102	281-0775-00		CAP., FXD, CER DI: 0.1UF, 20%, 50V	72982	8005D9AABZ5U104M
A16C1111	281-0775-00		CAP., FXD, CER DI: 0.1UF, 20%, 50V	72982	8005D9AABZ5U104M
A16C1201	281-0775-00		CAP., FXD, CER DI: 0.1UF, 20%, 50V	72982	8005D9AABZ5U104M
A16C1202	281-0757-00		CAP., FXD, CER DI: 10PF, 20%, 100V	72982	8035-D-COG-100G
A16C1211	281-0775-00		CAP., FXD, CER DI: 0.1UF, 20%, 50V	72982	8005D9AABZ5U104M
A16C1221	281-0775-00		CAP., FXD, CER DI: 0.1UF, 20%, 50V	72982	8005D9AABZ5U104M
A16C1231	281-0775-00		CAP., FXD, CER DI: 0.1UF, 20%, 50V	72982	8005D9AABZ5U104M
A16C1232	281-0773-00		CAP., FXD, CER DI: 0.01UF, 10%, 100V	72982	8005H9AADW5R103K
A16C1233	290-0535-00		CAP., FXD, ELCTLT: 33UF, 20%, 10V	56289	196D336X0010KA1
A16C1301	281-0775-00		CAP., FXD, CER DI: 0.1UF, 20%, 50V	72982	8005D9AABZ5U104M
A16C1311	281-0775-00		CAP., FXD, CER DI: 0.1UF, 20%, 50V	72982	8005D9AABZ5U104M
A16C1331	281-0775-00		CAP., FXD, CER DI: 0.1UF, 20%, 50V	72982	8005D9AABZ5U104M
A16C1401	281-0775-00		CAP., FXD, CER DI: 0.1UF, 20%, 50V	72982	8005D9AABZ5U104M
A16C1402	290-0755-00		CAP., FXD, ELCTLT: 100UF, +50-10%, 10V	56289	502D223
A16C1403	290-0755-00		CAP., FXD, ELCTLT: 100UF, +50-10%, 10V	56289	502D223
A16C1411	281-0775-00		CAP., FXD, CER DI: 0.1UF, 20%, 50V	72982	8005D9AABZ5U104M
A16C1412	281-0775-00		CAP., FXD, CER DI: 0.1UF, 20%, 50V	72982	8005D9AABZ5U104M
A16C1420	281-0775-00		CAP., FXD, CER DI: 0.1UF, 20%, 50V	72982	8005D9AABZ5U104M
A16C1421	281-0775-00		CAP., FXD, CER DI: 0.1UF, 20%, 50V	72982	8005D9AABZ5U104M
A16C1422	281-0775-00		CAP., FXD, CER DI: 0.1UF, 20%, 50V	72982	8005D9AABZ5U104M
A16C1431	281-0775-00		CAP., FXD, CER DI: 0.1UF, 20%, 50V	72982	8005D9AABZ5U104M
A16C1501	281-0775-00		CAP., FXD, CER DI: 0.1UF, 20%, 50V	72982	8005D9AABZ5U104M
A16CR1201	152-0141-02		SEMICONV DEVICE: SILICON, 30V, 150MA	01295	1N4152R
A16CR1221	152-0071-00		SEMICONV DEVICE: GERMANIUM, 15V, 40MA	14433	G865
A16CR1222	152-0141-02		SEMICONV DEVICE: SILICON, 30V, 150MA	01295	1N4152R
A16CR1431	152-0141-02		SEMICONV DEVICE: SILICON, 30V, 150MA	01295	1N4152R
A16CR1432	152-0141-02		SEMICONV DEVICE: SILICON, 30V, 150MA	01295	1N4152R
A16CR1433	152-0141-02		SEMICONV DEVICE: SILICON, 30V, 150MA	01295	1N4152R
A16CR1501	152-0141-02		SEMICONV DEVICE: SILICON, 30V, 150MA	01295	1N4152R
A16CR1502	152-0141-02		SEMICONV DEVICE: SILICON, 30V, 150MA	01295	1N4152R
A16CR1503	152-0141-02		SEMICONV DEVICE: SILICON, 30V, 150MA	01295	1N4152R
A16CR1521	152-0141-02		SEMICONV DEVICE: SILICON, 30V, 150MA	01295	1N4152R
A16CR1522	152-0141-02		SEMICONV DEVICE: SILICON, 30V, 150MA	01295	1N4152R
A16CR1523	152-0141-02		SEMICONV DEVICE: SILICON, 30V, 150MA	01295	1N4152R
A16CR1524	152-0141-02		SEMICONV DEVICE: SILICON, 30V, 150MA	01295	1N4152R
A16CR1531	152-0141-02		SEMICONV DEVICE: SILICON, 30V, 150MA	01295	1N4152R
A16CR1532	152-0141-02		SEMICONV DEVICE: SILICON, 30V, 150MA	01295	1N4152R
A16J1210	131-1934-00		TERM. SET, PIN: 1 X 36, 0.1 CTR, 0.9 L	22526	65539-001
A16J1211	131-1934-00		TERM. SET, PIN: 1 X 36, 0.1 CTR, 0.9 L	22526	65539-001
A16J1331	131-1857-00		TERM. SET, PIN: 36/0.025 SQ PIN, ON 0.1 CTRS	22526	65500136
A16J1411	131-1857-00		TERM. SET, PIN: 36/0.025 SQ PIN, ON 0.1 CTRS	22526	65500136
A16J1412	131-1857-00		TERM. SET, PIN: 36/0.025 SQ PIN, ON 0.1 CTRS	22526	65500136
A16J1413	131-1857-00		TERM. SET, PIN: 36/0.025 SQ PIN, ON 0.1 CTRS	22526	65500136
A16J1431	131-1857-00		TERM. SET, PIN: 36/0.025 SQ PIN, ON 0.1 CTRS	22526	65500136
A16L1401	108-0422-00		COIL, RF: FIXED, 82UH	80009	108-0422-00
A16Q1001	151-0342-00		TRANSISTOR: SILICON, PNP	07263	S035928
A16Q1002	151-0341-00		TRANSISTOR: SILICON, NPN	07263	S040065
A16Q1003	151-0462-00		TRANSISTOR: SILICON, PNP	80009	151-0462-00
A16Q1201	151-0188-00		TRANSISTOR: SILICON, PNP	04713	SPS6868K
A16Q1211	151-0220-00		TRANSISTOR: SILICON, PNP	07263	S036228
A16Q1212	151-0220-00		TRANSISTOR: SILICON, PNP	07263	S036228
A16Q1213	151-0220-00		TRANSISTOR: SILICON, PNP	07263	S036228
A16Q1221	151-0220-00		TRANSISTOR: SILICON, PNP	07263	S036228

Component No.	Tektronix Part No.	Serial/Model No. Eff Dscont	Name & Description	Mfr Code	Mfr Part Number
A16Q1301	151-0190-00		TRANSISTOR: SILICON, NPN	07263	S032677
A16Q1421	151-0223-00		TRANSISTOR: SILICON, NPN	04713	SPS8026
A16Q1431	151-0302-00		TRANSISTOR: SILICON, NPN	07263	S038487
A16Q1432	151-0302-00		TRANSISTOR: SILICON, NPN	07263	S038487
A16R1001	315-0681-00		RES., FXD, CMPSN: 680 OHM, 5%, 0.25W	01121	CB6815
A16R1002	315-0361-00		RES., FXD, CMPSN: 360 OHM, 5%, 0.25W	01121	CB3615
A16R1003	315-0511-00		RES., FXD, CMPSN: 510 OHM, 5%, 0.25W	01121	CB5115
A16R1011	315-0751-00		RES., FXD, CMPSN: 750 OHM, 5%, 0.25W	01121	CB7515
A16R1012	307-0108-00		RES., FXD, CMPSN: 6.8 OHM, 5%, 0.25W	80009	307-0108-00
A16R1013	315-0201-00		RES., FXD, CMPSN: 200 OHM, 5%, 0.25W	01121	CB2015
A16R1101	307-0540-00		RES, NTWK, FXD, FI: (5) 1K OHM, 10%, 0.7W	01121	206A102
A16R1102	315-0511-00		RES., FXD, CMPSN: 510 OHM, 5%, 0.25W	01121	CB5115
A16R1111	315-0512-00		RES., FXD, CMPSN: 5.1K OHM, 5%, 0.25W	01121	CB5125
A16R1112	307-0540-00		RES, NTWK, FXD, FI: (5) 1K OHM, 10%, 0.7W	01121	206A102
A16R1201	315-0512-00		RES., FXD, CMPSN: 5.1K OHM, 5%, 0.25W	01121	CB5125
A16R1202	315-0512-00		RES., FXD, CMPSN: 5.1K OHM, 5%, 0.25W	01121	CB5125
A16R1203	315-0303-00		RES., FXD, CMPSN: 30K OHM, 5%, 0.25W	01121	CB3035
A16R1211	315-0910-00		RES., FXD, CMPSN: 91 OHM, 5%, 0.25W	01121	CB9105
A16R1212	315-0910-00		RES., FXD, CMPSN: 91 OHM, 5%, 0.25W	01121	CB9105
A16R1213	315-0220-00		RES., FXD, CMPSN: 22 OHM, 5%, 0.25W	01121	CB2205
A16R1214	315-0220-00		RES., FXD, CMPSN: 22 OHM, 5%, 0.25W	01121	CB2205
A16R1215	315-0512-00		RES., FXD, CMPSN: 5.1K OHM, 5%, 0.25W	01121	CB5125
A16R1221	315-0512-00		RES., FXD, CMPSN: 5.1K OHM, 5%, 0.25W	01121	CB5125
A16R1222	315-0512-00		RES., FXD, CMPSN: 5.1K OHM, 5%, 0.25W	01121	CB5125
A16R1223	315-0512-00		RES., FXD, CMPSN: 5.1K OHM, 5%, 0.25W	01121	CB5125
A16R1224	315-0151-00		RES., FXD, CMPSN: 150 OHM, 5%, 0.25W	01121	CB1515
A16R1225	315-0151-00		RES., FXD, CMPSN: 150 OHM, 5%, 0.25W	01121	CB1515
A16R1226	315-0104-00		RES., FXD, CMPSN: 100K OHM, 5%, 0.25W	01121	CB1045
A16R1227	315-0393-00		RES., FXD, CMPSN: 39K OHM, 5%, 0.25W	01121	CB3935
A16R1230	315-0272-00		RES., FXD, CMPSN: 2.7K OHM, 5%, 0.25W	01121	CB2725
A16R1231	315-0151-00		RES., FXD, CMPSN: 150 OHM, 5%, 0.25W	01121	CB1515
A16R1232	315-0151-00		RES., FXD, CMPSN: 150 OHM, 5%, 0.25W	01121	CB1515
A16R1233	315-0103-00		RES., FXD, CMPSN: 10K OHM, 5%, 0.25W	01121	CB1035
A16R1234	315-0105-00		RES., FXD, CMPSN: 1M OHM, 5%, 0.25W	01121	CB1055
A16R1235	315-0102-00		RES., FXD, CMPSN: 1K OHM, 5%, 0.25W	01121	CB1025
A16R1236	321-0311-00		RES., FXD, FILM: 16.9K OHM, 1%, 0.125W	91637	MFF1816G16901F
A16R1237	321-0318-00		RES., FXD, FILM: 20K OHM, 1%, 0.125W	91637	MFF1816G20001F
A16R1238	321-0318-00		RES., FXD, FILM: 20K OHM, 1%, 0.125W	91637	MFF1816G20001F
A16R1239	321-0318-00		RES., FXD, FILM: 20K OHM, 1%, 0.125W	91637	MFF1816G20001F
A16R1301	315-0101-00		RES., FXD, CMPSN: 100 OHM, 5%, 0.25W	01121	CB1015
A16R1302	315-0512-00		RES., FXD, CMPSN: 5.1K OHM, 5%, 0.25W	01121	CB5125
A16R1303	315-0512-00		RES., FXD, CMPSN: 5.1K OHM, 5%, 0.25W	01121	CB5125
A16R1304	315-0512-00		RES., FXD, CMPSN: 5.1K OHM, 5%, 0.25W	01121	CB5125
A16R1305	315-0104-00		RES., FXD, CMPSN: 100K OHM, 5%, 0.25W	01121	CB1045
A16R1311	315-0512-00		RES., FXD, CMPSN: 5.1K OHM, 5%, 0.25W	01121	CB5125
A16R1321	315-0104-00		RES., FXD, CMPSN: 100K OHM, 5%, 0.25W	01121	CB1045
A16R1322	315-0103-00		RES., FXD, CMPSN: 10K OHM, 5%, 0.25W	01121	CB1035
A16R1323	315-0302-00		RES., FXD, CMPSN: 3K OHM, 5%, 0.25W	01121	CB3025
A16R1331	315-0302-00		RES., FXD, CMPSN: 3K OHM, 5%, 0.25W	01121	CB3025
A16R1402	315-0150-00		RES., FXD, CMPSN: 15 OHM, 5%, 0.25W	01121	CB1505
A16R1403	315-0150-00		RES., FXD, CMPSN: 15 OHM, 5%, 0.25W	01121	CB1505
A16R1404	315-0150-00		RES., FXD, CMPSN: 15 OHM, 5%, 0.25W	01121	CB1505
A16R1405	315-0150-00		RES., FXD, CMPSN: 15 OHM, 5%, 0.25W	01121	CB1505
A16R1411	315-0150-00		RES., FXD, CMPSN: 15 OHM, 5%, 0.25W	01121	CB1505
A16R1412	315-0150-00		RES., FXD, CMPSN: 15 OHM, 5%, 0.25W	01121	CB1505
A16R1413	315-0150-00		RES., FXD, CMPSN: 15 OHM, 5%, 0.25W	01121	CB1505
A16R1421	315-0512-00		RES., FXD, CMPSN: 5.1K OHM, 5%, 0.25W	01121	CB5125

Replaceable Electrical Parts—DC 509

Component No.	Tektronix Part No.	Serial/Model No. Eff Dscont	Name & Description	Mfr Code	Mfr Part Number
A16R1431	315-0470-00		RES.,FXD,CMPSN:47 OHM,5%,0.25W	01121	CB4705
A16R1432	315-0150-00		RES.,FXD,CMPSN:15 OHM,5%,0.25W	01121	CB1505
A16R1433	315-0242-00		RES.,FXD,CMPSN:2.4K OHM,5%,0.25W	01121	CB2425
A16R1434	315-0242-00		RES.,FXD,CMPSN:2.4K OHM,5%,0.25W	01121	CB2425
A16R1435	315-0512-00		RES.,FXD,CMPSN:5.1K OHM,5%,0.25W	01121	CB5125
A16R1436	315-0103-00		RES.,FXD,CMPSN:10K OHM,5%,0.25W	01121	CB1035
A16R1437	315-0104-00		RES.,FXD,CMPSN:100K OHM,5%,0.25W	01121	CB1045
A16R1438	315-0512-00		RES.,FXD,CMPSN:5.1K OHM,5%,0.25W	01121	CB5125
A16R1531	315-0104-00		RES.,FXD,CMPSN:100K OHM,5%,0.25W	01121	CB1045
A16R1532	315-0104-00		RES.,FXD,CMPSN:100K OHM,5%,0.25W	01121	CB1045
A16R1533	315-0104-00		RES.,FXD,CMPSN:100K OHM,5%,0.25W	01121	CB1045
A16S1511	263-0081-00		SW LEVER ASSY:FUNCTION SELECTOR	80009	263-0081-00
A16S1512	263-0082-00		SW LEVER ASSY:FUNCTION SELECTOR	80009	263-0082-00
A16S1521	263-0010-01		SWITCH PB ASSY:1 PUSH,7.5 MM,1 CONTACT	80009	263-0010-01
A16S1522	263-0010-01		SWITCH PB ASSY:1 PUSH,7.5 MM,1 CONTACT	80009	263-0010-01
A16S1523	263-0010-01		SWITCH PB ASSY:1 PUSH,7.5 MM,1 CONTACT	80009	263-0010-01
A16S1524	263-0010-01		SWITCH PB ASSY:1 PUSH,7.5 MM,1 CONTACT	80009	263-0010-01
A16S1531	263-0010-01		SWITCH PB ASSY:1 PUSH,7.5 MM,1 CONTACT	80009	263-0010-01
A16S1532	263-0010-01		SWITCH PB ASSY:1 PUSH,7.5 MM,1 CONTACT	80009	263-0010-01
A16S1533	263-0010-01		SWITCH PB ASSY:1 PUSH,7.5 MM,1 CONTACT	80009	263-0010-01
A16S1534	263-0010-01		SWITCH PB ASSY:1 PUSH,7.5 MM,1 CONTACT	80009	263-0010-01
A16TP1301	214-0579-00		TERM,TEST POINT:BRS CD PL	80009	214-0579-00
A16TP1302	214-0579-00		TERM,TEST POINT:BRS CD PL	80009	214-0579-00
A16TP1310	214-0579-00		TERM,TEST POINT:BRS CD PL	80009	214-0579-00
A16U1002	156-0576-00		MICROCIRCUIT,DI:8 BIT PRL INP-SERIAL OUTPT	04713	MC14021BCL
A16U1011	156-0576-00		MICROCIRCUIT,DI:8 BIT PRL INP-SERIAL OUTPT	04713	MC14021BCL
A16U1012	156-0545-01		MICROCIRCUIT,DI:12 BIT BINARY CNTR	80009	156-0545-01
A16U1101	156-0576-00		MICROCIRCUIT,DI:8 BIT PRL INP-SERIAL OUTPT	04713	MC14021BCL
A16U1102	156-0576-00		MICROCIRCUIT,DI:8 BIT PRL INP-SERIAL OUTPT	04713	MC14021BCL
A16U1103	156-0576-00		MICROCIRCUIT,DI:8 BIT PRL INP-SERIAL OUTPT	04713	MC14021BCL
A16U1111	156-0579-02		MICROCIRCUIT,DI:DUAL 4 BIT BIN COUNTER,SEL	80009	156-0579-02
A16U1112	156-1172-01		MICROCIRCUIT,DI:DUAL 4 BIT CNTR,BURN IN	80009	156-1172-01
A16U1113	156-0388-02		MICROCIRCUIT,DI:DL D FLIP-FLOP,CHK	80009	156-0388-02
A16U1201	156-0331-03		MICROCIRCUIT,DI:DUAL D TYPE POSITIVE EDGE	80009	156-0331-03
A16U1202	156-0385-01		MICROCIRCUIT,DI:HEX. INVERTER	80009	156-0385-01
A16U1211	156-0230-01		MICROCIRCUIT,DI:DUAL D MA-SLAVE FF,SEL	80009	156-0230-01
A16U1221	156-0880-02		ICROCIRCUIT,DI:DUAL D MASTER SLAVE FF	07263	SL81662
A16U1222	156-1225-01		MICROCIRCUIT,LI:DUAL COMPARATOR,SCREENED	27014	LM393N/AT
A16U1311	156-1482-00		MICROCIRCUIT,DI:8-BIT MICROPROC	34576	R6504(P OR C)
A16U1312	160-1076-01		MICROCIRCUIT,DI:4096 X 8 EPROM,PRGM	80009	160-1076-01
A16U1321	156-0494-00		MICROCIRCUIT,DI:HEX INVERTER/BUFFER	80009	156-0494-00
A16U1322	156-0649-00		MICROCIRCUIT,DI:3 STATE HEX. NON INVT BFR	80009	156-0649-00
A16U1331	156-0469-00		MICROCIRCUIT,DI:3-LINE TO 8-LINE DECODER	01295	SN74LS138N
A16U1332	156-1530-00		MICROCIRCUIT,DI:RAM AND I/O CNTR,PROTO	34576	R6531P098
A16U1333	156-0469-00		MICROCIRCUIT,DI:3-LINE TO 8-LINE DECODER	01295	SN74LS138N
A16U1411	156-1190-00		MICROCIRCUIT,DI:7 XSTR,CA3082	80009	156-1190-00
A16U1412	156-1407-00		MICROCIRCUIT,DI:MOS-TO-LED 8-DIGIT DRVR	27014	DS8863N OR J
A16U1421	156-0795-00		MICROCIRCUIT,DI:BCD 7-SEG LCHDCDR/DRVR	04713	MC14511BCL
A16U1431	156-0391-00		MICROCIRCUIT,DI:HEX LATCH WITH CLEAR	04713	74LS174(N OR J)
A16U1432	156-0799-00		MICROCIRCUIT,DI:DECADE CNTR/DIV	80009	156-0799-00
A16VR1301	152-0195-00		SEMICONV DEVICE:ZENER,0.4W,5.1V,5%	04713	SZ11755

Component No.	Tektronix Part No.	Serial/Model No. Eff Dscnt	Name & Description	Mfr Code	Mfr Part Number
CHASSIS PARTS					
J500	131-0955-00		CONN, RCPT, ELEC: BNC, FEMALE	13511	31-279
J510	131-0955-00		CONN, RCPT, ELEC: BNC, FEMALE	13511	31-279
J520	136-0387-00		JACK, TIP: GRAY	71279	450-4352-01-0318
J530	136-0387-00		JACK, TIP: GRAY	71279	450-4352-01-0318
J540	136-0387-00		JACK, TIP: GRAY	71279	450-4352-01-0318
J550	136-0387-00		JACK, TIP: GRAY	71279	450-4352-01-0318
J560	136-0387-00		JACK, TIP: GRAY	71279	450-4352-01-0318
J570	136-0387-00		JACK, TIP: GRAY	71279	450-4352-01-0318
J580	136-0387-00		JACK, TIP: GRAY	71279	450-4352-01-0318
R500	311-2105-00 -----		RES., VAR, NONWW: PNL, 10K OHM, 10%, 0.5W (FURNISHED AS A UNIT WITH S500)	12697	CM41776
R510	311-2095-00		RES., VAR, NONWW: PNL, 10K OHM, 10%, 0.5W	12697	CM41763
S500	-----		(FURNISHED AS A UNIT WITH R500)		

DIAGRAMS AND CIRCUIT BOARD ILLUSTRATIONS

Symbols

Graphic symbols and class designation letters are based on ANSI Standard Y32.2-1975.

Logic symbology is based on ANSI Y32.14-1973 in terms of positive logic. Logic symbols depict the logic function performed and may differ from the manufacturer's data.

The overline on a signal name indicates that the signal performs its intended function when it is in the low state.

Abbreviations are based on ANSI Y1.1-1972.

Other ANSI standards that are used in the preparation of diagrams by Tektronix, Inc. are:

- Y14.15, 1966 Drafting Practices.
- Y14.2, 1973 Line Conventions and Lettering.
- Y10.5, 1968 Letter Symbols for Quantities Used in Electrical Science and Electrical Engineering.

American National Standard Institute
1430 Broadway
New York, New York 10018

Component Values

Electrical components shown on the diagrams are in the following units unless noted otherwise:

- Capacitors = Values one or greater are in picofarads (pF).
Values less than one are in microfarads (μ F).
- Resistors = Ohms (Ω).

———— The information and special symbols below may appear in this manual. ————

Assembly Numbers and Grid Coordinates

Each assembly in the instrument is assigned an assembly number (e.g., A20). The assembly number appears on the circuit board outline on the diagram, in the title for the circuit board component location illustration, and in the lookup table for the schematic diagram and corresponding component locator illustration. The Replaceable Electrical Parts list is arranged by assemblies in numerical sequence; the components are listed by component number *(see following illustration for constructing a component number).

The schematic diagram and circuit board component location illustration have grids. A lookup table with the grid coordinates is provided for ease of locating the component. Only the components illustrated on the facing diagram are listed in the lookup table. When more than one schematic diagram is used to illustrate the circuitry on a circuit board, the circuit board illustration may only appear opposite the first diagram on which it was illustrated; the lookup table will list the diagram number of other diagrams that the circuitry of the circuit board appears on.

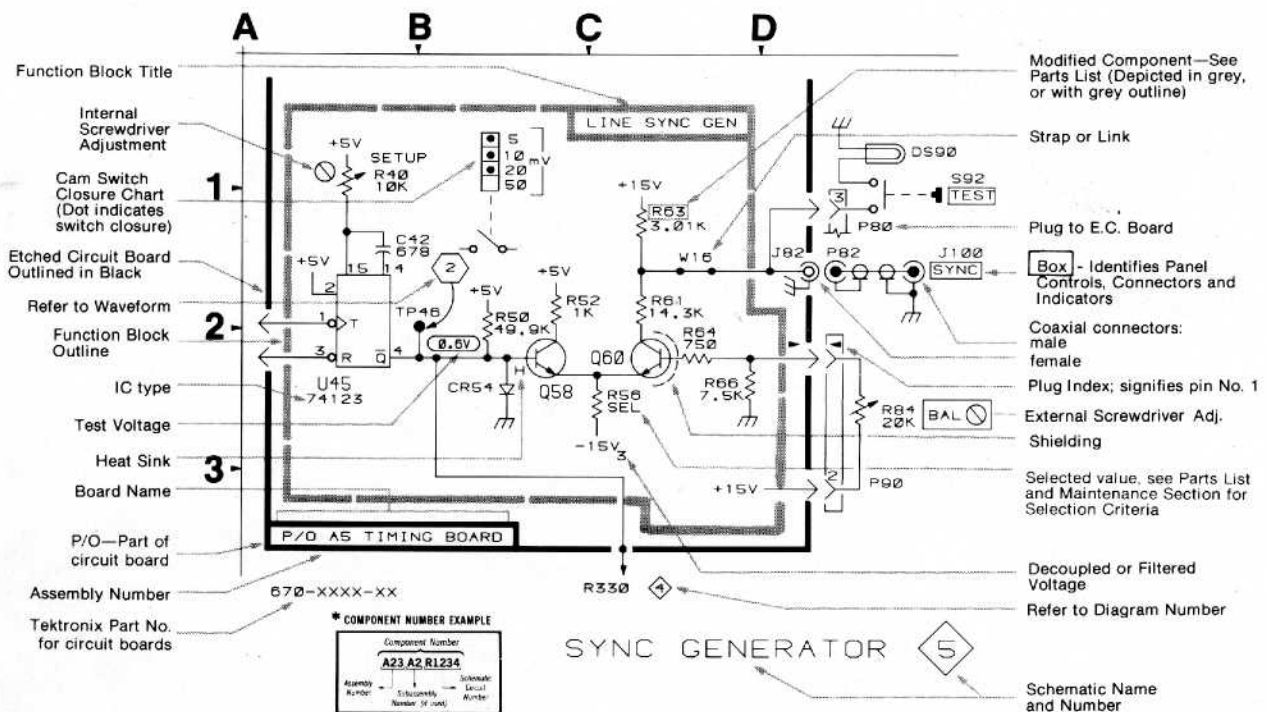

ADJUSTMENT LOCATIONS

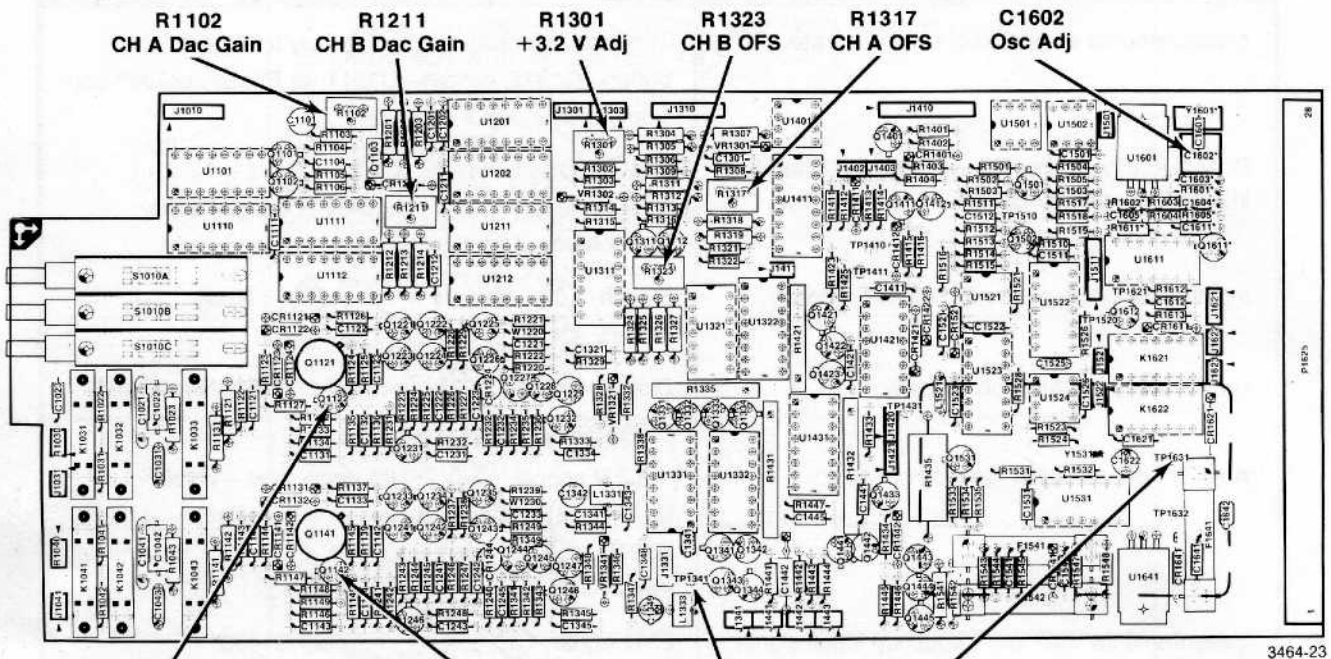

Q1122
*CH A Probe Comp
& Input Cap.

Q1142
*CH B Probe Comp
& Input Cap.

TP1341
+3.2 V

TP1631
-12 V

*Performance check locations

NOTE: OPTION 1 OSC ADJ Y1531 located on reverse side of board.

Fig. 8-1. Analog Board (A12).

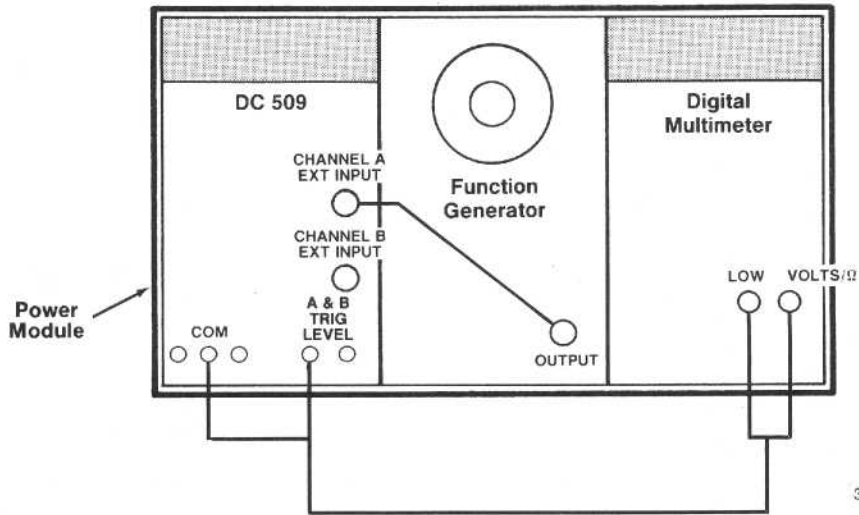

3464-24

Fig. 8-2. Adjustment setup for steps 5 and 6.

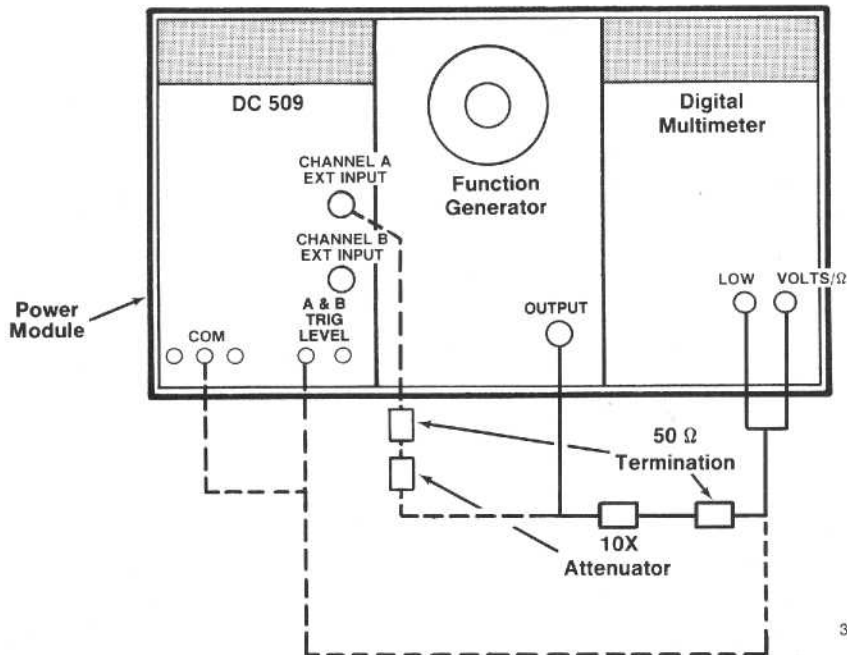

3464-25

Fig. 8-3. Adjustment setup for steps 7 and 8.

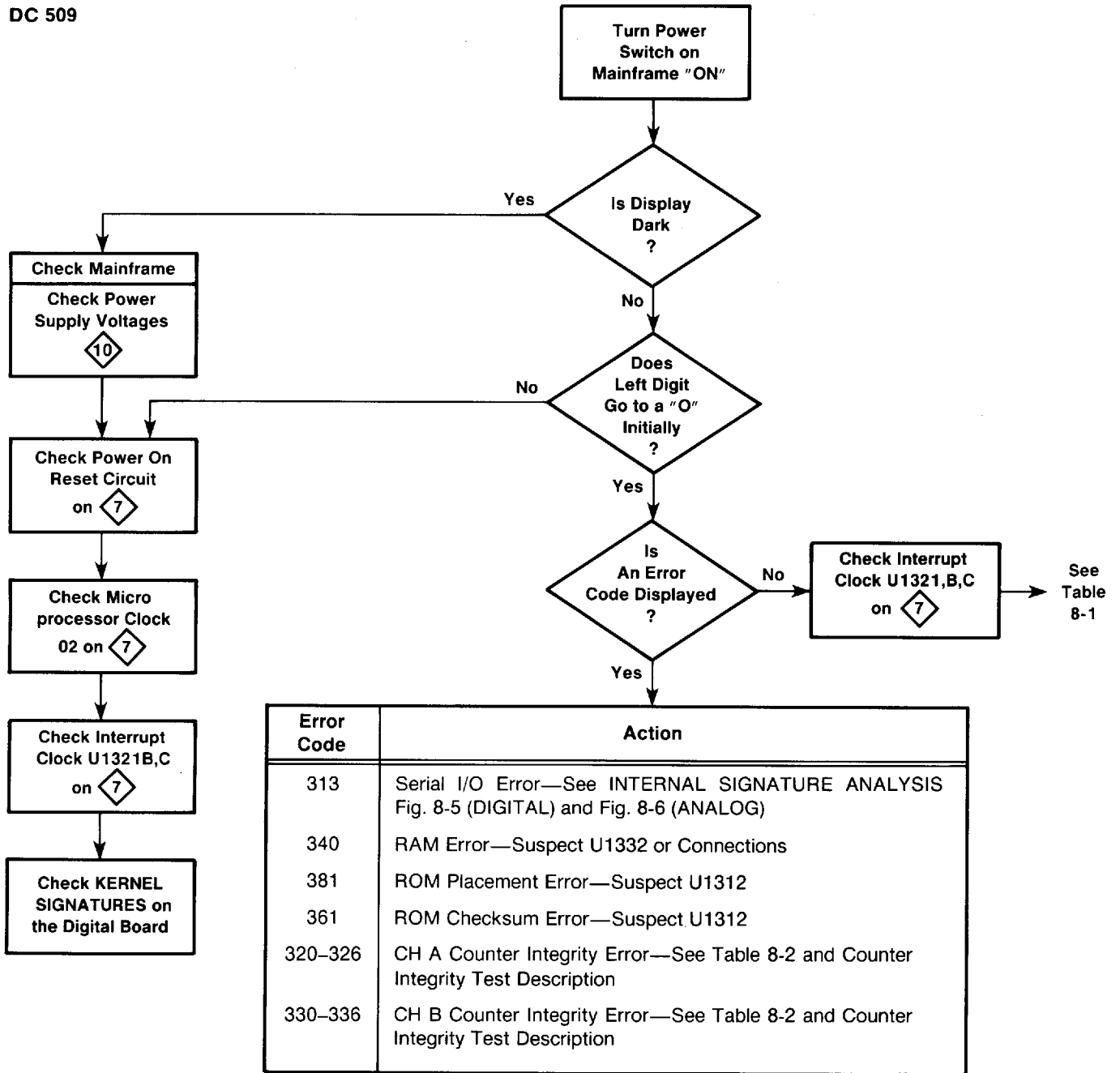





























































Fig. 8-4. General troubleshooting flow chart.

**Table 8-1
GENERAL PROBLEMS**

PROBLEM	SUSPECT CIRCUITRY
Measurements are stable but not accurate.	Time base oscillator (+18 V supply for Opt. 1), buffer—Q1612, divider—U1611, or Phase Locked Loop Components. 
Does not trigger properly (may be indicated by incorrect shaped outputs).	Dual DMOS in amplifier  ,  ; +12 V, -12 V  ; +5 V ₂ supplies  ; amplifier components  ,  .
Input conditioning does not function properly.	Switch  ; Relays  ,  ; Relay Drivers  ,  ; U1332-4  .
Display does not function properly.	Display Circuitry  , see INTERNAL SIGNATURE ANALYSIS Fig. 8-5 (DIGITAL).
Auto Trigger does not function properly.	+3.2 V supply  ; D/A converters—U1201, U1211  ; Serial-to-Parallel shift registers—U1202, U1212  ; Input amplifiers  ,  ; Analog switch—U1311  ; buffers—U1321  .
Measurements with low frequency input signal are not stable.	$\overline{\text{END}}$ signal  ,  suspect Q1433, U1421B,  ; U1332  ; Schmitt triggers, amplifiers  ,  .
Gate light always on. No measurement completed.	$\overline{\text{END}}$ signal  ,  suspect Q1433, U1421B,  ; U1332  .

**Table 8-2
COUNTER INTEGRITY ERRORS**

ERROR CODE	SUSPECT CIRCUITRY
320	1. Check that Input signal is within Trigger Level range, or no input. 2. Make sure ARM input is high  3. Check MR and MR lines  4. Check CH A DAC  5. Check CH A AMP  6. Check Gating  7. Check Input to Accumulator  8. Suspect U1221A  9. Suspect U1102 
321	1. Suspect U1211A  2. Suspect U1102 
322	1. Suspect Level Shifter Q1211 2. Suspect U1201A 3. Suspect U1102 } 
323	1. Suspect U1113A  2. Suspect U1102 
324	1. Suspect U1112A 2. Suspect U1102 3. Suspect U1101 } 
325	1. Suspect U1111A  2. Suspect U1101 
326	1. Suspect U1332 
330	1. Check CH B DAC  2. Check CH B AMP  3. Check Gating  4. Check Input to Accumulator  5. Suspect U1221B  6. Suspect U1103 
331	1. Suspect U1211B 2. Suspect U1103 } 
332	1. Suspect Level Shifter Q1212 2. Suspect U1201B 3. Suspect U1103 } 
333	1. Suspect U1113B 2. Suspect U1103 } 
334	1. Suspect U1112B 2. Suspect U1103 } 
335	1. Suspect U1111B 2. Suspect U1011 } 
336	1. Suspect U1012 2. Suspect U1002 } 

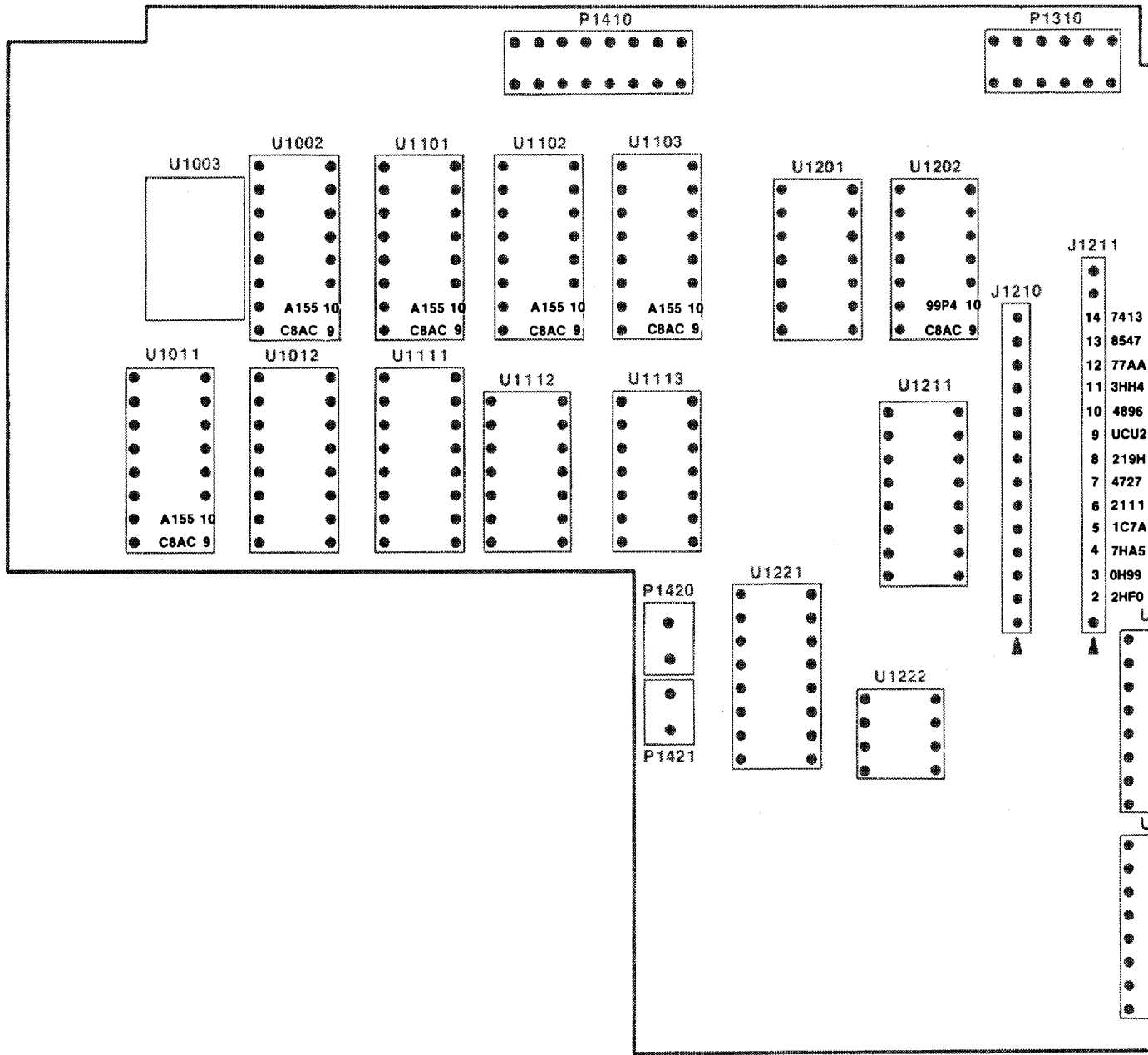
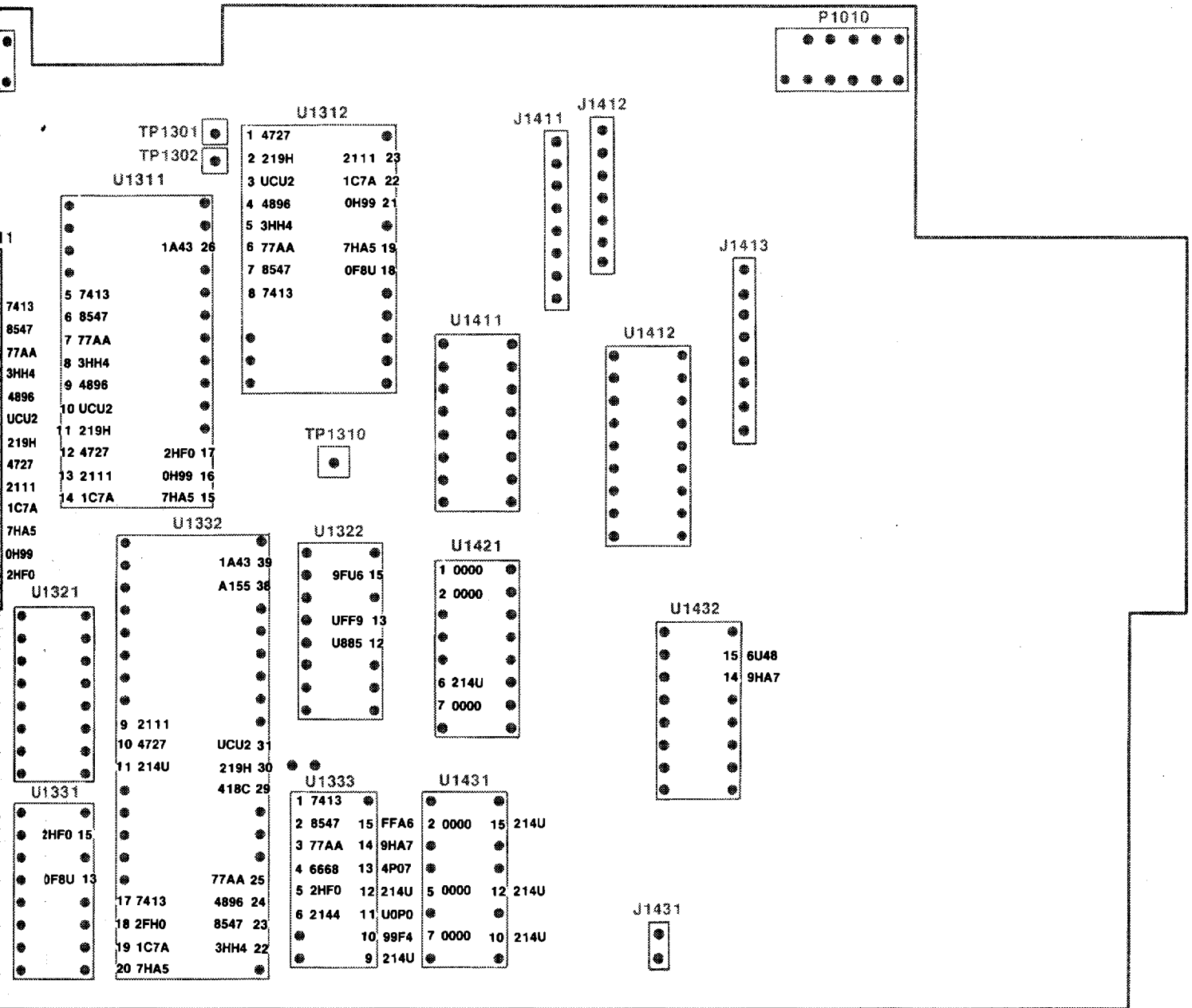

Fig. 8-5A. Internal signature



Signature analysis "A" (Digital board).

+ 5 V Signature = 214U

3464-27

SETUP CONDITIONS

Internal Signatures (Digital Board)

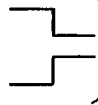
SA CLOCK		TP 1302 (Ø2 on digital board)
SA START		TP 1301 (STRT/STP on digital board)
SA STOP		
GROUND		TP 1310 (digital board)

NOTE

All front panel switches in out position.
FUNCTION switch set to FREQUENCY A.
AVERAGES switch set to AUTO.

SETUP CONDITIONS

Internal Signatures (Analog Board)

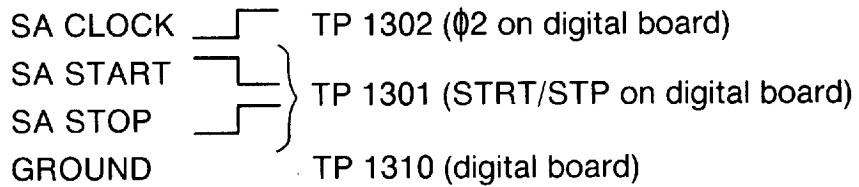

NOTE

*All front panel switches in out position.
FUNCTION switch set to FREQUENCY A.
AVERAGES switch set to AUTO.*

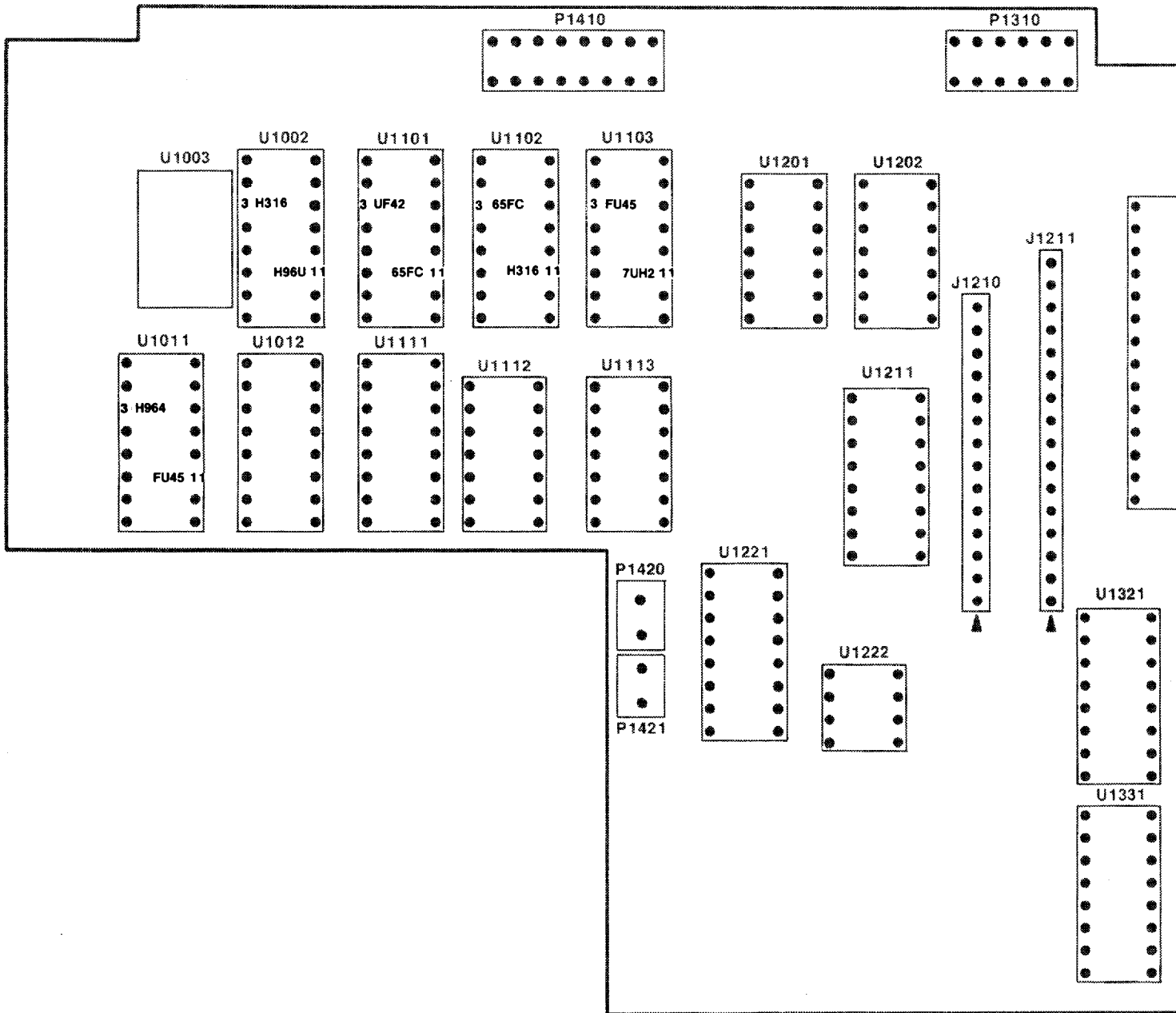
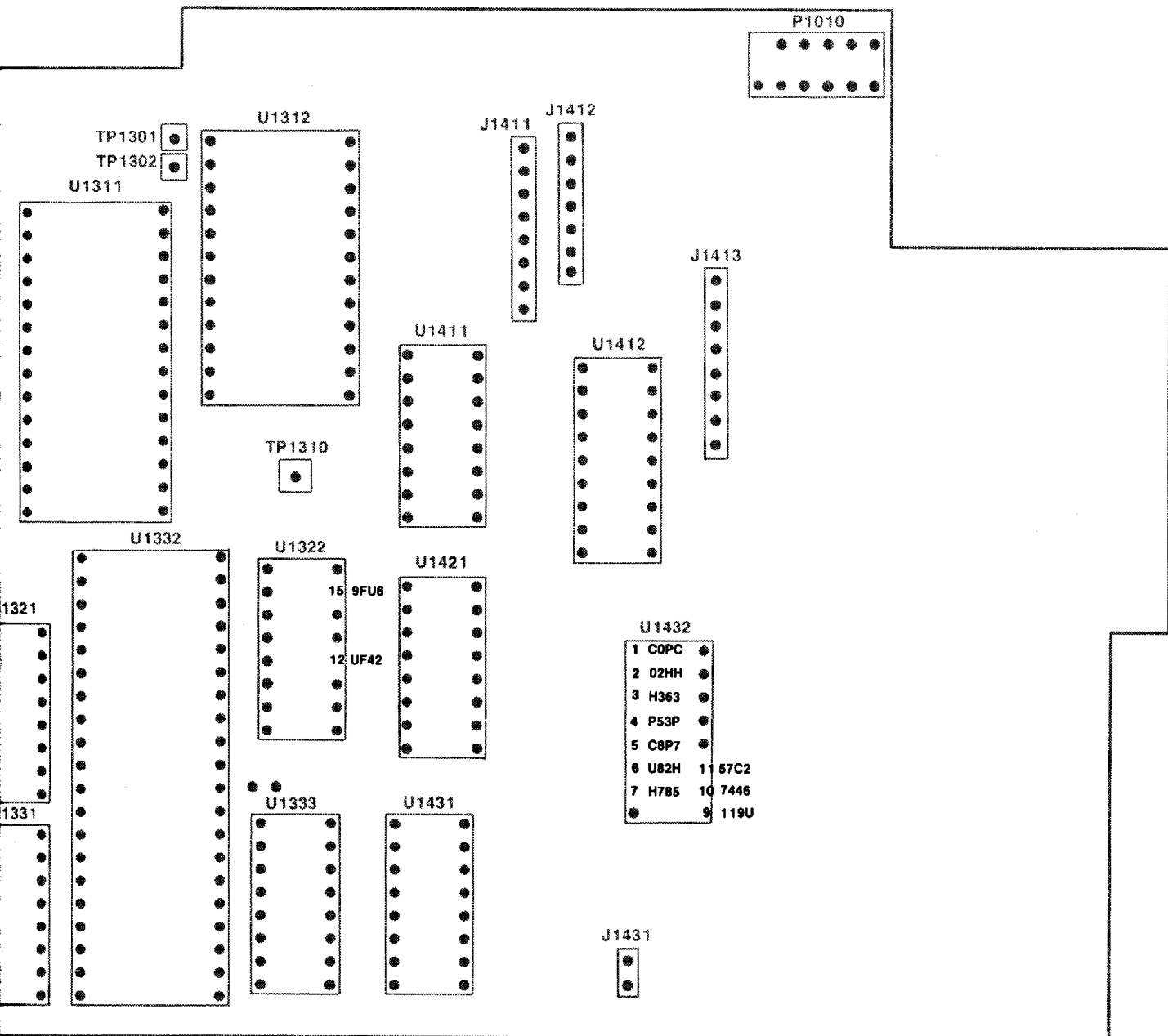

Fig. 8-5B. Internal signature ar



+ 5 V Signature = 214U

3464-28

Signature analysis "B" (Digital board).

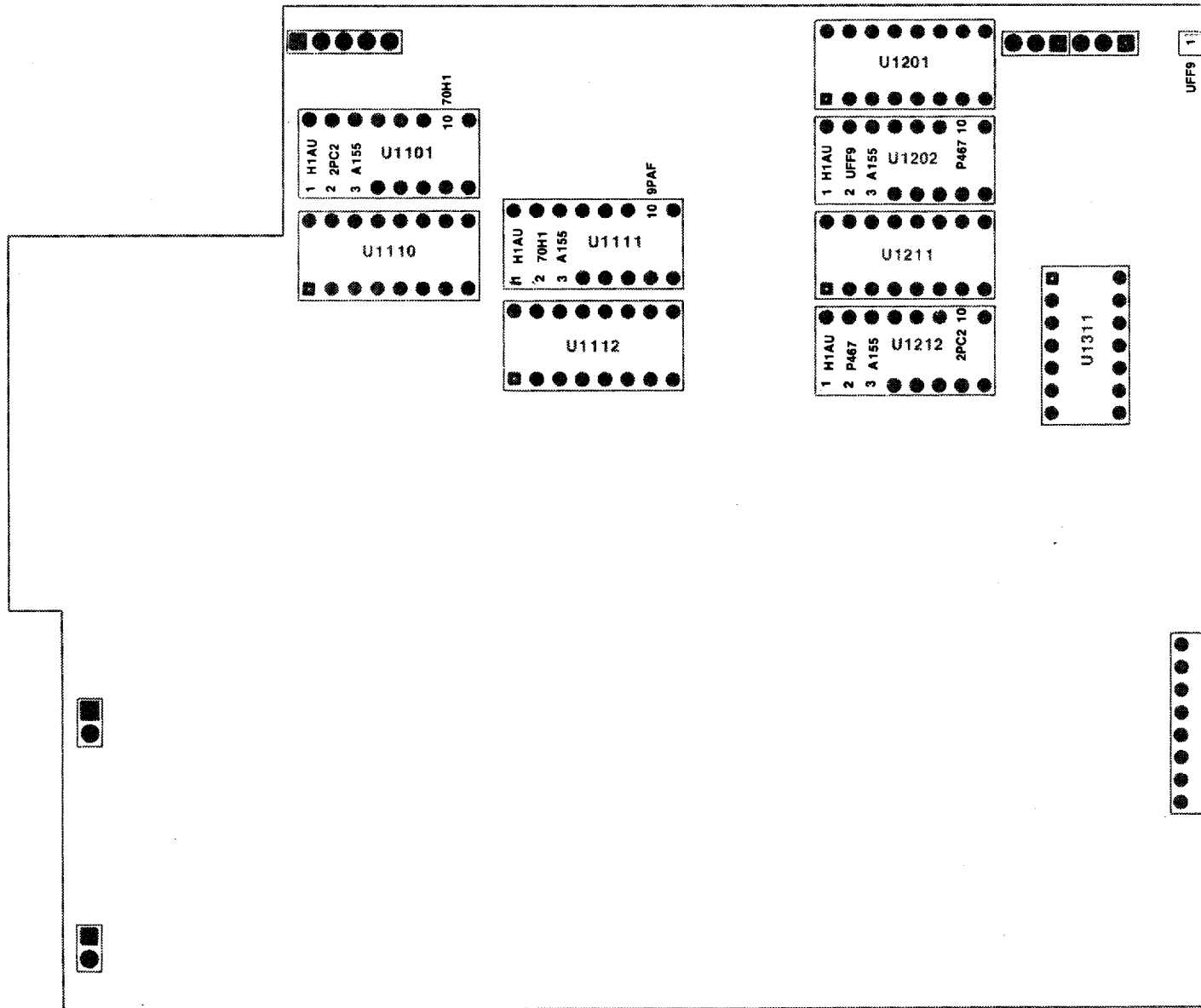
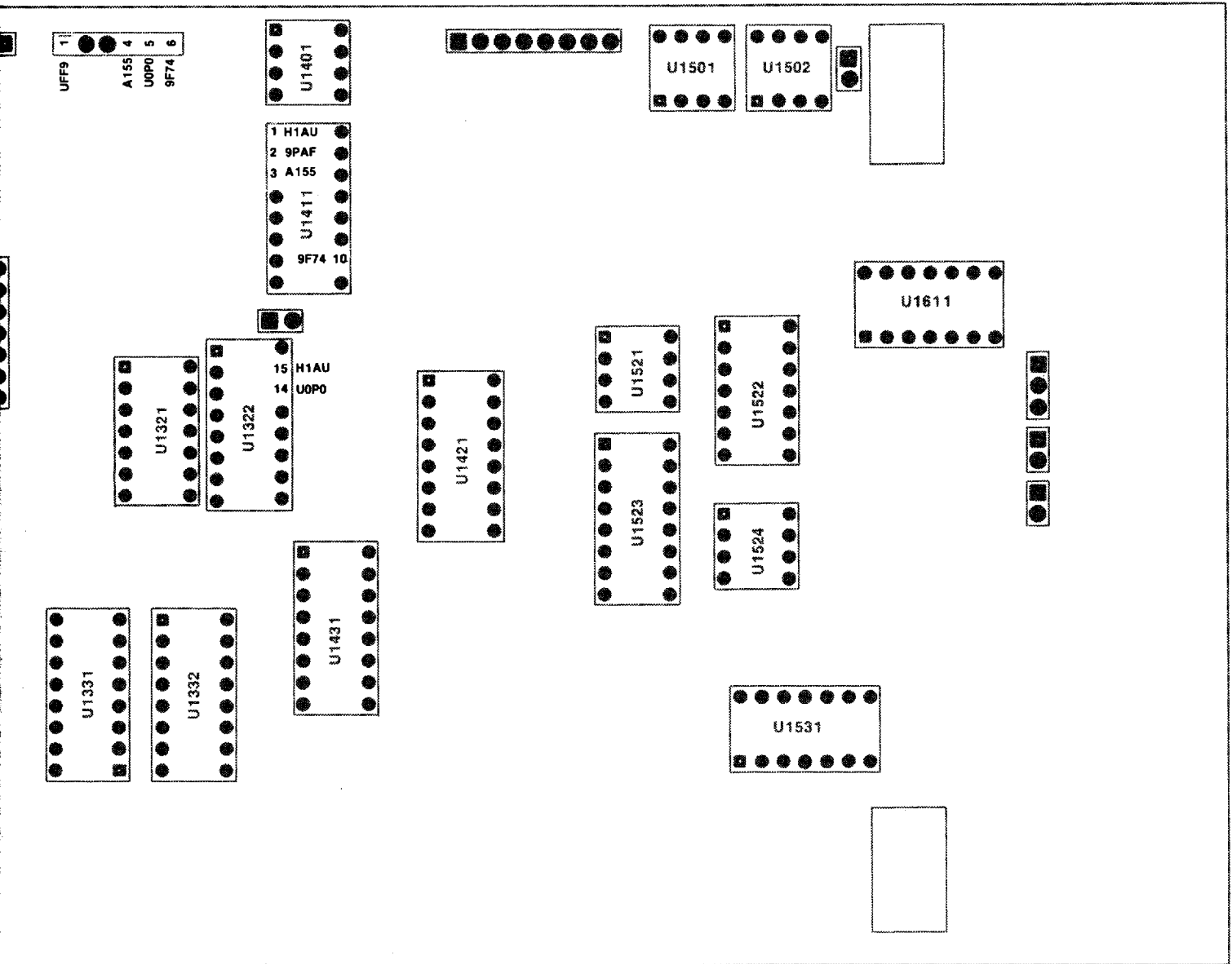

Fig. 8-6. Internal signature





signature analysis (analog board).

+ 5 V Signature = 214U

3464-29

SETUP CONDITIONS

Internal Signatures (Analog Board)



SA CLOCK		TP 1302 (ϕ 2 on digital board)
SA START		TP 1301 (STRT/STP on digital board)
SA STOP		
GROUND		TP 1310 (digital board)

NOTE

*All front panel switches in out position.
FUNCTION switch set to FREQUENCY A.
AVERAGES switch set to AUTO.*

SETUP CONDITIONS

Kernel Test Signatures (Digital Board)

SA CLOCK		(ϕ 2 on digital board)
SA START		} (START/STOP test point on kernel test board)
SA STOP		
GROUND		TP 1310 (digital board)

NOTE

All front panel switches in out position.
FUNCTION switch set to FREQUENCY A.
AVERAGES switch set to AUTO.

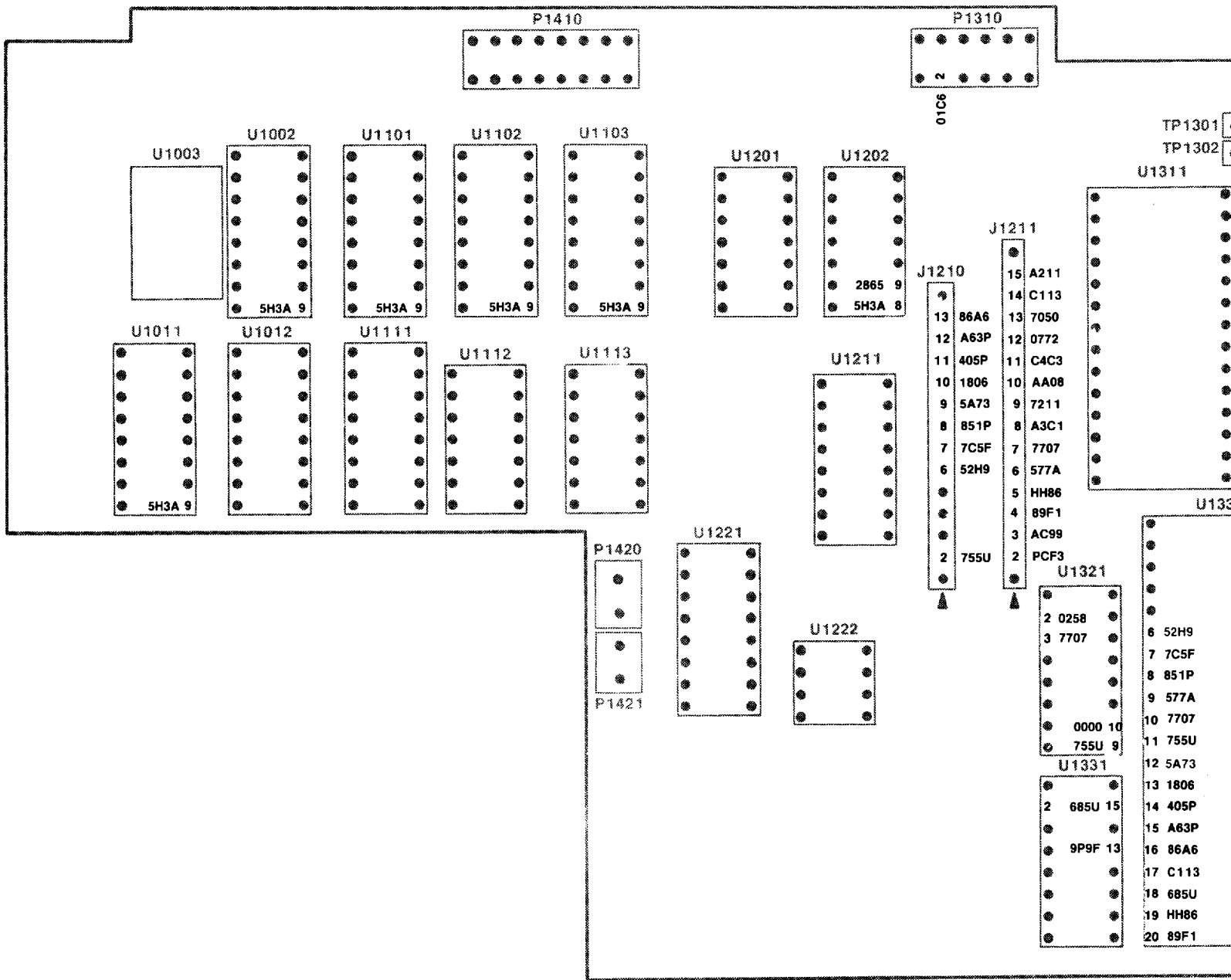
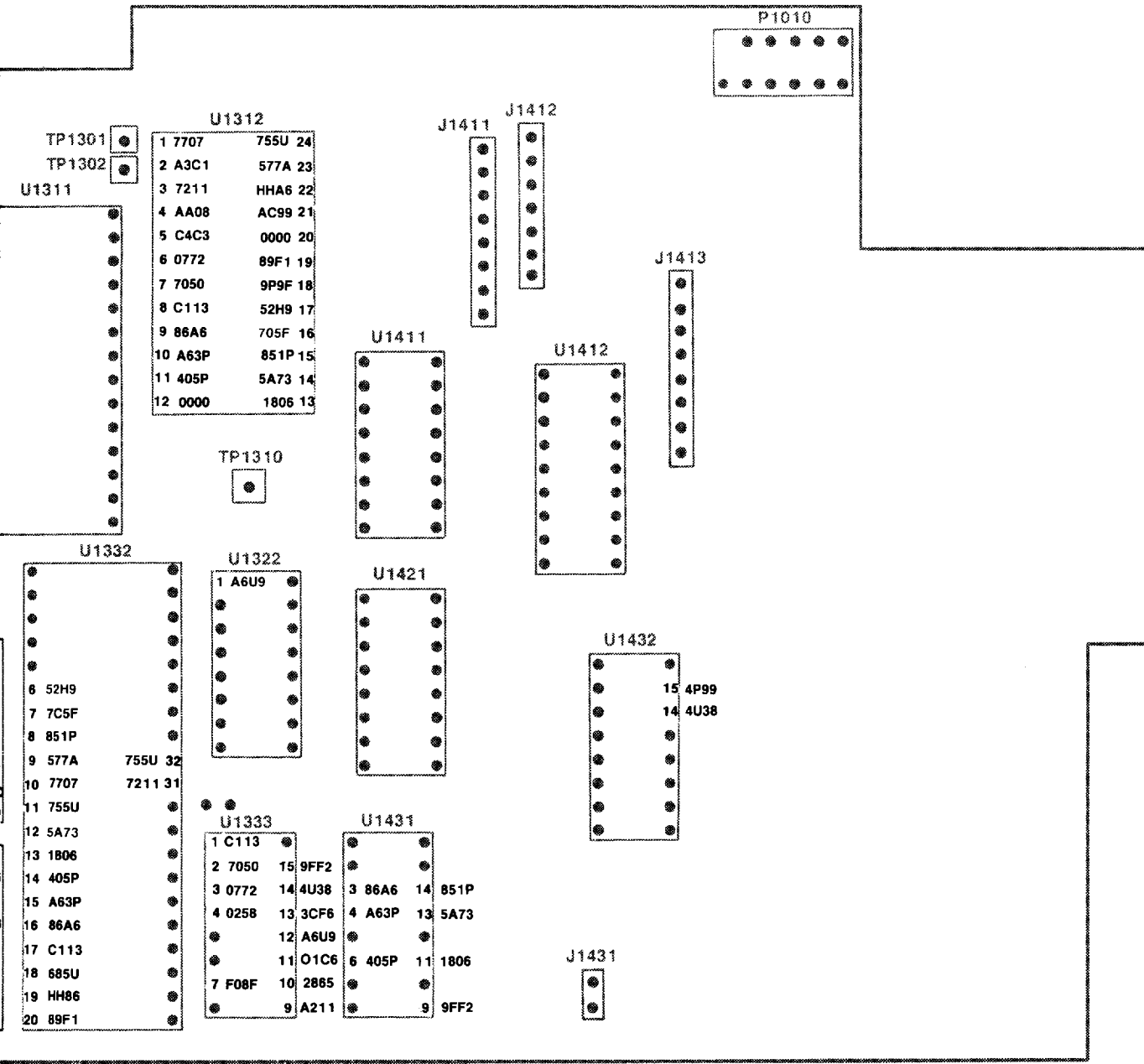
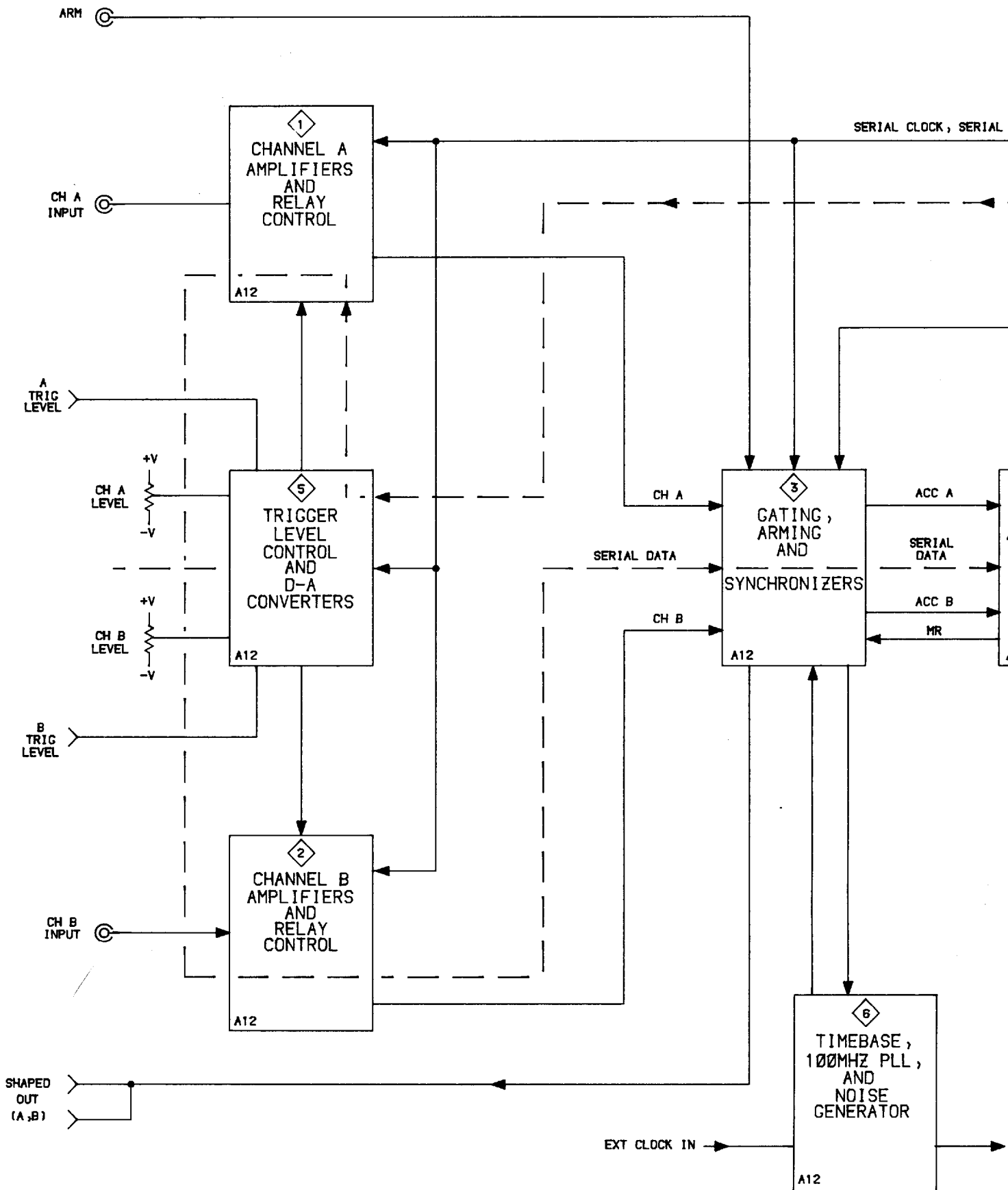

Fig. 8-7. Kernel signature analysis



+ 5 V Signature = 755U

Signature analysis (digital board).



DC 509

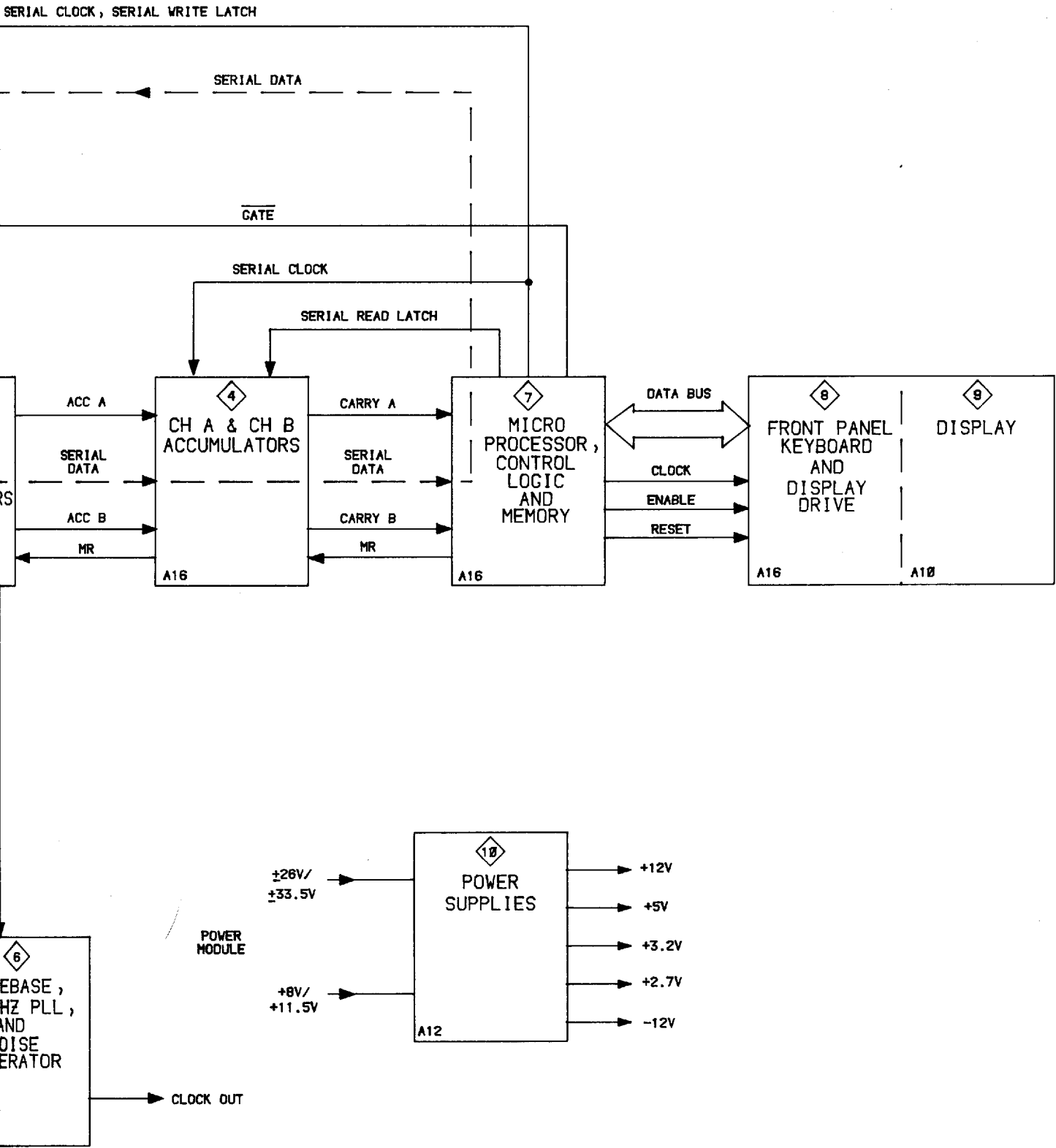

PARTS LOCATION

ANALOG BOARD (A12)
PARTS LOCATION GRID

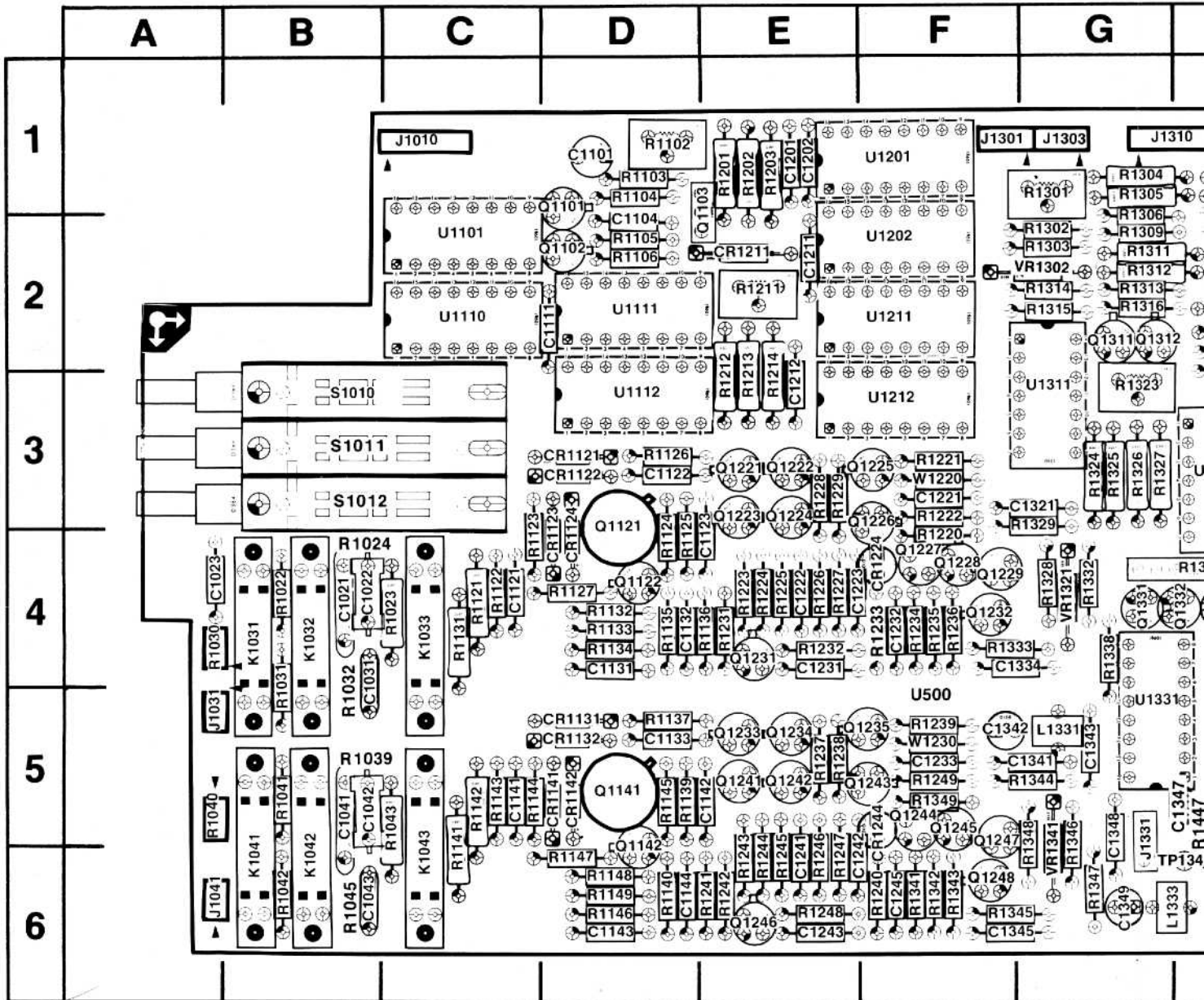
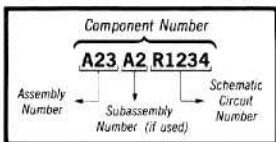

Fig. 8-8. Analog bo

 Static Sensitive Devices
See Maintenance Section

COMPONENT NUMBER EXAMPLE



Chassis-mounted components have no Assembly Number prefix—see end of Replaceable Electrical Parts List.

CATION GRID

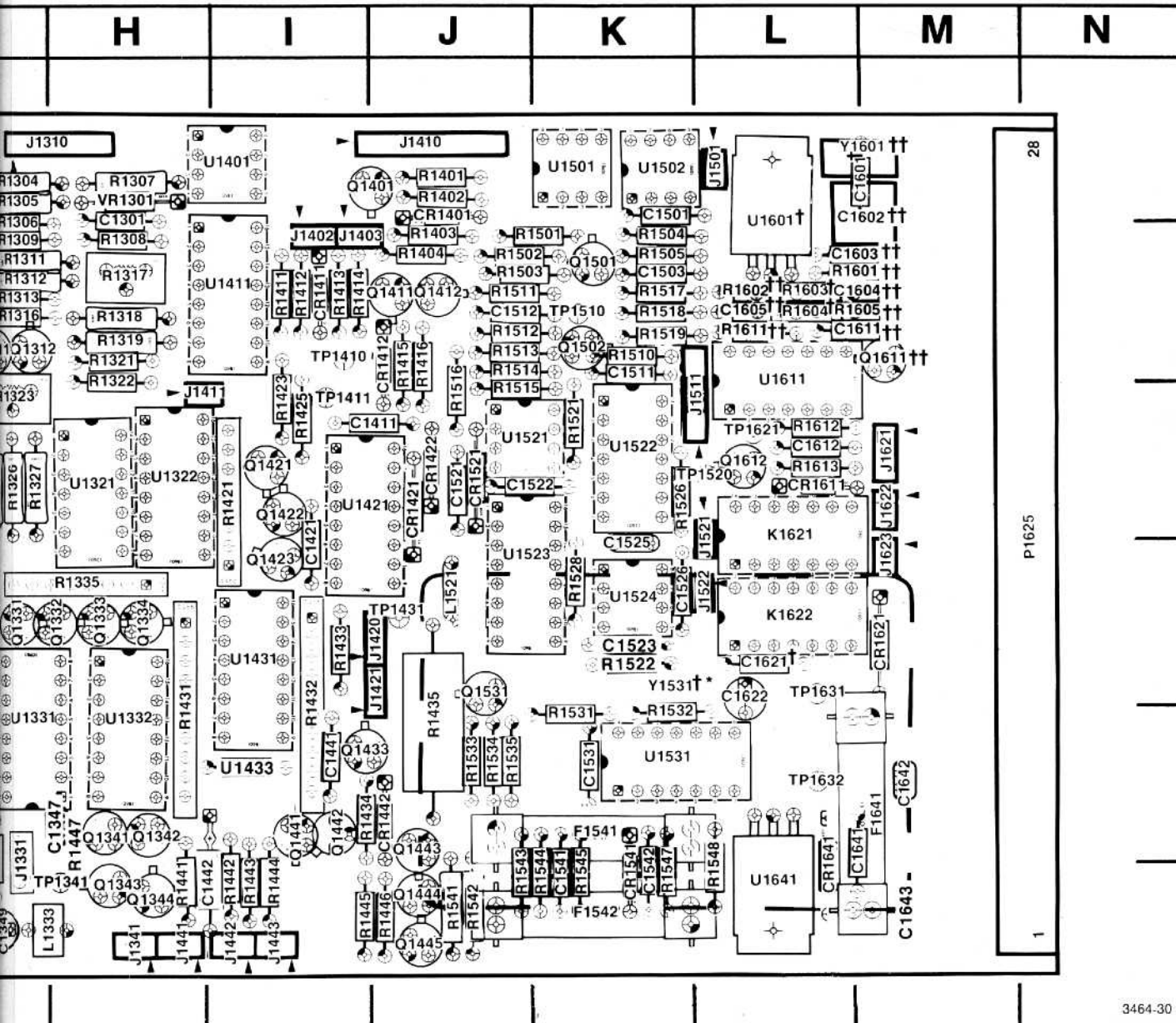

3464-30

ASSY A12

Analog board (A12).

†† Delete for Option 01.

† Add for Option 01.

* Component located on back of board.

Table 8-3
COMPONENT REFERENCE CHART
 (see Fig. 8-8)

P/O A12 ASSY			CHANNEL A AMPLIFIERS AND RELAY CONTROL		
CIRCUIT NUMBER	SCHEMATIC LOCATION	BOARD LOCATION	CIRCUIT NUMBER	SCHEMATIC LOCATION	BOARD LOCATION
C1021	E7	B4	Q1229	M8	F4
C1022	F6	B4	Q1231	L8	E4
C1023	E2	A4	Q1232	L8	F4
C1031	F8	B4			
C1101	D1	D1	R1022	E7	B4
C1104	C2	D1	R1023	F6	C4
C1111	E4	D2	R1024	F6	B4
C1121	H6	C4	R1030	C7	A4
C1122	K7	D3	R1031	D7	B4
C1123	J5	E4	R1032	H8	B5
C1131	J8	D4	R1103	D2	D1
C1132	H7	D4	R1104	D2	D1
C1221	M4	F3	R1105	C1	D2
C1222	L6	E4	R1106	C1	D2
C1223	K4	E4	R1121	H7	C4
C1231	J4	E4	R1122	H6	C4
C1232	M5	F4	R1123	J7	C4
C1321	L6	G3	R1124	J5	D4
C1334	M8	F4	R1125	K5	D4
C1342	D8	F2	R1126	K7	D3
C1343	D8	G5	R1127	J7	D4
C1348	D8	G6	R1131	F7	C4
C1349	D8	G6	R1132	H8	D4
			R1133	H7	D4
CR1121	J6	D3	R1134	J8	D4
CR1122	J7	D3	R1135	J8	D4
CR1123	J6	D4	R1136	L8	E4
CR1124	J7	D4	R1220	M4	F4
CR1211	E1	E2	R1221	L4	F3
CR1224	L4	F4	R1222	M4	F3
			R1223	L6	E4
J1010	B2	C1	R1224	K6	E4
J1031	C7	A5	R1225	K6	E4
J1331	M2	G6	R1226	K5	E4
J1521	C7	L3	R1227	K4	E4
			R1228	L4	E3
K1031	D6	B4	R1229	K4	E3
K1032	E6	B4	R1231	K7	E4
K1033	F6	C4	R1232	J4	E4
K1621	B7	L3	R1233	M5	F4
			R1234	M5	F4
L1331	D8	G5	R1235	M5	F4
L1333	D8	G6	R1236	M8	F4
			R1328	L8	G4
P1031	C7	A5	R1329	M6	G3
P1331	M2	G6	R1332	M7	G4
P1521	C7	L3	R1333	M8	F4
P1625	B7	N3	R1338	M7	G4
Q1101	B2	D1	U1101	D3	C2
Q1102	C2	D2	U1110	E3	C2
Q1103	D1	E1	U1331	M7	G5
Q1121	J6	D3			
Q1122	J8	D4	VR1321	L7	G4
Q1221	L5	E3			
Q1222	L5	E3	W1220	L4	F3
Q1223	K5	E3			
Q1224	K5	E3			
Q1225	L5	F3	J500	A7	Chassis
Q1226	M5	F3	P500	M2	Chassis
Q1227	M6	F4	U500	M2	Chassis
Q1228	L6	F4	W500	C7	Chassis

P/O A12 ASSY also shown on



A | B | C | D | E | F | H | J

1
2
3
4
5
6
7
8

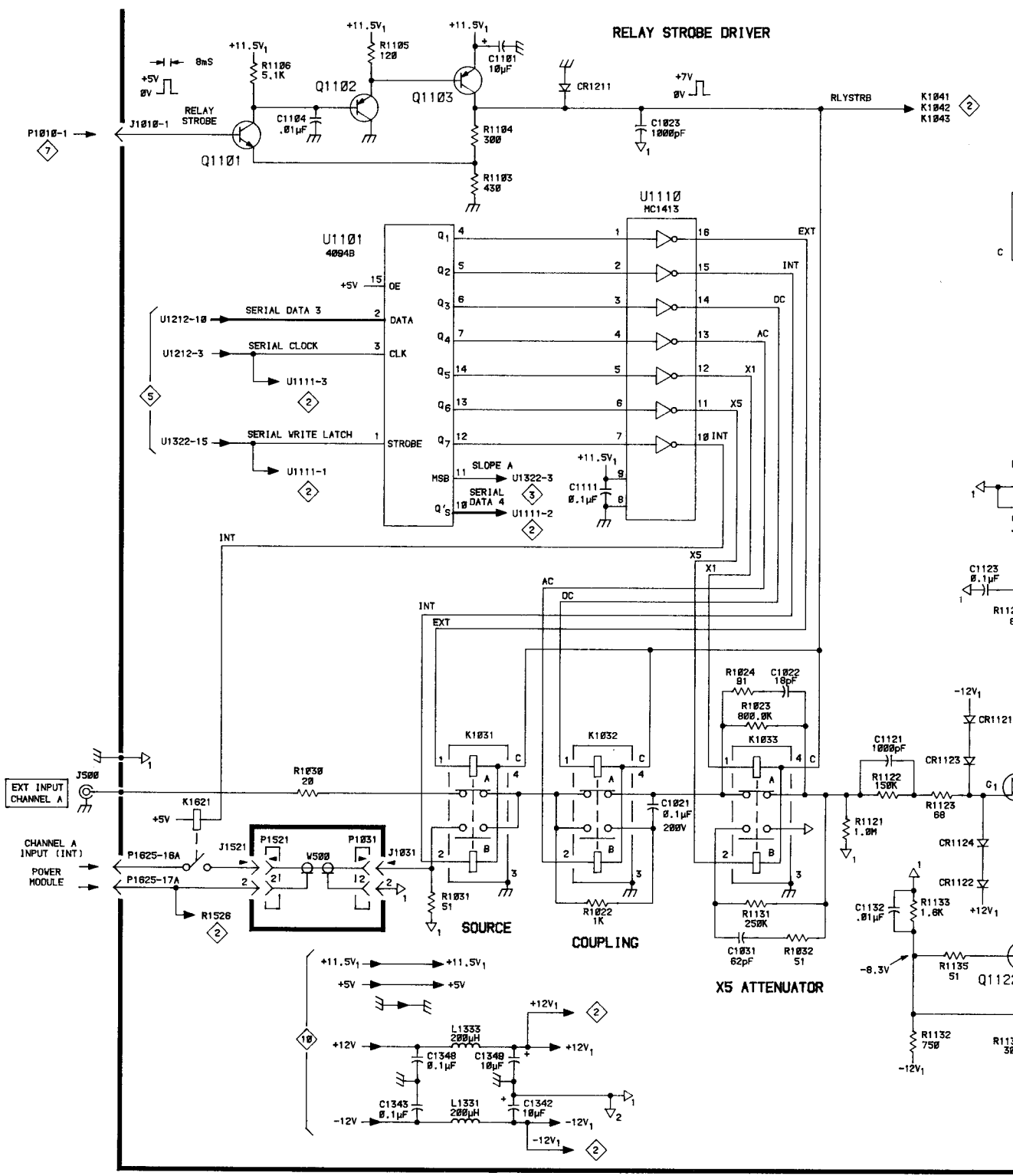

DC 509

H | J | K | L | M

LYSTRB → K1041
K1042
K1043

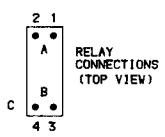

MODE	RELAY POSITION
EXT	A
JNT	B
DC	A
AC	B
X1	A
X5	B

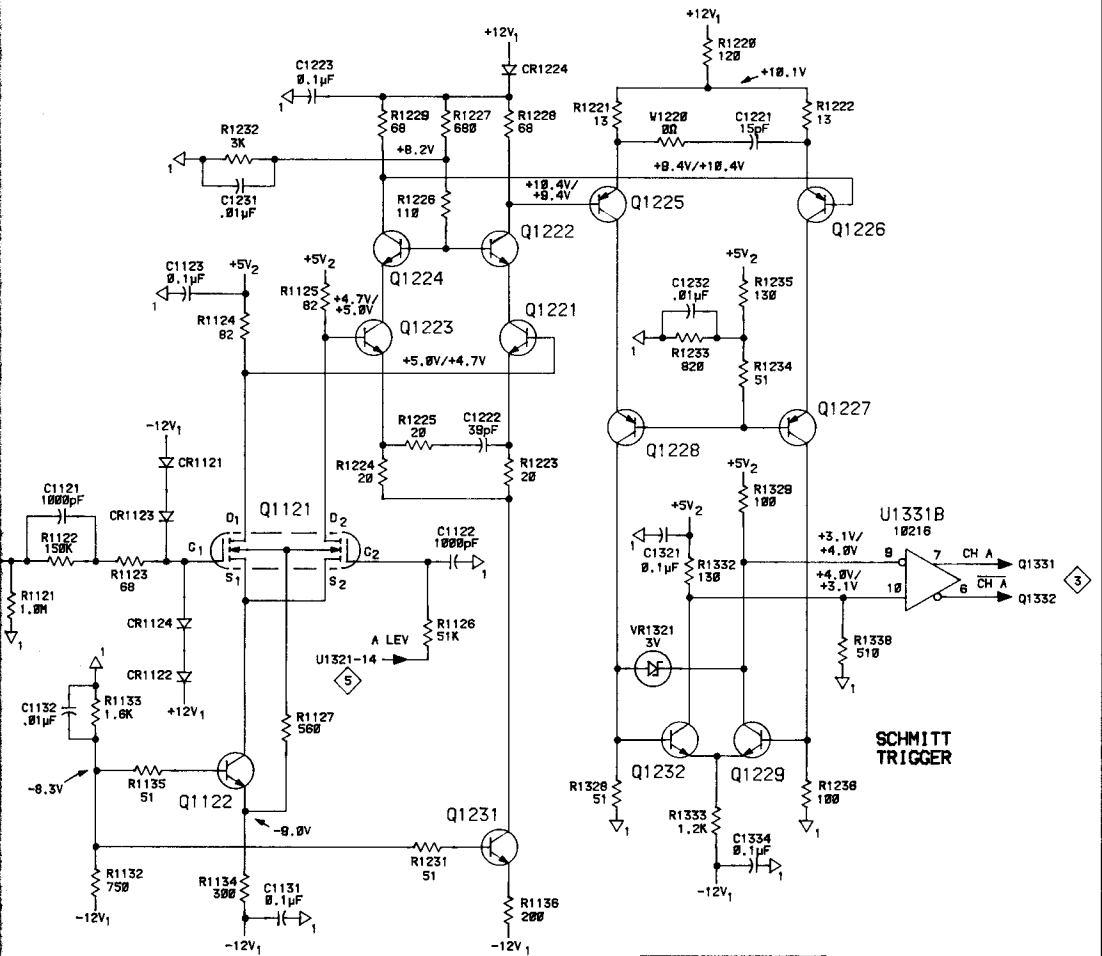
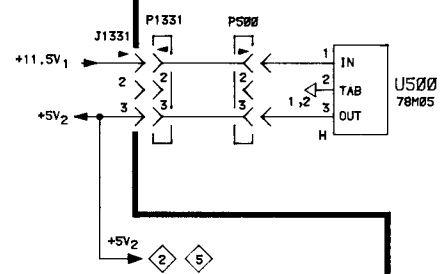

NOTE: US00 MOUNTED ON BOARD HEATSINK.

TYPE	+11.5V ₁	+5V	GND
4004B	16	8	8
MC1413	9		8

P/O A12 ANALOG BOARD

Static Sensitive Devices
See Maintenance Section

COMPONENT NUMBER EXAMPLE

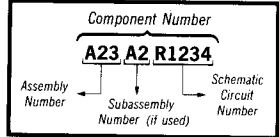

Chassis-mounted components have no Assembly Number prefix—see end of Replaceable Electrical Parts List.

CHANNEL A AMPLIFIERS & RELAY CONTROL

PARTS LOCATI

DIGITAL BOARD (A16)
PARTS LOCATION GRID

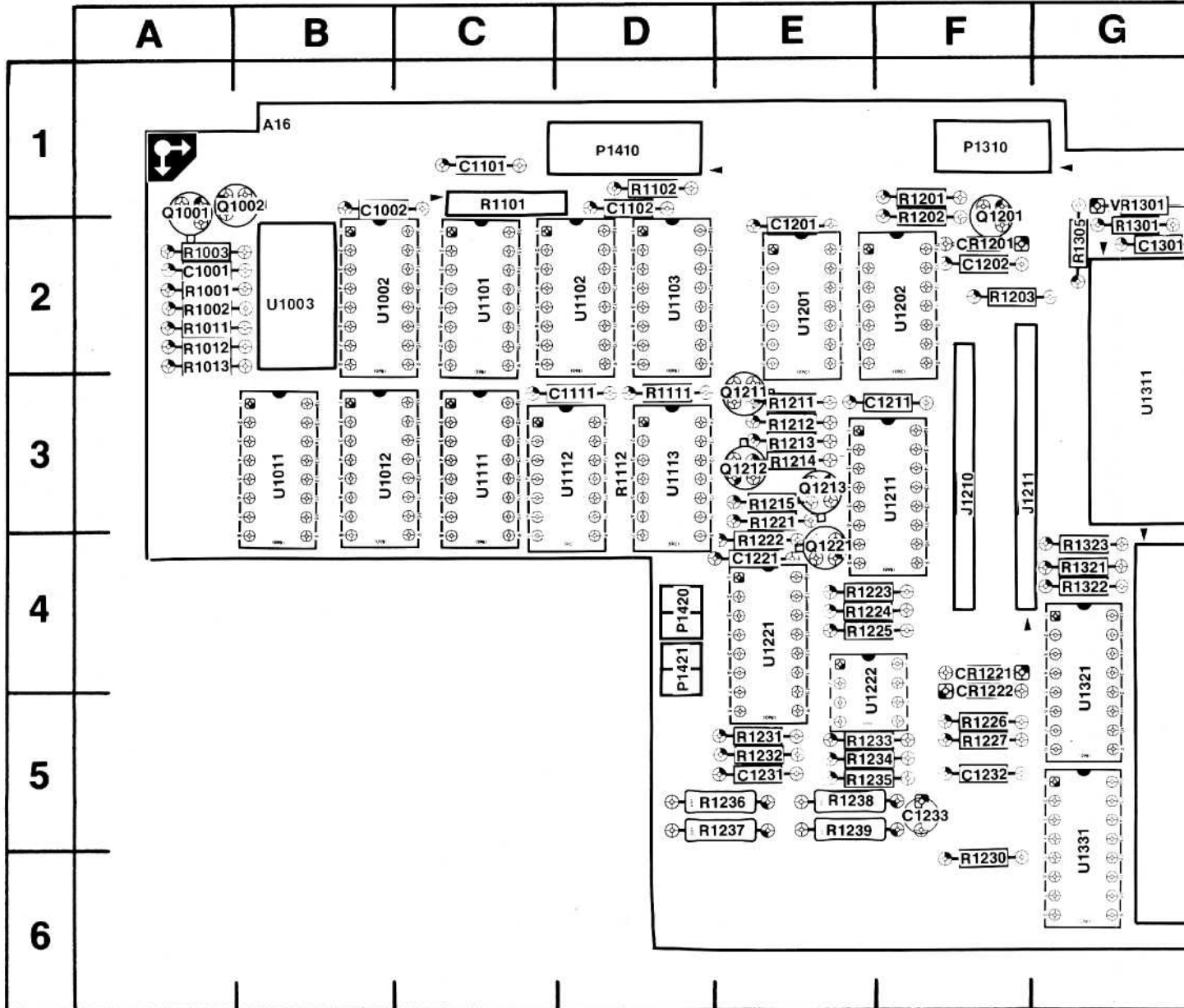

 Static Sensitive Devices
See Maintenance Section

COMPONENT NUMBER EXAMPLE

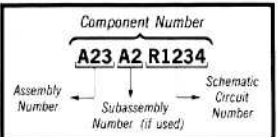

Chassis-mounted components have no Assembly Number prefix—see end of Replaceable Electrical Parts List.

Fig. 8-9. Digital board

LOCATION GRID

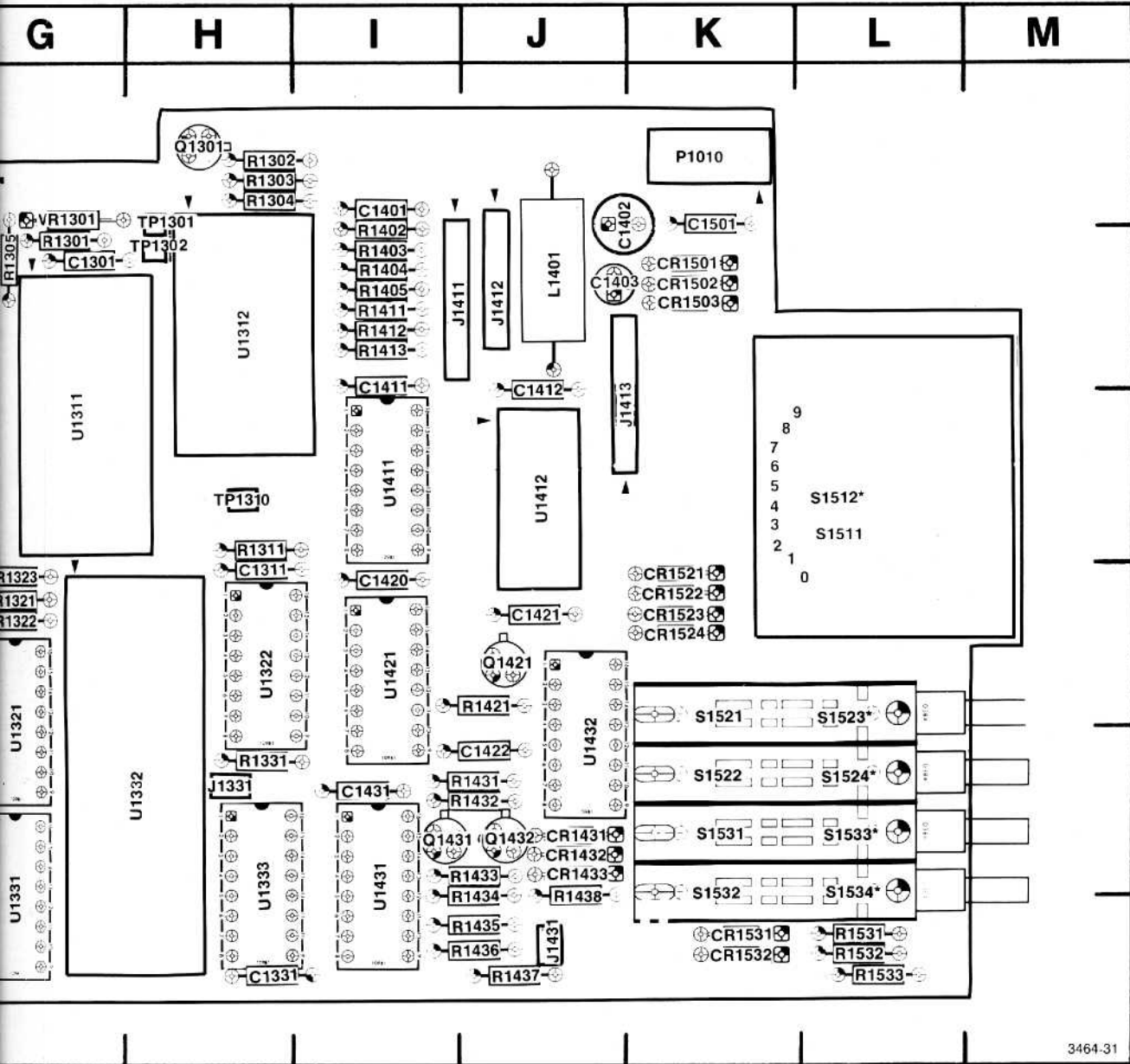

3464-31

*Components located on back of board

ASSY A16

9. Digital board (A16).

Table 8-4
COMPONENT REFERENCE CHART
 (see Fig. 8-8)

P/O A12 ASSY			CHANNEL B AMPLIFIERS AND RELAY CONTROL 2		
CIRCUIT NUMBER	SCHEMATIC LOCATION	BOARD LOCATION	CIRCUIT NUMBER	SCHEMATIC LOCATION	BOARD LOCATION
C1041	F6	B5	R1041	E7	B5
C1042	F5	B5	R1042	D7	A6
C1043	F7	A6	R1043	F6	C5
C1133	K6	D5	R1045	H7	B6
C1141	H6	C5	R1137	K6	D5
C1142	J4	E5	R1139	K4	D5
C1143	J8	D6	R1140	J7	D6
C1144	H7	D6	R1141	F7	C5
C1233	M4	F5	R1142	H6	C5
C1241	L5	E6	R1143	H6	C5
C1242	K3	E6	R1144	J6	C5
C1243	K4	E6	R1145	J4	D5
C1245	M5	F6	R1146	J8	D6
C1341	L6	G5	R1147	J7	D6
C1345	M8	F6	R1148	H8	D6
C1347	M8	H5	R1149	H7	D6
CR1131	J5	D5	R1237	L4	E5
CR1132	J7	D5	R1238	K4	E5
CR1141	J6	D5	R1239	L4	F5
CR1142	J6	D5	R1239	M4	F5
CR1244	L3	F5	R1240	M5	F6
J1041	D7	A6	R1241	L8	E6
J1522	C7	L4	R1242	K8	E6
K1041	D6	A6	R1243	L6	E6
K1042	E6	A6	R1244	K6	E6
K1043	F6	A6	R1245	K5	E6
K1622	B6	L4	R1246	K4	E6
P1041	C7	A6	R1247	K4	E6
P1522	C7	L4	R1248	K4	E6
P1625	B7	N3	R1249	M4	F5
Q1141	J6	D5	R1341	M5	F6
Q1142	J7	D6	R1342	M5	F6
Q1233	L5	E5	R1343	M7	F6
Q1234	L4	E5	R1344	M6	G5
Q1235	L4	F5	R1345	M7	F6
Q1241	K5	E5	R1346	L7	G6
Q1242	K4	E5	R1347	M7	G6
Q1243	M4	F5	R1348	M6	G6
Q1244	M5	F5	R1349	M3	F5
Q1245	L5	F5	R1526	B7	K3
Q1246	L8	E6	U1111	D2	D2
Q1247	M7	F5	U1112	E2	D3
Q1248	M7	F6	U1331	M6	G5
R1039	F5	B5	VR1341	L7	G6
R1040	C6	A5	W1230	L4	F5
			J510	A6	Chassis
			W510	C7	Chassis

P/O A12 ASSY also shown on



A | B | C | D | E | F | H | J

1
—
2
—
3
—
4
—
5
—
6
—
7
—
8
—

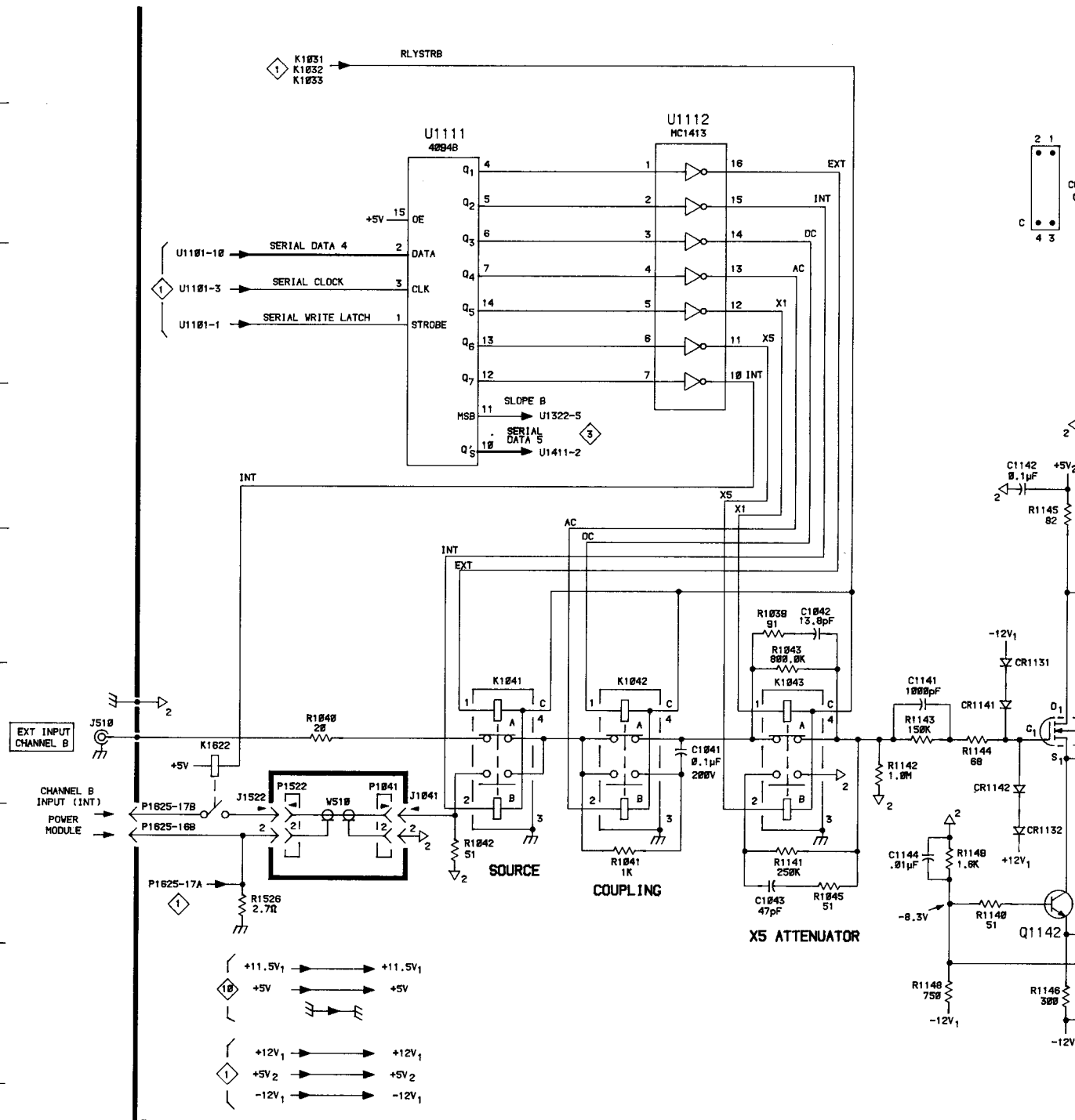

DC 509

3484-36

H | J | K | L | M

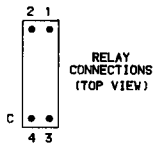

MODE	RELAY POSITION
EXT	A
INT	B
DC	A
AC	B
X1	A
X5	B

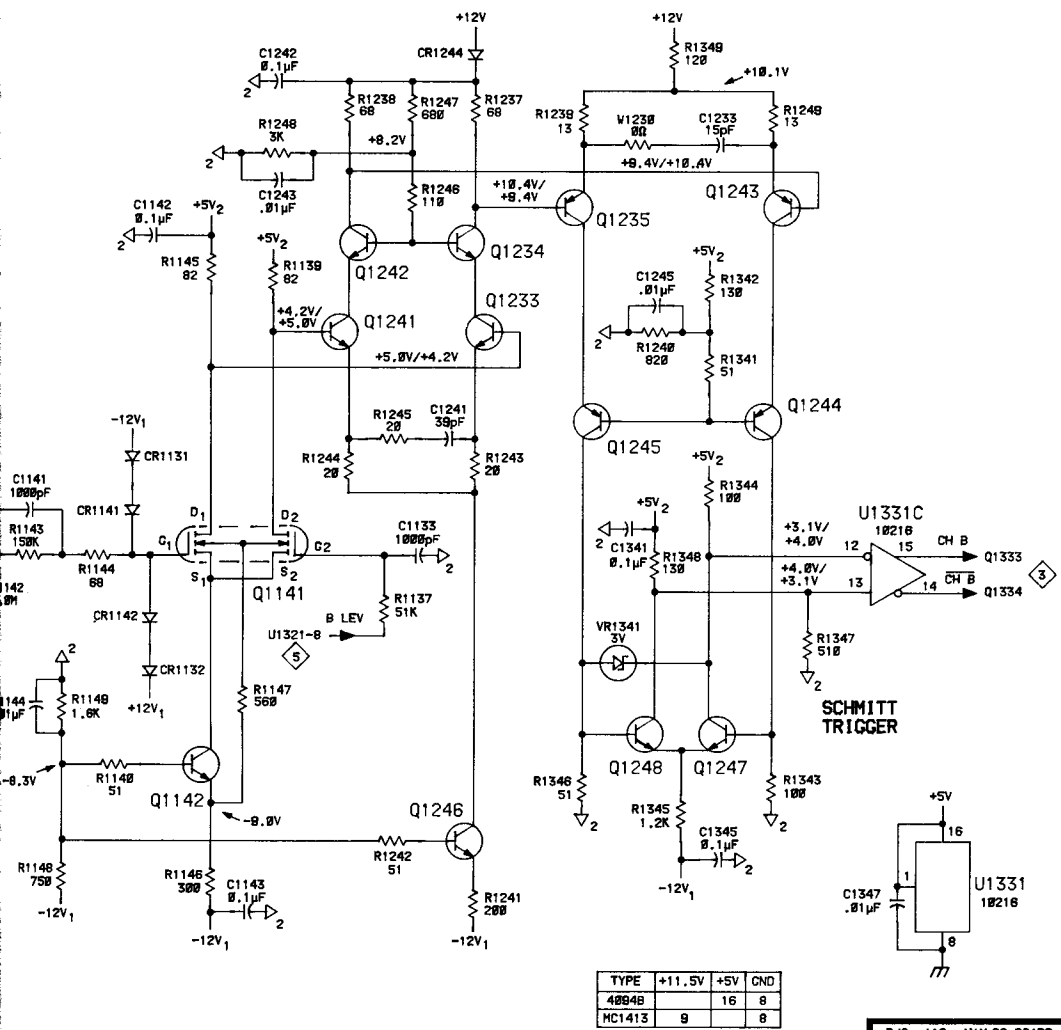

TYPE	+11.5V	+5V	CND
4884B		16	8
HC1413	9		8

P/O A12 ANALOG BOARD

Static Sensitive Devices
See Maintenance Section

COMPONENT NUMBER EXAMPLE

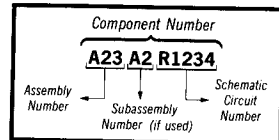

Chassis-mounted components have no Assembly Number prefix—see end of Replaceable Electrical Parts List.

CHANNEL B AMPLIFIERS & RELAY CONTROL

2 JS

CH B AMPLIFIERS AND RELAY CONTROL 2

PARTS LOCATION

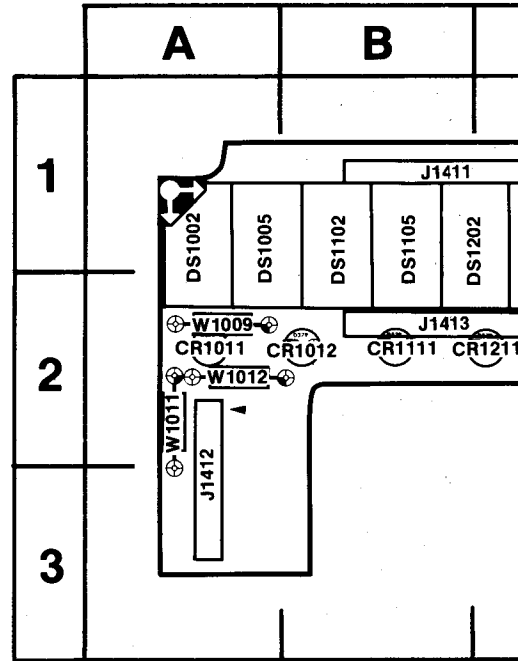
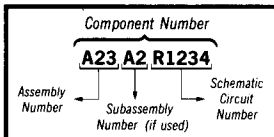

Fig. 8-10. Display board

 **Static Sensitive Devices**
See Maintenance Section

COMPONENT NUMBER EXAMPLE



Chassis-mounted components have no Assembly Number prefix—see end of Replaceable Electrical Parts List.

LOCATION GRID

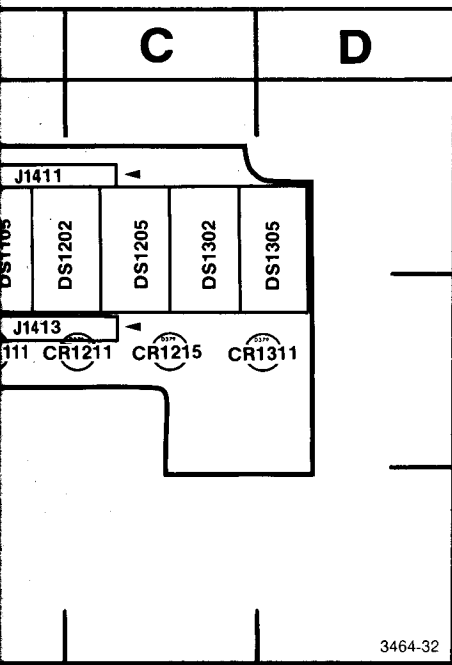

ASSY A10

Display board (A10).

**Table 8-5
COMPONENT REFERENCE CHART
(see Fig. 8-8)**

P/O A12 ASSY			GATING, ARMING AND SYNCHRONIZERS 3		
CIRCUIT NUMBER	SCHEMATIC LOCATION	BOARD LOCATION	CIRCUIT NUMBER	SCHEMATIC LOCATION	BOARD LOCATION
C1411	M8	I3	Q1423	F7	I4
C1421	M8	I4	Q1433	M5	I5
C1441	M5	I5	Q1441	E7	I5
C1442	E4	H6	Q1442	E4	I5
CR1401	H1	J1	R1335	D7	H4
CR1411	D2	I2	R1401	L1	J1
CR1412	E1	J2	R1402	J2	J1
J1310	E8	G1	R1403	H1	J2
J1341	C4	H6	R1404	F1	J2
J1402	C2	I2	R1411	F4	I2
J1403	C2	I2	R1412	C2	I2
J1410	A8	J1	R1413	D2	I2
J1410	L1	J1	R1414	D1	I2
J1410	M4	J1	R1415	H2	J2
J1420	M3	J4	R1416	F2	J2
J1421	M7	J4	R1421	K8	I3
J1441	C5	H6	R1423	F6	I3
J1442	C7	I6	R1425	F7	I3
J1443	C8	I6	R1431	L3	H4
J1501	B2	L1	R1432	J5	I4
J1622	B8	M3	R1433	M5	I4
J1623	B5	M4	R1441	E4	H6
P1341	C4	H6	R1442	E3	H6
P1402	C2	I2	R1443	E6	H6
P1403	C2	I2	R1444	E7	H6
P1441	C5	H6	R1447	K4	I5
P1442	C7	I6	R1533	M6	J5
P1443	C8	I6	U1322	C4	H3
P1501	B2	L1	U1331	E3	G5
P1622	B8	M3	U1332	E6	H5
P1623	B5	M4	U1411	D8	I2
P1625	A8	N3	U1421A	K5	I3
P1625	A2	N3	U1421B	L5	I3
P1625	A5	N3	U1431A	J6	I4
Q1331	D3	G4	U1431B	J6	I4
Q1332	C3	H4	U1431C	M7	I4
Q1333	C6	H4	U1431D	J6	I4
Q1334	D6	H4	J520	B2	Chassis
Q1341	F6	H5	J530	B2	Chassis
Q1342	H4	H5	J540	B4	Chassis
Q1343	K3	H6	J550	B4	Chassis
Q1344	F5	H6	J560	B7	Chassis
Q1401	K1	J1	W520	B2	Chassis
Q1411	F2	J2	W530	B2	Chassis
Q1412	F2	J2	W540	B4	Chassis
Q1421	K4	I3	W550	B5	Chassis
Q1422	L8	I3	W560	B7	Chassis
			W570	B8	Chassis

P/O A12 ASSY also shown on 1 2 5 6 7 8 10

A | B | C | D | E | F | H | J

1
2
3
4
5
6
7
8

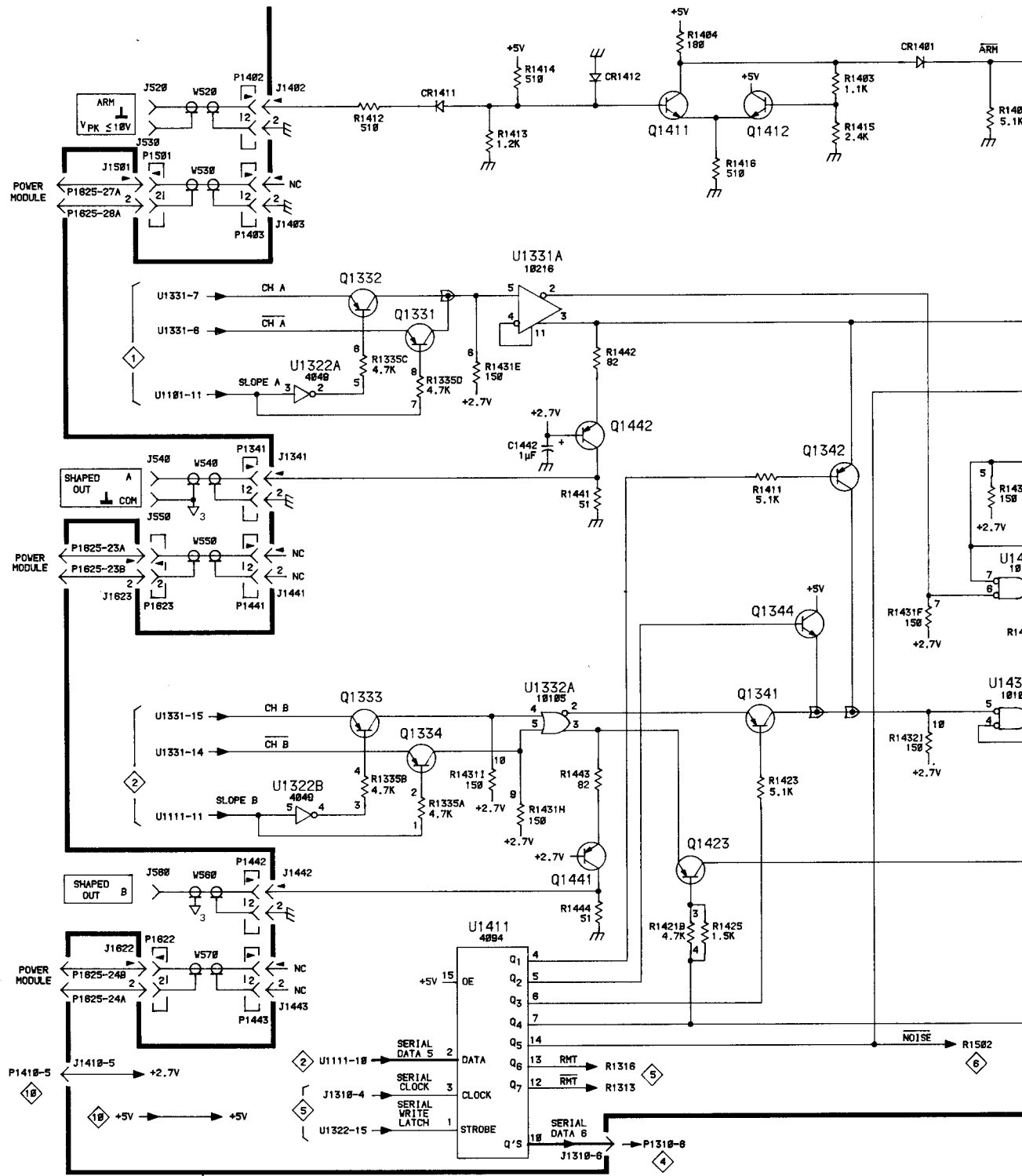

DC 509

3484-37

H | J | K | L | M

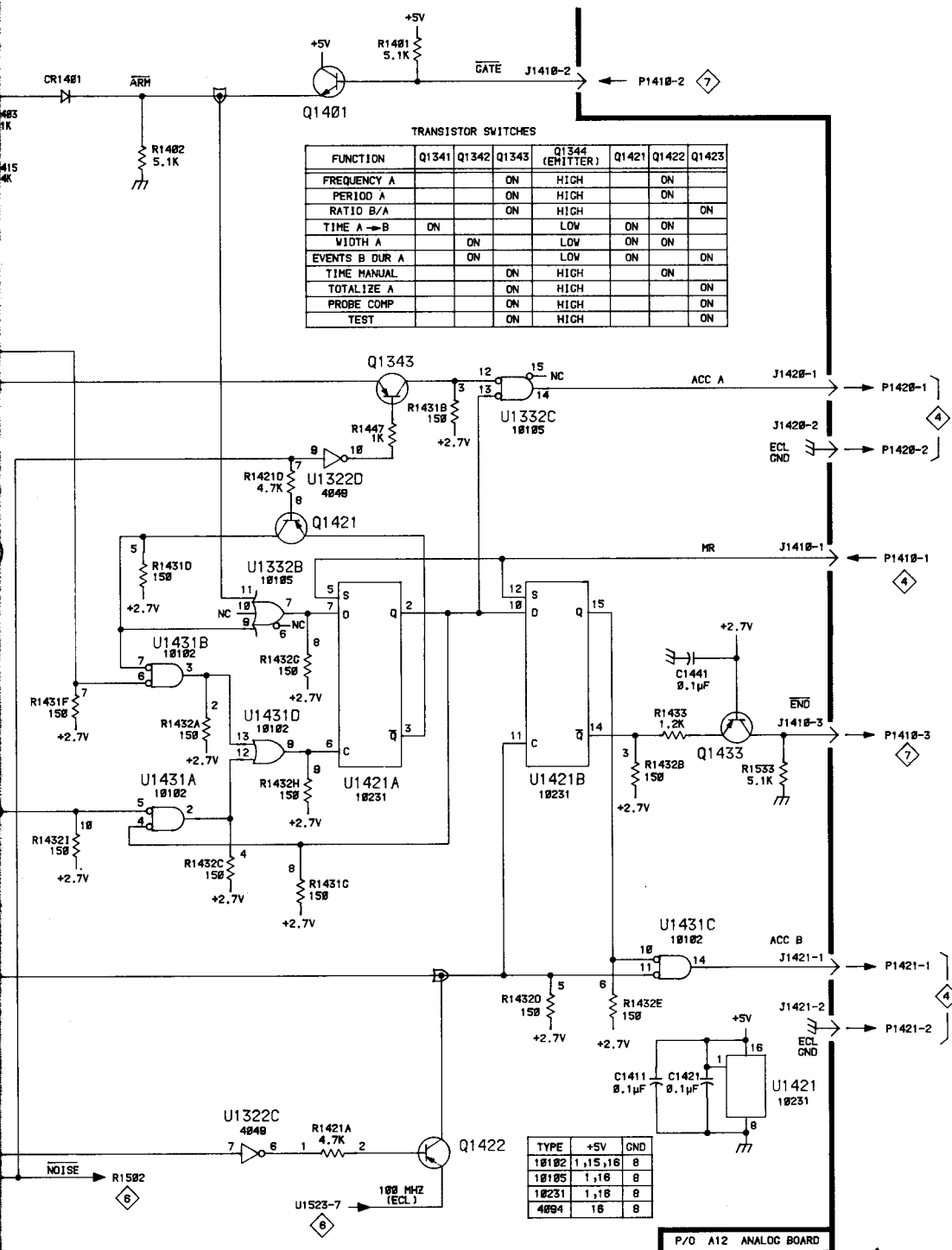

GATING, ARMING, & SYNCHRONIZERS

3 JS

Static Sensitive Devices
See Maintenance Section

COMPONENT NUMBER EXAMPLE

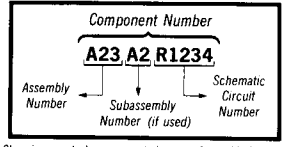

Chassis-mounted components have no Assembly Number prefix—see end of Replaceable Electrical Parts List.

**Table 8-6
COMPONENT REFERENCE CHART
(see Fig. 8-9)**

P/O A16 ASSY			CH A AND CH B ACCUMULATORS 4		
CIRCUIT NUMBER	SCHEMATIC LOCATION	BOARD LOCATION	CIRCUIT NUMBER	SCHEMATIC LOCATION	BOARD LOCATION
C1002	M8	B1	R1211	F4	E3
C1111	M8	D3	R1212	E8	E3
C1201	M8	E2	R1213	E2	E3
C1211	L8	F3	R1214	E8	E3
C1221	L8	E4	R1215	C4	E3
C1231	B1	E5	R1221	C2	E3
CR1201	B2	F2	R1222	D7	E4
P1310	B6	F1	R1223	C6	E4
P1410	B3	D1	R1224	C2	E4
P1420	B1	D4	R1225	C8	E4
P1420	B2	D4	R1231	B2	E5
P1421	A8	D4	R1232	A8	E5
Q1201	B2	F1	U1002	M6	B2
Q1211	E2	E3	U1011	K6	B3
Q1212	E8	E3	U1012	L7	B3
Q1213	C3	E3	U1101	K5	C2
Q1221	D7	E4	U1102	G5	D2
R1101	K4	C1	U1103	H6	D2
R1102	M8	D1	U1111	L3	C3
R1111	G1	D3	U1112	J2	D3
R1112	H7	D3	U1113	G2	D3
R1201	B2	F1	U1201	F2	E2
R1202	B3	F1	U1202	F4	F2
			U1211	D2	F3
			U1221	C2	E4

P/O A16 ASSY also shown on 7 8 10

A | B | C | D | E | F | G | H

1
2
3
4
5
6
7
8
9

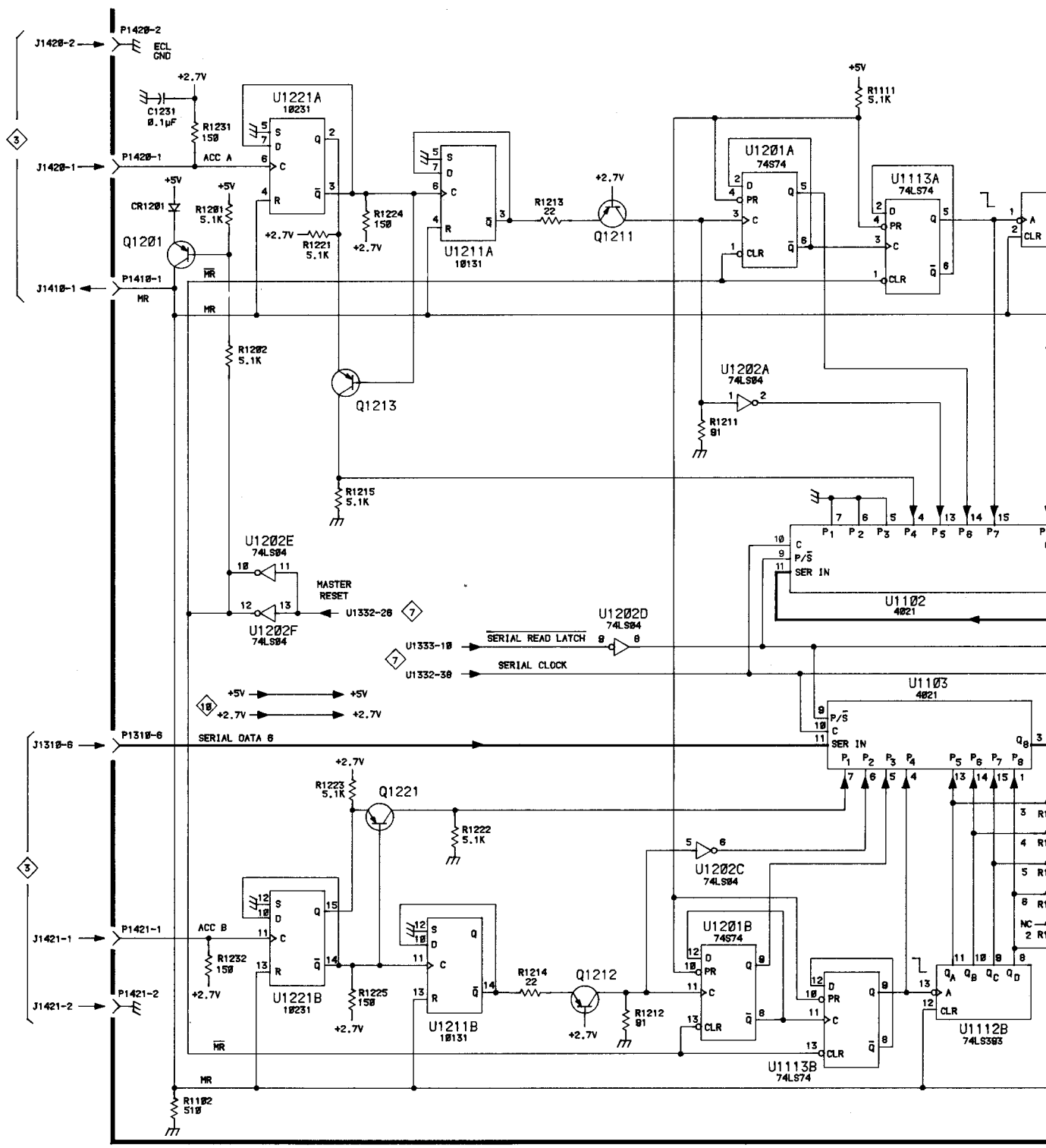

DC 509

3484-38

H | J | K | L | M | N

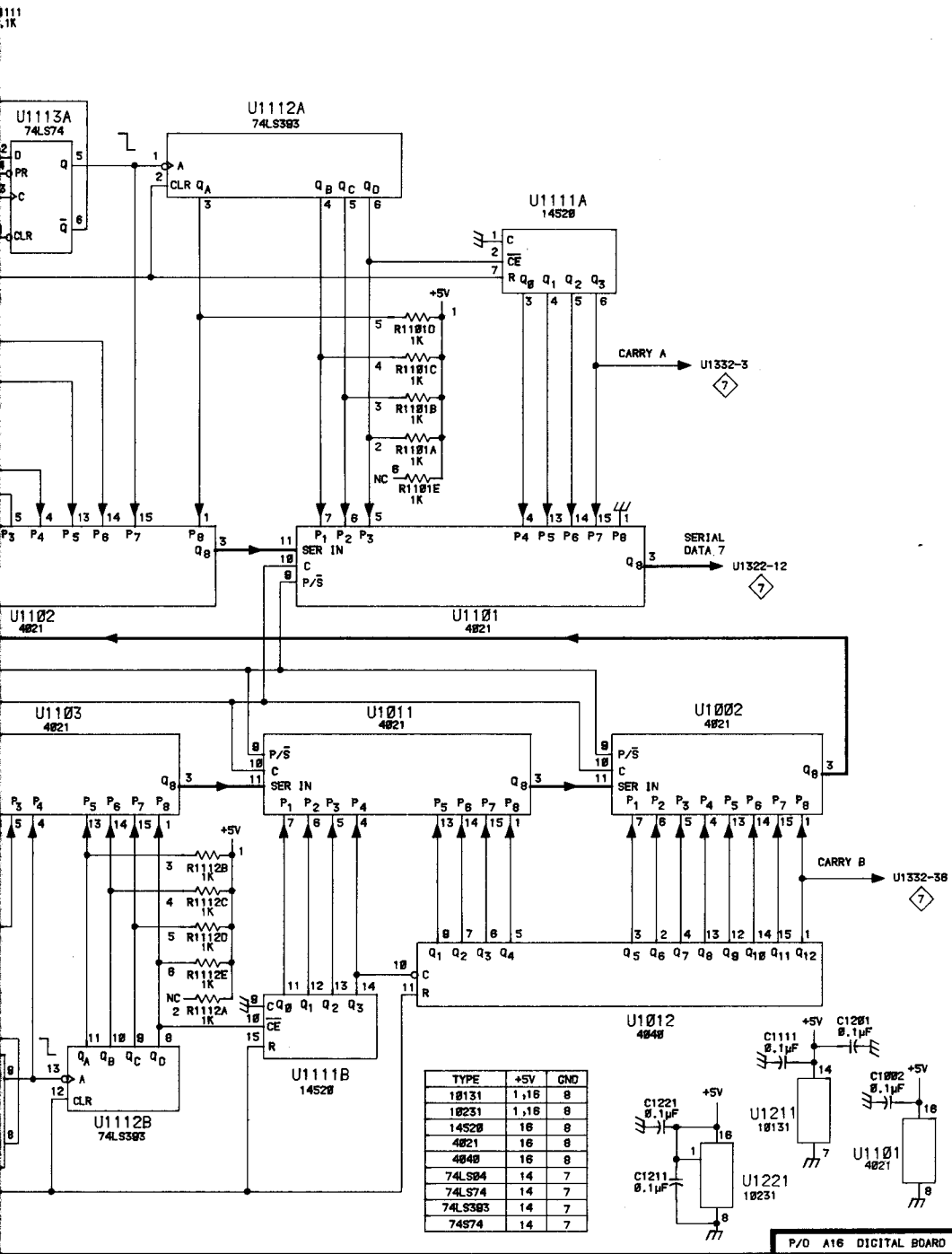

TYPE	+5V	GND
10131	1,16	8
10231	1,16	8
14520	16	8
4821	16	8
4848	16	8
74LS04	14	7
74LS74	14	7
74LS393	14	7
74974	14	7

Static Sensitive Devices
See Maintenance Section

COMPONENT NUMBER EXAMPLE

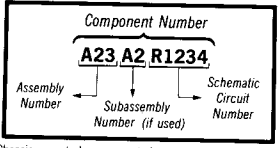

Chassis-mounted components have no Assembly Number prefix—see end of Replaceable Electrical Parts List.

CH A & CH B ACCUMULATORS

Table 8-7
COMPONENT REFERENCE CHART
(see Fig. 8-8)

P/O A12 ASSY			TRIGGER LEVEL CONTROL AND D-A CONVERTERS 5		
CIRCUIT NUMBER	SCHEMATIC LOCATION	BOARD LOCATION	CIRCUIT NUMBER	SCHEMATIC LOCATION	BOARD LOCATION
C1201	E3	E1	R1313	K5	G2
C1202	E4	E1	R1314	J5	G2
C1211	E4	E2	R1315	J5	G2
C1212	E7	E3	R1316	H5	G2
J1301	F8	F1	R1317	L1	H2
J1303	F8	G1	R1318	L1	H2
J1310	B2	G1	R1319	L2	H2
J1310	B6	G1	R1321	L3	H2
J1411	M4	H3	R1322	L2	H2
P1301	F8	F1	R1323	L3	G3
P1303	F8	G1	R1324	L3	G3
P1411	M4	H3	R1325	M3	G3
P1625	M4	N3	R1326	L3	G3
Q1311	K5	G2	R1327	L3	G3
Q1312	J5	G2	U1201	F2	F1
R1102	D1	D1	U1202	D2	F2
R1201	E1	E1	U1211	F5	F2
R1202	E2	E1	U1212	D6	F3
R1203	G1	E1	U1311	H3	G3
R1211	D4	E2	U1321	K2	H3
R1212	E4	E3	U1321	M1	H3
R1213	E5	E3	U1322	B7	H3
R1214	G2	E3	VR1302	G6	G2
R1302	G8	G2	J570	N4	Chassis
R1303	F8	G2	J580	N4	Chassis
R1306	G8	G1	P590	E8	Chassis
R1309	G8	G2	P600	E8	Chassis
R1311	L2	G2	R500	D8	Chassis
R1312	M1	G2	R510	D8	Chassis

P/O A12 ASSY also shown on 1 2 3 6 7 8 10

A | B | C | D | E | F | G

1
2
3
4
5
6
7
8
9

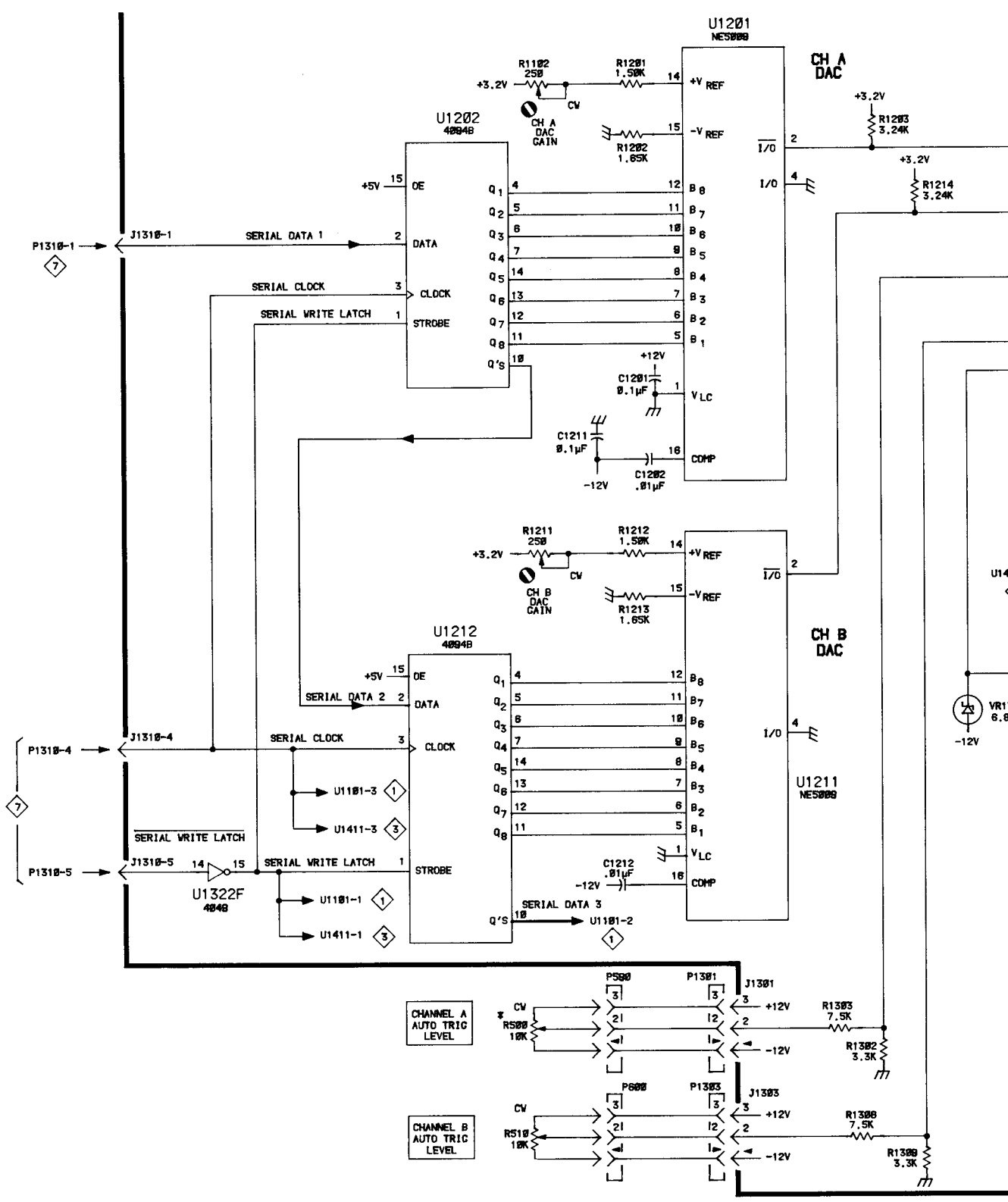

DC 509

3484-38

G | H | J | K | L | M | N

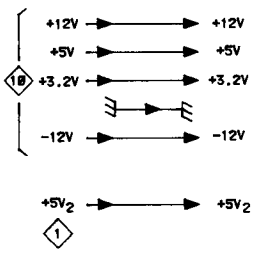
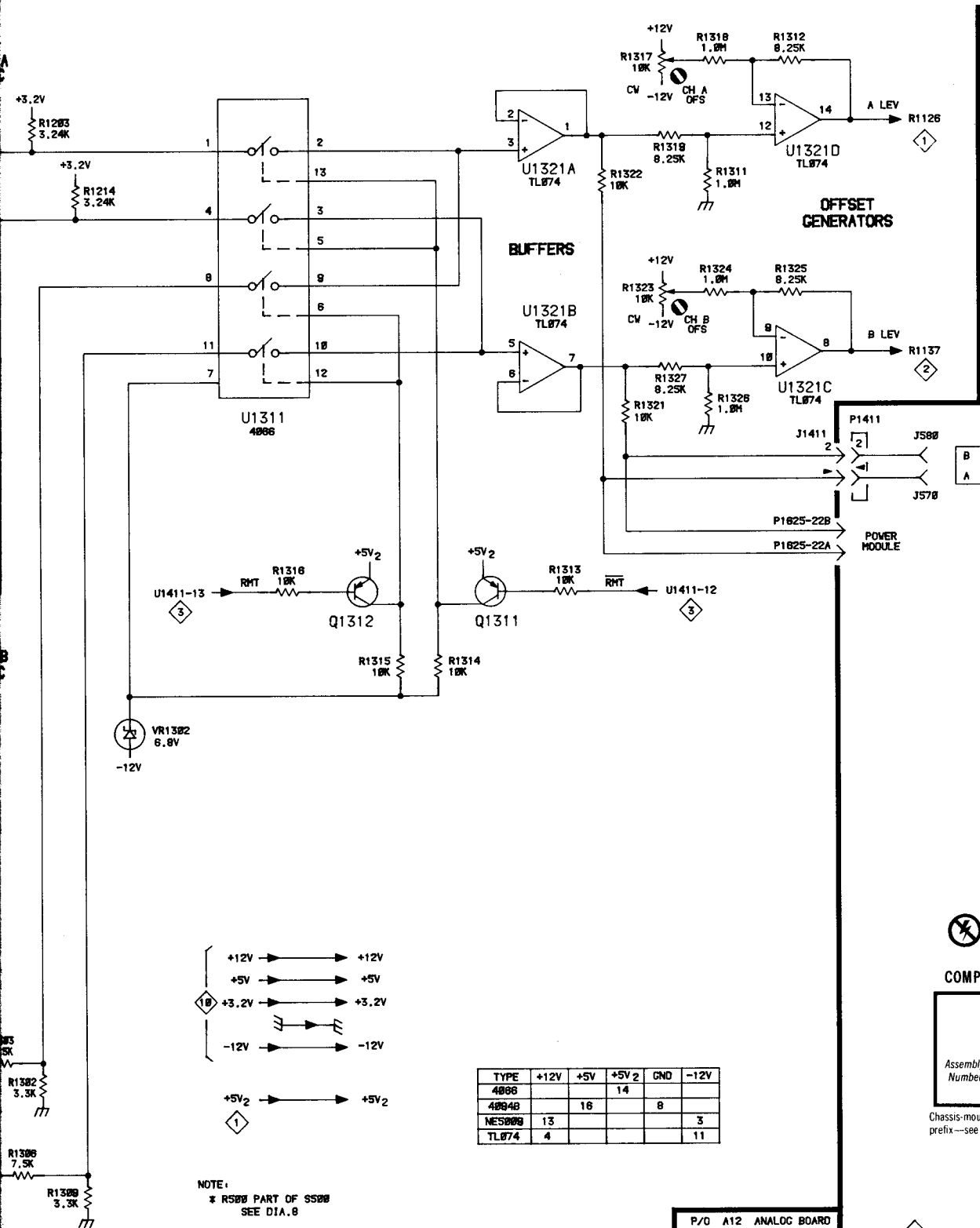

TYPE	+12V	+5V	+5V 2	GND	-12V
4886			14		
4884B		16		8	
NE5000	13				3
TL074	4				11

NOTE:
* R500 PART OF S500
SEE DIA. 8

P/O A12 ANALOG BOARD

Static Sensitive Devices
See Maintenance Section

COMPONENT NUMBER EXAMPLE

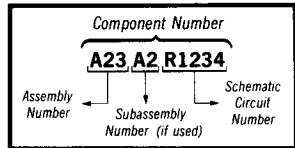

Chassis-mounted components have no Assembly Number prefix—see end of Replaceable Electrical Parts List.

TRIG LEVEL CONTROL AND D-A CONVERTERS

5

TRIGGER LEVEL CONTROL AND D-A CONVERTERS

5 JS

Table 8-8 COMPONENT REFERENCE CHART (see Fig. 8-8)

P/O A12 ASSY			TIME BASE, 100 MHz PLL AND NOISE GENERATOR 6		
CIRCUIT NUMBER	SCHEMATIC LOCATION	BOARD LOCATION	CIRCUIT NUMBER	SCHEMATIC LOCATION	BOARD LOCATION
C1501	M6	K1	R1505	E3	K2
C1503	C4	K2	R1510	C3	K2
C1511	F3	K2	R1510	C4	K2
C1512	J2	J2	R1511	H2	J2
C1521	L3	J3	R1512	J3	J2
C1522	L6	J3	R1513	K3	J2
C1523	L4	J4	R1514	H3	J2
C1525	K4	K3	R1515	H3	J3
C1526	J4	K4	R1516	K3	J3
C1601††	F8	L1	R1517	D3	K2
C1602††	C7	L1	R1518	C4	K2
C1603††	C7	L2	R1519	C3	K2
C1604††	D6	L2	R1521	H3	K3
C1605††	D7	L2	R1522	M4	K4
C1611††	D7	L2	R1528	M3	J4
C1612	B6	L3	R1601††	C7	L2
C1621†	J8	L4	R1602††	C7	L2
CR1422	L2	J3	R1603	H8	L2
CR1521	L3	J3	R1604	H8	L2
CR1611	C5	L3	R1605††	D7	L2
J1511	A3	K3	R1611††	D8	L2
J1621	A6	M3	R1612	C5	L3
L1521	L3	J4	R1613	C6	L3
P1511	A3	K3	TP1410	K2	I2
P1621	A6	M3	TP1510	F3	K2
P1625	B5	N3	TP1520	H4	L3
Q1501	C1	K2	TP1621	B3	L3
Q1502	C3	K2	U1501	D3	K1
Q1611††	D7	M2	U1502	D1	K1
Q1612	C6	L3	U1521	K3	J3
R1501	E3	J2	U1522	F3	K3
R1502	C1	J2	U1523	L3	J4
R1503	E3	J2	U1524	J4	K4
R1504	D2	K2	U1601†	H7	L1
			U1611	D5	L2
			Y1531†*	J7	K4
			Y1601††	B7	L1

P/O A12 ASSY also shown on 1 2 3 5 7 8 10

†† Delete for Option 01.

† Add for Option 01.

* Component located on back of board.

A | B | C | D | E | F | H |

1
2
3
4
5
6
7
8

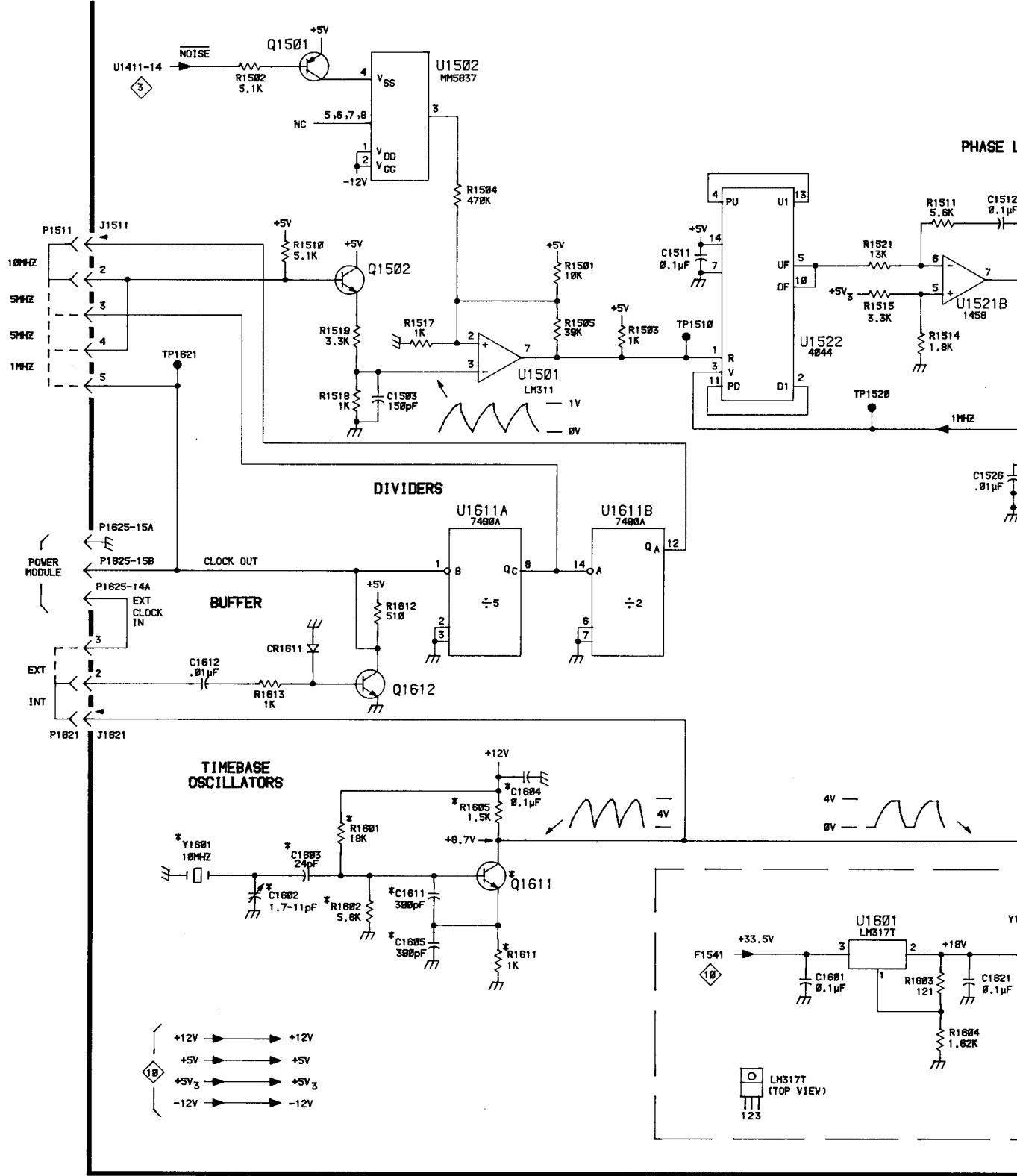

DC 509

H | J | K | L | M

PHASE LOCKED LOOP

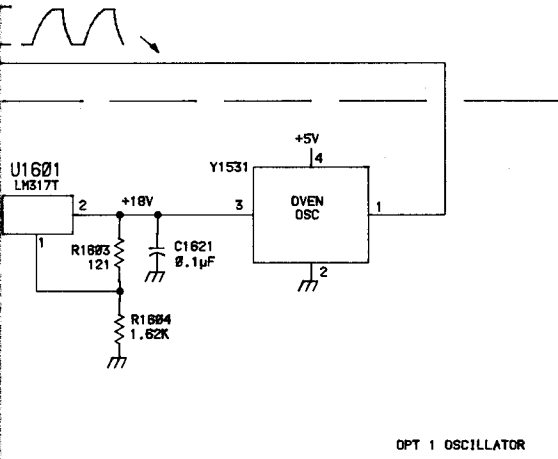
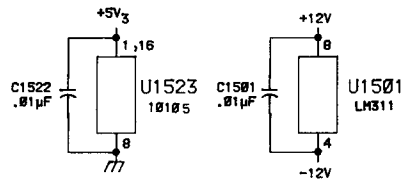
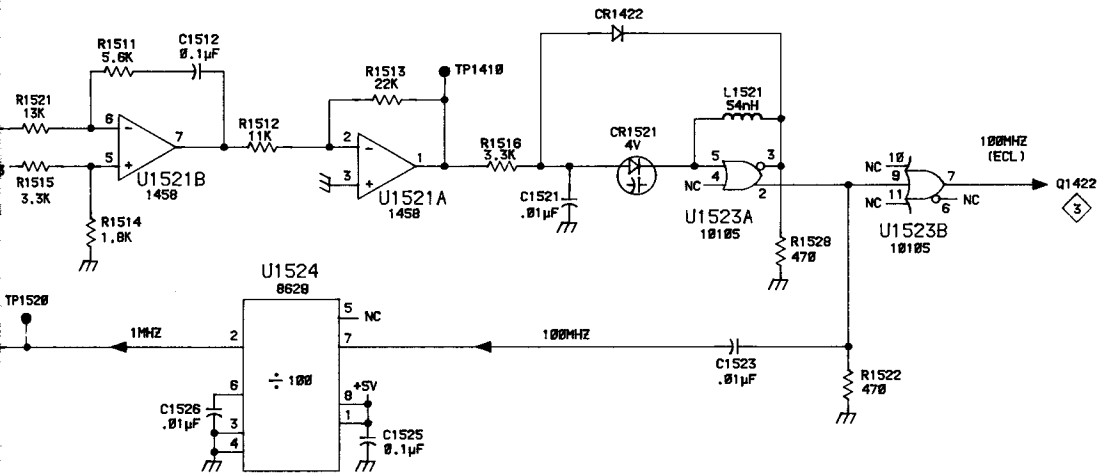

TYPE	+12V	+5V	+5V3	GND	-12V
18105			1,16	8	
1458			8		4
4044		14		7	
7490A		5		10	
LM311	8			1	4

NOTE:
COMPONENTS MARKED WITH "*" ARE DELETED IN OPTION.

P/O A12 ANALOG BOARD

TIME BASE, 100MHz PLL & NOISE GENERATOR

Static Sensitive Devices
See Maintenance Section

COMPONENT NUMBER EXAMPLE

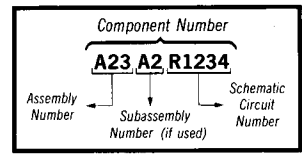

Chassis-mounted components have no Assembly Number prefix—see end of Replaceable Electrical Parts List.

TIME BASE, 100 MHz PLL AND NOISE GENERATOR

6 JS

**Table 8-9
COMPONENT REFERENCE CHART
(see Fig. 8-8 and Fig. 8-9)**

P/O A16 ASSY			MICROPROCESSOR, CONTROL LOGIC AND MEMORY 7		
CIRCUIT NUMBER	SCHEMATIC LOCATION	BOARD LOCATION	CIRCUIT NUMBER	SCHEMATIC LOCATION	BOARD LOCATION
C1202	D8	F2	R1230	A5	F5
C1232	B3	F5	R1233	C7	E5
C1233	A8	F5	R1234	B8	E5
C1301	D8	G2	R1235	B8	E5
C1311	D3	H4	R1236	B7	E5
C1331	H7	H6	R1237	B8	E5
C1401	K4	I1	R1238	A8	E5
			R1239	A8	E5
CR1221	F1	F4	R1301	H3	G2
CR1222	H1	F4	R1302	H3	H1
			R1303	F3	H1
J1210	M8	F3	R1304	F4	H1
J1210	M3	F3	R1305	F3	G2
J1211	M7	F3	R1311	F2	H3
J1211	M8	F3	R1321	H1	G4
J1310	K3	G1	R1322	H1	G4
J1310	K1	G1	R1323	D6	G4
J1331	J4	H5	R1331	F4	H5
J1410	K2	J1	R1435	M2	J6
			TP1301	F2	H1
P1010	J4	K1	TP1302	F5	H2
P1310	J2	F1			
P1310	J1	F1	U1202	F2	F2
P1310	M8	F1	U1222	B8	F4
P1331	J4	H5	U1311	E7	G3
P1410	J2	D1	U1312	K5	H2
P1410	J3	D1	U1321	H8	G4
P1625	K3	M3	U1321	E8	G4
P1625	K1	M3	U1322	C2	H4
			U1331	B5	G5
Q1301	H4	H1	U1332	D2	H5
			U1333	H7	H5
R1203	D8	F2	VR1301	F3	G1
R1226	B3	F5			
R1227	B3	F5			

P/O A16 ASSY also shown on 4 8 10

COMPONENT REFERENCE CHART

A | B | C | D | E | F | G | H

1
2
3
4
5
6
7
8

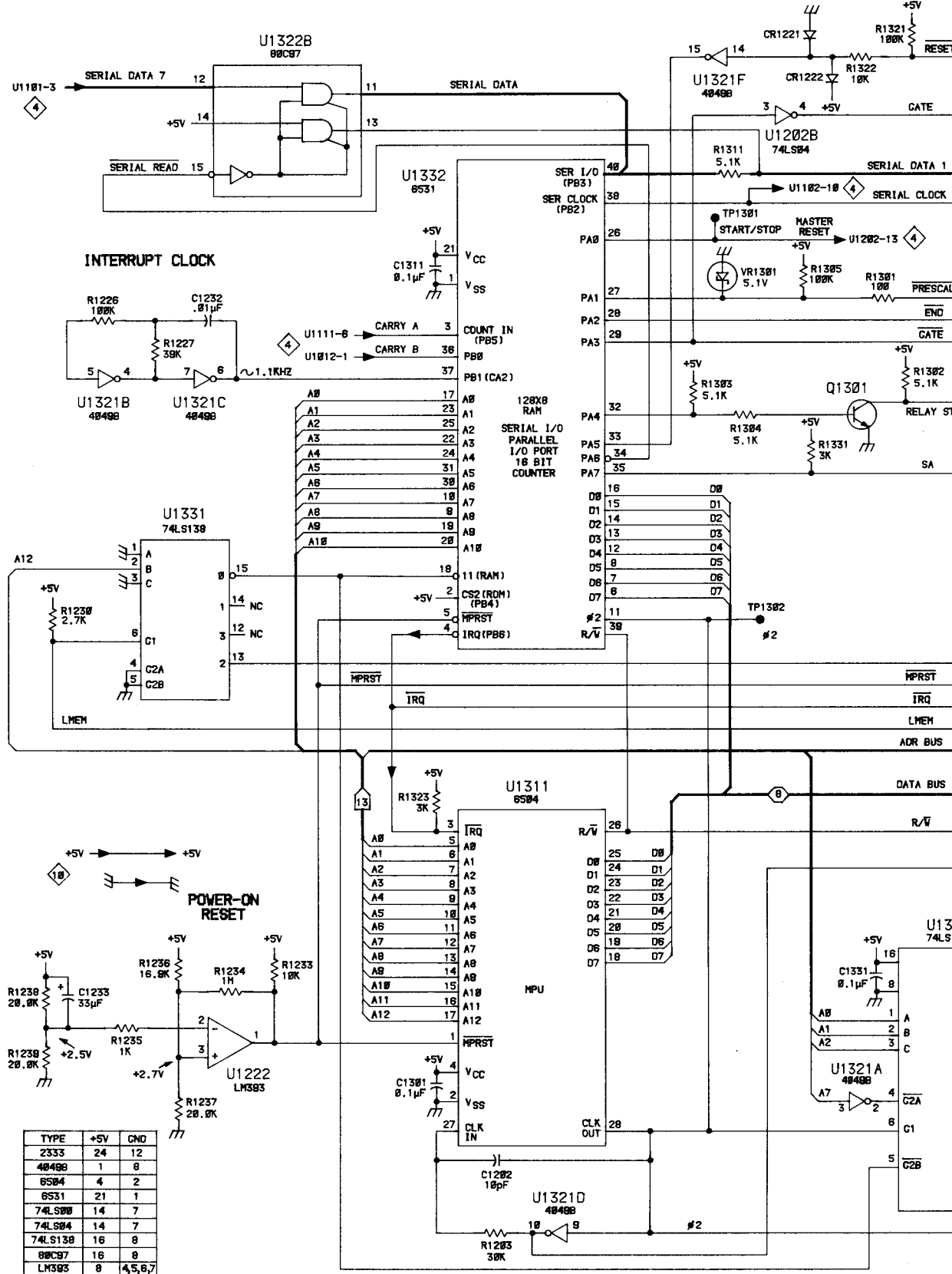

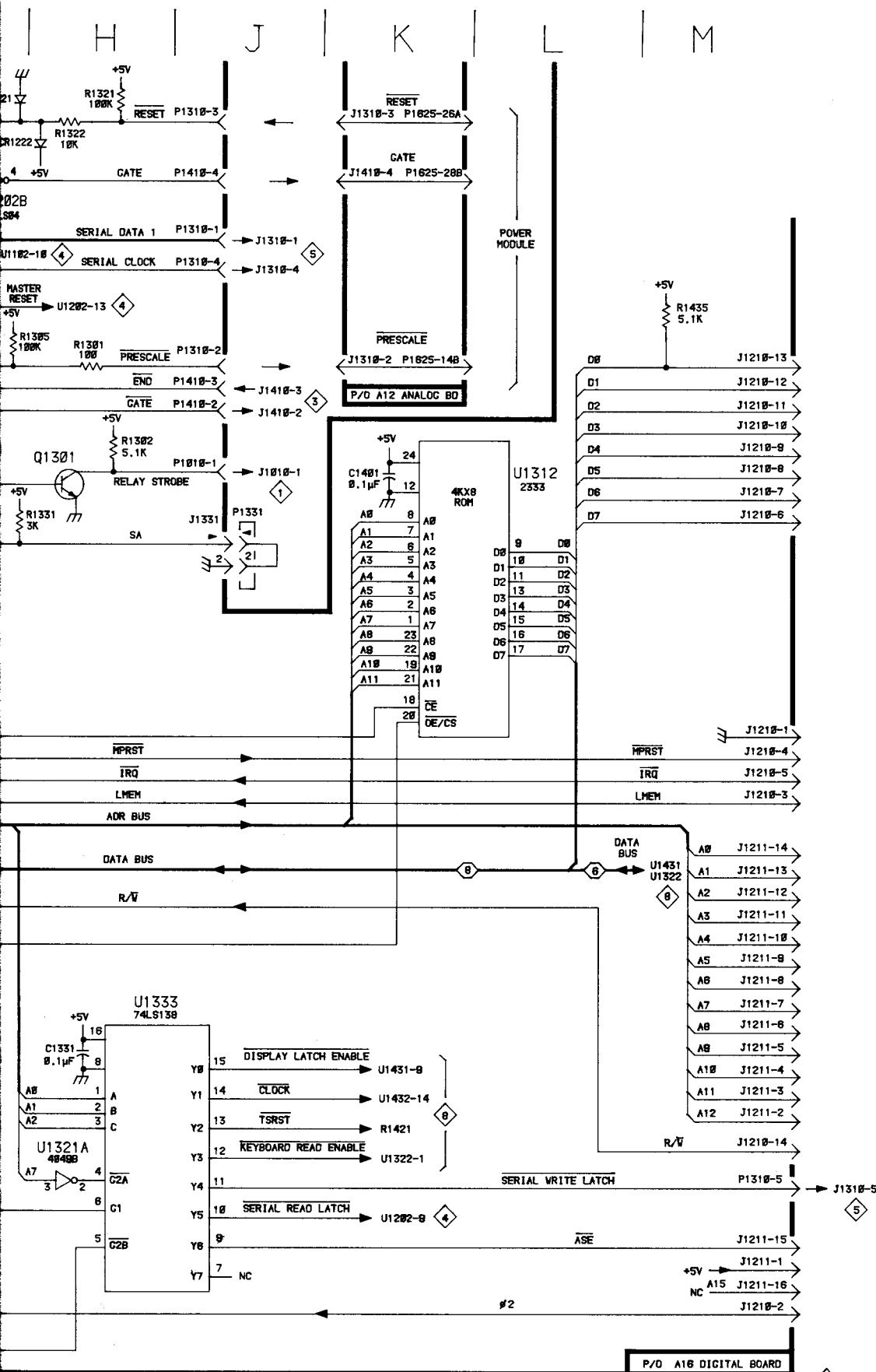

MICROPROCESSOR, CONTROL LOGIC & MEMORY

7 JS

Static Sensitive Devices
See Maintenance Section

COMPONENT NUMBER EXAMPLE

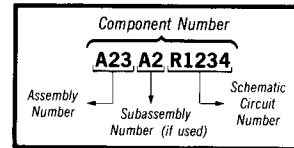

Chassis-mounted components have no Assembly Number prefix—see end of Replaceable Electrical Parts List.

**Table 8-10
COMPONENT REFERENCE CHART
(see Fig. 8-8 and Fig. 8-9)**

P/O A16 ASSY			FRONT PANEL, KEYBOARD AND DISPLAY DRIVE 8		
CIRCUIT NUMBER	SCHEMATIC LOCATION	BOARD LOCATION	CIRCUIT NUMBER	SCHEMATIC LOCATION	BOARD LOCATION
C1411	E2	I2	R1404	J1	I2
C1412	D6	J2	R1405	J2	I2
C1420	D2	I4	R1411	J2	I2
C1421	B4	J4	R1412	J2	I2
C1422	B1	J5	R1413	J2	I2
C1431	B1	I5	R1421	B5	J4
CR1431	D6	J5	R1431	J3	J5
CR1432	C6	J5	R1432	J3	J5
CR1433	D6	J5	R1433	F3	J5
CR1501	E6	K2	R1434	F3	J5
CR1502	H7	K2	R1436	K6	J6
CR1503	F7	K2	R1437	K7	J6
CR1521	C6	K4	R1438	B5	J5
CR1522	B6	K4	R1531	K6	L6
CR1523	K7	K4	R1532	K5	L6
CR1524	B6	K4	R1533	K5	L6
CR1531	D6	K6	S1511	H5	L3
CR1532	J7	K6	S1512*	J5	L3
J1411	J1	I2	S1521	B7	K4
J1412	M4	J2	S1522	B7	K5
J1413	M6	J3	S1523*	C7	L4
J1431	K7	J6	S1524*	C8	L5
P1010	F7	K1	S1531	D8	K5
P1411	J1	I2	S1532	D8	K5
P1412	M4	J2	S1533*	D8	L5
P1413	M6	J3	S1534*	E8	L5
P1431	K7	J6	U1322	L5	H4
Q1421	B5	J4	U1411	F1	I3
Q1431	H3	J5	U1412	E5	J3
Q1432	H3	J5	U1421	D2	I4
R1402	J1	I1	U1431	C2	I5
R1403	J1	I2	U1432	C5	J5
			S500	J8	Chassis
P/O A16 ASSY also shown on 4 7 10					
P/O A12 ASSY			FRONT PANEL, KEYBOARD AND DISPLAY DRIVE 8		
J1010	F7	C1			
S1010	H8	B3			
S1011	H8	B3			
S1012	F7	B3			

*Component located on back of board

A | B | C | D | E | F | H

1
2
3
4
5
6
7
8

DISPLAY LATCH

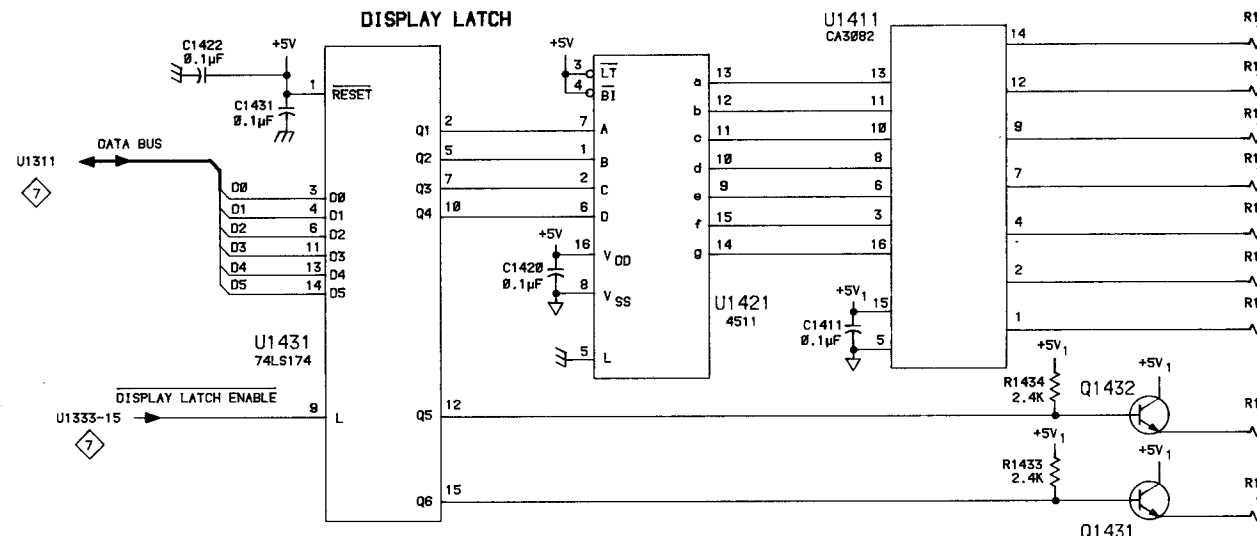

TIME SLOT GENERATOR

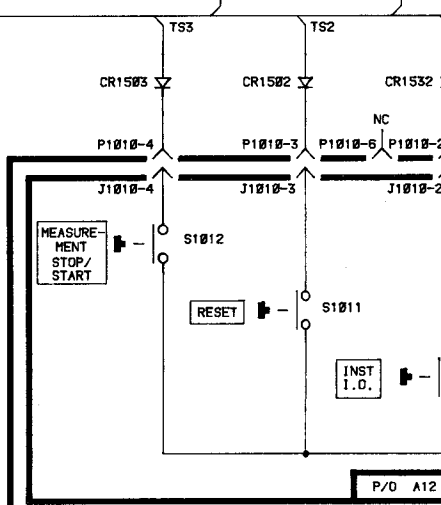
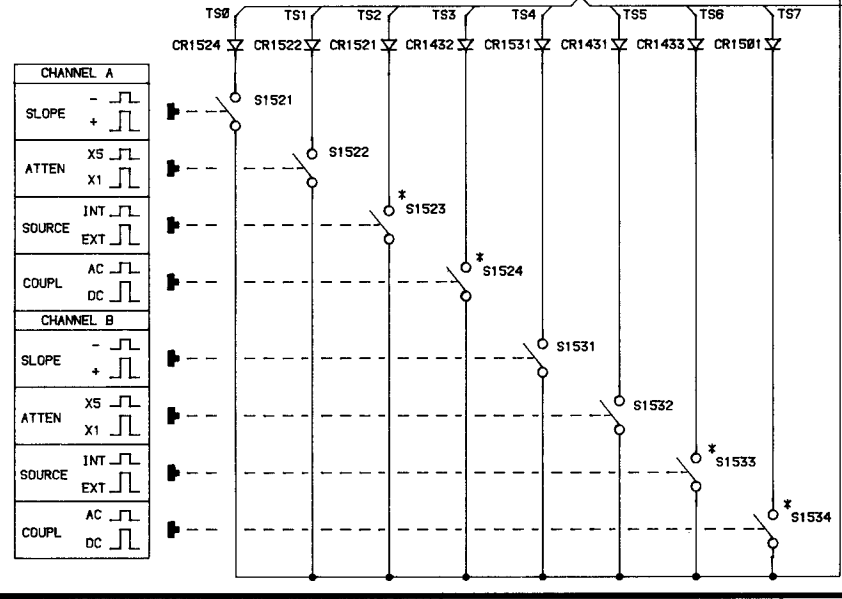
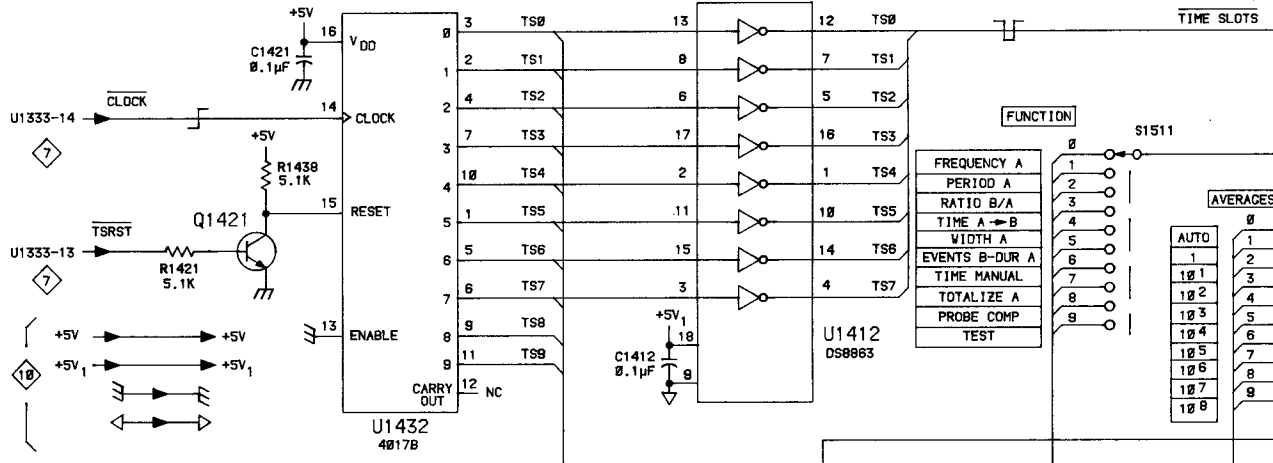

NOTES:
 * SWITCH ON BACK OF CIRCUIT BOARD
 ** S500 PART OF R500 - SEE DIA. 5
 ALL FRONT PANEL PUSH BUTTON SWITCHES SHOWN IN OUT POSITION.

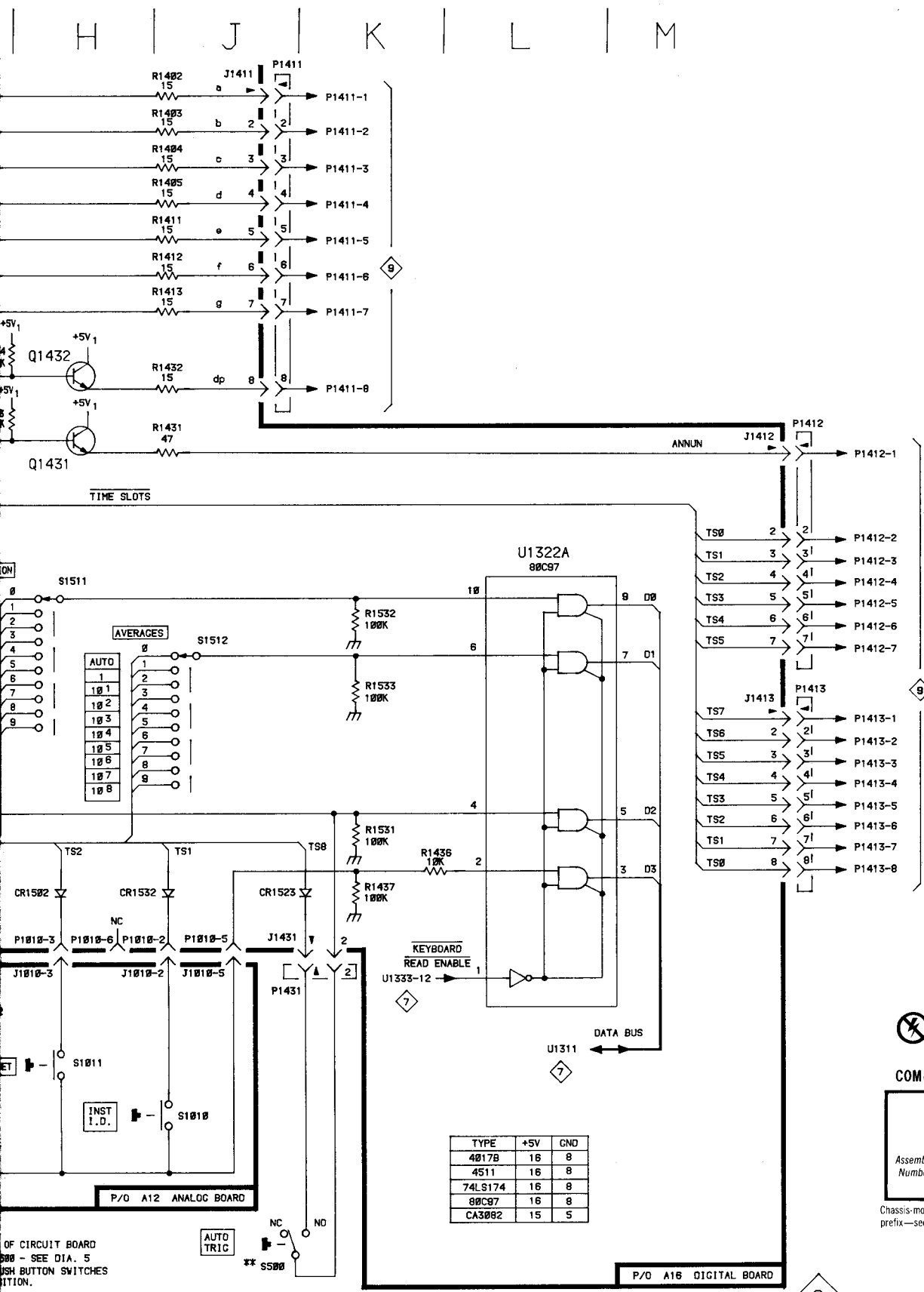

Static Sensitive Devices
See Maintenance Section

COMPONENT NUMBER EXAMPLE

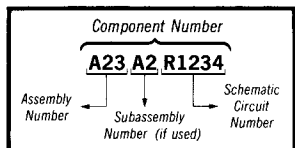

Chassis-mounted components have no Assembly Number prefix—see end of Replaceable Electrical Parts List.

TYPE	+5V	GND
4017B	16	8
4511	16	8
74LS174	16	8
90C97	16	8
CA3082	15	5

FRONT PANEL, KEYBOARD & DISPLAY DRIVE

Table 8-11
COMPONENT REFERENCE CHART
 (see Fig. 8-10)

P/O A10 ASSY			DISPLAY 		
CIRCUIT NUMBER	SCHEMATIC LOCATION	BOARD LOCATION	CIRCUIT NUMBER	SCHEMATIC LOCATION	BOARD LOCATION
CR1011	D6	A2	J1411	B4	B1
CR1012	D7	B2	J1412	B6	A3
CR1111	D7	B2	J1413	B1	B2
CR1211	D7	C2			
CR1215	D8	C2	P1411	B4	B1
CR1311	D8	D2	P1412	B6	A3
			P1413	B1	B2
DS1002	C3	A1			
DS1005	D3	A1	W1009	F7	A2
DS1102	E3	B1	W1011	F6	A2
DS1105	F3	B1	W1012	F7	A2
DS1202	J3	B1			
DS1205	K3	C1			
DS1302	L3	C1			
DS1305	M3	D1			

A | B | C | D | E | F | H

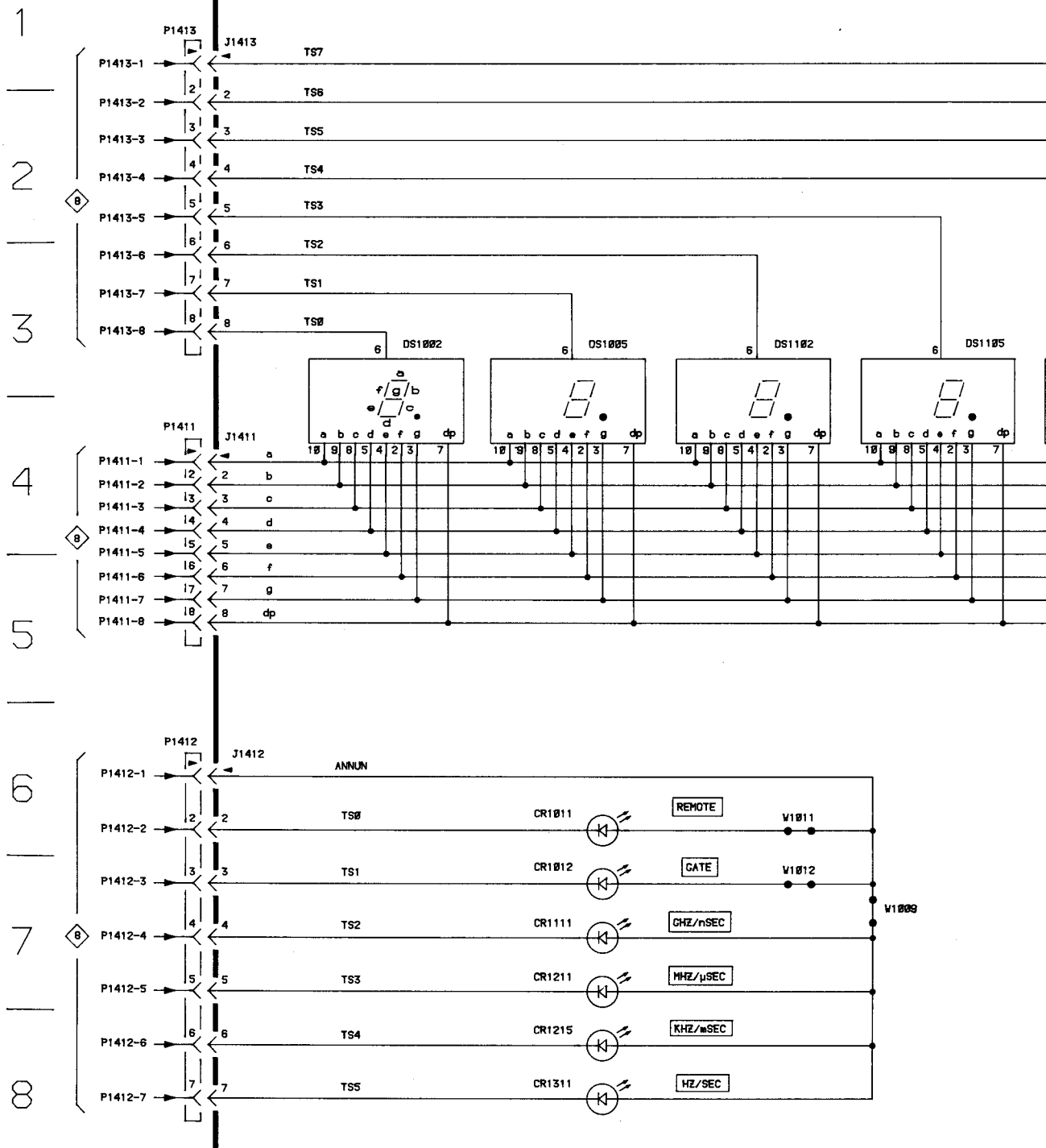

DC 509

H | J | K | L | M

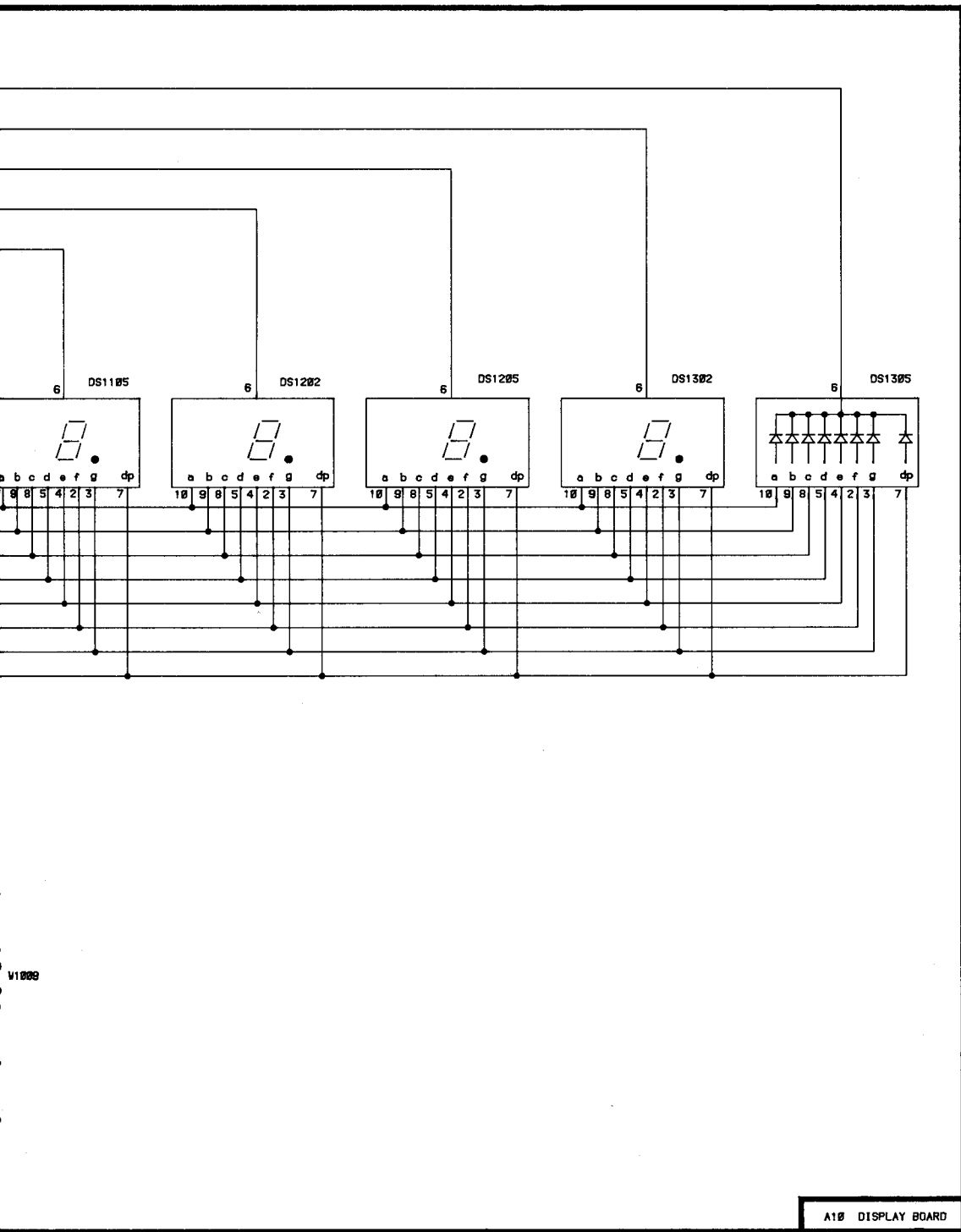

DISPLAY 9

 **Static Sensitive Devices**
See Maintenance Section

COMPONENT NUMBER EXAMPLE

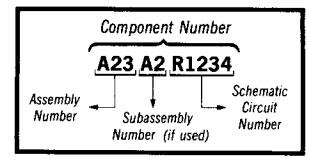

Chassis-mounted components have no Assembly Number prefix—see end of Replaceable Electrical Parts List.

V1009







3464-43

A10 DISPLAY BOARD
DISPLAY



9 JS

**Table 8-12
COMPONENT REFERENCE CHART
(see Fig. 8-8 and Fig. 8-9)**

P/O A12 ASSY			POWER SUPPLIES 		
CIRCUIT NUMBER	SCHEMATIC LOCATION	BOARD LOCATION	CIRCUIT NUMBER	SCHEMATIC LOCATION	BOARD LOCATION
C1301	B7	H1	R1301	D7	G1
C1531	C4	K5	R1304	D7	G1
C1541	F8	K6	R1305	C6	G1
C1542	C2	K6	R1307	D6	H1
C1622	K8	L4	R1308	D5	H2
C1641	D2	M5	R1434	F6	I5
C1642	F4	M5	R1435	F3	J5
C1643	B3	M6	R1445	H7	I6
CR1421	H3	J3	R1446	H7	J6
CR1442	H6	J5	R1531	J7	K5
CR1541	C1	K6	R1532	K7	K5
CR1621	L8	M4	R1534	H8	J5
CR1641	D1	L6	R1535	H8	J5
F1541	B1	K5	R1541	E6	J6
F1542	B8	K6	R1542	E7	J6
F1641	B3	M5	R1543	E4	J6
J1410	J2	J1	R1544	F8	K6
P1625	B8	N3	R1545	B4	K6
P1625	B3	N3	R1547	C3	K6
P1625	E3	N3	R1548	C2	L6
P1625	J8	N3	TP1341	E6	H6
P1625	B5	N3	TP1411	B5	I3
P1625	B1	N3	TP1431	H3	J4
Q1443	H8	J5	TP1631	L8	L4
Q1444	F6	J6	TP1632	D1	L5
Q1445	F6	J6	U1401	C6	I1
Q1531	J7	J4	U1433	C2	I5
			U1531	D4	K5
			U1641	C1	L6
			VR1301	C5	H1

P/O A12 ASSY also shown on       

P/O A16 ASSY			POWER SUPPLIES 		
CIRCUIT NUMBER	SCHEMATIC LOCATION	BOARD LOCATION	CIRCUIT NUMBER	SCHEMATIC LOCATION	BOARD LOCATION
C1001	K5	A2	Q1001	K5	A1
C1101	L5	C1	Q1002	J5	B1
C1102	K2	D1	Q1003	K5	B2
C1402	K3	J1	R1001	J4	A2
C1403	L3	J2	R1002	J5	A2
C1501	L3	K1	R1003	J5	A2
L1401	L3	J2	R1011	J5	A2
P1410	K2	D1	R1012	K6	A2
P1410	L5	D1	R1013	K6	A2
			TP1310	K2	H3

P/O A16 ASSY also shown on   

COMPONENT REFERENCE CHART

A | B | C | D | E | F |

1
2
3
4
5
6
7
8

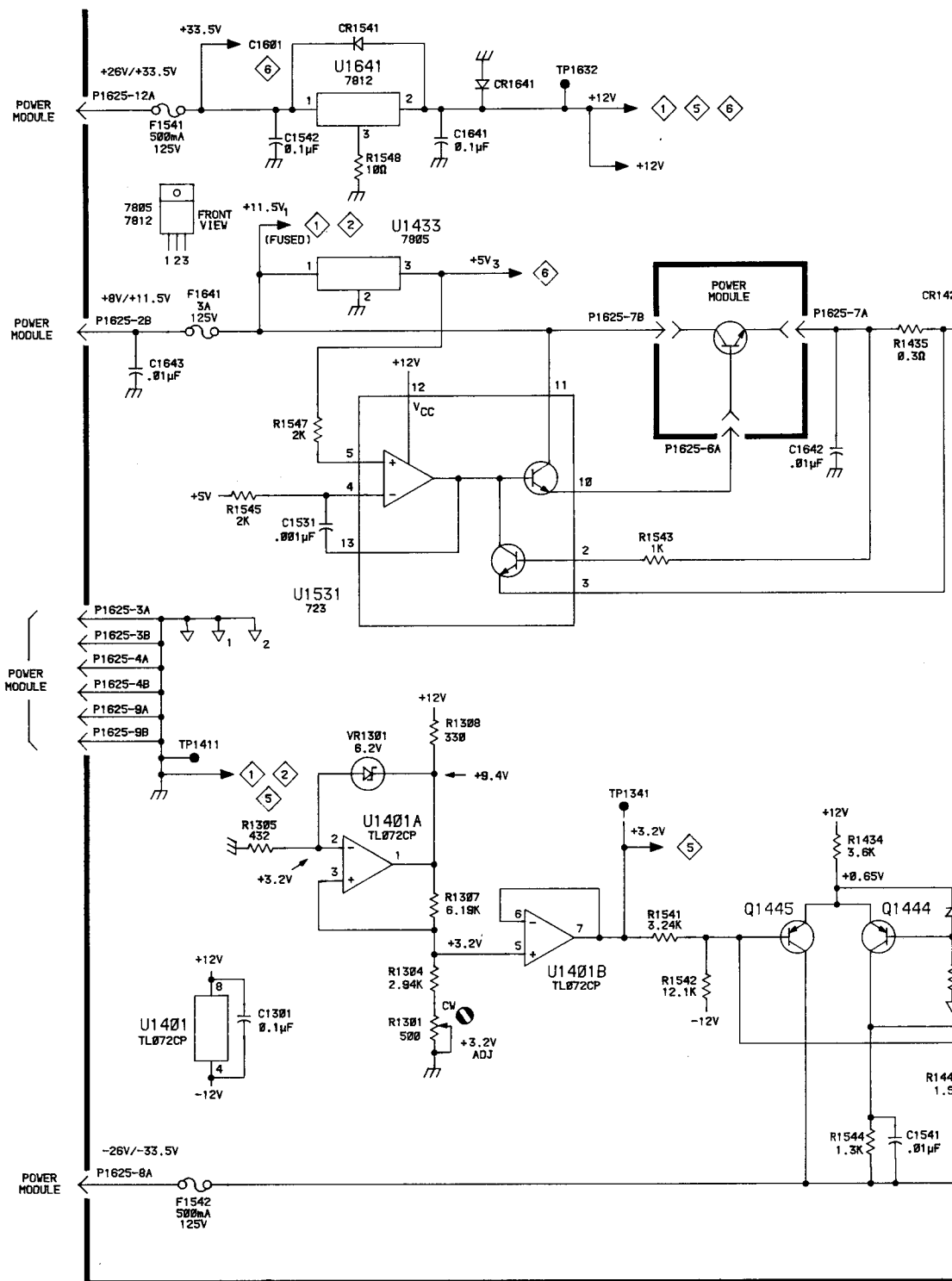

DC 509

F | H | J | K | L | M

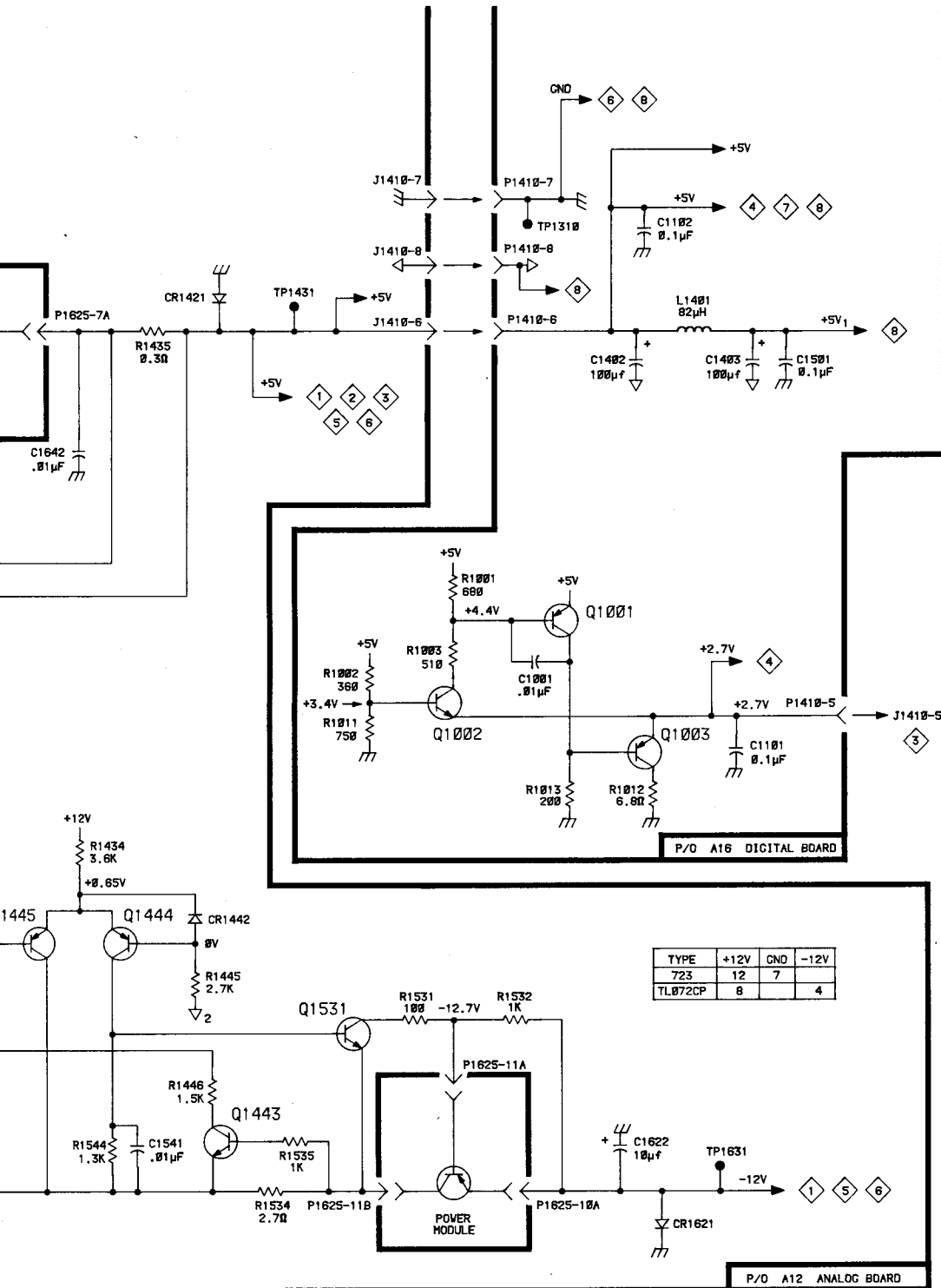

TYPE	+12V	GND	-12V
723	12	7	
TL072CP	8		4

Static Sensitive Devices
See Maintenance Section

COMPONENT NUMBER EXAMPLE

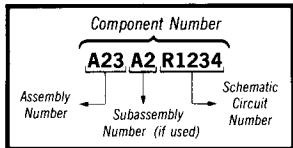

Chassis-mounted components have no Assembly Number prefix—see end of Replaceable Electrical Parts List.

REPLACEABLE MECHANICAL PARTS

PARTS ORDERING INFORMATION

Replacement parts are available from or through your local Tektronix, Inc. Field Office or representative.

Changes to Tektronix instruments are sometimes made to accommodate improved components as they become available, and to give you the benefit of the latest circuit improvements developed in our engineering department. It is therefore important, when ordering parts, to include the following information in your order: Part number, instrument type or number, serial number, and modification number if applicable.

If a part you have ordered has been replaced with a new or improved part, your local Tektronix, Inc. Field Office or representative will contact you concerning any change in part number.

Change information, if any, is located at the rear of this manual.

SPECIAL NOTES AND SYMBOLS

X000 Part first added at this serial number
00X Part removed after this serial number

FIGURE AND INDEX NUMBERS

Items in this section are referenced by figure and index numbers to the illustrations.

INDENTATION SYSTEM

This mechanical parts list is indented to indicate item relationships. Following is an example of the indentation system used in the description column.

1	2	3	4	5	Name & Description
					<i>Assembly and/or Component</i>
					<i>Attaching parts for Assembly and/or Component</i>
					-----*
					<i>Detail Part of Assembly and/or Component</i>
					<i>Attaching parts for Detail Part</i>
					-----*
					<i>Parts of Detail Part</i>
					<i>Attaching parts for Parts of Detail Part</i>
					-----*

Attaching Parts always appear in the same indentation as the item it mounts, while the detail parts are indented to the right. Indented items are part of, and included with, the next higher indentation. The separation symbol ---*--- indicates the end of attaching parts.

Attaching parts must be purchased separately, unless otherwise specified.

ITEM NAME

In the Parts List, an Item Name is separated from the description by a colon (:). Because of space limitations, an Item Name may sometimes appear as incomplete. For further Item Name identification, the U.S. Federal Cataloging Handbook H6-1 can be utilized where possible.

ABBREVIATIONS

#	INCH NUMBER SIZE	ELCTRN	ELECTRON	IN	INCH	SE	SINGLE END
ACTR	ACTUATOR	ELEC	ELECTRICAL	INCAND	INCANDESCENT	SECT	SECTION
ADPTR	ADAPTER	ELCTLT	ELECTROLYTIC	INSUL	INSULATOR	SEMICOND	SEMICONDUCTOR
ALIGN	ALIGNMENT	ELEM	ELEMENT	INTL	INTERNAL	SHLD	SHIELD
AL	ALUMINUM	EPL	ELECTRICAL PARTS LIST	LPHLDR.	LAMPHOLDER	SHLDR	SHOULDERED
ASSEM	ASSEMBLED	EQPT	EQUIPMENT	MACH	MACHINE	SKT	SOCKET
ASSY	ASSEMBLY	EXT	EXTERNAL	MECH	MECHANICAL	SL	SLIDE
ATTEN	ATTENUATOR	FIL	FILLISTER HEAD	MTG	MOUNTING	SLFLKG	SELF-LOCKING
AWG	AMERICAN WIRE GAGE	FLEX	FLEXIBLE	NIP	NIPPLE	SLVG	SLEEVING
BD	BOARD	FLH	FLAT HEAD	NON WIRE	NOT WIRE WOUND	SPR	SPRING
BRKT	BRACKET	FLTR	FILTER	OBD	ORDER BY DESCRIPTION	SQ	SQUARE
BRS	BRASS	FR	FRAME or FRONT	OD	OUTSIDE DIAMETER	SST	STAINLESS STEEL
BRZ	BRONZE	FTNR	FASTENER	OVH	OVAL HEAD	STL	STEEL
BSHG	BUSHING	FT	FOOT	PH BRZ	PHOSPHOR BRONZE	SW	SWITCH
CAB	CABINET	FXD	FIXED	PL	PLAIN or PLATE	T	TUBE
CAP	CAPACITOR	GSKT	GASKET	PLSTC	PLASTIC	TERM	TERMINAL
CER	CERAMIC	HDL	HANDLE	PN	PART NUMBER	THD	THREAD
CHAS	CHASSIS	HEX	HEXAGON	PNH	PAN HEAD	THK	THICK
CKT	CIRCUIT	HEX HD	HEXAGONAL HEAD	PWR	POWER	TNSN	TENSION
COMP	COMPOSITION	HEX SOC	HEXAGONAL SOCKET	RCPT	RECEPTACLE	TPG	TAPPING
CONN	CONNECTOR	HLCPS	HELICAL COMPRESSION	RES	RESISTOR	TRH	TRUSS HEAD
COV	COVER	HLEXT	HELICAL EXTENSION	RGD	RIGID	V	VOLTAGE
CPLG	COUPLING	HV	HIGH VOLTAGE	RLF	RELIEF	VAR	VARIABLE
CRT	CATHODE RAY TUBE	IC	INTEGRATED CIRCUIT	RTNR	RETAINER	W/	WITH
DEG	DEGREE	ID	INSIDE DIAMETER	SCH	SOCKET HEAD	WSHR	WASHER
DWR	DRAWER	IDNT	IDENTIFICATION	SCOPE	OSCILLOSCOPE	XFMR	TRANSFORMER
		IMPLR	IMPELLER	SCR	SCREW	XSTR	TRANSISTOR

CROSS INDEX—MFR. CODE NUMBER TO MANUFACTURER

Mfr. Code	Manufacturer	Address	City, State, Zip
000BB	BERQUIST COMPANY	4350 WEST 78TH	MINNEAPOLIS, MN 55435
00779	AMP, INC.	P O BOX 3608	HARRISBURG, PA 17105
07707	USM CORP., USM FASTENER DIV.	510 RIVER RD.	SHELTON, CT 06484
22526	BERG ELECTRONICS, INC.	YOUK EXPRESSWAY	NEW CUMBERLAND, PA 17070
31223	MICRO PLASTICS, INC.	20821 DEARBORN STREET	CHATSWORTH, CA 91311
71785	TRW, CINCH CONNECTORS	1501 MORSE AVENUE	ELK GROVE VILLAGE, IL 60007
73743	FISCHER SPECIAL MFG. CO.	446 MORGAN ST.	CINCINNATI, OH 45206
73803	TEXAS INSTRUMENTS, INC., METALLURGICAL MATERIALS DIV.	34 FOREST STREET	ATTLEBORO, MA 02703
78189	ILLINOIS TOOL WORKS, INC. SHAKEPROOF DIVISION	ST. CHARLES ROAD	ELGIN, IL 60120
79807	WROUGHT WASHER MFG. CO.	2100 S. O BAY ST.	MILWAUKEE, WI 53207
80009	TEKTRONIX, INC.	P O BOX 500	BEAVERTON, OR 97077
83385	CENTRAL SCREW CO.	2530 CRESCENT DR.	BROADVIEW, IL 60153
85471	BOYD, A. B., CO.	2527 GRANT AVENUE	SAN LEANDRO, CA 94579
93907	TEXTRON INC. CAMCAR DIV	600 18TH AVE	ROCKFORD, IL 61101

Fig. & Index No.	Tektronix Part No.	Serial/Model No. Eff	Dscont	Qty	1	2	3	4	5	Name & Description	Mfr Code	Mfr Part Number
1-1	337-1399-10			1						SHIELD,ELEC:LEFT SIDE	80009	337-1399-10
-2	337-1399-11			1						SHIELD,ELEC:RIGHT SIDE	80009	337-1399-11
-3	366-1059-02			1						PUSH BUTTON:GRAY,3.0 H X 0.277 OD	80009	366-1059-02
-4	366-1215-01			1						KNOB:GY,0.127 ID X 0.5 OD,0.531	80009	366-1215-01
-5	-----			1						RES.,VAR,NONWW:(SEE R500/S500 REPL) (ATTACHING PARTS)		
-6	210-0583-00			1						NUT,PLAIN,HEX.:0.25-32 X 0.312 INCH,BRS	73743	2X20317-402
-7	210-0940-00			1						WASHER,FLAT:0.25 ID X 0.375 INCH OD,STL - - - * - - -	79807	OBD
-8	366-0494-05			1						KNOB:GRAY,0.127 ID X 0.5 OD,0.531H	80009	366-0494-05
-9	-----			1						RES.,VAR,NONWW:(SEE R510 REPL) (ATTACHING PARTS)		
-10	210-0583-00			1						NUT,PLAIN,HEX.:0.25-32 X 0.312 INCH,BRS	73743	2X20317-402
-11	210-0940-00			1						WASHER,FLAT:0.25 ID X 0.375 INCH OD,STL - - - * - - -	79807	OBD
-12	366-1690-00			1						KNOB,LATCH:SIL GY,0.53 X 0.23 X 1.059	80009	366-1690-00
-13	-----			2						CONN,RCPT,ELEC:(SEE J500,J510 REPL)		
-14	210-0255-00			2						TERMINAL,LUG:0.391" ID INT TOOTH	80009	210-0255-00
-15	366-1512-00			10						PUSH BUTTON:GRAY,0.18 SQ X 0.83 INCH LG	80009	366-1512-00
-16	366-1512-03			1						PUSH BUTTON:BLUE,0.18 SQ X 0.83	80009	366-1512-03
-17	334-3817-00			1						PLATE,IDENT:BLANK	80009	334-3817-00
-18	378-0157-00			1						LENS,LED DSPLY:PRINTED	80009	378-0157-00
-19	333-2655-00			1						PANEL,FRONT: (ATTACHING PARTS)	80009	333-2655-00
-20	213-0875-00			2						SCR ASSEM WSHR:6-32 X 0.5,TAPTITE,PNH - - - * - - -	93907	OBD
-21	105-0719-00			1						LATCH,RETAINING:PLUG-IN (ATTACHING PARTS)	80009	105-0719-00
-22	213-0113-00			1						SCR,TPG,THD FOR:2-32 X 0.312 INCH,PNH STL - - - * - - -	93907	OBD
-23	105-0718-01			1						BAR,LATCH RLSE:	80009	105-0718-01
-24	-----			1						CKT BOARD ASSY:DISPLAY(SEE A10 REPL) (ATTACHING PARTS)		
-25	211-0008-00			2						SCREW,MACHINE:4-40 X 0.25 INCH,PNH STL - - - * - - -	83385	OBD
-26	-----			-						. CKT BOARD ASSY INCLUDES:		
-27	136-0252-07			1						. TERM SET,PIN(SEE A10J1411,J1412,J1413 REPL)	22526	75060-012
-28	386-4427-01			12						. SOCKET,PIN CONN:W/O DIMPLE	80009	386-4427-01
-29	213-0868-00			1						SUBPANEL,FRONT:W/INSERTS (ATTACHING PARTS)		
-30	-----			2						SCREW,TPG,TF:6-32 X 0.375 L,FILM,STEEL - - - * - - -	93907	OBD
-31	337-2758-00			-						. SUBPANEL INCLUDES:		
-32	386-4426-00			7						. JACK,TIP:(SEE J520,J530,J540,J550,J650,J570, . J580 REPL)	80009	337-2758-00
-33	213-0868-00			1						SHIELD,ELEC:SUBPANEL	80009	386-4426-00
-34	386-3657-01			1						SUPPORT,FRAME:REAR,AL (ATTACHING PARTS)	80009	
-35	343-0954-01			2						SCREW,TPG,TF:6-32 X 0.375 L,FILM,STEEL	93907	OBD
-36	211-0008-00			2						SUPPORT,PLUG IN: - - - * - - -	93907	OBD
-37	348-0693-00			-						. RETAINER INCLUDES:		
-38	-----			1						. PAD CUSHIONING:1.95 X 1.188 X 0.062	85471	3M-4116
-39	211-0012-00			1						CKT BOARD ASSY:ANALOG(SEE A12 REPL) (ATTACHING PARTS)		
-40	210-0551-00			2						SCREW,MACHINE:4-40 X 0.375,PNH STL CD PL	83385	OBD
-41	129-0884-00			1						NUT,PLAIN,HEX.:4-40 X 0.25 INCH,STL	83385	OBD
-42	211-0008-00			1						SPACER,POST:0.8 L W/4-40 EXT THD ONE	80009	129-0884-00
				2						SCREW,MACHINE:4-40 X 0.25 INCH,PNH STL - - - * - - -	83385	OBD

Replaceable Mechanical Parts—DC 509

Fig. & Index No.	Tektronix Part No.	Serial/Model No. Eff Dscont	Qty	1	2	3	4	5	Name & Description	Mfr Code	Mfr Part Number
1-43	-----	-----	-	CKT BOARD ASSY INCLUDES:		
	-----	-----	1	MICROCIRCUIT:(SEE A12U1601 REPL)		
	-----	-----	-	(OPTION 01 ONLY)		
									(ATTACHING PARTS)		
-44	210-1181-00	-----	1	WASHER,SHLDR:1.22 ID X 0.20D	31223	OBD
	-----	-----	-	(OPTION 01 ONLY)		
									* - - - -		
-45	342-0355-00	-----	1	INSULATOR,PLATE:TRANSISTOR,SILICONE RUBBER	000BB	7403-09FR-51
	-----	-----	-	(OPTION 01 ONLY)		
-46	136-0252-07	-----	44	SOCKET,PIN CONN:W/O DIMPLE	22526	75060-012
-47	-----	-----	9	TERM,TEST POINT:(SEE A12TP1341,TP1410,TP1411,		
	-----	-----	-	TP1431,TP1510,TP1520,TP1621,TP1631,TP1632		
	-----	-----	-	REPL)		
-48	344-0154-03	-----	6	CLIP,ELECTRICAL:FUSE,CKT BD MT	80009	344-0154-03
-49	136-0269-02	-----	5	SKT,PL-IN ELEK:MICROCIRCUIT,14 DIP,LOW CLE	73803	CS9002-14
-50	136-0260-02	-----	15	SKT,PL-IN ELEK:MICROCIRCUIT,16 DIP,LOW CLE	71785	133-51-92-008
-51	136-0514-00	-----	5	SKT,PL-IN ELEC:MICROCIRCUIT,8 DIP	73803	CS9002-8
-52	131-0993-00	-----	2	BUS,CONDUCTOR:2 WIRE BLACK	00779	530153-2
-53	-----	-----	44	TERMINAL,PIN:(SEE A12J1031,J1041,J1301,		
	-----	-----	-	J1303,J1341,J1402,J1403,J1411,J1441,J1442,		
	-----	-----	-	J1443,J1501,J1511,J1521,J1522,J1621,J1622,		
	-----	-----	-	J1623 REPL)		
-54	-----	-----	1	MICROCIRCUIT:(SEE A12U500 REPL)		
									(ATTACHING PARTS)		
-55	211-0007-00	-----	1	SCREW,MACHINE:4-40 X 0.188 INCH,PNH STL	83385	OBD
-56	210-0551-00	-----	1	NUT,PLAIN,HEX.:4-40 X 0.25 INCH,STL	83385	OBD
-57	337-2898-00	-----	1	SHIELD,ELEC:RELAY,BRASS	80009	337-2898-00
-58	-----	-----	1	MICROCIRCUIT:(SEE A12U1641 REPL)		
-59	-----	-----	3	SWITCH PB ASSY:(SEE A12S1010,S1011,S1012 REPL)		
-60	343-0495-03	-----	1	CLIP,SWITCH:FRONT,7.5 MM,3 UNIT	80009	343-0495-03
									(ATTACHING PARTS)		
-61	210-3033-00	-----	3	EYELET,METALLIC:0.59 OD X 0.156 INCH LONG	07707	SE-25
									* - - - -		
-62	343-0499-03	-----	1	CLIP,SWITCH:7.5 MM,4 UNIT	80009	343-0499-03
									(ATTACHING PARTS)		
-63	210-3033-00	-----	3	EYELET,METALLIC:0.59 OD X 0.156 INCH LONG	07707	SE-25
									* - - - -		
-64	220-0449-00	-----	1	NUT,SLEEVE:4-40 X 0.188 X 0.50" LONG	80009	220-0449-00
									(ATTACHING PARTS)		
-65	211-0008-00	-----	1	SCREW,MACHINE:4-40 X 0.25 INCH,PNH STL	83385	OBD
-66	210-0003-00	-----	1	WASHER,LOCK:EXT:0.123 ID X 0.245" OD,STL	78189	1104-00-00-0541C
									* - - - -		
-67	-----	-----	1	OSCILLATOR,RF:(SEE A12Y1531 REPL)		
	-----	-----	-	(OPTION 01 ONLY)		
									(ATTACHING PARTS)		
-68	211-0097-00	-----	2	SCREW,MACHINE:4-40 X 0.312 INCH,PNH STL	83385	OBD
	-----	-----	-	(OPTION 01 ONLY)		
-69	361-0548-00	-----	2	SPACER,RING:0.125 ID X 0.25 OD X 0.110 ID	80009	361-0548-00
	-----	-----	-	(OPTION 01 ONLY)		
									* - - - -		
-70	-----	-----	1	CONTACT ASSY,EL:(SEE A12J1420,J1421 REPL)		
-71	-----	-----	1	TERM. SET,PIN:(SEE A12J1010,J1310,J1410 REPL)		
-72	384-0617-00	-----	2	SPACER,POST:0.375 L X 0.25 HEX	80009	384-0617-00
									(ATTACHING PARTS)		
-73	211-0008-00	-----	2	SCREW,MACHINE:4-40 X 0.25 INCH,PNH STL	83385	OBD
									* - - - -		
-74	-----	-----	1	CKT BOARD ASSY:DIGITAL(SEE A16 REPL)		
									(ATTACHING PARTS)		
-75	211-0008-00	-----	5	SCREW,MACHINE:4-40 X 0.25 INCH,PNH STL	83385	OBD
-76	129-0315-00	-----	5	SPACER,POST:0.45 L,4-40 THRU THD	80009	129-0315-00
									* - - - -		
									(ATTACHING PARTS)		
-77	-----	-----	-	CKT BOARD ASSY INCLUDES:		
	-----	-----	8	SWITCH PB ASSY:(SEE A16S1521,S1522,S1523,		
	-----	-----	-	S1524,S1531,S1532,S1533,S1534 REPL)		

Replaceable Mechanical Parts—DC 509

Fig. & Index No.	Tektronix Part No.	Serial/Model No. Eff	Dscont	Qty	1	2	3	4	5	Name & Description	Mfr Code	Mfr Part Number
1-78	343-0495-04			2	.	CLIP, SWITCH: FRONT, 7.5 MM, 4 UNIT				(ATTACHING PARTS)	80009	343-0495-04
-79	210-3050-00			8	.	EYELET, METALLIC: 0.218 L X 0.059 OD, BRS				- - - * - - -	07707	SE-27
-80	343-0499-04			2	.	CLIP, SWITCH: REAR, 7.5MM X 4 UNIT				(ATTACHING PARTS)	80009	343-0499-04
-81	210-3050-00			8	.	EYELET, METALLIC: 0.218 L X 0.059 OD, BRS				- - - * - - -	07707	SE-27
-82	-----			1	.	SW LEVER ASSY: (SEE A16S1511 REPL)				(ATTACHING PARTS)		
-83	213-0872-00			3	.	SCREW, TPG, TF: 2-28 X 0.75, TYPE 2, PNH				- - - * - - -	93907	OBD
-84	-----			1	.	SW LEVER ASSY; (SEE A16S1512 REPL)						
-85	136-0260-02			8	.	SKT, PL-IN ELEK: MICROCIRCUIT, 16 DIP, LOW CLE					71785	133-51-92-008
-86	136-0670-00			1	.	SKT, PL-IN ELEK: MICROCKT, 18 PIN, LOW PROFILE					73803	CS9002-18
-87	136-0578-00			1	.	SKT, PL-IN ELEK: MICROCKT, 24 PIN, LOW PROFILE					73803	C S9002-24
-88	-----			1	.	TERM. SET, PIN: (SEE A16J1331, J1411, J1412,						
				-	.	J1413, J1431 REPL)						
-89	136-0263-04			4	.	SOCKET, PIN TERM: FOR 0.025 INCH SQUARE PIN					22526	75377-001
-90	-----			1	.	TERM. SET, PIN: (SEE A16J1210, J1211 REPL)						
-91	136-0499-06			2	.	CONN, RCPT, ELEC: CIRCUIT BD, 6 CONTACTS					00779	3-380948-6 AMP
-92	136-0499-08			1	.	CONNECTOR, RCPT, : 8 CONTACT					00779	30380949-8
-93	-----			3	.	TERM, TEST POINT: (SEE A16TP1301, TP1302,						
				-	.	TP1303 REPL)						
-94	136-0694-00			1	.	SKT, PL-IN ELEK: MICROCIRCUIT, 28 CONTACT					73803	CS9002-28
-95	136-0623-00			1	.	SOCKET, PLUG-IN: 40 DIP, LOW PROFILE					73803	CS9002-40
-96	131-0993-07			1	.	LINK, TERM. CONNE: 2 WIRE VIOLET					00779	530153-7
-97	214-1061-00			1	.	SPRING, GROUND: FLAT					80009	214-1061-00
-98	426-1763-00			1	.	SR SECT, PLUG-IN: TOP					80009	426-1763-00
-99	426-0724-01			1	.	FR SECT, PLUG-IN: BOTTOM					80009	426-0724-01

Replaceable Mechanical Parts—DC 509

Fig. & Index No.	Tektronix Part No.	Serial/Model No. Eff Dscnt	Qty	1	2	3	4	5	Name & Description	Mfr Code	Mfr Part Number
WIRE ASSEMBLIES											
175-3233-00			1						CABLE ASSY,RF:50 OHM COAX,12.0 L,9-N	80009	175-3233-00
-----			-						(FROM J520,J530 TO A12J1402)		
352-0169-00			1						. HLDR,TERM CONN:2 WIRE BLACK	80009	352-0169-00
175-3239-00			1						CABLE ASSY,RF:50 OHM COAX,14.0 L,9-5	80009	175-3239-00
-----			-						(FROM J540 TO A12J1341)		
352-0169-05			1						. CONN BODY,PL,EL:2 WIRE GREEN	80009	352-0169-05
175-3238-00			1						CABLE ASSY,RF:50 OHM COAX,14.0 L,9-4	80009	175-3238-00
-----			-						(FROM J560 TO A12J1442)		
352-0169-04			1						. CONN BODY,PL,EL:2 WIRE YELLOW	80009	352-0169-04
175-3232-00			1						CABLE ASSY,RF:50 OHM COAX,12.0 L,RIBBON	80009	175-3232-00
-----			-						(FROM J570,J580 TO A12J1411)		
352-0169-01			1						. HLDR TERM CONN:2 WIRE,BROWN	80009	352-0169-01
175-3227-00			1						CA ASSY,SP,ELEC:3,26 AWG,6.0 L,RIBBON	80009	175-3227-00
-----			-						(FROM R500/S500 TO A12J1301)		
352-0161-02			2						. CONN BODY,PL,EL:3 WIRE RED	80009	352-0161-02
175-2623-00			1						CA ASSY,SP,ELEC:2,26 AWG,3.0 L	80009	175-2623-00
-----			-						(FROM R500/S500 TO A16J1431)		
352-0169-00			1						. HLDR,TERM CONN:2 WIRE BLACK	80009	352-0169-00
175-3228-00			1						CA ASSY,SP,ELEC:3,26 AWG,7.0 L,RIBBON	80009	175-3228-00
-----			-						(FROM R510 TO A12J1303)		
352-0161-03			1						. CONN BODY,PL,EL:3 WIRE ORANGE	80009	352-0161-03
352-0161-02			1						. CONN BODY,PL,EL:3 WIRE RED	80009	352-0161-02
175-3229-00			1						CA ASSY,SP,ELEC:7,26 AWG,3.5 L,RIBBON	80009	175-3229-00
-----			-						(FROM A10J1012 TO A16J1412)		
352-0165-03			2						. CONN BODY,PL,EL:7 WIRE ORANGE	80009	352-0165-03
175-3235-00			1						CABLE ASSY,RF:50 OHM COAX,10.0 L,9-0	80009	175-3235-00
-----			-						(FROM A10J1031 TO A12J1521)		
352-0169-00			2						. HLDR,TERM CONN:2 WIRE BLACK	80009	352-0169-00
175-3240-00			1						CABLE ASSY,RF:50 OHM COAX,10.0 L,9-6	80009	175-3240-00
-----			-						(FROM A10J1041 TO A12J1522)		
352-0169-06			2						. CONN BODY,PL,EL:2 WIRE BLUE	80009	352-0169-06
175-3230-00			1						CA ASSY,SP,ELEC:8,26 AWG,4.0 L,RIBBON	80009	175-3230-00
-----			-						(FROM A10J1101 TO A16J1411)		
352-0166-04			2						. CONN BODY,PL,EL:8 WIRE YELLOW	80009	352-0166-04
175-3231-00			1						CA ASSY,SP,ELEC:8,26 AWG,3.5 L,RIBBON	80009	175-3231-00
-----			-						(FROM A10J1102 TO A16J1413)		
352-0166-05			2						. CONN BODY,PL,EL:8 WIRE GREEN	80009	352-0166-05
175-3234-00			1						CABLE ASSY,RF:50 OHM COAX,3.5 L,9-1	80009	175-3234-00
-----			-						(FROM A12J1403 TO A12J1501)		
352-0169-01			2						. HLDR TERM CONN:2 WIRE,BROWN	80009	352-0169-01
175-3236-00			1						CABLE ASSY,RF:50 OHM COAX,7.5 L,9-2	80009	175-3236-00
-----			-						(FROM A12J1441 TO A12J1622)		
352-0169-02			2						. CONN BODY,PL,EL:2 WIRE RED	80009	352-0169-02
175-3237-00			1						CABLE ASSY,RF:50 OHM COAX,6.0 L,9-3	80009	175-3237-00
-----			-						(FROM A12J1443 TO A12J1623)		
352-0169-03			2						. CONN BODY,PL,EL:2 WIRE ORANGE	80009	352-0169-03
175-3433-00			1						CA ASSY,SP,ELEC:2,26 AWG,3.0 L,RIBBON	80009	175-3433-00
-----			-						(FROM A12J1621 TO A12U500) SUBPART OF A12		
352-0161-06			2						. CONN BODY,PL,EL:3 WIRE BLUE	80009	352-0161-06

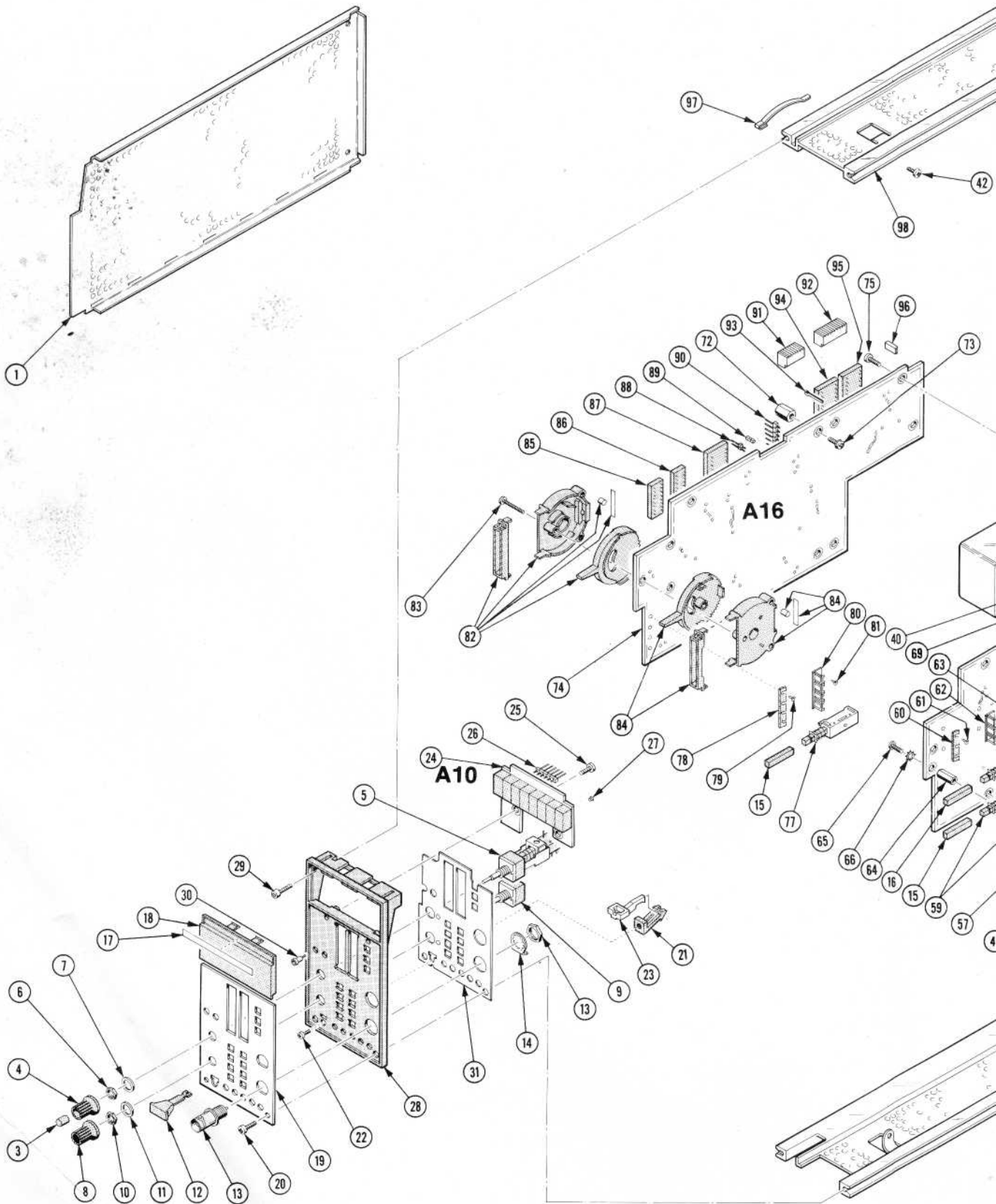
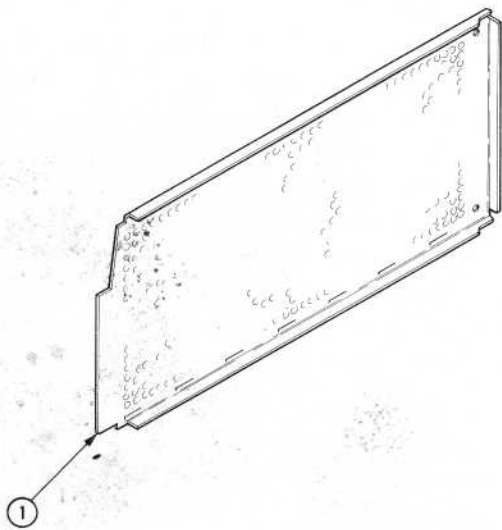

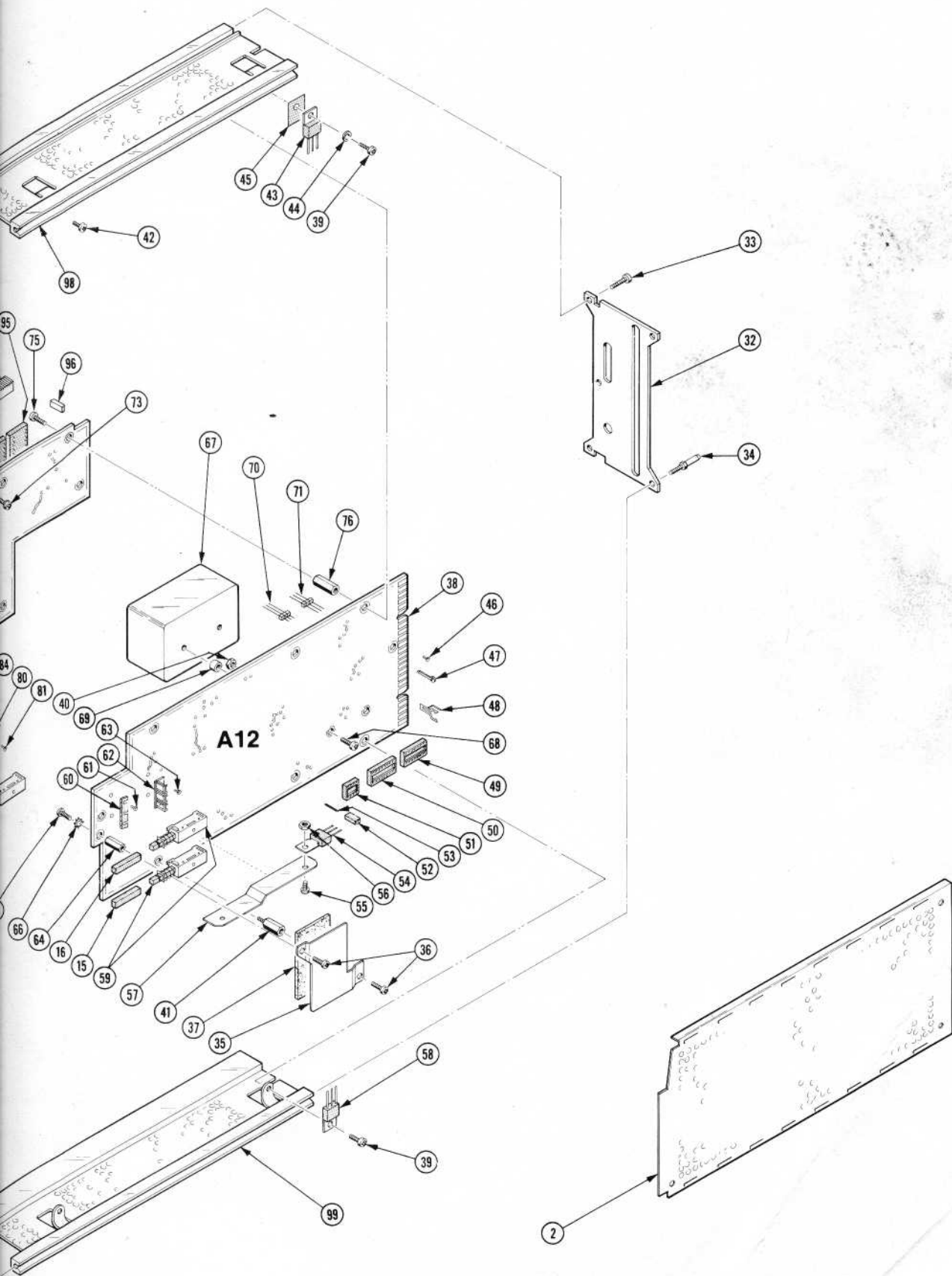

Fig. & Index No.	Tektronix Part No.	Serial/Model No. Eff	Dscont	Qty	1	2	3	4	5	Name & Description	Mfr Code	Mfr Part Number
------------------------	-----------------------	-------------------------	--------	-----	---	---	---	---	---	--------------------	-------------	-----------------

ACCESSORIES

070-3464-00				1						MANUAL, TECH: INSTRUCTION	80009	070-3464-00
175-3765-01				1						CABLE ASSY, RF: 50 OHM COAX, 48.0 L, 8-N	80009	175-3765-01

MANUAL CHANGE INFORMATION

At Tektronix, we continually strive to keep up with latest electronic developments by adding circuit and component improvements to our instruments as soon as they are developed and tested.

Sometimes, due to printing and shipping requirements, we can't get these changes immediately into printed manuals. Hence, your manual may contain new change information on following pages.

A single change may affect several sections. Since the change information sheets are carried in the manual until all changes are permanently entered, some duplication may occur. If no such change pages appear following this page, your manual is correct as printed.

SERVICE NOTE

Because of the universal parts procurement problem, some electrical parts in your instrument may be different from those described in the Replaceable Electrical Parts List. The parts used will in no way alter or compromise the performance or reliability of this instrument. They are installed when necessary to ensure prompt delivery to the customer. Order replacement parts from the Replaceable Electrical Parts List.

CALIBRATION TEST EQUIPMENT REPLACEMENT

Calibration Test Equipment Chart

This chart compares TM 500 product performance to that of older Tektronix equipment. Only those characteristics where significant specification differences occur, are listed. In some cases the new instrument may not be a total functional replacement. Additional support instrumentation may be needed or a change in calibration procedure may be necessary.

Comparison of Main Characteristics

DM 501 replaces 7D13		
PG 501 replaces 107	PG 501 - Risetime less than 3.5 ns into 50 Ω .	107 - Risetime less than 3.0 ns into 50 Ω .
108	PG 501 - 5 V output pulse; 3.5 ns Risetime	108 - 10 V output pulse 1 ns Risetime
PG 502 replaces 107		
108	PG 502 - 5 V output	108 - 10 V output
111	PG 502 - Risetime less than 1 ns; 10 ns Pretrigger pulse delay	111 - Risetime 0.5 ns; 30 to 250 ns Pretrigger pulse delay
PG 508 replaces 114	Performance of replacement equipment is the same or better than equipment being replaced.	
115		
2101		
PG 506 replaces 106	PG 506 - Positive-going trigger output signal at least 1 V; High Amplitude output, 60 V.	106 - Positive and Negative-going trigger output signal, 50 ns and 1 V; High Amplitude output, 100 V.
067-0502-01	PG 506 - Does not have chopped feature.	0502-01 - Comparator output can be alternately chopped to a reference voltage.
SG 503 replaces 190, 190A, 190B	SG 503 - Amplitude range 5 mV to 5.5 V p-p.	190B - Amplitude range 40 mV to 10 V p-p.
191	SG 503 - Frequency range 250 kHz to 250 MHz.	0532-01 - Frequency range 65 MHz to 500 MHz.
067-0532-01		
SG 504 replaces 067-0532-01	SG 504 - Frequency range 245 MHz to 1050 MHz.	0532-01 - Frequency range 65 MHz to 500 MHz.
067-0650-00		
TG 501 replaces 180, 180A	TG 501 - Trigger output-slaved to marker output from 5 sec through 100 ns. One time-mark can be generated at a time.	180A - Trigger pulses 1, 10, 100 Hz; 1, 10, and 100 kHz. Multiple time-marks can be generated simultaneously.
181	TG 501 - Trigger output-slaved to marker output from 5 sec through 100 ns. One time-mark can be generated at a time.	181 - Multiple time-marks
184	TG 501 - Trigger output-slaved to marker output from 5 sec through 100 ns. One time-mark can be generated at a time.	184 - Separate trigger pulses of 1 and 0.1 sec; 10, 1, and 0.1 ms; 10 and 1 μ s.
2901	TG 501 - Trigger output-slaved to marker output from 5 sec through 100 ns. One time-mark can be generated at a time.	2901 - Separate trigger pulses, from 5 sec to 0.1 μ s. Multiple time-marks can be generated simultaneously.

NOTE: All TM 500 generator outputs are short-proof. All TM 500 plug-in instruments require TM 500-Series Power Module.

DESCRIPTION

EFF SN B010100

ELECTRICAL PARTS LIST AND SCHEMATIC CHANGES

REF.

CHANGE TO:

A12R1135	315-0101-00	RES., FXD, CMPSN:100 OHM, 5%, 0.25W	PC 12
A12R1140	315-0101-00	RES., FXD, CMPSN:100 OHM, 5%, 0.25W	PG 12
A12R1231	315-0101-00	RES., FXD, CMPSN:100 OHM, 5%, 0.25W	PC 12
A12R1242	315-0101-00	RES., FXD, CMPSN:100 OHM, 5%, 0.25W	PC 12
A16R1311	315-0302-00	RES., FXD, CMPSN:3K OHM, 5%, 0.25W	PC 15

R1135, R1140, R1231 and R1242 are located on the ANALOG circuit board assembly.

R1135 and R1231 are shown on diagram 1 CH A AMPLIFIERS AND RELAY CONTROL.

R1231 and R1242 are shown on diagram 2 CH B AMPLIFIERS AND RELAY CONTROL.

R1311 is located on the DIGITAL circuit board assembly and is shown on diagram 2 MICROPROCESSOR, CONTROL LOGIC AND MEMORY.

MECHANICAL PARTS LIST CHANGES

PC 22

REMOVE:

129-0884-00	1	SPACER, POST:0.8 L W/4-40 EXT THD ONE
210-0003-00	1	. WASHER, LOCK:EXT, 0.123 ID X 0.245" OD, STL
211-0008-00	2	SCREW, MACHINE:4-40 X 0.25 INCH, PNH STL
220-0449-00	1	. NUT, SLEEVE:4-40 X 0.188 X 0.50" LONG
343-0954-01	1	RETAINER, RELAY:W/CUSHIONING PAD

ADD

213-0848-00	12	SCREW, TPG, TF:0-40 X 0.25 INCH, PLASTITE, FIL HD STEEL CD PL
-------------	----	---

TEXT CORRECTION

Page 5-2 Step 3.

CHANGE TO READ:

3. Remove the relay hold-down screws.

DESCRIPTION

Page 5-2 Fig. 5-1

CHANGE as shown below:

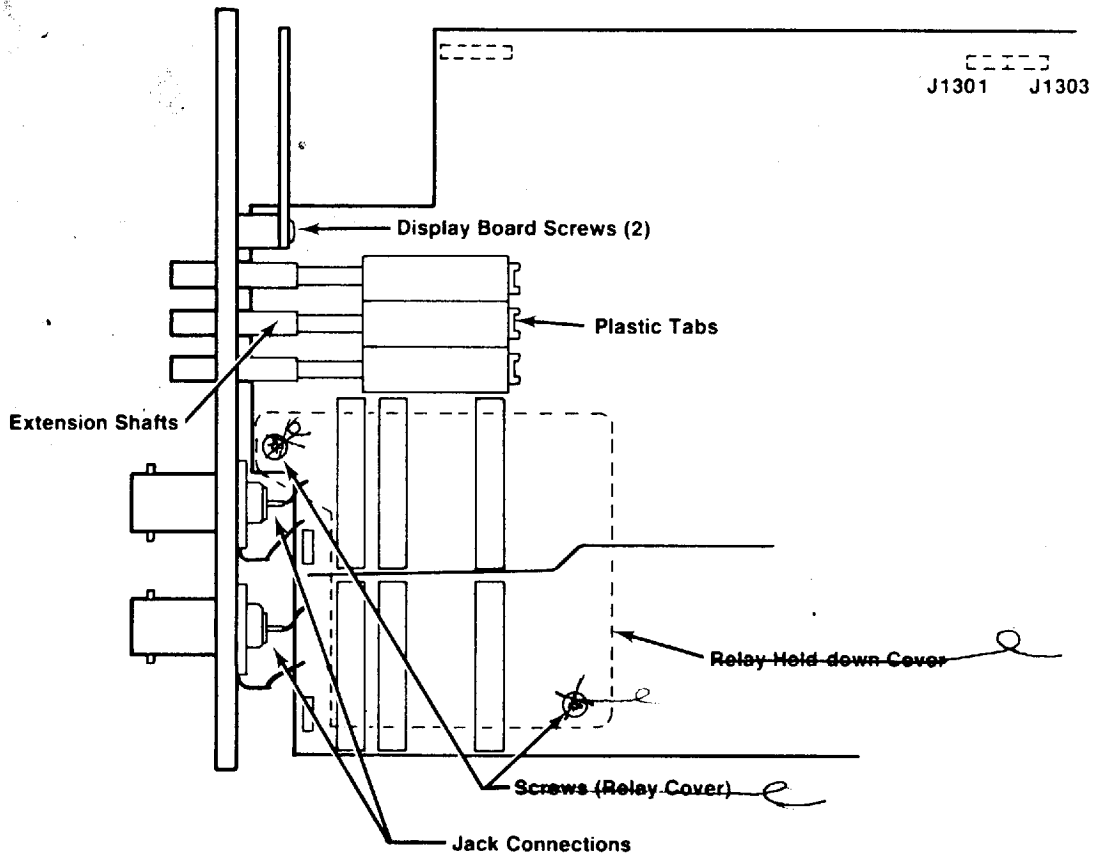

3464-17

Fig. 5-1. Partial right view of instrument with cover removed (pictorial).

Date: 5-27-81Change Reference: C2/581Product: DC 509 UNIVERSAL COUNTER/TIMERManual Part No.: 070-3464-00

DESCRIPTION

TEXT ADDITION

Page 1-1

ADD: To end of Instrument Description

This instrument is listed with underwriters Laboratories Inc. under UL standard 1244 (Electrical and Electronic Measuring and Testing Equipment) beginning with serial number B010455.

REPLACEABLE ELECTRICAL PARTS AND SCHEMATIC CHANGES

(PC #24)

EFF SN B010195

ADD:

A12C1120 281-0773-00 CAP., FXD, CER DI:0.01UF, 10%, 100V

A12C1130 281-0773-00 CAP., FXD, CER DI:0.01UF, 10%, 100V

DIAGRAM  CH A AMPLIFIERS AND RELAY CONTROL

C1120 is added from the cathode of CR1122 to the ground side of C1122.

DIAGRAM  CH B AMPLIFIERS AND RELAY CONTROL

C1130 is added from the cathode of CR1132 to the ground side of C1133.