

Tektronix 575 Modification Summaries

MOD SUMMARY INDEX

PRODUCT FILE 575,175

PAGE 1

SECTION TITLE	LOC	REFERENCE	PAGES
STEP GENERATOR	B1,B3	101.01	E1 101.06 E6
		101.02	E2 101.07 E7
		101.03	E3 101.08 E8
		101.04	E4 101.09 E10
		101.05	E5
STEP AMPLIFIER	B5,B7	102.01	E13 102.08 F7
		102.02	E14 102.09 F9
		102.03	F1 102.10 F10
		102.04	F2 102.11 F11
		102.05	F4 102.12 F12
		102.06	F5 102.13 F13
		102.07	F6
HORIZONTAL & VERTICAL AMPLIFIERS	B9,B11,B13	103.01	G1 103.09 G12
		103.02	G2 103.10 G13
		103.03	G4 103.11 G14
		103.04	G5 103.12 H1
		103.05	G6 103.13 H2
		103.06	G7 103.14 H3
		103.07	G8 103.15 H4
		103.08	G9
COLLECTOR SWEEP	C1	104.XX	See pg. 2-3
SWITCHING CIRCUIT	C5	105.XX	See pg. 2-3
LOW VOLTAGE POWER SUPPLY	C9	106.XX	See pg. 2-3
CRT & HIGH VOLTAGE	C13	107.XX	See pg. 2-3
MISCELLANEOUS	03	108.XX	See pg. 3-3
MODIFICATION KITS	D9	109.XX	See pg. 3-3
PARTS REPLACEMENT KITS	011	110.XX	See pg. 3-3
B,G,H MOD CROSS REFERENCE	D13		

MOD SUMMARY INDEX

PRODUCT FILE 575,175

PAGE 2

REFERENCE PAGE NO.	LOC	REFERENCE PAGE NO.	LOC
104.01	B1	107.08	G12
104.01	B2	107.09	G13
104.03	B3	107.10	G14
104.04	B4	107.11	H1
104.05	B5		
104.06	D5		
104.07	D7		
104.08	D8		
105.01	D10		
105.02	D11		
105.03	D12		
105.04	D13		
105.05	D14		
105.06	E1		
105.07	E3		
105.08	E4		
105.09	E5		
105.10	E9		
106.01	E11		
106.02	F12		
106.03	E13		
106.04	F1		
106.05	F2		
106.06	F10		
106.07	F11		
106.08	F12		
106.09	F13		
106.10	F14		
106.11	G2		
107.01	G3		
107.02	G4		
107.03	G5		
107.04	G6		
107.05	G7		
107.06	G8		
107.07	G11		

PRODUCT MODIFICATION INDEX

Type 575



1 STEP GENERATOR

CLASSIFICATIONS	
1	Required
2	Recommended
3	Information Only
U	Unclassified

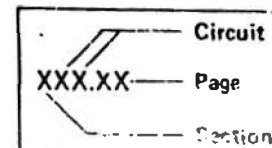

EFF. SN.	DESCRIPTION	CL	MOD. NO.	PAGE NO.	LABOR TIME	KIT NO.
151	Poor linearity of Step Zero Control corrected by changing R207 from a 500kΩ potentiometer, pn 311-0034-00, to a 100kΩ potentiometer, pn 311-0026-00.	U	1690	-----	-----	-----
328	Over-dissipation of Miller tube plate load resistor R172 prevented by changing from 100kΩ 0.5W, pn 302-0104-00 to 100kΩ 1W, pn 304-0104-00.	U	1783	-----	-----	-----
342	Change in amplitude of the step generator waveform when switching from 120 to 240 steps/second prevented by adding voltage divider to the cathode of V172A.	U	1810	101.01	-----	-----
537	To assure 90° phasing for both 50 and 60 cycle operation, R103 changed from 1MΩ 0.50W resistor, pn 301-0105-00, to 680kΩ 0.50W 5% resistor, pn 301-0684-00.	U	1920	-----	-----	-----
634	Trigger multi, V155, cathode resistor, R156, changed from 27kΩ 0.50W 10% resistor, pn 302-0273-00, to 27kΩ 1W 10% resistor, pn 304-0273-00.	U	1942	-----	-----	-----
7570	C177, a .01μF capacitor, pn 291-0019-00, does not meet 500V rating as marked. Part number changed to 291-0038-00 with 300V rating. New rating meets circuit requirements.	U	7313	-----	-----	-----
8030	Changes in step size due to temperature and time variations reduced by changing components to reduce circuit impedance.	U	8244-5	101.02	-----	-----
9260	Jitter on step voltage eliminated by removing bare wire connected between pins 3 and 6 of V152.	U	9719	-----	-----	-----
10650	Sweep jitter eliminated by adding a semiconductor diode in series with the Miller tube control grid disconnect diode.	U	10189	101.03	-----	-----

8-25-78

(continued)

##Changed since last publication.



Page 1A

PRODUCT MODIFICATION INDEX

Type 575

◇ 1 STEP GENERATOR (continued)

CLASSIFICATIONS	
1	Required
2	Recommended
3	Information Only
U	Unclassified

XXX.XX	—	Circuit
	—	Page
	—	Section

EFF. SN.	DESCRIPTION	CL	MOD. NO.	PAGE NO.	LABOR TIME	KIT NO.
11194	Drift and grid current corrected from a 6AU6 to a premium 8425 type tube.	U	11540	101.04	----	----
11430	Need to select V104B or V124B for gain reduced by changing R117 from a 10k Ω 0.50W resistor to a 27k Ω 0.50W resistor.	U	11704	101.05	----	----
11490	STEP/SECOND switch replaced with more reliable type.	U	10986	101.06	----	----
11870	SINGLE FAMILY/REPETITIVE/OFF switch changed to improved type.	U	10989	101.07	----	----
12260	Erratic display at 120 steps/second corrected by replacing grid resistors of V124B and V104B.	U	12715-1	101.08	----	----
12310	Calibration accuracy improved by changing the base volts step adjust circuit from a high impedance divider network to a low impedance clamp circuit.	U	12704	101.09	----	----
14110	Trace drift when going from REPETITIVE to OFF prevented by adding R152, a 100m Ω 0.125W resistor, pn 317-0107-00, between pins 1 and 7 of V152.	U	14419-1	-----	-----	-----

8-22-78

#Changed since last publication.



Page 18

PRODUCT MODIFICATION INDEX

Type 575

◇ 2 STEP AMPLIFIER

CLASSIFICATIONS
 1 Required
 2 Recommended
 3 Information Only
 U Unclassified

Circuit
 Page
 Section

EFF. SN.	DESCRIPTION	CL	MOD. NO.	PAGE NO.	LABOR TIME	KIT NO.
103	STEP SELECTOR switch resistors changed from 0.50W 1% to 8W 1%.	U	1588	102.01	-----	-----
397	Possibility of shorting the step amplifier power transistors to ground prevented by changing the mounting hardware.	U	1774	102.02	-----	-----
580	DC shift when switching the lower current ranges of the STEP SELECTOR switch in the base step generator prevented by changing the value of two resistors.	U	1933	102.03	-----	-----
1089	Error in step waveform eliminated by replacing base STEP GENERATOR POLARITY switch with a lower contact resistance type switch.	U	2058	102.04 110.01	----- 2.0h	----- 050-0021-00
1142	An error in the three highest ranges of the STEP SELECTOR switch corrected by changing the value of three resistors. See Mod 2273.	U	2059	102.05	-----	-----
1320	2% error in step generator with the STEP SELECTOR switch in the .2 or .1V position corrected by changing the value of three resistors.	U	2273	102.06	-----	-----
3370	To prevent the possibility of high transient currents passing through U the transistor under test when switching the STEP SELECTOR switch from milliamps/STEP to VOLTS/STEP, the switch was modified.	U	3285	102.07	-----	-----
4270	An adjustment of relative gains between the + and - step of the step generator is provided by changing R204 from a fixed resistor to a 200Ω mini-potentiometer.	U	3820	102.08	-----	-----
6630	To prevent over-dissipating R238, a 47kΩ 0.50W resistor, pn 302-0473-00, was changed to a 47kΩ 1W resistor, pn 304-0473-00.	U	7105-3	-----	-----	-----
7880	60kHz oscillation in the step amplifier prevented by changing Q243 from a 2N301 transistor, pn 151-0001-00, to a 2N2148 transistor, pn 151-0137-00. New transistor is a direct replacement.	U	7831	102.09	-----	-----

8-25-78

(continued)
 ##Changed since last publication.



Page 2A

PRODUCT MODIFICATION INDEX

Type 575

2 STEP AMPLIFIER (continued)

CLASSIFICATIONS	
1	Required
2	Recommended
3	Information Only
U	Unclassified

	Circuit
XXX.XX	Page
	Section

EFF. SN.	DESCRIPTION	CL	MOD. NO.	PAGE NO.	LABOR TIME	KIT NO.
8030	Error in SERIES RESISTOR switch circuit corrected by changing the 75Ω coax cable to 53.5Ω cable and adding 0.25W resistors in parallel with the series resistors.	U	8244-4	102.10	-----	-----
9540	Base drive changes when the SERIES RESISTOR switch is wiggled prevented by changing the mounting hardware for the SERIES RESISTOR switch.	U	9922	102.11	-----	-----
10430	Difficulty in selecting 6AU6 and 12AU6 tubes due to microphonics interface and grid current corrected by changing to premium 8425/6AU6 and 8426/12AU6 type tubes.	U	10548	102.12	-----	-----
10880	Low gain 12AU6 tubes compensated by changing plate resistors from 470kΩ to 510kΩ.	U	11017	102.13	-----	-----
14100	Possible damage to R241 when R243 overheats prevented by changing R243 from a 100Ω 8W, pn 308-0110-00, to a 300Ω 5W, pn 308-0070-00 resistor and relocating R243 away from R241.	U	15247	-----	-----	-----
14110	Gain change when moving STEP SELECTOR from .01VOLTS to .2VOLTS when in BASE SOURCE VOLTS position prevented by replacing R274 with a #22 bare wire and changing R273 to a 560Ω 0.125W 5% resistor, pn 317-0561-00.	U	14419-2	-----	-----	-----

8-25-78

≠ Changed since last publication.



Page 26

PRODUCT MODIFICATION INDEX

Type 575



3 HORIZONTAL AND VERTICAL AMPLIFIERS

CLASSIFICATIONS	
1	Required
2	Recommended
3	Information Only
U	Unclassified

	Circuit
XXX.XX	Page
	Section

EFF. SN.	DESCRIPTION	CL	MOD. NO.	PAGE NO.	LABOR TIME	KIT NO.
103	Collector current sampling resistors replaced to improve accuracy of the vertical display.	U	1586	103.01	----	----
148	Collector current sampling resistor replaced.	U	1583	103.02	----	----
316	Silkscreen data on rear overlay panel changed from horizontal input to external horizontal differential input .1V/DIV and vertical input changed to external vertical differential input .1V/DIV.	U	1697	-----	-----	-----
822	Damage to gain potentiometers prevented by relocating from switch wafers to a bracket mounted on the rear of the switch.	U	1755	103.03	----	----
822	SW405, the vertical VOLT/DIV switch changed to facilitate a field modification. Part number of switch changes from 262-0138-00 to 262-0189-00. See Mod 2038.	U	2003	-----	-----	-----
1280	Decrease in CRT sensitivity compensated by replacing R491 and R498 100k Ω 0.50W 1% resistor, pn 309-0045-00, to 78k Ω 0.50W 1% resistors, pn 309-0168-00.	U	2254	-----	-----	-----
1352	Vertical amplifier gain adjust range increased to compensate for CRT's with too high or too low sensitivity.	U	2352	103.04	----	----
2765	Damage to horizontal and vertical Diff Bal Mini-potentiometers prevented by relocating potentiometers from ceramic strips to a bracket on the step generator chassis. Part number of the bracket is 406-0619-00.	U	3121	-----	-----	-----
3660	Horizontal and vertical amplifier external inputs removed.	U	3456	103.05	----	-----

8-25-78

(continued)
changed since last publication.



Page 3A

PRODUCT MODIFICATION INDEX

Type 575



3 HORIZONTAL AND VERTICAL AMPLIFIERS (continued)

CLASSIFICATIONS
 1 Required
 2 Recommended
 3 Information Only
 U Unclassified

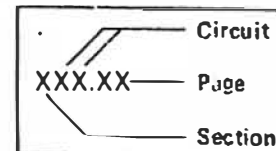

EFF. SN.	DESCRIPTION	CL	MOD. NO.	PAGE NO.	LABOR TIME	KIT NO.
4030	V344, V354, V444 and V454 changed from aged 12AU6 tubes, pn 157-0017-00, to a checked pair of 12AU6 tubes, pn 157-0065-00, to reduce test time and to provide better tubes for replacement purposes. See Mod 3805.	U	3744	-----	-----	-----
4180	To standardize the checked 12AU6's to the type with the best yield in selection V344, V354, V444 and V454 were changed from pn 157-0065-00 to pn 157-0050-00.	U	3805	-----	-----	-----
5120	Maximum gain adjust is difficult to obtain due to wiring error resulting from Mod 1583.	U	6003	103.06	-----	-----
6055	The 5% 0.25W carbon resistors changed to 0.5% 0.125W oxide film type resistors to improve reliability and availability of parts.	U	3873	103.07 103.08	----- 0.5h	----- 050-0065-00
6630	Drift due to grid current variations in input amplifier tubes reduced by changing screen voltage from 43V to 72V.	U	7105-1	103.09	-----	-----
6630	Inadequate range of horizontal and vertical amplifier DC balance potentiometers corrected by changing potentiometers from 5k Ω to 10k Ω .	U	7105-2	103.10	-----	-----
6975	Mod 122C ONLY. 2% error in vertical or collector current reading corrected by relocating ground point on the horizontal V/DIV switch and adding a compensating resistor.	U	7493	103.11	-----	-----
8030	Non-linear operation of the horizontal and vertical amplifiers corrected by raising the plate voltage to change the operating point of the first two stages.	U	8244-2	103.12	-----	-----
10430	Difficulty in selecting 6AU6 and 12AU6 tubes due to microphonics interface in grid current corrected by changing to premium 8425/6AU6 and 8426/12AU6 type tubes.	U	10548	102.12	-----	-----

8-25-78

(continued)
 ##Changed since last publication.



Page 38

PRODUCT MODIFICATION INDEX

Type 575

3 HORIZONTAL AND VERTICAL AMPLIFIERS (continued)

CLASSIFICATIONS
 1 Required
 2 Recommended
 3 Information Only
 U Unclassified

Circuit
 XXX.XX Page
 Section

EFF. SN.	DESCRIPTION	CL	MOD. NO.	PAGE NO.	LABOR TIME	KIT NO.
11510	ZERO VOLTS - ZERO CURRENT lever switch replaced with more reliable type.	U	10934	103.13	-----	-----
12110	Low gain of horizontal and vertical amplifiers compensated by changing R345 in the horizontal amplifier and R445 in the vertical amplifier to test selected parts.	U	12361	103.14 103.15	----- 1.0h	Included In. 050-0383-00

8-25-76

##Changed since last publication.



Page 3C

PRODUCT MODIFICATION INDEX

Type 575

◇ COLLECTOR SWEEP

CLASSIFICATIONS	
1	Required
2	Recommended
3	Information Only
U	Unclassified

/	Circuit
XXX.XX	Page
-	Section

EFF. SN.	DESCRIPTION	CL	MOD. NO.	PAGE NO.	LABOR TIME	KIT NO.
196	Collector sweep balance capacitor range snifted nearer to the center of its range by changing C734 from a 52pF 500V 5% capacitor, pn 283-0534-00, to a 120pF 500V capacitor, pn 283-0507-00. Superseded by Mod 1943.	U	1717	-----	-----	-----
359	Collector sweep chassis modified to reduce possibility of shorting the collector sweep chassis to the instrument chassis.	U	1843	104.01	-----	-----
509	Collector sweep chassis modified to reduce assembly time and to improve appearance.	U	1879	104.02	-----	-----
724	Collector sweep balance adjust capacitor range increased.	U	1943	104.03	-----	-----
6975	Collector sweep Mod 122C set up as production special	U	5801	104.04 104.05	----- 10.0h	----- 040-0276-00
8030	To assure that the COLLECTOR SWEEP voltage reaches 20V or 200V with line voltage at 105V, the turns ratio of the collector sweep transformer was increased 15%. Part number of the transformer remains the same.	U	8244-3	-----	-----	-----
9631	Irregular trace looping at high sensitivities prevented by insulating U the collector sweep transformer support post from the chassis.	U	10353	104.06	-----	-----
12197	PEAK volts powerstat changed from a 60Hz only type to a 50-50Hz type.	U	11904	104.07	-----	-----
13190	Collector sweep restarts at 50V instead of 0V; corrected by adding a fixed 270kΩ load across the collector supply.	U	13884	104.08	-----	-----
NA	To facilitate manufacturing, variable autotransformer (T701), pn 120-0476-00, was replaced with a new variable autotransformer, pn 120-0808-00.	3	32088	-----	-----	-----

8-25-78

(continued)
 # Changed since last publication.



Page 4A

PRODUCT MODIFICATION INDEX

Type 575

◇ 4 COLLECTOR SWEEP (continued)

CLASSIFICATIONS
 1 Required
 2 Recommended
 3 Information Only
 U Unclassified

— Circuit
 XXX.XX — Page
 — Section

EFF. SN.	DESCRIPTION	CL	MOD. NO.	PAGE NO.	LABOR TIME	KIT NO.
NA	To insure component availability, SW602, pn 260-0249-00, was replaced by a new switch, pn 260-0249-01.	3	S32317	-----	-----	-----

8-25-78

###Changed since last publication.



Page 48

PRODUCT MODIFICATION INDEX

Type 575

◇ 5 SWITCHING CIRCUIT

CLASSIFICATIONS
 1 Required
 2 Recommended
 3 Information Only
 U Unclassified

Circuit
 XXX.XX Page
 Section

EFF. SN.	DESCRIPTION	CL	MOD. NO.	PAGE NO.	LABOR TIME	KIT NO.
103	Collector current sampling resistors replaced to improve accuracy of the vertical display.	U	1586	103.01	-----	-----
103	STEP SELECTOR switch resistors changed from 0.50W 1% to 8W 1%.	U	1588	102.01	-----	-----
145	Collector current sampling resistors replaced.	U	1582	105.01	-----	-----
233	Collector current sampling resistors changed from 1% to 1/2% tolerance to improve the accuracy of the vertical display. Superseded by Mod 1759.	U	1587	105.02	-----	-----
246	Collector current sampling resistors replaced.	U	1752	105.03	-----	-----
793	Collector current sampling resistors changed to improve the accuracy of the vertical display.	U	1759	105.04	-----	-----
861	Range of the COLLECTOR CURRENT/DIV switch extended by adding a X2 and a X.1 pushbutton collector current multiplier.	U	2038	105.05	-----	-----
1089	Error in step waveform eliminated by replacing base STEP GENERATOR POLARITY switch with a lower contact resistance type switch.	U	2058	102.04	-----	-----
1142	An error in the three highest ranges of the STEP SELECTOR switch corrected by changing the value of three resistors.	U	2059	102.05	-----	-----
1320	A 2% error in the step generator with the STEP SELECTOR switch in the .2 or .1V position was corrected by changing the value of three resistors.	U	2273	102.06	-----	-----
3370	To prevent the possibility of high transient currents passing through U the transistor under test when switching the STEP SELECTOR switch from milliamps/STEP to VOLTS/STEP, the switch was modified.	U	3285	102.07	-----	-----

8-28-78

(continued)
 # Changed since last publication.



Page 5A

PRODUCT MODIFICATION INDEX

Type 575

◇ 5 SWITCHING CIRCUIT (continued)

CLASSIFICATIONS	
1	Required
2	Recommended
3	Information Only
U	Unclassified

—	Circuit
XXX.XX	Page
—	Section

EFF. SN.	DESCRIPTION	CL	MOD. NO.	PAGE NO.	LABOR TIME	KIT NO.
3900	An erroneous saturation slope display when checking high current transistors, caused by wire resistance, prevented by changing the pick-off point of the horizontal sensing voltage.	U	3658	105.06	-----	-----
4820	Mesa transistors can cause the collector sweep to oscillate and distort the display.	U	5516-1	105.07	-----	-----
4820	To improve isolation between base and collector sections of the transistor selector switch, a bare wire was added between contacts on the selector switch. Superseded by Mod 6375.	U	5516-2	-----	-----	-----
5910	Transistor selector switch, SW730, changed from pn 260-0197-00 to pn 260-0423-00 to improve reliability.	U	6375	105.08 105.09	----- 2.0h	----- 050-0070-01
6055	The 5% 0.25W carbon resistors changed to 0.5% 0.125W oxide film type resistors to improve reliability and availability of parts.	U	3873	103.07	-----	-----
8030	Error in SERIES RESISTOR switch circuit corrected by changing the 75Ω coax cable to 53.5Ω cable and adding 0.25W resistors in parallel with the series resistors.	U	8244-4	102.10	-----	-----
See Mod	Switch contacts changed to gold plated type to reduce noise.	U	10070	105.10	-----	-----
9540	Base drive changes when the SERIES RESISTOR switch is wiggled prevented by changing the mounting hardware for the SERIES RESISTOR switch.	U	9922	102.11	-----	-----
14490	R246G changed from 5kΩ 0.50W 1% precision carbon, pn 309-0159-00, to 5kΩ 0.25W 1% metal film, pn 322-0677-00. R246G is located on the STEP SELECTOR switch.	U	15767	-----	-----	-----

8-23-78

≠ Changed since last publication.



Page 58

PRODUCT MODIFICATION INDEX

Type 575



6 LOW VOLTAGE POWER SUPPLY

CLASSIFICATIONS	
1	Required
2	Recommended
3	Information Only
U	Unclassified

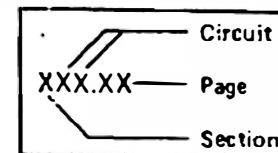

EFF. SN.	DESCRIPTION	CL	MOD. NO.	PAGE NO.	LABOR TIME	KIT NO.
233	To prevent line fuse from blowing during line voltage surges, F601, was changed from a 4A fast-blo, pn 159-0017-00, to a 3A slo-blo, pn 159-0005-00. Superseded by Mod 3610.	U	1754	-----	-----	-----
511	Motor base connector changed from two contact to three contact type to provide separate ground circuit.	U	1912	105.01	-----	-----
511	Motor base connector wires color coded to assure that hot side of line is connected to the power switch.	U	1934	-----	-----	-----
901	Power cable changed so that all switching takes of line.	U	2015	106.02	-----	-----
3660	Motor base connector changed to recessed type.	U	3456	103.05	-----	-----
3810	A 3 amp slo-blo fuse is not adequate for use with 50 cycle power source. F601 changed from a 3 amp slo-blo, pn 159-0005-00, to a 4 amp slo-blo, pn 159-0027-00, for 117V operation. The 1.6A slo-blo, pn 159-0003-00, used for 234V operation was changed to a 2A slo-blo, pn 159-0023-00.	U	3610	-----	-----	-----
3990	Silkscreening on power chassis changed to make standard chassis compatible with Mod 122C chassis. Part number of power chassis changes from 441-0161-00 to 441-0627-00.	U	9032	-----	-----	-----
4770	Radiation of 60 cycle line signal into collector sweep balance circuit prevented by changing AC power wires to shielded cable.	U	5217	106.03	-----	-----
4930	Selenium rectifiers replaced with more reliable silicon diodes.	U	5272	106.04 106.05	----- 1.0h	----- 040-0223-00

(continued)

8-28-78

Changed since last publication.



Page 6A

PRODUCT MODIFICATION INDEX

Type 575

◇ 6 LOW VOLTAGE POWER SUPPLY (continued)

CLASSIFICATIONS	
1	Required
2	Recommended
3	Information Only
U	Unclassified

—	Circuit
XXX.XX	Page
—	Section

EFF. SN.	DESCRIPTION	CL	MOD. NO.	PAGE NO.	LABOR TIME	KIT NO.
8030	To protect power transformer T501 when diodes or capacitors short, F240 and F241, 5A fast-blo fuses, were added in the + and -15V supply circuits.	U	8244-1	106.06	-----	-----
9169	Multiple taps added to primary of power transformer to permit operating on a wider selection of input voltages.	U	9181	106.07	-----	-----
10090	Inadequate range of -150V supply adjustment corrected by changing the value of two resistors.	U	10413	106.08	-----	-----
10650	Silicon diode type changed to facilitate layout.	U	9973	106.09	-----	-----
11790	A bare wire connected between the line fuse and the hot side of the 117V AC line connector was replaced with a 3" length of #18 insulated wire.	U	12107	-----	-----	-----
12260	Deterioration of the -150V power supply regulation with aging of tubes decreased by changing the value of several components.	U	12715-2	106.10	-----	-----
12360	Power light color changed to standard green. Part number of pilot light jewel changes from 378-0518-00 to 378-0513-00.	U	12031	-----	-----	-----
12390	Motor base ground connection improved.	U	12876	106.11	-----	-----
NA	100V 15A semiconductor rectifier w/mounting hardware, pn 152-0088-00, replaced by rectifier pn 152-0088-01 and TEFLON® washer pn 210-1115-00 to provide closer tolerance control of washers.	U	16181	-----	-----	-----

8-28-78

TEFLON is a registered trademark of E.I. duPont de Nemours and Company, Inc.

≡ Changed since last publication.



Page 6B

PRODUCT MODIFICATION INDEX

Type 575

7 CRT AND HIGH VOLTAGE

CLASSIFICATIONS
 1 Required
 2 Recommended
 3 Information Only
 U Unclassified

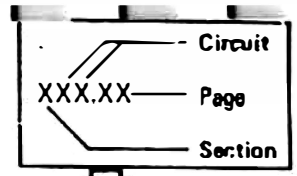

EFF. SN.	DESCRIPTION	CL	MOD. NO.	PAGE NO.	LABOR TIME	KIT NO.
346	CRT anode connector changed to an improved type.	U	1659	107.01	-----	-----
1620	To permit easier and more precise CRT rotation, the CRT mounting bracket was redesigned and a rotator added.	U	2354	107.02	-----	-----
1943	C813 changed from a 0.105µF 3kV oil-filled capacitor, pn 285-0513-00, to a 0.01µF 2kV ceramic capacitor, pn 283-0011-00.	U	2895	-----	-----	-----
2390	High voltage capacitors changed from oil-filled to more reliable ceramic type capacitors.	U	2844	107.03	-----	-----
NA	CRT light filter changed from pn 378-0503-00 to pn 378-0514-00.	U	3029	-----	-----	-----
4690	Intensity modulation reduced by relocating -1700V test point wire.	U	5457	107.04	-----	-----
4929	Slippage of the CRT during shipment of instrument prevented by replacing CRT securing ring assembly with an improved type.	U	5400	107.05 107.06	----- 1.0h	----- 050-0063-00
7410	High voltage oscillator V810 tube socket, pn 136-0008-00, and shield socket, pn 337-0004-00, replaced by shielded socket, pn 136-0010-00, to facilitate assembly.	U	7328	-----	-----	-----
9710	Shape and color of CRT light filters standardized to eliminate stocking of unnecessary parts.	U	9022	107.07	-----	-----
9830	Standard CRT phosphor changed from P1 to P31.	U	10164	107.08	-----	-----
10220	High failure of C809 reduced by changing to a 3kV type capacitor.	U	10797	107.09	-----	-----
10320	Trace flicker eliminated by relocating C818 from the intensity potentiometer to the plate of V822.	U	11091	107.10	-----	-----

(continued)

8-28-78

Changed since last publication.



Page 7A

PRODUCT MODIFICATION INDEX

Type 575

◇ 7 CRT AND HIGH VOLTAGE (continued)

CLASSIFICATIONS
 1 Required
 2 Recommended
 3 Information Only
 U Unclassified

Circuit
 XXX.XX Page
 Section

EFF. SN.	DESCRIPTION	CL	MOD. NO.	PAGE NO.	LABOR TIME	KIT NO.
12420	FOCUS and INTENSITY potentiometers R822 and R826 changed from pn 311-0043-00 to pn 311-0043-02 to improve quality of parts and provide better supply of potentiometers.	U	11639	-----	-----	-----
13500	CRT rotator stud retaining plate added to prevent the stud from working loose.	U	13795	107.11	-----	-----

8-28-78

##Changed since last publication.



Page 78

PRODUCT MODIFICATION INDEX

Type 575

◇ 8 MISCELLANEOUS

CLASSIFICATIONS
 1 Required
 2 Recommended
 3 Information Only
 U Unclassified

Circuit
 XXX.XX Page
 Section

EFF. SN.	DESCRIPTION	CL	MOD. NO.	PAGE NO.	LABOR TIME	KIT NO.
107	R731, a 100Ω 0.50W 10% resistor, pn 302-0101-00, added from the contact arm of the transistor selector switch to the DISSIPATION LIMITING RESISTOR switch and to V733 to restore the trace for the SELECTOR switch in the center position.	U	1698	-----	-----	-----
227	Information on the resistors selection chart was reworded to make it more understandable.	ii	1738	108.01	-----	-----
434	Two power transistor test adapters, pn 013-0012-00, added to list of standard accessories to accommodate the new power transistors.	U	1854	-----	-----	-----
531	Left and right cabinet sides changed from pn 386-0706-00 and pn 386-0677-00 to pn 386-0773-00 and pn 386-0783-00, respectively.	ii	1736	-----	-----	-----
iiA	To provide quick identification of Tek-made selenium rectifiers, part number will be stamped on the end plate of the rectifier.	U	1932	-----	-----	-----
789	To eliminate possible confusion resulting from the use of a knob with a single dot to apply to information on the panel both above and below the knob, the PEAK VOLT RANGE knob is replaced with a knob with two dots. Part number of knob changes from 366-0033-00 to 366-0089-00.	U	2024	-----	-----	-----
1280	Ceramic strips changed to clip-mounted type to facilitate production.	U	2203	108.02	-----	-----
1449	Instrument handle, pn 376-0001-00, and bar, pn 381-0092-00, replaced with an improved design. Part number of new handle is 376-0011-00 and part number of bar is 381-0126-00.	U	2027	-----	-----	-----
2266	To obtain a tougher easier to clean finish, material used for cabinet side, bottom, overlays, etc., wash changed to textured aluminum.	U	2545	108.03	-----	-----

8-28-78

(continued)
 # Changed since last publication.



Page 8A

PRODUCT MODIFICATION INDEX

Type 575

◇ 8 MISCELLANEOUS (continued)

CLASSIFICATIONS	
1	Required
2	Recommended
3	Information Only
U	Unclassified

—	Circuit
XXX.XX	Page
—	Section

EFF. SN.	DESCRIPTION	CL	MOD. NO.	PAGE NO.	LABOR TIME	KIT NO.
2266	Rear panel and subpanel modified to permit installing the Type 175 high current adapter interconnect plug. A cover plate, pn 387-0207-00, is installed on Type 575's which are shipped without the Type 175.	U	2815	-----	-----	-----
2700	Transistor test socket replaced with an improved type. Part number of socket changes from 136-0050-00 to 136-0095-00.	U	3181	-----	-----	-----
2828	To provide means of supplying signal and power between the Type 575 and Type 175 an interconnecting plug was added to the rear panel. Cover plate, pn 387-0207-00, was no longer required. Part number of cable adapter, 179-0485-00, and interconnect socket, 136-0089-00.	U	3247	-----	-----	-----
NA	Semiconductor information standardized. All semiconductor types are deleted from chassis leaving only the circuit designation. Circuit designation of silicon diodes changes from V to D and circuit designation of transistors changes from V to Q.	U	3535	-----	-----	-----
4860	Top support bar assembly, pn 381-0151-00, replaced with lighter assembly, pn 381-0206-00.	U	3861	-----	-----	-----
5410	Test jack panel mounting modified and revised to permit use in the Type 570 and the Type 575. No part number changes.	U	3801	-----	-----	-----
NA	Transistor test adapter modified to prevent breakage. Part number 013-0010-00 and 013-0012-00 replaced by 013-0069-00 and 013-0070-00, respectively.	U	6309	-----	-----	-----
8020	NE2 type neons replaced with more stable and reliable NE23 type neons.	U	7843	108.04	-----	-----
8510	Switch noise reduced by adding a thin coat Cramolin cleaner and lubricant to the switch rotors to retard corrosion.	U	8662	-----	-----	-----

8-28-78

(continued)

##Changed since last publication.



Page 8B

PRODUCT MODIFICATION INDEX

Type 575



MISCELLANEOUS (continued)

CLASSIFICATIONS	
1	Required
2	Recommended
3	Information Only
U	Unclassified

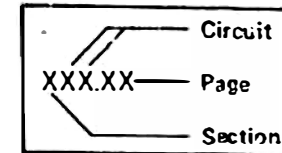

EFF. SN.	DESCRIPTION	CL	MOD. NO.	PAGE NO.	LABOR TIME	KIT NO.
NA	Electrolytic capacitor assemblies changed to facilitate replacement.	U	S8959	108.05	-----	-----
11790	Inadequate ground connection between power cord and instrument motor base corrected by adding a ground spring to the non-current carrying ground receptacle.	U	11292	108.06 108.07	----- 0.3h	----- 040-0424-01
12030	Motor base connector redesigned to facilitate production. Superseded by Mod 12876.	U	9271	108.08	-----	-----
12510	Bottom cabinet frame modified to accommodate anti-slide feet.	U	12380	108.09	-----	-----
13080	A more obvious warning sign is needed to indicate presence of lethal voltages which can be present on the front panel during testing of certain types of transistors.	U	13165	108.10 108.11	----- 0.3h	----- 040-0486-00
13430	Transistor test adapter replaced with a new type which will accommodate either small or large power transistors.	U	13141	108.12	-----	-----
14673	3/4 inch ceramic strips replaced with 7/16 inch ceramic strips.	U	16795	108.13	-----	-----
14670	Carbon film resistors, pn 309-XXXX-XX (0.5W) and 310-XXXX-XX (1W) were replaced with more reliable metal film resistors, pn 323-XXXX-XX and 325-XXXX-XX.	U	18313	108.14	-----	-----
NA	To insure component availability, transistor adapter, pn 013-0070-00, 3 was replaced with a new transistor adapter, pn 013-0070-01.		S32841	-----	-----	-----

8-28-78

Changed since last publication.



Page 8C

PRODUCT MODIFICATION INDEX

Type 575



9 MODIFICATION KITS

CLASSIFICATIONS
 1 Required
 2 Recommended
 3 Information Only
 U Unclassified

Circuit
 XXX.XX Page
 Section

EFF. SN.	DESCRIPTION	CL	MOD. NO.	PAGE NO.	LABOR TIME	KIT NO.
101-4929	SILICON RECTIFIER MODIFICATION KIT		5272	106.05	1.0h	040-0223-00
ALL	INCREASED COLLECTOR VOLTS MODIFICATION KIT		5801	104.05	10.0h	040-0276-00
ALL	CRADLE MOUNT MODIFICATION KIT		-----	109.01	2.0h	040-0281-00
ALL	3-WIRE POWER CORD FEMALE GROUND CONNECTION IMPROVEMENT MODIFICATION KIT		11292	108.07	0.3h	040-0424-01
101-13080	TEST TERMINAL VOLTAGE WARNING TAG MODIFICATION KIT		13165	108.11	0.3h	040-0486-00

8-28-78

##Changed since last publication.



Page 9

Type 575

10 PARTS REPLACEMENT KITS

1	Required
2	Recommended
3	Information Only
U	Unclassified

XXX.XX	Page
	Section

EFF. SN.	DESCRIPTION	CL	MOD. NO.	PAGE NO.	LABOR TIME	KIT NO.
101-1088	IMPROVED BASE STEP GENERATOR POLARITY SWITCH		2058	110.01	2.0h	050-0021-00
1620-4928	CRT SECURING RING		5400	107.06	1.0h	050-0063-00
101-6054	PRECISION RESISTORS		3873	103.08	0.5h	050-0065-00
101-5909	TRANSISTOR SELECTOR SWITCH		6375	105.09	2.0h	050-0070-01
101-6054	HORIZONTAL VOLTS/DIV SWITCH		-----	110.02	0.5h	050-0104-00
101-1351	T0520-7 (P-7 PHOSPHOR) CRT REPLACEMENT		-----	110.03	1.0h	050-0218-10
101-1351	T0520-11 (P-11 PHOSPHOR) CRT REPLACEMENT		-----	110.04	1.0h	050-0218-11
101-1351	T0520-31 (P-31 PHOSPHOR) CRT REPLACEMENT		-----	110.05	1.0h	050-0218-12
101-12109	HORIZONTAL AND VERTICAL AMPLIFIER TUBES		12361	103.15	1.0h	050-0383-00
ALL	CRT REPLACEMENT		-----	110.06	1.0h	050-0778-00

10-9-78

≡ Changed since last publication.



Page 10



Beaverton Mods - Guernsey/Holland S/Ns.

TYPE Instrument 575

Page 1 of 2

November 1972

PRODUCED BY FIELD SUPPORT, TETRONIX LTD.

FOR FULL MOD DETAILS REFER TO MICROFICHE

BEAVERTON MOD. NO.	EFFECTIVE SERIAL NUMBERS				MODIFICATION KIT PART NUMBERS
	GUERNSEY	DATE	HEERENVEEN	DATE	
M5516	100001	27.6.62			
-	100092	28.3.63			
M6375	100106	29.5.63			050-0070-00
M8861	-	30.9.63			
M7328	100143	13.11.63			
M7313	100133	19.11.63			
M7105-1	100143	14.12.63			
M7105-2	100143	14.12.63			
M7105-3	100143	14.12.63			
M7493	100143	7.1.64			
M6309	100178	20.4.64			
M7831	100208	29.10.64			
M8662	-	22.11.64			
M8244-1	100223	11.12.64			
M8244-2	100223	11.12.64			
M8244-3	100223	11.12.64			
M8244-4	100223	11.12.64			
M8244-5	100223	11.12.64			
M7543	100346	5.1.65			
M9032	100306	25.6.65			
M9719	100306	19.7.65			
M9922	100306	20.10.65			
M9181	100334	26.10.65			
M10353	100348	4.1.66			
M10413	100378	19.4.66			
M10164	100382	27.4.66			
M10797	100408	2.5.66			
M10189	100412	16.6.66			
M10070	100434	8.7.66			(for SW 246)
M10070	100430	8.7.66			(for SW 305)
M10070	100426	8.7.66			(for SW 248)
M10070	100420	8.7.66			(for SW 405)

* COPIES OF MODIFICATION INSTRUCTIONS OR MOD KIT. INSTRUCTIONS ARE AVAILABLE FROM BEAVERTON - PLEASE ORDER BY DESCRIPTION - QUOTING MU AND MOD NUMBER



Beaverton Mods - Guernsey/Holland S/Nos.

TYPE Instrument 575 continued

Page 2 of 2

November, 1972

PRODUCED BY FIELD SUPPORT, TEKTRONIX LTD.

FOR FULL MOD DETAILS REFER TO MICROFILM

BEAVERTON MOD. NO.	EFFECTIVE SERIAL NUMBERS				MODIFICATION KIT PART NUMBERS
	GUERNSEY	DATE	HEERENVEEN	DATE	
M11017	100448	6.9.66			
M10070	100453	20.9.66			(for SW 710)
M10070	100450	20.9.66			(for SW 706)
M10070	100454	20.9.66			(for SW 708)
M10070	100483	17.10.66			(for SW 305)
M10070	100479	17.10.66			(for SW 305)
M10070	100475	17.10.66			(for SW 210)
M10070	100534	17.10.66			(for SW 708)
M10070	100483	17.10.66			(for SW 706)
M10548	-	24.10.66			
M11540	100468	20.10.66			
M11704	100485	23.11.66			
M12107	100531	7.3.67			
M12031	100662	13.3.67			
M10986	100559	18.4.67			
M10934	100576	31.5.67			
M11292	100574	2.6.67			040-04271-01
M11091	100599	11.7.67			
M12715-1	100607	23.8.67			MI-12715-1
M12715-2	100607	23.8.67			MI-12715-2
M12704	100607	23.8.67			
M9271	100647	5.12.67			050-0383-00
M12876	100677	5.12.67			MI-12876
M10989	100690	8.4.68			MI-10989
M12361	100700	24.5.68			050-0383-00
M13884	100707	10.6.68			
M13165	100746	24.12.68			040-0486-00
M13165					
Part. 2	100777	10.7.69			
M12380	100778	11.7.69			
	100061				040-0276-00
	100091				040-0281-00

* COPIES OF MODIFICATION INSTRUCTIONS OR MOD KIT. INSTRUCTIONS ARE AVAILABLE FROM BEAVERTON - PLEASE ORDER BY DESCRIPTION - QUOTING 'MI' AND MOD NUMBER

CHARGING DIODES CIRCUIT CHANGED

Effective Prod SN 342

Usable in SN 101-341

An apparent change in step amplifier sensitivity occurs when switching the step generator from 120 to 240 steps/sec. This appears as a change in amplitude of the step generator waveform.

A small 'low contact resistance' current flow through diode V172 during its non-conducting period, especially with unaged diodes, causing a slight drop in plate voltage of the Miller tube, V171, between steps.

Current flow through V172 during the non-stepping period of the stairstep waveform is prevented by biasing the cathode of the diode approximately 1 volt positive with respect to the plate.

Parts Added:

R173	302-0104-00	Resistor, comp.,	100k	1/2W	10%
R176	302-0102-00	Resistor, comp.,	1k	1/2W	10%

INSTALLATION:

Parts Required: See 'Parts Added'.

- Install R176, a 1k 1/2W 10% resistor, from the cathode of V172B to ground.
- Install R173, a 100k 1/2W 10% resistor, from the cathode of V172B to the +100V supply.

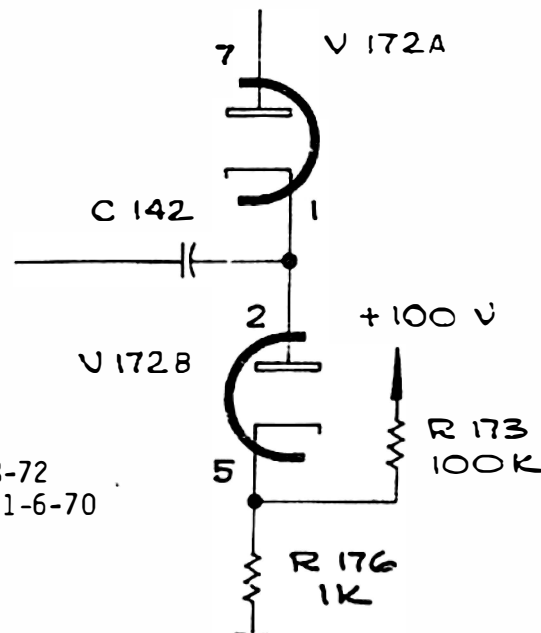

STEP GENERATOR TEMPERATURE STABILITY IMPROVED

Effective Prod SN 8030

Changes in step size, caused by temperature and time variations, reduced by changing component values to reduce circuit impedance and replacing composition components with more stable wire-wound and metal-film types, and by adding other circuitry.

Parts Removed:

R102	311-0018-00	Potentiometer, comp.,	20k		
R136 R138	302-0105-00	Resistor, comp.,	1M	1/2W	10%
R139	311-0026-00	Potentiometer, comp.,	100k		
R142	302-0473-00	Resistor, comp.,	47k	1/2W	10%
R143	306-0473-00	Resistor, comp.,	47k	2W	10%
R168	302-0104-00	Resistor, comp.,	100k	1/2W	10%
R176	302-0102-00	Resistor, comp.,	1k	1/2W	10%

Parts Added:

R102	311-0151-00	Potentiometer, WW	20k		
R135	323-0481-00	Resistor, prec.,	1M	1/2W	1%
R136	323-0414-00	Resistor, prec.,	200k	1/2W	1%
R138	323-0452-00	Resistor, prec.,	499k	1/2W	1%
R139	311-0218-00	Resistor, WW,	50k	2W	
R142	323-0353-00	Resistor, prec.,	46.4k	1/2W	1%
R143	324-0356-00	Resistor, prec.,	49.9k	1W	1%
R168	302-0563-00	Resistor, comp.,	56k	1/2W	10%
R176	302-0222-00	Resistor, comp.,	2.2k	1/2W	10%

D152 ADDED TO REDUCE SELECTION OF V152

Effective Prod SN 10650

Usable in SN 101-10649

Excessive leakage of the Miller disconnect diode was causing sweep jitter.

A low leakage semiconductor diode was added in series with the Miller tube control grid disconnect diode. This combines the low leakage characteristics of the semiconductor with the fast turn-off capability of the vacuum diode.

Parts Added:

D152	152-0246-00	Diode, low leakage silicon
------	-------------	----------------------------

INSTALLATION:

Parts Required: See 'Parts Added'.

Replace the bare wire between the pin 1 of V152 and the ceramic strip notch with D152, install with cathode (banded end) toward the ceramic strip.

V171 REPLACED TO ELIMINATE DRIFT

Effective Prod SN 11194

Miller run-up tube, V171, in the Step Generator circuit had a drift and grid current problem which increased with the age of the tube.

The Miller run-up tube was changed from a 6AU6 to a premium 8425/6AU6 tube.

Parts Removed:

V171	154-0022-00	Tube, raw, vacuum, 6AU6
------	-------------	-------------------------

Parts Added:

V171	154-0022-07	Tube, raw, vacuum, 8425/6AU6
------	-------------	------------------------------

V104B AND V124B SCREEN VOLTAGE INCREASED

Effective Prod SN 11430

Usable in SN 101-11429

Step generator mixer tubes, V104B and V124B, were frequently rejected because of low gain.

The screen divider resistor, R117, for V104B and V124B was changed from 10k to 27k which changed the screen voltage from 24 volts to 51 volts.

Parts Removed:

R117 302-0103-00 Resistor, comp., 10k 1/2W 10%

Parts Added:

R117 302-0273-00 Resistor, comp., 27k 1/2W 10%

INSTALLATION:

Parts Required: See 'Parts Added'.

Replace R117, a 10k 1/2W 10% resistor located between CSG-i3 and CSH-13, with a 27k 1/2W 10% resistor.

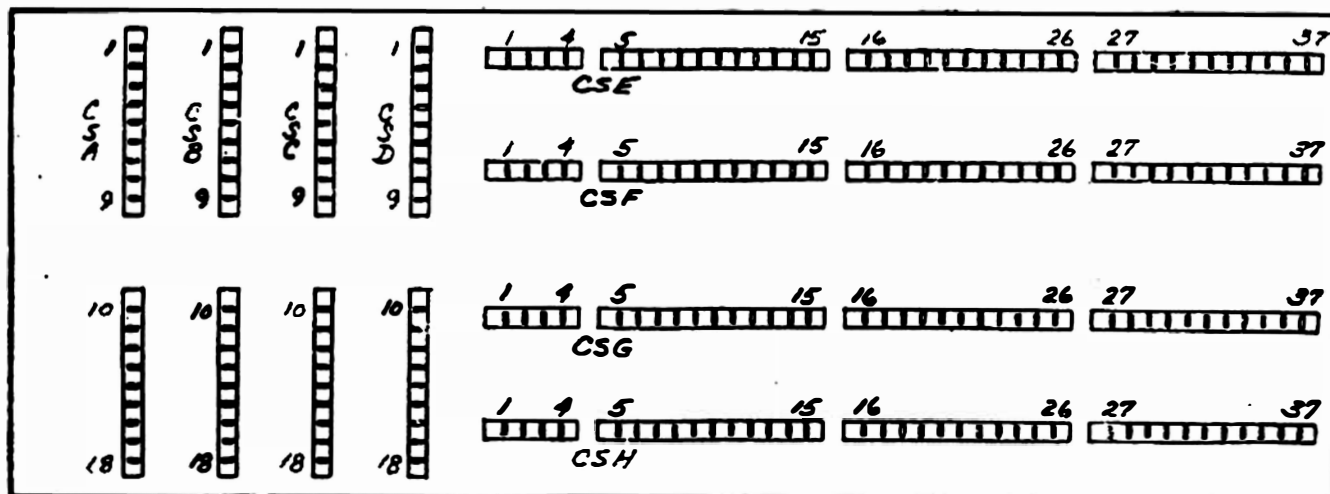

SW114 REPLACED WITH MORE RELIABLE TYPE

Effective Prod SN 11490

Usable in SN 101-11489

No steps in 240 STEPS/SEC position.

STEPS/SEC fails to make contact in center (240 STEPS/SEC) position. Switch failure caused by metal fatigue. Switch has a lifetime of approximately 100,000 cycles.

The STEPS/SEC lever switch was replaced with a new type lever switch.

Parts Removed:

SW114	260-0195-00	Switch, raw, lever, SPDT locking
-------	-------------	----------------------------------

Parts Added:

SW114	260-0195-01	Switch, raw, lever, SPDT locking
-------	-------------	----------------------------------

INSTALLATION:

Parts Required: See 'Parts Added'.

Replace the STEPS/SEC switch with the new type switch. The new switch is a direct replacement.

SW145 CHANGED TO MORE RELIABLE TYPE

Effective Prod SN 11870

Usable in SN 101-11869

Armature switch leaves break after approximately 50,000 cycles. This life can be exceeded in a short time when instruments are used in production line testing.

An alternate source was chosen for better construction of switch leaves and 400% increase in mechanical life.

Parts Removed:

SW145	260-0190-00	Switch, raw, lever DPDT locking position	(1)
-------	-------------	---	-----

Parts Added:

SW145	260-0190-02	Switch, raw, lever DPDT locking position	(1)
-------	-------------	---	-----

INSTALLATION:

Parts Required: See 'Parts Added'.

Replace the SINGLE FAMILY-REPETITIVE-OFF switch with the new type switch. The new switch is wired the same as the old switch except as follows: Add a bare wire from the two center contacts to the center ground connector.

ELIMINATES ERRATIC DISPLAY IN 120/SEC DISPLAY

Effective Prod SN 12260

Usable in SN 101-12259

The transistor displays are erratic when the BASE STEP GENERATOR STEPS/SEC switch is in either of the 120 steps positions.

R114 and R134, two 10M resistors, are connected from the grids of V104B and V124B to the 120 steps positions of the STEPS/SEC switch. In the 120 steps positions of the STEPS/SEC switch, one of the mixer tubes (V104B or V124B) is biased off. Because of the high value of R114 and R134, any grid current over $2\mu\text{A}$ will prevent the mixer tube (6AN8) from being completely cut-off, and cause an erratic step function to be applied to the base of the transistor under test.

The grid resistors, R114 and R134, were reduced in value from 10M to 4.7M.

Parts Removed:

R114	302-0106-00	Resistor, 10M 1/2W 10%
R134		

Parts Added:

R114	302-0475-00	Resistor, 4.7M 1/2W 10%
R134		

INSTALLATION:

Parts Required: See 'Parts Added'.

- a) Replace R114, a 10M 1/2W 10% resistor located between CSE-28 and CSF-28, with a 4.7M resistor.
- b) Replace R134, a 10M 1/2W 10% resistor located between CSE-17 and CSF-17, with a 4.7M resistor.

Continued.

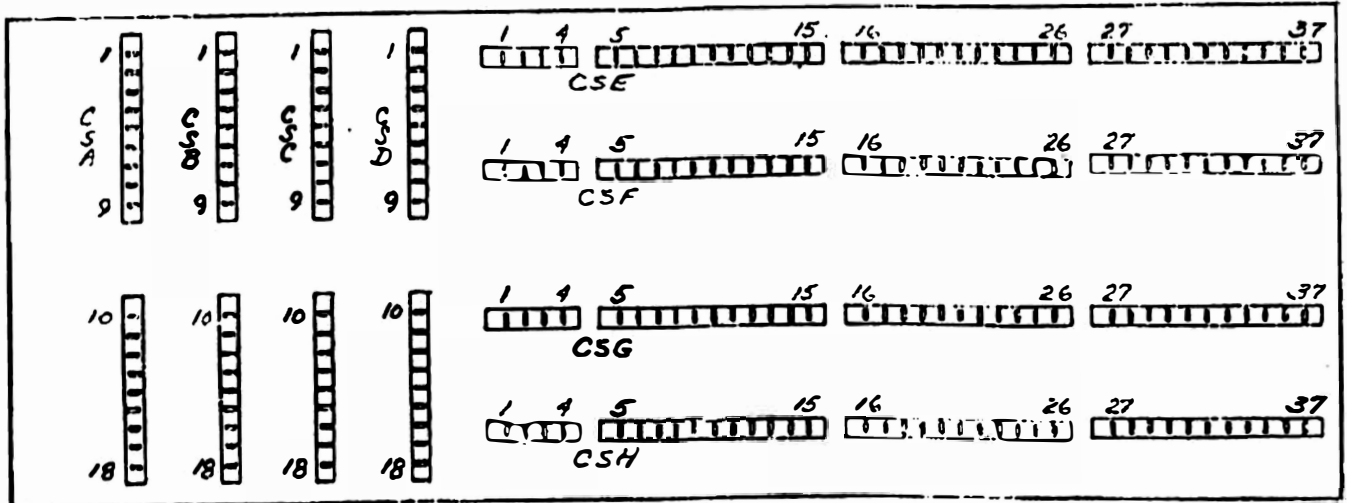

IMPROVES CALIBRATION ACCURACY OF STEP GENERATOR

Effective Prod SN 12310

Usable in SN 101-12309

The clamp and mixer tubes, V163B, V104B and V124B (6AN8's) have a common plate load network. Because of the high impedance of this network, the circuit is greatly affected by plate leakage. Many 6AN8's have leakages as high as $30\mu\text{A}$ when the grid is biased way beyond cut-off. The leakage is somewhat dependent on cathode temperature, i.e., line voltage. At high line, the step generator may be as much as 10% out of calibration.

The Base Volts/Step Adj circuit was changed from a high impedance divider network to a lower impedance clamp circuit as follows (see schematic:

R135 was changed from a 1M 1% resistor to a 1M 5% resistor

R136 was removed

R13B was replaced with a silicon diode

R168 was replaced with a 100k resistor

Parts Removed:

R135	323-0481-00	Resistor, 1M 1/2W 1%
R136	323-0414-00	Resistor, 200k 1/2W 1%
R138	323-0452-00	Resistor, 499k 1/2W 1%
R168	302-0563-00	Resistor, 56k 1/2W 10%

Parts Added:

D138	152-0107-00	Diode, silicon, 1N647
R135	301-0105-00	Resistor, 1M 1/2W 5%
R168	302-0104-00	Resistor, 100k 1/2W 10%

INSTALLATION:

Parts Required:

Serial numbers 101-8029 only:

152-0107-00	Diode silicon 1N647
301-0105-00	Resistor, comp., 1M 1/2W 5%

Serial numbers 8030-12309 only:

152-0107-00	Diode, silicon, 1N647
302-0104-00	Resistor, comp., 100k 1/2W 10%

Continued.

INSTALLATION: (Continued)

SERIAL NUMBERS 101-8029 ONLY:

- a) Remove R136, a 1M 1/2W 10% resistor, connected between CSG-17 and CSH-18.
- b) Replace R138, a 1M 1/2W 10% resistor connected between CSG-33 and CSH-33, with D138, a 1N647 type diode. Install D138 with cathode at CSG-33.
- c) Install R135, a 1M 1/2W 5% resistor, between pin 1 of V143 and CSH-18.

SERIAL NUMBERS 8030-12309 ONLY:

- a) Remove R136, a 200k 1/2W 1% resistor, connected between CSG-17 and CSH-18.
- b) Replace R138, a 499k 1/2W 1% resistor connected between CSG-33 and CSH-33, with D138, a 1N647 type diode. Install D138 with cathode to CSG-33.
- c) Replace R168, a 56k 1/2W 10% resistor connected between pin 7 of V152 and CSG-27, with a 100k 1/2W 10% resistor.

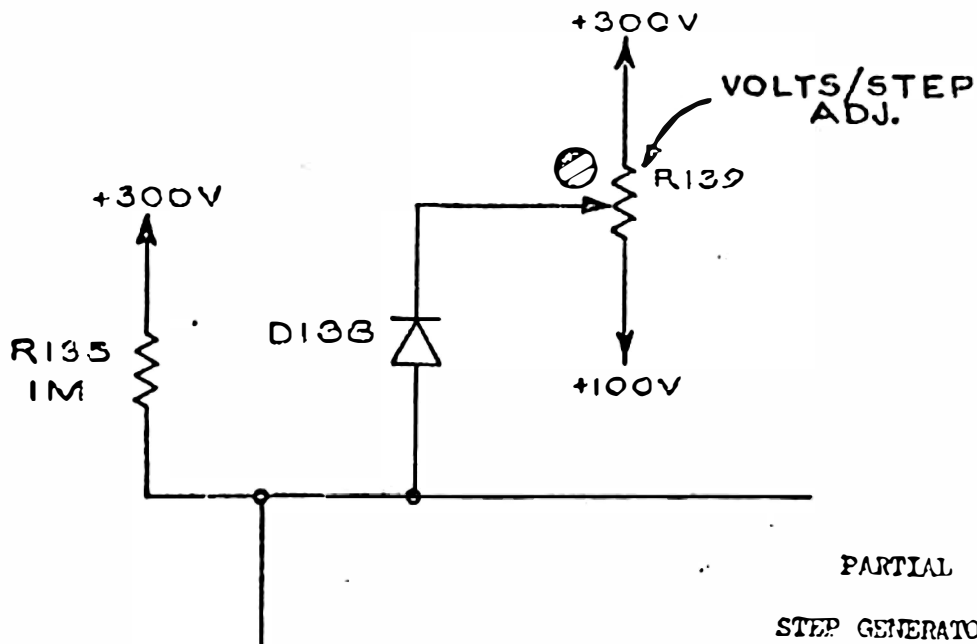

Continued.

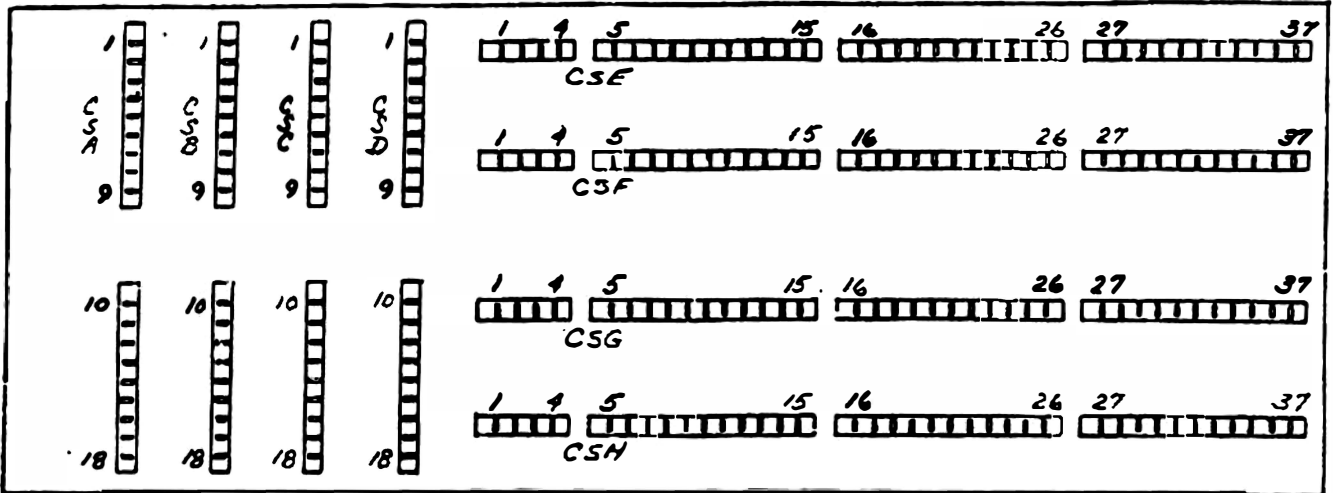

RESISTORS CHANGED TO 8W TO PREVENT OVER-DISSIPATION

Effective Prod SN 103

Under certain conditions, four resistors on the VOLTS/STEP SELECTOR switch have been operating with loads exceeding their rated dissipation. This condition exists when V223 fails, or is removed, while the STEP SELECTOR switch is in the VOLTS/STEP position. To eliminate the possible overload, the four resistors are changed to 8W mica plate resistors.

Parts Removed:

R246N	309-0128-00	Resistor, prec.,	50 Ω	1/2W	1%
R246P	309-0177-00	Resistor, prec.,	25 Ω	1/2W	1%
R246Q	309-0096-00	Resistor, prec.,	10 Ω	1/2W	1%
R246R	310-0538-00	Resistor, prec.,	5 Ω	3W	1%

Parts Added:

R246N	310-0542-00	Resistor, prec.,	50 Ω	8W	1%
R246P	310-0543-00	Resistor, prec.,	25 Ω	8W	1%
R246Q	310-0544-00	Resistor, prec.,	10 Ω	8W	1%
R246R	310-0545-00	Resistor, prec.,	5 Ω	8W	1%

Q243 AND Q253 HEAT SINK MOUNTING IMPROVED

Effective Prod SN 397

The possibility of shorting Q243 and Q253 Heat Sinks to ground, due to faulty fiber insulating washers or breaking through the shoulder of washer because of a slight misalignment of mounting holes, has been corrected with the use of shouldered bakelite washers. The more durable washers increase the insulating material between Heat Sink and mounting screws to 1/8in. as opposed to the previous 1/64in.

Instruments prior to SN 397 can be modified by redrilling the four 3/16in. Heat Sink mounting holes to 3/8in. and installing the bakelite washers.

Parts Removed:

210-0811-00	Washer, fiber	(4)
211-0510-00	Screw, 6-32 x 3/8	(4)

Parts Added:

210-0802-00	Washer, steel	(4)
210-0859-00	Washer, bakelite	(4)
211-0511-00	Screw, 6-32 x 1/2	(4)

DC SHIFT ELIMINATED

Effective Prod SN 580

Usable in SN 101-579

The screen voltage of V214-V224 and V254-V264 was increased to insure proper cut-off of each tube. Previously, a DC shift was visible on the CRT when switching the lower current ranges of the STEP SELECTOR switch in the Base Step Generator. The screen voltage has been raised to approximately 70 volts by decreasing the screen resistors to 4.7k.

Parts Removed:

R216		
R255	302-0223-00	Resistor, comp., 22k 1/2W 10%

Parts Added:

R216		
R255	302-0472-00	Resistor, comp., 4.7k 1/2W 10%

INSTALLATION:

Parts Required: See 'Parts Added'.

Replace the two 22k 1/2W resistors, located on ceramic strips above V224, with 4.7k 1/2W resistors.

BASE STEP GENERATOR POLARITY SWITCH CHANGED

Effective Prod SN 1089

Usable in SN 101-1088

High contact resistance of sections C and D of the 8ASE STEP GENERATOR POLARITY switch causes an error in the step waveform. The contact resistance forms a voltage divider with R246 to reduce the feedback. The error is most noticeable in the three highest current positions of the STEP SELECTOR switch. To eliminate the error, the 8ASE STEP GENERATOR POLARITY switch was replaced with a lower contact resistance type switch to compensate for part of the error. R245 was added to compensate for the remainder of the 2% error. Refer to 050-0021-XX for installation instructions.

PARTS REMOVED:

SW240	260-0178-00	Switch, Base Step Gen
-------	-------------	-----------------------

PARTS ADDED:

R245	308-0136-00	Resistor, WW, 0.05 Ω 20% 1W
SW240	260-0258-00	Switch, Base Step Gen

STEP SELECTOR SWITCH RESISTORS REPLACED

Effective Prod SN 1142

Contact resistance in the STEP SELECTOR switch causes an error in the three highest current ranges. To eliminate the error, the 50, 100, and 200mA/Step resistors were replaced.

Superseded by Mod 2273.

Parts Removed:

R246Q	310-0544-00	Resistor, prec.,	10 Ω	1%
R246R	310-0545-00	Resistor, prec.,	5 Ω	1%
R246S	310-0537-00	Resistor, prec.,	2.5 Ω	1%

Parts Added:

R246Q	310-0544-00	Resistor, prec.,	9.94 Ω	1%
R246R	310-0545-00	Resistor, prec.,	4.94 Ω	1%
R246S	310-0537-00	Resistor, prec.,	2.44 Ω	1%

STEP SELECTOR RESISTORS REPLACED

Effective Prod SN 1320

Usable in SN 101-1319

There is a 2% error in the Step Generator when the STEP SELECTOR switch is in the 0.2 or 0.1 VOLT/STEP position. The error is caused by approximately 0.03Ω added resistance in series with R246 and R249. To eliminate the error, R246Q, R246R, and R246S were changed by 0.03Ω .

Supersedes Mod 2059.

Parts Removed:

R246Q	310-0544-00	Resistor, prec.,	9.94 Ω	1%
R246R	310-0545-00	Resistor, prec.,	4.94 Ω	1%
R246S	310-0537-00	Resistor, prec.,	2.44 Ω	1%

Parts Added:

R246Q	310-0544-00	Resistor, prec.,	9.97 Ω	1%
R246R	310-0545-00	Resistor, prec.,	4.97 Ω	1%
R246S	310-0537-00	Resistor, prec.,	2.47 Ω	1%

INSTALLATION:

Parts Required: See 'Parts Added'.

Replace R246Q, R246R, and R246S, located on the STEP SELECTOR switch, with the new values.

STEP SELECTOR SWITCH MODIFIED

Effective Prod SN 3370

To eliminate the possibility of high transient currents passing through the transistor under test, when switching the STEP SELECTOR switch from mA/STEP to VOLTS/STEP, replace rear (shorting type) rotor blade with a non-shorting type on wafer 1 of the STEP SELECTOR switch.

The part number of the STEP SELECTOR switch was not changed.

+STEP ADJ ADDED TO STEP AMPLIFIER

Effective Prod SN 4270

Usable in SN 101-4269

To provide an adjustment of relative gains between the plus and minus steps of the Step Generator, caused by changes in tubes due to aging, R204 was changed from a 68Ω fixed resistor to a 200Ω minipotentiometer.

Parts Removed:

R204	302-0680-00	Resistor, comp., 68Ω 1/2W 10%
	179-0169-00	Cable, Step Generator

Parts Added:

R204	311-0158-00*	minipotentiometer, 200Ω
	406-0576-00*	Bracket, minipotentiometer
	179-0620-00	Cable, Step Generator

installation;

Parts Required: See 'Parts Added' with asterisk.

- a) Drill two $5/32$ in. holes in the chassis near V214 socket, as shown in drawing. It may be necessary to temporarily remove some resistors from the ceramic strips.
- b) Solder two lengths of white-orange wire to the minipotentiometer; one to the center terminal, and one to an outside terminal.
- c) Mount the minipotentiometer on the bracket and install on the tube side of the chassis in the holes drilled in step a.
- d) Remove R204, a 68Ω 1/2W resistor, connected between CSE-3 and CSF-3.
- e) Remove a bare wire that connects CSE-2, CSE-3, and CSE-4.
- f) Remove a bare wire that connects CSE-5 and CSF-4.
- g) Relocate R273, a 330Ω 1/2W 5% resistor, from CSE-4 and CSF-4 to CSE-2 and CSE-5.
- h) Dress the wires from the minipotentiometer past the geometry potentiometer and up through the grommet and connect as follows: 1) to CSF-3; 2) to pin 8 of V233.

Continued.

M3820 (Continued)

Type 575

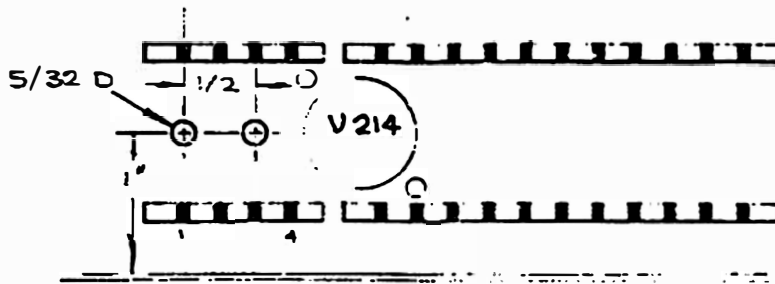
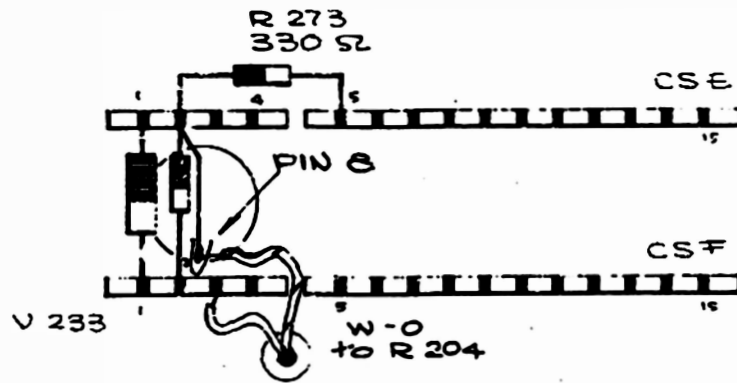

Q243 REPLACED TO ELIMINATE OSCILLATIONS

Effective Prod SN 7880

Usable in SN 101-7879

To reduce phase shift in the step amplifier, which is causing oscillations in the 60kHz range, Q243 was changed to a 2N2148 transistor. The new transistor is a direct replacement.

Parts Removed:

Q243	151-0001-00	Transistor, germanium 2N301
------	-------------	-----------------------------

Parts Added:

Q243	151-0137-00	Transistor, 2N2148
------	-------------	--------------------

INSTALLATION:

Parts Required: See 'Parts Added'.

Replace Q243 with a 2N2148 transistor.

SERIES RESISTOR SWITCH CIRCUIT MODIFIED

Effective Prod SN 8030

Usable in SN 101-8029

Actual resistance in lower settings of Series Resistor switch are in error with front panel markings. This is corrected by changing the 75Ω coax cable, used between ZERO CURRENT-ZERO VOLTS switch and the STEP SELECTOR switch, SW246/Transistor Selector switch, to 53.5Ω to reduce apparent 8% error to approximately 2% in the 1Ω position and by adding 1/4W resistors in parallel with the resistors on the SERIES RESISTOR switch, which reduces the 15, 22, 33, 47, and 68Ω position errors.

Parts Removed:

SW248	262-0136-00	Switch, Series Res
-------	-------------	--------------------

Parts Added:

*R247R	316-0472-00	Resistor, comp., 4.7k	1/4W	10%
*R247S	316-0222-00	Resistor, comp., 2.2k	1/4W	10%
*R247T	316-0102-00	Resistor, comp., 1k	1/4W	10%
*R247U	316-0471-00	Resistor, comp., 470Ω	1/4W	10%
*R247V	316-0181-00	Resistor, comp., 180Ω	1/4W	10%
SW248	262-0673-00	Switch, Series Res		
	*175-0007-00	Coax, RG58, 9-1/2in.		
		10-1/2in.		

INSTALLATION:

Parts Required: See 'Parts Added' with asterisks.

- Replace the 75Ω coax that connects the ZERO CURRENT-ZERO VOLTS switch to the Transistor Selector switch with a 10-1/2in. length of 53.5Ω coax.
- Replace the 75Ω coax that connects the ZERO CURRENT-ZERO VOLTS switch to the STEP SELECTOR switch with a 9-1/2in. length of 53.5Ω coax.
- Remove the SERIES RESISTOR switch and install the following resistors:
 - R247R (4.7k) in parallel with R248R (68Ω)
 - R247S (2.2k) in parallel with R248S (47Ω)
 - R247T (1k) in parallel with R248T (33Ω)
 - R247U (470Ω) in parallel with R248U (22Ω)
 - R247V (180Ω) in parallel with R248V (15Ω)
- Reinstall the SERIES RESISTOR switch.

BASE STEP GENERATOR SWITCH MOUNTING IMPROVED

Effective Prod SN 9540

Base drive changes when the series resistor switch is wiggled.

The 3/8 x 1/2 in. internal potentiometer lockwasher between the STEP SELECTOR switch and subpanel was not heavy enough to allow the switch to be secured properly. The switch was working loose, resulting in poor grounding. Also, the ground connection for R249 was sometimes found to be poor solder joint because of the large amount of heat required to properly solder to the detent plate. In the past a standard soldering iron had been used.

The internal lockwasher on the STEP SELECTOR switch was changed from 3/8 x 1/2 to 3/8 x 11/16.

The point where the solder lug is soldered on the detent plate was moved to the point on the detent plate where the R249 ground strap is soldered. This was done so that when the R249 ground strap was soldered to the detent plate the solder connection could be made at a well-tinned point. The solder lug is soldered to the detent plate with a large soldering iron.

Parts Removed:

210-0012-00 Lockwasher, int., potentiometer 3/8 x 1/2

Parts Added:

210-0013-00 Lockwasher, int., 3/8 x 11/16

INSTALLATION:

Parts Required: See 'Parts Added'.

- a) Remove the Base Step Generator Series Switch knob, mounting nut, and pull the switch out of the mounting hole.
- b) Replace the bare wire that connects R249 to the detent plate with a longer wire and solder it to the point on the detent plate where the solder lug is soldered.
- c) Remove the 3/8 x 1/2 in. lockwasher, install a 3/8 x 11/16 in. lockwasher, and reinstall the switch and knob.

TUBES REPLACED TO REDUCE MICROPHONICS, INTERFACE, AND GRID CURRENT PROBLEMS

Effective Prod SN 10430

Usage of 6AU6 and 12AU6 tubes results in high reject rate and length of selection time because of microphonics, interface, and grid current.

Type 6AU6 and 12AU6 tubes were replaced by 8425 and 8426 premium tubes.

Parts Removed:

V254		
V264	157-0050-00	Tubes, raw 12AU6 (154-0040-00) Subpart of
V364		
V374	154-0022-00	Tubes, raw 6AU6
V464		
V474		

Parts Added:

V254		
V261	157-0050-00	Tubes, raw 8426/12AU6 (154-0040-05) Subpart of
V364		
V374	154-0022-07	Tubes, raw 8425/6AU6
V464		
V474		

RESISTORS CHANGED TO INCREASE GAIN OF STEP AMPLIFIERS

Effective Prod SN 10880

Usable in SN 101-10879

Slope of "Horizontal" lines is more than 40% (specification is 10% to 40%).

Some of the 12AU6 tubes have low transconductance. This causes the loop gain of the step amplifier to be too low, which in turn, causes the Step Amplifier output impedance to increase, causing the slope of the "horizontal" lines to be greater than 40%.

None of the instruments are shipped with this problem, but the problem could develop as the tubes age and lower in gm.

R210 and R264, the plate resistors of V214 and V264, were changed from 470k 1/2W 10% resistor to 510k 1/2W 5% resistors.

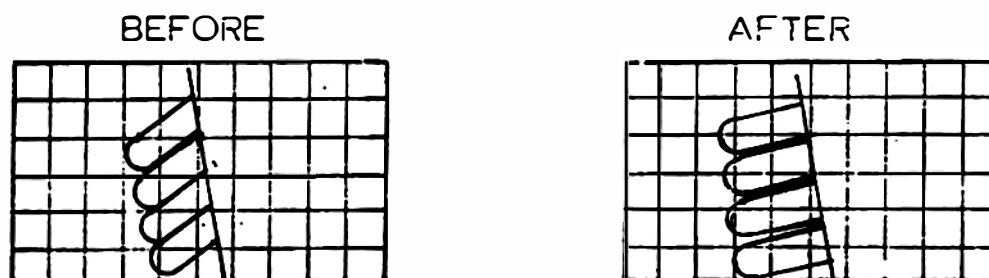

Parts Removed:

R210	302-0474-00	Resistor, comp., 470k 1/2W 10%
R264		

Parts Added:

R210	301-0514-00	Resistor, comp., 510k 1/2W 5%
R264		

Continued.

INSTALLATION:

Parts Required: See 'Parts Added' on preceding page.

Replace R210 and R264, two 470k 1/2W 10% resistors, located between CSG-5 to CSH-5 and CSE-8 to CSF-8 respectively, with two 510k 1/2W 5% resistors.

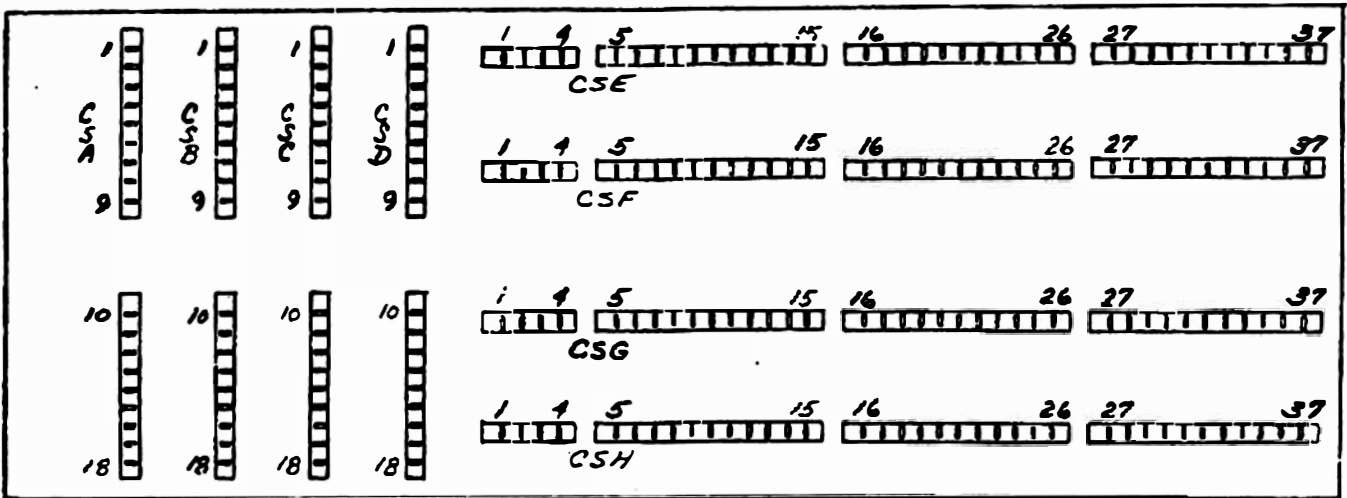

VERTICAL DISPLAY ACCURACY IMPROVED

Effective Prod SN 103

Collector current sampling resistors were changed to improve the accuracy of the vertical display.

Superseded by Mod 1759.

Parts Removed:

R417	309-0183-00	Resistor, prec., 3.05k 1/2W 1%
R418	309-0190-00	Resistor, prec., 5.19k 1/2W 1%

Parts Added:

R417	301-0123-00	Resistor, comp., 12k 1/2W 5%	Parallel
	309-0105-00	Resistor, prec., 4.21k 1/2W 1%	
R418	301-0154-00	Resistor, comp., 150k 1/2W 5%	Parallel
	309-0132-00	Resistor, prec., 5.6k 1/2W 1%	

AMPLIFIER MAX GAIN ADJUSTMENT IMPROVED

Effective Prod SN 148

Usable in SN 101-147

To improve the setting of the Horizontal and Vertical amplifier maximum gain adjust, the resistor in series with the gain potentiometers was increased in value, and a resistor was added in parallel with the gain potentiometer and the series resistor.

NOTE: The parallel resistor was installed incorrectly and was actually wired in parallel with the series resistor only. This was corrected at SN 5120 by Mod 6003.

Parts Removed:

R333 R433	309-0103-00	Resistor, prec., 808 Ω 1/2W 1%
--------------	-------------	---------------------------------------

Parts Added:

R332 R432	309-0098-00	Resistor, prec., 2k 1/2W 1%
R333 R433	309-0030-00	Resistor, prec., 1.8k 1/2W 1%

INSTALLATION:

Parts Required: See 'Parts Added'.

- Replace R333, an 808 Ω 1% resistor located on the HORIZONTAL VOLTS/DIV switch between contacts W3-9F and W4-9R, with a 1.8k resistor.
- Replace R433, an 808 Ω 1% resistor located on the VERTICAL VOLTS/DIV switch between contacts W3-9F and W4-9R, with a 1.8k resistor.
- Add R332, a 2k resistor, between W3-5F and W3-10F on the HORIZONTAL VOLTS/DIV switch.
- Add R432, a 2k resistor, between W3-5F and W3-10F on the VERTICAL VOLTS/DIV switch.

Continued.

INSTALLATION: (Continued)

NOTE: The following method is used to identify the HORIZ and VERT VOLTS/OIV switch terminals:

The wafers are numbered from front to rear.

The contact positions are numbered 1 through 12 relative to the index key as shown in the drawing.

The contacts have an 'F' or 'R' suffix which denotes that they are on the front or rear of the wafer.

Example: W2-7R (denoted by * on drawing) is contact #7 on the rear of wafer #2.

The sample drawing shows a switch with 12 contacts. The HORIZ and VERT VOLTS/DIV switches have 24 contact positions and they are numbered in the same way.

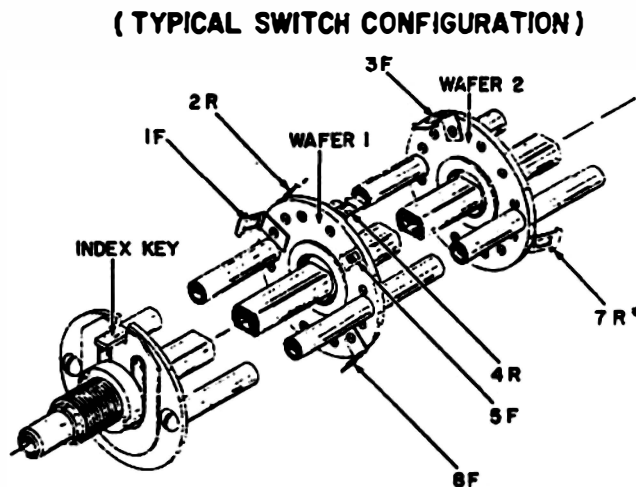

HORIZ AND VERT MAXIMUM GAIN ADJUST POTENTIOMETERS RELOCATED

Effective Prod SN 822

The Horiz and Vert Max Gain Adjust potentiometers were removed from the VERT V/DIV switch and the HORIZ V/DIV switch to prevent damage which resulted from bending the terminals of the potentiometers to match switch contacts. The potentiometers were mounted on a bracket which was added to the HORIZ V/DIV switch.

Parts Removed:

SW305	262-0137-00	Switch HORIZ V/DIV
SW405	262-0138-00	Switch VERT V/DIV

Parts Added:

SW305	262-0195-00	Switch HORIZ V/DIV
SW405	262-0189-00	Switch VERT V/DIV
	406-0330-00	Bracket, minipotentiometer

VERT AMP GAIN ADJUST RANGE INCREASED

Effective Prod SN 1352

Usable in SN 101-1351

To permit the use of CRT's with either too high or too low sensitivity, the Vertical output amplifier Min Gain Adj potentiometer and deflection plate coupling capacitors were increased in value.

Supersedes Mod 2254.

Parts Removed:

R491 R498	309-0168-00	Resistor, 78k 1/2W 1%
R493	311-0026-00	Resistor, var, 100k 2W

Parts Added:

R491 R498	309-0045-00	Resistor, 100k 1/2W 1%
R493	311-0032-00	Resistor, var., 250k 2W

INSTALLATION:

Parts Required: See 'Parts Added'.

For instruments in SN range 101-1279, perform step a only.

For instruments in SN range 1280-1351, perform both steps a and b.

- a) Replace the Min Gain Adj potentiometer, R493, with a 250k 2W potentiometer.
- b) Replace R491 and R498, located on ceramic strips above V484 socket, with 100k 1/2W resistors.

HORIZ AND VERT AMP EXT INPUTS REMOVED AND MOTOR BASE CONNECTOR REPLACED

Effective Prod SN 3660

The four Horiz and Vert Amp Ext Input UHF connectors, which are no longer required, were removed and the 175 adapter cable was connected directly to the VOLTS/DIV and the CURRENT/DIV switches. The motor base connector was changed to a recessed type.

Parts Removed:

R300		
R301		
R400	302-0175-00	Resistor, comp., 1M 1/2W 10%
R401		
SW305	262-0195-00A	Switch, VOLTS/DIV
SW405	262-0202-00A	Switch, CURRENT/DIV
	131-0102-00	Motor base, connector
	179-0176-00	Cable
	387-0092-00	Overlay, rear

Parts Added:

SW305	262-0416-00	Switch, VOLTS/DIV
SW405	262-0417-00	Switch, CURRENT/DIV
	131-0150-00	Connector, motor base
	179-0534-00	Cable
	387-0374-00	Subpanel, rear
	387-0376-00	Overlay, rear

VOLTS/DIV SWITCH REWIRED TO CONFORM TO MANUAL

Effective Prod S/N 5120

Usable in SN 148**-5119

Maximum gain adjust is difficult to obtain due to wiring error (see note after Mod 1583). R332 is relocated on the VOLTS/DIV switch to be in agreement with the Manual schematic.

**See Mod 1583 for pre-SN 148 instruments.

INSTALLATION:

Relocate lead of R332, a 2k 1/2W resistor, from contact W3-9F on VOLTS/DIV switch to W3-10F.

HORIZONTAL VOLTS/DIV SWITCH RESISTORS CHANGED

Effective Prod SN 6055

The history of reliability, availability, temperature coefficient, and shelf life of the 1/4% precision resistors established a need for a resistor of greater stability. The 1/4% carbon resistors were changed to 1/2% oxide film type. The two types cannot be mixed in the Type 575 due to differences in temperature coefficients.

Parts Removed:

R302	309-0189-00	Resistor, prec.,	116k	1/2W	1/4%
R303	309-0188-00	Resistor, prec.,	2.4k	1/2W	1/4%
R304	309-0187-00	Resistor, prec.,	800Ω	1/2W	1/4%
R305	309-0186-00	Resistor, prec.,	400Ω	1/2W	1/4%
R306	309-0185-00	Resistor, prec.,	240Ω	1/2W	1/4%
R307					
R308	309-0184-00	Resistor, prec.,	80Ω	1/2W	1/4%
SW404	262-0416-00	Switch, HORIZ V/DIV			

Parts Added:

R302	309-0405-00	Resistor, prec.,	116k	1/2W	1/2%
R303	309-0409-00	Resistor, prec.,	2.4k	1/2W	1/2%
R304	309-0408-00	Resistor, prec.,	800Ω	1/2W	1/2%
R305	309-0407-00	Resistor, prec.,	400Ω	1/2W	1/2%
R306	309-0406-00	Resistor, prec.,	240Ω	1/2W	1/2%
R307					
R308	309-0400-00	Resistor, prec.,	80Ω	1/2W	1/2%
SW405	262-0494-00	Switch, HORIZ V/DIV			



product modification

050-0065-00

Type 575

M3873

PRECISION RESISTOR REPLACEMENT

For TEKTRONIX® Type 575 and 575-Mod 122C TRANSISTOR-CURVE TRACERS
Serial Numbers 101-6054

Oxide film resistors replace the 1/4% carbon resistors previously used in the Type 575 HORIZONTAL VOLTS/DIV switch. Because of their greater stability, the new resistors need only have a tolerance of 1/2%.

Since the oxide film and the carbon resistors have different temperature co-efficients, the complete set of carbon resistors should be replaced with the oxide film type when any one is replaced.

The part numbers of the resistors changed are as follows:

309-0400-00	replaces	309-0184-00
309-0405-00	replaces	309-0189-00
309-0406-00	replaces	309-0185-00
309-0407-00	replaces	309-0186-00
309-0408-00	replaces	309-0187-00
309-0409-00	replaces	309-0188-00

NOTE: If the serial number of your instrument is above those listed, or if this kit has been installed, disregard the instructions as PN's 309-0400-00, 309-0405-00, 309-0406-00, 309-0407-00, 309-0408-00 and 309-0409-00 are direct replacements.

PARTS INCLUDED IN PARTS REPLACEMENT KIT:

Ckt. No.	Quantity	Part Number	Description
R307 R308	2 ea	309-0400-00	Resistor, prec., 80 Ω 1/2W 1/2%
R302	1 ea	309-0405-00	Resistor, prec., 115K 1/2W 1/2%
R306	1 ea	309-0406-00	Resistor, prec., 240 Ω 1/2W 1/2%
R305	1 ea	309-0407-00	Resistor, prec., 400 Ω 1/2W 1/2%
R304	1 ea	309-0408-00	Resistor, prec., 800 Ω 1/2W 1/2%
R303	1 ea	309-0409-00	Resistor, prec., 2.4K 1/2W 1/2%

INSTRUCTIONS:

- () Replace the seven resistors on the HORIZONTAL VOLTS/DIV switch with the resistors of corresponding value from the kit.
- () Check wiring for accuracy.
- () Fasten the insert page in your Instruction Manual

JT:mh

INSTRUCTION MANUAL

MODIFICATION INSERT

PRECISION RESISTORS REPLACEMENT

Type 575 -- SN 101-6054

Installed in Type _____ SN _____ Date _____

This insert has been written to supplement the Instruction Manual for these instruments. The information given in this insert will supersede that given in the manual.

This Insert Material Copyright © 1964 by Tektronix, Inc., Beaverton, Oregon. Printed in the United States of America. All rights reserved. Contents of this insert may not be reproduced in any form without the permission of the copyright owner.

GENERAL INFORMATION

Oxide film resistors replace the 1/4% carbon resistors previously used on the Type 575 HORIZONTAL VOLTS/DIV switch. Because of their greater stability, the new resistors need only have a tolerance of 1/2%.

Since the oxide film and the carbon resistors have different temperature co-efficients, the complete set of carbon resistors should be replaced with the oxide film type when any one is replaced.

ELECTRICAL PARTS LIST

RESISTORS

All resistors are 1/2% precision.

Ckt. No.	Part Number	Description
R302	309-0405-00	116K 1/2W
R303	309-0409-00	2.4K 1/2W
R304	309-0408-00	800Ω 1/2W
R305	309-0407-00	400Ω 1/2W
R306	309-0406-00	240Ω 1/2W
R307	309-0400-00	80Ω 1/2W
R308	309-0400-00	80Ω 1/2W

INPUT AMP SCREEN VOLTAGE INCREASED TO REDUCE DRIFT

Effective Prod SN 6630

Usable in SN 101-6629

To reduce grid current variations in 12AU6 matched pairs in the Horizontal and Vertical amplifiers, the screen voltage was increased from 43 to 72 volts.

Parts Removed:

R355		
R357		
R455	302-0473-00	Resistor, comp., 47k 1/2W 10%
R457		

Parts Added:

R355		
R357		
R455	302-0104-00	Resistor, comp., 100k 1/2W 10%
R457		

INSTALLATION:

Parts Required: See 'Parts Added'.

Replace R355, R455, R357, and R457 (47k 1/2W 10% resistors) connected between pins 6 and ground of V344, V354, V444, and V454 respectively, with 100k 1/2W 10% resistors.

9-19-72

DC BALANCE POTENTIOMETERS REPLACED

Effective Prod S/N 6630

Usable in S/N 101-6629

To increase the range of the DC Balance potentiometers in the Horiz and Vert amplifiers, the DC Bal potentiometers were changed from 5k to 10k.

Parts Removed:

R356 R456	311-0011-00	Potentiometer, comp., 5k
R358 R458	302-0223-00	Resistor, comp., 22k 1/2W 10%

Parts Added:

R356 R456	311-0191-00	Potentiometer, comp., 10k
R358 R458	302-0103-00	Resistor, 10k 1/2W 10%

INSTALLATION:

Parts Required: See 'Parts Added'.

- a) Replace R358, 22k 1/2W resistor mounted on ceramic strips over V364 socket, with a 10k resistor.
- b) Replace R458, 22k 1/2W resistor mounted on ceramic strips over V464, with a 10k resistor.
- c) Replace R356 and R456, located on the front panel, with 10k potentiometers.

HORIZ VOLTS/DIV SWITCH CHANGED

Effective Prod SN 6975 - MOD 122C ONLY

Usable in SN 101-6974

To correct 2% error in the vertical or collector current reading, the ground point location on the HORIZ VOLTS/DIV switch was relocated and a compensating resistor was added:

Parts Removed.

SW305	262-0513-00	Switch, VOLTS/DIV
-------	-------------	-------------------

Parts Added:

R319	309-0001-00	Resistor, prec., 433k 1/2W 1%
SW305	262-0633-00	Switch, VOLTS/DIV

AMPLIFIER LINEARITY IMPROVED

Effective Prod SN 8030

Non-linear operation of the Horiz and Vert amplifiers was corrected by raising the plate voltage in amplifier circuits to change operating points of the first two stages.

Parts Removed:

R343,R353 R443,R453	301-0684-00	Resistor, comp.,	580k	1/2W	5%
R364,R374 R464,R474	302-0333-00	Resistor, comp.,	33k	1/2W	10%
R366 R466	306-0683-00	Resistor, comp.,	68k	2W	10%
R377 R477	302-0153-00	Resistor, comp.,	15k	1/2W	10%
R380,R381 R480,R481	302-0102-00	Resistor, comp.,	1k	1/2W	10%

Parts Added:

C380,C381 C480,C481	281-0523-00	Capacitor, cer.,	100pF	350V	
R343,R353 R443,R453	301-0474-00	Resistor, comp.,	470k	1/2W	5%
R364,R374 R464,R474	302-0124-00	Resistor, comp.,	120k	1/2W	10%
R366,R377 R466,R477	306-0823-00	Resistor, comp.,	82k	2W	10%
R379,R380 R381,R382 R479,R480 R481,R482	302-0124-00	Resistor, comp.,	120k	1/2W	10%

9-19-72

SW249 CHANGED TO A MORE RELIABLE TYPE

Effective Prod SN 11510

Usable in SN 101-11509

ZERO VOLTS-ZERO CURRENT lever switch electrically remains in ZERO CURRENT position when mechanically it is returned to normal center position due to metal fatigue. Switch has a lifetime of approximately 100,000 cycles.

ZERO-CURRENT-ZERO VOLTS switch replaced with a new type. The only wiring change required was to relocate the strap from directly between the two center contacts, to over the center ground on the switch.

Parts Removed:

SW249	260-0196-00	Switch, raw, lever, non-locking
-------	-------------	---------------------------------

Parts Added:

SW249	260-0196-01	Switch, raw, lever, non-locking
-------	-------------	---------------------------------

INSTALLATION:

Parts Required: See 'Parts Added'.

Replace the ZERO CURRENT-ZERO VOLTS switch with the new type. The new switch is a direct replacement except it is necessary to install the bare wire between the center contacts around the switch center ground.

RESISTORS MADE SELECTABLE TO MEET GAIN SPECS

Effective Prod SN 12110

Usable in SN 101-12109

The current batch of 12AU6's used in the Horizontal and Vertical Amplifier have cathode slump, which results in low gain.

R345 in the Horizontal Amplifier and R445 in the Vertical Amplifier were changed from a fixed 3.3M to a test selected part. The optimum value is 8.2M.

Parts Removed:

R345	302-0335-00	Resistor, 3.3M 1/2W 10%
R445		

Parts Added:

R345	302-0825-00	Resistor, 8.2M 1/2W 10%
R445		

INSTALLATION:

Parts Required:

050-0383-00	Parts Replacement Kit.
-------------	------------------------

Refer to kit instructions.



product modification

050-0383-00
M12361
Type 575

HORIZONTAL AND VERTICAL AMPLIFIER TUBE REPLACEMENT

For TEKTRONIX® Type 575 Transistor Curve Tracers
Serial Numbers 101-12109

When replacing Horizontal Amplifier tubes V344 and V354, or Vertical Amplifier tubes V444 and V454, with a matched pair of tubes (PN 157-0050-00), it is also necessary to change the value of R345 (Horizontal), or R445 (Vertical), from its present value of 3.3M (302-0335-00) to a selected part with a nominal value of 8.2M (302-0825-00).

NOTE 1: V344 and V354, or V444 and V454, are matched tubes and must be replaced as a pair. If you intend to replace V344 - V354 and V444 - V454 at the same time, order two kits.

NOTE 2: If the serial number of your instrument is above those listed, or if this kit has been installed, disregard the instructions as PN 157-0050-00 is a direct replacement in the modified amplifier.

PARTS INCLUDED IN PARTS REPLACEMENT KIT:

Ckt. Number	Quantity	Part Number	Description
V344 - V354 or V444 - V454	1 ea	157-0050-00	Tubes, matched pair, 12AU6
R345 or R445	1 ea	302-0825-00	Resistor, comp., 8.2M 1/2W 10%

INSTRUCTIONS:

HORIZONTAL AMPLIFIER

- () 1. Replace V344 and V354, two 12AU6 tubes in the Horizontal Amplifier, with the matched pair of 12AU6 tubes from the kit.
- () 2. Replace R345, a 3.3M 1/2W 10% resistor located on a ceramic strip between V344 and V354, with an 8.2M 1/2W 10% resistor from the kit.

VERTICAL AMPLIFIER

- () 1. Replace V444 and V454, two 12AU6 tubes in the Vertical Amplifier, with the matched pair of 12AU6 tubes from the kit.
 - () 2. Replace R445, a 3.3M 1/2W 10% resistor located on a ceramic strip between V444 and V454, with an 8.2M 1/2W 10% resistor from the kit.
- () Refer to your Instruction Manual and recalibrate the Horizontal or Vertical Amplifier as required.
- () Correct your Manual schematic and parts list to conform to kit parts list.

INSTRUCTIONS (continued)

When adjusting Horizontal or Vertical Amplifier gain, select R345 or R445 as follows:

HORIZONTAL GAIN

- a) Switch the BASE STEP GENERATOR REPETITIVE-OFF-SINGLE FAMILY switch to the OFF position and set the HORIZONTAL VOLTS PER DIVISION switch to .5 BASE VOLTS.
- b) Hold the HORIZONTAL AMPLIFIER CALIBRATION switch in the ZERO CHECK position and move the trace directly behind the right hand edge of the graticule.
- c) Switch the AMPLIFIER CALIBRATION switch to the -10 DIVISION position. If the Min Gain Adj is set properly, the trace will move to the left hand edge of the graticule (10 divisions).
- d) Change the HORIZONTAL VOLTS/DIVISION switch to .1 or .05 BASE VOLTS and check gain and adjust Max Gain Adj for 10 divisions of deflection.

Change the HORIZONTAL VOLTS/DIVISION switch to .01 or .5 BASE VOLTS and check for 10 divisions of deflection. If deflection does not meet test specifications, adjust gain by selecting R345 as follows: Use standard RMA resistance values from 3.3M to 10M. If the gain is low (less than 10 divisions) use a lower value for R345, and if gain is high (more than 10 divisions) use higher value for R345.

VERTICAL GAIN

- a) Switch the BASE STEP GENERATOR REPETITIVE-OFF-SINGLE FAMILY switch to the OFF position and set the VERTICAL CURRENT or VOLTAGE PER DIVISION switch to 1000 COLLECTOR MA.
- b) Hold the VERTICAL AMPLIFIER CALIBRATION switch in the ZERO CHECK position and move the trace directly behind the fifth line above the center of the graticule.
- c) Switch the AMPLIFIER CALIBRATION switch to the -10 DIVISION position. If the Min Gain Adj is set properly, the trace will move to the fifth line below the center graticule (10 divisions).
- d) Change the VERTICAL CURRENT or VOLTAGE PER DIVISION switch to .1 or .05 BASE VOLTS and check gain and adjust Max Gain Adj for 10 divisions of deflection.

Change the VERTICAL CURRENT or VOLTAGE PER DIVISION switch to .01 or .5 BASE VOLTS and check for 10 divisions of deflection. If deflection does not meet specifications, adjust gain by selecting R445 as follows: Use standard RMA resistance values from 3.3M to 10M. If the gain is low (less than 10 divisions) use a lower value for R445, and if gain is high (more than 10 divisions) use a higher value for R445.

JT:mh

COLLECTOR SWEEP CHASSIS MODIFIED

Effective Prod SN 359

Two mechanical changes have been made in the Collector Sweep chassis to lessen the possibility of shorting the chassis to ground through the adjacent cabinet side:

- a) A new nylon washer (210-0869-00), which allows the heads of the four mounting screws to be recessed within the insulating material, is now being used in place of the previous steel washer.
- b) The dimensions of the Collector Sweep chassis have been altered slightly to allow 3/16 in. additional space between the cabinet side and chassis. The assembled Collector Sweep chassis is a direct replacement for the old.

Parts Removed:

210-0803-00	Washer, 6L x 3/8	(4)
337-0180-00	Shield, Sweep Collector	
386-0651-00	Plate, aluminum	
441-0160-00	Chassis, Collector	

Parts Added:

210-0869-00	Washer, nylon	(4)
337-0189-00	Shield, Sweep Collector	
386-0656-00	Plate, aluminum	
441-0193-00	Chassis, Collector	

COLLECTOR SWEEP CHASSIS IMPROVED

Effective Prod SN 509

Two changes have been made in the Collector Sweep chassis to reduce assembly time and improve appearance:

- a) 180° rotation of R710 through R718, stack of wirewound resistors mounted on the Collector Sweep chassis, to allow more access to the terminals.
- b) Combining of the Collector Sweep and Dissipation switch cables into one unit to simplify wiring procedure. The new cable is a direct replacement for the old if R710 through R718 are rotated 180°.

Parts Removed:

179-0170-00	Cable, Collector power
179-0172-00	Cable, Dissipation switch

Parts Added:

179-0240-00	Cable, Col Pwr/Dis Sw
-------------	-----------------------

C734 RANGE SHIFTED

Effective Prod SN 724

Usable in SN 101-723

C735, Collector Sweep Balance Adj capacitor, has insufficient range to balance out the leakage current through the vertical current sampling resistors.

This mod does not apply if Mod 1226 is installed.

Supersedes Mod 1717.

Parts Removed:

C734	283-0507-00	Capacitor, cer., 120pF 500V	
C735	281-0012-00	Capacitor, var., 7-45pF	
	166-0031-00	Spacer	(2)

Parts Added:

C734	283-0534-00	Capacitor, cer., 82pF 500V	
C735	281-0028-00	Capacitor, var., 20-125pF	
	166-0026-00	Spacer	(2)

INSTALLATION:

Parts Required: See 'Parts Added'.

- a) Replace C734, a 120pF capacitor located on ceramic strips near V733 socket, with an 82pF capacitor.
- b) Replace C735, a 7-45pF capacitor, and the two spacers located on the front right-hand side of the power chassis, with a 20-125pF capacitor.

MOD 122C SET UP AS PRODUCTION SPECIAL

Effective Prod SN 6975

Type 575 Mod 122C which provides the features described below is set up as a production special because of increased demand.

- a) A maximum Collector Sweep voltage of 400V (instead of 200V), rated at 0.5A maximum.
- b) Three more sensitivities (50, 100 and 200V/DIV) on the HORIZONTAL VOLTS/DIV switch.
- c) A $\pm 1.5\text{kV}$ supply for checking peak inverse voltage of rectifiers. The high voltage is accessible at the Collector test terminals, and the supply current is limited by an internal impedance of 1.8M.

NOTE: The output voltage (Collector terminal voltage) of the 1.5kV supply varies directly with the line voltage and inversely with the load current (i.e., at 117V (234V) line voltage and zero load current, the output voltage is approximately 1.8kV; with a load current of 1mA, the output voltage is zero).

For information on part changes refer to Type 575 instruction manual.



product modification

040-0276-00

Type 575

INCREASED COLLECTOR VOLTS

For the TEKTRONIX® Type 575 Oscilloscopes:
All Serial Numbers

Modification Kit, PN 040-0276-00, converts the Type 575 to Type 575 Mod 122C, providing the following features:

- a) A maximum Collector Sweep voltage of 400V (instead of 200V), rated at 0.5 amp maximum.
- b) Three more sensitivities (50, 100 and 200V/Div) on the HORIZONTAL VOLTS/DIV switch.
- c) A ± 1.5 kV supply for checking peak inverse voltage of rectifiers. The high voltage is accessible at the Collector test terminals, and the supply current is limited by an internal impedance of 1.8 meg.

NOTE: The output voltage (Collector terminal voltage) of the 1.5kV supply varies directly with the line voltage and inversely with the load current (i.e., at 117V (234V) line voltage is approximately 1.8kV; with a load current of 1mA, the output voltage is zero).

PARTS INCLUDED IN MODIFICATION KIT:

Ckt.No.	Quantity	Part Number	Description
	(1 ea)		Assembly, Switch, PEAK VOLTS RANGE (262-0496-00), consisting of:
	1 ea	210-0012-00	Lockwasher, int. 3/8 x 1/2, small pot
	1 ea	210-0413-00	Nut, hex 3/8-32 x 1/2
	1 ea	210-0840-00	Washer, flat, 0.390 x 9/16
##	SW706	1 ea	260-0403-01 Switch, raw
			Wire, #22 solid, 175-0522-00 wht-vio 4-1/4"
			Wire, #22 solid, 175-0522-00 wht-blu 3-1/4"
			Wire, #22 solid, 175-0522-00 wht 2-1/2"
	(1 ea)		Assembly, Switch, HORIZ. VOLTS/DIV (262-0633-00), consisting of:
	4 ea	210-0001-00	Lockwasher, int. #2
	2 ea	210-0006-00	Lockwasher, int. #6
	4 ea	210-0438-00	Nut, 1-72
	2 ea	210-0449-00	Nut, hex, 5-40 x 1/4
	4 ea	210-0801-00	Washer, flat, #5S
##	SW305	1 ea	260-0591-01 Switch, raw
##	C318	1 ea	281-0010-00 Capacitor, cer. 4.5-25pF var.
##	R300,R301	2 ea	302-0105-00 Resistor, comp. 1meg 1/2W 10%
##	R319	1 ea	309-0001-00 Resistor, prec. 433k 1/2W 1%
##	*R250,R258	4 ea	309-0020-00 Resistor, prec. 1.8meg 1/2W 1%
##	R333	1 ea	309-0030-00 Resistor, prec. 1.8k 1/2W 1%
##	R315,R323	2 ea	309-0041-00 Resistor, prec. 60k 1/2W 1%
##	R317,R325	2 ea	323-0414-00 Resistor, prec. 200k 1/2W 1%
##	R332	1 ea	309-0098-00 Resistor, prec. 2k 1/2W 1%
##	R312,R313	4 ea	309-0100-00 Resistor, prec. 10k 1/2W 1%
##	R320,R321		
##	R314,R322	2 ea	309-0153-00 Resistor, prec. 20k 1/2W 1%
##	R331	1 ea	309-0180-00 Resistor, prec. 1.063k 1/2W 1%
##	R330	1 ea	309-0191-00 Resistor, prec. 4.535k 1/2W 1%
##	R329	1 ea	309-0192-00 Resistor, prec. 11.48k 1/2W 1%
##	R328	1 ea	309-0194-00 Resistor, prec. 32.31k 1/2W 1%
##	R316,R324	2 ea	309-0260-00 Resistor, prec. 100k 1/2W 1%
##	R307,R308	2 ea	309-0400-00 Resistor, prec. 80Ω 1/2W 1/2%
##	R302	1 ea	309-0405-00 Resistor, prec. 116k 1/2W 1/2%
##	R306	1 ea	309-0406-00 Resistor, prec. 240Ω 1/2W 1/2%
##	R305	1 ea	309-0407-00 Resistor, prec. 400Ω 1/2W 1/2%
##	R304	1 ea	309-0408-00 Resistor, prec. 800Ω 1/2W 1/2%
##	R303	1 ea	309-0409-00 Resistor, prec. 2.4k 1/2W 1/2%
##	R334,R434	2 ea	311-0056-00 Potentiometer,comp. 500Ω minipot 20%
	1 ea	388-0523-00	Board, etched circuit
			Tubing, plastic, #20, 162-0504-00 blk 1"
			Wire, #22 solid, 175-0517-00 orn 4-1/2"
			Wire, #22 solid, 175-0522-00 wht-red 3"

*R250 & R258 are 3.6 Meg resistors consisting of 2 ea. 1.8 Meg resistors connected in series.

PARTS INCLUDED IN MODIFICATION KIT: Continued

Ckt.No.	Quantity	Part Number	Description
	(1 ea)		Assembly, Switch, HORIZ. VOLTS/DIV (262-0633-00), consisting of: (continued)
			Wire, #22 solid, 175-0522-00 wht-red 3-1/2"
			Wire, #22 solid, 175-0522-00 wht-grn 3"
			Wire, #22 solid, 175-0522-00 wht-grn 3-1/2"
			Wire, #22 solid, 175-0522-00 wht-grn 4-1/2"
			Wire, #22 solid, 175-0522-00 wht-blk 3-1/4"
			Wire, #22 solid, 175-0522-00 wht-blk 4"
			Wire, #22 solid, 175-0522-00 wht-vio 2-1/2"
	2 ea		Wire, #22 solid, 175-0522-00 wht-orn 3-1/2"
			Wire, #22 solid, 175-0522-00 wht-yel 3"
			Wire, #22 solid, 175-0522-00 wht-orn-blk-brn 4-3/4"
			Wire, #22 solid, 175-0544-00 gry
	(2 ea)		Assembly, Capacitor, consisting of:
	2 ea	166-0025-00	Spacer, tube mech.
	2 ea	210-0406-00	Nut, hex, 4-40 x 3/16
	4 ea	210-0906-00	Washer, fiber
	2 ea	211-0017-00	Screw, 4-40 x 3/4 RHS
##	C7068,C706C	1 ea	281-0010-00 Capacitor, cer, 4.5-25pF var.
	(1 ea)		Assembly, Transformer bracket, consisting of:
	1 ea	120-0226-00	Transformer, 2KV
	2 ea	124-0106-00	Strip, cer, 7/16 x 11 notches, clip-mounted
	4 ea	166-0025-00	Spacer, tube mech.
	4 ea	210-0004-00	Lockwasher, int. #4
	7 ea	210-0010-00	Lockwasher, int. #10
	1 ea	210-0206-00	Lug, solder, #10
	4 ea	210-0406-00	Nut, hex, 4-40 x 3/16
	4 ea	210-0410-00	Nut, hex, 10-32 x 5/16
	8 ea	210-0906-00	Washer, fiber
	4 ea	211-0017-00	Screw, 4-40 x 3/4 RHS
	4 ea	212-0553-00	Screw, 10-32 x 1-1/2 RHS
##	C706A	1 ea	281-0007-00 Capacitor, cer, 3-12pF var.
##	C7060	1 ea	281-0010-00 Capacitor, cer, 4.5-25pF var.
##	R729,A,B,C,D	4 ea	306-0474-00 Resistor, comp, 470k 2W 10%
	4 ea	361-0039-00	Spacer, nylon molded, 13/32
	1 ea	406-0743-00	Bracket, 2KV transformer mounting
			Tubing, plastic, #20, 162-0504-00 blk 11/16"
			Wire, #22 solid, 175-0522-00 wht-blk 11"
			Wire, #22 solid, 175-0522-00 wht-yel 4-1/2"
			Wire, #20 str.,HV ins. 175-0513-00 wht-yel 5-1/2"
			Wire, #20 str.,HV ins. 175-0513-00 wht-yel 2-1/2"
	(1 ea)		Assembly, Switch, pushbutton and cable, PRESS TO CHECK, consisting of:
	(1 ea)		Cable, harness (179-0668-00), consisting of:
			Wire, #22 solid, 175-0522-00 wht 16-3/4"
			Wire, #18 solid, 175-0504-00 yel-brn-grn-brn 19"
			Wire, #18 solid, 175-0504-00 yel-brn-orn-brn 16-1/4"

PARTS INCLUDED IN MODIFICATION KIT: Continued

Ckt.No.	Quantity	Part Number	Description
	(1 ea)		Assembly, Switch, pushbutton and cable, PRESS TO CHECK, consisting of: (continued)
	1 ea	210-0013-00	Lockwasher, 3/8 x 11/16
	2 ea	210-0202-00	Lug, solder, SE6 w/2 wire holes
	1 ea	210-0207-00	Lug, solder, pot, 3/8
	2 ea	210-0413-00	Nut, hex, 3/8-32 x 1/2
	1 ea	210-0840-00	Washer, flat, 0.390 x 1/2
##	SW700	1 ea	260-0017-00 Switch, raw Wire, #18 solid, 175-0503-00 yel-brn-orn-brn 4-1/2"
	(1 ea)		Assembly, Rectifier, Germanium, consisting of:
##	GR707	1 ea	106-0060-00 Rectifier, Germanium stack
	2 ea	210-0457-00	Nut, Keps, 6-32 x 5/16
	2 ea	210-0802-00	Washer, flat, #6S
	2 ea	211-0507-00	Screw, 6-32 x 5/16 BHS
			Wire, #22 solid, 175-0522-00 wht-orn 24"
			Wire, #22 solid, 175-0522-00 wht-brn 20"
			Wire, #22 solid, 175-0522-00 wht-brn 3"
			Wire, #22 solid, 175-0522-00 wht-blw 24"
	(1 ea)		Assembly, Switch, Transistor Selector, consisting of:
	2 ea	210-0021-00	Lockwasher, int. 3/8 x 1/2
	1 ea	210-0845-00	Washer, 5/8 x 1/2 x 0.020"
##	SW735	1 ea	260-0463-00 Switch, lever, locking
##	R731	1 ea	302-0101-00 Resistor, comp, 100Ω 1/2W 10%
	1 ea	361-0048-00	Spacer, toggle switch, 5/8 x 0.130L
			Wire, HyRad, 175-0549-00 5-1/2"
			Wire, #22 solid, 175-0522-00 wht-yel 6-1/2"
			Wire, #22 solid, 175-0522-00 wht-grn 5"
			Wire, #22 solid, 175-0522-00 wht 2-1/2"
	(1 ea)		Assembly, Switch, POLARITY, consisting of:
	1 ea	210-0012-00	Lockwasher, int. 3/8 x 1/2, small pot
	1 ea	210-0413-00	Nut, hex, 3/8 x 1/2
	1 ea	210-0840-00	Washer, flat, 0.390 x 9/16
##	SW708	1 ea	260-0404-01 Switch, raw
##	R705	1 ea	304-0274-00 Resistor, comp. 270k 1W 10%
			Wire, #18 solid, 175-0504-00 wht-brn 11"
			Wire, #20 stranded, HV ins. 175-0513-00 wht-yel 4-1/4"

PARTS INCLUDED IN MODIFICATION KIT:

Ckt.No.	Quantity	Part Number	Description
##	1 ea	003-0220-00	Template
	2 ea	124-0120-00	Strip, cer, 7/16 X 4 notches, clip-mounted
	2 ea	166-0030-00	Spacer, 3/16 (for transformer mounting bracket)
	2 ea	210-0006-00	Lockwasher, int, #6
	1 ea	210-0205-00	Lug, solder, SE-8
	2 ea	210-0206-00	Lug, solder, #10
	2 ea	210-0407-00	Nut, 6-32 x 1/4
	1 ea	210-0505-00	Nut, 3/8-27 x 1/2
	2 ea	210-0803-00	Washer, flat, #6L
	1 ea	210-0812-00	Washer, fiber #10
	1 ea	210-0813-00	Washer, fiber #10 shouldered
	6 ea	210-0869-00	Washer, nylon, insulating
	6 ea	211-0504-00	Screw, 6-32 x 1/4 PHS, Phillips
	2 ea	211-0507-00	Screw, 6-32 x 5/16 PHS, Phillips
	2 ea	211-0511-00	Screw, 6-32 x 1/2 PHS, Phillips
##	SW602	1 ea	260-0249-00 Switch, circuit breaker, 0.8 amp
##	C239	1 ea	281-0044-00 Capacitor, mica, 80-480pF var.
##	C734	1 ea	283-0555-00 Capacitor, mica, 0.002µF 500V
##	*R730	4 ea	309-0025-00 Resistor, prec, 2.5M 1/2W 1%
##	R732	1 ea	309-0125-00 Resistor, prec, 300k 1/2W 1%
##	R732A	1 ea	311-0126-00 Potentiometer, comp. 1M minipot var.
		1 ea	333-0690-00 Panel, (for Mod 122C)
##		2 ea	334-1529-00 Insert, (for Mod 122C and serial number)
		1 ea	334-0820-00 Tag, overlay
		1 ea	337-0476-00 Shield, Collector Sweep side
		2 ea	343-0002-00 Clamp, cable, 3/16
##		4 ea	361-0392-00 Spacer, nylon molded, 0.593
		1 ea	366-0033-00 Knob, small black
		2 ea	Tubing, plastic, #16, 162-0502-00 blk 1-7/8"

*R730 is composed of 4 2.5M resist rs connected in series.

PARTS INCLUDED IN MODIFICATION KIT:

Ckt.No.	Quantity	Part Number	Description
			Wire, HyRad, high voltage, 175-0549-00 13"
			Wire, HyRad, high voltage, 175-0549-00 24"
			Wire, #22 solid, 175-0522-00, wht 3-1/2"
			Wire, #22 solid, 175-0522-00, wht 7-1/2"
			Wire, #22 solid, 175-0522-00, wht-orn 5-1/4"
			Wire, #22 solid, 175-0522-00, wht-orn 3"
			Wire, #22 solid, 175-0522-00, wht-gry 5-1/2"
			Wire, #22 solid, 175-0522-00, wht-gry 4"
			Wire, #22 solid, 176-0122-00, bare 12"
			Wire, #16 solid, 176-0124-00, bare 12"
			Wire, solder, silver-bearing

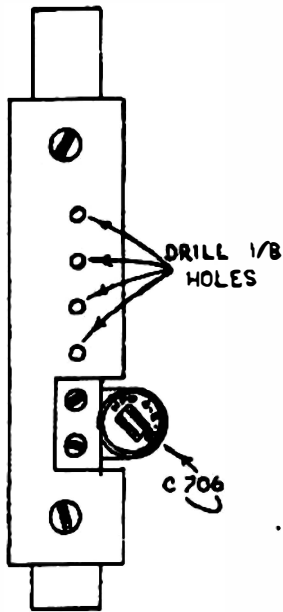

FIG. 1

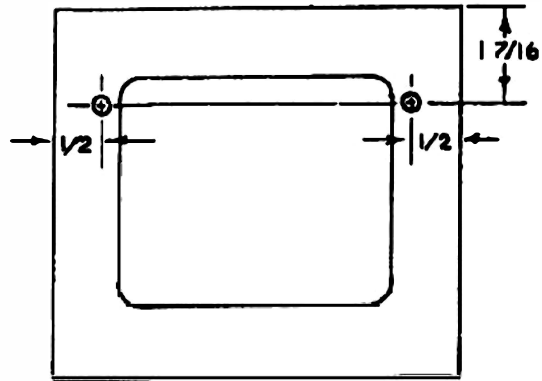

FIG. 2

INSTRUCTIONS

IMPORTANT: When soldering to the ceramic strips, use the silver-bearing solder supplied with this kit.

- () 1. Remove the cabinet sides and bottom.
- () 2. Remove the side shield covering the Collector Sweep (C.S.) box at left of instrument.

NOTE: Save all hardware until the modification is completed.

- () 3. Unsolder the six wires connected to the Collector Sweep transformer (T702). (Terminals accessible inside C.S. box.)
- () 4. Unsolder and remove the ground strap connecting C706 (small trimmer capacitor, at rear of C.S. box) to ground lug on the resistor stack.
- () 5. Turn the instrument upside down and locate the white-red wire which is dressed through the grommet in the front of the C.S. box, through a grommet in the lower main chassis, and connects to the Transistor Selector (TRANSISTOR A - TRANSISTOR B) switch mounted on the Transistor Test Panel.
() Unsolder this wire from the Transistor Selector switch and pull it back through the grommet in the lower chassis.
- () 6. Remove the four nuts and insulated spacers holding the C.S. box to the lower chassis.
- () 7. Turn the instrument right side up and locate the white-brown wire which comes from the C.S. box and connects to the lower side of the VERTICAL CURRENT OR VOLTAGE PER DIVISION switch.
() Unsolder this wire from switch and pull it down toward the C.S. box.

NOTE: In some instruments, this wire will be secured with a cable clamp. If so, pull the wire back through the clamp.

- () 8. Loosen the allen setscrews at the back side of the flexible couplers which connect the PEAK VOLTS RANGE, POLARITY and the DISSIPATION LIMITING RESISTOR controls to the C.S. box.
() Slide the shafts of these controls all the way forward.
- () 9. Remove the cable clamp (not in all instruments), secured to the right side (as viewed from front) of the C.S. box.
- () 10. Carefully lift up the C.S. box and remove it from the instrument.
- () 11. Mount the drilling template (from kit) on the rear edge of C.S. box, as shown in Fig. 1. If not already present, drill four 1/8 inch holes as indicated. Remove template.
- () 12. If not already present, mark and drill two 5/32 inch holes in the back of the C.S. box, as shown in Fig. 2.

INSTRUCTIONS (continued)

- () 13. If not already present, mark and drill three 5/32 inch holes in the right side of the C.S. box, as shown in Fig. 3. To locate the support plate mounting holes, temporarily place transformer support plate assembly over the top outside edge of the C.S. box and mark the two 5/32 inch mounting holes. DO NOT DRILL THROUGH HOLES IN PLATE.

CAUTION: Remove any metal shaving made by drilling!

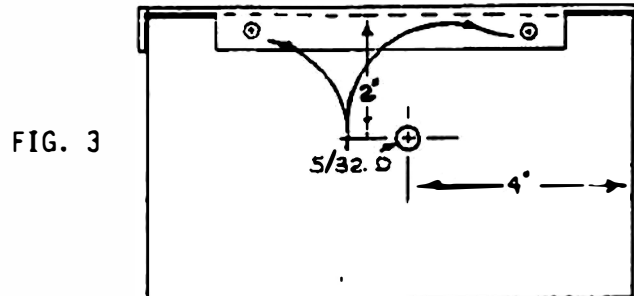

FIG. 3

- () 14. Mount the cable assembly (from kit) on the side of the C.S. box with the two cable clamps (from kit). See Fig. 5. Use the 6-32 PHS screws, flat washers, lockwashers and nuts from the kit.

DO NOT MOUNT TRANSFORMER SUPPORT PLATE AT THIS TIME.

- () 15. Mount the Germanium rectifier (GR707) assembly (from kit), using the holes drilled in step 12.

NOTE: The assembly mounts directly over the existing rectifiers, with the contacts facing downward.

- () 16. Mount the two 4.5-25pF variable capacitors from the kit. Use the four holes drilled in step 11 and mount in the same manner as the two capacitors mounted on the transformer support plate, from the kit. DO NOT OVER TIGHTEN!
- () 17. Unsolder all the wires from the PULARITY and PEAK VOLTS RANGE switches.
- () Remove these two switches from the C.S. box.
- () 18. Mark and drill a 5/32 inch keyway hole in the front of the C.S. box for the PEAK VOLTS RANGE switch, as shown in Fig. 4.

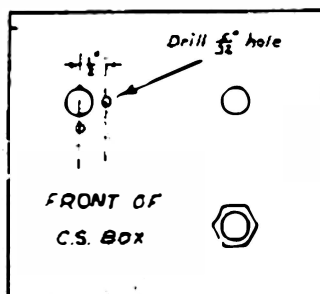

FIG. 4

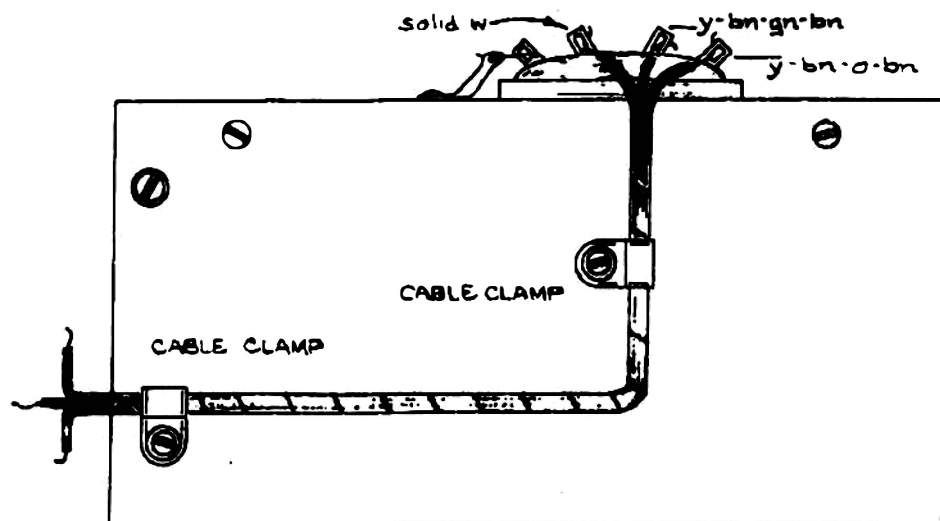

FIG. 5

INSTRUCTIONS (continued)

- () 19. Install the new POLARITY switch (from kit) and solder the wires to it, as shown in Fig. 6.

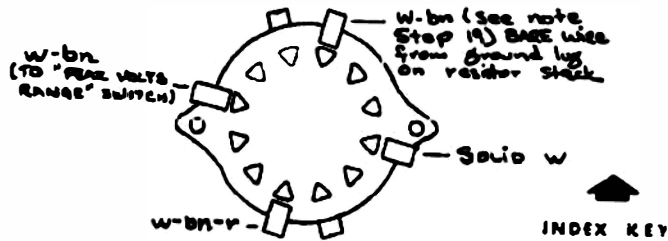

FIG. 6

NOTE: There were two white-brown wires previously connected to the POLARITY switch. Connect only the one which is dressed through the grommet in the front of the C.S. box (check with ohmmeter) to the new POLARITY switch. The other one will connect to the PEAK VOLTS RANGE switch, as called out in Fig. 7.

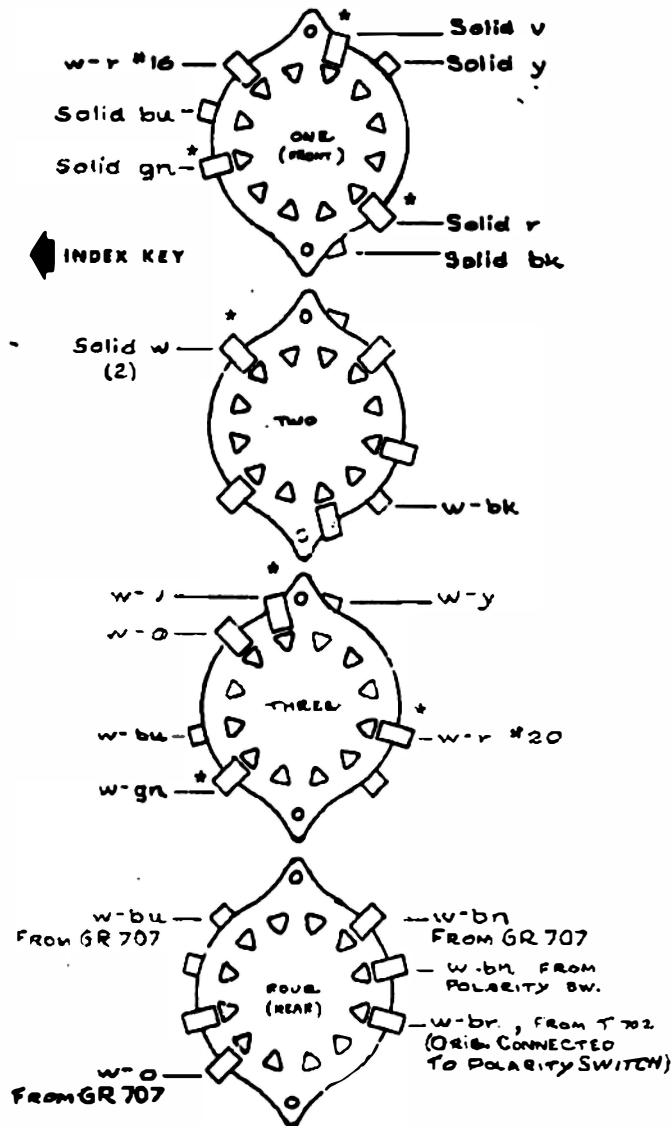

FIG. 7

*These are double contacts; one of the front of the v...er and the other on the rear. Solder the wire to both contacts.

INSTRUCTIONS (continued)

- () 20. Dress the three wires (white-blue, white-brown and white-orange) from the Germanium rectifier (GR707, mounted in step 15) down along the cable toward the front of the C.S. box.
- () 21. Locate the white-red wire which is dressed through the grommet in the front of the C.S. box and connects to the wiper contact on the front wafer of the DISSIPATION LIMITING RESISTOR switch.
- () Replace this wire with the 13 inch length of HyRad high voltage wire from the kit. (Cut off the white-red wire where it enters the cable, and also where it leaves the C.S. box.)
- () 22. Install the new PEAK VOLTS RANGE switch (from kit) and solder the wires to it as shown in Fig. 7.
- () 23. Solder the rear terminals (terminals nearest rear of instrument) of C706B, C and E together. Leave about 3 inches of extra wire coming from C706C. (This point will later be grounded outside of the C.S. box.)

NOTE: Determine the C numbers by looking at the new C.S. box side shield in the kit.

- () 24. Solder the short length of white-brown wire from GR707 to the front terminal of C706B (the upper trimmer capacitor).
- () 25. THIS COMPLETES THE REWORK OF THE C.S. BOX. Recheck wiring for accuracy. It is easier to check it now, before it is put back into the instrument.
- () 26. Remove the bottom cover from the Transistor Test Panel assembly.

NOTE: There may be four white-yellow wires soldered to the Transistor Selector switch. If 050-0070-00 has been installed, remove only the two white-yellow wires that are connected to the same contact.

- () 27. Unsolder the two shielded cables and the white-yellow wires from the Transistor Selector switch.
- () 28. Unsolder the white-brown wire from the ground point inside the test panel.
- () 29. Remove the Test Panel assembly from the instrument. (It is held with the four nuts at the back of the sub-panel.)

NOTE: If the TRANSISTOR SELECTOR switch in your instrument is the same type as the switch from the kit, omit steps 30 through 37.

- () 30. Unsolder the wires from the Transistor Selector switch and remove it from the Test Panel assembly.
- () 31. Unsolder the two white-green wires from the ground lug on the Test Panel.

NOTE. Some instruments have a ground buss soldered between two ground lugs. If your Test Panel is wired this way, unsolder only one white-green wire from buss.

INSTRUCTIONS (continued)

- () 32. Enlarge the Transistor Selector switch mounting hole in the Test Panel to 1/2 inch, using a drill or reamer.
- () Install the Transistor Selector switch (from kit) as shown in Fig. 8. Orient switch so that the white-green wire comes out to the TRANSISTOR B side.

NOTE: On some older instruments it may be necessary to file away a small portion of the frame to make the switch mount straight.

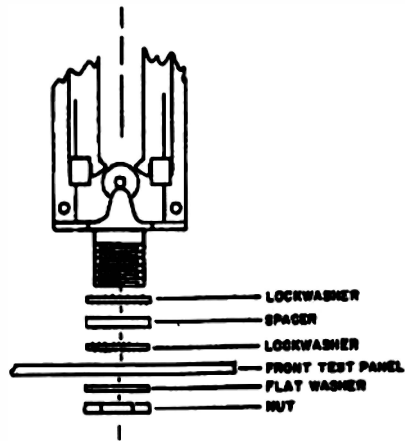

FIG. 8

- () 33. Add a ground lug, a no. 16 buss wire and two lengths of tubing (from kit), as shown in Fig. 9. (Disregard this step for instruments which already have a ground buss.)
- () 34. Solder the white-green wire from the Transistor Selector switch to the center of the ground buss (see Fig. 9).

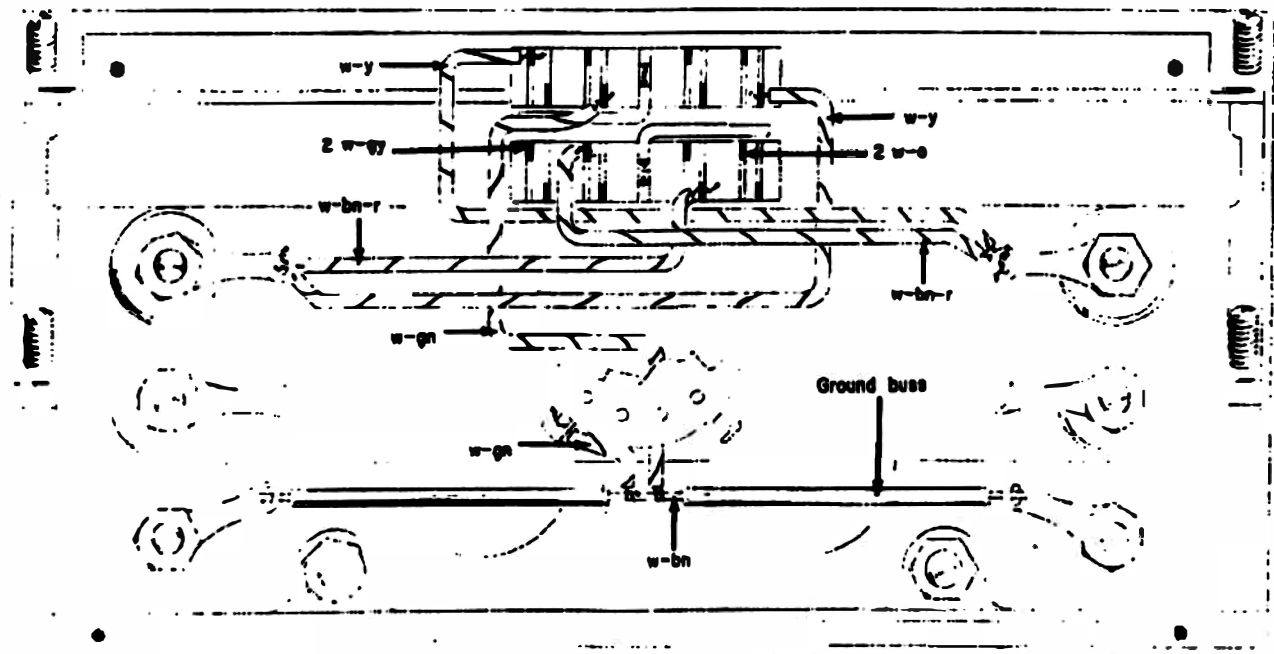

FIG. 9

INSTRUCTIONS (continued)

- () 35. Solder the white-green wire from EMITTER GROUNDED - BASE GROUNDED switch to the center of the ground buss (see Fig. 9).

NOTE: Omit this step for instruments which already have a bare wire connected here.

- () 36. Solder the two white-yellow wires from the Selector switch to the Collector Test terminals, as shown in Fig. 9. (Some instruments already have two white-yellow wires connected to the test terminals. If so, remove and discard them.)
- () 37. Solder the two white-gray, the two white-orange and the two white-brown-red wires to the Selector switch, as shown in Fig. 9.

NOTE: If any white-gray or white-orange wire is too short, replace it with a longer one from the kit.

The white-brown wire, called out to center of the ground buss, will be connected at a later step --- after the Test Panel is re-installed.

- () 38. Replace the front panel with the new one from the kit. BE SURE THAT THE TWO INSERT TABS ARE IN PLACE AND THAT THE SERIAL NUMBER IS CORRECT.

NOTE: If your instrument is below SN 861, and does not have the Collector Current multiplier pushbuttons, apply the small panel decal (from kit) to cover the holes.

- () 39. FOR INSTRUMENTS BELOW SERIAL NUMBER 861 ONLY:
Replace the Collector Sweep fuse holder (not in instrument above SN 860) with the Circuit Breaker from the kit.
- () 40. Turn the instrument upside down and remount the Transistor Test Panel assembly.
- () 41. Locate the white-brown wire, previously grounded inside the Test Panel. Solder it to the center of the ground buss, as indicated in Fig. 9.
- () Replace the bottom cover on the Test Panel assembly.
- () 42. Turn the instrument right side up.
- () 43. Center-punch and drill a 3/8 inch hole through the front sub-panel for the PRESS TO CHECK pushbutton switch.

CAUTION: Blow out any metal shavings made by drilling!

- () 44. Reinstall the C.S. box in the instrument using old mounting hardware.
- () (SN 101-4769 ONLY) place a solder lug under the nut holding the C.S. box, nearest to the power transformer, T601.
- () Resolder the six wires (unsoldered in step 3) to the Collector Sweep transformer (T702).

INSTRUCTIONS (continued)

NOTE: Replace cable clamp (removed in step 9) on the side of the C.S. box.

- () 45. Install the pushbutton switch in the hole drilled in step 43.
- () 46. Dress the white-brown wire from the C.S. box, up to the VERTICAL CURRENT OR VOLTAGE PER DIVISION switch.
- () Solder it to the terminal on the rear wafer, from which it was disconnected in step 7.
- () 47. Solder the short yellow-brown-orange-brown wire from the PRESS TO CHECK pushbutton switch to fused side of the CIRCUIT BREAKER.

NOTE: You can find the fused side by connecting an ohmmeter (use the lowest range) between terminal 3 (center arm) of the PERCENT OF PEAK VOLTS RANGE auto transformer and the CIRCUIT BREAKER. The terminal on the CIRCUIT BREAKER which indicates the highest resistance (approximately 1Ω higher) is the fused side.

- () 48. Solder the yellow-brown-green-brown wire from the cable mounted on the side of the C.S. box (step 14) to terminal 1 of the PERCENT OF PEAK VOLTS RANGE auto transformer.
- () 49. Dress the high voltage lead, from the C.S. box, through the grommet hole in the lower chassis.
- () 50. Mount the Transformer Support Plate assembly (from kit) on top of the C.S. box, using two 6-32 x 1/4 PHS screws.

NOTE: Instruments BELOW SN 359 have a wider C.S. box. For these instruments, use the 3/16 inch spacers (from kit) between the inside edge (edge nearest center of instrument) of the C.S. box and the support plate. Mount with the 6-32 x 1/2 PHS screws from the kit.

- () 51. Solder the three wires to the transformer terminals, as shown in Fig. 5.
- () 52. Solder the white-blue wire from the PEAK VOLTS RANGE switch to the lower terminal of C706A.
- () 53. Solder the white-violet wire from the PEAK VOLTS RANGE switch to the lower terminal of C706D.
- () 54. Solder the no. 22 white-yellow solid wire from the 11-notch ceramic strip, on the support plate, to C706E.
- () 55. Solder the white-yellow stranded wire from the support plate assembly to the POLARITY switch, as shown in Fig. 10.
- () Solder the white-yellow stranded wire from the POLARITY switch to terminal 8 of T703.

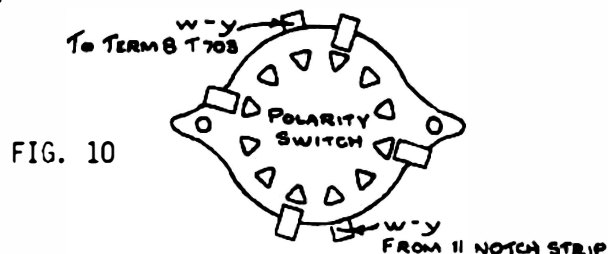

INSTRUCTIONS (continued)

- () 56. Dress the white-black wire from C706A and C706D along the inside edge of the transformer support plate towards the rear of the C.S. box, down the back of the box to a point near C706B, C and E.
- () Solder this wire, along with the bare wire connecting C706B, C and E together, to the ground lug on the resistor stack outside and to the rear of the C.S. box.
- () Remove the rubber bumper from the Collector Sweep shield and install in new cover.
- () 57. Install the C.S. side shield from the kit. The additional 6-32 x 1/4 BHS screws and insulating washers are provided in the kit.
- () Reconnect the switch shaft couplers to the C.S. box.
- () 58. If your instrument has a PEAK VOLTS RANGE knob with two white dots, replace it with the new one from the kit.
- () 59. Turn the instrument upside down.
- () 60. If not already present, mark and drill four 5/32 inch holes, as shown in Fig. 11.

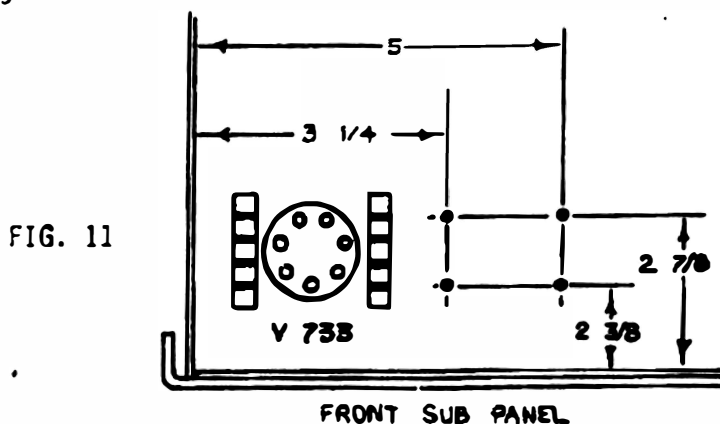

- () 61. Insert four nylon spacers (from kit) in the holes just drilled and press the two 4-slot ceramic strips (from kit) into them. (See Fig. 12).
- () 62. Unsolder and remove all the components on the 4-slot ceramic strips mounted over the V733 tube socket. SAVE THE 100k, 1W RESISTOR FOR RE-USE.
- () 63. Remove C735 (variable ceramic capacitor).
- () 64. Unsolder the solid orange, the two white-yellow wires, and the bare jumper wire from CSB (see Fig. 12).
- () Unsolder the bare wire from CSA to -in-1 of V733.
- () 65. Unlace the three wires (just unsoldered) back to the grommet.
- () Discard the short white-yellow wire, which is now free.
- () 66. Unsolder the black-brown-green-brown wire from CSB and resolder it, as shown in Fig. 12.

INSTRUCTIONS (continued)

- () 67. Resolder the solid orange wire to the point vacated by the black-brown-green-brown wire in step 66 (see Fig. 12).

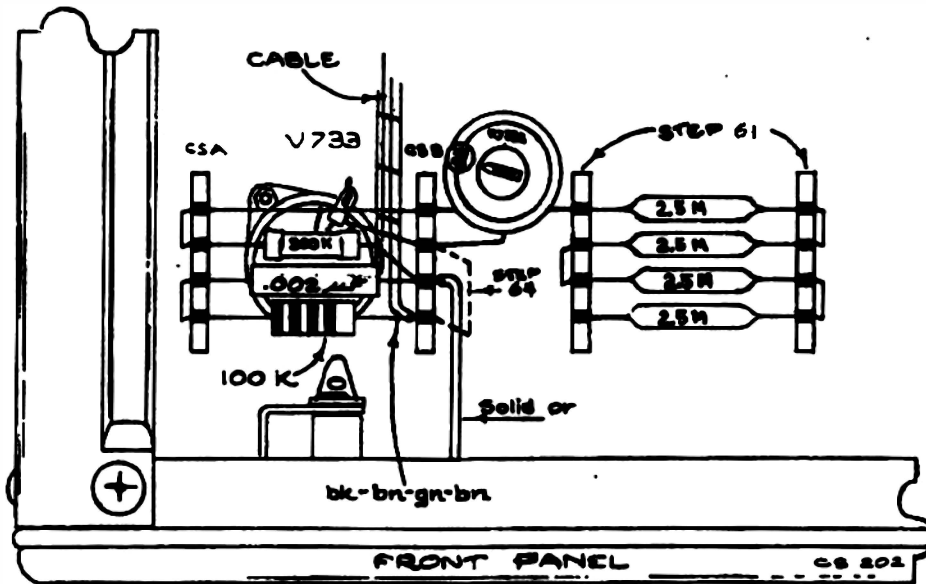

FIG. 12

- () 68. Replace the white-yellow wire (unsoldered in step 64) with the 24 inch length of high voltage wire from the kit.

NOTE: First, unsolder the white-yellow wire from the HORIZONTAL VOLTS/DIV switch, then pull it out of the cable from the bottom of the instrument. It is not necessary for the high voltage wire to go into the cable.

DO NOT SOLDER THE HIGH VOLTAGE WIRE AT EITHER END AT THIS TIME.

- () 69. Wire all four ceramic strips, as shown in Fig. 12.
 () 70. Wire the Transistor Selector switch and connect the two high voltage leads to the ceramic strips, as shown in Fig. 13.

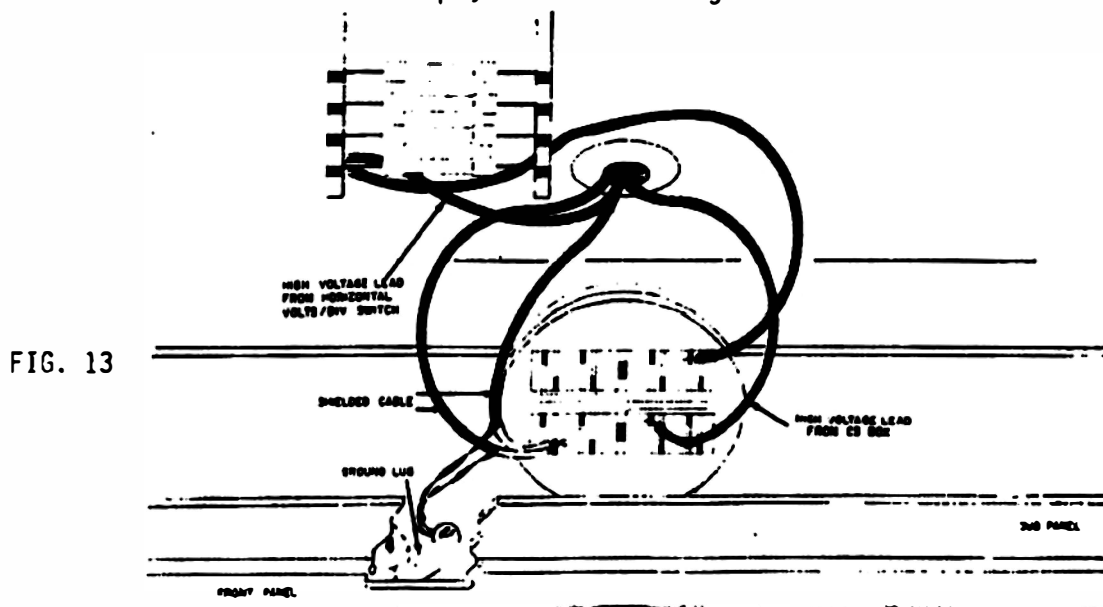

FIG. 13

INSTRUCTIONS (continued)

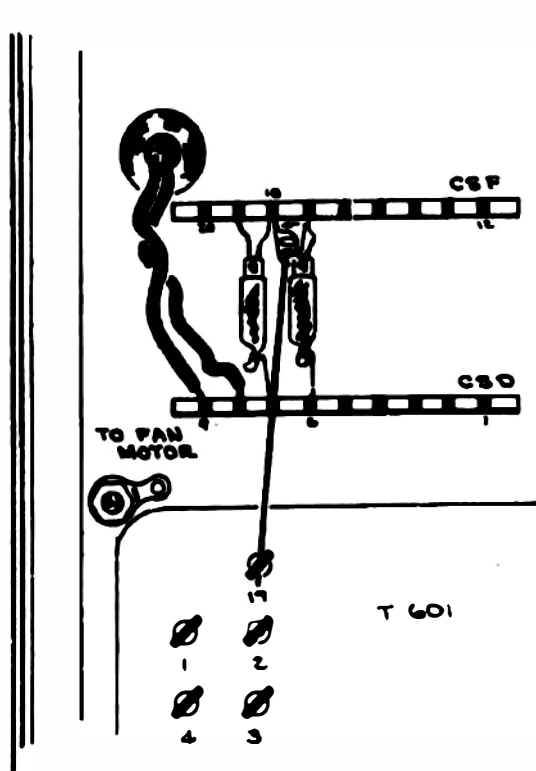

Fig. 14A BEFORE

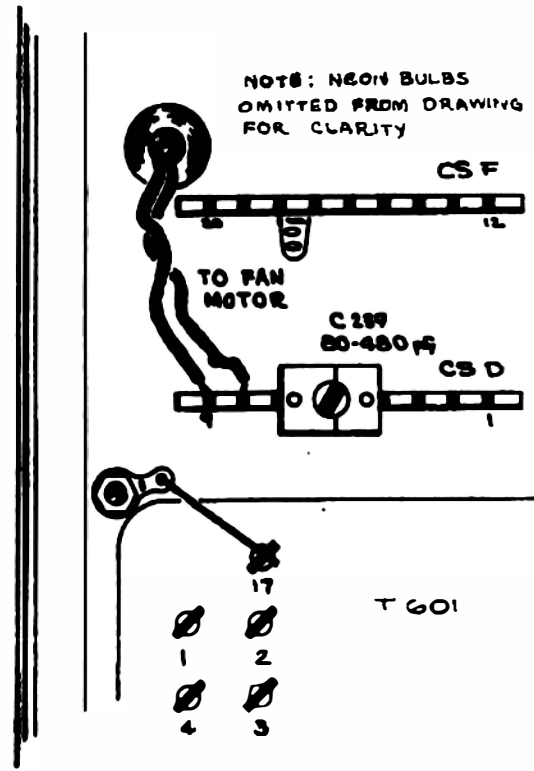

Fig. 14B AFTER

NOTE: Fan motor leads may be connected differently than shown.

INSTRUCTIONS (continued)

PERFORM STEPS 71 AND 72 FOR SN 101-4769 ONLY

- () 71. Move the neon holder from CSD-7 to CSO-6. See Fig. 14A for locations.
- () If a bare wire is connected from terminal 17 of T601 to CSD-7 to the ground lug indicated in Fig. 14A, remove this wire completely; instead, install a #16 bare wire (from kit) between terminal 17 and the ground lug shown in Fig. 14B. (If no lug is present, install a #10 solder lug from the kit.)
- () 72. Connect a 7-1/2 inch length of #22 solid white wire (from kit) from CSO-4 to the solder lug installed in step 44.
- () Connect a 3-1/2 inch length of #22 solid white wire (from kit) from terminal 14 of T601 to CSD-7. See recalibration instructions.
- () Install C239, an 80-480pF capacitor (from kit) between CSO-4 and CSD-7. See Fig. 14B.
- () 73. Carefully unsolder all the wires from the HORIZONTAL VOLTS/DIV switch.
- () FOR INSTRUMENTS ABOVE SERIAL NUMBER 821 ONLY:
Unsolder the wires connected to the potentiometers (R434 and R334) on the rear bracket at the potentiometer terminals.
- () 74. Remove the switch from the instrument.
- () 75. Re-install the HORIZONTAL VOLTS/OIV switch and secure with the pot nut and washer.
- () 76. Install the HORIZONTAL VOLTS/OIV knob.
- () 77. Solder the wires to the switch as shown in Fig. 15.

NOTE: Potentiometers R334 and R434, previously mounted on rear bracket of HORIZONTAL VOLTS/DIV switch, are now mounted on the printed circuit board attached to rear of switch. In instruments BELOW SN 822, R334 was mounted on HORIZONTAL VOLTS/OIV switch and R434 was mounted on VERTICAL CURRENT OR VOLTAGE PER DIVISION switch.

- () 78. FOR INSTRUMENTS BELOW SERIAL NUMBER 822 ONLY:
Remove potentiometer R434 from VERTICAL CURRENT OR VOLTAGE PER DIVISION switch. Note switch terminals used and solder the white-black and white-red wires from the new R434 to these terminals. The white-red wire is soldered to the switch terminal nearest to the outside of the instrument.
- () 79. FOR INSTRUMENTS ABOVE SERIAL NUMBER 821 ONLY:
Solder the white-black and the white-red wires from R434 to the terminals on the VERTICAL CURRENT OR VOLTAGE PER DIVISION switch that this potentiometer was previously connected to. Discard the old white-red and white-black wires.

INSTRUCTIONS (continued)

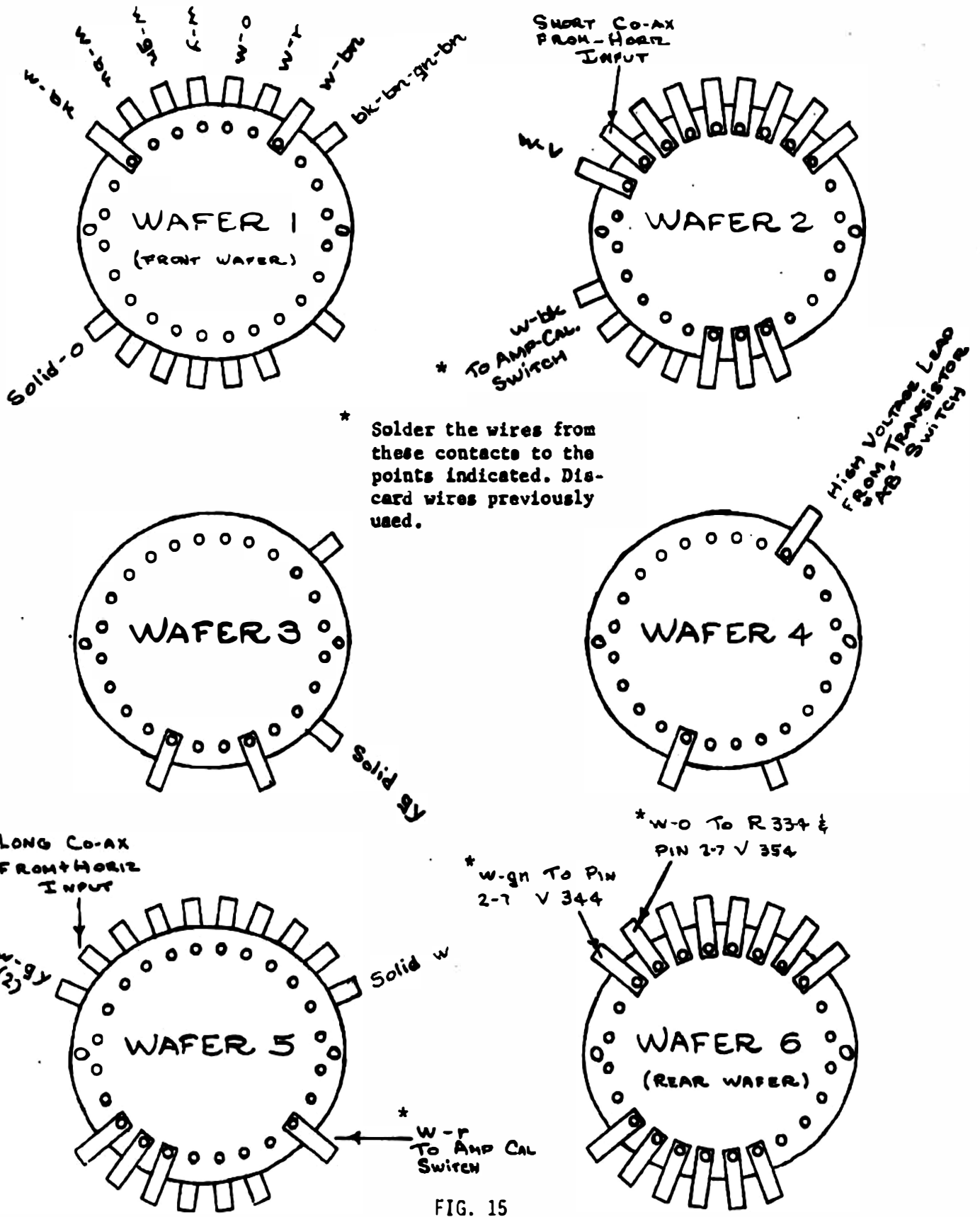

FIG. 15

INSTRUCTIONS (continued)

- () 80. For instruments which have Horizontal and Vertical coaxial inputs on the rear panel, remove the 1 Meg 1/2W resistor on the Horizontal inputs.
- () 81. Turn instrument upside down and refer to Fig. 16 while performing steps 82 through 84.
- () 82. Remove the frame brace that is bolted to the side rails and the Collector Sweep Transformer (T702) support post. Save the hardware.
- () 83. Enlarge the support post mounting hole to 17/64 inch diameter.
- () 84. Reinstall the frame brace, using the insulating washers for the support post as shown in the drawing.
- () Recheck wiring for accuracy.

CAUTION: Blow out all shavings made from drilling!

- () Refer to the Manual inser pages for recalibration procedure.
- () Fasten the Manual insert pages in your Instruction Manual.

JT:ljs

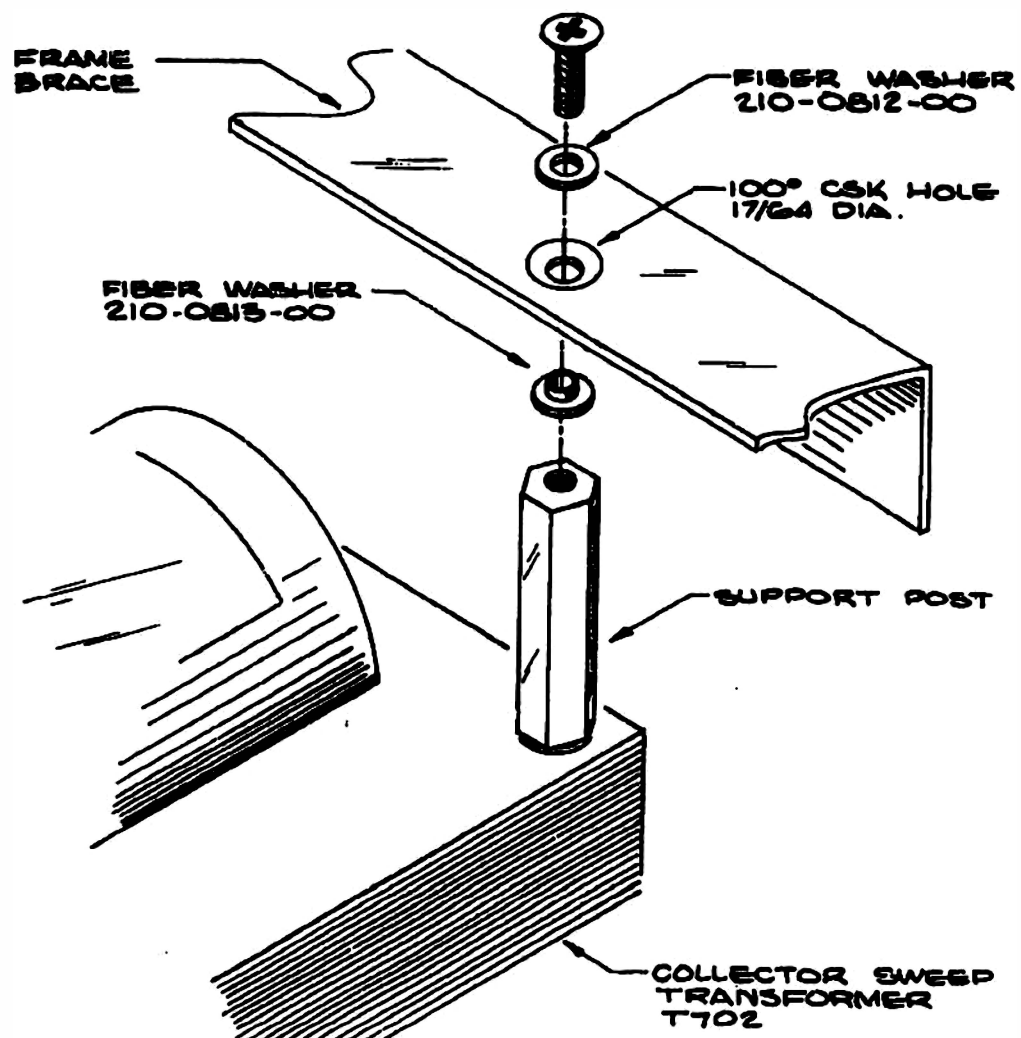

FIG. 16

INSTRUCTION MANUAL

MODIFICATION INSERT

INCREASED COLLECTOR VOLTS

Type 575 -- All Serial Numbers

Installed in Type 575 SN _____ Date _____

This insert has been written to supplement the Instruction Manual for this instrument. The information given in this insert will supersede that given in the manual.

This Insert Material Copyright © 1964 by Tektronix, Inc., Beaverton, Oregon. Printed in the United States of America. All rights reserved. Contents of this insert may not be reproduced in any form without the permission of the copyright owner.

GENERAL INFORMATION

Modification Kit, PN 040-0276-00, converted the Type 575 to Type 575 Mod 122C, and provided the following features:

- a) A maximum Collector Sweep voltage of 400V (instead of 200V), rated at 0.5 amp maximum.
- b) Three more sensitivities (50, 100 and 200V/Div) on the HORIZONTAL VOLTS/DIV switch.
- c) At ± 1.5 kV supply for checking peak inverse voltage of rectifiers. The high voltage is accessible at the Collector test terminals, and the supply current is limited by an internal impedance of 1.8 meg.

NOTE: The output voltage (Collector terminal voltage) of the 1.5kV supply varies directly with the line voltage and inversely with the load current (i.e., at 117V (234V) line voltage is approximately 1.8kV; with a load current of 1mA, the output voltage is zero).

OPERATING INSTRUCTIONS

For operating purposes, several important front panel changes have been made in the Type 575 by the addition of the Increased Collector Volts Mod. The HORIZONTAL VOLTS/OIV switch has three additional positions, 50, 100, and 200 VOLTS/DIV, added to the Collector Volts Range.

There are also changes in the COLLECTOR SWEEP switching, with an added 0-400 position on the PEAK VOLTS RANGE switch and a third position on the POLARITY switch. This third position, labeled $\pm 1.5\text{kV}$, 1mA MAX is brought to the Collector terminal posts, on the front Test Panel, by turning the POLARITY switch fully clockwise and pressing the PRESS TO CHECK button, which energizes the primary of the High Voltage Transformer. The high voltage can be varied by turning the PER CENT OF PEAK VOLTS RANGE control.

RECALIBRATION

When recalibrating your instrument, use the following procedure in lieu of step 9 in your Manual.

NOTE: If this Mod has just been installed and the instrument does not need a complete recalibration, it will be necessary to use only this procedure plus steps 4 and 5 in your Manual, which refer to Vertical Gain (R434) and Horizontal gain (R334).

STEP 9 -- ADJUST COLLECTOR SWEEP BALANCE

Set controls:

VERTICAL COLL MA/DIV	-- 0.01
HORIZ COLL VOLTS/DIV	-- 20
PEAK VOLTS RANGE	-- 0-200
PEAK VOLTS PER CENT	-- 80
POLARITY	-- MINUS (-)
TRANSISTOR A-B SWITCH	-- B

With controls set as noted above, adjust R732A, *C239 (under lower chassis) and C706A for minimum trace separation. If trace separation is greater than 2 or 3mm, change the white wire added in step 7 to terminal 16 of T601, and adjust for minimum separation as indicated in steps a through e on the following page.

(Complications will arise if a 575 Mod 122C is used on a 3-wire power Source and the hot and common leads are revised. The 60 cycle line voltage appears mixed with the collector sweep wave form, and it becomes impossible to adjust R732A and C706A for a satisfactory minimum trace separation.

Normally, one primary lead to T703 is connected to the common lead in the instrument and the other primary lead is switched to the hot side of the line through the 'PRESS TO CHECK' switch. If the primary lead normally connected to the common side becomes hot, a large 60 cycle AC signal is coupled into the Collector Sweep supply via the electrostatic shield at the secondary of T703.

RECALIBRATION (continued)

If this problem is encountered, first check the power Source at the 3-wire connector. The "hot" terminal should show the full line voltage (see drawing below).

*Effective SN 101-4769 only

If the Source is okay, check the wiring of the instrument against the schematics. The "hot" side should be the only side switched or fused.

- a. Set PEAK VOLTS RANGE to 0-400, and adjust C706B.
- b. Set POLARITY to PLUS (+), and adjust C706C.
- c. Turn PEAK VOLTS RANGE to 0-200, and adjust C706D. Then turn PEAK VOLTS RANGE to 0-400.
- d. Set HORIZONTAL to 50 COLLECTOR VOLTS/DIV, and adjust C318 (on etched circuit board at rear of HORIZONTAL VOLTS/DIV switch).
- e. Set PEAK VOLTS RANGE to 0-20, POLARITY to $\pm 1.5\text{kV}$, and depress the PRESS TO CHECK button. While holding the button depressed, adjust C706E.

If all adjustments are made carefully and in proper sequence, there should be no need to repeat any step, since there is then a minimum of inter-action between adjustments.

ELECTRICAL PARTS LIST

Values fixed unless marked variable. Only new parts and circuit numbers listed.

Ckt.No.	Part Number	Description
---------	-------------	-------------

CAPACITORS

Tolerance ±20% unless otherwise indicated.

*C239	281-0044-00	80-480pF	Mica	Var.
C318	281-0010-00	4.5-25pF	Cer.	Var.
C706A	281-0007-00	3-12pF	Cer.	Var.
C706B	281-0010-00	4.5-25pF	Cer.	Var.
C706C	281-0010-00	4.5-25pF	Cer.	Var.
C706D	281-0010-00	4.5-25pF	Cer.	Var.
C706E	281-0010-00	4.5-25pF	Cer.	Var.
C734	283-0555-00	0.002μF	Mica	

RECTIFIERS

GR707	106-0060-00	6 Germanium rectifier cells, each cell rated at 0.5 amp, 300V peak inverse
-------	-------------	--

RESISTORS

Resistors are 10% composition unless otherwise indicated.

R250	309-0020-00	3.6 Meg	1.8 Meg	1/2W	prec.	1%
	309-0020-00		1.8 Meg	1/2W	prec.	1%
R258	309-0020-00	3.6 Meg	1.8 Meg	1/2W	prec.	1%
	309-0020-00		1.8 Meg	1/2W	prec.	1%
R319	309-0001-00	433k		1/2W	prec.	1%
R705	304-0274-00	270k		1W	prec.	10%
R729A	306-0474-00	470k		2W		
R729B	306-0474-00	470k		2W		
R729C	306-0474-00	470k		2W		
R729D	306-0474-00	470k		2W		
R730	309-0025-00	10 Meg		2.5 Meg	1/2W	prec. 1%
	309-0025-00			2.5 Meg	1/2W	prec. 1%
	309-0025-00			2.5 Meg	1/2W	prec. 1%
	309-0025-00			2.5 Meg	1/2W	prec. 1%
R732	309-0125-00	300k		1/2W	prec.	1%
R732A	311-0126-00	1 Meg	minipot		Var.	

SWITCHES

SW305	260-0591-01(unwired)	262-0633-00(wired)	Rotary	HORIZONTAL VOLTS/DIV
SW700	260-0017-00(unwired)		SPST Push	PRESS TO CHECK
SW706	260-0403-00(unwired)	262-0496-00(wired)	Rotary	PEAK VOLTS RANGE
SW708	260-0404-01(unwired)		Rotary	POLARITY
SW735	260-0463-00(unwired)		Lever	TRANSISTOR SELECTOR

TRANSFORMERS

T703	120-0226-00	High Voltage for Diode Test
------	-------------	-----------------------------

NOTE: The following circuit numbers should be deleted from the Standard Manual parts list: C706, C730, C735.

*Effective SN 101-4769 ONLY.

MECHANICAL PARTS LIST

Part Number	Description
388-0523-00	Board, etched circuit
406-0743-00	Bracket, 2kV transformer mounting
179-0668-00	Cable, harness, power for 2kV transformer
343-0002-00	Clamp, cable, 3/16
366-0033-00	Knob, small, black
210-0001-00	Lockwasher, int. no. 2
210-0004-00	Lockwasher, int. no. 4
210-0006-00	Lockwasher, int. no. 6
210-0010-00	Lockwasher, int. no. 10
210-0012-00	Lockwasher, int. 3/8 x 1/2, small potentiometer
210-0013-00	Lockwasher, int. 3/8 x 11/16, large potentiometer
210-0202-00	Lug, solder, SE6 w/2 wire holes
210-0205-00	Lug, solder, SE8
210-0206-00	Lug, solder, no. 10
210-0207-00	Lug, solder, 3/8, potentiometer
210-0406-00	Nut, hex, 4-40 x 3/16
210-0407-00	Nut, hex, 6-32 x 1/4
210-0410-00	Nut, hex, 10-32 x 5/16
210-0413-00	Nut, hex, 3/8-32 x 1/2
210-0438-00	Nut, 1-72
210-0449-00	Nut, hex, 5-40 x 1/4
210-0457-00	Nut, Keps, 6-32 x 5/16
210-0505-00	Nut, hex, 3/8-27 x 1/2
333-0690-00	Panel, (for Mod 122C)
211-0017-00	Screw, 4-40 x 3/4 RHS
211-0504-00	Screw, 6-32 x 1/4 8HS, Phillips
211-0507-00	Screw, 6-32 x 5/16 8HS, Phillips
211-0511-00	Screw, 6-32 x 1/2 8HS, Phillips
212-0553-00	Screw, 10-32 x 1-1/2 RHS
337-0476-00	Shield, Collector Sweep side
166-0025-00	Spacer, tube, mech.
166-0030-00	Spacer, 3/16 (for transformer mounting bracket)
361-0007-00	Spacer, nylon molded, 0.063
361-0009-00	Spacer, nylon molded, 0.313
361-0048-00	Spacer, toggle switch, 5/8 x 0.130L
124-0088-00	Strip, cer, 3/4 x 4 notches, clip-mounted
124-0091-00	Strip, cer, 3/4 x 11 notches, clip-mounted
334-0820-00	Tag, overlay
003-0220-00	Template
210-0801-00	Washer, flat, no. 5S
210-0802-00	Washer, flat, no. 6S
210-0803-00	Washer, flat, no. 6L
210-0840-00	Washer, flat, 0.390 x 9/16
210-0869-00	Washer, nylon, insulating
210-0906-00	Washer, fiber
210-0812-00	Washer, fiber #10
210-0813-00	Washer, fiber #10, shouldered

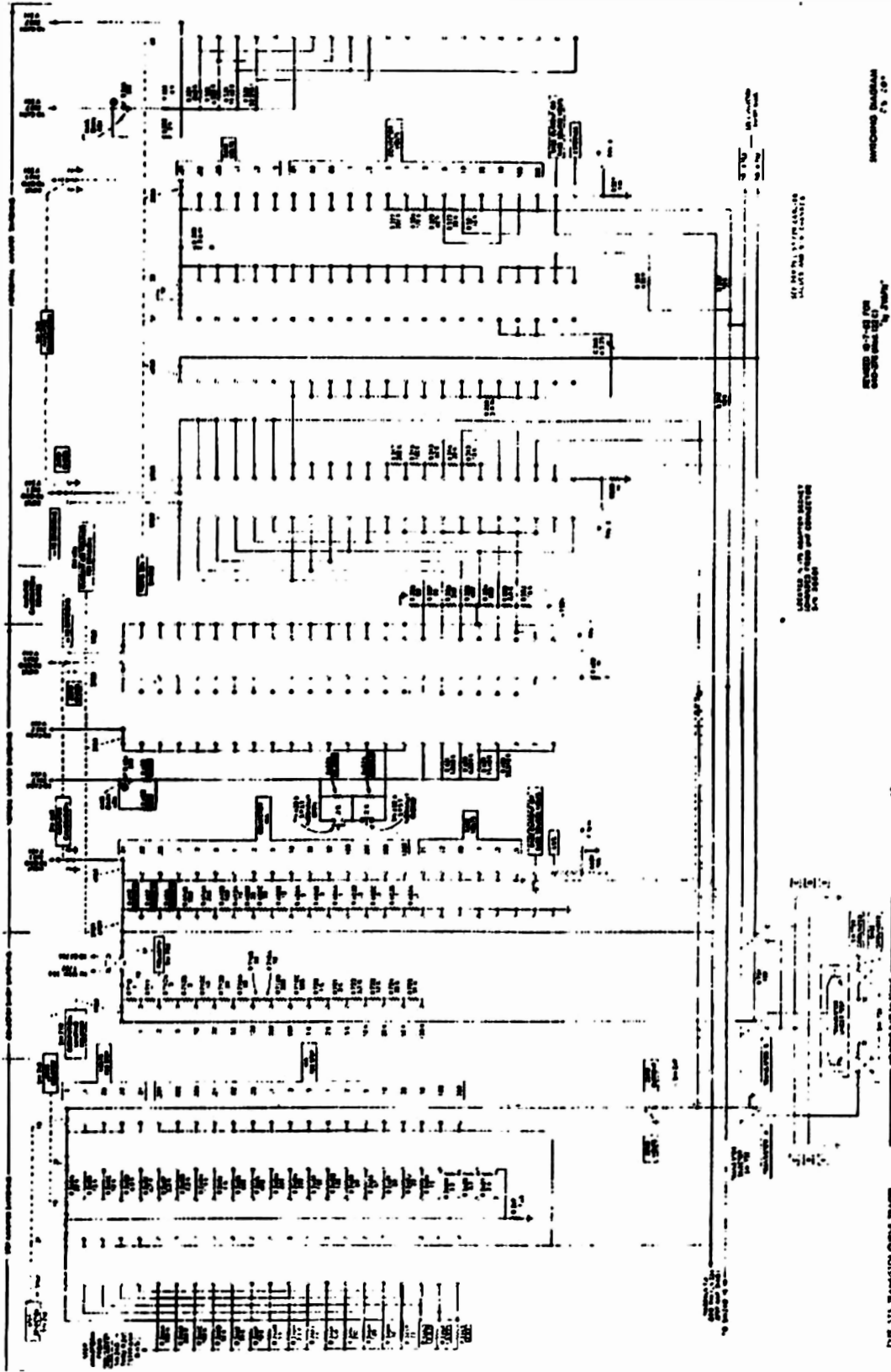

SUPPORT POST INSULATED TO REDUCE TRACE LOOPING

Effective Prod SN 9631

Usable in SN 4770-9630

Irregular trace looping at high sensitivities.

The collector sweep transformer, T702, was causing ground currents which in turn resulted in irregular trace looping at high sensitivities.

The collector sweep transformer support post was insulated from the frame brace by adding two #10 fiber washers as shown in the sketch. To allow proper seating of the shoulder washer, it was necessary to enlarge the frame brace hole from 13/64 dia. to 17/64 dia.

Parts Added:

210-0812-00

Washer, fiber, #10

210-0813-00

Washer, fiber, #10 shouldered

INSTALLATION:

Parts Required: See 'Parts Added'.

Insulate the Collector Sweep transformer support post as shown in drawing on following page.

Continued.

M10353 (Continued)

Type 575

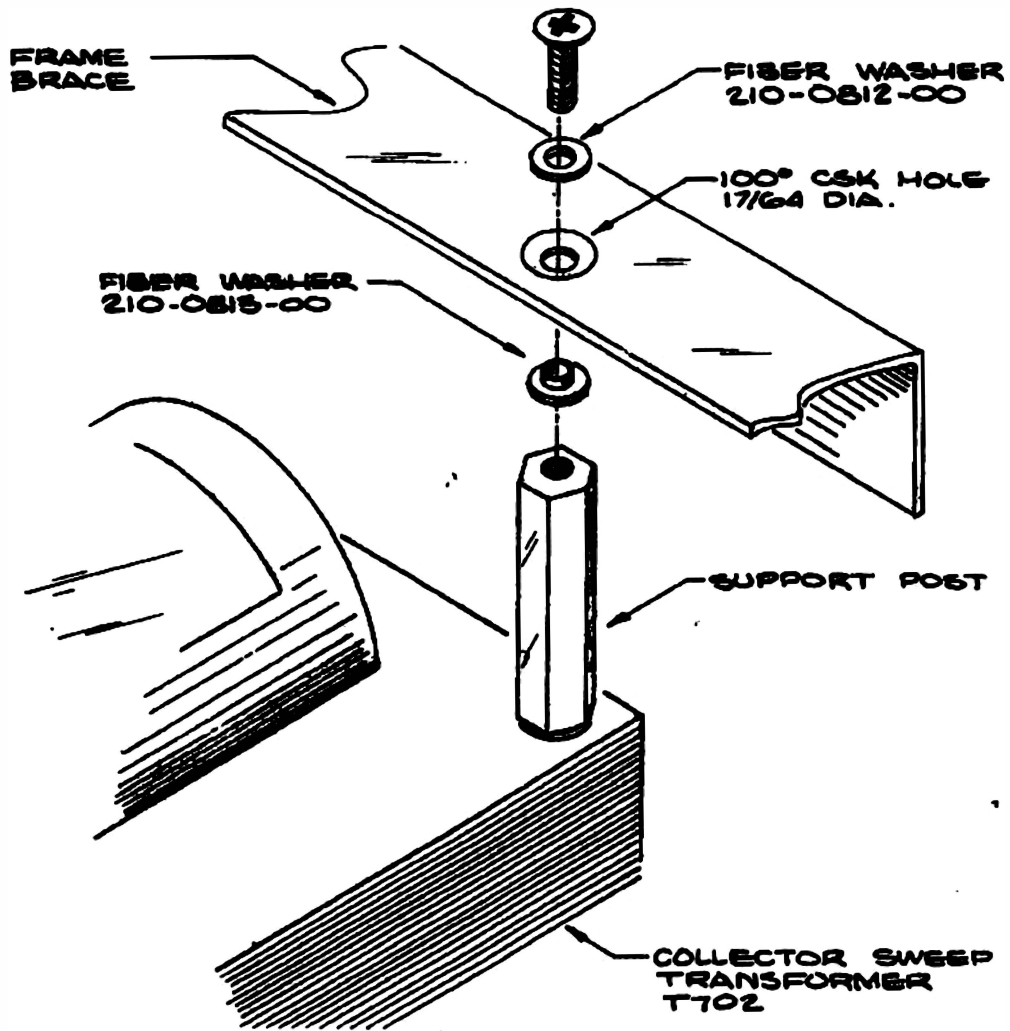

T701 CHANGED TO 50-60Hz TYPE

Effective Prod SN 12197

Usable in SN 101-12196

PEAK VOLTS powerstat was designed to operate on 60Hz line voltage, would overheat when operated on 50Hz line voltage.

PEAK VOLTS powerstat was changed from a 60Hz only type to a 50-60Hz type.

Parts Removed:

T701	120-0089-00	Transformer, variable voltage 60Hz
------	-------------	------------------------------------

Parts Added:

T701	120-0476-00	Transformer, Variable voltage 50/50Hz
------	-------------	---------------------------------------

INSTALLATION:

Parts Required: See 'Parts Added'.

Replace T701, the PEAK VOLTS powerstat, located on the front panel, with a 50-60Hz type. The new unit is a direct replacement.

COLLECTOR SWEEP RESTART AT ZERO WITH NO LOAD ASSURED

Effective Prod SN 13190

Usable in SN 101-13189

With collector sweep at 400V, the Horizontal display at 50V/CM and no collector load, the collector sweep will start at 50V instead of zero.

The collector circuit stray capacitance charges during the sweep and is not fully discharged to zero by the input impedance of the horizontal amplifier before another sweep starts.

This is not an error but an annoyance and can lead to questions about the stability of the horizontal display.

A fixed load of 270k was added across the collector supply.

Parts Added:

304-0274-00

Resistor, comp., 1W 270k 10%

INSTALLATION:

Install R705, a 270k 1W resistor between contacts W1-6R and W1-12R of the COLLECTOR SWEEP POLARITY switch (SW708).

NOTE: The following method is used to identify the COLLECTOR SWEEP POLARITY switch terminals:

The wafers are numbered from front to rear.

The contact mounting holes are numbered relative to the index key as shown in the sample drawing. (The number of contact mounting holes will vary from switch to switch, but the method of numbering them is the same.)

The contacts have an 'F' or 'R' suffix which denotes that they are on the front or rear of the wafer.

Example: W2-7R (denoted by * on drawing) is contact #7 on the rear of wafer 2.

Continued.

M13884 (Continued)

Type 575

(TYPICAL SWITCH CONFIGURATION)

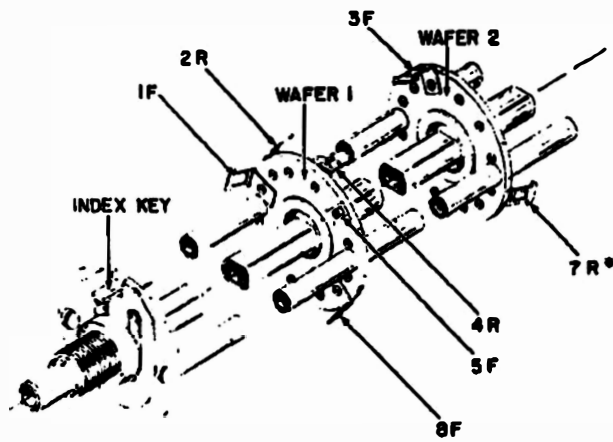

COLLECTOR CURRENT SAMPLING RESISTOR REPLACED

Effective Prod SN 145

To improve the vertical current measuring accuracy, R414A and B have been slightly increased in value. R414A was changed from 300 Ω to 301 Ω , and R414B was changed from 500 Ω to 504 Ω . Superseded by Mod 1758.

For replacement purposes, the entire set of nine resistors that are part of R414 must be replaced as a unit.

Parts Removed:

R414A		Resistor, prec., 300 Ω	1/2%
R414B	308-0109-00	Resistor, prec., 500 Ω	1/2%

Parts Added:

R414A		Resistor, prec., 301 Ω	1/2%
R414B	309-0109-00	Resistor, prec., 504 Ω	1/2%

COLLECTOR CURRENT SAMPLING RESISTORS REPLACED

Effective Prod SN 233

Collector current sampling resistors were changed to improve the accuracy of the vertical display.

Superseded by Mod 1759.

Parts Removed:

R416	310-0081-00	Resistor, prec., 1.01k	1W	1%
R417	309-0183-00	Resistor, prec., 3.05k	1/2W	1%
R418	309-0190-00	Resistor, prec., 5.19k	1/2W	1%

Parts Added:

R416	310-0060-00	Resistor, prec., 1.015k	1W	1/2%
R417	309-0196-00	Resistor, prec., 3.108k	1/2W	1/2%
R418	309-0197-00	Resistor, prec., 5.398k	1/2W	1/2%

COLLECTOR CURRENT SAMPLING RESISTORS REPLACED

Effective Prod SN 246

Vertical Current/Division measuring resistors were changed to improve the accuracy of the vertical display.

Parts Removed:

R414A		Resistor, WW, 301 Ω	1/2%
R414B	part of 308-0109-00	Resistor, WW, 504 Ω	1/2%

Parts Added:

R414A		Resistor, WW, 300 Ω	1/2%
R414B	308-0132-00**	Resistor, WW, 502 Ω	1/2%
R420	302-0184-00	Resistor, comp., 180k	1/2W 10%
R421	302-0124-00	Resistor, comp., 120k	1/2W 10%

**R414A and B (308-0132-00) is an 802 Ω resistor with a tap at 300 Ω . It is a part of 308-0109-00.

See Mod 1759.

COLLECTOR CURRENT SAMPLING RESISTORS REPLACED

Effective Prod SN 793

Usable in SN 101-792

Collector current sampling resistors were changed to improve the accuracy of the vertical display.

This mod supersedes Mod 1586, Mod 1587, and Mod 1758.

Parts Removed:

R416	310-0060-00	Resistor, prec., 1.015k	1W	1/2%
R417	309-0196-00	Resistor, prec., 3.108k	1/2W	1/2%
R418	309-0197-00	Resistor, prec., 5.398k	1/2W	1/2%

Parts Added:

R416	310-0062-00	Resistor, prec., 1.008k	1W	1/2%
R417	309-0198-00	Resistor, prec., 3.053k	1/2W	1/2%
R418	309-0199-00	Resistor, prec., 5.193k	1/2W	1/2%

INSTALLATION:

Parts Required: See 'Parts Added'.

Replace R416, R417, and R418, located on the VERTICAL CURRENT or VOLTAGE PER DIVISION switch.

COLLECTOR CURRENT/DIV RANGE INCREASED

Effective Prod SN 861

The range of the COLLECTOR CURRENT/DIV switch was extended from 100-0.01mA/Div to 200-0.001mA/Div by adding a X2 and X0.1 pushbutton Collector Current Multiplier. Also better protection for the Collector Sweep circuit was provided by replacing the 1A fuse with an 0.8A circuit breaker.

Parts Removed:

F702	159-0022-00	Fuse, 1A
SW405	262-0189-00	Switch, Rotary
	333-0329-00	Panel, front
	352-0014-00	Holder, fuse

Parts Added:

R432A	309-0245-00	Resistor, prec., 20.83k 1/2W 1%
R432B	309-0192-00	Resistor, prec., 11.48k 1/2W 1%
SW405	262-0202-00	Switch, Rotary
SW432A	260-0248-00	Switch, SPST
SW432B	260-0247-00	Switch, SPST
SW602	260-0249-00	Circuit breaker
	210-0476-00	Nut, for circuit breaker
	333-0527-00	Front panel

TRANSISTOR TEST PANEL CHANGED

Effective Prod SN 3900

Usable in SN 101-3899

An erroneous saturation slope display when checking high current transistors caused by wire resistance is prevented by changing the pick-off point of the horizontal sensing voltage.

The emitter circuit voltage drop of transistors A and B are balanced by center-tapping the connecting lead of emitters A and B.

The Transistor Selector switch was replaced by a heavy duty 16 contact switch. For details see Mod 6375.

Parts Added:

210-0206-00	Lug, solder	(3)
-------------	-------------	-----

INSTALLATION:

Parts Required: See 'Parts Added'.

- a) Add a solder lug (210-0206-00) to the 'A' and 'B' Collector binding posts.
- b) Remove the #16 bare wires between Transistor Selector switch contacts 3LT, 2LB and 2LT, 1LB sensing contacts.
- c) Add a 6-1/4in. #22 white-yellow wire from 3LT to new solder lug at Collector 'B' binding post.
- d) Add a 5-1/4in. #22 white-yellow wire from 2LT to new solder lug at Collector 'A' binding post.
- e) Add a solder lug (210-0206-00) to the Emitter 'A' binding post.
- f) Add a #16 bare wire between Emitter 'A' and 'B' binding post.
- g) Change connections from Emitter 'B' binding post to center of #16 bare wire just installed.

Continued.

M3658 (Continued)

Type 575

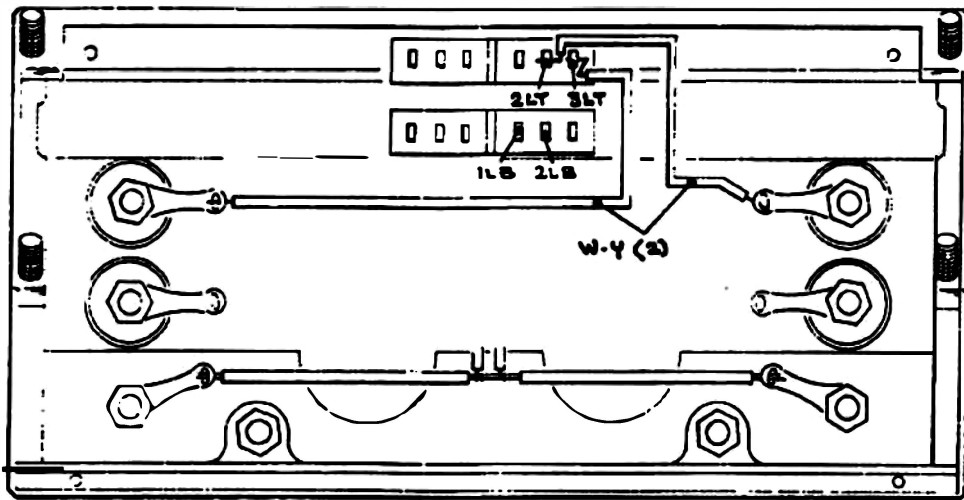

TRANSISTOR TEST CIRCUIT MODIFIED

Effective Prod SN 4B20

Usable in SN 101-4819

Mesa transistors, under certain test conditions, cause the Collector Sweep to oscillate and distort the display. The oscillation is eliminated by adding a ferramic suppressor in the lead that connects the 'C' binding post and the 'C' pin on the test socket.

Parts Added:

L734
L735

276-0517-00

Ferramic suppressor

INSTALLATION:

Parts Required: See 'Parts Added'.

Install L734 and L735 as follows: Add two loops of wire on a ferramic core on the white-red wires that connect the 'C' binding posts to their respective transistor test sockets.

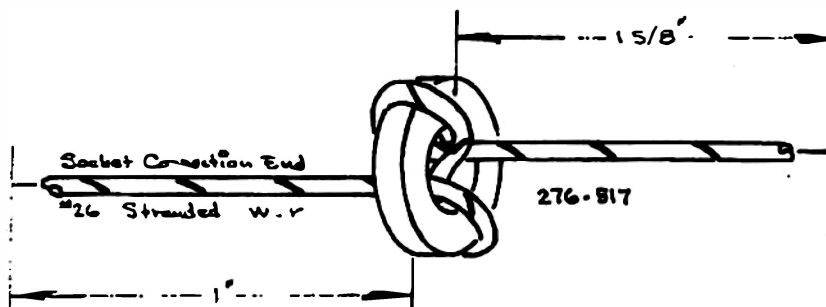

TRANSISTOR SELECTOR SWITCH REPLACED

Effective Prod SN 5910

To provide more reliability, the Transistor Selector switch was replaced with a switch designed to prevent freezing.

Parts Removed:

SW730	260-0197-00	Lever
-------	-------------	-------

Parts Added:

SW730	260-0463-00	Lever
-------	-------------	-------

INSTALLATION:**Parts Required:**

050-0070-00	Parts Replacement Kit
-------------	-----------------------

Refer to kit instructions.



050-0070-01

M6375

Type 575,
575-MOD 122C

TRANSISTOR SELECTOR SWITCH REPLACEMENT

For the TEKTRONIX® Types 575 and 575-Mod 122C Transistor Curve Tracers

Serial Numbers 101-5909

Transistor selector switch, pn 260-0463-00, replaces pn 260-04C9-00, or pn 260-0197-00. The new switch has an improved action, designed to prevent 'freezing' and to increase reliability.

NOTE: If the serial number of your instrument is above those listed, or if this kit has been installed, disregard the instructions and use pn 260-0463-00 as a direct replacement.

PARIS INCLUDED IN PARTS REPLACEMENT KIT:

Quantity	Part Number	Description
1 ea		Assembly, Transistor Selector switch, consisting of:
1 ea	210-0845-00	Washer, flat, 5/8 x 1/2 x 0.020
1 ea	260-0463-00	Switch, lever, locking
1 ea	302-0101-00	Resistor, cmpsn, 100Ω 10% 0.5W
1 ea		Wire, #22 solid, white, 3 in
1 ea	210-0206-00	Lug, solder, SE10, long
2 ea	162-0502-00	Tubing, plastic, #16, black, 2 in
2 ea		Wire, #22 solid, white-yellow, 7 in
1 ea		Wire, #22 solid, white-green, 5 in
1 ea		Wire, #22 solid, white-green, 2 in
1 ea		Wire, #16 solid, bare, 5 in
1 ea		Marker, identification

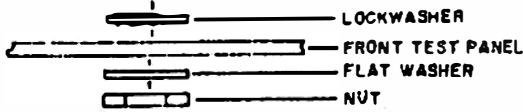
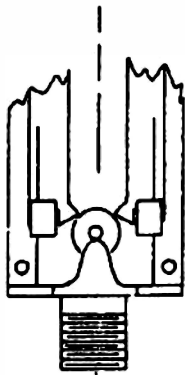

Fig. 1

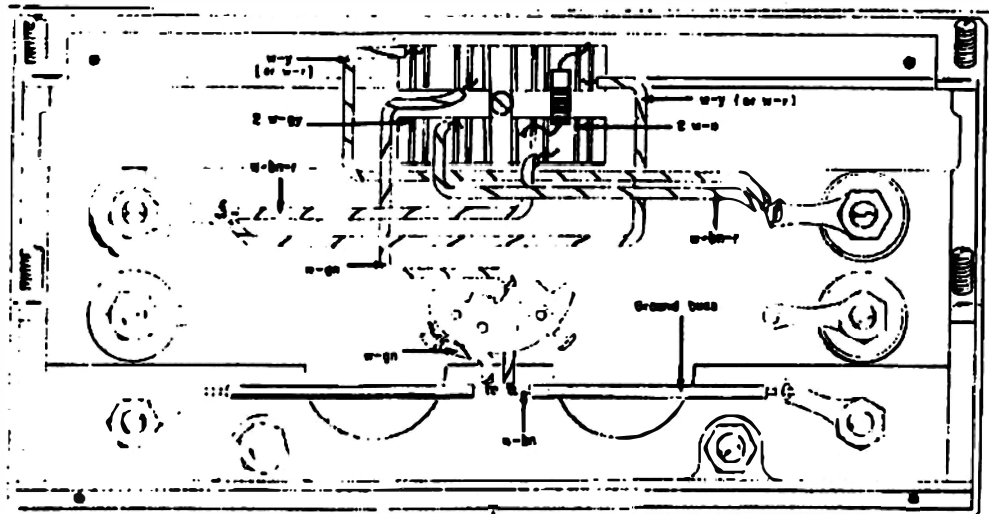

Fig. 2

INSTRUCTIONS:

- () 1. Remove the bottom covers from both the instrument and the transistor test panel assembly.
- () 2. Unsolder the white-brown wire from the ground buss (or lug) inside the test panel.
- () 3. Unsolder all the wires from the Transistor Selector switch (TRANSISTOR A.- TRANSISTOR B), except those wires soldered between lugs on the switch itself.

NOTE: For Type 575 only, completely remove the white-green wire (to ground) and two white-yellow (or white-red) wires (to collector terminals on test panel).

- () 4. Remove the entire test panel assembly from the instrument (held with four nuts behind the front subpanel).
- () 5. Remove the Transistor Selector switch from the test panel assembly.
- () 6. Cut away that portion of the ridge, located inside the test panel frame, that interferes with the installation of the new switch (approximately 0.25 inch from both sides). Also, if necessary, enlarge the mounting hole with a drill or reamer.
- () 7. Install the Transistor Selector switch assembly (from kit) as shown in Figs. 1 and 2. Orient the switch so the 100 Ω resistor is on the TRANSISTOR A side.
- () 8. Add a ground lug, a buss wire and two lengths of plastic tubing (from kit) as shown in Fig. 2. (Disregard this step for instruments which already have a ground buss).
- () 9. Solder the 2 in. white-green wire from EMITTER GROUNDED - BASE GROUNDED switch to the center of the ground buss (see Fig. 2).

NOTE: Omit this step for instruments which already have a wire connected here.

STEPS 10 AND 11 REFER TO TYPE 575 ONLY.

- () 10. Solder the 5 in. white-green wire (from kit) between the Transistor Selector switch and the center of the ground buss (see Fig. 2).
- () 11. Solder the two white-yellow wires (from kit) between the Transistor Selector switch and the collector test terminals, as shown in Fig. 2.

INSTRUCTIONS (continued)

ALL INSTRUMENTS.

- () 12. Solder the remaining wires to the Transistor Selector switch, as shown in Fig. 2.
- () 13. Remount the transistor test panel assembly, removed in step 4.
NOTE: Be sure to replace ground lug under mounting nut.
- () 14. Solder the white-brown wire to the ground buss, as shown in Fig. 2.

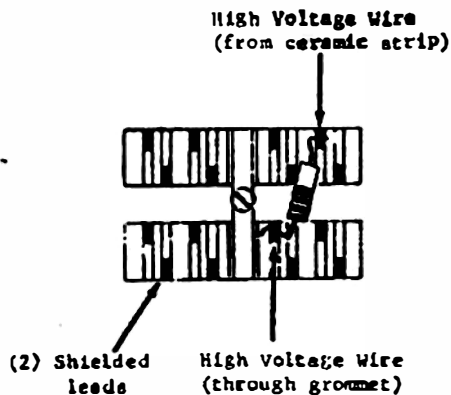

Fig. 3.

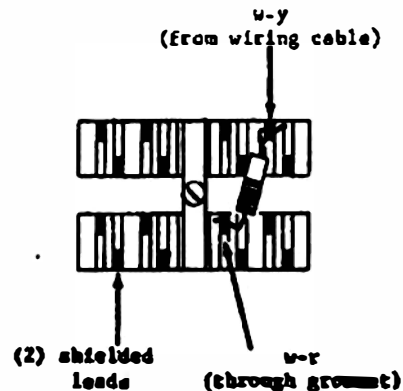

Fig. 4.

- () 15. TYPE 575 - MOD 122C ONLY
Resolder the shielded leads from the main chassis and HV wires to the Transistor Selector switch (see Fig. 3).
- () 16. TYPE 575 ONLY
Solder the white-yellow, white-red and shielded leads to the Transistor Selector switch (see Fig. 4).
- () Check wiring for accuracy.
- () Replace the bottom covers removed in step 1.
- () For future reference, an identification marker has been included to indicate that this kit has been installed. After removing the protective backing, place the marker on the instrument rear panel.
- () Change the part number for SW730 in the parts list of your Instruction Manual to 260-0463-00.

JG:cs

SWITCH CONTACTS GOLD PLATED TO REDUCE NOISE

Effective Prod SW 10100 (SW735)
 10220 (SW710) 575-122C SW 10240
 10290 (SW246) 575-122C SW 10370
 10307 (SW305) 575-122C SW 10110
 10350 (SW240) 575-122C SW 10370
 10350 (SW248) 575-122C SW 10370
 10350 (SW405) 575-122C SW 10370
 10350 (SW706) 575-122C SW 10282
 10350 (SW708) 575-122C SW 10370

*Other serial numbers will be supplied when available.

Electrical noise was being caused by a buildup of switch contact resistance.

All rotary switches were replaced with new lower-noise type that are identical to the old except the coin silver rotors and contacts have an 0.0002 minimum hard gold plate added.

Parts Removed:

SW240	260-0258-00	Switch, raw, rotary, 1 sect.	2 pos.	30° rotation
SW246	260-0182-00	Switch, raw, rotary, 3 sect.	22 pos.	15° rotation
SW248	260-0183-00	Switch, raw, rotary, 2 sect.	24 pos.	15° rotation
SW305	260-0184-00	Switch, raw, rotary, 4 sect.	19 pos.	15° rotation
SW305 (575-122C)	260-0591-00	Switch, raw, rotary, 6 sect.	22 pos.	15° rotation
SW405	260-0243-00	Switch, raw, rotary, 6 sect.	24 pos.	15° rotation
SW706	260-0180-00	Switch, raw, rotary, 3 sect.	2 pos.	60° rotation
SW706 (575-122C)	260-0403-00	Switch, raw, rotary, 4 sect.	3 pos.	30° rotation
SW708	260-0179-00	Switch, raw, rotary, 1 sect.	2 pos.	60° rotation
SW708 (575-122C)	260-0404-00	Switch, raw, rotary, 1 sect.	3 pos.	60° rotation
SW710	260-0181-00	Switch, raw, rotary, 2 sect.	17 pos.	20° rotation
SW735	260-0189-00	Switch, raw, rotary, 1 sect.	2 pos.	30° rotation

Continued.

M10070 (Continued)

Type 575

Parts Added:

SW240	260-0258-01	Switch, raw, rotary, 1 sect.	2 pos.	30° rotation
SW246	260-0182-01	Switch, raw, rotary, 3 sect.	22 pos.	15° rotation
SW248	260-0183-01	Switch, raw, rotary, 2 sect.	24 pos.	15° rotation
SW305	260-0184-01	Switch, raw, rotary, 4 sect.	19 pos.	15° rotation
SW305 (575-122C)	260-0591-01	Switch, raw, rotary, 6 sect.	22 pos.	15° rotation
SW405	260-0243-01	Switch, raw, rotary, 6 sect.	24 pos.	15° rotation
SW706	260-0180-01	Switch, raw, rotary, 3 sect.	2 pos.	60° rotation
SW706 (575-122C)	260-0403-01	Switch, raw, rotary, 4 sect.	3 pos.	30° rotation
SW708	260-0179-01	Switch, raw, rotary, 1 sect.	2 pos.	60° rotation
SW708 (575-122C)	260-0404-01	Switch, raw, rotary, 1 sect.	3 pos.	60° rotation
SW710	260-0181-01	Switch, raw, rotary, 2 sect.	17 pos.	20° rotation
SW735	260-0189-01	Switch, raw, rotary, 1 sect.	2 pos.	30° rotation

MOTOR BASE CHANGED TO 3-CONTACT TYPE

Effective Prod SN 611

Usable in SN 101-610

Change motor base connector from 2-contact to 3-contact type to provide separate ground circuit.

Parts Removed:

131-0010-00 Connector, 2-wire

Parts Added:

103-0013-00	Adapter, 3-wire to 2-wire	
131-0102-00	Connector, 3-wire	
161-0008-00	Cord, 3-cond, 8 ft.	
210-0457-00	Nut	(2)
211-0537-00	Screw	(2)

INSTALLATION:

Parts Required: See 'Parts Added'.

Replace 2-wire power cord and connector with a 3-wire type.

POWER CABLE CHANGED

Effective Prod SN 901

The thermal cutout is in the neutral leg. All switching should be done in the 'hot' leg.

Modify the cable so that the fuse, power switch, and thermal cutout are all the 'hot' side of the line and no switching or fusing takes place in the neutral side. The cable color-code standardized at the same time. Wire all fuses so that with the fuse removed the outer ring is 'cold'.

(Inner ring connected to motor base, outer ring to switch.)

AC POWER WIRES CHANGED TO SHIELDED CABLE

Effective Prod SN 4770

Usable in SN 101-4769

To remove the 60 cycle radiation from the 100V AC cable into the Collector Sweep Balance circuit (V733), the AC supply wires to the power switch and the variable voltage transformer (T701) were changed to shielded cables.

The radiation causes a distorted display in the 0.01 Collector mA/DIV with 0.1 Multiplier, 2.0 Collector V/DIV settings. At the same time, the connections between T701 and T601 were reversed which reverses the phase of the Collector Sweep voltage.

NOTE: Instruments in SN range 101-610 that do not have the 3-wire input connector should install Mod 1912 before installing Mod 5217.

Parts Added:

175-0239-00	Cable, 2-cond, shielded (28 in.)
	Cable, 2-cond, shielded (36 in.)

INSTALLATION:

Parts Required: See 'Parts Added'.

Remove the motor base connector and rotate 180° and reinstall. Wire as shown in drawing on following page.

Continued.

M5217 (Continued)

Type 575

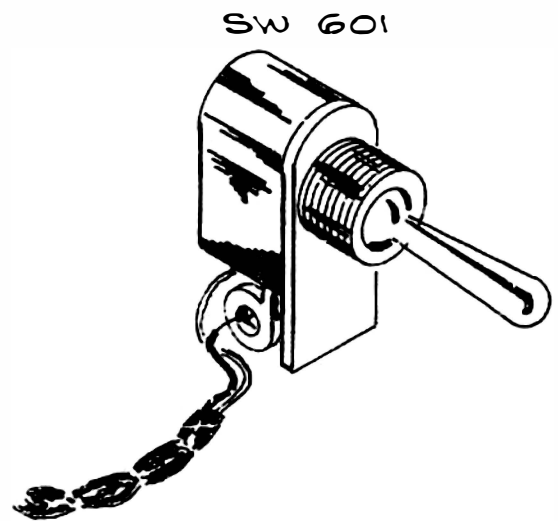
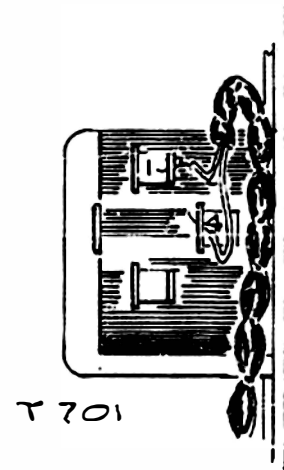
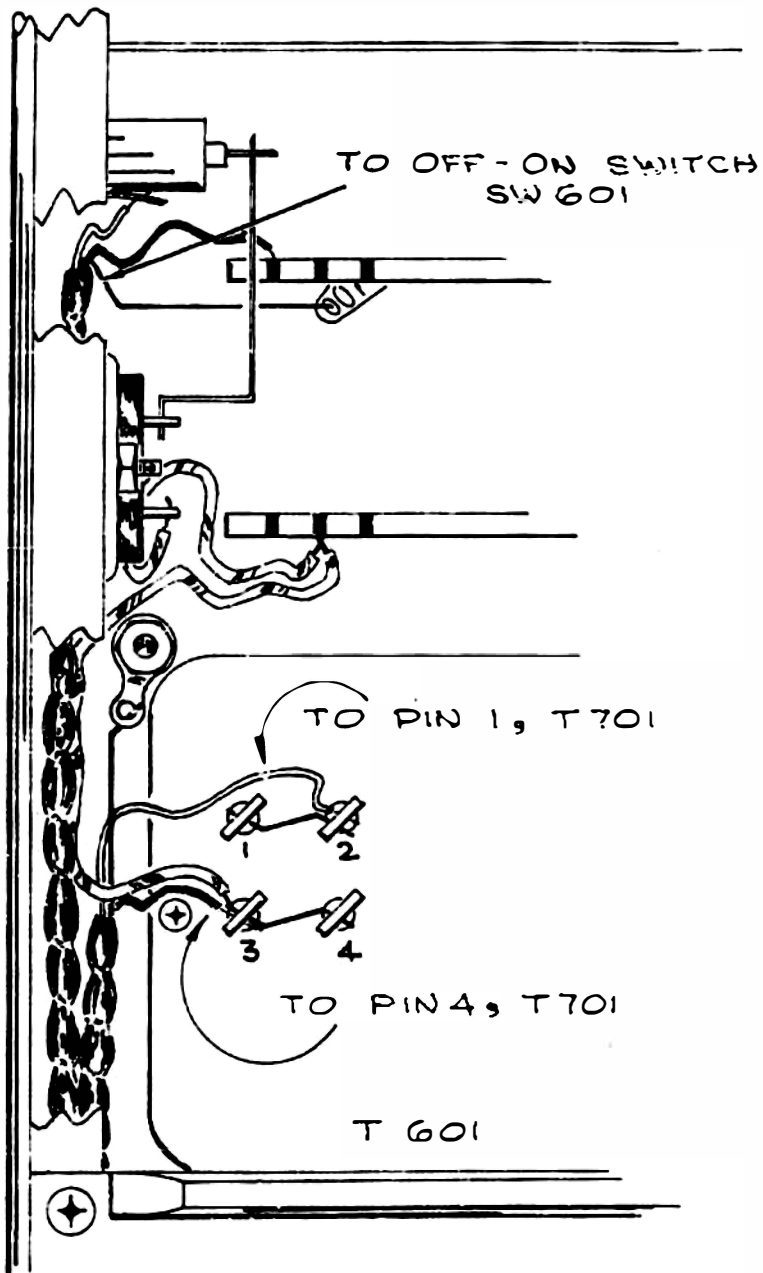

2 of 2

106.03

LV DIDDOS CHANGED

Effective Prod SH 4930

Usable in SH 101-4929

To improve instrument reliability and to standardize the silicon rectifiers, the selenium rectifiers were replaced with silicon rectifiers.

Parts Removed:

SR241	106-0043-00	Rectifier, selenium	
SR620	106-0044-00	Rectifier, selenium	
	406-0299-00	Bracket, rectifier	(2)

Parts Added:

D241A	152-0088-00	Diode, silicon, 1N3209
D241B		
D241C	152-0047-00	Diode, silicon, 1N2862
D241D		
D620A-D		
	406-0815-00	Bracket, rectifier

INSTALLATION:

Parts Required:

040-0223-00	Modification Kit
-------------	------------------

Refer to kit instructions.



040-0223-00

M5272

Type 575

SILICON RECTIFIER

For the TEKTRONIX® Type 575 Transistor Curve-Tracer

Serial Numbers 101-4929

This Modification Kit replaces the selenium rectifiers with silicon rectifiers. Silicon rectifiers offer more reliability and longer life.

The following selenium rectifiers are replaced: SR241 (pn 106-0043-00); SR62C (pn 106-0044-00).

PARTS INCLUDED IN MODIFICATION KIT:

Ckt. No.	Quantity	Part Number	Description
	(1 ea)		Assembly, silicon rectifier, consisting of:
	2 ea	124-0094-00	Strip, cer. 3/4 X 7 notches, clip-mounted
D241C,D D620A-D	6 ea	152-0066-00	Diode, silicon, 500-750mA 400 PIV
D241A,8	2 ea	152-0088-00	Diode, silicon 15A 100 PIV
F240 F241	2 ea	159-0053-00	Fuse, w/pigtail 5A Fast-blo
	1 ea	210-0201-00	Lug, solder, SE4
	1 ea	348-0002-00	Grommet, rubber, 1/4"
	4 ea	361-0039-00	Spacer, nylon-molded, 0.156
	1 ea	406-0815-00	Bracket, silicon rectifier mounting
	1 ea	162-0004-00	Tubing, clear vinyl plastic, 1-1/4"
	1 ea	175-0504-00	Wire, #18 solid, white-red 4"
	3 ea	210-0803-00	Washer, flat, 6L X 3/8
	3 ea	211-0507-00	Screw, 6-32 X 5/16 PHS, Phillips
	2 ea	213-0088-00	Screw, 4-40 X 1/4 PHS, thread-forming Type 8 Phillips
	1 ea	214-0210-00	Spool, w/3 ft. silver-bearing solder

INSTRUCTIONS:

IMPORTANT: When soldering to the ceramic strips, use the silver-bearing solder supplied with this kit.

- () 1. Remove the air filter from the rear of the instrument.
- () 2. Remove the six screws which hold the fan ring to the rear panel and move the fan assembly to one side. Do not unsolder the two fan motor leads.
- () 3. Unsolder all the wires from the selenium rectifier stacks, SR241 and SR620, located behind the fan motor.
- () Unsolder the two wires from the thermal cutout, mounted on the selenium rectifier bracket.
- () 4. Remove the selenium rectifiers and brackets from the instrument.

NOTE: One of the nuts holding a bracket to the chassis is under the high voltage shield and can be removed with needle-nose pliers.

INSTRUCTIONS (continued)

- () 5. Remove the thermal cutout from the selenium rectifier bracket and install it on the silicon rectifier bracket (from kit), using the 4-40 X 1/4 thread-forming screws from the kit.

NOTE: Mount the solder lug between the screw head and the thermal cutout (see Fig. 1, Step 5).

- () 6. Mount the silicon rectifier assembly (from kit), as shown in Fig. 1. Use the 6-32 X 5/16 PHS screws and #6 flat washers (from kit), placing a flat washer under each screw head. (Insert screws from bottom of chassis.)
- () 7. Wire the silicon rectifier assembly, as shown in Fig. 2.
- () Resolder the wires, unsoldered in step 3, to the thermal cutout.
- () Check wiring for accuracy.
- () Replace the air filter, removed in step 1, and the fan assembly, displaced in step 2.
- () Turn the instrument on and check the power supplies for proper voltages and regulation.
- NOTE: If adjustments are made to the power supply, it will be necessary to check the calibration of the instrument.
- () Place the Manual Insert page in your Instruction Manual.

JT:mh

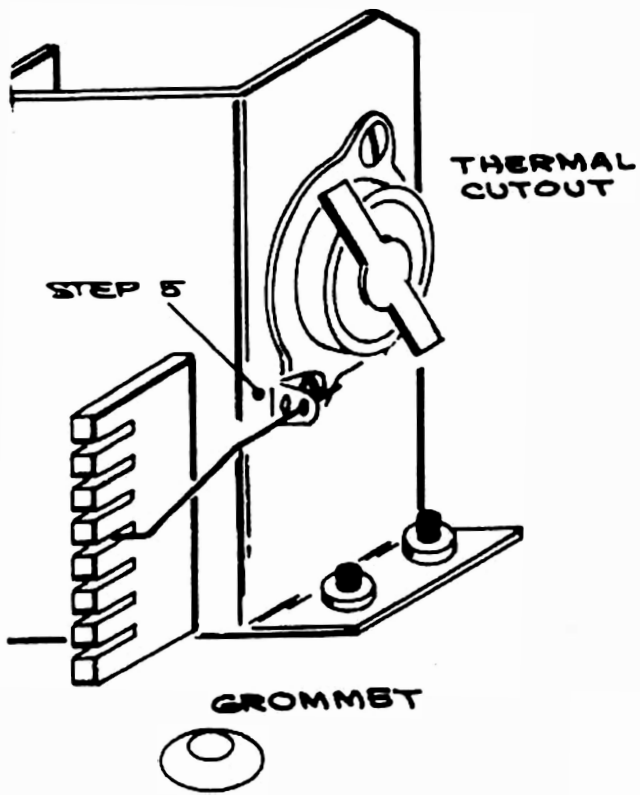

FIG. 1

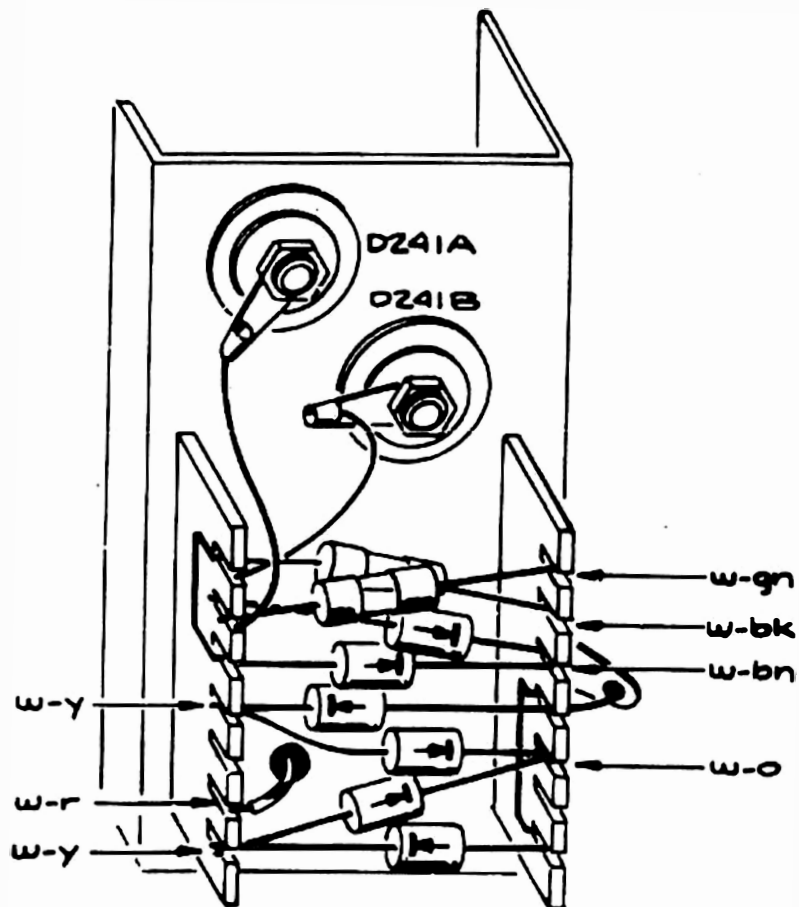
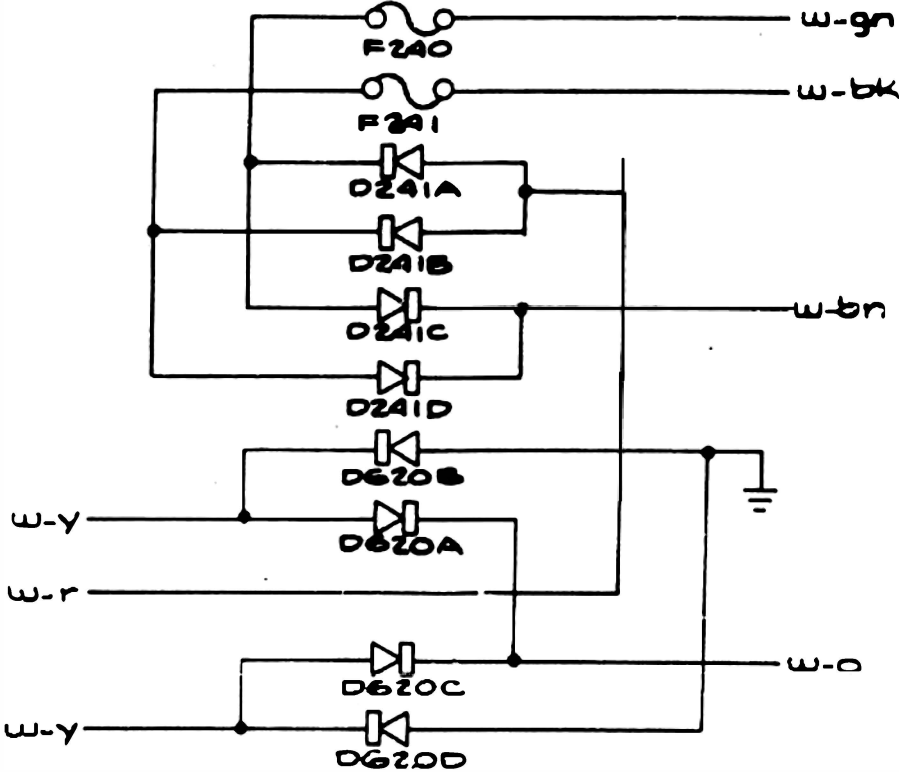

FIG. 2

(See wiring schematic on following page.)

continued

INSTRUCTIONS (continued)



INSTRUCTION MANUAL

MODIFICATION INSERT

SILICON RECTIFIER

TYPE 575 -- SN 101-4929

Installed in Type 575 SN _____ Date _____

This insert has been written to supplement the Instruction Manual for this instrument. The information given in this insert will supersede that given in the manual.

This Insert Material Copyright © 1965 by Tektronix, Inc., Beaverton, Oregon. Printed in the United States of America. All rights reserved. Contents of this insert may not be reproduced in any form without the permission of the copyright owner.

GENERAL INFORMATION

This modification replaced the selenium rectifiers with silicon rectifiers. Silicon rectifiers offer more reliability and longer life.

ELECTRICAL PARTS LIST:

Only new parts listed.

Ckt. No.	Part Number	Description
DIODES		
D241A, B	152-0088-00	15 A 100 PIV silicon
D241C, D	152-0066-00	500-750 mA 400 PIV silicon
D620A, B, C, D	152-0066-00	500-750 mA 400 PIV silicon
FUSES		
F240	159-0053-00	5 A fast-blo w/pigtail
F241	159-0053-00	5 A fast-blo w/pigtail

SCHEMATIC:

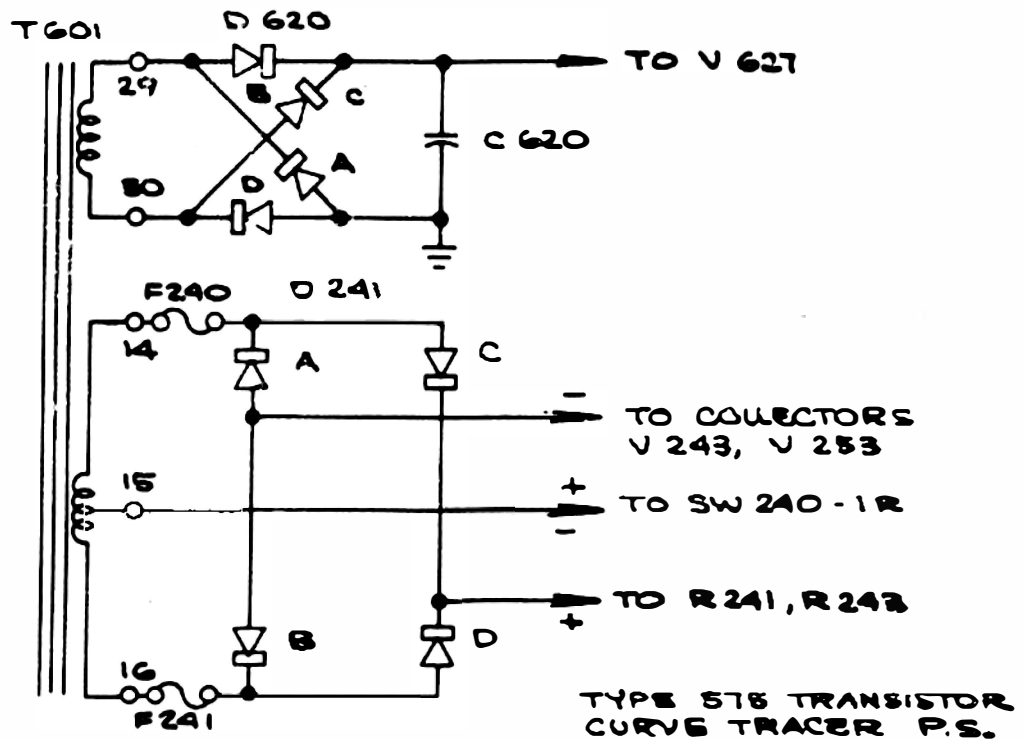

POWER TRANSFORMER PROTECTIVE FUSES ADDED

Effective Prod SN 8030

Usable in SN 101-8029

To protect the main power transformer (T601) when diodes or capacitors short, fuses were added in the + and -15V supply circuits between T601 and the rectifier diodes.

Parts Added:

F240	159-0053-00	Fuse, 5 amp fast-blo
F241		

INSTALLATION:

Parts Required: See 'Parts Added' and listed below:

124-0086-00	Ceramic strip, 3/4 x 2 notches
361-0009-00	Spacer, nylon molded,

- a) Drill a 5/32" hole as shown in drawing, and mount the 2-notch ceramic strip.
- b) Install F240 and F241 as shown in drawing.

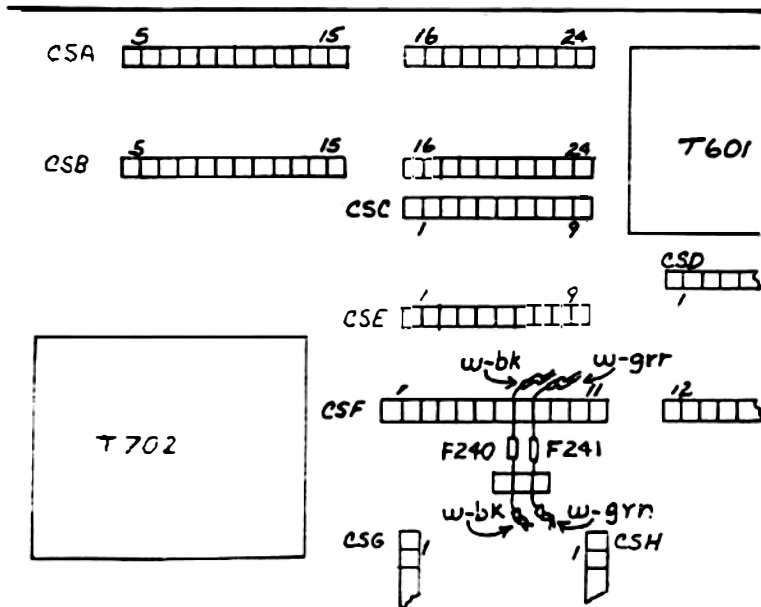

MULTIPLE TAPS ADDED TO PRIMARY OF T601

Effective Prod SN 9169

Provides additional auxiliary primary transformer windings to permit a wider selection of input voltages. Windings will be added within existing shells, thereby retaining same physical size of transformers.

Sets up new transformer tag 334-0958-00 with hookup data for different nominal primary voltages of 107, 117, 127, 214, 234, or 254. Tag will be used on all listed transformers except 120-0122-01, which will use existing tag 334-0634-00 with nominal voltages of 110, 117, 124, 220, 234, or 248.

-150V SUPPLY ADJUSTMENT RANGE INCREASED

Effective Prod SN 10090

Usable in SN 101-10089

The adjustment range of R664 was inadequate to compensate for the operating voltage spread of V649. This caused a high reject rate for the Type 5651 tube used for V649.

R662 was changed from 50k 1/2W 1% to 39.2k 1/2W 1% metal film and R666 was changed from 68k 1/2W 1% to 52.3k 1/2W 1% metal film, in order to increase the -150V adjustment range.

Parts Removed:

R662	309-0090-00	Resistor, prec., 50k 1/2W 1%
R666	309-0042-00	Resistor, prec., 68k 1/2W 1%

Parts Added:

R662	323-0346-00	Resistor, prec., 39.2k 1/2W 1% metal film
R666	323-0358-00	Resistor, prec., 52.3k 1/2W 1% metal film

INSTALLATION:

Parts Required: See 'Parts Added'.

- a) Replace R662, a 50k 1/2W precision resistor, located on ceramic strips over V657, with a 39.2k metal film type resistor.
- b) Replace R666, a 68k 1/2W precision resistor, located on ceramic strips over V657, with a 52.3k metal film type resistor.

SILICON DIODE TYPE CHANGED TO FACILITATE LAYOUT

Effective Prod S/n 10650

A smaller diameter and higher current rated silicon diode was available to facilitate layout and improve dress.

D241C-D, and D620A-D were changed from top hat type diodes to tubular type diodes.

Parts Removed:

D241C,D D620A,B,C,D	152-C047-01	Diode, silicon, 400PIV 500mA
------------------------	-------------	------------------------------

Parts Added:

D241C,D D620A,B,C,D	152-0066-01	Diode, silicon, 400PIV 500-750mA
------------------------	-------------	----------------------------------

-150V POWER SUPPLY REGULATION IMPROVED

Effective Prod SN 12260

The -150V power supply goes out of voltage specifications as the grid current of the difference amplifier increases with tube age.

R644 and R656 were decreased in value from 470k to 100k. At the same time, two capacitors in the -150V supply were increased from .01 μ F to .047 μ F.

Parts Removed:

C644	285-0510-00	Capacitor, .01 μ F 400V
C655		
R644	302-0474-00	Resistor, 470k 1/2W 10%
R656		

Parts Added:

C644	285-0519-00	Capacitor, .047 μ F 400V
C655		
R644	302-0104-00	Resistor, 100k 1/2W 10%
R656		

INSTALLATION:

Parts Required: See 'Parts Added'.

- a) Replace R644 and R656, two 470k 1/2W 10% resistors located between CSA-8 and CSB-8, and CSA-12 and CSB-12 respectively, with two 100k 1/2W 10% resistors.
- b) Replace C644 and C655, two 0.01 μ F capacitors located on the Power Supply chassis, between CSA-7 and CSB-7, and CSA-13 and CSB-13 respectively with two 0.047 μ F capacitors.

Continued.

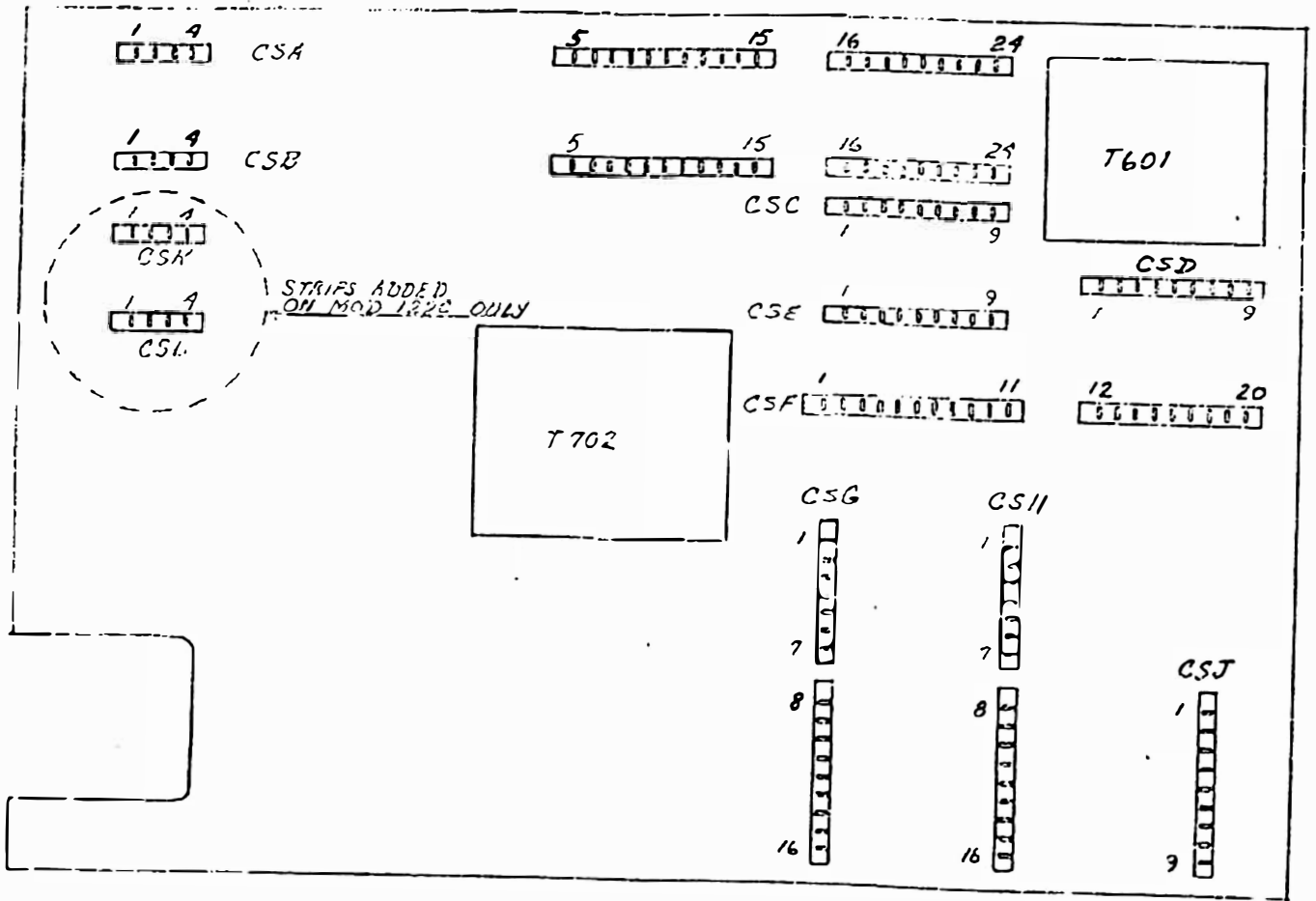

MOTOR BASE GROUND CONNECTION IMPROVED

Effective Prod SN 12390

Usable in SN 101-12389

The present motor base grounding is not adequate, due to cold flow of the plastic between the ground post and the mounting plate.

The method used to attach the ground post in the motor base assemblies was changed. The new mounting eliminates plastic between the ground post and the mounting plate and provides a metal to metal ground connection. To insure a good fit between mating parts, the size of the mounting screws was changed from #4 to #6, and the clearance holes in the mounting plate and shell were increased to #6.

To prevent corrosion between new ground post and mounting plate, the plate was changed from etched aluminum to cad plated steel.

Parts Removed:

131-0150-01	Motor base
-------------	------------

Parts Added:

131-0572-00	Motor base
-------------	------------

INSTALLATION:

Parts Required: See 'Parts Added'.

Replace the motor base connector with the new type.

CRT ANODE CONNECTOR IMPROVED

Effective Prod SN 346

An improved, automatic method of connecting the anode lead to the anode button of the CRT, with complete light shielding of the CRT anode opening, has been installed in all oscilloscopes using 5 inch Tektronix CRT's. The unit consists of an anode connector plate inserted into the anode opening of the CRT shield, an anode cover, cap, brush connector, and CRT contact plug fitted into the CRT anode contact.

To accommodate the new anode connector and provide improved centering of the connector brush on the anode of the CRT, shields have been modified to deepen the anode opening 3/16 in. However, the new anode connector can be installed in unmodified shields and provides satisfactory contact, with a minor alteration of the anode connector plate.

To allow for easier installation of the new using three phosphor bronze springs to hold and position the CRT, the spring adjacent to the anode opening has been removed. It has been found that the automatic connector provides sufficient pressure to obviate the need for the third spring. For easier rotation of the CRT, and to eliminate interference with installation of the new anode connector, the felt strip at the bottom of the CRT shield has been repositioned to leave 1/2 in. clearance from the bottom edge of the shield anode opening.

Parts Removed:

131-0026-00	Clip, anode
200-0023-00	Cover, anode

Parts Added:

131-0073-00	Connector, CRT brush
134-0031-00	Plug, CRT contact
200-0110-00	Cap, anode
200-0111-00	Cover, anode
386-0647-00	Plate, anode

CRT MOUNTING BRACKET CHANGED

Effective Prod SN 1620

To permit easier and more precise CRT rotation, and to permit parallax adjustment, the CRT mounting bracket was redesigned and a rotator added.

Parts Removed:

343-0027-00	Clamp	
406-0280-00	Bracket, CRT shield	(2)

Parts Added:

166-0031-00	Tube spacer, 1/4 in.
210-0502-00	Nut, CRT rotator
354-0078-00	Ring, securing
354-0079-00	Ring, clamping
355-0049-00	Shaft, CRT rotator
366-0032-00	Knob, CRT rotator
406-0368-00	Bracket, CRT mtg (M2327)
406-0514-00	Bracket, CRT support
432-0022-00	Base, CRT rotator

HV CAPACITORS CHANGED TO CERAMIC

Effective Prod SN 2390

Usable in SN 101-2389

The manufacturer is having difficulty supplying HV oil-filled capacitors due to high reject rate and failure rate from oil leaks. Replace 285-0508-00 oil-filled capacitor with a ceramic capacitor.

Parts Removed:

C812		
C815	285-0508-00	Capacitor, PTM 0.0068 μ F 3kV
C818		

Parts Added:

C812		
C818	283-0011-00	Capacitor, cer., 0.01 μ F 2kV
C815	283-0034-00	Capacitor, cer., 0.005 μ F 4kV

INSTALLATION:

Parts Required: See 'Parts Added'.

- a) Replace C815, 0.0068 μ F 3kV capacitor (directly above V804 socket), with an 0.005 μ F ceramic capacitor.
- b) Replace C812 and C818, 0.0068 μ F capacitors, with 0.01 μ F ceramic capacitors.

INTENSITY MODULATION REDUCED

Effective Prod SN 4690

Usable in SN 101-4689

To reduce high voltage intensity modulation caused by the high voltage lead to the -1700V test point, the wire which now runs from CSH-16 through the cable leg forward of CSK to the HV test point, was rerouted between the same points through the cable leg forward of CSJ.

INSTALLATION:

- a) Locate the white-blue HV wire that connects CSH-16 to the HV test point.
- b) Remove from the bundle and reroute between CSJ and the shield.

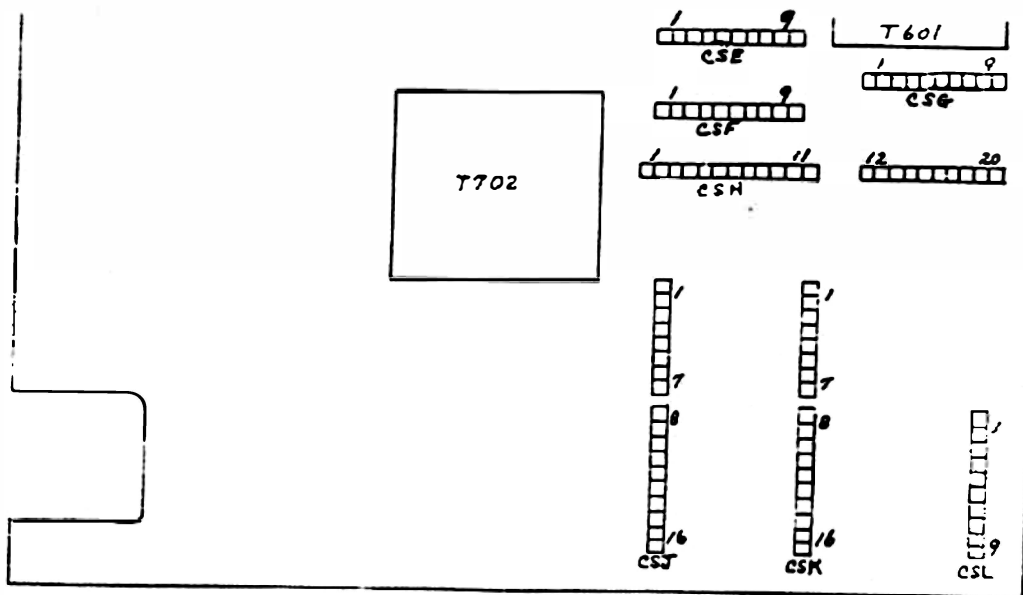

CRT SECURING RING REPLACED

Effective Prod S/N 4929

Longitudinal slippage of the CRT inside the Rotator assembly may occur during shipment. To prevent this movement, the "hard" butyrate securing ring (Between clamping ring and CRT base) is replaced with a "soft" natural urethane ring. Physical dimensions remain the same. At the same time, the CRT rotator base is modified, by adding a flange and hole to secure the rotator stud at the other end. This will restrict the movement of the securing ring within the rotator base. (Part number of the rotator base is unchanged.)

NOTE: Parts Replacement Kit 050-0063-00 is available to facilitate the replacement of CRT securing ring 354-0078-00 in premodified instruments.

Parts Removed:

354-0078-00	Ring, CRT securing
-------------	--------------------

Parts Added:

354-0178-00	Ring, CRT securing
-------------	--------------------



product modification

050-0063-00

Instruments
See Below

CRT SECURING RING

For the following Tektronix Oscilloscopes:

502 SN 2380- 7519	535A SN 21350-28840
503 SN 101- 2379	RM35A SN 1230- 2739
RM503 SN 101- 1334	536 SN 1090- 2209
504 SN 101- 529	541A SN 20470-22308
RM504 SN 101- 529	RM41A SN 1030- 1435
507* SN 180- 415	543 SN 1250- 3000
515A SN 4804- 7499	543A SN 3001- 3909
RM15**SN 882- 2416	RM43 SN 112- 1000
516 SN 101- 1319	RM43A SN 1001- 1044
525 SN 870- 1449	545A SN 22060-34039
526 SN 101- 279	RM45A SN 1200- 3009
531A SN 20410-23759	551 SN 1820- 4199
RM31A SN 1060- 1949	560 SN 101- 378
532 SN 6520- 7249	561 SN 101- 1618
RM32 SN 331- 559	570 SN 5200- 5369
533 SN 1470- 3000	575 SN 1620- 4928
533A SN 3001- 3939	581 SN 440- 1089
RM33 SN 140- 1000	585 SN 741- 3049
RM33A SN 1001- 1114	661 SN 101- 249

*507-211A SN 170- 415

**RM15-209C SN 882-1572 (approx)

New CRT securing ring, 354-0178-00, replaces 354-0078-00 previously used.

The new CRT securing ring, plus an improved CRT Rotator base, prevent CRT from rotating or sliding, thereby making adjustment more reliable.

NOTE: If the serial number of your instrument is above those listed, or if this kit has been installed, disregard the instructions as PN 354-0178-00 is a direct replacement.

PARTS INCLUDED IN PARTS REPLACEMENT KIT:

Quantity	Part Number	Description
1 ea	354-0178-00	Ring, CRT securing
1 ea	432-0022-02	Base, CRT Rotator

INSTRUCTIONS

() 1. Remove the CRT from the instrument.

REFER TO DRAWING OF CRT ROTATOR ASSEMBLY ON FOLLOWING PAGE.

() 2. Remove screws holding CRT rotator base to mounting bracket.

NOTE: Use same holes when installing new base.

() 3. Remove clamping ring and adjusting screw from the old assembly and install on new CRT rotator base from the kit.

() 4. Reinstall CRT rotator assembly on mounting bracket.

() 5. Install new CRT securing ring (from kit) onto assembly.

NOTE: Make certain the ears on both sides of the ring are properly positioned.

() 6. Install CRT and complete mechanical work as required.

() Check installation for proper operation.

() Turn instrument on and align trace.

NOTE: After aligning trace, back off on adjustment 1/4 turn to relieve strain. If not relieved, the strain tends to cause a creeping rotation of the CRT.

TL:ls

INSTRUCTIONS (continued)

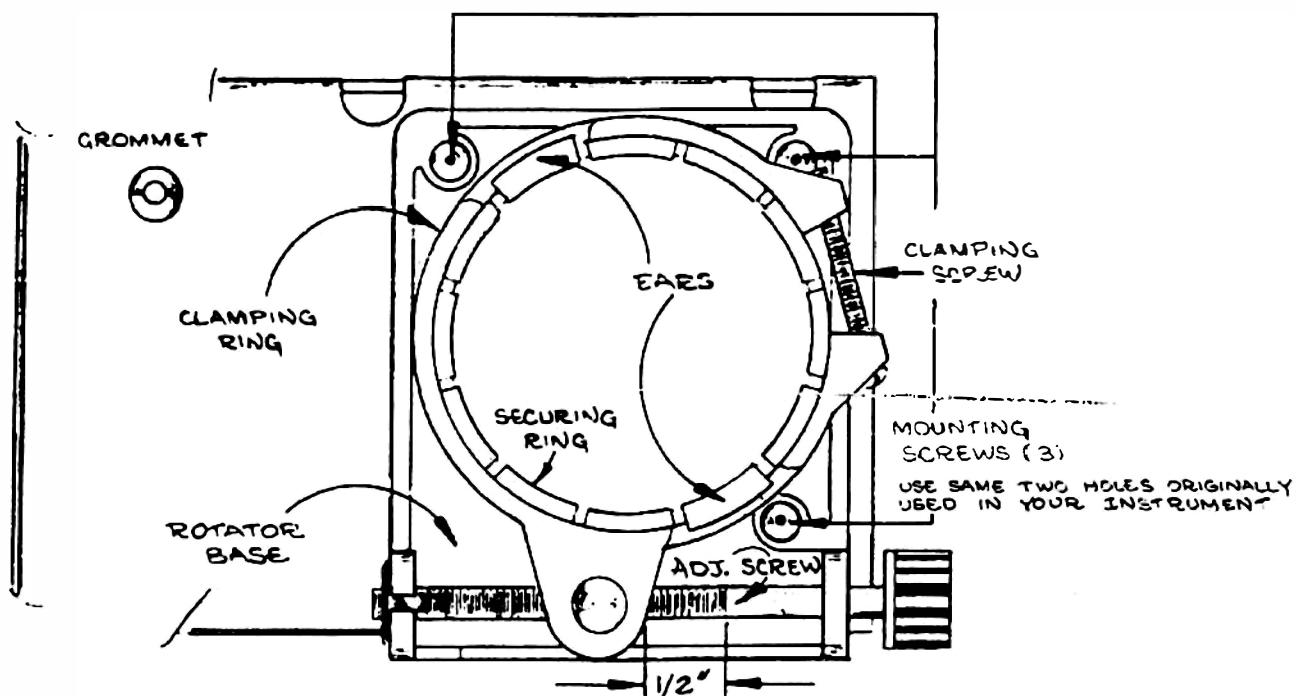

CRT ROTATOR ASSEMBLY

CRT FILTER SHAPE AND COLOR STANDARDIZED

Effective Prod SN 9710

Shape and color of CRT light filters standardized. This was accomplished by replacing 0.060" thick green, blue, and amber filters for 5" rectangular and round external graticule instruments and 0.030" thick smoke gray filter for 5" rectangular internal graticule instruments with new 0.030" thick green, blue, amber, and smoke gray filters with configuration acceptable for both internal and external graticule use.

Also replaces 0.060" thick green, blue, and amber filters for 3" CRT instruments with new 0.030" thick green, blue, amber, and smoke gray filters with same configurations. Change the configuration of internal graticule clear scratch plates (5" round and 5" rectangular) to conform to new filter configurations, thereby allowing use of common tooling.

Smoke gray will replace green as standard filter shipped with external graticule instruments. Amber, green, and blue filters in all configurations will be set up as optional filters supplied on customer demand and with special phosphors.

The recommended optional filters for various phosphors is as follows:

Smoke gray filter	P1	P2	P20	P28	P31	P7	
Blue filter	P5	P11	P14	P17	P32		
Amber filter	P12	P13	P19	P25	P26	P27	P7
No filter necessary	P15	P16	P24				

P7 phosphor requires both a smoke gray and an amber filter

Parts Removed:

378-0502-00	Filter, light, yellow
378-0514-00	Filter, light, green
378-0515-00	Filter, light, blue
378-0516-00	Filter, light, amber

Parts Added:

378-0567-00	Filter, light, smoke gray
378-0568-00	Filter, light, green
378-0569-00	Filter, light, blue
378-0570-00	Filter, light, amber

CRT CHANGED FROM P1 TO P31

Effective Prod S/N 9830

Usable in S/N 101-9829

Modified out of sequence:

9526	9580	9658	9706	9730	9732	9794
9560	9623-4	9663-4	9715	9733	9786	9799
9569	9630	9693	9721	9735	9790-1	9814

Display remains on CRT at lower intensity after intensity control is turned off.

The CRT would exhibit a phenomenon known as "Bright Burn" in which the display would remain on the CRT at a much lower level, but still noticeable, intensity level. It was primarily a batch problem in that certain CRT's would exhibit this more than others. It could sometimes be temporarily cured by flooding the CRT which would in effect "Bright Burn" the entire face.

The CRT was changed from a P1 (T0520-1) to a P31 phosphor (T0520-31).

Parts Removed:

V639	154-0093-00	Tube, vacuum, CRT T0520-1
------	-------------	---------------------------

Parts Added:

V639	154-0343-00	Tube, vacuum, CRT T0520-31
------	-------------	----------------------------

INSTALLATION:

Parts Required: See 'Parts Added'.

Replace the CRT with the new type.

C809 CHANGED TO REDUCE FAILURES

Effective Prod SN 10220

Usable in SN 101-10219

No high voltage -- no display.

C809, located across the primary of the HV transformer, shorts and kills the HV oscillator. It is rated at 500V, when there is approximately 800V AC across it.

C809, 600V capacitor, was replaced with a 3kV discap.

Parts Removed:

C809 285-0501-00 Cap., PTM, 0.001 μ F 600V

Parts Added:

283-0044-00 Cap., ceramic, 0.001 μ F 3kV disc

INSTALLATION:

Parts Required: See 'Parts Added'.

Replace C809, an 0.001 μ F 600V capacitor, located between terminals 11 and 12 of the high voltage transformer (T801), with an 0.001 μ F 3kV disc type capacitor.

ELIMINATES TRACE FLICKER

Effective Prod SN 10320

Modified out of sequence:

9502	9898	10010-2	10077	10190	10275
9810	9913-4	10014	10104	10201	10289-91
9827	9945-6	10016-7	10106-7	10224-5	10294-5
9837-9	9949	10021	10109	10230	10297-300
9845	9956	10043	10142	10232	10303
9847	9969	10046	10144	10236-7	10306-8
9852	9971	10048	10148	10239	10310-5
9855	9977-8	10065	10171	10243	10317-8
9887	9988	10070	10174	10249	
9893-4	9998	10072	10178	10258	

Intensity flicker.

Trace flicker could occur under certain operating conditions, and with parts close to tolerance limits in the CRT circuit.

C818, a 0.01 μ F capacitor in the High Voltage regulator circuit, was relocated from the top end of the intensity potentiometer (Junction of R812-C813, 8827 and R826) to the plate of V822.

CRT ROTATOR STUD ASSEMBLY IMPROVED

Effective Prod SN 13500

If the bottom rear section of the instrument is bumped or jolted, the CRT rotator stud may come out of the slot in the CRT rotator base.

A 2-56 hole was tapped adjacent to the slot in the CRT rotator base and a retaining plate was bolted to the base.

Parts Removed:

432-0022-00	Base, CRT Rotator
-------------	-------------------

Parts Added:

211-0022-00	Screw, 2-56 x 3/16
386-1485-00	Plate, Retaining
432-0022-02	Base, CRT Rotator
432-0023-00	Base, CRT Rotator, Casting

RESISTOR SELECTION CHART TAG CHANGED

Effective Prod SN 227

The information on the Resistor Selection Chart, fastened to the cabinet, was reworded to make it more understandable.

TRANSISTOR LOAD RESISTANCE

OLD: The load resistance of the transistor under test is the sum of the collector-power supply impedance, the dissipation-limiting resistor, and the current-measuring resistor.

The collector-power supply impedance is 0.25Ω in the 20V range and 15Ω in the 200V range.

NEW: The load resistance of the transistor under test is the sum of the collector-power supply resistance, and the dissipation-limiting resistor, and the current-sampling resistor.

The collector-power supply resistance is approximately 0.25Ω in the 0-20V range from 2 to 10 amperes and approximately 15Ω in the 0-200V range from 0.1 to 1 ampere.

Parts Removed:

334-0641-00 Tag, resistor selection

Parts Added:

334-0659-00 Tag, Resistor selection

CERAMIC STRIPS CHANGED

Effective Prod SN 1280

Ceramic strips were changed to a clip-mounted type.

Parts Removed:

124-0012-00	Strip, ceramic, 4-notch	(4)
124-0016-00	Strip, ceramic, 11-notch	(12)
124-0066-00	Strip, ceramic, 9-notch	(8)

Parts Added:

124-0058-00	Strip, ceramic, 4-notch	(4)
124-0090-00	Strip, ceramic, 9-notch	(8)
124-0091-00	Strip, ceramic, 11-notch	(12)

CABINET FINISH IMPROVED

Effective Prod SN 2266

To obtain a tougher, easier to clean finish, the material used for cabinet sides, bottoms, overlays, etc., was changed to textured aluminum (Reynold's pebble grain, 5005, H154), and the paint was changed from blue wrinkle to blue vinyl of approximately the same color. The filter housings, top rails, bottom rails, and dot fasteners were painted with blue vinyl also.

Parts Removed:

122-0037-00	Angle frame, alum., ext bottom	(2)
380-0008-00	Housing, air filter	
381-0126-00	Bar, alum, ext top	
386-0620-00	Cabinet bottom	
386-0659-00	Overlay, rear	
386-0773-00	Cabinet side, left	
386-0783-00	Cabinet side, right	
432-0019-00	Jack panel mtg.	

Parts Added:

122-0073-00	Angle frame, alum, ext bottom	(2)
380-0018-00	Housing, air filter	
381-0151-00	Bar, alum, ext top	
387-0087-00	Cabinet side, right	
387-0089-00	Cabinet bottom	
387-0091-00	Cabinet side, left	
387-0092-00	Overlay, rear	
432-0030-00	Jack panel mtg.	

NEON BULBS REPLACED

Effective Prod SN B020

Usable in SN 101-8019

NE2 neons may not fire after they have been subjected to prolonged darkness, because of increased firing potential. They are replaced with NE23 neons, which contain a small deposit of radioactive material to aid in the ionization process.

Parts Removed:

B174		
B231		
B266	150-0002-00	Bulb, neon NE2
B826		
B827		

Parts Added:

B174		
B231		
B266	150-0027-00	Bulb, neon NE23
BB26		
BB27		

INSTALLATION:

Parts Required: See 'Parts Added'.

- a) Replace B174, located near V163, with an NE23.
- b) Replace B231, located near V233A, and B266, located near V233B, with NE23's.
- c) Replace B826 and B827, located near the high voltage transformer TB01, with NE23's.

ELECTROLYTIC CAPACITOR ASSEMBLIES REPLACED

Effective Prod SN Not Given

All electrolytic capacitor assemblies were replaced with their equivalent raw capacitor, metal or fiber flange, plastic cover, and DELRIN® base (when required) to eliminate unnecessary part numbers and to facilitate replacement of electrolytic capacitors by customers. For replacement of capacitor assemblies, Customer Service will supply raw capacitors with both metal and fiber flanges and plastic covers when required.

Parts Removed:

C240		
C241	290-0074-00	Capacitor, EMT 2000 μ F 20V
C242		
C243		
C244	290-0046-00	Capacitor, EMT 150 μ F 150V
C602		
C641	290-0036-00	Capacitor, EMT 2 x 20 μ F 450V
C666		
C611	290-0037-00	Capacitor, 2 x 20 μ F 450V
C620	290-0052-00	Capacitor, 125 μ F 350V

Parts Added:

C240		
C241	290-0029-00	Capacitor, EMT 2000 μ F 20V
C242		
C243		
C244	290-0018-00	Capacitor, EMT 150 μ F 150V
C602		
C611	290-0010-00	Capacitor, EMT 2 x 20 μ F
C641		
C666		
	200-0256-00	Cover
	200-0257-00	Cover
	200-0260-00	Cover
	386-0252-00	Flange
	386-0253-00	Flange
	386-0254-00	Flange
	386-0255-00	Flange

DELRIN Reg. TM of The Du Pont Co.

POWER CORD GROUND CONNECTION IMPROVED

Effective Prod S/N 11790

Usable in S/N 101-11789

Inadequate ground connection between power cord and instrument motor base.

A ground spring was added to the non-current carrying ground receptacle on the female connector end of the power cord.

Parts Added:

214-0698-00

Spring, power cord ground
(subpart of power cord 161-0010-03)

INSTALLATION:

Parts Required: See 'Parts Added' or part listed below.

040-0424-01

Modification Kit

NOTE: Modification kit includes enough springs to modify 25 power cords.

Refer to mod kit instructions.



product modification

040-0424-01

M11292

General

3-WIRE POWER CORD FEMALE GROUND CONNECTION IMPROVEMENT

For 3-Wire Power Cords

Used on TEKTRONIX® Type Instruments

Modification Kit, PN 040-0424-01, improves the non-current carrying ground contact on the 3-wire power cords, used on TEKTRONIX Type instruments, by adding a spring to the female contact.

The kit includes enough springs to modify twenty-five power cords.

PARTS INCLUDED IN MODIFICATION KIT:

Quantity	Part Number	Description
25 ea	214-0698-00	Spring, power cord ground

INSTRUCTIONS

- () Insert the spring (from kit) as indicated in the drawing below, and push it in by plugging the male end of the power cord into the female end.

THIS COMPLETES THE INSTALLATION.

- () Add the spring to the Mechanical Parts List of your Instruction Manual (if applicable).

DF:ls

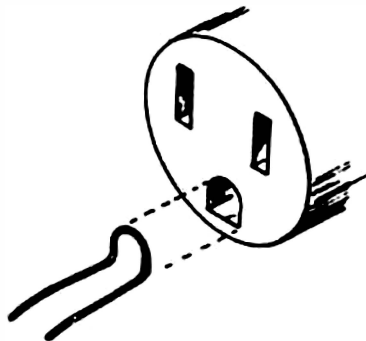

MOTOR BASE CONNECTOR IMPROVED

Effective Prod SW 12030

To facilitate fabrication of Tektronix made motor bases by adapting them for automated machinery.

Tektronix made motor base 131-0150-00 was replaced with a new assembly and their subparts. Old motor bases use a #4 nut, lockwasher and screw on one side and a #4 nut, lockwasher and externally threaded ground post on other side. New motor bases use a #4 self-tapping screw into new cover 200-0185-01 on one side and a #4 sems screw into new internally threaded ground post 129-0041-01 on other side.

This mod is superseded by Mod 12876.

The ground connection for the 3-wire motor base installed by this mod proved to be inadequate.

Parts Removed:

131-0150-00	Motor base
-------------	------------

Parts Added:

131-0150-01	Motor base
-------------	------------



product modification

050-0104-00

Type 575

HORIZONTAL VOLTS/DIV SWITCH REPLACEMENT

For Tektronix Type 575 Transistor-Curve Tracers
Serial Numbers 101-6054

HORIZONTAL VOLTS/DIV switch 262-0494-00 replaces the following:
262-0137-00 (SN 101-821); 262-0195-00 (SN 822-3659); 262-0416-00
(SN 3660-6054).

Oxide film resistors replace the 1/4% carbon resistors previously
used on the switch. Because of their greater stability, the new
resistors need only have a tolerance of 1/2%. The following
resistor changes are involved:

309-0400-00 replaces 309-0184-00
309-0405-00 replaces 309-0189-00
309-0406-00 replaces 309-0185-00
309-0407-00 replaces 309-0186-00
309-0408-00 replaces 309-0187-00
309-0409-00 replaces 309-0188-00

Two 1 meg resistors have been added to the switch for instruments
below serial number 3660, to replace those on the rear panel connectors.

NOTE: If the serial number of your instrument is
above those listed, or if this kit has been installed,
disregard the instructions as PN 262-0494-00 is a
direct replacement.

Refer to the Calibration section of your Instruction Manual and recalibrate as necessary.

For future reference, correct the Electrical Parts List in your Instruction Manual as shown in the kit Parts List.

JG:mr

SCHMATIC
for improved POLARITY switch

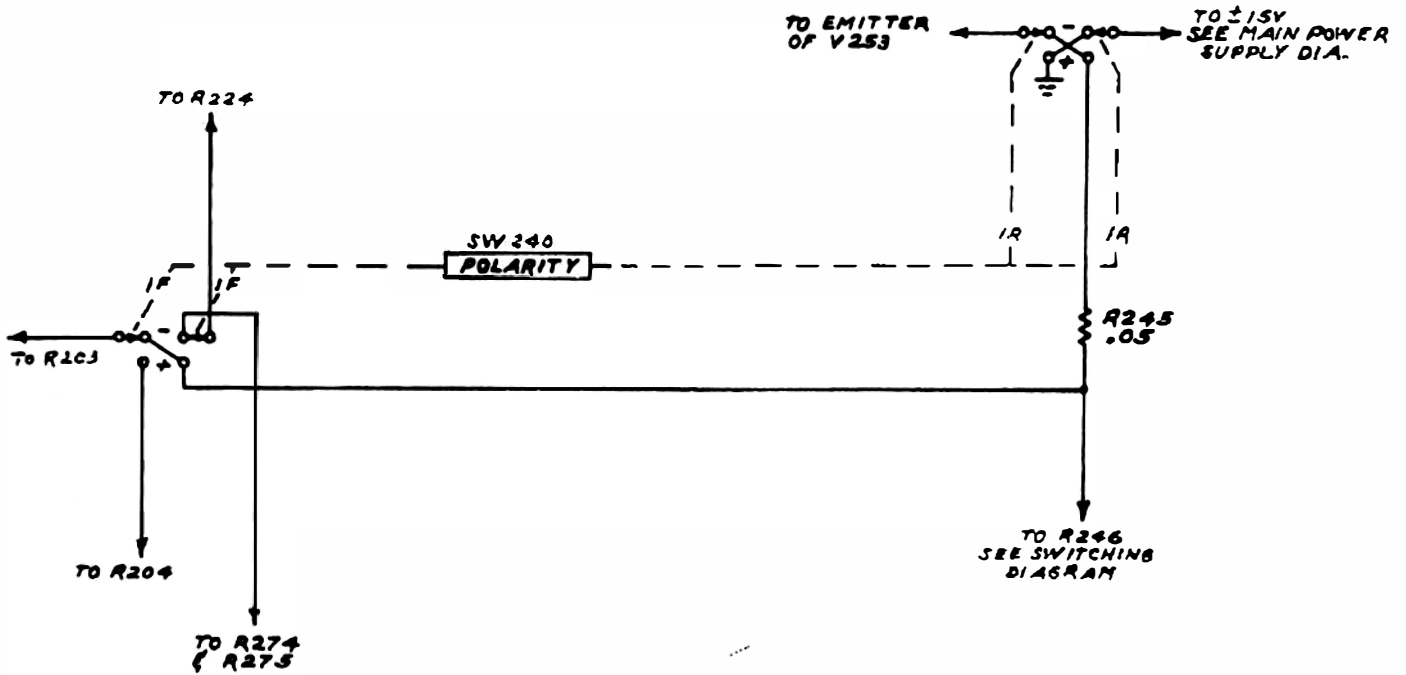

- () 1. To facilitate the installation of the new POLARITY switch, remove the knurled nut from the STEPS/SEC switch and temporarily move the switch to the top of the sweep chassis.

NOTE: If it becomes necessary to remove any tubes during the switch replacement, they should be marked and returned to the same socket.
- () 2. Locate the bare wire connecting contact W1-3F of the POLARITY switch (see drawing) to contact W2-21R of the STEP SELECTOR switch.

Note the location of this bare wire on STEPS/SELECTOR switch. Unsolder and remove this bare wire. The bare wire included in this kit will be soldered to this point in step 13.
- () 3. Unsolder all the wires from the POLARITY switch and remove the switch from the instrument.
- () 4. Cut the bare wire removed in the previous step to approximately one inch long and solder it between W1-9R and the detent plate of the new switch, included in the kit.
- () 5. Install R245, the 0.05 Ω resistor included in the kit, between W1-1R and W1-3F.

NOTE: To allow the addition of wires to these contacts in later steps, R245 should only be spot soldered into place.
- () 6. Install the new switch in the instrument. Refer to drawing for switch contact identification.
- () 7. Solder the white-gray wire to contact W1-10R.
- () 8. Solder the white-red wire to contact W1-12F.
- () 9. Solder the white-violet wire to contact W1-2F.
- () 10. Solder the white-orange wire to contact W1-4F.
- () 11. Solder the white wire to contact W1-5R.
- () 12. Solder the white-brown wire to contact W1-6F.
- () 13. Solder the bare wire, included in this kit, from contact W1-3F of POLARITY switch to contact W2-21R of STEP SELECTOR switch, (point from which a bare wire was removed in step 2).
- () 14. Reinstall STEPS/SEC switch.

PARTS INCLUDED IN PARTS REPLACEMENT KIT:

Ckt. No.	Quantity	Part Number	Description
SW240	1 ea	260-0258-01	Switch
R245	1 ea	308-0136-00	Resistor, WW, 0.05 Ω 20% 1/4
	0.334 ft		Wire, bare, #20AWG solid

INSTRUCTIONS:

WARNING

Before proceeding, position the POWER switch to OFF; then disconnect the instrument from the power source.

NOTE: The following method is used to identify the BASE STEP GENERATOR POLARITY switch terminals:

Wafers are numbered from front to rear.

Contact positions are numbered 1 through 12 relative to the index key as shown in drawing.

Contacts have an 'F' or 'R' suffix which denotes that they are on the front or rear of the wafer.

Example: W2-7R (denoted by * on drawing) is contact #7 on the rear of wafer 2.

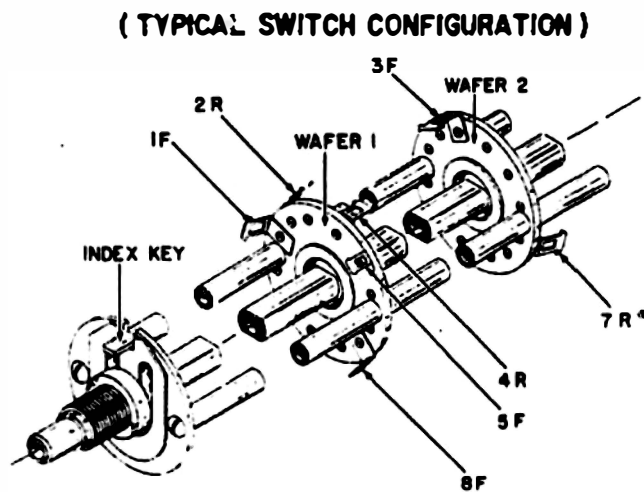



050-0021-00
 M2058, M10070
 M8244
 Type 575

BASE STEP GENERATOR
 POLARITY SWITCH REPLACEMENT

For TEKTRONIX® Type 575 Characteristic
 Curve Tracer

Serial Numbers 101 - 1088

Base Step Generator POLARITY switch (SW240), pn 260-0258-01,
 replaces pn 260-0178-00. The new POLARITY switch will
 correct for a 2% error (due to a difference in contact
 resistance between negative and positive positions of
 POLARITY switch) in the base current reading.

NOTE: If the serial number of your instrument is above
 those listed, or if this kit has been installed,
 disregard the instructions and use pn 260-0258-01
 as a direct replacement for SW240.

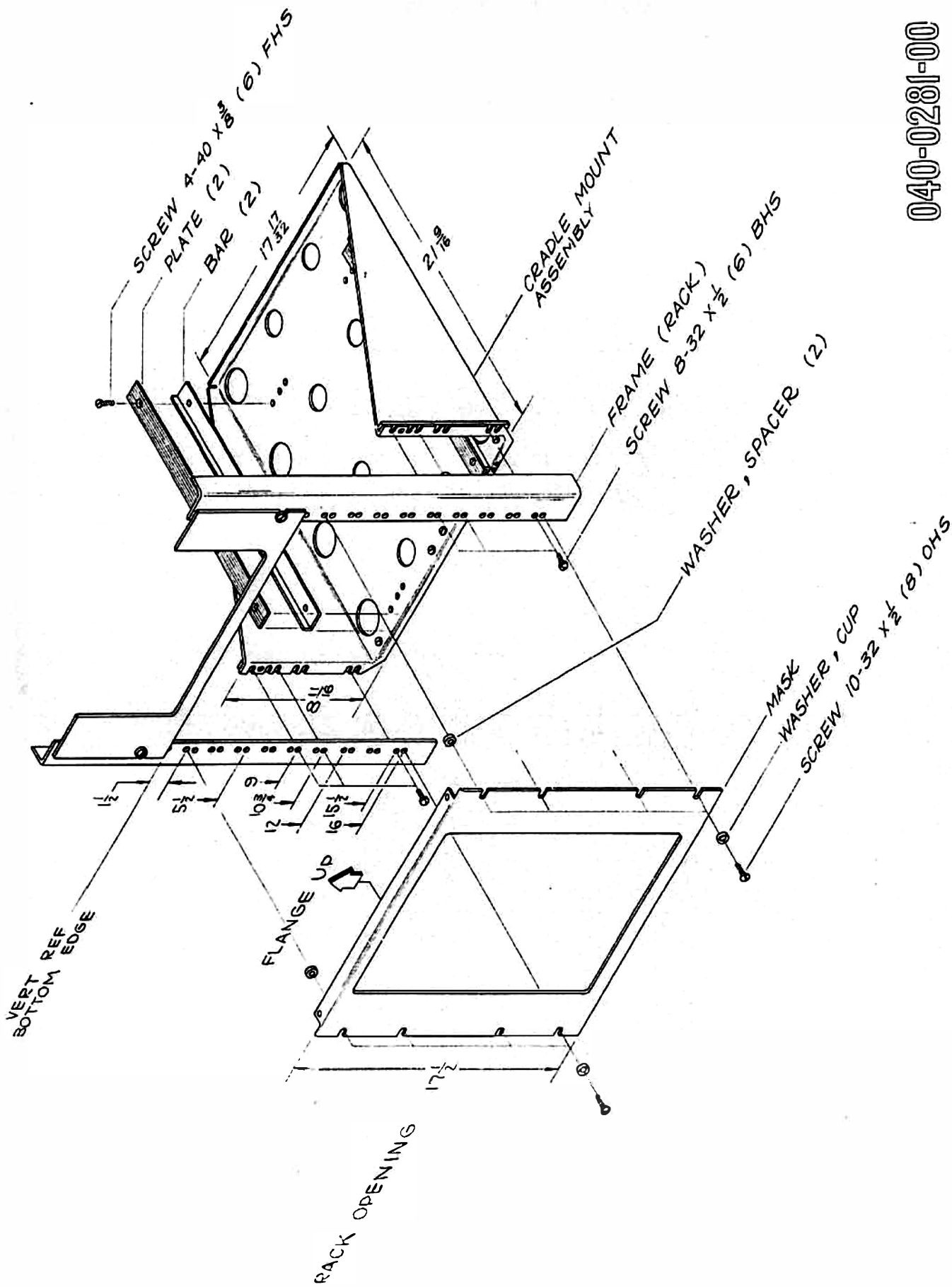

FIG. 6

040-0281-00

INSTRUCTIONS (cont)

- () 8. Position the instrument so that the stainless steel ring touches the mask all the way around the instrument (see Fig. 4).
- () 9. Place the instrument stop (from kit) on the cradle so that it meshes with the hold-down bracket on the instrument (see Fig. 5). If necessary, the hold-down bracket may be adjusted up or down.
- () Mark the exact location of the stop on the cradle.
- () 10. Remove the mask and the instrument.
- () 11. Place the instrument stop in the location marked in step 7. Select two of the tapped holes in the stop, and mark and drill 11/64in. holes in the cradle at these points.
- () 12. Mount the stop, using the 8-32 x 5/16 PHS screws, flat washers and lock-washers from the kit (see Fig. 5).
- () 13. Replace the instrument. Make sure the hold-down bracket and instrument stop come together properly.
- () 14. Replace the mask, using the 10-32 x 1/2 OHS screws, the #10 cup washers, and the two spacer washers from the kit (see Fig. 6).

THIS COMPLETES THE INSTALLATION

JT:1s

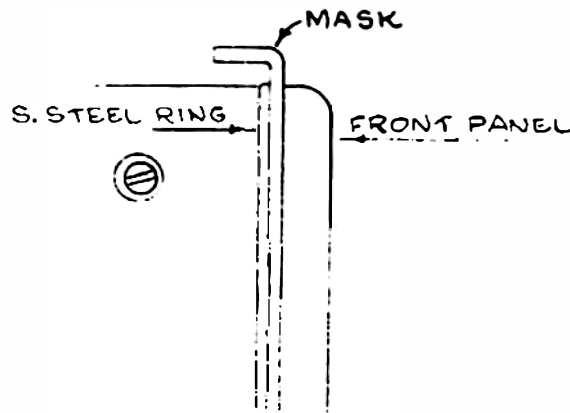

FIG. 4

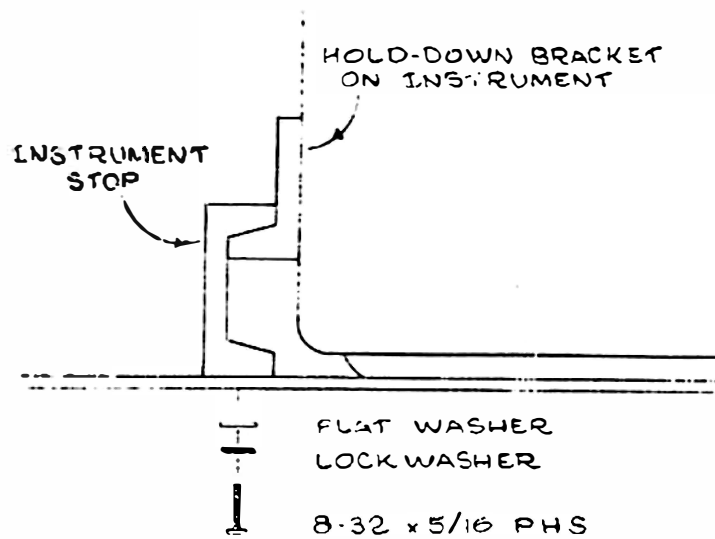

FIG. 5

INSTRUCTIONS (cont)

- () c. If the instrument will be subject to excessive vibration, the 8-32 nuts (from kit) should be added.
- () 6. Place the instrument on the cradle guide rails and slide it into place.
- () 7. Temporarily mount the mask (from kit) on the front of the relay rack, over the instrument front panel, and hold it in place with three or four of the 10-32 x 1/2 OHS screws from the kit.

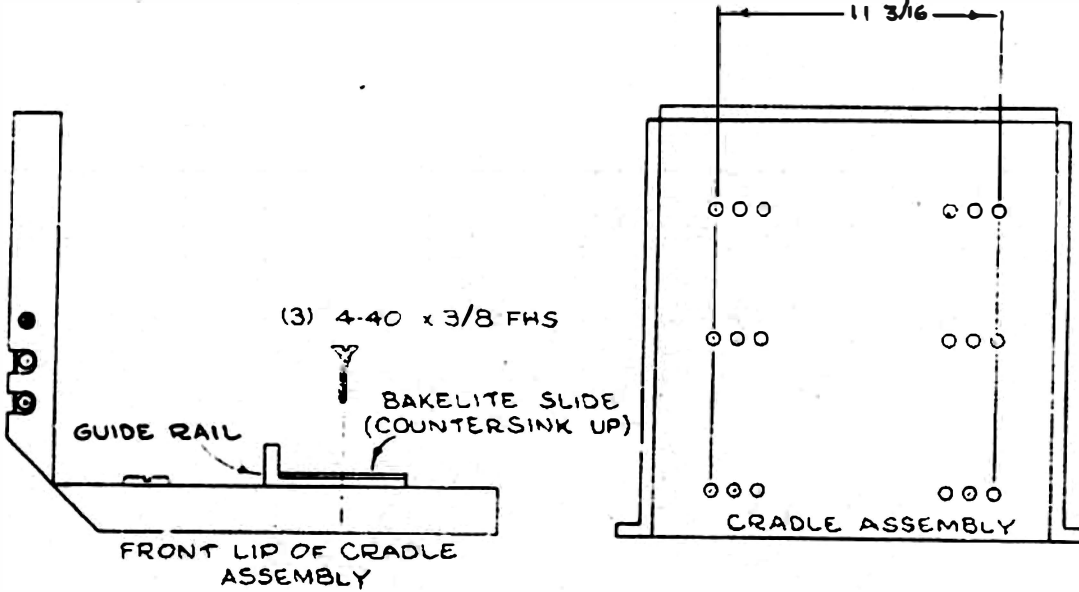

FIG. 1

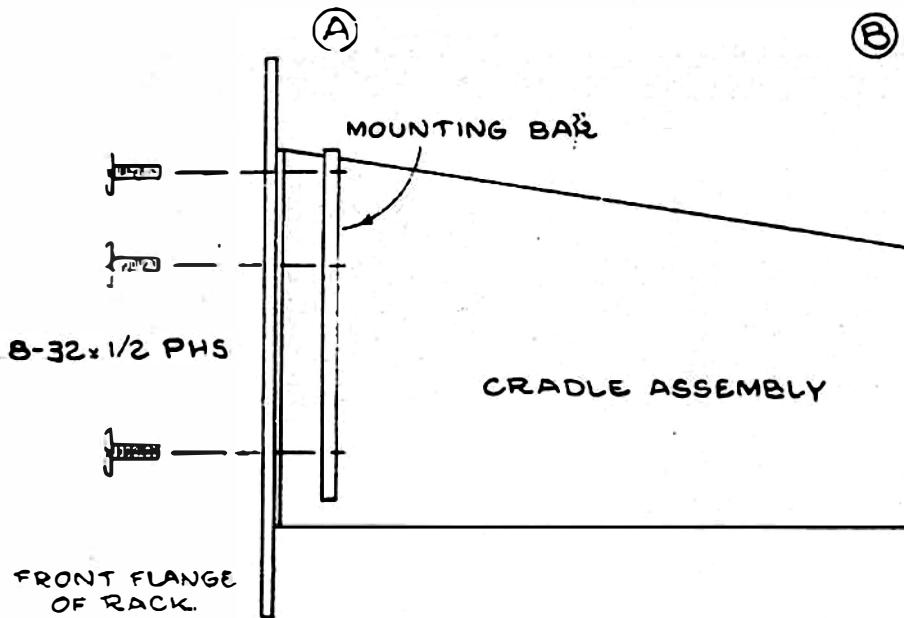

FIG. 2

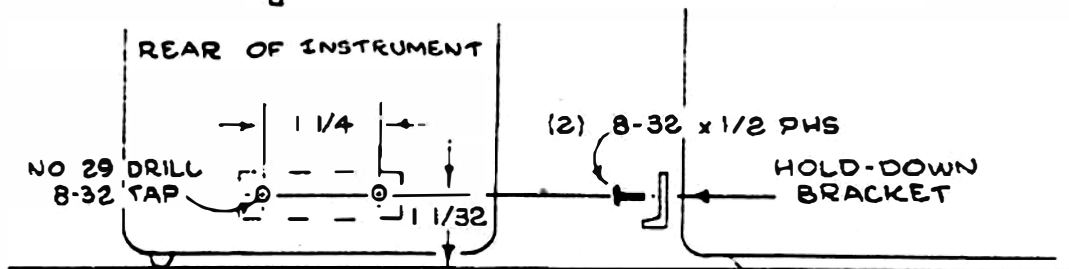

FIG. 3

PARTS INCLUDED IN MODIFICATION KIT

Quantity	Part Number	Description
1 ea.	426-0208-00	Assembly, cradle mount, oscilloscope, including:
2 ea.	(211-0025-00)	Screw, 4-40 x 3/8 FHS
4 ea.	(212-0023-00)	Screw, 8-32 x 3/8 PHS, Phillips
1 ea.	(381-0198-00)	Bar, stiffening, 1/4 x 5/8 x 16-5/8
2 ea.	(381-0211-00)	Bar, mounting, 1/4 x 1/2 x 8-1/8
1 ea.	105-0013-00	Stop, instrument
2 ea.	210-0008-00	Lockwasher, int #8
2 ea.	210-0409-00	Nut, hex, 8-32 x 5/16
2 ea.	210-0804-00	Washer, flat, 8S x 3/8
8 ea.	210-0833-00	Washer, cup, #10
2 ea.	210-0852-00	Washer, spacer, 3/16ID x 3/8OD x 0.091
6 ea.	211-0025-00	Screw, 4-40 x 3/8 FHS
2 ea.	212-0004-00	Screw, 8-32 x 5/16 PHS, Phillips
8 ea.	212-0008-00	Screw, 8-32 x 1/2 PHS, Phillips
8 ea.	212-0512-00	Screw, 10-32 x 1/2 OHS
1 ea.	333-0491-00	Panel, front, mask for rackmounting
2 ea.	381-0202-00	Bar (guide rail), aluminum, angle, 18 in.
2 ea.	387-0636-00	Plate (slide), BAKELITE [®] , 1-1/8 x 18 in.
1 ea.	406-0424-00	Bracket, hold-down

INSTRUCTIONS

- () 1. Mount the two guide rails and BAKELITE slides (from kit) on the cradle assembly, with the rail lip on the outside (Fig. 1A). Use the threaded holes in the cradle, spaced according to the lengths listed for the kits in Fig. 1B. Mount the rails with the 4-40 x 3/8 FHS screws from the kit.
- () 2. Fasten each side of the cradle assembly to the front flange of the relay rack, with three 8-32 x 1/2 PHS screws from the kit (see Figs. 2 and 6). Each mounting bar is fastened to the cradle by a single 4-40 screw, allowing it to be adjusted for slight variations in rack width.

NOTE: To install the cradle assembly in channel-type racks, it will be necessary to tilt the assembly sideways, while bending one side inward.

- () 3. Remove the voltage tap on the rear right hand side of the instrument.
- () 4. Relocate the voltage tap on the middle left hand side of the instrument, use a #43 drill (see Fig. 3).
- () 5. Mount the hold-down bracket (from kit) on the rear panel of the instrument, as near to the vertical center line as possible (see Fig. 3).
 - () a. Drill and tap the two holes in the rear panel shown in Fig. 3. Use a #29 drill and an 8-32 tap.

CAUTION: BE CAREFUL NOT TO DRILL INTO COMPONENTS MOUNTED BEHIND THE REAR SUB-PANEL.

- () b. Mount the hold-down bracket, using two 8-32 x 1/2 PHS screws from the kit.

BAKELITE, Reg. TM of Union Carbide Corp.



product modification

040-0281-00

Instrument Types
See Below

CRADLE MOUNT

For the following TEKTRONIX® Type Oscilloscopes:

Type	524AD	Serial Numbers	5001-up
Type	531	Serial Numbers	5001-up
Type	531A	Serial Numbers	All Serial Numbers
Type	532	Serial Numbers	5001-up
Type	533A	Serial Numbers	All Serial Numbers
Type	535	Serial Numbers	5001-up
Type	535A	Serial Numbers	All Serial Numbers
Type	536	Serial Numbers	All Serial Numbers
Type	541	Serial Numbers	5001-up
Type	541A	Serial Numbers	All Serial Numbers
Type	543	Serial Numbers	All Serial Numbers
Type	543A	Serial Numbers	All Serial Numbers
Type	543B	Serial Numbers	All Serial Numbers
Type	544	Serial Numbers	All Serial Numbers
Type	545	Serial Numbers	5001-up
Type	545A	Serial Numbers	All Serial Numbers
Type	5458	Serial Numbers	All Serial Numbers
Type	546	Serial Numbers	All Serial Numbers
Type	547	Serial Numbers	All Serial Numbers
Type	549	Serial Numbers	All Serial Numbers
Type	570	Serial Numbers	5001-up
Type	575	Serial Numbers	All Serial Numbers
Type	581	Serial Numbers	All Serial Numbers
Type	581A	Serial Numbers	All Serial Numbers
Type	585	Serial Numbers	All Serial Numbers
Type	585A	Serial Numbers	All Serial Numbers
Type	661	Serial Numbers	All Serial Numbers

Modification Kit, PN 040-0281-00, enables the above TEKTRONIX Type instruments to be rackmounted in a standard 19 inch relay rack. A vertical front panel space of 17-1/2 inches is required.

Future instruments with the same front panel dimensions may also be used with this kit, providing they have bottom rails similar to those on the above listed instruments. This kit directly replaces 040-0182-00.

CARBON FILM RESISTORS REPLACED

Effective Prod SN 14670

All 1/2W and 1W carbon film resistors were replaced with more reliable 1/2W and 1W metal film resistors.

PARTS REMOVED:

R316 R324	309-0045-00	Resistor, prec.	100K
R317 R325	309-0051-00	Resistor, prec.	200K
R613 R730 R732	309-0014-00	Resistor, prec.	1M

PARTS ADDED:

R316 R324	323-0385-00	Resistor, prec.	100K
R317 R325	323-0414-00	Resistor, prec.	200K
R613 R730 R732	323-0481-00	Resistor, prec.	1M

CERAMIC STRIPS CHANGED

Effective Prod SN 14673

All 3/4" wide ceramic strips were replaced by 7/16" wide strips for standardization.

Ceramic strips were replaced where used as follows:

Parts Removed:		Parts Added:
3/4" ceramic strips	<u>Notches</u>	7/16" ceramic strips
124-0100-00	1	124-0118-00
124-0086-00	2	124-0119-00
124-0087-00	3	124-0092-00
124-0088-00	4	124-0120-00
124-0089-00	7	124-0094-00
124-0090-00	9	124-0095-00
124-0091-00	11	124-0106-00

To maintain approximately the same height between the chassis and the top of the ceramic strips, replace spacers used to mount 3/4" ceramic strips with spacers listed below:

Spacer used with 3/4" strip		Replacement spacer used with 7/16" strip	
	<u>Height</u>		<u>Height</u>
361-0007-00	.093	361-0039-00	.406
361-0008-00	.156	361-0039-00	.406
361-0009-00	.281	361-0392-00	.593

To provide adequate stud length on the 7/16" strips for the longer replacement spacers, the 7/16" ceramic strips listed above were modified by replacing the ceramic studs, 355-0046-00 (.777 overall length) with new longer studs, 355-0158-00 (1.108 overall length).

TRANSISTOR TEST ADAPTER CHANGED

Effective Prod SN 13430

Modified out of sequence:

12846	13065	13175-76	13247-48	13296-97	13392
13004-06	13067	13178-79	13262	13299	13394
13045	13114-15	13188	13265	13316-17	13396-98
13047	13117-19	13203	13268-69	13352	13401
13049	13143-44	13208	13282	13354	13404
13053	13146-48	13222-28	13292	13373-78	13426
13062	13171-72	13243-44			

Test adapter will not accommodate the smaller power transistors.

The transistor test adapter was replaced with a new type which will accommodate either small or large power transistors.

Parts Removed:

013-0070-00	Adapter, 575, 3 terminal transistor (For large power transistors w/2 pins)
-------------	---

Parts Added:

013-0070-01	Adapter, 575, 3 terminal transistor (For large or small power transistors w/2 pins)
-------------	---

PARTS LIST

Quantity	Part Number	Description
1 ea	3:34-1196-00	Tag, instruction, w/gummed back

INSTRUCTIONS

- () Clean the front panel below the COLLECTOR SWEEP block where the tag is to be mounted, remove the protective backing from the tag, and install the tag as shown in the drawing.

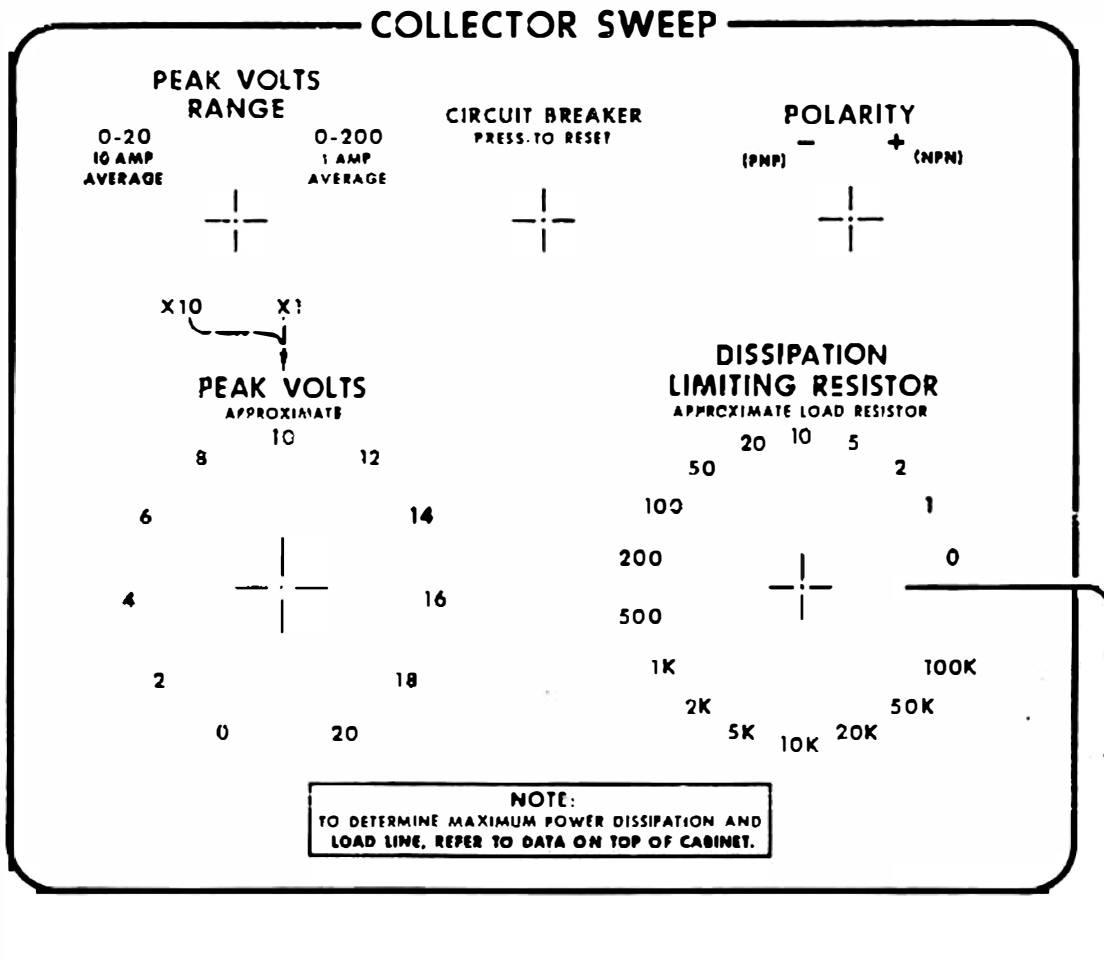

WARNING
 DANGEROUS VOLTAGES
 WILL APPEAR AT
 COLLECTOR TERMINALS
 FOR SEVERAL SETTINGS
 OF ABOVE CONTROLS

TEKTRONIX, INC.
 PORTLAND, OREGON, U.S.A.

JT:jb



modification instructions

Mi - 040-0486-00

TYPE 575

TEST TERMINAL VOLTAGE WARNING TAG

For Tektronix Type 575 Oscilloscopes
Serial Numbers 101-13080

Modification Kit, PN 040-0486-00, adds a more noticeable voltage warning tag to the instrument front panel. The tag cautions the user about possible dangerous voltages that may appear on the Collector terminals.

FRONT PANEL TAG ADDED TO WARN OF SHOCK HAZARD

Effective Prod SN 13080

Usable in SN 101-13079

A more obvious warning sign is needed due to lethal voltages, which can be present on the front panel.

A yellow warning tag will be added to the front panel in the lower left hand corner. To provide space for the tag, the Tektronix emblem will be moved to a location near the power switch.

Parts Removed:

333-0527-00	Panel, front, Standard
333-0690-00	Panel, front, Mod 122C

Parts Added:

333-0527-02	Panel, front, Standard
333-0690-02	Panel, front, Mod 122C
334-1196-00	Plate, instruction

INSTALLATION:

Parts Required: Modifi

040-0486-00	Modification kit
-------------	------------------

Refer to kit instructions.



BOTTOM CABINET FRAME MODIFIED TO ACCOMMODATE ANTI-SLIDE FEET

Effective Prod SN 12510

Usable in SN 101-12509

Instrument could slide off of the SCOPEMOBILE® oscilloscope cart when the shelf is tilted to the extreme forward position.

The ends of the bottom cabinet frames were machined flat to accommodate the anti-slide feet.

Parts Removed:

122-0073-00	Angle Frame, bottom
-------------	---------------------

Parts Added:

212-0010-00	Screw, 8-32 x 5/8 PHS pozidriv
348-0128-00	Foot, cabinet anti-slide
426-0391-00	Frame, section cabinet (bottom)

INSTALLATION:

Parts Required: See 'Parts Added'.

- a) Remove the cabinet sides and the bottom plate.
- b) Replace the bottom cabinet frames with the new type, and install the anti-slide feet.
- c) Reinstall the cabinet sides and the bottom plate.

SCOPEMOBILE Reg. TM of Tektronix, Inc.

PARTS INCLUDED IN PARTS REPLACEMENT KIT:

Quantity	Part Number	Description		
1 ea		Assembly, switch, HORIZONTAL VOLTS/DIV (262-0494-00), consisting of:		
2 ea	210-0006-00	Lockwasher, int. #6		
4 ea	210-0438-00	Nut, hex, 1-72 x 5/32		
2 ea	210-0449-00	Nut, hex, 5-40 x 1/4		
1 ea	260-0184-01	Switch, raw		
2 ea	302-0105-00	Resistor, comp, 1 meg.	1/2W	10%
1 ea	309-0030-00	Resistor, prec, 1.8k	1/2W	1%
3 ea	309-0041-00	Resistor, prec, 60k	1/2W	1%
2 ea	309-0045-00	Resistor, prec, 100k	1/2W	1%
2 ea	309-0051-00	Resistor, prec, 200k	1/2W	1%
1 ea	309-0098-00	Resistor, prec, 2k	1/2W	1%
4 ea	309-0100-00	Resistor, prec, 10k	1/2W	1%
2 ea	309-0153-00	Resistor, prec, 20k	1/2W	1%
1 ea	309-0180-00	Resistor, prec, 1.063k	1/2W	1%
1 ea	309-0191-00	Resistor, prec, 4.535k	1/2W	1%
1 ea	309-0192-00	Resistor, prec, 11.480k	1/2W	1%
1 ea	309-0194-00	Resistor, prec, 32.31k	1/2W	1%
2 ea	309-0400-00	Resistor, prec, 80Ω	1/2W	1/2%
1 ea	309-0405-00	Resistor, prec, 116k	1/2W	1/2%
1 ea	309-0406-00	Resistor, prec, 240Ω	1/2W	1/2%
1 ea	309-0407-00	Resistor, prec, 400Ω	1/2W	1/2%
1 ea	309-0408-00	Resistor, prec, 800Ω	1/2W	1/2%
1 ea	309-0409-00	Resistor, prec, 2.4k	1/2W	1/2%
2 ea	311-0056-00	Potentiometer, comp, 500Ω	0.1W	
1 ea	406-0330-00	Bracket, aluminum		
3-1/2 in.	(175-0517-00)	Wire, #22 solid, orange		
4 in.	(175-0522-00)	Wire, #22 solid, white-red		
3-1/2 in.	(175-0522-00)	Wire, #22 solid, white-green		
4 in.	(175-0527-00)	Wire, #22 stranded, white-black		
3-1/2 in.	(175-0527-00)	Wire, #22 stranded, white-orange		

INSTRUCTIONS

- () 1. Remove the HORIZONTAL VOLTS/DIV switch, noting contact connections for replacement.
- () 2. Install the new switch, from the kit.
- () 3. FOR INSTRUMENTS BELOW SN 3660 Remove both 1 meg resistors (R300 and R301) across the rear panel EXTERNAL HORIZ. DIFFERENTIAL INPUT (or HORIZ. INPUT) connectors.

NOTE: These resistors have been moved to the HORIZONTAL VOLTS/DIV switch.

THIS COMPLETES THE INSTALLATION

- () Check wiring for accuracy.
- () Fasten the insert page in your Instruction Manual.

JT:ls

INSTRUCTION MANUAL

MODIFICATION INSERT

HORIZONTAL VOLTS/DIV SWITCH

Type 575 -- SN 101-6054

Installed in Type 575 SN _____ Date _____

This insert has been written to supplement the Instruction Manual for this instrument. The information given in this insert will supersede that given in the manual.

This Insert Material Copyright © 1965 by Tektronix, Inc., Beaverton, Oregon. Printed in the United States of America. All rights reserved. Contents of this insert may not be reproduced in any form without the permission of the copyright owner.

GENERAL INFORMATION

HORIZONTAL VOLTS/DIV switch 262-0494-00 replaces the following: 262-0137-00 (SN 101-821); 262-0195-00 (SN 822-3659); 262-0416-00 (SN 3660-6054).

Oxide film resistors replace the 1/4% carbon resistors previously used on the Type 575 HORIZONTAL VOLTS/DIV switch. Because of their greater stability, the new resistors need only have a tolerance of 1/2%.

Two 1 meg resistors have been added to the switch, for instruments below serial number 3660, to replace those on the rear panel connectors.

ELECTRICAL PARTS LIST:

Values fixed unless marked variable. Only new parts listed (delete old entries in Manual).

Ckt.No.	Part Number	Description
---------	-------------	-------------

RESISTORS

Resistors are 1/2% precision.

R302	309-0405-00	116k 1/2W
R303	309-0409-00	2.4k 1/2W
R304	309-0408-00	800Ω 1/2W
R305	309-0407-00	400Ω 1/2W
R306	309-0406-00	240Ω 1/2W
R307	309-0400-00	80Ω 1/2W
R308	309-0400-00	80Ω 1/2W

SWITCHES

SW305	262-0494-00	HORIZONTAL VOLTS/DIV
-------	-------------	----------------------



product modification

050-0218-10

Type 575

T0520-7 (P-7 PHOSPHOR) CRT REPLACEMENT

For Tektronix® Type 575 Transistor-Curve Tracers

Serial Numbers 101 - 1351

When replacing the CRT in the above listed instruments, it is necessary to change the Vertical Min Gain Adj potentiometer, R493, from 100k to 250k. This increases the adjustment range to compensate for differences in cathode ray tube deflection plate sensitivities.

NOTE: If the serial number of your instrument is above those listed, or if this kit or 050-0218-00 has been installed, disregard the instructions as PN's 154-0102-00 and 311-0032-00 are direct replacements.

© 1964, 1976, Tektronix, Inc. 8-4-76
All Rights Reserved Supersedes: 050-0218-00

Page 1 of 2
110.03

PARTS INCLUDED IN PARTS REPLACEMENT KIT

Ckt. No.	Quantity	Part Number	Description
V859	1 ea	154-0102-00	Tube, vacuum, CRT
R493	1 ea	311-0032-00	Potentiometer, comp. 250k Type J

WARNING

High vacuum cathode ray tubes are dangerous to handle. To prevent personal injury from flying glass in case of tube breakage, wear a face mask or safety goggles, and gloves.

Handle the CRT with extreme care. Do not strike or scratch it. Never subject it to more than moderate force or pressure when removing or installing.

Always store spare CRT's in original protective cartons. Save cartons to dispose of used CRT's.

INSTRUCTIONS

BE SURE TO DISCONNECT THE INSTRUMENT FROM ITS POWER SOURCE & THAT THE HI VOLTAGE POWER SUPPLY IS COMPLETELY DISCHARGED BEFORE REPLACING THE CRT!

() 1. Remove the left and right hand cabinet sides.

Replace CRT as follows:

() 2. Disconnect the leads (five) from the neck of the CRT and disconnect the socket from the base of the CRT.

() 3. Remove the graticule cover and the graticule. Loosen the clamp at the base of the CRT and slide the CRT out of the front panel.

() 4. Install the new CRT by performing steps 2 and 3 in reverse.

() 5. Replace the Min Gain Adj potentiometer R493 (100k) with the 250k potentiometer from the kit.

() Add the following to your Manual Parts List:

R493 311-0032-00 250k 2W comp variable

V859 154-0102-00 CRT, P-7 Phosphor

050-0218-10



product modification

050-0218-11

Type 575

T0520-11 (P-11 PHOSPHOR) CRT REPLACEMENT

For Tektronix® Type 575 Transistor-Curve Tracers

Serial Numbers 101 - 1351

When replacing the CRT in the above listed instruments, it is necessary to change the Vertical Min Gain Adj potentiometer, R493, from 100k to 250k. This increases the adjustment range to compensate for differences in cathode ray tube deflection plate sensitivities.

NOTE: If the serial number of your instrument is above those listed, or if this kit or 050-0218-00 has been installed, disregard the instructions as PN's 154-0103-00 and 311-0032-00 are direct replacements.

PARTS INCLUDED IN PARTS REPLACEMENT KIT

Ckt. No.	Quantity	Part Number	Description
V859	1 ea	154-0103-00	Tube, vacuum, CRT
R493	1 ea	311-0032-00	Potentiometer, comp. 250k Type J

WARNING

High vacuum cathode ray tubes are dangerous to handle. To prevent personal injury from flying glass in case of tube breakage, wear a face mask or safety goggles, and gloves.

Handle the CRT with extreme care. Do not strike or scratch it. Never subject it to more than moderate force or pressure when removing or installing.

Always store spare CRT's in original protective cartons. Save cartons to dispose of used CRT's.

INSTRUCTIONS

BE SURE TO DISCONNECT THE INSTRUMENT FROM ITS POWER SOURCE & THAT THE HI VOLTAGE POWER SUPPLY IS COMPLETELY DISCHARGED BEFORE REPLACING THE CRT!

() 1. Remove the left and right hand cabinet sides.

Replace CRT as follows:

() 2. Disconnect the leads (five) from the neck of the CRT and disconnect the socket from the base of the CRT.

() 3. Remove the graticule cover and the graticule. Loosen the clamp at the base of the CRT and slide the CRT out of the front panel.

() 4. Install the new CRT by performing steps 2 and 3 in reverse.

() 5. Replace the Min Gain Adj potentiometer R493 (100k) with the 250k potentiometer from the kit.

() Add the following to your Manual Parts List:

R493	311-0032-00	250k 2W comp variable
V859	154-0103-00	CRT, P-11 Phosphor



Product
Replacement

050-0218-12

Type 575

T0520-31 (P-31 PHOSPHOR) CRT REPLACEMENT

For TEKTRONIX® Type 575 Transistor-Curve Tracers

Serial Numbers 101-1351

When replacing the CRT in the above listed instruments, it is necessary to change the Vertical Min Gain Adj potentiometer, R493, from 100k Ω to 250k Ω . This increases the adjustment range to compensate for differences in cathode ray tube deflection-plate sensitivities.

NOTE: If the serial number of your instrument is above those listed, or if this kit or 050-0218-00 has been installed, disregard the instructions and install pn 154-0763-00 as a direct replacement.

PARTS INCLUDED IN PARTS REPLACEMENT KIT:

Ckt. No.	Quantity	Part Number	Description
V859	1 ea	154-0763-00	Tube, vacuum CRT
R493	1 ea	311-0032-00	Resistor, variable, 250k Ω Type J

WARNING

High vacuum cathode ray tubes are dangerous to handle. To prevent personal injury from flying glass in case of tube breakage, wear a face mask or safety goggles, and gloves.

Handle the crt with extreme care. Do not strike or scratch it. Never subject it to more than moderate force or pressure when removing or installing.

Always store spare crt's in original protective cartons. Save cartons to dispose of used crt's.

INSTRUCTIONS:

BEFORE REPLACING THE CRT, BE SURE THE INSTRUMENT IS DISCONNECTED FROM AC POWER AND THE HIGH-VOLTAGE POWER SUPPLY IS COMPLETELY DISCHARGED.

- () 1. Remove the left and right hand cabinet sides.

Replace crt as follows:

- () 2. Disconnect the leads (five) from the neck of the crt and disconnect the socket from the base of the crt.
- () 3. Remove the graticule cover and the graticule. Loosen the clamp at the base of the crt and slide the crt out of the front panel.
- () 4. Install the new crt by performing steps 2 and 3 in reverse.
- () 5. Replace the Min Gain Adj R493 (100k Ω) with the 250k Ω variable resistor from the kit.
- () 6. Recalibrate the Vertical Sensitivity of your instrument as directed in the Instruction Manual.
- () Revise the Electrical Parts List in your Instruction Manual as indicated by the parts list at the top of this page.

KM:cs



product modification

050-0778-00

Type: See Below

CRT REPLACEMENT

For the following TEKTRONIX® INSTRUMENTS

515A	Oscilloscopes All SN's	RM33A	Oscilloscopes All SN's
RM15	Oscilloscopes All SN's	535A	Oscilloscopes All SN's
516	Oscilloscopes All SN's	RM35A	Oscilloscopes All SN's
525	TV Waveform Monitors All SN's	536	X-Y Oscilloscope All SN's
570	Vacuum Tube Curve Tracer All SN's	541A	Oscilloscopes All SN's
575	Transistor Curve Tracer All SN's	RM41A	Oscilloscopes All SN's
526	Vectorscopes All SN's	543A	Oscilloscopes All SN's
531A	Oscilloscopes All SN's	RM43A	Oscilloscopes All SN's
RM31A	Oscilloscopes All SN's	545A	Oscilloscopes All SN's
533A	Oscilloscopes All SN's	RM45A	Oscilloscopes All SN's

Ceramic bulb CRT's replace glass bulb CRT's providing improved availability. The new ceramic CRT's are not a direct replacement.

THE CRT IS NOT INCLUDED IN THIS KIT! ORDER CRT FROM LIST ON PAGE 2.

NOTE: If your instrument has a ceramic CRT, or if this kit has been installed, disregard the instructions and use the CRT's listed on page 2 as direct replacements.

THE CRT IS NOT INCLUDED IN THIS KIT. ORDER CRT FROM LIST BELOW:

	Old CRT		New CRT	
515A/RM15 Oscilloscopes 516	T0550-31	154-0344-00	T0551-31	154-0764-00
	T0550-7	154-0126-00	T0551-7	154-0764-03
	T0550-11	154-0127-00	T0551-11	154-0764-04
	T0550-1	154-0125-00	- -	- -
525 TV Waveform Monitors 570 Vacuum Tube Curve Tracers 575 Transistor Curve Tracers	T0520-31	154-0343-00	T0521-31	154-0763-00
	T0520-7	154-0102-00	T0521-7	154-0763-03
	T0520-11	154-0103-00	T0521-11	154-0763-04
	T0520-2	154-0097-00	- -	- -
526 Vectorscopes	T5260-31	154-0289-01	T5261	154-0759-00
531A/RM Oscilloscopes 533A/RM Oscilloscopes 535A/RM Oscilloscopes	T5330-31	154-0350-00	T5331-31	154-0757-00
	T5330-7	154-0179-00	T5331-7	154-0757-03
	T5330-11	154-0180-00	T5331-11	154-0757-04
536 X-Y Oscilloscopes	T5360-31	154-0351-00	T5361-31	154-0765-00
	T5360-7	154-0135-00	T5361-7	154-0765-03
	T5360-11	154-0136-00	T5361-11	154-0765-04
	T5360-2	154-0133-00	- -	- -
541A/RM41A 543A/RM Oscilloscopes 545A/RM Oscilloscopes	T5430-31	154-0339-00	T5432-31	154-0758-00
	T5430-7	154-0182-00	T5432-7	154-0758-03
	T5430-11	154-0183-00	T5432-11	154-0758-04

PARTS INCLUDED IN PARTS REPLACEMENT KIT

Quantity	Part Number	Description
1 ea	331-0191-01	Mask, CRT
4 ea	348-0070-01	Cushion, CRT support

INSTRUCTIONS

- () 1. Remove the four graticule nuts, graticule cover (or Bezel if present), graticule, light filter (if present, and black mask (if present).
- () 2. Disconnect the deflection plate connectors from the neck pins on the CRT.
- () 3. Disconnect the CRT socket connector and loosen the clamp at the base of the CRT.
- () 4. Remove the old CRT, felt cushions, or any padding from inside the CRT shield. Leave the metal clips inside the CRT shield (if present).
- () 5. Install the four (4) cushions as shown in the drawing.
- () 6. Install the new CRT and complete the installation by performing steps 1 through 3 in reverse, except replace the black mask with the new mask from the kit.

Refer to the calibration procedure in your Instruction Manual and recalibrate as necessary.

