



Tools



French manufacturer
since 1964



Chargers, Boosters & Starters

Charge & entretien des batteries

Batterieservicegeräte-Katalog

Caricabatterie, Booster & Avviatore

Catálogo de Cargadores

2
0
2
0



CHARGER

BOOSTER

STARTER

TESTER

JUMPER CABLE

ACCESSORIES



GYS FRANCE
Laval

🕒 1964
👤 × 530

Created in 1964, GYS is a French industrial group with 700 employees around the world. Built around continuous investment in Research & Development and in the acquisition of knowledge, the company is now a major player in the design and manufacture of welding machines, battery chargers and car body repair equipment.



Nicolas & Bruno Bouygues

“ The market realities are constantly changing and the size of our family business requires us to quickly adapt to new contexts and new challenges.

We are convinced that our future is closely linked to the future of our partners. This is why we do everything in our power to understand what distributors and users expect from us and what challenges they face every day. To support them in facing these challenges, we wish to become and remain their privileged partner on the path we will travel together. ”

Bruno Bouygues,
C.E.O.

A worldwide coverage

125 countries

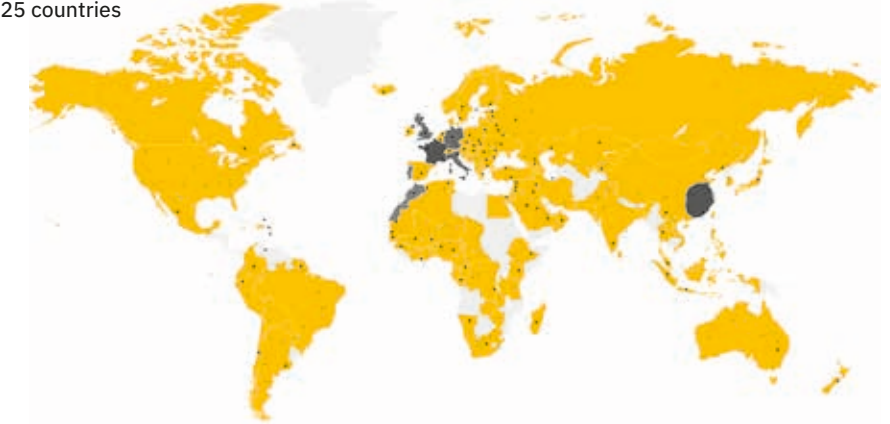

INVEST IN THE FUTURE

FR

Créé en 1964, GYS est un groupe industriel français regroupant plus de 700 collaborateurs dans le monde. Fort d'un centre de recherche de premier plan, GYS est un acteur majeur dans la conception et la fabrication d'équipements de soudage, de chargeurs de batteries et de systèmes de réparation carrosserie.

Les nouvelles réalités du marché sont en perpétuel changement et la taille de notre entreprise familiale nous impose une adaptation rapide aux nouveaux contextes et à leurs enjeux.

Nous sommes convaincus que notre avenir est étroitement lié à celui de nos clients. Pour cela, nous mettons tout en oeuvre pour comprendre ce que les distributeurs et les utilisateurs attendent de nous, savoir à quels défis ils font face et voir dans quelle mesure nous pouvons leur permettre de les relever afin de devenir et rester leur partenaire privilégié pour le chemin que nous avons à parcourir ensemble.

DE

GYS wurde 1964 gegründet und ist ein französisches Familienunternehmen mit mehr als 700 Mitarbeitern auf der ganzen Welt. Dank einem erstklassigen Forschungszentrum ist GYS ein wichtiger Akteur in der Entwicklung und Herstellung von Schweißgeräten, Batterieladegeräten und Karosseriereparatursystemen.

Neue Marktbedingungen sind in fortwährender Veränderung und die Größe unseres Familienunternehmens veranlasst eine rasche Anpassung an neue Umstände und an ihre Herausforderungen.

Wir sind überzeugt, dass unsere Zukunft eng mit der unserer Kunden verbunden ist. Dafür setzen wir all unser Können ein, um zu verstehen, was die Händler und Anwender von uns erwarten, welchen Herausforderungen sie gegenüberstehen und um zu schauen, in welchem Maße wir sie unterstützen können, damit wir ihr bevorzugter Partner werden und bleiben auf dem Weg, den wir gemeinsam beschreiten.

ES

Creado en 1964, GYS es un grupo industrial francés con más de 700 empleados en todo el mundo. Con un centro de investigación líder, GYS es un actor importante en el diseño y fabricación de equipos de soldadura, cargadores de baterías y sistemas de reparación de carrocerías.

Las nuevas realidades del mercado cambian constantemente y el tamaño de nuestra empresa familiar nos obliga a adaptarnos rápidamente a los nuevos contextos y a sus retos.

Estamos convencidos de que nuestro futuro está estrechamente ligado al de nuestros clientes. Para ello, hacemos todo lo que está en nuestras manos para comprender lo que los distribuidores y usuarios esperan de nosotros, los retos a los que se enfrentan y ver hasta qué punto podemos permitirles que los cumplan para convertirnos y seguir siendo su socio preferido en el camino que tenemos que recorrer juntos.



GYS GERMANY
Aachen

🕒 2006
👤 × 60

GYS U.K.
Rugby

🕒 2008
👤 × 30

GYS CHINA
Shanghai

🕒 2004
👤 × 110

GYS ITALIA
Venezia

🕒 2015
👤 × 10

740 people

55 000 m²
590 000 sqf
2 factories

Partners





GYS ACADEMY

Training centre dedicated to professionals

Centre de formation agréé

Trainingcenter für Profis

Centro di formazione dedicato ai professionisti

Ref. 52 53 0068153

3 catalogues

2400+ references



Welding & Cutting



Car body Welding Systems



Chargers, Boosters & Starters

CHARGERS

Smart HF

GYSFLASH (Pb)
p.6



GYSFLASH PL (Pb/LiFePO₄/Li-ion)
p.9



GYSFLASH LITHIUM (LiFePO₄)
p.11

Connectors p.12
Selection p.13

BSU

GYSFLASH PRO
p.14

BSU-CNT

GYSFLASH PRO CNT
p.16

Chargers



ARTIC
p.20



ENERGY & TCB
p.21



CT
p.22



CA & WATTMATIC
p.23



BATIUM
p.24

STARTERS & CHARGERS



START & NEOSTART
p.26



STARTIUM
p.28



DIAGSTARTIUM
p.29

BOOSTERS

Traditional (Pb)

GYSPACK
p.30

GYSPACK PRO
p.33



STARTPACK TRUCK
p.34



STARTPACK
p.35



ENERGYSTATION
p.37

Selection
p.38

Lithium technology



NOMAD POWER & POWER PRO
p.40

Super capacitors technology



STARTRONIC
p.42



GYSCAP
p.43

TESTERS



TBP, BT, BTW
p.44



ACCESSORIES



Power inverter
p.48



Jumper cables
p.50



Clamps & consumables
p.52

Working lights
p.53

Accessories
p.39

+ MORE

NATO/OTAN
selection
p.54

Traction selection
p.54

Charging curves
p.55

Marketing
p.55

Advanced R&D

75

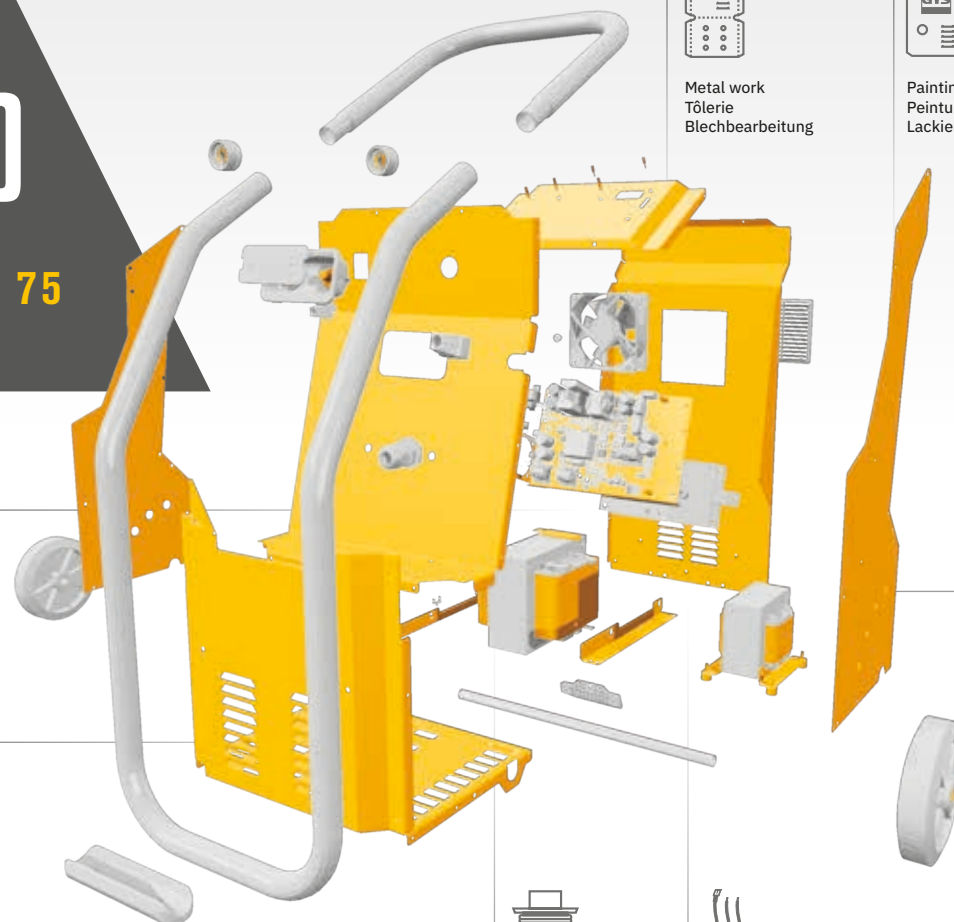

Metal work
Tôlerie
Blechbearbeitung



Painting & marking
Peinture & marquage
Lackierstraße

Assembly
Montage/tests
Montage



Electronics
Électronique
Elektronik



Mechanical
Mécanique
CNC-Bearbeitung



Transformers
Transformateurs
Transformatoren



Cable work
Filerie
Kabelkonfektionierung

100%
in house
production

www.gys.fr



Pb

GYSFLASH

12 V

SSM
Self Start
Memory

GYSFLASH TECHNOLOGIES



Start/stop Engine :
Compatible véhicules Start/Stop.
Compatible with Start/Stop vehicles.
Geeignet für START-STOP- Fahrzeuge.



Can bus ready : compatible avec la technologie Can Bus, le Gysflash se branche directement sur la prise 12 V de la moto (câble en option).

Can Bus ready: compatible with Can Bus Technology, the Gysflash can be connected to the motorcycle 12V socket (cable is optional).

Can-Bus Ready: Mit der Can-Bus Technologie kompatibel. Das GYSFLASH wird direkt an den 12V-Anschluss des Motorrads angeschlossen (Kabel optional).



Mode "Cold charge" : optimisation des performances en cas de temps froid ou de gel.

"Cold charge" mode: performance-enhancing charging mode for cold or freezing weather conditions.

Cold Charge--Modus: Leistungsoptimierung bei kaltem Wetter oder bei Frost.



Refresh : rééquilibrage des cellules de la batterie pour plus de longévité (suivant modèle).

Refresh : rebalancing of the battery cells for greater longevity (not available on all models).

Refresh: Regenerierung der Batteriezellen für eine längere Lebensdauer (je nach Modell).



Mémorisation des réglages. Redémarrage automatique en cas de coupure électrique.

Save and load settings. Automatic restart in case of power cut.
Einstellungsspeicherung. Automatisches Starten nach einem Netzausfall.



Équipé d'un capteur haute sensibilité, le Gysflash ajuste automatiquement les paramètres de charge en fonction de la température ambiante.

Fitted with a highly sensitive sensor, Gysflash automatically adjusts the charge based on ambient temperature.

Ausgestattet mit einem hochempfindlichen Sensor stellt das GYSFLASH automatisch die Ladeparameter der Umgebungstemperatur entsprechend ein.



Source d'énergie : mode de maintien optimal de l'état de charge.
Idéal pour les véhicules en hivernage, de démonstration, ou pour le remplacement de batterie.

Power supply mode: Optimum floating charge, ideal for use during battery change to protect vehicle memory. Also for when the vehicle is not in use for extended periods or for demonstration use.

Energiequelle: Aufrechterhaltung des Batteriezustands. Ideal für Saison-, Ausstellungsfahrzeuge oder bei Batteriewechsel.

GYSFLASH TECHNOLOGIES LiFePO₄



UVP Wake up (Under Voltage Protection)
Réactivation de la batterie en protection UVP.
Battery reactivation when in UVP protection.
Reaktivierung der Batterie mit UVP-Schutz.



Équilibrage des cellules.
Balancing of the battery cells.
Ausgleich der Batteriezellen.



GYSFLASH 1.12

1 A 12V **GO > 7 V**



029361 **47,80 € HT**
029514



GYSFLASH 4.12 RENAULT

0,8/4 A 12V **GO > 2 V**



029422 **64,50 € HT**
029521



GYSFLASH 6.12

0,8/6 A 12V **GO > 2 V**



029378 **81,20 € HT**
029613



GYSFLASH 8.12

8 A 12V **GO > 2 V**



029385 **99,70 € HT**
029545



GYSFLASH 12.12

12 A 12V **GO > 2 V**



029392 **153,50 € HT**
029552



DISPLAY BOX
4.12 x 5
026001 **322,30 € HT**



	PATENTS REGISTERED NUMBERS 002280008 & 002279927 EUROPEAN TRADEMARK & DESIGN	50 / 60 Hz	Power	I _{charge}	V	Charge	Maintenance	Zz	Ondulation/ Ripple	Charging curve	IP	Weight	Dimensions	SOS RECOVERY
GYSFLASH 1.12		220-240 V AC	18 W	1 A	12 V	2 > 32 Ah	2 > 100 Ah	<0.4 Ah/month	<150 mV Rms	IUoU	7 steps	0.44 kg	130 × 80 × 38 mm	Automatic
GYSFLASH 4.12		220-240 V AC	70 W	0,8/4 A	12 V	1.2 > 90 Ah	1.2 > 125 Ah	<0.4 Ah/month	<150 mV Rms	IUoU	7 steps	0.69 kg	170 × 90 × 51 mm	Automatic
GYSFLASH 6.12		220-240 V AC	90 W	0,8/6 A	12 V	1.2 > 125 Ah	1.2 > 170 Ah	<0.4 Ah/month	<150 mV Rms	IUoU	8 steps	0.77 kg	190 × 100 × 52 mm	Automatic
GYSFLASH 8.12		220-240 V AC	130 W	8 A	12 V	15 > 160 Ah	15 > 240 Ah	<0.4 Ah/month	<150 mV Rms	IUoU	8 steps	0.85 kg	190 × 100 × 52 mm	Automatic
GYSFLASH 12.12		220-240 V AC	195 W	12 A	12 V	20 > 250 Ah	20 > 330 Ah	<0.4 Ah/month	<100 mV Rms	IUoU	8 steps	1.1 kg	221 × 111 × 58 mm	Automatic

GYSFLASH SMART HF INVERTER

DESIGN
GYS FRANCE

Pb

7



6/12 V

Pb

GYSFLASH

6/ 12/ 24 V

SSM
Self Start
Memory



GYSFLASH 6 HERITAGE

0,8/6 A 6/12V GO > 2V



029538 81,20 € HT

GYSFLASH 6.24

0,8/6 A 6/12/24V GO > 2V



029460 104,00 € HT

GYSFLASH 9.24

9 A 6/12/24V GO > 2V



029477 164,40 € HT

GYSFLASH 1.12 PL

1 A 12V GO > 7V



026902 59,80 € HT

Pb

LiFePO₄

GYSFLASH

12 & 12/ 24 V

SSM
Self Start
Memory

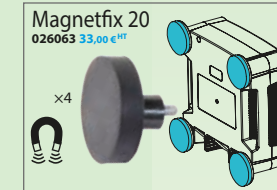

OPTION
Gysflash 18.12 PL, 30.12 PL, 20.12/24 PL,
10.36/48 PL

GYSFLASH 18.12 PL

7/12/18 A 12V GO > 2V



026926 251,30 € HT

GYSFLASH 30.12 PL

7/15/30 A 12V GO > 2V



029668 292,50 € HT

GYSFLASH 20.12/24 PL

7/15/20 A 12/24V GO > 2V



026049 302,80 € HT



PATENTS REGISTERED NUMBERS 002280008 & 002279927 EUROPEAN TRADEMARK & DESIGN	50/60 Hz	Power	I _{charge}	V	Charge	Maintenance	Z _z	Ondulation/ Ripple	Charging curve	IP	Weight	Dimensions	SOS RECOVERY	
														Design
GYSFLASH 6 HERITAGE	220-240 V AC	90 W	0,8/6 A	6/12 V	1.2 · 125 Ah	1.2 · 170 Ah	<0.4 Ah/month	<150 mV Rms	IUoU	8 steps	IP 65	0.77 kg	190 × 100 × 52 mm	Automatic
				6/12/24 V	1.2 · 125 Ah	1.2 · 170 Ah	<0.4 Ah/month	<150 mV Rms	IUoU	7 step	IP 65	0.85 kg	190 × 100 × 52 mm	Automatic
GYSFLASH 6.24	220-240 V AC	130 W	0,8/6 A	6/12 V	1.2 · 125 Ah	1.2 · 170 Ah	<0.4 Ah/month	<150 mV Rms	IUoU	7 step	IP 65	0.85 kg	190 × 100 × 52 mm	Automatic
			0,8/4 A	24 V	1.2 · 100 Ah	1.2 · 140 Ah	<0.4 Ah/month	<150 mV Rms	IUoU	8 step	IP 65	1.1 kg	221 × 111 × 58 mm	Automatic
GYSFLASH 9.24	220-240 V AC	190 W	9 A	6/12 V	18 · 220 Ah	18 · 300 Ah	<0.4 Ah/month	<100 mV Rms	IUoU	8 step	IP 65	1.1 kg	221 × 111 × 58 mm	Automatic
			6 A	24 V	15 · 125 Ah	15 · 170 Ah	<0.4 Ah/month	<100 mV Rms	IUoU	8 step	IP 65	1.1 kg	221 × 111 × 58 mm	Automatic

PATENTS REGISTERED NUMBERS 002280008 & 002279927 EUROPEAN TRADEMARK & DESIGN	50/60 Hz	Power	I _{charge}	V	Charge	Maintenance	Z _z	Ondulation/ Ripple	Charging curve	IP	Weight	Dimensions	SOS RECOVERY	
														Design
GYSFLASH 1.12 PL	220-240 V AC	20 W	1 A	12 V	2 · 32 Ah (Pb) 0.5 · 20 Ah (LiFePO ₄)	2 · 100 Ah (Pb) 0.5 · 50 Ah (LiFePO ₄)	<0.4 Ah/month	<150 mV Rms	IUoU	7 step (Pb) 8 step (LiFePO ₄)	IP 65	0.69 kg	170 × 90 × 51 mm	DESIGN GYS FRANCE
GYSFLASH 18.12 PL	220-240 V AC	300 W	7/12/18 A	12 V	15 · 270 Ah (Pb) 7 · 270 Ah (LiFePO ₄)	15 · 300 Ah (Pb) 7 · 300 Ah (LiFePO ₄)	<0.5 Ah/month	<100 mV Rms	IUoU	7 step (Pb) 8 step (LiFePO ₄)	IP 43	1.55 kg	190 × 190 × 73 mm	
GYSFLASH 20.12/24 PL	220-240 V AC	500 W	7/15/20 A	12 V	15 · 240 Ah (Pb) 7 · 240 Ah (LiFePO ₄)	15 · 375 Ah (Pb) 7 · 375 Ah (LiFePO ₄)	<1 Ah/month	<150 mV Rms	IUoU	7 step (Pb) 8 step (LiFePO ₄)	IP 43	1.85 kg	190 × 190 × 73 mm	MADE IN FRANCE
			7/15 A	24 V	15 · 240 Ah (Pb) 7 · 240 Ah (LiFePO ₄)	15 · 375 Ah (Pb) 7 · 375 Ah (LiFePO ₄)	<0.5 Ah/month	<150 mV Rms	IUoU	7 step (Pb) 8 step (LiFePO ₄)	IP 43	1.85 kg	190 × 190 × 73 mm	
GYSFLASH 30.12 PL	220-240 V AC	500 W	7/15/30 A	12 V	15 · 270 Ah (Pb) 7 · 270 Ah (LiFePO ₄)	15 · 300 Ah (Pb) 7 · 300 Ah (LiFePO ₄)	<0.5 Ah/month	<150 mV Rms	IUoU	7 step (Pb) 8 step (LiFePO ₄)	IP 43	1.85 kg	190 × 190 × 73 mm	

Pb - Pb/LiFePO₄

GYSFLASH SMART HF INVERTER

Pb
LiFePO₄
Li-ion+

GYSFLASH

24 V & 36/48 V

SSM
Self Start
Memory

ELECTRICAL
MOBILITY

INDUSTRY
ELECTRICAL
MOBILITY

GYSFLASH 6.24 PL

6 A 24V GO > 2 V



027398 160,30 € HT

GYSFLASH 3.48 PL

3 A 48V GO > 5 V



027893

GYSFLASH 10.36/48 PL

10 A 36/48V GO > 5 V



027060 313,00 € HT
027916

NEW

NEW



54.0V : LFP 15 serial cells Li 13 serial cells
58.0V : LFP 16 serial cells Li 14 serial cells

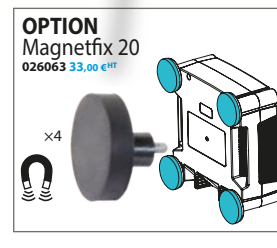
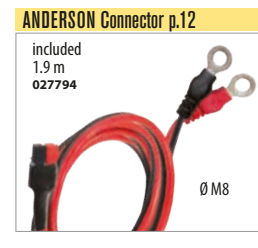

LiFePO₄

GYSFLASH

12 V

SSM
Self Start
Memory

Lithium

GYSFLASH 1.12 Lithium

1 A 12V GO > 7 V



029675 62,90 € HT

GYSFLASH 6.12 Lithium

4/6 A 12V GO > 2 V



029729 102,20 € HT



MOBILITY



OUTDOOR



MEDICAL



INDUSTRY



GYS

11

Pb/Lithium/Lion - LiFePO₄

GYSFLASH SMART HF INVERTER

10

DESIGN GYS FRANCE	PATENTS REGISTERED NUMBERS 002280008 & 002279927 EUROPEAN TRADEMARK & DESIGN	50 / 60 Hz	Power	I _{charge}	V	Charge	Maintenance	Z _z	Ondulation/ Ripple	Charging curve	IP	Weight	Dimensions	
														Charge
GYSFLASH 6.24 PL		220-240 V AC	2 m 195 W	6 A	24 V	15 > 125 Ah (Pb) 2 > 125 Ah (Li)	15 > 170 Ah (Pb) 2 > 170 Ah (Li)	<0.4 Ah /month	<150 mV Rms	IUOu	7 step (Pb) 8 step (Li)	IP 65	1,1 kg	221x111x58 mm
GYSFLASH 3.48 PL		220-240 V AC	2 m 195 W	3 A	48 V	6 > 60 Ah 3 > 60 Ah	6 > 85 Ah 3 > 85 Ah	<0.4 Ah /month	<150 mV Rms	IUOu	7 step (Pb) 8 step (Li)	IP 65	1,1 kg	221x111x58 mm
GYSFLASH 10.36/48 PL		220-240 V AC	2 m 500 W	10 A 8 A	36 V 48 V	20 > 230 Ah (Pb) 10 > 230 Ah (Li) 15 > 160 Ah (Pb) 8 > 160 Ah (Li)	<0.4 Ah /month	<150 mV Rms	IUOu	7 step (Pb) 8 step (Li)	IP 43	1,85 kg	190x190x73 mm	

DESIGN GYS FRANCE	PATENTS REGISTERED NUMBERS 002280008 & 002279927 EUROPEAN TRADEMARK & DESIGN	50 / 60 Hz	Power	I _{charge}	V	Charge	Maintenance	Z _z	Ondulation/ Ripple	Charging curve	IP	Weight	Dimensions	
														Charge
GYSFLASH 1.12 Lithium		220-240 V AC	1 m 18 W	1 A	12 V	0.5 > 20 Ah	0.5 > 50 Ah	<0.4 Ah/month	<150 mV Rms	IUOu	8 step	IP 65	0,44 kg	130 x 80 x 38 mm
GYSFLASH 6.12 Lithium		220-240 V AC	2 m 90 W	4/6 A	12 V	1.2 > 125 Ah	1.2 > 170 Ah	<0.4 Ah/month	<150 mV Rms	IUOu	8 step	IP 65	0,77 kg	190 x 100 x 52 mm

DESIGN
GYS FRANCE

BATTERY SUPPORT UNITS

BSU-CHARGERS

12 V

FAN LESS
TECHNOLOGY

HIGH EFFICIENCY
Up to 15%
Energy Saving **93%**

SSM
Self Start
Memory

Lithium

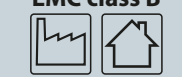

GYSFLASH 50.12 FV

50 A 12 V **PFC FV** FLEXIBLE VOLTAGE
2,5 m - 10 mm²
026056 **671,30 € HT**



GYSFLASH 30.12

30 A 12 V **PFC**
029224 **560,20 € HT**



GYSFLASH 32.12 PL 2,5 m - 6 mm²

30 A 12 V **7 STEP Pb** **8 STEP LiFePO₄**
027381 **391,30 € HT**



GYSFLASH 102.12 5 m - 16 mm²

100 A 12 V **PFC**
029606 **799,00 € HT**

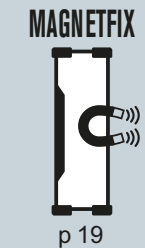

GYSFLASH 100.12 **100 A** 12 V **PFC**

2,5 m - 16 mm² **029071 747,50 € HT**
029453
5 m - 16 mm² **029415 768,10 € HT**
029002



BATTERY SUPPORT UNITS

BSU-CHARGERS

6/ 12/ 24 V



GYSFLASH 30.24 **30 A** 6/12/24V **PFC** **029231 560,20 € HT**

GYSFLASH 50.24 **50 A** 6/12/24V **PFC** 2,5 m - 10 mm² **029095 677,50 € HT** 5 m - 16 mm² **029620 724,90 € HT**



	50/60 Hz	L	mm ²		START MINI	I _{max}	25°C @100%	40°C @100%		TRACTION BATTERIES			SULPHATED BATTERIES AUTOMATIC RECOVERY		
GYSFLASH 30.12	230V	2,5 m	6	12V	540W	2V	30 A	30 A	30 A	10 · 400Ah	—	25,5 × 10,5 × 23 cm	4,9 kg	•	
GYSFLASH 50.12 FV	85 > 265V	2,5 m	10	12V	850W	2V	50 A	50 A	40 A	10 · 600Ah	—	30 × 10,5 × 29 cm	6,6 kg	•	
GYSFLASH 100.12	230V	2,5 m	16	12V	1600W	2V	100 A	75 A	66 A	20 · 1200Ah	—	32 × 10,5 × 29,2 cm	7,4 kg	•	
		5 m	16										8,3 kg	•	
GYSFLASH 32.12 PL	230V	2,5 m	6	12V	500W	2V	30 A	30 A	25 A	10 · 400Ah	—	8 × 25 × 20 cm	4,9 kg	•	
GYSFLASH 102.12	230V	5 m	16	12V	1600W	2V	100 A	75 A	66 A	20 · 1200Ah	—	12 × 34,5 × 29,5 cm	9,1 kg	•	
GYSFLASH 30.24	230V	2,5 m	6	6V	540W	2V	30 A	30 A	30 A	10 · 400Ah	•	25,5 × 10,5 × 23 cm	4,9 kg	•	
				12V			30 A	30 A	30 A						
				24V			15 A	15 A	15 A	10 · 200Ah					
GYSFLASH 50.24	230V	2,5 m	10	6V	1600W	2V	50 A	50 A	45 A	10 · 600Ah	•	30 × 10,5 × 29,2 cm	6,6 kg	•	
				12V			50 A	50 A	40 A						
				24V			45 A	45 A	35 A					7,9 kg	•

BSU-CNT

CONNECT TECHNOLOGY

12 & 24 V Lithium

Contact us for special projects

GYSFLASH 101.12 CNT 5 m - 16 mm²
100 A 12 V **CNT** **PFC** **TEST**

026988 **809,30 €HT**

GYSFLASH 121.12 CNT FV 5 m - 25 mm²
120 A 12 V **CNT** **PFC** **FV** **TEST**

026971 **978,20 €HT**
 027756



GYSFLASH 123.12 CNT 5 m - 16 mm²
120 A 12 V **CNT** **FV** **PFC**

025677



MAGNETFIX



p 19

BATTERY SUPPORT UNITS

BSU-CHARGERS

6/ 12/ 24 V

GYSFLASH 103.24 CNT 5 m - 16 mm²
100 A 6/12/24 V **CNT** **FV** **PFC**

025684

NEW
01/2020



CNT - TECHNOLOGY

STANDARD MODES

CHARGE				BSU				TEST MODES	
Pb AUTOMOTIVE BATTERY	6 CURVES	Lithium BATTERY	LFP/LiFePO4	Pb TRACTION BATTERY	2 CURVES	DIAG +	SHOWROOM	CHANGE BATTERY	POWER SUPPLY
	GEL AGM LIQUID EASY EXPERT LFP				LIQUID GEL				
		Lithium				U2 ADJUSTABLE			U2 & I2 max ADJUSTABLE

+ CNT ADDITIONAL MODE

TOTAL CUSTOMIZATION										
Pb AUTOMOTIVE BATTERY	10 CURVES & +	Lithium BATTERY	4 CURVES & +	Li-SUPPLY LFP	Li-SUPPLY Li-ion	
	NORMAL BOOST RECOVERY + ...		LFP/LiFePO4 Li-ion standard LFP Cell+ Li-ion Cell+ ...							
		Lithium				U2 & I2 max ADJUSTABLE	U2 & I2 max ADJUSTABLE			VOLTAGE TEST START-UP TEST ALTERNATOR TEST

+ CNT EXTENDED CAPABILITIES

UPDATE Gysflash evolutions

TRACEABILITY History data export

USB Connection

- Update
- Customized settings
- Charging data recovery (traceability)

Personal configuration

Contact us for special projects

Quick customization
Modes, curves & parameter management

	DIRECT MODULE	AUTOMATISM	COMMUNICATION
	Smart Printer Mobile (p 18)	Smart Extender Module (SEM) <i>Coming soon</i>	Communication Module <i>Coming soon</i>
	Smart Light Module <i>Coming soon</i>	Remote MMI <i>Coming soon</i>	...
SMC Smart Module Connector			

	50/60 Hz	L	mm ²	START MINI	I max	25°C @100%	40°C @100%	TRACTION BATTERIES	1 2 3	SULPHATED BATTERIES AUTOMATIC RECOVERY	CNT	
GYSFLASH 101.12 CNT	230V	5 m	16	12V	1600W	2V	100 A	75 A	66 A	20 > 1200Ah	•	•
GYSFLASH 121.12 CNT FV	85 > 265V	5 m	25	12V	2000W	2V	110 V: 100 A 230 V: 120 A	75 A 110 A	55 A 90 A	20 > 1500Ah	•	•
GYSFLASH 123.12 CNT FV	85 > 265V	5 m	25	12V	2000W	2V	110 V: 100 A 230 V: 120 A	100 A 120 A	85 A 120 A	20 > 1500Ah	•	•
GYSFLASH 103.24 CNT FV	85 > 265V	5 m	25	6/12V 24V	3200W	2V	110 V: 100 A 230 V: 100 A 230 V: 100 A	100 A 100 A 95 A	68 A 79 A 72 A	20 > 1200Ah	•	•

PRO CNT

GYSFLASH SMART HF INVERTER & BSU

MADE IN FRANCE

SPM - Smart Printer Module with CNT technology for Gysflash 101.12 CNT & 121.12 CNT



026919 **243,00 €HT** **NEW**

OPTION : Support Scanner 025745 **NEW**



Barcode Scanner	USB Keyboard	Standard roller	Support Scanner	SMC Cable
10/20 - USB	AZERTY	X2 included 57mm x 7,5 m Ø 25 mm		L = 3 m
027718 90,70 €HT	QWERTY	056633 2,90 €HT	025745	025691

	10 L12 CNT	121.12 CNT	Smart Printer Module	USB Barcode Scanner 10/20	Support Scanner	USB Keyboard AZERTY	USB Keyboard QWERTY	Trolley Gysflash XL	Standard Roller (57 mm)
Pack Gysflash CNT 1 027817 1 535,00 €HT	026988	—	026919	027718	025745	—	027770	027749	056633
Pack Gysflash CNT 2 027824 1 528,80 €HT	026988	—	026919	027718	025745	027725	—	027749	056633
Pack Gysflash CNT 3 027831 1 703,80 €HT	—	026971	026919	027718	025745	—	027770	027749	056633
Pack Gysflash CNT 4 027848 1 697,70 €HT	—	026971	026919	027718	025745	027725	—	027749	056633

GYS

Battery Charger Unit
GYSFLASH 101.12 CNT

SN: 00.00.000000.000000
Software version: 03.00
Date: 06/01/2019 01:47
Charge number: 457

Vehicle data
Customer: M. Smith
Model: Golf 4
VIN: 65SG4654D4DGH654G
Number plate: HJ-456-GH

Battery data
Model: Varta
Number: 56789
Rated voltage: 12V
Rated capacity: 67Ah
Type: Lead-acid

Charge data
Type: Pb-CHARGE
Profile: AGM
Selected voltage: 12V
Selected capacity: 67Ah

Initial battery status
Initial voltage: 12.4 V
Initial status: CHARGED

Charging information
Charging process: 100%
Charge duration: 00:04:10
Injected Ah: 0.0Ah

Final battery status
Charging voltage: 14.7V
Final voltage: 13.5V
Final status: CHARGED

CNT - Connect technology for Gysflash 101.12 CNT & 121.12 CNT



Customer data → Battery data → Charge data → Simply request printing

Chargeurs intelligents • Smart chargers • Intelligente Ladegeräte

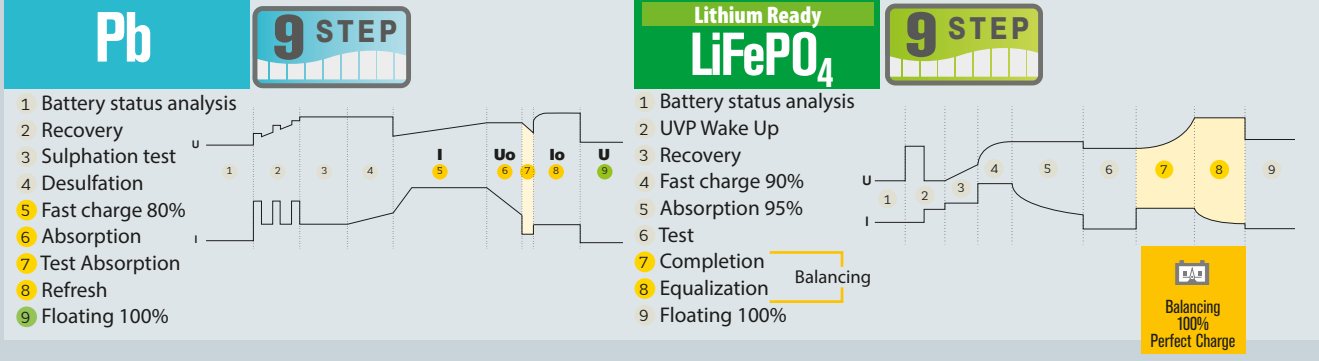

Interface high resolution



22 languages

GB FR DE NL ES PT IT RU SE DK
FI TR HR GR CZ PL SK UA HU

+ CN (simplified & traditional) & JP integrated

ergonomique

OPTION
Gysflash 32.12, 102.12, 123.12 CNT, 103.24 CNT
MAGNETFIX 50
029637 74,20 €HT

included fixation
Gysflash 32.12, 102.12

Tablette - Wall support - Wandhalterung
055513 43,30 €HT

Valise de chantier Heavy-duty case Hartschalenkoffer
-L: 21 x 43 x 57 cm / 3,9 kg
060432 123,60 €HT

Chariot - Trolley - Fahrwagen
027749 356,30 €HT
GYSFLASH XL

029491 328,50 €HT
(Not for Gysflash 121.12)

Standard cable & taxis	GYSFLASH	NATO/Anderson	NATO/Texas	NATO CONNECTOR	Fuse internal	Fuse external
5 m - 25 mm ² 027886	121.12 CNT FV 123.12 CNT FV 103.24 CNT FV	5 m - 16 mm ² 026810 203,90 €HT	5 m - 25 mm ² 025707	026780 88,60 €HT	Gysflash 30 - 40 A 054646 5,20 €HT Gysflash 40/50 - 80 A 054653 6,40 €HT	Gysflash 30 - 6.3 A 054578 3,10 €HT Gysflash 40/50/100/101/102 : 10 A 056527 3,10 €HT
Standard cables Anderson	GYSFLASH : 30.12 - 30.24 32-12 PL - 50.12 FV 50.24 - 100.12 102.12 - 101.2 CNT	8 m - 16 mm ² 056572 92,70 €HT	103.24 CNT FV 121.12 CNT FV 123.12 CNT FV		Gysflash 100/101/102 : 125 A 054585 5,60 €HT	Gysflash 121/123/103 : 150 A 027930
5 m - 16 mm ² 054615 78,30 €HT						
5 m - 16 mm ² 054615 78,30 €HT						
5 m - 25 mm ² 025721						
Cables Anderson 175A/Texas	GYSFLASH : 103.24 CNT FV 121.12 CNT FV 123.12 CNT FV					
5 m - 25 mm ² 025714						

CHARGERS & STARTERS

AUTOMATIC

6/ 12/ 24 V IWUoU

AUTOMATIC CHARGE = Batium

SULPHATED BATTERIES AUTOMATIC RECOVERY

OVER VOLTAGE PROTECTION AUTOMATIC CONTROL

AUTOMATIC START

UNIVERSAL MODE (autoselection)

START STOP All batteries

GO >1V



TEST ALTERNATOR TIMER

TEST ALTERNATOR TIMER

TEST ALTERNATOR TIMER

TEST ALTERNATOR TIMER 35/50 mm²

BATTERY EXPERT **3 in 1** CHARGER, STARTER & BSU TEST ALTERNATOR TIMER POWER SUPPLY DIAG+ 60A U2 adjustable 12 V · 15 V

STARTIUM 330E
25 A 12/24 V

026469 **502,50 € HT**

STARTIUM 480E
40 A 12/24 V

026483 **646,60 € HT**
☎ : 025578

STARTIUM 680E
45 A 12/24 V

026490 **677,50 € HT**
☎ : 025585

STARTIUM 980E
50 A 12/24 V

026506 **885,50 € HT**

DIAG STARTIUM 60-12
60 A 12 V

026513 **895,80 € HT**

DIAG STARTIUM 60-24
60 A 6/12/24 V

026520 **937,00 € HT**
☎ : 025592



1,9 m - 10 mm²



1,9 m - 16 mm²



2,2 m - 25 mm²



2,5 m - 35 mm²



2,2 m - 25 mm²



2,2 m - 25 mm²

AUTOMATIC CHARGERS/STARTERS

	I ₁	CHARGE kW	START kW	CHARGE						START			BSU	FUSE	Weight		
				min > max	Efficace / RMS	Moyen / Average (EN 60335)	Reg	Boost	Automatic	1V/C	0V/C	AUTO START					
STARTIUM 330E	230 V	16 A	0,8	6,5	12 V : 20 > 370 Ah 24 V : 20 > 300 Ah	40 A	25 A	4	—	•	12 V : 165 A 24 V : 130 A	270 A 210 A	•	—	100 A	43 × 26 × 26 cm	16,3 kg
STARTIUM 480E	230 V	16 A	1,7	9	12 V : 20 > 600 Ah 24 V : 20 > 450 Ah	65 A	30 A	4	40 A	•	12 V : 280 A 24 V : 210 A	390 A 290 A	•	—	200 A	31 × 48 × 80 cm	28,6 kg
STARTIUM 680E	230 V	16 A	2	10	12 V : 20 > 675 Ah 24 V : 20 > 525 Ah	75 A	30 A	4	45 A	•	12 V : 380 A 24 V : 270 A	550 A 380 A	•	—	200 A	31 × 48 × 80 cm	31 kg
STARTIUM 980E	230 V	16 A	2	12	12 V : 20 > 750 Ah 24 V : 20 > 525 Ah	80 A	40 A	4	50 A	•	12 V : 500 A 24 V : 400 A	720 A 560 A	•	—	250 A	31 × 48 × 80 cm	36 kg
DIAG STARTIUM 60-12	230 V	16 A	2	10	12 V : 20 > 900 Ah	95 A	60 A	4	—	•	12 V : 310 A	440 A	•	•	200 A	48 × 35 × 90 cm	36 kg
DIAG STARTIUM 60-24	230 V	16 A	2	10	6 V : 20 > 900 Ah 12 V : 20 > 900 Ah 24 V : 20 > 525 Ah	65 A 95 A 65 A	40 A 60 A 40 A	4	—	•	6 V : — 12 V : 300 A 24 V : 280 A	— 430 A 410 A	•	•	200 A	48 × 35 × 90 cm	36 kg

AUTOMATIC CHARGERS/STARTERS + BSU

Fuses 100 A x 2 (Startium 330E) 054394 3,80 € HT | Fuses 200 A x 2 (480E, 680E, Diag. 60-12, 60-24) 054547 3,80 € HT | Fuses 250 A x 2 (980E) 055568 6,00 € HT

RECOMMENDATION	6V	12V	24V	5 Ah	10 Ah	15 Ah	20 Ah	40 Ah	80 Ah	90 Ah	110 Ah	120 Ah	180 Ah	240 Ah	300 Ah	+ Ah
STARTIUM 330E	•	•														
STARTIUM 480E	•	•														
STARTIUM 680E	•	•														
STARTIUM 980E	•	•														
DIAG STARTIUM 60-12	•	•														
DIAG STARTIUM 60-24	•	•														

Precharge (± 10 mm)

BOOSTERS

+ POWER SUPPLY 12 V DC

28 Ah



POWER SUPPLY
12 V / 22 Ah

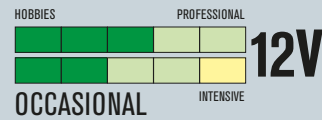

12V

GYSPACK 660

1 900 A

12V

1V DC
640 A



027862
027879



12V

GYSPACK 750

2 500 A

12V

1V DC
750 A

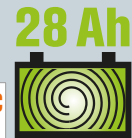

026179 **405,70 € HT**
026353

Insulated clamps
600 A
1,3 m
ø 25 mm²

NEW



Insulated clamps
600 A
1,3 m
ø 25 mm²



I REGULATED
IuOu
FAST CHARGE

INCLUDED
POWER SUPPLY
Flexible Voltage



Gyspack 660 ⊖ Power in 100-240 V / out 12 V
50/60 Hz



027992

Gyspack 750 ⊖ Power in 110-240 V / out 12 V
50/60 Hz



054684 **18,00 € HT**
054691



GYSPACK 660/750
Fuse 200 A x2
054547 **3,00 € HT**



Après chaque utilisation
After each use
Nach jeder Anwendung

	12V	START			TEST	CHARGER INSIDE	EXTERNAL Charge 230V	Protection		Power out		Fuse	Fuse	Dimensions	Weight		
		Inside	1V/C	Cranking CC				Peak Battery	ON	OFF	Memory					12V DC	
MADE IN GYS CHINA	GYSPACK 660	28 Ah	12V	640 A	1200 A	1900 A	•	—	12V/2 A DC	•	•	⊕ 12V DC	—	1 × 200 A	35×19 ×40 cm	39×23 ×45 cm	13,5 kg
	GYSPACK 750	28 Ah	12V	750 A	1450 A	2500 A	•	—	12V/2 A DC	•	•	⊕ 12V DC	—	2 × 200 A	35×19 ×40 cm	39×23 ×45 cm	13,5 kg
MADE IN FRANCE	GYSPACK 700	16 Ah	12V	640 A	1200 A	1800 A	•	2.5 A	—	•	•	⊕ 12V DC	15 A	1 × 200 A	33 × 15 × 32 cm	35 × 24 × 36 cm	12 kg
	GYSPACK 900	30 Ah	12V	830 A	1700 A	3100 A	•	2.5 A	—	•	•	⊕ 12V DC	15 A	2 × 200 A	33 × 15 × 32 cm	35 × 24 × 36 cm	16 kg

BOOSTERS

CAR 12 V

16/30 Ah

I REGULATED
IuOu
FAST CHARGE



EnerSys
HIGH QUALITY BATTERIES



12V

GYSPACK PRO 700

1 800 A

12V

1V DC
640 A



027077 **545,70 € HT**
027947



RENAULT
1 096 701

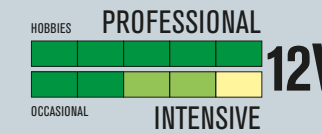

12V

GYSPACK PRO 900

3 100 A

12V

1V DC
830 A



027084 **710,50 € HT**
027954



RENAULT
1 096 701

NEW DESIGN



← 600 A
1,4 m ø 25 mm²

NEW DESIGN



← 600 A
1,8 m ø 35 mm²

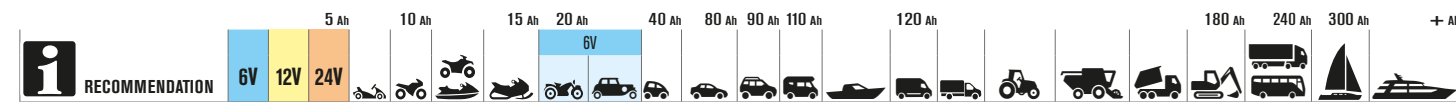

	6V	12V	24V	5 Ah	10 Ah	15 Ah	20 Ah	40 Ah	80 Ah	90 Ah	110 Ah	120 Ah	180 Ah	240 Ah	300 Ah	+ Ah
GYSPACK 660		•														> 90 Ah
GYSPACK 750		•														> 150 Ah
GYSPACK 700		•														> 100 Ah
GYSPACK 900		•														> 150 Ah

BOOSTERS
GYSPACK

SPECIAL HOBBY - Utilisation non professionnelle
• Non professional use • Nicht für gewerblichen Gebrauch.

NOMAD POWER 10

200 A 12 V 026384 **108,20 €HT**
026537



NOMAD POWER 15

300 A 12 V 026377 **120,90 €HT**



NOMAD POWER 20

350 A 12 V 026629 **151,80 €HT**



NOMAD POWER 30

500 A 12 V **COMPRESSOR**
027503 **257,40 €HT**



PRO ★

NEW

SMART CABLES
SAFETY PROTECTION



PRO ★★

NEW



LITHIUM BOOSTER

NP PRO 700

600 A 12 V

027510 **208,00 €HT**



NP PRO TRUCK

600 A 12 V
600 A 24 V

027527 **323,30 €HT**



NOMAD POWER 10										
NOMAD POWER 15										
NOMAD POWER 20										
NOMAD POWER 30										
NP PRO 700										
NP PRO TRUCK										

	LITHIUM		I START 1V/C	I START Cranking CC	I PEAK Battery	J 3s	START		CABLE	SMART CABLES	INPUT	MICRO USB
	CAPACITY/CELL	FULL CHARGE										
NOMAD POWER 10	3,7 Ah - 44.4 Wh	5 h	200 A	400 A	600 A	4500 J	12 V, PETROL & DIESEL	—	12 V - 1 A	• MULTI SECURITIES	12 V/1 A	5V/1 A (Type B)
NOMAD POWER 15	4 Ah - 55.5 Wh	5 h	300 A	600 A	800 A	7000 J	12 V, PETROL & DIESEL	—	12 V - 1 A	• MULTI SECURITIES	14 V/1 A	—
NOMAD POWER 20	6 Ah - 66.6 Wh	6 h	350 A	700 A	900 A	8000 J	12 V, PETROL & DIESEL	—	12 V - 1 A	• MULTI SECURITIES	14 V/1 A	—
NOMAD POWER 30 COMPRESSOR	6 Ah - 88.8 Wh	7 h	500 A	1000 A	1300 A	11000 J	12 V, PETROL & DIESEL	58 PSI / 4 Bar	12 V - 1 A	• MULTI SECURITIES	15 V/1 A 12 V/10 A	—
NP PRO 700	6 Ah - 92.5 Wh	9 h	600 A	1500 A	2000 A	14000 J	12 V, PETROL & DIESEL	—	—	• MULTI SECURITIES	9V/2 A 12V/1.5 A	5V/2 A (Type C)
NP PRO TRUCK	5,3 Ah - 137 Wh	10 h	600 A	1500 A	2000 A	12 V : 14000 J 24 V : 35000 J	12 V/24 V, PETROL & DIESEL	—	—	• MULTI SECURITIES Integrated	9V/2 A 12V/1.5 A	5V/2 A (Type B)

OUTPUT	POWER SUPPLY				LIGHT	MODES	cm	kg	
				OBD					
5V/2 A - 19V/3.5 A	•	—	—	1	—	2 × LEDs	LIGHT / S.O.S. / SPOT	17 × 8,2 × 3,2	0.408
5V/1 A - 5V/2.1 A - 19V/3.5 A	•	—	—	2	•	1 × LED	LIGHT / S.O.S. / SPOT	16,5 × 8 × 3,8	0.476
5V/2.1 A - 5V/1 A - 12V/10 A - 19V/3.5 A	•	•	•	2	•	1 × LED	LIGHT / S.O.S. / SPOT	22,5 × 9 × 3	0.680
5V/2 A - 5V/1 A - 12V/10 A	•	•	•	1	•	1 × LED	LIGHT / S.O.S. / SPOT	26,5 × 16 × 6	1.7
5V/2.4 A - 9V/2 A - 12V/1.5 A - 15V/10 A	•	•	•	2	•	1 × LED	LIGHT / S.O.S. / SPOT	22,8 × 10 × 3,8	0.82
5V/1 A - 5V/2.1 A - 12V/10 A	•	•	•	2	•	1 × LED	LIGHT / S.O.S. / SPOT	24,8 × 24,8 × 9,6	2.4

BOOSTERS SANS BATTERIE

BATTERYLESS / OHNE BATTERIE

NEW TECHNOLOGY FULL ELECTRONIC CONTROL



- ✓ NO BATTERY INSIDE
- ✓ NO MAINTENANCE
- ✓ ALWAYS READY

- ✓ BOOSTER SANS BATTERIE INTERNE
- ✓ AUCUNE MAINTENANCE
- ✓ TOUJOURS PRÊT

- ✓ KEINE INTERNE BATTERIE
- ✓ KEINE WARTUNG
- ✓ IMMER BEREIT



EASY TO USE : 2 minutes!

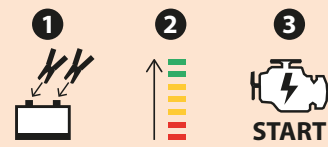

STARTRONIC 800

800 A 12 V **GO >5 V**

026735 **276,00 €HT**



STARTRONIC HYBRID 950

SUPERCAPACITORS + LITHIUM

950 A 12 V **GO >1 V**

026117 **333,60 €HT**



INCLUDED STARTRONIC HYBRID 950

Lithium battery

027411



- ✓ SMART
- ✓ SECURITY
- ✓ POWER



Digital control



CIGARETTE LIGHTER CHARGER INCLUDED

STARTRONIC 400,
600, 800
& HYBRID 950
027404 **6,20 €HT**



INPUT CHARGE

Charging time

	START 1V / C	Number of Capacitors	Integrated Inverter	12 V				5 V / 2 A		internal lithium battery	cm	kg	
				OFF	ON	OFF	ON	MICRO USB Type B					
MADE IN CHINA STARTRONIC 800	800 A	12 V	5 × 800 F	•	4 min	60 s	4 min	4 min	5 V/2 A	40 min	-	26,7 × 19,5 × 5	1,86
STARTRONIC HYBRID 950	950 A	12 V	5 × 950 F	•	4 min	60 s	4 min	4 min	5 V/2 A	40 min	•	25 × 18,5 × 6	1,86
MADE IN FRANCE GYSCAP 500E	1600 A	12 V	6 × 3000 F	—	—	120 s	—	15 min	—	—	—	35 × 44 × 19	8,2
GYSCAP 680E					—	—	—	—	—	—	—	—	—



026742 **1 317,90 €HT**



GYSCAP 680E

1600 A 12 V **GO >1 V**

026773



SUPERCAPACITORS

- ✓ 1 MILLION CYCLES
- ✓ ULTRA FAST CHARGE
- ✓ NO CHARGE STORAGE
- ✓ UNLIMITED STARTS

EASY CHARGE

INCLUDED



Cables 100% Cu
25 mm² - 1.7 m



✓ SMART STARTER
MANAGEMENT
SYSTEM



i Recommendation

STARTRONIC 800

STARTRONIC HYBRID 950

GYSCAP 680 E



TESTERS

ELECTRONIC & PRINTER



All batteries

BT551 START-STOP DHC

6/12 V

7 > 240 Ah

+ alternator (12/24 V)

055452 **296,60 €HT**



10 LANGUAGES SPRACHEN



x2 (included) 056220

PBT 700

12 V

7 > 240 Ah

+ alternator (12/24 V)

024229 **302,80 €HT**



10 LANGUAGES SPRACHEN



Standard 57 mm (W)

x1 (included) 056237

BT2010 START-STOP DHC

6/12 V

7 > 240 Ah

+ alternator (12/24 V)

055339 **418,10 €HT**



9 LANGUAGES SPRACHEN



GESTION LOGICIELLE DE LA BATTERIE
BATTERY-MANAGEMENT SOFTWARE
SOFTWARE BATTERIE MANAGEMENT

Clamps 056510 **35,10 €HT**

M/F plug



x1 (included) 056237

TESTERS

ELECTRONIC & CONNECTED

BTW 300 DHC

6/12 V

7 > 240 Ah

+ alternator

056664 **178,20 €HT**



All batteries

6 LANGUAGES SPRACHEN



Bluetooth



NOT INCLUDED



HIGH TECH BT MOBILITY
TRACK DATA
by E-devices

BATTERY MONITOR
- Indicateur de charge sans fil -
Wireless battery monitor

024212 **25,20 €HT**

4 LANGUAGES SPRACHEN



					Compatible
056220 5,50 €HT	x2	37 mm	7,5 m	25 mm	BT 301 / BT 501 / BT 551
056237 5,00 €HT	x1	57 mm	28 m	50 mm	RT 777 / PBT 700 / BT 2010
056633 2,90 €HT	x2	57 mm	7,5 m	25 mm	PBT 550 / PBT 600 / PBT 700 / BT 2010 / SPM

LANGUAGES SPRACHEN	GB	FR	DE	IT	ES	PT	CZ	NL	PL	RU	TR
DBT 300											
DBT 400											
PBT 550											
PBT 600											
BT 551											
BT 2010											
PBT 700											
BTW 300DHC											
BATTERY MONITOR											

	BATTERY	TEST		CHARGING & STARTING SYSTEM VEHICLE	PRINT PAPER	DIGITAL	RESULT	TEMPERATURE COMPENSATION	cm	kg	
		BATTERY A	BATTERY V								
BT 551 DHC electronic	6-12V	7 > 240 Ah	• min 1,5V	12/24V	•	rétro-éclairé /back-lit	1s	instant	•	11x4x19,5	0,4
PBT 700 electronic	12V	7 > 240 Ah	• min 8 V	12/24V	•	rétro-éclairé /back-lit	1s	instant	•	23,5x10,2 x6,8	0,7
BT 2010 DHC electronic	6-12V	7 > 240 Ah	• min 1,5V	12/24V	•	rétro-éclairé /back-lit	1s	instant	•	13x6,4x25,1	0,7
BTW 300 DHC electronic	6-12V	7 > 240 Ah	• min 1,5V	12/24V	—	—	1s	instant	•	10x3x7	0,33
BATTERY MONITOR	12-24V	7 > 240 Ah	— min 7 V	12/24V	—	—	1s	instant	—	6,5x5x1,5	0,1

i Recommendation	TEST		PRINT PAPER	LIQUID	START /STOP ENGINE	EFB	AGM VRLA/GEL	🏍️	🚗	🚘	🚚	🚛	CURRENT CCA SAE	
	batteries/Battery/Ladegeräte	Circuit alternateur/ Alternator Circuit/Lichtmaschinenchaltkreis												
BT 551 DHC electronic	6V 12V	🚗 12V 24V	•	•	•	•							7 > 240 Ah	40 > 2000 A
PBT 700 electronic	12V	🚗 12V 24V	•	•	•	•							7 > 240 Ah	40 > 2000 A
BT 2010 DHC electronic	6V 12V	🚗 12V 24V	•	•	•	•							7 > 240 Ah	40 > 3000 A
BTW 300 DHC electronic	6V 12V	🚗 12V 24V	—	•	•	•							7 > 240 Ah	40 > 2000 A
Battery monitor	12V 24V	🚗 12V 24V	—	•	•	•							7 > 240 Ah	—



POWER INVERTER

12 V • 24 V > 230 V

Available for UK socket 

-  Micro-Ondes
-  Grille Pain
-  Réfrigérateur (40 L)
-  Bouilloire
-  Cafetière capsules/dosettes
-  Cafetière filtre

-  Téléphone
-  Ordinateur portable
-  Radio
-  TV 15"
-  TV 21"
-  Console de jeux vidéo
-  Appareil photo

-  Eclairage
-  Chauffage électrique
-  Ventilateur
-  Sèche cheveux

-  Feux de navigation
-  Radar
-  Pilote automatique
-  GPS

	Convergys 150	Convergys 300	PSW600W	PSW 1000W	PSW 1500W* 12 V ou 24 V	MSW82000	70 Ah	200 Ah
					700 - 1000 W		30 - 50 min	1 h 30 - 2 h
					800 - 1500 W		20 - 40 min	1 h - 2 h
				45 W			12 h	35 h
					700 - 2500 W		15 - 45 min	35 min - 2 h
					1000 - 1600 W		20 - 30 min	1 h - 1 h 30
					800 - 1200 W		25 - 40 min	1 h 30 - 2 h
				5 - 10 W			55 - 110 h	155 - 310 h
				60 - 95 W			5 - 9 h	16 - 28 h
				10 - 40 W			14 - 55 h	40 - 155 h
				40 W			13 h 30	39 h
				50 W			11 h	31 h
				39 - 100 W			5 - 13 h	16 - 39 h
				4 - 19 W			25 - 135 h	78 - 390 h
				100 W			5 h 30	16 h
					1800 - 2500 W		12 - 20 min	35 - 45 min
				50 W			11 h	31 h
					1000 - 2000 W		15 - 30 min	45 min - 1 h 30
				24 W			30 h	80 h
				24 W			30 h	80 h
				60 W			9 h	30 h
				6 W			110 h	310 h

48

PSW → PURE SINE WAVE

PSW 600W-12 12 V

027275 **158,60 € HT**
027343



PSW 1000W-12 12 V

027282 **255,40 € HT**



PSW 1500W RC-12 12 V

027701 **331,60 € HT**
027732



Tension faible / Surtension /
Surcharge / Surchauffe / Court-
circuit
Low volt / Over volt / Over load /
Overheating / Output short-circuit
Niedervolt / Überspannung / Über-
lastung / Überhitzung /
Kurzschluss am Ausgang

Remote Control
Included

CONVERGYS → CONVERGYS

CONVERGYS 150 12 V

027022 **38,10 € HT**
027039



CONVERGYS 300 12 V

027053 **55,20 € HT**
027046



	Power	Peak power	Pure Sin Wave	Optimum Efficiency	Input DC	Output AC	Output USB (2.1) DC	max 150 W	Universal	Remote Control	Dimensions	Weight
CONVERGYS 150	150W	300W	—	90,5 %	12V	230V	5V - 2A	•	•	—	6 × 10 × 5 cm	0,5 kg
CONVERGYS 300	300W	600W	—	85 %	12V	230V	5V - 2A	•	•	—	10 × 15 × 6 cm	0,95 kg
PSW 600W-12	600W	1200W	•	85 %	12V	230V	5V - 2A	—	cables	•	23 × 31 × 15 cm	2,2 kg
PSW 1000W-12	1000W	2000W	•	85 %	12V	230V	5V - 2A	—	cables	•	23 × 39 × 15 cm	3,4 kg
PSW 1500W RC-12	1500W	3000W	•	85 %	12V	230V	5V - 2A	—	cables	•	23 × 39 × 15 cm	3,6 kg
PSW 1500W-24	1500W	3000W	•	85 %	24V	230V	5V - 2A	—	cables	•	23 × 39 × 15 cm	3,6 kg
MSW 82000	2000W	4000W	—	80 %	24V	230V	5V - 2A	—	cables	•	35 × 20 × 9,8 cm	5,8 kg

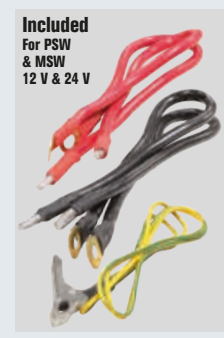

MSW → MODIFIED SINE WAVE

MSW 82000 24 V

027237 **311,00 € HT**
027244



PSW → PURE SINE WAVE

PSW 1500W-24 24 V

027305 **313,00 € HT**
027374



ACCESSORIES

CONVERTERS



49

MADE IN CHINA

CHARGERS

ACCESSORIES

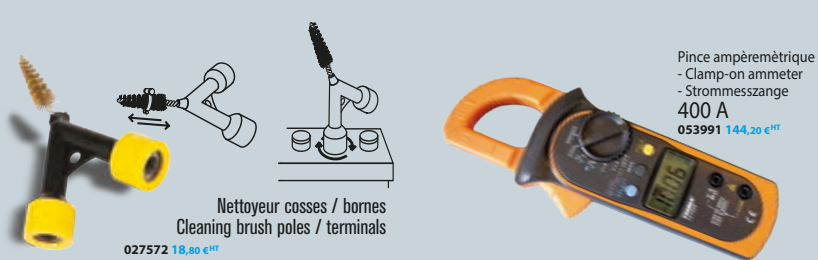

HIGH FLEXIBILITY ELECTRICAL CABLES

↔ L	A (60%)	A (35%)
10 mm ²	100 m 054882	054875 88 92
16 mm ²	100 m 054905	054899 120 130
25 mm ²	100 m 054929	054912 164 184
35 mm ²	100 m 054943	054936 210 240
50 mm ²	100 m 054967	054950 273 320
70 mm ²	50 m —	056565 310 380

CABLES EN 60246-5/H01N2-D (Caoutchouc - Rubber)

↔ L	A (60%)	A (35%)
50 mm ²	100 m 046801	273 320
70 mm ²	100 m 046832	18,60 € HT 348 417
95 mm ²	100 m 046863	25,20 € HT 430 525

PINCES - Clamps - Klemmen - Pinzas - Garras - Ακροδέκτες - Зажимы - 充电夹

40 A	60 A	200 A	300 A	600 A	650 A	850 A	1000 A	300 A	600 A
↔ 30 mm	↔ 25 mm	↔ 38 mm	↔ 45 mm	↔ 40 mm	↔ 35 mm	↔ 44 mm	↔ 55 mm	↔ 38 mm	↔ 38 mm
055537 4,50 € HT	055520 4,50 € HT	053502 6,10 € HT	053403 6,10 € HT	053700 12,10 € HT	053601 12,10 € HT	053779 9,80 € HT	053786 9,80 € HT	055551 15,00 € HT	055544 15,00 € HT
053816 19,40 € HT	053793 19,40 € HT	025769	025752	038059 14,70 € HT	038066 23,50 € HT				

COSSES BATTERIE - Battery Terminal - Polklemmen - Terminales batería - Accupool - Terminais de bateria - Πόλος μπαταρίας - Контакты аккумуляторной - батареи - 电池端子

ø 10 mm / 35 mm ²	ø 13 mm / 50 mm ²	ø 16 mm / 70 mm ²
054400 7,60 € HT	054431 66,40 € HT	054332 71,10 € HT
054448 63,90 € HT	054349 71,10 € HT	054424 92,70 € HT
	054363 86,50 € HT	054387 152,40 € HT

COSSES - Cable lugs - Terminal Kabelschuhe - Kabelsohlen

16 mm ² M10 ×10	038219 26,80 € HT
25 mm ² M10 ×10	038226 28,90 € HT
35 mm ² M14 ×10	038233 35,10 € HT
50 mm ² M14 ×10	038240 45,40 € HT
75 mm ² M16 ×10	038257 71,10 € HT
125 mm ² M15 ×5	038264 46,40 € HT

FUSIBLES - Fuses - Sicherungen - Fusibles - Zekeringen - Fusíveis - Ασφάλεις - Плавкие предохранители - 保险丝

10 A 054530 3,30 € HT	100 A 054486 4,20 € HT	200 A 054547 3,80 € HT	40 A 054646 5,20 € HT
15 A 054493 3,30 € HT		250 A 055568 6,00 € HT	50 A 054622 5,00 € HT
20 A 054509 3,30 € HT		300 A 054561 5,00 € HT	80 A 054653 6,40 € HT
25 A 054516 3,30 € HT			125 A 054585 5,60 € HT
30 A 054523 3,30 € HT			150 A 054639 11,20 € HT
40 A 054554 3,80 € HT			
6.3 A 054578 3,10 € HT	100 A 054394 3,80 € HT		
10 A 056527 3,10 € HT			

Quick Connector ø 10 mm / 50 mm² I max = 1000 A 054455 20,40 € HT

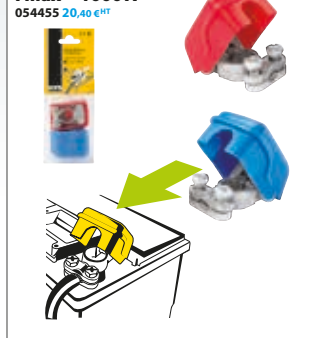

PROTECTION ANTI-ARC 12V - Anti-arc protection 12V - Lichtbogenschutz 12V - Protección anti-arco 12V - Piekspanningsbeveiliging 12V - Protecção anti-faixa 12V - Αντι-σπινθηρική προστασία 12V - Защита против дуги 12В - 12V 抗电弧保护



POIGNÉE PORTE-BATTERIE AJUSTABLE - Adjustable battery carrier - Einstellbarer Batteriehalter - Porta-baterias ajustable - Переноска для аккумулятора



PÈSE ACIDE ANTIGEL - Acidimeter (PH Meter) - Säure/Frostschutzmittel-Tester - Acido densimetro anticongelante - Zuurweger - Medidor de PH (ácido) - Μετρητής οξύτητας (PH) - Αцидиметр (рН-метр) - 防冻酸度计



100-250 lumens (x3)



400 lumens



250-600 lumens



200-400 lumens



100-200 lumens



50 > 500 lumens



100-280 lumens



0 > 600 lumens



60 > 1000 lumens



300-600 lumens

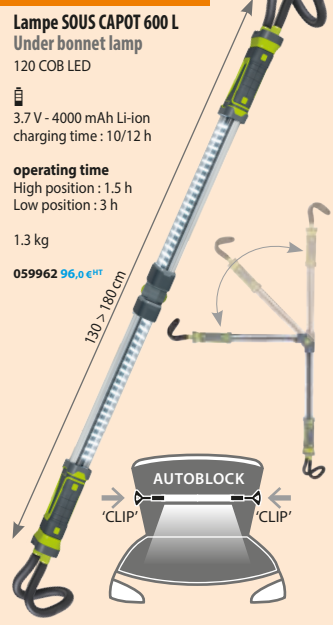

250-800 lumens

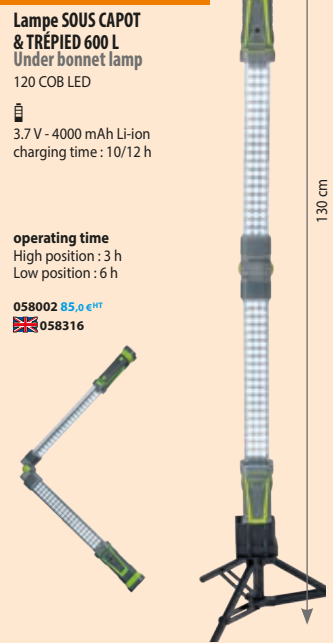

800-1600 lumens



1800 lumens

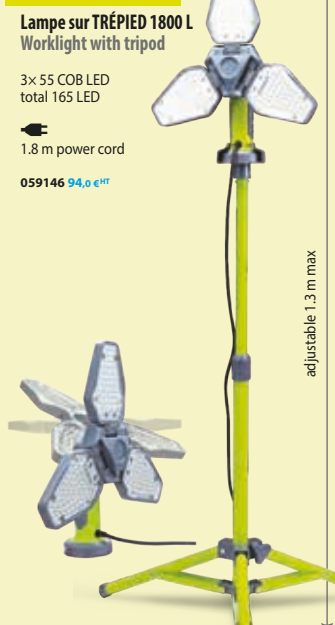

4000 lumens

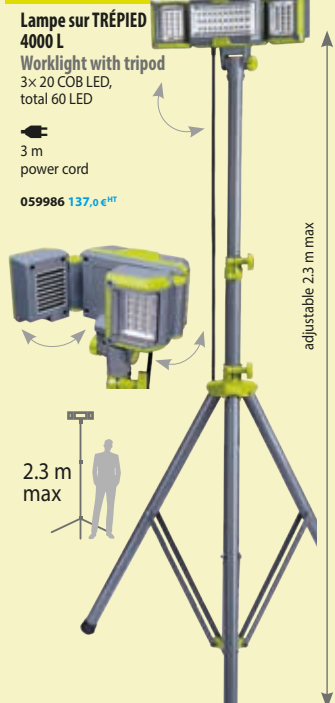

3000 lumens





NATO / OTAN :
Produits compatibles / Compatible Products /
kompatible Produkte



NATO Cables 2 m - 25 mm ² 026803 210,10 €HT	NATO/Texas 5 m - 25 mm ² 025707
NATO/Anderson 5 m - 16 mm ² 026810 203,90 €HT	NATO Connector 026780 88,60 €HT

GYSFLASH 32.12 / 123.12 / 103.24 p. 15 / 16	GYSFLASH 30.12 / 50.12 / 100.12 / 30.24 / 50.24 p. 14 / 15	(Coming soon) Startium 980E p. 29	Startpack Pro 12.24 XL p. 36
---	--	---	--

Batteries de traction :
Produits compatibles / Compatible Products /
kompatible Produkte

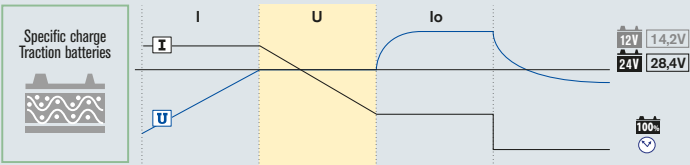

BATIUM 25 / 24
p. 24



- 1 Battery status analysis
- 2 Recovery
- 3 Fast charge 90%
- 4 Absorption 95%
- 5 Test
- 6 Completion
- 7 Equalization **Balancing**
- 8 Floating 100%

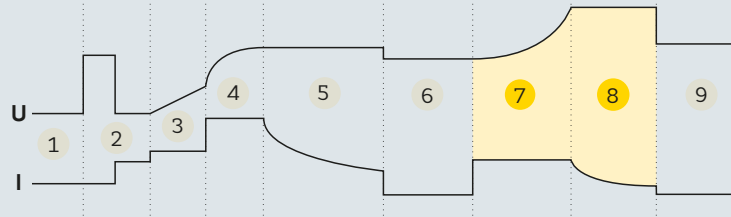

Cables Anderson 175A/Texas 5 m - 25 mm ² 025721	GYSFLASH 30.24 & 50.24 p. 15	GYSFLASH 103.24 p. 16
Cables REMA/Texas 5 m - 25 mm ² 025714		

		6 h	7 h	8 h	9 h	10 h	11 h	12 h	13 h	14 h	CURRENT
24 V	BATIUM 25-24	75 Ah	90 Ah	120 Ah	125 Ah	130 Ah	140 Ah	155 Ah	165 Ah	180 Ah	25 A
	GYSFLASH 30-24	130 Ah	140 Ah	170 Ah	190 Ah	210 Ah	230 Ah	250 Ah	270 Ah	300 Ah	30 A
	GYSFLASH 50-24	210 Ah	230 Ah	280 Ah	315 Ah	350 Ah	380 Ah	415 Ah	450 Ah	500 Ah	50 A
	GYSFLASH 103-24	420 Ah	460 Ah	560 Ah	630 Ah	700 Ah	760 Ah	830 Ah	900 Ah	1000 Ah	100 A

BATTERIES DE DÉMARRAGE - Automotive batteries - Starterbatterien - Baterías de arranque - Automotive accu's - Baterias de Automóvil - Μπαταρίες οχημάτων - Пусковые батареи - 汽车启动电池

	LIQUID CALCIUM	Silver/AGMv	START/STOP (A)	GEL Sealed	OPTIMA maXXima	
W	★	★	★	★	★	TRADITIONAL UNIVERSAL MAINTENANCE HIGH TECH
W2	★	★	★	★	★	AUTOMATIC UNIVERSAL MAINTENANCE HIGH TECH
WU	★★	★★	★★	★★	★★	UNIVERSAL MAINTENANCE HIGH TECH
WUoU	★★★	★★★	★★★	★★★	★★★	UNIVERSAL MAINTENANCE HIGH TECH
IWUoU	★★★★	★★★★	★★★★	★★★★	★★★★	AUTOMATIC FAST CHARGE UNIVERSAL MAINTENANCE HIGH TECH
I REGULATED IUoU FAST CHARGE	★★★★	★★★★	★★★★	★★★★	★★★★	UNIVERSAL MAINTENANCE HIGH TECH
Pb Pb + Lithium LifePO4	★★★★	★★★★	★★★★	★★★★	★★★★	FULL CONTROL HIGH TECH CHARGE UNIVERSAL MAINTENANCE HIGH TECH
Lithium LifePO4		★★★		★★★	★★★	UNIVERSAL MAINTENANCE HIGH TECH

MARKETING

NEW A

Podium de présentation
Display stand
Podest
(machines not included)

063204 A: 45 cm, B: 50 cm, C: 50 cm
063211 A: 80 cm, B: 50 cm, C: 50 cm

A - Barnum 3 x 3 m 098022
B - Open Barnum 2 x 2 m 098039
C - Oriflamme 1,75 x 0,50 m 098015

FA1 FA2 SB1

Linéaire de vente avec 2 étagères
- Retail display space with 2 shelves
- Lochwandregal mit 2 Böden
060784 617,80 €HT (machines not included)

Type	FA1	FA2	SB1
complet - complete - komplett	062429 6 734,90 €HT	062443 8 785,80 €HT	061149 5 242,60 €HT
sans linéaire - without display stand - ohne Regal	062436 6 117,10 €HT	062450 8 168,10 €HT	062412 4 624,80 €HT

Catalogs and posters available for download on our website www.gys.fr

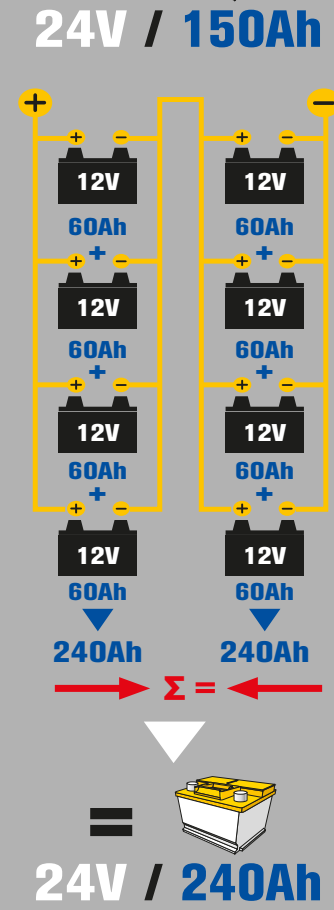
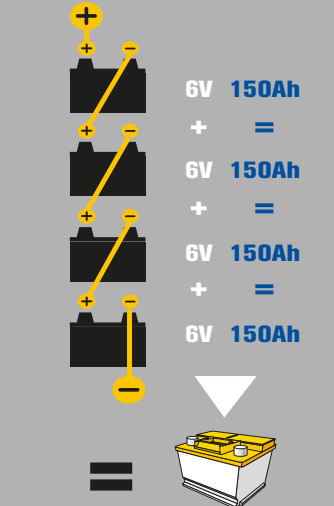
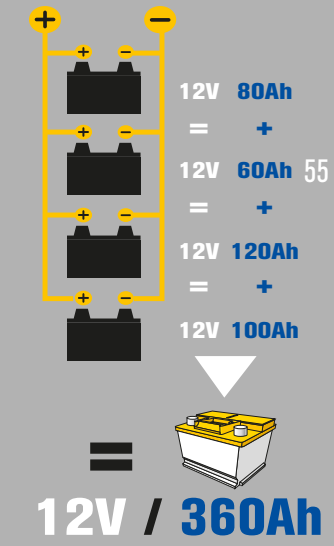



French manufacturer
since 1964

INVEST IN THE
FUTURE

www.gys.fr



Tools

Tel: +32 (0)10 39 51 50 • Fax: +32 (0)10 46 02 78
info@vbtools.be • www.vbtools.be

Voor technisch advies,
Pour toutes informations techniques,

Roy Backeljauw

Oost-, West-Vlaanderen, Provincie Antwerpen
roy.Backeljauw@vbtools.be
0490/11.91.96

Jonathan Govaers

Hainaut, Brabant Wallon, Vlaams Brabant, Limburg
jonathan.govaers@vbtools.be
0490/11.00.87

Sebastien Akel

Province de Namur, Liège, Luxembourg et du Grand-Duché.
sebastien.akel@vbtools.be
0490/11.91.95

Gedistribueerd door:
Distribué par :

2
0
2
0

Uitsluitend bestemd voor de vakman. De vermelde prijzen zijn zonder BTW. Zij zijn niet bindend en kunnen op elk moment zonder voorafgaandelijk bericht gewijzigd worden. De foto's zijn illustratief en worden zonder verbintenis gegeven. Aanbiedingen zijn geldig tot 31 juli 2020.
Ce catalogue est exclusivement réservé aux professionnels. Les prix mentionnés sont hors TVA. Ils ne sont pas impératifs et peuvent être changés à chaque instant sans avis préalable. Les photos sont illustratives et non contractuelles.
Prix variables jusqu'au 31 juillet 2020